

HOBBY ELECTRONICS

From the Publishers of
Radio-Electronics

NOW—6 TIMES A YEAR

43784

Hands-on Electronics

\$2.50 U.S.
\$2.95 CANADA
JANUARY/FEBRUARY
1986

THE MAGAZINE FOR THE ELECTRONICS ACTIVIST!

NEW: DataCard

Tearout file-card information
Start your collection today!

IDENTIFY UNKNOWN IC'S

Give the unknown DIP a name!

DIGITAL CRIBBAGE BOARD

A 17th century card game that's gone digital!

SWR

Discover what and how important it is for getting the signal out!

Before & After Clock

Displays time the way you say it!

6
One-Evening
PROJECTS
Anyone Can
Build

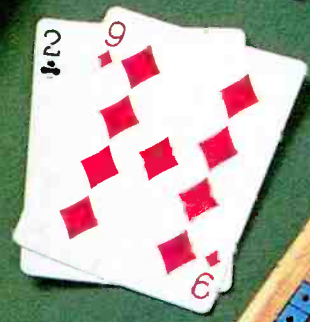

A
GERNSBACK
PUBLICATION

Now! Tek quality and expert advice are just a free phone call away!

The industry standard in CRT performance. Crisp, easy-to-read, bright CRT; 14kV accelerating potential, provides high writing rate and small spot size. Full size 8x10 cm display for measurement accuracy.

Display controls are flexible and easy to use. Separate intensity controls reduce blooming in alternate sweep mode. Focus tracking minimizes control adjustment and BEAM FIND eliminates confusion.

Vertical system provides measurement assurance. Flat transient response and high accuracy ensures true reproduction of your signals. Fast risetime and high bandwidth is well suited for a variety of measurement.

Perform delayed sweep measurements accurately and easily. The sweeps can be displayed alternately making differential measurements easy and accurate (1%). An interlocking SEC/DIV control simplifies set-up.

Stable hands-off triggering. P-P AUTO detects signal peaks, then sets the trigger level for you. Display asynchronous signals using VERT MODE triggering. Independent TV field and line selection.

Front panel laid out by function for ease of use. Color coding aids the user in operation. Functions and modes are placed logically. All nomenclature is clearly labeled, and protected behind a scratchless Lexan surface.



1-800-426-2200

Our direct order line gets you the industry's leading price/performance portables... and fast answers from experts! The 60 MHz single time base delay 2213A, the 60 MHz dual time base 2215A and the 100 MHz dual time base 2235 offer unprecedented reliability and affordability, plus the industry's first 3-year warranty* on labor and parts, CRT included.

The cost: just \$1275 for the 2213A, \$1525 for the 2215A, \$1750 for the 2235.† Even at these low prices, there's no scrimping on performance. You

have the bandwidth for digital and analog circuits. The sensitivity for low signal measurements. The sweep speeds for fast logic families. And delayed sweep for fast, accurate timing measurements. All scopes are UL Listed and CSA approved.

You can order, or obtain literature, through the Tek National Marketing Center. Technical personnel, expert in scope applications, will answer your questions and expedite delivery. Direct orders include comprehensive 3-year warranty*, operator's

manual, two 10X probes, 15-day return policy and worldwide service backup.

Order toll free: 1-800-426-2200, Ask for Rick.

In Oregon, call collect: (503) 627-9000. Or write Tektronix, Inc. P.O. Box 1700 Beaverton, OR 97075

Tektronix®
COMMITTED TO EXCELLENCE

SPECIAL PROJECT-BUILDERS 16-PAGE SECTION

53

Budget Project Parade

- 53 Multi-purpose Flashing LED
- 56 Electronic Dice
- 59 A Simple Amplifier
- 62 Home and Car Alarm
- 65 Integrated Shortwave Receiver
- 67 Electronic Siren

FEATURES

32

Identifying Unknown IC's—let the chip's "signature" detect its function and type

41

SWR—what it means in practice

82

Assemble a Computer Monitor from a Kit—we check out the Heathkit HVM-122A 12-inch monitor

85

Digital Fundamentals—Understanding counters and shift registers

91

Inside Oscilloscopes—Application rules you should know

PROJECTS YOU CAN BUILD

23

Digital Cribbage Board—modern day computer scoring for an old card game

45

Before and After Clock—see the time as you tell it

52

Adjustable Timer—the beginning of many new projects

69

Telephone Remote Control System—let the touch-tone signals trip in-house switches

94

Quicky Telephone Tester—are your lines polarized correctly?

96

Power-Supply Balance Indicator—the test-bench designer's tool

SPECIAL COLUMNS

16

Saxon on Scanners—some good news and some bad news

22

Jensen on DX'ing—Listen to the lands of the tango, cumbia, mariachi, and huayno

98

Friedman on Computers—what a hard-disk system can do for your personal computer

DEPARTMENTS

2

Editorial—you're eyeballing a collector's item

4

Letter Box—we get letters

6

New Product Showcase—consumer goodies we all can use

12

Bookshelf—from tomes to catalogs

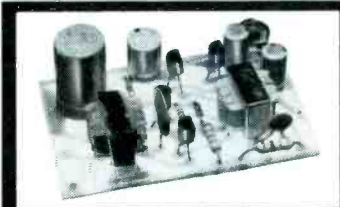

Budget projects parade—page 53

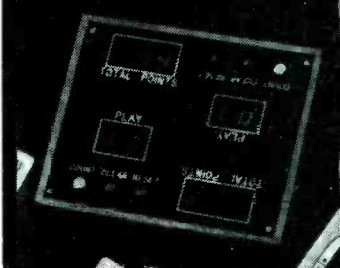

Digital cribbage board—page 23



Before and after clock—page 45

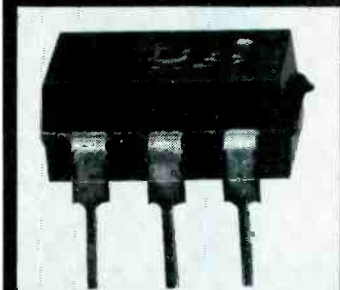

Identifying unknown IC's—page 32



Telephone BSR system—page 69

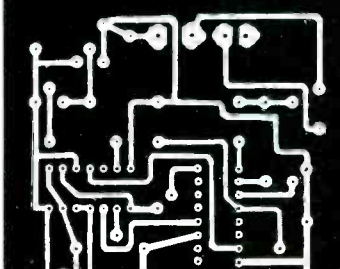

You're eyeballing a collector's item!

It's a new year for **Hands-on Electronics** and we're bringing to our readers a more exciting magazine! Let me tell you about some of the highlights.

The people at Dick Smith Electronics cooperated with the editors of **Hands-on Electronics** in the generation of a special 16-page construction section in this issue. The projects presented are some of the most often requested by builders of the editors and Dick Smith Electronics. We put them all together in one special section. All project parts are available in kit form making the building experience enjoyable and *brief*. Turn to page 53.

In this issue you find the first of a series of FactCards prepared for the project builder. They are located right after page 38. Clip these valuable cards and save them. More will follow each issue. In time your card collection will be an invaluable asset and will find its place on your workbench.

There are two projects in this issue that are real sleepers. They may become the most talked about projects in 1986. They are the *Digital Cribbage Board* (page 23) and *Telephone Remote Control System* (page 69). In fact you'd best hang on to this issue; don't lend it to friends. The Editor is forecasting a *sell out*, and that includes office copies, too!



Julian S. Martin, KA2GUN
Editor

Composition and interior design by
Mates Graphics

Cover photography by
Walter Herstatt

STAFF

Hugo Gernsback (1884-1967) founder
M. Harvey Gernsback, editor-in-chief
Larry Steckler, CET, publisher
Art Kleiman, editorial director
Julian S. Martin, KA2GUN, editor
Robert A. Young, associate editor

Brian C. Fenton, associate editor
Byron G. Wels, K2AVB, editor and associate
Carl Larson, associate editor
Ruby M. Yee, production manager
Robert A. W. Lowndes, production
associate
Karen S. Tucker, production assistant
Geoffrey S. Weil, production assistant
Jacqueline P. Cheeseboro, circulation director
Arline R. Fishman, advertising coordinator

BUSINESS AND EDITORIAL OFFICES

Gernsback Publications, Inc.
200 Park Ave. S., New York, NY 10003
212/777-6400
Chairman of the Board: M. Harvey Gernsback
President: Larry Steckler

NATIONAL ADVERTISING SALES

(For Advertising Inquiries Only)
Joe Shere
1507 Bonnie Doone Terrace
Corona Del Mar, CA 92625
714/760-8697



Hands-on Electronics, (ISSN 0743-2968) Published by-monthly (Jan./Feb., March/April, May/June, July/Aug., Sept./Oct., Nov./Dec.) by Gernsback Publications, Inc., 200 Park Avenue South, New York, NY 10003. Second-Class postage pending at New York, NY and at additional mailing offices. One-year, six issues, subscription rate U.S.A. and possessions \$14.00, Canada \$17.00, all other countries \$21.00. Subscription orders payable in U.S. funds only. international postal money order or check drawn on a U.S.A. bank. U.S. single copy price \$2.50. © 1985 by Gernsback Publications, Inc. All rights reserved. Printed in U.S.A.

Postmaster: Please send address changes to **Hands-On Electronics**, Subscription Dept., P.O. Box 338, Mount Morris, IL 61054.

A stamped self-addressed envelope must accompany all submitted manuscripts and/or artwork or photographs if their return is desired should they be rejected. We disclaim any responsibility for the loss or damage of manuscripts and/or artwork or photographs while in our possession or otherwise.

As a service to readers, **Hands-on-Electronics** publishes available plans or information relating to newsworthy products, techniques and scientific and technological developments. Because of possible variances in the quality and condition of materials and workmanship used by readers, **Hands-on-Electronics** disclaims any responsibility for the safe and proper functioning of reader-built projects based upon or from plans or information published in this magazine.

Build Circuits Faster and Easier With Our \$20 Solderless Breadboard



...and do even
more with our
\$40 breadboard

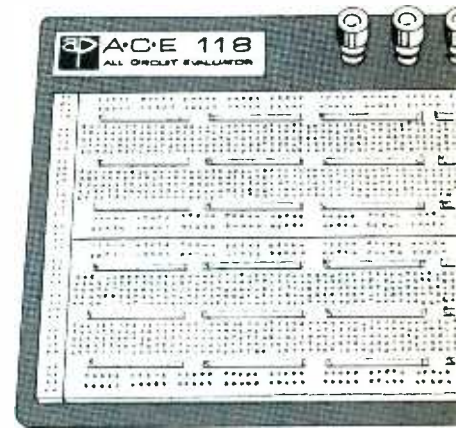

Introducing the plug-in world of AP Product's versatile, low cost breadboards.

Now you can design, build and test prototype circuits just like the professionals...and make changes in seconds. No messy soldering or desoldering. No more twisted leads or damaged devices.

With our ACE 109 and 118 blue breadboards, you simply plug in components and interconnect them with ordinary hook-up wire. All sizes of DIPs and other discrete components up to 22 gauge lead diameters snap right into the 0.1" x 0.1" matrix of the solderless tie points...anywhere on the layout. You don't need expensive sockets or special tools. Buses of spring clip terminals form a distribution network for power, ground and clock lines.

AP Products 100 series breadboards give you all the functions and flexibility of more expensive circuit evaluators. The spring terminals have mechanically independent contact fingers to

accommodate most DIPs and discrete components.

The ACE 109 has two terminals for separate voltages plus a ground connection. The larger ACE 118 offers the same three terminals, plus an additional terminal which can be used for clocking or another voltage. The backplates are heavy steel to keep the boards stationary.

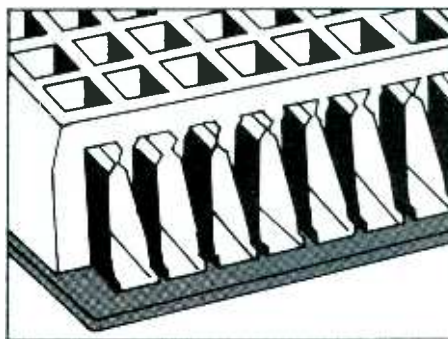

Don't wait. These low prices won't last forever. See your local AP Products dealer today, or send for a list of dealers in your area.

CIRCLE 706 ON FREE INFORMATION CARD



**A P PRODUCTS
INCORPORATED**

9325 Progress Parkway
P.O. Box 540
Mentor, Ohio 44060
800-321-9668
(Ohio, 216/354-2101)

Yes! I'm ready for breadboarding! Send:
 Names of dealers More information
Name: _____
Address: _____
City: _____ State: _____
Zip: _____

LETTER BOX

Vintage Radio Kit

Help! Is there someone or some company that sells a kit of parts for the Vintage Radio published in your Fall 1984 (#2) issue of **Hands-on Electronics**?

I repeat—*Heeelp!* M.B., Richboro, PA
Yes! First, many readers write to us for plans on the "1920-Style Wireless Receiver" (we called it the Unidyne) that were published in the above issue. The issue is still available, although the supply is limited. You can obtain your back issue by writing to our New York office. Be sure to include \$4.00 for the issue and \$1.00 for postage and handling.

A kit of parts is available from **Technicraft Electronics** by writing to them at 338 Katoomba Street, Katoomba N.S.W. 2780, Australia. Send two International Reply Coupons for a response on their latest prices and information on other vintage radio kits.

The above information holds true for

the "Build an Antique Shortwave Receiver" (Reinartz 2) that appeared in the Spring 1985 issue of **Hands-on Electronics**, should shortwave fans be interested!

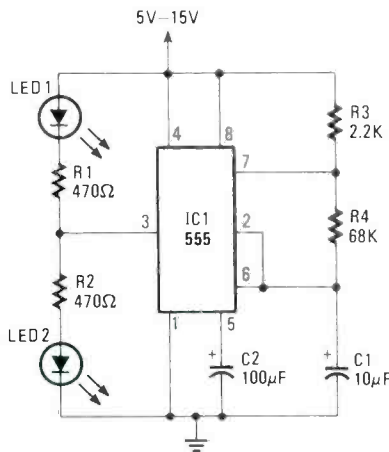

A Blink May Be a Boo!

My baby has a small teddy bear and I'd like to replace the eyes with a pair of alternately-flashing LED's. Have you got a schematic I can use?

R.T., Fresno, CA

◀ Yes, but first a brief word. Children are usually afraid of the dark, because they are unable to orient themselves. A small night light, kept in the same place all the time, eliminates that fear. Also, when you add the LED eyes to that teddy bear, don't be surprised if everybody else says it's cute; but the youngster suddenly becomes afraid of it. That kind of thing has happened more than once!

For Better Hold Ups

In your Summer edition, 1985, page 74, the story "Put Your Telephone on Hold" makes mention of 48-volts DC originating at the telephone exchange. In my area, that voltage is 52.5-volts DC. The voltage at my telephone is 51.7. I

THE BOOKS THAT MADE ELECTRONICS FUN!

DICK SMITH'S FUN WAY INTO ELECTRONICS

Join the thousands of people, young and old, who have discovered Dick Smith's Fun Way Into Electronics. Electronics should be fun, but far too often, it is presented as a difficult mysterious subject. Even books for beginners have not been successful in presenting as successful in breaking down this barrier. Dick Smith Electronics changed all that with the Fun Way Series. From the very basics of Fun Way One through to the advanced projects of Fun Way Three, electronics is dealt with in a fun way that's really easy to understand & most of all enjoyable!

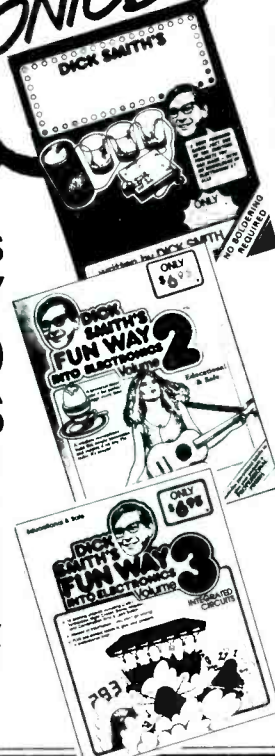

20 EXCITING PROJECTS FOR YOU TO BUILD

Volume 1

Fun Way 1 assumes you know absolutely nothing! It will show you what the components look like, how to connect them into the circuit, even how to go on with further experiments with your circuits when they are finished. Cat B-2600

\$4.95

Volume 2

Fun Way Volume 2 takes over where Fun Way 1 finishes, with 20 exciting new projects to try out. But these projects are different! They're all built the modern way—on printed circuit boards. Which means, of course, all components are soldered into position. Cat B-2605

\$6.95

Volume 3

The logical progression for those who have worked through Fun Way Vol. 1 and 2. It's for the more advanced hobbyist, because Fun Way Volume 3 projects are all based on integrated Circuits. Cat B-2610

ONLY **\$6.95**

AS SEEN THIS ISSUE FUNWAY TWO KITS

Flasher



Make it as the latest in electronic jewellery, or a burglar warning light, etc. The choice is yours and it's easy! Cat K-2621

\$2.95

LED Dice



Just as much fun using it as it is building it! And it's really random—no cheating with this dice! Cat K-2625

\$4.95

Electronic Siren

Just what you need with the alarm! Also makes a great sound effects circuit—and Fun Way 2 tells you what to do! Cat K-2636

\$4.95

Basic Amplifier

Use to make the intercom (project 18) or use as a general purpose amplifier. Really handy, good sound output too. Cat K-2630

\$6.50

Intercom

Build your own intercom & use it around the home. Practical, simple to build with the intercom amplifier above (Project 10). Cat K-2638

\$8.95

Shortwave Receiver

You will be able to tune a variety of short wave stations or, with simple modifications, emergency services and amateurs, etc. Easy and fun to build. Cat K-2640

\$6.95

OTHER GREAT FUN WAY VOL 2 KITS

Metal/Pipe Locator

Extremely handy for locating pipes, wires, etc. in walls before drilling holes. Surprisingly effective for such a simple circuit. Cat K-2633



\$6.50

Mono Organ

Sneaky little circuit uses the back of the PCB as the keyboard! Play a tune—it's easy. Cat K-2626

\$7.95



Touch Switch

Ever wondered how those lift buttons worked? Build this touch switch yourself and you'll be able to work it out. Variety of functions explained. Cat K-2628

\$5.50

Ding Dong Doorbell

Yes, it actually sounds like a great old fashioned doorbell. But it's electronic, and you can build it! Cat K-2622

\$4.50

Home/Car Alarm

Very practical! You could use this alarm to protect your home and property! Uses any of the normal alarm triggering devices. Cat K-2635

\$6.50

These kits do NOT include instructions. All information is published in Fun Way Vol. 2, which is necessary before construction can begin on any kit.

ORDER TOLL FREE 1-800-332 5373

dropped the voltage an additional 4 volts; and now have a nice hold feature built into the telephone set itself. One other fact, a Radio Shack 276-1067 works equally well in place of the SK3638 SCR. I tried both.
H.K., Caldwell, ID

At the consumer end of the line the DC voltage across the line should be a nominal 48-volts DC. We received several letters about this telling that the voltage varied from 41- to 56-volts. What good is a standard if you can't deviate?

Almost Like Remote Control

I know it's an old problem in basic electricity, how to wire an upstairs lamp so it can be controlled from a downstairs switch and an upstairs switch. I want to use the same kind of set-up to control a different electrical circuit. Can you save me some head-knocking?
B.G., Dallas, TX

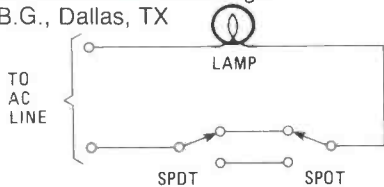

You weren't very specific, but here's the circuit I think you're looking for.

Auto Battery/Alternator Monitor Update

Recently, a reader who had built the Auto Battery/Alternator Monitor project (page 49, Spring 1985) experienced a problem. He built three (3) units at the same time and all three appear to have the same problem: it would appear that a difference in vendors of the LM3914 and a variation in lead lengths in the vehicles may be creating a situation whereby more than one LED will be lit at the same time even when in the "Dot Mode" of operation. All the units work fine on the bench, but they begin to act up when placed into the car.
D.D., Skokie, IL

The unit does have a tendency to break into parasitic oscillation and would, under certain circumstances, cause more than one LED to light at once. The first red LED would be lit very dimly if viewed in darkness. That problem has been traced to poor filtering on the input line. Install a 5-10- μ F tantalum capacitor across the pins where the voltage is supplied to the IC. The same effect can be had by a 1- μ F capacitor from pin 5 to the common (V-) lead. Both changes may be made, but chances are

good that only one of them will be required—most likely the latter one.

The published diagram shows the Mode pin (9) connected to either pin 11 for a dot display or to pin 3 for a graph display. Try pin 9 floating for the dot display, and jumpered to pin 3 for the graph mode. Pin 11 connection is used only when cascading more than one LM3914 for 20 or more dots.

Another problem is that the LED's polarities are shown reversed in Fig. 5 diagram. The pictorial wiring in Fig. 4 shows them wired correctly.

Check for RFI generation by tuning the car radio to a quiet spot on the upper end of the AM band with the engine running and the Monitor operating. There should be no interference when the above capacitors are added.

Learn by Degree

In your Letter Box column in the Summer 1985 issue of Hands-on Electronics, you offered advice to an individual who was interested in obtaining an electronics engineering degree through home study. While your answer did fit the question, I think it could be improved upon. The University of the State of New

(Continued on page 18)

Universal Timer
Eggs too hard? Time them with this great little timer. It really works—set for a few seconds to 15 minutes!
Cat K-2624 **\$5.50**

LED Level Display
Hook it up to your stereo and it can warn you of dangerous overloads. Looks pretty nifty too—the LEDs light up in time to the music!
Cat K-2637 **\$8.95**

Morse Code Trainer
You can turn this audible alarm into just about anything requiring sound. Even for Morse code—and it's fun to learn!
Cat K-2623 **\$4.50**

LED Counter Module
A perfect introduction to the world of integrated circuits. And this useful counter can be used for a huge variety of counting applications or just for fun!
Cat K-2639 **\$7.95**

Wireless Mic.
Just like the 'bugs' used in spy movies! Transmits to any standard FM radio in another room or next door, etc. You can really hear it all!
Cat K-2631 **\$6.50**

Pocket Transistor Radio
Building this small set will teach you a lot about the fundamentals of radio. And then you'll have fun using it too!
Cat K-2627 **\$7.95**

LEARN ABOUT I.C.S WITH FUNWAY 3 SEE VOL. 3 FOR CONSTRUCTION DETAILS

Cricket
Here's a ton of fun! Hide the cricket; when the lights go out it starts chirping. Turn the lights on or make a noise and it stops. Makes it so hard to find! It really is infuriating!
Cat K-2663 **\$9.95**

Two-up
Australia's 'national game' has finally been converted to electronics. And you don't have to find any King George pennies! Simulates the throw, the spin and the final result. Come in spinner!
Cat K-2661 **\$9.95**

Mini Stereo Amp
Want an amplifier for your 'walkie' stereo or radio? Don't be tied to 'phones; use this project and listen in comfort! Or you can build this into a mini PA amplifier.
Cat K-2667 **\$14.95**

Binary Bingo
A great school project: it's a fun game—but even more it demonstrates binary numbers very well. And they're the basis of all computers! It seems pretty simple to play... but try it!
Cat K-2668 **\$19.95**

Mini Synth
It's a real beauty; this one's a real 'live' musical synthesizer—and it's live because it uses YOU as the note generator! You get an amazing range of control over the sound.
Cat K-2669 **\$19.95**

Lil' Pokey
You'll have a ball with this one—and you don't risk losing a single cent! A digital project which not only shows how the one armed bandit works—it teaches you how logic circuits work, too.
Cat K-2662 **ONLY \$19.95**

Mini Color Organ
Your very own disco colour organ—but ours is battery operated—so it's much safer than mains devices! Connect it to your radio, cassette or stereo for a real lightshow!
Cat K-2664 **\$12.95**

FUN WAY ONE VALUE PACK Projects 1 - 10
Enables you to build any of the first ten Projects in Fun Way One. And because the components are not soldered, they are all reusable so you can build any other of the first ten projects, too.
Cat K-2600 **FOR ONLY \$7.25**

FUN WAY ONE VALUE PACK Projects 11 - 20
Contains the more specialised components required to complete the last ten projects (11 - 20) in Fun Way One. Note: you will also need the 1 - 10 kit above to build these projects.
Cat K-2610 **ONLY \$7.90**

FUN WAY THREE BONUS PACK!
And what value! Buy this kit with two of the most popular kits in the Fun Way Three book... and we throw in the book FREE! Yes, you get both the Electronic Cricket project (known to his friends as Nocturnal's Stridulus Grillidae) plus the Miniature Amplifier project together valued at \$24.90, and as a bonus, the Fun Way Three book itself at no extra charge!!
Cat K-2670 **FOR ONLY \$24.95**

DICK SMITH #1 FOR KITS

NEW PRODUCTS SHOWCASE

Automatic Digital SWR/Wattmeter

The MFJ-818 automatic, digital SWR/wattmeter has bright-orange LED digits on the SWR display. But more importantly, this SWR/wattmeter is automatic, eliminating three steps in reading SWR: switching to set, setting the meter needle for full-scale deflection, and switching back to SWR to read. The meter reads SWR 1:1 to 1:9.9 directly and instantaneously. There is no need to adjust the SWR set knob!

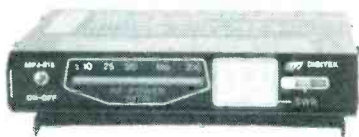

CIRCLE 728 ON FREE INFORMATION CARD

The MFJ-818 reads up to 200-watts of RF output on its LED bargraph display. The 12-bar display indicates the on-air power level instantly and correctly to show instantaneous peak power. The unit features a tri-color indicator that lights up

to indicate the antenna matching condition: Green for good, yellow for not very good, and red for a mismatched condition.

The MFJ-818 meter, which measures only 5 1/2 x 4 1/4 x 1 inches, carries a one-year unconditional warranty, and retails for only \$89.95. In addition, if you order directly from MFJ, you get a 30-day money back guarantee. If not completely delighted, send the product back within 30 days for full refund, less shipping.

The MFJ-818 can be charged to your Visa or Mastercard account if you wish to order over the phone. Call 800/647-1800 toll-free, or write to: MFJ Enterprises, Inc., P.O. Box 494, Mississippi State, MS 39762.

Locking Leads For DMM

TPI has eliminated the nuisance of test leads accidentally disconnecting from the meter. A thumb screw expands the banana plug inside the meter jack for a tight, secure connection. The LTL1000 is ideal for low-voltage and resistance measure-



CIRCLE 736 ON FREE INFORMATION CARD

ments. Its silver-plated contacts minimize thermal EMF and contact resistance. The LTL1000 also features rubber shielded banana plugs for maximum safety, and soft and flexible cables that have strain reliefs at both ends. Ratings are 1000-volts rms

'Widen your stereo sound'
Stereo Enhancer
 The greatest stereo hi-fi system loses its magnificence if the effect is so narrow you can't hear it. This project lets you cheat on being cheated and creates an enhanced stereo effect with a small unit which attaches to your amp.
 Cat K-3419
ONLY \$49.95
GREAT VALUE

UNBEATABLE VALUE!
Economy Soldering Iron
 General purpose main powered iron that's ideal for all those hobbyist and technician jobs. Comfy, tapered handle and nicely balanced iron for hours of fatigue-free use. Stainless steel barrel and 110 volt, 30 watt element is just right for most assembly or repair soldering. Great beginner's iron. Tool Comes ready to use with hints on soldering.
 Cat T-1300
\$4.95

Transistor Nipper ONLY \$9.95
 Ideal for PCB work. Very sharp precision cut with long life cutting edge. 3.7" body with spring return. .35" cutting blades. Cat T-3205

Mini Needle Nose Plier ONLY \$5.95
 Precise, non-serrated tip and jaw. Ideal for use with semi-conductors - the very fine (.04) tip will reach into places others won't! Cat T-3570

Solder Stand with Magnifier!
 The helping hand when you need it most: when you have a 'hot stick' in your hand! Heavy die-cast base, solder stand, clips for holding PCB, etc - plus a unique magnifying lens for those close assembly jobs.
 Cat T-5710
\$6.95

HAVE YOU GOT YOURS YET?
 OUR HUGE 132 PAGE COLOR CATALOG IS CRAMMED WITH KITS, BOOKS, COMPONENTS, DATA, HAM GEAR AND MORE! PLUS BONUS COUPONS WORTH \$2 REDEEMABLE OFF YOUR FIRST ORDER.
 IF YOU HAVEN'T GOT A COPY YET, SEND JUST \$1 TO COVER SHIPPING AND WE'LL SEND YOU YOUR FREE COPY!

DICK SMITH #1 FOR KITS

EVERYTHING FOR THE ELECTRONICS ENTHUSIAST

DICK SMITH ELECTRONICS
 INCORPORATED IN THE STATE OF CALIFORNIA
 NEARLY 70 STORES IN THREE COUNTRIES

STORES AT:
 BERKELEY: 2474 Shattuck Ave., Ph:(415) 486 0755
 REDWOOD CITY: 390 Convention Way, Ph:(415) 368 8844
 SAN JOSE: 4980 Stevens Creek Blvd. Ph:(408) 241 2266
 STORE HOURS: San Jose & Berkeley 10 AM - 6PM EVERYDAY
 Redwood City 10AM -6PM Mon - Sat; 12-5PM Sunday
 MAIL ORDERS: PO Box 8021, Redwood City, CA 94063
 HEAD OFFICE: 390 Convention Way, Redwood City, CA 94063

HANDLING - ALL ORDERS \$1.00 PLUS SHIPPING
 INSIDE USA 5% OF ORDER TOTAL (MIN \$1.50)
 OUTSIDE USA 10% OF ORDER TOTAL (MIN \$3.00)



HANDS-ON ELECTRONICS

ORDER TOLL FREE 1-800-332 5373

CIRCLE 717 ON FREE INFORMATION CARD

and 10-A continuous current. It's priced at \$15. For more information, write to Test Probes, Inc., P.O. Box 2113, La Jolla, CA 92038; Tel. 800/368-5719; in California, 800/643-8382.

Lap Computer

The portable ZP-150 lap computer, a diskless unit from Heath, is being offered as a fully assembled computer product. It weighs only 7.7 pounds and has an LCD (Liquid Crystal Display) screen built into its flip top. It is the first lap computer to use Microsoft WORKS, a ROM-based software package developed by Microsoft Corporation, which is compatible with MS-DOS machines. The ZP-150 has 224 kilobytes of ROM and 32 kilobytes RAM



CIRCLE 748 ON FREE INFORMATION CARD

user memory, which is expandable to 416 kilobytes.

Built into WORKS are several business programs: including PLAN, a subset of Microsoft's Multiplan; WORD, a subset of the powerful word processor WORD by Microsoft; FILE, a recently developed Data Base Management System (DBMS); CALENDAR an appointment secretary; TELCOM, a telecommunications program complete with auto-dialing capability, and BASIC, a large subset of the popular programming language GW-BASIC. In addition to the ROM-based business software, the ZP-150 has a parallel printer port, an RS-232 serial port, an audio cassette player port, and a telephone jack to be used with the internal 300-baud modem. The unit is powered by ten AA alkaline batteries, which allow 8-10 hours of operation. An AC-power converter is supplied for use on standard 117-VAC lines.

The portable ZP-150 lap computer, priced at \$995.00 and available through Heath Company and 64 Heath/Zenith computers and electronics stores nationwide, is just one of over 400 products offered in the latest Heathkit Catalog. For your free copy of the Heath catalog, write to Heath Company, Dept. 150-586, Benton Harbor, MI 49022.

Two Compact Radar Detectors

Uniden has added two compact radar detectors to their line. The model RD 9, measuring only 4.2 x 2.76 x 0.71-inches, may be the smallest self-contained radar detector currently on the market. It is very sensitive, and features separate X-



CIRCLE 734 ON FREE INFORMATION CARD

and K-band LED and audio indicators. The RD 9 also features Electronic Data Interference Terminator (E.D.I.T.) circuitry, which assures accurate radar signal detection by helping to eliminate erroneous signal interference. Housed in a pocket-sized carrying case, the dual-conversion, superheterodyne radar detector can be installed in almost any size vehicle.

A two-position highway/city selector switch allows the user to select unfiltered
(Continued on page 8)

ENJOY THE HEALTHY BENEFITS OF NEGATIVE IONS - FOR LESS!

BUILD YOUR OWN Negative Ion Generator

You've heard all about Negative Ion Generators and their benefits, now buy the kit and find out what it's all about. Many commercial units run from the mains, but our kit is safe - it runs on 12V DC, which also means that you can put one in your car! Kit includes exclusive Dick Smith emitter head, power pack and tough moulded plastic case. Cat K-3335 ★★

FOR ONLY \$34.95



UPDATE YOUR CAR WITH OUR LED Tacho

Don't spend a fortune buying a tachometer - build your own and save! Displays engine speed in an analog form in an illuminated row of LED's. Instructions included - a great kit! Cat K-3240 ★

ONLY \$19.95

FOR TV

POOR SIGNAL AREA?

Masthead Amp
Don't put up with lousy TV (we can't do much about the content, but this kit should fix the pix!) Reduces or even eliminates snow, also great for reducing ghosting. Covers both UHF and VHF TV Bands plus FM bands. Includes 110V supply in price. Cat K-3232 ★★

\$29.95

The Economy Car Alarm
This alarm senses the voltage drop in your car's electrical system when a thief breaks into it. Visual warning for thieves so chances are they will not even attempt a break-in. Cat K-3250 ★

\$9.95

THE BEST PROTECTION FOR YOUR HOME IN KIT FORM.



INCLUDES QUALITY CASE

The Dick Smith Home Alarm

What a superb kit! This highly developed design offers features which you'd normally find only on units costing more.

- FEATURES**
- Security key operation for both alarm function and box access
 - 2 instant and six delay sectors, capable of handling normally open or normally closed in any mix
 - Inbuilt mains power supply with battery backup
 - Siren (up to two speakers) PLUS bell(relay)output and also capable of driving telephone diallers, strobes, etc
 - Inbuilt local test facilities, including buzzer
- Complete kit including case and all electronics. Cat K-3424 ★★ ★★

EA FOR ONLY \$99.95

PROTECT YOUR PRECIOUS VIDEO GEAR

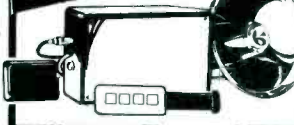

VCR Theft Alarm

That VCR sitting on top of your TV set is a very expensive appliance. It is also portable and marketable, which makes it a prime target for thieves. The simple alarm described here will sound off immediately the VCR is lifted - and it makes a lot of noise. The circuit could also form the basis of a burglar alarm for an entire house. Cat K-3423 ★★

EA ONLY \$39.95

A NEW DIMENSION IN CAR PROTECTION! Ultrasonic Detector

The problem with 99% of car alarms is that they cannot prevent the thief who breaks a window and reaches in for the goodies. While this kit won't prevent the window being broken, it will protect your property inside the car. Silent ultrasonic rays detect any movement and trigger the main alarm system. Cat K-3251 ★★

EA USE WITH YOUR EXISTING ALARM OR THE DICK SMITH CAR ALARM Cat K-3252



ONLY \$19.95 GREAT VALUE!

ORDER TOLL FREE 1-800-332 5373

MUST LIQUIDATE AT FAR BELOW DEALER COST! Computer Products

PUBLIC NOTICE

We are authorized liquidators of consumer products that must be quickly sold by manufacturers at drastic price reductions for many reasons, such as:

Discontinued lines. Last year's models. Distributor surplus. Cancelled orders. Out-of-season products. Tailends of inventories.

Whatever the reason for the liquidation, you are assured of fine quality at money saving low prices! Supplies are limited. Order now!

Famous U.S. Brand Dot Matrix PRINTER

Factory reconditioned!
Factory warranty!

Compatible
with C64,
SX64, VIC20,
Educator 64,
Plus/4 and C16



PERSONAL
COMPUTERS
AVAILABLE.
TOO, AT BIG
SAVINGS!
Phone Toll-Free:
1-800-328-0609
for information.

Here's a great opportunity to add a fine quality printer to your Personal Computer...at a **BIG SAVINGS!**

Now you can get neat, clean printouts of reports, correspondence, mailing lists, charts, inventories, financial figures...or anything else you have in computer memory. And it all comes out at the speed of 60 characters per second.

These are factory reconditioned units that look and work as good as brand new. And they're backed by the manufacturer's standard new product warranty!

Sorry, we're NOT permitted to print the famous brand name in this ad. But we can "tell all" if you phone us Toll-Free: 1-800-328-0609.

- PRINT METHOD:** Bi-directional impact dot matrix.
- CHARACTER MATRIX:** 6 x 7 dot matrix.
- CHARACTERS:** Upper and lower case letters, numerals and symbols. All PET graphic characters.
- GRAPHICS:** 7 vertical dots, maximum 480 columns. Dot addressable.
- CHARACTER CODES:** CBM ASCII code.
- PRINT SPEED:** 60 characters per second.
- MAXIMUM COLUMNS:** 80 columns.
- CHARACTER SPACING:** 10 per inch.

LINE FEED SPACING: 6 lines per inch in character mode or 8 lines per inch selectable. 9 lines/inch in graphic mode.

LINE FEED SPEED: 5 lines per second in character mode. 7.5 lines per second in graphics mode.

PAPER FEED: Friction feed (Tractor feed is optional. Available from dealers nationwide.)

PAPER WIDTH: 4 1/2" to 8 1/2" width. Up to 10" with optional tractor feed.

MULTIPLE COPIES: Original, plus two.

SIZE: 13"W x 8"D x 3 1/4" H. **WEIGHT:** 8 1/2 lbs.

Mfr. List When New **\$199.95**

Liquidation
Price Now Only **\$119**

Item H-796-63831-00 Ship, handling: \$7.00



FCC Approved!
Factory
New!

90
day
Limited
Factory
Warranty

64K MODEM

Liquidation due to manufacturer's overproduction. The modem plugs into Commodore 64K or SX64, so you can access new worlds of information on a subscription basis. Has modular jacks for quick hookup to phone. Works on TouchTone® and Rotary (Pulse) systems (not PBX). Super intelligent software, completely menu-driven. 30K software buffer. Auto dial, auto answer. Price includes FREE trial subscription to over 52 database services.

Mfr. List: **\$124.95**

Liquidation Price **\$19**

Item H-796-63646-00 Ship, handling: \$4.00

Price subject to change after 60 days. Sales outside continental U.S. are subject to special conditions. Please call or write to inquire.

Credit card customers can order by phone, 24 hours a day, 7 days a week.



Toll-Free: 1-800-328-0609



Your check is welcome!
No delays in orders paid by check.

C. O. M. B. Direct Marketing Corp. Item H-796
14605 28th Ave. N. / Minneapolis, MN 55441-3397

Send the following items. (Minnesota residents add 6% sales tax. Allow 3-4 weeks for delivery. Sorry, no C.O.D.)
— Dot Matrix Printer(s) Item H-796-63831-00 at \$119 each plus \$7 each for shipping and handling.
— 64K Modem(s) Item H-796-63646-00 at \$19 each plus \$4 each for shipping and handling.

My check or money order is enclosed. (No delays in processing orders paid by check, thanks to Telecheck.)

Charge to my: MasterCard® VISA

Acct. No. _____ Exp. _____

PLEASE PRINT CLEARLY

Name _____

Address _____

City _____

State _____ Zip _____

Phone _____

Sign here _____

New Products Showcase

(Continued from page 7)

sensitivity for highway travel or filtered sensitivity for urban travel. A single three-position switch permits selection of either audible or visual, or combined alert when radar is detected. The unit may be either visor- or dash-mounted. A power cord supplied with the RD 9 can be used for either positive or negative-ground vehicles. Its suggested retail price is \$269.00.

The other unit, the RD 35, also features E.D.I.T. circuitry and, like the RD 9, is protected by a 12-month warranty. The RD 35 is lightweight, compact and offers state-of-the-art features and quality. Because of technology efficiencies inherent in its design, it is priced at only \$139.95.

The RD 35 may be either dash- or visor-mounted and warns the operator by sound and a red warning light when X- and K-band police radar signals are detected. Its E.D.I.T. superheterodyne circuitry is designed to virtually eliminate false-alarm sources, such as nearby microwave relay stations, radar door openers, and aircraft and boat weather radar systems.

For more information on the RD 9 and RD 35, write to Uniden Corp. of America, 6345 Castleway Court, Indianapolis, IN 46250.

Audio/Video Cable

Hitachi recently introduced the latest in its line of audio/video cable, which is said to offer superior reproductive quality. The cable uses linear-crystal/oxygen-free copper (LC-OFC), a recent audio/video technology development from Hitachi. The



CIRCLE 744 ON
FREE INFORMATION CARD

linear-crystal cable provides dramatically lower distortion and reduced signals loss compared to conventional cable. One critic claims that using the cable is equivalent to upgrading a full level in loudspeaker quality.

Hitachi researchers suspected that a major source of distortion and signal loss lay in the boundaries between crystals, which act as a gap that electrical impulses have to cross. One way to minimize the problem, they reasoned, was simply to reduce the number of crystals. To do so,

(Continued on page 18)

C.O.M.B.
Direct Marketing Corp.
Authorized Liquidator

14605 28th, AVENUE NORTH
MINNEAPOLIS, MINNESOTA 55441-3397

With NRI training at home, you can...

Move up to a high paying career servicing computers



And you can start by actually building NRI's 16-bit IBM-compatible computer.

You can create your own bright, high paying future as an NRI trained computer service technician. The biggest growth in jobs between now and 1995, according to Department of Labor predictions, will occur in computer service and repair, where demand for trained technicians will double. There is still plenty of room for you to get in on the action—if you get the proper training now.

Total computer systems training, only from NRI

To learn how to work on computers, you have to get inside one. And only NRI takes you inside a computer, with total systems training that gives you hands-on experience with computers, peripherals, and software. As part of your training, you'll build a Sanyo MBC-550-2, which experts have hailed as the "most intriguing" of all the new IBM-compatibles. The Sanyo even surpasses the IBM PC in computing speed and graphics quality.

Even if you've never had any previous training in electronics, you can succeed with NRI training. You'll start with the basics, rapidly building on the fundamentals of electronics until you master advanced concepts like digital logic, microprocessor design and computer memory. You'll probe into electronic circuits, using the exclusive

NRI Discovery Lab® and professional Digital Multimeter, that you keep.

You'll assemble Sanyo's intelligent keyboard, install the power supply and disk drive, and attach the high resolution monitor—all the while performing hands-on experiments and demonstrations that reinforce your skills.

Learn to service today's computers

As you complete your Sanyo, you grasp the "secrets" that qualify you for a new career. You'll learn to program in BASIC and machine language. You'll use utility programs to check out the operation of the Sanyo's 8088 microprocessor (the same chip used in the IBM PC). And you also get over \$1,000 worth of software, including WordStar and CalcStar.

Most importantly, you'll understand the principles common to all computers. Only a person who fully understands all the fundamentals can hope to be able to tackle all computers. NRI makes sure that you'll gain the knowledge and skills to maintain, troubleshoot and service computers.

Learn at home in spare time

With NRI training, you'll learn at home on your own time. That means your preparation for a new career or part-time job doesn't have to interfere

with your current job. You'll learn at your own pace, in the comfort and convenience of your own home. No classroom pressures, no rigid night school schedules. You're always backed up by the NRI staff and your instructor, who will answer questions, give you guidance and be available for special help if you need it.

Let others worry about computers taking their jobs. With NRI training, you'll soon have computers making good paying jobs for you.

Send for Free NRI Catalog

Send the post-paid reply card today for NRI's 100-page catalog, with all the facts about computer training plus career training in Robotics, Data Communications, TV/Video Servicing and many other fields. If some other ambitious person beat you to the card, write to NRI at the address below.

NRI SCHOOLS

McGraw-Hill Continuing Education Center
3939 Wisconsin Avenue, NW
Washington, DC 20016

We'll Give You Tomorrow.



IBM is a Registered Trademark of International Business Machines Corporation.

★ QUALITY PARTS
★ DISCOUNT PRICES
★ FAST SHIPPING!
ALL ELECTRONICS CORP.
905 S. VERMONT • P.O. BOX 20406 • LOS ANGELES, CA 90006

SEND FOR
FREE FALL 1985 CATALOG
48 PAGES!

**ULTRA-MINIATURE
5 VDC RELAY**

Fujitsu #
FBR211NED005M20
High sensitivity
COIL 120 ohms
CONTACTS 1 amp
Mounts in 14 pin DIP socket

\$1.25 each
10 for \$10.00

**D.P.S.T. LIGHTED
ROCKER SWITCH**

115 vac lighted rocker
snap mounts in
1/8 x 1 1/8 hole
Orange lens 16 amp
contact

\$1.50

MINIATURE TOGGLE SWITCHES
ALL ARE RATED 5 AMPS @ 125 VAC

**S.P.D.T.
(on-on)**

PC style
non-threaded
bushing
75¢ each
10 for \$7.00



**S.P.D.T.
(on-on)**

Solder lug
terminals
\$1.00 each
10 for \$9.00
100 for \$80.00



**S.P.D.T.
(on-off-on)**

Solder lug
terminals
\$1.00 each
10 for \$9.00
100 for \$80.00



13.8 VDC REGULATED POWER SUPPLY



These are solid state, fully regulated 13.8 vdc power supplies. Both feature 100% solid state construction fuse protection, and L E D power indicator U L listed

2 amp constant, 4 amp surge \$18.00 each
3 amp constant, 5 amp surge \$25.00 each

8" P.A. SPEAKER

C T S Model 8B3079
8 ohms coil
3 0 oz ferrite magnet
Typical response range
100 - 10,000 hz
Power rating 15 watts max
Drilled to mount line
matching transformers

\$5.00 each
CASE OF
8 SPEAKERS
\$32.00



**COMPUTER
GRADE
CAPACITORS**



2,000 mfd. 200 VDC
1 3/4 DIA x 5 HIGH \$2.00
3,600 mfd. 40 VDC
1 3/8 DIA x 3 3/4 HIGH \$1.00
6,400 mfd. 60 VDC
1 3/8 DIA x 4 1/4 HIGH \$2.50
9,700 mfd. 50 VDC
1 3/8 DIA x 4 1/2 HIGH \$3.00
31,000 mfd. 15 VDC
1 3/4 DIA x 4 HIGH \$2.50
72,000 mfd. 15 VDC
2 DIA x 4 3/4 HIGH \$3.50
185,000 mfd. 6 VDC
2 1/2 DIA x 4 1/2 HIGH \$1.50

**EDGE
CONNECTORS**

ALL ARE 1.56" SPACING.

22/44 EDGE CONNECTOR
PC style \$2.00 each
10 for \$18.00
22/44 EDGE CONNECTOR
solder lug \$2.50
style each
28/56 EDGE CONNECTOR
PC style \$2.50 each
10 for \$22.00
36/72 EDGE CONNECTOR
PC style \$3.00 each
43/86 EDGE CONNECTOR
PC style \$4.50 each



CIRCLE 739 ON FREE INFORMATION CARD

components, it is possible to make any of the projects by re-using the components and printed-circuit board.

Each project comes with a circuit description, circuit diagram, component layout diagram, parts list, and construction notes. All projects operate from a 9-volt battery, making them a safe introduction to electronics for the beginner.

Multi-circuit Board Projects (published by Bernard Babani Publishing Ltd., London, England) is available through Electronics Technology Today, Inc., P.O. box 240, Massapequa Park, NY 11762-0240, priced at \$6.00 (including shipping and handling).

**Basic Electronics Technology
By Avis J. Evans, Jerry D. Mullen,
and Danny H. Smith**

Texas Instruments has published a one-volume 464-page ready reference to semiconductor circuits and systems. The book is an overview of electronics technology based on integrated circuits. It explains simply and thoroughly both the basic concepts and

By Barmard de Backus

BOOKSHELF

**Multi-Circuit Board Projects
By R.A. Penfold**

The Multi-Circuit Board Project book contains information that allows the reader to build 21 fairly-simple electronic projects: all of which may be constructed on the same specially designed printed-circuit board. In addition, wherever possible, the same components are used in each design so that, with a relatively small number of



CIRCLE 725 ON FREE INFORMATION CARD

the practical applications of electronic circuits and systems. Engineers, technicians, students, and technically interested consumers will all find it a valuable tool for learning and as review or as a reference.

Basic Electronics Technology covers most of the primary functions and associated circuits that go into the electronic systems that touch our lives every day. It explains how semiconductors and circuits work as amplifiers and oscillators; in power supplies, audio systems, AM/FM radio, TV and other video systems, as well as microprocessors and computers.

The book's initial chapter explains basic semiconductor theory, how semiconductor devices operate and what they do in a circuit, giving the beginning reader a solid foundation for the more complicated concepts and applications that follow. Each chapter contains a summary, followed by a short quiz to reinforce the information presented.

The authors of Basic Electronics Technology combined their many years of teaching experience and hands-on knowledge to present an easy-to-understand guide to basic electronics theory, application, and troubleshooting. Basic Electronics Technology will be available through bookstores and college stores at a suggested retail price of \$19.95.

**Linear IC Equivalents And Pin Connections
By Adrian Michaels**

Linear IC Equivalents and Pin Connections (Book No. 141), based on

(Continued on page 15)

TI SWITCHING POWER SUPPLY

Compact, well-regulated switching power supply designed to power Texas Instruments computer equipment

INPUT 14 - 25 vac @ 1 amp
OUTPUT - 12 vdc @ 350 ma
- 5 vdc @ 1.2 amp
- 5 vdc @ 200 ma

SIZE 4 3/4 x 4 1/4 x 1 1/4 high

\$5.00 each



***SPECIAL PRICE*
DUAL L.E.D. DISPLAYS**



560 high, 7 segment L E D read outs Mount in 24 Pin DIP socket

FND-5148 red c c 75¢ each
DL-527 red c a 75¢ each

**STANDARD JUMBO
DIFFUSED T 1 1/2**

RED 10 for \$1.50
100 for \$13.00
GREEN 10 for \$2.00
100 for \$17.00
YELLOW 10 for \$2.00
100 for \$17.00

FLASHER LED

5 volt operation
red jumbo T 1 1/2 size \$1.00 each

BI-POLAR

jumbo T 1 1/2 size
2 for \$1.70

LED HOLDERS

Two piece holder
for jumbo LED
10 for 65¢

**CASSETTE
MECHANISM**



New stereo cassette mechanism Includes record/playback and erase heads 2 12VDC motors drive belts pulleys 3 12VDC solenoids pinch wheels and other mechanical parts These parts used on other current mode decks would cost several times our selling price if purchased separately 5 3/4 x 3 1/2 x 3 1/4 \$7.50 EACH 2 FOR \$12.50

MINI-PUSH BUTTON

S P S T momentary normally open 1/4 bushing Red button 35¢ each 10 for \$3.00

**TOLL FREE ORDERS
1-800-826-5432**

(IN CA: 1-800-258-8888)
INFO: (213) 380-8000
TWX - 5101010163 ALL ELECTRONIC

QUANTITIES LIMITED
MINIMUM ORDER \$10.00
USA \$3.00 SHIPPING
NO C.O.D.
FOREIGN ORDERS
INCLUDE SUFFICIENT
SHIPPING
CALIF RES ADD 6.7%

CIRCLE 709 ON FREE INFORMATION CARD

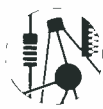

ELECTRONICS BOOK CLUB

Keep In Step With the Future . . . Become a Part of the Fascinating World of Technology!

- High-Tech How-To
- Space Age Projects
- Digital Electronics
- Artificial Intelligence
- Robotics
- Computers
- Telecommunications
- *And much more!*

Select 5 Books for Only \$2⁹⁵

(Values to \$107.75)



1690
List \$19.95



1199
List \$21.95



800P
List \$19.50 (paper)



1277
List \$21.95



1544
List \$21.95



1339P
List \$7.95 (paper)



1685
List \$17.95



1529P
List \$14.95 (paper)



1553
List \$15.95



1241P
List \$10.25 (paper)



1672
List \$18.95

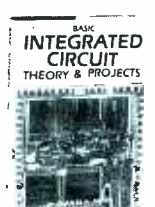

1699
List \$19.95



1474P
List \$12.95 (paper)



1431
List \$17.95



1532P
List \$12.95 (paper)

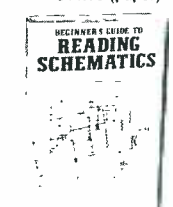

1536
List \$14.95



1909
List \$21.95

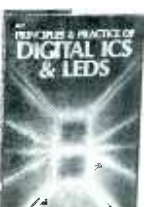

1577
List \$19.95



1599P
List \$15.95 (paper)

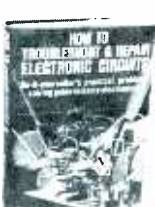

1218
List \$18.95



1539P
List \$15.95 (paper)



1013
List \$14.95

FREE guide to mail order sources for electronic parts and components

A \$6.95 Value!

Electronics Buyer's Guide
3rd Edition

FREE When You Join Now

7 very good reasons to join the Electronics Book Club

- **Big Savings.** Save 20% to 75% on books sure to increase your electronics know-how
- **No-Risk Guarantee.** All books returnable within 10 days without obligation
- **Club News Bulletins.** All about current selections—mains, alternates, extras—plus bonus offers. Comes 13 times a year with hundreds of up-to-the-minute titles to pick from
- **Automatic Order.** Do nothing, and the Main selection will be shipped automatically! But . . . if you want an Alternate selection—or no books at all—we'll follow the instructions you give on the reply form provided with every News Bulletin
- **Bonus Books.** Immediately get Dividend Certificates with every book purchased and qualify for big discounts of 60% to 80%
- **Extra Bonuses.** Take advantage of added-value promotions, plus special discounts
- **Exceptional Quality.** All books are first-rate publisher's editions selected by our Editorial Board and filled with useful up-to-the-minute information

ELECTRONICS BOOK CLUB

P.O. Box 10,
Blue Ridge Summit, PA 17214

Please accept my membership in the Electronics Book Club and send the 5 volumes circled below, plus my FREE copy of *The Electronics Buyer's Guide* billing me only \$2.95 plus shipping and handling charges. If not satisfied, I may return the books within ten days without obligation and have my membership canceled. I agree to purchase 4 or more books at regular Club Prices (plus shipping/handling) during the next 12 months, and may resign any time thereafter.

800P 1013 1183 1199 1218 1241P 1245P 1277 1339P
 1431 1474P 1529P 1531 1532P 1536 1539P 1544 1553 1577
 1599P 1602 1672 1685 1690 1699 1719 1909 1992

Name _____
 Address _____
 City _____
 State _____ Zip _____ Phone _____

Valid for new members only. Foreign applicants will receive ordering instructions. Canada must remit in U.S. currency. This order subject to acceptance by the Electronics Book Club.

RESP-186

This will be coming to you when you subscribe to **Radio-Electronics**

• **HELPFUL CONSTRUCTION ARTICLES...**

Test Equipment
Hi-Fi Accessories
Telephone Accessories
Music Synthesizers
Computer Equipment
Automotive Equipment
Intruder Alarms-
Home & Car
Video Accessories

• **NEWS ON NEW TECHNOLOGY**

Computers
Microprocessors
Satellite TV
Teletext
Automotive Electronics
Speech Synthesizers
IC Applications

• **FASCINATING "HOW TO DO IT" ARTICLES...**

Build Your Own Projects
Make Your Own PC Boards
Wiring Techniques
Soldering and Desoldering
Design and Prototyping



• **HOW YOU AND THE COMPUTER CAN BE FRIENDS...**

Getting Started
Programs, Circuit Design, Games
A/D-D/A Interfacing
Peripheral Equipment

• **NEW AUDIO DIMENSIONS FOR YOUR PLEASURE...**

Noise-Reduction Devices
How to Connect that Extra Add-On
Hi-Fi Accessories
New Technology

• **TV WONDERS FOR YOUR FUTURE...**

Latest Receivers and Circuits
The Home Entertainment Center
Projection TV
Satellite TV Receivers
Jack Darr's Monthly Service Clinic
Service Problems and Solutions

• **REGULAR MONTHLY FEATURES**

DESIGNERS NOTEBOOK by Robert Grossblatt
HOBBY CORNER by "Doc" Savage, K4SDS
STATE-OF-SOLID-STATE by Bob Scott
WHAT'S NEWS, new products, stereo news
VIDEOGAMES, new products, game reviews and NEW IDEAS, STEREO PRODUCTS, NEW COMPUTER PRODUCTS FOR HOME/JOB and MUCH MORE!

Radio-Electronics covers all aspects of the fast moving electronics field...featuring
**COMPUTERS • VIDEO • STEREO
TECHNOLOGY • SERVICE
COMMUNICATIONS • PROJECTS**

Get it all!

Subscribe today to **Radio-Electronics!** Don't miss a single issue and...see subscription card in back of this issue for big savings.

When you select one of the subscription offers listed on the handy coupon—you'll be assured of having your copy reserved, even if it sells out on the newsstand. Make sure you get all the excitement in every issue of **Radio-Electronics**, every month, by filling in and mailing your subscription card today.

Bookshelf

(Continued from page 12)

the original Linear IC Equivalents book, shows the equivalents and pin connections, as well as the country of origin, manufacturer, and functions of popular user-orientated selections of linear integrated circuits. It includes European, American, and Japanese devices manufactured by Advance Micro Devices, Analog Devices, Fairchild, Harris, Intersil, ITT, Motorola, NEC, National Semiconductor, Philips, Precision Monolithics, RCA, Raytheon, Siemens, Sescosem, SGS-Ates, Silicon General, Signetics, Sprague, Siliconix, Teledyne, AEG-Telefunken,

Linear IC Equivalents and Pin Connections

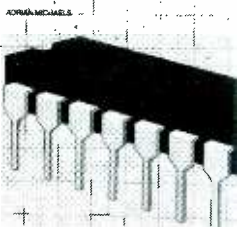

CIRCLE 725 ON FREE INFORMATION CARD

Toshiba and Texas Instruments, as well as Pro Electron numbered devices. The author's selection was made based on his own experience of usefulness and practicality to hobbyist, designers and service engineers, etc.

A key is provided to show how to use the tables; but it must be remembered that with some of the equivalents shown, there may be slight differences between the types listed in the first column and those listed in the last five columns of the tables. Those differences might be in dimensions, in dissipations, or in some other mechanical or electrical characteristic. Therefore, it is recommended that if the conditions under which the replacement IC operate are critical, reference should be made to the appropriate manufacturer's literature before a final replacement choice is made.

Linear IC Equivalents and Pin Connections (published by Bernard Babani Publishing Ltd, London, England) is available from Electronics Technology Today, P.O. Box 240, Massapequa, NY 11762-0240. It sells for \$12.50 plus \$1.00 for postage and handling.

Powerful Projects with Your Timex/Sinclair By Jim Stephens

You will find in this book the

How to live with someone who's living with cancer.

When one person gets cancer, everyone in the family suffers.

Nobody knows better than we do how much help and understanding is needed. That's why our service and rehabilitation programs emphasize the whole family, not just the cancer patient.

Among our regular services we provide information and guidance to patients and families, transport patients to and from treatment, supply home care items and assist patients in their return to everyday life.

Life is what concerns us. The life of cancer patients. The lives of their families. So you can see we are even more than the research organization we are so well known to be.

No one faces cancer alone.

AMERICAN CANCER SOCIETY

BLOWN any GOOD P.C. TRACES LATELY?



REPLACE THEM FAST WITH CIRCUIT-FIX

The CF-1 CIRCUIT-FIX™ KIT lets you repair or modify printed circuits in minutes. Just put an adhesive copper foil sheet in the patented clamp and cutter guide, adjust the trace width (.013" minimum) and cut a perfect copper strip every time. Kit includes clamp-guide, knife, copper foil, 154 assorted diameter donuts and instructions. The CF-1 is stocked by many electronic parts distributors, or order direct. Price includes shipping. Minimum order, \$20.00. NJ and CA residents must add state sales tax to order total.

CF-1 CIRCUIT-FIX™ Kit	\$23.50
CF-2 306 Assorted Adhesive Copper Donuts	4.30
CF-3 2 Sheets Adhesive Copper Foil, 3/4" x 10"	4.30

DATAK'S COMPLETE CATALOG lists hundreds of printed circuit products and art patterns. Also contains dry transfer letter sheets and electronic title sets for professional looking control panels. **WRITE FOR IT NOW!**

The DATAK Corporation • 65 71st Street • Guttenberg, NJ 07093

CIRCLE 710 ON FREE INFORMATION CARD

nicest synopsis of Z80 assembly language published to date. The text was prepared especially for hobbyists and experimenters, novice or experienced. *Powerful Projects with Your Timex/Sinclair* shows you how to build creative electronic projects in your home.

Beginning with the basic, the author clearly explains all the wiring techniques and components you'll need to control external devices with your computer. You'll learn how to

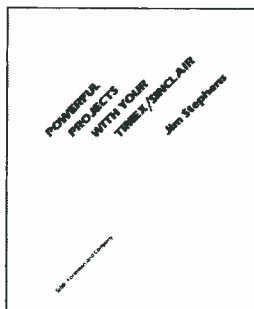

CIRCLE 731 ON FREE INFORMATION CARD

construct simple yet powerful control circuits, build an interface connector, assemble a weather station, build your own robot, construct a speech synthesizer for your robot, and more! The text will help you develop a solid

(Continued on page 18)



One tree can make
3,000,000 matches.



One match can burn
3,000,000 trees.



AMAZING DEVICES

PERSONAL DEFENSE AND PROPERTY PROTECTION UTILIZE SPACE AGE TECHNOLOGY
CAUTION THESE DEVICES CAN BE HAZARDOUS AND MAY SOON BE ILLEGAL

PHASORS

POCKET PAIN FIELD GENERATOR — IPG50
Assembled \$64.50
IPG5 Plans \$8.00 IPG5K Kit/Plans \$44.50

PHASOR PAIN FIELD CROWD CONTROLLER — PPF10
Assembled \$250.00
PPF1 Plans \$15.00 PPF1K Kit/Plans \$175.00

BLASTER - Provides a plasma discharge capable of puncturing a can. Produces a 100,000 WATT PULSE

BLS10 ASSEMBLED \$89.50
BLS1 PLANS \$10.00 BLS1K KIT/PLANS \$69.50

PLASMA STUN GUN - Very intimidating and affective 5 to 10 feet 100,000 VOLTS

ITM10 ASSEMBLED \$99.50
ITM1 PLANS \$10.00 ITM1K KIT/PLANS \$69.50

RUBY LASER RAY GUN — Intense visible red beam burns and welds hardest of metals. **MAY BE HAZARDOUS.**

RUB3 All Parts Available for Completing Device \$15.00

CARBON DIOXIDE BURNING, CUTTING LASER — Produces a continuous beam of high energy. **MAY BE HAZARDOUS.**

LC5 All Parts Available for Completing Device \$15.00

VISIBLE LASER LIGHT GUN — produces intense red beam for sighting, spotting, etc. Hand held complete

LGU3 Plans \$10.00 (Kit & Assembled Units Available)

IR PULSED LASER RIFLE — Produces 15-30 watt infra-red pulses at 200-2000 per sec.

LRG3 All Parts & Diodes Available \$10.00

BEGINNERS LOW POWER VISIBLE LASER — Choice of red, yellow, green — provides an excellent source of monochromatic light

LHC2 Plans \$5.00 LHC2K Kit \$34.50

SNOOPER PHONE — Allows user to call his premises and listen in without phone ever ringing

SNP20 Assembled \$89.50
SNP2 Plans \$9.00 SNP2K Plans/Kit \$59.50

LONG RANGE WIRELESS MIKE — Miniature device clearly transmits well over one mile. Super sensitive, powerful

MFT1 Plans \$7.00 MFT1K Plans/Kit \$49.50

WIRELESS TELEPHONE TRANSMITTER Transmits both sides of phone conversation over one mile, shuts off automatically

VWPM5 Plans \$8.00 VWPM5K Plans/Kit \$39.50

TALK & TELL AUTOMATIC TELEPHONE RECORDING DEVICE — Great for monitoring telephone use

TAT20 Assembled \$24.50
TAT2 Plans \$5.00 TAT2K Plans/Kit \$14.50

Our phone is open for orders anytime. Technicians are available 9-11 a.m., Mon-Thurs for those needing assistance or information. Send \$1.00 for catalog of hundreds more similar devices. Send check, cash, MO, Visa, MC CDD to **INFORMATION UNLIMITED**
DEPT R8 P.O. Box 716 Amherst N.H. 03031 Tel: 603-673-4730

CIRCLE 712 ON FREE INFORMATION CARD

SUPER LONG PLAY TAPE RECORDERS

10 Hour Model — \$95.00*
14 Hour Model — \$159.00*

Modified Panasonic Simulink
high quality AC-DC
Recorders provide 5 or 7
continuous hours of quality
recording & playback on
each side of cassette for a
total of 10 or 14 hours
depending on model. Built-in
features include: • Voice
level control • Digital
counter etc. TDK DC 180
Cassette Furnished

PHONE RECORDING ADAPTER
Records calls automatically. All Solid
State connects to your telephone
jack and tape recorder. Starts
recording when phone is lifted.
Stops when you hang up. **\$24.50***
FCC APPROVED

VOX VOICE ACTIVATED CONTROL SWITCH
Solid state Self contained Adjust
able sensitivity. Voices or other
sounds automatically activate and
control recorder. Uses either re-
corder or remote mike. **\$24.95***

*Add for ship & hdg. Phone Adapter & Vox \$1.50 ea.
Recorders \$4.00 ea. Cal Res. add tax. Mail order. VISA
MIC COD'S OK. Money Back Guarantee. Free data
avail. Dealer Inquiries invited. Free data
AMC SALES INC Dept A 9335 Lubec
Box 928, Downey, CA
90427 (213) 869-8519

CIRCLE 711 ON FREE INFORMATION CARD

SAXON ON SCANNERS

By Mark Saxon

About cops, Portland, MARS, tow trucks, trains, and other scanner topics!

□ SCANNER FOLKS KEEP MAKING THE headlines, although all of the news isn't that good.

One of the more interesting items to recently show up tells of "Junior" Bellomy of Muncie, IN. This guy's an enthusiastic scanner user and keeps his scanner tuned in on the pulse of his community.

While monitoring his local police frequency he overheard a national police bulletin issued by the police in Madeira Beach, FL. They were looking for an auto theft suspect who was also wanted for questioning in a murder.

Bellomy thought the suspect's name had a familiar ring, it was a name that was identical to that of his 20 year old nephew who was visiting Muncie from Florida. Bellomy drove over to the Muncie PD station house and asked the Captain if it was his nephew that they were seeking. After hearing Bellomy's description, the police agreed that it was, indeed, just the man they wanted.

What could be easier—Bellomy told the Captain that the suspect was "out in the car." The police promptly arrested the young man who was being sought by the Florida agency!

On the darker side of the headlines, a VHF enthusiast with a powerful transmitter tuned it to a frequency where it didn't belong a few months ago.

Police in Portland, Oregon, reported that they were looking for the wiseguy who spent about an hour deliberately jamming the communications of that city's Bureau of Emergency Communication.

They knew it was no accident because the intruder was using rather salty language not normally encountered on the air. Furthermore, he was identifying his jamming station as *Radio Free Portland*.

Luckily, the prankster's antics took place during a usually quiet period for the victimized agency: no critical calls were delayed or lost because of the jamming.

A tip of the **Hands-on** hat to "Junior" Bellomy, and a knock in the noggin" to any and all connected with the operation of *Radio Free Portland*; may their antenna shrivel and truly wither.

Handy Hand-Held

Regency Electronics notes that their HX-750 scanner is a 6-channel hand-held



unit covering 30 to 50 MHz, 118 to 136 MHz, 146 to 174 MHz and 450 to 512 MHz.

Individual channel lock-out switches temporarily skip over unwanted channels. LED's indicate which channel is being monitored. The HX-750 comes with an AC adapter/charger, a rugged flexible rubberized antenna and a wire antenna. A built-in speaker is provided, but you can plug in an ear-
phone.

CIRCLE 742 ON FREE INFORMATION CARD

Operation is by means of four AA batteries; it can also run from its external 6-volts DC, plug-in power pack.

The HX-750 uses plug-in crystals; that's why, at a suggested list price of only \$159.95, Regency can offer so much for such a reasonable tab. A keyboard-programmable receiver offering less frequency coverage than the HX-750 would cost about twice as much! Nice going, Regency!

See the HX-750 at your nearest Regency dealer.

Want To Monitor MARS?

It's not too difficult to hear MARS on your scanner. No, not the red planet with all of the imaginary canals. This MARS is the Military Affiliate Radio System, an emergency communications system run by volunteer operators who are usually licensed Hams. MARS comes in three different versions, Army, Navy and Air Force, and the frequencies used span the entire shortwave and scanner spectrum with Voice, CW, and RTTY traffic.

Army MARS stations appear to be especially plentiful and they offer much good listening. On the VHF low band, look for these stations on 40.95, 46.79, 49.79 and 49.93 MHz.

When it comes to the high band, check out 143.415, 143.99, 148.65, and 150.625

HANDS-ON ELECTRONICS

New Products Showcase

(Continued from page 8)

they developed a technique that produces oversize copper crystals called, logically enough, "giant crystals." Then they devised a copper extrusion process that stretches the giant crystals until they are thousands of times longer than usually made.

LC-OFC cable also makes use of a purer grade of copper, known as oxygen-free copper (OFC). Ordinary copper (like the kind used in so-called "monster" cables that are currently on the market), con-

tains an impurity called copper oxide, which forms barriers between the copper crystals, making distortion and signal loss even worse.

Linear-crystal/oxygen-free copper cables are made only by Hitachi Cable, Ltd (U.S. patent pending). The LC-OFC cable is available for a wide variety of audio and video applications (at prices starting at \$28.00 for a pair for stereo interconnecting cables and \$2.50 per foot for speaker cable) through audio/high-fidelity outlets throughout North America.

Letters

(Continued from page 5)

York offers a variety of associate and bachelor's degrees through its Regents College. Those include: AS, Computer Information Systems; AS, Electronics Technology; BS, Computer Information Systems; BS, Computer Technology; and BS, Electronics Technology. The degrees may be earned through a wide variety of methods.

M.S., Springfield, OH

One reader called to tell us that she is enrolled in a Cleveland Institute of Technology (CIE) course that will reward her with an Associate in Applied Science Degree in Electronics Engineering Technology when completed. ■

Bookshelf

(Continued from page 15)

understanding of computer electronics while you're building those enjoyable projects. As an added bonus, this how-to book gives you detailed instructions for doing those projects with the TS 2068, 1500, and 100 computers.

Jim Stephens is an educator and a devoted electronics hobbyist. A resident of Nashville, Tennessee, he has worked with the Tennessee Department of Education for the past ten years. Stephens constructed his own microcomputer in 1978 and has published numerous articles in such popular magazines as *Microcomputing*, *Sync*, *Times/Sinclair User*, *Radio-Electronics*, and *Run Magazine*.

Scott, Foresman and Company, 1900 East Lake Avenue, Glenview, IL 60025. Paperback, 228 pages, \$12.95.

Saxon on Scanners

(Continued from page 17)

to us for help and we, in turn, looked up the wanted frequencies in several reference guides in our own library. *Rail Scan* and *Air Scan*.

The Texas State Railroad Commission operates on 39.94 MHz; NASA in El Paso is on 121.75 MHz. Long ago we realized that some of the frequency directories offered by chain stores were satisfactory for beginners and those with a very casual or passing interest in scanners, but those references were a waste of time and money for hobbyists pursuing scanner use on a serious level.

For directories oriented more towards the serious scanner user, request a free catalog from CRB Research, P.O. Box 56-GP, Commack, NY 11725. They publish the *Rail Scan* and *Air Scan* directories mentioned above and also offer many other books and guides for scanner and shortwave enthusiasts.

Tune you in next time around! ■



Get every issue!

SUBSCRIBE TODAY!

Use the order form below.

■ YOU CAN HAVE THE NEXT SIX ISSUES of **Hands-on Electronics** delivered directly to your home for only \$14.00. We pay the postage. If you want the next twelve issues, you can even save two dollars off the newsstand price. Get twelve issues for \$28.00

■ IF YOU'RE THE KIND OF READER that doesn't want to wait, you can order your next copy of **Hands-on Electronics** now. **Hands-on Electronics** is crammed full of electronic projects that you won't be able to wait to build for yourself. You can expect top-notch digital projects, fun-to-play electronic games, valuable add-on computer projects, BCB and shortwave receivers, photographic/darkroom gadgets, devices to improve your car's performance, test equipment ideas, and more in every issue of **Hands-on Electronics**.

■ TO HELP YOU TO BE SURE that you don't miss any future issues of **Hands-on Elec-**

tronics—SUBSCRIPTIONS ARE NOW AVAILABLE!

■ EVERY ISSUE OF **Hands-on Electronics** will continue to contain a variety of construction articles to suit every taste. In addition, feature articles on electronics fundamentals, test equipment and tools will round out each issue. Of course, **Hands-on Electronics** will continue to provide new product and literature listings to keep you up to date on the latest developments in electronic technology.

■ GET IN ON THE ACTION! Order your next issue of **Hands-on Electronics** today. Use the convenient order coupon below. Be sure to send check or money order—no cash!

Hands-on Electronics SUBSCRIPTION

I want to be sure I don't miss any issues. Send me the next six issues of **Hands-on Electronics** for \$14.00. Postage is free in U.S. For Canada add \$3.00. Foreign add \$7.00

I want to be sure I don't miss any issues and want to save \$2.00 too. Send me the next twelve issues of **Hands-on Electronics** for \$28.00. Postage is free in U.S. For Canada add \$6.00. Foreign add \$14.00.

Allow 6-8 weeks for the first issue to arrive.

Please print

(Name)

(Street Address)

(City)

(State)

(Zip)

Detach and mail today to:
HANDS-ON ELECTRONICS
SUBSCRIPTION DEPT.
P.O. BOX 338
MOUNT MORRIS, IL 61054

AHOA6

WITH CIE, THE WORLD OF ELECTRONICS CAN BE YOUR WORLD, TOO.

Look at the world as it was 20 years ago and as it is today. Now, try to name another field that's grown faster in those 20 years than electronics. Everywhere you look, you'll find electronics in action. In industry, aerospace, business, medicine, science, government, communications—you name it. And as high technology grows, electronics will grow. Which means few other fields, if any, offer more career opportunities, more job security, more room for advancement—if you have the right skills.

SPECIALISTS NEED SPECIALIZED TRAINING.

It stands to reason that you learn anything best from a specialist, and CIE is the largest independent home study school specializing exclusively in electronics, with a record that speaks for itself. According to a recent survey, 92% of CIE graduates are employed in electronics or a closely related field. When you're investing your time and money, you deserve results like that.

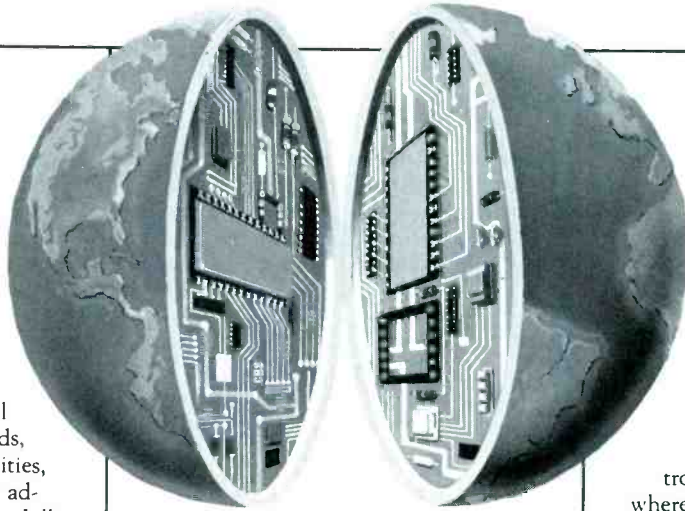

INDEPENDENT STUDY BACKED BY PERSONAL ATTENTION.

We believe in independent study because it puts you in a classroom of one. So you can study where and when you want. At your pace, not somebody else's. And with over 50 years of experience, we've developed proven programs to give you the support such study demands. Programs that give you the theory you need backed with practical experience using some of the most sophisticated electronics tools available anywhere, including our Microprocessor Training Laboratory with 4K of random access memory. Of course, if you ever have a question or problem, our instructors are only a phone call away.

START WHERE YOU WANT, GO AS FAR AS YOU WANT.

CIE's broad range of entry, intermediate, and advanced level courses in a variety of career areas gives you many options. Start with the Career Course that best suits your talents and interests and go as far as you want—all the way, if you wish, to your Associate in Applied Science Degree in Electronics Engineering Technology. But wherever you start, the time to start is now. Simply use the coupon below to send for your FREE CIE catalog and complete package of career information. Or phone us at 1-800-321-2155 (in Ohio, 1-800-362-2105). Don't wait, ask for your free catalog now. After all, there's a whole world of electronics out there waiting for you.

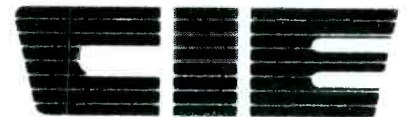

**Cleveland Institute of
Electronics, Inc.**

1776 East 17th Street
Cleveland, Ohio 44114
216-781-9400

A half century teaching electronics.



Cleveland Institute of Electronics, Inc.

1776 East 17th Street, Cleveland, Ohio 44114

RP-35

YES...I want to learn from the specialists in electronics—CIE. Please send me my FREE CIE school catalog, including details about CIE's Associate Degree program, plus my FREE package of home study information.

Print Name _____

Address _____

City _____ State _____ Zip _____

Age _____ Area Code/Phone No. _____ / _____

Check box for G.I. Bill bulletin on educational benefits: Veteran Active Duty

MAIL TODAY!

ELECTRONIC COMPONENTS

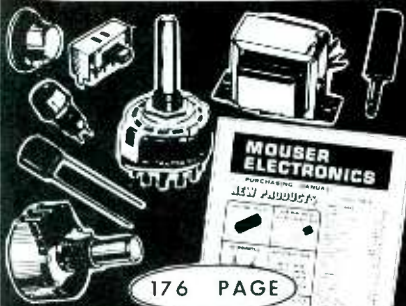

176 PAGE
FREE CATALOG

MANUFACTURERS OF QUALITY ELECTRONIC COMPONENTS

- BATTERY CLIPS & HOLDERS
- CABLE SETS • CONNECTORS • CAPACITORS
- DISPLAYS • LEDs • FUSES • JACKS & PLUGS
- KNOBS • LAMPS • POTENTIOMETERS
- RF COILS • RELAYS • RESISTORS
- SWITCHES • SEMICONDUCTORS • SPEAKERS
- TEST EQUIPMENT • TRANSFORMERS • TOOLS
- WIRE & CABLE

OVER 15,000 DIFFERENT ITEMS IN STOCK!

- Sales and Order Desk
Open from 6:00a.m. (PST)
- TERMS C.O.D., Visa,
MasterCharge
(Open Accounts Available)
- Phone and Mail
Orders Welcome
- Catalogs Mailed
Outside USA
Send \$2.00

MOUSER ELECTRONICS
11433 WOODSIDE AVE. SANTEE, CA 92071
PHONE: (619) 449-2222 TWX 910-331-1175

CIRCLE 714 ON FREE INFORMATION CARD

Get
**professional
quality at home.**



KeproClad is the quick, easy and inexpensive approach to home production of quality printed circuit boards. Minimum investment required

Complete package.

KeproClad comes packaged—pre-sensitized negative acting dry film photoresist. Extremely rugged yet holds fine lines. Available in two sizes with one or two-sided copper foil. Developer included.

For your local distributor write or call:
1-800-325-3878 1-314-343-1630 (in Missouri)



630 Axminster Drive, Fenton, MO 63026-2992

HANDS-ON ELECTRONICS

CIRCLE 713 ON FREE INFORMATION CARD

By Don Jensen

JENSEN ON DX'ING

Listen to the lands of the tango, cumbia, mariachi, and huayno

IN THE PAST FEW COLUMNS, WE'VE taken an overview of the world, continent by continent, looking at the different countries and their shortwave stations.

This time we complete the global junket by turning our eyes—make that ears!—toward Latin America.

Shortwave listeners, like other *nor-teamericanos*, tend to think of Latin America as being right next door. But like many other of our perceptions of the world, that is only partly correct.

Certainly, Mexico, Cuba, and the Central American nations are our southern neighbors. But Latin America also includes countries such as Argentina, Brazil, and Chile—far more distant than we may realize.

New York, for instance, is closer to Moscow than it is to Rio de Janeiro. From San Francisco it's about 5,000 miles to Tokyo, but nearly 6,000 to Santiago, Chile. A beeline from Chicago to Istanbul is shorter than one between the Windy City and Buenos Aires!

In the common stereotype, a Latin country is purely Spanish in language and flavor. But in fact, Brazil, the largest South American country, is Portuguese-speaking; and in French Guiana, Guyana, and Surinam, French, English, and

Dutch, respectively, are the predominant tongues. Many native-born citizens of the southern tier of South American countries have German, Italian, even Japanese as their first language. Additionally, there are many who speak the various Indian and Creole languages.

SWL's soon find that there is no single type of music typical of Latin America. The Argentine *tango*, the Colombian *cumbia*, the Mexican *Mariachi*, the Peruvian *huayno*—they're no more alike than Mozart and Madonna!

What that all means is that when it comes to listening to the shortwave stations of Central and South America, and their off-shore islands, there is a tremendous variety of programming awaiting you.

Unfortunately, beginning shortwave listeners tend to shy away from those stations. There are hundreds of Latin stations on the bands, but compared to most of the powerhouse broadcasters of Europe and Asia, most are relatively low powered. Signals, typically, aren't as big and booming.

Also, the majority—but no means all—of those Latin voices operate on the so-called Tropical Bands; the SW chan-

(Continued on page 102)

SAYING GOOD-BY TO OLD FRIENDS



CLAYTON
HOWARD

Clayton

HELEN
HOWARD

Helen

Helen and Clayton Howard sent this farewell card to many of their listeners when they retired from the staff of HCJB in Quito, Ecuador, in 1984. Clayton served the station for 43 years. Both Howards were familiar to listeners as hosts of the popular "DX Party Line" program.

DIGITAL CRIBBAGE BOARD

The Digital Cribbage Board may not improve your game, but it will make scorekeeping quicker and a lot more fun than a board and pegs!

By W. Schopp

IN THE CARD GAME CALLED CRIBBAGE, scorekeeping requires a counter (scorekeeper) that not only tallies total points, but also shows the point count of the last play entered. Our Digital Cribbage Counter fills those requirements and is a pleasure to use. Of course, the winners smile and the losers still say "hurry up and deal," but the Digital Cribbage Board verifies to both players that each entry is correct.

Since the scorekeeper is composed of two identical circuits to accommodate two players, only one circuit is shown schematically in Fig. 1. However, keep in mind that two such circuits are needed and are arranged side-by-side in opposite directions on the printed-circuit foil pattern. When the board is placed between two opposing players, each player has one half (turn page,

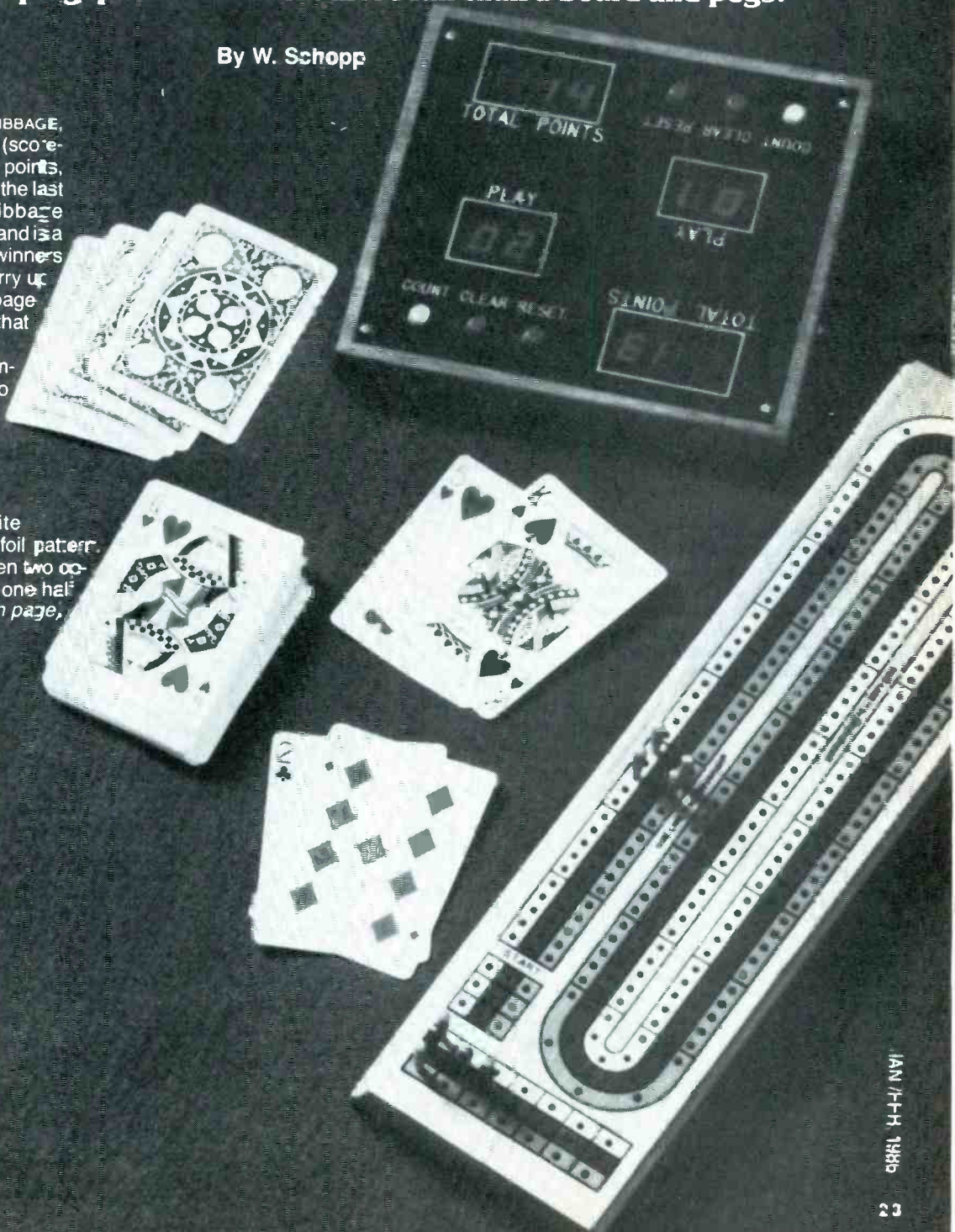

of the board facing him while he is still able to view his opponent's score on the other half.

Each circuit is composed of two separate counters with the score count being fed into both. One counter, a two-digit unit capable of counting to ninety nine, registers play points. That counter, which resets to zero before entering each new play, displays the last play count entered. The other, a three-digit counter, counts to one hundred and ninety-nine, and is reset only at the start of a new game. The second counter shows total points for all points entered during the game.

With low cost in mind, the circuit was constructed of all CMOS integrated circuits (IC's). Inexpensive computer-type keyboard switches were used for the COUNT, PLAY CLEAR, and game RESET controls. The controls and readouts were mounted directly on the circuit board for simplicity, but could easily be remotely located by wiring between components and board. The readouts are modulated with a 50% duty cycle squarewave to reduce the current drain of the readouts to a level that makes battery operation feasible.

The Circuit

The input pulses from the count pushbutton switch, S1, are conditioned by a debounce circuit consisting of U6-d (1/6 of a hex Schmitt trigger) and fed to the pin 9 inputs of two CD4518 dual up-counters, U2 and U8. Both U2 and U8 are configured so that one of its internal counters counts units while the other serves as a decade (tens) counter. After a count of ten, the units counters of U8 and U2 feed one pulse into their respective decade counters via AND gates U5-a and U5-c.

Fig. 1—The Digital Cribbage Board is made up two identical circuits that share only one common component, C4; therefore, only one-half of the circuit is shown. The circuit's low power, CMOS construction makes battery operation practical.

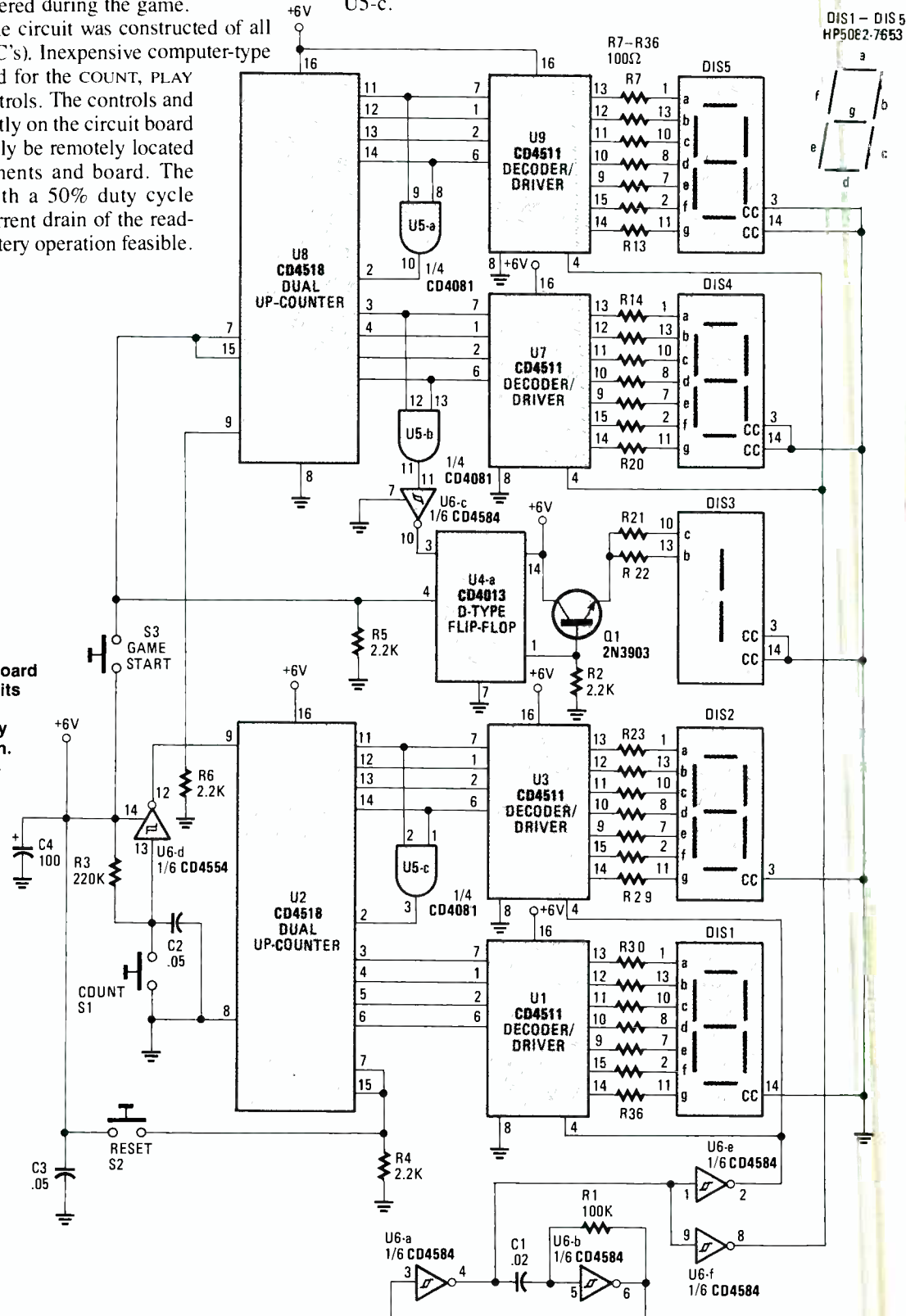

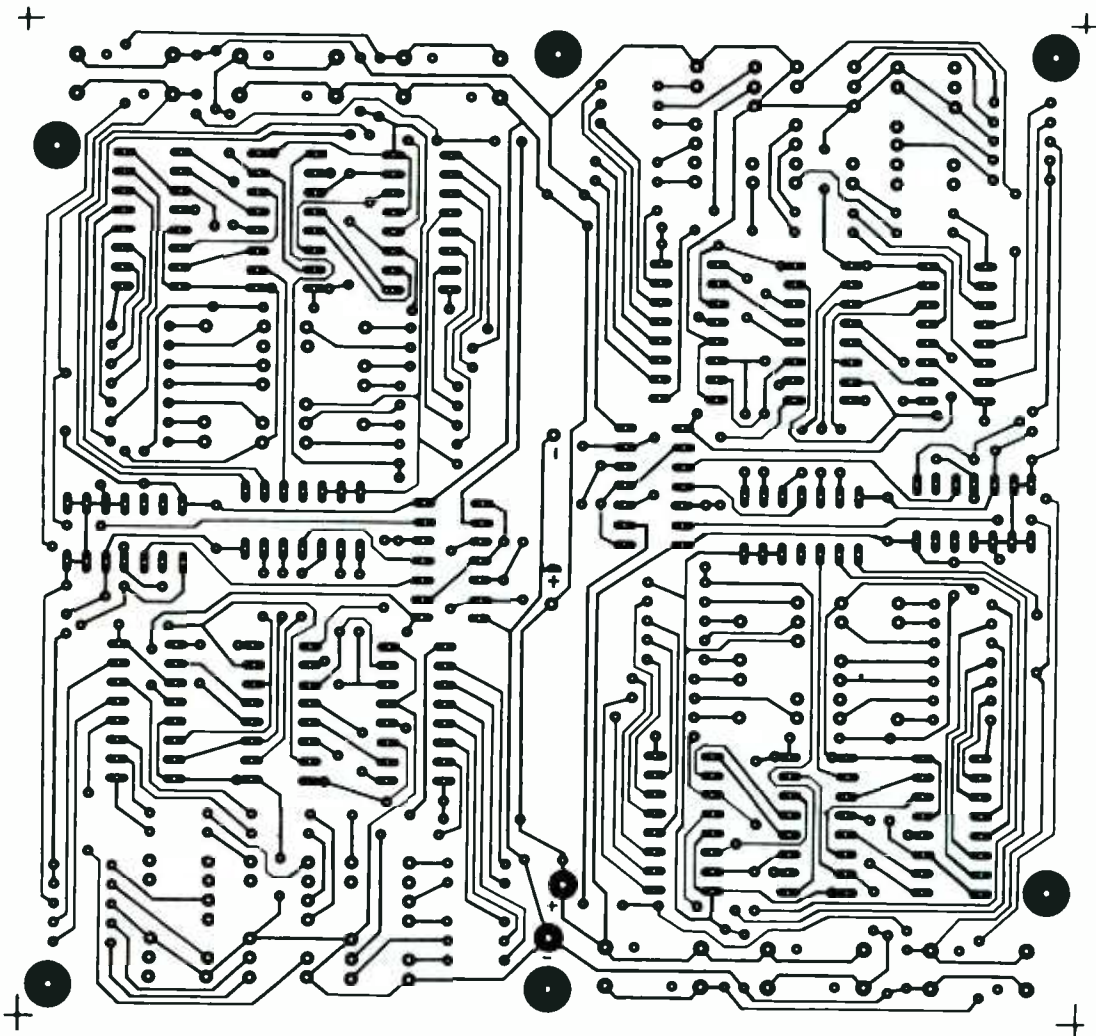

Fig. 2—Foil pattern for the Digital Cribbage Board's printed circuit is shown full-scale. Note that if the pattern were cut down the center, you'd have two identical circuit-board patterns.

The counter circuit that's made up of U2 and the decoder/driver chips U1 and U3 constitute the two digit PLAY counter. Pushbutton switch S2 clears the play counter before entering each new play count. The counter circuit comprised of U8 along with decoder/drivers U7 and U9 and flip-flop U4 make up the three-digit total point counter. The flip-flop was used instead of another counter to indicate one hundred. The output of U4 is coupled to Q1, which acts as a driver for the

two segments used to indicate the number "1" on DIS3. Pushbutton switch S3 clears counter U8 and resets flip-flop U4 to start a new game.

The inverting Schmitt triggers, U6-a and U6-b, make up a squarewave generator with a 50% duty cycle. The output of that generator is coupled through U6-e to the blanking inputs of U1 and U3. The generator output is also fed to the blanking inputs of U7 and U9 through U6-f. That squarewave signal

PARTS LIST FOR DIGITAL CRIBBAGE BOARD

SEMICONDUCTORS

DIS1-DIS5—HP-5082-7653, 7-segment, common-cathode display (Jameco Electronics)
 Q1—2N3903 NPN silicon bipolar transistor
 U1, U3, U7, U9—CD4511 BCD to 7-segment decoder/driver, integrated circuit
 U2, U8—CD4518 dual up-counter, integrated circuit
 U4—CD4013 dual D-type flip-flop, integrated circuit
 U5—CD4081 quad two-input NAND gate, integrated circuit
 U6—CD4084 hex Schmitt trigger, integrated circuit

RESISTORS

(All resistors are ¼ watt, 5% units)
 R1—100,000-ohm
 R2, R4-R6—2200-ohm
 R3—220,000-ohm
 R7-R36—100-ohm

CAPACITORS

C1—0.02- μ F, 25-WVDC, electrolytic
 C2, C3—0.05- μ F, 25-WVDC, electrolytic
 C4—100- μ F, 16-WVDC, electrolytic

ADDITIONAL PARTS AND MATERIALS

S1-S3—Normally open pushbutton switch
NOTE: Two of each semiconducting, resistive, and capacitive components listed above, except C4 (only one required), are needed to assemble the project.
 Printed-circuit material, 4 C- or D-cell batteries and holder; or 6-volt, 200-mA plug-in wall power supply, enclosure, wire, solder, hardware, etc.
 The Digital Cribbage Board's printed-circuit board, part No. CR-7, is available from Electronics Enterprises (priced at \$14.95, plus \$1.50 for postage and handling), 3305 Pesanta Way, Livermore, CA 94550. Please allow 6 to 8 weeks for delivery.

Fig. 3—The parts layout for the Digital Cribbage Board shows that two matching circuit boards make up the entire project. Component designations are duplicated in each half. That means that two U1's, two U2's, and so on are needed to complete the project. The only component that's not mirrored in each half of the circuit is C4, which is a filter that is common to both halves. The dashed lines indicate jumper connections that are located under components.

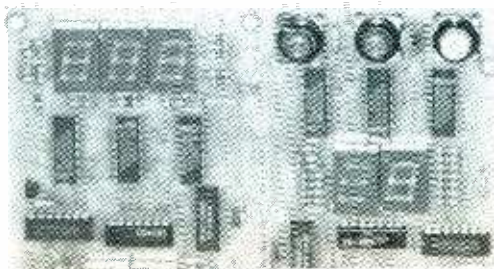
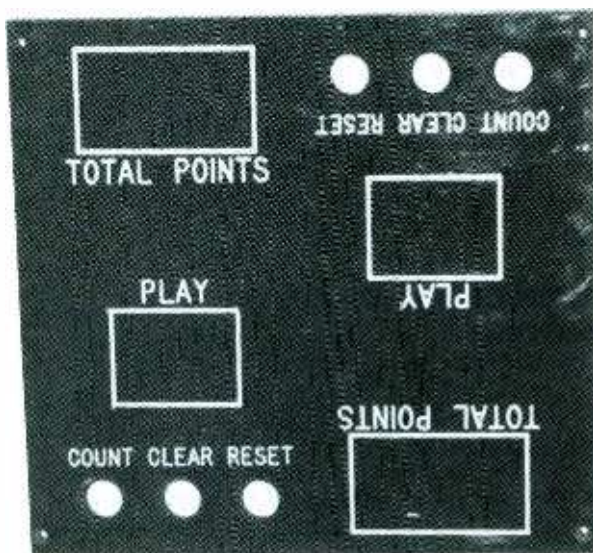
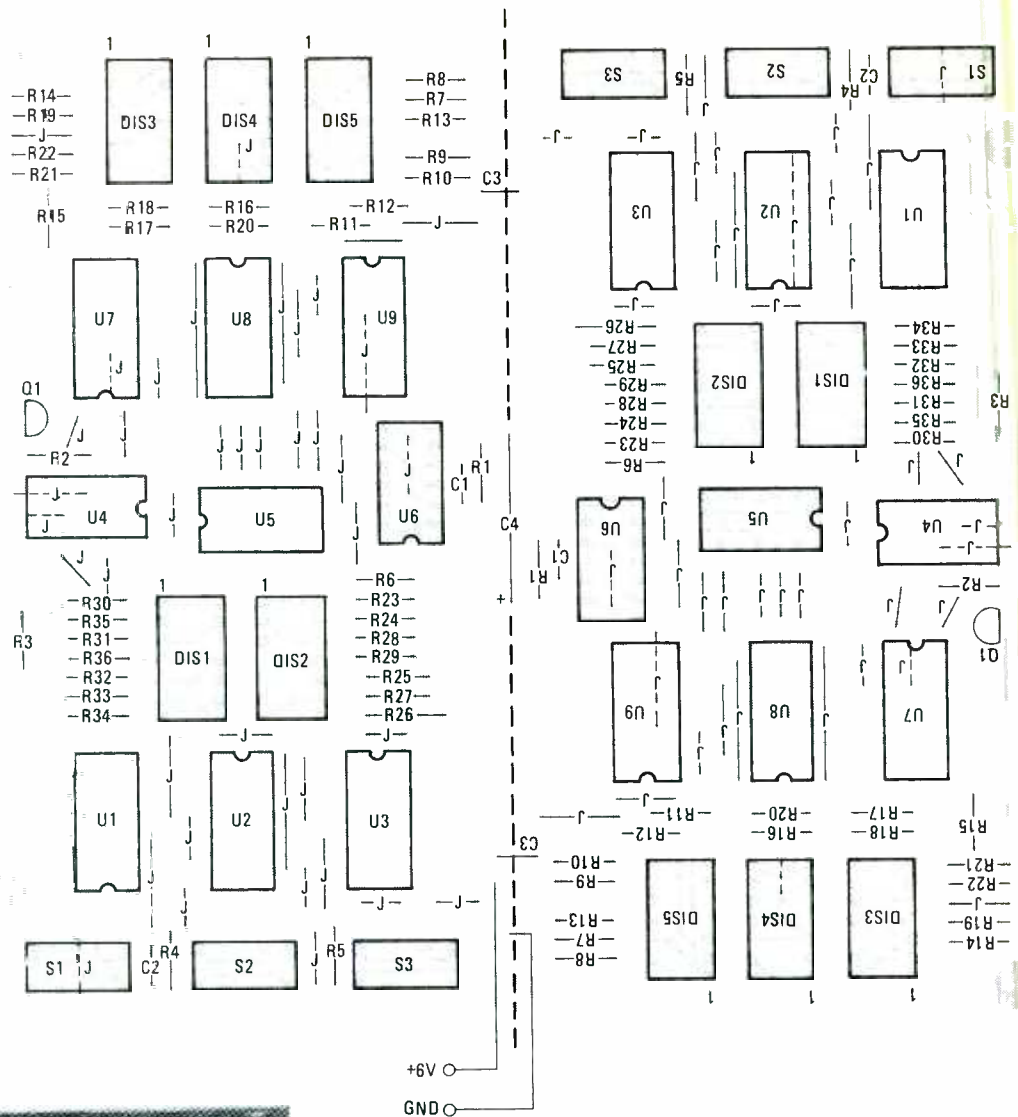

modulates the seven-segment readouts, reducing the current drain of the readouts by about 50%. Display DIS3 was not modulated because it only illuminates two segments on counts over one hundred.

Construction

In order to lay out the circuit on a single-sided printed-circuit board, many wire jumpers were used. Double-sided board with plated-through holes would simplify and speed construction, but the cost of double-sided boards make wire jumpers more economically desirable. You may make your own board from the foil pattern shown in Fig. 2, or purchase the etched, tinned, and drilled board from the supplier given in the Parts List.

Figure 3 gives the location of the components on the printed-circuit board. Note that the layout is divided in half by a dashed line. Each half is identical; therefore, component designations are duplicated on each half of the board and that condition is reflected in the Parts List, where the parts given are only for half the board. When purchasing the components, all except C4 (a 100- μ F unit common to both circuits and located at the center dividing line of the board) are multiplied by two. In other words, two U1's, two U2's, and so

A piece of red plastic about $\frac{1}{8}$ -inch thick covers the PC board. Holes are drilled to align with the pushbuttons and white lettering added.

TABLE 1
CRIBBAGE SCORING COMBINATIONS AND TERMS

Card Values												
Ace	2	3	4	5	6	7	8	9	10	J	Q	K
1	2	3	4	5	6	7	8	9	10	10	10	10
Scoring Combinations												
Term	Meaning											Pegs
Pair	Two cards of the same rank											2
Pair Royal	Three cards of the same rank											6
Double Pair Royal	Four cards of the same rank											12
Run	Three or more cards in sequence											1/card
Flush	Three or more cards of the same suit											1/card
Fifteen	Any two or more cards totaling 15 (i.e.: 5-Q, 7-8, A-8-6, etc.)											2
For Last	To non-dealer in five-card game only											3
His Heels	To dealer only if Jack is turned up											2
His Nob	For holding Jack of the same suit as the starting card											1
Go	For playing last card toward 31											1
	If exactly 31											2

on. When *populating* the board, do one side, then flip the board around and do the other.

Start construction by mounting and soldering all the resistors. Clip off the excess resistor leads, but do not throw them away. Those short lengths of leads provide an adequate supply of wire jumpers. Next, make all the jumper connections; some of them, those indicated by dashed lines, are located under components DIS4, U2, U4, U6, U7, U9, and S1. After all the jumpers are in place, mount the balance of the components.

As always, exercise care when handling the CMOS chips to prevent electrostatic damage to the components. Pins 3 and 6 of DIS1, and pins 9 and 14 of DIS2 were clipped off. Those pins are not used and eliminating them simplifies the circuit-board layout.

The power supply chosen will depend on whether a "carry around" portable or an AC-powered device is desired. The power supply chosen, which should output 6 volts with a current of at least 150 milliamperes, will dictate the final enclosure size. Four C- or D-type cells can furnish adequate power for a portable model. Or a small plug-in wall power supply can be used to power the circuit from any 117-VAC outlet. A third option would be using rechargeable batteries and a charging supply (several of which have been presented in past issues of *Hands-on Electronics* and *Radio Electronics*).

When your Digital Cribbage Board is complete, and you sit down across the table from your opponent, you will definitely find that keeping score is effortless, faster, and a lot more fun than the conventional Cribbage board and pegs. You may still lose the game—sorry to say, we still haven't figured out how to make every one a winner. But, at least the circuit helps to cut down on the problem of scorekeeping. ■

The author's prototype is housed in a simple wooden enclosure, without an internal power supply. Instead, the author opted to use a wall-mounted power supply like those used for TV-games and calculators.

GETTING INTO CRIBBAGE

The game of *Cribbage*, which dates back to about the 17th century, has several variations—five card, six card, and seven card. However, we will only concern ourselves with the most basic form, five-card. Table 1 gives the the scoring combinations and terms used in the game. Cribbage is usually played to 61 points or *pegs* (but may also be played to 121); the first player to reach that figure wins. If, when one player reaches that score, the other has not yet scored 31 or more (91 when the winning score is 121), he is said to be in the *lurch* or simply *lurched*. A more colorful word used is *skunked!*

Play starts by determining which player gets first deal by a cut of the cards; low card deals first (Ace being the lowest). Either player may shuffle, but the dealer must shuffle last. Five cards, one at a time, are dealt to each player face down; the first going to the non-dealer. The non-dealer immediately pegs (advances his peg on the scoreboard unique to Cribbage) *three for last*—but only on the first deal of a new game. If he fails to do so before the play begins, he loses those pegs. Each player then discards two cards face down, forming a *crib* of four. The crib belongs to the dealer at the end of that deal, and any scoring combinations that are found in the crib are added to the dealers point tally. Thus, in his own interest, the non-dealer attempts to discard the least combinable cards that he can imagine.

In addition, there is a *play-off* in which each player lays down a card and announces cumulative total of the cards played. First, the non-dealer cuts the cards and the dealer turns up the first card of the bottom half of the deck, let's say a deuce. Then, the first player lays down a card, perhaps a 3 and announces. The game continues with the next player discarding another card, let's say a 10 this time, announcing 15 for 2 (he then pegs to holes), and so on to a total of 31 points or less. Points are scored for making a total of 15 and 31, for the last play without exceeding 31, and for any scoring combinations that may be made between both players' cards along the way. Finally, the non-dealer scores for combinations contained in his own cards. And the dealer scores for his own cards as well as those contained within the crib.

What we've attempted to do here is give some of the most basic rules of Cribbage. For a better understanding of the game, you might want to pick up a copy of *The Penguin Book of Card Games* by David Parlett (published by Penguin Books). ■

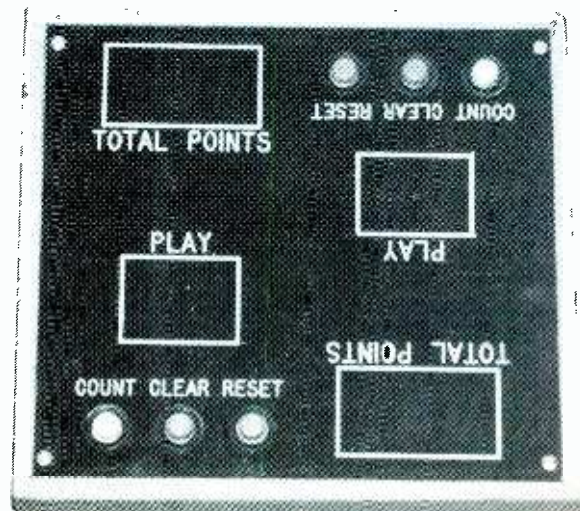

Electronics Paperback Books

NEW OFFERINGS AT SPECIAL INTRODUCTORY PRICES



WRITE ZX SPECTRUM GAMES PROGRAMS Reg Price ~~\$5.00~~ **NOW ONLY \$5.00**. Step-by-step guide shows how to write graphics games



INTO THE QL ARCHIVE Reg Price ~~\$5.00~~ **NOW ONLY \$5.00**. How you can use this database program supplied with the Sinclair QL



ART OF PROGRAMMING THE ZX SPECTRUM Reg Price ~~\$6.25~~ **NOW ONLY \$6.25**. Using BASIC to make your Spectrum do clever things



20 PROGRAMS FOR THE ZX SPECTRUM & 16K ZX81 Reg Price ~~\$4.00~~ **NOW ONLY \$4.00**. Programs with flow charts. Card games Battleships, Calendar, and more



LINEAR IC EQUIVALENTS AND PIN CONNECTIONS Reg Price ~~\$12.50~~ **NOW ONLY \$12.50** (shipping free). 247 pages 7 x 10-in. shows equivalents and pin connections for popular user oriented IC's



ELECTRONIC PROJECTS USING SOLAR CELLS Reg Price ~~\$4.00~~ **NOW ONLY \$4.00**. Simple circuits powered by the energy of the sun



ELECTRONIC HOUSEHOLD PROJECTS Reg Price ~~\$3.75~~ **NOW ONLY \$3.75**. Includes 2-tone Door Buzzer Auto Porch Light Lamp Dimmer and more



INTRODUCTION TO VIDEO Reg Price ~~\$4.00~~ **NOW ONLY \$4.00**. For the person who has just or is about to buy a video recorder



ELECTRONIC SECURITY DEVICES Reg Price ~~\$4.00~~ **NOW ONLY \$4.00**. Three basic sections. Switch activated alarms, infra-red & ultrasonic systems, smoke gas, water detection

THE PRE-BASIC BOOK. Reg ~~\$5.00~~ **NOW \$5.00**.
BUILD TREASURE LOCATORS. Reg ~~\$4.00~~ **NOW \$4.00**.
AUDIO AMPLIFIER CONSTRUCTION. Reg ~~\$4.50~~ **NOW \$4.50**.
AUDIO PROJECTS. Reg ~~\$4.00~~ **NOW \$4.00**.

OFFER GOOD TILL FEBRUARY 28, 1986

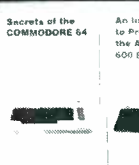

SECRETS OF THE COMMODORE 64 \$5.00. Masses of useful info and programming tips not found in any user's manual



INTRO TO PROGRAMMING THE ATARI 600/800 XL \$5.00. Perfect complement to the Atari users manual. Even shows how to use animated graphics

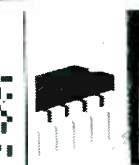

COMPUTER TECHNOLOGY EXPLAINED \$5.00. Explanations for computer terms often encountered. A dictionary for computer lingo

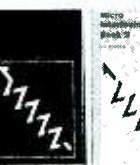

INTRO TO 2-80 MACHINE CODE \$5.75. Speed up your programs. They may be harder to write, but it's worth learning how. Some demo programs are included



ANTENNA PROJECTS \$5.00. Practical radio antenna designs that deliver good performance and are relatively simple and inexpensive to build



WHITE'S RADIO LOG \$4.94. An up-to-date directory of AM FM and TV stations, including a section on worldwide shortwave stations



CONFIDENTIAL FREQUENCY LIST, 6th edition. \$13.95. Latest info on unusual and exotic shortwave broadcast stations



25 SIMPLE AMATEUR BAND ANTENNAS \$5.00. All kinds of antennas for all kinds of amateur radio reception



INTRODUCTION TO RADIO DXING \$5.00. How to optimize the reception of distant short-wave broadcast and amateur stations

Quality Paperbacks



HOW TO DESIGN ELECTRONIC PROJECTS \$5.00. A practical and authoritative introduction to this unusual aspect of electronics



HOW TO GET YOUR ELECTRONIC PROJECTS WORKING \$5.75. How to use standard circuit elements to make custom electronic projects



ELECTRONIC SCIENCE PROJECTS \$5.75. Simple to complex a group of projects with a strongly scientific flavor



CRYSTAL SET CONSTRUCTION \$4.50. A variety of crystal radio receivers for the experimenter and hobbyist



DESIGN & MAKE YOUR OWN PCB BOARDS \$5.75. Everything you need to know before you make printed circuit boards for your projects



HANDBOOK OF IC EQUIVALENTS AND SUBSTITUTES \$5.00. Includes digital and linear IC's made in US Great Britain Japan etc



INTERNATIONAL TRANSISTOR EQUIVALENTS \$7.50. Locates possible substitutes for a popular user-oriented selection of modern transistors. Japanese European and American types



PRACTICAL ELECTRONIC BUILDING BLOCKS. Book 1 \$5.75. Build the blocks and then combine them to form almost any custom project of your choice



PRACTICAL ELECTRONIC BUILDING BLOCKS. Book 2 \$5.75. Amplifiers of all kinds to add to the circuits from Book 1 of this series

Affordable Prices



FIRST BOOK OF DIODE CHARACTERISTICS, EQUIVS, AND SUBS \$5.00. Shows full interchangeability data for thousands of diodes



MODERN OP-AMP PROJECTS \$5.00. Includes a Slide Timer AF Signal Gen. Mike Pre-amp Scratch Filter, and much more

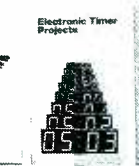

ELECTRONIC SYNTHESIZER PROJECTS \$4.50. How to assemble the elements of a synthesizer and then put them all together



ELECTRONIC TIMER PROJECTS \$5.00. Timing circuits to fit just about every application. Required for every experimenter



SINGLE IC PROJECTS \$4.25. All projects in this book are based on one IC and are simple to construct. Great way to get started with IC's



POPULAR ELECTRONIC PROJECTS \$4.75. A collection of a wide range of electronic projects and circuits for the experimenter



IC PROJECTS FOR BEGINNERS \$5.00. Written especially for the less experienced experimenter. Complete parts layouts and wiring diagrams



555 PROJECTS \$5.00. So useful that this IC has an unparalleled reputation. Here's a book full of useful applications



POPULAR ELECTRONIC CIRCUITS. Book 1 \$5.00. More circuits for hobbyists. Audio radio test music household and more

CHECK OFF THE BOOKS YOU WANT

ELECTRONIC TECHNOLOGY TODAY INC.
 P.O. Box 240, Massapequa Park, NY 11762-0240

Name _____
 Address _____
 City _____ State _____ Zip _____

*Canadian Shipping (\$1.50 1st two books 50c ea. additional)

Number of books ordered _____
 Total Price of Books \$ _____
 Sales Tax (NY State Residents) \$ _____
 *Shipping in U.S. only (\$1.00 1st two books, 40c ea additional) \$ _____
 TOTAL ENCLOSED \$ _____

H01-86

Heathkit



Robotics technology comes to life in building HERO[®] 1 and teaching manipulation, speech and object



Hams! Get the latest in amateur radio technology including high-speed Packet Radio Communication.



Powerful new IBM-PC compatible Heathkit computers are yours to build easily and save with, or to buy assembled.



Build from our full line of precision test instruments and see how they can increase your troubleshooting effectiveness.



New Digital Rain Gauge records rainfall accurately and reads out inside your home in 100ths of an inch.

Your guide to everything that's new in electronics, computers and technical education. Over 400 items. Discover fascinating kits to build, enjoy and learn with, as well as assembled high tech products for home, business and hobby.

Get our famous High Tech Catalog

FREE

Heathkit[®]
Heath
Company

A subsidiary of Zenith Electronics Corporation

Heath Company
Dept. 107-374
Benton Harbor, Michigan 49022

MAIL COUPON TODAY and receive the latest issue of the Heathkit Catalog free of charge

Name _____

Address _____

City _____ State _____

CL-783BR1 _____ Zip _____

CIRCLE 719 ON FREE INFORMATION CARD

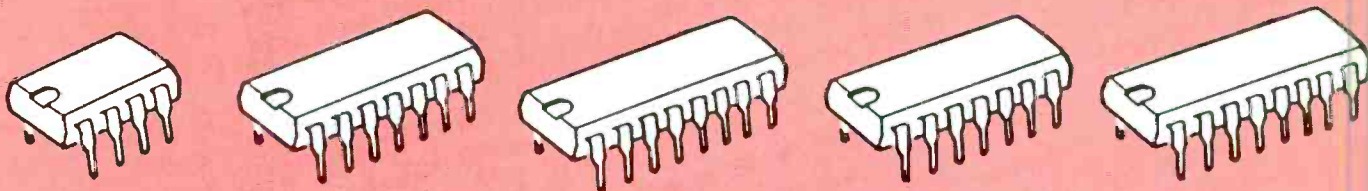

How to Identify

Every IC has its own signature, or *DIP-ature*. A logical exploration of characteristics will uncover the chip's function and help you give it a proper name!

□ ONE OF TODAY'S BEST SURPLUS BUYS IS THE *LOADED* printed-circuit board. The experimenter can buy a board containing a dozen or more digital IC's and other useful parts for less than a dollar. Usually the IC's alone are worth several times the price of the board. Unfortunately, many of the best boards are passed up by the hobbyist because the IC's are not marked with recognizable industry-standard numbers. There is a solution to the problem of unmarked IC's.

This article describes a way to make TTL, DTL, and even RTL IC chips sign in once they are removed from the board. The IC signature shows you which pin is V_{cc} and which is *ground*. The IC signature tells you which pins are probably output terminals. And it requires nothing more than a piece of paper and an ohmmeter. After that, a few voltage and current measurements and you should know what kind of IC you've got. Here's how it works.

An IC signature is an array of resistance readings derived from the IC and displayed in an organized way. The $\times 100$ range of an ohmmeter is used. (Be sure that you know which ohmmeter lead is positive; some ohmmeters change polarity when switching from volts to ohms especially in the low-ohm ranges.)

The signature is obtained by recording the resistances between all terminal pairs of the IC. Use the signature chart shown in Fig. 1. Connect the ohmmeter's positive lead to pin 1, and move the negative lead sequentially through the remaining pins (3, 4, 5, etc.). Record the measured resistance across the top row of the signature chart. A resistance measurement of over several hundred thousand ohms does not convey very much useful information, so there is no need to record it—put a dash through the box instead.

Move the positive lead to pin 2 and fill in the second row of the signature chart (Fig. 1) by moving the negative lead to pin 1, 3, 4..., etc. Continue in the same manner until every row of the signature chart is completed. If that is done properly, you should have as many rows in your chart as there are IC pins.

The steps that follow show how to use the completed signature to identify your IC.

Step 1

Examine the signature chart that you generated from an unknown IC, and circle each terminal-to-terminal resistor—you can tell which ones those are because each purely re-

sistive connection between two terminals reads approximately the same in both directions.

For the purpose of an explanatory example, refer to Fig. 2 which illustrates a completed signature chart for an unknown IC. In Fig. 2 there are twelve circled boxes, six above the diagonal and six below. The circled number in row 5, column 3 has its mirror image on the opposite side of the diagonal in Row 3, Column 5. The resistance is 7000 ohms in both directions; therefore, it is a terminal-to-terminal resistance. That fact is noted to the right of the chart (Fig. 2), along with the other resistance value and identified as Step 1. The remaining terminal pairs show grossly different resistance measurements in opposite directions, indicating the presence of one or possibly several semiconductor junctions in the path.

It is highly unlikely that a TTL IC, or for that matter any linear IC, would contain 6 identically valued terminal-to-terminal resistances. Maybe the IC is RTL or DTL?

Step 2

Disregard all circled boxes and scan the signature to locate the row with the lowest resistance readings—Row 4 in this case. That characteristic uniquely identifies pin 4 as the substrate connection of the IC or, in other words, the most negative terminal of the IC.

Scan across Row 4 for the lowest uncircled reading—in this case it is the 750-ohm reading in Column 11. That distinctive reading tells us that pin 11 is the V_{cc} terminal of the IC. Record those numbers in the place provided at the right of the chart—Step 2, Fig. 2.

The other uncircled low-resistance readings in the ground row usually identify transistor collectors; i.e., output terminals. That is an important clue to be used later.

Step 3

Before proceeding to the identification of other terminals we measure I_{cc} . Apply a low voltage, say 3.6 volts (RTL supply voltage), to the IC through a milliammeter or multimeter preset to read in the 100-milliampere range. The positive voltage goes to the V_{cc} terminal (in this case pin 11) and the return connects to the IC substrate (in this case pin 4).

To protect the IC and the equipment, place a 120-ohm resistor in series with the current meter. A dead short in the IC

(Continued on page 36)

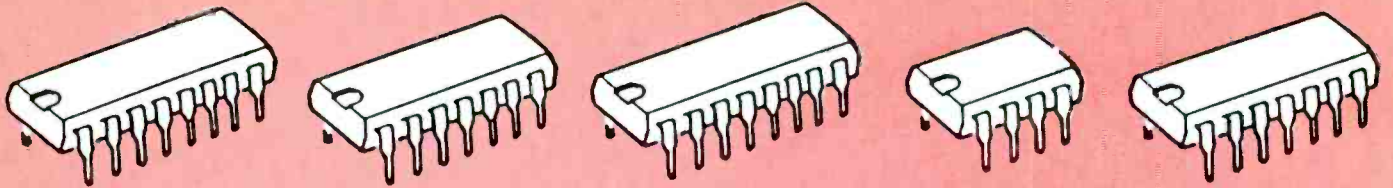

Unknown IC's

By Kenneth H. Recorr

	V _{CC} = PM _____				GND = PM _____				ICC = PM _____							
	NEGATIVE															
	1	2	3	4	5	6	7	8	9	10	11	12	13	14	15	16
1	■															
2		■														
3			■													
4				■												
5					■											
6						■										
7							■									
8								■								
9									■							
10										■						
11											■					
12												■				
13													■			
14														■		
15															■	
16																■
VOLTS TO GND																
mA TO V _{CC} (RES)																
mA TO GND																

Fig. 1—This form is used to record all resistances between terminal pairs of the unknown IC up to 16-pins in size. Copy it on a Xerox machine so that you'll have a supply of signature charts. In fact, should your Xerox copier provide enlargements, go for a larger-size form and make your note-taking easier.

**F
A
S
T

A
N
D

E
A
S
Y**



**AT THE PUSH OF
JUST ONE BUTTON !**

THE MARK III HV CIRCUIT SCANNER

- ★ Checks the horiz output circuit for open / shorts,
- ★ Checks the flyback, yoke, PC, and HV mult,
- ★ Checks all scan derived B+ sources,
- ★ Checks all circuits that rely on scan derived B+ voltage,
- ★ Checks for open safety capacitor,
- ★ Checks the emitter circuit of the horiz output,

THEN,

- ★ Provided the green normal light is lit, the Mark III will safely power up the TV set so that **you** can "look" for open circuits by examining the picture on the CRT.
- ★ Circumvents all start up and horiz drive related shut down circuits.

APPLICATIONS: The Mark III will analyze the horiz, flyback, hi-voltage, scan derived B+ sources, yoke, pin cushion, HV multiplier circuits in any TV set that employs either an **NPN** transistor or a single **SCR** for its horiz output device. This applies to any age, any model, any chassis, any brand - - - including Sony.

In brief, the "test" function scans for shorts, the "run" function permits you to observe any "open" circuits via the symptoms that appear in the CRT screen.

HOOK - UP: Simply remove the set's horiz output device and replace it with the scanner's interface plug. No wires to disconnect, no other connections required (not even a ground connection).

MISTAKE PROOF: No damage will result if an error is made during hook up. The scanner simply won't turn on until the error is corrected.

RED OPEN LIGHT means the emitter circuit of the horiz output stage is open (no ground path)

YELLOW SHORT LIGHT means the flyback primary, HV multiplier, vertical output, horiz driver, and R-B-G color output stages are **not** shorted. Instead, a circuit that normally draws a small amount of current is shorted (i.e. the tuner, IF, AGC, video chroma, matrix, vertical or horiz oscillator).

RED SHORT LIGHT means either the flyback, the HV multiplier, the vertical output, horiz driver or one of the **R-B-G** output transistors is shorted.

GREEN NORMAL LIGHT means the TV set's entire flyback circuit is totally free of shorts. It also means that it is safe to power up the TV set with the "run" button so that you can look for open circuits by observing the symptoms on the CRT screen.

FEATURES: All **start up** circuits and all horiz drive related **shut down** circuits are automatically circumvented by the Mark III during all test and run functions. During the test function all flyback secondary output is limited to approx 80% of normal. 2nd anode voltage is limited to approx 5 KV.

This means all circuits that are not shorted will have some 80% of their normal B+ voltage during the "test" phase. It also means that any shorted circuit will have zero DC volts on it. This feature makes any short easy to isolate.

The MARK III sells for only \$595⁰⁰

The money you are now spending for unnecessary flybacks alone will easily pay for your Mark III. Why not order yours today!

Visa and Mastercharge Welcome !

Diehl Engineering • 6661 Canyon Drive "F" • Amarillo, TX 79110
Phone: (806) 359-0329 or (806) 359-1824

PUSH THE TEST BUTTON Just one of the four lights will lite.

**A
M
A
Z
I
N
G**

THE

MARK V

HV CIRCUIT ANALYST

- ★ Checks the horiz output stage for opens / shorts,
- ★ Checks flyback, yoke, PC, and HV mult,
- ★ Checks all scan derived B+ sources,
- ★ Checks for open safety capacitors
- ★ Checks for open ground path for horiz output stage
- ★ Checks for open primary LV supply,
- ★ Checks for error in interface connections,
- ★ Checks for proper LV regulation,
- ★ Checks for proper start up circuit operation,
- ★ Checks for shorted horiz driver transistor,
- ★ Checks the operation of the horiz osc / driver circuits,
- ★ Checks B+ "run" supply for the horiz osc / driver circuits,
- ★ Checks all circuits in the TV set that rely on scan derived B+,
- ★ Automatically circumvents all start up circuits and horiz drive related shut down circuits

HOOK UP: (Identical to Mark III)

OPERATION: Turn the Mark V on, turn the TV set on, then, simply look at the lights

RED "HOOK UP" LIGHT means that you have made an error in hook up. No damage has been done, correct the problem then continue.

RED "EMITTER" LIGHT means that the ground path for horiz output stage is open. Correct the problem then continue.

RED "B + OPEN" LIGHT means that the primary LV supply in the TV set is open. Correct the problem then continue.

No "top row lights" equals normal.

Look at the middle row of lights

RED "START UP" LIGHT means that the start up circuit in the TV set is not working (no start up pulse).

GREEN "START UP" LIGHT means the start up circuit in the TV set is working normally. Yes, it is 100% accurate. Even on Zenith's single pulse start up circuit !

RED "HORIZ DRIVE" LIGHT with a green start up light means that the horiz driver transistor in the TV is shorted (E to C).

GREEN HORIZ DRIVE LIGHT means that the horiz oscillator and driver circuits are operational.

READ THE DC VOLTAGE METER THEN, PUSH THE TEST BUTTON

If the meter comes up to, or, falls back to, factory specified DC collector voltage, the LV regulator circuit is working. If it fails to do so, it is not working!

RED "B + RUN" LIGHT means that the B+ source that normally keeps the horiz osc / driver circuits running after the start up B+ pulse has been consumed has become open.

GREEN "B + RUN" LIGHT means that the B+ resupply voltage (scan derived) is being provided. All is normal if all three lights are now green.

The scan circuit short detector in the Mark V is identical in all ways to that which is used in the Mark III. Operation is also identical. Both units are virtually indestructible when simple directions are followed. Both units carry a full year's warranty against defects in materials and workmanship (parts and labor). Either unit can be easily repaired by almost any technician in his own shop.

If the green "circuits clear" light is now lit

It is now safe to push the "run" button and examine the symptoms that appear on the CRT screen, for the purpose of isolating any "open" circuits.

Except for hook up and CRT filament warm up time, this test can easily be completed in two to five seconds!

The Mark V sells for only \$995⁰⁰

Stop losing money on start up / shut down scan derived B+ problems; order your Mark V today!

Visa and Mastercharge Welcome !

Diehl Engineering • 6661 Canyon Drive "F" • Amarillo, TX 79110
Phone (806) 359-0329, or (806) 359-1824

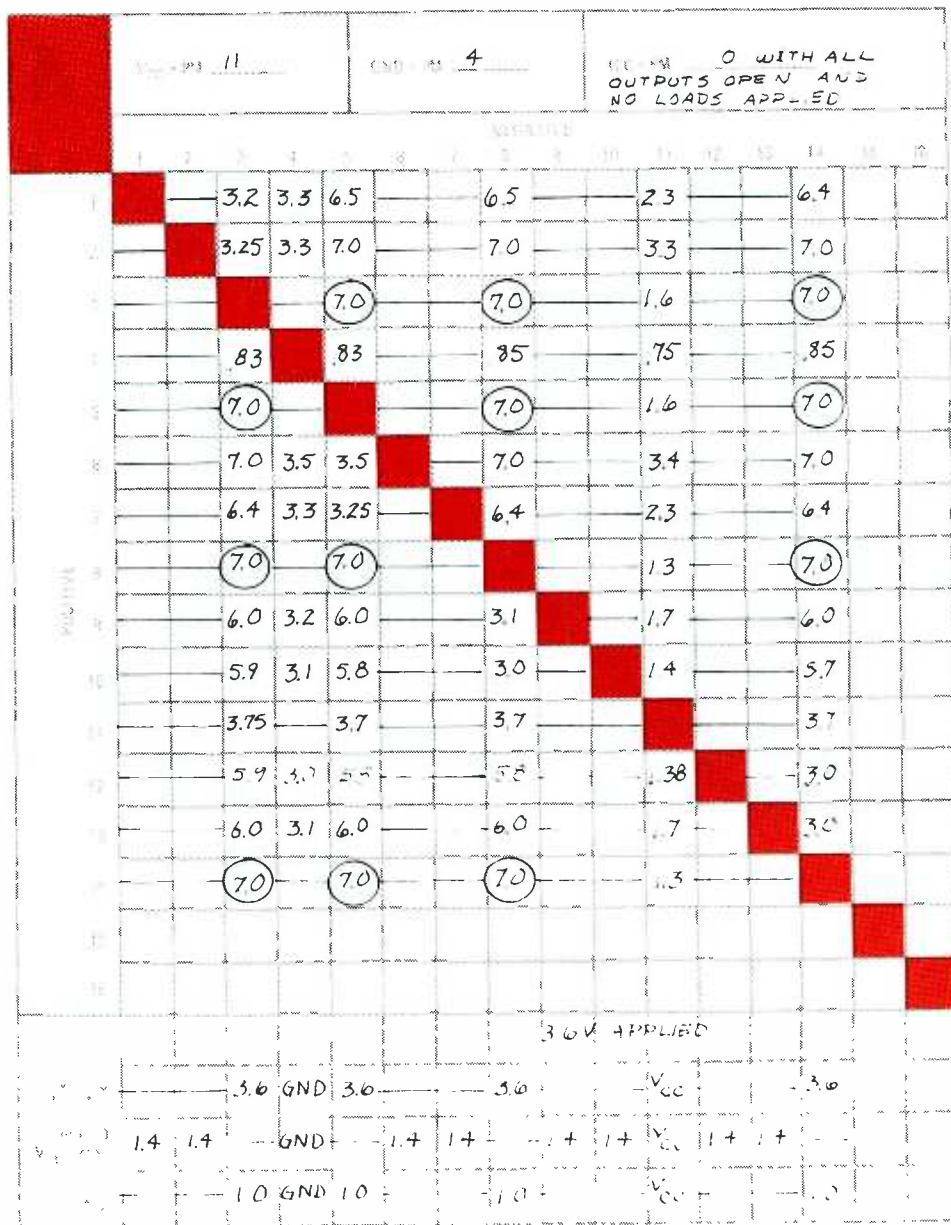

3 TO 5 = $7K\Omega$
 3 TO 8 = $7K\Omega$
 5 TO 8 = $7K\Omega$
 3 TO 14 = $7K\Omega$
 5 TO 14 = $7K\Omega$
 8 TO 14 = $7K\Omega$

RTL } 5
 MC717P } 8

3, 5, 8, 14 - OUTPUTS } 4
 1, 2, 6, 7, 9, 10, 12
 AND 13 - INPUTS

3 GOES LOW WHEN
 1 OR 2 OR BOTH
 GO HIGH.

5 GOES LOW WHEN
 6 OR 7 OR BOTH
 GO HIGH.

8 GOES LOW WHEN
 9 OR 10 OR BOTH
 GO HIGH.

14 GOES LOW WHEN
 12 OR 13 OR BOTH
 GO HIGH.

DEVICE IS QUAD, 2
 INPUT NOR GATE IC.

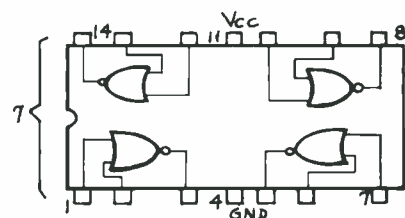

Fig. 2—Completed signature chart for an unknown IC. The IC turned out to be a quad, 2-input NOR gate.

will only draw 30 mA (milliamperes). Remove the resistor and re-connect the current meter only when it is clearly safe to do so. Most standard TTL gates draw between 2 to 4 mA: Thus, a quad NAND or NOR would draw 12 to 15 mA. In the case at hand, there was no current flow at all. DTL or TTL would have shown some current--so again the evidence suggests RTL.

A third clue: If there is a normal current flow, raise the voltage to 5 volts, measure, and record I_{CC} in the space provided at the right of the IC signature chart.

Step 4

Remove the milliammeter and apply the selected voltage directly between the V_{CC} and ground pins. Measure volts-to-ground, mA-to V_{CC} (through a 330-ohm resistor) and mA-to-ground for each pin of the IC. Record the measured values in the rows at the bottom of the signature chart.

The "volts-to-ground" row generally identifies all inputs and outputs. Voltages from about 2.2 volts up to the applied

voltage indicate outputs in the high state (for a logic chip). Thus, pins 3, 5, 8, and 14 are likely candidates for output terminals. (You will recall in Step 2 that those are the same terminals that were suggested as outputs by their low readings in Row 4.)

A voltage less than 0.2, but greater than zero, usually indicates logic outputs in the low state. None of those appear in Fig. 2.

Now is the time to remove and reapply power to the IC. Do that several times, each time comparing the voltage at each suspected output to its original recorded value. Often a flip-flop will reveal itself by changing the state of one or more of its outputs. A simple gate will never change state in response to that little trick. The IC in Fig. 2 did not change state so I assumed it was *not* a flip-flop.

Voltages from about 1.8 down to 0.8 usually indicate TTL or DTL inputs. The fact that there are no such voltages in the "volts-to-ground" row of Fig. 2 was certainly a surprise to me, but it did lead to a pretty solid conclusion: If the IC is not

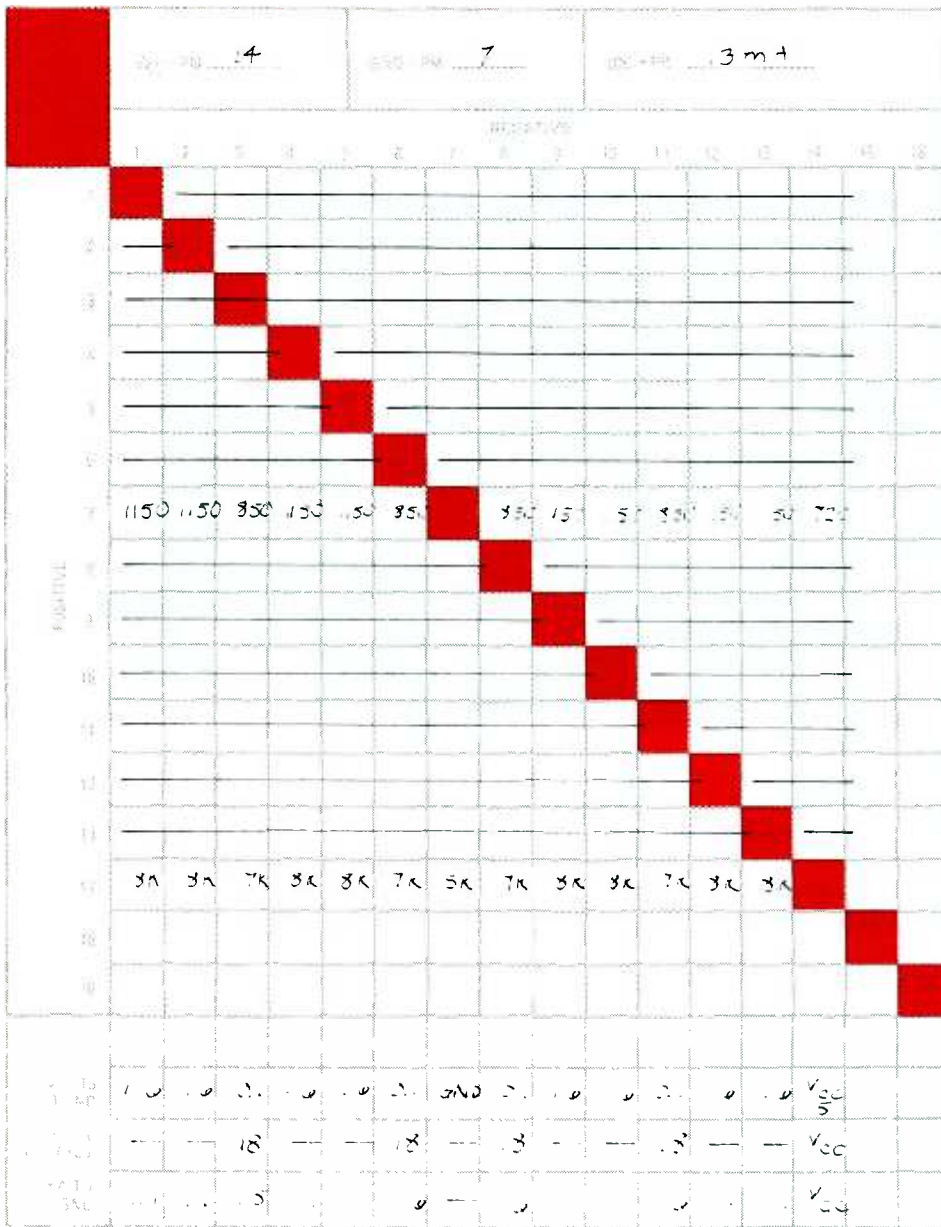

Fig. 3—Signature chart for a TTL 7400 quad 2-input NAND IC. All but a few TTL IC's have this typical two-row signature.

there should be four identical resistors to V_{cc} --one from each output. And that implies we should read twice the pull-up resistor value between any two outputs. In that case, the circled 7000 ohm values in the signature point to 3500 ohm pull-ups in each output. With a V_{cc} of 3.6 volts applied, grounding any output through the current meter should cause a current flow of just about 1 mA. And that's what we got! List the outputs and inputs on the signature chart.

defective, then it is *not* TTL or DTL.

Currents in the low state should read 10 to 20 mA when measured between the output and V_{cc} . Currents in the high state can read anywhere from 2 to 30 mA when measured between the output and ground if the IC is TTL. As an example of typical TTL signature, Fig. 3 shows the signature chart for a 7400 TTL quad 2-input NAND IC.

Input currents for RTL, DTL, and TTL fall between 0.8 mA and 2.0 mA. In Fig. 2, all the probable inputs draw 1.4 mA referenced to V_{cc} and nothing referenced to ground. That verifies that they are inputs and shows they are active (draw current) when the input is pulled high. RTL is active-high. DTL and TTL are active low. Since there appear to be twice as many inputs as outputs, the chart suggest that our IC is a quad gate of some sort. It is reasonable to conclude that pins 1, 2, 6, 7, 9, 10, 12, and 13 *are* inputs.

The bottom row of the chart shows that the outputs provide only 1 mA to ground despite the fact that the voltage measured at those terminals is 3.6. That suggests an internal pull-up resistor connected to the output terminal (see Fig. 4). If that is so, and the device is a quad gate (which seems very likely),

Step 5

The symmetrical pattern of resistances in the signature and the strong evidence for four independent outputs with logic-level voltages pretty much rules out any linear IC. Resistive pull-up could be DTL, but DTL inputs are active low and our IC is active-high. After reviewing all the evidence I felt there was absolutely no doubt that this device was RTL. That conclusion was recorded in Fig. 2.

Step 6

We now manipulate the inputs and observe the output responses to determine what kind of logic device we have.

With V_{cc} applied, we connect a voltmeter from ground to a terminal thought to be an output. Ground the inputs one at a time, noting the change, if any, in the metered output. If that output does not change state for any grounded input, repeat the procedure, this time connecting one input at a time to V_{cc} instead of ground. In this example it happened that pin 3 went low when either pin 1 or pin 2 was pulled high (to V_{cc}). None of the other outputs responded to changes in pin 1 or pin 2. That indicates that pins 1 and 2 are inputs to one gate whose

A LOGIC-FAMILY TREE

Mention is made in this article of the RTL (Resistor-Transistor Logic), DTL (Diode-Transistor Logic) families. Of the three, TTL is the only one that is still in common use, but a look at its predecessors is worthwhile. (Refer to Fig. 4.)

As advances in technology have made it possible to construct more complicated devices on a silicon chip, we have been able to take advantage of their sophistication to create faster and more elaborate logic families.

All three of those logic-family IC's work by causing their output transistors to go into saturation (a condition where no amplification takes place—only conduction), but differ in the way input signals are processed to bring about that state.

RTL was the first IC logic-family to find widespread use. Each input line going to the output transistor contains a resistor. Its purpose is to reduce the amount of current consumed by the device and to isolate the logic-gate inputs. The input voltage passed through the resistors drives the output stage into saturation, making the collector voltage of the output transistor drop and causing the output to go "low."

The resistors, though, slow down the switching speed

of RTL devices because they increase the time needed to charge and discharge the input capacitance of the output transistor.

Typically, RTL has a switching speed on the order of 50 nanoseconds and operates at a 3.6-volt supply.

The next phase in IC evolution was DTL. That family substitutes diodes for the resistors used in RTL. The diodes provide better isolation at the inputs and, because of their low forward resistance, make it possible for DTL circuits to switch more rapidly than their RTL equivalents.

DTL has a typical switching speed of 25 nanoseconds and requires a four-volt supply.

Finally, TTL uses multi-emitter transistors in the input stage. The base-collector junction of those transistors is never fully off, meaning that a state of saturation can be reached considerably more quickly than with either RTL or TTL.

Switching speeds for simple TTL IC's are frequently under 10 nanoseconds. TTL uses a five-volt supply.

While it is still possible to find RTL and DTL IC's on the surplus market, the TTL family is now the dominant one. Its two most common forms are standard TTL and "LS" (Low-power Schottky) TTL.

output appears on pin 3. That procedure is continued until all inputs and outputs are related in some way. Truth tables can be consulted to identify the gates. The device turned out to be a quad, 2-input NOR gate.

The relationships between the inputs and outputs and the conclusion as to the type of device I was dealing with are listed in Fig. 2 as Step 6.

Had the device not responded at all to any of the above

techniques, I would have tried exercising two, or even three, inputs at a time and I would have begun to search for a possible "enable" or "inhibit" input. The more complicated devices require a little ingenuity and some intelligent guesswork.

Step 7

Use the results of Step 6 to draw the schematic diagram of the IC. At that point the device could be used in the average hobby project without needing to know any more about it. But, if you feel compelled to assign a number to your IC, it's time to consult the IC data books. That's what I did.

Step 8

It took quite a while to locate a Motorola IC book containing RTL data sheets. The electronics department at the local college was good enough to let me look through their copy. If you need that kind of assistance, let me urge that you make the local college your first stop. I wish I had—it would have saved a lot of time.

The Motorola book had 256 pages of RTL data—whew! Fortunately the plastic-case style of my IC eliminated two of the three RTL sections. The index of the remaining section listed only two IC's that were quad 2-input NOR gates. The collector pull-up resistors of the first IC type were nominally 640 ohms. The collector resistors in the second IC type were nominally 3600 ohms. Bingo! (We measured 3500 ohms in Step 4—not bad!).

The device is without a doubt an MC717P/817P, and all the information on that data sheet applies to this IC. I am unable to differentiate further between the 717P and its higher-performance counterpart the 817P. Since the safer move is to assume that the more restricted temperature range applies, I declared the device placed under inspection to be a Motorola RTL IC, type MC717P. *(Continued on page 101)*

Fig. 4—Five typical logic input and output circuits are presented here. Use these circuits along with your resistance measurements to determine the logic family of the unknown IC.

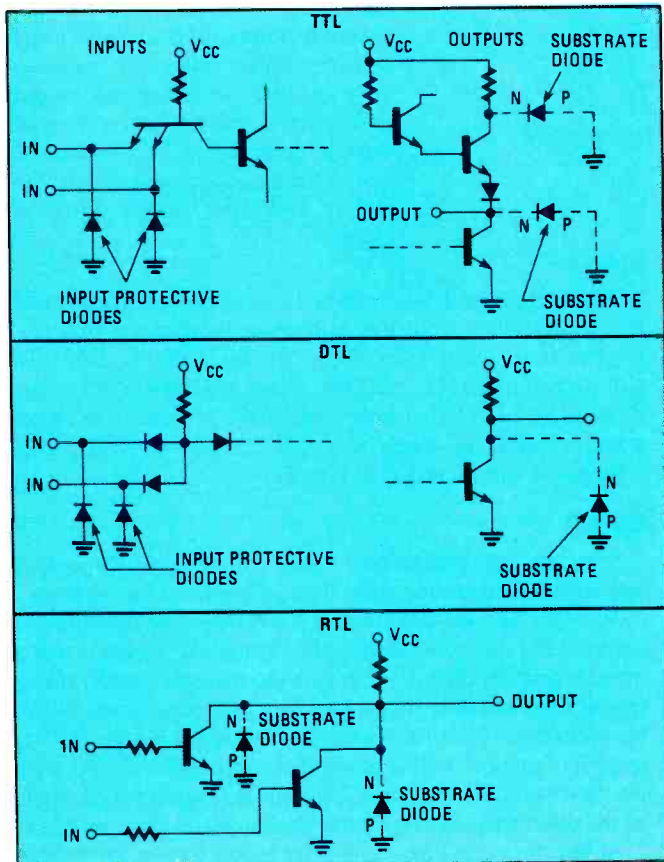

SWR

WHAT IT MEANS IN PRACTICE

When amateurs get together, and the talk turns to antennas, it is not long before the magic phrase "SWR" is heard. Just what is SWR and how important is it in practice?

By Philip Watson, VK2ZPW*

■ IT IS AN UNFORTUNATE FACT THAT SWR, ALONG WITH antenna and transmission line theory in general, is one of the most misunderstood subjects in the whole of amateur radio. It boasts as many myths and old wives tales as does pregnancy and childbirth, some of them perpetuated by supposedly reputable text books.

In trying to get a mental picture of what is, admittedly, an extremely complex subject, it is often a help to start with a theoretically perfect situation, against which we can compare the usually imperfect practical situation.

The Antenna

Let's start with the antenna. In any transmitter installation, the antenna has to satisfy two basic requirements. One is to radiate the RF energy fed to it by the transmitter in the most efficient manner possible. The other is to present the transmitter with the correct load in order that the transmitter may deliver the level of RF power which the designer intended.

While both are important, the second requirement is, in many ways, the more important one. Suppose we have a typical commercial transmitter designed to deliver 10 watts into a 50-ohm load. If we connect a non-reactive, 50-ohm resistor directly across the antenna terminals or socket at the set, and energize the transmitter, it will deliver 10 watts to the resistor, which will appear as heat.

If we were to substitute some other value of resistor a number of things could happen. The most likely one is that the transmitter would no longer deliver its 10 watts. By how much it would fall short would depend on the error in the load value and the design and tolerance of the particular transmitter output stage.

Another possibility, again depending on the output stage design, is that it would try to deliver more than its rated power, but run into overload in the process, and destroy the output circuit and other circuit sections as a result. Fortunately, most commercially designed transmitters are well protected in this regard, but there is no point in taking unnecessary risks.

But, that risk aside, we should make every endeavor to present the correct load to the transmitter simply to ensure that it delivers the maximum power for which it was designed. On the other hand, there is little to be gained by simply feeding that energy into a resistor; it will radiate very little of the RF energy and waste virtually all of it as heat.

So we replace the resistor with an antenna and, fairly obviously, this antenna should look (to the transmitter) like a 50-ohm resistor if it is to deliver maximum power. Assuming the antenna is resonant at the transmitter frequency, and fed at the right point, it will look like a resistor. If it is not resonant it will exhibit either a capacitive or inductive component, according to which way it is off resonance.

Assuming that the antenna is resonant, the next question concerns the value of resistance it presents to the transmitter. And this is where the going gets tough because, in other than a very few clearly defined cases, that is very largely an unknown or, at best, *guesstimated* value.

We can, for example, nominate the resistance at the center of a half-wave dipole (Fig. 1A) as being in the region of 72 ohms, while a folded version of the half-wave dipole (Fig. 1B) will have four times that impedance, or 288 ohms (often rounded off to 300 ohms). A number of factors can cause minor variations to those values, such as the diameter of the elements, relative to their length, space between folded dipole elements, etc.

A more controversial value is that for the popular quarter-wave ground plane (Fig. 1C). For years value has been stated, in many popular amateur textbooks, that the impedance is approximately half the value of the simple dipole, or 36 ohms (in fact, various values have been quoted between 30 and 36 ohms). That figure appears to have been based on a theoretically calculated value for a quarter-wave radiator working against an infinitely large, perfectly conducting ground plane.

Some of those text books even went so far as to describe matching devices which would match that value to the popular 50-ohm coax cable and transmitter load requirements. As anyone who has tried to make one of those matching systems work, or who has attempted to confirm that 50-ohm value

*Original story appeared in Electronics Australia, November, 1984 edition, and reappears here by permission.



CIRCLE 746 ON FREE INFORMATION CARD

Here's a view of today's combination SWR meter and antenna matcher with added features. This MFJ product is the 949-C Deluxe Versa Tuner. It uses a cross-needle meter that reads forward power, reflected power, and SWR simultaneously on either 30 or 300-watt scales.

with an impedance bridge will testify, the real-life ground plane, using four quarter-wave radials, is a vastly different device.

Strangely enough, the true situation has been known for many years. At least as early as 1962 when it was stated that the radiation resistance of a ground quarter-wave antenna is 35 ohms, but that of a ground-plane is less than 20 ohms. More recently other authorities have been emphasizing that same point but, unfortunately, old ideas die hard, and the point needs to be emphasized a good deal more strongly if the error is to be corrected.

But that is a separate argument. The point we set out to make is that, apart from those few simple designs, it is exceedingly difficult to nominate the feed point impedance of an antenna. We do know the general effect of many design factors; that, for example, the addition of director or reflector elements to a dipole will lower the impedance. But by how much is another matter.

So we are faced with the situation that the impedance of all but the simplest antenna systems is largely an unknown quantity. With experience we can make a rough estimation that it will be between this and that figure, or below some other figure, but beyond that we must resort to some form of measurement or *suck-it-and-see* approach.

SWR Meters

One such approach involves the use of a standing-wave-ratio meter, or SWR meter. But it would be premature to go into details at this stage. We need to talk about SWR in some detail first.

So far we have considered only those situations where a resistor or an antenna—which looked like the same resistor—was connected directly across the transmitter output terminals. Apart from a few special cases, feeding an antenna in that manner is not very practical. We need to locate the antenna as high as possible and clear of objects which might

shield it, while we need to put the transmitter in a convenient indoor working location, some distance away. Those practical considerations are always self defeating; however, they can be minimized.

And, to couple the two together, we need a special kind of cable; one that will convey the transmitter output to the antenna with minimum loss and which, in itself, will not radiate any significant amount of that energy into a shielded environment, where much of it would be wasted.

There are two types of cable commonly used by amateurs, the open-wire line and the coaxial cable. The open-wire line can be homemade, has very low losses, and can be made to have any impedance characteristic over a wide range. On the other hand it can be awkward to install and is much less popular than it once was.

Coaxial cable is a commercial product, with somewhat higher losses, and is commonly available in two popular impedance values: 50 and 72-ohm. It is reasonably flexible and relatively easy to install. For most of our discussion we will assume the use of coaxial cable, although most of the points would be just as valid for open-wire lines.

Characteristic Impedance

Undoubtedly the most important single characteristic of a coaxial cable, for the beginner to understand, is its characteristic impedance—typically 50 or 72-ohm. That is not an easy concept to grasp and the beginner may have to content himself with accepting some basic statements at their face value, at least initially.

Coaxial cable consists of two conductors, one within the other, and insulated from each other. A common form uses solid or stranded wire as the central conductor, copper braid as the outer conductor, and a polythene insulating material between them.

The characteristic impedance is a factor of the inductance of the two conductors, relative to the capacitance between them, per unit length. Those factors, in turn, are determined by the physical characteristics of the components; the inductance by the cross sectional area of the conductors, and the capacitance by their area relative to each other, the distance between them, and the dielectric constant of the insulating material. The length of the line is not a factor.

The effect of that inductance/capacitance relationship is to establish an equally firm relationship between the voltage and current of RF energy travelling up the line. That relationship is exactly the same as would have occurred across and through a pure resistor having the same value (say 50 ohms) as the characteristic impedance of the cable.

It may help to grasp this concept if one is to visualize a very short burst of RF energy transmitted up the line; so short that

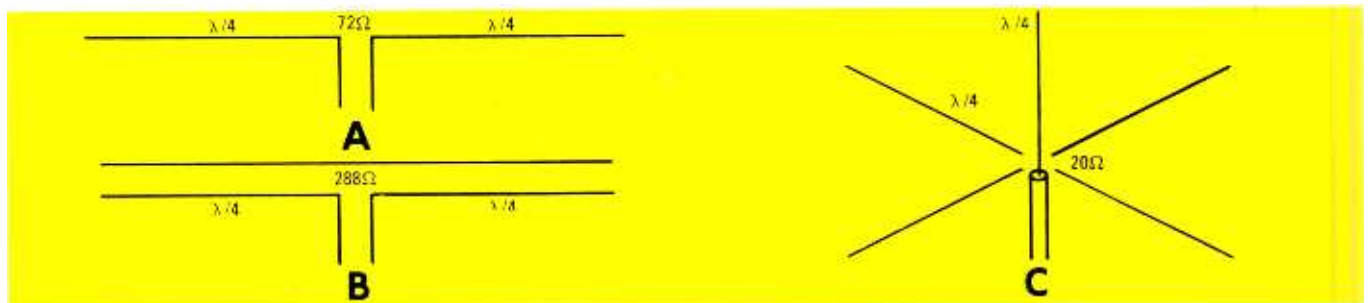

Fig. 1—Three basic antennas for which the feed-point impedances are known with reasonable accuracy. The quarter-wave dipole (A) has an approximate impedance of 72-ohms; the quarter-wave folded dipole (B), approximately 288 ohms; and the quarter-wave ground plane antenna (C), a bit less than 20 ohms. If you differ on the last impedance, refer to the text.

its trailing edge has left the transmitter long before its leading edge has reached the load at the far end. Thus, something in the manner of a fired projectile, or even a thrown tennis ball, it is in a kind of limbo; while influenced initially by the manner of its launch its subsequent movement is largely a factor of its environment. And it knows nothing about what lies in store for it at the end of its journey.

We can carry the analogy a little further. If the tennis ball ultimately hits a brick wall it will bounce off (or be reflected) simply because the brick wall represents a gross mismatch to the manner in which energy is stored in the moving ball. A softer object such as a bale of hay, may well have absorbed all the energy with no bounce (or reflection).

The same applies to our burst of RF energy. When it reaches the end of the cable it will need to meet exactly the right load if all its energy is to be dissipated in that load. And it doesn't take much imagination to conclude that the load should look like (in that case) a 50-ohm resistor that exhibits no reactance whatsoever.

If it encounters any other value then only part of the energy will be absorbed by the load, and the remainder will be reflected down the line in the direction of the transmitter. And that is what creates what are called *standing waves* on the transmission line.

Standing Waves

In greater detail, the standing waves are actually peaks of voltage between the conductors, or peaks of current through the conductors, which occur at regular intervals along the line. They occur at those points where (say) the voltage of the outgoing energy encounters voltage of reflected energy which is exactly in phase with it. Similarly for the current peaks.

The position of each peak is fixed and will always be one-half wavelength away from its neighbor. Exactly between each peak, one-quarter wavelength away, will be a dip or voltage minimum, and it is the ratio between those two voltages which constitutes our *standing wave ratio* or SWR. (Note: wavelengths in coaxial cable will be physically shorter than in free space, according to the characteristics of the insulating material. A factor of 0.66 is typical, commonly referred to as the *velocity factor*.)

In the theoretically perfect situation, where the cable is correctly terminated, all the energy is absorbed by the load, there will be no reflected wave, and the voltage and current values will remain essentially constant along the length of the line. Such a situation is said to constitute a *flat line*.

By now the reason for our interest in the SWR should be apparent. Because it occurs only if there is a mismatch, and its value is directly related to the degree of mismatch, its measurement provides a very useful *suck-it-and-see* approach to ensuring that the transmitter is presented with its correct load.

In greater detail, an SWR of 2 to 1 will mean that the load is in error, relative to the cable impedance, by this ratio. But it cannot indicate in which direction the error lies. Assuming a 50-ohm cable the 2 to 1 error could mean that the load is half (25 ohms) or twice (100 ohms) the correct value. Note, however, that the relationship is true only when the load is purely resistive.

Considering all the foregoing, and with the benefit for hindsight, one wonders whether the term SWR, to some extent, might be misleading; and that some other term, like *mismatch ratio*, might not have been a better choice.

But it is essential to keep one very important point in mind at this stage of the discussion. The existence of standing waves, in itself, is only a secondary problem. It is a useful measurement only because it tells us whether the transmitter is being correctly loaded or not and that our efforts should be directed to correcting this aspect of the problem. Whether we correct the SWR in the process may not even matter. Let us consider a practical example.

Suppose an SWR meter reading indicates that there is a serious mismatch between antenna and cable. We have two options: either fit some kind of matching device between the antenna and the cable so that the antenna now looks like the correct value, or fit a matching device between the transmitter and the cable so that the transmitter sees a correct load.

In theory the first option is the preferred one, since we not only present the transmitter with its optimum load, but we eliminate the standing waves at the same time. In practice the second option may well be very much more practical and convenient. It will have achieved the same primary objective of loading the transmitter correctly and in many cases the SWR can be ignored.

But what happens to the RF energy reflected by an antenna which does not match the cable? If it is sent back down the line, is it not wasted? No, it isn't. The practical situation is that the transmitter presents a gross mismatch to the line, and deliberately so. Its (source) impedance is kept as low as possible in order that as little as possible of the RF energy it generates is wasted as heat in the final stage.

So the reflected RF energy encounters that gross mismatch and is promptly reflected up the line again to the antenna, where the major proportion of it is radiated and a minor proportion reflected. After a couple of such journeys virtually all of the energy will have been radiated. (In typical audio

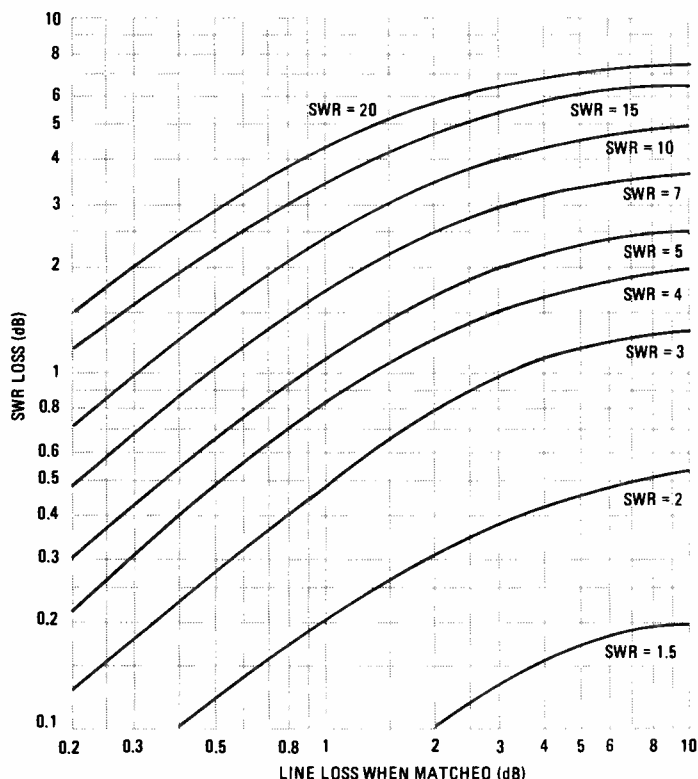

Fig. 2—The graph indicates the amount of additional loss, due to SWR, which occurs for various values of cable loss when the cable is correctly terminated to a resistive, matching load.

transmission systems the time delays involved are not important. In a TV transmission system they can be significant, and more careful designing is necessary to avoid transmitting *ghosts*.)

Cable Losses

In fact, there is a flaw in the previous argument. We can only assume that no energy is wasted if we ignore the inherent losses in the cable. All cables have some losses, and those increase with frequency. For example, a popular foam-filled coax, RG-8/U, has a loss of 0.9-dB/30-meters at 30 MHz which rises to 3.5-dB/30-meters at 400 MHz. The presence of such losses means that any signal which has to traverse the line more than once will suffer additional losses on each excursion.

So we have to concede that, in practice, standing waves do create some loss. But how much, and how important is it? If we assume a 3-dB loss in a cable system which is correctly terminated (no standing waves), then an SWR of 3 to 1 will add a further 1-dB loss. The graph in Fig. 2 indicates the additional loss for a wide range of basic cable losses and SWR values.

At 450 MHz, using RG-8/U cable, with a run approaching 30 meters, a loss of 3 dB could be expected and, if it had to be tolerated, than anything which would minimize further losses would be worth considering. That is a case where, all else being equal, correction at the antenna might be preferable to that at the transmitter.

At lower frequencies losses become less important. At 150 MHz, RG-8/U wastes only 2-dB/30-meters (an additional 0.8 dB for a 3:1 SWR); and a 30 MHz, 0.9dB (plus 0.48 dB for 3:1 SWR).

So, hopefully, that should put the SWR problem into some kind of perspective. But there are other misconceptions which we might perhaps comment upon. One is that the reflected energy finds its way back into the final stage and overheats it. Wrong!

It is true that a transmitter working into a transmission line with a high SWR may show signs of distress. But the distress is not due to the SWR; rather it is due to the incorrect load at the antenna into which the transmitter is trying to work.

Cable Length?

Another popular untruth claims that the length of the cable is critical; that it must be an exact multiple of a half wavelength long if the transmitter is to be properly loaded (and the standing waves eliminated) even when the antenna is presenting a proper load.

The truth is that, if the load is correct, then that value will be *seen* at the other end of the cable regardless of its length. If the load is incorrect, then that value will be seen at half-wavelength intervals along the cable. But since it is wrong anyway there seems little point in trying to reproduce it.

In fact, in such circumstances, the length of the line can be critical for a quite different reason. Between the half wavelength points the cable will exhibit a range of impedances, one of which may match the transmitter. So, by adjusting its length the cable may be made to act as a matching transformer, and load the transmitter correctly.

But don't try to do it using the SWR meter because altering the line length will have *no* effect on the SWR. If that trick is to be used other measurements must be used, such as that from a field strength meter at a fixed distance from the

antenna. Stay away from *trick* solutions.

So, after all that, what is the role of the SWR meter? Well, it obviously isn't the universal answer to all antenna/transmission line problems. On the other hand, if it is the only instrument available it can be quite useful. An important point to realize is that, while it can indicate that there is something wrong with a particular set-up, it cannot indicate what is wrong.

Thus an antenna may present the wrong load for a number of reasons. It may not be resonant, the design may be wrong or may have been misinterpreted by the constructor, or the matching device (if one is used) may be incorrect. Alternatively, the cable impedance may be other than that claimed. (There is the story about the dishonest electronics surplus dealer who could supply either 50-ohm or 75-ohm cable at a very attractive price, both off the same reel!)

In other words, when the SWR meter indicates that there is something wrong, the important thing is to make a systematic approach to finding out what it is. For example, terminating the cable in a good dummy load having the same resistance will quickly indicate whether or not the cable is at fault. If it is not, the antenna is the next obvious suspect.

Exactly what needs to be done, or can be done, to change the antenna's impedance will, of course, depend on the particular type of antenna and what is physically convenient or practical. But, whatever the approach, the SWR meter can be used to monitor the effect of the changes or adjustments that are required.

Finally, one more controversial point. Just where should the SWR meter be connected in the line: at the transmitter end or the antenna end? Some authorities are adamant that it should be at the antenna end, while others are equally emphatic that the precaution isn't necessary.

While, in theory, it can be shown that the antenna is the right place to make this measurement, the practical situation is that that is seldom a very convenient, or even feasible, arrangement. So, in practice, most people tend to make it at the transmitter end. When an antenna tuning unit, or other matching device is used at the transmitter, fitting the meter between the two is a perfectly legitimate way of determining when the tuning unit is presenting the correct load to the transmitter.

The main objection to measurements made at the transmitter end is that the cable losses will mask the true ratio, the forward signal having been attenuated before it was reflected, and the reflected signal attenuated again on the way back. Depending on the severity of the losses, the user may obtain a reading below what he has set as an acceptable maximum when, in fact, the true value is appreciably higher.

Unfortunately, cable losses become worse as the frequency increases and, in the 420-450 MHz (70-cm) band that problem could be very real. So, be prepared to work at the antenna unless the coax line can be kept short. In cases like that it is sometimes better to move the transmitter close to the antenna, and use a much shorter line.

Summing Up

The most important characteristic of an antenna system is to present the transmitter with its optimum load. An SWR measurement can indicate whether that is happening and, if not, the degree of error. It is valuable primarily for that reason, the standing waves being relatively unimportant.

So let's keep things in perspective. ■

BEFORE AND AFTER CLOCK



A clock that talks your language; it displays time the same way that you say it!

By Al Plavcan

OVER THE YEARS, MANY CLOCK VARIATIONS HAVE BEEN created: everything from the grandfather type of centuries past, to the present-day digital devices. Well, in this article we'll be looking at yet another clock—a digital one—but, with a twist.

Instead of displaying time in the conventional way, it displays time in the manner in which it is spoken: "9 O'clock," "20 before 10," "10 after 5," and so on. (Hence its name, the "Before and After Clock.") Aside from this clock's being unusual, it also has some practical applications. By placing it next to an analog clock, it can be used to teach the little ones to tell time. It might also prove useful in places such as a radio or TV station, where time is announced continually.

How It Works

In the circuit for the Before and After Clock, the 60-Hz clocking signal is picked off the AC line and fed to a squaring circuit, comprised of a sin-

gle NAND Schmitt trigger, before being sent to the divider chain. After being divided, that signal is fed to the clock input of the up/down counters.

The counter outputs are then fed to a set of seven-segment LED display decoder/drivers, which drive four LED modules. The up/down counters also control several lamps that are used to illuminate the other non-LED displays. Decoding is performed at the hour and half-hour to control the up/down counters and light the appropriate display. Zero blanking is included to eliminate leading zeros.

In operation, the minutes display advances to a full count

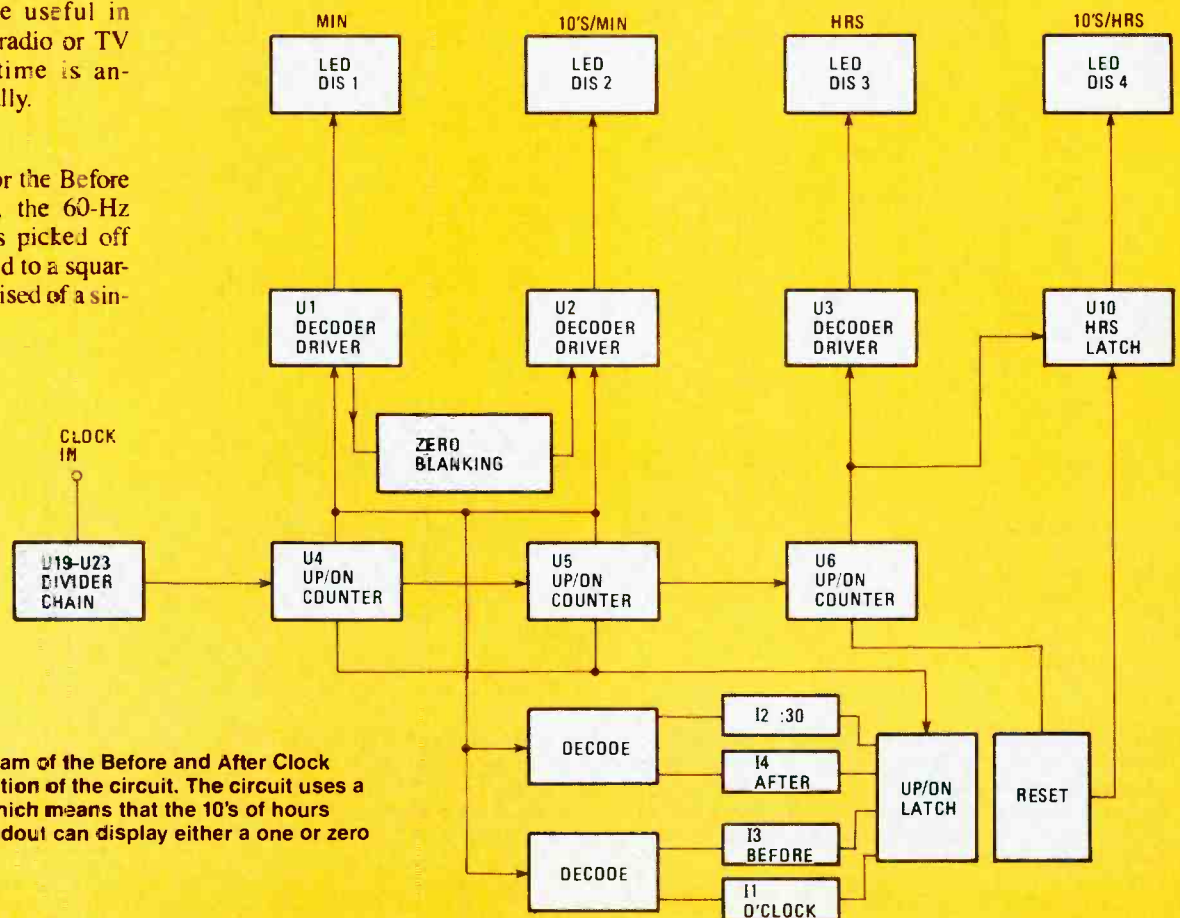

Fig. 1—Block diagram of the Before and After Clock outlining the operation of the circuit. The circuit uses a 4½ digit display, which means that the 10's of hours seven-segment readout can display either a one or zero only.

of nine, then resets to zero and begins to count up again. When the minutes display shows a zero, the ten's of minutes display lights showing a 1, as the minutes display continues the count. That process is repeated until the count reaches 30; at that time, the Clock begins to count down, going from 29 to zero. At zero, the hours display lights showing the hour and the after-the-hour count begins again until the next hour is decoded.

The Big Picture

Turning to Fig. 2, a schematic diagram of the Before and After Clock, let's take a look at the overall view of what is really happening in the circuit. Timing for the circuit is

derived from the 60-cycle line frequency through a resistor network made up of R36, R37 (in the power-supply circuit). That signal is fed to U19, a hex Schmitt trigger, which shears off the rounded peaks of the signal to produce a squarewave suitable for driving the dividers that follow.

That squarewave signal is sent to U20 and U21 where it is divided by 60—U20 is set up to divide by ten and U21 to divide by six—resulting in a frequency of one cycle per second at the output of U21. That point is tapped off and fed to three switches on the rear panel and routed to the inputs of U4, U5, and U6. (More on that later.)

The output of U21 is also fed to U22 and U23 where, it is farther divided so that a signal frequency of one pulse per

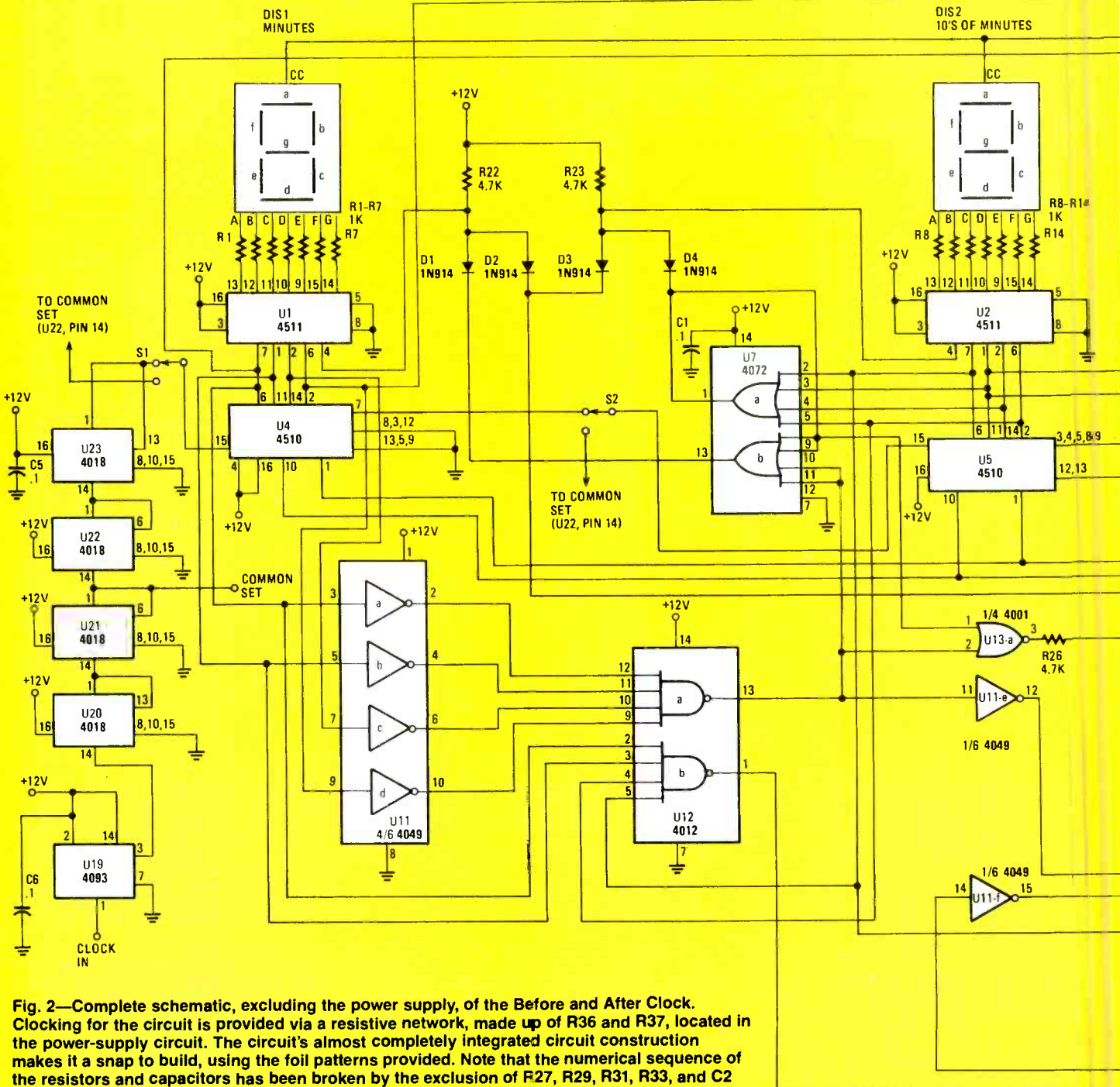

Fig. 2—Complete schematic, excluding the power supply, of the Before and After Clock. Clocking for the circuit is provided via a resistive network, made up of R36 and R37, located in the power-supply circuit. The circuit's almost completely integrated circuit construction makes it a snap to build, using the foil patterns provided. Note that the numerical sequence of the resistors and capacitors has been broken by the exclusion of R27, R29, R31, R33, and C2 from the final layout.

minute is now arriving at the input of U4 (pin 15). Up/down counter U4 sends timing information to U1, a seven-segment display decoder/driver, which then lights the display, DIS1, to show the minutes count.

The pin-4 output of U4 is fed to the input of U5 at pin 15, where the signal is divided still farther and used to feed U2, another display decoder/driver. That decoder/driver's output feeds the 10's of minutes display, DIS2. The decoding necessary to control the up/down counting is tapped off the Q outputs of U4 and U5, and processed through U11, U12, and U14.

When the Q outputs of U4 (pins 6, 11, 14, 2) are all low, their inverted outputs (through U11) is fed to U12-a. All high

inputs to U12-a cause pin 13 of U12-a to go low. That's the zero decode for minutes. Pins 8 and 9 of U14-d go to U5 pin 11 and U5 pin 6, respectively. When those two pins are high (at the count of 3), pin 10 of U14-d goes low. That is the 10's of minutes decode of 3. Thus pin 13 of U13-a is low (zero decode) and pin 10 of U14-d is low (10's of minutes decode of 3).

Those signals are now fed to U14-c pins 1 and 2 through inverters U11-e and U11-f. U14-c pins 1 and 2 are now high, causing pin 3 to go low. That point is the 30-minute decode. Several things happen at this time. First, Q2 is turned on through U17-c, causing I2 to light showing ":30" on the front panel.

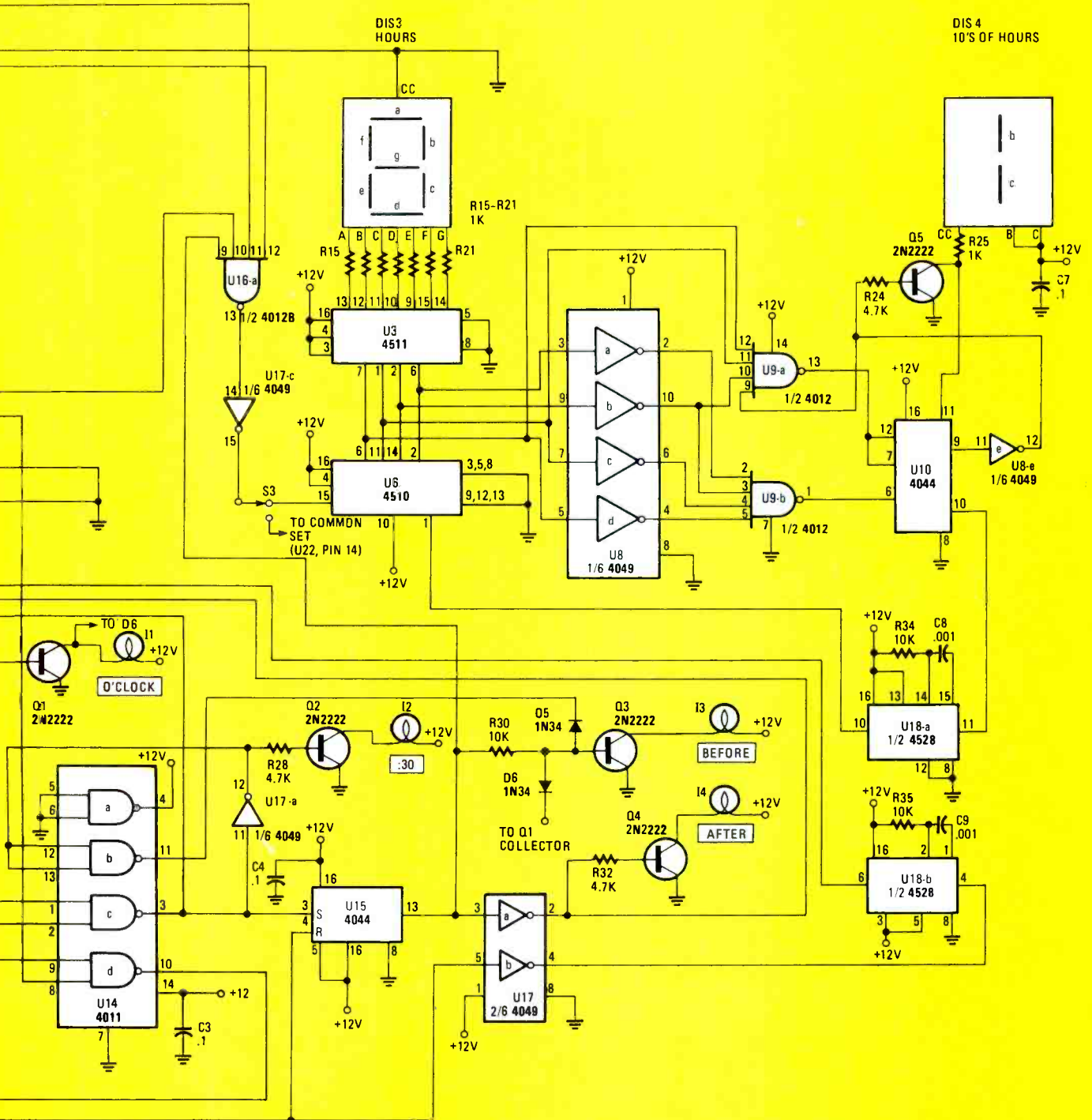

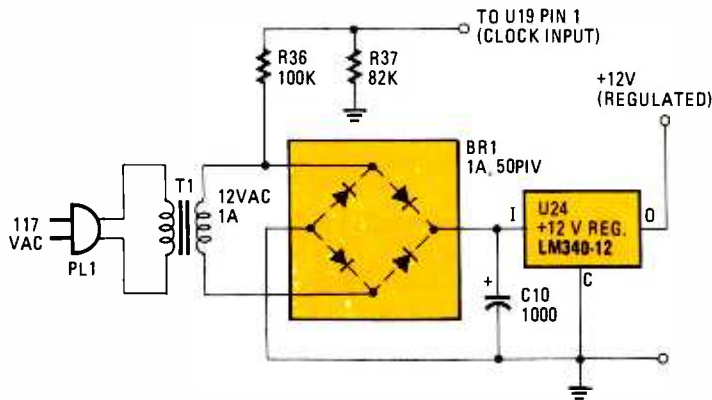

Fig. 3—Schematic diagram of the power supply for the Clock circuit. Note that, aside from the resistor network (R36 and R37), which provides timing for the Clock, there is nothing unusual about it. Although a bridge rectifier is shown, there is no reason why discrete diodes cannot be substituted.

At the same time, the cathodes D2 and D3 are pulled to ground, causing pin 4 of both U1 and U2 to go low and blank the seven-segment. Also pin 13 of U15 goes high, forcing pin 2 of U17-a to go low, turning Q4 off. The signal at pin 13 of U15 is also fed to Q3 is turned on causing the display to show "BEFORE." (Note that it will be blanked for one count through D5 to avoid having I3, "BEFORE," and I2, ":30," on at the same time).

At the next count, the display showing ":30" goes out and "BEFORE" lights and remains on for the next half hour. The clock now reads "29 BEFORE" the next hour, whatever that happens to be. (Note that D5 and D6 must be germanium diodes to effectively inhibit.) A low from U17-a pin 2 is fed to pin 10 of both U4 and U5, causing those units to count down. Thus, the first 30 minutes of the hour has been decoded, and the Clock now begins to decode (count) the next half hour.

With the "BEFORE" lamp still lit and the counter counting down, the count continues until the hour is reached. At the hour, the Q outputs of U1 and U2 are all low, the seven-segment display would show "00" (if it were not blanked). The minute's zero decode at signal U12-b, pin 13 and the 10's of minutes' zero decode signal at pin 1 of U7 are respectively fed to pins 2 and 1 of U13-a.

That causes pin 3 of U13-a to go high, causing Q1 to turn on and light the "O'CLOCK" lamp, II. The clock now reads "O'CLOCK." At the same time, D6 goes low, inhibiting the "BEFORE" lamp for one count. At the end of the hour decode, U12-b pin 1 goes low causing U15 pin 4 to reset. Pin 13 of U15 goes low causing U17 pin 2 to go high, causing I4 to light so that "AFTER" is displayed on the front panel. Also pin 10 of both U4 and U5 goes high causing them to start counting up. Pin 4 of U17-b goes high and causes U18-b, the one-shot multivibrator, to trigger the preset/enable inputs of U4 and U5. (Those counters had been preset to a "1" on U4 and a "0" on U5).

Thus, after II, the "O'CLOCK" lamp, has gone out, the next display will be "1 AFTER ." (Leading zero blanking is used on U2 to permit the readout to display "01 AFTER .") Whenever the Q outputs of U5 are all low, U7-a pin 1 is low, which pulls the cathode of D4 to ground, blanking the seven-segment display.

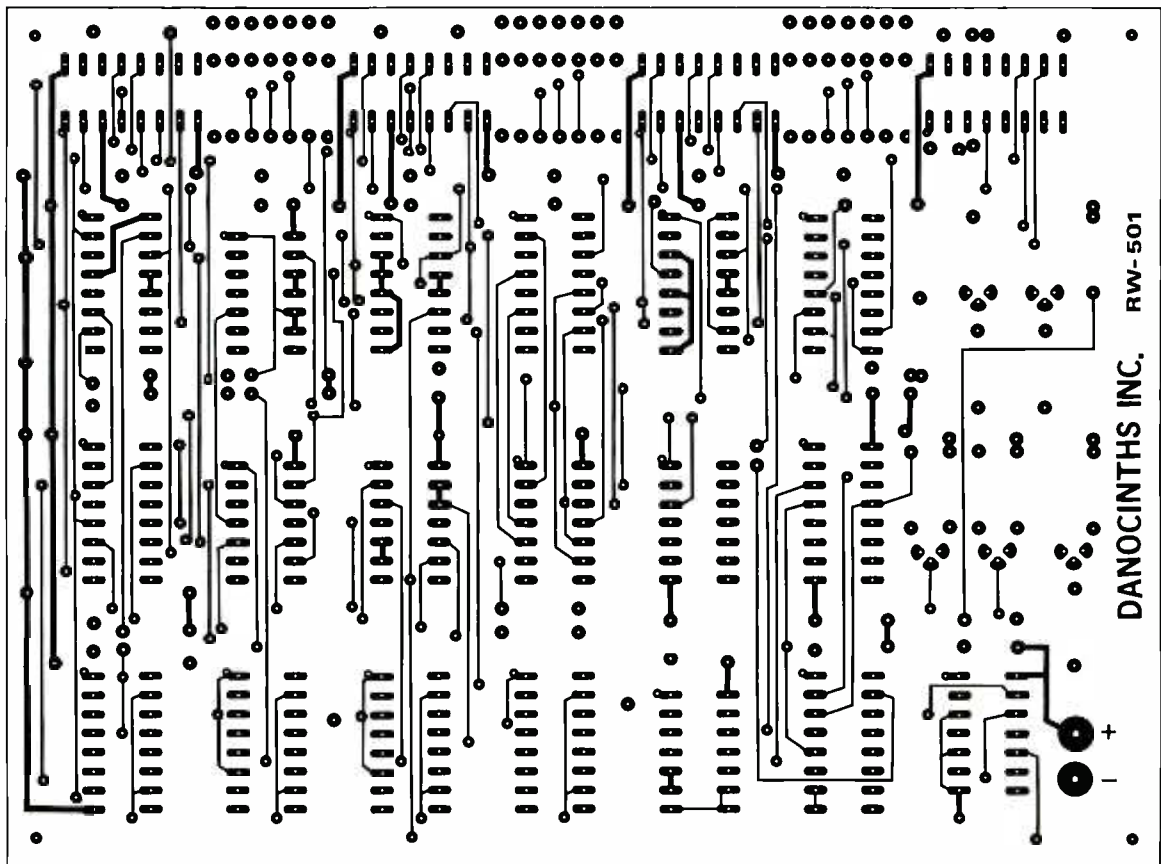

Fig. 4—Foil pattern for the solder side of the Before and After Clock's double-sided, printed-circuit board. If you etch your own board using this pattern and the one shown in Fig. 5, be sure that the two line up properly.

An overhead view of the Clock's printed-circuit board mounted in its housing. At the top, note that the power-supply components, including the resistor network (R36 and R37) and excluding the power transformer (T1), are mounted on a barrier terminal strip.

Pin 1 of U9-b goes low, causing the U8-e pin 12 to go high through U10. That turns on Q5 and a "1" is displayed on the hours readout. Thus, we've now gone from a 9 to a 10.

The count continues until the hours and 10's of hours readout displays 12. On the next hour count, the clock must display a 1 (for 1 O'clock). With the 10's of hours counter (U6) outputting a high at pin 11, the next count causes U6 pin 6 to go high, which then causes U9-a pin 13 to go low and U10 pin 9 to go high. After inversion in U8-e, Q5 is turned off and the 10's of hours readout goes out.

At the same time, U9-a pin 13 also causes pin 10 of U10 to go low. That, in turn, triggers U18-a pin 11 and causes a positive-going pulse (from pin 10) to be sent to U6 pin 1, preset enable. U6 had been preset to a 1, so a 1 is shown on the display.

Power Supply

Figure 3 shows a schematic of the recommended power supply. You'll notice that there's nothing spectacular about it. In fact, except for the tap off the secondary of the power transformer, it just like what you'd expect to find in any other construction project. The tap off the secondary feeds a voltage-divider network. That network is used to attenuate (or lower) the voltage from the transformer to a level low enough to be used by the counting circuits. It is from that signal that the clocking frequency is obtained.

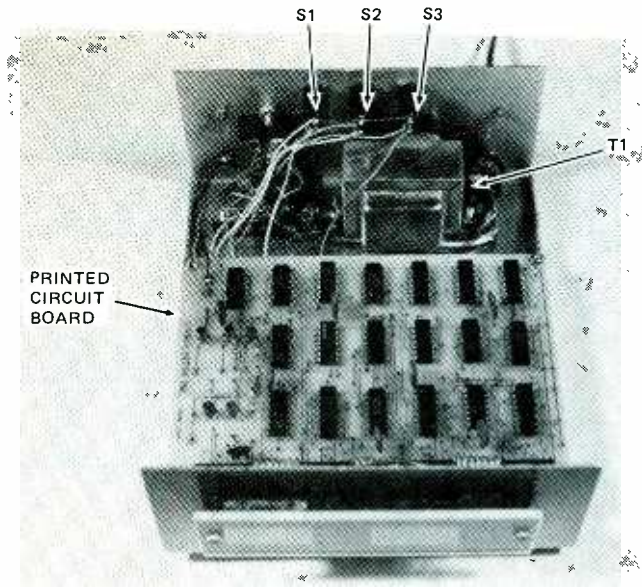

From that point, the count continues until ":30" appears and then repeats. One more thing happens at ":30." The 10's of hours counter (which is only an up counter) gets a pulse from U16-b pin 13 through inverter U17-c pin 15. At a count of ten, the ten's of hours display lights and the hours readout then changes to the next hour. For example, if it was "29 AFTER 9;" then "9:30;" then "29 BEFORE 10."

With the 10's of hours counter at nine, the next count, a "0," is decoded by U9-b through U8-a, U8-b, U8-c, U8-d.

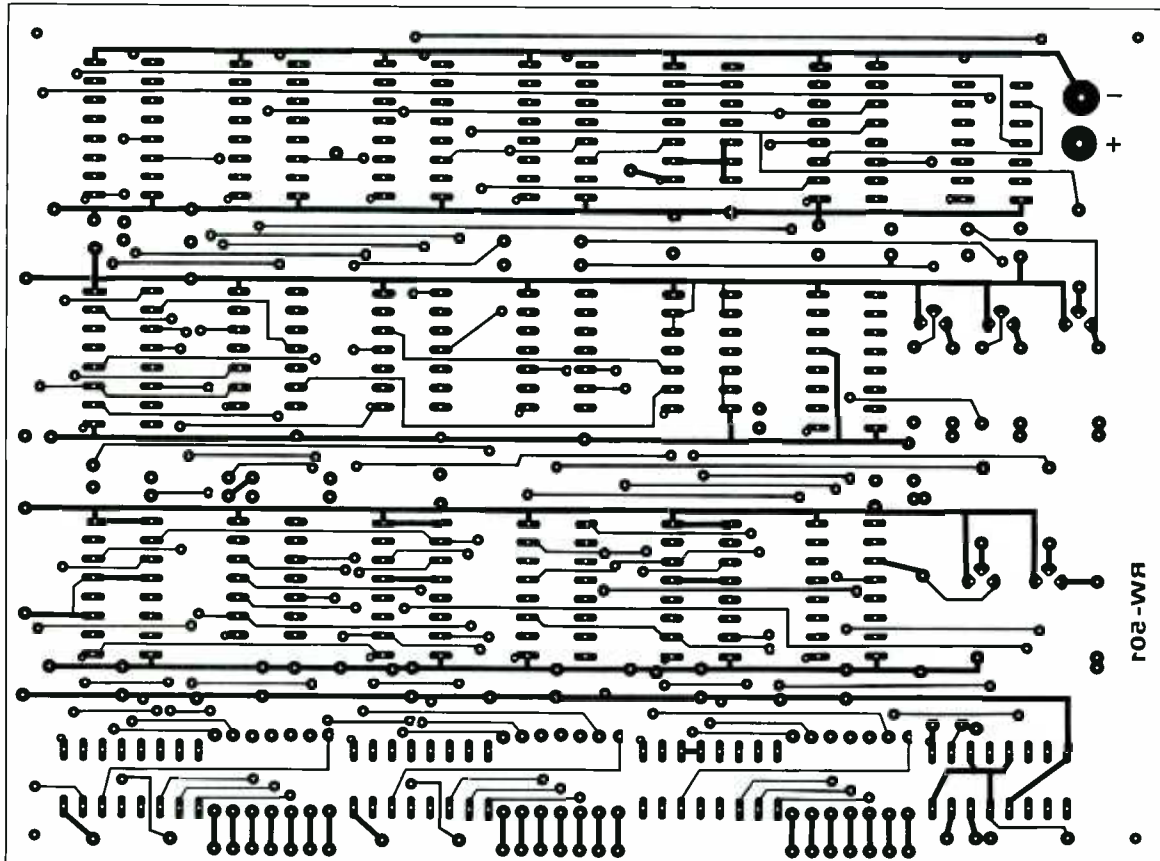

Fig. 5—Full-scale foil pattern for the component side of the Clock's printed-circuit board. If you decide to etch your own board, contact transfer film may be used to lift the patterns directly from the page. It's also a good idea to add markers to the film to ensure accurate alignment PC board foils.

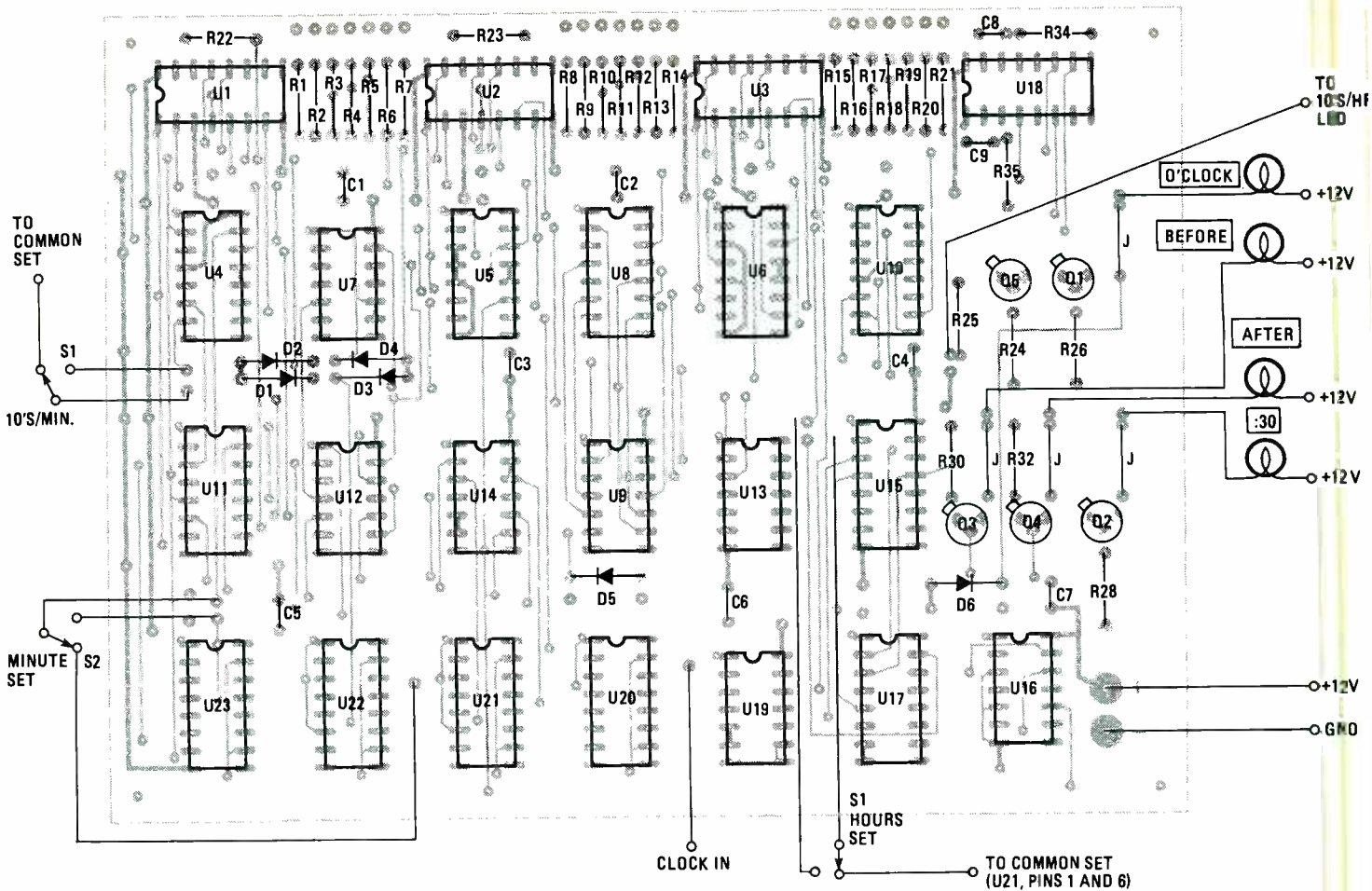

Fig. 6—Parts layout for the Clock circuit's double-sided board. Note that all IC's, with the exception of the top four, have their U-shaped notch facing the top of the card. Pay strict attention to the orientation of IC's, diodes, transistors, and any other polarized component. Also note that the power-supply components are not included on this board.

You may be wondering why the clocking signal is being picked off prior to rectification. Consider that the AC line frequency is 60 Hz, and that the bridge rectifier puts out a positive-going pulse during both the positive and negative transition of the input wave. That means that when the input is positive, a positive-going wave appears at the output and when the input goes negative, the bridge outputs a positive wave. Thus, the frequency of the signal at the output of the bridge rectifier is 120 Hz and would require more division than is used in the Before and After Clock circuit.

Construction

Building the Before and After Clock is rather straightforward, whether you purchase the printed-circuit board from the supplier given in the Parts List, or etch your own board. If you'd prefer to etch your own board, Fig. 4 and Fig. 5 show the foil pattern for the Before and After Clock's double-sided printed-circuit board. But since the board is double sided, you may want to go the easy route.

After you've obtained the board, the rest is simple. For the most part, all you have to do is stuff the printed-circuit board with integrated circuits, and a few assorted other components, as Fig. 6 shows. Just be careful that the integrated circuits, diodes, transistors, and so on are properly oriented. Integrated circuits of the "B" series are recommended.

Once the board has been populated and all components checked for correct orientation, bring out wires as shown in

the figure for the +12-volt power supply (as it is not included in the printed-circuit board layout), the seven-segment displays, and time set switches, S1-S3. In the author's prototype (see top view of the unit), the power supply was built on a barrier terminal strip using point-to-point wiring.

In building that portion of the unit, refer to Fig. 3 as a guide on how it should be wired, but not until housing for the unit has been prepared. Prepare the cabinet that is to house the Before and After Clock by first cutting out suitable holes in the front panel, following the front-panel visor template of Fig. 7, for the "BEFORE," "AFTER," "O'CLOCK," ":30" lamps, and the seven-segment displays. Then, using that template, prepare the visor through which those lamps will glow.

One way to make the visor is to make an overlay of Fig. 7 and simply paste it on a small piece of clear plastic. To make the overlay, you can take a photocopy of the figure and either have an acetate film made of it, or use Lift-it film to transfer the diagram to the plastic.

Once that's done, mount the chassis components, wire up the power supply, and then mount and connect the printed-circuit board according to Fig. 6. After the Before and After Clock is completely wired and all connections checked for accuracy, it's time to try it out.

Use

Now that you've finished the construction, the next step is

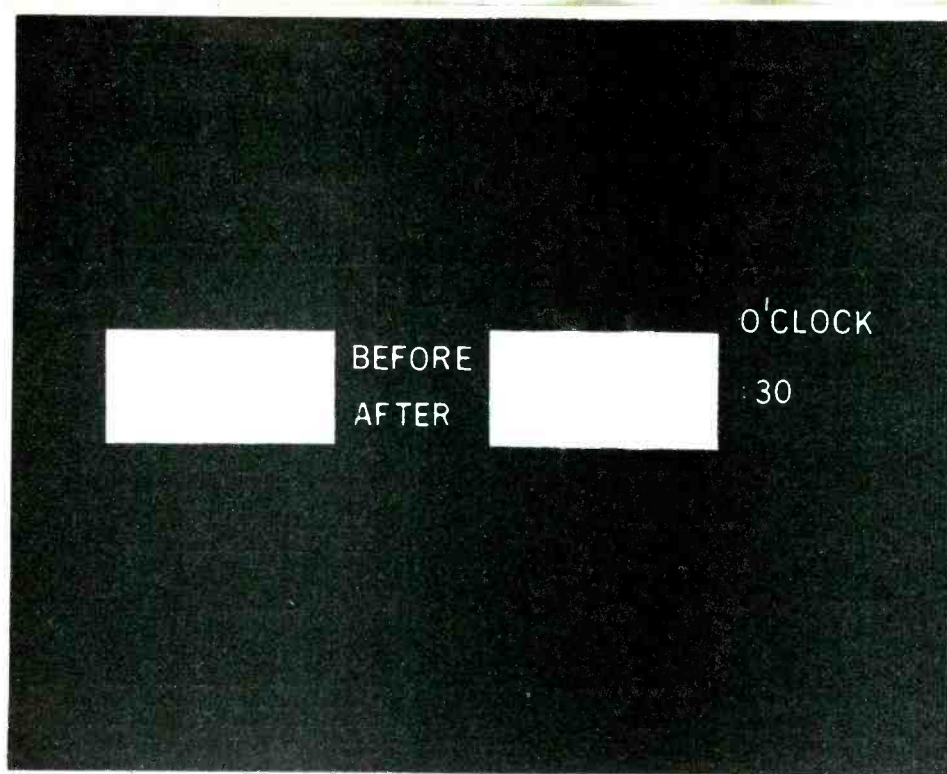

Fig. 7—The template for the front-panel may be lifted from the page with contact transfer film (or it can be copied on acetate by a photo shop) and glued to a small piece of Plexiglas. This bezel is needed to produce the desired effect.

to turn it on and set the time. You may have a minor problem with some 4012's. The hours display should change only at ":30." If it changes at 19 minutes (counting down), a .001 μ F capacitor connected from U16, pin 13 to ground should clear up the problem.

The first thing to do after applying power is to run each number through a "0" to clear. (Note: The 10's of minutes display will go past a 3 when clearing, but not during opera-

tion.) Set the minutes first, 10 of minutes next, then the hours, using the 3 time-set switches. No problems should be incurred in accomplishing this.

To change from "BEFORE" to "AFTER," step the minutes past the hour. To change from "AFTER" to "BEFORE," step the minutes past the half hour. As a novelty, this clock is a unique addition to any mantle, and is sure to be a conversation piece. ■

PARTS LIST FOR THE BEFORE AND AFTER CLOCK

SEMICONDUCTORS

BR1—1-A, 50-PIV, fullwave bridge rectifier (Radio Shack No. 276-1161 or similar)
 D1—D4—1N914 silicon diode
 D5, D6—1N34 germanium diode
 DIS1—DIS4—Seven-segment, common-cathode, LED display (FND-503 or Radio Shack 276-1647)
 Q1—Q5—2N2222 NPN general-purpose silicon transistor
 U1—U3—4511B BCD-to-7-segment latch/decoder/driver, integrated circuit
 U4—U6—4510B presettable up/down counter, integrated circuit
 U7—4072B dual four-input OR gate, integrated circuit
 U8, U11, U17—4049B hex buffer/converter, integrated circuit
 U9, U12, U16—4012B dual four-input NAND gate, integrated circuit
 U10, U15—4044B quad three-state R/S latch, integrated circuit
 U13—4001B quad two-input NOR gate, integrated circuit
 U14—4011B quad two-input NAND gate, integrated circuit
 U18—4528B dual monostable multivibrator, integrated circuit
 U19—4093B quad two-input NAND Schmitt trigger, integrated circuit
 U20—U23—4018B presettable divide-by-N counter, integrated circuit

U24—LM340-12 (or LM7812) positive 12-volt, 1 A voltage regulator

RESISTORS

(All resistors 1/4-watt, 5% fixed resistors)
 R1—R21, R25—1000-ohm
 R22—R24, R26, R28, R32—4,700-ohm
 R30, R34, R35—10,000-ohm
 R36—100,000-ohm
 R37—82,000-ohm

CAPACITORS

C1—C7—.1- μ F, 25-WVDC ceramic disc
 C8, C9—.001- μ F, 25-WVDC ceramic disc
 C10—1000- μ F, 35-WVDC electrolytic

ADDITIONAL PARTS AND MATERIALS

I1—I4—12-volt, 25-mA, incandescent lamps (Radio Shack #272-1141)
 S1—S3—SPDT toggle switch
 T1—Step-down power transformer: 117-VAC primary; 12-volts, 1-A secondary
 Cabinet, hardware, printed-circuit materials, bezel material, line cord with molded plug, wire, solder, etc.

A printed-circuit board, part No. RW501 (with plated-through holes and reflowed solder), for the Before and After Clock is available for \$27.00, plus \$2.00 postage and handling from Danocinths, Inc., P.O. Box 261, Westland, MI 48185. Please allow 6 to 8 weeks for delivery.

Build and checkout this...

ADJUSTABLE TIMER

With just a little imagination, this simple timing circuit can be made to control any number of elaborate functions.

By Warren Baker

□ WHEN IT COMES TO DESIGNING ANYTHING ELECTRONIC these days, you are almost sure to need some form of timing circuit. Well, for almost any timing function, the amazing little NE555 oscillator/timer is nearly unmatched in its field. One need only consider simplicity of design, ease of assem-

They allow you to stop the timing cycle at any point.

Once the RESET switch, S1, makes contact, the timer remains in that state until the START switch, S2, is pressed. When either switch is activated, LED1 (READY) and the TIME indicator, LED2, keep track of the situation. Although not necessary, the two light-emitting diodes should be of different colors—say, red for READY and green for TIME—for

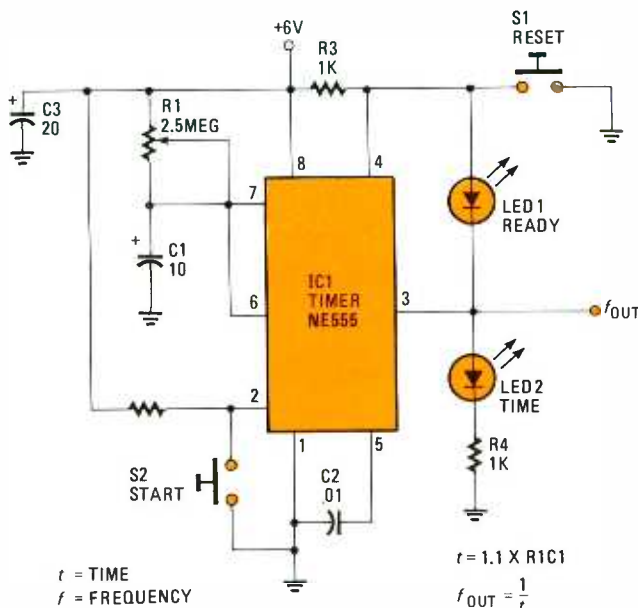

PARTS LIST FOR THE ADJUSTABLE TIMER

- C1—10- μ F, 25-WVDC electrolytic capacitor
- C2—0.01- μ F, 15-WVDC ceramic disc capacitor
- C3—20- μ F, 15-WVDC electrolytic capacitor
- LED1—Jumbo green light-emitting diode
- LED2—Jumbo red light-emitting diode
- R1—R4—1000-ohm, 1/4-watt, fixed resistor
- S1, S2—Normally-open, SPST pushbutton switch
- U1—NE555 oscillator timer integrated circuit
- Cabinet, pre-etched printed-circuit material, 6-volt battery, 8-pin DIP socket, hardware, etc.

Fig. 1—Note the simplicity of the Adjustable Timer. A single resistor, R1 (a 2.5-Megohm potentiometer), makes the timing of the circuit continuously adjustable.

ease of interpretation as shown in Fig. 1. You may have other ideas, so follow your own dictates.

As outlined, the Adjustable Timer is set up to be built on a solderless breadboard system. The physical layout has been aided by use of a solderless breadboard. One nice thing about using such a system is that a pre-printed paper overlay of the board can be used to map out the circuit, making all changes in the layout as necessary. Then, using that paper version as a template, you can transfer your final layout to some form of permanent board, if desired.

Putting It Together

A pre-etched phenolic circuit board, having the same basic pattern as the solderless breadboard and the layout sheet, can be used to permanently mount the circuit. When parts are
(Continued on page 103)

bly, and low cost to see why that unit, as a circuit-building block, is hard to beat. The timing circuit described below exemplifies each of the NE555's capabilities in an easily-duplicated circuit that may even serve a useful purpose in your own design projects.

Simple Timing Circuit

A quick glance at the schematic diagram in Fig. 1 will reveal the ease with which the unit may be assembled. The circuit is, for the most part, of the textbook variety; yet, there are a couple of features added for the user's benefit. One of those additions, light-emitting diodes (LED's), indicate to the user at a glance what the status of the circuit is at any given moment. The switches are a second added feature.



THE PROJECT PARADE

**Here are 5 popular projects that are goof-proof!
Build them tonight and put them to use tomorrow.**

THE PROJECTS CONTAINED IN THIS SPECIAL SECTION OF **Hands-on Electronics** have been carefully selected for their universal appeal and many applications in the home, office, workshop, factory; in fact, anywhere people go!

The projects are based on those selected by the Editor from the *Dick Smith Electronics* catalog, assembled and reported in detail in the section. Since the parts are supplied in kit form, their availability is assured should you not be able find them in your junkbox or to purchase them locally. The parts designations are not consistent with those usually used in this

magazine. For example: TR is the symbol used for a transistor in this section instead of Q. The reason for this change is to permit the Parts Lists and diagrams to coincide with the printed material supplied by *Dick Smith Electronics*.

We have provided more information, instructions, and diagrams than we normally would do because it is the intention of this section to encourage neophyte and novice builders to get totally involved with their hobby. The old *pros* are urged to read a bit faster and plug in the soldering iron immediately. Happy soldering! ■

MULTI-PURPOSE FLASHING LED

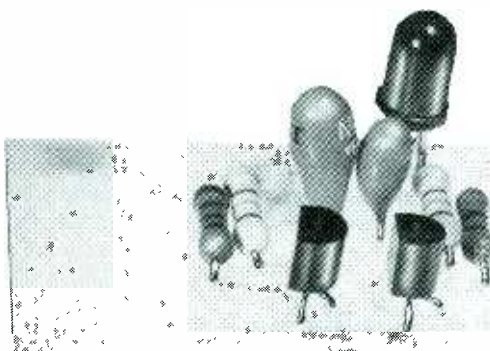

This simple circuit can be used in almost any application; everything from warning indicators to jewelry to decorative window ornaments, anything else that you can think of!

THE MULTI-PURPOSE FLASHING LED project can be used as a simple warning indicator—outside a darkroom door, for example. Or it can be used to warn a thief that your car is fitted with a burglar alarm, even if it really isn't! Or, if you're so inclined, you can turn this little circuit into the latest in electronic jewelry. The board has been designed to wear as a brooch or pendant. So why pay \$50 or more when you can make your own?

How It Works

When power is applied (refer to Fig. 1), capacitors C1 and C2 start to charge to the

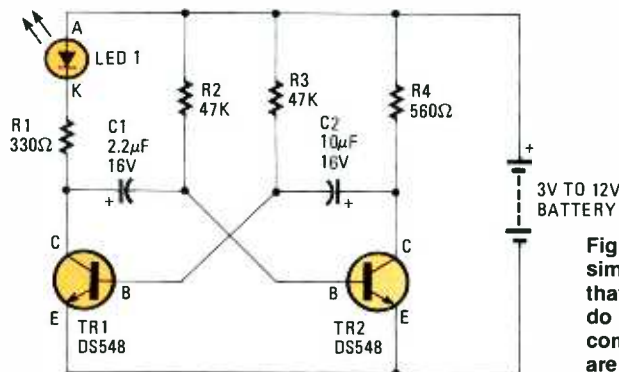

Fig. 1—The circuit is really simple and the only problem that might be encountered has to do with the polarity of the components: Over half of them are polarized! It will operate from a very wide voltage range.

supply voltage via the base-emitter junctions of TR1 and TR2. That charging current tries to turn both the transistors on. But both cannot turn on at the same time, as we will see in a moment. By a combination of component tolerance, one of the two transistors will turn on first.

By the time the transistor has turned on (let's assume it to be TR1) the capacitors have reached a reasonable state of charge. They could have quite a few volts across them. So the positive end of the capacitors would be a few volts positive with respect to the negative ends.

As you can see, the positive ends of the capacitors are connected to the transistor collectors, with their negative ends to the opposite transistor's base. When TR1 turns on, its collector voltage drops to a low level—probably around 1 volt. But wait; the capacitor connected to that point has a potential of 6 volts. What happens here? Because the capacitor has resistance in series, it cannot discharge immediately. So whatever voltage the positive end becomes, the negative end must go another 6 volts below that again! If the collector of TR1 goes to 1 volt, the negative end of C1 must go to around minus 5 volts!

As the negative end of C1 is connected to the base of TR2, it turns off, and it remains in that state while C1 discharges through R1, the LED, and R2.

Eventually C1 discharges, and TR2 can then turn on via R2. As soon as that happens, C2's negative end drops down to -5 volts, turning off TR1. Capacitor C2 eventually discharges, allowing TR1 to turn on again, turning off TR2. That cycle continually repeats as long as power is applied. As there is an LED in series with TR1, every time TR1 turns on, the current flowing through it must also flow through the LED: Thus it flashes, giving us one flash for each cycle.

A second LED can be connected in series with TR2's collector, giving two flashes per cycle. The rate at which flashing occurs is governed by the value of resistors R2 and R3, and capacitors C1 and C2. Varying the value of any or all of those components will vary the circuit speed.

Putting It Together

Obtain the parts specified in the Parts List; there is a low-priced kit available. Mount the components as shown in the parts-placement diagram, Fig. 2. Place and solder the resistors and capacitors first, taking care to observe the capacitors' polarity. Make sure that all components are "dressed" (neatly positioned) before soldering them in place. Mount the LED; the anode (positive) lead is the longer of the two and goes towards the outer edge of the PC board. The LED can be soldered in place as shown, or tacked to the opposite side (see photo). Which ever side is

PARTS LIST FOR THE MULTI-PURPOSE LED FLASHER

LED1—Jumbo red light-emitting diode
 TR1, TR2—DS548, ECG123A, 2N2222, 2N2222A, or similar NPN transistor
 R1—330 ohm, 1/4-watt, 5% fixed resistor
 R2, R3—47,000-ohm, 1/4-watt, 5% fixed resistor
 R4—560-ohm, 1/4-watt, 5% fixed resistor
 C1—2.2- μ F, 16-WVDC tantalum capacitor
 C2—10- μ F, 16-WVDC tantalum capacitor

ADDITIONAL PARTS AND MATERIALS

Battery snap, solder, hookup wire, 9-volt battery or other 9-volt DC source, optional LED identical to LED1, suitable mounting board or printed-circuit board of correct design (The Dick Smith K-2621 Flasher Kit contains the printed circuit).

Order the Flasher Kit of parts, K-2621 for \$2.95 from Dick Smith Electronics, Telephone 1-800/332-5373, and tell them you saw it in Hands-on Electronics.

chosen, a link (jumper wire) must be soldered in the opposite position labeled LINK.

Position and solder TR1 and TR2. If you are unsure about your soldering ability, use a heatsink on the transistor leads to prevent overheating. Solder in the battery wires, again taking care with polarity. There's not much good getting everything else right if the battery is reversed! The positive (red) lead goes to the end of the printed-circuit board with the LED on it; the negative (black) lead goes to the end with the transistors on it. The printed-circuit board has been designed to accommodate two LED's, but at the moment, we need only one. Thus, a link (mentioned earlier), made from a short length of cut component lead, is used to jumper out the extra LED position.

Go over the board, checking all components, battery connections, etc. If you're satisfied that everything is correct, connect the battery and the LED should start to flash, immediately. If it doesn't, disconnect the battery, and recheck everything component, soldered joint, and wire. (It may be that your battery is dead?)

Putting It to Good Use

A circuit such as this has several uses.

One use for this type of circuit is as an alarm indicator, let's say, for your car. You've probably seen those rather expensive auto alarms systems with a flashing lights to warn thieves away. This flashing LED can be used for exactly the same purpose: and you don't even have to have an alarm! You might consider combining this project and a Car Alarm to produce a complete system.

When connecting the circuit to your auto's electrical system, no circuit modifications are needed for 12-volt operation, because this circuit is designed to operate over a wide voltage range. Just wire the positive lead to the car battery's positive terminal (or other convenient 12-volt source), and the negative lead to the car's chassis (assuming a negative ground vehicle). Unless your car battery's charge is pretty low, it won't hurt to leave the LED flashing all the time.

Darkroom Warning Indicator: This circuit makes a great little warning for darkrooms, etc, with the flashing LED meaning "stay out!" Because it might be inconvenient to change batteries all the time, you may wish to power the circuit from a plug-in battery eliminator (wall-mounted, DC power supply). Figure 3 shows full connection details.

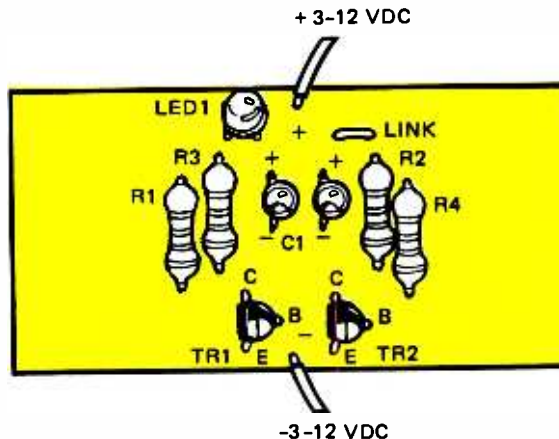

Fig. 2—The printed-circuit board can be made with one LED, as shown, or twin LED's (see text). The printed-circuit board can also be cut into a circular shape, allowing it to be worn as a brooch, badge, or pendant.

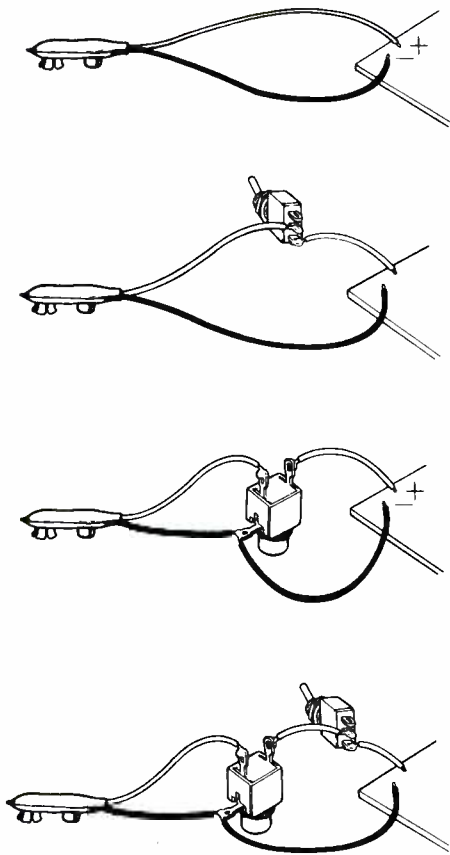

Fig. 3—The diagrams illustrate how to add an on/off switch or a socket for an external wall mounted DC power supply to your projects. The same wiring can be used for almost any battered powered project. In a, a 9-volt snap-on battery connector is shown without a switch. The solid black lead is negative in all cases. b shows how to add an on/off switch. The red lead, or positive, is broken by the switch (only the center and one of the outside terminals are used). In c, an 3.5-mm socket replaces the switch. The socket automatically cuts off the battery if wired as shown. The wiring scheme in d allows for greater power supply flexibility: Both the battery snap and socket for external power are included with the switch controlling the power supplied.

So far, we've shown a basic single-LED flasher: But (as has been mentioned), the printed-circuit board was designed to operate with either one or two LED's. If you wish to add a second LED, simply connect it in place of the link, with the anode (the longer lead) going to the track connected to the positive supply. Why not use a green LED in the second position, so the indicator would alternately flash red and green?

If you do connect a second LED, the 560-ohm resistor should be reduced to the same value as in series with LED1, for roughly equal brightness. We've shown a 330-ohm resistor in series, which is fine for 9 or 12-volt operation. If you want to operate the circuit from a lower supply voltage, you might want to use a lower

value resistor to get sufficient LED brightness. Values as low as 100 ohms should be satisfactory; remember, however, that the lower the resistor, the heavier the current drain on the battery.

Other modifications you can make to your flasher include the altering of the LED's on/off times. With the capacitors values shown, the on time is much shorter than the off time. If those capacitors are made equal, the on/off times of the LED's will be equal. (Watch the capacitor polarity!)

If you want to use the Flasher as an alarm device, we assume that you will want to protect it in a box. The PC board supplied with the kit has been designed to fit into the smallest slotted Zippy box, see Fig. 4 (Dick Smith Cat. H-2755) with plenty of room for the battery. If that box is used, we would assume further that you will want to include an on/off switch. Once again, Figure 3 gives the details. *Making electronic jewelry:* A printed-circuit pattern has been provided, that's larger than the circuit board supplied with the kit, for those who want to make electronic jewelry (see Fig. 5). The extra size is to allow room behind the main printed circuit for batteries. The smaller board isn't big enough. Figure 6 shows the printed-circuit pattern needed for battery mounting on the electronic jewelry. The pattern can be copied and etched.

You may have noticed that all the tracks on the printed-circuit board are crowded into a small circle in the middle of the board. Normally, that would be *taboo*, and bare-board material should be avoided. Obviously, there is a reason for that! We have designed the board that way so that the circular pattern can be cut out (with a fine hacksaw and filed down) allowing the printed circuit to be used as a brooch or badge. Electronic jewelry is all the rage overseas, and is now being seen elsewhere. However, the prices have been very high; now you can make your own at a fraction of the cost!

There are a number of ways you can assemble and wear the circuit. Perhaps the easiest way is to connect fine wires and hide the battery in your pocket or behind

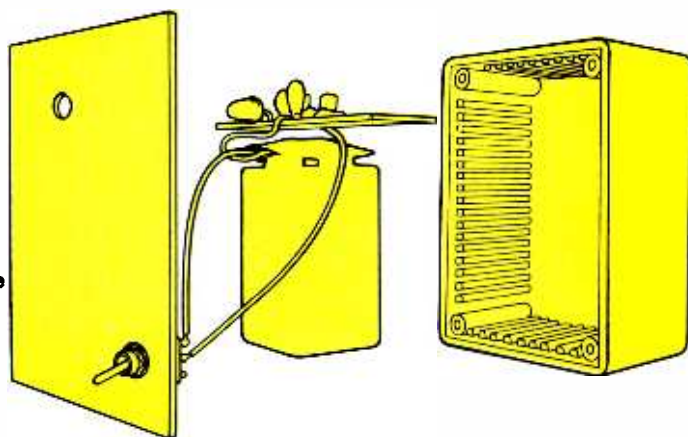

Fig. 4—There is plenty of room inside the smallest Zippy box for the printed circuit. A hole is drilled in the front panel for the LED to poke through.

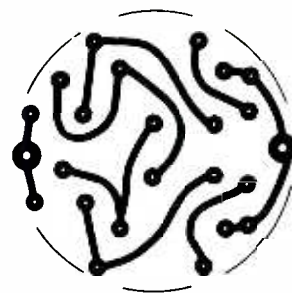

Fig. 5—A same-size pattern of the LED flasher board for electronic jewelry. Cut the circle shape with a hacksaw, and finish off with a file.

your collar. The badge itself can be held on by a tab of double-sided adhesive tape (available from most stationary and other stores), or a normal pin clasp glued to the back of the board.

Another suggestion is to mount the brooch on a gold chain, and use the chain itself to carry power down to the board. Obviously, the two halves of the chain would have to be insulated from each other. Another idea we've seen is to have the circuit worn behind a jumper or tee-shirt, with the LED's poked through fine holes between the strands of fabric. That idea looks really neat if the jumper or teeshirt has a design or pattern on it that can be worked in with the LED's!

However, the most logical idea—as far as convenience goes—is to actually mount the batteries on the back of the board itself. (Use small silver oxide or mercury batteries, the type used in watches.) The drawing and photos should give you a good idea of how to make up your own brooch or badge.

Once you've made up your printed-circuit board, you must decide whether you're going to leave it as is, or just have the LED's showing. The second method certainly protects the components, but is much more involved. It normally means going through a process called "potting," in which the components are set in a clear or translucent liquid that turns hard after a time. Normally a mold is used to form a desired shape: When the mold is removed, the potting compound has taken the shape of the mold. If the potting compound sets

Fig. 6—Details for making an on-board power supply for use in electronic jewelry is shown. Three additional boards of the same shape and size, etched as shown are required.

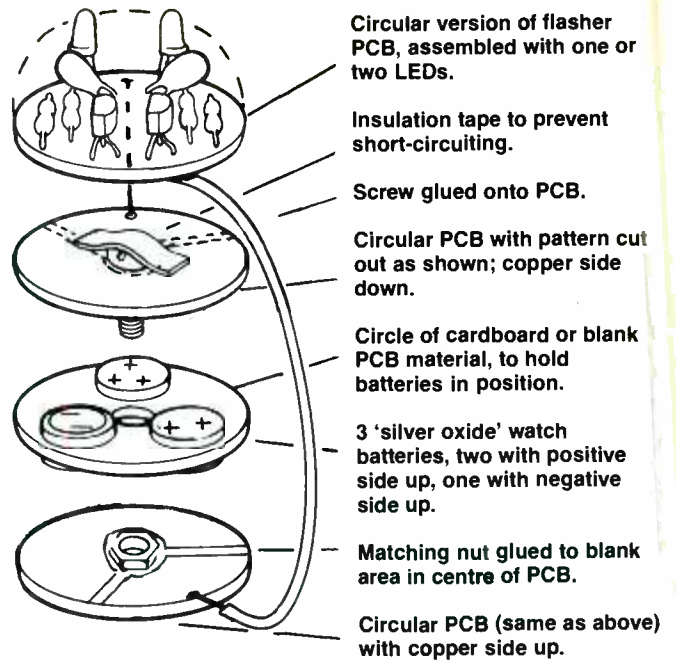

clear, all the components can be seen inside. (It normally sets as clear as glass!)

Other compounds set with a "haze," so all that can be seen coming from them is the glow of the LED's. Sometimes the whole board seems to glow, if the LED's are set far enough down in the compound. The compound is non-conductive; so once it sets, there are no problems with short circuits. Potting compound is available from most hobby shops: Simply explain what you want to do and you should get the right material. As for a mold, various things can be used—bottle tops, paper cups, etc.—or you can even make your own mold from plaster of paris if you want to achieve some unusual shape.

When potting, you must be careful that the potting material does not "ooze" down into the battery compartment and stop conduction between the battery and the printed circuit. Another thing that can stop good contact is small breaks in the copper traces; we coated (tinned) both battery boards with solder to prevent the copper from tarnishing, which also bridges any gaps in the traces.

An opposite problem to that is unwanted connections (short circuits) between components of the battery holders. The screw head can short onto or between the traces of the printed circuit, so we covered the head of the screw with insulation tape before assembly. The nut on the back battery printed-circuit board is not soldered to the copper; it is glued to blank board to prevent short circuits.

In our simple flasher, we didn't fit an on/off switch: rather, we used the negative lead from the batteries to connect with a small hook soldered to the negative connection point on the main printed circuit. There are other ideas you could try, of course. A pin clasp glued to the back of the rear printed-circuit board which, when closed, completes the circuit.

We have barely scratched the surface of this exciting subject: the limit is your own imagination!

This is one way to make a brooch or badge with its own battery supply glued to the back! The batteries are "sandwiched" between two circular printed-circuit boards. A slot is cut into the boards so that when they are placed together (copper facing in) with the batteries sandwiched between, the batteries are connected in series, giving a 4.5-volt supply. It is im-

portant that the slots are oriented correctly to each other: if you had X-ray eyes and could look through the assembly, the slots would form a "Y" pattern.

If the printed-circuit boards are assembled and the battery polarities oriented as shown, you shouldn't have any problems. The supply assembly can be glued to the back of the flasher board, or it can be held on by the wire connecting the positive supply to the flasher. The supply is turned on and off by screwing and unscrewing the rearmost PCB so that contact is made or broken with the batteries.

This is just one idea: of course, there are many other ways to go. For other ideas, why not have a look at some electronic brooches in a modern jewelry shop. See how their brooches are made, and copy them. ■

ELECTRONIC DICE

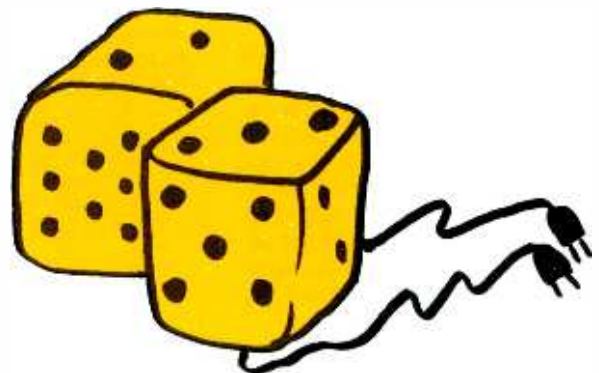

Imagine an electronic die that not only "rolls," and displays the result, but turns off automatically! And if you wish, you can build two dice into the same box for games such as *Backgammon*, *Monopoly*, etc.!

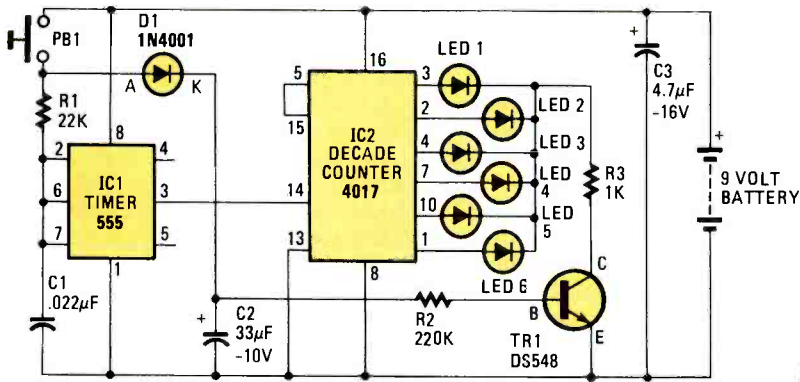

Fig. 1—The circuit is very simple: but take care with the CMOS IC and the LED's. Note especially that LED2, LED4, and LED6 are oriented differently from LED1, LED3, and LED5!

THE ELECTRONIC DICE CIRCUIT IS GREAT for those who enjoy the fun and excitement of casino gambling. This article tells you how to wire up one "dice," or die (that is the singular word); and two dice (dice is a plural word).

How It Works

Refer to Fig. 1. When the pushbutton switch (PB1) is pressed, power is supplied to C1 via R1. C1 gradually charges, until a certain voltage is reached, causing IC1 to conduct, supplying a pulse to IC2, as it discharges C1. Capacitor C1 then starts to charge again, repeating the process.

The combination of R1, C1, and IC1 form a *relaxation oscillator*—every time a pulse occurs, the circuit "relaxes," ready to start over.

IC2 is a counter, which simply detects the pulses supplied by IC1 and counts them. It shows how many pulses it has counted by causing an LED to glow representing that number. That IC can, in fact, count to ten; however, we want it to count up to six. So instead of causing an LED to glow on the seventh pulse, the pin that would be used for that purpose (pin 5) is connected to another pin (pin 15), which causes the counter to reset to zero, ready to start counting again.

The counter keeps counting as pulses continue to arrive. When the push button is released, the oscillator stops and no more pulses are output by the timer. The counter then shows the number to which it has counted during the time the PB1 was depressed.

Because, it is not desirable for the LED

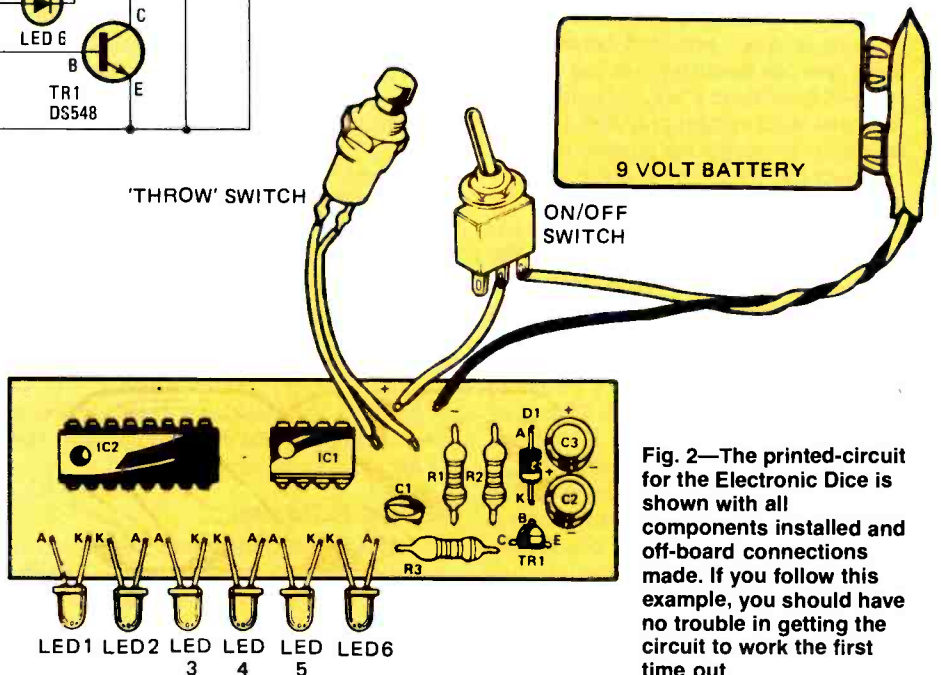

Fig. 2—The printed-circuit for the Electronic Dice is shown with all components installed and off-board connections made. If you follow this example, you should have no trouble in getting the circuit to work the first time out.

to stay on indefinitely (wasting the battery), a separate circuit causes the LED to go out after a short time. That circuit consists of D1, C2, TR1, and its associated resistors. Whenever PB1 is pressed, C2 charges via D1. That allows TR1 to turn on. When the button is released, the charge on C2 is bled off through R2 and the base/emitter junction of TR1. After a short time, the current through the transistor becomes too small to keep it conducting, so it turns off and the LED is extinguished.

With the .022-µF capacitor shown, the LED's flash in sequence so quickly that they all appear to be on at once (although dimly). That's necessary so that anyone using the die will not be able to cheat by

releasing the button at a certain time to obtain a certain number.

Increasing the value of R1 and/or C1 will cause the speed to slow down, due to the longer charging time required. Wired as a flashing broach, with C1 now valued at 3.3-µF and a jumper across switch PB1, the LED's will flash slowly in sequence as long as the battery is connected.

Putting It Together

The first thing that you'll need is to obtain a printed-circuit board and components in the values given in the Parts List. You may choose to make your own board and then go hunting for the parts, or order a complete kit from the supplier given in the Parts List.

PARTS LIST FOR THE ELECTRONIC DICE

- D1—1N4001 1-A, 50-PIV rectifier diode
- LED1-LED6—Miniature red LED
- IC1—555 timer/oscillator, integrated circuit
- IC2—4017 decade counter, CMOS integrated circuit
- TR1—DS548, 2N2222, or similar NPN transistor
- R1—22,000-ohm, ¼-watt, 5% fixed resistor
- R2—220,000-ohm, ¼-watt, 5% fixed resistor
- R3—1000-ohm, ¼-watt, 5% fixed resistor
- C1—.022-µF ceramic or polyester capacitor (dice). For jewelry use 3.3-µF, 10-WVDC electrolytic not supplied in basic kit)
- C2—33-µF, 10-WVDC electrolytic capacitor

- C3—4.7-µF, 16-WVDC electrolytic capacitor
- PB1—Momentary contact pushbutton switch

ADDITIONAL PARTS AND MATERIALS

Printed-circuit material, 9-volt transistor battery or some other DC power supply, battery snap, hook-up wire, solder, etc.

A complete Electronic Dice kit (not including 9-volt battery) catalog No. DSW2 K-2625 priced at \$4.95, is available from Dick Smith Electronics, P.O. Box 8021, Redwood City, CA 94063.

Mount the components as shown in the parts-placement diagram, Fig. 2; resistors and capacitors first, being careful to mount C2 and C3 capacitors the right way, because they are polarized. If you are building the broach, C1 is also an electrolytic and requires the same caution as C2 and C3 in mounting. It is possible that in some cases you will have an axial-lead electrolytic to mount on the circuit board. If there is space provided between the holes, you can mount it flat as you would a resistor; but if there is not, the unit may be mounted in an upright position. Take extra care that you get the polarity right.

Solder the six LED's in place, making sure that they are properly oriented—remember that the short lead is the cathode (K) also marked by the flat side of the LED. Keep all the LED leads at the same length to facilitate mounting in a suitable enclosure. Place D1 in position and, once you are sure that it's correctly oriented (the banded end nearest TR1's mounting pads), solder it in place. Install TR1, moving with caution, and solder it in place. Note that the base of TR1 connects to R2.

The 4017 integrated circuit is a CMOS device and therefore static-sensitive. It is supplied stuck into special conducting foam, which shorts out all the pins and prevents damage from static charges. Leave it in the foam until you are actually ready to solder it in place. Insert IC1 into the holes on the printed-circuit board. Make sure it is the right way around by

noting that pin 1 (marked with the small circular indentation on top) is connected to the negative track on the circuit board. Turn the circuit board over and carefully solder each of the pins to the pads, making sure that you don't run solder between the pads.

Solder one wire to the pushbutton switch; then connect and solder the free ends to the circuit board, at the position marked PB1. You are now ready to connect and solder the battery snap wires; take care to see that you have the red positive lead going to the pad marked "+," and black negative to the pad marked "-." After checking to make sure that all components are correctly inserted and soldered, connect the battery; then check the circuit by pressing PB1. All LED's should appear to come on dimly; one should come on brightly when you release the button, then slowly die out. Figure 3, shows the circuit and the slotted project box in which it will be housed. The panel has holes drilled to accommodate the those components that are to be mounted there.

What To Do Next

It is very easy to add a second die circuit for games such as *Backgammon*, *Monopoly*, etc, where two dice are normally thrown at one time. Of course, you could simply build a second die circuit (identical to the first) and press both buttons at one time; but that's inconvenient. Our

method of mounting the second die avoids the second pushbutton—and, indeed, a few other components—by "sharing" some of the functions between the two Dice, as shown in Fig. 4.

Obviously, we cannot share the oscillator components or the counter, as we would simply get a duplicate reading between the two dice. So two individual oscillators and counters are provided, giving two completely random numbers. (Because of the "tolerance" of components, the two oscillators will run at different speeds, even though we use components of nominally the same value.)

To build the dual dice, you will need to build two kits. The first is exactly as we have discussed (you could use your single die if you wish). The second is virtually identical, except that D1, C2, and C3, as well as the wires to the switch and battery, are left out. Where shown in figure 5, jumper the two boards together with short lengths (about 30-mm or so) of hook-up wire. Those jumpers should go from the component side of the second board to the trace side of the first. It is fairly easy to solder to the copper pads—just be careful that you don't bridge (short) two pads together.

All that remains is to connect the battery and push the button. Both rows of LED's should come on dimly (as above), with one LED in each row glowing brightly when you release the button. Both

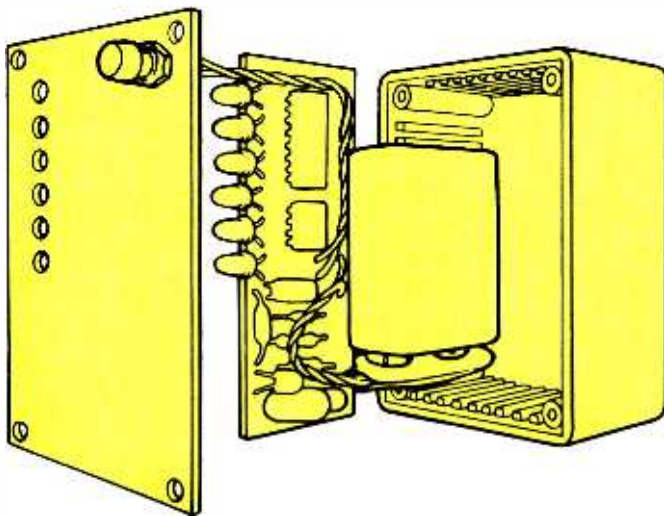

Fig. 3—A single Dice printed-circuit board fits easily into the Zippy box; along with the battery. If you want to add a jack so the circuit can be powered from an external supply, wire the jack in place of or across (in parallel with) the battery connector.

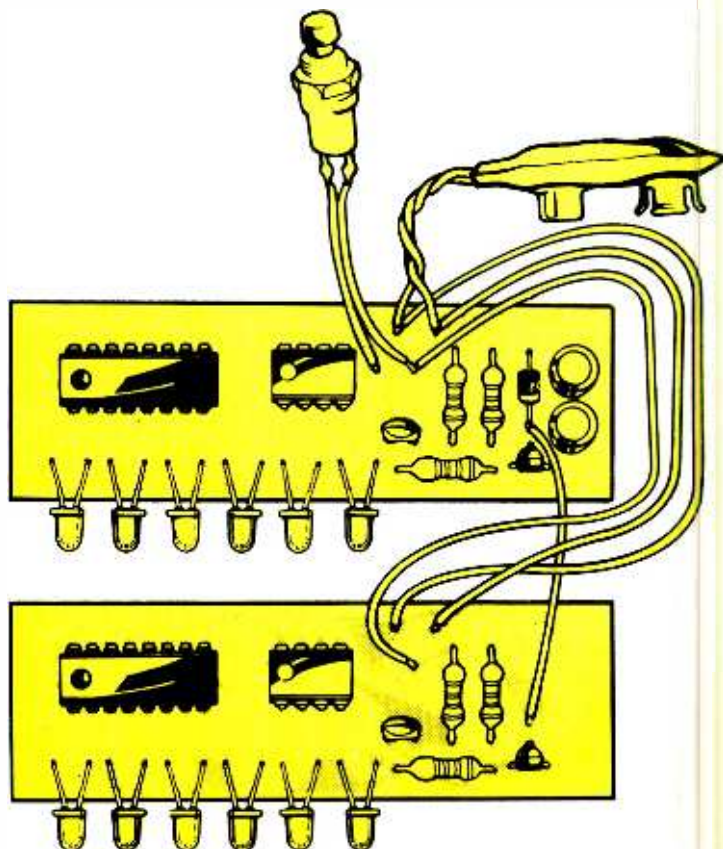

Fig. 4—Wire the double LED Dice as shown. Note that in making the double unit, there are a number of components that not needed on the second board.

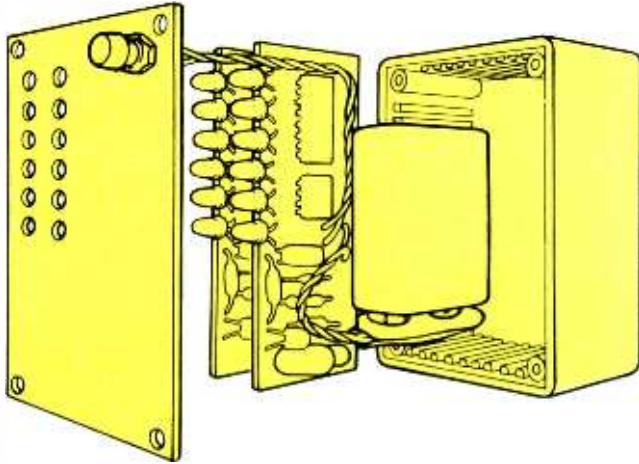
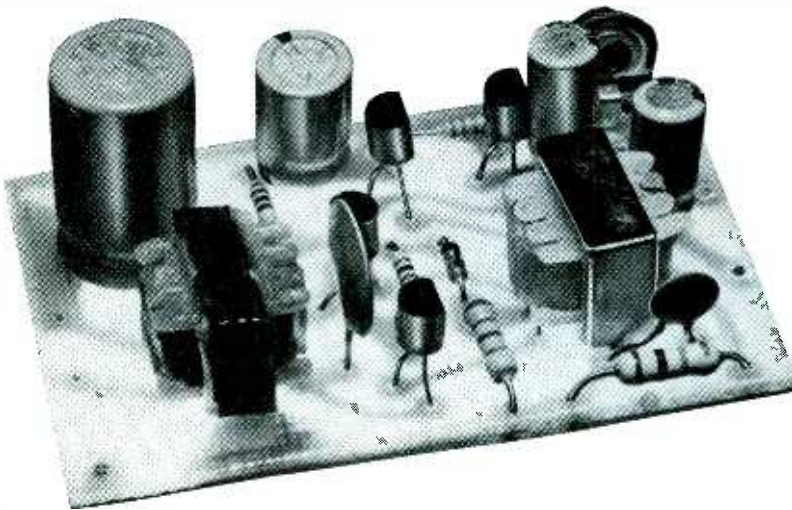

Fig. 5.—Two Dice PC boards fit easily into the box. The addition of the extra board is the only difference between this figure and Fig. 3.

LED's should then die out at about the same rate.

If you wish to mount the dual dice in a project box, you will have to drill a second row of holes, as shown in Fig. 5. The second board mounts three slots behind the first to allow the LED's to line up. (You may need to lay over capacitor C1 to allow for the close spacing. That gives plenty of room for the battery to lie in front of board 1 when both boards are in the box. ■



A SIMPLE AMPLIFIER

This easy-to-build amplifier circuit has several useful applications, ranging from audio amplification to electronic troubleshooting!

□ ONE OF THE MOST POPULAR PROJECTS for the electronics hobbyist is the audio amplifier. After all, an audio amplifier is particularly useful. As well as the more obvious uses, it can be used to troubleshoot other projects (and we'll show you how).

Amplifiers are one of the most common of all electronic circuits; every piece of communication and entertainment equipment has at least one! But they all work in much the same way, taking a very small electrical signal (one too small to be of much use) and adding power to it to produce a much larger signal. Well, the Simple Amplifier can be made at a relatively low cost, and still prove more useful than its price indicates.

How It Works

RV1, the VOLUME control (see Fig. 1), selects a certain proportion of the applied audio signal to be amplified. Capacitors C1 and C2 do not impede the audio signal:

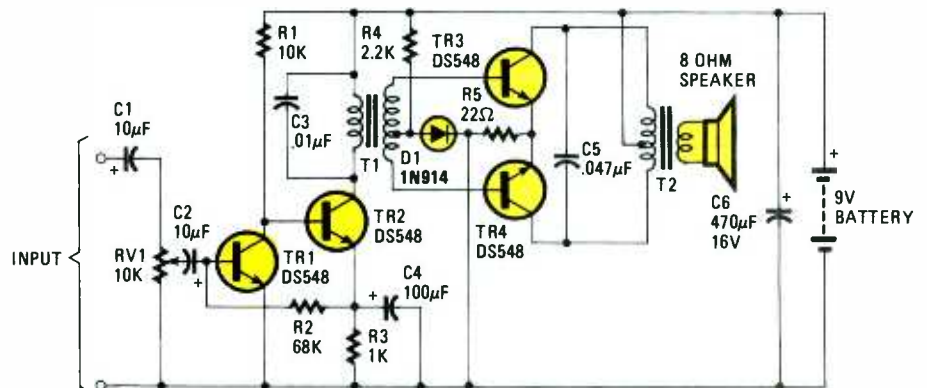

Fig. 1—In the Amplifier circuit, RV1 is used as a volume control. That component allows you to adjust the amount of signal presented to the amplifier; thus, you can raise or lower the volume at will.

They are merely DC blocking capacitors, which prevent any direct current flowing through the potentiometer from entering the audio circuit. TR1 and TR2 amplify the audio level significantly, but not

enough to drive a loudspeaker. They can be regarded as preamplifiers.

The varying output current of TR2 must pass through the primary winding of T1. A varying voltage is, hence, induced in

the secondary of T1—which, as you may have noticed, is split in half. Two separate currents flow in the secondary; each are identical to the other, but opposite in phase. That means that at any given instant, the two voltages are of the same magnitude, but opposite in polarity: One is so many volts above zero, while the other is an equal amount below zero (a negative voltage). If that sounds confusing, don't let it worry you. Phase relationship is quite an involved subject; it will all come to you eventually!

What those out-of-phase currents do, however, is the secret behind this type of audio-amplifier circuit. Audio signals are alternating current; that is, they follow a fixed cycle. On the first half cycle, the voltage from the top end of the transformer might be going positive, and the voltage from the bottom end going negative. In the next half cycle, the roles are reversed; the top end goes negative, while the bottom end goes positive.

As you may remember, an NPN transistor needs to have a positive voltage (of at least 0.6-volt or so) applied to its base before it can conduct. Obviously, if the voltage from T1 is negative during any half-cycle, the transistor does not conduct. But during the next positive half cycle, the transistor that was off, turns on as the waveform swings positive (and vice versa).

In fact, R4 and D1 keep the transistors just about conducting, so that the moment the signal voltage swings positive they conduct, immediately. Because each transistor can be driven harder during its half

cycle, that arrangement is much more efficient than using a single transistor to do the same job. Thus, the output power of that type of circuit is greater than that of a single transistor circuit. Capacitor C5 is connected between the two transistors to minimize distortion, which can occur as one transistor turns off and the other turns on.

Both TR3 and TR4 are connected to the positive supply via half the winding of T2—so the current flowing through them must also flow through the transformer. Unlike T1, where two out-of-phase currents were induced in the transformer from a single-input signal, T2 induces a single-output current in its secondary from two out-of-phase currents in its primary. That output is enough to drive a loudspeaker. This type of circuit is called a *push-pull* amplifier, as in the first half cycle one transistor pushes, then in the second half cycle the other pulls.

Putting It Together

The first step in building the Simple Am-

plifier is to obtain a printed-circuit board and the necessary parts. The board may be purchased from the supplier given in the Parts List, or you can make your own. However, if desired, perforated construction or experimenter's board may be used.

Assuming that you have purchased the kit, mount and solder the components as shown in Fig. 2, the parts-placement diagram—resistors and capacitors first, taking great care to ensure that C1, C2, C4, and C6 are correctly oriented. When mounting the two audio transformers, be very careful to ensure that you have the correct one in the correct place, and facing in the right direction. Note that the coupling transformer has three wires on each side, but that only two are used on the primary side; the spare one should be bent upward and out of the way.

The output transformer has three wires (one center tap) on the primary side and only two on the secondary or output side. Although they look very similar, those transformers are definitely *not* interchangeable! Once the transformers are in place, solder the diode in, again ensuring that it's correctly oriented. Carefully place the four transistors so that their leads contact the right pads and solder them in using a heatsink to prevent damage from overheating.

Next connect and solder the speaker wires to the board and then to the speaker, making sure that you do not damage the speaker by overheating. Solder the wires from the battery snap to the board, making sure that they are correctly polarized; i.e., red to positive (+) and black to negative (-). Clip off all excess wire neatly, making sure that all of the soldered connections are properly made. Finally, check all components to ensure correct

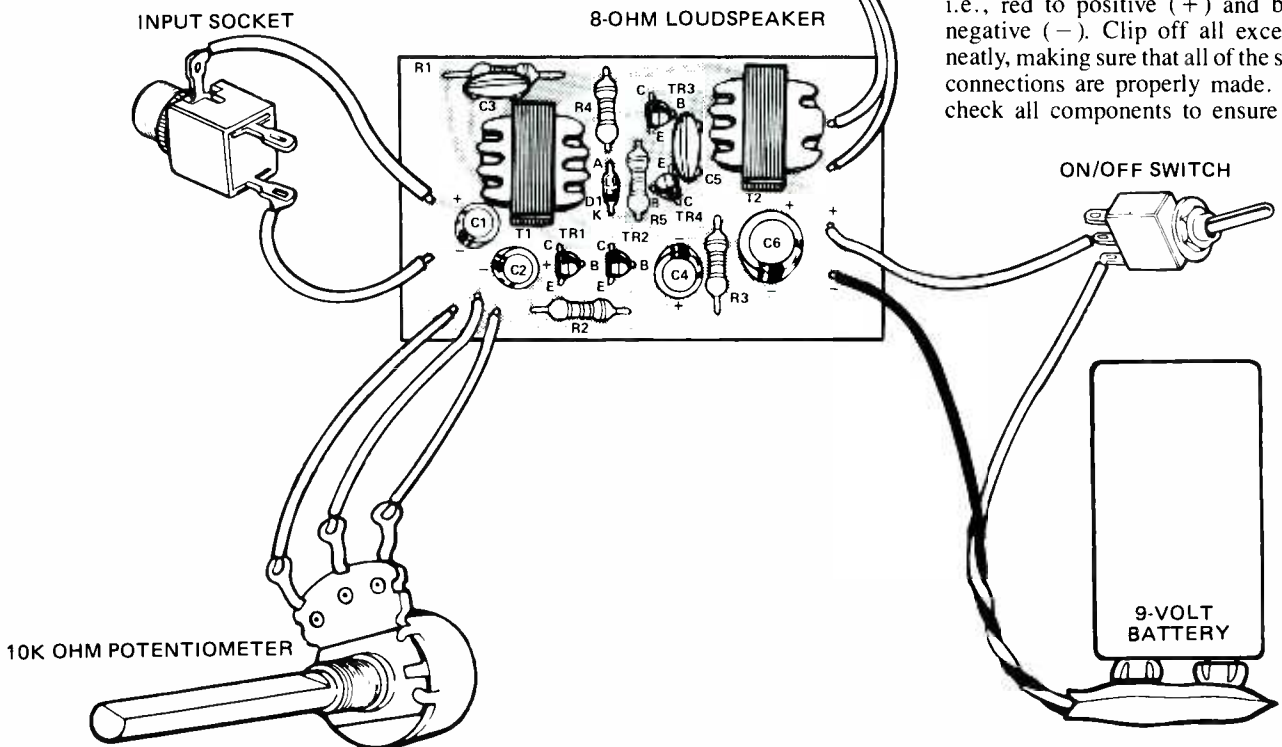

Fig. 2—This diagram should make construction and component orientation a snap. If so desired, a jack may be placed in parallel with the batteries so that an external power supply may be used.

PARTS LIST FOR THE SIMPLE AUDIO AMPLIFIER

C1—10- μ F, 16-WVDC, electrolytic capacitor
 C2—10- μ F, 16-WVDC, electrolytic capacitor
 C3—0.01- μ F, 16-WVDC ceramic disc capacitor
 C4—100 μ F, 16-WVDC electrolytic capacitor
 C5—0.047- μ F, 16-WVDC ceramic disc capacitor
 C6—470- μ F, 16-WVDC electrolytic capacitor
 D1—1N914, small signal, silicon, switching diode
 R1—10,000-ohm, 1/4-watt, 5% fixed resistor
 R2—68,000-ohm, 1/4-watt, 5% fixed resistor
 R3—1000-ohm, 1/4-watt, 5% fixed resistor
 R4—2200-ohm, 1/4-watt, 5% fixed resistor
 R5—22-ohm, 1/4-watt, 5% fixed resistor
 RV1—10,000-ohm, trimmer potentiometer
 TR1, TR2, TR3, TR4—DS548, or 2N2222 NPN silicon transistor

T1—Audio coupling transformer, 3000-ohm to 3000-ohms
 T2—Audio output transformer, 1000-ohm to 8-ohm (center trapped).

ADDITIONAL PARTS AND MATERIALS

Printed-circuit material, 8-ohm loudspeaker, 9-volt transistor battery, battery snap, enclosure, solder, hook-up wire, etc.

A complete kit of parts (minus the 9-volt battery), catalog No. DSW2 K-2630, for the Simple Amplifier circuit is available from Dick Smith Electronics, P.O. Box 8021, Redwood, CA 94063, priced at \$6.50; Tel. 1-800/332-5373.

polarity and position before connecting the battery.

To test the Simple Amplifier, connect the battery and short a wire across the input terminals. That should produce a clicking sound in the speaker. The next step is to find a suitable enclosure for the amplifier. The kit's printed circuit has been made to slot sideways into a Zippy box, as shown in Fig. 3. There is enough room in the box for the speaker and battery, too. We have shown the amplifier with a standard potentiometer instead of the trimmer supplied with the kit, the standard unit is convenient if the circuit is to be mounted in a box. We have included an audio input socket and a power switch to allow for easy on/off operation once the circuit is placed in an enclosure. If you wish to run your amplifier from a plug-pack adaptor, a socket can be wired in parallel with the battery, as indicated by the dashed line in Fig. 3. If everything works as it should, it is time to put the Amplifier to use.

Applications

One rather useful application of the Amplifier circuit's in an electronic *megaphone*. It will be necessary to remove the 8-ohm loudspeaker from the output of the amplifier, and instead fit it to the input. Connect a horn speaker (Dick Smith Cat. C-2705 or similar) to the output terminals, and speak into the original speaker, which is now functioning as a microphone. Your voice will be amplified, just as in a megaphone. It's as simple as that.

Another use for the circuit is to hook it up to a pocket transistor radio. A speaker is much more convenient than an ear-phone! Refer to Fig. 4. Start by removing the wires to the earphone socket from the printed-circuit board and, in their place, solder a 100-ohm resistor. The two wires to the socket are then re-soldered to the circuit board each one pad to the right of their previous position: They now connect to the collector of TR1 and the negative supply.

The two sockets can be connected together via a short twin "jumper lead"

Fig. 3—The Amplifier circuit can be placed in a small slotted box and wired, as shown, with the speaker, volume control, and input jack mounted to the lid of the box.

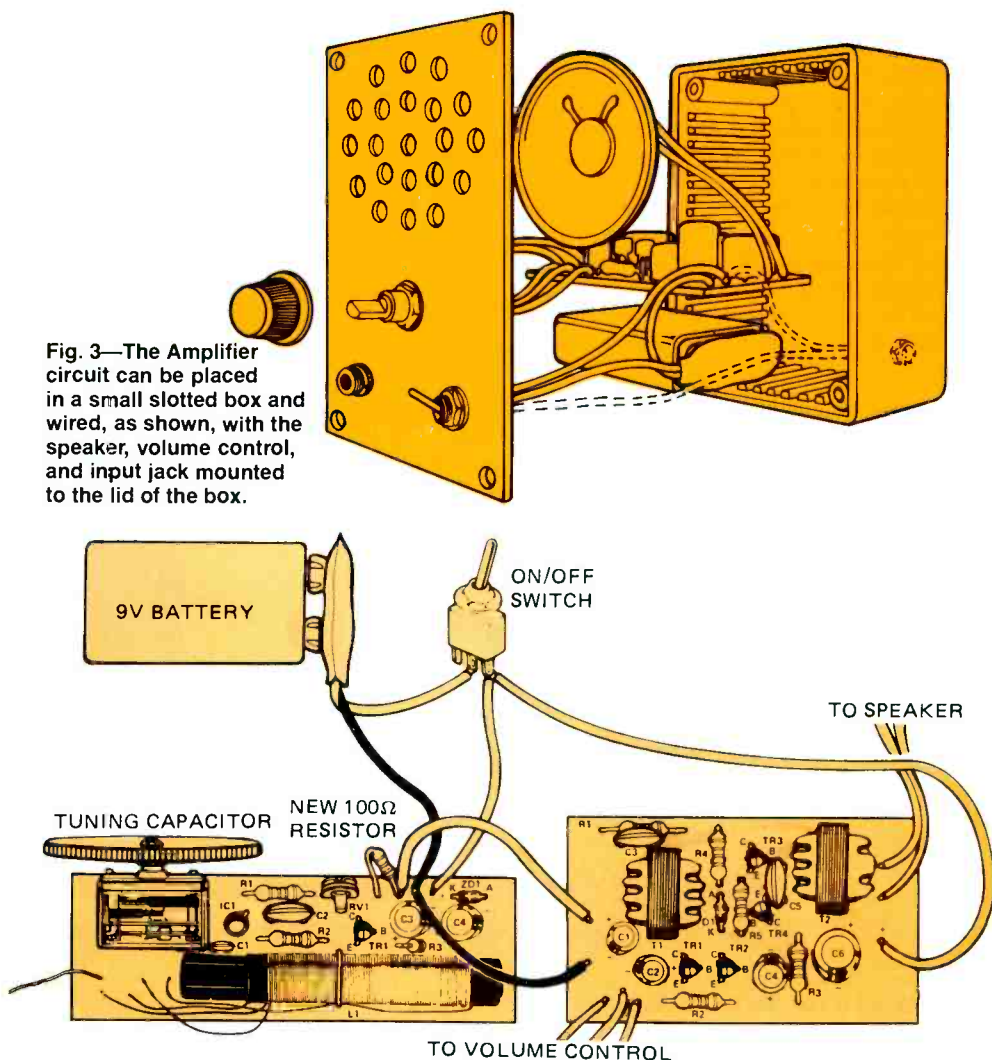

Fig. 4—By connecting the input of the Amplifier to a signal source, it can be used in many applications; for instance, as an audio amplifier in a radio or intercom system.

with 3.5-mm plugs on each end.

A further refinement is to place both the radio and Amplifier's printed circuit in the same box, running from the same battery, and wired directly together to so that no sockets are involved, as shown. When wiring the portable radio and amplifier together, note that the 100-ohm resistor is

the only modification to the circuit. It may appear that a battery lead has been left off the Amplifier board; however, the black ground lead is jumpered from the radio board to the Amplifier.

You can also use the Amplifier circuit to make a *signal tracer* to troubleshoot other audio projects, or equipment—for



Fig. 5—The signal tracer probe can be nothing more than a plug, connected to a length of wire, or probe tips may be soldered to the free end.



Fig. 6—By connecting the Amplifier's input to a probe, you can trace back through a circuit (say an audio amplifier) until the point where a signal is picked up, thus allowing the circuit to be used as signal tracer.

example, a stereo amplifier that works in one channel, but not in the other. Where is the fault? By connecting the input to the amplifier to a probe, you can trace the circuit back from the speaker toward the input of the dead channel, until you find the point where the signal is picked up. Obviously, the fault is somewhere in that vicinity. Then, using your multimeter, you can compare components and voltages between the good channel and the dead one to identify the component or components that need replacing—simple, isn't it?

A word of warning! This amplifier is ideal for use as a signal tracer in 99% of the solid-state (transistorized/IC etc.) circuits you are likely to come across. However, it is *not* suitable for a lot of vacuum-tube circuits. Apart from that, vacuum-tube circuits contain a lot of high voltages; if you're not careful, you might get zapped! Keep away from such circuits, for safety's sake. Of course, you should also keep well clear of any power supply or mains wiring in transistor circuits, too!

To build a signal tracer, all you need do is make a probe and solder a length of wire

to it (say around 350 mm or so). Solder the other end of the lead to the center pin of a 3.5-mm plug (see Fig. 5). Another length of wire connects the barrel of the 3.5mm plug to an insulated alligator clip (black is the best color, but it really doesn't matter).

Plug the lead into your audio Amplifier (see Fig. 6) and connect the alligator clip to the negative supply (ground) of the circuit to be tested. Your probe can then be touched onto various points of the circuit to see what signal is present: any signal will be amplified by the audio amplifier and heard through the speaker. ■

HOME AND CAR ALARM

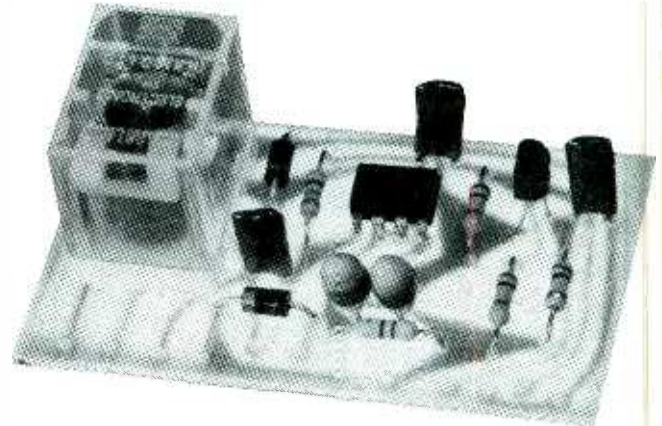

A burglar alarm can help you save money, not only by foiling thieves, but through lower insurance premiums!

□CRIME IS ON THE INCREASE! CARS ARE stolen and homes are illegally entered. The Home and Car Alarm could stop your property from becoming the next target on the list! It is extremely easy to build, and should prove very reliable. It has features found in professional alarm systems costing hundreds of dollars. The Alarm doesn't have complicated timing circuits and setting procedures like many others. What's more, it's simple to operate, because it is controlled by a key switch just like the ignition switch in a car—you turn the key one way and the switch is on, back the other way and it's off.

Key switches are normally installed on or near the front door of the house or, in the case of a car, on the door or fender. Inside the house, connected to any vulnerable door or window, are sensor switches that detect any opening. The sensors are usually magnetic reed switches, which we'll explain later.

When you leave the house, you make sure that all windows and doors are locked, then turn your key in the switch. The circuit is then "armed," ready to detect any intruders. The main alarm circuit is a normally-closed type, meaning that a small current flows through the sensors

when the Alarm is armed. If any of the sensors are opened, or if the intruder tries to cheat by cutting a wire, the Alarm triggers instantly. Any warning device connected (such as a bell, siren, etc.) sounds for around five minutes. After which, it turns off and the circuit resets so that your neighbors aren't annoyed by the noise!

There also is a secondary normally-open circuit in the Alarm that you can use with under-carpet pressure mats, or connect as a bedside panic switch in case an intruder has gained entry by a method that has failed to trigger the door or window switches. Another feature of the Alarm

circuit is that it operates normally from the main supply via an adaptor. And, if for some reason, the power should fail (either accidentally or intentionally), a battery stand-by circuit comes into action so that the Alarm is not disabled. Only the legitimate user can turn it off via the key switch.

How It Works

Power for the circuit shown in Fig. 1 is derived from two sources: a wall-mounted DC power supply and a battery back-up should the main supply fail or be tampered with by an intruder. So long as the voltage from the adaptor is equal to or greater than the battery voltage, the battery is kept isolated by D2. As a diode needs at least 0.6-volts between its anode and cathode to turn on (with the anode the more positive), it does not allow any current to flow from the battery while the main supply is operational. That prolongs battery life.

When power is turned on, via the key switch, the circuit is armed. No action occurs because the IC shorts out C3 and C4, preventing them from charging. The normally-closed switches between TR1's base and emitter stop TR1 from turning on. The circuit remains in that state until triggered. If one of the normally-closed window or door switches open, TR1 immediately turns on, taking the collector voltage to some low level.

If, on the other hand, one of the normally-open switches is closed (by an intruder stepping on a pressure mat, for example), the collector of TR1 is connected directly to the negative supply (even though TR1 itself remains off). In either event, the sudden reduction in the voltage at the collector causes a similar voltage drop to be transmitted to IC1 via C2, which immediately triggers the IC into conduction, causing current to flow in the relay. That, in turn, causes the relay contacts to close, allowing whatever Alarm device that's connected to its contacts to operate.

When the IC fires, the short circuit across C3 and C4 is removed and they begin to charge through R3. After a delay of around 5 minutes, the voltage across the capacitors rises above the threshold voltage of pins 6 and 7, and the IC is forced off. Thus, the relay drops out, and the Alarm device stops. The Alarm duration may be reduced by reducing the values of R3, C3, and C4, or increased by increasing them.

If a door or window has been left open, the Alarm will not retrigger, thus obeying noise laws. However, if the window, door, etc. is closed and subsequently reopened, the Alarm will be triggered.

Construction Details

The first thing that we have to do is to get a printed-circuit and all the parts. A kit

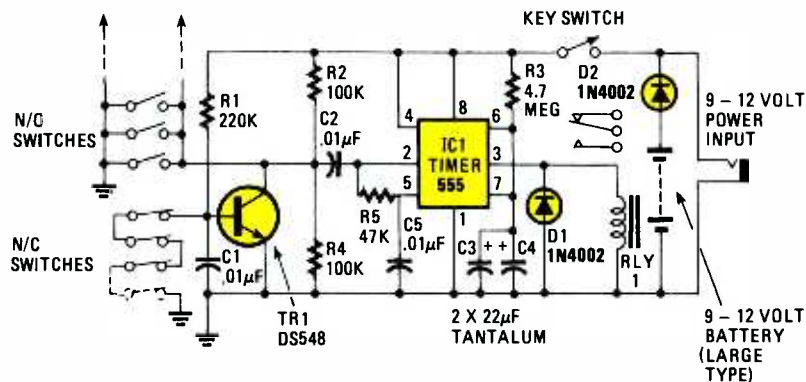

Fig. 1—The complete schematic diagram for the Home and Car Alarm shows that the sensors can be wired in two ways; the input that enters the circuit through the base of TR1 is series connected. But, the other input, fed directly through C2 to the timer circuit (IC1) is wired in parallel; thus, the builder has a choice of wiring schemes.

of parts is available from the supplier given in the Parts List. You may also choose to etch your own circuit board, or build the circuit on experimenters or perforated construction board. The choice is yours. Once you have everything that you need, construction can begin.

Mount the components as shown in the parts placement diagram, Fig. 2—solder the resistors and capacitors first, taking extra care to mount C3 and C4 (the two tantalum units) the right way, as they are polarized. The small "+" sign marks the positive lead positions. Make sure that all the components are positioned neatly and correctly dressed before soldering them in. Next, position and solder RLY1 after ensuring that you have it correctly oriented, that is simplified by its five pins, which only line up one way.

Moving right along, position diodes D1 and D2, taking care to see that they are correctly polarized. Remember, the cathode (K) is the banded end and corresponds to the bar in the circuit diagram. Solder them in, taking care not to overheat them. TR1 is next; care must again be taken to ensure correct polarity with the base connecting to C1. Solder the transistor in, using a heatsink to prevent damage from overheating.

The 555 timer, IC1, is the last compo-

nent to be placed and soldered to the board. It is done last to reduce the risk of thermal damage. Insert the integrated circuit into the holes on the board until the little shoulders on the pins prevent it from going any farther and make sure it's correctly oriented by noting that pin 1 (marked with a circular indentation) is connected to the ground trace on the board. Then turn the board over and carefully solder each of the pins to the pads making sure that you don't run solder between the pads. Inspect the connections to make sure you've soldered them all without shorting out any of the pads—and that's it.

Solder on the battery snap wires to the points indicated in Fig. 3, taking care to see that they have the correct polarity—red (positive) to the pad marked "+" and black to the negative pad marked "-." Before you connect the battery, check again to be certain that all the components are in the right place, correctly oriented, and soldered properly. Clip off any excess wire or lead.

Connect the battery and test the circuit by bridging the key-switch pads. That should cause the relay to operate as the normally closed (NC) contacts would still be open. (We haven't connected them yet.) The relay will stay activated for about

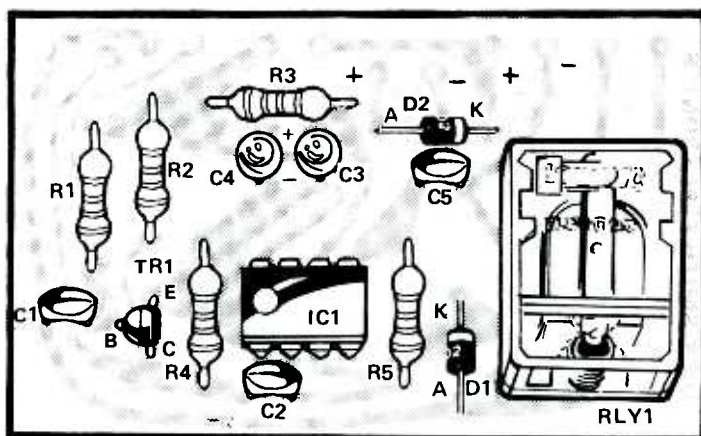

Fig. 2—By following this layout, you should have no problem installing the components in the right positions, with the proper polarization.

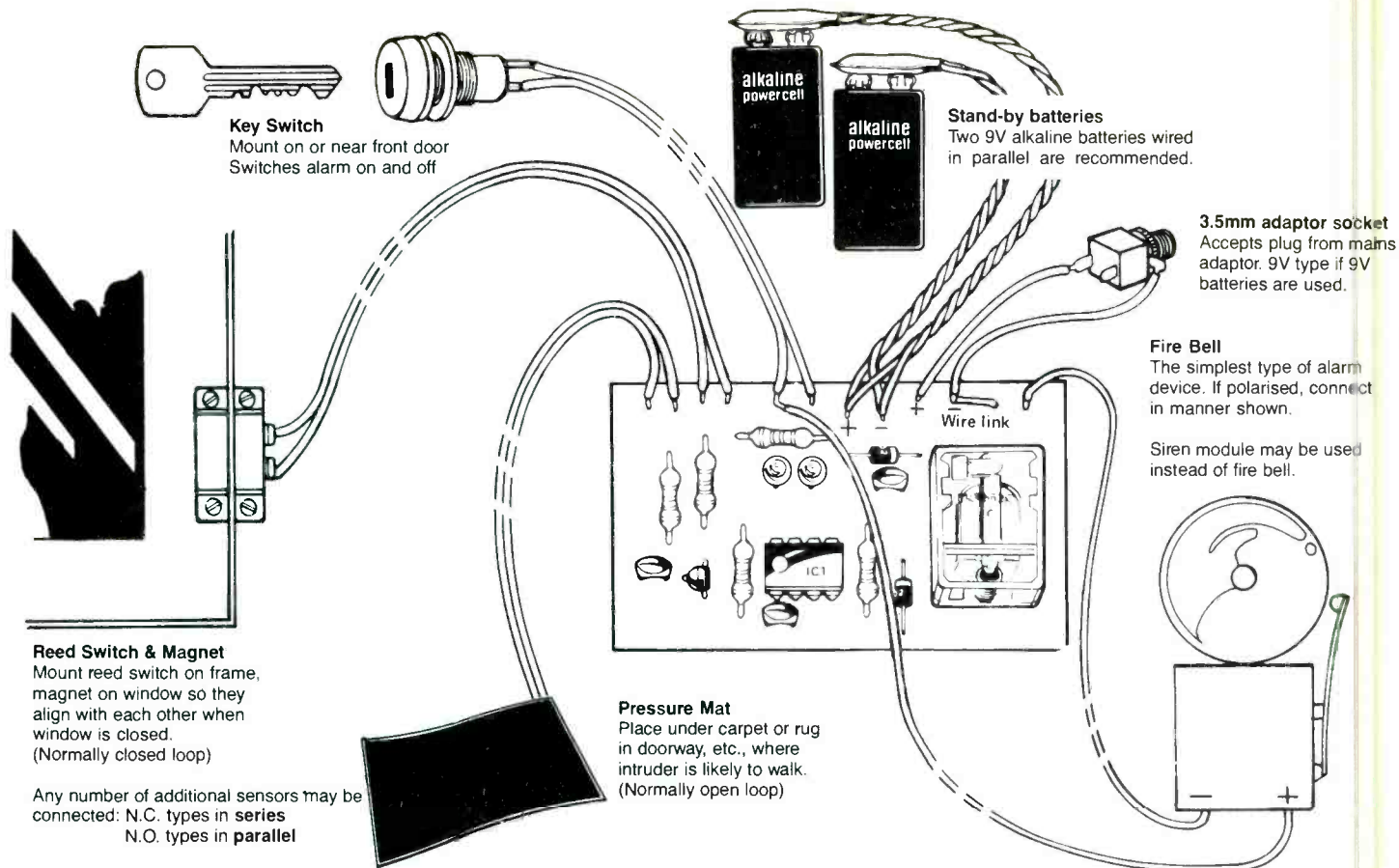

Fig. 3—When connecting the controls, power, ringer, and sensor follow this outline. The pressure mat is connected to the board at the position in the schematic diagram that's shown with paralleled switches.

5 to 7 minutes, and then deactivate if the circuit is working correctly.

Applications

First of all, you must decide what use (home or auto) your Alarm will be put to. Different connections are required for each purpose.

For a Home-Alarm system, the next step is to place the Alarm circuit in a protective case. In a normal Home-Alarm installation, the Alarm "works" are normally hidden away for security (in a cupboard or closet, for example). We assembled the prototype into a project box with two terminal strips on the lid to allow for easy connection of the sensor wires. The circuit is easily mounted in a project box as shown in Fig. 4, which further

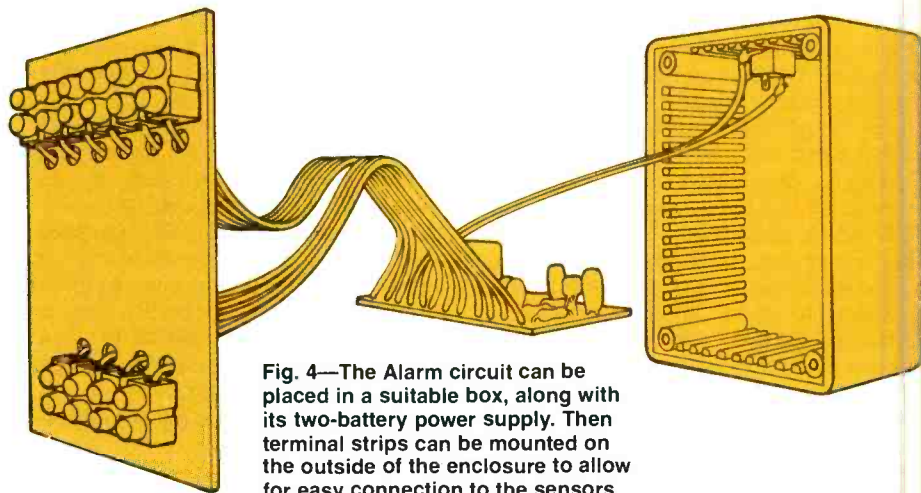

Fig. 4—The Alarm circuit can be placed in a suitable box, along with its two-battery power supply. Then terminal strips can be mounted on the outside of the enclosure to allow for easy connection to the sensors.

PARTS LIST FOR THE HOME AND AUTO ALARM

C1—0.01- μ F, 16-WVDC polyester capacitor
C2—0.01- μ F, 16-WVDC polyester capacitor
C3, C4—22- μ F, 16-WVDC tantalum capacitor
C5—0.01- μ F, 16-WVDC polyester capacitor
D1, D2—1N4002, 1-A, 100-PIV rectifier diode
IC1—555 timer/oscillator, integrated circuit
R1—220,000-ohm, 1/4 watt, 5% fixed resistor
R2—100,000-ohm, 1/4 watt, 5% fixed resistor
R3—4.7-Megohm, 1/4 watt, 5% fixed resistor
R4—100,000-ohm, 1/4 watt, 5% fixed resistor

R5—47,000-ohms, 1/4 watt, 5% fixed resistor
TR1—DS548 or 2N2222, NPN silicon transistor

ADDITIONAL PARTS AND MATERIALS

Printed-circuit material, 8-ohm speaker, two 9-volt, alkaline batteries or some other 9–12-volt DC source, solder, hook-up wire, etc.

A complete kit (catalog No. DSW2 K-2635) of parts is available, priced at \$6.50, from Dick Smith Electronics, P.O. Box 8021, Redwood City, CA 94063.

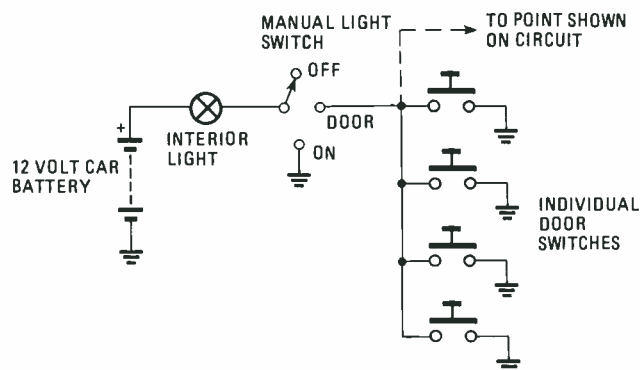

Fig 5—Wiring scheme for installing the Alarm in an auto. The dotted line represents the wire that connects the sensors to the Alarm circuit at the open end of R2 and the pushbutton switches represent the sensors located at various openings.

simplifies things, since no mounting hardware is required.

A four-way block at one end connects to the sensing loops (represented by the switches in Fig. 5), while a six-way at the other end connects to the battery, key switch, and signaling device. A separate 3.5-mm socket is fitted to the case to accommodate the plug of an external power supply.

We have shown the Alarm system powered by a plug-in power supply and backed up by a battery in case of a power failure. The battery can be an external type, such as a large 12-volt unit, to give

extra long life. However, there is plenty of room if you wish to place two standard 9-volt transistor-radio type batteries (in parallel) inside the case. For longest life, alkaline batteries are recommended.

The sensing devices themselves can be any of a large number of types specifically designed for that purpose. In the normally-closed loop, one might find tiny magnetic reed-switches buried in, or screwed to, the window sill or door post, which are held closed by a small magnet on the window or door itself. If a window or door opens, the magnet moves away and the switch opens. Alternatively,

micro switches, thermal switches, metallic window tape, etc., may all be used in the loop. The important thing to remember is that all normally-closed devices are connected in series.

In the normally-open loop (see Fig. 5), such things as pressure mats, panic switches, trap switches, etc. are connected in parallel. If the circuit is to be used as a car Alarm, it will require the certain components be left out: the modified schematic diagram is shown in Fig. 6.

Remember that whatever Alarm device you choose, it should have its own battery back-up if operated from an AC adaptor. ■

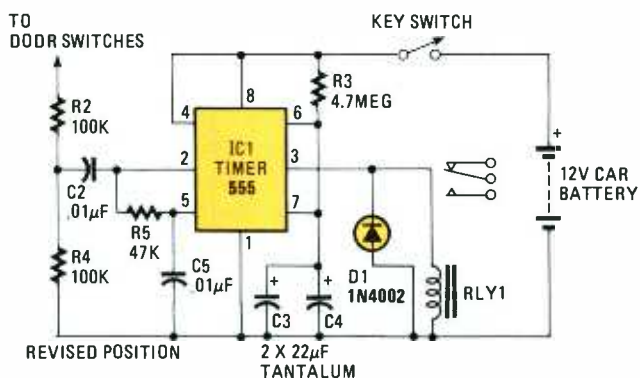

Fig. 6—The schematic diagram for the Auto Alarm circuit differs from the circuit in Fig. 1, in that, it only has one sensor input, and no socket is provided for an alternate power source.



INTEGRATED SHORTWAVE RECEIVER

Keep tabs on the world with this budget receiver

IMAGINE BEING ABLE TO TUNE IN ON the world with your own shortwave receiver! Well, you can with this project. It's simple to build, and uses a CMOS integrated circuit to provide enough amplification to drive a loudspeaker. With it, you can tune in shortwave broadcasts from other countries, listen to amateurs talking to each other, and learn Morse code. What's more, you'll be able to tell everyone you made it yourself.

How It Works

Figure 1 is a schematic diagram of the Shortwave Receiver. Radio waves of all frequencies are picked up by the antenna, and are amplified by TR1. The amplified

signals are fed via capacitor C2 to a tuned circuit (consisting of L1 and CV1) that attenuates much of the lower frequencies. The tuned circuit acts like a short circuit to all frequencies except one. Varying the tuning capacitor alters the range of frequencies that are attenuated. So as far as 99% of the signals picked up by the antenna are concerned, that is the end of the road.

Current derived from the RF signal that has not been rejected by the tuned circuit then passes through a diode detector (D1). The detector chops off half the waveform (otherwise the two halves would cancel each other out). The clipped waveform, which contains all the audio information,

is then fed to the first of the amplification stages. Along the way, the RF component of the half waveform is filtered out, as it's no longer needed, leaving only the audio signal.

IC1 is of a type normally regarded as a "digital" (having found its greatest use in digital circuits such as computers), and is used in a completely different way than normal. In our circuit, we use it as an amplifier. That unit consists of four individual circuits (we're using only three). Each one increases the level of the signal until the final stage, where it has been increased to a point that's sufficient to drive a loudspeaker.

While at that point, the signal level is of

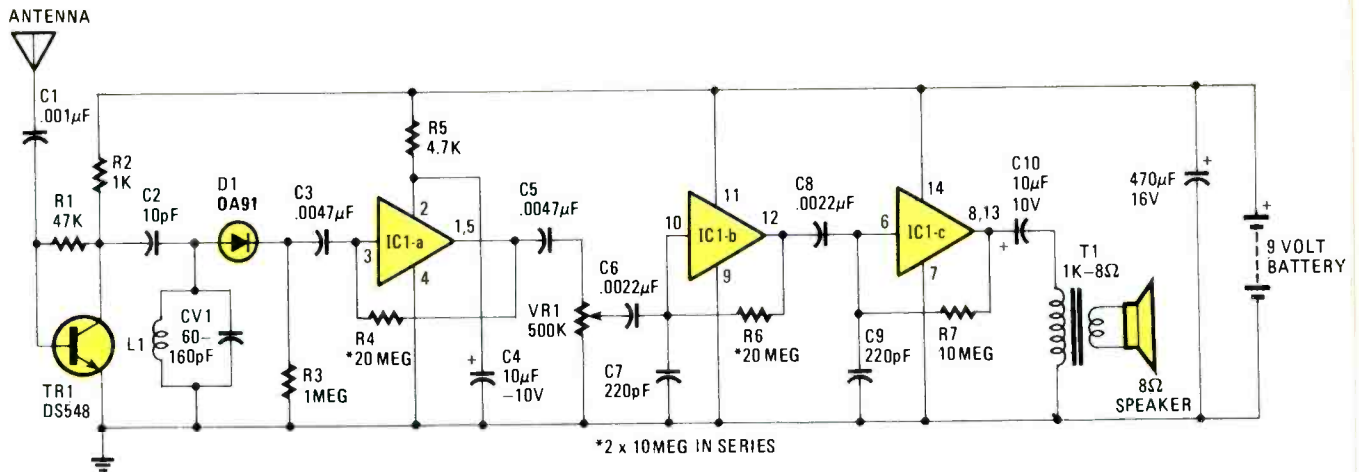

Fig. 1—The signal picked up by the antenna is fed across a tuned circuit, which attenuates unwanted frequencies, to three series connected amplifier stages to provide sufficient drive current for the speakers.

sufficient magnitude to drive a speaker, that would not make the IC very happy: It wants to work into a load with a reasonably high impedance (resistance). So the output of IC1-c is fed through a 1000-ohm to 8-ohm matching transformer, T1, to the speaker.

Putting It Together

Using Fig. 2 as a guide, begin assembling the circuit. Place and solder the resistors and capacitors first, taking extra care that C4, C10, and C11, are properly oriented. Note: To obtain R4 and R6 (the two 20-megohm resistors), wire two 10-megohm resistors in series. There is room allowed for two resistors in those positions on the printed-circuit board. Make sure that all the components are positioned neatly and are properly dressed before soldering them in. Connect the 470,000-ohm trimmer potentiometer (RV1) to the circuit in the position shown. Note that Fig. 2 shows a 500,000-ohm chassis-mounted potentiometer in that position to allow the circuit to be tuned once placed inside a project box. Next, solder in the variable capacitor, CV1.

Notice that only two of the three terminals are actually used. Next solder in T1, leaving the center tap on the 1000-ohm side unconnected; bend it up and out of the way, or snip it off.

Connect and solder D1, the signal diode, making sure that its properly polarized—remember that the banded end is the cathode (K). Then position and solder TR1 (watch the orientation), using a heat-sink on the leads to prevent thermal damage. Make a coil by winding 18 turns of plastic coated hookup wire around the case of a plastic ballpoint pen, or something similar, and solder the leads to the pads marked L1 so that it is parallel with the tuning capacitor. The combination of the coil and capacitor form the tuned circuit.

Solder on the battery snap and speaker leads. The speaker is not polarized but the battery is, so take care to make sure its leads are correctly connected; the red (positive) lead goes to the pad marked “+” and the black lead to the negative pad marked “-.” Do not connect the battery! Now insert and solder the CMOS integrated circuit (IC1) in place. As that

device is static sensitive, do not remove it from the special conducting foam packaging until you are ready to mount it. Do not touch the pins of the IC, either; carefully remove the foam and place the integrated circuit into the correct mounting holes.

Neatly clip off the excess wire, making sure that all of the soldered connections are properly made. Check all components to ensure correct position and polarity before connecting the battery. Connect the battery and tune the radio by varying CV1 until you pick up a station.

What To Do Next

Because the slightest bump to the coil will cause the receiver to “drift” from the tuned station, the circuit should be mounted in some form of protective case. The circuit has been designed to allow no-holes mounting in a slotted project box. The power switch and volume-control potentiometer are mounted on the front panel of the box. You can also fit a socket on the front panel for an external wall-mounted DC power supply.

When the circuit board is placed in the slotted box, the shaft of the tuning capaci-

PARTS LIST FOR THE INTEGRATED SHORTWAVE RECEIVER

C1—0.001- μ F ceramic disc capacitor
 C2—10-pF ceramic disc capacitor
 C3—0.0047- μ F polyester capacitor
 C4—10- μ F 10-WVDC electrolytic capacitor
 C5—0.0047- μ F polyester capacitor
 C6, C8—0.0022- μ F polyester capacitor
 C7, C9—220-pF ceramic disc capacitor
 C10—10- μ F 10-WVDC electrolytic capacitor
 C11—470- μ F 16-WVDC electrolytic capacitor
 CV1—60–160-pF tuning capacitor
 D1—0A91, 1N34, 1N60, 1N270 or almost any signal diode
 IC1—4007 CMOS, dual complementary-pair inverter, integrated circuit
 L1—(see text)
 R1—47,000-ohm, 1/4-watt, 5% fixed resistor
 R2—1000-ohm, 1/4-watt, 5% fixed resistor

R3—1-Megohm, 1/4-watt, 5% fixed resistor
 R4, R6—20-Megohm, 1/4-watt, 5% fixed resistor
 R5—4700-ohm, 1/4-watt, 5% fixed resistor
 R7—10-Megohm, 1/4-watt, 5% fixed resistor
 RV1—470,000-ohm, trimmer potentiometer
 T1—1000-ohm to 8-ohm audio impedance matching transformer
 TR1—DS548, or 2N2222 NPN silicon transistor

ADDITIONAL PARTS AND MATERIALS

Printed-circuit material, enclosure, 8-ohm loudspeaker, 9-volt transistor-radio battery, battery snap, solder, hookup wire, etc.

A complete kit of parts (battery not included) is available from Dick Smith Electronics, P.O. Box 8021, Redwood City, CA 94063, priced at \$6.95. When ordering refer to catalog No. DSFW2 K-2640. Tel.: 1-800/332-5373.

tor falls into just the right place so that the tuning knob can be screwed on through the hole in the front panel. The performance of the set is only as good as the antenna and ground system to which it's connected: For that reason, we have shown terminals for both the antenna and ground connections on the front panel.

The frequency range of your receiver (with the 18-turn coil) is approximately 11 to 35 MHz. By substituting an 80-turn coil, the range of the receiver becomes around 6 to 11-MHz. Even more turns will reduce the range even further.

Alternatively, you can try changing the variable capacitor to see what bands you can cover. While other variable capacitors may not fit in the box, or even on the printed circuit board, you can connect them via short lengths of wire. If you wish, you can even try putting in a fixed value capacitor (equal in value to the variable types and up to a few hundred picofarads) and connect a small trimmer capacitor in parallel to give you very fine tuning. ■

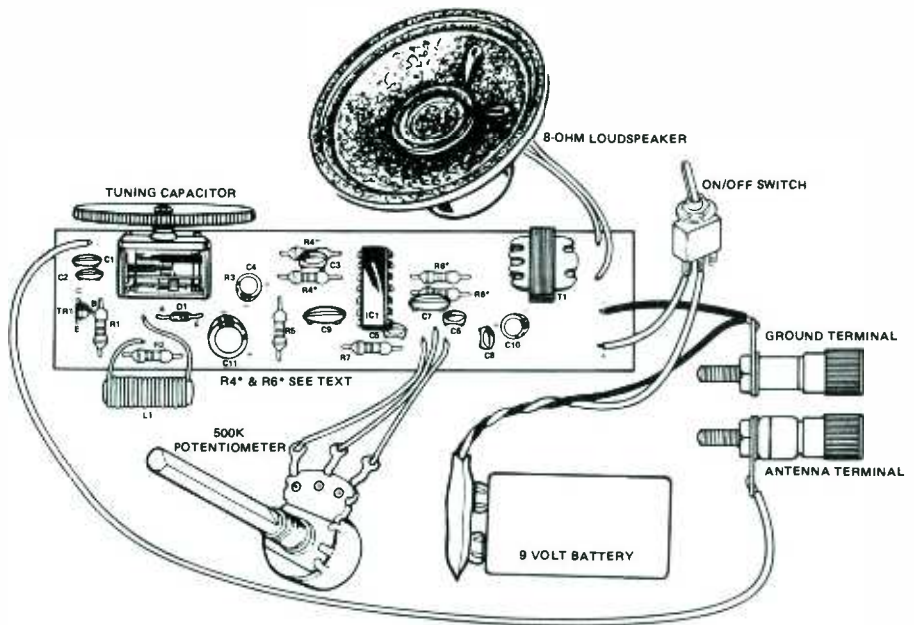
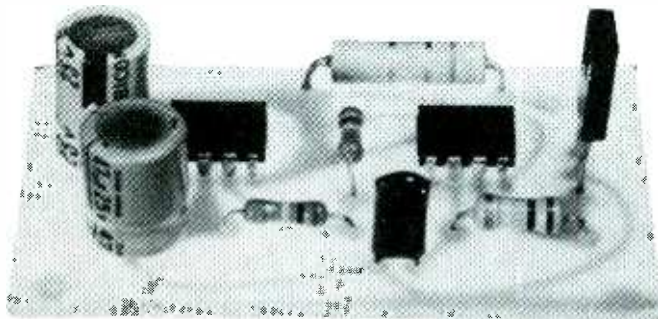

Fig. 2—The printed circuit board for the Shortwave Receiver is shown with the components installed; by following that layout, you should have no problem putting the circuit together.



ELECTRONIC SIREN

This simple electronic siren can be incorporated into your home-brew circuits as a warning or signaling device.

□ELECTRONIC SIRENS HAVE MANY PRACTICAL applications. As a warning device or other type of signal, it's hard to beat a siren! This simple circuit simulates the "hee-haw" sound that modern police sirens make. But you're not stuck with that racket because it can be tailored to produce other sounds, as well. Further, you can add a horn speaker to this project to make a first rate burglar-alarm siren.

How It Works

The Siren is a good example of how electronic circuits can control one another. In the Siren circuit (see Fig. 1), there are two oscillators, one of which switches the other to produce the characteristic "hee-haw" sound. The oscillator based on IC2 is responsible for producing the sound. Its output is connected to the base of TR1, which amplifies it to drive the speaker. Resistor R4 is included in the circuit to limit the current through TR1 to a safe and reasonable level.

The oscillation frequency of IC2 is partially dependent on values of R3 and C2—change either one's value and IC2's output frequency also changes. Another factor that governs the frequency of oscillation is the magnitude of voltage fed to pin 5 of IC2. If a voltage of varying magnitude is fed to pin 5, the internal circuitry of the IC is forced to reset at a different rate, changing the frequency.

IC1 is also connected as an oscillator, but it runs much slower than IC2; around 1 Hz. Each time the IC triggers, the voltage at pin 3 goes high. As pin 3 is connected to pin 5 of IC2, this forces IC2 to change its note. That gives the "hee-haw" sound of the Siren. (Later we'll show a couple of ways to change the sound produced by the oscillator, if you want to do some experimenting.)

Fig. 1—The heart of Siren circuit consists of two 555 timer/oscillators, with one controlling the other to get the desired affect.

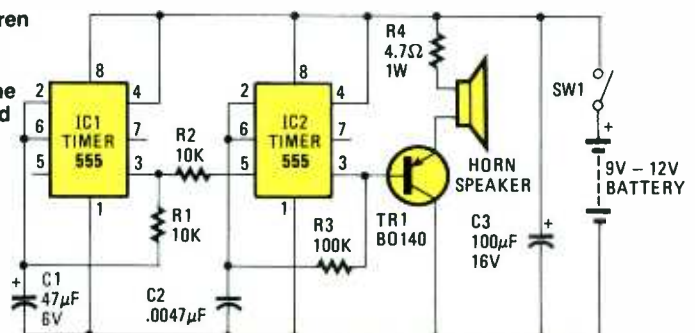

Construction

First you'll need a suitable printed-circuit board of your own design and the parts. Another option is to use perfboard or pre-etched experimenters board. However, a complete kit is offered by the supplier given in the Parts List. Check off the components against the list to make sure they are all there and are the correct types and values. Assuming that you've purchased the kit, mount the components as shown in Fig. 2. Place and solder the resistors and capacitors first, taking extra care with C1 and C3 as they are electrolytic and therefore polarized. Make sure that all components are positioned neatly and properly dressed before soldering them in place.

Next mount TR1 in the correct place and with the correct polarity, taking particular care because it will fit either way. Notice that the emitter (E), collector (C) and base (B) are clearly marked on the transistor; match them up with the correct pin holes in the board. Solder the transistor in, using a heatsink to prevent damage from overheating.

Now move on to the integrated circuits, IC1 and IC2. Those may be the first IC's you have ever attempted to solder in, but if you follow the steps and you will find that it's not too difficult. Insert the IC into the holes on the circuit board until the little shoulders on the pins prevent it from going farther, making sure that it's correctly oriented with pin 1 (marked with a small circular indentation) connected to the negative bus, which is common to C1. Then turn the board over and carefully solder each of the pins to the pads, making sure you don't bridge the pads.

Inspect the connections to make sure you've soldered them all without shorting out any of the pads. Then do the same for IC2 (pin 1 of IC2 also goes to the negative bus that joins C2 and the collector of TR1). Connect and solder the speaker wires to the board at the pads marked SPKR and then solder the other ends to the speaker. Solder on the battery snap wires, again taking care to see that you have them correctly polarized—red (positive) to the pad marked "+" and black to the negative pad, marked "-."

Before you connect the battery, make certain that all of the components are in the right place, correctly oriented, and

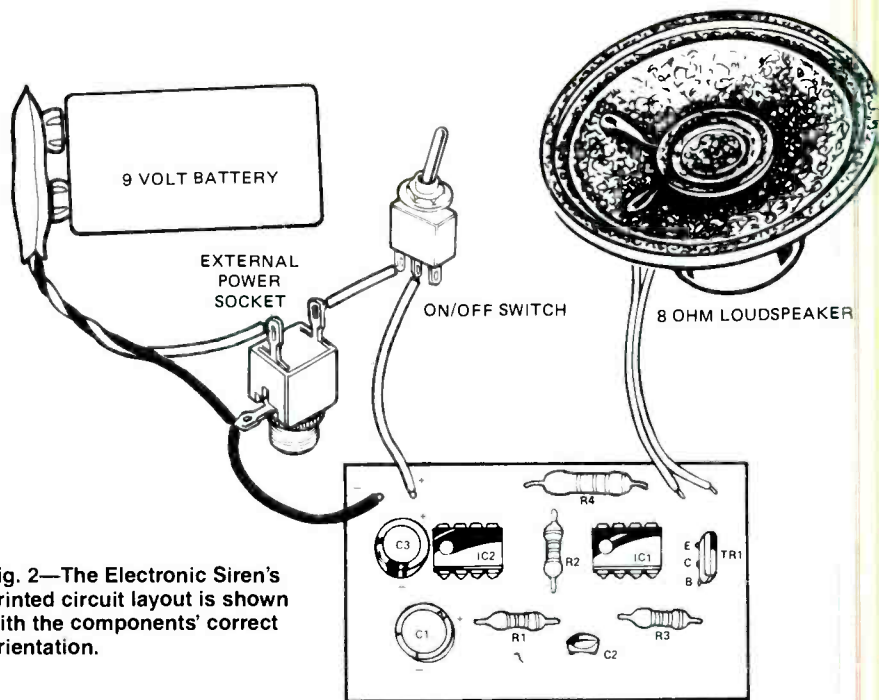

Fig. 2—The Electronic Siren's printed circuit layout is shown with the components' correct orientation.

properly soldered. Clip off all excess wire and leads. Then connect the battery to the Siren; it should make the characteristic "hee-haw" sound.

What To Do Next

The circuit should be placed, along with a small speaker, on/off switch, and extension power socket, in a project box. The slotted enclosure shown allows the circuit to be mounted without the use of hardware. The external power socket is a good idea, particularly if you have a serious security usage in mind. While it will operate for a reasonable time on the 9-volt transistor radio battery, an external supply is a much better proposition (even if it is only a much larger battery!)

The Siren is shown with a small 8-ohm speaker (which makes enough noise to drive anyone mad!). However, if you are using the Siren in an application where a lot of noise is needed (in an alarm, for example), you would be much better off replacing the small 8-ohm speaker with a horn speaker. Horn speakers are highly efficient compared to the normal type.

A further modification you may care to make involves replacing the switch. If you are using the Siren in conjunction with an alarm of some sort, the contacts of the

alarm relay can be used to switch the Siren on. Simply remove the switch, and connect the "normally open" relay contacts.

Obviously, there are a host of other uses not involving security systems. For example, if you have a phone that's difficult to hear outside the house, why not place a sound-operated switch close to the phone and connect it to the Siren circuit with a horn speaker outside where you can hear it? Such an arrangement doesn't require that a physical connection be made to the phone or wiring.

The "hee-haw" Siren sound may not be everyone's cup of tea, especially in applications, like a remote-telephone ringer. It is easy to change the circuit to produce two other sounds for other applications. Removing C1 (or including a switch so it can be switched in and out of circuit) stops the "hee-haw" sound so the Siren gives a single tone. You might also try connecting an electrolytic capacitor from pin 5 of IC2 to ground. Depending on the value you choose (say 10–1000 μ F), the Siren produces a variety of different sounds. Or you can alter the speed of the Siren by increasing or decreasing the value of C1, which has the affect of increasing and decreasing the lengths of the "hees" and "haws," respectively. ■

PARTS LIST FOR THE ELECTRONIC SIREN

- C1—47- μ F, 25-WVDC electrolytic capacitor
- C2—0.0047- μ F, 25-WVDC polyester capacitor
- C3—100- μ F, 25-WVDC electrolytic capacitor
- IC1, IC2—555 timer/oscillator, integrated circuit
- R1, R2—10,000-ohm, 1/4-watt, 5% fixed resistor
- R3—100,000-ohm, 1/4-watt, 5% fixed resistor
- R4—4.7-ohm, 1-watt, 5% fixed resistor
- SPKR1—8-ohm loudspeaker
- TR1—BD140, or ECG-185 PNP silicon transistor

ADDITIONAL PARTS AND MATERIALS

Printed-circuit materials, enclosure, 9-volt transistor-type battery (or other 9-volt DC source), hook-up wire, solder, switch, etc.

A complete kit of parts (not including battery) is available from Dick Smith Electronics, P.O. Box 8021, Redwood City, CA 94063, priced at \$4.95. When ordering, refer to catalog No. DSFW2 K-2636.

TELEPHONE REMOTE/CONTROL SYSTEM

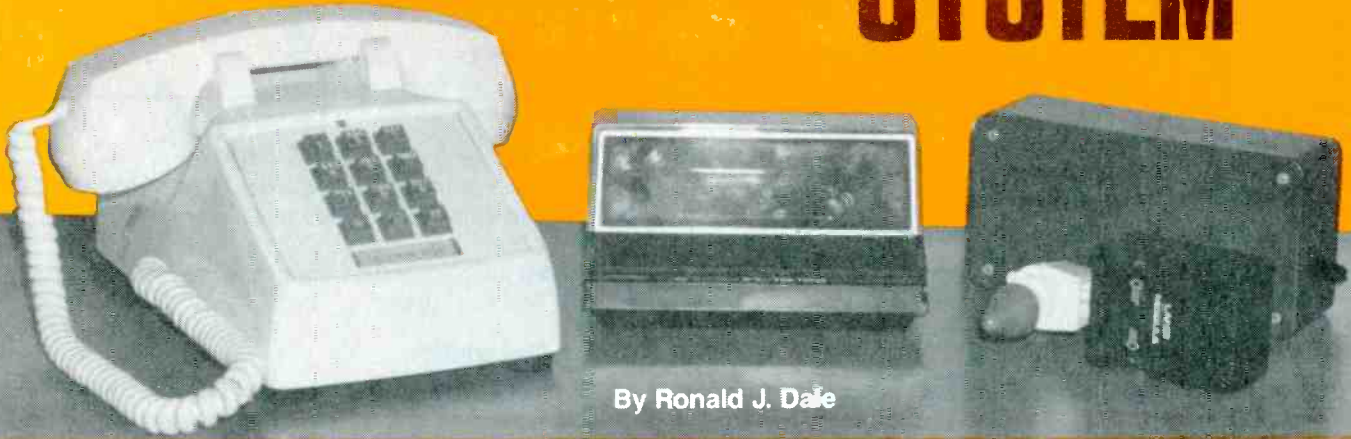

By Ronald J. Dale

□IT BECAME RATHER OBVIOUS TO ME AFTER A FEW MONTHS that the problem with owning and operating a BSR Control Center System was to decide where to locate the command console so that it would be easily accessible when I needed it. My first unit was placed on the night stand next to my bed. I could easily turn indoor or outdoor lights on if I heard any noises in the middle of the night. Later, I decided to expand my system and control my stereo receiver—a great idea if you're in the bedroom when you want to turn the stereo on or off. I happen to live in a Dutch Colonial house with the stereo receiver located in my studio, which is located on a different floor at the opposite end.

What I needed was a control system that would allow me the same capability as the BSR Command Console, but conveniently accessible without purchasing more control units. Besides, my wife thinks computer-oriented equipment belongs in the cellar or in a computer room—not a part of the house decor.

Well, what I decided was that since most families have two to three telephones in their homes, why not use them to their fullest potential? Let each telephone be a control unit; and as you add more phones to your home, you would automatically add a control unit at no additional cost. Also, with the advent of cordless telephones, you would be getting wireless remote-control of lights and appliances—here again at no additional expense. Imagine what all that would cost you if you purchased these items separately in the marketplace! Well, I figured that if I were going this far, I might as well provide a built-in security feature that would automatically turn all lights on when the existing in-house alarm system was enabled. The lights would remain on until the alarm system was secured or reset. All of the above has been implemented in what I call the *Telephone Remote-Control System*.

How It Works

The Telephone Remote-Control System is used with the standard telephone and remote-control modules, like the ones listed below. The Control System may also be used in conjunction with an existing alarm system to turn on all lights when the alarm sounds. The Control System operates when the telephone is taken off-hook and a pre-programmed access code is entered, followed by the device number to be turned on or off. The Control System transmits control signals over existing house wiring to remote-control modules. Those signals cause the remote-control modules to turn lights and appliances on and off.

Four types of remote-control modules exist that can be used with the Control System. They are:

Wall Switch Module—Replaces standard wall light switch. It is capable of switching incandescent lamps rated at up to 500 watts on and off.

Three-way Wall Switch Module—Replaces 3-way upstairs/downstairs switches. It turns incandescent lamps rated at up to 500 watts on and off.

Lamp Module—When plugged into a wall outlet, it turns incandescent lamps rated at up to 300 watts on and off.

Wall Receptacle Module—Replaces the standard wall receptacle. It turns appliances rated at up to 15 amperes, or 1/3-HP AC motors, or 500-watt lamps on and off.

One remote-control module is required for each lamp or appliance that you want to control. When the Control System is used to control appliances, an extra precaution should be taken. For example, if an electric heater is turned on by remote control while clothing is draped over it, a fire could result. Please keep that in mind and be alert to potential problems like the one mentioned. That will help you get the most convenience and pleasure from your Control System.

More than just another remote-control system, this project makes use of existing telephone installations in your home to manage the modules and switches in your BSR-10 system

TABLE 1—SWITCH SETTINGS FOR HOUSE CODES

Switch Settings				House Code
S1	S2	S3	S4	
ON	ON	ON	ON	A
ON	ON	ON	OFF	B
ON	ON	OFF	ON	C
ON	ON	OFF	OFF	D
ON	OFF	ON	ON	E
ON	OFF	ON	OFF	F
ON	OFF	OFF	ON	G
ON	OFF	OFF	OFF	H
OFF	ON	ON	ON	I
OFF	ON	ON	OFF	J
OFF	ON	OFF	ON	K
OFF	ON	OFF	OFF	L
OFF	OFF	ON	ON	M
OFF	OFF	ON	OFF	N
OFF	OFF	OFF	ON	O
OFF	OFF	OFF	OFF	P

About the System

The Telephone Remote-Control System is under micro-computer control and requires some minor programming prior to use. The system is equipped with a seven-bit switch to eliminate interference with numbers or area codes frequently dialed and to avoid transmitting or receiving signals to or from a neighbor's system.

While referring to a photo showing the 7-section DIP switch (S1-S7), select and set your own code as follows. Each of the seven switches can be set in either of two positions: ON or OFF. To set the switches, use the tip of a ballpoint pen. Push them *up* to turn them ON and *down* to turn them OFF.

The four switches closest to U6 select one of the 16 possible house codes. Their settings are used to represent house code letters (A through P) as shown in Table 1.

The three switches closest to K1 select one of the eight possible access codes. Their settings represent different access codes as shown in Table 2.

More About the Access Codes

The access code is actually a 2-digit number. The first number is already programmed into your Control System and is always the number 2. The second number you must program. Carefully select a number that will not normally interfere with local numbers or exchanges frequently dialed. If you decide to change your access code, follow the procedure below.

1. Disconnect the plug of the Control System's AC power cord from the 117-volt AC outlet.
2. Select your new access code.
3. Insert the plug of the Control System's AC power cord into a 117-volt AC outlet.

More About the House Codes

There are sixteen house codes to choose from. The letters A through P are used. The house code selected on the Control System and the remote-control modules must be the same. For instance, if the Control System's house code is set to A, then all the remote-control modules must have their house-code selectors set to A in order to receive the control signals transmitted from the Control System. If you decide to change your house code on the Control System, perform the following procedure.

1. Disconnect the plug of the Control System's AC

TABLE 2—SWITCH SETTINGS FOR ACCESS CODES

Switch Setting			Access Code
S5	S6	S7	
ON	ON	ON	1
ON	ON	OFF	2
ON	OFF	ON	3
ON	OFF	OFF	4
OFF	ON	ON	5
OFF	ON	OFF	6
OFF	OFF	ON	7
OFF	OFF	OFF	8

power cord from the 117-volt AC outlet.

2. Select your new house code. (Remember to set all remote-control modules to the same house code.)

3. Insert the plug of the Control System's AC power cord into a 117-volt AC outlet.

Circuit Description

The Telephone Remote-Control System can be divided into four sections. Those include the power supply, processor, telephone interface and the RF oscillator. The schematic diagram of the power supply and RF oscillator is shown in Fig. 1.

The power supply is configured as a full-wave rectifier consisting of a center-tap transformer T1, diodes D4 and D5, capacitors C1 and C2, and voltage regulator U5. The voltage regulator is in its simplest form and provides +5-volts DC to all the integrated circuits. Even though the maximum average power dissipated is below that required for no heat-sink operation of the voltage regulator, a heat sink has been designed onto the printed-circuit board to provide a thermal safety margin.

The RF oscillator is basically an astable, or free-running, multivibrator designed to operate at 120 kHz. The two Sprague high-voltage, high-current Darlington NPN transistor-array drivers (shown diagrammatically as inverter drivers U4-a through U4-d) are R-C coupled; the output of the second stage is coupled back to provide the input to the first stage. When the first stage is saturated, it serves to cut off the second stage and *vice-versa*. With all the circuit elements the same value, the operation of the multivibrator will be symmetrical (equal intervals).

The RF oscillator is controlled by the processor, U1, (to be discussed shortly) using two inverters (U4-e and U4-f) that are connected to the multivibrator inputs (U4-a through U4-d). The RF oscillator is disabled when the processor outputs a logic high on its output Port 2 pin 38 to input B in Fig. 1. The RF oscillator is coupled to the AC power line using a Sprague pulse transformer, T2, and capacitor C3. It is that 120-kHz frequency superimposed onto the AC power lines, occurring at the right time in the correct format of on-off cycles that control the BSR remote-control modules. The right time is established when the signal is transmitted within 100–200 microseconds after *zero cross* is detected. (Zero cross occurs when the AC signal crosses its average DC level.) That synchronization is provided as an input to the processor via transistor Q1 circuitry shown in Fig. 2. An active low signal signifies a zero cross of the AC line voltage. The transmit format required (see Fig. 3) is a bit more involved.

There exist two types of operations. You can talk to remote-control modules individually, or address specific remote-

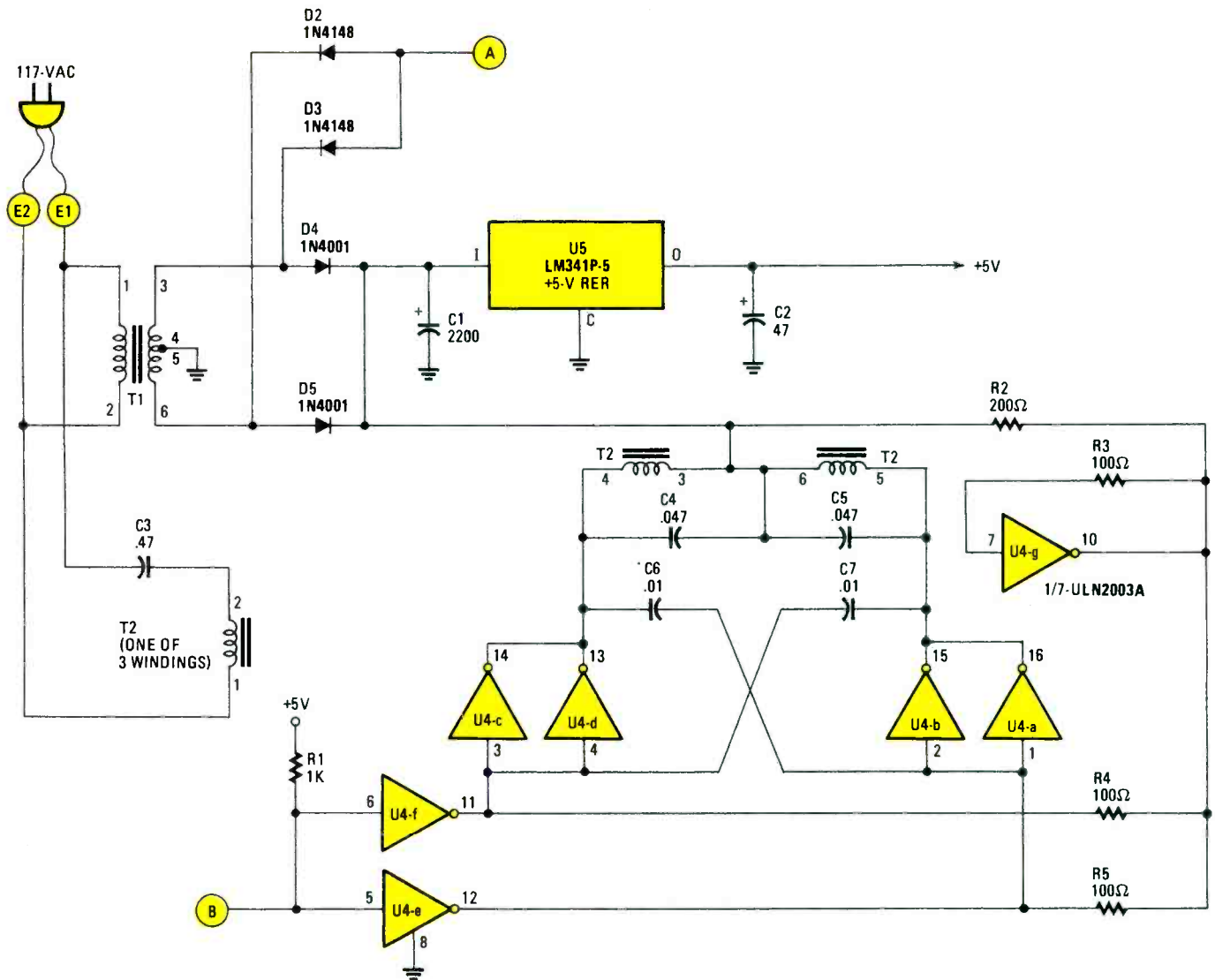

Fig. 1—Power supply and RF oscillator circuit combine to produce the voltages and signals necessary to operate the Control System's circuitry. Two diodes, D4 and D5 form a fullwave rectifier circuit. A signal, picked off the anodes of D2 and D3, is fed to the base of Q1 located on the control circuit board to form the zero-cross detector.

control modules all at one time (i.e.; ALL LIGHTS ON). The first consists of transmitting a sync identifier, followed by the house code; then the unit number waiting 50 milliseconds; then transmitting another sync identifier, followed by the house code, and then the command code. The whole process takes about 416 milliseconds. The second operation consists of transmitting a sync identifier, followed by the house code, then the command code; then the cycle is repeated again. That transmission takes about 366 milliseconds.

Table 3 lists the house codes and Table 4 lists the unit numbers and command codes that will work for the Telephone Remote-Control system.

The sync identifier is required at the beginning of each transmission and consists of the bit pattern 1110. In all cases, a "one" is transmitted as 3 bursts of 120 kHz lasting 1 millisecond in duration and separated by 1.6 millisecond. All that takes place in 1/2 AC cycle (8.3 millisecond). A "zero" is transmitted as no burst of 120 kHz in a 1/2 AC cycle. (Therefore the sync identifier takes 4 1/2 AC cycles, or approximately 32 milliseconds).

In contrast to the sync identifier, all remaining bit patterns are transmitted in their true form during the first 1/2 AC cycle,

then it's complement form during the next 1/2 AC cycle after zero cross is detected. As an example, if you were to transmit house code A, the format would be as shown in Fig. 4.

The processor circuitry shown in Fig. 2 consists of single-component microprocessor U1, erasable programmable read-only memory chip (or EPROM) U3, and an address latch U2. The microprocessor, U1, is a 40-pin package that contains an 8-bit CPU, 64 bytes of RAM (of which 32 bytes are actually user available), 27 I/O lines, and an 8-bit timer/event counter.

All instructions are either one or two bytes long and can be executed in one or two cycles. Thus, using a 6-MHz crystal,

TABLE 3—HOUSE CODES

House Code	Bit Pattern	House Code	Bit Pattern
A	0110	I	0111
B	1110	J	1111
C	0010	K	0011
D	1010	L	1011
E	0001	M	0000
F	1001	N	1000
G	0101	O	0100
H	1101	P	1100

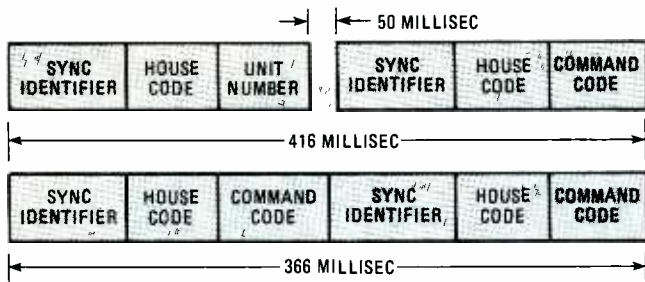

Fig. 3—These block illustrations indicate the sequence of events that occur during the two types of operation. The upper diagram shows what happens when a single module is addressed. The lower is the sequence that occurs when addressing multiple individual modules (see text for clarification).

zero crossing, which is a pre-condition requirement prior to transmitting to the remote-control modules. The second signal, T1, monitors the telephone line and provides ring/dial information to the microprocessor for processing.

The telephone interface uses an opto-isolator, which connects to terminal T1 on the microprocessor and is used to monitor and record dialing pulses and the ring signal without introducing any harm or disturbances to the telephone line. With the phone line properly connected, the forward dynamic impedance of the 4N33 LED (light-emitting diode), is considerably lower than the resistance value of R12 and R13. Lifting the phone from the cradle places approximately 300-ohms resistance across the line, causing 20 milliamperes of line current to flow.

Since dial pulses are a quick succession of line-current interruptions, most of the current flows through the LED, causing +5-volts-to-ground pulses at terminal T1 of the same duration. With the phone in its cradle, on-hook, the incoming ring signal is approximately 20 Hz, 90-volts rms. An inverse diode, D1, is paralleled with the LED to provide for the AC currents during ringing. The timing diagram of Fig. 5 depicts the relationship between dial pulses, ring pulses, and on-hook/off-hook. Those are the signals that the microprocessor uses to determine telephone-line activity.

Any connection to the phone line is controlled by the FCC, Part 68 and your local telephone company. Since each telephone company may have its own rules, I suggest you contact yours before making any connections. In general, the FCC is concerned that no harm or disturbances of any type may occur to the telephone line. All connections to the telephone line must be made through standard plugs or jacks. In that way, the device can be easily disconnected if suspected of causing an interference problem. The Telephone Remote-Control System has been designed to meet those require-

TABLE 4—UNIT NUMBERS AND COMMAND CODES

Unit Number/Command Code	Bit Pattern
Unit 1	01100
2	11100
3	00100
4	10100
5	00010
6	10010
7	01010
8	11010
ALL UNITS OFF	00001
ALL LIGHTS ON	00011
ON	00101
OFF	00111

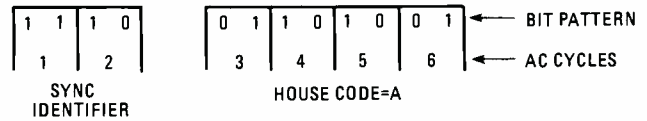

Fig. 4—This diagram shows the bit patterns and where they occur during the AC cycle. Note that the house code is preceded by a four-bit sync identifier, 1110. That pattern is transmitted as three bursts of 120 kHz with a duration of 1 millisecond (during half cycles of 8.3 milliseconds) with the zero indicated as an absence of the 120-kHz burst during the final half cycle. The total time of that transmission is about 32 milliseconds. The house code, on the other hand, is transmitted in its true form during the first half cycle followed by its complement during the second half.

ments if assembled properly. Even the relay chosen, K1, is an FCC-approved component and I urge that it not be substituted unless by another qualified, FCC-approved relay.

Relay K1 and resistors R11 and R15 (Fig. 2) form part of the interface and are primarily used to temporarily fool the telephone network into seeing an off-hook condition after the access code has been entered. Remember that the telephone network identifies dial pulses by current interruptions. With R11 and R15 ohms across the telephone line, any number can be dialed and the microprocessor can then process dial pulses with no telephone network interference. That state remains valid for approximately 20 seconds; then the telephone network injects a vocal message that informs you that you have dialed a wrong number or "Please hang up and re-dial." Refer to Fig. 5. Anyway, without that part of the interface, it would be very difficult for the Control System to differentiate dial pulses from telephone network interference.

Building the Control System

The patterns for the components and foil sides of the circuit board are shown in Figs. 6 and 7, respectively. A pictorial diagram, which shows the parts placement on the circuit card, is provided in Fig. 8. The circuit board has been designed to fit into Radio Shack's 6 × 3 3/16 × 1 7/8-inch economy case.

When installing the integrated circuits, note that they all face in the same direction. Be especially careful when installing the diodes and electrolytic capacitors. Observe the polarity of those parts as referred to on the pictorial diagram in Fig. 8. Transformer T1 has a red dot located on one side and should be installed near terminals E1 and E2. Pulse transformer T2's pin numbers are marked on the underside and careful attention should be observed during its installation.

The AC power cord connects to the circuit board at connection points E1 and E2. The alarm feature, if desired, is connected to E7 and E8. A short applied across those two

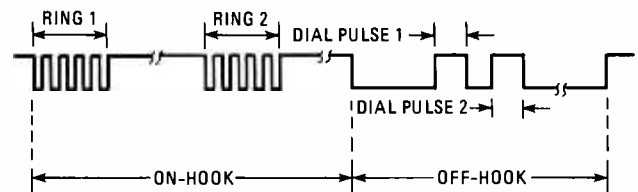

Fig. 5—This diagram visually illustrates the ring signal and dial pulses that normally occur during the on-hook and off-hook condition of the phone. It is these signals that are used by the microprocessor to determine telephone line activity.

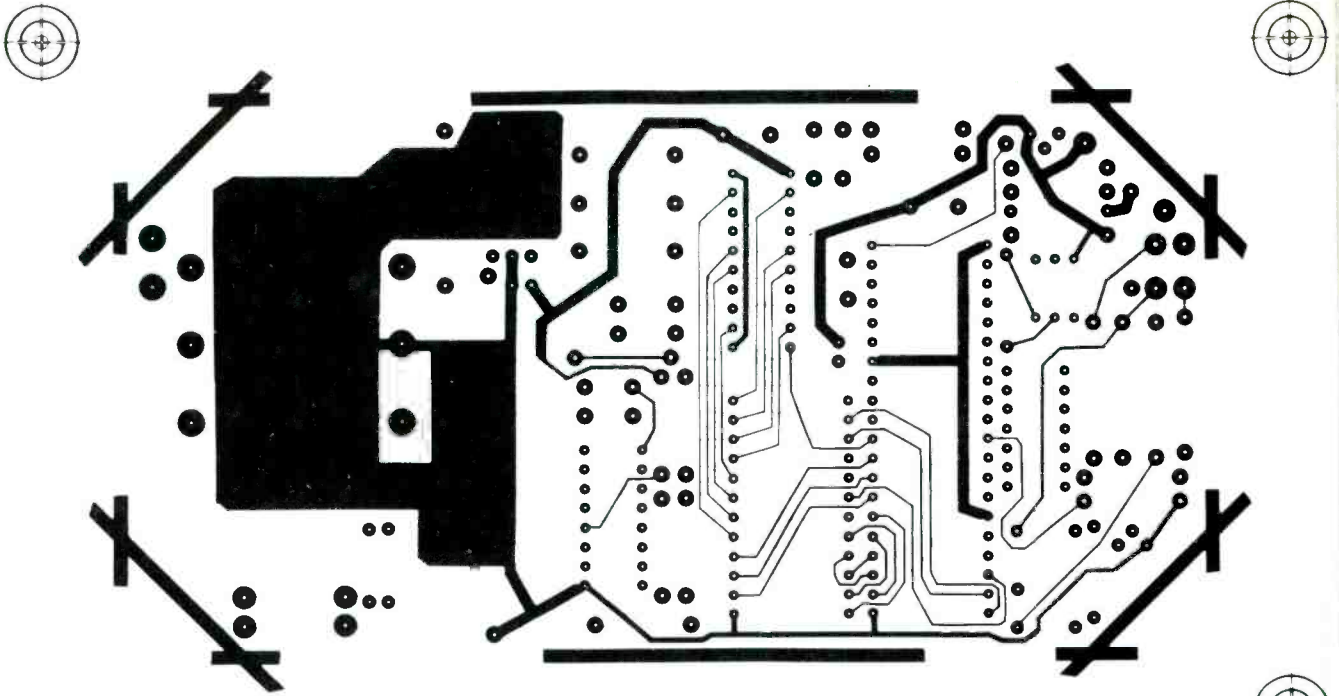

Fig. 6—The Control System is built on double-sided, printed-circuit board, which makes for a less cumbersome finished unit. The printed-circuit foil patterns for the component side of the board is shown; it is to be used in conjunction with the foil pattern of the solder side of the board shown in Fig. 7.

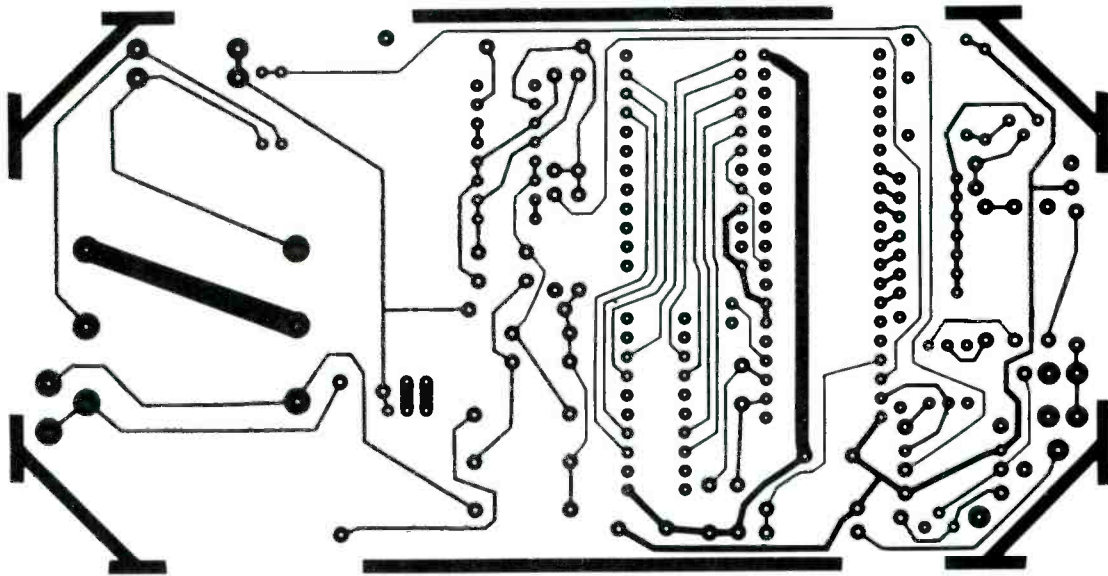

Fig. 7—Since the Control System is built on a double-sided board, it is necessary that the foil pattern of Fig. 6 line up as close as possible with the above when preparing to etch your own board.

points produces the all-lights-on condition. Usually, those points are connected to an existing alarm system's normally-open contacts.

Connections E3 and E4 should be soldered to the red and green wires, respectively, of the modular-phone extension cord. That part may be bought at Radio Shack, or made-up if you purchase the items required separately and have access to a modular crimping tool. That line should be tagged *Output* to distinguish it from the other modular-phone extension

cord's red and green wires, which should be connected to E5 and E6, respectively, and tagged *Input*.

When the LM341 (U5) is positioned on the printed-circuit board, the voltage-regulator heat sink may protrude slightly outside the printed-circuit board area. The excess should be trimmed off if you're using the Radio Shack case. A good pair of pliers does the job nicely. The LM341 should then be soldered to the printed-circuit board heat sink or, as a minimum, you should apply some silicon between the board and

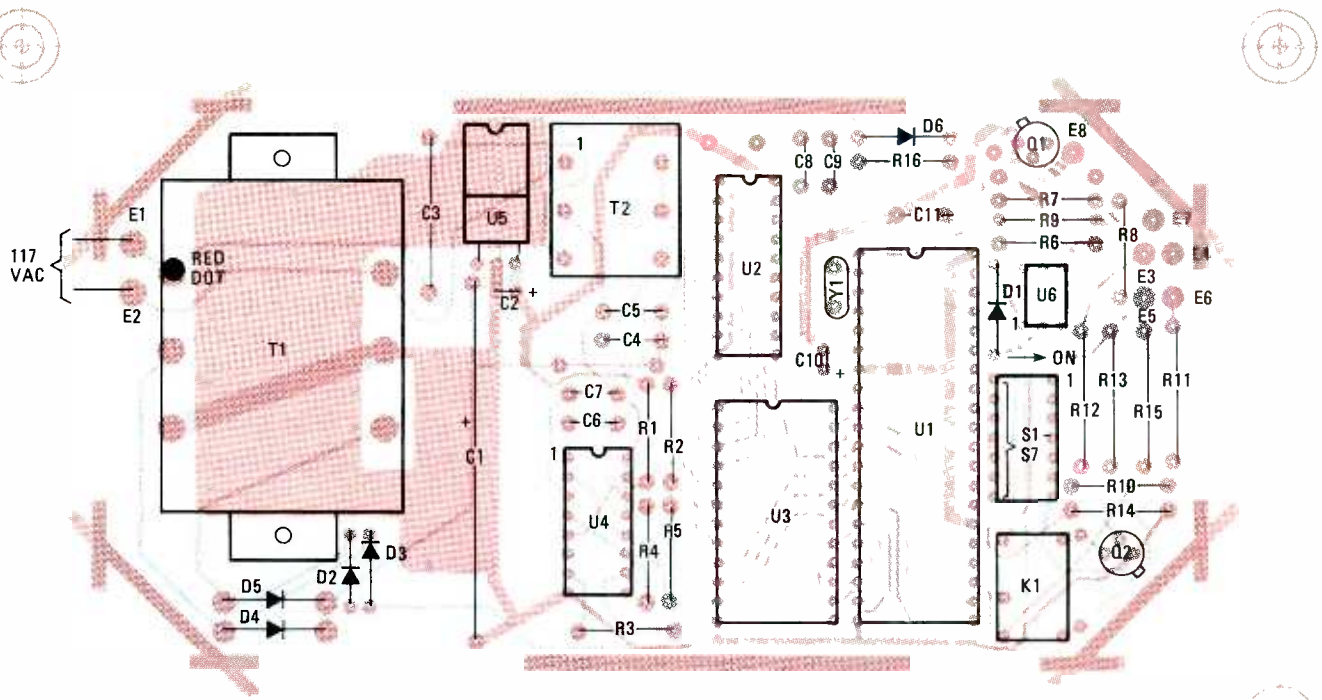

Fig. 8—Parts placement for the Control System's printed-circuit board. Note the orientation of the IC's, which have all their notches facing in the same direction. That allows you to spot, at a glance, any misoriented IC.

the voltage regulator before soldering the three terminals.

Integrated circuit U4 could be damaged if the system has not been assembled properly. Therefore, U4 should be installed only after a quick test is made to determine that the parts have been installed correctly and that the system is functioning properly.

Construction Checkout

It is important that you verify that the breadboard was assembled correctly and is functioning properly. To run the construction checkout, the Telephone Remote-Control System software, if purchased, has a built-in diagnostic test that is performed prior to connecting the unit to the telephone lines. This test uses the Telephone Remote-Control System and existing wall switches and lamp modules. If your BSR system does not have either of the modules, then proceed to Single/Multiple Installation Checkout. Otherwise, perform the following procedure:

1. Set Control System and wall switch module to the same house code.
2. Insert the plug of the Control System's AC power cord into a 117-volt AC outlet.
3. Verify the light(s) connected to the aforementioned module(s) turn on for approximately 1 second, and then goes off. If not, check the following:
 - a. Module installation is correct.
 - b. The module house code selected is the same as the Control System's house code selection.
 - c. The circuit breaker that provides power to the module is on.
 - d. Verify that all circuit board components have been installed correctly.
 - e. Verify +5 volts power on U1 pin 40.

Since most homes are powered from two 117-volt AC lines, the transmitter connected to one of those lines may not be

able to communicate reliably to all remote-control modules connected to the other line. Intermittent operation may be noticed. Any 220-volt AC appliance—such as an electric clothes dryer in operation—may serve as a temporary path between the two lines. However, a permanent solution is to connect a .1- μ F, 600-WVDC capacitor across the two lines. Some experimentation on the remote-control module placement should also help.

Connecting the Unit

The Telephone Remote-Control System is equipped with two modular-phone plugs labelled Input and Output. Those plugs are designed to be plugged into a modular jack. See Fig. 9. If your home or phone does not have a modular-phone jack, you may install one yourself or have the phone company install one. (Ma Bell will charge for that service). If your home is equipped with an older style four-pin jack, you can convert it to a modular-phone jack with an adapter. Adapters may be purchased at your local phone company or electronics parts store.

Single Telephone Installation

Here's the step-by-step procedure for connecting the Telephone Remote-Control System to the telephone line for a single telephone system.

1. Disconnect existing telephone modular-phone plug from wall phone plate. Refer to Fig. 9.
- +2. Insert Control System modular-phone plug labelled input into modular-phone jack in wall phone plate.
- +3. Insert Control System modular-phone plug labelled output into existing telephone base. (If telephone cord is permanently attached to the phone, an "in-line coupler" that inter-connects two modular-phone line cords will be required. They may be purchased at your local phone company or electronic parts store.)

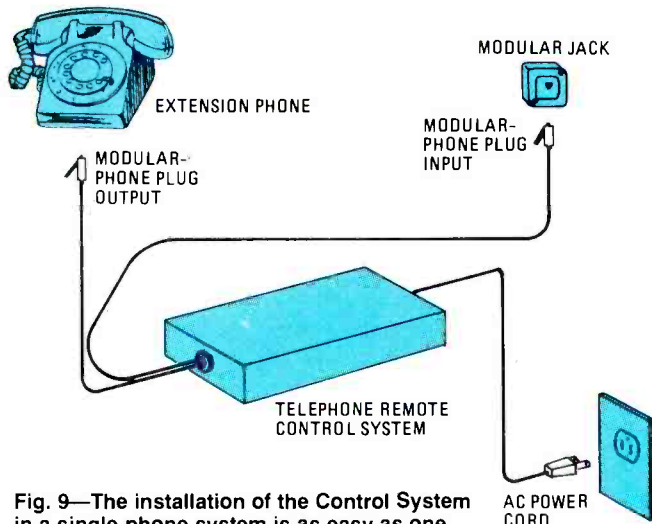

Fig. 9—The installation of the Control System in a single-phone system is as easy as one, two, three. The control circuit is placed between the existing phone installation and the phone company network, and then plugged into the nearest AC outlet as shown.

+ 4. Insert the plug of the Control System's AC power cord into a 117-volt AC outlet.

Multiple Telephone Installation

The Telephone Remote-Control System installation allows any phone connected to the line to be used to turn lights and appliances ON and OFF using one Telephone Remote-Control System. Refer to Fig. 10. The installation is similar to the single-phone installation except the Control System is installed at the feed-in point (where the telephone line enters the premises).

This installation involves working with wire and jacks which carry an electric current. Telephone jacks or wires must not be installed unless you first disconnect the in-house wiring at the protected interface (a point between the telephone company's wiring and wiring in your home). If you cannot disconnect your wiring from the telephone network, you may be exposed to hazardous voltage during installation

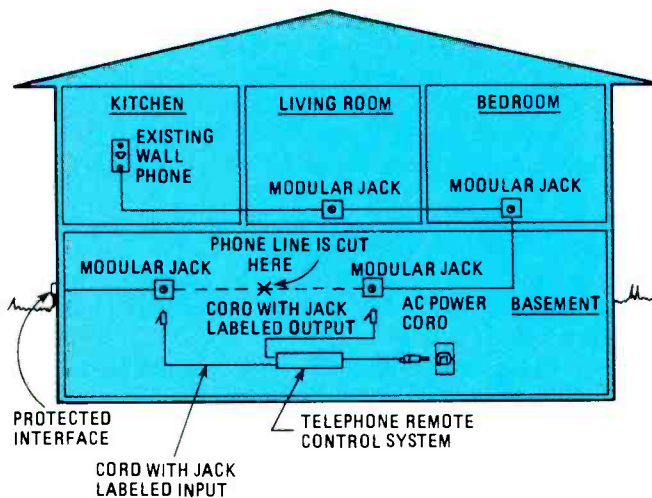

Fig. 10—To connect the Control System to a multiple-phone installation is similar to that of the single-phone installation, except that the input to the Remote Control is connected to the main feed-in and the output feeds the in-house telephone network.

and you should use a professional installer. Never attempt that work during a storm.

1. Find a place close to an AC outlet.
2. Cut the phone-line with an insulated-handle wire-cutter.
3. Carefully strip back the outer telephone wire jacket about 3 inches on both cables, then remove ¼-inch of insulation from the individual wires.
4. Install two modular-phone jacks with standard wiring blocks. Next, connect the two cables (one at a time) to the two wiring blocks. Connect the 4-color coded wires to the corresponding screws on the wiring block. If your house wires do not match, you probably have a 6-wire network and should use the color codes specified in Table 5. Use an existing wired telephone to determine which pair is used.

TABLE 5—CABLE COLOR CODE

4-Conductor Cable	6-Conductor Cable
Red Green Yellow Black	Blue with White Band White with Blue Band Orange with White Band White with Orange Band
	Spare Wires
	Green with White Band White with Green Band

5. Insert the Control System's modular-phone plug labelled INPUT into the modular-phone jack which is now connected to the protected interface.
6. Insert the Control System's modular-phone plug labelled OUTPUT into the modular-phone jack connected to inside house wiring.

PARTS LIST FOR TELEPHONE

SEMICONDUCTORS

- D1, D2, D3, D6—1N4148 silicon switching diode
- D4, D5—1N4001 rectifying diode
- Q1, Q2—2N2222A silicon NPN transistor
- U1—8035-6 microprocessor (National), integrated circuit
- U2—74LS373, 8-bit latch, integrated circuit
- U3—2716 EPROM, integrated circuit
- U4—ULN2003A hex Darlington NPN transistor-array driver (Sprague), integrated circuit
- U5—LM341P-5, +5-volt regulator, integrated circuit
- U6—4N33, opto-isolator, integrated circuit

RESISTORS

- (All resistors are ¼-watt, 5% units unless otherwise noted.)
- R1—1000-ohm
 - R2—200-ohm
 - R3—R5—100-ohm
 - R6, R14, R16—10,000-ohm
 - R7, R8, R10—4700-ohm
 - R9—510-ohm
 - R11, R15—430-ohm, ½-watt
 - R12, R13—51-ohm, ½-watt

CAPACITORS

- C1—2200-µF, 10-WVDC, electrolytic
- C2—47-µF, 6-WVDC, electrolytic
- C3—.47-µF, 250-WVDC
- C4, C5—.047-µF, ceramic disc

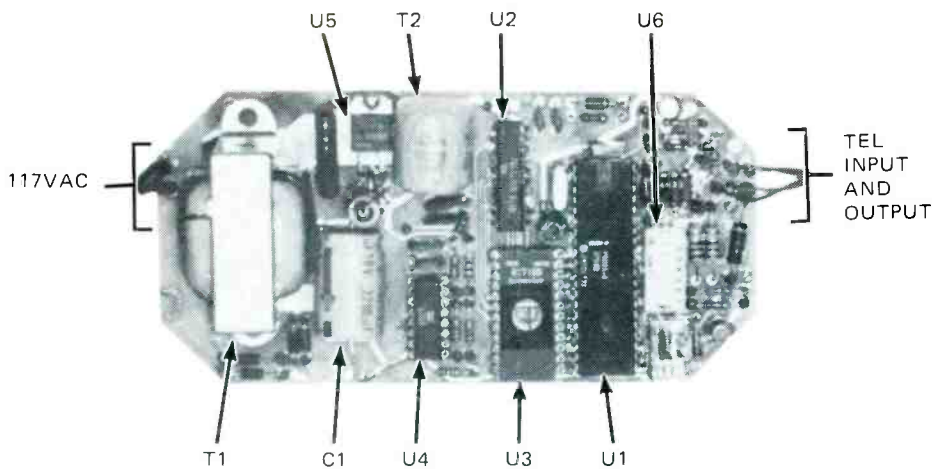

The printed-circuit board for the Telephone Remote Control System is sized to fit inside a standard hobbyist plastic box. Corners are cut off so that board will clear the box's cover mounting posts. Compare Fig. 7 to this photo and observe that one resistor mounted "caty-corner" replaces R11 and R15. The latter are connected in series. The author found an unusual resistor (not standard) that filled the bill and used one resistor in place of two. Hobbyists would not be that lucky, so two resistors, whose ohmic resistance add to the desired value, are used.

7. Insert the plug of the Control System's AC power cord into a 117-volt AC outlet.

8. Re-connect the in-house wiring to the telephone company's wiring at the protected interface.

Single/Multiple Telephone Checkout

1. For the single phone installation, take the telephone connected to the Control System off-hook and listen for a dial tone. (For a multiple installation, any telephone can be taken off-hook).

2. Make a call to verify that the jacks are working properly, then hang-up the telephone.

3. Lift the telephone off-hook, wait 1-second, then dial your access code followed by the digit 9. Remember that the access code is a two-digit number, the first of which is always 2.

4. Verify that the light(s) connected to the wall-switch

module or lamp modules turn on. If not, follow the previous installation instructions, and reverse the red and green wires.

Using the Control System

The Telephone Remote-Control System operates when the telephone is taken off-hook and the access code is entered followed by the device number to be turned ON or OFF. The Control System allows you to perform two operations or events after the access code is dialed. Those operations include:

Operation	Telephone Command
1. Turning a Device ON	Dial Telephone Number 1-8
2. Turning a Device OFF	Dial 0, then Device Number 1-8
3. Turning All Lights ON	Dial 9
4. Turning All Devices OFF	Dial 0, then Dial 9

The numbers 1 through 8 on your telephone dial correspond to the remote-control module's unit (device) code. If for example, you want the telephone number 2 to control a specific switch module, set the wall-switch module unit code to 2.

To eliminate possible interference with the telephone company's central office circuits, the two operations should be performed within 15 seconds after the access code is entered.

Practice Session

Let's turn all the lights on!

1. Lift the telephone off-hook and wait approximately one second.

(Continued on page 102)

REMOTE-CONTROL SYSTEM

C6, C7, C11—.01- μ F, ceramic disc
 C8—6.8 to 10-pF, ceramic disc
 C9—18-pF, ceramic disc
 C10—4.7- μ F, 6-WVDC, electrolytic

ADDITIONAL PARTS AND MATERIALS

K1—5-volt relay, SPDT (Aromat P/N DS1-M-DC5V or similar)
 S1-S7—7 SPST switches in a DIP package, printed-circuit mount
 T1—Transformer: 117-VAC primary winding; 12.6-volts, center-tapped, 350-ma secondary winding (EDW P/N EL-12-350A6 or similar)
 T2—Pulse transformer (Sprague 11Z2100)
 Y1—6.00-MHz crystal
 Miscellaneous: AC line cord, modular-phone extension cords, printed-circuit board, plastic case with plastic cover, mounting hardware, wire, solder, etc.

The following are available from Master Control Systems, Inc., P.O. Box 78, South Windsor, CT 06074:

Kit 1—Kit of all parts including programmed EPROM and miscellaneous items; \$92.50. Add \$4.00 for shipping and handling.

Kit 2—Programmed EPROM and etched, drilled, plated-through printed circuit board: \$26.00. Add \$2.00 for shipping and handling.

Connecticut residents include 7 1/2% sales tax. Please allow 6-8 weeks for delivery.

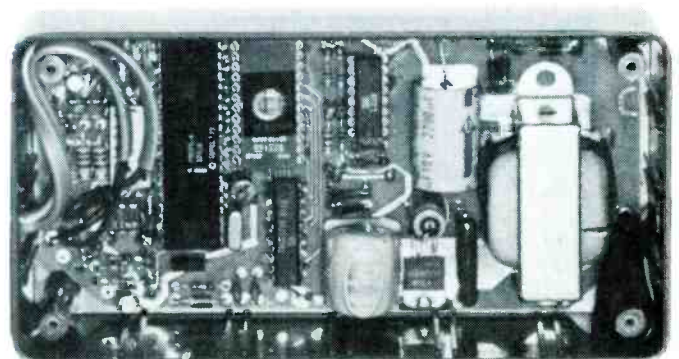

The Telephone Remote Control Unit with the cover removed. The AC line cable (left) and the input and output telephone cables (right) pass through holes in the plastic box, wrap around screw-mounting posts used to secure the cover, and connect to the circuit board. The posts provide cable strain-relief.

THE NATIONAL SEMICONDUCTOR • PANASOK MACHINE • EWC INC. • INTERSIL • EAC, INC. • J. W. MILLER • AAVID ENGR'G • F. JOHNSON • AT ANTICOM/CM/D

256K (262,144 x 1) DRAM 150NS \$5.70/1; \$39.95/9

LED DIODES • DIAMOND TOOL • UNGAR • ISTRON • CW INDUSTRIES • AMDEP • G. E. UNGAR • YAGEO • J. W. MILLER • LUXO • G. C. CHEMICALS • ARIES • PLESSEY

IDC Assemblies

Socket Connector (Style S)

Part No.	Pin Count	Price
8011-18ND	18	1.10
8011-24ND	24	1.20
8011-30ND	30	1.30
8011-36ND	36	1.40
8011-42ND	42	1.50
8011-48ND	48	1.60
8011-54ND	54	1.70
8011-60ND	60	1.80
8011-66ND	66	1.90
8011-72ND	72	2.00
8011-78ND	78	2.10
8011-84ND	84	2.20
8011-90ND	90	2.30
8011-96ND	96	2.40
8011-102ND	102	2.50
8011-108ND	108	2.60
8011-114ND	114	2.70
8011-120ND	120	2.80
8011-126ND	126	2.90
8011-132ND	132	3.00
8011-138ND	138	3.10
8011-144ND	144	3.20
8011-150ND	150	3.30
8011-156ND	156	3.40
8011-162ND	162	3.50
8011-168ND	168	3.60
8011-174ND	174	3.70
8011-180ND	180	3.80
8011-186ND	186	3.90
8011-192ND	192	4.00
8011-198ND	198	4.10
8011-204ND	204	4.20
8011-210ND	210	4.30
8011-216ND	216	4.40
8011-222ND	222	4.50
8011-228ND	228	4.60
8011-234ND	234	4.70
8011-240ND	240	4.80
8011-246ND	246	4.90
8011-252ND	252	5.00
8011-258ND	258	5.10
8011-264ND	264	5.20
8011-270ND	270	5.30
8011-276ND	276	5.40
8011-282ND	282	5.50
8011-288ND	288	5.60
8011-294ND	294	5.70
8011-300ND	300	5.80
8011-306ND	306	5.90
8011-312ND	312	6.00
8011-318ND	318	6.10
8011-324ND	324	6.20
8011-330ND	330	6.30
8011-336ND	336	6.40
8011-342ND	342	6.50
8011-348ND	348	6.60
8011-354ND	354	6.70
8011-360ND	360	6.80
8011-366ND	366	6.90
8011-372ND	372	7.00
8011-378ND	378	7.10
8011-384ND	384	7.20
8011-390ND	390	7.30
8011-396ND	396	7.40
8011-402ND	402	7.50
8011-408ND	408	7.60
8011-414ND	414	7.70
8011-420ND	420	7.80
8011-426ND	426	7.90
8011-432ND	432	8.00
8011-438ND	438	8.10
8011-444ND	444	8.20
8011-450ND	450	8.30
8011-456ND	456	8.40
8011-462ND	462	8.50
8011-468ND	468	8.60
8011-474ND	474	8.70
8011-480ND	480	8.80
8011-486ND	486	8.90
8011-492ND	492	9.00
8011-498ND	498	9.10
8011-504ND	504	9.20
8011-510ND	510	9.30
8011-516ND	516	9.40
8011-522ND	522	9.50
8011-528ND	528	9.60
8011-534ND	534	9.70
8011-540ND	540	9.80
8011-546ND	546	9.90
8011-552ND	552	10.00
8011-558ND	558	10.10
8011-564ND	564	10.20
8011-570ND	570	10.30
8011-576ND	576	10.40
8011-582ND	582	10.50
8011-588ND	588	10.60
8011-594ND	594	10.70
8011-600ND	600	10.80
8011-606ND	606	10.90
8011-612ND	612	11.00
8011-618ND	618	11.10
8011-624ND	624	11.20
8011-630ND	630	11.30
8011-636ND	636	11.40
8011-642ND	642	11.50
8011-648ND	648	11.60
8011-654ND	654	11.70
8011-660ND	660	11.80
8011-666ND	666	11.90
8011-672ND	672	12.00
8011-678ND	678	12.10
8011-684ND	684	12.20
8011-690ND	690	12.30
8011-696ND	696	12.40
8011-702ND	702	12.50
8011-708ND	708	12.60
8011-714ND	714	12.70
8011-720ND	720	12.80
8011-726ND	726	12.90
8011-732ND	732	13.00
8011-738ND	738	13.10
8011-744ND	744	13.20
8011-750ND	750	13.30
8011-756ND	756	13.40
8011-762ND	762	13.50
8011-768ND	768	13.60
8011-774ND	774	13.70
8011-780ND	780	13.80
8011-786ND	786	13.90
8011-792ND	792	14.00
8011-798ND	798	14.10
8011-804ND	804	14.20
8011-810ND	810	14.30
8011-816ND	816	14.40
8011-822ND	822	14.50
8011-828ND	828	14.60
8011-834ND	834	14.70
8011-840ND	840	14.80
8011-846ND	846	14.90
8011-852ND	852	15.00
8011-858ND	858	15.10
8011-864ND	864	15.20
8011-870ND	870	15.30
8011-876ND	876	15.40
8011-882ND	882	15.50
8011-888ND	888	15.60
8011-894ND	894	15.70
8011-900ND	900	15.80
8011-906ND	906	15.90
8011-912ND	912	16.00
8011-918ND	918	16.10
8011-924ND	924	16.20
8011-930ND	930	16.30
8011-936ND	936	16.40
8011-942ND	942	16.50
8011-948ND	948	16.60
8011-954ND	954	16.70
8011-960ND	960	16.80
8011-966ND	966	16.90
8011-972ND	972	17.00
8011-978ND	978	17.10
8011-984ND	984	17.20
8011-990ND	990	17.30
8011-996ND	996	17.40
8011-1002ND	1002	17.50
8011-1008ND	1008	17.60
8011-1014ND	1014	17.70
8011-1020ND	1020	17.80
8011-1026ND	1026	17.90
8011-1032ND	1032	18.00
8011-1038ND	1038	18.10
8011-1044ND	1044	18.20
8011-1050ND	1050	18.30
8011-1056ND	1056	18.40
8011-1062ND	1062	18.50
8011-1068ND	1068	18.60
8011-1074ND	1074	18.70
8011-1080ND	1080	18.80
8011-1086ND	1086	18.90
8011-1092ND	1092	19.00
8011-1098ND	1098	19.10
8011-1104ND	1104	19.20
8011-1110ND	1110	19.30
8011-1116ND	1116	19.40
8011-1122ND	1122	19.50
8011-1128ND	1128	19.60
8011-1134ND	1134	19.70
8011-1140ND	1140	19.80
8011-1146ND	1146	19.90
8011-1152ND	1152	20.00
8011-1158ND	1158	20.10
8011-1164ND	1164	20.20
8011-1170ND	1170	20.30
8011-1176ND	1176	20.40
8011-1182ND	1182	20.50
8011-1188ND	1188	20.60
8011-1194ND	1194	20.70
8011-1200ND	1200	20.80
8011-1206ND	1206	20.90
8011-1212ND	1212	21.00
8011-1218ND	1218	21.10
8011-1224ND	1224	21.20
8011-1230ND	1230	21.30
8011-1236ND	1236	21.40
8011-1242ND	1242	21.50
8011-1248ND	1248	21.60
8011-1254ND	1254	21.70
8011-1260ND	1260	21.80
8011-1266ND	1266	21.90
8011-1272ND	1272	22.00
8011-1278ND	1278	22.10
8011-1284ND	1284	22.20
8011-1290ND	1290	22.30
8011-1296ND	1296	22.40
8011-1302ND	1302	22.50
8011-1308ND	1308	22.60
8011-1314ND	1314	22.70
8011-1320ND	1320	22.80
8011-1326ND	1326	22.90
8011-1332ND	1332	23.00
8011-1338ND	1338	23.10
8011-1344ND	1344	23.20
8011-1350ND	1350	23.30
8011-1356ND	1356	23.40
8011-1362ND	1362	23.50
8011-1368ND	1368	23.60
8011-1374ND	1374	23.70
8011-1380ND	1380	23.80
8011-1386ND	1386	23.90
8011-1392ND	1392	24.00
8011-1398ND	1398	24.10
8011-1404ND	1404	24.20
8011-1410ND	1410	24.30
8011-1416ND	1416	24.40
8011-1422ND	1422	24.50
8011-1428ND	1428	24.60
8011-1434ND	1434	24.70
8011-1440ND	1440	24.80
8011-1446ND	1446	24.90
8011-1452ND	1452	25.00
8011-1458ND	1458	25.10
8011-1464ND	1464	25.20
8011-1470ND	1470	25.30
8011-1476ND	1476	25.40
8011-1482ND	1482	25.50
8011-1488ND	1488	25.60
8011-1494ND	1494	25.70
8011-1500ND	1500	25.80
8011-1506ND	1506	25.90
8011-1512ND	1512	26.00
8011-1518ND	1518	26.10
8011-1524ND	1524	26.20
8011-1530ND	1530	26.30
8011-1536ND	1536	26.40
8011-1542ND	1542	26.50
8011-1548ND	1548	26.60
8011-1554ND	1554	26.70
8011-1560ND	1560	26.80
8011-1566ND	1566	26.90
8011-1572ND	1572	27.00
8011-1578ND	1578	27.10
8011-1584ND	1584	27.20
8011-1590ND	1590	27.30
8011-1596ND	1596	27.40
8011-1602ND	1602	27.50
8011-1608ND	1608	27.60
8011-1614ND	1614	27.70
8011-1620ND	1620	27.80
8011-1626ND	1626	27.90
8011-1632ND	1632	28.00
8011-1638ND	1638	28.10
8011-1644ND	1644	28.20
8011-1650ND	1650	28.30
8011-1656ND	1656	28.40
8011-1662ND	1662	28.50
8011-1668ND	1668	28.60
8011-1674ND	1674	28.70
8011-1680ND	1680	28.80
8011-1686ND	1686	28.90
8011-1692ND	1692	29.00
8011-1698ND	1698	29.10
8011-1704ND	1704	29.20
8011-1710ND	1710	29.30
8011-1716ND	1716	29.40
8011-1722ND	1722	29.50
8011-1728ND	1728	29.60
8011-1734ND	1734	29.70
8011-1740ND	1740	29.80
8011-1746ND	1746	29.90
8011-1752ND	1752	30.00
8011-1758ND	1758	30.10
8011-1764ND	1764	30.20
8011-1770ND	1770	30.30
8011-1776ND	1776	30.40
8011-1782ND	1782	30.50
8011-1788ND	1788	30.60
8011-1794ND	1794	30.70
8011-1800ND	1800	30.80
8011-1806ND	1806	30.90
8011-1812ND	1812	31.00
8011-1818ND	1818	31.10
8011-1824ND	1824	31.20
8011-1830ND	1830	31.30
8011-1836ND	1836	31.40
8011-1842ND	1842	31.50
8011-1848ND	1848	31.60
8011-1854ND	1854	31.70
8011-1860ND	1860	31.80
8011-1866ND	1866	31.90
8011-1872ND	1872	32.00
8011-1878ND	1878	32.10
8011-1884ND	1884	32.20
8011-1890ND	1890	32.30
8011-1896ND	1896	32.40
8011-1902ND	1902	32.50
8011-1908ND	1908	32.60



ASSEMBLE A COMPUTER MONITOR FROM A KIT

The Heathkit HVM-122A 12-inch amber monochrome video monitor provides excellent character definition for 40 or 80-characters per line at a fraction of the cost of comparable units

By Herb Friedman

□ IF YOU ARE PRESENTLY USING ONE OF THE HOME-AND-family computers, there's a good chance that you'll get more enjoyment and performance from the computer if you switch to a conventional wide-bandwidth monochrome monitor such as the top-rated, amber-screen Zenith ZVM-122A. Unfortunately, the over-\$100 price of the ZVM-122A might make it difficult to squeeze the Zenith monitor into a tight computer equipment budget. But you can knock off almost 30 percent of the price—dropping the cost to under \$100—by building the monitor yourself.

Actually, you won't be building the ZVM-122A, but instead Heathkit's HVM-122A (see photos), which is essentially a clone-kit version of the Zenith unit. The price difference between the two monitors is primarily the cost of the factory assembly, which can be done by you in two short evenings.

Why Monochrome

At this point you're probably wondering why you should use a monochrome monitor when your home computer can generate color displays on a conventional TV set? The answer to that is simple: For most non-color applications—like word processing, data files, spreadsheets—a sharper, more legible, and more convenient display is obtained from a con-

ventional wide-band monochrome monitor like the Heath HVM-122A. Because of inherent limitations caused by the 4.5-MHz bandwidth of our TV system, about 40-characters per line is the most we can squeeze onto a TV screen before the display gets fuzzy.

Unfortunately, modern business correspondences are usually 60-characters wide, while spreadsheets and databases can be even more per line of sophisticated data. So much professional software becomes either inconvenient or unusable when a TV set is used as the computer monitor. On the other hand, a professional-quality monochrome monitor, like Heath's HVM-122A, has a bandwidth of 15 to 25 MHz, which can easily resolve at least 80 razor-sharp characters per line. Even if the computer cannot produce more than 40-characters per line, the monochrome characters will still be sharper than those displayed on a TV set.

In fact, the monitor's display is so superior to that of a TV set that most home and family computers provide a composite-video output for conventional color and monochrome monitors in addition to the RF (TV set) output. And when a composite output is not provided, aftermarket dealers sell composite-video adapters for those computers that are not normally provided with a video output. One of the hottest selling retrofit devices is a video output adapter for Radio

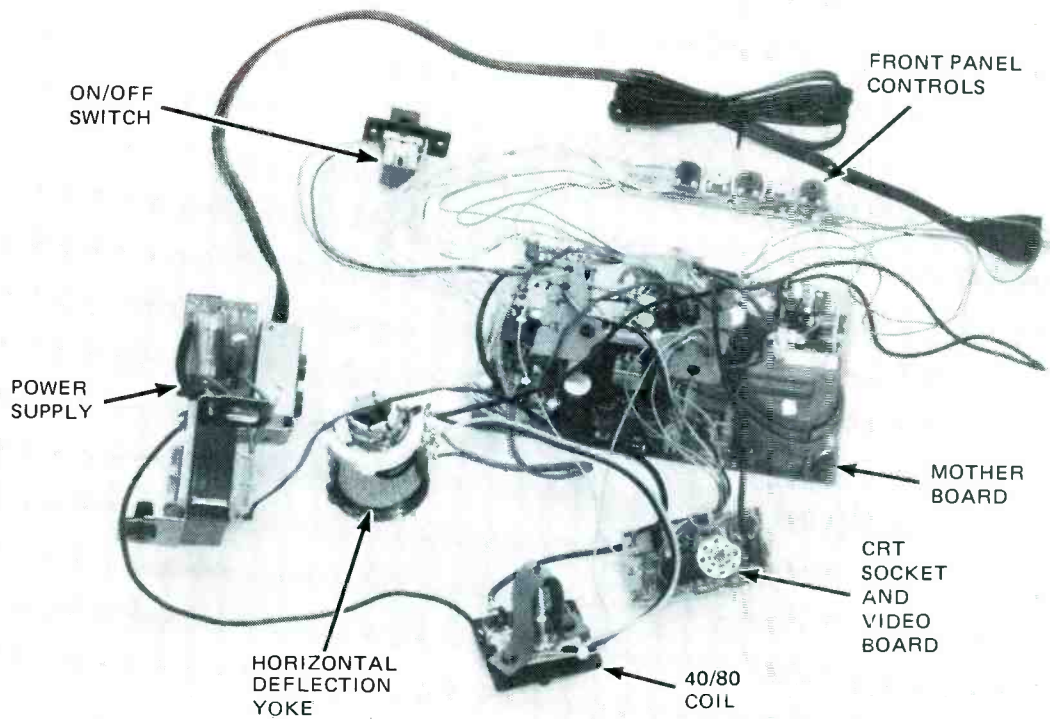

ON/OFF SWITCH

FRONT PANEL CONTROLS

POWER SUPPLY

MOTHER BOARD

HORIZONTAL DEFLECTION YOKE

CRT SOCKET AND VIDEO BOARD

40/80 COIL

This is what the motherboard and all the subassemblies look like when interconnected and ready for installation in the cabinet. It might appear to be a rat's nest of wiring, but it all slides problem-free directly into the cabinet.

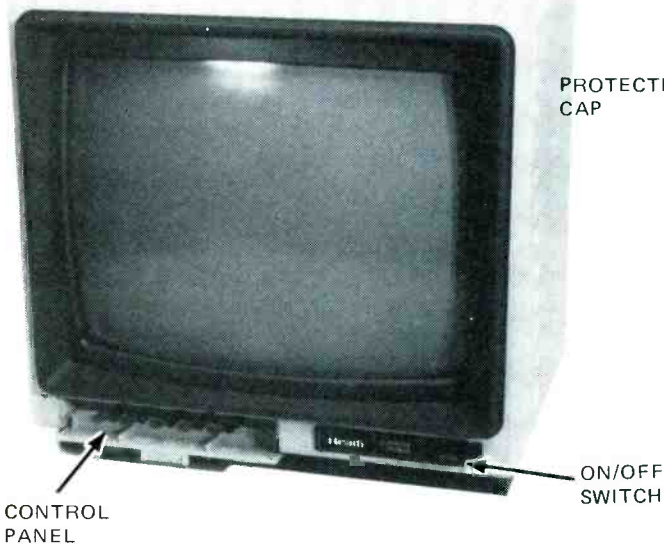

CONTROL PANEL

ON/OFF SWITCH

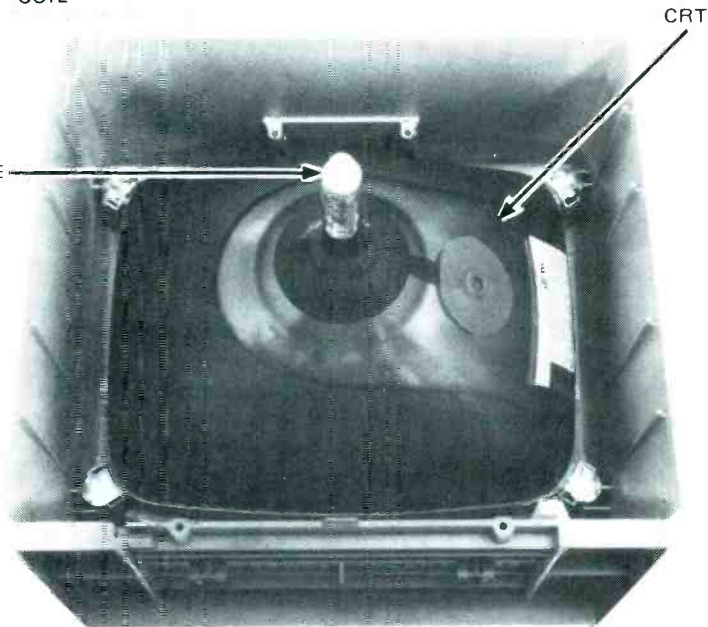

PROTECTIVE CAP

CRT

Unlike many other monitors, the Heathkit HVM-112A has all the frequently-used operating adjustments, including a vertical and a horizontal sweep control, on the front panel: normally concealed behind a small door that swings down.

The CRT is supplied factory-installed inside the cabinet. Notice the small white plastic protector over the CRT's pins. To prevent accidental damage to the pins it should not be removed until the instant you're ready for final assembly.

Shack's Color Computer, which doesn't have an inherent video output.

A Look At The Monitor

Because there is no standard for how many characters and lines are actually transmitted by a home-and-family computer, Heath's HVM-112A monochrome video monitor has user adjustments that can be used to compensate the size of the screen display for the particular computer with which it is used. Firstly, there is a 40/80 character switch located on the rear, which inserts or removes a small coil in series with the horizontal deflection yoke. When the coil is switched out, the horizontal sweep stretches out so that 40-characters per line

fills almost the entire screen.

When the coil is switched in, the horizontal sweep is compressed so that 80 characters will fill the screen—40 characters would fill approximately half the screen. A "tweaking" adjustment for the 40/80 coil allows the user to optimize the sweep for his or her computer's specific display.

Since the number of display lines from a computer can vary between 16 and 25, Heath's HVM-112A monitor also permits the vertical height to be similarly "tweaked" for optimum size. A front panel VERTICAL SIZE adjustment, hidden behind a small door along with the BRIGHTNESS, CONTRAST, HORIZONTAL, and VERTICAL SYNC controls, allows the vertical height to be optimized for a particular computer. You can

This is what the kit looks like with the circuits in place, ready for the rear cover. It might appear to be messy because of the connecting wires between the assemblies, but everything is rigidly mounted and secure when the cover is installed.

simply adjust the VERTICAL-SIZE control until the display—regardless what it is—fills most or all of the screen.

Other HVM-122A features include a 15-MHz bandwidth, a 12-inch diagonal screen, and an RCA-type phono jack that accepts an NTSC 1-volt peak-to-peak input signal. It takes about two evenings to build the kit. As is typical of most Heathkits, there is little factory assembly of anything; even the "tweaking" adjustment for the horizontal coil must be user assembled. In fact, the only item that's factory-installed is the CRT, which comes firmly clamped inside the monitor cabinet (see photos).

Lots of Diagrams

Although most of the monitor is assembled on a large printed-circuit board that simply slides into the base of the cabinet, there are six small subassemblies that are connected to it. To simplify the assembly and interconnection of the various boards and parts, a separate illustration booklet is provided along with the usual step-by-step assembly manual. The booklet treats each individual assembly as a separate project, and provides pictorials of only the parts used by that assembly.

A separate pictorial is given for every component used in a particular assembly, and each component pictorial is identified with an individual identification number exclusive of the conventional Heathkit part number. Since the kit contains a goodly number of parts—many of which resemble others—the individual keying of the components makes for almost goof-proof assembly. In fact, the only problem we had in assembling the unit came about when we thought we knew so much that we didn't have to check the pictorial. Sure enough, we found that we'd used the wrong screws. So when it came time for the final assembly, we couldn't get the monitor together, which meant that we had to go back and find out where we'd swapped similar-appearing screws.

Although most of the work is quite easy, the illustrations for the final assembly may be misleading, which caused our builder to spend more than an hour looking for trouble that didn't exist. Firstly, there is the installation of the deflection yoke. The main pictorials in the illustration booklet show the yoke with with the wrong orientation: If you install it the way it appears in the booklet, you'll end up with an inverted screen display. If you look at the back of the CRT, the deflection yoke's wires should stick out the left side to 9 o'clock, not down and to the right at 4 o'clock as shown in the illustration booklet. (The proper yoke position is shown in the main assembly manual on page 49.) The illustration book's pictorials should be used as a guide for wiring the yoke, not for installing it.

The next problem is the small video board that fits on the back of the CRT. It is shown in all illustrations as being horizontal. Depending on the particular CRT supplied in your kit, the board can be horizontal or angled at approximately 30 degrees. If your video board is angled, do not assume you've

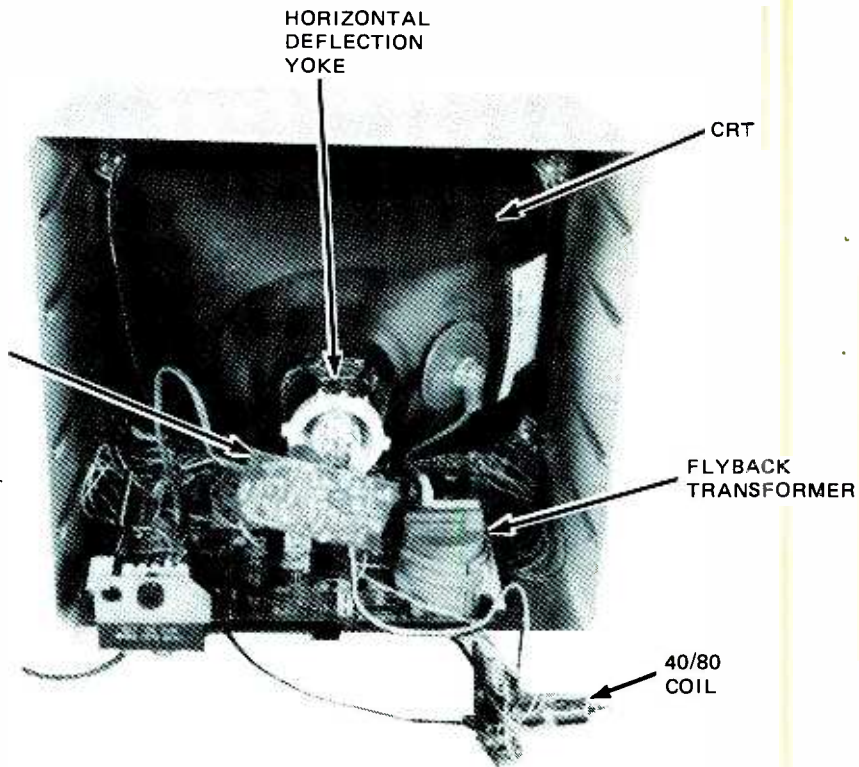

installed the CRT socket incorrectly and start hacking away at the board to remove the socket. You probably have it correct, because the socket's orientation cannot be changed, without damaging the board or the socket. If the board is angled when installed on the CRT, leave it alone.

Final Adjustments

The only user adjustments are the CRT focusing and the picture centering; neither of which can be accurately done unless the monitor is being fed from a computer. If you can, run a short BASIC program that will fill the screen with large characters such as the "H" or "Z," and then make the focus and centering adjustments.

According to the manual, the focus adjustment requires that a small screwdriver be passed through a hole in the video board to the focus adjustment. The hole is so small, however, that we could find no screwdriver that would pass through, so the adjustment had to be made from the front of the video board, which places your hand very close to the CRT and the high voltage wiring. There's just no way around it, so make certain that you use a very short miniature screwdriver, remove any rings or watches from the hand that's used to hold the screwdriver, and be *extremely* careful. If you've never worked around a CRT before, wearing a rubber glove is suggested when making the focus adjustment.

To the trained eye, the Heathkit HVM-122A had a slight degree of barrel distortion, which was not evident on two factory-assembled Zenith monitors that we used for comparison. The monitor was connected to the IBM PC-AT and Apple II for comparison. The images were typically crisp and sharp from edge to edge. The monitor will work equally as well with other personal computers, such as the PCjr, Apple III, all Heath and Zenith models, Compaq, TI 99/4, and Atari 800 and 1200. Remember, with a monochrome monitor the TV set will be freed for the afternoon soaps and weekend ball games.

DIGITAL FUNDAMENTALS

We look into the sequential logic circuits and discover what makes binary counters and shift registers do their thing!

LESSON 5: Understanding Counters and Shift Registers

By Louis E. Frenzel

□THE TWO BASIC TYPES OF LOGIC CIRCUITS ARE *combinational* circuits and *sequential* circuits. Combinational circuits are made up of logic gates connected in a special way. The outputs are a function of the inputs and how the gates are interconnected. Sequential circuits are made up of both gates and flip-flops. The flip-flops are the primary components as they are used to store binary states. Those states can be changed by input signals to form new states. As a result, the outputs change in response.

Sequential logic circuits are designed to perform a variety of storage and timing operations. A sequential logic circuit can retain a binary word or manipulate it in various ways. Sequential circuits can also perform many different kinds of timing and sequencing operations. The two most commonly used sequential logic circuits are *counters* and *shift registers*. Virtually every digital circuit contains either a counter or a shift register of some type.

Binary Counters

A binary counter is a sequential logic circuit made up of JK flip-flops that together count the number of input pulses that appear at the input. The counter stores the number of input pulses that occur as a binary number. To determine the number of input pulses applied to the counter, you simply look at the flip-flop outputs and read the binary number stored

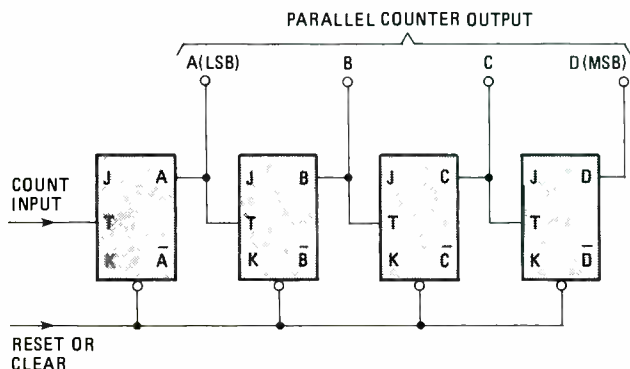

there. Many digital circuits require that you keep track of the number of pulses that occur at a given point in the circuit. A counter is used for that purpose.

Figure 1 shows a logic diagram of a simple 4-bit binary counter. The JK flip-flops are designated A through D. Note that the normal output of each flip-flop is connected to the clock or toggle (T) input of the next flip-flop in series. Connecting flip-flops in a chain like that is referred to as cascading. The input pulses to be counted are applied to the toggle input of the A flip-flop. All J and K inputs are assumed to be at binary 1 (high).

Another important connection shown in Fig. 1 is that all of the clear (C) or reset inputs to the JK flip-flops are connected together. That forms a clear or reset line. A binary 0 applied to the line will reset the flip-flops so that the binary number stored in the counter is zero (0000). You observe the binary number stored in the counter by looking at the logic states of the normal flip-flop outputs. You read them from right to left or DCBA. If all the flip-flops are reset, the normal outputs will all be binary 0. The A bit is the LSB (least significant bit) and the D bit is the MSB (most significant bit).

Now let's see how the counter operates. Assume that we are using JK flip-flops that toggle or change state when the clock or T input switches from high to low or from binary 1 to binary 0. We call that the trailing edge or the negative-going transition of the input pulse. Now assume that an input pulse occurs and it switches from high to low. That causes the A flip-flop to toggle, switching from the binary 0 to 1 state. Looking at the flip-flop outputs and reading them in the DCBA order, we see that the binary number stored in the counter is 0001. Naturally, that is the binary reading for the decimal number 1. It means that one input pulse occurred.

When the second input pulse occurs, the A flip-flop is toggled again. This time it switches from the 1 to 0 state. As

Fig. 1—Four-bit binary counter. All J and K inputs to the flip-flops are connected to a binary 1 (high). Flip-flop toggles on the trailing edge of T count input to T.

NUMBER OF INPUT PULSES	D	C	B	A
0	0	0	0	0
1	0	0	0	1
2	0	0	1	0
3	0	0	1	1
4	0	1	0	0
5	0	1	0	1
6	0	1	1	0
7	0	1	1	1
8	1	0	0	0
9	1	0	0	1
10	1	0	1	0
11	1	0	1	1
12	1	1	0	0
13	1	1	0	1
14	1	1	1	0
15	1	1	1	1

Fig. 2—Truth table for a 4-bit binary counter.

its state changes, the A output switches from high to low. That in turn causes the B flip-flop to toggle and set. As the B flip-flop sets, its normal output goes from 0 to 1. The transition appears at the clock input to the C flip-flop, but the flip-flop ignores low to high transitions. Looking at the counter outputs you see that the number stored there is 0010 or the binary equivalent of the decimal number 2. Two input pulses have occurred.

If you continue to apply input pulses to the counter, one flip-flop will simply toggle the next in sequence and the binary number stored in the counter will simply increase by one for each input pulse that occurs. When that happens, we say that the counter is being incremented. The counter counts up from 0 to the maximum value that the counter is capable of holding.

Figure 2 shows the truth table of the 4-bit binary counter. Note that the decimal number of input pulses applied to the counter corresponds to the binary value displayed by the outputs. That is true only if the counter has been reset prior to counting.

An important point to note is that when fifteen input pulses have occurred, the binary number stored is 1111. When the 16th input pulse occurs, flip-flop A toggles to 0; that in turn toggles B to 0, which in turn toggles C to 0; and in turn toggles D to 0. The binary number indicated in the counter at that time is 0000. That is equivalent to the initial reset state described earlier. In other words, the number 16 is too large

for the counter which cannot store it. Once that 4-bit counter counts to 15, the next input pulse simply recycles it back to zero and it starts again.

Figure 3 shows the input and output waveforms for the 4-bit binary counter as 16 input pulses are applied. Those timing waveforms illustrate all possible states of the counter. You may want to trace through the logic diagram of the counter and correlate each of the pulses shown in the timing diagram with each flip-flop. That will ensure that you understand how each flip-flop changes state on the high-to-low transition of the next input pulse.

Counting to Higher Values

To count to larger numbers, all you have to do is add more flip-flops to the counting chain. Each additional flip-flop lengthens the binary word of the counter by one bit, thereby doubling its maximum count capability. The total number of states that a counter can assume is 2^N where N is the number of flip-flops. With 4 flip-flops, the total number of states is $2^4 = 2 \times 2 \times 2 \times 2 = 16$. Those states are 0 (0000) through 15 (1111).

You can determine the maximum count-capability of the counter with the simple formula shown below:

$$M = 2^N - 1$$

where M = maximum count number, and N = number of flip-flops.

With four flip-flops the maximum count capability is:

$$M = 2^4 - 1 = 2 \times 2 \times 2 \times 2 - 1$$

$$M = 16 - 1 = 15$$

A 5-bit counter has a maximum count capability of 31. A 6-bit counter can count to 63, a 7-bit counter to 127, and an 8-bit counter to 255, a 12-bit counter to 4095, and so on.

Frequency Counter Applications

A binary counter can also be used as a frequency divider. Take a look at the waveforms shown in Fig. 3. Recall that a JK flip-flop acts as a divide-by-2 circuit. As you can see in Fig. 3, the output of the first flip-flop has a period that is twice the period of the input pulses being counted. That means that the output of the A flip-flop has a frequency that is half that of the input pulse frequency.

Now look at the output of the B flip-flop. Again, you can see that its frequency is half that of the A flip-flop output. A similar relationship exists in the remaining waveforms. The output frequency of the B flip-flop is one-fourth that of the input. The outputs of the C and D flip-flops are 1/8th and 1/16th of the input frequency respectively.

The frequency division factor of a binary counter is simply 2. With four flip-flops, the frequency division factor is 16. A binary counter with eight flip-flops will divide an input frequency by:

$$2^8 = 2 \times 2 \times 2 \times 2 \times 2 \times 2 \times 2 \times 2 = 256$$

If a 6.4 MHz input signal is applied to the 4-bit binary counter, the output of the D flip-flop will be $6.4 \div 16 = .4$ MHz or 400 kHz.

Preset Counters

The term preset means to put a flip-flop into one state or the other prior to another operation taking place. Presetting a counter simply means loading a binary number into the counter prior to the input pulses being applied. In many applications, the preset can simply be a clear or reset operation. If that were not done, the binary numbers stored in the counter would have no meaning unless you knew the binary

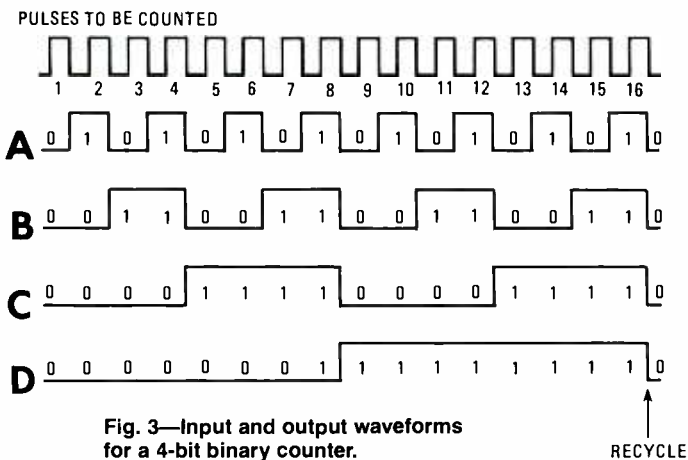

Fig. 3—Input and output waveforms for a 4-bit binary counter.

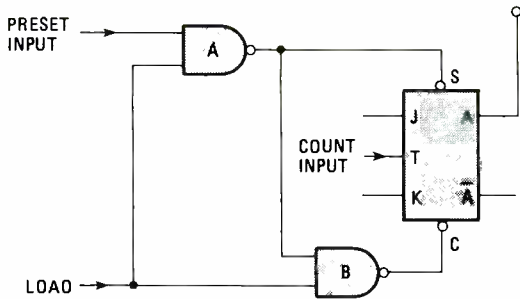

Fig. 4—Flip-flop pre-set circuitry.

number stored in the counter previously. Then you would have to subtract that number from the count to determine the number of input pulses that occurred. It is not too hard to see that it's a lot simpler to clear the counter first so that the binary number stored in the counter exactly represents the number of input pulses that occurred.

On the other hand, there are other applications where it is desirable to begin counting at some predetermined number. For those applications we must have a way to preset the counter. It is done with preset circuitry that takes advantage of the asynchronous set (S) and clear (C) inputs of the JK flip-flops. A typical circuit for one flip-flop is shown in Fig. 4. If you would like to preset the flip-flop to binary 1, you apply a binary 1 input to the preset input at gate A. Then you apply a binary 1 to the LOAD input. That forces the output of gate A low and the output of gate B high. The result is that the asynchronous set input of the flip-flop causes it to store a binary 1. Applying a binary 0 to the preset input and then switching LOAD from low to high will cause the flip-flop to be reset or store a binary 0.

When all flip-flops in the counter have the preset circuitry shown, then a parallel binary number can be applied to the counter and loaded into it prior to beginning the count operation.

To show how that presetting works, assume that the 4-bit binary counter described previously has preset circuitry. Suppose we apply the binary number 1010 to the preset inputs and load it into the counter. The counter outputs D C B A will read 1010 (decimal 10). Then assume that input pulses occur. If four input pulses occur, the counter is incremented to 1110. The four input pulses increment the counter from 10 to 14.

Down Counters

The binary counter described previously is an up counter as each input pulse increments the binary number stored in the flip-flop. That is, as each input pulse occurs, one is added to the count.

It is also possible to construct a down counter so that the binary number in the counter is decremented by one as each input pulse occurs. As a result, down counters count backward. For example, if a 4-bit binary down counter were preset

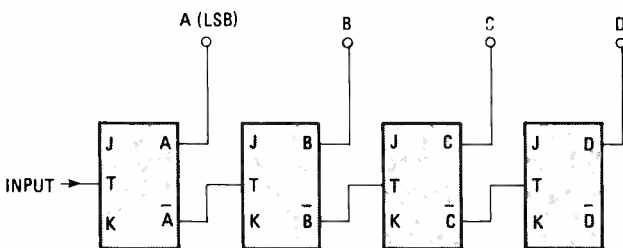

Fig. 5—Four-bit binary down counter.

Fig. 6—Count sequence of a 4-bit down counter.

INPUT PULSE	D	C	B	A
0	1	1	1	1
1	1	1	1	0
2	1	1	0	1
3	1	1	0	0
4	1	0	1	1
5	1	0	1	0
6	1	0	0	1
7	1	0	0	0
8	0	1	1	1
9	0	1	1	0
10	0	1	0	1
11	0	1	0	0
12	0	0	1	1
13	0	0	1	0
14	0	0	0	1
15	0	0	0	0

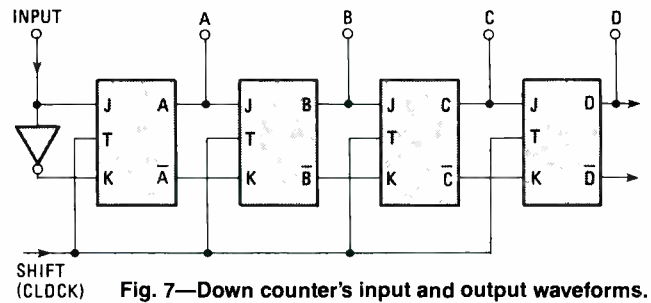

Fig. 7—Down counter's input and output waveforms.

to 1111, sequential input pulses would decrement it to 1110, 1101, 1100, etc. Some digital applications require just such a capability.

Figure 5 shows how to connect four JK flip-flops to form a down counter. Again the flip-flops are cascaded by connecting the output of one flip-flop to the clock (T) input of the next in series. The main difference here is that we connect the complement output of each flip-flop to the clock (T) input of the next. However, we still monitor the normal flip-flop outputs to determine the count stored there. With that arrangement, the count sequence shown in Fig. 6 is obtained. The table shows the counter starting with the maximum count stored in the flip-flops (1111). When the counter is decremented to zero, the next input pulse will simply recycle the counter back to its maximum count value of 1111. The cycle then repeats.

That down count and recycling process is illustrated in the timing waveforms of Fig. 7. Those output waveforms are the ones that occur at the normal flip-flop outputs. Since the complement flip-flop outputs are not shown, it is more difficult to trace the operation of that counter. If you'd like to see how each input pulse causes the toggling and triggering of each flip-flop in sequence, simply draw the complement signals to each of the waveforms in Fig. 7 before doing a pulse-by-pulse analysis. Keep in mind that a down counter can also include preset circuitry so that the counter may begin decrementing at some particular point.

By adding some logic circuitry to the counter you can make it count either up or down. That is illustrated in Fig. 8. An up/down COUNT CONTROL line is added to determine the direction of count. If a binary 1 is applied to that input, the counter will count up. That binary 1 enables all of the A gates. It causes the normal flip-flop outputs to pass through the gates to the clock (t) inputs of the next flip-flop in sequence. The B gates are inhibited at that time by inverter 1.

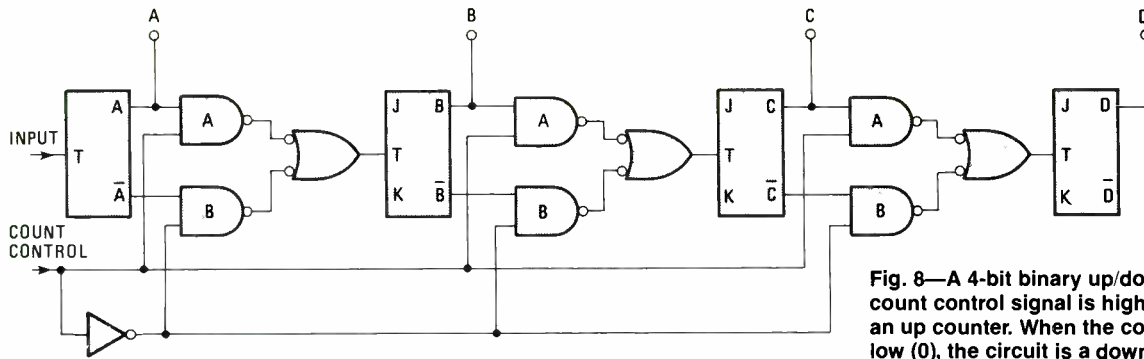

Fig. 8—A 4-bit binary up/down counter. When the count control signal is high (1), the circuit is an up counter. When the count control signal is low (0), the circuit is a down counter.

If the up/down control line is made binary 0, the B gates are enabled by inverter 1 and the A gates are inhibited. That causes the complement outputs to be passed through to the clock inputs. The counter then counts down.

While binary counters can easily be made up of individual flip-flops and gates, that is rarely done anymore. The integrated-circuit manufacturers have already constructed binary counters in a variety of configurations, usually in multiples of four or eight bits. Different TTL, CMOS and ECL integrated circuit's are available depending upon the features included such as presetting, down counting, etc.

A Typical IC Counter

One of the most used IC counters is the 4-bit MSI device shown in Fig. 9. The device is a 4-bit binary up or down counter with presetting. In other words, it incorporates all of the features that we discussed previously. The counter has four outputs, which are monitored to determine the number stored in the counter. Four parallel data-input lines are used for applying a preset input. The load-input line causes the parallel binary word applied to the data inputs to be loaded into the flip-flops. The counter also has a clear input line used for resetting the counter to zero.

Instead of having a single count input like the up/down counter discussed previously, that counter has two count inputs. To decrement the counter, you apply input pulses to the down-count input. To increment the counter, you apply pulses to the up-count input.

The carry and borrow outputs have not been discussed previously. Those lines are used when the counters are to be cascaded. The carry output is produced by an AND gate that looks at the normal flip-flop outputs. It says, in effect, that the counter contents is 1111. That means that the counter is at its maximum value and the next input pulse will cause it to recycle to zero. When it happens, the carry output generates a pulse that is applied to the next counter in series so that the overflow will be recorded.

The borrow output is used for cascading the counters in a down count application. The borrow output signal is generated by an AND gate that monitors the complement outputs of the flip-flops. When the counter is decremented to 0000, the borrow output signal is generated indicating that the counter is about to recycle. The borrow output pulse is applied to the down count input to the next counter in series. With those signals, multiple counters can be cascaded to form binary counters with lengths of 8, 12, 16, 20 and other multiples of 4-bits.

Binary counters have a maximum count capability that is some power of two. Each time an additional flip-flop is added to the binary counter, the maximum number of states it can represent doubles. Some commonly used counter sizes and the count capability are given below.

Name of Bits (Flip Flops)	Maximum States	Maximum Count
4	16	15
8	256	255
10	1024	1023
12	4096	4095
16	65536	65535

While such counters are useful in practice, there are many situations where it is more desirable to use a decimal-like representation. Humans use the decimal number system and are more comfortable with it than with binary. In working with electronic equipment, it is desirable to enter data in decimal form and read it out in decimal form. To ease the man-machine communications problem, some special binary codes have been developed. The most popular of those is binary coded decimal (BCD). BCD is still a binary code in that decimal values are represented with binary numbers. However, only the decimal numbers 0 through 9 are used. The

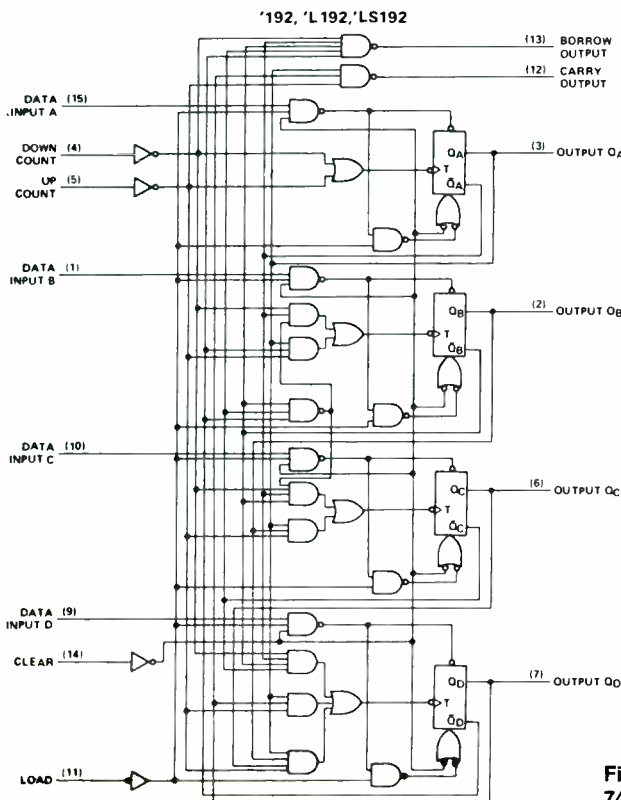

Fig. 9—Schematic diagram for the Texas Instrument 74192 4-bit binary up/down counter.

DECIMAL	BCD			
	D	C	B	A
0	0	0	0	0
1	0	0	0	1
2	0	0	1	0
3	0	0	1	1
4	0	1	0	0
5	0	1	0	1
6	0	1	1	0
7	0	1	1	1
8	1	0	0	0
9	1	0	0	1

Fig. 10—Decimal to binary-coded-decimal (BCD) equivalents.

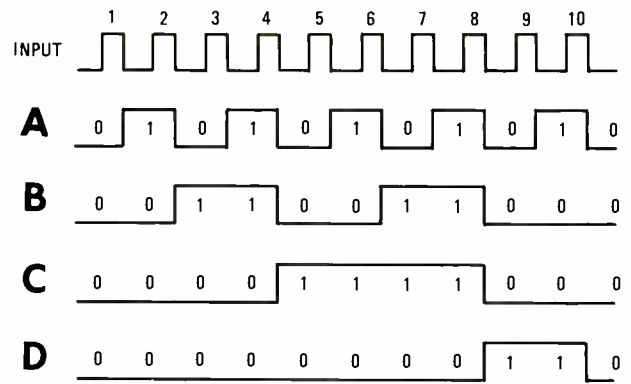

Fig. 12—BCD counter's input and output waveforms.

BCD code is shown in Fig. 10. Decimal numbers are represented by 4-bit BCD numbers, one for each digit. For example, the number 729 in BCD is 0111 0010 1001.

By using flip-flops and gates it is possible to construct a BCD counter, that is one that counts by tens. It has ten states, 0 through 9. Such a counter is called a BCD counter, decimal or decade counter; you see one in Fig. 11. Notice that the first three flip-flops are cascaded as in a standard 4-bit binary counter with the normal output connected to the clock input of the next flip-flop in the chain. The last flip-flop on the other hand has its clock (T) input connected to the normal output of the A flip-flop. Note that the signal controlling the J input on the D flip-flop is derived from an AND gate that monitors flip-flops B and C. Also note that the complement output of the D flip-flop is fed back to the J input of the B flip-flop. The result of all those unusual inter-connections is that the counter has only ten states instead of the usual 16 for a 4-bit counter. The counter counts in the BCD sequence previously described in Fig. 10.

The waveforms generated by the BCD counter are shown in Fig. 12. The counter counts from 0 (0000) to 9 (1001) in the normal sequence. When the tenth input pulse is received (trailing edge), the counter recycles to 0 and the sequence repeats.

The operation of that counter is generally similar to a 4-bit binary counter. That is particularly true of the first eight states from 0000 through 0111. The A, B and C flip-flops toggle off and on as you learned previously.

After the 7th input pulse, the output states are 0111. The B and C outputs are high, thereby enabling the AND gate which applies a binary 1 to the J input of the D flip-flop. At that point, the flip-flop is enabled and will toggle when a trailing edge signal appears at the clock input. That happens when the eighth input pulse occurs. The eighth input pulse changes the state of the A flip-flop which in turn changes the state of the B flip-flop, and then the C flip-flop. The output change of the A flip-flop also sets the D flip-flop. The code now in the counter is 1000.

The complement output of the D flip-flop is now binary 0.

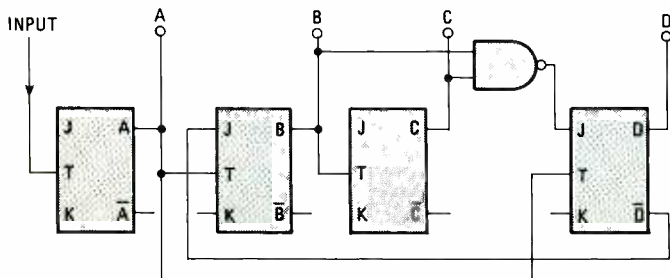

Fig. 11—Schematic diagram for a BCD counter. All unconnected J and K inputs are connected to a binary high (1).

It is fed back to the J input of the B flip-flop. That signal will keep flip-flop B from setting the next time it receives a trailing edge pulse from flip-flop A.

When the 9th input pulse occurs, the A flip-flop becomes set. The code is now 1001, the maximum count capability of the BCD counter. Flip-flops B and C are reset at that time so that the output of the AND gate is binary 0. That makes the J input of the D flip-flop zero. The J and K inputs are now such that when the A flip-flop toggles again, it will cause the D flip-flop to reset.

When the 10th input pulse occurs, the A and D flip-flops both reset. The feedback from the complement output of the D flip-flop prevents the B flip-flop from setting. Therefore, the counter cycles back to its original state of 0000. Following that description you may want to trace through the circuit yourself using the waveforms in Fig. 11 as a guide.

While it is possible to construct a BCD flip-flop from individual gates and flip-flops, normally circuits such as that are available as a single MSI integrated circuit. Most of those devices feature a master clear or reset line and many of them feature both presetting as well as up and down counting capabilities.

To use a BCD counter for counting to values higher than 9, all you do is cascade them as shown in Fig. 13. The first or input BCD counter then counts in units of 0 through 9. After ten input pulses occur, the MSB output of the first counter (D) triggers the next BCD counter in sequence. That second counter represents the tens position. It will be incremented for every ten input pulses. The tens counter in turn drives the third or hundreds counter. It will be incremented each time one hundred input pulses occur. Additional counters can be added for thousands, tens of thousands, hundreds of thousands, and so on.

To read the content of the counter, you observe the BCD codes at the counter outputs. For example, the number stored in the counter shown is 853. Note that in reading the output of a BCD counter, the 4-bit groups are separated from one another. The outputs do not form a continuous 12-bit binary number. The output is three 4-bit BCD numbers (1000 0101 0011).

Just as you can use binary counters for frequency division so can you use BCD counters for that application. The circuit

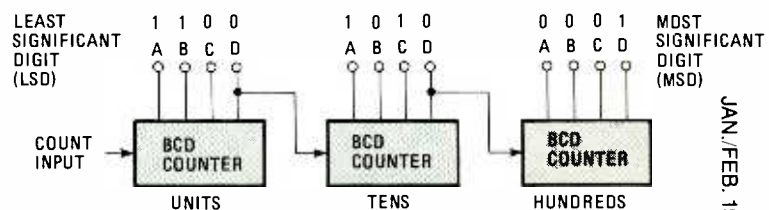

Fig. 13—Cascaded BCD counters.

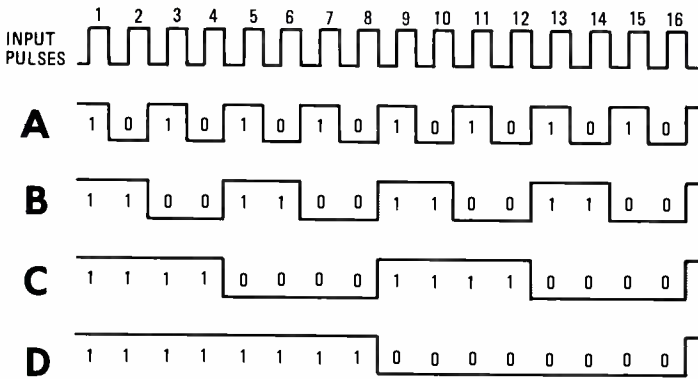

Fig. 14—Logic diagram for a 4-bit shift register.

shown in Fig. 13 will produce frequency division by some multiple of 10. The first BCD counter will divide the input frequency by 10. The D output will be one-tenth the frequency of the input. The second counter will produce division by 100 while the third will produce division by 1000.

Both binary and BCD counters can be used in counting and frequency dividing applications at very high frequencies. Standard TTL MSI counters can achieve speeds upward of 50 MHz. Schottky TTL counters can achieve speeds up to 125 MHz. CMOS counters have a much lower limit of approximately 25 MHz, but progress is being made in extending that frequency capability. ECL counters are available for frequencies up to 2 GHz.

Shift Registers

Another sequential circuit made up of flip-flops is the shift register. Like a counter, multiple flip-flops are used to store a binary word. However, the flip-flops are interconnected in such a way that incrementing and decrementing counting operations are not achieved. Instead, the connections are such that the binary word stored in the counter is shifted either to the right or to the left. That is, as each clock pulse occurs, the bit stored in one flip-flop is shifted into the flip-flop next to it. A common 4-bit shift register is illustrated in Fig. 14. All of the clock (T) inputs are connected together to a single line. Periodic clock signals are applied to that line. The normal and complement outputs of one flip-flop are connected to the J and K inputs respectively of the next flip-flop in sequence. A single input line is used for entering data into the shift register a bit at a time.

A shift register is used to deal with serial data words. A

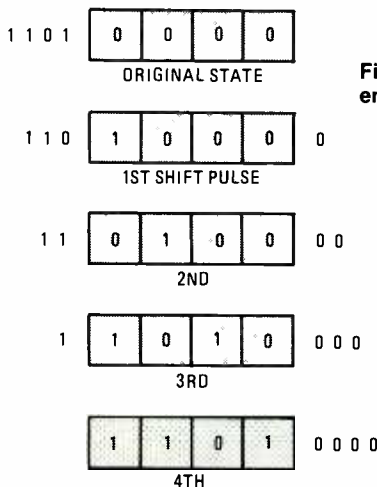

Fig. 15—How serial data is entered into a shift register.

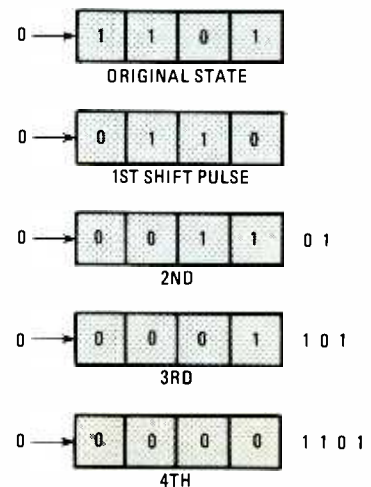

Fig. 16—How serial data is removed from a shift register.

serial pulse train, that occurs in synchronism with the shift clock pulses, applied to the input will be entered into the shift register a bit at a time. That is illustrated in simplified form in Fig. 15. The individual blocks represent each of the flip-flops in the shift register. All the flip-flops are initially reset. When the first clock pulse occurs, the first bit in the serial pulse train at the input will be shifted into the first flip-flop. The binary 0 is shifted out of the D flip-flop. As each shift clock pulse occurs, the next serial input bit is shifted into the register. The first bit moves over to the B flip-flop to accommodate the new input bit. After four clock pulses have occurred, the entire serial word is now contained in the shift register as shown.

Holding the input line at zero and applying four additional shift pulses will cause the binary number stored in the shift register to be shifted out a bit at a time, thereby generating a serial output word. The process is illustrated in Fig. 16. As you can see, the shift register can be used to accept, store, and generate serial binary data words.

One of the most common applications for a shift register is serial-to-parallel data conversion. A serial data word can be shifted into the shift register. If the outputs of the individual flip-flops are available, then that word will appear as a parallel data word as shown in Fig. 17A.

If the flip-flops in the shift register have presetting circuitry similar to that described earlier for binary counters, then the shift register can be loaded with a parallel binary number. Once the shift register is preset with the parallel number, shift pulses will shift the word out a bit at a time. That creates a serial version of the parallel input word. Thus, the shift register accomplishes parallel-to-serial data conversion as that shown in Fig. 17B.

Like counters, shift registers are available as prepackaged circuits in a variety of forms. MSI devices with four and eight bits are common. Those feature preset, clear, shift right or shift right and left. Larger shift registers can be created by simply cascading available 4- and 8-bit devices. For example, a 32-bit shift register can be created by simply cascading four 8-bit circuits.

Very large LSI shift registers are also available for special applications. For example, a 256-bit shift register made with MOS circuitry is available for memory applications. Such a register is not used to store a single 256-bit word. Instead, it is used to store many smaller words. For example, a 256-bit shift register can store $256 \div 8 = 32$ bytes. Those bytes are retained in the shift register flip-flops end to end as illustrated

(Continued on page 105)

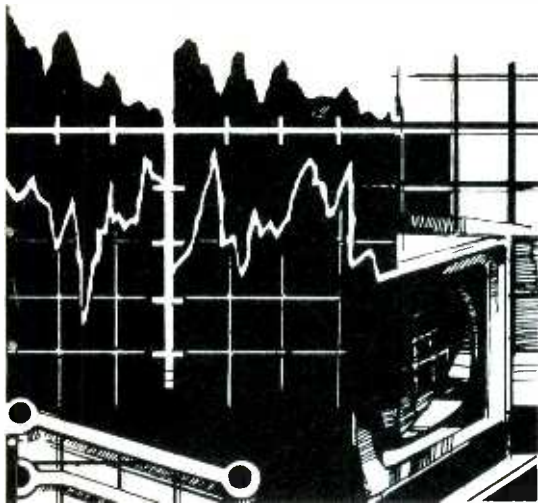

INSIDE THE OSCILLOSCOPE

Using the oscilloscope is not difficult when you know how! We look at some simple application rules that will help you get almost all scopes up and running in no time.

By Marge Gustafson*, Larry Johnson*, and Carl Laron**

ONE OF THE things you can own. If you are familiar with oscilloscopes, you are using one of the most powerful tools in the electronics industry. To the experienced user, the oscilloscope is not a complex piece of electronic equipment. In fact, there is a simple rule of thumb currently

of the rules of thumb techniques that can be used to get an oscilloscope up and running. These are more sophisticated and more sophisticated techniques for success.

When you are familiar with the unit, the first step is to warm up the unit. An important purpose of the warm-up is to bring the unit to a minimum when it gives you a familiar and familiar feel. It is important to understand the idiosyncrasies of the unit and head

time and head scratching later when you get down to work. But surprisingly, that step is often overlooked, especially by so-called *experienced* users.

Once the unit has warmed up sufficiently, the next step is to obtain a trace. Be sure that the trigger mode is set to *AUTOMATIC* and the trigger source is set to *INTERNAL*. Then select a medium sweep speed, using the *TIME-BASE* control (often labeled *TIME/DIV*, or something similar). Set the *HORIZONTAL* and *VERTICAL* trace-position controls to about *midrange*, and adjust the *INTENSITY* control until the trace appears. If at full intensity no trace appears, see if one edge or another of the CRT appears lit, or glowing slightly. If so, that gives an indication that the trace is positioned off-screen in the direction of the lighting. Use the *LEFT-RIGHT* and *UP-DOWN* position controls to move the trace so that it can be seen near the center of the display.

If you can not find the trace by using that technique, the following systematic approach can be used. Set the *HORIZONTAL* position control fully counterclockwise. Now, rotate the *HORIZONTAL* control a small amount in the clockwise direction and then rotate the *VERTICAL* control through its entire range. (Rotate the *VERTICAL* control slowly or the trace may shoot across the CRT display screen too rapidly to be seen.) Repeat that procedure until the trace is located.

Displaying a Waveform

Once the trace is obtained, set the position controls such that the trace is centered vertically and begins at the left side of the CRT. Obviously, if a waveform is to be displayed, a signal must be input to the scope. That is done (usually) via a front-panel, vertical-input connector. Next, depending on the type of measurement you are making, the *VERTICAL INPUT* switch should be set to the appropriate setting: *AC* or *DC*. Set the vertical attenuator control (labeled *VOLTS/DIV*, or something similar) so that the entire waveform can be displayed over one-half to three-quarters of the screen height. If you are unsure about the amplitude of the input signal, select the highest attenuation setting.

Once the trace is displayed, the *TIME-BASE* control should be set so that a few cycles of the input waveform can be seen. Note that the trace may not be stable at this time. If not, the triggering level control will need to be adjusted to lock in the display. For accurate measurements, be sure that both the *TIME-BASE* and the *VERTICAL-ATTENUATOR* controls are used in their calibrated modes.

Triggering

Most scopes have two triggering-mode switch settings: *AUTOMATIC* (or *AUTO*) and *NORMAL*. Automatic triggering is the most frequently used setting. In that mode, a trace is displayed even when the signal level is too low for triggering.

In the *AC-coupled*, automatic-trigger mode, a trigger signal is generated when the displayed waveform passes through the 0-volt point of the *AC* portion of the input waveform. Because of that, the automatic mode is not usually appropriate for low-frequency work; if the frequency of the input signal is below that of the oscilloscope's baseline generator, that generator cuts in between cycles of the displayed waveform.

When the *DC-coupled* automatic-triggering mode is used,

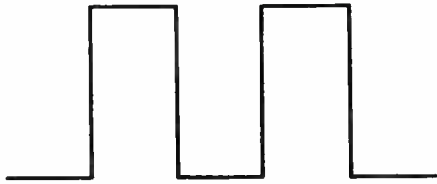

A



B



Fig. 1—When DC-coupled, automatic triggering is used, it is important that the displayed waveform cross the 0-volt line. Otherwise, (as shown) untriggered operation will result.

Fig. 3—Oscilloscopes display peak-to-peak voltages. AC voltmeters provide rms measurements.

Fig. 4—In the AC-coupled mode, there is no way to be sure that the baseline of the displayed waveform (A) is actually 0-volts. In B, the DC-coupled mode has been selected; there the signal shown in A can be seen riding on a DC voltage of 3. (Note the change in the VERTICAL ATTENUATOR settings.)

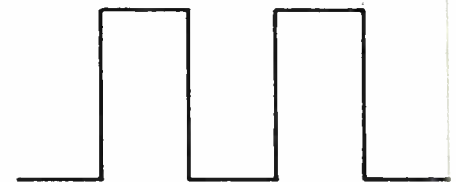
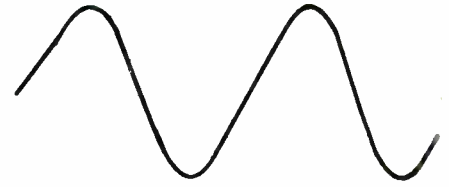

A



B

Fig. 2—On a dual-trace scope, assuming that the two signals are time related, use the channel with the lower frequency signal as the triggering source.

the trigger signal is generated when the signal passes through an imaginary line on the display representing 0-volts (usually the center of the screen). Note that it is important to be sure that the waveform *does* cross through that line or an untriggered display will result. See Fig. 1. The positioning of the trace can be altered by using the VERTICAL position control to ensure that triggering does occur.

Whether triggering takes place on the leading or trailing edge of the waveform is determined by the SLOPE control.

Normal-mode triggering is used when proper triggering can not be obtained using the automatic mode. That could occur with complex input waveforms, or waveforms that are near the upper and lower frequency limits of the scope. It is also used when triggering at a specific point (other than the 0-volt crossing point) is desired.

Using a Dual-Trace Scope

Dual-trace scopes can operate in either the alternate or chopped mode. In some scopes, the selection of the display

mode is automatic, but in others the decision is left to the operator. Which display mode is best to use will, of course, vary with the time base selected and with the scope. As a general rule-of-thumb, however, use the chopped mode at time-base lengths of less than 1 millisecond, and the alternate mode at 1 millisecond, and faster.

Usually, dual-trace scopes can be triggered from either channel 1 or channel 2. If the inputs to the two channels are time-related (have the same phase) but are of different frequencies, the channel with the lower-frequency signal should be used for triggering. For example, Fig. 2 shows a dual-trace display. The upper trace is the clock signal being input to a BCD counter. The lower trace is the output of that device. There, triggering would be selected to be on the trailing edge of the lower waveform. Selecting the triggering in that way ensures that there will be only one sweep for each output pulse.

Also, some dual-trace scopes have composite triggering. In that type of triggering, the trigger signal is derived from

both channel 1 and channel 2; as the display alternates between channel 1 and channel 2, so does the trigger source. The result is that both signals are solidly locked in, despite any differences in phase or frequency.

Making Measurements

Now that we have a locked in (i.e. triggered) waveform displayed on the CRT, we need to interpret what it is we are seeing.

Consider the display shown in Fig. 3. In it we see a sine wave. To obtain the AC voltage of the waveform, we need only count the number of divisions between the positive and negative peaks of the signal and multiply that by the VERTICAL ATTENUATOR setting. For instance, if the attenuator were set at 2-VOLTS-PER-DIV, the voltage of the signal shown in Fig. 3 would be 8-volts.

But what kind of AC voltage are we measuring? Readings obtained using an AC voltmeter are *rms* (root mean square). But oscilloscopes can not measure *rms* voltages directly; the waveform observed on an oscilloscope is peak-to-peak. For a sine wave, the two quantities can be related to one another through the equation

$$V_P = 1.414V_{RMS}$$

For a square wave, the peak-to-peak and *rms* values are identical. For more complex waveforms, more complex relationships exist.

We can use DC coupling to allow an oscilloscope to measure DC-voltage levels. Consider the waveform shown in Fig. 4A. Assuming that the vertical attenuator is set for 10-mV-PER-DIV, and AC coupling is selected, it shows a 40-mV peak-to-peak square wave. However, there is no way to know whether the baseline is actually zero volts.

In Fig. 4B the same signal is shown; but there DC coupling is selected, which reveals that the AC signal is superimposed, or *riding*, on a 3-volt DC voltage. (Note that the vertical attenuator has been reset to 1-VOLT-PER DIV.) The 0-volt line had been previously established as the fourth (middle) line of the graticle (using the GROUND position of the INPUT COUPLING switch).

Oscilloscopes are also used to measure the period (directly) and frequency (indirectly) of a waveform. The period of the waveform is easily found by counting the number of divisions each cycle occupies and multiplying that by the setting of the time base. For the triangular wave of Fig. 5, assuming that a time base of 5-MS-PER-DIV has been selected, the period is simply 20 milliseconds. Since the frequency is simply equal to 1 divided by the period, here it is equal to 5



Fig. 5—Oscilloscopes can be used to determine the period (directly) and the frequency (indirectly) of waveforms displayed on the screen of the CRT.

kHz. When calculating the period or frequency of a waveform, be sure to take into account the effect of a magnifier, if used.

X-Y measurements

The X-axis of an oscilloscope display need not necessarily be time. Many oscilloscopes have an X-Y mode in which one of the input channels is applied to the horizontal amplifier. What is the use of such a mode? Well, one popular use is to measure frequency and phase using *Lissajous* patterns. A Lissajous pattern is the pattern that is generated when a sine wave of one frequency is plotted against the cosine wave (a sine wave that is shifted 90°) of another. Studying those patterns can reveal the frequency and phase relationships of the two signals. Several simple patterns are shown in Fig. 6.

The most basic of those patterns, the circle of Fig. 6A, can be used to determine an unknown frequency. The circle is generated when the frequency, amplitude, and phase of the two input signals are identical. The technique is simple: a frequency generator output is fed to one amplifier, say the vertical one, while the unknown signal is applied to the horizontal amplifier. The output of the generator is varied until the perfect circle is formed. The frequency can then be determined from the generator's settings.

Common Errors

Because an oscilloscope can be among the most complicated test instruments to operate, errors are often made in its use. As is usually the case, those errors are unnecessary.

Most errors are caused by incorrect assumptions. For in-

(Continued on page 108)

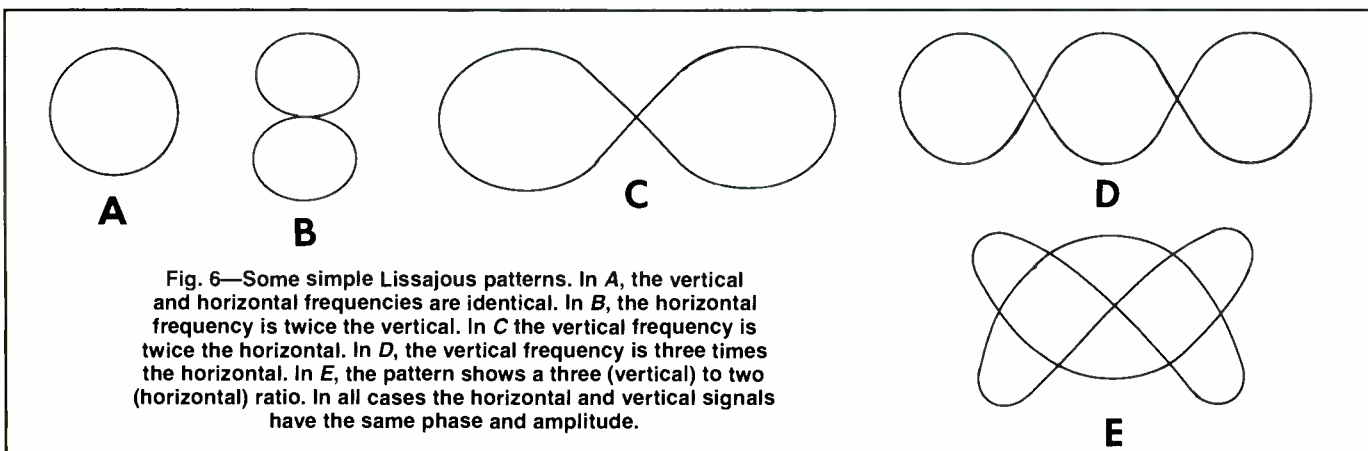
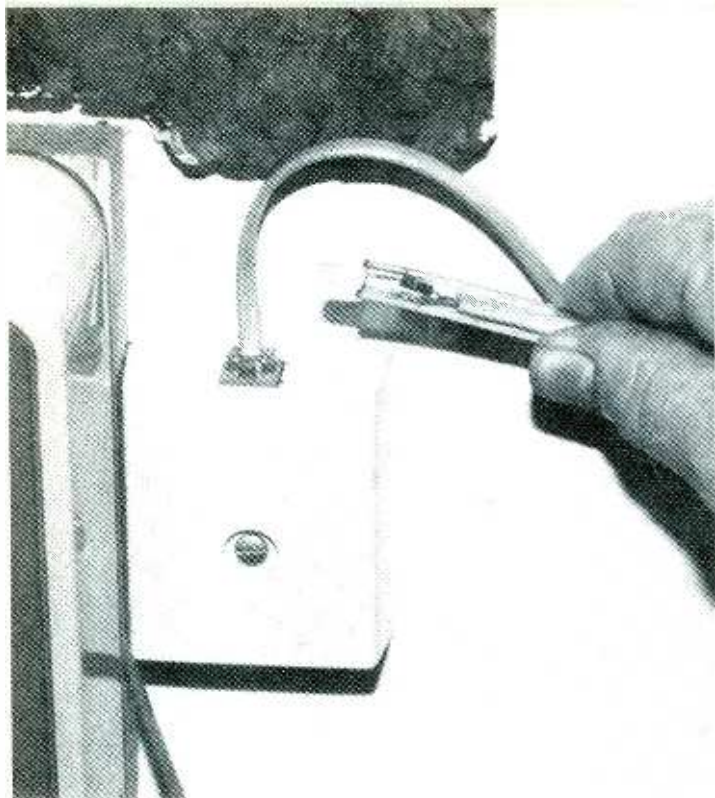

Fig. 6—Some simple Lissajous patterns. In A, the vertical and horizontal frequencies are identical. In B, the horizontal frequency is twice the vertical. In C the vertical frequency is twice the horizontal. In D, the vertical frequency is three times the horizontal. In E, the pattern shows a three (vertical) to two (horizontal) ratio. In all cases the horizontal and vertical signals have the same phase and amplitude.



QUICKY TELEPHONE- LINE TESTER

Getting telephone service restored is a snap when you know who to call—this simple tester points you in the right direction.

By Herb Friedman

□ WITH ONE BOLD STROKE OF A PEN, OUR GOVERNMENT broke up Ma Bell and created a multitude of problems for the consumer. Unfortunately, one of the disastrous effects of that so-called "victory" is that responsibility for repair of telephone equipment has been foisted on the subscriber. Now your local telephone company handles only repairs to the line itself, while what's left of Ma Bell takes care of the instrument itself—provided that you rent your equipment from them. (If you don't rent from them, it's "tough luck, fella.")

Essentially, you end up playing Russian Roulette when your phone doesn't work. If you call in the wrong outfit, you can be stuck for a "service charge" of about \$50 or more and still not get your service restored, because, as they say, "It's not my job." The problem has become so bad that there's been a rush of test equipment to the marketplace to help both users and TV service technicians do telephone repairs.

Unfortunately, "professional" test equipment often costs more than a new telephone, yet it doesn't do much more than our Quickie Telephone-Line Tester, which, incidentally, can be built for just a few dollars.

About The Circuit

The Quickie Tester—which consists of only two electronics components (see Fig. 1)—tests the polarity of the telephone jack's wiring, the presence of sufficient voltage to run the telephone, the telephone's "off-hook" loading (to determine if the telephone is really connected), and ringing voltage. To use the device, you need only plug it into a telephone's modular jack. If the jack is wired correctly, the Quickie Tester will emit a *green* glow. If, on the other hand, the jack's connections have been reversed, the tester glows *red*. Either way, if the tester glows the line is "alive."

If you want to check the telephone instrument itself, first install a two-set modular adapter on the wall jack. That adapter is available at most electronics parts outlets and variety stores—you'll even find them in supermarkets. Connect the Quickie Tester to one socket and the telephone to the

other. After the tester glows to certify the line is alive, pick up the telephone's handset (placing the telephone off-hook). If the telephone connects to the line, the Quickie Tester's glow will extinguish; if it doesn't, the telephone isn't connected to the line. (There is probably an internal problem in the instrument.)

To check the ringing voltage, you simply dial your local telephone company's *ring back* number and hang up the phone. If you don't know that number, ask a friend to call

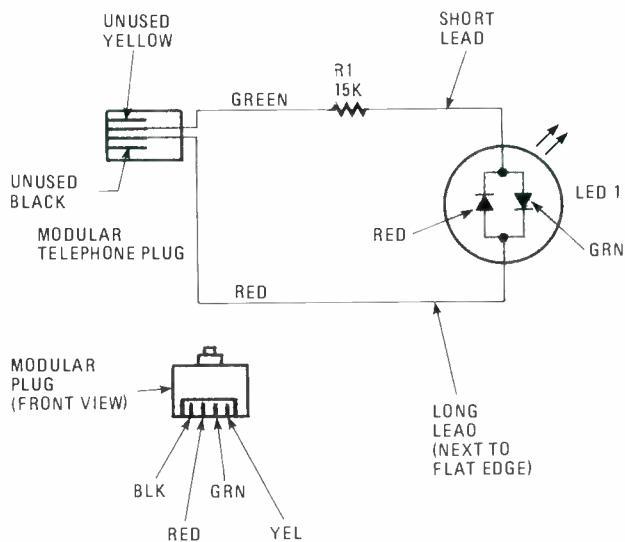
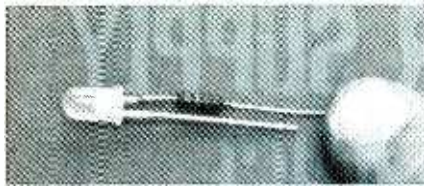
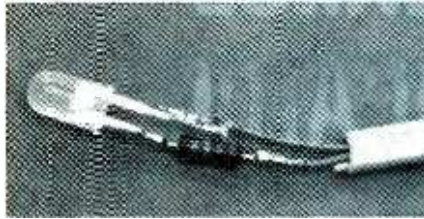

Fig. 1—The Quickie Telephone-Line Tester consists of only two components, a 15,000-ohm resistor and tri-color light-emitting diode. The tri-color unit is actually two LED's (red and green) housed in a single package that are connected reversed bias and in parallel with each other. Thus, when one is turned on the other is off. When an alternating current is applied, the two LED's alternately glow, giving the appearance of a third color (yellow).



Tack solder the resistor to the short lead of the LED.



Slip the plastic tubing over the modular cord, push it back out of the way, and tack solder the LED's long lead and the resistor. See Fig. 1.

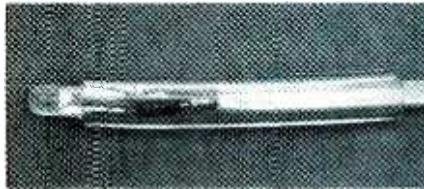

Slide the plastic tubing up to the LED. If it's loose, apply a drop of glue where the tubing meets the cord's insulation.

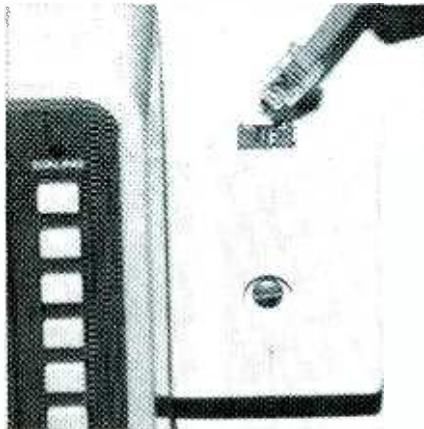

To use the Quickie Telephone-Line Tester just plug it into a modular jack. The LED's glow and color tells all is okay; well, maybe.

you. At the instant the phone is hung up the tester will glow. After a few seconds the tester will flicker intermittently, indicating that there is ringing voltage. If the phone doesn't ring in step with the flickering, or doesn't ring at all, the problem is most likely a defective ringer circuit in the telephone. In that instance, the easiest thing to do is simply borrow another phone and try again. If the new phone rings, the old phone is defective. If the new phone also doesn't ring, it's time to call the local telephone company—their ringing voltage might be too low.

Why Worry About Polarity?

A logical question is, "Why worry about the polarity of the jack's wiring? What does it matter if the glow is red or green?" Normally, polarity doesn't make any difference at all to a conventional telephone or to accessories like an answering machine. But some aftermarket equipment is sensitive to polarity: For example, some "conference" devices, which simply connect two telephone lines together, disable both lines if the polarity of one line is reversed.

In addition, some telephones may ring or "tick" when an extension on the same line goes "on-hook" (is hung up) if the polarity at one jack is reversed. Normally, the telephone installer should have wired the jacks so that the *green* wire is positive and the *red* is negative.

How It Works

LED1 is a Tri-Color light-emitting diode—which actually consists of separate green and red LED's in a single package and wired back-to-back (as shown in Fig. 1) so that a positive DC voltage causes the device to glow green, while a negative DC voltage causes a red glow. Resistor R1's value must be large enough so that the current produced by the 90-volt AC ringing signal doesn't overload the LED. And yet, R1's resistance value must be small enough so that the LED glows in response to the 48-volt DC line voltage. A 15,000-ohm unit is capable of handling both situations.

The reason the glow extinguishes when a telephone is connected to the line is that the telephone represents a load of approximately 200–250 ohms, which causes the line voltage to drop to about 5 volts. Part of the reason for R1's 15,000-ohm value is to drop the current to the LED so low at 5-volts DC that the glow is too dim to be seen; thereby, serving as a test that a telephone has, in fact, been connected to the telephone line.

Similarly, if you want to check an extension telephone, simply connect the tester at one jack and pick up the extension phone in the other room. The tester's glow should extinguish when the extension goes off-hook.

Construction

There is absolutely no sense in turning the Quickie Telephone-line Tester into an expensive project by using a fancy cabinet and construction. The "pocket-tester" assembly shown in the photos will work just as well as anything else, and it will fold neatly into a short pocket; it's built that way. The shorter lead of the LED—the one that's not adjacent to the "flat" edge of the LED itself—is cut to $\frac{1}{4}$ of an inch. The long lead, the one adjacent to the flat edge, is cut to a $\frac{1}{2}$ inch. Then, cut one lead of a $\frac{1}{4}$ -watt, 15,000-ohm resistor to a $\frac{1}{4}$ inch, and tack-solder the resistor to the LED's $\frac{1}{4}$ -inch lead.

Cut the other resistor lead to a quarter of an inch after the soldering. (You'll need the extra lead length to hold the resistor in position when soldering.) Now, cut a length of salvaged modular telephone wire to about 12 inches, strip off the outer insulation on one end to three-quarters of an inch, and clip off the black and yellow wires at the insulation. Strip a quarter-of-an-inch of insulation from the red lead and tin (coat with solder) the bare wire. Cut the green lead to $\frac{3}{8}$ of an inch and strip away a $\frac{1}{4}$ inch of insulation.

PARTS LIST FOR THE QUICKY TELEPHONE-LINE TESTER

LED1—Tri-color light-emitting diode (Radio Shack 276-035 or similar)

R1—15,000-ohm, $\frac{1}{4}$ -watt, 10% resistor

Modular cable, plastic tubing, solder, etc.

Next, slip a 2-inch length of $\frac{3}{16}$ -inch diameter clear plastic tubing (which costs about 12-cents per foot at local hardware stores) over the wire, and push it down and out of the way. Tack solder the red wire on the free LED lead directly opposite the body of the resistor, and then tack solder the green wire to the resistor and trim. If done correctly, both wires are insulated from each other by the resistor—there should be no need to use tape or spaghetti. Finally, slide the plastic tubing up the wire to the LED.

It takes about 15 minutes to assemble the device, yet it can easily save a \$50 service charge the next time your telephone fails to work. ■

POWER SUPPLY BALANCE INDICATOR

By J. Daniel Gifford

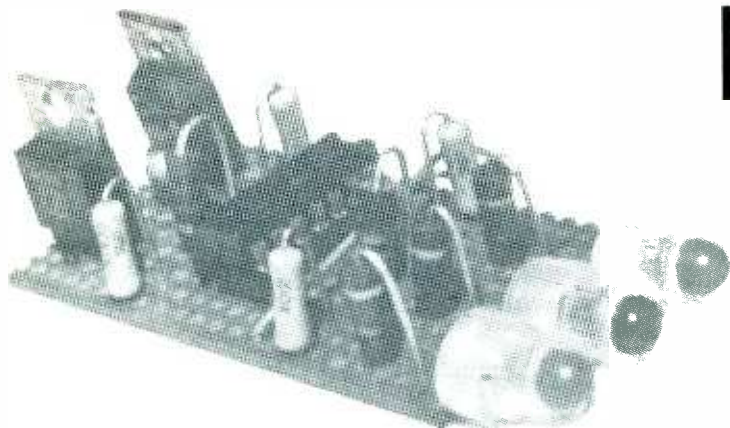

If you're into circuit testing or design using integrated circuits—which often require precision, split-power supplies—then this little balance indicator is for you.

□ A SPLIT POWER SUPPLY, ONE WITH BOTH POSITIVE AND negative outputs, is often a necessity when working with many types of linear or digital integrated circuits. Most such IC's and their surrounding circuits require that the two halves of the supply be equal to each other within a few percent. When you test or design such circuits, if the positive and negative supply levels differ by a significant amount, the circuit can malfunction or even self-destruct. The "significant amount" is a function of the IC's characteristics that appear in the part's specification sheet prepared by the manufacturer.

Unless you are fortunate enough to own a split-power supply with a precision meter for each side, you know that it's difficult to get and keep both sides in perfect alignment. You must either rely on a single, built-in meter switched between the positive and negative outputs, or use a digital multimeter (DMM) or volt-ohm meter (VOM) to carefully set each level. Both methods are clumsy, and neither one gives any warning of shifting voltage levels. Your first indication of a power-supply imbalance could be a strange odor, or smoke coming from an integrated circuit!

The Power Supply Balance Indicator is designed to be an inexpensive quick fix for that problem. Its small circuit board and three LED's can be tucked into a corner of even the most compact power supply; and its operation is automatic and adjustment-free.

The only visible part of the Indicator are the three LED's, which can be mounted anywhere on the power supply's faceplate. The operation of the circuit is simple: When the positive supply is set to a higher level than the negative, the yellow " + " indicator, LED1, will light. When the negative supply is set higher than the positive, the yellow " - " one, LED2, will light. When the two supply-voltage levels are within 1% of each other, both LED1 and LED2 glow, indicat-

ing a balanced output. If either one differs from the other by more than 10% a red WARN light-emitting diode, LED3 will light to tell you there's potential trouble.

How it Works

At the heart of the Power Supply Balance Indicator, there are two comparator pairs from an LM339N quad comparator. One set of comparators drives the yellow positive (+) and negative (-) indicators; the other pair jointly drives the red WARN LED3. The circuit, shown in Fig. 1, draws its power from the unregulated portion of the power supply, which is regulated into a 30-volt supply for the circuit by U1 and U2, a positive and negative regulator pair. Although the LM339N "sees" 30 volts, the supply is actually +15 volts, since it straddles the power-supply ground. One input of each comparator is also tied to ground.

The four comparators get their switching inputs from two parallel resistor divider strings. Both strings have their ends tied between the power supply's positive and negative output terminals. The first string, consisting of R4, R5, and R6,

Fig. 1—The schematic of the Power Supply Balance Indicator. As you can see, there is very little to the circuit. Also, note that the schematic diagram specifies 28,000-ohm resistors for R1–R3. If those values are not readily available, simply measure several 27,000-ohm, 5% units until you come up with the necessary values.

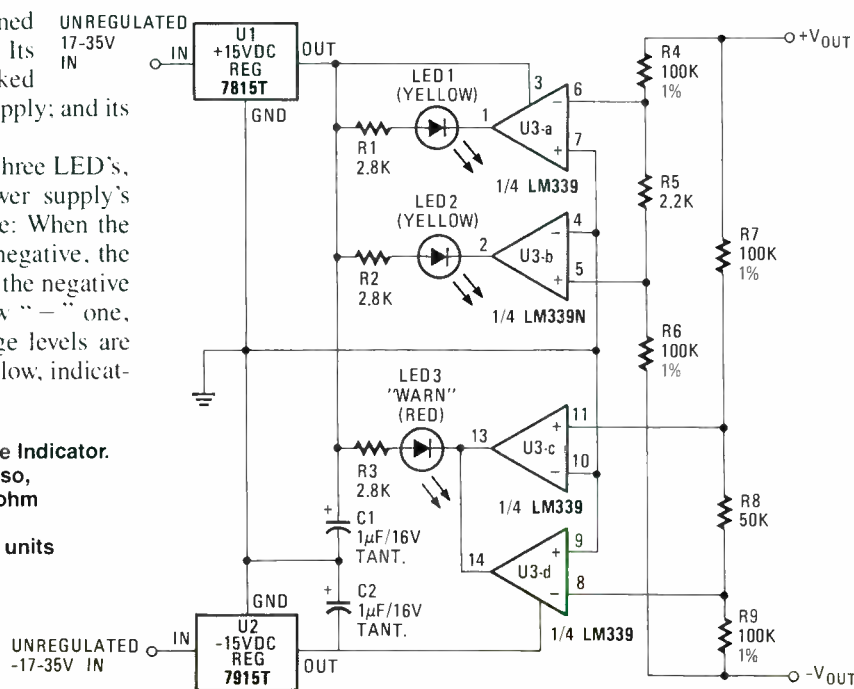

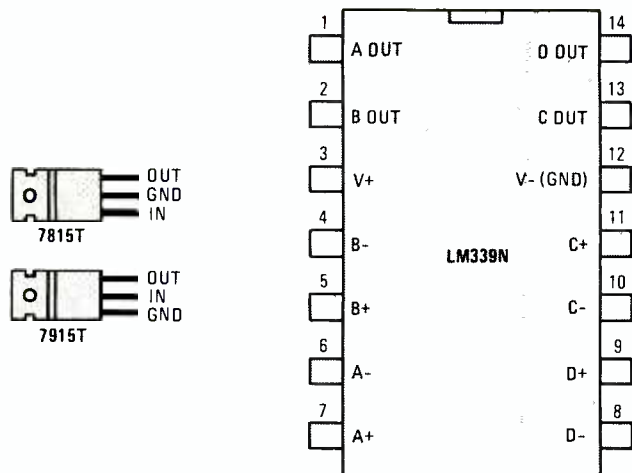

Fig. 2—The pinouts of the integrated circuit and the two three-terminal regulators used in the Indicator. Those units, in TO-220 packages, are rated for currents up to 1 ampere.

divides the input voltage in half, with output taps at 0.5%. The other string, made up of R7, R8, and R9, also divides the input voltage in half, with taps at +10%.

The 0.5% R4/R5/R6 string drives the two comparators controlling the positive and negative indicators (LED1 and LED2). Their inputs are crossed so that LED2 does not fire until the positive supply is at least 0.5% higher than the negative, and the positive indicator does not go off until the negative supply is at least 0.5% higher than the positive (in relative levels.) That overlap permits both LED's to be on when the two supplies are in 1% or better balance.

The +10% R7/R8/R9 string drives the other two comparators, which control the WARN indicator. If either side of the supply is 10% or more higher than the other, one of the two comparators will switch its output low and light the red LED3 (the LM339N has opened-collector outputs, allowing such wired-or connections.) The inputs are not crossed as with the other comparator pair, so there is a band in the middle where neither comparator's output is low so the LED remains off.

Note that the schematic diagram (Fig. 1) shows 28,000-ohm resistors used for R1-R3. While that value is standard in 1% units, it is not in 5% resistors. However, by measuring the actual value of several 27,000-ohm, 5% units, you are sure to get exactly what you need.

Construction

There is very little that is critical about the construction of the Power Supply Balance Indicator. It can be built on per-board using point-to-point wiring techniques (soldered or wire wrap) or you may choose to etch your own board; it's your choice. The pinouts for the integrated circuit and the two

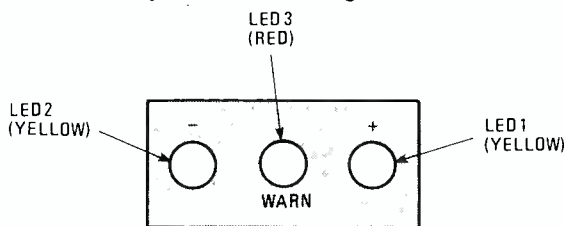

Fig. 3—The recommended layout of the indicator LED's; but if necessary, they may be arranged in any way that's convenient for you. Just be sure to observe the proper polarity when connecting them to the board.

regulators are shown in Fig. 2.

The two 15-volt regulators require at least two 17-volt inputs for proper operation. Since the Indicator has been designed for use with the most common 15-volt output type of power supply, that voltage should be available at the supply's unregulated portion. If the power supply output is less than 17 volts, the unregulated voltage probably will be lower, too. If that's the case, lower output regulators may be used in place of the 15-volt units. Most IC regulators require an input voltage of 1.5-2 volts greater than their rated output.

With higher power-supply output levels (up to about 30 volts), the 15-volt regulators may still be used; but the Indicator should not be used with power supplies that have more than 25-volt outputs, to prevent damage to the LM339N integrated circuit. Other than the voltage requirements, the only portion of the Indicator that is critical are the two divider strings.

The four 100,000-ohm resistors (R4, R6, R7, R9) are the backbone of the dividers and should have a tolerance of 1% or better. Resistors R4 and R6 are particularly critical, because imbalance between those two units would result in an erroneous balance indication from the indicator LED's. Therefore, that resistor pair should be matched as closely as possible. The 1% units need not be purchased: By measuring the actual resistance of several 100,000-ohm, 5% units, you can come very close to the specified value, with the two resistors well within 1% of each other. The other pair of 100,000-ohm units, R7 and R9, are not as critical, an unmatched tolerance of 1% will be adequate, but using the method those two units gives greater accuracy.

The circuit board of the Power Supply Balance Indicator can be mounted anywhere within the power supply where there is room. All of the components except the three LED's should be mounted on the circuit board. The positive and negative power inputs and the ground input should be connected to the power supply at the supply's filter capacitors.

The two inputs to the divider strings should be connected internally to the positive and negative output terminals of the power supply.

The three LED's may be mounted anywhere that is convenient on the power supply's faceplate. If the controls for the positive and negative sides of the supply are on different sides of the face, the LED's may be mounted on corresponding sides and wired to the Indicator board. If the controls are not arranged in that manner, follow the layout in Fig. 3. ■

PARTS LIST FOR POWER SUPPLY BALANCE INDICATOR

- C1, C2—1- μ F, 16-WVDC, tantalum capacitor
- LED1, LED2—Jumbo yellow or amber light-emitting diode
- LED3—Jumbo red light-emitting diode
- R1-R3—2.7,000-ohm, 1/2-watt resistor (see text)
- R4, R6, R7, R9—100,000-ohms, 1/2-watt, 1% resistor (see text)
- R5—2200-ohm, 1/2-watt resistor
- R8—50,000-ohm, 1/2-watt resistor
- U1—7815T positive 15-volt regulator (Radio Shack #276-1772)
- U2—7915T negative 15-volt regulator
- U3—LM339N quad comparator integrated circuit (Radio Shack #276-1712)

By Herb Friedman

ON COMPUTERS



FRIEDMAN

A hard-disk system can give your personal computer the power it needs to handle almost any large application program available!

□ WHILE THE DOUBLE-SIDED floppy disks that are common to the new generation of computers are generally more than adequate for single-application programs, modern multi-function programs are often so large that just the program itself—without its data files—can easily approach the capacity of the double-sided floppy disk. And even routine use of such software can require frequent time-consuming and annoying disk-swaps. From word processing to spreadsheets to CAD (computer aided design), much of the latest software requires on-line disk storage that's substantially greater than that of the conventional double-sided floppy disk. Although it is possible to attain such storage by using one or more high-density floppy disk drives such as the one used in the IBM PC/AT, a hard disk provides a more practical and cost-effective answer to greater on-line disk storage for conventional personal computers.

A Magnetized Surface

Hard disk is a generic term for any kind of mechanism that uses a rigid metallic disk with a magnetic coating. As far as the user is concerned it doesn't make any difference what the specific coating material is as long as it can store magnetic information in the same manner as a conventional floppy disk. Although there are several different kinds of hard-disk mechanisms on the market, because of their reliability and unusually low retail price, the most popular is a design known as a *Winchester*. Winchester is IBM's internal code name for the particular mechanism when it was being developed.

More Storage

Hard-disk drives provide greater storage capacity because of the way in which the device is built. Because the disk is rigid, it has a more precise surface in relationship to the read/write head, which permits a denser track count. And for the same reason, it can be rotated at more than ten times the speed of a floppy disk. Since the amount of magnetic information that

can be written to a disk is proportional to the speed of the disk, the hard disk can store more data per unit of track than a floppy.

The most modern conventional (sealed) hard-disk drives generally contain one or more internal disks. As a rule of thumb, the latest and most cost-effective designs can store 2.5 MB (megabytes) per side, or 5 MB per disk. A 5-1/2 inch hard-disk mechanism providing 10 MB of storage usually has two disks: A 20 MB drive generally has four disks, etc. The figures 2.5 MB, 5 MB, etc. refer to the amount of user storage. In fact, the disks are capable of slightly more than their rated capacities, but some of the disk's storage capacity is required for *formatting*—formatting being data that must be on the disk for the hard-disk system to work.

Often, you'll see a hard disk advertised

as having "11 MB of storage: 10 MB formatted," meaning that the blank disk (which can't possibly be used as is) can store 11 megabytes. But after the disk(s) is formatted only 10 megabytes are available to the user. That's because an unformatted disk cannot be used by the typical applications-oriented personal computer user. Only the formatted capacity is available for user storage. Because some of the formatting data is common to all the disks in the drive, the storage progression is not necessarily linear. A particular family of hard-disk drives might be available in storage capacities of 10 MB, 20 MB, 42 MB.

Hard Disk Cartridges

Although the most commonly used hard-disk drives have the magnetic disks sealed in some manner so they are pro-

(Continued on page 104)



Hard disk drive units come in all shapes, sizes, and configurations. This assortment of 5-1/4 inch drives are from a single manufacturer, and are designed for use with a single computer, an IBM-compatible. There is at least one hard disk unit available for every conventional personal computer.

Identify IC's

(Continued from page 38)

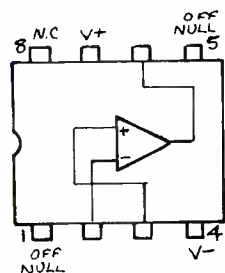
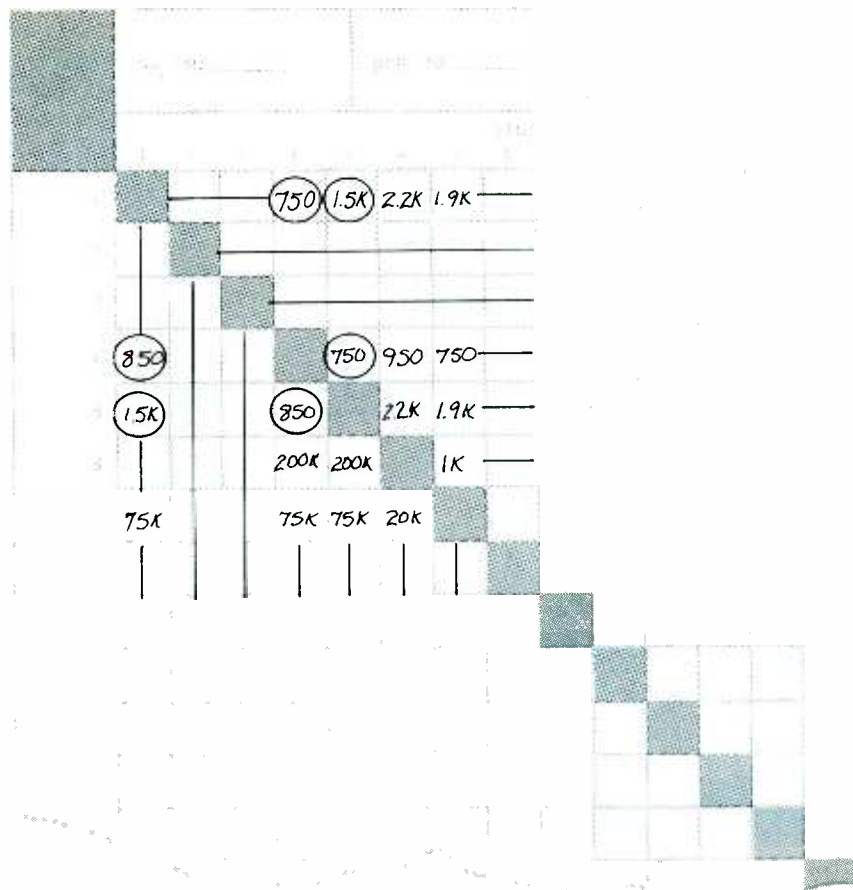

Fig. 5—Linear devices can also be identified using the signature chart. This completed signature chart reveals the signature of a 741 op-amp IC.



Those techniques work on linear, as well as digital devices.

For example: A signature of an 8-pin DIP 741 op-amp is shown in Fig. 5. Note that the low-resistance row still identifies the substrate, $-V$, for an op-amp, and also that the lowest reading in that row identifies $+V$. The only other uncircled reading in row 4 is 950 ohms in column 6, identifying pin 6 as the output terminal.

The 741 8-pin DIP op-amp has nominal 1000-ohm resistors from each offset-null terminal to $-V$. The circled resistances in Fig. 5 illustrate some interesting facts about IC resistors: They do not always read the same in both directions—750

ohms one way, 850 ohms the other (pins 1 and 4, and 5 and 4), and they may deviate quite a bit from nominal 1000 ohms given in *spec* sheets. Nevertheless the offset-null-terminals are clearly identified.

The op-amp inputs are almost impossible to identify from a signature, but the information already obtained is enough to identify the IC in the data books.

The alert electronics experimenter uses all the clues he can get, using the test equipment he has on hand. But when there aren't any advance clues—when there is no PC board, or when there are no partial markings to go by—then the only alternative you have to go on is the IC signature. ■

WHAT MAKES THE IC SIGNATURE POSSIBLE

Practically all IC outputs, linear or digital, are formed from transistor collectors. All NPN collectors are embedded in a P-type substrate that is designated ground ($-V$ for linear IC's). As shown in the accompanying diagram, the collector substrate forms a PN junction that, like any other

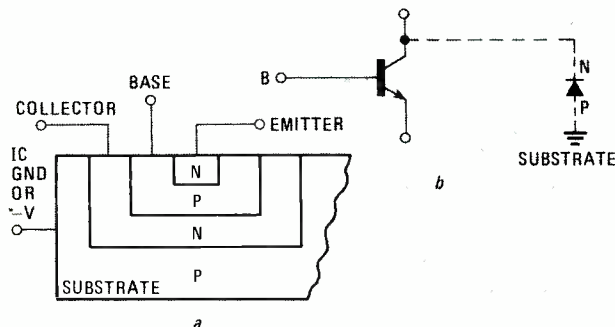

diode, conducts well in one direction and poorly in the other.

Connecting an ohmmeter from substrate to collector in the forward direction (positive lead to substrate) will cause the ohmmeter to indicate between 500 and 900 ohms. Other diodes in the same IC will read between 950 and 1300 ohms. Actual resistance values will vary with the type of ohmmeter and the degree of doping in the IC, but the IC outputs will always give the lowest readings.

Thus it is possible to locate every output terminal on an IC. The row containing all those low-resistance readings will be the ground ($-V$) row.

In every IC there are usually several transistors whose collectors are connected to V_{cc} either directly or through some resistance, when reading forward resistance from substrate to V_{cc} ($+V$ in linear IC's), that multiplicity of paths will give a lower reading than any other terminal on the IC.

Thus it is possible to identify the V_{cc} terminal.

Telephone Remote/Control System

(Continued from page 79)

2. Dial 2 (first number of the access code).
3. Dial your pre-programmed access code.
4. Dial 9 (all lights on).
5. Place telephone on-hook.

Let's turn all the control modules off!

1. Perform steps 1 through 3 above.
2. Dial 0 (off).
3. Dial 9 (all control modules).
4. Place telephone on-hook.

Let's turn device 1 (could be any appliance or lamp you

so designate) on, then device 3 off!

1. Perform steps 1 through 3 above.
2. Dial 1 (device 1 on).
3. Dial 0 (off).
4. Dial 3 (device 3).
5. Place telephone on-hook.

NOTE: Steps 2 through 4 should be performed within 15 seconds after step 1.

That's all there is to it! Your Telephone Remote/Control System is up and running, and so are your BSR remote control modular and switches throughout the house. ■



- ★WHAT TO KNOW BEFORE YOU BUY
- ★SATELLITE-TV BASICS
- ★ALL ABOUT SATELLITE-TV DISHES
- ★TURNKEY SYSTEMS
- ★HOW TO INSTALL A TVRO SYSTEM
- ★SATELLITE-TV...



**UPDATED EDITION
Just Off Press!
Reprints Now Available!**

Don't miss out again!

Send away today for your 48-page booklet containing a complete reprint of all seven articles in the series on Backyard Satellite TV Receivers by Robert B. Cooper, Jr.

This all-inclusive report gives you all the data you need to build your own Backyard Satellite TV Receiver.

- TELLS ALL ABOUT domestic satellite communications, with full details on how you can pull those elusive TV signals from space.
- LEGAL REQUIREMENTS, technical

specifications, and how you, the home constructor, can meet them. Find out what mechanical and electronics skills you need.

- RECEIVER CHARACTERISTICS, technical details and specifications, along with examples of actual receivers built at comparatively low cost
- ANTENNA DESIGN... and exactly how you can build a spherical antenna, while keeping total earth-station cost for the complete system under \$1,000.
- THE FRONT END is critical when you build your own system. We help you explore several different approaches to

making one that will work for you.

- RECEIVER-SYSTEM hardware, and how it goes together to bring you direct-from-satellite TV reception in your own home.

To order your copy:

Complete coupon and enclose it with your check or money order for \$7.00, plus \$1.00 for postage and handling. We will ship your reprint within 6 weeks of receipt of your order. All others add \$4.00 for postage. New York State residents must add 58c sales tax.

Jensen on DX'ing

(Continued from page 22)

nels below 6 MHz (megaHertz). With reception generally limited to the hours of darkness, the higher static levels, co-channel interference from other stations and, in short, tougher reception conditions, SWLs often tend to avoid those bands.

Finally, while some of the major stations in South America have English language programming, most broadcasts are in Spanish or Portuguese.

Still, if you're bold enough to try, you'll find much listening enjoyment—particularly in the musical offerings, and some exotic catches among those stations.

To get started, if you've been avoiding Latin America DX'ing thus far, here are some stations to dial. Some have English broadcasts; some don't.

Almost as sure as death and taxes is the likelihood that one of your first South American loggings will be HCJB, the *Voice of the Andes*, in Quito, Ecuador.

HCJB is a religious station which has been on shortwave since the 1930's. It was my very first SW logging back in 1947, so it retains a special place in my memories. Signals are strong and there are plenty of English broadcasts. You can find HCJB on several frequencies, including 9,745 kHz and 15,155 kHz during the evening hours in North America.

You may enjoy, "Passport," at 0100 GMT/UTC, an English show which focuses on South American features, music and news, plus some religious items. It is broadcast each weeknight.

Also with an English schedule is the government station in Buenos Aires, Argentina. RAE, *Radiodifusora Argentina al Exterior*, has English programs daily on 9,690 kHz and 11,710 kHz from 0100 to 0200 and from 0400 to 0500 GMT/UTC.

From Brazil, the English programs from *Radio Nacional Brasilia*, or *Rádiorabras*—are, it is reported, an endangered species. Brazilian government funding is at a bare minimum. But as of this writing, the schedule included programming at 0200 GMT/UTC on 11,745 kHz, and, at

(Continued on page 104)

<p>Radio Electronics</p> <p>Satellite TV Reprints 45 East 17th Street New York, N.Y. 10003</p>	Please Print	
	(Name) _____	
I want _____ reprints (at \$7.00 each, plus \$1 for handling & First Class postage.)	(Street address) _____	
I have enclosed \$ _____ N.Y. State residents must add sales tax. (U.S. and Canada only)	(City) _____	(State) _____ (Zip) _____

Adjustable Timer

(Continued from page 52)

installed according to the layout obtained from the paper record (or the breadboard) and soldered in place on the pre-etched board, you end up with a neatly assembled printed circuit. And the paper overlay can be filed away for future use should you decide to duplicate the circuit.

With the values shown for R1, R2, and C1, the timer will have a range of from 0 to about 30 seconds. The range can be either increased or decreased by changing the value of C1. The duty cycle may be altered by varying the value of R2, but that shouldn't be necessary under most conditions. As will be evident, the output at pin 3 will remain low when the circuit is in the reset state. Upon pressing the START button, S1, the output will go high and remain at that level until it has timed out; then, it will once more return to a low. That low-to-high transition (or pulse) may be used as a keying signal for operation of some peripheral circuit or equipment.

The capacitors designated as C2 and C3 are somewhat optional. However, they are recommended for best overall operation. Stray signal pickup may be introduced into pin 5 if it is left unbypassed. If C3 is omitted and the power-supply bus is not too stable, the pulses from the timer may find their way back onto the common supply lines and into other circuits being supplied by that potential. The values of C2 and C3 are not critical; however, for C2, the manufacturer recommends a 0.01- μ F unit—but for C3, almost any small electrolytic available to you that's in the range indicated in Fig. 1 should do just fine.

Boxing Time

If you intend (after experimenting with the circuit) to build the Adjustable Timer into a permanent adjunct to your test

bench, it is suggested that it be placed into a suitable enclosure. There is very little reason to use a metal case unless, of course, you just happen to have one handy; otherwise, any small box or chassis may be used. Regardless of the type of box that you choose, it should have some form of front panel on which to mount the time-selection dial (potentiometer R1), the two pushbutton switches, and the status lamps.

If such construction is decided on, a small toggle or slide switch should also be used to disconnect the battery when not in use. By the way, even though a 6-volt battery is suggested, there is little reason why a 9-volt unit cannot be substituted, as the frequency of oscillation (timing) is almost entirely independent of battery potential. You may, however, want to check to make sure that the light-emitting diodes are not passing too much current.

When mounting the time-adjustment potentiometer, R1, a pointer type knob should be affixed to the shaft. A stopwatch or other timer may be used to check the time at each individual position the control will represent. Mark major portions such as 1 second, 10 seconds, etc. until you have enough markings to be able to make use of the timer for the intended application. In general, the better the quality of the capacitor used for C1, the more useful the time settings become. For just experimenting, one of the poorer quality units, having a 20-percent tolerance, is fine. But if you are serious about using the unit for testing, or in some application where timing is all important, then you may want to consider a tantalum capacitor.

The Adjustable Timer circuit has been built several times from scratch and has never failed to operate the first time. One word of caution, though! If the unit does not start timing immediately, make sure that R1 is not set to the extreme low end of its range. No other special precautions are needed. ■

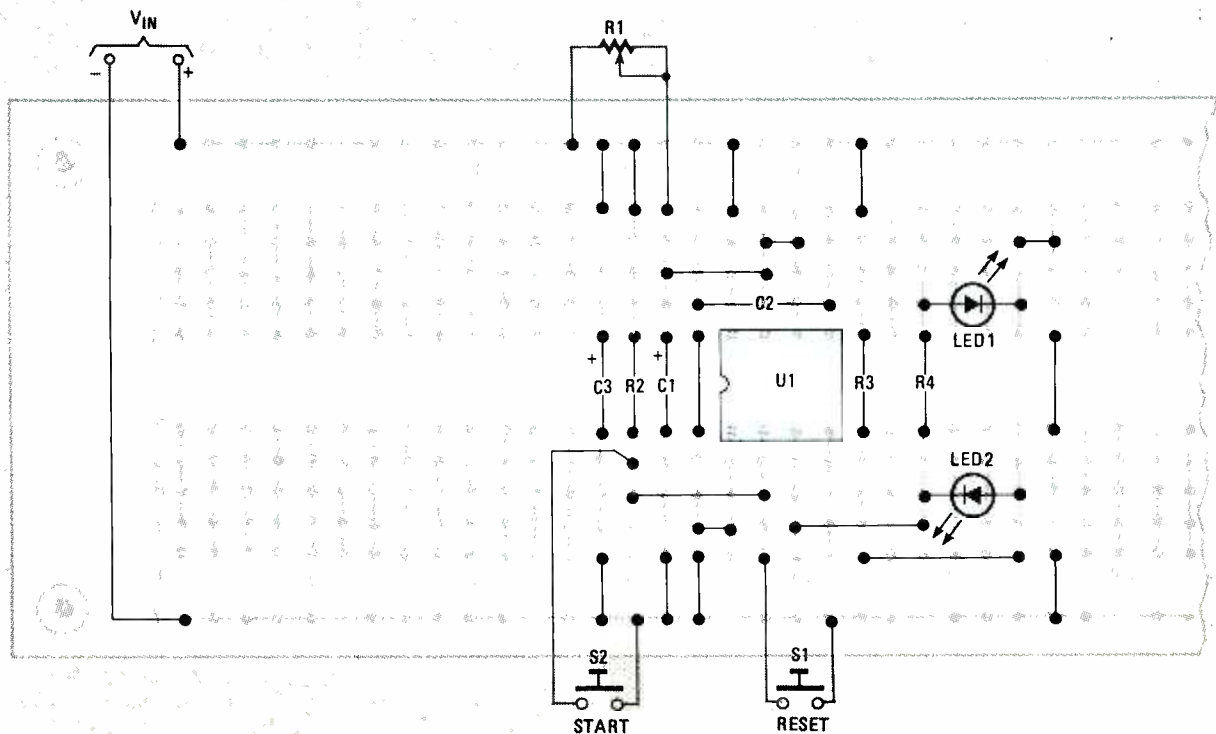

Fig. 2—The construction of the circuit is simplified by the use of a pre-etched experimenter's board. The layout is not critical and any arrangement convenient may be substituted.

(Continued from page 102)
1800 GMT/UTC on 11,955 kHz.

There are plenty of privately owned Brazilian SW stations. In fact, Brazil is one of the most "radio-active" countries, in numbers of stations, on shortwave. Programs are, of course, in Portuguese.

Several stations to look for during the late afternoon and early evening hours are: *Radiodifussora Macapa*, 4,915 kHz; *Radio Inconfidencia*, 6,000 kHz; *Radio Aparecida*, 6,010 kHz; *Radio Clube Paranaense*, 6,045 kHz; *Radio Universo*, 9,545 kHz; *Radio Guaiba*, 11,785 kHz;

Radio Globo, 11,805 kHz; *Radio Bandeirantes*, 11,925 kHz, and *Radio Record*, 11,965 kHz.

From Colombia, one of the strongest and the most consistent signals is that of *Radio Sutatenza*, operated by a Roman Catholic agency, although its programming is not typically religious in tone. You'll find that Spanish-language station quite easy to hear since it is all alone on its 5,095 kHz frequency most of the time, mornings and evenings.

Radio Nacional de Chile from Santiago operates on two shortwave frequencies,

currently 9,550 kHz and 15,140 kHz. Its daily schedule runs from 0930 until 0330 GMT/UTC, and it has been heard recently in Spanish about 0100 GMT/UTC with decent signals.

Another Chilean shortwave station is *Radio Mineria*, which transmits on 9,750 kHz.

There are a number of Peruvian outlets on SW. There seem to be more new stations on the air from Peru lately than from any other Latin-American country. Many of them, however, seem to be unlicensed.

Almost all of the Peruvian stations are broadcasting to domestic audiences. For that reason, most signals are not as powerful as those from other countries and there is no English programming to be heard. Here are some DX opportunities for you: 4,790 kHz, *Radio Atlantida* in Iquitos; 4,885 kHz, *Radio Huancavelica* in the town of the same name; 4,990 kHz, *Radio Ancash*; 5,199 kHz, *Radio Imagen*; 6,115 kHz, *Radio Union*; and 6,188 kHz, *Radio Oriente*.

On a number of those Peruvian stations, you'll hear *huayno* selections, the typical music of the Andes. You'll quickly peg it as the sound duplicated a few years back by Simon and Garfunkel on their recording of "*El Condor Pasa*."

Venezuela's national shortwave voice, *Radio Nacional* from Caracas broadcasts on 9,540 kHz, plus, at the moment, a parallel 9,500 kHz frequency; apparently a change from the former 11,695-kHz outlet.

As with most of those South American SW stations, the best times to try for them are the early morning hours, about dawn, and during the evening.

A favorite for music is another Caracas. (Concluded on page 108)

Friedman on Computers

(Continued from page 98)

tected by a filtered air supply from airborne dust, there are available for the latest generation of personal computers, hard-disk drives that use plug-in disk cartridges—the hard disk is enclosed in a plastic case that can be easily removed from the drive mechanism. That kind of design permits almost unlimited hard-disk storage because a fresh hard disk can be quickly substituted for a full disk. Of course, the removable hard disk has the same disk-swapping limitations of a floppy disk if some of the desired data is on one disk and the remainder on another. But, because hard disks can be substituted at will, it's just as easy to group related software and data files on the hard disk as it is on a floppy.

Although the marketplace is overflowing with various kinds of surplus 5-1/4 inch hard-disk units and complete upgrade kits for non-cartridge hard-disk drives, the 10 MB hard disk is unofficially recognized as

(Continued on page 106)

Radio-Electronics REPRINT BOOKSTORE

- | | |
|---|---|
| <input type="checkbox"/> Radio-Electronics back issues (1985) \$3.00
Write in issues desired _____ | <input type="checkbox"/> Special Projects #4 (Summer 1982) \$4.50 |
| <input type="checkbox"/> Radio-Electronics back issues (1984) \$3.50
(January 1984 not available)
Write in issues desired _____ | <input type="checkbox"/> Special Projects #5 (Winter 1983) \$4.50 |
| <input type="checkbox"/> Radio-Electronics back issues (1983) \$3.50
(January, February 1983, May 1983 not available)
Write in issues desired _____ | <input type="checkbox"/> Special Projects #6 (Spring 1983) \$4.50 |
| <input type="checkbox"/> Radio-Electronics back issues (1982) \$4.00
Write in issues desired _____ | <input type="checkbox"/> Special Projects #7, #8, #9 NOT AVAILABLE |
| <input type="checkbox"/> Radio-Electronics back issues (1981) \$4.00
(Jan., Feb., March, Dec. 1981 not available)
Write in issues desired _____ | <input type="checkbox"/> Special Projects #10 (Spring 84) \$4.50 |
| <input type="checkbox"/> Etch your own PC boards \$3.00 | <input type="checkbox"/> Radio-Electronics Annual 1983 \$3.50 |
| <input type="checkbox"/> Hands On Electronics #1 \$4.00 | <input type="checkbox"/> Radio-Electronics Annual 1984 \$3.50 |
| <input type="checkbox"/> Hands On Electronics #2 \$4.00 | <input type="checkbox"/> Radio-Electronics Annual 1985 \$3.50 |
| <input type="checkbox"/> Hands On Electronics #3 \$4.00 | <input type="checkbox"/> Radio-Electronics Annual 1986 \$2.50 |
| <input type="checkbox"/> Hands On Electronics #4 \$3.50 | <input type="checkbox"/> How to Make PC Boards \$2.00 |
| <input type="checkbox"/> Hands On Electronics #5 \$2.50 | <input type="checkbox"/> All About Kits \$2.00 |
| <input type="checkbox"/> VCR Repairs \$3.00 | <input type="checkbox"/> Modern Electrics (Vol. 1, #1 April 1908) \$2.25 |
| <input type="checkbox"/> IBM Typewriter to
Computer Interface \$3.00 | <input type="checkbox"/> Electro Importing Co. Catalog \$4.95
(1918) (176 pp) |
| | <input type="checkbox"/> Low Frequency Receiving Techniques \$6.00
Building and using VLF Antennas |
| | <input type="checkbox"/> New ideas - 42 circuits for experimenters . . . \$3.50 |
| | <input type="checkbox"/> Descrambler (Jan., Feb., 1981) \$3.00 |
| | <input type="checkbox"/> Descrambling (Feb., 1984) \$2.00 |
| | <input type="checkbox"/> Receiving Satellite Television \$7.00 |

To order any of the items indicated above, check off the ones you want. Complete the order form below. **Include your payment**, check or money order (DO NOT SEND CASH), and mail to Radio-Electronics, Reprint Department, 200 Park Ave. South, New York, NY 10003. Please allow 4-6 weeks for delivery.

If you need a copy of an article that is in an issue we indicate is unavailable you can order it directly from us. We charge 50¢ per page. Indicate the issue (month & year), pages and article desired. Include payment in full, plus shipping and handling charge.

ARTICLE _____

PAGES _____

MONTH _____

YEAR _____

TOTAL PAGES _____

@ 50¢ each

TOTAL PRICE _____

MAIL TO: Radio-Electronics

Reprint Department, 200 Park Ave. South, New York, NY 10003

All payments must be in U.S. funds

Total price of order \$ _____

Sales Tax (New York State Residents only) \$ _____

Shipping & Handling (U.S. & Canada only) (Includes FIRST CLASS POSTAGE) \$1.00 per item \$ _____

All other countries (\$2.00 per item, sea mail) \$ _____

(\$4.00 per item, air mail) \$ _____

Total Enclosed \$ _____

Name _____

Address _____

City _____ State _____ Zip _____

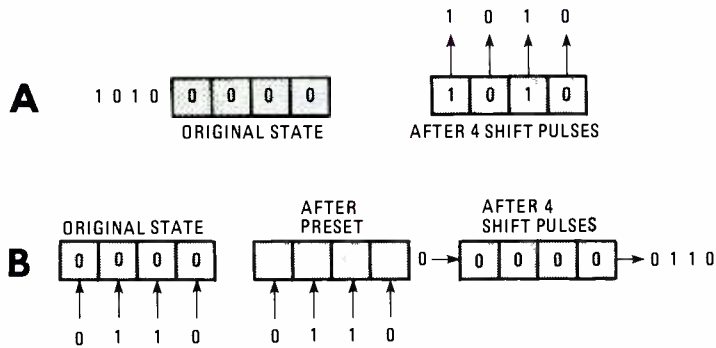

Fig. 17—Shift register applications for (A) serial-to-parallel conversion and (B) parallel-to-serial conversion.



Fig. 18—A 256-bit shift register used as a serial memory to store 32 bits of data.

in Fig. 18. The data is entered serially and read out serially. Because there are so many flip-flops, parallel output is not feasible.

Figure 19 shows a complete circuit for using the 256-bit shift register as a memory. The gates at the input of the shift register are used for entering serial data when it is desired to store a byte and for data recirculation. When clock pulses are applied to a shift register, data that is shifted out is generally lost. However, it doesn't have to be. By taking the serial output of the shift register and feeding it back into the shift register input, as the serial word is read out it is restored at the input. That is accomplished with gates A and C at the input to the shift register. The CONTROL line is used to select whether new serial data is to be stored or whether recirculation is to be accomplished. When the CONTROL input is high, the shift register will recirculate. Serial data output is fed to gate A which is enabled by the control line. That passes through OR

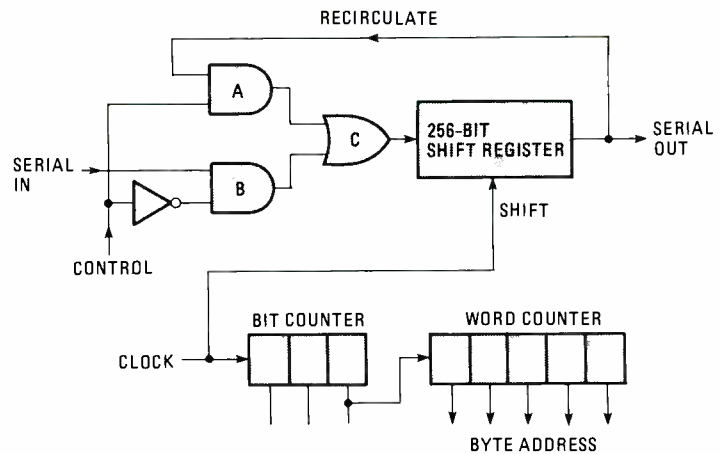

Fig. 19—A 256-bit shift register used as a memory bank.

gate C to the shift register input. During that time, any new serial data is ignored at gate B which is inhibited by the inverter operated by the CONTROL line.

To enter new data, the CONTROL line is set to binary 0. That enables gate B and inhibits gate A. No recirculation will take place. However, as shift pulses are applied, the new serial byte to be stored will be shifted in a bit at a time.

To keep track of where the different bytes are stored in the shift register memory, the circuit in Fig. 19 uses a 3-bit binary counter and a 5-bit binary counter. The 5-bit binary counter is a word counter and its output is a 5-bit binary word we call the address. Remember that we said that it is possible to store 32 bytes in a 256-bit shift register. We label those bytes byte 0 through byte 31. The 5-bit counter has a maximum count capability of 31, therefore, the address appearing at the output of the counter designates which byte appears at the far right of the shift register ready to be shifted out.

The 3-bit binary counter is used to count clock pulses. That 8-state counter counts to eight for each byte stored or read out. Recall that it takes eight clock pulses to either shift a byte in or shift a byte out. For every eight clock pulses that occur, the 5-bit word counter or address counter is incremented to up-date the address.

SHORT QUIZ ON DIGITAL FUNDAMENTALS—LESSON 5: COUNTERS AND SHIFT REGISTERS

1. A four bit binary up counter is preset to 0010. Seven input pulses occur. The decimal value of the counter content is:
 - a. 2
 - b. 7
 - c. 9
 - d. 11
2. The maximum number of states that a 6-bit counter can represent is _____.
3. The maximum number count capability of a 7-bit counter is _____.
4. A three bit binary counter is cascaded with a BCD counter. An input frequency of 400 kHz is applied to the circuit. The output frequency is _____ kHz.
5. How many BCD counters does it take to represent the number 19900?
 - a. 2
 - b. 3
 - c. 4
 - d. 5

6. A four bit binary down counter is preset to 0011. Six input pulses occur. The binary value of the counter content is:
 - a. 0011
 - b. 0110
 - c. 1010
 - d. 1101
7. Clearing a counter or shift register means the same as presetting it to _____.
8. The maximum count of a four bit BCD counter is:
 - a. 1000
 - b. 1001
 - c. 1010
 - d. 1111
9. Counters and shift registers are a type of _____ logic circuits.
10. List four ways that data can be entered, stored, and read out of a shift register.
 - a. _____
 - b. _____
 - c. _____
 - d. _____

(Concluded on page 108)

Friedman on Computers

(Continued from page 104)

the minimum practical value in terms of convenience and cost-effectiveness because 5 MB gets used up quickly by much of the new super-sophisticated software. Also, a good part of the cost of a hard-disk upgrade is represented by the disk controller, which is the same price of 5, 10, 20, 30, and 40 MB units. In fact, it's often wise to consider going directly to a 20 MB unit because the additional 10 MB does not increase the overall costs disproportionately. That is, the price to performance relationship isn't linear—20 MB doesn't cost twice as much as 10 MB; usually, the difference is less than 25%.

Three Kinds Of Hard Disks

There are basically three kinds of hard disk upgrades: Internal, external and external/expansion. The kind that you can use depends on your particular computer. The least expensive is an internal drive that replaces an existing drive, or one that fits into a space reserved for a floppy-disk drive. Either way, you end up with one floppy and a hard disk.

An *internal* hard disk usually "steals" power from the computer's power supply, so you must be certain the power supply can carry the extra load. And if it can't, you must use an external power supply for the hard-disk unit.

External hard disks are used when there's no room inside of the computer for unit, or you want a hard disk in addition to the computer's normal complement of floppies. External hard disks can be nothing more than the hard drive itself installed in its own a cabinet along with a dedicated (separate) power supply, and

often a fan for cooling. While there are variations in the way external hard-disk units connect to various computers, most retain the same kind of controller board used for internal hard disk. The difference between them is that the external drive mechanism connects to the computer through cables that provide for some kind of disconnect of the unit.

As far as operation of the hard disk drive is concerned there are only two substantial differences between the internal and external hard disk: The external hard disk does not result in loss of a floppy, and it can be independently turned off by simply turning off its power.

The *external-expansion* hard-disk upgrade is usually possible only for IBM-compatible computers, which normally have five or less expansion slots. One of those slots must be used by the floppy-disk controller and another by the monitor adaptor. With the hard-disk controller, three of the five slots are used, leaving only two empty slots for additional expansion—which isn't much, when you consider the great variety of accessories available for the IBM PC's.

One of the most convenient ways to get around the shortage of expansion slots and still use a hard disk is to use an external/expansion, hard-disk upgrade. The external/expansion type is basically similar to the conventional external hard disk, in that it is self contained in a cabinet with its own power supply. The difference is that the external-expansion unit also contains five to eight empty expansion slots; the precise number depends on the particular model. Although the hard disk controller uses one of the computer's slots, the external unit provides from three

to five additional slots.

And then there are the "streaming tape" drives...but that's a subject for another time.

Security First

The importance of being able to shut down a hard disk independent of the computer isn't all that obvious. If a computer is to function as a host for telecommunications, meaning the computer is connected to a modem that's always connected to a telephone line, someone can access the computer by simply dialing the telephone. While that is a convenient way to permit people to log-in from their home or a field office, it also places all disk files at the mercy of the user. While the files can be protected by sophisticated security software that permit only authorized users to access specific files, the use of such software doesn't necessarily stop a determined meddler. If your computer has an internal hard disk it's always at the mercy of whoever accesses the computer—the security software only slows them down. If the security software is so good that it cannot be easily defeated, it might prove to be more trouble than it's worth.

On the other hand, to protect the files of an external hard disk, you need only turn off its power switch. Data that's needed at remote stations can simply be copied to the floppies. In that way, unauthorized users cannot muck around in your hard disk's files to steal or destroy data. If you wanted to provide access to specific hard disk data, while maintaining security, you could copy it from the hard disk to a floppy A: drive and then turn off the hard disk. Users would then have access to only the data copied from the hard disk. ■



\$350

NEW IDEAS

**42 PROJECTS
COMPLETE PARTS LISTS
ONE-EVENING PROJECTS
EASY TO BUILD**

■ NEW IDEAS is packed with 42 practical circuits for the Electronics Experimenter and Project Builder. In addition to the headlight alarm, the voltage freezer, and the remote telephone ringer, you get complete plans for a simple Tesla coil project that can generate 25,000-volts AC and draw one-inch sparks. Other interesting projects are: a sound-effects generator, a crystal tester, a stereo remote control, and much, much more! Each project was selected for its low cost of parts!

■ WANT TO EXPAND your knowledge of electronics? Build gadgets that only you can have on your block? Acquire a library of projects? NEW IDEAS is the gold mine of circuits you should own and read. You could start the first night building a project that will have others praising what it can do and admiring you for building it.

■ THERE ARE PROJECTS for everyone—automotive, household, test equipment, audio and hi-fi, and projects just for fun.

NEW IDEAS—Circuits for Experimenters and Project Builders!

Please send one copy of NEW IDEAS at \$3.50. First Class postage and handling \$1.00 (U.S. and Canada only). All other countries: \$2.00 for sea mail, \$3.00 for air mail.

Please send _____ copies of New Ideas. Total cost is sum of copy price and First Class postage and handling cost multiplied by number of issues ordered

Please print

Allow 6-8 weeks for the material to arrive.

Detach and mail today
HANDS-ON ELECTRONICS
Reprint Department
200 Park Avenue South
New York, NY 10003

(Name)

(Street Address)

(City)

(State)

(Zip)

All Payment must be in U.S. Funds!

HANDS-ON MARKETPLACE

PRINTED CIRCUITS

PRINTED circuit boards—TORCCC Electronics will print any schematic, 6" by 9" maximum, on a circuit board for \$1.50. (Larger circuits —add \$1.25 per additional 50 square inches). Send check and schematic to: **TORCCC**, 2161 North California, Chicago, IL 60647.

REEL-TO-REEL TAPES

AMPEX professional series open reel tape, 1800— or—2400-feet on 7 inch reels, used once. Case of 40, \$45.00, 10½ × 3600 feet and cassettes available. MasterCard Visa. **VALTECH ELECTRONICS**, Box 6-HE, Richboro, PA 18954. (215) 322-4866.

FOR SALE

MONITOR CB crystals, \$1.00 each in quantity, over 7000 in stock. Free list, **G&G COMMUNICATIONS**, Main Road, Stafford, NY 14143.

ELECTRONIC parts. 600 resistors, capacitors, diodes. All new, long leads. \$6.00 ppd. **STAR-TRONICS**, Box 683, McMinnville, OR 97128.

CLASSIFIED AD ORDER FORM

To run your own classified ad, put one word on each of the lines below and send this form along with your check to:

Hands-on-Electronics Classified Ads, 200 Park Avenue South, N.Y., N.Y. 10003

PLEASE INDICATE in which category of classified advertising you wish your ad to appear. For special headings, there is a surcharge of **\$10.00**.

() Plans/Kits () Business Opportunities () For Sale
() Education/Instruction () Wanted () Satellite Television
() _____

Special Category: \$10.00

PLEASE PRINT EACH WORD SEPARATELY, IN BLOCK LETTERS.

(No refunds or credits for typesetting errors can be made unless you clearly print or type your copy.) Rates indicated are for standard style classified ads only. See below for additional charges for special ads. **Minimum: 15 words.**

1	2	3	4	5
6	7	8	9	10
11	12	13	14	15 (\$18.75)
16 (\$20.00)	17 (\$21.25)	18 (\$22.50)	19 (\$23.75)	20 (\$25.00)
21 (\$26.25)	22 (\$27.50)	23 (\$28.75)	24 (\$30.00)	25 (\$31.25)
26 (\$32.50)	27 (\$33.75)	28 (\$35.00)	29 (\$36.25)	30 (\$37.50)
31 (\$38.75)	32 (\$44.00)	33 (\$41.25)	34 (\$42.50)	35 (\$43.75)

We accept MasterCard and Visa for payment of orders. If you wish to use your credit card to pay for your ad fill in the following additional information (Sorry, no telephone orders can be accepted.):

Card Number _____

Expiration Date _____

PRINT NAME _____

SIGNATURE _____

IF YOU USE A BOX NUMBER YOU MUST INCLUDE YOUR PERMANENT ADDRESS AND PHONE NUMBER FOR OUR FILES. ADS SUBMITTED WITHOUT THIS INFORMATION WILL NOT BE ACCEPTED.

CLASSIFIED COMMERCIAL RATE: (for firms or individuals offering commercial products or services) \$1.25 per word prepaid (no charge for ZIP code)...**MINIMUM 15 WORDS**. 10% discount for same ad in 6 issues within one year; if prepaid. **NON-COMMERCIAL RATE:** (for individuals who want to buy or sell a personal item) \$1.00 per word, prepaid....no minimum. **ONLY FIRST WORD AND NAME** set in bold caps at no extra charge. Additional bold face (not available as all caps) **25¢ per word additional (20% premium)**. Entire ad in boldface, **add 20% premium** to total price. **TINT SCREEN BEHIND ENTIRE AD: add 25% premium** to total price. **TINT SCREEN BEHIND ENTIRE AD PLUS ALL BOLD FACE AD: add 45% premium** to total price. **EXPANDED TYPE AD: \$1.85 per word prepaid**. All other items same as for **STANDARD COMMERCIAL RATE**. **TINT SCREEN BEHIND ENTIRE EXPANDED TYPE AD: add 25% premium** to total price. **TINT SCREEN BEHIND ENTIRE EXPANDED TYPE AD PLUS ALL BOLD FACE AD: add 45% premium** to total price. **DISPLAY ADS:** 1" × 2¼"—\$135.00; 2" × 2¼"—\$270.00; 3" × 2¼"—\$405.00. **General Information:** Frequency rates and prepayment discounts are available. **ALL COPY SUBJECT TO PUBLISHERS APPROVAL. ADVERTISEMENTS USING P.O. BOX ADDRESS WILL NOT BE ACCEPTED UNTIL ADVERTISER SUPPLIES PUBLISHER WITH PERMANENT ADDRESS AND PHONE NUMBER.** Hands-on Electronics is published bi-monthly, therefore copy to be in our hands for Jan./Feb. 86, 10/4; March/April, 12/4; etc.

THIS IS AN EXPANDED-TYPE AD WITH A TINT SCREEN. See how it jumps out on the page. To order your ad in this format calculate the cost at **\$3.75 per word for the expanded-type** and **add 25% for the tint background.**

PLANS/KITS

DIGITAL Klock Kit plays 1-of-12 melodies each quarter hour. Displays time, date, and other features. Send \$2.50 for assembly plans and pricing to **KERBER KLOCK KO**, 36117 Hillcrest Dr., Eastlake, OH 44094.

CATALOG: Hobby, radio broadcasting, CB, lowfrets. Transmitters, linears, active antennas, converters, scramblers, bugging devices, more! **PANAXIS**, Box 130-HO7, Paradise, CA 95969.

BUILD this five-digit panel meter and square wave generator including an ohms, capacitance and frequency meter. Detailed instructions \$2.50, refundable plus 50 cents. **BAGNALL ELECTRONICS**, 179 May, Fairfield, CT 06430.

INCREASE power output of Amateur Band converted CB radios. Complete instructions \$6.00. May be illegal for use on CB band. (CA residents add 6.5%). **CAS ELECTRONICS**, 1559-J Amar Road, suite 456, West Covina, CA 91792.

ETCHING tank. Complete, easy to assemble kit. Temp controlled, self agitating for quality PC boards in minutes. Send \$74.95 to **QUINTEC ELECTRONICS**, 444 Lincoln Blvd., Dept. 225B, Venice, CA 90291.

MASTERCARD AND VISA are now accepted for payment of your advertising. Simply complete the form on this page of the Market Center and we will bill you.

SATELLITE TV

SATELLITE Handbook and Buyers Guide tells everything you need to know, \$10.00. **SVS**, Box 422, Seaford, NY 11783.

BUILD your own Satellite-TV receiving system and save! Instruction manuals, schematics, circuit boards, parts kits! Send stamped envelope for complete product listing: **XANDI**, 201 E. Southern, Suite 100, Dept. 32A, Tempe, AZ 85282.

BUSINESS OPPORTUNITIES

US\$8.00 including disk thousand name brand programs for Apple IBM-PC details, **US\$1.00 RELIANT**, P.O. Box 33610, Sheungwan, Hong Kong.

DO-IT-YOURSELF TV REPAIR

NEW...Repair any TV...easy. Anyone can do it. Write, **RESEARCH** Rt. 3, Box 601BR, Colville, WA 99114.

BUY BONDS

JAM IT!

**Even the Very Best Radar Detector
Can't Protect You from the Newest Radar**

NEW
MODEL 1/III
RADAR JAMMER



THE ULTIMATE IN RADAR PROTECTION

Radar Jammer: Compact under-dash unit causes speed radar guns to read out a percentage of your true speed, or whatever speed you dial in. Or, new "SCRAMBLE" mode will prevent radar from obtaining any reading. Activated by Whistler, Escort, or other detector. Best defense against instant on radar. Operates on both X and K bands. **WARNING:** This device is not legal for use against police radar, and is not FCC approved.

Transmitters: The heart of the jammer is the microwave oscillator (transmitter). In the past, these were very expensive, and limited to only about 100 milliwatts of power. We now have our own *Low Cost, High Power* Transmitters up to 300 milliwatts or more. Please call for prices.

Radar Detectors: We highly recommend using a remote detector that is mounted so that nothing is readily visible to either the police, or thieves. (A dash mount detector is an invitation to thieves and an irritation to police!) We agree with Motor Trend and Autoweek that WHISTLER SPECTRUM is the best detector available, and we know of no other remote detector that is even in the same LEAGUE as the SPECTRUM REMOTE. Order the best for yourself now. (Our detectors are already modified for direct connection to the jammer.)

ORDER TODAY—MONEY BACK GUARANTEE

- Complete Literature & Plans Pkg. \$ 14.95
- Set of Circuit Boards 40.00
- X and K-band Microwave Oscillators (Transmitters) **Call**
- Whistler Spectrum (modified for use with jammer) 259.00
- Whistler Spectrum Remote (modified) 259.00
- Modify your Spectrum for use w/jammer 55.00

CALL or send the following information:

• Items Ordered • Name • Shipping Address

• Payment: Check, Money Order, VISA or MC (include card number, expiration date, and signature)

SFPD 10 Oregon Microwave Inc., 9513 S.W. Barber Blvd. #108H
Portland, OR 97219 ORDER LINE: (503) 626-6764
Formerly Philips Instrument Design Co.

CIRCLE 715 ON FREE INFORMATION CARD

**Take
stock
in America.**

ADVERTISING INDEX

HANDS-ON ELECTRONICS magazine does not assume any responsibility for errors that may appear in the index below.

Free Information No.	Page
709	All Electronics 12
711	AMC Sales 16
706	AP Products 3
—	CIE 19-21
—	C.O.M.B. 8
710	Datak-West 15
716,717	Dick Smith 4-5,6-7
—	Diehl Engineering 34-35
705	Digi-Key 80-81
—	Electronic Book Club 13
—	Electronic Technology Today 28
707	Fluke CV4
719	Heath 29
712	Information Unlimited 16
708	J&W Electronics, Inc. CV3
713	Keypro Circuit Systems 22
714	Mouser 22
—	NRI 9-11
715	Oregon Microwave 108
—	Pacific Cable 17
—	RE Bookstore 104
718	Tektronix CV2

HANDS-ON ELECTRONICS

(Continued from page 104)
Venezuela station, *Radio Rumbos*, which can be heard without difficulty on 9,660 kHz.

Throughout the evening hours, from 0000 to 0600 GMT/UTC, you can find English programs from *Radio Havana Cuba*. Frequencies are 6,090, 6,100 and 9,745 kHz. Those who appreciate the Cuban rhythms will enjoy the show called "From the Land of Music" at 0435 hours.

Mexico has a number of different short-wave outlets in operation. XEWW, *La Voz de America Latina* (The Voice of Latin American) can be heard in Spanish throughout the evening on 6,165 and 9,515 kHz.

The Mexican government operates its own station, XERMX, *Radio Mexico International*, with some occasional English segments, on 9,705 and 15,430 kHz. The daily schedule runs from 2000 to 0500 hours GMT/UTC.

Skimming the bands for other Latin American signals we find:

Guatemala: *Radio Tezcutatln*, 4,835 kHz., can be heard with lovely marimba music during the early evenings.

Ecuador: *Emisora Gran Colombia* in the capital, Quito, has been putting decent signals into North America recently.

French Guiana: Cayenne's shortwave station, in French, can be found operating on 5,055 kHz.

Guyana: This small country on the "shoulder" of South America used to be called British Guiana before independence. The Guyana Broadcasting Service

station at Georgetown broadcasts on 5,950 kHz. It is best heard early in the morning, about 0930 UTC/GMT.

Nicaragua: Sometimes interesting listening from this controversial Central American nation. *La Voz de Nicaragua* has English programming about 0130 GMT/UTC on 6,015 kHz.



This 5/2 inch, full-color decal was sent to listeners by stations belonging to the Caracol Broadcasting Network in Columbia

Costa Rica: Another Spanish-language station is *Radio Impacto*, a commercial operation in San Jose. It broadcasts on 6,150 kHz. Listen around 1100 or 0200 GMT/UTC.

There are, literally, hundreds more to hear from Latin America. There's no way I can list even a small proportion of those stations. ■

Inside the Oscilloscope

(Continued from page 93)

stance, failing to be sure that the VERTICAL attenuator and the time base are in their calibrated positions. Other similar errors include the failure to compensate the probes (see *Selecting the Best Voltage Probe...*, page 28, Nov.-Dec. 1985), improper trigger selection, or incorrect inter-

pretation of the time base or vertical attenuator settings.

Other errors are caused by a lack of understanding of the equipment's specifications. (For instance, using a 25-MHz scope to examine a 100-MHz signal.) But if you keep in mind the points we have made in this article and those that preceded it, all those errors can be left to someone else to make. ■

Digital Course

(Continued from page 105)

11. It takes _____ clock pulses to shift one byte into or out of a shift register.

12. A long shift register has a 6-bit word counter whose output is called a(n) _____. It can store _____ bytes. The shift register length is _____ bits.

ANSWERS TO THE ABOVE QUESTIONS

1. c. 9; or 0010 + 7 = 2 + 7 = 1001 = 9
2. $64 - 2^6 = 2^2 \times 2 \times 2 \times 2 \times 2 \times 2 = 64$
3. $127 - 2^7 - 1 = (2 \times 2 \times 2 \times 2 \times 2 \times 2 \times 2 \times 2) \times 2 - 1 = 127$
4. 5 kHz. The 3-bit counter divides by 8, the BCD counter by 10 for a total of $8 \times 10 = 80$. $400 \text{ kHz} \div 80 = 5 \text{ kHz}$.
5. d. 5—one BCD counter for each digit.
6. d. 1101—0011 (decimal 3) is decremented six times to 0010, 0001, 0000, 1111, 1110, 1101.
7. Zero
8. b. 1001 (decimal 9)
9. sequential
10. a. serial in, serial out
- b. parallel in, parallel out
- c. serial in, parallel out
- d. parallel in, serial out
11. 8—one per bit
12. address—a 6-bit address indicates 64 words or bytes. At 8-bits per byte, the shift register length is $8 \times 64 = 512$ bits.

cable tv

DESCRAMBLER PARTS!

We stock the exact parts, PC board and AC adaptor for Radio Electronics February 1984 article on building your own **Cable TV Descrambler**.

- #701 PARTS PACKAGE** \$29.95
Includes all the original resistors, capacitors, diodes, transistors, integrated circuits, coils, IF transformers (toko BKAN-K5552AXX).
- #702 PC BOARD** \$12.95
Original etched & drilled silk-screened PC board used in the article.
- #704 AC ADAPTOR** \$12.95
Original (14 volts DC @ 285ma) ac adaptor used in the article.

S □ P □ E □ C □ I □ A □ L □ S

- BOTH #701 & #702 NOW \$39
- ALL THREE #701, #702 & #704 NOW \$49

FREE

Reprint of Radio Electronics article (February 1984) on Building Your Own **CABLE TV DESCRAMBLER** with any purchase of above.

AC ADAPTOR
9 VDC @ 500mA \$5.95

PROMS 4k x 8
P2732A (21V) \$3.25

ADD \$2.50 SHIPPING AND HANDLING
\$4.50 FOR CANADIAN ORDERS
WE ALSO OFFER QUANTITY DISCOUNTS
ON 5 OR MORE UNITS



ORDER TOLL FREE
1-800-227-8529

inside MA 617-339-5372
VISA • MASTERCARD OR C.O.D.

Call or write for a free catalog.

J & W
ELECTRONICS, INC.

P.O. BOX 800R MANSFIELD, MA 02048

The best DMM in its class just got better.



The Fluke 80TK. One innovation leads to another.

First there was the 70 Series, which set a new standard for low-cost, high-performance, Fluke-quality multimeters.

And now, another first. The Fluke 80TK K-type Thermocouple Converter. A temperature measurement device that adds instant temperature measurement capabilities to the 70 Series DMMs.

Or any DMM, for that matter.

Feature for feature, the versatile 80TK is the most affordable unit of its kind. For quick comparison readings, it can measure °C or °F at the flick of a switch. It includes a built-in battery test. And the availability of 3 Fluke probes give you the flexibility to measure any

form of temperature, from freezer to furnace, with just one base unit.

No other thermocouple converter we know of offers DMM users so much for so little. Just \$59, including a general-purpose bead probe.

So even if you don't own a Fluke 70 Series multimeter, the 80TK will help the DMM you're now using measure up when things get hot. Or cold.

For your nearest distributor, call toll-free **1-800-227-3800, ext. 229**, day or night. Outside the U.S., call 1-402-496-1350, ext. 229.

FROM THE WORLD LEADER
IN DIGITAL MULTIMETERS.



Surface, immersion and general-purpose probes with "mini" thermocouple connectors are available for the Fluke 80TK.

80TK SPECIFICATIONS

Temperature Measurement Range
-50 to 1000°C
-58 to 1832 °F
Battery Life: 1600 Hours (9V)

FLUKE®

IN THE U.S. AND NON-EUROPEAN COUNTRIES: John Fluke Mfg. Co., Inc. P.O. Box C9090, M/S 250C, Everett, WA 98206. Sales: (206) 356-5400. Other: (206) 347-6100.
EUROPEAN HEADQUARTERS: Fluke (Holland) B.V. P.O. Box 2269, 5600 CG Eindhoven, The Netherlands. (040) 458045. Telex: 51846.
© Copyright 1985 John Fluke Mfg. Co., Inc. All rights reserved. Ad No 4709-70/80

CIRCLE 707 ON FREE INFORMATION CARD