



PHILIPS

dynalite 

Networked Controls

The Dynalite System explained

Intuitive advanced lighting control explained – from basic controls to a fully networked building-wide system.

The Dynalite difference

Contents

The Dynalite difference	3-5
Dimming controls fundamentals	6-8
Network components	9-10
Communications protocol DyNet	11
Boardroom example	12
A boardroom with traditional switches/ dimmers	13
A boardroom with network controls	14
A boardroom with preset lighting scenes	15
Adjoining boardrooms working as one	16
Adding sensors to the system	17
Timeclock facilitates further functionality	18
Integrating third-party systems	19-20
Corridor hold function	21
Network system over entire floorplan	22-23
Network system over entire floorplan using DALI	24-25
Network system over entire floorplan using DALI MultiMaster	26-27
The advantages of a DALI office lighting control system	28-29
Building-wide network system	30-31

The Philips Dyalite lighting control platform offers best of breed lighting control with over 25 years of reliable service in over 35,000 projects around the world. Whatever your application, there is likely a Dyalite system already in operation with similar functionality. It is from this experience, as an industry-leading innovator, that we can confidently provide solutions to suit customers both large and small.

The intention of this brochure is to explain the Dyalite system in detail, particularly its application to the office segment. It has been designed to explain basic controls and network components, using a boardroom example, then eventually explaining the system over an entire floor plan and a building-wide network system.

Although focused on the office environment, these fundamental principles can also be applied to a wide range of other energy management and architectural lighting applications. Philips Dyalite solutions blend advanced high-level functionality with aesthetic and sustainable lighting control that enhances economic return, productivity and user comfort. The strength of the Dyalite network control system has been proven across a wide range of sectors, from residential to retail, hospitality to healthcare, sports arenas to large venues, and industry to outdoor applications.

Please consult with your local Philips Dyalite Representative for information on specific applications.

The benefits of the Dyalite System at a glance:

- **Preset lighting control** – More than just on/off lighting control. Dyalite controls allow you to create ambiance and recall different lighting scenes to suit your mood and the occasion.
- **Distributed control and monitoring** – You can configure and control all the lights from any point on the network. In addition, you can monitor all of the system components from any point on the network and create reports on the status of the system.
- **Ease of installation and configuration** – The DyNet system is easier to install and takes less time to configure than conventional systems.
- **Flexibility in design** – when layouts or control methods require modification, changes are carried out by a simply reprogramming the system using EnvisionSuite software.
- **Energy savings** – By using intelligent lighting systems, natural light is harvested and supplementary lighting adjusted accordingly, resulting in optimized environmental performance and minimized operating and maintenance costs.
- **Scalability** – To accommodate 'building churn' where tenancies change, staff numbers fluctuate and office activities vary, Philips Dyalite adopts a flexible approach. User interfaces can access any function and all output channels can be easily reconfigured without wiring changes. The same components can be used in a single room application or in larger projects involving thousands of controlled units.
- **Advanced integration into other systems** – Philips Dyalite's range of integration devices and network gateways, allows the DyNet system to be configured to work in conjunction with other systems such as blinds, audio-visual, temperature control and building management systems.
- **Increased lamp life** – Philips Dyalite's 'soft start' and surge limiting voltage regulation technologies protect lamps from high inrush currents and power surges, thus dramatically increasing lamp life.

Dynalite system overview – Typical Layout

The diagram below illustrates the typical layout of luminaires and physical devices in a two story building. Users simply interact with the user interfaces and see the resulting lighting effect.

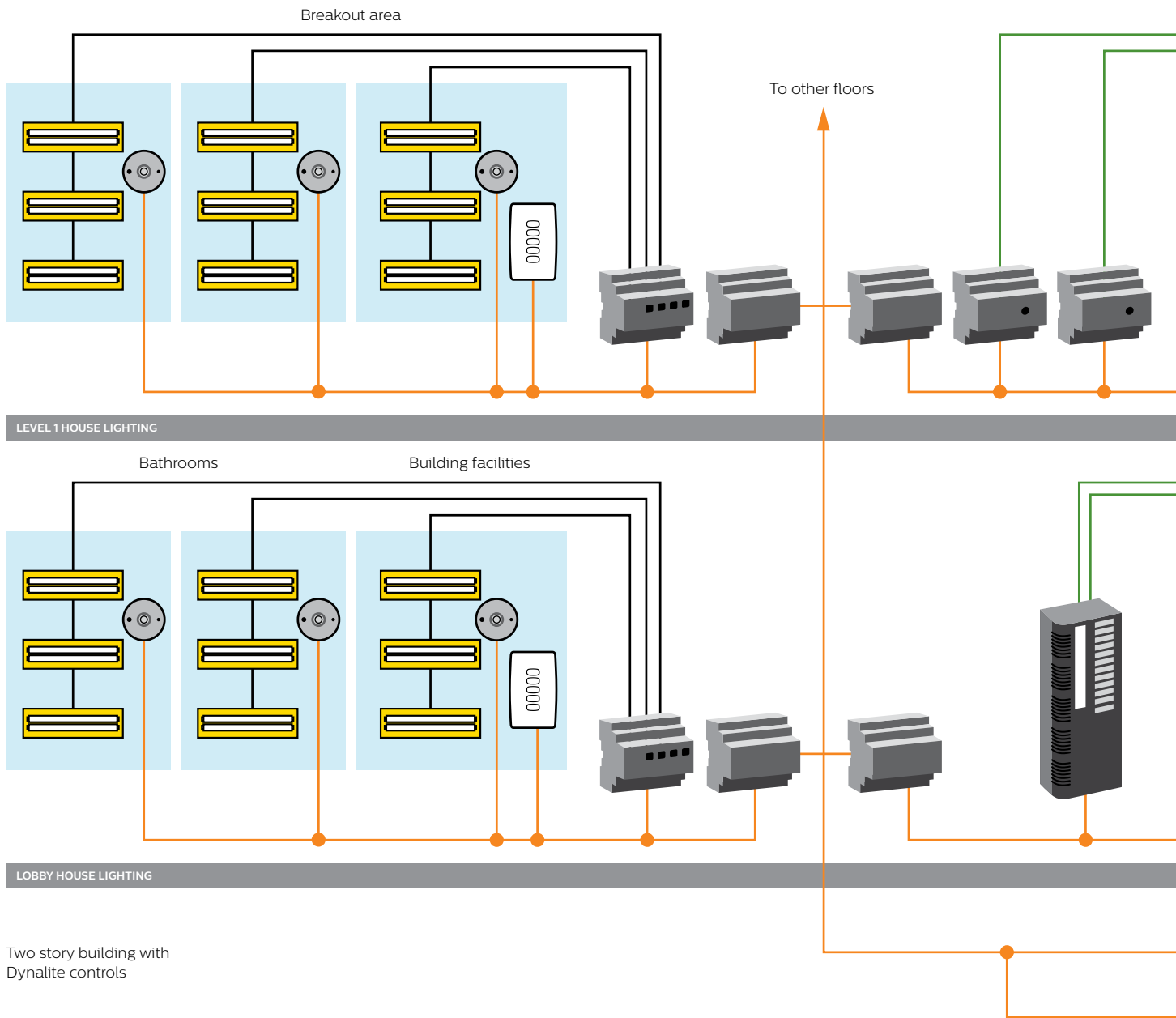

“Our solutions are able to achieve any combination of sophisticated outcomes customized to the exact needs of each living space.”

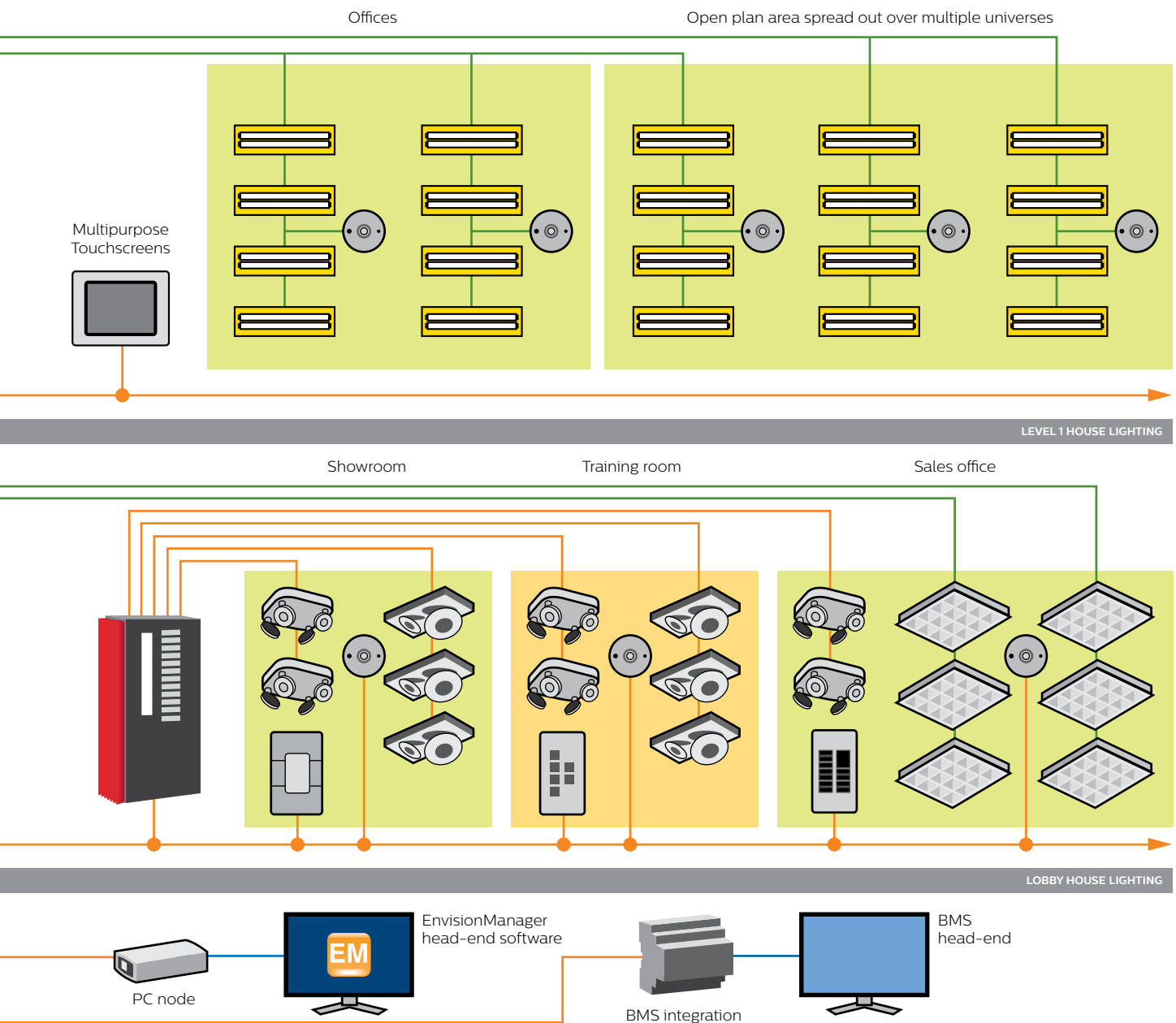

Dimming controls fu

The following six pages briefly describe some network lighting control fundamentals to help you build a background knowledge of network lighting control systems.

Mains supply power

Mains supply changes constantly and is commonly subject to noise, frequency shift, surges and brownouts. A quality lighting control solution monitors the mains supply and compensates for inconsistencies to ensure a smooth and consistent light level.

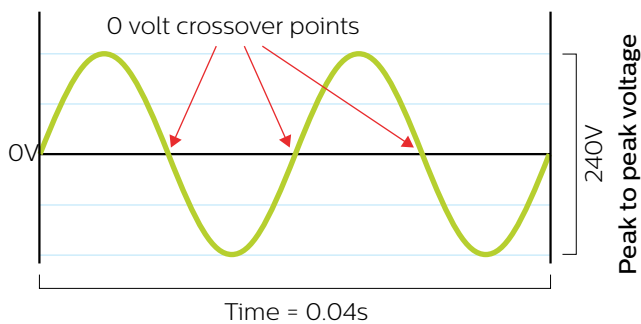

Example of ideal power supply

Switching

Switching control is the most common and simple method of lighting control. For power switching, Philips Dynalite employs relays that have been purpose built for the lighting industry to cope with the high inrush current demands of lighting loads.



Network switch control

Phase-cut dimming

Phase-cut dimming is the modification of the mains supply to reduce the overall power supplied to the lamps. This is achieved by 'chopping out' a varying section of each cycle depending on the amount of dimming required. This method requires constant measurement and detection of the mains supply. Most critical is the 0-volt crossover point, as this is the point where the dimmer unit bases its calculations and timing on how to drive the output channel. To accommodate different lamps on the market, two styles of phase-cut dimming are available: leading-edge dimming; and trailing-edge dimming. Care must be taken to ensure the correct control type is properly matched to the lamp requirements.

For leading-edge dimming, the supply is stopped from the 0-volt crossover point until the correct time when the power for the desired dimming level is reached. At this point, the supply is switched back on and allowed to flow. Leading-edge dimmers typically use an SCR or TRIAC for their driving componentry. To safeguard smooth operations and maintained outputs, the drivers are managed using a combination of digital and analog components.

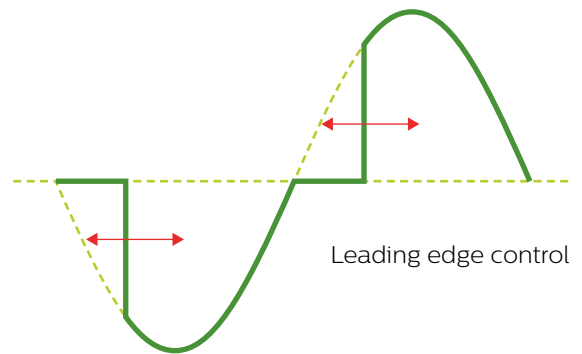

Leading edge control

Conversely, for trailing-edge dimming, the supply is allowed to flow through from the 0-volt crossover point until the correct power is reached for the desired dimming level. At this point, the supply is switched off. Trailing-edge dimmers typically employ MOSFETs for their driving componentry. To ensure smooth operations and maintained output, the drivers are managed using digital components only.

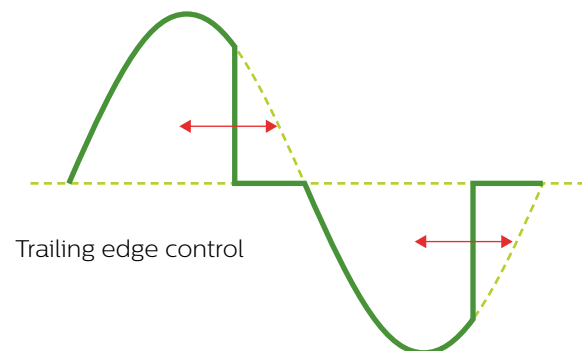

Trailing edge control

ndamentals

Signal dimming

Some lamps depend on an external transformer or ballast to modify the supply in order to perform the dimming requirements. Each external device receives signals from the lighting control system, which sends instructions to modify the dimming level.

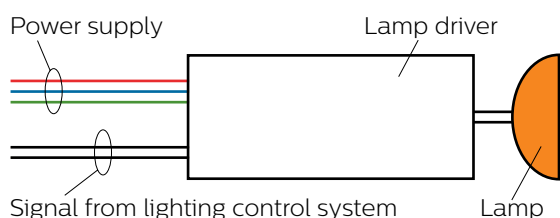

Wiring of fittings for signal lighting control

For analogue or 1-10V lighting control systems, the load controller transmits a low voltage signal: 1 volt equates to 0 per cent of lighting output; 10 volts equates to 100 per cent output. All fittings within one lighting group will respond to this dimming instruction at the same time. There is no method of error checking and, as any voltage on the control line will be considered by the fittings as a correct signal, the lighting control system might not be able to turn lamps off through the control line alone. Switching off the power supply to the fittings from a relay in parallel with the control signal will be required to ensure correct operation.

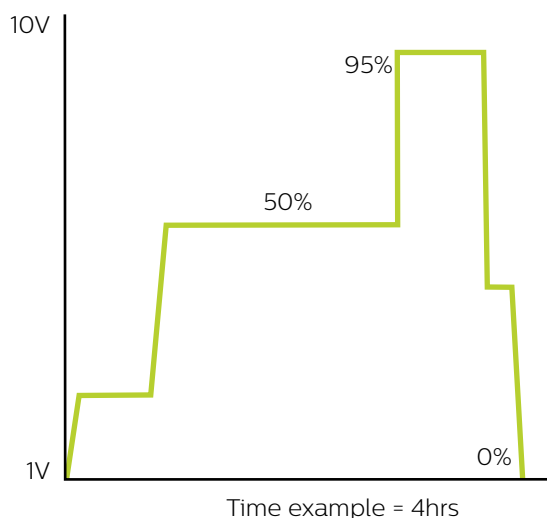

Lightning control system varies between 0 and 10V to adjust the output level of the lighting

For a Digital Serial Interface (DSI) control system, the load controller transmits a digital signal to the lamps. All fittings within one lighting group will respond to the dimming instruction at the same time. As the signal is based on the Manchester code – which includes a discreet 'off' message – the lamps can be switched off through the control signal alone.

For a Digital Addressable Lighting Interface (DALI) lighting control system, the load controller transmits a more sophisticated digital signal to the lamps. DALI fittings have built-in intelligence, that allows for multiple levels of addressing and more advanced feedback functions. DALI can operate in two distinct modes: DALI Broadcast; and DALI Addressing.

With DALI Broadcast, all lamps within one lighting group will respond at the same time. All Dynalite signal load controllers are able to perform this function. In DALI broadcast mode, lamps cannot perform any feedback or additional DALI addressing functions.

By comparison, DALI Addressing allows individual lamps and defined groups to be controlled on the same physical network. DALI Addressing is able to support many advanced features including lamp status and emergency lighting testing.

More details on DALI operation are available in the 'Network system over entire floorplan' section.

For Digital Multiplex 512 Channels (DMX512), network gateways are used to transmit a digital signal to the lamps. DMX is an extremely fast method of controlling lighting and consequently delivers a very smooth ramping of the dimming channels. As a theatrical-based communications protocol, DMX is able to control more than just lighting. For example, smoke machines and direction stepper motors can also be driven through DMX protocols.

Unlike DALI, DMX does not contain additional methods of addressing or grouping light fittings into logical areas. Equally, there is no provision for the lamps to report their status back to the lighting control system.



Pulse-width-modulation dimming

Pulse-width-modulation control is often referred to as PWM dimming. As the output from PWM controllers is a DC voltage, dimming is achieved through the rapid switching on/off of this output in pulses to reduce the average power output over time. The extent of the dimming is regulated by the ratio of 'on' and 'off' phases between the pulses. The switching occurs faster than the human eye can possibly detect, ensuing smooth dimming.

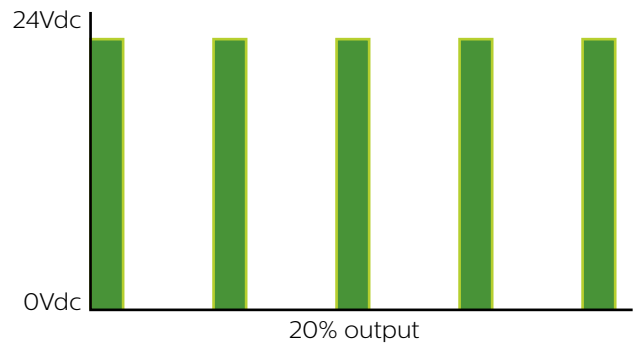
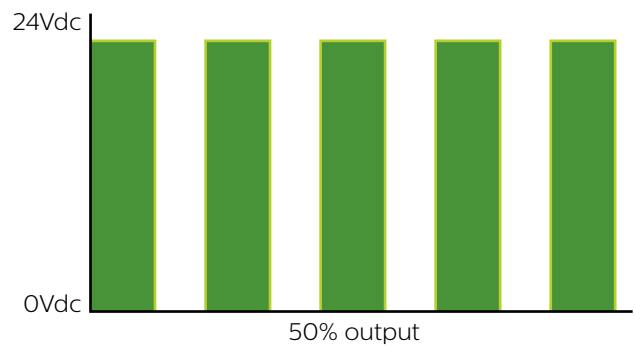
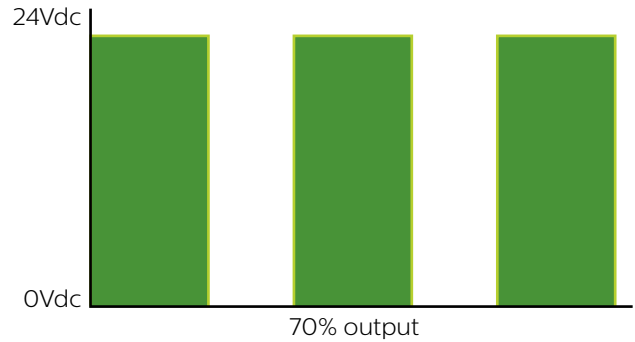

PWM is able to maintain the voltage and current supplied to the fitting and performs dimming by rapidly switching the supply on and off. Difference in the dimming is from the ratio between on and off pulses.

Network components

Load controllers

Load controllers receive instructions from the DyNet network and adjust their controlled outputs as required. They contain all the elements – the power supply, the network ports, the output drivers and the microprocessor management – needed to operate the lighting groups for which they are responsible. Moreover, all channel naming information, channel addressing, logical area addressing and channel scene levels are stored within the load controller.



DDLE802
DIN-rail dimmer
controller

There is a wide range of load controllers that can be mixed and matched for different types of luminaires and different project lighting requirements. The load controller range features different types of output channels for switching, leading edge dimming, trailing edge dimming, PWM dimming and signal control. Equally, different channel capacities are available – including 2A, 5A, 10A and 20A – as well as the choice of wall- or DIN-rail mounting options.



DLE1220GL wall mounted
dimmer controller

User interfaces

All network sensors are universally able to manage presence detection and light level measurement at the same time. The sensors communicate directly to load controllers and other devices on the DyNet network and can receive network instructions to give them different behaviors. The sensor range includes different mounting options, ultrasonic operation, IR-receive capability, plus 360° or 90° occupancy detection.

Similar to the sensors, network control panels communicate directly to the load controllers and other devices on the DyNet network. They are able to perform a wide range of standard functions, such as presets, channel switching/dimming, one-touch dimming, room join or panel disable.

Network control panels are available in a broad spectrum of finishes, plus a number of options and button configurations. All buttons have individual indicator LEDs and support engraving to describe their functionality. Timeclocks and touchpanels provide time dependent responses, while scripted tasks can be written into all user interfaces to achieve advanced behavior.

User interface options further include software applications for PCs, smart phone devices and tablets. These allow for control of the lighting control system and are also when integrated, able to control blind motors and set thermostat temperatures.



DUS804C
Multifunction Sensor



AntumbraButton
User Interface



Revolution Series
User Interface

Network integration

A range of different network gateways enable integration with a comprehensive array of third-party network systems (shown right). These devices allow multiple systems to be controlled from a single user interface.

Commissioning software

The EnvisionProject software package enables full commissioning of all devices without the need for additional add-ons. The software is able to display different perspectives of the system, such as an overall network view, individual logical areas and floor plans. These enable the commissioning engineer to have a clear view of the entire system – or discreet aspects of the system – to reduce set-up time. As an integral part of the commissioning process, configuration data is exported to the EnvisionManager software so that all relevant system information is made available to the end-user.

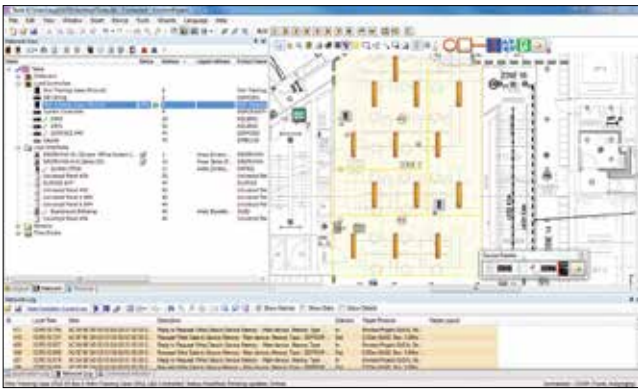

The EnvisionProject Interface

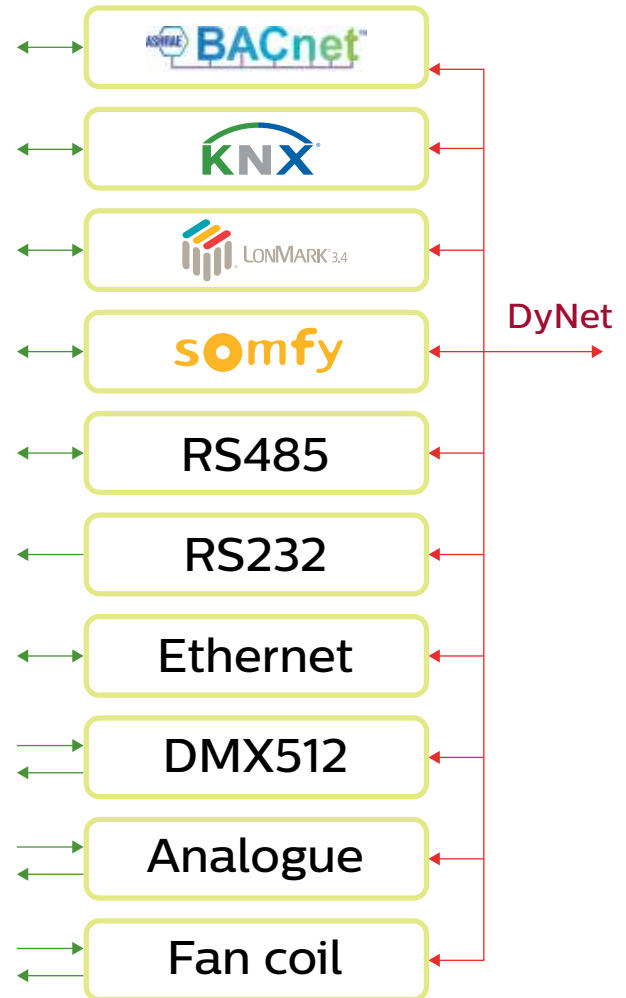

Head-end software

The EnvisionManager software package provides central control of the entire lighting system. EnvisionManager delivers industry leading levels of control, monitoring and management delivering flexibility to optimize energy efficiency and maximize user comfort.

This easy to use software allows multiple operators to access and view the lighting control system and perform a wide range of lighting system maintenance activities. With a complete overview of a building's lighting control system, it's possible to navigate to any location and make adjustments to network devices and functions, controlled areas, presets and channel levels, task editing and run building maintenance programs.

EnvisionManager allows you to set-up alerts, schedule activities, view usage and performance reports, override functions, adjust timer events and edit system settings from different or remote locations. The software also has both

notional and metered energy management reporting capability that accurately details lighting energy consumption, enabling operators to set and meet energy management targets and reduce operational costs.

EnvisionManager is compatible with all current Dynalite products/solutions and can be used on any Philips Dynalite project. EnvisionManager seamlessly integrates with building management systems and is simple to implement as it re-uses the EnvisionProject configuration file created during commissioning.

EnvisionManager is designed to meet the needs and expectations of both building users and facility managers. It provides invaluable insights into the way a lighting system is operating, highlighting areas where improvements can be made on a daily basis as well as providing analytics for long-term strategies.



Communications protocol **DyNet**

DyNet uses a system strategy of distributed intelligence to define the relationship between the user interfaces and the load controllers. DyNet details how each device manages its responsibility within the system to ensure continuous operation.

This forward-thinking protocol allows advanced features to be added to meet the growing demands of modern projects. Details of the DyNet open protocol and network messages are available from the Philips public web site.

DyNet is incredibly scalable, allowing for trunk-and-spur network configuration in large projects, where up to 16,776,960 devices can be connected onto a single network. Advanced addressing methods enable physical channels to be allocated into logical areas, to match any layout. Up to 65,353 physical channels can be allocated to a single logical area and up to 65,353 logical areas can be created within a single system.

Based on the industry-standard RS485 network, the DyNet system responds to correctly transmitted messages from any device on the network or an integrated third-party network.

All Dyalite devices support at least one DyNet port, with the same protocol used for system commissioning and the day-to-day operations of the system.

The channels in an area are used by the system to alter any electronically controlled dimension of a space. Presets then simultaneously recall the individual levels for a group of channels. The preset states can also be used throughout the system by sequential and conditional logic to perform an endless variety of sophisticated tasks.

Sequential Logic – instructions executed in sequence.

Conditional Logic – instructions (such as if-then) that execute based on a status request.

In one network message, the DyNet protocol can implement the required lighting scene and fade rate to affect a single area or an entire building. The single network message is able to change the status of thousands of lighting channels across thousands of different physical dimmers, while also updating the status of all indicators in the user interfaces. This makes the DyNet protocol one of the most efficient in the lighting control market.

Boardroom example

In order to fully understand the many benefits that the Dynalite lighting control system has to offer, compare the Dynalite solution to a standard switched lighting control arrangement. Using two adjacent boardrooms as an example, it is possible to demonstrate how each 'layer' of the Dynalite architecture can improve usability, flexibility and efficiency of the lighting control system for the end-user.

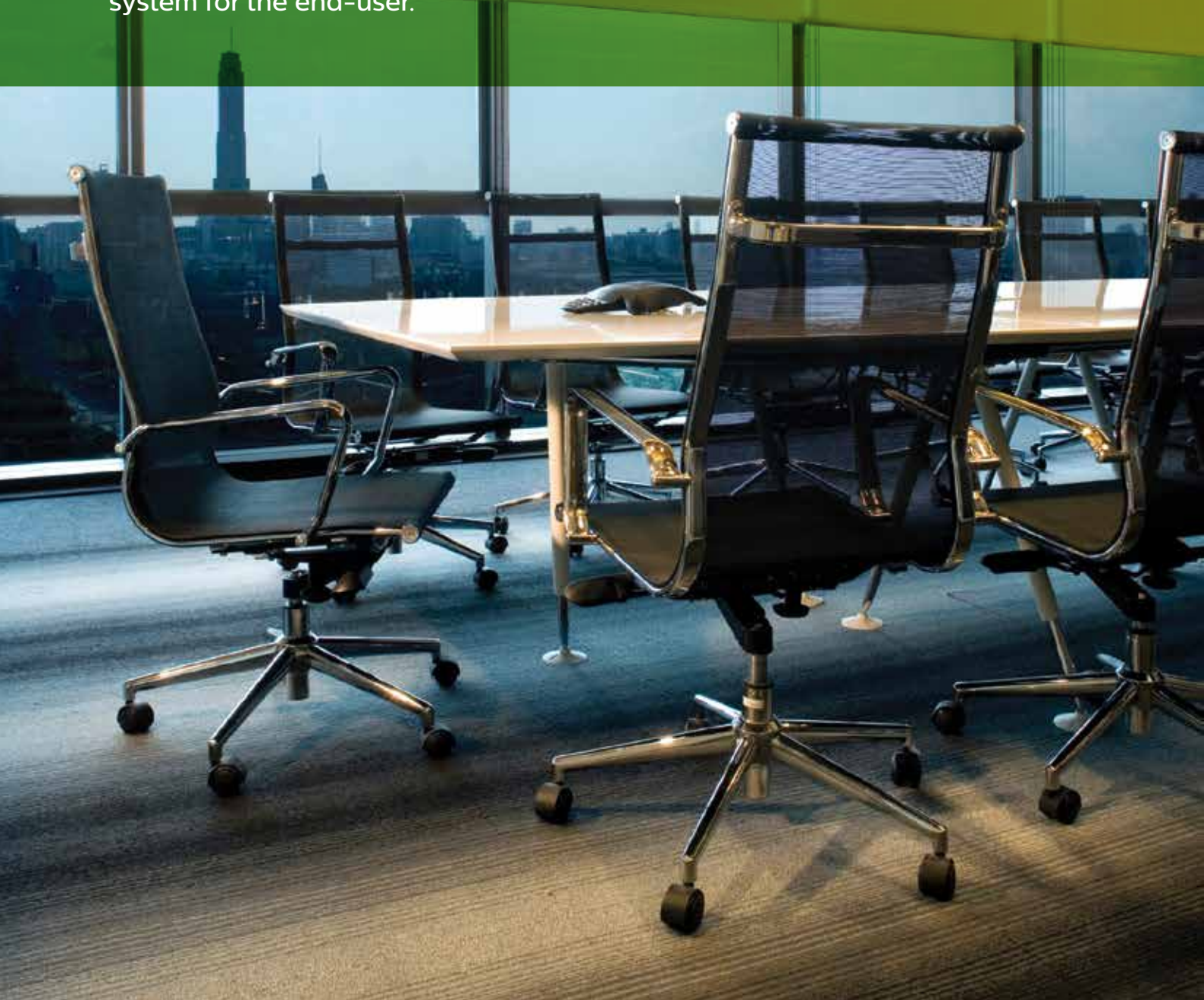

A boardroom with traditional switches/dimmers

The requirements for two boardrooms – Boardroom A and Boardroom B – might comprise four dimmed lighting groups for each.

1. Fluorescent lighting above the table.
2. Fluorescent lighting against the wall.
3. LED task downlight above the table.
4. LED wall wash downlights around the perimeter of the room.

As each room has two entry points, it is necessary to provide a two-way switching function to allow the lighting for each room to be able to be turned on and off from either switch adjacent to each door. However, dimming is only available from one side of the room to reduce the complexity of the wiring. Each boardroom has standalone lighting control, achieved with the use of locally mounted fluorescent dimming rotary pots, LED dimming rotary pots, mechanical switches and extensive cabling.

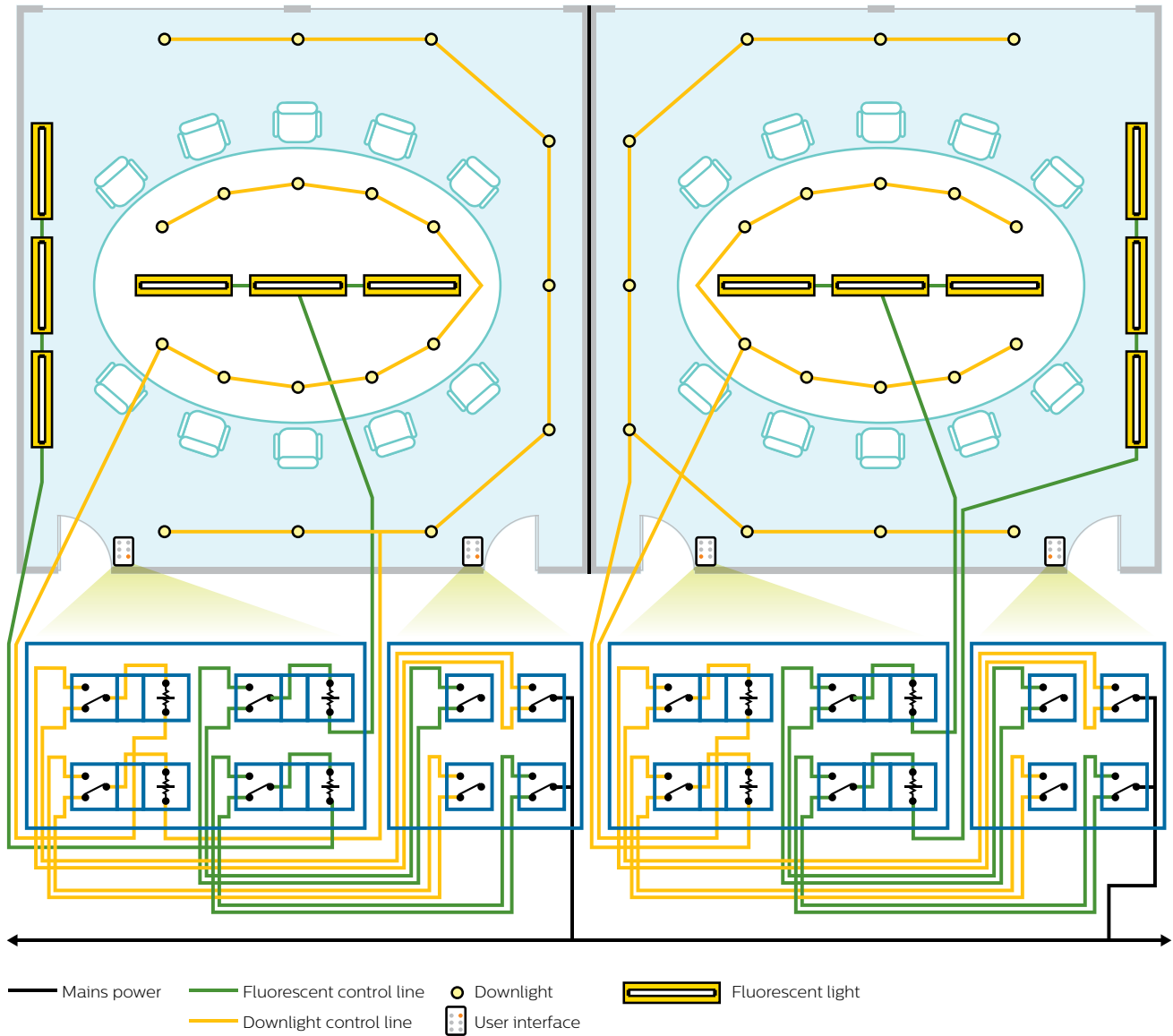

Manual controls hardwired to each boardroom.

A boardroom with network controls

A network control solution is not determined by the wiring configuration. Instead all devices use logical addressing to communicate with each other. This common logical addressing layer allows for flexible configuration and choice of functionality independent of the physical wiring.

For the boardroom, two different dimming controllers would be used to match the different styles of lamps (fluorescent and LED). The control devices do not need to be co-located in the area they serve and may control lighting groups for more than one room or area. Conversely, physical lighting channels from any controller can be assigned to any logical area. This allows for a more intuitive view of the lighting groups that matches the floor plan rather than a complex wiring diagram.

The logical groupings enable switching, dimming and preset scenes to efficiently control different circuits and lighting types across devices, resulting in a faster response from the lighting circuits. This avoids the undesirable 'wave' effect where multiple discreet messages need to be sent from one device to many.

The network communicates with the DyNet protocol – represented here by the orange lines – which virtually connects the control panels to both dimmer control units. Lighting levels and area groupings are easily changed and saved to the network. Initial programming is minimized, while future adjustments are easily applied and overall system implementation is simplified.

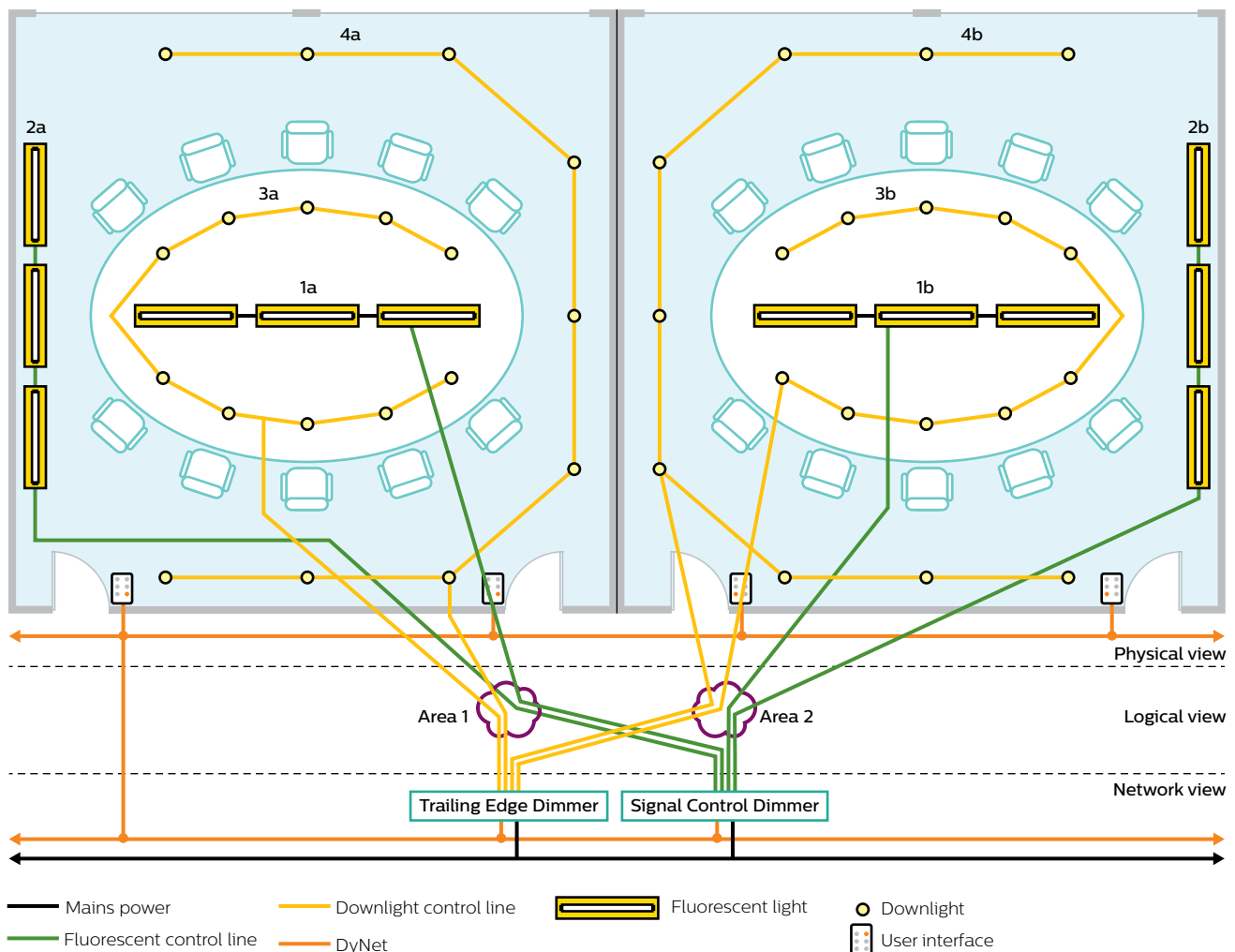

Responsibility for controlling the four lighting groups in the two rooms is divided over two different controller types to match the lamps requirements.

A boardroom with preset lighting scenes

Once switching and dimming control channels are assigned to a logical area, the next enhancement to a lighting system is the provision of preset scenes. The scene data is stored within the load controllers themselves and requested from the user interface panels. User interfaces do not need to be sending multiple messages across the network to each physical channel or user interface status indicators. The DyNet architecture allows for one network message to change the status of all physical devices assigned to a logical area.

In Boardroom A, the levels of four physical lighting groups are assigned into two logical areas. For this example Boardroom A is currently set to Preset 2 and Boardroom B to Preset 3. Each preset is a preferred scene that the client has requested.

Here, Preset 2 might represent 'Meeting' mode, in which more lighting is centered over the table. The presets are programmed to set different lighting groups to the desired lighting levels. The dimming setting for each lighting channel can be easily adjusted at the time of initial configuration or subsequently as the end-user's operation preferences are taken into account.

This logical view of the dimming levels of each lighting channel is the most intuitive way to view the presets. This simplifies fine-tuning of the dimming presets for each lighting channel to ensure the best overall lighting effect is achieved.

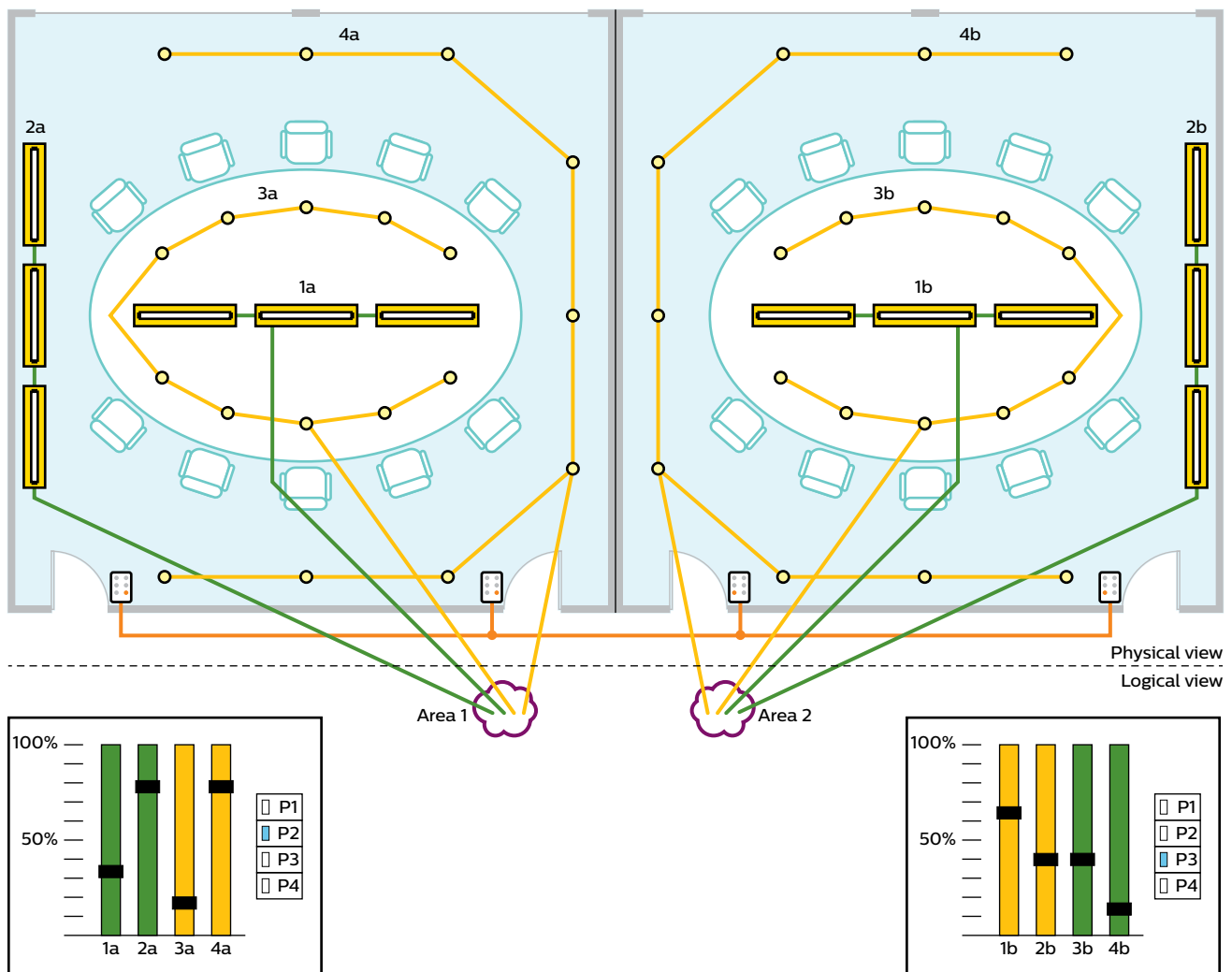

- DyNet
- Fluorescent control line
- Downlight control line
- Fluorescent light
- Downlight
- User interface

Preset scenes stored within each load controller provide the most powerful and flexible lighting control functionality.

Adding sensors to the system

Incorporating sensors enhances energy-management strategies, as well as optimizing user safety and comfort.

Philips Dynalite uses multifunction sensors that are capable of both presence (occupancy) and light-level detection at the same time. At the most basic level, a sensor detects when a room is first occupied and instructs the system to turn the lighting on by recalling a preset scene for a particular area. In room-join mode, the presence detection by any sensor in the joined area will update the required scene in both sections of the adjoining room, changing the lighting and updating the status indicators in the local control panels with one network message.

The automatically activated preset lighting level – or any alternative preset subsequently selected by the occupant – will be maintained until a ‘time-out’ period has elapsed without ongoing presence detection occurring.

As the multifunction sensors incorporate light-level detection, they can also be used for daylight-harvesting strategies. In this role, the sensors are able to detect natural light levels from the windows and maintain a pre-determined lux-level target by automatically regulating the light output while the room is occupied.

Where the presets include different light intensities for several lighting channels, such as for lights that are further away from the windows, the daylight-harvesting operation acts like a ‘master-slider’ controller, proportionally increasing/decreasing all the lighting groups in parallel, while maintaining the desired ratio between the different lighting groups.

The lighting in the area continually responds to any network messages generated either automatically by a sensor or manually through a user interface.

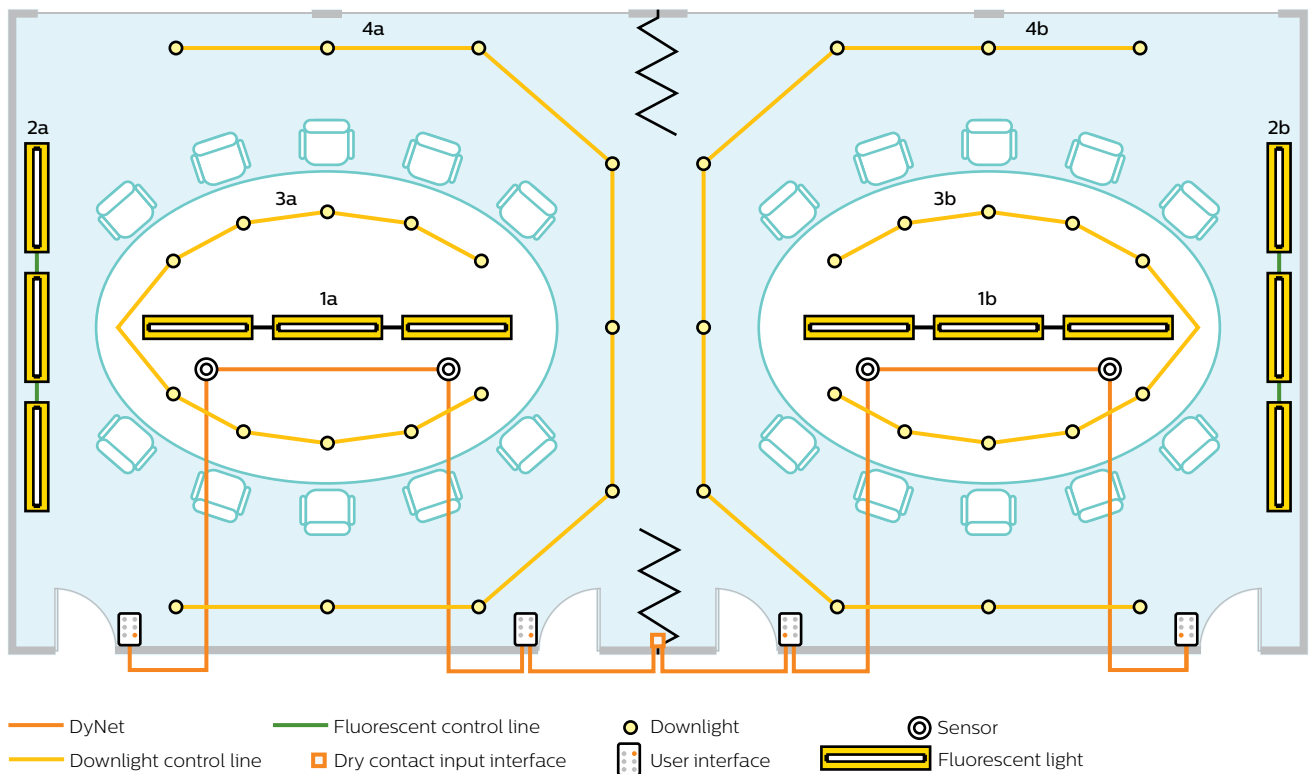

Sensors modify lighting based on presence detection and light level detection.

Timeclock facilitates further functionality

To leverage yet more functionality from the Dynalite system, an astronomical 365-day timeclock can be included in the network. Programmed with longitude and latitude details, the timeclock ensures that the Dynalite system 'knows' when sunrise and sunset times are throughout the year. This enables events to occur at set times relative to sunrise or sunset times, such as activating certain lighting channels before sunset. Local daylight saving and public holiday data can also be included, so that the system recognizes local time and understands which days are working days and which are not.

The timeclock facilitates any time-based activity. For instance, during normal operating hours on a standard working day, lighting groups can be automatically turned on to a low background lighting level for unoccupied zones preventing people from walking into an unlit area.

Timeclock functionality can also be employed to fine-tune sensor behavior. Typically, an office might be configured for a 30-minute time-out period during working hours and a 5-minute timeout for out-of-hours periods. This safeguards that the time-out operation will not present a nuisance during the working day, while simultaneously allowing a more aggressive energy-management strategy out-of-hours.

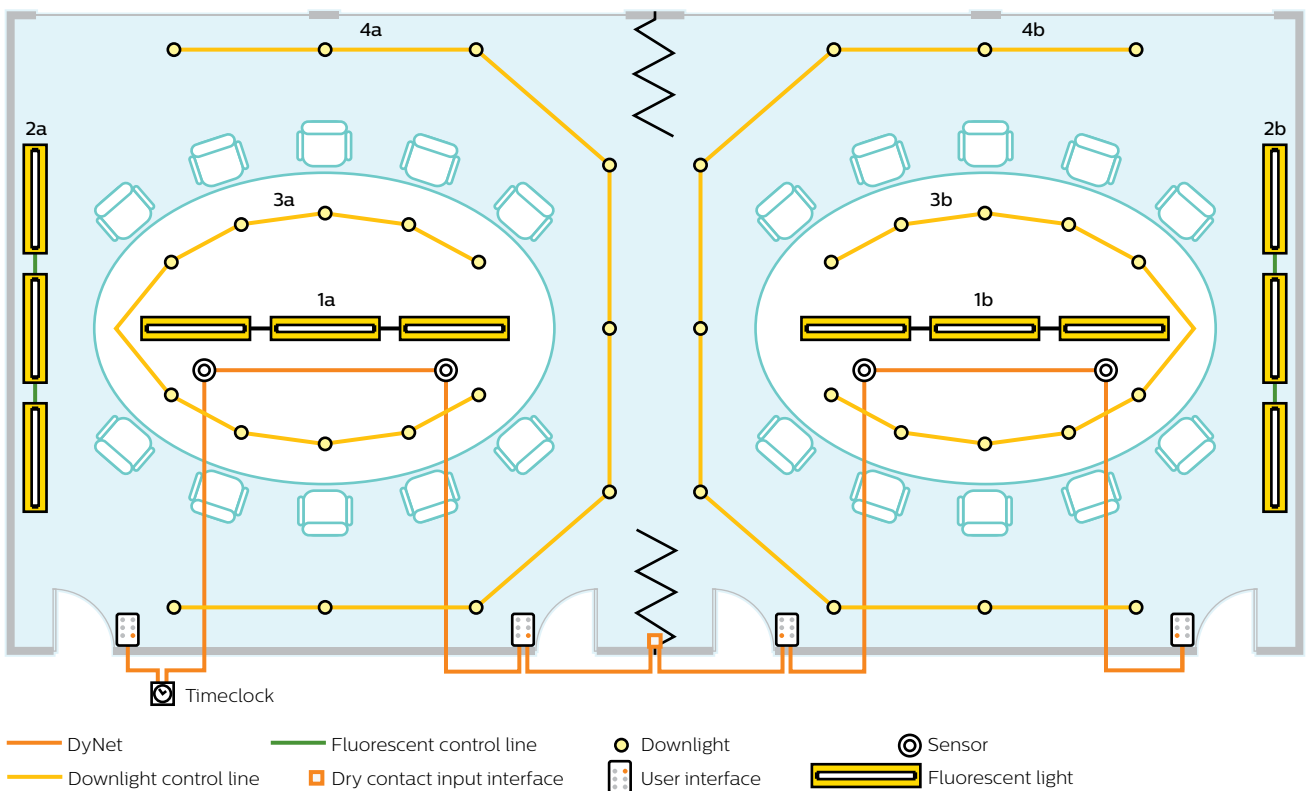

Automated functionality scheduled by Timeclock.

Integrating third-party systems

As all devices are networked they can also control and respond to any integrated third-party systems – such as blinds, HVAC or AV. This provides seamless operation and a single consistent interface is provided to the end-user for all network systems.

Supporting a range of temperature sensors, the Dynalite platform minimizes ‘wall clutter’ of different user interfaces. Occupants only need to interact with a single user interface each time they enter or leave the room. This also brings in an additional benefit of having multiple services responding to one timeclock schedule.

HVAC integration

HVAC control can be linked with presence detection, so the HVAC system will be instructed to engage at a particular set point when a room is occupied. The HVAC system can then ensure the room’s heating/cooling level is set to a suitable temperature. When the presence detection times out, a further message informs the system that the room is now unoccupied, allowing the HVAC to either be turned off completely or simply adjusted to a more energy-efficient setting.

The timeclock can initiate different strategies for winter and summer to meet the changing requirements for heating and air-conditioning at different times of the year. In the wintertime,

for example, the target temperature would usually be reduced for an unoccupied room to reduce unnecessary energy expenditure, whereas in the summertime it would be increased.

This automated process removes the need for users to remember to activate the heating or cooling or to set the temperature as they enter or leave different areas of the building. The system is able to turn the HVAC on or off and make the necessary adjustments to enhance occupant comfort and optimize the ambient environment.

AV integration

Likewise, a Dynalite system can be configured to both send and receive instructions from AV systems. Commonly, presets for a boardroom include options such as ‘Meeting’, ‘Presentation’, ‘Speech’ and ‘Video Conference’. If the ‘Presentation’ button is selected, the system can be programmed to dim the different lighting groups to a predetermined level, lower the projector screen and switch on the projector. In this way, various elements of the system can come together, giving the impression of a single seamless platform operating all systems within a room.

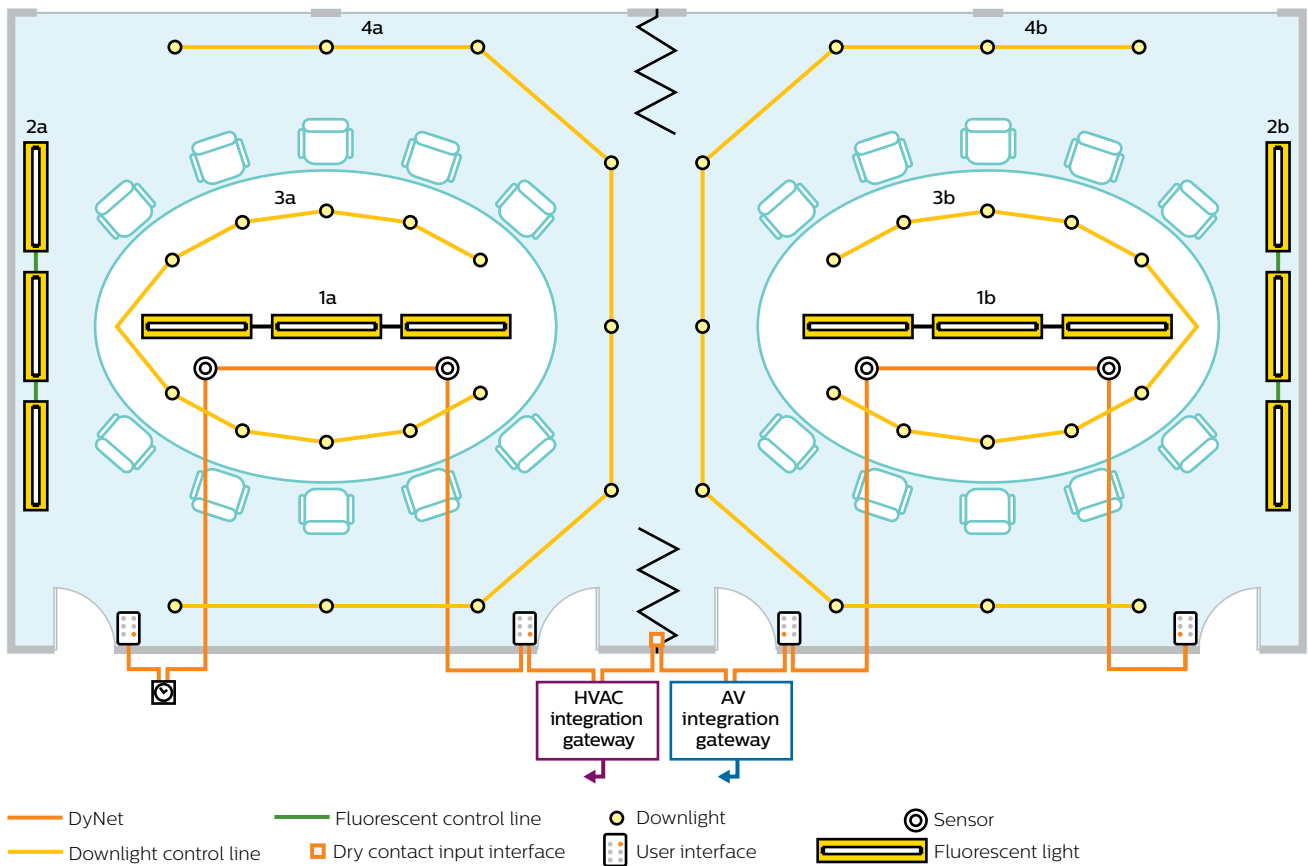

Seamless integration of other building systems.

Each integrated system communicates in both directions: the preset button on the user interface can be selected to activate the AV system along with the respective lighting preset; or conversely, activating the AV system can engage the appropriate lighting preset. In this way, the user can initiate the 'Presentation' setting intuitively from either interface – without the worry of 'pressing the wrong button' or 'doing things in the wrong order'.

By minimizing the need for user input, the system is able to provide the surety that the settings are always consistent for a presentation or video conference.

Blind integration

Motorized blinds can also be integrated into the Dynalite platform and respond to various preset options. For 'Presentation' mode, for instance, in addition to the lowering of the lights and activation of the AV equipment, the blinds can also be closed automatically. Equally, blinds can be incorporated into daylight-harvesting strategies, helping minimize glare if target lux levels are exceeded by incoming natural light and limiting heat build-up in summer, caused by direct sunlight on windows.



Corridor hold function

The examples seen so far – incorporating various levels of functionality for Boardroom A and Boardroom B – provide a fairly focused view of only a small aspect of the Dynalite platform. Panning out to a larger view, it is possible to see how the networked control system controls the interaction of the corridor lighting and the individual rooms. Here, we see four boardrooms – Boardrooms A, B, C and D – and their connecting corridor. Boardrooms A and B are shown in room-join mode, while Boardrooms C and D are being used separately.

Boardrooms A, B and C are occupied, as evident by the activated lighting presets (Preset 2 for Boardrooms A and B, and Preset 1 for Boardroom C), while Boardroom D is unoccupied (with Preset 4 providing energy-saving minimized lighting levels only).

During meetings, if no occupancy is detected in the corridor for the duration of the time-out period, this would normally result

in the corridor lighting being turned off or at the very least, minimized to an energy-saving level. However, the Dynalite system can be programmed with a 'Corridor Hold-On' function, where the system recognizes that Boardrooms A, B and C are still occupied. Presence detected in these areas via the sensors will keep the associated corridor lighting on at the last selected preset level.

The inbuilt conditional logic ensures that sensors in one logical area (in this example, each of the boardrooms) can affect the lighting in a different logical area (the corridor). This function has both comfort and safety implications, ensuring people never emerge from a room into a darkened corridor. The same strategy can be applied to reception areas and lobbies to ensure an egress pathway is always illuminated, regardless of where a person is working within a building.

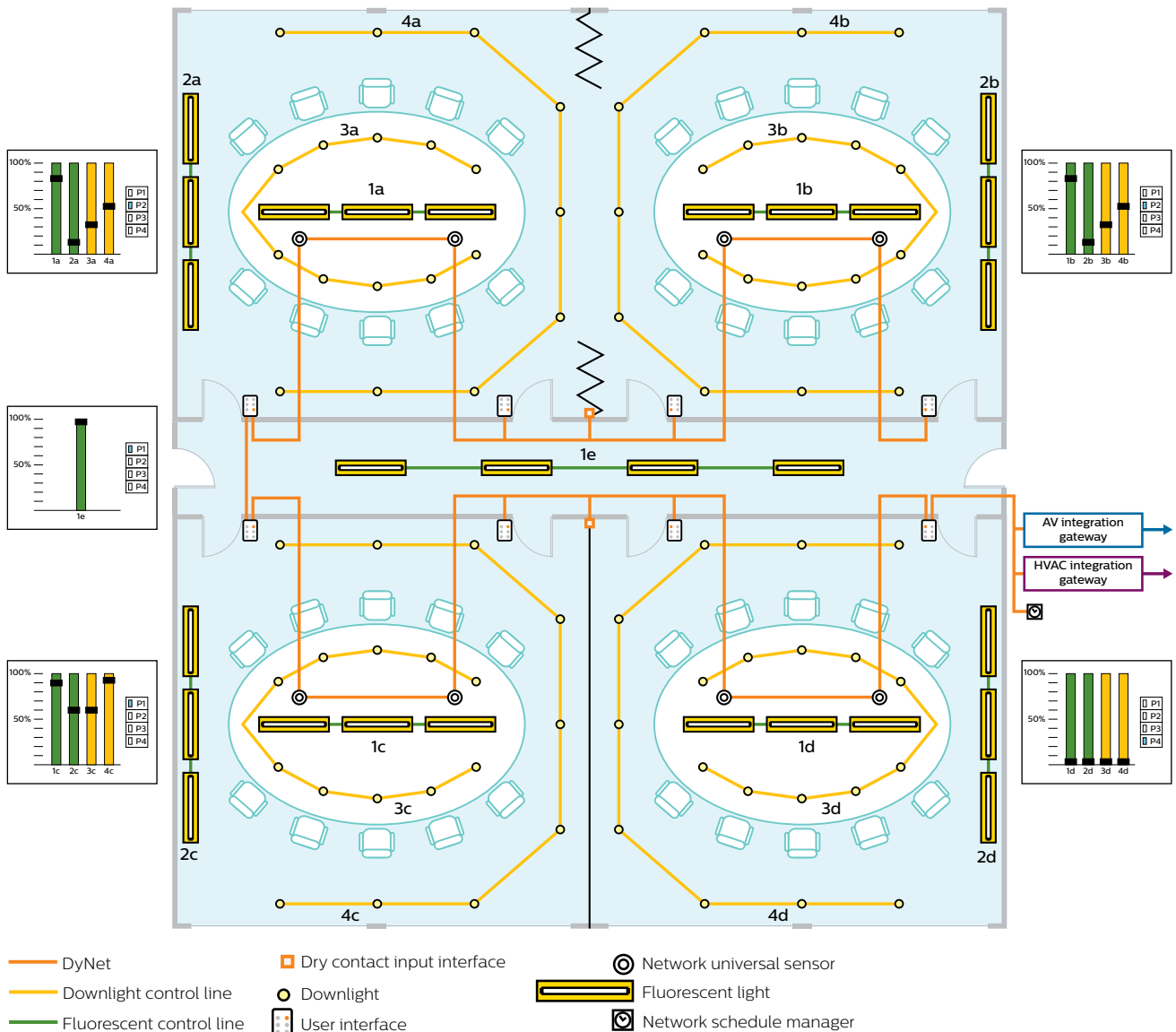

Network system over entire floorplan

Expanding the view to an entire floor, the concepts of the network solution remain the same, with the same building blocks that were used for the meeting rooms equally able to be applied to open office areas. In this example there are:

- two adjoined meeting rooms,
- a reception area
- an open-plan office

In the open area, five clusters of workstations, each comprising eight desks, are separated by a central walkway. Each cluster has dedicated fluorescent lighting, managed by a local sensor and the central walkway also has its own fluorescent lighting.

Each sensor is linked to its local lighting cluster. If one or more desks are occupied in any one cluster, the lighting for that entire cluster will be activated. However, the sensor for each

cluster is also logically linked to the lighting down the central access aisle, plus the reception lighting. This ensures that a local sensor will not only activate the lighting over the occupied cluster, but will also illuminate the walkway and the reception area while ever an occupant is present anywhere on the floor. In this way, an occupant always has a lit pathway from their work area to the exit.

Based on time-of-day, the lighting control system may instruct the sensors to adjust the lighting appropriately to maintain the optimum balance between energy management and occupant comfort.

In addition to presence detection, the sensors are also able to facilitate daylight-harvesting strategies by detecting ambient light levels for those clusters adjacent to windows, to reduce artificial lighting levels and balance incoming natural light.



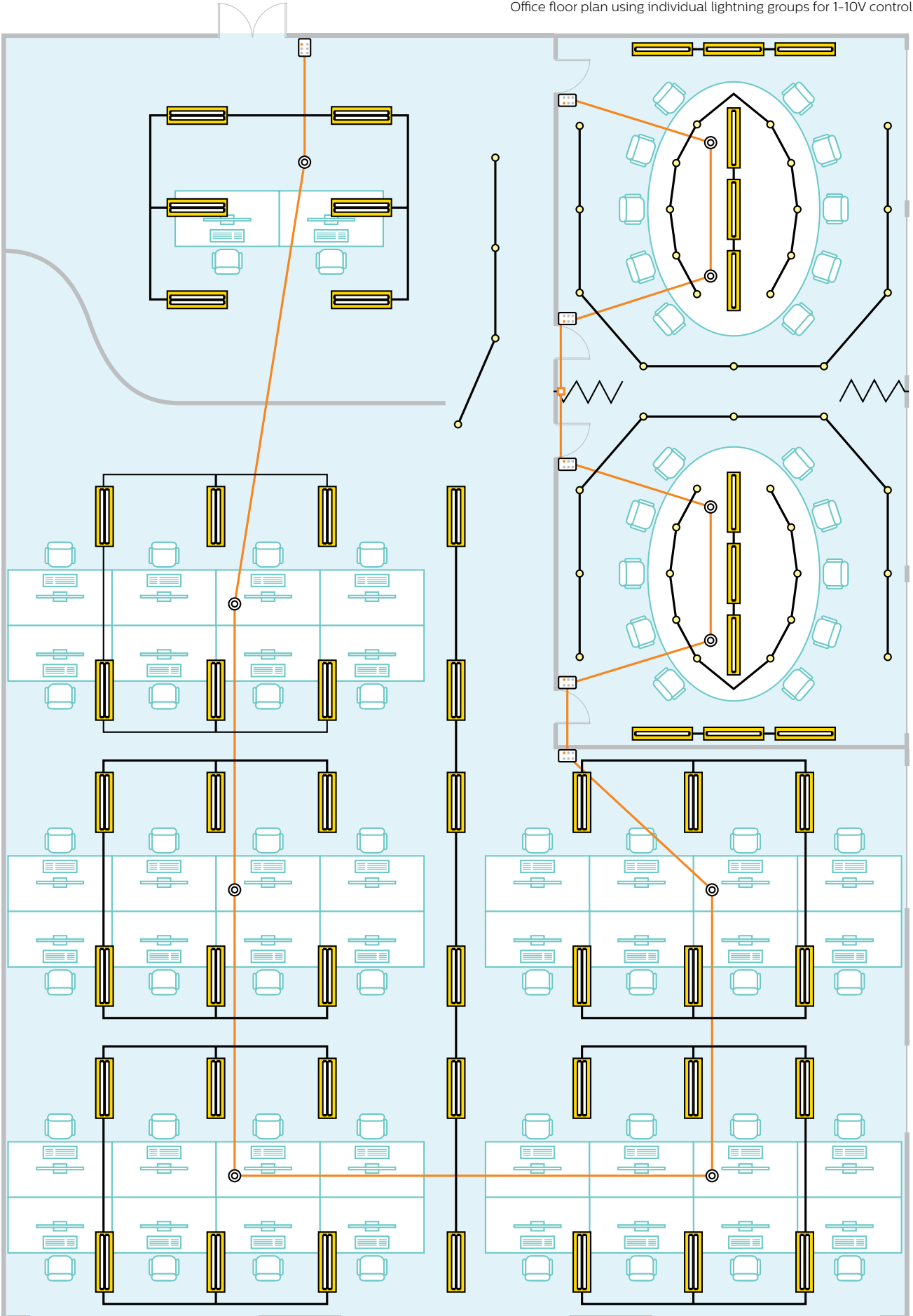



Network system over entire floorplan using DALI

This layout is similar to the layout previously seen, but using a Digital Addressable Lighting Interface (DALI) solution. Whereas the wiring for each lighting clusters in the previous example was independently connected back to the control system, with a DALI system one control cable connects every lamp. As the DALI system is able to address each lamp, it is not necessary to connect each lighting cluster separately. The system is intelligent enough to know where each luminaire is located through its unique address.

This approach has a number of important benefits. Firstly, less cabling is required, as it is no longer necessary to provide individual wiring looms for each lighting group. The second advantage is that a DALI system saves on labor costs during installation, which is now simplified due to the fewer connections that need to be made. The savings that can be made on a project through the combination of less wiring, less complexity and less on site personnel can have a significant impact on the bottom line of a project.

While the installation is simpler, DALI systems do require some extra commissioning than non-DALI, as each luminaire needs to be identified, addressed and assigned to a logical area. However, the additional time spent on commissioning is more than outweighed by the reduction in time during installation.

Moreover, once commissioned, a DALI system provides the ultimate flexibility for the future. If a floorplan is rearranged, for example, no changes to the physical cabling are required, as luminaires can simply be reassigned from one logical group to another through the software interface.

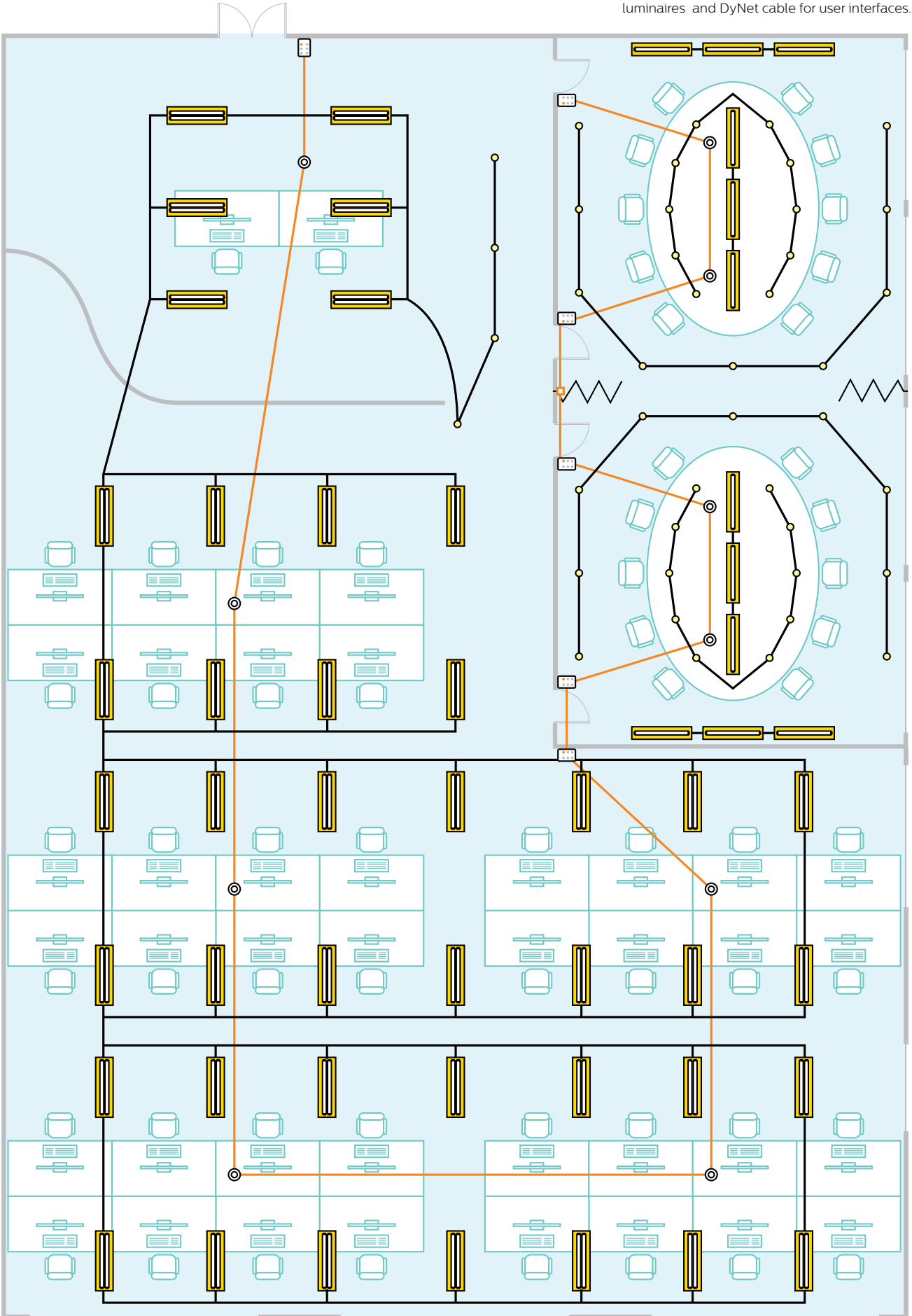

Network system over entire floorplan using DALI MultiMaster

The Philips' DALI MultiMaster solution expands the benefits of DALI yet further. This architecture enables the DALI network to carry power and network messages to all user-interface (UI) devices. This removes the need for a separate DyNet network cable to be run in parallel to the DALI network. Major savings are achieved as, the sensors and button panels are now connected directly into the lighting network, rather than wired into a separate control network.

By removing control infrastructure, cabling requirements plus associated labor costs – DALI MultiMaster magnifies the savings that can be achieved by DALI. This factor is particularly relevant where labor costs represent a high proportion of overall project costs.

From the occupants' perspective, it is impossible to distinguish between a standard network control system, a traditional DALI architecture or the innovative DALI MultiMaster solution, as each system is able to offer virtually identical levels of comfort, control and functionality. However, the way these results are achieved can have important implications to a project, both from a cost installation and a flexibility standpoint.

Each network option allows all lighting functions to occur automatically, without the need for manual intervention from the occupant. However, while not functionally necessary, it may be a legal requirement for commercial buildings in certain markets to enable the user to manually override the automated control. Similarly, many end-users also request the inclusion of a UI for the additional surety that this gives.



Office floor plan using single cable for DALI addressable luminaires and MultiMaster user interfaces.

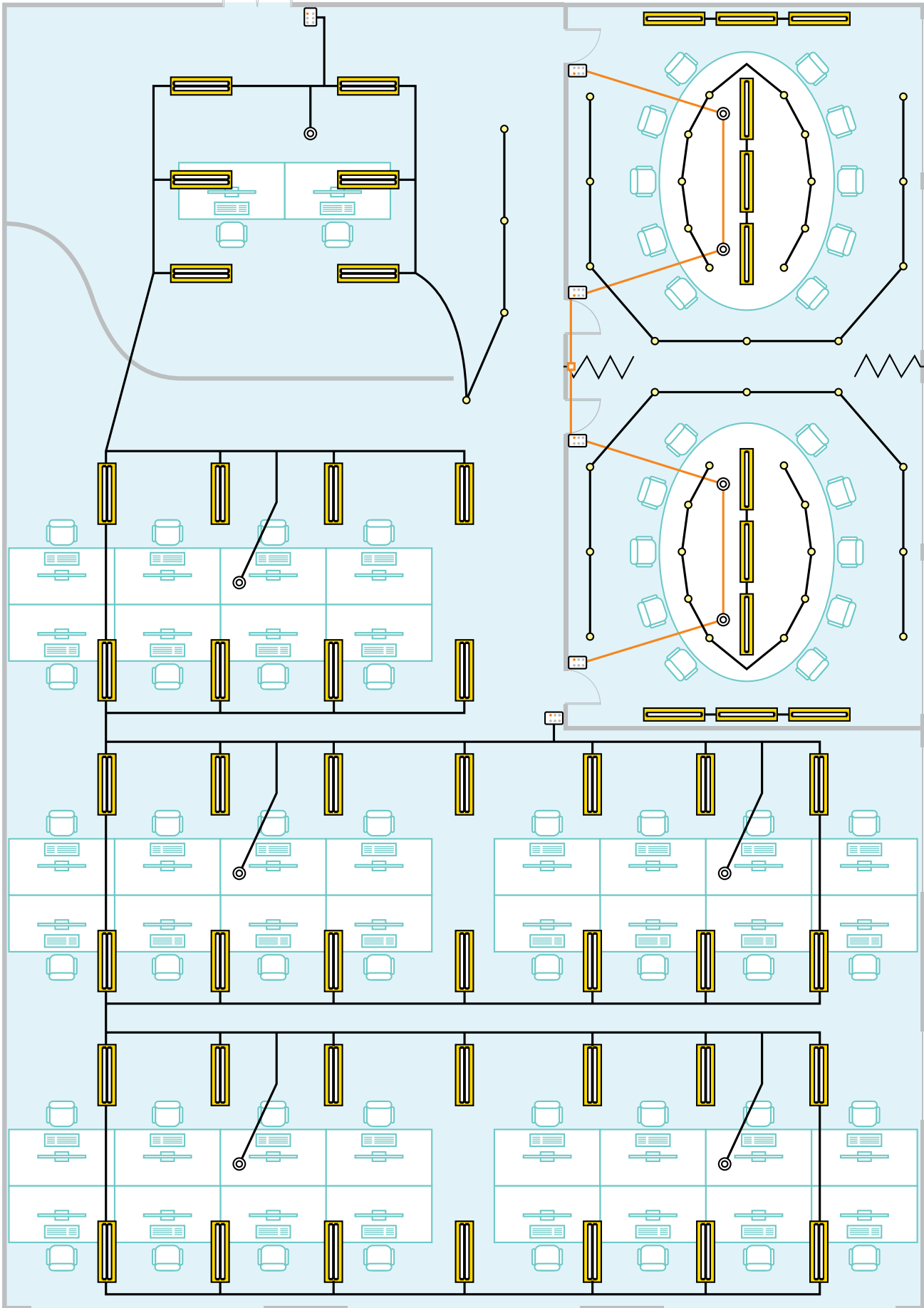

The advantages of a DALI office lighting control system

The DALI system at work

Traditional DALI allows for individual light fittings to be networked. The DALI protocol allows for a maximum of 64 fittings on a single network with 16 different area groupings.

Shown on page 29 is an example of 64 DALI light fittings connected in a single network, which is divided into seven different areas.

Standby power management

DALI fittings control the output level of the lamps. However, once a lamp has been instructed by the control system to dim to 0 per cent, it is still consuming a standby current consumption.

While individual lamp standby power consumption may not seem significant, multiplied by the total number of lamps within a project and it becomes considerable. Without a power management strategy, this standby power consumption does not stop, 24 hours a day, 365 days a year.

The Philips Dynalite solution eliminates standby power consumption when the lamps are in the 'Off' state, thus allowing greater savings and true energy management.

Unlimited scalability with multiple DALI networks

The DALI specification details how to operate a single network. However, most projects require multiple DALI networks operating together to create a single seamless lighting system solution.

Often a project floor layout is not known until the late stages of construction, which means electrical installers need to change the DALI bus to match the desired floor plan, ensuring that each area does not cross the physical boundary from one DALI network into another.

The Philips Dynalite system overcomes these restrictions by directly connecting each of the load controllers in the electrical switchboard via DyNet.

The Dynalite portfolio allows unlimited scalability by combining multiple DALI networks into one system. Any single area can be supported by multiple DALI networks that are coordinated via a common user interface.

Controlling more than DALI

Often a project requires more than DALI to be installed. For instance, lighting groups that require phase-cut dimming, switching control or blind integration, will need more than a DALI system.

The Philips Dynalite platform supports the full range of user interfaces, sensors, load controllers and integration gateways.

All devices in the Dynalite portfolio support DyNet communication, which allows any device to communicate directly with any other device on the network without additional network gateways or central micro-controllers.

Grouped lighting and emergency light monitoring

The DALI specification allows for a maximum of 64 lamps per network, which can be broken up into 16 different groups. The diagram on page 29 shows all the fittings directly connected to each other.

DALI emergency exit fittings are also compatible, allowing for scheduled testing of the lamp and battery with the Philips Dynalite EnvisionManager software. This makes the monitoring of emergency exit fittings easy.

“The system is designed for **intuitive operation of multiple functions from a single button press.**”

Reduce network cabling by up to 50 per cent

A DALI system normally consists of DALI compatible light fittings and a DALI controller. Normally, the DALI system has all fittings connected in one network and the sensors connected on a separate control network.

DALI MultiMaster allows the existing DALI bus to be used for user interface communication effectively reducing the required network cabling by half. As the user interfaces are still networked devices, they can issue commands to change any lighting group on their own DALI network or any other lighting group within the Philips Dynalite network.

This allows the Dynalite system to coordinate multiple DALI networks into one seamless system. So, a sensor physically connected in one DALI network can control a fitting in another, reducing the number of user interfaces and allowing for unlimited area shapes and sizes.

In the example below, each colored area represents a potential area within a project. Two of the required control areas have crossed from one physical DALI network into another. The Dynalite system automatically manages the logical areas so that the DALI network physical boundaries are no longer a restriction.

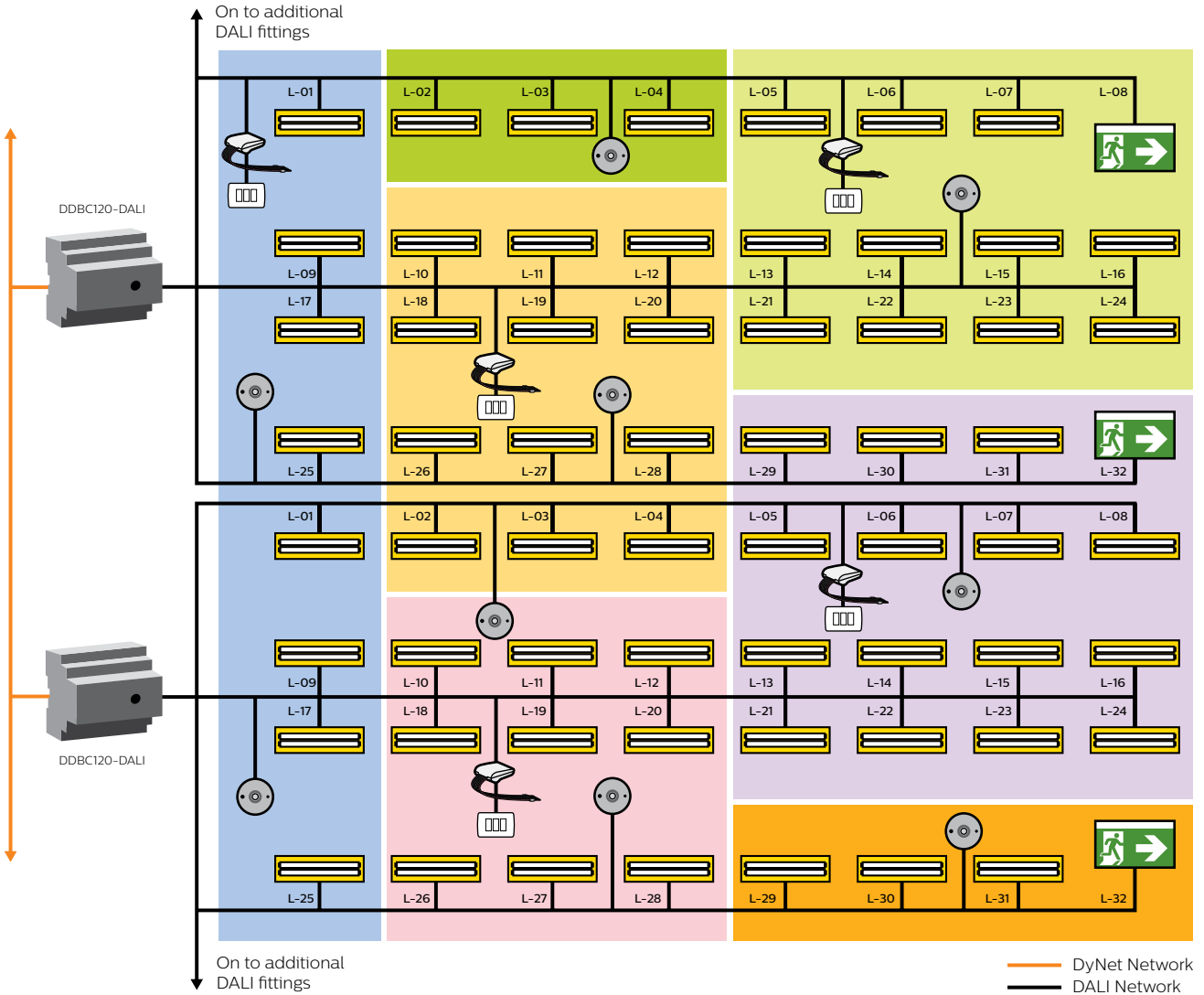

Building-wide network system



As the lighting extends to every space in a building, the lighting control network can be viewed as a building's nervous system. In previous examples, we have explored various lighting control options for single floors. In a multi-floored building, these can be connected together using a trunk-and-spur topology, as shown here. The trunk is the network communication running vertically through the building to provide a central connection – via a network gateway – to the horizontal spurs on each floor.

The network gateway manages messages between the Building Management System (BMS) and the lighting on each floor. Often referred to as 'a supervisory system', this topology averts the need for the BMS to send multitudes of messages to each light group. Instead, pre-programmed functional modes can be triggered through the receipt of a single message by the network gateway.

In effect, each spur operates like a standalone network, the network gateways providing inbuilt fail-safes to the system to ensure that a fault occurring on one spur will be isolated from spurs on other floors. The trunk-and-spur topology enables very large systems to be built up in a modular manner, optimizing both the hardware requirements and the operational efficiency of the system.

With a capacity for up to 36,000 devices on a single spur, systems of unlimited size can be created through the addition of more spurs – or, extra trunks – all wired back to a single BMS. For example, one of Philip's largest projects to date, the Burj Khalifa in Dubai, comprises 13 Ethernet trunks, 170 spurs and over 32,000 network devices covering 170 floors on a single DyNet network.

“ Well-designed easy to use lighting control not only helps your bottom line, it helps to grow your business by providing energy savings, flexibility and comfort for all occupants.”

Building-wide
system solution

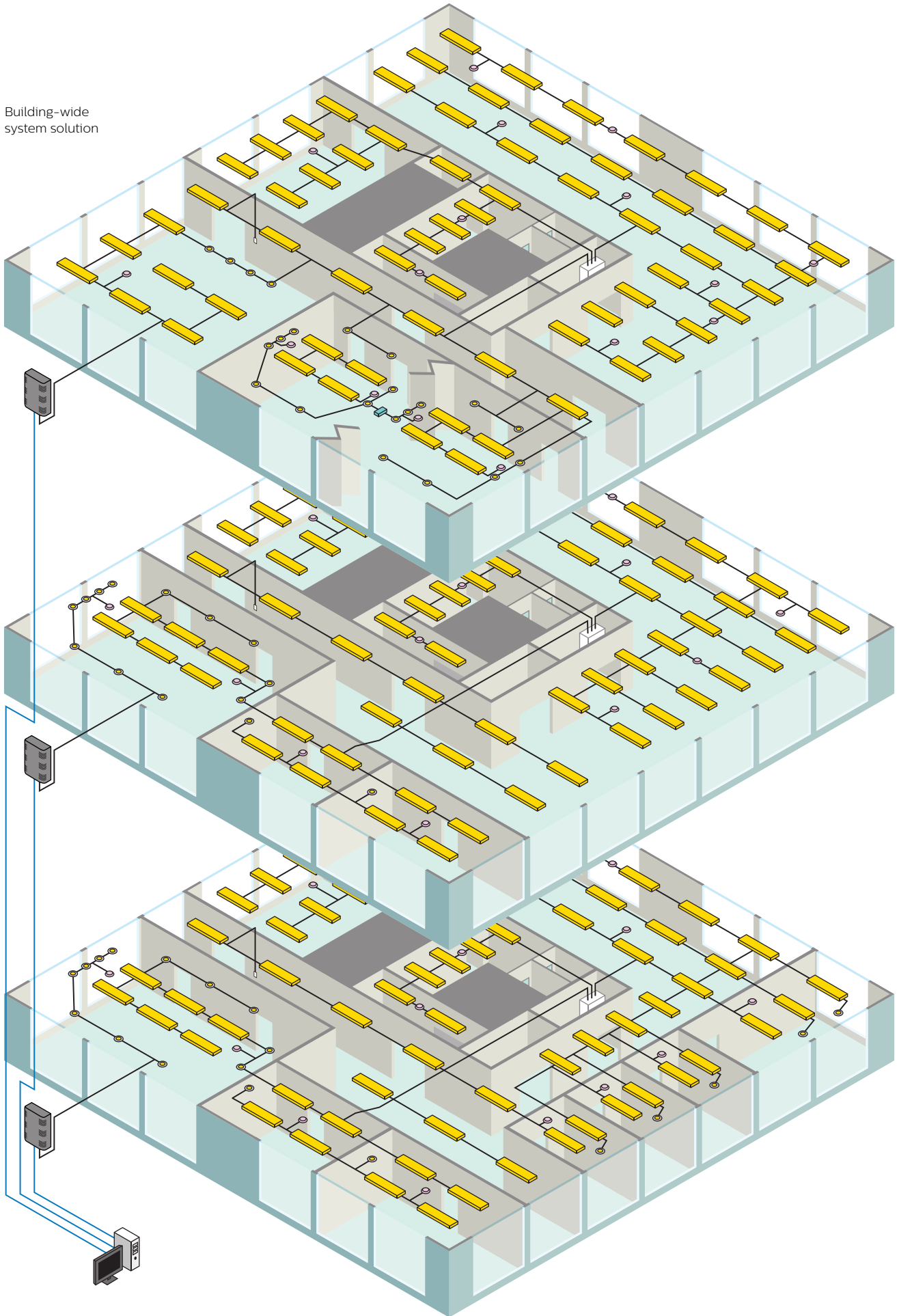



www.philips.com/dynalite

© 2015 Koninklijke Philips N.V. All rights reserved.

All rights reserved. Reproduction in whole or in part is prohibited without the prior written consent of the copyright owner. The information presented in this document does not form part of any quotation or contract, is believed to be accurate and reliable and may be changed without notice. No liability will be accepted by the publisher for any consequence of its use. Publication thereof does not convey nor imply any license under patent – or other industrial or intellectual property rights. Document order number: TECH0107 Data subject to change.

TECH0107-0615-AZZAUS