

TITAN®

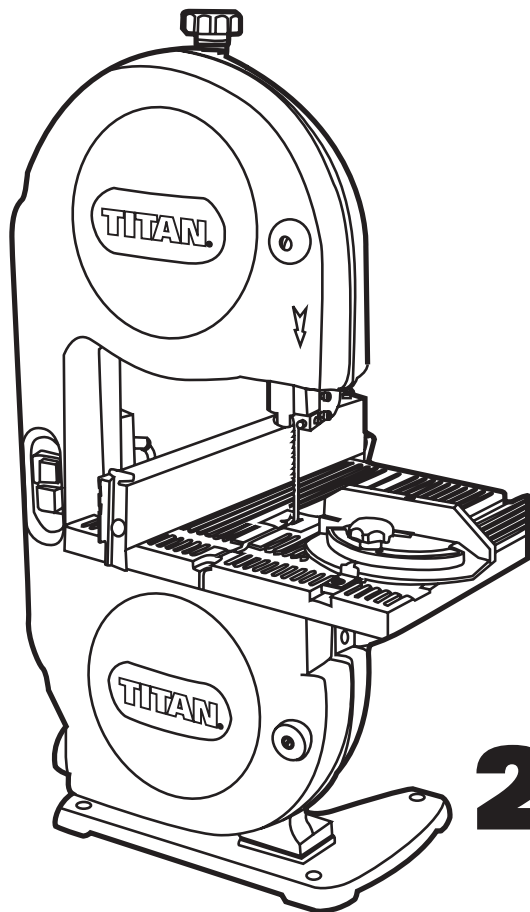

24 month
Full
Manufacturer's
Warranty

SAFETY AND OPERATING MANUAL

Original instructions

BAND SAW

TTB364BDS

TITAN®

Congratulations on your purchase of a TITAN power tool from Titan Power Tools (UK) Ltd. We want you to continue getting the best performance from it so this handbook includes information on safety, handling and care. Please retain this handbook in case you need to refer to any of the information in the future.

Your TITAN power tool comes with a 24-month guarantee, so should it develop a fault within this period contact your retailer.

GUARANTEE

This **TITAN** product carries a guarantee of 24 months. If your product develops a fault within this period, you should, in the first instance contact the retailer where the item was purchased.

This guarantee specifically excludes losses caused due to:

- Fair wear and tear
- Misuse or abuse
- Lack of routine maintenance
- Failure of consumable items (such as batteries)
- Accidental damage
- Cosmetic damage
- Failure to follow manufacturer's guidelines
- Loss of use of the goods

This guarantee does not affect your statutory rights. This guarantee is only valid in the UK.

For further technical advice, spare parts or repair service (outside of guarantee) please contact the customer helpline number on 0845 607 6380

SAFETY INSTRUCTIONS



WARNING! When using electric tools basic safety precautions should always be followed to reduce the risk of fire, electric shock and personal injury including the following.

Read all these instructions before attempting to operate this product and save these instructions.

Safe operation

1. Keep work area clear.

- Cluttered areas and benches invite injuries.

2. Consider work area environment.

- Do not expose tools to rain.
- Do not use tools in damp or wet locations.
- Keep work area well lit.
- Do not use tools in the presence of flammable liquids or gases.

3. Guard against electric shock.

- Avoid body contact with earthed or grounded surfaces (e.g. Pipes, radiators, ranges, refrigerators, other metal surfaces).

4. Keep other persons away.

- Do not let persons, especially children, not involved in the work touch the tool or the extension cord and keep them away from the work area

5. Store idle tools.

- When not in use, tools should be stored in a dry locked-up place, out of reach of children.

6. Do not force the tool.

- It will do the job better and safer at the rate for which it was intended.

7. Use the right tool.

- Do not force small tools to do the job of a heavy duty tool.
- Do not use tools for purposes not intended; for example do not use circular saws to cut tree limbs or logs.

8. Dress properly.

- Do not wear loose clothing or jewellery, they can be caught in moving parts.
- Non-skid footwear is recommended when working outdoors.
- Wear protective hair covering to contain long hair.

9. Use protective equipment.

- Use safety glasses.
- Use face or dust mask if working operations create dust.

10. Connect dust extraction equipment.

- If the tool is provided for the connection of dust extraction and collecting equipment, ensure these are connected and properly used.

11. Do not abuse the cord.

- Never yank the cord to disconnect it from the socket Keep the cord away from heat, oil and sharp edges.

12. Secure work.

- Where possible use damps or a vice to hold the work. It is safer than using your

hand.

13. Do not overreach.

- Keep proper footing and balance at all times.

14. Maintain tools with care.

- Keep cutting tools sharp and clean for better and safer performance.

- Follow instruction for lubricating and changing accessories.

- Inspect tool cords periodically and if damaged have them repaired by an authorized service facility.

- Inspect extension cords periodically and replace if damaged.

- Keep handles dry, clean and free from oil and grease.

15. Disconnect tools.

- When not in use, before servicing and when changing accessories such as blades, bits and cutters, disconnect tools from the power supply.

16. Remove adjusting keys and wrenches.

- Form the habit of checking to see that keys and adjusting wrenches are removed from the tool before turning it on.

17. Avoid unintentional starting.

- Ensure switch is in "off" position when plugging in.

18. Use outdoor extension leads.

- When the tool is used outdoors, use only extension cords intended for outdoor use and so marked.

19. Stay alert.

- Watch what you are doing, use common sense and do not operate the tool when you are tired.

20. Check damaged parts.

- Before further use of tool, it should be carefully checked to determine that it will operate properly and perform its intended function.

- Check for alignment of moving parts, binding of moving parts, breakage of parts, mounting and any other conditions that may affect its operation.

- A guard or other part that is damaged should be properly repaired or replaced by an authorized service centre unless otherwise indicated in this instruction manual.

- Have defective switches replaced by an authorized service centre.

- Do not use the tool if the switch does not turn it on and off.

21. Warning.

- The use of any accessory or attachment other than one recommended in this instruction manual may present a risk of personal injury.

22. Have your tools repaired by qualified person.

- This electric tool complies with the relevant safety rules. Repairs should only be carried out by qualified persons using original spare parts, otherwise this may result in considerable danger to the user.

23. If the replacement of the supply cord is necessary, this has to be done by the manufacturer or his agent in order to avoid a safety hazard.

24. For tools intended to be connected to a water supply.

- for tools provided with a PRCD: Never use the tool without the PRCD delivered with the tool.

- for tools provided with an isolating transformer: Never use the tool without the transformer delivered with the tool or of the type as specified in these instructions.
- Replacement of the plug or the supply cord shall always be carried out by the manufacturer of the tool or his service organisation.
- Keep water clear off the electrical parts of the tool and away from persons in the working area.

ADDITIONAL SAFETY INSTRUCTIONS FOR YOUR BAND SAW

1. Safety precautions

- 1) Do not use saw blade which are damaged or deformed;
- 2) Replace the table insert when worn;
- 3) Lock the work table firmly before operation;
- 4) Tension the saw blade properly;
- 5) Do not clean the saw band whilst it is in motion;
- 6) Wear suitable personal protective equipment, when necessary, this could include:
 - a) Hearing protection to reduce the risk of induced hearing loss,
 - b) Respiratory protection to reduce the risk of inhalation of harmful dust,
 - c) Gloves for handling the saw band and rough material.

2. Safe operation

- 1) When straight cutting against the fence use a push;
- 2) This saw must be attached to a solid secure work surface by means of the fixing holes in the base.
- 3) Never adjust or assemble the rip fence or mitre gauge when the machine is working;
- 4) When the workpiece is near to the saw blade, never use your hand to push it. Always use the push stick provided (See 25 on main diagram)
- 5) Never tension the saw blade when working;
- 6) If need to adjust the blade guide, stop the machine first.

VIBRATION

The European Physical Agents (Vibration) Directive has been brought in to help reduce hand arm vibration syndrome injuries to power tool users. The directive requires power tool manufacturers and suppliers to provide indicative vibration test results to enable users to make informed decisions as to the period of time a power tool can be used safely on a daily basis and the choice of tool.

Further Advice can be found at www.hse.gov.uk

Vibration total values (triax vector sum) determined according to EN61029:	
Work mode description 1 (if required by the relevant Part 2)	Vibration emission value $a_h = 3.0\text{m/s}^2$
	Uncertainty $K = 1.5\text{m/s}^2$

The declared vibration emission value should be used as a minimum level and should be used with the current guidance on vibration.

Calculating the actual period of the actual period off use can be difficult and the HSE website has further information.

The declared vibration emission been measured in accordance with a standardised test stated above and may be used to compare one tool with another
The declared vibration emission value may also be used in a preliminary assessment of exposure.

 **Warning:** The vibration emission value during actual use of the power tool can differ from the declared value depending on the ways in which the tool is used dependant on the following examples and other variations on how the tool is used:-

How the tool is used and the materials being cut or drilled.

The tool being in good condition and well maintained

The use the correct accessory for the tool and ensuring it is sharp and in good condition.

The tightness of the grip on the handles.

And the tool is being used as intended by its design and these instructions.

This tool may cause hand-arm vibration syndrome if its use is not adequately managed

 **Warning:** identify safety measures to protect the operator that are based on an estimation of exposure in the actual conditions of use (taking account of all parts of the operating cycle such as the times when the tool is switched off and when it is running idle in addition to the trigger time). Note The use of other tools will reduce the users' total working period on this tool.

Helping to minimise your vibration exposure risk.
ALWAYS use sharp chisels, drills and blades

Maintain this tool in accordance with these instructions and keep well lubricated (where appropriate)

Avoid using tools in temperatures of 10°C or less

Plan your work schedule to spread any high vibration tool use across a number of days.

Health Surveillance

All employees should be part of an employer's health surveillance scheme to help identify any vibration related diseases at an early stage, prevent disease progression and help employees stay in work.

SYMBOLS



Read the manual



Warning



Wear gloves



Wear ear protection



Wear eye protection



Wear dust mask



Conforms to relevant safety standards

RyyWxx Manufacturing date code; Year of manufacturing (20yy) and week of manufacturing (Wxx); "R": Complies with Directive 2002/95/EC on the restriction of the use of certain hazardous substances in electrical and electronic equipment.

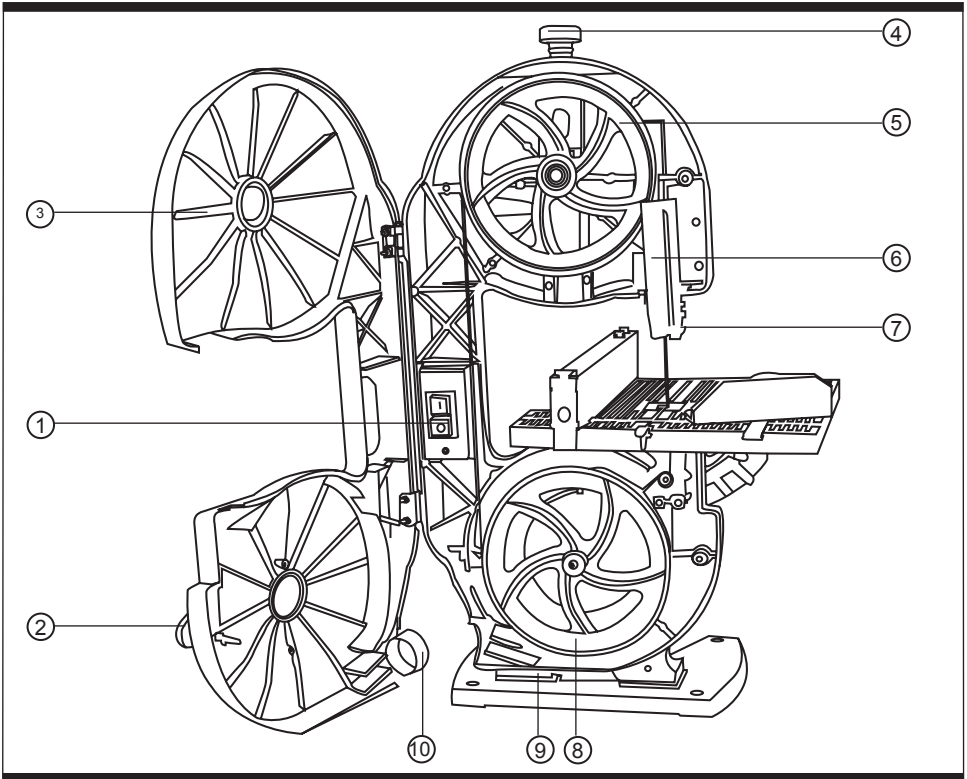

1. ON/OFF SWITCH

2. FIXING KNOB

3. SIDE COVER

4. BLADE TENSION KNOB

5. UPPER BAND PULLEY

6. SAW BLADE GUARD

7. UPPER BLADE GUIDE

8. LOWER BLADE PULLEY

9. BASE

10. DUST EXTRACTION PORT

11. SETTING SCREW FOR UPPER BAND PULLEY

12. SETTING KNOB FOR BLADE GUIDE

13. MACHINE FRAME

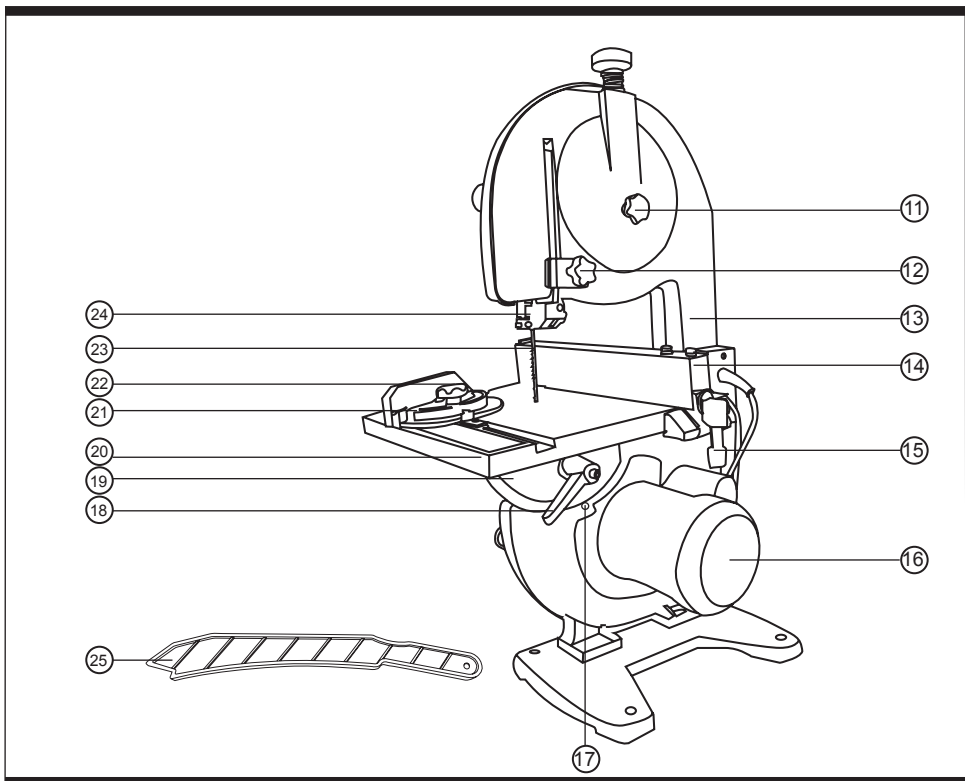

14. RIP FENCE

15. RIP FENCE LOCKING HANDLE

16. MOTOR

17. ANGLE SCALE POINTER

18. FIXING HANDLE FOR TABLE

19. DIAL SCALE FOR TILT ANGLE

20. WORK TABLE

21. MITRE GAUGE

22. FIXING KNOB

23. SAW BLADE

24. FIXING SCREW FOR BAND GUIDE

25. PUSH STICK

BAND SAW

TTB364BDS

TECHNICAL DATA

Volts:	230V~50Hz
Power Input:	350W
No load speed:	1450min ⁻¹
Saw line speed:	14.7m/s
Cutting Capacity:	85mm
Table Size:	300x300mm
Weight:	17.6kg
Bevel angle:	0° - 45°
Saw blade length:	1425mm
Saw blade width:	6.4mm

NOISE DATA

Sound pressure level	67.5dB(A)
Sound power level	80.5dB(A)
Uncertainty:	3dB(A)
Wear ear protection when sound pressure is over	85dB (A)



ACCESSORIES

Parallel fence:	1pc
Mitre guage:	1pc
Spanners for machine assembly:	3pcs
Saw blade:	1pc
Push stick:	1pc
Push stick storage hook:	1pc

OPERATION INSTRUCTIONS

 **Warning:** Before using your band saw, read the instruction manual carefully.

Before putting the machine into operation

1. Make sure the machine stands securely, i.e. bolt it to a workbench or solid base. There are two holes for this purpose in the machine foot.
2. All covers and safety devices have to be properly fixed before the machine is switched on.
3. It must be possible for the blade to run freely.
4. When working with wood that has been processed before, watch out for foreign bodies such as nails or screws etc.
5. Before you actuate the On/Off switch, make sure that the saw blade is correctly fitted and that the machine's moving parts run smoothly.
6. Before you connect the machine to the power supply, make sure the data on the rating plate is the same as that for your mains.

ASSEMBLY

WARNING: Pull out the power plug before carrying out any maintenance, resetting or assembly work on the bandsaw!

1. Fitting the machine table (See Fig1 & Fig3)

- 1) Undo the fixing handle (18)
- 2) Remove the retaining screw (a).
- 3) Place the work table (20) on the machine frame (13) from the right. Please note that the saw blade (23) is positioned in the center of the table.
- 4) The dial scale (19) of the table (20) must be fitted in the guide on the machine frame (13)
- 5) Screw on the fixing handle (18) again to clamp the saw table (20) in place.
- 6) Insert the retaining screw (a) and tighten. Please note that the wing nut (b) of the retaining screw (a) is located on the underside of the table.

2. Tensioning the saw blade (See Fig4)

1) Note:

Remove the tension from the saw blade if the band saw is not going to be used for some time. Be sure to re-tension the saw blade before you

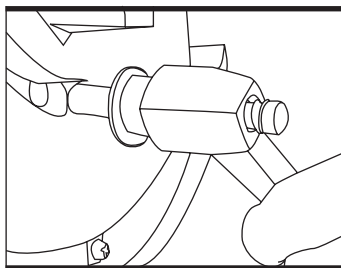

Fig 1

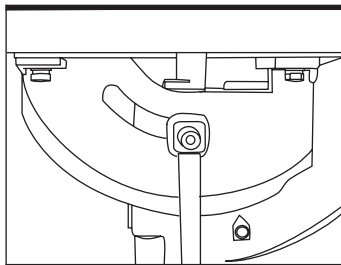

Fig 2

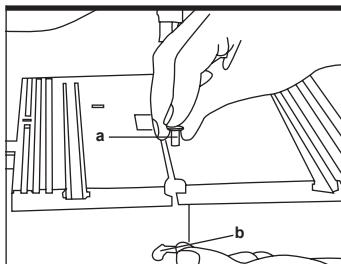

Fig 3

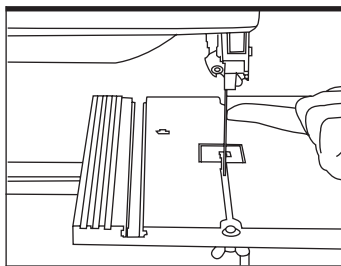

Fig 4

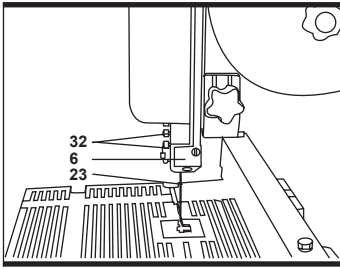

Fig 5

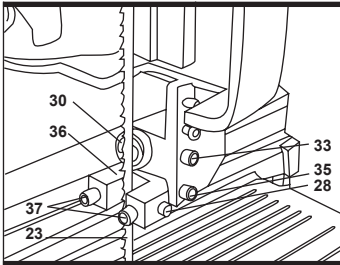

Fig 6

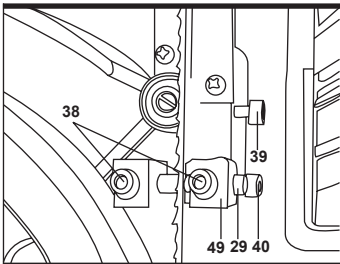

Fig 7

start the machine.

2) Turn the tightening screw (4) for tensioning the saw blade (23) in a clockwise direction.

3) The correct saw blade tension can be checked by applying pressure to the side of the band with your finger, carry out this check at a point roughly between the two band pulleys. You should only be able to bend the blade (23) very slightly (approx. 1-2 mm).

4) **IMPORTANT!** The saw blade may break if the tension is too high. **BEWARE OF INJURY!** If the tension is too high, the powered band pulley (8) will spin while the band does not move.

3. Adjusting the saw blade

1) Note:

The saw blade tension has to be set correctly before you can adjust the saw blade.

2) Undo the fixing knobs (2) and open the left side cover (3).

3) Slowly turn the upper band pulley (5) clockwise by hand. The saw blade (23) should run in the middle of the pulley. If it does not, you will have to adjust the tilt of the upper blade pulley (5).

4) If the blade (23) tends to run to the back of the blade pulley (5), i.e. towards the machine frame (13), turn the setting screw (11) anti-clockwise while turning the blade pulley (5) by hand until the blade (23) runs in the middle.

5) If the blade (23) tends to run to the front edge of the blade pulley (5), turn the setting screw (11) in a clockwise direction.

6) After setting the upper band pulley you need to check the blade (23) position on the lower band pulley (8). The blade (23) should run in the middle of the band pulley (8), as above. If it does not, you will have to adjust the tilt of the upper band pulley (5) again.

7) Turn the upper band pulley several times until the adjustment to the upper band pulley (5) has an effect on the blade position of the lower band pulley (8).

8) Close the side cover (3) when you have finished adjusting the blade and fasten with the Allen screws.

4. Adjusting the blade guide (See Fig 5, 6 & 7)

Whenever you change the blade you must reset both the support bearings (30) and the guide pins

(28 + 29).

Undo the fixing knobs (2) to open the left side cover (3).

Undo the hex screws (32) and remove the blade guard (6).

4.1. Upper support bearing (30)

1) Undo the hex screw (33).

2) Move the support bearing (30) so that it is almost touching the blade (23). There should be a gap of approx. 0.5mm.

3) Re-tighten the hex screws (33).

4.2. Adjusting the lower support bearing (31)

Adjust in the same way the upper support bearing adjusted.

The blade (23) is only supported by the support bearings (30) during cutting.

When idle the blade should not touch the ball bearings.

4.3. Adjusting the upper guide pins (28)

1) Undo the hex screw (35).

2) Move the mount (36) of the guide pins (28) so that there is a gap of approx. 1mm between the front edge of the guide pins (28) and the gullet of the blade in front.

3) Re-tighten the hex screw (35).

4) CAUTION! The blade will be rendered useless if the teeth touch the guide pins while the blade is running.

5) Undo the hex screws (37).

6) Move the guide pin (28) towards the blade so that there is a gap of approx. 0.5 mm between the guide pins (28) and the blade (23). The blade must not jam.

7) Re-tighten the hex screws (37).

8) Turn the upper band pulley (5) several times in a clockwise direction.

9) Check the setting of the guide pins (28) again and re-adjust if necessary.

4.4. Adjusting the lower guide pins (29)

1) Undo the hex screw (40).

2) Move the mount (49) of the guide pins (29) so that there is a gap of approx. 1mm between the front edge of the guide pins (29) and the gullet of the blade in front.

3) Re-tighten the hex screw (40).

4) CAUTION! The blade will be rendered useless if the teeth touch the guide pins while the blade is running.

5) Re-tighten the hex screws (38).

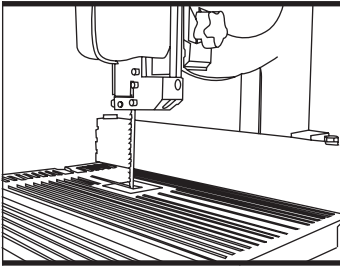

Fig 8

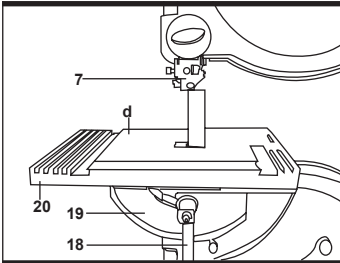

Fig 9

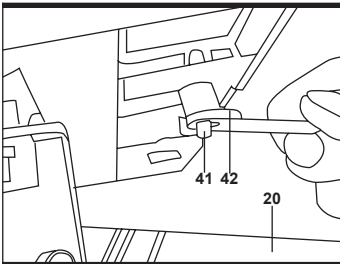

Fig 10

6) Move the guide pins (29) towards the blade so that there is a gap of approx. 0.5mm between the guide pins (29) and the blade (23). The blade must not jam.

7) Re-tighten the hex. screws (38).

8) Turn the lower band pulley (8) several times in a clockwise direction.

9) Check the setting of the guide pins (29) again and re-adjust if necessary.

IMPORTANT! After completing the above adjustments, the upper (6) and lower (34) band guards must be refitted.

5. Adjusting the upper band guide (7) (See Fig8)

1) Undo the fixing handle (18).

2) Turn the setting wheel (12) to lower the band guide (7) as close as possible to the workpiece to be cut. The gap should be approx. 2-3 mm.

3) Re-tighten the fixing handle (18).

4) Check the setting before each cut and re-adjust if necessary.

6. Adjusting the work table (20) to 90° (See Fig9 & 10)

1) Move the upper blade guide (7) to the top.

2) Undo the fixing handle (18).

3) Set the angle between the blade (23) and the table (20).

4) Turn the setting knob (12) to tilt the work table (20) until it is at an angle of exactly 90° to the blade (23).

5) Re-tighten the fixing handle (18).

6) Undo the nut (42).

7) Adjust the hex. screw (41) until there is contact with the machine frame (13).

8) Re-tighten the nut (42) to fasten the hex. screw (41).

9) Undo the recessed head screw locked on the scale pointer (17) to position the angle scale pointer (17) on the 0° mark on the dial scale (19).

7. Blade selection

The blade supplied with the band saw is designed for all-purpose use. When you select a blade you should have regarded to the following criteria:

1) Use a narrow blade to cut tighter radii than you can with a wider blade.

2) Wide blades are used to saw straight cuts. This

is particularly important in cutting wood because the blade has a tendency to follow the grain of the wood and thereby deviate easily from the cutting line.

3) Finely toothed blades provide smoother cuts but are slower than coarse blades.

IMPORTANT: Never use warped or lacerated blades!

8. Changing the blade (See Fig11)

1) Move the blade guide (7) into a position approximately half way between the table (20) and the machine frame (13).

2) Undo the fixing knobs (2) and open the side cover (3).

3) Undo the two allen screws (32) and remove the blade guard (6) (see Fig5).

4) Unscrew and remove the wing nut (b) and retaining screw (a) (see Fig3).

5) Turn the tightening screw (4) anti-clockwise to remove the tension from the blade (23).

6) Remove the blade (23) from the blade pulleys (8,5) and take out through the slot in the table (19).

7) Fit the new blade (23), aligned centrally on the blade pulleys (8,5).

The teeth of the blade (23) must point down towards the table.

8) Tension the blade by turning the tightening screw (4) clockwise to tension the blade.

9) Re-fix the blade guard (6) and close the side cover (3).

9. Changing the rubber tires on the band pulleys (See Fig12)

After a certain time the rubber tires (46) on the band pulleys (8,5) will get worn by the sharp teeth of the bands and must be replaced.

1) Open the side cover (3).

2) Remove the blade (23) (see assembly item 8).

3) Lift the edge of the tire (46) with a small screwdriver (f) and remove from the band pulley (5).

4) Repeat for the lower band pulley (8).

5) Fit the new tire (46), replace the blade (23) and close the side cover (3)

10. Changing the table insert (See Fig13)

To prevent increased likelihood of injury the table

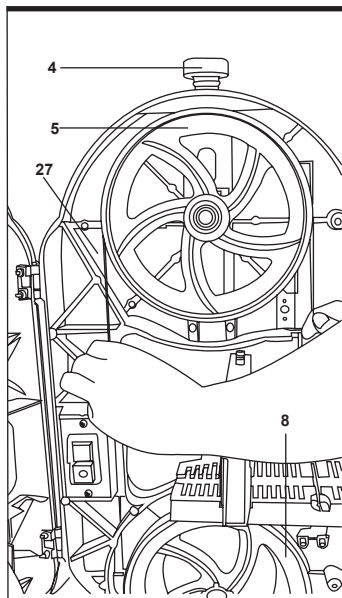

Fig 11

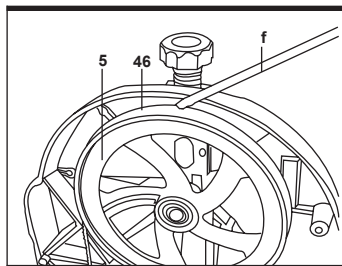

Fig 12



Fig 13

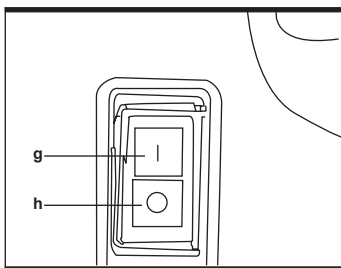

Fig 14

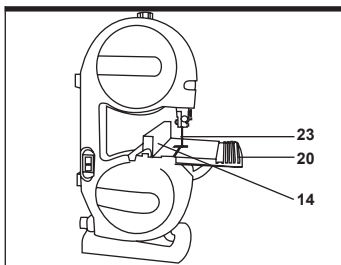

Fig 15

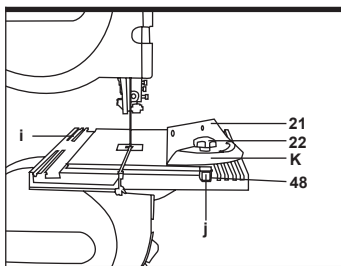

Fig 16

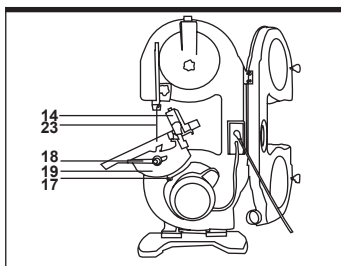

Fig 17

insert (44) should be changed whenever it is worn or damaged.

- 1) Detach the table (20) (see assembly 1).
- 2) Lift out the worn table insert (44).
- 3) Fit the replacement table insert by following the above in reverse.

11. Dust extraction port

The band saw is equipped with dust extraction port (10) for extracting sawdust and chips. Using the extractor adapter, connection to a range of different sawdust extractors is straightforward.

CONTROL ELEMENTS & OPERATION

Control elements

1. On/Off switch (See Fig14)

- 1) To turn the machine on, press the green button "1" (g).
- 2) To turn the machine off again, press the red button "0" (h).
- 3) Your band saw has a switch with under voltage release. After a power failure you must reactivate the switch.

2. Rip fence (See Fig15)

- 1) Push the clip on the rip fence(14) upwards.
- 2) Move the rip fence (14) along the table (20), from either the right or left of the blade (23), and position as required.
- 3) Push the clip down to fix the rip fence (14). If the clip does not give enough hold, turn it clockwise several times until the rip fence is securely fixed.
- 4) You must always ensure that the rip fence (14) is positioned parallel to the blade (23).

3. Mitre gauge (See Fig16)

- 1) Slide the mitre gauge (21) into the groove (i or j) of the table (20).
- 2) Undo the fixing knob (22).
- 3) Turn the mitre gauge (21) until the arrow (48) points to the angle required (k).
- 4) Re-tighten the fixing knob.

4. Angle cuts (See Fig17)

To enable you to perform angle cuts parallel to the blade (23); the table (19) can be tilted forwards

between 0° - 45°.

- 1) Undo the fixing handle (18).
- 2) Tilt the work table (20) forward until the pointer (17) coincides with the required angle value on the man scale (19).
- 3) Re-tighten the fixing handle (18).
- 4) Important: When the table (20) is tilted, place the rip fence (14) stop to the right of the blade (23) on the downward pointing side (provided the workpiece is wide enough) in order to stop the workpiece from slipping off.

OPERATION

NOTE:

After every new adjustment we recommend you to make a trial cut in order to check the new settings.

- For all cutting operations it is important to position the blade guide (6) as close as possible to the workpiece (see assembly 5).
- It will be better and safer to guide the workpiece with push stick, holding workpiece flat on the table (20) in order to prevent the blade (23) from jamming.
- Feed the workpiece at a uniform speed that enables the blade to cut through the material without difficulty and without blocking.
- Always use the rip fence (14) or the mitre gauge (21) on all cuts for which they are intended.
- Always aim at making a complete cut in one pass rather than in a stop-and-go operation requiring the workpiece to be withdrawn. If you have to withdraw the workpiece, switch off the band saw first and wait for the blade (23) to stop before freeing the workpiece.
- The workpiece must always be guided by the longer side during cutting.

1. Longitudinal cuts (See Fig 18)

Longitudinal cutting is when you use the saw to cut along the grain of the wood.

- 1) Place the rip fence (14) to the left of the blade (23), as far as possible, for the width required.
- 2) Lower the blade guide (7) down to the workpiece (see assembly 5).
- 3) Switch on the saw.
- 4) Press the edge of the workpiece with your right hand to hold it securely against the rip fence (14)

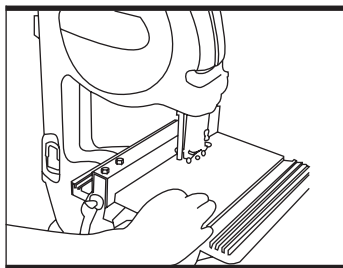

Fig 18

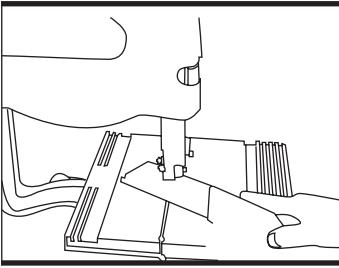

Fig 19

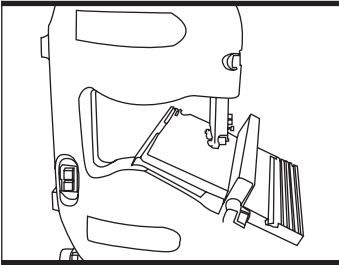

Fig 20

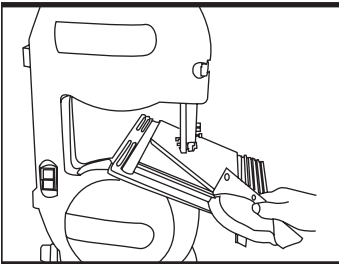

Fig 21

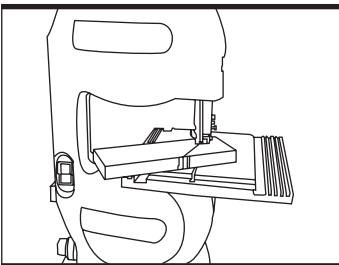

Fig 22

and flat on the table (20).

5) Guide the workpiece along the parallel fence (14) and through the blade (23) at a uniform speed.

2. Cross cuts (See Fig 19)

1) Slide the mitre gauge (21) into one of the grooves in the table (20) and adjust to the required angle (see control elements 3).

2) Lower the blade guard (6) to the workpiece (see assembly 5).

3) Switch on the saw.

4) Hold the workpiece securely against the mitre gauge (21) and the table (20) and guide it at a uniform speed through the blade (23).

3. Angle cuts and double mitre cuts (See Fig 20 & 21)

Compound using with control elements item 3 and 4.

4. Freehanded cuts (See Fig 22)

One of the most outstanding features of a band saw is the ease with which it allows you to make curved cuts and radii.

1) Lower the blade guide (7) to the workpiece (see assembly 5).

2) Switch on the saw.

3) Hold the workpiece securely on the table (20) and guide slowly through the blade (23).

4) Freehanded cuts should be made at low feed speed so that you can guide the blade (23) along the required line.

5) It often pays to first cut off surplus curves and corners up to about 6 mm from the cutting line.

6) In the case of curves which are too tight for the band to cut correctly, it can help to make a series of close-lying cuts at right angles to the curved line. When you saw the radius the material will simply drop off.

5. Storage of push stick(See Fig 23-26)

The hook is to storage push stick which is assembled in the back of band saw, see below details.

Details steps:

1. To unscrew the left hinge screw which has big washer, then attach the storage hook and re-secure the screw.

2. Always store the push stick in position when not in use.

MAINTENANCE

- **Caution! Pull out the power plug first.**
- **Remove dust and dirt regularly from the bandsaw. Cleaning is best carried out with a fine brush or a cloth.**
- **Do not use caustic cleaning agents for cleaning plastic.**

ENVIRONMENTAL PROTECTION



Waste electrical products should not be disposed of with household waste. Please  recycle where facilities exist. Check with your Local Authority or retailer for recycling advice. For further information visit www.recycle-more.co.uk

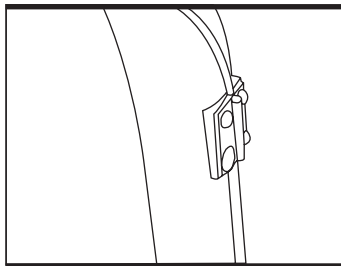

Fig 23

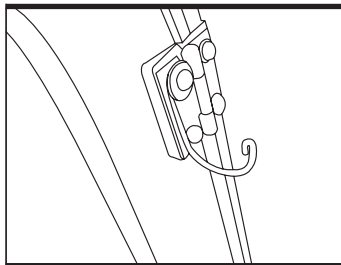

Fig 24

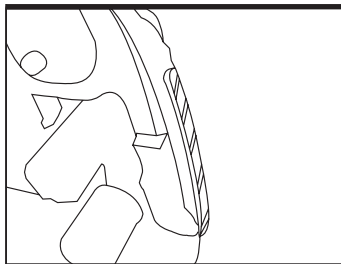

Fig 25

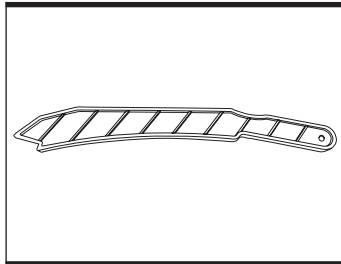

Fig 26

PLUG REPLACEMENT

The fuse in the main plug of your power tool should always be replaced with one of identical rating.

Check the voltage given on your power tool matches the supply voltage.

The power tool is supplied with a fitted plug, however if you should need to fit a new plug follows the instruction below.

IMPORTANT

The wire in the mains lead are coloured in accordance with the following code:

Green & yellow ---Earth

Blue ---Neutral

Brown ---Live

The wire which is coloured green & yellow must be connected to the terminal which is marked with E or $\frac{\perp}{\perp}$.

The wire that is coloured blue must be connected to the terminal that is marked with the letter N.

The wire that is coloured brown must be connected to the terminal that is marked with the letter L.

A 13AMP (BS1363 or BS1363/A) plug must be used and a 5 AMP fuse must be fitted.

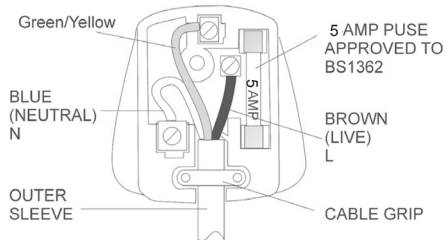

TITAN®

DECLARATION OF CONFORMITY

We, Importer

Titan Power Tools (UK) Ltd
BA22 8RT

Declare that the product

BAND SAW
TTB364BDS

Complies with the following directives:

2004/108/EC Electromagnetic Compatibility Directive.

2006/95/EC Low Voltage Directive

2006/42/EC Machinery Directive.

2002/95/EC Restrictions of the Use of Certain Hazardous Substances in Electrical and Electronic Equipment

2002/96/EC and **2003/108/EC** Waste Electrical and Electronic Equipment (WEEE)

Standards and technical specifications referred to:

EN 61029-1

EN 61029-2-5

EN 55014-1

EN 55014-2

EN 61000-3-2

EN 61000-3-3

Authorised Signatory and technical file holder

Date: 01/01/11

Signature: P.C. Harries

Name: Peter Harries

Titan Power Tools (UK)Ltd. Trade House , Mead Avenue ,BA22 8RT
Quality Manager



BAND SAW

TTB364BDS





TITAN®