



Liebert®

EXL™ Uninterruptible Power System

Operation and Maintenance Manual—625-1200kVA, 60Hz, Three-Phase,
Single & Multi-Module

The information contained in this document is subject to change without notice and may not be suitable for all applications. While every precaution has been taken to ensure the accuracy and completeness of this document, Vertiv assumes no responsibility and disclaims all liability for damages resulting from use of this information or for any errors or omissions. Refer to other local practices or building codes as applicable for the correct methods, tools, and materials to be used in performing procedures not specifically described in this document.

The products covered by this instruction manual are manufactured and/or sold by Vertiv. This document is the property of Vertiv and contains confidential and proprietary information owned by Vertiv. Any copying, use or disclosure of it without the written permission of Vertiv is strictly prohibited.

Names of companies and products are trademarks or registered trademarks of the respective companies. Any questions regarding usage of trademark names should be directed to the original manufacturer.

Technical Support Site

If you encounter any installation or operational issues with your product, check the pertinent section of this manual to see if the issue can be resolved by following outlined procedures. Visit <https://www.VertivCo.com/en-us/support/> for additional assistance.

TABLE OF CONTENTS

IMPORTANT SAFETY INSTRUCTIONS	1
SAVE THESE INSTRUCTIONS	1
BATTERY CABINET PRECAUTIONS	3
1.0 INTRODUCTION	4
1.1 General Description	4
1.2 Modes of Operation	7
1.2.1 Normal Mode	7
1.2.2 Bypass Mode	7
1.2.3 Battery Mode	7
1.2.4 Eco Mode	8
1.2.5 Maintenance Bypass	8
1.3 Options	9
2.0 LCD TOUCHSCREEN	10
2.1 Features	10
2.2 Touchscreen Navigation	11
2.2.1 Main Display Screen (Home)	11
2.2.2 Configuration Menu Rating (Config)	11
2.2.3 Reports	13
2.2.4 Metering	14
2.2.5 Operation Menu	15
2.2.6 Reset	16
2.2.7 Silence	16
2.2.8 System View—1+N Systems Only	16
2.2.9 Remote Breaker Display	17
3.0 OPERATION	18
3.1 Manual Operations—Single-Module Systems	18
3.1.1 Startup—Single Module System with Internal Breakers	18
3.1.2 Startup for a Single-Module System with Remote Breakers	20
3.1.3 Load Transfer and Retransfer—Single Module System	22
3.1.4 Maintenance Bypass Load Transfers—Single Module System	23
3.1.5 Maintenance Bypass Load Transfers—Single Module System: If Load is on Maintenance Bypass ²⁴	
3.1.6 Conditions to Activate Eco Mode Operation	24
3.1.7 Conditions to Suspend Eco Mode	25
3.1.8 Conditions to Terminate Eco Mode	25
3.1.9 Bypass Source Qualification for Eco Mode	25
3.1.10 Critical Bus Disqualification for Eco Mode	26
3.1.11 Settings for Eco Mode	26
3.1.12 Enabling Eco Mode	26
3.1.13 Eco Mode—Scheduled Operation	27
3.1.14 Eco Mode—Manual Start	28
3.1.15 Exiting Eco Mode Manually	28
3.1.16 Shutdown—Single Module UPS	28

3.2	Manual Operations—1+N Systems.....	30
3.2.1	Startup—1+N Module System.....	30
3.2.2	Load Transfer-1+N System: Remove a UPS from System (Collective).....	31
3.2.3	Load Transfer-1+N System: Add a UPS to the System (Collective).....	32
3.2.4	Load Transfer-1+N System: Transfer System to Bypass.....	32
3.2.5	Load Transfer-1+N System: Transfer System to Inverter.....	32
3.2.6	Maintenance Bypass Load Transfers-1+N Module System.....	33
3.2.7	Shutdown—1+N UPS: UPS Module Inverter Shutoff.....	34
3.2.8	Shutdown—1+N UPS: UPS Module System Shutdown (Remove UPS Module from the Collective)35	
3.2.9	Shutdown—1+N System Shutdown.....	35
3.2.10	Startup for 1+N System with Remote Breakers.....	36
3.3	Shutdown for Systems with Remote Breakers.....	37
3.4	Automatic Operations.....	37
3.4.1	Overloads.....	38
3.4.2	Automatic Transfers to Bypass.....	38
3.4.3	Automatic Transfers to Bypass, UPS Faults.....	38
3.4.4	Automatic Retransfers to UPS.....	38
4.0	OPTIONS.....	40
4.1	Input Contact Isolator Board.....	40
4.2	Programmable Relay Board.....	42
4.2.1	Configuring the Programmable Relay Board Settings.....	43
4.3	Remote Alarm Status Panel.....	43
4.3.1	Lamp Test/Reset Push Button.....	44
4.3.2	Audio Reset Push Button.....	44
4.4	Digital Load Bus Sync.....	44
4.4.1	System Description.....	44
4.4.2	LBS Configurations.....	44
4.4.3	Normal Operations.....	44
4.4.4	Slave Priority.....	44
4.4.5	Master System.....	45
4.4.6	Slave System.....	45
5.0	MAINTENANCE.....	46
5.1	Safety Precautions.....	46
5.2	Routine Maintenance.....	48
5.2.1	Record Log.....	48
5.2.2	Air Filters.....	48
5.2.3	Limited Life Components.....	49
5.3	Battery Maintenance.....	50
5.3.1	Battery Safety Precautions.....	50
5.3.2	Torque Requirements.....	53
5.4	Detecting Trouble.....	53
5.5	Reporting a Problem.....	53
5.6	Upstream Feeder Circuit Breaker Setting Inspections.....	54
6.0	SPECIFICATIONS.....	55
6.1	Battery Operation.....	55

6.2	Other DC Sources.....	55
6.3	Environmental Conditions	55
7.0	DISCLOSURES WITH REGARD TO EMBEDDED SOFTWARE LICENSED FROM NOKIA, INC., (“SUBLICENSED SOFTWARE”)	58
	Appendix A - Inverter Overload Curve	A59
	Appendix B - UPS Alarm and Status Messages	A60

FIGURES

Figure 1	Typical single module UPS one-line diagram.....	4
Figure 2	Main component locations—625kVA, 750kVA and 800kVA (typical).....	5
Figure 3	Main components for remote breaker configuration—Single module with static bypass or 1+N multi-module; 625kVA-800kVA	6
Figure 4	Main component locations—1000kVA, 1100kVA, and 1200kVA (typical)	6
Figure 5	Main components for remote breaker configuration—Single module with static bypass or 1+N multi-module; 1000kVA-1200kVA.....	7
Figure 6	Main display screen, typical	10
Figure 7	Configuration menu	11
Figure 8	System Meter menu	14
Figure 9	Battery Meter menu	15
Figure 10	UPS Operation menu	15
Figure 11	Status View—1+N systems only.....	16
Figure 12	Main display screen—Remote breaker configuration	17
Figure 13	Input Contact Isolator dialog box	40
Figure 14	Optional Input Contact Isolator Board	41
Figure 15	Control wiring, Programmable Relay Board	42
Figure 16	Programmable Relay Board menu.....	43
Figure 17	Liebert EXL inverter overload curve	59

TABLES

Table 1	Input Contact Isolator Board pre-assigned values	41
Table 2	Input Contact Isolator Board control wiring connections	41
Table 3	Programmable Relay Board pinout	42
Table 4	RAS indicators	43
Table 5	UPS component service life	49
Table 6	Environmental specifications	55
Table 7	Electrical specifications and standards	56
Table 8	Physical data	57
Table 9	UPS Alarm and Status Messages.....	60

IMPORTANT SAFETY INSTRUCTIONS

SAVE THESE INSTRUCTIONS

This manual contains important instructions that should be followed during installation and maintenance of the Liebert *EXL* uninterruptible power system and DC source.

WARNING

Risk of electric shock. Can cause equipment damage, injury or death.

Exercise extreme care when handling UPS cabinets to avoid equipment damage or injury to personnel. Refer to separate installation manual for equipment handling information and installation procedures.

Follow all DC source safety precautions in **5.0 - Maintenance** when installing, charging or servicing DC sources. In addition to the hazard of electric shock, gas produced by batteries can be explosive and sulfuric acid can cause severe burns.

In case of fire involving electrical equipment, use only carbon dioxide fire extinguishers or others approved for use in electrical fire fighting.

Extreme caution is required when performing maintenance. Service and maintenance work must be performed only by properly trained and qualified personnel and in accordance with applicable regulations as well as with manufacturers' specifications.

Be constantly aware that the UPS contains high DC as well as AC voltages. With input power off and the DC source disconnected, high voltage at filter capacitors and power circuits should be discharged within 5 minutes. However, if a power circuit failure has occurred, assume that high voltage still exists after shutdown. Check with a voltmeter before making contact.

AC voltage will remain on the system bypass, the UPS output terminals and the static bypass switch, unless associated external circuit breakers are opened.

Check for voltage with both AC and DC voltmeters prior to making contact.

When the UPS is under power, both the operator and any test equipment must be isolated from direct contact with earth ground and the UPS chassis frame by using rubber mats.

Some components within the cabinets are not connected to the chassis ground. Any contact between floating circuits and the chassis is a lethal shock hazard. Exercise caution that the test instrument exterior does not make contact, either physically or electrically, with earth ground.

AVERTISSEMENT

Risque de décharge électrique pouvant entraîner des dommages matériels, des blessures et même la mort.

Faites preuve d'une extrême prudence lors de la manutention des armoires ASC afin d'éviter de les endommager ou de blesser le personnel. Reportez-vous au manuel d'installation approprié pour connaître les consignes de manutention et les procédures d'installation de l'équipement. Observez toutes les mesures de sécurité relatives à la source d'alimentation c.c. décrites dans la section 4.0 - Entretien lors de l'installation, de la charge ou de l'entretien des sources c.c. Outre les risques de décharge électrique associés aux batteries, les gaz qu'elles produisent peuvent être explosifs et l'acide sulfurique qu'elles contiennent peut provoquer des brûlures graves.

En cas d'incendie associé à du matériel électrique, n'utilisez que des extincteurs à dioxyde de carbone ou homologués pour la lutte contre les incendies d'origine électrique.

Les opérations d'entretien requièrent une extrême prudence. Les opérations d'entretien ne doivent être confiées qu'à du personnel qualifié et dûment formé. Toutes les interventions doivent être effectuées conformément aux règlements applicables et aux spécifications du fabricant. Soyez toujours conscient du fait que le système ASC contient des tensions c.c. et c.a. élevées.

Une fois l'alimentation d'entrée coupée et la source d'alimentation c.c. débranchée, la haute tension aux condensateurs de filtrage et aux circuits d'alimentation devrait se dissiper en moins de 5 minutes. En cas de défaillance d'un circuit d'alimentation, toutefois, il importe de présumer qu'une tension élevée est présente même après l'arrêt. Vérifiez toujours les tensions avec un voltmètre avant d'établir des contacts.

Le circuit de dérivation, les bornes de sortie ASC et le commutateur statique de dérivation continueront d'afficher une tension c.a. à moins que les disjoncteurs externes associés ne soient ouverts.

Vérifiez les tensions avec des voltmètres c.a. et c.c. avant d'établir tout contact.

Lorsque le système ASC est sous tension, les responsables de l'entretien et l'équipement d'essai doivent reposer sur des tapis de caoutchouc pour prévenir tout contact direct avec le sol et avec le châssis du système lors des interventions.

Certains composants à l'intérieur des armoires ne sont pas connectés à la masse du châssis. Tout contact entre les circuits flottants et le châssis présente un risque de décharge mortelle. Il importe de veiller à ce que l'extérieur des équipements d'essai n'entre pas en contact physique ou électrique avec le sol.

This equipment contains circuitry that is energized with high voltage. Only test equipment designated for troubleshooting should be used. This is particularly true for oscilloscopes. Always check with an AC and DC voltmeter to ensure safety before making contact or using tools. Even when the power is turned Off, dangerously high voltage may exist at the capacitor banks.

Observe all DC source precautions when near the DC source for any reason.

ONLY properly trained and qualified service personnel should perform maintenance on the UPS system. When performing maintenance on any part of the equipment under power, service personnel and test equipment should be standing on rubber mats. The service personnel should wear insulating shoes for isolation from direct contact with the floor (earth ground).

One person should never work alone. A second person should be standing by to assist and summon help in case an accident should occur. This is particularly true when work is performed on the DC source.

BATTERY CABINET PRECAUTIONS

The following warning applies to all battery cabinets supplied with UPS systems. Additional warnings and cautions applicable to battery cabinets may be found in **Important Safety Instructions on page 1 and 5.3 - Battery Maintenance**.

WARNING

Internal battery strapping must be verified by manufacturer prior to moving a battery cabinet (after initial installation).

- Battery cabinets contain non-spillable batteries.
- Keep units upright.
- Do not stack.
- Do not tilt.

Failure to heed this warning could result in smoke, fire or electric hazard.

Call 800-543-2378 before moving battery cabinets (after initial installation).

For systems using DC sources other than batteries, refer to the manufacturer's recommendations for handling and care.

AVERTISSEMENT

L'arrimage des batteries internes doit être vérifié par le fabricant avant de déplacer une armoire de batteries (après l'installation initiale).

- Les armoires de batteries contiennent des batteries étanches.
- Maintenir les systèmes à la verticale.
- Ne pas empiler.
- Ne pas incliner.
- Le non-respect de ces consignes comporte des risques liés à la fumée, au feu ou à l'électricité.
- Composez le 800 543-2378 avant de déplacer des armoires de batteries (après l'installation initiale).

Reportez-vous aux recommandations du fabricant relatives à la manipulation et à l'entretien pour les systèmes qui utilisent d'autres sources d'alimentation c.c. que les batteries

Contacting Vertiv® for Support

Contact Vertiv for information or repair service in the United States at 800-543-2378.

For repair or maintenance service outside the 48 contiguous United States, contact Vertiv, if available in your area. For areas not covered by Vertiv, the authorized distributor is responsible for providing qualified, factory-authorized service.

Have the following information available before calling Vertiv:

Part Numbers: _____

Serial Numbers: _____

kVA Rating: _____

Date Purchased: _____

Date Installed: _____

Location: _____

Input Voltage/Frequency: _____

Output Voltage/Frequency: _____

DC Source Reserve Time: _____

1.0 INTRODUCTION

1.1 GENERAL DESCRIPTION

The Liebert EXL provides continuous, high-quality AC power to business-critical equipment, such as telecommunications and data processing equipment. The Liebert EXL supplies power that is free of the disturbances and variations in voltage and frequency common to utility power, which is subject to brownouts, blackouts, surges and sags.

The Liebert EXL utilizes the latest in high-frequency, double-conversion pulse-width modulation technology and fully digital controls to enhance its reliability and increase the ease of use.

As shown in **Figure 1**, the AC utility source is input at the rectifier and the rectifier converts the AC utility into DC power. The inverter converts that DC power from the rectifier or DC power from the DC source- into AC power for the load. The DC source will power the load through the inverter in the event of a power failure. The utility source can also power the load through the static bypass.

If maintenance or repair of the UPS is necessary, the load can be switched without interruption in service to the optional maintenance bypass.

Figure 1 Typical single module UPS one-line diagram

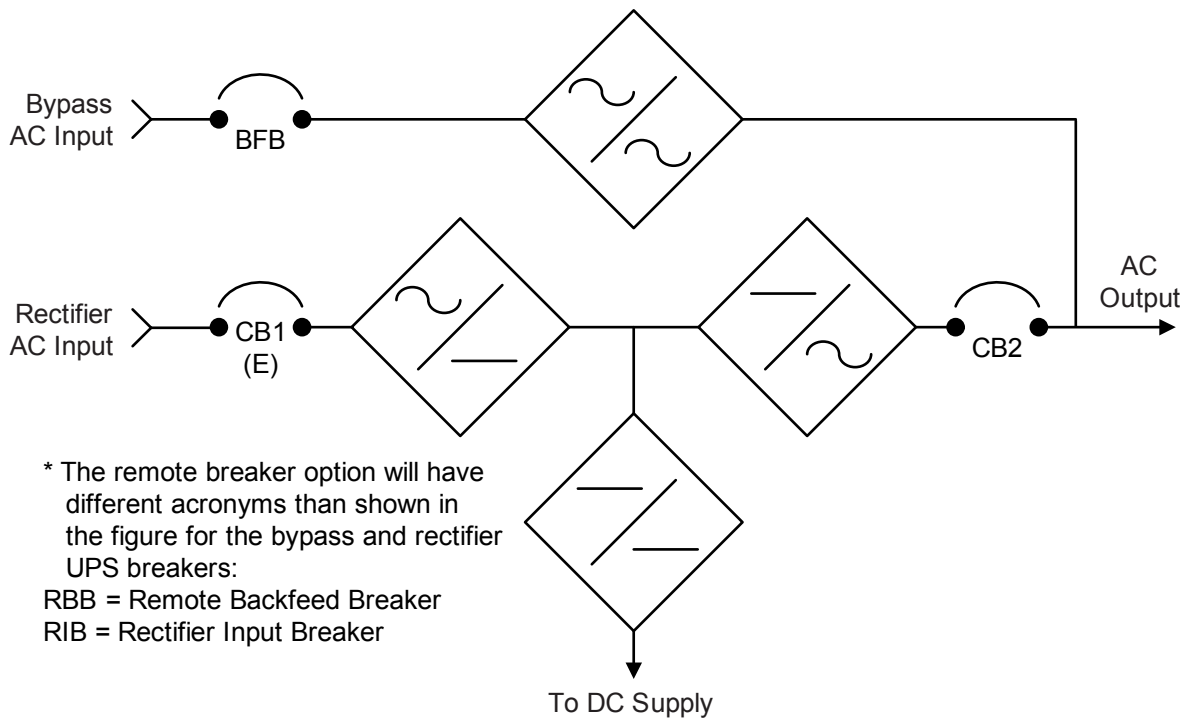

Figure 2 Main component locations—625kVA, 750kVA and 800kVA (typical)

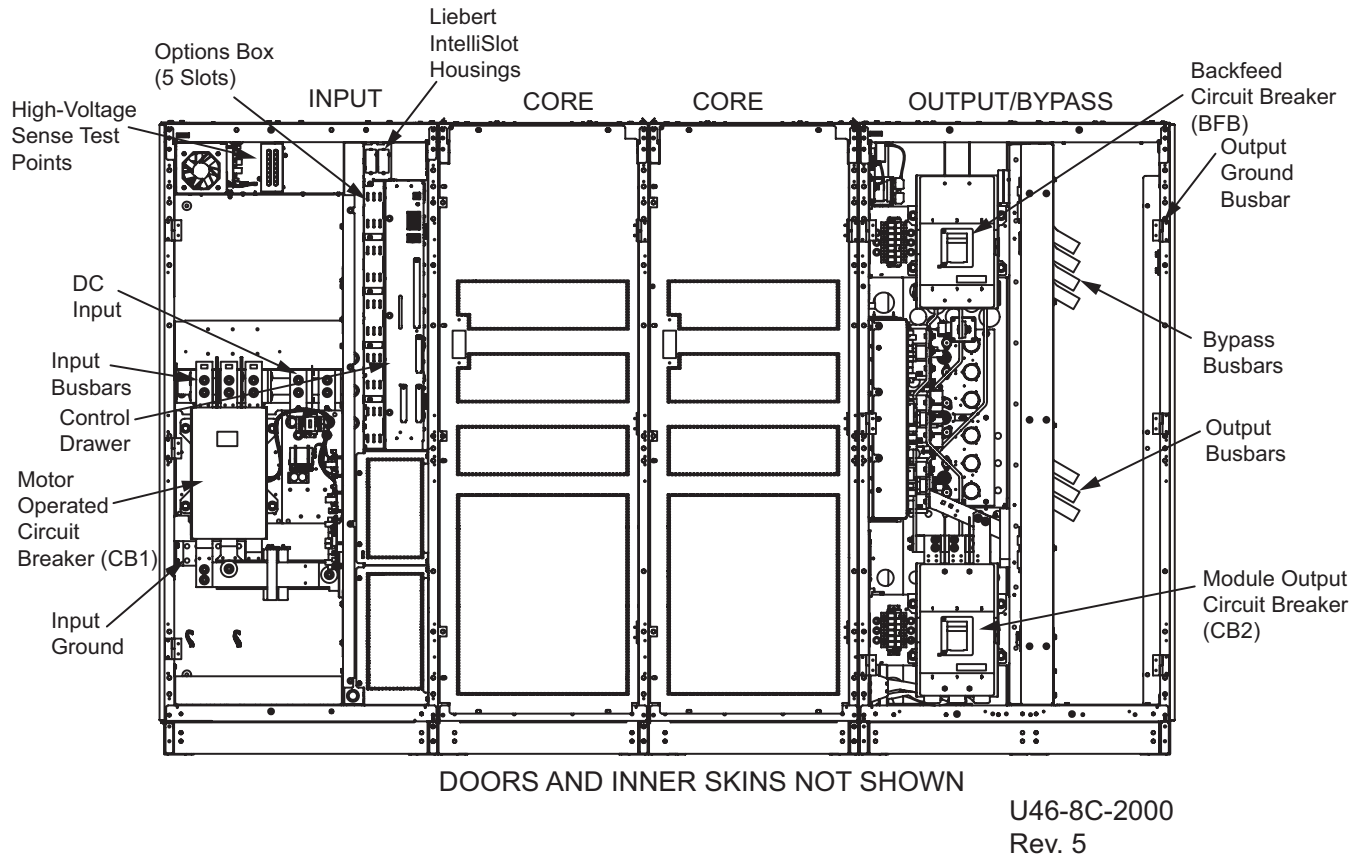

Figure 3 Main components for remote breaker configuration—Single module with static bypass or 1+N multi-module; 625kVA-800kVA

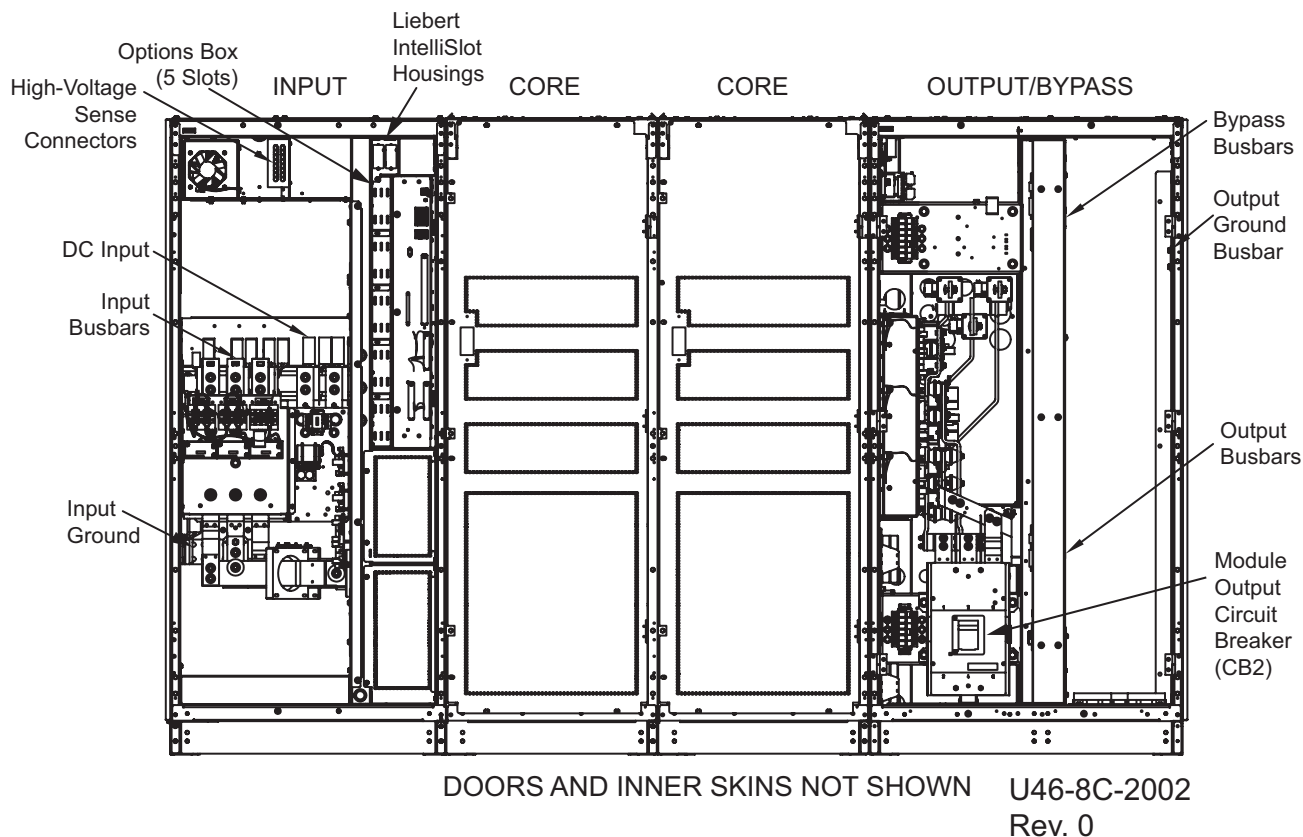

Figure 4 Main component locations—1000kVA, 1100kVA, and 1200kVA (typical)

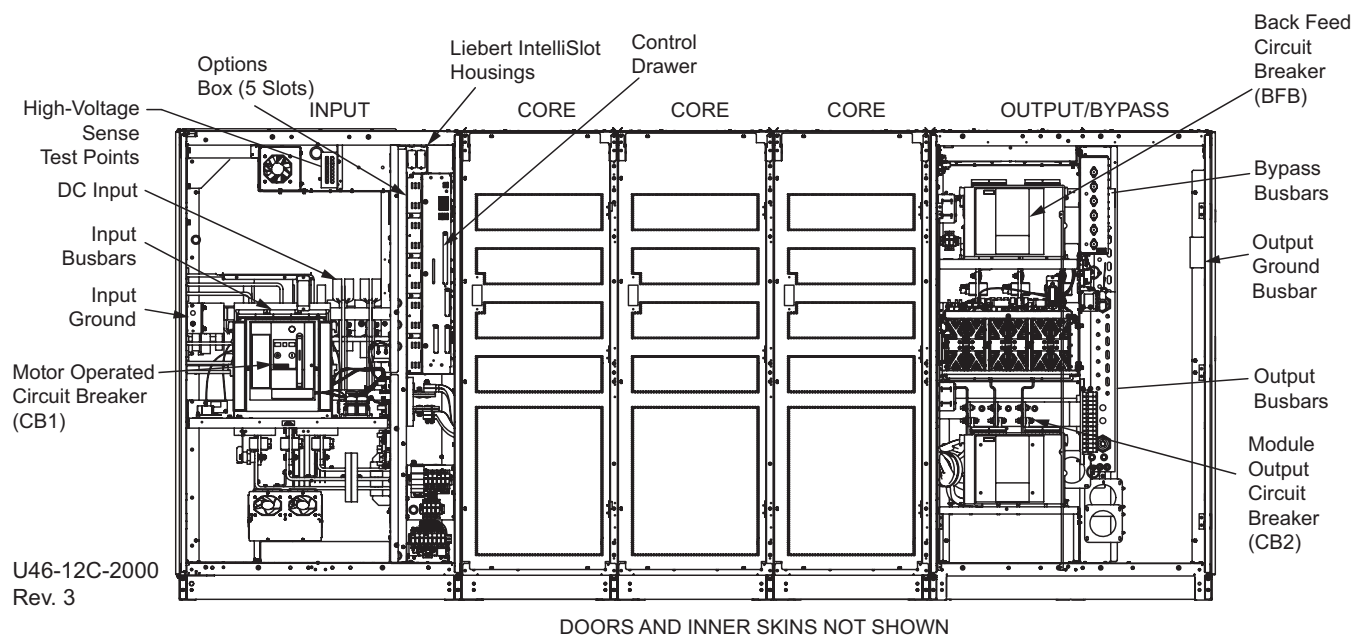
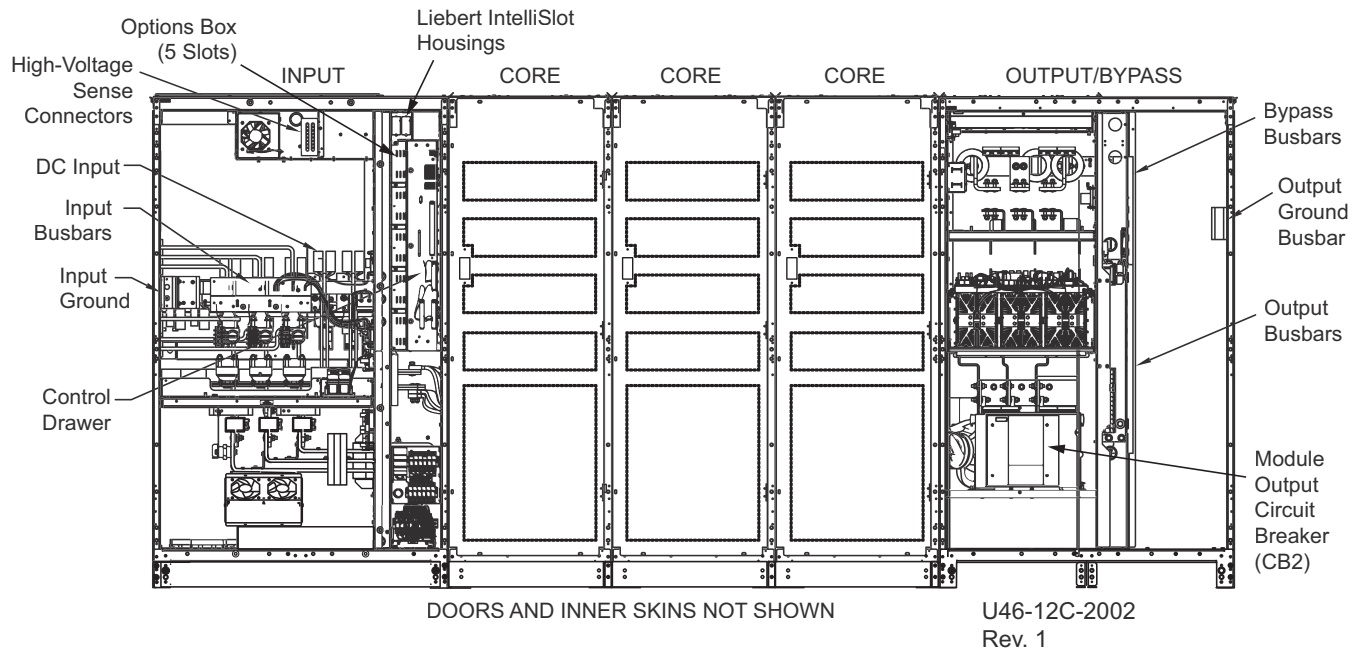

Figure 5 Main components for remote breaker configuration—Single module with static bypass or 1+N multi-module; 1000kVA-1200kVA



1.2 MODES OF OPERATION

1.2.1 Normal Mode

Operating in normal mode, the Liebert EXL's rectifier derives power from a utility AC source and supplies regulated DC power to the inverter, which regenerates precise AC power to supply the connected equipment. The rectifier also uses the utility source power to charge the DC sources.

1.2.2 Bypass Mode

When the Liebert EXL is in bypass mode, the load is directly supported by utility power and is without DC source backup protection.

The Liebert EXL's inverter and bypass static switch will shift the load from the inverter to bypass mode without an interruption in AC power if the inverter is synchronous with the bypass and any of the following occurs:

- Inverter fails
- Inverter overload capacity is exceeded
- Inverter is manually turned Off



NOTE

If the inverter is asynchronous with the bypass, the static switch will transfer the load from the inverter to the bypass WITH interruption in AC power to the critical load. This interruption is 167ms when the Bypass-Interrupted Transfer is set to Normal. The interruption is 33ms when the Bypass-Interrupted Transfer is set to Fast. The default setting for interrupted transfer is Fast (2ms), but Vertiv can adjust the interrupted transfer to Slow (10ms).

1.2.3 Battery Mode

When utility AC power fails, the Liebert EXL protects the critical load by instantaneously channeling DC source power to the inverter, which continues supporting the critical load without interruption.

When utility power returns and is within acceptable limits, the Liebert EXL automatically shifts back to Normal mode, with the rectifier powering the critical load.

1.2.4 Eco Mode

The Liebert EXL 800 and 1200 and derate single module systems have Eco Mode available for user configuration. Eco Mode is a standard feature of the Liebert EXL system and is factory-installed. The feature must be enabled in the field through the configuration menu on the UPS control screen as described in this document.

The feature is also known as *Active Inverter Eco Mode* because the UPS inverter is On and available to receive the load immediately. While in Eco Mode, the inverter is in zero power mode, increasing system efficiency. The operation allows powering the critical load from the bypass source when that source is within acceptable operating limits. If the bypass source voltage or frequency goes outside of the acceptable operation band, the critical load is automatically transferred to the UPS inverter without interruption. The load can be transferred from the bypass source to the inverter in a make-before-break operation.

1.2.5 Maintenance Bypass

The installation of a Maintenance Bypass Cabinet or Assembly is recommended to allow total isolation of the UPS from all power sources while continuing to supply power to the critical load. Maintenance Bypass use is described in **3.0 - Operation**.

1.3 OPTIONS

A number of options are available from Vertiv® for the Liebert EXL. (Some options are not available for all ratings.) Described below are the most frequently provided options. Other options are available. Contact your Vertiv representative for more information.

- **Battery and Racks**—The batteries provide power in the event of a power outage. The Liebert EXL can use a variety of battery types, provided the battery plant is designed for the UPS DC voltage range and the load requirements of the application.
- **Battery Cabinets**—Valve-regulated, lead-acid (VRLA) sealed batteries are available in matching cabinets for convenient installation and maintenance in otherwise unprotected space. Depending on the UPS module rating, two or more cabinets may be connected in parallel to provide the additional run time. This option is required to complete the UPS system.
- **Maintenance Bypass**—This switchboard provides make-before-break maintenance bypass. It includes: Maintenance Bypass Breaker (MBB) and Maintenance Isolation Breaker (MIB). The Maintenance Bypass is a buyout item and not available from Vertiv for the Liebert EXL.
- **Customer Alarm Interface**—This optional Input Contactor Isolator board allows the input and display of eight alarms from customer-supplied contacts, each with a customer-selected name.
- **External Control**—The optional Programmable Relay Board allows the UPS to trigger external devices when a UPS event occurs. For example, the UPS can turn On an external LED if it senses a battery cabinet temperature imbalance.
- **Remote Breakers**—Remote input and bypass breakers can be used instead of the internal UPS breakers. The UPS provides connections for remote breaker status, control and voltage monitoring.
- **Load Bus Synchronization (LBS)**—Allows synchronizing the outputs of two or more modules when the source for one of more modules supplied by a separate non-synchronized source.
- **DC (Battery) Ground Fault**—Permits setting a user-defined alarm caused by detection of a DC ground fault. An optional input contact isolator board must be installed for processing a DC ground fault.
- **Seismic Bracing**—A separate kit for tying down the UPS module allows the unit to meet International Building Code (IBC).
- **Remote Alarm Status Panel**—Provides alarm lamps for up to eight UPS alarms. The optional power supply must be included when purchasing this option.
- **AC Ground Fault**—When the unit is in discharge (battery) mode, AC ground faults are detected by the system and an alarm is activated to the control screen.
- **Module Battery Disconnect**—The UPS system utilizes a separate Module Battery Disconnect (MBD) for remotely located batteries. A sensing circuit in the UPS module, set at the battery low voltage limit, trips the Module Battery Disconnect to safeguard the battery from excessive discharge. The Module Battery Disconnect has an undervoltage release mechanism designed to ensure that during any shutdown or failure mode all battery potential is removed from the UPS system.
- **Battery Isolation Switch**—A Battery Isolation Switch (BIS) is used to isolate individual battery strings when a system MBD is used. When the optional Battery Interface Box is used, the status of the Battery Isolation Switch is displayed on the UPS HMI. A temperature sensor is recommended to allow proper battery charging and overtemperature protection.
- **Battery Interface Box**—A Battery Interface Box (BIB) is available to support the UPS and third-party battery cabinets or rack-mounted batteries. A BIB is required for each MBD (stand-alone or inside the third-party battery cabinet). A BIB is optional with each Battery Isolation Switch. A BIB is required for each temperature sensor.
- **Temperature Sensor**—Allows the UPS module to compensate battery charging voltage, depending on temperature, to prolong battery life. The Temperature Sensor is required for battery solutions utilizing a non-matching Module Battery Disconnect or Battery Isolation Switch. Liebert battery packs have built-in temperature sensors. The Temperature Sensor option includes a remote sensor that must be field-installed.

2.0 LCD TOUCHSCREEN

The Liebert EXL is equipped with a microprocessor-based human-machine interface (HMI) designed for convenient and reliable operation. The display is driven by an easy-to-follow, menu-prompted software.

2.1 FEATURES

The Liebert EXL HMI enables the operator to perform such tasks as:

- Quickly check operational status
- Monitor the power flow through the UPS system and all meter readings
- Execute operational procedures
- Check status reports and history files
- Adjust programmable parameters (access limited by security access function)

The HMI is a touchscreen display with multicolor text and white background (see **Figure 6**). The display turns on automatically, but after 15 minutes of inactivity the back-light will go out and the display will appear very dim. Touching the screen will reactivate the back-light; the back-light will again be active for 15 minutes. If any screen other than the mimic screen is accessed, that screen will be displayed for 5 minutes without any interaction. If there is no activity for 5 minutes, the display will revert to the basic mimic screen.

Figure 6 Main display screen, typical

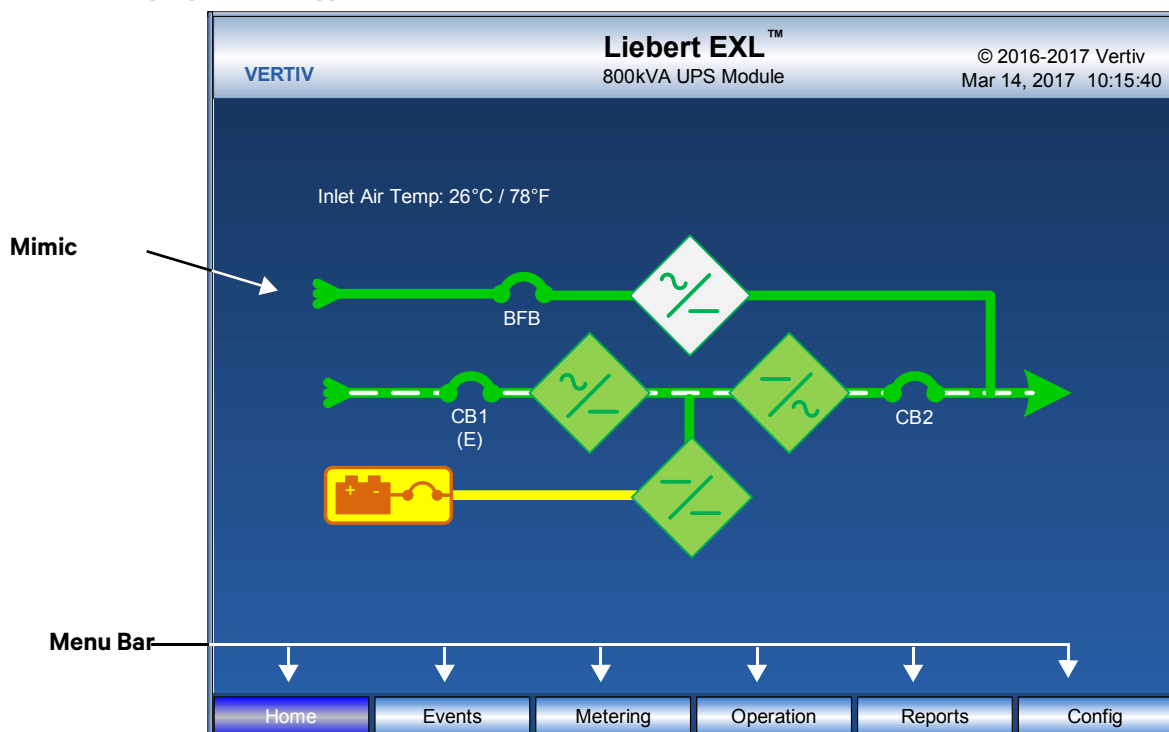

Bypass Input—The bypass circuit breaker (BFB) status is shown as Open or Closed.

UPS Input Power—The input circuit breaker (CB1) (if installed), is shown as Open or Closed.

UPS Output Power—The output circuit breaker is shown as Open or Closed.

Rectifier Block—Displays the state of the rectifier: On (solid green); Disabled (gray); Off (green outline, gray interior); or Walking In (green outline, flashing green interior).

Inverter Block—Displays the state of the inverter: On (solid green); Disabled (gray); Off (green outline, gray interior).

Bypass Static Switch Block—Displays the state of the bypass static switch: On (solid green), disabled (gray), Off (green outline, gray interior).

DC/DC Converter Block—Displays the state of the DC/DC converter: On (solid green); Disabled (gray); Off (green outline, gray interior); or Walking In (green outline, flashing green interior).

Battery Block—Displays the state of the battery block and module battery disconnect: Normal (solid green); Fail or High (gray); Low (yellow); and the module battery disconnect is shown as open or closed.

2.2 TOUCHSCREEN NAVIGATION

2.2.1 Main Display Screen (Home)

Several menu items can be accessed from the main display screen (see **Figure 6**). These menu items are detailed in subsequent sections.

2.2.2 Configuration Menu Rating (Config)

This menu item will display a popup showing the following parameters. These parameters are entered during commissioning when the UPS is installed by Vertiv.

Figure 7 Configuration menu

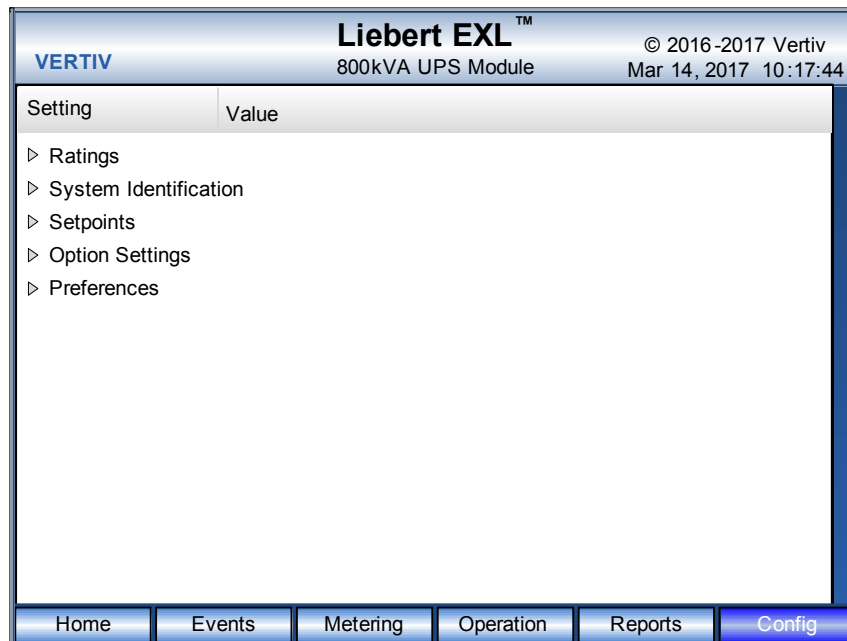

Ratings

This menu shows the basic information of the module. These parameters will set automatically based on the other parameters entered.

- Nominal Input Voltage
- Nominal Bypass Voltage
- Nominal Output Voltage
- Nominal Source Frequency
- Nominal Output Frequency
- Output kVA
- Output kW
- Configuration Type
- Nominal Cell Count

System Identification

This menu shows the model numbers and serial numbers:

- Unit Model Number
- Unit Serial Number
- Maintenance Bypass Model Number
- Maintenance Bypass Serial Number
- DC Source Cabinet Model Number
- DC Cabinet Serial Numbers
- Order Numbers
- Service Telephone Number
- Site ID Number
- Module Locator
 - Location ID
 - System Number
 - Module Label

Setpoints (User Adjustable)

The following will change the settings of the modules:

- Temperatures
 - Inlet Air Temp Warning—86°F to 104°F (30°C to 40°C) (default: 95°F [35°C])
- Bypass/Transfer
 - Manual Xfer to Bypass Voltage High Limit% - 1% to 15% (default: 10%)
 - Manual Xfer to Bypass Voltage Low Limit% - 1% to 20% (default: 10%)
- Output
 - Max Load Exceeded
 - The module will activate a warning when the load is above any of these settings:
 - Phase A (%)—10% to 105% (default: 100%)
 - Phase B (%)—10% to 105% (default: 100%)
 - Phase C (%)—10% to 105% (default: 100%)
 - Delay (seconds)—0 to 60 (default: 5 seconds)
- Event Management
 - This menu item permits changing how the Liebert EXL handles Alarms, Faults and Status information. Each event can be configured for the following:
 - Latch (yes/no)—Event stays active in the event window, even if cleared, until acknowledged (by pressing the *Reset* button)
 - Audible (yes/no)—Will set Audible alarm when event occurs
 - Event log (yes/no)—Will display event in Event log when it occurs

- DC Source
 - Float Voltage
 - Battery Float Voltage, VPC: 2.15 to 2.3 (default: 2.25)
 - Cell Count Adjustment
 - Cell Count Adjustment: -12 cells to 6 cells (default: 0)
 - Discharge Alarms
 - Time Low Warning, minutes: 2 to 15, the upper limit is dependent on configured batteries (default: 5 minutes)
 - DC Source Charging: Settings not user-adjustable
 - DC Source Equalize
 - When Battery Equalize is activated, the module will charge the batteries to the Equalize Voltage for the length of Equalized Time.
 - Equalize Voltage, VPC—2.30 to 2.45 (default: 2.3)
 - Equalize Time, hours—0 to 200 hours (default: 0)
- DC Source Temperature

NOTE

DC Source Temperature values should be set by Vertiv according to the battery manufacturer's requirements.

- Battery Temp Warning—30°C to 50°C (default: 40°C)
- Battery Temp Limit—35°C to 60°C (default: 50°C)
- Disconnect—Enable/Disable (default: disabled)

NOTE

If Disconnect is set to Enable and the Battery Temp Limit is met, the Battery breaker will open.

Factory/Witness

- Touch Screen Calibration

Options Settings

If any Input Contact Isolator (ICI) cards or Programmable Relay Board (PRB) cards are installed, this menu will allow these options to be configured. See **4.1 - Input Contact Isolator Board** and **4.2 - Programmable Relay Board** for details on these options.

Preferences

These display settings cannot be changed from the touchscreen. Press the box to the left of each parameter to bring a popup window that will allow the parameter to be changed.

- Time (24hr format)—Adjust Hour, Minute or Seconds
- Date (MM DD, YYYY format)—Adjust Month, Day or Year
- Password—Reset the password (up to 5 characters, alphanumeric, case-sensitive; default is EXL)

2.2.3 Reports

This menu accesses the events records.

- Event Log—Up to 2048 time- and date-stamped events are captured in the log. The oldest record will be overwritten with a new record once the log reaches 2048 events.

2.2.4 Metering

This menu accesses the System Meter and Battery Meter.

System Meter

- Input volts (line-line) per phase
- Input amps (line-line) per phase
- Input frequency
- Bypass volts (line-line) per phase
- Bypass frequency
- DC bus voltage
- DC bus amps
- Output volts (line-line) per phase
- Output amps (line-line) per phase
- Output kVA% per phase
- Output kW% per phase
- Output power factor (PF) per phase
- Total kVA/kW
- Output frequency
- Bypass/Inverter sync window.

Figure 8 System Meter menu

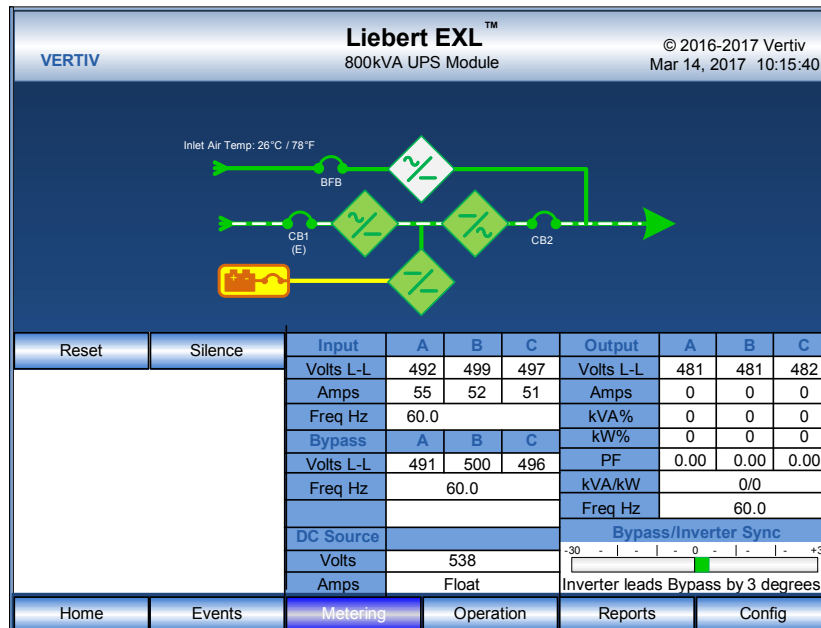

Battery Meter

- DC volts per string
- Temperature, degrees Celsius, per string
- Battery commissioning date
- Operating time on DC source
- Discharge time
- Time remaining
- Charge %
- Amp-Hour, AH, consumed
- DC power

Figure 9 Battery Meter menu

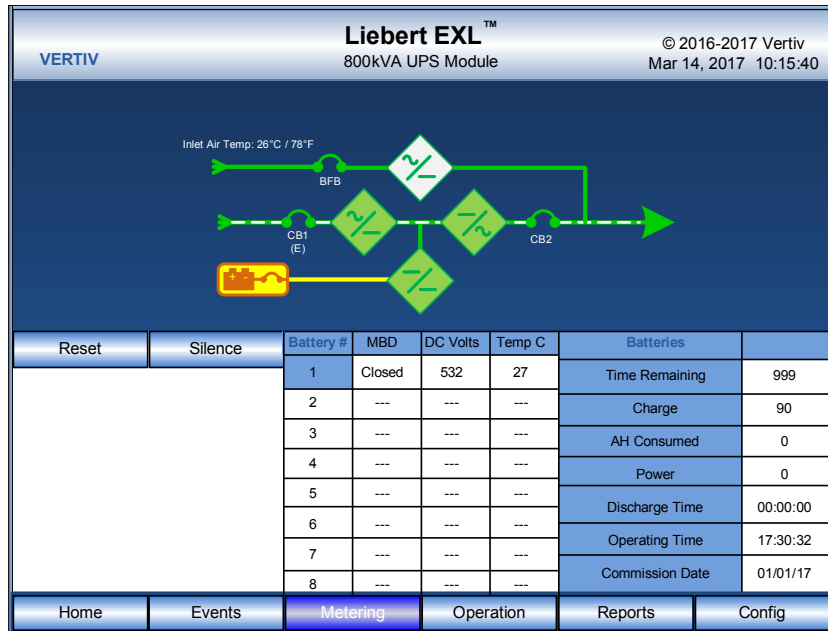

2.2.5 Operation Menu

- Startup—Activates the module startup process
- Shutdown
 - UPS—Turns Off inverter, rectifier and trips all DC source breakers; transfers to bypass, if available.
 - System—Turns Off inverter, rectifier and trips all DC source breakers; Will shut down UPS.

NOTICE

Risk of equipment damage. This command will result in the load being shut down.

- Transfer—Permits switching between UPS and Bypass mode.
- Battery Breaker Control—Allows the user to activate the UVR to close the battery breakers
- Battery Equalize—Allows the user to use an equalize charge to charge the batteries

Figure 10 UPS Operation menu

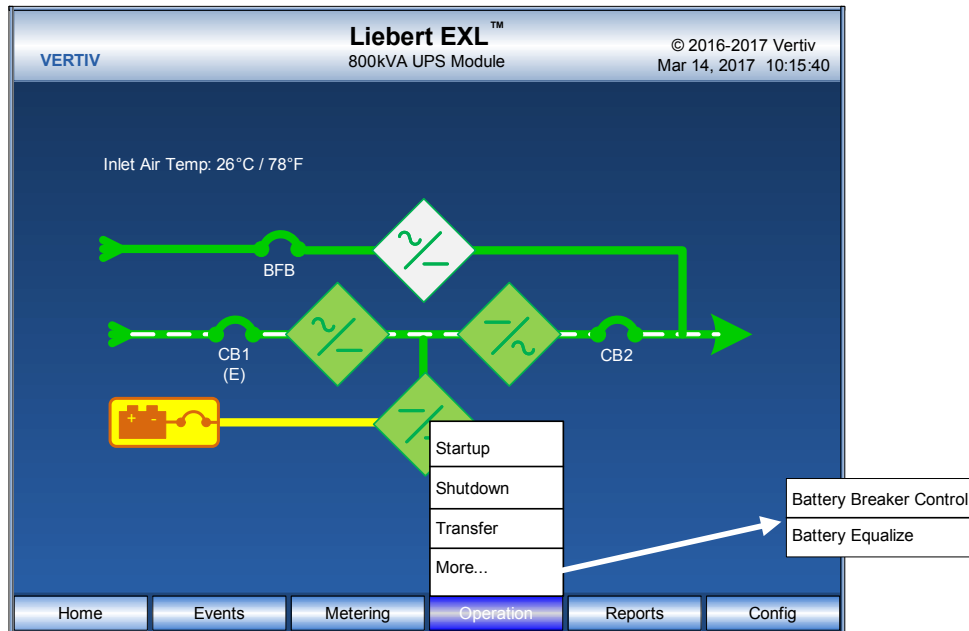

2.2.6 Reset

This button will reset any non-active latched events.

2.2.7 Silence

This button will silence the audible alarm.

2.2.8 System View—1+N Systems Only

System View will display the status of each of the system breakers (MOB’s, MIB, MBB). It will display the system output information including the voltage, current, kVA/kW, frequency and number of modules in the system.

Figure 11 Status View—1+N systems only

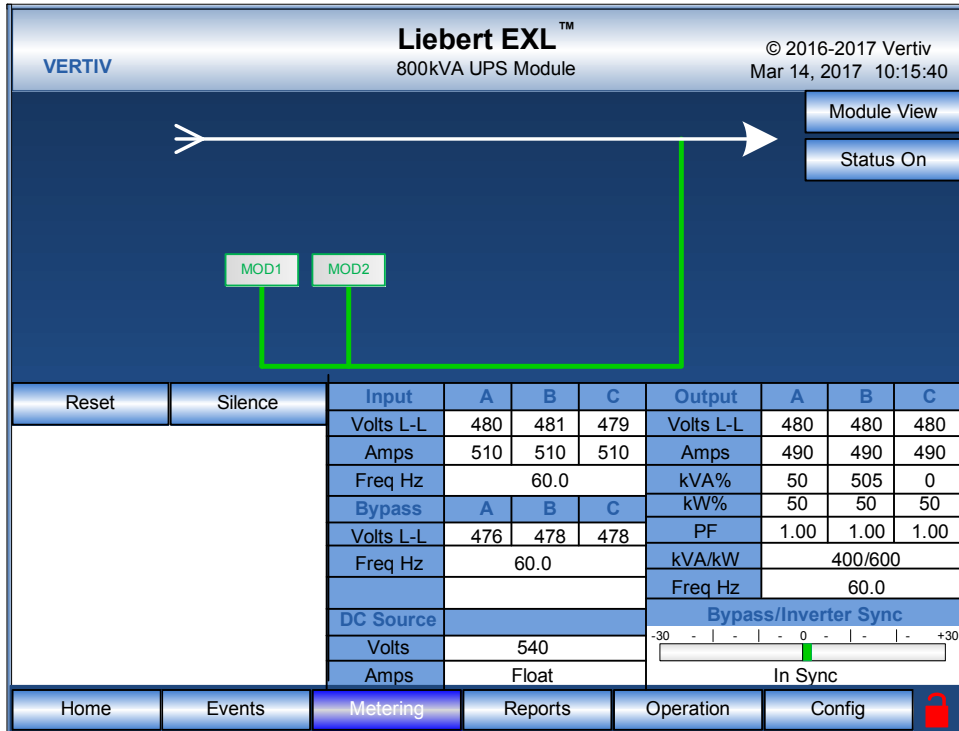

2.2.9 Remote Breaker Display

The Liebert EXL 800 and 1200 remote breaker option has remote circuit breakers for CB1 and BFB. The remote circuit breakers are referred to as Rectifier Input Breaker (RIB) and Remote Backfeed Breaker (RBB).

Figure 12 Main display screen—Remote breaker configuration

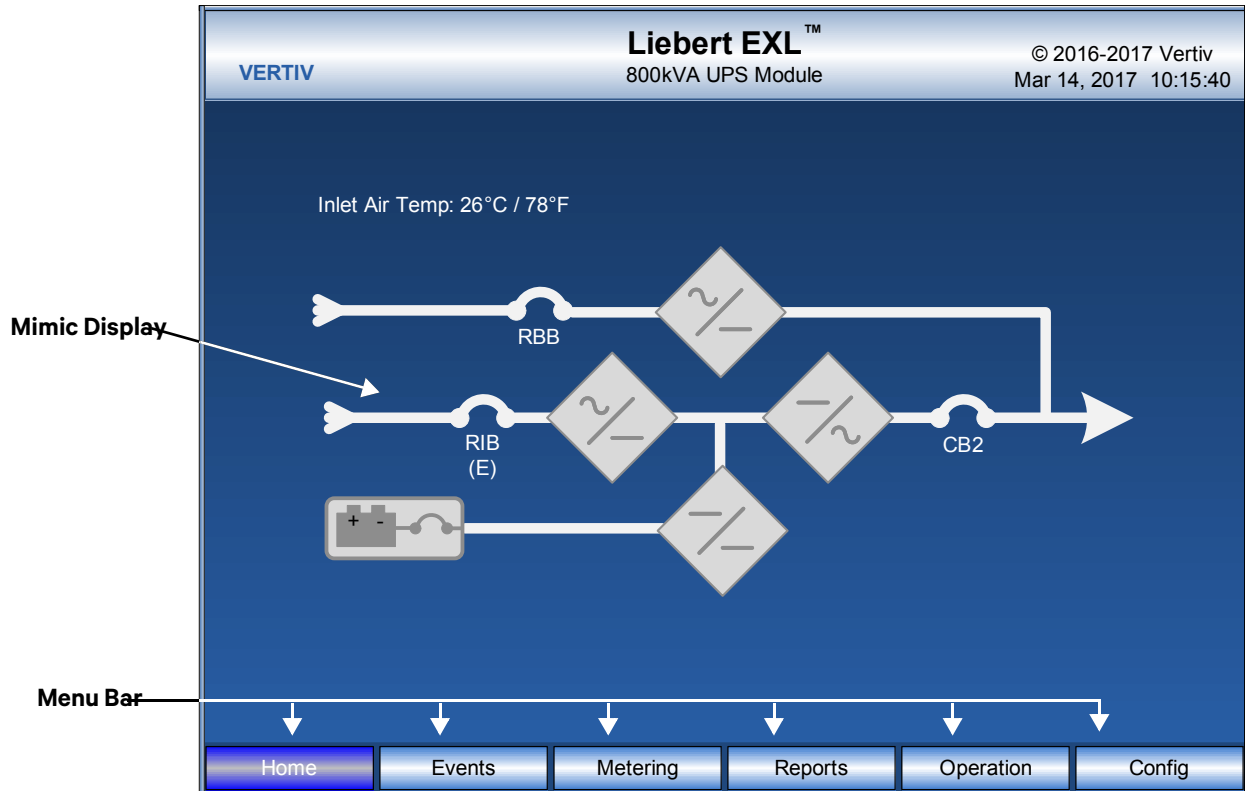

3.0 OPERATION

3.1 MANUAL OPERATIONS—SINGLE-MODULE SYSTEMS

The Liebert EXL is designed to function while unattended by an operator. The system control logic automatically handles many important functions, as explained in **3.4 - Automatic Operations**. Other procedures must be performed manually.

Manual procedures available to the operator include startup, load transfers and shutdowns. These procedures are performed by using the touchscreen and some manually operated circuit breakers and switches.

This section lists typical step-by-step instructions. The touchscreen will list all steps required for the process, based on the unit's condition and other factors.

- Startup—including initial startup, recovering from input power failure, recovering from DC source shutdown and recovering from shutdowns for emergencies or maintenance.
- Load Transfers—including transfers from UPS to bypass and retransfers from bypass to the UPS system.
- Maintenance Bypass Load Transfers—including transfers from internal bypass to maintenance bypass and transfers from maintenance bypass to internal bypass.
- Shutdowns—including module shutdowns for maintenance and emergency shutdowns.



NOTE

The following procedure assumes that the UPS installation inspection and initial startup have been performed by Vertiv. A Vertiv-authorized representative must perform the initial system startup to ensure proper system operation.

3.1.1 Startup—Single Module System with Internal Breakers



WARNING

Risk of electrical shock. Can cause equipment damage, personal injury and death. The following procedure provides power to the critical load distribution system. Verify that the critical load distribution is ready to accept power. Make sure that personnel and equipment are ready for the critical load distribution system to be energized.



AVERTISSEMENT

Risque de décharge électrique pouvant entraîner des dommages matériels, des blessures et même la mort.

La procédure suivante fournit de l'énergie au système de distribution de la charge critique. Vérifiez que ce système est prêt à être alimenté. Assurez-vous que le personnel et les équipements sont préparés pour la mise sous tension du système de distribution de la charge critique.

If the installation includes a Maintenance Bypass, power may already be supplied to the critical load equipment through the Maintenance Bypass. If there is no power to the critical load, apply power through the UPS bypass line per the following procedure.

During startup, power is supplied to the critical load through the UPS (internal) bypass line while the UPS system is being energized. Depending on the reason for the UPS system shutdown,

power may be present in the bypass line. To determine this, check the Monitor/Mimic Display screen after control power is available.



NOTE

If the system was shut down in response to an Emergency Off, there may be alarm messages on the touchscreen that describe system conditions before (or at the time of) the shutdown. Some or all of the alarm conditions may have been resolved. Contact Vertiv for assistance in clearing any remaining alarm messages.



WARNING

Risk of electrical shock and high short circuit current. Can cause equipment damage, personal injury and death.

If the UPS has been shut down for maintenance, verify that all of the UPS doors are closed and latched. All test equipment must be removed from the system. All electrical connections must be secure.



AVERTISSEMENT

Risque de décharge électrique et de présence de courant de court-circuit élevé pouvant entraîner des dommages matériels, des blessures et même la mort.

Si l'alimentation sans coupure a été interrompue à des fins d'entretien, assurez-vous que toutes les portes du système ASC sont fermées et verrouillées. Tous les appareils de test doivent être retirés du système. Tous les branchements électriques doivent être serrés.

This section lists typical step-by-step instructions. The touchscreen will list all steps required for the process, based on the unit's condition and other factors.

1. Before applying power to the UPS modules, determine the location and position of the following circuit breakers and switches:
 - Input Circuit Breaker *—Verify that this breaker (**Figure 2**) is in the open position.
 - Module Battery Disconnect—Verify that this external breaker is open or tripped. If DC source cabinets are used, verify that breakers on all the cabinets are open.
 - Bypass Circuit Breaker *—Normally this circuit breaker (**Figure 2**) should be open. However, if the critical load is already supplied through this breaker, keep this breaker closed.
 - Output Circuit Breaker—This circuit breaker (**Figure 2**) should be open.

*If remote breakers are used, these breakers will be located in the appropriate switch gear.
2. Provide power to the UPS controls of the UPS module starting up to permit the display touchscreen and system logic to function properly.
Close all breakers feeding power to the Bypass Circuit Breaker and Input Circuit Breaker of the unit.
3. Start the module:
 - a. Press *Operation*.
 - b. A pop-up window will appear to enter the password. Enter the password (see **Preferences on page 14**).
 - c. Press the *Startup* menu button
 - d. The message *Close BFB* will appear in the multipurpose window.
 - e. Close the BFB breaker. The message *Press OK to turn on SBS* will appear.
 - f. Press *OK* to continue. This will energize the load on the UPS internal bypass.
 - g. The message *Press OK to start Rectifier* will appear.
 - h. Press *OK*. This will start the UPS's rectifier. Load is still on internal bypass.
The DC Bus will charge up.
 - i. CB1 breaker will close. The rectifier will turn On.
 - j. The message *Press OK to turn Inverter on* will appear.
 - k. Press *OK*. The Inverter will be on standby. Load is still on internal bypass.
 - l. The message *Press OK to DC/DC Converter on* will appear.
 - m. Press *OK* to continue.
 - n. The message *Press OK to close all Battery Breaker(s)* will appear.
 - o. Press *OK* to continue.
 - p. Close all battery/DC breakers. The UPS will stay in this mode until all breakers are closed.
If the DC sources are not ready to be started up, skip this command. The DC breakers can be closed individually from the startup command later (see **2.2.5 - Operation Menu**).



NOTE

The DC source charge current may increase quickly, but should slowly decrease. If the system is recovering from a DC source shutdown or an input power failure, the UPS rectifier will be recharging the DC source. Recharge current can be more than 100A. The maximum allowable recharge current for any unit depends on the kVA rating and the DC source recharge current limit.

- q. The message *Press OK to transfer to UPS* will appear.
- r. Press *OK*.
- s. The message *Close CB2* will appear.
- t. Close CB2.

If the critical load is supported by maintenance bypass, follow the procedure for returning from maintenance bypass (see **Maintenance Bypass Load Transfers—Single Module System: If Load is on Maintenance Bypass on page 28**). Otherwise, the load is now energized from the UPS inverter.

NOTICE

Risk of equipment damage. If an abnormal situation occurs during this startup procedure, open the input circuit breaker and investigate the problem. Call Vertiv if help is required.

WARNING

Risk of electric shock, explosive reaction, hazardous chemicals and fire. Can cause equipment damage, personal injury and death.

Do not use equalize charging with valve-regulated, lead-acid batteries. Refer to the battery manufacturer's manual, available on the manufacturer's Web site, for specific information about equalize charging.

AVERTISSEMENT

Risque de décharge électrique, de réaction explosive, d'incendie et d'exposition à des produits chimiques dangereux pouvant entraîner des dommages matériels, des blessures et même la mort.

N'utilisez pas de charge d'égalisation avec les batteries au plomb-acide à régulation par soupape. Reportez-vous au manuel du fabricant des batteries, disponible sur le site Web du fabricant, pour obtenir des renseignements précis sur la charge d'égalisation.

3.1.2 Startup for a Single-Module System with Remote Breakers

WARNING

Risk of electrical shock. Can cause equipment damage, personal injury and death.

The following procedure provides power to the critical load distribution system. Verify that the critical load distribution is ready to accept power. Make sure that personnel and equipment are ready for the critical load distribution system to be energized.

AVERTISSEMENT

Risque de décharge électrique pouvant entraîner des dommages matériels, des blessures et même la mort.

La procédure suivante fournit de l'énergie au système de distribution de la charge critique. Vérifiez que ce système est prêt à être alimenté. Assurez-vous que le personnel et les équipements sont préparés pour la mise sous tension du système de distribution de la charge critique.

This section details how to start a single UPS module with both the Rectifier Input Breaker (RIB) and Remote Backfeed Breaker (RBB) installed. If either of the remote breakers is not installed, refer to the relevant internal breaker (CB1 or BFB) for that part of the operation.

If the installation includes a Maintenance Bypass, power may already be supplied to the critical load equipment through the Maintenance Bypass. If there is no power to the critical load, apply power through the UPS bypass line per the following procedure.

During startup, power is supplied to the critical load through the UPS (internal) bypass line while the UPS system is being energized. Depending on the reason for the UPS system shutdown, power may be present in the bypass line. To determine this, check the Monitor/Mimic Display screen after control power is available.



NOTE

If the system was shut down in response to an Emergency Off, there may be alarm messages on the touchscreen that describe system conditions before (or at the time of) the shutdown. Some or all of the alarm conditions may have been resolved. Contact Vertiv for assistance in clearing any remaining alarm messages.



WARNING

Risk of electrical shock and high short circuit current. Can cause equipment damage, personal injury and death.

If the UPS has been shut down for maintenance, verify that all of the UPS doors are closed and latched. All test equipment must be removed from the system. All electrical connections must be secure.



AVERTISSEMENT

Risque de décharge électrique et de présence de courant de court-circuit élevé pouvant entraîner des dommages matériels, des blessures et même la mort.

Si l'alimentation sans coupure a été interrompue à des fins d'entretien, assurez-vous que toutes les portes du système ASC sont fermées et verrouillées. Tous les appareils de test doivent être retirés du système. Tous les branchements électriques doivent être serrés.

This section lists typical step-by-step instructions to start a single-module UPS with remote breakers. The touchscreen will list all steps required for the process, based on the unit's condition and other factors.

1. Before applying power to the UPS modules, determine the location and position of the following circuit breakers and switches:
 - Input Circuit Breaker *—Verify that this breaker (**Figures 3 and 5**) is in the open position.
 - Module Battery Disconnect—Verify that this external breaker is open or tripped. If DC source cabinets are used, verify that breakers on all the cabinets are open.
 - Bypass Circuit Breaker *—Normally this circuit breaker (**Figures 3 and 5**) should be open. However, if the critical load is already supplied through this breaker, keep this breaker closed.
 - Output Circuit Breaker—This circuit breaker (**Figures 3 and 5**) should be open.

* If remote breakers are used, these breakers will be in the appropriate switch gear.
2. Provide power to the UPS controls of the UPS module starting up to permit the display touchscreen and system logic to function properly.

Close all breakers feeding power to the Bypass Circuit Breaker and Input Circuit Breaker of the unit.
3. Start the module:
 - a. Press *Operation* on the HMI.
 - b. A pop-up window will appear to enter the password. Enter the password; the default is *EXL*.
 - c. Press the *Startup* menu button
 - d. The message *Close RBB* will appear in the multipurpose window.
 - e. Close the RBB breaker. The message *Press OK to turn on SBS* will appear.
 - f. Press *OK* to continue. This will energize the load on the UPS internal bypass.
 - g. The *Press OK to start Rectifier* message will appear.
 - h. Press *OK*. This will start the UPS's rectifier. Load is still on internal bypass.

The DC Bus will charge up.
 - i. The RIB breaker will close. The rectifier will turn On.
 - j. The message *Press OK to turn Inverter on* will appear.
 - k. Press *OK*. The rectifier will be On and the Inverter will be on standby. Load is still on internal bypass.
 - l. The message *Press OK to turn DC/DC Converter on* will appear.
 - m. Press *OK* to continue.
 - n. The message *Press OK to close all Battery Breaker(s)* will appear.
 - o. Press *OK* to continue.

- p. Close all battery/DC breakers. The UPS will stay in this mode until all breakers are closed. If the DC sources are not ready to be started up, skip this command. The DC breakers can be closed individually from the startup command later (refer to **2.2.5 - Operation Menu**).



NOTE

The DC source charge current may increase quickly, but should slowly decrease. If the system is recovering from a DC source shutdown or an input power failure, the UPS rectifier will be recharging the DC source. Recharge current can be more than 100A. The maximum allowable recharge current for any unit depends on the kVA rating and the DC source recharge current limit.

- q. The message *Press OK to transfer to UPS* will appear.
- r. Press *OK*.
- s. The message *Close CB2* will appear.
- t. Close CB2, then press *OK* to continue.

If the critical load is supported by maintenance bypass, follow the procedure for returning from maintenance bypass (see **Maintenance Bypass Load Transfers—Single Module System: If Load is on Maintenance Bypass on page 28**). Otherwise, the load is now energized from the UPS inverter.

NOTICE

Risk of equipment damage. If an abnormal situation occurs during this startup procedure, open the input circuit breaker and investigate the problem. Call Vertiv if help is required.



WARNING

Risk of electric shock, explosive reaction, hazardous chemicals and fire. Can cause equipment damage, personal injury and death.

Do not use equalize charging with valve-regulated, lead-acid batteries. Refer to the battery manufacturer's manual, available on the manufacturer's Web site, for specific information about equalize charging.



AVERTISSEMENT

Risque de décharge électrique, de réaction explosive, d'incendie et d'exposition à des produits chimiques dangereux pouvant entraîner des dommages matériels, des blessures et même la mort.

N'utilisez pas de charge d'égalisation avec les batteries au plomb-acide à régulation par soupape. Reportez-vous au manuel du fabricant des batteries, disponible sur le site Web du fabricant, pour obtenir des renseignements précis sur la charge d'égalisation.

3.1.3 Load Transfer and Retransfer—Single Module System

Changing the load from the UPS system to the UPS bypass is called a *transfer*. Changing the load from UPS bypass to the UPS system is called a *retransfer*. Note that the UPS system control logic can initiate automatic load transfers and retransfers. Refer to **3.4 - Automatic Operations**.

Transfer Procedure

1. Press the *Operation* then *Transfer* menu buttons on the touchscreen. The message *Press OK to transfer to Bypass* will appear in the multipurpose window.
2. Press the *OK* button. This will transfer the load from the UPS to the bypass.
If the UPS output is not synchronized with the bypass, the module will not allow a transfer.

Retransfer Procedure

1. Press the *Operation* then *Transfer* menu buttons on the touchscreen. The message *Press OK to transfer to UPS* will appear in the multipurpose window.
2. Press the *OK* button. This will transfer the load from the Bypass to the UPS.
If the UPS output is not synchronized with the bypass, the module will not allow a retransfer.

3.1.4 Maintenance Bypass Load Transfers-Single Module System

Follow these instructions to manually transfer the load between the Maintenance Bypass and the UPS bypass line. Do not transfer the load between the Maintenance Bypass and the UPS module (inverter) output. Use the Monitor/Mimic Display screen to verify that the UPS bypass line is available.

NOTICE

Risk of equipment damage. Failing to follow the proper sequence when operating any circuit breaker may cause damage to the connected equipment. Operating a Maintenance Bypass circuit breaker out of sequence could cut off power to the critical load.

NOTICE

Risk of equipment damage. The UPS must be on internal bypass before performing the following procedures and operating the MIB or the MBB, or damage to the UPS may occur and the critical load may be lost.

Maintenance Bypass Load Transfers-Single Module System: If Load is on UPS Bypass

After the UPS been transferred to bypass (see **3.1.3 - Load Transfer and Retransfer—Single Module System**), the *OK to transfer* lamp on the key-release unit will light.



NOTE

If the maintenance bypass cabinet or switchboard has any other type of custom interlock, follow the specific instructions for that interlock system to remove the key.

1. If using a key interlock system, depress the key-release unit push button, turn the key and remove from key-release unit.



NOTE

The UPS is now locked in bypass and cannot be retransferred to the inverter until the key is reinserted.

2. If using a key interlock system, insert the key into the lock for the Maintenance Bypass Breaker (MBB); retract the bolt.
3. Close the Maintenance Bypass Breaker (MBB).

NOTICE

Risk of improper operation sequence. May cause equipment damage.

Failure to close the Maintenance Bypass Breaker (MBB) will interrupt power to the load.

4. Open the Maintenance Isolation Breaker (MIB). The UPS is now isolated from the critical load and the load is now on Maintenance Bypass.
5. If using a key interlock system, remove the key from the lock for the Maintenance Isolation Breaker (MIB).
6. If the maintenance bypass cabinet or switchboard has an optional two-key interlock system, replace the key into the solenoid.
7. If UPS bypass shutdown is required, following instructions in Section **3.1.16 - Shutdown—Single Module UPS**.

3.1.5 Maintenance Bypass Load Transfers—Single Module System: If Load is on Maintenance Bypass

1. Verify that power is available to the module's bypass and rectifier inputs.
2. Verify that the module is started and in Bypass Mode.
3. If using a key interlock system:
 - a. Depress the key-release unit push button
 - b. Turn the key and remove it from the key-release unit.



NOTE

The UPS is now locked in bypass and cannot be retransferred to the Inverter until the key is returned.

4. If using a key interlock system:
 - a. Insert the key into the lock for the Maintenance Isolation Breaker (MIB)
 - b. Retract the bolt.
5. Close the Maintenance Isolation Breaker (MIB).

NOTICE

Risk of improper operation sequence. May cause equipment damage.

Failure to close the Maintenance Isolation Breaker (MIB) will interrupt power to the load.

6. Open the Maintenance Bypass Breaker (MBB). Load is now on UPS Internal Bypass.
7. If using a key interlock system, remove the key from the lock for the Maintenance Bypass Breaker (MBB) to lock it open.
8. If the maintenance bypass cabinet or switchboard has an optional two-key interlock system, insert the key into the solenoid.

The UPS system may now be transferred from bypass to UPS (see **3.1.3 - Load Transfer and Retransfer—Single Module System**).

3.1.6 Conditions to Activate Eco Mode Operation

Automatic Eco Mode Activation

The system will activate Eco Mode when all of the following are true:

- Eco Mode session is active
- Bypass Source Qualification is satisfied
- The Load On UPS event has been active for a specified time
- Input Contact Interface 1 (Channel 5) event is not active
- Load kW is greater than 10%
- Backfeed Breaker Open event is not active
- Bypass Static Switch Unable event is not active (SCR Short, SCR Open)

When conditions to activate have been satisfied, the system will coordinate turning on the BPSS and place the inverter(s) into an idle state (zero power mode).

Manual Eco Mode Operation

The rules that apply to users that initiate the following manual operations while Eco Mode is active:

- When the Eco Mode Active event is set, the system will allow the user to shutdown the system.
- When the Eco Mode Active event is set, the system will allow the user to transfer to inverter.

Automatic Eco Mode Reactivation

When an Eco Mode session is suspended, the system will automatically reactivate Eco Mode when the following are true:

- Excessive Eco Mode Suspension event is not set.
- Conditions to automatically activate have been satisfied for the full duration of Restart Delay setting.

3.1.7 Conditions to Suspend Eco Mode

When an Eco Mode session is active and the Eco Mode Active event is active, the system will suspend Eco Mode when at least one of the following is true:

- Bypass Source Qualification is not satisfied.
- Input Contact Interface 1 (Channel 5) event is active.
- Load kW is less than 10%.
- Bypass Line Fault or Critical Bus Load Fault is detected.

When the conditions to suspend Eco Mode are met, the inverter(s) will power the load and the bypass will be turned Off. When an Eco Mode Session is active but the conditions to activate are not met, the system will set the Eco Mode Suspended event.

3.1.8 Conditions to Terminate Eco Mode

The system will terminate Eco Mode when at least one of the following conditions is met:

- Eco Mode-Stop command is received.
- Scheduling stop time is reached and Continuous Operation setting is disabled.
- Excessive Eco Mode Suspension event is set.
- Eco Mode Operation setting is disabled.
- System transfers to inverter, either automatically or manually.
- Backfeed Breaker Open event is active.
- Bypass Static Switch Unable event is active (SCR Short, SCR Open).
- Inverter Output Breaker (CB2/IOB) Open event is active.
- Module Output Breaker (MOB) Open event is active.
- Critical Bus Voltage Disqualification is satisfied.

When conditions to terminate have been met, the inverter(s) will power the load and the bypass static switch will be turned Off.

3.1.9 Bypass Source Qualification for Eco Mode

All of the following bypass source conditions must be met for Eco Mode operation to start:

- Bypass voltage is less than Manual Transfer Bypass Voltage High Limit setting
Minimum: 1%
Maximum: +10%
- Bypass voltage is greater than Manual Transfer Bypass Voltage Low Limit setting
Minimum: -10%
Maximum: -1%
- Bypass frequency is within the Bypass Tracking Window setting
Minimum: 0.1Hz
Maximum: 5Hz, Iteration 0.1Hz
- Bypass is within the slew limits per Bypass Tracking Slew Rate setting
Minimum: 0.1Hz/s
Maximum: 3.0Hz/s
Iteration 0.1Hz/s
- Bypass Sync Error event is not active.
Bypass input phase differential is greater than 8 degrees

3.1.10 Critical Bus Disqualification for Eco Mode

At least one of the following critical bus voltage conditions must be met to suspend or terminate Eco Mode operations:

- Critical bus voltage is higher than the Manual Transfer Bypass Voltage High Limit setting
Minimum: 1%
Maximum: +10%
- Critical bus voltage is lower than Manual Transfer Bypass Voltage Low Limit setting
Minimum: -10%
Maximum: -1%
- Critical bus frequency exceeds the Bypass Tracking Window setting.
Minimum: 0.1Hz
Maximum: 5Hz
Iteration: 0.1Hz
- Critical bus exceeds the slew limits per Bypass Tracking Slew Rate setting.
Minimum: 0.1Hz/s
Max: 3.0Hz/s
Iteration 0.1Hz/s

3.1.11 Settings for Eco Mode

Mode of Operation

- Setting Range: Disabled/Scheduled/Continuous (Default setting is *Disabled*)
 - Disabled prevents the unit from entering Eco Mode
 - Scheduled allows the operator to setup a day of the week/time of the day for Eco Mode active pending activation conditions are met
 - Continuous allows the unit to operate in Eco Mode constantly, pending activation conditions being met

Schedule Day of Week

- Setting Range: Sun, Mon, Tues, Wed, Thurs, Fri, Sat
- Default: Monday

Schedule Time

- Setting Range: hh:mm
- Default: 00:00

Schedule Action

- Setting Range: Start, Stop
- Default: Start (1st entry), Opposite of previous entry afterwards

3.1.12 Enabling Eco Mode

This addendum lists typical step-by-step instructions to configure and to start and exit Eco Mode. The touchscreen will list all steps required for the process, based on the unit's condition and other factors. It assumes that the module has been started and is operating in Normal Mode.

1. Login as User by entering the applicable password. The default is *exl*, but may have been changed on-site.
2. Select Config>Setpoints>ECO Mode.
3. A Settings popup will be displayed.

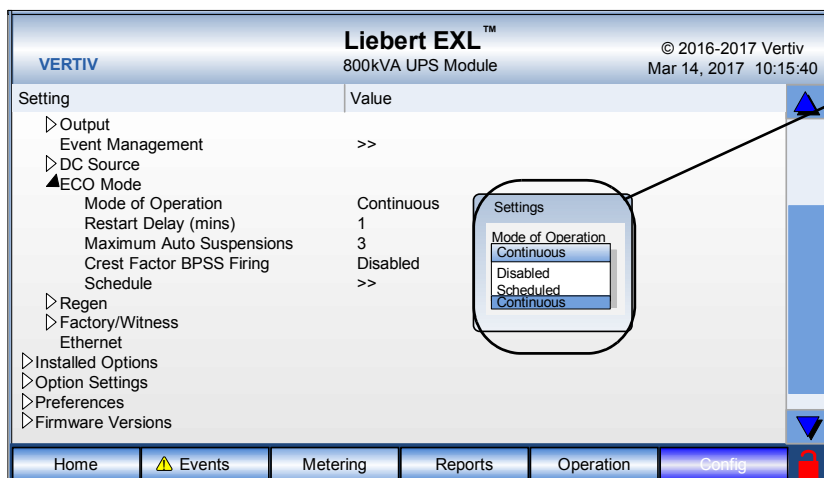

Select the type of Eco Mode operation to enable; Continuous operation is selected

4. Select the appropriate mode of operation.

3.1.13 Eco Mode—Scheduled Operation

If *Scheduled* mode of operation is selected, the schedule for Eco Mode to begin and end must be set. To set a schedule for Eco Mode:

1. Select *Scheduled* in the ECO Mode menu.
2. Set the appropriate start and stop times to schedule Eco Mode.

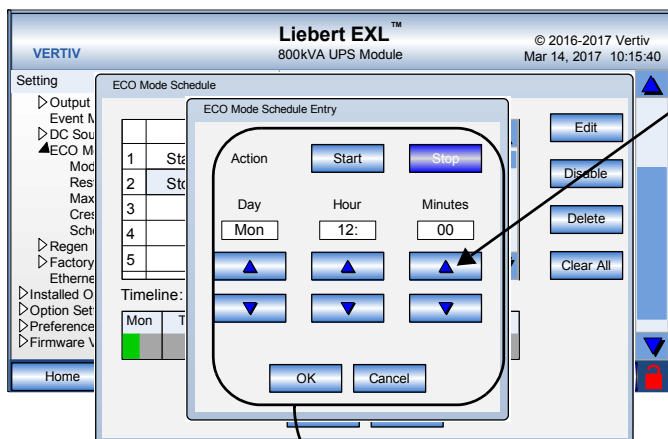

Use the Up and Down arrows to set the Start and Stop times and the days Eco Mode will be scheduled and click OK.

The Start and Stop times will be entered on the Eco Mode

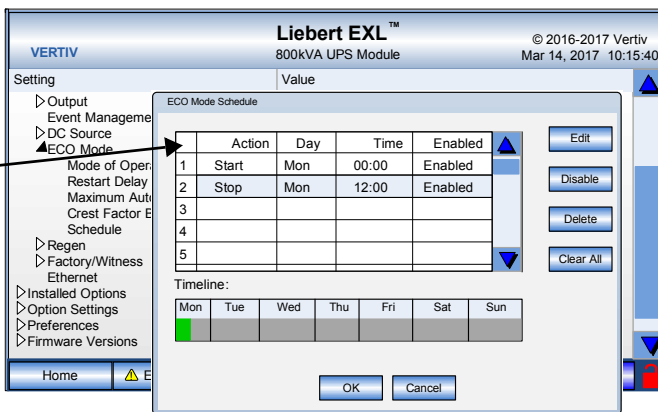

3.1.14 Eco Mode—Manual Start

If Eco Mode will be started and stopped manually:

1. Select *Operation>More...* then select *Eco Mode*.

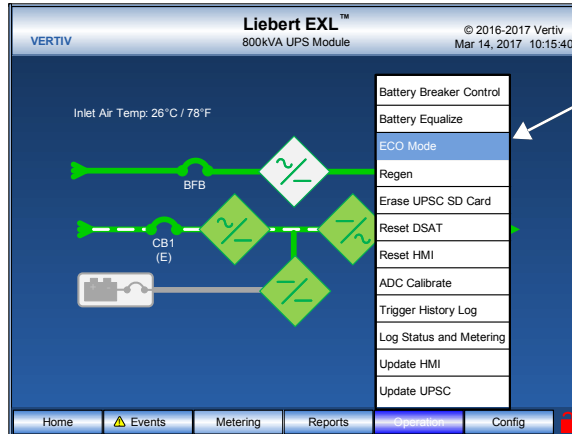

Select ECO Mode to begin enabling the operational mode.

2. Select *Start* in the popup window then select *Exit*. A pop-up window will appear with choices of *Stop* and *Exit*. Selecting *Stop* will prevent startup in Eco Mode; choosing *Exit* will close the pop-up window and startup in Eco Mode will proceed.

The module will enter Eco Mode according to the scheduled times or will enter it immediately if Continuous Mode of Operation was selected.

3.1.15 Exiting Eco Mode Manually

1. Select *Operation>More>Eco Mode*.
2. Select *Stop* in the popup window.
3. The unit will exit Eco Mode.

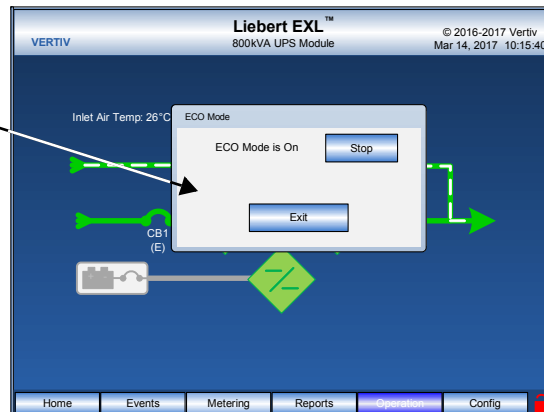

A pop-up window will state that ECO Mode is On. Select *Stop* to end Eco Mode.

When the Liebert EXL exits Eco Mode, a popup will ask whether the UPS should return to Eco Mode. If the UPS should operate in another mode, select *Exit* on the prompt.

3.1.16 Shutdown—Single Module UPS

Perform a Module Shutdown to remove power from a UPS module.

Read all warnings in **5.0 - Maintenance** before performing any maintenance on the Liebert EXL UPS. These warnings and cautions must be observed during any work on the UPS.



NOTE

Service and maintenance work must be performed only by properly trained and qualified personnel and in accordance with applicable regulations as well as with manufacturers' specifications.

Use the module Monitor/Mimic Display to determine the operating condition of the UPS module.

UPS Shutdown



NOTE

This shutdown turns Off the inverter and the rectifier and trips CB1, CB2 and all DC source breakers. The critical load will transfer to bypass if bypass is available.

1. Press the *Operations* then *Shutdown* menu buttons on the touchscreen. The Shutdown screen will appear in the multipurpose window.
2. Press the *UPS* button. This brings up a warning that pressing *OK* will shut down the UPS and, if bypass is not available, drop the load.
 - a. Press *OK* to continue the shutdown process.
 - b. Press *Exit* to abort shutdown.
3. Pop-up will appear *Proceed with UPS Shutdown?*
 - a. Press *Yes* to shut down the UPS.
 - b. Press *Cancel* to abort shutdown.
4. Once shutdown is complete, a message *Shutdown complete* will appear. Press *Exit* to return to main screen.

UPS System Shutdown



NOTE

This shutdown turns Off the inverter and the rectifier and trips the BFB, CB1, CB2 and all DC source breakers. This will shut down the UPS completely.

1. Press the *Operations* then *Shutdown* menu buttons on the touchscreen. The Shutdown screen will appear in the multipurpose window.
2. Press the *System* button. This brings up a warning that pressing *OK* will shut off the UPS output completely - Load Drop will occur.
 - a. Press *OK* to continue Shutdown process.
 - b. Press *Exit* to abort shutdown.
3. This pop-up will appear: *Proceed with System Shutdown?*
 - a. Press *Yes* to shutdown system.
 - b. Press *Cancel* to abort shutdown.
4. Once shutdown is complete, a message *Shutdown complete* will appear. Press *Exit* to return to main screen.

3.2 MANUAL OPERATIONS—1+N SYSTEMS

3.2.1 Startup—1+N Module System

WARNING

Risk of electrical shock. Can cause equipment damage, personal injury and death. The following procedure provides power to the critical load distribution system. Verify that the critical load distribution is ready to accept power. Make sure that personnel and equipment are ready for the critical load distribution system to be energized.

AVERTISSEMENT

Risque de décharge électrique pouvant entraîner des dommages matériels, des blessures et même la mort. La procédure suivante fournit de l'énergie au système de distribution de la charge critique. Vérifiez que ce système est prêt à être alimenté. Assurez-vous que le personnel et les équipements sont préparés pour la mise sous tension du système de distribution de la charge critique.

If the installation includes a Maintenance Bypass, power may already be supplied to the critical load equipment through the Maintenance Bypass. If there is no power to the critical load, apply power through the UPS bypass line per the following procedure.

During startup, power is supplied to the critical load through the UPS (internal) bypass line while the UPS system is being energized. Depending on the reason for the UPS system shutdown, power may be present in the bypass line. To determine this, check the Monitor/Mimic Display screen after control power is available.



NOTE

If the system was shut down in response to an Emergency Off, there may be alarm messages on the touchscreen that describe system conditions before (or at the time of) the shutdown. Some or all of the alarm conditions may have been resolved. Contact Vertiv for assistance in clearing any remaining alarm messages.

WARNING

Risk of electrical shock and high short circuit current. Can cause equipment damage, personal injury and death. If the UPS has been shut down for maintenance, verify that all of the UPS doors are closed and latched. All test equipment must be removed from the system. All electrical connections must be secure.

AVERTISSEMENT

Risque de décharge électrique et de présence de courant de court-circuit élevé pouvant entraîner des dommages matériels, des blessures et même la mort. Si l'alimentation sans coupure a été interrompue à des fins d'entretien, assurez-vous que toutes les portes du système ASC sont fermées et verrouillées. Tous les appareils de test doivent être retirés du système. Tous les branchements électriques doivent être serrés.

WARNING

Risk of electrical shock and arc flash. Can cause property damage, injury and death. The following procedure must be performed exactly as described. Deviating from the procedure can result in electric shock hazard to personnel and the risk of fire.

AVERTISSEMENT

Risque de coup d'arc et d'électrocution. Peut causer la mort, des blessures et des dommages matériels.

La procédure suivante doit être suivie à la lettre. Dévier de cette procédure peut entraîner des risques d'électrocution à la personne ainsi que des risques d'incendie.

This section lists typical step-by-step instructions. The touchscreen will list all steps required for the process, based on the unit's condition and other factors.

1. Before applying power to the UPS modules, determine the location and position of the following circuit breakers and switches:
 - Input Circuit Breaker *—Verify that this breaker is in the open position (see **Figure 2**).
 - Module Battery Disconnect—Verify that this external breaker is open or tripped. If DC source cabinets are used, verify that breakers on all the cabinets are open.
 - Bypass Circuit Breaker *—Normally this circuit breaker should be open (see **Figure 2**). However, if the critical load is already supplied through this breaker, keep this breaker closed.
 - Output Circuit Breaker—This circuit breaker should be open (see **Figure 2**).

* If remote breakers are used, these breakers will be located in the appropriate switch gear.
2. Provide power to the UPS controls of each UPS module starting up to permit the display touchscreen and system logic to function.
3. Start the modules via the Module 1 HMI.
 - a. If the critical load is energized through the MBB, leave this breaker closed and verify that the MIB and MOB's are open before startup.
 - b. Press *Operation*.
 - c. Enter the password in the pop-up window (see **Preferences on page 14**).
 - d. Press the *Startup* menu button.
 - e. Press *All Modules*. The message *Press OK to start rectifier* will appear.
 - f. Press *OK*. This will start the UPS's rectifier. The DC bus will charge up, CB1 will close and the rectifier will turn On. The message *Close BFB* will appear.
 - g. Close the BFB. The message *Press OK to turn inverter on* will appear.
 - h. Press *OK* to turn the inverter On. The message *Press OK to turn DC/DC Converter on* will appear.
 - i. Press *OK* to continue. The message *Press OK to close all Battery Breaker(s)* will appear.
 - j. Press *OK* to continue.
 - k. When prompted by the HMI, close all the battery breakers.
The message *Start enough modules to support system load* will appear.
 - l. Go to the next module and select *Operation>Startup>This Module* and follow the HMI instructions.
 - m. Repeat **Step I** for each module to be started up.
 - n. When finished starting modules, return to Module 1 to complete the process.
 - o. Follow the HMI prompts on Module 1 to complete placing the system on inverter with all MOB's closed.

If the critical load is supported by maintenance bypass, follow the procedure for returning from maintenance bypass (see **Maintenance Bypass Load Transfers—1+N Module System: If Load is on Maintenance Bypass on page 38**). Otherwise, the load is now energized from the UPS system.

3.2.2 Load Transfer-1+N System: Remove a UPS from System (Collective)

1. Press *Operation*, then *Transfer*, then *This Module* menu buttons on the touchscreen.
2. If the system has enough capacity to turn Off the unit, the message *Press OK to remove module from the collective* will appear. Press *OK*. CB2 will open on this module.



NOTE

The module will disable the Remove a UPS from the system command sequence if disengaging the UPS from the system would cause an overload on the other UPS units in the system.

3. To isolate the UPS from the critical bus, open the MOB breaker.

3.2.3 Load Transfer-1+N System: Add a UPS to the System (Collective)

1. Provide power to all the UPS controls of the module to be added to permit the display touchscreen and system logic to function.
2. Press *Operation*.
3. Enter the password in the pop-up window (see **Preferences on page 14**).
4. Press the *Startup* menu button.
5. Press *This Module*. The message *Close MOB* will appear.
6. Close the MOB. The message *Press OK to start rectifier* will appear.
7. Press *OK*. This will start the UPS's rectifier. The DC bus will charge up, CB1 will close and the rectifier will turn On. The message *Close BFB* will appear.
8. Close the BFB. The message *Press OK to turn inverter on* will appear.
9. Press *OK* to turn the inverter On. The message *Press OK to turn DC/DC Converter on* will appear.
10. Press *OK* to continue. The message *Press OK to close all Battery Breaker(s)* will appear.
11. Press *OK* to continue.
12. When prompted by the HMI, close all the battery breakers. The message *Press OK to add module to collective* will appear.
13. When prompted by the HMI, close CB2.



NOTE

The module will disable the Add a UPS to the system command sequence.

3.2.4 Load Transfer-1+N System: Transfer System to Bypass

1. Press *Operation*, then *Transfer*, then *All Modules*.
2. If the UPS outputs are synchronized with their bypass, press *OK* to transfer all modules to bypass. This will transfer the load on every module to bypass.



NOTE

The Transfer all modules to bypass command will not be activated if this UPS is not part of the collective.



NOTE

The load will now be on static bypass in each UPS.

3.2.5 Load Transfer-1+N System: Transfer System to Inverter

1. Verify that all the UPS units are On and the inverters are in Standby Mode and on bypass.
2. Press *Operation*, then *Transfer*, then *All Modules*.
3. Press *OK* to transfer all modules to UPS. This will transfer the load to the inverters on all UPS modules.



NOTE

The Transfer all modules to Inverter command will not be activated if the UPS is not synchronized with the other units in the system.

3.2.6 Maintenance Bypass Load Transfers-1+N Module System

Follow these instructions to manually transfer the load between Maintenance Bypass and the UPS bypass line. Do not transfer the load between Maintenance Bypass and the UPS module inverter output. Use the Monitor/Mimic Display screen to verify that the UPS bypass line is available.

NOTICE

Risk of improper operating sequence. Can cause equipment damage.

Failing to follow the proper sequence when operating any circuit breaker may cause damage to the connected equipment. Operating a Maintenance Bypass circuit breaker out of sequence could cut off power to the critical load.

NOTICE

Risk of improper load transfer. Can cause equipment damage.

The UPS must be on internal bypass before performing the following procedures and operating the MIB or the MBB, or damage to the UPS may occur and the critical load may be lost.

Maintenance Bypass Load Transfers-1+N Module System: If Load is on UPS Bypass

1. Transfer the UPS system to bypass (see **3.2.4 - Load Transfer-1+N System: Transfer System to Bypass**). The *OK to transfer* lamp on the key-release unit will light.



NOTE

If the maintenance bypass cabinet or switchboard has any other type of custom interlock, follow the instructions for that interlock systems to remove the key.

2. If using a key interlock system:
 - a. Press the key-release unit push button.
 - b. Turn the key and remove it from key-release unit.



NOTE

The UPS is now locked in bypass and cannot be retransferred to the inverter until the key is reinserted.

3. If using a key interlock system, insert the key into the lock for the Maintenance Bypass Breaker (MBB); retract the bolt.
4. Close the MBB.

NOTICE

Risk of improper operation sequence. May cause equipment damage.

Failure to close the MBB will interrupt power to the load.

5. Open the Maintenance Isolation Breaker (MIB). The UPS system is now isolated from the critical load and the load is now on Maintenance Bypass.
6. If using a key interlock system, remove the key from the lock for the MIB.
7. If the maintenance bypass cabinet or switchboard has an optional, two-key interlock system, insert the key into the solenoid.
8. If UPS bypass shutdown is required, follow the instruction in **3.2.8 - Shutdown—1+N UPS: UPS Module System Shutdown (Remove UPS Module from the Collective)**

Maintenance Bypass Load Transfers—1+N Module System: If Load is on Maintenance Bypass

1. If the UPS modules are Off, start the system. Refer to **3.2.1 - Startup—1+N Module System**.
2. Place all the UPS units in the system in Bypass Mode. Refer to **3.2.4 - Load Transfer-1+N System: Transfer System to Bypass**.
3. If using a key interlock system:
 - a. Press the key-release unit push button.
 - b. Turn the key and remove from key-release unit.



NOTE

The UPS is now locked in bypass and cannot be retransferred to the inverter until the key is reinserted.

4. If using a key interlock system, insert the key into the lock for the Maintenance Isolation Breaker (MIB); retract the bolt.
5. Close the MIB.

NOTICE

Risk of improper operation sequence. May cause equipment damage.
Failure to close MIB will interrupt power to the load.

6. Open the Maintenance Bypass Breaker (MBB). The load is now on UPS internal bypass.
7. If using a key interlock system, remove the key from the lock for the MBB to lock it open.
8. If the maintenance bypass cabinet or switchboard has an optional two-key interlock system, insert the key into the solenoid.

The UPS system can now be transferred from bypass to UPS (see **3.2.5 - Load Transfer-1+N System: Transfer System to Inverter**).

3.2.7 Shutdown—1+N UPS: UPS Module Inverter Shutoff

Perform a module shutdown procedure to turn Off a single UPS module inverter in the system. Read all warnings in **5.0 - Maintenance** before performing any maintenance on the UPS. These warnings and cautions must be observed during any work on the UPS.



NOTE

This shutdown turns Off the inverter and the rectifier and trips all DC source breakers. Transfers to bypass if available.

1. Press *Operation*, then *Shutdown*, then *This Module* on the module to be turned Off.
2. Press the *UPS* button to transfer the load to the Bypass Static Switch and shut Off the inverter.
3. The message *Press OK to turn Off UPS* will appear. Press *OK*.
4. A pop-up window will appear with the message *Proceed with This Module's UPS Shutdown?* Press *Yes* to continue shutting down the UPS.
5. Open the module MOB.

3.2.8 Shutdown—1+N UPS: UPS Module System Shutdown (Remove UPS Module from the Collective)

Perform a module shutdown procedure to remove power from a single UPS module in the system. Read all warnings in **5.0 - Maintenance** before performing any maintenance on the UPS. These warnings and cautions must be observed during any work on the UPS.



NOTE

This shutdown turns Off the inverter and the rectifier and trips all DC source breakers. This will shut down the UPS completely.

1. Press *Operation*, then *Shutdown*, then *This Module* on the module to be turned off. The shutdown screen will appear.
2. Press the *System* button to shut down the UPS, including the Bypass Static Switch.
3. The message *Press OK to turn Off the UPS and bypass* will appear. Press *OK*.
4. A pop-up window will appear with the message *Proceed with This Module's System Shutdown?* Press *Yes* to continue shutting down the UPS.
5. Open the module MOB.

3.2.9 Shutdown—1+N System Shutdown

Perform a system shutdown procedure when you want to remove power from the entire UPS system.

Read all warnings in **5.0 - Maintenance** before performing any maintenance on the UPS. These warnings and cautions must be observed during any work on the UPS.



NOTE

Service and maintenance must be performed only by properly trained and qualified personnel and in accordance with applicable regulations as well as with manufacturer's specifications.

1. If an external, wraparound bypass is installed, perform the following steps; otherwise skip to **Step 2**.
 - a. If using a key interlock system:
 1. Press the key-release unit push button.
 2. Turn the key and remove it from the key-release unit.



NOTE

The UPS system is now locked in bypass and cannot be transferred until the key is returned.

- b. If using a key interlock system, insert the key into the lock for the MBB; retract the bolt.
- c. Close the MBB.



NOTE

Failure to close the Maintenance Bypass Breaker (MBB) will interrupt power to the load.

- d. Open the MIB. The UPS system is now isolated from the critical load and the load is now on Maintenance Bypass.
- e. If using a key interlock system, remove the key from the lock for the MIB.

- f. If the maintenance bypass cabinet or switchboard has an optional, two-key interlock system, insert the key into the solenoid.
2. On any module, press *Operation*, then *Shutdown*, then *All Modules*. The following message will appear: *Press OK to turn off the UPS and bypass of every module. Load drop will occur.*
3. Press *OK*. The shutdown screen will appear.
4. The pop-up message: *Proceed with All Modules Shutdown?* will appear. Press *Yes* to continue the shutdown.
5. The system will transfer to bypass.
6. The message *Press OK to proceed with shutdown* will appear.
7. Press *OK*.
8. All the UPS breakers—CB1, CB2, BFB and DC source—will open. The message *Open all MOB's* will appear.
9. Open all the MOB breakers to isolate the UPS units from each other.
10. To isolate the system, open all the breakers and utility feeds to the bypass and rectifier inputs.

3.2.10 Startup for 1+N System with Remote Breakers

WARNING

Risk of electrical shock. Can cause equipment damage, personal injury and death. The following procedure provides power to the critical load distribution system. Verify that the critical load distribution is ready to accept power. Make sure that personnel and equipment are ready for the critical load distribution system to be energized.

AVERTISSEMENT

Risque de décharge électrique pouvant entraîner des dommages matériels, des blessures et même la mort.

La procédure suivante fournit de l'énergie au système de distribution de la charge critique. Vérifiez que ce système est prêt à être alimenté. Assurez-vous que le personnel et les équipements sont préparés pour la mise sous tension du système de distribution de la charge critique.

This section details how to start a UPS system with both the Rectifier Input Breaker (RIB) and Remote Backfeed Breaker (RBB) installed. If either of the remote breakers is not installed, refer to the relevant internal breaker (CB1 or BFB) for that part of the operation

If the installation includes a Maintenance Bypass, power may already be supplied to the critical load equipment through the Maintenance Bypass. If there is no power to the critical load, apply power through the UPS bypass line per the following procedure.

During startup, power is supplied to the critical load through the UPS (internal) bypass line while the UPS system is being energized. Depending on the reason for the UPS system shutdown, power may be present in the bypass line. To determine this, check the Monitor/Mimic Display screen after control power is available.



NOTE

If the system was shut down in response to an Emergency Off, there may be alarm messages on the touchscreen that describe system conditions before (or at the time of) the shutdown. Some or all of the alarm conditions may have been resolved. Contact Vertiv for assistance in clearing any remaining alarm messages.

WARNING

Risk of electrical shock and high short circuit current. Can cause equipment damage, personal injury and death.

If the UPS has been shut down for maintenance, verify that all of the UPS doors are closed and latched. All test equipment must be removed from the system. All electrical connections must be secure.

AVERTISSEMENT

Risque de décharge électrique et de présence de courant de court-circuit élevé pouvant entraîner des dommages matériels, des blessures et même la mort.

Si l'alimentation sans coupure a été interrompue à des fins d'entretien, assurez-vous que toutes les portes du système ASC sont fermées et verrouillées. Tous les appareils de test doivent être retirés du système. Tous les branchements électriques doivent être serrés.

WARNING

Risk of electrical shock and arc flash. Can cause property damage, injury and death. The following procedure must be performed exactly as described. Deviating from the procedure can result in electric shock hazard to personnel and the risk of fire.

AVERTISSEMENT

Risque de coup d'arc et d'électrocution. Peut causer la mort, des blessures et des dommages matériels.

La procédure suivante doit être suivie à la lettre. Dévier de cette procédure peut entraîner des risques d'électrocution à la personne ainsi que des risques d'incendie.

1. Before applying power to the UPS modules, determine the location and position of the following circuit breakers and switches:
 - Input Circuit Breaker *—Verify that this breaker is in the open position (see **Figure 2**).
 - Module Battery Disconnect—Verify that this external breaker is open or tripped. If DC source cabinets are used, verify that breakers on all the cabinets are open.
 - Bypass Circuit Breaker *—Normally this circuit breaker should be open (see **Figure 2**). However, if the critical load is already supplied through this breaker, keep this breaker closed.
 - Output Circuit Breaker—This circuit breaker should be open (see **Figure 2**).

* If remote breakers are used, these breakers will be located in the appropriate switch gear.
2. Provide power to the UPS controls of each UPS module starting up to permit the display touchscreen and system logic to function.
3. Startup the modules via the Module 1 HMI
 - a. If the critical load is energized through the MBB, leave this breaker closed and verify that the MIB and MOB's are open before startup.
 - b. Press *Operation*.
 - c. Enter the password in the pop-up window (see **Preferences on page 14**).
 - d. Press the *Startup* menu button.
 - e. Press *All Modules*. The message *Press OK to start rectifier* will appear.
 - f. Press *OK*. This will start the UPS's rectifier. The DC bus will charge up, CB1 will close and the rectifier will turn On.
The message *Close BFB* will appear.
 - g. Close the BFB. The message *Press OK to turn inverter on* will appear.
 - h. Press *OK* to turn the inverter On. The message *Press OK to turn DC/DC Converter on* will appear.
 - i. Press *OK* to continue. The message *Press OK to close all Battery Breaker(s)* will appear.
 - j. Press *OK* to continue.
 - k. When prompted by the HMI, close all the battery breakers. The message *Start enough modules to support system load* will appear.
 - l. Go to the next module and select *Operation>Startup>This Module* and follow the HMI instructions.
 - m. Repeat **Step 1** for each module to be started up.
 - n. When finished starting modules, return to Module 1 to complete the process.
 - o. Follow the HMI prompts on Module 1 to complete placing the system on inverter with all MOB's closed.

If the critical load is supported by maintenance bypass, follow the procedure for returning from maintenance bypass (see **Maintenance Bypass Load Transfers—1+N Module System: If Load is on Maintenance Bypass on page 38**). Otherwise, the load is now energized from the UPS system.

3.3 SHUTDOWN FOR SYSTEMS WITH REMOTE BREAKERS

The shutdown sequence for the remote breaker option is the same as that for a module with internal breakers; refer to **3.1.16 - Shutdown—Single Module UPS** or **3.2.9 - Shutdown—1+N System Shutdown**.

3.4 AUTOMATIC OPERATIONS

The Liebert EXL is designed to function while unattended by an operator. The system control logic monitors the performance of the UPS, the availability of power sources and the current required by the critical load.

The system control logic:

- Determines what overload conditions can be sustained without a transfer to bypass.
- Initiates an automatic transfer to bypass to sustain an overload or when selected UPS faults occur.
- Can initiate an automatic retransfer to the UPS after an overload has been cleared.
- Initiates an automatic transfer to bypass and emergency module shutdown when specified UPS faults occur.

3.4.1 Overloads

The UPS is capable of sustaining full output voltage ($\pm 2\%$ of the nominal voltage) for overload conditions that remain within (under) the Current versus Time curve of overload capacity (**Figure 17**). Note that the time scale is not linear.

For high current demands of short duration (momentary overloads) the critical load is supplied simultaneously by both the UPS and the bypass line. Whenever an overload condition occurs, the cause of the overload should be determined. If an overload condition exceeds the overload capacity, the UPS initiates an automatic load transfer to the bypass line.

For overloads above the Input Current Limit, a DC source, such as a battery system or a generation source must be available. The Input Current limit has a default setting of 125% rated output current.

3.4.2 Automatic Transfers to Bypass

The UPS will initiate an automatic load transfer to the bypass line if an overload condition exceeds the current-versus-time curve of overload capacity or if specified UPS faults occur.

The Overload Transfer and Output Undervoltage alarm messages will initiate an automatic transfer to bypass and the Load On Bypass message will be displayed. The active event window will display the Automatic Transfer to Bypass message. Other UPS faults will initiate an automatic transfer to bypass followed immediately by the shutdown and isolation of the UPS. Refer to **3.4.3 - Automatic Transfers to Bypass, UPS Faults**.

3.4.3 Automatic Transfers to Bypass, UPS Faults

For specified UPS faults, the control logic will initiate an automatic transfer to bypass followed immediately by a shutdown and isolation of the UPS. The output, DC source (MBD) and input circuit breakers are open. The bypass breaker will be closed if the bypass line is available. Note that the bypass line is usually not available during Low Battery Shutdown.

The following UPS faults will initiate an automatic transfer to bypass:

- DC Overvoltage Shutdown
- Inverter Fault
- Output Overvoltage and Undervoltage
- Overload Shutdown
- Equipment Overtemperature
- Rectifier Fuse Blown



NOTE

A load transfer to the bypass line will be completed whenever an automatic transfer to bypass is initiated and the bypass line is available. If the OK to Transfer condition is present, the load transfer will be uninterrupted. If the Static Switch Unable alarm message is present for any reason, the automatic transfer will be interrupted for 40 to 120 milliseconds. Because of the reliability of the UPS components, an interrupted load transfer is a very unlikely occurrence.

Some installations may include a Remote Emergency Power Off mode that can be initiated automatically by a contact closure in the critical load equipment.

3.4.4 Automatic Retransfers to UPS

The following conditions will prevent an automatic retransfer of the critical load from the bypass source to the UPS inverter:

Bypass conditions are outside the range for a manual transfer or the current load would cause the inverter(s) to be in an overload condition.

The UPS module rectifier or inverter is not operating.

The static bypass switch is not operating properly as indicated by:

- SBS SCR Shorted
- Bypass Sync Error

The inverter is not operating properly as indicated by:

- Inverter Output Breaker (CB2) Open Fail
- Inverter Output Breaker (CB2) Close Fail

The cooling system is not operating properly or the ambient conditions are out of operating range as indicated by:

- Equipment Overtemperature Limit

The load is connected to the maintenance bypass source as indicated by:

- Maintenance Bypass Breaker (MBB) Closed and Maintenance Isolation Breaker (MIB) Closed are active.
- Maintenance Bypass Isolator (QBP) Closed and Output Isolator (QOP) Closed are active.
- Maintenance Isolator (Q3) Closed and Output Isolator (Q4) Closed are active.
- Transfer to Inverter Inhibited is active.

Automatic Retransfer Limit Exceeded

The number of retransfers to the UPS has exceeded the maximum allowed in one hour. The values that can be set range from 0 to 5. Selecting a value from 1 through 5 will limit the number of retransfers permitted in an hour to the chosen value. Selecting 0 means that there is no limit on the number of retransfers per hour. The default is 5.

4.0 OPTIONS



NOTE

These items must be enabled by service before they become functional. If a feature is disabled, the feature will not be available and the menu item will not be displayed.

4.1 INPUT CONTACT ISOLATOR BOARD

The Input Contact Isolator Board (ICI) provides a Liebert EXL module interface for up to eight external user alarm or message inputs to be routed through the EXL's alarm network. The eight contacts are normally open dry contacts. When a contact closes, an event is triggered.



NOTE

Up to two ICI's can be installed in a Liebert EXL.

The Input Contact Isolator options are configured through the Input Contact Isolator dialog box, which is accessed from the Option Settings under the Config menu on the HMI touchscreen display. The Input Contact Isolator dialog box contains eight choices to match the eight channel input board. Each button can be labeled to identify the event associated with the contact. When the dialog box is accessed, each button flashes to display the Input Contact Isolator number and the user entered label. This label also appears in the Display Panel when an event related to an Input Isolator Connector is triggered.

The Input Contact Isolator dialog box allows:

- Labeling the input contact assignments for the setup.
- Setting the delay for an external event triggering an alarm.
- Reviewing the isolator contact assignments, once the labels are entered.

The delay allows setting the number of seconds that a condition must exist before it will trigger an alarm.

Figure 13 Input Contact Isolator dialog box

Channel	Custom	Preset	String	Delay (secs)
1	✓	—	Input Contact 11	0.0
2	✓	—	Input Contact 12	0.0
3	✓	—	Input Contact 13	0.0
4	✓	—	Input Contact 14	0.0
5	✓	—	Input Contact 15	0.0
6	✓	—	Input Contact 16	0.0
7	✓	—	Input Contact 17	0.0
8	✓	—	Input Contact 18	0.0

To configure the Input Contact Isolator relays:

1. Press *Option Settings* from the Config menu.
2. Press which Input Contact Isolator is to be configured. The *Input Contact Isolator* dialog box will be displayed.
 - Assignment-Custom, Preset (default: *Input Contact XY*)
 - Delay, sec-0 to 99.9 (default: 0)
 - Message-Custom: 0-19 characters
3. To assign labels for each channel:
 - a. Press *Preset* for default labels and associated action (see **Table 1**).
 - b. For Custom labels:
 1. Press the *Custom* radio button.
 2. Click on *Input Contact XY* button. A keyboard is displayed to allow naming alarms.
 3. Enter the name of the alarm set for that input. For example, a fan problem could be indicated by naming the button *FAN*.
 4. Press *OK* on the keyboard to keep the label.
 5. Press *DELAY*.
 - a. A keypad is displayed, prompting for a delay time, in seconds, for a condition to exist before the alarm is triggered.
 - b. Enter the delay value. The range for the values are from 0 (zero) to 99.9 seconds.
 - c. Press *OK* on the keypad to keep the setting. The value entered is displayed in the field adjacent to the corresponding input contact.
6. Repeat **Steps 3** and **4** for each input contact.
7. Press *SAVE* after all input contacts have been configured.

Figure 14 Optional Input Contact Isolator Board

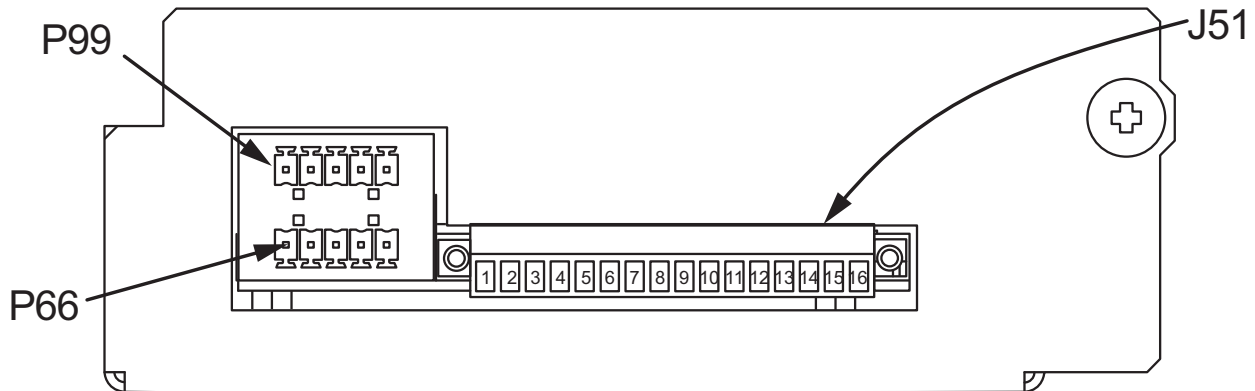

Table 1 Input Contact Isolator Board pre-assigned values

Channel #	ICI #1	ICI #2
	Pre-Assigned Label	Pre-Assigned Label
1	Reduced Rect ILimit	None
2	Reduced Batt ILimit	None
3	Stop Battery Charge	None
4	None	None
5	EcoMode Suspended	None
6	None	None
7	None	None
8	None	None

Table 2 Input Contact Isolator Board control wiring connections

Input Contact	Pin #	Input Contact	Pin #
1	1	5	9
	2		10
2	3	6	11
	4		12
3	5	7	13
	6		14
4	7	8	15
	8		16

4.2 PROGRAMMABLE RELAY BOARD

The Programmable Relay Board (PRB) provides a means to trigger an external device when an event occurs in the Liebert EXL. Each PRB has eight channels. Each channel has Form-C dry contacts rated at 1A @ 30VDC or 125VAC @ 0.45A.

Any alarm/event can be programmed to any channel or channels. Up to four (4) events can be programmed to a relay. If multiple events are grouped to one relay, any of the events becoming active will activate the channel. The same alarm/event can be programmed to more than one channel. Up to two Programmable Relay Boards can be installed in the Liebert EXL for a total of 16 channels. Programming is performed through the HMI touchscreen display.



NOTE

Up to two PRB's can be installed in a Liebert EXL.

Figure 15 Control wiring, Programmable Relay Board

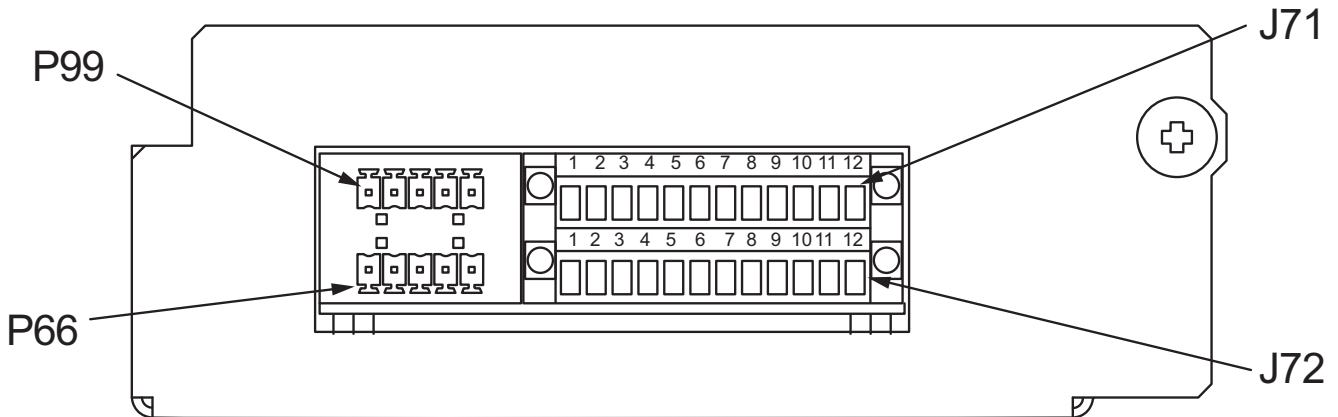

Table 3 Programmable Relay Board pinout

Terminal Block	Channel	Pin No.	Common	Normally Closed	Normally Open
J71	CH1	1-3	1	2	3
	CH2	4-6	4	5	6
	CH3	7-9	7	8	9
	CH4	10-12	10	11	12
J72	CH5	1-3	1	2	3
	CH6	4-6	4	5	6
	CH7	7-9	7	8	9
	CH8	10-12	10	11	12

4.2.1 Configuring the Programmable Relay Board Settings

1. Press *Option Settings* from the Config menu.
2. Press which Programmable Relay Board will be configured. The *Programmable Relay Board* dialog box is displayed.
3. Press the *Relay to program* channel.
4. Select an event from the Available Events list and then press the Right arrow button ►. Up to four (4) events may be selected. All selected events will appear in *Assigned Events*.
To deselect an Assigned event, highlight the event and press the Left arrow button ◀.
5. Set the delay that events must be present for the relay to activate
 - Delay, sec—0 to 99.9 (default: 0)
6. Repeat **Steps 3, 4** and **5** for each relay.
7. Press *SAVE* to keep the settings.

Figure 16 Programmable Relay Board menu

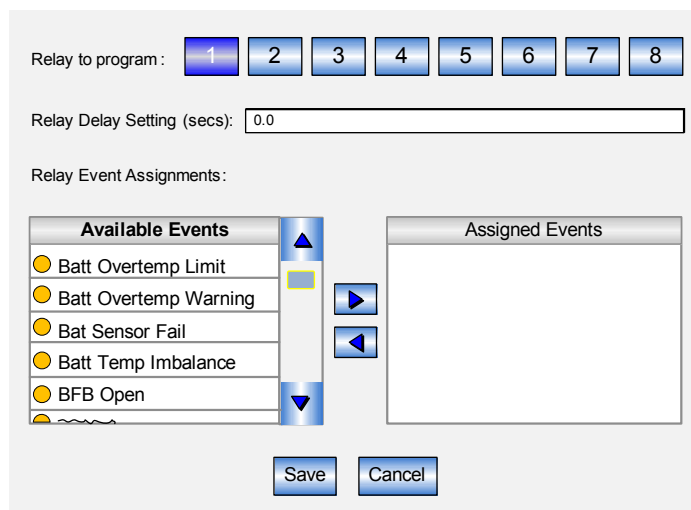

4.3 REMOTE ALARM STATUS PANEL

The Remote Alarm Status Panel (RAS) uses LED status indicators that allow the operator to monitor the UPS.

The main purpose of the Remote Alarm Status Panel option is to report the status of the load and the UPS. To interpret the LED indicators, see **Table 4**.

Table 4 RAS indicators

LED Name	LED Color	Meaning
Load on UPS	Green	The load is fully protected and no alarm conditions are present. The UPS is supplying uninterrupted power to the load.
Load on Bypass Alarm	Red	Power to the load is bypassing the UPS. The UPS is no longer supplying power to the load.
Battery Discharge Alarm	Red	The DC source is providing power to the UPS.
Low Battery Reserve Alarm	Red	DC source capacity is low and has reached the low-battery alarm setting.
Overload	Red	System load has exceeded the system rating.
Ambient Overtemp	Red	UPS inlet cooling air temperature has exceeded the specified limits.
System Summary Alarm	Red	An alarm has occurred at the UPS.
New Alarm Condition	Red	The New Alarm Condition LED lights when the UPS Alarm Condition LED has been triggered and has not been reset at the RAS.

The RAS also includes:

- An audible alarm
- Lamp Test/Reset push button to test the LED indicators
- Audio Reset push button to silence an audible alarm

4.3.1 Lamp Test/Reset Push Button

The Lamp Test/Reset push button is used to verify that each LED indicator is in working condition and to reset an LED indicator that has been triggered by a condition at the load or UPS. To test the LEDs, press the *Lamp Test/Reset* push button. This lights all of the LED indicators for visual inspection.

If an LED indicator does not respond to the lamp test, contact your local Vertiv® representative for assistance.

To reset an activated LED, press the *Lamp Test/Reset* push button.

4.3.2 Audio Reset Push Button

The *Audio Reset* push button is used to silence an audible alarm that has been triggered and reset the alarm to activate on the next alarm condition. After correcting the alarm condition, press the push button to reset the audible alarm.

4.4 DIGITAL LOAD BUS SYNC

4.4.1 System Description

Liebert's Load Bus Sync™ (LBS) option keeps the output of two or more independent Uninterruptible Power Systems in synchronization, even when the systems are operating from different power sources. The Liebert LBS works by synchronizing the Designates Slave System (DSS) to the output of the Designated Master System (DMS). There are no other connections between the logic or controls of either UPS. This ensures maximum system independence and reliability.

4.4.2 LBS Configurations

- Load Bus Sync—Enable or Disabled (default: Disable)
- LBS Master Select—Master or Slave (default: Slave)



NOTE

The LBS settings permit proper operation with only one UPS set as the Master unit.

- LBS Slave Priority – 0 to 7 (default: 0)



NOTE

Setting of '0' will disable LBS Slave Priority

4.4.3 Normal Operations

The LBS will synchronize the Designated Slave Systems (DSS) to the Designated Master System (DMS). The DSS will synchronize to the DMS output if the DMS is in Normal, Battery, Bypass or Maintenance Bypass Mode.

If the DSS transfers to Bypass Mode or Maintenance Bypass mode, the DMS will synchronize to the output bus of the DSS. This re-selection of master will occur automatically.

4.4.4 Slave Priority

When Slave Priority is enabled, the LBS system will work the same as Normal operations (See 4.4.2 -LBS Configurations except when the DMS disqualifies it bypass source. If the DMS's bypass is disqualified, the LBS system will synchronize to the output of the DSS with the lowest Slave Priority number that has a qualified bypass. The LBS system will synchronize back to the DMS when the DMS's bypass is qualified or all DSS's bypass are disqualified.

If a DSS LBS Slave Priority is set to 0, it will not assume the synchronization of the system if the DMS disqualifies its bypass.

4.4.5 Master System

The unit designated at power-up/reset to be the Master will monitor the LBS Sync Pulse line. If two units are designated as Master, the second designated Master Unit to come on-line will inhibit the LBS and synch to its own bypass.

The LBS Master will monitor the LBS Sync Pulse continuously; if the LBS Master detects that another unit has transferred to bypass, the LBS Master will follow the unit on bypass.

- Slave can no longer follow the Master; the Master must follow the Slave.

When the Master unit is following a Slave LBS Sync Signal, it will generate the LBS Active event.

If the Slave LBS Sync Pulse stops, the Master will resume generating the LBS Sync Pulse.

4.4.6 Slave System

Any unit designated as the Slave upon power-up / reset will monitor and lock to the Master LBS Sync Pulse.

When the Slave unit is on bypass, the Slave will generate the LBS Sync Pulse.

- The Slave will slew to be locked to its own bypass source. The inverter in the LBS Slave system will follow the local bypass.
- When the Slave unit is on UPS, the Slave will stop generating the LBS Sync Pulse.

When more than one Slave unit goes to bypass:

- All systems on UPS will follow the first Slave's LBS Sync Pulse
- All other Slave systems on Bypass will follow their own local Bypass Source.

5.0 MAINTENANCE

5.1 SAFETY PRECAUTIONS

Observe the safety precautions in the **Important Safety Instructions on page 1** of this manual. Observe all of the warnings and cautions in this document before performing any maintenance on the UPS and associated equipment. Also observe the manufacturer's safety precautions pertaining to the battery system, along with the battery safety precautions in this section.

WARNING

Risk of electric shock. Can cause injury and death.

Only Vertiv or Vertiv-trained service personnel should work on this equipment. Both AC and DC high voltages are present in lethal amounts within this equipment. Extreme care should be taken when working around UPS equipment.

Always identify the source of connecting wiring before disconnecting it. Mark any disconnected wires so they can be properly reconnected.

Do not substitute parts except as authorized by Vertiv.

Keep the UPS cabinets free of foreign materials such as solder, wire cuttings, etc.

Call Vertiv if you are not sure of the procedures to follow or if you are not familiar with the design or operation of the equipment.

AVERTISSEMENT

Risque de décharge électrique et de présence de courant de court-circuit élevé pouvant entraîner des dommages matériels, des blessures et même la mort.

L'entretien et la réparation de cet équipement doivent être confiés exclusivement à un personnel qualifié du Vertiv ou formé par Vertiv. Des hautes tensions c.a. et c.c. mortelles sont présentes dans cet équipement. Faites preuve d'une grande prudence lorsque vous travaillez à proximité d'un système ASC.

Identifiez tous les circuits de connexion avec de débrancher des câbles.

Ne remplacez aucun composant sans l'autorisation expresse du Vertiv.

Assurez-vous que les armoires d'ASC sont exemptes de matériaux étrangers tels que des résidus de soudure, des bouts de câble, etc.

Communiquez avec Vertiv si vous doutez de la procédure à suivre ou si les circuits ne vous sont pas familiers.

WARNING

Extreme caution is required when performing maintenance.

Be constantly aware that the UPS system contains high DC as well as AC voltages. With input power off and the battery disconnected, high voltage at filter capacitors and power circuits should be discharged within 30 seconds. However, if a power circuit failure has occurred, assume that high voltage still exists after shutdown. Check with a voltmeter before making contact.

AC voltage will remain on the bypass and output contactors and the static bypass switch unless associated external circuit breakers are opened. Check for voltage with both AC and DC voltmeters before making contact.

When the UPS system is under power, both the operator and any test equipment must be isolated from direct contact with earth ground and the UPS chassis frame by using rubber mats.

Some components within the cabinets are not connected to chassis ground.

Any contact between floating circuits and the chassis is a lethal shock hazard. Use differential oscilloscopes when measuring a floating circuit. The differential input should have at least 800 vrms common mode input rating and a common mode rejection ratio of at least 80db.

Exercise caution that the test instrument exterior does not make contact either physically or electrically with earth ground.

In case of fire involving electrical equipment, use only carbon dioxide fire extinguishers or others approved for use in fighting electrical fires.

AVERTISSEMENT

Faire preuve d'une extrême prudence lors de travaux d'entretien.

Soyez conscient en tout temps que le système d'alimentation sans coupure contient des tensions élevées c.c. et c.a. Lorsque la tension d'entrée est coupée et que les batteries sont déconnectées, les tensions élevées aux condensateurs de filtrage et aux circuits de puissance devraient être dissipées en moins de 30 secondes. Toutefois, si une panne est survenue dans un circuit de puissance, il est présumé qu'une tension élevée est toujours présente après l'arrêt du système. Vérifiez à l'aide d'un voltmètre avant d'établir le contact.

Une tension c.a. reste présente sur les contacteurs de dérivation et de sortie et sur le sectionneur de dérivation statique, à moins que les disjoncteurs externes associés ne soient ouverts (position OFF). Vérifiez si une tension est présente à l'aide de voltmètres c.c. et c.a. avant d'établir le contact.

Lorsqu'un système d'alimentation sans coupure est sous tension, l'exploitant et l'équipement de test doivent être isolés de tout contact direct avec la terre et le cadre de châssis du système d'alimentation sans coupure en utilisant des tapis de caoutchouc.

Certains composants à l'intérieur des armoires ne sont pas raccordés à la masse du châssis.

Tout contact entre des circuits isolés et le châssis représente un danger de secousse électrique fatale. Utiliser des oscilloscopes différentiels lors de mesures sur un circuit isolé. L'entrée différentielle doit avoir une tension d'entrée nominale en mode commun d'au moins 800 V efficace et un rapport de réjection en mode commun d'au moins 80 décibels. Prendre les précautions nécessaires pour empêcher l'extérieur de l'instrument de test d'entrer en contact physique ou électrique avec la terre.

En cas d'incendie impliquant de l'équipement électrique, n'utiliser que des extincteurs au dioxyde de carbone ou autres extincteurs approuvés pour combattre des incendies d'origine électrique.

5.2 ROUTINE MAINTENANCE

Become thoroughly familiar with the equipment, but never go beyond the specific procedures in this manual while performing maintenance or correcting a malfunction. If there is any doubt as to what must be done, call Vertiv at 800-543-2378 for assistance.

The UPS is designed for unattended operation, but does require some common sense maintenance.

- Keep good records—Troubleshooting is easier there are good service records.
- Keep it clean—Keep the UPS free of dust and moisture.
- Keep it cool—Battery systems must be kept in the range of 72-77°F (22-25°C) to meet design specifications for capacity and longevity. The UPS will reliably meet all performance specifications at temperatures up to 104°F (40°C) and can be slightly derated for operation at even higher temperatures. However, performance and longevity will be optimized when the UPS is operated at the same temperature as the batteries.
- Keep connections tight—Tighten all connections at installation and at least annually thereafter.

5.2.1 Record Log

Set up a maintenance log to record scheduled checks and any abnormal conditions.

The log should have space for all metered data, including phase readings, alarm messages, UPS mode of operation, air filter replacement date and observations. Maintain a second log for the battery module as directed by the battery manufacturer.

Vertiv recommends periodic walk-through inspections of the UPS and battery rooms to check for visible and audible indications of problems. Log the inspection, metered parameter indications and any discrepancies.

5.2.2 Air Filters

The air filters must be inspected and serviced regularly. The frequency of inspections will depend on environmental conditions. Under normal conditions, the air filters will require cleaning or replacement approximately every two months. Abnormal or dusty conditions will require more frequent cleaning and replacement of air filters.

Inspect installations in new buildings more often, then alter the inspection period as experience dictates.

All Liebert EXL models have a replaceable air filter inside the front doors. These filters can be changed while the UPS is in operation.



NOTE

Service and maintenance must be performed only by properly trained and qualified personnel and in accordance with applicable regulations as well as with manufacturer's specifications.

5.2.3 Limited Life Components

The Liebert EXL has a design life well in excess of 10 years. Well-maintained units can continue to provide economic benefits for 20 years or more. Long-life components are used in the UPS wherever practical and cost-effective. However, due to the currently available component material, manufacturing technology limitations and the general function and use of the component, a few components in the Liebert UPS will have a shorter life cycle and require replacement in less than 10 years.

The following components utilized in the UPS have a limited life cycle and are specifically exempt from warranty. To prevent a wear-out failure of one of these components affecting the critical load operations, Vertiv® recommends these components be periodically inspected and replaced before the expected expiration of their life cycle. The expected life of each component listed below is simply an estimate and is not a guarantee. Individual users may have site-specific requirements, maintenance and other environmental conditions that affect the length of the component’s useful life cycle.

In most cases, replacement components must exactly match the original component specifications.

These replacement components are not readily available from third-party component distributors.

For assistance with specific component specifications, replacement component selection and sourcing, call 800-543-2378. For customers using Vertiv’ preventive maintenance services, periodic inspection of these components is part of this service, as well as recommending component replacement intervals to customers to avoid unanticipated interruptions in critical load operations.

Table 5 UPS component service life

Component	Expected Life	Replace in:
Power AC Filter Capacitors	15 years	12 to 15 years
Power DC Filter Capacitors	15 years	12 to 15 years
Low-Profile Fans	> 7 years	5 to 6 years
Air Filters	1 to 3 years	Check four times per year
Battery, Lithium Logic Memory Backup	10 years	8 to 9 years
Battery, Storage		
Lead-Acid Wet-Cell (User Selection)	15 to 20 years	12 to 15 years
Valve-Regulated, Lead-Acid (VRLA)	5 years	2 to 3 years
	10 years	3 to 4 years
	20 years	8 to 12 years

Expected Life is sometimes referred to as Design Life.

5.3 BATTERY MAINTENANCE

WARNING

Risk of electrical shock and high short circuit current. Can cause equipment damage, personal injury and death.

These maintenance procedures will expose hazardous live parts. Refer servicing to qualified personnel.

DC fuses operate at the rated battery voltage at all times. A blown DC bus fuse indicates a serious problem. Serious injury or damage to the equipment can result if the fuse is replaced without knowing why it failed. Call Vertiv for assistance.

AVERTISSEMENT

Risque de secousse électrique et de courant élevé de court-circuit. Peuvent causer des dommages aux équipements, des blessures corporelles et la mort. Des composants affichant des tensions dangereuses seront accessibles durant ces procédures d'entretien. Faire exécuter l'entretien par du personnel qualifié. Les fusibles c.c. fonctionnent en tout temps à la tension nominale des batteries. Un fusible c.c. grillé indique un problème majeur. De graves blessures ou des dommages importants aux équipements peuvent survenir si le fusible est remplacé sans avoir identifié la cause de la panne. Communiquer avec le centre de service de Liebert pour de l'assistance.

5.3.1 Battery Safety Precautions

Servicing of batteries must be performed or supervised by personnel experienced with batteries and the required precautions. Keep unauthorized personnel away from batteries.

When replacing batteries, use the same number and type of batteries.

Regular maintenance of the battery module is an absolute necessity. Periodic inspections of battery and terminal voltages, specific gravity, and connection resistance should be made. Strictly follow the procedures in the battery manufacturer's manual. (See battery manufacturer's Web site.)

Valve-regulated lead-acid batteries require periodic visual inspections and checks of battery voltage and connection resistance.

Since individual battery characteristics are not identical and may change over time, the UPS module is equipped with circuitry to equalize battery cell voltages. This circuit temporarily increases charging voltage to maintain flooded type battery cells at full capacity.

WARNING

Risk of electrical shock. Can cause personal injury and death.

Special care must be taken when working with the batteries associated with this equipment. Be constantly aware that the battery system contains high DC as well as AC voltages. Check for voltage with AC and DC voltmeters before making contact.

Observe all DC safety precautions before working on or near the DC system.

Follow all battery safety precautions when installing, charging or servicing batteries. In addition to the hazard of electric shock, gas produced by batteries can be explosive and sulfuric acid can cause severe burns.

Lead-acid batteries contain hazardous materials. Batteries must be handled, transported, and recycled or discarded in accordance with federal, state and local regulations. Because lead is a toxic substance, lead-acid batteries should be recycled rather than discarded.

Do not dispose of battery or batteries in a fire. The battery may explode.

Do not open or mutilate the battery or batteries. Released electrolyte is harmful to the skin and eyes. It is toxic.

A battery can present a risk of electrical shock and high short circuit current. The following precautions should be observed when working on batteries:

- Remove watches, rings and other metal objects.
- Use tools with insulated handles.
- Wear rubber gloves and boots.
- Do not lay tools or metal parts on top of batteries.
- Disconnect charging source prior to connecting or disconnecting battery terminals.
- Determine if battery is inadvertently grounded. If inadvertently grounded, remove source of ground. Contact with any part of a grounded battery can result in electrical shock. The likelihood of such shock will be reduced if such grounds are removed during installation and maintenance.
- Lead-acid batteries can present a risk of fire because they generate hydrogen gas. In addition, the electrical connections must be protected against accidental short circuits which can cause sparks. The following procedures should be followed:
 - Do not smoke when near batteries.
 - Do not cause flame or spark in battery area.
 - Discharge static electricity from body before touching batteries by first touching a grounded metal surface.
 - After replacing battery jars in a battery cabinet, replace the retaining straps that hold the jars in place on the shelves. This will limit accidental movement of the jars and connectors should the cabinet ever need to be repositioned or relocated.

AVERTISSEMENT

Risque de secousse électrique. Peut causer des blessures corporelles et la mort.

Il faut prendre des précautions particulières lors de tout travail exécuté sur les batteries associées à cet équipement. Soyez conscient en tout temps que le système de batteries contient des tensions élevées c.c. et c.a. Vérifiez si une tension est présente à l'aide de voltmètres c.c. et c.a. avant d'établir le contact.

Observer toutes les mesures de sécurité relatives aux tensions c.c. avant de travailler sur le système c.c. ou près de celui-ci.

Observer toutes les mesures de sécurité relatives aux batteries avant d'installer ou de charger des batteries ou d'en faire l'entretien. En plus du danger de secousse électrique, les gaz produits par les batteries peuvent causer des explosions et l'acide sulfurique peut causer de graves brûlures.

Les batteries au plomb-acide contiennent des matières dangereuses. Les batteries doivent être manipulées, transportées et recyclées selon les stipulations de la réglementation fédérale, provinciale et locale. Puisque le plomb est une substance toxique, les batteries au plomb-acide doivent être recyclées plutôt que d'être mises aux rebuts.

Ne pas jeter une ou plusieurs batteries dans un feu. Elle(s) pourrai(en)t exploser.

Ne pas ouvrir ou abîmer la ou les batteries. Les projections d'électrolyte sont dangereuses pour la peau et les yeux. L'électrolyte est également toxique.

Une batterie peut présenter un risque de secousse électrique et un courant élevé de court-circuit. Il faut observer les mesures de sécurité suivantes lors de travaux exécutés sur les batteries :

- Retirer les montres, les bijoux et tout autre objet métallique.
- Utiliser des outils dont les manches sont isolés.
- Porter des gants et des bottes de caoutchouc.
- Ne pas déposer d'outils ou de pièces métalliques sur le dessus des batteries.
- Débrancher l'équipement de charge avant de connecter ou de déconnecter les bornes de batteries.
- Vérifier si les batteries sont accidentellement mises à la terre. Si elles sont accidentellement mises à la terre, enlever la source de mise à la terre. Tout contact avec une partie quelconque d'une batterie mise à la terre peut causer une secousse électrique. Le danger d'une telle secousse sera réduit si de telles mises à la terre sont enlevées durant l'installation et l'entretien.
- Les batteries au plomb-acide peuvent présenter un risque d'incendie, car elles génèrent de l'hydrogène sous forme de gaz. De plus, les connexions électriques doivent être protégées contre les courts-circuits accidentels, lesquels peuvent produire des étincelles. Suivre les procédures suivantes :
- Ne pas fumer près des batteries.
- Ne pas produire de flamme ou d'étincelles dans l'environnement immédiat des batteries.
- Décharger l'électricité statique de votre corps avant de toucher aux batteries en touchant d'abord une surface de métal mise à la terre.
- Après avoir remplacé des bacs de batteries dans une armoire de batteries, remettre en place les sangles de rétention maintenant les bacs en place sur les étagères. Ceci limitera tout mouvement accidentel des bacs et connecteurs si l'armoire doit éventuellement être repositionnée ou déplacée.



NOTE

Do not use cleaners on the batteries. Solvents can make the battery cases brittle. Use only a dry cloth or a cloth moistened in water



NOTE

Do not use equalize charging with valve-regulated lead-acid batteries, such as those used in Liebert battery cabinets.

Consult the battery manufacturer's manual for specific information about equalize charging.

The equalizing charge time is adjustable from zero to 200 hours and can be initiated automatically or manually.

5.3.2 Torque Requirements

All electrical connections must be tight. Refer to the torque values for the connections in the UPS below. Use these values unless the equipment is labeled otherwise.



NOTE

Refer to battery manufacturer's manual for the proper torque values required for the battery. (See battery manufacturer's Web site.)

Circuit Breakers With Compression Lugs for Power Wiring

- Current Rating: 400 - 1200 Amps
- Torque: 300 Lb-in (34Nm)

Terminal Block with Compression Lugs for Control Wiring

- AWG Wire Size or Range: #22 - #14
- Torque: 3.5 to 5.3 Lb-in (0.4 to 0.6N-m)

5.4 DETECTING TROUBLE

The operator must check the instrument readings if abnormal equipment performance is suspected. Any metered value that differs appreciably from normal could mean an impending malfunction, and should be investigated.

Items to check on the various UPS display screens include:

- **Output Voltage Levels:** Output voltages of all phases should be within 1% of normal voltage. Output currents on each phase should not normally differ by more than 20%. If difference is greater, the load is unbalanced and must be corrected.
- **Battery Charge Current Levels:** If the UPS has not operated on battery power during the last 10 hours, the batteries should require little charging current. Battery mimic should indicate normal DC voltage with relatively little battery charge current.
- **Input Current:** Input current on each phase should be within 10% of the average input current. Alarm messages indicate malfunction or impending malfunction. A daily check of the Operator Control Panel will help to provide an early detection of problems. Refer to **Table 9** to interpret alarm messages.
- **Status Reports:** Alarm messages and the metered parameter indications help in tracing a problem to a particular section. These are stored in the Status Reports and can be displayed at the Operator Control Panel or at an optional terminal.

5.5 REPORTING A PROBLEM

If a problem occurs within the UPS, review all alarm messages along with other pertinent data. This information should be given via telephone to the Vertiv dispatcher. This information can also be automatically sent by telephone modem. Call 800-543-2378 to report a problem or to request assistance.

5.6 UPSTREAM FEEDER CIRCUIT BREAKER SETTING INSPECTIONS

During normal UPS operations, short-term overload current demand from the bypass source may reach 10 times the UPS output current rating. This overload current demand may be caused by the magnetizing inrush current of one or more downstream transformers (i.e., power distribution units) or faults on downstream branch circuits. The instantaneous trip point(s) of the upstream bypass feeder breaker(s) must be set to support these temporary overloads. The magnitude of short-term overload bypass current demand is typically six to eight times the UPS current rating, but must be determined by analysis on a per-site basis. This analysis, generally known as an End-to-End Fault Coordination Study, must be done by a registered professional engineer experienced in this activity and familiar with local codes and related requirements.

Vertiv® highly recommends periodic inspections of the bypass feeder breaker instantaneous trip settings, as well as the module input (rectifier) feeder breaker trip settings, to ensure that they are correct. For a variety of reasons, although typically during circuit breaker maintenance procedures by others, trip settings have been inadvertently left improperly set. Correct trip setting of these circuit breakers is most important to achieving high-availability from the Liebert UPS.

For further information regarding proper trip settings for the feeder breakers, call 800-543-2378.



NOTE

The instantaneous trip setting of the breaker feeding the UPS bypass input should be high enough to accommodate short-duration overloads. The bypass static switch power path inside the UPS can draw up to 10 times the system's rated current for up to three cycles.



NOTE

While Vertiv can provide typical guidelines, the responsibility for the proper breaker trip settings outside the Liebert-manufactured UPS equipment resides with the owner. Contact Vertiv at 800-543-2378 for further details.

6.0 SPECIFICATIONS

6.1 BATTERY OPERATION

The separate battery manufacturer's manual, available on the manufacturer's Web site, provides the necessary information for the installation, operation and maintenance of the battery. Use the battery manual in conjunction with this manual.

The float charge voltage for a battery is equal to the number of cells in series making up the battery multiplied by the charge voltage for each cell.

Because the charging voltage level is critical to proper battery operation, refer to the battery manual, available on the manufacturer's Web site, for information about the system.

For models with nominal 240-cell battery, the DC bus nominal float voltage range is 2.15 to 2.3VPC.

Maximum equalize voltage is 2.45VPC. The number of battery cells required ranges from 228 to 246, depending on the application.

6.2 OTHER DC SOURCES

The separate DC source manufacturer's manual, available on the manufacturer's Web site, provides the necessary information for installing, operating and maintaining the DC source. Use the DC source manual in conjunction with this manual.

6.3 ENVIRONMENTAL CONDITIONS

Table 6 Environmental specifications

Parameter	Specification
Enclosure	The UPS is housed in a NEMA-1 enclosure. The enclosure is designed for indoor use only and is not to be subjected to falling objects or precipitation.
Recommended Operating Temperature, °F (°C)	77 (25) ambient
Maximum Operating Temperature, °F (°C)	95 (35) ambient (design temperature) without derating; (see Notes 2 and 3).
Minimum Operating Temperature, °F (°C)	32 (0)
Storage Temperature, °F (°C)	-4 to 104 (-20 to 40) ¹
Typical Battery Temperature Requirements	Average annual temperature must not exceed 80°F (27°C). Peak temperature must not exceed 109°F (43°C). See battery manufacturer's recommendations.
Relative Humidity	0 to 95% without condensation
Operating Elevation	Sea level to 3300 ft. (1000m) without derating
Storage Elevation	Sea level to 50,000 ft. (15,240m)
Audible Noise, Typical; UPS in Normal Mode with 100% Load, free field environment method used	84 dBA (relative to 20microPa) ²

1. Contact factory for information about storage above 104°F (40°C).

2. * Applies to the 800kVA and derated units; 1200kVA and derated units will be slightly higher

Notes on Environmental Specifications

1. This category of electronic equipment is agency rated for use in an atmosphere free of conductive particles. Some industrial facilities may require a room air filtration system to keep the UPS free of excess moisture and contaminants.
2. The UPS is designed to operate continuously at 95°F (35°C). However, design equipment life expectancy will be extended with lower temperatures (77°F [25°C] is recommended).
3. Ambient temperature is the maximum ambient temperature during any 24-hour period. For operation at higher temperatures, consult your Vertiv® sales representative or call Vertiv at 800-543-2378.
4. Exercise care during installation to ensure unimpeded airflow through the UPS.

For operation at higher elevations, consult your Vertiv sales representative or call Vertiv at 800-543-2378.

Table 7 Electrical specifications and standards

	625-1200kVA Models
Input Parameters	
Input Voltage to Rectifier, VAC, 3-Phase, 3-Wire	480V
Input Voltage to Bypass, VAC, 3-Phase, 3-Wire	480V
Input Voltage Range, VAC %	+10% to -30%; voltage must be within $\pm 10\%$ for UPS startup
Input Frequency, Hz	60
Permissible Input Frequency Range, Hz	55 to 65
Reflected Input THDi at Nominal Voltage at Full Load, %	<5%
Rectifier Power Walk-In, sec	1 to 30 (selectable) in 1 second Increments (1.5 second qualification before walk-in)
DC Parameters	
Battery Type	VRLA (Valve Regulated Lead Acid) or FLA (Flooded Lead Acid)
DC Float Voltage, VDC	540V
End-Cell Voltage, VDC	384-420 (for both VRLA and FLA) (based on 240 cells at 1.6V/cell to 1.75V/cell)
DC Ripple Voltage in Float and Const V Ch. mode, %	< 1 (RMS value) < 3.4% Vpp
Output Parameters	
Inverter Type	IGBT-based Sine Wave PWM Controlled
Output Voltage, 3-phase, 3-wire	480V
Output Voltage Regulation, %	< 1% (3-phase RMS average)
Output Voltage Regulation (Unbalanced Load)	< 2% (3-phase RMS average)
Output Frequency, Hz	60
Output Frequency Regulation, %	± 0.1
Output THDv at Nominal Voltage (Linear Load), %	< 3
Output THDv at Nominal Voltage Including a 100kVA Non-Linear Load per EN 62040-3	6% (maximum)
Capacity to Handle Step Load, %	6.5% deviation and 2.5% recovery (at fifth cycle and beyond after transient)
Transient Recovery (Linear Loads), %, msec	Meets IEC 62040-3: 2010 Figure 2 Curve 1, Class 1
Load Power Factor Supported (Without Derating)	0.7 Leading to 0.7 Lagging
Voltage Displacement, °	120° $\pm 1^\circ$ (with unbalanced load)
Overload Conditions, % FL (with DC source available)	See Figure 17
Degree of Protection for UPS Enclosure	
	IP 20 (with and without front door open)
Standards & Conformities	
	UL 1778, 5th Ed.
	CSA 22.2 107.3
	FCC Part 15, Class A (with option filter installed)
	IEC62040-2, Level 4, Criteria A
	ANSI C62.41, Category A3 & B3
	ISTA
	WEEE

Table 8 Physical data

	625-800kVA	1000-1200kVA
Dimensions, in (mm)		
WxDxH (Single Module and 1+N Systems with Static Bypass)	123.6 x 34.4 x 77.5 (3140 x 874 x 1969)	170.7 x 34.4 x 77.5 (4335 x 874 x 1969)
Weight, lb. (kg)		
Single Module System with Static Bypass	5187 (2353)	7595 (3445)
1+N System with Static Bypass	5587 (2534)	8095 (3672)
Color	Black (RAL 7021)	

Width dimensions are with side panels attached. Subtract 1.4" (35mm) for dimensions with both side panels removed.
The depth dimensions include the front door and rear panel.

7.0 DISCLOSURES WITH REGARD TO EMBEDDED SOFTWARE LICENSED FROM NOKIA, INC., (“SUBLICENSSED SOFTWARE”)

1. Limits on Use, Distribution and Derivative Works: User is not given any rights to modify or create derivative works based on Sublicensed Software, or reproduce Sublicensed Software, or distribute any copies of Sublicensed Software, or disclose any Sublicensed Software to any third party, or decompile, disassemble or otherwise reverse engineer Sublicensed Software, or use any information learned there from. User acknowledges that Nokia, Inc., and its licensors own the copyrights and other intellectual property in and to the Sublicensed Software.
2. Responsibility of User: The Sublicensed Software is not designed, intended or licensed for use in or with systems, devices or products intended for surgical implant into the body or other applications intended to support or sustain life or for any aviation or nuclear reactor. It is User’s responsibility to ascertain the suitability of Sublicensed Software for any situation or application.

Appendix A - Inverter Overload Curve

Figure 17 Liebert EXL inverter overload curve

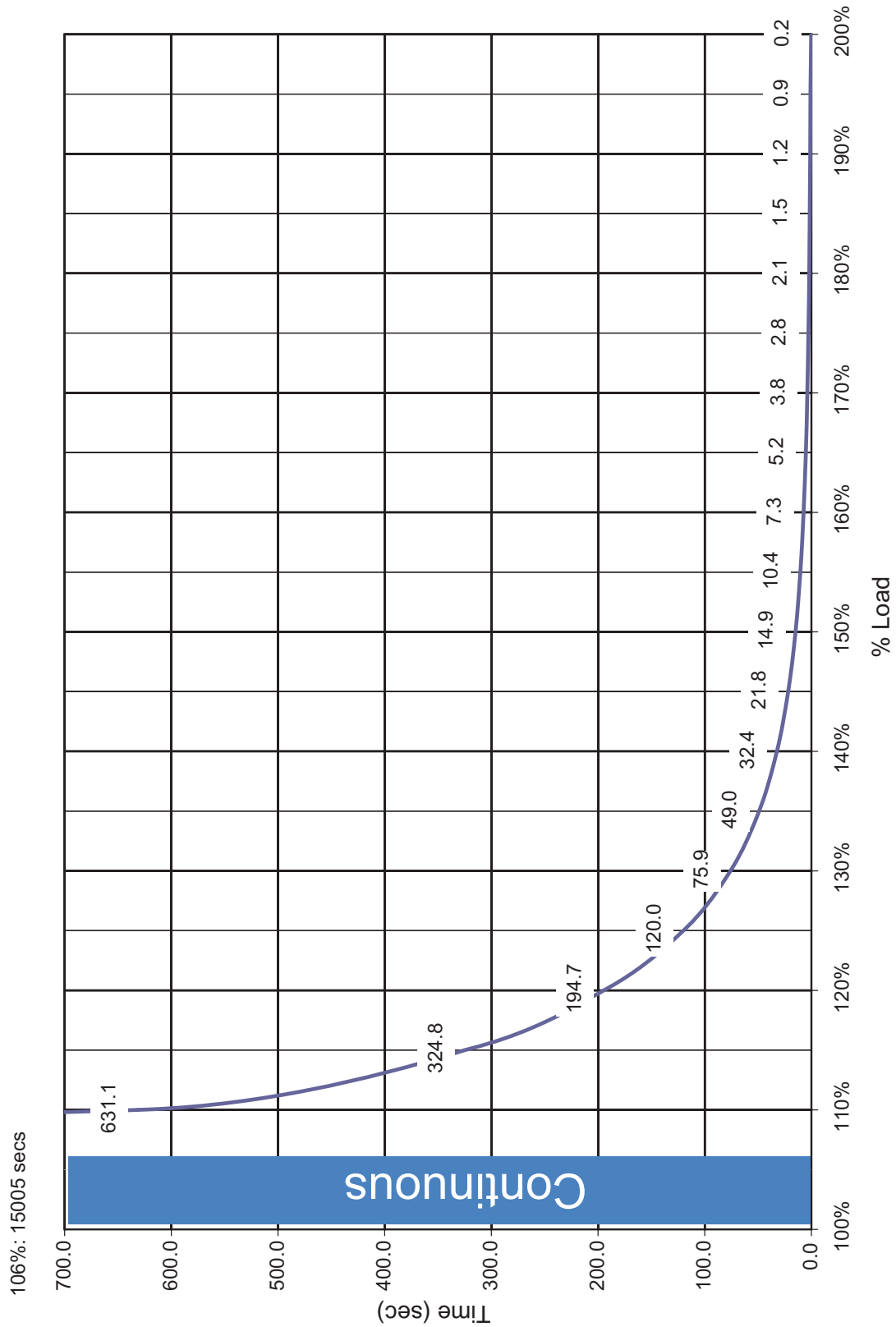

Appendix B - UPS Alarm and Status Messages

Table 9 UPS Alarm and Status Messages

Message Text	Condition
SET - Bypass Not Available CLEAR - Bypass Available	The bypass is not a qualified source due to voltage level, frequency or other condition
SET - Bypass Line Fail CLEAR - Bypass Not Failed	All three phases of bypass voltage are less than the minimum required.
SET - Bypass Overvoltage CLEAR - Bypass Overvoltage Clr	One or more bypass source phase voltages are greater than maximum allowed.
SET - Bypass Undervoltage Warn CLEAR - Bypass Undervoltage Warn Clr	One or more bypass source phase voltages is less than minimum.
SET - Bypass Undervoltage CLEAR - Bypass Undervoltage Clr	One or more bypass source phase voltages is less than minimum required.
SET - Bypass Freq Error CLEAR - Bypass Freq OK	Bypass Line Fail is not active the bypass frequency is outside of specified range.
SET - Bypass Phase Rotation CLEAR - Bypass Phase Rotation OK	Bypass Line Fail is not active and the phase rotation is not A-B-C.
SET - Bypass Sync Error CLEAR - Bypass Sync Error Clr	Bypass is not synchronized.
SET - Manual Xfer Inhibit CLEAR - Manual Xfer Clr	SMS-With Load on UPS active and bypass conditions outside of specific ranges, or BPSS Phase Open, or Bypass Static Switch Board Communication Failure or Bypass Fuse Failure are active.
SET - Man Rexfer Inhibit CLEAR - Man Rexfer Clr	See Manual Transfer to Inverter.
SET - MMS Xfer Inhibit CLEAR - MMS Xfer Clr	With the collective on UPS, Module Output Breaker (MOB) Open is active or bypass conditions outside of specific ranges or Bypass Static Switch Phase Open active or Bypass Fuse Failure active or Bypass Static Switch Board Communication Failure active or not enough BPSS's are available to support the measured load or any module's BPSS is connected to the collective.
SET - MMS Rexfer Inhibit CLEAR - MMS Rexfer Clr	With the collective not on the UPS, the Module Output Breaker (MOB) Open is active or Manual Transfer to Inverter conditions are met or not enough inverters are available to support the measured load or any module's inverter is connected to the collective.
SET - Auto Rexfer Ready CLEAR - Auto Rexfer Off	A recoverable automatic transfer to bypass has occurred.
SET - Auto Rexfer Failed CLEAR - Auto Rexfer Failed Clr	A recoverable transfer to SBS has occurred but an automatic retransfer to inverter did not happen within a specified delay.
SET - Excess Auto Rexfers CLEAR - Excess Auto Rexfers Clr	The number of auto retransfers in the past hour has exceeded a specified setting.
SET-Input Not Available CLEAR-Input Available	Summary event based on the detection of at least one of the following faults: Input Line Fail Input Overvoltage Input Undervoltage Input Frequency Error Input Phase Rotation Error Input Sync Error Input Phase Loss
SET -Input Line Fail CLEAR - Input Not Failed	All three phases of input voltage are less than a specified voltage.
SET -Input Overvoltage CLEAR - Input Overvoltage Clr	The input line-to-line voltages are greater than a specified percentage of nominal voltage for a specified delay.

Table 9 UPS Alarm and Status Messages (continued)

Message Text	Condition
SET - Input Undervoltage Warn CLEAR - Input Undervoltage Warn Clr	Input line-to-line voltages are too low a percentage of nominal voltage for a specified delay.
SET - Input Undervoltage CLEAR - Input Undervoltage Clr	With the rectifier enabled and the disconnect closed, one or more of the input line-to-line voltages are less than minimum required.
SET - Input Freq Error CLEAR - Input Freq OK	The input frequency has exceeded a specified range.
SET - Input Phase Rotation CLEAR - Input Phase Rotation OK	With the input source voltage above minimum threshold, the phase rotation is not A-B-C.
SET - Input Sync Error CLEAR - Input Synchronized	With the input NOT failed the rectifier cannot synchronize to input voltage.
SET - Input Current Limit CLEAR - Input Current Normal	RMS input current has reached the input current limit setting.
SET - Output Fault CLEAR - Output OK	Summary event based on the detection of at least one of the following faults: Output Overvoltage Output Undervoltage
SET - Output Overvoltage CLEAR - Output Overvoltage Clr	With the load on inverter, the output voltage has exceeded Overvoltage versus Time.
SET - Output Undervoltage CLEAR - Output Undervoltage Clr	With the load on inverter and the inverter not in current limit operation, the output voltage has exceeded Undervoltage versus Time.
SET - Output Freq Error CLEAR - Output Freq OK	With the load on inverter, the output frequency has exceeded a specified range for a specified period of time.
SET - Load on UPS CLEAR -	Load is now being supplied power from the inverter.
SET - Load on Bypass CLEAR -	Load is now being supplied power from the bypass source.
SET - Load on Maint Byp CLEAR -	Maintenance Bypass Breaker (MBB) Open is not active.
SET - Low Power Factor CLEAR - Load Power Factor OK	When any output phase is supplying at least 30% of nominal load current and the output power factor is below a specified value.
SET - Over Max Load Ph A CLEAR - Under Max Load Ph A	The load on Phase A has exceeded a specified setting.
SET - System Overload CLEAR - System Load Normal	One or more modules in a multi-module system is reporting an overload on at least one phase.
SET - Over Max Load Ph B CLEAR - Under Max Load Ph B	The load on Phase B has exceeded a specified setting.
SET - Over Max Load Ph C CLEAR - Under Max Load Ph C	The load on Phase C has exceeded a specified setting.
SET - BPSS Unable CLEAR - BPSS Available	Summary event based on the detection of at least one of the following faults: BPSS Phase Open BPSS SCR Shorted
SET - BPSS Phase Open CLEAR -	With load on bypass, one or more of the bypass static switch phases is open when static switch operation is intended.
SET - BPSS SCR Shorted CLEAR - BPSS SCR Shorted Clr	A short has been detected across one phase of the bypass static switch.
SET - Pulse Paralleling CLEAR - Pulse Parallel Done	With load on inverter, the load current exceeds a specified setting and the bypass static switch is available.
SET - Excess Paralleling CLEAR - Excess Paralleling Clr	The unit has performed five or more pulse parallels within 60 seconds.
SET - Xfer to Byp Failed CLEAR - Xfer to Byp Failed Clr	Automatic transfer to bypass was unsuccessful.

Table 9 UPS Alarm and Status Messages (continued)

Message Text	Condition
SET - BPSS Is On CLEAR - BPSS Is Off	The controls have instructed the BPSS to turn On. DO NOT CREATE EVENT!
SET - BPSS Overload CLEAR - BPSS Overload Clr	With the load on bypass static switch, at least one phase of the RMS current has reached the RMS Current versus Time curve.
SET - Bypass Overload Ph A CLEAR - Bypass Ph A Overload Clr	Load is on bypass static switch, the measured Phase A output RMS current is too high.
SET - Bypass Overload Ph B CLEAR - Bypass Ph B Overload Clr	With the load on bypass static switch, the measured Phase B output RMS current has exceeded a specified percentage of the nominal per-phase RMS current rating.
SET - Bypass Overload Ph C CLEAR - Bypass Ph C Overload Clr	With the load on bypass static switch, the measured Phase C output RMS current has exceeded a specified percentage of the nominal per-phase RMS current rating.
SET - Rectifier Fault CLEAR - Rectifier OK	Summary event indicating at least one of the following faults: DC Bus Voltage Sense Fail Failure of and IGBT in Rectifier A, B or C DC Overvoltage Transient Rectifier Current Sensor Failure
SET - Vdc Sense Fail CLEAR - Vdc Sense OK	With rectifier on or the DC/DC converter discharging and the DC Bus Qualified event active, the DC Bus Voltage drops a specified percentage within a specified delay. Note: The basic algorithm is to detect a rapidly falling DC Bus that goes below 50% of Nominal in a very short period of time.
SET - Rect A IGBT Fault CLEAR - Rect A IGBT OK	The DSAT circuit related to one or more of the IGBT's in Rectifier A are activated.
SET - Rect B IGBT Fault CLEAR - Rect B IGBT OK	The DSAT circuit related to one or more of the IGBT's in Rectifier B are activated.
SET - Rect C IGBT Fault CLEAR - Rect C IGBT OK	The DSAT circuit related to one or more of the IGBT's in Rectifier C are activated.
SET - DC OV Transient CLEAR - DC OV Transient Clr	The DC bus voltage has increased to a specified value.
SET - Rect Sense Fail CLEAR - Rect Sense OK	A critical rectifier sensor has failed.
SET - Rect Not Sharing CLEAR - Rect Sharing OK	The measured rectifier power for one or more rectifier core is greater than maximum allowed.
SET - Inverter Fault CLEAR - Inverter OK	Summary event indicating at least one of the following faults: Inverter Overvoltage Inverter Undervoltage Inverter A, B or C IGBT Fault Inverter Backfeed Shutdown Inverter Current Sensor Failure
SET - Inv Overvoltage CLEAR - Inv Overvoltage Clr	The inverter voltage is too high.
SET - Inv Undervoltage CLEAR - Inv Undervoltage Clr	The inverter voltage is too low and the inverter is not limiting current.
SET - Inv A IGBT Fault CLEAR - Inv A IGBT OK	The DSAT circuit related to one or more of the IGBT's in inverter A are activated.
SET - Inv B IGBT Fault CLEAR - Inv B IGBT OK	The DSAT circuit related to one or more of the IGBT's in inverter B are activated.
SET - Inv C IGBT Fault CLEAR - Inv C IGBT OK	The DSAT circuit related to one or more of the IGBT's in inverter C are activated.
SET - Inv Backfeed Warn CLEAR - Inv Backfeed Clr	The unit had detected reverse power through the inverter at a specified level for a specified time.

Table 9 UPS Alarm and Status Messages (continued)

Message Text	Condition
SET - Inv Backfeed Shutdn CLEAR - Inv Backfeed Done	The unit had detected reverse power through the inverter at a specified level for a specified time.
SET - Inv Current Limit CLEAR - Inv Current OK	With Pulse Parallel not active, the instantaneous inverter current of any one phase has exceeded a specified setting.
SET - Inv Overload Shutdn CLEAR - Inv Overload Done	At least one phase RMS Current has reached the RMS Current versus Time curve.
SET - Inv Overload Ph A CLEAR - Inv Overload Ph A Clr	Phase A RMS Current has reached the kW or RMS Current versus Time curve.
SET - Inv Overload Ph B CLEAR - Inv Overload Ph B Clr	Phase B RMS Current has reached the kW or RMS Current versus Time curve.
SET - Inv Overload Ph C CLEAR - Inv Overload Ph C Clr	Phase C RMS Current has reached the kW or RMS Current versus Time curve.
SET - Inv Sense Fail CLEAR - Inv Sense OK	A critical inverter sensor has failed.
SET - Inv Not Sharing CLEAR - Inv Sharing OK	The measured inverter power for one or more inverter core is greater than a specified percent of the average power for a specified period of time.
SET - DC/DC IGBT Fault CLEAR - DC/DC IGBT Fault Clr	The DSAT circuit related to one or more of the IGBT's in the DC/DC Converter is active
SET - DC/DC Not Sharing CLEAR - DC/DC Sharing OK	Discharge Only: The measured DC/DC converter current for one or more cores is greater than a specified value for a specified period of time.
SET - DC Bal IGBT Fault CLEAR - DC Bal IGBT Fault Clr	The DSAT circuit related to one or more of the IGBT's in the DC Balancer is active.
SET - System Low Battery CLEAR - System Battery OK	When the number of modules with a Battery Low Warning event active exceeds the number of redundant modules on line.
SET - Batt Discharging CLEAR - Batt Discharge Ends	With at least one battery circuit breaker closed and common MBD is closed (if applicable), the DC bus has reached a specified setting or the discharge current has reached a specified setting.
SET - Low Battery Warning CLEAR - Low Battery Clr	With the battery breaker closed, the calculated Battery Time Remaining has reached a specified setting.
SET - Low Batt Shutdown CLEAR - Low Batt Shutdown Clr	With the battery breaker closed, the battery voltage has dropped below the calculated End-Of-Discharge (EOD) limit.
SET - Low Batt Capacity CLEAR - Low Batt Capacity Clr	With the load on UPS inverter and common MBD is closed (if applicable) and at least one battery breaker is closed, at least one other battery breaker is open.
SET - System On Battery CLEAR - System Not On Battery	When the number of modules on battery exceeds the number of redundant modules on line.
SET - Batt Sensor Fail CLEAR - Batt Sensor OK	Summary event indicating at least one active Battery Temperature Sensor Failure for Cabinet #1-#8.
SET - Batt Sense Fail Service CLEAR - Batt Sense Service OK	With the corresponding Battery Temperature setting enabled, the battery temperature sensor reports a temperature outside of the range of expected operation.
SET - Batt Temp Imbalance CLEAR - Batt Temp Balance OK	For strings with the battery breaker closed, two battery temperatures have a difference greater than a specified value for a specified delay and associated battery temperature sensor fail event not active.
SET - Batt Ovtemp Warning CLEAR - Batt Ovtemp Warn Clr	The battery temperature of any string with the battery breaker closed exceeds tolerance.
SET - Batt Ovtemp Stop Chrg CLEAR - Batt Ovtemp Stop Chrg Clr	The battery temperature of any string with the battery breaker closed exceeds.
SET - Batt Ovtemp Limit CLEAR - Batt Ovtemp Limit Clr	Summary event based on the detection of an overtemperature fault in one or more of up to eight battery cabinets.

Table 9 UPS Alarm and Status Messages (continued)

Message Text	Condition
SET - Batt Ovttemp Limit Service CLEAR - Batt Ovttemp Limit Ser Clr	With the a given battery breaker, the given battery temperature has reached a specified setting.
SET - Batt Test Failed CLEAR -	The battery test has failed.
SET - Batt Test Inhibit CLEAR -	Battery testing has been inhibited (See Parametric Data or Testing Start Conditions for more detail).
SET - Batt Test Passed CLEAR -	The battery has passed a battery test.
SET - Batt Self Test CLEAR - Batt Test Done	See operation for Battery Testing.
SET - Batt Test Stopped CLEAR -	The Battery Test-Manual Stop command is present.
SET - Batt Log Cleared CLEAR -	The system has received a command to clear the battery log data.
SET - DC Bus Not Qualified CLEAR - DC Bus Qualified	DC Bus is outside specified limits.
SET - Batt Cycle Log Full CLEAR - Batt Cycle Log OK	The system has detected that the number of records in the battery log has exceeded a specified number.
SET - Batt Equalizing CLEAR - Batt Equalize Done	See operation for Equalize Charging.
SET - Batt Commissioning CLEAR - Batt Commiss Done	See operation for Commissioning.
SET - Batt Mon 1 Maint CLEAR - Batt Mon 1 Maint Clr	The Battery Interface Board with Battery Monitor 1 enabled has the Maintenance Alarm become active.
SET - Batt Mon 1 Critical CLEAR - Batt Mon 1 Crit Clr	The Battery Interface Board with Battery Monitor 1 enabled has the Critical Alarm become active.
SET - Internal Comm Error CLEAR - Internal Comm Error Clr	Summary event indicating at least one of the following faults: UPSC (UPS Control Board) Communication Failure CBIB (Circuit Breaker Interface Board) Communication Failure HMI Communication Failure Fan Interface Board Communication Failure Programmable Relay Board Communication Failure Input Contact Interface Communication Failure MBD/BCB Communication Failure MBD / BIS Communication Failure Temperature Interface Board Communication Failure Remote Alarm Status Panel Interface Communication Failure UPS Module Communication Failure
SET - Controls Comm Fail CLEAR - Controls Comm Fail Clr	With Main Controller Fault not active, the UPSC is no longer communicating with the system.
SET - BPSS Comm Fail CLEAR - BPSS Comm Fail Clr	The “BPSS Is Ok” signal between the UPSC and the BPSS control board has failed to toggle.
SET - HMI Comm Fail CLEAR - HMI Comm Fail Clr	HMI is no longer communicating with the system.
SET - FIB Comm Fail CLEAR - FIB Comm Fail Clr	FIB is no longer communicating with the system.
SET - PRB Comm Fail CLEAR - PRB Comm Fail Clr	With Programmable Relay Board set as “Enabled” communication by the board is stopped.
SET - ICI Comm Fail CLEAR - ICI Comm Fail Clr	With Input Contact Interface set as “Enabled” communication by the board is stopped.

Table 9 UPS Alarm and Status Messages (continued)

Message Text	Condition
SET - MBD/BCB Comm Fail CLEAR - MBD/BCB Comm Fail Clr	With Battery Interface Board MBD set as “Enabled” communication by the BIB addressed as MBD/BCB is stopped.
SET - MBD/ BIS Comm Fail CLEAR - MBD/ BIS Comm Fail Clr	With Battery Interface Board String 1 set as “Enabled,” communication by the BIB addressed as MBD/BIS is stopped.
SET - TIB Comm Fail CLEAR - TIB Comm Fail Clr	TIB is no longer communicating with the system.
SET - Parallel Comm Warn CLEAR - Parallel Comm Warn Clr	One of the paralleling control communication busses is no longer communicating within the system.
SET - System Comm Fail CLEAR - System Comm Fail Clr	Summary event based on the detection of at least one of the following faults: UPS Module #1 Communication Failure UPS Module #2 Communication Failure UPS Module #3 Communication Failure UPS Module #4 Communication Failure UPS Module #5 Communication Failure UPS Module #6 Communication Failure SCC Communication Failure
SET - SCC Comm Fail CLEAR - SCC Comm Fail Clr	SCC is no longer communicating with the system.
SET - RSP Comm Fail CLEAR - RSP Comm Fail Clr	RSP is no longer communicating with the system.
SET - UPS Comm Fail CLEAR - UPS Comm Fail Clr	UPS module is no longer communicating with the system.
SET - Password Changed CLEAR -	The user has changed the password.
SET - Manual Xfer to Byp CLEAR -	Transfer to Bypass command is active.
SET - Manual Xfer to Inv CLEAR -	Transfer to Inverter command is active.
SET - System Xfer to Byp CLEAR -	MMS Transfer to Bypass command is active.
SET - System Xfer to Inv CLEAR -	MMS Transfer to Inverter command is active.
SET - EPO Shutdown CLEAR - EPO Shutdown Clr	The EPO signal is active.
SET - EMO Shutdown CLEAR - EMO Shutdown Clr	The EMO signal is active.
SET - User Event Reset CLEAR -	From the HMI Event Reset is active
SET - User Shutdown CLEAR -	Shutdown-UPS Command or Shutdown-System Command is present.
SET - Config Modified CLEAR -	One or more settings on the configuration screen have been modified.

Table 9 UPS Alarm and Status Messages (continued)

Message Text	Condition
SET - Controls Reset Req CLEAR -	One or more of the following settings has changed: Nominal Input Voltage Nominal Bypass Voltage Nominal Output Voltage Nominal Source Frequency Nominal Output Frequency Output kVA Output kW Configuration Type Rectifier Type Nominal Cell Count-Lead Acid System Amp Rating Unit Model Number Bypass Breaker Input Breaker Operation Input Breaker Type Output Breaker Operation (SMS, 1+N) Output Breaker Type Battery Configuration Battery Type Common Battery Disconnect Maintenance Bypass Model Number System Paralleling Cabinet Model Number
SET - User kWh Reset CLEAR -	kWh Reset command is active.
SET - User Peak kW Reset CLEAR -	Peak kW Demand Reset command is active.
SET - Service Code Active CLEAR -	Open loop service code running.
SET - Service Reminder CLEAR -	See Service Reminders Operations.
SET - Multi Fan Fail CLEAR - Multi Fan Fail Clr	Summary event indicating at least two fans (out of up to 32 fans, depending on UPS model) have failed.
SET - Fan Fail CLEAR - Fan Fail Clr	Summary event indicating that one fan (out of up to 32 fans, depending on UPS model) have failed.
SET - Fan Fail Service CLEAR - Fan Fail Service Clr	With the critical bus energized, a given fan is no longer operational.
SET - Fuse Fail CLEAR - Fuse Fail Clr	Summary event based on the detection of at least one of the following faults: Input Fuse Failure Rectifier Fuse Failure Inverter Fuse Failure Bypass Static Switch Fuse Failure Battery Static Switch Fuse Failure Core-2-Core Fuse Failure
SET - Input Fuse Fail CLEAR -	One or more input fuses are open on a unit configured and operating with an input fuses.
SET - Rectifier Fuse Fail CLEAR -	A rectifier fuse indicates that it is failed
SET - Inv Fuse Fail CLEAR -	An inverter fuse indicates that it is failed.
SET - Bypass Fuse Fail CLEAR -	Any bypass fuse indicates that it is failed.
SET - Batt Fuse Fail CLEAR - Batt Fuse Fail Clr	One or more of the battery fuses indicates it is open.

Table 9 UPS Alarm and Status Messages (continued)

Message Text	Condition
SET - Core Fuse Fail CLEAR -	One or more of the core-to-core fuses indicate open
SET - Power Supply Fail CLEAR - Power Supply Fail Clr	Summary event indicating at least one of the following faults: Input Power Supply Fail Bypass Power Supply Fail DC Power Supply Fail Output Power Supply Fail
SET - Power Supply Service Fail CLEAR - Power Supply Service Fail Clr	Power Supply Board reports a failure of one or more power supplies.
SET - Breaker Open Fail CLEAR - Breaker Open Fail Clr	Summary event based on the detection of at least one of the following faults: Backfeed Breaker Open Fail System Output Breaker (UOB) Open Fail Rectifier Input Breaker (CB1) Open Fail Bypass Breaker (SBB) Open Fail Module Battery Disconnect Open Fail Battery CB (#1-5) Open Fail Inverter Output Breaker (CB2) Open Fail
SET - Breaker Close Fail CLEAR - Breaker Close Fail Clr	Summary event based on the detection of at least one of the following faults: System Output Breaker (UOB) Close Fail Rectifier Input Breaker (CB1) Close Fail Bypass Breaker (SBB) Close Fail Module Battery Disconnect Close Fail Battery CB (#1-5) Close Fail Inverter Output Breaker (CB2) Close Fail
SET - BFB Trip Signaled CLEAR -	A command to trip the backfeed breaker is active.
SET - BFB Open Fail CLEAR - BFB Open Fail Clr	The backfeed breaker open signal did not transition to a TRUE state within a specified delay.
SET - BFB Open CLEAR - BFB Closed	BFB is open.
SET - UOB Open Fail CLEAR - UOB Open Fail Clr	UOB open signal did not transition to a TRUE state within a specified delay.
SET - UOB Close Fail CLEAR - UOB Close Fail Clr	UOB close signal did not transition to a TRUE state within a specified delay.
SET - UOB Open CLEAR - UOB Closed	UOB indicates that it is open.
SET - CB1/RIB Open Fail CLEAR - CB1/RIB Open Fail Clr	Rectifier Input Breaker (CB1/RIB) open signal did not transition to a TRUE state within a specified delay.
SET - CB1/RIB Close Fail CLEAR - CB1/RIB Close Fail Clr	Rectifier Input Breaker (CB1/RIB) closed signal did not transition to a TRUE state within a specified delay.
SET - CB1/RIB Open CLEAR - CB1/RIB Closed	CB1/RIB indicates that it is open.
SET - CB2/IOB Open Fail CLEAR - CB2/IOB Open Fail Clr	Inverter Output Breaker (CB2/IOB) open signal did not transition to a TRUE state within a specified delay.
SET - CB2/IOB Close Fail CLEAR - CB2/IOB Close Fail Clr	Inverter output breaker close signal did not transition to a TRUE state within a specified delay.
SET - CB2/IOB Open CLEAR - CB2/IOB Closed	CB2/IOB indicates that it is open.
SET - SBB Open Fail CLEAR - SBB Open Fail Clr	Bypass Breaker (SBB) open signal did not transition to a TRUE state within a specified delay.

Table 9 UPS Alarm and Status Messages (continued)

Message Text	Condition
SET - SBB Close Fail CLEAR - SBB Close Fail Clr	Bypass Breaker (SBB) closed signal did not transition to a TRUE state within a specified delay.
SET - SBB Open CLEAR - SBB Closed	Bypass circuit breaker indicates that it is open.
SET - MBD/BCB Open Fail CLEAR - MBD/BCB Open Fail Clr	Module Battery Disconnect open signal did not transition to a TRUE state within a specified delay.
SET - MBD/BCB Close Fail CLEAR - MBD/BCB Close Fail Clr	Module Battery Disconnect closed signal did not transition to a TRUE state within a specified delay.
SET - MBD/BCB Open CLEAR - MBD/BCB Closed	MBD is open.
SET - Batt CB Open Fail CLEAR - Batt CB Open Fail Clr	One or more Battery CB open signal did not transition to a TRUE state within a specified delay.
SET - Batt CB Close Fail CLEAR - Batt CB Close Fail Clr	One or more Battery CB closed signal did not transition to a TRUE state within a specified delay.
SET - Batt CB(#1-8) Open CLEAR - Batt CB1 Closed	Battery breaker (#1-8) 1 indicates that it is open.
SET - RFB Open CLEAR - RFB Closed	RFB indicates that it is open.
SET - BIB Open CLEAR - BIB Closed	BIB indicates that it is open.
SET - MBB Open CLEAR - MBB Closed	MBB indicates that it is open.
SET - MIB Open CLEAR - MIB Closed	MIB indicates that it is open.
SET - MOB Open CLEAR - MOB Closed	MOB indicates that it is open.
SET - LBB Open CLEAR - LBB Closed	LBB indicates that it is open.
SET - Summary CLEAR - Summary Clr	At least one User Alarm or Fault has become active. DO NOT CREATE EVENT!
Custom: Input Contact 1.1 Pre - Assigned: Reduced Rect Limit	Input contact channel signal is active.
Custom: Input Contact 1.2 Pre - Assigned: Reduced Batt Limit	Input contact channel signal is active.
Custom: Input Contact 1.3 Pre - Assigned: Stop Battery Charge	Input contact channel signal is active.
Custom: Input Contact 1.4 Pre - Assigned: Inhibit Auto Restart	Input contact channel signal is active.
Custom: Input Contact 1.5 Pre - Assigned: EcoMode Suspended	Input contact channel signal is active.
Custom: Input Contact 1.6 Pre - Assigned: Inhibit BPSS	Input contact channel signal is active.
Custom: Input Contact 1.7 Pre - Assigned: Manual Xfer to UPS	Input contact channel signal is active.
Custom: Input Contact 1.8 Pre - Assigned: Manual Xfer to BPSS	Input contact channel signal is active.
Custom: Input Contact 2.1 Pre - Assigned: Inhibit Intelligent Paralleling	Input contact channel signal is active.

Table 9 UPS Alarm and Status Messages (continued)

Message Text	Condition
Custom: Input Contact 2.2 Pre - Assigned: None	Input contact channel signal is active.
Custom: Input Contact 2.3 Pre - Assigned: None	Input contact channel signal is active.
Custom: Input Contact 2.4 Pre - Assigned: None	Input contact channel signal is active.
Custom: Input Contact 2.5 Pre - Assigned: None	Input contact channel signal is active.
Custom: Input Contact 2.6 Pre - Assigned: None	Input contact channel signal is active.
Custom: Input Contact 2.7 Pre - Assigned: None	Input contact channel signal is active.
Custom: Input Contact 2.8 Pre - Assigned: None	Input contact channel signal is active.
SET - History Log Full CLEAR - History Log Available	All history logs are full.
SET - History Log 1 Clear CLEAR -	History Log 1 Clear commands is active.
SET - History Log 2 Clear CLEAR -	History Log 2 Clear commands is active.
SET - Event Log Clear CLEAR -	Event log has been cleared.
SET - Equip Ovtemp CLEAR - Equip Ovtemp Clr	Summary event indicating at least one of the following faults: Rectifier Heat Sink Overtemperature Warning Inverter Heat Sink Overtemperature Warning Bypass Static Switch Heat Sink Overtemperature Warning DC/DC Heat Sink Overtemperature Warning DC Balancer Heat Sink Overtemperature Warning
SET - Equip Ovtemp Limit CLEAR - Equip Ovtemp Limit Clr	Summary event based on the detection of at least one of the following faults: Rectifier Heat Sink Overtemperature Limit Inverter Heat Sink Overtemperature Limit Bypass Static Switch Heat Sink Overtemperature Limit DC/DC Heat Sink Overtemperature Limit DC Balancer Heat Sink Overtemperature Limit
SET - Inlet Ovtemp CLEAR - Inlet Ovtemp Clr	The inlet air temperature exceeds a specified setting.
SET - Outlet Ovtemp Limit CLEAR - Outlet Ovtemp Limit Clr	With the critical bus energized (power applied to the cooling fans), the difference between the Outlet Air Temperature 1 and the Inlet Air Temperature or Outlet Air Temperature 2 and the Inlet Air Temperature or Outlet Air Temperature 3 and the Inlet Air Temperature or Outlet Air Temperature 4 and the Inlet Air Temperature exceeds a specified value.
SET - Rect Ovtemp Warn CLEAR - Rect Ovtemp Warn Clr	Rectifier semiconductor heat sink temperature exceeds a specified value.
SET - Rect Ovtemp Limit CLEAR - Rect Ovtemp Limit Clr	Rectifier semiconductor heat sink temperature exceeds a specified value.
SET - Inv Ovtemp Warn CLEAR - Inv Ovtemp Warn Clr	Inverter semiconductor heat sink temperature exceeds a specified value.
SET - Inv Ovtemp Limit CLEAR - Inv Ovtemp Limit Clr	Inverter semiconductor heat sink temperature exceeds a specified setting.

Table 9 UPS Alarm and Status Messages (continued)

Message Text	Condition
SET - BPSS Ovttemp Warn CLEAR - BPSS Ovttemp Warn Clr	Bypass static switch semiconductor heat sink temperature exceeds a specified value.
SET - BPSS Ovttemp Limit CLEAR - BPSS Ovttemp Limit Clr	Bypass static switch semiconductor heat sink temperature exceeds a specified value.
SET - DC/DC Ovttemp Warn CLEAR - DC/DC Ovttemp Warn Clr	DC/DC heat sink temperature exceeds a specified value.
SET - DC/DC Ovttemp Limit CLEAR - DC/DC Ovttemp Limit Clr	DC/DC heat sink temperature exceeds a specified value.
SET - DC Bal Ovttemp Warn CLEAR - DC Bal Ovttemp Warn Clr	DC Balancer heat sink temperature exceeds a specified value.
SET - DC Bal Ovttemp Limit CLEAR - DC Bal Ovttemp Limit Clr	DC Balancer heat sink temperature exceeds a specified value.
SET - Temp Sense Fail CLEAR - Temp Sense OK	One or more temperature sensors report a temperature outside of the range of expected operation.
SET - Regen Active CLEAR - Regen Completed	Regeneration Testing Start command is present.
SET - Regen Terminated CLEAR -	Regeneration is active and Regeneration Testing Stop command is present or Regeneration Operating Duration time is completed.
SET - Regen Failure CLEAR -	Regeneration Active is active and Bypass not Qualified or DC Bus Qualified is not active or Load On UPS is not active or Manual Transfer Inhibit is active or Inverter Overload Exceeded is active or any attempt to automatically transfer to bypass.
SET - ECO Mode Active CLEAR - ECO Mode Complete	Conditions to Activate or Automatic Reactivation have been satisfied.
SET - ECO Mode Suspended CLEAR - ECO Mode Allowed	When an ECO Mode Session is suspended.
SET - Excess ECO Suspends CLEAR - Excess ECO Recovered	When an ECO Mode Session is active, the number of automatic suspensions has exceeded the ECO Mode-Maximum Auto Suspensions setting.
SET - Main Control Fault CLEAR - Main Control OK	The redundant system has detected that the main UPS control has failed via a “watchdog” timeout mechanism.
SET - Controller Error CLEAR - Controller OK	Summary event based on the detection of at least one of the following faults: MCU Communications Failure Control DSP Failure
SET - MCU Comm Failure CLEAR - MCU Comm OK	The system has detected a loss of communication with one or more MCU cores.
SET - Control DSP Failure CLEAR - Control DSP OK	One or both of the control DSP’s have failed.
SET - On Gen Active CLEAR - On Gen Inactive	Generator Installed setting is “Installed” and the generator input channel is active.
SET - LBS Active Slave CLEAR - LBS Slave Inactive	With the Load Bus Sync Operation setting enabled, the functional LBS Slave is following the LBS sync pulse.
SET - LBS Active Master CLEAR - LBS Master Inactive	With the Load Bus Sync Operation setting enabled, the functional LBS Master is generating the LBS sync pulse.
SET - LBS Inhibited CLEAR - LBS Allowed	With the Load Bus Sync Operation setting enabled and LBS Type setting is Analog, LBS Voltage RMS is not qualified or LBS Voltage frequency is out of tolerance or LBS Voltage has incorrect phase rotation. With the Load Bus Sync Operation setting enabled and LBS Type setting Digital and Load Bus Sync-Master Select setting Master, a valid LBS sync signal is detected. With the Load Bus Sync Operation setting enabled and LBS Type setting Digital and Load Bus Sync-Master Select setting Slave, LBS Sync Signal is outside Bypass Tracking Window setting.

Table 9 UPS Alarm and Status Messages (continued)

Message Text	Condition
SET - Restart in Process CLEAR - Restart Complete	With Auto Restart setting set to Enable and Battery Low Shutdown active and Auto Restart Failed is not active and Auto Restart Inhibited is not active, the conditions for automatic restart are active. See Auto Restart Sequences
SET - Auto Restart Fail CLEAR -	With Auto Restart Initiated active, the conditions for automatic restart have failed. See Conditions to Terminate Auto Restart
SET - Restart Inhibited CLEAR - Restart Allowed	With Auto Restart setting set to Enable and Battery Low Shutdown active and Auto Restart Failed is not active, Input Contact Interface 1 (Channel #4) is active or Input Contact Interface 1 (Channel #5) is active or Input Contact Interface 1 (Channel #6) is active
SET - Loss of Redundancy CLEAR - Redundancy Restored	When the Redundant Module setting is YES, the number of modules of redundancy is less than a specified value.
SET - Module Alarm Active CLEAR - Module Alarm Clr	When any module reports an active alarm or fault to the SCC.
SET - Share Calib Active CLEAR - Share Calib Complete	When a module has begun calibration of sharing integral or a module has reloaded the stored calibrated sharing integral.
SET - Module In Standby CLEAR - Module Standby Exit	The conditions for Module Standby operations are active.
SET - Cont Tie Active CLEAR - Cont Tie Inactive	Power Tie Cabinet indicates that continuous power tie is active.
SET - DC Charger OV CLEAR - DC Charger OV Clr	The voltage output of the DC Charger has exceeded a specified threshold.
SET - IGBT Desat Fault CLEAR - IGBT Desat Fault Clr	This is a fault that is detected by either the Rectifier MCU or the Inverter MCU or both. A signal is generated by the corresponding IGBT driver board for the various power electronic circuits, (1) Rectifier, (2) Inverter, (3) DC/DC Converter and (4) DC Balancer. The DC/DC Converter and the DC Balancer share the same signal so if either power electronic circuit has an IGBT Desat fault, both triggers will occur, 2 events will be logged and both circuits will be disabled. Each MCU will generate this same event but parametric data will be used to distinguish which power electronic circuit created the fault. ---- A desat fault signal from an IGBT driver board is active.
SET - Emergency Transfer CLEAR - Emergency Transfer Clr	The system has detected a condition that requires an immediate transfer to bypass. Parametric data is used to distinguish which conditions triggered the transfer.
SET - Precharge Fail CLEAR - Precharge Fail Clr	Startup: After a specified delay from the time the precharge contactor close command is sent, the DC Bus failed to be greater than or equal to a specified value. Shutdown: Following a full system shutdown, CB1 Open, Inverter Off, Bypass Off, the DC BUS is above a specified voltage for a specified period of time.
SET - CBIB Comm Fail CLEAR - CBIB Comm Fail Clr	The system has detected that one or more CBIB are communicating.
SET - Critical Bus Off CLEAR -	Load is not being supported by UPS, Bypass or Maintenance Bypass
SET - SD Card Removed CLEAR -	SD card has been removed.
SET - Text - Auto Calib Active CLEAR - Auto Calib Done	Auto calibration sequence has begun.
SET - Text - Auto Calib Failed CLEAR - Auto Calib Failed Clr	UPSC has detected an error during ADC channel calibration.
SET - Input Phase Loss CLEAR - Input Phase Loss Clr	Any one input phase current is less than a specified percentage of the 3-phase average input current for a specified period of time.

Table 9 UPS Alarm and Status Messages (continued)

Message Text	Condition
SET - Manual Remove Module CLEAR -	Remove module (Xfer to Bypass) command is active.
SET - Manual Add Module CLEAR -	Add module (Xfer to UPS) command is active.

NOTES



