

MODELS CN2408 AND CN2404 PID CONTROLLERS

INSTALLATION AND OPERATION HANDBOOK

Contents	Page
Chapter 1	INSTALLATION 1-1
Chapter 2	OPERATION 2-1
Chapter 3	ACCESS LEVELS 3-1
Chapter 4	TUNING 4-1
Chapter 5	PROGRAMMER OPERATION 5-1
Chapter 6	CONFIGURATION 6-1
Chapter 7	USER CALIBRATION 7-1
Appendix A	UNDERSTANDING THE ORDERING CODE A-1
SAFETY and EMC INFORMATION.....	B-1

Chapter 1 INSTALLATION

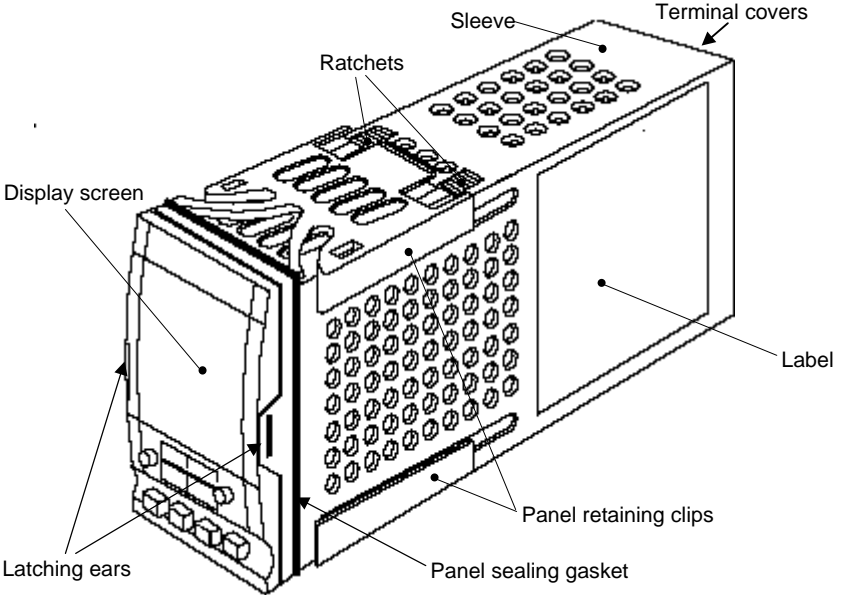

Figure 1-1 CN2408 1/8 DIN controller

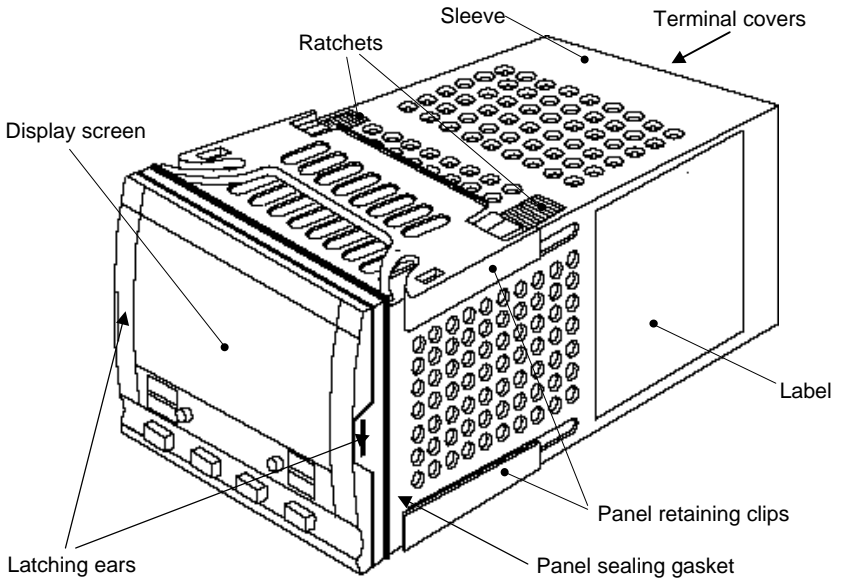

Figure 1-2 CN2404 1/4 DIN controller

Outline dimensions Model CN2408

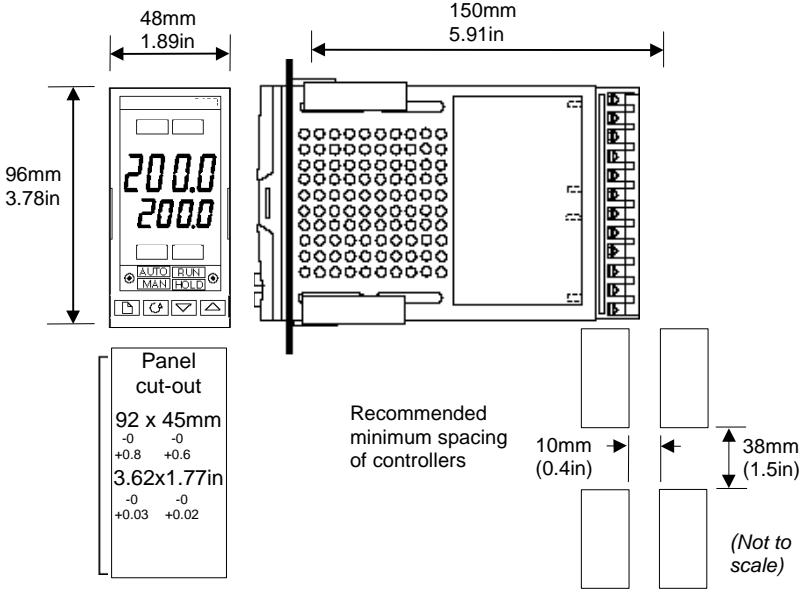

Figure 1-3 Outline dimensions Model CN2408 controller

Outline dimensions Model CN2404

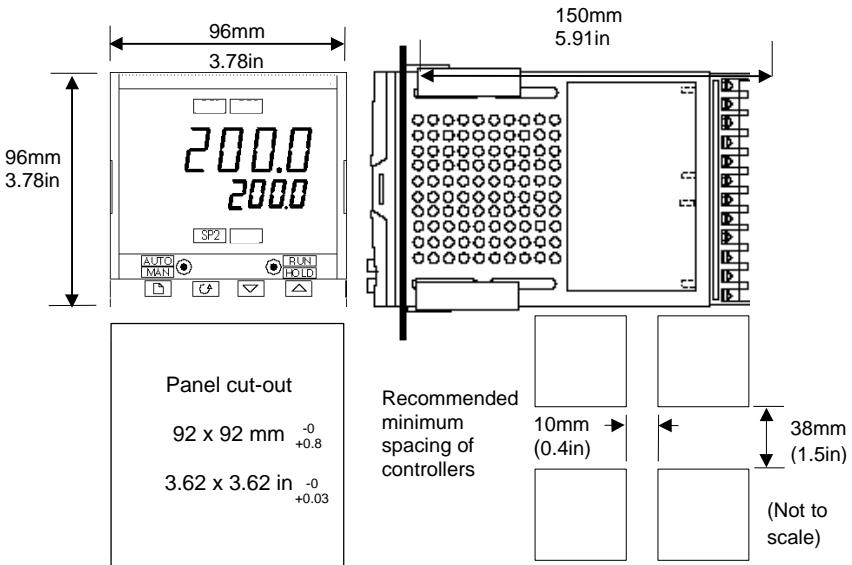

Figure 1-4 Outline dimensions Model CN2404 controller

The electronic assembly of the controller plugs into a rigid plastic sleeve, which in turn fits into the standard DIN size panel cut-out shown in Figures 1-3 and 1-4.

INTRODUCTION

Models CN2408 and CN2404 are high stability, temperature or process controllers with self and adaptive tuning. They have a modular hardware construction which accepts up to three plug-in Input/Output modules and two interface modules to satisfy a wide range of control requirements. Two digital inputs and an optional alarm relay are included as part of the fixed hardware build. In addition, the Model CN2404 has an optional plug-in 10A heating output.

The instruments are available as:

standard controllers	which include a basic 8-segment programmer Models CN2408-CG and CN2404-CG
setpoint programming controllers:	Models CN2408-CP, P4, CM and CN2404-CP, P4, CM
motorized valve controllers	which include a basic 8-segment programmer Models CN2408-VC and CN2404-VC
setpoint programming motorized valve controllers:	Models CN2408-VP, V4, VM and CN2404-VP, V4, VM

Before proceeding, please read the chapter called, *Safety and EMC Information*.

Controller labels

The labels on the sides of the controller identify the ordering code, the serial number, and the wiring connections.

Appendix A, *Understanding the Ordering Code*, explains the hardware and software configuration of your particular controller.

MECHANICAL INSTALLATION

To install the controller

1. Prepare the control panel cut-out to the size shown in Figure 1-3, or 1-4.
2. Insert the controller through the panel cut-out.
3. Spring the upper and lower panel retaining clips into place. Secure the controller in position by holding it level and pushing both retaining clips forward.

Note: If the panel retaining clips subsequently need removing, in order to extract the controller from the control panel, they can be unhooked from the side with either your fingers, or a screwdriver.

Unplugging and plugging-in the controller

If required, the controller can be unplugged from its sleeve by easing the latching ears outwards and pulling it forward out of the sleeve. When plugging the controller back into its sleeve, ensure that the latching ears click into place in order to secure the IP65 sealing.

ELECTRICAL INSTALLATION

This section consists of five topics:

- Rear terminal layouts
- Fixed connections
- Plug-in module connections
- Typical wiring diagrams
- Motorized valve connections.

WARNING

You must ensure that the controller is correctly configured for your application. Incorrect configuration could result in damage to the process being controlled, and/or personal injury. It is your responsibility, as the installer, to ensure that the configuration is correct. The controller may either have been configured when ordered, or may need configuring now. See Chapter 6, *Configuration*.

Model CN2408 rear terminal layout

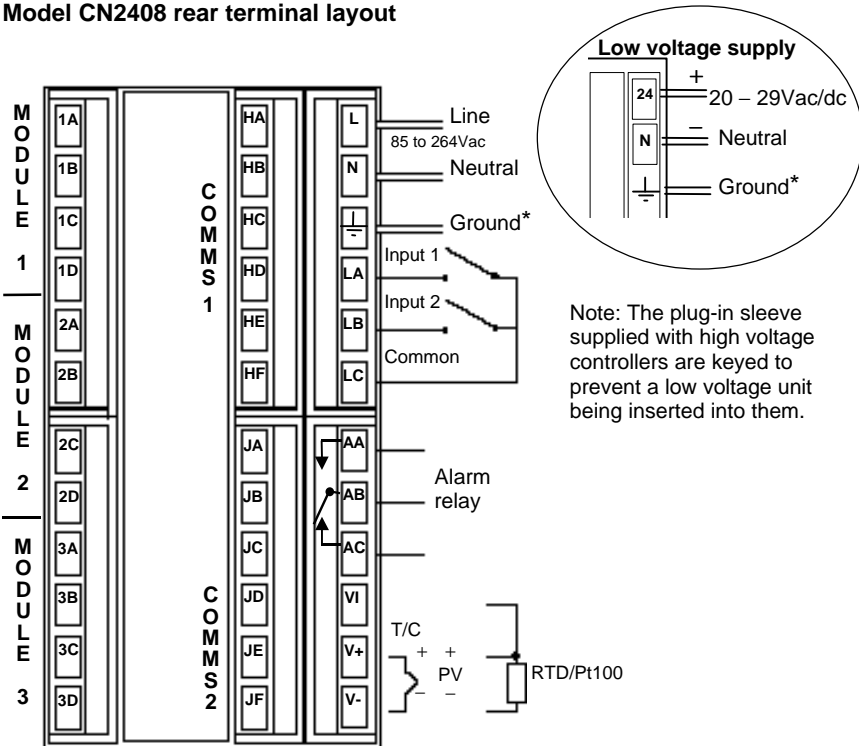

Figure 1-5 Rear terminal layout – Model CN2408

* The ground connection is provided as a return for internal EMC filters. It is not required for safety purposes, but must be connected in order to satisfy EMC requirements.

All electrical connections are made to the screw terminals at the rear of the controller. These screw terminals accept wire sizes from 0.5 to 2.5mm² (14 to 22 awg) and should be tightened to a torque of 0.4 Nm (3.5 lb. in). Crimp connectors that accept wire sizes from 0.5 to 1.5 mm² (16 to 22 AWG) can be used. The terminals are protected by a clear plastic hinged cover to prevent hands, or metal, making accidental contact with live wires.

Rear terminal layouts

The rear terminal layouts are shown in Figures 1-5 and 1-6. The right-hand column carries the connections to the power supply, digital inputs 1 and 2, alarm relay and sensor input. The second and third columns from the right carry the connections to the plug-in modules. The connections depend upon the type of module installed, if any. To determine which plug-in modules are fitted, refer to the ordering code and wiring data on the controller side labels. The Model CN2404 has the option of 10Amp heating output in the left-hand column.

Model CN2404 rear terminal layout

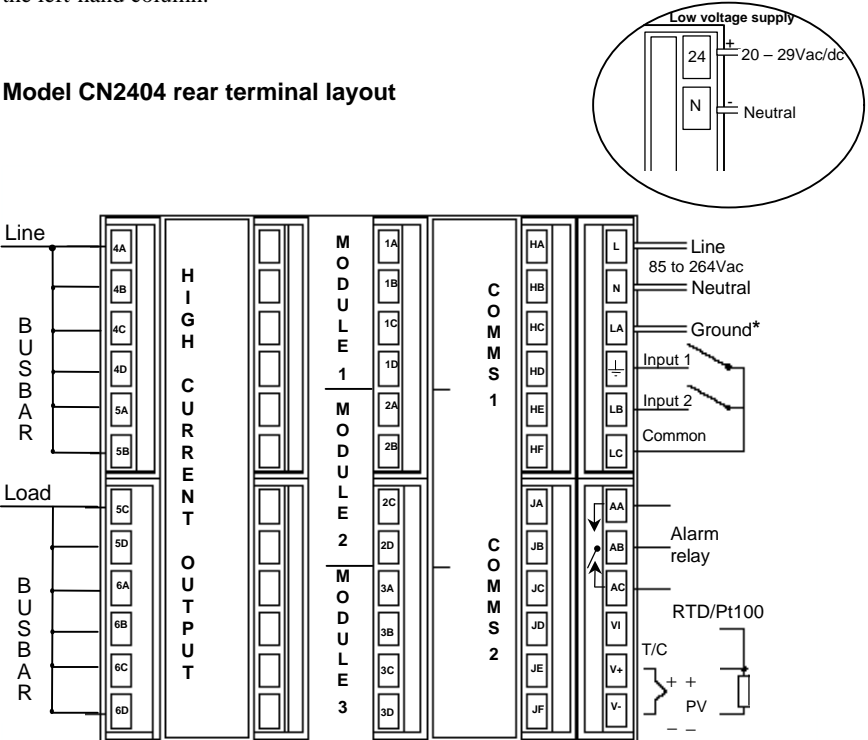

Figure 1-6 Rear terminal layout – Model CN2404

* The ground connection is provided as a return for internal EMC filters. It is not required for safety purposes, but must be connected in order to satisfy EMC requirements

Sensor input connections

The connections for the various types of sensor input are shown below.

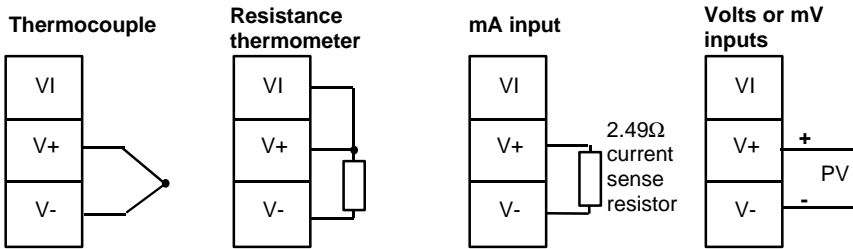

Fig 1-7 Sensor input connections

PLUG-IN MODULE CONNECTIONS

Module 1, 2 and 3

Module positions 1, 2 and 3 are plug-in modules. They can be either two terminal modules of the types shown in Table 1-1, or four terminal modules of the types shown in Table 1-2.

The tables show the connections to each module and the functions that they can perform. Module 1 is normally used for heating and module 2 for cooling, although the actual functions will depend upon how the controller has been configured.

PDLINK modes

Table 1-8 refers to PDLINK modes 1 and 2.

PDLINK stands for 'Pulse Density Signaling Input/Output'. This is a for bi-directional transmission of analog and digital data over a simple 2-wire connection.



PDLINK 1 mode uses a dc pulse module to control an Omega SSC-TE10S solid state relay and provides a load failure alarm.

PDLINK 2 mode uses a dc pulse module to control an Omega SSC-TE10S solid state relay, provide load/SSR failure alarms, and read back the load current for display on the controller.

Two terminal modules

Table 1-1 Two terminal module connections

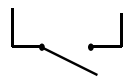
Note: Module 1 is connected to terminals 1A and 1B
 Module 2 is connected to terminals 2A and 2B
 Module 3 is connected to terminals 3A and 3B.

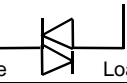
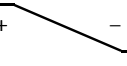
Module type	Terminal identity				Possible functions
	A	B	C	D	
Relay: 2-pin (2A, 264 Vac max.)			Unused		Heating, cooling, alarm, program event, valve raise, or valve lower
dc pulse non-isolated (18Vdc at 20mA)			Unused		Heating, cooling, PDLINK mode 1, PDLINK mode 2, program event
AC SSR (1A, 30 to 264Vac)			Unused		Heating, cooling, program event, valve raise, or valve lower
DC output: non-isolated (10Vdc, 20mA max.)			Unused		Heating, or cooling, or retransmission of PV, setpoint, or control output

Snubbers

The relay and AC SSR modules have an internal 15nF/100Ω ‘snubber’ connected across their output, which is used to prolong contact life and to suppress interference when switching inductive loads, such as mechanical contactors and solenoid valves.

WARNING

When the relay contact is open, or the AC SSR is off, the snubber circuit passes 0.6mA at 110Vac and 1.2mA at 240Vac. You must ensure that this current, passing through the snubber, will not hold on low power electrical loads. It is your responsibility as the installer to ensure that this does not happen. If the snubber circuit is not required, it can be removed from the relay module (BUT NOT THE AC SSR) by breaking the PCB track that runs crosswise, adjacent to the edge connectors of the module. This can be done by inserting the blade of a small screwdriver into one of the two slots that bound it and twisting.

Four terminal modules

Table 1-2 Four terminal module connections

Note: Module 1 is connected to terminals 1A, 1B, 1C and 1D
 Module 2 is connected to terminals 2A, 2B, 2C and 2D
 Module 3 is connected to terminals 3A, 3B, 3C and 3D

Module type	Terminal identity				Possible functions
	A	B	C	D	
Relay: changeover (2A, 264 Vac max.)					Heating, cooling, alarm, or program event output
DC control: Isolated (10V, 20mA max.)					Heating, or cooling
24Vdc transmitter supply					To power process inputs
Potentiometer input 100Ω to 15KΩ					Motorized Valve Position feedback
DC retransmission					Retrans. of setpoint, or process value
DC remote input or Process Value 2 (Module 3 only)	0-10Vdc	RT source	±100mV 0-20mA	COM	Remote Setpoint Second PV
(Refer to Fig. 1-8)					
Dual output modules					
Dual relay (2A, 264 Vac max.)					Heating + cooling Dual alarms Valve raise & lower
Dual AC SSR (1A, 30 to 264Vac)					Heating + cooling Valve raise & lower
Dual dc pulse + relay (dc pulse is non-isolated)					Heating + cooling
Dual dc pulse + AC SSR (dc pulse is non-isolated)					Heating + cooling
Triple logic input and output modules - see ratings on the next page					
Triple contact input	Input 1	Input 2	Input 3	Common	
Triple logic input	Input 1	Input 2	Input 3	Common	
Triple dc pulse output	Output 1	Output 2	Output 3	Common	Program events

Connections for Process Value 2 in module position 3

The diagrams below show the connections for the various types of input. The input will have been configured in accordance with the ordering code.

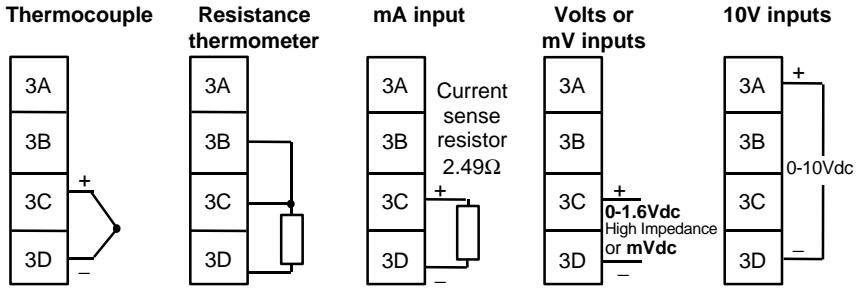

Figure 1-8 Connections for Process Value 2 (PV2)

Triple Logic Input and Triple DC Pulse output ratings

- Triple logic input (current sinking)

OFF state:	-3 to 5Vdc
ON state:	10.8 to 30Vdc(max), at 2 to 8mA
- Triple contact closure or open collector transistor input

Internally generated switching Vdc & mA:	15 to 19Vdc at 10 to 14mA
OFF state	>28KΩ input resistance
OFF state voltage	>14Vdc
ON state	<100Ω resistance
ON state voltage	<1.0Vdc
- Triple dc pulse output (current sourcing)

OFF state output	0 to 0.7Vdc.
ON state output	12 to 13Vdc, at up to 8mA.

Communication modules 1

The Models CN2408 and CN2404 will accept two plug-in communications modules. The possible module types are shown in the table below.

Only one of the two modules can be for serial communications and this will normally be installed in position COMMS 1, as shown below. However, it is possible to install the serial communications module in position COMMS 2.

The serial communications can be configured for Modbus® protocol.

Table 1-3 Communication modules 1 and 2 connections

Communications module 1	Terminal identity (COMMS 1)					
	HA	HB	HC	HD	HE	HF
2-wire RS-485 (EIA-485) serial communications	–	–	–	Common	A (+)	B (–)
RS-232 (EIA-232) serial communications	–	–	–	Common	Rx	Tx
4-wire RS-485 (EIA-485) serial communications	–	A' (Rx+)	B' (Rx–)	Common	A (Tx+)	B (Tx–)

Wiring of 2-wire RS-485 (EIA-485) serial communications link

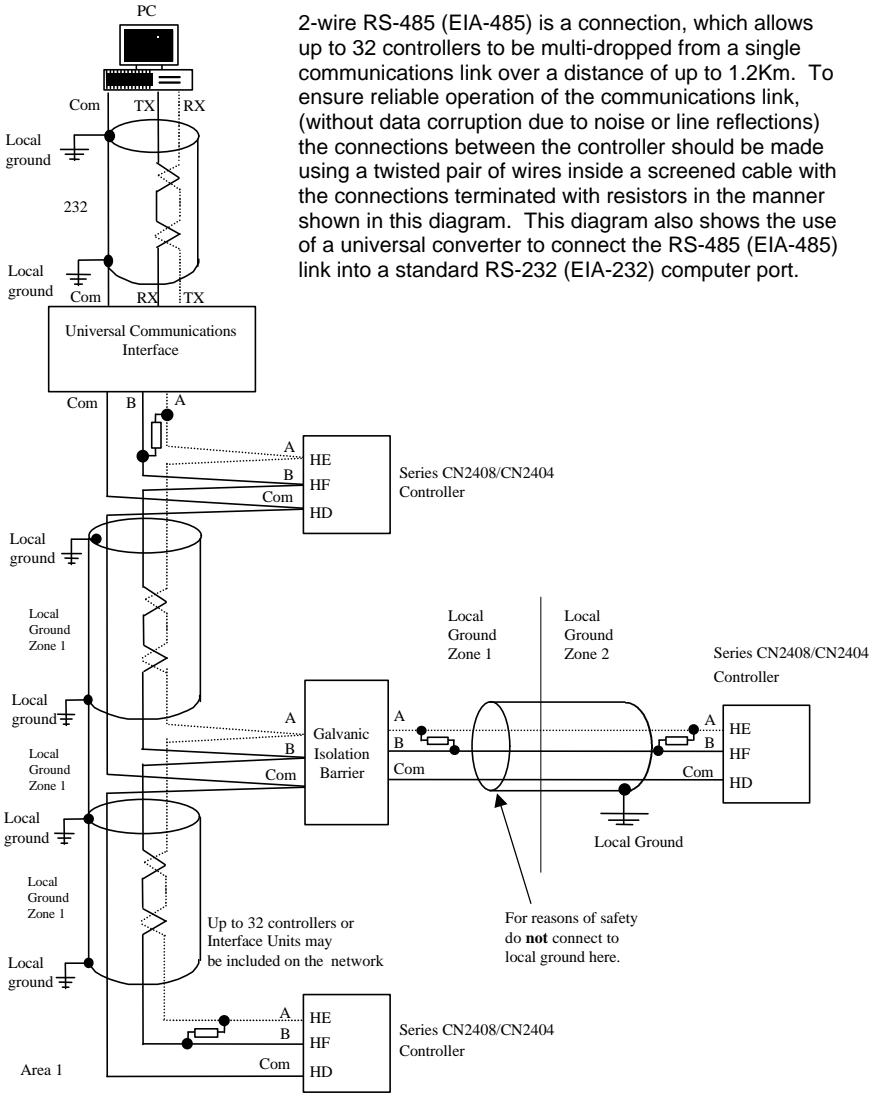

Note:

All resistors are 220 ohm 1/4W carbon composition.
 Local grounds are at equipotential. Where equipotential is not available wire into separate zones using a galvanic isolator.
 Use a repeater for more than 32 units.

Figure 1-9 RS-485 (EIA-485) wiring

TYPICAL WIRING DIAGRAM

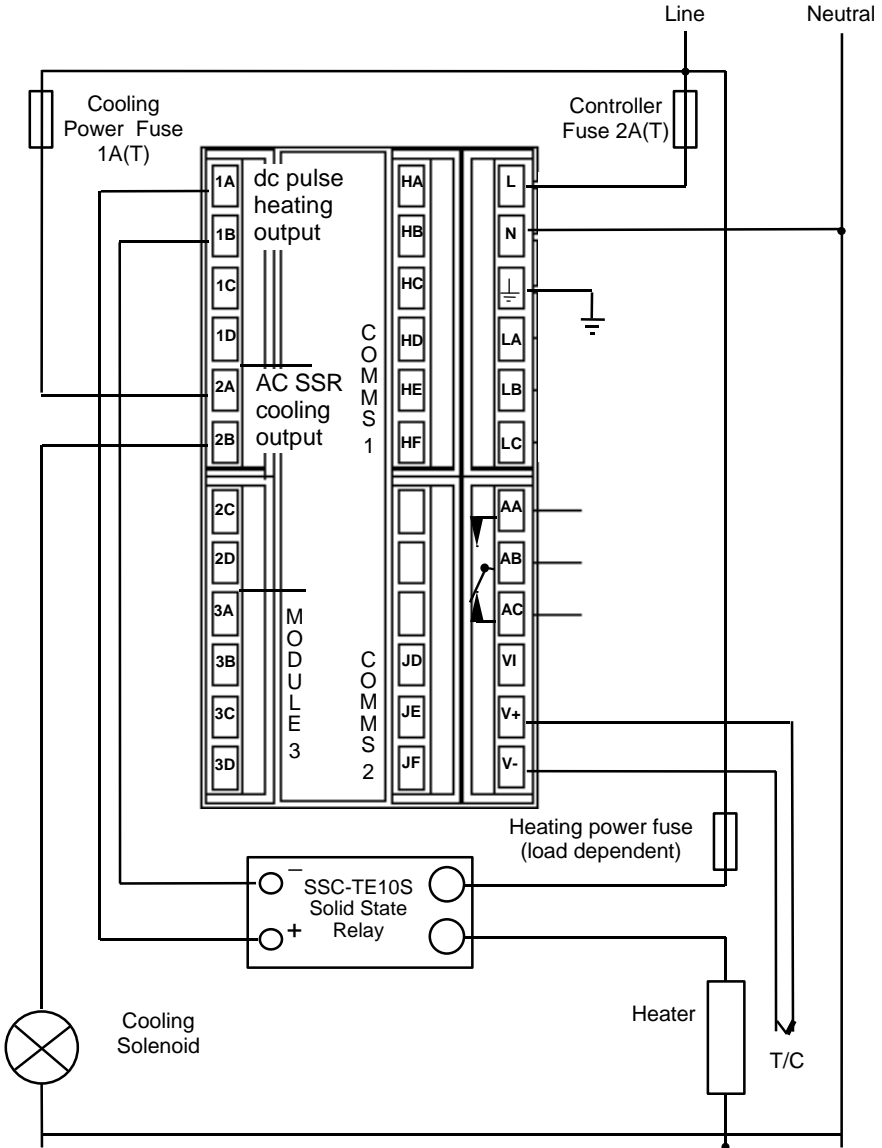

Fig 1-10 Typical wiring diagram, Model CN2408 Controller

MOTORIZED VALVE CONNECTIONS

Motorized valves will normally be wired either to dual relay, or dual AC SSR, output modules installed in the Module 1 position, or to single channel relay and AC SSR outputs installed in Module positions 1 and 2. In the latter case, the convention is to configure output 1 as the raise output and output 2 as the lower output.

Depending on the configuration, control of the valve is achieved in one of three ways:

1. With no position feedback potentiometer.
2. With a feedback potentiometer used to monitor the valve's position. It does not influence the control.
3. With a feedback potentiometer, where the valve's position is controlled in response to the signal from it.

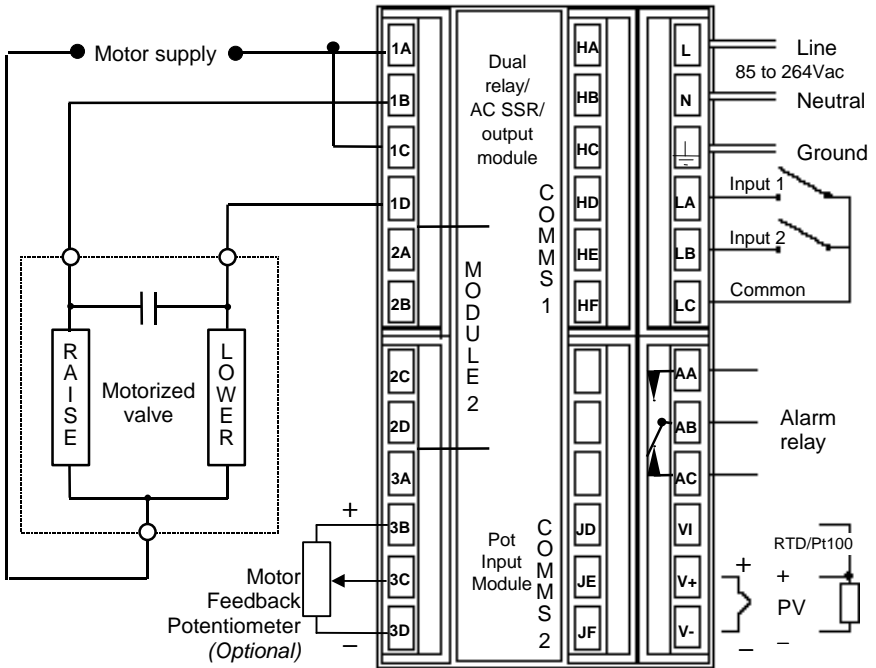

Fig 1-11 Motorized valve connections

Chapter 2 OPERATION

This chapter has nine topics:

- FRONT PANEL LAYOUTS
- BASIC OPERATION
- OPERATING MODES
- AUTOMATIC MODE
- MANUAL MODE
- PARAMETERS AND HOW TO ACCESS THEM
- NAVIGATION DIAGRAM
- PARAMETER TABLES
- ALARMS

FRONT PANEL LAYOUTS

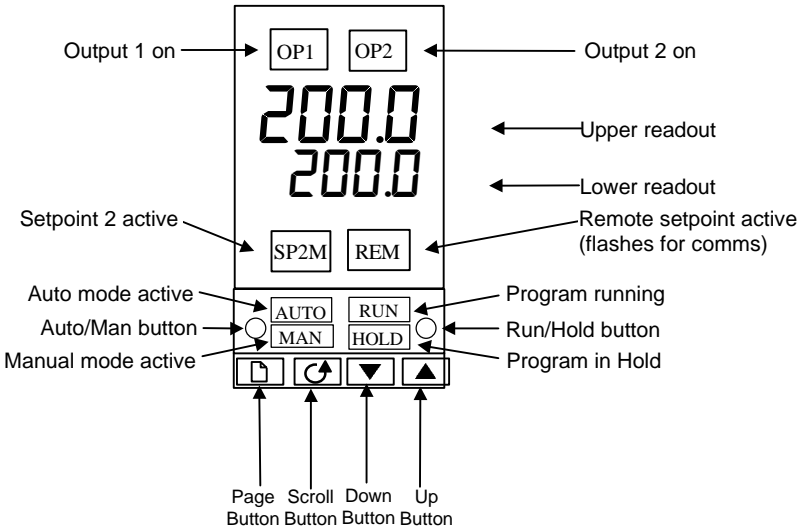

Figure 2-1 Model CN2408 front panel layout

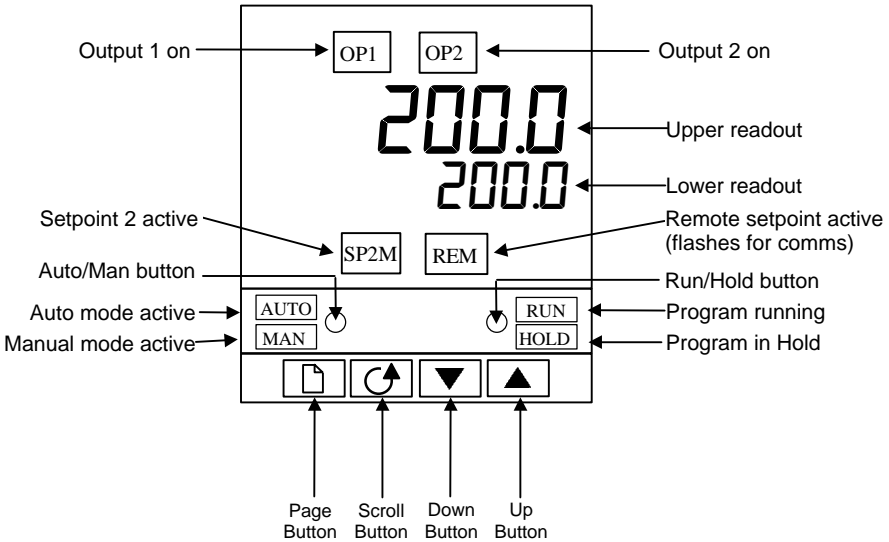







Figure 2-2 Model CN2404 front panel layout

Button or indicator	Name	Explanation
OP1	Output 1	When lit, it indicates that the output installed in module position 1 is on. This is normally the heating output on a temperature controller.
OP2	Output 2	When lit, it indicates that the output installed in module position 2 is on. This is normally the cooling output on a temperature controller.
SP2	Setpoint 2	When lit, this indicates that setpoint 2, (or a setpoint 3-16) has been selected.
REM	Remote setpoint	When lit, this indicates that a remote setpoint input has been selected. 'REM' will also flash when communications is active.
	Auto/Manual button	When pressed, this toggles between automatic and manual mode: If the controller is in automatic mode the AUTO light will be lit. If the controller is in manual mode, the MAN light will be lit. The Auto/Manual button can be disabled in configuration level.
	Run/Hold button	Press once to start a program (RUN light on.) Press again to hold a program (HOLD light on) Press again to cancel hold and continue running (HOLD light off and RUN light ON) Press and hold in for two seconds to reset a program (RUN and HOLD lights off) The RUN light will flash at the end of a program. The HOLD light will flash during holdback.
	Page button	Press to select a new list of parameters.
	Scroll button	Press to select a new parameter in a list.
	Down button	Press to decrease a value in the lower readout.
	Up button	Press to increase a value in lower readout.

BASIC OPERATION

Switch on the power to the controller. It runs through a self-test sequence for about three seconds and then shows the measured temperature, or process value, in the upper readout and the target value, called the *setpoint*, in the lower readout. This is called the **Home display**.

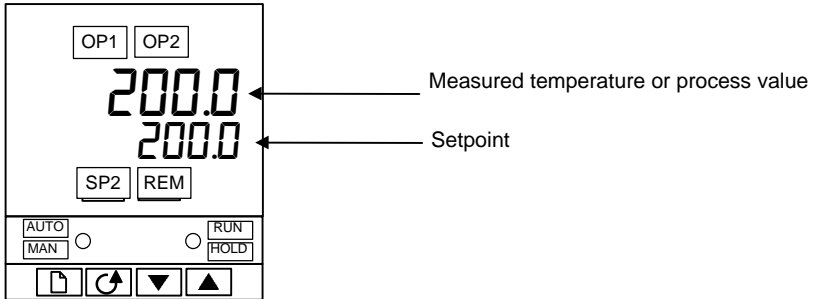





Figure 2-3 Home display

You can adjust the setpoint by pressing the  or  buttons. Two seconds after releasing either button, the display blinks to show that the controller has accepted the new value.

OP1 will light whenever output 1 is ON. This is normally the heating output when used as a temperature controller.

OP2 will light whenever output 2 is ON. This is normally the cooling output when used as a temperature controller.

Note: You can get back to this display at any time by pressing  and  together. Alternatively, you will always be returned to this display if no button is pressed for 45 seconds, or whenever the power is turned on.

Alarms

If the controller detects an alarm condition, it flashes an alarm message in the Home display. For a list of all the alarm messages, their meaning and what to do about them, see *Alarms* at the end of this chapter.

OPERATING MODES

The controller has two basic modes of operation:

- **Automatic mode** in which the output is automatically adjusted to maintain the temperature or process value at the setpoint.
- **Manual mode** in which you can adjust the output independently of the setpoint. You toggle between the modes by pressing the AUTO/MAN button. The displays which appear in each of these modes are explained in this chapter.

Two other modes are also available:

- **Remote Setpoint mode**, in which the setpoint is generated from an external source. In this mode, the REM light will be on.
- **Programmer mode** which is explained in Chapter 5, *Programmer Operation*.

AUTOMATIC MODE

You will normally work with the controller in automatic mode. If the MAN light is on, press the AUTO/MAN button to select automatic mode. The AUTO light comes on

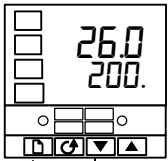

The Home display

Check that the AUTO light is on.

The upper readout shows the measured temperature.

The lower readout shows the setpoint.

To adjust the setpoint up or down, press or .

(Note: If Setpoint Rate Limit has been enabled, then the

lower readout will show the active setpoint. If or pressed, it will change to show and allow adjustment of, the target setpoint.)



Press once.

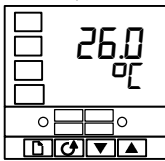

Display units

A single press of will flash the display units for 0.5 seconds, after which you will be returned to the **Home** display.

Flashing of the display units may have been disabled in configuration in which case a single press will take you



Press twice.

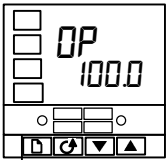

% Output power demand

The % output power demand is displayed in the lower readout. This is a read-only value. You cannot adjust it.

Press and together to return to the **Home** display.

Press

Pressing from the Output Power display may access further parameters. These may be in this scroll list if the 'Promote' feature has been used (see Chapter 3, *Edit Level*).

When you reach the end of this scroll list, pressing will return you to the **Home** display.



MANUAL MODE

If the AUTO light is on, press the AUTO/MAN button to select manual mode. The MAN light will come on.



The Home display

Check that the MAN light is on.

The upper readout shows the measured temperature or process value. The lower readout shows the % output.

To adjust the output, press  or 

(Note: If Output Rate Limit has been enabled, then the

lower readout will show the working output. If  or  is pressed, it will change to show and allow adjustment of, the target output.)

Press  once



Display units

A single press of  will flash the display units for 0.5 seconds, after which you will be returned to the Home display.

Flashing of the display units may have been disabled in configuration in which case you a single press will take you straight to the display shown below.



Press  twice

Setpoint

To adjust the setpoint value, press  or .

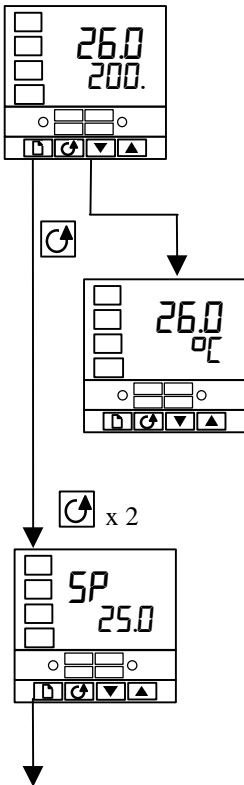
Press 



Pressing  from the Output Power display may access further parameters. Other parameters may be in this scroll list if the 'Promote' feature has been used (see Chapter 3, *Edit Level*). When you reach the end of this scroll list, pressing  will return you to the **Home** display.

PARAMETERS AND HOW TO ACCESS THEM

Parameters are settings within the controller that determine how it will operate.

For example, alarm setpoints are parameters that set the points at which alarms will occur. For ease of access, the parameters are arranged in lists as shown in the navigation diagram on the following page. The names of these lists are called the *list headers*. The lists are:

<i>Home list</i>	<i>PID list</i>	<i>Communications list</i>
<i>Run list</i>	<i>Motor list</i>	<i>Information list</i>
<i>Programmer list</i>	<i>Setpoint list</i>	<i>Access list.</i>
<i>Alarm list</i>	<i>Input list</i>	
<i>Autotune list</i>	<i>Output list</i>	

Each list has a 'List Header' display.

List header displays

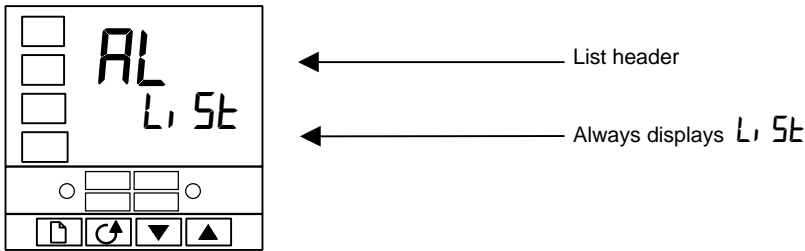

Figure 2-4 Typical list header display

A list header can be recognized by the fact that it always shows 'L, St' in the lower readout. The upper readout is the name of the list. In the above example, *AL* indicates that it is the Alarm list header. List header displays are read-only.

To step through the list headers press . Depending upon how your controller has been configured, a single press may momentarily flash the display units. In this case, a double press will be necessary to take you to the first list header. Continued pressing of

will step through the list headers eventually returning you to the **Home** display.

To step through the parameters within a particular list, press . When you reach the end of the list, you will return to the list header.

From within a list you can return to the list header at any time can by pressing. step to the next list header, press once again.

Parameter names

In the navigation diagram, each box depicts the display for a selected parameter.

The upper readout shows the name of the parameter and the lower readout its value. The Operator parameter tables later in this chapter list all the parameter names and their meaning.

The navigation diagram shows all the parameters that can, *potentially*, be present in the controller. In practice, only those associated with a particular configuration will appear.

The shaded boxes in the diagram indicate parameters that are hidden in normal operation. To see all the available parameters, you must select Full access level. For more information about this, see Chapter 3, *Access Levels*.

Parameter displays

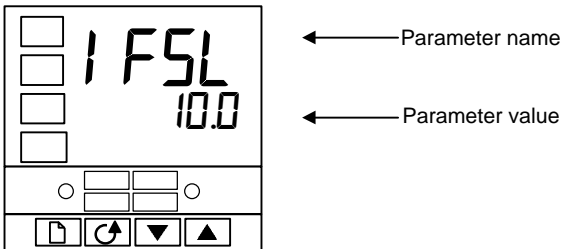





Figure 2-5 Typical parameter display

Parameter displays show the controller's current settings. The layout of parameter displays is always the same: the upper readout shows the parameter name and the lower

readout its value. Alterable parameters can be changed using  or . In the above example, the parameter mnemonic is *1FSL* (indicating *Alarm 1, full scale low*), and the parameter value is *10.0*.

To change the value of a parameter

First, select the required parameter. The parameter name is shown in the upper readout and the parameter value in the lower readout.

To change the parameter value, press either  or . During adjustment, single presses change the value by one digit.

Keeping the button pressed speeds up the rate of change.

Two seconds after releasing either button, the display blinks to show that the controller has accepted the new value.

NAVIGATION DIAGRAM (PART A)

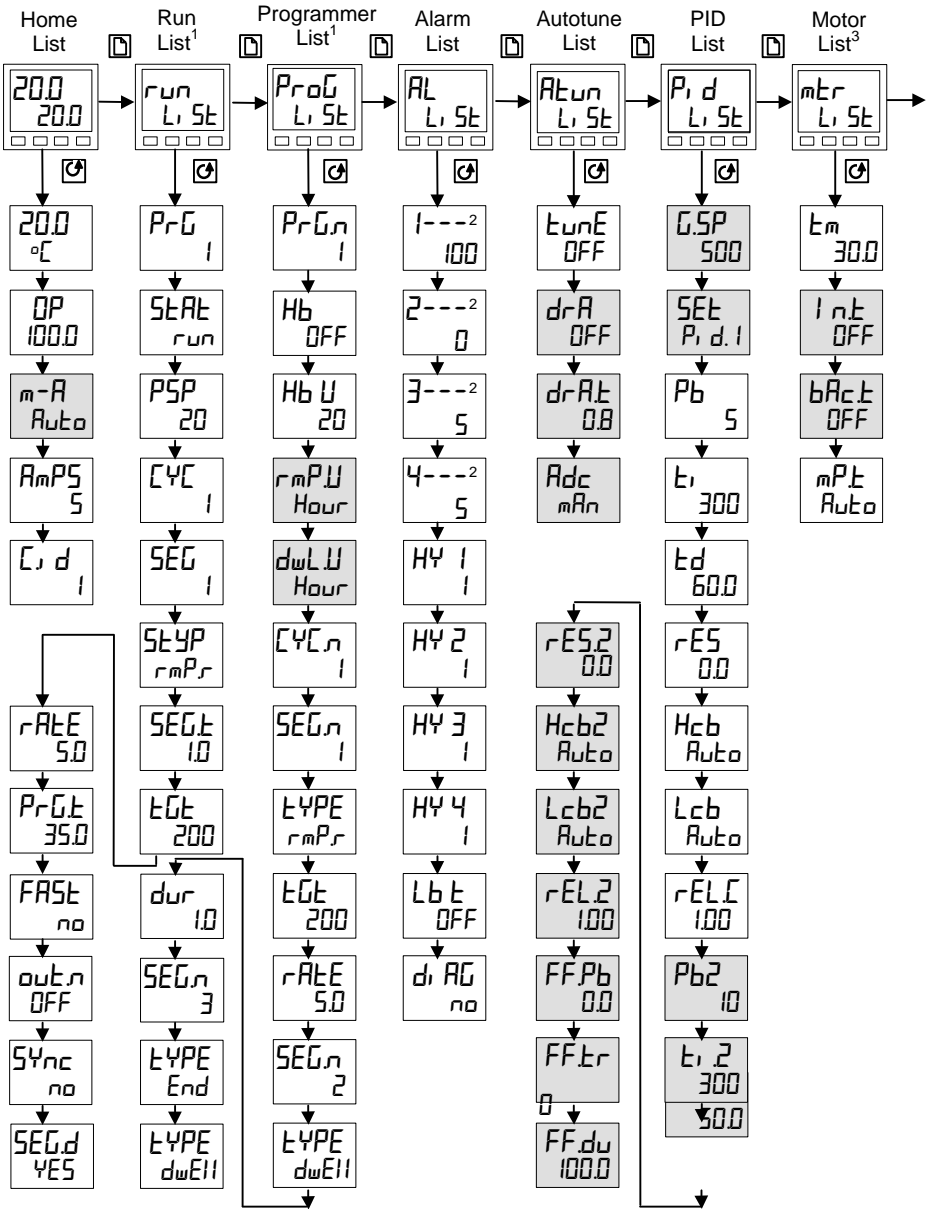

Figure 2-6a Navigation diagram (Part A)

NAVIGATION DIAGRAM (PART B)

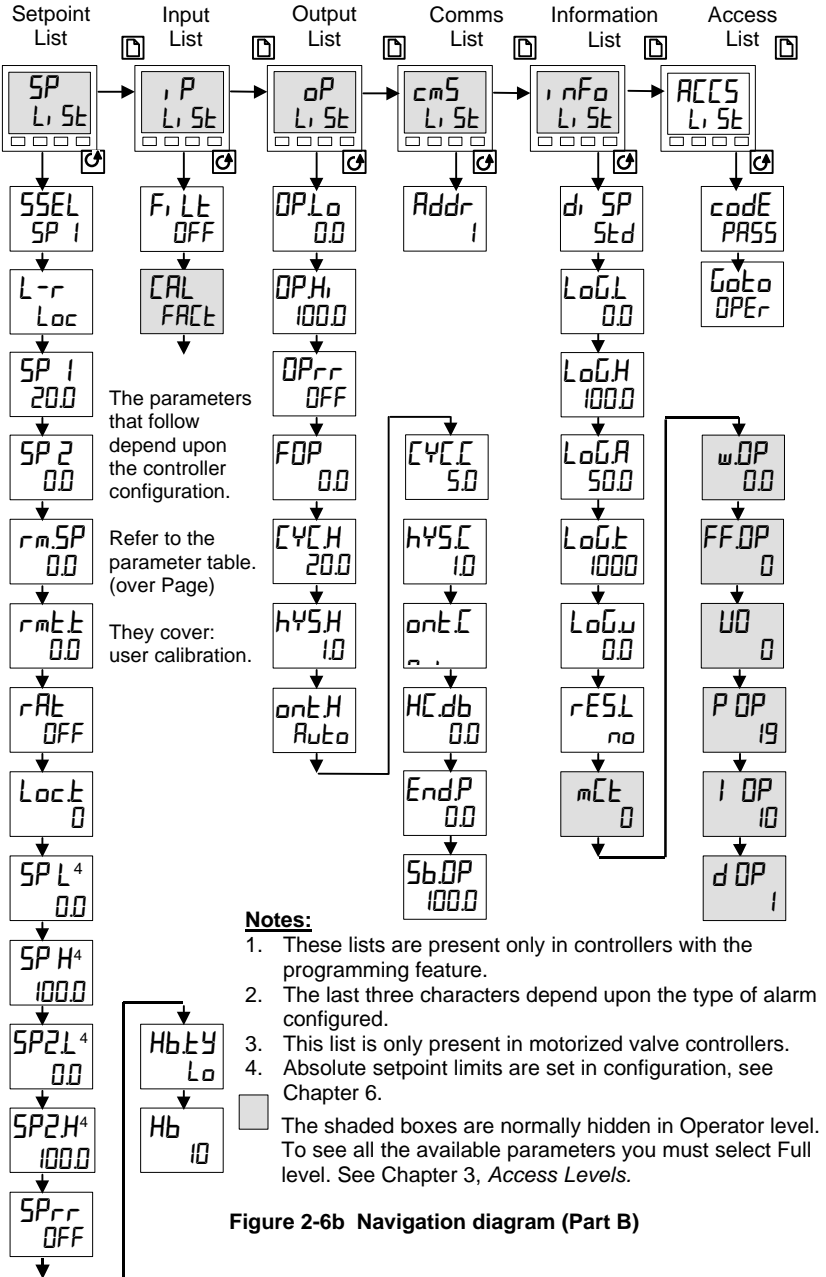

Figure 2-6b Navigation diagram (Part B)

PARAMETER TABLES

Name	Description
Home list	
Home	Measured value and Setpoint
OP	% Output level
SP	Target setpoint (if in Manual mode)
m-A	Auto-man select
AmPS	Heater current (With PDLINK mode 2)
C, d	Customer defined identification number
+ Extra parameters, if the 'Promote' feature has been used (see Chapter 3, <i>Edit Level</i>).	

run	Program run list – Present only in setpoint programming controllers
PrG	Active program number (Only on 4, or 20, program versions)
Stat	Program status (OFF, run, hold, HbAc, End)
PSP	Programmer setpoint
CYC	Number of cycles remaining in the program
SEG	Active segment number
StYP	Active segment type
SEGE	Segment time remaining in the segment units
tGE	Target setpoint
rAEE	Ramp rate (if a rate segment)
PrGE	Program time remaining in hours
FASt	Fast run through program (no / YES)
out.n	Event output states (OFF / on) (not 8-segment programmer)
SYnc	Segment synchronization (no / YES) (not 8-segment programmer)
SEGE	Flash active segment type in the lower readout of the home display (no / YES)

Name	Description
------	-------------

Prog	Program edit list – Present only in setpoint programming controller. For a fuller explanation of these parameters refer to Chapter 5s
PrGn	Select program number (Only on 4, or 20, program versions)
Hb	Holdback type for the program as a whole (if configured)(OFF, Lo, Hi, or bAnd)
HbU	Holdback value (in display units)
rmpU	Ramp units (SEc, mi n, or Hour) [for both rmpR and rmpT type segments]
dwLU	Dwell units (SEc, mi n, or Hour)
CYCn	Number of program cycles (1 to 999, or 'cont')
SEGn	Segment number
TYPE	Segment type:(End) (rmpR=ramp rate) (rmpT=ramp time) (dwEl) (STEP) (cALL)

The following parameters depend on the TYPE selected, as shown below.

	End	rmpR	rmpT	dwEl	STEP	cALL	
Hb							Holdback type: OFF, Lo, Hi, or bAnd
EGt		✓	✓		✓		Target setpoint for a 'rmp' or 'STEP' segment
rRE		✓					Ramp rate for a 'rmpR' segment
dur			✓	✓			'dwEl' time / Time to target for a 'rmpT' segment
PrGn						✓	cALLed PrGm number
cYCn						✓	No. of cycles of cALLed program
outn	✓	✓	✓	✓	✓		Event output: OFF/on (not 8-segment programmer)
SYnc		✓	✓	✓	✓		Segment synchronization: no/YES (not 8-seg progr)
Endt	✓						End of prog – dwEl, STEP, S OP
Pwr							Power level in end segment

Name	Description
------	-------------

AL	Alarm list
1 - - -	Alarm 1 setpoint value
2 - - -	Alarm 2 setpoint value
3 - - -	Alarm 3 setpoint value
4 - - -	Alarm 4 setpoint value
<i>In place of dashes, the last three characters indicate the alarm type. See alarm types table:</i>	
HY 1	Alarm 1 Hysteresis (display units)
HY 2	Alarm 2 Hysteresis (display units)
HY 3	Alarm 3 Hysteresis (display units)
HY 4	Alarm 4 Hysteresis (display units)
Lb t	Loop Break Time in minutes
d, AG	Enable Diagnostic alarms 'm' / 'YES'
Alarm types table	
-FSL	PV Full scale low alarm
-FSH	PV Full scale high alarm
-dEu	PV Deviation band alarm
-dH ₁	PV Deviation high alarm
-dLo	PV Deviation low alarm
-LCL	Load Current low alarm
-HCL	Load Current high alarm
-FL2	Input 2 Full Scale low alarm
-FH2	Input 2 Full Scale high alarm
-LOP	Working Output low alarm
-HOP	Working Output high alarm
-LSP	Working Setpoint low alarm
-HSP	Working Setpoint high alarm
4rAL	Rate of change alarm (AL 4 only)

ALtun	Autotune list
tunE	One-shot autotune enable
drA	Adaptive tune enable
drALt	Adaptive tune trigger level in display units. Range = 1 to 9999
Rdc	Automatic Droop Compensation (PD control only)

Name	Description
------	-------------

P, d	PID list
GSP	If Gain Scheduling has been enabled (see Chapter 4), this parameter sets the PV below which 'P, d, I' is active and above which 'P, d, I' is active.
SEt	'P, d, I' or 'P, d, I' selected
Pb	Proportional Band (SEE I) (in display units)
t _I	Integral Time in secs (SEE I)
t _D	Derivative Time in secs (SEE I)
rES	Manual Reset (%) (SEE I)
Hcb	Cutback High (SEE I)
Lcb	Cutback Low (SEE I)
rELI	Relative Cool Gain (SEE I)
Pb2	Proportional Band (SEE 2)
t _I 2	Integral Time in secs (SEE 2)
t _D 2	Derivative Time in secs (SEE 2)
rES2	Manual Reset (%) (SEE 2)
Hcb2	Cutback High (SEE 2)
Lcb2	Cutback Low (SEE 2)
rEL2	Relative Cool Gain (SEE 2)
<i>The following three parameters are used for cascade control. If this facility is not being used, then they can be ignored.</i>	
FFPb	SP, or PV, feedforward propband
FFt _r	Feedforward trim %
FF.du	PID feedforward limits ± %

mtr	Motor list - see Table 4-3
t _m	Valve travel time in seconds
i n.t	Valve inertia time in secs
bAc t	Valve backlash time in secs
mP t	Minimum ON time of output pulse
Ubr	Valve sensor break strategy

Name	Description
SP	Setpoint list
<i>SSeL</i>	Select <i>SP 1</i> to <i>SP 16</i> , depending on configuration
<i>L-r</i>	Local (<i>LoC</i>) or remote (<i>rM</i>) setpoint select
<i>SP 1</i>	Setpoint one value
<i>SP 2</i>	Setpoint two value
<i>rM.SP</i>	Remote setpoint value
<i>rM.t</i>	Remote setpoint trim
<i>rAt</i>	Ratio setpoint
<i>Lo.t</i>	Local setpoint trim
<i>SP L</i>	Setpoint 1 low limit
<i>SP H</i>	Setpoint 1 high limit
<i>SP2L</i>	Setpoint 2 low limit
<i>SP2H</i>	Setpoint 2 high limit
<i>SP.r</i>	Setpoint Rate Limit
<i>Hb.t</i>	Holdback Type for setpoint rate limit (<i>OFF</i> , <i>Lo</i> , <i>Hi</i> , or <i>band</i>)
<i>Hb</i>	Holdback Value for setpoint rate limit in display units. (<i>Hb.t</i> ≠ <i>OFF</i>)

<i>i, P</i>	Input list
<i>F, t</i>	IP1 filter time constant (0.0 - 999.9 seconds).
<i>F, t 2</i>	IP2 filter time constant (0.0 - 999.9 seconds).
<i>H, i, P</i> <i>Lo, i, P</i>	Transition of control between <i>P, 1</i> and <i>P, 2</i> . (if configured) The transition region is set by the values of ' <i>Lo, i, P</i> ' and ' <i>H, i, P</i> '. PV = <i>P, 1</i> below ' <i>Lo, i, P</i> ' PV = <i>P, 2</i> above ' <i>H, i, P</i> '
<i>F, 1</i> <i>F, 2</i>	Derived function, (if configured) PV = (<i>F, 1</i> × <i>P, 1</i>) + (<i>F, 2</i> × <i>P, 2</i>). ' <i>F, 1</i> ' and ' <i>F, 2</i> ' are scalars with the range -9.99 to 10.00
<i>P, i, P</i>	Selects <i>P, 1</i> or ' <i>P, 2</i> '

Continued in next column

Name	Description
<i>i, P</i>	Input list - continued
	<i>The next 3 parameters appear if User Calibration has been enabled. (Refer to Chapter 7.) By default they are hidden when in Operator level. To prevent unauthorized adjustment, we recommend that they are only made available in Full access level.</i>
<i>CAL</i>	' <i>FACT</i> ' - reinstates the factory calibration and disables User calibration. Next 2 parameters will not appear. ' <i>USER</i> ' - reinstates any previously set User calibration. All parameters below now appear.
<i>CAL.S</i>	Selected calibration point - ' <i>nonE</i> ', ' <i>P, 1L</i> ', ' <i>P, 1H</i> ', ' <i>P, 2L</i> ', ' <i>P, 2H</i> '
<i>Adj *</i>	User calibration adjust, if <i>CAL.S</i> = ' <i>P, 1L</i> ', ' <i>P, 1H</i> ', ' <i>P, 2L</i> ', ' <i>P, 2H</i> '
<i>OF5.1</i>	IP1 calibration offset
<i>OF5.2</i>	IP2 calibration offset
<i>mU.1</i>	IP1 measured value (at terminals)
<i>mU.2</i>	IP2 measured value (at terminals), if DC input in Module 3 position
<i>CJC.1</i>	IP1 cold junction temp. reading
<i>CJC.2</i>	IP2 cold junction temp. reading
<i>L, 1</i>	IP1 Linearized value
<i>L, 2</i>	IP2 Linearized value
<i>PUSL</i>	Shows the currently selected PV input - ' <i>P, 1</i> ' or ' <i>P, 2</i> '

* Do not make adjustments using the *Adj* parameter unless you wish to change the controller calibration.

Name	Description
------	-------------

OP	Output list
<i>Does not appear if Motorized Valve control configured.</i>	
OPLo	Low power limit (%)
OPHi	High power limit (%)
OPrr	Output Rate Limit (% per sec)
FOP	Forced output level (%)
CYCH	Heat cycle time (0.2S to 999.9S)
HYSH	Heat hysteresis (display units)
onEH	Heat output min. on-time (secs) Auto (0.05S), or 0.1 - 999.9S
CYCL	Cool cycle time (0.2S to 999.9S)
HYSL	Cool hysteresis (display units)
onEL	Cool output min. on-time (secs) Auto (0.05S), or 0.1 - 999.9S
HCLdb	Heat/cool deadband (display units)
SbOP	Sensor Break Output Power (%)

cmS	Comms list
Addr	Communications Address

info	Information list
diSP	Configure lower readout of Home display to show: VPos Valve position Std Standard - display setpoint Amps Load current in amps OP Output STAT Program status PrGt Program time remaining in hours L ₂ Process value 2 rAt Ratio setpoint PrG Selected program number rSP Remote setpoint
LoGL	PV minimum
LoGH	PV maximum
LoGA	PV mean value
LoGt	Time PV above Threshold level
LoGw	PV Threshold for Timer Log
<i>Continued in next column</i>	

Name	Description
------	-------------

info	Information list - <i>continued</i>
rESL	Logging Reset - 'YES/no'
<i>The following set of parameters is for diagnostic purposes.</i>	
mCt	Processor utilization factor
wOP	Working output
FFOP	Feedforward component of output
UD	PID output to motorized valve
P OP	Proportional component of output
I OP	Integral component of output
d OP	Derivative component of output



ACCESS	Access List
codE	Access password
Goto	Goto level - OPEr, FuLL, Ed, t or conF
ConF	Configuration password

ALARMS

Alarm annunciation

Alarms are flashed as messages in the Home display. A new alarm is displayed as a double flash followed by a pause, old (acknowledged) alarms as a single flash followed by a pause. If there is more than one alarm condition, the display cycles through all the relevant alarm messages. Table 2-1 and Table 2-2 list all of the possible alarm messages and their meanings.

Alarm acknowledgement and resetting

Pressing both  and  at the same time will acknowledge any new alarms and reset any latched alarms.

Alarm modes

Alarms will have been set up to operate in one of several modes, either:

- **Non-latching**, which means that the alarm will reset automatically when the Process Value is no longer in the alarm condition.
- **Latching**, which means that the alarm message will continue to flash even if the alarm condition no longer exists and will only clear when reset.
- **Blocking**, which means that the alarm will only become active after it has first entered a safe state on power-up.

Alarm types

There are **two** types of alarm: **Process alarms** and **Diagnostic alarms**.

Process alarms

These warn that there is a problem with the process which the controller is trying to control.

Table 2-1 Process alarms

Alarm Display	What it means
_F5L*	PV Full Scale Low alarm
_F5H*	PV Full Scale High alarm
_dE <u>u</u> *	PV Deviation Band alarm
_dH <u>i</u> *	PV Deviation High alarm
_dL <u>o</u> *	PV Deviation Low alarm
_L <u>C</u> r*	Load Current Low alarm
_H <u>C</u> r*	Load Current High alarm

Alarm Display	What it means
_F2*	Input 2 Full Scale Low alarm
_F2*	Input 2 Full Scale High alarm
_L <u>O</u> P*	Working Output Low alarm
_H <u>O</u> P*	Working Output High alarm
_L <u>S</u> P*	Working Setpoint Low alarm
_H <u>S</u> P*	Working Setpoint High alarm
4r <u>A</u> t	PV Rate of change alarm <i>Always assigned to Alarm 4</i>

* In place of the dash, the first character will indicate the alarm number

Diagnostic alarms

These indicate that a fault exists in either the controller or the connected devices.

Table 2-2a Diagnostic alarms

Display shows	What it means	What to do about it
EEEr	<i>Electrically Erasable Memory Error:</i> The value of an operator, or configuration, parameter has been corrupted.	This fault will automatically take you into Configuration level. Check all of the configuration parameters before returning to Operator level. Once in Operator level, check all of the operator parameters before resuming normal operation. If the fault persists, or occurs frequently, contact Omega .
5.br	<i>Sensor Break:</i> Input sensor is unreliable or the input signal is out of range.	Check that the sensor is correctly connected.
L.br	<i>Loop Break</i> The feedback loop is open circuit.	Check that the heating and cooling circuits are working properly.
LdF	<i>Load failure</i> Indication that there is a fault in the heating circuit or the solid state relay.	This is an alarm generated by feedback from a Omega SSC-TE10S solid state relay (SSR) operating in PDLINK mode 1 - see Chapter 1, <i>Electrical Installation</i> . It indicates either an open or short circuit SSR, blown fuse, missing supply or open circuit heater.
SSr.F	<i>Solid state relay failure</i> Indication that there is a fault in the solid state relay.	This is an alarm generated by feedback from a Omega SSC-TE10S solid state relay (SSR) operating in PDLINK mode 2 - see Chapter 1, <i>Electrical Installation</i> . It indicates either an open or short circuit condition in the SSR.
Hr.F	<i>Heater failure</i> Indication that there is a fault in heating circuit.	This is an alarm generated by feedback from a Omega SSC-TE10S solid state relay (SSR) operating in PDLINK mode 2 - see Chapter 1, <i>Electrical Installation</i> . It indicates either a blown fuse, missing supply, or open circuit heater.
HwEr	<i>Hardware error</i> Indication that a module is of the wrong type, missing, or faulty.	Check that the correct modules are fitted.
no I/O	<i>No I/O</i> None of the expected I/O modules is fitted.	This error message normally occurs when pre-configuring a controller without installing any of the required I/O modules.

Diagnostic alarms (continued)

These indicate that a fault exists in either the controller, or the connected devices.

Table 2-2b Diagnostic alarms

Display shows	What it means	What to do about it
<i>r m E F</i>	<i>Remote input failure.</i> Either the PDLINK input, or the remote DC input, is open or short circuit	Check for open, or short circuit wiring on the PDLINK, or remote DC, input.
<i>LLLL</i>	<i>Out of range low reading</i>	Check the value of the input.
<i>HHHH</i>	<i>Out of range high reading</i>	Check the value of the input.
<i>Err 1</i>	<i>Error 1: ROM self-test fail</i>	Return the controller for repair.
<i>Err 2</i>	<i>Error 2: RAM self-test fail</i>	Return the controller for repair.
<i>Err 3</i>	<i>Error 3: Watchdog fail</i>	Return the controller for repair.
<i>Err 4</i>	<i>Error 4: Keyboard failure</i> Stuck button, or a button was pressed during power up.	Switch the power off and then on, without touching any of the controller buttons.
<i>Err 5</i>	<i>Error 5: Faulty internal communications.</i>	Check printed circuit board interconnections. If the fault cannot be cleared, return the controller for repair.

Chapter 3 ACCESS LEVELS

This chapter describes the different levels of access to the operating parameters within the controller.

There are three topics:

- THE DIFFERENT ACCESS LEVELS
- SELECTING AN ACCESS LEVEL
- EDIT LEVEL

THE DIFFERENT ACCESS LEVELS

There are four access levels:

- **Operator level**, which you will normally use to operate the controller.
- **Full level**, which is used to commission the controller.
- **Edit level**, which is used to set up the parameters that you want an operator to be able to see and adjust when in Operator level.
- **Configuration level**, which is used to set up the fundamental characteristics of the controller.

Access level	Display shows	What you can do	Password Protection
Operator	<i>OPER</i>	In this level, operators can view and adjust the value of parameters defined in Edit level (see below).	No
Full	<i>FULL</i>	In this level, all the parameters relevant to a particular configuration are visible. All alterable parameters may be adjusted.	Yes
Edit	<i>EDIT</i>	In this level, you can determine which parameters an operator is able to view and adjust in Operator level. You can hide, or reveal, complete lists, individual parameters within each list and you can make parameters read-only or alterable. (See <i>Edit level</i> at the end of this chapter).	Yes
Configuration	<i>CONF</i>	This special level allows access to set up the fundamental characteristics of the controller.	Yes

Figure 3-1 Access levels

SELECTING AN ACCESS LEVEL

Access to Full, Edit or Configuration levels is protected by a password to prevent unauthorized access.

If you need to change the password, see Chapter 6, *Configuration*.

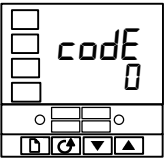
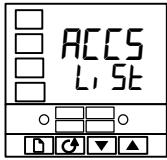



Access list header

Press  until you reach the access list header 'ACCESS'.

Press .

Password entry

The password is entered from the 'CODE' display.

Enter the password using  or . Once the correct password has been entered, there is a two second delay after which the lower readout will change to show 'PASS', indicating that access is now unlocked.



The pass number is set to '1' when the controller is shipped from the factory.



Note: A special case exists if the password has been set to '0'. In this case access will be permanently unlocked and the lower readout will always show 'PASS'.

Press  to proceed to the 'HOME' page.

(If an *incorrect* password has been entered and the controller is still 'locked' then pressing  returns you to the 'ACCESS' list header.)

Access to Read-only Configuration

From this display, pressing  and  together will take you into Read-Only Configuration without entering a password. This will allow you to view all of the configuration parameters, but not adjust them. If no button is pressed for ten seconds, you will be returned to the Home display.

Alternatively, pressing  and  together takes you immediately back to the Home display.

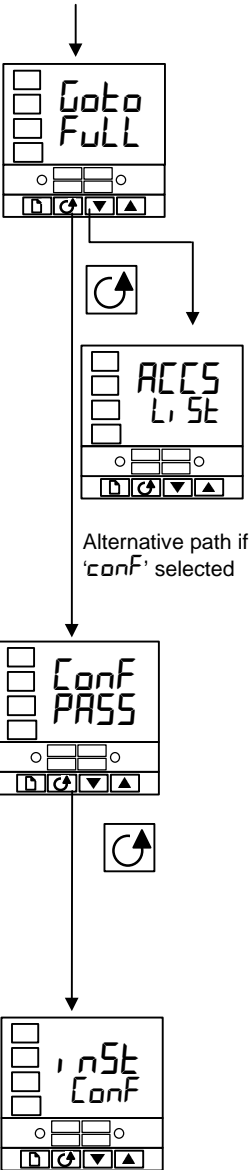

Level selection

The 'Goto' display allows you to select the required access level.

Use and to select from the following display codes:

- OPER*: Operator level
- FULL*: Full level
- EDIT*: Edit level
- CONF*: Configuration level

Press

If you selected either 'OPER', 'FULL' or 'EDIT' level you will be returned to the 'ACCS' list header in the level that you chose. If you selected 'CONF', you will get a display showing 'CONF' in the upper readout (see below).

Configuration password

When the 'CONF' display appears, you must enter the Configuration password in order to gain access to this level. Do this by repeating the password entry procedure described in the previous section.

The configuration password is set to '2' when the controller is shipped from the factory. If you need to change the configuration password, see Chapter 6, *Configuration*.

Press

Configuration level

The first display of configuration is shown. See Chapter 6, *Configuration*, for details of the configuration parameters. For instructions on leaving configuration level, see Chapter 6, *Configuration*.

Returning to Operator Level

To return to operator level from either 'FULL' or 'EDIT' level, repeat entry of the password and select 'OPER' on the 'Goto' display.

In 'EDIT' level, the controller will automatically return to operator level if no button is pressed for 45 seconds



EDIT LEVEL

Edit level is used to set which parameters you can view and adjust in Operator level. It also gives access to the 'Promote' feature, which allows you to select and add ('Promote') up to twelve parameters into the Home display list, thereby giving simple access to commonly used parameters.



Setting operator access to a parameter

First you must select **Edi t** level, as shown on the previous page.

Once in **Edi t** level, you select a list, or a parameter within a list, in the same way as you would in Operator, or Full, level – that is to say, you move from list header to list

header by pressing , and from parameter to parameter within each list using .

However, in Edit level what is displayed is not the value of a selected parameter, but a code representing that parameter's availability in Operator level.

When you have selected the required parameter, use  and  buttons to set its availability in Operator level.

There are four codes:

- ALtEr** Makes a parameter alterable in Operator level.
- PrO** Promotes a parameter into the Home display list.
- rEAd** Makes a parameter, or list header, read-only (*it can be viewed but not altered*).
- HI dE** Hides a parameter, or list header.

For example:

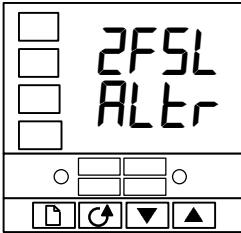

The parameter selected is Alarm 2, Full Scale Low

It is alterable in Operator level

Hiding or revealing a complete list

To hide a complete list of parameters, all you have to do is hide the list header. If a list header is selected, only two selections are available: **rEAd** and **HI dE**.

(It is not possible to hide the 'ACCs' list, which always displays the code: 'L, SE'.)

Promoting a parameter

Scroll through the lists to the required parameter and choose the '**PrO**' code. The parameter is then automatically added (promoted) into the Home display list. (The parameter will also be accessible, as normal, from the standard lists.) A maximum of twelve parameters can be promoted. Promoted parameters are automatically 'alterable'. Please note, in the '**PrOG L, SE**', the parameters from segment number (**SEGr**) onwards *cannot* be promoted.

Chapter 4 TUNING

Before tuning please read Chapter 2, *Operation*, to learn how to select and change a parameter.

This chapter has five main topics:

- WHAT IS TUNING?
- AUTOMATIC TUNING
- MANUAL TUNING
- COMMISSIONING OF MOTORIZED VALVE CONTROLLERS
- GAIN SCHEDULING

WHAT IS TUNING?

In tuning, you match the characteristics of the controller to that of the process being controlled in order to obtain good control. Good control means:

- Stable ‘straight-line’ control of the temperature at setpoint without fluctuation
- No overshoot, or undershoot, of the temperature setpoint
- Quick response to deviations from the setpoint caused by external disturbances, thereby restoring the temperature rapidly to the setpoint value.

Tuning involves calculating and setting the value of the parameters listed in Table 4-1. These parameters appear in the ‘ $P_i d'$ ’ list.

Table 4-1 Tuning parameters

Parameter	Code	Meaning or Function
Proportional band	P_b	The bandwidth, in display units, over which the output power is proportioned between minimum and maximum.
Integral time	t_i	Determines the time taken by the controller to remove steady-state error signals.
Derivative time	t_d	Determines how strongly the controller will react to the rate-of-change of the measured value.
High Cutback	H_{cb}	The number of display units, above setpoint, at which the controller will increase the output power, in order to prevent undershoot on cool down.
Low cutback	L_{cb}	The number of display units, below setpoint, at which the controller will cutback the output power, in order to prevent overshoot on heat up.
Relative cool gain	r_{EL}	Only present if cooling has been configured and a module is fitted. Sets the cooling proportional band, which equals the P_b value divided by the r_{EL} value.

AUTOMATIC TUNING

Two automatic tuning procedures are provided in the CN2408 and CN2404:

- **A one-shot tuner** which automatically sets up the initial values of the parameters listed in Table 4-1 on the previous page.
- **Adaptive tuning** which continuously monitors the error from setpoint and modifies the PID values if necessary.

One Shot Tuning

The 'one-shot' tuner works by switching the output on and off to induce an oscillation in the measured value. From the amplitude and period of the oscillation, it calculates the tuning parameter values.

If the process cannot tolerate full heating or cooling being applied during tuning, then the level of heating or cooling can be restricted by setting the heating and cooling power limits in the ' ΔP ' list. However, the measured value *must* oscillate to some degree for the tuner to be able to calculate values.

A One-shot Tune can be performed at any time, but normally it is performed only once during the initial commissioning of the process. However, if the process under control subsequently becomes unstable (because its characteristics have changed), you can re-tune again for the new conditions.

It is best to start tuning with the process at ambient temperature. This allows the tuner to calculate more accurately the low cutback and high cutback values, which restrict the amount of overshoot or undershoot.

How to tune

1. Set the setpoint to the value at which you will normally operate the process.
2. In the ' ΔTun ' list, select ' $\Delta Tun E$ ' and set it to ' ΔOn '.
3. Press the Page and Scroll buttons together to return to the Home display. The display will flash ' $\Delta Tun E$ ' to indicate that tuning is in progress.
4. The controller induces an oscillation in the temperature by first turning the heating on, and then off. The first cycle is not complete until the measured value has reached the required setpoint.
5. After two cycles of oscillation the tuning is completed and the tuner switches itself off.
6. The controller then calculates the tuning parameters listed in Table 4-1 and resumes normal control action.

If you want 'Proportional only', 'PD', or 'PI' control, you should set the ' ΔI ' or ' Δd ' parameters to ΔOff before commencing the tuning cycle. The tuner will leave them off and will not calculate a value for them.

Typical automatic tuning cycle

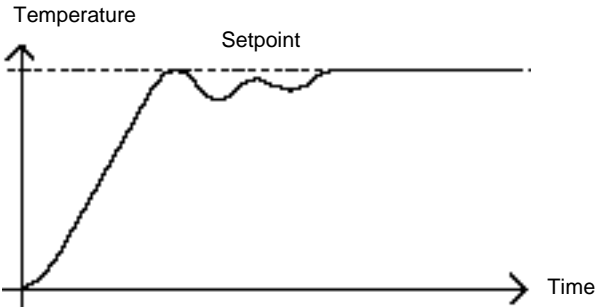

Calculation of the cutback values

Low cutback and *High cutback* are values that restrict the amount of overshoot or undershoot that occur during large step changes in temperature (for example, under start-up conditions).

If either low cutback, or high cutback, is set to 'Auto' the values are fixed at three times the proportional band, and are not changed during automatic tuning.

Adaptive tune

Adaptive tuning is a background algorithm, which continuously monitors the error from setpoint and analyses the control response during process disturbances. If the algorithm recognizes an oscillatory, or under-damped, response it recalculates the Pb , Ed , and Ed values.

Adaptive tune is triggered whenever the error from setpoint exceeds a trigger level. This trigger level is set in the parameter 'd-R-E', which is found in the Autotune list. The value is in display units. It is automatically set by the controller, but can also be manually re-adjusted.

Adaptive tune should be used with:

1. Processes whose characteristics change as a result of changes in the load, or setpoint.
2. Processes that cannot tolerate the oscillation induced by a One-shot tune.

Adaptive tune should not be used:

1. Where the process is subjected to regular external disturbances that could mislead the adaptive tuner.
2. On highly interactive multiloop applications. However, moderately interactive loops, such as multi-zone extruders, should not give a problem.

MANUAL TUNING

If for any reason automatic tuning gives unsatisfactory results, you can tune the controller manually. There are a number of standard methods for manual tuning. The one described here is the Ziegler-Nichols method.

With the process at its normal running temperature:

1. Set the Integral Time ' t_i ' and the Derivative Time ' t_d ' to *OFF*.
2. Set High Cutback and Low Cutback, ' Hcb ' and ' Lcb ', to *Auto*.
3. Ignore the fact that the temperature may not settle precisely at the setpoint.
4. If the temperature is stable, reduce the proportional band ' Pb ' so that the temperature just starts to oscillate. If the temperature is already oscillating, increase the proportional band until it just stops oscillating. Allow enough time between each adjustment for the loop to stabilize. Make a note of the proportional band value 'B' (engineering units) and the period of oscillation 'T' (seconds or minutes).
5. Set the Pb , t_i and t_d parameter values according to the calculations given in Table 4-2.

Table 4-2 Tuning values

Type of control	Proportional band 'Pb'	Integral time 'ti'	Derivative time 'td'
Proportional only	2xB	OFF	OFF
P + I control	2.2xB	0.8xT	OFF
P + I + D control	1.7xB	0.5xT	0.12xT

Setting the cutback values

The above procedure sets up the parameters for optimum steady state control. If unacceptable levels of overshoot or undershoot occur during start-up, or for large step changes in temperature, then manually set the cutback parameters ' L_{cb} ' and ' H_{cb} '.

Proceed as follows:

1. Set the low and high cutback values to three proportional bandwidths (that is to say, $L_{cb} = H_{cb} = 3 \times P_b$).
2. Note the level of overshoot, or undershoot, that occurs for large temperature changes (see the diagrams below).

In example (a) increase ' L_{cb} ' by the overshoot value. In example (b) reduce ' L_{cb} ' by the undershoot value.

Example (a)

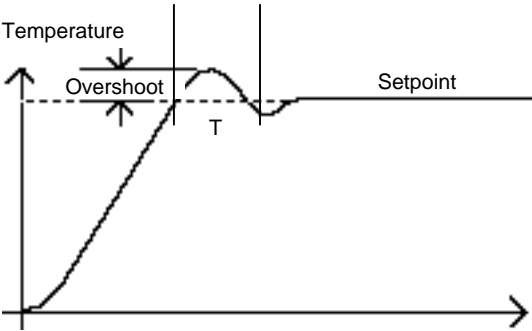

Example (b)

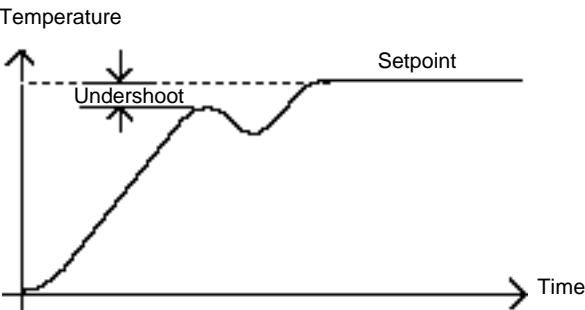

Where the temperature approaches setpoint from above, you can set ' H_{cb} ' in a similar manner.

Integral action and manual reset

In a full three-term controller (that is, a PID controller), the integral term 'i' automatically removes steady state errors from the setpoint. If the controller is set up to work in two-term mode (that is, PD mode), the integral term will be set to 'OFF'. Under these conditions the measured value may not settle precisely at setpoint. When the integral term is set to 'OFF' the parameter *manual reset* (code 'rES') appears in the 'P, d, I, S, E' in 'FULL' level. This parameter represents the value of the power output that will be delivered when the error is zero. You must set this value manually in order to remove the steady state error.

Automatic droop compensation (Adc)

The steady state error from the setpoint, which occurs when the integral term is set to 'OFF' is sometimes referred to as 'droop'. 'Adc' automatically calculates the manual reset value in order to remove this droop. To use this facility, you must first allow the temperature to stabilize. Then, in the autotune parameter list, you must set 'Adc' to 'on'. The controller will then calculate a new value for manual reset, and switch 'Adc' to 'OFF'.

'Adc' can be repeated as often as you require, but between each adjustment you must allow time for the temperature to stabilize.

MOTORIZED VALVE CONTROL

The CN2408 AND CN2404 can be configured for motorized valve control as an alternative to the standard PID control algorithm. This algorithm is designed specifically for positioning motorized valves.

These are ordered, pre-configured, as Model numbers:

- CN2408-VC AND CN2404-VC motorized valve controllers
- CN2408-VP AND CN2404-VP motorized valve controllers with a single setpoint programmer
- CN2408-V4 AND CN2404-V4 motorized valve controllers storing four setpoint programs.

Figure 1-11 in Chapter 1 shows how to connect a motorized valve controller. The control is performed by sending open or close pulses in response to the control demand signal.

The motorized valve algorithm can operate in one of three ways:

1. The so-called *boundless* mode, which does not require a position feedback potentiometer for control purposes; although one can be connected and used purely to display the valve's position.
2. Bounded, (*or position*), control mode, which requires a feedback potentiometer. This is closed-loop control determined by the valve's position.
3. The desired control mode is selected in the 'n5t' list in configuration level.

The following parameter list will appear in the navigation diagram shown in Chapter 2, if your controller is configured for motorized valve control.

Table 4-3 Motorized valve parameter list

Name	Description	Values		
		Min	Max	Default
<i>mtr</i>	Motor list			
<i>tm</i>	Valve travel time in seconds. This is the time taken for the valve to travel from its fully closed position to its fully open position.	0.1	240.0	30.0
<i>int</i>	Valve inertia time in seconds. This is the time taken for the valve to stop moving after the output pulse is switched off.	OFF	20.0	OFF
<i>brct</i>	Valve backlash time in seconds. This is the minimum on-time required to reverse the direction of the valve. i.e. the time to overcome the mechanical backlash.	OFF	20.0	OFF
<i>mpct</i>	Output pulse minimum on-time, in seconds.	<i>RuLo</i>	100.0	<i>RuLo</i>
<i>ubr</i>	Valve sensor break strategy.	rEST uP dwn		dwn

COMMISSIONING THE MOTORIZED VALVE CONTROLLER

The commissioning procedure is the same for both bounded and boundless control modes, except in bounded mode you must first calibrate the position feedback potentiometer, as described in the section below.

Proceed as follows:

1. Measure the time taken for the valve to be raised from its fully closed to its fully open position and enter this as the value in seconds into the ' t_m ' parameter.
2. Set all the other parameters to the default values shown in Table 4-3.

The controller can then be tuned using any of the automatic, or manual, tuning procedures described earlier in this chapter. As before, the tuning process, either automatic or manual, involves setting the values of the parameters in Table 4-1. The only difference with boundless control is that the derivative term ' t_d ', although present, will have no effect.

Adjusting the minimum on-time ' mP_t '

The default value of 0.2 seconds is satisfactory for most processes. If, however, after tuning the process, the valve activity is excessively high, with constant oscillation between raise and lower pulses, the minimum on-time can be increased.

The minimum on-time determines how accurately the valve can be positioned and therefore the control accuracy. The shorter the time, the more precise the control.

However, if the time is set too short, process noise will cause an excessively busy valve.

Inertia and backlash settings

The default values are satisfactory for most processes, i.e. ' OFF '.

Inertia is the time taken for the valve to stop after the output pulse is turned off. If this causes a control problem, the inertia time needs to be determined and then entered into the parameter, ' t_n '. The inertia time is subtracted from the raise and lower output pulse times, so that the valve moves the correct distance for each pulse.



Backlash is the output pulse time required to reverse the direction of the valve, i.e. the time taken to overcome the mechanical backlash of the linkages. If the backlash is sufficient to cause a control problem, then the backlash time needs to be determined and then entered into the parameter, ' $back_t$ '.

























The above two values are not part of the automatic tuning procedure and must be entered manually.

CALIBRATING THE POSITION FEEDBACK POTENTIOMETER

Before proceeding with the feedback potentiometer calibration, you should ensure, in configuration level, that module position 2 ($2A$), or 3 ($3A$), has its ' d ' indicating ' Pot_t ', (meaning *Potentiometer Input*). Continue to scroll down the module configuration list. ' $Func$ ' should be set to ' $UPoS$ ', ' VAL_L ' must be set to ' 0 ' and ' VAL_H ' to ' 100 '.

Exit from configuration and you are now ready to calibrate the position feedback potentiometer. Proceed as follows.

1. In Operator level, press the AUTO/MAN button to put the controller in Manual mode.
2. Drive the valve to its fully open position using 
3. Press  until you get to ' $P-L, 5t$ '.

4. Press  to get to 'PCAL-OFF'.
5. Press  or  to turn 'PCAL' to 'on'.
6. Press  and the upper readout indicates 'Pot'.
7. Press  or  to get to 'Pot-3AH'. (Assuming that the Potentiometer Input Module is in module position 3.)
8. Press  to go to 'GO-no'.
9. Press  or  to see 'GO-YES', which starts the calibration procedure.
10. Calibration is complete when the display returns to 'GO-no'.
11. Press  and  together to return directly to the Operator level.
12. The controller should still be in Manual mode.
13. Drive the valve to its fully closed position using .
14. Press  until you get to 'P-L, 5t'.
15. Press  to get to 'PCAL-OFF'.
16. Press  or  to turn 'PCAL' to 'on'.
17. Press  and the upper readout indicates 'Pot'.
18. Press  or  to get to 'Pot-3ALo'.
19. Press  to go to 'GO-no'.
20. Press  or  to see 'GO-YES', which starts the calibration procedure.
21. Calibration is complete when the display returns to 'GO-no'.
22. Press  and  together to return directly to the Operator level.
23. Press the AUTO/MAN button to place the controller in AUTO and the calibration of the position feedback potentiometer is now complete.

Chapter 5 PROGRAMMER OPERATION

This chapter deals with the setpoint programming option. All CN2408 and CN2404 instruments have a basic 8-segment programmer built-in as standard. This facility must be enabled by the user, as explained in the section, *Configuring the Programmer*.

Other programmer versions are listed below, and have 16-segments in each program.

16-segment programmer with:

a single program:	Models CN2408-CG and CN2404-CG Models CN2408-CP and CN2404-CP
four stored programs:	Models CN2408-P4 and CN2404-P4
twenty stored programs:	Models CN2408-CM and CN2404-CM

16-segment Motorized Valve programmer with:

a single program:	Models CN2408-VG and CN2404-VG Models CN2408-VP and CN2404-VP
four stored programs:	Models CN2408-V4 and CN2404-V4
twenty stored programs:	Models CN2408-VM and CN2404-VM.

The 8-segment programmer differs from the other programmers in that it will not provide event outputs and program synchronization. Otherwise, they all operate in the same way.

There are eight topics:

- WHAT IS SETPOINT PROGRAMMING?
- PROGRAMMER STATES
- RUNNING A PROGRAM FROM THE RUN LIST
- RUNNING A PROGRAM USING THE RUN/HOLD BUTTON
- AUTOMATIC BEHAVIOUR
- CONFIGURING THE PROGRAMMER
- CONFIGURING DIGITAL INPUTS TO SELECT PROGRAM NUMBER
- CREATING A NEW PROGRAM, OR MODIFYING AN EXISTING PROGRAM.

To understand how to select and change parameters in this chapter you need to have read Chapter 2, *Operation* and Chapter 3, *Access Levels*.

WHAT IS SETPOINT PROGRAMMING?

Many applications need to vary temperature, or process value, with time. Such applications need a controller which varies a setpoint as a function of time; all CN2408 and CN2404 models can do this.

The setpoint is varied by using a *setpoint program*. Within each CN2408 and CN2404 controller, there is a software module called *the programmer*, which stores one, or more, such programs and drives the setpoint according to the selected program. The program is stored as a series of 'ramp' and 'dwell' segments, as shown below.

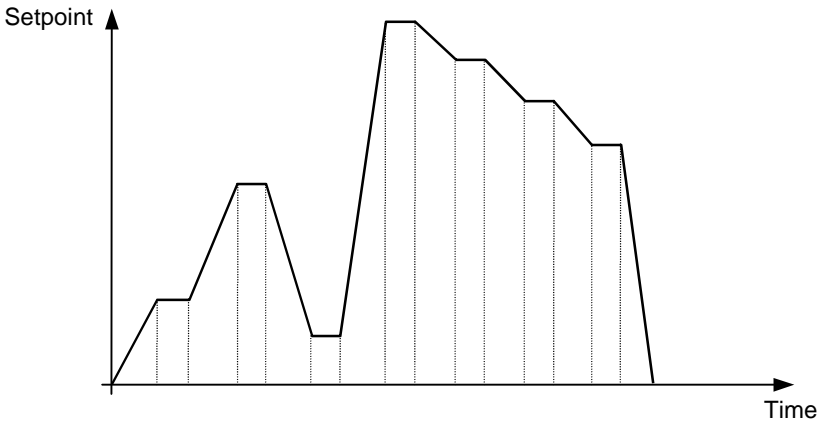

Fig 5-1 Setpoint profile



*(If the 8-segment programmer is being used, then the information in the next paragraph does **not** apply.)*

In each segment you can define the state of up to eight (8) digital outputs, each of which can be used to trigger external events. These are called *event outputs* and can drive either relay, logic, or AC SSR outputs, depending on the modules installed.

A program is executed either, once, repeated a set number of times, or repeated continuously. If repeated a set number of times, then the number of cycles must be specified as part of the program.

There are five different types of segment:

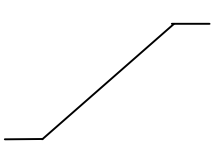
Table 5-1 Segment Types

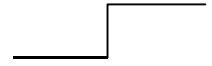
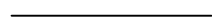
Ramp		The setpoint ramps linearly , from its current value to a new value, either at a set rate (called <i>ramp-rate programming</i>), or in a set time (called <i>time-to-target programming</i>). You must specify the ramp rate or the ramp time, and the target setpoint, when creating or modifying a program.
Dwell		The setpoint remains constant for a specified period.
Step		The setpoint steps instantaneously from its current value to a new value.
Call		The main program calls another program as a subroutine. The called program then drives the setpoint until it returns control to the main program. This facility is available on those controllers with 4, or 20, stored programs.
End		The program either ends in this segment, or repeats. You specify which is the case when you create, or modify, the program (see the final topic in this chapter). When the program ends, the programmer is put into either, a continuous Dwell state with all outputs staying unchanged, or the Reset state, or to a settable power level.

PROGRAMMER STATES

The programs have five states: *Reset*, *Run*, *Hold*, *Holdback* and *End*.

Table 5-2 Program States

State	Description	Indication
Reset	In Reset, the programmer is inactive and the controller behaves as a standard controller, with the setpoint determined by the value set in the lower readout.	Both the RUN and HOLD lights are OFF
Run	In Run, the programmer varies the setpoint according to the active program.	RUN light on
Hold	In Hold, the program is frozen at its current point. In this state you can make temporary changes to any program parameter (for example, a target setpoint, a dwell time, or the time remaining in the current segment). Such changes will only remain effective until the program is reset and run again, when they will be overwritten by the stored program values. Note: When a program is running, you <u>cannot</u> alter a CALL ed program until it becomes active within that program.	HOLD light on
Holdback	Holdback indicates that the measured value is lagging the setpoint by more than a preset amount and that the program is in Hold, waiting for the process to catch up. See <i>Holdback</i> in the section on Automatic behavior later this chapter.	HOLD light flashes
End	The program is complete.	RUN light flashes

RUNNING A PROGRAM FROM THE RUN LIST

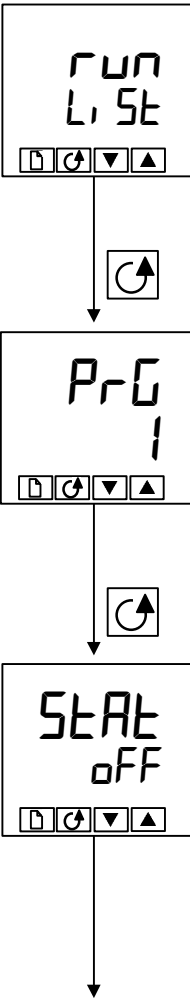

The Run List

From the Home display, press until you reach the 'run' list header.

Press .

Program number

This display only appears on programmers that can store more than one program. Use or to select the required program number, from 1 to 4, or 1 to 20, depending on the particular controller.

Alternatively, the program number can be selected remotely, using digital inputs on the rear terminals. See the section on *Configuring Digital Inputs to Select a Program Number* for information on how this is done.

Press .

Status selection

Use or to select:

- **run:** Run program.
- **hold:** Hold program.
- **OFF:** Program reset.

After two seconds, the lower readout blinks and the chosen state is now active.

To return to the Home display press and together.

Other parameters

To access the other parameters in the 'run' list, continue to Press . These parameters are shown in the 'Program run list' in Chapter 2, Parameter Tables. They show the current status of the active program.

Temporary changes

Temporary changes can be made to the parameters in this 'run' list, (for example a setpoint, ramp rate, or an unelapsed time), by first placing the programmer into 'hold'. Such changes remain active only for the duration of the segment; the segment parameters will revert to their original (stored) values whenever the segment is re-executed.

RUNNING A PROGRAM USING THE RUN/HOLD BUTTON

If you are using a 4, or 20, program version of the controller, you must first select the number of the program that you want to run. Do this in the 'run' list – see the previous topic, *Running a program from the Run list*. Then:

	<p>RUN / HOLD button</p>	<p>Press once to run a program (RUN light on) Press again to hold a program (HOLD light on) Press again to cancel hold and continue running (HOLD light off, RUN light on) Press and hold in for two seconds to reset a program (RUN and HOLD lights off).</p>
---	------------------------------	--

Note: The RUN/HOLD button can be disabled, either when ordering the controller, or subsequently in configuration. This will force you to operate the programmer from the 'run' list all the time. The main advantage of this method is that it will reduce the chance of accidentally changing the state of a program.

AUTOMATIC BEHAVIOR

The preceding topics explain how to operate the programmer manually.

The following topics cover aspects of its automatic behavior: *Servo*, *Holdback* and *Power Failure*.

Servo

When a program is RUN, the setpoint can start either from the initial controller setpoint, or from the process value. Whichever it is, the starting point is called the 'servo' point and you set it up in configuration. When the program starts, the transition of the setpoint to its starting point is called 'servoing'.

The normal method is to servo to the process value, because this will produce a smooth and bumpless start to the process. However, if you want to guarantee the time period of the first segment, you should set the controller to servo to its setpoint.

Holdback

As the setpoint ramps up, or down (or dwells), the measured value may lag behind, or deviate from, the setpoint by an undesirable amount. 'Holdback' is available to freeze the program at its current state, should this occur. The action of Holdback is the same as a deviation alarm. It can be enabled, or disabled. Holdback has **two** parameters - a *value* and a *type*.

If the error from the setpoint exceeds the set 'holdback' value, then the Holdback feature, if enabled, will automatically freeze the program at its current point and flash the HOLD light. When the error comes within the holdback value, the program will resume normal running.

There are *four* different Holdback types. The choice of type is made by setting a parameter when creating a program, and may be one of the following:–

'OFF' – **Disables Holdback** – therefore no action is taken.

'Lo' – **Deviation Low Holdback** holds the program back when the process variable deviates *below* the setpoint by more than the holdback value.

'Hi' – **Deviation High Holdback** holds the program back when the process variable deviates *above* the setpoint by more than the holdback value.

'band' – **Deviation Band Holdback** is a combination of the two. It holds the program back when the process variable deviates *either above, or below*, the setpoint by more than the holdback value.

There is a single Holdback Value which applies to the whole program. However, the Holdback type and whether or not it is enabled, can be applied to the program as a whole, or individually in each segment.

Power failure

If power is lost and then restored, while a program is running, the behavior of the programmer is determined by the setting of the parameter 'PwrF' Power fail strategy in Programmer configuration. This can have one of three settings:– **cont** (Continue), **rmpb** (Ramp from PV), or **rSET** (Reset).

If '**cont**' is selected, then when power is restored the program continues from where it was interrupted when power was lost. All parameters, such as the setpoint and time remaining in the active segment, will be restored to their power-down values. For applications that need to bring the measured process value to the setpoint as soon as possible, this is the best strategy.

If '**rmpb**' is selected, then when power is restored the setpoint starts at ('servos to') the current measured value, and then ramps to the target setpoint of the active segment at the last ramp rate used by the program. This strategy provides a smoother recovery. The two diagrams below illustrate the respective responses, Fig 5-2 if power fails during a dwell segment and Fig 5-3 if it fails during a ramp segment.

Figure 5-2 Continue after a power fail

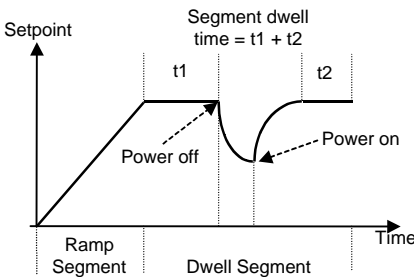
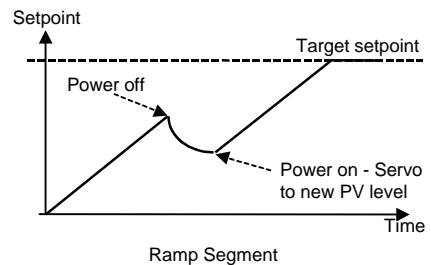

Figure 5-3 Ramp back after a power fail



If '**rSET**' is selected, then when power is restored the program terminates.

CONFIGURING THE PROGRAMMER

When first installing a programmer, you should check that the configuration conforms to your requirement.

Configuration defines:

- the number of stored programs *(multi-programmer only)*
- the holdback strategy
- the power fail strategy
- the servo type
- if event outputs are available *(not 8-segment programmer)*
- if program synchronization is available. *(not 8-segment programmer)*
- selection of program number using digital inputs *(multi-programmer only)*

To **check or change** the configuration, select Configuration level. See Chapter 6.

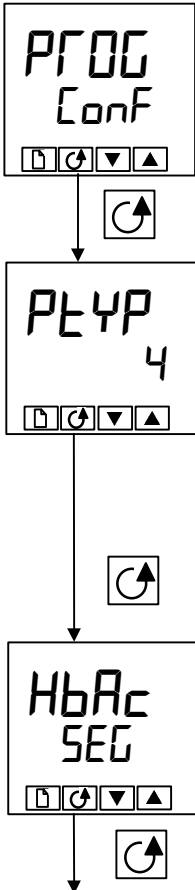

Programmer list header

After selecting Configuration mode, press  until the **PRPG Conf** header is displayed.

Press 

Number of programs

Use  or  to select:

- **nonE**: Disable built-in 8-segment programmer
- **!**: Enable built-in 8-segment programmer

For 16-segment programmers:

- **nonE**: no programs
- **1**: One stored program
- **4**: Four stored programs
- **20**: Twenty stored programs

Press 

Holdback Strategy

Use  or  to select:

SEG: Holdback type to be set in each segment

PRPG: Holdback type to be set for the whole program

Press 

Continued on the next page.

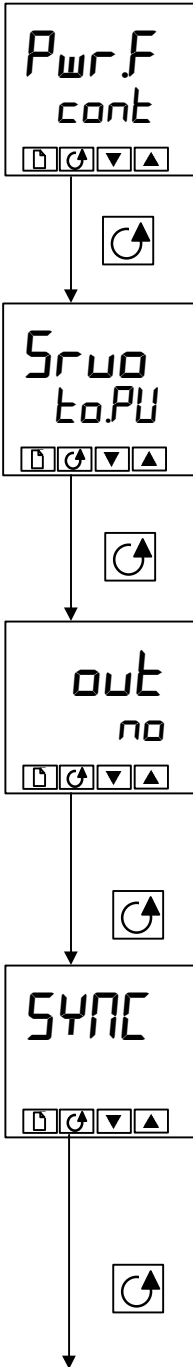

Power fail strategy

Use or to select

- *cont*: Continue from last setpoint
- *rmPb*: Ramp from PV to setpoint at last ramp rate
- *rSEt*: Reset the program.

Press

Servo type

Use or to select:

- *to.PU*: Servo to PV
- *to.SP*: Servo to SP

Press

Event Outputs *(not in 8-segment programmer)*

Use or to select:

- *no*: Event outputs disabled
- *YES*: Event outputs enabled

Press

Synchronization *(not in 8-segment programmer)*

Use or to select:

- *no*: Synchronization disabled
- *YES*: Synchronization enabled

Press to return the list header.

CONFIGURING DIGITAL INPUTS TO SELECT PROGRAM NUMBER



The program number can be selected by external BCD inputs from, for example, a thumbwheel switch.

The appropriate number of digital inputs must be installed in the controller and be configured for this function - see Chapter 6, *Configuration*.

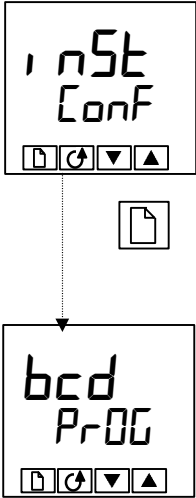
To invoke this mode of operation, the parameter 'bcd' in 'i nSt-Conf' must be set to 'PrOG'.



Press  until you reach 'bcd'.

Use the  or  buttons, to select 'PrOG'.

CREATING A NEW PROGRAM, OR MODIFYING AN EXISTING ONE

The only difference between creating a new program, and modifying an existing one, is that a new program starts with all its segments set to *End* in the *TYPE* parameter. The procedure for both consists of setting up the parameters in the *PrOG* list of the Operator Navigation Diagram shown in Chapter 2. As explained earlier under ‘Programmer states’, temporary changes can be made to these parameters while in the *HOLD* state but permanent changes (to the stored values) can only be made when the programmer is in the Reset state. So, before modifying a stored program, first make sure that it is in Reset and then follow the procedure below

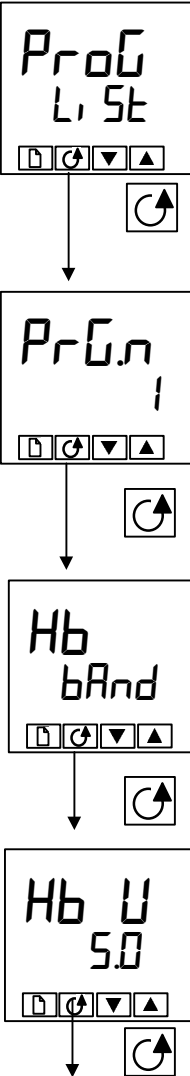



Program edit list

From the Home display press  until you reach the *PrOG L, St* header.

Press 

Program number

This display appears only on the multi-program controllers.

Use  or  to select the number of the program which you wish to modify (from 1 to 4, or 1 to 20).

Press 

Holdback type

[Only appears when Holdback has been selected for the whole program.]

Use  or  to select:

- *OFF*: Holdback disabled
- *Lo*: Deviation Low Holdback
- *Hi*: Deviation High Holdback
- *bAnd*: Deviation Band Holdback

Press 

Holdback value

Note! The value set in this parameter is always for the whole program.

Use  or  to set the value.

Press 

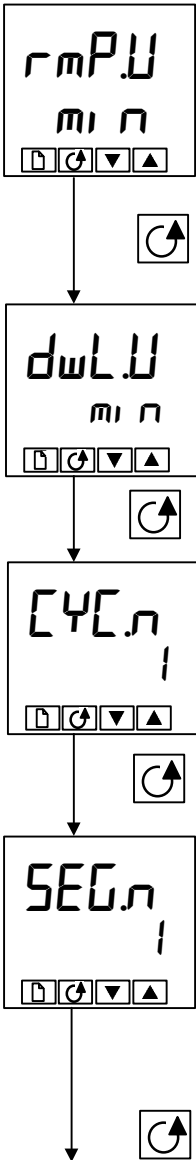

Ramp units

Use or to select:

- SEc
- min
- Hour

Press

Dwell units

Use or to select:

- SEc
- min
- Hour

Press

Number of program cycles

Use or to set the number of program cycles required from 1 to 999, or 'cont' for continuous cycling.

Press

Segment number

Use or to select the number, from 1 to 16.



(1 to 8 in 8-segment programmers)

The parameters that follow 'SEG.n' set up the characteristics of the individually selected segment number. By defining the characteristics of each segment of the program, you define the whole program.

Press

Continued on the next page

Segment type

Select the segment type using  or: 

- *rmpR*: Ramp to a new setpoint at a set rate
- *rmpT*: Ramp to a new setpoint in a set time
- *dwEll*: Dwell for a set time
- *StEP*: Step to a new setpoint
- *cALL*: Call another program as a subroutine
(only available in multi-program controllers)
- *End*: Make this segment the end of the program.



Press 

The parameters that follow 'TYPE' depend on the type of segment selected as shown in the table below. The function of each parameter follows the table.

Table 5.3 Parameters that Follow Segment TYPE

Parameter	Segment type selected					
	<i>rmpR</i>	<i>rmpT</i>	<i>dwEll</i>	<i>StEP</i>	<i>cALL</i>	<i>End</i>
<i>Hb</i>	✓	✓	✓	✓		
<i>tGt</i>	✓	✓		✓		
<i>rAtE</i>	✓					
<i>dur</i>		✓	✓			
<i>PrGn</i>					✓	
<i>cYcn</i>					✓	
<i>SYnc</i>	✓	✓	✓	✓		
<i>Endt</i>						✓
<i>Pwr</i>						✓

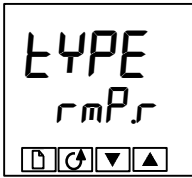

Press 



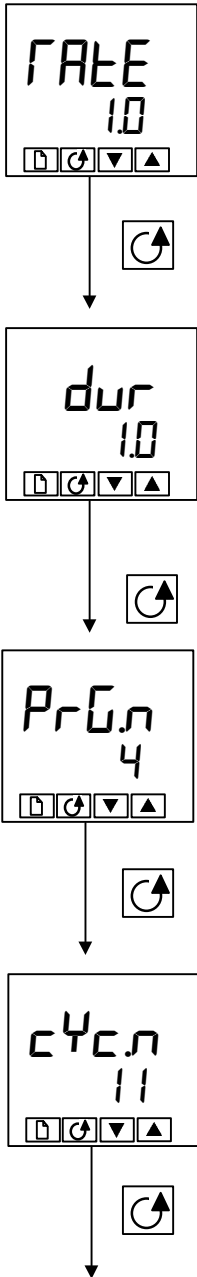

Ramp rate

Ramp rate for 'r mP_r ' segments

Using or set a value for the ramp rate, ranging from 0.01 to 99.99. The units are the ramp units (r mP_U) set earlier in this sequence.

Press

Duration time

Time for a 'd wE_l ' segment, or time to target for a 'r mP_t ' segment.

Set the time using or You have set the units earlier in this sequence. [*'d wL_U ' defines the units for 'd wE_l ' segments: 'r mP_U ' defines the units for 'r mP_t ' segments.]*

Press

Called program number

Only appears for 'c ALL ' segments. (*multi-program controllers only*)

Set a called program number from 1 to 4, or from 1 to 20, using or .

Press

Number of cycles of the c $ALLED$ program

Only appears for 'c ALL ' segments. (*multi-program controllers only*)

Sets the number of cycles of the c $ALLED$ program from 1 to 999, using or .

Press

Continued on the next page.

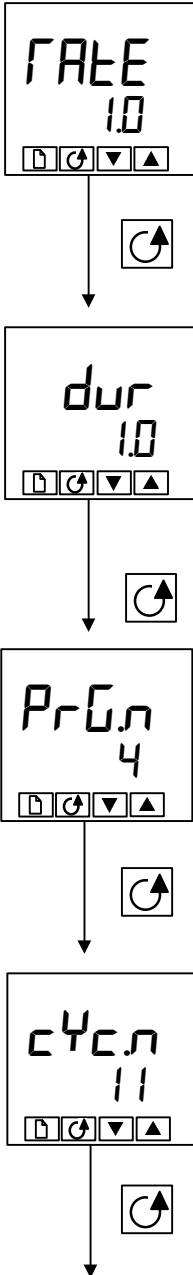

Event output 1 (16-segment programmers only)

Appears in all segments, except 'cALL' segments.

Use or to set output 1:

- OFF: Off in the current segment
- on: On the current segment.

Press

Further event outputs (16-segment programmers only)

Up to eight (8) event outputs may appear in this list where 'n' = event number.

Pressing will step through all the remaining event outputs.

Note: If you are not using all of the event outputs, you can step immediately to the next segment number by pressing.

Press

Synchronization event output (only appears if configured)

Use or to select:

- YES: Synchronization Enabled
- no: Synchronization Disabled

Note: This event output, if used, occupies the position of 'outB'.

Press

End segment



Use or to select:

- dwell: An indefinite dwell
- rSEt: Reset.
- S OP: End Segment Output Power Level

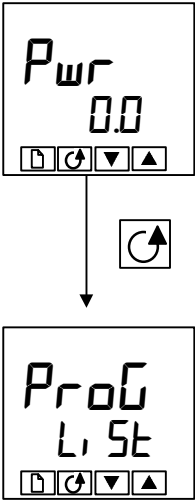
Press



Power Value [End Segment]

Use  or  to set the power value in the range $\pm 100.0\%$.

This power level is clipped by the parameters 'OPHi' and 'OPLo' before being applied to the process.

Press  to return to the Prog-List

Chapter 6 CONFIGURATION

This chapter consists of six topics:

- SELECTING CONFIGURATION LEVEL
- LEAVING CONFIGURATION LEVEL
- SELECTING A CONFIGURATION PARAMETER
- CHANGING THE PASSWORDS
- NAVIGATION DIAGRAM
- CONFIGURATION PARAMETER TABLES.

In configuration level you set up the fundamental characteristics of the controller. These are:



- The type of control (e.g. reverse or direct acting)
- The Input type and range
- The Setpoint configuration
- The Alarms configuration
- The Programmer configuration
- The Digital input configuration
- The Alarm Relay configuration
- The Communications configuration
- The Modules 1, 2 & 3 configuration
- Calibration
- The Passwords.

WARNING

Configuration is protected by a password and should only be carried out by a qualified person, authorized to do so. Incorrect configuration could result in damage to the process being controlled and/or personal injury. It is the responsibility of the person commissioning the process to ensure that the configuration is correct.

SELECTING CONFIGURATION LEVEL

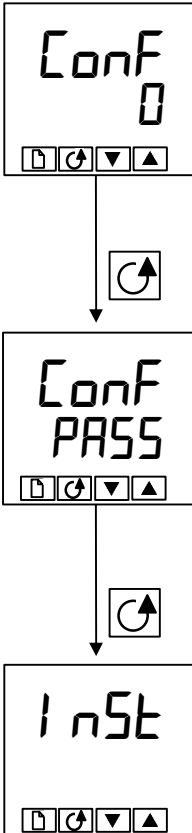

There are two alternative methods of selecting Configuration level:

- If you have already powered up, then follow the access instructions given in Chapter 3, *Access levels*.
- Alternatively, press  and  together when powering up the controller. This will take you directly to the 'ConF' password display.



Password entry



When the 'ConF' display appears, you must enter the Configuration password (which is a number) in order to gain access to Configuration level.

Enter the password using the  or  buttons. The configuration password is set to '2' when the controller is shipped from the factory.

Once the correct password has been entered, there is a two second delay, after which the lower readout will change to 'PASS' indicating that access is now unlocked.

Note: A special case exists if the password has been set to '0'. In this situation, access is permanently unlocked and the lower readout will always show 'PASS'.



Press  to enter configuration.

(If an incorrect password has been entered and the controller is still 'locked' then pressing  at this point will take you to the 'Exit' display with 'no' in the lower readout. Simply press  to return to the 'ConF' display



You will obtain the first display of configuration.

LEAVING CONFIGURATION LEVEL

To leave the Configuration level and return to Operator level Press  until the 'Exit' display appears.

Alternatively, pressing  and  together will take you directly to the 'Exit' display.



Use  or  to select 'YES'. After a two-second delay, the display will blank and revert to the Home display in Operator level.

SELECTING A CONFIGURATION PARAMETER

The configuration parameters are arranged in lists as shown in the navigation diagram in Figure 6.1.



To step through the list headers, press the Page  button.

To step through the parameters within a particular list press the Scroll  button.

When you reach the end of the list you will return to the list header.

You can return directly to the list header at any time by pressing the Page  button.

Parameter names

Each box in the navigation diagram shows the display for a particular parameter. The upper readout shows the name of the parameter and the lower readout its value. For a definition of each parameter, see the Configuration Parameter Tables at the end of this chapter. To change the value of a selected parameter, use the  and  buttons.

The navigation diagram shows all the lists headers and parameters that can, potentially, be present in the controller. In practice, those actually present will vary according to the particular configuration choices you make.

CHANGING THE PASSWORDS

There are TWO passwords. These are stored in the Password configuration list and can be selected and changed in the same manner as any other configuration parameter.

The password names are:

'*Full*', which protects access to Full level and Edit level

'*Conf*', which protects access to Configuration level.

NAVIGATION DIAGRAM (PART A)

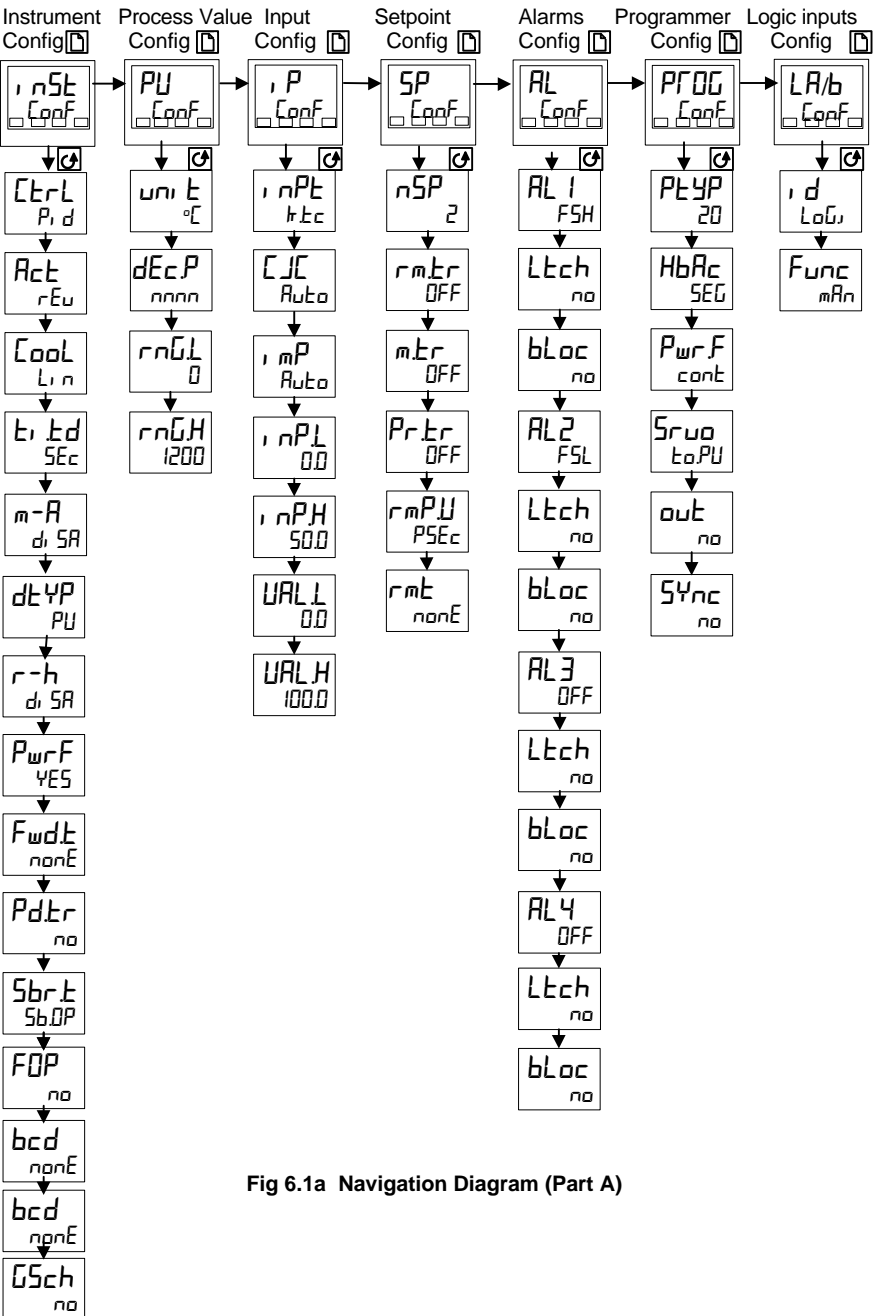

Fig 6.1a Navigation Diagram (Part A)

NAVIGATION DIAGRAM (PART B)

Alarm relay Config Comms 1 Config Comms 2 Config Module 1 Config Module 2 Config Module 3 Config Module 4⁽²⁾ Config Custom⁽³⁾ Config

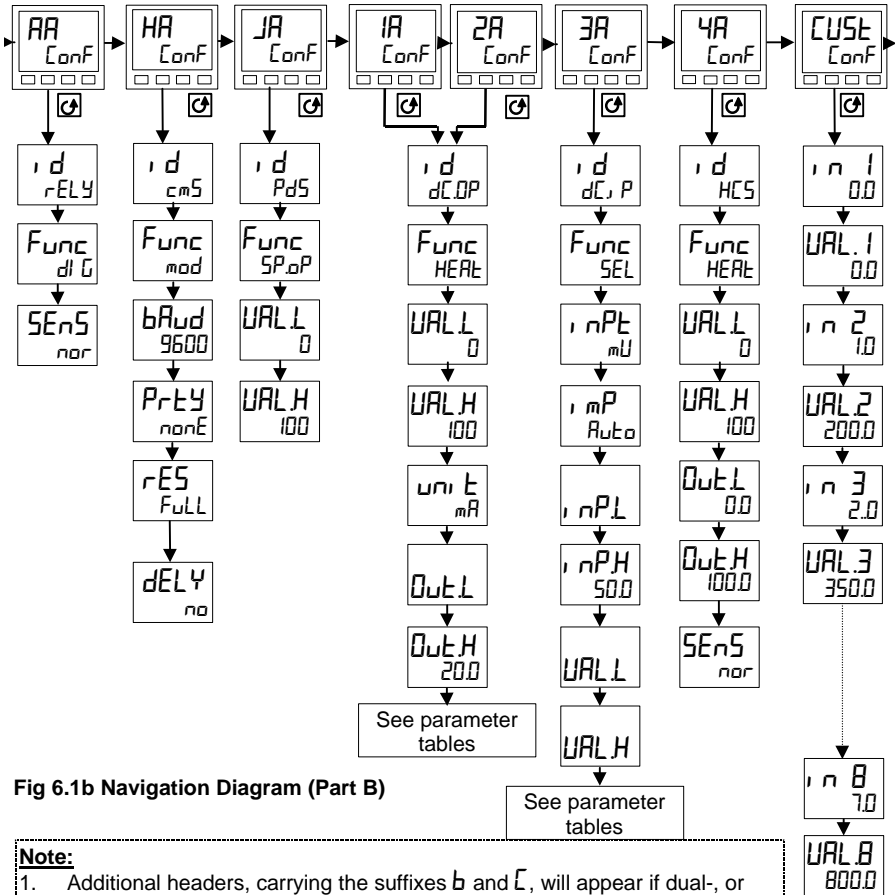

Fig 6.1b Navigation Diagram (Part B)

- Note:**
1. Additional headers, carrying the suffixes **b** and **C**, will appear if dual-, or triple-, channel modules have been installed. The header denotes the labelling of the terminal to which the output function is connected.
 2. Module 4 is the High Current Switch Module. This is only available in the Model CN2404 controller.
 3. 8-point custom linearization. Only appears when either '3A' or 'i P-Conf' has 'inPE' = 'mULC', or 'mALC', or 'ULC'.
 4. The navigation diagram shows typical parameters, but is dependant upon the exact configuration of the instrument. The following sheets show the full list of parameters.

NAVIGATION DIAGRAM (PART C)

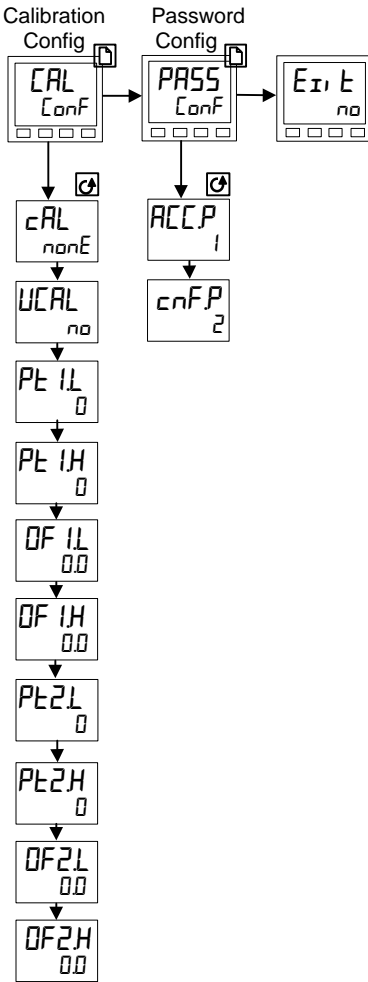

Fig 6.1c Navigation Diagram (Part C)

CONFIGURATION PARAMETER TABLES

Name	Description	Values	Meaning
Inst	Instrument configuration		
Ctrl	Control type	PID ONOFF UP UPb	PID control On/off control Boundless motorized valve control - <i>no feedback required</i> Bounded motorized valve control - <i>feedback required</i>
Act	Control action	REV DIR	Reverse acting Direct acting
Cool	Type of cooling	Lin oL H2O FAN PROP ONOFF	Linear Oil (50mS minimum on-time) Water (non-linear) Fan (0.5S minimum on-time) Proportional only to error On/off cooling
Intd	Integral & derivative time units	SEC min	Seconds, OFF to 9999 Minutes, OFF to 999.9
m-A	Front panel Auto/Man button	ENAB DISA	Enabled Disabled
r-h	Front panel Run/Hold button	ENAB DISA	Enabled Disabled
PwrF	Power feedback	on OFF	On Off
Fwdt	Feed forward type	none FEED SPFF PUFF	None Normal feed forward Setpoint feed forward PV feed forward
Pdtr	Manual/Auto transfer when using PD control	no YES	Non-bumpless transfer Bumpless transfer - (<i>Pre-loads Manual Reset value</i>)
Sbrt	Sensor break output	SbOP HoLd	Go to pre-set value Freeze output
FOP	Forced manual output	no trAc STEP	Bumpless Auto/Manual transfer Returns to the Manual value that was set when last in Manual mode Steps to forced output level. Value set in 'FOP' of 'oP-LiSt' in Operator Level
bcd	BCD input function	none PROG SP	Not used Select program number Select setpoint number
Gsch	Gain schedule enable	no YES	Disabled Enabled

continued on the next page

Name	Description	Values	Meaning
PU	Process value config		
uni E	Instrument units	0C 0F 0K	Celsius Fahrenheit Kelvin
dECP	Decimal places in the displayed value	none one two	Display units blanked None One Two
rnl	Range low		Low range limit. Also setpoint limit for alarms and programmers
rnh	Range high		High range limit. Also setpoint limit for alarms and programmers

Name	Description	Values	Meaning
------	-------------	--------	---------

i P	Input configuration		
i nPt	Input type	JtC KtC LtC RtC BtC NtC TtC StC PL 2 EtC rtd mU uoLt mA Sr U Sr A mUC UC mAEC	J thermocouple K thermocouple L thermocouple R thermocouple (Pt/Pt13%Rh) B thermocouple (Pt30%Rh/Pt6%Rh) N thermocouple T thermocouple S thermocouple (Pt/Pt10%Rh) PL 2 thermocouple Custom downloaded t/c (default=type E) 100Ω platinum resistance thermometer Linear millivolt Linear voltage Linear milliamps Square root volts Square root milliamps 8-point millivolt custom linearization* 8-point Voltage custom linearization* 8-point milliamp custom linearization*
	* see 'CUST' List.		
CC	Cold Junction Compensation	AutO 0°C 45°C 50°C OFF	Automatic internal compensation 0°C external reference 45°C external reference 50°C external reference No cold junction compensation
i mP	Sensor Break Impedance	OFF AutO Hi Hi, Hi	Disabled (<i>only with linear inputs</i>) Factory set Impedance of input > 5KΩ Impedance of input > 15KΩ

Linear Input Scaling – The next 4 parameters only appear if a linear or sq rt input is chosen.

i nPL		Input value low
i nPH		Input value high
UAL L		Displayed reading low
UAL H		Displayed reading high

Name	Description	Values	Meaning
SP	Setpoint configuration		
<i>nSP</i>	Number of setpoints	2, 4, 16	Select number of setpoints available
<i>rmt</i>	Remote Tracking	OFF LOCAL	Disable Local setpoint tracks remote setpoint
<i>mt</i>	Manual Track	OFF LOCAL	Disable Local setpoint tracks PV when in manual
<i>Prtr</i>	Programmer Track	OFF LOCAL	Disable Local setpoint tracks programmer SP
<i>rpmU</i>	Setpoint rate limit units	PSEC PMIN PHR	Per second Per minute Per hour
<i>rmt</i>	Remote setpoint configuration	nonSP LOCAL rmt	Disable Remote setpoint Remote setpoint + local trim Remote trim + local setpoint

AL	Alarm configuration	Values
<p>The controller contains four 'soft' alarms, which are configured in this list. Once configured, they can be attached to a physical output as described in the alarm relay configuration list, 'ALARCONF'.</p>		
AL1	Alarm 1 Type	see Table A
<i>Ltch</i>	Latching	no/YES/EUNT/mRN*
<i>blac</i>	Blocking	no/YES
AL2	Alarm 2 Type	see Table A
<i>Ltch</i>	Latching	no/YES/EUNT/mRN*
<i>blac</i>	Blocking	no/YES
AL3	Alarm 3 Type	see Table A
<i>Ltch</i>	Latching	no/YES/EUNT/mRN*
<i>blac</i>	Blocking	no/YES
AL4	Alarm 4 Type	see Table A
<i>Ltch</i>	Latching	no/YES/EUNT/mRN*
<i>blac</i>	Blocking (not if AL4 = 'rAL')	no/YES

Table A - Alarm types	
Value	Alarm type
OFF	No alarm
FSL	PV Full scale low
FSH	PV Full scale high
dEUB	PV Deviation band
dHi	PV Deviation high
dLo	PV Deviation low
LCr	Load Current low
HCr	Load Current high
FL2	Input 2 Full Scale low
FH2	Input 2 Full Scale high
LOP	Working Output low
HOP	Working Output high
LSP	Working Setpoint low
HSP	Working Setpoint high
rAL	PV Rate of change AL4 only

Alarm Modes

'no' means that the alarm will be non-latching.

'YES' means that the alarm will be latched, with automatic resetting. Automatic resetting means that if a reset is actioned before the alarm has cleared, then it will automatically reset when it clears.

'EUNT' means that the alarm is used to trip an external event. If this option is selected the front panel alarm message will not appear.





'mRN' means that the alarm will be latched, and can only be reset after it has first cleared (called 'manual reset mode').

*The following parameters apply if the **standard 8-segment programmer** is to be configured.*

PF0G	Programmer configuration	Values	Meaning
PEYP	Programmer type	nonE I	Programmer disabled (factory setting) 8-segment programmer enabled
HbAc	Holdback	SEG Prog	Holdback is individually selectable in each segment. Holdback is applied across the whole Program.
Pwr.F	Power fail recovery	cont rmpb rSEt	Continue from last setpoint (SP) Ramp from PV to SP at last ramp rate Reset the program
Sruo	Starting setpoint of a program (Servo point)	toPV toSP	From the Process Value (PV) From the setpoint

*The following parameters apply if a **16-segment programmer** is to be configured.*

PF0G	Programmer configuration	Values	Meaning
PEYP	Programmer type	nonE I 4 20	Programmer disabled Single program Four programs Twenty programs
HbAc	Holdback	SEG Prog	Holdback is individually selectable in each segment. Holdback is applied across the whole Program.
Pwr.F	Power fail recovery	cont rmpb rSEt	Continue from last setpoint (SP) Ramp from PV to SP at last ramp rate Reset the program
Sruo	Starting setpoint of a program (Servo point)	toPV toSP	From the Process Value (PV) From the setpoint
out	Programmable event outputs	no YES	Disabled Enabled
SYnc	Synchronization of programs of several programmers	no YES	Disabled Enabled

Name	Description	Values	Meaning
LR	Digital input 1 configuration		Action on contact closure
<i>i d</i>	Identity	<i>LdL</i>	Logic input
<i>Func</i>	Function of input <i>The function is active when the input has a contact closure to the common terminal - LC</i>	<i>nonE</i> <i>mAn</i> <i>rmE</i> <i>SP2</i> <i>Pi d2</i> <i>Et H</i> <i>tunE</i> <i>drA</i> <i>AcAL</i> <i>AccS</i> <i>Locb</i> <i>uP</i> <i>dwn</i> <i>ScrL</i> <i>PAGE</i> <i>run</i> <i>HoLd</i> <i>r-H</i> <i>rES</i> <i>Sfr, P</i> <i>HbAc</i> <i>bcd.1</i> <i>bcd.2</i> <i>bcd.3</i> <i>bcd.4</i> <i>bcd.5</i> <i>bcd.6</i> <i>rmPE</i> <i>Sync</i> <i>rrES</i> <i>rESr</i> <i>Stby</i> <i>PUSL</i> <i>AdU</i>	No function Manual mode select Remote setpoint select Setpoint 2 select PID set 2 select Integral hold One-shot self-tune enable Adaptive tune enable Acknowledge alarms Select Full access level Keylock Simulate pressing of the  button Simulate pressing of the  button Simulate pressing of the  button Simulate pressing of the  button Run program Hold program Run program (<i>closed</i>) / Hold (<i>open</i>) Reset program Skip to End of Current Segment, without changing the setpoint Program holdback enabled Least significant BCD digit 2nd BCD digit 3rd BCD digit 4th BCD digit 5th BCD digit Most significant BCD digit Setpoint Rate Limit Enable Program waits at the end of the current segment Program Run (<i>closed</i>) / Reset (<i>open</i>) Program Reset (<i>closed</i>) / Run (<i>open</i>) Standby - ALL control outputs turned OFF (alarm Outputs are not affected) PV Select: Closed = PV1 / Open=PV2 Advance to End of Segment and to Target Setpoint
	<i>These BCD inputs are used to select either a program number or the setpoint number according to the setting of the parameter 'bcd' in the 'rSt' configuration list</i>		

Lb	Digital input 2 configuration		Action on contact closure
As per Digital input 1 configuration			

Name	Description	Values	Meaning
RR	Alarm relay configuration		
<i>id</i>	Identity	<i>rELY</i>	Relay output
<i>Func</i>	Function	<i>nonE</i> <i>dl G</i>	No function Digital output
<i>SEnS</i>	Digital output sense	<i>nor</i> <i>inu</i>	Normal (output energizes when TRUE, e.g. program events) Inverted (output de-energizes when TRUE, e.g. alarms)
<p>The following digital events appear after 'SEnS'. Any one, or more, of the events can be combined on to the output (see Fig. 6-2) by selecting 'YES' in the lower readout.</p>			
<i>1 - -</i>	Alarm 1 active	<i>YES / no</i>	(- - -) = alarm type (e.g. FSL). If an alarm has not been configured in 'AL CONF' list, then display will differ:- e.g. Alarm 1 = 'AL 1'.
<i>2 - -</i>	Alarm 2 active	<i>YES / no</i>	
<i>3 - -</i>	Alarm 3 active	<i>YES / no</i>	
<i>4 - -</i>	Alarm 4 active	<i>YES / no</i>	
<i>mAn</i>	Controller in manual mode	<i>YES / no</i>	
<i>Sbr</i>	Sensor break	<i>YES / no</i>	
<i>SPAn</i>	PV out of range	<i>YES / no</i>	
<i>Lbr</i>	Loop break	<i>YES / no</i>	
<i>LdF</i>	Load failure alarm	<i>YES / no</i>	
<i>tunE</i>	Tuning in progress	<i>YES / no</i>	
<i>dcF</i>	Voltage output open circuit, or mA output open circuit	<i>YES / no</i>	
<i>rmEtF</i>	PDLINK module connection open circuit	<i>YES / no</i>	
<i>nwAL</i>	New Alarm has occurred	<i>YES / no</i>	
<i>End</i>	End of setpoint rate limit, or end of program	<i>YES / no</i>	
<i>Sync</i>	Program Synchronization active	<i>YES / no</i>	
<i>PrGn</i>	Programmer event output active, where 'n' = event number from 1 to 8. (Not available with 8-segment programmer.)	<i>YES / no</i>	

Digital Events

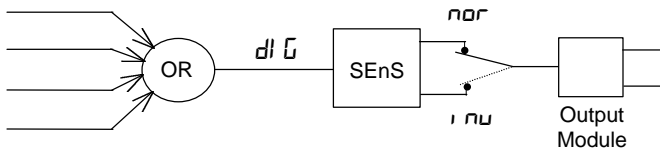

Figure 6-2 Combining several digital events onto one output

Name	Description	Values	Meaning
HR	Comms 1 module config		
i d	Identity of the module installed	c m 5 P d 5 P d 5 j	RS-232 (EIA-232), or 2-wire RS-485 (EIA-485), or 4-wire RS-485 (EIA-485) comms Not Used Not Used

For 'i d' = 'c m 5' (Digital communications) use this parameter table:			
F u n c	Function	m o d b t b j	Modbus® protocol Not used
b a u d	Baud Rate	1 2 0 0 , 2 4 0 0 , 4 8 0 0 , 9 6 0 0 , 1 9 2 0	(19,200)
d e l y	Delay - quiet period, required by some comms adaptors	n o Y E S	No delay Delay active - 10mS
<i>The following parameters only appear if the function chosen is Modbus® protocol.</i>			
P a r i t y	Comms Parity	n o n E E v e n O d d	No parity Even parity Odd parity
r e s	Comms Resolution	F u l l I n t	Full resolution Integer resolution

Name	Description	Values	Meaning
IR/b/I⁽¹⁾	Module 1 configuration		
d	Identity of module installed <i>(1) If a dual-, or triple-, channel module is installed then the list headers Ib and IC also appear</i>	nonE rELY dCOP LoG LoG, SSr dcrE dcOP	Module not fitted Relay output Non-isolated DC output Logic/PDLINK output Logic input AC SSR output DC retransmission (isolated) Isolated DC output

For 'd' = 'rELY', 'LoG', or 'SSr' use this parameter table:			
Func	Function <i>(Only Channels IR and IC can be Heating, or Cooling)</i> <i>(Only if 'd' = 'LoG')</i> <i>(Only if 'd' = 'LoG')</i>	nonE	Function disabled
		dIG	Digital output function
		HEAT	Heating output
		COOL	Cooling output
		uP	Open motorized valve
		dwn	Close motorized valve
		SSr.1 SSr.2	PDLINK mode 1 heating PDLINK mode 2 heating
VAL.L	<p>PID Demand Signal</p> <p>VAL.H</p> <p>VAL.L</p> <p>Out.L</p> <p>Out.H</p> <p>Electrical Output</p>		% PID demand signal giving minimum output – 'OUT.L'
VAL.H			% PID demand signal giving maximum output – 'OUT.H'
OUT.L			Minimum average power
OUT.H			Maximum average power
SEN5	Sense of output <i>(Only if 'Func' = 'dIG')</i>	nor inu	Normal <i>(output energizes when TRUE, e.g. program events)</i> Inverted <i>(output de-energizes when TRUE, e.g. alarms)</i>

Notes:

- When 'SEN5' appears, then further parameters are available. These are identical to those in the 'RA CONF' list on Page 6-12.
- To invert a PID output, the Val. H can be set below the Val.L

Name	Description	Values	Meaning	
For 'd' = 'dC.OP', 'dC.rE', or 'dC.OP' use this parameter table:				
<i>F_{UNC}</i>	Function	<i>nonE</i>	Function disabled	
		<i>HEAT</i>	Heating output	
		<i>COOL</i>	Cooling output	
		<i>PV</i>	Retransmission of PV	
		<i>wSP</i>	Retransmission of setpoint	
		<i>Err</i>	Retransmission of error signal	
		<i>OP</i>	Retransmission of OP power	
<i>VAL.L</i>	<p>%PID, or Retransmission Value</p> <p>VAL.H</p> <p>VAL.L</p> <p>Out.L</p> <p>Out.H</p> <p>Electrical Output</p>		% PID, or Retrans'n Value, giving minimum output	
<i>VAL.H</i>			% PID, or Retrans'n Value, giving maximum output	
<i>unit</i>			<i>volt</i> = Volts, <i>mA</i> = milliamps	
<i>Out.L</i>				Minimum electrical output
<i>Out.H</i>				Maximum electrical output

For 'd' = 'LOG' (i.e. logic input) use the *LRCONF* list on Page 6-11.

<i>2R/b/c</i>	Module 2 configuration		
As per module 1 configuration, but excluding the 'SSr.1', 'SSr.2' functions.			
<i>d</i>	Identity of module installed. As per module 2 plus:	<i>EPSU</i> <i>Pot</i>	Transmitter power supply Potentiometer input

For 'd' = 'Pot' (i.e. potentiometer input module) use this parameter table:			
<i>F_{UNC}</i>	Function	<i>nonE</i> <i>rSP</i> <i>Fwd</i> <i>rOPh</i> <i>rOPl</i> <i>UPoS</i>	Function disabled Remote Setpoint Feedforward input Remote OP power max. Remote OP power min. Motorized valve position
<i>VAL.L</i>	<p>Displayed value</p> <p>VAL.H</p> <p>VAL.L</p> <p>0%</p> <p>100%</p> <p>Potentiometer position</p>		Displayed value low equivalent to 0% potentiometer position
<i>VAL.H</i>			Displayed value high equivalent to 100% potentiometer position

3A/b/c	Module 3 configuration		
As per module 2 configuration, plus 'd' = 'dC, P'			

For 'd' = 'dC, P' use this parameter table.
THIS INCLUDES THE SECOND PV FUNCTIONS

F_{unc}	Function	nonE rSP Fwd_i rOP_h rOP_L H_i L_o F_{tn} SEL tran	Function disabled Remote Setpoint Feedforward input Remote OP power max. Remote OP power min. PV = The highest of 'P. 1', or 'P. 2' PV = The lowest of 'P. 1', or 'P. 2' Derived function, where PV = (F. 1 x, P. 1) + (F. 2 x, P. 2). 'F. 1' and 'F. 2' are scalars which are found in 'P-L, St' of Operator Level Select 'P. 1', or 'P. 2' via Comms, front panel buttons, or a digital input Transition of control between 'P. 1' and 'P. 2'. The transition region is set by the values of 'L _o P' and 'H _i P', which are found in 'P-L, St' of Operator Level. PV = 'P. 1' below 'L _o P' PV = 'P. 2' above 'H _i P'
i_nP_t	Input type		Refer to 'P C _{on} F' for all types, + the following: H_i I_n High Impedance (range = 0 to 2 volt)
C_J	Cold Junction Compensation	OFF Auto 0°C 45°C 50°C	No cold junction compensation Automatic internal compensation 0°C external reference 45°C external reference 50°C external reference
i_mP	Sensor Break Impedance	OFF Auto H_i H_i, H_i	Disabled (<i>only with linear inputs</i>) Factory set Impedance of input > 15KΩ Impedance of input > 30KΩ

Linear Input Scaling – The next four parameters only appear if a linear input is chosen.

i_nP_L		Input value low
i_nP_H		Input value high
U_{RL}L		Displayed value low
U_{RL}H		Displayed value high

Name	Description	Values	Meaning
4R	Module 4 configuration		
<i>i d</i>	Identity of module installed	<i>HCS</i>	High Current Switch
<i>Func</i>	Function	<i>nonE</i> <i>dl G</i> <i>HEAT</i> <i>COOL</i>	Function disabled Digital output function Heating output Cooling output
<i>URL L</i>	PID Demand Signal 		% PID demand signal giving minimum output – ‘ <i>Out.L</i> ’
<i>URL H</i>			% PID demand signal giving maximum output – ‘ <i>Out.H</i> ’
<i>Out.L</i>			Minimum electrical output
<i>Out.H</i>			Maximum electrical output
<i>SEN5</i>	Sense of output (Only if ‘ <i>Func</i> ’ = ‘ <i>dl G</i> ’)	<i>nor</i> <i>inv</i>	Normal (<i>output energizes when TRUE, e.g. program events</i>) Inverted (<i>output de-energizes when TRUE, e.g. alarms</i>)
When ‘ <i>SEN5</i> ’ appears, then further parameters are available. These are identical to those in the ‘ <i>RR Conf</i> ’ list on Page 6-12.			

cusE	8-point Custom Linearization ⁽¹⁾	
<i>in 1</i>	Displayed Value 	Custom input 1
<i>URL. 1</i>		Linearization Value representing <i>in 1</i>
.....	
<i>in 8</i>		Custom input 8
<i>URL. 8</i>	Linearization Value representing <i>in 8</i>	

Note:

1. Custom Linearization is only available when ‘*3R-Conf*’ or ‘*P- Conf*’ list has ‘*inPE*’ set to ‘*mUL*’, or ‘*mAL*’, or ‘*UL*’.
2. The values and inputs must be continuously increasing or decreasing

Name	Description	Values	Meaning
CAL	Calibration		
<p><i>In this mode you can</i></p> <ol style="list-style-type: none"> 1. Calibrate the instrument using a mV source - rCAL or ref source cal. 2. Offset the calibration to account for errors in actual sensor measurement and a ref sensor - UCAL or user calibration 3. Return to factory set calibration - FACT or factory set calibration. 			
rCAL	Calibration point	none	No calibration
		PU	Calibrate main Process Value input.
		PU2	Calibrate DC input, or PV 2.
		IAHi	Calibrate DC output high - Module 1
		IALo	Calibrate DC output low - Module 1
		2AHi	Calibrate DC output high - Module 2
		2ALo	Calibrate DC output low - Module 2
		3AHi	Calibrate DC output high - Module 3
		3ALo	Calibrate DC output low - Module 3

Go to User CalibrationTable- See also chapter 7

Go to Input CalibrationTable

Go to DC Output Calibration Table

INPUT CALIBRATION			
For 'CAL' = 'PU', or 'PU2', the following parameters apply.			
PU	PV Calibration Value	Idle	Idle
		mV L	Select 0mV as the calibration point
		mV H	Select 50mV as the calibration point
		0V	Select 0Volt as the calibration point
		10V	Select 10V as the calibration point
		CJC	Select 0°C CJC calibration point
		400Ω	Select 400Ω as the calibration point
		Hi 0	High impedance: 0Volt cal'n point
		Hi 1.0	High impedance: 1.0 Volt cal'n point
		FACT	Restore factory calibration
GO	Start calibration Select 'YES' with ▼ or ▲ Wait for calibration to complete.	no	Waiting to calibrate PV point
		YES	Start calibration
		busy	Busy calibrating
		done	PV input calibration completed
		FAIL	Calibration failed

See Note below.

Note. When a DC input module is installed for the first time, or there is a requirement to change one, then the microprocessor in the controller needs to read the factory calibration data stored in the module. Select 'FACT' as the calibration value. Step to 'GO' and start calibration.

DC Output Calibration			
<i>The following parameters apply to DC output modules i.e. for rCAL = 1A.Hi to 3A.Lo</i>			
cALH	Output Calibration High	<input type="checkbox"/>	<input type="checkbox"/> = Factory set calibration. Trim value until output = 9V, or 18mA
cALL	Output Calibration Low	<input type="checkbox"/>	<input type="checkbox"/> = Factory set calibration. Trim value until output = 1V, or 2mA

User calibration		
UCAL	User calibration enable	Yes/no
PE1L	Low calibration point for Input 1	The factory calibration point at which the low point offset was performed.
PE1H	High calibration point for Input 1	The factory calibration point at which the high point offset was performed.
OF1L	Offset Low for Input 1	Calculated offset, in display units.
OF1H	Offset High for Input 1	Calculated offset, in display units.
PE2L	Low calibration point for Input 2	The factory calibration point at which the low point offset was performed.
PE2H	High calibration point for Input 2	The factory calibration point at which the high point offset was performed.
OF2L	Offset Low for Input 2	Calculated offset, in display units.
OF2H	Offset High for Input 2	Calculated offset, in display units.

Name	Description	Values	Meaning
PASS	Password configuration		
ACEP	FuLL or Edit level password		
cnFP	Configuration level password		
EXIT	Exit configuration	no/YES	

Chapter 7 USER CALIBRATION

This chapter has five topics:

- WHAT IS THE PURPOSE OF USER CALIBRATION?
- USER CALIBRATION ENABLE
- OFFSET CALIBRATION
- TWO POINT CALIBRATION
- CALIBRATION POINTS AND CALIBRATION OFFSETS

To understand how to select and change parameters in this chapter you will need to have read Chapter 2 - *Operation*, Chapter 3 - *Access Levels* and Chapter 6 - *Configuration*.

WHAT IS THE PURPOSE OF USER CALIBRATION?

The basic calibration of the controller is highly stable and set for life. User calibration allows you to offset the 'permanent' factory calibration to either:

1. Calibrate the controller to the your reference standards.
2. Match the calibration of the controller to that of a particular transducer or sensor input.
3. Calibrate the controller to suit the characteristics of a particular installation.
4. Remove long term drift in the factory set calibration.

User calibration works by introducing a single point, or two-point, offset onto the factory set calibration.

USER CALIBRATION ENABLE

The User calibration facility must first be enabled in configuration level by setting the parameter 'UCAL' in the input conf list to 'YES'. This will make the User calibration parameters visible in Operator 'FULL' level.

Select configuration level as shown in Chapter 6, *Configuration*.

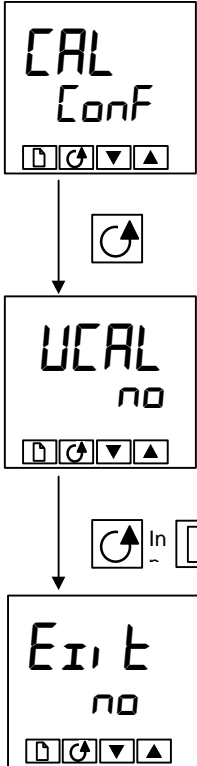

The Calibration Configuration List

Press until you reach the 'CAL-CONF' list.

Press until you reach 'UCAL'.

User Calibration Enable

Use or to select:

- YES: Calibration enable
- no: Calibration disabled

Press and together to go to the EXIT display.

Exit configuration

Use or to select 'YES' to return to Operator level.

OFFSET CALIBRATION

Offset calibration is used to apply a single fixed offset over the full display range of the controller.

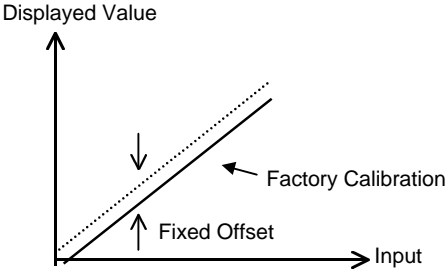

To calibrate, proceed as follows:

1. Connect the input of the controller to the source device to which you wish to calibrate.
2. Set the source to the desired calibration value.
3. The controller will display the current measurement of the value.
4. If the displayed value is correct, then the controller is correctly calibrated and no further action is necessary. If it is incorrect, then follow the steps shown below.

Select 'FULL' access level, as described in Chapter 3.

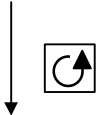
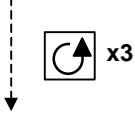
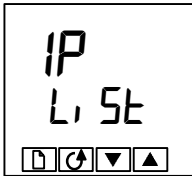



Input list header

Press  until you reach the input list header.

Press  until you reach the 'CAL' display.

Calibration type

- **FACT:** Factory Calibration
- **USER:** User Calibration

Use  or  to select 'FACT'.

Selecting 'FACT' reinstates the factory calibration and allows the application of a single fixed offset.

Press 

continued next page

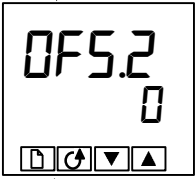
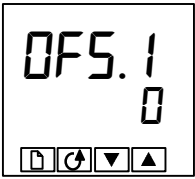

See table on right for additional parameters

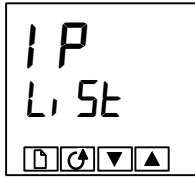

Set Offset 1

Use or to set the offset value of Process Value 1 (PV1). The offset value is in display units.

Press

Set Offset 2

Use or to set the offset value of Process Value 2 (PV2), *if configured*. The offset value is in display units.

Press

The table below shows the parameters which appear after 'OFS.2'. These are all read only values and are for information.

Press to step through them.

<i>mU.1</i>	IP1 measured value (at terminals)
<i>mU.2</i>	IP2 measured value (at terminals), if DC input in Module 3 position
<i>CJC.1</i>	IP1 Cold Junction Compensation
<i>CJC.2</i>	IP2 Cold Junction Compensation
<i>L1.1</i>	IP1 Linearized Value
<i>L1.2</i>	IP2 Linearized Value
<i>PUSL</i>	Shows the currently selected input

If you do not want to look at these parameters, then press and this returns you to the 'P-L1 SE' header.

To protect the calibration against unauthorized adjustment, return to Operator level and make sure that the calibration parameters are hidden. Parameters are hidden using the 'Edit' facility described in Chapter 3, *Access Levels*.

TWO-POINT CALIBRATION

The previous section described how to apply an offset, or trim, calibration, which applies a fixed offset over the full display range of the controller. A two-point calibration is used to calibrate the controller at two points and applies a straight line between them. Any readings above, or below, the two calibration points will be an extension of this straight line. For this reason it is best to calibrate with the two points as far apart as possible.

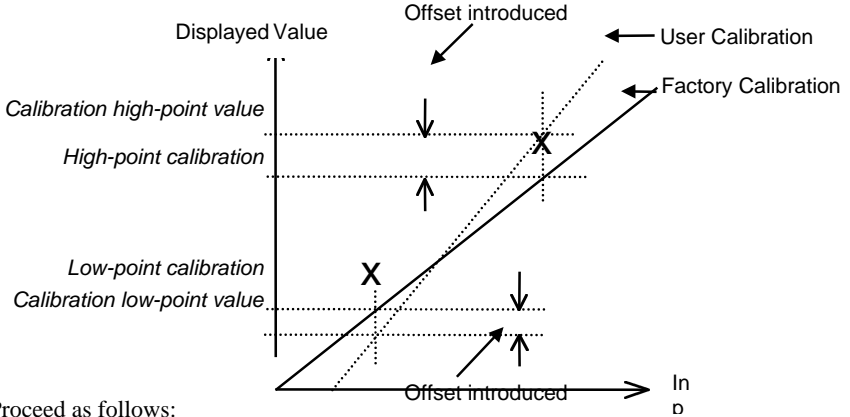

Proceed as follows:

1. Decide upon the low and high points at which you wish to calibrate.
2. Perform a two point calibration in the manner described below.

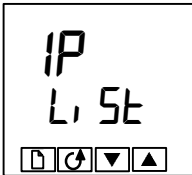

Input list header

Press until you reach the input list header, 'IP L, St'.

Press until you reach the 'CAL' display.

Calibration type

- *FACT*: Factory Calibration
- *USER*: User Calibration

Use or to select 'USER'.

Selecting 'USER' enables two-point calibration.

[If two-point calibration is unsatisfactory, select 'FACT' to return to the factory set calibration.]

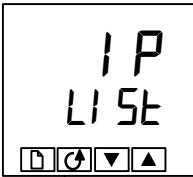
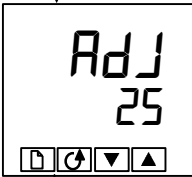

Press



Select Low-point Calibration

This is the Calibration Status display. This display shows that no input is selected for calibration.



- none: No selection
- , P 1L: Input 1 (PV1) calibration low-point selected
- , P 1H: Input 1 (PV1) calibration high-point selected
- , P 2L: Input 2 (PV2) calibration low-point selected
- , P 2H: Input 2 (PV2) calibration high-point selected

Use  /  to select the parameter for the Low Calibration point of Input 1, ' , P 1L '.

Press 

Adjust low-point calibration

This is the display for adjusting the Low Calibration point of Input 1. The lower readout is a live reading of the process value, which changes as the input changes.

Make sure that the calibration source is connected to the terminals of Input 1, switched on and feeding a signal to the controller. It should be set to the desired low-point calibration value. If the lower readout does not show this value, then use  /  to adjust the reading to the required value.

Press  to return to the ' , P -L, SE ' header.

To perform the High-point Calibration, repeat the above procedure, selecting ' , P 1H ' in the 'CAL.S' display for adjustment.

Press  three times.

Calibration type

'USER' was selected for the Low-point Calibration, and has remained selected.

Press 

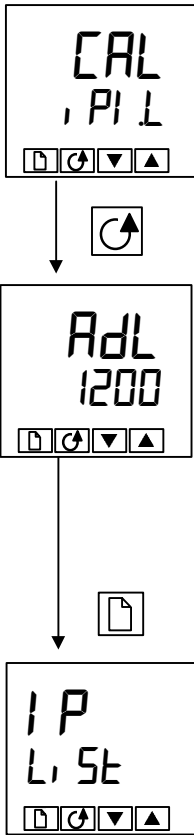

Select High-point Calibration

This is the Calibration Status display, again.

Use / to select the parameter for the High-point Calibration of Input 1, 'P1H'.

Press

Adjust High-point Calibration

This is the display for adjusting the High Calibration point of Input 1. The lower readout is a live reading of the process value, which changes as the input changes.

Feed the desired high-point calibration signal to the controller, from the calibration source. If the lower readout does not show this value, then use / to adjust the reading to the required value.

Press to return to the 'P-L, St' header.

To protect the calibration against unauthorised adjustment return to Operator level and make sure that the calibration parameters are hidden. Parameters are hidden using the 'Edit' facility described in Chapter 3.

To perform a User Calibration on Input 2, proceed as with Input 1 above, except that when 'CAL S-nonE' appears,



Press / until 'CAL S-P2L' is obtained, then proceed as with Input 1. Repeat the procedure for 'P2H'.

CALIBRATION POINTS AND CALIBRATION OFFSETS

If you wish to see the points at which the User calibration was performed and the value of the offsets introduced, then these are shown in Configuration, in 'CAL-CONF'.

The parameters are:

Name	Parameter description	Meaning
PE 1L	Low calibration point for Input 1	The factory calibration point at which the low point offset was performed.
PE 1H	High calibration point for Input 1	The factory calibration point at which the high point offset was performed.
OF 1L	Offset Low for Input 1	Calculated offset, in display units.
OF 1H	Offset High for Input 1	Calculated offset, in display units.
PE 2L	Low calibration point for Input 2	The factory calibration point at which the low point offset was performed.
PE 2H	High calibration point for Input 2	The factory calibration point at which the high point offset was performed.
OF 2L	Offset Low for Input 2	Calculated offset, in display units.
OF 2H	Offset High for Input 2	Calculated offset, in display units.

Note: The value of each of the parameters in the above table may also be altered by using the  /  buttons.

Appendix A

UNDERSTANDING THE ORDERING CODE

To Order (Specify Model Number)	
Model Number	Single Output Type
CN2404(*)	1/4 DIN temperature PID process controller
CN2408 (*)	1/8 DIN temperature PID process controller

*Add Output and other options. Refer to the Option tables below. OMEGACARESM extended warranty program is available for models shown on this page. Ask you sales representative for full details when placing an order. *Specify output code from the output options table

Ordering Example: CN2404-RI-R2-PVSV3-A-C4, dual output controller with two form A relay outputs, analog retransmission, alarm contact. RS-485 (EIA-485) communications, power supply voltage: 85-264 Vac, OWC-1 OmegacareSM extends standard 2-year warranty to a total of 3 years.

Output and Additional Input Options (field installable options)			
Output Type	Output 1* Order Suffix	Output 2** Order Suffix	Output 3*** Order Suffix
Relay	-R1	-R2	-R3
020 mA/0 5/10 Vdc Isolated	-FI1	-FI2	-
dc Pulse (18 Vdc @ 20 mA)	-D1	-D2	-D3
AC SSR	-T1	-T2	-T3
Dual Relays	-RR1	-RR2	-RR3
Dual AC SSR	-TT1	--	--
Dual Pulse/Relay	-DR1	--	--
Dual Pulse/AC SSR	-DT1	--	--
Triple Pulse (12 Vdc @ 8 mA)	-3D1	-3D2	3D3
Analog Retransmission	--	-PVSV2	-PVSV3
Triple Contact Input	-3C1	-3C2	-3C3
Triple Logic input	-3L1	-3L2	-3L3
Remote Setpoint	--	-	-RSP
Transmitter Supply	--	-TP2	-TP3

Note:*PDLINKI will function only with the “-DI” (dc pulse) output.

Communication Options (field installable)	
Order Suffix	Description
-C2	RS-232 (EIA-232) Communications
-C3	4-wire RS-422/485 (EIA-422/485) Communications
-C4	2-wire RS-485 (EIA-485) Communications

Only one communications option available per unit

Accessories	
Model Number	Description
SSC-TE10S*	Solid State Contactor
CNQUENCHARC	Noise Suppression Kit, 110-230 Vac

*To order, refer to the SSC-TE10S specification sheet

Other Alarm and High Current Options (field installable)	
Order Suffix	Description
-A*	Alarm Relay
-HC	10 A High Current Relay Output (CN2404 only)

Only one option available

Low Voltage Power Options	
Order Suffix	Description
-LV	20 to 29 Vac/dc

Control Function Options				
Order Suffix	Control Function	Number of Profiles	Segments	Valve Positioner
-CG	PID Controller	1	8	-
-CP	PID Controller	1	16	-
-P4	PID Controller	4	16	-
-CM	PID Controller	4	20	-
-VC	Valve Positoner	0	0	√
-VG	Valve Positoner	1	8	√
-VP	Valve Positoner	1	16	√
-V4	Valve Positoner	4	16	√
-VM	Valve Positoner	4	20	√

Sensor Inputs and Display Ranges (Temperature Scales Conform to the ITS90 Standard)			
Standard Sensor Inputs		°C Range	°F Range
J	Iron-Constantan	-210 to 1200	-350 to 2192
K	CHROMEKA®-ALOMEGA®	-200 to 1372	-325 to 2500
T	Copper-Constantan	-200 to 400	-325 to 750

Standard Sensor Inputs (continued)		°C Range	°F Range
L	J DIN-Iron-Constantan DIN	-200 to 900	-325 to 1650
N	OMEGA®-P-OMEGA®-N	-250 to 1300	-420 to 2370
E*	CHROMEGA®-Constantan	-270 to 1000	-450 to 1830
R	Pt/13%Rh/Pt	-50 to 1768	-60 to 3200
S	Pt/10%Rh/Pt	-50 to 1768	-60 to 3200
B	Pt/30%Rh/Pt/6%Rh	0 to 1820	32 to 3310
PL II	Platinel II	0 to 1369	32 to 2500
RTD	Pt, 385, 100 ohm	-200 to 850	-325 to 1560
Linear Process Inputs		Linear Process Range	
±100V, 0 to 20 mA**, 0 to 10 Vdc		Scalable (-999 to 9999)	

** When used with 2.49 OHM shunt resistor

*Type E input can be replaced with Type C input, as well as custom IR input, consult engineering

Field Installable Output Modules	
Model Number	Description
BD2400-R	Relay output module
BD2400-D	dc Pulse output module
BD2400-T	ac SSR output module
BD2400-F1	Isolated 0-20mA, 0 to 5, 0 to 10 V output module
BD2400-RR	Dual relay output module
BD2400-TT	Dual ac SSR output module
BD2400-DR	Dual dc Pulse and relay output module
BD2400-DT	Dule dc Pulse and ac SSR output module
BD2400-3D	Triple dc Pulse output module
BD2400-3C	Triple contact input module
BD2400-3L	Triple logic input module
BD2400-PVSV	Analog retransmission module
BD2400-RSP	Analog remote setpoint module
BD2400-C2	RS-232 (EIA-232) communications module
BD2400-C3	4-wire RS-422.485 (EIA-422/485) communications module
BD2400-C4	2-wire RS-485 (EIA-485) communications module
BD2400-TP	Transmitter power supply module

Notes:

1. **PDLINK** is a proprietary technique for bi-directional communication over a single pair of wires. There are several operating modes.

In **mode 1** a DC pulse output delivers a power demand signal to a SSC-TE10S solid state (SSR) relay and the SSR responds with a single load circuit failure message.

In **mode 2** a DC pulse output delivers a power demand signal to an SSC-TE10S and the SSR responds with the ON state rms load current, and two fault messages - SSR failure or heater circuit failure.
2. **Range min and Range max:** Enter a numeric value, with a decimal point if required. Thermocouple and RTD sensor inputs will always display over the full operating range shown in the sensor input table. The values entered here will act as low and high setpoint limits. For linear inputs, the values entered are used to scale the input signal.

SAFETY and EMC INFORMATION

Please read this section carefully before installing the controller.

This controller is intended for industrial temperature and process control applications when it will meet the requirements of the European Directives on Safety and EMC. Use in other applications, or failure to observe the installation instructions of this handbook may impair the safety or EMC protection provided by the controller. It is the responsibility of the installer to ensure the safety and EMC of any particular installation.

Safety

This controller complies with the European Low Voltage Directive 73/23/EEC, amended by 93/68/EEC, by the application of the safety standard EN 61010.

Electromagnetic compatibility

This controller conforms with the essential protection requirements of the EMC Directive 89/336/EEC, amended by 93/68/EEC, by the application of a Technical Construction File.

This instrument satisfies the general requirements of an industrial environment as described by EN 50081-2 and EN 50082-2. For more information on product compliance, refer to the Technical Construction File.

SERVICE AND REPAIR

This controller has no user serviceable parts. Contact your nearest Omega agent for repair.

Caution: Charged capacitors

Before removing an instrument from its sleeve, disconnect the supply and wait at least two minutes to allow capacitors to discharge. Failure to observe this precaution will expose capacitors that may be charged with hazardous voltages. In any case, avoid touching the exposed electronics of an instrument when withdrawing it from the sleeve.

Electrostatic discharge precautions

When the controller is removed from its sleeve, some of the exposed electronic components are vulnerable to damage by electrostatic discharge from someone handling the controller. To avoid this, before handling the unplugged controller discharge yourself to ground.

Cleaning

Do not use water or water based products to clean labels or they will become illegible. Isopropyl alcohol may be used to clean labels. A mild soap solution may be used to clean other exterior surfaces of the product.

INSTALLATION SAFETY REQUIREMENTS

Safety Symbols

Various symbols are used on the instrument, they have the following meaning:



Caution, (refer to the accompanying documents)



Functional ground (earth) terminal

The functional ground connection is not required for safety purposes but to ground RFI filters.

Personnel

Installation must only be carried out by qualified personnel.

Enclosure of live parts

To prevent hands or metal tools touching parts that may be electrically live, the controller must be installed in an enclosure.

Caution: Live sensors

The fixed digital inputs, non-isolated dc, dc pulse and PDLINK outputs and the dc pulse output of dual output modules, are all electrically connected to the main process variable input. If the temperature sensor is connected directly to an electrical heating element then these non-isolated inputs and outputs will also be live. The controller is designed to operate under these conditions. However, you must ensure that this will not damage other equipment connected to these inputs and outputs and that service personnel do not touch connections to these i/o while they are live. With a live sensor, all cables, connectors and switches for connecting the sensor and non-isolated inputs and outputs must be mains rated.

Wiring

It is important to connect the controller in accordance with the wiring data given in this handbook. Take particular care not to connect AC supplies to the low voltage sensor input or other low level inputs and outputs. Only use copper conductors for connections (except thermocouple inputs) and ensure that the wiring of installations comply with all local wiring regulations. (For example, in the UK use the latest version of the IEE wiring regulations, (BS7671). In the USA use NEC Class 1 wiring methods.)

Power Isolation

The installation must include a power isolating switch or circuit breaker. This device should be in close proximity to the controller, within easy reach of the operator and marked as the disconnecting device for the instrument.

Earth leakage current

Due to RFI Filtering, there is ground leakage current of less than 0.5mA. This may affect the design of an installation of multiple controllers protected by Residual Current Device, (RCD) or Ground Fault Detector, (GFD) type circuit breakers.

Overcurrent protection

To protect the internal PCB tracking within the controller against excess currents, the AC power supply to the controller and power outputs must be wired through the fuse or circuit breaker specified in the technical specification.

Voltage rating

The maximum continuous voltage applied between any of the following terminals must not exceed 264Vac:

- line or neutral to any other connection;
- relay or AC SSR output to logic, dc or sensor connections;
- any connection to ground.

The controller should not be wired to a three-phase supply with an ungrounded star connection. Under fault conditions such a supply could rise above 264Vac with respect to ground and the product would not be safe.

Voltage transients across the power supply connections, and between the power supply and ground, must not exceed 2.5kV. Where occasional voltage transients over 2.5kV are expected or measured, the power installation to both the instrument supply and load circuits should include a transient limiting device.

These units will typically include gas discharge tubes and metal oxide varistors that limit and control voltage transients on the supply line due to lightning strikes or inductive load switching. Devices are available in a range of energy ratings and should be selected to suit conditions at the installation.

Conductive pollution

Electrically conductive pollution must be excluded from the cabinet in which the controller is mounted. For example, carbon dust is a form of electrically conductive pollution. To secure a suitable atmosphere in conditions of conductive pollution, fit an air filter to the air intake of the cabinet. Where condensation is likely, for example at low temperatures, include a thermostatically controlled heater in the cabinet.

Over-temperature protection

When designing any control system, it is essential to consider what will happen if any part of the system should fail. In temperature control applications the primary danger is that the heating will remain constantly on. Apart from spoiling the product, this could damage any process machinery being controlled, or even cause a fire.

Reasons why the heating might remain constantly on include:

- the temperature sensor becoming detached from the process;
- thermocouple wiring becoming short circuit;
- the controller failing with its heating output constantly on;
- an external valve or contactor sticking in the heating condition;
- the controller setpoint set too high.

Where damage or injury is possible, we recommend fitting a separate over-temperature protection unit, with an independent temperature sensor, which will isolate the heating circuit.

Please note that the alarm relays within the controller will not give protection under all failure conditions.

Grounding of the temperature sensor shield

In some installations it is common practice to replace the temperature sensor while the controller is still powered up. Under these conditions, as additional protection against electric shock, we recommend that the shield of the temperature sensor is grounded. Do not rely on grounding through the framework of the machine.

INSTALLATION REQUIREMENTS FOR EMC

To ensure compliance with the European EMC directive certain installation precautions are necessary as follows:

- When using relay or AC SSR outputs it may be necessary to fit a filter suitable for suppressing the emissions. The filter requirements will depend on the type of load. (For typical applications, we recommend Schaffner FN321 or FN612.)
- If the unit is used in table top equipment which is plugged into a standard power socket, then it is likely that compliance to the commercial and light industrial emissions standard is required. In this case to meet the conducted emissions requirement, a suitable mains filter should be installed. We recommend Schaffner types FN321 and FN612.

Routing of wires

To minimize the pick-up of electrical noise, the wiring for low voltage dc and particularly the sensor input should be routed away from high-current power cables. Where it is impractical to do this, use shielded cables with the shield grounded at both ends.

TECHNICAL SPECIFICATION

Environmental ratings

Panel sealing:	Instruments are intended to be panel mounted. The rating of panel sealing is IP65, (EN 60529), or (NEMA 250).
Operating temperature:	0 to 55°C. Ensure the enclosure provides adequate ventilation.
Relative humidity:	5 to 95%, non-condensing.
Atmosphere:	The instrument is not suitable for use above 2000m or in explosive or corrosive atmospheres.

Equipment ratings

Supply voltage:	100 to 240Vac -15%, +10%, or optionally: 24Vac or dc, -15%, +20%.
Supply frequency:	48 to 62Hz.
Power consumption:	15 Watts maximum.
Relay 2-pin (isolated):	Max.: 264Vac, 2A resistive.\ Min: 12Vdc, 100mA.
Relay changeover (isolated):	Max: 264Vac, 2A resistive.\ Min: 6Vdc, 1mA.
AC SSR outputs (isolated):	30 to 264Vac. Max current: 1A resistive.
Leakage current:	The leakage current through AC SSR and relay contact suppression components is less than 2mA at 264Vac, 50Hz
Over current protection:	External over current protection devices are required that match the wiring of the installation. A minimum of 0.5mm ² or 16awg wire is recommended. Use independent fuses for the instrument supply and each relay or AC SSR output. Suitable fuses are T type, (EN 60127 time-lag type) as follows; Instrument supply: 85 to 264Vac, 2A, (T). Relay outputs: 2A (T). AC SSR outputs: 1A (T).
Low level i/o:	All input and output connections other than AC SSR and relay are intended for low level signals less than 42V.
Single dc pulse:	18V at 24mA. (Non-isolated.)
Triple dc pulse:	12 to 13V at up to 8mA. (Isolated.)
DC output (Isolated):	0 to 20mA (600Ω max), 0 to 10V (500Ω min).
DC output (Non isolated):	0 to 20mA (600Ω max), 0 to 10V (500Ω min).
Fixed digital inputs:	Contact closure. (Non isolated.)
Triple contact input:	Contact closure. (Isolated.)
Triple logic input:	11 to 30Vdc. (Isolated.)
DC or 2 nd PV input:	As main input plus 0-1.6Vdc, Impedance, >100MΩ. (Isolated.)
Potentiometer input:	0.5V excitation, 100Ω to 1.5kΩ Potentiometer. (Isolated.)
Transmitter supply:	24Vdc at 20mA. (isolated.)
Strain gauge supply:	10Vdc. Minimum bridge resistance 300Ω. (Isolated.)
PDLINK output (non-isolated):	Setpoint, PV or o/p retransmission to a slave PDLINK controller.
PDLINK input (isolated):	Setpoint input from and holdback to a master PDLINK controller.
Digital Communications:	RS-232 (EIA-232), 2-wire RS-485 (EIA-485) or 4-wire RS-485 (EIA-485). All are isolated.

General

Main PV Input range: $\pm 100\text{mV}$, 0 to 10Vdc (auto ranging) and 3 wire Pt100.
Calibration accuracy: The greater of $\pm 0.2\%$ of reading, ± 1 LSD or $\pm 1^\circ\text{C}$.
Cold junction compensation: $>30:1$ rejection of ambient temperature-for thermocouple i/p.

Electrical safety

Standards: EN 61010, Installation category II, pollution degree 2.
CSA C22.2 No.142-M1987.

Installation category II: Voltage transients on any mains power connected to the instrument must not exceed 2.5kV.

Pollution degree 2: Conductive pollution must be excluded from the cabinet in which the instrument is mounted.

Isolation: All isolated inputs and outputs have reinforced insulation to provide protection against electric shock. The fixed digital inputs, non-isolated dc, dc pulse and PDLINK outputs and the dc pulse output of dual output modules, are all electrically connected to the main process variable input, (thermocouple etc.).