

**WF-C20600/WF-C20750/WF-C21000/  
WF-M21000 User's Guide**



---

# Contents

<b>WF-C20600/WF-C20750/WF-C21000/WF-M21000 User's Guide</b> .....	<b>15</b>
<b>Product Basics</b> .....	<b>16</b>
Product Parts Locations .....	16
Product Parts - Front and Inside .....	17
Product Parts - Back.....	20
Optional Accessories and Replacement Parts .....	22
Using the Control Panel .....	23
Control Panel Buttons and Lights .....	23
Status Icon Information .....	24
Selecting the Date and Time .....	25
Selecting Your Country or Region .....	27
Setting a Password and Locking the Control Panel .....	28
Entering Characters on the LCD Screen.....	30
Using Presets.....	31
Setting User Feature Restrictions (Access Control) .....	34
Changing LCD Screen Language.....	35
Adjusting Control Panel Sounds .....	36
Adjusting the Screen Brightness.....	37
Turning Off the Operation Time Out Setting .....	38
Preventing PC Connection via USB .....	39
Checking the Print Counter.....	40
Checking for Software Updates.....	41
Using Power Saving Settings .....	42
Changing the Sleep Timer Settings .....	42
Changing the Power Off Timer Settings .....	44
Epson Connect Solutions for Smartphones, Tablets, and More .....	44
Setting Up Epson Connect Services.....	45
Using Epson Email Print .....	46
Using the Epson iPrint Mobile App .....	47
Using Epson Remote Print .....	47

Using Epson Scan to Cloud .....	48
Android Printing Using the Epson Print Enabler .....	49
Using Fire OS Printing .....	49
Using the Mopria Print Service .....	50
Using Windows 10 Mobile Printing .....	50
Using Epson Print and Scan App with Windows Tablets .....	51
<b>Wi-Fi or Wired Networking.....</b>	<b>52</b>
Network Security Recommendations .....	52
Wi-Fi Infrastructure Mode Setup.....	53
Selecting Wireless Network Settings from the Control Panel .....	54
Wi-Fi Direct Mode Setup .....	56
Enabling Wi-Fi Direct Mode .....	57
Wi-Fi Protected Setup (WPS).....	59
Using WPS to Connect to a Network .....	59
Printing a Network Status Sheet.....	61
Printing a Network Connection Report .....	61
Network Connection Report Codes and Messages .....	63
Configuring Email Server Settings.....	69
Changing or Updating Network Connections .....	70
Accessing the Web Config Utility .....	70
Changing a USB Connection to a Wi-Fi Connection.....	71
Changing a Wi-Fi Connection to a Wired Network Connection.....	71
Connecting to a New Wi-Fi Router .....	71
Disabling Wi-Fi Features .....	72
<b>Enabling Epson Universal Print Driver (PCL) or PostScript Printing.....</b>	<b>74</b>
Installing the Epson Universal Print Driver - Windows .....	74
Installing the PostScript (PS3) Printer Software - Windows .....	78
Installing the PostScript (PS3) Printer Software - Mac .....	78
Selecting PDL (Page Description Language) Settings .....	79
PDL Print Configuration Options.....	80
Selecting Printer Language and Interface Settings .....	82
Printing Language and Interface Options .....	83
Printing a PCL or PS3 (PostScript) Status Sheet .....	84

<b>Loading Paper .....</b>	<b>86</b>
Loading Paper in the Cassettes and Paper Tray .....	86
Using the Optional Paper Cassette Lock.....	91
Paper Loading Capacity .....	92
Double-sided Printing Capacity .....	97
Compatible Epson Papers (U.S. and Canada).....	99
Compatible Epson Papers (Latin America) .....	100
Paper or Media Type Settings - Printing Software.....	100
Selecting the Paper Settings for Each Source - Control Panel .....	101
Paper Type Settings - Control Panel .....	103
Selecting Default Paper Settings - Administrator.....	104
Selecting the Default Printer Settings .....	105
Paper Source Settings Options.....	106
Selecting the Universal Print Settings.....	106
Universal Print Settings Options .....	107
<b>Placing Originals on the Product .....</b>	<b>109</b>
Placing Originals on the Scanner Glass .....	109
Placing Originals in the Automatic Document Feeder .....	111
<b>Copying .....</b>	<b>115</b>
Copying Documents or Photos.....	115
Copying Options.....	117
Saving Groups for Copying .....	121
Editing or Deleting a Saved Group for Copying.....	122
Omitting Red Characters in Originals When Copying (WF-C20600/WF-C20750/WF-C21000) .....	123
<b>Printing from a Computer .....</b>	<b>125</b>
Printing with the Standard Epson Printer Software - Windows .....	125
Synchronizing Printer Settings for Optional Units - Windows .....	126
Selecting Basic Print Settings - Windows .....	127
Paper Source Options - Windows .....	130
Print Quality Options - Windows .....	130
Multi-Page Printing Options - Windows.....	131
Selecting Double-sided Printing Settings - Windows .....	131
Double-sided Printing Options - Windows.....	133

Selecting Finishing Options - Windows .....	134
Finishing Options - Windows.....	136
Selecting Additional Print Options - Windows .....	137
Custom Color Correction Options - Windows.....	138
Image Options and Additional Settings - Windows.....	139
Header/Footer Settings - Windows .....	140
Selecting a Printing Preset - Windows.....	142
Selecting Extended Settings - Windows .....	142
Extended Settings - Windows .....	144
Printing Your Document or Photo - Windows.....	146
Locking Printer Settings - Windows .....	147
Locked Setting Options .....	148
Entering a User ID and Password for Printing .....	150
Selecting Default Print Settings - Windows.....	151
Changing the Language of the Printer Software Screens .....	152
Changing Automatic Update Options .....	153
Printing with the Epson Standard Printer Software - Mac.....	154
Selecting Basic Print Settings - Mac .....	154
Paper Source Options - Mac.....	158
Print Quality Options - Mac .....	158
Print Options - Mac .....	159
Selecting Page Setup Settings - Mac .....	159
Selecting Print Layout Options - Mac.....	160
Selecting Double-sided Printing Settings - Mac.....	160
Double-sided Printing Options and Adjustments - Mac.....	161
Managing Color - Mac .....	161
Color Matching and Color Options - Mac .....	162
Selecting Finishing Options - Mac .....	163
Finishing Options - Mac .....	164
Selecting Printing Preferences - Mac .....	164
Printing Preferences - Mac.....	165
Printing Your Document or Photo - Mac .....	166
Checking Print Status - Mac.....	167

Printing with the Epson Universal Print Driver - Windows.....	168
Synchronizing Printer Settings - Epson Universal Print Driver - Windows .....	169
Selecting Print Settings - Epson Universal Print Driver - Windows .....	170
Selecting Default Print Settings - Epson Universal Print Driver - Windows.....	172
Locking Printer Settings - Epson Universal Print Driver - Windows .....	174
Epson Universal Print Driver Locked Setting Options .....	175
Adding Network Printers - Epson Universal Print Driver - Windows.....	176
Printing with the PostScript (PS3) Printer Software - Windows .....	179
Selecting Basic Print Settings - PostScript Printer Software - Windows .....	179
Selecting Default Print Settings - PostScript Printer Software - Windows.....	182
Printing with the PostScript (PS3) Printer Software - Mac .....	183
Selecting Basic Print Settings - PostScript Printer Software - Mac .....	184
Cancelling Printing Using the Product Control Panel .....	188
<b>Scanning .....</b>	<b>189</b>
Starting a Scan.....	189
Starting a Scan Using the Product Control Panel .....	189
Scanning to Email .....	191
Scanning to a Connected Computer .....	194
Scanning to a Memory Device .....	198
Scanning to the Product's Hard Drive .....	199
Scanning to the Cloud.....	202
Setting Up a WSD Port (Windows 7/Windows Vista) .....	204
Control Panel Scanning Options.....	204
Setting Up and Scanning to a Network Folder or FTP Server.....	207
Creating a Shared Network Folder.....	207
Registering Contacts for Network Folder or FTP Scanning - Web Config .....	209
Registering Contacts for Email, Network, or FTP Scanning - Control Panel .....	210
Scanning to a Network Folder or FTP Server.....	212
Starting a Scan Using the Epson Scan 2 Icon .....	215
Starting a Scan from a Scanning Program.....	217
Starting a Scan from a Smart Device.....	219
Scanning in Epson Scan 2 .....	219
Additional Scanning Settings - Main Settings Tab .....	223

Additional Scanning Settings - Advanced Settings Tab .....	224
Saving Scanned Documents as a Searchable PDF Using Epson Scan 2 .....	225
Image Format Options .....	227
Scan Resolution Guidelines .....	227
Scanning with Document Capture Pro or Document Capture .....	228
Scanning with Simple Scan in Document Capture Pro - Windows .....	228
Scanning with Job Scan in Document Capture Pro - Windows .....	230
Adding and Assigning Scan Jobs with Document Capture Pro - Windows .....	231
Scanning Two Originals onto One Sheet (Stitching Images) - Windows .....	234
Scanning Multi-Page Originals as Separate Files - Windows .....	237
Scanning with Document Capture - Mac .....	240
Adding and Assigning Scan Jobs with Document Capture - Mac .....	243
Entering a User ID and Password for Scanning .....	244
<b>Faxing.....</b>	<b>245</b>
Connecting a Telephone or Answering Machine .....	245
Setting Up Fax Features .....	251
Setting Up Basic Fax Features .....	251
Using the Fax Setup Wizard .....	251
Selecting the Line Type.....	253
Setting the Number of Rings to Answer .....	254
Selecting Advanced Fax Settings .....	255
Basic Settings - Fax .....	256
Send Settings - Fax.....	259
Receive Settings - Fax .....	259
Report Settings - Fax .....	262
Security Settings - Fax .....	263
Setting Up the Fax Utility - Windows.....	264
Setting Up Contacts and Contact Groups.....	266
Creating a Contact.....	266
Editing or Deleting a Contact .....	270
Creating a Contact Group.....	271
Editing or Deleting a Contact Group .....	274
Sending Faxes .....	275



Sending Faxes from the Product Control Panel.....	276
Sending a Fax Using the Keypad, Contact List, or History.....	276
Fax Sending Options .....	279
Sending a Fax at a Specified Time .....	280
Sending a Fax on Demand .....	282
Sending a Stored Fax .....	283
Dialing Fax Numbers from a Connected Telephone .....	285
Sending Faxes Using the Fax Utility - Windows .....	285
Sending Faxes Using the Fax Utility - Mac .....	288
Receiving Faxes.....	291
Fax Reception .....	291
Receiving Faxes Automatically .....	292
Receiving Faxes Manually.....	292
Forwarding Received Faxes.....	293
Receiving a Fax by Polling .....	294
Viewing a Fax on the LCD Screen (Using the Fax Box).....	295
Checking Fax Status .....	297
Printing Fax Reports.....	298
Fax Report Options .....	299
<b>Using External USB Devices with Your Product.....</b>	<b>300</b>
Connecting a USB Device.....	300
Disconnecting a USB Device.....	300
Viewing and Printing from the LCD Screen .....	301
Printing JPEG Photos.....	301
Print Setting Options - JPEG Mode.....	303
Printing TIFF and PDF Files .....	305
Print Setting Options - TIFF Mode.....	307
Print Setting Options - PDF Mode.....	309
Transferring Files on a USB Device .....	310
Setting Up USB Device Access .....	311
<b>Using Your Product's Internal Storage.....</b>	<b>312</b>
Storage Folder Types.....	312
Printing a Stored File.....	314

Saving Groups for Printing from Storage.....	316
Editing or Deleting a Saved Group .....	319
Saving Stored Files to an External USB Device .....	322
Emailing Stored Files .....	327
Saving Stored Files to a Network Folder .....	331
Saving Stored Files to Cloud Services .....	336
Storage Menu Options .....	338
Searching for Folders and Files.....	341
Deleting Folders and Files from Storage .....	342
Changing the Storage Period of Files.....	344
Restricting Shared Folder Access .....	345
<b>Replacing Ink Cartridges and Maintenance Boxes.....</b>	<b>346</b>
Check Cartridge and Maintenance Box Status.....	346
Checking Ink Status on the LCD Screen.....	347
Checking Ink and Maintenance Box Status with Windows .....	348
Checking Cartridge and Maintenance Box Status - Mac .....	351
Purchase Epson Ink Cartridges and Maintenance Box (U.S. and Canada).....	353
Purchase Epson Ink Cartridges and Maintenance Box (Latin America) .....	353
Ink Cartridge and Maintenance Box Part Numbers .....	353
Removing and Installing Ink Cartridges.....	354
Replacing the Maintenance Box.....	356
<b>Adjusting Print Quality.....</b>	<b>358</b>
Print Head Maintenance .....	358
Checking the Nozzles Using the Product Control Panel .....	358
Cleaning the Print Head Using the Product Control Panel.....	361
<b>Cleaning and Transporting Your Product .....</b>	<b>363</b>
Cleaning Your Product .....	363
Cleaning the Scanner Glass.....	363
Cleaning the Automatic Document Feeder.....	365
Moving or Transporting Your Product.....	369
<b>Solving Problems .....</b>	<b>370</b>
Viewing the Help Screen .....	370

Product Status Messages .....	371
Job Status Error Codes .....	374
Running a Product Check .....	379
Resetting Control Panel Defaults .....	381
Solving Setup Problems .....	383
Product Does Not Turn On or Off.....	383
Noise After Ink Installation .....	383
Software Installation Problems .....	383
Solving Network Problems .....	384
Product Cannot Connect to a Wireless Router or Access Point .....	385
Network Software Cannot Find Product on a Network.....	386
Wireless Network Connection is Unstable on a Mac .....	387
USB 3.0 Connection is Unstable When Using a USB 2.0 Cable.....	388
Wired Network Connection Becomes Unstable .....	388
Product Does Not Appear in Mac Printer Window .....	389
Cannot Print Over a Network.....	389
Cannot Scan Over a Network .....	391
Solving Copying Problems .....	392
Product Cannot Copy .....	392
Product Makes Noise, But Nothing Copies.....	392
Product Makes Noise When It Sits for a While.....	393
Solving Copy Quality Problems .....	393
Copies Have Incorrect or Faint Colors.....	393
Position, Size, or Margins of Copies are Incorrect.....	394
Solving Paper Problems .....	394
Paper Feeding Problems.....	395
Originals Do Not Feed From the Automatic Document Feeder.....	396
Paper Jam Problems .....	397
Paper Ejection Problems .....	397
Solving Problems Printing from a Computer.....	397
Nothing Prints .....	398
Product Icon Does Not Appear in Windows Taskbar .....	399
Printing is Slow .....	400

Solving Page Layout and Content Problems .....	401
Inverted Image.....	402
Too Many Copies Print .....	402
Blank Pages Print .....	402
Incorrect Margins on Printout.....	403
Incorrect Characters Print.....	403
Incorrect Image Size or Position .....	404
Slanted Printout .....	405
Solving Print Quality Problems .....	405
White or Dark Lines in Printout .....	405
Blurry or Smearred Printout .....	406
Faint Printout or Printout Has Gaps .....	408
Grainy Printout.....	408
Incorrect Colors .....	409
Solving Scanning Problems .....	411
Scanning Software Does Not Operate Correctly .....	411
Cannot Start Epson Scan 2 .....	411
Solving Scanned Image Quality Problems .....	412
Image Consists of a Few Dots Only.....	413
Line of Dots Appears in All Scanned Images .....	413
Straight Lines in an Image Appear Crooked .....	413
Scanned Image Quality Problems .....	414
Image Colors are Patchy at the Edges .....	415
Ripple Patterns Appear in an Image .....	416
Scanned Image Edges are Cropped .....	416
Solving Faxing Problems.....	416
Cannot Send or Receive Faxes .....	417
Cannot Receive Faxes with a Telephone Connected to Your Product .....	419
Fax Memory Full Error Appears.....	419
Fax Quality is Poor .....	420
Sent Fax is Received in an Incorrect Size .....	421
Received Fax is Not Printed .....	422
Solving USB Device Problems .....	422

Cannot View or Print from a USB Device.....	422
Cannot Save Files on a USB Device .....	423
Cannot Transfer Files To or From a USB Device.....	423
Uninstall Your Product Software.....	424
Uninstalling Product Software - Windows .....	424
Uninstalling Product Software - Mac.....	425
Where to Get Help (U.S. and Canada) .....	425
Where to Get Help (Latin America).....	426
<b>Technical Specifications .....</b>	<b>429</b>
Windows System Requirements .....	429
Mac System Requirements .....	430
Paper Specifications .....	431
Printable Area Specifications .....	433
Scanning Specifications .....	434
Automatic Document Feeder (ADF) Specifications .....	435
Fax Specifications .....	435
Ink Cartridge Specifications.....	436
Dimension Specifications .....	437
Electrical Specifications .....	439
Environmental Specifications .....	440
Interface Specifications .....	440
External USB Device Specifications.....	441
Network Interface Specifications (U.S. and Canada) .....	442
Network Interface Specifications (Latin America).....	444
Safety and Approvals Specifications (U.S. and Canada) .....	445
Safety and Approvals Specifications (Latin America).....	446
<b>Notices .....</b>	<b>448</b>
Important Safety Instructions.....	448
General Product Safety Instructions .....	448
Ink Cartridge Safety Instructions.....	451
Wireless Connection Safety Instructions .....	452
LCD Screen Safety Instructions.....	452
Telephone Equipment Safety Instructions .....	453

FCC Compliance Statement.....	453
Binding Arbitration and Class Waiver .....	456
Trademarks .....	459
Copyright Notice.....	460
libTIFF Software Acknowledgment.....	460
A Note Concerning Responsible Use of Copyrighted Materials.....	461
Default Delay Times for Power Management for Epson Products .....	461
Copyright Attribution .....	461

---

# WF-C20600/WF-C20750/WF-C21000/WF-M21000 User's Guide

**Note:** The WF-M21000 is a monochrome product. The sections of this guide that refer to color printing do not apply to this product.

Welcome to the WF-C20600/WF-C20750/WF-C21000/WF-M21000 *User's Guide*.

For a printable PDF copy of this guide, [click here](#).

**Note:** Availability of products in this guide varies by country.

---

## Product Basics

See these sections to learn about the basic features of your product.

**Note:** This product contains an encrypted hard drive that is used for storing large and/or authenticated print, copy, and scan jobs. You may erase data stored on the encrypted hard drive by following the steps outlined in the *Administrator's Guide*. It is recommended that data is erased before disposing or giving away the product.

**Note:** Your product may differ from the images in this guide, but the instructions are the same unless otherwise noted.

**Note:** Printing software instructions in this manual are intended for use with the standard Epson printer software. For more information on using the Printer Command Language (PCL) or PostScript (PS3) printer software, please see the appropriate sections.

[Product Parts Locations](#)

[Using the Control Panel](#)

[Checking for Software Updates](#)

[Using Power Saving Settings](#)

[Epson Connect Solutions for Smartphones, Tablets, and More](#)

[Android Printing Using the Epson Print Enabler](#)

[Using Fire OS Printing](#)

[Using the Mopria Print Service](#)

[Using Windows 10 Mobile Printing](#)

[Using Epson Print and Scan App with Windows Tablets](#)

## Product Parts Locations

See these sections to identify the parts on your product.

[Product Parts - Front and Inside](#)

[Product Parts - Back](#)

[Optional Accessories and Replacement Parts](#)

**Parent topic:** [Product Basics](#)



## Product Parts - Front and Inside

Certain parts are labeled with a letter and number code. If you encounter any paper jams or errors, you can use these codes to locate and correct the problem.

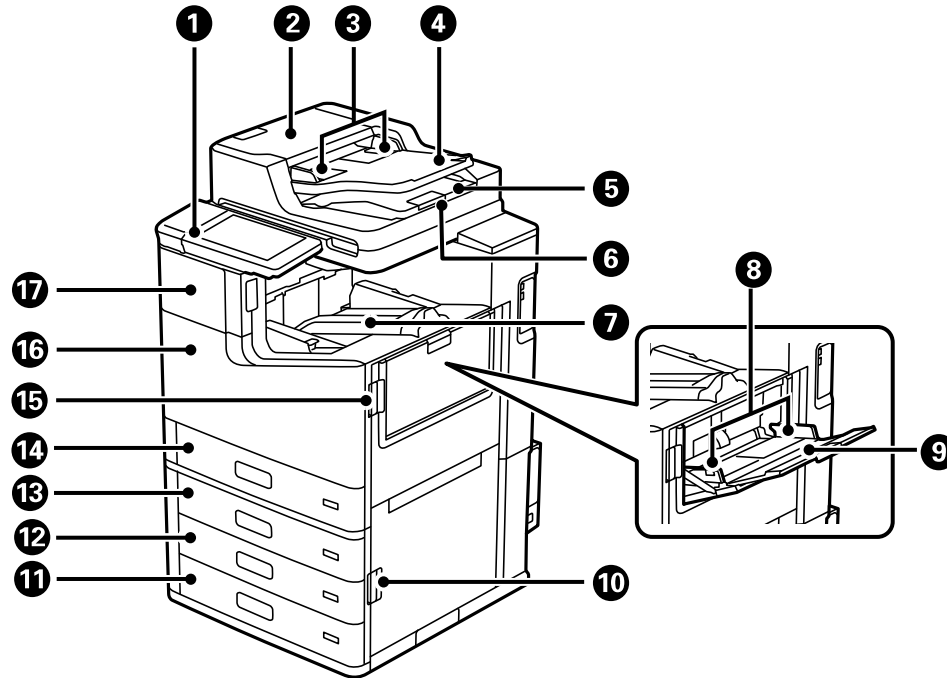

- 1 Control panel
- 2 Automatic Document Feeder (ADF) cover (F)
- 3 ADF edge guides
- 4 ADF input guide
- 5 ADF output tray
- 6 ADF paper stopper
- 7 Facedown paper eject tray (K)
- 8 Paper tray edge guide
- 9 Paper tray (B)

- 10 Cover (E)
- 11 Paper cassette 4 (C4)
- 12 Paper cassette 3 (C3)
- 13 Paper cassette 2 (C2)
- 14 Paper cassette 1 (C1)
- 15 Cover (J)
- 16 Front cover (L)
- 17 Ink cartridge cover (A)

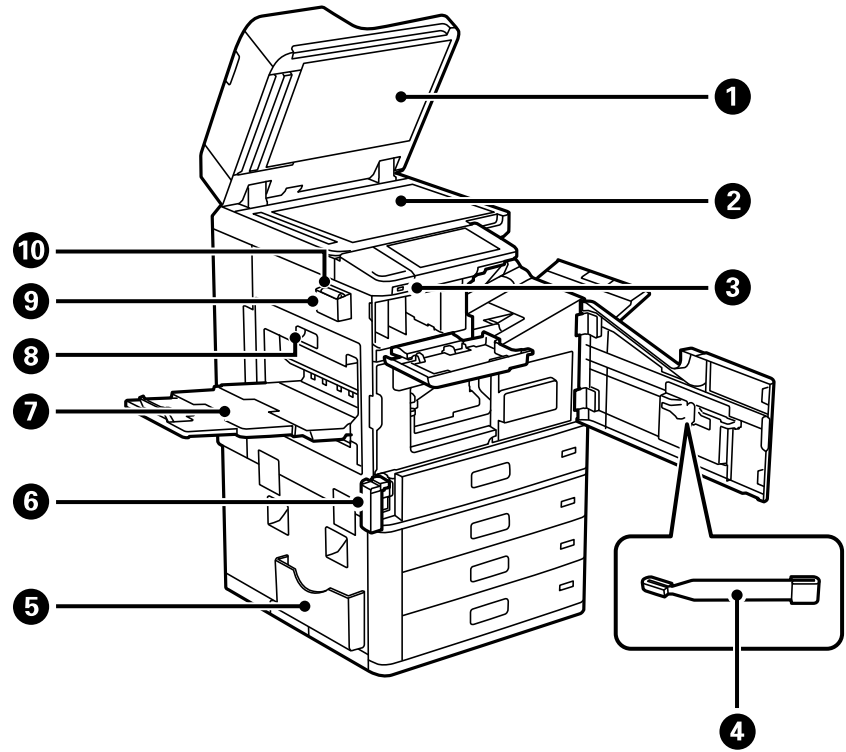

1 Document cover

- 2 Scanner glass
- 3 External USB interface port
- 4 Cleaning stick
- 5 Document holder
- 6 Maintenance box holder (H)
- 7 Faceup tray (G)
- 8 Duplexing unit (D1)
- 9 Cleaning cloth holder
- 10 Cleaning cloth

**Parent topic:** [Product Parts Locations](#)

## Product Parts - Back

Certain parts are labeled with a letter and number code.

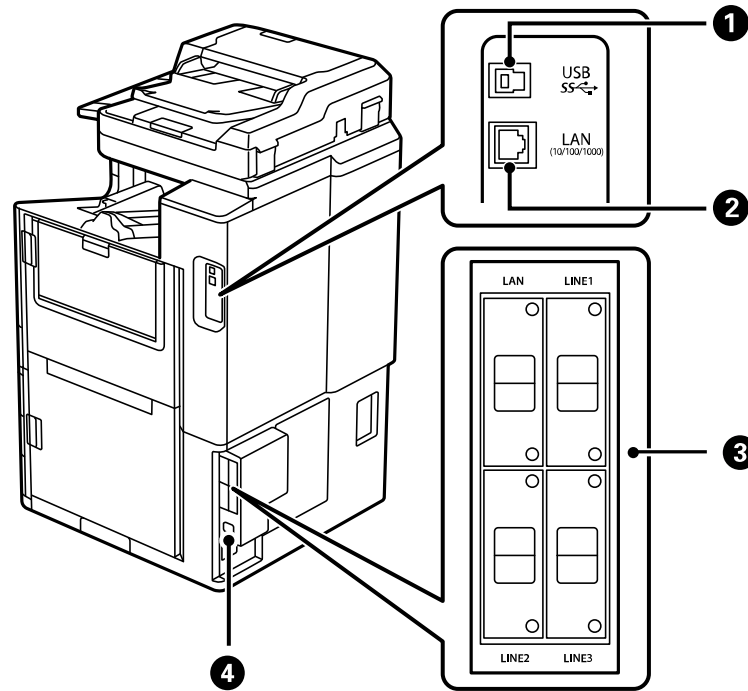

- 1 **USB** port
- 2 **LAN** port
- 3 Optional fax/Ethernet board mounting point
- 4 AC inlet

**Note:** If you are using a USB connection, make sure you insert the cable in the correct orientation.

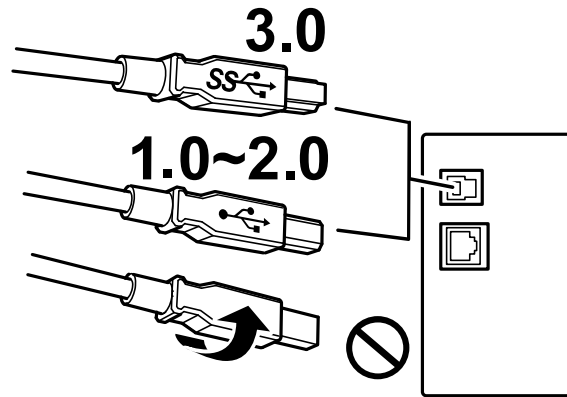

**With the optional fax boards installed**

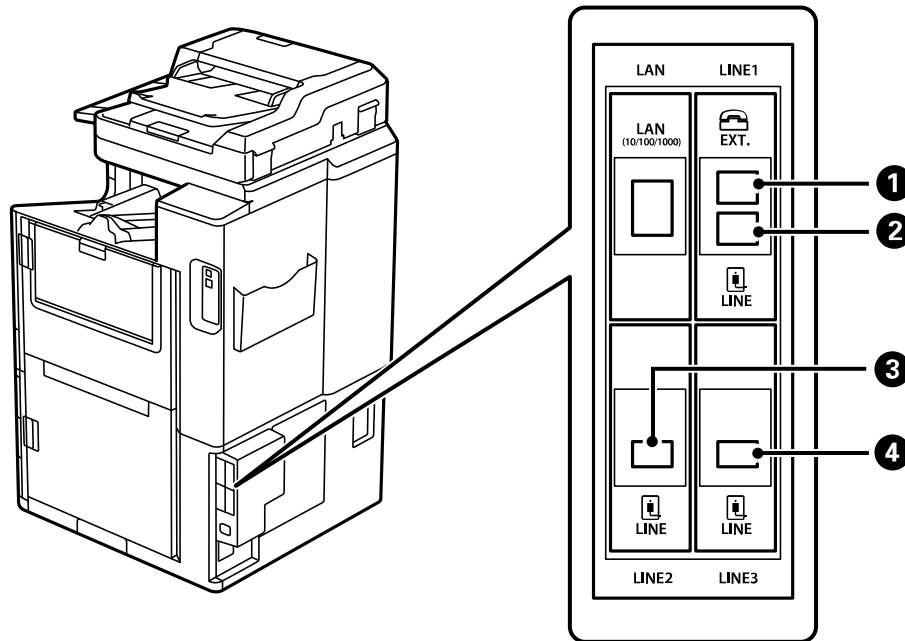

- 1 **EXT.** port
- 2 **LINE1** port
- 3 **LINE2** port
- 4 **LINE3** port

**Parent topic:** [Product Parts Locations](#)

**Related references**

[Optional Accessories and Replacement Parts](#)

## Optional Accessories and Replacement Parts

You can purchase genuine Epson accessories at [epson.com](http://epson.com) (U.S. sales), [epson.ca](http://epson.ca) (Canadian sales), or [epson.com.jm](http://epson.com.jm) (Caribbean sales). You can also purchase accessories from an Epson authorized reseller. To find the nearest one, call 800-GO-EPSON (800-463-7766) in the U.S. or 800-807-7766 in Canada.

Option or part	Part number
Replacement maintenance box	T671300
Paper cassette lock	C12C933231
Optional paper guide*	C12C935901
Staple finisher*	C12C935031BU
Booklet finisher*	C12C935061BU
2/4 Hole punch kit*	C12C935171
2/3 Hole punch kit*	C12C935181
Staple cartridge (side stitch)	C12C935401
Staple cartridge (saddle stitch)	C12C935411
Optional fax board*	C12C935251
Optional Ethernet board*	C12C934471
High-capacity input tray*	C12C933331

\* Must be installed by an Epson authorized reseller or technician.

**Parent topic:** [Product Parts Locations](#)

## Using the Control Panel

See these sections to learn about the control panel and select control panel settings.

[Control Panel Buttons and Lights](#)

[Selecting the Date and Time](#)

[Selecting Your Country or Region](#)

[Setting a Password and Locking the Control Panel](#)

[Setting User Feature Restrictions \(Access Control\)](#)

[Changing LCD Screen Language](#)

[Adjusting Control Panel Sounds](#)

[Adjusting the Screen Brightness](#)

[Turning Off the Operation Time Out Setting](#)



[Preventing PC Connection via USB](#)

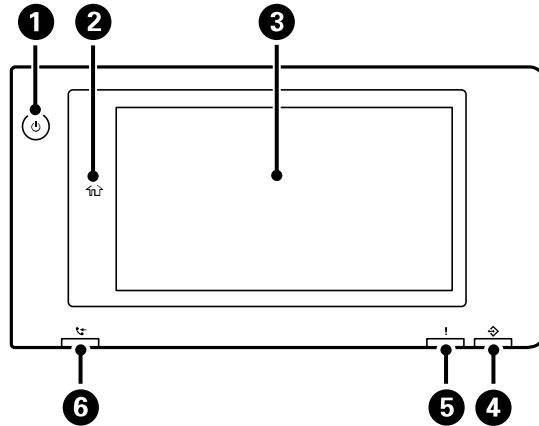

[Checking the Print Counter](#)

**Parent topic:** [Product Basics](#)

### Control Panel Buttons and Lights



- 1  power button and light
- 2  home button
- 3 LCD screen

- 4  data light
- 5  error light
- 6  fax reception light

**Note:** If the LCD screen is dark, touch the screen to wake the product from sleep mode.









[Status Icon Information](#)

**Parent topic:** [Using the Control Panel](#)













**Status Icon Information**

Your product displays status icons on the LCD screen for certain product status conditions. Press the

 icon to view or change the current network settings.

Icons	Description
 or <b>Job/Status</b>	Displays the <b>Job Status</b> , <b>Printer Status</b> , and <b>Consumables/Others</b> screens.
	No Ethernet connection.
	An Ethernet connection is established.
	No Wi-Fi connection.
	A Wi-Fi network error has occurred or the product is searching for a connection.
	A Wi-Fi connection is established. The number of bars indicates the connection's signal strength.
	No Wi-Fi Direct connection.
	A Wi-Fi Direct connection is established.
	The Mute setting is enabled. The product does not make any sound when you press buttons or select icons on the control panel. Select this icon to change the setting.



Icons	Description
	Quiet Mode is enabled. Noise is reduced during printing, but the print speed may be reduced. Select this icon to change the setting.
	Quiet Mode is disabled. Select this icon to change the setting.
	Enables sleep mode and turns off the LCD screen.
	Displays the help screen with how-to and troubleshooting topics.
	Displays the <b>Fax Data Information</b> screen (models with optional fax board installed).
	Enters job interruption mode. Select again to turn this mode off.
	Displays the <b>Paper Setting</b> screen.
	Displays additional information or instructions, such as loading paper or placing a document.
	The indicated setting has changed.
	There is a problem with the indicated setting. Select the icon to resolve the problem.
	Access to the product's functions are restricted to authorized users. Select the icon to log in using a user name and password. Contact your administrator if you do not know the login information.
	Access to the product's functions are restricted to authorized users and a user is currently logged in. Select the icon to log out of the current user account.

Parent topic: [Control Panel Buttons and Lights](#)

## Selecting the Date and Time

Before using your product, select the current date, time, and daylight saving phase in your area, and choose your preferred date and time format.

**Note:** This setting can be locked by an administrator. If you cannot access or change this setting, contact your administrator for assistance.

1. Press the  home button, if necessary.
2. Select **Settings > General Settings > Basic Settings > Date/Time Settings**.

You see a screen like this:

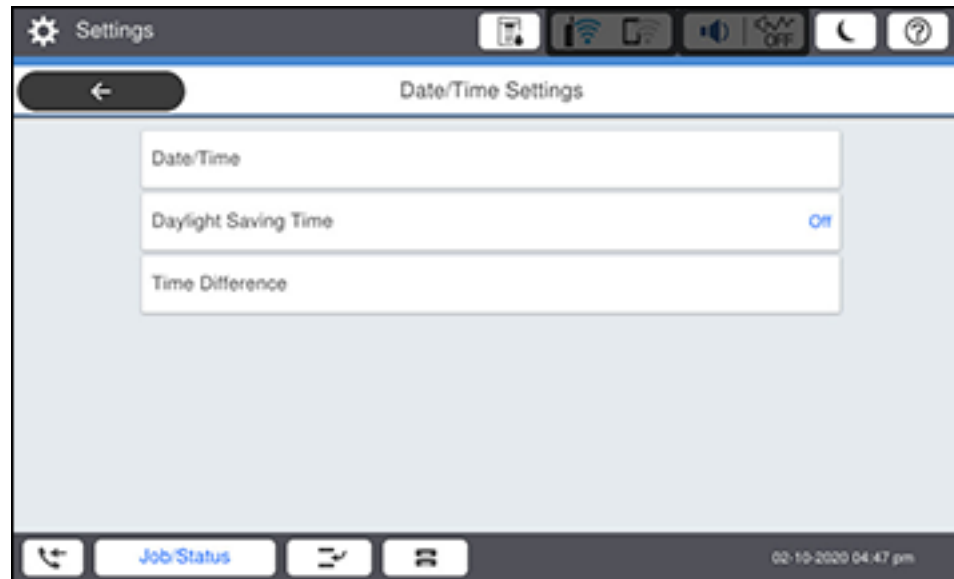

3. Select **Daylight Saving Time**.
4. Select the setting that applies to your area:
  - **Winter**: it is winter or your region does not use Daylight Saving Time (DST)
  - **Summer**: it is spring or summer and your region uses Daylight Saving Time (DST)

**Note:** If your region uses Daylight Saving Time (DST), you must change this setting to match the season. When you change from **Winter** to **Summer**, your product automatically sets its clock ahead one hour. When you change from **Summer** to **Winter**, it sets its clock back one hour.

5. Select **Date/Time**.
6. Select the date format you want to use.
7. Use the on-screen keypad to enter the current date and select **OK**.
8. Select the time format you want to use.
9. Use the on-screen keypad to enter the current time and select **OK**.

**Parent topic:** [Using the Control Panel](#)

## Selecting Your Country or Region

Before using your product, select the country or region in which you are using your product.

**Note:** You must have the optional fax board installed to see this setting. If you change the country or region, your fax settings return to their defaults and you must select them again. This setting can be locked by an administrator. If you cannot access or change this setting, contact your administrator for assistance.

1. Press the  home button, if necessary.
2. Select **Settings** > **General Settings** > **Basic Settings** > **Country/Region**.

You see a screen like this:

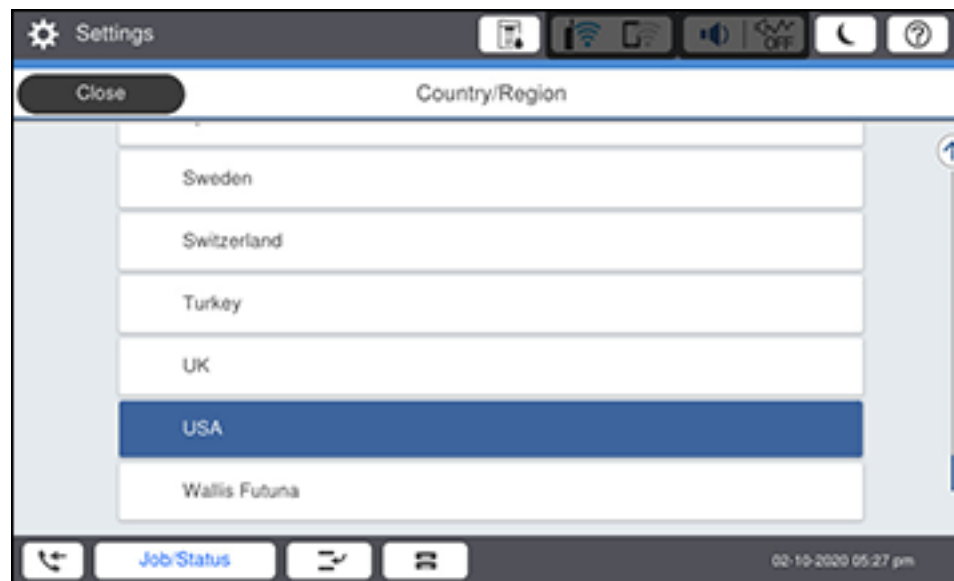

3. Scroll up or down, if necessary, and select your country or region.  
You see a confirmation screen.
4. If the setting is correct, select **Yes**. (If not, select **No** and retry.)

**Parent topic:** [Using the Control Panel](#)

## Setting a Password and Locking the Control Panel

You can set an administrator password to lock the following settings and prevent them from being changed:

- Network settings
- Web Service settings
- Scan settings
- System Administration settings
- Fax settings (models with optional fax board installed)
- Web Config settings
- EpsonNet Config settings

**Note:** If you want to make specific password settings, go to **Settings > General Settings > System Administration > Security Settings > Password Policy**. For more information on administration settings, see the [Administrator's Guide](#).

1. Press the  home button, if necessary.
2. Select **Settings > General Settings > System Administration > Security Settings > Admin Settings**.

You see a screen like this:

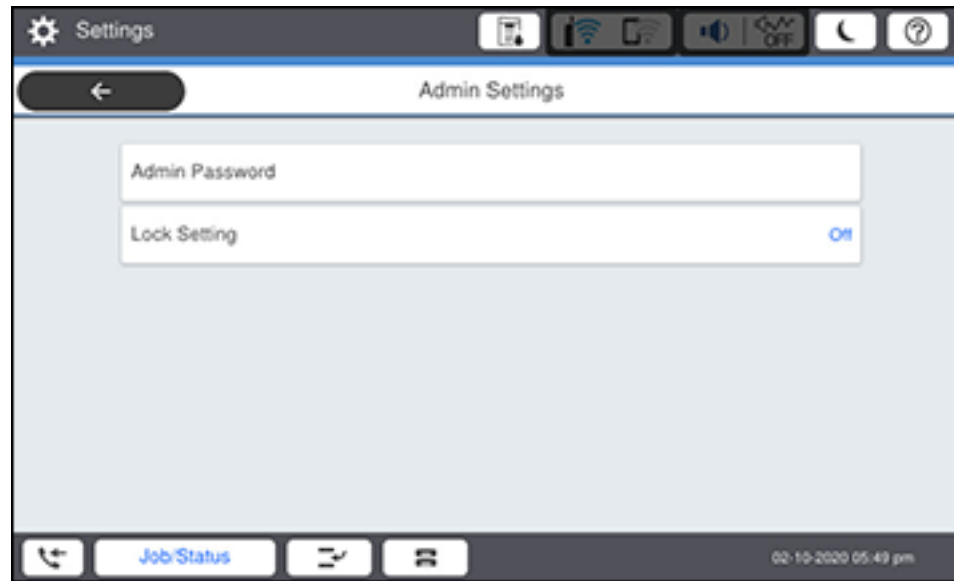

3. Select **Admin Password**.
4. Select **Register**.
5. Use the displayed keyboard to enter a password and select **OK**.
6. Enter your password again to confirm and select **OK**.

**Note:** Keep a copy of your password in a safe place.

7. Select **OK**.
8. Turn **Lock Setting** on.

When the control panel is locked, you must enter the password to access any of the locked settings.

**Note:** If you forget your password, contact Epson for assistance.

[Entering Characters on the LCD Screen](#)

[Using Presets](#)

**Parent topic:** [Using the Control Panel](#)

**Related references**

[Where to Get Help \(U.S. and Canada\)](#)

[Where to Get Help \(Latin America\)](#)

**Related tasks**

[Setting User Feature Restrictions \(Access Control\)](#)

**Entering Characters on the LCD Screen**

Follow these guidelines to enter characters on the LCD screen for passwords and other settings.

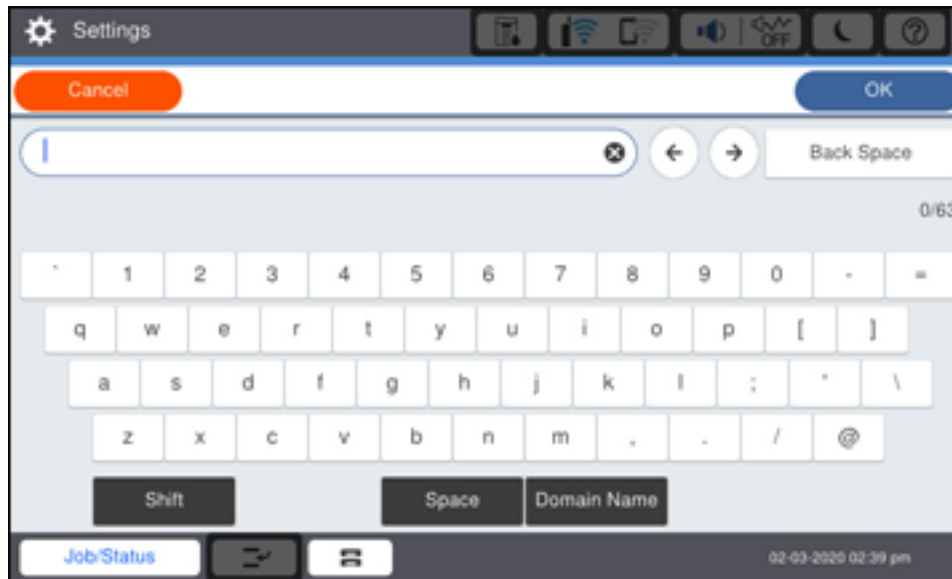

- To move the cursor, select the left or right arrows.
- To change the case of letters, select **Shift**.
- To delete the previous character, select **Back Space**.
- To enter a space, select **Space**.

**Parent topic:** [Setting a Password and Locking the Control Panel](#)

## Using Presets

You can save frequently used copy, fax (models equipped with the optional fax board), and scan settings as presets. This lets you easily reuse them whenever necessary.

**Note:** Presets can be locked by an administrator. If you cannot access or change presets, contact your administrator for assistance.

1. Press the  home button, if necessary.
2. Select **Presets**.

You see a screen like this:

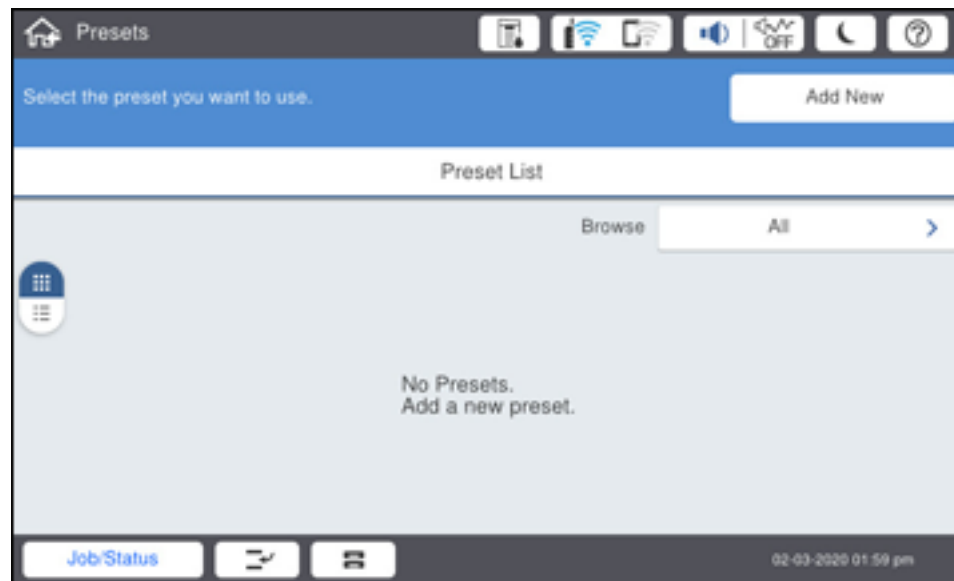

3. Select **Add New**.

**Note:** You can save up to 50 presets.

4. Select the function for which you want to set up a preset, such as **Copy**.

You see a screen like this:



5. Select the settings you want to save and select **Save**.



You see a screen like this:

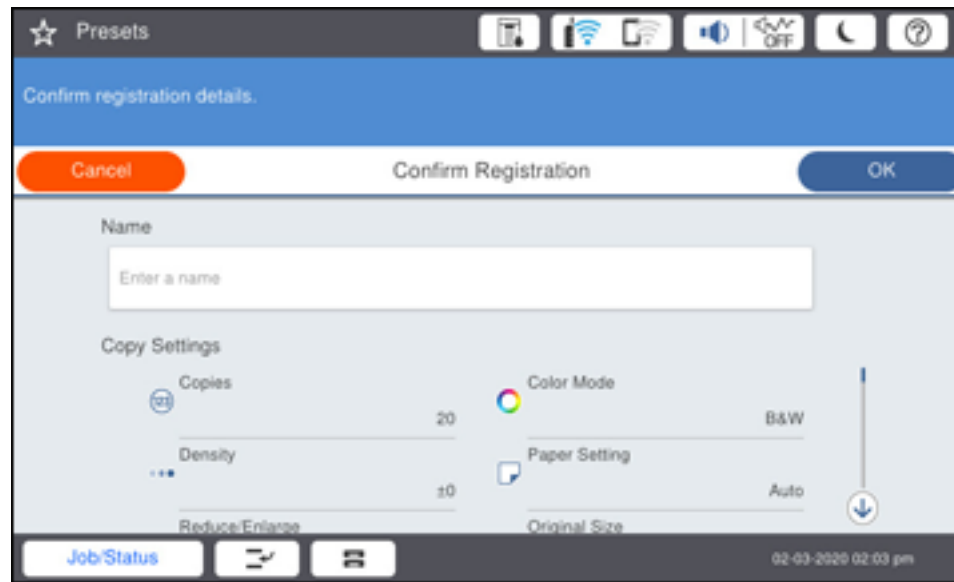

6. Select the **Name** field.

You see a screen like this:

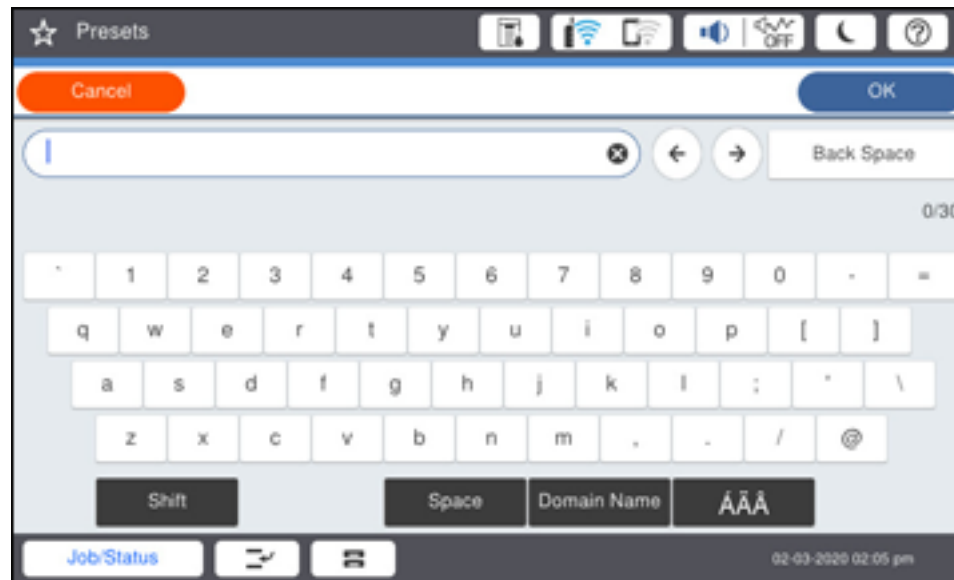

7. Use the on-screen keyboard to enter a name for the preset and select **OK**.
8. When you finish, select **OK**.

When you copy, fax (models with optional fax board installed), or scan, you can use the preset by selecting **Presets** and selecting your preset name from the list.

**Parent topic:** [Setting a Password and Locking the Control Panel](#)

#### **Related tasks**

[Entering Characters on the LCD Screen](#)

## **Setting User Feature Restrictions (Access Control)**

Using Web Config Access Control Settings, you can restrict product features for individual users to prevent misuse of the product. Restricted features require the user to enter an ID and password on the product control panel.

After you set up feature restrictions, you must enable them using the product's control panel.

**Note:** For more information on administration settings, see the [Administrator's Guide](#).

1. Press the  home button, if necessary.
2. Select **Settings** > **General Settings** > **System Administration** > **Security Settings** > **Access Control**.

You see a screen like this:

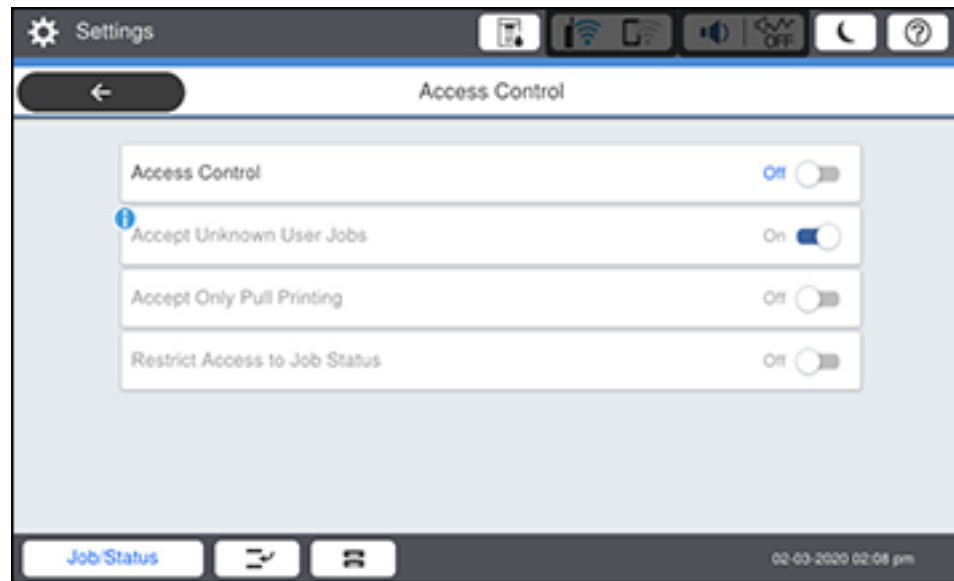

3. Select **On**.
4. Enable **Accept Unknown User Jobs** to allow users to print from generic drivers or use the WSD scanning function.

**Parent topic:** [Using the Control Panel](#)

#### **Related tasks**

[Entering a User ID and Password for Scanning](#)

[Entering a User ID and Password for Printing](#)

[Setting a Password and Locking the Control Panel](#)

## **Changing LCD Screen Language**

You can change the language used on the LCD screen.

**Note:** This setting can be locked by an administrator. If you cannot access or change this setting, contact your administrator for assistance.

1. Press the  home button, if necessary.
2. Select **Settings > General Settings > Basic Settings > Language**.

You see a screen like this:



3. Select a language.

**Parent topic:** [Using the Control Panel](#)

## Adjusting Control Panel Sounds

You can adjust the sound level heard when you press buttons on the control panel.

**Note:** This setting can be locked by an administrator. If you cannot access or change this setting, contact your administrator for assistance.

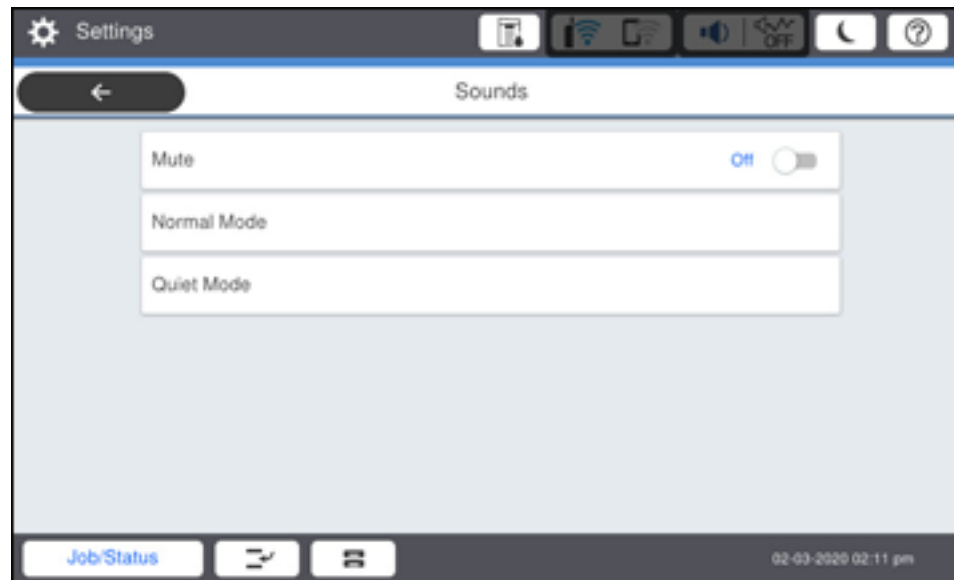

1. Press the  home button, if necessary.
2. Select **Settings > General Settings > Basic Settings > Sounds**.

You see a screen like this:



3. Select **Mute** to turn off all control panel sounds, then go to step 7.
4. Select **Normal Mode** or **Quiet Mode** to adjust control panel sounds.

**Note:** You can also select the  icon on the home screen to adjust sounds.

5. Select **Button Press**.
6. Select  to decrease or  to increase the sound and select **OK** when you are finished.
7. Select the back arrow to exit.

**Note:** You can also adjust the **Sound Type** and the sound level for various product functions.

**Parent topic:** [Using the Control Panel](#)

## Adjusting the Screen Brightness

You can adjust the brightness of the LCD screen.

1. Press the  home button, if necessary.
2. Select **Settings** > **General Settings** > **Basic Settings** > **LCD Brightness**.

You see a screen like this:

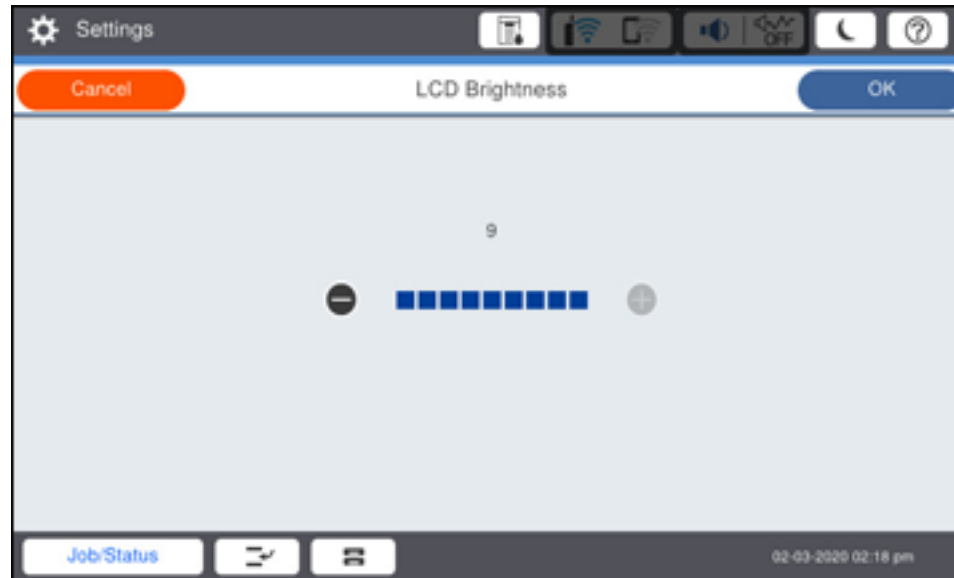

3. Select the – or + icons to decrease or increase the brightness.
4. Select **OK** to exit.

**Parent topic:** [Using the Control Panel](#)

## Turning Off the Operation Time Out Setting

The Operation Time Out setting causes the LCD screen to return to the Home screen after a few minutes of inactivity. This feature is enabled by default, but you can turn it off.

**Note:** This setting can be locked by an administrator. If you cannot access or change this setting, contact your administrator for assistance.

1. Press the  home button, if necessary.
2. Select **Settings** > **General Settings** > **Basic Settings**.

You see a screen like this:



3. Set **Operation Time Out** to **Off**.

Parent topic: [Using the Control Panel](#)

## Preventing PC Connection via USB

You can disable access from a USB-connected computer. This restricts non-network access to the product and protects the security of confidential scanned documents.

1. Press the  home button, if necessary.
2. Select **Settings** > **General Settings** > **Printer Settings**.

You see a screen like this:

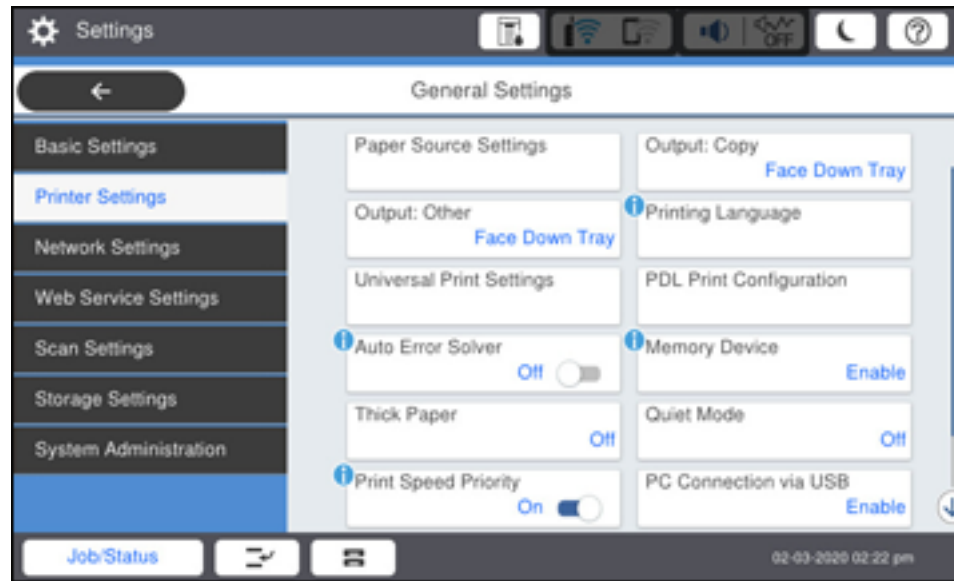

3. Scroll down and select **PC Connection via USB**.
4. Select **Disable**.

**Note:** Select **Yes** to restart the product. Changes are not enabled until the product is restarted.

**Parent topic:** [Using the Control Panel](#)

## Checking the Print Counter

You can check the total number of prints, black-and-white prints, and color prints that have been printed.

1. Press the  home button, if necessary.
2. Select **Settings > Print Counter**.



You see a screen like this:





3. Select **Print Sheet** if you want to print out the counter results.
4. Press the  home button to exit.

**Parent topic:** [Using the Control Panel](#)

## Checking for Software Updates

It's a good idea to check Epson's support website occasionally for free updates to your product software. Visit [epson.com/support](http://epson.com/support) (U.S.), [epson.ca/support](http://epson.ca/support) (Canada), or [latin.epson.com/support](http://latin.epson.com/support) (Caribbean) and select your product.

**Note:** Epson strongly recommends the use of genuine ink to ensure optimal printing quality and performance.

- **Windows:** Your printer software automatically checks for updates. You can also manually update the software by selecting **Software Update** here:
  - Accessing the Windows Desktop and right-clicking the  icon for your product in the right side of the Windows taskbar, or clicking the up arrow and right-clicking .
  - On the **Maintenance** tab in the printer settings window

You can also update the software by selecting **EPSON Software Updater** in the **EPSON** or **Epson Software** program group, accessible by the **Start** button, or on the **Start** or **Apps** screens, depending on your version of Windows.
- **OS X:** You can manually update the software by opening the **Applications > Epson Software** folder and selecting **EPSON Software Updater**.
- **macOS 10.12.x, 10.13.x, 10.14.x, or 10.15.x:** You can manually update the software by opening the **App Store**, selecting **Updates**, searching for a software update option for Epson Software, and selecting **Update**.

Parent topic: [Product Basics](#)

## Using Power Saving Settings

Your product enters sleep mode automatically and turns off the LCD screen if it is not used for a period of time. You can make the time period shorter and select other options to save energy and resources.

[Changing the Sleep Timer Settings](#)

[Changing the Power Off Timer Settings](#)

Parent topic: [Product Basics](#)

## Changing the Sleep Timer Settings

You can adjust the time period before your product enters sleep mode and turns off the LCD screen.

**Note:** This setting can be locked by an administrator. If you cannot access or change this setting, contact your administrator for assistance.

1. Press the  home button, if necessary.
2. Select **Settings > General Settings > Basic Settings > Sleep Timer**.

**Note:** Enter the administrator password, if necessary.

You see a screen like this:

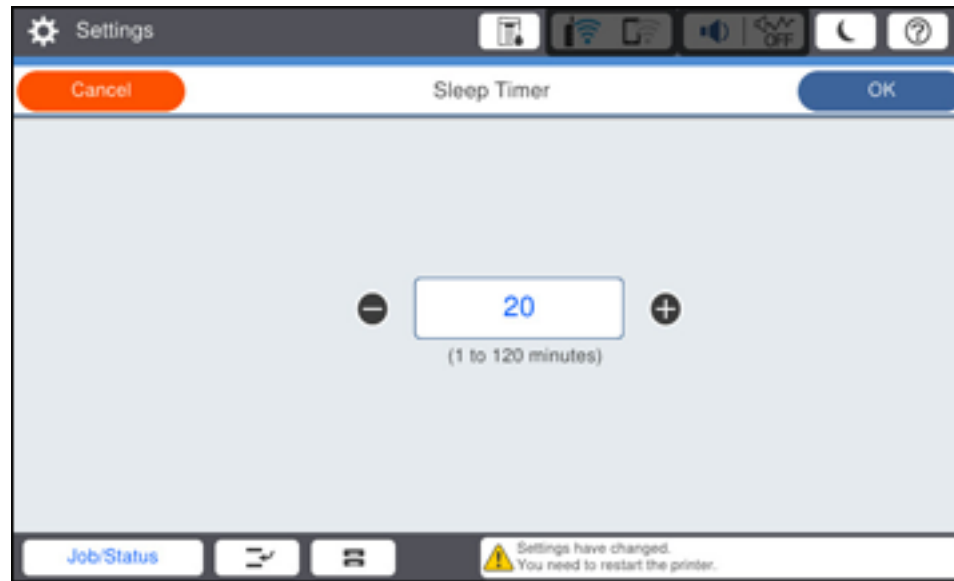

3. Do one of the following:
  - Select the – or + icon to decrease or increase the number of minutes.
  - Select the number of minutes on the LCD screen, select the number of minutes from the on-screen keypad, and select **OK**.
4. Select **OK**.
5. Select **Wake from Sleep**.
6. Select **Wake with LCD Screen Touch**.
7. Do one of the following:
  - Select **On** to wake the printer from sleep mode by tapping the LCD touchscreen or by pressing a button on the control panel.
  - Select **Off** to wake the printer from sleep mode by only pressing a button on the control panel. This prevents unintentional operations due to objects bumping the LCD touchscreen.
  - Select **Scheduled** to set a time range for the feature to be enabled.

**Parent topic:** [Using Power Saving Settings](#)

## Changing the Power Off Timer Settings

You can have the product turn off automatically if it is not used for a specified period of time.

**Note:** This setting can be locked by an administrator. If you cannot access or change this setting, contact your administrator for assistance.

1. Press the  home button, if necessary.
2. Select **Settings** > **General Settings** > **Basic Settings** > **Power Off Timer**.

You see a screen like this:



3. Select a time period between **30minutes** and **12h** (12 hours).

Parent topic: [Using Power Saving Settings](#)

## Epson Connect Solutions for Smartphones, Tablets, and More

Use your smartphone, tablet, or computer to print and scan documents, photos, emails, and web pages from your home, office, or even across the globe.

**Note:** If you are using your Epson product with the Windows 10 S operating system, you cannot use the software described in this section. You also cannot download and install any Epson product software from the Epson website for use with Windows 10 S; you must obtain software only from the Windows Store.

Print from anywhere with these Epson Connect solutions:

- Epson Email Print
- Epson iPrint Mobile App
- Epson Remote Print

Scan and send a file as an email or upload it to an online service directly from your Epson product with Epson Scan to Cloud or the Epson iPrint Mobile App.

[Setting Up Epson Connect Services](#)

[Using Epson Email Print](#)

[Using the Epson iPrint Mobile App](#)

[Using Epson Remote Print](#)

[Using Epson Scan to Cloud](#)

**Parent topic:** [Product Basics](#)

**Related topics**

[Wi-Fi or Wired Networking](#)

## Setting Up Epson Connect Services

If you did not activate your product's email address for use with Epson Connect when you set up your product, you can activate it using the product control panel.

1. Press the  home button, if necessary.
2. Select **Settings > General Settings > Web Service Settings > Epson Connect Services**.

You see a screen like this:

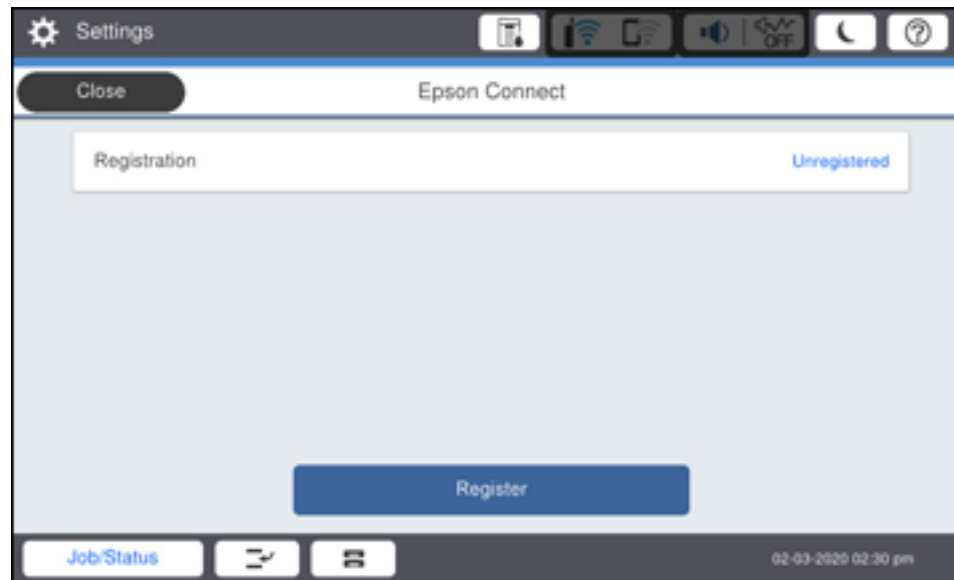

3. Select **Register**.
4. Follow the instructions on the screen to activate your product's email address.

**Parent topic:** [Epson Connect Solutions for Smartphones, Tablets, and More](#)

## Using Epson Email Print

With Epson Email Print, you can print from any device that can send email, such as your smartphone, tablet, or laptop. Just activate your product's unique email address. When you want to print, attach a PDF, Microsoft Office document, or photo to an email and send it to your product. Both the email and the attachments will print automatically.

1. Connect your product to your network. See the link below.
2. If you did not already set up Email Print when you installed your product software, see the link below to use your product control panel to activate your unique email address. Or visit [epson.com/connect](http://epson.com/connect) (U.S), [epson.ca/connect](http://epson.ca/connect) (Canada), or [epsonconnect.com](http://epsonconnect.com) (Caribbean) to learn more about Email Print, create your Epson Connect account, and register your product to the Epson Connect service.
3. Now you are ready to send and print emails to your product's Email Print address.

**Note:** Go to [epsonconnect.com](http://epsonconnect.com) and log into your Epson Connect account to personalize your product's email, adjust print settings, and set up other Epson Connect services.

**Parent topic:** [Epson Connect Solutions for Smartphones, Tablets, and More](#)

**Related topics**

[Wi-Fi or Wired Networking](#)

## Using the Epson iPrint Mobile App

Use this free Apple and Android app to print and scan with networked Epson products. Epson iPrint lets you print PDFs, Microsoft Office documents, photos, and web pages over a wireless network. You can scan and save a file on your device, send it as an email, or upload it to an online service such as Box, Dropbox, Evernote, or Google Drive.

1. Connect your product to your wireless network. See the link below.
2. Visit [epson.com/connect](http://epson.com/connect) (U.S), [epson.ca/connect](http://epson.ca/connect) (Canada), or [latin.epson.com/connect](http://latin.epson.com/connect) (Caribbean) to learn more about Epson iPrint and check the compatibility of your mobile device.
3. Download Epson iPrint from the Apple App Store or Google Play.
4. Connect your mobile device to the same wireless network as your product.
5. Open Epson iPrint and select your Epson product.

Now you are ready to print or scan with your mobile device and your Epson product.

**Parent topic:** [Epson Connect Solutions for Smartphones, Tablets, and More](#)

**Related topics**

[Wi-Fi or Wired Networking](#)

## Using Epson Remote Print

With Epson Remote Print software, you can print from your laptop or desktop computer to an Epson Email-enabled product anywhere in the world.

1. Connect your Epson product to your wireless network. See the link below.
2. If you did not already set up an Epson Connect account when you installed your product software, visit [epsonconnect.com](http://epsonconnect.com) to create your account and register your product to the Epson Connect service.

**Note:** Make a note of your product's email address.

3. Visit [epsonconnect.com](http://epsonconnect.com) to learn more about Remote Print and how to download the Remote Print Driver software.
4. Download and install the Remote Print software.
5. Enter the email address and optional access key of your Epson product during Remote Print setup.
6. Now you are ready to print remotely. Select the print command in your laptop or desktop computer application and choose the Remote Print option for your Epson product.

**Parent topic:** [Epson Connect Solutions for Smartphones, Tablets, and More](#)

**Related topics**

[Wi-Fi or Wired Networking](#)

## Using Epson Scan to Cloud

The Epson Scan to Cloud service allows you to scan and send a file as an email or upload it to an online service directly from your Epson product. Register an email address or online services such as Box, DropBox, Evernote, or Google Drive with your Epson Connect account.

1. Connect your Epson product to your network. See the link below.
2. If you did not already set up an Epson Connect account when you installed your product software, visit [epsonconnect.com](http://epsonconnect.com) to create your account and register your product to the Epson Connect service.

**Note:** Make a note of your product's email address and password.

3. Visit [epsonconnect.com](http://epsonconnect.com) to sign into your account with the email address and password you selected.
4. Select your product, select **Scan to Cloud**, and select **Destination List**.
5. Click **Add**, then follow the instructions on the screen to create your destination list.
6. Now you are ready to use Scan to Cloud. Select the setting for scanning to Scan to Cloud on your Epson product control panel.

**Parent topic:** [Epson Connect Solutions for Smartphones, Tablets, and More](#)

**Related topics**

[Wi-Fi or Wired Networking](#)



## Android Printing Using the Epson Print Enabler

You can wirelessly print your documents, emails, photos, and web pages right from your Android phone or tablet (Android v4.4 or later). With a few taps, your Android device will discover your nearby Epson product and print.

1. Connect your Epson product to your wireless network. See the link below.
2. On your Android device, download the Epson Print Enabler plug-in from Google Play.
3. Go to **Settings** on your Android device, select **Printing**, and enable the Epson plug-in, if necessary.
4. Connect your Android device to the same wireless network as your product.
5. Now you are ready to print. From an Android application such as Chrome or Gmail, tap the menu icon and print whatever is on the screen.

**Note:** If you do not see your product, tap **All Printers** and select your product.

**Parent topic:** [Product Basics](#)

### Related topics

[Wi-Fi or Wired Networking](#)

## Using Fire OS Printing

You can wirelessly print from Amazon Fire tablets and phones to your nearby networked Epson product. There is no software to download, no drivers to install, and no cables to connect. With just a few taps in Email, Calendar, Contacts, and WPS Office, you can send whatever is on the screen to an Epson product.

1. Connect your Epson product to your wireless network. See the link below.
2. Connect your Amazon device to the same wireless network as your product.
3. Now you are ready to print. From your Amazon application, tap the print option and select your product to print whatever is on the screen.

**Note:** If you see a message telling you that a plug-in is required, tap **OK** and tap **Download**. If your Amazon Fire product uses Fire OS 5 and above, your device automatically uses the built-in Mopria Print Service app to print.

**Parent topic:** [Product Basics](#)

### Related topics

[Wi-Fi or Wired Networking](#)

## Using the Mopria Print Service

You can use the Mopria Print Service to print from your Android phone or tablet (Android v4.4 or later) to your Epson product or any Mopria-certified product from other manufacturers. You can download the Mopria Print Service from Google Play.

**Note:** For details on the Mopria Print Service, [click here](#) (U.S.) or [click here](#) (Canada).

1. Connect your Epson product to your wireless network. See the link below.
2. On your Android device, download the Mopria Print Service app from Google Play.

**Note:** On some Samsung Galaxy devices, Mopria may come preinstalled.

3. Go to **Settings** on your Android device, select **Printing**, and enable the Mopria Print Service, if necessary.
4. Connect your Android device to the same wireless network as your product.
5. Now you are ready to print. From an Android application such as Chrome or Gmail, tap the menu icon and select **Print**. Then select **All printers**, select your Epson product, adjust your print settings, and print.

**Parent topic:** [Product Basics](#)

### Related topics

[Wi-Fi or Wired Networking](#)

## Using Windows 10 Mobile Printing

You can wirelessly print from Windows 10 Mobile tablets and phones to your nearby networked Epson product. There is no software to download, no drivers to install, and no cables to connect. Look for the print option in your Windows 10 application to send whatever is on the screen to an Epson product.

1. Connect your Epson product to your wireless network. See the link below.
2. Connect your Windows 10 Mobile device to the same wireless network as your product.
3. Now you are ready to print. From your Windows 10 application, tap the print option and select your product to print whatever is on the screen.

**Parent topic:** [Product Basics](#)

### Related topics

[Wi-Fi or Wired Networking](#)

## Using Epson Print and Scan App with Windows Tablets

You can use this free app to print photos and scan from your Windows (Windows 8 or higher) Surface RT or Pro tablet with networked Epson products. The Epson Print and Scan app allows you to scan and capture images right to your tablet or to Microsoft OneDrive.

**Note:** The Epson Print and Scan app does not support Windows 10 Mobile printing and does not supply scanning functions for products without scanners.

1. Connect your Epson product to your wireless network. See the link below.
2. Download the Epson Print and Scan app from the Microsoft Windows Store.
3. Connect your Windows tablet to the same wireless network as your product.
4. Open the Epson Print and Scan app and select your Epson product.

Now you are ready to print photos or scan.

**Parent topic:** [Product Basics](#)

### Related topics

[Wi-Fi or Wired Networking](#)

---

# Wi-Fi or Wired Networking

See these sections to use your product on a Wi-Fi or wired network.

**Note:** Your product may differ from the images in this guide, but the instructions are the same unless otherwise noted.

[Network Security Recommendations](#)

[Wi-Fi Infrastructure Mode Setup](#)

[Wi-Fi Direct Mode Setup](#)

[Wi-Fi Protected Setup \(WPS\)](#)

[Printing a Network Status Sheet](#)

[Printing a Network Connection Report](#)

[Configuring Email Server Settings](#)

[Changing or Updating Network Connections](#)

## Network Security Recommendations

To help deter unauthorized access to your product over a network, you should protect your network environment using appropriate security measures.

Security measures such as these can help deter threats such as loss of user data, use of telephone and fax lines, and other intrusions:

- **Enable security on your wireless LAN**

Enable the appropriate security on the wireless LAN you plan to use with your product. Network security such as a network password can deter interception of traffic over the wireless LAN. Your router may already have a default password enabled by your Internet service provider (ISP). See your ISP and router documentation for instructions on how to change the default password and better secure your network.

- **Connect your product only to a network protected by a firewall**

Connecting your product directly to the Internet may leave it vulnerable to security threats. Instead, connect it to a router or other network connection protected by a firewall. Your router may already have a firewall set up by your Internet service provider; check with your ISP for confirmation. For best results, set up and use a private IP address for your network connection.

- **Change the default administrator password on your product**

If your product has an option to set an administrator password, change the default administrator password to deter access by unauthorized users to personal data stored on your product, such as IDs, passwords, and contact lists.

Parent topic: [Wi-Fi or Wired Networking](#)

## Wi-Fi Infrastructure Mode Setup

You can set up your product to communicate with your computer using a wireless router or access point. The wireless router or access point can be connected to your computer over a wireless or wired network.

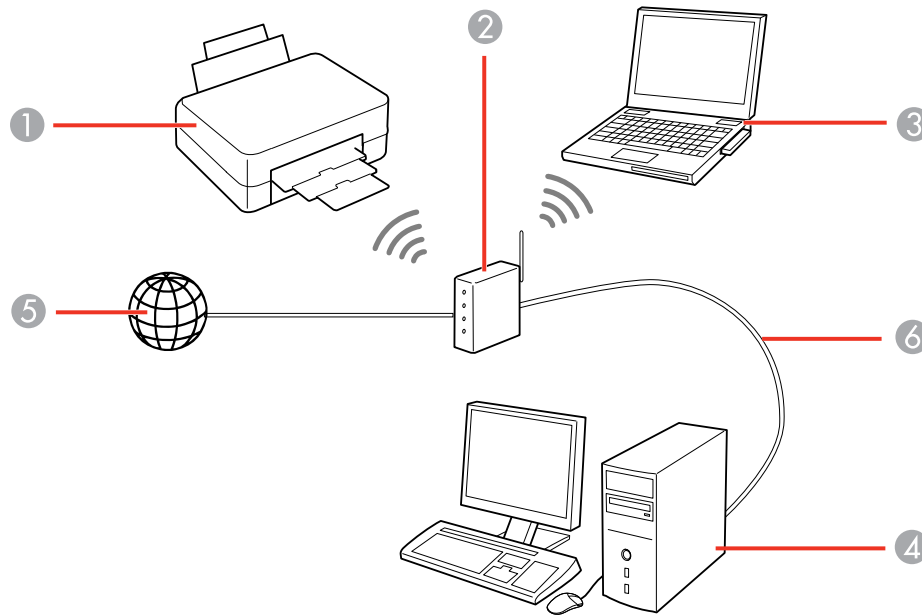

- 1 Epson product
- 2 Wireless router or access point
- 3 Computer with a wireless interface
- 4 Computer
- 5 Internet
- 6 Ethernet cable (used only for wired connection to the wireless router or access point)

## Selecting Wireless Network Settings from the Control Panel



Parent topic: [Wi-Fi or Wired Networking](#)

### Selecting Wireless Network Settings from the Control Panel

You can select or change wireless network settings using your product control panel.

To install your product on a wireless network, install the necessary software by downloading it from the Epson website. The installer program guides you through network setup.

**Note:** Breakdown or repair of this product may cause loss of fax and network data and settings. Epson is not responsible for backing up or recovering data and settings during or after the warranty period. We recommend that you make your own backup or print out your fax and network data and settings.

1. Press the  home button, if necessary.
2. Select the   icon.

You see a screen like this:

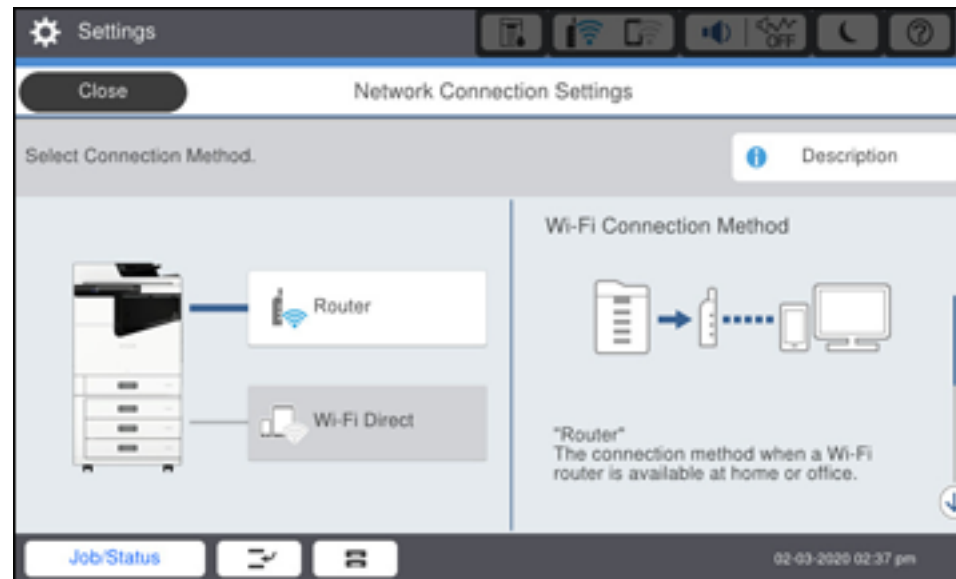

3. Select **Router**.

4. Select **Start Setup** or **Change Settings**.
5. Select **Wi-Fi Setup**.
6. Select **Wi-Fi Setup Wizard**.
7. Select the name of your wireless network or select **Enter Manually** to enter the name manually. Use the on-screen keyboard to enter your network name.
8. Select the **Enter Password** field and enter your wireless password using the on-screen keyboard.

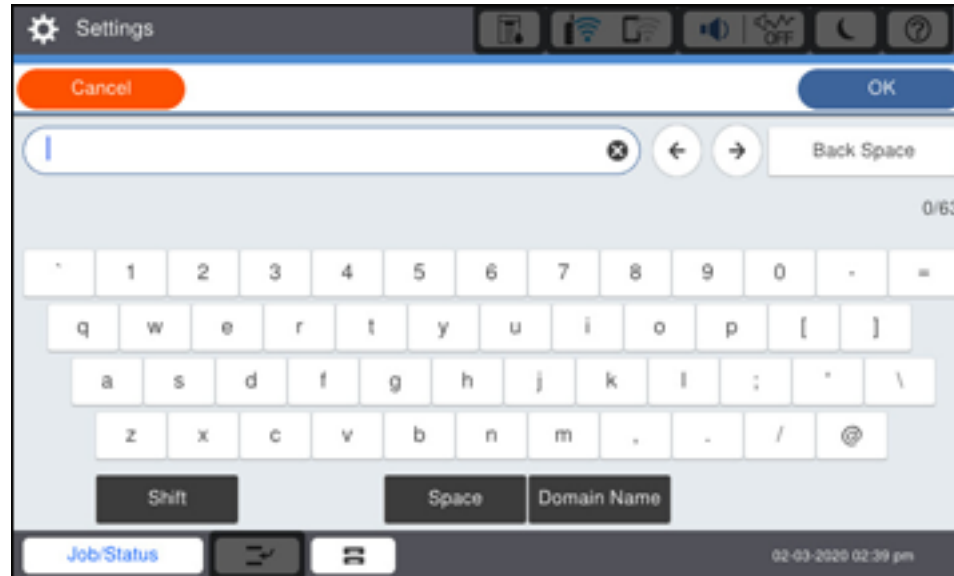



**Note:** The network name and password are case sensitive. Be sure to correctly enter uppercase and lowercase letters, and numeric or special characters.

- To move the cursor, press the left or right arrows.
  - To change the case of letters, select **Shift**.
  - To delete the previous character, select **Back Space**.
  - To enter a space, select **Space**.
9. Select **OK** when you finish entering your password.
  10. Confirm the displayed network settings and select **Start Setup** to save them.

A message appears when setup is complete.

11. If setup was unsuccessful, select **Print Check Report** to print a network setup report, or select **Re-enter** to try again.
12. Press the  home button to exit.

You see the  icon on the LCD screen and should be able to connect to your product directly from your computer or device, and then print. If you are printing from a computer, make sure you installed the network software from the Epson website.

**Note:** If you don't see the  icon, you may have selected the wrong network name or entered the password incorrectly. Repeat these steps to try again.

**Parent topic:** [Wi-Fi Infrastructure Mode Setup](#)

**Related references**

[Status Icon Information](#)

**Related tasks**

[Entering Characters on the LCD Screen](#)

[Setting a Password and Locking the Control Panel](#)

## Wi-Fi Direct Mode Setup

You can set up your product to communicate directly with your computer or another device without requiring a wireless router or access point. In Wi-Fi Direct Mode, the product itself acts as a network access point for up to 8 devices.

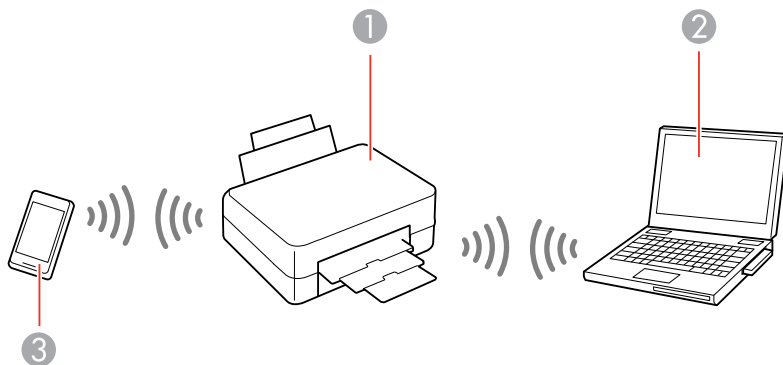





- 1 Epson product
- 2 Computer with a wireless interface
- 3 Other wireless device

### Enabling Wi-Fi Direct Mode

Parent topic: [Wi-Fi or Wired Networking](#)

## Enabling Wi-Fi Direct Mode

You can enable Wi-Fi Direct mode to allow direct communication between your product and computer or other devices without a wireless router or access point.

1. Press the  home button, if necessary.
2. Press the   icon.

You see a screen like this:

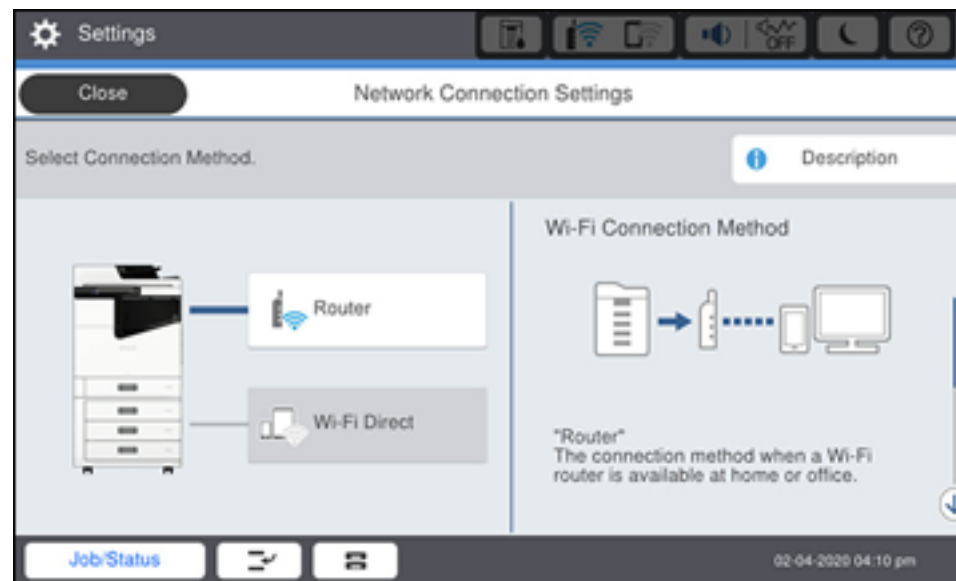

3. Select **Wi-Fi Direct**.

4. Select **Start Setup**.

You see a screen like this:



5. Do one of the following:

- For iOS devices, select **iOS**. Scan the QR code with the camera app on your device and follow the instructions on your device. Select **Next** on the LCD screen to verify the product information, then open the Epson iPrint app on your device and select the product displayed on the LCD screen. Select **Complete** on the LCD screen.
- For Android devices, select **Android**. Open the Epson iPrint app on your device and select the product displayed on the LCD screen. Select **Complete** on the LCD screen.
- For other types of devices, select **Other OS Devices**. Use your device to select the Wi-Fi network name (SSID) displayed on the LCD screen, and enter the password shown. Select **Next** on the LCD screen to verify the product information, then open the Epson iPrint app on your device and select the product displayed on the LCD screen. Select **Complete** on the LCD screen.

**Note:** If you want to change the network name or password, or disable Wi-Fi Direct, select **Change**.

6. When you are finished, the **Network Connection Settings** screen returns.

You should see the number of connected devices (for example, **1/8**).

7. Select **Close** to return to the home screen.

The  Wi-Fi Direct icon is displayed on the LCD screen and indicates if Wi-Fi Direct is enabled on the product.

**Parent topic:** [Wi-Fi Direct Mode Setup](#)

**Related references**

[Status Icon Information](#)

## Wi-Fi Protected Setup (WPS)

If your network uses a WPS-enabled wireless router or access point, you can quickly connect your product to the network using Wi-Fi Protected Setup (WPS).

**Note:** To check if your router is WPS-enabled, look for a button labeled **WPS** on your router or access point. If there is no hardware button, there may be a virtual WPS button in the software for the device. Check your network product documentation for details.

[Using WPS to Connect to a Network](#)

**Parent topic:** [Wi-Fi or Wired Networking](#)

## Using WPS to Connect to a Network

If you have a WPS-enabled wireless router or access point, you can use Wi-Fi Protected Setup (WPS) to connect your product to the network.

1. Press the  home button, if necessary.

2. Select the   icon.

You see a screen like this:

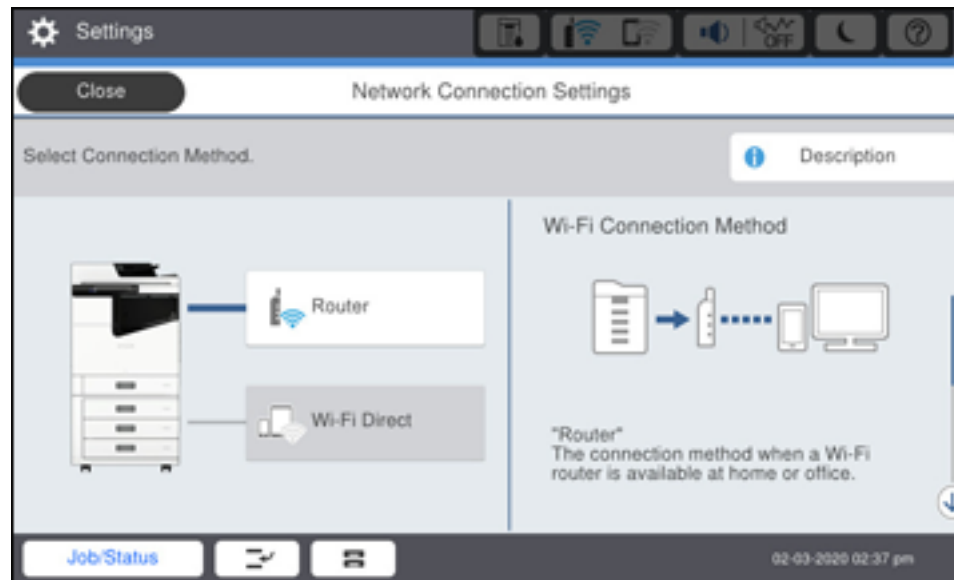

3. Select **Router**.
4. Select **Start Setup**.
5. Select **Wi-Fi Setup**.
6. Select **Push Button Setup (WPS)**.
7. Follow the instructions on the LCD screen to complete WPS setup.
8. Press the  home button to exit.

You see the  icon on the LCD screen and should be able to connect to your product directly from your computer or device, and then print. If you are printing from a computer, make sure you installed the network software from the Epson website.

**Note:** If you don't see the  icon, repeat these steps to try again.

**Parent topic:** [Wi-Fi Protected Setup \(WPS\)](#)

## Printing a Network Status Sheet

You can print a network status sheet to help you determine the causes of any problems you may have using your product on a network.

1. Press the  home button, if necessary.
2. Select **Settings** > **General Settings** > **Network Settings** > **Network Status** > **Print Status Sheet**.

You see a screen like this:

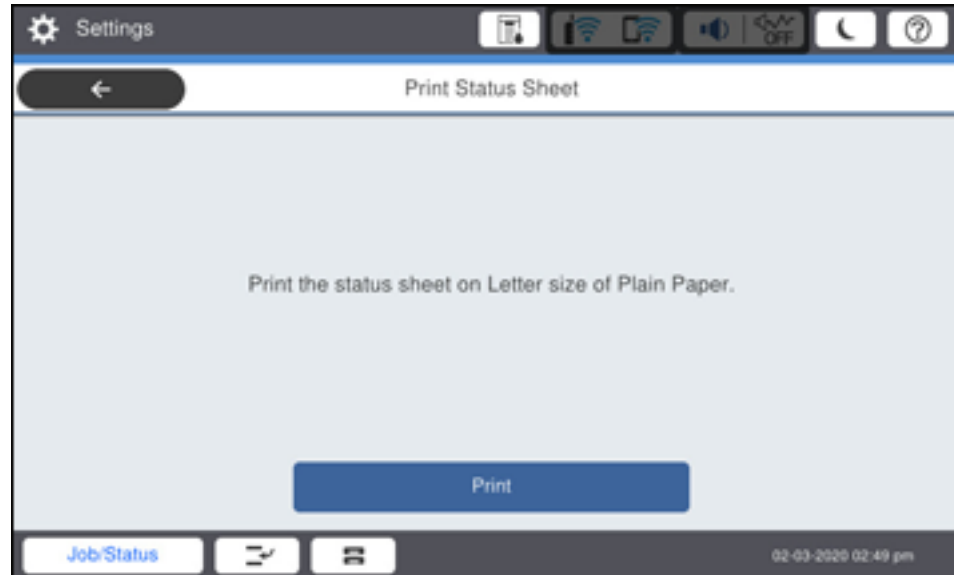

3. Select **Print**.

Examine the settings shown on the network status sheet to diagnose any problems you have.

**Parent topic:** [Wi-Fi or Wired Networking](#)

## Printing a Network Connection Report

You can print a network connection report to view solutions to any problems you may have using your product on a network.

1. Press the  home button, if necessary.
2. Select **Settings** > **General Settings** > **Network Settings** > **Connection Check**.

You see a screen like this:

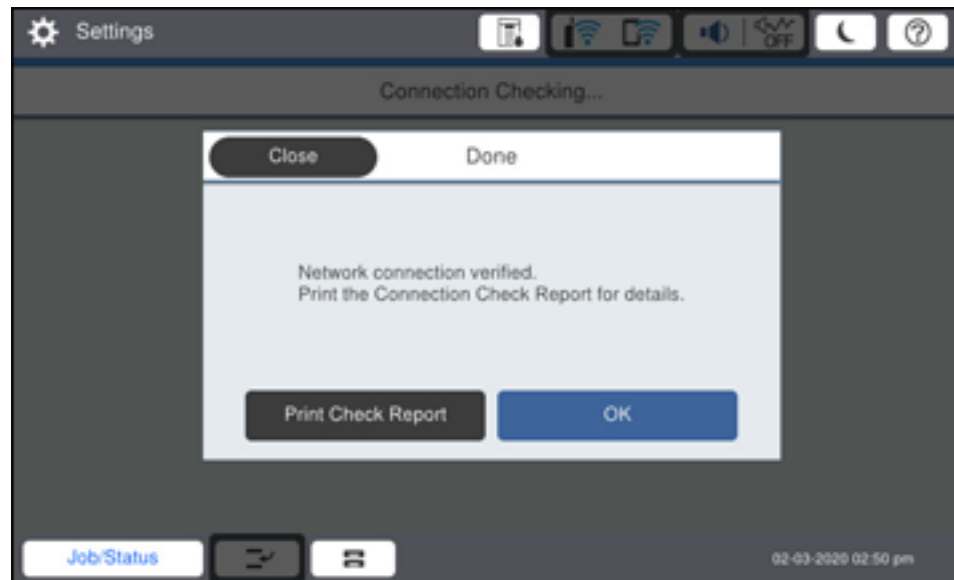

3. Select **Print Check Report**.

**Note:** Select **OK** to return to the **Network Settings** menu without printing a report.

4. Select **Print**.

Examine the error codes and solutions shown on the network connection report.

[Network Connection Report Codes and Messages](#)

**Parent topic:** [Wi-Fi or Wired Networking](#)

## Network Connection Report Codes and Messages

Check the error codes and messages on the network connection report to solve problems you may encounter with network connections. The tables here list solutions to problems based on the error codes and messages that may appear on the top of the report.

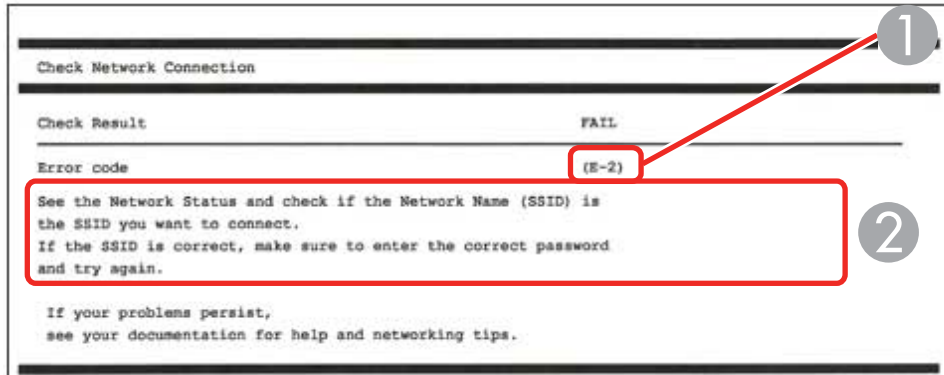

- 1 Error code
- 2 Message

**Note:** Error codes and messages listed here may not all apply to your product.

### Error Codes and Messages

Error code and message	Solution
<b>E-1</b> Confirm that the network cable is connected and network devices such as hub, router, or access point are turned on.	Make sure your router, access point, and/or hub are turned on, and the network cable is securely connected to your device and to your product.  If you are trying to set up Wi-Fi, remove the network cable and set up Wi-Fi again. Ethernet and Wi-Fi cannot be connected at the same time.

Error code and message	Solution
<p><b>E-2, E-3, or E-7</b></p> <p>No wireless network names (SSID) found. Confirm that the router/access point is turned on and the wireless network (SSID) is set up correctly. Contact your network administrator for assistance.</p> <p>No wireless network names (SSID) found. Confirm that the wireless network name (SSID) of the PC you wish to connect is set up correctly. Contact your network administrator for assistance.</p> <p>Entered security key/password does not match the one set for your router/access point. Confirm security key/password. Contact your network administrator for assistance.</p>	<p>Check the following:</p> <ul style="list-style-type: none"> <li>• Make sure your router or access point is turned on, and is correctly connected to your computer or network device.</li> <li>• Turn off the router or access point, wait about 10 seconds, and turn it on again.</li> <li>• Move your product closer to your router or access point, and remove any obstacles between them. Also move your product away from devices such as wireless phones or microwaves.</li> <li>• Confirm that the SSID shown on the network connection report matches the label on your router or access point. Also make sure your SSID uses only ASCII characters and symbols, or your product cannot display the SSID correctly.</li> <li>• If you are trying to connect using the WPS push button method, make sure your router or access point supports it.</li> <li>• If you are using a network password, check the label on your router or access point to confirm that you are using the correct password, or check with your network administrator or router/access point documentation.</li> <li>• If you are connecting to a smart device that generates an SSID, check the device documentation for the SSID and password you should use.</li> <li>• If your wireless connection suddenly disconnects, and another smart device was added to the network using a WPS push button method or your network was set up using a non-WPS push button method, try downloading and installing your product software again.</li> </ul>



Error code and message	Solution
<p><b>E-5</b> Security mode (e.g. WEP, WPA) does not match the current setting of the printer. Confirm security mode. Contact your network administrator for assistance.</p>	<p>If the security on your router or access point is not one of the following types, change the type of security on your router or access point and reset your product's network settings.</p> <ul style="list-style-type: none"> <li>• WEP-64 bit (40 bit)</li> <li>• WEP-128 bit (104 bit)</li> <li>• WPA PSK (TKIP/AES); also known as WPA Personal</li> <li>• WPA2 PSK (TKIP/AES); also known as WPA2 Personal</li> <li>• WPA (TKIP/AES)</li> <li>• WPA2 (TKIP/AES)</li> <li>• WPA3-SAE (AES)</li> <li>• WPA2/WPA3-Enterprise</li> </ul> <p>Latin America: Also make sure you are connecting to the 2.4GHz band on your network and using the password for that band.</p>
<p><b>E-6</b> MAC address of your printer may be filtered. Check whether your router/access point has restrictions such as MAC address filtering. See the documentation of the router/access point or contact your network administrator for assistance.</p>	<p>If your router or access point has MAC address filtering enabled, register your product's MAC address so it is not filtered. Locate the MAC address on the network connection report and check your router or access point documentation for instructions.</p> <p>If your router or access point is using shared authentication with WEP security, confirm that you are using the correct authentication key and index.</p> <p>If your router or access point limits the number of connected devices, raise the connection limit. See your router or access point documentation for instructions.</p>

Error code and message	Solution
<p><b>E-8</b></p> <p>Incorrect IP address is assigned to the printer. Confirm IP address setup of the network device (hub, router, or access point). Contact your network administrator for assistance.</p>	<p>If your product's <b>Obtain IP Address</b> setting is set to <b>Auto</b>, enable DHCP on your router or access point. If it is set to <b>Manual</b>, the IP address may be out of range or on a different network segment; set a valid IP address using your product control panel or the Web Config utility.</p> <p>You can also try turning off your product and the router or access point, waiting about 10 seconds, and turning them on again.</p>
<p><b>E-9</b></p> <p>Confirm the connection and network setup of the PC or other device. Connection using the EpsonNet Setup is available. Contact your network administrator for assistance.</p>	<p>Make sure your computer or network device are turned on. Also make sure that you can access the Internet and other devices on the same network from the devices you are trying to connect to your product.</p> <p>If you still cannot connect to your product, turn off your router or access point, wait about 10 seconds, and turn it on again. Download and install your product software again to reset your network settings.</p>
<p><b>E-10</b></p> <p>Confirm IP address, subnet mask, and default gateway setup. Connection using the EpsonNet Setup is available. Contact your network administrator for assistance.</p>	<p>Make sure other devices on the network are turned on and do the following:</p> <ul style="list-style-type: none"> <li>• If your product's <b>Obtain IP Address</b> setting is set to <b>Manual</b>, check the IP address, subnet mask, and default gateway addresses on the network connection report to see if they are correct. If not, correct the settings.</li> <li>• If DHCP is enabled, set your product's <b>Obtain IP Address</b> setting to <b>Auto</b>. If you want to use the DHCP-assigned address as a static address, set the <b>Obtain IP Address</b> setting to <b>Manual</b>, enter the product's IP address as listed on the network connection report, and set the subnet mask to 255.255.255.0.</li> </ul> <p>If you still cannot connect to your product, turn off your router or access point, wait about 10 seconds, and turn it on again.</p>

Error code and message	Solution
<p><b>E-11</b> Setup is incomplete. Confirm default gateway setup. Connection using the EpsonNet Setup is available. Contact your network administrator for assistance.</p>	<p>If you set your product's <b>TCP/IP Setup</b> setting to <b>Manual</b>, check that the default gateway address listed on the network connection report is correct. Also turn on the device that is set as the default gateway.</p>
<p><b>E-12</b> Confirm the following: -Entered security key/password is correct -Index of the security key/password is set to the first number -IP address, subnet mask, or default gateway setup is correct Contact your network administrator for assistance.</p>	<p>Make sure other devices on the network are turned on and do the following:</p> <ul style="list-style-type: none"> <li>• Make sure the IP address, subnet mask, and default gateway addresses are correct, if you are entering them manually.</li> <li>• Confirm that the subnet mask and default gateway addresses for other devices are the same.</li> <li>• Make sure the IP address does not conflict with other devices.</li> </ul> <p>If you still cannot connect to your product, do the following:</p> <ul style="list-style-type: none"> <li>• Turn off your router or access point, wait about 10 seconds, and turn it on again.</li> <li>• Download and install your product software again to reset your network settings.</li> <li>• If your router or access point uses WEP security with several registered passwords, make sure that the first registered password is set on your product.</li> </ul>

Error code and message	Solution
<p><b>E-13</b></p> <p>Confirm the following:</p> <ul style="list-style-type: none"> <li>-Entered security key/password is correct</li> <li>-Index of the security key/password is set to the first number</li> <li>-Connection and network setup of the PC or other device is correct</li> </ul> <p>Contact your network administrator for assistance.</p>	<p>Make sure your router, access point, and/or hub are turned on. Also make sure the TCP/IP setup on your router, access point, and/or hub is not set manually; this may cause your product's network settings to differ from the manually set up devices.</p> <p>If you still cannot connect to your product, do the following:</p> <ul style="list-style-type: none"> <li>• Turn off your router or access point, wait about 10 seconds, and turn it on again.</li> <li>• Download and install your product software again to reset your network settings.</li> <li>• If your router or access point uses WEP security with several registered passwords, make sure that the first registered password is set on your product.</li> </ul>

### Network Environment Messages

Message	Solution
<p>The Wi-Fi environment needs to be improved. Turn the wireless router off and then turn it on. If the connection does not improve, see the documentation for the wireless router.</p>	<p>Move your product closer to your router or access point, and remove any obstacles between them. Then turn off your router or access point, wait about 10 seconds, and turn it back on again. If you still cannot connect to your product, check the documentation that came with your router or access point for solutions.</p>
<p>*No more devices can be connected. Disconnect one of the connected devices if you want to add another one.</p>	<p>You can connect up to 8 computers or other devices to your product using a Wi-Fi Direct (Simple AP) connection. If you want to add another device, disconnect an existing connected device first.</p>
<p>The same SSID as Wi-Fi Direct exists in the environment. Change the Wi-Fi Direct SSID if you cannot connect a smart device to the printer.</p>	<p>Change the Wi-Fi Direct SSID.</p>

Parent topic: [Printing a Network Connection Report](#)

## Configuring Email Server Settings

To use features such as scanning to email or forwarding faxes to email, you need to configure the email server. You can select settings for the email server using the control panel on the product.

**Note:** These settings can be locked by an administrator. If you cannot access these settings, contact your administrator for assistance.

1. Press the  home button, if necessary.
2. Select **Settings** > **General Settings** > **Network Settings** > **Advanced** > **Email Server** > **Server Settings**.

You see a screen like this:

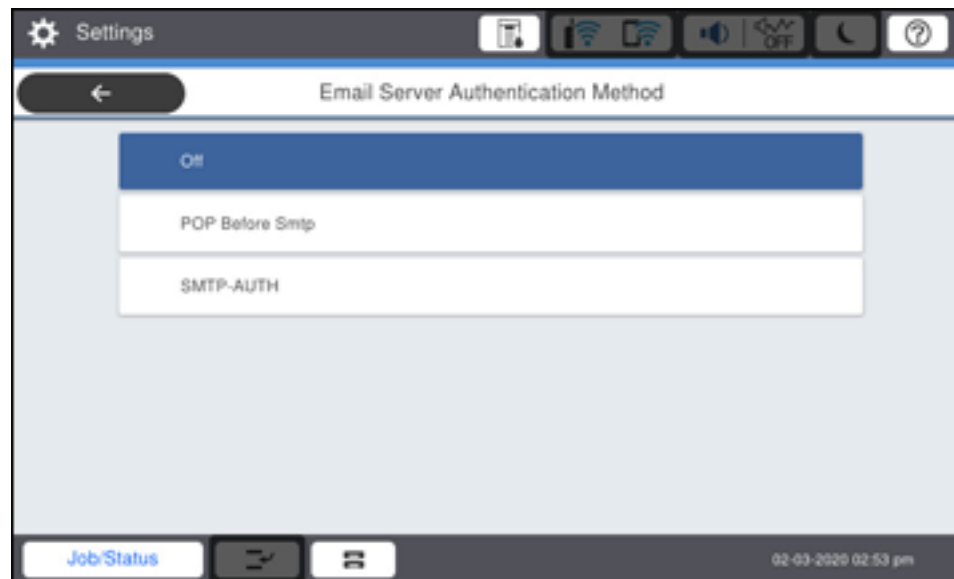

3. Select one of the options shown above, then select the settings you want to use. Contact your internet service provider if necessary to confirm the authentication method for the email server.
4. Select **Proceed** to save your settings.
5. Select **Close** to exit.
6. Select **Connection Check** to verify the connection to the email server.

**Parent topic:** [Wi-Fi or Wired Networking](#)

**Related tasks**

[Scanning to Email](#)

[Forwarding Received Faxes](#)

## Changing or Updating Network Connections

See these sections to change or update how your product connects to a network.

[Accessing the Web Config Utility](#)

[Changing a USB Connection to a Wi-Fi Connection](#)

[Changing a Wi-Fi Connection to a Wired Network Connection](#)

[Connecting to a New Wi-Fi Router](#)

[Disabling Wi-Fi Features](#)

**Parent topic:** [Wi-Fi or Wired Networking](#)

## Accessing the Web Config Utility

You can select your product's network settings and confirm its operating status using a web browser. You do this by accessing your product's built-in Web Config utility from a computer or other device that is connected to the same network as your product.

**Note:** For more information on administration settings, see the [Administrator's Guide](#).

1. Print a network status sheet.
2. Locate the IP address for your product that is listed on the network status sheet.
3. On a computer or other device connected to the same network as your product, open a web browser.
4. Enter your product's IP address into the address bar.
5. On the first visit to the Web Config utility, you will be prompted to set an administrator password. The administrator password is required to access the full capabilities of the Web Config utility.

You see the available Web Config utility options.

**Parent topic:** [Changing or Updating Network Connections](#)

**Related tasks**

[Printing a Network Status Sheet](#)

## Changing a USB Connection to a Wi-Fi Connection

If you have already connected your product to your computer using a USB connection, you can change to a Wi-Fi connection.

1. Disconnect the USB cable from your product.
2. Uninstall your product software.
3. Download and install your product software from the Epson website.

**Parent topic:** [Changing or Updating Network Connections](#)

### Related concepts

[Uninstall Your Product Software](#)

## Changing a Wi-Fi Connection to a Wired Network Connection

If you have already connected your product to your computer wirelessly, you can change to a wired network connection if necessary.

1. Disable your product's Wi-Fi features.
2. Connect one end of an Ethernet network cable to the product's **LAN** port.
3. Connect the other end to any available LAN port on your router or access point.
4. Uninstall your product software.
5. Download and install your product software from the Epson website.
6. Follow the on-screen instructions to install the software.
7. When you see the Select Your Connection screen, select **Wired network connection**.
8. If you see a Select Setup Option screen, select **Set up printer for the first time**.
9. Continue following the rest of the on-screen instructions.

**Parent topic:** [Changing or Updating Network Connections](#)

### Related tasks

[Disabling Wi-Fi Features](#)

## Connecting to a New Wi-Fi Router

If you change the wireless router you have been using on your network, you need to update your product's Wi-Fi connection to the new router.

**Note:** If your router uses a single network name (SSID) for both the 2.4 GHz and 5 GHz band, give each band its own network name (SSID) instead, such as Home Network 2.4 GHz and Home Network 5 GHz. See your router documentation for instructions.

1. Do one of the following:
  - **Windows:** Uninstall your product software.
  - **Mac:** Go to the next step.
2. Download and install your product software from the Epson website.

**Parent topic:** [Changing or Updating Network Connections](#)



**Related tasks**

[Uninstalling Product Software - Windows](#)

## Disabling Wi-Fi Features

You may need to disable your product's Wi-Fi features if you change your network connection type or need to solve a problem with your network connection.

**Note:** Before disabling Wi-Fi features, make a note of your product's SSID (network name) and password, and any network settings selected for the Epson Connect services you may use.

1. Press the  home button, if necessary.
2. Select the  icon.



You see a screen like this:

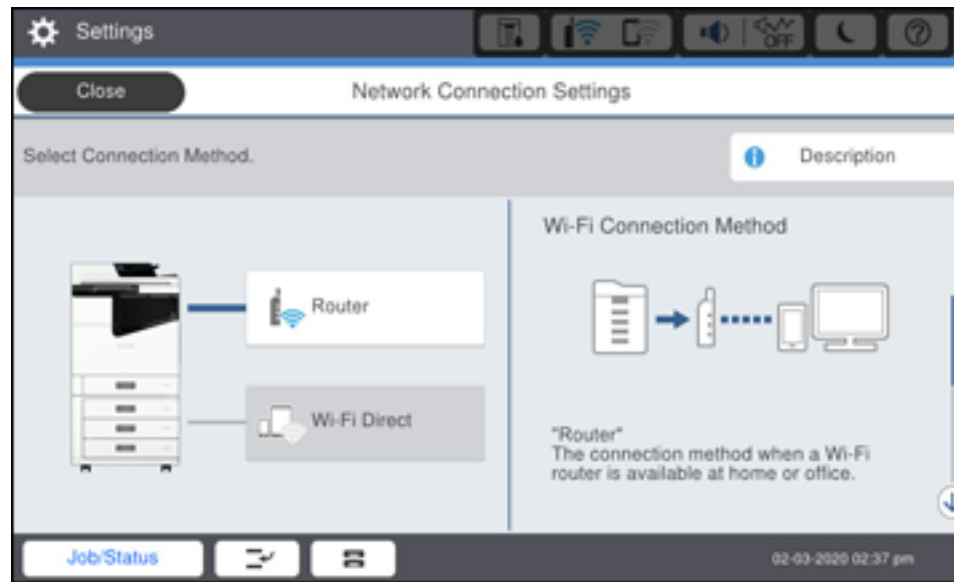

3. Select **Router > Start Setup > Wi-Fi Setup > Others > Disable Wi-Fi.**
4. Select **Start Setup** to disable Wi-Fi.

**Parent topic:** [Changing or Updating Network Connections](#)

---

# Enabling Epson Universal Print Driver (PCL) or PostScript Printing

Before enabling Epson Universal Print Driver (PCL) or PostScript printing on your product, make sure you have installed the software from the Epson website.

To download the Epson Universal Print Driver or PostScript drivers, visit [epson.com/support](http://epson.com/support) (U.S.), [epson.ca/support](http://epson.ca/support) (Canada), or [epson.com.jm/support](http://epson.com.jm/support) (Caribbean) and select your product.

**Note:** Your product may differ from the images in this guide, but the instructions are the same unless otherwise noted.

[Installing the Epson Universal Print Driver - Windows](#)

[Installing the PostScript \(PS3\) Printer Software - Windows](#)

[Installing the PostScript \(PS3\) Printer Software - Mac](#)

[Selecting PDL \(Page Description Language\) Settings](#)

[Selecting Printer Language and Interface Settings](#)

[Printing a PCL or PS3 \(PostScript\) Status Sheet](#)

## Installing the Epson Universal Print Driver - Windows

The Epson Universal Print Driver supports multiple printer languages, such as PCL and ESC/P-R, and can be installed on a Windows computer.

**Note:** Make sure your product is turned on and connected to the same network as your computer before installing the printer software. Depending on your model, not all printer languages may be supported.

1. To download the **EPSON Universal Print Driver** file, visit [epson.com/support](http://epson.com/support) (U.S.), [epson.ca/support](http://epson.ca/support) (Canada), or [epson.com.jm/support](http://epson.com.jm/support) (Caribbean) and select your product.
2. After downloading the installer file, double-click the downloaded file to install the software.

3. Follow the on-screen instructions until you see this screen:

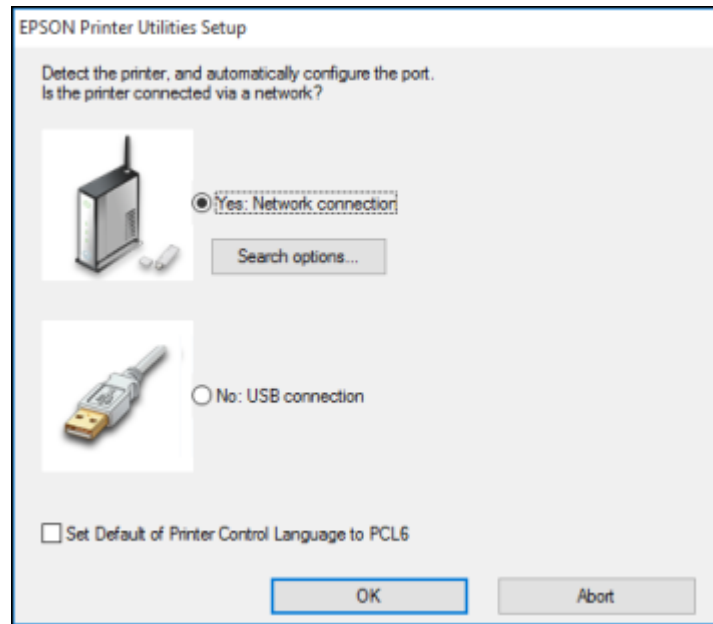

4. Select **Yes: Network connection** and click **OK**.

**Note:** Select the **Set Default of Printer Control Language to PCL6** checkbox if you want to set the default printer language to PCL6. Leave this option deselected to set the printer language to ESC/P-R. (You can change this setting later as needed.)

After the software finishes searching for products, you see a screen like this:

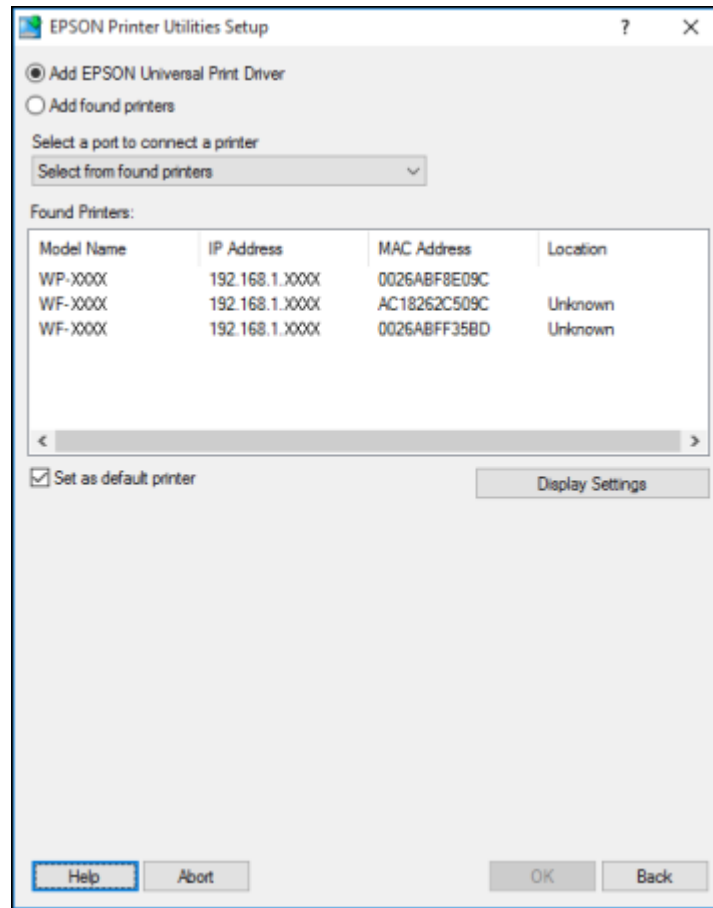

5. Do one of the following:
  - If you are installing one product, make sure **Add EPSON Universal Print Driver** is selected and continue with the next step.
  - If you are installing more than one product, select **Add found printers** and go to step 9.

**Note:** You can customize and filter your product search results by clicking **Display Settings**.

6. Open the **Select a port to connect a printer** menu and select an existing printer port, if necessary. Otherwise, skip this option to create a new port automatically.
7. Select the product you want to install from the Found Printers list.

**Note:** Deselect the **Set as default printer** checkbox if you do not want the product to be set as your default printer.

8. Click **OK**, then skip the remaining steps.
9. If you are installing more than one product, select the products from the Found Printers list and click **Add to Printer Folder**.

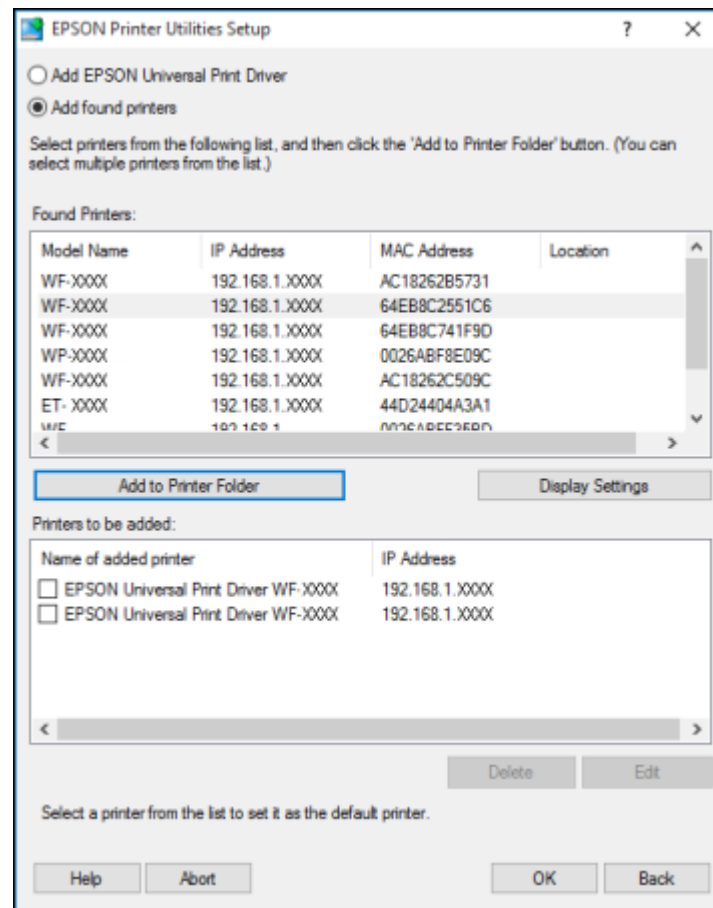

The selected products appear in the lower section of the screen.

10. Select the checkbox next to the product you want to make your default printer, if necessary.
11. Click **OK**.

**Parent topic:** [Enabling Epson Universal Print Driver \(PCL\) or PostScript Printing](#)

## Installing the PostScript (PS3) Printer Software - Windows

If you did not install the standard Epson printer software or Epson Universal Print Driver, you need to install the PostScript (PS3) printer software before you can adjust the print settings and print to your network printer.

**Note:** Make sure your product is turned on and connected to the same network as your computer before installing the printer software.

1. To download the **Drivers and Utilities Combo Package - PS3 PostScript** file, visit [epson.com/support](http://epson.com/support) (U.S.), [epson.ca/support](http://epson.ca/support) (Canada), or [epson.com.jm/support](http://epson.com.jm/support) (Caribbean) and select your product.
2. After downloading the installer file, double-click the downloaded file to install the software.
3. Click **OK**.
4. Click **Accept**.
5. Click **Install**.
6. Click **Next** and follow the on-screen instructions.

**Parent topic:** [Enabling Epson Universal Print Driver \(PCL\) or PostScript Printing](#)

## Installing the PostScript (PS3) Printer Software - Mac

If you did not install the standard Epson printer software, you need to install the PostScript (PS3) printer software before you can adjust the print settings and print to your network printer.

**Note:** Make sure your product is turned on and connected to the same network as your computer before installing the printer software.

1. To download the **Drivers and Utilities Combo Package - PS3 PostScript** file, visit [epson.com/support](http://epson.com/support) (U.S.), [epson.ca/support](http://epson.ca/support) (Canada), or [epson.com.jm/support](http://epson.com.jm/support) (Caribbean) and select your product.
2. After downloading the installer file, double-click the downloaded file to install the software.

3. Double-click **EPSON**.
4. Click **Continue** on the next two screens.
5. Click **Agree**.
6. Click **Install**.
7. If necessary, enter the administrator password.
8. Click **Start** and follow the on-screen instructions.

**Parent topic:** [Enabling Epson Universal Print Driver \(PCL\) or PostScript Printing](#)

## Selecting PDL (Page Description Language) Settings

You can select settings for PCL and PostScript printing using the control panel on the product.

**Note:** These settings can be locked by an administrator. If you cannot access these settings, contact your administrator for assistance.

1. Press the  home button, if necessary.
2. Select **Settings** > **General Settings** > **Printer Settings** > **PDL Print Configuration**.

You see a screen like this:



3. Select one of the options shown above, then select the PDL print configuration options you want to use.
4. When you are finished, press the  home button to exit.

[PDL Print Configuration Options](#)

**Parent topic:** [Enabling Epson Universal Print Driver \(PCL\) or PostScript Printing](#)

## PDL Print Configuration Options

Select the **PDL Print Configuration** options you want to use for PCL or PostScript printing.

PDL Print Configuration option	Available settings	Description
<b>Common Settings</b>		
<b>Paper Size</b>	Various sizes	Sets the default paper size for PCL or PostScript printing
<b>Paper Type</b>	Various paper types	Sets the default paper type for PCL or PostScript printing
<b>Orientation</b>	<b>Portrait</b>	Sets the default orientation for PCL or PostScript printing
	<b>Landscape</b>	
<b>Quality</b>	<b>Draft</b>	Sets the quality for PCL or PostScript printing
	<b>Standard</b>	
<b>Ink Save Mode</b>	<b>Off</b>	Saves ink by reducing print density
	<b>On</b>	
<b>Print Order</b>	<b>Last Page on Top</b>	Starts printing from the first page of a file
	<b>First Page on Top</b>	Starts printing from the last page of a file
<b>Number of Copies</b>	1 to 999	Selects the number of copies to print
<b>Binding Margin</b>	<b>Left Edge</b>	Specifies the binding edge for double-sided documents
	<b>Top Edge</b>	



PDL Print Configuration option	Available settings	Description
<b>Auto Paper Ejection</b>	<b>Off</b>	Ejects paper automatically when printing is stopped during a print job
	<b>On</b>	
<b>2-Sided Printing</b>	<b>Off</b>	Selects duplex printing
	<b>On</b>	
<b>PCL Menu</b>		
<b>Font Source</b>	<b>Resident</b>	Uses a font preinstalled on the printer
	<b>Download</b>	Uses a font you have downloaded
<b>Font Number</b>	0 to 65535	Selects the default font number for the default font source
<b>Pitch</b>	0.44 to 99.99 cpi	Selects the default font pitch if the font is scalable and fixed-pitch (availability depends on font source and number settings)
<b>Height</b>	4.00 to 999.75 pt	Selects the default font height if the font is scalable and proportional (availability depends on font source and number settings)
<b>Symbol Set</b>	Various	Selects the default symbol set. If the selected font is not available for the selected symbol set, the font source and number are replaced with <b>IBM-US</b> (the default setting).
<b>Form</b>	5 to 128 lines	Sets the number of lines for the selected paper size and orientation. Changes the line spacing (VMI) stored in the printer. Later changes in page size or orientation cause changes in the <b>Form</b> value based on the stored VMI.
<b>CR Function</b>	<b>CR</b>	Selects the line feed command when printing with a driver from a specific operating system
	<b>CR+LF</b>	
<b>LF Function</b>	<b>LF</b>	
	<b>CR+LF</b>	

PDL Print Configuration option	Available settings	Description
Paper Source Assign	4	Makes the paper source select command compatible with HP LaserJet 4
	4K	Makes the paper source select command compatible with HP LaserJet 4000, 5000, and 8000
	5S	Makes the paper source select command compatible with HP LaserJet 5S
<b>PS Menu</b>		
Error Sheet	Off	Prints a sheet showing the status when errors occur during PostScript or PDF printing
	On	
Coloration	Color	Selects the color mode for PostScript printing
	Mono	
Binary	Off	Enable when printing files that contain binary images (available when the product is connected to the network). Allows you to print binary images even if the driver is set to ASCII.
	On	
PDF Page Size	Various sizes	Selects the paper size when printing a PDF file. If <b>Auto</b> is selected, the paper size is determined based on the size of the first page.

Parent topic: [Selecting PDL \(Page Description Language\) Settings](#)

## Selecting Printer Language and Interface Settings

You can select printer language and interface settings using the control panel on the product.

**Note:** These settings can be locked by an administrator. If you cannot access these settings, contact your administrator for assistance.

1. Press the  home button, if necessary.
2. Select **Settings** > **General Settings** > **Printer Settings** > **Printing Language**.

You see a screen like this:

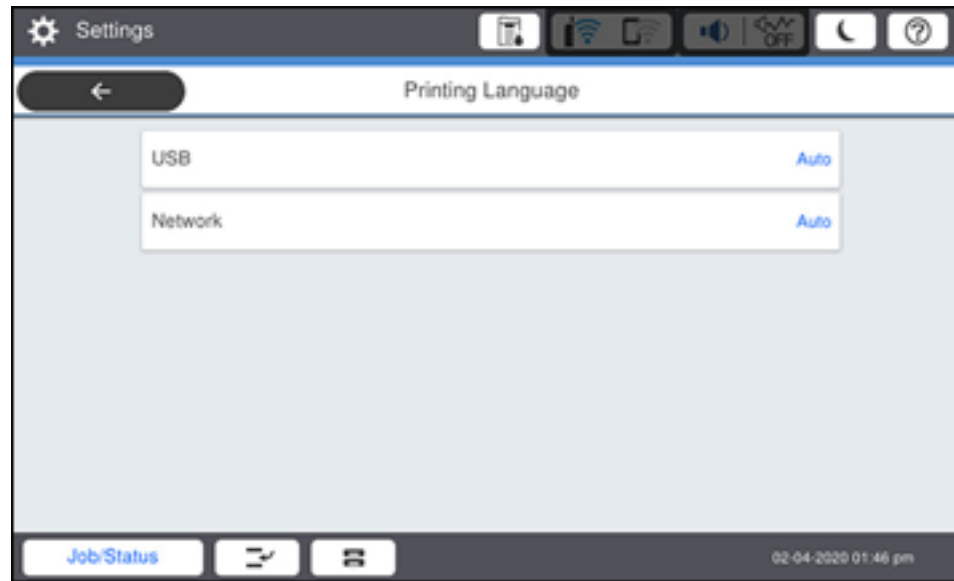

3. Select the printing language and interface options for your connection type.
4. When you are finished, press the  home button to return to the Home screen.

[Printing Language and Interface Options](#)

**Parent topic:** [Enabling Epson Universal Print Driver \(PCL\) or PostScript Printing](#)

## Printing Language and Interface Options

Select the printing language and interface options you want to use.

Main **Printer Settings** menu

Option	Available settings	Description
PC Connection via USB	Enable	Select whether to allow USB communication with the product
	Disable	

Option	Available settings	Description
<b>USB I/F Timeout Setting</b>	0, or 5 to 300 seconds	Specify the length of time before ending USB communication from a computer using the PCL or PostScript driver. This setting is necessary to avoid endless USB communication. If you do not want USB communication to timeout, enter 0.

**Printing Language** menu

Option	Available settings	Description
<b>USB</b>	<b>Auto</b>	Select the language for the USB or network interface
<b>Network</b>	<b>PCL</b> <b>PS</b> <b>PDF</b> <b>ESC/Page</b>	

Parent topic: [Selecting Printer Language and Interface Settings](#)

## Printing a PCL or PS3 (PostScript) Status Sheet

You can print a PCL or PS3 (PostScript) status sheet to confirm the current font information.

1. Press the  home button, if necessary.
2. Select **Settings > Printer Status/Print > Print Status Sheet**.

You see a screen like this:

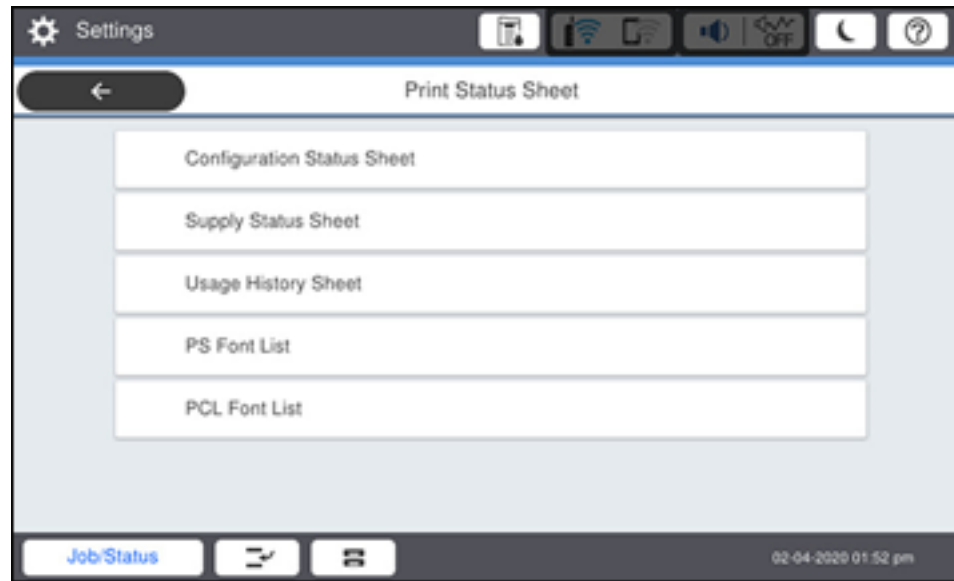

3. Select **PS Font List** or **PCL Font List**.
4. Select **Print** to print the status sheet.

**Parent topic:** [Enabling Epson Universal Print Driver \(PCL\) or PostScript Printing](#)

---

# Loading Paper

Before you print, load paper for the type of printing you will do.

**Note:** Your product may differ from the images in this guide, but the instructions are the same unless otherwise noted.

[Loading Paper in the Cassettes and Paper Tray](#)

[Using the Optional Paper Cassette Lock](#)

[Paper Loading Capacity](#)

[Double-sided Printing Capacity](#)

[Compatible Epson Papers \(U.S. and Canada\)](#)

[Compatible Epson Papers \(Latin America\)](#)

[Paper or Media Type Settings - Printing Software](#)

[Selecting the Paper Settings for Each Source - Control Panel](#)

[Selecting Default Paper Settings - Administrator](#)

## Loading Paper in the Cassettes and Paper Tray

You can load paper up to this size in the paper cassettes and paper tray: 13 × 19 inches (330 × 483 mm). The paper tray can accommodate user-defined paper sizes from 2.2 × 5 inches (55 × 127 mm) to 13 × 47.2 inches (330.2 × 1200 mm) for single-sided printing. The paper tray can accommodate user-defined paper sizes from to 5.5 × 7.2 inches (139.7 × 182 mm) to 11.7 × 17 inches (297 × 431.8 mm) for double-sided printing.

You can view instructions on how to load paper in the cassettes or paper tray on the control panel.

1. Select the  icon on the LCD screen.

You see this screen:

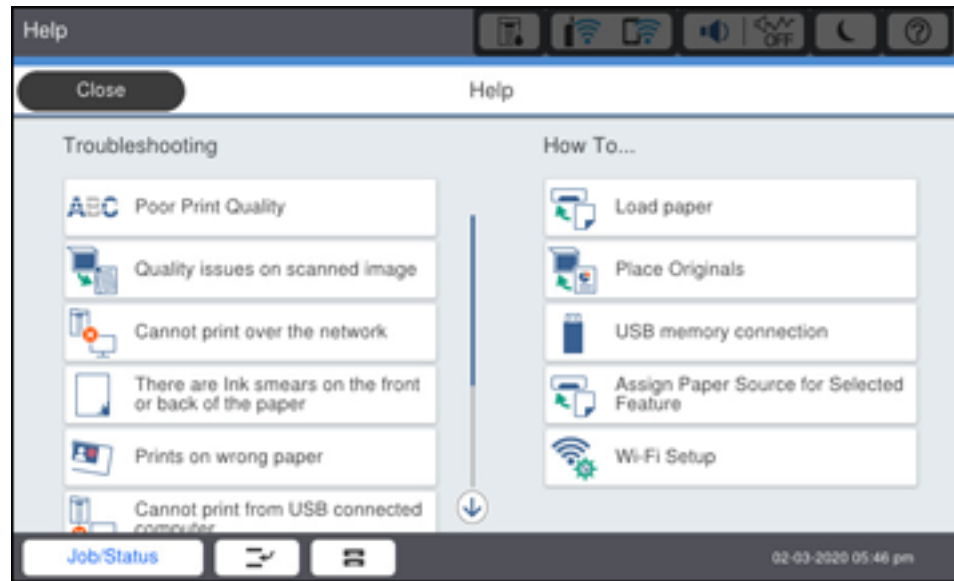

2. Select **Load paper** under the How To options.

You see this screen:

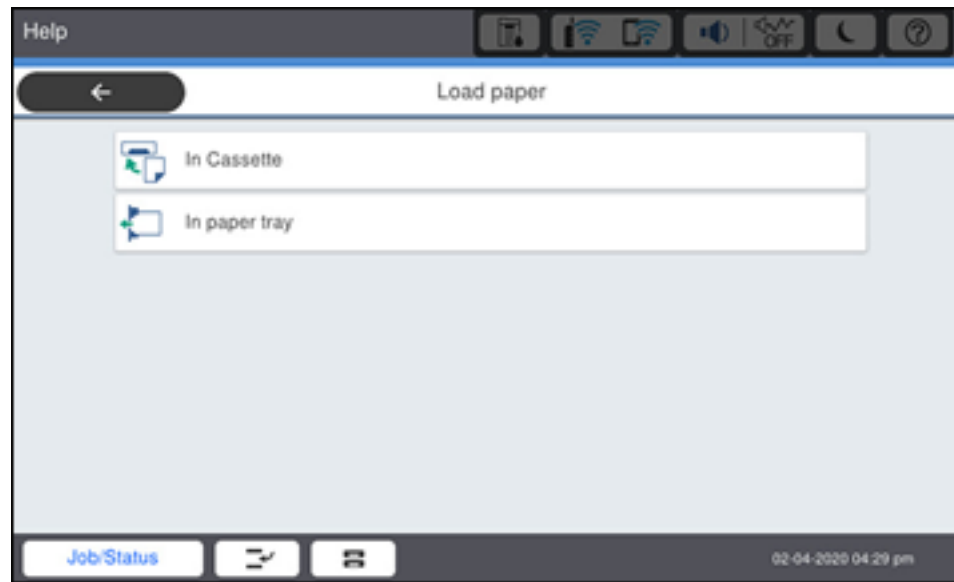

3. Select one of the options.



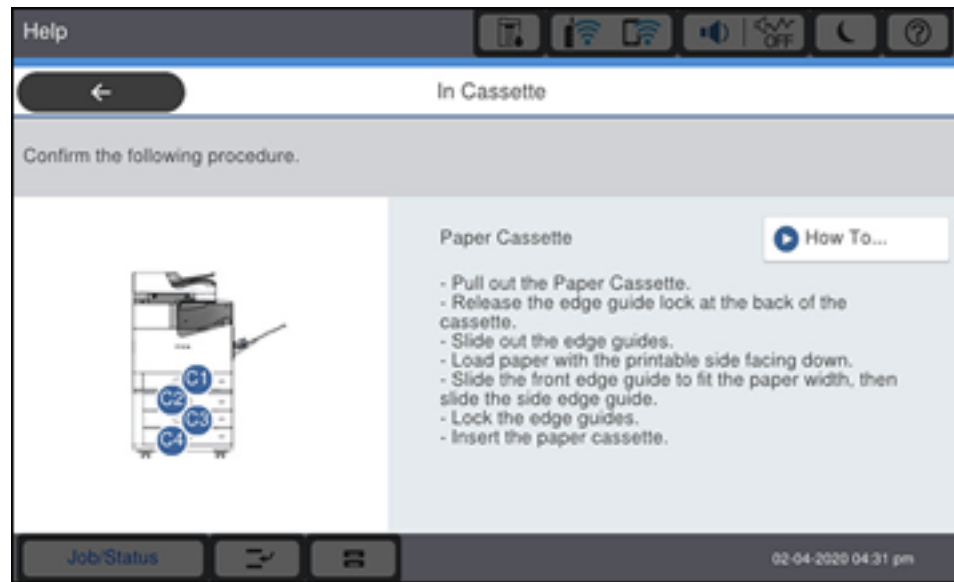

You see a screen like this:

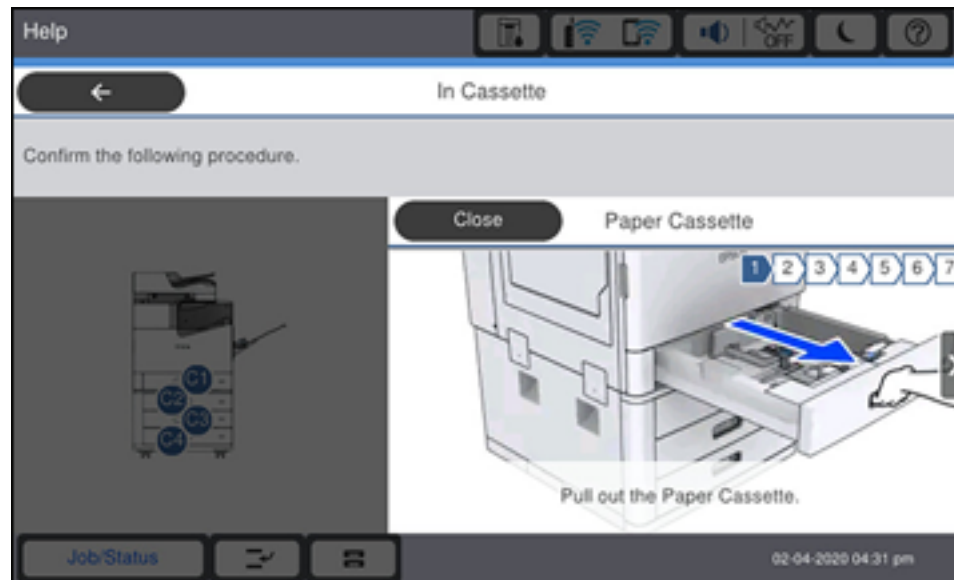

4. Select **How To**.

You see a screen like this:



5. Select the  icon to scroll through the paper loading instructions.
6. If necessary, select the  icon and select the size and type of paper you loaded on the LCD screen.

**Note:** If the **Paper Size Auto Detect** setting is enabled, your product will automatically detect the size of the paper you loaded. To select a user-defined paper size, disable the **Paper Size Auto Detect** setting.

Always follow these paper loading guidelines:

- Load only the recommended number of sheets.
- Load the printable side facedown.
- Load letterhead or pre-printed paper top edge first.
- Do not load paper above the arrow mark inside the edge guides.
- Insert and remove paper cassettes slowly.

- Load pre-punched paper with the punched side toward you. Loading pre-punched paper in an incorrect direction can cause paper jams or smears inside the product. Make sure the **Prepunched** setting is set to **On** in the product's paper settings.
- Check the paper package for any additional loading instructions.

**Caution:** Do not use the following papers; they may cause paper jams, smears on the printout, or damage to the printer.

- Papers that are wavy or damp
- Papers that have not dried after printing on one side
- Papers that are wadded or curled
- Papers that are torn, cut, or folded
- Papers that are too thick or thin
- Preprinted papers printed by other inkjet printers, thermal transfer printers, page printers, or copiers
- Papers that are perforated
- Papers that have stickers
- Papers held together with tape, staples, or paper clips
- Envelopes with adhesive surfaces or windows

**Parent topic:** [Loading Paper](#)

**Related references**

[Paper Loading Capacity](#)

[Paper Specifications](#)

## Using the Optional Paper Cassette Lock

You can use the optional paper cassette lock to keep a paper cassette locked. Make sure you keep the key in a safe place.

You can purchase genuine Epson accessories at [epson.com](http://epson.com) (U.S. sales), [epson.ca](http://epson.ca) (Canadian sales), or [epson.com.jm](http://epson.com.jm) (Caribbean sales). You can also purchase accessories from an Epson authorized reseller. To find the nearest one, call 800-GO-EPSON (800-463-7766) in the U.S. or 800-807-7766 in Canada.

1. Insert the paper cassette lock into the cassette handle.

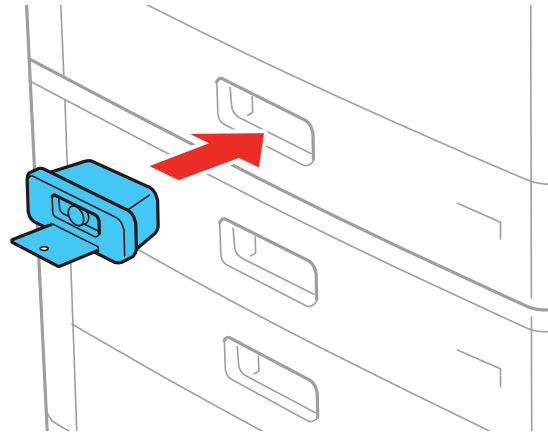

2. Press the button on the paper cassette lock to pop out the key.

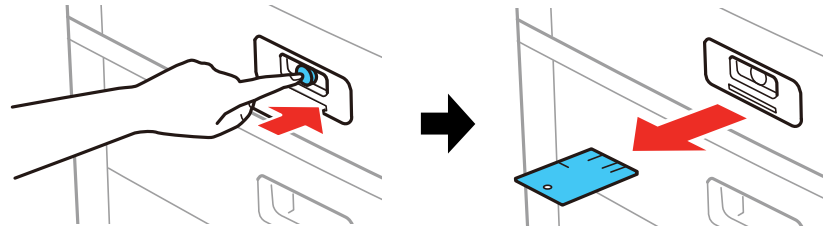

**Note:** To unlock the paper cassette, insert the key all the way into the lock and pull out the lock.

Parent topic: [Loading Paper](#)

Related references

[Optional Accessories and Replacement Parts](#)

## Paper Loading Capacity

Paper Cassettes

<b>Paper type</b>	<b>Loading capacity</b>
Plain paper	550 sheets:
Pre-printed paper	A5 (5.8 × 8.2 inches [148 × 210 mm]), A4 (8.3 × 11.7 inches [210 × 297 mm]), A3 (11.7 × 16.5 inches [297 × 420 mm]), B6 (5 × 7.2 inches [128 × 182 mm]), B5 (7.2 × 10.1 inches [182 × 257 mm]), B4 (13.9 × 9.84 inches [353 × 250 mm])
Letterhead paper	
Colored paper	
Recycled paper	Letter (8.5 × 11 inches [216 × 279 mm]), Half Letter (5.5 × 8.5 inches [140 × 216 mm]), Legal (8.5 × 14 inches [216 × 356 mm]), Executive (7.25 × 10.5 inches [184 × 267 mm])
Card Stock (25 to 69 lb [91 to 256 g/m <sup>2</sup> ])	
Card Stock 1 (25 to 28 lb [91 to 105 g/m <sup>2</sup> ])	Oficio 9 (8.46 × 12.4 inches [215 × 315 mm]), Mexico-Oficio (8.5 × 13.4 inches [216 × 340 mm])
Card Stock 2 (29 to 36 lb [106 to 135 g/m <sup>2</sup> ])	8.5 × 13 inches (216 × 330 mm), 11 × 17 inches (279 × 432 mm), 13 × 19 inches (330 × 483 mm)
Card Stock 3 (37 to 42 lb [136 to 160 g/m <sup>2</sup> ])	User-defined (5.5 × 7.2 inches to 11.7 × 17 inches [139.7 × 182 mm to 297 × 431.8 mm])
Epson Bright White Premium Paper	500 sheets: Letter (8.5 × 11 inches [216 × 279 mm])
Epson Multipurpose Plus Paper	
Epson Bright White Pro Paper	500 sheets: A3 (11.7 × 16.5 inches [297 × 420 mm]) Letter (8.5 × 11 inches [216 × 279 mm])
Card Stock 4 (43 to 66 lb [161 to 250 g/m <sup>2</sup> ])	550 sheets: Executive (7.25 × 10.5 inches [184 × 267 mm])

### Paper Tray

Paper type	Loading capacity
Plain paper Pre-printed paper Letterhead paper Colored paper Recycled paper Card Stock (25 to 69 lb [91 to 256 g/m <sup>2</sup> ]) Card Stock 1 (25 to 28 lb [91 to 105 g/m <sup>2</sup> ]) Card Stock 2 (29 to 36 lb [106 to 135 g/m <sup>2</sup> ]) Card Stock 3 (37 to 42 lb [136 to 160 g/m <sup>2</sup> ])	150 sheets: A6 (4.1 × 5.8 inches [105 × 148 mm]), A5 (5.8 × 8.2 inches [148 × 210 mm]), A4 (8.3 × 11.7 inches [210 × 297 mm]), A3 (11.7 × 16.5 inches [297 × 420 mm]), B6 (5 × 7.2 inches [128 × 182 mm]), B5 (7.2 × 10.1 inches [182 × 257 mm]), B4 (13.9 × 9.84 inches [353 × 250 mm]) Letter (8.5 × 11 inches [216 × 279 mm]), Half Letter (5.5 × 8.5 inches [140 × 216 mm]), Legal (8.5 × 14 inches [216 × 356 mm]), Executive (7.25 × 10.5 inches [184 × 267 mm]) Oficio 9 (8.46 × 12.4 inches [215 × 315 mm]), Mexico-Oficio (8.5 × 13.4 inches [216 × 340 mm]) 8.5 × 13 inches (216 × 330 mm), 11 × 17 inches (279 × 432 mm), 12 × 18 inches (305 × 457 mm), 13 × 19 inches (330 × 483 mm) SRA3 (12.6 × 17.7 inches [320 × 450 mm]) User-defined 1-sided (2.2 × 5 inches to 13 × 47.2 inches [55 × 127 mm to 330.2 × 1200 mm]) User-defined 2-sided (5.5 × 7.2 inches to 11.7 × 17 inches [139.7 × 182 mm to 297 × 431.8 mm])
Epson Bright White Premium Paper Epson Multipurpose Plus Paper	150 sheets: Letter (8.5 × 11 inches [216 × 279 mm])
Epson Bright White Pro Paper	150 sheets: A3 (11.7 × 16.5 inches [297 × 420 mm]) Letter (8.5 × 11 inches [216 × 279 mm])
Epson Ultra Premium Presentation Paper Matte	20 sheets: Letter (8.5 × 11 inches [216 × 279 mm]) A4 (8.3 × 11.7 inches [210 × 297 mm]) A3 (11.7 × 16.5 inches [297 × 420 mm]) 13 × 19 inches (330 × 483 mm)

Paper type	Loading capacity
Epson Premium Presentation Paper Matte	20 sheets: A4 (8.3 × 11.7 inches [210 × 297 mm]) A3 (11.7 × 16.5 inches [297 × 420 mm]) 13 × 19 inches (330 × 483 mm) 8 × 10 inches (203 × 254 mm)
Epson High Quality Ink Jet Paper Epson Presentation Paper Matte	50 sheets: A3 (11.7 × 16.5 inches [297 × 420 mm]) 13 × 19 inches (330 × 483 mm) 100 sheets: Letter (8.5 × 11 inches [216 × 279 mm]) A4 (8.3 × 11.7 inches [210 × 297 mm])
Card Stock 4 (43 to 66 lb [161 to 250 g/m <sup>2</sup> ])	30 sheets: A6 (4.1 × 5.8 inches [105 × 148 mm]), A5 (5.8 × 8.2 inches [148 × 210 mm]), A4 (8.3 × 11.7 inches [210 × 297 mm]), A3 (11.7 × 16.5 inches [297 × 420 mm]), B6 (5 × 7.2 inches [128 × 182 mm]), B5 (7.2 × 10.1 inches [182 × 257 mm]), B4 (13.9 × 9.84 inches [353 × 250 mm]), Letter (8.5 × 11 inches [216 × 279 mm]), Half Letter (5.5 × 8.5 inches [140 × 216 mm]), Legal (8.5 × 14 inches [216 × 356 mm]), 8.5 × 13 inches (216 × 330 mm), 11 × 17 inches (279 × 432 mm), 12 × 18 inches (305 × 457 mm), SRA3 (12.6 × 17.7 inches [320 × 450 mm]), 13 × 19 inches (330 × 483 mm), Oficio 9 (8.46 × 12.4 inches [215 × 315 mm]), Mexico-Oficio (8.5 × 13.4 inches [216 × 340 mm]) User-defined 1-sided (2.2 × 5 inches to 13 × 47.2 inches [55 × 127 mm to 330.2 × 1200 mm]), User-defined 2-sided (5.5 × 7.2 inches to 11.7 × 17 inches [139.7 × 182 mm to 297 × 431.8 mm]) 150 sheets: Executive (7.25 × 10.5 inches [184 × 267 mm])

Paper type	Loading capacity
Card Stock 5 (67 to 90 lb [251 to 350 g/m <sup>2</sup> ])	<p>30 sheets:</p> <p>A6 (4.1 × 5.8 inches [105 × 148 mm]), A5 (5.8 × 8.2 inches [148 × 210 mm]), A4 (8.3 × 11.7 inches [210 × 297 mm]), A3 (11.7 × 16.5 inches [297 × 420 mm]), B6 (5 × 7.2 inches [128 × 182 mm]), B5 (7.2 × 10.1 inches [182 × 257 mm]), B4 (13.9 × 9.84 inches [353 × 250 mm])</p> <p>Letter (8.5 × 11 inches [216 × 279 mm]), Half Letter (5.5 × 8.5 inches [140 × 216 mm]), Executive (7.25 × 10.5 inches [184 × 267 mm]), Legal (8.5 × 14 inches [216 × 356 mm])</p> <p>Oficio 9 (8.46 × 12.4 inches [215 × 315 mm]), Mexico-Oficio (8.5 × 13.4 inches [216 × 340 mm]), 8.5 × 13 inches (216 × 330 mm), 11 × 17 inches (279 × 432 mm), 12 × 18 inches (305 × 457 mm), SRA3 (12.6 × 17.7 inches [320 × 450 mm]), 13 × 19 inches (330 × 483 mm)</p> <p>User-defined 1-sided (2.2 × 5 inches to 13 × 47.2 inches [55 × 127 mm to 330.2 × 1200 mm]), User-defined 2-sided (5.5 × 7.2 inches to 11.7 × 17 inches [139.7 × 182 mm to 297 × 431.8 mm])</p>
Envelopes	10

Parent topic: [Loading Paper](#)



## Double-sided Printing Capacity

Paper type	Auto duplex (paper cassettes)
Plain paper (17 to 24 lb [64 to 90 g/m <sup>2</sup> ])	550 sheets: A5 (5.8 × 8.2 inches [148 × 210 mm]) A4 (8.3 × 11.7 inches [210 × 297 mm]) A3 (11.7 × 16.5 inches [297 × 420 mm]) B5 (7.2 × 10.1 inches [182 × 257 mm]) B4 (13.9 × 9.84 inches [353 × 250 mm]) Half Letter (5.5 × 8.5 inches [140 × 216 mm]) Executive (7.25 × 10.5 inches [184 × 267 mm]) Oficio 9 (8.46 × 12.4 inches [215 × 315 mm]) Letter (8.5 × 11 inches [216 × 279 mm]) 8.5 × 13 inches (216 × 330 mm) Mexico-Oficio (8.5 × 13.4 inches [216 × 340 mm]) Legal (8.5 × 14 inches [216 × 356 mm]) 11 × 17 inches (279 × 432 mm) User-defined (5.5 × 7.2 inches to 11.7 × 17 inches [139.7 × 182 mm to 297 × 431.8 mm])

Paper type	Auto duplex (paper cassettes)
Plain paper 1 (16 to 20 lb [60 to 75 g/m <sup>2</sup> ]) Plain paper 2 (21 to 24 lb [76 to 90 g/m <sup>2</sup> ]) Pre-printed paper Letterhead paper Colored paper Recycled paper Card Stock (25 to 69 lb [91 to 256 g/m <sup>2</sup> ]) Card Stock 1 (25 to 28 lb [91 to 105 g/m <sup>2</sup> ]) Card Stock 2 (29 to 36 lb [106 to 135 g/m <sup>2</sup> ]) Card Stock 3 (37 to 42 lb [136 to 160 g/m <sup>2</sup> ])	550 sheets: A4 (8.3 × 11.7 inches [210 × 297 mm]) A3 (11.7 × 16.5 inches [297 × 420 mm]) B5 (7.2 × 10.1 inches [182 × 257 mm]) B4 (13.9 × 9.84 inches [353 × 250 mm]) Half Letter (5.5 × 8.5 inches [140 × 216 mm]) Executive (7.25 × 10.5 inches [184 × 267 mm]) Oficio 9 (8.46 × 12.4 inches [215 × 315 mm]) Letter (8.5 × 11 inches [216 × 279 mm]) 8.5 × 13 inches (216 × 330 mm) Mexico-Oficio (8.5 × 13.4 inches [216 × 340 mm]) Legal (8.5 × 14 inches [216 × 356 mm]) 11 × 17 inches (279 × 432 mm) User-defined (5.5 × 7.2 inches to 11.7 × 17 inches [139.7 × 182 mm to 297 × 431.8 mm])
Epson Bright White Pro Paper	500 sheets: A3 (11.7 × 16.5 inches [297 × 420 mm]) Letter (8.5 × 11 inches [216 × 279 mm])
Epson Bright White Premium Paper Epson Multipurpose Plus Paper	500 sheets: Letter (8.5 × 11 inches [216 × 279 mm])
Card Stock 4 (43 to 66 lb [161 to 250 g/m <sup>2</sup> ])	550 sheets: Executive (7.25 × 10.5 inches [184 × 267 mm])

**Parent topic:** [Loading Paper](#)

**Related tasks**

[Selecting Double-sided Printing Settings - Windows](#)

[Selecting Double-sided Printing Settings - Mac](#)

## Compatible Epson Papers (U.S. and Canada)

You can purchase genuine Epson ink and paper at [epson.com](http://epson.com) (U.S. sales) or [epson.ca](http://epson.ca) (Canadian sales). You can also purchase supplies from an Epson authorized reseller. To find the nearest one, call 800-GO-EPSON (800-463-7766) in the U.S. or 800-807-7766 in Canada.

Paper Type	Size	Part number	Sheet count
Epson Bright White Pro Paper	Letter (8.5 × 11 inches [216 × 279 mm])	S041586	500
Epson Bright White Premium Paper	Letter (8.5 × 11 inches [216 × 279 mm])	S450218-4	500
Epson Multipurpose Plus Paper	Letter (8.5 × 11 inches [216 × 279 mm])	S450217-4	500
Epson High Quality Ink Jet Paper	Letter (8.5 × 11 inches [216 × 279 mm])	S041111	100
	A4 (8.3 × 11.7 inches [210 × 297 mm])	S041117	100
Epson Presentation Paper Matte	13 × 19 inches (330 × 483 mm)	S041069-L	100
	Letter (8.5 × 11 inches [216 × 279 mm])	S041062	100
Epson Premium Presentation Paper Matte	8 × 10 inches (203 × 254 mm)	S041467	50
	Letter (8.5 × 11 inches [216 × 279 mm])	S041257	50
		S042180	100
	13 × 19 inches (330 × 483 mm)	S041263	50
Epson Ultra Premium Presentation Paper Matte	A3 (11.7 × 16.5 inches [297 × 420 mm])	S041260	50
		S041343	50
	13 × 19 inches (330 × 483 mm)	S041339	50
S041605		100	

Parent topic: [Loading Paper](#)

## Compatible Epson Papers (Latin America)

You can purchase genuine Epson ink and paper from an Epson authorized reseller. To find the nearest reseller, visit [latin.epson.com](http://latin.epson.com) or call your nearest Epson sales office.

Paper Type	Size	Part number	Sheet count
Epson Bright White Pro Paper	Letter (8.5 × 11 inches [216 × 279 mm])	S041586	500
Epson High Quality Ink Jet Paper	Letter (8.5 × 11 inches [216 × 279 mm])	S041111	100
	A4 (8.3 × 11.7 inches [210 × 297 mm])	S041117	100
Epson Presentation Paper Matte	13 × 19 inches (330 × 483 mm)	S041069-L	100
Epson Premium Presentation Paper Matte	Letter (8.5 × 11 inches [216 × 279 mm])	S041257-ML	50
	13 × 19 inches (330 × 483 mm)	S041263	50
	A3 (11.7 × 16.5 inches [297 × 420 mm])	S041260	50
Epson Ultra Premium Presentation Paper Matte	13 × 19 inches (330 × 483 mm)	S041339	50
		S041605	100

Parent topic: [Loading Paper](#)

## Paper or Media Type Settings - Printing Software

For this paper	Select this paper Type or Media Type setting
Plain paper	Plain Paper 1
Epson Bright White Pro Paper	Plain Paper 2
Epson Bright White Premium Paper	
Epson Multipurpose Plus Paper	

For this paper	Select this paper Type or Media Type setting
Letterhead paper	Letterhead
Recycled paper	Recycled
Colored paper	Color
Pre-printed paper	Preprinted
Epson High Quality Ink Jet Paper	High quality plain paper
Thick paper (25 to 28 lb [91 to 105 g/m <sup>2</sup> ])	Card Stock 1
Thick paper (29 to 36 lb [106 to 135 g/m <sup>2</sup> ])	Card Stock 2
Thick paper (37 to 42 lb [136 to 160 g/m <sup>2</sup> ])	Card Stock 3
Thick paper (43 to 66 lb [161 to 250 g/m <sup>2</sup> ])	Card Stock 4
Envelopes	Envelope
Epson Presentation Paper Matte Epson Premium Presentation Paper Matte Epson Ultra Premium Presentation Paper Matte	Premium Presentation Paper Matte

**Note:** The settings listed here are available only when printing from your computer; they do not apply to your product's control panel settings.

Parent topic: [Loading Paper](#)

## Selecting the Paper Settings for Each Source - Control Panel

You can change the default paper size and paper type for each source using the control panel on the product.

1. Select the  icon.

You see a screen like this:

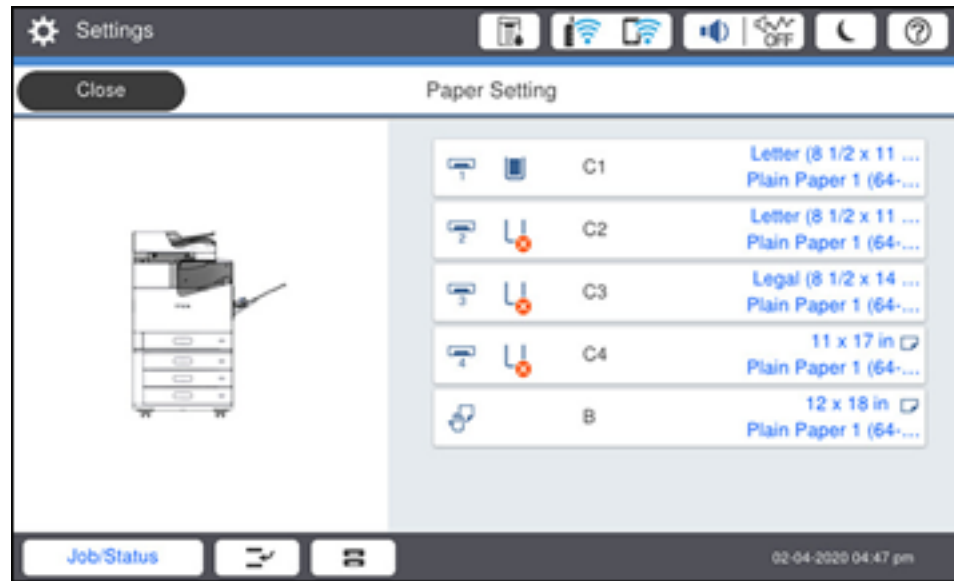

2. Select the paper source you want to select settings for.

You see a screen like this:

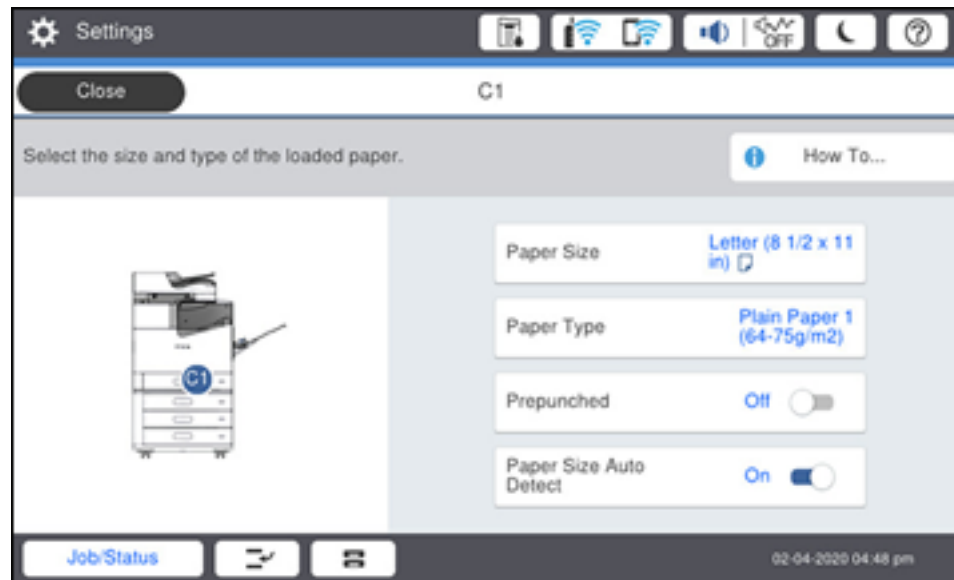

3. Select **Paper Size**.
4. Select the paper size you loaded.
5. Select **Paper Type**.
6. Select the paper type for the paper you loaded.
7. Enable the **Prepunched** setting if you are using pre-punched paper.
8. To automatically detect the size of paper loaded in the paper source, select the **Paper Size Auto Detect** field to turn this setting on.
9. Select **Close**.
10. Select another paper source to change or press the  home button to exit.

[Paper Type Settings - Control Panel](#)

Parent topic: [Loading Paper](#)

## Paper Type Settings - Control Panel

Select a **Paper Type** setting that matches the paper you loaded.

Paper type loaded	Paper Type setting
Plain paper	Plain Paper 1 (64-75g/m <sup>2</sup> )
Epson Bright White Pro Paper	Plain Paper 2 (76-90g/m <sup>2</sup> )
Epson Bright White Premium Paper	
Epson Multipurpose Plus Paper	
Letterhead paper	Letterhead
Recycled paper	Recycled
Colored paper	Color
Pre-printed paper	Preprinted
Epson High Quality Ink Jet Paper	High Quality Plain Paper
Thick paper up to 25 to 28 lb (91 to 105 g/m <sup>2</sup> )	Card Stock 1 (91-105g/m <sup>2</sup> )
Thick paper up to 29 to 36 lb (106 to 135 g/m <sup>2</sup> )	Card Stock 2 (106-135g/m <sup>2</sup> )
Thick paper up to 37 to 42 lb (136 to 160 g/m <sup>2</sup> )	Card Stock 3 (136-160g/m <sup>2</sup> )
Thick paper up to 43 to 66 lb (161 to 250 g/m <sup>2</sup> )	Card Stock 4 (161-250g/m <sup>2</sup> )
Thick paper up to 67 to 90 lb (251 to 350 g/m <sup>2</sup> )	Extra Thick Paper
Envelopes	Envelope
Epson Presentation Paper Matte	Prem. Matte
Epson Premium Presentation Paper Matte	
Epson Ultra Premium Presentation Paper Matte	

Parent topic: [Selecting the Paper Settings for Each Source - Control Panel](#)

## Selecting Default Paper Settings - Administrator

As an administrator, you can adjust default paper settings that apply to all print jobs sent to the product.

**Note:** These settings can be locked by an administrator. If you cannot access these settings, contact your administrator for assistance.

[Selecting the Default Printer Settings](#)

[Selecting the Universal Print Settings](#)



Parent topic: [Loading Paper](#)

## Selecting the Default Printer Settings

You can change default printer settings using the control panel on the product.

**Note:** These settings can be locked by an administrator. If you cannot access these settings, contact your administrator for assistance.

1. Press the  home button, if necessary.
2. Select **Settings** > **General Settings** > **Printer Settings**.

You see a screen like this:

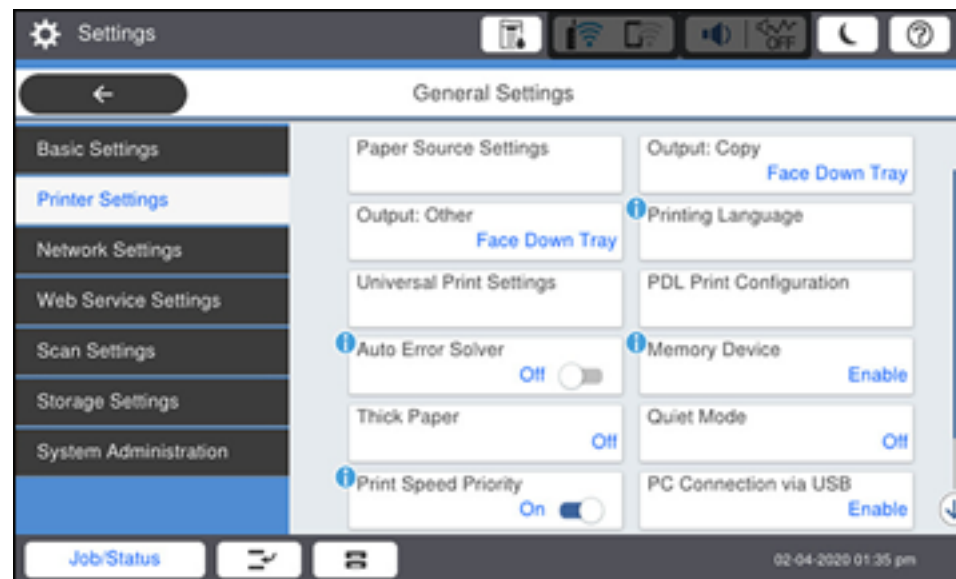

3. Select an **Auto Error Solver** setting:
  - Select **On** to display a warning and print single-sided when a 2-sided printing error occurs, or to print only what the printer could process when a full memory error occurs.
  - Select **Off** to display an error message and stop printing if an error occurs.
4. Select **Paper Source Settings**.

5. Select the options you want to use.
6. When you are finished, press the  home button to exit.

[Paper Source Settings Options](#)

**Parent topic:** [Selecting Default Paper Settings - Administrator](#)

### Paper Source Settings Options

Select the paper source options you want to use for your print jobs.

Paper Source Settings option	Available settings	Description
<b>Paper Setting</b>	Various	Select the paper size and type for each paper source.
<b>Paper Tray Priority</b>	<b>On</b>	Select <b>On</b> to give printing priority to paper loaded in the paper tray.
	<b>Off</b>	
<b>A4/Letter Auto Switching</b>	<b>On</b>	Select <b>On</b> to switch the selected paper size to match the loaded paper (Letter or A4) if the wrong size is selected.
	<b>Off</b>	
<b>Auto Select Settings</b>	<b>Copy</b>	Select <b>On</b> for any of these settings to automatically print on paper from any source containing paper that matches your paper settings.
	<b>Fax</b>	
	<b>Other</b>	
<b>Error Notice</b>	<b>Paper Size Notice</b>	Select <b>On</b> for either of these settings to display an error message when the selected paper type or size does not match the loaded paper.
	<b>Paper Type Notice</b>	
<b>Paper Setup Auto Display</b>	<b>On</b>	Select <b>On</b> to automatically display a menu that lets you select the paper size and type when you load paper in the product.
	<b>Off</b>	
<b>User-Defined Paper Size List</b>	20 settings	Enter a user-defined paper size setting.

**Parent topic:** [Selecting the Default Printer Settings](#)

### Selecting the Universal Print Settings

You can change the default universal print settings using the control panel on the product.

**Note:** These settings can be locked by an administrator. If you cannot access these settings, contact your administrator for assistance.

1. Press the  home button, if necessary.
2. Select **Settings** > **General Settings** > **Printer Settings** > **Universal Print Settings**.

You see a screen like this:

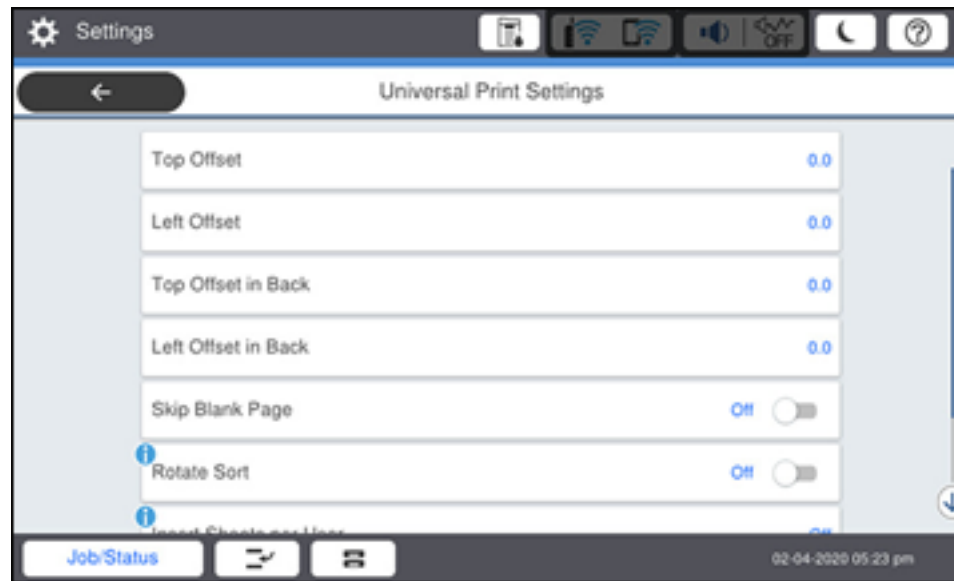

3. Adjust the settings as necessary.
4. When you are finished, press the  home button to exit.

[Universal Print Settings Options](#)

**Parent topic:** [Selecting Default Paper Settings - Administrator](#)

### **Universal Print Settings Options**

Select the universal print setting options you want to use for your print jobs.

Universal Print Settings option	Available settings	Description
Top Offset	—	Adjust the top or left margin.
Left Offset		
Top Offset in Back	—	Adjust the top or left margin of the back page when printing double-sided.
Left Offset in Back		
Skip Blank Page	On	Select <b>On</b> to skip printing of blank pages automatically.
	Off	
Job Separation	On	Select <b>On</b> to separate printed copies by job.
	Off	
Rotate Sort	On	Select <b>On</b> to rotate each copy when printing multiple copies.
	Off	
Insert Sheets per User	On	Select <b>On</b> to insert a blank sheet between copies or print jobs sent to the printer from the printer driver. Select the paper source you want the sheets to come from.
	Off	
Color Correction	On	Select <b>On</b> to adjust settings such as brightness, contrast, saturation, and more.
	Off	

Parent topic: [Selecting the Universal Print Settings](#)

---

# Placing Originals on the Product

Follow the instructions here to place your original documents or photos on the product.

**Caution:** Do not place anything on top of your product or use its cover as a writing surface to avoid damaging it.

**Note:** Your product may differ from the images in this guide, but the instructions are the same unless otherwise noted.

[Placing Originals on the Scanner Glass](#)

[Placing Originals in the Automatic Document Feeder](#)

## Placing Originals on the Scanner Glass

You can place originals up to this size on the scanner glass: A3 (11.7 × 16.5 inches [297 × 420 mm]).

**Note:** To view animated instructions on how to place originals on the scanner glass, select the ⓘ help icon and select **How To > Place Originals > Scanner Glass**.

**Note:** When originals are placed in the ADF and on the scanner glass, priority is given to the originals in the ADF.

1. Open the document cover.

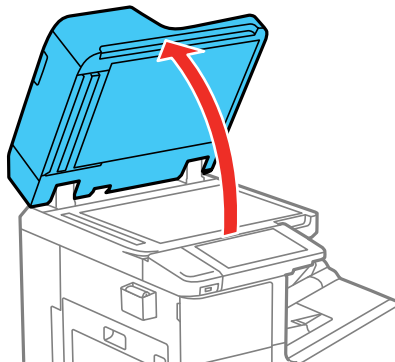

2. Place your original facedown on the scanner glass with the top facing into the corner. Slide the original to the edges of the indicated corner.

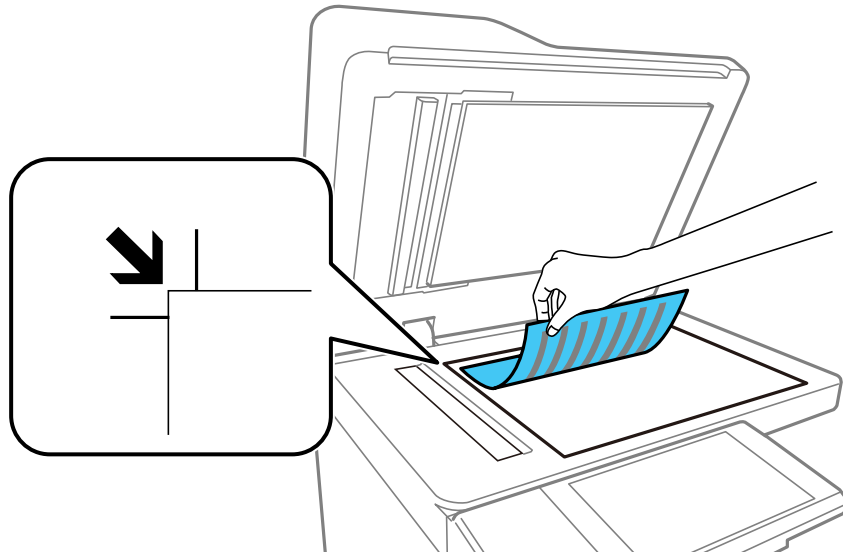

**Note:** The edges of your original may be cropped by 0.06 inch (1.5 mm) from the edge of the scanner glass.

3. Close the document cover gently to keep your original in place.

Remove your originals after scanning. If you leave the originals on the scanner glass for a long time, they may stick to the glass surface.

**Parent topic:** [Placing Originals on the Product](#)

**Related topics**

[Copying](#)

[Scanning](#)

[Faxing](#)

## Placing Originals in the Automatic Document Feeder

You can place single- or multi-page original documents in the Automatic Document Feeder (ADF). You can also use the ADF to scan both sides of a 2-sided document. Make sure the originals meet the Automatic Document Feeder specifications before loading them.

**Caution:** Make sure your originals are not creased or folded, and do not contain holes, staples, tape, or other materials that could obstruct the feeder.

**Caution:** Do not place photographs or valuable artwork in the ADF. Place fragile or valuable originals on the scanner glass to avoid wrinkling or damaging them.

**Note:** To view animated instructions on how to place originals in the ADF, select the  icon and select **How To > Place Originals > ADF**.

**Note:** When originals are placed in the ADF and on the scanner glass, priority is given to the originals in the ADF.

1. Slide the ADF edge guides outward.

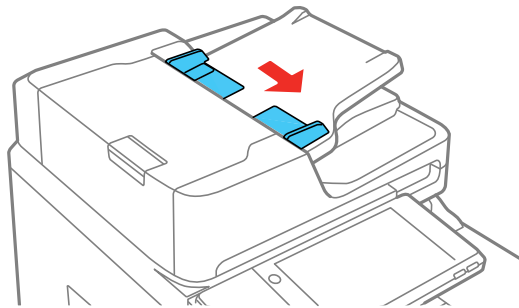

2. Fan your stack of originals and tap them gently on a flat surface to even the edges.

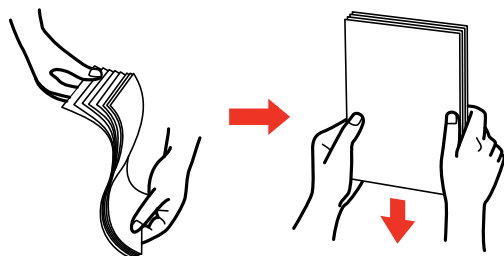

3. Insert the originals into the ADF faceup and short edge first.

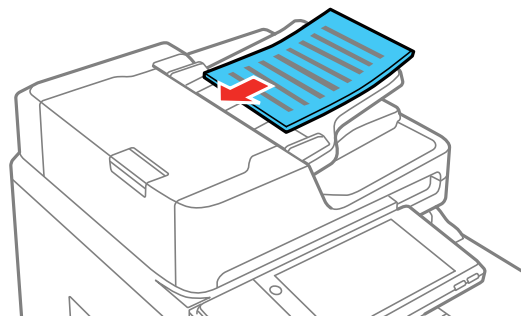



**Note:** Do not load originals above the arrow mark on the ADF edge guide.

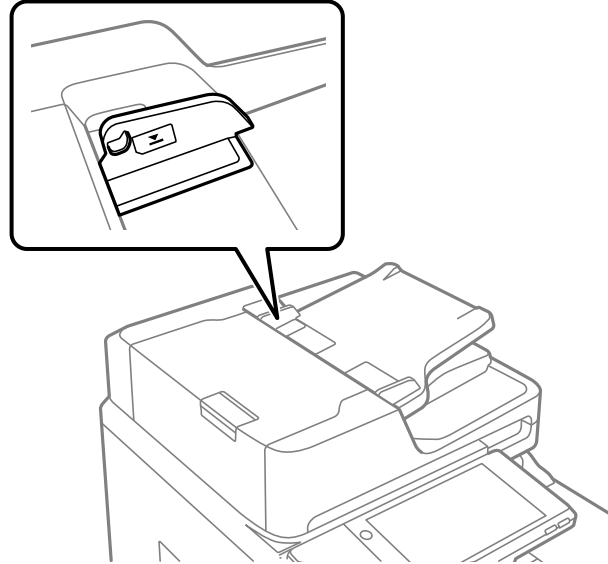

The **ADF** icon on the Copy, Scan, and Fax (models equipped with the optional fax board) screens lights up.

**Note:** The ADF should automatically detect the size of your original. If the document size isn't automatically detected, you need to manually select it.

4. Slide the ADF edge guides against the originals, but not too tightly.

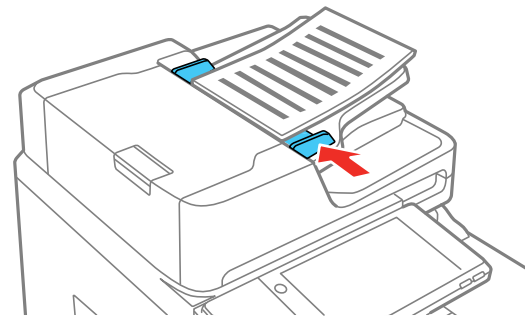

**Note:** If you are copying two originals onto one sheet, make sure the originals are loaded as shown. Select the link below to select the copy orientation setting that matches how you loaded your original.

**Readable direction**

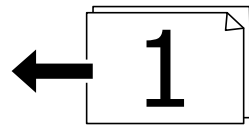
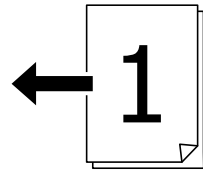

**Left direction**

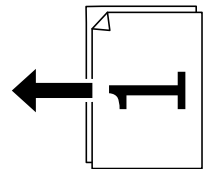
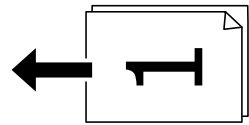

**Parent topic:** [Placing Originals on the Product](#)

**Related topics**

[Copying](#)

[Scanning](#)

[Faxing](#)

---

# Copying

See the information here to copy documents or photos using your product.

**Note:** Copies may not be exactly the same size as your originals.

**Note:** Your product may differ from the images in this guide, but the instructions are the same unless otherwise noted.

[Copying Documents or Photos](#)

[Copying Options](#)

[Saving Groups for Copying](#)

[Editing or Deleting a Saved Group for Copying](#)

[Omitting Red Characters in Originals When Copying \(WF-C20600/WF-C20750/WF-C21000\)](#)

## Copying Documents or Photos

You can copy documents or photos onto various sizes and types of paper, including Epson special papers.

1. Load the paper you want to print on.
2. Place your original document or photo on the scanner glass, or place multi-page documents in the ADF.
3. Press the  home button, if necessary.
4. Select **Copy**.

You see a screen like this:



5. To print more than one copy, press a number key on the product's control panel, or select **Copies** and use the on-screen keyboard to enter the number of copies.

**Note:** If you want to print copies using a saved group, select **Advanced** and then select **Print Sets**. Select the group you want to use and select **OK**.

6. Change any of the displayed settings as necessary.
7. Select **Advanced** to view and change additional copy settings, if necessary.

**Note:** To save the copied image to the product's internal storage, select **File Storing** and enable the **File Storing** setting. Change any of the displayed settings as needed.

**Note:** If there is an image at the hole punch position, select **Binding Margin** and set a binding margin of 0.71 inch (18 mm) before copying. If you set a binding margin, you can select **Binding Width**, **Reduce to Fit Paper**, or **Erase Image Over Margin** to adjust your image accordingly.

8. Select **Preview** to preview your copy on the LCD screen.

9. Select **Presets** to save your copy settings.

**Note:** Presets can be locked by an administrator. If you can't access or change this setting, contact your administrator for assistance.

10. When you are ready to copy, select the **Copy** icon.

**Note:** To cancel printing, select **Cancel** on the LCD screen, then select **Cancel Copy** to confirm.

**Parent topic:** [Copying](#)

**Related references**

[Copying Options](#)

**Related tasks**

[Using Presets](#)

**Related topics**

[Placing Originals on the Product](#)

[Loading Paper](#)

## Copying Options

Select the copying options you want to use for your copies.

**Note:** Not all options or settings may be available, depending on other copying settings.

### Basic Settings

Copying option	Available settings	Description
<b>Auto</b>	—	Copies the document in the detected color of the original.
<b>B&amp;W</b>	—	Copies the document in black and white.
<b>Color</b>	—	Copies the document in color.
<b>Density</b>	Varying levels	Adjusts the lightness or darkness of copies.
<b>Paper Setting</b>	Various sources	Select the paper source that you want to use. If you select <b>Auto</b> , paper is fed automatically depending on the paper settings you selected for the paper sources.

Copying option	Available settings	Description
<b>Reduce/Enlarge</b>	<b>Auto</b>	Automatically sizes the image to fit the paper size you selected.
	<b>Reduce to Fit Paper</b>	Automatically decreases the size of the image by the percentage you select.
	<b>100%</b>	Displays the conversion percentage. Use the + and - icons to adjust the percentage in increments of 1 or select the value and use the on-screen keypad to enter a percentage.
	<b>Minimum</b>	Copies the original at the minimum size (25%).
	<b>Maximum</b>	Copies the original at the maximum size (400%).
	<b>Actual Size and other conversions</b>	Copies the original at its full size or automatically converts from one size to another.
<b>Original Type</b>	<b>Text</b>	Specifies the document type of your originals and adjusts the quality of your copies.
	<b>Text &amp; Image</b>	
	<b>Photo</b>	
	<b>Barcode</b>	
<b>2-Sided</b>	<b>1&gt;1-Sided</b>	Select to make 2-sided copies. When you select <b>1&gt;2-Sided</b> or <b>2&gt;1-Sided</b> , you can select the orientation and binding edge for your originals or copies.
	<b>2&gt;2-Sided</b>	
	<b>1&gt;2-Sided</b>	
	<b>2&gt;1-Sided</b>	
<b>Multi-Page</b>	<b>Single Page</b>	Copies each page of the original onto an individual sheet.
	<b>2-up</b>	Copies multiple page documents onto one sheet. Scroll down and select the document orientation and layout order settings as necessary.
	<b>4-up</b>	

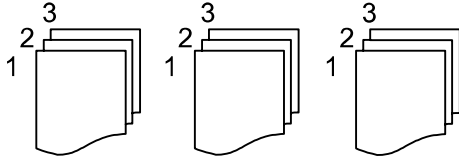
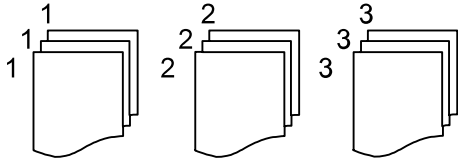
Copying option	Available settings	Description
<b>Finishing</b>	<b>Collate (Page Order)</b>	Select to print multiple copies of a multi-page document in ordered sets. 
	<b>Group (Same Pages)</b>	Select to print multiple copies of a multi-page document in unordered groups. 
	<b>Eject Paper</b>	Select <b>Rotate Sort</b> to print alternate paper orientations and paper sources (make sure the <b>Paper Setting</b> is set to <b>Auto</b> for this option).
	<b>Staple*</b>	Select the staple location.

\* Displayed when the optional finisher unit is installed.

#### Advanced settings

Copying option	Available settings	Description
<b>Booklet</b>	Various settings	Adjust these settings to make booklets from your copies.
<b>Cover &amp; Slip Sheet</b>	<b>Cover</b>	Adjust these settings to add covers to your copies.
	<b>Slip Sheet</b>	Adjust these settings to insert slip sheets into your copies.
<b>Original Size</b>	Various sizes	Select the document size of your original.
<b>Mixed Size Originals</b>	<b>Off</b>	Select <b>On</b> to copy originals of varying sizes in their original sizes.
	<b>On</b>	
<b>Orientation (Original)</b>	<b>Readable Direction</b>	Specifies the orientation of your originals.
	<b>Left Direction</b>	

Copying option	Available settings	Description
<b>Book&gt;2Pages</b>	<b>Off</b>	Select <b>On</b> to copy two pages of a book onto separate sheets of paper. You can also choose the <b>Scan Order</b> .
	<b>On</b>	
<b>Continuous Scanning</b>	<b>Off</b>	Select <b>On</b> to scan a large quantity of originals placed in the ADF as one job.
	<b>On</b>	
<b>Image Quality</b>	Various settings	Select advanced quality settings such as <b>Saturation</b> and <b>Sharpness</b> .
<b>Binding Margin</b>	<b>Off</b>	Select <b>On</b> to adjust the margin and orientation of the pages when copying a book. You can also select the <b>Binding Position</b> and <b>Orientation</b> . Select <b>Binding Width</b> to shift the image out of the binding margin, <b>Reduce to Fit Paper</b> to shrink the image to fit into the printing area, or <b>Erase Image Over Margin</b> to only print the part of the image that is outside of the binding margin.
	<b>On</b>	
<b>Reduce to Fit Paper</b>	<b>Off</b>	Select <b>On</b> to automatically decrease the image by the percentage you select.
	<b>On</b>	
<b>Remove Shadow</b>	<b>Off</b>	Select <b>On</b> to erase the shadows that appear in the center of a document when copying a book or that appear around a document when copying thick paper.
	<b>On</b>	
<b>Remove Punch Holes</b>	<b>Off</b>	Select <b>On</b> to erase the binding holes on a document. You can also select the <b>Erasing Position</b> and <b>Orientation</b> .
	<b>On</b>	
<b>ID Card Copy</b>	<b>Off</b>	Select <b>On</b> to copy both sides of an ID card onto one side of a sheet of paper. You can also select the <b>Orientation</b> .
	<b>On</b>	
<b>Print Sets</b>	Various settings	Allows you to copy the document in groups of saved quantities and settings.
<b>Output Tray</b>	Various settings	Select the output tray for your copies.



Copying option	Available settings	Description
<b>Page Numbering</b>	<b>Page Numbering</b>	Select <b>On</b> to print page numbers on your copies.
	<b>Format</b>	Selects the page numbering format.
	<b>Stamp Position</b>	Selects where the page number is placed on each copy.
	<b>Change Numbering</b>	Specifies on which page numbering begins.
	<b>Size</b>	Adjusts the font size of the page numbers.
	<b>Background</b>	Adjusts the background color of the page number.
<b>Erase Red Color</b>	<b>Off</b>	Select <b>On</b> to print copies with any red characters in the original omitted.
	<b>On</b>	
<b>File Storing</b>	—	Select <b>On</b> to save the copied file to the product's internal storage. Adjust the save settings, including whether to print and save the copied file or to only save the file.

Parent topic: [Copying](#)

## Saving Groups for Copying

You can save groups of frequently used copy quantities and sets so that you can print or copy without entering the number of copies each time. This is useful when you are printing a different number of copies for each set.

**Note:** You can save up to 12 print set groups with up to 60 subgroups in each. Print set groups are also accessible when printing a file from a storage folder.

1. Press the  home button, if necessary.
2. Select **Copy**.

You see a screen like this:



3. Select **Advanced** and then select **Print Sets**.
4. Select **Not Set** from the list.
5. Select **Register/Overwrite** and enter a group name.
6. Set the number of copies and sets on the **Copies & Sets** tab.

**Note:** You can enter up to 9999 copies and 99 sets.

7. Select any other settings as necessary.
8. Select **OK** to save.

Parent topic: [Copying](#)

## Editing or Deleting a Saved Group for Copying

You can edit or delete a print set group.

1. Press the  home button, if necessary.

2. Select **Copy**.

You see a screen like this:



3. Select **Advanced** and then select **Print Sets**.
4. Select the group you want to edit or delete from the list.
5. Do one of the following:
  - Select **Register/Overwrite** to edit the group and modify the settings as desired. Proceed to the next step.
  - Select **Delete** to delete the group. You are done.
6. Select **OK** to save.

Parent topic: [Copying](#)

## Omitting Red Characters in Originals When Copying (WF-C20600/WF-C20750/WF-C21000)

You can set red characters in the originals to not be printed in copies.

**Note:** Depending on the original, red characters may still appear. If you select **Color** as the color mode, the copy itself will be monochrome but it is counted as a color copy. If you select **Auto** as the color mode and the scanner detects that the original is in color, it is counted as a color copy even if the copy itself is monochrome.

1. Place your original document or photo on the scanner glass, or place multi-page documents in the ADF.
2. Press the  home button, if necessary.
3. Select **Copy**.

You see a screen like this:



4. Select **Advanced** and then enable **Erase Red Color**.

**Note:** The preview screen displays an image of the original before red characters are removed.

5. Select the **Copy** icon.

**Parent topic:** [Copying](#)

---

# Printing from a Computer

Before printing from your computer, make sure you have set up your product and installed its software from the Epson website.

**Note:** If you have an Internet connection, it is a good idea to check for updates to your product software on Epson's support website. If you see a Software Update screen, select **Enable automatic checking** and click **OK**. The update scans your system to see if you have the latest product software. Follow the on-screen instructions.

**Note:** Your product may differ from the images in this guide, but the instructions are the same unless otherwise noted.

[Printing with the Standard Epson Printer Software - Windows](#)

[Printing with the Epson Standard Printer Software - Mac](#)

[Printing with the Epson Universal Print Driver - Windows](#)

[Printing with the PostScript \(PS3\) Printer Software - Windows](#)

[Printing with the PostScript \(PS3\) Printer Software - Mac](#)

[Cancelling Printing Using the Product Control Panel](#)

## Printing with the Standard Epson Printer Software - Windows

You can print with the standard Epson printer software using any Windows printing program, as described in these sections.

**Note:** If you are using your Epson product with the Windows 10 S operating system, you cannot use the software described in this section. You also cannot download and install any Epson product software from the Epson website for use with Windows 10 S; you must obtain software only from the Windows Store.

[Synchronizing Printer Settings for Optional Units - Windows](#)

[Selecting Basic Print Settings - Windows](#)

[Selecting Double-sided Printing Settings - Windows](#)

[Selecting Finishing Options - Windows](#)

[Selecting Additional Print Options - Windows](#)

[Selecting a Printing Preset - Windows](#)





[Selecting Extended Settings - Windows](#)

[Printing Your Document or Photo - Windows](#)  
[Locking Printer Settings - Windows](#)  
[Entering a User ID and Password for Printing](#)  
[Selecting Default Print Settings - Windows](#)  
[Changing Automatic Update Options](#)

**Parent topic:** [Printing from a Computer](#)

## Synchronizing Printer Settings for Optional Units - Windows

You must sync the printer driver before you can use any optional equipment installed on the product.

1. Do one of the following:
  - **Windows 10:** Click  and select  (Settings) > **Devices** > **Printers & scanners**. Select your product and select **Manage** > **Printer properties**.
  - **Windows 8.x:** Navigate to the **Apps** screen and select **Control Panel** > **Hardware and Sound** > **Devices and Printers**. Right-click your product and select **Printer properties**.
  - **Windows 7:** Click  and select **Devices and Printers**. Right-click your product and select **Printer properties**.
  - **Windows Vista:** Click  and select **Control Panel**. Click **Printer** under **Hardware and Sound**, then right-click your product and select **Properties**.
  - **Windows XP:** Click **Start** and select **Printers and Faxes**. Right-click your product and select **Properties**.
2. Click the **Optional Settings** tab.

You see a window like this:

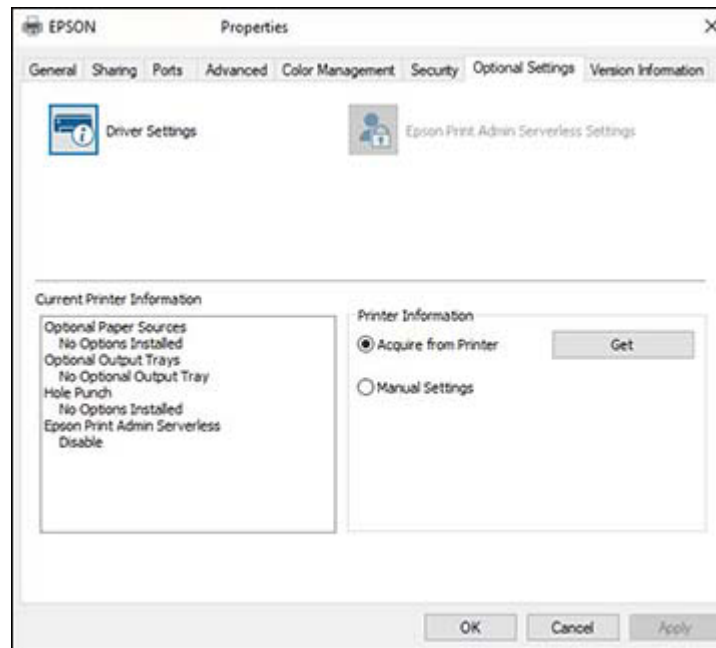

3. Make sure **Acquire from Printer** is selected and click **Get**.  
The product's settings and other information appears in the Current Printer Information area.
4. If you want to select specific options to sync, select **Manual Settings** and click **Settings**. Select the options you want to sync and click **OK**.
5. Click **OK**.

**Parent topic:** [Printing with the Standard Epson Printer Software - Windows](#)

## Selecting Basic Print Settings - Windows

Select the basic settings for the document or photo you want to print.

1. Open a photo or document for printing.

2. Select the print command in your application.

**Note:** You may need to select a print icon on your screen, the **Print** option in the **File** menu, or another command. See your application's help utility for details.

3. If necessary, select your product name as the printer you want to use.

**Note:** You may also need to select **Properties** or **Preferences** to view your print settings.

You see the **Main** tab of your printer settings window:

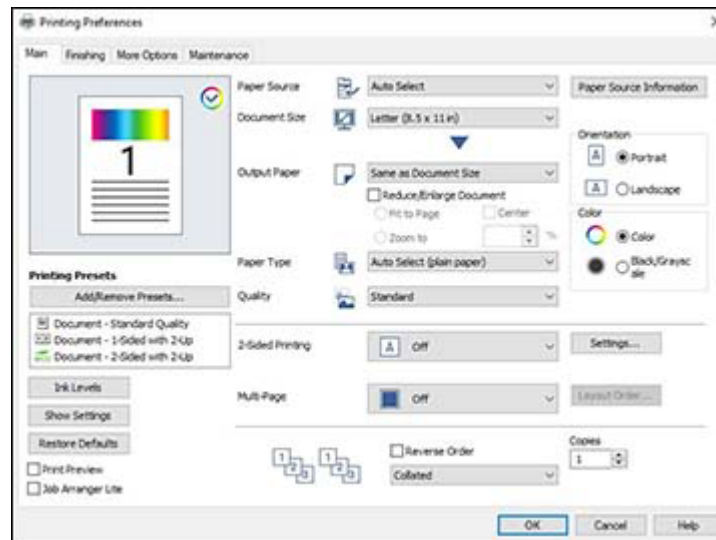

4. For the **Paper Source** setting, select where you loaded the paper you want to print on. Select **Auto Select** to automatically select the paper source in the paper setting menu on the product.

**Note:** Click **Paper Source Information** to view the paper type and size loaded in each paper cassette or the rear paper feeder.



5. Select the size of your document or photo as the **Document Size** setting, and the size of your paper as the **Output Paper** setting.
  - To change the size of your printed document or photo, select the **Reduce/Enlarge Document** checkbox.
  - Select the **Fit to Page** option to size your image to fit the paper you loaded.
  - Select the **Center** checkbox if you want to center your image on the paper.
  - Select the **Zoom to** option to reduce or enlarge your document or photo by a specific percentage. Select the percentage in the % dropdown.
6. Select the type of paper you loaded as the **Paper Type** setting. Select **Auto Select** to automatically use the paper type selected on the product control panel.

**Note:** The setting may not exactly match the name of your paper. Check the paper type settings list for details.

7. Select the **Quality** setting that matches the print quality you want to use.
8. Select the orientation of your document.

**Note:** If you are printing an envelope, select **Landscape**.

9. Select a Color option:
  - To print a color document or photo, select the **Color** setting.
  - To print text and graphics in black or shades of gray, select the **Black/Grayscale** setting.
10. To print on both sides of the paper, select a **2-Sided Printing** option and click **Settings** to select printing options.
11. To print multiple pages on one sheet of paper, or print one image on multiple sheets of paper, select one of the **Multi-Page** options and click **Layout Order** to select the printing options.
12. To print multiple copies and arrange their print order, select the **Copies**, **Reverse Order**, and **Collated** options.
13. To preview your job before printing, select the **Print Preview** checkbox.
14. To save your print job as a project that can be modified and combined with other print jobs, select **Job Arranger Lite**.

[Paper Source Options - Windows](#)

[Print Quality Options - Windows](#)

[Multi-Page Printing Options - Windows](#)

**Parent topic:** [Printing with the Standard Epson Printer Software - Windows](#)

**Related references**

[Paper or Media Type Settings - Printing Software](#)

**Related tasks**

[Printing Your Document or Photo - Windows](#)

[Entering a User ID and Password for Printing](#)

[Selecting Double-sided Printing Settings - Windows](#)

**Paper Source Options - Windows**

You can select any of the available options in the Paper Source menu to print on the paper loaded in that source.

**Auto Select**

Automatically selects the paper source based on the selected paper size.

**Paper Tray**

Selects the paper in the rear paper feeder as the paper source.

**Paper Cassette 1**

Selects the paper in cassette 1 as the paper source.

**Paper Cassette 2**

Selects the paper in cassette 2 as the paper source.

**Paper Cassette 3**

Selects the paper in cassette 3 as the paper source.

**Paper Cassette 4**

Selects the paper in cassette 4 as the paper source.

**High Capacity Tray**

Selects the optional high capacity tray as the paper source if it is connected to the printer.

**Set separately for each paper**

Set a different paper source for the first paper and subsequent papers.

**Parent topic:** [Selecting Basic Print Settings - Windows](#)

**Print Quality Options - Windows**

You can select any of the available Quality options to fine-tune the quality of your print. Some settings may be unavailable, depending on the paper type and border setting you have chosen.

### Standard

For everyday text and image printing.

### High

For photos and graphics with high print quality.

**Parent topic:** [Selecting Basic Print Settings - Windows](#)

## Multi-Page Printing Options - Windows

You can select any of the available options in the Multi-Page menu to set up your multi-page print job.

### 2-Up, 4-Up, 6-Up, 8-Up, 9-Up, and 16-Up

Prints several pages on one sheet of paper. Click the **Layout Order** button to select page layout and border options.

### 2×1 Poster, 2×2 Poster, 3×3 Poster, 4×4 Poster

Prints one image on multiple sheets of paper to create a larger poster. Click the **Settings** button to select image layout and guideline options.

**Parent topic:** [Selecting Basic Print Settings - Windows](#)

## Selecting Double-sided Printing Settings - Windows

You can print on both sides of the paper by selecting one of the **2-Sided Printing** options on the **Main** tab.

**Note:** Some options may be pre-selected or unavailable, depending on other settings you have chosen or if you are accessing the product over a network.



1. Select one of the following options for **2-Sided Printing**:
  - **Auto (Long-edge binding)** to print your double-sided print job by automatically flipping the paper on the long edge.
  - **Auto (Short-edge binding)** to print your double-sided print job by automatically flipping the paper on the short edge.
2. Click the **Settings** button.

You see this window:

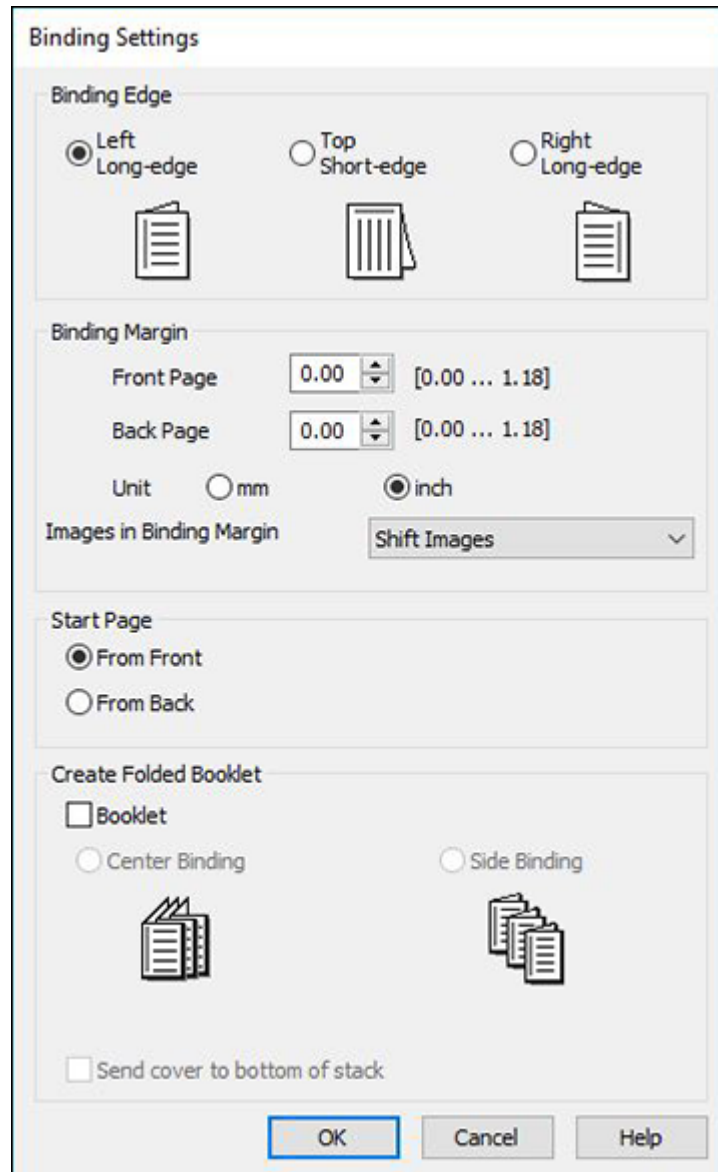

3. Select the double-sided printing options you want to use.
4. Select an option from **Images in Binding Margin** to change how the binding margin affects images.
  - **Shift Images**: Moves images out of the binding margin.
  - **Reduce Images**: Scales down images so that they are not in the binding margin.
  - **Erase Images**: Only prints parts of images outside of the binding margin.
5. Click **OK** to return to the **Main** tab.
6. Print a test copy of your double-sided document to test the selected settings.
7. Follow any instructions displayed on the screen during printing.

[Double-sided Printing Options - Windows](#)

**Parent topic:** [Printing with the Standard Epson Printer Software - Windows](#)

#### **Related references**

[Double-sided Printing Capacity](#)

#### **Related tasks**

[Selecting Basic Print Settings - Windows](#)

### **Double-sided Printing Options - Windows**

You can select any of the available options on the Binding Settings window to set up your double-sided print job.

#### **Binding Edge Options**

Select a setting that orients double-sided print binding in the desired direction.

#### **Binding Margin Options**

Select options that define a wider margin to allow for binding.

#### **Start Page**

Selects whether printing starts on the front or back page.

#### **Create Folded Booklet Options**

Select the **Booklet** checkbox and a binding option to print double-sided pages as a booklet.

**Parent topic:** [Selecting Double-sided Printing Settings - Windows](#)

## Selecting Finishing Options - Windows

You can select a variety of finishing options for your document or photo on the Finishing tab.

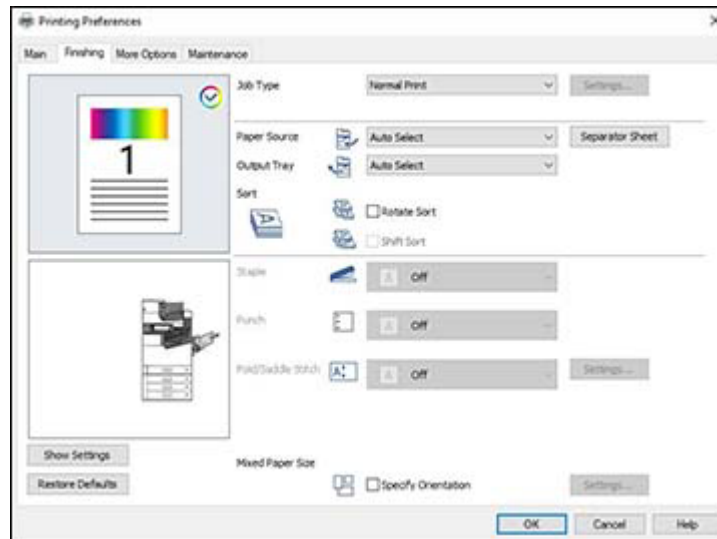

1. To store print jobs in the product's memory, select one of the **Job Type** options:

- Select **Normal Print** to print jobs without storing them.
- Select **Confidential Print** to add a password to a print job.

**Note:** Confidential jobs are stored in the product's memory without being printed. To print the job, enter the password for the confidential job on the product's control panel. Confidential print jobs are cleared from the product's memory after printing. If the product is turned off or restarted before the confidential job is printed, the job is cleared from the product's memory.

- When printing multiple copies, select **Verify Job** to print one copy to verify content and settings. You can then continue printing from the product control panel.
- Select **Re-Print Job** to store a print job in the product's memory. You can then print from the product control panel.
- Select **Save to Storage** to save the file to the product's hard drive without printing it.
- Select **Save to Storage and Print** to print the file and save it to the product's hard drive.

2. Select the **Paper Source** and **Output Tray** options you want to use.
3. Select **Separator Sheet** if you want to print a blank sheet of paper in between copies or print jobs.

**Note:** You can also adjust this setting from the control panel using the **Insert Sheets per User** option.

4. Select one of the following **Sort** options:
  - Select **Rotate Sort** to stack printouts alternately in landscape and portrait orientations. The **Paper Source** and **Output Tray** settings must be set to **Auto Select**.
  - Select **Shift Sort** to offset each set of copies. The **Output Tray** setting must be set to **Finisher Tray**.

**Note:** This option is available only when the optional finisher unit is installed.

5. If optional finisher and punch units are installed, you can choose the following options:
  - Select a **Staple** option to choose the staple location on the document.
  - Select a **Punch** option to choose where the holes are punched.

**Caution:** When using the optional hole punch unit with the optional staple or booklet finisher, adjust the printed area so it does not overlap with the holes being punched. You should also set the binding margin so that it is not printed at the hole punch position. Punching holes over any printed area may cause hole punch failure or a paper jam.

- Select a **Fold/Saddle Stitch** option to choose the booklet settings.
6. When printing documents of mixed sizes, select **Specify Orientation**. Click **Settings** to select orientation and binding margin options.

[Finishing Options - Windows](#)

**Parent topic:** [Printing with the Standard Epson Printer Software - Windows](#)

#### **Related references**

[Epson Universal Print Driver Locked Setting Options](#)

#### **Related tasks**

[Selecting Double-sided Printing Settings - Windows](#)

## Finishing Options - Windows

You can select any of the Finishing options to customize your print. Some options may be pre-selected or unavailable, depending on other settings you have chosen.

### **Job Type**

Select whether to store a print job in the product's memory.

### **Paper Source**

Select the paper cassette or tray to use.

### **Output Tray**

Select where printed jobs are output.

### **Sort**

Select how to sort print jobs with multiple copies.

### **Staple**

Select the staple location for printed documents.

### **Punch**

Select the hole punch location for printed documents.

### **Fold/Saddle Stitch**

Select binding settings for folded or folded and saddle stitched printed documents.

**Note:** The **Staple**, **Fold/Saddle Stitch**, and **Punch** options are available only when the necessary options are installed.

**Parent topic:** [Selecting Finishing Options - Windows](#)



## Selecting Additional Print Options - Windows

You can select a variety of additional printing options for your document or photo on the More Options tab.

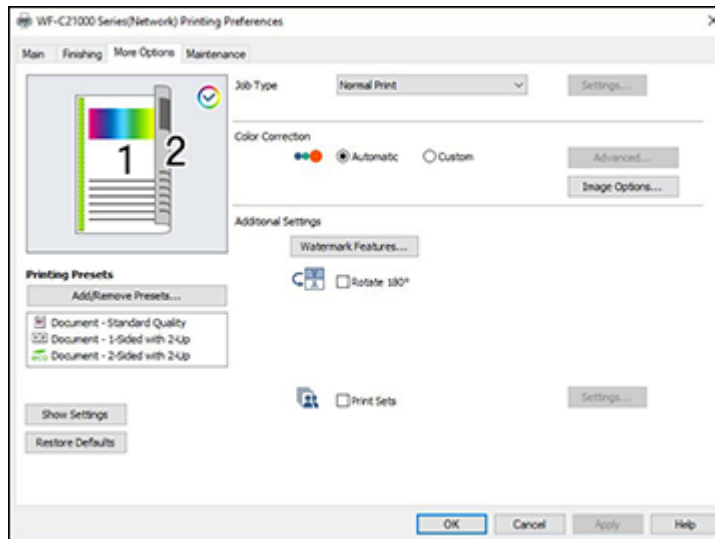

1. Select one of the following Color Correction (WF-C20600/WF-C20750/WF-C21000) or Tone Correction (WF-M21000) options:
  - Select **Automatic** to automatically adjust the sharpness, brightness, contrast, and color saturation for your image.
  - Select **Custom** and click the **Advanced** button to manually adjust the color correction settings or turn off color management in your printer software.
  - Select **Image Options** to access additional settings for improving printed images.
2. To add the following features, click the **Watermark Features** button:
  - **Anti-copy Pattern**: adds a watermark that only appears when your printout is copied
  - **Watermark**: adds a visible watermark to your printout
  - **Header/Footer**: adds information such as the date and time to the top or bottom of your printout

**Note:** Click the **Settings** button to customize the text and location of the header or footer.

3. Select **Rotate 180°** to print the image rotated 180° from its original orientation.
4. Select **Print Sets** to print the document in groups of saved quantities and settings.

**Note:** Click the **Settings** button to customize the groups.

[Custom Color Correction Options - Windows](#)

[Image Options and Additional Settings - Windows](#)

[Header/Footer Settings - Windows](#)

**Parent topic:** [Printing with the Standard Epson Printer Software - Windows](#)

### Related tasks

[Printing Your Document or Photo - Windows](#)

## Custom Color Correction Options - Windows

You can select any of the available options in the Color Correction window to customize the image colors for your print job.

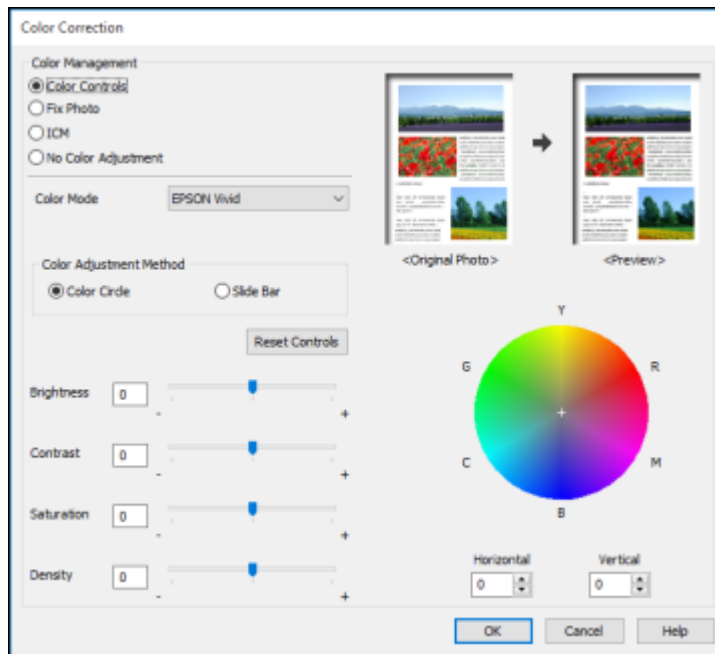

### **Color Controls**

Lets you select a **Color Mode** setting, individual settings for **Brightness**, **Contrast**, **Saturation**, and **Density**, and individual color tones. Depending on the selected color mode, you can also adjust the midtone density using the **Gamma** setting.

### **Fix Photo**

Improves the color, contrast, and sharpness of flawed photos.

**Note:** Fix Photo uses a sophisticated face recognition technology to optimize photos that include faces. For this to work, both eyes and the nose must be visible in the subject's face. If your photo includes a face with an intentional color cast, such as a statue, you may want to turn off **Fix Photo** to retain the special color effects.

### **ICM**

Lets you manage color using installed color printing profiles.

### **No Color Adjustment**

Turns off color management in your printer software so you can manage color using only your application software.

**Parent topic:** [Selecting Additional Print Options - Windows](#)

## **Image Options and Additional Settings - Windows**

You can select any of the Image Options and Additional Settings to customize your print. Some options may be pre-selected or unavailable, depending on other settings you have chosen.

### **Image Options**

#### **Emphasize Text**

Adjusts the weight of printed text to increase readability.

#### **Emphasize Thin Lines**

Adjusts the weight of printed lines to increase visibility.

#### **Edge Smoothing**

Smooths jagged edges in low-resolution images such as screen captures or images from the Web.

#### **Fix Red-Eye**

Reduces or removes red-eye in photos.

#### **Reduce Edge Blurriness**

Reduces blurriness in the edges of letters and images. This function only works on black edges.

#### **Print Text in Black**

Prints colored text in black.

**For Color Text**

Prints colored text on a background pattern or underlined.

**For Color Graphs and Images**

Prints colored graphics and images with overlay patterns.

**For Color Text, Graphs, and Images**

Prints colored text, graphics, and images with overlay patterns.

**Enhancement Options**

Specifies Color Universal Print enhancement settings for text, graphics, and images.

**Additional Settings Options****Rotate 180°**

Prints the image rotated 180° from its original orientation.

**Parent topic:** [Selecting Additional Print Options - Windows](#)

**Header/Footer Settings - Windows**

You can select any of the Header/Footer Settings options to add headers or footers when you print. The items are available to print at the top or bottom of your pages, in either the left, right, or center of the page.

**Note:** These settings are not saved with your document.

Header/Footer Settings

Top Left	Top Center	Top Right
User Name	None	Date/Time
Bottom Left	Bottom Center	Bottom Right
None	None	None

Starting number: 1

Start printing on page: 1

Text:

Color: Black

Font: Arial

Size: 11 pt [6 ... 72]

Style: Bold, Italic

Reset Defaults OK Cancel Help

You can select to print the following information:

- User Name
- Computer Name
- Date
- Date/Time
- Document Name
- Collate Number (copy number)
- Page Number

- Text

**Note:** The user name, computer name, date, and time come from the Windows Control Panel on your computer.

**Parent topic:** [Selecting Additional Print Options - Windows](#)

## Selecting a Printing Preset - Windows

For quick access to common groups of print settings, you can select a printing preset on the **Main** or **More Options** tab.

**Note:** You can create your own preset by clicking the **Add/Remove Presets** button.

1. Click the **Main** or **More Options** tab.  
You see the available **Printing Presets** on the left:

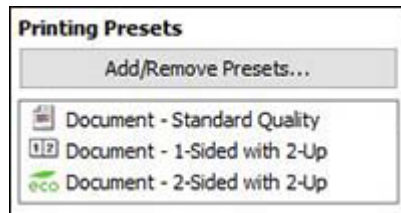



2. Place your cursor over one of the **Printing Presets** to view its list of settings.
3. Click on a preset to change its settings or delete it, or use any of the available options on the screen to control your printing presets.
4. To choose a preset for printing, select it.
5. Click **OK**.

**Parent topic:** [Printing with the Standard Epson Printer Software - Windows](#)

## Selecting Extended Settings - Windows

You can select additional settings that apply to all the print jobs you send to your product.

1. Access the Windows Desktop and right-click the  icon for your product in the right side of the Windows taskbar, or click the up arrow and right-click .

2. Select **Printer Settings**.
3. Click the **Maintenance** tab.  
You see the maintenance options:

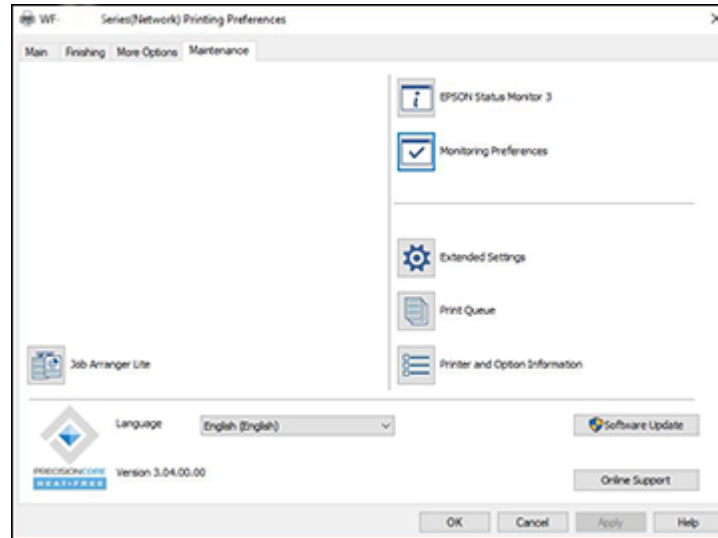

4. Click the **Extended Settings** button.

You see a window like this:

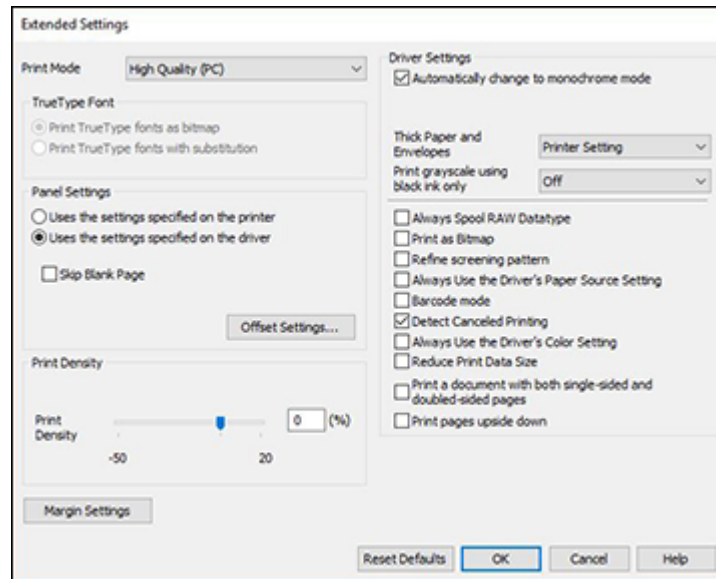

5. Select any of the extended settings to customize your print.
6. Click **OK** to close the Extended Settings window.
7. Click **OK** to close the printer software window.

[Extended Settings - Windows](#)

**Parent topic:** [Printing with the Standard Epson Printer Software - Windows](#)

### **Extended Settings - Windows**

You can select from these settings on the Extended Settings window.

#### **Print Mode**

Selects how print jobs are processed by the computer's or product's memory.

#### **TrueType Font**

Lets you select how you want to print TrueType fonts.

#### **Panel Settings**

Prioritizes settings from the product control panel or the printer driver software.



**Skip Blank Page**

Ensures that your product does not print pages that contain no text or images.

**Offset Settings**

Lets you make fine-tune adjustments to the print position of data on your printout.

**Print Density**

Sets the level of ink coverage for double-sided printing.

**Automatically change to monochrome mode**

Select to print automatically in monochrome instead of color.

**Optimize Finishing**

Reduces paper misalignment to improve stapling and stacking printouts. Print speed is decreased.

**Note:** Displayed when the optional finisher unit is installed.

**Thick Paper and Envelopes**

Select an option to prevent ink from smearing when you print on envelopes or other thick paper.

**Print grayscale using black ink only**

Prints in grayscale using only black ink.

**Always Spool RAW Datatype**

Increases print speed and may solve other printing problems.

**Print as Bitmap**

Increases print speed when printing is extremely slow or the print head stops during printing, and other settings do not help.

**Refine screening pattern**

Prints graphics with a finer screening pattern.

**Always Use the Driver's Paper Source Setting**

Prints using the paper source setting in the printer driver, rather than the setting in your application.

**Barcode mode**

Reduces bleeding when printing barcodes on plain paper, letterhead paper, recycled paper, preprinted paper, envelopes, and thick paper.

**Detect Canceled Printing**

Displays a message on the computer screen when a print job is canceled from the product control panel.

**Always Use the Driver's Color Setting**

Prioritizes color settings from the printer driver software.

### Reduce Print Data Size

Increases print data compression to improve print speed. Not recommended when printing fine patterns.

### Print a document with both single-sided and double-sided pages

Prints an entire document that contains both single- and double-sided pages.

### Print pages upside down

Prints pages upside down when printing double-sided.

Parent topic: [Selecting Extended Settings - Windows](#)

## Printing Your Document or Photo - Windows

Once you have selected your print settings, you are ready to save your settings and print.

1. Click **OK** to save your settings.

You see your application's Print window, such as this one:

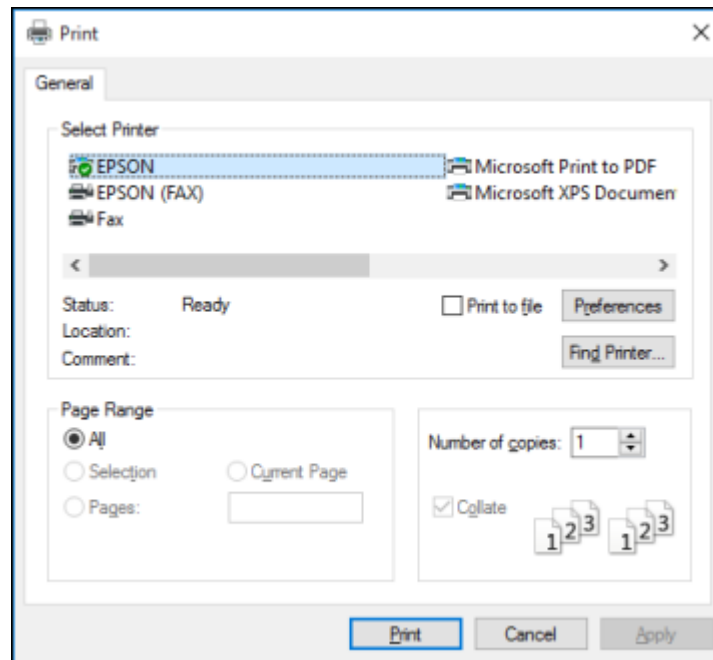





2. Click **OK** or **Print** to start printing.

## Locking Printer Settings - Windows

Windows administrators can lock access to some printer settings to prevent unauthorized changes.

1. Do one of the following:

- **Windows 10:** Click  and select  (Settings) > **Devices** > **Printers & scanners**. Select your product name and select **Manage** > **Printer properties**.
- **Windows 8.x:** Navigate to the **Apps** screen and select **Control Panel** > **Hardware and Sound** > **Devices and Printers**. Right-click your product and select **Printer properties**.
- **Windows 7:** Click  and select **Devices and Printers**. Right-click your product and select **Printer properties**.
- **Windows Vista:** Click  and select **Control Panel**. Click **Printer** under **Hardware and Sound**, then right-click your product and select **Properties**.
- **Windows XP:** Click **Start** and select **Printers and Faxes**. Right-click your product and select **Properties**.

2. Click the **Optional Settings** tab.

**Note:** You can prevent access to the **Optional Settings** tab by changing the user or group permissions in the **Security** tab.

3. Click **Driver Settings**.

You see this window:

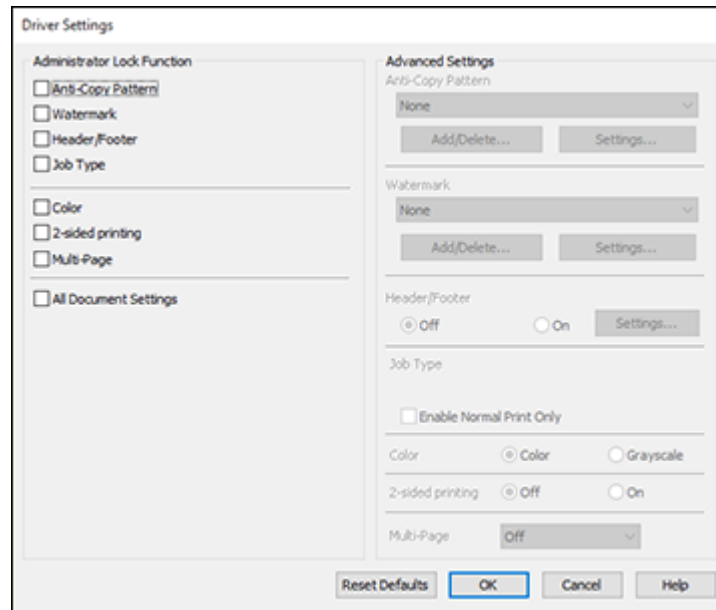

4. Select the checkbox for each setting you want to lock. To lock all print settings, select **All Document Settings**.
5. Under **Advanced Settings**, select the setting option you want to use for each locked setting.
6. Click **OK**.

[Locked Setting Options](#)

**Parent topic:** [Printing with the Standard Epson Printer Software - Windows](#)

### Locked Setting Options

Select the options you want to use for any locked print settings.

<b>Setting</b>	<b>Options</b>	<b>Description</b>
<b>Anti-Copy Pattern</b>	Various data items	Lets you select the data to use for the pattern or prohibit anti-copy patterns
	<b>Add/Delete</b>	Lets you add or delete a customized anti-copy pattern
	<b>Settings</b>	Lets you select the arrangement, size, and other settings for the custom anti-copy pattern
<b>Watermark</b>	Various text watermarks	Lets you select the text for the watermark or prohibit watermarks
	<b>Add/Delete</b>	Lets you add or delete a customized text or image-based watermark
	<b>Settings</b>	Lets you select the size, position, and other watermark settings
<b>Header/Footer</b>	<b>Off</b>	Prohibits headers or footers
	<b>On</b>	Allows headers and footers
	<b>Settings</b>	Lets you select the text and position for printing headers and footers
<b>Job Type</b>	—	Lets you select the <b>Enable Normal Print Only</b> checkbox so only the Normal Print option is available
<b>Color</b>	<b>Color</b>	Allows color printing
	<b>Grayscale</b>	Allows printing in black or shades of gray only
<b>2-sided printing</b>	<b>Off</b>	Allows printing on one side of the paper only
	<b>On</b>	Allows printing on both sides of the paper
<b>Multi-Page</b>	<b>Off</b>	Prohibits multi-page settings
	<b>2-Up</b>	Allows printing of 2 pages on one sheet of paper
	<b>4-Up</b>	Allows printing of 4 pages on one sheet of paper
	<b>6-Up</b>	Allows printing of 6 pages on one sheet of paper
	<b>8-Up</b>	Allows printing of 8 pages on one sheet of paper
	<b>9-Up</b>	Allows printing of 9 pages on one sheet of paper
	<b>16-Up</b>	Allows printing of 16 pages on one sheet of paper



Setting	Options	Description
<b>All Document Settings</b>	—	Lets you lock all print settings

Parent topic: [Locking Printer Settings - Windows](#)

## Entering a User ID and Password for Printing

If you enabled Access Control on the product, you must enter a user ID and password in the printer driver to be able to print.

**Note:** If you do not know the user ID or password, contact your administrator for assistance.

1. Access the Windows Desktop and right-click the  icon for your product in the right side of the Windows taskbar, or click the up arrow and right-click . Select **Printer Settings** and click the **Maintenance** tab.

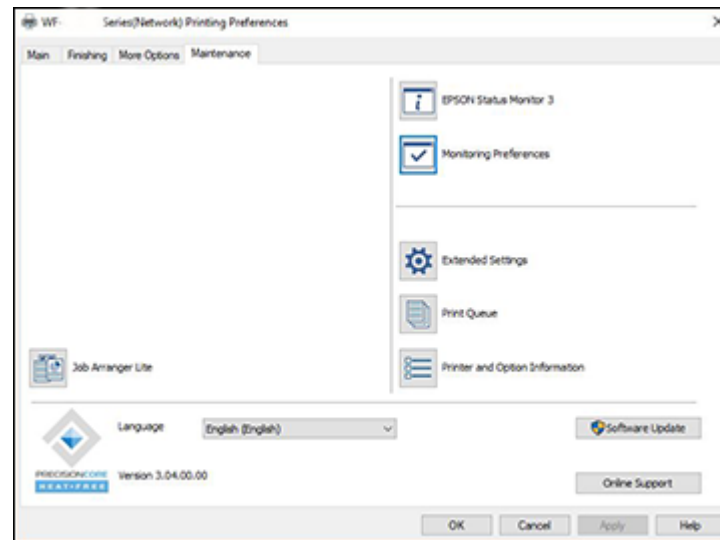



2. Click the **Printer and Option Information** button.
3. Select the **Save Access Control settings** checkbox.

4. Click the **Settings** button.
5. Enter your user name and password.
6. Click **OK**.

**Parent topic:** [Printing with the Standard Epson Printer Software - Windows](#)

## Selecting Default Print Settings - Windows

When you change your print settings in a program, the changes apply only while you are printing in that program session. If you want to change the print settings you use in all your Windows programs, you can select new default print settings.

1. Access the Windows Desktop and right-click the  icon for your product in the right side of the Windows taskbar, or click the up arrow and right-click .
2. Select **Printer Settings**.

You see the printer settings window:

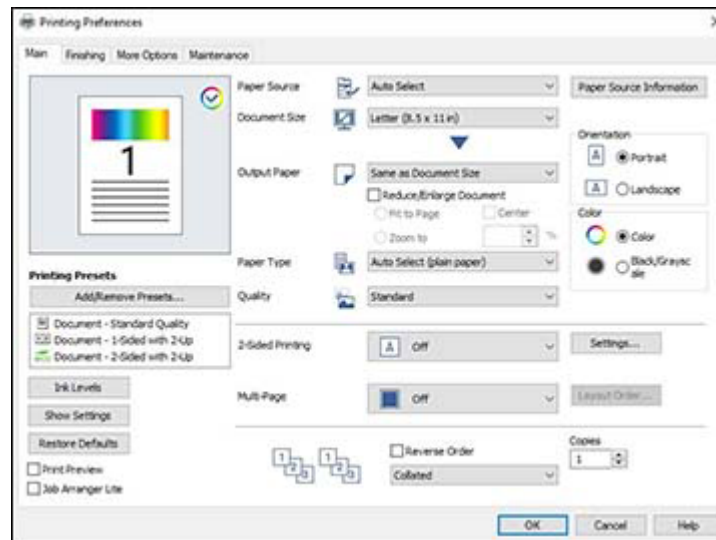

3. Select the print settings you want to use as defaults in all your Windows programs.
4. Click **OK**.



These settings are now the defaults selected for printing. You can still change them as needed for printing in any program session.

### [Changing the Language of the Printer Software Screens](#)

**Parent topic:** [Printing with the Standard Epson Printer Software - Windows](#)

## Changing the Language of the Printer Software Screens

You can change the language used on the Windows printer software screens.

1. Access the Windows Desktop and right-click the  icon for your product in the right side of the Windows taskbar, or click the up arrow and right-click .
2. Select **Printer Settings**.  
You see the printer settings window.
3. Click the **Maintenance** tab.  
You see the maintenance options:

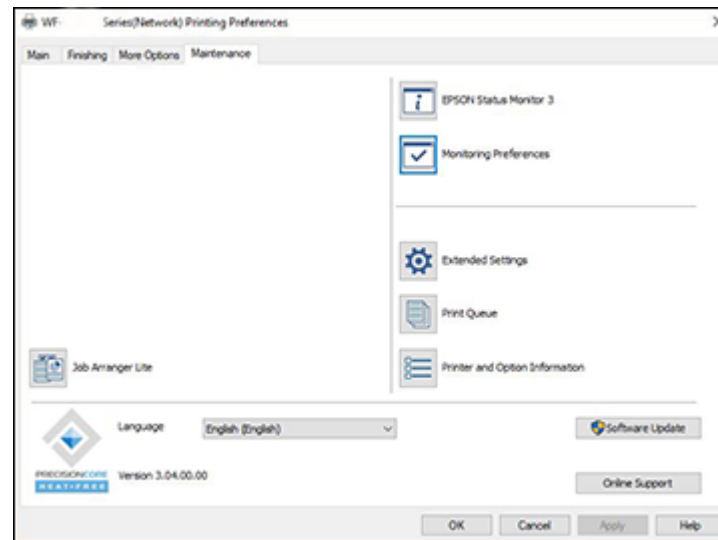

4. Select the language you want to use as the **Language** setting.
5. Click **OK** to close the printer software window.



The printer software screens appear in the language you selected the next time you access them.



Parent topic: [Selecting Default Print Settings - Windows](#)

## Changing Automatic Update Options

Your printer software for Windows automatically checks for updates to the product software. You can change how often the software checks for updates or disable this feature.

1. Access the Windows Desktop and right-click the  icon for your product in the right side of the Windows taskbar, or click the up arrow and right-click .
2. Select **Software Update Settings**.

You see this window:

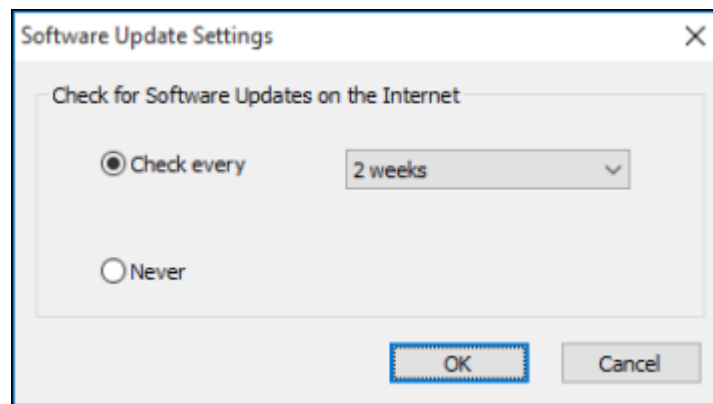

3. Do one of the following:
  - To change how often the software checks for updates, select a setting in the **Check every** menu.
  - To disable the automatic update feature, select the **Never** option.
4. Click **OK** to exit.

**Note:** If you choose to disable the automatic update feature, you can check for updates manually.

Parent topic: [Printing with the Standard Epson Printer Software - Windows](#)

### Related tasks

[Checking for Software Updates](#)

## Printing with the Epson Standard Printer Software - Mac

You can print with your product using any Mac printing program, as described in these sections.

**Note:** If you have an Internet connection, it is a good idea to check for updates to your product software on Epson's support website.

[Selecting Basic Print Settings - Mac](#)

[Selecting Page Setup Settings - Mac](#)

[Selecting Print Layout Options - Mac](#)

[Selecting Double-sided Printing Settings - Mac](#)

[Managing Color - Mac](#)

[Selecting Finishing Options - Mac](#)

[Selecting Printing Preferences - Mac](#)

[Printing Your Document or Photo - Mac](#)

**Parent topic:** [Printing from a Computer](#)

### Selecting Basic Print Settings - Mac

Select the basic settings for the document or photo you want to print.

1. Open a photo or document for printing.
2. Select the print command in your application.

**Note:** You may need to select a print icon on your screen, the **Print** option in the File menu, or another command. See your application's help utility for details.

3. Select your product as the **Printer** setting.

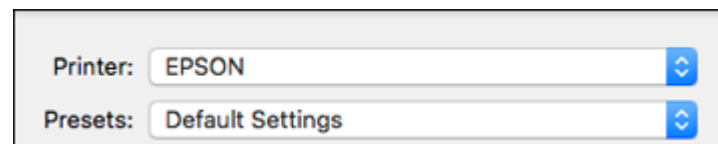

4. If necessary, click the arrow next to the Printer setting or the **Show Details** button to expand the print window.

You see an expanded printer settings window like this:

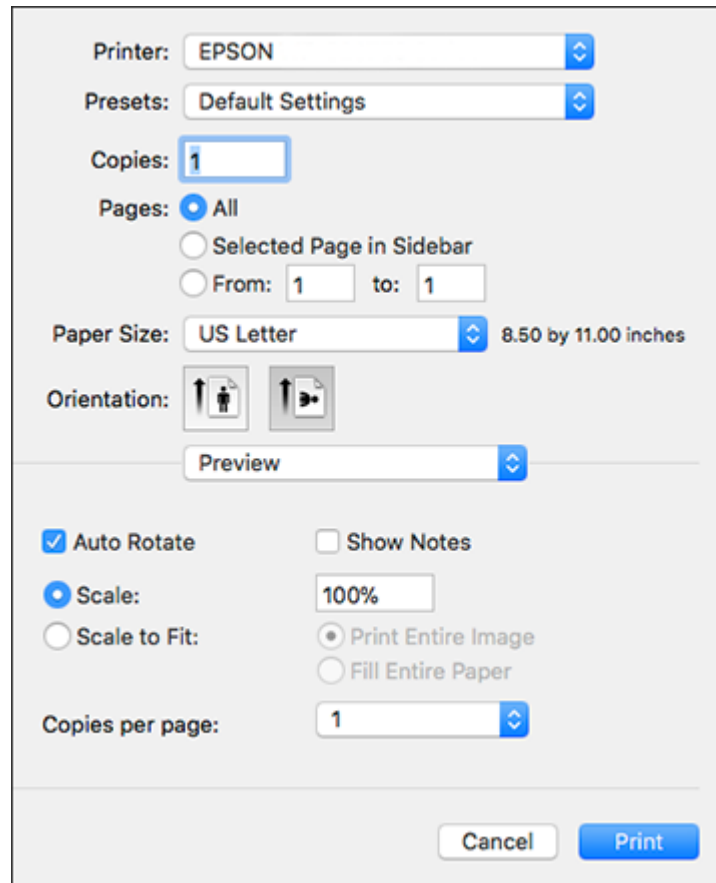

**Note:** The print window and pop-up menu may look different, depending on the Mac OS version and the application you are using.

5. Select the **Copies** and **Pages** settings as necessary.

**Note:** If you do not see these settings in the print window, check for them in your application before printing.

6. Select the page setup options: **Paper Size** and **Orientation**.

**Note:** If you do not see these settings in the print window, check for them in your application before printing. They may be accessible by selecting **Page Setup** from the File menu.

7. Select any application-specific settings that appear on the screen, such as those shown in the image above for the Preview application.
8. Select **Print Settings** or **Printer Features** from the pop-up menu.

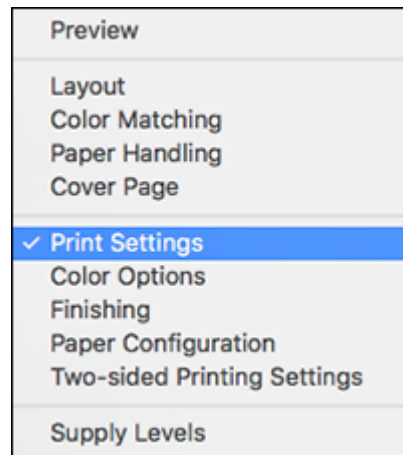

**Note:** If the **Print Settings** menu is not displayed, the Epson printer driver has not been installed correctly. Remove the printer and re-add it in the System Preferences. MacOS 10.14 does not show the **Print Settings** menu in applications made by Apple.

You see a menu like this:

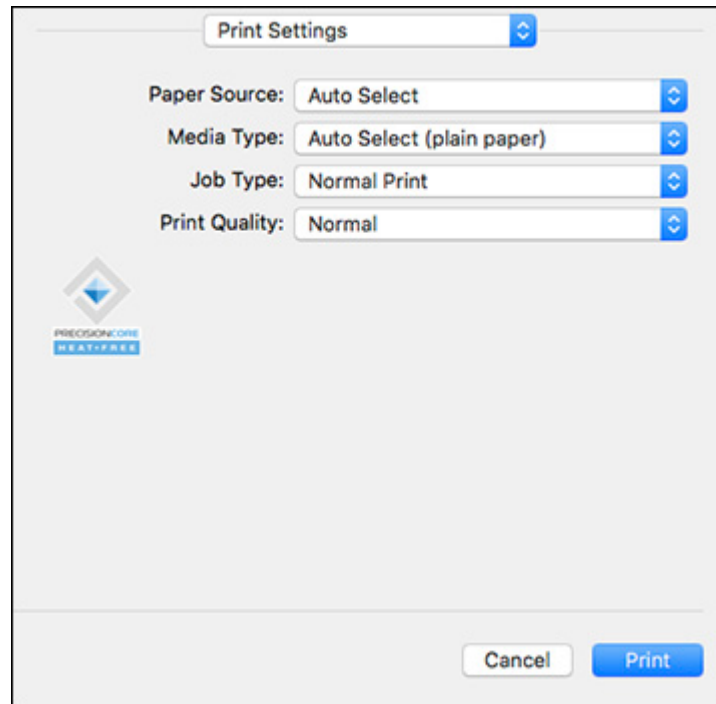

9. Select the **Paper Source** you wish to print from.
10. Select the type of paper you loaded as the **Media Type** setting.

**Note:** The setting may not exactly match the name of your paper. Check the paper type settings list for details.

11. Change the **Job Type** setting if you want to save the file to the product's hard drive.
12. Select the **Print Quality** setting you want to use.
13. Select any of the available print options.

[Paper Source Options - Mac](#)

[Print Quality Options - Mac](#)

[Print Options - Mac](#)

**Parent topic:** [Printing with the Epson Standard Printer Software - Mac](#)

**Related references**

[Paper or Media Type Settings - Printing Software](#)

**Related tasks**

[Selecting Page Setup Settings - Mac](#)

**Paper Source Options - Mac**

You can select any of the available options in the Paper Source menu to print on the paper loaded in that source.

**Auto Select**

Automatically selects the paper source based on the selected paper size.

**Paper Tray**

Selects the paper in the rear paper feeder as the paper source.

**Cassette 1**

Selects the paper in cassette 1 as the paper source.

**Cassette 2**

Selects the paper in cassette 2 as the paper source.

**Cassette 3**

Selects the paper in cassette 3 as the paper source.

**Cassette 4**

Selects the paper in cassette 4 as the paper source.

**High Capacity Tray**

Selects the optional high capacity tray as the paper source if it is connected to the printer.

**Parent topic:** [Selecting Basic Print Settings - Mac](#)

**Print Quality Options - Mac**

You can select any of the available Print Quality options to fine-tune the quality of your print. Some settings may be unavailable, depending on the paper type setting you have chosen.

**Normal**

For everyday text and image printing.

**Fine**

For text and graphics with good quality and print speed.

**Parent topic:** [Selecting Basic Print Settings - Mac](#)

## Print Options - Mac

You can select any of the print options to customize your print. Some options may be unavailable, depending on other settings you have chosen.

### Grayscale

Prints text and graphics in black or shades of gray.

### Mirror Image

Lets you flip the printed image horizontally.

Parent topic: [Selecting Basic Print Settings - Mac](#)

## Selecting Page Setup Settings - Mac

Depending on your application, you may be able to select the paper size and orientation settings from the print window.

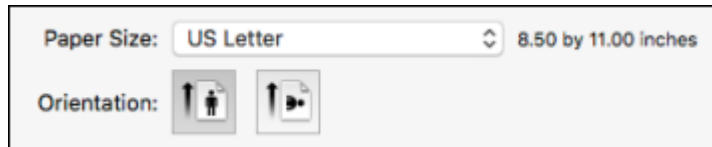

**Note:** If you do not see these settings in the print window, check for them in your application before printing. They may be accessible by selecting **Page Setup** from the File menu.

1. Select the size of the paper you loaded as the **Paper Size** setting.
2. Select the orientation of your document or photo as shown in the print window.

**Note:** If you are printing an envelope, select the  icon.

**Note:** You can reduce or enlarge the size of the printed image by selecting **Paper Handling** from the pop-up menu and selecting a scaling option.

Parent topic: [Printing with the Epson Standard Printer Software - Mac](#)

## Selecting Print Layout Options - Mac

You can select a variety of layout options for your document or photo by selecting **Layout** from the pop-up menu on the print window.

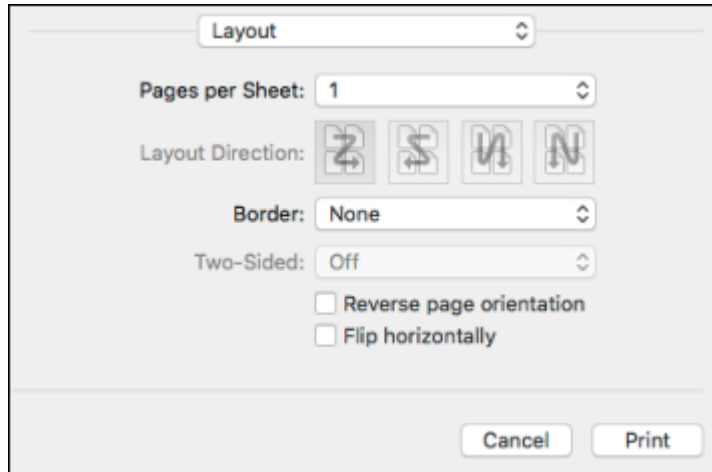

- To print multiple pages on one sheet of paper, select the number of pages in the **Pages per Sheet** pop-up menu. To arrange the print order of the pages, select a **Layout Direction** setting.
- To print borders around each page on the sheet, select a line setting from the **Border** pop-up menu.
- To print on both sides of each page, select a setting from the **Two-Sided** pop-up menu.
- To invert or flip the printed image, select the **Reverse page orientation** or **Flip horizontally** settings.

**Parent topic:** [Printing with the Epson Standard Printer Software - Mac](#)

## Selecting Double-sided Printing Settings - Mac

You can print on both sides of the paper by selecting **Two-sided Printing Settings** from the pop-up menu on the print window.

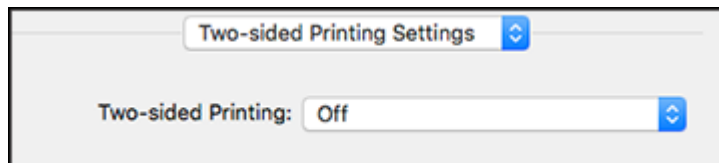



**Note:** Some options may be pre-selected or unavailable, depending on other settings you have chosen or if you are accessing the product over a network. This screen may be different, depending on the Mac OS version you are using.

1. Select one of the **Two-sided Printing** options.
2. Print a test copy of your double-sided document to test the selected settings.
3. Follow any instructions displayed on the screen during printing.

[Double-sided Printing Options and Adjustments - Mac](#)

**Parent topic:** [Printing with the Epson Standard Printer Software - Mac](#)

#### **Related references**

[Double-sided Printing Capacity](#)

### **Double-sided Printing Options and Adjustments - Mac**

You can select any of the available options in the **Two-sided Printing Settings** or **Output Settings** pop-up menu to set up your double-sided print job.

#### **Long-Edge binding**

Orients double-sided printed pages to be bound on the long edge of the paper.

#### **Short-Edge binding**

Orients double-sided printed pages to be bound on the short edge of the paper.

**Parent topic:** [Selecting Double-sided Printing Settings - Mac](#)

### **Managing Color - Mac**

You can adjust the Color Matching and Color Options settings to fine-tune the colors in your printout or turn off color management in your printer software.

1. Select **Color Matching** from the pop-up menu in the print window.

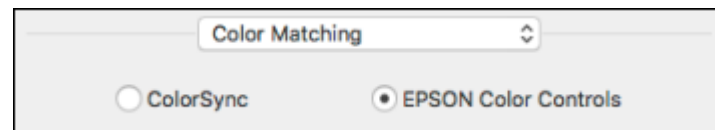

2. Select one of the available options.

3. Select **Color Options** from the pop-up menu in the print window.

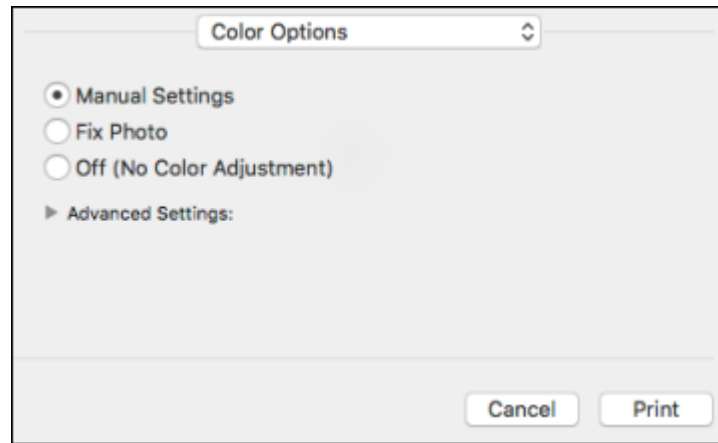

**Note:** The available settings on the Color Options menu depend on the option you selected on the Color Matching menu.

4. Select one of the available options.

[Color Matching and Color Options - Mac](#)

**Parent topic:** [Printing with the Epson Standard Printer Software - Mac](#)

### **Color Matching and Color Options - Mac**

You can select these settings on the **Color Matching** and **Color Options** menus.

#### **Color Matching Settings**

##### **EPSON Color Controls**

Lets you manage color using controls in your printer driver or turn off color management.

##### **ColorSync**

Prints using standard color profiles for your product and paper to help match image colors. You can customize the conversion method and filter settings on the ColorSync pop-up menu in the print window.

## Color Options Settings

### Manual Settings

Lets you select manual color adjustments. Click the arrow next to **Advanced Settings** and select settings for **Brightness**, **Contrast**, **Saturation**, and individual color tones. You can also select a color **Mode** setting for printing photos and graphics and the **Fix Red-Eye** setting to reduce or remove red-eye in photos. Depending on the selected color mode, you can also adjust the midtone density using the **Gamma** setting.

### Fix Photo

Improves the color, contrast, and sharpness of flawed photos. Click the arrow next to **Advanced Settings** and select the **Fix Red-Eye** setting to reduce or remove red-eye in photos.

**Note:** Fix Photo uses a sophisticated face recognition technology to optimize photos that include faces. For this to work, both eyes and the nose must be visible in the subject's face. If your photo includes a face with an intentional color cast, such as a statue, you may want to turn off **Fix Photo** to retain the special color effects.

### Off (No Color Adjustment)

Turns off color management in your printer software so you can manage color using only your application software.

**Note:** An ICC profile is required if color management is turned off.

Parent topic: [Managing Color - Mac](#)

## Selecting Finishing Options - Mac

You can choose finishing options by selecting **Finishing** from the pop-up menu on the print window.

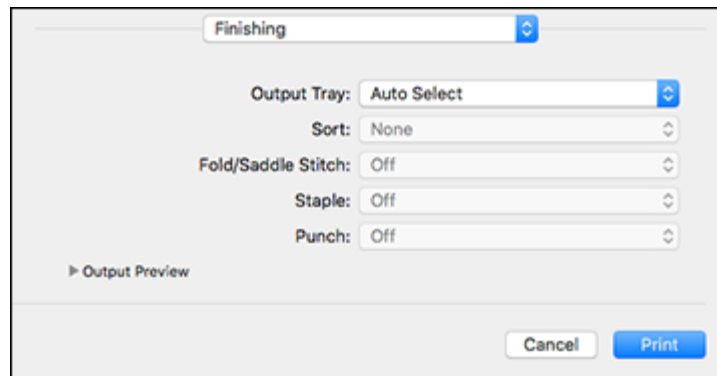

1. Select the **Output Tray** you want to output your print jobs to.
2. If you are printing multiple copies, select a **Sort** option.
3. If optional finisher and punch units are installed, you can choose the following options:
  - Select a **Fold/Saddle Stitch** option to choose the booklet settings.
  - Select a **Staple** option to choose the staple location on the document.
  - Select a **Punch** option to choose where the holes are punched.

#### [Finishing Options - Mac](#)

**Parent topic:** [Printing with the Epson Standard Printer Software - Mac](#)

### **Finishing Options - Mac**

You can select any of the available options in the **Finishing** pop-up menu.

#### **Output Tray**

Select where printed jobs are output.

#### **Sort**

Select how to sort print jobs with multiple copies.

#### **Fold/Saddle Stitch**

Select binding settings for folded or folded and saddle stitched printed documents.

#### **Staple**

Select the staple location for printed documents.

#### **Punch**

Select the hole punch location for printed documents.

**Note:** The **Staple**, **Fold/Saddle Stitch**, and **Punch** options are available only when the necessary optional equipment is installed.

**Parent topic:** [Selecting Finishing Options - Mac](#)

### **Selecting Printing Preferences - Mac**

You can select printing preferences that apply to all the print jobs you send to your product.

1. In the Apple menu or the Dock, select **System Preferences**.
2. Select **Print & Fax**, **Print & Scan**, or **Printers & Scanners**, select your product, and select **Options & Supplies**.
3. Select **Driver** or **Options**.

You see a screen like this:

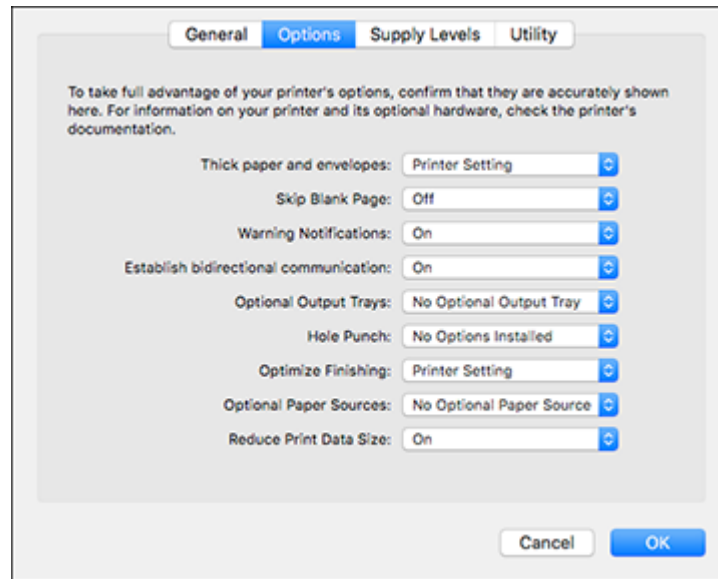

4. Select any of the available printing preferences.
5. Click **OK**.

[Printing Preferences - Mac](#)

**Parent topic:** [Printing with the Epson Standard Printer Software - Mac](#)

### Printing Preferences - Mac

You can select these settings on the **Options** or **Driver** tab.

**Note:** Some settings are available only if the necessary options are installed.

#### Thick Paper and Envelopes

Prevents ink from smearing when you print on envelopes or other thick paper.

#### Skip Blank Page

Ensures that your product does not print pages that contain no text or images.

**Warning Notifications**

Lets you choose whether or not to receive warning notifications from the printer software for various operating conditions.

**Establish bidirectional communication**

Allows the product to communicate with the computer. Do not change the default setting unless you experience issues when using a shared printing pool.

**Reduce Print Data Size**

Increases print data compression to improve print speed. Not recommended when printing fine patterns.

**Optional Output Trays**

Select an output tray option if the optional finisher unit is installed.

**Optional Paper Sources**

Select an optional paper source option if the optional high-capacity input tray is installed.

**Hole Punch**

Select a hole punch setting.

**Optimize Finishing**

Reduces paper misalignment to improve stapling and stacking printouts. Print speed is decreased.

**Parent topic:** [Selecting Printing Preferences - Mac](#)

## Printing Your Document or Photo - Mac

Once you have selected your print settings, you are ready to print.

Click **Print** at the bottom of the print window.

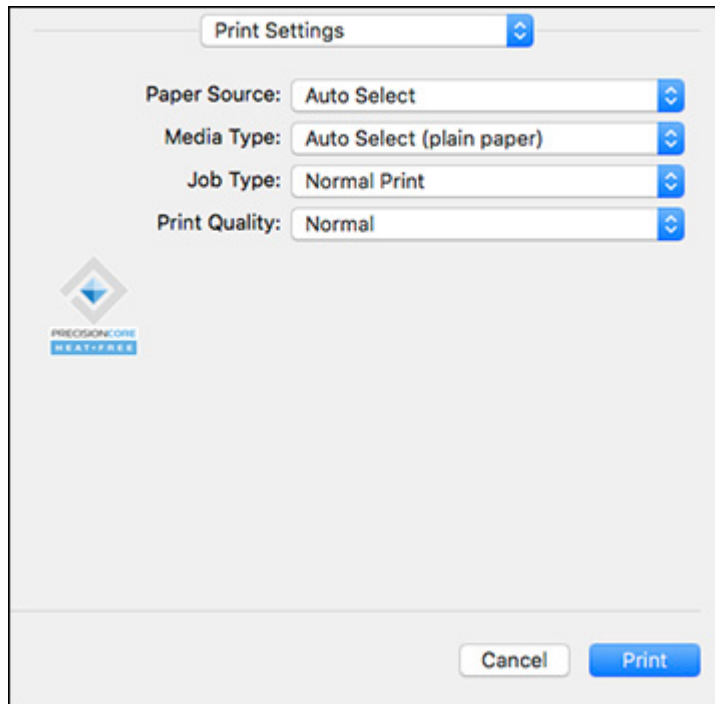

[Checking Print Status - Mac](#)

**Parent topic:** [Printing with the Epson Standard Printer Software - Mac](#)

### Checking Print Status - Mac



During printing, you can view the progress of your print job, control printing, and check ink status.

1. Click the printer icon when it appears in the Dock.

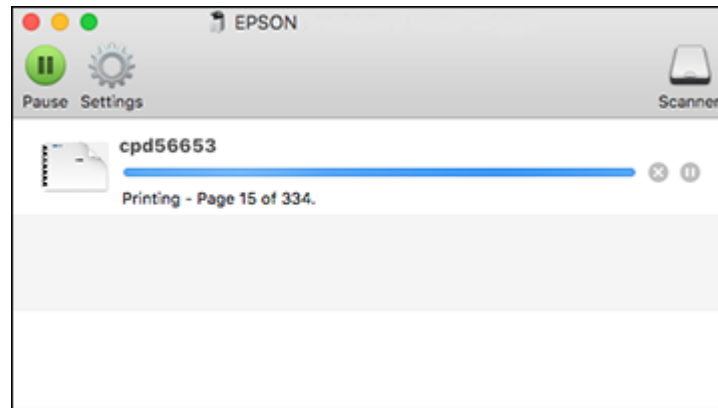
You see the print status window:



2. Select the following options as necessary for your Mac OS version:

- To cancel printing, click the print job and click  or **Delete**.
- To pause a print job, click the print job and click  or **Hold**. To resume a print job, click the paused print job and click  or **Resume**.
- To pause printing for all queued print jobs, click **Pause** or **Pause Printer**.
- To display other printer information, click **Settings** or **Supply Levels**.

**Parent topic:** [Printing Your Document or Photo - Mac](#)

## Printing with the Epson Universal Print Driver - Windows

You can print with the Epson Universal Print Driver using any Windows printing program, as described in these sections.

[Synchronizing Printer Settings - Epson Universal Print Driver - Windows](#)

[Selecting Print Settings - Epson Universal Print Driver - Windows](#)

[Selecting Default Print Settings - Epson Universal Print Driver - Windows](#)

[Locking Printer Settings - Epson Universal Print Driver - Windows](#)

[Adding Network Printers - Epson Universal Print Driver - Windows](#)





**Parent topic:** [Printing from a Computer](#)



## Synchronizing Printer Settings - Epson Universal Print Driver - Windows

You may need to synchronize the printer driver with the product if the printer driver does not detect the correct information or settings from the product.

**Note:** You must sync the printer driver before you can use any optional equipment installed on the product.

1. Do one of the following:
  - **Windows 10:** Click  and select  (Settings) > **Devices > Printers & scanners**. Select **EPSON Universal Print Driver** and select **Manage > Printer properties**.
  - **Windows 8.x:** Navigate to the **Apps** screen and select **Control Panel > Hardware and Sound > Devices and Printers**. Right-click **EPSON Universal Print Driver** and select **Printer properties**.
  - **Windows 7:** Click  and select **Devices and Printers**. Right-click **EPSON Universal Print Driver** and select **Printer properties**.
  - **Windows Vista:** Click  and select **Control Panel**. Click **Printer** under **Hardware and Sound**, then right-click **EPSON Universal Print Driver** and select **Properties**.
  - **Windows XP:** Click **Start** and select **Printers and Faxes**. Right-click **EPSON Universal Print Driver** and select **Properties**.
2. Click the **Optional Settings** tab.

You see a window like this:

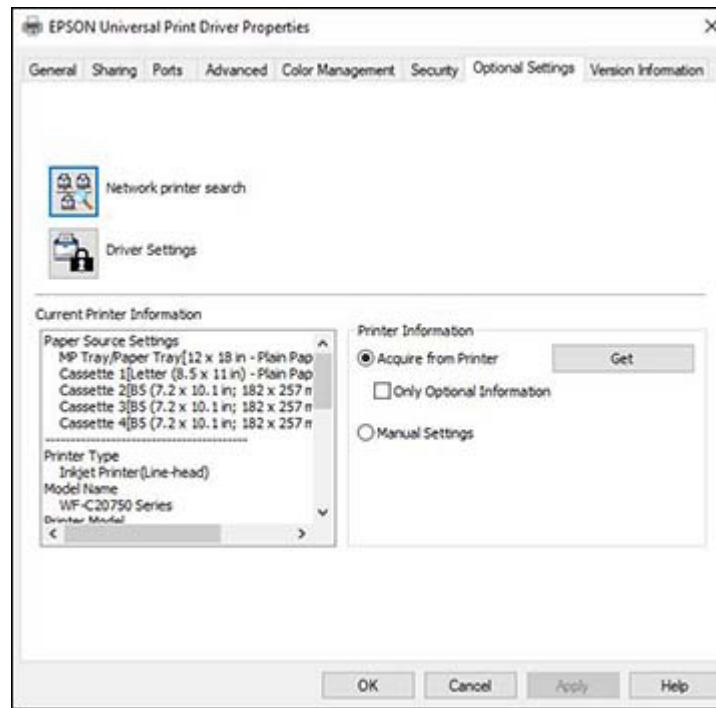

3. Make sure **Acquire from Printer** is selected and click **Get**.

**Note:** Select the **Only Optional Information** checkbox if you only want to enable any optional equipment installed on the product.

The product's settings and other information appears in the Current Printer Information area.

4. Click **OK**.

**Parent topic:** [Printing with the Epson Universal Print Driver - Windows](#)

## Selecting Print Settings - Epson Universal Print Driver - Windows

Select the basic settings for the document or photo you want to print.

**Note:** The names of settings on the universal print driver screens may vary slightly, depending on the version of the print driver you have installed.

1. Open a photo or document for printing.
2. Select the print command in your application.

**Note:** You may need to select a print icon on your screen, the **Print** option in the **File** menu, or another command. See your application's help utility for details.

3. If necessary, select **EPSON Universal Print Driver** as the printer you want to use.

**Note:** You may also need to select **Properties** or **Preferences** to view your print settings.

You see the **Main** tab of your printer settings window:

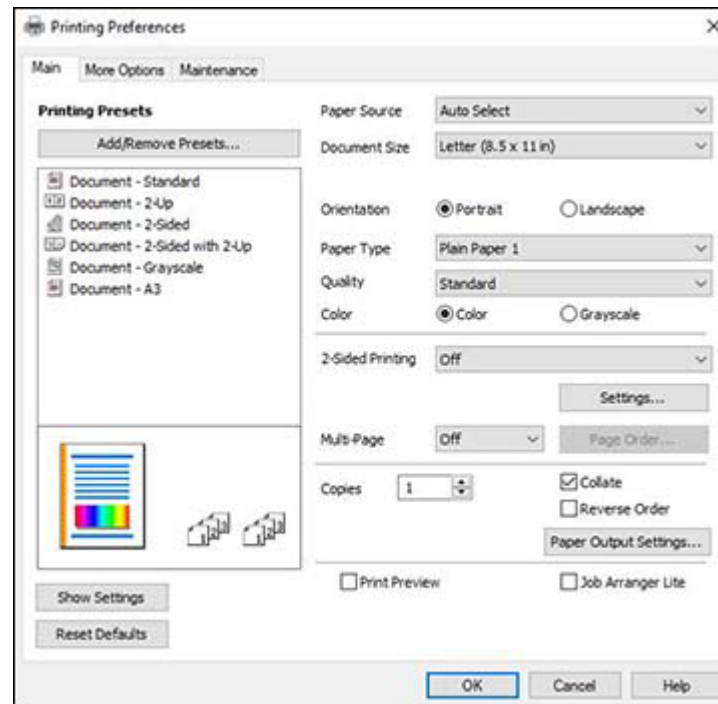

**Note:** For more information about a setting, right-click it and select **Help**.

4. For the **Paper Source** setting, select where you loaded the paper you want to print on.
5. Select the size of the paper you loaded as the **Document Size** setting.

**Note:** You can also select the **User-Defined** setting to create a custom paper size.

6. Select the orientation of your document.

**Note:** If you are printing an envelope, select **Landscape**.

7. Select the type of paper you loaded as the **Paper Type** setting.



**Note:** The setting may not exactly match the name of your paper. Check the paper type settings list for details.

8. Select any of the available print options.
9. To select a variety of additional layout and printing options for your document or photo, select the **More Options** tab and select the printing options you want.
10. To select maintenance and other optional settings, select the **Maintenance** tab and select the options you want.

**Parent topic:** [Printing with the Epson Universal Print Driver - Windows](#)

## Selecting Default Print Settings - Epson Universal Print Driver - Windows

When you change your print settings in a program, the changes apply only while you are printing in that program session. If you want to change the print settings you use in all your Windows programs, you can select new default print settings.

1. Do one of the following:
  - **Windows 10:** Click  and select  (Settings) > **Devices** > **Printers & scanners**. Select **EPSON Universal Print Driver** and select **Manage** > **Printing Preferences**.
  - **Windows 8.x:** Navigate to the **Apps** screen and select **Control Panel** > **Hardware and Sound** > **Devices and Printers**. Right-click **EPSON Universal Print Driver** and select **Print Preferences**.
  - **Windows 7:** Click  and select **Devices and Printers**. Right-click **EPSON Universal Print Driver** and select **Printing Preferences**.

- **Windows Vista:** Click  and select **Control Panel**. Click **Printer** under **Hardware and Sound**, right-click **EPSON Universal Print Driver**, and select **Printing Preferences**.
- **Windows XP:** Click **Start** and select **Printers and Faxes**. Right-click **EPSON Universal Print Driver** and select **Printing Preferences**.

You see the printer settings window:

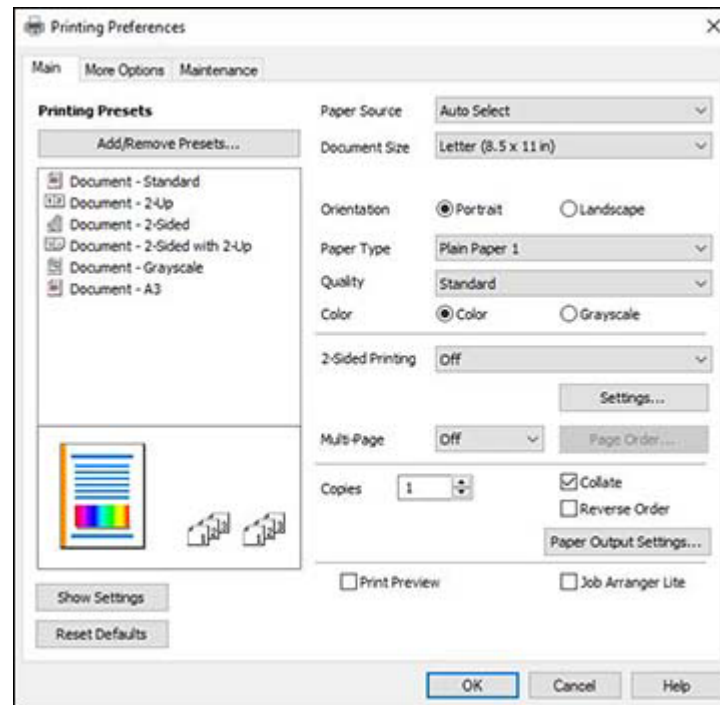

**Note:** For more information about a setting, right-click it and select **Help**.





2. Select the print settings you want to use as defaults in all your Windows programs.
3. Click **OK**.

These settings are now the defaults selected for printing. You can still change them as needed for printing in any program session.

**Parent topic:** [Printing with the Epson Universal Print Driver - Windows](#)

## Locking Printer Settings - Epson Universal Print Driver - Windows

Administrators can lock some printer settings to prevent unauthorized changes.

1. Do one of the following:
  - **Windows 10:** Click  and select  (Settings) > **Devices** > **Printers & scanners**. Select **EPSON Universal Print Driver** and select **Manage** > **Printer properties**.
  - **Windows 8.x:** Navigate to the **Apps** screen and select **Control Panel** > **Hardware and Sound** > **Devices and Printers**. Right-click **EPSON Universal Print Driver** and select **Printer properties**.
  - **Windows 7:** Click  and select **Devices and Printers**. Right-click **EPSON Universal Print Driver** and select **Printer properties**.
  - **Windows Vista:** Click  and select **Control Panel**. Click **Printer** under **Hardware and Sound**, then right-click **EPSON Universal Print Driver** and select **Properties**.
  - **Windows XP:** Click **Start** and select **Printers and Faxes**. Right-click **EPSON Universal Print Driver** and select **Properties**.
2. Click the **Optional Settings** tab.
3. Click **Driver Settings**.

You see this window:

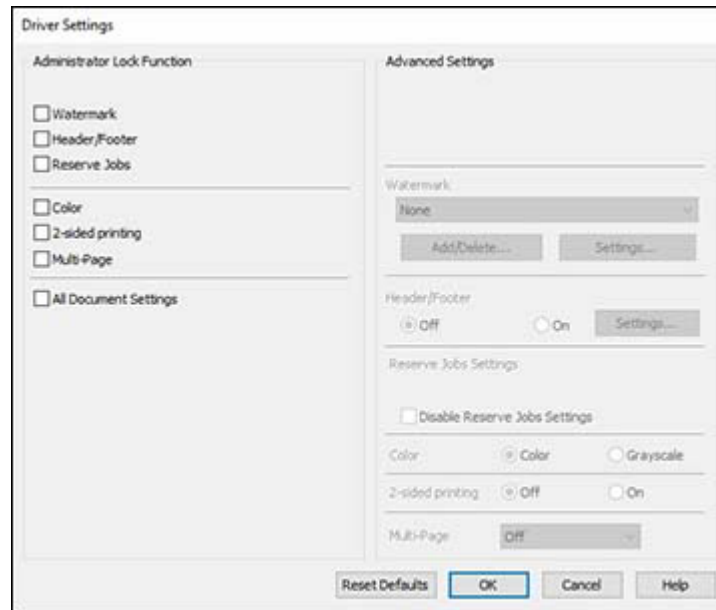

4. Select the checkbox for the settings you want to lock. To lock all print settings, select **All Document Settings**.
5. Under **Advanced Settings**, select the setting option you want to use for each locked setting.
6. Click **OK**.

[Epson Universal Print Driver Locked Setting Options](#)

**Parent topic:** [Printing with the Epson Universal Print Driver - Windows](#)

### **Epson Universal Print Driver Locked Setting Options**

Select the options you want to use for any locked print settings.

<b>Setting</b>	<b>Options</b>	<b>Description</b>
<b>Watermark</b>	Various text watermarks	Lets you select the text for the watermark or prohibit watermarks
	<b>Add/Delete</b>	Lets you add or delete a customized text or image-based watermark
	<b>Settings</b>	Lets you select the size, position, and other watermark settings
<b>Header/Footer</b>	<b>Off</b>	Prohibits headers or footers
	<b>On</b>	Allows headers and footers
	<b>Settings</b>	Lets you select the text and position for printing headers and footers
<b>Reserve Jobs</b>	—	Select the Disable Reserve Jobs Settings checkbox to prevent a user from creating settings for print jobs stored in the product's memory
<b>Color</b>	<b>Color</b>	Allows color printing
	<b>Grayscale</b>	Allows printing in black or shades of gray only
<b>2-sided printing</b>	<b>Off</b>	Allows printing on only one side of the paper
	<b>On</b>	Allows printing on both sides of the paper
<b>Multi-Page</b>	<b>Off</b>	Prohibits multi-page settings
	<b>2-Up</b>	Allows printing of 2 pages on one sheet of paper
	<b>4-Up</b>	Allows printing of 4 pages on one sheet of paper
	<b>6-Up</b>	Allows printing of 6 pages on one sheet of paper
	<b>8-Up</b>	Allows printing of 8 pages on one sheet of paper
	<b>9-Up</b>	Allows printing of 9 pages on one sheet of paper
	<b>16-Up</b>	Allows printing of 16 pages on one sheet of paper





Parent topic: [Locking Printer Settings - Epson Universal Print Driver - Windows](#)

## **Adding Network Printers - Epson Universal Print Driver - Windows**

You can use the Epson Universal Print Driver to find and add network printers.



1. Do one of the following:

- **Windows 10:** Click  and select  (Settings) > **Devices** > **Printers & scanners**. Select **EPSON Universal Print Driver** and select **Manage** > **Printer properties**.
- **Windows 8.x:** Navigate to the **Apps** screen and select **Control Panel** > **Hardware and Sound** > **Devices and Printers**. Right-click **EPSON Universal Print Driver** and select **Printer properties**.
- **Windows 7:** Click  and select **Devices and Printers**. Right-click **EPSON Universal Print Driver** and select **Printer properties**.
- **Windows Vista:** Click  and select **Control Panel**. Click **Printer** under **Hardware and Sound**, then right-click **EPSON Universal Print Driver** and select **Properties**.
- **Windows XP:** Click **Start** and select **Printers and Faxes**. Right-click **EPSON Universal Print Driver** and select **Properties**.

2. Click the **Optional Settings** tab.

You see this window:

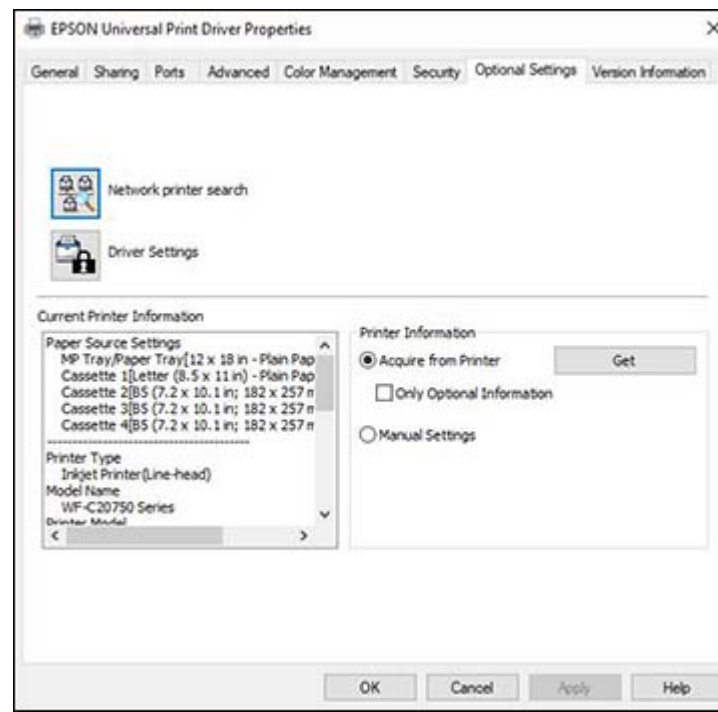

3. Click **Network printer search**.
4. When you see the search results, select **Add found printers**.  
You see a screen like this:

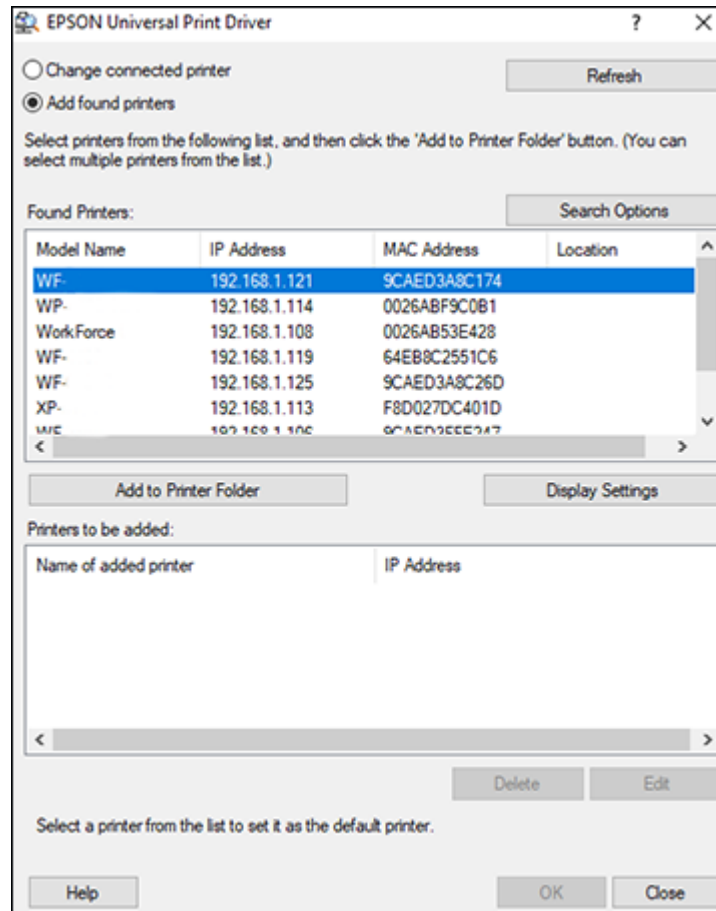

5. Select the printer or printers you want to add.
6. Click **Add to Printer Folder**.  
The selected printer or printers appear in the lower section of the screen.
7. Select the checkbox next to the product you want to make your default printer, if necessary.

8. Click **OK**.

**Parent topic:** [Printing with the Epson Universal Print Driver - Windows](#)

## Printing with the PostScript (PS3) Printer Software - Windows

You can print with the PostScript (PS3) printer software using any Windows printing program, as described in these sections.

[Selecting Basic Print Settings - PostScript Printer Software - Windows](#)

[Selecting Default Print Settings - PostScript Printer Software - Windows](#)

**Parent topic:** [Printing from a Computer](#)

## Selecting Basic Print Settings - PostScript Printer Software - Windows

Select the basic settings for the document or photo you want to print.

The PostScript printer software supports plain paper printing on these paper and envelope sizes:

- A4 (8.3 × 11.7 inches [210 × 297 mm])
- Letter (8.5 × 11 inches [216 × 279 mm])
- Legal (8.5 × 14 inches [216 × 356 mm])
- 17 × 22 inches (432 × 559 mm)
- A3 (11.7 × 16.5 inches [297 × 420 mm])
- A3+ (13 × 19 inches [329 × 483 mm])
- A6 (4.1 × 5.8 inches [105 × 148 mm])
- B6 (5 × 7.2 inches [128 × 182 mm])
- A5 (5.8 × 8.2 inches [148 × 210 mm])
- 8 × 10 inches (203 × 254 mm)
- 8.5 × 13 inches (216 × 330 mm)
- 11 × 17 inches (279 × 432 mm)
- 12 × 18 inches (305 × 457 mm)
- SRA3 (12.6 × 17.7 inches [320 × 450 mm])
- Executive (7.25 × 10.5 inches [184 × 267 mm])
- Half Letter (5.5 × 8.5 inches [140 × 216 mm])

- Mexico-Oficio (8.5 × 13.4 inches [216 × 340 mm])
- Oficio 9 (8.46 × 12.4 inches [215 × 315 mm])
- No. 10 (4.1 × 9.5 inches [105 × 241 mm])

1. Open a photo or document for printing.
2. Select the print command in your application.

**Note:** You may need to select a print icon on your screen, the **Print** option in the **File** menu, or another command. See your application's help utility for details.

3. If necessary, select your product name as the printer you want to use, and then click the **Preferences** button.

You see this window:

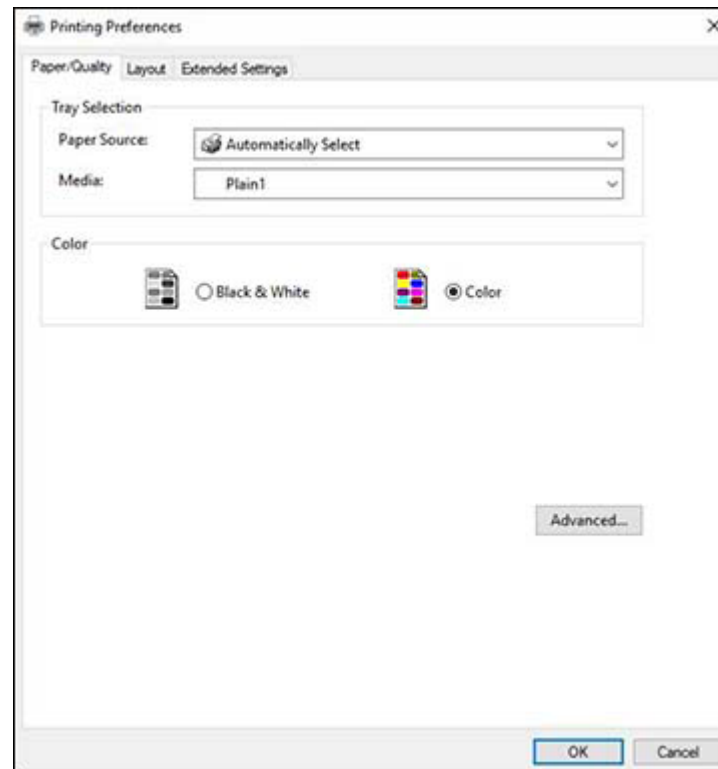

4. Select the **Paper Source** that matches where you loaded the paper you want to print on.
5. Select the paper type as the **Media** setting.
6. Select one of the following as the Color setting:
  - To print text and graphics in black only, select the **Black & White** setting.
  - To print a color document or photo, select the **Color** setting.
7. To select additional layout and printing options, select **Advanced** and select additional settings as necessary.
8. Click the **Layout** tab.

You see this window:

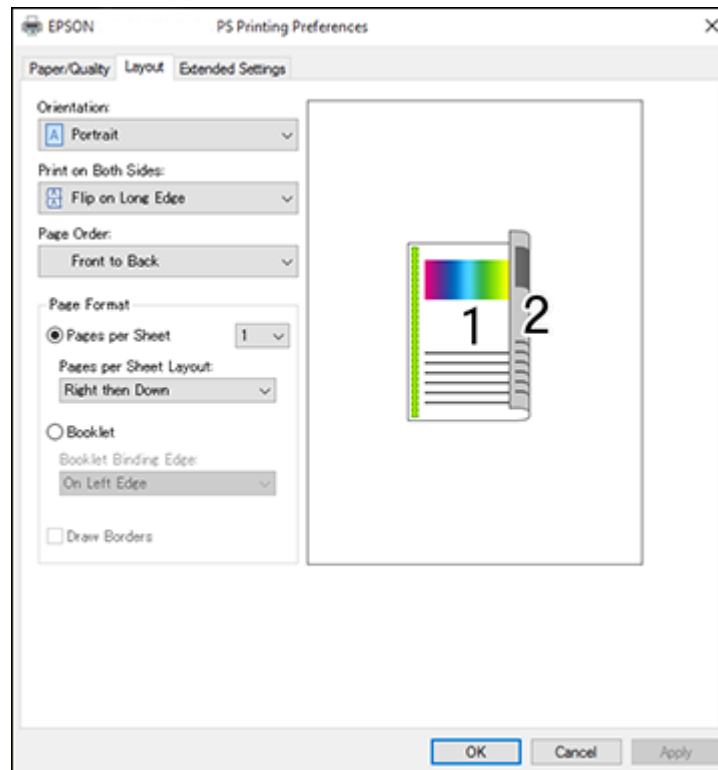

9. Select the print options as necessary.

10. Click **OK** when you are finished.

**Parent topic:** [Printing with the PostScript \(PS3\) Printer Software - Windows](#)

**Related references**





[Paper or Media Type Settings - Printing Software](#)

[Paper Source Options - Windows](#)

## Selecting Default Print Settings - PostScript Printer Software - Windows

When you change your print settings in a program, the changes apply only while you are printing in that program session. If you want to change the print settings you use in all your Windows programs, you can select new default print settings.

1. Do one of the following:

- **Windows 10:** Click  and select  (Settings) > **Devices** > **Printers & scanners**. Select your product name and select **Manage** > **Printing preferences**.
- **Windows 8.x:** Navigate to the **Apps** screen and select **Control Panel** > **Hardware and Sound** > **Devices and Printers**. Right-click your product name and select **Print Preferences**.
- **Windows 7:** Click  and select **Devices and Printers**. Right-click your product name and select **Printing Preferences**.
- **Windows Vista:** Click  and select **Control Panel**. Click **Printer** under **Hardware and Sound**, right-click your product name, and select **Printing Preferences**.
- **Windows XP:** Click **Start** and select **Printers and Faxes**. Right-click your product name and select **Printing Preferences**.

You see the printer settings window:

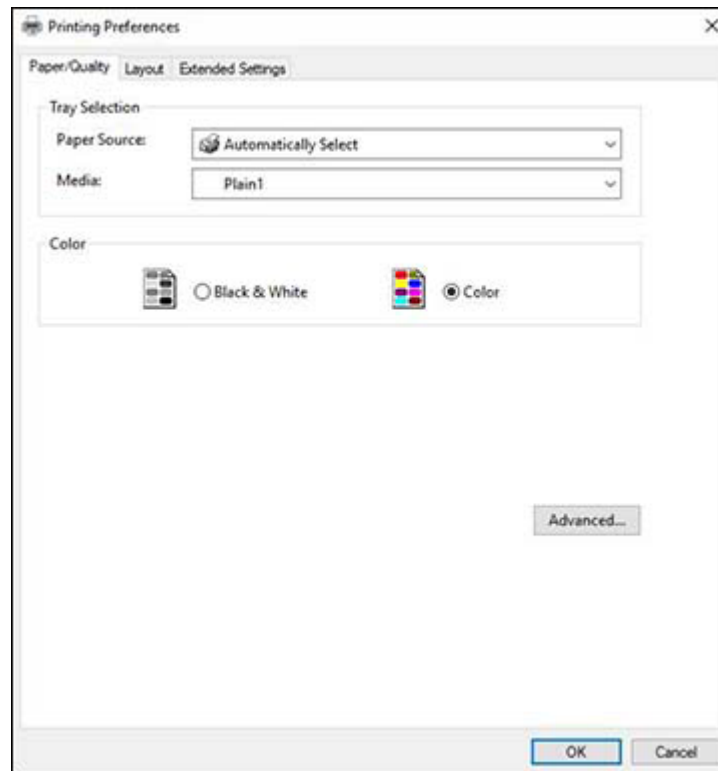

2. Select the print settings you want to use as defaults in all your Windows programs.
3. Click **OK**.

These settings are now the defaults selected for printing. You can still change them as needed for printing in any program session.

**Parent topic:** [Printing with the PostScript \(PS3\) Printer Software - Windows](#)

## Printing with the PostScript (PS3) Printer Software - Mac

You can print with the PostScript (PS3) printer software using any Mac printing program, as described in these sections.

[Selecting Basic Print Settings - PostScript Printer Software - Mac](#)

Parent topic: [Printing from a Computer](#)

## Selecting Basic Print Settings - PostScript Printer Software - Mac

Select the basic settings for the document or photo you want to print.

The PostScript printer software supports plain paper printing on these paper and envelope sizes:

- A4 (8.3 × 11.7 inches [210 × 297 mm])
- Letter (8.5 × 11 inches [216 × 279 mm])
- No. 10 (4.1 × 9.5 inches [105 × 241 mm])
- A5 (5.8 × 8.2 inches [148 × 210 mm])
- B5 (7.2 × 10.1 inches [182 × 257 mm])
- A6 (4.1 × 5.8 inches [105 × 148 mm])
- B6 (5 × 7.2 inches [128 × 182 mm])
- Executive (7.25 × 10.5 inches [184 × 267 mm])
- Legal (8.5 × 14 inches [216 × 356 mm])
- A3 (11.7 × 16.5 inches [297 × 420 mm])
- A3+ (13 × 19 inches [329 × 483 mm])
- 11 × 17 inches (279 × 432 mm)
- B4 (13.9 × 9.84 inches [353 × 250 mm])
- 17 × 22 inches (432 × 559 mm)

1. Open a photo or document for printing.
2. Select the print command in your application.

**Note:** You may need to select a print icon on your screen, the **Print** option in the **File** menu, or another command. See your application's help utility for details.

3. Select your product as the **Printer** setting.

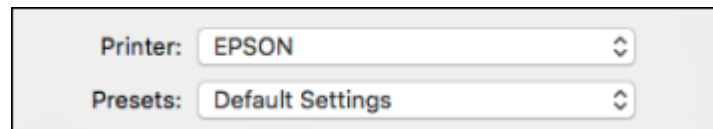



4. If necessary, click the arrow next to the Printer setting or the **Show Details** button to expand the print window.

You see the expanded printer settings window for your product:

The image shows a print dialog box with the following settings:

- Printer: EPSON
- Presets: Default Settings
- Copies: 1 (with a blue highlight around the input field)  Two-Sided
- Pages:  All,  Selected Page in Sidebar,  From: 1 to: 1
- Paper Size: US Letter (8.50 by 11.00 inches)
- Orientation: Portrait (selected), Landscape
- Preview: Preview
- Auto Rotate  Show Notes
- Scale:  Scale: 77%,  Scale to Fit:  Print Entire Image,  Fill Entire Paper
- Copies per page: 1

Buttons: Cancel, Print

**Note:** The print window may look different, depending on the Mac OS version and the application you are using.

5. Select the **Two-Sided**, **Copies**, and **Pages** settings as necessary.

**Note:** If you do not see these settings in the print window, check for them in your application before printing.

6. Select the page setup options: **Paper Size** and **Orientation**.

**Note:** If you do not see these settings in the print window, check for them in your application before printing. They may be accessible by selecting **Page Setup** from the File menu.

7. Select any application-specific settings that appear on the screen, such as those shown in the image above for the Preview application.
8. Select **Paper Feed** from the pop-up menu.

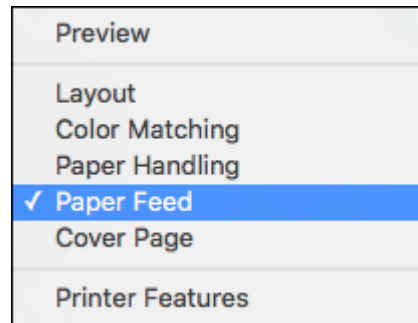

You see these settings:

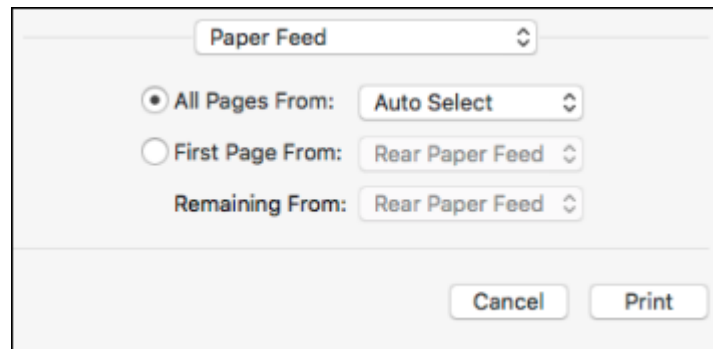

9. Select **All Pages From** or **First Page From** and select the paper source you want to print from.
10. Select **Printer Features** from the pop-up menu.

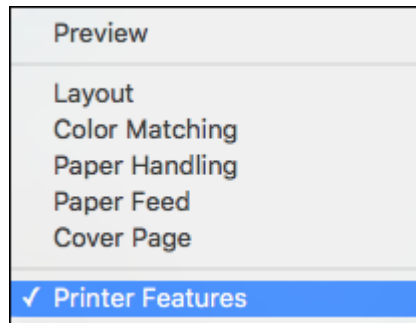

You see these settings:

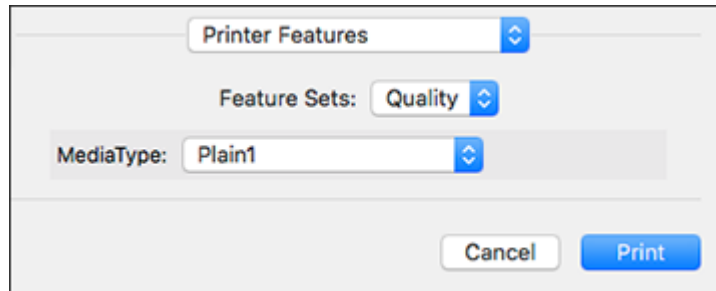

11. Select a **MediaType** setting.
12. Select any of the following from the pop-up menu as necessary:
  - Select **Layout** to adjust a variety of layout options for your document or photo.
  - Select **Paper Handling** to adjust the size of the image as you print it.
  - Select **Color Matching** to fine-tune the colors in your printout.

**Parent topic:** [Printing with the PostScript \(PS3\) Printer Software - Mac](#)

#### **Related tasks**

[Selecting Page Setup Settings - Mac](#)

[Selecting Print Layout Options - Mac](#)

[Printing Your Document or Photo - Mac](#)

## **Cancelling Printing Using the Product Control Panel**

If you need to cancel printing, select **Stop** on the LCD screen, then select **Job List**. Select the job you want to cancel and select **Delete**, then select **Yes** to confirm.

**Parent topic:** [Printing from a Computer](#)

---

# Scanning

You can scan your originals and save them as digital files.

**Note:** Your product may differ from the images in this guide, but the instructions are the same unless otherwise noted.

[Starting a Scan](#)

[Scanning in Epson Scan 2](#)

[Scanning with Document Capture Pro or Document Capture](#)

[Entering a User ID and Password for Scanning](#)

## Starting a Scan

After placing your originals on your product for scanning, start scanning using one of these methods.

**Note:** You can also scan using Document Capture Pro (Windows) or Document Capture (Mac).

[Starting a Scan Using the Product Control Panel](#)

[Setting Up and Scanning to a Network Folder or FTP Server](#)

[Starting a Scan Using the Epson Scan 2 Icon](#)

[Starting a Scan from a Scanning Program](#)

[Starting a Scan from a Smart Device](#)

**Parent topic:** [Scanning](#)

**Related topics**

[Scanning with Document Capture Pro or Document Capture](#)

[Placing Originals on the Product](#)

## Starting a Scan Using the Product Control Panel

You can scan an image to a variety of destinations using your product's control panel.

1. Make sure you installed the product software and connected the product to your computer or network.

**Note:** Restart your computer after installing the product software to enable scanning from the control panel.

2. Place your original on the product for scanning.

**Note:** To scan a double-sided or multi-page document, place your originals in the ADF.

3. Press the  home button, if necessary.
4. Select **Scan**.

You see a screen like this:

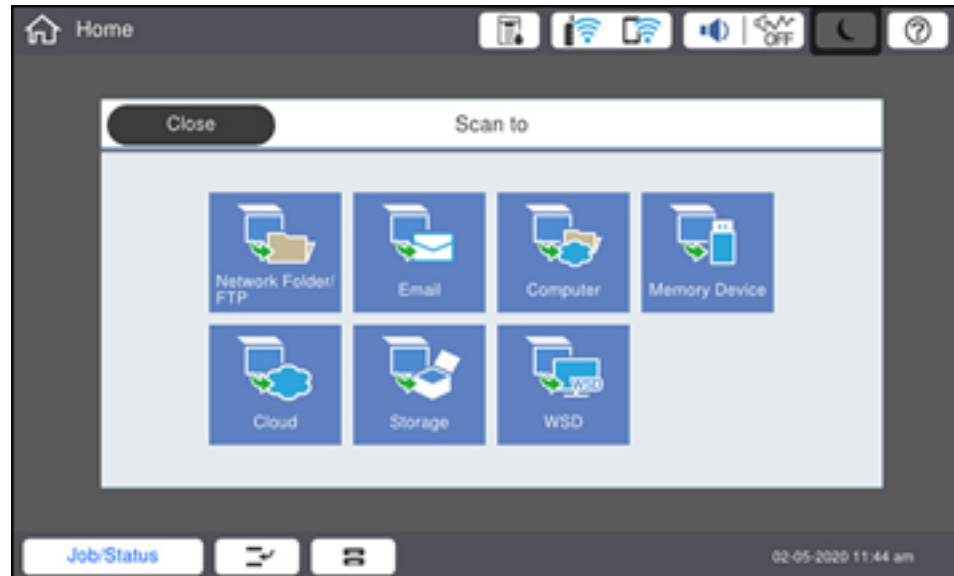

5. Select one of the following **Scan to** options:
  - **Network Folder/FTP** saves your scanned file to a specified folder on a network.
  - **Email** lets you send scanned files through a pre-configured email server.
  - **Computer** lets you scan to a connected computer using Document Capture Pro (Windows) or Document Capture (Mac).
  - **Memory Device** saves your scanned file on a USB device and lets you select the file format, quality, and other settings.
  - **Cloud** sends your scanned files to a destination that you have registered with Epson Connect.
  - **Storage** saves your scanned file to a specified folder in the product's hard drive.

- **WSD** lets you manage network scanning in Windows 10, Windows 8.x, Windows 7, or Windows Vista (English only). To use this feature, you must first set up a WSD (Web Services for Devices) port on your Windows 7 or Windows Vista computer (the port is set up automatically on Windows 10 and Windows 8.x).

6. Follow the instructions in the links below to complete your scan.

[Scanning to Email](#)

[Scanning to a Connected Computer](#)

[Scanning to a Memory Device](#)

[Scanning to the Product's Hard Drive](#)

[Scanning to the Cloud](#)

[Setting Up a WSD Port \(Windows 7/Windows Vista\)](#)

[Control Panel Scanning Options](#)

**Parent topic:** [Starting a Scan](#)

**Related tasks**

[Using Epson Scan to Cloud](#)

[Using Presets](#)

[Entering Characters on the LCD Screen](#)

**Related topics**

[Placing Originals on the Product](#)

## Scanning to Email

You can scan an original and email the scanned file using your product's control panel. You need to have a preconfigured email server before you can scan to email. You can enter email addresses directly on the product's control panel or select them from the **Recipient** tab. Make sure the date and time are set correctly so the time stamps on your emails are accurate.

1. Place your original on the product for scanning.

**Note:** To scan a double-sided or multi-page document, place all of the pages in the ADF.

2. Press the  home button, if necessary.

3. Select **Scan**.

You see a screen like this:

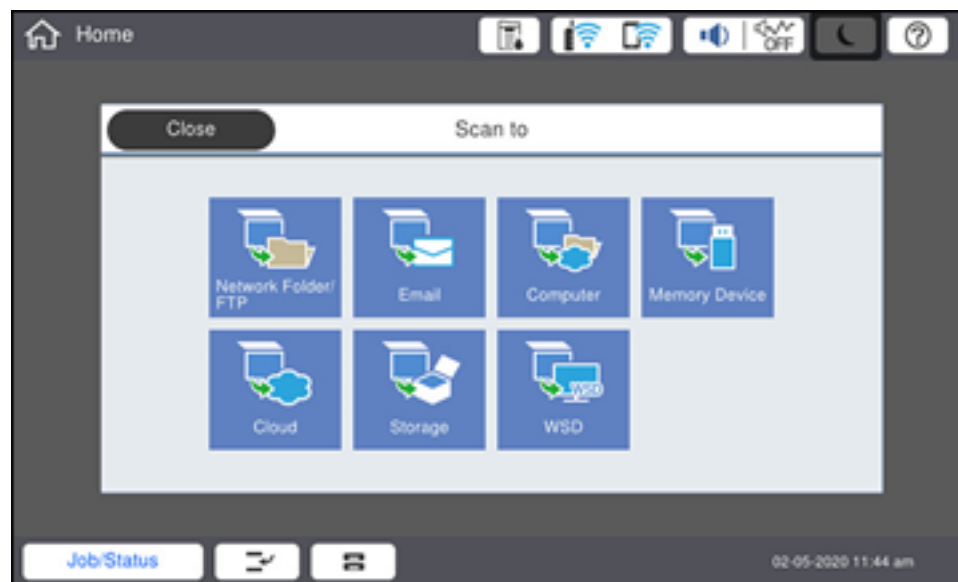

4. Select **Email**.



You see a screen like this:



5. Do one of the following:
  - Select an email address from any of the displayed frequent contacts.
  - Select **Keyboard** to use the on-screen keyboard to enter the email address for the recipient(s) and select **OK**.
  - Select **Recipient** and choose an email address from the list.
  - Select the  icon to choose an email address from your recent scan history.
6. Select **Scan Settings**.
7. Select **File Format** to choose the file format for your scan.
8. Scroll down to change the **Subject** and **File Name**, if necessary.
9. Select any additional scan settings as necessary.

**Note:** To save the scanned image to the product's hard drive, select **File Storing** and enable the **File Storing** setting. Change any of the displayed settings as needed.

10. Select **Presets** to save your scan settings.

**Note:** Presets can be locked by an administrator. If you cannot access or change this setting, contact your administrator for assistance.

11. Select the **Send** icon.

Your product scans your original and emails the scanned file.

**Parent topic:** [Starting a Scan Using the Product Control Panel](#)

**Related topics**

[Placing Originals on the Product](#)

### Scanning to a Connected Computer

You can scan an original and save it to a connected computer using your product's control panel. The computer must be on the same network as the product.

You can save the scanned file as a PDF file. You can also set up custom scan settings using Document Capture Pro (Windows) or Document Capture (Mac) and automatically scan using those settings on your product control panel.

**Note:** Be sure you have installed Epson Scan 2 and Document Capture Pro (Windows) or Document Capture (Mac) on your computer before scanning to your computer.

1. Place your original on the product for scanning.

**Note:** To scan a multi-page document, place all of the pages in the ADF.

2. Press the  home button, if necessary.
3. Select **Scan**.

You see a screen like this:



4. Select **Computer**.

You see a screen like this:

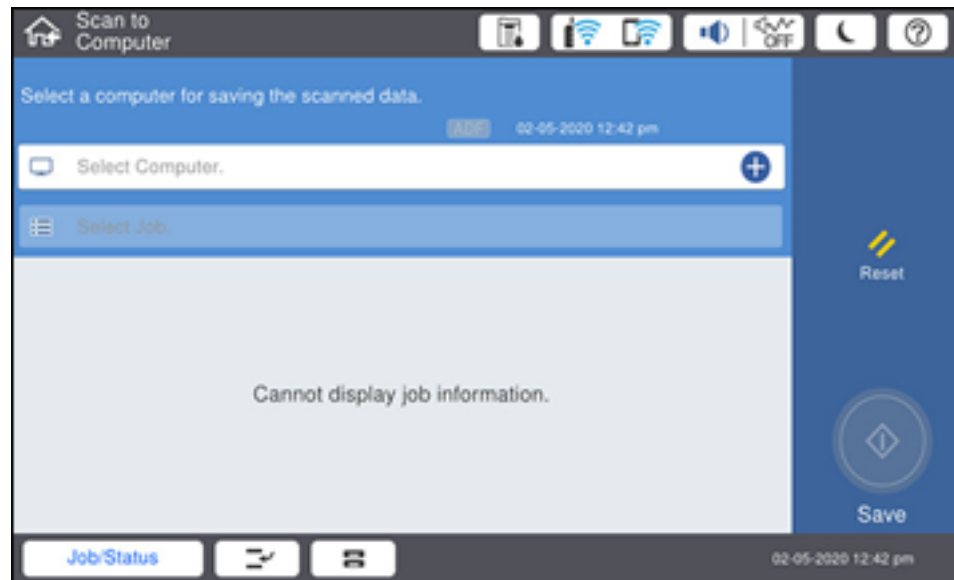

5. Select the + icon to choose a computer to scan to, and select it when it appears.

**Note:** The computer you want to scan to must be on the same network as the product or connected to the product with a USB cable.

The **Select Job** screen appears:

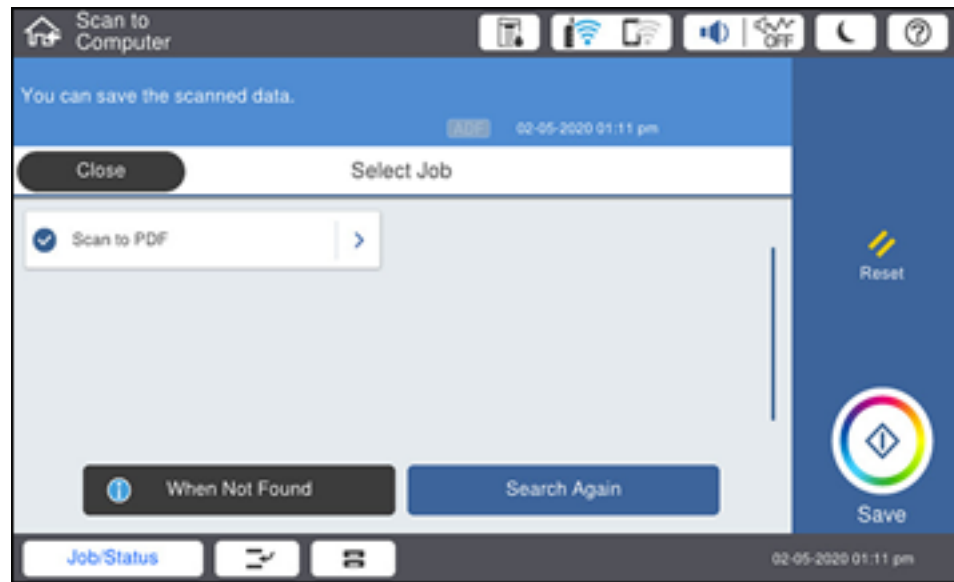

6. Select one of the scan job options.

**Note:** The default scan job is **Scan to PDF**. Any additional scan job options must be added in Document Capture Pro (Windows) or Document Capture (Mac).

7. Select the **Save** icon.

Document Capture Pro (Windows) or Document Capture (Mac) scans the original to the connected computer.

**Parent topic:** [Starting a Scan Using the Product Control Panel](#)

#### **Related tasks**

[Scanning with Job Scan in Document Capture Pro - Windows](#)

[Adding and Assigning Scan Jobs with Document Capture Pro - Windows](#)

#### **Related topics**

[Placing Originals on the Product](#)

## Scanning to a Memory Device

You can scan an original and save the scanned image to a external USB device connected to your product.

1. Insert an external USB device into the product's USB port.
2. Place your original on the product for scanning.

**Note:** To scan a double-sided or multi-page document, place all of the pages in the ADF.

3. Press the  home button, if necessary.
4. Select **Scan**.

You see a screen like this:

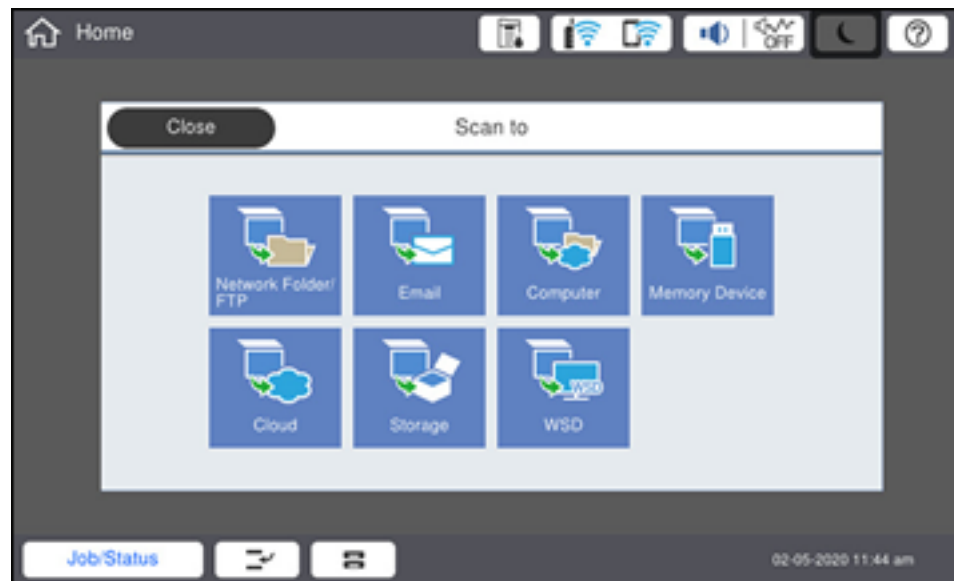

5. Select **Memory Device**.

You see a screen like this:



6. Select the settings as necessary.
7. Select **Presets** to save your scan settings.

**Note:** Presets can be locked by an administrator. If you cannot access or change this setting, contact your administrator for assistance.

8. Select the **Save** icon.

Your product scans your original and saves the scanned file to the connected memory device.

**Parent topic:** [Starting a Scan Using the Product Control Panel](#)

#### **Related tasks**

[Connecting a USB Device](#)

#### **Related topics**

[Placing Originals on the Product](#)

### **Scanning to the Product's Hard Drive**

You can use the control panel to scan files and save them to the product's hard drive.

1. Place your original on the product for scanning.

**Note:** To scan a double-sided or multi-page document, place all of the pages in the ADF.

2. Press the  home button, if necessary.
3. Select **Scan**.

You see a screen like this:

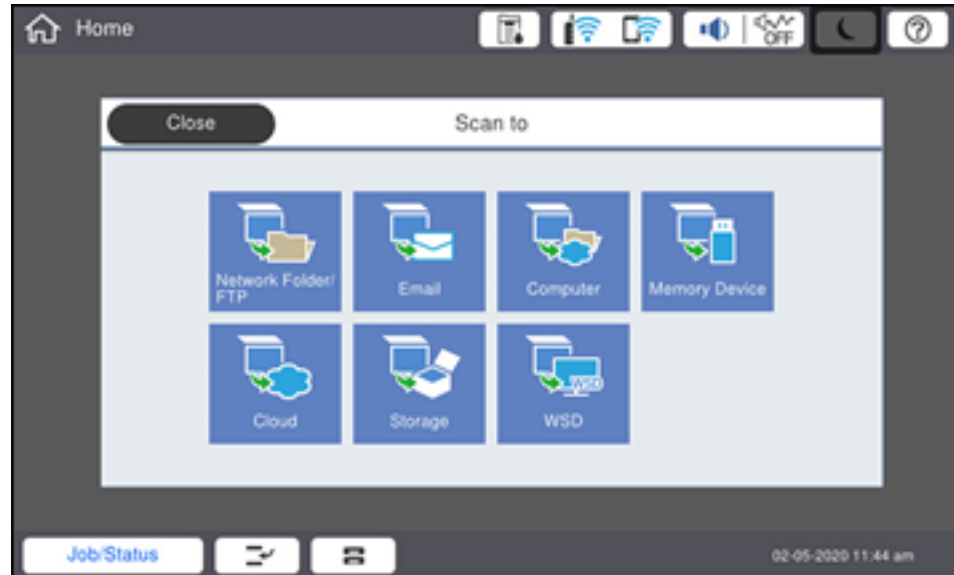

4. Select **Storage**.



You see a screen like this:

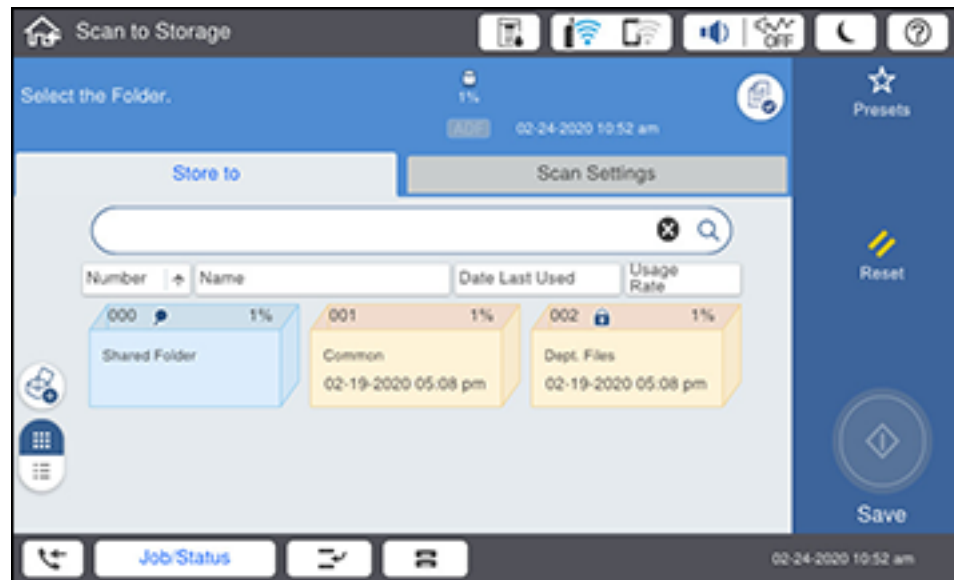

5. Select a folder destination.
6. Select settings as necessary.
7. Select **Presets** to save your scan settings.

**Note:** Presets can be locked by an administrator. If you cannot access or change this setting, contact your administrator for assistance.

8. Select the **Save** icon.

Your product scans your original and saves the scanned file to the selected folder.

**Parent topic:** [Starting a Scan Using the Product Control Panel](#)

#### **Related tasks**

[Using Presets](#)

#### **Related topics**

[Placing Originals on the Product](#)

## Scanning to the Cloud

You can use the control panel to send your scanned files to a destination that you have registered with Epson Connect.

**Note:** Make sure to set up your product using Epson Connect before using this feature.

1. Place your original on the product for scanning.

**Note:** To scan a double-sided or multi-page document, place all of the pages in the ADF.

2. Press the  home button, if necessary.
3. Select **Scan**.

You see a screen like this:



4. Select **Cloud**.

You see a screen like this:



5. Select the **+** icon and select a cloud destination.
6. Select the settings as necessary.
7. Select **Presets** to save your scan settings.

**Note:** Presets can be locked by an administrator. If you cannot access or change this setting, contact your administrator for assistance.

8. Select the **Upload** icon.

Your product scans your original and saves the scanned file to the selected destination.

**Parent topic:** [Starting a Scan Using the Product Control Panel](#)

#### **Related tasks**

[Setting Up Epson Connect Services](#)

#### **Related topics**

[Placing Originals on the Product](#)

## Setting Up a WSD Port (Windows 7/Windows Vista)

You can scan to a networked Windows computer using WSD (Web Services for Devices). You must first set up a WSD port on your Windows 7 or Windows Vista system (the port is set up automatically on Windows 10 and Windows 8.x).

Before you set up a WSD port, make sure you installed your product software, and connected your product and computer to the same network.

1. Turn on your product.
2. Print a network status sheet so you can identify the network name and model name for your product on the network.
3. Click  or **Start** and select **Computer**.
4. On the left side of the window, select **Network**.
5. Locate your product on the Network screen, right-click it, and select **Install**.
6. When you see the User Account Control screen, click **Continue**.

**Note:** If you see an Uninstall screen, click **Uninstall** and repeat these steps as necessary.

7. When you see the message **Your device is ready to use** in the Windows taskbar, click the message.
8. On the Driver Software Installation screen, make sure your product is listed as **Ready to use**. Then click **Close**.
9. Do one of the following:
  - **Windows 7:** Click  and select **Devices and Printers**.
  - **Windows Vista:** Click **Start** and select **Control Panel > Hardware and Sound > Printers**.
10. Make sure that an icon appears for your product's name on the network.

When you use WSD, select your product name to scan over the network.

**Parent topic:** [Starting a Scan Using the Product Control Panel](#)

### Related tasks

[Printing a Network Status Sheet](#)

## Control Panel Scanning Options

Select the options you want to use for scanning.

**Note:** Not all options or settings may be available, depending on the **Scan to** option selected.

Scan Settings	Available options	Description
<b>Color Mode</b>	<b>B&amp;W</b>	Select to scan images in black and white
	<b>Color</b>	Select to scan images in color
<b>File Format</b>	<b>JPEG</b>	Select for photos. You can also select the <b>Compression Ratio</b> .
	<b>PDF (Single Page)</b>	Select for documents. You can also select the <b>Compression Ratio</b> and <b>PDF Settings</b> .
	<b>PDF (Multi Page)</b>	
	<b>PDF/A (Single Page)</b>	
	<b>PDF/A (Multi Page)</b>	
	<b>TIFF (Single Page)</b>	Select for scanned files that you can print from a device. Multi Page TIFF documents are scanned in black and white.
<b>TIFF (Multi Page)</b>		
<b>Resolution</b>	<b>200dpi</b>	Select for documents
	<b>300dpi</b>	Select for photos
	<b>600dpi</b>	Select for highest quality printing
<b>2-Sided</b>	<b>1-Sided</b>	Lets you scan 2-sided originals placed in the ADF. If you select <b>2-Sided</b> , you can also select the <b>Binding (Original)</b> setting.
	<b>2-Sided</b>	
<b>Scan Area</b>	<b>Auto Detect</b>	Select to automatically adjust the scan area
	Various sizes	Select the page size for documents
	<b>User-Defined</b>	Enter a custom scan area
<b>Original Type</b>	<b>Text</b>	Specify the type of original you are scanning
	<b>Text &amp; Image</b>	
	<b>Photo</b>	
<b>Orientation (Original)</b>	<b>Readable Direction</b>	Select the orientation direction for how you placed the originals
	<b>Left Direction</b>	

Scan Settings	Available options	Description
<b>Mixed Size Originals</b>	<b>Off</b>	Select <b>On</b> to scan originals of varying sizes in their original sizes
	<b>On</b>	
<b>Density</b>	Varying levels	Adjust the lightness or darkness of scanned images.
<b>Remove Background</b>	Varying levels	Select the darkness of the background
<b>Remove Shadow</b>	<b>Off</b>	Erase the shadows that appear in the center of a document when copying a book or the shadows that appear around a document when copying thick paper
	<b>On</b>	
<b>Remove Punch Holes</b>	<b>Off</b>	Erase the binding holes on a document
	<b>On</b>	
<b>ADF Continuous Scan</b>	<b>Off</b>	Select <b>On</b> to scan a large number of originals placed in the ADF as one scanning job
	<b>On</b>	
<b>Subject</b>	—	Enter a subject for your email
<b>Attached File Max Size</b>	Various sizes	Select the maximum file size that can be attached to an email
<b>File Storing</b>	<b>Off</b>	Select <b>On</b> to save the scanned file to the printer's internal storage. Adjust the save settings, including whether to save and print or send the scanned file, or to only save the file.
	<b>On</b>	
<b>File Name</b>	—	Enter a prefix, the date, and the time to the file name for your scanned file
<b>Mail Encryption</b>	<b>Off</b>	Select <b>On</b> to encrypt emails before sending
	<b>On</b>	
<b>Digital Signature</b>	<b>Off</b>	Select <b>On</b> to attach a digital signature to emails
	<b>On</b>	
<b>File Storing</b>	—	Set the password for the file
<b>User Name</b>	—	Set the user name for the file

Parent topic: [Starting a Scan Using the Product Control Panel](#)

## Setting Up and Scanning to a Network Folder or FTP Server

Before you can scan to a network folder on your computer or on an FTP server, you need to create a shared folder and optionally register its location to your product's contact list. Select the links below as necessary to create and register the folder, and to scan to it over the network.

[Creating a Shared Network Folder](#)

[Registering Contacts for Network Folder or FTP Scanning - Web Config](#)

[Registering Contacts for Email, Network, or FTP Scanning - Control Panel](#)

[Scanning to a Network Folder or FTP Server](#)

**Parent topic:** [Starting a Scan](#)

### Creating a Shared Network Folder

You can create a shared network folder on your computer or an FTP site and register its location to your product's **Contacts** list.

**Note:** If you are creating a shared network folder on a Mac, see your Mac documentation for instructions on creating the folder. The instructions here are for Windows.

First make sure you connected your product and computer to the same network.

**Note:** If you are running a Home version of the Windows operating system, you cannot create a shared folder on your Windows desktop or in the Documents or Pictures folder unless you have created a Home Group Configuration for sharing. You can, however, create a shared folder in the root of the C: drive on your system.

If you want to scan to a folder on an FTP server, contact the FTP server administrator for the server address and authentication access to a shared folder on the server.

1. If you are scanning to a network folder on your computer, do one of the following to check the format of your computer name:
  - **Windows 10 or Windows 8.x:** Hold down the Windows key on your keyboard and press the **X** key. Select **System** from the list that appears. Check the Computer Name or Device Name listed for your computer on the System window.
  - **Windows 7:** Click , right-click **Computer**, and select **Properties**. Check the Computer Name listed for your computer on the System window.

**Note:** The settings in these steps may vary, depending on your version of Windows. See Windows Help for details on your operating system.

2. If the computer's name uses any characters that are not alphanumeric (letters or numbers), do one of the following to change the computer's name:
  - **Windows 10 or 8.x:** Select **Rename this PC** and follow the on-screen prompts.
  - **Windows 7:** Select **Change Settings**, change the computer's name, and click **OK**. (See Windows Help for instructions, if necessary.)

**Note:** You need to be logged into Windows as an administrator to change the computer's name. After changing the name, restart your computer.

3. Start File Explorer or Windows Explorer.
4. Create a folder on the Windows desktop with a folder name of 12 characters or less; otherwise, your product may not be able to access the folder.

**Note:** You need to be logged into Windows as an administrator to access the desktop folder and the document folder under each User folder.

5. Right-click the folder you created and select **Properties**.
6. On the **General** tab, deselect the **Read-only** checkbox to allow users to access the folder over the network.
7. Select the **Sharing** tab and click the **Advanced Sharing** button.

**Note:** You need to be logged into Windows as an administrator to select the **Advanced Sharing** button.

8. On the Advanced Sharing screen, select the **Share this folder** checkbox.
9. Click the **Permissions** button and select the following on the Share Permissions tab:
  - Select **Everyone** under Group or user names.
  - Select the checkbox in the **Allow** column for the **Change** setting.
10. Click **OK** to save the settings, then click **OK** again to close the Advanced Sharing window.
11. Select the **Security** tab and check that the Group or user names list at the top includes the current computer user and the administrators who can now access the folder.
12. Select the **Sharing** tab again and write down the **Network Path** listed under Network File and Folder Sharing at the top. This is the path you will register to your product contacts list so you can select it for network scanning.



13. Click **OK** or **Close**.

Now you can register the folder path to your product contacts list.

**Parent topic:** [Setting Up and Scanning to a Network Folder or FTP Server](#)

### Registering Contacts for Network Folder or FTP Scanning - Web Config

You can register a list of contacts for scanning to a network folder or FTP server using Web Config and your computer's internet browser.

Before you begin, print a network status sheet and locate the IP address for your product on the sheet.

**Note:** These instructions use Internet Explorer as an example browser.

1. Start Internet Explorer on a computer that is using the same network as your product.
2. Type your product's IP address into the address bar and press **Enter**.
3. Click **Continue to this website (not recommended)**.
4. Click the **Scan/Copy** tab.
5. Click **Contacts**.
6. Select an empty number you want to use for the contact you are adding and click **Edit**.
7. Enter the following information for the contact:
  - **Name:** The name to display in your product's contact list.
  - **Index Word:** Enter a word to identify this entry when searching for it (up to 30 characters). This field is optional.
  - **Type:** Select **Network Folder (SMB)** or **FTP**.
  - **Assign to Frequent Use:** If you want to identify the contact as a frequently used address, select **On**. This makes it quicker to select the contact when you scan.
  - **Save to:** The network path to the shared folder.  
Enter the folder path name in one of the following formats depending on the **Type** setting you selected:
    - **SMB:** host\_name\folder
    - **FTP:** host\_name/folder\_name
  - **Secure Connection:** For FTP locations, select the secure connection type.
  - **User Name** and **Password:** Enter only if you have set up a password on your computer.

- **Connection Mode:** For FTP locations, select **Passive Mode** if there is a firewall between the product and FTP server.
  - **Port Number:** For FTP locations, enter the port number.
  - **Certificate Validation:** For FTP locations, choose to enable or disable an imported certificate.
8. Click **Apply**.  
After a moment, you see a message telling you that contact registration is complete.
  9. Close your web browser.

**Parent topic:** [Setting Up and Scanning to a Network Folder or FTP Server](#)

#### **Related tasks**

[Printing a Network Status Sheet](#)

### **Registering Contacts for Email, Network, or FTP Scanning - Control Panel**

You can create a list of contacts for scanning to email or to a network folder or FTP.

**Note:** Contacts can be locked by an administrator. If you cannot access or change contacts, contact your administrator for assistance. You can create up to 2,000 contacts and contact groups combined (including fax contacts for models with optional fax board installed).

1. Press the  home button, if necessary.
2. Select **Settings**.
3. Select **Contacts Manager**.
4. Select **Add/Edit/Delete**.

You see a screen like this:



5. Select **Add New**.
6. Select **Add Contact**.
7. Do one of the following:
  - To create a contact for scanning to fax, select **Fax** (models with optional fax board installed).
  - To create a contact for scanning to email, select **Email**.
  - To create a location for scanning to a network folder or FTP, select **Network Folder/FTP**.
8. Select the number you want to use for the contact you are adding.
9. Select the **Name** field. Use the on-screen keyboard to enter the contact name (up to 30 characters) and select **OK**.
10. Select the **Index Word** field. Use the on-screen keyboard to enter a word to use when searching for an entry (up to 30 characters) and select **OK**. (This field is optional.)
11. Do one of the following:
  - For a fax contact (models with optional fax board installed), select the **Fax Number** field. Use the displayed keyboard to enter the fax number and select **OK**.

Select any other fax settings as necessary.

- For an email contact, select the **Email Address** field. Use the on-screen keyboard to enter the address and select **OK**.
- For a network folder or FTP location, select the **Communication Mode** field and select **Network Folder (SMB)** or **FTP**. Then select the **Location** field, use the on-screen keyboard to enter the location, and select **OK**. Enter other information if necessary.

Enter the folder path name for the **Location** setting in one of the following formats depending on the **Communication Mode** setting you selected:

- **SMB:** \\host name\folder
- **FTP:** ftp://host name/folder name

12. Select **OK**.

**Note:** If you need to edit or delete scanning contacts, the procedures are the same as for fax contacts.

**Parent topic:** [Setting Up and Scanning to a Network Folder or FTP Server](#)

#### **Related tasks**

[Entering Characters on the LCD Screen](#)

### **Scanning to a Network Folder or FTP Server**

You can scan an image and save it to a network folder using your product's control panel. You can either enter the folder path directly on the product's control panel or select a folder from the **Destination** tab.

**Note:** Make sure the date and time are set correctly before using this feature.

1. Place your original on the product for scanning.

**Note:** To scan a double-sided or multi-page document, place your originals in the ADF.

2. Press the  home button, if necessary.

3. Select **Scan**.

You see a screen like this:

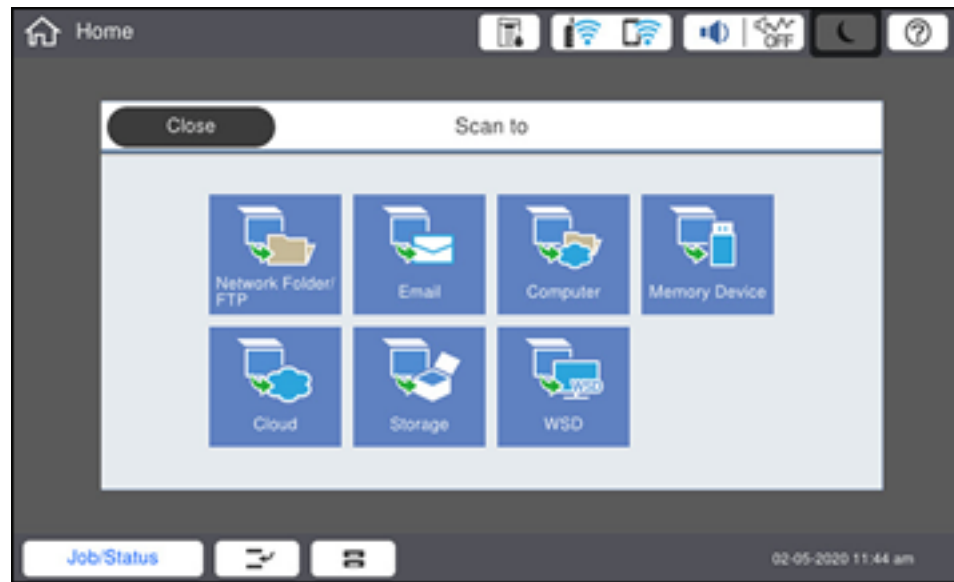

4. Select **Network Folder/FTP**.

You see a screen like this:

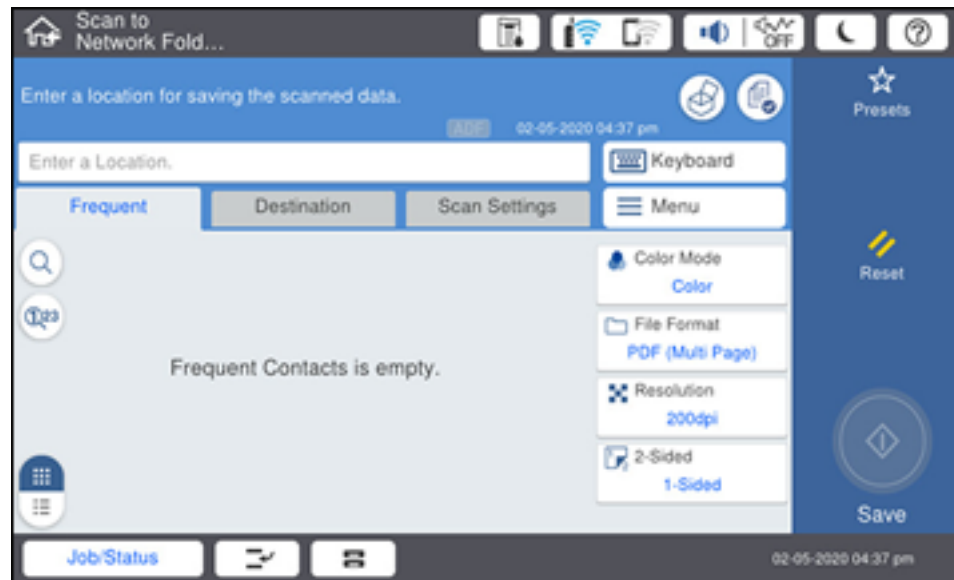

5. Do one of the following:
  - Choose a saved location on the **Destination** tab.
  - Select **Keyboard**, select the **Communication Mode** field, and select **Network Folder (SMB)** or **FTP**. Then select the **Enter Location** field, enter the folder location, and select **OK**. Enter other information as necessary.

Enter the folder path name for the location setting in one of the following formats depending on the **Communication Mode** setting you selected:

    - **SMB**: \\host name\folder
    - **FTP**: ftp://host name/folder name
  - Select an email address from any displayed frequent contacts.
6. Select **Scan Settings**.
7. Select **File Format** to choose the file format for your scan.
8. Scroll down to select **File Name** and change it if necessary.
9. Select any additional scan settings as necessary.

10. Select **Presets** to save your scan settings.

**Note:** Presets can be locked by an administrator. If you cannot access or change this setting, contact your administrator for assistance.

11. Select the **Save** icon.

Your product scans your original and saves it in the selected location.

**Parent topic:** [Setting Up and Scanning to a Network Folder or FTP Server](#)

**Related references**

[Control Panel Scanning Options](#)

**Related tasks**

[Entering Characters on the LCD Screen](#)

[Registering Contacts for Email, Network, or FTP Scanning - Control Panel](#)

[Selecting the Date and Time](#)



**Related topics**

[Placing Originals on the Product](#)

## Starting a Scan Using the Epson Scan 2 Icon

You can start the Epson Scan 2 program to select scan settings, scan, and save the scanned image to a file.

**Note:** If you are using your Epson product with the Windows 10 S operating system, you cannot use the software described in this section. You also cannot download and install any Epson product software from the Epson website for use with Windows 10 S; you must obtain software only from the Windows Store.

- **Windows 10:** Click  and select **EPSON > Epson Scan 2**.
- **Windows 8.x:** Navigate to the **Apps** screen and select **Epson Scan 2**.
- **Windows (other versions):** Click  or **Start**, and select **All Programs** or **Programs**. Select **EPSON > Epson Scan 2 > Epson Scan 2**.
- **Mac:** Open the **Applications** folder, open the **Epson Software** folder, and select **Epson Scan 2**.

You see an Epson Scan 2 window like this:

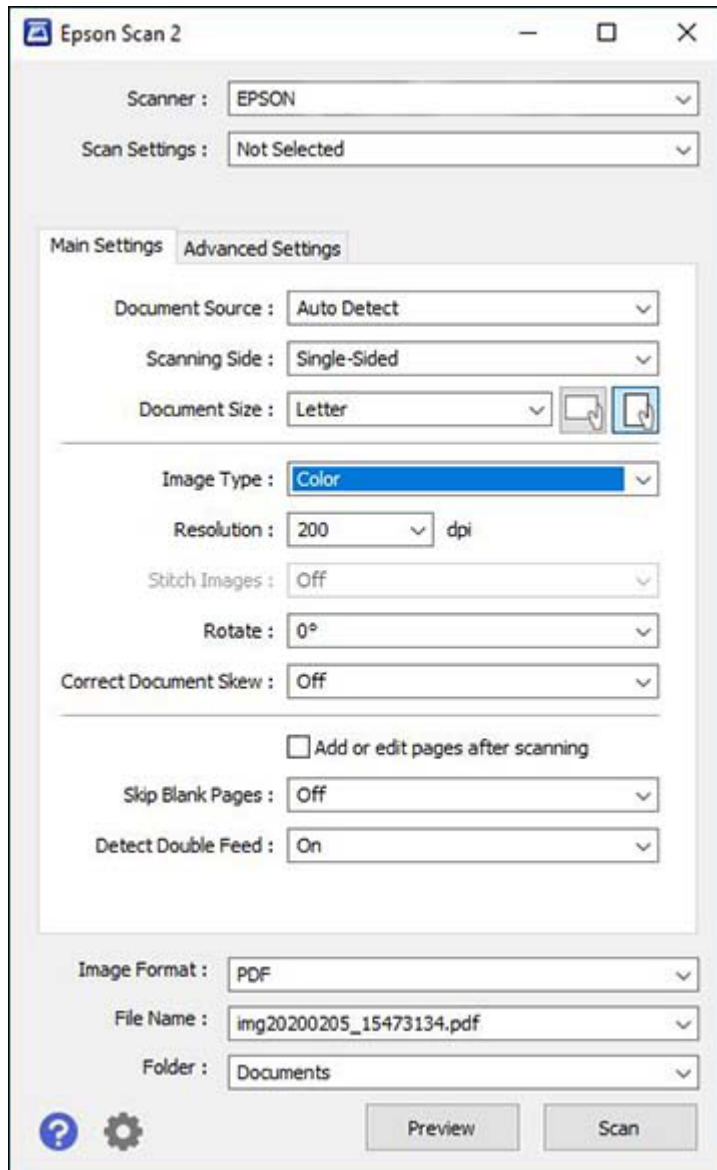



**Parent topic:** [Starting a Scan](#)

**Related tasks**

[Entering a User ID and Password for Scanning](#)

[Starting a Scan from a Scanning Program](#)

**Related topics**

[Placing Originals on the Product](#)

## Starting a Scan from a Scanning Program

You can start Epson Scan 2 from a TWAIN-compliant scanning program to select scan settings, scan, and open the scanned image in the program.

**Note:** If you are using your Epson product with the Windows 10 S operating system, you cannot use the software described in this section. You also cannot download and install any Epson product software from the Epson website for use with Windows 10 S; you must obtain software only from the Windows Store.

1. Open your scanning program and select its scanning option. (See your scanning program help for instructions.)
2. Select your product.

**Note:** In certain programs, you may need to select your product as the "source" first. If you see a **Select Source** option, choose it and select your product. With Windows, do not select a **WIA** option for your product; not all scan functions will be available.

You see an Epson Scan 2 window like this:

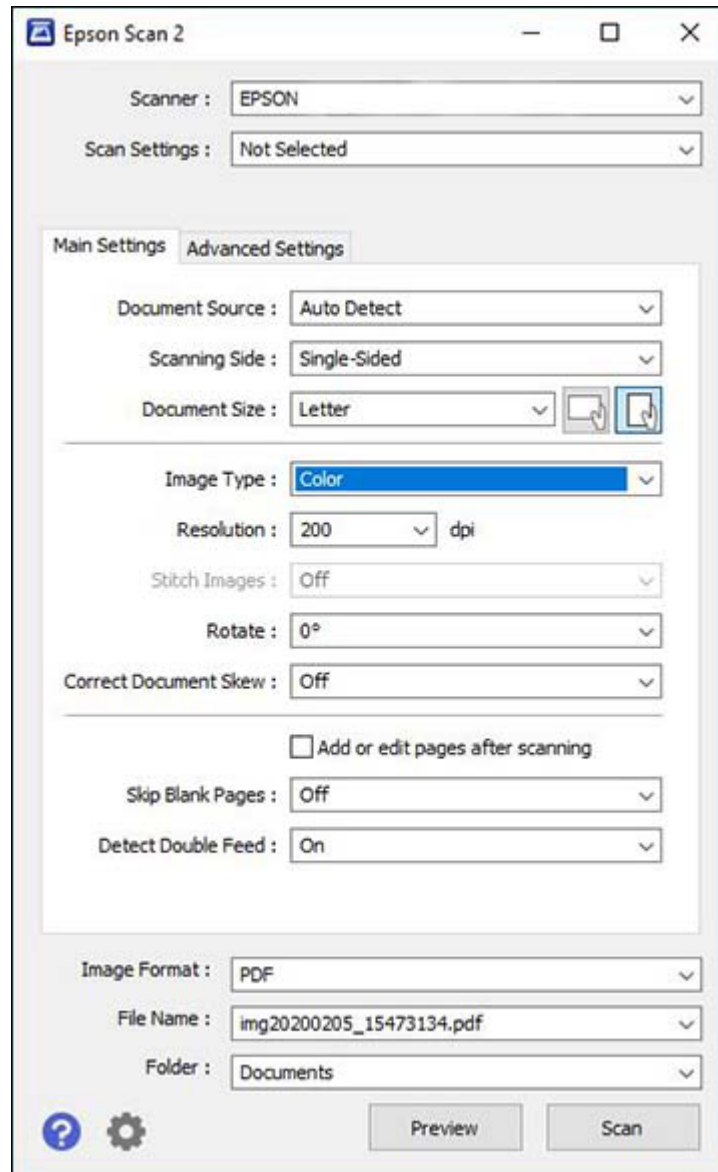

**Parent topic:** [Starting a Scan](#)

**Related tasks**

[Entering a User ID and Password for Scanning](#)

**Related topics**

[Placing Originals on the Product](#)

## Starting a Scan from a Smart Device

You can start a scan from a smart device using the Epson iPrint app. You can save the scanned document to your device or a cloud service, e-mail it, or print it.

**Note:** If you are using your Epson product with the Windows 10 S operating system, you cannot use the software described in this section. You also cannot download and install any Epson product software from the Epson website for use with Windows 10 S; you must obtain software only from the Windows Store.

**Note:** Your device must be connected to the same wireless network as your Epson product.

1. Download the Epson iPrint app from your device's app store or from Epson's website.
2. Place your original on the product for scanning.
3. Open the Epson iPrint app and select your product.
4. Select the scan settings and scan your original.
5. Save your scanned image to a file or cloud location.

**Parent topic:** [Starting a Scan](#)

**Related tasks**

[Using the Epson iPrint Mobile App](#)

**Related topics**

[Placing Originals on the Product](#)

## Scanning in Epson Scan 2

Epson Scan 2 gives you access to basic and advanced scanning features. You can scan your document and save the scanned image in various file formats in your operating system's Documents or My Documents folder, or open it in your scanning program. You can preview the scanned image and select or change settings as necessary.

**Note:** If you are using your Epson product with the Windows 10 S operating system, you cannot use the software described in this section. You also cannot download and install any Epson product software from the Epson website for use with Windows 10 S; you must obtain software only from the Windows Store.

1. Start Epson Scan 2.

You see this window:

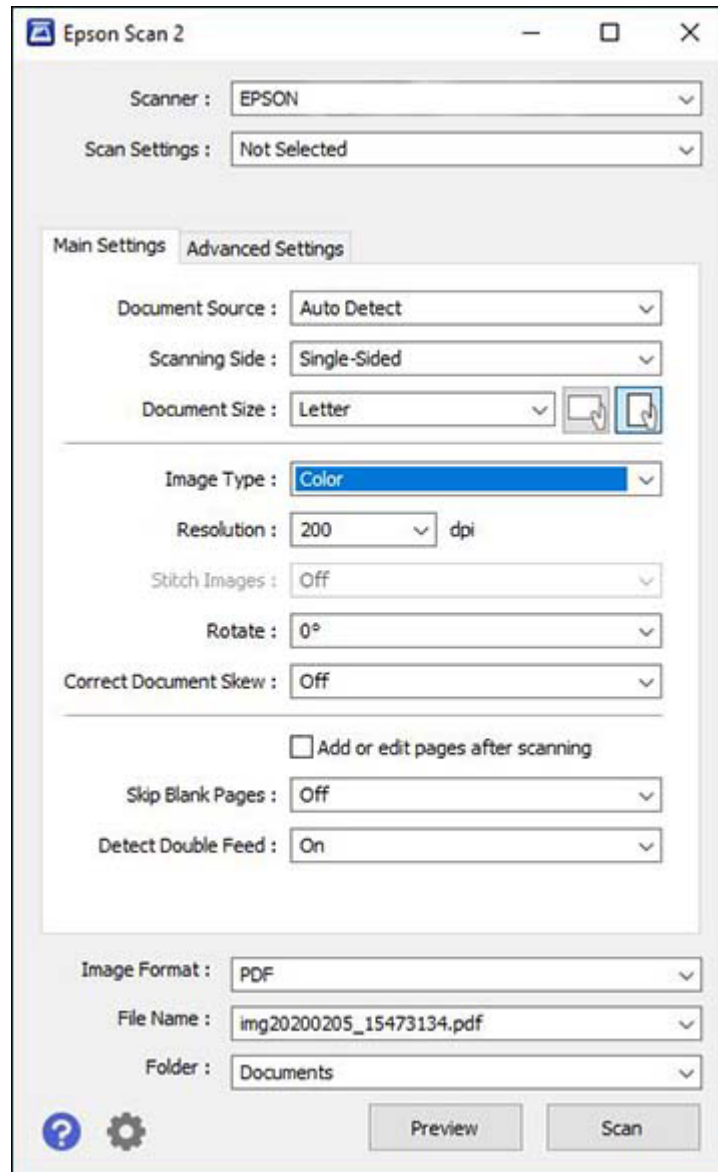

2. Select the **Document Source** setting that matches where you placed your original, or select **Auto Detect** to have Epson Scan 2 automatically detect the source.
3. Select the **Scanning Side** setting if you are scanning from the ADF.
4. Select the **Document Size** setting that matches the size of your original, or select **Auto Detect** to have Epson Scan 2 automatically detect the size. You can select **Customize** to enter a custom size, if necessary.
5. Select the image type of your original and how you want it scanned as the **Image Type** setting.
6. Select the **Resolution** setting you want to use for your scan.
7. Select the **Rotate** setting to rotate the scanned image.
8. Select the **Correct Document Skew** setting to correct skewed originals, image contents, or both.
9. Click the **Preview** button.

Epson Scan 2 previews your original and displays the results in the Epson Scan 2 window.

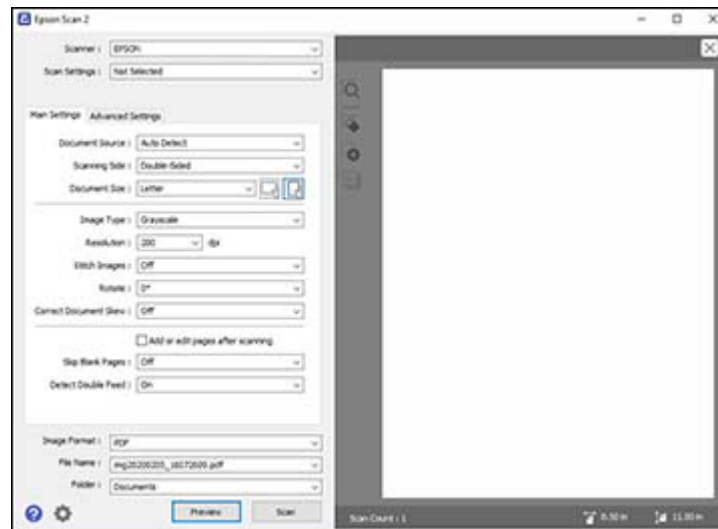

10. Reinsert your original into the ADF, if necessary.
11. Select any of the additional settings that you want to use on the Main Settings tab.
12. Click the **Advanced Settings** tab and select any settings that you want to use.

13. Select the format in which you want to save your scanned file as the **Image Format** setting. If necessary, select **Options** and select any desired format options.
14. Enter the file name for your scanned file in the **File Name** field. If necessary, select **Settings** to modify the file name settings.
15. Select the location in which you want to save your scanned file as the **Folder** setting. If necessary, select **Select** to create a new folder.
16. Click **Scan**.

The product scans your original and saves the scanned file in the location you specified.

[Additional Scanning Settings - Main Settings Tab](#)

[Additional Scanning Settings - Advanced Settings Tab](#)

[Saving Scanned Documents as a Searchable PDF Using Epson Scan 2](#)

[Image Format Options](#)

[Scan Resolution Guidelines](#)

**Parent topic:** [Scanning](#)

**Related topics**

[Placing Originals on the Product](#)

## Additional Scanning Settings - Main Settings Tab

You can select these additional scanning settings on the Epson Scan 2 Main Settings tab. Not all adjustment settings may be available, depending on other settings you have chosen.

### **Stitch Images**

When scanning double-sided originals, lets you lay out images from both sides of the original onto one scanned page.

### **Rotate**

Rotates the original image clockwise to the desired angle before scanning it. Select **Auto** to allow your product to automatically rotate the image based on the orientation of the text (may take longer to scan).

### **Correct Document Skew**

Corrects skewed originals, image contents, or both.

### **Add or edit pages after scanning**

Lets you add, remove, or edit the pages in a scan, including rotating pages and changing the page order.

**Note:** To save multiple pages in a single file, you must select a file format that supports multiple pages such as **PDF** or **Multi-TIFF**. If you select another file format, each scanned image or page is saved as a separate file.

**Skip Blank Pages**

If the scanner detects marks from the other side of a blank page and adds the marks to the scanned image, adjust this setting to prevent this.

**Detect Double Feed**

Detects a double-feed paper error in the ADF. If you are scanning an original envelope or plastic card, select **Off**.

Parent topic: [Scanning in Epson Scan 2](#)

## **Additional Scanning Settings - Advanced Settings Tab**

You can select these additional scanning settings on the Epson Scan 2 Advanced Settings tab. Not all adjustment settings may be available, depending on other settings you have chosen.

**Remove Background**

Removes the background of the originals.

**Text Enhancement**

Sharpens the appearance of letters in text documents.

**Auto Area Segmentation**

Makes black and white images clearer and text recognition more accurate by separating the text from the graphics.

**Threshold**

Adjusts the level at which black areas in text and line art are delineated, improving text recognition in OCR (Optical Character Recognition) programs.

**Color Enhance**

Enhances the shades of the color you select in the scanned image. This setting is available only if you select **Grayscale** or **Black & White** as the Image Type setting.

**Brightness**

Adjusts the overall lightness and darkness of the scanned image.

**Contrast**

Adjusts the difference between the light and dark areas of the overall scanned image.

**Gamma**

Adjusts the midtone density of the scanned image.



**Unsharp Mask**

Makes the edges of certain image areas clearer. Turn off this option to leave softer edges.

**Descreening**

Removes the ripple pattern that might appear in subtly shaded image areas, such as skin tones. This option improves results when scanning magazines or newspapers. (The results of descreening do not appear in the preview image, only in your scanned image.)

**Edge Fill**

Corrects shadowing around the edges of the image by filling the shadows with black or white.

**Dual Image Output**

Scans the original image twice using different output settings (Windows only).

Parent topic: [Scanning in Epson Scan 2](#)

## Saving Scanned Documents as a Searchable PDF Using Epson Scan 2

You can scan a document and save the text in a searchable PDF. In a searchable PDF, text is recognized using Optical Character Recognition (OCR) and then embedded in the scanned original.

**Note:** The required Epson Scan 2 OCR Component is installed automatically when you install your product software. If you install your scanner software programs individually, be sure to also install this component if you want to perform OCR.

1. Load your original in the product for scanning.
2. Start Epson Scan 2.
3. Select your scan settings.
4. Click **Preview** and adjust the area you want to scan, if necessary.
5. If you are using the ADF, reload the ejected original.
6. Select **Searchable PDF** as the Image Format setting.
7. Select **Options** from the Image Format list.

You see this window:

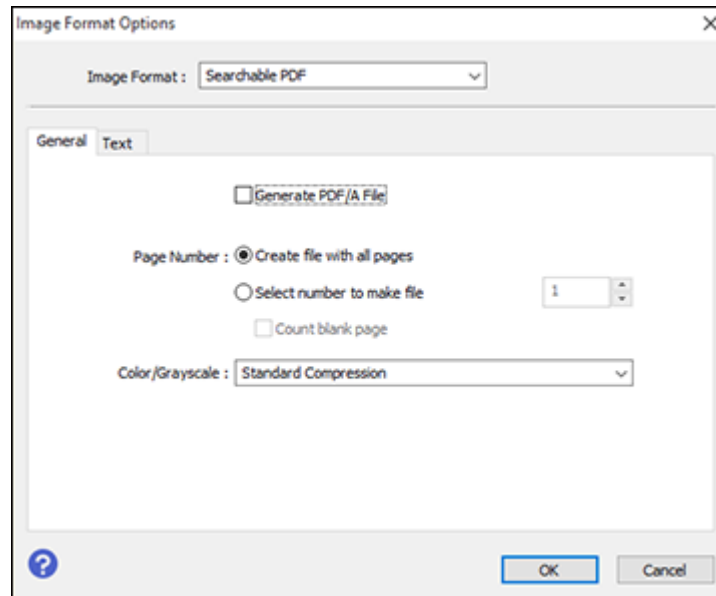

8. Select any of the options on the **General** tab.
9. Select the **Text** tab.
10. Make sure the language used in the document text is selected as the **Text Language** setting.
11. Click **OK**.
12. Confirm the **File Name** setting and select a **Folder** setting for your document.
13. Click **Scan**.

The scanned image is saved as a searchable PDF.

**Parent topic:** [Scanning in Epson Scan 2](#)

**Related topics**

[Placing Originals on the Product](#)

## Image Format Options

You can select different image formats and related options. For details on available options, click the ? icon on the Epson Scan 2 Image Format Options window. Not all image formats have options.

### **BITMAP (\*.bmp)**

A standard image file format for most Windows programs.

### **JPEG (\*.jpg)**

An image format that lets you highly compress image data. However, the higher the compression, the lower the image quality. (The TIFF format is recommended when you need to modify or retouch your scanned image.)

### **PNG (\*.png)**

An image format that does not lose quality during editing.

### **TIFF (\*.tif)**

A file format created for exchanging data between many programs, such as graphic and DTP software.

### **Multi-TIFF (\*.tif)**

A TIFF file format when multiple pages are saved to the same file, allowing you to edit the images using a compatible program.

### **PDF (\*.pdf)**

A document format that is readable by Windows and Mac systems using Adobe Reader, Acrobat, or other programs. You can save multi-page documents in one PDF file.

### **Searchable PDF (\*.pdf)**

A document format that is readable by Windows and Mac systems using Adobe Reader, Acrobat, or other programs. You can save multi-page documents in one PDF file. Recognized text in the scanned document can be searched.

**Parent topic:** [Scanning in Epson Scan 2](#)

## Scan Resolution Guidelines

The **Resolution** setting, measured in dpi (dots per inch), controls the amount of detail captured in your scans. Increasing the resolution raises the amount of detail captured but comes with the following disadvantages:

- Larger file sizes
- It takes longer to scan your originals, send/receive your scans by email or fax, and to print your scans
- The image may become too large to fit on your display or print on paper

If you plan to enlarge a scanned image so you can print it at a larger size, you may need to increase the resolution from the default resolution set by Epson Scan 2. Follow these guidelines to determine the resolution setting you need:

- You will scan the image at its original size but enlarge it later in an image-editing program.  
Increase the Epson Scan 2 Resolution setting in your scan. Increase the resolution by the same amount you will increase the image size to retain a high image quality. For example, if the resolution is 300 dpi (dots per inch) and you will double the image size later, change the Resolution setting to 600 dpi.
- You will scan the image at 100% or a smaller size.  
Select the Epson Scan 2 Resolution setting based on how you will use the scanned image:
  - Email/view on a computer screen/post on the web: 96 to 200 dpi
  - Print/fax/convert to editable text (OCR)/create searchable PDF: 200 to 300 dpi

**Parent topic:** [Scanning in Epson Scan 2](#)

## Scanning with Document Capture Pro or Document Capture

When you scan with Document Capture Pro (Windows) or Document Capture (Mac), the program automatically saves your scanned file on your computer in the folder you specify. You can preview and edit the scanned file, change the scanned file settings, and send to a destination if necessary.

[Scanning with Simple Scan in Document Capture Pro - Windows](#)

[Scanning with Job Scan in Document Capture Pro - Windows](#)

[Scanning Two Originals onto One Sheet \(Stitching Images\) - Windows](#)

[Scanning Multi-Page Originals as Separate Files - Windows](#)

[Scanning with Document Capture - Mac](#)



**Parent topic:** [Scanning](#)

## Scanning with Simple Scan in Document Capture Pro - Windows

You can use the Simple Scan option in Document Capture Pro to quickly scan an original.

**Note:** Settings may vary depending on the software version you are using. Click the **Help** icon in Document Capture Pro at any time for more information.

1. Load your original in the product.

2. Do one of the following to start Document Capture Pro:
  - **Windows 10:** Click  and select **Epson Software > Document Capture Pro**.
  - **Windows 8.x:** Navigate to the **Apps** screen and select **Document Capture Pro**.
  - **Windows (other versions):** Click  or **Start**, and select **All Programs** or **Programs**. Select **Epson Software > Document Capture Pro**.

You see the Document Capture Pro window.

**Note:** You may need to select your scanner from the list, if necessary.

3. Select the **Simple Scan** tab.

You see a window like this:

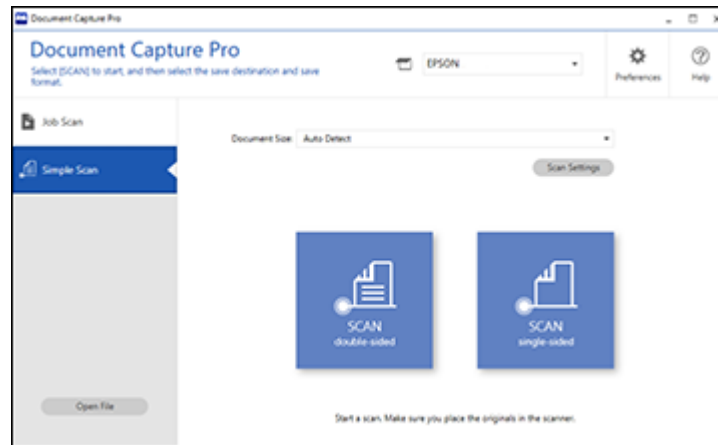

4. Select the size of your original from the **Document Size** menu.
5. If you want to change specific settings for the scan, click the **Scan Settings** button. Change any of the settings as necessary and click **OK**. For additional settings, click the **Detailed Settings** button on the Scan Settings screen.
6. Do one of the following:
  - To scan the front side of an original, select **SCAN single-sided**.
  - To scan both sides of an original, select **SCAN double-sided**.

Your product scans the original and the image appears in the Edit Scanned Results window.

7. Review and edit the scanned image as necessary and click **Next** when you are finished.
8. Select a destination for the scanned image, change any settings as necessary, and click **Complete**.

**Note:** If you are sending the scanned image to a server or cloud destination, you need to enter your login information.

**Parent topic:** [Scanning with Document Capture Pro or Document Capture](#)



**Related topics**

[Placing Originals on the Product](#)

## Scanning with Job Scan in Document Capture Pro - Windows

You can create scan jobs in Document Capture Pro and use them to quickly scan originals and save them to various destinations.

**Note:** Settings may vary depending on the software version you are using. Click the **Help** icon in Document Capture Pro at any time for more information.

1. Load your original in the product.
2. Do one of the following to start Document Capture Pro:
  - **Windows 10:** Click  and select **Epson Software > Document Capture Pro**.
  - **Windows 8.x:** Navigate to the **Apps** screen and select **Document Capture Pro**.
  - **Windows (other versions):** Click  or **Start**, and select **All Programs** or **Programs**. Select **Epson Software > Document Capture Pro**.

You see the Document Capture Pro window.

**Note:** You may need to select your scanner from the list, if necessary.

3. Select the **Job Scan** tab.

You see a window like this:

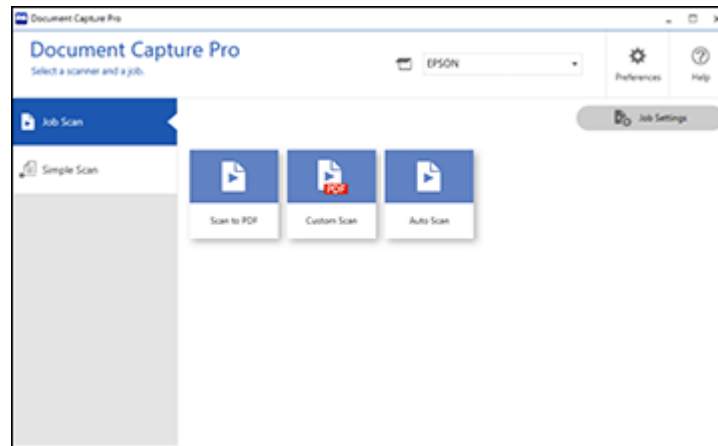

4. Select one of the scan jobs (or click **Job Settings** to create a new scan job).  
The product scans the loaded original and saves it according to the job settings.
5. Depending on the settings for the scan job you selected, you may be able to view and edit the pages before saving them. If so, click **Complete** when finished.  
The scanned image is saved according to the job settings.

[Adding and Assigning Scan Jobs with Document Capture Pro - Windows](#)

**Parent topic:** [Scanning with Document Capture Pro or Document Capture](#)



**Related topics**

[Placing Originals on the Product](#)

### **Adding and Assigning Scan Jobs with Document Capture Pro - Windows**

You can add scan jobs that contain specific scan settings and use the jobs when you scan from your product control panel or the Job Scan option in Document Capture Pro. You can save up to 30 scan jobs.

**Note:** Settings may vary depending on the software version you are using. Click the **Help** icon in Document Capture Pro at any time for more information.

1. Do one of the following to start Document Capture Pro:
  - **Windows 10:** Click  and select **Epson Software > Document Capture Pro**.
  - **Windows 8.x:** Navigate to the **Apps** screen and select **Document Capture Pro**.
  - **Windows (other versions):** Click  or **Start**, and select **All Programs** or **Programs**. Select **Epson Software > Document Capture Pro**.

You see the Document Capture Pro window.

2. Select the **Job Scan** tab.

You see a window like this:

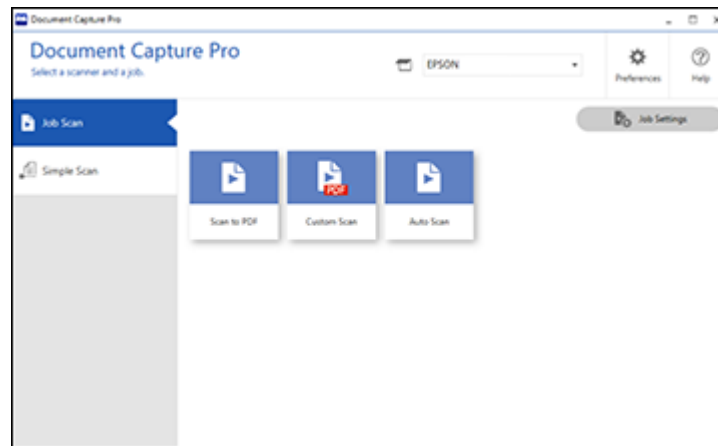

3. Click the **Job Settings** button.



You see a window like this:

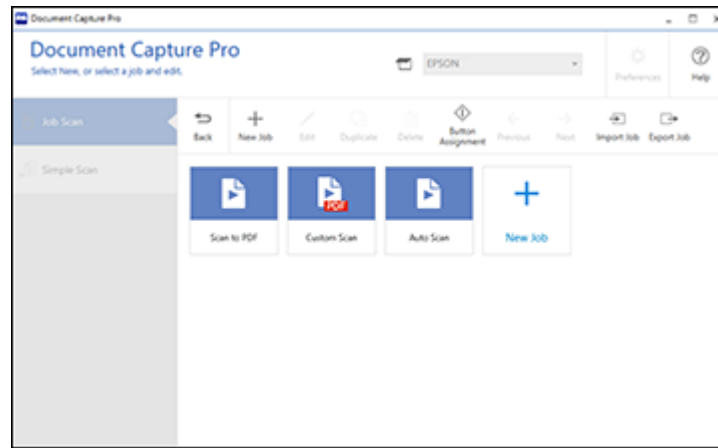

4. To add a scan job, click the **New Job** icon.
5. Enter a name for the new job, and select any settings as necessary from the following options:
  - **Scan**: select the size, color, or resolution
  - **Save**: select the file name, file type, or destination folder
  - **Index**: enable the index setting and choose output options for an index file
  - **Send**: select the destination for the scanned file, or choose to email or print the file
  - **Confirm/Test**: select the job button icon and color, choose display settings, and run a test scan if necessary
6. Click **Save** when you are finished.  
The new job appears in the Job Scan window.
7. To assign a scan job to the product control panel, click the **Button Assignment** icon.

You see a screen like this:

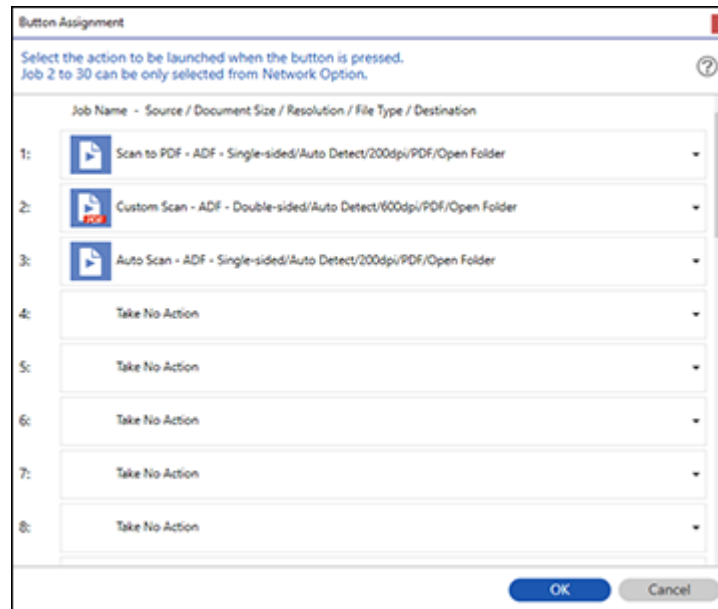

8. Select the jobs that you want to assign to the product control panel using any of the pull-down menus.

**Note:** The number of pull-down menus available may vary, depending on your product and any connected options.

9. Click **OK**, then click **Back**.

You can now use the added scan jobs when you scan from the product control panel.

**Parent topic:** [Scanning with Job Scan in Document Capture Pro - Windows](#)

#### **Related tasks**

[Scanning to a Connected Computer](#)

## **Scanning Two Originals onto One Sheet (Stitching Images) - Windows**



You can scan both sides of a double-sided or folded original in Document Capture Pro and combine them into a single image with the Epson Scan 2 Stitch Images setting (not available for all products).

**Note:** Settings may vary depending on the software version you are using. Click the **Help** icon in Document Capture Pro at any time for more information.

1. Load your original in the product.

**Note:** If an optional carrier sheet is included with your product, use it when scanning a folded original or damage to the original may occur. Place the original into the carrier sheet with the folded edge against the right side of the carrier sheet. Make sure to insert the carrier sheet into your product with the white edge facing down.

2. Do one of the following to start Document Capture Pro:

- **Windows 10:** Click  and select **Epson Software > Document Capture Pro**.
- **Windows 8.x:** Navigate to the **Apps** screen and select **Document Capture Pro**.
- **Windows (other versions):** Click  or **Start** and select **All Programs** or **Programs**. Select **Epson Software > Document Capture Pro**.

3. Select the **Simple Scan** tab.

You see a window like this:

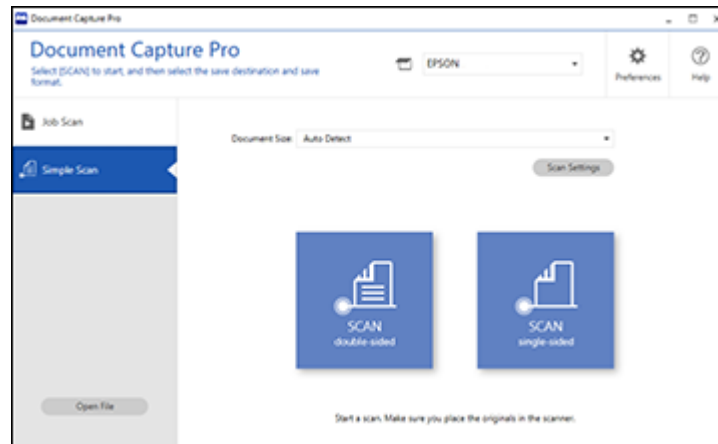

4. Click **Scan Settings > Detailed Settings**.

You see an Epson Scan 2 window like this:

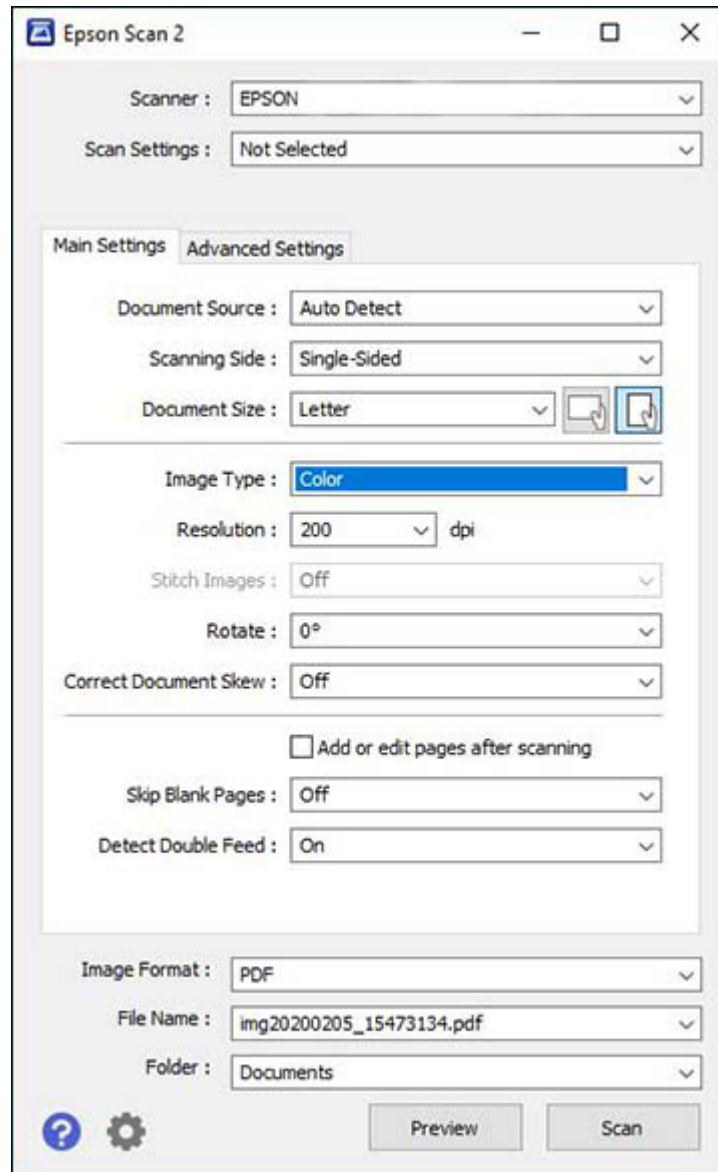

5. Select **Double-Sided** as the **Scanning Side** setting.
6. Select the original document size or **Auto Detect** as the **Document Size** setting.
7. Select one of the following as the **Stitch Images** setting:
  - **Top & Bottom**: Places the scanned images one above the other.
  - **Left & Right**: Places the scanned images side by side.
8. Select the **Advanced Settings** tab and verify that the **Edge Fill** setting is set to **None**.
9. Click **Save**.
10. Click **OK**.
11. Click **SCAN double-sided**.

Your product scans the original and the image appears in the Edit Scanned Results window.

**Note:** If the scanned images are not stitched together in the correct orientation, click **Scanning Side** on the Epson Scan 2 window, select **Settings**, set the Binding Edge to **Left** or **Top**, and rescan the document.

12. Review and edit the scanned pages as necessary and click **Next** when you are finished.
13. Select a destination and any settings as necessary and click **Complete**.

**Parent topic:** [Scanning with Document Capture Pro or Document Capture](#)

#### **Related topics**

[Placing Originals on the Product](#)

## **Scanning Multi-Page Originals as Separate Files - Windows**

You can use Document Capture Pro to scan multi-page originals as separate scanned files. You can indicate how the separate files are created by defining a maximum page count per file or by inserting blank pages, barcodes, or characters that can be detected by the software as separation markers.

**Note:** Settings may vary depending on the software version you are using. Click the **Help** icon in Document Capture Pro at any time for more information.

1. Load your multi-page original in the product.
2. Do one of the following to start Document Capture Pro:
  - **Windows 10:** Click  and select **Epson Software > Document Capture Pro**.

- **Windows 8.x:** Navigate to the **Apps** screen and select **Document Capture Pro**.
- **Windows (other versions):** Click  or **Start**, and select **All Programs** or **Programs**. Select **Epson Software > Document Capture Pro**.

You see the Document Capture Pro window.

3. Select the **Job Scan** tab.

You see a window like this:

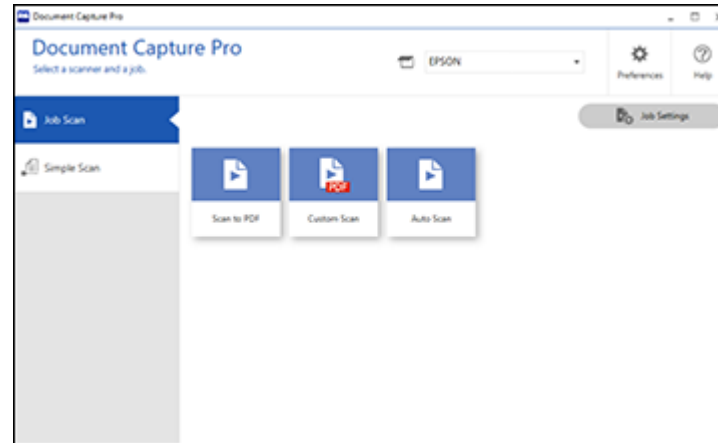

4. Click the **Job Settings** button.

You see a window like this:

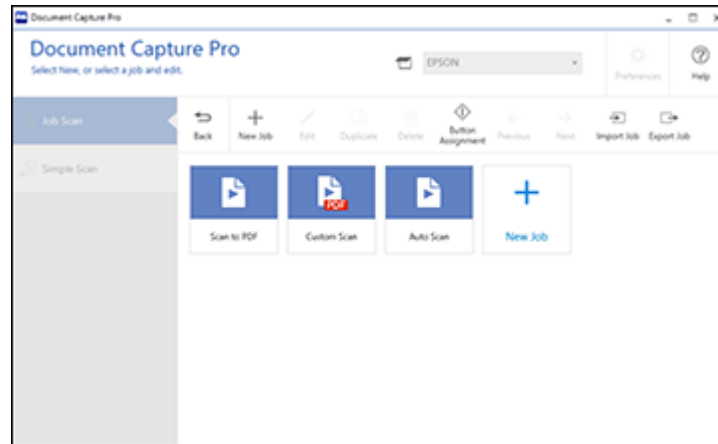

5. Select **New Job** and select the scan settings. Click **Next** when finished. You see a window like this:

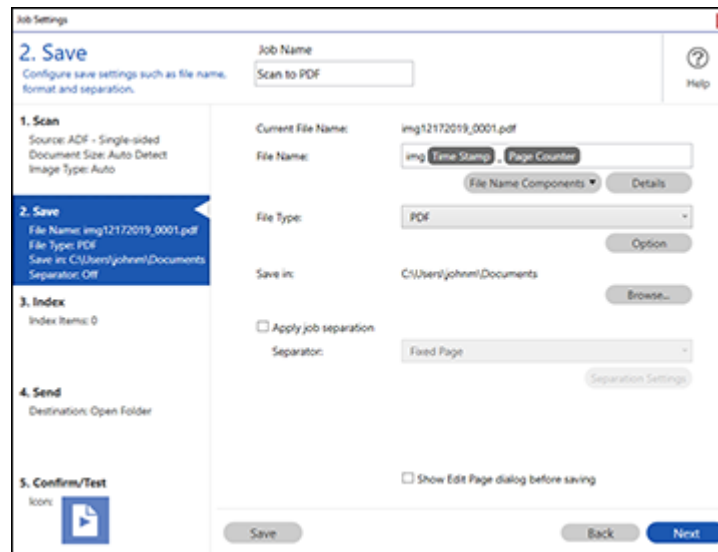

6. Select the **Apply job separation** checkbox.
7. Select the method you want to use to separate the originals as the **Separator** setting. Click **Separation Settings** to specify the settings for the selected option.

8. Finish creating the new scan job and click **Save**.
9. Click **Back** on the Job Settings screen.

Your originals are saved into separate files and folders as specified when the job is run.

**Parent topic:** [Scanning with Document Capture Pro or Document Capture](#)

**Related topics**

[Placing Originals on the Product](#)

## Scanning with Document Capture - Mac

When you scan with Document Capture, the program automatically saves your scanned file on your computer in the folder you specify. You can select settings, preview, and change the scanned file settings as necessary.

**Note:** Settings may vary depending on the software version you are using. See the **Help** menu in Document Capture at any time for more information.

1. Load your original in the product.
2. Open the **Applications** folder, open the **Epson Software** folder, and select **Document Capture**.

You see a window like this:

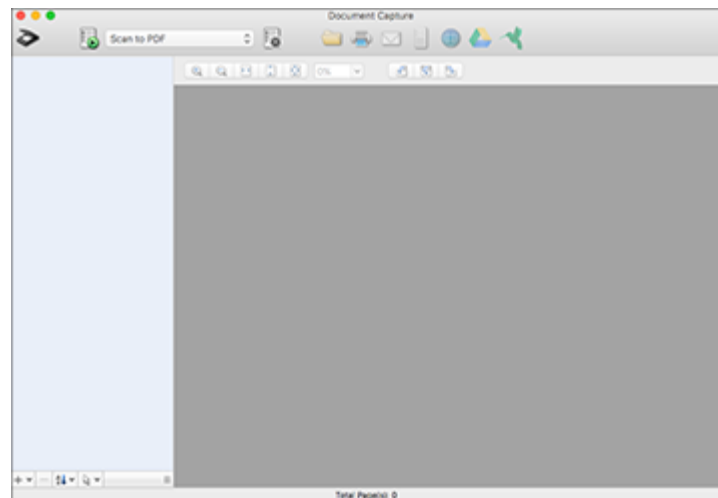





**Note:** You may need to select your scanner from the scanner list.

3. Click the  scan icon.

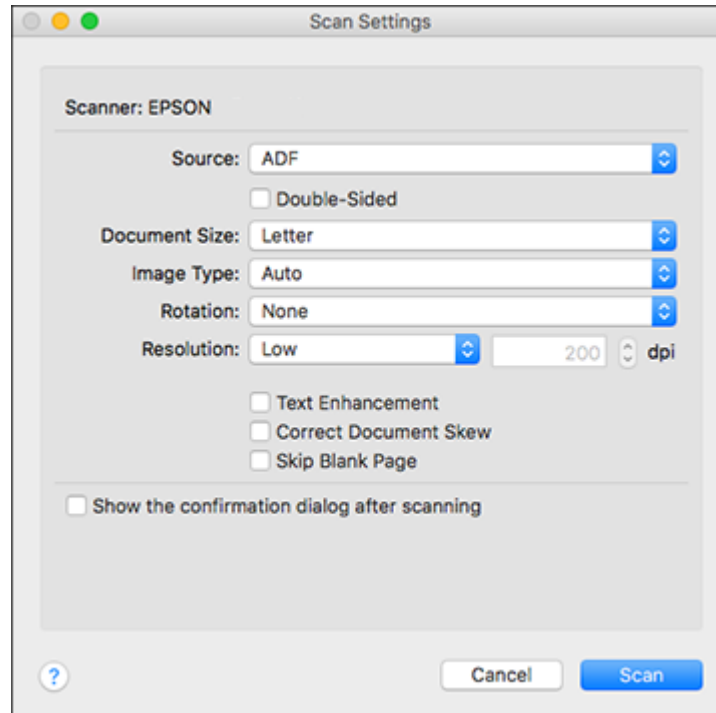
You see a window like this:



**Note:** If you want to use a scan job that you created instead, select it from the Job list in the Document Capture window, click the  Start Job button, and skip the rest of these steps.

4. Select any displayed scan settings you want to use.

**Note:** See the Help information in Document Capture for details.

5. If you want to select detailed scan settings, close the Scan Settings window, open the **Scan** menu at the top of the Mac desktop, and select **Displays the EPSON Scan Setup Screen**.

6. Click the  Scan icon and select any detailed scan settings you want to use from the Epson Scan 2 window.
7. Click **Scan**.

You see a preview of your scan in the Document Capture window.

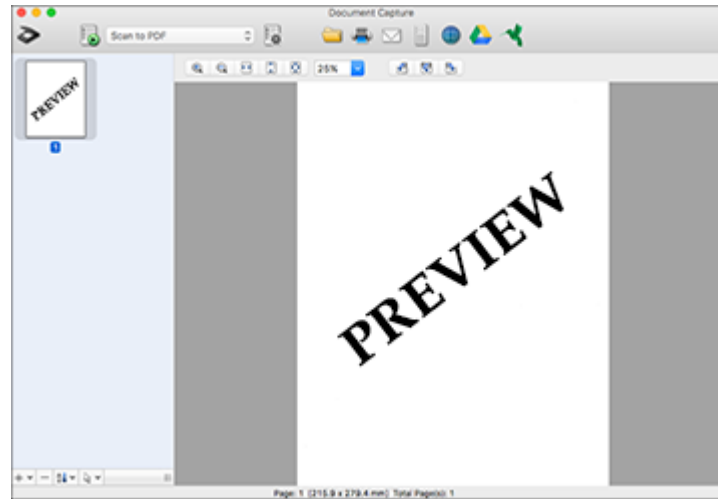

**Note:** You may have to close the Epson Scan 2 window to view your scan in the Document Capture window.

8. If you would like to scan additional originals and add them to the current captured images, click the + icon, select **Acquire from Scanner**, and repeat the previous steps.
9. Check the scanned images and edit them as necessary.
10. Click one of the destination icons to choose where to send your scanned files. (If you cannot see all of the icons below, click the arrow next to the icons.) Change any settings as necessary.



**Note:** If you are sending the scanned image to a server or cloud destination, you need to enter your login information.

11. Depending on the destination you chose, click **OK** or **Send** to complete the operation.

[Adding and Assigning Scan Jobs with Document Capture - Mac](#)

**Parent topic:** [Scanning with Document Capture Pro or Document Capture](#)



**Related topics**

[Placing Originals on the Product](#)

### **Adding and Assigning Scan Jobs with Document Capture - Mac**

You can add scan jobs that contain specific scan settings and use the jobs when you scan from your product control panel or Document Capture. You can save up to 30 scan jobs.

**Note:** Settings may vary depending on the software version you are using. See the **Help** menu in Document Capture at any time for more information.

1. Start Document Capture on a computer connected to the product.
2. Click the  Manage Job icon from the toolbar at the top of the window.  
You see a window showing the current scan job list.
3. To add a scan job, click the **+** icon, enter a name for the new job, select settings as necessary, and click **OK**.  
You can now use the new scan job when you scan with Document Capture.
4. To assign a scan job to the product control panel, click the  settings icon at the bottom of the window and click **Event Settings**.
5. Select the jobs that you want to assign to the product control panel using any of the pull-down menus.

**Note:** The number of pull-down menus available may vary, depending on your product and any connected options.

6. Click **OK**, then click **OK** again.  
You can now use the added scan jobs when you scan from the product control panel.

**Parent topic:** [Scanning with Document Capture - Mac](#)

## Entering a User ID and Password for Scanning

If you enabled Access Control on your product, a user ID and password may be required to scan. You can enter the user ID and password in Epson Scan 2.

**Note:** If you do not know the user ID or password, contact your administrator for assistance.

1. Start Epson Scan 2.
2. Select **Settings** from the **Scanner** drop-down list.

You see this window:

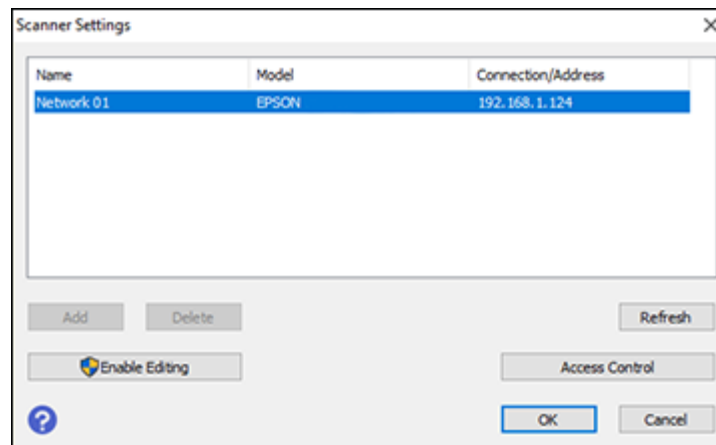

3. Select **Access Control**.
4. Enter your user name and password.
5. Click **OK**.

**Parent topic:** [Scanning](#)

---

## Faxing

See these sections to fax using your product.

**Note:** An optional fax board must be installed on your product before you can fax. Once the optional fax board is installed, download and install the Epson Fax Utility software. Visit [epson.com/support](http://epson.com/support) (U.S.), [epson.ca/support](http://epson.ca/support) (Canada), or [epson.com.jm/support](http://epson.com.jm/support) (Caribbean) and select your product.

**Note:** This product allows you to store names, telephone numbers, and fax data in its memory even when the power is turned off. Make sure you restore all of the default settings if you give away or dispose of the product. This will erase all of your network settings and fax data.

**Note:** When using the Epson Universal Print Driver or PostScript (PS3) printer software with the product, you can fax using the printer buttons or the utilities included with the standard Epson printer software. To download the standard Epson printer software, visit [epson.com/support](http://epson.com/support) (U.S.), [epson.ca/support](http://epson.ca/support) (Canada), or [epson.com.jm/support](http://epson.com.jm/support) (Caribbean) and select your product.

**Note:** Your product may look different from the illustrations in this guide, but the instructions are the same unless otherwise noted.

[Connecting a Telephone or Answering Machine](#)

[Setting Up Fax Features](#)

[Setting Up Contacts and Contact Groups](#)

[Sending Faxes](#)

[Receiving Faxes](#)

[Checking Fax Status](#)

[Printing Fax Reports](#)

## Connecting a Telephone or Answering Machine

You must connect your product to a telephone wall jack to send or receive faxes. If you want to use the same telephone line to receive calls, you can connect a telephone or answering machine to your product using an additional phone cable.

**Note:** If you do not connect a telephone to your product, make sure **Receive Mode** is set to **Auto**. Otherwise, you cannot receive faxes.

1. Connect a phone cable to your telephone wall jack and to the **LINE** port on your product.

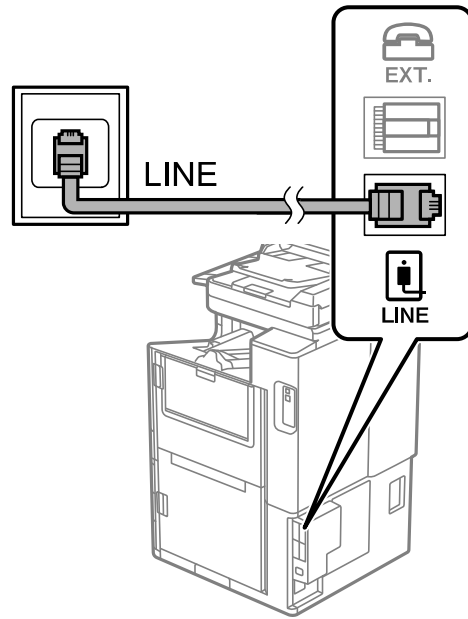

**Note:** If more than one optional fax board is installed on your product, you can connect more than one phone cable.

**Note:** If you have a DSL or ISDN connection, you must connect the appropriate DSL filter, or ISDN terminal adapter or router to the wall jack to be able to use the line for faxing or voice calls using your product. Contact your DSL or ISDN provider for the necessary equipment.

## DSL connection

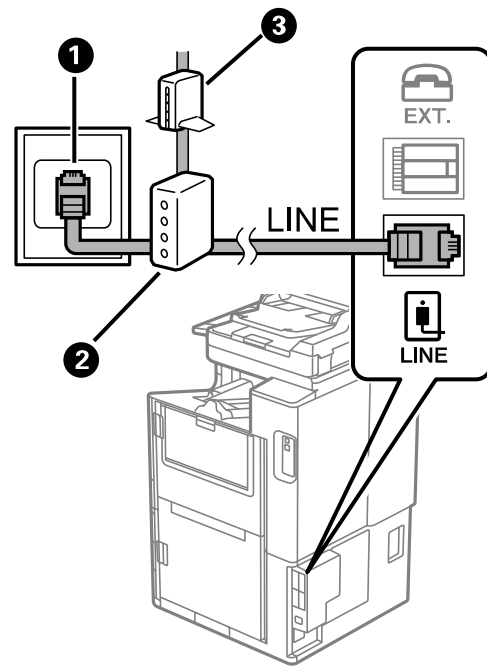

- 1 Telephone wall jack
- 2 DSL filter
- 3 DSL modem

## ISDN connection

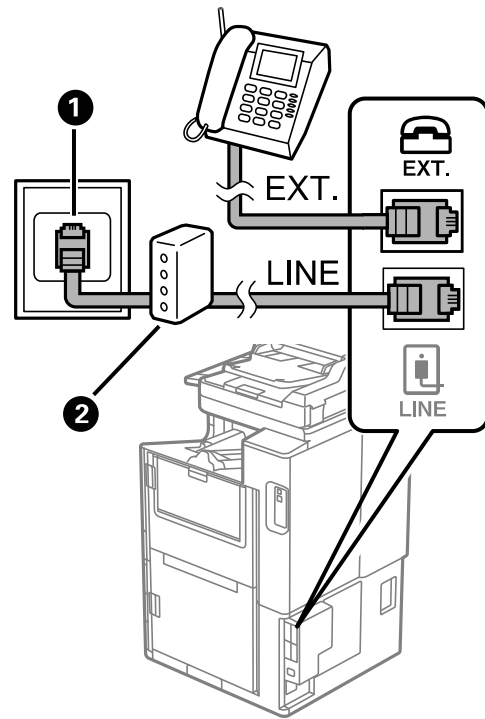

- 1 ISDN wall jack
- 2 Terminal adapter or ISDN router



2. If you are connecting a telephone or answering machine to your product using a second phone cable, remove the cap from the **EXT** port on your product.

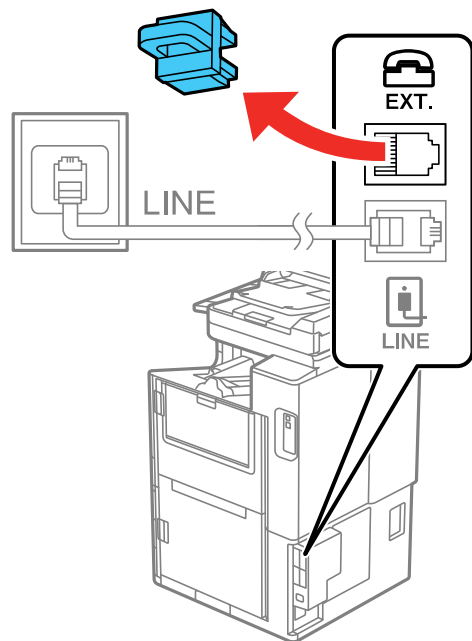

3. Connect a second phone cable to your telephone or answering machine and to the **EXT** port on your product.

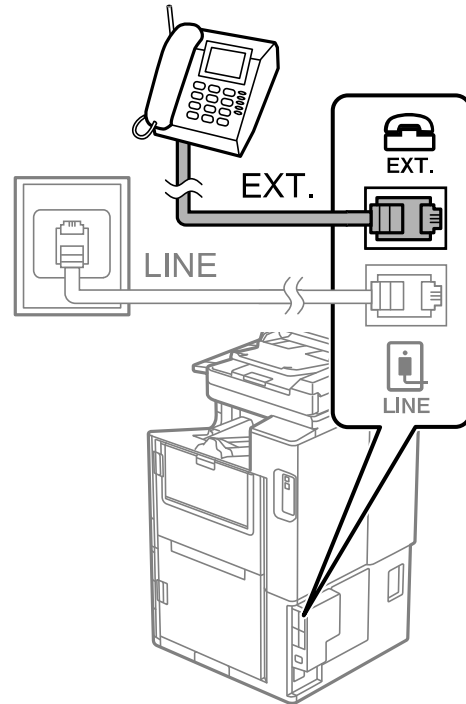

**Note:** If you connect an answering machine and **Receive Mode** is set to **Auto**, set the number of rings before your product answers a call to a number that is higher than your answering machine's setting for the number of rings.

Any phone or answering machine must be connected to the **EXT** port for your product to detect an incoming fax call when the phone is picked up. Epson cannot guarantee compatibility with VoIP, cable phone systems, or fiberoptic digital services such as FIOS.

**Parent topic:** [Faxing](#)

**Related references**

[Optional Accessories and Replacement Parts](#)

[Cannot Receive Faxes with a Telephone Connected to Your Product](#)

### Related tasks

[Receiving Faxes Automatically](#)

[Using the Fax Setup Wizard](#)

[Setting the Number of Rings to Answer](#)

## Setting Up Fax Features

Before faxing with your product, set up your fax header and select the fax features you want to use.

**Note:** If you leave your product unplugged for a long period of time, you may need to reset the date and time settings for faxes.

[Setting Up Basic Fax Features](#)

[Selecting Advanced Fax Settings](#)

[Setting Up the Fax Utility - Windows](#)

**Parent topic:** [Faxing](#)

## Setting Up Basic Fax Features

See these sections to select the basic settings you need to use the product's fax features.

[Using the Fax Setup Wizard](#)

[Selecting the Line Type](#)

[Setting the Number of Rings to Answer](#)

**Parent topic:** [Setting Up Fax Features](#)

### Using the Fax Setup Wizard

You can setup the product's basic fax settings using the Fax Setting Wizard. This wizard is automatically displayed when the product is turned on for the first time. You can also change these settings individually from the Fax Settings menu.

**Note:** These settings can be locked by an administrator. If you cannot access or change these setting, contact your administrator for assistance.

1. Press the  home button, if necessary.
2. Select **Settings > General Settings > Fax Settings > Fax Setting Wizard**.

You see a screen like this:

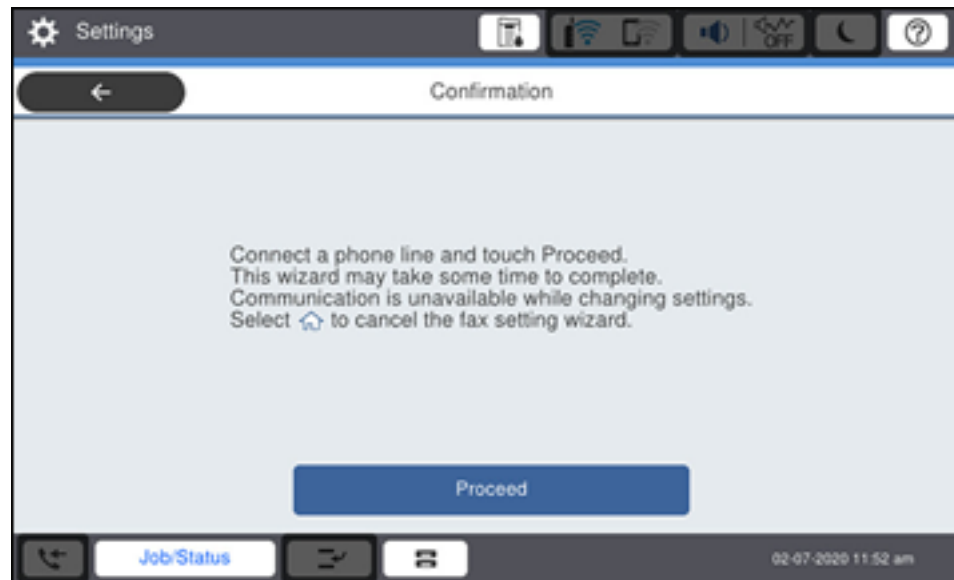

3. Select **Proceed**.
4. On the fax header screen, use the displayed keypad to enter the sender name for your fax source, such as your name or a business name. You can enter up to 40 characters. Select **OK** when you are done.
5. On the phone number screen, use the displayed keypad to enter your fax number, up to 20 characters. Select **OK** when you are done.

**Note:** The name and phone number in the fax header identifies the source of the faxes you send.

6. On the Distinctive Ring Setting screen, do one of the following:
  - If you have subscribed to a distinctive ring service from your telephone company, select **Proceed**. Select the ring pattern to be used for incoming faxes and skip to step 9. If you select **All**, go to the next step.

- If you do not have a distinctive ring service, select **Skip** and go step 9.

**Note:** Distinctive ring services allows you to have several phone numbers on one phone line. Each number is assigned a different ring pattern. You can use one number for voice calls and another for fax calls. Select the ring pattern assigned to fax calls in the DRD Setting. If you select a ring pattern other than **All**, Receive Mode is automatically set to **Auto**.

7. On the Receive Mode Setting screen, do one of the following:
  - If you have connected an external telephone or answering machine to the product, select **Yes** and go to the next step.
  - If you did not connect an external telephone or answering machine, select **No** and go to step 9. (Receive Mode is automatically set to **Auto**; otherwise you cannot receive faxes.)
8. On the next Receive Mode Setting screen, select **Yes** to receive faxes automatically or select **No** to receive faxes manually.

**Note:** If you connect an external answering machine and select to receive faxes automatically, make sure the **Rings to Answer** setting is correct. If you select to receive faxes manually, you need to answer every call and operate the product's control panel or your phone to receive faxes.

9. On the Proceed screen, confirm the displayed settings and select **Proceed**, or press the back arrow to change the settings.
10. On the Run Check Fax Connection screen, select **Start Checking** and follow the on-screen instructions to check the fax connection and print a report of the check result. If there are any errors reported, try the solutions on the report and run the check again.

If the Select Line Type screen appears, select the correct line type.

If the Select Dial Tone Detection screen appears, select **Disable**. However, disabling the dial tone detection function may drop the first digit of a fax number and send the fax to the wrong number.

**Parent topic:** [Setting Up Basic Fax Features](#)

#### **Related tasks**

[Entering Characters on the LCD Screen](#)

### **Selecting the Line Type**

If you connect the product to a PBX phone system or terminal adapter, you must change the product's line type. PBX (Private Branch Exchange) is used in office environments where an external access code such as "9" must be dialed to call an outside line. The default Line Type setting is PSTN (Public Switched Telephone Network), which is a standard home phone line.

**Note:** This setting can be locked by an administrator. If you can't access or change this setting, contact your administrator for assistance.

1. Press the  home button, if necessary.
2. Select **Settings** > **General Settings** > **Fax Settings** > **Basic Settings** > **Line Type** > **PBX**.

You see a screen like this:

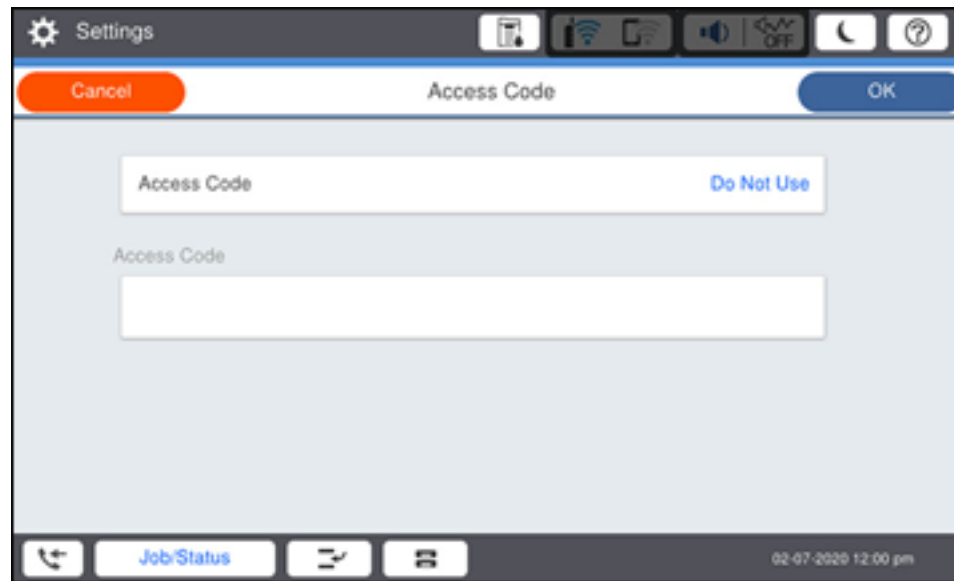

3. Select **Access Code**.
4. Select **Use**.
5. Select the Access Code field.
6. Use the displayed keypad to enter the access code, such as 9, and select **OK**.

**Parent topic:** [Setting Up Basic Fax Features](#)

### **Setting the Number of Rings to Answer**

If you connect an external answering machine and select to receive faxes automatically, make sure the Rings to Answer setting is correct. The number of rings should be higher than the number of rings your answering machine is set to for answering a call.

**Note:** This setting can be locked by an administrator. If you cannot access or change this setting, contact your administrator for assistance.

1. Press the  home button, if necessary.
2. Select **Settings** > **General Settings** > **Fax Settings** > **Basic Settings** > **Rings to Answer**.

You see a screen like this:



3. Select the number of rings and select **OK**. Make sure to select a number higher than the number of rings your answering machine is set to for answering a call.

**Note:** An answering machine picks up every call faster than the product, but the product can detect fax tones and start receiving faxes. If you answer the phone and hear a fax tone, check that the product has started receiving the fax, then hang up the phone.

**Parent topic:** [Setting Up Basic Fax Features](#)

## Selecting Advanced Fax Settings

You can select a variety of advanced fax settings.

**Note:** These settings can be locked by an administrator. If you cannot access or change these setting, contact your administrator for assistance.

1. Press the  home button, if necessary.
2. Select **Settings** > **General Settings** > **Fax Settings**.

You see a screen like this:

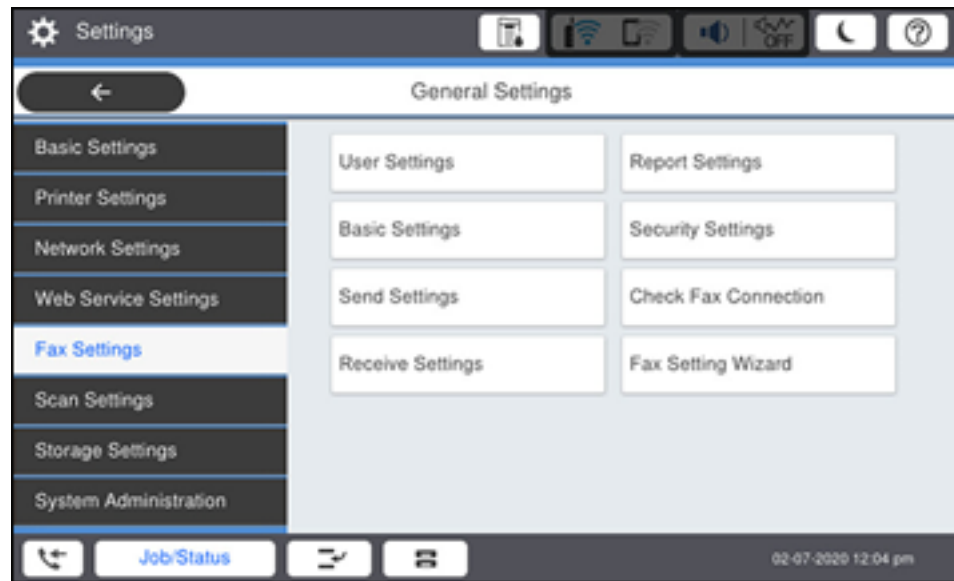

3. Select the group of settings you want to change.

[Basic Settings - Fax](#)

[Send Settings - Fax](#)

[Receive Settings - Fax](#)

[Report Settings - Fax](#)

[Security Settings - Fax](#)

**Parent topic:** [Setting Up Fax Features](#)

### **Basic Settings - Fax**

Set the basic options you want to use for incoming and outgoing faxes.



**Note:** If more than one optional fax board is installed on your product, the **Expansion Line Settings** menu appears. You can select certain settings below for each added line.

Setting	Options	Description
<b>Fax Speed</b>	<b>Fast(33,600bps)</b>	Sets the speed at which you send and receive faxes.
	<b>Medium(14,400bps)</b>	
	<b>Slow(9,600bps)</b>	
<b>ECM</b>	<b>On</b>	Turns on Error Correction Mode (ECM) to automatically correct errors in sent or received fax data.
	<b>Off</b>	Turns off Error Correction Mode (ECM); color faxes cannot be sent or received.
<b>Dial Tone Detection</b>	<b>On</b>	Automatically dials the number you enter for faxing when the product detects a dial tone.
	<b>Off</b>	Turns off automatic dial tone detection, which may be necessary if the product is connected to a PBX (Private Branch Exchange) or a TA (Terminal Adapter). However, turning this setting off may cause the product to drop the first digit of a fax number.
<b>Line Type</b>	<b>PSTN</b>	Selects a standard phone line (Public Switched Telephone Network).
	<b>PBX</b>	Selects Private Branch Exchange, the type of phone line used in office environments where an access code such as 9 must be used to call an outside line.
<b>Header</b>	<b>Your Phone Number</b>	Select to enter the header information and your phone number for inclusion on outgoing faxes.
	<b>Fax Header</b>	
<b>Receive Mode</b>	<b>Manual</b>	Lets you confirm whether an incoming fax should be printed; a telephone must be connected to the product
	<b>Auto</b>	Automatically receives and prints faxes.

Setting	Options	Description
<b>Distinctive Ring</b>	<b>All</b>	If you are using a Distinctive Ring Service on your phone line, your telephone company can assign two or more phone numbers to the same line and assign different ring patterns to each. If you use this service, select the number of rings for your fax number so your product can receive faxes on the correct number of rings. Select <b>All</b> for phones lines that do not use this service.
	<b>Single</b>	
	<b>Double</b>	
	<b>Triple</b>	
	<b>Double&amp;Triple</b>	
<b>Rings to Answer</b>	1 to 9	Sets the number of rings before your product receives a fax. If Receive Mode is set to <b>Auto</b> and an answering machine is connected to the product, make sure this setting is set higher than the number of rings your answering machine is set to answer a call.
<b>Remote Receive</b>	<b>Off</b>	Lets you start receiving faxes using your phone instead of operating the product (if the Receive Mode is set to <b>Auto</b> ). When you select <b>On</b> , you must also set a <b>Start Code</b> . If you are using a cordless handset with its base connected to the product, you can start receiving the fax by entering the code using the handset.
	<b>On</b>	
	<b>Start Code</b>	
<b>Rejection Fax</b>	Various	Lets you automatically reject faxes from blocked numbers, with blank headers, or from unrecognized contacts.
<b>Receiving Paper Size</b>	Various	Selects the paper size for incoming faxes.
<b>Save/Forward File Format</b>	<b>PDF</b>	Saves or forwards a fax as a PDF file. You can also set a password for opening the PDF or allowing printing and editing permissions.
	<b>TIFF</b>	Saves or forwards a fax as a TIFF file.

Parent topic: [Selecting Advanced Fax Settings](#)

#### Related tasks

[Selecting the Date and Time](#)

[Starting a Scan Using the Product Control Panel](#)

## Related topics

[Setting Up Contacts and Contact Groups](#)

### Send Settings - Fax

Set the send options you want to use for outgoing faxes.

Setting	Options	Description
Auto Rotation	Off	Sends an A4 or letter-size document that is placed long edge first into the ADF as an A3-size fax.
	On	
Quick memory send	Off	Sends the first page of a multi-page document as soon as it finishes scanning. Select this option to decrease the amount of time it takes to fax a document.
	On	
Batch Send	Off	Sorts outgoing faxes by recipient in the product's memory, and then sends them as a batch.
	On	
Save Failure Data	Off	Saves faxes that failed to be sent in the product's memory. You can resend the faxes from the product's Job/Status screen.  When you select <b>On</b> , you can select a time period to store the saved faxes.
	On	
Wait Time for Next Original	Off	Sets a time in between sending the next fax.
	On	
Fax Preview Display Time	Off	Sets a time for previewing the scanned document on the LCD screen before it is sent.
	On	
Allow Backup	Allowed	Allows you to back up sent faxes. Select <b>Fax &gt; Fax Settings &gt; Backup</b> to view backed up faxes.
	Not Allowed	

Parent topic: [Selecting Advanced Fax Settings](#)

### Receive Settings - Fax

Set the save/forward or print options you want to use for incoming faxes.

#### Save/Forward Settings

Setting	Options	Description
<b>Unconditional Save/Forward</b>	<b>Save to Inbox</b>	Saves received faxes in printer's inbox
	<b>Save to Computer</b>	Converts received faxes to PDFs and saves them on a computer connected to the printer
	<b>Save to Memory Device</b>	Converts received faxes to PDFs and saves them on an external memory device connected to the printer
	<b>Forward</b>	Forwards received faxes to another fax machine, or converts them to PDFs and forwards them to a shared folder on a network or an email address. Forwarded faxes are deleted from the printer.
	<b>Email Notifications</b>	Sends an email notification after a fax is received, printed, saved, or forwarded
<b>Conditional Save/Forward</b>	—	Sets up conditions to save, forward, or print received faxes. Select <b>Unregistered</b> to enter conditions and other settings.
<b>Common Settings</b>	<b>Inbox Settings</b>	Sets up what happens when the fax memory is full, or sets up a password for the inbox.
	<b>Email Subject to Forward</b>	Specifies a subject when forwarding a fax to an email address.
	<b>Box Document Delete Settings</b>	Select <b>On</b> to automatically delete received faxes after a set period of time.

### Print Settings

Setting	Options	Description
<b>Auto Reduction</b>	<b>On</b>	Select to reduce the size of large received faxes to fit on the paper size in the selected paper source.
	<b>Off</b>	Select to print large incoming faxes at their original size on multiple sheets, if necessary.
<b>Split Page Settings</b>	<b>Delete Print Data After Split</b>	Select how to split large incoming faxes across multiple sheets when using the <b>Auto Reduction</b> option.
	<b>Overlap When Split</b>	

Setting	Options	Description
Acting Print	On(Split to Pages)	Select to split large incoming faxes across multiple sheets.
	On (Reduce to Fit)	Select to reduce the size of large received faxes to fit on the paper size in the selected paper source.
	Off	Select to print large incoming faxes at their original size on multiple sheets, if necessary.
Auto Rotation	On	If you have loaded A5-size paper, select <b>On</b> to rotate landscape-oriented incoming faxes so that they print correctly on the paper.
	Off	
Add Reception Information	On	Select <b>On</b> to include the date, time, the sender's information, and a page number in the header of your incoming faxes.
	Off	
2-Sided	On	Select <b>On</b> to print incoming faxes double sided. You can also select the <b>Binding Margin</b> .
	Off	
Print Start Timing	All Pages Received	Select to print incoming faxes after the product receives all of the pages of the document.
	First Page Received	Select to print incoming faxes as soon as the product receives the first page of the document.
Collation Stack	On	Select <b>On</b> to print incoming faxes so that the pages are stacked in the correct page order. (When the product is low on memory, this option may not be available.)
	Off	
Print Suspend Time	Off	Select <b>On</b> to set a time period to stop automatic printing of faxes or reports and save received faxes in the product's memory. (Make sure there is enough free memory before using this function.)
	On	
	Time to Stop	
	Time to Restart	
Quiet Mode	On	Select <b>On</b> to reduce noise during printing (printing speed may be reduced).
	Off	

Parent topic: [Selecting Advanced Fax Settings](#)

## Report Settings - Fax

Set the options you want for fax reports.

Setting	Options	Description
<b>Forwarding Report</b>	<b>Print on Error</b>	Prints a report after forwarding a received document only if an error occurs
	<b>Print</b>	Prints a report after forwarding a received document
	<b>Do Not Print</b>	Does not print a report after forwarding a received document
<b>Backup Error Report</b>	<b>On</b>	Select <b>On</b> to print a report when a backup error for sending faxes occurs
	<b>Off</b>	
<b>Fax Log Auto Print</b>	<b>Off</b>	Does not print a fax log
	<b>On(Every 100)</b>	Prints a fax log after every 100 fax jobs are completed
	<b>On(Time)</b>	Prints a fax log at a specified time. If the number of completed fax jobs exceeds 30, the fax log prints before the specified time.
<b>Reception Report</b>	<b>Print on Error</b>	Prints a report after receiving a fax only if an error occurs
	<b>Print</b>	Prints a report after receiving a fax
	<b>Do Not Print</b>	Does not print a report after receiving a fax
<b>Attach Fax Image to Report</b>	<b>Off</b>	Does not include an image on the Transmission Report
	<b>On(Large Image)</b>	Prints a Transmission Report that includes the upper part of the first page of the sent document
	<b>On(Small Image)</b>	Prints a Transmission Report that includes a reduced size of the entire first page of the sent document
<b>Fax Log Layout</b>	<b>Combine Send and Receive</b>	Prints a Transmission Report and a Reception Report on the same sheet when you print a fax log
	<b>Separate Send and Receive</b>	Prints a Transmission Report and a Reception Report on separate sheets when you print a fax log

Setting	Options	Description
Report Format	Simple	Prints a simple fax report
	Detail	Prints a fax report that includes error codes
Fax Log Output Method	Print	Prints fax reports
	Save to Memory Device	Saves fax reports to an inserted memory device. Select <b>Create a folder to save fax data</b> to create a folder on the inserted memory device.
	Forward	Forwards fax reports to a specified destination

Parent topic: [Selecting Advanced Fax Settings](#)

### Security Settings - Fax

Set the security options you want to use for fax data.



Setting	Options	Description
Direct Dialing Restrictions	Off	Does not restrict dialed fax numbers.
	On	Allows faxing only to numbers stored in the contacts list or history.
	Enter Twice	Requires you to enter fax numbers twice to prevent errors.
Broadcasting Restrictions	Off	Select <b>On</b> to allow only one fax number to be entered as the recipient
	On	
Confirm Address List	Off	Selects whether or not to display a recipient confirmation screen before a fax is sent.
	On	
Backup Data Auto Clear	Off	Automatically erases sent or received fax data from your product's memory.
	On	
Clear Backup Data	—	Deletes all sent or received fax data remaining in your product's memory; run this function if you are giving away or disposing of your product.

Parent topic: [Selecting Advanced Fax Settings](#)

## Setting Up the Fax Utility - Windows

You can set up the FAX Utility for Windows for use with your product.

**Note:** Before using the FAX Utility for Windows, make sure you have set up the fax features on your product using the product control panel. Also first confirm that you can send and receive faxes using the control panel.

1. Do one of the following:
  - **Windows 10:** Click  and select **EPSON Software**.
  - **Windows 8.x:** Navigate to the **Apps** screen.
  - **Windows (other versions):** Click  or **Start > Programs** or **All Programs > EPSON Software**.
2. Select **FAX Utility**.

The first time you use the FAX Utility, you see this introduction window:

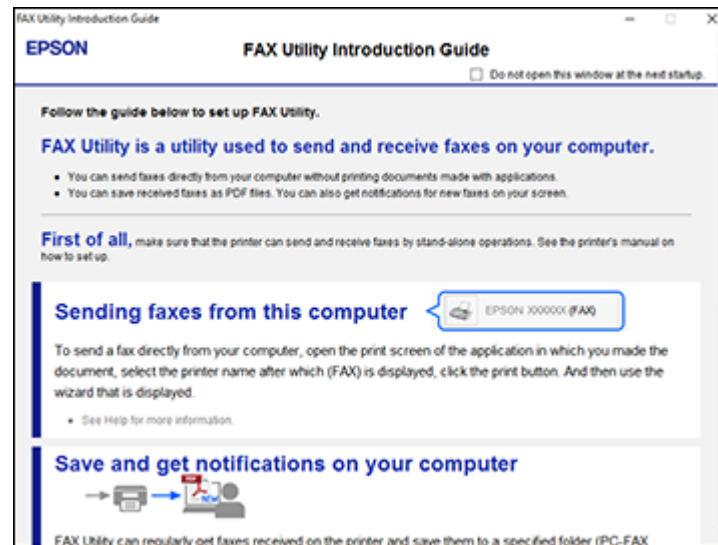

3. Read about the FAX Utility and click **Return to the main window** at the bottom of the window.



You see this window:

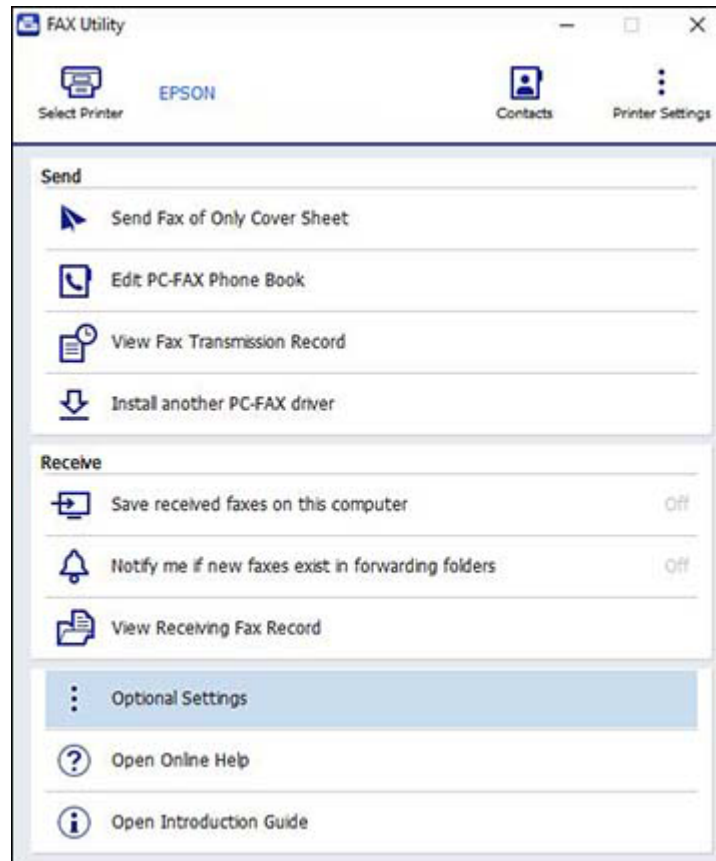

4. Click **Select Printer** and follow the on-screen instructions to transfer your product's fax settings to the FAX Utility.

**Note:** For detailed information, click **Help** or **Open Online Help**.

**Parent topic:** [Setting Up Fax Features](#)

## Setting Up Contacts and Contact Groups

You can set up a list of contacts and their fax numbers so you can quickly select them for faxing. You can also set up contact groups to send a fax message to multiple contacts.

**Note:** Contacts can be locked by an administrator. If you cannot access or change contacts, contact your administrator for assistance.

[Creating a Contact](#)

[Editing or Deleting a Contact](#)

[Creating a Contact Group](#)

[Editing or Deleting a Contact Group](#)

**Parent topic:** [Faxing](#)

### Creating a Contact

You can create a list of contacts to save frequently used fax numbers.

**Note:** You can create up to 2,000 contacts and contact groups combined.

1. Press the  home button, if necessary.
2. Select **Fax**.

You see a screen like this:

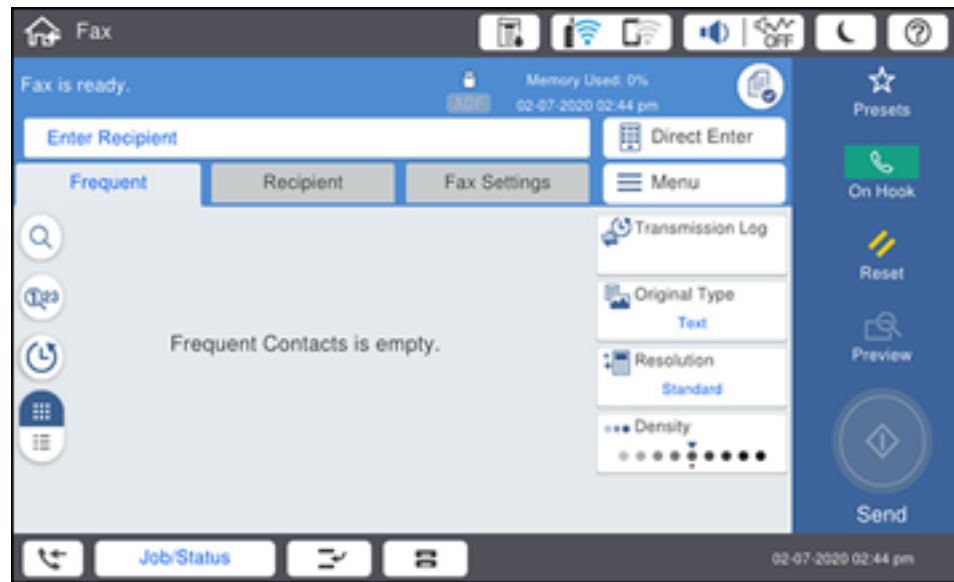

3. Select the **Recipient** tab. Enter the administrator password, if necessary.

You see a screen like this:



4. Select the  icon.
5. Select **Add Contact**.

You see a screen like this:

The screenshot shows a mobile application interface for adding a contact. At the top, there is a 'Settings' header with a gear icon and a status bar with various system icons. Below the header, a blue banner contains the text: 'You can Register a contact. Enter information for the contact.' Below the banner are three buttons: 'Cancel' (orange), 'Add New' (white), and 'OK' (blue). The main form area has three input fields: 'Registry Number' with the value '0004', 'Name' with the placeholder 'Enter Name', and 'Index Word' which is currently empty. At the bottom of the screen, there is a navigation bar with icons for 'Job/Status', a list icon, and a home icon, along with a timestamp '02-07-2020 02:52 pm'.

6. Select the registry number you want to use for the contact you are adding.
7. Select the **Name** field, use the displayed keyboard to enter the contact name (up to 30 characters), and select **OK**.
8. Select the **Index Word** field, use the displayed keyboard to enter a word to use when searching for an entry (up to 30 characters), and select **OK**.

**Note:** This field is automatically populated after you enter the name. This field is optional.

9. Select the **Fax Number** field, and use the numeric keypad on the LCD screen or the buttons on the product to enter the fax number. You can enter up to 64 characters. Select **OK** when you are done.

**Note:** If necessary, enter an outside line access code (such as **9**) at the beginning of the fax number. If the access code has been set up in the **Line Type** setting, enter the **#** pound sign instead of the code.

10. Set the **Fax Communication Mode**, **Subaddress**, and **Password** settings, if necessary.
11. Set **Assign to Frequent Use** to **On** if you want the contact to appear on the **Frequent** tab.

12. Select **OK**.

**Parent topic:** [Setting Up Contacts and Contact Groups](#)

**Related tasks**

[Entering Characters on the LCD Screen](#)

## Editing or Deleting a Contact

You can edit or delete any of the contacts on your list.

1. Press the  home button, if necessary.
2. Select **Fax**.

You see a screen like this:

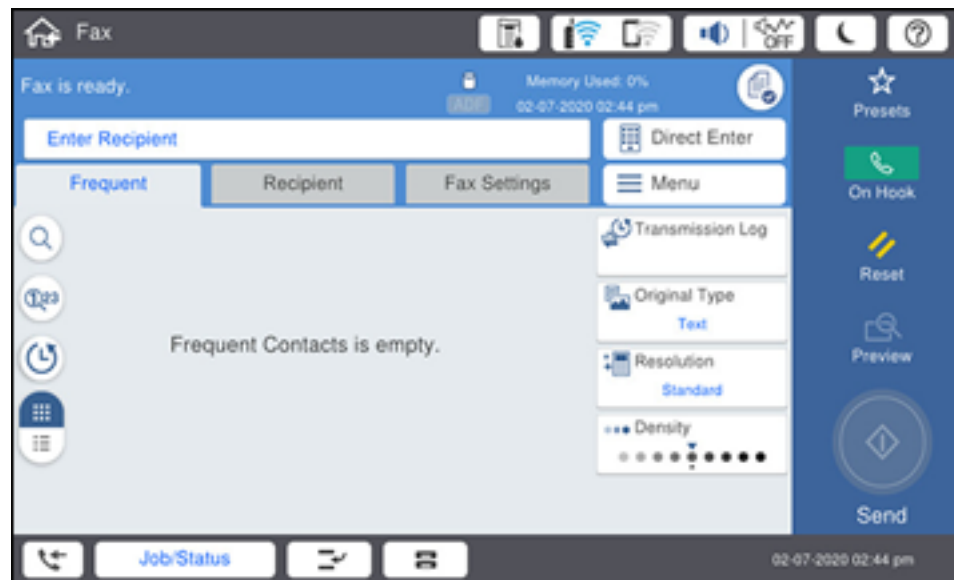

3. Select the **Recipient** tab. Enter the administrator password, if necessary.

4. Select the  icon next to the contact you want to edit or delete.

You see a screen like this:

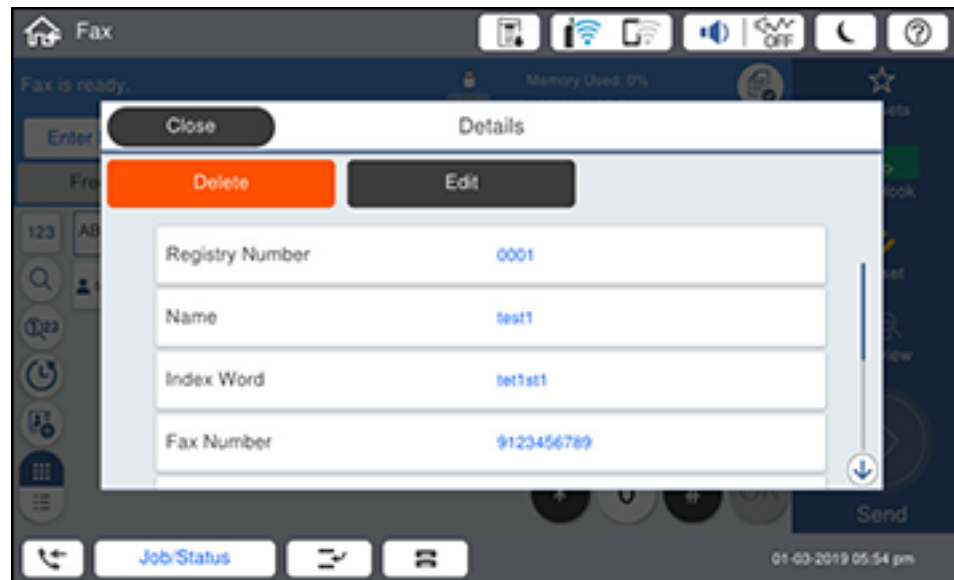

5. Do one of the following:
  - To delete the contact, select **Delete** and select **Yes** on the confirmation screen.
  - To edit the contact, select **Edit**, select the item you want to change, enter the correct information, and select **OK**. When you are finished editing, select **OK**.

**Parent topic:** [Setting Up Contacts and Contact Groups](#)

## Creating a Contact Group

You can create a group of contacts so that you can easily send faxes to multiple recipients.

**Note:** You can create up to 2,000 contacts and contact groups combined.

1. Press the  home button, if necessary.
2. Select **Fax**.

You see a screen like this:

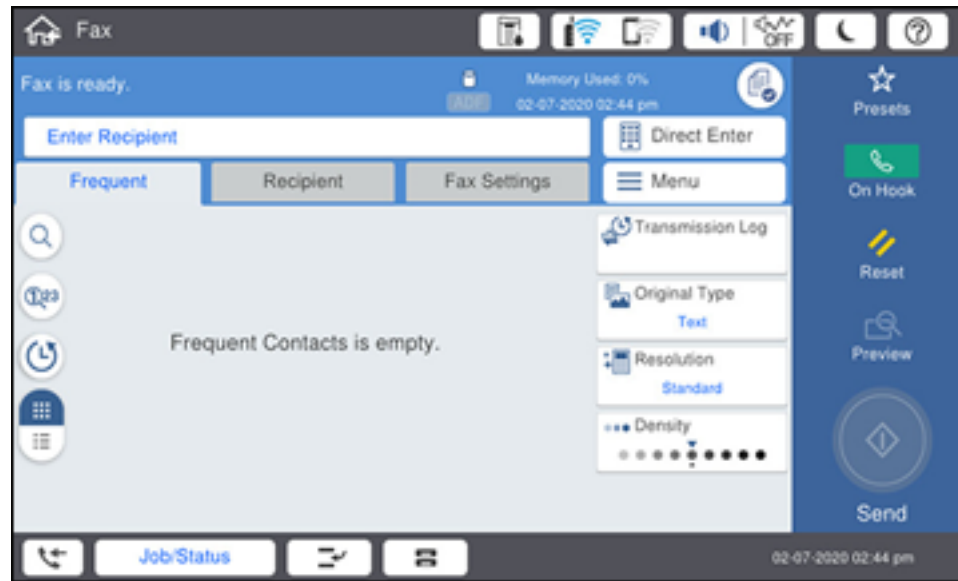

3. Select the **Recipient** tab. Enter the administrator password, if necessary.
4. Select the  icon.
5. Select **Add Group**.



You see a screen like this:

The screenshot shows a mobile application interface for adding a group. The title bar at the top says "Settings" and includes various system icons. Below the title bar, a blue banner contains the text "You can Register a contact. Enter information for the contact." Below the banner, there are three buttons: "Cancel" (orange), "Add Group" (white), and "OK" (blue). The main content area has three input fields: "Registry Number" with the value "0005", "Group Name (Required)" with the placeholder "Enter Group Name", and "Index Word" which is currently empty. At the bottom of the screen, there is a navigation bar with a "Job Status" button and a date/time stamp "02-07-2020 03:07 pm".

6. Select the registry number you want to use for the group you are adding.
7. Select the **Group Name** field, use the displayed keyboard to enter the group name (up to 30 characters), and select **OK**.
8. Select the **Index Word** field, use the displayed keyboard to enter a word to use when searching for a group (up to 30 characters), and select **OK**.

**Note:** This field is automatically populated after you enter the group name. This field is optional.

9. Select **Contact(s) Added to the Group**.  
You see your contacts list.
10. Select each contact you want to include in your group.  
Each selected contact is highlighted.
11. Select **Close**.
12. Set **Assign to Frequent Use** to **On** if you want the group to appear on the **Frequent** tab.
13. Select **OK**.

**Parent topic:** [Setting Up Contacts and Contact Groups](#)

**Related tasks**

[Entering Characters on the LCD Screen](#)

## Editing or Deleting a Contact Group

You can edit an existing contact group to add or delete entries. You can also delete the entire contact group.

1. Press the  home button, if necessary.
2. Select **Fax**.

You see a screen like this:

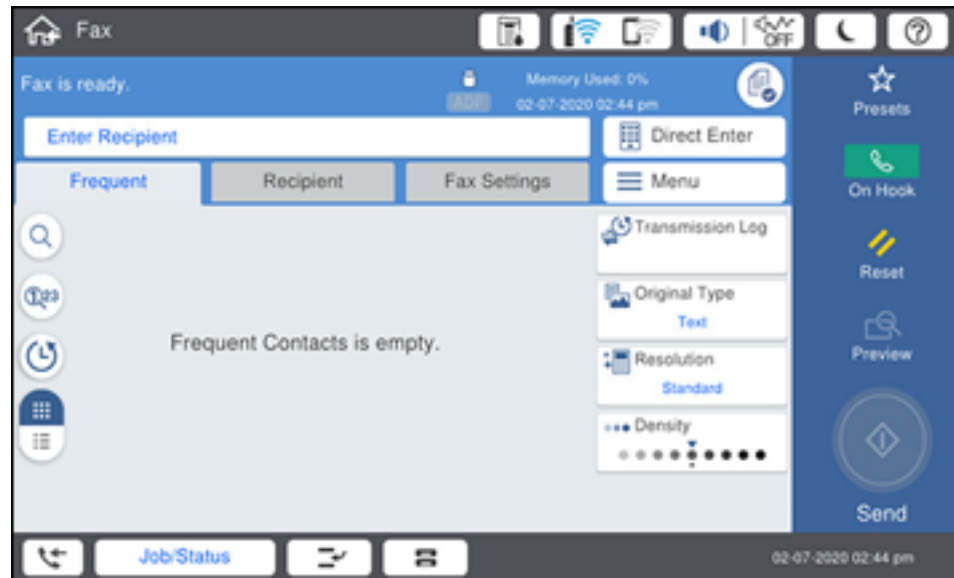

3. Select the **Recipient** tab. Enter the administrator password, if necessary.
4. Select the  icon next to the group you want to edit or delete.

You see a screen like this:

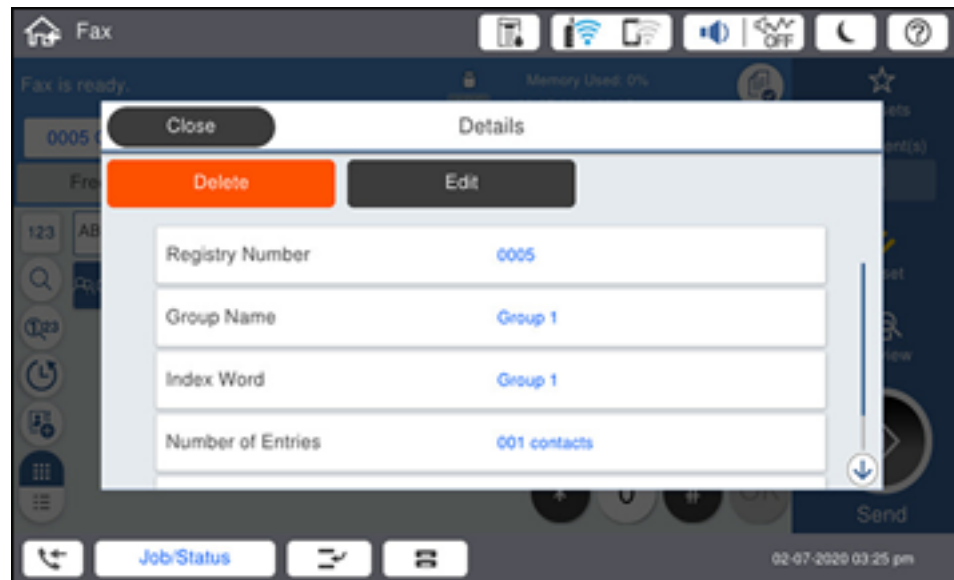

**Note:** If you want to delete the entire group, select **Delete**.

5. To edit the group, select **Edit**.
6. Select **Contact(s) Added to the Group**.  
You see a list of the contacts in your group.
7. Select the contact you want to add or delete.  
Each selected contact is highlighted.
8. Select **Close**.
9. Select **OK**.

**Parent topic:** [Setting Up Contacts and Contact Groups](#)

## Sending Faxes

See these sections to send faxes using your product.

[Sending Faxes from the Product Control Panel](#)

[Sending Faxes Using the Fax Utility - Windows](#)

[Sending Faxes Using the Fax Utility - Mac](#)

**Parent topic:** [Faxing](#)

## **Sending Faxes from the Product Control Panel**

See these sections to send faxes using the product's control panel.

[Sending a Fax Using the Keypad, Contact List, or History](#)

[Fax Sending Options](#)

[Sending a Fax at a Specified Time](#)

[Sending a Fax on Demand](#)

[Sending a Stored Fax](#)

[Dialing Fax Numbers from a Connected Telephone](#)

**Parent topic:** [Sending Faxes](#)

### **Sending a Fax Using the Keypad, Contact List, or History**

You can send a fax from your product control panel by entering the fax number, or selecting the number from either the contact list or fax history.

**Note:** You can send a black-and-white fax to up to 200 recipients at a time, or send a color fax to one recipient at a time. If your recipient's fax machine does not print in color, your fax is automatically sent in black-and-white.

**Note:** The product can queue up to 50 black-and-white fax jobs. You can check or cancel fax jobs in the queue from the Job/Status screen.

1. Place your original on the product for faxing.
2. Press the  home button, if necessary.
3. Select **Fax**.

You see a screen like this:

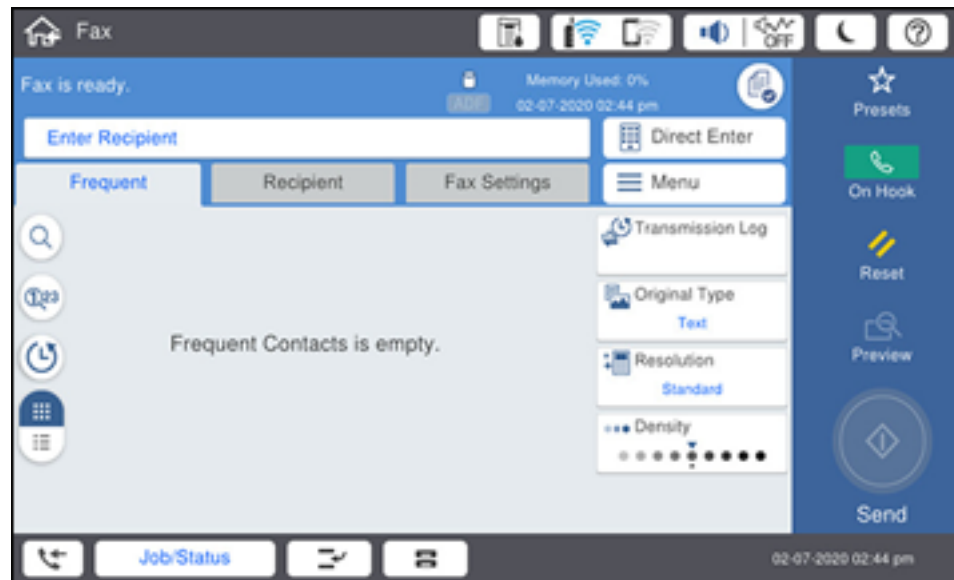



**Note:** To fax a double-sided document, place your document in the ADF and turn on the **ADF 2-Sided** setting. (You cannot fax double-sided documents in color.)

4. Do one of the following to select fax recipients:

- Select **Direct Enter** and enter a fax number. Select **OK** when done. To add another fax number, repeat the same steps.

**Note:** If direct dialing has been restricted, you can only select the number from the contact list or fax history. If necessary, enter an outside line access code (such as 9) at the beginning of the fax number. If the access code has been set up in the **Line Type** setting, enter the # pound sign instead of the code. If your fax number requires a brief pause, select the  icon to insert a pause symbol (–).

- Select **Recipient** to display the contact list. Select one or more contacts (select the contact again to deselect it). You can also select the  icon to search for recipients by name or index word. Select **Close** when you are finished.

- Select the  icon to display the sent fax history.

**Note:** To delete entered recipients, select the **Enter Recipient** field, select the recipient you want to delete, and select **Remove**.

5. If you need to change any fax settings, select **Fax Settings** and select your settings.
6. If you want to preview your fax in black-and-white on the LCD, press the  **Preview** icon. (If the preview looks incorrect, select **Cancel**, reposition the document or change the fax settings, and repeat this step.)

**Note:** If **Fax Preview Display Time** is enabled and you do not touch the preview screen for 20 seconds, your product sends the fax automatically. You cannot preview images when the Direct Send setting is turned on.

7. If you want to save your fax settings for later use, select **Presets** and add a new entry.
8. Select the **Send** icon.

**Note:** To cancel faxing, select **Stop** or **Cancel**, then select **Cancel Fax to Send**. You can also cancel the job or check the job status from the Job/Status screen.

Your product scans your original and prompts you to place additional pages, if necessary. After scanning your originals, your product dials the number and sends the fax.

**Note:** Your product does not save sent color faxes to its memory. If the **Save Failure Data** option is enabled, faxes that failed to be sent are stored to the product's memory and you can resend them from the Job/Status screen.

**Parent topic:** [Sending Faxes from the Product Control Panel](#)

#### **Related references**

[Fax Sending Options](#)

#### **Related tasks**

[Using Presets](#)

[Selecting the Line Type](#)

[Checking Fax Status](#)

## Related topics

[Placing Originals on the Product](#)

[Setting Up Contacts and Contact Groups](#)

## Fax Sending Options

While sending a fax, you can select **Fax Settings** and select these options.

Setting	Options	Description
<b>Original Size (Glass)</b>	Various sizes	Sets the size for a document placed on the scanner glass
<b>Original Type</b>	<b>Text</b>	Specifies the document type of your originals and adjusts the quality of your copies
	<b>Text &amp; Image</b>	
	<b>Photo</b>	
<b>Color Mode</b>	<b>Color</b>	Selects whether to scan images in color or black and white
	<b>B&amp;W</b>	
<b>Resolution</b>	<b>Standard</b>	Adjusts the scan resolution and print quality of outgoing faxes
	<b>Fine</b>	
	<b>Super Fine</b>	
	<b>Ultra Fine</b>	
<b>Density</b>	Varying levels	Select from various density levels.
<b>Remove Background</b>	<b>Auto</b>	Automatically removes any background color on scanned images
	Varying levels available	Lets you select from various levels of background color adjustment
<b>Sharpness</b>	Varying levels available	Adjusts the sharpness level of outgoing faxes
<b>ADF 2-Sided</b>	<b>Off</b>	Select <b>On</b> to enable 2-sided faxing from the ADF. The <b>Direct Send</b> setting and color faxing are disabled when you turn on this setting.
	<b>On</b>	
<b>ADF Continuous Scan</b>	<b>Off</b>	Select <b>On</b> to have the product to ask if you want to scan another page after a document in the ADF has finished scanning
	<b>On</b>	

Setting	Options	Description
<b>Direct Send</b>	<b>Off</b>	Select <b>On</b> to send black-and-white faxes to a single recipient as soon as the connection is made, without saving the scanned image to memory. You cannot use this setting when sending a color fax or sending a fax to multiple recipients.
	<b>On</b>	
<b>Priority Send</b>	<b>Off</b>	Select <b>On</b> to send the current fax before other faxes waiting to be sent
	<b>On</b>	
<b>Send Fax Later</b>	<b>Off</b>	Select <b>On</b> to send the current fax at a selected time
	<b>On</b>	
<b>Add Sender Information</b>	<b>Off</b>	Includes a header, your phone number, or a destination list in the selected location on your outgoing faxes
	<b>Outside of Image</b>	
	<b>Inside of Image</b>	
<b>Notify Send Result</b>	<b>Off</b>	Sends a notification to the selected email address when an outgoing fax is sent
	<b>On</b>	
<b>Transmission Report</b>	<b>Print on Error</b>	Selects when or if to print transmission reports
	<b>Print</b>	
	<b>Do Not Print</b>	
<b>Backup</b>	<b>Off</b>	Saves a copy of the scanned fax to the selected email address or network folder/FTP location
	<b>On</b>	

Parent topic: [Sending Faxes from the Product Control Panel](#)

### Sending a Fax at a Specified Time

You can send a fax at a time of your choice.

**Note:** Make sure the product's date and time settings are correct. You can only send faxes in black-and-white when you use this option.

1. Place your original on the product for faxing.
2. Press the  home button, if necessary.
3. Select **Fax**.



You see a screen like this:

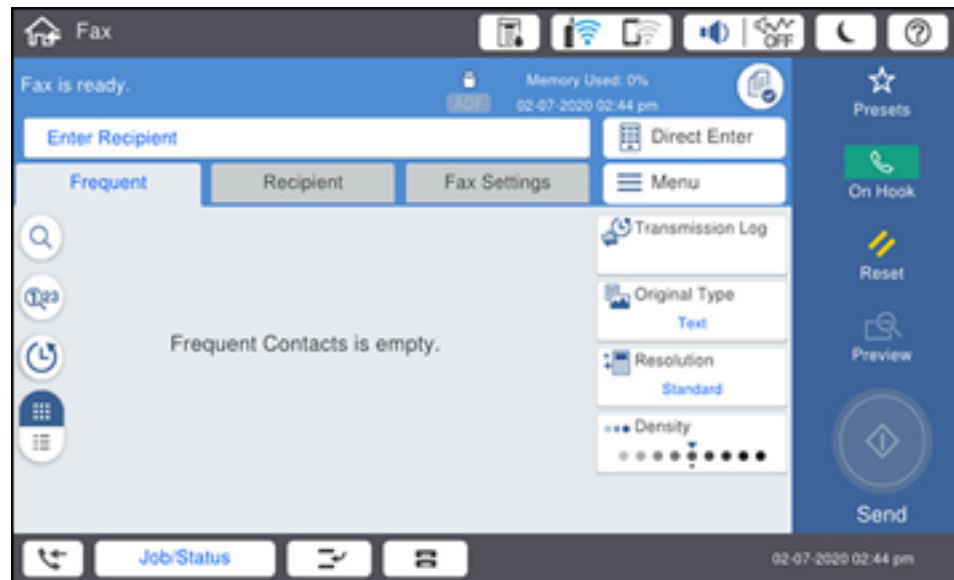

4. Enter a fax number or select a number from the **Frequent**, **Recipient** or **Recent** lists.
5. Select **Fax Settings**.
6. Select **Send Fax Later**.
7. Select **On**.
8. Select **Time**, use the displayed keypad on the LCD screen to enter your desired time, and select **OK**.
9. Select the **Send** icon.

**Note:** To cancel faxing, select **Stop** or **Cancel**, then select **Cancel Fax to Send**.

After scanning your originals, your product dials the number and sends the fax at the specified time.

**Note:** If the product is turned off at the specified time, the fax is sent when it is powered on.

**Parent topic:** [Sending Faxes from the Product Control Panel](#)

### Related references

[Fax Sending Options](#)

### Related tasks

[Selecting the Date and Time](#)

[Checking Fax Status](#)

### Related topics

[Placing Originals on the Product](#)

[Setting Up Contacts and Contact Groups](#)

## Sending a Fax on Demand

You can store one scanned document (up to 100 black-and-white pages) and have it sent automatically when another fax machine requests it. Other fax users can receive the document by calling your fax number and using the polling receive function on their fax machines.

1. Place your original on the product for faxing.
2. Press the  home button, if necessary.
3. Select **Fax Box**.

You see a screen like this:



4. Select **Polling Send/Board**.
5. Select **Polling Send**.
6. Review the displayed Polling Send Box settings. If you need to make changes, select **Settings**. Make any necessary changes and select **OK**.
7. Select **Add Document**.
8. Review the displayed Fax Settings. Make any necessary changes.
9. Select the **Store** icon.

Your document is scanned and stored until you overwrite or delete it.

You can store only one document at a time. Subsequent documents overwrite the existing document. You can also delete a stored document from the Job/Status screen.

**Parent topic:** [Sending Faxes from the Product Control Panel](#)

**Related references**

[Fax Sending Options](#)

**Related tasks**

[Checking Fax Status](#)

**Related topics**

[Placing Originals on the Product](#)

### **Sending a Stored Fax**

You can store one black-and-white scanned document (up to 100 pages) and send it whenever necessary.

1. Place your original on the product for faxing.
2. Press the  home button, if necessary.
3. Select **Fax**.

You see a screen that looks like this:

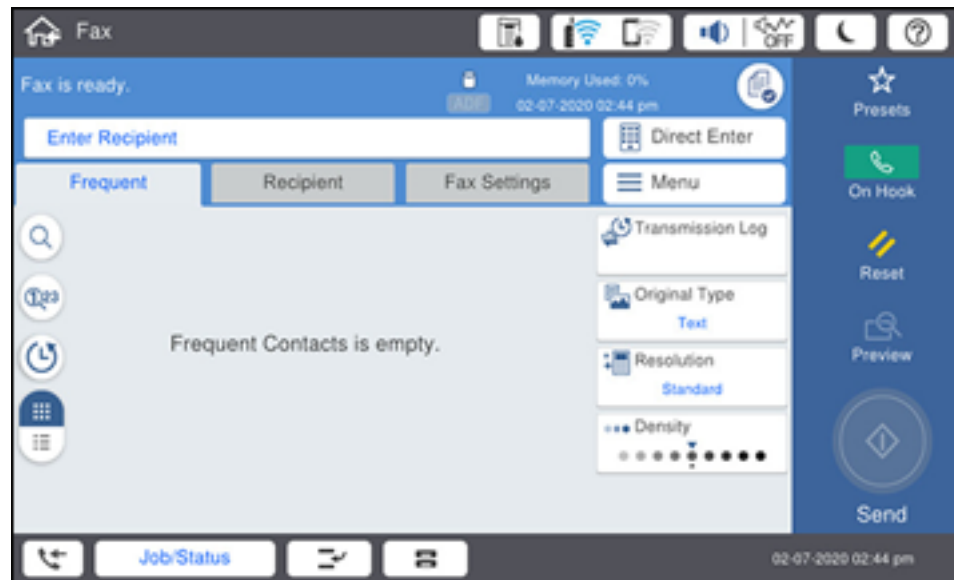

4. Select **Menu**.
5. Set **Store Fax Data** to **On**.
6. Select **Close**.
7. Select any other fax settings as necessary and select **Close**.
8. Select the **Store** icon.  
Your document is scanned, stored, and briefly previewed.
9. When you are ready to send the document, press the  home button, if necessary, and select **Fax Box**.
10. Select **Stored Documents**.
11. Select the stored fax job you want to send.
12. Select the **Send** icon.

You can store only one document at a time. Subsequent documents overwrite the existing document.

**Parent topic:** [Sending Faxes from the Product Control Panel](#)

## Dialing Fax Numbers from a Connected Telephone

If you have connected a telephone to the **EXT** port on your product, you can send a fax by dialing the fax number from the connected telephone. If the recipient's phone number and fax number are the same, you can speak to the recipient before sending the fax.

1. Place your original on the product for faxing.
2. Press the  home button, if necessary.
3. Dial the fax number from the connected telephone. Speak to the recipient if necessary.

**Note:** If you are using a pre-paid calling card, enter the number and password required to use the card before entering the destination fax number.

4. Select **Fax** on the LCD screen.
5. Select **Fax Settings** and select any settings as necessary.

**Note:** Your product now communicates with the recipient's fax machine. Do not hang up the telephone.

6. When you hear a fax tone, select the **Send** icon to start sending the fax.

**Note:** If your recipient's fax machine does not print in color, your fax is automatically sent in black-and-white.

7. Hang up the telephone.

**Parent topic:** [Sending Faxes from the Product Control Panel](#)

### Related references

[Fax Sending Options](#)

### Related topics

[Placing Originals on the Product](#)

## Sending Faxes Using the Fax Utility - Windows

You can send a fax from a printing program in Windows. You can fax up to 100 pages at a time, including a cover sheet.

1. Open the file you want to fax and select the print command.

You see a window like this:

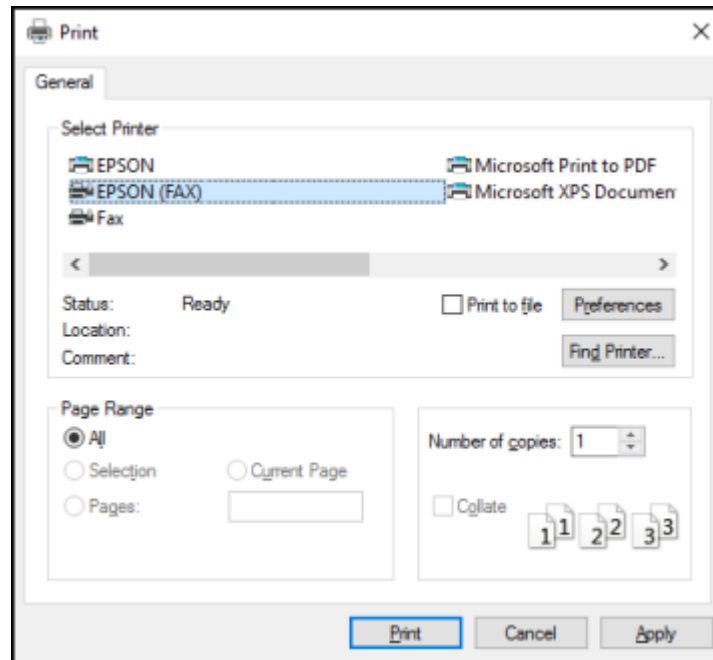

2. Select your product with the **FAX** option as the printer.
3. To change the Paper Size, Orientation, Color, Image Quality, or Character Density settings, click the **Preferences** or **Properties** button.

**Note:** If you see a **Setup**, **Printer**, or **Options** button, click it. Then click **Preferences** or **Properties** on the next screen. For more information about selecting fax print settings, click **Help**.

4. Select the Page Range as necessary. (Leave the Number of copies set to 1.)
5. Click **Print** or **OK**.

If you're faxing for the first time, you see a window like this one:

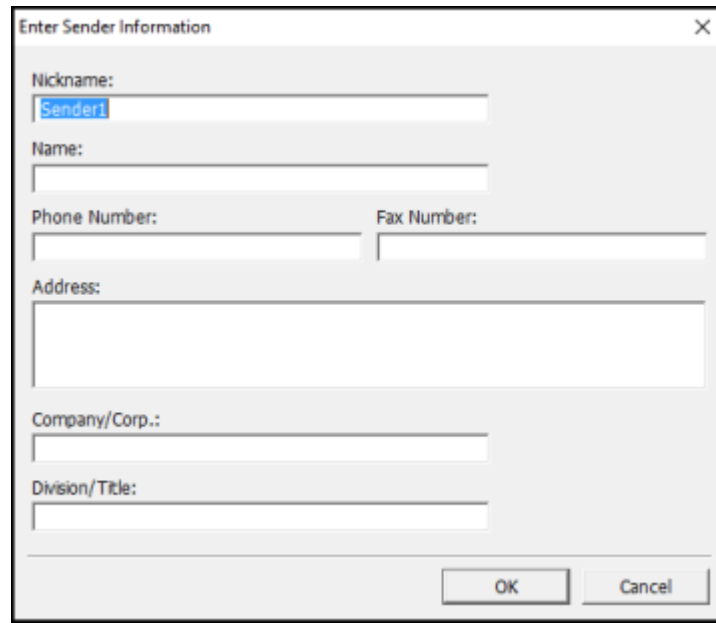

The image shows a dialog box titled "Enter Sender Information" with a close button (X) in the top right corner. The dialog contains several input fields: "Nickname:" with the text "Sender1" entered; "Name:" which is empty; "Phone Number:" and "Fax Number:" which are empty; "Address:" which is a large empty text area; "Company/Corp.:" which is empty; and "Division/Title:" which is empty. At the bottom right, there are two buttons: "OK" and "Cancel".

6. Enter your sender information so that recipients can identify the origin of the fax. Then click **OK** to save the sender information.

You see a window like this:

Recipient Settings (1 / 3)

Recipient List: Recipient Total: 0

Name/Group Name	Fax Number	Company/Corp.	Division/Title
-----------------	------------	---------------	----------------

Add Delete

Phone Book Manual Dial

Name:  Fax Number:

Title:  Because "-" acts as a pause, do not use it to punctuate phone numbers.

Company/Corp.:  Division/Title:

Save to Phone Book... Clear

< Back Next > Cancel Help

7. Enter the recipient's name and fax number or select a recipient from the phonebook, then click **Next**.

**Note:** For detailed instructions on using the Epson FAX Utility, click **Help**.

8. Select a cover sheet and enter a subject and message, then click **Next**.
9. Click **Send** to transmit your fax.

**Parent topic:** [Sending Faxes](#)

## Sending Faxes Using the Fax Utility - Mac

You can send a fax from a Mac printing program using the FAX Utility. You can fax up to 100 pages at a time, including a cover sheet.

1. Open the file you want to fax.



2. Select the print command in your application.

**Note:** You may need to select a print icon on your screen, the **Print** option in the **File** menu, or another command. See your application's help utility for details.

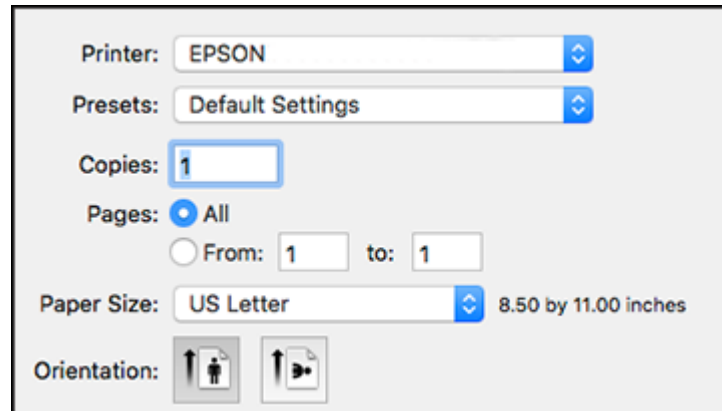

The image shows a print settings dialog box with the following controls:

- Printer:** A dropdown menu set to "EPSON".
- Presets:** A dropdown menu set to "Default Settings".
- Copies:** A text input field containing the number "1".
- Pages:** A radio button labeled "All" is selected. Below it, an unselected radio button is followed by "From: 1" and "to: 1" in separate input fields.
- Paper Size:** A dropdown menu set to "US Letter" with the dimensions "8.50 by 11.00 inches" displayed to the right.
- Orientation:** Two icons: the first shows a vertical page with an upward arrow, and the second shows a horizontal page with a rightward arrow.

3. Select your product **FAX** option as the **Printer** setting.
4. If necessary, click the arrow next to the Printer setting or the **Show Details** button to expand the print window.
5. Select the number of pages you are faxing as the **Pages** setting.

**Note:** Leave the **Copies** setting set to **1**.

6. Select **Recipient Settings** from the pop-up menu.

You see this window:

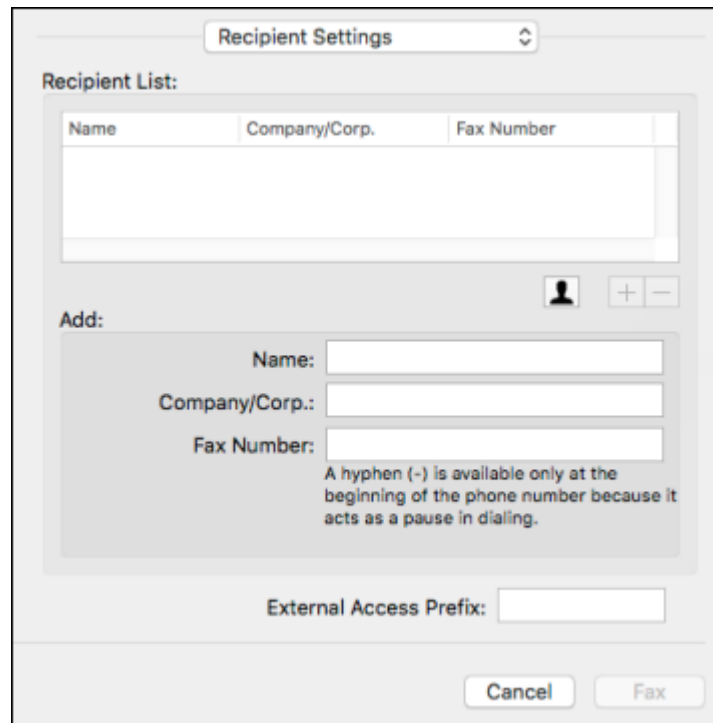

The image shows a 'Recipient Settings' dialog box. At the top, there is a dropdown menu labeled 'Recipient Settings'. Below it is a section titled 'Recipient List' containing a table with three columns: 'Name', 'Company/Corp.', and 'Fax Number'. The table is currently empty. To the right of the table are a person icon, a '+' button, and a '-' button. Below the table is an 'Add:' section with three input fields: 'Name:', 'Company/Corp.:', and 'Fax Number:'. Below the 'Fax Number:' field is a note: 'A hyphen (-) is available only at the beginning of the phone number because it acts as a pause in dialing.' At the bottom of the dialog is an 'External Access Prefix:' input field. At the very bottom are two buttons: 'Cancel' and 'Fax'.

7. Do one of the following to choose your recipient:
  - Select a name or group from the **Recipient List**.
  - Enter a name, company, and fax number and click the **+** button.
  - Click the  icon and select a recipient from your address book.
8. Select **Fax Settings** from the pop-up menu.

You see this window:

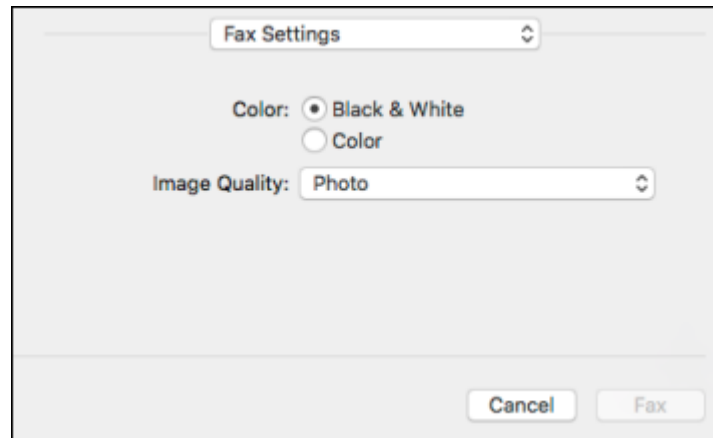

9. Select the **Color** and **Image Quality** settings you want to use for your fax.
10. Click **Fax**.

**Parent topic:** [Sending Faxes](#)

## Receiving Faxes

See these sections to receive faxes with your product.

[Fax Reception](#)

[Receiving Faxes Automatically](#)

[Receiving Faxes Manually](#)

[Forwarding Received Faxes](#)

[Receiving a Fax by Polling](#)

[Viewing a Fax on the LCD Screen \(Using the Fax Box\)](#)

**Parent topic:** [Faxing](#)

## Fax Reception

Your product will automatically receive and print faxes when you set the Receive Mode to **Auto**.

If you connected a telephone to your product so you can use the same phone line for faxes and voice calls, you can also set your product to receive faxes manually. This allows you to check for a fax tone using the telephone and press a button on your product to receive the fax.

Make sure to load paper in your product and select your fax settings before receiving a fax.

**Note:** If you run out of paper during fax printing, load more paper and press the button indicated on your product's LCD screen to continue.

**Parent topic:** [Receiving Faxes](#)

## Receiving Faxes Automatically

To receive faxes automatically, make sure Receive Mode is set to **Auto** (the default setting for the product).

To change the Receive Mode if necessary, select **Settings > General Settings > Fax Settings > Basic Settings > Receive Mode**.

If an answering machine is connected, make sure the product's **Rings to Answer** setting is set higher than the number of rings your answering machine is set to answer a call. For example, if the answering machine is set to pick up on the fourth ring, set the product to pick up on the fifth ring or later.

**Parent topic:** [Receiving Faxes](#)

### Related references

[Basic Settings - Fax](#)

### Related tasks

[Receiving Faxes Manually](#)

## Receiving Faxes Manually

You can set up your product to receive faxes manually by setting the Receive Mode to **Manual**. This lets you check for a fax tone on the connected telephone before receiving a fax.

1. To change the Receive Mode, select **Settings > General Settings > Fax Settings > Basic Settings > Receive Mode** and select **Manual**.
2. When the connected telephone rings, answer the call.
3. If you hear a fax tone, select **Fax** on the LCD display.
4. Select **Send/Receive**.
5. Select **Receive**.

6. Select the **Receive** icon to start receiving the fax.
7. Hang up the telephone.

**Parent topic:** [Receiving Faxes](#)

**Related references**

[Basic Settings - Fax](#)

**Related tasks**

[Receiving Faxes Automatically](#)

## Forwarding Received Faxes

You can forward received faxes to another fax machine, or convert the faxes into PDF documents and forward them to a shared folder on the network or to an email address. Forwarded faxes are deleted from the product's memory. Before using this feature, make sure the date and time are set correctly, the forwarding destination is set up in the contact list, and the email server settings are configured.

1. Press the  home button, if necessary.
2. Select **Settings** > **General Settings** > **Fax Settings** > **Receive Settings** > **Save/Forward Settings** > **Unconditional Save/Foward** > **Forward** > **Yes**.

You see a screen like this:

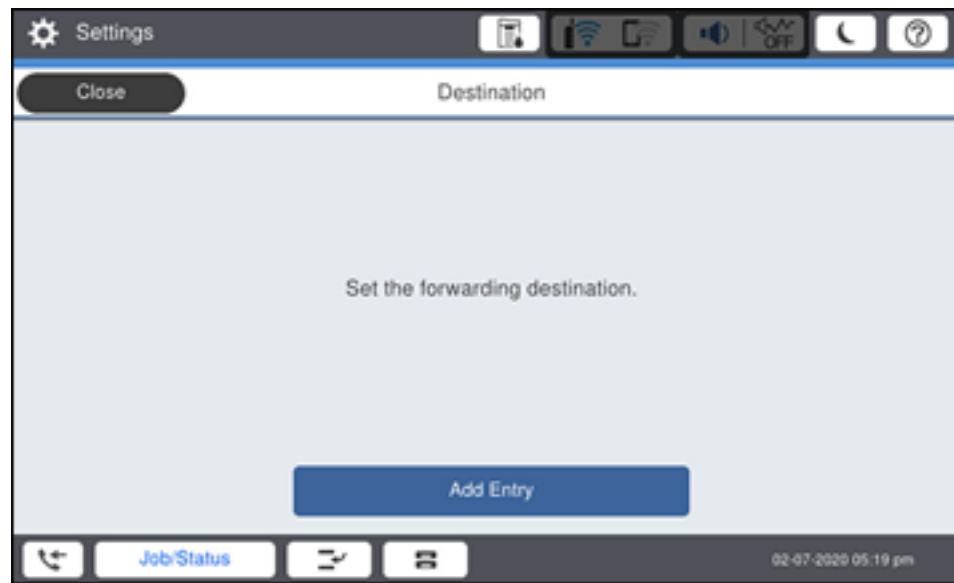

**Note:** If you want to print the fax automatically before forwarding it, select **Yes and Print**.

3. Select **Add Entry** and select the forwarding destinations from the contacts list.
4. When you are finished selecting your forwarding destinations, select **Close**.
5. Confirm the displayed forwarding destinations and select **Close**.
6. Select an **Options When Forwarding Failed** option to choose whether you want to print the faxes or save them in the printer's inbox if forwarding received faxes fails.

Parent topic: [Receiving Faxes](#)

## Receiving a Fax by Polling

You can use polling to receive a fax from another fax machine (such as a fax information service).

**Note:** You cannot use polling to receive a fax from a fax information service that uses audio guidance.

1. Press the  home button, if necessary.
2. Select **Fax**.

You see a screen like this:

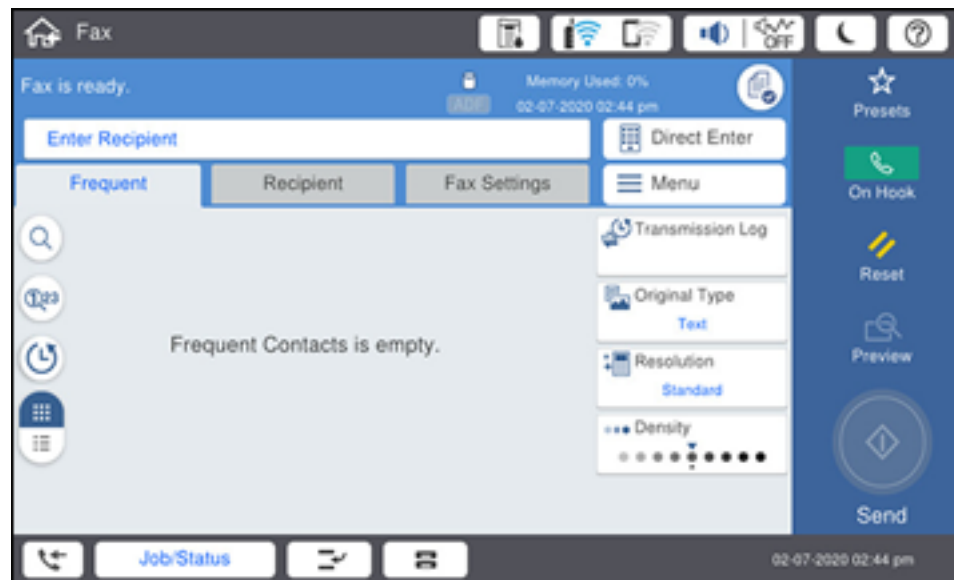

3. Select **Menu**.
4. Select **Extended Fax**.
5. Set **Polling Receive** to **On**.
6. Select **Close**.
7. Enter the fax number you expect to receive the fax from.
8. Select the **Polling** icon to start receiving the fax.

**Parent topic:** [Receiving Faxes](#)

## Viewing a Fax on the LCD Screen (Using the Fax Box)

You can save received faxes in your product's memory and view them on the LCD screen.

**Note:** The Inbox can be locked by an administrator. If you cannot access the Inbox, contact your administrator for assistance.

1. Press the  home button, if necessary.
2. Select **Settings > General Settings > Fax Settings > Receive Settings > Save/Forward Settings > Unconditional Save/Forward**.

You see a screen like this:

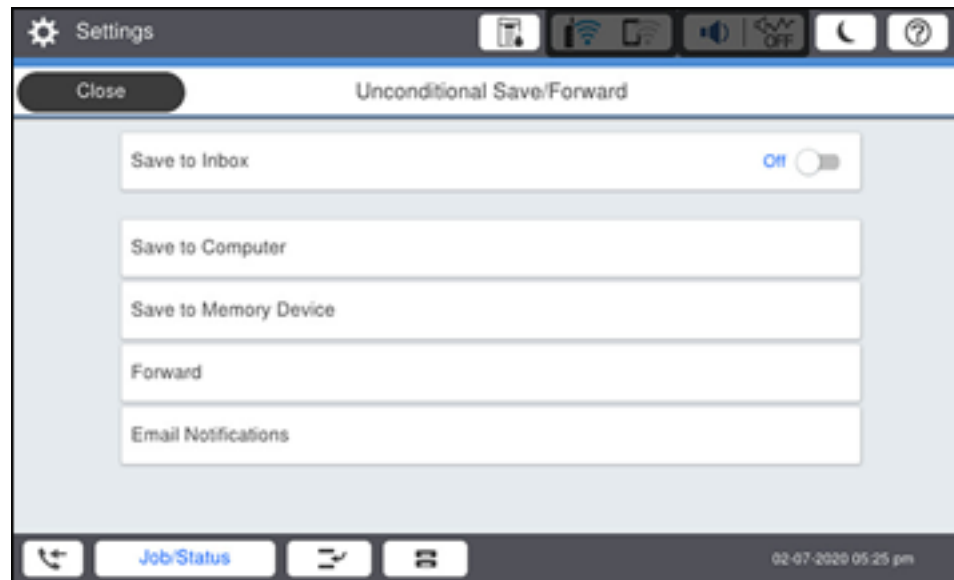

3. Set **Save to Inbox** to **On**.
4. Press the  home button.
5. Select **Fax Box**.
6. Do one of the following:
  - Select **Inbox/Confidential** to view received documents.
  - Select **Stored Documents** to view saved documents that have not been sent when **Store Fax Data** is set to **On**.
  - Select **Polling Send/Board** to view documents that are stored for fax polling.
7. Select the fax you want to view.  
You see the fax displayed on the screen.
8. Select **Menu**.
9. Select one of the printing or deleting options, and follow the on-screen instructions.



**Note:** Delete faxes after you print or view them to prevent the product's memory from filling up. When the memory is full, you can only forward or print incoming faxes.

Parent topic: [Receiving Faxes](#)

## Checking Fax Status

You can check the status of current fax jobs, or faxes that have been received or sent on the product control panel.

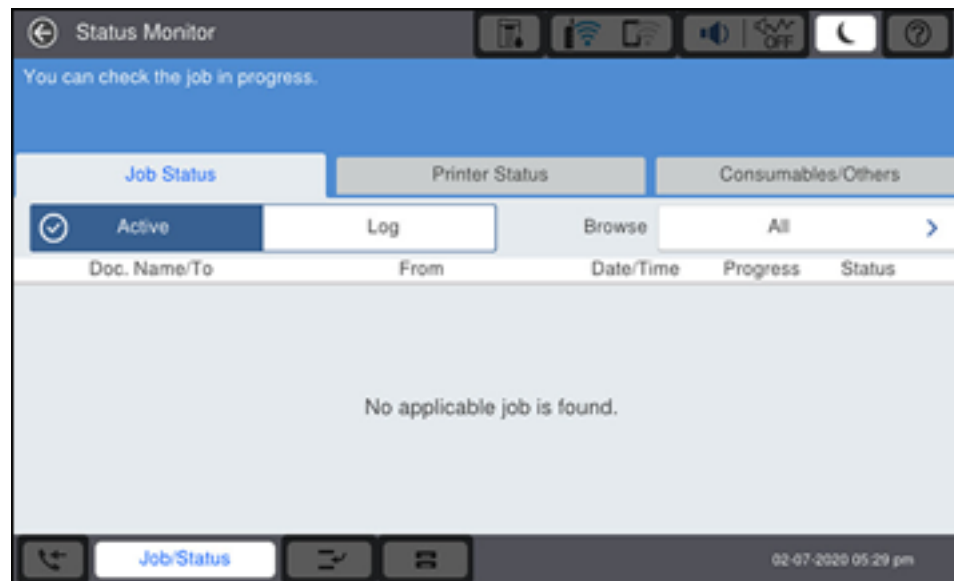

1. Select **Job/Status**. Select the **Job/Status** tab if necessary.

You see a screen like this:



2. Do one of the following:
  - To check the status of current fax jobs, select the fax job you want to check.

- To check the history of faxes that have been sent, received, or saved, select **Log** and select the job you want to check.

**Note:** If you see a numbered icon above the  icon on your product's LCD screen or the  fax reception light is flashing, received faxes have been temporarily saved to the product's memory.

Parent topic: [Faxing](#)

## Printing Fax Reports

You can print several types of fax reports whenever necessary. You can also print the fax log printed automatically by turning on **Fax Log Auto Print**.

1. Press the  home button, if necessary.
2. Select **Fax**.

You see a screen like this:

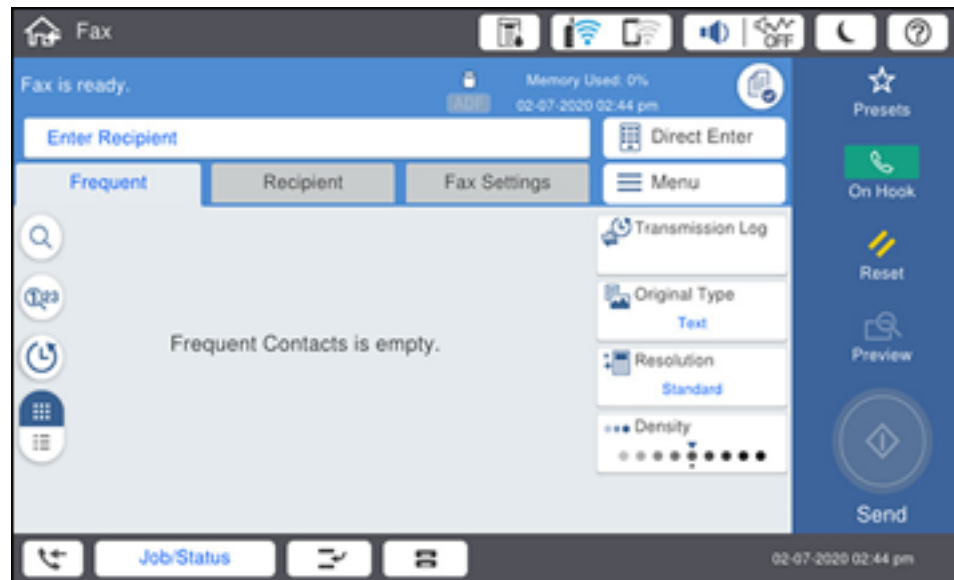

3. Select **Menu**.
4. Under **Fax Report**, select the fax report you want to print.

[Fax Report Options](#)

**Parent topic:** [Faxing](#)

**Related references**

[Report Settings - Fax](#)

## **Fax Report Options**

Select the fax report or list you want to print.

### **Last Transmission**

Print a report on the previous fax that was sent or received through polling.

### **Fax Log**

View or print a report on recent fax transmissions.

### **Stored Fax Documents**

Print a list of the fax jobs currently stored in the product's memory.

### **Fax Settings List**

Print a list of the current fax communication settings.

### **Conditional Save/Forward List**

Print a list of the current conditional save/forward settings.

### **Protocol Trace**

Print a detailed report for the previous sent or received fax.

**Parent topic:** [Printing Fax Reports](#)

---

# Using External USB Devices with Your Product

Follow the instructions here to work with an external USB device connected to your product.

**Note:** Your product may differ from the images in this guide, but the instructions are the same unless otherwise noted.

[Connecting a USB Device](#)

[Disconnecting a USB Device](#)

[Viewing and Printing from the LCD Screen](#)

[Transferring Files on a USB Device](#)

## Connecting a USB Device

Connect a USB device or its USB cable to the USB port on the front of the product.

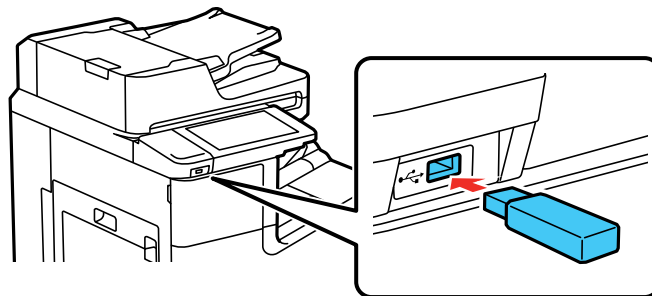

**Note:** Epson cannot guarantee the compatibility of your device. Make sure the files on the device are compatible with the product.

**Parent topic:** [Using External USB Devices with Your Product](#)

**Related tasks**

[Disconnecting a USB Device](#)

## Disconnecting a USB Device

After you finish working with a USB device, follow these steps to remove it.

1. If your product is connected to your computer using a USB cable, do one of the following:
  - **Windows:** Open the **My Computer**, **Computer**, **This PC**, or **Windows Explorer** utility. Then right-click the name of your USB device (listed as a removable disk) and select **Eject**.
  - **Mac:** Drag the removable disk icon for your USB device from the desktop into the trash.

**Caution:** Do not remove a USB device before completing the procedure above or you may lose data from the flash drive.

2. Pull the USB device or cable out of the USB port on the front of the product.

**Parent topic:** [Using External USB Devices with Your Product](#)

## Viewing and Printing from the LCD Screen

See these sections to view and print photos or other files displayed on your product's LCD screen.

[Printing JPEG Photos](#)

[Printing TIFF and PDF Files](#)

**Parent topic:** [Using External USB Devices with Your Product](#)

## Printing JPEG Photos

You can select JPEG photos for printing as you view them on the LCD screen.

1. Press the  home button, if necessary.
2. Select **Memory Device**.

You see a screen like this:

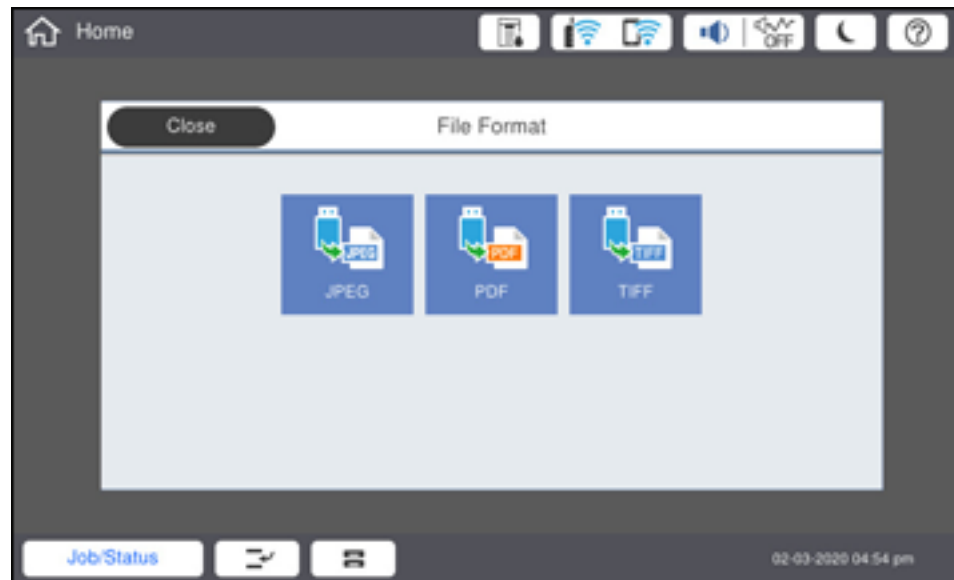

3. Select **JPEG**.

**Note:** If you have more than 999 JPEG images on your device, the images are divided into groups, and you must first select the group you want to display.

4. Do one of the following to select your photos:
  - In **Tile View**, select the thumbnail images of the photos you want to print.
  - In **Single View**, select the thumbnail image of the photo you want to print, then press the left or right arrow buttons to scroll through and select additional photos, or select **Tile View** to return to the thumbnail image view and select additional photos.
  - To select all photos, select the ☰ icon and select **Select All Images**.
5. To change the print settings, select **Basic Settings** and select the necessary settings.
6. To adjust the photos (adjustments modify only your printed copies, not the original files), select **Advanced** and make the necessary adjustments.

7. Select **Copies** on the LCD screen and use the numeric keypad on the screen to select the number of copies (up to 9999).
8. When you are ready to print, select the **Print** icon.

**Note:** To cancel printing, select **Stop** or **Cancel** on the LCD screen, then select **Cancel Print From Memory Device** to confirm.

[Print Setting Options - JPEG Mode](#)

**Parent topic:** [Viewing and Printing from the LCD Screen](#)

**Print Setting Options - JPEG Mode**

Select the print settings you want to use when printing a JPEG from a USB device.

**Note:** Not all options or settings may be available, depending on the file format.

**Basic Settings**

<b>Print settings</b>	<b>Available options</b>	<b>Description</b>
<b>Paper Setting</b>	Various paper size and type settings	Select the paper source that you want to use.
<b>Layout</b>	<b>1-up</b>	Print one photo per page.
	<b>20-up</b>	Print 20 photos per page.
	<b>Index</b>	Print numbered photo thumbnails with date information.
<b>Fit Frame</b>	<b>On</b>	Automatically crops the photo to fit into the selected photo layout.
	<b>Off</b>	Turns off automatic cropping.
<b>B&amp;W</b>	—	Prints a color photo in black and white.
<b>Auto</b>	—	Automatically detects whether the photo is in color or black and white.

**Advanced settings**

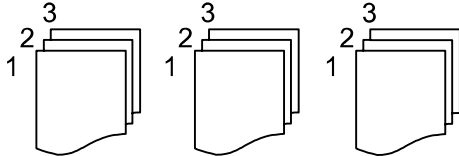
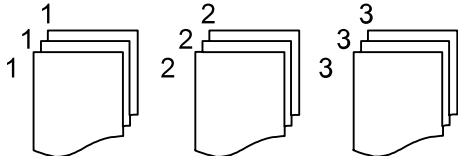
Print settings	Available options	Description
<b>Finishing</b>	<b>Collate (Page Order)</b>	Select to print multiple copies of a multi-page document in ordered sets.  
	<b>Group (Same Pages)</b>	Select to print multiple copies of a multi-page document in unordered groups.  
	<b>Eject Paper</b>	Choose if you want printouts ejected offset for each set of copies.
	<b>Staple*</b>	Select the staple location.
<b>Quality</b>	<b>Standard</b>	Provides good quality for most prints.
	<b>Best</b>	Provides the highest quality for special prints.
<b>Fix Photo</b>	Various settings	Automatically adjusts the brightness, contrast, and saturation of the photo based on the setting that is selected.
	<b>Enhance Off</b>	Turns off automatic adjustments.
<b>Fix Red-Eye</b>	<b>Off</b>	Automatically fixes the red-eye effect in photos; see Note below.
	<b>On</b>	
<b>Date</b>	Various date formats	Prints the date the photo was taken on the photo in the format you select.



Print settings	Available options	Description
<b>File Storing</b>	<b>Setting</b>	Select the file storage settings you want to use.
	<b>Folder (Required)</b>	
	<b>File Name</b>	
	<b>File Password</b>	
	<b>User Name</b>	

\* Displayed when the optional finisher unit is installed.

**Note: Fix Red-Eye** makes corrections to printouts, not the original photo files. Depending on the type of photo, parts of the image other than the eyes may be corrected.

Parent topic: [Printing JPEG Photos](#)

## Printing TIFF and PDF Files

You can select and print TIFF or PDF files from a USB flash drive.

1. Press the  home button, if necessary.
2. Select **Memory Device**.

You see a screen like this:

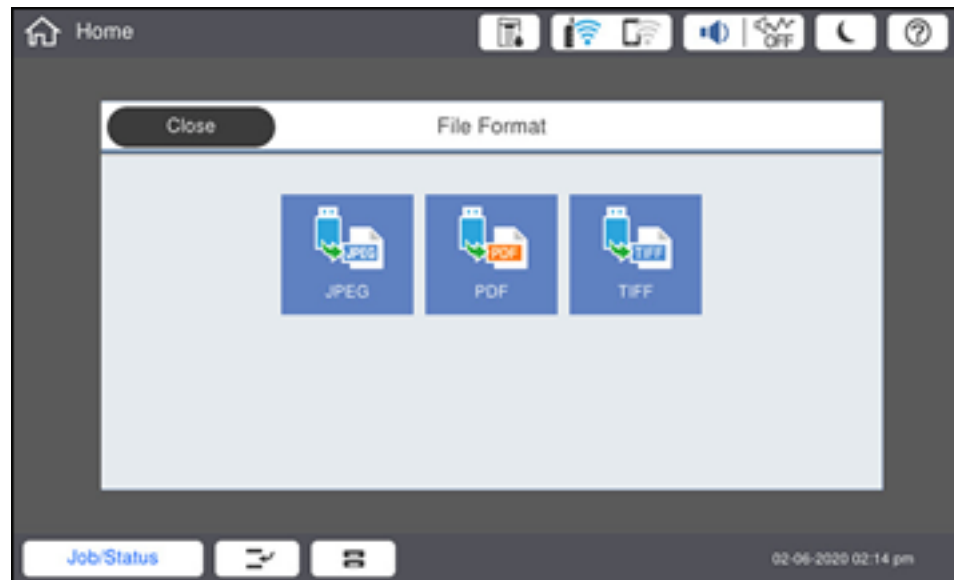

3. Select **TIFF** or **PDF**.

You see a list of the available files.

4. Select the file you want to print.

**Note:** To view information about the file, select the arrow icon at the end of the file name.

5. Do the following as necessary:

- To print more than one copy, select **Copies** on the LCD screen and use the numeric keypad on the screen to select the number of copies (up to 9999).
- To change the print settings, select **Basic Settings** or **Advanced** and select the necessary settings.

6. When you are ready to print, select the **Print** icon.

**Note:** To cancel printing, select **Stop** or **Cancel** on the LCD screen, then select **Cancel Print From Memory Device** to confirm.

[Print Setting Options - TIFF Mode](#)

[Print Setting Options - PDF Mode](#)

**Parent topic:** [Viewing and Printing from the LCD Screen](#)

### Print Setting Options - TIFF Mode

Select the print settings you want to use when printing a TIFF from a USB device.

**Note:** Not all options or settings may be available, depending on the file format.

#### Basic Settings

Print settings	Available options	Description
<b>Recent to old or Old to recent</b>	—	Change the order of the photos displayed on the LCD screen.
<b>Paper Setting</b>	Various paper size and type settings	Select the paper source that you want to use.
<b>Layout</b>	<b>1-up</b>	Print one photo per page.
	<b>20-up</b>	Print 20 photos per page.
	<b>Index</b>	Print numbered photo thumbnails with date information.
<b>Fit Frame</b>	<b>On</b>	Automatically crops the photo to fit into the selected photo layout.
	<b>Off</b>	Turns off automatic cropping.
<b>B&amp;W</b>	—	Prints a color photo in black and white.
<b>Auto</b>	—	Automatically detects whether the photo is in color or black and white.

#### Advanced settings

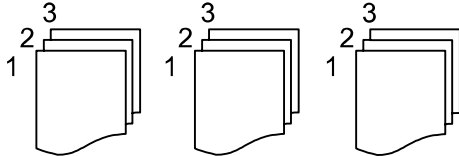
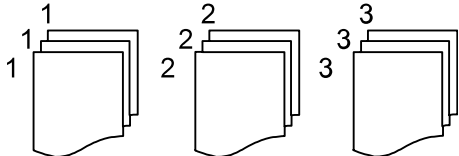
Print settings	Available options	Description
<b>Finishing</b>	<b>Collate (Page Order)</b>	Select to print multiple copies of a multi-page document in ordered sets.  
	<b>Group (Same Pages)</b>	Select to print multiple copies of a multi-page document in unordered groups.  
	<b>Eject Paper</b>	Select <b>Shift Sort*</b> to eject offset printouts for each set of copies.
	<b>Staple*</b>	Select the staple location.
<b>Quality</b>	<b>Standard</b>	Provides good quality for most prints.
	<b>Best</b>	Provides the highest quality for special prints.
<b>Print Order</b>	—	Select the printing order for multi-page documents.
<b>Date</b>	Various date formats	Prints the date the photo was taken on the photo in the format you select.
<b>File Storing</b>	<b>Setting</b>	Select the file storage settings you want to use.
	<b>Folder (Required)</b>	
	<b>File Name</b>	
	<b>File Password</b>	
	<b>User Name</b>	

\* Displayed when the optional finisher unit is installed.

Parent topic: [Printing TIFF and PDF Files](#)

## Print Setting Options - PDF Mode

Select the print settings you want to use when printing a PDF from a USB device.

**Note:** Not all options or settings may be available, depending on the file format.

### Basic Settings

Print settings	Available options	Description
<b>Recent to old or Old to recent</b>	—	Change the order of the documents displayed on the LCD screen.
<b>Paper Setting</b>	Various paper size and type settings	Select the paper source that you want to use.
<b>2-Sided</b>	<b>Off</b>	Two-sided printing is off.
	<b>On</b>	Two-sided printing is on.
	<b>Binding Position</b>	Select the binding position for the document.
<b>Print Order</b>	—	Select the printing order for multi-page documents.
<b>B&amp;W</b>	—	Prints a color photo in black and white.
<b>Auto</b>	—	Automatically detects whether the photo is in color or black and white.

### Advanced settings

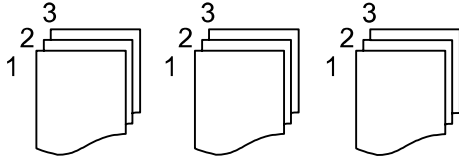
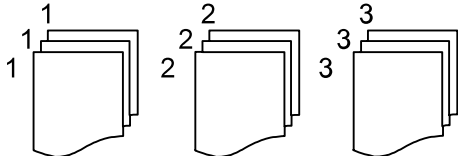
Print settings	Available options	Description
Finishing	<b>Collate (Page Order)</b>	Select to print multiple copies of a multi-page document in ordered sets.  
	<b>Group (Same Pages)</b>	Select to print multiple copies of a multi-page document in unordered groups.  
	<b>Eject Paper</b>	Select <b>Rotate Sort</b> to print alternate paper orientations and paper sources (make sure the <b>Paper Setting</b> is set to <b>Auto</b> for this option). Select <b>Shift Sort*</b> to eject offset printouts for each set of copies.
	<b>Staple*</b>	Select the staple location.
File Storing	<b>Setting</b>	Select the file storage settings you want to use.
	<b>Folder (Required)</b>	
	<b>File Name</b>	
	<b>File Password</b>	
	<b>User Name</b>	

\* Displayed when the optional finisher unit is installed.

Parent topic: [Printing TIFF and PDF Files](#)

## Transferring Files on a USB Device

You can transfer files to and from a USB device inserted into the USB port on the front of your product.

[Setting Up USB Device Access](#)

Parent topic: [Using External USB Devices with Your Product](#)

## Setting Up USB Device Access

Before you can access a USB device inserted into the USB port on the front of your product, you may need to enable the access setting.

**Caution:** Remove the USB device before you change this setting or you may lose data from the device.

**Note:** These settings can be locked by an administrator. If you cannot access these settings, contact your administrator for assistance.

1. Press the  home button, if necessary.
2. Select **Settings** > **General Settings** > **Printer Settings** > **Memory Device**.

You see a screen like this:



3. Select **Enable**.

Parent topic: [Transferring Files on a USB Device](#)

---

# Using Your Product's Internal Storage

You can store files to the product's internal hard drive to quickly and easily print, email, or transfer them later without using a computer.

Follow the instructions here to access and save files to the product's internal hard drive.

**Note:** Your product may differ from the images in this guide, but the instructions are the same unless otherwise noted.

[Storage Folder Types](#)

[Printing a Stored File](#)

[Saving Groups for Printing from Storage](#)

[Editing or Deleting a Saved Group](#)

[Saving Stored Files to an External USB Device](#)

[Emailing Stored Files](#)

[Saving Stored Files to a Network Folder](#)

[Saving Stored Files to Cloud Services](#)

[Storage Menu Options](#)

[Searching for Folders and Files](#)

[Deleting Folders and Files from Storage](#)

[Changing the Storage Period of Files](#)

[Restricting Shared Folder Access](#)

## Storage Folder Types

You can store files in folders on the product's hard drive and access them later. The legend and table below outline the different types of available storage folders.



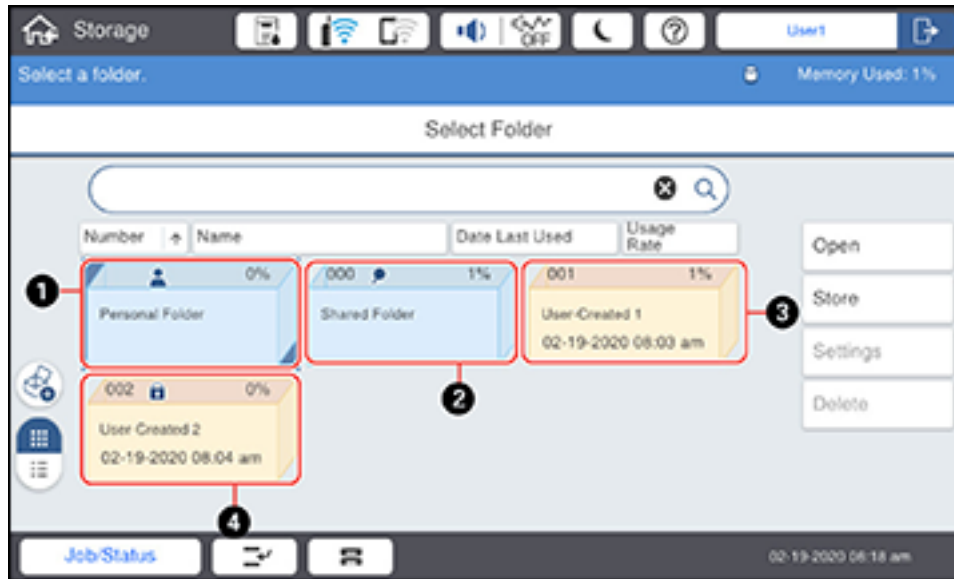

- 1 Personal folder
- 2 Default folder
- 3 User-created folder
- 4 User-created folder with password protection

Type of folder	Description
<b>Default folder</b>	The default folder is <b>Shared Folder</b> . You cannot rename, set a password for, or delete this folder. All users can store files in the default folder. Files in the default folder can be password-protected to limit access.
<b>User-created folder</b>	Users can create up to 199 individual folders for storage. Unless a password is set for the created folder, any user can access this folder, along with any files that are not password-protected. Users can set a password for the created folder and any files in it.

Type of folder	Description
Personal folder	If the product is equipped with user authentication, an administrator can create personal folders for specific users. A personal folder is only displayed if it belongs to the user that is logged in, and only that user can store and access the files. Only one personal folder can be created per user.

Parent topic: [Using Your Product's Internal Storage](#)

## Printing a Stored File

You can print a file saved in a storage folder.

1. Press the  home button, if necessary.
2. Select **Storage**.

You see a screen like this:

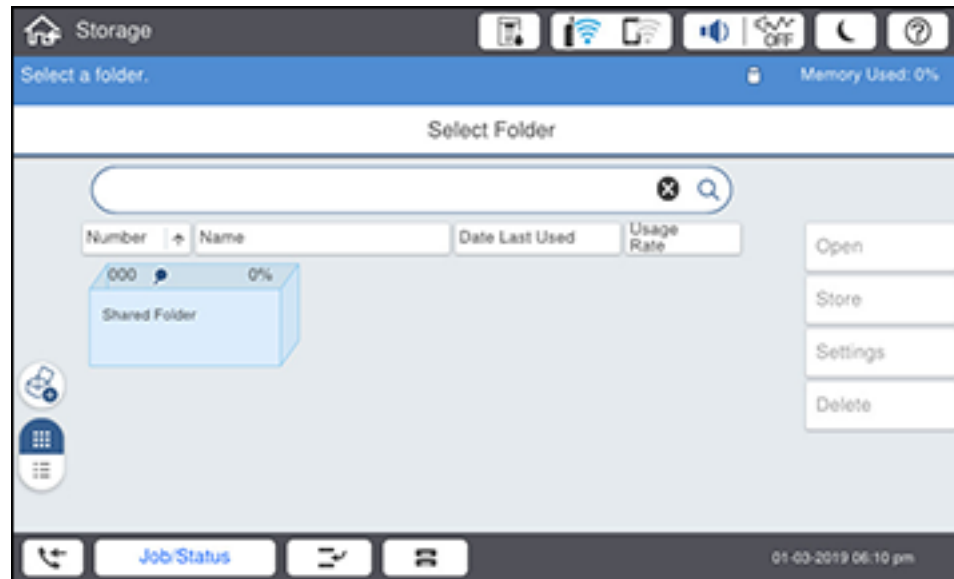

3. Select the folder containing the file you want to print and select **Open**.

You see a screen like this:

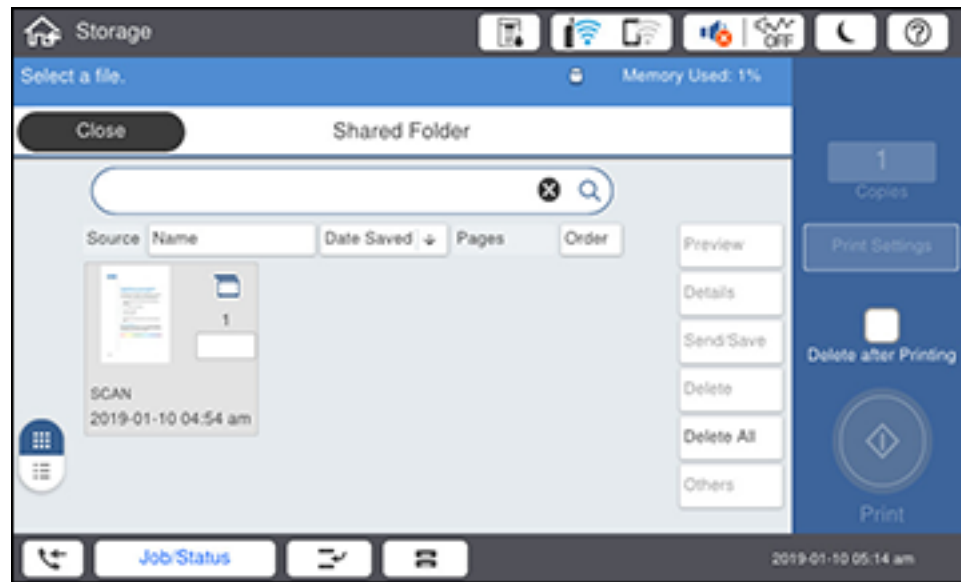

4. Select the file you want to print.

You see a screen like this:

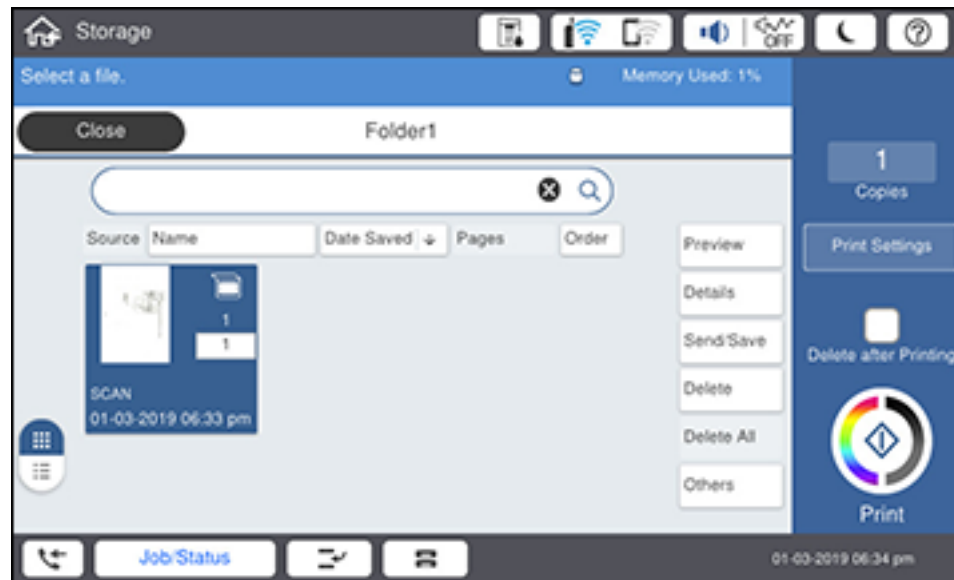

5. Select **Copies** and set the number of copies you want to print.

**Note:** If you want to print using a saved group, select **Print Settings**, then select **Advanced**. Select **Print Sets** and then select the group you want to use. Select **OK**.

6. Change any print settings as needed.
7. Select the **Print** icon.

**Parent topic:** [Using Your Product's Internal Storage](#)

## Saving Groups for Printing from Storage

You can save groups of frequently used print quantities and sets so that you can print a file without entering the number of copies each time. This is useful when you are printing a different number of copies for each set.

**Note:** You can save up to 12 print set groups with up to 60 subgroups in each. Print set groups are also accessible when copying.

1. Press the  home button, if necessary.
2. Select **Storage**.

You see a screen like this:

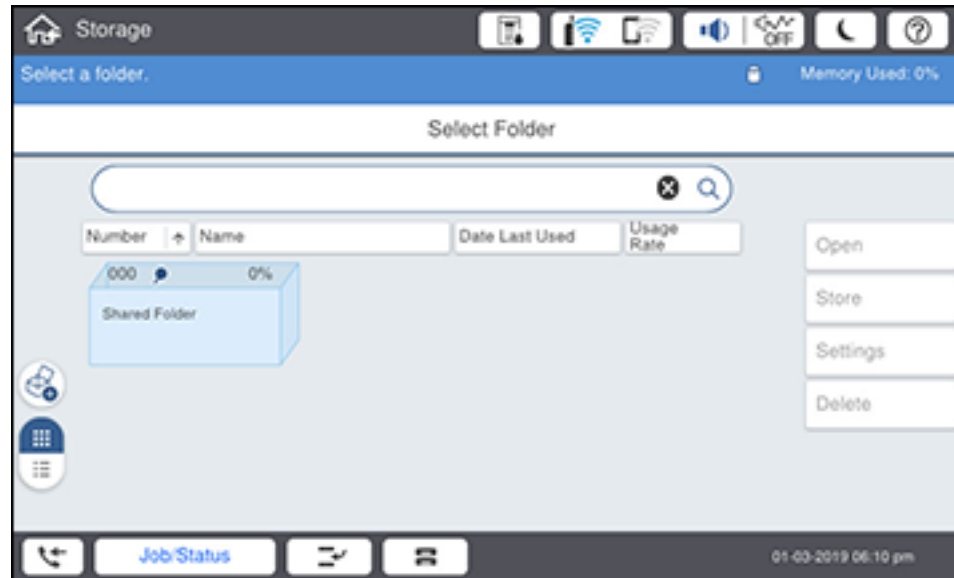

3. Select the folder containing the file you want to print and select **Open**.

You see a screen like this:

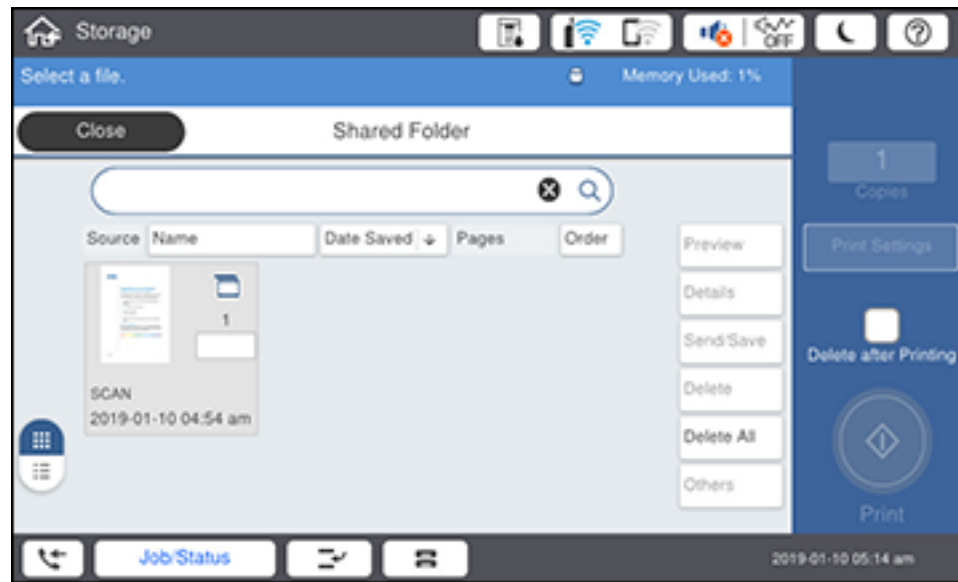

4. Select the file you want to print.

You see a screen like this:

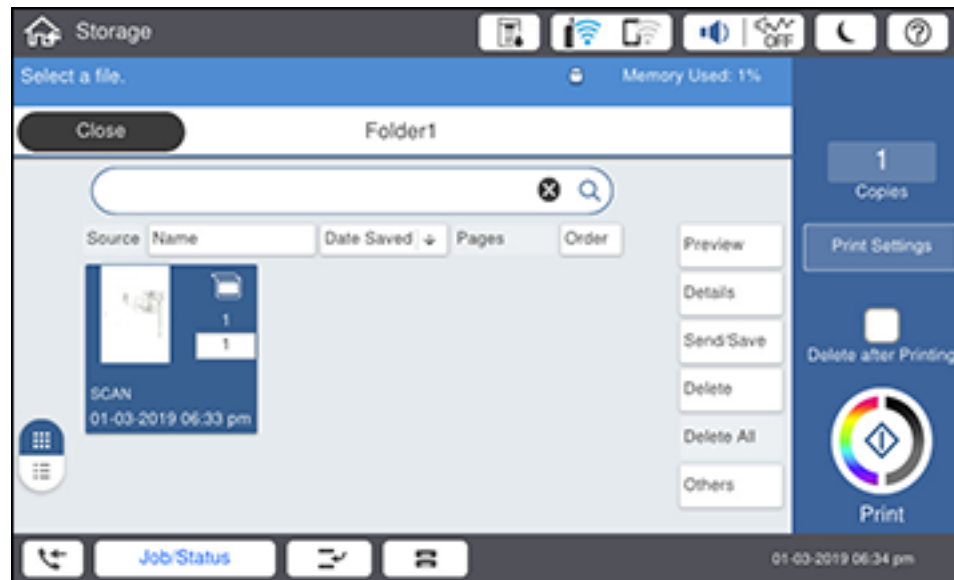

5. Select **Print Settings** and select the **Advanced** tab.
6. Select **Print Sets** and then select **Not Set** from the list.
7. Select **Register/Overwrite** and enter a group name.
8. Set the number of copies and sets on the **Copies & Sets** tab.
9. Select any other settings as necessary.
10. Select **OK** to save.

Parent topic: [Using Your Product's Internal Storage](#)

## Editing or Deleting a Saved Group

You can edit or delete a print set group.

1. Press the  home button, if necessary.
2. Select **Storage**.

You see a screen like this:

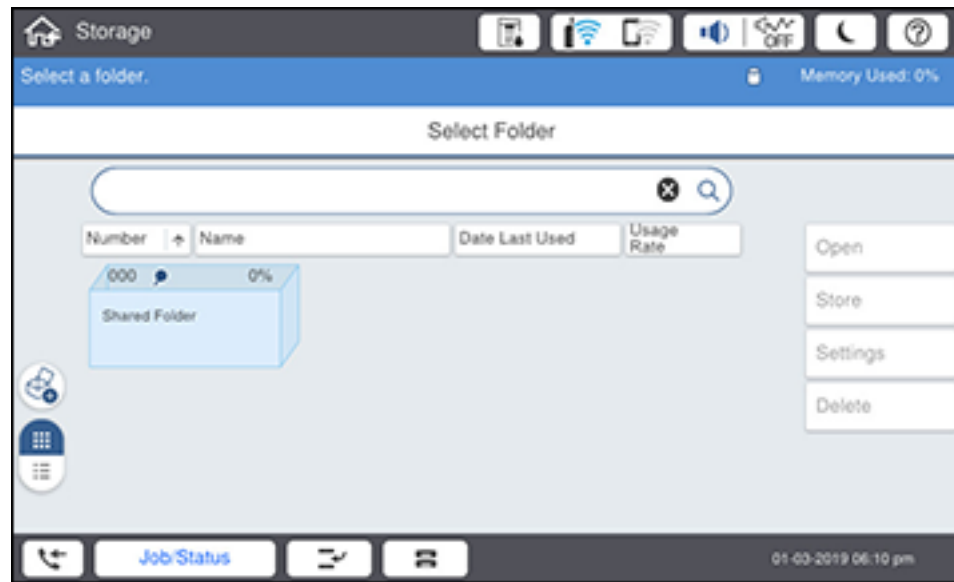

3. Select the folder containing the group you want to edit or delete and select **Open**.



You see a screen like this:

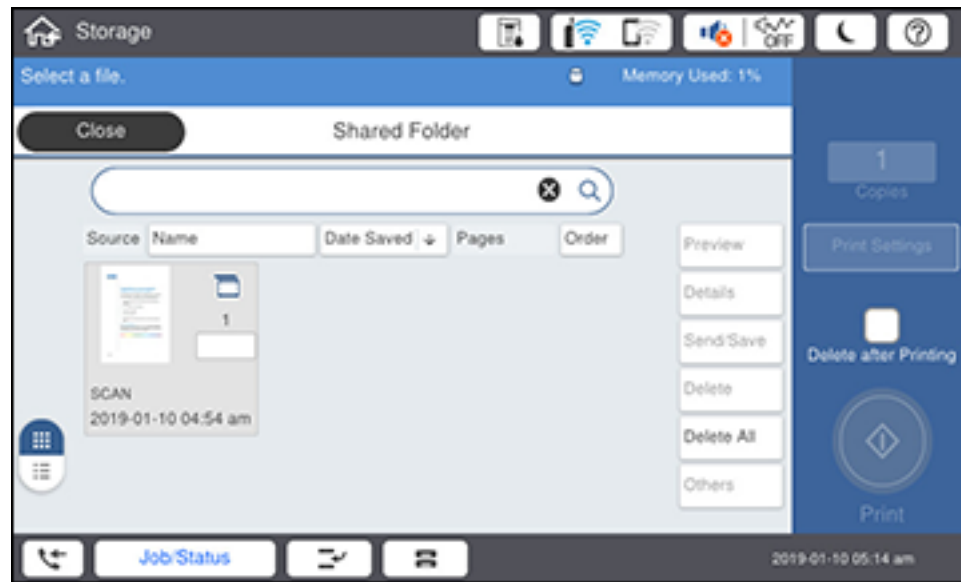

4. Select a file.

You see a screen like this:

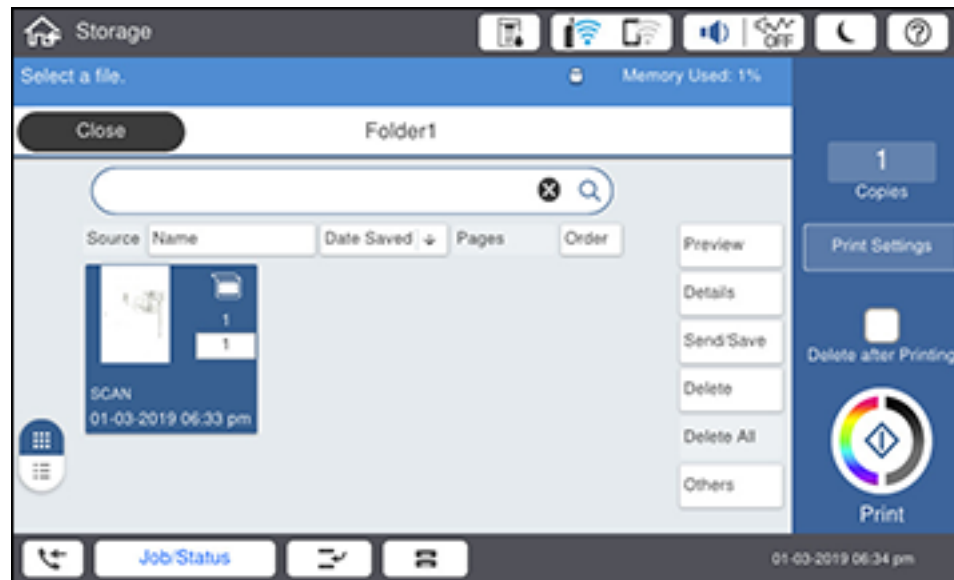

5. Select **Print Settings** and select **Advanced**.
6. Select **Print Sets** and then select the group you want to edit or delete from the list.
7. Do one of the following:
  - Select **Register/Overwrite** to edit the group and modify the settings as desired. Proceed to the next step.
  - Select **Delete** to delete the group. You are done.
8. Select **OK** to save.

Parent topic: [Using Your Product's Internal Storage](#)

## Saving Stored Files to an External USB Device

You can save a file in a storage folder to an external USB device connected to your product.

1. Press the  home button, if necessary.
2. Select **Storage**.

You see a screen like this:

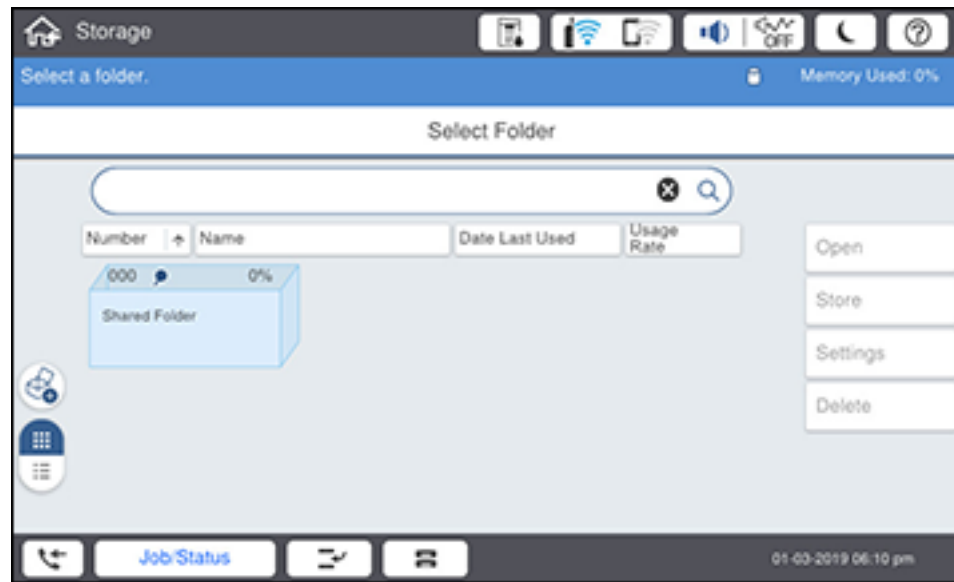

3. Select the folder containing the file you want to save to an external USB device and select **Open**.

You see a screen like this:

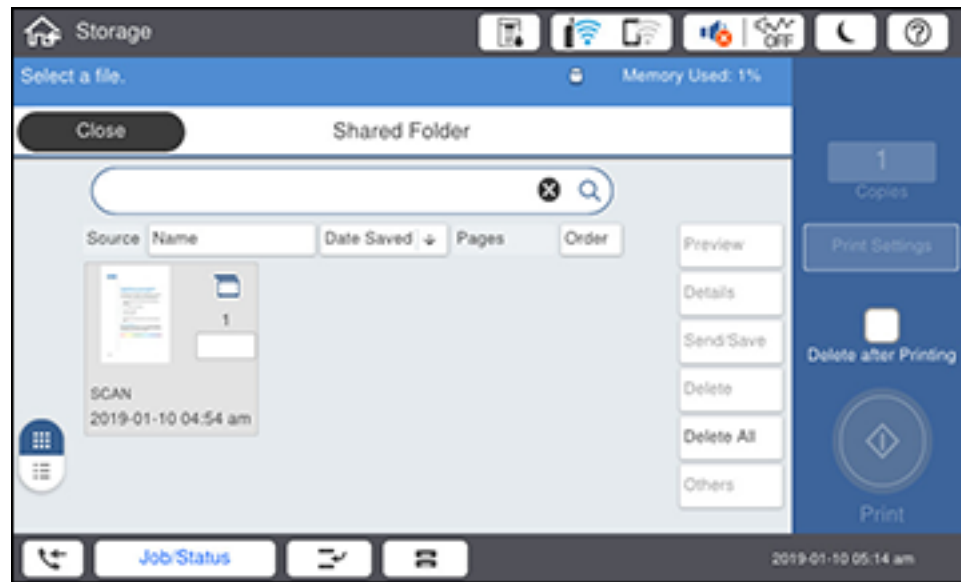

4. Select the file.

You see a screen like this:

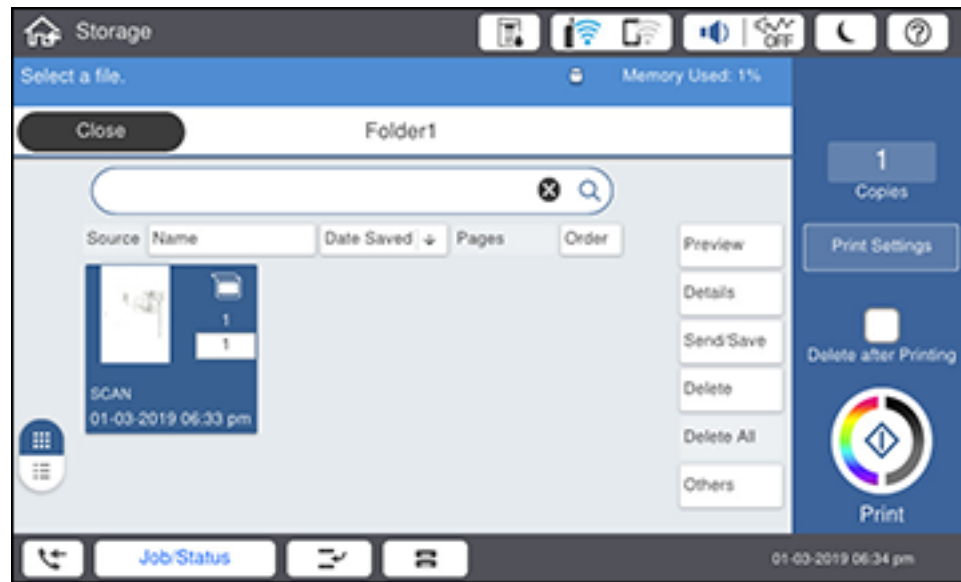

5. Select **Send/Save**.

You see a screen like this:



6. Select **Storage to Memory Device**.

You see a screen like this:

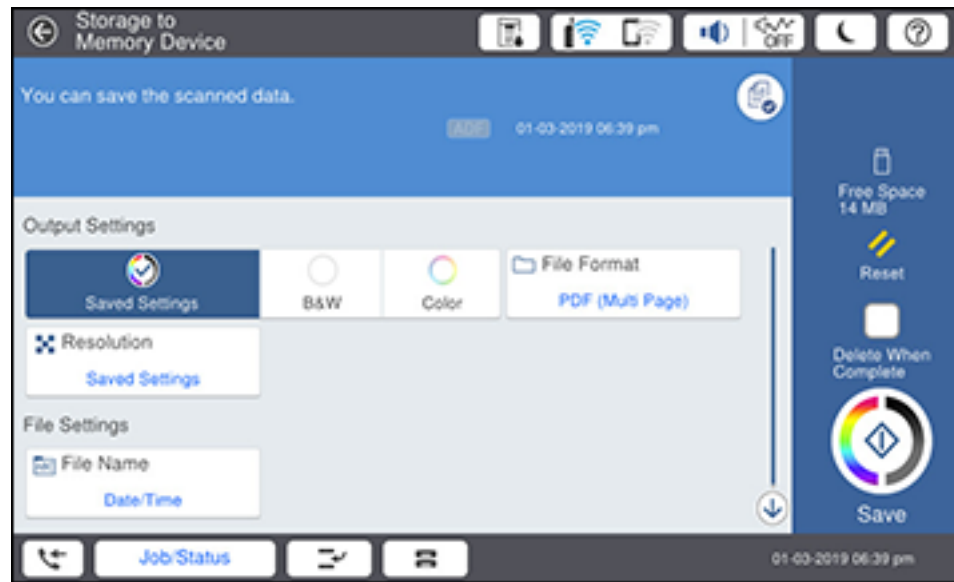

7. Change any save settings as necessary.

8. Select the **Save** icon.

**Parent topic:** [Using Your Product's Internal Storage](#)

**Related tasks**

[Connecting a USB Device](#)

## Emailing Stored Files

You can email a file saved in a storage folder.

**Note:** Email server settings must be configured before you can send email.

1. Press the  home button, if necessary.
2. Select **Storage**.

You see a screen like this:

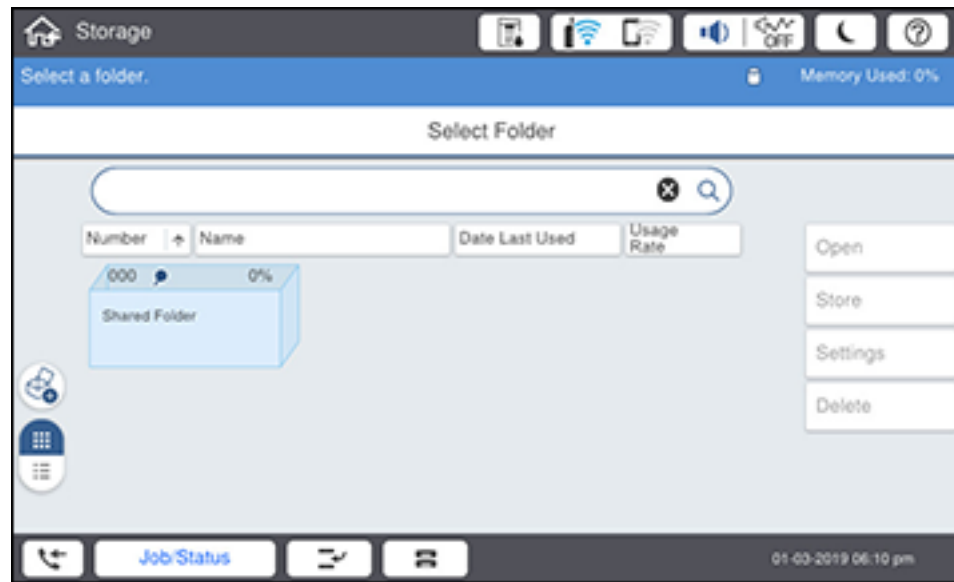

3. Select the folder containing the file you want to print and select **Open**.



You see a screen like this:

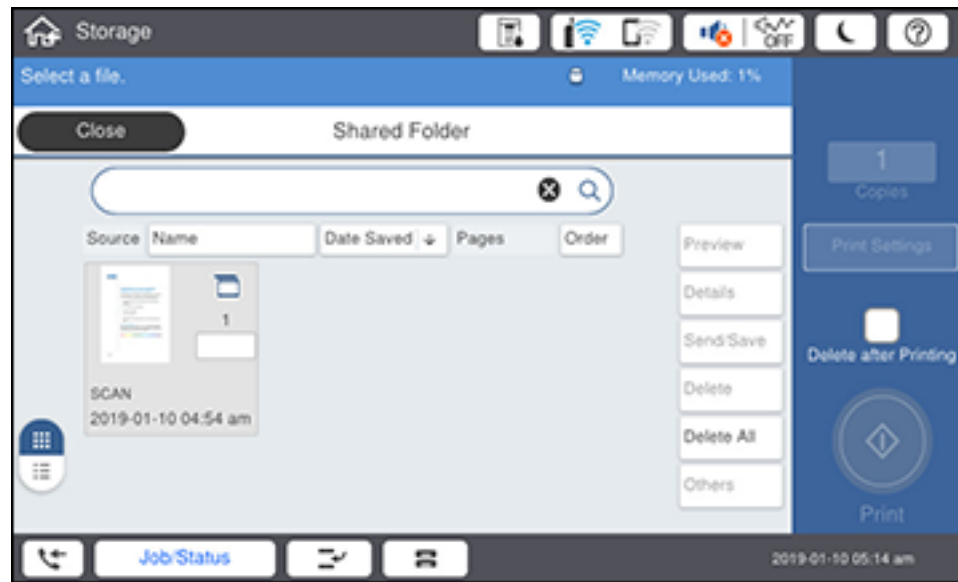

4. Select the file.
5. Select **Send/Save**.

You see a screen like this:



6. Select **Storage to Email**.

You see a screen like this:



7. Select a contact or select **Keyboard** to enter the recipient's email address.
8. Set the save settings as necessary.
9. Select the **Send** icon.

**Parent topic:** [Using Your Product's Internal Storage](#)

#### **Related tasks**

[Configuring Email Server Settings](#)

## **Saving Stored Files to a Network Folder**

You can save a file saved in a storage folder to a network folder.

**Note:** A network folder must already be set up. See the link below to set up a network folder.

1. Press the  home button, if necessary.
2. Select **Storage**.

You see a screen like this:

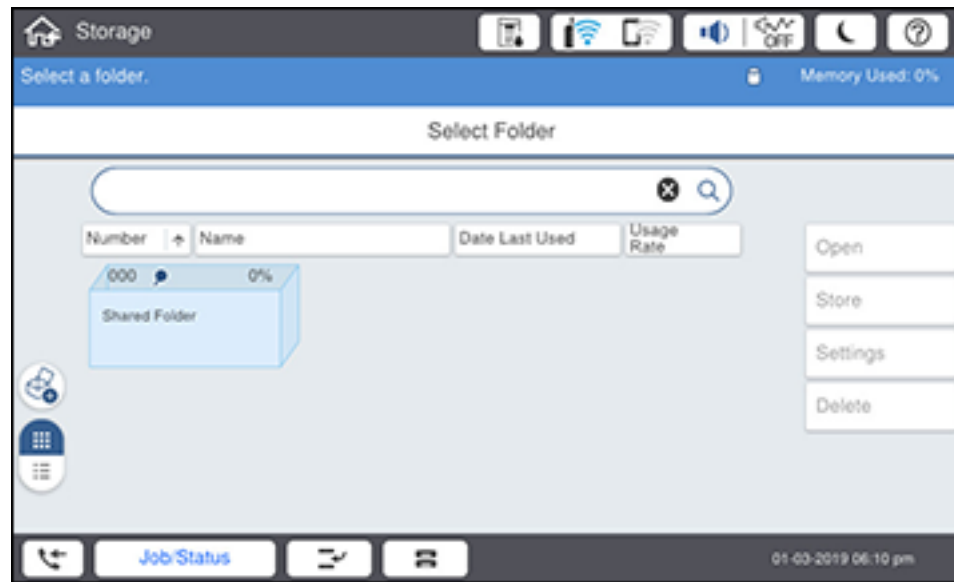

3. Select the folder containing the file you want to print and select **Open**.

You see a screen like this:

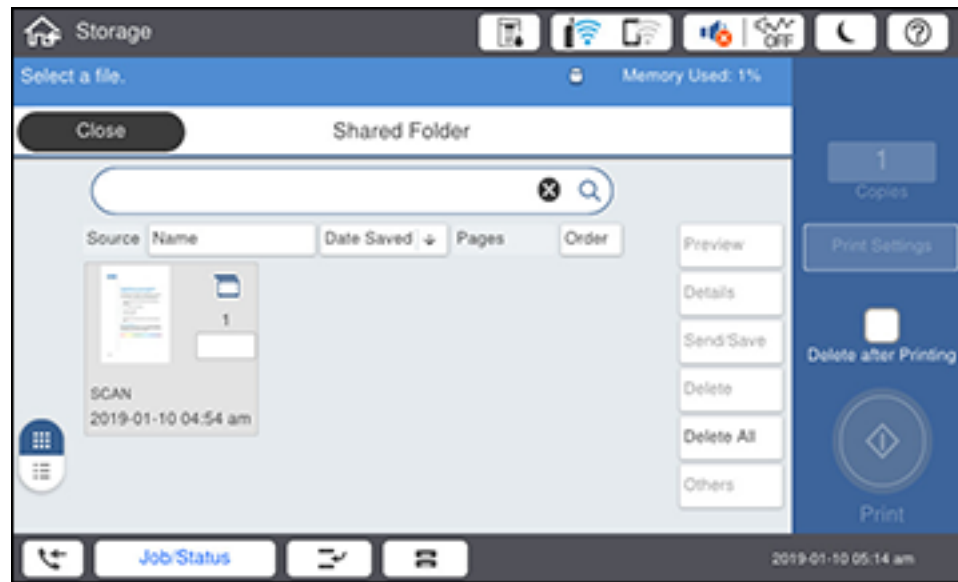

4. Select the file.
5. Select **Send/Save**.

You see a screen like this:



6. Select **Storage to Network Folder/FTP**.

You see a screen like this:



7. Select the destination field and specify the destination by entering the folder path in the following format:
  - **SMB:** \\host\folder name
  - **FTP:** ftp://host name/folder name
  - **FTPS:** ftps://host name/folder name
  - **WebDAV (HTTPS):** https://host name/folder name
  - **WebDAV (HTTP):** http://host name/folder name
8. Set the save settings as necessary.
9. Select the **Save** icon.

**Parent topic:** [Using Your Product's Internal Storage](#)

#### **Related tasks**

[Creating a Shared Network Folder](#)

## Saving Stored Files to Cloud Services

You can save a file saved in a storage folder to a cloud service.

**Note:** Epson Connect services must already be set up.

1. Press the  home button, if necessary.
2. Select **Storage**.

You see a screen like this:

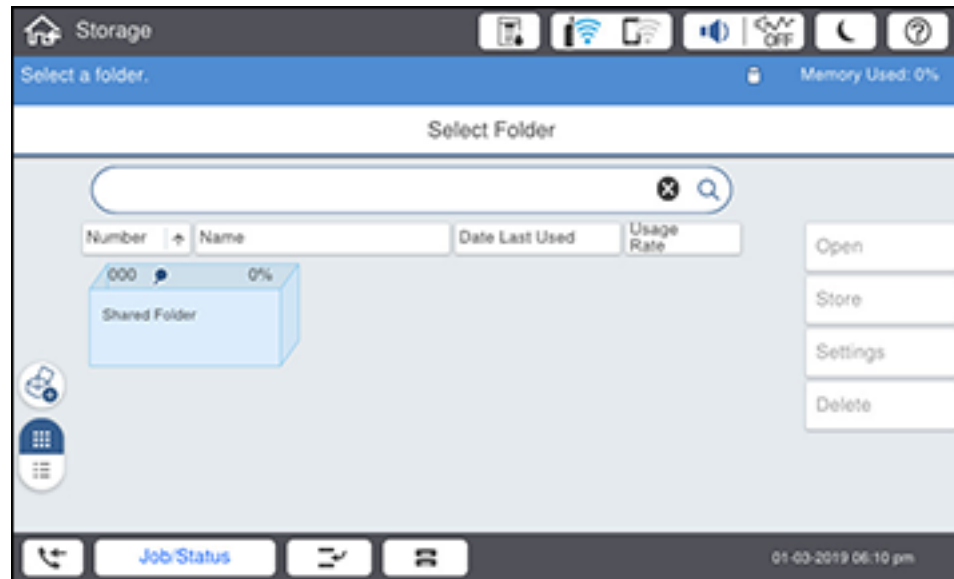

3. Select the folder containing the file you want to print and select **Open**.



You see a screen like this:

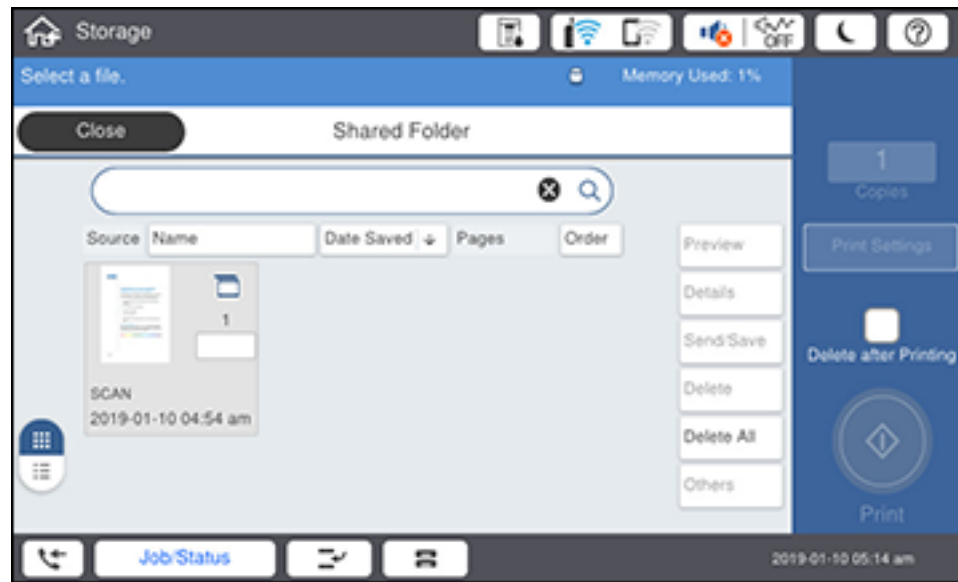

4. Select the file.
5. Select **Send/Save**.

You see a screen like this:



6. Select **Storage to Cloud**.
7. Specify the destination.
8. Set the save settings as necessary.
9. Select the **Save** icon.

**Parent topic:** [Using Your Product's Internal Storage](#)

**Related tasks**

[Setting Up Epson Connect Services](#)

## Storage Menu Options

You can select the printing settings you want to use for your stored files.

**Note:** Not all options or settings may be available, depending on other settings.

### Basic Settings

Printing option	Available settings	Description
<b>Auto</b>	—	Prints the document in the detected color of the original.
<b>Color</b>	—	Prints the document in color.
<b>B&amp;W</b>	—	Prints the document in black and white.
<b>Paper Setting</b>	Various sources	Select the paper source that you want to use. If you select <b>Auto</b> , paper is fed automatically depending on the paper settings you selected for the paper sources.
<b>Reduce/Enlarge</b>	<b>Auto</b>	Automatically sizes the image to fit the paper size you selected.
	<b>100%</b>	Prints the original at its full size.
	<b>50%-&gt;200%</b> and other conversions	Automatically converts from one size to another.
	<b>Reduce to Fit Paper</b>	Automatically decreases the size of the image by the percentage you select.
<b>2-Sided</b>	<b>On</b>	Select <b>On</b> for 2-sided printouts and then scroll down to select the orientation and binding edge for your printouts.
	<b>Off</b>	
<b>Multi-Page</b>	<b>Single Page</b>	Copies each page of the original onto an individual sheet.
	<b>2-up</b>	Copies multiple page documents onto one sheet. Scroll down and select the document orientation and layout order settings as necessary.
	<b>4-up</b>	

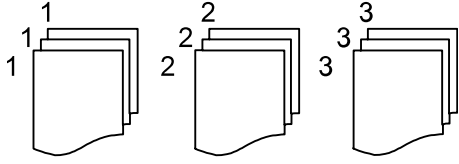
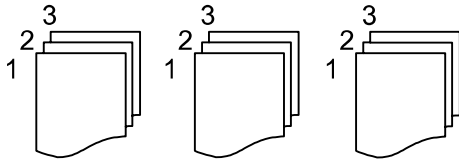
Printing option	Available settings	Description
<b>Finishing</b>	<b>Group (Same Pages)</b>	Select to print multiple copies of a multi-page document in unordered groups  
	<b>Collate (Page Order)</b>	Select to print multiple copies of a multi-page document in ordered sets  
	<b>Eject Paper</b>	Select <b>Rotate Sort</b> to stack printouts alternately in landscape and portrait orientations. Select <b>Shift Sort</b> to offset each set of printouts.
	<b>Staple</b>	Select a staple option to choose the staple location on the printouts.
<b>Booklet</b>	<b>On</b>	Select <b>On</b> and then adjust settings as necessary when making a booklet from your printouts.
	<b>Off</b>	

#### Advanced settings

Printing option	Available settings	Description
<b>Cover &amp; Slip Sheet</b>	<b>Cover</b>	Adjust these settings to add covers to your printouts.
	<b>Slip Sheet</b>	Adjust these settings to insert slip sheets into your printouts.
<b>Binding Margin</b>	<b>Off</b>	Select <b>On</b> to adjust the margin, binding position, and orientation of the pages for 2-sided printing.
	<b>On</b>	
<b>Reduce to Fit Paper</b>	<b>Off</b>	Select <b>On</b> to automatically decrease the image by the percentage you select.
	<b>On</b>	

Printing option	Available settings	Description
<b>Print Sets</b>	<b>Off</b>	Select <b>On</b> to print the document in groups of saved quantities and settings.
	<b>On</b>	
<b>Output Tray</b>	<b>Face Down Tray</b>	Select which output tray to use.
	<b>Finisher Tray</b>	
<b>Page Numbering</b>	<b>Off</b>	Select <b>On</b> to print page numbers on your printouts and select the format settings as necessary.
	<b>On</b>	
<b>Print Position Shift</b>	<b>Off</b>	Select <b>On</b> and set the margins at the top and left of the paper to adjust the print position of the document.
	<b>On</b>	

Parent topic: [Using Your Product's Internal Storage](#)

## Searching for Folders and Files

You can search for folders and files in storage using a folder name, folder number, file name, or user name.

1. Press the  home button, if necessary.
2. Select **Storage**.

You see a screen like this:

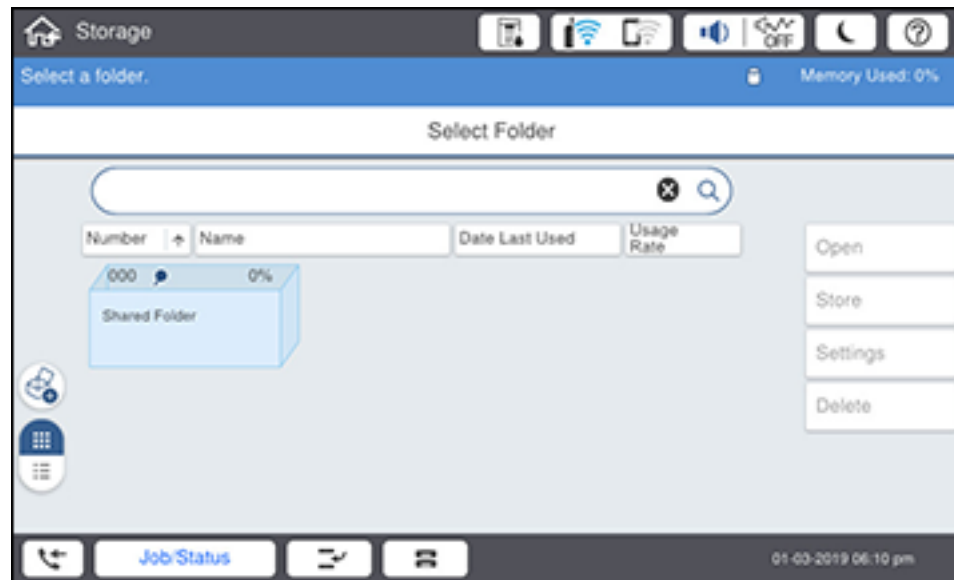

3. Do one of the following:
  - To search for a folder, select the search field and use the on-screen keyboard to enter keywords, then select **OK**.
  - To search for a file, select the folder you want to search in and select **Open**. Select the search field and use the on-screen keyboard to enter keywords, then select **OK**.

**Parent topic:** [Using Your Product's Internal Storage](#)

## Deleting Folders and Files from Storage

You can delete folders and files from your product's hard drive.

**Note:** Users can only delete shared folders when the **Access** setting for **Shared Folder Access Control** is set to **Allowed** and the **Operation Authority** setting is set to **User**.

1. Press the  home button, if necessary.
2. Select **Storage**.

You see a screen like this:

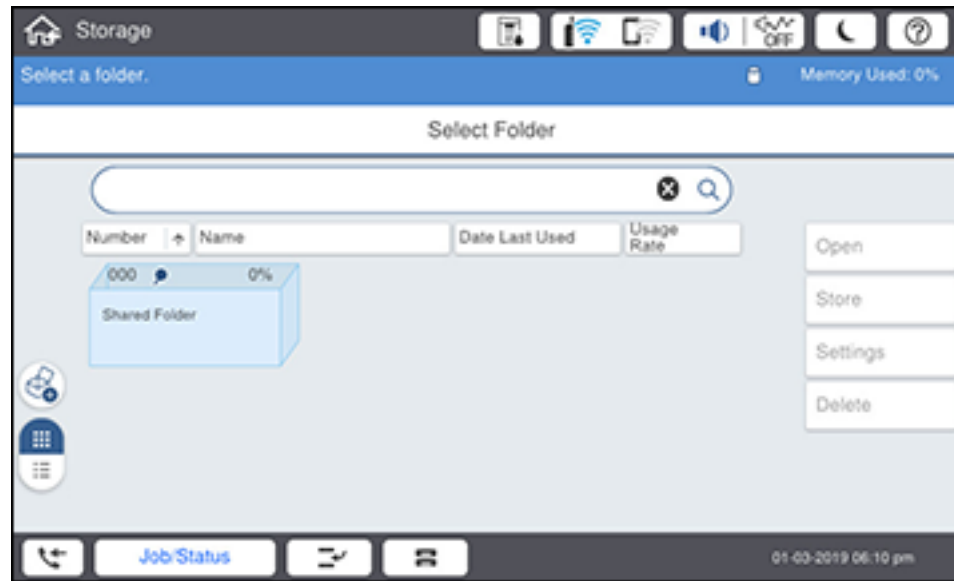

3. Do one of the following:

- To delete a folder, select the folder and select **Delete**. Enter the password, if necessary.

**Note:** Only administrators can delete folders that contain password-protected files.

- To delete a file, select the folder that contains the file, then select **Open**. Select the file and select **Delete**.

**Note:** You can select multiple files to be deleted.

- To delete all files in a folder, select the folder, then select **Open**. Select **Delete All**.

4. Select **Yes** to confirm.

**Parent topic:** [Using Your Product's Internal Storage](#)

## Changing the Storage Period of Files

You can change the storage period for files before they are deleted from shared folders. By default, files are not deleted automatically.

You can also set the file storage period for individual folders by selecting the folder, selecting **Settings > Automatic File Delete Settings**, and adjusting any of the displayed settings.

**Note:** Users can only change the storage period when the **Access** setting in **Shared Folder Access Control** is set to **Allowed** and the **Automatic Delete Setting Authority** setting is set to **User**.

1. Press the  home button, if necessary.
2. Select **Settings > General Settings > Storage Settings > Shared Folder File Management**.

You see a screen like this:

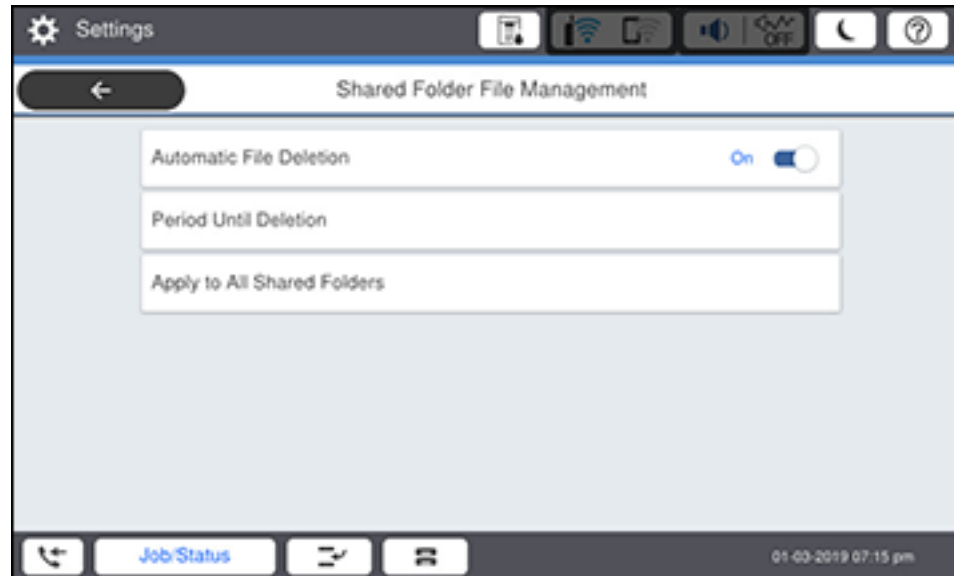

3. Do one of the following:
  - Enable **Automatic File Deletion** to set a period of time before files are automatically deleted from shared storage folders. Select **Period Until Deletion** and adjust the settings as desired.
  - Disable **Automatic File Deletion** to never delete files in shared storage folders.



Parent topic: [Using Your Product's Internal Storage](#)

## Restricting Shared Folder Access

You can set who has access to shared folders.

**Note:** If you cannot access or change this setting, contact your administrator for assistance.

1. Press the  home button, if necessary.
2. Select **Settings** > **General Settings** > **Storage Settings** > **Shared Folder Access Control** > **Operation Authority**.

You see a screen like this:

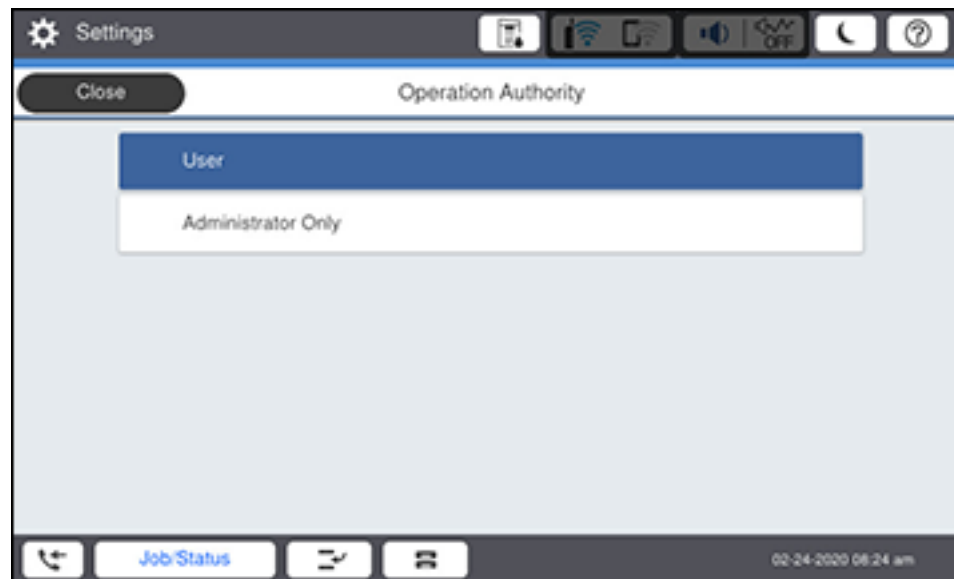

3. Do one of the following:
  - Select **User** if you want any user to have shared folder access.
  - Select **Administrator Only** if you want only the administrator to have shared folder access.

Parent topic: [Using Your Product's Internal Storage](#)

---

# Replacing Ink Cartridges and Maintenance Boxes

The maintenance box stores ink that gets flushed from the system during print head cleaning. When an ink cartridge is expended or the maintenance box is at the end of its service life, you need to replace it.

You may also need to replace a cartridge that is more than six months old if your printouts do not look their best, even after cleaning and aligning the print head.

**Note:** Please dispose of your used Epson branded ink cartridges and maintenance boxes responsibly and in accordance with local requirements. If you would like to return your used ink cartridges and maintenance boxes to Epson for proper disposal, please go to [epson.com/recycle](https://www.epson.com/recycle) for more information.

[Check Cartridge and Maintenance Box Status](#)

[Purchase Epson Ink Cartridges and Maintenance Box \(U.S. and Canada\)](#)

[Purchase Epson Ink Cartridges and Maintenance Box \(Latin America\)](#)

[Ink Cartridge and Maintenance Box Part Numbers](#)

[Removing and Installing Ink Cartridges](#)

[Replacing the Maintenance Box](#)

## Check Cartridge and Maintenance Box Status

Your product and its software will let you know when an ink cartridge is low or expended, or when the maintenance box needs to be replaced.

**Note:** When using the Epson Universal Print Driver or PostScript (PS3) printer software with the product, you can check ink cartridge and maintenance box status by using the printer buttons or the utilities included with the standard Epson printer software. To download the standard Epson printer software, visit [epson.com/support](https://www.epson.com/support) (U.S.), [epson.ca/support](https://www.epson.ca/support) (Canada), or [epson.com.jm/support](https://www.epson.com.jm/support) (Caribbean) and select your product.

[Checking Ink Status on the LCD Screen](#)

[Checking Ink and Maintenance Box Status with Windows](#)

[Checking Cartridge and Maintenance Box Status - Mac](#)

**Parent topic:** [Replacing Ink Cartridges and Maintenance Boxes](#)

## Checking Ink Status on the LCD Screen

When one of your ink cartridges is low or expended, you see a message on the LCD screen. Select **How-to** and follow the steps on the LCD screen to replace the ink cartridge.

You can also check the status of the ink cartridges and maintenance box from the product control panel.

**Note:** You can continue printing while the low ink message is displayed. Replace the ink cartridges when required.

1. Press the  home button, if necessary.

2. Select the  icon.

3. Select the **Consumables/Others** tab.

You see a screen like this:

**WF-C20600/WF-C20750/WF-C21000:**



## WF-M21000:



**Note:** The displayed ink and maintenance box levels are approximate.

**Parent topic:** [Check Cartridge and Maintenance Box Status](#)

### Related tasks



[Replacing the Maintenance Box](#)

[Removing and Installing Ink Cartridges](#)

## Checking Ink and Maintenance Box Status with Windows

You can check your ink cartridge or maintenance box status at any time using a utility on your Windows computer.

**Note:** You can continue printing while the low ink message is displayed. Replace the ink cartridges when required.

1. To check your status, access the Windows Desktop and double-click the  icon for your product in the right side of the Windows taskbar, or click the up arrow and double-click . Then click **Details**.

You see this window:

**WF-C20600/WF-C20750/WF-C21000:**



## WF-M21000:

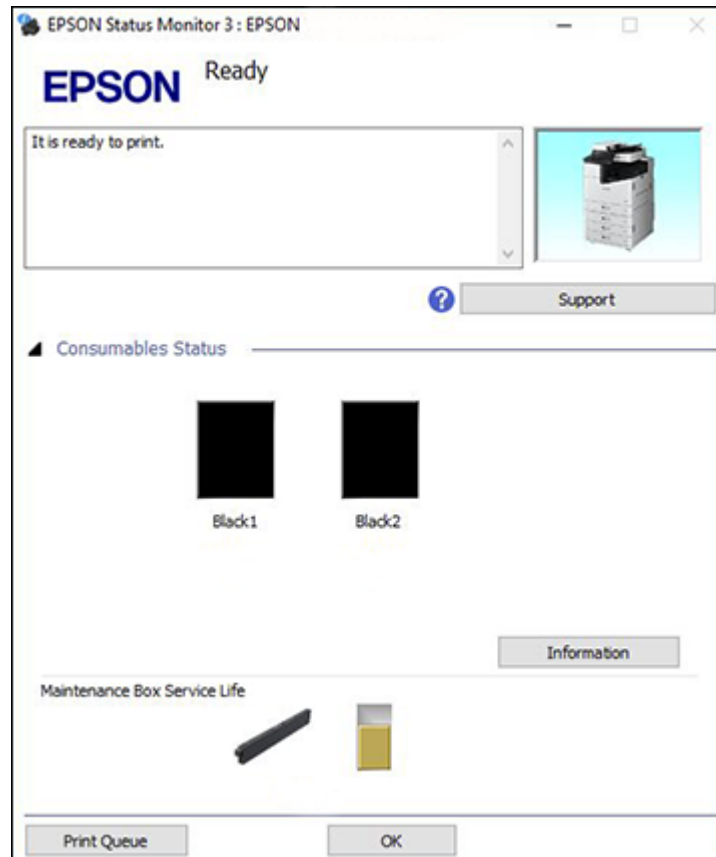

2. Replace or reinstall the ink cartridge or maintenance box as indicated on the screen.

**Note:** If any of the ink cartridges installed in the product is broken, incompatible with the product model, or improperly installed, Epson Status Monitor will not display an accurate ink status.

**Parent topic:** [Check Cartridge and Maintenance Box Status](#)

### Related tasks

[Replacing the Maintenance Box](#)

[Removing and Installing Ink Cartridges](#)

## Checking Cartridge and Maintenance Box Status - Mac

You can check the status of your ink cartridges and maintenance box using a utility on your Mac.

**Note:** You can continue printing while the low ink message is displayed. Replace the ink cartridges when required.

1. In the Apple menu or the Dock, select **System Preferences**. Select **Print & Fax**, **Print & Scan**, or **Printers & Scanners**, select your product, and select **Options & Supplies**. Select **Utility** and select **Open Printer Utility**.
2. Select **EPSON Status Monitor**.

You see this window:

**WF-C20600/WF-C20750/WF-C21000:**

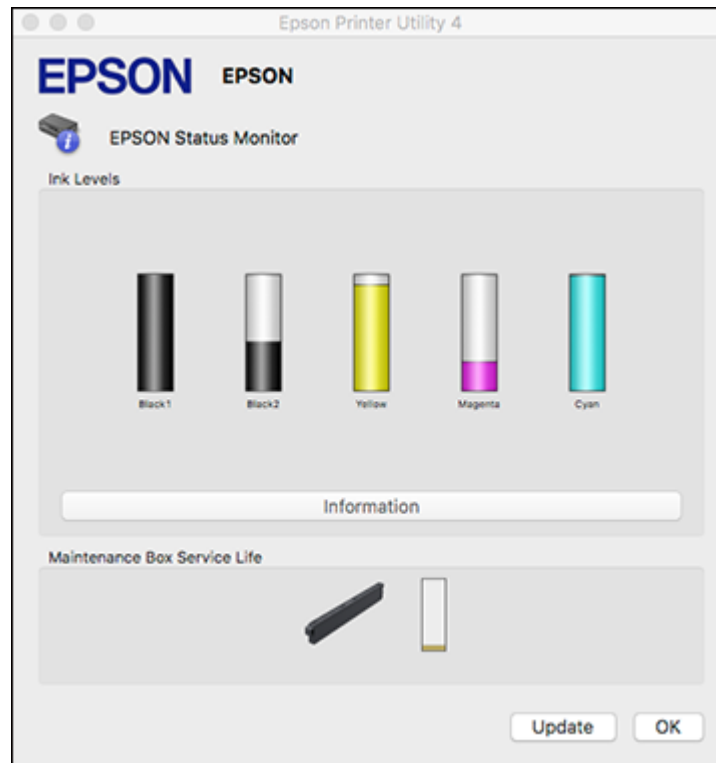

## WF-M21000:

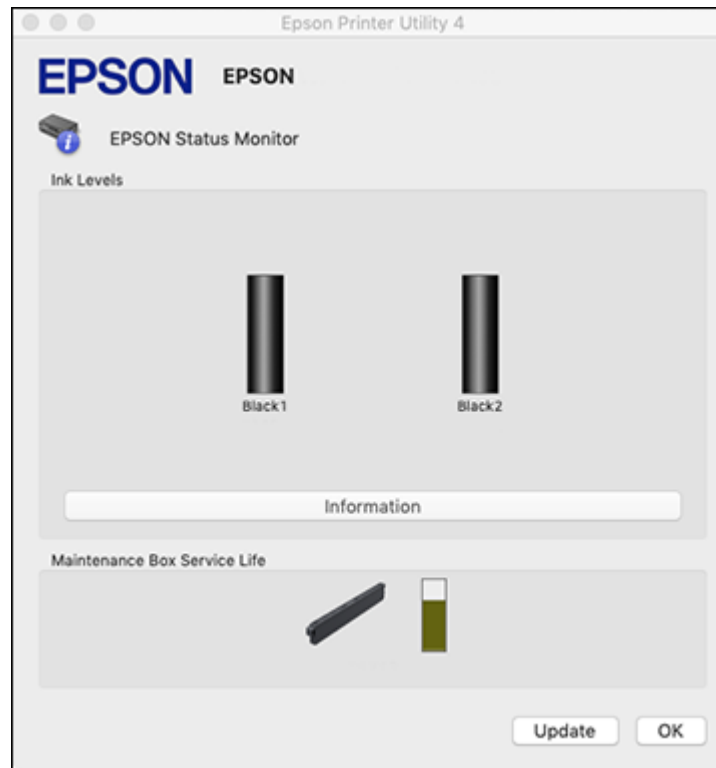

3. Do the following as necessary:
  - You can update the ink cartridge and maintenance box status by clicking **Update**.
  - Replace or reinstall the maintenance box or any ink cartridge as indicated on the screen.

**Note:** If any of the cartridges installed in the product is broken, incompatible with the product model, or improperly installed, Epson Status Monitor will not display an accurate cartridge status.

**Parent topic:** [Check Cartridge and Maintenance Box Status](#)

### Related tasks

[Replacing the Maintenance Box](#)

[Removing and Installing Ink Cartridges](#)



## Purchase Epson Ink Cartridges and Maintenance Box (U.S. and Canada)

You can purchase genuine Epson ink, maintenance boxes, and paper at [epson.com](http://epson.com) (U.S. sales), [epson.ca](http://epson.ca) (Canadian sales), or [epson.com.jm](http://epson.com.jm) (Caribbean sales). You can also purchase supplies from an Epson authorized reseller. To find the nearest one, call 800-GO-EPSON (800-463-7766) in the U.S. or 800-807-7766 in Canada.

**Note:** This product is designed to work with genuine Epson inks. Non-Epson ink or any other ink not specified for this printer could cause damage not covered by Epson's warranties.

**Parent topic:** [Replacing Ink Cartridges and Maintenance Boxes](#)

## Purchase Epson Ink Cartridges and Maintenance Box (Latin America)

You can purchase genuine Epson ink, maintenance boxes, and paper from an Epson authorized reseller. To find the nearest reseller, visit [latin.epson.com](http://latin.epson.com) or call your nearest Epson sales office.

**Note:** This product is designed to work with genuine Epson inks. Non-Epson ink or any other ink not specified for this printer could cause damage not covered by Epson's warranties.

**Parent topic:** [Replacing Ink Cartridges and Maintenance Boxes](#)

## Ink Cartridge and Maintenance Box Part Numbers

Use these part numbers when you order or purchase new ink cartridges or maintenance boxes.

Maintenance box part number: T671300

### WF-C20600

Ink color	Part number
Black	T02Q100
Cyan	T02Q200
Magenta	T02Q300
Yellow	T02Q400

### WF-C20750

Ink color	Part number
Black	T02S100
Cyan	T02S200
Magenta	T02S300
Yellow	T02S400

### WF-C21000

Ink color	Part number
Black	T02Y100
Cyan	T02Y200
Magenta	T02Y300
Yellow	T02Y400

### WF-M21000

Ink color	Part number
Black	T04Q100

Parent topic: [Replacing Ink Cartridges and Maintenance Boxes](#)

## Removing and Installing Ink Cartridges

If an ink cartridge is low or expended, a message appears on your product's LCD screen. Note which ink cartridge needs to be replaced. Select **How To** and follow the steps on the LCD screen to remove and install the ink cartridges.

Make sure you have the replacement ink cartridge(s) handy before you begin. You must install new cartridges immediately after removing the old ones.

**Caution:** Leave your old cartridges in the printer until you are ready to replace them to prevent the print head nozzles from drying out. Do not open ink cartridge packages until you are ready to install the ink. Cartridges are vacuum packed to maintain reliability.

1. Open the ink cartridge cover.

2. Push in the ink cartridge that you want to remove until it pops out, then slowly pull it all the way out.

**Note:** Dispose of used cartridges carefully. Do not take the used cartridge apart or try to refill it.

3. Gently shake the new ink cartridge horizontally back and forth about 15 times, then remove it from its package.

**Caution:** Do not remove any labels or seals, or ink will leak. Do not touch the green chip or the ink supply port on the cartridge. Install the new cartridge immediately after removing the old one; if you do not, the print head may dry out and be unable to print.

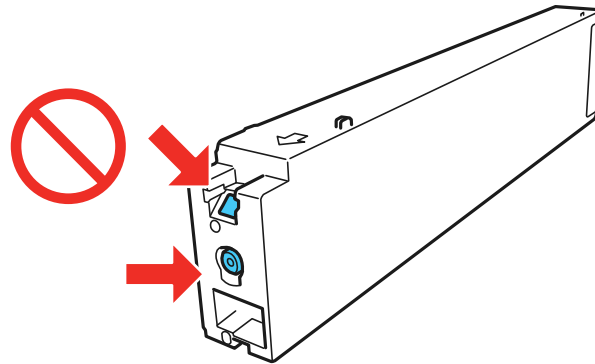

**Warning:** If ink gets on your skin, wash it thoroughly with soap and water. If ink gets into your eyes, flush them immediately with water. If ink gets into your mouth, spit it out and see a doctor right away. Keep ink cartridges out of the reach of children.

4. Insert the new cartridge and push it all the way in until it clicks into place.
5. Close the ink cartridge cover.

The home screen appears and the product starts charging the ink. This may take a few minutes. A status message counts down until the product is ready. When the status message disappears, ink replacement is complete.

**Note:** Do not turn off the product while charging or you will waste ink.

**Caution:** If you remove an ink cartridge for later use, protect the ink supply area from dirt and dust and store it in the same environment as the printer. The valve in the ink supply port is designed to contain

any excess ink, but do not touch the ink supply port or surrounding area. Always store ink cartridges with the label facing up; do not store cartridges upside-down.

**Parent topic:** [Replacing Ink Cartridges and Maintenance Boxes](#)

**Related concepts**

[Purchase Epson Ink Cartridges and Maintenance Box \(U.S. and Canada\)](#)

[Purchase Epson Ink Cartridges and Maintenance Box \(Latin America\)](#)

## Replacing the Maintenance Box

If the maintenance box is full, a message appears on your product's LCD screen. Select **How To** and follow the steps on the LCD screen to replace the maintenance box.

Make sure you have the replacement maintenance box handy before you begin.

**Caution:** Do not reuse a maintenance box that has been removed and left uninstalled for more than a week. Keep the maintenance box away from direct sunlight.

1. Open the front cover (L).
2. Push the maintenance box cover (H) tab and open the cover.
3. Pull the maintenance box all the way out.

**Note:** Do not tilt the used maintenance box or take it apart.

**Caution:** Be careful when removing the maintenance box; ink may leak when it is pulled out.

**Warning:** If ink gets on your skin, wash it thoroughly with soap and water. If ink gets into your eyes, flush them immediately with water. If ink gets into your mouth, spit it out and see a doctor right away. Keep the maintenance box out of the reach of children and do not drink the ink.

4. Remove the new maintenance box from its package.

**Caution:** Do not touch the areas shown below on the maintenance box.

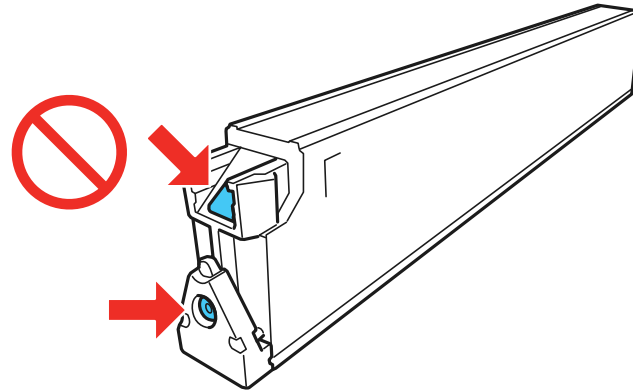

5. Insert the new maintenance box and push it all the way in.
6. Close the maintenance box cover (H).
7. Close the front cover (L).

The home screen appears and a status message counts down until the product is ready. When the status message disappears, maintenance box replacement is complete.

**Parent topic:** [Replacing Ink Cartridges and Maintenance Boxes](#)

**Related concepts**

[Purchase Epson Ink Cartridges and Maintenance Box \(U.S. and Canada\)](#)

[Purchase Epson Ink Cartridges and Maintenance Box \(Latin America\)](#)

**Related references**

[Optional Accessories and Replacement Parts](#)

---

## Adjusting Print Quality

If your print quality declines, you may need to run a utility to clean or align the print head.

**Note:** If you are using your Epson product with the Windows 10 S operating system, you cannot use the software described in this section. You also cannot download and install any Epson product software from the Epson website for use with Windows 10 S; you must obtain software only from the Windows Store.

If running these utilities does not solve the problem, you may need to replace the ink cartridges.

**Note:** Your product may differ from the images in this guide, but the instructions are the same unless otherwise noted.

[Print Head Maintenance](#)

### Print Head Maintenance

If your printouts become too light, or you see dark or light bands across them, you may need to clean the print head nozzles. Cleaning uses ink, so clean the nozzles only if print quality declines.

You can check for clogged nozzles before you clean them so you don't clean them unnecessarily.

**Note:** You cannot clean the print head if an ink cartridge is expended, and may not be able to clean it when a cartridge is low. You must replace the cartridge first.

[Checking the Nozzles Using the Product Control Panel](#)

[Cleaning the Print Head Using the Product Control Panel](#)

**Parent topic:** [Adjusting Print Quality](#)

**Related topics**

[Replacing Ink Cartridges and Maintenance Boxes](#)

### Checking the Nozzles Using the Product Control Panel

You can check the print head nozzles using the control panel on your product.

1. Make sure there are no errors on the LCD screen.
2. Load a few sheets of plain paper in the product.

3. Press the  home button, if necessary.
4. Select **Settings** > **Maintenance** > **Print Head Nozzle Check**.

You see a screen like this:

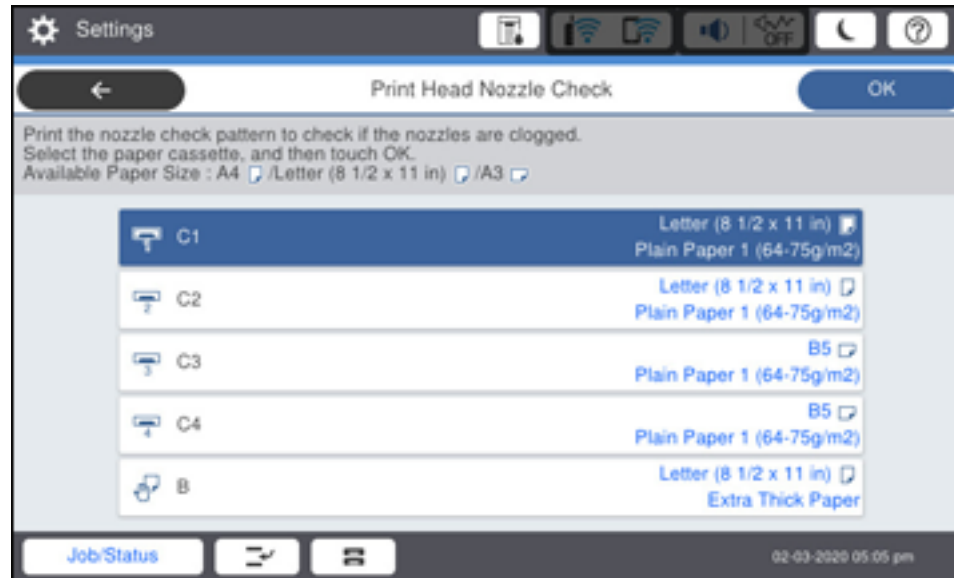

5. Select the paper cassette you want and select **OK**.  
The nozzle pattern prints.
6. Check the printed pattern to see if there are gaps in the lines.

**Print head is clean**

**WF-C20600/WF-C20750/WF-C21000:**



**WF-M21000:**



**Print head needs cleaning**

**WF-C20600/WF-C20750/WF-C21000:**

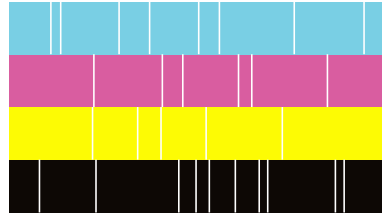

**WF-M21000:**



7. Do one of the following:
  - If there are no gaps, select **OK**.
  - If there are gaps or the pattern is faint, select **NG** and continue.
8. Follow the instructions on the screen to clean the print head, check the nozzles, and repeat the process as necessary.

**Caution:** Never turn off the product or open the front cover during a cleaning cycle or you may not be able to print.

If you don't see any improvement after cleaning the print head up to 4 times, wait at least 6 hours without printing. Then try cleaning the print head again.

**Parent topic:** [Print Head Maintenance](#)

**Related tasks**

[Cleaning the Print Head Using the Product Control Panel](#)



## Related topics

[Loading Paper](#)

## Cleaning the Print Head Using the Product Control Panel

You can clean the print head using the control panel on your product.

1. Make sure there are no errors on the LCD screen.
2. Load a few sheets of plain paper in the product.
3. Press the  home button, if necessary.
4. Select **Settings** > **Maintenance** > **Print Head Cleaning**.

You see a screen like this:

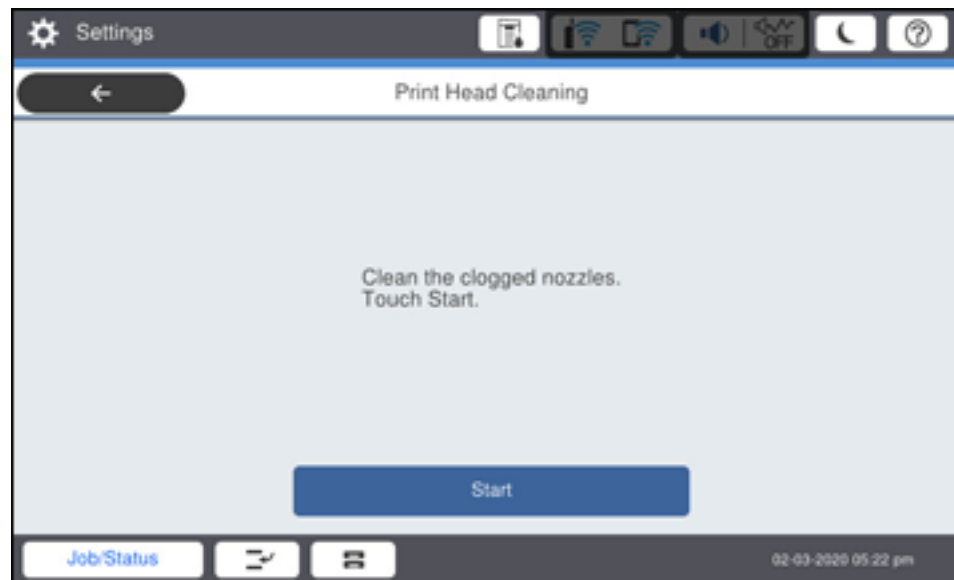

5. Select **Start** to clean the print head.

When the cleaning cycle is finished, you see a message on the LCD screen.

**Caution:** Never turn off the product or open the front cover during a cleaning cycle or you may not be able to print.

6. Select **Yes** to print a nozzle check pattern and follow the on-screen instructions.

If you don't see any improvement after cleaning the print head up to 4 times, wait at least 6 hours without printing. Then try cleaning the print head again.

**Parent topic:** [Print Head Maintenance](#)

**Related tasks**

[Checking the Nozzles Using the Product Control Panel](#)

**Related topics**

[Replacing Ink Cartridges and Maintenance Boxes](#)

[Loading Paper](#)

---

# Cleaning and Transporting Your Product

See these sections if you need to clean or transport your product.

**Note:** Your product may differ from the images in this guide, but the instructions are the same unless otherwise noted.

[Cleaning Your Product](#)

[Cleaning the Scanner Glass](#)

[Cleaning the Automatic Document Feeder](#)

[Moving or Transporting Your Product](#)

## Cleaning Your Product

To keep your product working at its best, you should clean it several times a year.

**Caution:** Do not use a hard brush, alcohol, or paint thinner to clean the product or you may damage it. Do not use oil or other lubricants inside the product or let water get inside it.

1. Turn off the product.
2. Unplug the power cord.
3. Disconnect any connected cables.
4. Clean the outer case and control panel with a soft, dry cloth. Do not use liquid or chemical cleansers.

**Parent topic:** [Cleaning and Transporting Your Product](#)

## Cleaning the Scanner Glass

You can clean the scanner glass if your copies or scanned images are smeared.

**Caution:** Do not use a hard brush, alcohol, or paint thinner to clean the product or you may damage it. Do not use oil or other lubricants inside the product or let water get inside it.

1. Open the document cover.

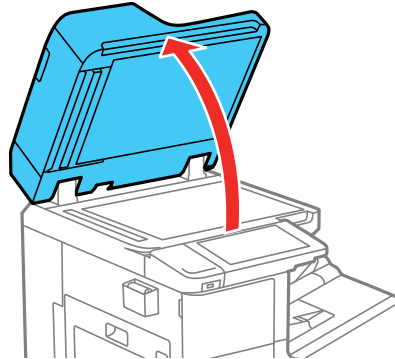

2. Remove the cleaning cloth from its holder.

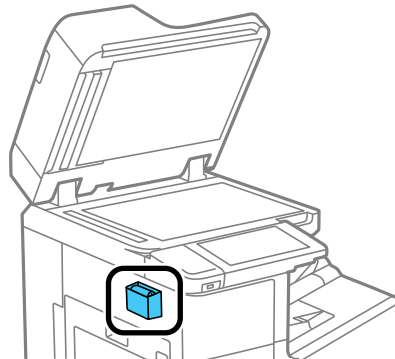

3. Use the cleaning cloth to wipe the scanner glass.

**Note:** If the glass is stained with grease or dirt, use a small amount of glass cleaner on a soft, dry cloth to remove it. Wipe off all remaining liquid after removing the dirt.

**Caution:** Do not spray glass cleaner directly on the glass and do not press the glass surface with any force.

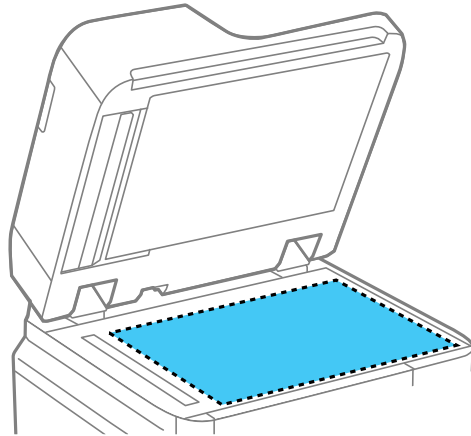

4. Return the cleaning cloth to its holder when you are finished.
5. Close the document cover.

**Parent topic:** [Cleaning and Transporting Your Product](#)

## Cleaning the Automatic Document Feeder

You can clean the ADF if you see lines or streaks in your copies or scanned images.

**Caution:** Do not use a hard brush, alcohol, or paint thinner to clean the product or you may damage it. Do not use oil or other lubricants inside the product or let water get inside it.

1. Lift the lever and open the ADF cover.

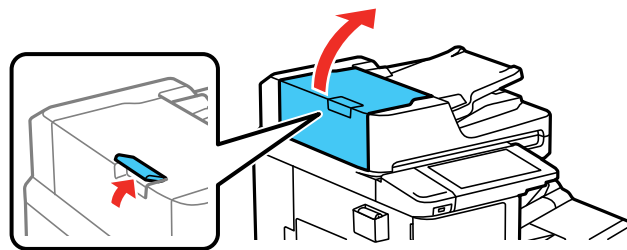

2. Use a soft, lint-free cloth (microfiber is recommended) moistened with a little water to clean the rollers and the interior of the ADF.

**Caution:** Do not use a dry cloth; you may damage the ADF rollers.

**Note:** Wait until the rollers are dry before using the ADF.

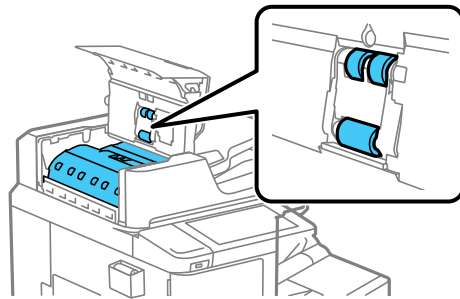

3. Close the ADF cover. The lever clicks when the cover is fully closed.

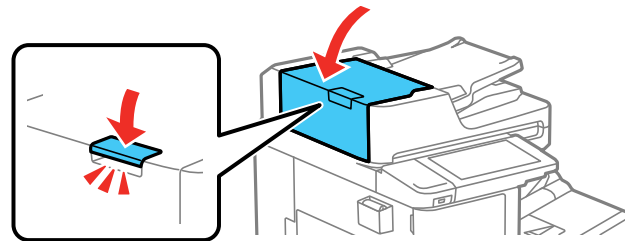

4. Open the document cover.

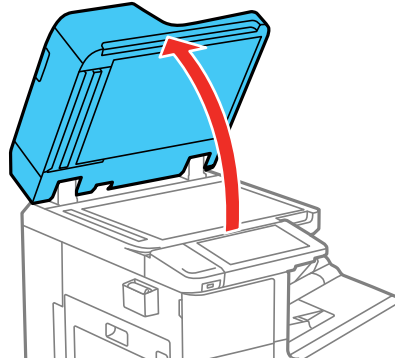

5. Remove the cleaning cloth from its holder.

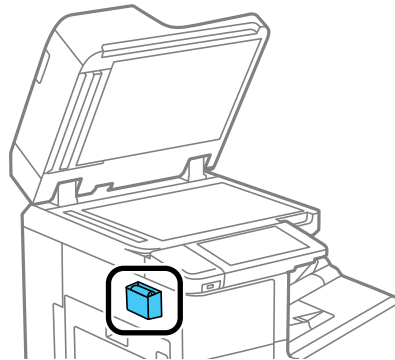

6. Clean the small strip of glass.

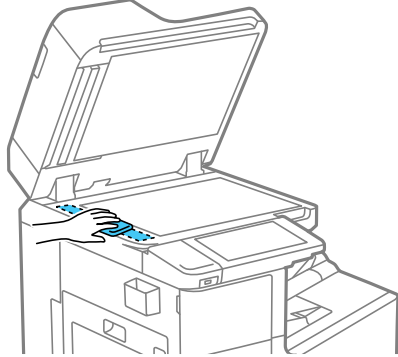

7. Lift the edge of the document cover as shown and use the cleaning cloth to clean the areas shown.

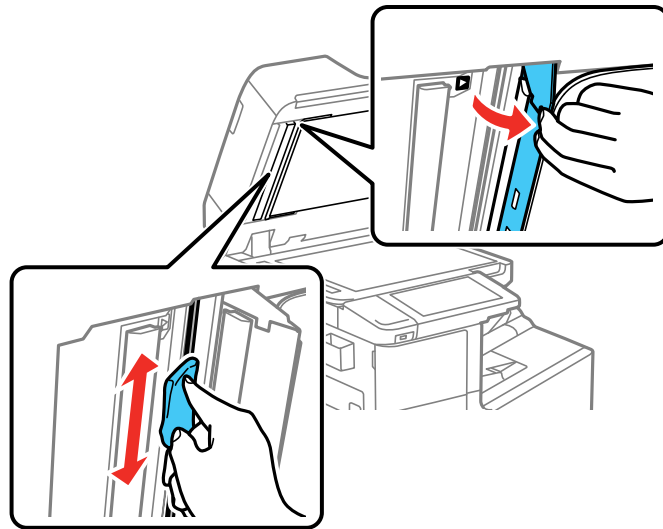

8. Return the cleaning cloth to its holder when you are finished.
9. Close the document cover.

**Parent topic:** [Cleaning and Transporting Your Product](#)



## Moving or Transporting Your Product

If you need to move or transport your product, contact Epson support or an authorized Epson service provider or technician.

**Caution:** At least four people are required to move the product.

**Parent topic:** [Cleaning and Transporting Your Product](#)

### Related references

[Where to Get Help \(U.S. and Canada\)](#)

[Where to Get Help \(Latin America\)](#)

### Related topics

[Replacing Ink Cartridges and Maintenance Boxes](#)

---

# Solving Problems

Check these sections for solutions to problems you may have using your product.

**Note:** Your product may differ from the images in this guide, but the instructions are the same unless otherwise noted.

[Viewing the Help Screen](#)

[Product Status Messages](#)

[Job Status Error Codes](#)

[Running a Product Check](#)

[Resetting Control Panel Defaults](#)

[Solving Setup Problems](#)

[Solving Network Problems](#)

[Solving Copying Problems](#)

[Solving Copy Quality Problems](#)

[Solving Paper Problems](#)

[Solving Problems Printing from a Computer](#)

[Solving Page Layout and Content Problems](#)

[Solving Print Quality Problems](#)

[Solving Scanning Problems](#)

[Solving Scanned Image Quality Problems](#)

[Solving Faxing Problems](#)

[Solving USB Device Problems](#)

[Uninstall Your Product Software](#)

[Where to Get Help \(U.S. and Canada\)](#)

[Where to Get Help \(Latin America\)](#)

## Viewing the Help Screen

You can view troubleshooting or how-to topics on the LCD screen at any time.

1. Select the  help icon.

You see this screen:

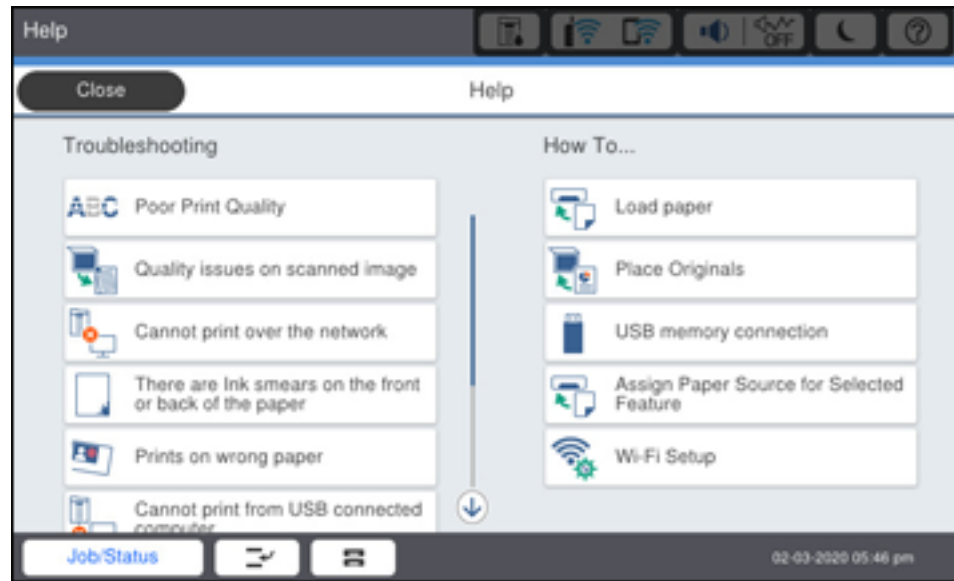

2. Select a **Troubleshooting** or **How To** option to view instructional images or animations.

Parent topic: [Solving Problems](#)

## Product Status Messages

You can often diagnose problems with your product by checking the messages and status icons on its LCD screen. You can also check for errors by selecting **Job/Status** > **Printer Status**.

**Note:** If the LCD screen is dark, press the screen to wake the product from sleep mode.

LCD screen message	Condition/solution
Printer error. Turn the power off and on again. For details, see your documentation.	Turn the product off and then back on again. If the error persists, check for and remove any jammed paper or protective materials from the product, and disconnect any optional installed units. If the error persists, contact Epson for support.
Printer error. For details, see your documentation.	The product may be damaged, but features such as scanning are still available. Contact Epson for support.

LCD screen message	Condition/solution
Cannot print because XX is out of order. You can print from another cassette.	Turn the product off and then back on again. Reinsert the indicated paper cassette. If the error persists, contact Epson for support.
HDD error. Turn the printer off and back on again. If the error continues, contact Epson support.	The hard disk drive is damaged. You may not be able to receive faxes (models equipped with optional fax board) or copy or print documents that contain images. Copying more than 50 pages of Text & Image A4 documents may fail. Contact Epson for support.
XX are nearing the end of their service life.	A consumable part in your product needs to be replaced. Contact Epson for support.
XX are nearing the end of their service life.	Contact Epson for support.
XX is at the end of its service life. Replace it.	
You need to replace the following ink cartridge(s). Confirm the procedure, and then replace them.	Replace the indicated ink cartridge(s).
No dial tone detected. (models with optional fax board installed)	Make sure the phone cable is connected correctly and the phone line works. If you connected the product to a PBX (Private Branch Exchange) phone line or Terminal Adapter, change the <b>Line Type</b> setting to <b>PBX</b> . Use # instead of the actual access code when entering an outside fax number. If you still cannot send a fax, turn off the <b>Dial Tone Detection</b> setting. (Turning off the Dial Tone Detection setting may cause the product to drop the first digit of a fax number.)
Failed to receive faxes because the fax data capacity is full. Touch the Job/Status at the bottom of the Home Screen for details. (Models equipped with optional fax board)	Select <b>Job/Status &gt; Printer Status</b> and resolve any errors that are preventing faxes from printing. Make sure the product is connected to a computer and it is turned on, or connect a memory device to the product.
The combination of the IP address and the subnet mask is invalid. See your documentation for more details.	There is a problem with the network connection to your product. Set up your product on the network again.

LCD screen message	Condition/solution
To use cloud services, update the root certificate from the Epson Web Config utility.	Access the Web Config utility and update the cloud service root certificate.
Check that the printer driver is installed on the computer and that the port settings for the printer are correct.	Make sure the printer port is correctly configured. In Windows, make sure the port is set to a <b>USBXXX</b> setting for a USB connection or <b>EpsonNet Print Port</b> for a network connection.
Check that the printer driver is installed on the computer and that the USB port settings for the printer are correct.	
The file name is already in use. Rename the file and scan again.	Change the file name settings, move or delete the files, or change the file name on the shared folder.
Scanned file(s) are too large. Only XX page(s) have been sent. Check if the destination has enough space.	There is not enough disk space on the computer. Increase the free space on the computer.
DNS error. Check DNS settings.	Unable to connect to the computer. Make sure the address in the contacts list on the product and of the shared folder match. If the IP address of the computer is static and is set manually, change the computer name in the network path to the IP address. For example, change \\EPSON02\SCAN to \\192.168.XX.XX\SCAN. Make sure the computer is turned on and is not going to enter sleep mode. Temporarily disable the computer's firewall and security software. If this clears the error, check the security software settings. If <b>Public network</b> is selected as the network place, you cannot save the scanned images to the shared folder. Set the forward settings for each port. If you are using a laptop computer and the IP address is set as DHCP, the IP address may change when reconnecting to the network. Obtain the IP address again. Make sure the DNS setting is correct. The computer name and IP address may differ when the management table of the DNS server is not updated. Contact your network administrator and your DNS server administrator.

LCD screen message	Condition/solution
Authentication error. Please check the Email Server Settings.	Make sure the user name and password on the computer, and the contacts on the printer, are correct. Also, make sure that the password has not expired.
Communication error. Check the Wi-Fi/network connection.	Unable to communicate with a network folder that is registered on the contacts list. Make sure <b>Use Microsoft network sharing (Network &gt; MS Network)</b> is enabled in the Web Config. Make sure the address in the contacts list on the product and of the shared folder match. Access rights for the user in the contacts list should be added on the <b>Sharing</b> and <b>Security</b> tabs of the shared folder's properties. Set the user's permissions to <b>allowed</b> .
Recovery mode Update Firmware	An error has occurred during firmware updating. Connect your product using a USB cable and try downloading the Firmware Update from the Epson support site. If you need help, contact Epson for support.

**Parent topic:** [Solving Problems](#)

#### **Related references**

[Where to Get Help \(U.S. and Canada\)](#)

[Where to Get Help \(Latin America\)](#)

#### **Related tasks**

[Connecting a Telephone or Answering Machine](#)

[Checking for Software Updates](#)

[Accessing the Web Config Utility](#)

[Selecting the Line Type](#)

[Removing and Installing Ink Cartridges](#)

#### **Related topics**

[Loading Paper](#)

[Wi-Fi or Wired Networking](#)

## **Job Status Error Codes**

If a printing, scanning, copying, or faxing (models equipped with optional fax board) job does not complete successfully, you can check the error code for the reason. Select **Job/Status > Job Status** to view the error codes.

<b>Code</b>	<b>Condition/solution</b>
001	The product was turned off by a power failure.
101	Memory is full. Reduce the size of the print job.
102	Collated printing has failed due to a lack of available memory. Reduce the size of the print job or print one copy at a time.
103	Print quality was decreased due to a lack of available memory. If the quality of the printout is unacceptable, try simplifying the page by reducing the number of graphics or the number and size of the fonts.
104 131	Reverse order printing has failed due to a lack of available memory. Reduce the size of the print job.
106	Cannot print from the computer due to access control settings. Contact your product administrator.
107	User authentication failed and the job has been canceled. Contact your product administrator.
108	Confidential job data was deleted when the product was turned off.
109	The received fax was already deleted (models equipped with optional fax board).
110	The job was printed 1-sided because the loaded paper does not support 2-sided printing.
111	Available memory is running low. Reduce the size of the print job.
120	Cannot communicate with a server using an open platform. Check the server or network for errors.
130	Collated printing has failed due to a lack of available memory. Reduce the size of the print job or change the collate settings.
132	Cannot print due to a lack of available memory. Reduce the size of the print job.
133	Cannot print 2-sided due to a lack of available memory. Only one side will print. Reduce the size of the print job.
141	HDD error. The job is canceled. Contact Epson for support.
151	Cannot print because the user name associated with the confidential job does not match.
201	The product's memory is full. You can send pages individually, or print received faxes and delete them to free up memory space (models equipped with optional fax board).

<b>Code</b>	<b>Condition/solution</b>
202	The line was disconnected by the recipient's fax machine (models equipped with optional fax board). Wait a moment, then try again.
203	The product cannot detect a dial tone (models equipped with optional fax board). Make sure the phone cable is connected correctly and the phone line works. If you connected the product to a PBX (Private Branch Exchange) phone line or Terminal Adapter, change the <b>Line Type</b> setting to <b>PBX</b> . If you still cannot send a fax, turn off the <b>Dial Tone Detection</b> setting. (Turning off the Dial Tone Detection setting may cause the product to drop the first digit of a fax number.)
204	The recipient's fax machine is busy (models equipped with optional fax board). Wait a moment, then try again.
205	The recipient's fax machine does not answer (models equipped with optional fax board). Wait a moment, then try again.
206	The phone cable is incorrectly connected to the product's <b>LINE</b> and <b>EXT</b> ports (models equipped with optional fax board). Connect the phone cable correctly.
207	The phone cable is not connected (models equipped with optional fax board). Connect the phone cable.
208	The fax could not be sent to some of the specified recipients (models equipped with optional fax board). Print a fax log to check which recipients failed to receive the fax. If the <b>Save Failure Data</b> setting is turned on, you can resend a fax by selecting <b>Job Status</b> in the Job/Status menu.
301 401	There is not enough storage space available to save the data in the external memory device. Clear space on the device or use a different device.
302 402	The external memory device is write-protected. Disable write protection.
303	No folder is available for saving the scanned file. Create a folder or use a different memory device.
304 404	The external memory device has been removed. Reinsert the device.
305 405	An error occurred while saving data to an external memory device. Reinsert the memory device or use a different device.
306	The product's memory is full. Wait until current jobs are finished processing.



Code	Condition/solution
307	The scanned image size exceeds the maximum limit. Lower the scanning resolution or increase the compression ratio to reduce the size of the scanned image.
311 321 411 421	A DNS error has occurred. From the Home screen, select <b>Settings &gt; General Settings &gt; Network Settings &gt; Advanced &gt; TCP/IP</b> and check the DNS settings for the server, computer, or access point.
312 412	An authentication error has occurred. From the Home screen, select <b>Settings &gt; General Settings &gt; Network Settings &gt; Advanced &gt; Email Server &gt; Server Settings</b> and check the server settings.
313 413	A communication error has occurred. From the Home screen, select <b>Settings &gt; General Settings &gt; Network Settings &gt; Advanced &gt; Email Server &gt; Server Settings</b> and check the server settings. Print a network connection report to check if the product is connected to the network. The authentication method of the settings and the email server may not match. If the authentication method is set to <b>Off</b> , make sure the authentication method of the email server is set to <b>None</b> .
314	The data size exceeds the maximum size for the attached files. From the Home screen, select <b>Scan &gt; Email &gt; Scan Settings</b> and scroll down to select <b>Attached File Max Size</b> . Increase the setting or lower the file size of the scanned image.
315 327	The memory is full. Wait for current jobs to finish and try again.
316	A mail encryption error has occurred. Make sure the encryption certificate setting and product time setting are correct.
317	A mail signature error has occurred. Make sure the signing certificate setting and product time setting are correct.
322	An authentication error occurred while scanning. From the Home screen, select <b>Scan &gt; Network Folder/FTP &gt; Keyboard &gt; Location</b> and check the settings.
323 331	A communication error has occurred while scanning. From the Home screen, select <b>Scan &gt; Network Folder/FTP &gt; Keyboard &gt; Location</b> and check the settings. You can also print a network status sheet to check the network connection.
324	A file with the same name already exists in the specified folder for scanning. Delete the duplicate file or change the file name prefix. From the Home screen, select <b>Scan &gt; Network Folder/FTP &gt; Scan Settings &gt; File Name</b> .

Code	Condition/solution
325 326	There is not enough storage space available in the specified folder. Increase the storage space in the specified folder, delete unnecessary files, or lower the file size of the scanned image.
328	The destination for scanning was wrong or the destination does not exist. From the Home screen, select <b>Scan &gt; Network Folder/FTP &gt; Keyboard &gt; Location</b> and check the settings.
329	The scanned image size exceeds the maximum limit for the <b>Network Folder/FTP</b> scan option. Lower the scanning resolution or increase the compression ratio.
330	An FTPS/FTPS secure connection error has occurred. Check the location in the destination settings. Run Web Config and update the root certificate, and import or update the CA certificate. If the error cannot be cleared, disable certificate verification in the destination settings.
332	There is not enough space available for saving the scanned files in the specified folder. Delete unnecessary files from the specified folder.
333	The destination could not be found because the destination information was uploaded to the server before sending the scanned data. Select the destination again.
334	An error occurred while sending the scanned data.
341	A communication error has occurred while scanning. Make sure the product is connected to the computer or network correctly and that you installed Document Capture Pro or Document Capture. Make sure the Event Manager program is not being blocked by your firewall or security software.
350	An FTPS/HTTPS certificate error has occurred. If the error cannot be cleared, disable certificate verification in the destination settings.
422	An authentication error has occurred while faxing (models equipped with optional fax board). From the Home screen, select <b>Settings &gt; General Settings &gt; Fax Settings &gt; Receive Settings &gt; Save/Forward Settings</b> and check the settings for the folder selected in <b>Destination</b> .
423	A communication error has occurred while faxing (models equipped with optional fax board). From the Home screen, select <b>Settings &gt; General Settings &gt; Fax Settings &gt; Receive Settings &gt; Save/Forward Settings</b> . Select the arrow icon at the end of an entry and check the <b>Save/Forward Destination</b> setting. You can also print a network status sheet to check the network connection.

Code	Condition/solution
425	There is not enough storage space available in the forwarding destination folder for faxing (models equipped with optional fax board). Increase the storage space.
428	The destination for faxing was wrong or the destination does not exist (models equipped with optional fax board). From the Home screen, select <b>Settings &gt; General Settings &gt; Fax Settings &gt; Receive Settings &gt; Save/Forward Settings</b> . Select the arrow icon at the end of an entry and check the <b>Save/Forward Destination</b> setting.
501	Cannot use the storage feature. Check the user permissions from Web Config.
502	The storage area is full. Delete unnecessary saved jobs from the control panel or Web Config.
504	The number of files has reached the maximum limit. Delete unnecessary saved jobs from the control panel or Web Config.
505	A read/write error has occurred in the product's storage. Contact Epson for support.

**Parent topic:** [Solving Problems](#)

#### **Related tasks**

[Connecting a Telephone or Answering Machine](#)  
[Viewing a Fax on the LCD Screen \(Using the Fax Box\)](#)  
[Selecting the Line Type](#)  
[Selecting Advanced Fax Settings](#)  
[Setting User Feature Restrictions \(Access Control\)](#)  
[Entering a User ID and Password for Printing](#)

#### **Related topics**

[Sending Faxes](#)  
[Wi-Fi or Wired Networking](#)

## **Running a Product Check**

Running a product check helps you determine if your product is operating properly.

1. Disconnect any interface cables connected to your product.
2. Load plain paper in the product.
3. Press the  home button, if necessary.
4. Select **Settings > Maintenance > Print Head Nozzle Check**.

You see a screen like this:

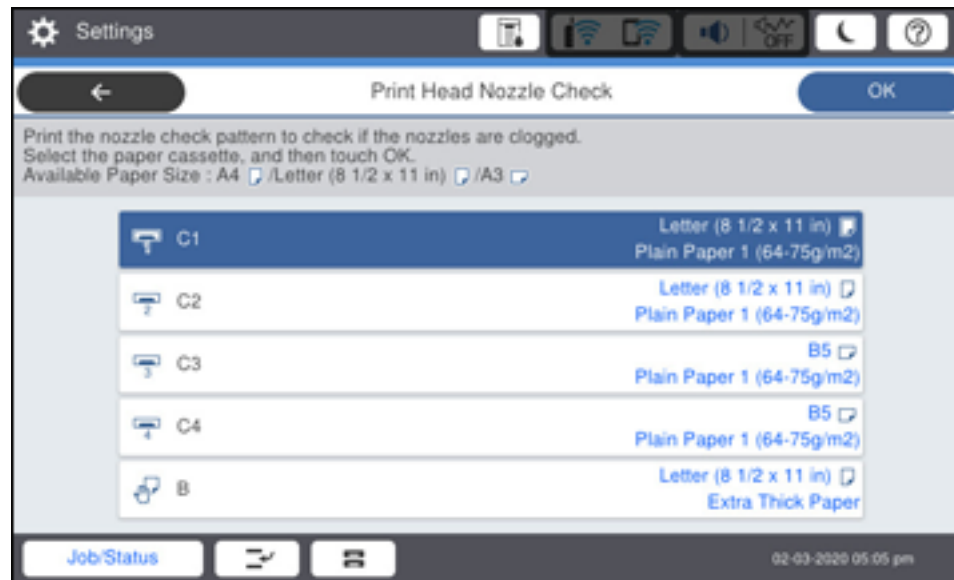

5. Select a paper cassette and select **OK**.  
The nozzle pattern prints.
6. Do one of the following, depending on the results of the product check:
  - If the page prints and the nozzle check pattern is complete, the product is operating properly. Any operation problem you may have could be caused by your computer, cable, software, or selected settings. Check the other solutions in this book or try uninstalling and reinstalling your printer software.
  - If the page prints but the nozzle check pattern has gaps, clean the print head.
  - If the page does not print, the product may have a problem. Check the other solutions in this manual. If they do not work, contact Epson.

**Parent topic:** [Solving Problems](#)

**Related concepts**

[Uninstall Your Product Software](#)

### Related references

[Where to Get Help \(U.S. and Canada\)](#)

[Where to Get Help \(Latin America\)](#)

### Related tasks

[Checking the Nozzles Using the Product Control Panel](#)

[Cleaning the Print Head Using the Product Control Panel](#)

## Resetting Control Panel Defaults

If you have a problem with settings on the product control panel, you can reset them to their factory defaults. You can choose which settings to reset or reset them all.

**Note:** This setting can be locked by an administrator. If you cannot access or change this setting, contact your administrator for assistance.

**Note:** This product automatically stores names, telephone numbers, and fax data (models equipped with an optional fax board) in its internal memory log when faxing or emailing jobs. This product also contains an encrypted hard drive that is used for storing large and/or authenticated print, copy and scan jobs. You may erase data stored on the encrypted hard drive by following the steps outlined in the link below or in the *Administrator's Guide*. It is recommended that data is erased before disposing or giving away the product.

1. Press the  home button, if necessary.
2. Select **Settings > General Settings > System Administration > Reset**.

**Note:** You may need to enter the administrator password.

You see a screen like this:

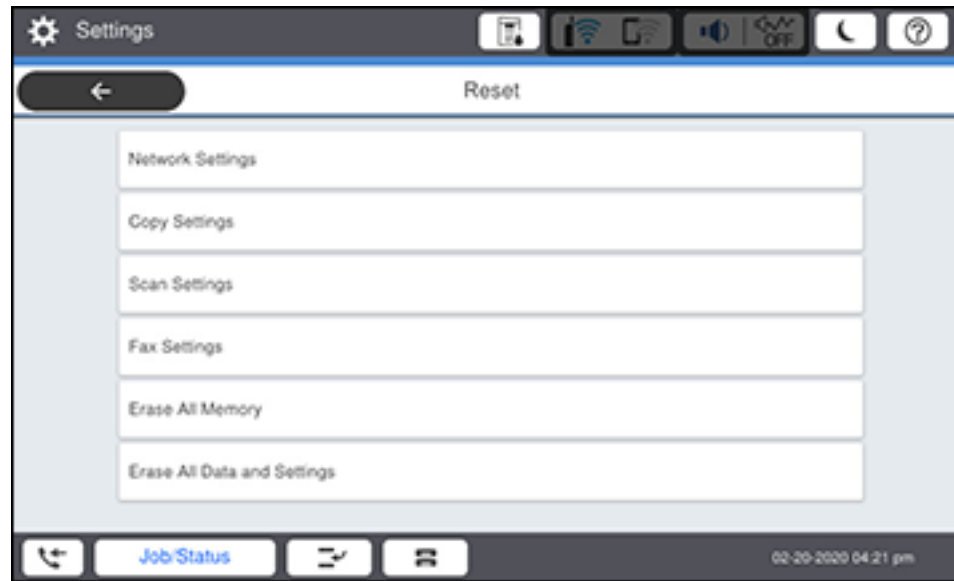

3. Select one of these options:

- **Network Settings:** Resets all network settings
- **Copy Settings:** Resets all settings for copying
- **Scan Settings:** Resets all settings for scanning
- **Fax Settings :** Resets all settings for faxing
- **Erase All Data and Settings:** Resets all control panel settings including the contacts list. Select from **High Speed**, **Overwrite**, or **Triple Overwrite**.

**Note:** **High Speed** erases the data on the hard drive. The **Overwrite** and **Triple Overwrite** options also overwrite any invalid data in the hard drive. **Overwrite** takes about 60 minutes to complete and **Triple Overwrite** takes about 280 minutes to complete.

You see a confirmation screen.

4. Select **Yes** to reset the selected settings. (Select **No** if you want to cancel the operation.)

**Parent topic:** [Solving Problems](#)

## Solving Setup Problems

Check these sections if you have problems while setting up your product.

[Product Does Not Turn On or Off](#)

[Noise After Ink Installation](#)

[Software Installation Problems](#)

**Parent topic:** [Solving Problems](#)

### Product Does Not Turn On or Off

If you cannot turn the product on or off, try these solutions:

- If you cannot turn on your product, make sure the power cord is securely connected and hold down the power button a little longer.
- If you cannot turn off your product, hold down the power button a little longer. If you still cannot turn off your product, unplug the power cord, plug the power cord back in, then turn your product on and off again using the power button.

**Parent topic:** [Solving Setup Problems](#)

### Noise After Ink Installation

If you hear noises from your product after installing ink, check the following:

- The first time you install the ink cartridges, the product must charge its print head. Wait until charging finishes before you turn off the product, or it may charge improperly and use excess ink the next time you turn it on.
- If the product's print head stops moving or making noise, and the charging process has not finished after approximately 5 minutes, turn off your product. Turn it back on and check to see if charging is still in progress. If it is still in progress, contact Epson for help.

**Parent topic:** [Solving Setup Problems](#)

### Software Installation Problems

If you have problems while installing your product software, try these solutions:

- Make sure your product is turned on and any necessary cables are securely connected at both ends. Also make sure your system meets the requirements for your operating system. If you still have problems installing software, contact your system administrator.
- Close any other programs, including screen savers and virus protection software, and install your product software again.

- In Windows, make sure your product is selected as the default printer and the correct port is shown in the printer properties.
- If you see any error message or your software does not install correctly in Windows, you may not have software installation privileges. Contact your system administrator.
- If you are printing over a network, make sure your product is set up properly on the network.

**Parent topic:** [Solving Setup Problems](#)

**Related concepts**

[Uninstall Your Product Software](#)

**Related references**

[Mac System Requirements](#)

[Windows System Requirements](#)

## Solving Network Problems

Check these solutions if you have problems setting up or using your product on a network.

**Note:** Breakdown or repair of this product may cause loss of fax and network data and settings. Epson is not responsible for backing up or recovering data and settings during or after the warranty period. We recommend that you make your own backup or print out your fax and network data and settings.

[Product Cannot Connect to a Wireless Router or Access Point](#)

[Network Software Cannot Find Product on a Network](#)

[Wireless Network Connection is Unstable on a Mac](#)

[USB 3.0 Connection is Unstable When Using a USB 2.0 Cable](#)

[Wired Network Connection Becomes Unstable](#)

[Product Does Not Appear in Mac Printer Window](#)

[Cannot Print Over a Network](#)

[Cannot Scan Over a Network](#)

**Parent topic:** [Solving Problems](#)



## Product Cannot Connect to a Wireless Router or Access Point

If your product has trouble finding or connecting to a wireless router or access point, try these solutions:

- If you are connecting the product via Wi-Fi Protected Setup (WPS) and the Wi-Fi icon on your product's LCD screen is not lit or does not appear, make sure you select one of the WPS options from the product control panel within 2 minutes of pressing the WPS button on your router.
- Make sure to place your product within contact range of your router or access point. Avoid placing your product near a microwave oven, cordless phone, or large metal object, such as a filing cabinet.

**Note for Latin America:** If you are using a 5 GHz wireless router, set the router to operate in dual band (2.4 GHz and 5 GHz) mode. If your router uses a single network name (SSID) for both the 2.4 GHz and 5 GHz band, give each band its own network name (SSID) instead, such as Home Network 2.4 GHz and Home Network 5 GHz. See your router documentation or contact your internet service provider for instructions.

- Verify that your router or access point is operating correctly by connecting to it from your computer or another device.
- Print a network connection report and check the codes and messages on the report to help determine the cause of the problem.
- You may need to disable the firewall and any anti-virus software on your wireless router or access point.
- Try restarting your router following the instructions in your router documentation.

**Note:** If you are reading these instructions online, you will lose your Internet connection when you restart your router.

- Check to see if access restrictions, such as MAC address filtering, are set on the router or access point. If access restrictions are set, add your product's MAC address to your router's address list. To obtain your product's MAC address, print a network status sheet. Then follow the instructions in your router or access point documentation to add the address to the list.
- If your router or access point does not broadcast its network name (SSID), follow the instructions that came with your product to enter your wireless network name manually.
- If your router or access point has security enabled, determine the kind of security it is using and any required password or passphrase for connection. Then make sure to enter the exact WEP key or WPA passphrase correctly.
- Check if your computer is restricting the available wireless channels. If so, verify that your wireless access point is using one of the usable channels and change to a usable channel, if necessary.

- If you cannot connect your product to a device using Wi-Fi Direct, you may have exceeded the maximum number of devices connected to your product (8). Print a network status sheet or access Web Config on the browser for your device and check the number of connected devices. If 8 devices are already connected, disconnect a device by deleting the product's SSID from the Wi-Fi screen of that device. If fewer than 8 devices are connected, check the accuracy of your other network settings, move your device closer to your product, and try connecting again.
- If you are using a Wi-Fi Direct connection that suddenly disconnects, the Wi-Fi direct password on your device may have been changed. If necessary, delete the existing **DIRECT-xxxxxxxx** connection settings from your device and enter a new password. See your device documentation for instructions.
- If you connected your product to a Windows computer using Wi-Fi Direct and it automatically selected Access Point Mode, you may have trouble accessing a low-priority Internet connection. Check the network connection or adapter settings in the Windows Control Panel and set the **Internet metric** setting to **100** for your version of the Internet Protocol.

**Parent topic:** [Solving Network Problems](#)

**Related concepts**

[Wi-Fi Direct Mode Setup](#)

**Related tasks**

[Selecting Wireless Network Settings from the Control Panel](#)

[Printing a Network Status Sheet](#)

**Related topics**

[Wi-Fi or Wired Networking](#)

## Network Software Cannot Find Product on a Network

If EpsonNet Setup cannot find your product on a network, try these solutions:

- Make sure your product is turned on and connected to your network. Verify the connection using your product control panel.
- Check if your network name (SSID) contains non-ASCII characters. Your product cannot display non-ASCII characters.
- Print a network connection report and check the codes and messages on the report to help determine the cause of the problem.
- Make sure your product is not connected to a guest network.
- If necessary, reinstall your product software and try running EpsonNet Setup again:
  1. Reset your product's network settings to their factory defaults.

2. **Windows only:** Uninstall your product software.
3. Restart your router following the instructions in your router documentation.

**Note:** If you are reading these instructions online, you will lose your Internet connection when you restart your router, so note the next step before restarting it.

4. Download your product software from the Epson website, or contact your system administrator.
- If you have replaced your router, reinstall your product software to connect to the new router.

**Note for Latin America:** If you are using a 5 GHz wireless router, set the router to operate in dual band (2.4 GHz and 5 GHz) mode. If your router uses a single network name (SSID) for both the 2.4 GHz and 5 GHz band, give each band its own network name (SSID) instead, such as Home Network 2.4 GHz and Home Network 5 GHz. See your router documentation or contact your internet service provider for instructions.

- Check to see if your wireless router or access point has an enabled Privacy Separator function that is preventing detection of your device over the network. See your router or access point documentation for instructions on disabling the Privacy Separator function.

**Parent topic:** [Solving Network Problems](#)

**Related concepts**

[Uninstall Your Product Software](#)

**Related topics**

[Wi-Fi or Wired Networking](#)

## Wireless Network Connection is Unstable on a Mac

If you connected a device to a USB 3.0 port on your Mac, you may experience wireless network interference between your product and your Mac.

If you cannot connect to your product over the wireless network or the connection becomes unstable, move the device connected to your Mac USB 3.0 port further away from your Mac.

If your wireless router or access point has a 5 GHz band, connect to it (U.S. and Canada only).

**Note for U.S. and Canada:** If your router uses a single network name (SSID) for both the 2.4 GHz and 5 GHz band, give each band its own network name (SSID) instead, such as Home Network 2.4 GHz and Home Network 5 GHz. See your router documentation or contact your internet service provider for instructions.

Parent topic: [Solving Network Problems](#)

## USB 3.0 Connection is Unstable When Using a USB 2.0 Cable

If you receive a communication error or experience an unstable connection when using a SuperSpeed USB port on your computer with a USB 2.0 cable, try these solutions:

- Use a USB 3.0 cable.
- Connect to a Hi-Speed USB port on your computer, if available.
- Connect to another SuperSpeed USB port on your computer, if available.

Parent topic: [Solving Network Problems](#)

## Wired Network Connection Becomes Unstable

When you connect the product to a wired network using a router or access point that supports IEEE 802.3az (Energy Efficient Ethernet), the connection may become unstable, you may be unable to connect to the product, and the communication speed may become slow. If you experience any of these issues, follow the steps below to disable IEEE 802.3az and then connect your product again.

1. Disconnect the Ethernet cables connected to the computer and your product.
2. Disable IEEE 802.3az for the computer's network adapter if it is enabled (check your operating system's Ethernet connection settings).
3. Connect the computer and your product directly with an Ethernet cable.
4. Print a network connection report from your product.
5. On the computer, open a web browser and enter your product's IP address from the network connection report.
6. Select **Network > Wired LAN**.
7. Select **OFF** for IEEE 802.3az. and click **Next**.
8. Click **OK** and remove the Ethernet cable connecting the computer and your product.
9. If you disabled IEEE 802.3az for your computer's network adapter, enable it.
10. Reconnect the Ethernet cables from the router or access point to your computer and product.

If problems still occur, other devices on the network may be causing them.

Parent topic: [Solving Network Problems](#)

### Related tasks

[Printing a Network Connection Report](#)

## Product Does Not Appear in Mac Printer Window

If your product does not appear in the Mac printer window, try these solutions:

- Turn your product off, wait 30 seconds, then turn it back on again.
- If you are connecting the product via Wi-Fi Protected Setup (WPS) and the Wi-Fi icon on your product's LCD screen is not lit, make sure you select one of the WPS options from the product control panel within 2 minutes of pressing the WPS button on your router.
- If you are connecting the product wirelessly via EpsonNet Setup and you do not see the Wi-Fi antenna icon with connection bars on your LCD screen, make sure your product software was installed correctly. If necessary, reinstall your software.

**Parent topic:** [Solving Network Problems](#)

### Related tasks

[Uninstalling Product Software - Mac](#)

## Cannot Print Over a Network

If you cannot print over a network, try these solutions:

- Make sure that your product is turned on.
- Make sure you install your product's network software as described in your product documentation, or contact your system administrator.
- Print a network status sheet and verify that the network settings are correct. If the network status is **Disconnected**, check any cable connections and turn your product off and then on again.
- Print a network connection report and check the codes and messages on the report to help determine the cause of the problem.
- If you are using TCP/IP, make sure the product's IP address is set correctly for your network. If your network does not assign IP addresses using DHCP, set the IP address manually.
- If the IP address assigned to the product is 169.254.XX.XX and the subnet mask is 255.255.0.0, the IP address may not be assigned correctly. Check the IP address and subnet mask assigned to the product (**Settings > General Settings > Network Settings > Advanced**) then restart the wireless router or reset the network settings for the product.
- Make sure your computer and product are both using the same wireless network.
- If network printing is slow, print a network status sheet and check the signal strength. If it is poor, place your product closer to your router or access point. Avoid placing your product near a microwave oven, cordless phone, or large metal object, such as a filing cabinet.

**Note for Latin America:** If you are using a 5 GHz wireless router, set the router to operate in dual band (2.4 GHz and 5 GHz) mode. If your router uses a single network name (SSID) for both the 2.4 GHz and 5 GHz band, give each band its own network name (SSID) instead, such as Home Network 2.4 GHz and Home Network 5 GHz. See your router documentation or contact your internet service provider for instructions.

- Try restarting your router following the instructions in your router documentation.

**Note:** If you are reading these instructions online, you will lose your Internet connection when you restart your router.

- Check to see if your wireless router or access point has an enabled Privacy Separator function that is preventing printing from a device over the network. See your router or access point documentation for instructions on disabling the Privacy Separator function.
- If you are connecting the product via Wi-Fi Protected Setup (WPS) and the Wi-Fi icon on your product's LCD screen is not lit, make sure you select one of the WPS options from the product control panel within 2 minutes of pressing the WPS button on your router.
- Check your wired LAN router or access point to see if the LED for the port to which your product is connected is on or flashing. If the link LED is off, try the following:
  - Make sure the Ethernet cable is securely connected to your product and to your router, access point, switch, or hub.
  - Try connecting your product to a different port or a different router, access point, switch, or hub.
  - Try connecting with a different Ethernet cable.
  - Try printing to your product from another computer on the network.
- If you are connecting the product via EpsonNet Setup and the Wi-Fi icon does not appear lit on the LCD screen, make sure your product software was installed correctly. If necessary, reinstall your software.

**Parent topic:** [Solving Network Problems](#)

**Related concepts**

[Uninstall Your Product Software](#)

**Related tasks**

[Printing a Network Status Sheet](#)

**Related topics**

[Wi-Fi or Wired Networking](#)

## Cannot Scan Over a Network

If you have problems scanning over a network, try these solutions:

- If you cannot scan from your product control panel, make sure you restarted your computer after installing the product software. Make sure the Event Manager program is not being blocked by your firewall or security software.

**Note for Latin America:** If you are using a 5 GHz wireless router, set the router to operate in dual band (2.4 GHz and 5 GHz) mode. If your router uses a single network name (SSID) for both the 2.4 GHz and 5 GHz band, give each band its own network name (SSID) instead, such as Home Network 2.4 GHz and Home Network 5 GHz. See your router documentation or contact your internet service provider for instructions.

- If you are scanning a large original at a high resolution, a network communication error may occur. Try scanning again at a lower resolution.
- If network communication was interrupted while starting Epson Scan 2, exit Epson Scan 2, wait a few seconds, and restart it. If Epson Scan 2 cannot restart, turn off your product, turn it back on, and try restarting Epson Scan 2 again.
- Check the scanner setting and reset the connection if necessary using Epson Scan 2 Utility:

**Windows 10:** Click  and select **EPSON > Epson Scan 2 Utility**. Make sure your product is selected. If necessary, select the **Other** tab and click **Reset**.

**Windows 8.x:** Navigate to the **Apps** screen, select **EPSON**, and select **Epson Scan 2 Utility**. Make sure your product is selected. If necessary, select the **Other** tab and click **Reset**.

**Windows (other versions):** Click  or **Start > All Programs** or **Programs > EPSON > Epson Scan 2 > Epson Scan 2 Utility**. Make sure your product is selected. If necessary, select the **Other** tab and click **Reset**.

**Mac:** Open the **Applications** folder, click **Epson Software**, and click **Epson Scan 2 Utility**. Make sure your product is selected. If necessary, select the **Other** tab and click **Reset**.

- You may need to disable the firewall and any anti-virus software on your wireless router or access point.
- Make sure the DNS settings and domain name are correct.

**Parent topic:** [Solving Network Problems](#)

### Related tasks

[Starting a Scan Using the Epson Scan 2 Icon](#)

[Starting a Scan Using the Product Control Panel](#)

[Entering a User ID and Password for Scanning](#)

## Solving Copying Problems

Check these solutions if you have problems copying with your product.

[Product Cannot Copy](#)

[Product Makes Noise, But Nothing Copies](#)

[Product Makes Noise When It Sits for a While](#)

**Parent topic:** [Solving Problems](#)

### Product Cannot Copy

If your product cannot make copies, try these solutions:

- If user restriction has been enabled, you may need to enter a user name and password. Contact your administrator for assistance.
- If the product has an error, such as a paper jam, you cannot make copies. Check the LCD screen for any errors, and follow the onscreen instructions to clear the error.

**Parent topic:** [Solving Copying Problems](#)

#### Related references

[Paper Jam Problems](#)

#### Related tasks

[Setting User Feature Restrictions \(Access Control\)](#)

### Product Makes Noise, But Nothing Copies

If your product makes a noise, but nothing copies, try these solutions:

- Run a nozzle check to see if any of the print head nozzles are clogged. Then clean the print head, if necessary.
- If the nozzle check page does not print, but the product's power is on, make sure your product software is installed correctly.
- Make sure your product is level (not tilted).

**Parent topic:** [Solving Copying Problems](#)

#### Related tasks

[Checking the Nozzles Using the Product Control Panel](#)

[Cleaning the Print Head Using the Product Control Panel](#)



## Product Makes Noise When It Sits for a While

Your product is performing routine maintenance. This is normal.

Parent topic: [Solving Copying Problems](#)

## Solving Copy Quality Problems

Check these sections if your copies have a quality problem.

[Copies Have Incorrect or Faint Colors](#)

[Position, Size, or Margins of Copies are Incorrect](#)

Parent topic: [Solving Problems](#)

## Copies Have Incorrect or Faint Colors

If your copies have incorrect, uneven, smeared, or faint colors, try these solutions:

- Run a print head nozzle check to see if any of the nozzles are clogged. Then clean the print head, if necessary.
- Do not press too hard on the original when you copy from the scanner glass.
- Clean the scanner glass with a soft, dry, lint-free cloth or use a small amount of glass cleaner on the cloth, if necessary. Paper towels are not recommended.

**Caution:** Do not spray glass cleaner directly on the scanner glass.

- Clean the ADF.
- Wipe any dirt or dust off of your originals.
- If the colors are smeared, try lowering the copy density setting on the LCD screen.
- Make sure your paper is not curled.
- When vertical banding appears or the paper is smeared, clean the paper path.
- When horizontal banding appears or the top or bottom of the paper is smeared, load paper in the correct direction and slide the edge guides to the edges of the paper.
- When copying on thick paper, select a **Thick Paper** setting from the control panel (**Settings > General Settings > Printer Settings > Thick Paper**). When this setting is enabled, copy quality may decline and copy speed may decrease.

- If you see a ripple pattern in your printout and your original is a printed document, such as a magazine or catalog, change the **Reduce/Enlarge** setting. If the ripple pattern still appears, place the original at a slightly different angle.
- If the back of the original appears in your printout, place a piece of black paper on the back of the original and copy it again. You can also try lowering the **Density** setting.

**Parent topic:** [Solving Copy Quality Problems](#)

#### **Related references**

[Copying Options](#)

#### **Related tasks**

[Checking the Nozzles Using the Product Control Panel](#)

[Cleaning the Print Head Using the Product Control Panel](#)

[Cleaning the Scanner Glass](#)

[Cleaning the Automatic Document Feeder](#)

## **Position, Size, or Margins of Copies are Incorrect**

If the position, size, or margins of your copies are incorrect, try these solutions:

- When placing originals in the ADF, make sure the edge guides are against the edges of the paper.
- When placing originals on the scanner glass, make sure the original is placed correctly for scanning. Align the corner of the original with the corner indicated by the symbol on the scanner glass. If necessary, move the original away from the edges of the scanner glass slightly.
- If the original is folded or wrinkled, use the scanner glass. Flatten any folds or wrinkles in the original and try using another sheet or card to keep the original in contact with the scanner glass.
- Clean the scanner glass and ADF.
- Make sure the paper is loaded in the correct direction.
- Select the appropriate copy size and paper size settings on the LCD screen.

**Parent topic:** [Solving Copy Quality Problems](#)

## **Solving Paper Problems**

Check these sections if you have problems using paper with your product.

[Paper Feeding Problems](#)

[Originals Do Not Feed From the Automatic Document Feeder](#)

[Paper Jam Problems](#)

## [Paper Ejection Problems](#)

**Parent topic:** [Solving Problems](#)

### **Paper Feeding Problems**

If you have problems feeding paper, try these solutions:

- Make sure the paper cassette is inserted all the way in the printer.
- Make sure the paper type setting matches the type of paper you loaded.
- If paper does not feed correctly, remove and reload it in the cassette and adjust the edge guides. Make sure the paper stack is not above the tab on the edge guides inside the cassette.
- If multiple pages feed at once, remove the paper, fan the edges to separate the sheets, and reload it.
- If multiple sheets continue to feed at once, load one sheet of paper at a time or load new paper.
- Do not load more than the recommended number of sheets.
- Make sure your paper meets the specifications for your product.
- If paper jams when you print on both sides of the paper, try loading fewer sheets.
- If a paper out error occurs when paper is loaded in the paper tray, reload the paper in the center of the paper tray.
- For best results, follow these guidelines:
  - Use new, smooth, high-quality paper that is not curled, creased, old, too thin, or too thick.
  - Load paper in the cassette printable side down.
  - Load paper in the paper tray printable side up.
  - Load paper in the correct direction and slide the edge guides against the edges of the paper.
  - Follow any special loading instructions that came with the paper.

**Note:** Your product will not operate properly while tilted at an angle. Place it on a flat, stable surface that extends beyond the base of the product in all directions.

**Parent topic:** [Solving Paper Problems](#)

#### **Related references**

[Paper Jam Problems](#)

[Paper Loading Capacity](#)

[Paper Specifications](#)

## Related topics

[Loading Paper](#)

### Originals Do Not Feed From the Automatic Document Feeder

If your originals do not feed when placed in the ADF, try these solutions:

- Make sure the **ADF** icon lights up on the Copy, Fax, or Scan screen on the LCD screen. If not, reload the originals.
- Make sure the size, weight, and number of your originals are supported by the ADF.
- Make sure the originals are loaded correctly.
- Slide the edge guides against the edges of the originals.
- Make sure the document is not curled or creased.
- Try cleaning the inside of the ADF.
- Do not load originals above the arrow mark on the ADF edge guide.

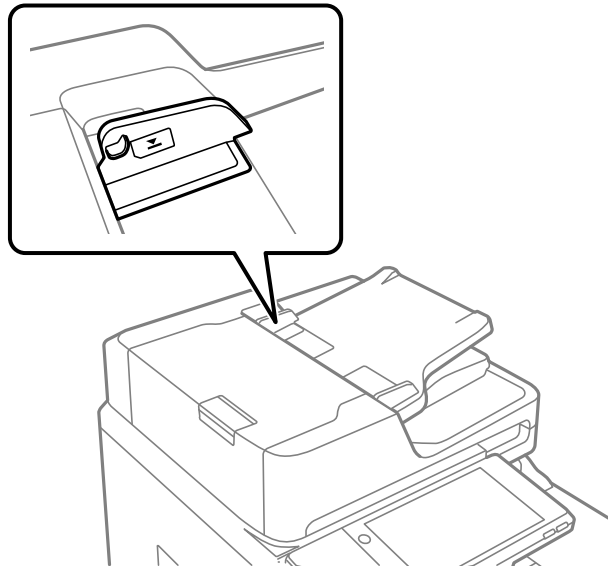

Parent topic: [Solving Paper Problems](#)

**Related references**

[Automatic Document Feeder \(ADF\) Specifications](#)

**Related tasks**

[Cleaning the Automatic Document Feeder](#)

[Placing Originals in the Automatic Document Feeder](#)

## Paper Jam Problems

If a paper jam occurs in the product, a message appears on the LCD screen. Follow the on-screen instructions to locate the paper jam and remove the paper.

**Caution:** Never touch the buttons on the control panel while your hand is inside the product. If the product starts operating, it could cause an injury. Be careful not to touch the protruding parts to avoid injury. Remove the jammed paper carefully or you may damage the product.

**Caution:** When using the optional hole punch unit with the optional staple or booklet finisher, adjust the printed area so it does not overlap with the holes being punched. You should also set the binding margin so that it is not printed at the hole punch position. Punching holes over any printed area may cause hole punch failure or a paper jam.

**Parent topic:** [Solving Paper Problems](#)

## Paper Ejection Problems

If you have problems with paper ejecting properly, try these solutions:

- If paper does not eject fully, you may have set the wrong paper size. Cancel printing to eject the paper. Select the correct paper size when you reprint.
- If paper falls from the output tray, extend the paper stopper.
- If paper falls after printing from the paper tray, extend the paper stopper or place a box to make sure the paper does not touch the floor.
- If paper is wrinkled when it ejects, it may be damp or too thin. Load new paper and be sure to select the correct paper type setting when you reprint.

**Parent topic:** [Solving Paper Problems](#)

## Solving Problems Printing from a Computer

Check these sections if you have problems while printing from your computer.

Nothing Prints

Product Icon Does Not Appear in Windows Taskbar

Printing is Slow

**Parent topic:** [Solving Problems](#)

## Nothing Prints

If you have sent a print job and nothing prints, try these solutions:

- Make sure your product is turned on and connected to your computer.
- Make sure any interface cables are connected securely at both ends.
- If you connected your product to a USB hub, make sure it is a first-tier hub. If it still does not print, connect your product directly to your computer instead of the hub.
- If the printer cannot print using a USB connection, disconnect the USB cable from the computer, right-click on the printer icon displayed on the computer, and select **Remove Device**. Then connect the USB cable to the computer and try a test print.
- If your computer is connected using a USB cable, try a different USB port on your computer or a different cable.
- Make sure the printer status is not offline or pending.
- Make sure you are using the Epson printer driver for your product or the available functions are limited.
- Run a product check to see if a test page prints. If the test page prints, check to see if your product software is installed correctly.
- Make sure your system meets the requirements for your operating system. If you are printing a high-resolution image, you may need more than the minimum requirements. Print the image at a lower resolution or if necessary, increase your system's memory.
- In Windows, make sure your product is selected as the default printer and the printer port setting matches the printer connection port.
- In Windows, delete all jobs from the Windows Spooler. Click **Print Queue** on the Maintenance tab in the printer settings window, and cancel any stalled print jobs.
- On a Mac, make sure the printer is added to the printer list and the printer is not paused.
- If you are using the PostScript printing software, make sure the printing language setting on the control panel is set to **Auto** or **PS**.
- In Windows, the product may not print if a large number of print jobs are sent. Try selecting **Print directly to the printer** on the Advanced tab in the printer properties.

**Parent topic:** [Solving Problems Printing from a Computer](#)

**Related tasks**

[Entering a User ID and Password for Printing](#)





[Running a Product Check](#)

[Selecting Printer Language and Interface Settings](#)

## Product Icon Does Not Appear in Windows Taskbar

If you do not see your product icon in the Windows taskbar, first try restarting your computer. If that does not work, try this solution:

1. Do one of the following:

- **Windows 10:** Click  and select  (Settings) > **Devices > Printers & scanners**. Select your product name and select **Manage > Printing preferences**.
- **Windows 8.x:** Navigate to the **Apps** screen and select **Control Panel > Hardware and Sound > Devices and Printers**. Right-click your product name, select **Printing Preferences**, and select your product name again if necessary.
- **Windows 7:** Click  and select **Devices and Printers**. Right-click your product name, select **Printing Preferences**, and select your product name again if necessary.
- **Windows Vista:** Click , select **Control Panel**, and click **Printer** under **Hardware and Sound**. Right-click your product name, select **Printing Preferences**, and select your product name again if necessary.
- **Windows XP:** Click **Start** and select **Printers and Faxes**. (Or open the **Control Panel**, select **Printers and Other Hardware**, if necessary, and **Printers and Faxes**.) Right-click your product name, select **Printing Preferences**, and select your product name again if necessary.

2. Click the **Maintenance** tab.

3. Click the **Extended Settings** button.

4. Select **Enable EPSON Status Monitor 3** and click **OK**.

5. Click the **Monitoring Preferences** button.

6. Click the checkbox for the option that adds the shortcut icon to the taskbar.

7. Click **OK** to close the open program windows.

**Parent topic:** [Solving Problems Printing from a Computer](#)

## Printing is Slow

If printing becomes slow, try these solutions:

- Make sure your system meets the requirements for your operating system. If you are printing a high-resolution image, you may need more than the minimum requirements. If necessary, increase your system's memory.
- If you are using Windows 7, close the **Devices and Printers** window before you print.
- Make sure **Quiet Mode** is turned off.
- Clear space on your hard drive or run a defragmentation utility to free up existing space.
- Close any programs you are not using when you print.
- If your product is connected to a USB hub, connect it directly to your computer instead.
- If printing becomes slower after printing continuously for a long time, the product may have automatically slowed down to protect the print mechanism from overheating or becoming damaged. Let the product rest with the power on for 30 minutes, then try printing again.
- If you are printing over a wireless network, factors such as interference, network traffic, or weak signal strength may affect your printing speed.

**Note for Latin America:** If you are using a 5 GHz wireless router, set the router to operate in dual band (2.4 GHz and 5 GHz) mode. If your router uses a single network name (SSID) for both the 2.4 GHz and 5 GHz band, give each band its own network name (SSID) instead, such as Home Network 2.4 GHz and Home Network 5 GHz. See your router documentation or contact your internet service provider for instructions.

- Enable the **Print Speed Priority** setting (**Settings > General Settings > Printer Settings > Print Speed Priority**).

For the fastest printing, select the following settings in your product software:

- Make sure the paper type setting matches the type of paper you loaded.
- Turn on any high speed settings in your product software.
- Select a lower print quality setting.
- Make sure the ink drying time has not been increased for double-sided printing.
- **Windows:** Click the **Maintenance** or **Utility** tab, select **Extended Settings** or **Speed and Progress**, and select the following settings:
  - **Always Spool RAW Datatype**



- **Page Rendering Mode**
- **Print as Bitmap**

If printing is still slow and you are using Windows 7 or Windows Vista, try the following:

1. Click  and select **Computer** or **My Computer**. Double-click the **C:** drive and open these folders: **ProgramData > EPSON > PRINTER**.

**Note:** If you do not see the ProgramData folder, open the **Organize** menu and select **Folder and search options**. In the window that appears, click the **View** tab, select **Show hidden files, folders, and drives** in the Advanced settings list, and click **OK**.

2. Right-click the **EPAUDF01.AUD** file and select **Delete**.
3. Restart your computer and try printing again.

**Parent topic:** [Solving Problems Printing from a Computer](#)

#### **Related references**

[Windows System Requirements](#)

[Mac System Requirements](#)

[Paper or Media Type Settings - Printing Software](#)

#### **Related tasks**

[Selecting Basic Print Settings - Windows](#)

[Selecting Basic Print Settings - Mac](#)

[Selecting Extended Settings - Windows](#)

## **Solving Page Layout and Content Problems**

Check these sections if you have problems with the layout or content of your printed pages.

[Inverted Image](#)

[Too Many Copies Print](#)

[Blank Pages Print](#)

[Incorrect Margins on Printout](#)

[Incorrect Characters Print](#)

[Incorrect Image Size or Position](#)

[Slanted Printout](#)

**Parent topic:** [Solving Problems](#)

## Inverted Image

If your printed image is inverted unexpectedly, try these solutions:

- Turn off any mirror or inversion settings in your printing application.
- Turn off the **Mirror Image**, **Flip horizontally**, or **Reverse page orientation** settings in your printer software. (This option has different names, depending on your operating system version.)

**Parent topic:** [Solving Page Layout and Content Problems](#)

### Related tasks

[Selecting Additional Print Options - Windows](#)

[Selecting Basic Print Settings - Mac](#)

## Too Many Copies Print

Make sure that the **Copies** setting in your printing program or printer software is not set for multiple copies.

**Parent topic:** [Solving Page Layout and Content Problems](#)

### Related tasks

[Selecting Basic Print Settings - Windows](#)

[Selecting Basic Print Settings - Mac](#)

## Blank Pages Print

If blank pages print unexpectedly, try these solutions:

- Make sure you selected the correct paper size settings in your printing program and printer software.
- If a blank page exists in a document you are printing and you want to skip printing it, select the **Skip Blank Page** setting in your printer software, if available.
- Run a print head nozzle check to see if any of the nozzles are clogged. Then clean the print head, if necessary.
- Make sure your product is selected as the printer in your printing program.
- Make sure your product is on a flat surface and operating in the recommended environmental conditions or multiple sheets of paper may be fed at the same time.

**Parent topic:** [Solving Page Layout and Content Problems](#)

### Related concepts

[Print Head Maintenance](#)

### Related tasks

[Selecting Basic Print Settings - Windows](#)

[Selecting Basic Print Settings - Mac](#)

[Selecting Extended Settings - Windows](#)

[Selecting Printing Preferences - Mac](#)

## Incorrect Margins on Printout

If your printed page has incorrect margins, try these solutions:

- Make sure you selected the correct paper size settings in your printing program and printer software.
- Make sure you selected the correct margins for your paper size in your printing program.
- Make sure your paper is positioned correctly for feeding into the product.
- Load paper in the correct direction and slide the edge guides against the edges of the paper.

You can use the preview option in your printer software to check your margins before you print.

**Parent topic:** [Solving Page Layout and Content Problems](#)

### Related tasks

[Selecting Basic Print Settings - Windows](#)

[Selecting Basic Print Settings - Mac](#)

### Related topics

[Loading Paper](#)

## Incorrect Characters Print

If incorrect characters appear in your prints, try these solutions before reprinting:

- Make sure any cables are securely connected at both ends.
- In Windows, delete all jobs from the Windows Spooler. Click **Print Queue** on the Maintenance tab in the printer settings window, and cancel any stalled print jobs.
- If your product is connected to a USB hub, connect it directly to your computer instead.
- If your computer entered sleep mode the last time you printed, the next print job after your computer exits sleep mode may contain garbled characters. Print your document again.
- Make sure you are using the printer software for this product. Check the product name at the top of the driver window.

- If you are using the PostScript printer software, EPS files created in binary format may not print correctly. Try creating the file in ASCII format instead.
- If you are using the Windows PostScript printer software, the product cannot print binary data if it is connected to the computer using a USB cable. Try selecting **ASCII** or **TBCP** as the **Output Protocol** setting on the Device Settings tab in the printer properties.
- If you are using the Windows PostScript printer software, select the appropriate substitution fonts on the Device Settings tab in the printer properties.

**Parent topic:** [Solving Page Layout and Content Problems](#)

## **Incorrect Image Size or Position**

If your printed image is the wrong size or in the wrong position, try these solutions:

- Make sure you selected the correct paper size and layout settings in your printing program and printer software.
- Make sure you selected the correct paper size on the control panel.
- Make sure your paper is positioned correctly for feeding into the printer.
- Clean the scanner glass and document cover.
- If the edges of a copy are cropped, slightly move the original away from the edges of the scanner glass.
- Be sure to select the appropriate original size setting for your original in the copy settings.

You can use the preview option in your printer software to check your margins before you print.

**Parent topic:** [Solving Page Layout and Content Problems](#)

### **Related references**

[Copying Options](#)

### **Related tasks**

[Selecting Basic Print Settings - Windows](#)

[Selecting Basic Print Settings - Mac](#)

[Selecting Additional Print Options - Windows](#)

[Selecting Page Setup Settings - Mac](#)

[Cleaning the Scanner Glass](#)

## Slanted Printout

If your printouts are slanted, try these solutions:

- Make sure the paper is loaded in the correct direction.
- Make sure your paper meets the specifications for your product.
- Do not load more than the recommended number of sheets.
- Slide the edge guides against the edges of the paper.
- Make sure the paper type setting matches the type of paper you loaded.
- Select a higher print quality setting in your printer software.
- Turn off any high speed settings in your product software.
- Make sure the product is not printing while tilted or at an angle.

**Parent topic:** [Solving Page Layout and Content Problems](#)

### Related tasks

[Selecting Basic Print Settings - Windows](#)

[Selecting Basic Print Settings - Mac](#)

### Related topics

[Loading Paper](#)

## Solving Print Quality Problems

Check these sections if your printouts have problems with print quality, but your image looks fine on your computer screen.

[White or Dark Lines in Printout](#)

[Blurry or Smearred Printout](#)

[Faint Printout or Printout Has Gaps](#)

[Grainy Printout](#)

[Incorrect Colors](#)

**Parent topic:** [Solving Problems](#)

## White or Dark Lines in Printout

If you notice white or dark lines in your prints (also called banding), try these solutions before you reprint:

- Run a nozzle check to see if any of the print head nozzles are clogged. Then clean the print head, if necessary.

- Make sure the paper type setting matches the type of paper you loaded.
- Make sure you loaded the printable side of the paper correctly for your product.
- Turn off any high speed settings in your product software.
- Adjust the print quality in the product software.
- When horizontal banding appears or the top or bottom of the paper is smeared, load paper in the correct direction and slide the edge guides to the edges of the paper.
- If you continue to see horizontal bands or streaks in your printouts after cleaning the print head and adjusting the print quality, make print quality adjustments for each paper type.
- If you are copying from the ADF, copy from the scanner glass instead or use a higher quality setting.
- When vertical banding appears or the paper is smeared, clean the paper path.
- You may need to replace the ink cartridges.

**Parent topic:** [Solving Print Quality Problems](#)

**Related concepts**

[Print Head Maintenance](#)

**Related references**

[Paper or Media Type Settings - Printing Software](#)

**Related tasks**

[Selecting Additional Print Options - Windows](#)

[Selecting Printing Preferences - Mac](#)

**Related topics**

[Loading Paper](#)

[Replacing Ink Cartridges and Maintenance Boxes](#)

## Blurry or Smeared Printout

If your printouts are blurry or smeared, try these solutions:

- Make sure your paper is not damp, curled, old, or loaded incorrectly in your product.
- Use a support sheet with special paper, or load special paper one sheet at a time.
- Make sure your paper meets the specifications for your product.
- Use Epson papers to ensure proper saturation and absorption of genuine Epson inks.
- If printouts are frequently smeared or scuffed, try using new paper.

- Do not load more than the recommended number of sheets. For plain paper, do not load above the line indicated by the triangle symbol on the edge guide.
- Make sure the paper type setting in your product software matches the type of paper you loaded.
- Make sure you loaded the printable side of the paper correctly for your product.
- If you are printing on thick paper, select a thick paper **Paper Type** setting on the control panel. In Windows, you can also try selecting a **Thick Paper and Envelopes** setting in the Extended Settings of the printer software.
- If paper is still smeared after enabling settings for thick paper, reduce the print density.
- When horizontal banding appears on the top or bottom of the paper is smeared, load paper in the correct direction and slide the edge guides to the edges of the paper.
- If you print on both sides of a sheet of paper, smudges may appear on the reverse side of heavily saturated or dark images. If one side of a sheet will contain a lighter image or text, print that side first. Make sure the ink has dried before reloading the paper to print on the other side. Adjust the density and/or ink drying time settings.
- Run a nozzle check to see if any of the print head nozzles are clogged. Then clean the print head, if necessary.

**Note:** Your product will not operate properly while tilted at an angle. Place it on a flat, stable surface that extends beyond the base of the product in all directions.

**Parent topic:** [Solving Print Quality Problems](#)

**Related concepts**

[Print Head Maintenance](#)

**Related references**

[Paper Specifications](#)

[Compatible Epson Papers \(U.S. and Canada\)](#)

[Compatible Epson Papers \(Latin America\)](#)

**Related tasks**

[Selecting Additional Print Options - Windows](#)

[Selecting Basic Print Settings - Windows](#)

[Selecting Double-sided Printing Settings - Windows](#)

## Faint Printout or Printout Has Gaps

If your printouts are faint or have gaps, try these solutions:

- Run a nozzle check to see if any of the print head nozzles are clogged. Then clean the print head, if necessary.
- The ink cartridges may be old or low on ink, and you may need to replace them.
- Make sure the paper type setting matches the type of paper you loaded.
- Make sure your paper is not damp, curled, old, or loaded incorrectly in your product.
- When copying, increase the **Density** setting on the product control panel.
- Adjust the print quality in the product software.
- If you are printing a file that was saved in Storage from a computer, re-save the file to Storage and select a higher quality setting in your Windows printer driver. On the **Main** tab, select **More Settings** from the **Quality** drop-down menu, and then select **Quality**.

**Parent topic:** [Solving Print Quality Problems](#)

### Related concepts

[Print Head Maintenance](#)

### Related references

[Paper or Media Type Settings - Printing Software](#)

### Related tasks

[Selecting Basic Print Settings - Windows](#)

[Selecting Basic Print Settings - Mac](#)

### Related topics

[Loading Paper](#)

[Replacing Ink Cartridges and Maintenance Boxes](#)

## Grainy Printout

If your printouts are grainy, try these solutions:

- Make sure you loaded the printable side of the paper correctly for your product.
- Select a higher print quality setting and turn off any high speed settings in your product software.
- Run a nozzle check to see if any of the print head nozzles are clogged. Then clean the print head, if necessary.
- Adjust the print quality in the product software.



- You may need to increase the image resolution or print a smaller size; see your software documentation.

**Note:** Images from the Internet may be low resolution and not result in a high quality printout.

- If you enlarged the image size in an image-editing program, you need to increase the image resolution setting to retain a high image quality. Increase the image resolution by the same amount you increase the image size. For example, if the image resolution is 300 dpi (dots per inch) and you will double the image size for printing, change the resolution setting to 600 dpi.

**Note:** Higher resolution settings result in larger file sizes, which take longer to process and print. Consider the limitations of your computer system when selecting a resolution, and select the lowest possible resolution that produces acceptable quality to keep file sizes manageable.

**Parent topic:** [Solving Print Quality Problems](#)

**Related concepts**

[Print Head Maintenance](#)

**Related tasks**

[Selecting Basic Print Settings - Windows](#)

[Selecting Basic Print Settings - Mac](#)

[Selecting Additional Print Options - Windows](#)

[Selecting Printing Preferences - Mac](#)

**Related topics**

[Loading Paper](#)

## Incorrect Colors

If your printouts have incorrect colors (WF-C20600/WF-C20750/WF-C21000), try these solutions:

- Make sure the paper type setting matches the paper you loaded.
- Make sure the **Black/Grayscale** or **Grayscale** setting is not selected in your printer software.
- Run a nozzle check to see if any of the print head nozzles are clogged. Then clean the print head, if necessary.
- The ink cartridges may be old or low on ink, and you may need to replace them.

- After you print, the colors in your printout need time to set as the ink dries. During this time, the colors may look different than you expect. To speed up drying time, do not stack your printouts on top of each other.
- Your printed colors can never exactly match your on-screen colors. However, you can use a color management system to get as close as possible. Try using the color management options in your printer software.
- Select **Custom** as the **Color Correction** setting on the More Options tab of the printer software, then click **Advanced**. Try changing the **Scene Correction** setting to something other than **Automatic**. If changing that setting does not work, change the **Color Management** setting to any color correction method other than **PhotoEnhance**.
- Enable the **Print grayscale using black ink only** setting in the Extended Settings of the printer software.
- If using the PostScript printer driver, try adjusting the **Color Mode** setting on the Advanced tab of the printer software.
- If you are using the PostScript printer driver and the file you are printing was created in an application that allows you to change the data format, make sure the settings in the application match the settings in the printer driver.
- For best results, use genuine Epson paper.
- On the product control panel, change the **Fix Photo** setting from **Auto** to another option, or select **Enhance Off**.
- If you are copying an original, lower the **Density** setting.

**Parent topic:** [Solving Print Quality Problems](#)

#### **Related concepts**

[Print Head Maintenance](#)

#### **Related references**

[Compatible Epson Papers \(U.S. and Canada\)](#)

[Compatible Epson Papers \(Latin America\)](#)

#### **Related tasks**

[Selecting Basic Print Settings - Windows](#)

[Selecting Basic Print Settings - Mac](#)

[Selecting Additional Print Options - Windows](#)

[Managing Color - Mac](#)

## Solving Scanning Problems

Check these solutions if you have problems scanning with your product.

[Scanning Software Does Not Operate Correctly](#)

[Cannot Start Epson Scan 2](#)

**Parent topic:** [Solving Problems](#)

### Scanning Software Does Not Operate Correctly

If your scanning software does not operate correctly, try these solutions:

- Make sure your computer has adequate memory and meets the system requirements for your operating system.
- Make sure your computer is not running in a power-saving mode, such as sleep or standby. If so, wake your system and restart your scanning software.
- If you upgraded your operating system but did not reinstall your scanning software, try reinstalling it.
- In Windows, make sure your product is listed as a valid device in the **Scanners and Cameras** control panel.

**Parent topic:** [Solving Scanning Problems](#)

#### Related concepts

[Uninstall Your Product Software](#)

#### Related references

[Mac System Requirements](#)

[Windows System Requirements](#)

### Cannot Start Epson Scan 2

If you cannot start Epson Scan 2, try these solutions:

- Make sure your product is turned on and any interface cables are securely connected at both ends.
- Make sure Epson Scan 2 is selected as your scanning program.
- Make sure your computer is not running in a power-saving mode, such as sleep or standby. If so, wake your system and restart Epson Scan 2.
- Check the connection setting and test the connection using Epson Scan 2 Utility:

**Windows 10:** Click  and select **EPSON > Epson Scan 2 Utility**. Make sure the correct product is selected. If necessary, select the **Other** tab and click **Reset**.

**Windows 8.x:** Navigate to the **Apps** screen and select **Epson Scan 2 Utility**. Make sure the correct product is selected. If necessary, select the **Other** tab and click **Reset**.

**Windows (other versions):** Click  or **Start > All Programs** or **Programs > EPSON > Epson Scan 2 > Epson Scan 2 Utility**. Make sure the correct product is selected. If necessary, select the **Other** tab and click **Reset**.

**Mac:** Open the **Applications** folder, click **Epson Software**, and click **Epson Scan 2 Utility**. Make sure the correct product is selected. If necessary, select the **Other** tab and click **Reset**.

- Make sure you do not have multiple versions of Epson Scan 2 installed. If you do, uninstall both versions and install one version.
- If you upgraded your operating system but did not reinstall Epson Scan 2, try reinstalling it.
- If the user restriction feature (Access Control) is enabled, a user ID and password are required to scan. If you do not know the user ID or password, contact your administrator for assistance.

**Parent topic:** [Solving Scanning Problems](#)

#### **Related tasks**

[Starting a Scan Using the Epson Scan 2 Icon](#)

[Entering a User ID and Password for Scanning](#)

## **Solving Scanned Image Quality Problems**

Check these sections if a scanned image on your computer screen has a quality problem.

**Note:** For solutions when using Document Capture Pro (Windows) or Document Capture (Mac) software, see the Document Capture Pro (Windows) or Document Capture (Mac) help utility.

[Image Consists of a Few Dots Only](#)

[Line of Dots Appears in All Scanned Images](#)

[Straight Lines in an Image Appear Crooked](#)

[Scanned Image Quality Problems](#)

[Image Colors are Patchy at the Edges](#)

[Ripple Patterns Appear in an Image](#)

[Scanned Image Edges are Cropped](#)

**Parent topic:** [Solving Problems](#)

## Image Consists of a Few Dots Only

If your scanned image consists only of a few dots, try these solutions:

- Make sure you placed your original for scanning facing the correct way.
- Remove any lint or dirt from your original.
- Clean the scanner glass.
- Do not press on the original or the document cover with too much force.

**Parent topic:** [Solving Scanned Image Quality Problems](#)

### Related references

[Additional Scanning Settings - Advanced Settings Tab](#)

### Related topics

[Placing Originals on the Product](#)

## Line of Dots Appears in All Scanned Images

If a line of dots appears in all your scanned images, try these solutions:

- Clean the scanner glass with a soft, dry, lint-free cloth or use a small amount of glass cleaner on the cloth, if necessary. Paper towels are not recommended.

**Caution:** Do not spray glass cleaner directly on the scanner glass.

- Make sure any interface cables are securely connected at both ends.

If you are scanning from the ADF, make sure the ADF edge guides fit against the loaded originals. You can also try cleaning the ADF and scanning again.

**Parent topic:** [Solving Scanned Image Quality Problems](#)

### Related tasks

[Cleaning the Scanner Glass](#)

[Cleaning the Automatic Document Feeder](#)

## Straight Lines in an Image Appear Crooked

If straight lines in an original appear crooked in a scanned image, make sure to place your original straight when you scan it.

If you are scanning from the ADF, make sure the ADF edge guides fit against the loaded originals. You can also try cleaning the ADF and scanning again.

**Parent topic:** [Solving Scanned Image Quality Problems](#)

**Related tasks**

[Cleaning the Automatic Document Feeder](#)

**Related topics**

[Placing Originals on the Product](#)

## Scanned Image Quality Problems

If you encounter quality problems with your scanned image, try these solutions:

### Image is Distorted or Blurry

- Make sure your original is not wrinkled or warped. This may prevent the original from laying flat on the scanner glass.
- Do not move your original or your product during scanning.
- Clean the scanner glass and the ADF and remove dirt or dust on your originals.
- Do not press on the document cover or the original with too much force.
- Your product will not operate properly while tilted at an angle. Place your product on a flat, stable surface that extends beyond its base in all directions.
- Adjust these Epson Scan 2 settings (if available) and try scanning again:
  - Make sure you select the correct **Image Type** for your original.
  - Increase the **Resolution** setting.
  - If the **Image Type** setting is **Black & White**, adjust the **Threshold** setting.
  - If the **Image Type** setting is **Color** or **Grayscale**, select the **Unsharp Mask** setting.
  - If the **Image Type** setting is **Black & White**, select **Text Enhancement**. If the **Image Type** setting is **Color** or **Grayscale**, change the **Text Enhancement** setting to **High**.

### Image is Too Dark

- Make sure you select the correct **Image Type** for your original.
- If the **Image Type** is set to **Auto**, **Color** or **Grayscale**, adjust the **Brightness** setting.
- Check the brightness and contrast settings of your computer monitor.

### Back of Original Image Appears in Scanned Image

- Place a piece of black paper on the back of the original and scan it again.

- Adjust these Epson Scan 2 settings (if available) and try scanning again:
  - Make sure you select the correct **Image Type** for your original.
  - Select the **Advanced Settings** tab and adjust the **Brightness** setting.
  - If the **Image Type** is set to **Black & White**, select **Text Enhancement**. If the **Image Type** is set to **Color** or **Grayscale**, change the **Text Enhancement** setting to **High**.

**Note:** The **Text Enhancement** and **Remove Background** settings depend on the selected **Image Type**.

### **Scanned Image Colors Do Not Match Original Colors**

Printed colors can never exactly match the colors on your computer monitor because printers and monitors use different color systems: monitors use RGB (red, green, and blue) and printers typically use CMYK (cyan, magenta, yellow, and black).

Check the color matching and color management capabilities of your computer, display adapter, and the software you are using to see if they are affecting the palette of colors you see on your screen.

To adjust the colors in your scanned image, adjust these Epson Scan 2 settings (if available) and try scanning again:

- Make sure you select the correct **Image Type** for your original.
- If the **Image Type** setting is **Auto**, **Color** or **Grayscale**, adjust the **Contrast** setting.
- If the **Image Type** setting is **Black & White** or **Grayscale**, adjust the **Color Enhance** setting.

**Parent topic:** [Solving Scanned Image Quality Problems](#)

#### **Related references**

[Additional Scanning Settings - Advanced Settings Tab](#)

### **Image Colors are Patchy at the Edges**

If you are scanning a thick or warped original, cover its edges with paper to block external light as you scan it.

**Parent topic:** [Solving Scanned Image Quality Problems](#)

## Ripple Patterns Appear in an Image

You may see a ripple pattern (called a moiré) in scanned images of printed documents. This is caused by interference from differing pitches in the scanner's screen and your original's halftone screen. To reduce this effect, adjust these Epson Scan 2 settings (if available) and try scanning again:

- Select the **Descreening** setting on the Advanced Settings tab.
- Select a lower **Resolution** setting.
- Place the original at a slightly different angle.

**Parent topic:** [Solving Scanned Image Quality Problems](#)

### Related references

[Additional Scanning Settings - Advanced Settings Tab](#)

[Additional Scanning Settings - Main Settings Tab](#)

## Scanned Image Edges are Cropped

If the edges of a scanned image are cropped, make sure your original is placed correctly for scanning. If necessary, move your original away from the edges of the scanner glass slightly.

**Parent topic:** [Solving Scanned Image Quality Problems](#)

### Related topics

[Placing Originals on the Product](#)

## Solving Faxing Problems

Check these solutions if you have problems faxing with your product (models with optional fax board installed).

[Cannot Send or Receive Faxes](#)

[Cannot Receive Faxes with a Telephone Connected to Your Product](#)

[Fax Memory Full Error Appears](#)

[Fax Quality is Poor](#)

[Sent Fax is Received in an Incorrect Size](#)

[Received Fax is Not Printed](#)

**Parent topic:** [Solving Problems](#)



## Cannot Send or Receive Faxes

If you cannot send or receive faxes, try these solutions:

- If an error code is displayed on the control panel, try the solutions suggested in the error code list.
- Use **Check Fax Connection** on the control panel (**Settings > General Settings > Fax Settings > Check Fax Connection**) to run the automatic fax connection check. Try the solutions suggested in the report.
- If you are faxing from a computer, use the Epson FAX Utility to send your fax.
- Make sure the recipient's fax machine is turned on and working.
- Make sure the recipient's fax number is correct and entered correctly.
- Make sure paper is loaded correctly in your product.
- Make sure you have set up your header information and have not blocked your caller ID. Otherwise, your faxes might be rejected by the recipient's fax machine.
- If user restriction has been enabled, you may need to enter a user name and password. Contact your administrator for assistance.
- Make sure Receive Mode is set to **Auto** so you can receive faxes automatically.
- Check that the cable connecting your telephone wall jack to your product's **LINE** port is secure.
- Print a fax connection report using your product control panel or fax software to help diagnose the problem.
- Verify that the telephone wall jack works by connecting a phone to it and testing it.
- Check the **Line Type** setting and set it to **PBX**. If your phone system requires an external access code to reach an outside line, register the code to the product and add a # (hash) to the beginning of the phone number when dialing.
- If you connected your product to a DSL phone line, you must connect a DSL filter to the phone jack to enable faxing over the line. Contact your DSL provider for the necessary filter.
- If you are connected to a DSL phone line, connect the product directly to a telephone wall jack and send a fax. If it works, the problem may be caused by the DSL filter. Contact your DSL provider.
- Make sure you installed the FAX driver for your product and that it is not paused.
- The data being sent may be too large. Try faxing the originals in batches, by using a connected phone, or by selecting **On Hook**. If you are faxing in monochrome, enable the **Direct Send** setting (**Fax > Fax Settings > Fax Send Settings**).
- Try lowering your product's fax speed setting.

- Try lowering the recipient's fax speed setting from the contact list menu.
- Make sure the error correction mode (ECM) setting is turned on if you are trying to send or receive a color fax.
- If your telephone line uses call waiting and you have trouble receiving faxes, turn off call waiting to prevent disruption of incoming faxes.
- If you have subscribed to a call forwarding service, the product may not be able to receive faxes. Contact your service provider for assistance.
- If the recipient fax machine does not answer your call within 50 seconds after the product has finished dialing, add pauses after the fax number to send the fax.
- Check your inbox and delete faxes after reading or printing them. If the inbox is full, the product cannot receive faxes.
- When sending faxes using the subaddress feature, ask the recipient if their fax machine can receive faxes using this feature. Check that the subaddress and password are correct, and that they match with the recipient subaddress and password. Check this when receiving faxes as well.
- If you enabled **Rejection Fax** options, check if the sender is blocked, did not set up header information, or is not registered in your contacts list, as necessary.
- If you cannot send faxes at a specified time, make sure the date and time are set correctly on the product.
- If more than one optional fax board is installed, make sure the **Transmission Setting By Line** setting for the line port is set accordingly (**Sending and Receiving**, **Sending Only**, or **Receiving Only**).
- If you cannot receive A3-size faxes, make sure you selected the correct paper size setting for the paper source containing the A3-size paper. Also, be sure to enable the paper source to receive faxes as the **Auto Select Settings** option.
- If you are receiving faxes using the Epson FAX Utility, check that your product is registered as a fax product in your operating system:

**Windows:** Make sure the product appears in **Devices and Printers**, **Printer**, or **Printers and Other Hardware**. If the product does not appear, uninstall and re-install the Epson FAX Utility.

**Mac:** Select **System Preferences > Printers & Scanners** (or **Print & Scan** or **Print & Fax**) and make sure your product appears. If your product does not appear, click **+** and add your product. If the product does appear, double-click it and make sure it is not paused.

**Note:** If your product is connected to a VoIP (Voice over Internet Protocol) phone line, keep in mind that fax machines are designed to work over analog phone lines. Epson cannot guarantee that fax transmission will work when using VoIP.

If your phone line includes voice mail answering services, calls or faxes may be inadvertently received by your voice mail service.

**Parent topic:** [Solving Faxing Problems](#)

**Related references**

[Job Status Error Codes](#)

**Related tasks**

[Connecting a Telephone or Answering Machine](#)

[Selecting the Line Type](#)

[Selecting Advanced Fax Settings](#)

[Receiving Faxes Automatically](#)

[Printing Fax Reports](#)

[Viewing a Fax on the LCD Screen \(Using the Fax Box\)](#)

[Using the Fax Setup Wizard](#)

**Related topics**

[Loading Paper](#)

## Cannot Receive Faxes with a Telephone Connected to Your Product

If you cannot receive faxes when a telephone is connected to your product, try these solutions:

- Make sure your telephone is connected to your product's **EXT** port.
- Make sure the Receive Mode is set to **Manual**.

**Note:** When answering a call that is a fax, wait until the product's LCD screen displays a message that a connection has been made before you hang up.

**Parent topic:** [Solving Faxing Problems](#)

## Fax Memory Full Error Appears

If you see an error message telling you that the product's fax memory is full, try these solutions:

- If you set the product to save received faxes in the product's memory or inbox, delete any faxes you have already read.

**Note:** Your product can store up to 200 faxes before its inbox is full.

- If you set the product to save received faxes on a computer, turn on the selected computer. Once the faxes are saved on the computer, they are deleted from the product's memory.
- If you set the product to save received faxes on a USB device, connect the selected USB device containing the save fax folder to the product. Once the faxes are saved on the USB device, they are deleted from the product's memory.

**Note:** Make sure the USB device has enough available memory and is not write protected.

- If the memory is full, try the following:
  - Send a monochrome fax using the direct sending feature
  - Send your fax using the on hook feature
  - Send your faxes in smaller batches
- If the product cannot print a received fax due to a product error, such as a paper jam, the memory full error may appear. Clear any product errors, then ask the sender to resend the fax.

**Parent topic:** [Solving Faxing Problems](#)

**Related references**

[Fax Sending Options](#)

**Related tasks**

[Viewing a Fax on the LCD Screen \(Using the Fax Box\)](#)

## Fax Quality is Poor

If you receive a poor quality fax, try these solutions:

- Try enabling the error correction mode (ECM) setting.
- Contact the fax sender and ask them to send the fax in a higher resolution.
- Try reprinting the received fax.

If the sent fax quality is poor, try these solutions:

- Clean the scanner glass.
- Clean the ADF.
- Try changing the resolution or density setting on the control panel.
- Do not press on the document cover or the original with too much force.
- Try changing the original type setting on the control panel.

- If you are sending a monochrome fax to a single recipient, try sending the fax using the **Direct Send** feature.

**Note:** If you send a high-resolution monochrome fax without using the **Direct Send** feature, the product may automatically lower the resolution.

- Try enabling the error correction mode (ECM) setting.
- If the back of the original appears in your sent fax, place a piece of black paper on the back of the original and fax it again.

**Parent topic:** [Solving Faxing Problems](#)

**Related references**

[Basic Settings - Fax](#)

[Fax Sending Options](#)

**Related tasks**

[Cleaning the Scanner Glass](#)

[Cleaning the Automatic Document Feeder](#)

## Sent Fax is Received in an Incorrect Size

If your recipient receives a fax in an incorrect size, try these solutions:

- If you are trying to fax an A3-size document, make sure the recipient's fax machine supports the paper size. If the message **OK (Reduced Size)** appears in the fax transmission report, the recipient's fax machine does not support A3-size documents.
- If you are sending a fax using the scanner glass, make sure your original is placed correctly and that the correct paper size is selected on the control panel.
- Clean the scanner glass and document cover.

**Parent topic:** [Solving Faxing Problems](#)

**Related tasks**

[Cleaning the Scanner Glass](#)

**Related topics**

[Placing Originals on the Product](#)

## Received Fax is Not Printed

If a received fax is not printed, try these solutions:

- Make sure the product is free of errors. The product cannot print received faxes if an error has occurred with the product, such as a paper jam.
- If the product has been set to save received faxes in the product's memory or inbox, received faxes are not automatically printed. Check the **Receive Settings** options on the product control panel and change them, if necessary.

**Parent topic:** [Solving Faxing Problems](#)

### Related references

[Receive Settings - Fax](#)

## Solving USB Device Problems

Check these solutions if you have problems using USB devices with your product.

[Cannot View or Print from a USB Device](#)

[Cannot Save Files on a USB Device](#)

[Cannot Transfer Files To or From a USB Device](#)

**Parent topic:** [Solving Problems](#)

## Cannot View or Print from a USB Device

If you cannot view or print photos or documents from a USB device connected to your product, try these solutions:

- Make sure memory devices are enabled on the product.
- Make sure your device is compatible with the product.
- Make sure the files on your device are in the correct format.
- If you see an X on the photo selection screen, the image file format is not supported.

**Parent topic:** [Solving USB Device Problems](#)

### Related references

[Interface Specifications](#)

[External USB Device Specifications](#)

### Related tasks

[Setting Up USB Device Access](#)

### **Related topics**

[Viewing and Printing from the LCD Screen](#)

## **Cannot Save Files on a USB Device**

If you cannot save files on a USB device connected to your product, try these solutions:

- To save faxes on a USB device, create a folder using the unconditional save/forward settings on the product control panel.
- Make sure the device is not write-protected.
- Make sure the device has enough available space.
- Make sure memory devices are enabled on your product.
- Make sure the device is compatible with the product.

**Parent topic:** [Solving USB Device Problems](#)

### **Related references**

[Receive Settings - Fax](#)

[Interface Specifications](#)

### **Related tasks**

[Setting Up USB Device Access](#)

## **Cannot Transfer Files To or From a USB Device**

If you have problems transferring files to or from a USB device connected to your product, try these solutions:

- Make sure your device is compatible with the product.
- Make sure the device is not write-protected.
- Make sure there is enough free space on the device.
- Make sure your product is securely connected to your computer.
- Make sure that the file sharing setting for your product is enabled.

**Parent topic:** [Solving USB Device Problems](#)

### **Related references**

[Interface Specifications](#)

## Uninstall Your Product Software

If you have a problem that requires you to uninstall and re-install your software, follow the instructions for your operating system.



[Uninstalling Product Software - Windows](#)

[Uninstalling Product Software - Mac](#)

**Parent topic:** [Solving Problems](#)

### Uninstalling Product Software - Windows

You can uninstall and then re-install your product software to solve certain problems.

1. Turn off the product.
2. Close any open programs or applications.
3. Disconnect any interface cables.
4. Do one of the following:
  - **Windows 10:** Click  and select  (Settings) > **Apps** or **System** > **Apps & features**. Then select the program you want to uninstall and select **Uninstall**.
  - **Windows 8.x:** Navigate to the **Apps** screen and select **Control Panel** > **Programs** > **Programs and Features**. Select the uninstall option for your Epson product, then select **Uninstall/Change**.

**Note:** If you see a **User Account Control** window, click **Yes** or **Continue**.

Select your product again, if necessary, then select **OK**, and click **Yes** to confirm the uninstallation.

- **Windows (other versions):** Click  or **Start**, and select **All Programs** or **Programs**. Select **EPSON**, select your product, then click **EPSON Printer Software Uninstall**.

**Note:** If you see a **User Account Control** window, click **Yes** or **Continue**.

In the next window, select your product and click **OK**. Then follow any on-screen instructions.

5. Do one of the following to uninstall Epson Scan 2, then follow any on-screen instructions:
  - **Windows 10:** Select **Epson Scan 2** and click **Uninstall**.
  - **Windows 8.x/Windows 7/Windows Vista:** Select **Epson Scan 2** and click **Uninstall/Change**.
  - **Windows XP:** Select **Epson Scan 2** and click **Change/Remove**.



6. Restart your computer, then re-install your software.

**Note:** If you find that re-installing your product software does not solve a problem, contact Epson.

**Parent topic:** [Uninstall Your Product Software](#)

## Uninstalling Product Software - Mac

In most cases, you do not need to uninstall your product software before re-installing it. However, you can download the Uninstaller utility from the Epson support website to uninstall your product software as described here.

**Note:** If you find that re-installing your product software does not solve a problem, contact Epson.

1. To download the Uninstaller utility, visit [epson.com/support](http://epson.com/support) (U.S.), [epson.ca/support](http://epson.ca/support) (Canada), or [latin.epson.com/support](http://latin.epson.com/support) (Caribbean) and select your product.
2. Click **Downloads**.
3. Select your operating system, click **Utilities**, locate the Uninstaller utility, and click **Download**.
4. Run the file you downloaded.
5. Double-click the **Uninstaller** icon.
6. In the Epson Uninstaller screen, select the checkbox for each software program you want to uninstall.
7. Click **Uninstall**.
8. Follow the on-screen instructions to uninstall the software.
9. Reinstall your product software.

**Note:** If you uninstall the printer driver and your product name remains in the **Print & Fax**, **Print & Scan**, or **Printers & Scanners** window, select your product name and click the – (remove) icon to remove it.

**Parent topic:** [Uninstall Your Product Software](#)

## Where to Get Help (U.S. and Canada)

If you need to contact Epson for technical support services, use the following support options.

### **Internet Support**

Visit Epson's support website at [epson.com/support](http://epson.com/support) (U.S.), [epson.ca/support](http://epson.ca/support) (Canada), or [epson.com.jm/support](http://epson.com.jm/support) (Caribbean) and select your product for solutions to common problems. You can download drivers and documentation, get FAQs and troubleshooting advice, or e-mail Epson with your questions.

### **Speak to a Support Representative**

Before you call Epson for support, please have the following information ready:

- Product name
- Product serial number (located on a label on the product)
- Proof of purchase (such as a store receipt) and date of purchase
- Computer configuration
- Description of the problem

Then call: (866) 212-8743, 6 AM to 6 PM, Pacific Time, Monday through Friday.

Days and hours of support are subject to change without notice. Toll or long distance charges may apply.

### **Purchase Supplies and Accessories**

You can purchase genuine Epson ink and paper at [epson.com](http://epson.com) (U.S. sales), [epson.ca](http://epson.ca) (Canadian sales), or [epson.com.jm](http://epson.com.jm) (Caribbean sales). You can also purchase supplies from an Epson authorized reseller. To find the nearest one, call 800-GO-EPSON (800-463-7766) in the U.S. or 800-807-7766 in Canada.

**Parent topic:** [Solving Problems](#)

## **Where to Get Help (Latin America)**

If you need additional help with your Epson product, contact Epson.

Epson provides these technical support services:

### **Internet Support**

Visit Epson's support website at [latin.epson.com/support](http://latin.epson.com/support) for solutions to common problems. You can download drivers and documentation, get FAQs and troubleshooting advice, or e-mail Epson with your questions.

### Speak to a Support Representative

Before you call Epson for support, please have the following information ready:

- Product name
- Product serial number (located on a label on the product)
- Proof of purchase (such as a store receipt) and date of purchase
- Computer configuration
- Description of the problem

Then call:

Country	Telephone
Argentina	(54 11) 5167-0300 0800-288-37766
Bolivia*	800-100-116
Brazil	0800-007-5000
Chile	(56 2) 2484-3400
Colombia	Bogota: (57 1) 592-2200 Other cities: 018000-915235
Costa Rica	800-377-6627
Dominican Republic*	1-888-760-0068
Ecuador*	1-800-000-044
El Salvador*	800-6570
Guatemala*	1-800-835-0358
Mexico	Mexico City: (52 55) 1323-2052 Other cities: 01-800-087-1080
Nicaragua*	00-1-800-226-0368
Panama*	00-800-052-1376
Paraguay	009-800-521-0019

Country	Telephone
Peru	Lima: (51 1) 418-0210 Other cities: 0800-10-126
Uruguay	00040-5210067
Venezuela	(58 212) 240-1111

\* Contact your local phone company to call this toll-free number from a mobile phone.

If your country does not appear in the list, contact the sales office in the nearest country. Toll or long distance charges may apply.

### **Purchase Supplies and Accessories**

You can purchase genuine Epson ink and paper from an Epson authorized reseller. To find the nearest reseller, visit [latin.epson.com](http://latin.epson.com) or call your nearest Epson sales office.

**Parent topic:** [Solving Problems](#)

---

# Technical Specifications

These sections list the technical specifications for your product.

**Note:** Epson offers a recycling program for end of life Epson products. Please go to [this site](#) (U.S) or [this site](#) (Canada) for information on how to return your Epson products for proper disposal.

[Windows System Requirements](#)

[Mac System Requirements](#)

[Paper Specifications](#)

[Printable Area Specifications](#)

[Scanning Specifications](#)

[Automatic Document Feeder \(ADF\) Specifications](#)

[Fax Specifications](#)

[Ink Cartridge Specifications](#)

[Dimension Specifications](#)

[Electrical Specifications](#)

[Environmental Specifications](#)

[Interface Specifications](#)

[External USB Device Specifications](#)

[Network Interface Specifications \(U.S. and Canada\)](#)

[Network Interface Specifications \(Latin America\)](#)

[Safety and Approvals Specifications \(U.S. and Canada\)](#)

[Safety and Approvals Specifications \(Latin America\)](#)

## Windows System Requirements

To use your product and its software, your computer should use one of these Microsoft operating systems:

- Windows 10
- Windows 8.x
- Windows 7
- Windows Vista
- Windows XP Professional x64 Edition SP2 or later

- Windows XP SP3 or later
- Windows Server 2019
- Windows Server 2016
- Windows Server 2012 R2
- Windows Server 2012
- Windows Server 2008 R2
- Windows Server 2008
- Windows Server 2003 R2
- Windows Server 2003 SP2 or later

Windows Server supports only the printer driver, Epson Scan 2, and Document Capture Pro Server; any additional included software is not supported.

If you are using Windows XP Professional x64 Edition SP2 or later or Windows XP SP3 or later, download and install the drivers for your product individually.

**Note:** For the latest product software available for your operating system, visit the Epson support site at [epson.com/support](http://epson.com/support) (U.S.), [epson.ca/support](http://epson.ca/support) (Canada), or [latin.epson.com/support](http://latin.epson.com/support) (Caribbean), select your product, and select **Downloads**.

**Parent topic:** [Technical Specifications](#)

## Mac System Requirements

To use your product and its software, your Mac should use one of these operating systems:

- macOS 11.x
- macOS 10.15.x
- macOS 10.14.x
- macOS 10.13.x
- macOS 10.12.x
- OS X 10.11.x
- OS X 10.10.x
- OS X 10.9.x
- OS X 10.8.x

- OS X 10.7.x
- OS X 10.6.8

**Note:** For the latest product software available for your operating system, visit the Epson support site at [epson.com/support](http://epson.com/support) (U.S.), [epson.ca/support](http://epson.ca/support) (Canada), or [latin.epson.com/support](http://latin.epson.com/support) (Caribbean), select your product, and select **Downloads**.

**Parent topic:** [Technical Specifications](#)

## Paper Specifications

**Note:** Since the quality of any particular brand or type of paper may be changed by the manufacturer at any time, Epson cannot guarantee the quality of any non-Epson brand or type of paper. Always test a sample of paper stock before purchasing large quantities or printing large jobs.

## Single-sheets

### Size

13 × 19 inches (330 × 483 mm)  
A3 (11.7 × 16.5 inches [297 × 420 mm])  
A4 (8.3 × 11.7 inches [210 × 297 mm])  
A5 (5.8 × 8.2 inches [148 × 210 mm])  
A6 (4.1 × 5.8 inches [105 × 148 mm])  
Executive (7.25 × 10.5 inches [184 × 267 mm])  
Half Letter (5.5 × 8.5 inches [140 × 216 mm])  
Letter (8.5 × 11 inches [216 × 279 mm])  
Legal (8.5 × 14 inches [216 × 356 mm])  
8.5 × 13 inches (216 × 330 mm)  
11 × 17 inches (279 × 432 mm)  
B4 (13.9 × 9.84 inches [353 × 250 mm])  
B5 (7.2 × 10.1 inches [182 × 257 mm])  
B6 (5 × 7.2 inches [128 × 182 mm])  
Oficio 9 (8.46 × 12.4 inches [215 × 315 mm])  
Mexico-Oficio (8.5 × 13.4 inches [216 × 340 mm])

### Paper types

Plain paper and thick paper

**Note:** Your product also supports compatible papers distributed by Epson. See the link at the end of this topic for a list of compatible Epson papers.

### Weight

Plain paper: 16 lb (60 g/m<sup>2</sup>) to 24 lb (90 g/m<sup>2</sup>)  
Thick paper: 28 lb (91 g/m<sup>2</sup>) to 90 lb (350 g/m<sup>2</sup>)

## Envelopes

### Size

No. 10 (4.1 × 9.5 inches [105 × 241 mm])

### Paper types

Plain bond paper

### Weight

20 lb (75 g/m<sup>2</sup>) to 27 lb (100 g/m<sup>2</sup>)



Parent topic: [Technical Specifications](#)

**Related references**

[Compatible Epson Papers \(U.S. and Canada\)](#)

[Compatible Epson Papers \(Latin America\)](#)

## Printable Area Specifications

### Single sheets

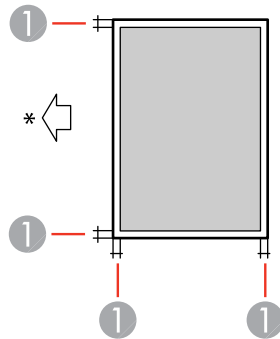

1 Margin: 0.12 inch (3 mm)

\* Direction paper is fed

### Envelopes

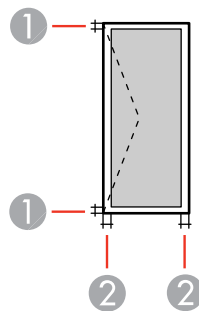

- 1 Left/right margin: 0.12 inch (3 mm)
- 2 Top/bottom margin: 0.12 inch (3 mm)

Parent topic: [Technical Specifications](#)

## Scanning Specifications

<b>Scanner type</b>	Flatbed, color
<b>Photoelectric device</b>	CIS
<b>Effective pixels</b>	7020 × 10200 pixels at 600 dpi
<b>Maximum scan area</b>	11.7 × 17 inches (297 × 431.8 mm)
<b>Maximum document size</b>	A3 (11.7 × 16.5 inches [297 × 420 mm]) 11 × 17 inches (279 × 432 mm)
<b>Scanning resolution</b>	600 dpi (main scan) 600 dpi (sub scan)
<b>Output resolution</b>	50 to 9600 dpi in 1 dpi increments
<b>Image data</b>	Color: 30 bits per pixel internal (10 bits per pixel per color internal) 24 bits per pixel external (8 bits per pixel per color external) Grayscale: 10 bits per pixel internal 8 bits per pixel external Black and white: 10 bits per pixel internal 1 bit per pixel external
<b>Light source</b>	LED

Parent topic: [Technical Specifications](#)

## Automatic Document Feeder (ADF) Specifications

<b>Paper size</b>	A6 (4.1 × 5.8 inches [105 × 148 mm]) to A3 (11.7 × 16.5 inches [297 × 420 mm])/11 × 17 inches (279 × 432 mm) (Maximum 11.7 × 17 inches [297 × 431.8 mm])
<b>Paper type</b>	Plain paper, high quality paper, recycled paper
<b>Paper weight</b>	One-sided printing: 10 lb (38 g/m <sup>2</sup> ) to 35 lb (128 g/m <sup>2</sup> ) Double-sided printing: 14 lb (50 g/m <sup>2</sup> ) to 35 lb (128 g/m <sup>2</sup> )
<b>Sheet feeding capacity</b>	Total thickness: 0.65 inch (16.5 mm) Approximately 150 sheets at 22 lb (80 g/m <sup>2</sup> )

**Note:** Depending on the quality of the paper, originals that meet the ADF specifications still may not feed or scan correctly.

**Caution:** Do not load the following types of originals in the ADF, or they may be damaged or may damage the scanner. Use the scanner glass for these types:

- Photos or valuable original artwork
- Thermal paper
- Originals containing staples or paper clips
- Originals with carbon paper backing
- Originals that are bound
- Originals with labels, stickers, or sticky notes
- Originals that are ripped, curled, folded, deteriorated, or wrinkled
- Originals with holes
- Originals that are irregularly cut or shaped
- Originals that have not dried or cooled from printing

**Parent topic:** [Technical Specifications](#)

## Fax Specifications

Specifications only applicable to models with optional fax board installed.

<b>Fax type</b>	Walk-up black-and-white and color fax capability (ITU-T Super Group 3)
<b>Support line</b>	Standard analog telephone lines PBX (Private Branch Exchange) telephone systems
<b>Speed</b>	Up to 33.6 kbps
<b>Resolution</b>	<b>Monochrome</b> Standard: 203 pixels per inch × 98 lines per inch (8 pixels per mm × 3.85 lines per mm) Fine: 203 pixels per inch × 196 lines per inch (8 pixels per mm × 7.7 lines per mm) Super Fine: 203 pixels per inch × 392 lines per inch (8 pixels per mm × 15.4 lines per mm) Ultra Fine: 406 pixels per inch × 392 lines per inch (16 pixels per mm × 15.4 lines per mm) <b>Color</b> 200 × 200 dpi
<b>Page memory</b>	Up to 550 pages (ITU-T No. 1 chart; monochrome draft mode)
<b>Redial</b>	2 times (with 1 minute interval)
<b>Interface</b>	RJ-11 Phone Line RJ-11 Telephone set connection

Parent topic: [Technical Specifications](#)

## Ink Cartridge Specifications

**Note:** We recommend that you use genuine Epson maintenance boxes and cartridges and do not refill them. The use of other products may affect your print quality and could result in printer damage.

Part of the ink from the included set of cartridges is used for charging the printer. Yields vary considerably based on images printed, print settings, paper type, frequency of use, and temperature. For print quality, a variable amount of ink remains in the cartridge after the "replace cartridge" indicator comes on.

<b>Color</b>	<b>WF-C20600/WF-C20750/WF-C21000:</b> Cyan, Magenta, Yellow, Black <b>WF-M21000:</b> Black
<b>Ink cartridge life</b>	Unopened package: do not use if the date on the package has expired
<b>Temperature</b>	Storage: -4 to 104 °F (-20 to 40 °C) 1 month at 104 °F (40 °C) Ink freezes at 6.8 °F (-14 °C) Ink thaws and is usable after approximately 12 hours at 77 °F (25 °C)

**Parent topic:** [Technical Specifications](#)

**Related references**

[Ink Cartridge and Maintenance Box Part Numbers](#)

## Dimension Specifications

### Printer only

Storage:

<b>Height</b>	48.9 inches (1243 mm)
<b>Width</b>	26.5 inches (674 mm)
<b>Depth</b>	29.8 inches (757 mm)

Printing:

<b>Height</b>	48.9 inches (1243 mm)
<b>Width</b>	56.1 inches (1426 mm)
<b>Depth</b>	29.8 inches (757 mm)

All covers, trays, cassettes, and the ADF open:

**Height** 64.0 inches (1626 mm)  
**Width** 60.8 inches (1544 mm)  
**Depth** 54.6 inches (1388 mm)

**Weight** (without consumables) Approx. 390.4 lb (177.1 kg)

**Printer with optional staple finisher unit, bridge unit, and high-capacity input tray**

Storage:

**Height** 48.9 inches (1243 mm)  
**Width** 78.8 inches (2002 mm)  
**Depth** 29.8 inches (757 mm)

Printing:

**Height** 48.9 inches (1243 mm)  
**Width** 85.9 inches (2183 mm)  
**Depth** 29.8 inches (757 mm)

All covers, trays, cassettes, and the ADF open:

**Height** 64.0 inches (1626 mm)  
**Width** 105.0 inches (2666 mm)  
**Depth** 54.6 inches (1388 mm)

**Weight** (without consumables) Approx. 744.9 lb (337.9 kg)

**Printer with optional booklet finisher unit, saddle unit, bridge unit, and high-capacity input tray**

Storage:

**Height** 48.9 inches (1243 mm)  
**Width** 91.6 inches (2327 mm)

**Depth** 29.8 inches (757 mm)

Printing:

**Height** 48.9 inches (1243 mm)

**Width** 93.1 inches (2364 mm)

**Depth** 29.8 inches (757 mm)

All covers, trays, cassettes, and the ADF open:

**Height** 64.0 inches (1626 mm)

**Width** 117.7 inches (2990 mm)

**Depth** 54.6 inches (1388 mm)

**Weight** (without consumables) Approx. 874.1 lb (396.5 kg)

Parent topic: [Technical Specifications](#)

## Electrical Specifications

**Power supply rating** 100 to 240 V

**Rated frequency range** 50/60 Hz

**Rated current** 9.0 to 4.5 A

**Power supply rating (Saddle Unit)** 110 to 120 V / 220 to 240 V (depending on your country)

<b>Power consumption</b> (with LAN and fax connection)	Standalone copying:
	<b>WF-C20600/WF-C20750</b> : Approx. 160 W (ISO/IEC24712)
	<b>WF-C21000/WF-M21000</b> : Approx. 170 W (ISO/IEC24712)
	Ready mode: 76 W
	Sleep mode: 1.7 W
	Power off mode: 0.1 W
	Maximum power consumption:
<b>WF-C20600/WF-C20750</b> : Approx. 300 W	
<b>WF-C21000/WF-M21000</b> : Approx. 320 W	

Parent topic: [Technical Specifications](#)

## Environmental Specifications

<b>Temperature</b>	Operating: 50 to 95 °F (10 to 35 °C)
	Storage (before initial ink charging): -4 to 104 °F (-20 to 40 °C)
	Storage (after initial ink charging): 6.8 to 104 °F (-14 to 40 °C) 1 month at 104 °F (40 °C)
<b>Humidity</b> (without condensation)	Operating: 15 to 85% RH
	Storage: 5 to 85% RH

Parent topic: [Technical Specifications](#)

## Interface Specifications

<b>Interface type</b>	Super-Speed USB (Device Class for computers)
	Hi-Speed USB (for Mass storage class for external storage)

**Note:** Epson cannot guarantee the operation of externally connected devices.

Parent topic: [Technical Specifications](#)



## External USB Device Specifications

Do not use devices with the following requirements:

- Dedicated driver
- Security settings

**Note:** Use only external storage devices with independent AC power sources. External storage devices that are powered via USB are not recommended. Epson cannot guarantee the operation of externally connected devices.

**USB flash drive** 2TB (formatted in FAT, FAT32, or exFAT)

You can use USB devices with your product containing files that meet these specifications.

<b>File format</b>	JPEG with the Exif version 2.31 standard taken by digital cameras with the DCF (Design Rule for Camera File system) version 1.0 or 2.0 standard <sup>1</sup> TIFF 6.0-compliant uncompressed images: RGB full-color or binary (not CCITT-encoded) PDF version 1.7 compliant data
<b>Image size</b>	80 × 80 pixels to 10200 × 10200 pixels
<b>File size</b>	Up to 2GB
<b>Number of files</b>	JPEG: Up to 9990 <sup>2</sup> TIFF: Up to 999 PDF: Up to 999

<sup>1</sup> Files stored on digital cameras with built-in memory are not supported.

<sup>2</sup> If the number of files exceeds 999, the files are displayed in groups.

**Parent topic:** [Technical Specifications](#)

# Network Interface Specifications (U.S. and Canada)

## Wi-Fi

<b>Standard</b>	IEEE802.11a/b/g/n/ac; IEEE802.11n available only on the 20 MHz channel
<b>Frequency ranges</b>	IEEE802.11a/n/ac: 5 GHz* (U.S. and Canada) IEEE802.11b/g/n: 2.4 GHz
<b>Wi-Fi channels</b>	5 GHz* (U.S. and Canada): W52 (36/40/44/48) W53 (52/56/60/64) W56 (100/104/108/112/116/132/136/140) W58 (149/153/157/161/165) 2.4 GHz: 1/2/3/4/5/6/7/8/9/10/11
<b>Wi-Fi Direct channels</b>	5 GHz* (U.S. and Canada): W52 (36/40/44/48) W58 (149/153/157/161/165) 2.4 GHz: 1/2/3/4/5/6/7/8/9/10/11
<b>Maximum radio-frequency power transmitted</b>	20 dBm (EIRP)
<b>Connection modes</b>	Infrastructure mode Wi-Fi Direct (Simple AP)

**Note:** Wi-Fi Direct (Simple AP) mode not available for IEEE 802.11b.

**Wireless security protocols**

WEP (64/128 bit)

WPA2-PSK (AES); complies with WPA2 standards with support for WPA/WPA2 Personal

WPA3-SAE (AES)

WPA2/WPA3-Enterprise

**Note:** Wi-Fi Direct supports only WPA2-PSK (AES).

\*The availability of outdoor use over these channels varies by location, as described in the table below.

**Limitations for Using 5GHz Frequencies Outdoors**

Frequency range	W52	W53	W56	W58
Frequency	5150-5250 MHz	5250-5350 MHz	5470-5725 MHz	5725-5850 MHz
Channel	36/40/44/48	52/56/60/64	100/104/108/112/116/ 120/124/128/132/136/1 40	149/153/157/161/ 165
U.S.	Outdoor use allowed	Outdoor use allowed	Outdoor use allowed	Outdoor use allowed
Canada	Outdoor use prohibited	Outdoor use allowed	Outdoor use allowed	Outdoor use allowed

**Ethernet****Standards**

IEEE802.3i (10BASE-T)

IEEE802.3u (100BASE-TX)

IEEE802.3ab (1000BASE-T)

**Note:** To prevent risk of radio interference, use a Category-5e or higher shielded twisted pair cable.

IEEE802.3az (Energy Efficient Ethernet); connected device should be IEEE802.3az compliant

**Communication mode** Auto, 10Mbps Full duplex, 10Mbps Half duplex, 100Mbps Full duplex, 100Mbps Half duplex

**Connector** RJ-45

#### **Security Protocol**

- IEEE802.1X (requires a connected device compliant with IEEE802.1X)
- IPsec/IP Filtering
- SSL/TLS; HTTPS Server/Client and IPPS
- SMTPS; STARTTLS and SSL/TLS
- SNMPv3

**Parent topic:** [Technical Specifications](#)

## **Network Interface Specifications (Latin America)**

**Note:** Wireless LAN standard complies with either IEEE802.11b/g or IEEE802.11 b/g/n, depending on purchase location.

#### **Wi-Fi**

**Standard** IEEE802.11b/g/n; complies with either IEEE802.11b/g or IEEE802.11b/g/n, depending on purchase location

**Frequency range** 2.4 GHz

**Channels** 1/2/3/4/5/6/7/8/9/10/11

**Maximum radio-frequency power transmitted** 20 dBm (EIRP)

**Connection modes** Infrastructure mode  
Wi-Fi Direct (Simple AP)

**Note:** Wi-Fi Direct (Simple AP) mode not available for IEEE 802.11b.

**Wireless security protocols** WEP (64/128 bit)  
WPA2-PSK (AES)  
WPA3-SAE (AES)  
WPA2/WPA3-Enterprise

## Ethernet

**Standards** IEEE802.3i (10BASE-T)  
IEEE802.3u (100BASE-TX)  
IEEE802.3ab (1000BASE-T)

**Note:** To prevent risk of radio interference, use a Category-5e or higher shielded twisted pair cable.

IEEE802.3az (Energy Efficient Ethernet); connected device should be IEEE802.3az compliant

**Communication mode** Auto, 10Mbps Full duplex, 10Mbps Half duplex, 100Mbps Full duplex, 100Mbps Half duplex

**Connector** RJ-45

## Security Protocol

- IEEE802.1X (requires a connected device compliant with IEEE802.1X)
- IPsec/IP Filtering
- SSL/TLS; HTTPS Server/Client and IPPS
- SMTPS; STARTTLS and SSL/TLS
- SNMPv3

**Parent topic:** [Technical Specifications](#)

## Safety and Approvals Specifications (U.S. and Canada)

**United States** Safety: UL60950-1  
EMC: FCC Part15 Subpart B Class B

## Canada

Safety: CAN/CSA-C22.2 No. 60950-1

EMC: CAN ICES-3 (B)/NMB-3 (B)

This equipment contains the following wireless module:

- Manufacturer: Seiko Epson Corporation
- Type: J26H005

This product conforms to Part 15 of FCC Rules and RSS-210 of the IC Rules. Epson cannot accept responsibility for any failure to satisfy the protection requirements resulting from a non-recommended modification of the product. Operation is subject to the following two conditions: (1) this device may not cause harmful interference, and (2) this device must accept any interference received, including interference that may cause undesired operation of the device.

To prevent radio interference to the licensed service, this device is intended to be operated indoors and away from windows to provide maximum shielding. Equipment (or its transmit antenna) that is installed outdoors is subject to licensing.

This equipment complies with FCC/IC radiation exposure limits set forth for an uncontrolled environment and meets the FCC radio frequency (RF) Exposure Guidelines in Supplement C to OET65 and RSS-102 of the IC radio frequency (RF) Exposure rules. This equipment should be installed and operated so that the radiator is kept at least 7.9 inches (20 cm) or more away from a person's body (excluding extremities: hands, wrists, feet and ankles).

Parent topic: [Technical Specifications](#)

## Safety and Approvals Specifications (Latin America)

### Notice for Argentina

WLAN Module: J26H005

Brand: EPSON

 CNC ID: C-23964

### Notice for Mexico

Operation is subject to the following two conditions: (1) this device may not cause harmful interference, and (2) this device must accept any interference received, including interference that may cause undesired operation of the device.

Product Model: C741A (WF-C20600/WF-C20750/WF-C21000)

WLAN Module Model: J26H005

Brand: EPSON

IFT Certification Number: RCPEPJ219-2102

**Notice for Paraguay**



NR:2019-10-I-0589

Imported by:

Fastrax, S.A.

Av. Perú esq. Río de Janeiro, Barrios Las Mercedes, Asunción, Paraguay

Imported by:

Sol Control S.R.L.

Av. Gral. Bernardino Caballero 810 esq. Celsa Speratti, Asunción, Paraguay

**Notice for Peru**

Product Model: WF-C20600/WF-C20750/WF-C21000 (C741A)

Brand: EPSON

This product uses the following WLAN module:

WLAN Module Model: J26H005

FCC ID: BKMFBJ26H005

Product Manufacturer: Seiko Epson Corporation

Address: 3-3-5 Owa Suwa-shi, Nagano-Ken 392-8502, Japan

**Parent topic:** [Technical Specifications](#)

---

## Notices

Check these sections for important notices about your product.

**Note:** Epson offers a recycling program for end of life Epson products. Please go to [this site](#) (U.S) or [this site](#) (Canada) for information on how to return your Epson products for proper disposal.

[Important Safety Instructions](#)

[FCC Compliance Statement](#)

[Binding Arbitration and Class Waiver](#)

[Trademarks](#)

[Copyright Notice](#)

## Important Safety Instructions

Before using your Epson product, read and follow these safety instructions.

[General Product Safety Instructions](#)

[Ink Cartridge Safety Instructions](#)

[Wireless Connection Safety Instructions](#)

[LCD Screen Safety Instructions](#)

[Telephone Equipment Safety Instructions](#)

**Parent topic:** [Notices](#)

## General Product Safety Instructions

- Be sure to follow all warnings and instructions marked on the product.
- Use only the type of power source indicated on the product's label.
- Use only the power cord that comes with the product. Use of another cord may cause fires or shock. Do not use the cord with any other equipment.
- Make sure the AC power cord meets the relevant local safety standard.
- Place the product near a wall outlet where the plug can be easily unplugged.
- Avoid plugging the product into an outlet on the same circuit as a photo copier or air control system that regularly switches on and off, or on an outlet controlled by a wall switch or timer.



- Do not let the power cord become damaged or frayed. Place it to avoid abrasions, cuts, fraying, crimping, and kinking. Do not place objects on top of it and do not allow it to be stepped on or run over. Be careful to keep the cord straight at each end.
- If you use an extension cord with the product, make sure the total ampere rating of the devices plugged into the extension cord does not exceed the cord's ampere rating. Also, make sure the total ampere rating of all devices plugged into the wall outlet does not exceed the wall outlet's ampere rating.
- Always turn off the product using the power button, and wait until the power light stops flashing before unplugging the product or cutting off power to the electrical outlet.
- If you will not be using the product for a long period, unplug the power cord from the electrical outlet.
- Place the product on a flat, stable surface that extends beyond its base in all directions. It will not operate properly if it is tilted or at an angle.
- Allow space behind the product for the cables, and space above the product so that you can fully raise the document cover.
- Leave enough space in front of the product for the paper to be fully ejected.
- Leave enough space in front and on the sides of the product for printing and maintenance.
- Avoid locations that are subject to rapid changes in heat or humidity, shocks or vibrations, or dust.
- Do not place or store the product outdoors.
- Do not place the product near excessive heat sources or in direct sunlight.
- Leave enough room around the product for sufficient ventilation. Do not block or cover openings in the case or insert objects through the slots.
- Keep the product away from potential sources of electromagnetic interference, such as loudspeakers or the base units of cordless telephones.
- When connecting the product to a computer or other device with a cable, ensure the correct orientation of the connectors. Each connector has only one correct orientation. Inserting a connector in the wrong orientation may damage both devices connected by the cable.
- Do not sit or lean on the product. Do not place heavy objects on the product.
- Do not move the print head by hand; this may damage the product.
- Do not put your hand inside the product while it is printing.
- Do not spill liquid on the product or use the product with wet hands.
- Do not use aerosol products that contain flammable gases inside or around the product. Doing so may cause fire.

- Do not press too hard on the scanner glass when placing originals.
- Do not open the scanner section while the product is copying, printing, scanning, or performing any other functions.
- Be careful not to trap your fingers when opening the covers, trays, cassettes, or when performing operations inside the product.
- Avoid touching the components inside the product unless as specifically instructed to do so in this guide.
- Except as specifically explained in your documentation, do not attempt to service or disassemble the product yourself.
- Unplug the product and refer servicing to qualified service personnel under the following conditions: if the power cord or plug is damaged; if liquid has entered the product; if the product has been dropped or the case damaged; if the product does not operate normally or exhibits a distinct change in performance. Adjust only those controls that are covered by the operating instructions.
- Leave the ink cartridges installed. Removing the cartridges can dehydrate the print head and may prevent the product from printing.
- When storing or transporting the product, do not tilt it, stand it on its side, or turn it upside down; otherwise, ink may leak.
- Do not attempt to move the product by yourself.
- Make sure the adjuster bolts are locked when using the product. Do not move the product when the adjuster bolts are locked.
- If the optional booklet finisher is installed on your product, use a power cord for the product and another power cord for the booklet finisher. The rated current of the product is 9 A, and the booklet finisher is 10 A. Connect the power cords to a power supply with a capacity larger than the total rated current. If the total rated current exceeds the power capacity, connect each power cord to a separate power source with an independent switchboard breaker.
- Do not touch the areas indicated by caution labels inside the product and any optional items.

- When using the optional booklet finisher, be careful not to touch the areas that are marked with a caution label or their surrounding areas. If the product has been in use, those areas may be very hot and may cause burns.

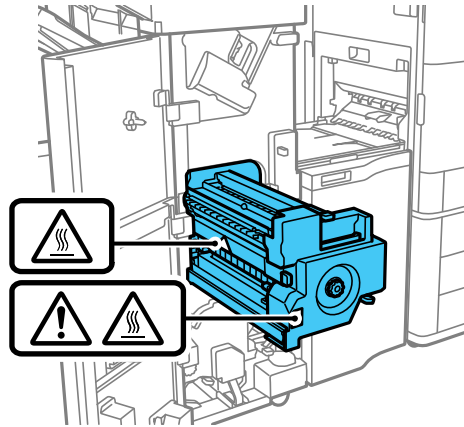

**For California customers only:** The lithium batteries in this product contain Perchlorate Material - special handling may apply. [Click here](#) for details.

**Parent topic:** [Important Safety Instructions](#)

## **Ink Cartridge Safety Instructions**

- Keep ink cartridges out of the reach of children and do not drink the ink.
- Be careful when you handle used ink cartridges; there may be ink remaining around the ink supply port. If ink gets on your skin, wash it off with soap and water. If it gets in your eyes, flush them immediately with water. If you experience discomfort or vision problems after flushing your eyes, see a doctor immediately. If ink gets in your mouth, see a doctor immediately.
- Do not put your hand inside the product or touch any cartridges during printing.
- Do not turn off the product during ink charging. If ink charging is incomplete, you may not be able to print.
- Install a new ink cartridge immediately after removing an expended one. Leaving cartridges uninstalled can dry out the print head and may prevent the product from printing.
- Do not remove or tear the label on the cartridge; this can cause leakage.
- Do not drop or knock ink cartridges against hard objects; this can cause leakage.

- Do not remove the transparent seal from the bottom of the cartridge. This may cause the cartridge to become unusable.
- Do not disassemble or modify the ink cartridge; you may not be able to print normally.
- Do not break the hooks on the side of the cartridge when removing it from the packaging.
- Do not touch the green IC chip on the side of the cartridge. This may prevent normal operation.
- Do not shake cartridges too vigorously; this can cause them to leak.
- If you remove an ink cartridge for later use, protect the ink supply area from dirt and dust and store it in the same environment as the product. Note that there is a valve in the ink supply port, making covers or plugs unnecessary, but care is needed to prevent the ink from staining items that the cartridge touches. Do not touch the ink cartridge ink supply port or surrounding area.
- Use an ink cartridge before the date printed on its package.
- Do not dismantle an ink cartridge. This could damage the print head.
- Store ink cartridges in a cool, dark place; do not store the ink cartridges in high or freezing temperatures.
- Make sure to install all ink cartridges. The printer only works when all ink cartridges are properly installed.
- After bringing an ink cartridge inside from a cold storage site, allow it to warm up at room temperature for at least 12 hours before using it.
- Store ink cartridges with their long narrow sides down and their labels facing upward.

**Parent topic:** [Important Safety Instructions](#)

## Wireless Connection Safety Instructions

Radio waves from this product may adversely affect the operation of medical equipment or automatically controlled devices, such as pacemakers, automatic doors or fire alarms. When using this product near such devices or inside a medical facility, follow the directions from authorized staff members at the facility, and follow all posted warnings and directions on the device to avoid causing an accident.

**Parent topic:** [Important Safety Instructions](#)

## LCD Screen Safety Instructions

- Use only a dry, soft cloth to clean the LCD screen. Do not use liquid or chemical cleansers.
- If the LCD screen is damaged, contact Epson. If the liquid crystal solution gets on your hands, wash them thoroughly with soap and water. If the liquid crystal solution gets into your eyes, flush them

immediately with water. If discomfort or vision problems remain after a thorough flushing, see a doctor immediately.

- Do not press too hard on the LCD screen or subject it to heavy impacts.
- Do not use a pointy or sharp object, such as a pen or your fingernail, to operate the LCD screen.
- If the LCD screen chips or cracks, do not touch or attempt to remove the broken pieces; contact Epson for support.
- Do not subject your product to sudden changes in temperature or humidity; this may cause condensation to develop inside the LCD screen and degrade its performance.
- The LCD screen may contain a few small bright or dark spots, and may display uneven brightness. These are normal and do not indicate that the screen is damaged in any way.

**Parent topic:** [Important Safety Instructions](#)

## Telephone Equipment Safety Instructions

When using telephone equipment, you should always follow basic safety precautions to reduce the risk of fire, electric shock, and personal injury, including the following:

- Do not use the Epson product near water.
- Avoid using a telephone during an electrical storm. There may be a remote risk of electric shock from lightning.
- Do not use a telephone to report a gas leak in the vicinity of the leak.

**Caution:** To reduce the risk of fire, use only a No. 26 AWG or larger telecommunication line cord.

**Parent topic:** [Important Safety Instructions](#)

## FCC Compliance Statement

### For United States Users

This equipment complies with Part 68 of the FCC rules and the requirements adopted by the Administrative Council for Terminal Attachments ("ACTA") . On the surface of this equipment is a label that contains, among other information, a product identifier in the format US:AAAEQ##TXXXX. If requested, this number must be provided to the telephone company.

Applicable certification jack Universal Service Order Codes ("USOC") for the equipment: RJ11C.

A plug and jack used to connect this equipment to the premises wiring and telephone network must comply with the applicable FCC Part 68 rules and requirements adopted by the ACTA. A compliant

telephone cord and modular plug is provided with this product. It is designed to be connected to a compatible modular jack that is also compliant. See installation instructions for details.

The REN is used to determine the number of devices that may be connected to a telephone line. Excessive RENs on a telephone line may result in the devices not ringing in response to an incoming call. In most but not all areas, the sum of RENs should not exceed five (5.0). To be certain of the number of devices that may be connected to a line, as determined by the total RENs, contact the local telephone company. For products approved after July 23, 2001, the REN for this product is part of the product identifier that has the format US:AAAEQ##TXXXX. The digits represented by ## are the REN without a decimal point (e.g., 03 is a REN of 0.3). For earlier products, the REN is separately shown on the label.

If this equipment causes harm to the telephone network, the telephone company will notify you in advance that temporary discontinuance of service may be required. But if advance notice isn't practical, the telephone company will notify the customer as soon as possible. Also, you will be advised of your right to file a complaint with the FCC if you believe it is necessary.

The telephone company may make changes in its facilities, equipment, operations or procedures that could affect the operation of the equipment. If this happens the telephone company will provide advance notice in order for you to make necessary modifications to maintain uninterrupted service.

If you have problems with this product and require technical or customer support, please visit [www.epson.com](http://www.epson.com) for more information.

This product is not intended to be repaired by the customer. If you experience trouble connecting this equipment to a telephone line, please contact:

Name: Epson America, Inc.

Address: 3131 Katella Ave., Los Alamitos, CA 90720 U.S.A.

Telephone: (562) 981-3840

If the equipment is causing harm to the telephone network, the telephone company may request that you disconnect the equipment until the problem is resolved.

This equipment may not be used on coin service provided by the telephone company. Connection to party line service is subject to state tariffs. Contact the state public utility commission, public service commission or corporation commission for information.

If your home has specially wired alarm equipment connected to the telephone line, ensure the installation of this equipment does not disable your alarm equipment. If you have questions about what will disable alarm equipment, consult your telephone company or a qualified installer.

The Telephone Consumer Protection Act of 1991 makes it unlawful for any person to use a computer or other electronic device, including fax machines, to send any message unless such message clearly contains in a margin at the top or bottom of each transmitted page or on the first page of the transmission, the date and time it is sent and an identification of the business or other entity, or other

individual sending the message and the telephone number of the sending machine or such business, other entity, or individual. (The telephone number provided may not be a 900 number or any other number for which charges exceed local or long-distance transmission charges.)

In order to program this information into your fax machine, click the link below for instructions on entering fax header information.

According to the FCC's electrical safety advisory, we recommend that you may install an AC surge arrester in the AC outlet to which this equipment is connected. Telephone companies report that electrical surges, typically lightning transients, are very destructive to customer terminal equipment connected to AC power sources and that this is a major nationwide problem.

This equipment has been tested and found to comply with the limits for a Class B digital device, pursuant to Part 15 of the FCC Rules. These limits are designed to provide reasonable protection against harmful interference in a residential installation. This equipment generates, uses, and can radiate radio frequency energy and, if not installed and used in accordance with the instructions, may cause harmful interference to radio or television reception. However, there is no guarantee that interference will not occur in a particular installation. If this equipment does cause interference to radio and television reception, which can be determined by turning the equipment off and on, the user is encouraged to try to correct the interference by one or more of the following measures:

- Reorient or relocate the receiving antenna.
- Increase the separation between the equipment and receiver.
- Connect the equipment into an outlet on a circuit different from that to which the receiver is connected.
- Consult the dealer or an experienced radio/TV technician for help.

### **WARNING**

The connection of a non-shielded equipment interface cable to this equipment will invalidate the FCC Certification or Declaration of this device and may cause interference levels which exceed the limits established by the FCC for this equipment. It is the responsibility of the user to obtain and use a shielded equipment interface cable with this device. If this equipment has more than one interface connector, do not leave cables connected to unused interfaces. Changes or modifications not expressly approved by the manufacturer could void the user's authority to operate the equipment.

### **For Canadian Users**

1. This product meets the applicable Innovation, Science and Economic Development Canada technical specifications.
2. The Ringer Equivalence Number indicates the maximum number of devices allowed to be connected to a telephone interface. The termination of an interface may consist of any combination of devices subject only to the requirement that the sum of the RENs of all the devices does not exceed five.

CAN ICES-3(B)/NMB-3(B)

Le présent produit est conforme aux spécifications techniques applicables d'Innovation, Sciences et Développement économique Canada.

L'indice d'équivalence de la sonnerie (IES) sert à indiquer le nombre maximal de dispositifs qui peuvent être raccordés à une interface téléphonique. La terminaison d'une interface peut consister en une combinaison quelconque de dispositifs, à la seule condition que la somme des IES de tous les dispositifs n'excède pas cinq.

CAN ICES-3(B)/NMB-3(B)

**Parent topic:** [Notices](#)

**Related tasks**

[Using the Fax Setup Wizard](#)

## Binding Arbitration and Class Waiver

### 1. DISPUTES, BINDING INDIVIDUAL ARBITRATION, AND WAIVER OF CLASS ACTIONS AND CLASS ARBITRATIONS

**1.1 Disputes.** The terms of this Section 1 shall apply to all Disputes between you and Epson. The term "Dispute" is meant to have the broadest meaning permissible under law and includes any dispute, claim, controversy or action between you and Epson arising out of or relating to this Agreement, Epson branded products (hardware and including any related software), or other transaction involving you and Epson, whether in contract, warranty, misrepresentation, fraud, tort, intentional tort, statute, regulation, ordinance, or any other legal or equitable basis. "DISPUTE" DOES NOT INCLUDE IP CLAIMS, or more specifically, a claim or cause of action for (a) trademark infringement or dilution, (b) patent infringement, (c) copyright infringement or misuse, or (d) trade secret misappropriation (an "IP Claim"). You and Epson also agree, notwithstanding Section 1.6, that a court, not an arbitrator, may decide if a claim or cause of action is for an IP Claim.

**1.2 Binding Arbitration.** You and Epson agree that all Disputes shall be resolved by binding arbitration according to this Agreement. **ARBITRATION MEANS THAT YOU WAIVE YOUR RIGHT TO A JUDGE OR JURY IN A COURT PROCEEDING AND YOUR GROUNDS FOR APPEAL ARE LIMITED.**

Pursuant to this Agreement, binding arbitration shall be administered by JAMS, a nationally recognized arbitration authority, pursuant to its code of procedures then in effect for consumer related disputes, but excluding any rules that permit joinder or class actions in arbitration (for more detail on procedure, see Section 1.6 below). You and Epson understand and agree that (a) the Federal Arbitration Act (9 U.S.C. §1, et seq.) governs the interpretation and enforcement of this Section 1, (b) this Agreement memorializes a transaction in interstate commerce, and (c) this Section 1 shall survive termination of this Agreement.



**1.3 Pre-Arbitration Steps and Notice.** Before submitting a claim for arbitration, you and Epson agree to try, for sixty (60) days, to resolve any Dispute informally. If Epson and you do not reach an agreement to resolve the Dispute within the sixty (60) days, you or Epson may commence an arbitration. Notice to Epson must be addressed to: Epson America, Inc., ATTN: Legal Department, 3131 Katella Ave., Los Alamitos, CA 90720 (the "Epson Address"). The Dispute Notice to you will be sent to the most recent address Epson has in its records for you. For this reason, it is important to notify us if your address changes by emailing us at [EAILEgal@ea.epson.com](mailto:EAILEgal@ea.epson.com) or writing us at the Epson Address above. Notice of the Dispute shall include the sender's name, address and contact information, the facts giving rise to the Dispute, and the relief requested (the "Dispute Notice"). Following receipt of the Dispute Notice, Epson and you agree to act in good faith to resolve the Dispute before commencing arbitration.

**1.4 Small Claims Court.** Notwithstanding the foregoing, you may bring an individual action in the small claims court of your state or municipality if the action is within that court's jurisdiction and is pending only in that court.

**1.5 WAIVER OF CLASS ACTIONS AND CLASS ARBITRATIONS. YOU AND EPSON AGREE THAT EACH PARTY MAY BRING DISPUTES AGAINST THE OTHER PARTY ONLY IN AN INDIVIDUAL CAPACITY, AND NOT AS A PLAINTIFF OR CLASS MEMBER IN ANY CLASS OR REPRESENTATIVE PROCEEDING, INCLUDING WITHOUT LIMITATION FEDERAL OR STATE CLASS ACTIONS, OR CLASS ARBITRATIONS. CLASS ACTION LAWSUITS, CLASS-WIDE ARBITRATIONS, PRIVATE ATTORNEY-GENERAL ACTIONS, AND ANY OTHER PROCEEDING WHERE SOMEONE ACTS IN A REPRESENTATIVE CAPACITY ARE NOT ALLOWED. ACCORDINGLY, UNDER THE ARBITRATION PROCEDURES OUTLINED IN THIS SECTION, AN ARBITRATOR SHALL NOT COMBINE OR CONSOLIDATE MORE THAN ONE PARTY'S CLAIMS WITHOUT THE WRITTEN CONSENT OF ALL AFFECTED PARTIES TO AN ARBITRATION PROCEEDING.**

**1.6 Arbitration Procedure.** If you or Epson commences arbitration, the arbitration shall be governed by the rules of JAMS that are in effect when the arbitration is filed, excluding any rules that permit arbitration on a class or representative basis (the "JAMS Rules"), available at <http://www.jamsadr.com> or by calling 1-800-352-5267, and under the rules set forth in this Agreement. All Disputes shall be resolved by a single neutral arbitrator, and both parties shall have a reasonable opportunity to participate in the selection of the arbitrator. The arbitrator is bound by the terms of this Agreement. The arbitrator, and not any federal, state or local court or agency, shall have exclusive authority to resolve all disputes arising out of or relating to the interpretation, applicability, enforceability or formation of this Agreement, including any claim that all or any part of this Agreement is void or voidable. Notwithstanding this broad delegation of authority to the arbitrator, a court may determine the limited question of whether a claim or cause of action is for an IP Claim, which is excluded from the definition of "Disputes" in Section 1.1 above. The arbitrator shall be empowered to grant whatever relief would be available in a court under law or in equity. The arbitrator may award you the same damages as a court could, and may award declaratory or injunctive relief only in favor of the individual party seeking relief and only to the extent necessary to provide relief warranted by that party's individual claim. In some instances, the costs of

arbitration can exceed the costs of litigation and the right to discovery may be more limited in arbitration than in court. The arbitrator's award is binding and may be entered as a judgment in any court of competent jurisdiction.

You may choose to engage in arbitration hearings by telephone. Arbitration hearings not conducted by telephone shall take place in a location reasonably accessible from your primary residence, or in Orange County, California, at your option.

a) Initiation of Arbitration Proceeding. If either you or Epson decides to arbitrate a Dispute, both parties agree to the following procedure:

(i) Write a Demand for Arbitration. The demand must include a description of the Dispute and the amount of damages sought to be recovered. You can find a copy of a Demand for Arbitration at <http://www.jamsadr.com> ("Demand for Arbitration").

(ii) Send three copies of the Demand for Arbitration, plus the appropriate filing fee, to: JAMS, 500 North State College Blvd., Suite 600 Orange, CA 92868, U.S.A.

(iii) Send one copy of the Demand for Arbitration to the other party (same address as the Dispute Notice), or as otherwise agreed by the parties.

b) Hearing Format. During the arbitration, the amount of any settlement offer made shall not be disclosed to the arbitrator until after the arbitrator determines the amount, if any, to which you or Epson is entitled. The discovery or exchange of non-privileged information relevant to the Dispute may be allowed during the arbitration.

c) Arbitration Fees. Epson shall pay, or (if applicable) reimburse you for, all JAMS filings and arbitrator fees for any arbitration commenced (by you or Epson) pursuant to provisions of this Agreement.

d) Award in Your Favor. For Disputes in which you or Epson seeks \$75,000 or less in damages exclusive of attorney's fees and costs, if the arbitrator's decision results in an award to you in an amount greater than Epson's last written offer, if any, to settle the Dispute, Epson will: (i) pay you \$1,000 or the amount of the award, whichever is greater; (ii) pay you twice the amount of your reasonable attorney's fees, if any; and (iii) reimburse you for any expenses (including expert witness fees and costs) that your attorney reasonably accrues for investigating, preparing, and pursuing the Dispute in arbitration. Except as agreed upon by you and Epson in writing, the arbitrator shall determine the amount of fees, costs, and expenses to be paid by Epson pursuant to this Section 1.6d).

e) Attorney's Fees. Epson will not seek its attorney's fees and expenses for any arbitration commenced involving a Dispute under this Agreement. Your right to attorney's fees and expenses under Section 1.6d) above does not limit your rights to attorney's fees and expenses under applicable law; notwithstanding the foregoing, the arbitrator may not award duplicative awards of attorney's fees and expenses.

**1.7 Opt-out. You may elect to opt-out (exclude yourself) from the final, binding, individual arbitration procedure and waiver of class and representative proceedings specified in this**

**Agreement by sending a written letter to the Epson Address within thirty (30) days of your assent to this Agreement (including without limitation the purchase, download, installation of the Software or other applicable use of Epson Hardware, products and services) that specifies (i) your name, (ii) your mailing address, and (iii) your request to be excluded from the final, binding individual arbitration procedure and waiver of class and representative proceedings specified in this Section 1. In the event that you opt-out consistent with the procedure set forth above, all other terms shall continue to apply, including the requirement to provide notice prior to litigation.**

**1.8 Amendments to Section 1.** Notwithstanding any provision in this Agreement to the contrary, you and Epson agree that if Epson makes any future amendments to the dispute resolution procedure and class action waiver provisions (other than a change to Epson's address) in this Agreement, Epson will obtain your affirmative assent to the applicable amendment. If you do not affirmatively assent to the applicable amendment, you are agreeing that you will arbitrate any Dispute between the parties in accordance with the language of this Section 1 (or resolve disputes as provided for in Section 1.7, if you timely elected to opt-out when you first assented to this Agreement).

**1.9 Severability.** If any provision in this Section 1 is found to be unenforceable, that provision shall be severed with the remainder of this Agreement remaining in full force and effect. **The foregoing shall not apply to the prohibition against class or representative actions as provided in Section 1.5. This means that if Section 1.5 is found to be unenforceable, the entire Section 1 (but only Section 1) shall be null and void.**

Parent topic: [Notices](#)

## Trademarks

EPSON® is a registered trademark, EPSON Exceed Your Vision is a registered logomark, and Epson Connect™, Epson iPrint™, and Remote Print™ are trademarks of Seiko Epson Corporation.

Windows is a registered trademark of Microsoft Corporation in the United States and/or other countries.

ColorSync, App Store, Mac, macOS, and OS X are trademarks of Apple Inc., registered in the U.S. and other countries.

Google® is a registered trademark and Android™, Gmail™, Google Chrome™, Google Drive™, and Google Play™ are trademarks of Google LLC.

Wi-Fi Direct® is a registered trademark of Wi-Fi Alliance®.

General Notice: Other product names used herein are for identification purposes only and may be trademarks of their respective owners. Epson disclaims any and all rights in those marks.

**EPSON®**  
EXCEED YOUR VISION

Parent topic: [Notices](#)

## Copyright Notice

All rights reserved. No part of this publication may be reproduced, stored in a retrieval system, or transmitted in any form or by any means, electronic, mechanical, photocopying, recording, or otherwise, without the prior written permission of Seiko Epson Corporation. The information contained herein is designed only for use with this Epson product. Epson is not responsible for any use of this information as applied to other products.

Neither Seiko Epson Corporation nor its affiliates shall be liable to the purchaser of this product or third parties for damages, losses, costs, or expenses incurred by purchaser or third parties as a result of: accident, misuse, or abuse of this product or unauthorized modifications, repairs, or alterations to this product, or (excluding the U.S.) failure to strictly comply with Seiko Epson Corporation's operating and maintenance instructions.

Seiko Epson Corporation shall not be liable for any damages or problems arising from the use of any options or any consumable products other than those designated as Original Epson Products or Epson Approved Products by Seiko Epson Corporation.

Seiko Epson Corporation shall not be held liable for any damage resulting from electromagnetic interference that occurs from the use of any interface cables other than those designated as Epson approved Products by Seiko Epson Corporation.

This information is subject to change without notice.

[libTIFF Software Acknowledgment](#)

[A Note Concerning Responsible Use of Copyrighted Materials](#)

[Default Delay Times for Power Management for Epson Products](#)

[Copyright Attribution](#)

Parent topic: [Notices](#)

## libTIFF Software Acknowledgment

Copyright © 1988-1997 Sam Leffler

Copyright © 1991-1997 Silicon Graphics, Inc.

Permission to use, copy, modify, distribute, and sell this software and its documentation for any purpose is hereby granted without fee, provided that (i) the above copyright notices and this permission notice appear in all copies of the software and related documentation, and (ii) the names of Sam Leffler and Silicon Graphics may not be used in any advertising or publicity relating to the software without the specific, prior written permission of Sam Leffler and Silicon Graphics.

THE SOFTWARE IS PROVIDED "AS-IS" AND WITHOUT WARRANTY OF ANY KIND, EXPRESS, IMPLIED OR OTHERWISE, INCLUDING WITHOUT LIMITATION, ANY WARRANTY OF MERCHANTABILITY OR FITNESS FOR A PARTICULAR PURPOSE.

IN NO EVENT SHALL SAM LEFFLER OR SILICON GRAPHICS BE LIABLE FOR ANY SPECIAL, INCIDENTAL, INDIRECT OR CONSEQUENTIAL DAMAGES OF ANY KIND, OR ANY DAMAGES WHATSOEVER RESULTING FROM LOSS OF USE, DATA OR PROFITS, WHETHER OR NOT ADVISED OF THE POSSIBILITY OF DAMAGE, AND ON ANY THEORY OF LIABILITY, ARISING OUT OF OR IN CONNECTION WITH THE USE OR PERFORMANCE OF THIS SOFTWARE.

**Parent topic:** [Copyright Notice](#)

## **A Note Concerning Responsible Use of Copyrighted Materials**

Epson encourages each user to be responsible and respectful of the copyright laws when using any Epson product. While some countries' laws permit limited copying or reuse of copyrighted material in certain circumstances, those circumstances may not be as broad as some people assume. Contact your legal advisor for any questions regarding copyright law.

**Parent topic:** [Copyright Notice](#)

## **Default Delay Times for Power Management for Epson Products**

This product will enter sleep mode after a period of nonuse. This is to ensure that the product meets Energy Star standards of energy efficiency. More energy savings can be achieved by setting the time to sleep to a shorter interval.

**Parent topic:** [Copyright Notice](#)

## **Copyright Attribution**

© 2021 Epson America, Inc.

2/21

CPD-58715R3

**Parent topic:** [Copyright Notice](#)