



2021

TAHOE 9C1 PPV



Preproduction model shown with equipment from independent suppliers not covered by the GM New Vehicle Limited Warranty. GM is not responsible for the safety or quality of independent supplier alterations.

GENERAL MOTORS FLEET





About This Publication

This catalog is not updated during the model year and should not be used for ordering purposes. It is intended as a source of basic information. All illustrations and specifications in this literature are based on the latest product information available at the time of publication. General Motors reserves the right to make changes at any time without notice. For further details, consult your local dealer.

Care must be taken during customer installation of equipment and wiring to ensure that all holes drilled in the body are corrosion protected, properly sealed and that vehicle wiring harnesses, piping or other components have not been displaced or damaged. Please return all police vehicles to factory condition and settings upon decommissioning to prevent civilians from using these new 2021 calibrations, lighting and other features intended only for police and emergency customers. Wiring connection or splice changes are to be removed before the vehicle is returned to civilian use. Aftermarket equipment installers must be mindful of applicable Federal Motor Vehicle Safety Standards. This information can be obtained directly from the National Highway Traffic Safety Administration. Adding non-dealer accessories or making modifications to the vehicle can affect vehicle performance, aerodynamics, and overall top speed.

These vehicles are equipped with an airbag system. The airbag system in your police vehicle includes frontal driver and front outboard passenger airbags, front seat back side impact airbags, roof rail mounted head-curtain airbags. Customer installed equipment such as security barriers behind the front seats should not be mounted so that the barrier ends are within the side airbag deployment zones. The sensors and other components for the airbag system must not be relocated to accommodate the installation of customer furnished equipment; please refer to the service manual for sensor and other component locations. For information concerning instrument panel top pad mounted equipment and airbag system deployment zones, see the airbag information section in this catalog and the vehicle owners manual.

A note about vehicle alterations by independent suppliers: This catalog shows pictures of vehicles that have been altered or upfitted with equipment or components supplied to Chevrolet or its dealers by independent suppliers. GM is not responsible for the safety or quality of design features, materials or workmanship of any alterations by third parties.

INDEX

2021 TAHOE POLICE PACKAGE

- **UPDATES FOR 2021 MODEL YEAR**
- **STANDARD FEATURES**
- **POWERTRAIN & EMISSIONS**
- **SPECIFICATIONS**
- **SPEEDOMETER/CLUSTER DISPLAY**
- **RADIO SCREEN DISPLAY**
- **STANDARD FEATURES HIGHLIGHTS**
- **COLORS, INTERIOR TRIM AND SEATS**
- **OPTIONAL FEATURES**
- **OnStar®**
- **OPTIONAL FEATURES HIGHLIGHTS**
- **WIRING DIAGRAMS**
- **STABILITRAK**
- **LOADING ZONES**
- **AIRBAG DIMENSIONS**
- **AIRBAGS FAQ**
- **MAINTENANCE AND WARRANTY**



This document shows vehicles that have been altered or upfitted with equipment, bodies or components. GM is not responsible for the safety or quality of design features, materials or workmanship of any alterations by third parties.

UPDATES FOR 2021

STANDARD NEW FEATURES

- **4-Wheel independent suspension**
- **Police specific front seats contoured to accommodate duty belts**
- **Brembo 6 piston front brake calipers with 16" rotors**
- **20" Steel wheels with V-Rated Firestone Firehawk Pursuit tires**
- **Push to Start and unique Passive Entry Passive Start (PEPS) Calibrations**
- **Steering wheel mounted switches to operate aftermarket emergency equipment**
- **Extensive electrical architecture to reduce up-fitting**
- **Vehicle Signals provided in harness:
Door Ajar, Brakes Applied, Park, Surveillance Mode, IP Dimming**
- **Protected Idle allows vehicle to be unlocked and idling but unable to be driven without key**
- **Dash mounted push-button transmission PRNDL**
- **Electronic park brake**
- **ID Card/gate pass/fuel card holder in dash**
- **Additional 120v outlet in cargo area**
- **Wireless Android Auto¹ / Apple Car Play²**
- **250-amp alternator replaces 170-amp**
- **900 CCA, 95 amp-hour primary battery replaces 760 CCA, 70 amp-hour**
- **Increased cargo capacity**
- **Increased approach angle**
- **Increased trailering capacity now 6,000lbs for 2WD & optional 4WD**
- **Tire pressure monitors³ automatically detect mounted location**
- **Larger side view mirrors**
- **USB C charging ports in rear cargo area and lower dash mounted**
- **Department radio microphone Provision wiring**
- **Wiring Provision for outside mirrors and cargo area side windows**
- **Wiring provision in front doors for customer furnished exterior mirror lighting**
- **Wiring provision in rear cargo headliner for customer furnished lighting**
- **Silver Metallic (GAN) discontinued, replaced by darker Satin Steel Metallic (G9K)**
- **New paint colors, (GS6) Garywood Metallic, (GLU) Midnight Blue Metallic and (GJW) Empire Beige Metallic**

OPTIONAL NEW FEATURES

- **Red & Blue LED tailgate lighting with on/off switch**
- **Rear Camera Mirror⁴ allows full view with K9 inserts and partitions**
- **Pedestrian Detection (included in PGA Safety Package⁴)**
- **LED Spot Lamps**
- **Second Row Seat Delete (ships as incomplete vehicle)**
- **Autotrac electronic transfer case with Auto 4WD, 4HI or 2WD setting (includes Terrain Mode)**

1. Vehicle user interface is a product of Google and its terms and privacy statements apply. Requires the Android Auto app on Google Play and an Android compatible smartphone running Android 5.0 Lollipop or higher. Data plan rates apply. Android Auto is a trademark of Google LLC. **2.** Vehicle user interface is a product of Apple and its terms and privacy statements apply. Requires compatible iPhone and data plan rates apply. Apple CarPlay is a trademark of Apple Inc. Siri, iPhone and iTunes are trademarks of Apple Inc., registered in the U.S. and other countries. **3.** Does not monitor spare tire. **4.** Read the vehicle owner's manual for important feature limitations and information.

The two-wheel drive and four-wheel drive Tahoe (9C1) Police Package has been designed for police work up to, and including high-speed emergency vehicle operations. GM restricts the sale of police vehicles and they are not to be sold to retail customers. Model CC10706 (two-wheel drive) or CK10706 (four-wheel drive) with equipment group 1FL are required when ordering 9C1 Police Package. Content, Options and Specifications shown are for the police version only which differ from retail civilian model.

9C1 PPV Package includes: Heavy-duty police-rated suspension with unique StabiliTrak performance calibration. Full independent suspension with monotube dampers, linear coil springs that set the trim height 20mm lower than civilian model, 35mm solid front stabilizer bar, 32mm hollow rear stabilizer bar. Police specific Brembo front brakes utilize 6-piston fixed calipers on 410mm rotors (32mm thick), 1-piston sliding rear calipers on 345mm rotors (20mm thick). 75/55R20 all-season V-Rated Firestone Firehawk Pursuit tires are mounted on 20" heavy-duty black steel wheels with bolt-on center caps and includes a matching full-size spare. High-capacity air filter, dual battery isolator with 760 cold-cranking amp auxiliary battery, 250 amp high output alternator, auxiliary battery circuit for customer connection located in rear cargo area, electrical power & vehicle signals for customer located on center front floor and cargo area with surveillance mode circuit. Certified speedometer, work truck steering wheel with two re-purposed switches to operate after-market emergency equipment and third row seat delete are standard. Police specific front seat backs and bolsters are skived to better accommodate officers wearing duty belts. Available 4WD with Autotrac electronic transfer case, includes 2HI, 4AUTO and 4HI settings.

STANDARD 9C1 INTERIOR FEATURES

AIRBAGS¹	Six airbags: Frontal airbags for driver and front outboard passenger; Seat-mounted side-impact airbags for driver and front outboard passenger; Head-curtain airbags for all rows in outboard seating positions
AIR CONDITIONING	Tri-zone automatic climate control, with individual climate settings for driver, right front passenger and rear seat occupants. Includes rear air conditioning.
ASSIST HANDLES	Overhead, driver and front passenger, located in headliner. Front passenger A-pillar and second row outboard B-pillar. Not available with (7X2) or (7X3) spotlights
AUDIO SYSTEM²	Chevrolet Infotainment 3 system, 8" diagonal color touchscreen, AM/FM stereo. Additional features for compatible phones include: Bluetooth audio streaming for 2 active devices, voice command pass-through to phone, Wireless Apple CarPlay and Android Auto capable. Includes 6 speaker system.
BLUETOOTH³	Personal cell phone connectivity to vehicle audio system
4G LTE WI-FI HOTSPOT	Available 4G LTE Wi-Fi [®] hotspot can connect up to 7 devices; includes 4G LTE data trial for 1 month or 3GB (whichever comes first). Requires properly equipped vehicle. Service varies with conditions and location. Requires active service plan. Data plans provided by AT&T, availability subject to change. Visit www.gmfleet.com/technology/connected-vehicle.html for details and limitations
COMPASS	Displayed in digital gauge cluster (see Picture on Speedometer/Cluster page)
CONSOLE, OVERHEAD	Includes map lights, OnStar buttons and Passenger air bag indicator
CRUISE CONTROL	Electronic with set and resume speed
DRIVER INFORMATION CENTER	4.2" diagonal color display, includes driver personalization
FLEET CONNECTED ACCESS	Fleet Connected Access with 10 years of standard connectivity which enables services such as, Vehicle Diagnostics, Dealer Maintenance Notification, Chevrolet Smart Driver, Marketplace and more. Limitations apply. Not transferable. Standard connectivity available to original purchaser for ten years from the date of initial vehicle purchase for model year 2021 or newer Chevrolet vehicles. See www.gmfleet.com/technology/connected-vehicle.html for details and further plan limitations. Connected Access does not include emergency or security services. Availability and additional services enabled by Connected Access are subject to change
FLOOR COVERING	Black rubberized vinyl. Deleted when (B30) floor covering is ordered.
KEY FOB	Two KEYS/FOBS and mechanical keys for ignition and doors. Four additional fobs are available. While unlimited number of learned KEYS/FOBS can operate Keyless start and Keyless open, for a particular vehicle, only the last 8 KEYS/FOBS learned will allow the key fob buttons to work. See Available Options page for ordering codes. See Optional Equipment page for programming procedure.
KEYLESS OPEN	Keyless Open allows you to lock and unlock the vehicle using the driver door or front passenger door handle without taking the key fob out your pocket. Keyless open, with the key fob in your possession, locks and unlocks your vehicle's doors without having to use the key fob, increasing convenience. If the key fob battery is depleted or due to wireless interference, vehicle may be unlocked using the mechanical key. See Owner's Manual for details.
KEYLESS START	Keyless Start allows you to start the vehicle when the key fob is inside the vehicle at the front seats and without taking the key fob out of your pocket. Keyless start uses an integrated key fob sensor instead of a traditional key. If the key fob battery is depleted or due to wireless interference, vehicle may also be started by resting the key fob on top of the start button. See Owners Manual for details.
GLASS	Deep-tinted, all windows (except for windshield, and front occupant side glass which are light-tinted). Windshield: >70% visible light transmittance; Front Doors: >70% visible light transmittance (UV is reduced to 35% or less); Rear Doors and Cargo Area: 12% +/- 3% visible light transmittance. Non-tinted, solar absorbing glass available (see option AKP)
GLOVE BOX	Locking door, includes courtesy light
HD REAR VISION CAMERA⁴	Provides driver a high-resolution digital image of the area directly behind the vehicle when in Reverse at low speeds
INSTRUMENTATION	Digital Speedometer and 140 mph certified analog speedometer, 1 mph increments and digital trip odometer with gauges for engine oil pressure, fuel, battery volts, coolant temperature and tachometer. Driver Information Center displays compass, time, tire pressure, fuel range, off-road gauges, remote key learn, vehicle warnings, and backup sensor proximity status while in reverse. The headlamps can be dimmed with the headlamp switch in the Auto position if 9G8, DRL Delete, is not present. If 9G8 is present, when the headlamps switch is in the Auto position, no exterior lights will be on, and the dash will assume daytime intensity. When 9G8 is present, the cluster can be dimmed with the headlamp switch in Manual Headlamps position.
LIGHTING	Interior with dome light, cargo lights, door handle or Remote Keyless Entry-activated illuminated entry and map lights in front and second seat positions with control switch in the roof console
MIRROR, INSIDE	Rearview, manual day/night

1. Always use seat belts and child restraints. Children are safer when properly secured in a rear seat in the appropriate child restraint. See the Owner's Manual for more information. **2.** Vehicle user interface is a product of Apple and its terms and privacy statements apply. Requires compatible iPhone and data plan rates apply. Apple CarPlay is a trademark of Apple Inc. Siri, iPhone and iTunes are trademarks of Apple Inc., registered in the U.S. and other countries. Vehicle user interface is a product of Google and its terms and privacy statements apply. Requires the Android Auto app on Google Play and an Android compatible smartphone running Android 5.0 Lollipop or higher. Data plan rates apply. Android Auto is a trademark of Google LLC. **3.** Go to my.chevrolet.com/learn to find out which Bluetooth phones are compatible with the vehicle. **4.** Safety or driver assistance features are no substitute for the driver's responsibility to operate the vehicle in a safe manner. The driver should remain attentive to traffic, surroundings and road conditions at all times. Visibility, weather, and road conditions may affect feature performance. Read the vehicle's owner's manual for more important feature limitations and information.

STANDARD 9C1 INTERIOR FEATURES (CONTINUED)

MICROPHONE, WIRING	Wiring provision for customer-installed microphone for customer radio above headliner over driver position.
OnStar®	Fleet orders with properly equipped vehicles receive a 3-month trial of Fleet Connected Services and 3 months of Fleet Safety & Security plan coverage. Connected Services includes Connected Navigation, Remote Access Plan and 1 month or 3GB of 4G LTE data (whichever comes first). OnStar links to emergency services. Services subject to user terms and limitations. Certain services require working electrical system, cell reception and GPS signal. OnStar links to emergency services. Data plans offered by AT&T. See gmfleet.com/connected-services for details. Availability subject to change. See www.gmfleet.com/technology/connected-vehicle.html for details and limitations.
OUTSIDE TEMPERATURE	Displays in top left corner of Driver Information Center and lower right corner of Infotainment screen
PASSENGER COMPARTMENT AIR FILTER	The filter reduces the dust, pollen, and other airborne irritants from outside air that is pulled into the vehicle. This filter is located behind the passenger side glove box.
POWER OUTLET	Front auxiliary, 12-volt, located in the center stack of instrument panel
PROTECTED IDLE	The Protected Idle Feature allows the vehicle to remain idling but will not allow the transmission to be shifted from Park without a valid key fob
REAR PARK ASSIST¹	Sensors for audible warning on rear bumper to assist with parking and avoiding objects while in reverse. (see illustration section for description)
RESTRAINT SYSTEM	Seat belts at all designated seating positions with driver and front outboard passenger pretensioners. Airbags ² : frontal airbags for driver and front outboard passenger; includes front outboard Passenger Sensing System. Seat-mounted side-impact airbags for driver and front outboard passenger; Head Curtain airbags for all rows at outboard seating positions. Note: Nine inch seatbelt extenders are available (part number 19259268) through our dealers at no charge.
SEATS, FRONT	CLOTH 40/20/40 individual seats, 3 passengers with 10-way power driver seat adjuster (fore/aft, up/down, tilt, recline, and lumbar), and 8-way power passenger seat adjuster (includes lumbar). Adjustable outboard head restraints and storage pockets. Center seat section can be deleted (5Y1) for 15" of open floor space (see front seats and interior trim illustration page for further details).
SEATS, REAR	CLOTH split-folding and sliding 60/40 bench seats includes folding center armrest with cup holders, outboard seating position headrests and reclining rear seat back (available in vinyl option code 5T5). 2nd row rear seat delete available with option code ATZ (ships as incomplete vehicle).
STEERING COLUMN	Manual tilt and telescopic
STEERING WHEEL CONTROLS	The steering wheel includes control buttons for Cruise Control, Driver Information Center and the Vehicle Radio. The two-position Radio Favorites up/down buttons on the left backside of the steering wheel have been re-purposed for operating customer furnished equipment, i.e., push-to-talk microphone, emergency warning devices, etc. The re-purposed Radio Favorites button no longer permits the selection of the radio broadcast stations.
TEEN DRIVER	A configurable feature that lets you activate customizable vehicle settings associated with a key FOB, to help encourage safe driving behavior. It can limit certain available vehicle features, and it prevents certain safety systems from being turned off. An in-vehicle report card gives you information on driving habits and helps you to continue to coach your new driver.
THEFT DETERRENT SYSTEM	Vehicle content, electrical, unauthorized entry
USB CHARGING ONLY PORTS	Four: two Type-C located on rear of center seat base and two Type -C located in cargo area (1 left and 1 right side below quarter glass side window). Not available with (A50) front bucket seats.
VISORS	Driver and front passenger illuminated vanity mirrors, sliding
WARNING TONES	Headlamp on, key-in-ignition, driver and right-front passenger seat belt unfasten, backup sensor with warning tone and turn signal on
WINDOWS, POWER	Power driver and passenger with Express-Up/Down. Power rear with Express-Down.

1. Safety or driver assistance features are no substitute for the driver's responsibility to operate the vehicle in a safe manner. The driver should remain attentive to traffic, surroundings and road conditions at all times. Visibility, weather, and road conditions may affect feature performance. Read the vehicle's owner's manual for more important feature limitations and information.

2. Always use seat belts and child restraints. Children are safer when properly secured in a rear seat in the appropriate child restraint. See the Owner's Manual for more information.

STANDARD 9C1 EXTERIOR FEATURES

ASSIST STEPS	Black, mounted between front and rear wheels
BODY SIDE MOLDINGS	Not available
CAPLESS FUEL FILL	This vehicle has a capless refueling system and does not have a fuel cap. The filling nozzle must be fully inserted and latched prior to starting fuel flow. Overfilling the fuel tank by more than three clicks of a standard fill nozzle may cause vehicle performance issues, including engine stalling and damage to the fuel system, fuel spills, potential fuel fires.
DEFOGGER	Electric, rear window
DOOR HANDLES	Body color
DOOR LOCKS	Door locks can be programmed via radio settings menu. Lock cylinder is only available on driver door. Other side doors and lift gate are controlled by driver door-mounted switches. Includes 2 remote transmitters. See also LOCKOUT PROTECTION.
FASCIA, FRONT	Front high-approach angle with recovery hook openings, but does not include hooks. See Option (V76) for recovery hooks. Body-color with recovery hook openings, but does not include hooks
FASCIA, REAR	Body color with step pad. Includes Trailer hitch receiver cover
FOG LAMPS	Not available
HEADLAMPS	LED Reflector high and low beam with flash-to-pass feature, automatic exterior lamp control and daytime running lamps. Daytime running lamps use reduced low-beam intensity. Altering headlamp assembly is not recommended, General Motors is not responsible for the effects of any modifications.
HORNS	Dual note
KEYLESS ENTRY REMOTES	Two extended range keys/fobs with non-functional panic button: exterior lamps flash and horn chirp are disabled as default setting. Remote feedback can be programmed via radio Vehicle Settings.
LUGGAGE RACK	Not available
MIRRORS, OUTSIDE	Outside heated power-adjustable, manual-folding, body-color
RADIO ANTENNA	Located inside liftgate spoiler
REAR LIFTGATE	Manual gate and hinged glass hatch. Unlock buttons located on exterior and remote FOB. Unique police programming only allows unlocking with the FOB or interior courtesy switch.
TIRE PRESSURE MONITOR WITH TIRE FILL ALERT	Tire Pressure Monitoring System. Full-size spare includes unprogrammed sensor. Includes Tire Fill Alert feature in addition to the DIC warning when a tire has low pressure. This feature provides audible and visual indication when air is being added to the low tire to aid in achieving optimal tire pressure.
TIRES	Firestone Firehawk Pursuit 275/55R20 all-season, V-rated, blackwall, (see standard equipment illustrations section) includes matching spare tire
TIRE, SPARE	Full-size matching spare with unprogrammed TPM, lockable with outside winch-type carrier mounted under frame at rear.
UNDER HOOD LAMP	Not available
WHEELS	20" x 9" black steel (includes matching full-size spare)
WHEEL CENTER CAP	Bolt-on aluminum with black finish
WINDSHIELD	Solar absorbing shaded upper with acoustic laminated glass
WIPERS, WINDSHIELD	Intermittent, with rain sensing
WIPER, REAR	Intermittent with washer

STANDARD 9C1 ELECTRICAL FEATURES

AUXILIARY POWER, FRONT	Wiring connection from circuits in upfitter branch harness between front seats. Two relays, one rated at 20 amp load, one rated at 25 amp load and one 50 amp auxiliary battery circuit for connection and control by customer. The relay coil fusing can be configured to operate the pair of relays via battery power or ignition controlled power. See the Upfit Circuits List and Wiring diagrams for 50E FUSE BLOCK AUXILIARY BATTERY and X51 JUNCTION BLOCK INSTRUMENT PANEL AUXILIARY.
AUXILIARY POWER, REAR	Wiring connection from circuits in upfitter branch harness at left side of cargo area. Two relays, one rated at 20 amp load, one rated at 25 amp load and one 100 amp auxiliary battery circuit for connection and control by customer. The relay coil fusing can be configured to operate the pair of relays via battery power or ignition controlled power. See the Upfit Circuits List and Wiring diagrams for 50E FUSE BLOCK AUXILIARY BATTERY and X51 JUNCTION BLOCK INSTRUMENT PANEL AUXILIARY .
LOCK-OUT PROTECTION	When a key is in the vehicle and the driver door is open with the ignition ON or ACC, an audible alarm will sound. If the doors are locked and closed, the driver door will remain locked. The engine will remain running if ON. When the ignition is OFF and the last door is closed and there is a key in the front seat area of the vehicle, the driver door will unlock. See also the PROTECTED IDLE procedure in the Standard Equipment section of this document.
POWER OUTLETS	A 60 Hertz, 110 volt AC outlet is located in the center section (20%) of the front seat. The outlet is rated at 150 watts. Overload power before auto shut off is 275 watts for 10 seconds or 418 watts for 1 second. Also included are four 12 volt auxiliary outlets, one on the instrument panel, one in the center seat section and two in the cargo area. 12 volt outlet power is configurable to be battery power or ignition controlled power. When option 5Y1, Center Seat Delete is ordered, the 110 volt AC power outlet and wire harness in the center seat console are shipped separately for customer installation.
SURVEILLANCE FEATURE	Body Control Module (BCM) calibration to disable all automatic lighting. See UPFIT WIRING CIRCUITS LIST.
UPFITTER WIRING PROVISIONS	Upfitter wiring circuits are provided in two branch harnesses to centralize upfitter connections to vehicle systems. One branch is coiled between the front seats and the second is coiled on the left side cargo area floor to the rear of the auxiliary battery. Each upfitter branch harness contains blunt-cut wires which are tagged with circuit numbers. The numbered tags are listed in the UPFIT WIRING HARNESS CIRCUIT IDENTIFICATION list provided in this Specification Guide.
WIRING DIAGRAMS	See Wiring Section for descriptions
WIRING PROVISION FOR EMERGENCY LIGHTING	Blunt-cut wire harnesses in front doors and above rear headliner near lift gate for connection to customer outside mirror and rear window emergency lamps

STANDARD 9C1 MECHANICAL FEATURES

AIR FILTER	High-capacity
ACTIVE HILL HOLD ASSIST	This feature is designed to prevent the vehicle from rolling, either forward or rearward, during vehicle drive off
ALTERNATOR	250 amps
AXLE	3.23 Ratio
BATTERIES	Primary 900 cca, 95 amp-hour rating with battery rundown protection (may be configured to protect customer installed equipment packaged behind left rear cargo area panel). Isolated, Auxiliary 760 cca, 70 amp-hour battery without battery run-down protection for customer installed equipment. (see SPECIFICATIONS PAGE for details)
BATTERY RELAY	Auxiliary-battery relay connects auxiliary battery to charging system when engine is running.
BRAKES	Police specific brakes with anti-lock calibration and eBoost utilizing 6-piston fixed front Brembo calipers on 410mm rotors (32mm thick), 1-piston sliding rear calipers on 345mm rotors (20mm thick)
COOLING	Heavy-duty high-capacity radiator, electric fans and extended life coolant; coolant hoses are EPDM (ethylene-propylene-diene monomer) rubber; silicone hoses are not required (coolant is DEX-COOL good for 5 years/150,000 miles, protects from -34° F to +265° F and against rust and corrosion)
ENGINE	5.3L V8 VVT (variable valve timing), Direct high-pressure fuel injection with Dynamic Fuel Management (DFM) that allows engine to operate in 17 different cylinder patterns (as few as two cylinders) to optimize power delivery and efficiency. The DFM controller calculates 80 times per second to determine how many cylinders are required to meet the driver's requested torque. (see powertrain page for description and emissions, see also specifications page)
ENGINE OIL COOLER	Engine oil is cooled by passing the fluid through a cooler located in the engine radiator assembly end tank. Engine oil is pumped by the engine oil pump from the driver side of the engine block through piping to an oil-to-coolant heat exchanger located within the passenger side end-tank of the coolant radiator and returned to engine.
EXHAUST	Single system, single-outlet
FRAME	All new fully boxed steel frame with high strength steel roll formed, hydroformed and stamped rails, design optimized for safety and crashworthiness, durability and stiffness.
FILTRATION MONITOR	Engine air filtration monitor
FUEL TANK CAPACITY	24 gallons (90.8 liters)
LIMITED WARRANTY	See Maintenance and Warranty page for information
PROP SHAFT	4-inch diameter aluminum
RADIO SUPPRESSION	The Tahoe vehicle systems are designed to prevent unwanted emissions and to minimize susceptibility and maximize immunity to external emissions (Electromagnetic (EMI) or Radio Frequency (RFI) Interference). Most emergency vehicle communications equipment operating at frequencies in the VHF Band (30-300 MHz) and up to frequencies in the UHF Band (300 MHz-3GHz) will function as intended without enhanced noise suppression. If additional noise suppression grounding is desired, see the Optional Equipment listing for UN9, Radio Suppression Ground Straps
REAR DIFFERENTIAL	Performance-optimized heavy-duty clutch-type limited slip
SKID PLATES, FRONT	Two-piece, heavy-duty aluminum front underbody shield that starts behind the front bumper and attaches to the front fascia. It protects front underbody components and oil pan.
SPARK PLUGS	Extended life - iridium tip
STABILITRAK	Automatically helps enhance control, particularly during emergency maneuvers, by adjusting the brakes and engine torque to help you stay on your intended path. Activates when vehicle sensors detect a difference between the driver's intended path and the direction the vehicle is actually travelling. Includes Traction Control that detects wheel slippage and applies brake pressure and/or reduces engine power to help the driver maintain control when accelerating on wet or snow-covered roads. Includes Brake Assist that senses how hard and fast a driver hits the brake pedal and gives extra braking assistance, if required. Unique calibrations to the PPV Tahoe recognize continuous high performance driving in 2WD or Auto 4WD Mode, the stability system will automatically enter Pursuit Mode. When engaged the Traction Control OFF light will illuminate. (see Standard Equipment Illustration section for StabiliTrak button location) Pursuit Mode can be disengaged by any of these three methods: -Discontinue high performance driving for approximately 2 minutes -Place transmission into Park for a brief period of time -Turn engine off
STEERING	The Electric Power Steering System consists of a Rack-and-Pinion steering gear assisted by an electronically controlled power steering motor and drive assembly. The steering gear is mechanically connected to the steering wheel system.
SUSPENSION	Heavy-duty police-rated suspension. Full independent suspension with monotube dampers, linear coil springs, 35mm solid front stabilizer bar and 32mm hollow rear stabilizer bar. PPV trim height is 20mm lower than civilian model.
TRAILERING EQUIPMENT¹	SAE Class IV hitch with 2" (51 mm) square receiver. Trailer may weigh up to 6,000 pounds (2,722 kg) with proper hitch selection. See the Owners Manual for additional information.
TRANSMISSION	The 10-speed automatic provides gear ratios that work to improve both fuel economy and acceleration, while also enabling quicker-smoother shifts. Intelligent electronics provide protection against over-revving the engine and can recognize driver intent, whereby holding gears longer when being driven aggressively. This enhances vehicle control while driving through corners and when throttling up at corner exit. Keeping the transmission in one gear instead of upshifting and downshifting avoids "hunting" for a gear state.
TRANSMISSION OIL COOLER	Transmission oil is pumped from the transmission through piping to an oil-to-air heat exchanger and then returns to the transmission. The transmission oil cooler is located in front of the air conditioning condenser as part of the Condenser, Radiator, and Fan Module (CRFM) assembly.

¹. Before you buy a vehicle or use it for trailering, carefully review the Trailering section of the Owner's Manual. The weight of passengers, cargo and options or accessories may reduce the amount you can tow.

POWERTRAIN

ENGINE				TRANSMISSION		AXLE	
OPTION CODE	TYPE	DISPLACEMENT SYSTEM	FUEL CODE	OPTION CODE	TYPE	OPTION	RATIO
L84	V8	5.3/325	VVT, DI, Dynamic Fuel Management	MQC	10L80 10-Speed auto. with OD	GU5	3.23

EMISSIONS - MUST BE SPECIFIED

FE9	Emissions , Federal requirements
YF5	Emissions , California state requirements
NE1	Emissions , Connecticut, Delaware, Maine, Maryland, Massachusetts, New Jersey, New York, Oregon, Pennsylvania, Rhode Island, Vermont and Washington state requirements
NB8	Emissions override , California (allows a dealer in states that require California emissions - California, Connecticut, Delaware, Maryland, Massachusetts, New Jersey, New York, Oregon, Pennsylvania, Rhode Island or Washington - to order Federal emissions for a vehicle that will be registered in a state that has Federal emission requirements). Do not use for vehicles that will be registered in California, Connecticut, Delaware, Maryland, Massachusetts, New Jersey, New York, Oregon, Pennsylvania, Rhode Island or Washington. Requires (FE9) Federal emissions requirements. Not available in Maine or Vermont.
NB9	Emissions override , state-specific (for dealers ordering vehicles in (YF5) or (NE1) emission states - California, Connecticut, Delaware, Maine, Maryland, Massachusetts, New Jersey, New York, Oregon, Pennsylvania, Rhode Island, Vermont and Washington) Allows a California dealer (YF5 emissions) to order (NE1) emissions with (NB9) emissions override code for registration in (NE1) states; or, a Connecticut, Delaware, Maine, Massachusetts, New Jersey, New York, Oregon, Pennsylvania, Rhode Island, Vermont and Washington dealer (NE1 emissions) to order (YF5) emissions with (NB9) emissions override code for registration in California.
NC7	Emissions override , Federal (for vehicles ordered by dealers in Federal emission states with (YF5) or (NE1) emissions - Not required for vehicles being shipped to California, Connecticut, Delaware, Maine, Maryland, Massachusetts, New Jersey, New York, Oregon, Pennsylvania, Rhode Island, Vermont or Washington) Requires (YF5) California state emissions requirements or (NE1) Connecticut, Delaware, Maine, Massachusetts, New York, Pennsylvania, Rhode Island or Vermont state emission requirements.

NOTE: The 2021 Chevrolet Tahoe Police Patrol Vehicle and Special Service Vehicle with the 5.3L Engine (L84) with Emission Option Codes:

FE9 NAME CERTIFICATION EMISSION, FEDERAL

NE1 NAME CERTIFICATION EMISSION, GEOGRAPHICALLY RESTRICTED

YF5 NAME CERTIFICATION EMISSION, CALIFORNIA is certified to EPA Tier 3 BIN 70 standards and qualifies as ULEV 70 (Ultra Low Emission Vehicle) under California Air Resources Board (CARB) requirements, meaning it is 50-state certified.

EPA engine family or test group: MGMXT05.3388

TIRES

MANUFACTURER	QUANTITY	SIZE	SPEED RATING	TYPE
Firestone	5	275/55R20	V	All season BW

NOTE:

Due to specific requirements for performance durability and safety, GM recommends only the original equipment tires for replacement.

Tire Plies = Tread 6 ply; 2 Polyester, 2 Steel, 2 Nylon, Sidewall, 2 Polyester

Tire Chains - Proper size Low Profile chains that add no more than 12 mm thickness to the tire tread and inner sidewall are approved for 2021 Tahoe Police Vehicles if the vehicle has 275/55R20 size tires. If traction devices are used, install them on the rear tires only and tighten them as tightly as possible with the ends securely fastened. Drive slowly and follow the chain manufacturer's instructions. If the chains contact the vehicle, stop and retighten them. If contact continues, slow down until it stops. Tire chains used on a vehicle without the proper amount of clearance can cause damage to the brakes, suspension, or other vehicle parts. The area damaged by the tire chains could cause loss of control and a crash. Driving too fast or spinning the wheels with chains on will damage the vehicle. If traction devices are used, install them on the rear tires only. Use tire chains only where legal and only when necessary.

5.3 LITER V8 ENGINE WITH DYNAMIC FUEL MANAGEMENT



Dynamic Fuel Management allows engine to operate in 17 different cylinder patterns (as few as two cylinders) to optimize power delivery and efficiency. The DFM controller calculates 80 times per second to determine how many cylinders are required to meet the driver's requested torque.

STANDARD HEAVY-DUTY STEEL WHEEL WITH FIRESTONE FIREHAWK PURSUIT TIRE



Firestone Firehawk Pursuit 275/55R20 all-season, V-rated, blackwall. Includes matching spare tire

SPECIFICATIONS

2-WHEEL DRIVE			4-WHEEL DRIVE		
Model	CC10706		Model	CK10706	
Projected top speed ¹ (without equipment)	130 mph		Projected top speed ¹ (without equipment)	124 mph	
Projected top speed in reverse (without equipment)	23 mph		Projected top speed in reverse (without equipment)	23 mph	
EPA-ESTIMATED MPG FUEL ECONOMY RATINGS			EPA-ESTIMATED MPG FUEL ECONOMY RATINGS		
5.3L engine 2WD (City/Highway/Combined)	TBD		5.3L engine 4WD (City/Highway/Combined)	TBD	
VEHICLE WEIGHT (LBS./KG.)			VEHICLE WEIGHT (LBS./KG.)		
Front Seat Type	40/20/40	40/40	Front Seat Type	40/20/40	40/40
GVWR ³ (Gross Vehicle Weight Rating)	7200/3266	7200/3266	GVWR ³ (Gross Vehicle Weight Rating)	7400/3357	7400/3357
FGAWR (Front Gross Axle Weight Rating)	3300/1497	3300/1497	FGAWR (Front Gross Axle Weight Rating)	3500/1588	3500/1588
RGAWR (Rear Gross Axle Weight Rating)	4300/1950	4300/1950	RGAWR (Rear Gross Axle Weight Rating)	4300/1950	4300/1950
Payload ⁴	1600/726	1600/726	Payload ⁴	1600/726	1600/726
Base curb weight	5542/ 2514	5529/2508	Base curb weight	5730/2599	5717/2593
Maximum Trailering Capacity ⁵	6000/2722	6000/2722	Maximum Trailering Capacity ⁵	6000/2722	6000/2722

PASSENGER COMPARTMENT VOLUME (cu.ft./liters)

Passenger Volume Front Row	64.1/1814
Passenger Volume Second Row	59.2/1676
Total Passenger Volume	123.2/3489.4

FRONT COMPARTMENT (in./mm)

Head room (Maximum)	42.3/1074
Shoulder room	66.0/1677
Hip room	61.5/1562
Leg room	44.5/1131

REAR COMPARTMENT (in./mm)

Head room	38.9/988
Shoulder room	64.8/1645
Hip room	61.3/1557
Leg room	42.0/1068

CARGO

Load floor length to center of front seat at floor (in./mm)	80.1/2034
Load floor length to center of 2nd seat at floor at seat (in./mm)	58.1/1475
Inside width between wheelhouse (in./mm)	49.4/1255
Cargo area height (in./mm)	36.5/927
Cargo volume ² maximum behind front seat (cu. ft./liters)	125.9/3565
Cargo volume ² maximum behind second seat (cu. ft./liters)	70.3/1991

EXTERIOR (in./mm)

Wheelbase	120.9/3071
Overall length	210.7/5351
Body width (with Mirrors)	81.0/2058
Overall height ⁶ 2- Wheel Drive (Maximum)	75.8/1925
Overall height ⁶ 4- Wheel Drive (Maximum)	75.9/1927
Lift in height ⁶ (Top of load floor to ground)	34.8/886
Step-in height	22.9/584
Front track width	68.5/1741
Rear track width	68.3/1734
Turning diameter curb to curb (ft./m)	39.0/11.9
Approach angle	31.6 deg
Departure angle	18.1 deg
Breakover angle	16.9 deg
Ground Clearance	7.1/191
Fording depth	20.0/508

1. Adding non dealer accessories or making modifications to the vehicle can affect vehicle performance, aerodynamics, and overall top speed. 2. Cargo and load capacity limited by weight and distribution. 3. Gross Vehicle Weight Rating (GVWR). When properly equipped, includes vehicle, passengers, cargo and equipment. 4. These maximum payload ratings are intended for comparison purposes only. Before you buy a vehicle or use it to haul people or cargo, carefully review the vehicle loading section of the Owner's Manual and check the carrying capacity of your specific vehicle on the label on the inside of the driver's door jamb. 5. Before you buy a vehicle or use it for trailering, carefully review the Trailering section of the Owner's Manual. The weight of passengers, cargo and options or accessories may reduce the amount you can tow. 6. Published dimension indicated is from ground and without optional equipment or accessories. Additional accessories or equipment ordered at the customer's request can result in a minor change in this dimension.

SPECIFICATIONS

ENGINE	STANDARD
Type	V8
Displacement: liters/cu. in.	5.3/325
Horsepower/rpm	355 @ 5600
Torque lb.-ft./rpm	383 @ 4100
Induction system	Direct high-pressure fuel injection with Fuel Management
Compression ratio	11.0:1
Exhaust	Single
Minimum recommended fuel octane	87
Approximate fuel tank capacity (gallons/liters)	24/90.8
Oil with filter (quarts/liters)	8.0/7.6
Cooling capacity (quarts/liters)	15.6/14.78

TRANSMISSION	
Automatic electronic with overdrive	10-speed

AXLE	
Ratio	3.23

BRAKES	
eBoost ABS	Disc/Disc
Front-swept area (sq. in./sq. cm)	221.0/1426
Rear-swept area (sq. in./sq. cm)	263.7/1701.6
Front rotor diameter (in./mm)	16.1/410
Rear rotor diameter (in./mm)	13.58/345
Front rotor thickness (in./mm)	1.26/32
Rear rotor thickness (in./mm)	.79/20

TIRES	
Type	Firestone Firehawk Pursuit, V-rated, All-season
Size	275/55R20

WHEELS	
Type	Black Steel with bolt on aluminum center cap
Size	20"x 9"

CHASSIS	
Frame	Full perimeter steel
Suspension	Heavy-duty police-rated suspension with unique StabiliTrak performance calibration. Full independent suspension with monotube dampers, linear coil springs, 35mm solid front stabilizer bar and 32mm hollow rear stabilizer bar. PPV trim height is 20mm lower than civilian model.
Steering type	Electric power-assisted rack and pinion
Steering ratio	16.0:1

BATTERIES	PRIMARY	AUXILIARY
Type	Maintenance free	Maintenance free
BCI group size	LN5	LN3
Volts	12	12
Amp hour rating	95	70
Reserve capacity	160	120
Cold cranking-amps	900	760

ALTERNATOR	
Type	Melco GX9-L25
Amps	77°F (25°C) 250

TAHOE POLICE ALTERNATOR OUTPUT

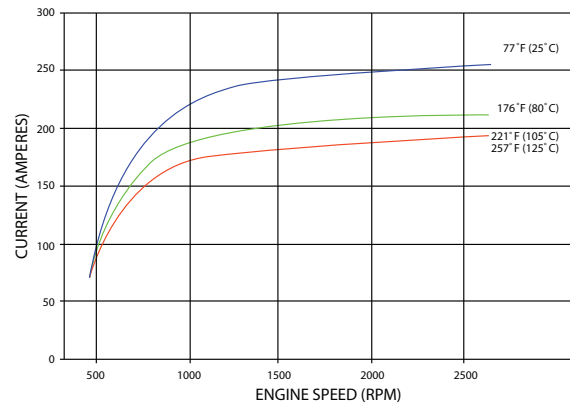

BOOST LEVEL	PARK/NEUTRAL	DRIVE
Normal Idle	550	500
1	800	650
2	800	725
3	1000	800

APPROACH AND DEPARTURE ANGLES

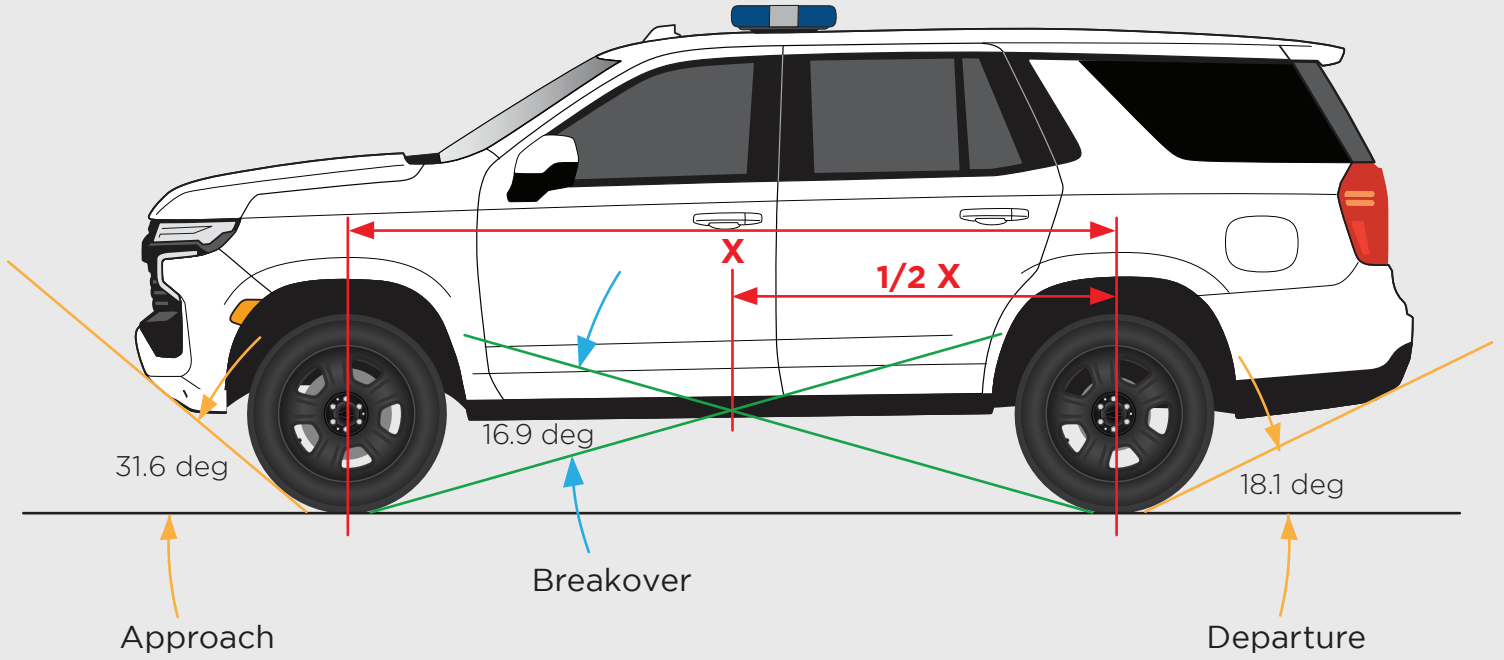

	PPV Tahoe	
	4WD	2WD
Approach Angle	31.6 deg	31.7 deg
Departure Angle	18.1 deg	18.1 deg
Breakover Angle	16.9 deg	16.9 deg
Ground Clearance	191 mm	191 mm
Fording Depth	20.0 in	20.0 in

MATERIAL DIMENSIONS FOR BODY WRAP AND GRAPHIC ESTIMATIONS

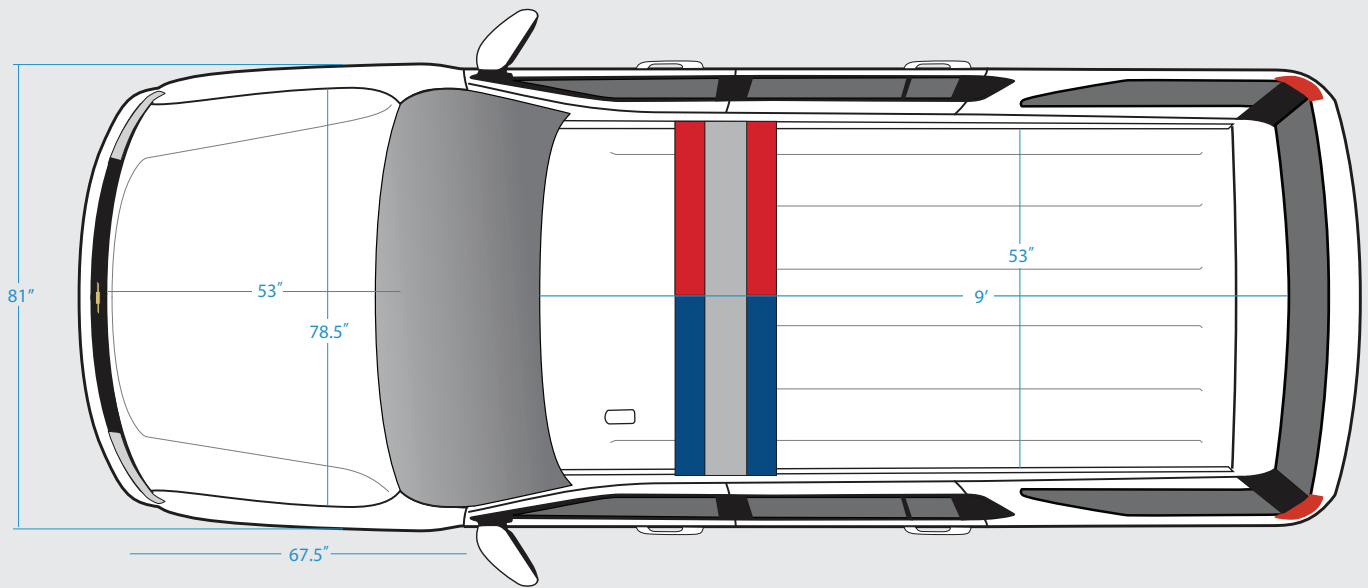
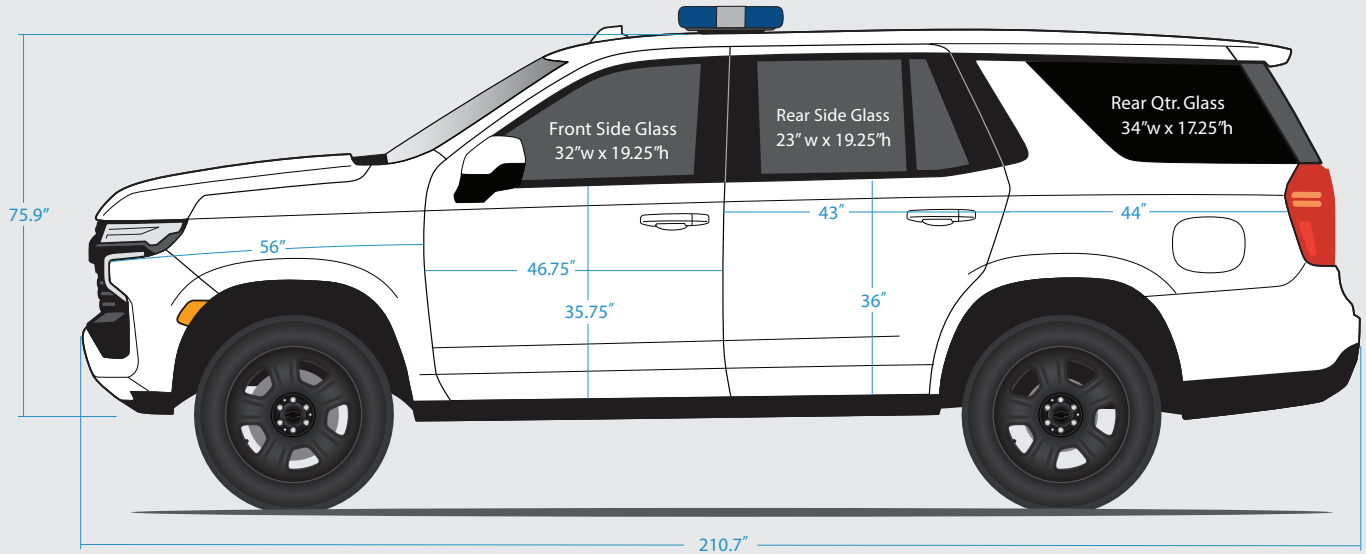

Estimated material sizes to wrap:

- Hood - 79" x 54"
- Front Doors - 48" x 37"
- Rear Doors - 45" x 38"
- Roof - 110" x 55"
- Rear hatch - 63" x 27"

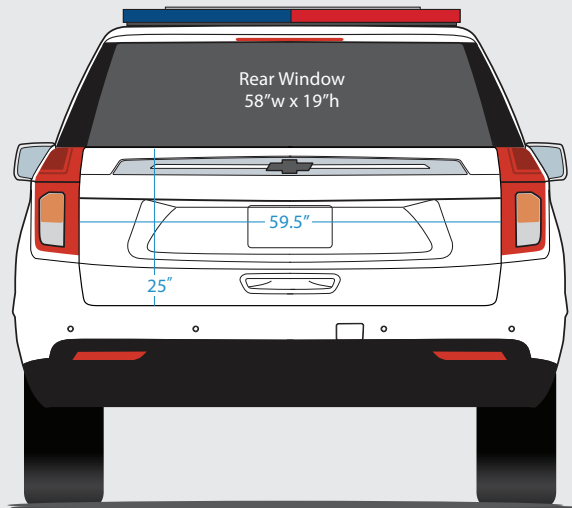

UNITED STATES CERTIFIED SPEEDOMETER/CLUSTER (CANADIAN SIMILAR)



DRIVER INFORMATION CENTER

DIC MAIN MENU

- INFO
- AUDIO
- PHONE
- NAVIGATION
- OPTIONS

ACTIVE INFO PAGES as listed in **DIC** main menu item **OPTIONS** above

- Speed
- Trip 1
- Fuel Range
- Oil Life
- Tire Pressure
- Air Filter Life
- Fuel Economy
- Engine Hours
- Remote Key Relearn

2021 TAHOE PPV SPEEDOMETER CERTIFICATION CALIBRATION

To Whom It May Concern:
The speedometer system in the 2021 model year and Police Tahoe vehicle is accurate to +/- 2mph in the temperature range of -23 to 49 °Celsius (-10 to 120 ° Fahrenheit) over the useful life of the vehicle. The speedometer system includes the vehicle integrated speed measurement system and indication of the vehicle speed on the speedometer.

GM specified vehicle maintenance is required to maintain the stated accuracy of the speedometer system. The accuracy of the speedometer system is dependent on and affected by the required vehicle maintenance including; following placard tire inflation pressure of 35 psi, monitoring tire wear as directed by the owner's manual, tire replacement with 275/55 R-20 Firestone tire size and manufacture, maintaining original OEM driveline ratios, maintaining original OEM electronic module calibration files and following vehicle loading limitations.

Regards,

Howard Smith
Police Vehicle Program Engineering
Manager



STEERING WHEEL MENU CONTROLS

VEHICLE TOUCH SCREEN SETTINGS



VEHICLE PERSONALIZATION MENU

The Personalization Menu is accessed by:

Touching the radio screen to display the HOME PAGE

Touch the SETTINGS icon and then

Touch VEHICLE to display the features

Select from the available features listed to change the item setting.

Important features in the Menu that can be changed are:

Rear Seat Reminder¹

Collision Detection

Comfort and Convenience

Lighting

Power Locks

See the Owner's Manual for a complete Vehicle Personalization Menu listing of items that may be available for your vehicle.

¹. Does not detect people or items. Always check rear seat before exiting.

STANDARD FEATURES

PUSH-BUTTON ELECTRONIC SHIFT



This vehicle is equipped with an electronic transmission with controls mounted next to the instrument panel for easy access. The shift switches are designed to prevent inadvertent shifting out of P (Park) unless the ignition is on and the brake pedal is applied. Push-to-shift transmission technology is intuitive to use, with pull switches for Drive (D) and Reverse (R) and push switches for Park (P), Neutral (N) and Low (L).

Push-button Electronic Shift also enables safety features previously not possible with a mechanical column shift. These include a back-up to the driver selecting P (Park) and should not be used as the primary method of achieving Park (P). If the vehicle is stopped, in Drive (D)/Low (L) or Reverse (R) and the ENGINE START/STOP button is pressed, the vehicle will turn off and shift the transmission to P (Park) automatically. The vehicle will remain in N (Neutral) if this same procedure is done while the vehicle is in Neutral (N). If the vehicle is sitting, or rolling slowly in Drive (D), Reverse (R), Neutral (N) or Low (L), and the driver exits the vehicle by unbuckling their seatbelt, releasing the brake pedal and opening the driver's door the vehicle will stop, set the parking brake and shift to Park (P). If the door is opened above 5 MPH, the vehicle will not automatically shift to P (Park) when the driver exits.

To drive the vehicle at low speeds with the door open, open the door while the vehicle is in P (Park) and select D (Drive) or R (Reverse). This disables the auto-park feature until the door is closed and then re-opened. The vehicle will not shift into P (Park) if it is moving too fast. Stop the vehicle and shift into P (Park). Also, selecting Park (P) while rolling at low speeds will invoke automatic braking to a stop, before shifting to Park (P). To use Low Mode the vehicle must be in Drive (D) prior to pressing the L (Low) button. Use this mode when driving downhill or towing a trailer to limit the top gear and vehicle speed. When shifting to L (Low), the transmission will shift to a preset lower gear range. Press the + (Plus) button to shift to a higher gear and press the - (Minus) button to shift to a lower gear. L (Low) will prevent shifting to a lower gear range if the engine speed is too high. See Owner's Manual for more information.

STANDARD SAFETY FEATURES

STABILITRAK CONTROL

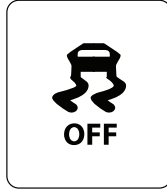

The StabiliTrak Electronic Stability Control and Traction Control System button is located to the left of the steering column on the instrument panel. See also Ride Control Systems in your Owner's Manual for an operation description of the system and related Driver Information Center messages.

OnStar®



- Voice Command Button
- Blue OnStar® Button
- Emergency Button

This vehicle is equipped with a comprehensive, in-vehicle system that can connect to a live OnStar® Advisor for Emergency, Security, Navigation, Connection, and Diagnostic Services. OnStar® services may require a paid subscription. OnStar® requires the vehicle battery and electrical system, cellular service, and GPS satellite signals to be available and operating. OnStar® acts as a link to existing public emergency service providers. OnStar® may collect information about you and your vehicle, including location information. See OnStar®'s Terms and Conditions and Privacy Statement for more details including system limitations at www.OnStar.com (U.S.) or www.OnStar.ca (Canada). The OnStar® system status light is next to the OnStar® buttons. If the status light is:

- Solid Green: System is on.
- Flashing Green: On a call.
- Red: Indicates a problem.
- Off: System is off. Press the blue OnStar® button twice to speak with an OnStar® Advisor.

Press or call 1-888-4-ONSTAR (1-888-466-7827) to speak to an Advisor.

Press to:

- Make a call, end a call, or answer an incoming call.
- Give OnStar® Hands-Free Calling voice commands.

NOTE: Do not activate OnStar® if you have no plans on using this feature

REAR PARK ASSIST



Rear Park Assist (RPA) uses sensors on the rear bumper to assist with parking and avoiding objects while in R (Reverse). It operates at speeds less than about 5 mph (8 km/hr). In addition, multiple beeps may occur if very close to an object. Rear Park Assist may display a warning triangle on the Rear Vision Camera screen and a graphic on the instrument cluster to provide how close the detected object is to the vehicle. The Rear Vision Camera displays a view of the area behind the vehicle on the radio screen display, when the vehicle is shifted into R (Reverse).

Note: Safety or driver assistance features are no substitute for the driver's responsibility to operate the vehicle in a safe manner. The driver should remain attentive to traffic surroundings and road conditions at all times. Visibility, weather and road conditions may affect feature performance. Read the Owner's Manual for more important limitations and information.

HD REAR VISION CAMERA

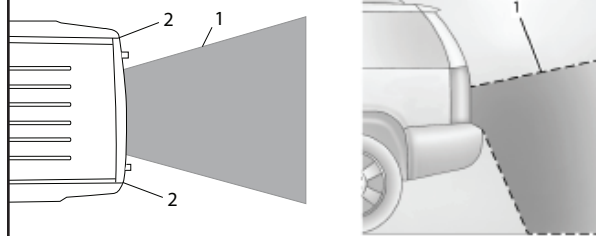

1. View Displayed by the Camera in Radio Screen
2. Corners of the Rear Bumper

Displayed images may be farther or closer than they appear. The area displayed is limited and objects that are close to either corner of the bumper or under the bumper do not display.

A warning triangle may display on the RVC screen to show where the RPA has detected an object. This triangle changes from amber to red the closer the object.

The camera(s) do not display children, pedestrians, bicyclists, crossing traffic, animals, or any other object outside of the cameras' field of view, below the bumper, or under the vehicle. Shown distances may be different from actual distances. Do not drive or park the vehicle using only these camera(s). Always check behind and around the vehicle before driving. Failure to use proper care may result in injury, death, or vehicle damage.

Note: Safety or driver assistance features are no substitute for the driver's responsibility to operate the vehicle in a safe manner. The driver should remain attentive to traffic surroundings and road conditions at all times. Visibility, weather and road conditions may affect feature performance. Read the Owner's Manual for more important limitations and information.

STANDARD MECHANICAL FEATURES

HEAVY DUTY BRAKES



Police specific brakes with anti-lock calibration and eBoost utilizing 6-piston fixed front Brembo calipers on 410mm rotors (32mm thick), 1-piston sliding rear calipers on 345mm rotors (20mm thick).

INDEPENDENT REAR SUSPENSION

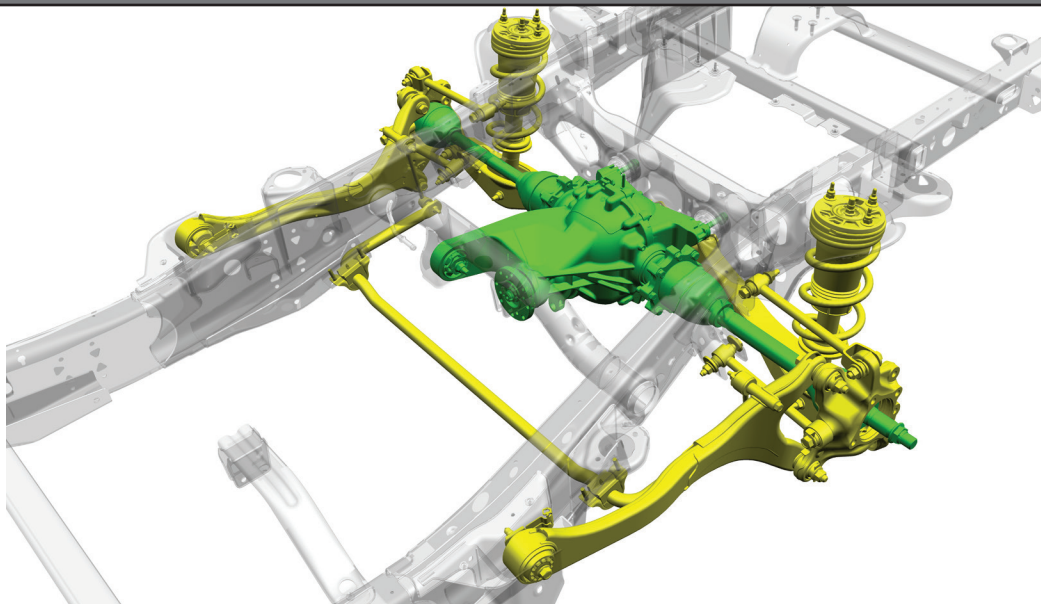

Heavy duty Clutch-type limited-slip differential (green), Fully independent multilink suspension (yellow) utilizing monotube dampers, linear coil springs, and 32mm hollow stabilizer bar

STANDARD MECHANICAL FEATURES

SERVICE PARTS IDENTIFICATION LABEL

SPID Label Content Now Included with Certification Label. The Service Parts Identification (SPID) label, often located in the trunk or glovebox of a vehicle, lists a vehicle's VIN, RPO codes and other information that identify the content of the vehicle. Beginning with the 2018 model year, much of this information will be available through a QR code on the Certification label.

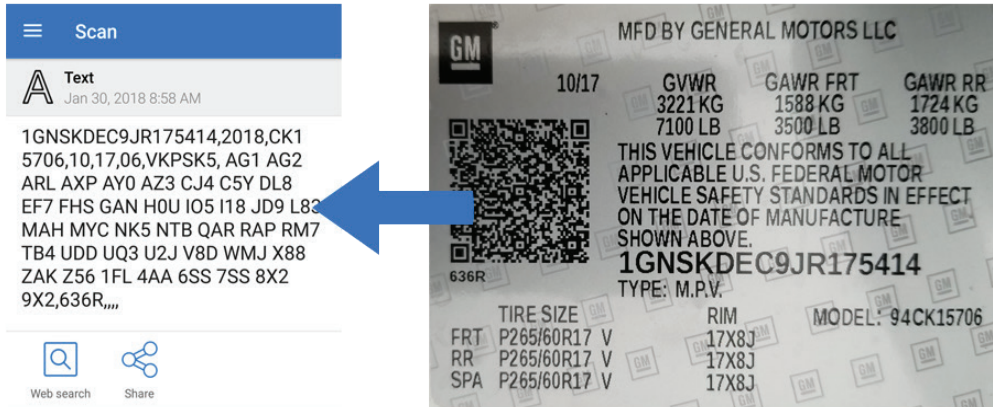

Software to read the QR code is commonly available for any Android, iPhone or Windows smartphone. Many basic applications can be downloaded for free. Tested QR code readers that are easy to use include NeoReader by NM LLC, inigma by 3GVision, QR Scanner by Honestly App, QR Droid by DroidLa and Bar-Code by PW2. GM does not recommend any particular software. Once the QR code is scanned, the vehicle information will appear in the following order: VIN, Model Year, Model, Build Month, Year, Engineering Book, Vehicle Order Number, 3 Digit RPO Codes sorted alphanumerically, and the Paint Code (same code appears in the lower left of the QR code).

ENGINE OIL COOLER

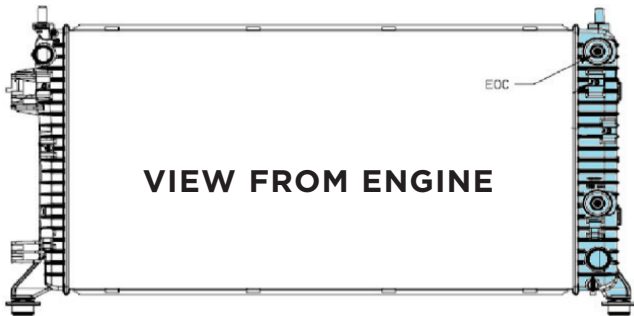

Engine Oil is cooled by passing the fluid through a cooler located in the engine radiator assembly end tank.

Engine oil is pumped by the engine oil pump from the driver side of the engine block through piping to an oil-to-coolant heat exchanger located within the passenger side end-tank of the coolant radiator and returned to engine.

TIRE PRESSURE MONITOR WITH TIRE FILL ALERT

The Tahoe Police Package is equipped with Tire Pressure Monitoring System (TPMS) which warns of low tire pressure. Refer to your owner's manual for additional information the Tire Pressure Monitor System Programming.

Tire Fill Alert feature is included in addition to the DIC warning when a tire has low pressure. This feature provides audible and visual indication when air is being added to the low tire to aid in achieving optimal tire pressure.

TRANSMISSION OIL COOLER

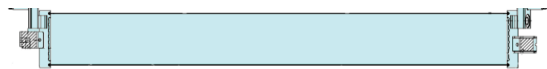

Transmission oil is pumped from the transmission through piping to an oil-to-air heat exchanger and then returns to the transmission. The transmission oil cooler is located in front of the air conditioning condenser as part of the Condenser, Radiator, and Fan Module (CRFM) assembly.

STANDARD MECHANICAL FEATURES

ELECTRIC POWER STEERING SYSTEM

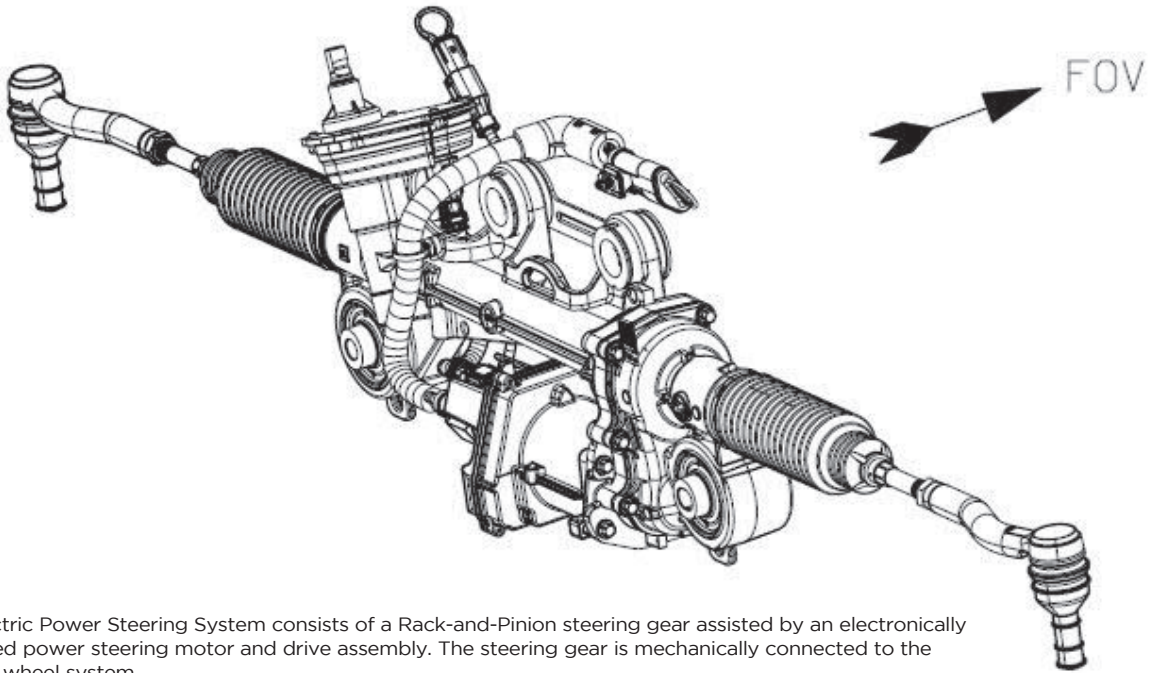

The Electric Power Steering System consists of a Rack-and-Pinion steering gear assisted by an electronically controlled power steering motor and drive assembly. The steering gear is mechanically connected to the steering wheel system.

SKID PLATES

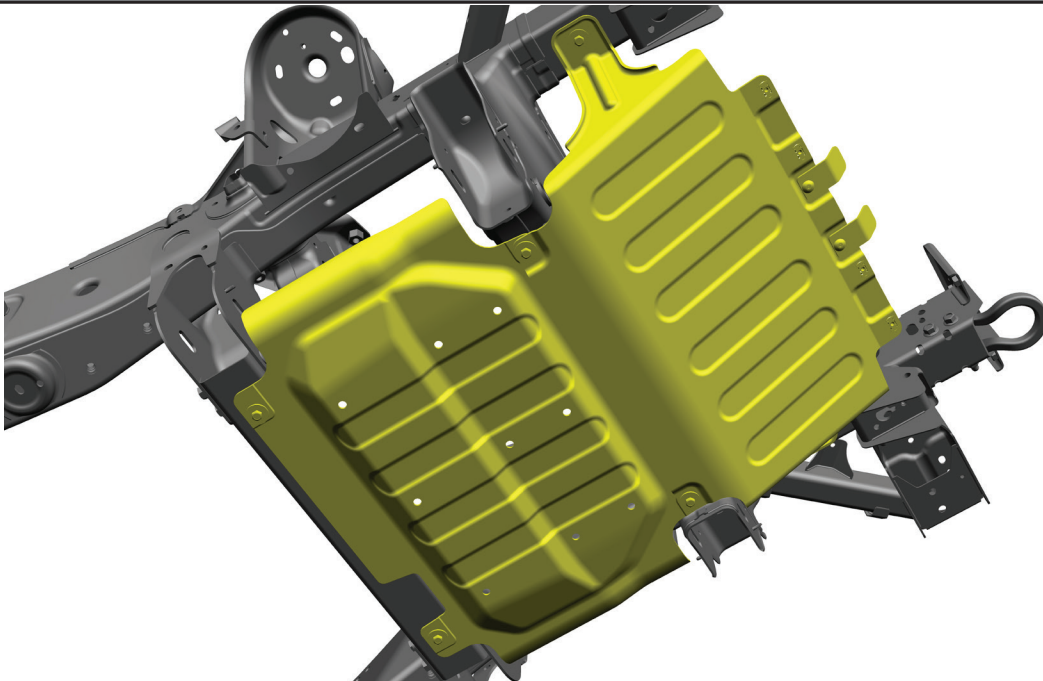

Two-piece, heavy-duty aluminum front underbody shield that starts behind the front bumper and attaches to the front fascia, protects front underbody components and oil pan.

STANDARD ENTRY & IGNITION

KEYLESS ACCESS



The remote key must be within 3 ft (1 m) of the liftgate or door being opened or locked. Press the button on the door handle to open.

REMOTE KEYLESS ENTRY



The Keyless Access system allows for the vehicle entry when the remote is within 3 ft (1 m)



The mechanical key inside the remote key is used for the driver door, glove box and spare tire access.

To remove the mechanical key press the button on the side of the remote key near the bottom and pull the mechanical key out. Never pull the mechanical key out without pressing the button.

PUSH TO START IGNITION



If key fob not detected, from low fob battery, or radio interference, hold key to start button to start

PROTECTED IDLE

The Protected Idle Feature allows the vehicle to remain idling but will not allow the transmission to be shifted from Park without a valid key fob.

ACTIVATING PROTECTED IDLE

Preconditions (All preconditions must be met.)

- Vehicle is in PROPULSION (engine running) state
- Vehicle is in Parked State
- Vehicle speed is less than 4 kilometers per hour
- Valid key fob is present.

Activation

Press and Hold the Cruise Cancel Switch for 2 seconds

Vehicle Feedback.

Upon activation of Protected Idle, the Digital Information

Center (DIC) will display the following:

- “Protected Idle ON”
- “Park in Open Area”
- “Take Your Key”

If any of the above preconditions are not met while activating Protected Idle, DIC will display the message:

“Protected Idle Unavailable”

DEACTIVATING PROTECTED IDLE

Valid key fob is present

Press brake pedal and shift out of Park

OR

Press and hold the Cruise Cancel Switch for 2 seconds

OR

Press the Ignition Switch with the Brake Pedal pressed.

DIC messages will turn off, indicating Protected Idle is no longer activated.

CONDITIONS UNDER WHICH THE PROTECTED IDLE WILL TURN OFF AND VEHICLE WILL TRANSITION TO OFF POWER MODE

Brake pedal pressed without a valid key fob present

OR

Cruise Cancel Switch depressed without a valid key fob present

OR

Ignition Switch pressed without a valid key fob present

OR

With a valid key fob present, ignition switch is pressed and brake pedal is not pressed (the system treats this action as a customer request to turn OFF the vehicle.)

OR

Engine stalls. Horn chirps occur.

OR

Low fuel condition. Horn chirps occur.

CONDITIONS UNDER WHICH THE PROTECTED IDLE WILL TURN OFF AND VEHICLE WILL TRANSITION TO RUN POWER MODE.

If the Shift Lock mechanism is defeated and shifted Out of Park while the Protected Idle is active, the vehicle will transition to the RUN power mode (the engine will be turned off) and Protected Idle will be deactivated and Horn chirps occur. DIC messages will turn off indicating Protected Idle is inactive.

STANDARD ELECTRICAL FEATURES

OVERHEAD DOME LAMPS



There are dome lamps in the overhead console and the headliner. To change the dome lamp settings, press the following:

- Press and hold any of the overhead console lens to turn all dome lamps on.
- Press and hold any of the overhead consoles lens again to turn all dome lamps off.
- Press OFF to turn off the dome lamps when a door is open. An indicator light on the button will turn on when the dome lamp override is activated.

STEERING WHEEL BUTTONS



The steering wheel has two momentary button switches on the left backside which have been re-purposed for the operation of emergency equipment such as lighting or radios! The switches close when depressed to operate emergency equipment via the Body Control Module (BCM) and open when released. The following customer device electrical specifications must be met to avoid damage to the BCM input circuitry:

- BCM can operate a single relay only with a maximum inductive energy of 2 millijoules.
- Current in Active State: 350 milliamps @ 16 volts.
- Voltage in Active State: 0.76 volts

ROUTING GROMMETS

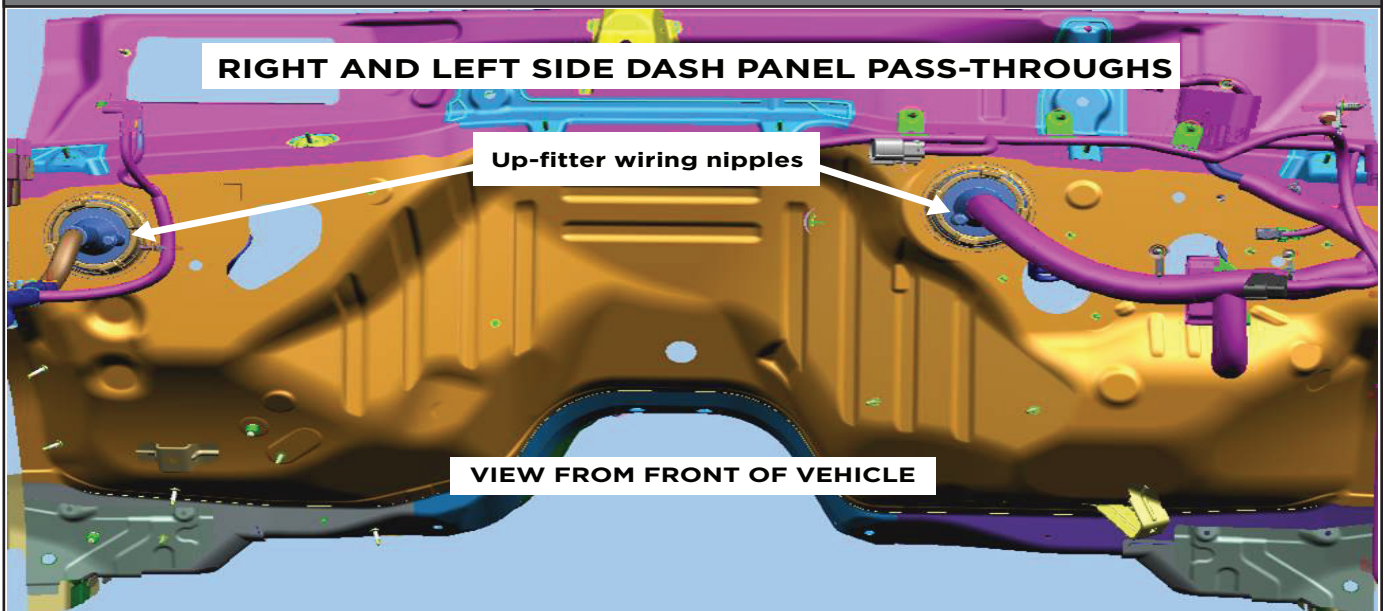

Provides pass throughs for a small number of wires and are located at the left and right sides of the front of dash. Carefully remove or puncture only the nipple portion for the passage of upfitter wires and silicone seal around the wire after installation. Note that a vehicle harness is passing through the grommets and care must be taken to avoid damaging these harnesses especially in the instrument panel interior.

1. GM is not responsible for the safety or quality of design features, materials or workmanship of any alterations by third parties.

STANDARD ELECTRICAL FEATURES

AUXILIARY BATTERY POWER REAR ELECTRICAL CENTER



The Auxiliary Battery and Rear Electrical Center (REC) are located to the rear of the left rear wheelhouse. The Upfitter branch harness¹ (CARGO) is coiled to the rear of the Auxiliary Battery.

CARGO UPFIT BRANCH HARNESS



Cargo area branch with circuits for customer connection¹. Tagged circuits listed in UPFIT WIRING HARNESS CIRCUIT LIST

FRONT CENTER UPFIT BRANCH HARNESS



Front Center area upfitter branch harness¹ with tagged circuits for customer connection. View with center front seat removed per Option 5Y1. Branch is forward of seat without Option 5Y1. Tagged circuits are listed in UPFIT WIRING HARNESS CIRCUIT LIST.

¹. GM is not responsible for the safety or quality of design features, materials or workmanship of any alterations by third parties.

STANDARD ELECTRICAL FEATURES

WIRING PROVISIONS FOR 12-VOLT BATTERY POWER SUPPLY

The vehicle is equipped with wiring provisions for connecting the Auxiliary Battery to customer installed equipment. Upfitter wiring harnesses are located between the front seats and at the left sided of the cargo area, rearward of the auxiliary battery. Wire circuits in the front (CONSOL) and rear (CARGO) upfitter harnesses are identified by numbered tags on the wires. The upfitter circuits are identified in the Upfit Wiring Harness Circuit Identification chart. A wiring diagram for the control relays is provided in this specification document.

The Auxiliary Battery provides 12 volt power to four relays which are controlled by customer grounding to the upfit relays via circuits 8895, 8896, 8897 and 8898. Customer equipment load is connected to the control relay contacts via circuits 8911, 8912, 8913 or 8914 listed in the Upfit Wiring chart. Ground circuit wires are also found in the Wiring Chart.

Refer also the the Wiring Chart for Vehicle Systems Signals for Vehicle Speed, Retained Accessory Power, Run/Crank Ignition Power, Driver Door Ajar, Surveillance On/Off, Brakes Applied, Park Enable and IP Dimming.

INSTRUMENT PANEL AUXILIARY JUNCTION BLOCK

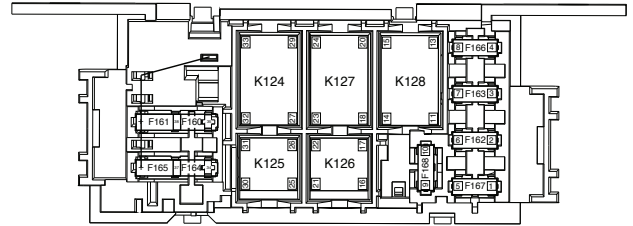

Auxiliary Fuse Block is located above brake pedal Junction Block Upfit Wiring Diagram

K124	KR161A
K125	KR161B
K126	KR161C
K127	KR161D
K128	Not Used

Fuse and Upfit Circuit Designations

F160	5A	239	F164	5A	239
F161	5A	2742	F165	5A	2742
F162	25A	8911	F166	20A	8913
F163	20A	8912	F167	25A	8914

AUXILIARY BATTERY FUSE BLOCK X50EA

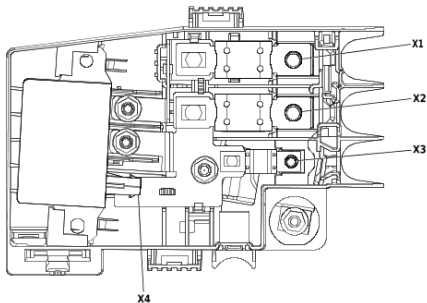

X4 = Auxiliary Battery Relay KR81

Fuse and Upfit Circuit Designations

X1 = F1BB	642	100A
X2 = F2BB	842	100A
X3 = F3BB	742	50A

RADIO MUTE FEATURE

A Radio Mute circuit is provided to permit muting of the vehicle radio when an emergency vehicle radio is transmitting. The White with Purple stripe blunt cut Radio Mute circuit wire is located between the front seats near the Upfitter Branch harness. The Radio Mute wire is listed in the Up-Fit Wiring Harness Circuit Identification List.

The following customer device electrical specifications must be met to avoid damage to the vehicle Exterior Lighting Module (ELM) input circuitry:

- No inductance allowed
- Maximum Load Capacitance: 600 nano-farads.
- Maximum Closed switch contact resistance: 20 ohms
- Minimum Open switch contact resistance: 100,000 ohms

SURVEILLANCE FEATURE MANUAL LAMP CONTROL AND 9G8

The headlamp control on the driver's side of the instrument panel operates the exterior lamps. If your Tahoe does not have option 9G8, DELETE DAYTIME RUNNING LAMPS and AUTOMATIC HEADLAMPS, the Daytime Running Lamps and Automatic Headlamps can be turned OFF for one ignition cycle by rotating the headlamp control knob momentarily counter-clockwise. See also Section 3 of your Tahoe Owner's Manual.

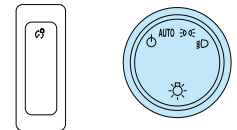

Surveillance Feature - The Body Control Module (BCM) is calibrated to disable the exterior and interior automatic lighting. When ground is applied to upfit circuit wire 6821 (see Upfit Wiring Harness Circuit List) in the front or cargo upfitter branch harness via a customer-provided switch, automatically controlled lighting is disabled or dimmed to a Federally regulated level.

Option SEO 9G8 - Delete Daytime Running Lamps and Automatic Headlamps. This option disables the Daytime Running Lamps and Automatic Headlamps control feature. Exterior lamps are only manually controlled (Option 9G8 is not available in Canada).

When the headlamp switch is in Auto with 9G8 installed, the instrument cluster, radio display and air conditioning illumination remains at daytime intensity and are dimmable only when the headlamp switch is rotated to the Parking Lamps or Headlamps positions. If SEO 9G8 is not installed, the displays are dimmable with the Headlamp switch in the AUTO position. The instrument cluster, radio and AC displays will dim if the Surveillance Feature is activated as described above.

NOTE: Wiring connection or splice changes are to be removed before the vehicle is returned to civilian use.

AVAILABLE EXTERIOR COLORS ACTUAL COLORS MAY VARY

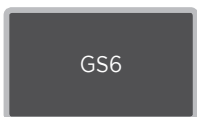

GS6
Graywood Metallic

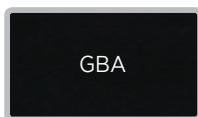

GBA
Black



GLU
Midnight Blue
Metallic



GJW
Empire Beige
Metallic

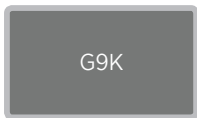

G9K
Satin Steel Metallic



GJI
Shadow Gray
Metallic

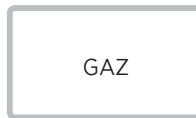

GAZ
Summit
White



GSK
Cherry Red
Tintcoat
Additional Charge.

SEO PAINT AVAILABLE ACTUAL COLORS MAY VARY



9V2
MSP Blue
WA-5665

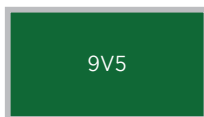

9V5
Woodland Green
WA-9015

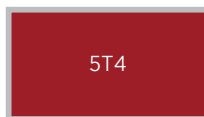

5T4
Victory Red
WA-9260



9W3
Wheatland Yellow
WA-253A

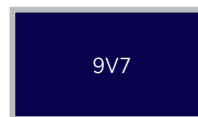

9V7
Dark Blue Metallic
WA-722J

Note: Will require 5 orders before sending to plant
1 - Requires SEO (5T4) Exterior body colored parts

AVAILABLE INTERIOR COLOR ACTUAL COLORS MAY VARY



HOU
Jet Black
Cloth



5T5
Jet Black
Vinyl



FRONT SEATS AND INTERIOR TRIM

STANDARD FRONT ROW SEATING

AZ3 40/20/40 INDIVIDUAL SEATS FOR 3 FRONT OCCUPANT (Center seat can be unbolted for removal). STANDARD 10-way power driver seat, includes power lumbar with power recline and STANDARD 8-way power passenger seat with power lumbar. Center seat back folds-down for access to armrest and cup holders. Bottom center seat cushion lifts for storage. 120v Power output and two USB-c charging ports are mounted on backside of seat with digital rear passenger climate controls.

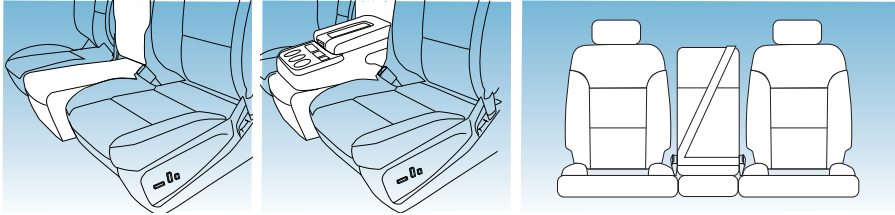

Seat Code	Seat Trim	Color	Color Code
AZ3	Cloth	Jet Black	HOU

- Front cloth and vinyl rear seat combination is available by ordering option 5T5 and requires Jet Black (HOU)
- Center seat can be unbolted for removal

5Y1

OPTIONAL FRONT ROW SEATING

20% FRONT CENTER SEAT DELETE WITH CLOTH 40/40 INDIVIDUAL SEATS (AZ3 & OPTION 5Y1)

Deletes center seat to provide 15" of open floor space between driver and passenger seats. STANDARD 10-way power driver seat includes power lumbar with power recline and STANDARD 8-way power passenger seat with power lumbar. A separate cable and connection kit for the 120v auxiliary power is provided loose in the vehicle when center seat is deleted.

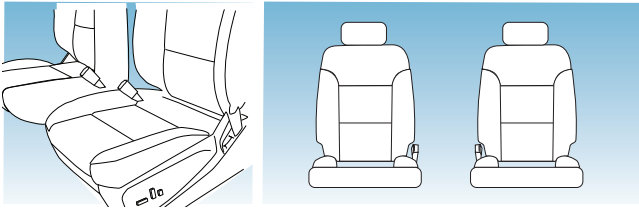

Seat Code	Seat Trim	Color	Color Code
AZ3 & 5Y1	Cloth	Jet Black	HOU

- Front cloth and vinyl rear seat combination is available by ordering option 5T5 and requires Jet Black (HOU)
- Requires (BG9) Black rubberized vinyl floor covering

A50

OPTIONAL FRONT ROW SEATING

A50 SEATS, FRONT BUCKET Includes Frontal airbags for driver and front outboard passenger; Seat-mounted side-impact airbags for driver and front outboard passenger; Head-curtain airbags for all rows at outboard seating positions. Floor console (DO7) without driver inboard seat-mounted side-impact airbag. Floor console includes two USB data ports: one type A and one type C. Option (5T5) Vinyl second row seat is not available when Option A50 is ordered. Always use seat belts and child restraints. Children are safer when properly secured in a rear seat in an appropriate child restraint. See the Owner's Manual for more information.

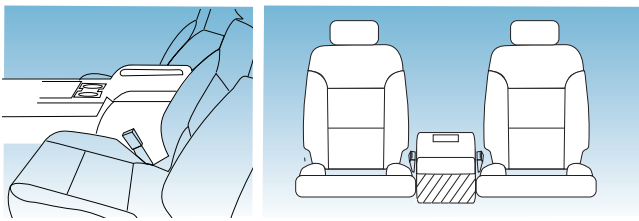

Seat Code	Seat Trim	Color	Color Code
5Y1	Cloth	Jet Black	HOU

- Option 5T5 vinyl second row seat not available when Option A50 is ordered.
- Console cannot be deleted
- Requires PQA Safety Package

REAR SEATS AND INTERIOR TRIM

STANDARD CLOTH SECOND ROW SEATING

CLOTH SECOND ROW 60/40 SPLIT-FOLDING BENCH SEAT (AT6)

Includes folding center armrest with cup holder

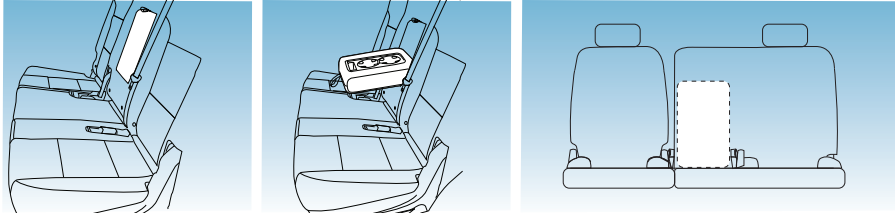

Seat Code	Seat Trim	Color	Color Code
AT6	Cloth	Jet Black	HOU

- Color is based on front seat choice

5T5

OPTIONAL VINYL SECOND ROW SEATING

OPTIONAL - SEO 5T5 VINYL REAR SEAT

Vinyl Second Row 60/40 Split-folding Bench Seat (Option 5T5)

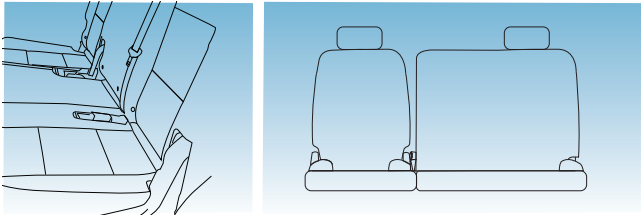

Seat Code	Seat Trim	Color	Color Code
5T5	Vinyl	Jet Black	HOU

- Front cloth and vinyl rear seat combination is available by ordering option 5T5 and requires Jet Black (HOU)
- Does not include rear passenger armrest or cup holders
- Not available with (A50)

ATZ

OPTIONAL SECOND ROW SEAT DELETE

OPTIONAL - ATZ SEAT DELETE, SECOND ROW

This feature deletes the 2nd row seat and seat belts from the vehicle to allow the customer to install aftermarket equipment such as a Hazmat seat or K9 kennel in the vehicle. Option VXT, Incomplete Vehicle is included and only available with ATZ. Customer or upfitter must meet FMVSS certification requirements for Incomplete Vehicle. This option is only available in the US and Canada.



OPTIONAL INTERIOR FEATURES

5J1	CALIBRATION - Keyless remote panic button and exterior lights/horn disable
B30	CARPET FLOOR COVERING - Color-keyed carpeting. Includes rear cargo area with front and 2nd row color keyed floor mats. Note: When (5Y1) Center Seat Delete is ordered there will be no vinyl or carpeting.
S10	CENTER CONSOLE LOCKABLE STORAGE BOX - Requires (A50) front bucket seats. Not available with (AZ3) 40/20/40 split-bench front seat.
RIA	FLOOR LINERS, ALL-WEATHER - 1st and 2nd rows. Not available with (BG9) Black rubberized vinyl floor covering, (VAV) all-weather floor mats, or (RIB) 1st, 2nd and 3rd row all-weather floor liners.
VAV	FLOOR MATS, ALL-WEATHER - Not available with (BG9) Black rubberized vinyl floor covering, (RIA) 1st and 2nd row all-weather floor liners, or (RIB) 1st, 2nd and 3rd row all-weather floor liners..
AAK	FLOOR LINER ALL WEATHER - 1st, 2nd and 3rd rows. Not available with (BG9) Black rubberized vinyl floor covering, (VAV) all-weather floor mats, or (RIA) 1st and 2nd row all-weather floor liners.
VAV	FLOOR MATS - All-weather floor mats. Not available with (BG9) Black rubberized vinyl floor covering, (RIA) 1st and 2nd row all-weather floor liners or (RIB) 1st, 2nd and 3rd row all-weather floor liners.
5Y1	FRONT CENTER SEAT (20% SEAT) DELETE - Power driver and passenger bucket seats in base cloth trim. Derived from RPO (AZ3) 40/20/40 split-bench seat with the 20% section removed, which also removes the auxiliary power outlet, USB port and input jack for audio system. The 110 volt AC outlet, 12 volt DC outlet and harness in the center seat section are shipped loose in a bag for customer connection. Does not include a floor console. All exposed floor area will remain untrimmed. Requires (BG9) Black rubberized vinyl floor covering. Not available with (A50) front bucket seats or (B30) color-keyed carpeting floor covering.
S08	HIGHWAY SAFETY KIT - Includes bowtie logo on case
6E2	KEYS/FOBS - All vehicles in fleet, provides 2 fobs and 2 mechanical keys with a specific code that is common to the door lock and ignition of all the vehicles in the vehicle fleet. This code is an alternate to SEO 6E8 for KEYS/FOBS and mechanical keys
6E8	KEYS/FOBS - All vehicles in fleet, provides 2 fobs and 2 mechanical keys with a specific code that is common to the door lock and ignition of all the vehicles in the vehicle fleet. This code is an alternate to SEO 6E2 for key fobs and mechanical keys.
AMF	KEY FOBS - Fleet Package includes 4 additional key fobs and mechanical keys. Key fobs are not programmed. Each additional key fob must be programmed together by the customer or a dealer at customer expense. Key fob programming is not a warranty item. See programming remote key fob instructions shown on OPTIONAL EQUIPMENT page.
T53	LAMPS - Alternate flashing Red and Blue rear compartment liftgate warning lamps (visible when liftgate is open) and controlled by liftgate -mounted switch or ground wire in upfitter harness connected to customer switching.
6C7	LIGHTING - Red and white front auxiliary dome, Red and white auxiliary dome lamp is located on headliner between front row seats (red is LED, white is incandescent). The auxiliary lamp is wired independently from standard dome lamp
BCV	LOCK CONTROL - Driver side auto door lock disable
RIK	NAMEPLATES - Black
W2D	NET - Vertical cargo net
UDA	ONSTAR - Deactivated (does not delete Bluetooth). Deletes (UE1) OnStar and (VV4) 4G LTE Wi-Fi Hotspot capable.
DRZ	REAR CAMERA MIRROR¹ - Inside rearview auto-dimming with full camera display. Includes (CWA) Rear Camera Mirror Washer. Not available with PQA Safety Package
6N6	REAR DOOR LOCKS AND HANDLES INOPERATIVE - Rear power locks are inoperable at rear door but operate from drivers position, rear doors can be opened only from outside the vehicle
6N5	REAR DOOR WINDOW SWITCHES INOPERATIVE - Rear windows only operate from drivers position
SFJ	REFLECTIVE WINDOW SHADE
BTV	REMOTE VEHICLE STARTER SYSTEM - Includes remote keyless entry
PQA	SAFETY PACKAGE¹ - Includes (UEU) Forward Collision Alert, (UHX) Lane Keep Assist with Lane Departure Warning, (UHY) Automatic Emergency Braking, (UKJ) Front Pedestrian Braking and (UE4) Following Distance Indicator. Not available with (DRZ) Rear Camera Mirror.
ATZ	SEAT DELETE, SECOND ROW - This feature deletes the 2nd row seat and seat belts from the vehicle to allow the customer to install aftermarket equipment such as a seat or kennel in the vehicle. Option VXT, Incomplete Vehicle is included and only available with ATZ. Customer or upfitter must meet FMVSS certification requirements for Incomplete Vehicle. This option is only available in the US and Canada.
A50	SEATS, FRONT BUCKET² - Includes Frontal airbags for driver and front outboard passenger; Seat-mounted side- impact airbags for driver and front outboard passenger; Head-curtain airbags for all rows at outboard seating positions. Floor console (DO7) without driver inboard seat-mounted side-impact airbag. Floor console includes two USB data ports: one type A and one type C. Requires (PQA) safety package. Option (5T5) Vinyl second row seat is not available when Option A50 is ordered. Always use seat belts and child restraints. Children are safer when properly secured in a rear seat in an appropriate child restraint. See the Owner's Manual for more information.
5T5	SEAT - Front cloth with vinyl rear seat (see front seats and interior trim illustration page for description)
VRS	SHADE - Cargo security
UTQ	THEFT DETERRENT SYSTEM - Content, disable, the alarm and horn become nonfunctional in an attempt of theft to the vehicle

1. Read the vehicle owner's manual for important feature limitations and information.

OPTIONAL EXTERIOR FEATURES

SFZ	BOWTIE EMBLEMS, BLACK - Not available with (R88) Black illuminated front bowtie emblem.
R88	BOWTIE EMBLEM, ILLUMINATED FRONT - Includes Black illuminated front bowtie and Black non-illuminated rear bowtie). Not available with (SFZ) Black bowtie emblems.
9G8	HEADLAMPS, DELETE DAYTIME RUNNING LIGHTS AND AUTOMATIC HEADLAMPS - Daytime Running Lamps and automatic headlamp control delete, deletes standard Daytime Running Lamps and automatic headlamp control features.
5T4	EXTERIOR BODY COLORED PARTS - Victory Red special painted exterior body parts in lieu of glossy Black color normally installed with special painted bodies, Victory Red painted parts will consist of front fascia, rear bumper fascia, rear liftgate handle, and door handles. Mirrors, rear D-pillar applique and liftgate spoiler will remain Black. Requires SEO (TGK) special paint solid, special paint color Victory Red WA-9260 and (V76) recovery hooks.
9V2	EXTERIOR BODY COLORED PARTS - MSP Blue WA-5665. Provides front and rear fascia that will be MSP Blue, WA-5665 all other non-metal body parts will be the same as (TGK) special paint solid. Requires SEO (TGK) special paint solid.
9W3	EXTERIOR BODY COLORED PARTS - Wheatland Yellow WA-253A. Provides front and rear fascia that will be Wheatland Yellow, WA-253A all other non-metal body parts will be the same as (TGK) special paint solid. Requires SEO (TGK) special paint solid.
9V7	EXTERIOR BODY COLORED PARTS - Dark Blue Metallic WA-722J. Provides front and rear fascia that will be Dark Blue Metallic, WA-722J all other non-metal body parts will be the same as (TGK) special paint solid. Requires SEO (TGK) special paint solid.
9V5	EXTERIOR BODY COLORED PARTS - Woodland Green WA-9015. Provides front and rear fascia that will be Woodland Green, WA-9015 all other non-metal body parts will be the same as (TGK) special paint solid. SEO (TGK) special paint solid.
6J7	FLASHER SYSTEM - Headlamp and taillamp, DRL compatible with control wire. Includes SEO (5J9) taillamp flasher calibration, Red/White and SEO (5LO) taillamp flasher calibration, Red/Red.
AKP	GLASS - Solar absorbing, non tinted
VK3	LICENSE PLATE - Front mounting package (included on orders with ship-to states that require front license plate)
RIK	NAMEPLATES - Black
V76	RECOVERY HOOKS¹, BLACK - Two front frame-mounted. Required on all models sold to Alaska, Guam, Hawaii, Puerto Rico and Virgin Islands. All Tahoe 9C1 Police and 5W4 Special Service Vehicles will include front fascia recovery hook openings but do not include the hooks. See optional equipment illustrations section. NOTE: Front recovery hooks are for vehicle recovery only. To avoid the risk of injury, never use recovery hooks to tow a vehicle.
TGK	SPECIAL PAINT SOLID - One color all normally body-colored non-sheet metal parts will be gloss Black. This includes front and rear fascias, liftgate handle and appliqué, 'D' Pillars and Upper liftgate appliqué. Mirrors and door handles will be grained Black parts. May require extended lead time. Required with any SEO paint selection. May require extended lead time.
TGL	SPECIAL PAINT TWO TONE - Body in black (GBA) with summit white (GAZ) hood. No other combinations available.
VQK	SPLASH GUARDS - Molded black
7X3	SPOTLAMP - Left hand, pillar-mounted unity, 6-inch with LED lamps; independently fused
7X2	SPOTLAMPS - Left and right hand, pillar-mounted unity, 6-inch with LED lamps: independently fused

NOTE: Factory installation of spotlamps are recommended. Special tooling is used to locate and drill the spotlamp shaft hole in the pillars. (Interior trim covers provided with factory installed lamps are not available as service parts). Field installation of spotlamps must not interfere with proper deployment of the roof rail mounted head-curtain airbags in the event of a crash.

OPTIONAL ELECTRICAL FEATURES

UN9	RADIO SUPPRESSION - Additional ground straps shipped loose to be installed by customer.
WX7	WIRING - For upfitter connection to front door speakers.
6J3	WIRING - For grille lamps and siren speaker
6J4	WIRING - Horn Transfer Loop wire permits customer connection of a switch to operate the vehicle horn or a customer-provided siren system via the steering wheel horn button

OPTIONAL MECHANICAL FEATURES

	TRANSFER CASE - REQUIRES CK10706 - AUTOTRAC WITH AUTO 4WD, 4HI OR 2WD ELECTRONIC SETTINGS (INCLUDES TERRAIN MODE). SINGLE-SPEED, ELECTRONIC TRANSFER CASE DOES NOT INCLUDE NEUTRAL AND CANNOT BE DINGHY TOWED.
VQZ	EXHAUST TIP - Polished
R9Y	FLEET FREE MAINTENANCE CREDIT - This option code provides a credit in lieu of the free oil changes, tire rotations and inspections for one maintenance service during 1st year of ownership. The invoice will detail the applicable credit. The customer will be responsible for all oil change, tire rotations and inspections costs for this vehicle. Requires one of the following Fleet or Government order types: FBC, FBN, FCA, FCN, FEF, FLS, FNR, FRC or FGO. Not available with FDR order types.
VSY	HEATER - Engine block (dealer installed) late availability

OPTIONAL SHIP THRU

VPV	SHIP THRU TO KERR INDUSTRIES - Included with SEO (6C7) red and white front auxiliary dome lighting, SEO (6N6) door locks and handles, SEO (7X2) left- and right-hand spotlamps, SEO (7X3) left-hand spotlamp, SEO (T53) alternate flashing Red & Blue rear compartment lid warning lamps, SEO (UN9) Radio Suppression Package, SEO (6J3) grille lamps and siren speakers wiring, SEO (6J4) horn and siren circuit wiring and SEO (WX7) auxiliary speaker wiring.
------------	---

1. Never pull on recovery hooks from the side. The hooks could break and you and others could be injured. When using recovery hooks, always pull the vehicle from the front

OnStar PLANS

POJ	OnStar¹ ADDITIONAL 21 MONTHS OF ONSTAR FLEET SAFETY AND SECURITY. Provides 21 months of Fleet Safety and Security service in addition to the 3 months of complimentary coverage that is included in the price of the vehicle. Total OnStar Fleet Safety and Security service duration is 24 months. Requires (UE1) OnStar. Requires one of the following Fleet or Government order types: FLS, FNR, FRC, FBC, FGO or FEF. Not available with POK, POL, PIR, PIS, PIT or PIU. Not available with a ship-to of Guam, Puerto Rico or the Virgin Islands.
POK	OnStar¹ ADDITIONAL 33 MONTHS OF ONSTAR FLEET SAFETY AND SECURITY. Provides 33 months of Fleet Safety and Security service in addition to the 3 months of complimentary coverage that is included in the price of the vehicle. Total OnStar Fleet Safety and Security service duration is 36 months. Requires (UE1) OnStar. Requires one of the following Fleet or Government order types: FLS, FNR, FRC, FBC, FGO or FEF. Not available with POJ, POL, PIR, PIS, PIT or PIU. Not available with a ship-to of Guam, Puerto Rico or the Virgin Islands.
POL	OnStar¹ ADDITIONAL 45 MONTHS OF ONSTAR FLEET SAFETY AND SECURITY. Provides 45 months of Fleet Safety and Security service in addition to the 3 months of complimentary coverage that is included in the price of the vehicle. Total OnStar Fleet Safety and Security service duration is 48 months. Requires (UE1) OnStar. Requires one of the following Fleet or Government order types: FLS, FNR, FRC, FBC, FGO or FEF. Not available with POJ, POK, PIR, PIS, PIT or PIU. Not available with a ship-to of Guam, Puerto Rico or the Virgin Islands.
POM	OnStar¹ ADDITIONAL 21 MONTHS OF ONSTAR FLEET REMOTE ACCESS. Provides 21 months of Fleet Remote Access service in addition to the 3 months of complimentary coverage that is included in the price of the vehicle. Total OnStar Fleet Remote Access service duration is 24 months. Requires (UE1) OnStar. Requires one of the following Fleet or Government order types: FLS, FNR, FRC, FBC, FGO or FEF. Not available with PON, POO, PIR, PIS, PIT or PIU. Not available with a ship-to of Guam, Puerto Rico or the Virgin Islands.
PON	OnStar¹ ADDITIONAL 33 MONTHS OF ONSTAR FLEET REMOTE ACCESS. Provides 33 months of Fleet Remote Access service in addition to the 3 months of complimentary coverage that is included in the price of the vehicle. Total OnStar Fleet Remote Access service duration is 36 months. Requires (UE1) OnStar. Requires one of the following Fleet or Government order types: FLS, FNR, FRC, FBC, FGO or FEF. Not available with POM, POO, PIR, PIS, PIT or PIU. Not available with a ship-to of Guam, Puerto Rico or the Virgin Islands.
POO	OnStar¹ ADDITIONAL 45 MONTHS OF ONSTAR FLEET REMOTE ACCESS. Provides 45 months of Fleet Remote Access service in addition to the 3 months of complimentary coverage that is included in the price of the vehicle. Total OnStar Fleet Remote Access service duration is 48 months. Requires (UE1) OnStar. Requires one of the following Fleet or Government order types: FLS, FNR, FRC, FBC, FGO or FEF. Not available with POM, PON, PIR, PIS, PIT or PIU. Not available with a ship-to of Guam, Puerto Rico or the Virgin Islands.
POV	OnStar¹ VEHICLE INSIGHTS - 1 YEAR OF SERVICE. INCLUDES 12 MONTHS OF ONSTAR VEHICLE INSIGHTS SERVICE. OnStar Vehicle Insights provides fleet managers and drivers the tools and data they need to help maximize fleet productivity and help maximize fleet's operational efficiencies. OnStar Vehicle Insights relays real-time vehicle data like vehicle location, driver performance information and more. Eligible customers must sign up for an account at www.onstarvehicleinsights.com in order to take advantage of this 12 months offer. Requires an active connected vehicle services plan. The OnStar Vehicle Insights service is included in the price of the vehicle. Total service duration is 12 months. Non- Transferrable. Non-Refundable. Requires (UE1) OnStar. Requires one of the following Fleet or Government order types: FLS, FNR, FRC, FBC, FGO or FEF. Not available with POW, POX, POY or POZ
POW	OnStar¹ VEHICLE INSIGHTS - 2 YEARS OF SERVICE. INCLUDES 24 MONTHS OF ONSTAR VEHICLE INSIGHTS SERVICE. OnStar Vehicle Insights provides fleet managers and drivers the tools and data they need to help maximize fleet productivity and help maximize fleet's operational efficiencies. OnStar Vehicle Insights relays real-time vehicle data like vehicle location, driver performance information and more. Eligible customers must sign up for an account at www.onstarvehicleinsights.com in order to take advantage of this 24 months offer. Requires an active connected vehicle services plan. The OnStar Vehicle Insights service is included in the price of the vehicle. Total service duration is 24 months. Non- Transferrable. Non-Refundable. Requires (UE1) OnStar. Requires one of the following Fleet or Government order types: FLS, FNR, FRC, FBC, FGO or FEF. Not available with POV, POX, POY or POZ. POX OnStar Vehicle Insights - 3 years of Service. Includes 36 months of OnStar Vehicle Insights service. OnStar Vehicle Insights provides fleet managers and drivers the tools and data they need to help maximize fleet productivity and help maximize fleet's operational efficiencies. OnStar Vehicle Insights relays real-time vehicle data like vehicle location, driver performance information and more. Eligible customers must sign up for an account at www.onstarvehicleinsights.com in order to take advantage of this 36 months offer. Requires an active connected vehicle services plan. The OnStar Vehicle Insights service is included in the price of the vehicle. Total service duration is 36 months. Non- Transferrable. Non-Refundable. Requires (UE1) OnStar. Requires one of the following Fleet or Government order types: FLS, FNR, FRC, FBC, FGO or FEF. Not available with POV, POW, POY or POZ. Not available with a ship-to of Guam, Puerto Rico or the Virgin Islands.
POX	OnStar¹ VEHICLE INSIGHTS - 3 YEARS OF SERVICE. Includes 36 months of OnStar Vehicle Insights service. OnStar Vehicle Insights provides fleet managers and drivers the tools and data they need to help maximize fleet productivity and help maximize fleet's operational efficiencies. OnStar Vehicle Insights relays real-time vehicle data like vehicle location, driver performance information and more. Eligible customers must sign up for an account at www.onstarvehicleinsights.com in order to take advantage of this 36 months offer. Requires an active connected vehicle services plan. The OnStar Vehicle Insights service is included in the price of the vehicle. Total service duration is 36 months. Non-Transferrable. Non-Refundable. Requires (UE1) OnStar. Requires one of the following Fleet or Government order types: FLS, FNR, FRC, FBC, FGO or FEF. Not available with POV, POW, POY or POZ. Not available with a ship-to of Guam, Puerto Rico or the Virgin Islands.
POY	OnStar¹ VEHICLE INSIGHTS - 4 YEARS OF SERVICE. INCLUDES 48 MONTHS OF ONSTAR VEHICLE INSIGHTS SERVICE. OnStar Vehicle Insights provides fleet managers and drivers the tools and data they need to help maximize fleet productivity and help maximize fleet's operational efficiencies. OnStar Vehicle Insights relays real-time vehicle data like vehicle location, driver performance information and more. Eligible customers must sign up for an account at www.onstarvehicleinsights.com in order to take advantage of this 48 months offer. Requires an active connected vehicle services plan. The OnStar Vehicle Insights service is included in the price of the vehicle. Total service duration is 48 months. Non- Transferrable. Non-Refundable. Requires (UE1) OnStar. Requires one of the following Fleet or Government order types: FLS, FNR, FRC, FBC, FGO or FEF. Not available with POV, POW, POX or POZ. Not available with a ship-to of Guam, Puerto Rico or the Virgin Islands.
POZ	OnStar¹ VEHICLE INSIGHTS - 5 YEARS OF SERVICE. INCLUDES 60 MONTHS OF ONSTAR VEHICLE INSIGHTS SERVICE. OnStar Vehicle Insights provides fleet managers and drivers the tools and data they need to help maximize fleet productivity and help maximize fleet's operational efficiencies. OnStar Vehicle Insights relays real-time vehicle data like vehicle location, driver performance information and more. Eligible customers must sign up for an account at www.onstarvehicleinsights.com in order to take advantage of this 60 months offer. Requires an active connected vehicle services plan. The OnStar Vehicle Insights service is included in the price of the vehicle. Total service duration is 60 months. Non-Transferrable. Non- Refundable. Requires (UE1) OnStar. Requires one of the following Fleet or Government order types: FLS, FNR, FRC, FBC, FGO or FEF. Not available on POV, POW, POX or POY. Not available with a ship-to of Guam, Puerto Rico or the Virgin Islands.

1. Services subject to user terms and limitations. Certain services require working electrical system, cell reception and GPS signal. OnStar links to emergency services. Data plans offered by AT&T. See gmfleet.com/connected services for details. Availability subject to change

OnStar PLANS CONTINUED

P1R	OnStar¹ ADDITIONAL 9 MONTHS OF ONSTAR ASSURANCE FOR TIER3 FLEETS. Provides 9 months of OnStar Assurance service in addition to the 3 months of complimentary Safety & Security coverage that is included in the price of the vehicle. Total Fleet OnStar Safety & Security service duration is 3 months and 9 months of OnStar Assurance. Requires (UE1) OnStar. Requires one of the following Fleet or Government order types: FLS, FNR, FRC, FBC, FGO or FEF. Not available with POJ, POK, POL, POM, PON, POO, P1S, P1T or P1U. Not available with a ship-to of Guam, Puerto Rico or the Virgin Islands.
P1S	OnStar¹ ADDITIONAL 21 MONTHS OF ONSTAR ASSURANCE FOR TIER3 FLEETS. Provides 21 months of OnStar Assurance service in addition to the 3 months of complimentary Safety & Security coverage that is included in the price of the vehicle. Total Fleet OnStar Safety & Security service duration is 3 months and 21 months of OnStar Assurance. Requires (UE1) OnStar. Requires one of the following Fleet or Government order types: FLS, FNR, FRC, FBC, FGO or FEF. Not available with POJ, POK, POL, POM, PON, POO, P1R, P1T or P1U. Not available with a ship-to of Guam, Puerto Rico or the Virgin Islands.
P1T	OnStar¹ ADDITIONAL 33 MONTHS OF ONSTAR ASSURANCE FOR TIER3 FLEETS. Provides 33 months of OnStar Assurance service in addition to the 3 months of complimentary Safety & Security coverage that is included in the price of the vehicle. Total Fleet OnStar Safety & Security service duration is 3 months and 33 months of OnStar Assurance. Requires (UE1) OnStar. Requires one of the following Fleet or Government order types: FLS, FNR, FRC, FBC, FGO or FEF. Not available with POJ, POK, POL, POM, PON, POO, P1R, P1S or P1U. Not available with a ship-to of Guam, Puerto Rico or the Virgin Islands. P1U OnStar Additional 45 months of OnStar Assurance for Tier3 Fleets. Provides 45 months of OnStar Assurance service in addition to the 3 months of complimentary Safety & Security coverage that is included in the price of the vehicle. Total Fleet OnStar Safety & Security service duration is 3 months and 45 months of OnStar Assurance. Requires (UE1) OnStar. Requires one of the following Fleet or Government order types: FLS, FNR, FRC, FBC, FGO or FEF. Not available with POJ, POK, POL, POM, PON, POO, P1R, P1S or P1T. Not available with a ship-to of Guam, Puerto Rico or the Virgin Islands.
P1U	OnStar¹ ADDITIONAL 45 MONTHS OF ONSTAR ASSURANCE FOR TIER3 FLEETS. Provides 45 months of OnStar Assurance service in addition to the 3 months of complimentary Safety & Security coverage that is included in the price of the vehicle. Total Fleet OnStar Safety & Security service duration is 3 months and 45 months of OnStar Assurance. Requires (UE1) OnStar. Requires one of the following Fleet or Government order types: FLS, FNR, FRC, FBC, FGO or FEF. Not available with POJ, POK, POL, POM, PON, POO, P1R, P1S or P1T. Not available with a ship-to of Guam, Puerto Rico or the Virgin Islands.

1. Services subject to user terms and limitations. Certain services require working electrical system, cell reception and GPS signal. OnStar links to emergency services. Data plans offered by AT&T. See gmfleet.com/connected services for details. Availability subject to change

OPTIONAL 1FL SAFETY PACKAGE

PQA

INCLUDES THE FOLLOWING FEATURES

UEU

FORWARD COLLISION ALERT



The Forward Collision Alert (FCA) system may help to avoid or reduce the harm caused by front-end crashes. When approaching a vehicle ahead too quickly, FCA provides a red flashing alert on the windshield and rapidly beeps. FCA also lights an amber visual alert if following another vehicle much too closely. FCA detects vehicles within a distance of approximately 60m (197 ft) and operates at speeds above 8 km/h (5 mph).

Warning FCA is a warning system and does not apply the brakes. When approaching a slower-moving or stopped vehicle ahead too rapidly, or when following a vehicle too closely, FCA may not provide a warning with enough time to help avoid a crash. It also may not provide any warning at all. FCA does not warn of pedestrians, animals, signs, guardrails, bridges, construction barrels, or other objects. Be ready to take action and apply the brakes. FCA can be disabled with either the FCA steering wheel control or, if equipped, through vehicle personalization. .

Detecting the Vehicle Ahead FCA warnings will not occur unless the FCA system detects a vehicle ahead. When a vehicle is detected, the vehicle ahead indicator will display green. Vehicles may not be detected on curves, highway exit ramps, or hills, due to poor visibility; or if a vehicle ahead is partially blocked by pedestrians or other objects. FCA will not detect another vehicle ahead until it is completely in the driving lane.

FCA does not provide a warning to help avoid a crash, unless it detects a vehicle. FCA may not detect a vehicle ahead if the FCA sensor is blocked by dirt, snow, or ice, or if the windshield is damaged. It may also not detect a vehicle on winding or hilly roads, or in conditions that can limit visibility such as fog, rain, or snow, or if the headlamps or windshield are not cleaned or in proper condition. Keep the windshield, headlamps, and FCA sensors clean and in good repair.

UE4

FOLLOWING DISTANCE INDICATOR

The following distance to a detected moving vehicle ahead in your path is indicated in following time in seconds on the Driver Information Center (DIC). The minimum following time is 0.5 seconds away. If there is no vehicle detected ahead, or the vehicle ahead is out of sensor range, dashes will be displayed.

Safety or driver assistance features are no substitute for the driver's responsibility to operate the vehicle in a safe manner. The driver should remain attentive to traffic, surroundings and road conditions at all times. Visibility, weather, and road conditions may affect feature performance. Read the vehicle's owner's manual for more important feature limitations and information.

UHY

AUTOMATIC EMERGENCY BRAKING

The brakes may be applied automatically in potential collision situations to help reduce damage or help avoid collisions with vehicles directly ahead.





When the system detects a vehicle ahead in your path that is traveling in the same direction that you may be about to crash into, it can provide a boost to braking or automatically brake the vehicle. This can help avoid or lessen the severity of crashes when driving in a forward gear. Depending on the situation, the vehicle may automatically brake moderately or hard. This forward automatic braking can only occur if a vehicle is detected. This is shown by the Forward Collision Alert.

To set the Automatic Emergency Braking and Forward Collision Alert systems to Alert and Brake, Alert, or Off, go to **Settings> Vehicle> Collision/Detection Systems> Forward Collision System**.

UHX

LANE KEEP ASSIST WITH LANE DEPARTURE WARNING

Lane Keep Assist (LKA) may help avoid crashes due to unintentional lane departures. It may also provide a Lane Departure Warning (LDW) system alert as the lane marking is crossed. The LKA system will not assist or provide an LDW alert if it detects that you are actively leaving your lane. Override LKA by turning the steering wheel. LKA uses a camera to detect lane markings between 60 km/h (37 mph) and 180 km/h (112 mph).

How the System Works The LKA camera sensor is on the Windshield. To turn LKA on and off, press  to the left of the steering wheel. When on,  is green if LKA is available to assist and provide LDW alerts. It may assist by gently turning the steering wheel and display  as amber if the vehicle approaches a detected lane marking without using a turn signal in that direction. It may also provide an LDW alert by flashing  amber as the lane marking is crossed. Additionally, there may be three beeps.

Take Steering The LKA system does not continuously steer the vehicle. If LKA does not detect active driver steering, an alert, chime, or DIC message may be provided. Steer the vehicle to dismiss.

UKJ

FRONT PEDESTRIAN BRAKING

The FPB system may help avoid or reduce the harm caused by front-end crashes with nearby pedestrians when driving in a forward gear. FPB displays an amber indicator, , when a nearby pedestrian is detected ahead. When approaching a detected pedestrian too quickly, FPB provides a red flashing alert on the windshield and rapidly beeps. FPB can provide a boost to braking or automatically brake the vehicle.

The FPB system can detect and alert to pedestrians in a forward gear at speeds between 8 km/h (5 mph) and 80 km/h (50 mph). During daytime driving, the system detects pedestrians up to a distance of approximately 40 m (131 ft). during nighttime or low visibility conditions, system performance is very limited.

OPTIONAL FEATURES

DRZ

REAR CAMERA MIRROR

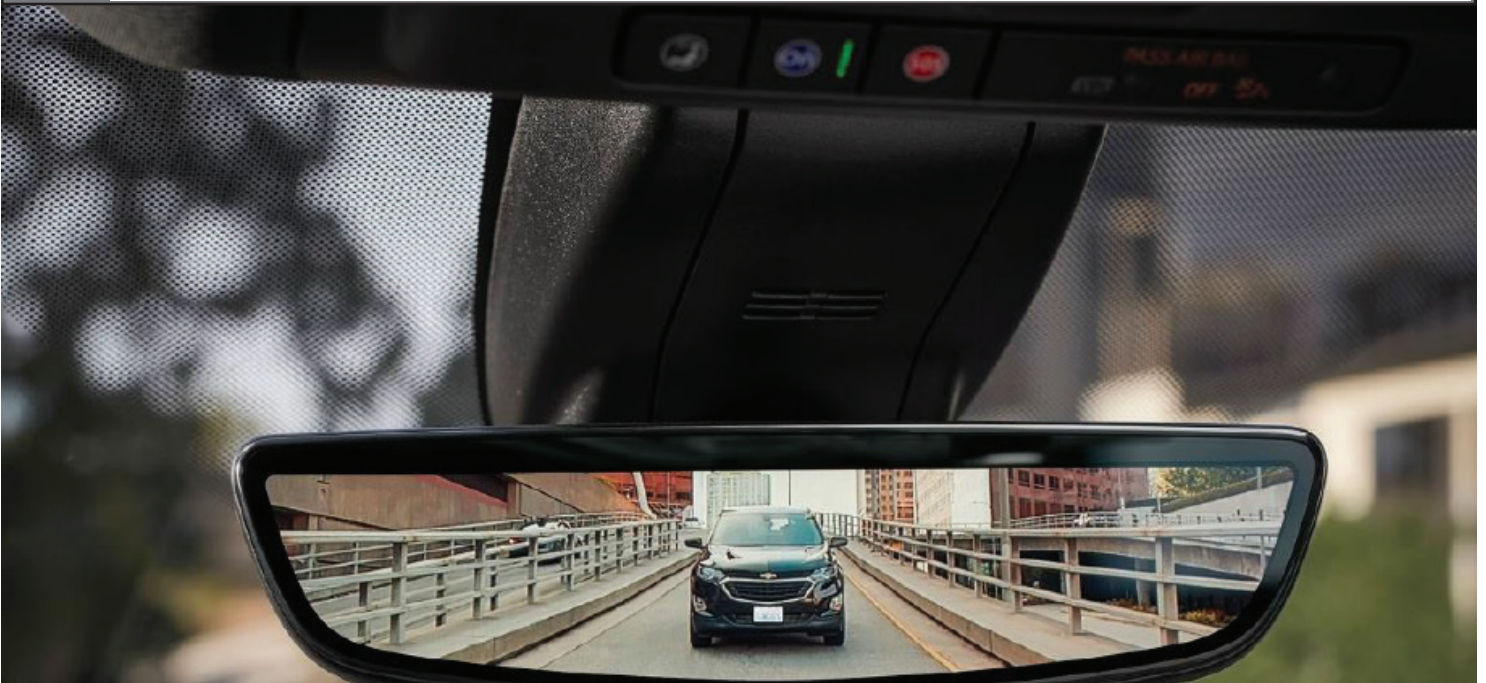

Inside rearview auto-dimming with full camera display. Includes (CWA) Rear Camera Mirror Washer. Not available with (PQA) Safety Package

This automatic dimming mirror provides a wide angle camera view of the area behind the vehicle. Pull the tab to turn on the display. Push the tab to turn it off. When off the mirror is automatic dimming. Adjust the mirror for a clear view of the area behind the vehicle while the display is off.

WARNING: The Rear Camera Mirror (RCM) has a limited view. Portions of the road,

vehicles, and other objects may not be seen. Do not drive or park the vehicle using only this camera. Objects may appear closer than they are. Check the outside mirrors or glance over your shoulder when making lane changes or merging. Failure to use proper care may result in injury, death, or vehicle damage.

The Rear Camera Mirror may not work properly or display a clear image if:

- There is glare from the sun or headlamps.

- This may obstruct objects from view. If needed, push the tab to turn off the display.

- Dirt, snow, or other debris blocks the camera lens. Clean the lens with Rear Camera Washer or a soft damp cloth.

- The camera's mounting on the vehicle has been damaged, and/or the position or the mounting angle of the camera has changed.

Safety or driver assistance features are no substitute for the driver's responsibility to operate the vehicle in a safe manner. The driver should remain attentive to traffic, surroundings and road conditions at all times. Visibility, weather, and road conditions may affect feature performance. Read the vehicle's owner's manual for more important feature limitations and information.

OPTIONAL EQUIPMENT

CK10706

4WD POWERTRAIN

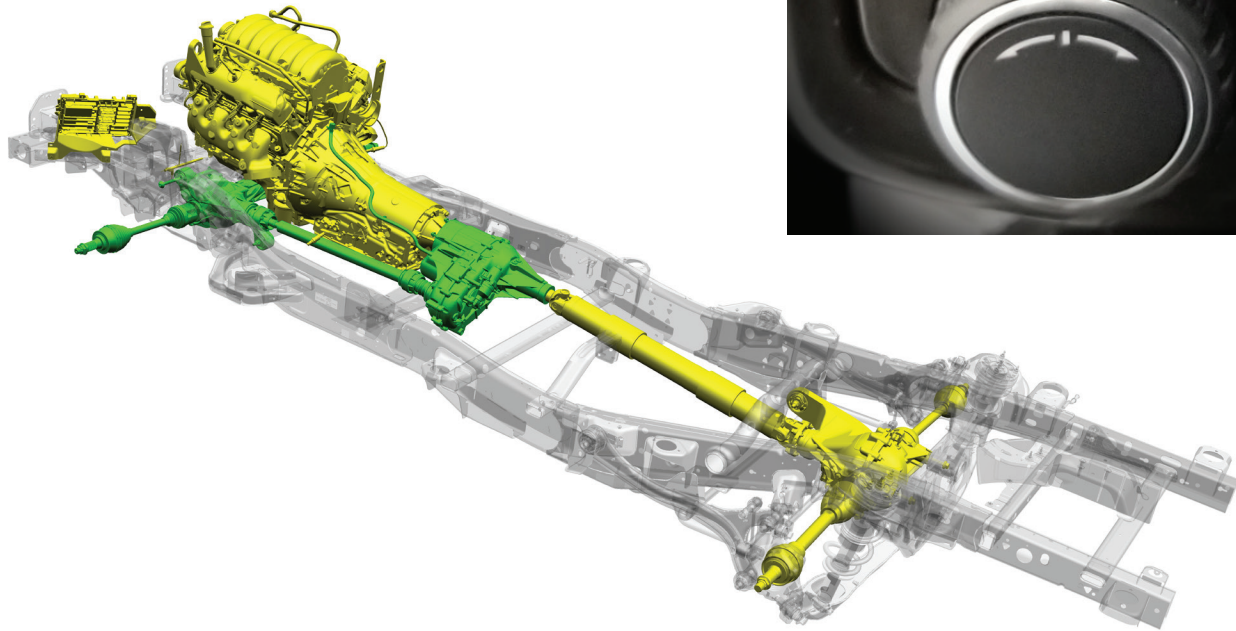

TRANSFER CASE - Requires CK10706 - Autotrac with AUTO 4WD, 4HI or 2HI electronic settings (includes Terrain Mode). Single-speed, electronic transfer case does not include neutral and cannot be dinghy towed.

OPTIONAL EQUIPMENT

V76

RECOVERY HOOKS



Two black front frame mounted.¹

NOTE: Front recovery hooks are for vehicle recovery only. To avoid the risk of injury, never use recovery hooks to tow a vehicle.

VQK

SPLASH GUARDS, MOLDED

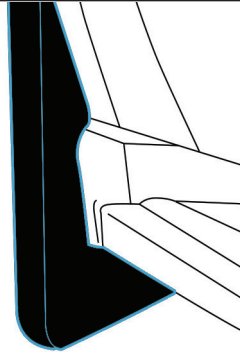

Black finish

AMF

PACKAGE OF FOUR UNPROGRAMMED KEYS/FOBS

An unlimited number of KEYS/FOBS can be learned for Keyless start and Keyless open, only the last 8 KEYS/FOBS learned will have the key fob buttons work for that vehicle. The programming procedure for SEO AMF KEYS/FOBS requires that one previously learned key fob be present in the vehicle.

One learned key fob is required for this procedure.

NOTE: If a previously learned key fob is not available, the programming of the new KEYS/FOBS must be performed by a dealer using the Service Programming System (SPS). Key fob programming is not a warranty item and programming is conducted by the customer or at a dealer at customer expense.

Vehicles ordered with (BTV) remote start will include KEYS/FOBS with remote start button.

PROGRAMMING PROCEDURE:

1. Using the learned key fob, turn the ignition ON but do not crank the engine. The transmission selector must be in PARK.
2. Using the SELECT and other buttons on the right side of the steering wheel, open the Driver Information Center (DIC) Main Menu. Scroll down to Main Menu item OPTIONS with the lower steering wheel button and then SELECT. Scroll to REMOTE KEY RELEARN and Select START. The DIC will display LEARNING ACTIVE.
3. Place the new key fob to be learned on top of the start button with buttons facing up and key head facing driver side
4. Press the start button to learn the key fob. The DIC will display "ready for Key #" where # is the next key fob to be learned.
5. Verify that key fob is learned by operating the door locks remotely.
4. Repeat Step 3 through 5 to learn the next key fob.
5. To exit key fob learning mode, press and hold the start button for approximately 15 seconds.

6E2

FLEET KEY & REMOTE FOB

6E8

The fleet key fob feature allows the user to program a fob to be recognized by a particular vehicle for full remote functionality (Lock/Unlock and Remote Start if equipped). Use of this remote on other fleet keyed-a-like vehicles will be limited to unlocking the driver's door by pressing the exterior door handle button and starting the vehicle once inside. The remote lock/unlock and remote start (if equipped) buttons will not function unless the operator uses the Driver Information Center (DIC) to program the newly introduced fob. Note that a vehicle is only capable of recognizing the last 8 key fobs programmed for full remote capability. Adding a 9th remote fob will bump fob #1 remote functionality until it is reprogrammed through the DIC, adding remote #1 back into the DIC will bump fob #2 remote button functionality, etc. There are no limitations to the amount of fleet keys that will be recognized to access and start the vehicle. Programming a newly introduced fleet fob through the DIC is required to use the Protected Idle feature.

¹ Never pull on recovery hooks from the side. The hooks could break and you and others could be injured. When using recovery hooks, always pull the vehicle from the front.

OPTIONAL EQUIPMENT

7X2

SPOTLAMPS

7X3



- 7X3 Spotlamp left hand, pillar-mounted unity, 6-inch with LED lamps; independently fused
- 7X2 Spotlamps left and right hand, pillar-mounted unity, 6-inch with LED lamps: independently fused

NOTE:

- For fuse location see Wiring Section
- Factory installation of spotlamps is recommended. Special tooling is used to locate and drill the spotlamp shaft hole in the windshield pillars.
- A customer furnished spotlamp assembly must be installed to avoid interference with proper deployment of roof rail mounted head-curtain and instrument panel passenger side airbags

T53

LIFTGATE WARNING LAMPS



Red and Blue flashing LED warning lamps are mounted in the bottom of the liftgate and alternately flash when the liftgate is opened. A switch mounted near the left warning lamp turns the lamps on and off. The switch is shipped separately and must be customer-installed in the liftgate. The switch is attached to the left side cargo area upfitter harness stowed to the rear of the auxiliary battery. Install the switch by removing the cover from the mounting hole in the trim near the left warning lamp. Extract the switch connector through the trim hole and connect to the switch. Install the switch and connector assembly by snapping the switch into the trim hole. Operate the switch to turn the warning lamps ON and to turn the lamps OFF verify operation of the lamps.

The warning lamps can also be operated by connecting a circuit wire (8868) in the UPFIT WIRING HARNESS LIST to a customer emergency lighting controller. When circuit 8868 is grounded by the customer controller the lamps will flash. The liftgate switch can turn off the lamps when being flashed by the customer controller.

6C7

AUXILIARY DOME LAMP

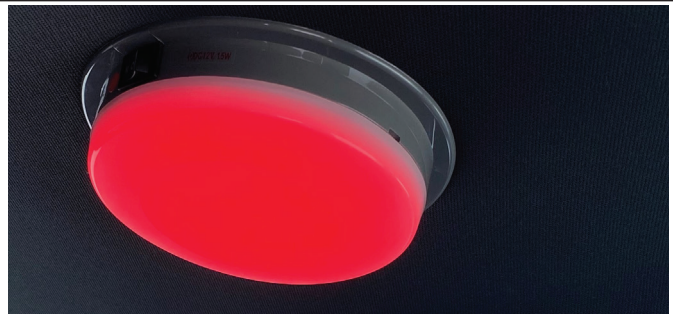

Auxiliary dome lamp is located on the headliner to the rear of the overhead console and is switched at the rear lamp base. Lamp is wired separately standard dome lamps with red and white LED bulbs.

OPTIONAL EQUIPMENT

6N5

SWITCHES - REAR WINDOW INOPERATIVE

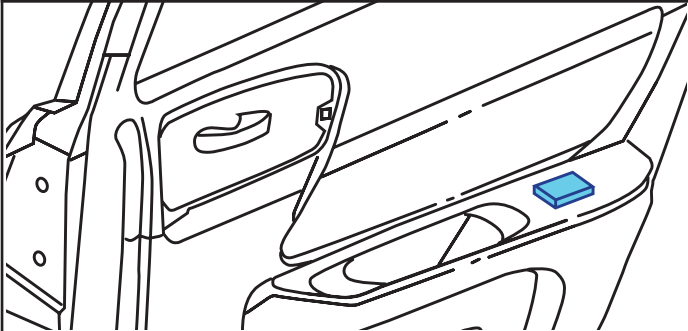

Rear door window switches are inoperable. Rear door power regulators are operable only from driver position switches.

6N6

REAR DOOR LOCKS AND HANDLES INOPERATIVE

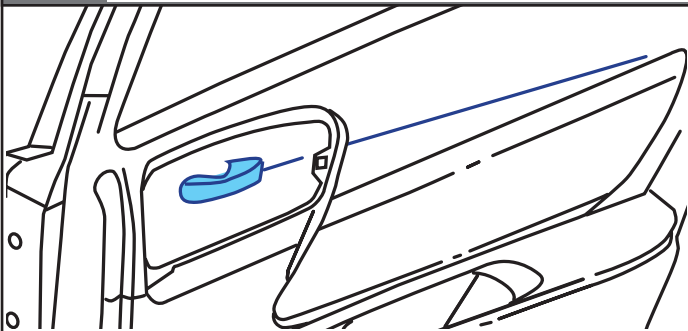

Rear door locking rods are disabled. Rear door locks are inoperable at rear doors, but operate from driver position. Inside rear door handles are disconnected. Rear doors can only be opened from the outside.

6J7

EXTERIOR LAMPS EMERGENCY FLASHING SYSTEM

Option 6J7 provides headlamp high beam flashing and rear lamps flashing via the Exterior Lighting Module (ELM). The exterior lamps flashing is activated by customer switching of ground circuits in the upfitter harness located between the front seats (CONSOL) in the rear cargo area (CARGO).

Headlamp high beam flashing is activated via connection of upfitter circuit 8863 to ground via customer switching. The headlamps and high beam indicator will flash alternately at 3 flashes per second. Rear lamps flashing is chosen by the customer to flash either Red-White alternately (Brake lamps and Reverse Lamps, grounding upfitter circuit 8865) or Red-Red alternately (Left and Right Brake Lamps, grounding upfitter circuit 8864). The rear lamps flash rate is 3 per second. Depressing the Brake pedal will override the brake lamp flashing and placing the transmission in Reverse will override the reverse lamps flashing.

During daylight conditions, the Daytime Running Lamps (DRL) are automatically turned off whenever the Lamp Flashing System is activated. During night time conditions the low beam headlamps and tail lamps automatically turn on while the high beams flash. Turning on the high beam headlamps will override high beam flashing. If Option 9G8 is present the low beam head lamps and tail lamps must be manually activated. The Center Mounted Stop Lamp will operated only when the service brakes are applied.

NOTES:

- Wiring connection or splice changes are to be removed before the vehicle is returned to civilian use.
- For wiring diagram see Wiring Section

UN9

RADIO SUPPRESSION GROUND STRAPS

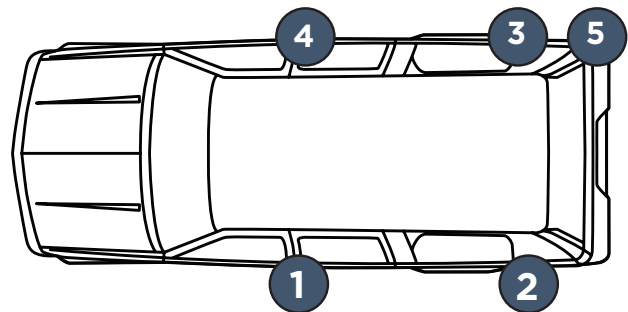

Provides additional grounding in the following locations:

1. Left hand front frame body mount bracket to underbody
2. Left hand rear frame body mount bracket to rear underbody
3. Right hand rear frame body mount bracket to rear underbody
4. Right hand front frame body mount bracket to underbody
5. Exhaust pipe hanger rod to rear frame hanger

OPTIONAL EQUIPMENT

6J3

WIRING PROVISIONS FOR VEHICLE GRILLE LAMPS AND SPEAKER/SIREN

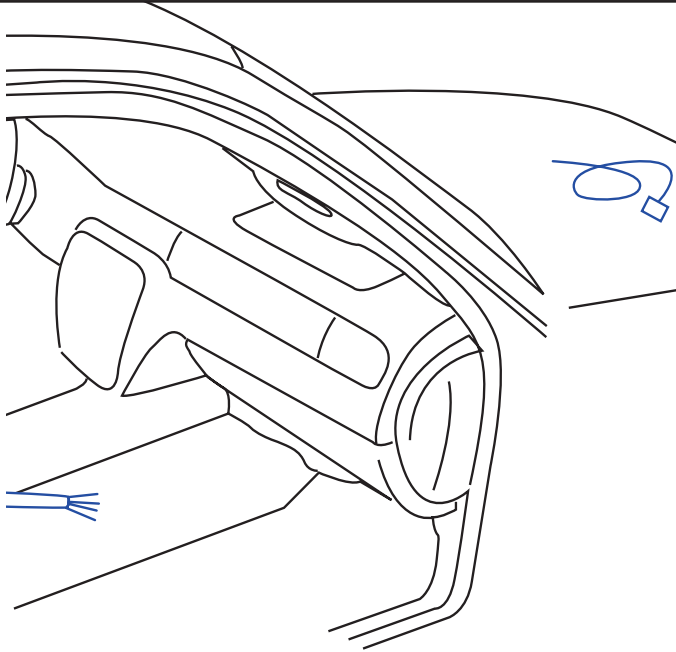

Blunt cut circuit wires are in the Upfit Branch Harness between front seats (CONSOL) and in cargo area (CARGO) as listed in Upfit Wiring Harness List. The blunt cut circuit wires for customer-furnished grille lamps and siren speaker are coiled at the radiator. Circuits 8855 and 8856 are for powering LED grille lamps. Circuit 8857 is ground, 8858 is for lamp sync and 8859 is for lamp steady burn. Circuit 8861 is speaker high and 8862 is speaker low. 8860 circuit is spare.

NOTES: Wiring connection or splices are to be removed before the vehicle is returned to civilian use.

WX7

WIRING PROVISION FOR FRONT SPEAKERS

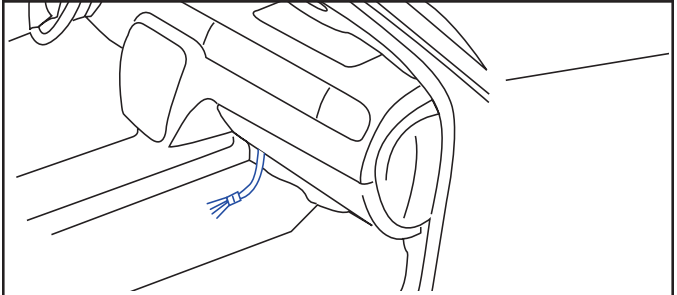

Approximately 60 inches (1.5 m) of auxiliary speaker wiring is coiled between the front seats (CONSOL) with the Upfitter Branch harness. The wiring permits connection of the front speaker pairs to customer-installed communication equipment. Vehicle radio front speaker outputs are re-routed to the rear speakers to maintain the required open door/key-in-ignition and other audible warnings.

NOTES:

- Wiring connection or splice changes are to be removed before the vehicle is returned to civilian use.
- For wiring diagram see Wiring Section

6J4

WIRING PROVISION FOR HORN SIREN CIRCUIT

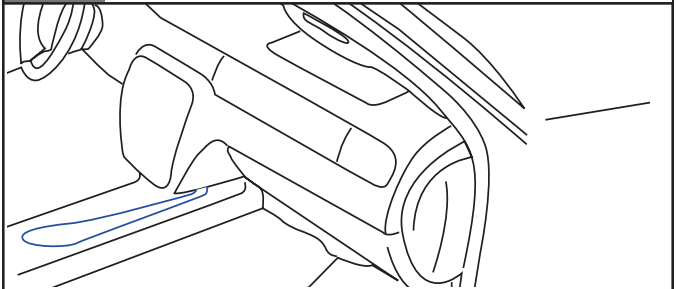

This provision permits customer connection of a switch to select either horn or siren operation when the horn pad is pressed. A 22-gauge (0.35 mm²) wire is connected to an in-line connector in the horn circuit of the instrument panel harness under the instrument panel. The end of this harness extension is a 5-foot (1.5 m) loop of wire coiled under the center of the instrument panel.

NOTES:

- Wiring connection or splice changes are to be removed before the vehicle is returned to civilian use.
- For wiring diagram see Wiring Section

UPFIT WIRING HARNESS CIRCUIT¹ IDENTIFICATION BETWEEN FRONT SEATS AND LEFT SIDE CARGO SPACE

Original Equipment Alterations: Warranty does not cover any damage or failure resulting from modification or alteration to the vehicle's original equipment as manufactured or assembled by General Motors. Examples of the types of alterations that would not be covered include: installation or use of any non-GM part, accessory, materials, or the cutting, welding or disconnecting of the vehicle's original equipment parts and components.

CIRCUIT NO.	WIRE COLOR	CIRCUIT DESCRIPTION	UPFITTER CONNECTION LOCATION
SEO 6J1 - WIRING PROVISIONS FOR 12 VOLT BATTERY POWER, IGNITION POWER AND SIGNALS			
X51AX IP AUXILIARY JUNCTION BLOCK RELAYS FOR CUSTOMER CONNECTION			
8895	BU/YE	COIL LOW SIDE, RY 1 of 4	IP RY CTR, CONSL, Ry coil grounding
8896	GN/YE	COIL LOW SIDE, RY 2 of 4	IP RY CTR, CONSL, via customer
8897	GY/YE	COIL LOW SIDE, RY 3 of 4	IP RY CTR, CARGO switching
8898	VT/YE	COIL LOW SIDE, RY 4 of 4	IP RY CTR, CARGO
8911	RD/GN	RELAY 1 CONTACT LOAD SIDE	IP RY CTR, CONSL F162 25A
8912	RD/GY	RELAY 2 CONTACT LOAD SIDE	IP RY CTR, CONSL F163 20A
8913	RD/WH	RELAY 3 CONTACT LOAD SIDE	IP RY CTR, CARGO F166 20A
8914	RD/YE	RELAY 4 CONTACT LOAD SIDE	IP RY CTR, CARGO F167 25A
AUXILIARY BATTERY POWER AND GROUND			
842	RD/VT	BATT FUSE 50 AMP	AUX BATT FUSE, CONSL,
742	RD	BATT FUSE 100 AMP	AUX BATT FUSE, CARGO
7350	BK - 100 sq mm	GROUND G409	CONSL, CARGO
7150	BK - 10 sq mm	GROUND G300,	CONSL
VEHICLE SYSTEMS SIGNALS			
817	GN/GY	4K PPM SPEED	ECBM, CONSL, CARGO
2801	VT	RETAINED ACCY PWR	RAP RY, CONSL, CARGO
4939	WH/VT	RUN/CRNK IGN 1	RUN/CRNK RY, CONSL, CARGO
8917	BU/BN	DR DOOR AJAR	DOOR AJAR CKT, CONSL, CARGO
6821	VT/WH	SURVEILLANCE	BCM, CONSL, CARGO
820	BN/YE	BRAKES APPLIED	CHMSL, CONSL, CARGO
5813	YE/BK	PARK ENABLE	TRANS IN PK RY, CONSL, CARGO
6817	YE	IP DIMMING	BCM, CONSL, CARGO
SEO 6J1/UT7, UT7 - GROUNDS			
7150	5 sq mm	GROUND - 60 AMP	CONSL
7350	10 sq mm	GROUND - 80 AMP	CARGO
STEERING WHEEL SWITCHES			
8021	BN/GY	PUSH-TO-TALK	BCM, CONSL, CARGO
8022	GY/VT	LIGHTS CONTROL	BCM, CARGO
WIRING PROVISION FOR CUSTOMER RADIO MICROPHONE ABOVE DRIVER POSITION.			
1850	BK	GROUND	HEADLNR, CONSL, CARGO
8899	BU/WH	POLICE MIC	HEADLNR, CONSL, CARGO
8900	BU/VT	POLICE MIC	HEADLNR, CONSL, CARGO

¹. GM is not responsible for the safety or quality of design features, materials or workmanship of any alterations by third parties.

UPFIT WIRING HARNESS CIRCUIT¹ IDENTIFICATION BETWEEN FRONT SEATS AND LEFT SIDE CARGO SPACE

Original Equipment Alterations: Warranty does not cover any damage or failure resulting from modification or alteration to the vehicle's original equipment as manufactured or assembled by General Motors. Examples of the types of alterations that would not be covered include: installation or use of any non-GM part, accessory, materials, or the cutting, welding or disconnecting of the vehicle's original equipment parts and components.

CIRCUIT NO.	WIRE COLOR	CIRCUIT DESCRIPTION	UPFITTER CONNECTION LOCATION
SEO 6J3 - WIRING PROVISION FOR GRILLE LAMPS AND SIREN SPEAKER (BRANCH HARNESS COILED AT GRILLE)			
8855	BN	12V-LED 1	CONSL, CARGO
8856	BN/BU	12V-LED 2	CONSL, CARGO
8857	BK/BN	GROUND	CONSL, CARGO
8858	WH	LED 1, 2 LAMPS SYNC	CONSL, CARGO
8859	BN/YE	STEADY BURN	CONSL, CARGO
8860	WH/BK	SPARE	CONSL, CARGO
8861	GN/WH	SIREN SPEAKER HIGH	CONSL, CARGO
8862	BU/WH	SIREN SPEAKER LOW	CONSL, CARGO

FLASHER SYSTEM, HEADLAMPS AND TAIL LAMPS ALTERNATE FLASHING			
8863	GN	HI BEAM HDLP FLASH ENABLE	ELM, CONSL, CARGO
8864	BU/GN	L/R TAIL LP RED/RED ENABLE	ELM, CONSL, CARGO
8865	GY/GN	L/R TAIL LP RED/WHT ENABLE	ELM, CONSL, CARGO

SEO 6J4 - WIRING PROVISION FOR HORN-SIREN ALTERNATE OPERATION			
28	BN/WHT	CUSTOMER SWITCH CONNECT	LOOP BETWEN FRONT SEATS

SEO WX7 - WIRING PROVISION FOR CUSTOMER CONNECTION TO FRONT DOOR SPEAKERS			
CIRCUITS FOR CONNECTION OF FRONT DOOR SPEAKERS TO POLICE RADIO			
LH FRT POS	BN/BU	LF DOOR SPEAKER	
LH FRT NEG	BU	LF DOOR SPEAKER	
RH FRT POS	YE/BK	RF DOOR SPEAKER	
RH FRT NEG	YE	RF DOOR SPEAKER	

CIRCUITS RECONNECT RADIO FRONT OUTPUT TO REAR DOOR SPEAKERS			
LH RR POS	GN/BK	TO LH RR SPEAKER	
LH RR NEG	GN	TO LH RR SPEAKER	Wire blunt cuts are positioned
RH RR POS	BU/BK	TO RH RR SPEAKER	between front center seats for
RH RR NEG	WH	TO RH RR SPEAKER	customer connection.

CIRCUITS RECONNECT RADIO OUT TO RR DOOR SPEAKERS			
LH FRT POS	BU/BN	RADIO OUT LF SPEAKER	
LH FRT NEG	BU	RADIO OUT LF SPEAKER	
RH FRT POS	YE/BK	RADIO OUT RF SPEAKER	
RH FRT NEG	YE	RADIO OUT RF SPEAKER	

CIRCUITS ABANDONED WHEN WX7 INSTALLED			
LH RR POS	GN/BK	RADIO OUT LR SPEAKER	
LH RR NEG	GN	RADIO OUT LR SPKER	
RH RR POS	BU/BK	RADIO OUT RR SPKER	
RH RR NEG	WH	RADIO OUT RR SPKER	

RADIO MUTE FEATURE WHEN POLICE RADIO TRANSMITTING			
10137	GN/WH	RADIO MUTE ENABLE	Blunt cut from IP to center floor

¹. GM is not responsible for the safety or quality of design features, materials or workmanship of any alterations by third parties.

UPFIT WIRING HARNESS CIRCUIT¹ IDENTIFICATION BETWEEN FRONT SEATS (CONSOLE) AND LEFT SIDE CARGO SPACE

Original Equipment Alterations: Warranty does not cover any damage or failure resulting from modification or alteration to the vehicle's original equipment as manufactured or assembled by General Motors. Examples of the types of alterations that would not be covered include: installation or use of any non-GM part, accessory, materials, or the cutting, welding or disconnecting of the vehicle's original equipment parts and components.

CIRCUIT NO.	WIRE COLOR	CIRCUIT DESCRIPTION	UPFITTER CONNECTION LOCATION
SEO T53 - LIFTGATE LED WARNING LAMPS			
8866	VT	12V LED LAMP	Ckts 8866, 7650, 8867 not available
7650	BK	GROUND	for customer connection.
8867	WH	LH, RH LED SYNC	Liftgate, CONSL, CARGO
8868	VT/YE	STEADY LED FLASH	ELM, CARGO
8869	VT/GN	LIFTGATE ENABLE SWITCH	Ckt 8869 not available for customer connection.

SEO T66 - WIRING PROVISION FOR OUTSIDE REARVIEW MIRRORS AND CARGO AREA SIDE WINDOWS			
LH OUTSIDE MIRROR STROBE			
8870	VT	12V LH LED	LH MIRROR, CARGO
8871	BK/VT	LED GROUND	Blunt cut ends to be in door.
8872	WH/VT	LF LED SYNC	
8873	BU/VT	STEADY BURN	
8874	YE/VT	FLASH ENABLE	

LH REAR WINDOW STROBE			
8875	GN	12V RR WDO LED	LH RR WDO, CARGO
8876	BK/GN	LED GROUND	Blunt cut ends to be above and,
8877	WH/GN	LR LED SYNC	forward of rear edge of headliner.
8878	BU/GN	STEADY BURN	
8879	YE/GN	FLASH ENABLE	

RH OUTSIDE MIRROR STROBE			
8880	GY	12V RH LED	RH MIRROR, CARGO
8881	BK/GY	LED GROUND	Blunt cut ends to be in door;
8882	WH/GY	RF LED SYNC	
8883	BU/GY	STEADY BURN	
8884	YE/GY	FLASH ENABLE	

RH REAR WINDOW STROBE			
8885	BN	12V RR WDO LED	RH RR WDO, CARGO
8886	BK/BN	LED GROUND	Blunt cut ends to be above and
8887	WH/BN	RR LED SYNC	forward of rear edge of headliner.
8888	BU/BN	STEADY BURN	
8889	YE/BN	FLASH ENABLE	

¹ GM is not responsible for the safety or quality of design features, materials or workmanship of any alterations by third parties.

UPFIT WIRING HARNESS CIRCUIT¹ IDENTIFICATION BETWEEN FRONT SEATS AND LEFT SIDE CARGO SPACE

Original Equipment Alterations: Warranty does not cover any damage or failure resulting from modification or alteration to the vehicle's original equipment as manufactured or assembled by General Motors. Examples of the types of alterations that would not be covered include: installation or use of any non-GM part, accessory, materials, or the cutting, welding or disconnecting of the vehicle's original equipment parts and components.

CIRCUIT NO.	WIRE COLOR	CIRCUIT DESCRIPTION	UPFITTER CONNECTION LOCATION
SEO 7X2, 7X2/7X3 - LED SPOT LAMPS 7X2 LH ONLY, 7X2/7X3 LH & RH			
10240	RD/GN	SECONDARY FUSE	7X2-LH A-PILLAR
1850	BK	GROUND	7X2-LH A-PILLAR
10340	RD	SECONDARY FUSE	7X3-RH A-PILLAR
1850	BK	GROUND	7X3-RH A-PILLAR

SEO 6C7 - AUXILIARY DOME LAMP

PRIMARY BATT	RD	12v POWER	VIA OVERHEAD CONSOLE
7350	BK	GROUND	

KEY FOR ACRONYMS AND TERMS

CONSOL = SPACE BETWEEN FRONT SEATS
 CARGO = CARGO AREA LEFT SIDE
 IP RY CTR = IP RELAY CENTER ABOVE AND TO RIGHT OF BRAKE PEDAL
 AUX BATT = AUXILIARY BATTERY AT LEFT SIDE OF CARGO AREA
 EBCM = ELECTRIC BRAKE CONTROL MODULE
 4K PPM = 4000 PULSES PER MILE SPEED SIGNAL
 ACCY = ACCESSORY
 SURVEILLANCE = ALL AUTOMATIC LIGHTING DISABLED WHEN ACTIVATED
 PARK ENABLE = PARK RELAY ACTIVATED
 CHML = CENTER HIGH MOUNTED STOP LAMP; ON WHEN BRAKES APPLIED
 BCM = BODY CONTROL MODULE
 ELM = EXTERIOR LIGHT MODULE
 WDO = WINDOW
 SYNC = SYNCHRONIZED

¹. GM is not responsible for the safety or quality of design features, materials or workmanship of any alterations by third parties.

OPERATION-DESCRIPTION OF SEO WIRING FEATURES

Refer to UPFIT WIRING CIRCUITS CHART for circuit wire numbers and colors

RELAY CONTROLLED 12 VOLT BATTERY POWER

A relay and fuse block (X51B) is located in the left instrument panel above the brake pedal. Four relays are provided for customer connection to 12 primary battery power. The relay coils are fused at 10 amps and are operated via connection to the coil ground side circuits in the upfitter harness branches between front seats or in the cargo area. Also in the upfitter harness branches are circuits for connection to the relay contact load sides. The relays are powered by the primary battery located in the engine compartment UBEC. Customer load is connected to the fused relay contact circuits (circuits chart 8911-8914). Power and ground from the Auxiliary Battery are located in the CONSOL upfitter branch (60 amp) and the CARGO area (80 amp).

VEHICLE SYSTEMS CIRCUITRY

The following Vehicle Systems Circuits are found in the upfitter branch harnesses between the front seats (CONSOL) and at the left side of the CARGO area:

817, Vehicle Speed Signal - 4000 pulses per mile square wave.

2801, Retained Accessory Power - 12 v when ignition in Accessory position. Times off after xx minutes.

4939, Run-Crank, Ignition - 12 v when engine is being cranked or running.

8917, Driver Door Ajar - Ground from door latch switch when driver door is open.

6821 Surveillance - BCM calibration. Grounding the circuit disables all automatic lighting.

820, Brakes Applied - 12 v available when service brakes applied. 12 v Not confirmed

5813, Park Enable - 12 v available when transmission in Park.

6817, I P Dimming - Calibration for IP lighting dimming when circuit is grounded. Not confirmed

SEO 6J3 -WIRING PROVISION FOR GRILLE LAMPS AND SIREN SPEAKER OPTIONAL

Circuits for wiring grille lamps and a siren speaker are located in the CONSOL and CARGO area upfitter branch harnesses and are listed in the UPFIT WIRING CIRCUITS chart (circuits 8855-8862). A wiring harness is coiled at the radiator for connection to the customer provided front emergency lamps and siren speaker.

SEO 6J4 - WIRING PROVISION FOR HORN-SIREN ALTERNATE OPERATION OPTIONAL

A single wire loop is connected to the instrument panel wiring and located near the CONSOL upfitter branch harness. The wire can be connected to a steering wheel switch or other customer provided switch to operate the siren with the steering wheel horn button in place of the vehicle horn.

STEERING WHEEL SWITCHES

The steering wheel is equipped with switches for police radio or siren speaker Push-to-Talk and a switch for emergency lighting control.

WIRING PROVISION FOR POLICE RADIO MICROPHONE

Wiring circuits are included in the CONSOL and CARGO upfitter branch harnesses to connect to customer-provided police radio speakers mounted in the vehicle headliner (circuits 1850, 8899-8900).

SEO WX7 - WIRING PROVISION FOR CUSTOMER CONNECTION OF TO FRONT DOOR SPEAKERS

Wiring circuits are provided near the CONSOL upfitter branch harness to permit customer-installed communication equipment to be connected to the front door speakers; see circuit chart for wire colors. The vehicle radio front speaker outputs are re-routed to the rear door speakers to maintain the required door open, key-in-ignition seat belt and other audible warnings. A vehicle radio mute circuit is included. OPTIONAL

OPERATION-DESCRIPTION OF SEO WIRING FEATURES

SEO 6J7 - FLASHER SYSTEM, HEADLAMPS AND TAIL LAMPS ALTERNATE FLASHING.

Calibrations are available to alternately flash the headlamp high beams and either the tail lamps alternately Red-White or alternately Red-Red (circuits 8863-8865). Selecting High Beam or applying service brakes overrides flashing.

SEO T53 - LIFTGATE WARNING LAMPS

LED lamps are mounted at the bottom of the rear liftgate and are enabled to flash red when the lift gate is opened. Customer must locate and connect a grounding wire found near an opening in the lift gate trim near the right warning lamp to enable the flash when the lift gate is opened. A switch is provided in glove box and is to be customer-installed to a connector located near the right warning lamp to permit disabling the lamps when the lift gate is open (8868 for steady flashing).

SEO T66 - WIRING PROVISION FOR OUTSIDE MIRRORS AND CARGO SIDE WINDOWS

Wiring provisions are provided for connection to customer-provided LED emergency lighting to be installed on the outside rear view mirrors and on the rear of the cargo area side windows. Blunt-cut wires are located in the front doors and above the cargo area headliner, forward of the lift gate. The wire circuits are included in the CONSOL and CARGO Upfitter branch harnesses for connection to customer- installed strobe lights, strobe power and flash controls (circuits 8870-8889).

7X2/7X3 LED spot lamps

Windshield pillar grab-handles are removed and alternate trim installed.

WIRING SCHEMATIC INDEX

STANDARD:

- **50EA Fuse Block Auxiliary Battery**
- **51AX Junction Block Instrument Panel Auxiliary**
- **Vehicle Systems Signals (1 Of 2, 2 Of 2)**
- **LH and RH Wiring Provisions For Outside Mirror and Rear Quarter Windows Strobes**
- **Steering Wheel Switches**
- **Radio Microphone Provisions**

OPTIONAL:

- **6J3 - Grille Lamps and Siren Speaker Wiring Provisions**
- **WX7 - Front Door Speakers Wiring Provisions**
- **6J4 - Horn and Siren Control Provision**
- **6J7 - Headlamps and Rear Lamps Flashing System Provisions**
- **T53 Liftgate Warning Lamps**
- **7X2-7X3 - LED Spotlamps**
- **6C7 - Auxiliary Dome Lamp**

WIRING

50EA FUSE BLOCK AUXILIARY BATTERY

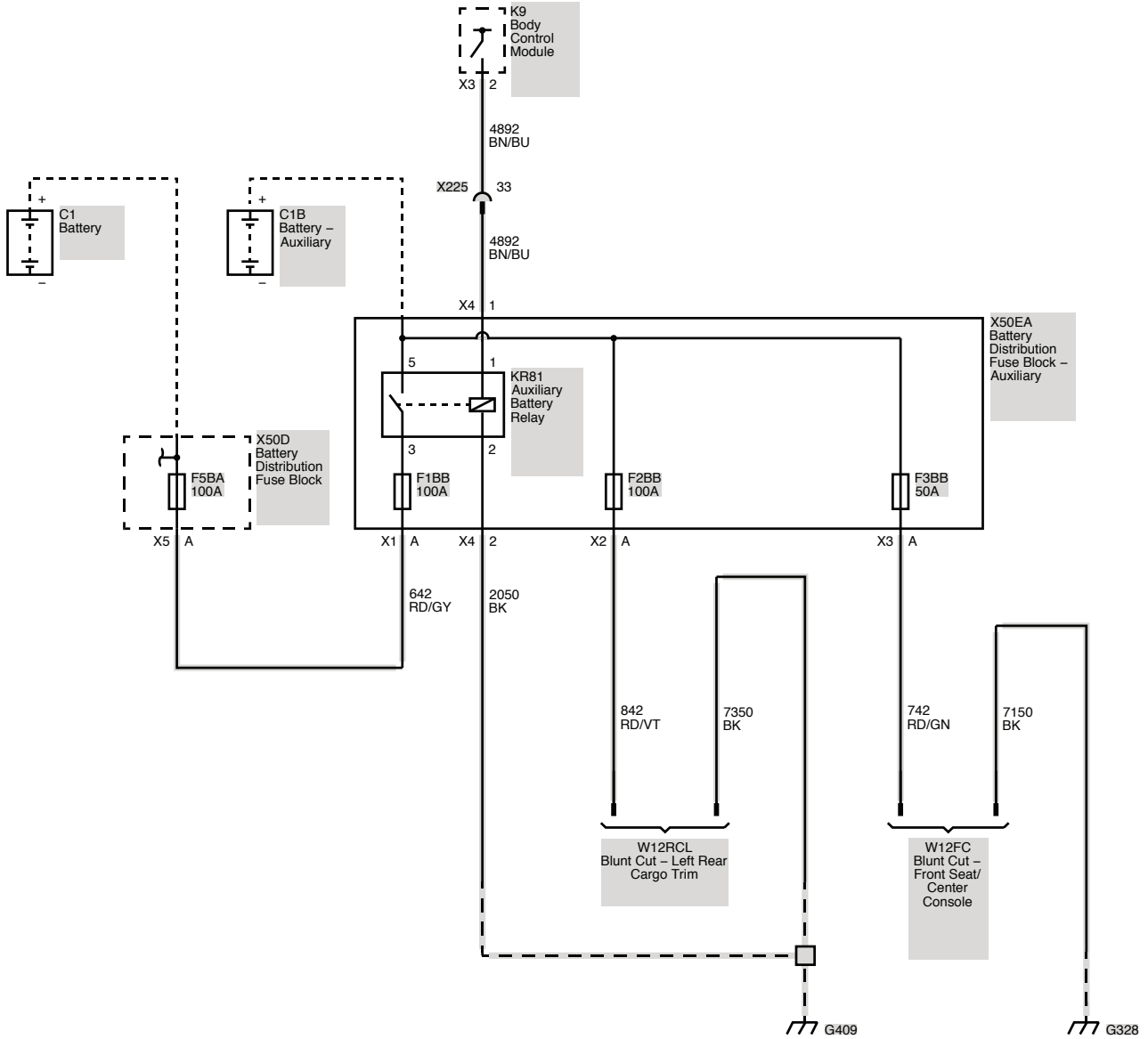

WIRING

X51AX JUNCTION BLOCK INSTRUMENT PANEL AUXILIARY

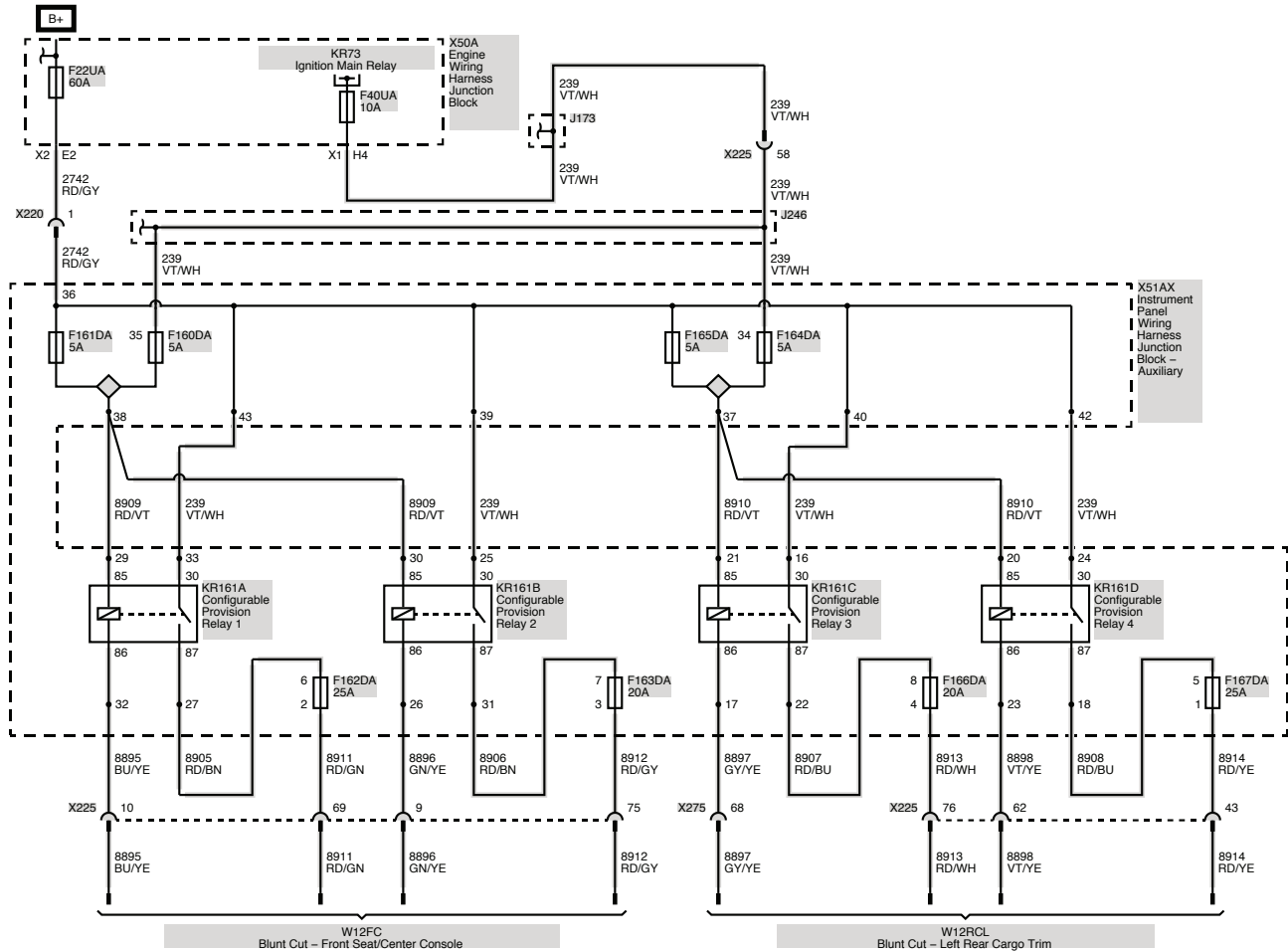

WIRING

VEHICLE SYSTEMS SIGNALS (1 OF 2)

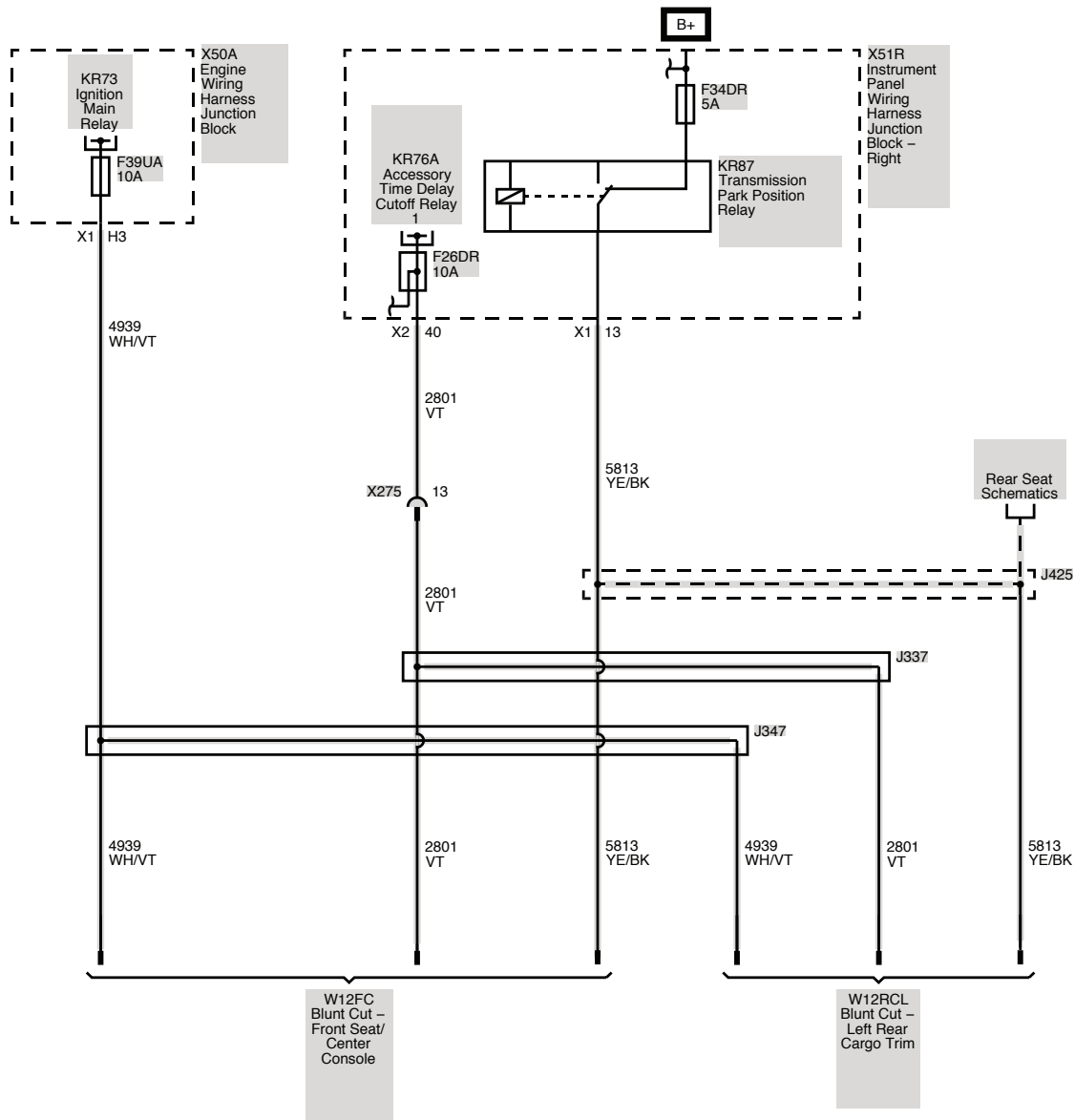

WIRING

VEHICLE SYSTEMS SIGNALS (2 OF 2)

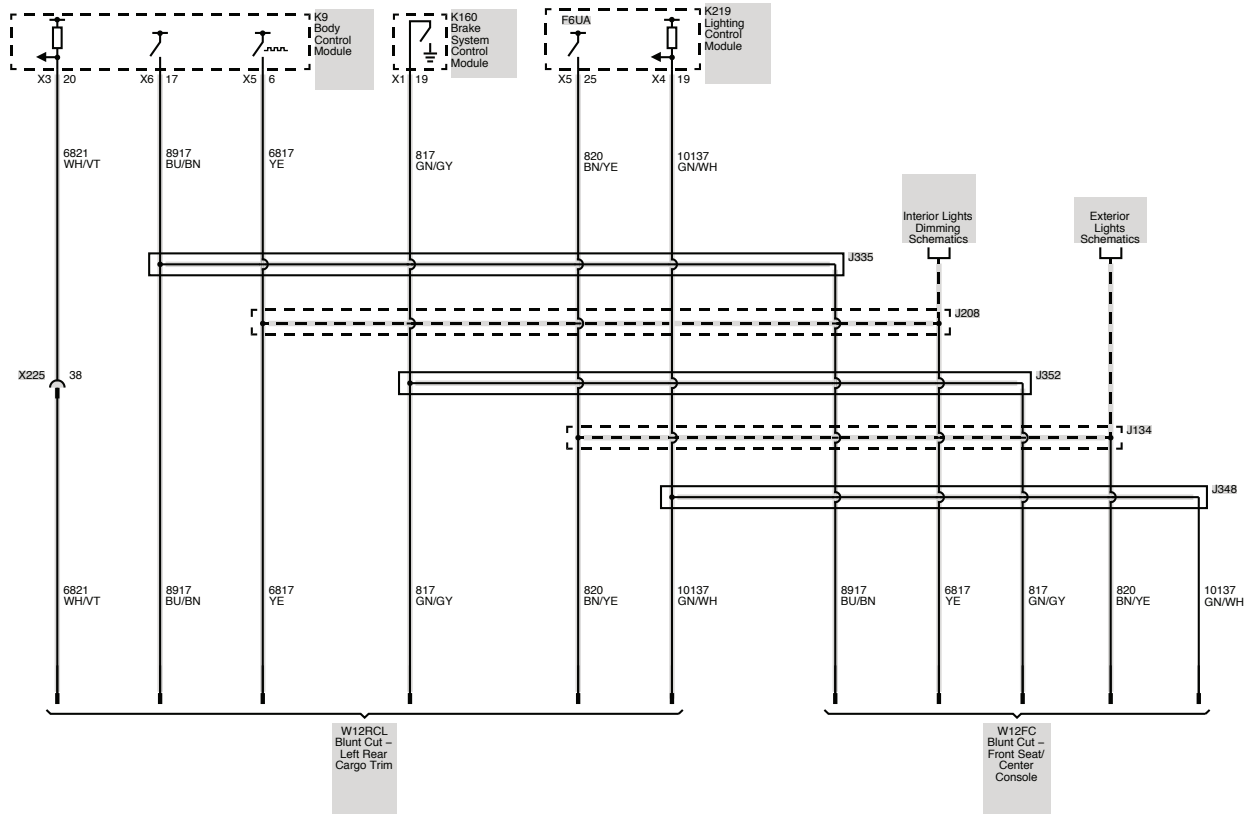

WIRING

T66 - OUTSIDE REARVIEW MIRROR AND REAR WINDOW STROBE PROVISION - LEFT

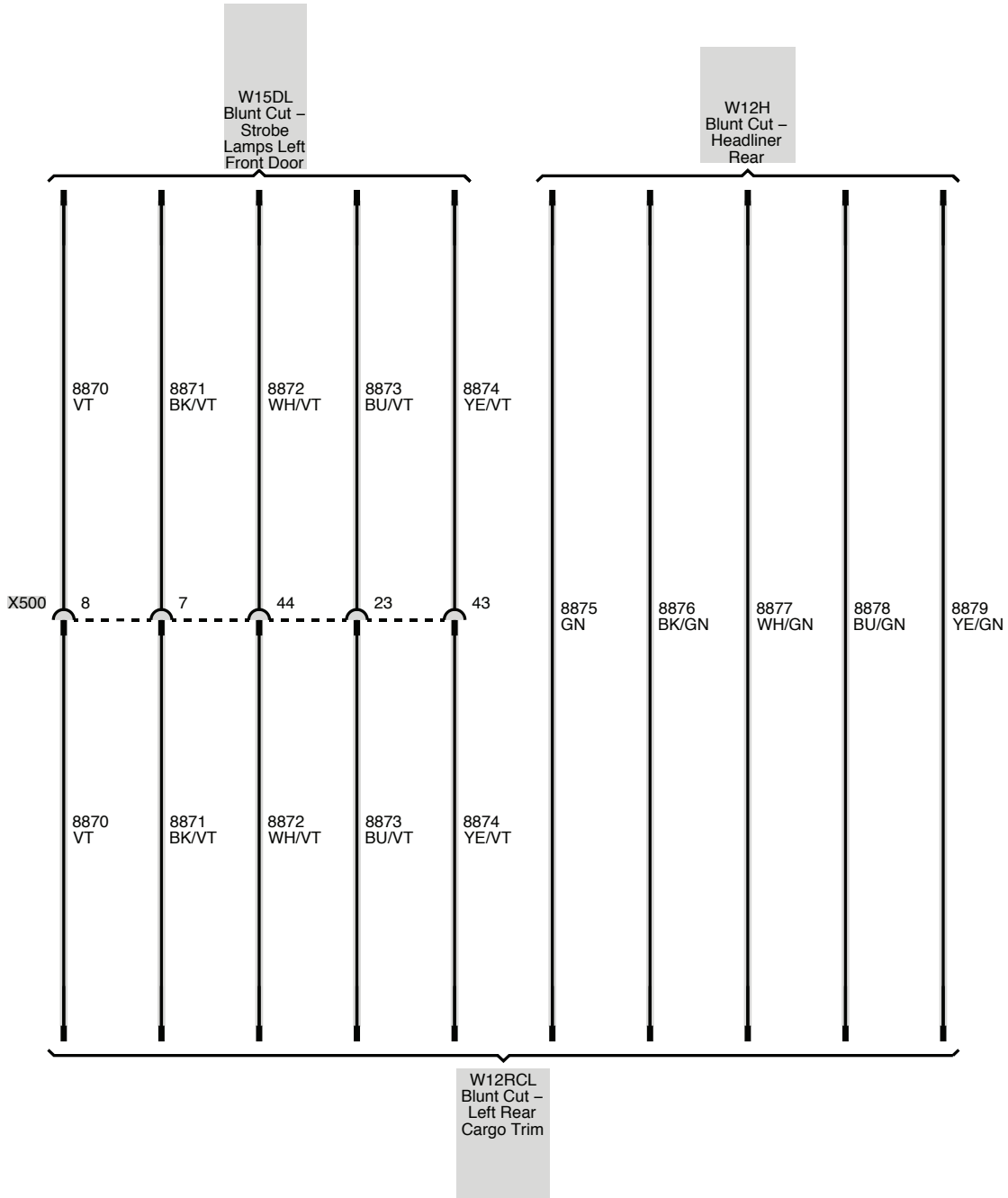

WIRING

T66 - OUTSIDE REARVIEW MIRROR AND REAR WINDOW STROBE PROVISION - RIGHT

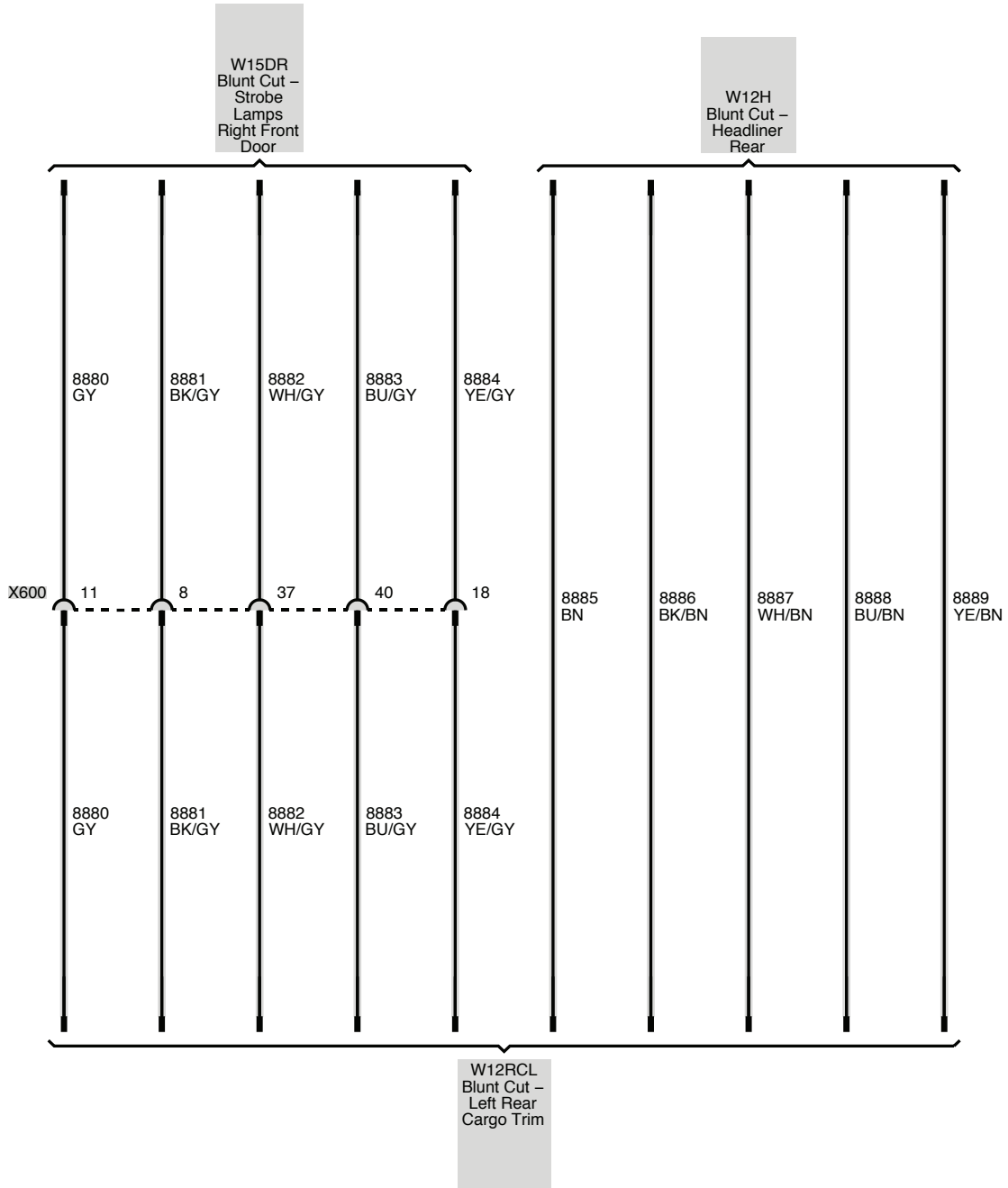

WIRING

STEERING WHEEL SWITCHES

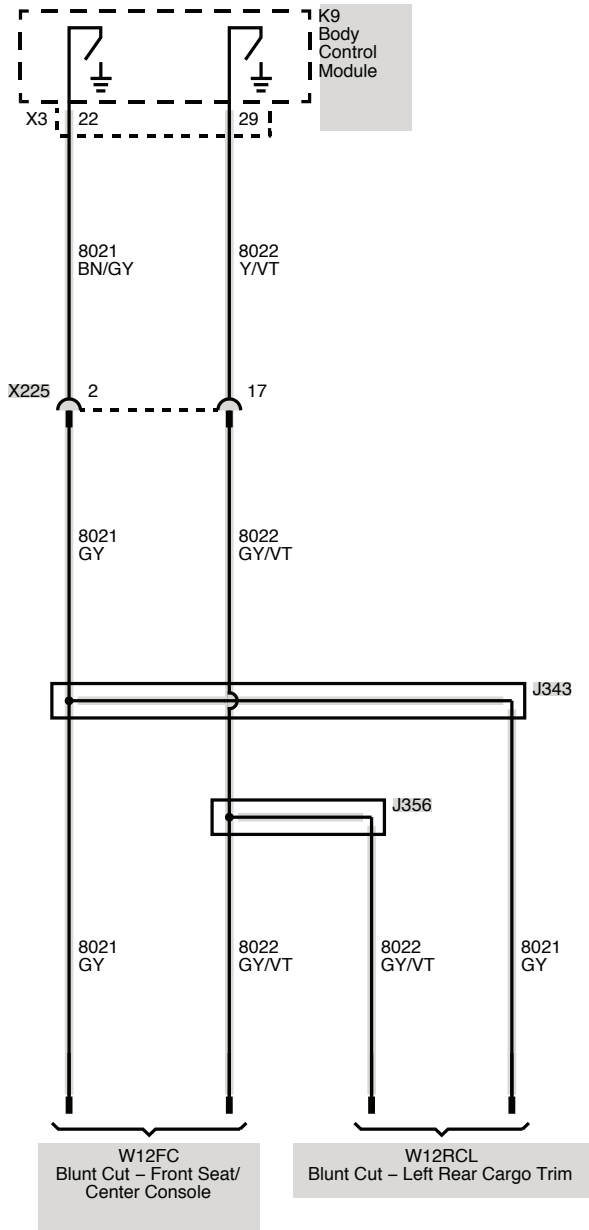

RADIO MICROPHONE PROVISIONS

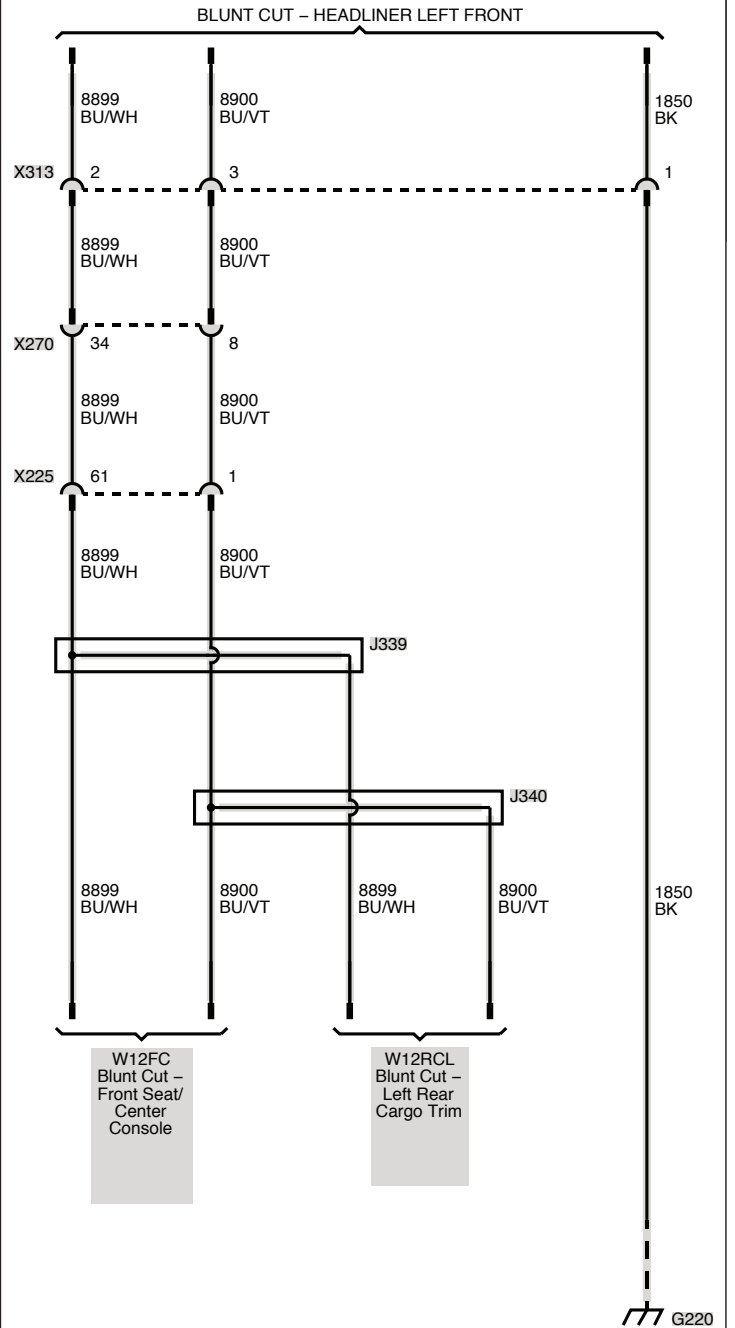

OPTIONAL WIRING

6J3 - GRILLE LAMPS AND SIREN SPEAKER PROVISIONS

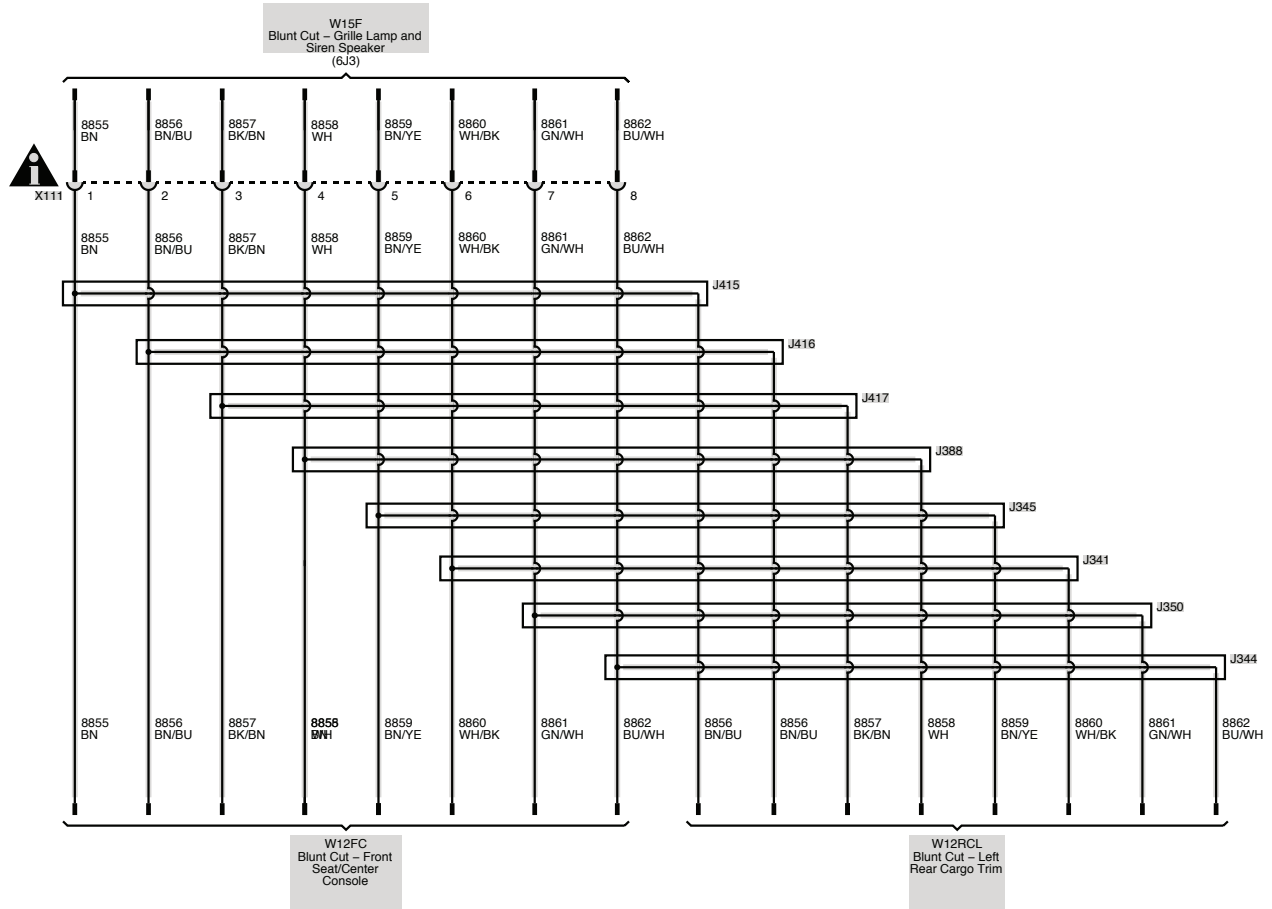

OPTIONAL WIRING

WX7 FRONT DOOR SPEAKERS PROVISIONS

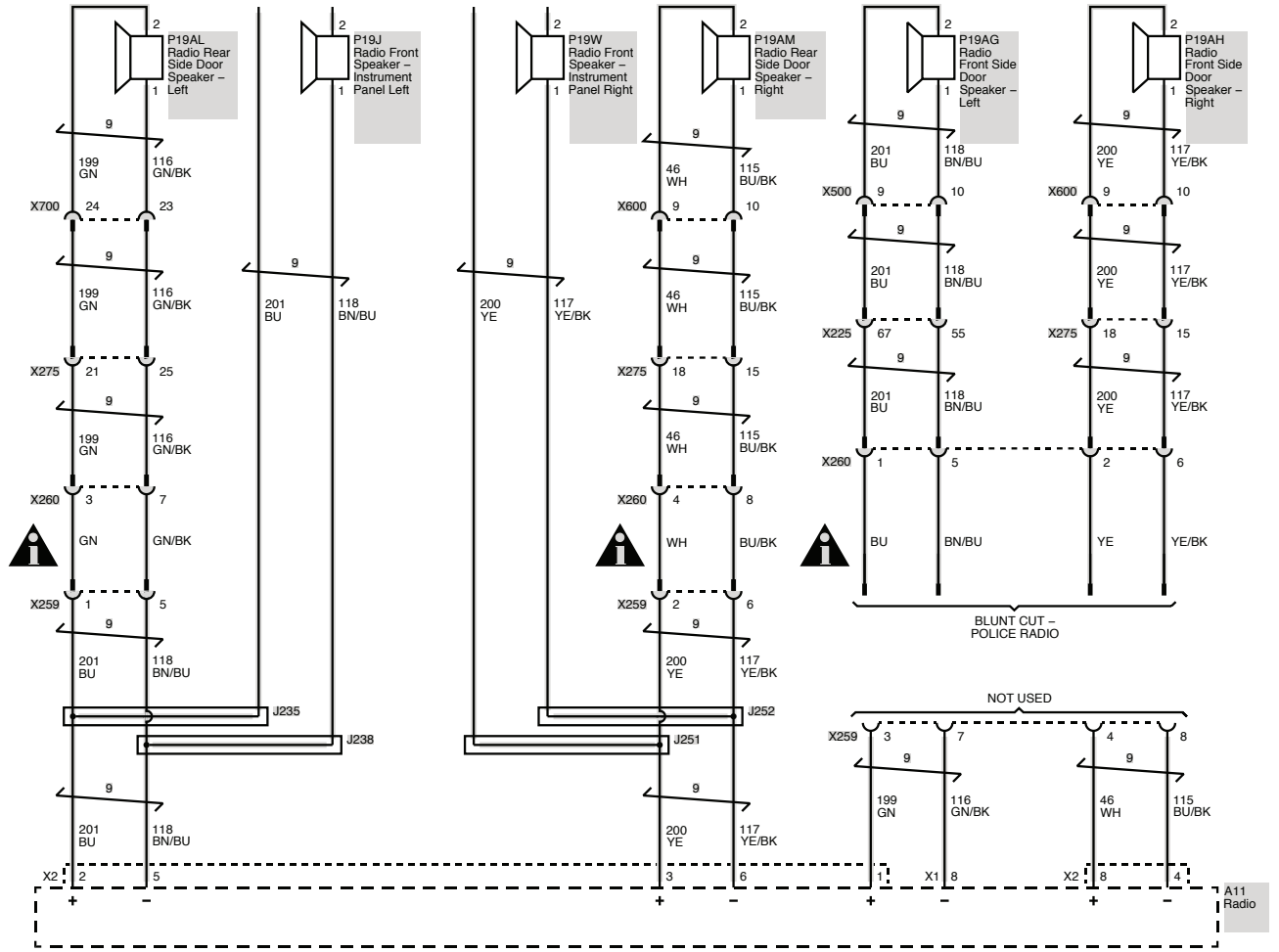

OPTIONAL WIRING

6J4 - HORN AND SIREN CONTROL PROVISION

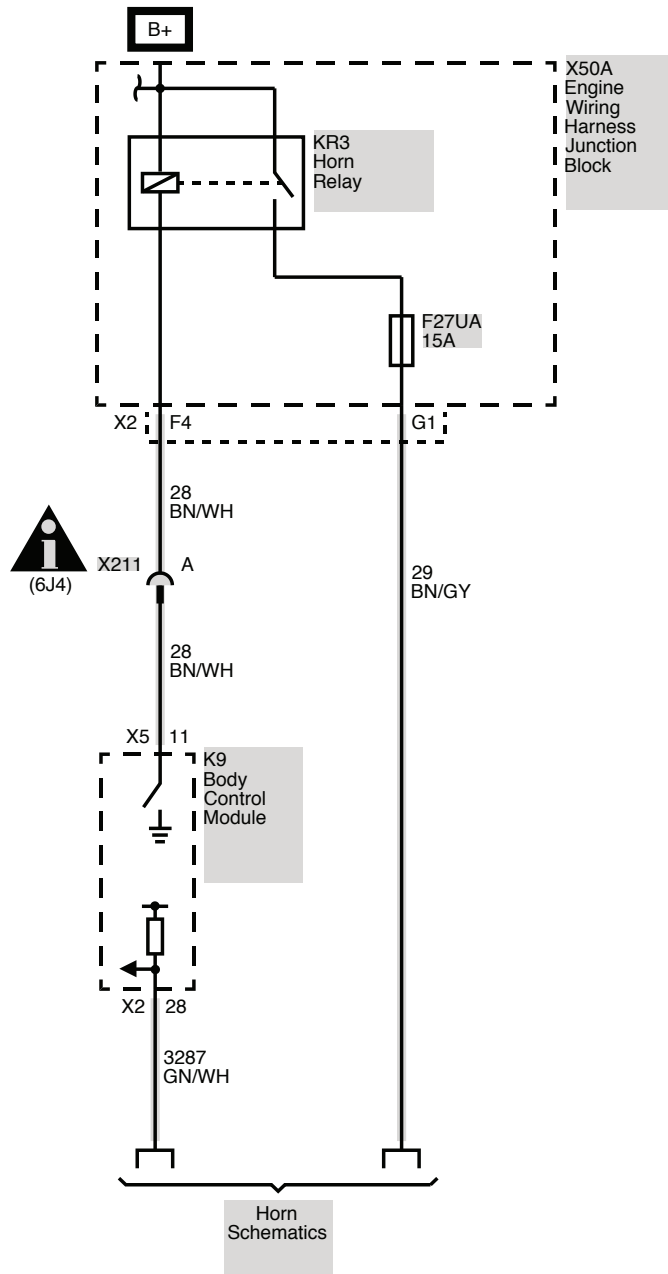

OPTIONAL WIRING

6J7 - HEADLAMPS AND REAR LAMPS FLASHING SYSTEM PROVISIONS

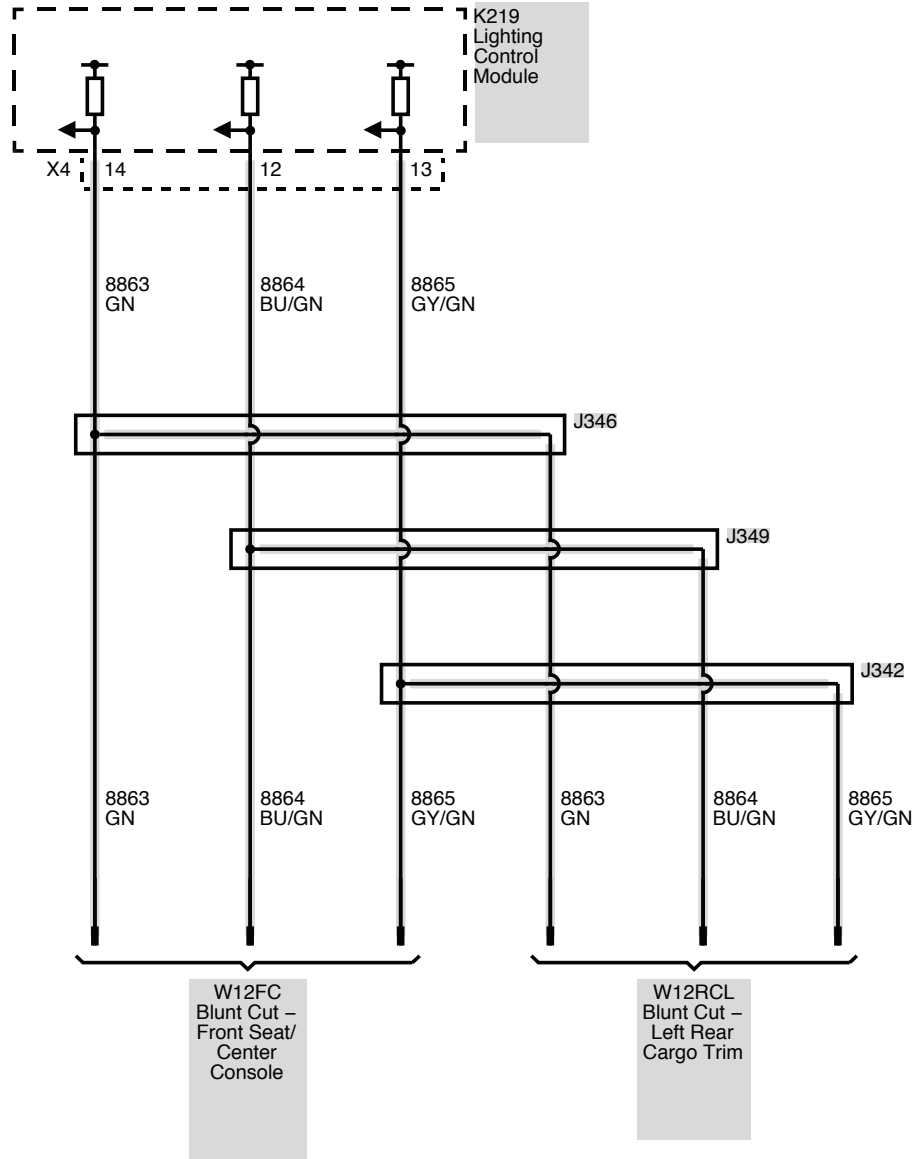

OPTIONAL WIRING

T53 - LIFTGATE WARNING LAMPS

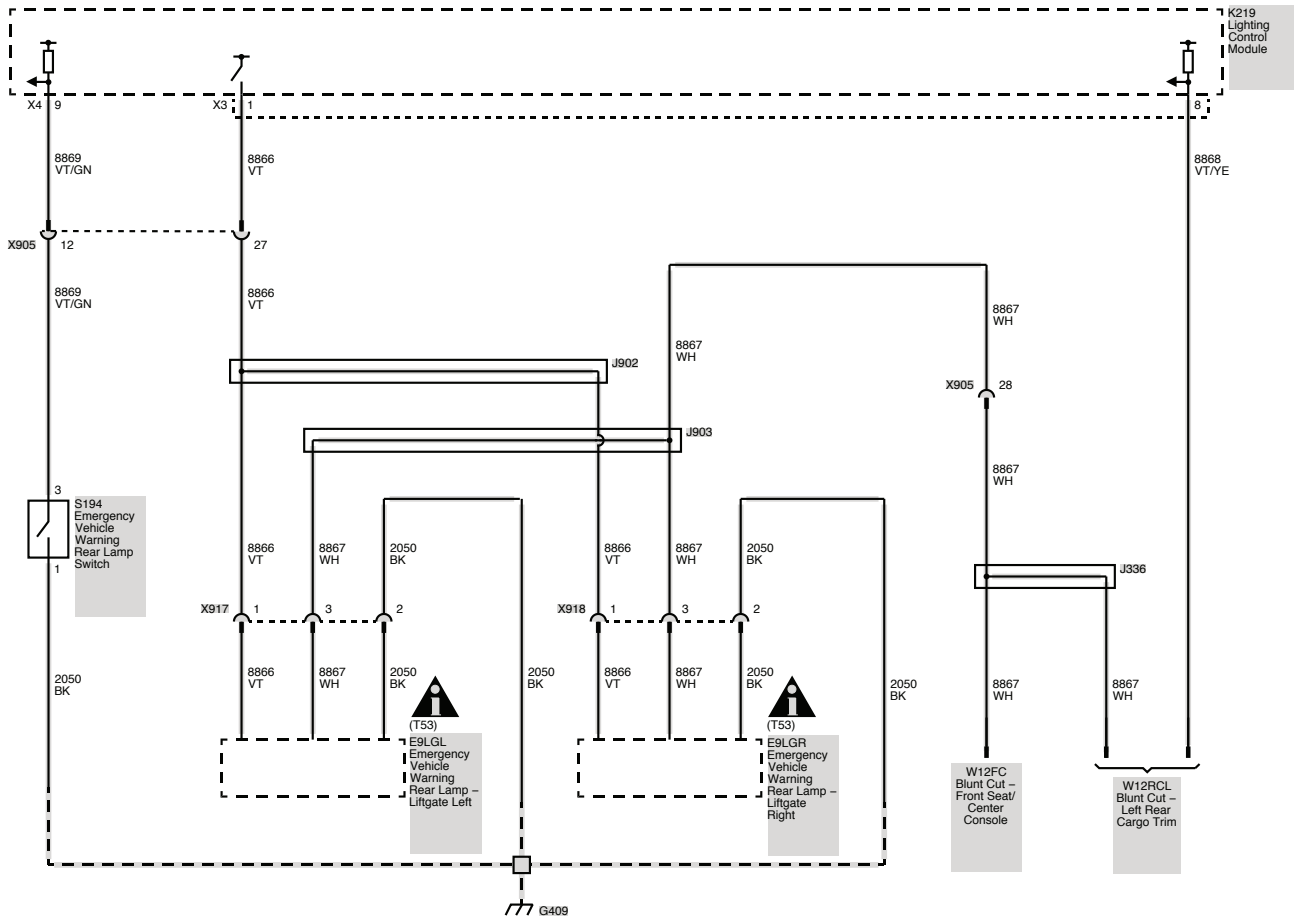

OPTIONAL WIRING

7X2-7X3 LED SPOT LAMPS

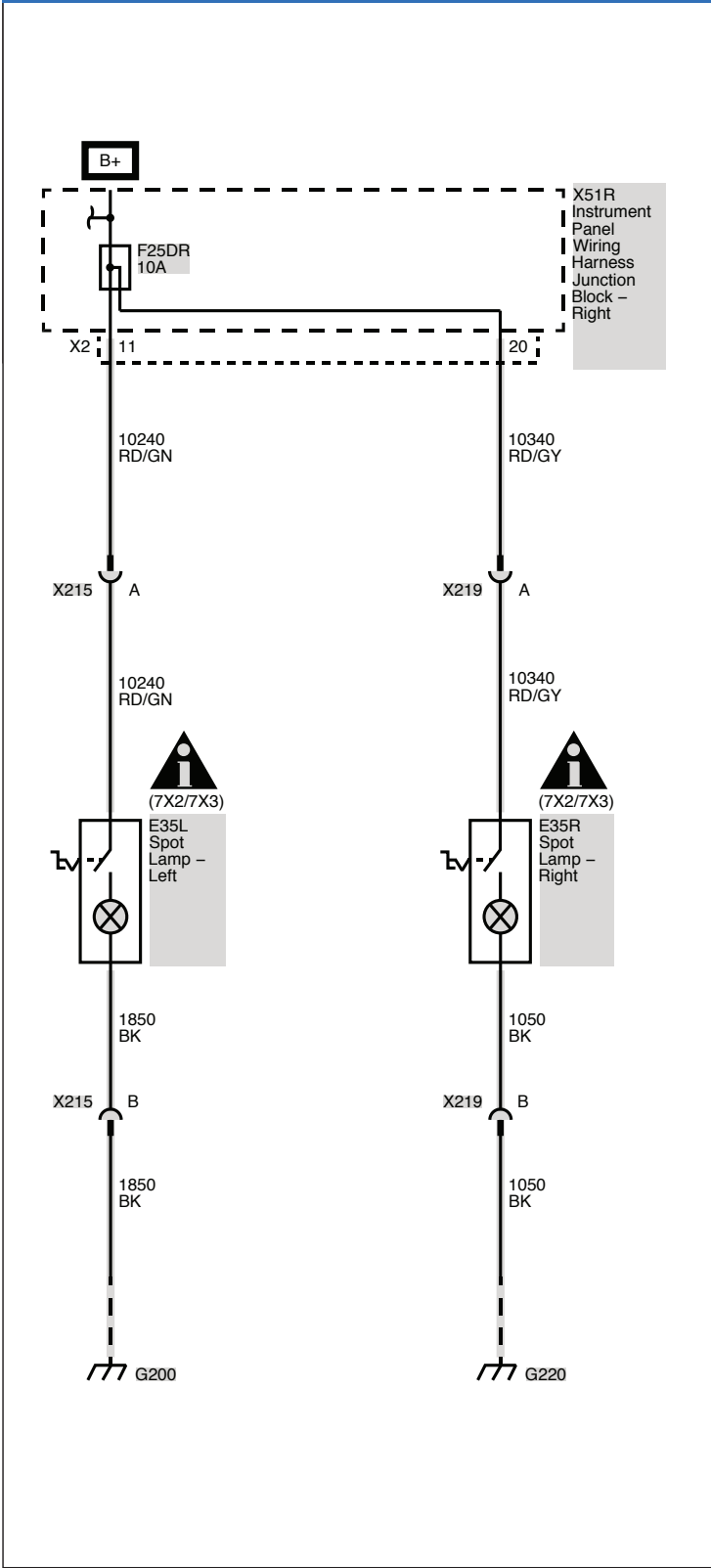

6C7 - AUXILIARY DOME LAMP

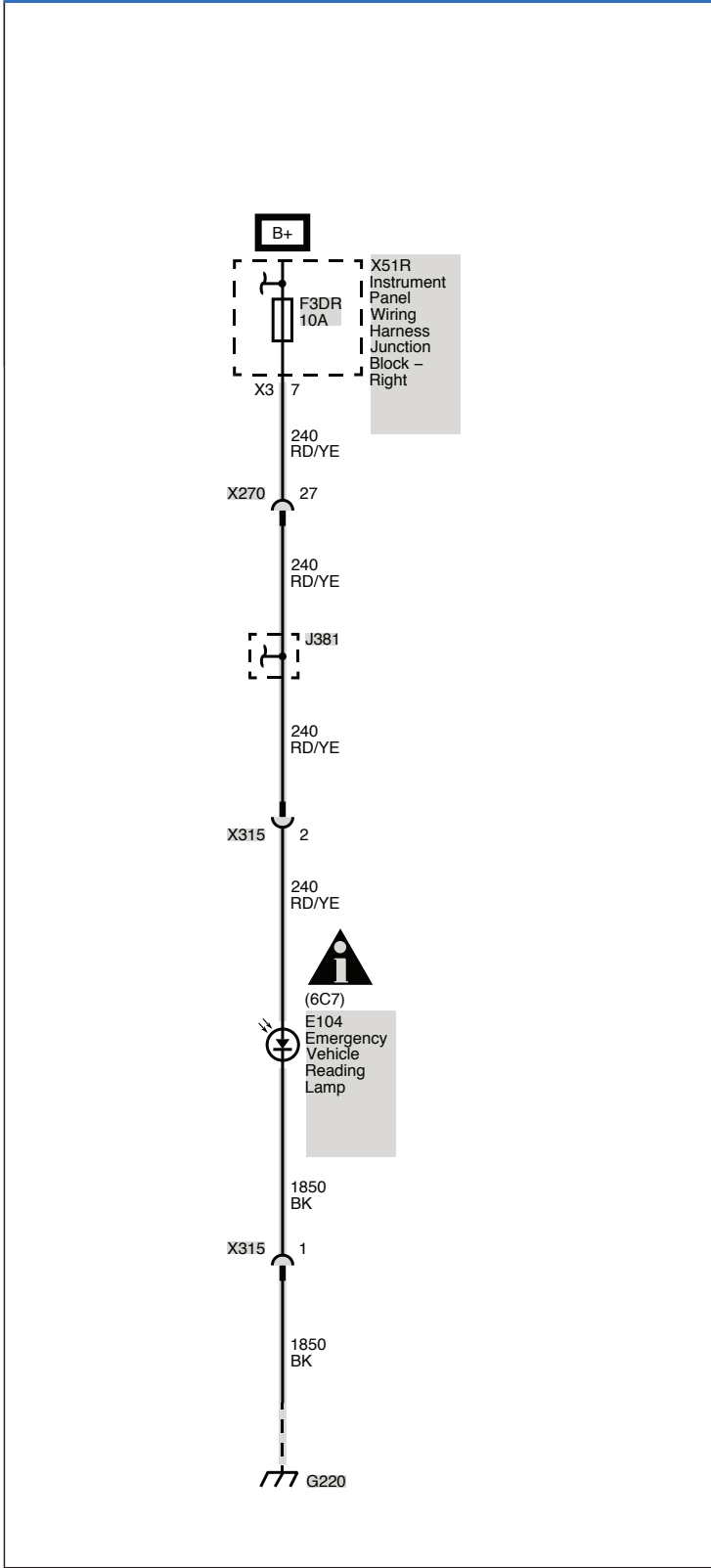

STABILITRAK

Stabilitrak systems help drivers maintain control of their vehicles, especially during emergency lane changes or avoidance maneuvers. Stabilitrak uses various sensors, such as steering wheel angle, wheel speed, yaw velocity, etc., to detect any difference between the path requested by the steering wheel position and vehicle's actual path. When appropriate, the system selectively controls brakes, engine power, and even suspension settings to enhance control of the vehicle's direction and help keep it on course. See your owner's manual for additional information about the operation of Stabilitrak.

Q. How do I use Stabilitrak?

A. Stabilitrak operates independently of the driver. You should continue to drive your Stabilitrak equipped vehicle with caution and care. GM's Stabilitrak system, Stabilitrak is designed to be as seamless as possible in operation, and part of the overall vehicle response.

Q. How does Stabilitrak work?

A. Stabilitrak has the ability to apply control forces to the vehicle independent of the driver. Stabilitrak uses sensors to continuously compare the path indicated by the steering wheel position to the vehicle's actual path. If a discrepancy is detected, Stabilitrak selectively controls vehicle brakes and engine torque to create a yaw moment that helps restore the vehicle's actual path to the path indicated by the steering wheel position. Stabilitrak has the ability to help correct both understeer (where the vehicle is not turning as much as the steering wheel position indicates) and oversteer (where the vehicle is turning more than the steering wheel position indicates).

Q. Will a tire change affect Stabilitrak?

A. Use of tires other than original equipment may affect Stabilitrak performance. Stabilitrak is designed to make the best use of available traction. The performance characteristics of the original equipment tires are part of the overall system effectiveness. When you replace tires check the recommendations in your owner's manual. On GM vehicles, the original equipment tires have a "TPC" (Tire Performance Criteria) code on the sidewall. Replacing the tires with the same "TPC" code will help assure proper Stabilitrak performance.

TRACTION CONTROL

An advanced computer controlled stability

Enhancement system assists the driver with directional control of the vehicle in difficult driving conditions. Each time the vehicle is started, the Stabilitrak system is fully on. Stabilitrak can be controlled by a Traction Control Button. The condition system is displayed by a Stabilitrak indicator light and Driver Information Center (DIC) Message. Push once to disable Traction Control. Push and hold to disable both Traction Control and Stabilitrak. In this condition, Stabilitrak will automatically turn ON when the vehicle speed exceeds 35 mph (56km/hr) while the Traction Control remains OFF. Push again to enable Traction Control and Stabilitrak.

VEHICLE LOAD LIMITS

This information is intended for those who intend to install additional equipment on the police vehicle after it has left the factory, and for those who will be driving and loading the vehicle with passengers and/or cargo. Two labels on your vehicle show how much weight it was designed to carry, the Tire and Loading Information label and the Certification/Tire label. These labels are attached to your vehicle and give you the maximum load capacity, the Gross Vehicle Weight Rating (GVWR) and the Gross Axle Weight Rating (GAWR) for your vehicle. See "Vehicle Load Limits" in the owner manual Index for additional loading information.

The following guidelines can help you with proper loading and load distribution when installing additional equipment on the Tahoe Police Package.

WARNING

DO NOT LOAD THE VEHICLE ANY HEAVIER THAN THE GROSS VEHICLE WEIGHT RATING (GVWR), NOR EITHER THE MAXIMUM FRONT OR REAR GROSS AXLE WEIGHT RATING (GAWR). THIS CAN CAUSE SYSTEMS TO BREAK AND CHANGE THE WAY THE VEHICLE HANDLES. THIS COULD CAUSE LOSS OF CONTROL AND A CRASH. OVERLOADING CAN ALSO SHORTEN THE LIFE OF THE VEHICLE.

ADDING EQUIPMENT TO YOUR VEHICLE

Before adding accessories or equipment to your police vehicle, there are some things you need to know

- The police vehicle's maximum capacity weight (payload). The weight of your police vehicle, including a full tank of fuel but without a driver and passengers.
- The weight of items you plan on adding to your police vehicle, like roof mounted light bar(s), push bumpers, security barrier(s), rear storage organizer, highway flares, fire extinguishers, weapons, ammunition, radios, and video equipment.
- The weight and number of passengers you intend to carry in your vehicle.
- The total weight of any additional cargo you intend to carry in your vehicle.

When planning your vehicle equipment installation remember not to exceed the Gross Vehicle Weight Rating (GVWR) or the Gross Axle Weight Rating (GAWR) of the front or rear axles. To keep the available load weight less than the vehicle capacity weight, you may need to limit the number of passengers you carry in your vehicle or change your choice of additional equipment. Towing a trailer may change the vehicle payload capacity.

CENTER OF GRAVITY (CG)

A vehicle's center of gravity is an imaginary location inside the vehicle and is a balance point for the vehicle mass as it moves down the road. The police vehicle's center of gravity, before you add a load and passengers, is approximately midway between the center of the axles, up from the ground to just below the front window, and between the driver and passenger. Equipment location and weight on the vehicle's center of gravity is important to keep in mind when planning an installation. Heavy equipment should be positioned as low and as far forward in the rear load compartment as possible. Try to mount the equipment below the bottom of the side windows. Refer to the Loading Zone chart and diagram to help with your installation plan.

A procedure to make the necessary measurements and formulas to calculate the vehicle longitudinal, lateral and vertical position of the center of gravity can be found in the GM Coachbuilders Manual.

Equipment required to conduct the measurements for calculating the center of gravity are:

- Weight scales of sufficient capacity to measure the vehicle weight at each wheel.
- A post type hoist or other means to safely elevate the front of the vehicle to at least an angle of 20 degrees above horizontal.

See your GM dealer to get more information about this coachbuilder procedure.

Keeping the center of gravity midway between the axles is also important to provide proper braking performance. About half the total vehicle weight on each axle is recommended.

Weigh your vehicle after the additional equipment has been installed to determine the actual weight of your vehicle. Weigh the vehicle with a full tank of fuel and without passengers. You may need to put a limit on how many people or other equipment you can carry inside your vehicle after the additional equipment has been installed.

Note: See loading zone weight chart and diagram

LOADING ZONES

**LOADING ZONES FOR CUSTOMER INSTALLED EQUIPMENT AND CARGO WITH SIX OCCUPANTS
REFER TO YOUR VEHICLE TIRE PLACARD FOR VEHICLE SEATING CAPACITY AND PAYLOAD CAPACITY
(OCCUPANTS + CARGO)**

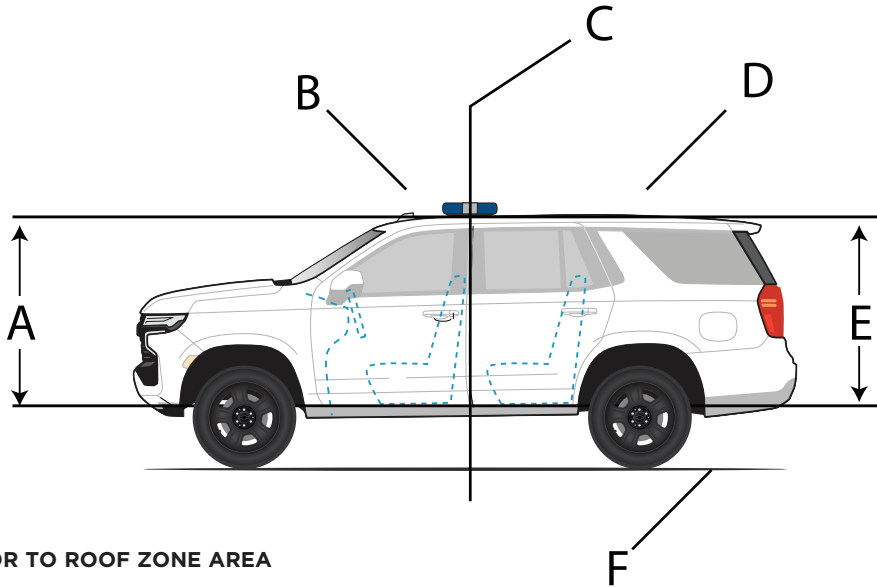

- A. FRONT FLOOR TO ROOF ZONE AREA
- B. FRONT ROOF ZONE AREA
- C. BACK OF FRONT DOOR
- D. REAR ROOF ZONE AREA
- E. REAR FLOOR TO ROOF ZONE AREA
- F. GROUND

LOADING ZONE WEIGHT CHART TAHOE POLICE PACKAGE 2WD 9C1

LOADING ZONES	FRONT AXLE WEIGHT	REAR AXLE WEIGHT	TOTAL
ROOF	34 LBS (15 KG)	47 LBS (21 KG)	81 LBS (36 KG)
FLOOR TO ROOF	125 LBS (57 KG)	494 LBS (224 KG)	619 LBS (281 KG)
TOTAL	159 LBS (72 KG)	541 LBS (245 KG)	700 LBS (317 KG)

LOADING ZONE WEIGHT CHART TAHOE POLICE PACKAGE 4WD 9C1

LOADING ZONES	FRONT AXLE WEIGHT	REAR AXLE WEIGHT	TOTAL
ROOF	34 LBS (15 KG)	47 LBS (21 KG)	81 LBS (36 KG)
FLOOR TO ROOF	125 LBS (57 KG)	494 LBS (224 KG)	619 LBS (281 KG)
TOTAL	159 LBS (72 KG)	541 LBS (245 KG)	700 LBS (317 KG)

NOTE:

CARGO WEIGHT CAN BE GREATER WITH FEWER OCCUPANTS. TOWING A TRAILER MAY CHANGE VEHICLE PAYLOAD REFER TO YOUR OWNER'S MANUAL SUPPLEMENT FOR DETERMINING MAXIMUM CARGO LOADING AND POSITIONING. USING HEAVIER SUSPENSION COMPONENTS TO GET ADDED DURABILITY MIGHT NOT CHANGE YOUR WEIGHT RATINGS AND MAY AFFECT THE VEHICLE PERFORMANCE AND HANDLING CHARACTERISTICS.

HIGH SPEED OPERATIONS SHOULD NOT BE ATTEMPTED WITH AN IMPROPERLY OR OVERLOADED VEHICLE OR WHILE TOWING A TRAILER.

YOUR GM DEALER CAN PROVIDE HELP WITH PROPERLY LOADING YOUR VEHICLE.

AIRBAGS

2021 TAHOE HEAD-CURTAIN AND FRONT SEAT SIDE IMPACT AIRBAGS

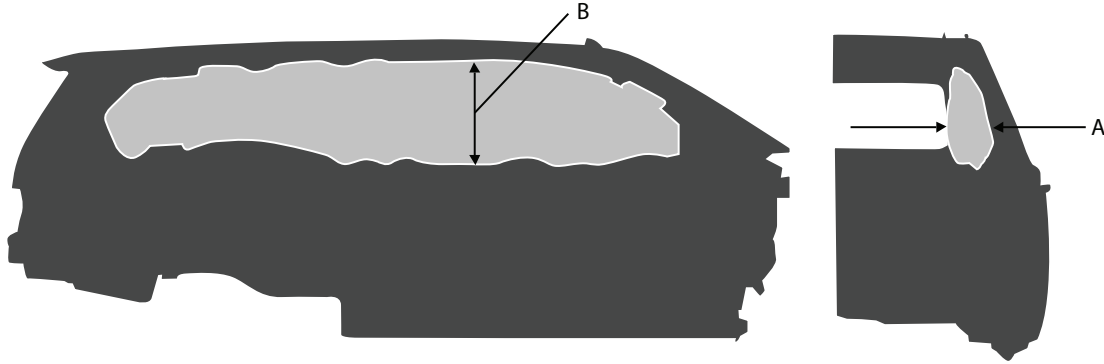

SIDE VIEW

FRONT VIEW

HEAD CURTAIN AIRBAG

DRIVER SIDE SHOWN - PASSENGER SIDE SIMILAR

- A. AIRBAG WIDTH 10.6IN / 270MM
- B. AIRBAG HEIGHT 19.7 IN / 500MM

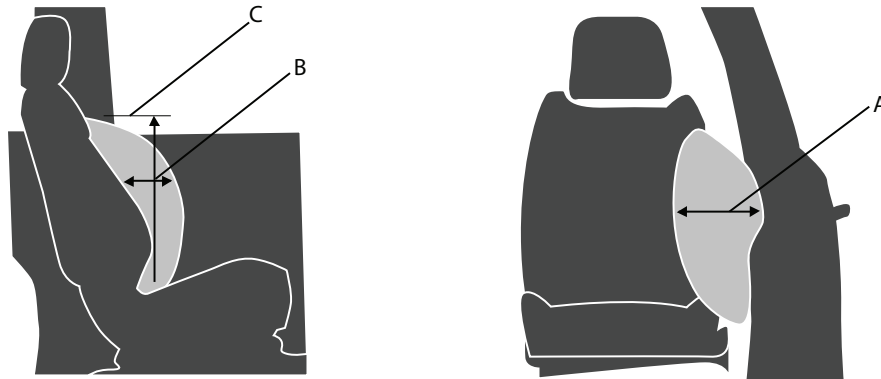

SIDE VIEW

FRONT VIEW

FRONT SEAT SIDE IMPACT AIRBAG

DRIVER SEAT SHOWN - FRONT OUTBOARD PASSENGER SIMILAR

- A. AIRBAG WIDTH 7.9IN / 201MM
- B. SEAT & AIRBAG FORWARD TRAVEL 6.6IN / 167MM
- C. AIRBAG HEIGHT 19.7IN / 500MM

Sitting too close to an airbag when it deploys can increase the risk of serious injury or death. Always properly wear your seat belt. See Owner's Manual for more information.

AIRBAGS

2021 TAHOE FRONTAL AIRBAGS

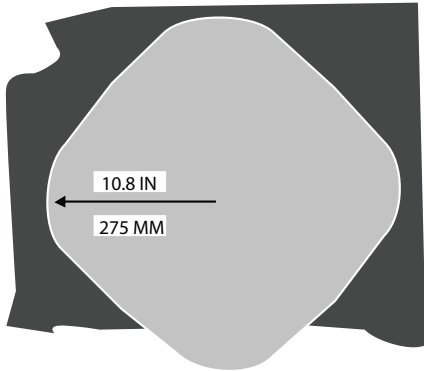

**STEERING WHEEL
DRIVER AIRBAG**

VIEW FROM DRIVER SEAT

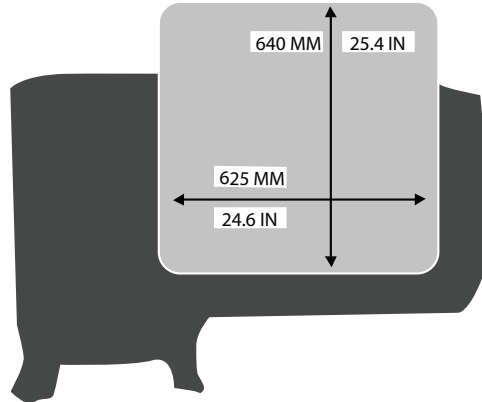

**FRONT OUTBOARD
PASSENGER AIRBAG**

VIEW FROM PASSENGER SEAT

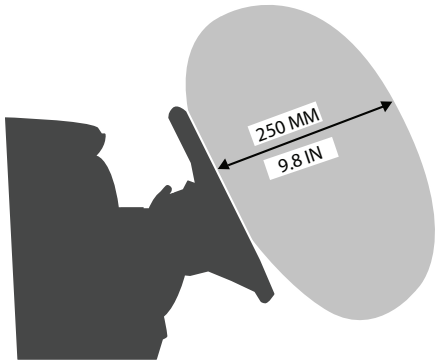

STEERING DRIVER AIRBAG

VIEW FROM DRIVER SIDE

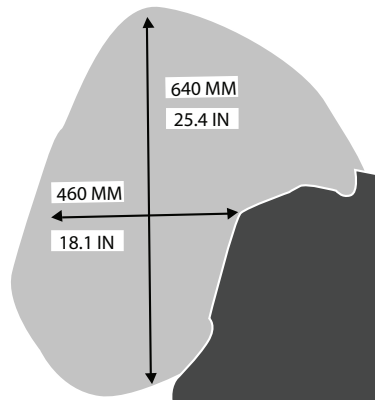

**FRONT OUTBOARD
PASSENGER AIRBAG**

VIEW FROM PASSENGER SIDE

Sitting too close to an airbag when it deploys can increase the risk of serious injury or death. Always properly wear your seat belt. See Owner's Manual for more information.

AIRBAGS FAQ

Q: Can equipment such as radar devices, video cameras, and radio trees be mounted in a specialty vehicle equipped with a right front passenger frontal airbag?

A: Yes, but care must be taken to properly mount the equipment outside of the airbag "deployment zone."

Q: What is the airbag "deployment zone"?

A: The term "deployment zone" describes the space an airbag takes up when fully inflated. Airbags need room to work properly, and anything in the "deployment zone" – such as improperly mounted equipment – can greatly affect the performance of the airbag.

Q: How can I identify the airbag "deployment zone" in my vehicle?

A: See Airbag Deployment Diagrams for more information. The diagrams provide the approximate dimensions of the "deployment zones" for your specialty vehicle. Before doing any service work, including the installation of any equipment, consult the appropriate service manual.

Q: Is it possible to shield equipment so it does not interfere with airbag deployment?

A: While shielding may protect certain equipment from being damaged or dislodged, it may also negatively affect how an airbag inflates. Therefore, we do not recommend the placement of any equipment in the deployment zone, even if shielded.

Q: Can the installation of push bumpers on the front end of the vehicle affect the deployment of the airbag?

A: It is not likely that installing push bumpers will affect deployment for the airbag as long as the vehicle structure itself is not modified. GM is not aware of any adverse defects effect on the deployment of the front airbags due to use of many aftermarket push bumpers installed on current GM police vehicles

See "Adding Equipment to the Airbag-Equipped Vehicle" in the owner manual for more information.

Customer-Installed Equipment

Before installing equipment, read the following.

Airbags inflate with great force, faster than the blink of an eye. No objects, such as shotguns, should be placed over or near the airbag covers. Equipment mounted too close to an inflating airbag could prevent the airbag from operating properly to protect the occupants or could be forced into an occupant or break and become a dangerous projectile, causing severe injury or even death. To help prevent injury and to allow the airbag to perform as it was designed, do not mount equipment inside the airbag deployment zones.

Do not attach anything to the steering wheel hub or mount any equipment within the deployment zone for the driver airbag.

Do not mount equipment on the passenger side of the instrument panel top pad deployment zone. Equipment should not be mounted on or around the passenger airbag opening because of a deploying airbag. To allow the airbag to perform as it was designed, do not mount equipment inside the airbag deployment zone.

Do not mount a security barrier such that the ends of the barrier or brackets are within the roof-rail airbag deployment zones.

Avoid installing wiring for roof-rail emergency lighting or radio antennas that may restrict the proper deployment of the roof-rail airbags.

GM approved service procedures must be followed to remove and reinstall the instrument panel to the pad to ensure proper airbag deployment.

The police vehicle has a rollover sensor mounted on the centerline of the vehicle between the driver and front outboard passenger positions. If the vehicle has individual front seats, the rollover sensor will be exposed. Do not mount equipment within 25 mm (1 in) of the rollover sensor. This may affect the performance of multiple restraint systems.

MAINTENANCE / LIMITED WARRANTY

INCLUDED MAINTENANCE	One visit within first year of vehicle delivery ¹
BUMPER-TO-BUMPER LIMITED WARRANTY	3 years/36,000 miles ² . Bumper-to-Bumper Limited Warranty with no deductible
TRANSFERABLE POWERTRAIN LIMITED WARRANTY	Qualified Fleet Customers: 5 years/100,000 miles ³
TIRES⁴	3 years/36,000 miles ² ; coverage prorated after first 12,000 miles
ROADSIDE ASSISTANCE AND COURTESY TRANSPORTATION	Qualified Fleet Customers: 5 years/100,000 miles ³
RUST-THROUGH	6 years/100,000 miles ²
CORROSION	3 years/36,000 miles ²
WHEEL ALIGNMENT AND BALANCE	Up to 7,500 miles ⁶

1. Includes first required maintenance visit as stated in vehicle maintenance schedule. Maintenance visit consists of oil change, tire rotation and Multi-Point Vehicle Inspection. Does not include air filters. See participating dealer for other restrictions and complete details. Excludes vehicles ordered with fleet delete option RY9. **2.** Whichever comes first. See dealer for limited warranty details. **3.** Whichever comes first. A Qualified Fleet User is defined as a company that has purchased and registered or leased five (5) or more new cars/or trucks solely for use in its operation during the current or preceding calendar year, model year, preceding twelve (12) month period, or that owns or leases fifteen (15) or more cars and trucks. Excludes rental customers. See dealer for details. **4.** Tires also covered under the Bumper-to-Bumper Warranty but are prorated based upon mileage. See dealer for warranty details. **5.** If the vehicle has a warrantable failure, see your Owner's Manual for full details on the Courtesy Transportation program. **6.** Customer maintenance item after 7,500 miles.



GM reserves the right to make changes at any time, without notice, in prices, colors, materials, equipment, specifications, models, and availability. Specifications, dimensions, measurements, ratings, and other numbers in this catalog and other printed materials provided at the dealership or affixed to vehicles are approximates based upon design and engineering drawings and prototypes and laboratory tests. Your vehicle may differ due to variations in manufacture and equipment. Since some information may have been updated since the time of printing, please check with your GM dealer for complete details. Some of the equipment shown or described throughout this publication may be available at extra cost, and/or is supplied by an independent supplier.

Copyright 2020 General Motors. All rights reserved. All text, images, graphics, and other materials in this publication are subject to the copyright and other intellectual property rights of General Motors. These materials may not be reproduced, distributed, or modified without the express written permission of General Motors. The marks appearing in this publication including, but not limited to: GM and the GM logo; Chevrolet and their respective logos, emblems, slogans, and vehicle model names and body designs; and other marks such as GM Fleet and Commercial are trademarks and/or service marks of General Motors, its subsidiaries, affiliates, or licensors.

For more detailed information, contact your District Sales Manager or see the online order guide at gmfleet.com/police.

GENERAL MOTORS FLEET

