

HANDBOOK



PEUGEOT RCZ



On-line handbook

Select one of the following means of access to view your handbook on-line...

Find your handbook on the PEUGEOT website, under "MyPEUGEOT".

This personal space offers advice and other useful information for the care and maintenance of your vehicle.

Scan this code for direct access to your handbook.



If the "MyPEUGEOT" function is not available on the PEUGEOT public website for your country, you can find your handbook at the following address:

<http://public.servicebox.peugeot.com/ddb/>

Select:

- > the language,
- > the vehicle, its body style,
- > the print edition of your handbook appropriate for the date of registration of your vehicle.

Referring to the handbook on-line also gives you access to the latest information available, easily identified by the bookmark, associated with this symbol:



Welcome

Thank you for choosing an RCZ, a symbol of confidence, passion and inspiration

This handbook has been designed to help to make the most of your RCZ in all circumstances and in complete safety.

Take the time to read through it so as to familiarise yourself with your vehicle.

This handbook covers all of the variations in equipment available across the whole RCZ range.

Your vehicle will be fitted with only some of the equipment described in this document, depending on version and the specification for the country in which it was sold.

The descriptions and illustrations are given as indications only.

Automobiles PEUGEOT reserves the right to modify the technical characteristics, equipment and accessories without having to update this edition of the handbook.

This document forms an integral part of your vehicle. Remember to pass it on to the new owner in the event of the sale of the vehicle.

Key

Warning

This symbol marks warnings which it is essential to observe for your own safety, for the safety of others or to avoid any risk of damaging your vehicle.

Protection of the environment

This symbol accompanies advice relating to protection of the environment.

For any work on your vehicle, use a qualified workshop that has the technical information, competence and equipment required, which a PEUGEOT dealer is able to provide.



We draw your attention to the following points:

- The fitting of electrical equipment or accessories not listed by PEUGEOT may cause faults and failures with the electrical system of your vehicle. Contact a PEUGEOT dealer for information on the range of recommended accessories.
- Any modification or adaptation not intended or authorised by Automobiles PEUGEOT or carried out without meeting the technical requirements defined by the manufacturer would lead to the suspension of the new vehicle warranty.



Information

This symbol draws your attention to additional information for better use of your vehicle.

CONTENTS

OVERVIEW				4-9	
ECO-dRIVING				10-11	
1/MONITORING				12-36	
Instrument panels	12	Instrument panel buttons	25	Monochrome screen C (PEUGEOT Connect Sound (RD5))	30
Warning and indicator lamps	14	Clock	26	Retractable colour screen (PEUGEOT	
Indicators	21	Trip computer	27	Connect Navigation (RT6))	34
2/ACCESS				37-49	
Remote control key	37	Electric windows	44	Boot	49
Alarm	41	Doors	46		
3/EASE OF USE AND COMFORT				50-74	
Front seats	50	Ventilation	59	Interior mood lighting	65
Steering wheel adjustment	54	Dual-zone digital air conditioning	61	Interior fittings	67
Mirrors	55	Rear screen demist - defrost	63	Front armrest	70
Rear seats	58	Courtesy lamp	64	Boot fittings	73
4/VISIBILITY				75-86	
Lighting controls	75	Headlamp adjustment	81	Automatic rain sensitive wipers	85
LED lamps	78	Directional lighting	82		
Automatic illumination of headlamps	79	Wiper controls	83		
5/SAFETY				87-114	
Direction indicators	87	Braking assistance systems	89	Front seat belts	96
Hazard warning lamps	87	Trajectory control systems	90	Airbags	99
Emergency or assistance call	88	Active bonnet	92	Child seats	104
Horn	88	Active spoiler	93	Deactivating the passenger's front airbag	106

6/DRIVING 115-137

Driving recommendations	115	Manual gearbox	121	Speed limiter	129
Starting-switching off the engine	116	Automatic gearbox	122	Cruise control	132
Parking brake	119	Gear shift indicator	126	Parking sensors	135
Hill start assist	120	Tyre under-inflation detection	127		

7/CHECKS 138-149

Fuel tank	139	Diesel engine	143	Checks	148
Bonnet	141	Running out of fuel (Diesel)	144		
Petrol engines	142	Checking levels	145		

8/PRACTICAL INFORMATION 150-191

Temporary puncture repair kit	150	Energy economy mode	164	Towing a trailer	186
Changing a wheel	157	12 V battery	165	Cleaning and maintenance	188
Snow chains	162	Changing a bulb	169	Accessories	190
Changing a wiper blade	163	Changing a fuse	177		
		Towing a vehicle	184		

9/TECHNICAL DATA 192-200

Petrol engines	192	Diesel engine	195	Dimensions	197
Weights (petrol)	193	Weights (Diesel)	196	Identification markings	199

10/AUDIO EQUIPMENT AND TELEMATICS 201-278

Emergency or assistance	201	PEUGEOT Connect Navigation (RT6)	203	PEUGEOT Connect Sound (RD5)	259
-------------------------	-----	----------------------------------	-----	-----------------------------	-----

ALPHABETICAL INDEX

279-283

ExTERIOR

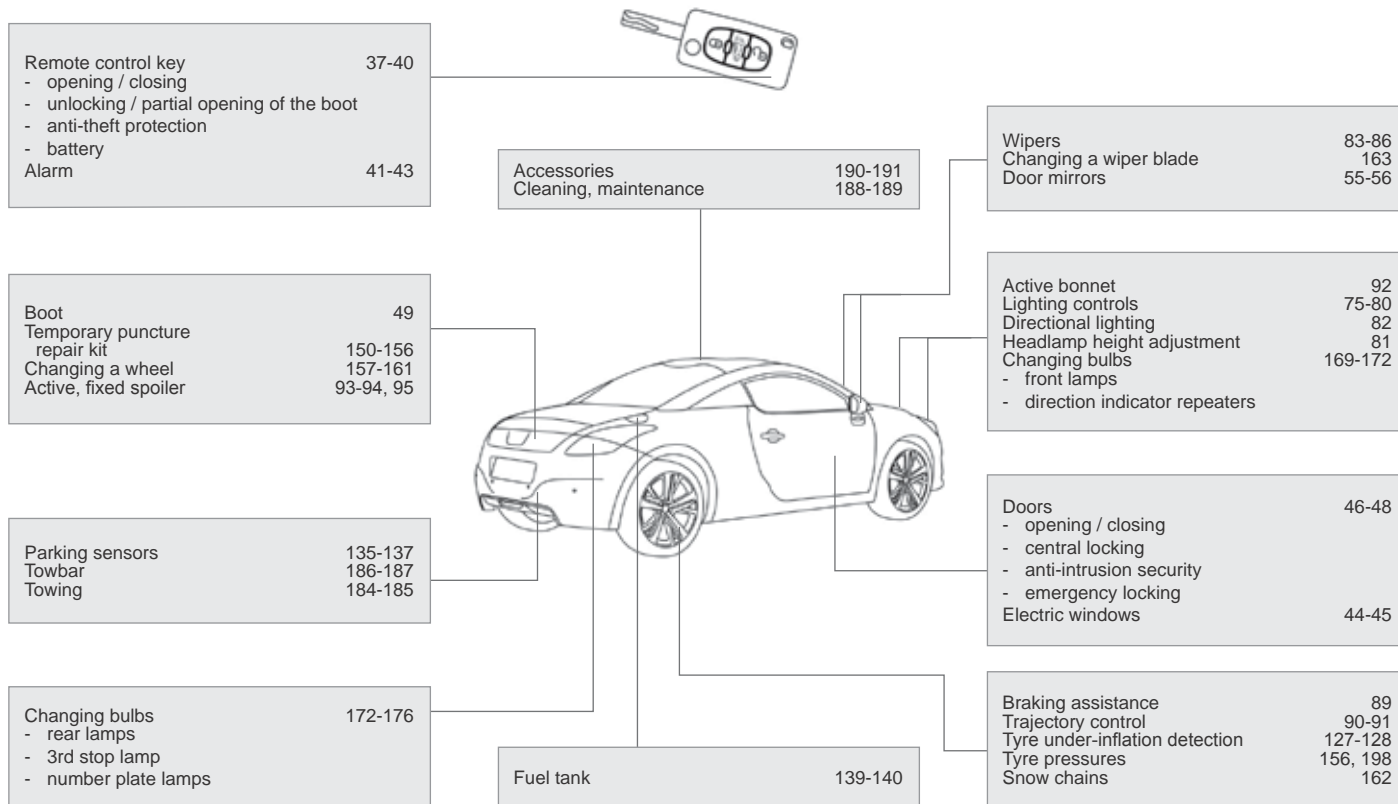

INTERIOR

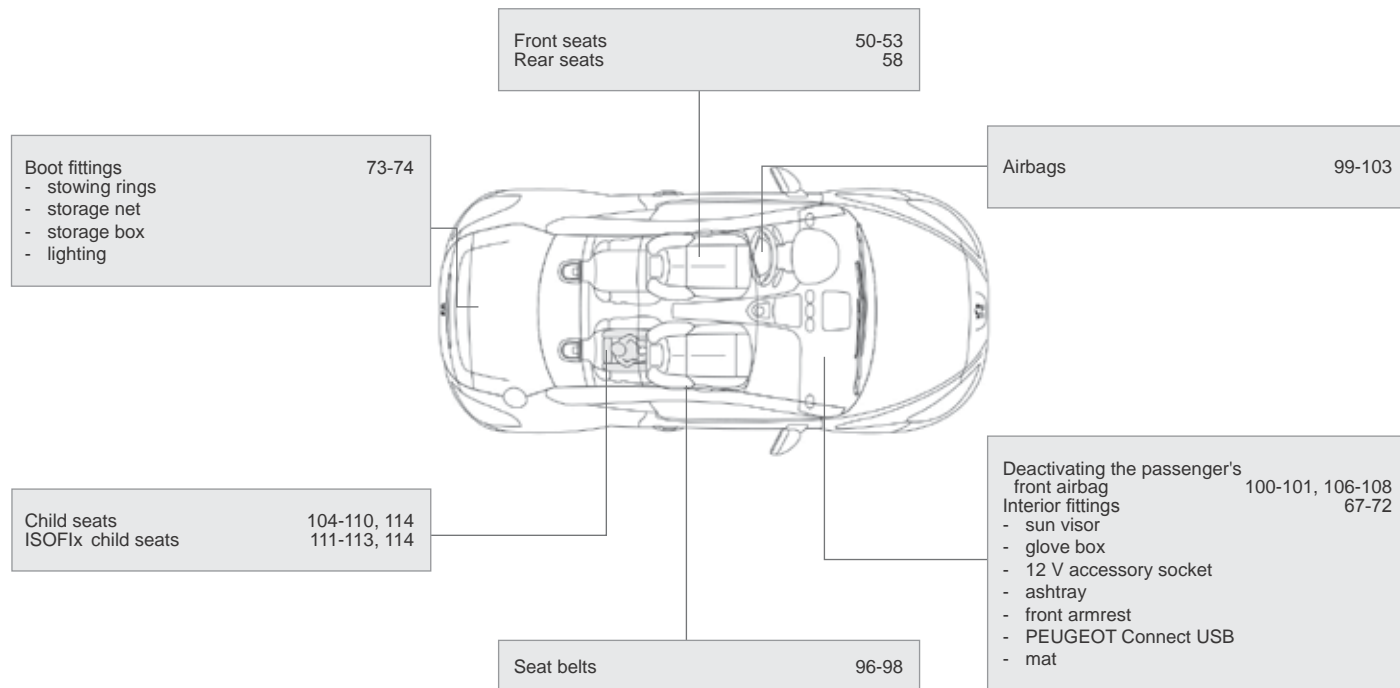

INSTRUMENTS AND CONTROLS

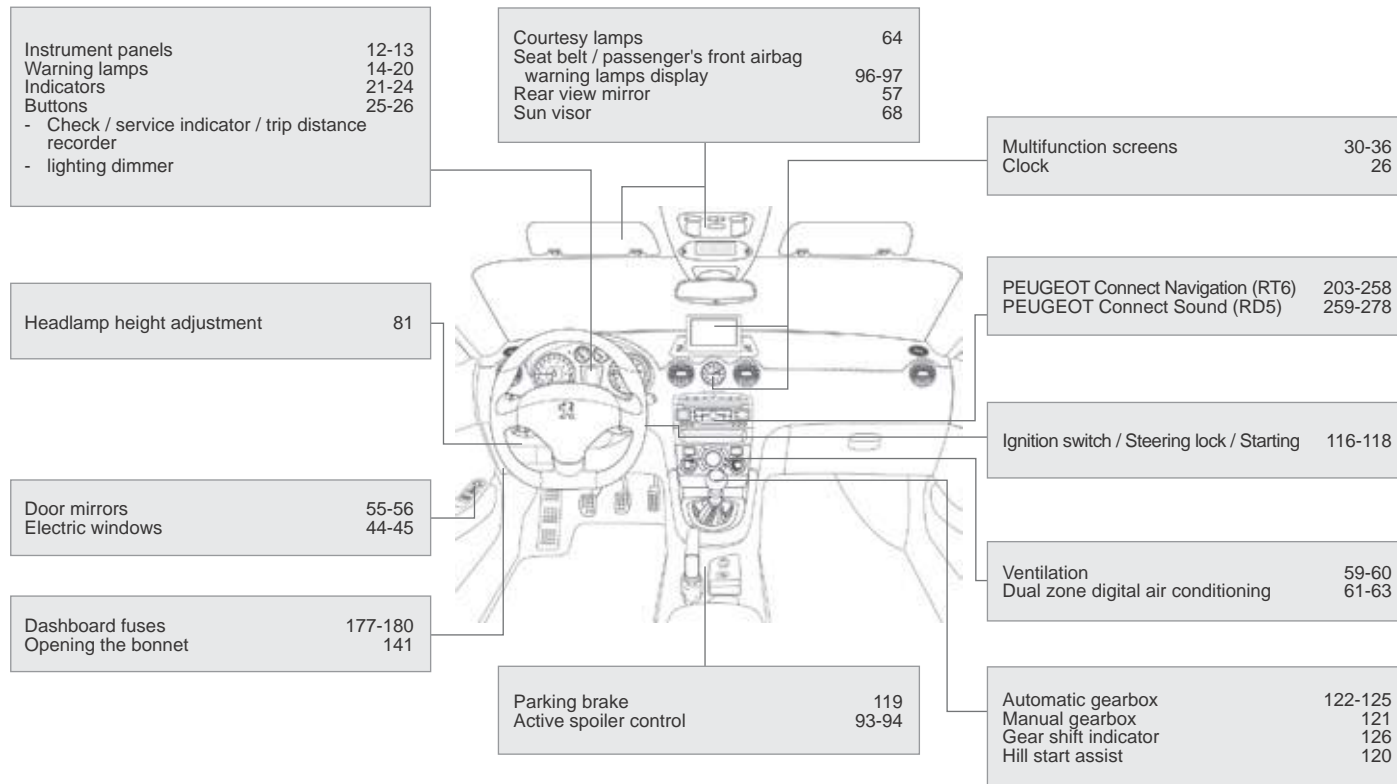

INSTRUMENTS AND CONTROLS

STEERING MOUNTED CONTROLS

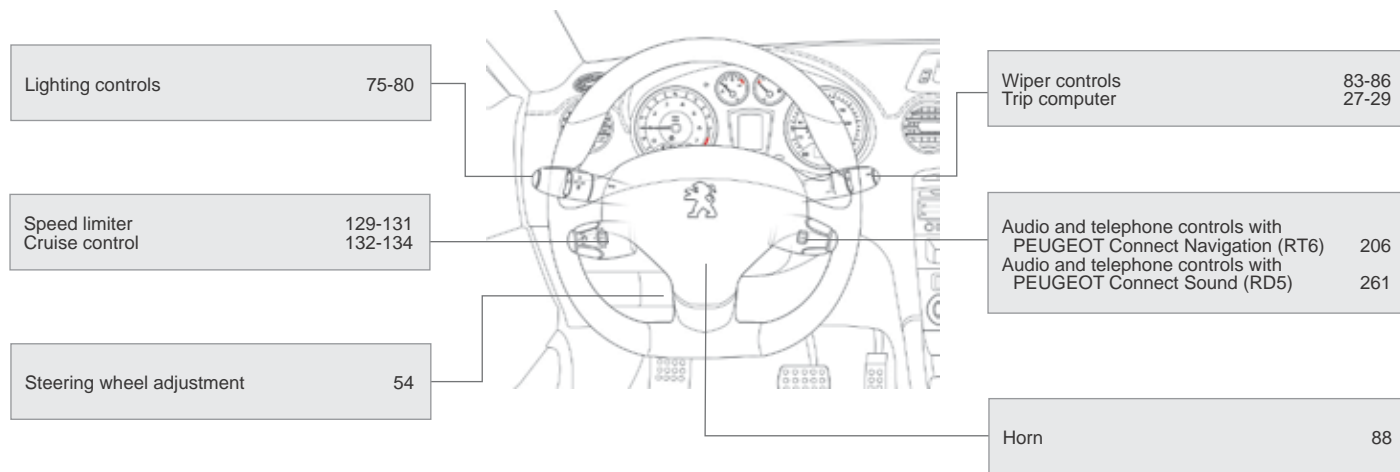

INSTRUMENTS AND CONTROLS

CENTRAL SWITCH PANEL

Emergency call 88, 201-202
Volumetric alarm monitoring 41-43
Central locking / Anti-intrusion security 47-48

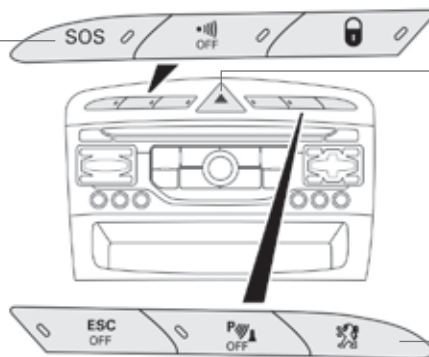

Hazard warning lamps 87

DSC/ASR system 90-91
Parking sensors 135-137
Assistance call 88, 201-202

TECHNICAL DATA - MAINTENANCE

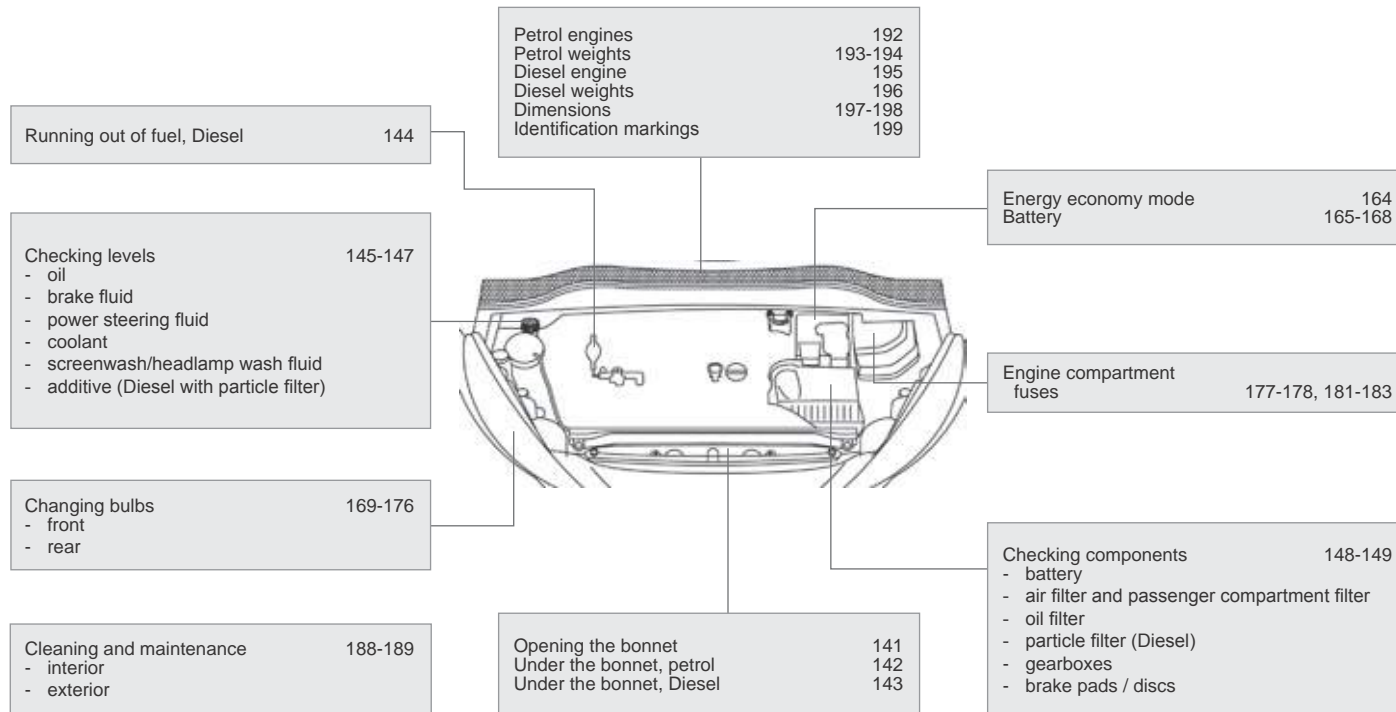

ECO-DRIVING

Eco-driving is a range of everyday practices that allow the motorist to optimise their fuel consumption and CO₂ emissions.

OPTIMISE THE USE OF YOUR GEARBOX

With a manual gearbox, move off gently and change up without waiting. During acceleration change up early.

With an automatic or electronic gearbox, give preference to automatic mode and avoid pressing the accelerator pedal heavily or suddenly.

The gear shift indicator invites you engage the most suitable gear: as soon as the indication is displayed in the instrument panel, follow it straight away.

For vehicles fitted with an electronic or automatic gearbox, this indicator appears only in manual mode.

dRIVE SMOOTHLY

Maintain a safe distance between vehicles, use engine braking rather than the brake pedal, and press the accelerator progressively. These practices contribute towards a reduction in fuel consumption and CO₂ emissions and also helps reduce the background traffic noise.

If your vehicle has cruise control, make use of the system at speeds above 25 mph (40 km/h) when the traffic is flowing well.

CONTROL THE USE OF YOUR ELECTRICAL EQUIPMENT

Before moving off, if the passenger compartment is too warm, ventilate it by opening the windows and air vents before using the air conditioning.

Above 30 mph (50 km/h), close the windows and leave the air vents open.

Remember to make use of equipment that can help keep the temperature in the passenger compartment down (sunroof and window blinds...).

Switch off the air conditioning, unless it has automatic regulation, as soon as the desired temperature is attained.

Switch off the demisting and defrosting controls, if not automatic.

Switch off the heated seat as soon as possible.

Switch off the headlamps and front foglamps when the level of light does not require their use.

Avoid running the engine before moving off, particularly in winter; your vehicle will warm up much faster while driving.

As a passenger, if you avoid connecting your multimedia devices (film, music, video game...), you will contribute towards limiting the consumption of electrical energy, and so of fuel.

Disconnect your portable devices before leaving the vehicle.

LIMIT THE CAUSES OF EXCESS CONSUMPTION

Spread loads throughout the vehicle; place the heaviest items in the bottom of the boot, as close as possible to the rear seats.

Limit the loads carried in the vehicle and reduce wind resistance (roof bars, roof rack, bicycle carrier, trailer...). Use a roof box in preference.

Remove roof bars and roof racks after use.

At the end of winter, remove snow tyres and refit your summer tyres.

OBSERVE THE RECOMMENDATIONS ON MAINTENANCE

Check the tyre pressures regularly, when cold, referring to the label in the door aperture, driver's side.

Carry out this check in particular:

- before a long journey,
- at each change of season,
- after a long period out of use.

Don't forget the spare wheel and the tyres on any trailer or caravan.

Have your vehicle serviced regularly (engine oil, oil filter, air filter, passenger compartment filter...) and observe the schedule of operations recommended in the warranty and maintenance record.

When refuelling, do not continue after the third cut-off of the nozzle to avoid any overflow.

At the wheel of your new vehicle, it is only after the first 1 800 miles (3 000 kilometres) that you will see the fuel consumption settle down to a consistent average.

INSTRUMENT PANELS: PETROL OR DIESEL, MANUAL OR AUTOMATIC GEARBOX

With small central display screen

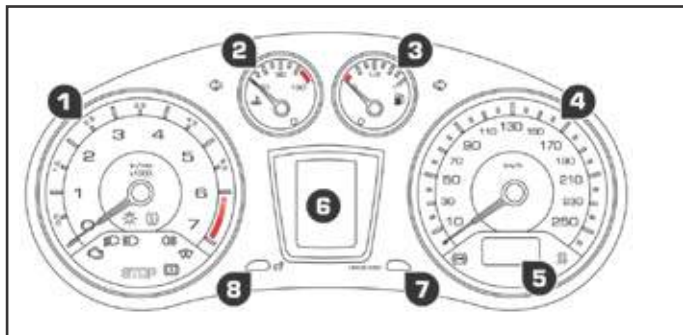

With large central display screen

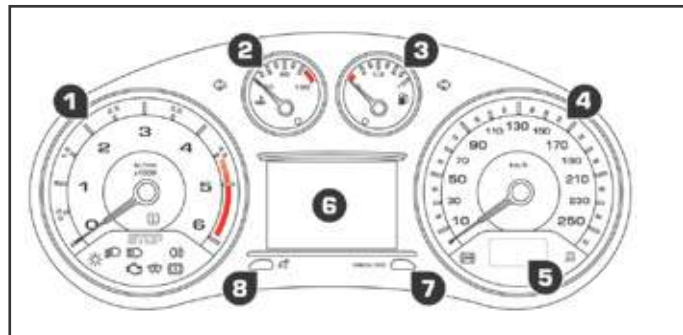

Panel grouping together the vehicle operation indication dials and warning lamps, with permanent back-lighting.

dIALS

- 1. Rev counter.**
Indicates the speed of rotation of the engine (x 1 000 rpm).
- 2. Coolant temperature gauge.**
Indicates the temperature of the engine coolant ($^{\circ}$ Celsius).
- 3. Fuel gauge.**
Indicates the quantity of fuel remaining in the tank.
- 4. Speedometer.**
Indicates the current speed of the moving vehicle (mph or km/h).
- 5. Small display screen.**
- 6. Central display screen.**
- 7. display management button.**
Starts a manual CHECK.
Recalls the service information.
Resets the selected function to zero (trip distance recorder or service indicator).
- 8. Lighting dimmer button.**
Adjusts the brightness of the lighting of the instruments and controls.



For more information, refer to the section relating to the button or function and its associated display.

DISPLAYS

Small display screen

- A. **Trip distance recorder.**
(miles or km)
- B. **distance recorder.**
(miles or km)
- C. **Service spanner**, if a service is due shortly or is overdue.

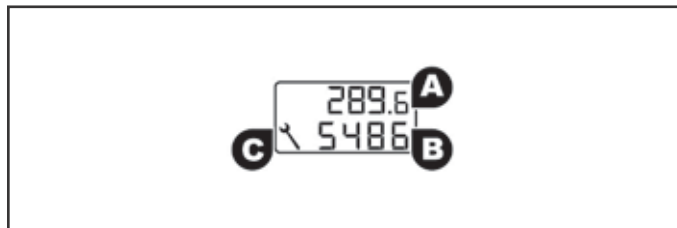

Central display screen

- d. **Speed limiter**
(mph or km/h) or
Cruise control.
- E. **Indication of:**
 - a gear change*,
 - or
 - the programme or gear (automatic gearbox).
- F. **Engine oil level indicator, service indicator.**
(miles or km)

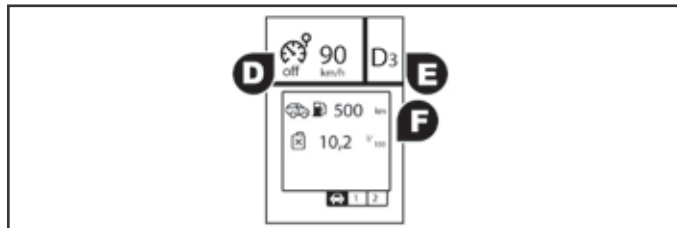

These two functions are displayed when the ignition is switched on, then disappear after a few seconds.

Warning and status indicator lamps / CHECK.

Trip computer.

Alert messages**.

Vehicle speed repeat**.

Navigation - Guidance**.

These functions are displayed according to the selection.

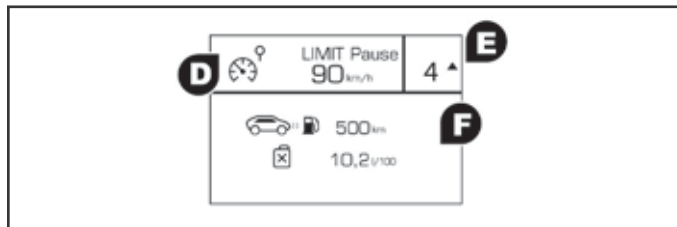

* According to engine.

** Only with the large central display screen.

WARNING AND INDICATOR LAMPS

Visual indicators which inform the driver of the occurrence of a fault (warning lamp) or of the operation of a system (operation or deactivation indicator lamp).

When the ignition is switched on

Certain warning lamps come on for a few seconds when the ignition is switched on.

When the engine is started, these warning lamps should go off.

If they remain on, before moving off, refer to the information for the warning lamp concerned.

Associated warnings

The illumination, fixed or flashing, of certain warning lamps may be accompanied by an audible signal and a message in the screen.

Depending on your version of instrument panel, illumination of the warning lamp is also accompanied by:

- a symbol in the central instrument panel screen and a message in the multi-function screen,
- or
- a symbol and a message in the central instrument panel screen.

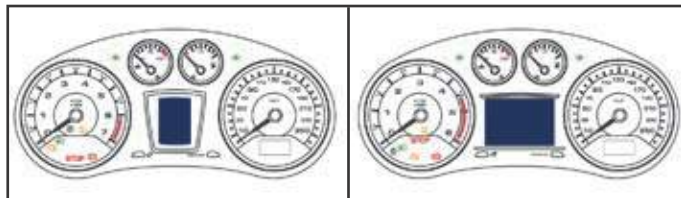



Warning lamps

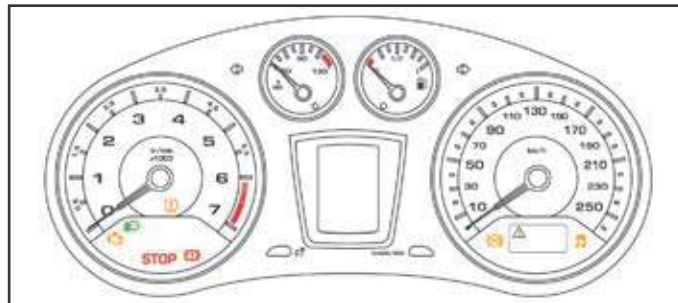

When the engine is running or the vehicle is being driven, the illumination of one of the following warning lamps indicates a fault which requires action on the part of the driver.







The illumination of a warning lamp is always accompanied by the display of an additional message, to assist you in identifying the fault.

If you encounter any problems, contact a PEUGEOT dealer or a qualified workshop.

Warning/indicator lamp		is on	Cause	Action / Observations
STOP	STOP	fixed, alone or associated with another warning lamp, accompanied by an audible signal and a message in the screen.	Illumination of this warning lamp is associated with a serious fault with the braking system, power steering, engine lubrication system or cooling system.	Stop as soon as it is safe to do so as there is a risk that the engine will cut out while driving. Park, switch off the ignition and contact a PEUGEOT dealer or a qualified workshop.
 + 	Braking	fixed, associated with the STOP warning lamp.	The braking system fluid level is too low.	You must stop as soon as it is safe to do so. Top up with brake fluid recommended by PEUGEOT. If the problem persists, have the system checked by a PEUGEOT dealer or a qualified workshop.
		fixed, associated with the STOP and ABS warning lamps.	The electronic brake force distribution (EBFD) system has a fault.	You must stop as soon as it is safe to do so. Have it checked by a PEUGEOT dealer or a qualified workshop.
	Maximum coolant temperature	fixed with the needle in the red zone.	The temperature of the cooling system is too high.	Stop as soon as it is safe to do so. Wait until the engine has cooled down before topping up the level, if necessary. If the problem persists, contact a PEUGEOT dealer or a qualified workshop.

Warning/indicator lamp		is on	Cause	Action / Observations
	Service	on temporarily.	A minor fault has occurred for which there is no specific warning lamp.	<p>Identify the fault by reading the message shown in the screen, such as, for example:</p> <ul style="list-style-type: none"> - opening of the doors, boot or bonnet, - low engine oil level, - low screenwash level, - flat remote control battery, - saturation of the particle emission filter (Diesel) <p>As soon as traffic conditions permit, regenerate the filter by driving at a speed of at least 36 mph (60 km/h) until the service warning lamp goes off.</p> <ul style="list-style-type: none"> - a fault with the tyre under-inflation detection system, - ... <p>For any other faults, contact a PEUGEOT dealer or a qualified workshop.</p>
		fixed.	A major fault has occurred for which there is no specific warning lamp.	Identify the fault by reading the message shown on the screen and contact a PEUGEOT dealer or a qualified workshop.
	Engine autodiagnosis system	flashing.	The engine management system has a fault.	Risk of destruction of the catalytic converter. Have it checked by a PEUGEOT dealer or a qualified workshop.
		fixed.	The emission control system has a fault.	The warning lamp should go off when the engine is started. If it does not go off, contact a PEUGEOT dealer or qualified workshop without delay.
	Low fuel level	fixed with the needle in the red zone, accompanied by an audible signal and a message.	<p>When it first comes on there remains approximately 5 litres of fuel in the tank.</p> <p>At this point, you begin to use the fuel reserve.</p>	<p>Refuel as soon as possible to avoid running out of fuel. Until sufficient fuel has been added, this warning lamp will come on every time the ignition is switched on, accompanied by an audible signal and a message. The audible signal and message are repeated with increasing frequency as the fuel level drops towards "0".</p> <p>Fuel tank capacity: approximately 55 litres.</p> <p>Never continue to drive until you run out of fuel, as this could damage the emission control and injection systems.</p>

Warning/indicator lamp		is on	Cause	Action / Observations
	Anti-lock Braking System (ABS)	fixed.	The anti-lock braking system has a fault.	The vehicle retains conventional braking. Drive carefully at reduced speed and contact a PEUGEOT dealer or a qualified workshop without delay.
	dynamic stability control (dSC/ASR)	flashing.	The DSC/ASR regulation is operating.	The system optimises traction and improves the directional stability of the vehicle in the event of loss of grip or trajectory.
		fixed.	The DSC/ASR system has a fault.	Have it checked by a PEUGEOT dealer or a qualified workshop.
	directional headlamps	flashing.	The directional headlamps system has a fault.	Have it checked by a PEUGEOT dealer or a qualified workshop.
	Seat belt not fastened / unfastened	fixed, then flashing in the passenger's seat belt and front airbag warning lamp display.	The driver or front passenger has not fastened or has unfastened their seat belt.	Pull on the belt in question and insert the tongue in the buckle. For more information, refer to the "Seat belts" section.
			At least one rear passenger has unfastened their seat belt.	
	Under-inflation	fixed.	The pressure in one or more wheels is too low.	Check the pressure of the tyres as soon as possible. This check should preferably be carried out when the tyres are cold.
		flashing then fixed, accompanied by the Service warning lamp.	The tyre pressure monitoring system has a fault or no sensor is detected on one of the wheels.	Under-inflation detection is not assured. Have the system checked by a PEUGEOT dealer or a qualified workshop.

Operation indicator lamps

If one of the following indicator lamps comes on, this confirms that the corresponding system has come into operation.

It may be accompanied by an audible signal.







Depending on your version of instrument panel, illumination of the indicator lamp may also be accompanied by:

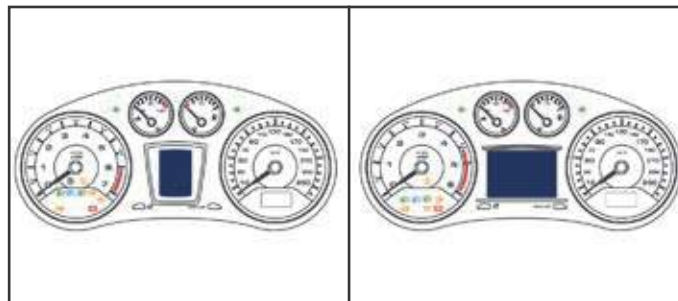



- a symbol in the central instrument panel screen and a message in the multifunction screen,

or

- a symbol and a message in the central instrument panel screen.



Warning/indicator lamp		is on	Cause	Action / Observations
	Left-hand direction indicator	flashing with buzzer.	The lighting stalk is pushed down.	
	Right-hand direction indicator	flashing with buzzer.	The lighting stalk is pushed up.	
	Hazard warning lamps	flashing with audible signal.	The hazard warning lamps switch, located on the dashboard, has been operated.	The left-hand and right-hand direction indicators and their associated indicator lamps flash simultaneously.
	Sidelamps	fixed.	The lighting stalk is in the "Sidelamps" position or the "AUTO" position with low light.	
	dipped beam headlamps	fixed.	The lighting stalk is in the "Dipped beam headlamps" position or in the "AUTO" position in conditions of low light.	
	Main beam headlamps	fixed.	The lighting stalk is pulled towards you.	Pull the stalk again to return to dipped beam headlamps.

Warning/indicator lamp		is on	Cause	Action / Observations
	Rear foglamp	fixed.	The rear foglamp has been switched on using the ring on the lighting control stalk.	Turn the ring on the lighting control stalk to the rear to switch off the rear foglamp.
	diesel engine pre-heating	fixed.	The key is at position 2 (ignition on) in the ignition switch.	Wait until the warning lamp goes off before starting. The period of illumination of the warning lamp is determined by the ambient conditions (up to about thirty seconds in very low temperatures). If the engine does not start, switch the ignition off and then on, wait until the warning lamp goes off again, then start the engine.
	Parking brake	fixed.	The parking brake is applied or not properly released.	Release the parking brake to switch off the warning lamp, keeping your foot on the brake pedal. Observe the safety recommendations. For more information on the parking brake, refer to the corresponding section.
	Passenger's front airbag	fixed on the seat belt and passenger's front airbag warning lamps display.	The control switch, located on the passenger's side of the dashboard, has been placed in the "ON" position. The passenger's front airbag is activated. In this case, do not install a "rearward facing" child seat.	While you do not have a rearward facing child seat fitted to the front passenger seat, it is recommended that the passenger's front airbag be activated. On the other hand, before fitting a rearward facing child seat, you must turn the control switch to the "OFF" position.

deactivation warning lamps

The other deactivation indicators appear in the form of symbols in the large screen, located in the centre of the instrument panel.

Their display may be accompanied by an audible signal and a message in the screen.

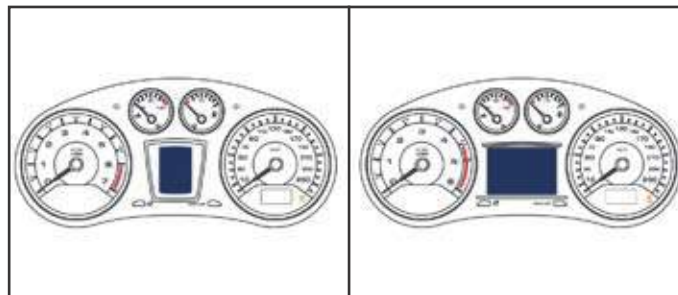

Warning/indicator lamp		is on	Cause	Action / Observations
	Passenger's front airbag	fixed, in the seat belt and front passenger's airbag warning lamps display.	<p>The control switch, located on the passenger's end of the dashboard, is set to the OFF position.</p> <p>The passenger's front airbag is deactivated.</p> <p>You can install a "rearward facing" child seat on the front seat.</p>	<p>Before installing a rearward facing child seat on the front seat, it is essential to deactivate the passenger's front airbag.</p> <p>On the other hand, where no rearward facing child seat is present, it is recommended that the airbag be reactivated: set the control to the ON position.</p>

COOLANT TEMPERATURE INDICATOR

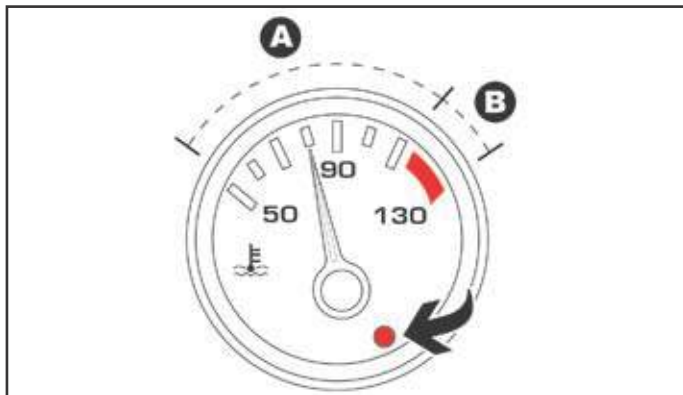

With the engine running, when the needle is:

- in zone **A**, the temperature is correct,
- in zone **B**, the temperature is too high; the maximum temperature warning lamp and the central **STOP** warning lamp come on, accompanied by an audible signal and the display of an alert message.

You MUST stop as soon as it is safe to do so.

Wait a few minutes before switching off the engine.

Contact a PEUGEOT dealer or a qualified workshop.

After driving for a few minutes, the temperature and pressure in the cooling system increase.

To top up the level:

- ☞ wait for the engine to cool,
- ☞ unscrew the cap by two turns to allow the pressure to drop,
- ☞ when the pressure has dropped, remove the cap,
- ☞ top up the level to the "MAX" mark.

ENGINE OIL LEVEL INDICATOR

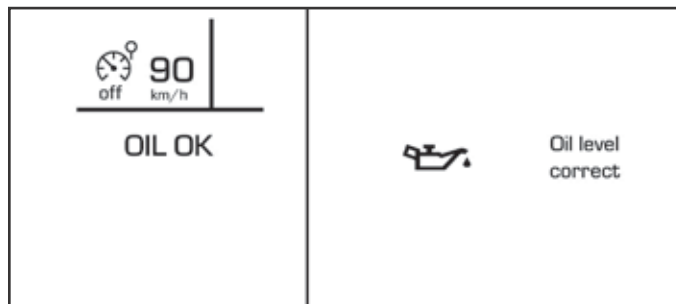

This information is displayed for a few seconds when the ignition is switched on, at the same time as the service information.



The check of this level is only valid if the vehicle is on a level surface, with the engine having been off for more than 30 minutes.

Oil level correct

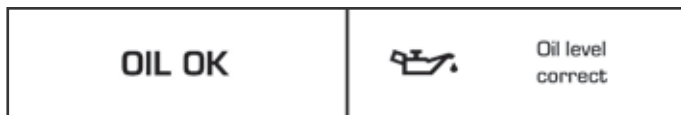

Lack of oil

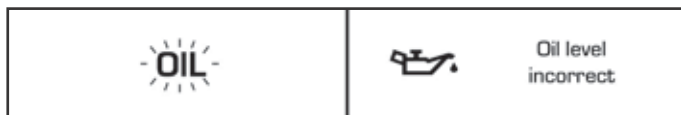

This is indicated by the flashing of "OIL" or an alert message in the instrument panel, accompanied by illumination of the service warning lamp and an audible signal.

If the lack of oil is confirmed by a check using the dipstick, it is essential that the level is topped up to prevent damage to the engine.

Refer to the "Checking levels" section.

Indicator fault

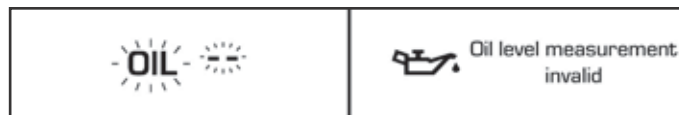

This is indicated by the flashing of "OIL--" or the appearance of an alert message in the instrument panel.

Contact a PEUGEOT dealer or a qualified workshop.

In the event of a fault with the electric gauge, the oil level is no longer monitored.

If the system is faulty, you should check the engine oil level using the dipstick under the bonnet.

Refer to the "Checking levels" section.

SERVICE INDICATOR

This information is displayed for a few seconds when the ignition is switched on. It informs the driver when the next service is due, in accordance with the manufacturer's service schedule.

The point at which the service is due is calculated from the last indicator zero reset. It is determined by two parameters:

- the distance travelled,
- the time elapsed since the last service (only on HDi Diesel versions).

More than 1 800 miles (3 000 km) remain before the next service is due

When the ignition is switched on, no service information appears on the instrument panel central screen.

Between 600 miles (1 000 km) and 1 800 miles (3 000 km) remain before the next service is due

For a few seconds after the ignition is switched on, the spanner symbolising the service operations comes on. The instrument panel central screen indicates the distance remaining before the next service is due.

Example: 1 700 miles (2 800 km) remain before the next service is due.

For a few seconds after the ignition is switched on, the central screen indicates:

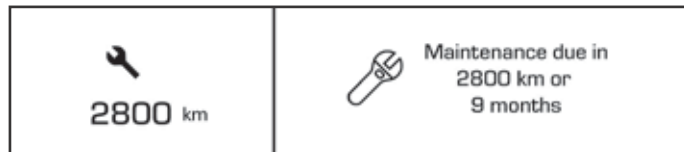

Less than 600 miles (1 000 km) remain before the next service is due

Example: 500 miles (900 km) remain before the next service is due.

For a few seconds after the ignition is switched on, the central screen indicates:

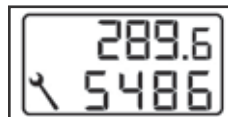
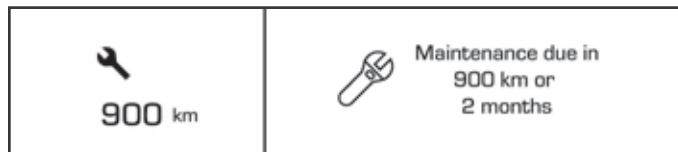

The spanner remains on in the small screen to indicate that a service must be carried out soon.

Service overdue

For a few seconds after the ignition is switched on, **the spanner flashes** to indicate that the service must be carried out as soon as possible.

Example: the service is overdue by 300 miles (300 km).

For a few seconds after the ignition is switched on, the central screen indicates:

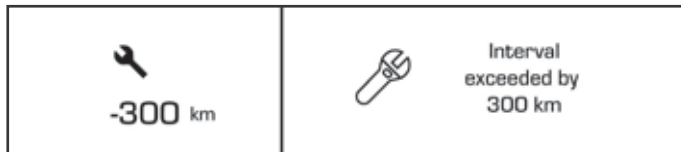

The spanner remains on in the small screen to indicate that a service should have been carried out.



The distance remaining may be weighted by the time factor, depending on the type of motoring the vehicle is used for. Therefore, the spanner may also come on if you have exceeded the period since the last service specified in the manufacturer's service schedule.

This indication applies only to HDi Diesel engines.

Service indicator reset

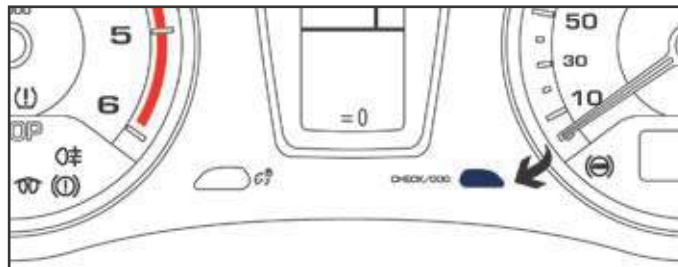

After each service, the service indicator must be reset.

If you have carried out the service on your vehicle yourself:

- ☞ switch off the ignition,
- ☞ press and hold the "**CHECK/000**" button,
- ☞ switch on the ignition; the distance recorder display begins a countdown,
- ☞ when the instrument panel central screen indicates "**=0**", release the button; the spanner disappears from the small screen.



Following this operation, if you wish to disconnect the battery, lock the vehicle and wait at least five minutes for the reset to be registered.

Retrieving the service information

You can access the service information at any time.

This information appears when running through the manual check procedure.

- ☞ Briefly press the "**CHECK/000**" button.
The service information is displayed for a few seconds on the instrument panel central screen, then disappears.

MANUAL CHECK

This function allows you to check the status of the vehicle (reminder of the active alert warnings) and the service information.

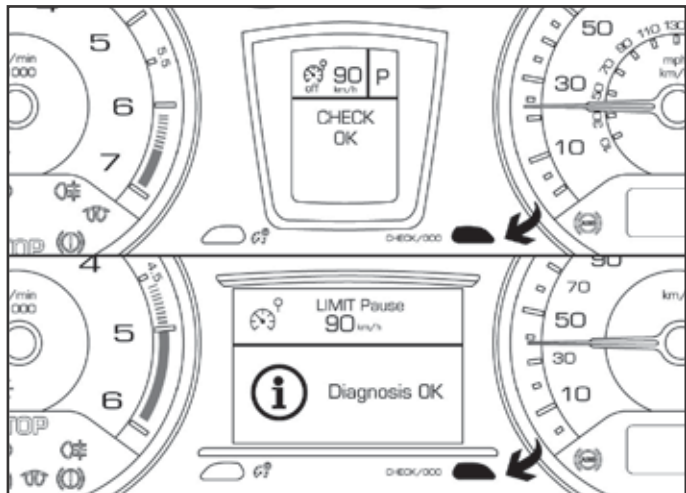

☞ With the engine running, to start a manual check, briefly press the **"CHECK/000"** button on the instrument panel.

If no faults have been detected, **"CHECK OK"** appears in the instrument panel central screen.

If a "minor" fault has been detected, the warning lamp concerned then **"CHECK OK"** appear in the instrument panel central screen. Contact a PEUGEOT or a qualified workshop.

If a "major" fault has been detected, only the warning lamps concerned appear in the instrument panel central screen. Have it checked by a PEUGEOT dealer or a qualified workshop.

DISTANCE RECORDERS

The total and trip distances are displayed for thirty seconds when the ignition is switched off, when the driver's door is opened and when the vehicle is locked or unlocked.

Total distance recorder

Measures the total distance travelled by the vehicle since its first registration.



Trip distance recorder

Measures the distance travelled since it was last reset to zero by the driver.

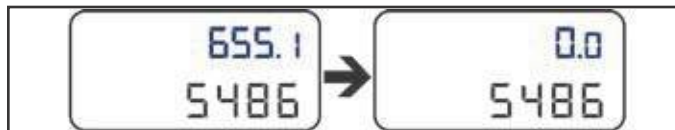

☞ With the ignition on, press and hold this button until zeros appear.

LIGHTING DIMMER

Permits manual adjustment of the brightness of the instruments and controls to suit the ambient light level. Only operates when the vehicle lighting is on, with the exception of the daytime running lamps.

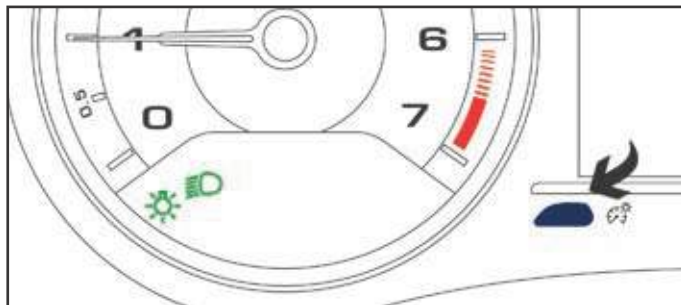

Activation

- ☞ Press the button to change the brightness of the instruments and controls.
- ☞ When the lighting reaches the minimum setting, release the button, then press again to increase it.

or

- ☞ When the lighting reaches the maximum setting, release the button, then press again to reduce it.
- ☞ When the lighting reaches the level of brightness required, release the button.

deactivation

When the vehicle lighting is off, or in day mode on vehicles fitted with daytime running lamps, pressing the button does not have any effect.

CLOCK

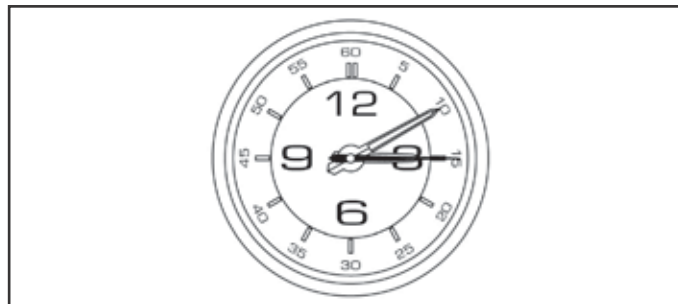

The analogue clock, located between the central vents of the dashboard, does not have an adjustment button.

To set the time, refer to the section relating to your multifunction screen's configuration menu.

The clock is synchronised with the multifunction screen time; once the the setting has been confirmed on the multifunction screen, the hands will turn to synchronise with the screen, and each time the ignition is switched on.

TRIP COMPUTER

System that gives you information on the current journey (range, fuel consumption...).

CENTRAL INSTRUMENT PANEL SCREEN

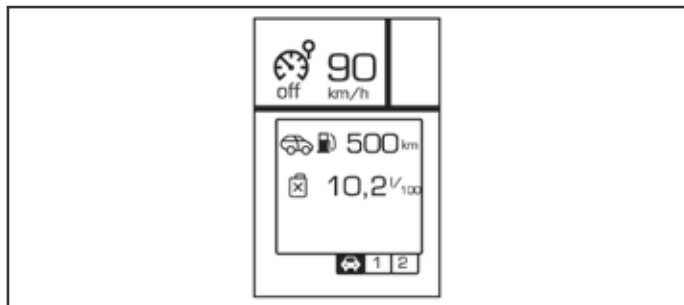

CENTRAL INSTRUMENT PANEL SCREEN WITH NAVIGATION

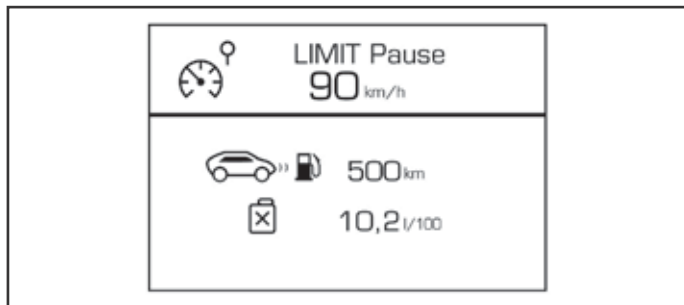

display of information

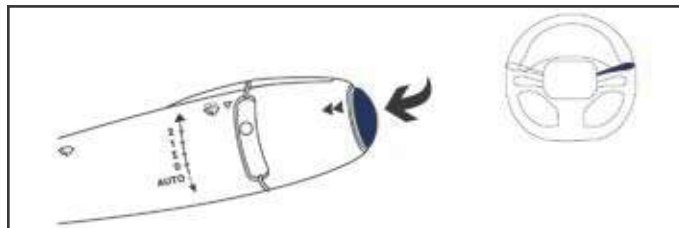

↻ Cycle through the information with successive short presses on this button.

The trip computer can display:



- The current information tab, for the trip in use, with:
 - the range,
 - the current fuel consumption.



- The trip "1" tab with:
 - the distance travelled,
 - the average fuel consumption,
 - the average speed.



- The trip "2" tab with:
 - the distance travelled,
 - the average fuel consumption,
 - the average speed.

- ☞ Pressing the button again takes you to a black screen.
A further press returns you to the normal display.

Trip reset

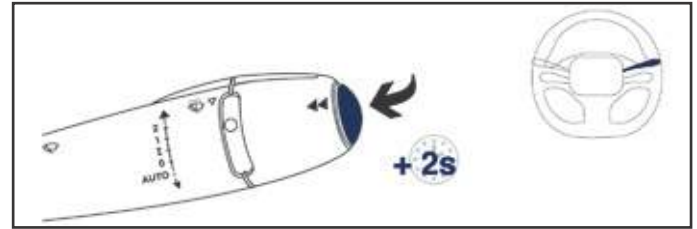

- ☞ When the trip required is displayed, press this button.

Trips "1" and "2" are independent but their use is identical.

For example, trip "1" can be used for daily figures, and trip "2" for monthly figures.

TRIP COMPUTER, A FEW DEFINITIONS



Range

(miles or km)

The distance which can still be travelled with the fuel remaining in the tank (related to the average fuel consumption over the last few miles (kilometres) travelled).



This value may vary following a change in the style of driving or the relief, resulting in a significant change in the current fuel consumption.

When the range falls below 20 miles (30 km), dashes are displayed. After filling with at least 5 litres of fuel, the range is recalculated and is displayed when it exceeds 60 miles (100 km).



If dashes are displayed continuously while driving in place of the digits, contact a PEUGEOT dealer or a qualified workshop.



Current fuel consumption

(mpg or l/100 km or km/l)

Calculated over the last few seconds.



This function is only displayed from 20 mph (30 km/h).



Average fuel consumption

(mpg or l/100 km or km/l)

Calculated since the last trip computer reset.

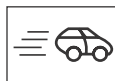

Average speed

(mph or km/h)

Calculated since the last trip computer reset.

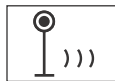

distance travelled

(miles or km)

Calculated since the last trip computer reset.

MONOCHROME SCREEN C (WITH PEUGEOT CONNECT SOUND (RD5))

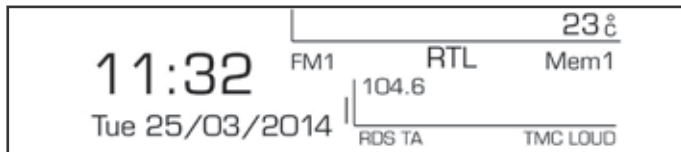

DISPLAYS IN THE SCREEN

Displays according to context:

- time,
- date,
- ambient temperature (the value displayed flashes if there is a risk of ice),
- visual parking assistance,
- audio functions,
- alert messages,
- the display and vehicle equipment settings menus.

CONTROLS

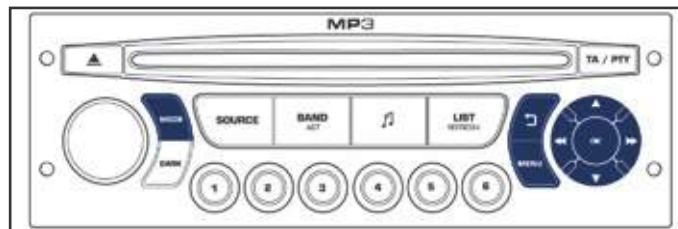

From the control panel of your PEUGEOT Connect Sound (RD5), you can:

- ☞ press the **"MENU"** button for access to the **main menu**,
 - ☞ press the **"▲"** or **"▼"** buttons to scroll through the items on the screen,
 - ☞ press the **"MOdE"** button to change the permanent application (audio source, telephone...),
 - ☞ press the **"◀"** or **"▶"** buttons to change a setting value,
 - ☞ press the **"OK"** button to confirm,
- or
- ☞ press the **"Back"** button to abandon the operation in progress.

MAIN MENU



- ☞ Press the **"MENU"** button to gain access to the **main menu**:
 - audio functions,
 - vehicle diagnostics,
 - personalisation-configuration,
 - telephone (Bluetooth system).
- ☞ Press the **"▲"** or **"▼"** buttons to select the menu required, then confirm by pressing the **"OK"** button.



"AUDIO FUNCTIONS" MENU

With the PEUGEOT Connect Sound (RD5) switched on, once this menu has been selected you can activate or deactivate the functions linked with use of the radio (RDS, REG, RadioText) or the CD (introscan, shuffle, CD repeat).

For more information on the "Audio functions" application, refer to the "PEUGEOT Connect Sound (RD5)" part of the "Audio equipment and telematics" section.



"DIAGNOSIS VEHICLE" MENU

Once this menu has been selected, you can consult information concerning the status of the vehicle.

Alert log

This summarises the active warning messages, displaying them in succession on the multifunction screen.

- ☞ Press the **"MENU"** button to gain access to the main menu.
- ☞ Press the arrows, then the **"OK"** button to select the **"diagnosis vehicle"** menu.



- ☞ On the **"diagnosis vehicle"** menu, select the following application:

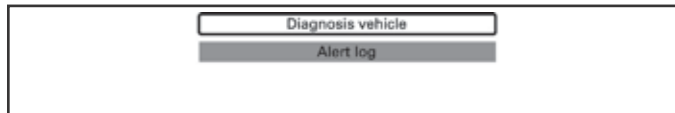

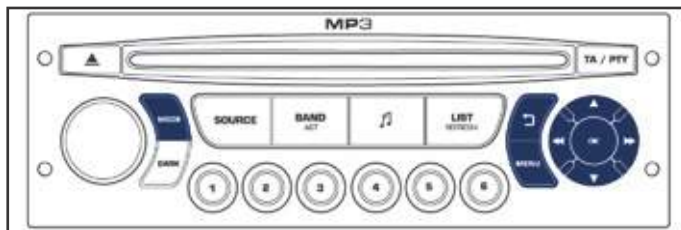

"PERSONALISATION-CONFIGURATION" MENU

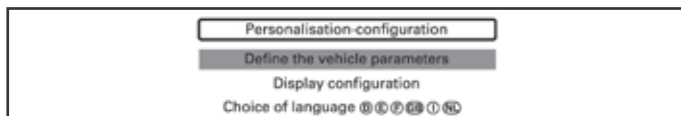

Once this menu has been selected, you can gain access to the following functions:

- define the vehicle parameters,
- display configuration,
- choice of language.

define the vehicle parameters*

Once this menu has been selected, you can activate or deactivate the following equipment:

- selective unlocking (refer to the "Access" section),
- guide-me-home lighting (refer to the "Visibility" section),
- interior mood lighting (refer to the "Ease of use and comfort" section),
- daytime running lamps** (refer to the "Visibility" section),
- rear parking sensors (refer to the "Driving" section).

Example: setting of the duration of the guide-me-home lighting

- ☞ Press the "▲" or "▼" buttons, then the "OK" button to select the menu required.

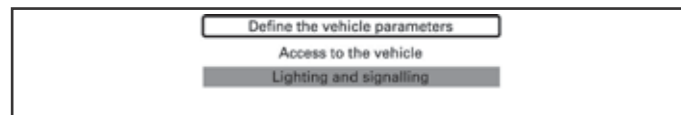

- ☞ Press the "▲" or "▼" buttons, then the "OK" button to select the "Guide-me-home headlamps" line.

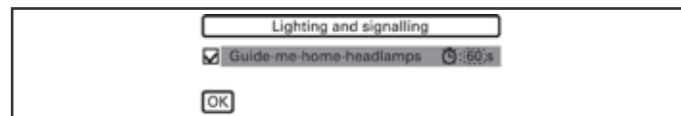

- ☞ Press the "◀" or "▶" buttons to set the value required (15, 30 or 60 seconds), then press the "OK" button to confirm.

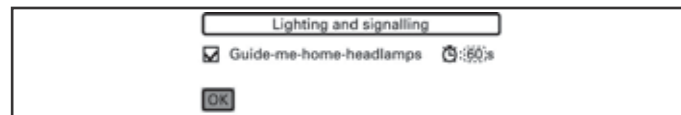

- ☞ Press the "▲" or "▼" buttons, then the "OK" button to select the "OK" box and confirm or press the "Back" button to cancel.

* Depending on version.

** Depending on country of sale.

display configuration

Once this menu has been selected, you have access to the following settings:

- brightness-video setting,
- date and time setting,
- choice of units.

Setting the date and time

- ☞ Press the "◀" or "▶" button to display the "Display configuration" menu, then the **"OK"** button.
- ☞ Press the "▲" or "▼" button to select the "Adjust date and time" line, then the **"OK"** button.
- ☞ Press the "◀" or "▶" button to select the setting to modify. Confirm by pressing the **"OK"** button then modify the setting and confirm again to save the modification.
- ☞ Adjust the settings one by one, confirming with the **"OK"** button.
- ☞ Press the "▲" or "▼" button, then the **"OK"** button to select the **"OK"** box and confirm, or the **"Back"** button to cancel.

Choice of language

Once this menu has been selected, you can change the language used by the display (Deutsch, English, Espanol, Français, Italiano, Nederlands, Portugues, Portugues-Brasil, Türkçe**).



"TELEPHONE" MENU

With the PEUGEOT Connect Sound (RD5) switched on, once this menu has been selected you can configure your Bluetooth hands-free system (pairing), consult the various telephone directories (calls log, services...) and manage your communications (pick up, hang up, call waiting, secret mode...).

For more information on the "Telephone" application, refer to the "PEUGEOT Connect Sound (RD5)" part of the "Audio equipment and telematics" section.



As a safety measure, configuration of the multifunction screen by the driver must only be done when stationary.

** According to country of sale.

RETRACTABLE COLOUR SCREEN (WITH PEUGEOT CONNECT NAVIGATION (RT6))



DISPLAYS IN THE SCREEN

Displays according to context:

- time,
- date,
- altitude,
- ambient temperature (the value displayed flashes if there is a risk of ice),
- visual parking sensor information,
- audio functions,
- telephone and contacts information,
- satellite navigation system information,
- alert messages,
- menus for settings of the screen, navigation system and vehicle equipment.

CONTROLS

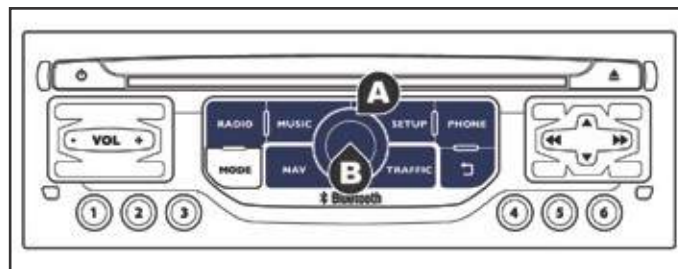

From the PEUGEOT Connect Navigation (RT6) control panel, to select one of the applications:

- ☞ press the dedicated "**RADIO**", "**MUSIC**", "**NAV**", "**TRAFFIC**", "**PHONE**" or "**SETUP**" button for access to the corresponding menu,
- ☞ turn dial **A** to select a function, an item in a list,
- ☞ press button **B** to confirm the selection,
or
- ☞ press the "**Back**" button to abandon the current operation and return to the previous display.

For more information on these applications, refer to the "PEUGEOT Connect Navigation (RT6)" part in the "Audio equipment and telematics" section.



For operation of the retractable screen (opening, closing, adjustment of the position, etc.), refer to the "Access to the retractable screen" section.

"SETUP" MENU

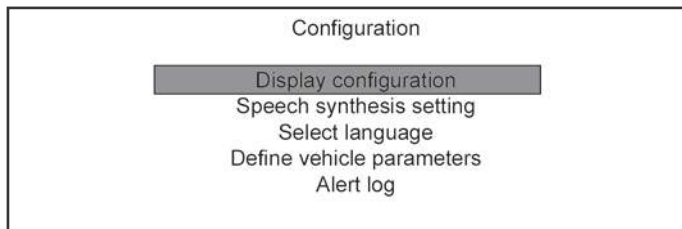

- ☞ Press the **"SETUP"** button to gain access to the configuration menu:
- "Display configuration",
 - "Voice synthesis",
 - "Choice of language",
 - "Vehicle parameters",
 - "Alert log".



As a safety measure, configuration of the multifunction screen by the driver must only be done when stationary.

display configuration

This menu allows you to choose a colour scheme for the screen, to adjust the brightness, set the date and time and choose the units for distance (km or miles), fuel consumption (l/100 km, mpg or km/l) and temperature (°Centigrade or °Fahrenheit).

Setting the date and time

- ☞ Press **"SETUP"**.
- ☞ Select "Display configuration" and confirm.
- ☞ Select "Set date and time" and confirm.

You can select **"Synchronise the minutes with GPS"**, so that the minutes are adjusted automatically by satellite reception.

- ☞ Select the setting to modify. Confirm by pressing **"OK"**, then adjust the setting and modify again.
- ☞ Adjust the settings one by one.
- ☞ Select **"OK"** in the screen then confirm to save the setting.

Voice synthesis

This menu allows you to adjust the volume for navigation instructions and to choose the type of voice (male or female).

Choice of language

This menu allows you to choose the language used by the screen (French, English, Italian, Portuguese, Spanish, German, Dutch, Turkish, Polish, Russian).

Vehicle parameters*

This menu allows you to activate or deactivate certain driving and comfort equipment, arranged by category:

- **Access to the vehicle**
 - Plip action (selective unlocking of the driver's door; refer to the "Access" section),
- **Parking sensors**
- **Lighting configuration (see the "Visibility" section) :**
 - Duration of the guide-me-home lighting,
 - Directional headlamps (main/additional directional lighting),
 - Mood lighting (Interior mood lighting),
 - Daytime running lamps**.

Alert log

It lists the active alerts by displaying their associated messages in turn.

* Depending on version.

** According to country of sale.

ACCESS TO THE RETRACTABLE SCREEN

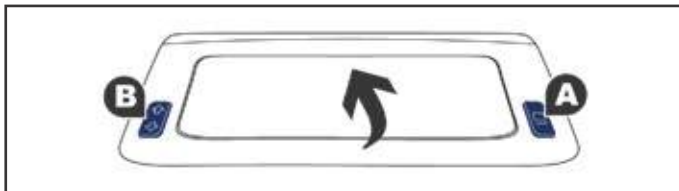

The screen opens automatically when the ignition is switched on. It closes automatically three seconds after switching off the ignition if the audio and telematics system is switched off.

You can open or close the screen at any time, with the ignition on, using control **A**.

- Press button **A**: the screen folds.
- Press button **A** again: the screen opens again.

Adjusting the angle of the screen

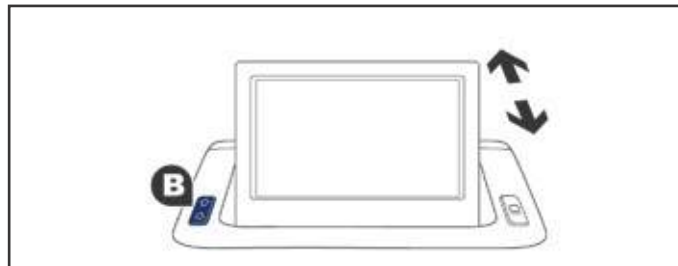

You can adjust the angle of the screen to one of four defined positions, by repeated presses on the front or back of the control **B**. The position of the screen is memorised on closing.



If you have closed the screen, it will open again automatically:

- on switching on the audio and navigation system (unless it had been closed manually while the system was in operation),
- when an outgoing telephone call is made,
- when a voice command is given,
- when a warning message linked with the STOP warning lamp is displayed (PEUGEOT Connect Navigation (RT6)).

REMOTE CONTROL KEY

System which permits central unlocking or locking of the vehicle using the lock or from a distance. It is also used to locate and start the vehicle, as well as providing protection against theft.

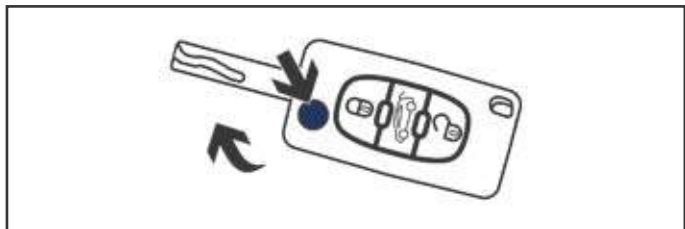

UNLOCKING THE VEHICLE

Unfolding the key

- ☞ First press this button to unfold the key.

Complete unlocking using the remote control



- ☞ Press the open padlock to unlock the vehicle.

Complete unlocking using the key

- ☞ Turn the key forwards in the driver's door lock to unlock the vehicle.

Selective unlocking using the remote control



- ☞ Press the open padlock once to unlock the driver's door and the fuel filler flap only.

- ☞ Press the open padlock again to unlock the passenger's door and the boot.

Selective unlocking using the key

- ☞ Turn the key forwards in the driver's door lock once to unlock the driver's door and the fuel filler flap only.
- ☞ Turn the key forwards in the driver's door lock again to unlock the passenger's door and the boot.

The direction indicators flash for a few seconds.

Depending on version, the door mirrors unfold, the alarm is deactivated.

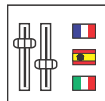

- The complete or selective unlocking parameter is set via the vehicle configuration menu.
- Complete unlocking is activated by default.

Unlocking and partial opening of the boot



- ☞ Press this button for more than two seconds to unlock the boot. The boot opens slightly.
- This action also unlocks the doors and the fuel filler flap.

LOCKING THE VEHICLE

Normal locking using the remote control



- ☞ Press the closed padlock to lock the vehicle completely.

Normal locking using the key

- ☞ Turn the key rearwards in the driver's door lock to lock the vehicle completely.

The direction indicators come on for a few seconds.

Depending on version, the door mirrors fold, the alarm is activated.

deadlocking using the remote control



- ☞ Press the closed padlock to lock the vehicle completely.
- ☞ Press the closed padlock again within five seconds to deadlock the vehicle.

deadlocking using the key

- ☞ Turn the key rearwards in the driver's door lock to lock the vehicle completely.
- ☞ Turn the key rearwards again within five seconds to deadlock the vehicle.

The direction indicators come on for a few seconds.

Depending on version, the door mirrors fold, the alarm is activated.



If one of the doors or the boot is still open, the central locking does not take place; the vehicle locks and then immediately unlocks, witnessed by the sound of the locks rebounding. However, the alarm (if fitted) will be fully activated after about 45 seconds.

When the vehicle is locked, if it is unlocked inadvertently, it will lock itself again automatically after thirty seconds unless a door is opened.

If the alarm had been activated previously, it will not be reactivated automatically.

The folding and unfolding of the door mirrors using the remote control can be deactivated by a PEUGEOT dealer or a qualified workshop.



Deadlocking renders the exterior and interior door controls inoperative.

It also deactivates the manual central control button.

Therefore, never leave anyone inside the vehicle when it is deadlocked.

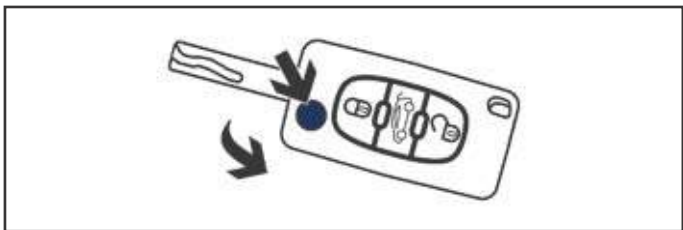

Folding the key

- ☞ First press this button to fold the key.

! If you do not press the button when folding the key, there is a risk of damage to the mechanism.

LOCATING YOUR VEHICLE



This function allows you to identify your vehicle from a distance, particularly in poor light. Your vehicle must be locked.

- ☞ Press the closed padlock on the remote control.
- This will switch on the courtesy lamps and the direction indicators will flash for around ten seconds.

REMOTE CONTROL PROBLEM

Following disconnection of the vehicle battery, replacement of the remote control battery or in the event of a remote control malfunction, you can no longer unlock, lock or locate your vehicle.

- ☞ First of all, use the key in the lock to unlock or lock your vehicle.
- ☞ Then, reinitialise the remote control.

If the problem persists, contact a PEUGEOT dealer as soon as possible.

Reinitialisation

- ☞ Switch off the ignition.
 - ☞ Turn the key to position **2 (Ignition on)**.
 - ☞ Press the closed padlock immediately for a few seconds.
 - ☞ Switch off the ignition and remove the key from the ignition switch.
- The remote control is fully operational again.

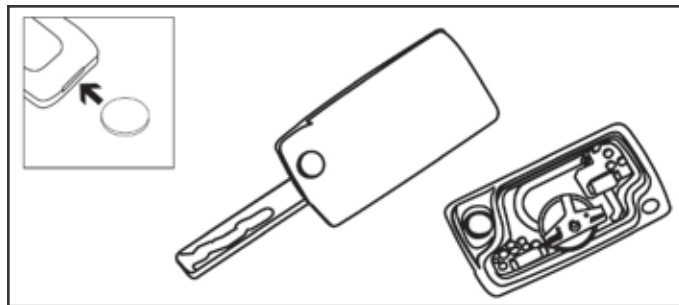

Changing the battery

Battery ref.: CR1620 / 3 volts.



If the battery is flat, you are informed by illumination of this warning lamp, accompanied by an audible signal and an alert message in the screen.

- ☞ Unclip the casing using a coin at the notch.
- ☞ Slide the flat battery out of its location.
- ☞ Slide the new battery into its location observing the original direction.
- ☞ Clip the casing.
- ☞ Reinitialise the remote control.



LOST KEYS

Go to a PEUGEOT dealer with the vehicle's registration document, your personal identification documents and if possible the key code label. The PEUGEOT dealer will be able to look up the key code and the transponder code required to order a new key.

REMOTE CONTROL

The high frequency remote control is a sensitive system; do not operate it while it is in your pocket as there is a possibility that it may unlock the vehicle, without you being aware of it.

Do not repeatedly press the buttons of your remote control out of range and out of sight of your vehicle. You run the risk of stopping it from working and the remote control would have to be reinitialised.

No remote control can operate when the key is in the ignition switch, even when the ignition is switched off, except for reinitialisation.

LOCKING THE VEHICLE

Driving with the doors locked may make access to the passenger compartment by the emergency services more difficult in an emergency.

As a safety precaution, never leave children alone in the vehicle, except for a very short period.

In all cases, it is essential to remove the key from the ignition switch when leaving the vehicle.

ANTI-THEFT PROTECTION

Do not make any modifications to the electronic engine immobiliser system; this could cause malfunctions.

WHEN PURCHASING A SECONd-HANd VEHICLE

Have the pairing of all of the keys in your possession checked by a PEUGEOT dealer, to ensure that only your keys can be used to open and start the vehicle.



Do not throw the remote control batteries away, they contain metals which are harmful to the environment.

Take them to an approved collection point.

ALARM*

System which protects and provides a deterrent against theft and break-ins. It provides the following types of monitoring:

- exterior perimeter

The system checks for opening of the vehicle.

The alarm is triggered if anyone tries to open a door, the boot, the bonnet...

- interior volumetric

The system checks for any variation in the volume in the passenger compartment.

The alarm is triggered if anyone breaks a window, enters the passenger compartment or moves inside the vehicle.

- tilt

The system checks for any change in the attitude of the vehicle.

The alarm is triggered if the vehicle is lifted, moved or knocked.



Self-protection function

The system checks for the putting out of service of its components.

The alarm is triggered if the battery, the central control or the siren wiring are put out of service or damaged.



For all work on the alarm system, contact a PEUGEOT dealer or a qualified workshop.

* According to country.

LOCKING THE VEHICLE WITH FULL ALARM SYSTEM

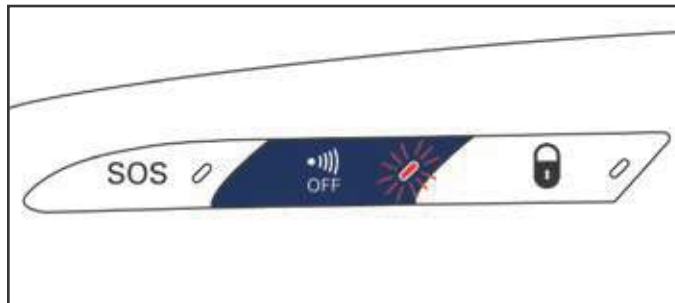

Activation

- ☞ Switch off the ignition and get out of the vehicle.
- ☞ Press the locking button on the remote control.

The monitoring system is active: the indicator lamp in the button flashes once per second.

After the locking button on the remote control is pressed, the exterior perimeter monitoring is activated after a delay of 5 seconds and the interior volumetric and anti-tilt monitoring after a delay of 45 seconds.



If an opening (door, boot...) is not closed fully, the vehicle is not locked but the exterior perimeter monitoring will be activated after a delay of 45 seconds at the same time as the interior volumetric and anti-tilt monitoring.

deactivation

- ☞ Press the unlocking button on the remote control.

The alarm system is deactivated: the indicator lamp in the button goes off.

LOCKING THE VEHICLE WITH EXTERIOR PERIMETER MONITORING ONLY

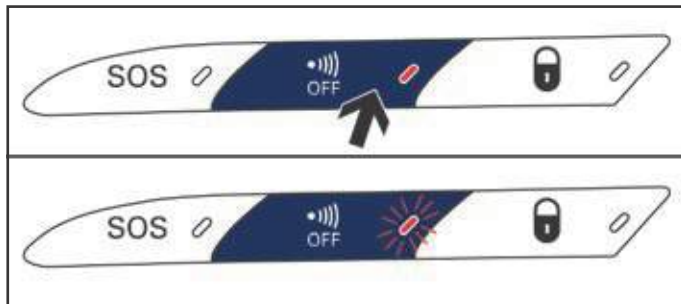

Deactivate the interior volumetric and anti-tilt monitoring to avoid unwanted triggering of the alarm in certain cases such as:

- leaving a pet in the vehicle,
- leaving a window partially open,
- washing your vehicle,
- changing a wheel,
- having your vehicle towed,
- transport by sea.

deactivation of the interior volumetric and anti-tilt monitoring

- ☞ Switch off the ignition.
- ☞ Within ten seconds, press the button until the indicator lamp is on continuously.
- ☞ Get out of the vehicle.
- ☞ Press the locking button on the remote control immediately.

The exterior perimeter monitoring alone is activated: the indicator lamp in the button flashes once per second.



To be effective, this deactivation must be carried out each time the ignition is switched off.

Reactivation of the interior volumetric and anti-tilt monitoring

- ☞ Press the unlocking button on the remote control to deactivate the exterior perimeter monitoring.
- ☞ Press the locking button on the remote control to activate all the monitoring functions.

The indicator lamp in the button again flashes once per second.

TRIGGERING OF THE ALARM

This is indicated by sounding of the siren and flashing of the direction indicators for thirty seconds.



The monitoring functions remain active until the alarm has been triggered eleven times in succession.

When the vehicle is unlocked using the remote control, rapid flashing of the indicator lamp in the button informs you that the alarm was triggered during your absence. When the ignition is switched on, this flashing stops immediately.

FAILURE OF THE REMOTE CONTROL

To deactivate the monitoring functions:

- ☞ unlock the vehicle using the key in the driver's door lock,
- ☞ open the door; the alarm is triggered,
- ☞ switch on the ignition; the alarm stops; the indicator lamp in the button goes off.

LOCKING THE VEHICLE WITHOUT ACTIVATING THE ALARM

- ☞ Lock or deadlock the vehicle using the key in the driver's door lock.

OPERATING FAULT

When the ignition is switched on, fixed illumination of the indicator lamp in the button indicates a fault with the system.

Have it checked by a PEUGEOT dealer or a qualified workshop.

AUTOMATIC ACTIVATION*

2 minutes after closing the last door or the boot, the system is activated automatically.

- ☞ To avoid triggering the alarm when entering the vehicle, first press the remote control unlocking button.

* Depending on country of sale.

ELECTRIC WINDOWS

Fitted with a safety anti-pinch system.

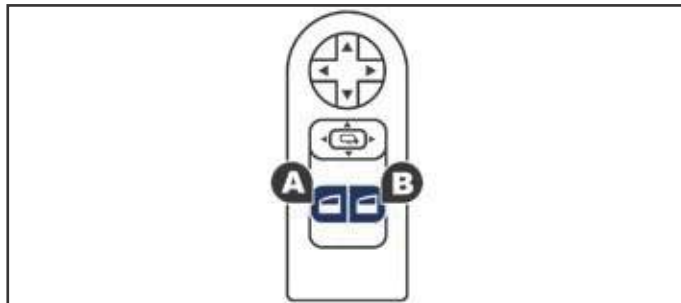

- A. Left-hand electric window.
- B. Right-hand electric window.

ONE-TOUCH ELECTRIC WINDOWS

There are two options:

- **manual mode**
 - ☞ Press or pull the switch gently. The window stops when the switch is released.
- **automatic mode**
 - ☞ Press or pull the switch firmly. The window opens or closes fully when the switch is released.
 - ☞ Pressing the switch again stops the movement of the window.



The electric window switches remain operational for approximately 45 seconds after the ignition is switched off or until the vehicle is locked after a door is opened.

If the passenger's window cannot be operated from the driver's door control panel, carry out the operation from the control panel of the passenger door.



After approximately ten consecutive complete opening/closing movements of the window, a protection function is activated which only authorises closing of the windows, so as to prevent damage to the electric window motor.

Once the window is closed, the switches will become operational again after approximately 40 minutes.

Safety anti-pinch

When the window rises and meets an obstacle, it stops and partially lowers again.



If the window cannot be closed (for example, in the presence of ice), immediately after the movement is reversed:

- ☞ press and hold the switch until the window opens fully,
- ☞ then pull the switch immediately and hold it until the window closes,
- ☞ continue to hold the switch for approximately one second after the window has closed.

The safety anti-pinch function is not operational during these operations.

Reinitialisation

If a window does not rise automatically, after reconnecting the battery for example, its operation must be reinitialised:

- ☞ pull the switch until the window stops,
- ☞ release the switch and pull it again until the window closes fully,
- ☞ continue to hold the switch for approximately one second after the window has closed,
- ☞ press the switch to lower the window automatically to the low position,
- ☞ when the window has reached the low position, press the switch again for approximately one second.

The safety anti-pinch function is not operational during these operations.



Always remove the key from the ignition when leaving the vehicle, even for a short time.

If an obstacle is encountered during operation of the electric windows, you must reverse the movement of the window. To do this, press the switch concerned.

When the driver operates the switch for the passenger's electric window, they must ensure that no one is preventing correct closing of the windows.

The driver must ensure that the passengers use the electric windows correctly.

Be aware of children when operating the windows.

DOORS

OPENING

From outside

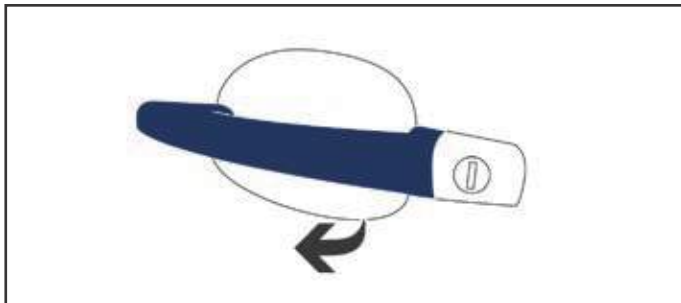

☞ After unlocking the vehicle completely using the remote control or the key, take hold of the door handle then pull it.

The window lowers automatically by a few millimetres to permit opening of the door.

 If you leave the door open for more than one minute, the window rises again.

Pull the handle again to reactivate the system.

In freezing conditions, the presence of ice may hinder the automatic partial opening of the window; remove the ice which may have formed along the lower seal, located at the base of the window.

 When the selective unlocking is activated, the first press of the remote control unlocking button permits unlocking of the driver's door only.

From inside

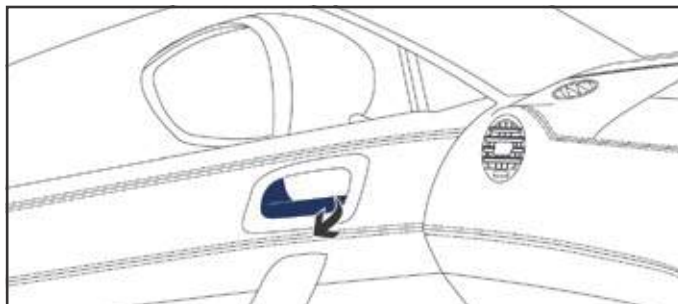

☞ Pull the door control to open the door; this unlocks this vehicle completely.

The window lowers automatically by a few millimetres to permit opening of the door.

 With the selective unlocking activated:

- the driver's door control unlocks the driver's door and the fuel filler flap only.
- the passenger's door control unlocks the passenger's door and the boot.

 The interior door controls do not operate when the vehicle is deadlocked.

CLOSING

The window rises automatically after a few seconds and adjusts to provide perfect sealing when closed.

- ! Be aware of the risk of pinching when the window rises automatically on closing the door.

When a door is not closed correctly:



- **when the engine is running**, this warning lamp comes on, accompanied by a message in the screen for a few seconds,
- **when the vehicle is moving** (speed higher than 6 mph (10 km/h)), this warning lamp comes on, accompanied by an audible signal and a message in the screen for a few seconds.

! When washing your vehicle:

- first lock the vehicle using the remote control or the key,
- avoid spraying the upper part of the windows,
- keep the end of the high pressure nozzle at least 1 metre from the windows and door seals.

CENTRAL LOCKING CONTROL

This control permits simultaneous locking or unlocking of the doors, boot lid and fuel filler flap from inside the vehicle.

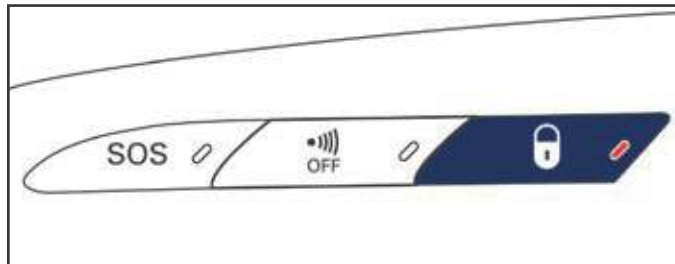

Locking

- ☞ Press this button to lock the vehicle. The red indicator lamp on the button comes on.



If one of the doors or the boot lid is open, the central locking from the inside does not take place.

Unlocking

- ☞ Press this button again to unlock the vehicle. The red indicator lamp on the button goes off.



Locking / deadlocking from the outside

- When the vehicle is locked or deadlocked from the outside, the red indicator lamp flashes and the button is inactive.
- ☞ With normal locking, pull on the interior door control lever to unlock the vehicle.
 - ☞ With deadlocking, you have to use the remote control or the key to unlock the vehicle.

ANTI-INTRUSION SECURITY

This function permits automatic and simultaneous locking of the doors, boot lid and fuel filler flap as soon as the vehicle speed exceeds 6 mph (10 km/h).

Operation

If one of the doors is open, the automatic central locking does not take place.

If the boot lid is open, the automatic central locking of the doors is active.

Pressing the central locking control unlocks the vehicle.

Opening a door from the inside, when stationary, also unlocks the vehicle, but the vehicle will be locked again when the speed exceeds 6 mph (10 km/h).

Activation / deactivation

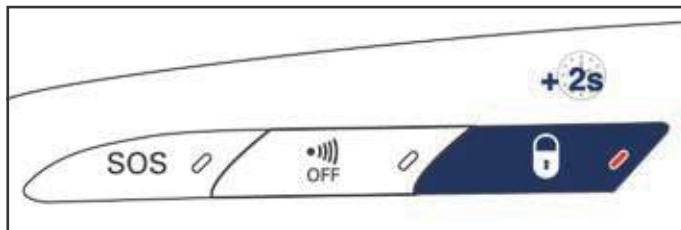

You can activate or deactivate this function.

- ☞ With the ignition on, press the button for more than two seconds. A confirmation message appears in the screen.

EMERGENCY LOCKING

To lock or unlock the doors mechanically in the event of a central locking system failure or flat battery.

Locking the driver's door

- ☞ Insert the key in the lock, then turn it to the right.

Unlocking the driver's door

- ☞ Insert the key in the lock, then turn it to the left.

Locking the passenger door

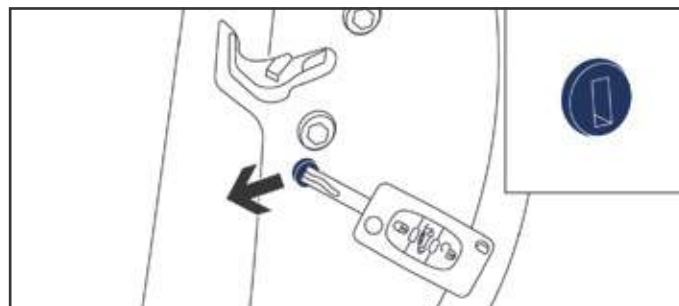

- ☞ Using the key, remove the black cap on the edge of the door.
- ☞ Insert the key in the cavity without forcing, then without turning it, move the the latch sideways towards the interior of the door.
- ☞ Remove the key and refit the cap.

Unlocking the passenger door

- ☞ Pull the interior door opening control.

BOOT

OPENING

Using the remote control



- ☞ Press this button for more than two seconds to unlock the boot lid. The boot lid opens slightly.
- ☞ Lift the boot lid.

This action also unlocks the doors and the fuel filler flap.

Using the manual control; vehicle unlocked

- ☞ Press the opening control above the number plate.
- ☞ Lift the boot lid.

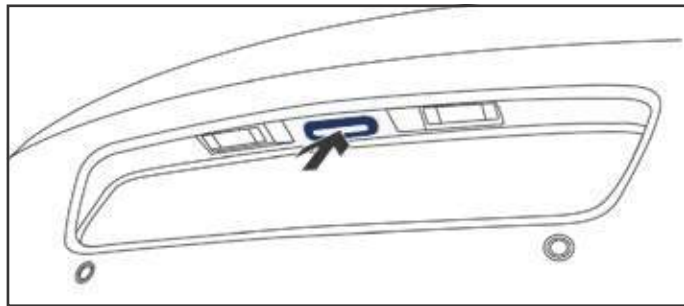

When selective unlocking is activated, the boot can also be opened by a second press on the open padlock on the remote control.

CLOSING

- ☞ Lower the boot lid using one of the interior grab handles.
- ☞ If necessary, press the top of the boot lid to close it fully.



Never grasp the boot lid by the active spoiler.

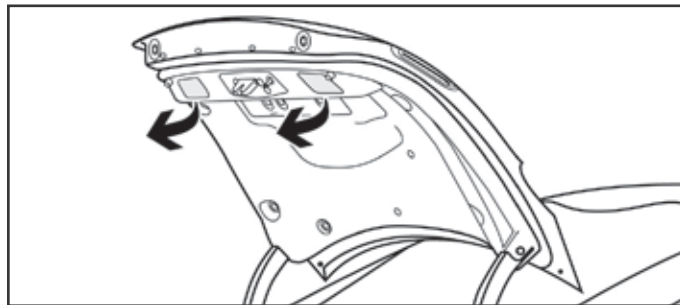

If the boot lid is not closed correctly:



- **when the engine is running**, this warning lamp comes on, accompanied by a message in the screen for a few seconds,
- **when the vehicle is moving** (speed above 6 mph (10 km/h)), this warning lamp comes on, accompanied by an audible signal and a message in the screen for a few seconds.

Emergency locking

If the central locking system fails (flat battery), you are advised to disconnect the battery.

FRONT SEATS

Seat with integral head restraint, consisting of a seat cushion and a seat back which can be adjusted to adapt your position for ease of driving and comfort.

MANUAL AdjustMENTS

Forwards-backwards adjustment

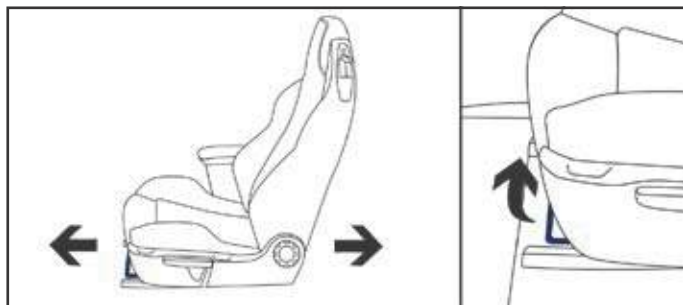

☞ Raise the control bar and slide the seat forwards or backwards.



Before moving the seat backwards, ensure that there is nothing that might prevent the full travel of the seat, so as to avoid the risk of jamming the seat caused by the presence of objects on the floor behind the seat or rear passengers. If the seat jams, stop the movement immediately.

Seat height adjustment

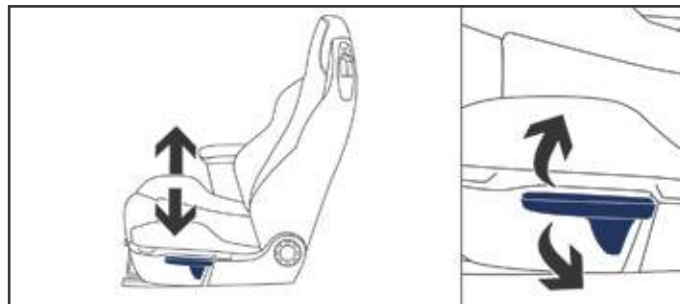

☞ Pull the control lever upwards to raise or push it downwards to lower, as many times as necessary, to obtain the position required.

Seat back angle adjustment

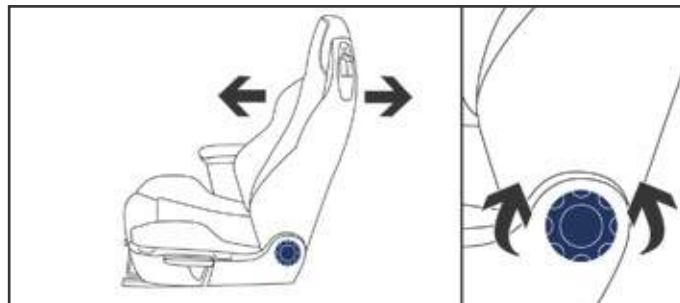

☞ Turn the knob to set the angle required.

FRONT SEATS

Seat with integral head restraint, consisting of a seat cushion and a seat back which can be adjusted to adapt your position for ease of driving and comfort.

- i** The electrical functions of the seat are deactivated approximately one minute after the ignition is switched off. To reactivate them, switch on the ignition. Carry out these adjustments with the engine running to avoid discharging the battery.

ELECTRIC ADJUSTMENTS

Forwards-backwards adjustment

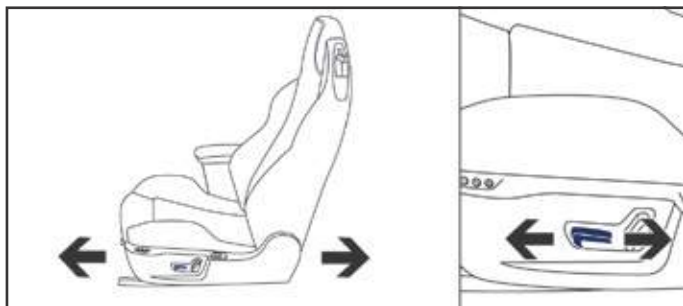

- ☞** Push the control forwards or rearwards to slide the seat.

- !** Before moving the seat backwards, ensure that there is nothing that might prevent the full travel of the seat, so as to avoid the risk of jamming the seat caused by the presence of objects on the floor behind the seat or rear passengers. If the seat jams, stop the movement immediately.

Seat cushion height adjustment

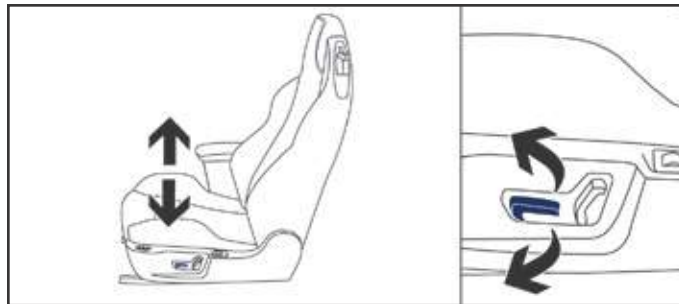

- ☞** Tilt the rear part of the control upwards or downwards to obtain the required height.

Seat back angle adjustment

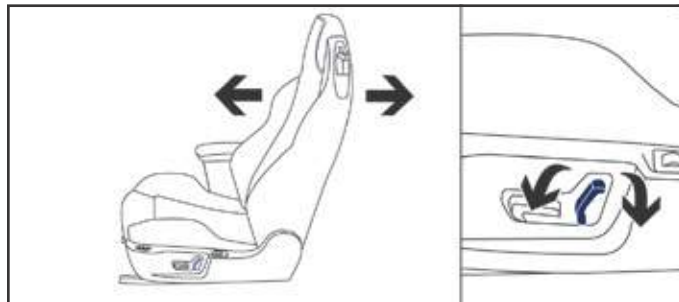

- ☞** Tilt the control forwards or rearwards to adjust the angle of the seat back.

MANUAL LUMBAR Adj USTMENT

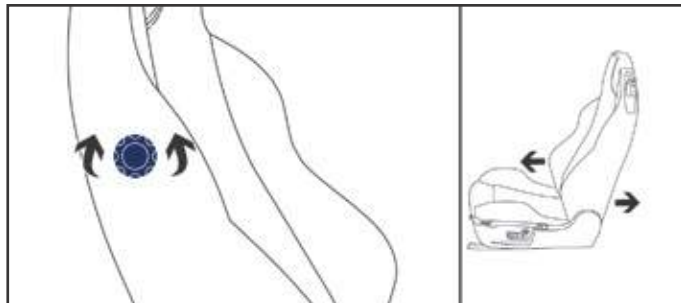

- ☞ Turn the knob manually to obtain the desired level of lumbar support.

HEATED SEATS CONTROL

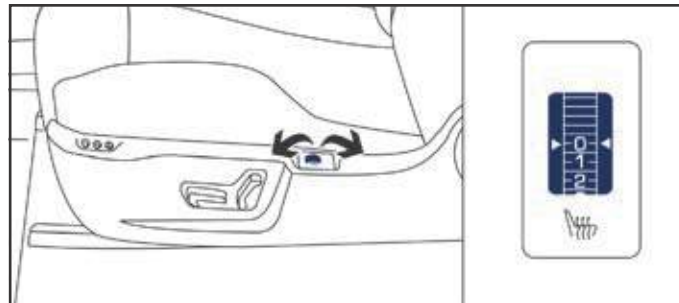

With the engine running, the front seats can be heated separately.

- ☞ Use the adjustment dial, placed on the side of each front seat, to switch on and select the level of heating required:
 - 0:** Off.
 - 1:** Low.
 - 2:** Medium.
 - 3:** High.

STORING DRIVING POSITIONS

System which takes into account the electrical settings of the driver's seat and the door mirrors. It enables you to store two positions using the buttons on the side of the driver's seat.

STORING A POSITION

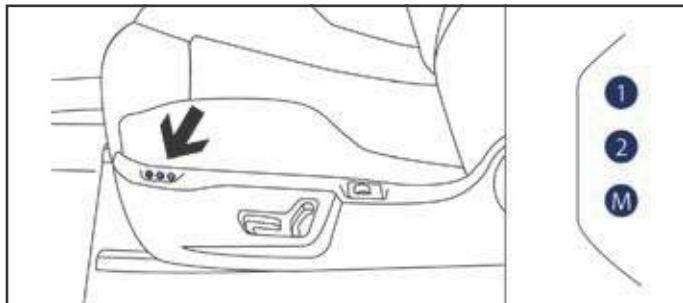

Using buttons M / 1 / 2

- ☞ Switch on the ignition.
- ☞ Adjust your seat and your door mirrors.
- ☞ Press button **M**, then press button **1** or **2** within four seconds.
An audible signal is heard indicating that the settings have been stored.



Storing a new position cancels the previous position.

RECALLING A STORED POSITION

Using button 1 or 2

- ☞ Press and hold button **1** or **2** until the audible signal is heard indicating the end of the adjustment.



When the ignition is off, after a few consecutive position recalls, the function will be deactivated until the engine is started, to prevent discharging of the battery.

STEERING WHEEL ADJUSTMENT

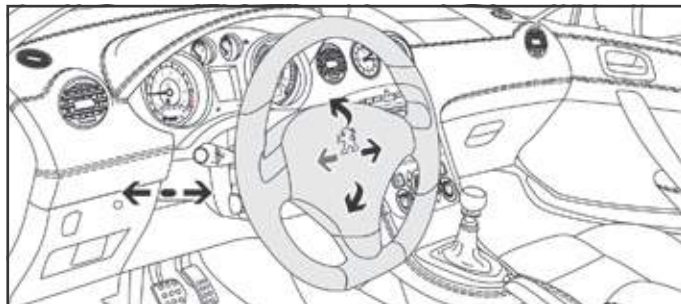

- ☞ **When stationary**, pull the control lever to release the adjustment mechanism.
- ☞ Adjust the height and reach to suit your driving position.
- ☞ Push the control lever to lock the adjustment mechanism.

! As a safety precaution, these operations should only be carried out with the vehicle stationary.

MIRRORS

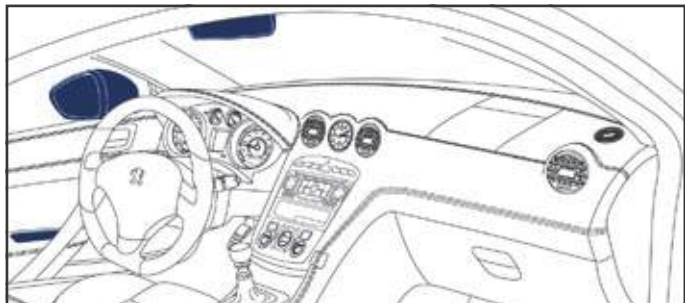

DOOR MIRRORS

Each fitted with an adjustable mirror glass permitting the lateral rearward vision necessary for overtaking or parking. They can be folded electrically.

demisting - defrosting



The demisting-defrosting of the door mirrors is effected with the engine running, by switching on the heated rear screen. See the "Demisting-defrosting the rear screen" section.

Adjustment

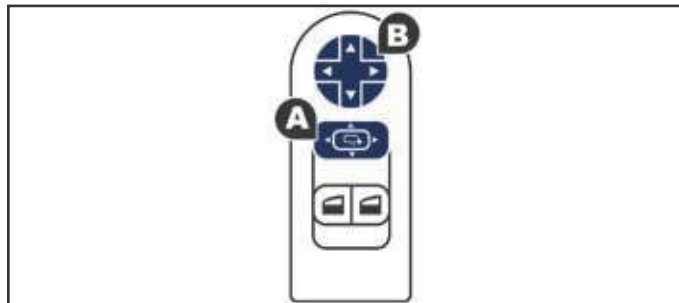

- ☞ Move control **A** to the right or to the left to select the corresponding mirror.
- ☞ Move control **B** in all four directions to adjust.
- ☞ Return control **A** to the central position.



As a safety measure, the mirrors should be adjusted to reduce the blind spot. The objects observed are, in reality, closer than they appear. Take this into account in order to correctly judge the distance of vehicles approaching from behind.

Folding

- ☞ From outside: lock the vehicle using the remote control or the key.
- ☞ From inside: with the ignition on, pull the control **A** in the central position rearwards.

 If the mirrors are folded using control **A**, they will not unfold when the vehicle is unlocked. Pull again on control **A**.

Unfolding

- ☞ From outside: unlock the vehicle using the remote control or the key.
- ☞ From inside: with the ignition on, pull the control **A** in the central position rearwards.

 The folding and unfolding of the door mirrors using the remote control can be deactivated by a PEUGEOT dealer or a qualified workshop.
If necessary the mirrors can be folded manually.

Automatic tilting in reverse gear

System which provides a view of the ground during parking manoeuvres in reverse gear.

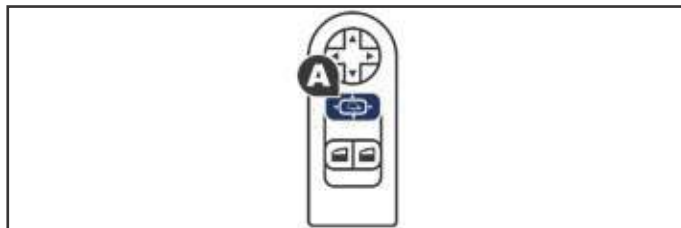

Programming

- ☞ With the engine running, engage reverse gear.
- ☞ Select and adjust the left-hand and right-hand mirrors in succession.

The adjustment is stored immediately.

Switching on

- ☞ With the engine running, engage reverse gear.
- ☞ Move control **A** to the right or to the left to select the corresponding mirror.

The glass of the mirror selected tilts downwards, in accordance with its programming.

Switching off

- ☞ Exit reverse gear and wait ten seconds.
- or
- ☞ Return control **A** to the central position.

The mirror glass returns to its initial position.

The mirror glass also returns to its initial position:

- if the speed exceeds 6 mph (10 km/h),
- if the engine is switched off.

REAR VIEW MIRROR

Adjustable mirror providing a central rearward view.

Equipped with an anti-dazzle system, which darkens the mirror glass and reduces the nuisance to the driver caused by the sun, headlamps from other vehicles...

Automatic day/night model

By means of a sensor, which measures the light from the rear of the vehicle, this system automatically and progressively changes between the day and night uses.

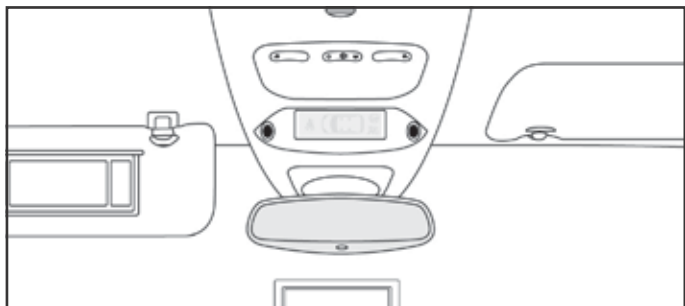

In order to ensure optimum visibility during your manoeuvres, the mirror lightens automatically when reverse gear is engaged.



Due to the curve of the rear screen, the image in the rear view mirror may be slightly distorted; take this into account when manoeuvring the vehicle.

REAR SEATS

Two-seat bench with one-piece fixed seat cushion and one-piece folding backrest.

The rear seat headrests are fixed.

ACCESS TO THE REAR SEATS

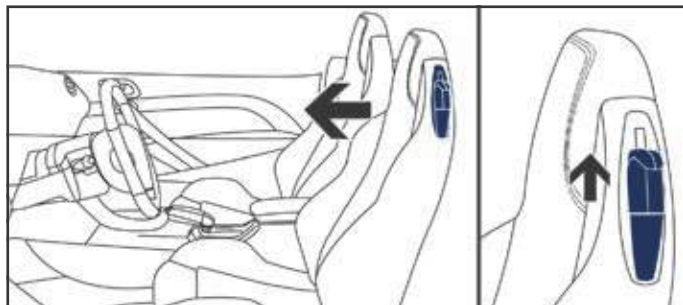

- ☞ Check that the front seat has been moved forward sufficiently.
- ☞ Pull the control upwards to fold the backrest; this control does not release the seat cushion.

When put back in place, the backrest returns to its initial position.

FOLDING DOWN THE REAR BACKREST

The backrest can be folded down to increase the boot storage space. The backrest release control is located in the boot.

- ☞ Check that the front seats have been moved forward sufficiently.
- ☞ Check that nothing has been left on the rear seats.
- ☞ Store the seat belt buckles on their respective securing points located between the headrests.

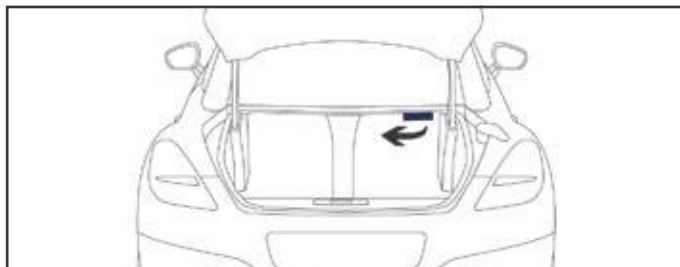

- ☞ Open the boot.
- ☞ Pull the backrest release handle, located under the shelf.

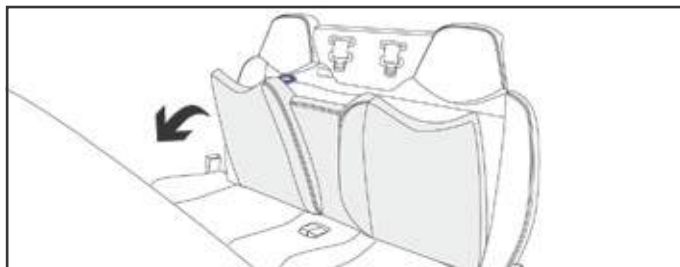

- ☞ Fold the backrest down onto the seat cushion.

- ⚠ When transporting long objects, do not place a load of more than 30 kg on the rear of the backrest. Do not place rough objects on the rear of the backrest which could damage it.

RETURNING THE REAR BACKREST TO THE UPRIGHT POSITION

When returning the backrest to the upright position, ensure that it is locked securely to assure your safety.

VENTILATION

AIR INTAKE

The air circulating in the passenger compartment is filtered and originates either from the outside via the grille located at the base of the windscreen or from the inside in air recirculation mode.

AIR FLOW PATHS

The incoming air follows various routes depending on the control positions selected by the driver:

- direct arrival in the passenger compartment (air intake),
- passage through a heating circuit (heating),
- passage through a cooling circuit (air conditioning).

The temperature control enables you to obtain the level of comfort required by mixing the air of the various circuits.

The air distribution control enables you to diffuse the air in the passenger compartment combining several air vents.

The air flow control enables you to increase or reduce the speed of the ventilation blower.

CONTROL PANEL

The controls for this system are grouped together on control panel **A** on the centre console. The functions offered are:

- the level of comfort required,
- air flow,
- air distribution,
- demisting/defrosting,
- manual or digital air conditioning controls.

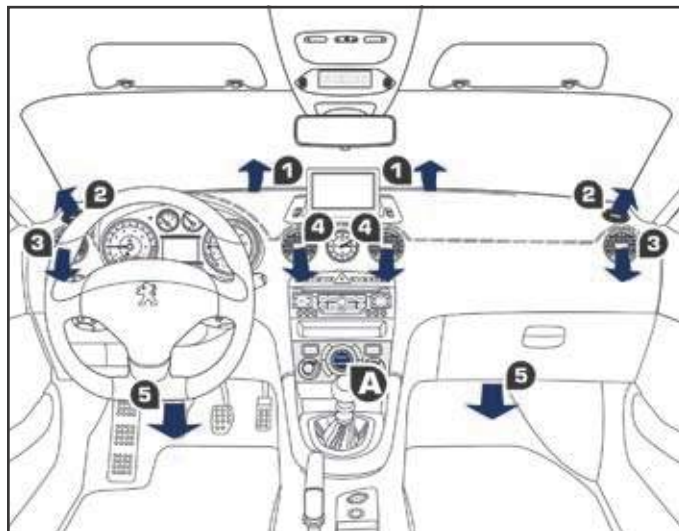

AIR DIFFUSION

1. Windscreen demisting/defrosting vents.
2. Front side window demisting/defrosting vents.
3. Side adjustable air vents.
4. Central adjustable air vents.
5. Air outlets to the front footwells.

RECOMMENDATIONS FOR VENTILATION AND AIR CONDITIONING



In order for these systems to be fully effective, follow the operation and maintenance guidelines below:

- ☞ To obtain an even air distribution, take care not to obstruct the exterior air intake grilles located at the base of the windscreen, the nozzles, the vents and the air outlets, as well as the air extractor located in the boot.
- ☞ Do not cover the sunshine sensor, located on the dashboard; this is used for regulation of the air conditioning system.
- ☞ Operate the air conditioning system for at least 5 to 10 minutes, once or twice a month to keep it in good working order.
- ☞ Ensure that the passenger compartment filter is in good condition and have the filter elements replaced regularly (refer to the "Checks" section).
We recommend the use of a combined passenger compartment filter. Thanks to its special active additive, it contributes to the purification of the air breathed by the occupants and the cleanliness of the passenger compartment (reduction of allergic symptoms, bad odours and greasy deposits).
- ☞ To ensure correct operation of the air conditioning system, you are also advised to refer to the warranty and maintenance record for information on when it should be checked.
- ☞ If the system does not produce cold air, switch it off and contact a PEUGEOT dealer or a qualified workshop.

When towing the maximum load on a steep gradient in high temperatures, switching off the air conditioning increases the available engine power and so improves towing performance.



If after an extended stop in sunshine, the interior temperature is very high, first ventilate the cabin for a few moments. Put the air flow control at a setting high enough to quickly change the air in the cabin.
The air conditioning system does not contain chlorine and does not present any danger to the ozone layer.



The condensation created by the air conditioning results in a discharge of water under the vehicle which is perfectly normal.

DUAL-ZONE DIGITAL AIR CONDITIONING

The air conditioning only operates when the engine is running.

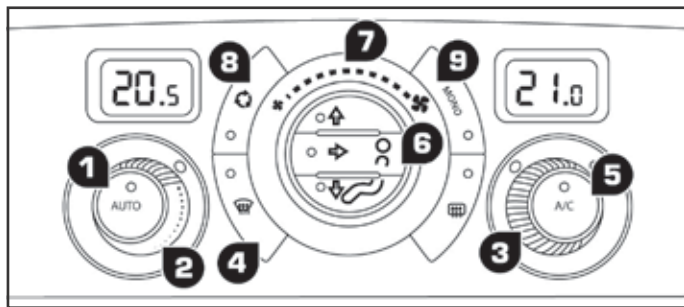

AUTOMATIC OPERATION

1. Automatic comfort programme



- ☞ Press the "AUTO" button. The indicator lamp in the button comes on.

We recommend the use of this mode: it permits automatic and optimised adjustment of all of the functions, passenger compartment temperature, air flow, air distribution and air recirculation, in accordance with the comfort value that you have chosen.

This system is designed to operate effectively in all seasons, with the windows closed.



When the engine is cold, to prevent too great a distribution of cold air, the air flow will reach its optimum level gradually. In cold weather, it favours the distribution of warm air to the windscreen, side windows and footwells only.

2. driver's side adjustment

3. Passenger's side adjustment



The driver and front passenger can each adjust the temperature to their requirements.

The value indicated on the display corresponds to a level of comfort and not to a temperature in degrees Celsius or Fahrenheit.

- ☞ Turn control **2** or **3** to the left or to the right respectively to decrease or increase this value.

A setting around the value 21 provides optimum comfort. However, depending on your requirements, a setting between 18 and 24 is normal.

You are advised to avoid a left / right setting difference of more than 3.



On entering the vehicle, if the interior temperature is much colder or warmer than the comfort value, there is no need to change the value displayed in order to obtain the comfort required. The system corrects the difference in temperature automatically and as quickly as possible.

4. Automatic visibility programme



The automatic comfort programme may not be sufficient to quickly demist or defrost the windscreen and side windows (humidity, several passengers, ice, etc.).

- ☞ Press this button to activate the automatic visibility programme. The indicator lamp in the button comes on.

The system automatically controls the air conditioning, the air flow and the air intake and provides optimum distribution of the ventilation to the windscreen and side windows.

- ☞ To switch the system off, press this button again or press **"AUTO"**. The indicator lamp in the button goes off and the indicator lamp in the **"AUTO"** button comes on.

MANUAL OPERATION

If you wish, you can make a different choice from that offered by the system by changing a setting. The other functions will still be controlled automatically.

- ☞ Pressing the **"AUTO"** button returns the system to completely automatic operation.



For maximum cooling or heating of the passenger compartment, it is possible to exceed the minimum value 14 or the maximum value 28.

- ☞ Turn control **2** or **3** to the left until **"LO"** is displayed or to the right until **"HI"** is displayed.

5. Air conditioning On / Off



- ☞ Press this button to switch off the air conditioning. Switching the system off could result in discomfort (humidity, condensation).

- ☞ Press this button again to return to automatic operation of the air conditioning. The indicator lamp in the **"A/C"** button comes on.

6. Air distribution adjustment



- ☞ Press one or more buttons to direct the air flow towards:

- the windscreen and side windows (demisting or defrosting),
- the windscreen, the side windows and the vents,
- the windscreen, the side windows, the vents and the footwells,
- the vents and the footwells,
- the vents,
- the footwells,
- the windscreen, the side windows and the footwells.

7. Air flow adjustment



- ☞ Turn this control to the left to decrease the air flow or to the right to increase the air flow.

The air flow indicator lamps, between the two fans, come on progressively in relation to the value requested.

8. Air intake / Air recirculation



- ☞ Press this button for recirculation of the interior air. The indicator lamp in the button comes on.

Air recirculation enables the passenger compartment to be isolated from exterior odours and smoke.

- ☞ As soon as possible, press this button again to permit the intake of outside air and prevent the formation of condensation. The indicator lamp on the button switches off.

9. Mono-zone / dual-zone



- ☞ Press this button to equalise the comfort value on the passenger's side with that on the driver's side (mono zone). The indicator lamp in the button comes on.

SWITCHING THE SYSTEM OFF

- ☞ Turn the air flow control to the left until all of the indicator lamps go off.

This action switches off the air conditioning and the ventilation.

Temperature related comfort is no longer guaranteed but a slight flow of air, due to the movement of the vehicle, can still be felt.

- ☞ Turn the air flow dial to the right or press the "**AUTO**" button to reactivate the system with the values set before it was switched off.



Avoid prolonged operation in interior air recirculation mode or driving for long periods with the system off (risk of condensation and deterioration of the air quality).

REAR SCREEN DEMIST - DEFROST



The control button is located on the heating or air conditioning system control panel.

SWITCHING ON

The rear screen demisting/defrosting can only operate when the engine is running.

- ☞ Press this button to demist/defrost the rear screen and (depending on version) the door mirrors. The indicator lamp associated with the button comes on.

SWITCHING OFF

The demisting/defrosting switches off automatically to prevent an excessive consumption of current.

- ☞ It is possible to stop the demisting/defrosting operation before it is switched off automatically by pressing the button again. The indicator lamp associated with the button switches off.



If the engine is switched off before the demisting/defrosting is switched off automatically, demisting/defrosting will resume next time the engine is switched on.



☞ Switch off the demisting/defrosting of the rear screen and door mirrors as soon as appropriate as lower current consumption results in reduced fuel consumption.

COURTESY LAMP

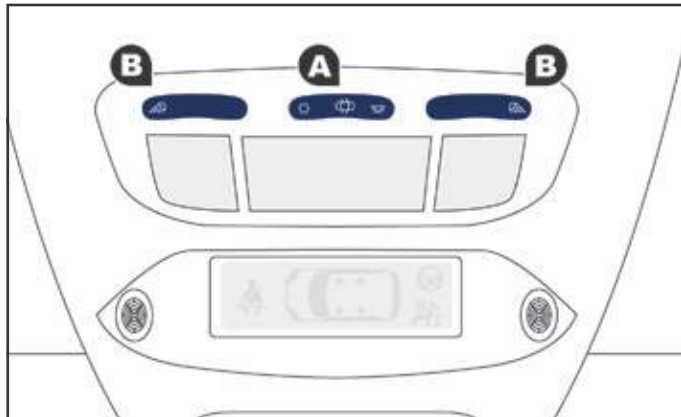

A. Courtesy lamp

B. Map reading lamps

COURTESY LAMP



In this position, the courtesy lamp comes on gradually:

- when the vehicle is unlocked,
- when the key is removed from the ignition,
- when a door is opened,
- when the remote control locking button is activated, in order to locate your vehicle.

It switches off gradually:

- when the vehicle is locked,
- when the ignition is switched on,
- 30 seconds after the last door is closed.



Permanently off.



Permanent lighting.



With the "permanent lighting" mode, the duration of lighting varies, depending on the circumstances:

- with the ignition off, approximately ten minutes,
- in energy economy mode, approximately thirty seconds,
- with the engine running, unlimited.

MAP READING LAMPS

☞ With the ignition on, press the corresponding switch.

INTERIOR MOOD LIGHTING

The dimmed passenger compartment lighting improves visibility in the vehicle when the light is poor.

SWITCHING ON

At night, the footwell lighting and the front courtesy mood lamp come on automatically when the sidelamps are switched on.

SWITCHING OFF

The interior mood lighting switches off automatically when the sidelamps are switched off.

PROGRAMMING



The function is activated or deactivated via the vehicle configuration menu.

This function is activated by default.

INTERIOR WELCOME LIGHTING

The remote switching on of the passenger compartment lighting makes your entry into the vehicle easier in poor light. It is activated in accordance with the light intensity detected by the brightness sensor.

SWITCHING ON

☞ Press the open padlock on the remote control.

The front door sill lighting, the footwell lighting and the courtesy lamps come on; your vehicle is also unlocked.

SWITCHING OFF

The interior welcome lighting switches off automatically after a certain time, when one of the doors is opened or the ignition is switched on.

EXTERIOR WELCOME LIGHTING

The remote switching on of the lighting makes your approach to the vehicle easier in poor light. It is activated according to the level of light detected by the sunshine sensor.

SWITCHING ON

- ☞ Press the open padlock on the remote control.
The dipped beam headlamps and the sidelamps come on; your vehicle is also unlocked.

SWITCHING OFF

The exterior welcome lighting switches off automatically after a set time, when the ignition is switched on or on locking the vehicle.



The duration of the welcome lighting is associated with and identical to that of the automatic guide-me-home lighting.

INTERIOR FITTINGS

1. **Sun visor**
(see details on following page)
2. **Central storage compartment**
3. **Storage compartment**
4. **Illuminated and cooled glove box**
(see details on following page)
5. **door pockets**
6. **Illuminated ashtray**
(see details on following page)
7. **Storage compartment with non-slip mat**
8. **12 V accessory socket**
(see details on following page)
9. **Cup holder**
10. **Adjustable front armrest**
(see details on following page)
11. **Open storage**

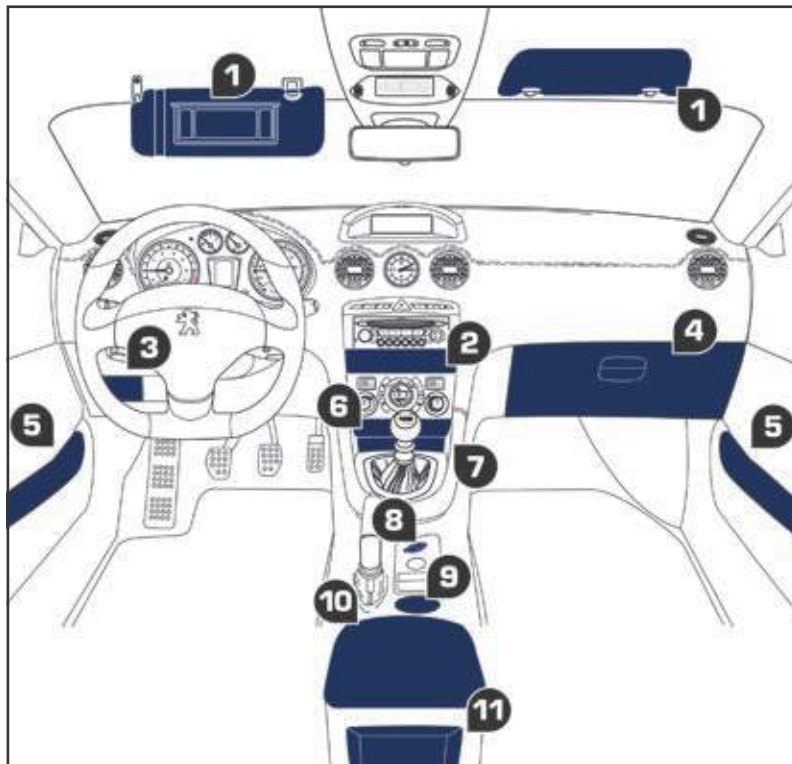

SUN VISOR

Component which protects against sunlight from the front or the side, also equipped with an illuminated vanity mirror.

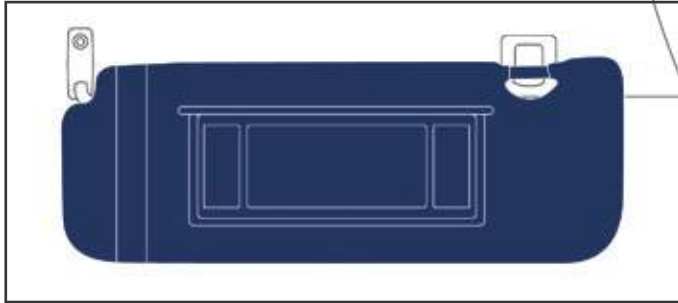

☞ With the ignition on, raise the concealing flap; the mirror is illuminated automatically.

This sun visor is also equipped with a ticket holder.

ILLUMINATED AND COOLED GLOVE BOX

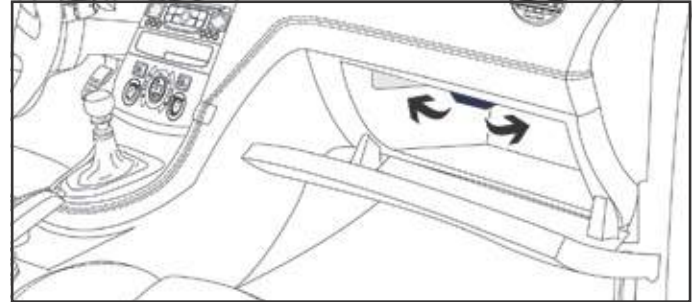

This has areas for storing a bottle of water, the vehicle's handbook pack... Its lid has areas for storing a pen, a pair of spectacles, tokens, cards, a can...

☞ To open the glove box, raise the handle.

The glove box is illuminated when the lid is opened.

It houses an air vent, which can be opened or closed. This distributes the same conditioned air as the vents in the passenger compartment.

12 V ACCESSORY SOCKET



- ☞ To connect a 12 V accessory (max power: 120 W), lift the cover and connect a suitable adaptor.



The connection of an electrical device not approved by PEUGEOT, such as a USB charger, may adversely affect the operation of vehicle electrical systems, causing faults such as poor telephone reception or interference with displays in the screens.

ILLUMINATED ASHTRAY

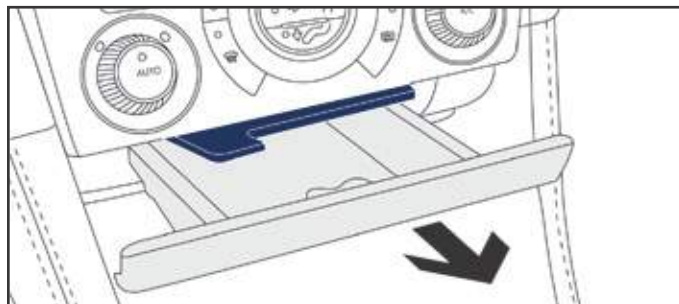

- ☞ Pull the drawer for access to the ashtray.
- ☞ To empty the ashtray, after opening, press the tab and remove the ashtray.

FRONT ARMREST

Comfort and storage for the driver and front passenger.
The height and length of the armrest cover can be adjusted.

Height adjustment

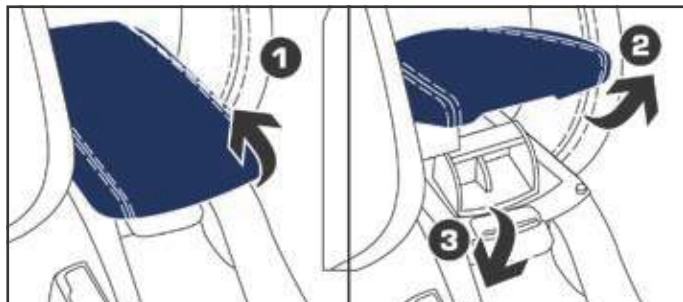

- ☞ Raise the cover to the required position (low, intermediate or high).
- ☞ If you raise the cover slightly beyond the high position, guide it when lowering it to the low position.

Longitudinal adjustment



- ☞ Slide the cover fully forwards or rearwards.

Storage



- ☞ Raise the lever.
- ☞ Raise the cover fully.

PEUGEOT CONNECT USB

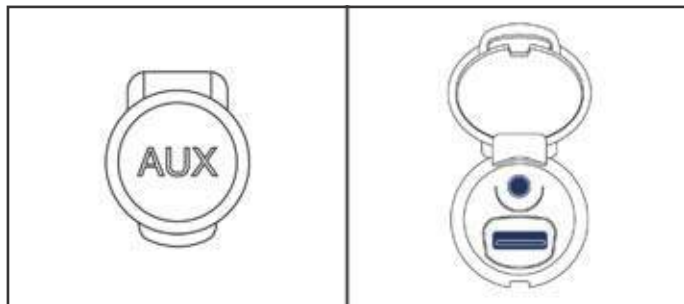

This connection box, consisting of a j ACK socket and a USB port, is located in the front armrest.

With the USB port, it permits the connection of a portable device, such as a digital audio player of the iPod® or USB memory stick type.

With the j ACK socket, it permits the connection of any type of portable player.

It reads the audio file formats (mp3, ogg, wma, wav...) which are transmitted to your audio equipment and heard via the vehicle's speakers.

If the device is connected to the USB port, you can manage these files using the steering mounted controls or the audio system control panel and display them in the multifunction screen.

 If the portable device is connected to the USB port, it is charged automatically when in use.

For more information on the use of this equipment, refer to the corresponding audio part of the "Audio equipment and telematics" section.

USB PLAYER

This connection box, consisting of a USB port, is located in the front armrest.

It permits the connection of a portable device, such as an iPod® digital audio player of generation 5 or later or a USB memory stick.

It reads the audio file formats (mp3, ogg, wma, wav...) which are transmitted to your audio equipment and heard via the vehicle's speakers.

You can manage these files using the steering mounted controls or the audio system control panel and display them in the multifunction screen.



When it is in use, the portable device charges automatically.

For more information on the use of this equipment, refer to the corresponding audio part of the "Audio equipment and telematics" section.

MATS

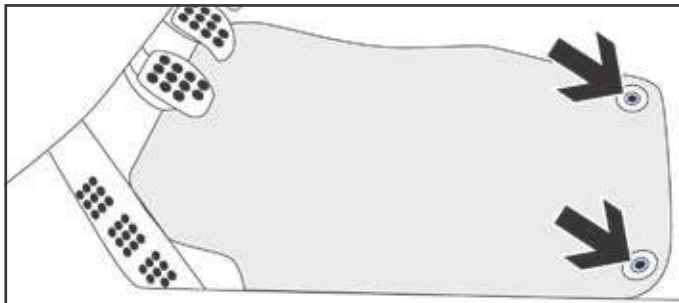

Fitting

When fitting the mat for the first time, on the driver's side use only the fixings provided in the wallet attached.

The other mats are simply placed on the carpet.

Removal

To remove the mat on the driver's side:

- ☞ move the seat as far back as possible,
- ☞ unclip the fixings,
- ☞ remove the mat.

Refitting

To refit the mat on the driver's side:

- ☞ position the mat correctly,
- ☞ refit the fixings by pressing,
- ☞ check that the mat is secured correctly.



To avoid any risk of jamming of the pedals:

- only use mats which are suited to the fixings already present in the vehicle; these fixings must be used,
- never fit one mat on top of another.

The use of mats not approved by PEUGEOT may interfere with access to the pedals and hinder the operation of the cruise control / speed limiter.

The mats approved by PEUGEOT have two fixings located below the seat.

BOOT FITTINGS

1. **Stowing rings**
 2. **Storage net**
 3. **Storage well**
- (see details on following page)

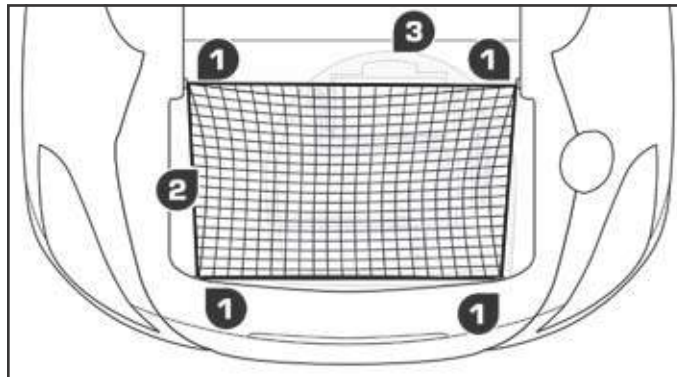

STORAGE BOX

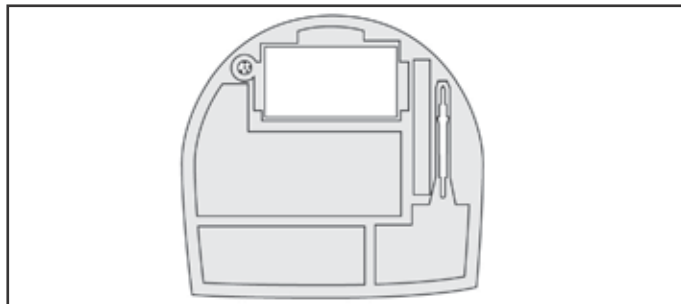

This has areas for storing a box of spare bulbs, a first aid kit, the temporary puncture repair kit, a warning triangle, the removable ball of the towbar system...

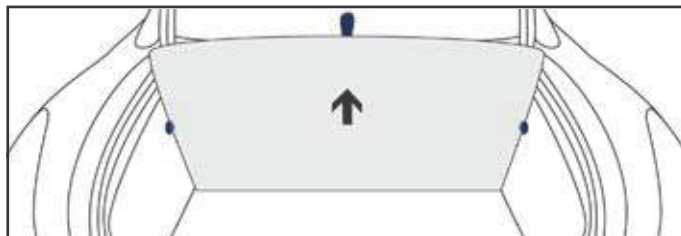

For access to it:

- ☞ raise the floor using the strap,
- ☞ secure it in the vertical position behind the stops, located on the sides of the boot.



A second warning triangle can be stored in the boot lid trim.

BOOT LAMPS

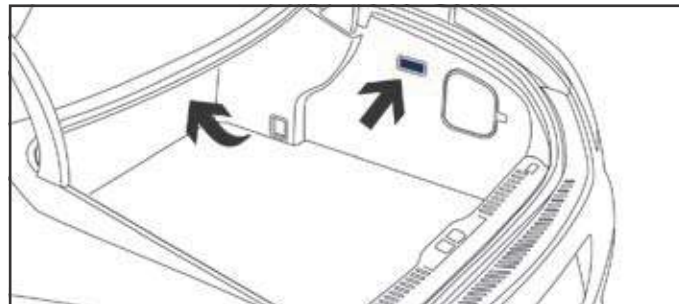

Your vehicle is fitted with two boot lamps; one in the right-hand boot side trim and a second in the centre under the rear shelf.

They come on automatically when the boot is opened and switch off automatically when the boot is closed.

They cannot be deactivated manually.



The duration of lighting varies, depending on the context:

- when the ignition is off, approximately ten minutes,
- in energy economy mode, approximately thirty seconds,
- when the engine is running, no limit.

ExTERIOR LIGHTING CONTROLS

Control stalk for the selection and control of the various front and rear lamps providing the vehicle's lighting.

MAIN LIGHTING

The various front and rear lamps of the vehicle are designed to adapt the driver's visibility progressively in relation to the climatic conditions:

- sidelamps, to be seen,
- dipped beam headlamps to see without dazzling other drivers,
- main beam headlamps to see clearly when the road is clear.

Add ITIONAL LIGHTING

Other lamps are fitted to fulfil the requirements of particular driving conditions:

- a rear foglamp to be seen from a distance,
- directional headlamps for improved visibility when cornering,
- daytime running lamps to be seen during the day.

SETTINGS

Various automatic lighting control modes are also available depending on options:

- daytime running lamps,
- automatic illumination of headlamps,
- directional lighting,
- guide-me-home lighting.



In some weather conditions (e.g. low temperature or humidity), the presence of misting on the internal surface of the glass of the headlamps and rear lamps is normal; it disappears after the lamps have been on for a few minutes.

Model without AUTO lighting

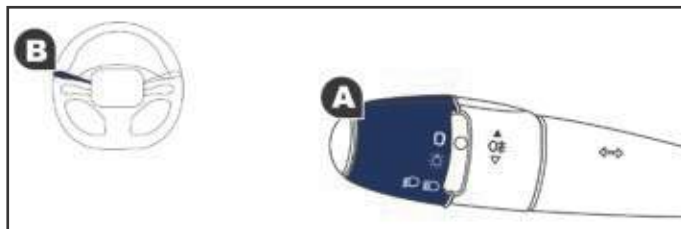

Model with AUTO lighting

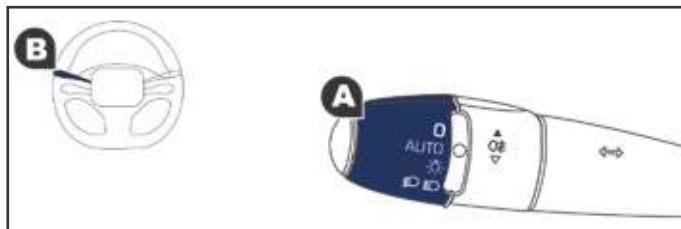

MANUAL CONTROLS

The lighting is controlled directly by the driver by means of the ring **A** and the stalk **B**.

- A.** Main lighting mode selection ring: turn it to position the symbol required facing the mark.



Lighting off / daytime running lamps.



Automatic illumination of headlamps.



Sidelamps only.



Dipped or main beam headlamps.

- B.** Stalk for switching headlamps: pull it to switch between dipped headlamps / main beam headlamps.

In the lamps off and sidelamps modes, the driver can switch on the main beam headlamps temporarily ("headlamp flash") by maintaining a pull on the stalk.

DISPLAYS

Lighting of the corresponding indicator lamp on the instrument panel confirms the switching on of the lighting selected.

The instrument panel has permanent back-lighting, both day and night. In this case, illumination of the instrument panel is not linked to the exterior lighting.

C. Foglamp selection ring.

The foglamp operates with the dipped and main beam headlamps.

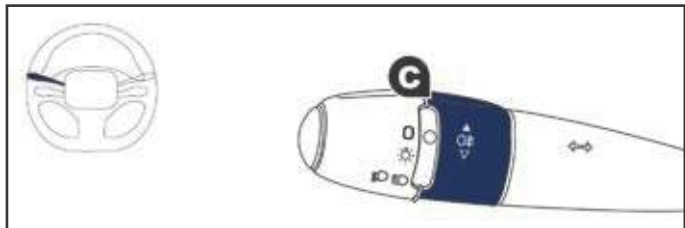

Rear foglamp.

☞ Turn the ring **C** forwards and release to switch on the rear foglamp.

When the lighting is switched off automatically (with AUTO model) or when the dipped beam headlamps are switched off manually, the foglamp and the sidelamps will remain on.

☞ Turn the ring **C** rearwards and release to switch off all the lamps.



In good or rainy weather, both day and night, use of the rear foglamp is prohibited. In these situations, the power of its beam may dazzle other drivers. It should only be used in fog or snow. In these weather conditions, it is your responsibility to switch on the foglamp and dipped beam headlamps manually as the sunshine sensor may detect sufficient light.

Do not forget to switch off the rear foglamp when it is no longer needed.



Switching off the lamps when the ignition is switched off

On switching off the ignition, all of the lamps turn off immediately, except for dipped beam if guide-me-home lighting is activated.

Switching on the lamps after the ignition is switched off

To reactivate the lighting control, rotate ring **A** to the "0" position - lamps off, then to the desired position.

On opening the driver's door a temporary audible signal warns the driver that the lighting is on.

The lamps, with the exception of the sidelamps, switch off automatically after a maximum duration of thirty minutes to prevent discharging of the battery.

LEd LAMPS

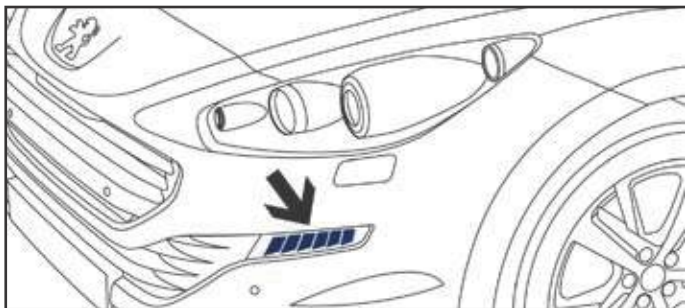

They come on when the engine is started.

Depending on the destination country, they are used for:

- daytime running lamps* in day mode and sidelamps in night mode (they are brighter when daytime running lamps),
or
- sidelamps in day and night mode.

Where LED lamps are fitted, the filament bulbs for the daytime running lamps / sidelamps in the front lamp units are not used.

DAYTIME RUNNING LAMPS

Daytime lighting, compulsory in certain countries, which comes on automatically when the engine is started providing better visibility of the vehicle by other road users.

In countries in which it is imposed by regulations:

- by default, this function is activated and cannot be deactivated,
- the dipped beam headlamps come on, associated with the sidelamps and the number plate lamps.

For other countries where the vehicle is sold, this function is assured by specific lamps. The lighting control stalk should be in position "0" or "AUTO".

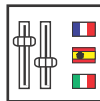

This function can be activated or deactivated via the vehicle configuration menu.

Deactivation of the daytime running lamps is effective after operation of the lighting control stalk or after the next engine start; activation is immediate.

* function that can be set in the vehicle configuration menu.

MANUAL GUIDE-ME-HOME LIGHTING

The temporary illumination of the dipped beam headlamps after the vehicle's ignition has been switched off makes the driver's exit easier when the light is poor.

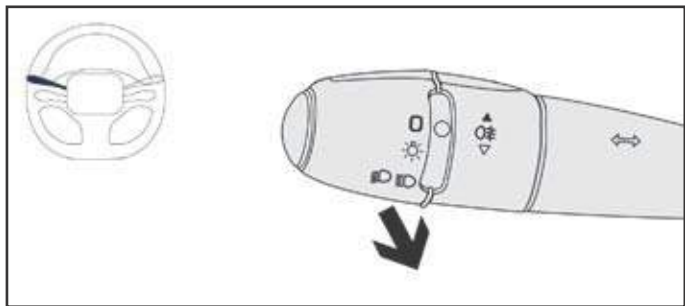

Switching on

- ☞ With the ignition off, "flash" the headlamps using the lighting stalk.
- ☞ A further "headlamp flash" switches the function off.

Switching off

The manual guide-me-home lighting switches off automatically after a set time.

AUTOMATIC ILLUMINATION OF HEADLAMPS

When a low level of ambient light is detected by a sunshine sensor, the number plate lamps, sidelamps and dipped beam headlamps are switched on automatically, without any action on the part of the driver. They can also come on if rain is detected, at the same time as automatic operation of the windscreen wipers.

As soon as the brightness returns to a sufficient level or after the windscreen wipers are switched off, the lamps are switched off automatically.



Activation

- ☞ Turn the ring to the "AUTO" position. The activation of the function is accompanied by the display of a message in the screen.

deactivation

- ☞ Turn the ring to another position. Deactivation of the function is accompanied by the display of a message in the screen.

Operating fault



In the event of a malfunction of the sunshine sensor, the lighting comes on, this warning lamp is displayed in the instrument panel and/or a message appears in the screen, accompanied by an audible signal.

Contact a PEUGEOT dealer or a qualified workshop.



In fog or snow, the sunshine sensor may detect sufficient light. In this case, the lighting will not come on automatically.

Do not cover the sunshine sensor, coupled with the rain sensor and located in the centre of the windscreen behind the rear view mirror; the associated functions would no longer be controlled.

AUTOMATIC GUIDE-ME-HOME LIGHTING

When the automatic illumination of headlamps function is activated (lighting control stalk in the "AUTO" position), under low ambient light the dipped beams headlamps come on automatically when the ignition is switched off.

Programming

Activation or deactivation, as well as the duration of the guide-me-home lighting, is set in the vehicle configuration menu.

MANUAL ADJUSTMENT OF HALOGEN HEADLAMPS

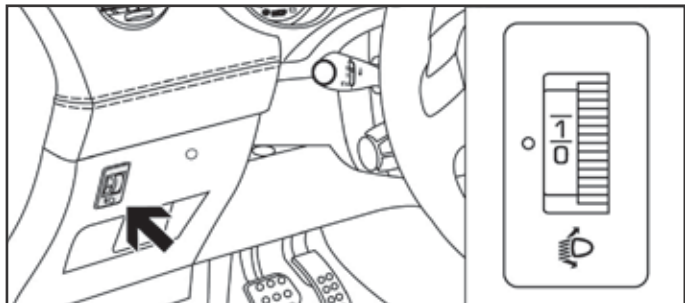

To avoid dazzling other road users, the height of the halogen bulb headlamps must be adjusted according to the load in the vehicle.

0. 1 or 2 people in the front seats.
 - 3 people.
1. 4 people.
 - Intermediate setting.
2. 4 people + maximum authorised loads.
 - Intermediate setting.
3. Driver + maximum authorised loads.



Initial setting is position "0".

AUTOMATIC ADJUSTMENT OF XENON HEADLAMPS

In order to avoid causing a nuisance to other road users, this system corrects the height of the xenon headlamp beams automatically and when stationary, in relation to the load in the vehicle.



If a malfunction occurs, this warning lamp is displayed on the instrument panel, accompanied by an audible signal and a message in the screen.

The system then places your headlamps in the lowest position.



Do not touch the xenon headlamp bulbs.
Contact a PEUGEOT dealer or a qualified workshop.



Travelling abroad

If using your vehicle in a country that drives on the other side of the road, the headlamps must be adjusted to avoid dazzling on-coming drivers.

Contact a PEUGEOT dealer or a qualified workshop.

DIRECTIONAL LIGHTING

When the dipped or main beam headlamps are on, this function enables the light beams to provide improved lighting of the side of the road when cornering.

The use of this function, from approximately 12 mph (20 km/h) and associated with the xenon headlamps only, considerably improves the quality of your lighting when cornering.

with directional lighting

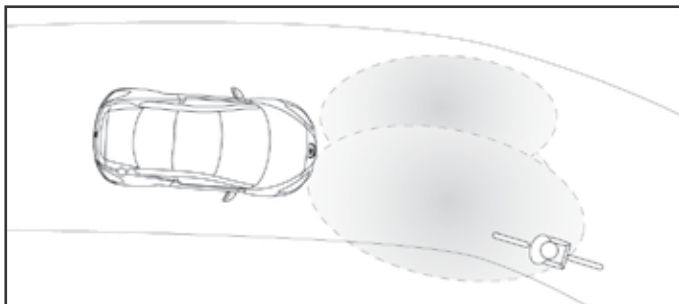

without directional lighting

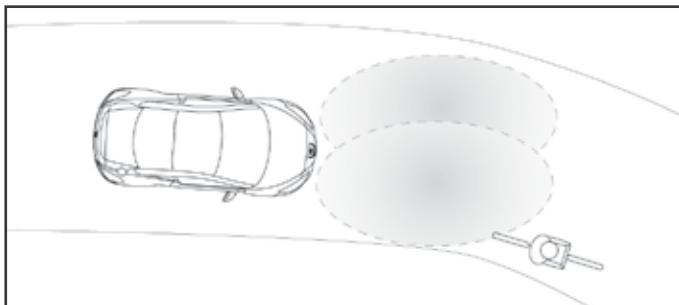

PROGRAMMING

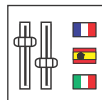

The function is activated or deactivated via the vehicle configuration menu.

OPERATING FAULT



If a fault occurs, this warning lamp flashes in the instrument panel, accompanied by a message in the screen. Contact a PEUGEOT dealer or a qualified workshop.



When stationary or moving at very low speed or when reverse gear is engaged, the function is inactive.

The status of the function remains in the memory when the ignition is switched off.

WIPER CONTROLS

Control stalk for the various windscreen wiping modes for clearing rain and cleaning the windscreen.

PROGRAMMING

An automatic mode is also available, providing automatic rain sensitive windscreen wipers.

MANUAL OPERATION OF THE WINDSCREEN WIPERS

This control stalk allows selection of the most suitable wiping speed according to the weather conditions.

- 2** Fast (heavy rain).
- 1** Normal (moderate rain).
- I** Intermittent (proportional to the speed of the vehicle).
- 0** Park.

AUTO ↓

Automatic, then single wipe (see the corresponding section).

Model with AUTO wiping

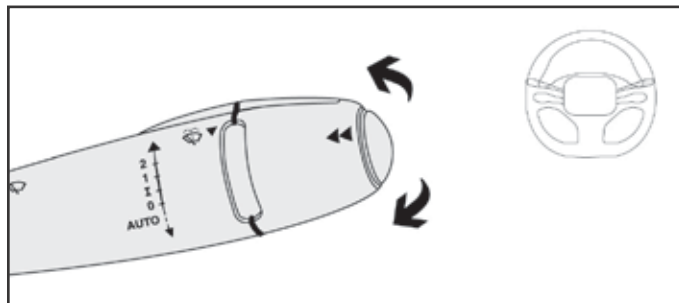

WINDSCREEN AND HEADLAMP WASH

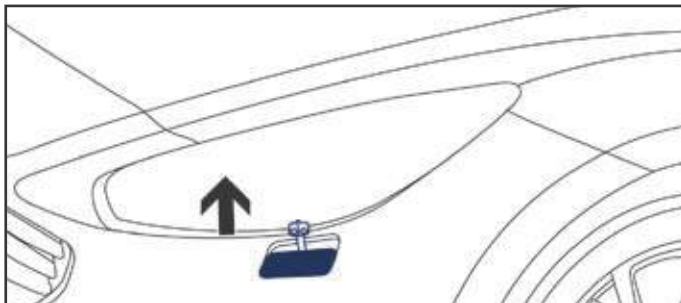

- ☞ Pull the windscreen wiper stalk towards you. The windscreen wash then the windscreen wipers operate for a fixed period.

The headlamp washers only operate when **the dipped or main beam headlamps are on, with the vehicle moving.**

- ℹ To reduce the consumption of the fluid by the headlamp washers, they operate only with every seventh use of the screenwash or every 25 miles (40 km) during a given journey.

Screenwash/headlamp wash low



In the case of vehicles fitted with headlamp washers, when the minimum level of the reservoir is reached, this warning lamp and/or the service warning lamp is displayed in the instrument panel, accompanied by an audible signal and a message in the screen.

Next time you stop, fill the screenwash / headlamp wash fluid reservoir. The warning lamp is displayed when the ignition is switched on, or every time the stalk is operated, until the reservoir is filled.

AUTOMATIC RAIN SENSITIVE WINDSCREEN WIPERS

The windscreen wipers operate automatically, without any action on the part of the driver, if rain is detected (sensor behind the rear view mirror), adapting their speed to the intensity of the rainfall.

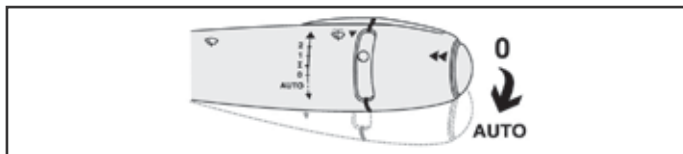

Activation

This is controlled manually by the driver by pushing the stalk downwards to the "AUTO" position.

It is accompanied by a message in the screen.

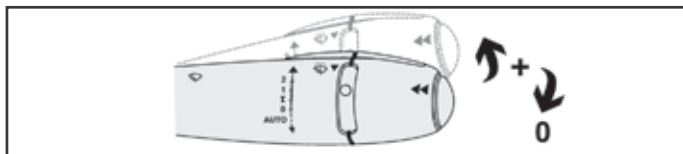

Switching off

This is controlled manually by the driver by moving the stalk upwards then returning it to position "0".

It is accompanied by a message in the screen.



The automatic rain sensitive wipers must be reactivated if the ignition has been off for more than one minute, by pushing the stalk downwards.

Operating fault

If an automatic wiping malfunction occurs, the wipers will operate in intermittent mode.

Have it checked by a PEUGEOT dealer or a qualified workshop.



Do not cover the rain sensor, linked with the sunshine sensor and located in the centre of the windscreen behind the rear view mirror.

Switch off the automatic rain sensitive wipers when using an automatic car wash.

In winter, to avoid damaging the wiper blades, it is advisable to wait until the windscreen is completely clear of ice before activating the automatic rain sensitive wipers.

SPECIAL POSITION OF THE WINDSCREEN WIPERS

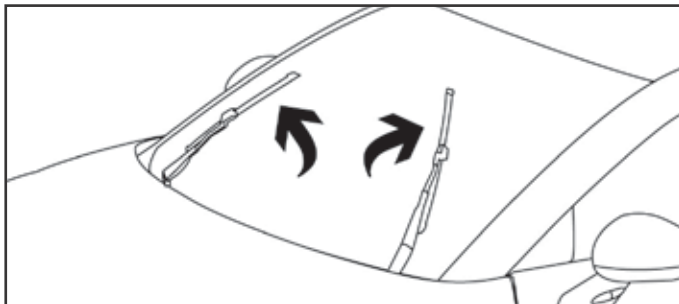

This position permits release of the windscreen wiper blades. It is used for cleaning or replacement of the blades. It can also be useful, in winter, to detach the blades from the windscreen.

- ☞ Any action on the wiper stalk in the minute after switching off the ignition places the blades vertically on the screen.
- ☞ To park the blades again, switch on the ignition and operate the wiper stalk.



To maintain the effectiveness of the flat wiper blades, it is advisable to:

- handle them with care,
- clean them regularly using soapy water,
- avoid using them to retain cardboard on the windscreen,
- replace them at the first signs of wear.

DIRECTION INDICATORS

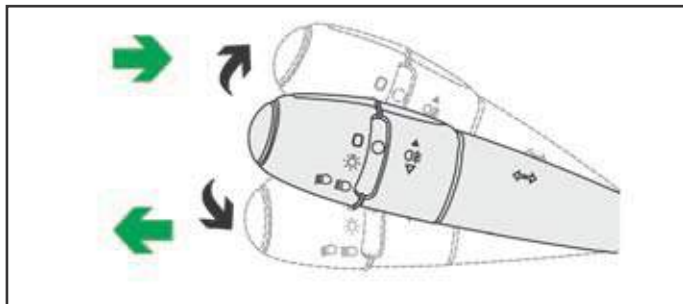

- ☞ Left: lower the lighting stalk passing the point of resistance.
- ☞ Right: raise the lighting stalk passing the point of resistance.



If you forget to cancel the direction indicators for more than twenty seconds, the volume of the audible signal will increase if the speed is above 40 mph (60 km/h).

Three flashes of the direction indicators

- ☞ Press briefly upwards or downwards, without going beyond the point of resistance; the direction indicators will flash 3 times.

HAZARD WARNING LAMPS

A visual warning by means of the direction indicators to alert other road users to a vehicle breakdown, towing or accident.

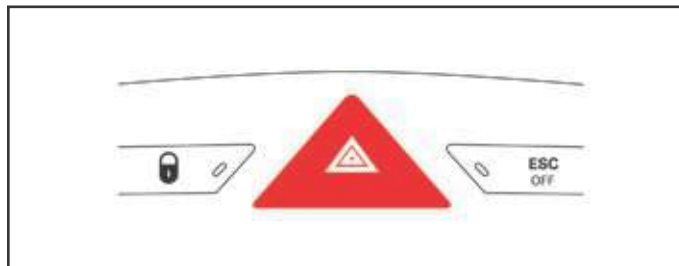

- ☞ Press this button, the direction indicators flash. They can operate with the ignition off.

AUTOMATIC OPERATION OF HAZARD WARNING LAMPS*

When braking in an emergency, depending on the deceleration, the hazard warning lamps come on automatically.

They switch off automatically the first time you accelerate.

- ☞ You can also switch them off by pressing the button.

Deactivating the DSC/ASR systems also deactivates the automatic operation of the hazard warning lamps; refer to the "Trajectory control systems - Deactivation" section.

* Except for the 1.6 THP 270 hp version.

EMERGENCY OR ASSISTANCE CALL

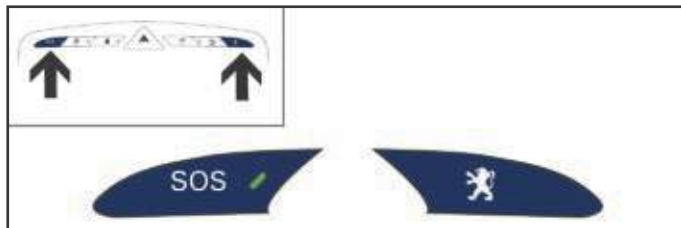

This system allows you to make an emergency or assistance call to the emergency services or to the dedicated PEUGEOT service.

 For more information on the use of this function, refer to the "Audio equipment and telematics" section.

HORN

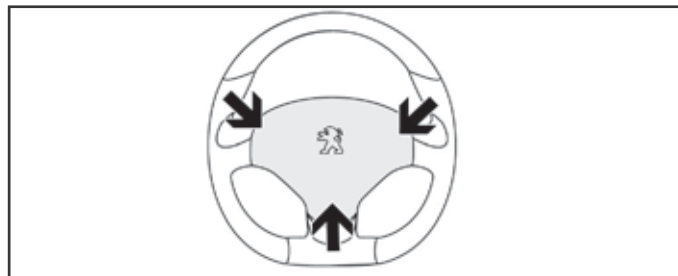

Audible warning to alert other road users to an imminent danger.

 Press one of the spokes of the steering wheel.

 Use the horn with moderation, observing the driving regulations of the country you are driving in.

BRAKING ASSISTANCE SYSTEMS

Group of supplementary systems which help you to obtain optimum braking in complete safety in emergency situations:

- anti-lock braking system (ABS),
- electronic brake force distribution (EBFD),
- emergency braking assistance (EBA).

ANTI-LOCK BRAKING SYSTEM AND ELECTRONIC BRAKE FORCE DISTRIBUTION

Linked systems which improve the stability and manoeuvrability of your vehicle when braking, in particular on poor or slippery surfaces.

Activation

The anti-lock braking system comes into operation automatically when there is a risk of wheel lock.

Normal operation of the ABS may make itself felt by slight vibration of the brake pedal.

 When braking in an emergency, press very firmly without releasing the pressure.

Operating fault



If this warning lamp comes on, accompanied by an audible signal and a message in the screen, it indicates a malfunction of the anti-lock braking system which could result in loss of control of the vehicle when braking.



If this warning lamp comes on, together with the **STOP** and **ABS** warning lamps, accompanied by an audible signal and a message in the screen, it indicates a malfunction of the electronic brake force distribution which could result in loss of control of the vehicle when braking.

You must stop as soon as it is safe to do so.

In either case, contact a PEUGEOT dealer or a qualified workshop.



When replacing wheels (tyres and rims), ensure that they conform to the manufacturer's recommendations.

EMERGENCY BRAKING ASSISTANCE

System which, in an emergency, enables you to obtain the optimum braking pressure more quickly, thus reducing the stopping distance.

Activation

It is triggered by the speed at which the brake pedal is pressed.

The effect of this is a reduction in the resistance of the pedal and an increase in braking efficiency.



When braking in an emergency, press firmly without releasing the pressure.

TRAJECTORY CONTROL SYSTEMS

dYNAMIC STABILITY CONTROL (dSC) AND ANTI-SLIP REGULATION (ASR)

The anti-slip regulation (also known as traction control) optimises traction to prevent skidding of the wheels, by acting on the brakes of the driving wheels and on the engine.

The electronic stability control acts on the brake of one or more wheels and on the engine to keep the vehicle on the trajectory required by the driver, within the limits of the laws of physics.

SNOW DRIVING ASSISTANCE (INTELLIGENT TRACTION CONTROL)

Your vehicle has a system to help driving on snow: **Intelligent Traction Control**.

This automatic system continuously checks for situations of difficult surface adhesion that could make it difficult to move off or make progress on deep fresh snow or compacted snow.

In these situations, **Intelligent Traction Control** limits the amount of wheel slip to provide the best traction and trajectory control.

In extremely severe conditions (deep snow, mud...), it can be useful to temporarily deactivate the **dynamic stability control** and **wheel anti-slip** systems to allow a degree of wheel spin and so recover grip.

It is recommended that the system be reactivated as soon as possible.

Snow tyres are strongly recommended on surfaces offering low levels of adhesion.

Activation

These systems are activated automatically each time the vehicle is started.

These systems act on the operation of the engine and brakes as soon as they detect a problem of grip or trajectory.



This is indicated by flashing of this warning lamp in the instrument panel.

deactivation

In exceptional conditions (starting a vehicle which is bogged down, stuck in snow, on soft ground...), it may be advisable to deactivate the DSC and ASR, so that the wheels can turn freely and regain grip.

Reactivate the systems as soon as the level of grip permits.

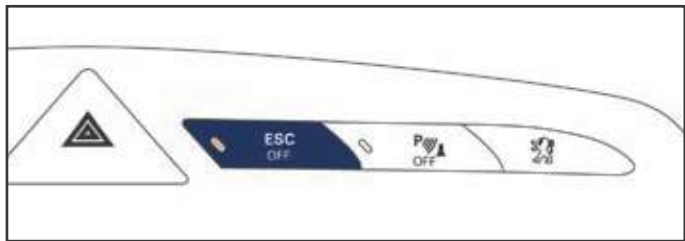

☞ Press this button.

The indicator lamp in the button comes on.

The DSC and ASR systems no longer act on the operation of the engine and on the brakes in the event of a involuntary change of trajectory.

This action also deactivates the automatic operation of hazard warning lamps (except for the 1.6 THP 270 hp version).

Reactivation

The systems are reactivated automatically every time the ignition is switched back on.

You can also reactivate them manually:

☞ Press this button again.

This action also reactivates the automatic operation of hazard warning lamps (except for the 1.6 THP 270 hp version).

Operating fault



Illumination of this warning lamp and the lamp in the deactivation button, accompanied by an audible signal and a message, indicate a fault with the system.

Contact a PEUGEOT dealer or a qualified workshop to have the system checked.

! dSC/ASR

The DSC and ASR systems offer increased safety in normal driving, but they should not encourage the driver to take extra risks or drive at high speed.

It is in difficult driving conditions (rain, snow, ice) that the risk of loss of grip increases. It is therefore important for your safety to keep the DSC and ASR systems activated in all conditions, and particularly in difficult conditions.

The correct operation of these systems depends on observation of the manufacturer's recommendations regarding as much the wheels (tyres and rims), braking and electronic components as the assembly and repair procedures used by PEUGEOT dealers.

To benefit in full from the effectiveness of the DSC and ASR systems in wintry conditions, the vehicle must be fitted with four snow tyres, allowing the the vehicle to retain neutral behaviour on the road.



After an impact, have these systems checked by a PEUGEOT dealer or a qualified workshop.

ACTIVE BONNET

The active bonnet has been designed to maximise the safety of pedestrians in the event of an impact with the front of the vehicle.

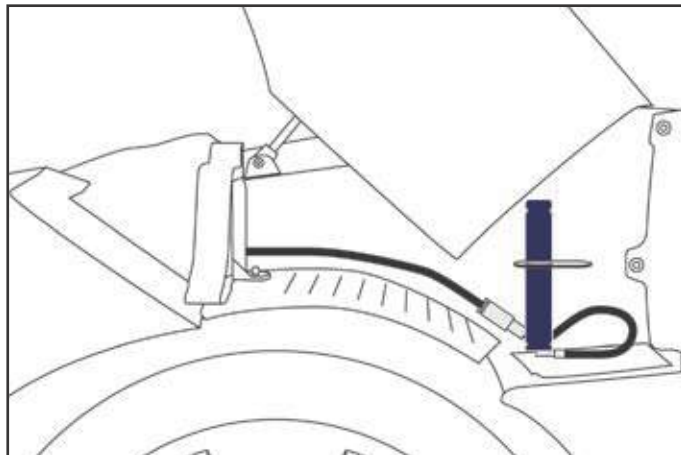

This system can only operate once. If a second impact occurs (during the same or a subsequent accident), the active bonnet will not operate.

After an accident or theft of the vehicle, have the system checked. Do not handle the pyrotechnic systems, located under the bonnet near the struts: risk of explosion.

All work on this system must be carried out only by the skilled personnel of a PEUGEOT dealer or a qualified workshop.

Operating fault



If this warning lamp comes on on the instrument panel, accompanied by an audible signal and a message in the screen, contact a PEUGEOT dealer or a qualified workshop to have the system checked. The active bonnet may no longer be deployed in the event of an impact.



The deployment of the active bonnet is accompanied by a slight emission of harmless smoke and a noise, due to the activation of the pyrotechnic cartridge integrated in the system. The airbag warning lamp comes on.

After deployment, close the bonnet by pressing on the hinges. Go to the nearest PEUGEOT dealer or a qualified workshop at a maximum speed of 20 mph (30 km/h).

ACTIVE SPOILER

Except the 1.6 THP 270 hp version

System which improves the aerodynamics and stability of the vehicle when driving. It can be controlled automatically or manually.



OPERATION

The use of the vehicle must comply with the legislation in force in your country. This system can be used to its full potential on a closed circuit.

Automatic mode

The spoiler rises automatically according to the speed and has two positions.

- When the speed of the vehicle is higher than 50 mph (85 km/h), the spoiler rises automatically to the intermediate position **A**. It remains in this position for as long as the speed remains above 35 mph (55 km/h).
- If the speed of the vehicle falls below 35 mph (55 km/h), the spoiler retracts automatically.
- When the speed of the vehicle is higher than 95 mph (155 km/h), the spoiler rises automatically to the maximum position **B**. It remains in this position for as long as the speed remains above 90 mph (142 km/h).
- If the speed of the vehicle falls below 90 mph (142 km/h), the spoiler retracts automatically to the intermediate position.

In this mode, the indicator lamp in the control button is off.

Manual mode

To control the operation of the spoiler manually, with the ignition on:

- ☞ press the control button briefly, the spoiler rises to the maximum position **B**.

In this mode, the indicator lamp on the control button is on.

When stationary or moving at less than 6 mph (10 km/h), press and hold the button until the indicator lamp goes off, the spoiler then retracts completely.

 Before operating the spoiler, ensure that no one is in the proximity of the moving parts to avoid any risk of injury. Nevertheless, in the event of pinching, you must reverse the movement of the spoiler. To do this, release the control button then press it again to raise the spoiler.

To exit from manual mode:

- ☞ press the button briefly: the indicator lamp on the button goes off (return to automatic mode).

 At speeds below 6 mph (10 km/h), the spoiler stays in the open position. It retracts automatically as soon as the vehicle exceeds this speed threshold.

MAINTENANCE

To maintain the spoiler, with the vehicle stationary, ignition on:

- ☞ raise the spoiler to the maximum position **B** by pressing the button briefly,
- ☞ once the cleaning is complete, retract the spoiler: press and hold the button until the end of the manoeuvre.

The keep this system in good working order, check the spoiler and its housing periodically preventing the unwanted accumulation of leaves, ice or snow.

 Before washing the vehicle, always retract the spoiler into its housing.

Keep the end of the high-pressure nozzle at least 1 metre from the spoiler housing.

OPERATING FAULT

If the control system fails, the indicator lamp in the control button flashes, accompanied by an audible signal and a message in the screen. As a safety precaution, the spoiler rises to the maximum position, regardless of the speed of the vehicle.

If the problem persists and you wish to retract the spoiler:

- ☞ stop where it is safe to do so,
- ☞ switch off the ignition,
- ☞ switch the ignition on again.

If the indicator lamp no longer flashes, the failure was temporary, the system has resumed normal operation. To retract the spoiler, refer to the paragraph "To exit from manual mode".

If the indicator lamp flashes again and the spoiler is still raised, the system is still faulty.

Have it checked by a PEUGEOT dealer or a qualified workshop.

In the event of a system operating fault (e.g. jamming of the spoiler), the indicator lamp in the control button flashes, accompanied by an audible signal and a message in the screen. For safety reasons, do not exceed a speed of 85 mph (140 km/h).

Have it checked by a PEUGEOT dealer or a qualified workshop.

 Never press on the spoiler to close the boot or push the vehicle as this may damage it.

The installation of load-carrying accessories on the vehicle limits the effectiveness of the spoiler.

Do not install load carrying accessories which are not recommended by PEUGEOT.

FIXED SPOILER

Only on the 1.6 THP 270 hp version

 When pushing the vehicle, do not press on the spoiler as there is a risk of damaging it.

 When washing your vehicle with a high pressure jet-wash, keep the end of the lance at least 1 metre away from the spoiler.

 The installation of carrying accessories on the vehicle reduces the effectiveness of the spoiler.

Only install carrying accessories that are recommended by PEUGEOT.

SEAT BELTS

FRONT SEAT BELTS

The front seat belts are fitted with a pretensioning and force limiting system.

This system improves safety in the front seats in the event of a front or side impact. Depending on the severity of the impact, the pretensioning system instantly tightens the seat belts against the body of the occupants.

The pretensioning seat belts are active when the ignition is on.

The force limiter reduces the pressure of the seat belt on the chest of the occupant, so improving their protection.

Fastening

- ☞ Pull the strap, then insert the tongue in the buckle.
- ☞ Check that the seat belt is fastened correctly by pulling the strap.

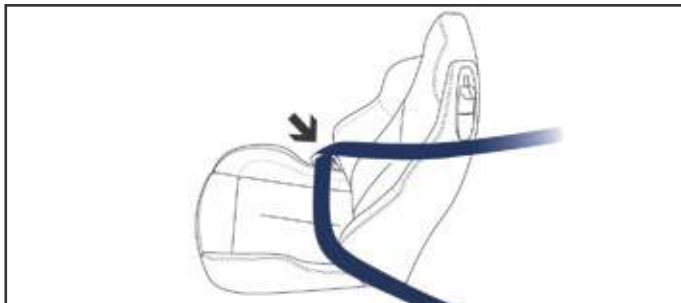

Unfastening

- ☞ Press the red button on the buckle.
- ☞ Guide the seat belt as it reels in.

Seat belt not fastened / unfastened warning lamps display

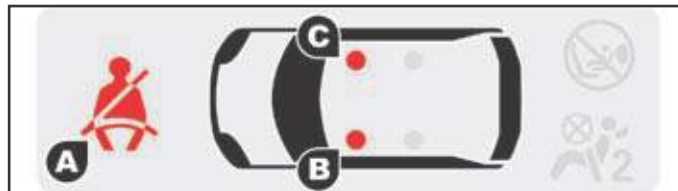

- A.** Front seat belts not fastened / unfastened warning lamp.
- B.** Front left seat belt warning lamp.
- C.** Front right seat belt warning lamp.

When the ignition is switched on, the warning lamp **A** comes on in the seat belt and passenger's front airbag warning lamp display, if the driver and/or the front passenger has not fastened their seat belt.

From approximately 12 mph (20 km/h) this warning lamp flashes for two minutes accompanied by an audible signal of increasing volume. Once these two minutes have elapsed, this warning lamp remains on until the driver and/or the front passenger fastens their seat belt.

The warning lamp **B** or **C** for the corresponding seat comes on in red if the seat belt is not fastened or is unfastened.

REAR SEAT BELTS

The rear seats are each fitted with a three-point inertia reel seat belt with force limiter.

Fastening

1. Pull the strap and insert the tongue **F** in the black buckle **F**, in the centre of the bench seat.
2. Insert the tongue **G** in the outer red buckle **G**.
3. Check that each buckle is fastened correctly by pulling the strap.

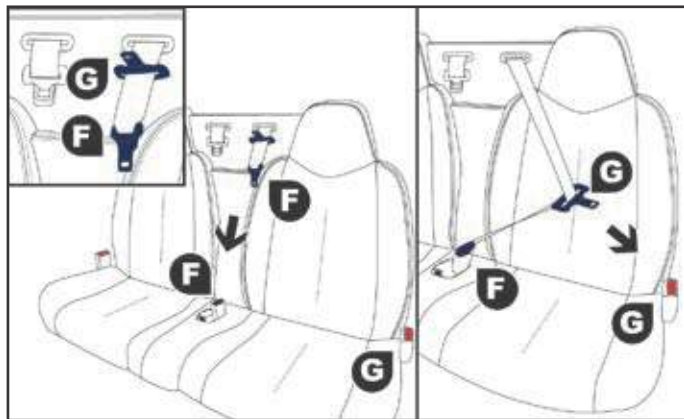

Unfastening

1. Press the red button on the buckle **G**, then the black button on the buckle **F**.
2. Guide the strap as it reels in and bring the tongue **G**, then the tongue **F** to the corresponding securing point on the backrest.

Seat belt unfastened warning lamps display

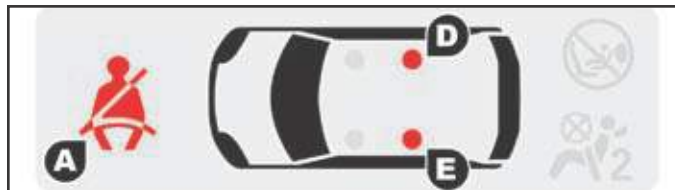

- A. Rear seat belts unfastened warning lamp.
- d. Rear right seat belt warning lamp.
- E. Rear left seat belt warning lamp.

The warning lamp **A** comes on, either on in the seat belt and passenger's front airbag warning lamps display, when one or more rear passengers unfasten their seat belt.

From approximately 12 mph (20 km/h), this warning lamp flashes for two minutes accompanied by an audible signal of increasing volume. Once these two minutes have elapsed, this warning lamp remains on until the one or more rear passengers fasten their seat belt.

When the ignition is switched on, with the engine running or the vehicle moving at a speed below approximately 12 mph (20 km/h), the corresponding warning lamps **d** and **E** come on in red for approximately 30 seconds, if the seat belt is not fastened.

When the vehicle is moving at a speed of more than approximately 12 mph (20 km/h), the corresponding warning lamp **d** or **E** comes on in red, accompanied by an audible signal and a message in the screen, if a rear passenger has unfastened their seat belt.



Unfastening is detected on both buckles of the seat belt. The corresponding warning lamp comes on when at least one of the two buckles is unfastened.



The driver must ensure that passengers use the seat belts correctly and that they are all restrained securely before setting off.

Wherever you are seated in the vehicle, always fasten your seat belt, even for short journeys.

Do not interchange the seat belt buckles as they will not fulfil their role fully.

The seat belts are fitted with an inertia reel permitting automatic adjustment of the length of the strap to your size. The seat belt is stowed automatically when not in use.

Before and after use, ensure that the seat belt is reeled in correctly.

The lower part of the strap must be positioned as low as possible on the pelvis.

The upper part must be positioned in the hollow of the shoulder.

The inertia reels are fitted with an automatic locking device which comes into operation in the event of a collision, emergency braking or if the vehicle rolls over. You can release the device by pulling the strap firmly and then releasing it so that it reels in slightly.

In order to be effective, a seat belt must:

- be tightened as close to the body as possible,
- be pulled in front of you with a smooth movement, checking that it does not twist,
- be used to restrain only one person,
- not bear any trace of cuts or fraying,
- not be converted or modified to avoid affecting its performance.

In accordance with current safety regulations, for all repairs on your vehicle's seat belts, go to a qualified workshop with the skills and equipment needed, which a PEUGEOT dealer is able to provide.

Have your seat belts checked regularly by a PEUGEOT dealer or a qualified workshop, particularly if the straps show signs of damage.

Clean the seat belt straps with soapy water or a textile cleaning product, sold by PEUGEOT dealers.

After folding or moving a seat or rear bench seat, ensure that the seat belt is positioned and reeled in correctly.

Recommendations for children

Use a suitable child seat if the passenger is less than 12 years old or shorter than one and a half metres.

Never use the same seat belt to secure more than one person.

Never allow a child to travel on your lap.

For more information, refer to the "Child seats" section.

In the event of an impact

depending on the nature and seriousness of the impact, the pretensioning device may be deployed before and independently of the airbags. Deployment of the pretensioners is accompanied by a slight discharge of harmless smoke and a noise, due to the activation of the pyrotechnic cartridge incorporated in the system.

In all cases, the airbag warning lamp comes on.

Following an impact, have the seat belts system checked, and if necessary replaced, by a PEUGEOT dealer or a qualified workshop.

AIRBAGS

The airbags have been designed to contribute towards improving the safety of the occupants in the event of violent collisions. They supplement the action of the force-limiting seat belts.

In this case, the electronic detectors record and analyse the front and side impacts suffered in the impact detection zones:

- in the event of a serious impact, the airbags are deployed instantaneously and contribute towards protecting the occupants of the vehicle; immediately after the impact, the airbags deflate rapidly so that they do not hinder the visibility of the occupants or their possible exit from the vehicle,
- in the event of a minor impact or rear impact and in certain roll-over conditions, the airbags may not be deployed; the seat belt alone contributes towards providing your protection in these situations.



The airbags do not operate when the ignition is off.

This equipment only operates once. If a second impact occurs (during the same or a subsequent accident), the airbag will not be deployed again.

Impact detection zones

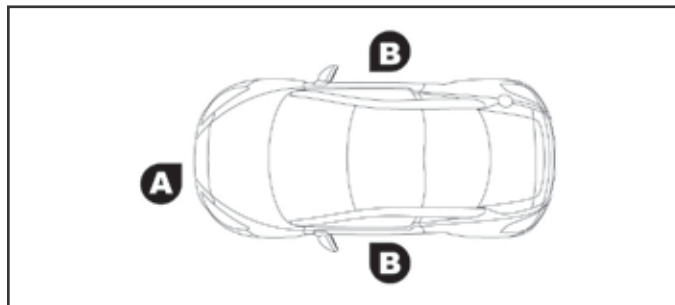

- A. Front impact zone.
- B. Side impact zone.



The deployment of one or more airbags is accompanied by a slight discharge of smoke and a noise, due to the activation of the pyrotechnic cartridge incorporated in the system. This smoke is not harmful, but sensitive individuals may experience some irritation. The noise of the detonation related to the deployment of one or more airbags may result in a slight loss of hearing for a short time.

FRONT AIRBAGS

System which protects the driver and front passenger in the event of a serious front impact in order to limit the risk of injury to the head and chest.

The driver's airbag is fitted in the centre of the steering wheel; the front passenger's airbag is fitted in the dashboard above the glove box.

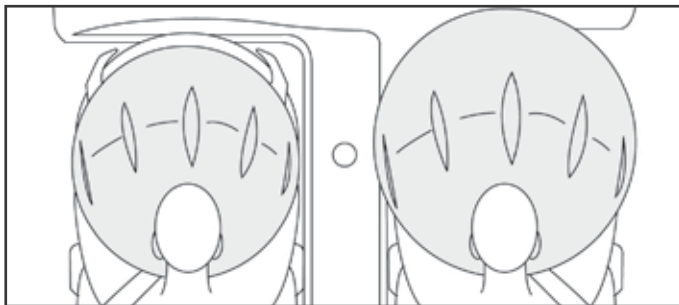

deployment

The airbags are deployed, except the passenger's front airbag if it is deactivated, in the event of a serious front impact to all or part of the front impact zone **A**, in the longitudinal centreline of the vehicle on a horizontal plane and directed from the front to the rear of the vehicle.

The front airbag inflates between the chest and head of the front occupant of the vehicle and the steering wheel, driver's side, and the dashboard, passenger's side to cushion their forward movement.

deactivation

Only the passenger's front airbag can be deactivated:

- ☞ **with the ignition off**, insert the key in the passenger airbag deactivation switch,
- ☞ turn it to the **"OFF"** position,
- ☞ then, remove the key keeping the switch in the new position.

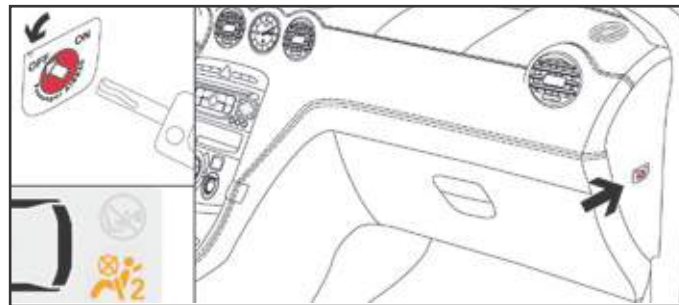

This warning lamp comes on in the passenger's front airbag warning lamps display when the ignition is on and until the airbag is reactivated.



To assure the safety of your child, the passenger's front airbag must be deactivated when you install a "rearward facing" child seat on the front passenger seat.

Otherwise, the child would risk being seriously injured or killed if the airbag were deployed.

Reactivation

When you remove the child seat, turn the switch to the "ON" position to reactivate the airbag and so assure the safety of your front passenger in the event of an impact.

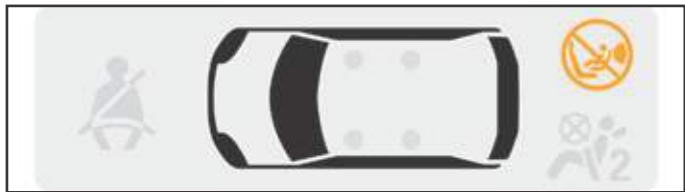

With the ignition on, this warning lamp comes on in the seat belt and passenger's front airbag warning lamps display for approximately one minute, if the passenger's front airbag is activated.

Operating fault



If this warning lamp comes on in the instrument panel, accompanied by an audible warning and a message in the screen, contact a PEUGEOT dealer or a qualified workshop to have the system checked. The airbags may no longer be deployed in the event of a serious impact.

LATERAL AIRBAGS

System which protects the driver and front passenger in the event of a violent side impact in order to limit the risks of injury to the pelvis, chest and head*.

The lateral airbags are installed on the outer side of the seat:

- one part in the front seat frame (chest-pelvis airbag),
- one part in the front head restraint* (head airbag).

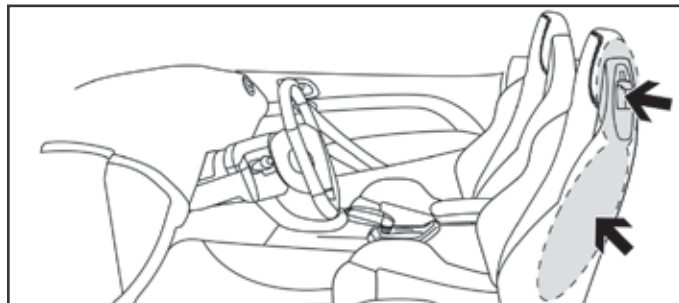

deployment

It is deployed unilaterally in the event of a violent impact applied to all or part of the side impact zone **B**, operating at right angles to the longitudinal axis of the vehicle in a horizontal plane and from the exterior of the vehicle towards the interior.

The lateral airbag comes between the front occupant of the vehicle and the corresponding door trim panel.

* Except for the 1.6 THP 270 hp version.

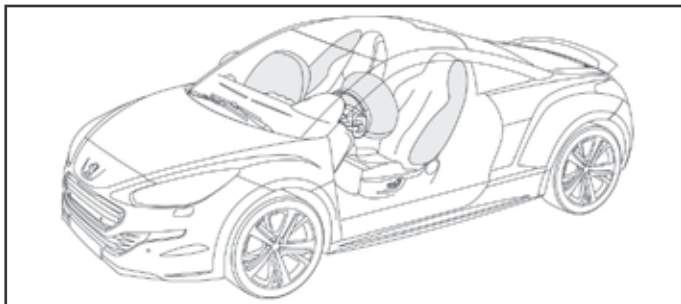

The airbag may not be deployed in an impact or minor accident on the side of the vehicle.

The airbag is not deployed in a front or rear impact.

Impact detection zones

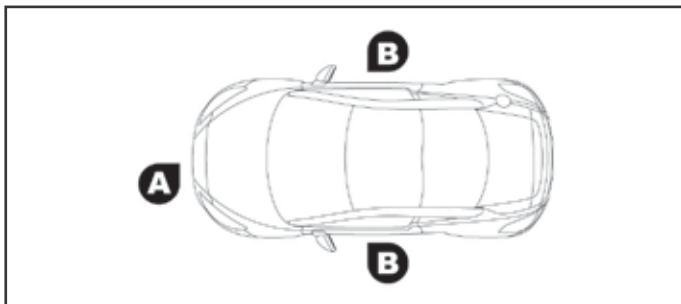

A. Front impact zone.

B. Side impact zone.

Operating fault



If this warning lamp comes on on the instrument panel, accompanied by an audible signal and a message in the screen, contact a PEUGEOT dealer or a qualified workshop to have the system checked. The airbags may no longer be deployed in the event of a violent impact.



For the airbags to be fully effective, observe the following safety rules:

Sit in a normal upright position.

Wear a correctly adjusted seat belt.

Do not leave anything between the occupants and the airbags (a child, pet, object...). This could hamper the operation of the airbags or injure the occupants.

After an accident or if the vehicle has been stolen or broken into, have the airbag systems checked.

All work on the airbag system must be carried out by a PEUGEOT dealer or a qualified workshop.

Even if all of the precautions mentioned are observed, a risk of injury or of minor burns to the head, chest or arms when an airbag is deployed cannot be ruled out. The bag inflates almost instantly (within a few milliseconds) then deflates within the same time discharging the hot gas via openings provided for this purpose.

Front airbags

Do not drive holding the steering wheel by its spokes or resting your hands on the centre part of the wheel.

Passengers must not place their feet on the dashboard.

Do not smoke as deployment of the airbags can cause burns or the risk of injury from a cigarette or pipe.

Never remove or pierce the steering wheel or hit it violently.

Do not fit or attach anything to the steering wheel or dashboard, this could cause injuries with deployment of the airbags.

Lateral airbags

Do not fix or attach anything to the seat backs. This could cause injury to the chest or arms if the lateral airbag is triggered.

Do not sit with the upper part of the body any nearer to the door than necessary.

GENERAL POINTS RELATING TO CHILD SEATS

Although one of PEUGEOT main criteria when designing your vehicle, the safety of your children also depends on you.

For maximum safety, please observe the following recommendations:

- in accordance with European regulations, **all children under the age of 12 or less than one and a half metres tall must travel in approved child seats suited to their weight**, on seats fitted with a seat belt or ISOFix mountings*,
- **statistically, the safest seats in your vehicle for carrying children are the rear seats**,
- **a child weighing less than 9 kg must travel in the rearward facing position both in the front and in the rear.**



CHILd SEAT AT THE REAR

Only children between 9 and 18 kg can be carried on the rear seats in a forward facing universal ISOFix child seat.

When a forward facing child seat is installed on a rear passenger seat, move the vehicle's front seat forward and straighten its backrest so that the child seat and the child's feet do not touch the vehicle's front seat.



PEUGEOT recommends that children should travel in the **outer rear seats** of your vehicle:

- **rearward facing** up to the age of 3,
- **forward facing** over the age of 3.

* The regulations on carrying children are specific to each country. Refer to the legislation in force in your country.

CHILD SEAT IN THE FRONT*

REARWARD FACING

When a rearward facing child seat is installed on the **front passenger seat**, adjust the seat to the intermediate longitudinal and highest position, with the backrest straightened.

The passenger's front airbag must be deactivated. Otherwise, **the child risks being seriously injured or killed if the airbag were to inflate.**

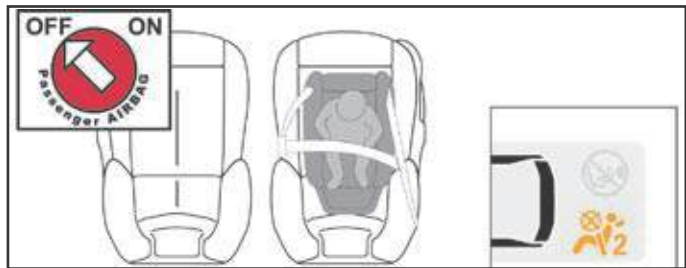

Ensure that the seat belt is correctly tensioned.

For child seats with a support leg, ensure that the support leg is in stable contact with the floor. If necessary, adjust the passenger seat.

* Refer to the current legislation in your country before installing a child seat on this seat.

FORWARD FACING

When a forward facing child seat is installed on the **front passenger seat**, adjust the vehicle's seat to the intermediate longitudinal and highest position with seat backrest straightened and leave the passenger's front airbag activated.



Passenger seat adjusted to the intermediate longitudinal position.



DEACTIVATING THE PASSENGER'S FRONT AIRBAG

! Never install a rearward facing child restraint system on a seat protected by an active front airbag. This could cause the death of the child or serious injury.

i The warning label present on both sides of the passenger's sun visor repeats this advice. In line with current legislation, the following tables contain this warning in all of the languages required.

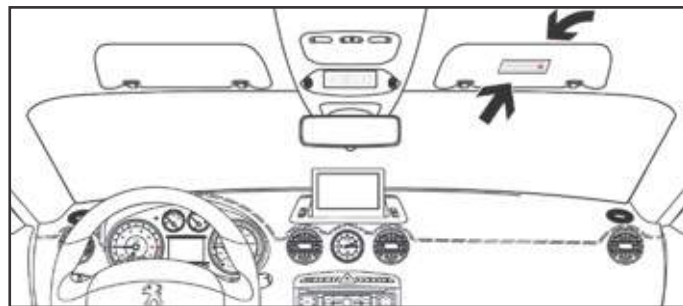

Passenger airbag OFF

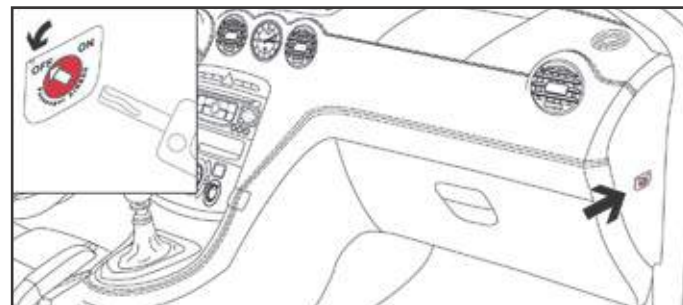

! For information on deactivating the passenger's front airbag, refer to the "Airbags" section.

AR	لا يجب أبداً تركيب نظام لإجلاس الطفل الوجه باتجاه الراء على مقعد سيارة مجهز بوسادة أمان هوائية أمامية مغلقة، فقد يؤدي هذا إلى التسبب بموت الطفل أو بإصابات خطيرة لديه.
BG	НИКОГА НЕ инсталирайте детско столче на седалка с АКТИВИРАНА предна ВЪЗДУШНА ВЪЗГЛАВНИЦА. Това може да причини СМЪРТ или СЕРИОЗНО НАРАНЯВАНЕ на детето.
CS	NIKDY neumistujte dětské zádržné zařízení orientované směrem dozadu na sedadlo chráněné AKTIVOVANÝM čelním AIRBAGEM. Hrozí nebezpečí SMRTI DÍTĚTE nebo VÁŽNĚHO ZRANĚNÍ.
DA	Brug ALDRIG en bagudvendt barnestol på et sæde, der er beskyttet af en AKTIV AIRBAG. BARNET risikerer at blive ALVORLIGT KVÆSTET eller DRÆBT.
DE	Montieren Sie auf einem Sitz mit AKTIVIERTEM Front-Airbag NIEMALS einen Kindersitz oder eine Babyschale entgegen der Fahrtrichtung, das Kind könnte schwere oder sogar tödliche Verletzungen erleiden.
EL	Μη χρησιμοποιείτε ΠΟΤΕ παιδικό κάθισμα με την πλάτη του προς το εμπρός μέρος του αυτοκινήτου, σε μια θέση που προστατεύεται από ΜΕΤΩΠΙΚΟ αερόσακο που είναι ΕΝΕΡΓΟΣ. Αυτό μπορεί να έχει σαν συνέπεια το ΘΑΝΑΤΟ ή το ΣΟΒΑΡΟ ΤΡΑΥΜΑΤΙΣΜΟ του ΠΑΙΔΙΟΥ
EN	NEVER use a rearward facing child restraint on a seat protected by an ACTIVE AIRBAG in front of it, DEATH or SERIOUS INJURY to the CHILD can occur
ES	NO INSTALAR NUNCA un sistema de retención para niños de espaldas al sentido de la marcha en un asiento protegido mediante un AIRBAG frontal ACTIVADO, ya que podría causar lesiones GRAVES o incluso la MUERTE del niño.
ET	Ärge MITTE KUNAGI paigaldage "seljaga sõidusuunas" lapseistetu juhi kõrvalistmele, mille ESITURVAPADI on AKTIVEERITUD. Turvapadja avanemine võib last TÕSISELT või ELUOHTLIKULT vigastada.
FI	ÄLÄ KOSKAAN aseta lapsen turvaistuinta selkää ajosuuntaan istuimelle, jonka edessä suojana on käyttööön aktivoitu TURVATYYNYY. Sen laukeaminen voi aiheuttaa LAPSEN KUOLEMAN tai VAKAVAN LOUKKAANTUMISEN.
FR	NE JAMAIS installer de système de retenue pour enfants faisant face vers l'arrière sur un siège protégé par un COUSSIN GONFLABLE frontal ACTIVÉ. Cela peut provoquer la MORT de l'ENFANT ou le BLESSER GRAVEMENT
HR	NIKADA ne postavljati dječju sjedalicu leđima u smjeru vožnje na sjedalo zaštićeno UKLJUČENIM prednjim ZRAČNIM JASTUKOM. To bi moglo uzrokovati SMRT ili TEŠKU OZLJEDU djeteta.
HU	SOHA ne használjon menetiránynak háttal beszerelt gyermekülést AKTÍVÁLT (BEKAPCSOLT) FRONTLÉGSZÁKKAL védett ülésen. Ez a gyermek HALÁLÁT vagy SÜLYÖS SÉRÜLÉSET okozhatja.
IT	NON installare MAI seggiolini per bambini posizionati in senso contrario a quello di marcia su un sedile protetto da un AIRBAG frontale ATTIVATO. Ciò potrebbe provocare la MORTE o FERITE GRAVI al bambino.
LT	NIEKADA neįrengkite vaiko prietaikymo priemonės su atgal atgręžtu vaiku ant sėdynės, kuri saugoma VEIKIANČIOS priekinės ORO PAGALVĖS. Išsiskleidus oro pagalvei vaikas gali būti MIRTINAI arba SUNKIAI TRAUMUOTAS.
LV	NEKAD NEuzstādiēt uz aizmuguri vērstu bērnu sēdekli priekšējā pasažiera sēdvietā, kurā ir AKTIVIZĒTS priekšējais DROŠĪBAS GAISA SPILVENS. Tas var izraisīt BĒRNA NĀVI vai radīt NOPIETNUS IEVAINOJUMUS.

MT	Qatt m'għandek thalli tifel/tifla marbut f'siggu dahru lejn l-Airbag attiva, għaliex tista' tikkawza korriment serju jew anke mewt lit-tifel/tifla
NL	Plaats NOOIT een kinderzitje met de rug in de rijrichting op een zitplaats waarvan de AIRBAG is INGESCHAKELD. Bij het afgaan van de airbag kan het KIND LEVENSGEVAARLIJ K GEWOND RAKEN
NO	Installer ALDRI et barnesete med ryggen mot kjøreretningen i et sete som er beskyttet med en frontal AKTIVERT KOLLISJ ONSPUTE, BARNET risikerer å bli DREPT eller HARDT SKADET.
PL	NIGDY nie instalować fotelika dziecięcego w pozycji "tyłem do kierunku jazdy" na siedzeniu wyposażonym w CZOŁOWĄ PODUSZKĘ POWIETRZNA w stanie AKTYWNYM. Może to doprowadzić do ŚMIERCI DZIECKA lub spowodować u niego POWAŻNE OBRAŻENIA CIAŁA.
PT	NUNCA instale um sistema de retenção para crianças de costas para a estrada num banco protegido por um AIRBAG frontal ACTIVADO. Esta instalação poderá provocar FERIMENTOS GRAVES ou a MORTE da CRIANÇA.
RO	Nu instalati NICIODATA un sistem de retenere pentru copii, dispus cu spatele in directia de mers, pe un loc din vehicul protejat cu AIRBAG frontal ACTIVAT. Aceasta ar putea provoca MOARTEA COPILULUI sau RANIREA lui GRAVA.
RU	ВО ВСЕХ СЛУЧАЯХ ЗАПРЕЩАЕТСЯ использовать обращенное назад детское удерживающее устройство на сиденье, защищенном ФУНКЦИОНИРУЮЩЕЙ ПОДУШКОЙ БЕЗОПАСНОСТИ, установленной перед этим сиденьем. Это может привести к ГИБЕЛИ РЕБЕНКА или НАНЕСЕНИЮ ЕМУ СЕРЬЕЗНЫХ ТЕЛЕСНЫХ ПОВРЕЖДЕНИЙ
SK	NIKDY neinštalujte detské zádržné zariadenie orientované smerom dozadu na sedadlo chránené AKTIVOVANÝM čelným AIRBAGOM. Mohlo by dôjsť k SMRTEĽNÉMU alebo VÁZNEMU PORANENIU DIEŤATA.
SL	NIKOLI ne nameščajte otroškega sedeža s hrbtom v smeri vožnje, če je VARNOSTNA BLAZINA pred sprednjim sopotnikovim sedežem AKTIVIRANA. Takšna namestitvev lahko povzroči SMRT OTROKA ali HUDE POŠKODBE.
SR	NIKADA ne koristite dečje sedište koje se okreće unazad na sedištu zaštićenim AKTIVNIM VAZDUŠNIM JASTUKOM ispred njega, jer mogu nastupiti SMRT ili OZBILJ NA POVRÉDA DETETA.
SV	Passagerarkrockkudden fram MÅSTE vara avaktiverad om en bakåtvänd bilbarnstol installerad på denna plats. Annars riskerar barnet att DÖDAS eller SKADAS ALLVARLIGT.
TR	KEŞİNLKLE HAVA YASTIĞI AKTİF olan ön koltuğa yüzü arkaya dönük bir çocuk koltuğu yerleştirmeyiniz. Bu ÇOCUĞUN ÖLMESİNE veya ÇOK AĞIR YARALANMASINA sebep olabilir.

CHILD SEATS RECOMMENDED BY PEUGEOT

PEUGEOT offers a range of recommended child seats which are secured using a **three point seat belt**:

Group 0+: from birth to 13 kg



L1

"RÖMER Baby-Safe Plus"

Installed in the rearward facing position.

Groups 2 and 3: from 15 to 36 kg



L4

"KLIPPAN Optima"

From 22 kg (approximately 6 years), the booster is used on its own.



L5



"RÖMER KIDFix "

Can be fixed to the vehicle's ISOFix mountings.

The child is restrained by the seat belt.

LOCATIONS FOR CHILD SEATS SECURED USING THE SEAT BELT

In accordance with European regulations, this table indicates the options for the installation of child seats secured using the seat belt and universally approved (a) in relation to the weight of the child and the seat in the vehicle.

Seat	Weight of the child /indicative age			
	Less than 13 kg (groups 0 (b) and 0+) Up to 1 year approx	From 9 to 18 kg (group 1) From 1 to 3 years approx	From 15 to 25 kg (group 2) From 3 to 6 years approx	From 22 to 36 kg (group 3) From 6 to 10 years approx
Front passenger seat (c) (d) 	U(R)	U(R)	U(R)	U(R)
Outer rear seats 	X	X	X	X

- (a) Universal child seat: child seat which can be installed in all vehicles using the seat belt.
- (b) Group 0: from birth to 10 kg. Infant car seats and "car" cots cannot be installed on the front passenger seat.
- (c) Consult the legislation in force in your country before installing your child on this seat.
- (d) When a **rearward facing** child seat is installed on the **front passenger seat**, the passenger's front airbag must be deactivated. Otherwise, **the child would risk being seriously injured or killed if the airbag were deployed.**

When a **forward facing** child seat is installed on the **front passenger seat**, the passenger's front airbag must be left active.

U(R): seat suitable for the installation of a child seat secured using the seat belt and universally approved rearward facing and/or forward facing, with the seat adjusted to its highest position.

X: seat not suited to the installation of a child seat for the weight group indicated.

"ISOFix" MOUNTINGS

Your vehicle has been approved to the **latest** ISOFix **regulations**.

The seats represented below are fitted with regulation ISOFix mountings:

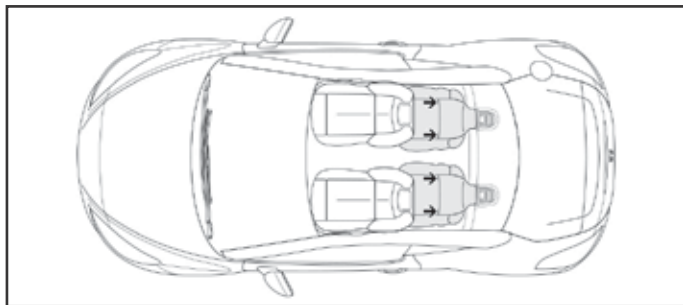

These are three rings for each seat:

- two rings **A**, located between the vehicle seat back and cushion, indicated by a label,
- a ring **B** referred to as the **TOP TETHER**, located under a cover behind the top of the backrest for fixing the upper strap.

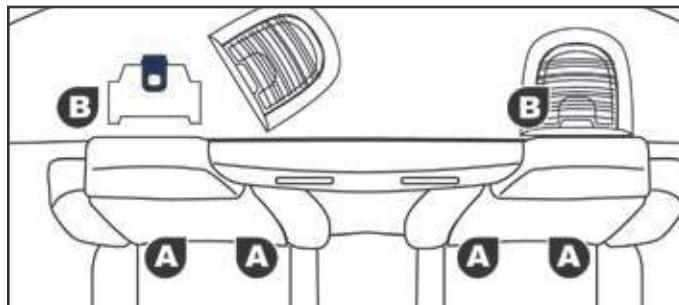
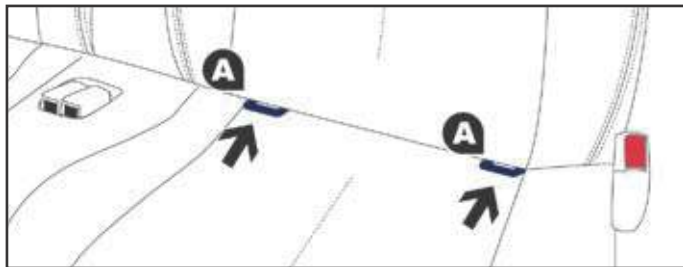

This ISOFix mounting system provides fast, reliable and safe fitting of the child seat in your vehicle.

The **ISOFix child seats** are fitted with two latches which are secured easily on the two rings **A**.

Some also have an **upper strap** which is attached to ring **B**.

To secure the child seat to the **TOP TETHER**:

- open the cover at the top of the backrest,
- fix the hook on the upper strap to the ring **B**,
- tighten the upper strap.

! The incorrect installation of a child seat in a vehicle compromises the child's protection in the event of an accident. Observe strictly the fitting instructions in the installation guide provided with the child seat.

i For information regarding the possibilities for installing ISOFix child seats in your vehicle, refer to the table.

ISOFIX CHILD SEAT

RECOMMENDED BY PEUGEOT AND APPROVED FOR YOUR VEHICLE

ISOFIX child seat with TOP TETHER	
RÖMER duo Plus ISOFIX (size category B1)	
Group 1: from 9 to 18 kg	
	<p>Installed only in the forward facing position.</p> <p>Is attached to the rings A, as well as the ring B, referred to as the TOP TETHER, using an upper strap.</p> <p>Three seat body angles: sitting, reclining, lying.</p>



This child seat can also be used on seats which are not fitted with ISOFIX mountings.

In this case, it must be attached to the vehicle seat using the three point seat belt.

Adjust the front seat of the vehicle so that the child's feet do not touch the backrest.

Follow the instructions for fitting the child seat given in the seat manufacturer's installation guide.

LOCATIONS FOR FITTING ISOFIX CHILD SEATS

In accordance with European Regulations, this table indicates the options for installing ISOFIX child seats on seats in the vehicle fitted with ISOFIX mountings.

In the case of universal and semi-universal ISOFIX child seats, the ISOFIX size category, determined by a letter from **A** to **G**, is indicated on the child seat next to the ISOFIX logo.

	Weight of the child / indicative age									
	Less than 10 kg (group 0) Up to approx. 6 months		Less than 10 kg (group 0) Less than 13 kg (group 0+) Up to approx. 1 year			From 9 to 18 kg (group 1) From approx. 1 to 3 years				
Type of ISOFIX child seat	Infant car seat*		rearward facing			rearward facing		forward facing		
ISOFIX size category	F	G	C	d	E	C	d	A	B	B1
ISOFIX universal and semi-universal child seats which can be installed on the outer rear seats	X		X			X		IUF		

IUF: seat suitable for the installation of an Isofix **U**niversal **F**orward facing child seat with a top tether.

It may be necessary to move the front seat forwards to facilitate the installation of a child seat on a rear seat.

X: seat which is not suitable for the installation of an ISOFIX seat of the size category indicated.

* Infant car seats and "car" cots cannot be installed on the front passenger seat.

ADVICE ON CHILD SEATS

The incorrect installation of a child seat in a vehicle compromises the child's protection in the event of an accident.

Ensure that there is no seat belt or seat belt buckle under the child seat, as this could destabilise it.

Remember to fasten the seat belts or the child seat harnesses keeping the slack relative to the child's body to a minimum, even for short journeys.

When installing a child seat using the seat belt, ensure that the seat belt is tightened correctly on the child seat and that it secures the child seat firmly on the seat of your vehicle. If your passenger seat is adjustable, move it forwards if necessary.

At rear seating positions, always leave sufficient space between the front seat and:

- a rearward facing child seat,
- the child's feet for a child seat fitted forward facing.

To do this, move the front seat forwards and, if necessary, move its backrest into the upright position.

For optimum installation of the forward facing child seat, ensure that the back of the child seat is as close as possible to the backrest of the vehicle's seat, in contact if possible.

You must remove the head restraint before installing a child seat with backrest to a passenger seat.

Ensure that the head restraint is stored or attached securely to prevent it from being thrown around the vehicle in the event of sharp braking. Refit the head restraint when the child seat is removed.

CHILDREN AT THE FRONT

The legislation on carrying children on the front passenger seat is specific to each country. Refer to the legislation in force in your country.

Deactivate the passenger's front airbag when a rearward facing child seat is installed on the front seat. Otherwise the child would risk being seriously injured or killed if the airbag were deployed.

INSTALLING A BOOSTER SEAT

The chest part of the seat belt must be positioned on the child's shoulder without touching the neck.

Ensure that the lap part of the seat belt passes correctly over the child's thighs.

PEUGEOT recommends the use of a booster seat which has a back, fitted with a seat belt guide at shoulder level.

As a safety measure, do not leave:

- a child or children alone and unsupervised in a vehicle,
- a child or an animal in a vehicle which is exposed to the sun, with the windows closed,
- the keys within reach of children inside the vehicle.

A FEW DRIVING RECOMMENDATIONS

Observe the driving regulations at all times and remain vigilant whatever the traffic conditions.

Pay close attention to the traffic and keep your hands on the wheel so that you are ready to react at any time to any eventuality.

On a long journey, a break every two hours is strongly recommended.

In difficult weather, drive smoothly, anticipate the need to brake and increase the distance from other vehicles.

dRIVING ON FLOOEd ROAdS

We strongly advise against driving on flooded roads, as this could cause serious damage to the engine or gearbox, as well as to the electrical systems of your vehicle.

If you are obliged to drive through water:



- check that the depth of water does not exceed 10 cm, taking account of waves that might be generated by other users,
- drive as slowly as possible without stalling. In all cases, do not exceed 6 mph (10 km/h),
- do not stop and do not switch off the engine.

On leaving the flooded road, as soon as circumstances allow, make several light brake applications to dry the brake discs and pads.

If in doubt on the state of your vehicle, contact a PEUGEOT dealer or a qualified workshop.

IMPORTANT!

- ! Never drive with the parking brake applied - Risk of overheating and damage to the braking system!
Do not park or run the engine when stationary in areas where inflammable substances and materials (dry grass, dead leaves...) might come into contact with the hot exhaust system - Risk of fire!
- ! Never leave a vehicle unsupervised with the engine running. If you have to leave your vehicle with the engine running, apply the parking brake and put the gearbox into neutral or position **N** or **P**, depending on the type of gearbox.

STARTING-SWITCHING OFF THE ENGINE

IGNITION SWITCH

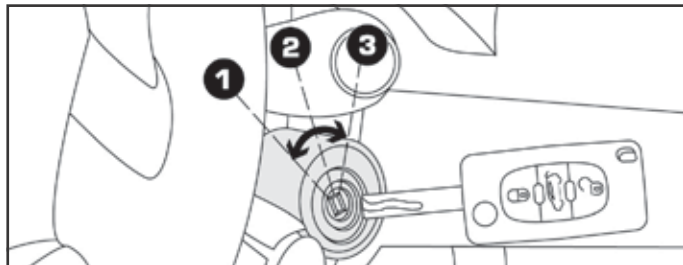

It has 3 positions:

- position **1 (Stop)**: insert and removing the key,
- position **2 (Ignition on)**: steering column unlocked, ignition on, Diesel preheating, engine running,
- position **3 (Starting)**.

Ignition on position

It allows the use of the vehicle's electric equipment or portable devices to be charged.

Once the state of charge of the battery drops to the reserve level, the system switches to energy economy mode: the power supply is cut off automatically to preserve the remaining battery charge.

 Switching off the engine leads to a loss of braking assistance.

 Avoid attaching heavy objects to the key, which would weigh down on its blade in the ignition switch and could cause a malfunction.

STARTING THE ENGINE

With the parking brake applied and the gearbox in neutral or position **N** or **P**:

- ☞ depress the clutch pedal fully (manual gearbox),
or
- ☞ press the brake pedal firmly (automatic gearbox),
- ☞ insert the key into the ignition switch; the system recognises the code,
- ☞ unlock the steering column by simultaneously turning the steering and the key.

 In certain cases, you may have to apply more force to the steering (wheels on full lock, for example).

- ☞ With a petrol engine, operate the starter motor by turning the key to position **3** without pressing the accelerator pedal, until the engine starts. Once the engine is running, release the key.
- ☞ With a Diesel engine, turn the key to position **2**, ignition on, to operate the engine pre-heating system.



Wait until this warning lamp goes off in the instrument panel then operate the starter motor by turning the key to position **3** without pressing the accelerator pedal, until the engine starts. Once the engine is running, release the key.

 In wintry conditions, the warning lamp can stay on for a longer period. When the engine is hot, the warning lamp does not come on.





 If the engine does not start straight away, switch off the ignition. Wait a few moments before operating the starter motor again. If the engine does not start after several attempts, do not keep trying: you risk damaging the starter motor or the engine. Contact a PEUGEOT dealer or a qualified workshop.

 In temperate conditions, do not leave the engine at idle to warm up but move off straight away and drive at moderate speed.

 Never leave the engine running in an enclosed area without adequate ventilation: internal combustion engines emit toxic exhaust gases, such as carbon monoxide. Danger of intoxication and death!

In very severe wintry conditions (temperatures below -23°C), to ensure the correct operation and durability of the mechanical components of your vehicle, engine and gearbox, it is necessary to leave the engine running for 4 minutes before moving off.

SWITCHING OFF THE ENGINE

-  Stop the vehicle.
-  With the engine running at idle, turn the key to position **1**.
-  Remove the key from the ignition switch.
-  To lock the steering column, turn the steering until it locks.

 To facilitate unlocking of the steering column, it is recommended that the wheels be returned to the straight ahead position before switching off the engine.

-  Check that the parking brake is correctly applied, particularly on sloping ground.

 Never switch off the ignition before the vehicle is at a complete stop. With the engine off, the braking and steering assistance systems are also cut off: risk of loss of control of the vehicle.

 When you leave the vehicle, keep the key with you and lock the vehicle.

Energy economy mode

After switching off the engine (position **1-Stop**), for a maximum of 30 minutes you can still use functions such as the audio and telematic system, the wipers, dipped beam headlamps, courtesy lamps, ...

 For more information, refer to the "Practical information" section, under "Energy economy mode".

ELECTRONIC ENGINE IMMOBILISER

The key contains an electronic chip which has a special code. When the ignition is switched on, this code must be recognised in order for starting to be possible.

A few minutes after the ignition is switched off, this electronic engine immobiliser locks the engine management system and prevents starting of the engine by anyone who does not have the key.



In the event of a malfunction, you are informed by lighting of this warning lamp, an audible signal and a message in the screen. In this case, your vehicle does not start; contact a PEUGEOT dealer as soon as possible.

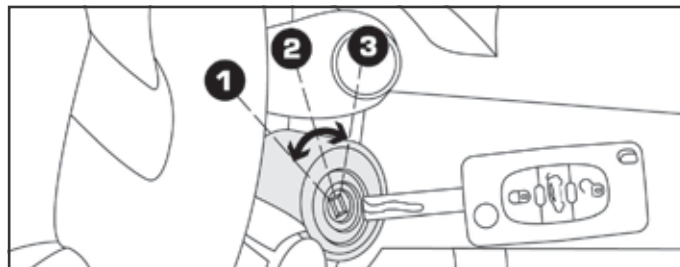

Key left in the "Ignition on" position

On opening the driver's door, an alert message is displayed, accompanied by an audible signal, to remind you that the key is still in the ignition switch at position **1 (Stop)**.

If the key has been left in the ignition switch at position **2 (Ignition on)**, the ignition will be switched off automatically after one hour.

To switch the ignition back on, turn the key to position **1 (Stop)**, then back to position **2 (Ignition on)**.

PARKING BRAKE

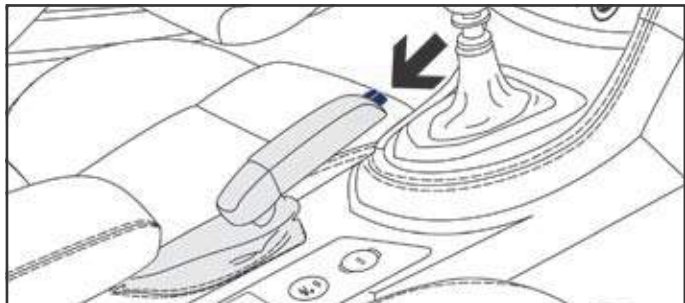

Applying

- ☞ Pull the parking brake lever fully up to immobilise your vehicle.

Releasing

- ☞ Pull the parking brake lever gently, press the release button then lower the lever fully.



When the vehicle is being driven, if this warning lamp and the **STOP** warning lamp come on, accompanied by an audible signal and a message in the screen, this indicates that the parking brake is still on or has not been properly released.



When parking on a slope, direct your wheels against the pavement, apply the parking brake and engage a gear.

HILL START ASSIST

System which keeps your vehicle immobilised temporarily (approximately 2 seconds) when starting on a gradient, the time it takes to move your foot from the brake pedal to the accelerator pedal.

This function is only active when:

- the vehicle is completely stationary, with your foot on the brake pedal,
- certain conditions of slope are met,
- with the driver's door closed.

The hill start assist system cannot be deactivated.

OPERATION

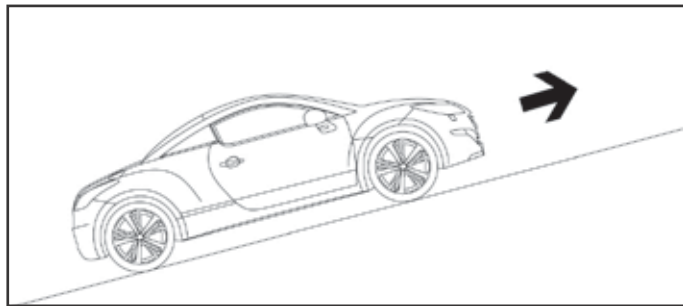

On an ascending slope, with the vehicle stationary, the vehicle is held for a brief moment when you release the brake pedal:

- provided you are in first gear or neutral on a manual gearbox,
- provided you are in position **d** or **M** on an automatic gearbox.

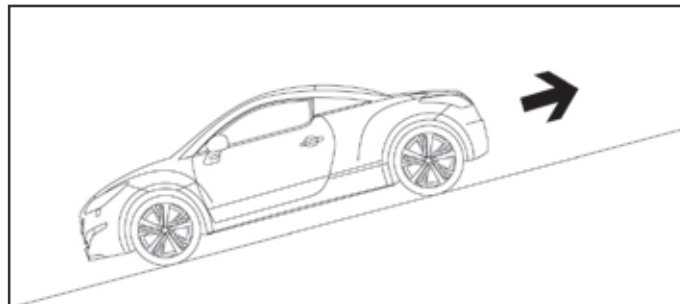

On a descending slope, with the vehicle stationary and reverse gear engaged, the vehicle is held for a brief moment when you release the brake pedal.



Do not exit the vehicle while it is being held in the hill start assist phase.



If you need to exit the vehicle with the engine running, apply the parking brake and then check that the corresponding warning lamp in the instrument panel is on.

OPERATING FAULT



If a malfunction of the system occurs, these warning lamps come on. Have it checked by a PEUGEOT dealer or a qualified workshop.

6-SPEED MANUAL GEARBOX

ENGAGING 5TH OR 6TH GEAR

☞ Move the lever fully to the right to engage 5th or 6th gear.

! Failure to observe this procedure may cause permanent damage to the gearbox (engaging 3rd or 4th gear by mistake).

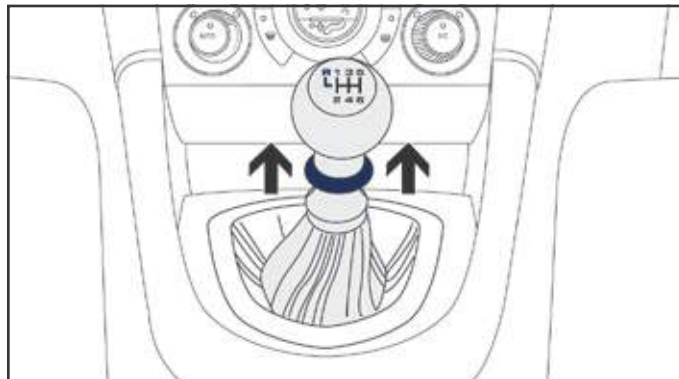

ENGAGING REVERSE GEAR

☞ Raise the ring under the knob and move the gear lever to the left then forwards.

Only engage reverse gear when the vehicle is stationary with the engine at idle.

! As a safety precaution and to facilitate starting of the engine:

- always select neutral,
- press the clutch pedal.

"PORSCHE TIPTRONIC SYSTEM" AUTOMATIC GEARBOX

Six speed automatic gearbox which offers a choice between the comfort of fully automatic operation, enhanced by sport and snow programmes, or manual gear changing.

There are two driving modes:

- **automatic** operation for electronic management of the gears by the gearbox, with the **sport** programme for a more dynamic driving style or the **snow** programme to facilitate driving when grip is poor.
- **manual** operation for sequential changing of the gears by the driver.

GEAR SELECTION GATE

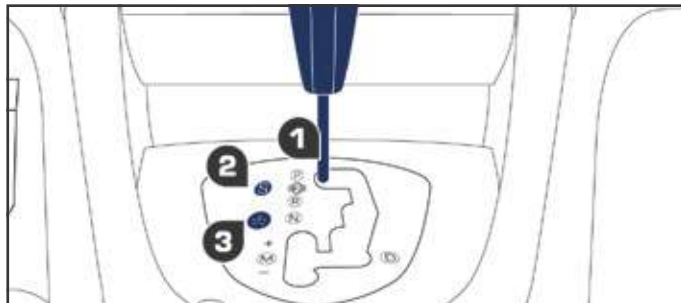

1. Gear selector.
2. Button "S" (**sport**).
3. Button "❄" (**snow**).

GEAR SELECTOR POSITIONS

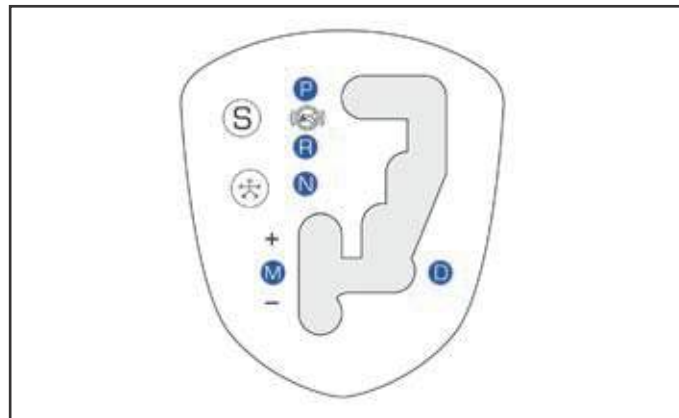

P. Park.

- Immobilisation of the vehicle, parking brake on or off.
- Starting the engine.

R. Reverse.

- Reversing manoeuvres, vehicle stationary, engine at idle.

N. Neutral.

- Immobilisation of the vehicle, parking brake on.
- Starting the engine.

d. Automatic operation.

M. + / - Manual operation with sequential changing of the six gears.

☞ Press forwards to change up through the gears.

or

☞ Press rearwards to change down through the gears.

DISPLAYS IN THE INSTRUMENT PANEL

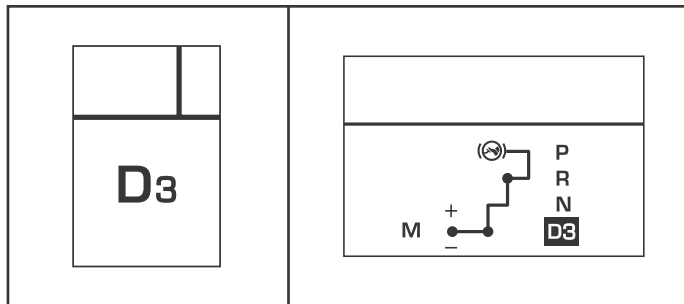

When you move the gear selector in the gate to select a position, the corresponding symbol is displayed in the instrument panel.

P. Park

R. Reverse

N. Neutral

d1... d6. Drive (Automatic driving)

S. Sport programme

* **Snow** programme

M1... M6. Manual (Sequential driving)

- . Invalid value during manual operation

MOVING OFF

- ☞ Apply the parking brake.
- ☞ Select position **P** or **N**.
- ☞ Start the engine.

If this procedure is not followed, there is an audible signal, accompanied by a message in the screen.

- ☞ With the engine running, **press the brake pedal**.
- ☞ Release the parking brake.
- ☞ Select position **R**, **d** or **M**,
- ☞ Gradually release the brake pedal.

The vehicle then moves off.



A message is displayed if you try to move the gear selector from position **P** without pressing the brake pedal.



If position **N** is engaged inadvertently while driving, allow the engine to return to idle then engage position **d** to accelerate.



When the engine is running at idle, with the brakes released, if position **R**, **d** or **M** is selected, the vehicle moves even without the accelerator being pressed.

When the engine is running, never leave children in the vehicle without supervision.

When carrying out maintenance with the engine running, apply the parking brake and select position **P**.

AUTOMATIC OPERATION

☞ Select position **d** for **automatic** changing of the six gears.

The gearbox then operates in auto-adaptive mode, without any intervention on the part of the driver. It continuously selects the most suitable gear according to the style of driving, the profile of the road and the load in the vehicle.

d and the gears selected automatically appear in succession in the instrument panel.

For maximum acceleration without touching the selector, press the accelerator pedal down fully (kick down). The gearbox changes down automatically or maintains the gear selected until the maximum engine speed is reached.

On braking, the gearbox changes down automatically to provide efficient engine braking.

If you release the accelerator sharply, the gearbox will not change to a higher gear for safety reasons.



Never select position **N** while the vehicle is moving.
Never select positions **P** or **R** unless the vehicle is completely stationary.

SPORT AND SNOW PROGRAMMES

These two special programmes supplement the automatic operation in very specific conditions of use.

Sport programme "S"

☞ Press button "**S**", after starting the engine.
The gearbox automatically favours a dynamic style of driving.



S appears in the instrument panel.

Snow programme "❄"

☞ Press button "❄", after starting the engine.
The gearbox adapts to driving on slippery roads.
This programme improves starting and drive when traction is poor.



❄ appears in the instrument panel.

RETURN TO AUTOMATIC OPERATION

☞ At any time, press the button selected again to quit the programme engaged and return to auto-adaptive mode.

MANUAL OPERATION

☞ Select position **M** for **sequential** changing of the six gears.
☞ Push the selector towards the **+** sign to change up a gear.
☞ Pull the selector towards the **-** sign to change down a gear.

It is only possible to change from one gear to another if the vehicle speed and engine speed permit; otherwise, the gearbox will operate temporarily in automatic mode.

M1

M and the gears engaged manually appear in succession in the instrument panel.

If the engine speed is too low or too high, the gear selected flashes for a few seconds, then the actual gear engaged is displayed.

It is possible to change from position **d** (automatic) to position **M** (manual) at any time.

When the vehicle is stationary or moving very slowly, the gearbox selects gear **M1** automatically.

The sport and snow programmes do not operate in manual mode.

Invalid value during manual operation



This symbol is displayed if a gear is not engaged correctly (selector between two positions).

STOPPING THE VEHICLE

Before switching off the engine, you can engage position **P** or **N** to place the gearbox in neutral.

In both cases, apply the parking brake to immobilise the vehicle.



If the selector is not in position **P**, when the driver's door is opened or approximately 45 seconds after the ignition is switched off, there is an audible signal accompanied by a message.

Return the selector to position **P**; the audible signal stops and the message disappears.

OPERATING FAULT



When the ignition is on, the illumination of this warning lamp, accompanied by an audible signal and a message in the screen, indicates a gearbox malfunction.

In this case, the gearbox switches to emergency mode and is locked in 3rd gear. You may feel a substantial knock when changing from **P** to **R** and from **N** to **R**. This will not cause any damage to the gearbox.

Do not exceed a speed of 60 mph (100 km/h), local speed restrictions permitting.

Have it checked by a PEUGEOT dealer or a qualified workshop.

This warning lamp may also come on if a door is opened.



There is a risk of damage to the gearbox:

- if you press the accelerator and brake pedals at the same time,
- if you force the selector from position **P** to another position when the battery is flat.



To reduce fuel consumption during a long period stationary with the engine running (traffic jam, etc.), place the gear selector in position **N** and apply the parking brake.

GEAR EFFICIENCY INDICATOR*

System which reduces fuel consumption by recommending the most appropriate gear.

OPERATION

Depending on the driving situation and your vehicle's equipment, the system may advise you to skip one (or more) gear(s). You can follow this instruction without engaging the intermediate gears.

The gear engagement recommendations must not be considered compulsory. In fact, the configuration of the road, the amount of traffic and safety remain determining factors when choosing the best gear. Therefore, the driver remains responsible for deciding whether or not to follow the advice given by the system.

This function cannot be deactivated.

With an automatic gearbox, the system is only active in manual mode.

Example:

- You are in third gear.
- You press the accelerator pedal.
- The system may suggest that you engage a higher gear.

The information appears in the instrument panel in the form of an arrow.

On vehicle fitted with a manual gearbox, the arrow may be accompanied by the gear recommended.

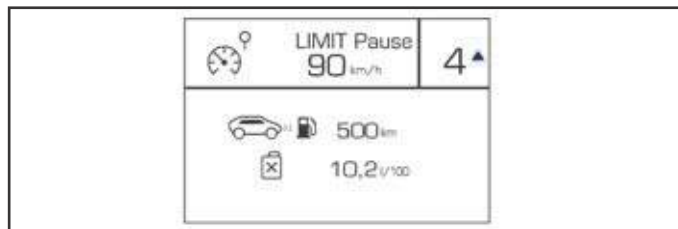

The system adapts its gear change recommendation according to the driving conditions (slope, load,...) and the demands of the driver (power, acceleration, braking,...).

The system never suggests:

- engaging first gear,
- engaging reverse gear.

* Depending on engine.

TYRE UNDER-INFLATION DETECTION

System which automatically checks the pressures of the tyres while driving.

The system continuously monitors the pressures of the four tyres, as soon as the vehicle is moving.

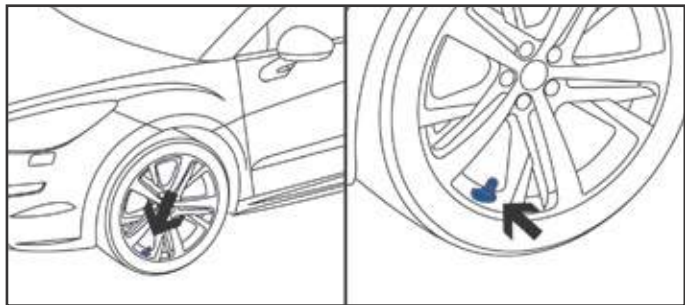

A pressure sensor is located in the valve of each of these tyres. The system triggers an alert if a drop in pressure is detected in one or more tyres.

! The tyre under-inflation detection system is an aid to driving which does not replace the need for vigilance on the part of the driver.

! This system does not avoid the need to check the tyre pressures regularly and before a long journey. Driving with under-inflated tyres adversely affects road holding, extends braking distances and causes premature tyre wear, particularly under arduous conditions (vehicle loaded, high speed, long journey).

♣ Driving with under-inflated tyres increases fuel consumption.

! The tyre pressures for your vehicle can be found on the tyre pressure label (see the "Identification markings" section). The tyre pressures must be checked when the tyres cold (vehicle stopped for 1 hour or after driving for less than 6 miles (10 km) at moderate speed). Otherwise, add 0.3 bar to the values indicated on the label.

i **Spare wheel**
Don't forget to also check the tyre pressure of the spare wheel. The alloy spare wheel also has a sensor. The steel spare wheel does not have a sensor.

UNdER-INFLATION ALERT



The alert is given by the fixed illumination of this warning lamp, accompanied by an audible signal and the display of a message.

In the event of a problem on one of the tyres, a symbol or a message is displayed, depending on equipment, to identify it.

- ☞ Reduce speed, avoid sudden steering movements or harsh brake applications.
- ☞ Stop as soon as it is safe to do so.
- ☞ In the event of a puncture, use the temporary puncture repair kit or the spare wheel (according to equipment),
or
- ☞ if you have a compressor, the one in the temporary puncture repair kit for example, check the four tyre pressures when cold,
or
- ☞ if it is not possible to check the tyre pressures at the time, drive carefully at reduced speed.

The alert is maintained until the tyre or tyres concerned is reinflated, repaired or replaced.



With the ignition on, the pressure must be increased by at least 0.2 bar. If necessary, adjust the pressures to the values given on the tyre pressure label.



The loss of pressure detected does not always lead to visible deformation of the tyre. Do not rely on just a visual check.

OPERATING FAULT



The flashing and then fixed illumination of this warning lamp accompanied by the illumination of the service warning lamp indicates a fault with the system.

In this case, monitoring of the tyre pressures is not assured.



This alert is also displayed when one or more wheels is not fitted with a sensor (steel spare wheel).

Go to a PEUGEOT dealer or a qualified workshop to have the system checked or, following the repair of a puncture, to have the original wheel, equipped with a sensor, refitted.

SPEED LIMITER

System which prevents the vehicle from exceeding the speed programmed by the driver.

When the programmed speed limit is reached, pressing the accelerator pedal no longer has any effect.

The speed limiter is **switched on** manually: it requires a programmed speed of at least 20 mph (30 km/h).

The speed limiter is **switched off** by manual operation of the control.

The programmed speed can be exceeded temporarily by pressing the accelerator firmly.

To return to the programmed speed, simply slow down to a speed below the programmed speed.

The programmed speed remains in the memory when the ignition is switched off.



The speed limiter cannot, in any circumstances, replace the need to respect speed limits, nor can it replace the need for vigilance on the part of the driver.

STEERING MOUNTED CONTROL

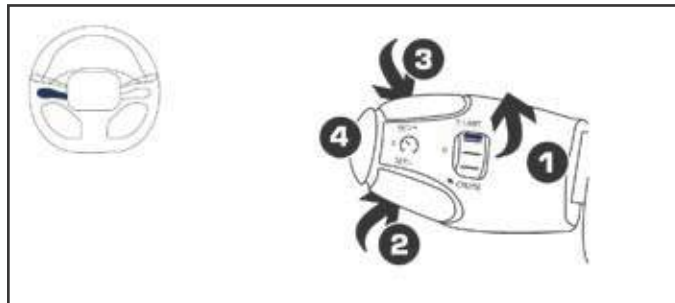

The functions of this system are grouped together on steering mounted control.

1. Speed limiter mode selection dial.
2. Value decrease button.
3. Value increase button.
4. Speed limiter on / off button.

DISPLAYS IN THE INSTRUMENT PANEL

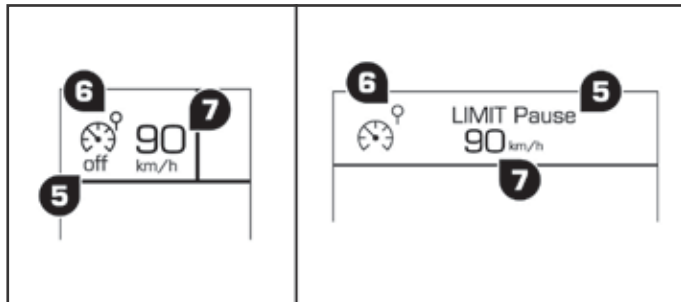

The programmed information is grouped together in the instrument panel screen.

5. Speed limiter on / off indication.
6. Speed limiter mode selection indication.
7. Programmed speed value.

PROGRAMMING

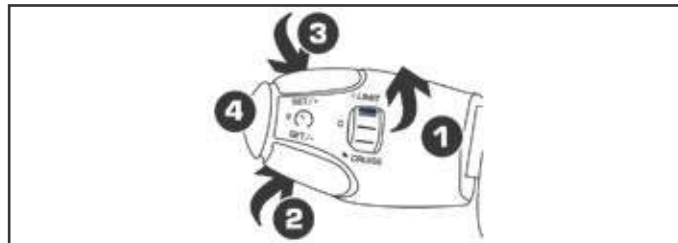

- ☞ Turn dial **1** to the "LIMIT" position: the speed limiter mode is selected but is not switched on (OFF / Pause).

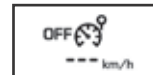

You do not have to switch the speed limiter on in order to set the speed.

- ☞ Set the speed value by pressing button **2** or **3** (e.g.: 55 mph (90 km/h)).



You can then change the programmed speed using buttons **2** and **3**:

- by + or - 1 mph (km/h) = short press,
- by + or - 5 mph (km/h) = long press,
- in steps of + or - 5 mph (km/h) = maintained press.

- ☞ Switch the speed limiter on by pressing button **4**.



- ☞ Switch the speed limiter off by pressing button **4**: the display confirms that it has been switched off (OFF / Pause).



- ☞ Switch the speed limiter back on by pressing button **4** again.



EXCEEDING THE PROGRAMMED SPEED

Pressing the accelerator pedal to exceed the programmed speed will not have any effect unless you press the pedal **firmly** past the **point of resistance**.



The speed limiter is deactivated temporarily and the programmed speed, which is still displayed, flashes.

Returning to the programmed speed, by means of intentional or unintentional deceleration of the vehicle, automatically cancels the flashing of the programmed speed.

EXITING THE SPEED LIMITER MODE

- ☞ Turn dial 1 to the "0" position: the speed limiter mode is deselected. It disappears from the display.

OPERATING FAULT

In the event of a speed limiter malfunction, the speed is cleared resulting in flashing of the dashes.

Have it checked by a PEUGEOT dealer or a qualified workshop.



On a steep descent or in the event of sharp acceleration, the speed limiter will not be able to prevent the vehicle from exceeding the programmed speed.

To avoid any risk of jamming of the pedals:

- ensure that the mat is positioned correctly,
- do not fit one mat on top of another.

CRUISE CONTROL

System which automatically maintains the speed of the vehicle at the value programmed by the driver, without any action on the accelerator pedal.

The cruise control is **switched on** manually: it requires a minimum vehicle speed of 25 mph (40 km/h) and the engaging:

- of fourth gear on the manual gearbox,
- of second gear on the automatic gearbox, in sequential driving mode,
- of position **d** on the automatic gearbox.

The cruise control is **switched off** manually or by pressing the brake or clutch pedal or on triggering of the trajectory control system for safety reasons.

It is possible to exceed the programmed speed temporarily by pressing the accelerator pedal.

To return to the programmed speed, simply release the accelerator pedal.

Switching off the ignition cancels any programmed speed value.

STEERING MOUNTED CONTROL

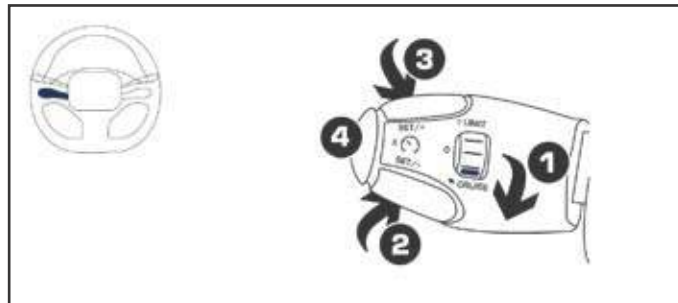

The functions of this system are grouped together on the steering mounted control.

1. Cruise control mode selection dial.
2. Speed programming / value decrease button.
3. Speed programming / value increase button.
4. Cruise control off / resume button.



The cruise control cannot, in any circumstances, replace the need to respect speed limits, nor can it replace the need for vigilance on the part of the driver.

You are advised to keep your feet near the pedals at all times.

DISPLAYS IN THE INSTRUMENT PANEL

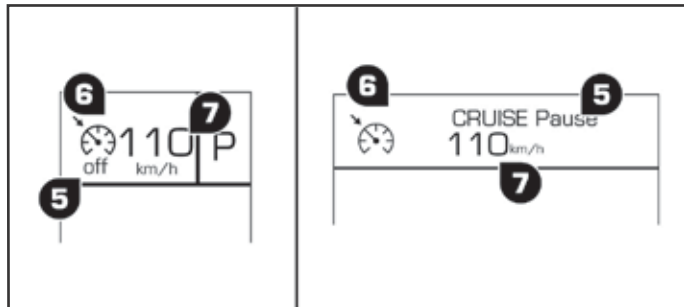

The programmed information is grouped together in the instrument panel screen.

5. Cruise control off / resume indication.
6. Cruise control mode selection indication.
7. Programmed speed setting.

PROGRAMMING

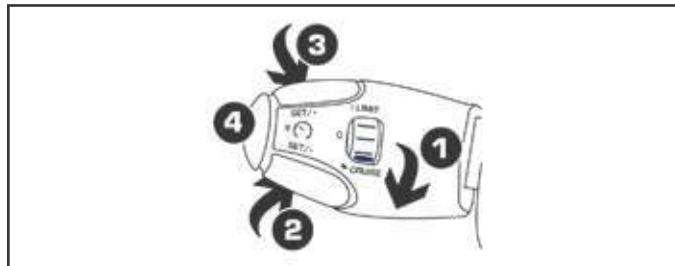

☞ Turn dial **1** to the **"CRUISE"** position: the cruise control mode is selected but is not switched on (OFF / Pause).



☞ Set the programmed speed by accelerating to the required speed, then press button **2** or **3** (e.g.: 70 mph (110 km/h)).



You can then change the programmed speed using buttons **2** and **3**:

- by + or - 1 mph (km/h) = short press,
- by + or - 5 mph (km/h) = long press,
- in steps of + or - 5 mph (km/h) = maintained press.

☞ Switch off the cruise control by pressing button **4**: the display confirms that it has been switched off (OFF / Pause).



☞ Switch the cruise control back on by pressing button **4** again.



EXCEEDING THE PROGRAMMED SPEED

Intentional or unintentional exceeding of the programmed speed results in flashing of this speed in the screen.



Return to the programmed speed, by means of intentional or unintentional deceleration of the vehicle, automatically cancels the flashing of the speed.

EXITING CRUISE CONTROL MODE

☞ Turn dial **1** to the "0" position: the cruise control mode is deselected. It disappears from the display.

OPERATING FAULT

In the event of a cruise control malfunction, the speed is cleared resulting in flashing of the dashes.

Have it checked by a PEUGEOT dealer or a qualified workshop.



When the cruise control is switched on, be careful if you maintain the pressure on one of the programmed speed changing buttons: this may result in a very rapid change in the speed of your vehicle.

Do not use the cruise control on slippery roads or in heavy traffic.

On a steep descent, the cruise control will not be able to prevent the vehicle from exceeding the programmed speed.

To avoid any risk of jamming of the pedals:

- ensure that the mat is positioned correctly,
- never fit one mat on top of another.

PARKING SENSORS

This system indicates the proximity of an obstacle (person, vehicle, tree, gate, etc.) which comes within the field of detection of sensors located in the bumper.

! This function cannot, in any circumstances, take the place of the vigilance of the driver.

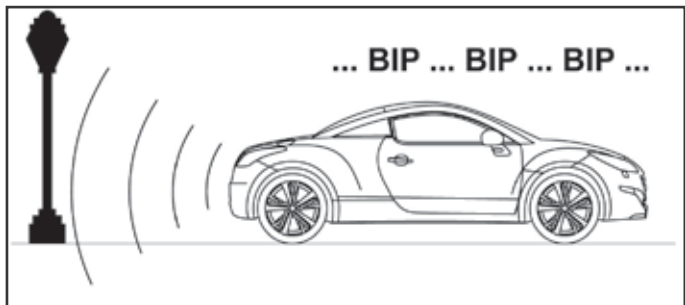
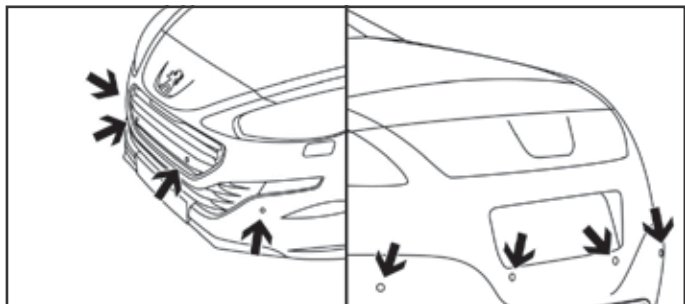

REAR PARKING SENSORS

The system is switched on by engaging reverse gear. This is accompanied by an audible signal.

The system is switched off when you come out of reverse gear.

Audible assistance

The proximity information is given by an intermittent audible signal, the frequency of which increases as the vehicle approaches the obstacle.

The sound emitted by the speaker (right or left) indicates the side on which the obstacle is located.

When the distance between the vehicle and the obstacle becomes less than approximately thirty centimetres, the audible signal becomes continuous.

! Certain types of obstacle (stake, roadworks cone, etc.) detected initially will no longer be detected at the end of the manoeuvre, if they are located in blind spots in the sensors' field of detection.

Visual assistance

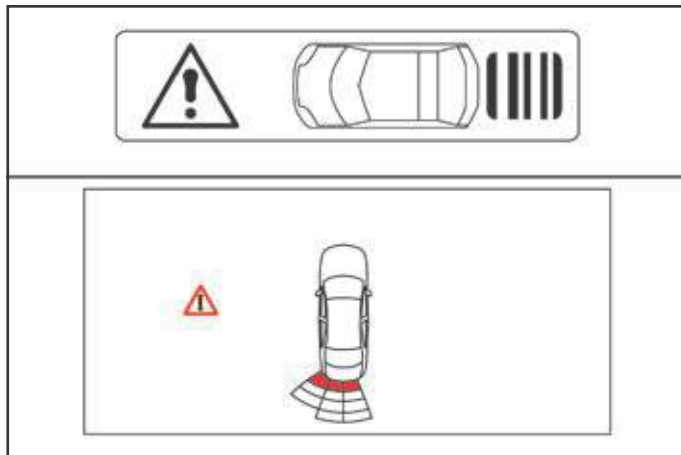

This supplements the audible signal by displaying bars in the multifunction screen which move progressively nearer to the vehicle. When the obstacle is near, the "Danger" symbol is displayed in the screen.

FRONT PARKING SENSORS

In addition to the rear parking sensors, the front parking sensors are triggered when an obstacle is detected in front and the speed of the vehicle is still below 6 mph (10 km/h).

The front parking sensors are interrupted if the vehicle stops for more than three seconds in forward gear, if no further obstacles are detected or when the speed of the vehicle exceeds 6 mph (10 km/h).

The sound emitted by the speaker (front or rear) indicates whether the obstacle is in front or behind.

deactivation / Activation of the front and rear parking sensors

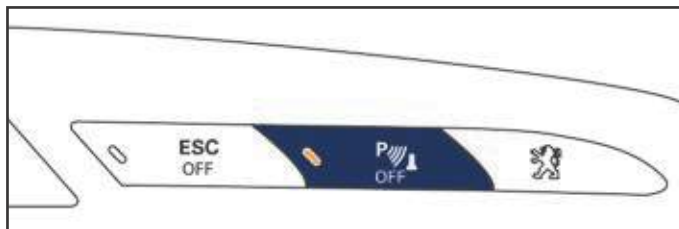

The function is deactivated by pressing this button. The indicator lamp in the button comes on.

Pressing this button again reactivates the function. The indicator lamp in the button goes off.

deactivation / Activation of the rear parking sensors

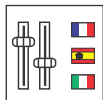

The function is deactivated or activated via the vehicle configuration menu.

The status of the function is stored when the ignition is switched off.



The function will be deactivated automatically if a trailer is being towed or a bicycle carrier is fitted (vehicle fitted with a towbar or bicycle carrier recommended by PEUGEOT).

OPERATING FAULT



In the event of a malfunction of the system, when reverse gear is engaged this warning lamp is displayed in the instrument panel and/or a message appears in the screen, accompanied by an audible signal (short beep).

Contact a PEUGEOT dealer or a qualified workshop.



In bad weather or in winter, ensure that the sensors are not covered with mud, ice or snow. When reverse gear is engaged, an audible signal (long beep) indicates that the sensors may be dirty. Certain sound sources (motorcycle, lorry, pneumatic drill, etc.) may trigger the audible signals of the parking sensor system.



- ▶ 208 Hybrid FE, a technology demonstrator with exceptional characteristics: 1.9 l/100 km (148.7 mpg) and 0 to 100 km/h (0 to 62 mph) in 8 seconds.

PEUGEOT & TOTAL, A PARTNERSHIP TO DELIVER BETTER PERFORMANCE!

Innovation, the key to success

The TOTAL Research and Development and PEUGEOT teams work together to develop high quality lubricants that meet the requirements of PEUGEOT vehicles. For you, this is the assurance that the performance of your engine is optimised while also ensuring its durability.

The 208 HYbrid FE demonstrates the ability of PEUGEOT and TOTAL to develop innovative technologies and provide other ways of moving towards the future.

Reduced exhaust emissions, a true reality

TOTAL lubricants are formulated to optimise the efficiency of engines and the protection of the emissions post-treatment systems. It is important to observe the servicing recommendations made by PEUGEOT to assure correct operation.

PEUGEOT RECOMMENDS TOTAL



FUEL TANK

Fuel tank capacity: approximately 55 litres.

LOW FUEL LEVEL



When the fuel tank minimum level is reached this warning lamp comes on on the instrument panel, accompanied by an audible signal and an alert message. When it first comes on there remains **approximately 5 litres** of fuel in the tank.

Until sufficient fuel is added, this warning lamp appears every time the ignition is switched on, accompanied by an audible signal and a message. When driving, this audible signal and display of the alert message are repeated with increasing frequency as the fuel level drops towards "0".

Refuel as soon as possible to avoid running out of fuel.

If you run out of fuel (Diesel), refer also to the "Running out of fuel (Diesel)" section.

REFUELLING



A label affixed to the inside of the flap reminds you of the type of fuel to be used depending on your engine.

Additions of fuel must be of at least 5 litres, in order to be registered by the fuel gauge.



Opening the filler cap may create a noise caused by an inrush of air. This vacuum is entirely normal, resulting from the sealing of the fuel system.

To fill the tank in complete safety:

- ☞ **the engine must be switched off,**
- ☞ press the rear part of the flap, then raise it to open it,
- ☞ turn the cap to the left,

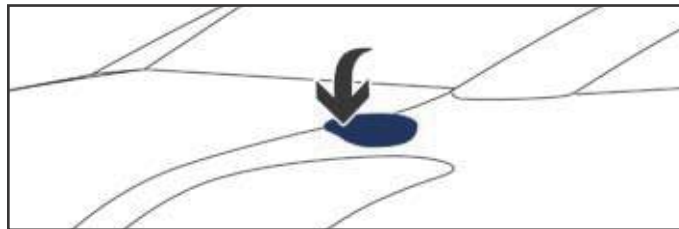

- ☞ remove the cap and hook it onto the clip located on the inside of the flap,
- ☞ fill the tank, **but do not continue after the 3rd cut-off of the pump**; this could cause malfunctions.

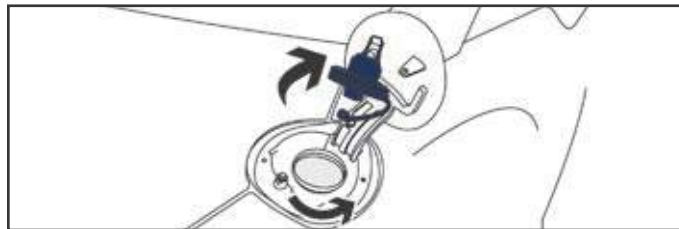

When you have filled the tank:

- ☞ put the cap back in place,
- ☞ turn it to the right,
- ☞ close the flap.



Freezing conditions

In these conditions, the filler flap may be jammed.

Opening the boot gives access to the flap, allowing it to be released by hand.

FUEL USED FOR DIESEL ENGINES

The Diesel engines are compatible with biofuels which conform to current and future European standards (Diesel fuel which complies with standard EN 590 mixed with a biofuel which complies with standard EN 14214) available at the pumps (containing up to 7 % Fatty Acid Methyl Ester).

B30 biofuel can be used in certain Diesel engines. However, this use, even occasional, requires strict application of the special servicing conditions. Contact a PEUGEOT dealer or a qualified workshop.

The use of any other type of (bio)fuel (vegetable or animal oils, pure or diluted, domestic fuel...) is strictly prohibited (risk of damage to the engine and fuel system).

FUEL USED FOR PETROL ENGINES

The petrol engines are compatible with E10 bio-petrol (containing 10 % ethanol), conforming to European standards EN 228 and EN 15376. E85 type fuels (containing up to 85 % ethanol) are reserved exclusively for vehicles marketed for the use of this type of fuel (BioFlex vehicles). The quality of the ethanol must comply with European standard EN 15293.



BONNET

- ⚠ The cooling fan may start after switching off the engine: take care with articles and clothing that might be caught by the fan blades.

OPENING

- ☞ Open the front left door.

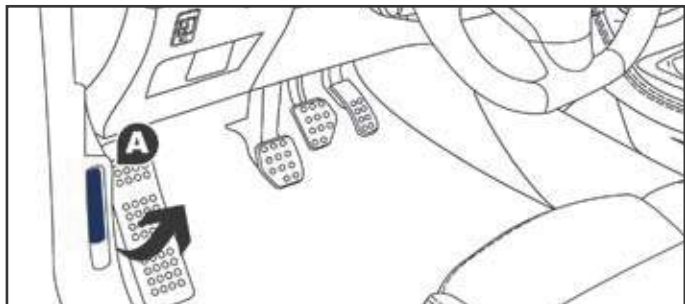

- ☞ Pull the interior release lever **A**, located at the bottom of the door aperture.

- ⓘ The location of the interior release lever prevents opening of the bonnet while the front left door is closed.

- ⚠ Do not open the bonnet in strong wind.
When the engine is hot, handle the safety catch with care (risk of burns).

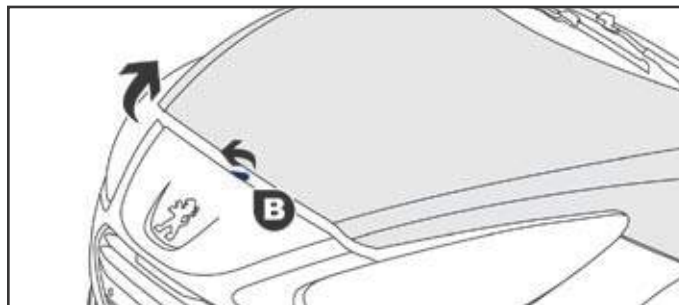

- ☞ Push the exterior safety catch **B** to the left and raise the bonnet. The bonnet is held open by the two side struts.

- ⚠ Because of the presence of electrical equipment under the bonnet, it is recommended that exposure to water (rain, washing, ...) be limited.

CLOSING

- ☞ Lower the bonnet and release it at the end of its travel.
- ☞ Pull the bonnet to check that it is fully latched.

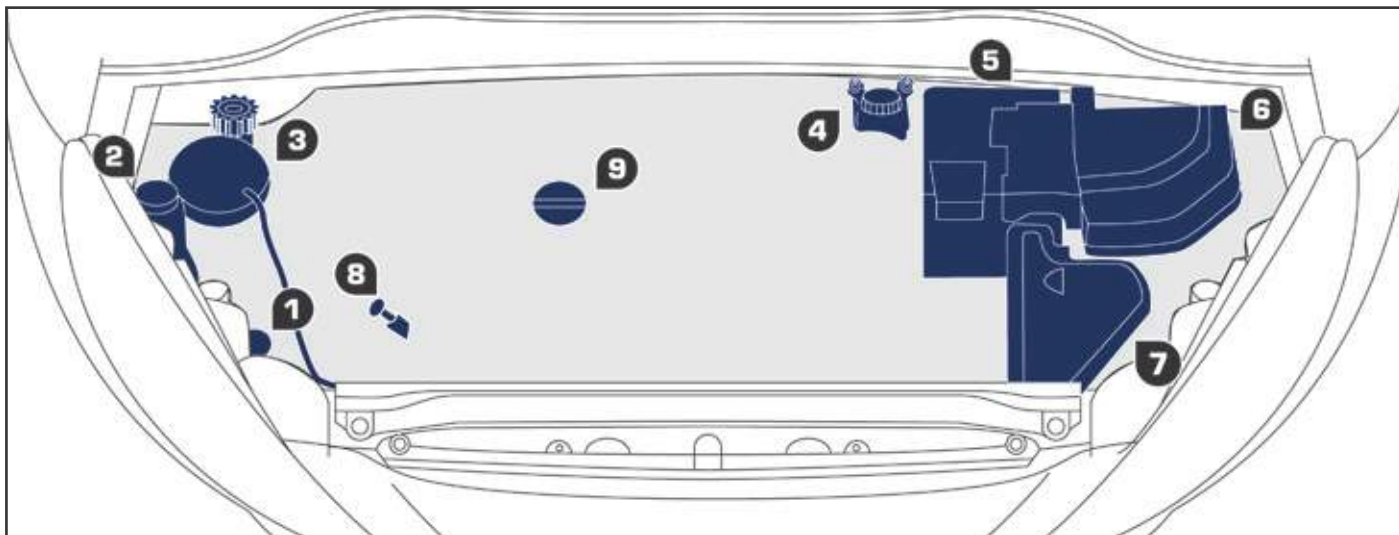

PETROL ENGINES

The various caps and covers allow access for checking the levels of the various fluids and for replacing certain components.

1. Power steering reservoir.
2. Screenwash and headlamp wash reservoir.
3. Coolant reservoir.
4. Brake fluid reservoir.
5. Battery / Fuses.
6. Fusebox.
7. Air filter.
8. Engine oil dipstick.
9. Engine oil filler cap.

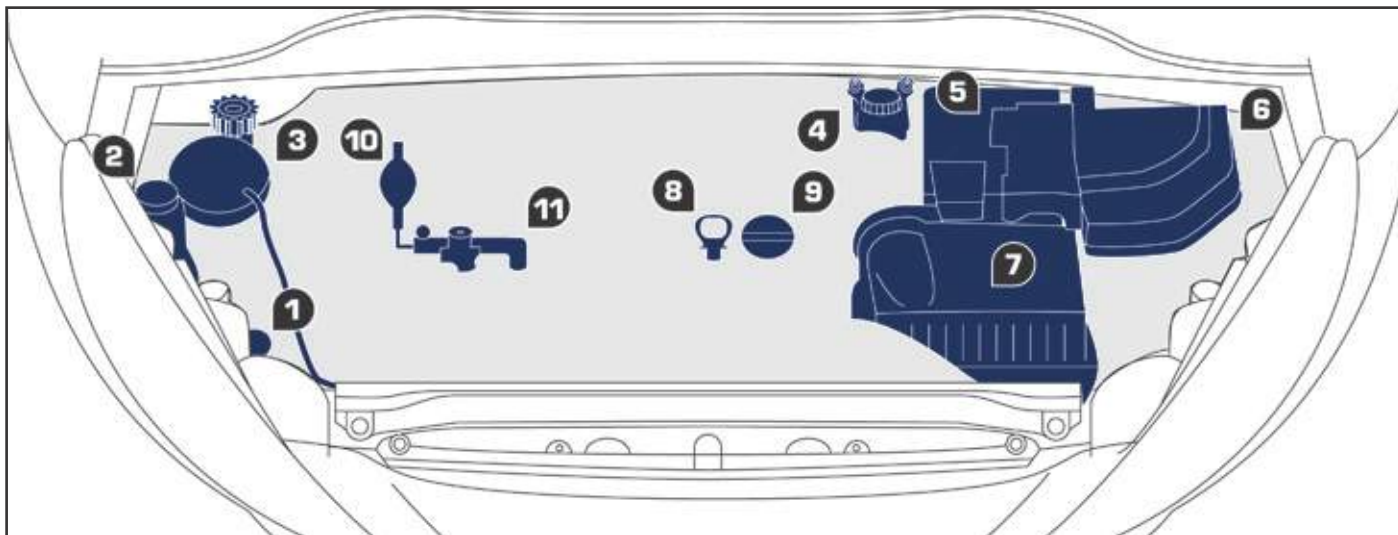

DIESEL ENGINE

The various caps and covers allow access for checking the levels of the various fluids, for replacing certain components and for priming the fuel system.

- | | |
|--|---------------------------|
| 1. Power steering reservoir. | 7. Air filter. |
| 2. Screenwash and headlamp wash reservoir. | 8. Engine oil dipstick. |
| 3. Coolant reservoir. | 9. Engine oil filler cap. |
| 4. Brake fluid reservoir. | 10. Priming pump. |
| 5. Battery / Fuses. | 11. Bleed screw. |
| 6. Fusebox. | |

RUNNING OUT OF FUEL (DIESEL)

On vehicle fitted with HDi engines, the fuel system must be primed manually if you run out of fuel; refer to the corresponding engine compartment view.



If the engine does not start first time, don't keep trying but start the procedure again from the beginning.

2.0 HdI ENGINE

- ☞ Fill the fuel tank with at least five litres of Diesel.
- ☞ Open the bonnet.
- ☞ If necessary, unclip the style cover for access to the priming pump.
- ☞ Slacken the bleed screw.
- ☞ Squeeze and release the priming pump repeatedly until fuel appears in the transparent pipe.
- ☞ Tighten the bleed screw.
- ☞ Operate the starter until the engine starts (if the engine fails to start at the first attempt, wait around 15 seconds before trying again).
- ☞ If the engine fails to start after a few attempts, operate the priming pump again, then the starter.
- ☞ Put the style cover back in position and clip it in place, ensuring that it has clipped correctly.
- ☞ Close the bonnet.

CHECKING LEVELS

Check all of these levels regularly, in line with the manufacturer's service schedule. Top them up if necessary, unless otherwise indicated. If a level drops significantly, have the corresponding system checked by a PEUGEOT dealer or a qualified workshop.

ENGINE OIL LEVEL



The check is carried out either when the ignition is switched on using the oil level indicator in the instrument panel, or using the dipstick.

To ensure that the reading is correct, your vehicle must be parked on level ground and the engine must have been off for more than 30 minutes.

It is normal to top up the oil level between two services (or oil changes). PEUGEOT recommends that you check the level, and top up if necessary, every 3 000 miles (5 000 kms).

Checking using the dipstick

Refer to the "Petrol engine" or "Diesel engine" section for the location of the dipstick in the engine compartment of your vehicle.

- ☞ Take the dipstick by its coloured grip and remove it completely.
- ☞ Wipe the end of the dipstick using a clean non-fluffy cloth.
- ☞ Refit the dipstick and push fully down, then pull it out again to make the visual check: the correct level is between the marks **A** and **B**.

! Take care when working under the bonnet, as certain areas of the engine may be extremely hot (risk of burns) and the cooling fan could start at any time (even with the ignition off).

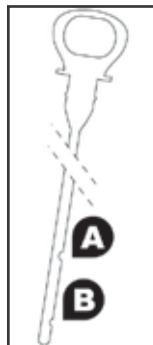

A = MAX

B = MIN

If you find that the level is above the **A** mark or below the **B** mark, **do not start the engine**.

- If the level is above the **MAX** mark (risk of damage to the engine), contact a PEUGEOT dealer or a qualified workshop.
- If the level is below the **MIN** mark, you must top up the engine oil.

Engine oil grade

Before topping up or changing the engine oil, ensure that you have the correct grade of oil for your engine and that it meets the manufacturer's recommendations.

Topping up the engine oil level

Refer to the "Petrol engine" or "Diesel engine" section to identify the location of the oil filler cap in the engine compartment of your vehicle.

- 🔧 Unscrew the oil filler cap to reveal the filler aperture.
- 🔧 Add oil in small quantities, avoiding any spills on engine components (risk of fire).
- 🔧 Wait a few minutes before checking the level again using the dipstick.
- 🔧 Add more oil if necessary.
- 🔧 After checking the level, carefully refit the oil filler cap and the dipstick in its tube.

After topping up the oil, the check when switching on the ignition with the oil level indicator in the instrument panel is not valid during the 30 minutes after topping up.

Engine oil change

Refer to the manufacturer's service schedule for details of the interval for this operation.

In order to maintain the reliability of the engine and emission control system, never use additives in the engine oil.

BRAKE FLUID LEVEL



The brake fluid level should be close to the "MAX" mark. If it is not, check the brake pad wear.

Changing the fluid

Refer to the manufacturer's service schedule for details of the interval for this operation.

Fluid specification

The brake fluid must conform to the manufacturer's recommendations.

POWER STEERING FLUID LEVEL



The power steering fluid level should be close to the "MAX" mark. With the engine cold, unscrew the cap to check the level.

COOLANT LEVEL



The coolant level should be close to the "MAx" mark but should never exceed it.

When the engine is warm, the temperature of the coolant is regulated by the fan.

The cooling fan may start after switching off the engine: take care with articles and clothing that might be caught by the fan blades.

In addition, as the cooling system is pressurised, wait at least one hour after switching off the engine before carrying out any work.

To avoid any risk of scalding, unscrew the cap by two turns to allow the pressure to drop. When the pressure has dropped, remove the cap and top up the level.

Fluid specification

The coolant must conform to the manufacturer's recommendations.

SCREENWASH AND HEADLAMP WASH FLUID



In the case of vehicles fitted with headlamp washers, the low fluid level is indicated by an audible signal and a message in the instrument panel screen.

Top up the reservoir when you next stop the vehicle.

Fluid specification

For optimum cleaning and to avoid freezing, this fluid must not be topped up with or replaced with plain water.

In wintry conditions, the use of an ethyl alcohol or methanol base fluid is recommended.

DIESEL FUEL ADDITIVE LEVEL (DIESEL WITH PARTICLE FILTER)



The additive reservoir low level is indicated by fixed illumination of this warning lamp, accompanied by an audible signal and a message that the particle filter additive level is too low.

Topping up

The reservoir must be topped up without delay by a PEUGEOT dealer or a qualified workshop.

USED PRODUCTS



Avoid prolonged contact of used oil or fluids with the skin. Most of these fluids are harmful to health or indeed very corrosive.



Do not discard used oil or fluids into sewers or onto the ground. Take used oil to a PEUGEOT dealer or a qualified workshop (France) or to an authorised waste disposal site.

CHECKS

Unless otherwise indicated, check these components in accordance with the manufacturer's service schedule and according to your engine. Otherwise, have them checked by a PEUGEOT dealer or a qualified workshop.

BATTERY



The battery does not require any maintenance.

However, check that the terminals are clean and correctly tightened, particularly in summer and winter.

When carrying out work on the battery, refer to the "Battery" section for details of the precautions to be taken before disconnecting the battery and following its reconnection.

AIR FILTER AND PASSENGER COMPARTMENT FILTER



Refer to the manufacturer's service schedule for details of the replacement intervals for these components.

Depending on the environment (e.g. dusty atmosphere) and the use of the vehicle (e.g. city driving), **replace them twice as often if necessary.**

A clogged passenger compartment filter may have an adverse effect on the performance of the air conditioning system and generate undesirable odours.

OIL FILTER



Replace the oil filter each time the engine oil is changed.

Refer to the manufacturer's service schedule for details of the replacement interval for this component.

PARTICLE FILTER (DIESEL)



The start of saturation of the particle filter is indicated by the temporary illumination of this warning lamp, accompanied by an audible signal and a message on the risk of blockage of the particle filter.

As soon as the traffic conditions permit, regenerate the filter by driving at a speed of at least 40 mph (60 km/h) until the warning lamp goes off. If the warning lamp stays on, refer to the "Additive level" section.



On a new vehicle, the first particle filter regeneration operations may be accompanied by a "burning" smell, which is perfectly normal.

Following prolonged operation of the vehicle at very low speed or at idle, you may, in exceptional circumstances, notice the emission of water vapour at the exhaust on acceleration. This does not affect the behaviour of the vehicle or the environment.

MANUAL GEARBOX



The gearbox does not require any maintenance (no oil change).

Refer to the manufacturer's service schedule for the checking interval for this component.

AUTOMATIC GEARBOX



The gearbox does not require any maintenance (no oil change).

Refer to the manufacturer's service schedule for details of the level checking interval for this component.

BRAKE PAdS



Brake wear depends on the style of driving, particularly in the case of vehicles used in town, over short distances. It may be necessary to have the condition of the brakes checked, even between vehicle services.

Unless there is a leak in the circuit, a drop in the brake fluid level indicates that the brake pads are worn.

BRAKE dISC WEAR



For information on checking brake disc wear, contact a PEUGEOT dealer or a qualified workshop.

PARKING BRAKE



If excessive travel or a loss of effectiveness of this system is noticed, the parking brake must be checked, even between two services.

Checking this system must be done by a PEUGEOT dealer or a qualified workshop.



Only use products recommended by PEUGEOT or products of equivalent quality and specification.

In order to optimise the operation of units as important as those in the braking system, PEUGEOT selects and offers very specific products.

After washing the vehicle, dampness, or in wintry conditions, ice can form on the brake discs and pads: braking efficiency may be reduced. Make light brake applications to dry and defrost the brakes.

TEMPORARY PUNCTURE REPAIR KIT

Complete system consisting of a compressor and a sealant cartridge which permits **temporary repair** of a tyre so that you can drive to the nearest garage.

It is designed to repair most punctures which could affect the tyre, located on the tyre tread or shoulder.

ACCESS TO THE KIT

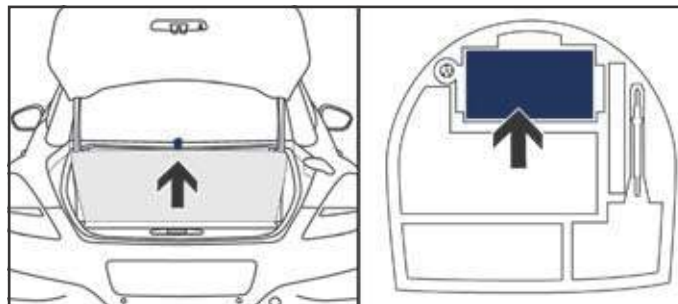

This kit is installed in the storage box, under the boot floor.

DESCRIPTION OF THE KIT

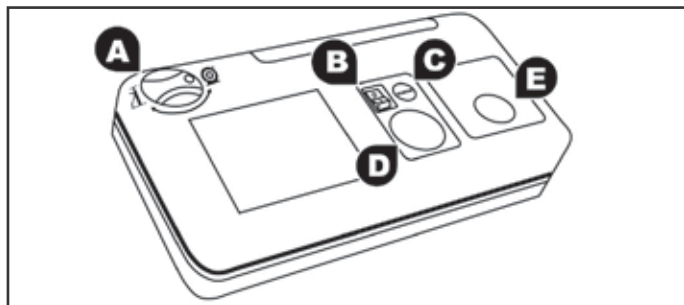

- A. "Sealant" or "Air" position selector.
- B. On "I" / off "O" switch.
- C. Deflation button.
- d. Pressure gauge (in bar and p.s.i.).
- E. Compartment housing:
 - a cable with adaptor for 12 V socket,
 - various inflation adaptors for accessories, such as balls, bicycle tyres...

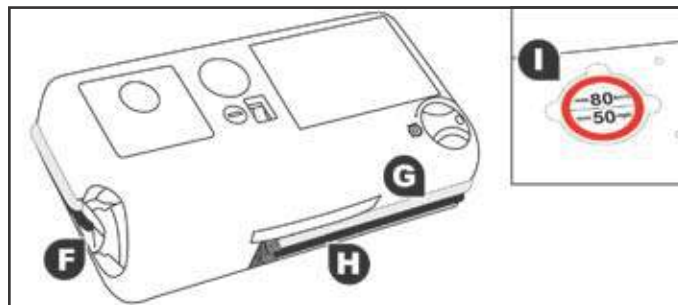

- F. Sealant cartridge.
- G. White pipe with cap for repair.
- H. Black pipe for inflation.
- I. Speed limit sticker.



The speed limit sticker I must be affixed to the vehicle's steering wheel to remind you that a wheel is in temporary use. Do not exceed a speed of 50 mph (80 km/h) when driving with a tyre repaired using this type of kit.



The vehicle's electric system allows the connection of a compressor for long enough to inflate a tyre after a puncture repair or for inflating a small inflatable accessory.

REPAIR PROCEDURE

1. Sealing

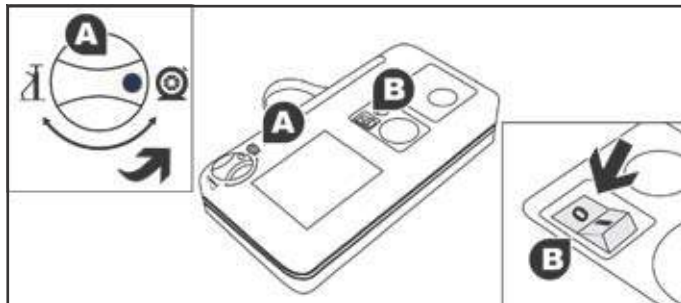

- ☞ Switch off the ignition.
- ☞ Turn the selector **A** to the "sealant" position.
- ☞ Check that the switch **B** is in position "O".

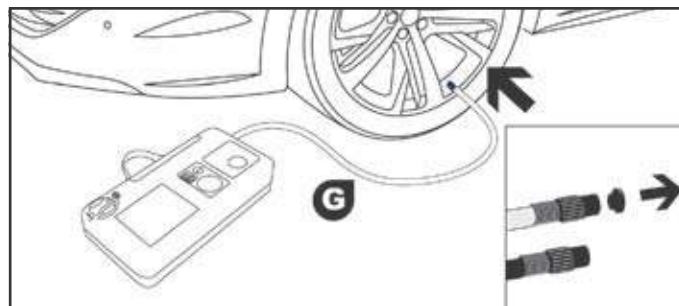

- ☞ Uncoil the white pipe **G** fully.
- ☞ Unscrew the cap from the white pipe.
- ☞ Connect the white pipe to the valve of the tyre to be repaired.

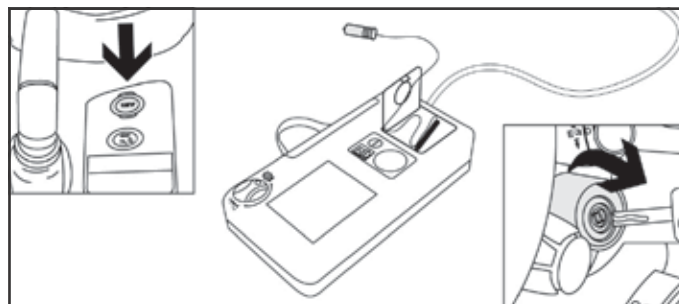

- ☞ Connect the compressor's electric plug to the vehicle's 12 V socket.
- ☞ Start the vehicle and leave the engine running.

 Avoid removing any foreign bodies which have penetrated into the tyre.

 Take care, this product is harmful (e.g. ethylene-glycol, colophony...) if swallowed and causes irritation to the eyes. Keep this product out of the reach of children.

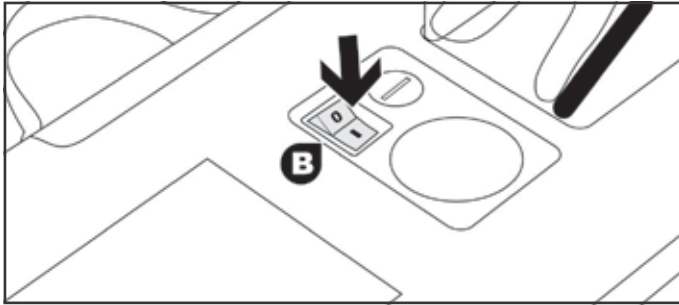

- ☞ Switch on the compressor by moving the switch **B** to position "I" until the tyre pressure reaches 2.0 bars.
The sealant is injected into the tyre under pressure; do not disconnect the pipe from the valve during this operation (risk of splashing).

i Do not start the compressor before connecting the white pipe to the tyre valve: the sealant product would be expelled through the pipe.

i If after around 5 to 7 minutes the pressure is not attained, this indicates that the tyre is not repairable; contact a PEUGEOT dealer or a qualified workshop for assistance.

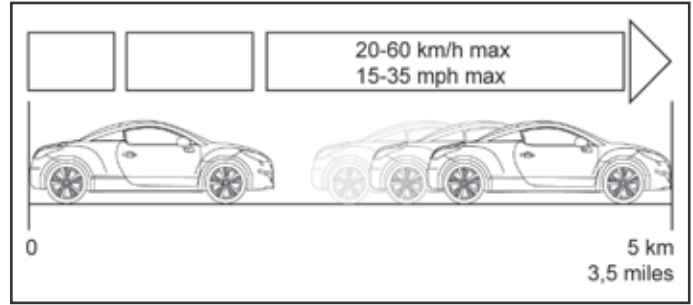

- ☞ Remove the kit and screw the cap back on the white pipe.
Take care to avoid staining your vehicle with traces of fluid. Keep the kit to hand.
- ☞ Drive immediately for approximately three miles (five kilometres), at reduced speed (between 15 and 35 mph (20 and 60 km/h)), to plug the puncture.
- ☞ Stop to check the repair and the tyre pressure using the kit.

i Tyre under-inflation detection

If the vehicle is fitted with tyre under-inflation detection, the under-inflation warning lamp will remain on after the wheel has been repaired until the system is reinitialised by a PEUGEOT dealer or a qualified workshop.

2. Inflation

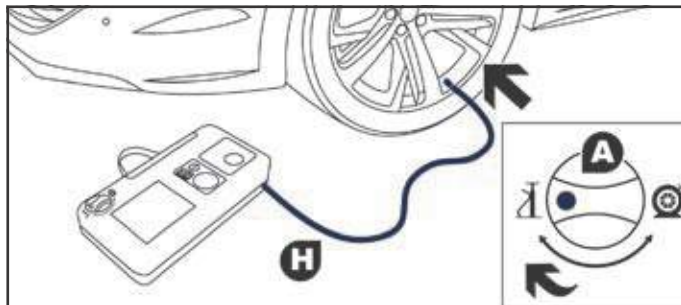

- ☞ Turn the selector **A** to the "air" position.
- ☞ Uncoil the black pipe **H** fully.
- ☞ Connect the black pipe to the valve of the wheel.

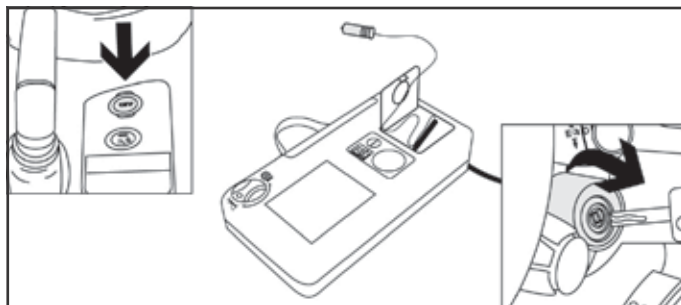

- ☞ Connect the compressor's electric plug to the vehicle's 12 V socket.
- ☞ Start the vehicle again and leave the engine running.

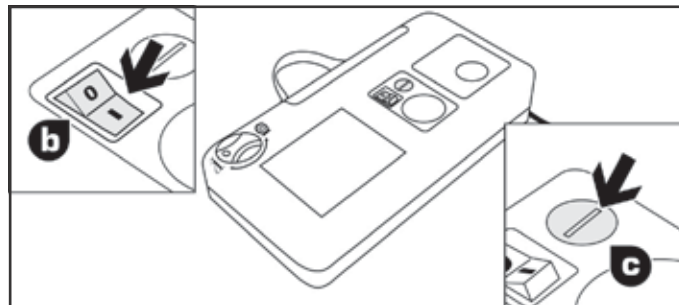

- ☞ Adjust the pressure using the compressor (to inflate: switch **B** in position "I"; to deflate: switch **B** in position "O" and press button **C**), in accordance with the vehicle's tyre pressure label (located on the left hand door aperture).

A loss of pressure indicates that the puncture has not been fully plugged; contact a PEUGEOT dealer or qualified workshop for assistance.

- ☞ Remove and stow the kit.
- ☞ Drive at reduced speed (50 mph [80 km/h] max) limiting the distance travelled to approximately 120 miles (200 km).



As soon as possible, go to a PEUGEOT dealer or a qualified workshop.

You must inform the technician that you have used this kit. After inspection, the technician will advise you on whether the tyre can be repaired or if it must be replaced.

REMOVING THE CARTRIDGE

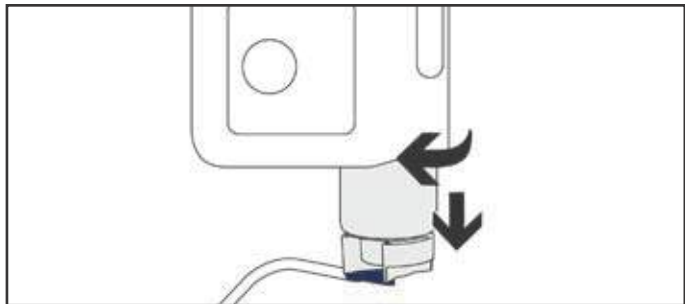

- ☞ Stow the black pipe.
- ☞ Detach the angled base from the white pipe.
- ☞ Support the compressor vertically.
- ☞ Unscrew the cartridge from the bottom.



Beware of discharges of fluid.

The expiry date of the fluid is indicated on the cartridge.

The sealant cartridge is designed for single use; even if only partly used, it must be replaced.

After use, do not discard the cartridge into the environment, take it to an authorised waste disposal site or a PEUGEOT dealer.

Do not forget to obtain a new sealant cartridge, available from PEUGEOT dealers or from a qualified workshop.

CHECKING TYRE PRESSURES / INFLATING ACCESSORIES

You can also use the compressor, without injecting any product, to:

- check or adjust the pressure of your tyres,
- inflate other accessories (balls, bicycle tyres...).

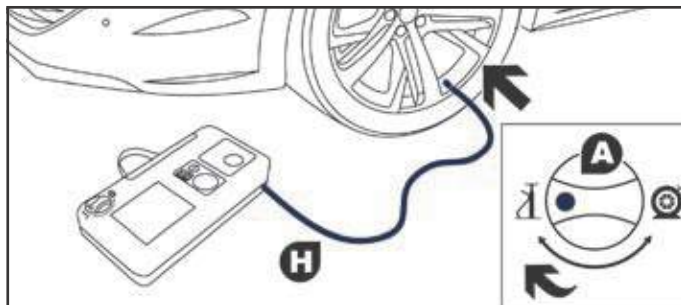

- ☞ Turn the selector **A** to the "Air" position.
- ☞ Uncoil the black pipe **H** fully.
- ☞ Connect the black pipe to the valve of the wheel or accessory.



If necessary, fit one of the adaptors supplied with the kit first.

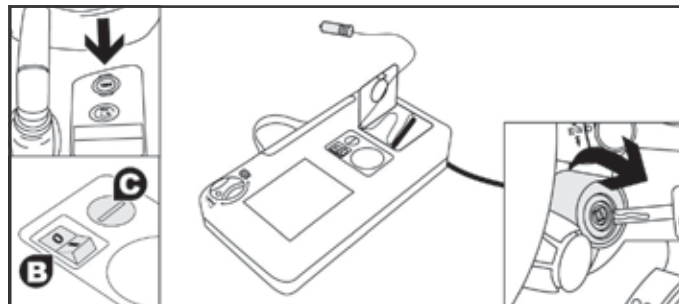

- ☞ Connect the compressor's electrical connector to the vehicle's 12 V socket.
- ☞ Start the vehicle and let the engine run.
- ☞ Adjust the pressure using the compressor (to inflate: switch **B** in position "I"; to deflate: switch **B** in position "O" and press button **C**), according to the vehicle's tyre pressure label or the accessory's pressure label.
- ☞ Remove the kit then stow it.

CHANGING A WHEEL

TOOLS REQUIRED*

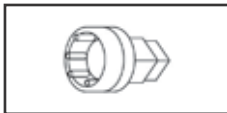

Security socket: for adaptation of the wheelbrace to the special "security" bolts. Specific to your vehicle, it is stored in the glove box.



Wheelbrace: for removal of the wheel fixing bolts.

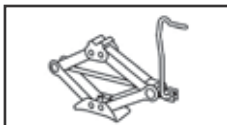

Jack with integrated handle: for lifting the vehicle.

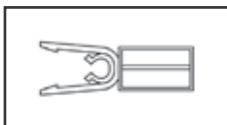

Bolt cover removal tool: for removal of the bolt finishers (covers) on alloy wheels.



Parking the vehicle

Immobilise the vehicle where it does not block traffic: the ground must be level, stable and non-slippery ground.

Apply the parking brake, switch off the ignition and engage first gear (position **P** for the automatic gearbox) to lock the wheels.

Check that the parking brake indicator lamps are on fixed (not flashing) in the instrument panel.

It is imperative that you ensure that the occupants get out of the vehicle and wait where they are safe.

If necessary, place a chock under the wheel diagonally opposite the wheel to be changed.

Never go underneath a vehicle raised using a jack; use an axle stand.



Do not use:

- the jack for any purpose other than lifting the vehicle,
- a jack other than the one supplied with the vehicle.

If the jack supplied with the vehicle is not present, contact a PEUGEOT dealer or a qualified workshop to obtain the jack defined for the vehicle by the manufacturer.

* Depending on the country of sale, the vehicle may be equipped with the tools needed to change a wheel and a spare wheel (see following pages).

REMOVING A WHEEL

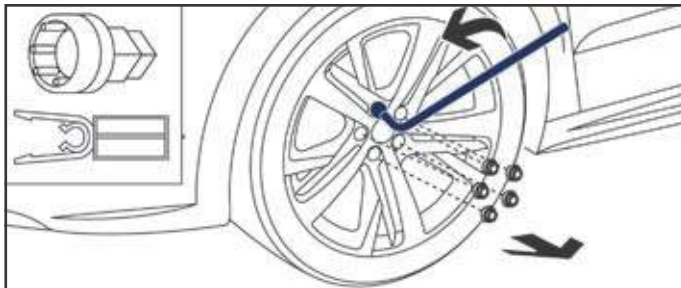

- ☞ Remove the cover on each of the bolts using the bolt cover removal tool.
- ☞ Fit the security socket on the wheelbrace to slacken the security bolt.
- ☞ Slacken the other bolts using the wheelbrace only.

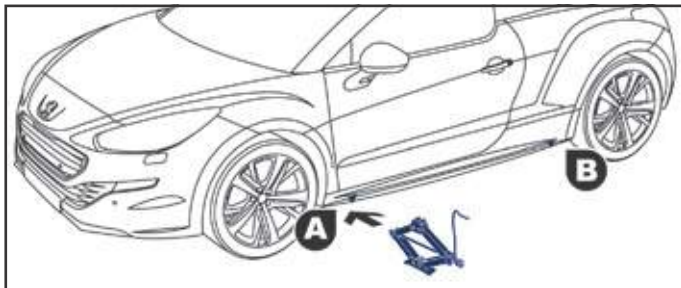

- ☞ Position the foot of the jack on the ground directly below one of the two front **A** or rear **B** jacking points provided on the underbody, whichever is closest to the wheel to be changed.

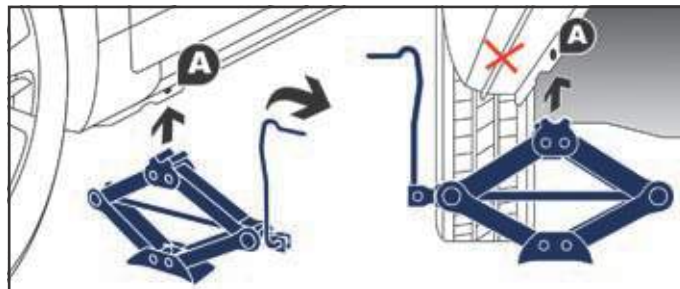

- ☞ Extend the jack until its head comes into contact with the jacking point **A** or **B** used; the vehicle's contact area **A** or **B** must be correctly engaged with the central part of the head of the jack.



Ensure that the jack is stable. If the ground is slippery or loose, the jack may slip or drop. - Risk of injury!

Ensure that the jack is positioned only at one of the jacking points **A** or **B** under the vehicle, making sure that the vehicle's contact area is centred on the head of the jack. Otherwise there is a risk of damage to the vehicle and/or of the jack dropping - Risk of injury!

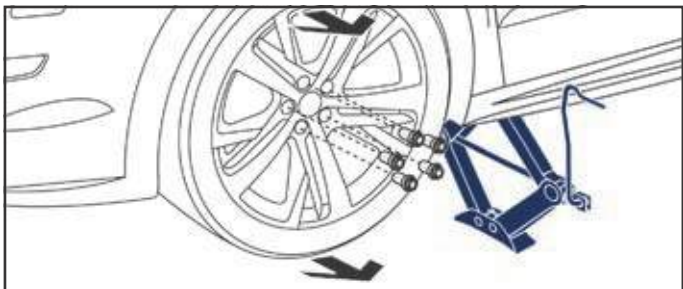

- ☞ Raise the vehicle until there is sufficient space between the wheel and the ground to admit the spare (not punctured) wheel easily.
- ☞ Remove the bolts and store them in a clean place.
- ☞ Remove the wheel.

FITTING A WHEEL

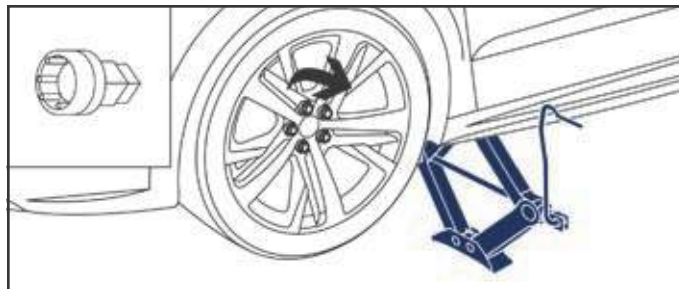

- ☞ Put the wheel in place on the hub.
- ☞ Screw in the bolts by hand.
- ☞ Pre-tighten the security bolt using the wheelbrace fitted with the security socket.
- ☞ Pre-tighten the other bolts using the wheelbrace only.

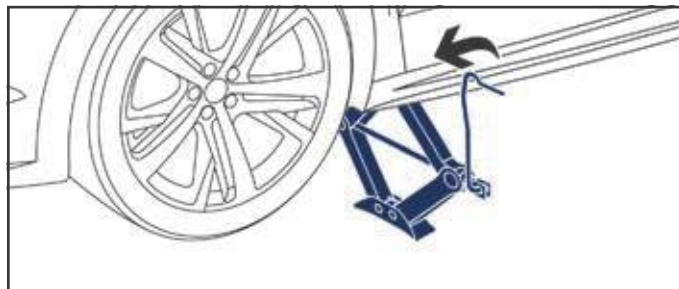

- ☞ Lower the vehicle fully.
- ☞ Fold the jack and detach it.

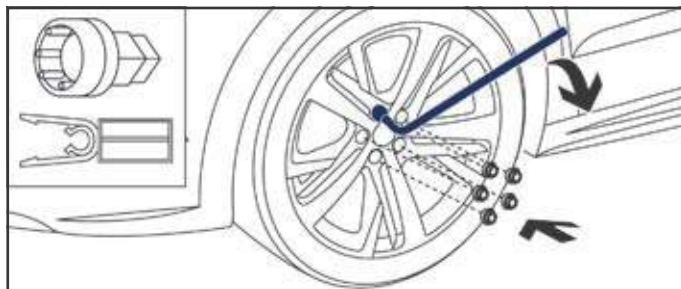

- ☞ Tighten the security bolt using the wheelbrace fitted with the security socket.
- ☞ Tighten the other bolts using the wheelbrace only.
- ☞ Refit the covers on each of the bolts.
- ☞ Store the tools in the storage box.

TOOLS AND SPARE WHEEL*

Depending on the country of sale, the vehicle is equipped with the tools needed to change a wheel and may also be equipped with a spare wheel.

The spare wheel is stowed in a protective cover, secured to the boot floor with Velcro®.

The tools are held in a storage box under the boot floor.



After changing a wheel

Have the tightening of the bolts and the pressure of the new wheel checked by a PEUGEOT dealer or a qualified workshop without delay.



Never drive with the rear seat folded when the spare wheel - or a punctured wheel - is present in the boot.

Warning marking

"Do not release the backrest of the rear seats!"

* According to country.

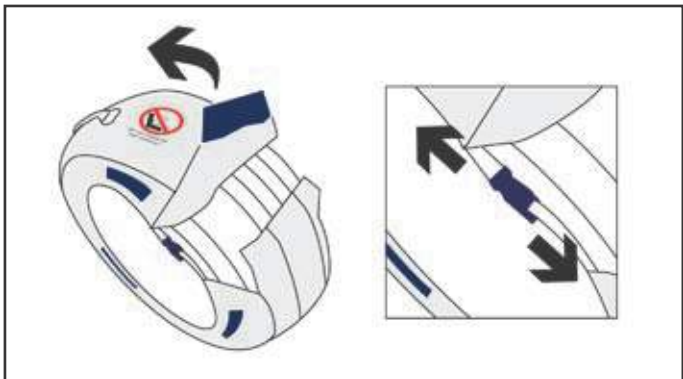

Access to the spare wheel*

- ☞ Open the boot lid.
- ☞ Remove the spare wheel by grasping the grip of its protective cover.
- ☞ Position the wheel vertically so as to read the warning markings.
- ☞ Remove the Velcro® located on the tyre tread.
- ☞ Detach the straps, located on each sidewall, then slacken them.
- ☞ Remove the wheel from its protective cover.

When refitting the wheel into its cover, place it so that the valve is opposite the strap fixings.

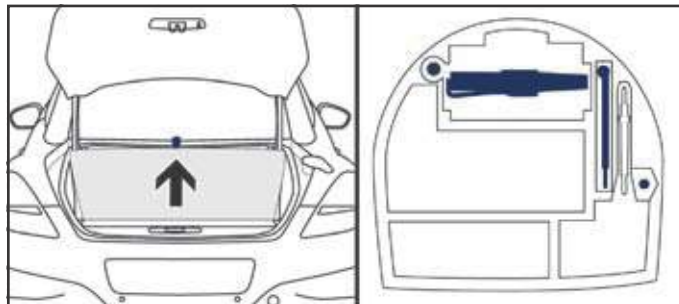

Access to tools*

- ☞ Open the boot lid.
- ☞ Lift the boot floor using its strap.
- ☞ Fix it in the vertical position beyond the stops located on the boot sides.
- ☞ Remove the temporary puncture repair kit for access to the jack.





All of these tools are specific to your vehicle. Do not use them for other purposes.

* According to country.

SNOW CHAINS

In wintry conditions, snow chains improve traction as well as the behaviour of the vehicle when braking.

 The snow chains must be fitted only to the front wheels. They must never be fitted to "space-saver" type spare wheels.

 It is strongly recommended that before you leave, you practise fitting the snow chains on a level and dry surface.

Use only the chains designed to be fitted to the type of wheel fitted to your vehicle:





Original tyre size	Maximum link size.
235/45 R18	cannot be fitted with chains
235/40 R19	
225/45 R18	9 mm

For more information on snow chains, contact a PEUGEOT dealer or a qualified workshop.

 Take account of the legislation in force in your country on the use of snow chains and the maximum running speed authorised.

 Avoid driving with snow chains on roads that have been cleared of snow, to avoid damaging your vehicle's tyres and the road surface. If your vehicle is fitted with alloy wheels, check that no part of the chain or its fixings is in contact with the wheel rim.

Advice on installation

-  If you have to fit the chains during a journey, stop the vehicle on a flat surface on the side of the road.
-  Apply the parking brake and position any wheel chocks to prevent movement of your vehicle.
-  Fit the chains following the instructions provided by the manufacturer.
-  Move off gently and drive for a few moments, without exceeding 30 mph (50 km/h).
-  Stop your vehicle and check that the snow chains are correctly tightened.

CHANGING A WIPER BLADE

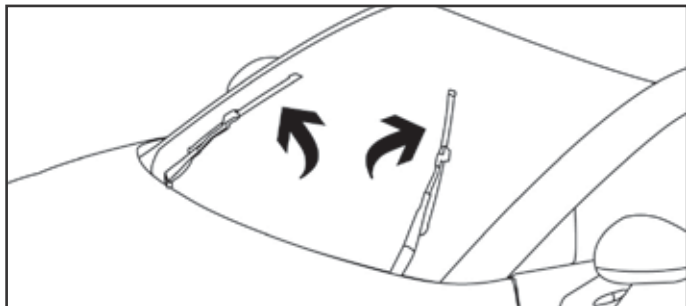

BEFORE REMOVING A WIPER BLADE

- ☞ Within one minute after switching off the ignition, operate the wiper stalk to position the wiper blades in the centre of the windscreen.

REMOVING

- ☞ Raise the corresponding wiper arm.
- ☞ Unclip the wiper blade and remove it.

FITTING

- ☞ Put the corresponding new wiper blade in place and clip it.
- ☞ Fold down the wiper arm carefully.

AFTER FITTING A WIPER BLADE

- ☞ Switch on the ignition.
- ☞ Operate the wiper stalk again to park the wiper blades.

ENERGY ECONOMY MODE

System which manages the duration of use of certain functions to conserve a sufficient level of charge in the battery.

After the engine has stopped, you can still use functions such as the audio and telematics system, windscreen wipers, dipped beam headlamps, courtesy lamps, etc. for a maximum combined duration of thirty minutes.



This period may be reduced considerably if the battery is not fully charged.

GOING INTO TO ECONOMY MODE

Once this period has elapsed, a message appears in the multifunction screen indicating that the vehicle has gone into economy mode and the active functions are put on standby.



If a telephone call is being made at this time, it will be maintained for 5 minutes with the hands-free kit of your PEUGEOT Connect Sound (RD5) or PEUGEOT Connect Navigation (RT6).

COMING OUT OF ECONOMY MODE

These functions are reactivated automatically next time the vehicle is started.

To resume the use of these functions immediately, start the engine and let it run for at least 5 minutes.

Observe this minimum period of engine running to maintain the correct level of charge in the battery.

Do not repeatedly restart of the engine to restore immediate use of systems.



A flat battery prevents the engine from starting (refer to the "12 V battery" section).

LOAD REDUCTION MODE

System which manages the use of certain functions according to the level of charge remaining in the battery.

When the vehicle is being driven, the load reduction function temporarily deactivates certain functions, such as the air conditioning, the heated rear screen...

The deactivated functions are reactivated automatically as soon as conditions permit.

12 V BATTERY

ACCESS TO THE BATTERY

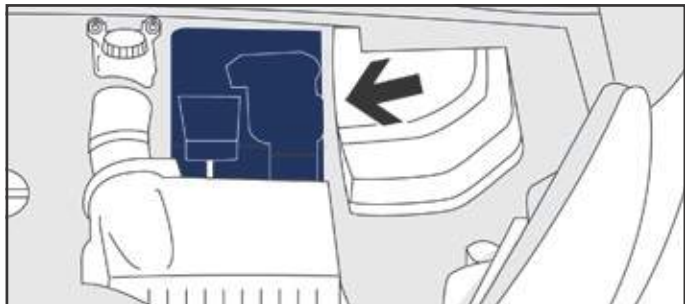

The battery is located under the bonnet.

For access to it:

- ☞ open the bonnet using the interior release lever, then the exterior safety catch,
- ☞ remove the plastic cover for access to the two terminals,
- ☞ unclip the fusebox to remove the battery, if necessary.



Before doing any work

Immobilise the vehicle: apply the parking brake, put the gearbox into neutral (or position **P** if your vehicle has an automatic gearbox), then switch off the ignition.

Check that all electrical systems are off.

Do not reverse the polarity and use only a 12 V charger.

Do not disconnect the terminals while the engine is running.

Do not charge the batteries without disconnecting the terminals first.



Ensure that the battery posts and terminals are clean. If covered in sulphate (white or green deposits), remove and clean them.



The batteries contain harmful substances such as sulphuric acid and lead. They must be disposed of in accordance with regulations and must not, in any circumstances, be discarded with household waste.

Take used remote control batteries and vehicle batteries to a special collection point.

STARTING USING ANOTHER BATTERY

When your vehicle's battery is discharged, the engine can be started using a slave battery (external or on another vehicle) and jump lead cables.

- ❗ First check that the slave battery has a nominal voltage of 12 V and a capacity at least equal to that of the discharged battery. Do not try to start the engine by connecting a battery charger. Do not disconnect the (+) terminal when the engine is running.

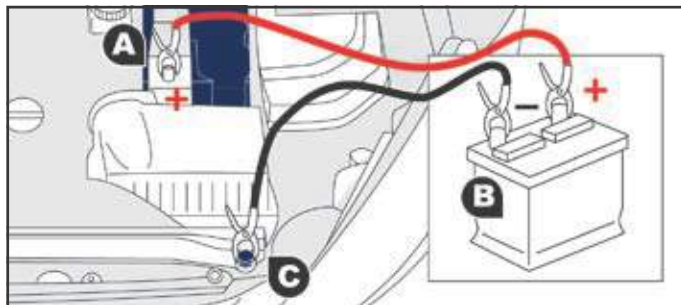

- ☞ Remove the plastic cover from the (+) terminal, if your vehicle has one.
- ☞ Connect the red cable to the positive terminal (+) of the flat battery **A**, then to the positive terminal (+) of the slave battery **B**.
- ☞ Connect one end of the green or black cable to the negative terminal (-) of the slave battery **B** (or earth point on the other vehicle).

- ☞ Connect the other end of the green or black cable to the earth point **C** on the broken down vehicle (or on the engine mounting).
- ☞ Start the engine of the vehicle with the good battery and leave it running for a few minutes.
- ☞ Operate the starter on the broken down vehicle and let the engine run.
If the engine does not start straight away, switch off the ignition and wait a few moments before trying again.
- ☞ Wait until the engine returns to idle then disconnect the jump lead cables in the reverse order.
- ☞ Refit the plastic cover to the (+) terminal, if your vehicle has one.

- ❗ Some functions are not available if the battery is not sufficiently charged.

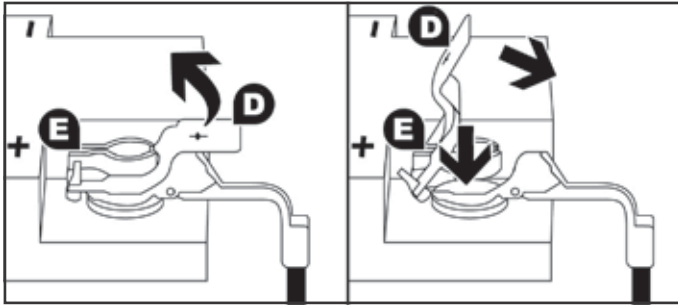

DISCONNECTING THE (+) TERMINAL

- ☞ Raise the lever **d** fully to release the clamp **E**.

RECONNECTING THE (+) TERMINAL

- ☞ Position the open clamp **E** of the cable on the positive post (+) of the battery.
- ☞ Press down on the clamp to position it correctly on the battery post.
- ☞ Lock the clamp by lowering the lever **d**.



Do not force the lever as locking will not be possible if the clamp is not positioned correctly; start the procedure again.

CHARGING THE BATTERY USING A BATTERY CHARGER

When your vehicle's battery is discharged or when the vehicle is to be out of use for a prolonged period, you can charge the battery using a battery charger.

Contact a PEUGEOT dealer or a qualified workshop for the specification of chargers compatible with your battery.

Before disconnecting

- ☞ Go to the battery.
- ☞ Withdraw the active spoiler.
- ☞ Check that the doors and boot are closed but not locked.
- ☞ Switch off the ignition and wait for at least four minutes.



If the vehicle is not going to be used for more than a month, it is recommended that the battery be disconnected.

To avoid discharging the battery, do not leave the lighting on for extended periods when the engine is not running (see the "Energy economy mode" section).

Charging

- ☞ Disconnect the (+) terminal.
- ☞ Follow the instructions for use provided by the manufacturer of the charger.
- ☞ Connect the charger's red cable to the (+) terminal of the battery, then the black cable to the (-) terminal.
- ☞ Once the battery is fully charged, disconnect the charger cables in reverse order.



Charging should be carried out in a well-ventilated area and away from naked flames and sources of sparks, so as to avoid any risk of explosion and fire.

Do not try to charge a frozen battery; first thaw it out so as to avoid the risk of explosion.

If the battery had frozen, before charging, have it checked by a PEUGEOT dealer or qualified workshop who will ensure that the internal components have not been damaged and that the casing is not cracked, which would cause a leak of toxic and corrosive acid.

REINITIALISATION AFTER RECONNECTION

After any reconnection of the battery, switch on the ignition and wait at least one minute before starting, to allow time for the initialisation of the electronic systems.

By referring to the corresponding sections, you should set or initialise the following systems yourself:

- remote control,
- electric windows and automatic partial opening of door glasses,
- time and date,
- audio and navigation system settings.

Check that no alert message or warning lamp comes on after switching on the ignition.

However, if minor problems persist after carrying out these operations, contact a PEUGEOT dealer or a qualified workshop.

CHANGING A BULB

! The headlamps are fitted with polycarbonate glass with a protective coating:

- ☞ **do not clean them using a dry or abrasive cloth, nor with a detergent or solvent product,**
- ☞ use a sponge and soapy water or a pH neutral product,
- ☞ when using a high pressure washer on persistent marks, do not keep the lance directed towards the lamps or their edges for too long, so as not to damage their protective coating and seals.

! Changing a bulb should only be done after the headlamp has been switched off for several minutes (risk of serious burns).

- ☞ Do not touch the bulb directly with your fingers, use a lint-free cloth.

It is imperative to use only anti-ultraviolet (UV) type bulbs to avoid damaging the headlamp.

Always replace a failed bulb with a new bulb with the same type and specification.

FRONT LAMPS

Model with halogen headlamps

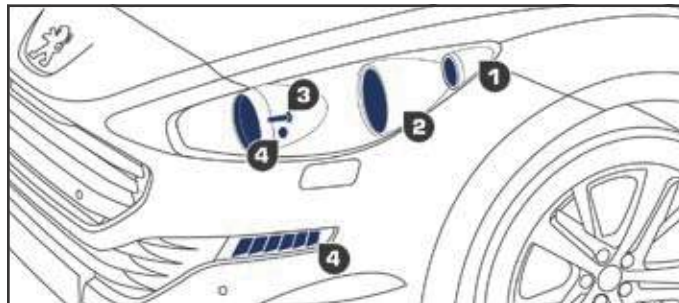

1. **direction indicators (PY21W amber).**
2. **dipped beam headlamps (H7).**
3. **Main beam headlamps (H1).**
4. **daytime running lamps / sidelamps (P21/5W)**
or
daytime running lamps / sidelamps (LEds).

Model with xenon and directional headlamps

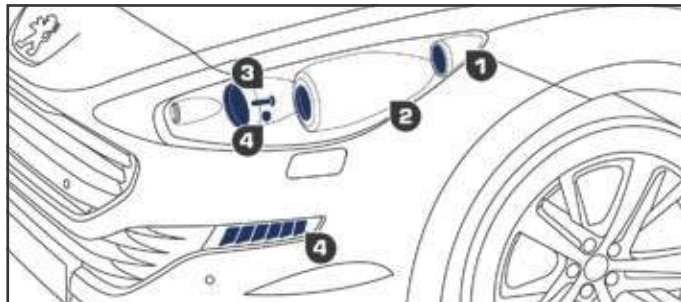

1. direction indicators (PY21W SV silver).
2. directional dipped / main beam headlamps (d1S).
3. Additional main beam headlamps (H1).
4. daytime running lamps / sidelamps (P21/5W)
or
daytime running lamps / sidelamps (LEds).

Risk of electrocution

xenon bulbs (D1S) must be replaced by a PEUGEOT dealer or a qualified workshop.

Changing direction indicator bulbs



- ☞ Turn the bulb holder a quarter of a turn and extract it.
 - ☞ Pull the bulb out and change it.
- To refit, carry out these operations in reverse order.

 Amber or silver coloured bulbs, such as the direction indicators, must be replaced with bulbs of identical specifications and colour.

 When refitting, close the protective cover carefully to assure the sealing of the headlamp.

Changing dipped beam headlamp bulbs

- ☞ Remove the protective cover by pulling the tab.
- ☞ Disconnect the bulb connector.
- ☞ Spread the springs to release the bulb.
- ☞ Pull the bulb out and change it.

To refit, carry out these operations in reverse order.

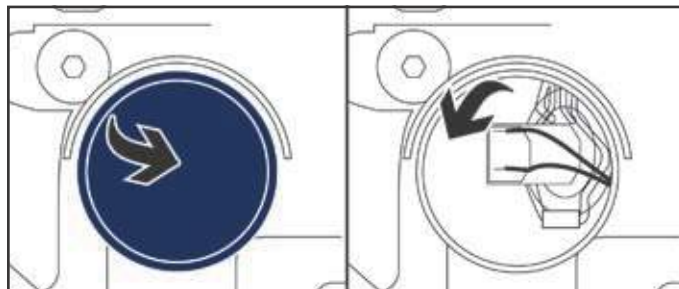

Changing main beam headlamp bulbs

- ☞ Remove the protective cover by pulling on the tab.
- ☞ Disconnect the bulb connector.
- ☞ Compress the springs to release the bulb.
- ☞ Remove the bulb and change it.

To refit, carry out these operations in reverse order.

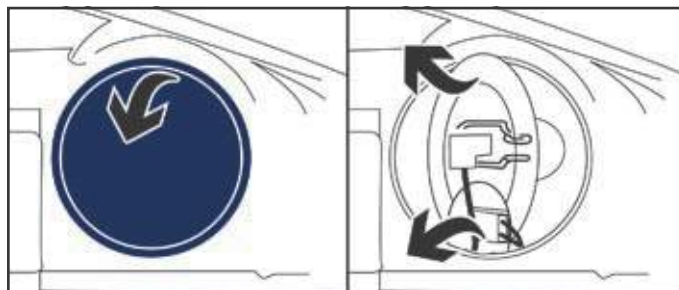

Changing daytime running lamp / sidelamp bulbs

- ☞ Remove the protective cover by pulling on the tab.
- ☞ Disconnect the bulb connector.
- ☞ Turn the bulb holder a quarter of a turn and extract it.
- ☞ Pull the bulb and change it.

To refit, carry out these operations in reverse order.

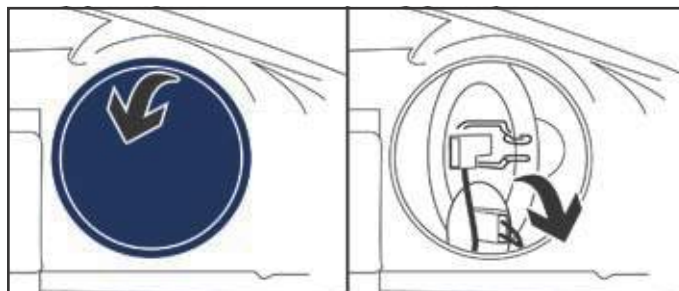

Changing integrated direction indicator side repeaters

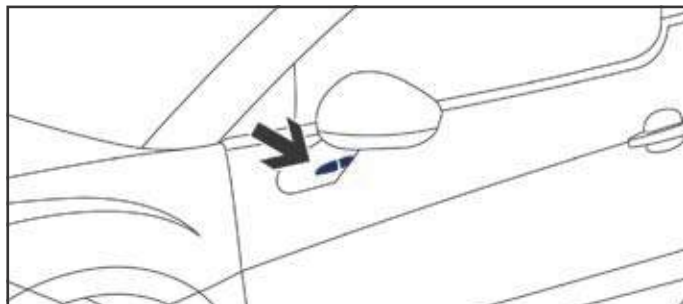

For the replacement of these bulbs, contact a PEUGEOT dealer or a qualified workshop.

Changing the daytime running lamps / sidelamps

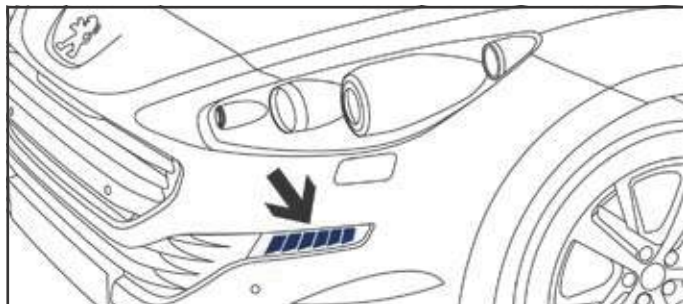

For the replacement of this type of LED lamp, contact a PEUGEOT dealer or a qualified workshop.

REAR LAMPS

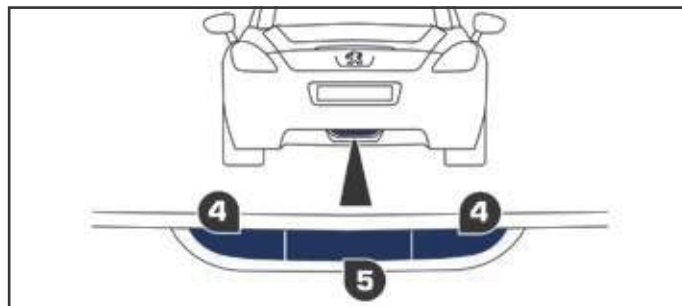
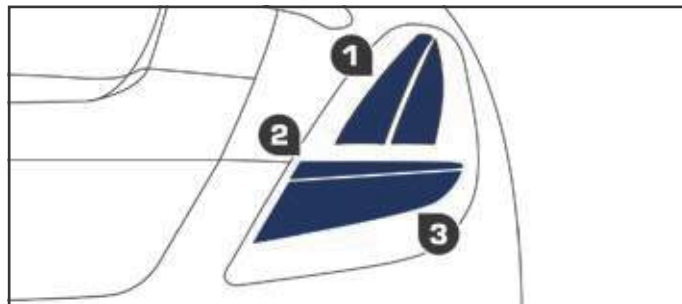

1. Sidelamps (LEds).
2. direction indicators (LEds).
3. Brake lamps / sidelamps (P21/5W).
4. Reversing lamps (P21W).
5. Foglamp (P21W).

Changing brake lamps / sidelamps

This bulb is changed from outside the boot, having first removed the rear lamp:

- ☞ open the boot lid,
- ☞ unclip the access flap of the corresponding side trim, then remove it,

- ☞ disconnect the lamp connector,
- ☞ remove the two lamp fixing bolts,

- ☞ unclip the lamp taking hold of it at the base, then tilt it,
- ☞ turn the bulb holder one quarter of a turn and remove it,
- ☞ turn the bulb one quarter of a turn and change it.

To refit, carry out these operations in reverse order.



Changing reversing lamps and foglamps

Version with asymmetrical twin exhaust tailpipes

These two bulbs are changed from outside the rear bumper:

- ☞ unclip the protective cover from the rear, then tilt it,
- ☞ remove it completely to gain access to the two lamp fixing bolts,

- ☞ turn these two bolts one quarter of a turn and remove them,
- ☞ push the lamp towards the inside to unclip it, then tilt it,
- ☞ pull the lamp towards the outside for access to the various bulb-holders.

- For the reversing lamps: pull the corresponding bulb holder,
- turn the bulb one quarter of a turn and change it.
- For the foglamp: turn the bulb holder one quarter of a turn and remove it,
- turn the bulb one quarter of a turn and change it.

To refit, carry out these operations in reverse order.

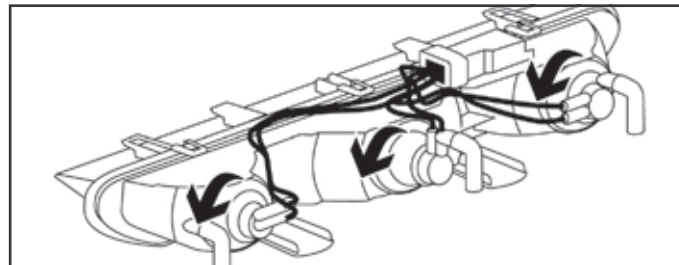
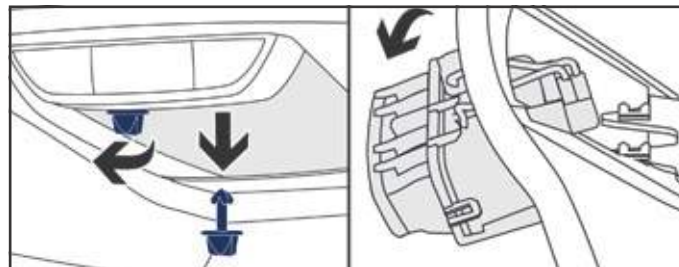
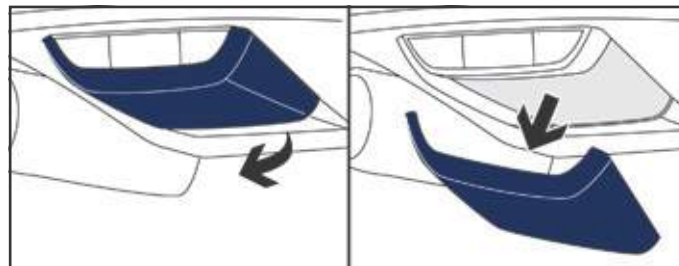

On the left-hand side, take care not to touch the silencer; risk of burns, if you change the bulb immediately after switching off the ignition.

Version with symmetrical twin exhaust tailpipes

The bulbs on these two types of lamp are changed by partly removing the lamp unit **A** in the rear bumper:

- ☞ using a screwdriver, remove the 3 fixing screws **B** located under the vehicle,
- ☞ without forcing, lower the rear part of the lamp unit for access to the bulb holders **C**,
- ☞ turn the corresponding bulb holder a quarter of a turn then remove it towards the front of the vehicle,
- ☞ turn the bulb one quarter of a turn and change it.

To refit, carry out these operations in reverse order.

! Take care not to touch the silencer; risk of burns, if you change the bulb immediately after switching off the ignition.

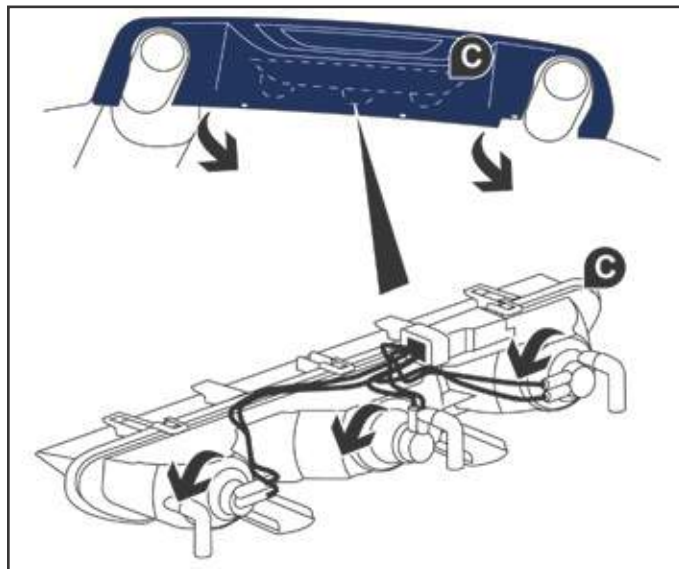
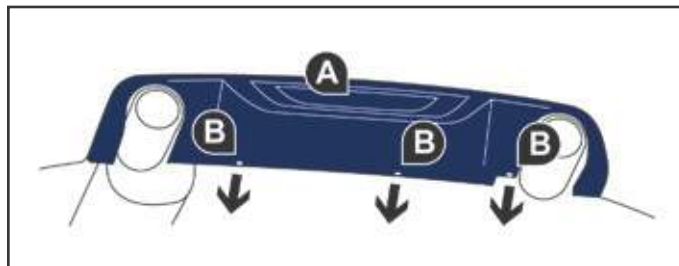

Changing sidelamps and direction indicators

For the replacement of this type of LED lamp, contact a PEUGEOT dealer or a qualified workshop.

Changing the third brake lamp (LEDs)

For the replacement of this type of LED lamp, contact a PEUGEOT dealer or a qualified workshop.

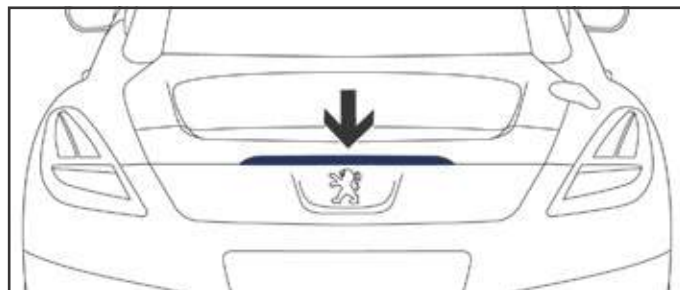

Changing number plate lamps (W5W)

- ☞ Insert the end of the vehicle's key in the hole in the transparent cover.
- ☞ Push towards the outside to unclip it.
- ☞ Remove the transparent cover.
- ☞ Pull the bulb out and change it.

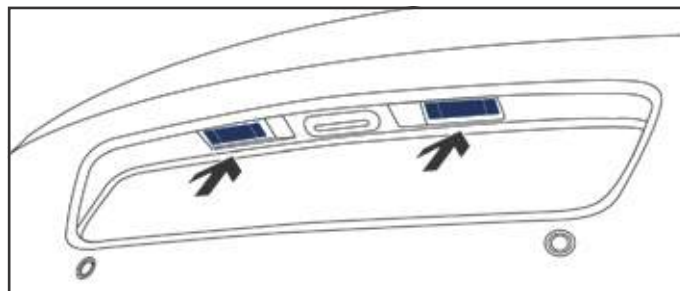

High pressure washing

When using this type of washing on stubborn dirt, do not persist on the headlamps, the lamps and their surrounds to avoid damaging their protective coating and seals.

CHANGING A FUSE

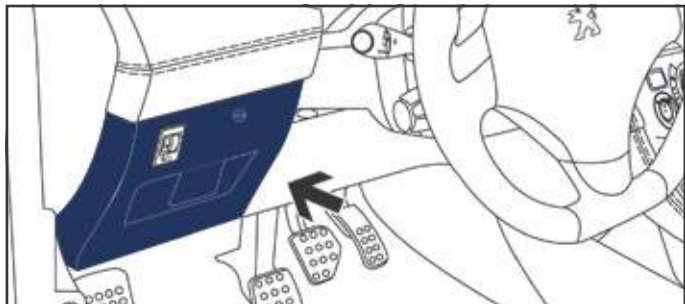

ACCESS TO THE TOOLS

The extraction tweezer is fitted to the back of the dashboard fusebox cover.

To gain access to them:

- ☞ turn the screw a quarter of a turn to the left,
- ☞ unclip the cover by pulling at the top right,
- ☞ remove the cover completely and turn it over,
- ☞ remove the carrier on which is fitted the tweezer.

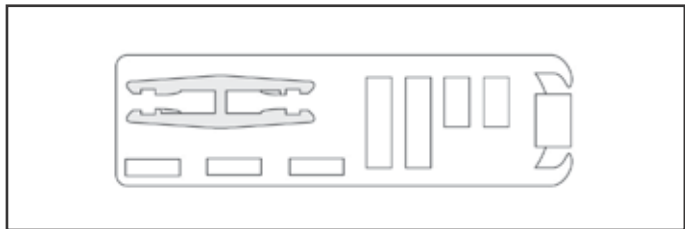

CHANGING A FUSE

Before changing a fuse, it is necessary to:

- ☞ identify the cause and correct it,
- ☞ switch off all electrical consumers,
- ☞ immobilise the vehicle and switch off the ignition,
- ☞ identify the failed fuse using the allocation tables and drawings presented on the following pages.

To replace a fuse, you must:

- use the special tweezer to extract the fuse from its housing and check the condition of its filament,
- always replace a failed fuse with a fuse of the same rating (same colour); a different rating fuse may cause malfunctions (risk of fire).



If the fault recurs soon after changing a fuse, have the electrical system of your vehicle checked by a PEUGEOT dealer or a qualified workshop.

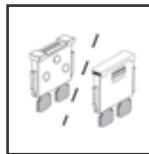

Good

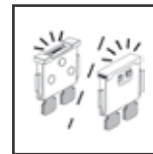

Failed

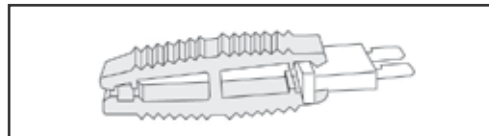

Tweezer



Installing electrical accessories

Your vehicle's electrical system is designed to operate with standard or optional equipment.

Before installing other electrical equipment or accessories on your vehicle, contact a PEUGEOT dealer or a qualified workshop.



PEUGEOT will not accept responsibility for the cost incurred in repairing your vehicle or for rectifying malfunctions resulting from the installation of accessories not supplied and not recommended by PEUGEOT and not installed in accordance with its instructions, in particular when the combined consumption of all of the additional equipment connected exceeds 10 milliamperes.

dASHBOARD FUSES

The fusebox is placed in the lower section of the dashboard (left-hand side). It consists of two boxes.

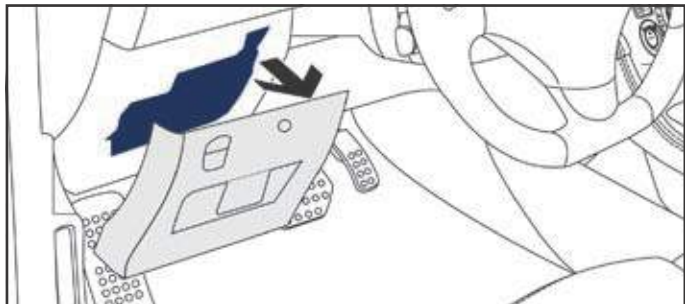

Access to the fuses

☞ Refer to the paragraph "Access to the tools".

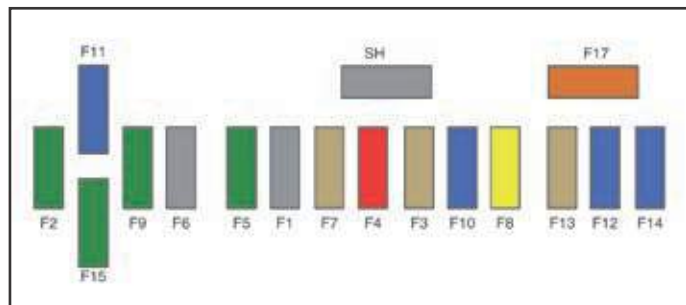

Box 1

Fuse tables

Fuse N°	Rating	Functions
F2	30 A	Locking and deadlocking earth.
F3	5 A	Airbags, active bonnet and pretensioners control unit.
F4	10 A	Clutch pedal switch, electrochromatic rear view mirror, automatic gearbox, switching and protection unit.
F5	30 A	One-touch electric windows, folding door mirrors supply.
F7	5 A	Front and rear courtesy lamps, map reading lamps, sun visor lighting, glove box lighting.
F8	20 A	Audio equipment, audio/telephone, multifunction screen, tyre under-inflation detection, clock.
F9	30 A	12 V socket.
F10	15 A	Steering mounted controls.
F11	15 A	Low current ignition switch.
F12	15 A	Instrument panel, air conditioning, driver's seat memory unit, rain / sunshine sensor, airbags.

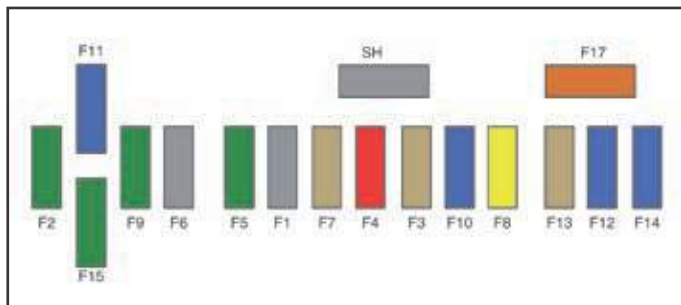

Fuse N°	Rating	Functions
F13	5 A	Engine fusebox, active bonnet.
F14	15 A	Multifunction screen, seat belt and passenger's front airbag warning lamps display, instrument panel screen, amplifier, Bluetooth system, parking sensors control unit, USB Box.
F15	30 A	Locking and deadlocking.
F17	40 A	Rear screen and door mirrors demist/ defrost.

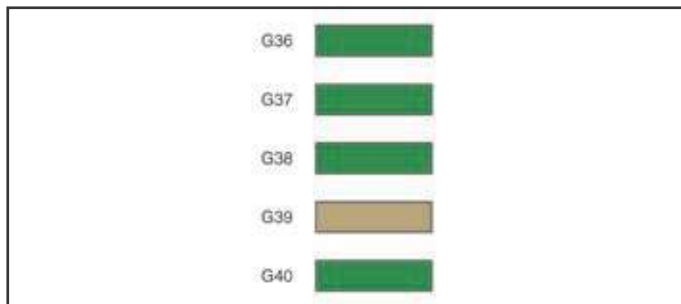

Box 2

Fuse N°	Rating	Functions
G36	30 A	Hi-Fi amplifier.
G37	30 A	Passenger's seat memory unit.
G38	30 A	Driver's seat memory unit.
G39	5 A	Lighting memory unit.
G40	30 A	Driver and passenger heated seats.

ENGINE COMPARTMENT FUSES

The fusebox is placed in the engine compartment near the battery (left-hand side).



Access to the fuses

- ☞ Unclip the cover.
- ☞ Change the fuse (see corresponding paragraph).
- ☞ When you have finished, close the cover carefully to assure the sealing of the fusebox.

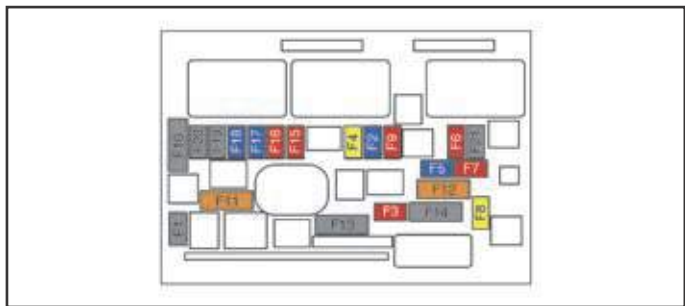

Fuse table

Fuse N°	Rating	Functions
F2	15 A	Horn.
F3	10 A	Front wash-wipe.
F4	20 A	Daytime running lamps.
F5	15 A	Air flow sensor, coolant pump, oil pump, thermostat, blow-by heater (petrol), by-pass and EGR electrovalves (Diesel), diesel heater (Diesel).
F6	10 A	Steering wheel angle sensor, ABS/DSC control unit, DSC sensor.
F7	10 A	Power steering control unit, automatic gearbox, dual function brake switch.
F8	25 A	Starter motor control.
F9	10 A	Diagnostic socket, directional headlamps, particle emission filter pump (Diesel).
F11	40 A	Air conditioning blower.

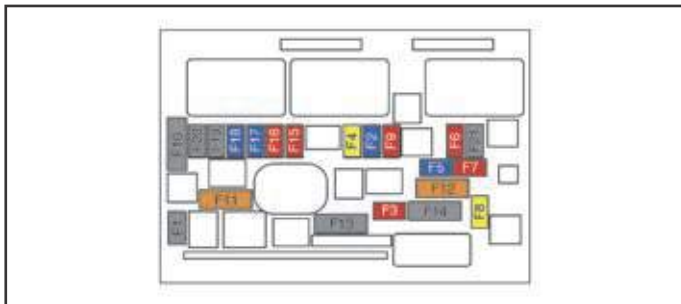

Fuse N°	Rating	Functions
F12	40 A	Windscreen wipers slow / fast speed.
F15	10 A	Right-hand main beam headlamp.
F16	10 A	Left-hand main beam headlamp.
F17	15 A	Left-hand dipped headlamp.
F18	15 A	Right-hand dipped headlamp.

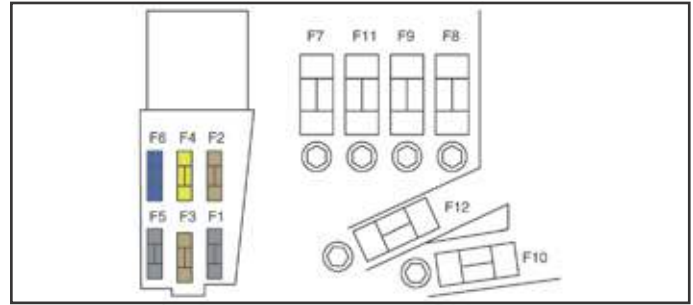
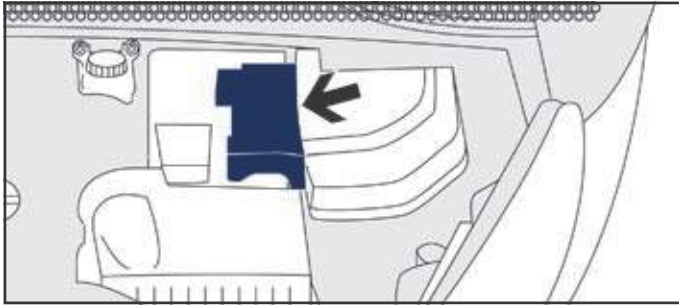

Table of fuses over the battery

Fuse N°	Rating	Functions
F2	5 A	Dual function brake switch.
F3	5 A	Battery charge unit.
F4	25 A	ABS/ESC electrovalves.
F6	15 A	Automatic gearbox.



All work on the other types of fuses (midi-fuses and maxi-fuses) must be carried out only by a PEUGEOT dealer or a qualified workshop.

TOWING A VEHICLE

TOWING EYE

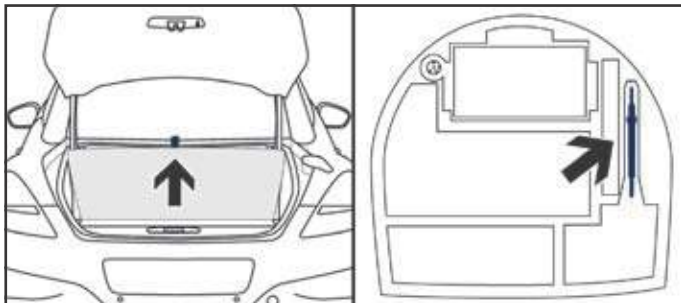

This is stored in the boot under the floor.

For access to it:

- ☞ open the boot,
- ☞ raise the floor using the strap,
- ☞ secure it in the vertical position beyond the stops, located on the sides of the boot,
- ☞ remove the towing eye from the storage box.



GENERAL RECOMMENDATIONS

Observe the legislation in force in your country.

Ensure that the weight of the towing vehicle is higher than that of the towed vehicle.

The driver must remain at the wheel of the towed vehicle and must have a valid driving licence.

When towing a vehicle with all four wheels on the ground, always use an approved towing arm; rope and straps are prohibited.

The towing vehicle must move off gently.

When towing a vehicle with the engine off, there is no longer any power assistance for braking or steering.

In the following cases, you must always call on a professional recovery service:

- vehicle broken down on a motorway or fast road,
- four-wheel drive vehicle,
- when it is not possible to put the gearbox into neutral, unlock the steering, or release the parking brake,
- towing with only two wheels on the ground,
- where there is no approved towing arm available...

TOWING YOUR VEHICLE

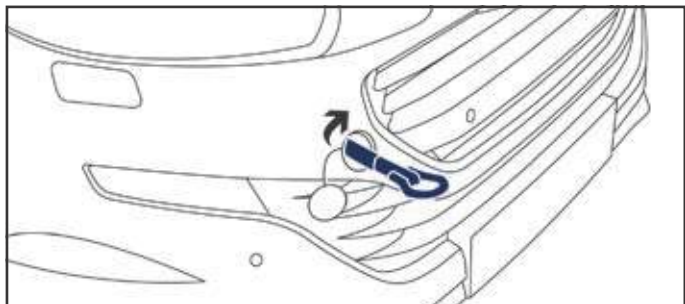

Towing from the front

- ☞ On the front bumper, unclip the cover by pressing on the left.
- ☞ Screw the towing eye in fully.
- ☞ Install the towing arm.



- ☞ Place the gear lever in neutral (position **N** for an automatic gearbox).

Failure to follow this advice could result in damage to certain components (braking, transmission...) and the absence of braking assistance the next time the engine is started.

- ☞ Unlock the steering by turning the ignition key one notch and release the parking brake.
- ☞ Switch on the hazard warning lamps on both vehicles.
- ☞ Move off gently and drive slowly and for a short distance only.

Towing from the rear

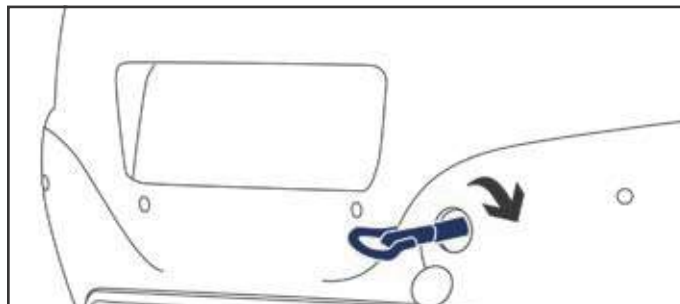

It is also possible to pull your vehicle from the rear, but only in exceptional circumstances (vehicle in a parking space, off the road...).

- ☞ On the rear bumper, unclip the cover by pressing on the left.
- ☞ Screw the towing eye in fully.
- ☞ Install the towing bar.
- ☞ Place the gear lever in neutral (position **N** for an automatic gearbox).
- ☞ Switch on the hazard warning lamps on both vehicles.
- ☞ Move off very gently to pull the vehicle out.

TOWING ANOTHER VEHICLE*

- ☞ On the rear bumper, unclip the cover by pressing on the left.
- ☞ Screw the towing eye in fully.
- ☞ Install the towing bar.
- ☞ Switch on the hazard warning lamps on both vehicles.
- ☞ Move off gently and drive slowly and for a short distance only.

* Except version with symmetrical twin exhaust tailpipes.

TOWING A TRAILER

Towbar suitable for the attachment of a trailer with additional lighting and signalling.

 Versions that have asymmetrical twin exhaust tailpipes cannot be fitted with a towbar.

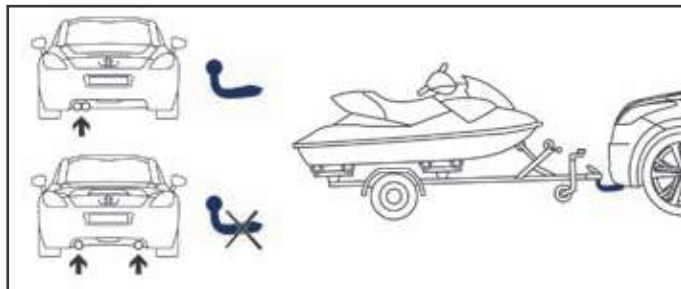

Your vehicle is primarily designed for transporting people and luggage, but it may also be used for towing a trailer.

 We recommend use of the PEUGEOT genuine towbar with ball which can be removed without tools and its harness that have been tested and approved from the design stage of your vehicle, and that the fitting of the towbar is entrusted to a PEUGEOT dealer or a qualified workshop.

If the trailer is fitted outside the PEUGEOT dealer network, it must be fitted in accordance with the manufacturer's instructions.

DRIVING AdVICE

Driving with a trailer subjects the towing vehicle to more significant stress and its driver must be particularly careful.

distribution of loads

 Distribute the load in the trailer so that the heaviest items are as close as possible to the axle and the nose weight approaches the maximum permitted without exceeding it.

Air density decreases with altitude, thus reducing engine performance. Above 1 000 metres, the maximum towing load must be reduced by 10 % and so on for every 1 000 metres of altitude.

Refer to the "Technical data" section for details of the weights and towing loads which apply to your vehicle version.

Side wind

 Take into account the increased sensitivity to side wind.

Cooling

Towing a trailer on a slope increases the temperature of the coolant. As the fan is electrically controlled, its cooling capacity is not dependent on the engine speed.

☞ To lower the engine speed, reduce your speed.

The maximum towing load on a long slope depends on the gradient and the ambient temperature.

In all cases, pay attention to the coolant temperature.



The rear parking sensors will be deactivated automatically if a genuine PEUGEOT towbar is used.



When not towing a trailer, remove the quickly-detachable tow ball before driving, so as to avoid masking the central rear lamp.



☞ If the warning lamp and the **STOP** warning lamp come on, stop the vehicle and switch off the engine as soon as possible.

Braking

Towing a trailer increases the braking distance.

Tyres

☞ Check the tyre pressures of the towing vehicle and of the trailer, observing the recommended pressures.

Lighting

☞ Check the electrical signalling on the trailer.

CLEANING AND MAINTENANCE

The general recommendations on cleaning and maintaining your vehicle are given in the servicing and warranty booklet.

PEUGEOT TECHNO TEP

To clean this trim, do not use solvents or detergents with a dry cloth. First remove dust, then use a soft cloth and soapy water. Dry with another soft cloth.

ALUMINIUM ARCHES

To clean these arches, do not use a dry cloth with an abrasive product. Use a sponge and soapy water.

HEADLAMPS AND LAMPS

The headlamps have polycarbonate lenses, finished with a protective lacquer.

Do not clean them with a dry or abrasive cloth, nor with detergent or solvent products.

Use a sponge and soapy water.



The use of a high pressure jet wash for cleaning the headlamps, lamps and their surrounds may damage the lacquer and seals. Observe the recommendations on pressure and distance for jet washing.

First clean persistent stains with a sponge and warm soapy water.

CUSTOMISING STICKERS

These customising parts are self-adhesive stickers, treated to give good resistance to ageing and tearing.

They are intended for customising the body.

Available also as accessories, we recommend that you have them fitted by a PEUGEOT dealer or a qualified workshop.



When washing your vehicle, keep the end of a high-pressure lance at least 30 centimetres from the stickers.

MATT PAINT

If your vehicle is finished with a clear matt lacquer, please observe the following recommendations to avoid damaging the paintwork by the use of an inappropriate cleaning procedures.

These recommendations are also valid for alloy road wheels finished with clear matt lacquer.



Never clean the vehicle without water.

Never wash your vehicle in an automatic roller brush car wash.

Never polish the vehicle body, nor the alloy wheels. Doing this will make the paintwork shiny.

Do not use paint cleaners, abrasive products or paint polishing or preserving products (such as wax, for example) on the paintwork. These products are only suitable for bright finishes. Application of these products on vehicles with a matt finish will seriously damage the paint surface of the vehicle, giving rise to irreversible shiny or stained areas.

Never use a high pressure jet wash with a lance fitted with a brush, this may scratch the paintwork.

Never select a wash programme that finishes with a hot wax cycle.

We recommend the use of a high pressure jet wash, or at least a water hose with a high output.

We recommend that the vehicle be rinsed using de-ionised water. Use only a microfibre cloth to dry the vehicle. It must be clean and used without heavy pressure.

Lightly wipe off any fuel stains present on the bodywork using a soft cloth, then leave to dry.

From the range of cleaning and maintenance products in the "TECHNATURE" range recommended and approved by PEUGEOT, use only the insect remover and car shampoo, which are the only products to be used on the bodywork.

The insect remover can also be used to remove minor marks (for example: finger marks...).

Always have paint repairs done by a PEUGEOT dealer or a qualified workshop.

ACCESSORIES

A wide range of accessories and genuine parts is available from the PEUGEOT dealer network.

These accessories and parts are all suitable for your vehicle and benefit from PEUGEOT's recommendation and warranty.

"Comfort":

front parking sensors, cool box...

"Transport solutions":

boot tray, boot spacers, towbar bicycle carrier, towbar with quickly detachable ball, towbar harnesses...

"Style":

leather and alcantara sport steering wheel, alcantara gear lever gaiter, alloy wheels, door mirror shells in carbon fibre...

"Safety and security":

anti-theft alarm, window etching, wheel security bolts, breathalyser, first aid kit, fire extinguisher, warning triangle, high visibility jacket, booster cushions and child seats, stolen vehicle tracking system, snow chains, anti-skid tyre covers...

"Protection":

boot liner, mats*, bumper protective strips, vehicle protective cover...



When fitting a trailer towbar and its harness outside the PEUGEOT dealer network, this must be done following the manufacturer's recommendations.

- * To avoid any risk of jamming of the pedals:
 - ensure that the mat is positioned and secured correctly,
 - never fit one mat on top of another.

"Multimedia":

portable navigation systems, Wi-Fi on Board...



Installation of radio communication transmitters

Before installing any after-market radio communication transmitter, you can contact a PEUGEOT dealer for the specification of transmitters which can be fitted (frequency, maximum power, aerial position, specific installation requirements), in line with the Vehicle Electromagnetic Compatibility Directive (2004/104/EC).

By going to a PEUGEOT dealer you can also obtain products for cleaning and maintenance (exterior and interior) - including ecological products from the "TECHNATURE" range, topping up products (screenwash, ...), touch-up pens and aerosols for the exact colour of your vehicle, refills (cartridge for temporary tyre repair kit...), ...



Depending on the legislation in force in the country, certain safety equipment may be compulsory: high visibility safety vests, warning triangles, breathalyzers, spare bulbs, spare fuses, fire extinguisher, first aid kit, mud flaps at the rear of the vehicle.



The fitting of electrical equipment or accessories which are not recommended by PEUGEOT may result in a failure of your vehicle's electronic system and excessive electrical consumption. Contact a PEUGEOT dealer for information on the range of recommended equipment and accessories.

PETROL ENGINES AND GEARBOXES

Engine	1.6 THP 150 hp	1.6 THP 155 hp		1.6 THP 160 hp	1.6 THP 200 hp	1.6 THP 270 hp
Gearbox	Automatic (6-speed)	Manual (6-speed)	Automatic (6-speed)	Automatic (6-speed)	Manual (6-speed)	Manual (6-speed)
Model code: 4j ...	5FE-j	5FV-8	5FV-A 5FV-A/GT**	5FM-j 5FM-j/GT**	5FU-8 5FU-M 5FU-8/GT** 5FU-M/GT**	5FG-M
Cubic capacity (cc)	1 598	1 598		1 598	1 598	1 598
Bore x stroke (mm)	77 x 85.8	77 x 85.8		77 x 85.8	77 x 85.8	77 x 85.8
Max power: EU standard (kW)*	110	115		120	147	199
Max power engine speed (rpm)	6 050	6 000		6 000	5 500	6 000
Max torque: EU standard (Nm)	240	240		240	275	330
Max torque engine speed (rpm)	1 400	1 400		1 400	1 700	1 900
Fuel	Unleaded	Unleaded		Unleaded	Unleaded	Unleaded
Catalytic converter	Yes	Yes		Yes	Yes	Yes
Engine oil capacity (in litres) (with filter replacement)	4.25	4.25		4.25	4.25	-

* The maximum power quoted is the type approved value obtained on a test bed, under the conditions defined in European legislation (directive 1999/99/CE).

** **GT Line** version.

PETROL WEIGHTS AND TOWED LOADS (IN KG)

Engine	1.6 THP 150 hp	1.6 THP 155 hp		1.6 litre THP 155 hp GT Line
Gearbox	Automatic (6-speed)	Manual (6-speed)	Automatic (6-speed)	Automatic (6-speed)
Model code: 4j ...	5FE-j	5FV-8	5FV-A	5FV-A/GT
- Unladen weight	1 297	1 275	1 297	1 297
- Kerb weight	1 372	1 350	1 372	1 372
- Payload	463	465	463	463
- Gross vehicle weight (GVW)	1 760	1 740	1 760	1 760
- Gross train weight (GVW) on a 12% gradient	2 260	2 240	2 260	1 760
- Braked trailer (within GTW limit) on a 10% or 12% gradient	500	500	500	0
- Braked trailer* (with load transfer within GTW limit)	650	650	650	0
- Unbraked trailer	500	500	500	0
- Recommended nose weight	65	65	65	0

* The weight of the braked trailer can be increased, within the GTW limit, on condition that the GVW of the towing vehicle is reduced by the same amount; warning: towing with a lightly loaded towing vehicle may have an adverse effect on its road holding.

The GTW and towed load values indicated apply up to a maximum altitude of 1000 metres; the towed load mentioned must be reduced by 10 % for every additional 1000 metres.

The maximum permitted speed is reduced when towing (observe the legislation in force in your country).

High ambient temperatures may result in a reduction in the performance of the vehicle to protect the engine; when the ambient temperature is higher than 37 °C, limit the towed weight.

Engine	1.6 THP 160 hp	1.6 THP 160 hp GT Line	1.6 THP 200 hp	1.6 THP 200 hp GT Line	1.6 litre THP 270 hp
Gearbox	Automatic (6-speed)	Automatic (6-speed)	Manual (6-speed)	Manual (6-speed)	Manual (6-speed)
Model code: 4j ...	5FM-j	5FM-j /GT	5FU-8 5FU-M	5FU-8/GT 5FU-M/GT	5FG-M
- Unladen weight	1 297	1 297	1 297	1 297	1 280
- Kerb weight	1 372	1 372	1 372	1 372	1 355
- Payload	463	463	483	483	425
- Gross vehicle weight (GVW)	1 760	1 760	1 780	1 780	1 780
- Gross train weight (GTW) on a 12% gradient	2 260	1 760	2 280	1 780	1 780
- Braked trailer (within GTW limit) on a 10% or 12% gradient	500	0	500	0	0
- Braked trailer* (with transfer of load within GTW limit)	650	0	650	0	0
- Unbraked trailer	500	0	500	0	0
- Recommended nose weight	65	0	65	0	0

* The weight of the braked trailer can be increased, within the GTW limit, on condition that the GVW of the towing vehicle is reduced by the same amount; warning: towing with a lightly loaded towing vehicle may have an adverse effect on its road holding.

The GTW and towed load values indicated apply up to a maximum altitude of 1000 metres; the towed load mentioned must be reduced by 10 % for every additional 1000 metres.

The maximum permitted speed is reduced when towing (observe the legislation in force in your country).

High ambient temperatures may result in a reduction in the performance of the vehicle to protect the engine; when the ambient temperature is higher than 37 °C, limit the towed weight.

DIESEL ENGINE AND GEARBOX

Engine	2.0 Hd i 160 hp
Gearbox	Manual (6-speed)
Model code: 4j ...	RHH-8
Cubic capacity (cc)	1 997
Bore x stroke (mm)	85 x 88
Max power: EU standard (kW)*	120
Max power engine speed (rpm)	3 750
Max torque: EU standard (Nm)	340
Max torque engine speed (rpm)	2 000
Fuel	Diesel
Catalytic converter	Yes
Particle filter	Yes
Engine oil capacity (in litres) (with filter replacement)	5.25

* The maximum power quoted is the type approved value obtained on a test bed, under the conditions defined in European legislation (directive 1999/99/CE).

DIESEL WEIGHTS AND TOWED LOADS (IN KG)

Engine	2.0 Hdi 160 hp
Gearbox	Manual (6-speed)
Model codes: 4j ...	RHH-8
- Unladen weight	1 370
- Kerb weight	1 445
- Payload	455
- Gross vehicle weight (GVW)	1 825
- Gross train weight (GTW) on a 12% gradient	2 325
- Braked trailer (within GTW limit) on a 10% or 12% gradient	500
- Braked trailer* (with load transfer within GTW limit)	650
- Unbraked trailer	500
- Recommended nose weight	65

* The weight of the braked trailer can be increased, within the GTW limit, on condition that the GVW of the towing vehicle is reduced by the same amount; warning: towing with a lightly loaded towing vehicle may have an adverse effect on its road holding.

The GTW and towed load values indicated apply up to a maximum altitude of 1000 metres; the towed load mentioned must be reduced by 10 % for every additional 1000 metres.

The maximum permitted speed is reduced when towing (observe the legislation in force in your country).

High ambient temperatures may result in a reduction in the performance of the vehicle to protect the engine; when the ambient temperature is higher than 37 °C, limit the towed weight.

DIMENSIONS (IN MM)

All versions, except 1.6 THP 270 hp

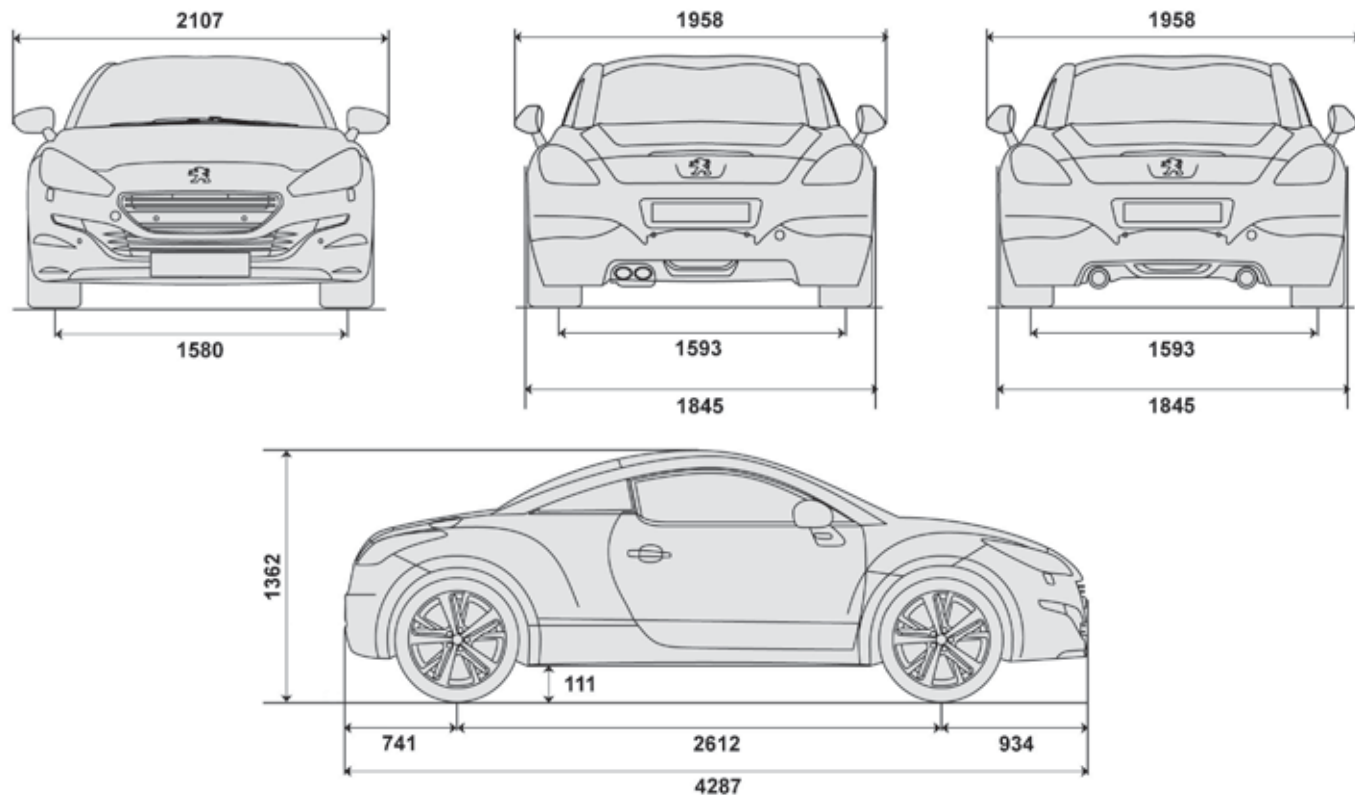

1.6 THP 270 hp version

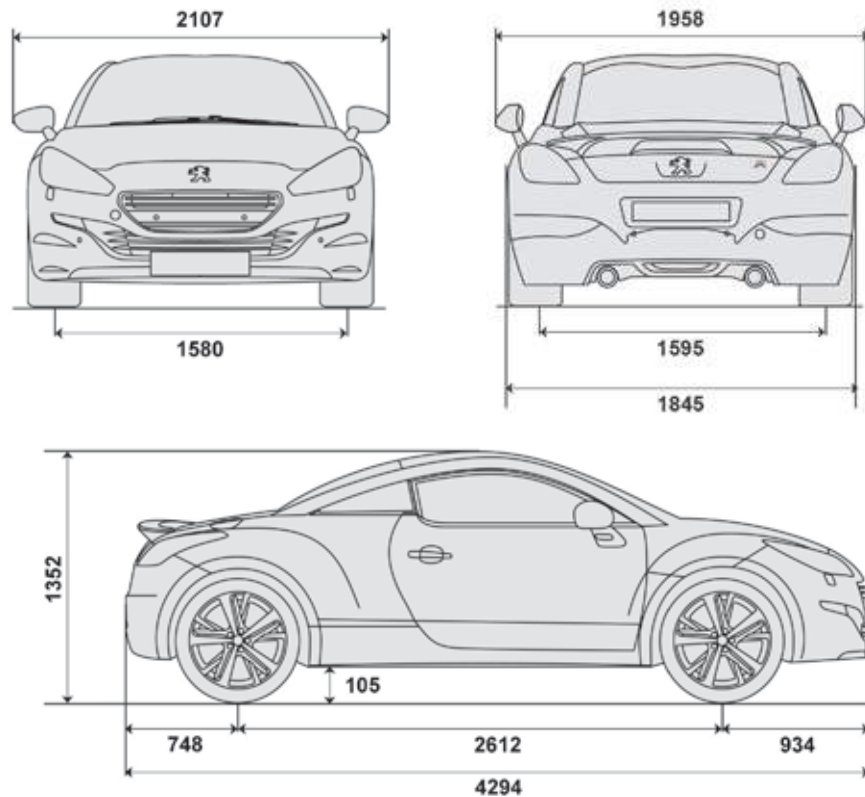

Bumpers and lower body

Your vehicle has reduced ground clearance. Take care when traversing kerbs, speed humps, access ramps, fords, unmade roads...

IDENTIFICATION MARKINGS

Various visible markings for the identification of your vehicle.

A. Vehicle identification number (VIN) under the bonnet.

This number is engraved on the bodywork near the damper support.

For access to it, raise the plastic cover.

B. Vehicle identification number (VIN) at the bottom of the windscreen.

This number is indicated on a self-adhesive label which is visible through the windscreen.

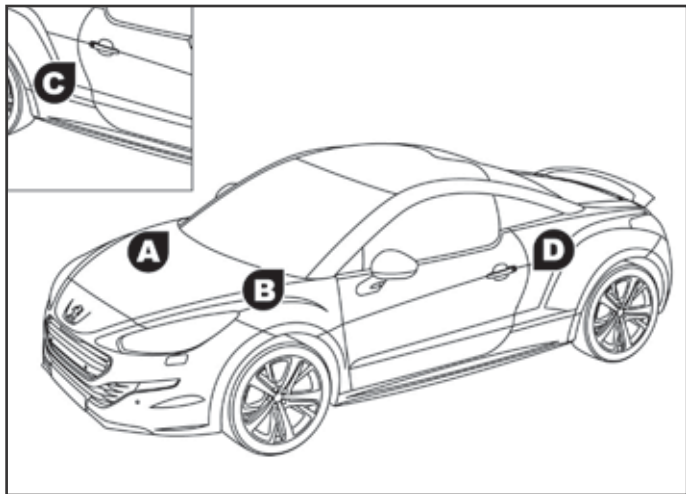

C. Manufacturer's label.

This self-destructing label affixed to the right hand middle door pillar carries the following information:

- the manufacturer's name,
- the European Type Approval number,
- the vehicle identification number (VIN),
- the gross vehicle weight (GVW),
- the gross train weight (GTW),
- the maximum front axle weight,
- the maximum rear axle weight.

d. Tyre/paint label.

This label, affixed to the door aperture, driver's side, carries the following information:

- the tyre inflation pressures, laden and unladen,
- the tyre sizes (including the load index and speed rating),
- the inflation pressure of the spare wheel,
- the paint colour code.



The tyre pressures must be checked when the tyres are cold, at least once a month.



Low tyre pressures increase fuel consumption.

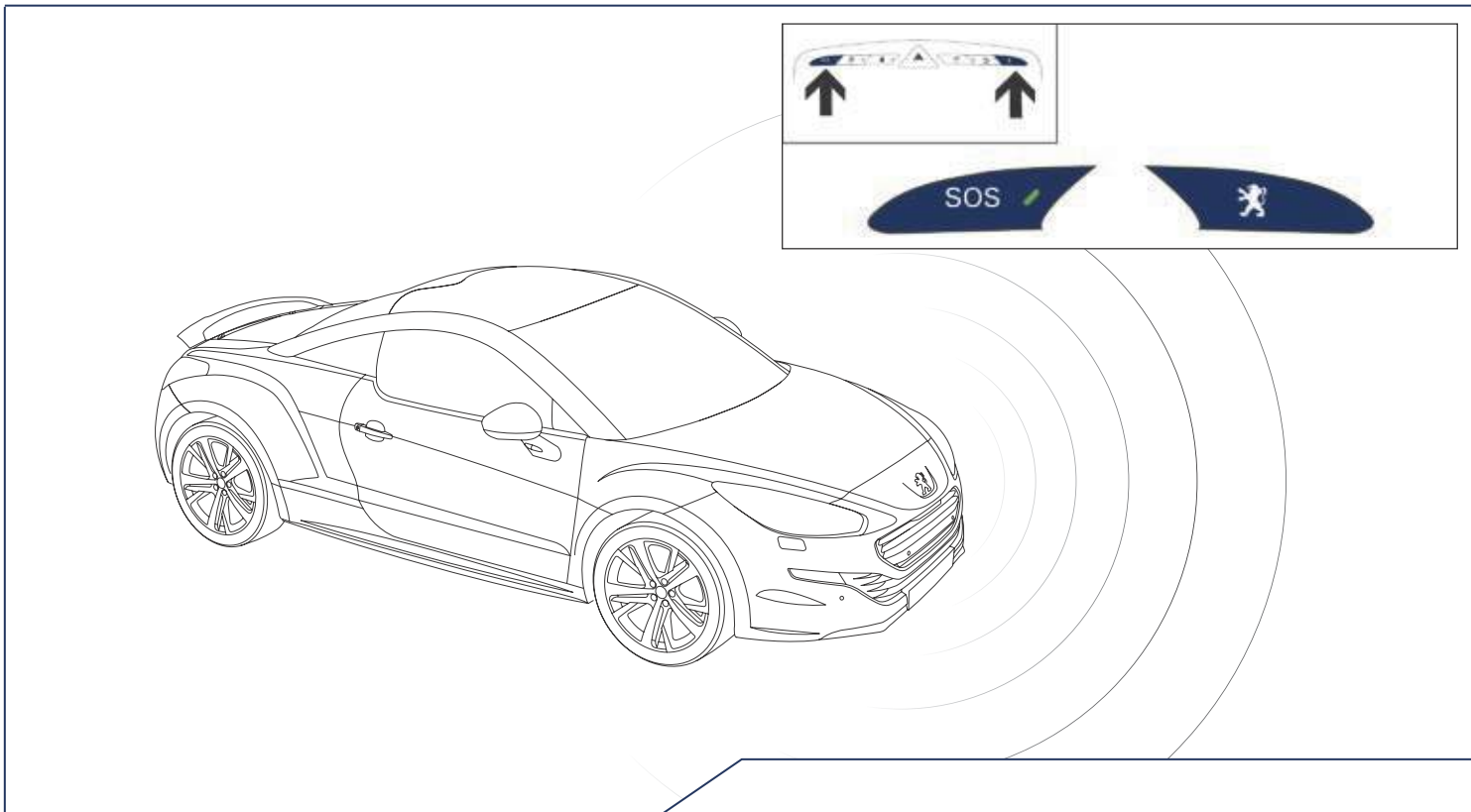

EMERGENCY OR ASSISTANCE CALL

EMERGENCY OR ASSISTANCE CALL

PEUGEOT Connect SOS



In an emergency, press this button for more than 2 seconds. Flashing of the green LED and a voice message confirm that the call has been made to the "PEUGEOT Connect SOS" centre*.

The green LED remains on (without flashing) when communication is established. It goes off at the end of communication.

Pressing this button again immediately cancels the request. The green LED goes off. Cancellation is confirmed by a voice message.

To cancel a call, tell the "PEUGEOT Connect SOS" call centre that the call was a mistake.

"PEUGEOT Connect SOS" immediately locates your vehicle, starts communication with you in your language**, and where necessary sends the appropriate public emergency services**. In countries where the service is not available, or when the locating service has been expressly declined, the call sent directly to the emergency services (112) without the vehicle location.

 If an impact is detected by the airbag control unit, and independently of the deployment of any airbags, an emergency call is made automatically.

* Subject to the general conditions for the service available from dealers and to technological and technical limitations.

** Depending on the geographical cover of "PEUGEOT Connect SOS", "PEUGEOT Connect Assistance" and the official national language selected by the owner of the vehicle.

The list of countries covered and PEUGEOT CONNECT services is available from dealers or at www.peugeot.co.uk.

PEUGEOT Connect Assistance



Press this button for more than 2 seconds to request assistance if the vehicle breaks down. A voice message confirms that the call has been made**.

Pressing this button again immediately cancels the request. The cancellation is confirmed by a voice message.

Operation of the system



When the ignition is switched on, the green LED comes on for 3 seconds indicating that the system is operating correctly.



If the orange LED flashes: there is a system fault.

If the orange LED is on continuously: the backup battery must be replaced.

In either case, contact a PEUGEOT dealer.

If you purchased your vehicle outside the PEUGEOT dealer network, we invite you to have a dealer check the configuration of these services and, if desired, modified to suit your wishes. In a multi-lingual country, configuration is possible in the official national language of your choice.

For technical reasons and in particular to improve the quality of "PEUGEOT CONNECT services" services to customers, the manufacturer reserves the right to carry out updates to the vehicle's on-board telematic system.



PEUGEOT Connect Navigation (RT6)

GPS navigation system

Multimedia audio system

Bluetooth® telephone



The system is protected in such a way that it will only operate in your vehicle.



For safety reasons, the driver must only carry out operations which require prolonged attention while the vehicle is stationary.

When the engine is switched off and to prevent discharging of the battery, the system switches off following the activation of the energy economy mode.

CONTENTS

01 First steps - Control panel	p. 204
02 Steering mounted controls	p. 206
03 General operation	p. 207
04 Navigation - Guidance	p. 209
05 Traffic information	p. 222
06 Using the telephone	p. 225
07 Radio	p. 235
08 Music media players	p. 240
09 Audio settings	p. 246
10 Configuration	p. 247
11 Screen menu map	p. 248
Frequently asked questions	p. 252

01 FIRST STEPS

Selection and confirmation OK knob:

Selection of an item on the screen or in a list or a menu, then confirmation with a short press.

Other than for menus and lists, a short press displays a contextual menu depending on the current screen.

Rotation with map displayed: zoom the map scale in and out.

Short press without the engine running: on / off.

Short press with the engine running: audio source off / restore.

Volume adjustment (each source is independent, including TA messages and navigation instructions).

MOdE button: Selection of the type of permanent display.

Long press: black screen (DARK).

Access to the **"Navigation - guidance"** menu and display the recent destinations.

Open the **"Traffic information"** menu and display the current traffic alerts.

Abandon the current operation, up one level in the menu.

Long press: return to the permanent display.

Open the **"Configuration"** menu.

Long press: access to the GPS coverage and the navigation demonstration mode.

Select:

- the previous/next line in a list or menu.
- the previous / next media folder.
- step by step selection of the previous/next radio frequency.
- the previous / next MP3 folder.

Move up/down, in **"Move the map"** mode.

Select:

- the next lower / higher radio frequency automatically.
- the previous / next CD track, MP3 track or media.
- the left / right of the screen when a menu is displayed.

Move left / right in **"Move the map"** mode.

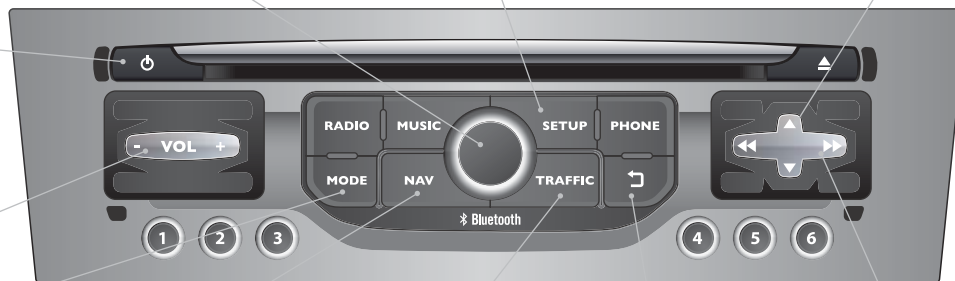

01 FIRST STEPS

Access to the **"Radio"** menu and display the list of stations received.

Long press: display the audio settings screen for the radio tuner source.

Access to the **"Music"** menu, and display of the CD/MP3/Apple® tracks and folders.

Long press: display the audio settings screen for the **"Media"** (CD/USB/iPod/Streaming/AUX) sources.

Open the **"Telephone"** menu and display the list of recent calls or accept an incoming call.

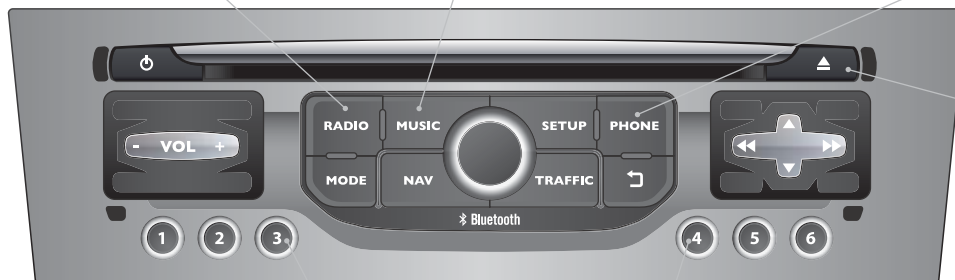

Continuous press: reinitialisation of the system.

Short press: select pre-set radio station.
Long press: pre-set the current station.

02 STEERING MOUNTED CONTROLS

RADIO: change to the next radio station in the list.
Long press: automatic search for a higher frequency.
CD: select the next track.
CD: continuous press: fast forward play.

SRC/TEL button:
change the audio source,
start a call from the address book,
call/end call on the telephone,
press for more than 2 seconds: access
to the address book.



RADIO: change to the previous radio
station in the list.
Long press: automatic search for a
lower frequency.
CD: select the previous track.
CD: continuous press: fast reverse.

RADIO: select the previous/next preset
station.
Select the next entry in the address book.



Volume increase.

Volume decrease.

Mute: press the volume
increase and decrease
buttons simultaneously.
Restore the sound by
pressing one of the
two volume buttons.

03 GENERAL OPERATION



Press the **MODE** button several times in succession for access to the following displays:

"**RADIO**"



"**TELEPHONE**"
(If conversation in progress)

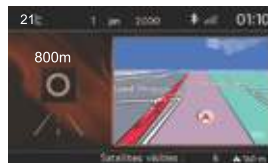
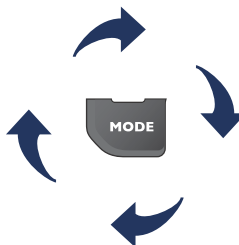

"**MAP IN WINDOW**"
(If navigation guidance in progress)



"**FULL SCREEN MAP**"



SETUP: PARAMETERS
date and time, display configuration, sound, vehicle settings.



Changing the audio source:
RADIO: RADIO broadcasts.
MUSIC: playing MUSIC.



For cleaning the screen, the use of a soft, non-abrasive cloth (spectacles cloth) is recommended, with no additional product.



For the details of the menus, refer to the "Screen menu map" section.

03 GENERAL OPERATION

display according to context



A press on the knob gives access to short-cut menus according to the display in the screen.

RADIO:

1 Change waveband

2 FM

2 dAB

2 AM

1 Service announcements

2 Traffic announcements (TA)

2 Information

2 Entertainment

2 Special or Urgent

TELEPHONE (call in progress):

1 Private mode

1 Put call on hold

1 dTMF ring tones

1 Hang up

MUSIC MEDIA PLAYERS, Cd or USB (according to media):

Play modes:

1 Normal

1 Random

1 Random on all media

1 Repetition

FULL SCREEN MAP OR IN A NEW WINDOW: Stop / Restore guidance

1

1 Select destination

2 Enter an address

2 directory

2 GPS coordinates

1 divert route

1 Move the map

2 Info. on location

2 Select as destination

2 Select as stage

2 Save this place (contacts)

2 Quit map mode

1 Guidance criteria

04 NAVIGATION - GUIDANCE

Access to the "NAVIGATION" menu



Press **NAV**.

A short press on the end of the lighting control stalk repeats the last navigation message.



To make full use of all of the functions of your navigation system, update the mapping regularly. Contact a PEUGEOT dealer or order your mapping update at <http://peugeot.navigation.com>

To delete the list of recent destinations, select "**Guidance options**" in the navigation menu then select "**delete last destinations**" and confirm. Select "**Yes**" then confirm. Deleting just one destination is not possible.

Go from the list to the menu (left/right).













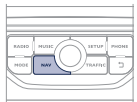

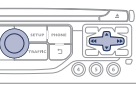

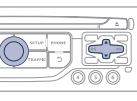

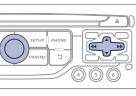
or

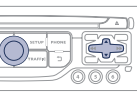

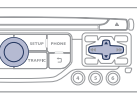
04 NAVIGATION - GUIDANCE

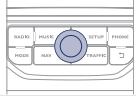
Selecting a destination

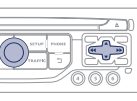
Towards a new destination

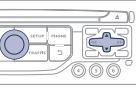
1	 <p>Press NAV to display the "Navigation - guidance" menu.</p>		6	 <p>Selection the town from the list offered, then confirm</p> <p>A pre-set list (by entering the first few letters) of the towns in the country selected can be accessed directly by selecting and confirming "List" in the screen.</p>	
2	 <p>Select "Select destination" and confirm, then select "Enter an address" and confirm.</p>		7	 <p>If possible, enter the "Road" and "N°/X" information in the same way.</p>	
3	 <p>Select the "Country" function then confirm.</p>		 <p>Select "Archive" to save the address entered in a contact file.</p> <p>After about 60 seconds with no address entered, the system returns to the last home page; to return to the current input, start again with steps 1 and 2 then press again to find the current input.</p>		
4	 <p>Select the "Town" or "Post code" function then confirm.</p>		8	 <p>Confirm "OK" to start guidance.</p>	
5	 <p>Select the letters in the name of the town or the characters in a post code one at a time, confirming each one with the knob.</p>		9	 <p>Select the guidance criteria: "Fastest route", "Shortest route" or optimised "distance/Time", then select the desired restriction criteria: "With tolls", "With Ferry", or "Traffic info" then confirm "OK".</p>	

04 NAVIGATION - GUIDANCE

Towards a recent destination

1  Press **NAV** to display the "Navigation - guidance" menu.

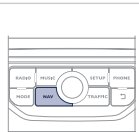

2  Select the desired destination and confirm to start guidance.

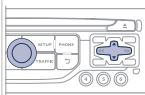

delete recent destinations

1  Press **NAV** to display the "Navigation - guidance" menu.

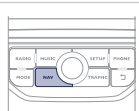

2  Select "Options" and confirm and then "delete recent destinations" and confirm.

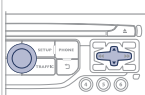

Towards a contact in the contacts directory

i Navigation towards a contact is only possible if it has an address entered in the audio navigation system.

1  Press **NAV** to display the "Navigation - guidance" menu.

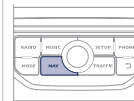

2  Select "Select destination" and confirm, then select "directory" and confirm.

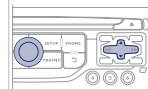

3  Selection the desired destination from your contacts and confirm "OK" to start the guidance.

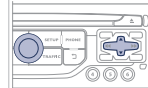

04 NAVIGATION - GUIDANCE

Towards GPS coordinates

1



Press **NAV** to display the "Navigation - guidance" menu.

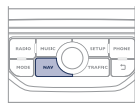

2



Select "**Select destination**" and confirm, then select "**GPS coordinates**" and confirm.

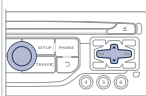

3



Enter the GPS coordinates and confirm "**OK**" to start the guidance.

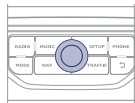

Towards a point on the map

1



With the map displayed, press **OK** to display the contextual menu. Select "**Move the map**" and confirm.

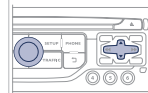

2



Move the cursor using the control to identify the desired destination.

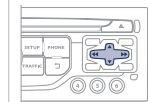

3



Press **OK** to display the contextual menu for "**Move the map**" mode.

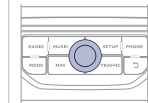

4



Select "**Select as destination**" or "**Select as stage**" and confirm.

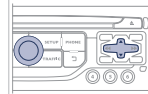

04 NAVIGATION - GUIDANCE

Towards points of interest (POI)

The points of interest (POI) indicate all of the service locations in the vicinity (hotels, various businesses, airports...).

1

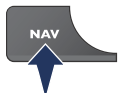

Press **NAV** to display the "**Navigation - guidance**" menu.

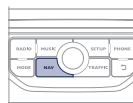

2



Select the "**Enter an address**" function and confirm, then select **Select destination** and confirm.

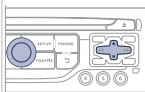

3



To select a POI close to your current location, select "**POI**" and confirm, then select "**Around the current place**" and confirm.

To select a POI as a stage on the route, select "**POI**" and confirm, then select "**On the route**" and confirm.

To select a POI as a destination, first enter the country and town (refer to the "Towards a new destination" section), select "**POI**" and confirm, finally select "**Near**" and confirm.

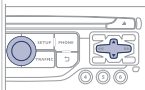

Select "**Search by Name**" to search for POIs by name and not by proximity.

4



Search for POIs in the categories suggested in the following pages.

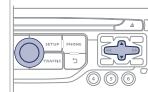

5



Select the POI and confirm "**OK**" to start the guidance.

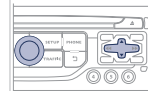













04 NAVIGATION - GUIDANCE



This icon appears when several POIs are grouped together in the same area. Zooming in on this icon shows details of the POIs.



List of principal points of interest (POI)

-  Service station
-  Garage
-  PEUGEOT
-  Covered car park
-  Car park
-  Rest area
-  Hotel
-  Restaurant
-  Cafeteria
-  Bed and breakfast

-  Airport
-  Railway station
-  Bus station
-  Port
-  Industrial estate
-  Supermarket
-  Vending machine
-  Sports complex, sports centre, sports ground
-  Swimming pool
-  Winter sports resort

-  Cinema
-  Theme parks
-  Hospital, Chemist, Vet
-  Police station
-  School
-  Town hall
-  Post office
-  Museum, Culture, Theatre, Historic monument
-  Tourist information, Tourist attraction
-  Risk areas / Danger areas*

An annual mapping update allows new points of interest to be presented to you. You can also update the Risk areas / Danger areas every month. The detailed procedure is available on: <http://peugeot.navigation.com>.

* According to availability in the country.

04 NAVIGATION - GUIDANCE

Settings for risk area / danger area alerts

1



Press **NAV** to display the "**Navigation - guidance**" menu.

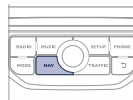

2



Select "**Guidance options**" and confirm, then select "**Set parameters for risk areas**" and confirm.

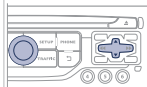

3



Select:

- "Visual alert"
- "Audible alert"
- "Alert only in guidance"
- "Overspeed alarm only".

The choice of time of notification defines how long in advance that Risk area warnings are given.



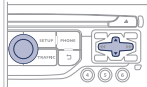



Select "**OK**" to confirm the screen.



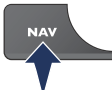
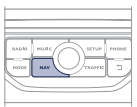

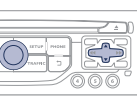

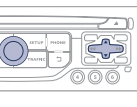

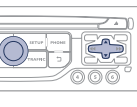
These functions are only available if risk areas have been downloaded and installed on the system.
The detailed procedure for updating risk area POIs can be found at <http://peugeot.navigation.com>.

04 NAVIGATION - GUIDANCE

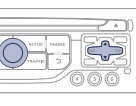
Adding a stage

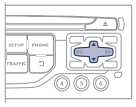
<p>1</p> 	<p>Press NAV to display the "Navigation - guidance" menu.</p>	
<p>2</p> 	<p>Select "j ourney leg and route" then confirm.</p>	
<p>3</p> 	<p>Select "Add a stage" then confirm. The address of the stage is entered as a destination, by "Enter an address", a contact in "directory", or "Previous destinations".</p>	
<p>4</p> 	<p>Select "Close to" a route passing close to the stage or "Strict" for a route passing through the stage. Confirm "OK" to start the guidance, and give a general indication of the guidance route.</p>	

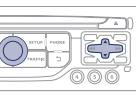
Organising stages

<p>1</p> 	<p>To organise stages, carry out operations 1 to 2 again, then select "Order/delete journey legs" and confirm.</p>	
<p>2</p> 	<p>Select the stage that you want to move in the order.</p>	
<p>3</p> 	<p>Select and confirm to save the modifications.</p>	
	<p>Select "d elete" to delete the stage.</p>	

04 NAVIGATION - GUIDANCE

Route options

Calculation criteria

1



Press **NAV** to display the "Navigation - guidance" menu.

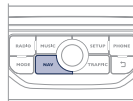

2



Select "**Guidance options**" and confirm.

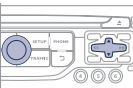

3



Select "**Define calculation criteria**" and confirm.

This function allows modification of:

- the guidance criteria: ("**Fastest route**", "**Shortest route**", "**distance/Time**"),
- the exclusion criteria: ("**With tolls**" or "**With Ferry**"),
- traffic avoidance: ("**Traffic info**").

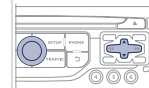

i

If traffic avoidance (Traffic info) is selected, the system suggests an alternative route if there is a delay on the guidance route.

4



Select "**OK**" and confirm to save the modifications.



04 NAVIGATION - GUIDANCE

Map management

Selecting the points of interest displayed on the map

1



Press **NAV** to display the "Navigation - guidance" menu.

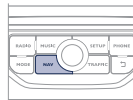

2



Select "**Map management**" and confirm.

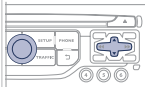

3



Select "**Map details**" and confirm.

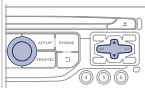

4



Select from the various categories the ones that you want to display on the screen.

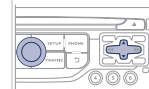

Select "**default**" to have only "**Filling stations, garages**" and "**Risk areas**" appear on the map (if installed in the system).

5



Select "**OK**" then confirm and select "**OK**" again then confirm to save the modifications.



04 NAVIGATION - GUIDANCE

Map orientation

1



Press NAV to display the "Navigation - guidance" menu.

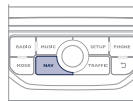

2



Select "Map management" and confirm.

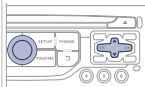

3



Select "Map orientation" and confirm.

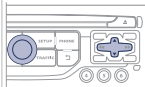

4



Select:

- "Vehicle direction" to have the map follow the direction of travel,
- "North direction" to keep the map always North up,
- "Perspective view" to display a perspective view.

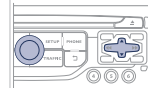

The colour of the map, different from the day and night mode, is configured in the "SETUP" menu.



Street names are visible on the map from the 100 m scale.

04 NAVIGATION - GUIDANCE

Navigation voice synthesis

Adjusting the volume / deactivation



The volume of messages can be adjusted during the transmission of the message using the volume adjustment control.



The volume setting of guidance messages is also accessible via the **"SETUP"** / **"Voice synthesis"** menu.

1



Press **NAV** to display the **"Navigation - guidance"** menu.

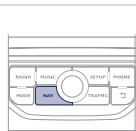

2



Select **"Guidance options"** and confirm.

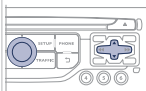

3



Select **"Set speech synthesis"** and confirm.

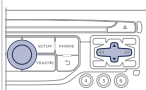

4



Select the volume graph and confirm.

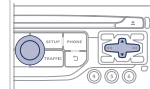

5



Adjust the volume to the desired level and confirm.

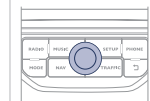

Select **"deactivate"** to deactivate voice messages.

6



Select **"OK"** and press the dial to confirm.

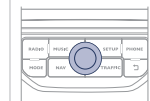

04 NAVIGATION - GUIDANCE

Male voice / Female voice

1



Press **SETUP** to display the configuration menu.

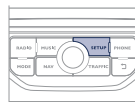

2



Select "**Voice synthesis**" and confirm.

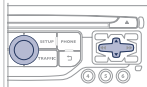

3



Select "**Select male voice**" or "**Select female voice**" then confirm "**Yes**" to activate a male or female voice. The system restarts.

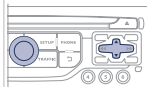

05 TRAFFIC INFORMATION

Access to the "TRAFFIC INFORMATION" menu



Press "TRAFFIC".

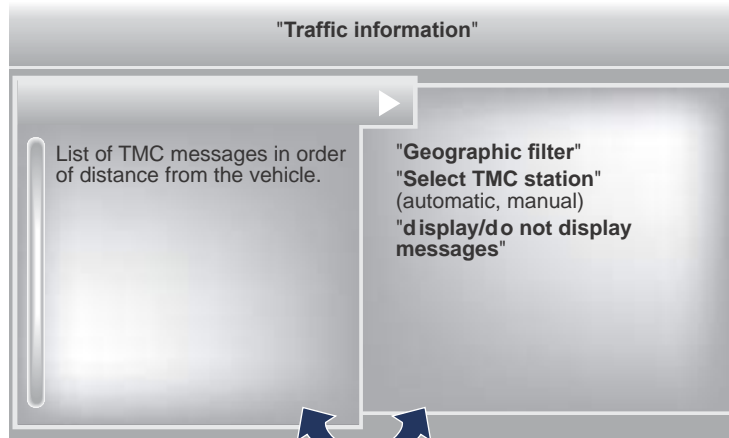

Go from the list to the menu (left/right).



or



05 TRAFFIC INFORMATION

Configure the filtering and display of TMC messages

TMC (Traffic Message Channel) messages with GPS Navigation provide traffic information in real time.

1



Press the **TRAFFIC** button to display the "Traffic information" menu.

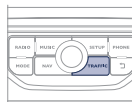

2



Select the "**Geographic filter**" function and confirm.

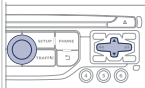

3



The system offers a choice of:

- "**Retain all the messages**",
- or
- "**Retain the messages**"
 - "**Around the vehicle**", (confirm the mileage to modify and select the distance),
 - "**On the route**".

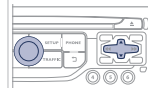

4



Confirm "**OK**" to save the modifications.

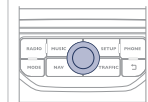

i

We recommend:

- a filter on the route and
- a filter around the vehicle of:
 - 12 miles (20 km) in urban areas,
 - 30 miles (50 km) on motorways.



05 TRAFFIC INFORMATION

Principal TMC symbols

1 Black and blue triangle: general information, for example:



2 Red and yellow triangle: traffic information, for example:



Receiving TA messages

! The TA (Traffic Announcement) function gives priority to TA alert messages. To operate, this function needs good reception of a radio station transmitting this type of message. When a traffic report is transmitted, the current audio source (Radio, CD, USB, ...) is interrupted automatically to play the TA message. Normal playback of the audio source resumes at the end of the transmission of the message.

1  Press **RADIO** to display the menu.



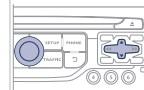

2  Select "**Service announcements**" then confirm.

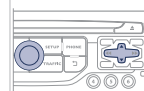

3  Activate or deactivate "**TA**" then confirm.



! The volume setting for TA messages can be adjusted only during the transmission of this type of alert.

  Activate or deactivate the function at any time by pressing the button.
During a message, press the button to interrupt it.

06 USING THE TELEPHONE

Access to the "TELEPHONE" menu



Press this button.

"Telephone"

List of recent calls sent and received with the telephone connected to the system.

"dial"
"directory of contacts"
"Contacts management"
"Phone functions"
"Bluetooth functions"
"Hang up"

In the top bar of the permanent display



No telephone connected.



Telephone connected.



Incoming call.



Outgoing call.



Synchronisation of contacts in progress.



Telephone call in progress.

To make a call, select a number in the list and confirm "OK" to start the call.



Connecting a different telephone deletes the list of recent calls.

Go from the list to the menu (left/right).



or



06 USING THE TELEPHONE

Pairing a Bluetooth® telephone First connection



You can check the compatibility of your telephone at [www.peugeot.co.uk \(services\)](http://www.peugeot.co.uk (services)).

Quick procedure from the telephone

1

In the Bluetooth menu of your telephone, select the name "PEUGEOT" from the list of devices detected.



2

Enter a minimum 4 figure code in the telephone and confirm.



3



Enter the same code in the system, select "OK" and confirm.

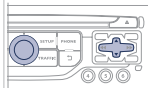

For reasons of safety and because they require prolonged attention on the part of the driver, the operations for pairing the Bluetooth mobile telephone to the hands-free system of the audio unit must be carried out with the **vehicle stationary**.

Procedure from the system

1

Activate the telephone's Bluetooth function and ensure that it is "visible to all" (telephone configuration).



2



Press this button.

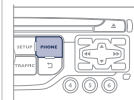

3



Select "**Bluetooth functions**" and confirm.

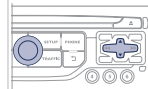

4



Select "**Peripherals search**" and confirm.
The list of peripheral devices detected is displayed. Wait until the "**Connect**" button is available.

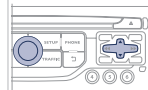

06 USING THE TELEPHONE



The services available depend on the network, the SIM card and the compatibility of the Bluetooth telephone used. Check the telephone manual and with your network provider for details of the services available to you.

5



Select the name of the desired peripheral from the list of devices detected then confirm.

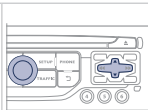

6



Select "**Connect**" and confirm.

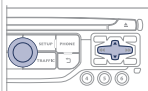

7



The system offers to connect the telephone:

- in "**Hands-free mode**" (telephone only),
- in "**Audio**" mode (streaming: playing music files on the telephone),
- or "**All**" (for selection of both modes).

Select "**OK**" and confirm.

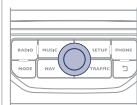

8

Enter a minimum 4 figure code in the telephone and confirm.



9



Enter the same code in the system, select "**OK**" and confirm.

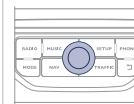

Then accept automatic connection on the telephone to allow the telephone to reconnect automatically every time the vehicle is started.



Depending on the type of telephone, the system will ask you to accept or not the transfer of your contacts.



The "**Hands-free mode**" should be used in preference if "Streaming" is not desired.













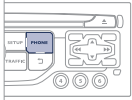

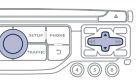
The ability of the system to connect in only one mode depends on the telephone. The two modes may both connect by default.

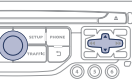

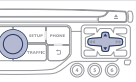
On return to the vehicle, the last telephone connected automatically reconnects, within around 30 seconds after switching on the ignition (Bluetooth activated and visible). To modify the automatic connection mode, remove the pairing and pair the telephone again with the desired mode.

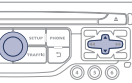

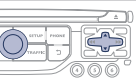

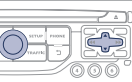



06 USING THE TELEPHONE

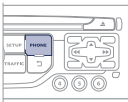

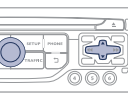
directory configuration / Synchronisation with the telephone

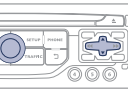
<p>1</p>  <p>Press PHONE then select "Contacts management" and confirm.</p>		<p>2d</p>  <p>Select "Import all the entries" to import all the contacts in the telephone and save them in the system. Once imported, a contact remains visible whatever telephone is connected.</p>	
<p>2a</p>  <p>Select "New contact" to enter a new contact.</p>		<p>2e</p>  <p>Select "Synchronization options":</p> <ul style="list-style-type: none">- No synchronization: only the contacts saved in the system (always present).- Display telephone contacts: only the contacts saved in the telephone.- Display SIM card contacts: only the contacts saved on the SIM card.- Display all phone contacts: contacts on the SIM card and in the telephone.	
<p>2b</p>  <p>Select "Sort by Name/First name" or "Sort by First name/Name" to choose the order in which they appear.</p>		<p>2f</p>  <p>Select "Contact mem. status" to see the number of contacts saved in the system or imported, and the free memory.</p>	
<p>2c</p>  <p>Select "delete all contacts" to delete the contacts saved in the system.</p>			

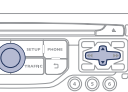
06 USING THE TELEPHONE

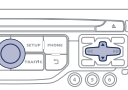
Editing, importing or deleting a contact

1 	Press PHONE then select " directory of contacts " and confirm.	
2 	Select " Search ", then turn the knob to choose in numerical or alphabetical order a group of contacts from the entries made previously, then confirm. Go to the list of contacts, select the desired contact then confirm.	
3a 	Select " Open " to view a contact on the telephone or modify a contact saved in the system.	
3b 	Select " Import " to copy a contact from the telephone to the system.	
3c 	Select " delete " to delete a contact recorded in the system.	

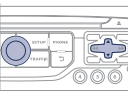
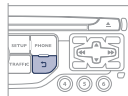
i It is not possible to modify or delete contacts in the telephone or the SIM card via the Bluetooth connection.	
i Once the contact has been imported, the Bluetooth symbol disappears, replaced by the telephone symbol which shows that the contact has been saved in the system.	
i In the " directory of contacts " menu, the import and deletion of contacts is done one by one.	
4   Select OK or press the back button to exit this menu.	 

06 USING THE TELEPHONE

Making a call

! Use of the telephone is not recommended while driving. We recommended that you park safely or make use of the steering mounted controls.

Calling a new number

1



Press **PHONE** twice.

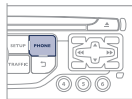

2



Select "**dial**" then confirm.

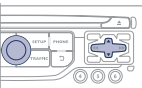

3



Dial the telephone number using the virtual keypad selecting each number in turn.
Confirm "**OK**" to make the call.

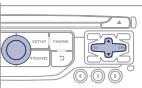

Calling a contact

1



Press **TEL** or twice on **PHONE**.

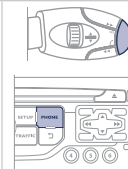

2



Select "**directory of contacts**" then confirm.

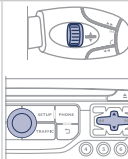

3



Select the desired contact and confirm.
If access was via the **PHONE** button, select "**Call**" and confirm.



4



Select the number and confirm to start the call.

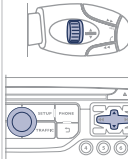

06 USING THE TELEPHONE

Calling a recently entered number

1



Press **TEL**, select "**Call list**" and confirm,

or



Press **PHONE** to display the calls log.

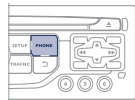
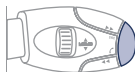

2



Select the desired number and confirm.

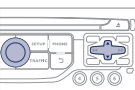

To erase the calls log, press **PHONE** twice, select "**Phone functions**" and confirm then select "**delete calls log**" and confirm.

i

It is always possible to start a call directly from the telephone; park the vehicle as a safety measure.

Ending a call

1a



Press **PHONE** then select "**OK**" to end the call.

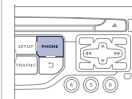

1b



Or make a long press on **TEL** at the steering mounted controls.



1c



Or make two short presses on **TEL** at the steering mounted controls.



1d



Or press the **MODE** button, as many times as necessary, until the telephone screen is displayed.



Press "**OK**" to display the contextual menu then select "**Hang up**" and confirm.

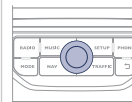

06 USING THE TELEPHONE

Receiving a call

1

An incoming call is announced by a ring and a superimposed display on the screen.

2



"Yes" to accept the call is selected by default.
Press "**OK**" to accept the call.
Select "**No**" and confirm to reject the call.

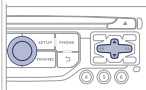











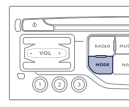
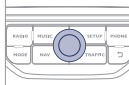
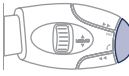

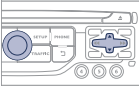
A short press on **TEL** accepts an incoming call.
A long press on **TEL** rejects an incoming call.

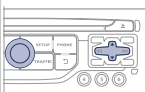

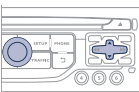
06 USING THE TELEPHONE

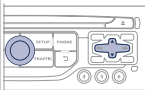

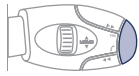

Options during a call*

<p>1</p>  <p>During a call, press the MODE button several times to select display of the telephone screen, then press "OK" to open the contextual menu.</p>  <p>Or make a short press on this button.</p> 	  	<p>2c</p>  <p>Select "dTMF ring tones" to use the numerical keypad, so as to navigate through the menu of an interactive vocal server.</p> 	
<p>2a</p>  <p>Select "Private mode" and confirm to take the call on the handset. Or select "Hands-free mode" and confirm to take the call via the vehicle's speakers.</p> 		<p>2d</p>  <p>Select "Hang up" to end the call.</p> 	
<p>2b</p>  <p>Select "Put call on hold" and confirm to put the current call on hold. Or select "Resume the call" and confirm to resume the call on hold.</p> 		<p> </p> <p>It is possible to hold a 3-way conference call by making 2 calls in succession*. Select "Conference mode call" in the contextual menu accessible using this button.</p> 	



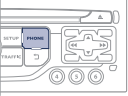

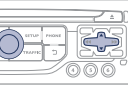

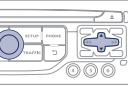

* Depending on the compatibility of the phone and your service plan.

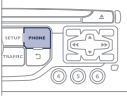
06 USING THE TELEPHONE

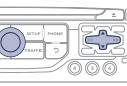
Managing paired telephones

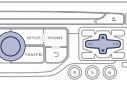
<p>1</p>  <p>Press PHONE twice.</p>	
<p>2</p>  <p>Select "Bluetooth functions".</p>	
<p>3</p>  <p>Select "List of the paired peripherals" and confirm.</p> <p>It is possible to:</p> <ul style="list-style-type: none">- "Connect" or "disconnect" the selected telephone,- delete the pairing of the selected telephone. <p>It is also possible to select all pairings.</p>	

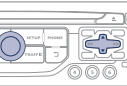
Changing the ringtone

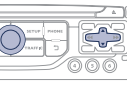
<p>1</p>  <p>Press PHONE twice.</p>	
<p>2</p>  <p>Select "Phone functions" and confirm.</p>	
<p>3</p>  <p>Select "Ring options" and confirm.</p>	
<p>4</p>  <p>You can adjust the volume and the type of ringtone.</p>	
<p>5</p>  <p>Select "OK" and confirm to save the changes.</p>	

07 RAdIO

Access to the "RAdIO" menu



Press RAdIO.

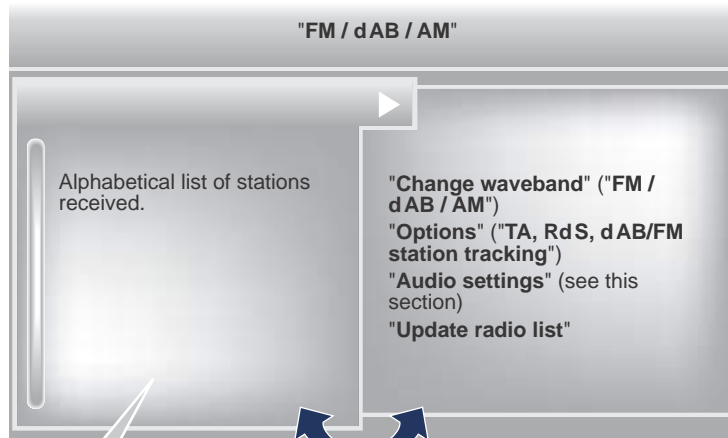

Press **▲** or **▼** or use the rotary control to select the previous or next station in the list.

Go from the list to the menu (left/right).



or



07 RAdIO

Changing waveband

! The external environment (hill, building, tunnel, underground car park...) may interfere with the reception, including in RDS station tracking mode. This phenomenon is a normal result of the way in which radio waves are transmitted and does not in any way indicate a fault with the audio system.

1



Press **RAdIO** or **OK** to display the contextual menu.

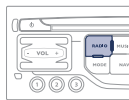

2



Select "**Change waveband**".

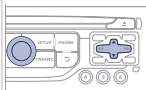

3



Select "**FM / dAB / AM**" and confirm.

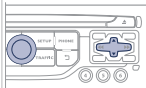

Selecting a station



The quality of reception is represented by the number of active waves in this symbol.

1a



By alphabetical list

Press **RAdIO**, select the station of your choice and confirm.

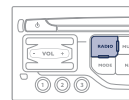

1b



By automatic frequency search

Press **◀** or **▶** for the automatic search for a lower or higher radio frequency.

Or turn the thumb wheel at the steering mounted controls.

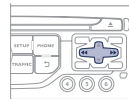

1c



By manual frequency search

Press **▲** or **▼** to adjust the radio frequency step by step.

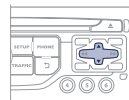

07 RAdIO

Presetting a station

1



After selecting a station, press one of the buttons on the numerical keypad for 2 seconds to preset the current station.
An audible signal confirms that the station has been preset.

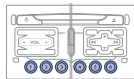

2



Press the button on the numerical keypad to recall a preset station.
Or press then turn the thumb wheel at the steering mounted controls.

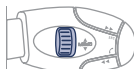
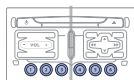

Activate / deactivate RdS

!

RdS, if activated, allows you to continue listening to the same station by automatic retuning to alternative frequencies. However, in certain conditions, coverage of an RdS station may not be assured throughout the entire country as radio stations do not cover 100 % of the territory. This explains the loss of reception of the station during a journey.

1



Press **RAdIO**.

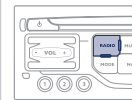

2



Select "**Guidance options**" then confirm.

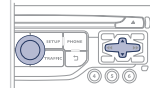

3



Activate or deactivate "**RdS**" then confirm.

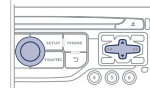

07 RAdIO

Display of the "DAB" or "DAB (FM)" band.

Represents the signal strength for the band being listened to.

Display of the name of the current station.

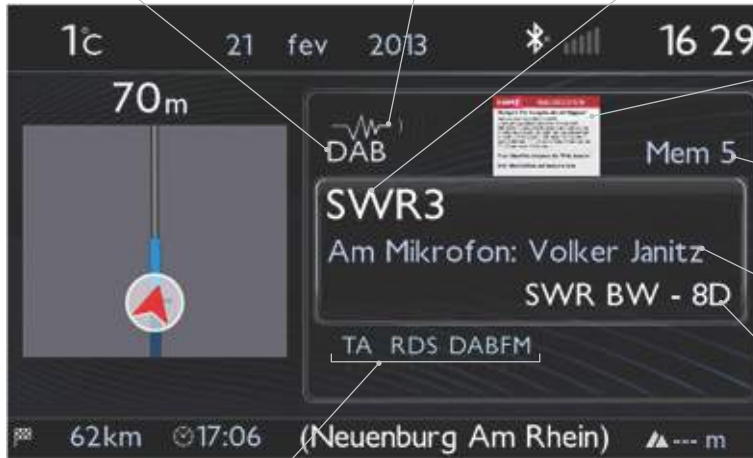

Any thumbnail broadcast by the station.

The "Video mode" allows the display to be enlarged.

Preset stations, buttons 1 to 6.

Short press: select the preset radio station.

Long press: preset a radio station.

Display of "Radiotext" for the current station.

Display the name and number of the multiplex service being used.

Display of options:
if active but not available, the display will be greyed out,
if active and available, the display will be empty.



If the "DAB" radio station being listened to is not available on "FM", the "DAB FM" option is greyed out.

07 RAdIO

dAB (digital Audio Broadcasting) digital radio

- !** Digital radio provides a higher quality reception and also the graphical display of information for the radio station, by selecting "Video mode" in "Radio favourites" (Options).
The different radio multiplex services offer a choice of stations displayed in alphabetical order.

- 1**  Press "**RAdIO**".

- 2**  Select "**Change band**" and confirm.

- 3**  Selection "**dAB**" and confirm.

  Change of station in the same "multiplex".

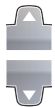



Manual search for a "multiplex".

digital radio - dAB/FM auto tracking

- i** "DAB" does not have 100% coverage of the country.
When the digital signal is weak, "DAB / FM auto tracking" allows you to continue listening to the same station, by automatically switching to the corresponding analogue "FM" station (if one exists).

- 1**  Press "**RAdIO**".

- 2**  Select "**Options**" and confirm.

- 3**  Select "**FM/dAB**" and confirm.

- i** If "DAB / FM auto tracking" is on, there will be a difference of a few seconds in the programme when the system changes to analogue "FM" radio with sometimes a variation in volume.
Display of the "DAB" band then becomes "DAB (FM)".
When the strength of the digital signal is good again, the system automatically switches back to "DAB".

- i** If the "DAB" station you are listening to is not available on "FM" ("**dAB/FM**" option greyed out), or if "DAB / FM auto tracking" is not on, the sound will be cut when the digital signal is too weak.

08 MUSIC MEDIA PLAYERS

Access to the "MUSIC MEDIA PLAYER" menu



Press **MUSIC**.

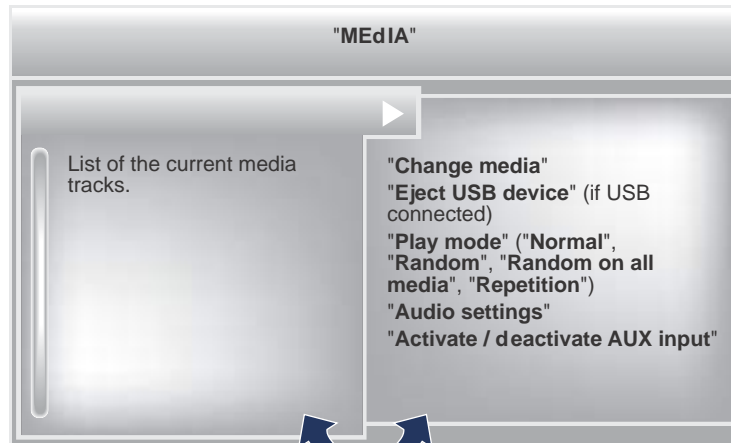

Go from the list to the menu (left/right).



or



08 MUSIC MEDIA PLAYERS

Cd, MP3 Cd / USB player

Information and advice

▶ The audio equipment will only play audio files with ".wma, .aac, .flac, .ogg and .mp3" file extensions and with a bit rate of between 32 Kbps and 320 Kbps.

It also supports VBR (Variable Bit Rate) mode.

No other type of file (.mp4, .m3u...) can be played.

WMA files must be of the standard wma 9 type.

The sampling rates supported are greater than 32 KHz.



It is advisable to restrict file names to 20 characters, without using of special characters (e.g.: " " ? ; ù) to avoid any playing and displaying problems.



In order to be able to play a recorded CDR or CDRW, when recording it is preferable to select the ISO 9660 level 1, 2 or j oliet standard.

If the disc is recorded in another format (udf, ...), it may not be played correctly.

It is recommended that the same recording standard is always used for an individual disc, with as low a speed as possible (4x maximum) for optimum sound quality.

In the particular case of a multi-session CD, the j oliet standard is recommended.



The system supports USB mass storage or iPod devices via the USB port (suitable cable not supplied). If a partitioned USB memory key is connected to the system, only the first partition is recognised.

Control of the peripheral device is with the audio system controls.

The number of tracks is limited to 2000 maximum, 999 tracks per folder.

If the current consumption at the USB port exceeds 500 mA, the system goes into protection mode and deactivates the port.

Other peripherals, not recognised on connection, must be connected to the auxiliary socket using a j ack cable (not supplied).



Use only USB memory sticks formatted FAT32 (File Allocation Table).



The system does not support the operation of an Apple® player and a USB memory stick connected at the same time.



It is recommended that official Apple® USB cables are used to ensure correct operation.

08 MUSIC MEDIA PLAYERS

Sources



Insert the CD in the player, insert the USB memory stick in the USB player or connect the USB peripheral to the USB port using a suitable cable (not supplied).

The system builds playlists (in temporary memory), an operation which can take from a few seconds to several minutes at the first connection.

Reduce the number of non-music files and the number of folders to reduce the waiting time.

The playlists are updated every time the ignition is switched off or connection of a USB memory stick. However, the system memorises these lists and if they are not modified, the loading time will be shorter.

Play starts automatically after a period which depends on the capacity of the USB memory stick.



Selection of source



The **SOURCE** button on the steering mounted controls allows a direct change to the next media source.

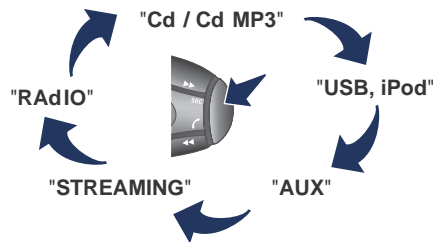

1



Press **MUSIC** to display the "MEdIA" menu.

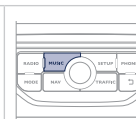

2





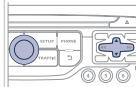



Select "**Following media source**" and confirm.







Repeat the operation as many times as necessary to obtain the desired media source (except for radio which is accessible either with **SOURCE** or **RADiO**).

08 MUSIC MEDIA PLAYERS

Selecting a track

Previous track.	
Next track.	
Previous folder.	
Next folder.	
Fast forward.	Long press 
Fast backward.	Long press 
Pause: long press on SRC .	

MUSIC: List of USB or Cd tracks or folders

	
Up or down in the list.	
Confirm, next menu level.	
Up one menu level.	

08 MUSIC MEDIA PLAYERS

Connecting APPLE® players

- 1 Connect the Apple® player to the USB port using a suitable cable (not supplied).
Play starts automatically.

- 2 Control is via the audio system.

i The classifications available are those of the portable device connected (artists / albums / genres / playlists / audiobooks / podcasts).
The default classification used is by artist. To modify the classification used, return to the first level of the menu then select the desired classification (playlists for example) and confirm to go down through the menu to the desired track.
The "Shuffle tracks" mode on an iPod® corresponds to the "Random" mode on the audio system.
The "Shuffle albums" mode on an iPod® corresponds to the "Random all" on the audio system.
"Shuffle tracks" is restored by default on each connection.

i The version of software in the audio system may not be compatible with the generation of your Apple® player.

Audio streaming



Streaming allows audio files on your telephone to be played via the vehicle's speakers.

1

Connect the telephone: refer to the "**USING THE TELEPHONE**" section.
Select "**Audio**" or "**All**" profile.

2

If play does not start automatically, it may be necessary to start the audio playback from the telephone.
Control is from the peripheral device or by using the audio system buttons.

!

Once connected in streaming mode, the telephone is considered to be a media source.
It is recommended that you activate "**Repeat**" on the Bluetooth peripheral.

08 MUSIC MEDIA PLAYERS

Using the auxiliary input (AUX) j ACK/USB audio cable not supplied

1

Connect the portable device (MP3, WMA player...) to the j ACK auxiliary audio socket or USB port using a suitable cable.



2



Press **MUSIC** to display the "MUSIC" menu.

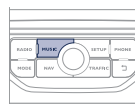

3



Select "**Activate / deactivate AUX input**" and confirm.

First adjust the volume of your portable device (to a high level). Then adjust the volume of your audio system.



!

Display and management of the controls are via the portable device.

09 AUDIO SETTINGS

1



They are accessible by the **MUSIC** button in the control panel or by a long press on **RADIO** according to the source in use.

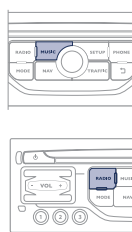

2

- "Equalizer" (choice of 6 musical ambiances)
- "Bass"
- "Treble"
- "Loudness" (Activate/Deactivate)
- "distribution" ("driver", "All passengers")
- "Le-Ri balance" (Left/Right)
- "Fr-Re balance" (Front/Rear)
- "Auto. Volume" depending on road speed (Activate/Deactivate)

!

The distribution (or spatialisation using the Arkamys® system) of sound is an audio process that allows the audio quality to be adapted to the number of listeners in the vehicle.

!

The audio settings (**Equalizer, Bass, Treble and Loudness**) are different and independent for each sound source.
The settings for distribution and balance are common to all sources.

i

On-board audio: Arkamys® Sound Staging optimises sound distribution in the the passenger compartment.

10 CONFIGURATION

display configuration

1



Press **SETUP** to display the "Configuration" menu.

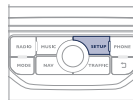

2



Select "**Display configuration**" and confirm.

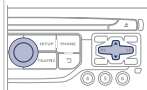

3a



Select "**Choose colour**" and confirm to select the screen colour harmony and the map presentation mode:

- day mode,
- night mode,
- automatic day/night mode, according to whether the headlamps are on.

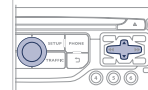

3b



Select "**Adjust luminosity**" and confirm to adjust the screen brightness. Press "**OK**" to save the changes. The settings for day and night are independent.



11 SCREEN MENU MAP(S)



MAIN FUNCTION

1 Option A

2 Option A1

3 Option A11

1 Option B...

"Navigation - guidance" MENU

1 Select destination

2 Enter an address

2 directory

2 GPS coordinates

1 j ourney leg and route

2 Add a stage

3 Enter an address

3 Directory

3 Previous destinations

2 Order/delete journey legs

2 divert route

2 Chosen destination

1 Guidance options

2 Define calculation criteria

3 Fastest route

3 Shortest route

3 Distance/Time

3 With tolls

3 With Ferry

3 Traffic info

2 Set speech synthesis

2 delete last destinations

2 Set parameters for risk areas

1 Map management

2 Map orientation

3 Vehicle direction

3 North direction

3 Perspective view

2 Map details

2 Move the map

2 Mapping and updating

2 description of risk areas database

1 Stop / Restore guidance

2 Fastest route

2 Shortest route

2 distance/Time

2 With tolls

2 With Ferry

2 Traffic info

11 SCREEN MENU MAP(S)

"TRAFFIC INFORMATION" MENU

1 Geographic filter

2 Retain all the messages

2 Retain the messages

3 Around the vehicle

3 On the route

1 Select TMC station

2 Automatic TMC

2 Manual TMC

2 List of TMC stations

1 display / do not display messages

"TELEPHONE" MENU

1 dial

1 directory of contacts

2 Call

2 Open

2 Import

2 Search

2 delete

2 Cancel

1 Contacts management

2 New contact

2 Sort by First name/Name

2 delete all contacts

2 Import all the entries

2 Synchronization options

3 No synchronization

3 Display telephone contacts

3 Display SIM card contacts

3 Display all phone contacts

2 Contact mem. status

1 Phone functions

2 Ring options

2 delete calls log

1 Bluetooth functions

2 List of the paired peripherals

3 Connect

3 Disconnect

3 Delete

3 Delete all

3 Cancel

2 Peripherals search

2 Rename radiotelephone

1 Hang up

11 SCREEN MENU MAP(S)

"RADiO" MENU

1 Change Waveband

2 FM

2 dAB

2 AM

1 Options

2 RdS station tracking

2 FM/dAB

1 Audio settings

2 Equalizer

3 None

3 Classical

3 jazz

3 Rock

3 Techno

3 Vocal

2 Bass

2 Treble

2 Loudness

3 Activated / Deactivated

2 distribution

3 Driver

3 All passengers

2 Le-Ri balance

2 Fr-Re balance

2 Auto. Volume

3 Activated / Deactivated

1 Update radio list

"MUSIC" MENU

1 Change Media

2 Cd

2 Bluetooth streaming

2 USB/iPod

2 AUX

1 Read mode

2 Normal

2 Random

2 Random on all media

2 Repetition

1 Audio settings

1 Activate / deactivate AUX input

11 SCREEN MENU MAP(S)

"SETUP" MENU

1 display configuration

2 Choose colour

3 Harmony

3 Cartography

4 Day mode

4 Night mode

4 Auto Day/Night

2 Adjust luminosity

2 Set date and time

2 Select units

1 Speech synthesis setting

2 Guidance instructions volume

2 Select male voice/Select female voice

1 Select language

2 Français

2 English

2 Italiano

2 Portuguese

2 Español

2 deutsch

2 Nederlands

2 Türkçe

2 Polski

2 Русский

2 Cestina

2 Hrvatski

2 Hungarian

1 define vehicle parameters*

1 Trip computer

2 Alert log

2 Status of functions

* The settings vary according to the vehicle.

FREQUENTLY ASKEd QUESTIONS

The following table groups together the answers to the most frequently asked questions concerning your audio system.

QUESTION	ANSWER	SOLUTION
The route calculation is not successful.	The guidance criteria may conflict with the current location (exclusion of toll roads on a toll motorway).	Check the guidance criteria on the Navigation Menu, "Guidance options\" "Define calculation criteria".
I am unable to enter my post code.	The system only accepts post codes of up to 7 characters.	
The POIs do not appear.	The POIs have not been selected.	Select the POIs in the list of POIs.
The risk areas audible warning does not work.	The audible warning is not active.	Activate audible warnings in the Guidance options menu, "Navigation - guidance", "Set parameters for risk areas".
The system does not suggest a detour around an incident on the route.	The guidance criteria do not take account of TMC messages.	Select the "Traffic info" function in the list of guidance criteria.
I receive a Risk area alert which is not on my route.	Other than guidance, the system announces all Risk areas positioned in a cone located in front of the vehicle. It may provide an alert for a Risk area located on nearby or parallel roads.	Zoom in on the map to view the exact position of the Risk area. Select "On the route" to no longer receive alerts other than guidance or to reduce the time for the announcement.

FREQUENTLY ASKEd QUESTIONS

QUESTION	ANSWER	SOLUTION
Certain traffic jams along the route are not indicated in real time.	On starting, it is several minutes before the system begins to receive the traffic information.	Wait until the traffic information is being received correctly (display of the traffic information icons on the map).
	The filters are too restrictive.	Modify the "Geographic filter" settings.
	In certain countries, only major routes (motorways...) are listed for the traffic information.	This phenomenon is normal. The system is dependent on the traffic information available.
The altitude is not displayed.	On starting, the initialisation of the GPS may take up to 3 minutes to receive more than 4 satellites correctly.	Wait until the system has started up completely. Check that there is a GPS coverage of at least 4 satellites (long press on the SETUP button, then select "GPS coverage").
	Depending on the geographical environment (tunnel...) or the weather, the conditions of reception of the GPS signal may vary.	This phenomenon is normal. The system is dependent on the GPS signal reception conditions.
I am unable to connect my Bluetooth telephone.	The telephone's Bluetooth function may be switched off or the telephone may not be visible.	<ul style="list-style-type: none"> - Check that your telephone's Bluetooth function is switched on. - Check in the telephone settings that it is "visible to all".
	The Bluetooth telephone is not compatible with the system.	You can check the compatibility of your telephone on www.peugeot.co.uk (services).
The volume of the telephone connected in Bluetooth mode is inaudible.	The volume depends both on the system and on the telephone.	Increase the volume of the audio system, to maximum if required, and increase the volume of the telephone if necessary.
	The ambient noise level has an influence on the quality of telephone communication.	Reduce the ambient noise level (close the windows, reduce the booster fan speed, slow down, ...).

FREQUENTLY ASKEd QUESTIONS

QUESTION	ANSWER	SOLUTION
Some contacts are duplicated in the list.	The options for synchronizing contacts are synchronizing the contacts on the SIM card, the contacts on the telephone, or both. When both synchronizations are selected, some contacts may be duplicated.	Select "Display SIM card contacts" or "Display telephone contacts".
Contacts are not shown in alphabetical order.	Some telephones offer display options. Depending on the settings chosen, contacts can be transferred in a specific order.	Modify the display setting in the telephone directory.
The system does not receive SMS text messages.	The Bluetooth mode does not permit sending SMS text messages to the system.	
The CD is ejected automatically or is not played by the player.	<p>The CD is inserted upside down, is unplayable, does not contain any audio data or contains an audio format which the player cannot play.</p> <p>The CD has been recorded in a format that is not compatible with the player (udf, ...).</p> <p>The CD is protected by an anti-pirating protection system which is not recognised by the audio system.</p>	<ul style="list-style-type: none"> - Check that the CD is inserted in the player the right way up. - Check the condition of the CD: the CD cannot be played if it is too damaged. - Check the content in the case of a recorded CD: refer to the information and advice in the "MUSIC MEDIA PLAYERS" section. - The audio system's CD player does not play DVDs. - Some recorded CDs will not be played by the audio system because they are not of the correct quality.
There is a long waiting period following the insertion of a CD or connection of a USB memory stick.	When a new medium is inserted, the system reads a certain amount of data (directory, title, artist, etc.). This may take from a few seconds to a few minutes.	This phenomenon is normal.
The CD player sound is poor.	The CD used is scratched or of poor quality.	Insert good quality CDs and store them in suitable conditions.
	The audio equipment settings (bass, treble, ambiances) are unsuitable.	Set the treble or bass level to 0, without selecting an ambience.

FREQUENTLY ASKEd QUESTIONS

QUESTION	ANSWER	SOLUTION
Some characters in the media information are not displayed correctly while playing.	The audio system does not read some types of characters.	Use standard characters to name tracks and folders.
Playing of streaming files does not start.	The peripheral device connected does not support automatic play.	Start the playback from the device.
The names of tracks and the track length are not displayed on the screen when streaming audio.	The Bluetooth profile does not allow the transfer of this information.	
The quality of reception of the radio station listened to gradually deteriorates or the stored stations do not function (no sound, 87.5 Mhz is displayed...).	The vehicle is too far from the transmitter used by the station listened to or there is no transmitter in the geographical area through which the vehicle is travelling.	Activate the "RDS" function by means of the short-cut menu to enable the system to check whether there is a more powerful transmitter in the geographical area.
	The environment (hills, buildings, tunnels, basement car parks...) block reception, including in RDS mode.	This phenomenon is normal and does not indicate a fault with the audio system.
	The aerial is absent or has been damaged (for example when going through an automatic car wash or in an underground car park).	Have the aerial checked by a PEUGEOT dealer.
I cannot find some radio stations in the list of stations received.	The station is not received or its name has changed in the list.	
	Some radio stations send other information in place of their name (the title of the song for example).	
The name of the radio station changes.	The system interprets this information as the name of the station.	

FREQUENTLY ASKED QUESTIONS

QUESTION	ANSWER	SOLUTION
When modifying the treble and bass setting, the choice of ambience is cancelled.	The selection of an ambience imposes specific treble and bass settings.	Modify the treble and bass settings or choose a musical ambience to obtain the desired sound quality.
When modifying the ambience, the treble and bass settings are cancelled.		
When modifying the balance settings, the "Driver" or "All passengers" setting is cancelled.	The choice of the "Driver" distribution setting imposes specific balance settings.	
When modifying the "Driver" or "All passengers" distribution setting, the balance settings are cancelled.		
There is a difference in sound quality between the different audio sources (radio, CD...).	For optimum sound quality, the audio settings for Volume, Bass, Treble, Equalizer and Loudness can be adapted to the different sound sources, which may result in audible differences when changing source (radio, CD...).	Check that the audio settings for (Volume, Bass, Treble, Equalizer, Loudness) are adapted to the sources listened to. It is advisable to set the AUDIO functions (Bass, Treble, Fr-Re balance, Le-Ri balance) to the middle position, select the "None", musical ambience and set the loudness correction to the "Active" position in CD mode or to the "Inactive" position in radio mode.

FREQUENTLY ASKEd QUESTIONS

QUESTION	ANSWER	SOLUTION
<p>With the engine off, the system switches off after a few minutes of use.</p>	<p>When the engine is switched off, the system's operating time depends on the state of charge of the battery.</p> <p>The switch-off is normal: economy mode is activated automatically to maintain the state of charge of the vehicle's battery, needed for engine starting. (See the "Energy economy mode" section).</p>	<p>Start the vehicle's engine to increase the battery charge.</p>
<p>Playback of my USB memory stick starts only after a very long wait (around 2 to 3 minutes).</p>	<p>Some files supplied with the memory stick may greatly slow down access to reading the memory stick (multiplication by 10 of the catalogue time).</p>	<p>Delete the files supplied with the memory stick and limit the number of sub-folders in the file structure on the memory stick.</p>
<p>When I connect my iPhone as telephone and to the USB port at the same time, I am unable to play the music files.</p>	<p>When the iPhone connects automatically as a telephone, it forces the streaming function. The streaming function takes the place of the USB function which is then not useable, there is a period without sound of the track being played with Apple® players.</p>	<p>Disconnect and reconnect to the USB port (the USB function takes priority over streaming).</p>

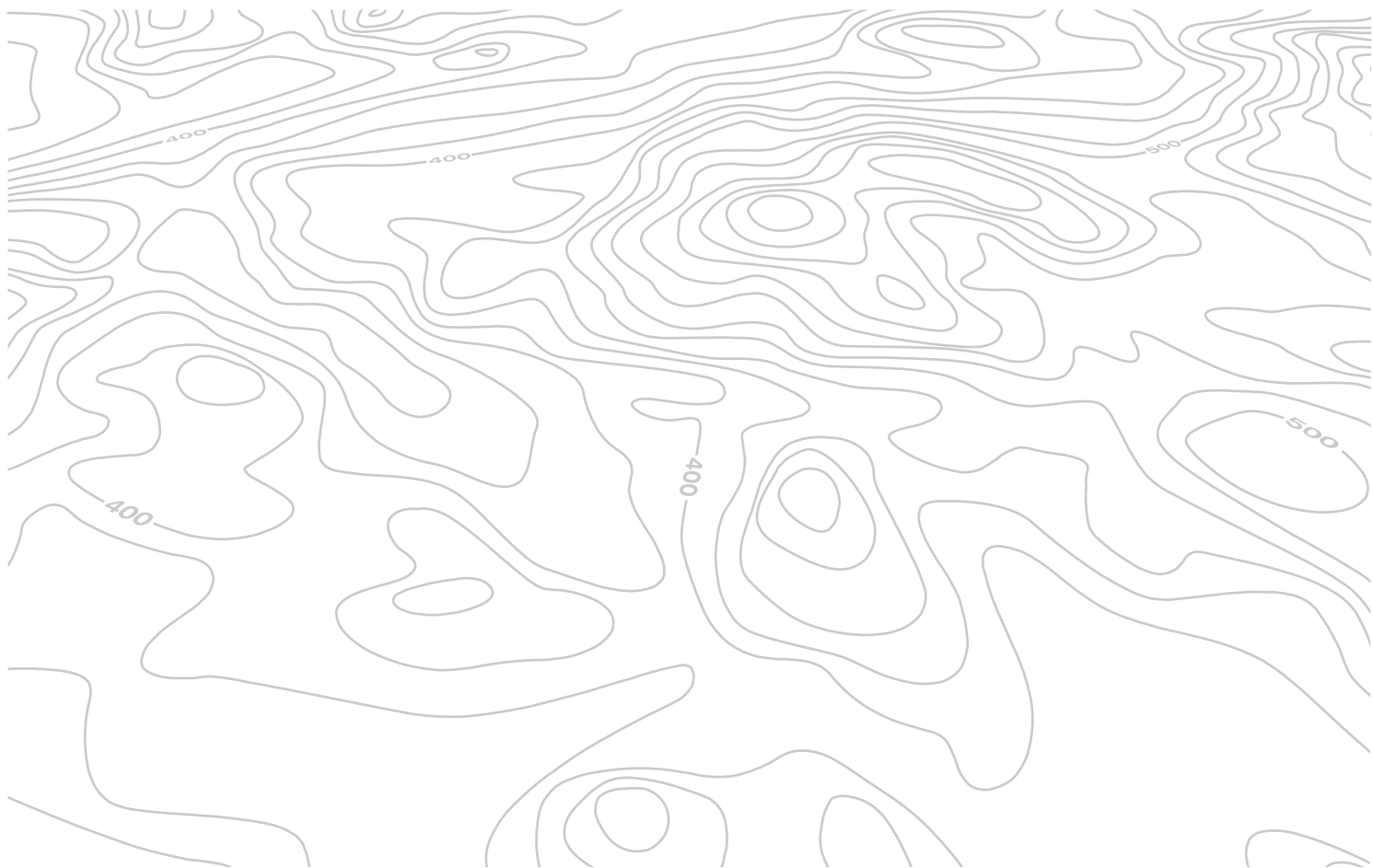



PEUGEOT Connect Sound (Rd5)

Audio system / Bluetooth®



Your PEUGEOT Connect Sound (RD5) is coded in such a way that it will only operate in your vehicle.



For safety reasons, the driver must only carry out operations which require prolonged attention while the vehicle is stationary.

When the engine is switched off and to prevent discharging of the battery, the audio equipment may switch off after a few minutes.

CONTENTS

01	First steps	p.	260
02	Steering mounted controls	p.	261
03	Main menu	p.	262
04	Audio	p.	263
05	PEUGEOT Connect USB	p.	267
06	Bluetooth	p.	270
07	Screen menu map(s)	p.	273
	Frequently asked questions	p.	276

01 FIRST STEPS

Select source:
radio, audio CD / MP3 CD, USB,
j ack connection, Streaming,
AUX.

Selection of FM / DAB /
AM* wavebands.

Audio settings: front/
rear fader, left/right
balance, bass/treble,
loudness, audio
ambiences.

Display the list of
local stations.
Long press: CD
tracks or MP3
folders (CD / USB).

Abandon the current
operation.

Eject CD.

Select the screen display
mode:
Date, audio functions, trip
computer, telephone.

On/off, volume setting.

The DARK button changes the screen display
for improved driving comfort at night.
1st press: upper bar only illuminated.
2nd press: black screen.
3rd press: return to standard display.

* Depending on model.



TA (Traffic Announcements)
on/off.
Long press: PTY* (radio
Programme Type) mode.

Automatic frequency search
down/up.
Select previous/next CD, MP3
or USB track.

Confirm.

Buttons 1 to 6:
Select a pre-set radio station.
Long press: pre-set a station.

Display main menu.

Select next frequency down/up.
Select previous/next MP3 folder.
Select previous/next folder / genre /
artist / playlist (USB).

* Available according to version.

02 STEERING MOUNTED CONTROLS

Radio: automatic search for a higher frequency.
CD / MP3 / USB: selection of the next track.
CD / USB: continuous press: fast forwards play.
Move in the list.



Change audio source.
Confirm a selection.
Call/end call on the telephone.
Press for more than 2 seconds:
telephone main menu.

Radio: select the previous/next pre-set
station.
USB: select genre / artist / folder from the
classification list.
Select the previous/next item in a menu.

Radio: automatic search for a lower
frequency.
CD / MP3 / USB: selection of the
previous track.
CD / USB: continuous press: fast
reverse.
Move in the list.



Volume increase.

Volume decrease.

Mute: press the volume
increase and decrease
buttons simultaneously.
The sound is restored
by pressing one of the
two volume buttons.

03 MAIN MENU

Screen C

AUDIO FUNCTIONS:
radio, CD, USB, options.

TELEPHONE:
hands-free kit, pairing,
management of a call.

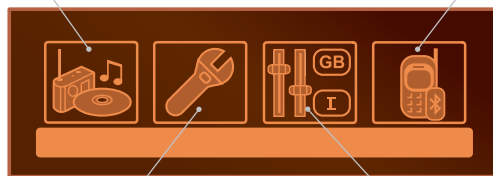

VEHICLE dIAGNOSTICS:
alert log.

**PERSONALISATION-
CONFIGURATION:**
vehicle parameters,
display, languages.









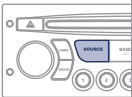

For a detailed global view of the menus available, refer to "Screen menu map" in this section.

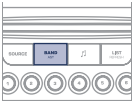
04 AUdIO

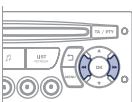

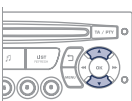

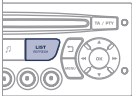



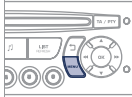

Radio Selecting a station

1	 Press the SOURCE button several times in succession and select the radio.	
2	 Press the BAND AST button to select a waveband: FM1, FM2, FMast, AM.	
3	 Briefly press one of the buttons to carry out an automatic search of the radio stations.	
4	 Press one of the buttons to carry out a manual search up / down for radio frequencies.	
	 Press the LIST REFRESH button to display the list of stations received locally (30 stations maximum). To update this list, press for more than two seconds.	

The external environment (hills, buildings, tunnels, basement car parks, ...) may block reception, including in RDS mode. This is a normal effect of the way in which radio waves are transmitted and does not indicate any failure of the audio system.

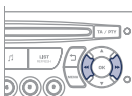
RdS

1	 Press the MENU button.	
2	 Select AUDIO FUNCTIONS then press OK.	
3	 Select the FM WAVEBAND PREFERENCES function then press OK.	
4	 Select ACTIVATE RDS then press OK. RDS appears on the screen.	
	In radio mode, press OK directly to activate / deactivate RDS mode.	
	The RDS, if displayed, enables you to continue listening to the same station by automatic retuning to alternative frequencies. However, in certain conditions, coverage of an RDS station may not be assured throughout the country as radio stations do not cover 100 % of the territory. Under conditions of very weak reception, the system may change to a regional station.	

04 AUdIO

Receiving TA messages

! The TA (Traffic Announcement) function gives priority to TA alert messages. To operate, this function needs good reception of a radio station transmitting this type of message. When a traffic report is transmitted, the current audio source (Radio, CD, ...) is interrupted automatically to play the TA message. Normal playback of the audio source resumes at the end of the transmission of the message.

1  Press the TA button to activate or deactivate traffic messages.

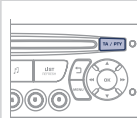

dAB (digital Audio Broadcasting) digital radio

i Digital radio provides a superior audio quality and also additional categories of traffic announcements (TA INFO). The different "multiplex services" offer a choice of radio stations in alphabetical order.



Change band (FM1, FM2, DAB, ...).



Change of station within the same "multiplex service".



Start a search for the next "multiplex service".



Long press: select the desired categories of announcements from Transport, News, Entertainment and Flash special (availability according to the station).



When the radio station is displayed in the screen, press on "OK" to display the contextual menu.
(Frequency hopping (RDS), DAB / FM auto tracking, RadioText (Tx T) display, Information on the station, ...)

04 AUdIO

digital radio - dAB / FM tracking

i "DAB" does not have 100% coverage of the country. When the digital signal is weak, "DAB / FM auto tracking" allows you to continue listening to the same station, by automatically switching to the corresponding analogue "FM" station (if it exists).

1  Press the **"Menu"** button.

2  Select **"Multimedia"** and confirm.

3  Select **"dAB / FM auto tracking"** and confirm

i If "DAB / FM auto tracking" is on, there will be a difference of a few seconds in the programme when the system changes to analogue "FM" radio, with sometimes a variation in volume. When the strength of the digital signal is good again, the system automatically switches back to "DAB"

! If the "DAB" station you are listening to is not available on "FM" ("dAB/FM" option barred), or if "DAB / FM auto tracking" is not on, the sound will be cut when the digital signal is too weak.

Cd Playing a Cd

! Insert circular compact discs only. Some anti-pirating systems, on original discs or CDs copied using a personal recorder, may cause faults which are no reflection on the quality of the vehicle's player. Without pressing the EJECT button, insert a CD in the player, play begins automatically.

1  To play a disc which has already been inserted, press the SOURCE button several times in succession and select CD.

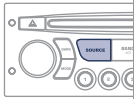

2  Press one of the buttons to select a track on the CD.

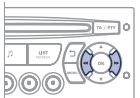

! Press the LIST REFRESH button to display the list of tracks on the CD.

3  Press and hold one of the buttons for fast forwards or fast backwards.

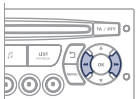

04 AUdIO

MP3 Cd Playing an MP3 compilation



Insert an MP3 compilation in the player.

The audio equipment searches for all of the music tracks, which may take anything between a few seconds and several tens of seconds, before play begins.



On a single disc, the CD player can read up to 255 MP3 files spread over 8 folder levels. However, it is advisable to keep to a limit of two levels to reduce the access time before the CD is played.

While the CD is being played, the folder structure is not followed. All of the files are displayed on a single level.

1



To play a disc which has already been inserted, press the SOURCE button several times in succession and select CD.

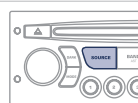

2



Press one of the buttons to select a folder on the CD.

Press one of the buttons to select a track on the CD.

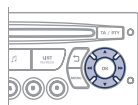

Press the LIST REFRESH button to display the list of directories of the MP3 compilation.

3



Press and hold one of the buttons for fast forward or backward play.

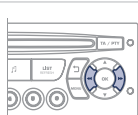

MP3 Cd Information and advice



The MP3 format, an abbreviation of MPEG 1.2 & 2.5 Audio Layer 3, is an audio compression standard which permits the recording of several tens of music files on a single disc.



In order to be able to play a recorded CDR or CDRW, when recording, the ISO 9660 level 1.2 or Joliet file format is recommended.

If the disc is recorded in another format, it may not be played correctly.

It is recommended that the same recording format is always used for an individual disc, with as low a speed as possible (4x maximum) for optimum sound quality.

In the particular case of a multi-session CD, the joliet format is recommended.



The audio system will only play files with the extension ".mp3" with a sampling rate of 22.05 KHz or 44.1 KHz. No other type of file (.wma, .mp4, .m3u...) can be played.



It is advisable to restrict file names to 20 characters without using special characters (e.g. " ? ; ù) to avoid any playing or displaying problems.



Empty CDs are not recognised and may damage the system.

05 PEUGEOT CONNECT USB

Using the PEUGEOT CONNECT USB

1

This unit consists of a USB port and an auxiliary Jack socket*. The audio files are transmitted from a portable device - digital player or a USB memory stick - to your PEUGEOT Connect Sound (RD5) and heard via the vehicle's speakers.



2

USB memory stick or Apple® player of generation 5 or later:

- Use only USB memory sticks formatted FAT32 (File Allocation Table),
- the Apple® player lead is essential,
- navigation through the file database is also possible by means of the steering mounted controls.



3

Other Apple® players of earlier generations and players using the MTP protocol*:

- play via jack-jack lead only (not supplied),
- navigation through the file database is from the portable device.



Connecting a USB memory stick

1

Connect the memory stick to the port, directly or using a lead. If the audio equipment is switched on, the USB source is detected as soon as it is connected. Play begins automatically after a delay which depends on the capacity of the USB memory stick.



The file formats supported are .mp3 (mpeg1 layer 3 only) and .wma (standard 9 only, 128 kbits/sec compression).

Certain playlist formats are supported (.m3u, ...)

On reconnection of the previous memory stick used, play is resumed automatically with the last track played.

!

The system puts together playlists (temporary memory) created over a period which depends on the capacity of the USB device. The other sources are available during this time.

The playlists are updated each time the ignition is switched off or each time a USB memory stick is connected.

When connecting for the first time, the classification suggested is by folder. When you reconnect, the classification selected previously is retained.

* Depending on vehicle.

05 PEUGEOT CONNECT USB

Using the PEUGEOT CONNECT USB

2

Press and hold LIST to display the different classifications.
Select by Folder / Artist / Genre / Playlist, press OK to select the classification required, then press OK again to confirm.



- by Folder: all folders containing audio files recognised on the peripheral device.
- by Artist: all of the artist names defined in the ID3 Tags, classified in alphabetical order.
- by Genre: all of the genres defined in the ID3 Tags.
- by Playlist: in accordance with the playlists recorded on the USB device.

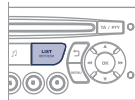

Press LIST briefly to display the previously selected classification.
Navigate through the list using the left/right and up/down buttons.
Confirm the selection by pressing OK.

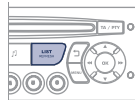

3



Press one of these buttons to gain access to the previous / next track on the classification list currently being played.
Press and hold one of the buttons for fast forward or backward play.

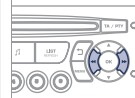

4



Press one of these buttons to gain access to the previous / next Genre, Folder, Artist or Playlist on the classification list currently being played.

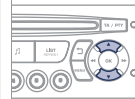

Connecting an Apple® player via the USB port

1

The lists available are Artist, Genre and Playlist (as defined in the Apple® player).
Selection and Navigation are described in steps 1 to 4 above.



Do not connect a hard disk or USB connection device other than audio equipment to the USB port. This could damage your installation.

05 PEUGEOT CONNECT USB

Using the auxiliary input (AUX)

j ACK socket or USB port (according to vehicle)



The auxiliary input, j ACK or USB, allows the connection of a portable device (MP3 player...).



Do not connect a device to both the j ACK socket and the USB port at the same time.

1

Connect the portable device (MP3 player...) to the j ACK socket or to the USB port, using a suitable cable (not supplied).



2



Press the SOURCE button several times in succession and select AUx.

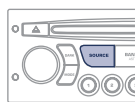

Adjusting the volume of the auxiliary source

1

First adjust the volume of your portable device.



2



Then adjust the volume of your audio system.

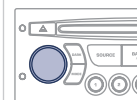

The display and control is via the portable device.



06 BLUETOOTH



Bluetooth telephone

Screen C

(Available according to model and version)

The services offered depend on the network, the SIM card and the compatibility of the Bluetooth equipment used.

Consult your telephone's manual and your operator to find out which services are available to you.

Pairing a telephone / First connection



!

For safety reasons and because they require prolonged attention on the part of the driver, the operations for pairing of the Bluetooth mobile telephone with the Bluetooth hands-free system of your audio equipment must be carried out with the vehicle stationary and the ignition on.



Go to www.peugeot.co.uk for more information (compatibility, more help, ...).

1

Activate the telephone's Bluetooth function and ensure that it is "visible to all" (telephone configuration).



2



Press the MENU button.

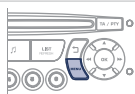

3



In the menu, select:

- Bluetooth telephone function - Audio
- Bluetooth configuration
- Perform a Bluetooth search

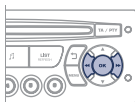

4

A window is displayed with a message that a search is in progress.

5

The first 4 telephones recognised are displayed in this window.

!

The TELEPHONE menu permits access to the following functions in particular: Directory*, Call list, Pairing management.

* If your telephone is fully compatible.

6

Select the telephone to be connected from the list. Only one telephone can be connected at a time.

7

A virtual keypad is displayed in the screen: enter a code with at least 4 digits. Confirm by pressing OK.



8

A message is displayed in the screen of the telephone chosen. To accept the pairing, enter the same code on the telephone, then confirm with OK.

If pairing fails, the number of attempts is not limited.



9

A message that the pairing has been successful appears in the screen.

i

The automatic connection authorised is only active after the telephone has been configured.

The directory and the call list can be accessed after the synchronisation period.

06 BLUETOOTH



Receiving a call

- 1 An incoming call is announced by a ring and a superimposed display in the vehicle's screen.

- 2  Select the YES tab on the display using the buttons and confirm by pressing OK.

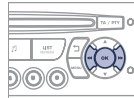

Press this button to accept the call.

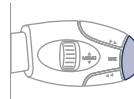

Making a call

- 1 From the Bluetooth telephone function Audio menu, select Manage the telephone call then Call, Call list or Directory.

- 2 Press this button for more than two seconds for access to your directory, then navigate with the thumb wheel.
Or
To dial a number, use your telephone's keypad, with the vehicle stationary.

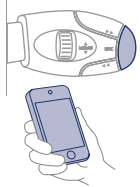

The system accesses the telephone's contacts directory, depending on compatibility, and while the Bluetooth connection with it is maintained.



With certain telephones connected by Bluetooth you can send a contact to the directory of the audio system. Contacts imported in this way are saved in a permanent directory visible to all, whatever the telephone connected. The menu for the directory is not accessible if it is empty.

06 BLUETOOTH



Ending a call

1

During a call, press this button for more than 2 seconds.
Confirm with OK to end the call.

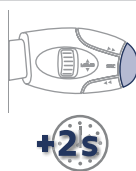

Bluetooth audio streaming*

!

Wireless transmission of music files on the telephone, played via the audio equipment. The telephone must be able to manage the appropriate Bluetooth profiles (Profiles A2DP / AVRCP).

1

Initiate the pairing between the telephone and the vehicle. This pairing can be initiated from the vehicle's telephone function menu or via the telephone's keypad. Refer to the steps in "Pairing a telephone" on the previous pages. During the pairing phase, the vehicle must be stationary with the key in the ignition.



2

Select the telephone to be connected from the telephone function menu.

The audio system connects to a newly paired telephone automatically.

3



Activate the streaming source by pressing the SOURCE button**. The tracks to be played can be controlled as usual via the buttons on the audio system control panel and the steering mounted controls***. The contextual information can be displayed on the screen.

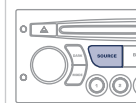

* Depending on the compatibility of the telephone.

** In certain cases, playing of the Audio files must be initiated from the keypad.

*** If the telephone supports the function.

07 SCREEN MENU MAP(S)



Screen C



Press the OK dial for access to short-cut menus according to the display in the screen:

OK

RAdIO

- 1 activate / deactivate RdS
- 1 activate / deactivate REG mode
- 1 activate / deactivate radiotext

Cd / MP3 Cd

- 1 activate / deactivate Intro
- 1 activate / deactivate track repeat (the entire current Cd for Cd, the entire current folder for MP3 Cd)
- 1 activate / deactivate random play (the entire current Cd for Cd, the entire current folder for MP3 Cd)

USB

- 1 activate / deactivate track repeat (of the current folder / artist / genre / playlist)
- 1 activate / deactivate random play (of the current folder / artist / genre / playlist)

07 SCREEN MENU MAP(S)



Screen C



Pressing the MENU button displays:



1 Audio functions

2 FM waveband settings

3 Alternative frequencies (RDS)

4 activate / deactivate

3 Regional mode (REG)

4 activate / deactivate

3 Radio-text information (RDTxT)

4 activate / deactivate

2 Play modes

3 Album repeat (RPT)

4 activate / deactivate

3 Track random play (RDM)

4 activate / deactivate



1 Vehicle diagnostics

2 Alert log

07 SCREEN MENU MAP(S)



1 Personalisation-Configuration

- 2 **Define the vehicle settings***
- 2 **Display configuration**
 - 3 Video brightness adjustment
 - 4 normal video
 - 4 inverse video
 - 4 brightness (- +) adjustment
 - 3 Date and time adjustment
 - 4 day/month/year adjustment
 - 4 hour/minute adjustment
 - 4 choice of 12 h / 24 h mode
 - 3 Choice of units
 - 4 l/100 km - mpg - km/l
 - 4 °Celsius / °Fahrenheit
 - 2 **Choice of language**



1 Bluetooth telephone

- 2 **Bluetooth configuration**
 - 3 Connect/Disconnect an equipment
 - 3 Telephone function
 - 3 Audio Streaming function
 - 4 Consult the paired equipment
 - 4 Delete a paired equipment
 - 4 Perform a Bluetooth search
- 2 **Call**
 - 3 Calls list
 - 4 Directory
- 2 **Manage the telephone call**
 - 3 Terminate the current call
 - 3 Activate secret mode

* The parameters vary according to vehicle.

FREQUENTLY ASKED QUESTIONS

QUESTION	ANSWER	SOLUTION
<p>There is a difference in sound quality between the different audio sources (radio, CD...).</p>	<p>For optimum sound quality, the audio settings (Volume, Bass, Treble, Ambience, Loudness) can be adapted to the different sound sources, which may result in audible differences when changing source (radio, CD...).</p>	<p>Check that the audio settings (Volume, Bass, Treble, Ambience, Loudness) are adapted to the sources listened to. It is advisable to set the AUDIO functions (Bass, Treble, Front-Rear Balance, Left-Right Balance) to the middle position, select the musical ambience "None" and set the loudness correction to the "Active" position in CD mode or to the "Inactive" position in radio mode.</p>
<p>The CD is ejected automatically or is not played by the player.</p>	<p>The CD is inserted upside down, is unplayable, does not contain any audio data or contains an audio format which the player cannot play. The CD is protected by an anti-pirating protection system which is not recognised by the audio equipment.</p>	<ul style="list-style-type: none"> - Check that the CD is inserted in the player the right way up. - Check the condition of the CD: the CD cannot be played if it is too damaged. - Check the content in the case of a recorded CD: consult the advice in the "Audio" section. - The audio equipment's CD player does not play DVDs. - Due to their quality level, certain writeable CDs will not be played by the audio system.
<p>The message "USB peripheral error" is displayed on the screen. The Bluetooth connection is cut.</p>	<p>The battery of the peripheral may not be sufficiently charged.</p>	<p>Recharge the battery of the peripheral device.</p>
	<p>The USB memory stick is not recognised. The memory stick may be corrupt.</p>	<p>Reformat the memory stick.</p>

FREQUENTLY ASKEd QUESTIONS

QUESTION	ANSWER	SOLUTION
I am unable to access my voicemail.	Few telephones or service providers allow the use of this function.	
The CD player sound is poor.	The CD used is scratched or of poor quality.	Insert good quality CDs and store them in suitable conditions.
	The audio equipment settings (bass, treble, ambiances) are unsuitable.	Set the treble or bass level to 0, without selecting an ambience.
The stored stations do not function (no sound, 87.5 Mhz is displayed...).	An incorrect waveband is selected.	Press the BAND AST button to return to the waveband (AM, FM1, FM2, FMAST) on which the stations are stored.
The traffic announcement (TA) is displayed. I do not receive any traffic information.	The radio station is not part of the regional traffic information network.	Tune to a radio station which broadcasts traffic information.
The quality of reception of the radio station listened to gradually deteriorates or the stored stations do not function (no sound, 87.5 Mhz is displayed...).	The vehicle is too far from the transmitter used by the station listened to or there is no transmitter in the geographical area through which the vehicle is travelling.	Activate the RDS function to enable the system to check whether there is a more powerful transmitter in the geographical area.
	The environment (hills, buildings, tunnels, basement car parks...) block reception, including in RDS mode.	This phenomenon is normal and does not indicate a failure of the audio equipment.
	The aerial is absent or has been damaged (for example when going through an automatic car wash or into an underground car park).	Have the aerial checked by a PEUGEOT dealer.

FREQUENTLY ASKEd QUESTIONS

QUESTION	ANSWER	SOLUTION
Sound cut-outs of 1 to 2 seconds in radio mode.	During this brief sound cut-out, the RDS searches for another frequency giving better reception of the station.	Deactivate the RDS function if the phenomenon is too frequent and always on the same route.
With the engine off, the audio equipment switches off after a few minutes of use.	When the engine is switched off, the audio equipment operating time depends on the battery charge. The switch-off is normal: the audio equipment switches to economy mode and switches off to prevent discharging of the vehicle's battery.	Start the vehicle's engine to increase the battery charge.
The message "the audio system is overheated" appears on the display.	In order to protect the installation if the surrounding temperature is too high, the audio equipment switches to an automatic thermal protection mode leading to a reduction of the volume or stopping of the playing of the CD.	Switch the audio system off for a few minutes to allow the system to cool.

ALPHABETICAL INDEX

A/ ABS and EBD systems.....	89
Accessories	190
Accessory socket, 12V	69
Access to rear seats.....	58
Active bonnet.....	92
Adjusting headlamps.....	81
Adjusting the steering wheel	54
Advice on driving	115
Airbags	99
Airbags, front.....	100, 103
Airbags, lateral.....	101, 103
Air conditioning.....	10
Air conditioning, digital	60, 61
Air filter	148
Air flow.....	59, 62
Air vents.....	59
Alarm	41
Alert / warning log.....	34
Alloy wheels.....	189
Anti-lock braking system (ABS).....	89
Anti-pinch.....	44
Anti-theft	118
Arches, aluminium	188
Armrest, front.....	70
Ashtray	69
Assistance call.....	88, 201, 202
Audible warning.....	88
Audio streaming (Bluetooth)	244, 272
Audio systems	203, 259

A/ Automatic illumination of headlamps	76, 79
Automatic operation of hazard warning lamps.....	87
Automatic rain sensitive windscreen wipers	83, 85
Auxiliary sockets.....	71, 245, 267, 269

B/ Battery	148, 165-167
Battery, charging.....	167
Battery, remote control	39, 40
Bluetooth (hands-free)	226, 270
Bluetooth (telephone).....	226, 270
Bodywork.....	188
Bonnet	141
Boot	33, 49
Boot lamp	74
Brake discs.....	149
Brake lamps.....	172, 175
Brake pads	149
Braking assistance system.....	89

C/ Capacity, fuel tank	139
CD MP3	241, 266
Central locking.....	38, 47
Changing a bulb	169-176
Changing a fuse	177-183
Changing a wheel.....	157-161
Changing a wiper blade.....	86, 163
Changing the remote control battery.....	39
Changing the time	26, 33, 35
CHECK	25
Checking levels	145-147
Checking the engine oil level.....	21, 145
Checking tyre pressures (using the kit)	156
Checks.....	142-149
Children	98, 100, 104-114
Child seats	104, 105, 109-114
Child seats, ISOFix	112
Cleaning (advice).....	188
Clock.....	26
Closing the boot.....	38, 49
Closing the doors.....	38, 46
Colour screen, retractable	34, 36
Connectors, audio	71, 245, 267, 269
Coolant level.....	21, 147
Coolant temperature indicator	21
Cruise control	132
Customising stickers.....	188
Cup holder	67

ALPHABETICAL INDEX

d/	DAB (Digital Audio Broadcasting).....	238, 239, 264, 265
	Date (setting).....	33, 35
	Daytime running lamps.....	78, 170, 171
	Deactivating ESP.....	91
	Deactivating the passenger airbag.....	100
	Deadlocking.....	38
	Demisting-Defrosting.....	63
	Dials and gauges.....	12
	Diesel additive level.....	147
	Diesel engine pre-heat warning lamp.....	19
	Dimensions.....	197
	Dipped beam.....	75, 170, 171
	Dipstick.....	21, 145
	Directional lighting.....	82
	Direction indicators.....	87, 170, 172, 175
	Doors.....	46
	Doors emergency control.....	48
	Door pockets.....	67
	Driving economically.....	10
	Driving positions (storing).....	53
	Dynamic stability control (DSC).....	17, 90

E/	EBA (Emergency braking assistance).....	89
-----------	---	----

E/	Eco-driving.....	10
	Economy mode.....	164
	Electric window controls.....	44
	Electronic brake force distribution (EBFD).....	89
	Electronic engine immobiliser.....	40, 118
	Electronic stability control (ESC).....	90
	Emergency braking system.....	89
	Emergency call.....	88, 201, 202
	Emergency warning lamps.....	87
	Energy economy mode.....	164
	Engine compartment.....	142, 143
	Engine compartment fusebox.....	181
	Engine, Diesel.....	19, 140, 143, 144, 195
	Engine oil level indicator.....	21, 145
	Engine, petrol.....	140, 142, 192
	Engines.....	192, 195
	Environment.....	10, 40, 60, 63, 125, 147, 165
	Equipment settings.....	30, 34
	ESC/ASR.....	90

F/	Filling with fuel.....	139, 140
	Fitting a wheel.....	159
	Fittings, boot.....	73
	Flashing indicators.....	87

F/	Front seats.....	50, 51
	Fuel.....	10, 140
	Fuel consumption.....	10
	Fuel filler flap.....	139
	Fuel gauge.....	12, 139
	Fuel tank.....	139
	Fusebox, dashboard.....	179
	Fuses.....	177

G/	Gearbox, automatic.....	10, 122, 149
	Gearbox, manual.....	10, 121, 149
	Gear lever, automatic gearbox.....	122
	Gear lever, manual gearbox.....	121
	Gear shift indicator.....	126
	Glove box.....	68
	G.P.S.....	209
	Guide-me-home.....	79, 80

H/	Halogen headlamps.....	169
	Hands-free kit.....	226, 270
	Hazard warning lamps.....	87
	Headlamp adjustment.....	81
	Headlamps, directional.....	82, 170
	Headlamp wash.....	84
	Headlamp wash reservoir.....	147
	Head rests, rear.....	58

ALPHABETICAL INDEX

H/	Heated seats	52
	Heating	61
	Height and reach adjustment, steering wheel.....	54
	Hill start assist	120
	Horn.....	88

I/	Identification plates.....	199
	Ignition	118
	Indicators, direction	87
	Inflating accessories (using the kit)	156
	Inflating tyres	10, 199
	Inputs for audio system	71, 245, 267, 269
	Instrument panel lighting	26
	Instrument panels	12, 25
	Instrument panel screen	12, 126
	Intelligent Traction Control	90
	Interior finish	188
	Interior fittings	67
	Interior lamp.....	64
	Interior mood lighting.....	65
	ISOFix	111-113
	ISOFix mountings	111

J/	j ACK socket.....	71, 245, 267, 269
-----------	-------------------	-------------------

K/	Keeping children safe	98, 100, 104-114
	Key in ignition warning.....	118
	Key with remote control.....	37-40, 118

L/	Labels, identification	199
	Lamps, front.....	169, 188
	Lamps, rear	172, 175, 188
	Lamps, warning and indicator.....	14-20
	LED daytime running lamps	78
	Level, brake fluid	146
	Level, headlamp wash.....	84, 147
	Level, power steering fluid.....	146
	Levels and checks	142-149
	Lighting bulbs (replacement)	169-176
	Lighting control stalk.....	75
	Lighting dimmer	26
	Lighting, guide-me home	79, 80
	Lighting, interior	64, 65
	Lighting on reminder.....	77
	Loading	10
	Load reduction mode.....	164
	Locating your vehicle.....	39
	Locking from the inside.....	47
	Locking the boot	49
	Low fuel level.....	16, 139

M/	Main beam.....	75, 170, 171
	Maintenance	10
	Maintenance (advice)	188
	Map reading lamps	64
	Markings, identification.....	199
	Mat	72
	Menu, main.....	262
	Mirror, rear view.....	57
	Mirrors, door	55, 56
	Motorway function (direction indicators)	87
	Mountings for ISOFix seats	111
	MP3 CD.....	241, 266
	Music media players.....	240, 265

N/	Navigation.....	209
	Number plate lamps	176

O/	Oil filter	148
	Oil level.....	21, 145
	Opening the bonnet.....	141
	Opening the boot	37, 49
	Opening the doors.....	37, 46, 48
	Opening the fuel filler flap.....	139
	Opening the retractable screen	36
	Operation indicator lamps.....	14-20

ALPHABETICAL INDEX

P/	Paint colour code.....	199
	Paintwork, matt.....	189
	Parking brake.....	119, 149
	Parking sensors, front.....	136
	Parking sensors, rear.....	135
	Particle filter.....	147, 148
	Passenger compartment filter.....	148
	PEUGEOT Connect Assistance.....	202
	PEUGEOT Connect Navigation (RT6).....	34, 203
	PEUGEOT Connect SOS.....	202
	PEUGEOT Connect Sound (RD5).....	30, 259
	Player, CD MP3.....	241, 266
	Port, USB.....	71, 245, 267, 269
	Preheater, Diesel.....	19
	Priming the fuel system.....	144
	Protecting children.....	98, 100, 104-114
	Puncture.....	150

R/	Radio.....	235, 236, 263
	Rear foglamp.....	77, 172, 175
	Rear screen (demisting).....	63
	Recharging the battery.....	167
	Reduction of electrical load.....	164
	Regeneration of the particle filter.....	148
	Reinitialising the electric windows.....	44
	Reinitialising the remote control.....	39

R/	Remote control.....	37-40
	Removing a wheel.....	158
	Removing the mat.....	72
	Repair kit, puncture.....	150
	Replacing bulbs.....	169-176
	Replacing fuses.....	177-183
	Replacing the air filter.....	148
	Replacing the oil filter.....	148
	Replacing the passenger compartment filter.....	148
	Replacing wiper blades.....	86, 163
	Resetting the service indicator.....	24
	Resetting the trip recorder.....	25
	Rev counter.....	12
	Reversing lamps.....	172, 175
	Risk areas (update).....	214
	Routine checks.....	142-149
	Running out of fuel (Diesel).....	144

S/	Screen, colour and mapping....	207, 248
	Screen menu map.....	248, 273
	Screen, monochrome.....	262
	Screen, multifunction (with audio equipment).....	30, 34, 36
	Screenwash fluid level.....	84, 147
	Screenwash, front.....	84
	Screen-wash reservoir.....	147
	Seat adjustment.....	50, 51
	Seat belts.....	17, 96, 98
	Seats, electric.....	51, 53

S/	Seats, rear.....	58
	Serial number, vehicle.....	199
	Service indicator.....	23
	Service warning lamp.....	16
	Servicing.....	10
	Setting the clock.....	26, 33, 35
	Short-cut menus.....	208
	Sidelamps.....	75, 78, 170-172, 175
	Side repeater.....	171
	Snow chains.....	162
	Spare wheel.....	127, 160
	Speed limiter.....	129
	Speedometer.....	12
	Spoiler, active.....	93
	Starting the engine.....	116
	Starting using another battery.....	166
	Steering mounted controls, audio.....	206, 261
	Stickers, customising.....	188
	Storage.....	67, 70, 73
	Storing driving positions.....	53
	Stowing rings.....	73
	Sun visor.....	68
	Switching off the engine.....	116
	Synchronising the remote control.....	39
	Synthesiser, voice.....	220
	System, navigation.....	209

ALPHABETICAL INDEX

T/	Table of weights.....	192, 195
	Tables of engines.....	193, 196
	Tables of fuses.....	177
	Tank, fuel.....	139
	Technical data.....	192-199
	Telephone.....	226, 270
	Temperature control for heated seats.....	52
	Temperature, coolant.....	21
	Temporary puncture repair kit.....	150
	Third brake lamp.....	172, 176
	TMC (Traffic info).....	223
	Tools.....	157, 160
	Total distance recorder.....	25
	Towbar.....	186
	Towed loads.....	193, 196
	Towing another vehicle.....	184
	Traction control (ASR).....	17, 90
	Traffic information (TA).....	224, 237, 264
	Traffic information (TMC).....	223, 224
	Trajectory control systems.....	90
	Trip computer.....	27, 29
	Trip distance recorder.....	25
	Tyre pressures.....	199
	Tyres.....	10
	Tyre under-inflation detection.....	127

U/	Under floor storage.....	74
	Under-inflation (detection).....	127
	Unlocking.....	37
	Unlocking from the inside.....	47
	Unlocking the boot.....	37, 49
	Update risk areas.....	214
	Updating the time.....	26, 33, 35
	USB (PEUGEOT Connect).....	71, 245, 267

V/	Vanity mirror.....	68
	Vehicle configuration.....	30, 34
	Vehicle diagnosis.....	30
	Vehicle identification.....	199
	Ventilation.....	59, 60, 62

W/	Warning lamps.....	14-20
	Washing (advice).....	188
	Weights.....	193, 196
	Welcome lighting.....	65, 66
	Window controls.....	44
	Wiper control stalk.....	83, 85
	Wipers.....	83, 85

X/	Xenon headlamps.....	170
-----------	----------------------	-----

Labels are fitted in various areas of your vehicle. They carry safety warnings as well as vehicle identification information. Do not remove them: they form an integral part of your vehicle.

Automobiles PEUGEOT declares, by application of the provisions of the European regulation (Directive 2000/53) relating to End of Life Vehicles, that it achieves the objectives set by this regulation and that recycled materials are used in the manufacture of the products that it sells.

Reproduction or translation of all or part of this document is prohibited without written authorisation from Automobiles PEUGEOT.

Printed in the EU
Anglais

01-15

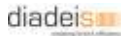

PEUGEOT

Automobiles PEUGEOT - Siège Social : 75, avenue de la Grande-Armée 75016 PARIS
Tél. 33 (0)1 40 66 55 11 - Fax 33 (0)1 40 66 54 14

Adresse postale : Automobiles PEUGEOT B.P. 01 75761 PARIS cedex 16 - Adresse Internet : <http://www.peugeot.com>

Société Anonyme au capital de 172 711 770 Euros - R.C.S. PARIS B 552 144 503. SIRET 552 144 503 00018. APE 341 Z

