



# Integrated Fixture Control Solutions



9:41

< Add Event X

Event Date Type Day of Week

Exceptions Holiday List 1

Event Time Type Astro

Astro Offset SR+ 00:30

Light Action On

Group All

Level 100%

Duration 1 Seconds

Behavior Auto On

Group Occupancy Zone 1

Repeat Event

Repeat Number 3

Repeat Period 1:00



# Controlling Next Generation Lighting

Offering customers a complete end-to-end professional lighting and wireless control solution

---

Streamlined solution that allows greater freedom of design in almost any space

---

Professional smart lighting control based on wireless technology

---

Select the integrated controls that best fits your needs—choose from a simple standalone sensor like **Solo** or for more advanced lighting control strategies, use **Intellect Wireless**











## Solo

Solo delivers a simple to install introduction to integrated fixture controls. When you need a straightforward solution for dimming, occupancy sensing and basic daylighting applications, choose Solo. Solo sensors are easily configured using traditional dip switches or an optional IR remote control programmer for multi-level lighting control.

### Easy Specification and Design

- Each fixture integrates a sensor for independent fixture control
- No additional gateway or hub needed
- No sensor layout required

### Easy Installation and Operation

- Out-of-the-box operation
- No commissioning required

### Easy Energy Savings

- Solo offers a self-contained solution that can be used to comply with IECC, ASHRAE 90.1 and 2019 Title 24, Part 6 occupancy sensing requirements

Comparison		
	Solo	Intellect Wireless
<b>Basic</b>		
Switching	Yes	Yes
Dimming	0-10V	0-10V
Daylight Harvesting	Yes	Yes
Technology	PIR	PIR
Power	12-24VDC	120-277V
Poles	1	1
Direct to Driver	Yes	-
<b>Configuration</b>		
Configuration Tool	Dip Switches or IR Remote	Phone/Tablet
Occupancy	Auto-ON	Configurable
Adjustable Sensitivity	Yes	Yes
Adjustable Delay Time	Yes	Yes
Adjustable Daylight Target	Yes	Yes
<b>Features</b>		
IP Rating	IP20	IP20
Partial-ON	-	Yes
Partial-OFF	Yes	Yes
Scheduling	-	Yes
Grouping	-	Yes
Scene Control	-	Yes
Projects	-	Yes
Security	-	Yes
System Load Shed	-	Yes



## Intellect Wireless

When you need more advanced lighting control strategies, turn to Intellect Wireless. Engineered to simplify energy management and code compliance, controls are integrated into the fixtures and paired with a GreenMAX DRC Keypad Room Controller. All configurable with the GreenMAX DRC App. Virtually any fixture can be Intellect-enabled.

### Easy Specification, Layout and Design

- Each Intellect-enabled fixture integrates a sensor or controller which wirelessly communicates with the Keypad Room Controller and other Intellect devices within the space
- No separate controls layout required
- No additional gateway or hub needed

### Easy Installation

- Plug and play operation
- Ladderless commissioning with the GreenMAX DRC App—the only setup tool needed

### Easy Operation

- Configure, monitor and control the system from an Android or iOS smart device with the GreenMAX DRC App
- Every fixture is controllable and not tied to physical zoning
- Highly robust, fully secure, self-healing, mesh network
- Easily program the Keypad Room Controller to meet the lighting needs of any space

### Easy Energy Savings

- Intellect Wireless fixtures offer out-of-the-box functionality, self-contained solutions that can be used to comply with IECC, ASHRAE 90.1 and 2019 Title 24, Part 6 dimming, occupancy/vacancy sensing and daylight harvesting requirements

# Intellect-Enabled Fixtures by Viscor

Cat. No.	Product Line	Description	Applications	
	ALRM	LED Allura Linear Pendant Type M	<ul style="list-style-type: none"> <li>Premium-grade, pendant-mount, bi-directional luminaire</li> <li>Architectural slim profile to enhance the visual space and offer maximum visual comfort</li> </ul>	Boardroom, Classroom, Office, Retail Store and Showroom

Type	CRI	Voltage	Options
M	8 - (80-89)	UNV - 120-277V 347 - 347V	<b>Driver Options</b> B39 Emergency Lighting Battery Pack - LED  <b>Downlight Aperture Options</b> Rectangular aperture is standard C76 Oval Downlight Aperture  <b>Light Distribution Options</b> 75% Up / 25% Down is Standard LD46 40% Up / 60% Down LD28 20% Up / 80% Down LD01 0% Up / 100% Down  <b>Controls Options</b> V99(LV02) Solo Sensor V99(LV01) Intellect Wireless Occ/Daylight Sensor V99(LV03) Intellect Wireless Tunable White Module
Size (Width x Length)	CCT	Fixture/Housing Construction	
24 48 96	30K - 3000 K 35K - 3500 K 40K - 4000 K 2765KT - 2700-6500 K** (Tunable White)	C91 - Stand-alone unit with two flat finished ends (power feed, canopies & air craft cables included)	
	Nominal Lumens	M56* - Start unit of configurable system with one flat finished end and one open end	
	48" 032L - 3200 052L - 5200 060L - 6000	M57* - Middle unit of configurable system with two open ends	
	96" 064L - 6400 105L - 10500 120L - 12000	M58* - End unit of configurable system with one flat finished end and one open end	

\*Power feeds, canopies & air craft cables ordered separately. See "How to order" section.

\*\*2765KT without compatible controller comes with two 0-10V cords for dimming and color tuning. For other control options, consult factory.

Other options may be available, consult factory. Specifications and data subject to change without notice.

Cat. No.	Product Line	Description	Applications	
	ALRA	LED ALLURA Linear Pendant Type A	<ul style="list-style-type: none"> <li>Premium-grade, pendant-mount, bi-directional luminaire</li> <li>Architectural slim profile with soft curves to enhance the visual space</li> <li>Available with row-mounting capability</li> <li>Crescent-shaped body and double tear drop shaped frosted diffuser offers a high level of efficiency and visual comfort</li> </ul>	Boardroom, Cafeteria, Classroom, Corridor, Education Facility, Hotel, Library, Office, Retail Store, Showroom and Supermarket

Type	CRI	Voltage	Options
A	8 - (80-89)	UNV - 120-277V 347 - 347V	<b>Driver Options</b> B39 Emergency Battery Pack  <b>Controls Options</b> V99(LV02) Solo Sensor V99(LV01) Intellect Wireless Occ/Daylight Sensor V99(LV03) Intellect Wireless Tunable White Module
Size (Nominal Length)	CCT	Fixture/Housing Construction	
24 48 96	30K - 3000 K 35K - 3500 K 40K - 4000 K 2765KT - 2700-6500 K** (Tunable White)	C91 - Stand-alone unit with two flat finished ends (power feed, canopies & air craft cables included)	
	Nominal Lumens	M56* - Start unit of configurable system with one flat finished end and one open end	
	48" 035L - 3500 040L - 4000 050L - 5000 060L - 6000	M57* - Middle unit of configurable system with two open ends	
	96" 070L - 7000 080L - 8000 100L - 10000 120L - 12000	M58* - End unit of configurable system with one flat finished end and one open end	

\*Power feeds, canopies & air craft cables ordered separately. See "How to order" section.

\*\*2765KT without compatible controller comes with two 0-10V cords for dimming and color tuning. For other control options, consult factory.

Other options may be available, consult factory. Specifications and data subject to change without notice.

# Intellect-Enabled Fixtures by Viscor

Cat. No.	Product Line	Description	Applications
 ALRB	LED ALLURA Linear Pendant Type B	<ul style="list-style-type: none"> <li>Premium-grade, pendant-mount, bi-directional luminaire</li> <li>Architectural slim profile with soft curves to enhance the visual space</li> <li>Available with row-mounting capability</li> <li>Crescent-shaped body and double tear drop shaped frosted diffuser offers a high level of efficiency and visual comfort</li> </ul>	Boardroom, Classroom, Corridor, Education Facility, Office, Retail Store and Supermarket

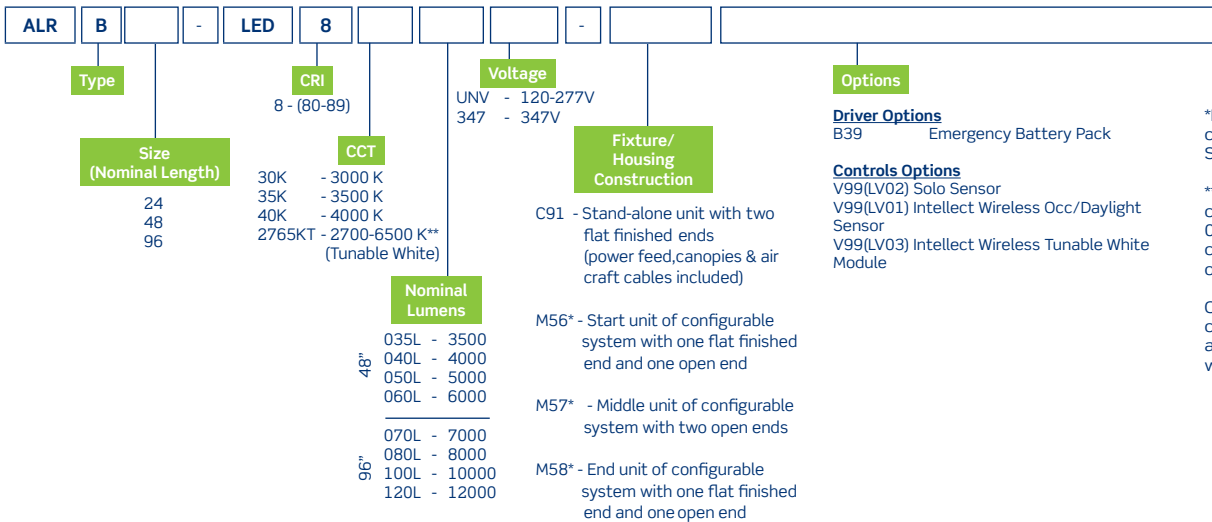

\*Power feeds, canopies & air craft cables ordered separately. See "How to order" section.

\*\*2765KT without compatible controller comes with two 0-10V cords for dimming and color tuning. For other control options, consult factory.

Other options may be available, consult factory. Specifications and data subject to change without notice.

Cat. No.	Product Line	Description	Applications
 LRTG	LRTG Clearform	<ul style="list-style-type: none"> <li>Premium-grade, recessed, lay-in T-Bar luminaire featuring a single piece luminous lens</li> <li>For use with indoor applications</li> <li>IC-rated low-profile design ideal for shallow or obstructed plenum applications</li> </ul>	Classroom, Education Facility, Office, Retail Store, Low Plenum, Nursing Homes and T-Bar

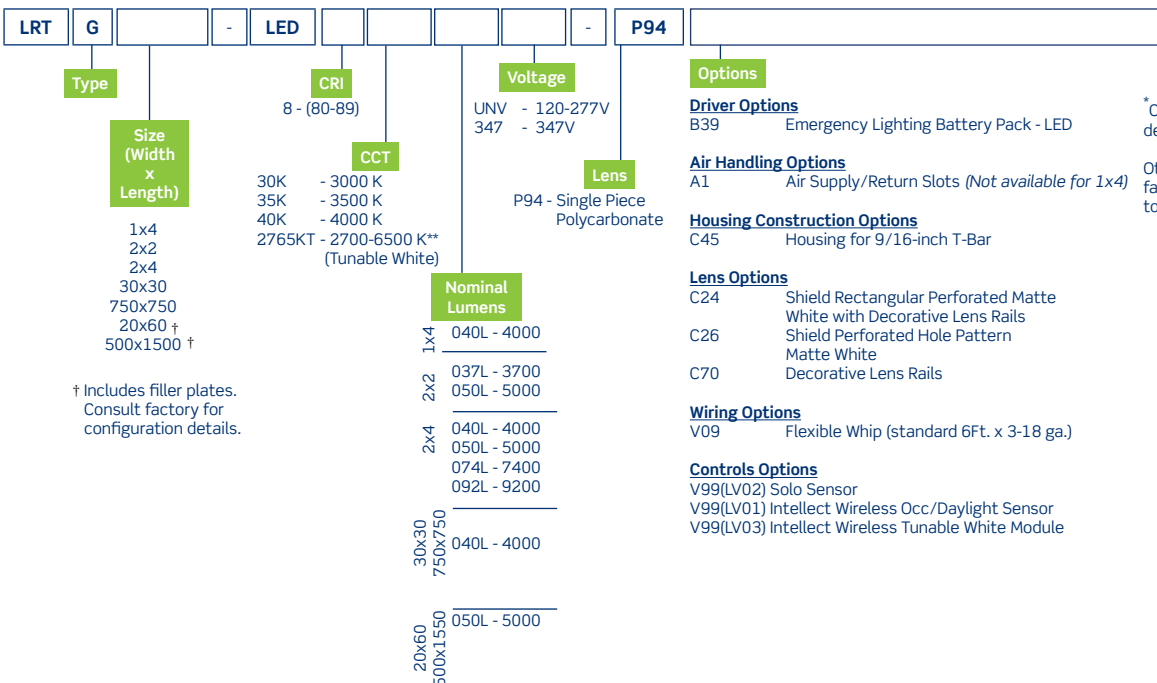

\* Consult factory for configuration details.

Other options may be available, consult factory. Specifications and data subject to change without notice.

† Includes filler plates. Consult factory for configuration details.



# Intellect-Enabled Fixtures by Viscor

Cat. No.	Product Line	Description	Applications	
	LRTH	LED Troffer Dish Lensed	<ul style="list-style-type: none"> <li>Commercial-grade, recessed, lay-in coffered T-Bar troffer with modern styling and high visual comfort featuring a single shallow semi-round lens</li> <li>For use with indoor applications</li> <li>IC-rated low-profile design ideal for shallow or obstructed plenum applications</li> </ul>	Classroom, Corridor, Office, Retail Store, Low Plenum, Nursing Homes, Hospitals and T-Bar

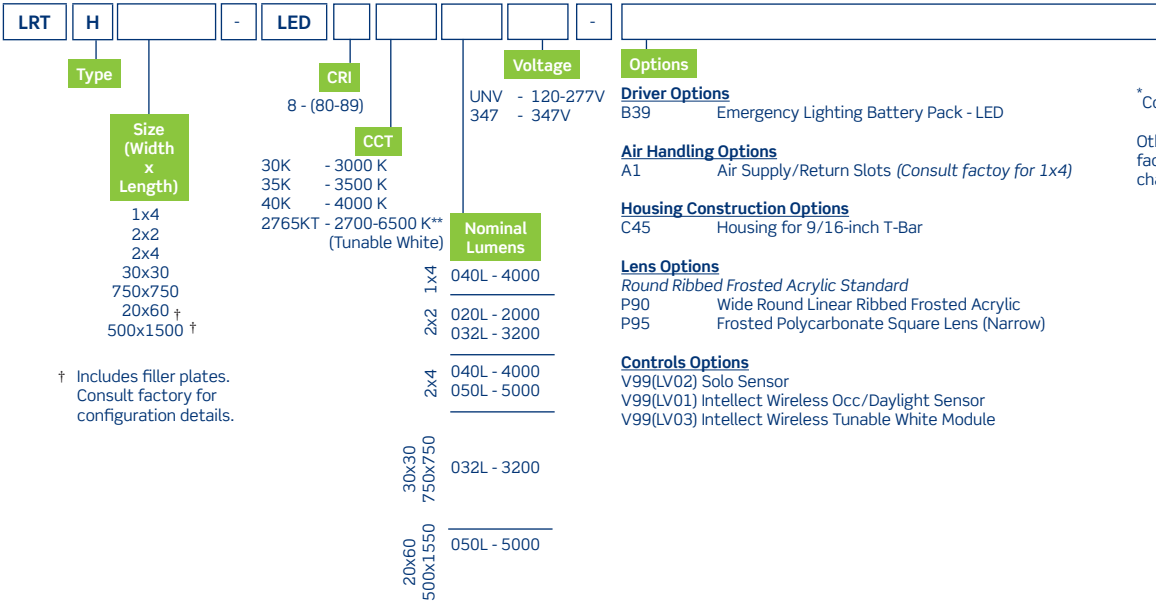

\* Consult factory for configuration details.  
Other options may be available, consult factory. Specifications and data subject to change without notice.

† Includes filler plates. Consult factory for configuration details.

Cat. No.	Product Line	Description	Applications	
	LCOMN SQ	LED Commercial Type N Square	<ul style="list-style-type: none"> <li>Commercial-grade, LED strip luminaire</li> <li>Ideal for many applications requiring a low-cost, small profile, lighting solution</li> </ul>	Aisle, Cove, Display, Education Facility, Retail Store, Utility Area and Warehouse

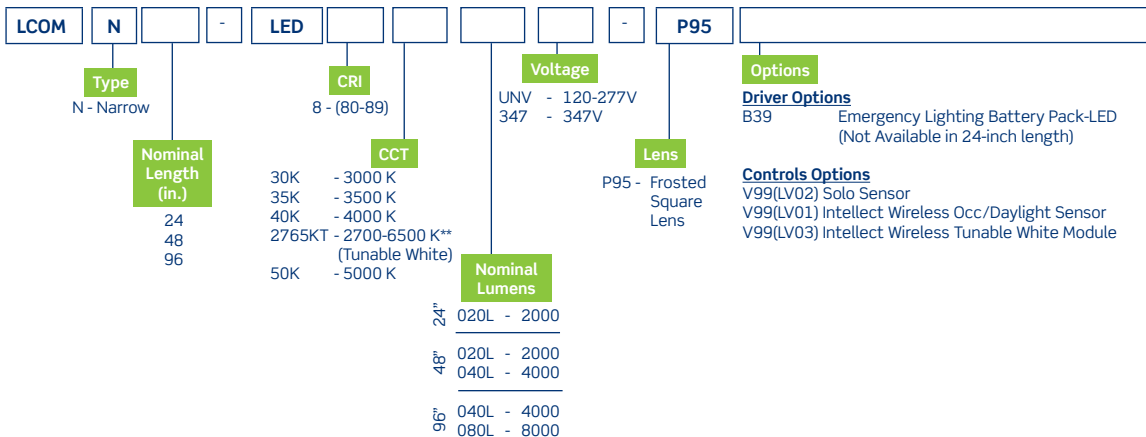

\*For pendant mounted applications only. Not for use in surface mount applications.

Other options may be available, consult factory. Specifications and data subject to change without notice.



# Intellect-Enabled Fixtures by Viscor

Cat. No.	Product Line	Description	Applications	
	LMEZ MICRO	LED Mezuzah	<ul style="list-style-type: none"> <li>• Specification-grade, LED modular linear lighting luminaire</li> <li>• For use with indoor applications where continuous linear lighting is desired such as perimeter lighting applications</li> <li>• Suitable for surface, suspended or wall-mounting individually or in continuous rows while offering an optional up light component with an internal baffle that separates up light and downlight components</li> </ul>	Classroom, Education Facility, Library, Office, Retail Store and Supermarket

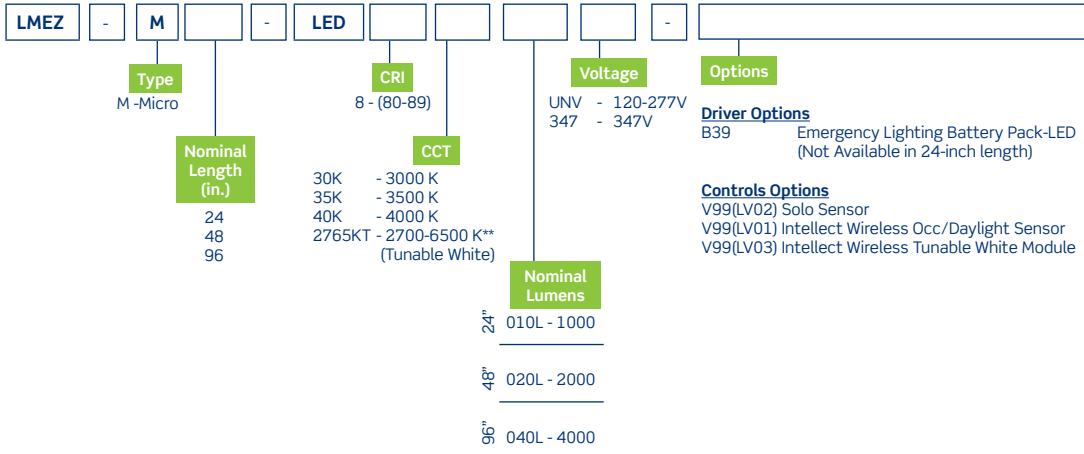

Other options may be available, consult factory. Specifications and data subject to change without notice.

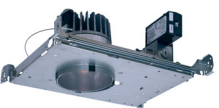

# Intellect-Enabled Fixtures by ConTech Lighting

Cat. No.	Product Line	Description	Applications
	R4NCIE	4" Integrated LED Universal New Construction Downlight	Office, Boardroom, Retail, Hospitality, Classroom

R4NCIE	Housing	LED Series	Electrical	Options
	1 - 10W, 1000lm 2 - 14W, 1400lm 3 - 20W, 2000lm 4 - 28W, 2600lm 5 - 37W, 3200lm 6 - 43W, 3600lm	27K-2700 K 30K-3000K 35K-3500K 40K-4000K 27KC-2700K, 90+ CRI 30KC-3000K, 90+ CRI 35KC-3500K, 90+ CRI 40KC-4000K, 90+ CRI	12 - 120V 27 - 277V	ER <sup>2</sup> - Factory Installed 7W/200mA Emergency Battery Backup [Remote Test Switch]
		<b>Color Temp</b>	<b>Dimming</b>	
			D6 <sup>1</sup> - eldoLED ECOdrive, 0-10V, 1% Dimming D8 <sup>1</sup> - eldoLED SOLOdrive, 0 -10V, 0.1% Dimming	

<sup>1</sup> eldoLED drivers are programmed for linear curve dimming as standard. For logarithmic curve dimming, please consult factory.  
<sup>2</sup> Emergency battery backup option: 725 lumen nominal average for any Series 1 through 6

Cat. No.	Product Line	Description	Applications
	R4SQNCIE	4" Square Integrated LED Universal New Construction Downlight	Office, Boardroom, Retail, Hospitality, Classroom

R4SQNCIE	Housing	LED Series	Electrical	Beam Distance	Options
	1 - 10W, 1000lm 2 - 14W, 1400lm 3 - 20W, 2000lm 4 - 28W, 2600lm 5 - 37W, 3200lm 6 - 43W, 3600lm	27K-2700 K 30K-3000K 35K-3500K 40K-4000K 27KC-2700K, 90+ CRI 30KC-3000K, 90+ CRI 35KC-3500K, 90+ CRI 40KC-4000K, 90+ CRI	12 - 120V 27 - 277V	N - 33° M - 39° W - 73° WW - Wall Wash	ER <sup>2</sup> - Factory Installed 7W/200mA Emergency Battery Backup [Remote Test Switch]
		<b>Color Temp</b>	<b>Driver Option</b>		
			D - 0-10V Dimming D6 <sup>1</sup> - eldoLED ECOdrive, 0-10V, 1% Dimming D8 <sup>1</sup> - eldoLED SOLOdrive, 0 -10V, 0.1% Dimming		

<sup>1</sup> eldoLED drivers are programmed for linear curve dimming as standard. For logarithmic curve dimming, please consult factory.  
<sup>2</sup> Emergency battery backup option: 725 lumen nominal average for an Series 1 through 6



# Intellect-Enabled Fixtures by ConTech Lighting

Cat. No.	Product Line	Description	Applications
	R6NCIE	6" Integrated LED Universal New Construction Downlight	Office, Boardroom, Retail, Hospitality, Classroom

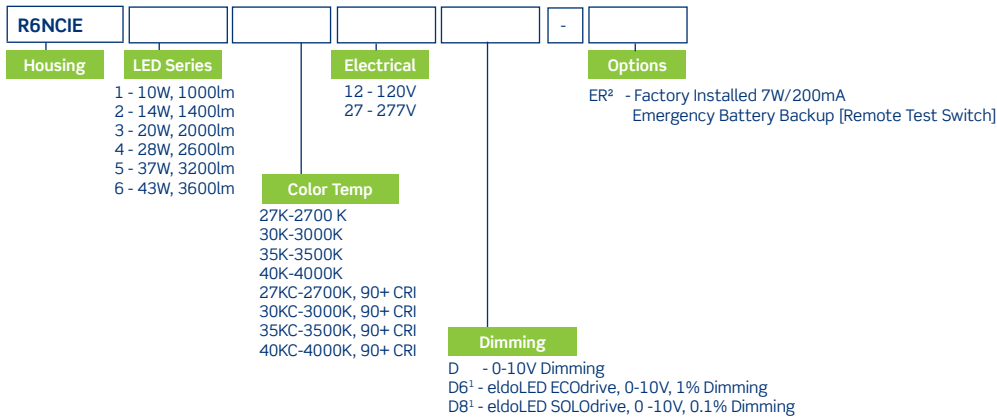

<sup>1</sup> eldoLED drivers are programmed for linear curve dimming as standard. For logarithmic curve dimming, please consult factory.  
<sup>2</sup> Emergency battery backup option: 725 lumen nominal average for any Series 1 through 6

# Additional Intellect-Enabled Fixtures by ConTech Lighting

Cat. No.	Description
CTL825 03	Horizontal Large Housing LED Track Luminaire
CTL18	Stealth LED Vertical and Horizontal Wall Wash/Flood Track Fixtures
CTL19	Mini Stealth LED Vertical and Horizontal Wall Wash/Flood Track Fixture

# Intellect-enabled Fixtures by Birchwood Lighting

Cat. No.	Product Line	Description	Applications
	JAK-LED	JAKE Recessed Linear <ul style="list-style-type: none"> <li>Architectural recessed linear for T-Grid installations</li> </ul>	Commercial Offices, Education, Hospitality

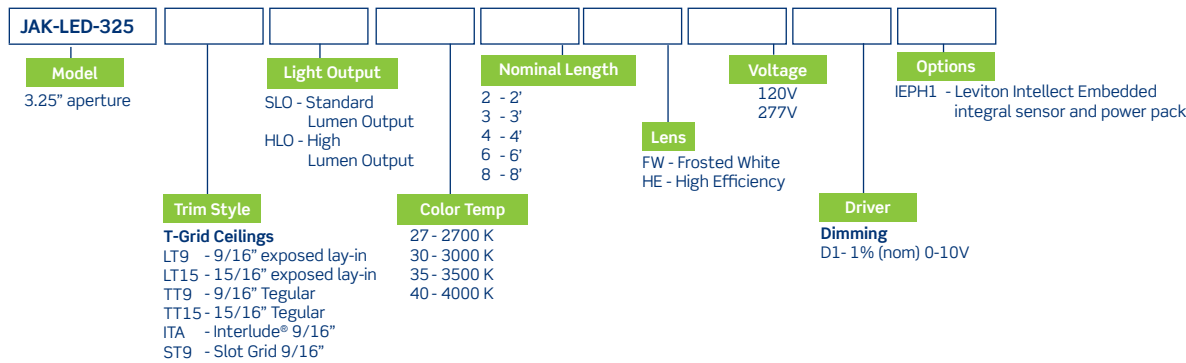

## Additional Intellect-enabled Fixtures by Birchwood Lighting

Cat. No.	Description
KEL-LED-125 KEL-LED-225 KEL-LED-325	KELSEY square linear LED profile featuring multiple mounting, lens and lamping options within 1.25", 2.25", or 3.25" extruded aluminum housings
ASH-LED	ASHLEY cove luminaire with uninterrupted diffuse illumination. Shadow-free cove lighting fixtures available in LED
NAT-LED	NATHAN compact 2 1/8" profile surface mount ledge luminaire with forward throw performance
BRA-LED	BRANDI Wet location fixtures. Available in 2' - 8' nominal lengths, continuous run available
VAN-LED-WW-400 VAN-LED-WG-400	VANESSA wet location IP65 rated wall wash. Available in 2' - 4' nominal lengths, continuous run available VANESSA wet location IP65 rated wall graze and wall wash. Available in 2' - 4' nominal lengths, continuous run available.
JILL-LED-xxx JIL-ASYM-LED-165	JILL drop-lens recessed linear luminaire Available in 1.65", 2.25", 3.25", and 5" apertures. 2', 3', 4', 6' and 8' nominal lengths, continuous run available. JILL Asymmetric luminaire with 1.65" aperture. Available in 2', 3', 4', 6' and 8' nominal lengths, continuous run available
KAT-DR	KATRINA circular dual distribution luminaire. Available in 2', 3', and 4' diameters
JAK-LED-WG	JAKE wall graze and wall wash recessed linear fixtures. Available in 2' - 8' nominal lengths, continuous run available.
HAI-LED HAI-LED-225-RSM	HAILEY round architectural fixture. Available in 1.25", 2.25" and 3.25" apertures. Continuous run available. HAILEY RSM rotational surface mount luminaire. Available in 2', 3' and 4' nominal lengths.
BW165 BW165 TW	Small Profile 1.65" Direct/Indirect Fixture Small Profile 1.65" Direct/Indirect Tunable White Fixture
COL-LED	COLLIN dual distribution luminaires. Available in 1.25", 2.25" and 3.25" apertures
NOL-LED	NOLAN precision-edged luminaire. 1.25", 2.25", and 3.25" profile linear fixture. Available in 2', 3', 4', 6' and 8' nominal lengths. Teardrop lens option for 225(TDW), continuous run available.
ERI-LED	ERIKA single direct or direct/indirect square or rectangular fixture. Constructed of 1.25", 2.25" or 3.25" mitered extruded aluminum.
MAD-xx-RING MAD-SRP MAD-FFC	MADELINE Ring standalone LED fixture available in 4' and 8' diameter rings MADELINE Serpentine continuous run LED pendant fixture MADELINE Free Form LED Fixture



# Intellect-Enabled Fixtures by Intense Lighting

Cat. No.	Product Line	Description	Applications
	SS4G4DR	4" SS Downlight	Commercial Offices, Education, Hospitality, Retail

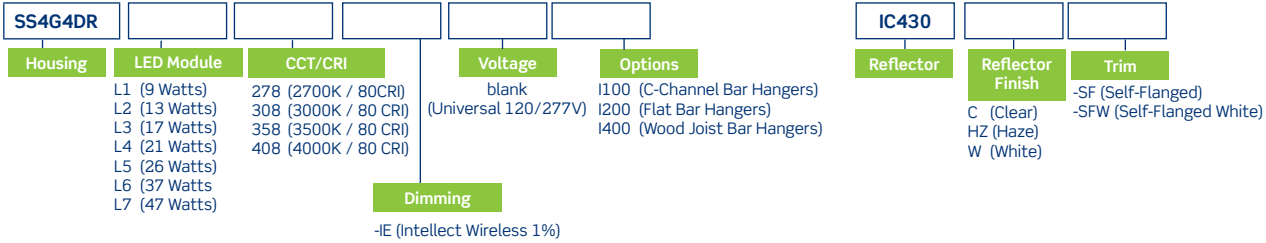

# Additional Intellect-Enabled Fixtures by Intense Lighting

Cat. No.	Description
SS4G4WS SS4G4WR SS4G4DS SS4G4DR	4" LED Square Wall Wash 4" LED Round Wall Wash 4" LED Square Downlight 4" LED Round Downlight
SS6G4DRR SS6G4WR SS6G4DR	6" LED Remodel Downlight 6" LED Wall Wash 6" LED Downlight
SS8G4WR SS8G4DRR SS8G4DR	8" LED Wall Wash 8" Remodel Downlight 8" Downlight
SD6DRR SD6DR	SD 6" LED Remodel Downlight SD 6" LED Downlight
SD8DRR SD8DR	SD 8" Remodel Downlight SD 8" LED Downlight
SD4WS SD4WR SD4DRR SD4DS SD4DR	SD 4" LED Square Wall Wash SD 4" LED Round Wall Wash SD 4" LED Remodel Downlight SD 4" LED Square Downlight SD 4" LED Round Downlight
MXG2 MXG2C	MX G2 Vertical Round Accent MX G2 Vertical Round Accent Warm Dim



Lighting & Controls  
20497 SW Teton Avenue  
Tualatin, OR 97062

Global Headquarters  
201 North Service Road  
Melville, NY 11747

©2021 Leviton Manufacturing Co., Inc. All rights reserved.  
Subject to change without notice.

LES-G-10430A/D21-aa  
REV APR 2021