

# Installation Instructions

Original Instructions



**Allen-Bradley**  
by ROCKWELL AUTOMATION



## SensaGuard Rectangular Flat Pack (Series B Models Only)

Catalog Number 440N-Z21x

**IMPORTANT** SAVE THESE INSTRUCTIONS FOR FUTURE USE.

Topic	Page
Summary of Changes	1
Introduction	1
Specifications	2
Dimensions	2
Mode of Operation – Status Indicator	2
Diagnostics	3
Mounting	3
Typical Wiring Diagram	3
Commissioning (Unique Coded Units) – Power the Sensor	4
OSSD Test Pulses	5
Timing Diagram	5
Troubleshooting	6
Application Wiring Examples	6
Recommended Safety Control Interfaces	11
Maintenance	11
Repair	11
Declaration of Conformity	11

### Summary of Changes

This publication contains a new Assured ON sensing distance for -CU models (see [page 2](#)).

### Introduction

Installation must be in accordance with the following instructions and specifications and implemented by suitable competent personnel. Adherence to the recommended maintenance instructions forms part of the warranty.

This unit is not to be used as a mechanical stop. Guard stops and guides must be fitted.

This device is intended to be part of the safety-related control system of a machine. Before installation, a risk assessment is performed to determine whether the specifications of this device are suitable for all foreseeable operational and environmental characteristics.



**WARNING:** Do not defeat, tamper, remove, or bypass this unit. Severe injury to personnel could result.



**ATTENTION:** This device must be provided with a 24V DC PELV or SELV power supply that conforms to the requirements of 414-3 of IEC 60364-4-41 where provisions have been taken. To confirm that, even if an internal fault, the voltage at the outgoing terminals cannot exceed 60V DC. Improper selection or installation of the devices affects the integrity of the safety systems.

Personal injury or death, property damage, or economic loss can result.

Comply with ISO 14119 including section, accessibility to the installation, arrangement, and mounting, possible substitute actuation, access to the escape release, motivation to defeat, and actuation mode.

Management controls, working procedures, training, and additional protective measures can be used to minimize the motivation to defeat and to manage the use and availability of spare actuators.

Comply with ISO 13857 and ISO 13855 for guard openings and minimum (safe) distances.

Comply with IEC 62061 or ISO 13849-1 and ISO 13849-2 for functional safety.

SensaGuard™ Series A and Series B non-contact switches only work with the appropriate series actuator. Series A and Series B actuators can be purchased separately.

This product is intended for industrial/business application only. It is not intended to be used in residential applications as it can cause radio interference on other residential devices.



**ATTENTION:** Read this document and the documents that are listed in the Additional Resources section about installation, configuration, and operation of this equipment before you install. Users are required to familiarize themselves with installation and connection instructions and requirements of all applicable codes, laws, and standards.

In accordance with applicable codes of practice, suitably trained personnel are required to implement installation, adjustments, service initiation, use, assembly, disassembly, and maintenance.

If this equipment is used in a manner that the manufacturer does not specify, the protection that is provided by the equipment can be impaired.



**ATTENTION:** Do not attempt to install this device unless the installation instructions have been studied and understood. This document acts as a guide for a typical installation and is available in additional languages at [rok.auto/literature](http://rok.auto/literature).

## Specifications

Attribute	Value
<b>Safety Ratings</b>	
Standards Safety Classification	IEC 60947-5-3, Cat. 4 PLe Per ISO 13849-1, Type 4 interlocking device according to ISO 14119 with either low (standard) or high (unique) coding, SIL CL 3 per IEC 62061 and IEC 61508
Functional Safety Data	PFH <sub>D</sub> = 1.32E-9 (Probability of dangerous failure per hr) T1 = 20 (Proof test interval)
Certifications	CE marked for all applicable directives, c-UL-us (UL 508), and TÜV, see <a href="http://rok.auto/certifications">rok.auto/certifications</a>
<b>Operating Characteristics</b>	
Sensing distance, Assured ON	15 mm (0.59 in.) <sup>(1)</sup>
Sensing distance, Assured OFF	25 mm (0.98 in.)
Operating voltage	24V DC 10%/-15% Class 2 SELV or PELV power supply
Response time (Off)	45 ms
Utilization Category according to Ue	DC-12 and DC-13
Ie	24V 200 mA
Frequency of operating cycle	0.25 Hz
No-load supply current	< 50 mA
<b>Outputs (OSSD)</b>	
Safe state	De-energized (2 x PNP, 0V), AUX energized (1 x PNP, 24V)
Run state	Energized (2 x PNP, 24V), AUX de-energized (1 x PNP, 0V)
Load current	200 mA, max
Voltage drop	< 1.5V
Switches connected in series	Unlimited, see <a href="#">Timing Diagram on page 5</a> .
<b>Mechanical</b>	
Sensor case material	Polycarbonate
Actuator case material	Polycarbonate
<b>Environmental</b>	
Operating temperature	-25...+70 °C (-13...+158 °F)
Operating humidity	5...95% relative
Washdown rating	IP66, IP67, IP69K
Shock and Vibration	IEC 60068-2-27: 30 g (1.06 oz), 11 ms IEC 60068-2-6: 10...55 Hz
Pollution Degree	IEC 60947-1: 3
<b>Electromagnetic Compatibility (EMC)</b>	
Electrostatic Discharge ESD	IEC 61000-4-2: air discharge Per IEC 61326-1 (functional): 8 kV Per IEC 61000-6-7 (fail-safe): 8 kV
Radiated EMF immunity	IEC 61000-4-3 Per IEC 61326-1 (functional): 10V/m Per IEC 61000-6-7 (fail-safe): 20V/m
Electrical Fast Transient/Burst Immunity	IEC 61000-4-4 Per IEC 61326-1 (functional): 2 kV/5 kHz Per IEC 61000-6-7 (fail-safe): 2 kV/5 kHz
Conducted Immunity	IEC 61000-4-6 Per IEC 61326-1 (functional): 10V Per IEC 61000-6-7 (fail-safe): 20V
Rated Impulse Withstand Voltage	IEC 60947-1: 1 kV
Protection	<ul style="list-style-type: none"> <li>• Short circuit</li> <li>• Overload</li> <li>• Reverse polarity</li> <li>• Overvoltage</li> <li>• Loss of ground</li> </ul>

(1) 13 mm (0.51 in.) for -CU models.

## Dimensions

Figure 1 - Actuator [mm (in.)]

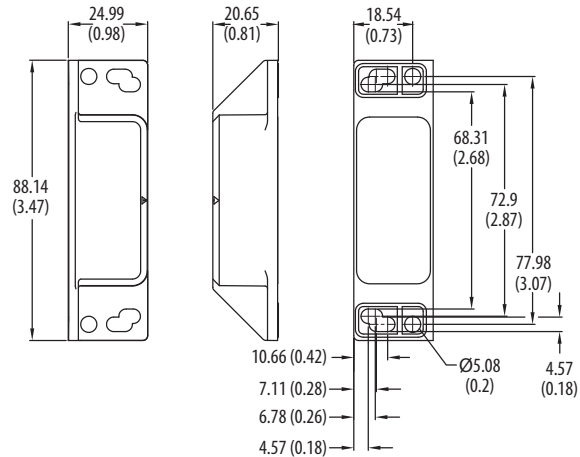
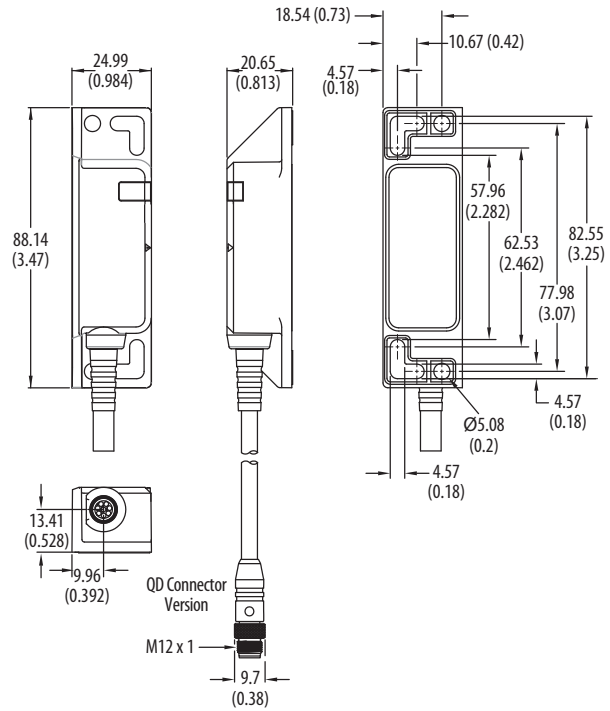
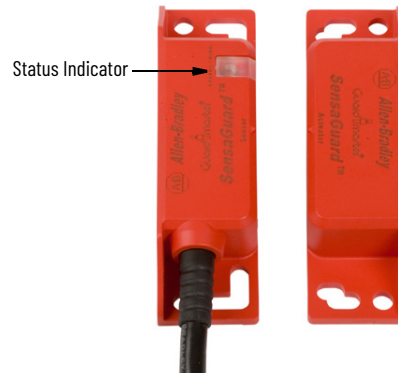

Figure 2 - Sensor Dimensions [mm (in.)]



## Mode of Operation – Status Indicator



The actuator is supplied with the sensor.

## Diagnostics

Table 1 - Status/Diagnostic Indicator

State	Status	Troubleshooting
Off	Not powered	—
Red	OSSD not active	—
Green	OSSD active	—
Flashing green	Power up test or OSSD inputs not valid	Check 24V DC or OSSD inputs (yellow or red wire)
Flashing red	0.5 Hz flash OSSD fault	OSSD fault—check OSSD outputs are not shorted to GND, 24V DC, or each other
	2 Hz flash internal fault	Cycle power
Flashing amber	Actuator at maximum sensing range (-N and -N9 models only)	Move actuator closer to sensor

See [Unique Coded Diagnostic on page 5](#) for learning sequence errors.

## Mounting

Use nonremovable screws, bolts, or nuts to mount the switch and actuator. Do not over torque the mounting hardware. Position the switch and actuator so they are aligned with each other.

## Nut Torque Specification

Switch/actuator: 2.20 N•m (19.5 lb•in)

Figure 3 - Minimum Distance Between Sensors

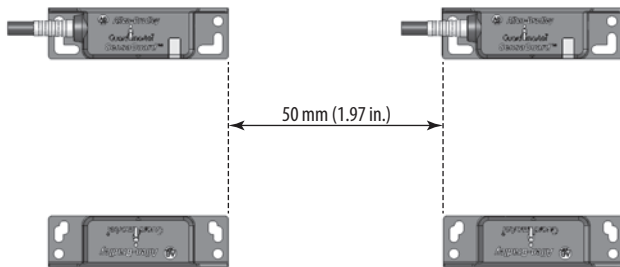
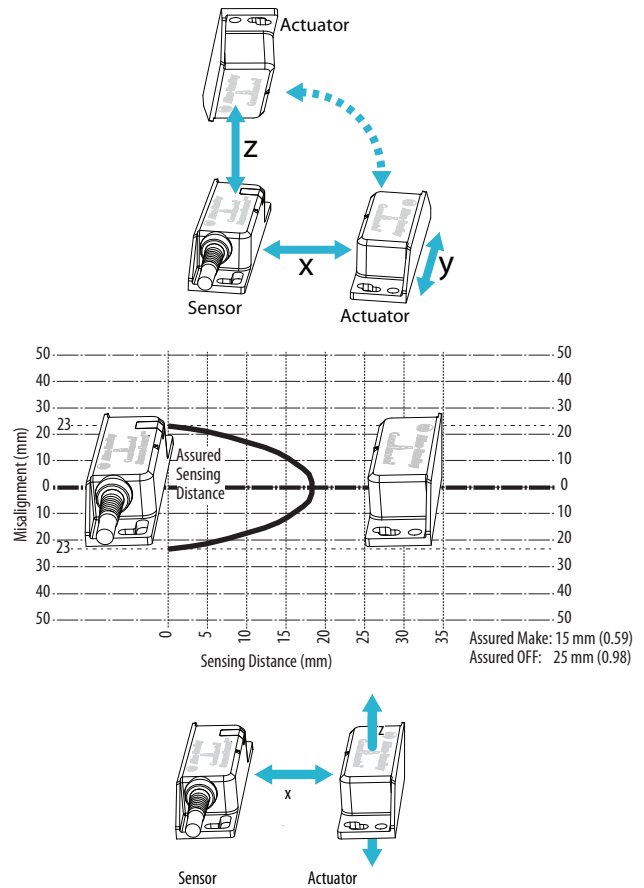
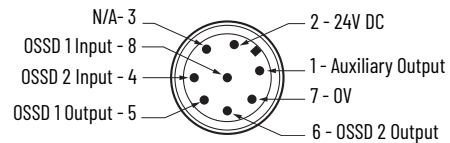

Figure 4 - Misalignment Curve



## Typical Wiring Diagram

Table 2 - 8-pin Unit



Pin Number	Wire Color	Signal
1	White	Auxiliary Output
2	Brown	24V DC
3	Green	—
4	Yellow	OSSD 2 Input
5	Gray	OSSD 1 Output
6	Pink	OSSD 2 Output
7	Blue	0V
8	Red	OSSD 1 Input

Recommended cable connection, 2 m (6.5 ft)—889D-F8AB-2. For additional lengths, replace the 2 with 5 (5 m [16.4 ft]) or 10 (10 m [32.8 ft]).

**Table 3 - 5-pin Unit**



Pin Number	Color	Signal
1	Brown	+24V
2	White	Safety OSSD 1 Output
3	Blue	0V
4	Black	Safety OSSD 2 Output
5	Gray	Auxiliary Output

The recommended cordset is 2 m (6.5 ft) - 889D-F5AC-2. For additional lengths, replace the 2 with 5 (5 m [16 ft]) or 10 (10 m [32.8 ft]).

**IMPORTANT** If you do not require the auxiliary signal, a 4-pin cordset (889D-F4AC-2) can be used.

The recommended patchcord for use with ArmorBlock® Guard I/O™ module is 2 m (6.5 ft) - 889D-F4ACDM-2. Replace the 2 with 0M3 (0.3 m [0.98 ft]), 1 (1 m [3.28 ft]), 5 (5 m [16.4 ft]), or 10 (10 m [32.8 ft]) for standard cable lengths.

**IMPORTANT** Do not use a 5-pin patchcord with the ArmorBlock® Guard I/O™ module.

## Commissioning (Unique Coded Units) – Power the Sensor

Connect the sensor to 24V DC (see [Typical Wiring Diagram on page 3](#) for help).

**IMPORTANT** The unique coded sensor is shipped from the factory unprogrammed and must be taught a unique coded actuator, see [Teaching the Actuator \(Ability to Learn an Additional Actuator\)](#).  
 A unique coded sensor can only learn a unique coded actuator and cannot learn a standard coded actuator. A standard coded sensor does not work with a unique coded actuator.  
 The unique coded sensor, “Status/Diag” indicator, begins to blink green eight times then repeats, which indicates that the sensor has not yet learned an actuator.  
 The unique coded sensor can be locked so it cannot learn another actuator, see [Teach the Unique Actuator \(One Time Learn Only; Unit Locked\)](#).

## Teaching the Actuator (Ability to Learn an Additional Actuator)

1. Power up the sensor and bring an actuator into the sensing range.
2. Leave the actuator in the sensing field for a minimum of 2 minutes.
3. Learn is complete.

**IMPORTANT** The sensor can learn a new actuator up to eight times. The Status/Diag indicator blinks the number of actuators left that a sensor can learn.

The sensor automatically starts the learning process as soon as an actuator is brought into the sensing range.

**Table 4 - Learning Sequence**

1. Target present	Status/Diag indicator flashing green 2 Hz rate (15 s)
2. Verifying actuator	Status/Diag indicator flashing green/red 1 Hz rate (15 s)
3. Program sensor	Status/Diag indicator flashing green/red 2 Hz rate (15 s)
4. Program complete	Status/Diag indicator flashing green 2 Hz rate (number of learns remaining) (15 s)
5. Ready state	Status/Diag indicator steady green
6. Learn is complete	

## Teach the Unique Actuator (One Time Learn Only; Unit Locked)

### Initially Teaching in the Actuator

The sensor automatically starts the learning process as soon as an actuator is brought into the sensing range.

**Table 5 - Learning Sequence**

1. Target present	Status/Diag indicator flashing green 2 Hz rate (15 s)
2. Verifying actuator	Status/Diag indicator flashing green/red 1 Hz rate (15 s)
3. Program sensor	Status/Diag indicator flashing green/red 2 Hz rate (15 s)
4. Program locking	Status/Diag indicator flashing green 2 Hz rate (number of learns remaining) (15 s)
5. Remove the actuator from the sensing field	Status/Diag indicator changes to steady red
6. Replace the actuator back into the sensing field	Status/Diag indicator continues flashing green 2 Hz rate (number of learns remaining), this action triggers the lock function.
7. Ready state	Status/Diag indicator steady green
8. Learn is complete	Sensor is locked and cannot learn another actuator.

## Learning a New Actuator (Unique Coded Actuator Only)

To learn a replacement actuator, bring the actuator to be taught into the sensing range of the safety switch.

The learn sequence is the same as the sequence for teaching the actuator (ability to learn an additional actuator).

A sensor cannot relearn a previously learned actuator or a standard SensaGuard actuator.

The sensor only recognizes the most recently learned actuator.

## Unique Coded Diagnostic

Error codes for learning process. Power cycle to clear fault.

Status/Diag Indicator—Flashes (2 Hz)	Error Code
Green	OSSD inputs not valid
Red-Red-Red-Green	Cannot learn a standard SensaGuard actuator
Red-Red-Red-Green-Green	Actuator already learned
Red-Red-Red-Green-Green-Green	Bad RFID; Target that is moved out of range
Red-Red-Red-Green-Green-Green-Green	Exceeded learning eight actuators
Red-Red-Red-Green-Green-Green-Green-Green	Unit locked: Cannot learn another actuator

## OSSD Test Pulses

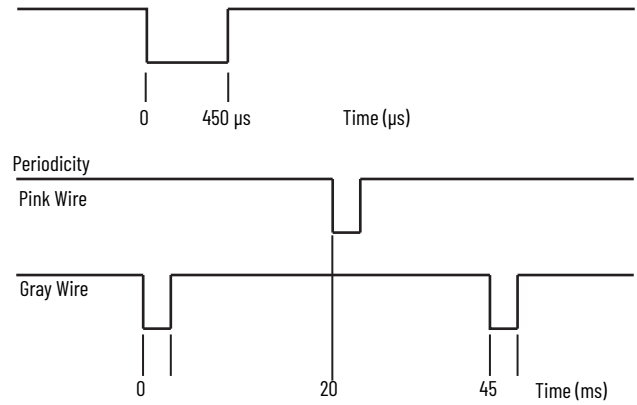

## Individual Pulses

Test pulses appear on each OSSD output. These pulses are approximately every 45 ms. The times that are shown are approximate and depend on the processing of the safety-related status.

## Timing Diagram

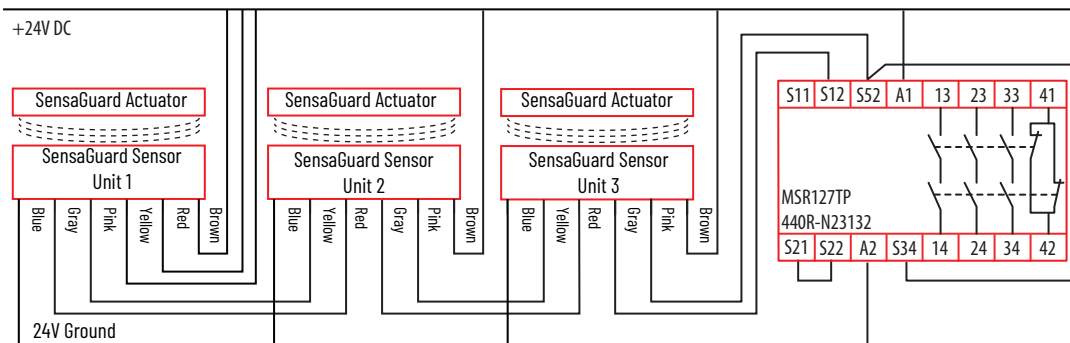

### Response Time: Safety Outputs Turn OFF

Initial Conditions: All actuators are in sensing distance.

Actuator 1 is moved out of sensing range.

Sensor 1 OSSD outputs (gray and pink) turn OFF. Sensor 1 indicator turns steady red.

Sensor 2 OSSD outputs (gray and pink) turn OFF. Sensor 2 indicator flashes green.

Sensor 3 OSSD outputs (gray and pink) turn OFF. Sensor 3 indicator flashes green.



### Response Time: Safety Outputs Turn ON

Initial Conditions: Actuator 1 is out of sensing range. Sensor 1 indicator is steady red. Actuators 2 and 3 are in sensing range. Sensor 2 and 3 indicators flash green.

Actuator 1 is moved into sensing range.

Sensor 2 OSSD inputs (red and yellow) transition to 24V DC from Sensor 1 OSSD outputs. Sensor 1 indicator turns steady green.

Sensor 3 OSSD inputs (red and yellow) transition to 24V DC from Sensor 2 OSSD outputs. Sensor 2 indicator turns steady green.

Sensor 3 OSSD outputs (gray and pink) are energized. Sensor 3 indicator turns steady green.



## Troubleshooting

Figure 5 - Series Circuit

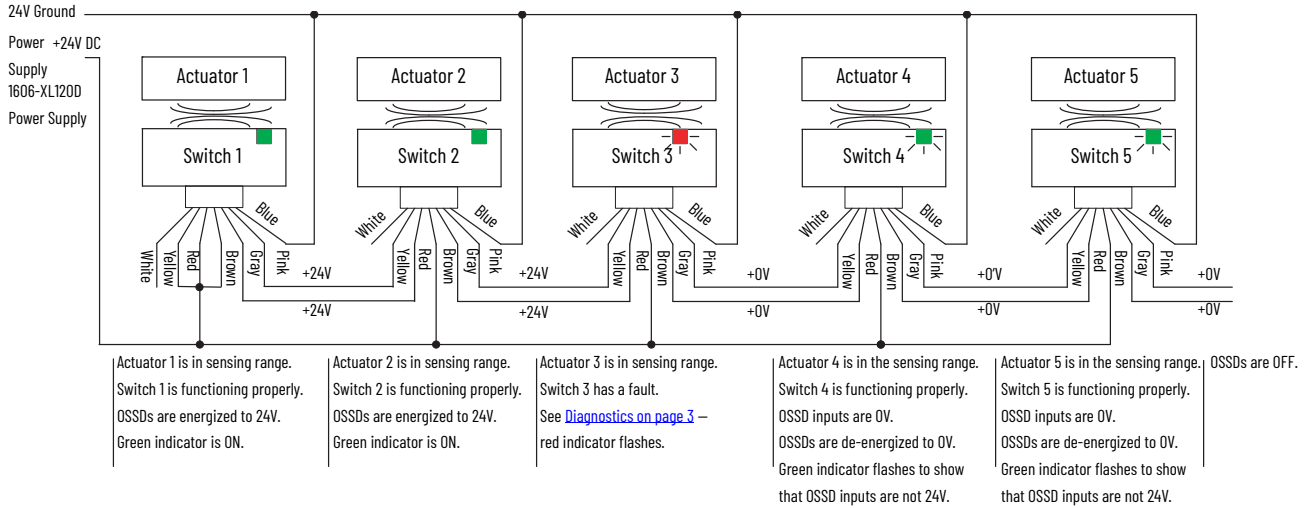

## Application Wiring Examples

Figure 6 - Wiring to MSR127 Safety Relay

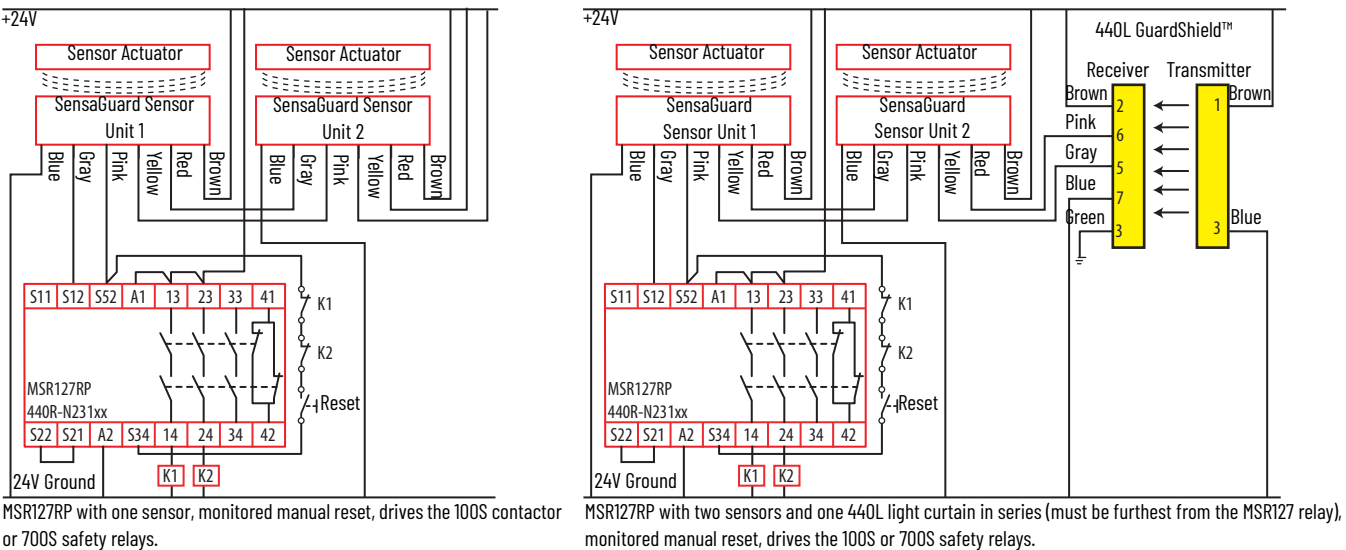
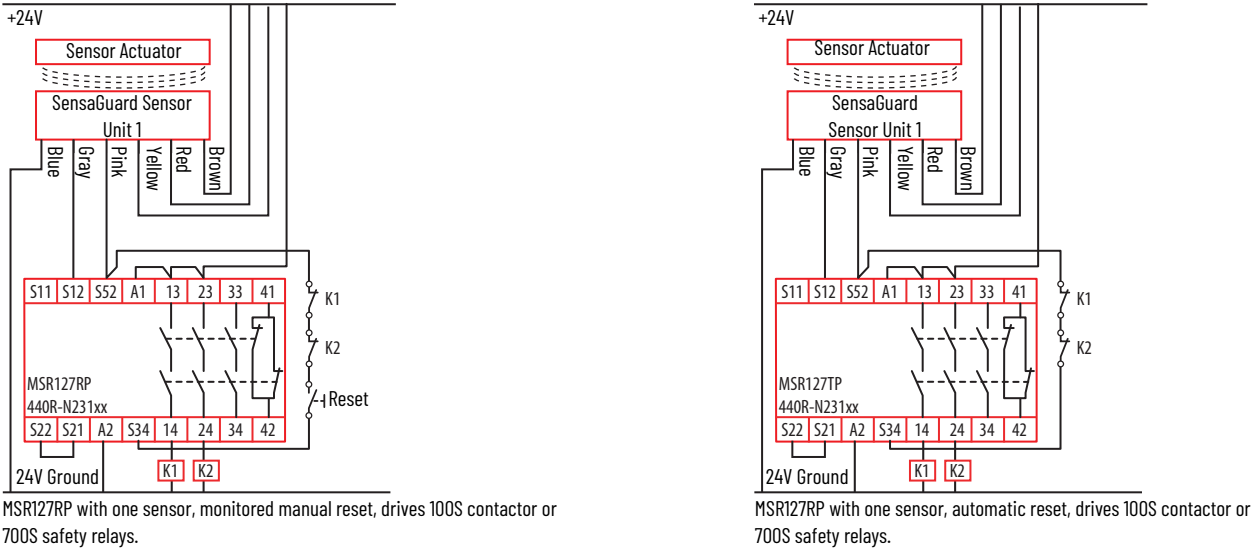

Figure 7 - Guardmaster® SI or DI Safety Relay Wiring

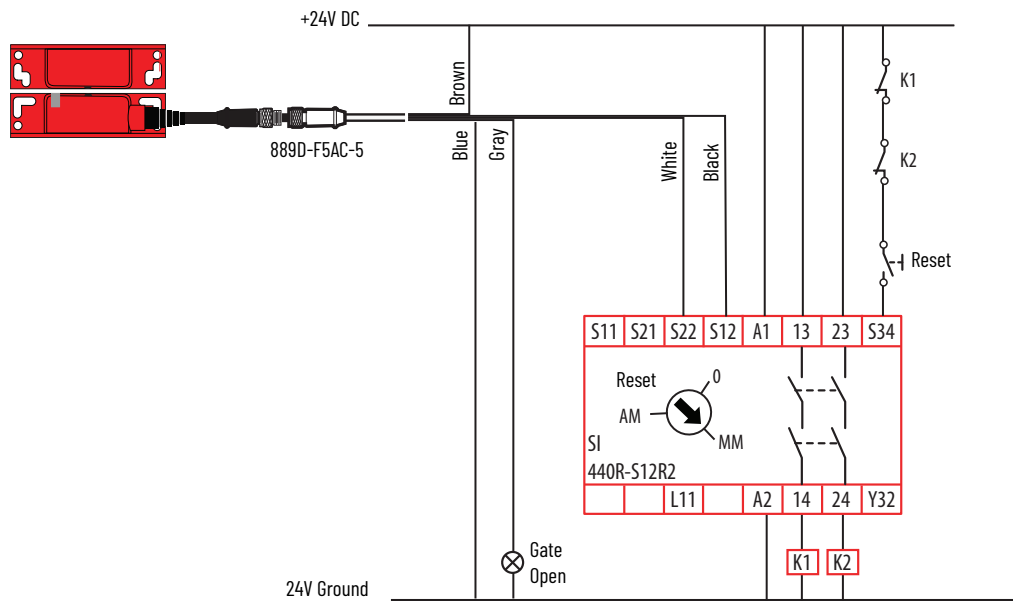
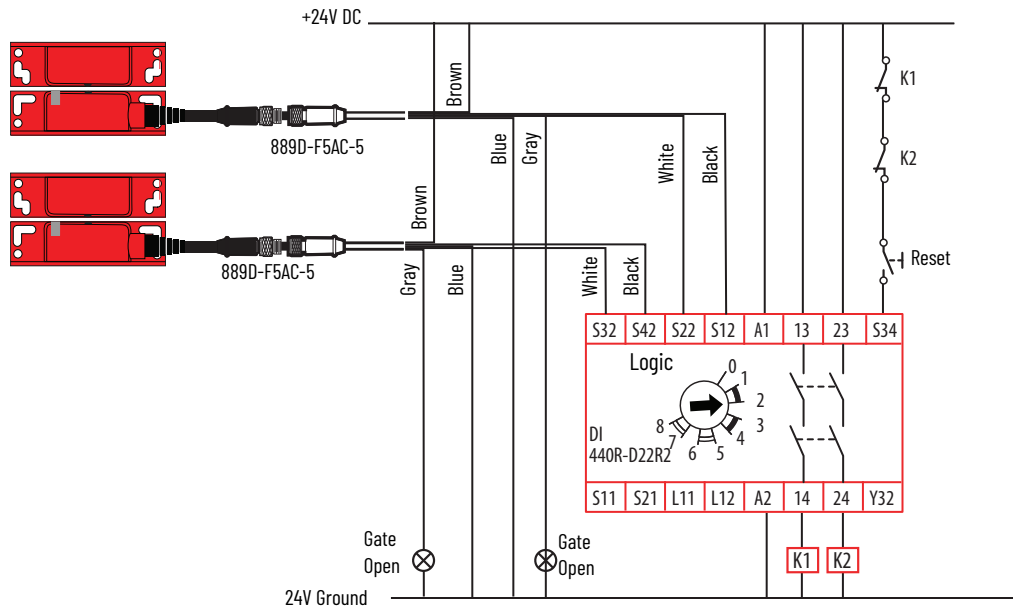

Figure 8 - CR30 Software Configurable Relay Wiring

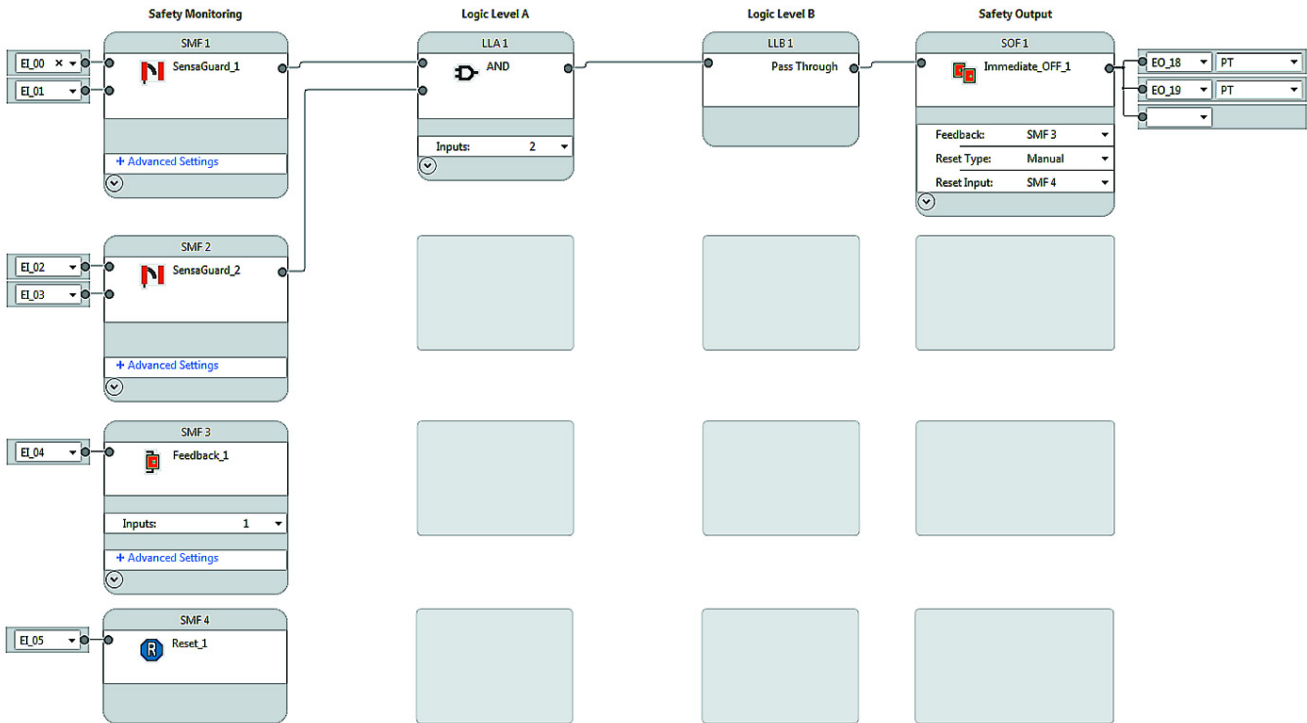
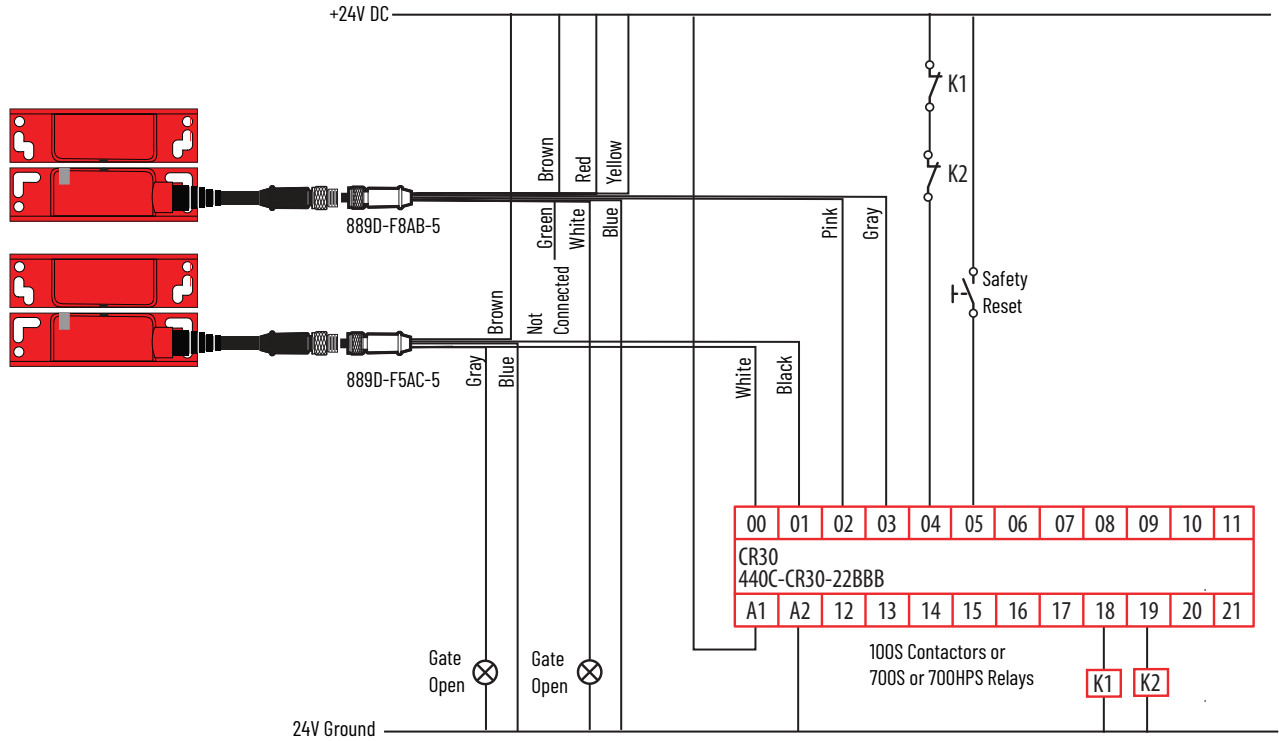
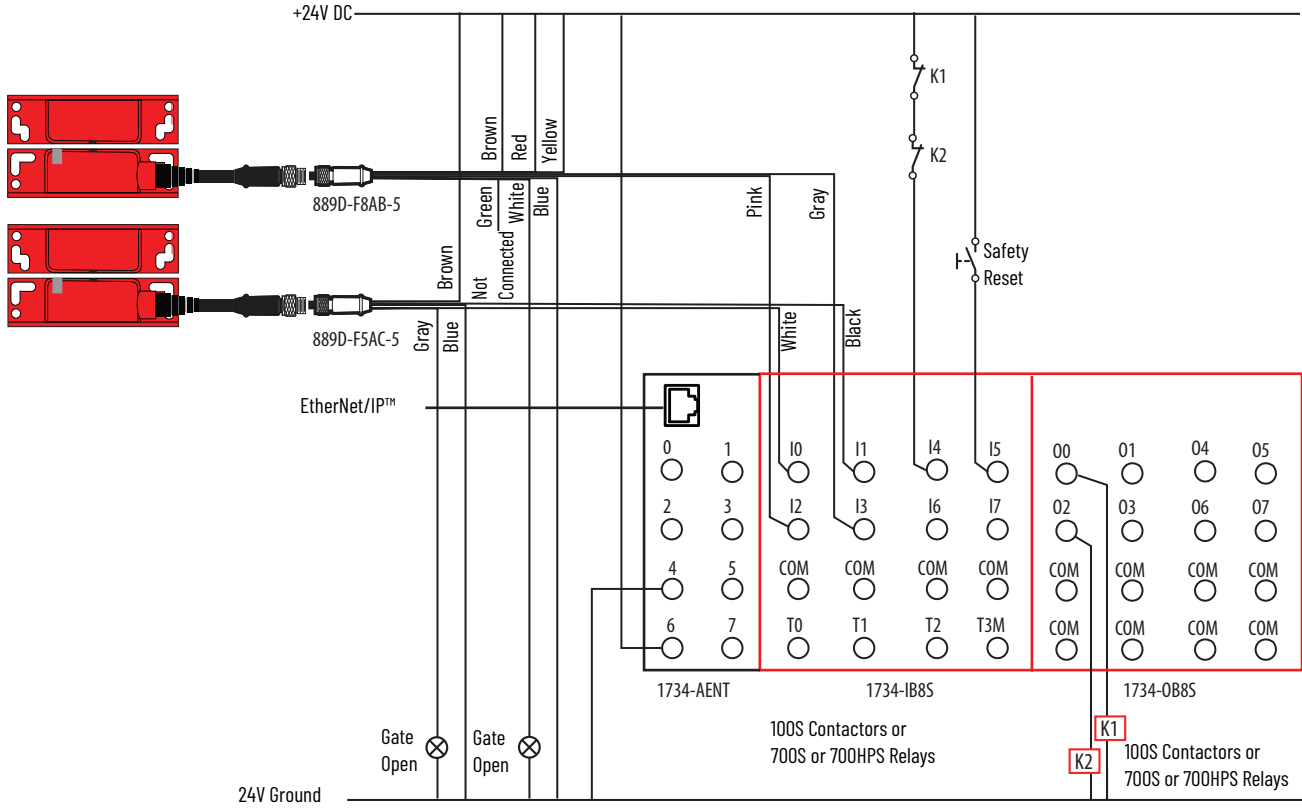



Figure 9 - 1734 POINT Guard I/O™ Wiring



Point	Point Operation		Point Mode	Test Source	Input Delay Time (ms)	
	Type	Discrepancy Time (ms)			Off->On	On->Off
0	Equivalent	10	Safety	None	0	6
1			Safety	None	0	6
2	Equivalent	10	Safety	None	0	6
3			Safety	None	0	6
4	Single	0	Standard	None	0	0
5			Standard	None	0	0
6	Single	0	Not Used	None	0	0
7			Not Used	None	0	0

Set On->Off Input Delay Time to 6ms to ignore the SenaGuard OSSD output test pulses

Figure 10 - 1732DS/ES ArmorBlock® Guard Safety I/O Wiring

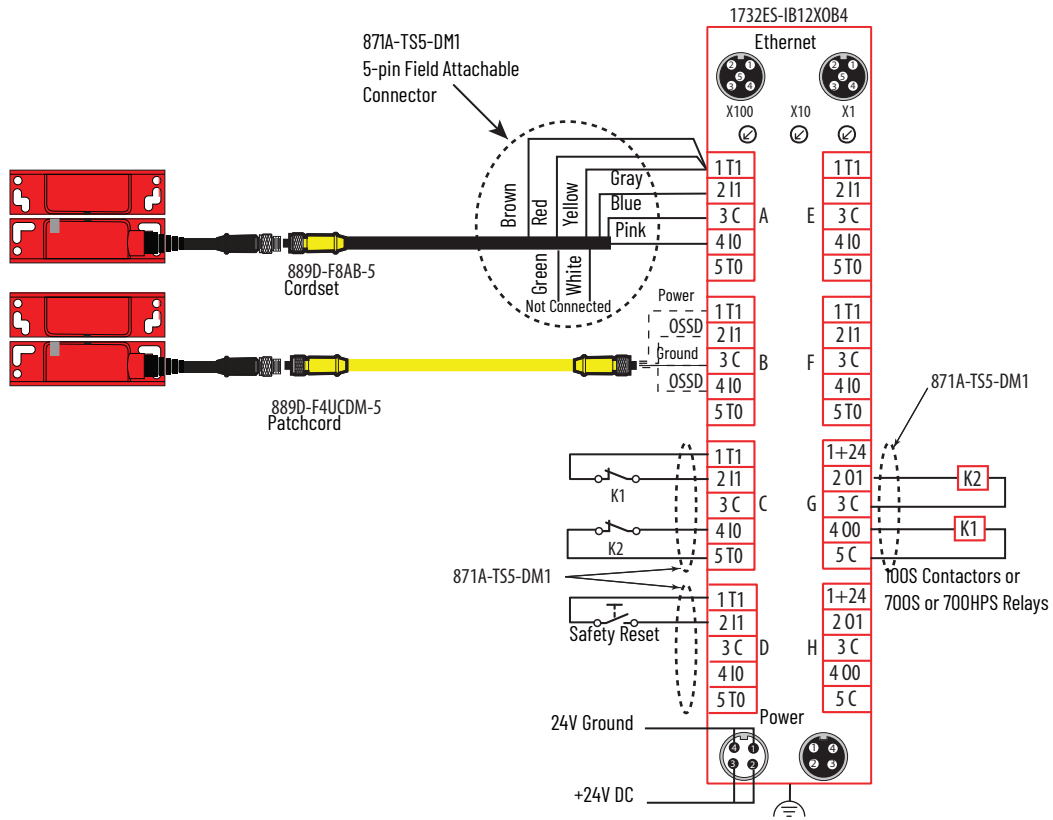

Input and Output Configuration for the 1732ES Module

Point	Point Operation		Point Mode	Test Source	Input Delay Time (ms)	
	Type	Discrepancy Time (ms)			Off->On	On->Off
0	Equivalent	10	Safety	None	0	6
1			Safety	None	0	6
2	Equivalent	10	Safety	None	0	6
3			Safety	None	0	6
4	Equivalent	10	Safety Pulse Test	4	0	0
5			Safety Pulse Test	5	0	0
6	Single	0	Standard	None	0	0
7			Not Used	None	0	0
8	Single	0	Not Used	None	0	0
9			Not Used	None	0	0
10	Single	0	Not Used	None	0	0
11			Not Used	None	0	0

Point	Point Mode
0	Not Used
1	Power Supply
2	Not Used
3	Power Supply
4	Pulse Test
5	Pulse Test
6	Not Used
7	Power Supply

Point	Point Operation Type	Point Mode
0	Dual	Safety
1		Safety
2	Dual	Not Used
3		Not Used

## Recommended Safety Control Interfaces

- Guardmaster safety relays:
  - Dual-input (DI)
  - Dual-input solid-state output (DIS)
  - Single input (SI)
  - CR30 software configurable
- Minotaur™ safety relays:
  - MSR126
  - MSR127
  - MSR131
  - MSR138
- SmartGuard™ controller
- 1791DS/ES CompactBlock™ Guard I/O™ module
- 1732DS/ES ArmorBlock Guard I/O module
- 1734 POINT Guard I/O module

## Maintenance

Frequency	Description
Every month	Check the correct operation of the switching circuit. Also check for signs of abuse or interference. Inspect the switch casing for damage.
Every 5 years	Check the correct operation of the switching circuit. Also check for signs of abuse or interference. Inspect the switch casing for damage. The switch must be disconnected and readjusted.

## Repair

If there is any malfunction or damage, no attempts at repair can be made. The unit must be replaced before machine operation is allowed.

## Declaration of Conformity

This declaration is to declare that the products that are shown in this document conform with the Essential Health and Safety Requirement (EHSRs) of the European Machinery Directive 2006/42/EC.

For the latest declaration, see [rok.auto/certifications](http://rok.auto/certifications).

## Additional Resources

Resource	Description
Industrial Automation Wiring and Grounding Guidelines, publication <a href="#">1770-4.1</a>	Provides general guidelines for installing a Rockwell Automation industrial system.
Product Certifications website, <a href="http://rok.auto/certifications">rok.auto/certifications</a> .	Provides declarations of conformity, certificates, and other certification details.

You can view or download publications at [rok.auto/literature](http://rok.auto/literature).

# Rockwell Automation Support

Use these resources to access support information.

<b>Technical Support Center</b>	Find help with how-to videos, FAQs, chat, user forums, and product notification updates.	<a href="http://rok.auto/support">rok.auto/support</a>
<b>Knowledgebase</b>	Access Knowledgebase articles.	<a href="http://rok.auto/knowledgebase">rok.auto/knowledgebase</a>
<b>Local Technical Support Phone Numbers</b>	Locate the telephone number for your country.	<a href="http://rok.auto/phonesupport">rok.auto/phonesupport</a>
<b>Literature Library</b>	Find installation instructions, manuals, brochures, and technical data publications.	<a href="http://rok.auto/literature">rok.auto/literature</a>
<b>Product Compatibility and Download Center (PCDC)</b>	Download firmware, associated files (such as AOP, EDS, and DTM), and access product release notes.	<a href="http://rok.auto/pcdc">rok.auto/pcdc</a>

## Documentation Feedback

Your comments help us serve your documentation needs better. If you have any suggestions on how to improve our content, complete the form at [rok.auto/docfeedback](http://rok.auto/docfeedback).

## Waste Electrical and Electronic Equipment (WEEE)







At the end of life, this equipment should be collected separately from any unsorted municipal waste.

Rockwell Automation maintains current product environmental compliance information on its website at [rok.auto/pec](http://rok.auto/pec).

Your comments help us serve your documentation needs better. If you have any suggestions on how to improve our content, complete the form at [rok.auto/docfeedback](http://rok.auto/docfeedback).  
For technical support, visit [rok.auto/support](http://rok.auto/support).

Rockwell Otomasyon Ticaret A.Ş. Kar Plaza İş Merkezi E Blok Kat:6 34752 Çerenköy, İstanbul, Tel: +90 (216) 5698400 EEE Yönetmeliğine Uygundur

Connect with us.    

**rockwellautomation.com** — expanding **human possibility**<sup>™</sup>

AMERICAS: Rockwell Automation, 1201 South Second Street, Milwaukee, WI 53204-2496 USA, Tel: (1) 414.382.2000, Fax: (1) 414.382.4444

EUROPE/MIDDLE EAST/AFRICA: Rockwell Automation NV, Pegasus Park, De Kleetlaan 12a, 1831 Diegem, Belgium, Tel: (32) 2 663 0600, Fax: (32) 2 663 0640

ASIA PACIFIC: Rockwell Automation, Level 14, Core F, Cyberport 3, 100 Cyberport Road, Hong Kong, Tel: (852) 2887 4788, Fax: (852) 2508 1846

Allen-Bradley, ArmorBlock, CompactBlock, Guard I/O, expanding human possibility, Guardmaster, GuardShield, Minotaur, POINT Guard I/O, Rockwell Automation, SensaGuard, and SmartGuard are trademarks of Rockwell Automation, Inc.

EtherNet/IP is a trademark of ODVA, Inc.

Trademarks not belonging to Rockwell Automation are property of their respective companies.

Publication 440N-IN018C-EN-P - August 2020 | Supersedes Publication 440N-IN018B-EN-P-April 2019

Copyright © 2020 Rockwell Automation, Inc. All rights reserved. Printed in the U.S.A.



PN-474220

PN-474220

10003829146 Ver 02