

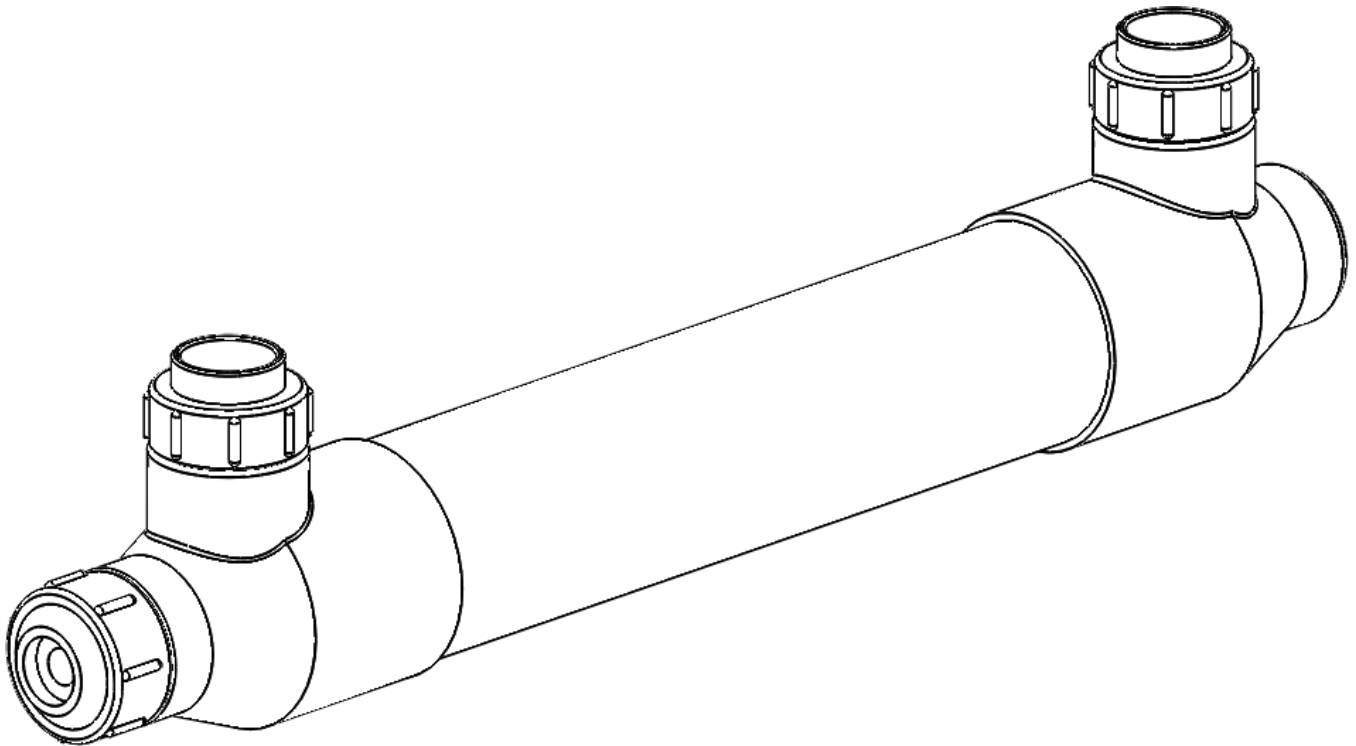

SMART UV[®]

UV DISINFECTION STERILIZER



INSTALLATION AND USER'S GUIDE

IMPORTANT SAFETY INSTRUCTIONS
READ AND FOLLOW ALL INSTRUCTIONS
SAVE THESE INSTRUCTIONS

CUSTOMER SERVICE / TECHNICAL SUPPORT

If you have questions about ordering Pentair replacement parts and products, please contact:

CUSTOMER SERVICE AND TECHNICAL SUPPORT, USA

Monday to Thursday: 8 AM to 6:30 PM EST

Friday: 8 AM to 5 PM EST

Phone: (877) 347-4788

Fax: (407) 886-6787

INTERNATIONAL

Phone: (407) 866-3939

Fax: (407) 866-4884

WEB SITE

Visit www.PentairAES.com for information about Pentair products.

©2018 Pentair Aquatic Eco-Systems, Inc. All rights reserved.

This document is subject to change without notice.

2395 Apopka Blvd., Apopka, FL 32703, USA

Phone: 407.886.3939 Web: PentairAES.com

All Pentair trademarks and logos are owned by Pentair or one of its global affiliates. Pentair Aquatic Eco-Systems® and SMART UV Systems™ are trademarks and/or registered trademarks of Pentair Aquatic Eco-Systems, Inc. and/or its affiliated companies in the United States and/or other countries. Unless expressly noted, names and brands of third parties that may be used in this document are not used to indicate an affiliation or endorsement between the owners of these names and brands and Pentair Aquatic Eco-Systems, Inc. Those names and brands may be the trademarks or registered trademarks of those third parties. Because we are continuously improving our products and services, Pentair reserves the right to change specifications without prior notice. Pentair is an equal opportunity employer.

P/N 02934-INS-SMART REV. D 8/18

TABLE OF CONTENTS

Important Warning and Safety Instructions	4	Maintenance	16
Warranty Information	5	Quartz Sleeve Cleaning	16
System Features and Specifications	6	Winterizing	16
SMART UV® Features	6	Lamp Connector Removal	17
System Specifications.....	6	Troubleshooting	18
Sizing Chart.....	6	Replacements Parts	19
Pre-Installation Inspection	7	SMART UV	19
Component Diagram	7	SMART HO UV	20
Power Supplies	7		
Quartz Sleeve and UV Lamp Inspection	8		
Installation	9		
Quartz Sleeve Assembly and Installation	9		
Sterilizer Installation and Operation	10		
Typical Installation	10		
Mounting the Vessel.....	10		
Mounting the Power Supply	11		
Mandatory Leak Test.....	11		
Electrical Connection	12		
UV Lamp Installation	12		
Lamp Styles.....	12		
Power Cord Adjustment.....	12		
SMART UV Installation and Operation	14		
Pond Installation Configurations.....	14		
Aquarium Installation Configurations	14		

IMPORTANT SAFETY INSTRUCTIONS



IMPORTANT NOTICE

This guide provides installation and operation instructions for the SMART UV® Sterilizer. Consult Pentair with any questions regarding this equipment.

Attention Installer: This guide contains important information about the installation, operation and safe use of this product. This information should be given to the owner and/or operator of this equipment after installation or left on or near the UV system.

Attention User: This manual contains important information that will help you in operating and maintaining this product. Please retain it for future reference.

IMPORTANT SAFETY INSTRUCTIONS! PLEASE READ PRIOR TO INSTALLATION AND OPERATION!

Strictly follow the instructions within this manual to ensure the health and safety of both, yourself and the UV system. The installation, operation and maintenance of the UV system can only be carried out after reading and understanding the information contained in this manual.

The installation of the UV system must be carried out in accordance with local regulations and codes.

READ AND FOLLOW ALL INSTRUCTIONS

 This is the safety alert symbol. When you see this symbol on your system or in this manual, look for one of the following signal words and be alert to the potential for personal injury.

 **DANGER** Warns about hazards that can cause death, serious personal injury, or major property damage if ignored.

 **WARNING** Warns about hazards that may cause death, serious personal injury, or major property damage if ignored.

 **CAUTION** Warns about hazards that may or can cause minor personal injury or property damage if ignored.

NOTE Indicates special instructions not related to hazards.

Carefully read and follow all safety instructions in this manual and on equipment. Keep safety labels in good condition; replace if missing or damaged.

When installing and using this electrical equipment, basic safety precautions should always be followed, include the following:

 **DANGER** FAILURE TO FOLLOW ALL INSTRUCTIONS AND WARNINGS CAN RESULT IN SERIOUS BODILY INJURY OR DEATH.

INSTALLERS, OPERATORS AND OWNERS MUST READ THESE WARNINGS AND ALL INSTRUCTIONS IN THE OWNER'S MANUAL BEFORE USING THIS PRODUCT. THESE WARNINGS AND THE OWNER'S MANUAL MUST BE LEFT WITH THE OWNER.

 **WARNING** Ultraviolet light is damaging to your eyes and skin! DO NOT handle or stare at an operating UV lamp. Note that the UV light rays are invisible to the human eye and precautions should be taken to prevent UV energy from entering the eyes.

 **DANGER** ULTRAVIOLET RADIATION. Disconnect all power from the unit before replacing lamps or servicing the unit.

 **CAUTION** The quartz sleeve and or the UV lamp shipped with this product may have been broken or damaged during transit. It is therefore essential that the unit be carefully inspected before connecting to electrical power.

 **CAUTION** To prevent possible fire or electrical shock, only use replacement lamps specified by the manufacturer.

 **WARNING** DO NOT allow system to exceed 50 PSI (Pounds Per Square Inch).

 **CAUTION** DO NOT operate this unit above rated flow rate. Operating the product in this manner may result in product failure and voiding of warranty.

 **DANGER** To avoid possible electrical shock, special care should be taken since water is employed in intended applications. For each of the following situation, DO NOT attempt repairs yourself. Call Pentair customer service department at 877-347-4788 for services or discard the appliance.

 **DANGER** If unit falls into the water, DO NOT REACH FOR IT! First power down the unit and then retrieve it. If the internal electrical components of the unit get wet, keep the unit powered down until internal electrical components have dried.

 **DANGER** If the unit shows any sign of water leakage, immediately power down the unit.

 **CAUTION** Carefully examine the unit after installation. It should not be powered on if there is water on any part not intended to be wet.

IMPORTANT SAFETY INSTRUCTIONS

⚠️ WARNING To reduce the risk of injury, DO NOT permit children to use this product.

⚠️ WARNING SMART UV® systems are designed for low-pressure water applications DO NOT use these units for any application outside of their intended use. The use of attachments not recommended or sold by the original manufacturer may cause unsafe conditions and may void any warranty.

⚠️ WARNING This unit must be wired in conjunction with a properly grounded, Ground Fault Circuit

Interrupter (GFCI). Only three (3) wire grounded cables suitable for outdoor use should be used to connect this unit. If joining cables for outdoor use, a suitable watertight cable connector must be used. If an extension cord is necessary, a cord with a proper rating should be used. A cord rated for less amperes or watts than the appliance's rating may overheat. Care should be taken to arrange the cord so that it will not be tripped over or pulled. If in doubt consult a qualified electrician.

⚠️ WARNING Warping of the UV body may occur when left in direct sunlight without water inside to help dissipate the heat.

⚠️ WARNING DO NOT operate the unit in "no-flow" situations.

SAVE THESE INSTRUCTIONS

WARRANTY INFORMATION

PENTAIR warrants to the original purchaser, the SMART UV Ultraviolet Sterilizers to be free from defects in workmanship or materials for a period of 1 year from the date purchase on power supply and all gaskets seals.

The UV vessel has a 3-year warranty if failure is caused from the UV lamp light exposure. Warranty will be void if water leaks are caused by failing to follow the proper assembly instructions.

The UV lamp has a 90-day warranty on the electrical operation only.

The warranty is only in effect provided the equipment is installed in accordance with the factory instructions, recommendation and operated within the environment and limitations for which it was designed.

SYSTEM FEATURES AND SPECIFICATIONS

All SMART UV® Systems UV Sterilizer models are packaged complete, with all necessary components that are required to operate the unit. When unpacking, it is recommended to perform a complete component inventory to ensure everything is accounted for and hasn't been damaged.

The serial number of your UV unit is located on a small white label near the electrical end of the unit's vessel.

The model number of your UV unit can be found in two locations:

1. On the bar code label at the end of the box.
2. On the label placed in the middle of the UV Vessel, with a hole punch indicating the model number.

SMART UV Features

Our GPH T-5 and T-6 low pressure mercury vapor germicidal amps, convert approximately 30% of their electrical input watts into UV-C output watts within the germicidal action spectrum (meaning 30% of electricity used is converted into useful germicidal UV light), the highest UV-C output conversion among all UV lamps.

- UL listed for indoor and outdoor use, fresh and salt water use.
- Long lasting GPH/T5 and GPH/T6 UV lamps (9,000 hours to 80% efficiency).
- Protective Quartz Sleeve (maximizes UV lamp output and safety)
- Watertight Design
- Easy-to-Remove Power Assembly
- Remote Power Supply
- UV Resistant High Density Plastic UV Vessel
- Utilizes the UV lamp to its maximum potential (maximum UV exposure)
- Non-UV Transmitting Clear Lamp Viewing Ports

System Specifications

Model No.	Max Flow Rate @ 30 mJ/cm ²	Lamp Wattage	Amperes (A)	UV-C Output Watts	Dimensions H x W (Inches)	Input Voltage (50/60 Hz)	Port Connection
EU18-U	6 GPM	18	0.34-0.17	5.4	23" X 4"	120-240 VAC	1.5" Union/ 1" Barb
EU25-U	9.5 GPM	25	0.40-0.20	7.5	29" X 4"	120-240 VAC	
EU40	15.5 GPM	40	0.44-0.22	12	44" X 4"	120-240 VAC	
EU65P	26 GPM	65	0.46-0.23	19.5	71" X 4"	120-240 VAC	
E50S	26 GPM	50	1.15/0.57	15	28" x 5.75"	120-240 VAC	2" Union
E80S	45 GPM	80	1.15/0.57	26	43" x 5.75"	120-240 VAC	
E120S	64 GPM	120	1.15/0.57	36	56" x 5.75"	120-240 VAC	
E150S	100 GPM	150	1.82	47	70" x 5.75"	120 VAC	
E150S-2	100 GPM	150	0.81	47	70" x 5.75"	240 VAC	

PRE-INSTALLATION INSPECTION

Component Diagram

Please review the component diagram below. Unpack your UV system, and lay out the packaged components for inspection. Please review the information listed in this section to become familiar with the equipment's various parts.

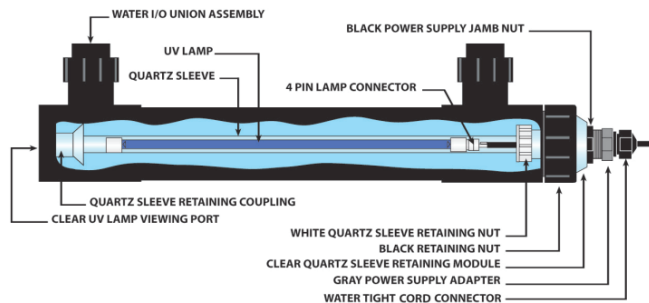

SMART UV® Sterilizer Models:
Part Numbers EU18-U, EU25-U, EU40 & EU65P

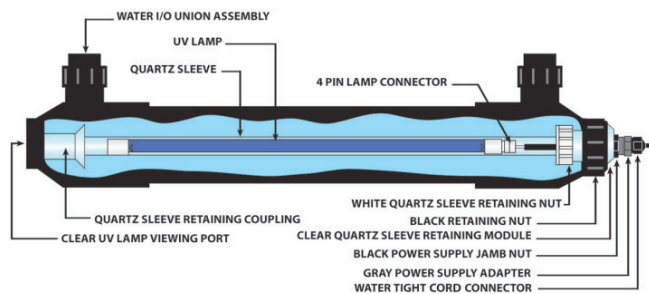

SMART UV HO Sterilizer Models:
Part Numbers E50S, E80S, E120S & E150S

Power Supplies

The power supply can either be a cylinder "POD" or a rectangle style. Below are the ballasts that are currently used with the SMART UV line.

**For SMART Lite and SMART
18W, 25W, 40W, and 65Watt Units.**



20120-MV – 120VAC/240VAC 50/60 Hz



20100 – 120VAC 50/60 Hz

For SMART HO 50W, 80W, and 120Watt Units.



20105-MV – 120VAC/240VAC 50/60 Hz

For SMART HO 150W (120VAC)



202150-1 – 120VAC 50/60 Hz

For SMART HO 150W (240VAC)



202150-2 – 240VAC 50/60 Hz

PRE-INSTALLATION INSPECTION

Quartz Sleeve and UV Lamp Inspection – When Packed in Tube

SMART UV® Disinfection Sterilizers are packaged with their quartz sleeve assembly pre-assembled inside the UV vessel.

The UV lamp is packaged separately in a corrugated tube.

The Quartz Sleeve Assembly must be removed from the UV vessel and inspected for damage prior to installation. Extreme care should be used while this procedure is being performed.

Note: DO NOT handle the lamp or quartz sleeve with bare hands. Your hands can deposit oils on the quartz sleeve and lamp that will decrease the efficiency of UV disinfection.

1. Carefully unpack the UV lamp from their corrugated packing tube and inspect for damage including broken glass, cracks, chips, fractures and pin holes. If damage has occurred please contact the place of original purchase immediately.



NOTE: Save the corrugated lamp packaging after unpacking the UV lamp. Storing the lamp and/or quartz sleeve in this packaging while performing maintenance on the UV system will protect these components from damage or fouling when outside of the vessel.

2. Carefully, remove the quartz sleeve by unthreading the Black Retaining Nut. Gently slide out the quartz sleeve assembly and inspect for damage including chips, cracks and pin holes. If damage has occurred please contact the place of original purchase immediately.



3. After inspection, reassemble the quartz sleeve back into the UV vessel. Perform the Mandatory Leak Test (see page 7).
4. Inspect all other UV system components (power supply, UV vessel unions and necessary mounting clamps) for damage.



After receipt and inspection of the unit, if broken glass is found (including cracks, chips, pin holes and hair line fractures of any kind) please contact the place of original purchase immediately for replacements.

INSTALLATION

⚠ WARNING Improper assembly may result in water damage to electrical components and unsafe conditions. The manufacturer is not responsible for damage cause by improper re-assembly of these parts.

Quartz Sleeve Assembly Includes:

1. Quartz Sleeve
2. White Quartz Sleeve Retaining Nut
3. Rubber Gasket
4. Clear Quartz Sleeve Module
5. Clear Quartz Sleeve Module O-ring
6. Power Supply Gasket

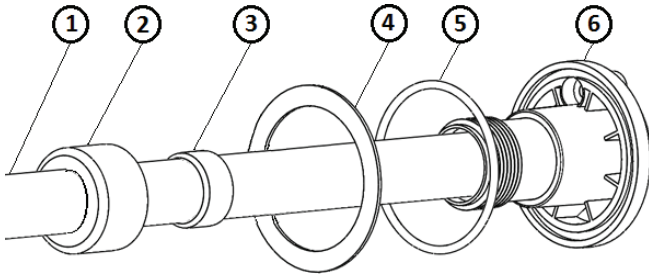

Assembly Instructions

1. Position the white quartz sleeve retaining nut and rubber gasket over the open end of the quartz sleeve.
3. Slide the “open-end” of the quartz sleeve (with nut and gasket in position) into the clear quartz sleeve module.
3. Thread the white retaining nut onto the clear quartz sleeve module’s male threads and hand-tighten.
4. While hand-tightening the white retaining nut onto the clear quartz sleeve module, use your index finger to ensure that the open-end of the quartz sleeve mates smoothly with the inside lip of the clear quartz sleeve module; this signifies a good fit. See Photo A.



5. With the quartz sleeve positioned inside the clear quartz sleeve module properly, finish hand-tightening the white retaining nut. When the white retaining nut is tight, the quartz sleeve should appear straight inside the clear quartz sleeve module (see Photo B).

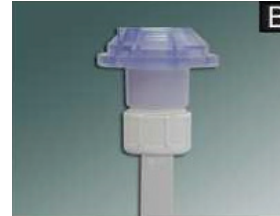

NOTE: If the quartz sleeve appears crooked it may leak. Disassemble and try again.

6. Carefully slide the quartz sleeve assembly into the UV vessel (see Photo D). The domed-end of the quartz sleeve should slide into the coupling located on the non-electrical end of the UV vessel (see Photo C).

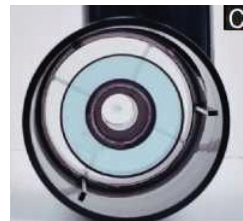

7. With the quartz sleeve assembly properly in place, the quartz sleeve retaining module should sit flush against the top of the UV vessel. See Photo E.



NOTE: Be sure that the clear quartz sleeve module O-ring and gasket is properly seated in the bottom of the quartz sleeve module (see item #6 on page 4).

INSTALLATION

8. Thread the black retaining nut (see **Photo F**) onto the male threads of the UV vessel. Hand tight only!



9. Using the instructions given on page 7, perform the Mandatory Leak Test. If no leaks are found proceed to page 8, *UV Lamp Installation*, for instructions on installing the UV lamp.

Sterilizer Installation and Operation

CAUTION DO NOT operate the UV system at flow rates higher than 90 GPM (341 LPM). Operating the product in this manner may result in product failure and voiding of warranty.

SMART UV® Disinfection Sterilizers are used in a variety of applications to control waterborne pathogens. Pentair encourages the consideration of the installation recommendations provided here.

Suspended solid debris will absorb UV light and reduce the UV transmittance through water. By operating the SMART UV system after the mechanical filter, the unit's overall performance will be increased.

The efficiency of the UV sterilizer operation is directly related to the recommended water flow rates found in the "Sizing Chart", on page 1.

Mounting the Vessel

Note: The way UV vessels are mounted/positioned plays a very important role in the unit's performance and degree of safety. We **STRONGLY RECOMMEND** that you follow these instructions and guidelines precisely. Any deviation from these mounting instructions will void any warranty associated with the UV vessel and all its components and may cause unsafe conditions.

CAUTION Trapped air inside the UV vessel during operation may create excessive heat thus damaging internal components.

Vertical Vessel Mounting

Mount the SMART UV Disinfection Sterilizer with the electrical end up. Use the bottom port as the inlet with the top port as the outlet.

Note: The UV vessel should be installed with a vertical clearance $1\frac{1}{2}$ times the vessel length. This will allow sufficient room for servicing the unit and replacing the UV lamp

WARNING The inlet and outlet plumbing **MUST** be supported to avoid vessel material stress.



Failure to support the inlet and outlet plumbing may lead to damage to the vessel.

Horizontal Vessel Mounting

Mount the SMART UV system horizontally with the inlet/outlet facing up. If the unit is mounted but not level, the electrical end of the unit should be positioned higher than the non-electrical end. Choose the lower port of the inlet

NOTE: The UV vessel should be installed with a horizontal clearance $1\frac{1}{2}$ times the vessel length. This will allow sufficient room for servicing the unit and replacing the UV lamp.

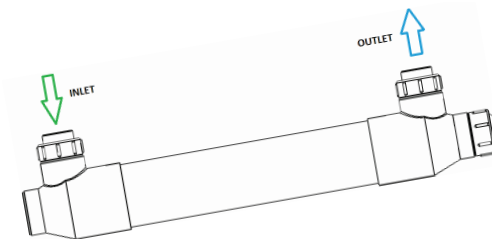

INSTALLATION

Mounting the Power Supply

Depending on the style of power supply cylinder or rectangle the SMART UV® system's power supply can be mounted two ways, mounting tabs at the corner of the ballast or using the mounting clamps for the cylinder type of ballast. The power supply should always be mounted to a surface that is sheltered from rain, splashing, heavy condensation or any other kind of prolonged contact with water.

NOTE: DO NOT mount the power supply in an extremely confined space where heat and moisture can be retained.

Your UV system will include one of two different power supplies based on the wattage of your unit:

- **50W, 80W and 120W UV systems** include a rectangular power supply. Four screws, one in each corner of the power supply, secure the power supply to the wall or shelf.

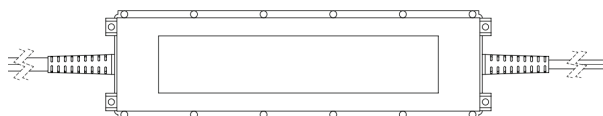

- **150W UV systems** include a cylindrical power supply that must be mounted with the two pipe clips packaged with the unit.

A single screw at the base of the pipe clip secures it to the wall or shelf. The power supply is then locked into the pipe clip by securing the retaining strap onto the clip.

Mandatory Leak Test

A leak test should be performed each time the quartz sleeve is installed inside the unit's vessel or when the quartz sleeve or gaskets are replaced [Once annually]. Performing a leak test is a precautionary measure that will determine whether or not the critical seal between the quartz sleeve and quartz sleeve module has been achieved.

Failure to achieve a proper quartz sleeve/quartz sleeve module seal during SMART UV Disinfection Sterilizer operation will allow water to leak into the inside of the quartz sleeve, potentially damaging the UV lamp and other electrical components, which could develop into dangerous situations.

IMPORTANT NOTE: Failure to perform a leak test could lead to conditions that will void your product warranty.

To Perform Mandatory Leak Test:

1. Prepare the UV system for permanent operation by plumbing it in-line, into a filter system using the plumbing hardware of your choice. If PVC glue is used, follow the glue manufacturer's instructions.
2. If UV lamp is installed, with the unit plumbed for operation and the clear quartz sleeve module securely in place, remove the UV lamp from the quartz sleeve module.
3. Roll-up a few paper towels creating a core approximately $\frac{3}{4}$ inch diameter, 10-inches long then slide into the open quartz sleeve module port. Insert about 6-inches of the paper towel core down into the quartz sleeve, as shown.



4. With the paper towel in place, turn on the pump and recirculate water through the UV vessel for at least thirty (30) minutes.
5. After thirty (30) minutes of recirculating water through the UV vessel, remove the paper towels from the quartz sleeve module. Inspect closely for moisture. If the paper towel is completely dry, your leak test is complete and successful.

If moisture is detected on the paper towel the quartz sleeve's rubber gasket and O-ring have failed to achieve a seal and must be re-assembled; repeat the leak test until a seal is achieved. See page 4 for assembly instructions.

INSTALLATION

Electrical Requirements

The electrical requirements for the UV sterilizer are marked on the unit's power supply label (Ex. 120VAC 50/60Hz.). The unit must be plugged into a well-grounded electrical outlet.

⚠️ WARNING Do not attempt to cut the ground post off of the 3-prong plug, doing so will void the unit's warranty.

This product must be grounded. If the unit should fail electrically, grounding provides a path of least resistance for electric current to pass to reduce the risk of electric shock. This product's cord is equipped with an equipment-grounding conductor and a grounding plug. The plug must be plugged into an appropriate outlet that is properly installed and grounded in accordance with all local codes and ordinances. If in doubt consult a qualified electrician.

⚠️ WARNING DO NOT operate this equipment with timing devices.

⚠️ DANGER Improper connection of the equipment-grounding conductor can result in a risk of electrocution. Check with a qualified electrician or service personnel if unsure that the outlet is properly grounded. Do not product's plug. If it will not fit into the electrical outlet, have a proper outlet installed by a qualified electrician. Type of plug adapter with this product.

Ground Fault Circuit Interrupter (GFCI) Protection

⚠️ WARNING This unit must be wired in conjunction with a properly grounded, Ground Fault Circuit Interrupter (GFCI). Only three (3) wire grounded cables suitable for outdoor use should be used to connect this unit. If joining cables for outdoor use, a suitable watertight cable connector must be used. If an extension cord is necessary, a cord with a proper rating should be used. A cord rated for fewer amperes or watts than the appliance's rating may overheat. Care should be taken to arrange the cord so that it will not be tripped over or pulled. If in doubt consult a qualified electrician.

GFCI's are designed to sense an imbalance in electrical current flow within the main electrical leads (leakage current). When this imbalance (maximum 5 mA per UL) occurs in the main leads, a comparator

within the GFCI outlet generates a trip signal which is applied to a coil that trips the main (normally closed) contacts. These contacts open and break the circuit.

Ghost Trips

Consider that all GFCI's must trip at a leakage current of 5 ma. GFCI "Ghost Trips" are caused by electrical devices that have small electrical leakage current to ground. Multiple outlets protected by one GFCI allow for potential cumulative leakage currents caused by multiple appliances each leaking small amounts of current.

Example: One pump plugged into an outlet that is part of a four outlet branch protected by one GFCI will not trip the GFCI with its 2 mA leakage current. However, two pumps and a UV with a cumulative leakage current of 7 mA will trip the GFCI. This is a common problem.

The solution to the GFCI "Ghost Trip" problem is to operate the device on its own GFCI protected outlet, or, remove other devices from the GFCI protected branch of outlets. If the GFCI is over ten years old, you may want to consider replacing it.

UV Lamp Installation Lamp Styles

UV lamps are manufactured with color coded ceramic bases. White-capped UV lamps signify a Standard-Output UV lamp while red-capped UV lamps signify a High-Output UV lamp.

Power Cord Adjustment

There should be 4-inches of cord between the Gray Adapter (3) and the 4-pin Lamp Connector (1). The 4-inch cord distance positions the lamp properly inside the quartz sleeve.

1. The $\frac{3}{8}$ inch Threaded Watertight Cord Connector (1) is adjustable. Loosen it gently move the cord through it. Care must be taken when retightening. If the Connector's Rubber Gasket Seal is dislodged during cord adjustment please make sure that it is properly re-seated inside the male threaded portion of the connector.

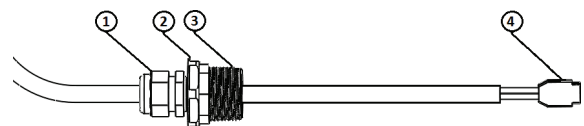

4 Inches between Gray Adapter (3) and 4-Pin Connector (4)

INSTALLATION

2. After a successful leak test and without the power supply connected to a control box, attach the lamp's 4-pins to the power cord's white 4-pin Connector (4), then slide the UV lamp back into the quartz sleeve.
3. Whether the SMART UV® Disinfection Sterilizer vessel is mounted horizontally or vertically, care should be taken when installing the UV lamp into the vessel's quartz sleeve. Vertical installations require extra attention to eliminate the chance of the lamp dropping into the quartz sleeve and breaking.
4. With the UV lamp/power cord connection complete and the lamp entirely inside the quartz sleeve, carefully screw down the Gray Power Supply Adapter (3) onto the Clear Quartz Sleeve Module (6); hand tighten only.
5. Screw down the Black Power Supply Jamb Nut (4) until it makes contact with the Clear Quartz Sleeve Module (6).

NOTE: By loosening the $\frac{3}{8}$ inch Threaded Watertight Cord Connector (5), Power Cord adjustments can be made. Make sure the $\frac{3}{8}$ inch Threaded Watertight Cord Connector's gasket is properly in place before retightening.

NOTE: If you do not have the Black Power Supply Jamb Nut (4) back far enough before tightening the Gray Power Supply Adapter (3), the gray adapter will not make contact with the power supply gasket and will enable outside moisture to enter the quartz sleeve assembly and cause a system failure.



OPERATION

SMART UV® Installation and Operation

SMART UV Systems UV Sterilizers are used in a variety of applications to control waterborne pathogens. Pentair encourages the consideration of the installation/operation recommendations provided here.

Suspended solid waste will absorb UV light and reduce the UV transmittance through water. By operating the SMART UV after the mechanical filter, the unit's overall performance will be increased.

When operating SMART UV sterilizers please consider the recommended water flow rates.

Pond Installation Configurations

Small to Moderately Sized Ponds (up to 5,000 Gallons) Using Skimmers and Falls

Placing the UV between the skimmer box and the filter ensures that pre-filtered water reaches the UV, increasing its performance while reducing maintenance.

Often the capacity of the pump exceeds the capacity of the UV. If this is the case, install a bypass manifold. Be sure that the skimmer is equipped with mechanical filtering capacity. See **Diagram 1**.

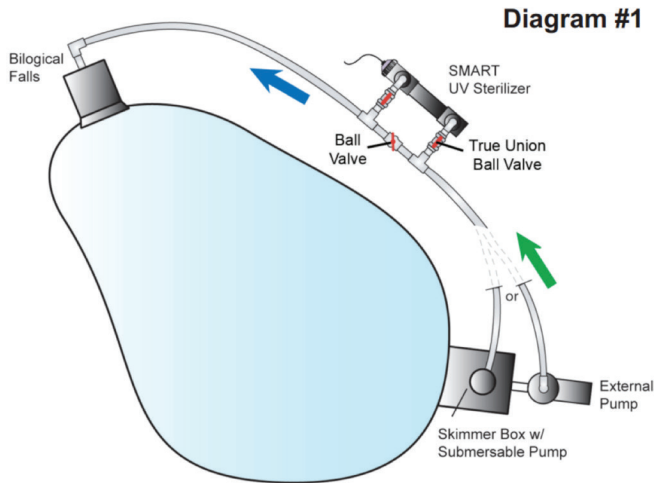

NOTE: Before gluing piping or reducer bushing into the UV's union or socket, remove the quartz sleeve assembly to prevent glue from dripping onto the quartz sleeve.

NOTE: Use threaded seal tape on all threaded connections.

Larger Sized Ponds (above 5,000 Gallons) Using Surface Skimmer and Pressurized Filter

This system is simple yet it achieves critical filtering goals, such as good water circulation for increased solid waste suspension. The bottom drain/surface skimming capabilities ensure maximum waste removal. See **Diagram 2**.

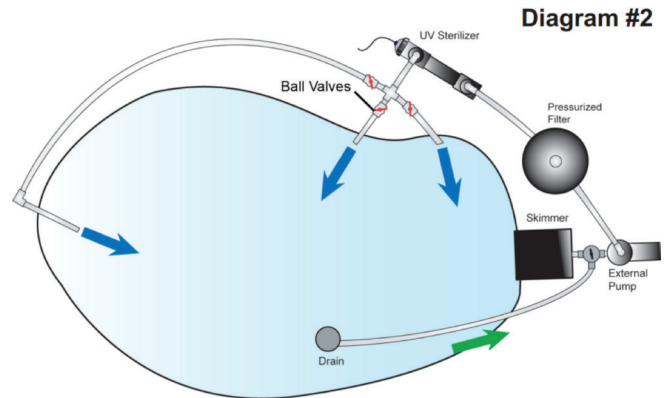

The SMART UV System UV Sterilizer is positioned after the mechanical filter where it can receive only solid waste free water, optimizing UV transmittance/performance. Notice the 3-way valve that regulates suction from the skimmer and drain to the pump, allowing flow control.

Next, multiple "clean water returns" improve circulation, suspending solid waste and helping it to find the filter. If you have a flow rate that exceeds the UV's, install a by-pass manifold. See **Diagram 1**.

NOTE: Before gluing piping or reducer bushing into the UV's union or socket, remove the quartz sleeve assembly to prevent glue from dripping onto the quartz sleeve.

NOTE: Use threaded seal tape on all threaded connections.

Aquarium Installation Configurations

Canister Filter/Aquarium Installation

Pressurized Canister filters are commonly used with small freshwater/saltwater aquariums. **Diagram 3** shows a SMART UV model.

It is important to match the Canister Filter's flow rate to the capacity of the SMART UV. If this is not feasible, use a bypass manifold (see **Diagram 5** on page 14). To prevent back-siphoning, consider installing

OPERATION

a check valve or ball valve (see filter instructions/recommendations). See **Diagram 3**.

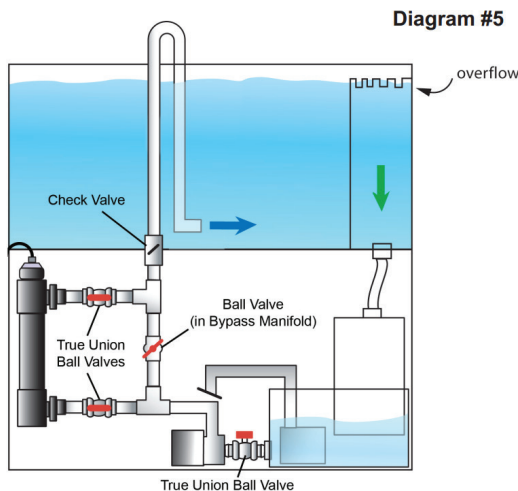
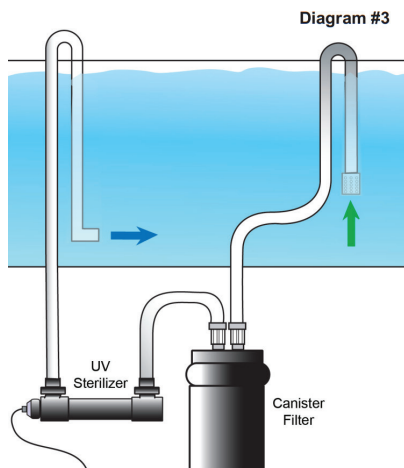

NOTE: Before gluing piping or reducer bushing into the UV's union or socket, remove the quartz sleeve assembly to prevent glue from dripping onto the quartz sleeve.

NOTE: Use threaded seal tape on all threaded connections.

Wet-Dry with External or Submersible Pump Installation

This installation configuration shows the SMART UV System® UV Sterilizer capacity matched to the recirculating flow rate performance of the pump. We recommend mechanical filter media being used inside the over-flow and at the top of the wet-dry filter.

Installing a check valve after the UV will eliminate back siphoning. Installing true-union ball valves will allow

flow adjustments and UV removal. For best results, install a saddle-style water flow meter, mounted horizontally on the outlet side of the UV. Follow the water flow meter manufacturer's instructions for proper installation and operation. See **Diagram 4**.

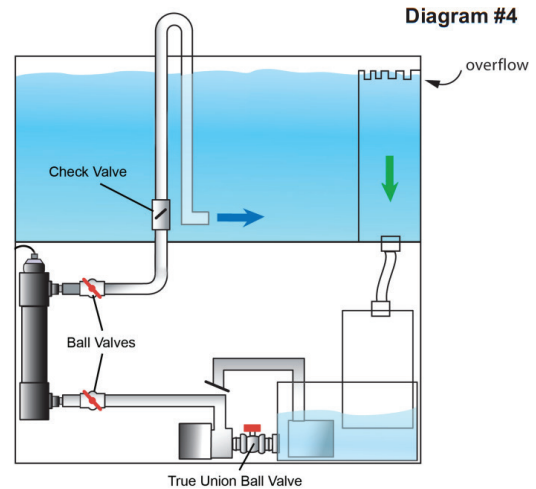

NOTE: Before gluing piping or reducer bushing into the UV's union or socket, remove the quartz sleeve assembly to prevent glue from dripping onto the quartz sleeve.

NOTE: Use threaded seal tape on all threaded connections.

Wet-Dry w/External or Submersible Pump Installation

This installation configuration is identical to Diagram 4 with the addition of a bypass manifold. The bypass is used to deliver a precise water flow to the SMART UV when the overall clean water return flow rate exceeds the UV's capacity.

Installing a check valve after the UV will eliminate back siphoning. Installing true union ball valves will allow flow adjustments and easy UV removal for servicing. For best results, install a saddle-style water flow meter, mounted horizontally on the outlet side of the UV. Follow the water flow meter manufacturer's instructions.

NOTE: Before gluing piping or reducer bushing into the UV's union or socket, remove the quartz sleeve assembly to prevent glue from dripping onto the quartz sleeve.

NOTE: Use threaded seal tape on all threaded connections

MAINTENANCE

Quartz Sleeve Cleaning

It is recommended that the quartz sleeve be visually inspected for cleaning once every six months of operation. Even the slightest layer of material (slim/dirt) coating the outside of the quartz sleeve can have a substantial effect on UV-C light transmittance through the glass and into the water.

Cleaning frequency is also dependent on how well water is being filtered before reaching the SMART UV® Systems UV Sterilizer. Water that contains solid waste will deposit greater amounts of material onto the quartz sleeve and will increase the frequency of necessary cleaning.

To Clean the Quartz Sleeve (for above water-level installations only):

1. Disconnect power to the UV sterilizer and pool pump at the circuit breaker.
2. Relieve any residual pressure that may remain in the system.
3. Unthread the Black Retaining Nut and gently remove the Quartz Sleeve Assembly and lamp from the UV vessel.
4. Inspect the Quartz Sleeve and clean as needed with a soft, clean cloth.
5. If calcium deposits are present use vinegar or a mixture of water and muriatic acid to dissolve the deposits. If using muriatic acid a ratio of four parts water to one part acid should suffice. Always introduce acid to the water and never introduce the water to the acid.

WARNING



Muriatic acid is corrosive and can lead to inflammation or burns to body tissue. ALWAYS wear rubber gloves, safety glasses and an N-95 dust mask when handling acid to prevent serious bodily injury.

To prevent degradation of the acid by UV light, store muriatic acid in an opaque container and away from direct sunlight.

6. Remove ALL vinegar or acid from the quartz sleeve assembly before reassembling.

Winterizing

Using the SMART UV Disinfection Sterilizer in extremely cold temperatures can cause damage to the unit, especially if the water is allowed to freeze inside the equipment. Please note that damage to the product due to freezing is not covered under warranty.

Pentair recommends shutting the UV system down when the temperature consistently falls below 40°F (4°C).

1. Drain all water from the UV system.
2. Disassemble the entire unit and carefully clean both the outside and interior of the UV body and components.
3. Once clean and dry, store the UV vessel and power supply in a dry place for the winter.
4. Return the UV system to service when temperatures consistently return to 40°F (4°C) or greater.

NOTE: Be sure to replace the quartz sleeve gasket and perform a leak test prior to operating the equipment.

MAINTENANCE

Lamp Connector Removal

In the event that you would need to replace your 4-pin lamp connector, follow these steps:

1. Unplug the UV sterilizer and disconnect power to the water pump at the circuit breaker.
2. Remove UV lamp from the quartz sleeve.
3. Unplug the UV lamp from the connector/power cord.
4. Grasp the white 4-pin lamp connector with a pair of pliers while standing on the power cord itself.
5. Pull hard, while twisting slightly. The connector will disconnect.
6. Check to be sure the ends of the electrical wires are still tinned; they are pre-soldered before they're pushed into the connector. If they are no longer tinned, you will need to dip them in flux and then solder to make them firm enough to push back in the new lamp connector.

NOTE: Clean away any residual flux off of the wires before assembling them into the lamp connector.

7. Using a "new" 4-pin lamp connector, push the power cord's tinned wires into the holes of the connector making sure that they are firmly attached. Once attached, the wires should not pull out of the connector. See Diagrams below for wire placement.
8. Plug lamp back into the connector.
9. When installing the lamp be sure to have Black Power Supply Jam Nut all the way back on gray adapter. Tighten down the Gray Power Supply Adapter first and then secure the black jam nut. See "UV Lamp Installation" on page 9.

NOTE: If you do not have the Black Power Supply Jam Nut back far enough before tightening the Gray Power Supply Adapter, the gray adapter will not make contact with the power supply gasket and will enable outside moisture to enter the quartz sleeve assembly system failure.

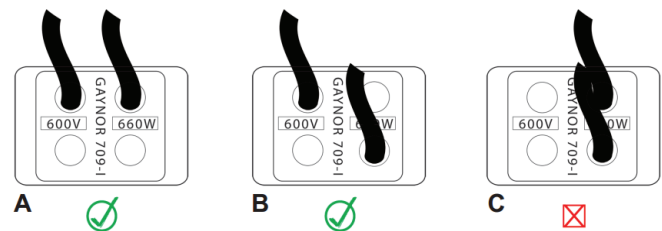

TROUBLESHOOTING

Paper Towel Leak Test Indicates a Leak

1. Turn off the pool pump at the circuit breaker and be sure all flow to the unit has been stopped.
2. Refer to pages 4–5 for “Quartz Sleeve Assembly” and page 8 for “UV Lamp Installation” (in reverse order) to disassemble the unit.
3. Ensure there are no cracks or breakages in the Quartz Sleeve, that the Quartz Sleeve Gasket is properly installed, and that the Quartz Sleeve Retaining Nut has been tightened down completely.
4. Reassemble the Quartz Sleeve (see page 4) and repeat the Mandatory Leak Test (see page 7) until there is no indications of a leak.

GFCI/Breaker is tripping

1. Immediately disconnect power to the SMART UV® Disinfection Sterilizer.
2. Turn off the pool pump at the circuit breaker and be sure all flow to the unit has been stopped.
3. Refer to pages 4–5 for “Quartz Sleeve Assembly” and page 8 for “UV Lamp Installation” (in reverse order) to disassemble the unit.
4. Check for water/moisture inside the quartz sleeve.
5. Multiple appliances connected to a circuit protected by one GFCI create the potential for cumulative leakage current resulting in a tripped GFCI.

Pond Still Green after a Week of UV Operation

1. Ensure the UV lamp is lit by utilizing the safe viewing port.
2. A dirty quartz sleeve can reduce the UV sterilizer’s performance. If the Quartz sleeve is dirty refer to “Quartz Sleeve Cleaning” on page 15 for cleaning procedures.
3. Double check the unit’s flow rate and compare to the flow rate chart for your specific UV model.

REPLACEMENT PARTS

#	PARTS	ITEM #
1	UV Lamp	
	EU18-U (18 WATT)	FL-2536-IP
	EU25-U (25 WATT)	FL-2542-IP
	EU40 (40 WATT)	FL-1957-IP
	EU65P (65 WATT)	FL-2529-IP

2	4-Pin Lamp Connector	709-1S
3	Power Supply Nut	8467
4	Cable Gland/Reducer	20600-AQ
5	Black Retaining Nut	8050B20

12	Quartz Sleeve	
	EU18-U (18 WATT)	FL-QZ173-IP
	EU25-U (25 WATT)	FL-QZ175-IP
	EU40 (40 WATT)	FL-QZ176-IP
	EU65P (65 WATT)	FL-QZ167-IP

13	UV Sterilizer Housing – with unions	
	EU18-U (18 WATT)	960359
	EU25-U (25 WATT)	20425
	EU40 (40 WATT)	20440
	EU65P (65 WATT)	20465
	EU80P (80 WATT)	NA
	EU130P (130 WATT)	NA

#	KITS	ITEM #
Quartz Sleeve Module – QSM		
	Includes 6 thru 11	Z000-005
6	Power Supply Gasket	20620-AQ
7	QSM	Part of QSM
8	QSM O-Ring	BN70-232
9	QSM Gasket	960409
10	Quartz Sleeve Gasket	960471
11	White Retaining Nut	25004

Union Assembly – 1.5”		
	Includes 14, 15, 16	ZUNIONB15
14	Inlet/Outlet O-Ring	EP70-228
15	Inlet/Outlet Socket	8458B15
16	Inlet/Outlet Nut	8050-B15

Barb/Reducer Assembly		
	Includes 17, 18	960090

Ballast Assembly – 120/230VAC, 50/60 Hz		
	Includes 2, 3, 4	20120-MV

Seal Kit – 18, 25, 40, 65W		
	Items 10, 11, 12, 16	20375

Seal Kit – 80w, 130w		
	Items 10, 11, 12, 16	20374-AQ

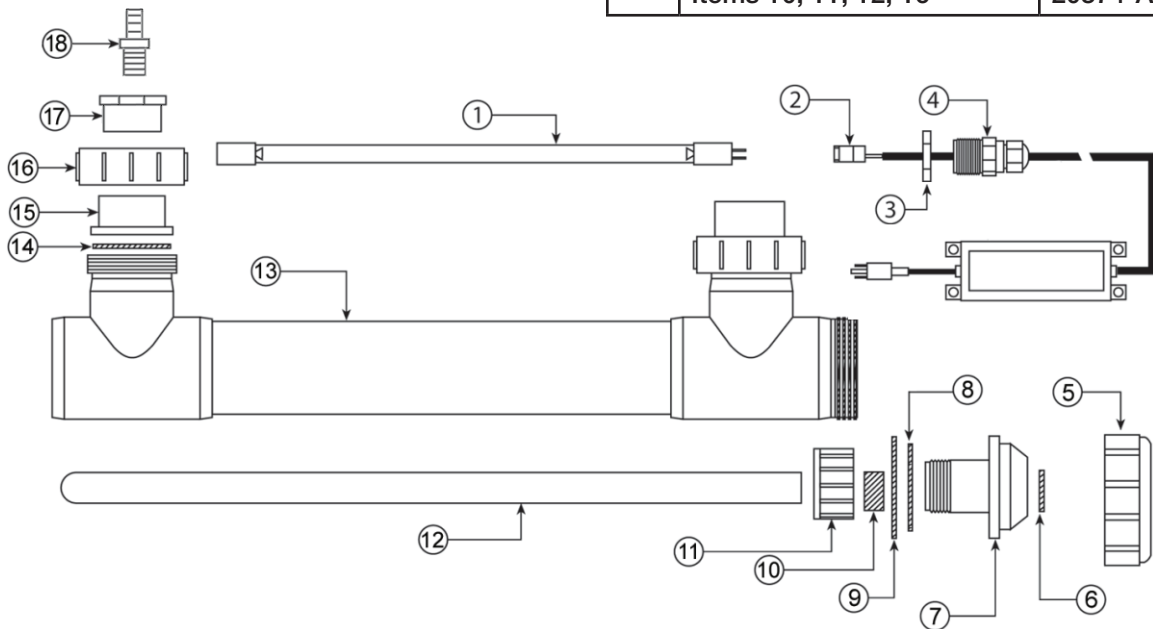

REPLACEMENT PARTS

#	PARTS	ITEM #
1	UV Lamp	
	E50S (50 WATT)	FL-2538-IP
	E80S (80 WATT)	FL-2997-IP
	E120S (120 WATT)	FL-2998-IP
	E150S (150 WATT)	FL-2999-IP

2	4-Pin Lamp Connector	709-1S
3	Power Supply Nut	8467
4	Cable Gland/Reducer	20600-AQ
5	Black Retaining Nut	8050B20

12.	Quartz Sleeve	
	E50S (50 WATT)	FL-QZ175-IP
	E80S (80 WATT)	FL-QZ176-IP
	E120S (120 WATT)	FL-QZ165-IP
	E150S (150 WATT)	FL-QZ167-IP

13.	UV Sterilizer Housing – with unions	
	E50S (50 WATT)	209050
	E80S (80 WATT)	209080
	E120S (120 WATT)	209120
	E150S (150 WATT)	209150

#	KITS	ITEM #
Quartz Sleeve Module – QSM		
	Includes 6 thru 11	Z000-005
6	Power Supply Gasket	20620-AQ
7	QSM	NA
8	QSM O-Ring	BN70-232
9	QSM Gasket	960409
10	Quartz Sleeve Gasket	960471
11	White Retaining Nut	25004

Union Assembly – 2”		
	Includes 14, 15, 16	ZUNIONB20
14	Inlet/Outlet O-Ring	BN70-232
15	Inlet/Outlet Socket	8458-B20
16	Inlet/Outlet Nut	8050B20

Ballast Assembly -50/60 Hz		
	Includes 2, 3, 4	ZUNIONB20
	50W, 80W, 120W (120/230VAC)	20105-MV
	150W (120VAC)	202150-1
	150W (230VAC)	202150-2

Seal Kit – 50, 80, 120, 150W		
	Items 10, 11, 12, 16	20375

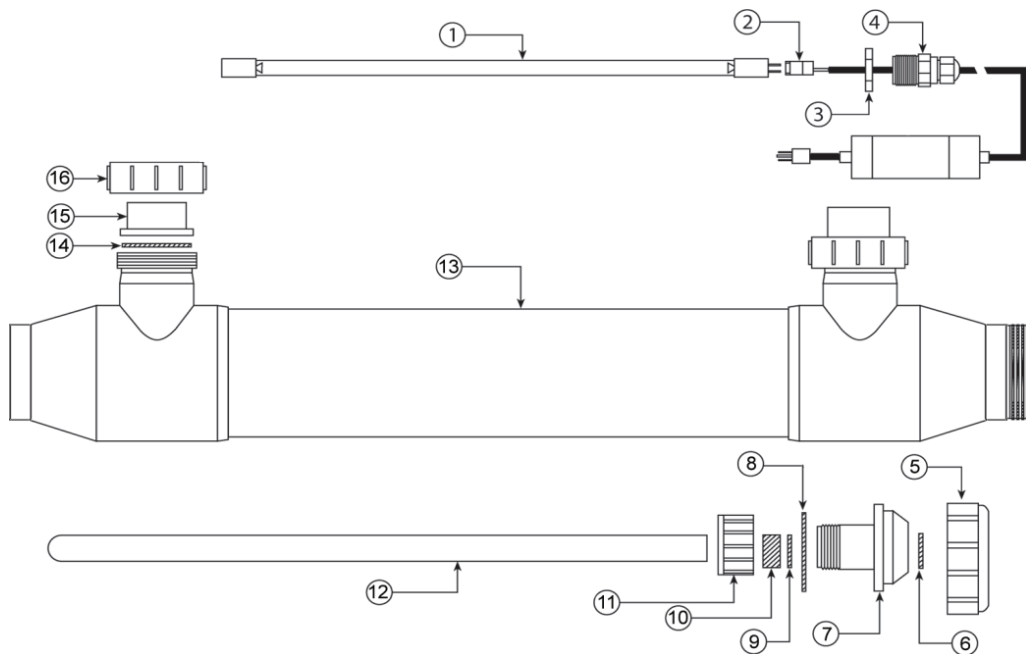

NOTES



2395 Apopka Blvd., Apopka, FL 32703, USA Phone: 407.886.3939

Web: PentairAES.com

©2018 Pentair Aquatic Eco-Systems, Inc. All rights reserved.

This document is subject to change without notice.

P/N 02934-INS-SMART Rev. D 8/18