



Motorcycle Operator's Manual

Georgia

Beginning July 1, 2012 DDS Issues Secure ID Driver's Licenses & ID Cards

If you currently hold a valid Georgia Driver's License/ID, it will be replaced with a Secure ID Driver's License/ID at your next renewal or license reinstatement.

If you currently do not hold a valid Georgia Driver's License/ID, you will be issued a Secure ID Driver's License/ID when you make application.

To obtain your Secure ID Driver's License or ID Card, you will need to provide the following to the DDS:

- Original or certified copy of your Birth Certificate (or other accepted identity document)
- A document showing your full Social Security Number
- Two documents showing your Residential Address
- Documents supporting legal name changes

CUSTOMER SERVICE CENTERS 73

*Lawrenceville	310 Hurricane Shoals Road
*Lithonia	8040 Rockbridge Road
*Locust Grove	619 Stanley K. Tanger Blvd
*Macon	200 Cherry St. Terminal Station
*Marietta	1605 County Services Parkway
*Milledgeville	200 Carl Vinson Road
*Newnan	128 Bullsboro Drive
*Norcross	2211 Beaver Ruin Road, Suite 100
*North Cobb	2800 Canton Road, Suite 1000
*Perry	450 Larry Walker Parkway
*Reidsville	3092 Highway 147
*Rincon	2792 Highway 21 South
Rock Spring	156 Pin Oak Drive
*Rome	3390 Martha Berry Highway
Sandersville	115 Jones Street
*Sandy Springs	8610 Roswell Road, Suite 710
*Savannah	1117 Eisenhower Drive
*Statesboro	202 Randy Lowery Road
Swainsboro	994 Highway 1 North
*Thomaston	281 Knight Trail
Thomasville	4800 US 84 Bypass
*Thomson	172 Bob Kirk Road
Tifton	413 Fulwood Blvd.
*Toccoa	144 E. Doyle Street
*Valdosta	371 Gil Harbin Industrial Blvd
*Warner Robins	198 Carl Vinson Parkway
*Waycross	3029 Memorial Drive

*** CSCs offering Rider Skills Test**

Our Customer Contact Center can answer any questions you have concerning Georgia driver's licenses. To reach our Customer Contact Center, please call (678) 413-8400, (678) 413-8500, (678) 413-8600, or outside metro Atlanta, toll free at (866) 754-3687 Monday through Friday from 7:00 AM until 4:00 PM.

REAL RIDING...REAL SKILLS -

The Georgia Motorcycle Safety Program's purpose is to improve the safety of motorcyclists on Georgia's streets and highways.

To reduce motorcycle crashes and injuries, the Georgia Motorcycle Safety Program supports rider education, licensing improvement, and public information for both riders and drivers.

For information about the Georgia Motorcycle Safety Program
visit www.dds.ga.gov/training
or call 1-866-754-3687 Outside Atlanta
(678) 413-8400 for Metro Atlanta

The information contained in this publication is offered for the benefit of those who have an interest in riding motorcycles. The information has been compiled from publications, interviews and observations of individuals and organizations familiar with the use of motorcycles, accessories, and training. Because there are many differences in product design, riding styles, federal, state and local laws, there may be organizations and individuals who hold differing opinions. The GMSP thanks the Motorcycle Safety Foundation for providing much of the material in this manual and the Georgia Governor's Office of Highway Safety for their support.



Printing and distribution courtesy of
Georgia Department of Driver Services
Motorcycle Safety Program
Revised February 2012

TRAINING SITES

The Georgia Motorcycle Safety Program Real Riding...Real Skills

The Georgia Motorcycle Safety Program (GMSP) is a part of the Georgia Department of Driver Services. In addition to offering rider education programs, the GMSP also promotes motorist awareness programs, share the road campaigns, and is focused on highway safety issues affecting Georgia motorcyclists. The GMSP directly operates 23 training sites and certifies 14 private sites.

For information about the Georgia Motorcycle Safety Program

visit www.dds.ga.gov/training

or call 1-866-754-3687 Outside Atlanta

(678) 413-8400 for Metro Atlanta

Training Sites

Acworth	Albany
Alpharetta*	Americus
Between	Atlanta*
Carrollton	Brunswick
Clarksville	Cartersville+
Conyers	Columbus
Greensboro	Dalton
Hinesville	Lawrenceville+
Lilburn*	Lithia Springs*
Lithonia*	Marietta*
Locus Grove	Morrow*
Martinez*	Perry
Newnan*	Savannah+
Rome	Thomson
Swainsboro	Thomasville
Tifton+	Tyrone*
Waycross	Valdosta

* Independent State-approved location

+ Both State & Independent locations

Check www.dds.ga.gov for new training sites added after publication.

Revised February 2012

RIDING IN GEORGIA

The Georgia Department of Driver Services Motorcycle Safety Program is providing this manual to current and future motorcyclists so their riding experience will be enjoyable and safe.

Motorcycles are fun to ride, easy to park, and inexpensive to operate. However, to operate a motorcycle safely in traffic requires special skills and knowledge.

The Georgia Motorcycle Safety Program (GMSP) offers low cost, professional training to assist riders in improving their skills:

Basic Course

The Basic Course highlights the safe operation of a motorcycle, with emphasis on the special skills and mental attitudes necessary for dealing with traffic.

Successful graduates receive a waiver of the DDS' administered written test and on-cycle license test (customers must pass the vision test and pay any applicable fees).

Experienced Course

The Experienced Course is designed to improve skills in braking, evasive maneuvers and cornering. It provides the experienced motorcyclist with the "street strategies" necessary for survival.

Students ride their own motorcycles in the course and practice the techniques of managing traction, stopping quickly, cornering and swerving.

Visit our website for more information on course offerings, locations, and schedules. You can register for training courses online by visiting:

www.dds.ga.gov/training



RIDING IN GEORGIA



Dear Georgia Riders,

Georgia's beautiful and varied landscapes provide motorcyclists with tremendous opportunities for enjoyable riding. With over 320,000 properly endorsed riders, the Department of Driver Services is committed to promoting rider education, motorcycle awareness, and licensing as the best means for keeping everyone safe on the road.

I know you will find this latest edition of the Georgia Motorcycle Operator Manual helpful when preparing to obtain your endorsement or as a refresher of the skills and techniques for safe riding. I hope you will use the manual not only to study, but as a tool to continually develop your motorcycle skills.

With more than 194,000 registered motorcycles on Georgia's roads, obeying traffic laws and practicing safe riding skills will go a long way for your safety and the safety of others who share the road with us. While motorcyclists have the same rights as other road users, safe driving is everyone's responsibility.

Because real riding takes real skills, I urge you to take both the Basic and Experienced Motorcycle Safety training courses, always wear protective gear, respect the ride, and don't drink and ride.

Sincerely,
Gregory C. Dozier
Commissioner
Department of Driver Services

CONTENTS

PREPARING TO RIDE

Wear the Right Gear	5
Helmet Use	5
Helmet Selection	5
Eye and Face Protection	6
Clothing	7
Know Your Motorcycle	7
The Right Motorcycle for You	7
Borrowing and Lending	8
Get Familiar with the Motorcycle Controls	8
Check Your Motorcycle	9
Know Your Responsibilities	10

RIDE WITHIN YOUR ABILITIES

Basic Vehicle Control	11
Body Position	11
Shifting Gears	11
Braking	12
Turning	12
Keeping Your Distance	13
Lane Positions	13
Following Another Vehicle	14
Being Followed	15
Passing and Being Passed	15
Lane Sharing	17
Merging Cars	17
Cars Alongside	17
SEE	18
Intersections	19
Blind Intersections	20
Passing Parked Cars	21
Parking at the Roadside	21
Increasing Conspicuity	22
Clothing	22
Headlight	22
Signals	22
Brake Light.....	23
Using Your Mirrors	23
Head Checks	24
Horn	24
Riding at Night	25
Crash Avoidance	25
Quick Stops	25
Swerving or Turning Quickly	26
Cornering	27
Handling Dangerous Surfaces	28

Uneven Surfaces and Obstacles	28
Slippery Surfaces	29
Railroad Tracks, Trolley Tracks and Pavement Seams	30
Grooves and Gratings	30

Mechanical Problems	31
Tire Failure	31
Stuck Throttle	31
Wobble	31
Chain Problems	32
Engine Seizure	32

Animals	32
----------------------	-----------

Flying Objects	33
-----------------------------	-----------

Getting Off the Road	33
-----------------------------------	-----------

Carrying Passengers and Cargo	33
Equipment	33
Instructing Passengers	34
Riding With Passengers	34
Carrying Loads	34

Group Riding	35
Keep the Group Small	35
Keep the Group Together	35
Keep Your Distance	35

BEING IN SHAPE TO RIDE

Why This Information Is Important	37
--	-----------

Alcohol and Other Drugs in Motorcycle Operation	37
--	-----------

Alcohol in the Body	38
Blood Alcohol Concentration	38

Alcohol and the Law	39
Consequences of Conviction	39

Minimize the Risks	39
---------------------------------	-----------

Step in to Protect Friends	40
---	-----------

Fatigue	40
----------------------	-----------

EARNING YOUR LICENSE

Knowledge Test	41
Rider Skill Test	43
Requirements.....	52
Signs, Signals, Markings.....	56

PREPARING TO RIDE 5

What you do before you start a trip goes a long way toward determining whether or not you'll get where you want to go safely. Before taking off on any trip, a safe rider makes a point to:

1. **Wear the right gear.**
2. **Become familiar with the motorcycle.**
3. **Check the motorcycle equipment.**
4. **Be a responsible rider.**

WEAR THE RIGHT GEAR

When you ride, your gear is “right” if it protects you. In any crash, you have a far better chance of avoiding serious injury if you wear:

- **An approved helmet.**
- **Face or eye protection.**
- **Protective clothing.**

Helmet Use

Crashes can occur — particularly among untrained, beginning riders. And one out of every five motorcycle crashes results in head or neck injuries. Head injuries are just as severe as neck injuries — and far more common. Crash analyses show that head and neck injuries account for a majority of serious and fatal injuries to motorcyclists. Research also shows that, with few exceptions, head and neck injuries are reduced by properly wearing an approved helmet.

Some riders don't wear helmets because they think helmets will limit their view to the sides. Others wear helmets only on long trips or when riding at high speeds. Here are some facts to consider:

- **An approved helmet** lets you see as far to the sides as necessary. A study of more than 900 motorcycle crashes, where 40% of the riders wore helmets, did not find even one case in which a helmet kept a rider from spotting danger.
- **Most crashes happen** on short trips (less than five miles long), just a few minutes after starting out.
- **Most riders** are riding slower than 30 mph when a crash occurs. At these speeds, helmets can cut both the number and the severity of head injuries by half.

No matter what the speed, helmeted riders are three times more likely to survive head injuries than those not wearing helmets at the time of the crash.

Helmet Selection

There are two primary types of helmets, providing two different levels of coverage: three-quarter and full face.

Whichever style you choose, you can get the most protection by making sure that the helmet:

6

PREPARING TO RIDE

HELMETS

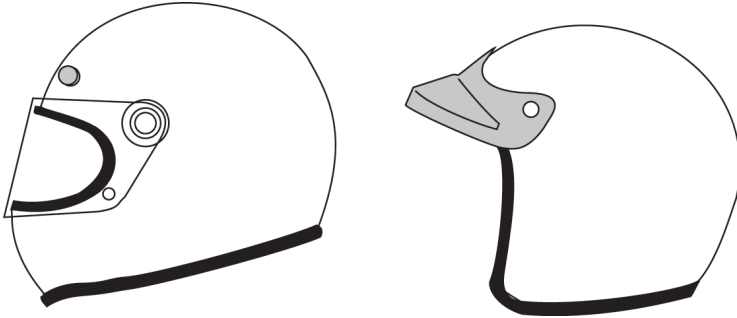

- **Is designed to meet U.S.** Department of Transportation (DOT) and state standards. Helmets with a label from the Snell Memorial Foundation give you an added assurance of quality.
- **Fits snugly**, all the way around.
- **Has no obvious defects** such as cracks, loose padding or frayed straps.

Whatever helmet you decide on, keep it securely fastened on your head when you ride. Otherwise, if you are involved in a crash, it's likely to fly off your head before it gets a chance to protect you.

Eye and Face Protection

A plastic shatter-resistant faceshield can help protect your whole face in a crash. It also protects you from wind, dust, dirt, rain, insects and pebbles thrown up from cars ahead. These problems are distracting and can be painful. If you have to deal with them, you can't devote your full attention to the road.

Goggles protect your eyes, though they won't protect the rest of your face like a faceshield does. A windshield is not a substitute for a faceshield or goggles. Most windshields will not protect your eyes from the wind. Neither will eyeglasses or sunglasses. Glasses won't keep your eyes from watering, and they might blow off when you turn your head while riding.

To be effective, eye or faceshield protection must:

- **Be free** of scratches.
- **Be resistant** to penetration.
- **Give a clear view** to either side.
- **Fasten securely**, so it does not blow off.
- **Permit air** to pass through, to reduce fogging.
- **Permit enough room** for eyeglasses or sunglasses, if needed.

Tinted eye protection should not be worn at night or any other time when little light is available.

Clothing

The right clothing protects you in a collision. It also provides comfort, as well as protection from heat, cold, debris and hot and moving parts of the motorcycle. It can also make you more visible to others

- **Jacket and pants** should cover arms and legs completely. They should fit snugly enough to keep from flapping in the wind, yet loosely enough to move freely. Leather offers the most protection. Sturdy synthetic material provides a lot of protection as well. Wear a jacket even in warm weather to prevent dehydration. Many are designed to protect without getting you overheated, even on summer days.
- **Boots or shoes** should be high and sturdy enough to cover your ankles and give them support. Soles should be made of hard, durable, slip-resistant material. Keep heels short so they do not catch on rough surfaces. Tuck in laces so they won't catch on your motorcycle.
- **Gloves** allow a better grip and help protect your hands in a crash. Your gloves should be made of leather or similar durable material.

In cold or wet weather, your clothes should keep you warm and dry, as well as protect you from injury. You cannot control a motorcycle well if you are numb. Riding for long periods in cold weather can cause severe chill and fatigue. A winter jacket should resist wind and fit snugly at the neck, wrists and waist. Good-quality rainsuits designed for motorcycle riding resist tearing apart or ballooning up at high speeds.

KNOW YOUR MOTORCYCLE

There are plenty of things on the highway that can cause you trouble. Your motorcycle should not be one of them. To make sure that your motorcycle won't let you down:

- **Read** the owner's manual first.
- **Start** with the right motorcycle for you.
- **Be familiar** with the motorcycle controls.
- **Check** the motorcycle before every ride.
- **Keep** it in safe riding condition between rides.
- **Avoid** add-ons and modifications that make your motorcycle harder to handle.

The Right Motorcycle For You

First, make sure your motorcycle is right for you. It should "fit" you. Your feet should reach the ground while you are seated on the motorcycle, and the controls should be easy to operate. Smaller motorcycles are usually easier for beginners to operate.

TEST YOURSELF 1

A plastic shatter-resistant face shield:

- A. Is not necessary if you have a windshield.
- B. Only protects your eyes.
- C. Helps protect your whole face.
- D. Does not protect your face as well as goggles.

Answer - page 41

8 PREPARING TO RIDE

At minimum, your street-legal motorcycle should have:

- **Headlight, taillight and brakelight.**
- **Front and rear brakes.**
- **Turn signals.**
- **Horn.**
- **Two mirrors.**

Borrowing and Lending

Borrowers and lenders of motorcycles, beware. Crashes are fairly common among beginning riders — especially in the first months of riding. Riding an unfamiliar motorcycle adds to the problem. If you borrow a motorcycle, get familiar with it in a controlled area. And if you lend your motorcycle to

friends, make sure they are licensed and know how to ride before allowing them out into traffic.

No matter how experienced you may be, ride extra carefully on any motorcycle that's new or unfamiliar to you. It takes time to adjust, so give yourself a greater margin for errors.

Get Familiar with the Motorcycle Controls

Make sure you are completely familiar with the motorcycle before you take it out on the street. Be sure to review the owner's manual. This is particularly important if you are riding a borrowed motorcycle.

If you are going to use an unfamiliar motorcycle:

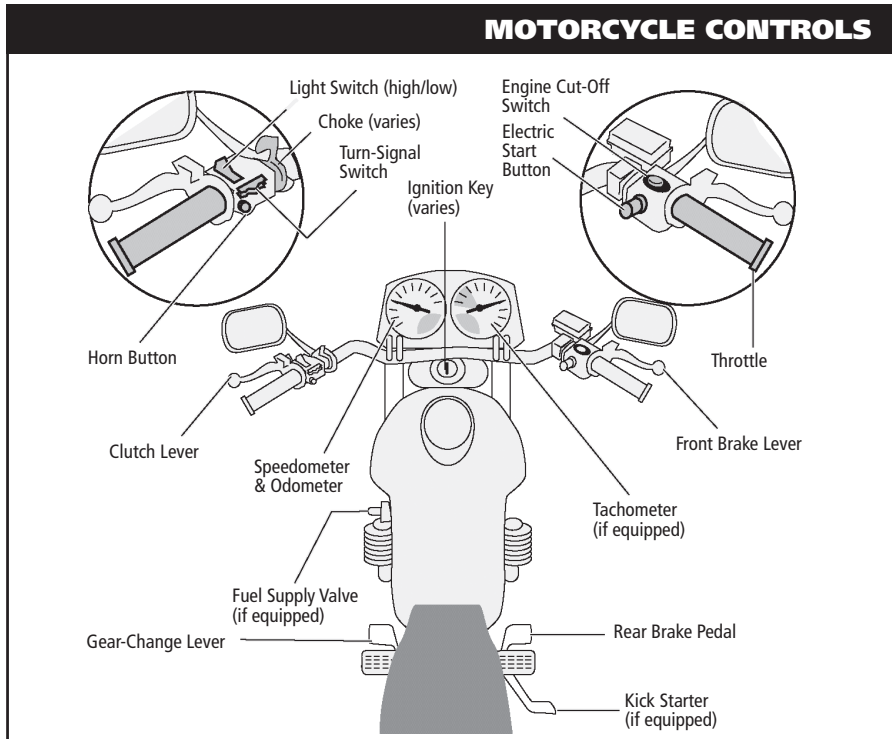

PREPARING TO RIDE 9

- **Make all the checks** you would on your own motorcycle.
- **Find out where everything is**, particularly the turn signals, horn, headlight switch, fuel-supply valve and engine cut-off switch. Find and operate these items without having to look for them.
- **Know the gear pattern.** Work the throttle, clutch and brakes a few times before you start riding. All controls react a little differently.
- **Ride very cautiously** and be aware of surroundings. Accelerate gently, take turns more slowly and leave extra room for stopping.

Check Your Motorcycle

A motorcycle needs more frequent attention than a car. A minor technical failure in a car seldom leads to anything more than an inconvenience for the driver.

If something's wrong with the motorcycle, you'll want to find out about it before you get in traffic. Make a complete check of your motorcycle before every ride.

Before mounting the motorcycle, make the following checks:

- **Tires** — Check the air pressure, general wear and tread.
 - **Fluids** — Oil and fluid levels. At a minimum, check hydraulic fluids and coolants weekly. Look under the motorcycle for signs of an oil or gas leak.
 - **Headlights and Taillight** — Check them both. Test your switch to make sure both high and low beams are working.
 - **Turn Signals** — Turn on both right and left turn signals. Make sure all lights are working properly.
 - **Brake Light** — Try both brake controls, and make sure each one turns on the brake light.
- Once you have mounted the motorcycle, complete the following checks before starting out:
- **Clutch and Throttle** — Make sure they work smoothly. The throttle should snap back when you let go. The clutch should feel tight and smooth.
 - **Mirrors** — Clean and adjust both mirrors before starting. It's difficult to ride with one hand while you try to adjust a mirror. Adjust each mirror so you can see the lane behind and as much as possible of the lane next to you. When properly adjusted, a mirror may show the edge of your arm or shoulder—but it's the road behind and to the side that's most important.
 - **Brakes** — Try the front and rear brake levers one at a time. Make sure each one feels firm and holds the motorcycle when the brake is fully applied.
 - **Horn** — Try the horn. Make sure it works.

In addition to the checks you should make before every trip, check the following items at least once a week: Wheels, cables, fasteners and fluid levels. Follow your owner's manual to get recommendations.

TEST YOURSELF 2

More than half of all crashes:

- A. Occur at speeds greater than 35 mph.
- B. Happen at night.
- C. Are caused by worn tires.
- D. Involve riders who have ridden their motorcycles less than six months.

Answer - page 41

10 PREPARING TO RIDE

KNOW YOUR RESPONSIBILITIES

“Accident” implies an unforeseen event that occurs without anyone’s fault or negligence. Most often in traffic, that is not the case. In fact, most people involved in a crash can usually claim some responsibility for what takes place.

Consider a situation where someone decides to try to squeeze through an intersection on a yellow light turning red. Your light turns green. You pull into the intersection without checking for possible latecomers. That is all it takes for the two of you to tangle. It was the driver’s responsibility to stop. And it was your responsibility to look before pulling out. Neither of you held up your end of the deal. Just because someone else is the first to start the chain of events leading to a crash, it doesn’t leave any of us free of responsibility.

As a rider you can’t be sure that other operators will see you or yield the right of way. To lessen your chances of a crash occurring:

- **Be visible** — wear proper clothing, use your headlight, ride in the best lane position to see and be seen.
- **Communicate your intentions** — use the proper signals, brake light and lane position.
- **Maintain an adequate space cushion** — following, being followed, lane sharing, passing and being passed.
- **Search your path** of travel 12 seconds ahead.
- **Identify and separate** multiple hazards.
- **Be prepared to act** — remain alert and know how to carry out proper crash-avoidance skills.

Blame doesn’t matter when someone is injured in a crash. There is rarely a single cause of any crash. The ability to ride aware, make critical decisions and carry them out separates responsible riders from all the rest. Remember, it is up to you to keep from being the cause of, or an unprepared participant in, any crash.

This manual cannot teach you how to control direction, speed or balance. That's something you can learn only through practice, preferably in a formal course of instruction like a GMSP *Motorcycle Safety Course*. But control begins with knowing your abilities and riding within them, along with knowing and obeying the rules of the road.

BASIC VEHICLE CONTROL

Body Position

To control a motorcycle well:

- **Posture** — Sit so you can use your arms to steer the motorcycle rather than to hold yourself up.
- **Seat** — Sit far enough forward so that arms are slightly bent when you hold the handlegrips. Bending your arms permits you to press on the handlebars without having to stretch.
- **Hands** — Hold the handgrips firmly to keep your grip over rough surfaces. Start with your right wrist flat. This will help you keep from accidentally using too much throttle. Also, adjust the handlebars so your hands are even with or below your elbows. This permits you to use the proper muscles for precision steering.

- **Knees** — Keep your knees against the gas tank to help you keep your balance as the motorcycle turns.
- **Feet** — Keep your feet firmly on the footrests to maintain balance. Don't drag your feet. If your foot catches on something, you could be injured and it could affect your control of the motorcycle. Keep your feet near the controls so you can get to them fast if needed. Also, don't let your toes point downward — they may get caught between the road and the footrests.

Shifting Gears

There is more to shifting gears than simply getting the motorcycle to pick up speed smoothly. Learning to use the gears when downshifting, turning or starting on hills is important for safe motorcycle operation.

Shift down through the gears with the clutch as you slow or stop. Remain in first gear while you are stopped so that you can move out quickly if you need to.

Make certain you are riding slowly enough when you shift into a lower gear. If not, the motorcycle will lurch, and the rear wheel may skid. When riding downhill or shifting into first gear you may need to use the brakes to slow enough before downshifting safely. Work toward a smooth, even clutch release, especially when downshifting.

HOLDING HANDGRIPS

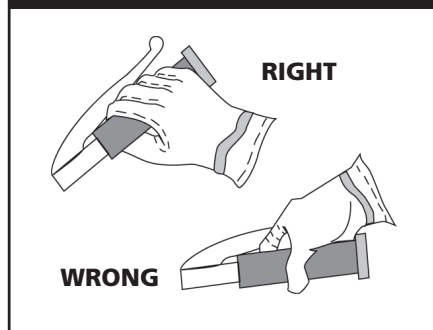

12 RIDE WITHIN YOUR ABILITIES

It is best to change gears before entering a turn. However, sometimes shifting while in the turn is necessary. If so, remember to do so smoothly. A sudden change in power to the rear wheel can cause a skid.

Braking

Your motorcycle has two brakes: one each for the front and rear wheel. Use both of them at the same time. The front brake is more powerful and can provide **at least three-quarters** of your total stopping power. The front brake is safe to use if you use it properly.

Remember:

- **Use both brakes** every time you slow or stop. Using both brakes for even “normal” stops will permit you to develop the proper habit or skill of using both brakes properly in an emergency. Squeeze the front brake and press down on the rear. Grabbing at the front brake or jamming down on the rear can cause the brakes to lock, resulting in control problems.
- **If you know the technique,** using both brakes in a turn is possible, although it should be done very carefully. When leaning the motorcycle some of the traction is used for cornering. Less traction is available for stopping. A skid can occur if you apply too much brake. Also, using the front brake incorrectly on a slippery surface may be hazardous. Use caution and **squeeze** the brake lever, never grab.

- **Some motorcycles** have integrated braking systems that activate the front and rear brakes together when applying the rear brake pedal. (Consult the owner’s manual for a detailed explanation on the operation and effective use of these systems.)

Turning

Riders often try to take curves or turns too fast. When they can’t hold the turn, they end up crossing into another lane of traffic or going off the road. Or, they overreact and brake too hard, causing a skid and loss of control. Approach turns and curves with caution.

Use four steps for better control:

- **SLOW** — Reduce speed before the turn by closing the throttle and, if necessary, applying both brakes.
- **LOOK** — Look through the turn to where you want to go. Turn just your head, not your shoulders, and keep your eyes level with the horizon.
- **PRESS** — To turn, the motorcycle must lean. To lean the motorcycle, press on the handgrip in the direction of the turn. Press left handgrip — lean left — go left. Press right handgrip — lean right — go right. The higher the speed in a turn, the greater the lean angle.
- **ROLL** — Roll on the throttle to maintain or slightly increase speed. This helps stabilize the motorcycle.

In normal turns, the rider and the motorcycle should lean together at the same angle.

NORMAL TURNS

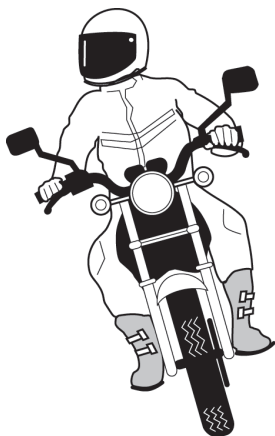

In slow, tight turns, counterbalance by leaning the motorcycle only and keeping your body straight.

SLOW, TIGHT TURNS

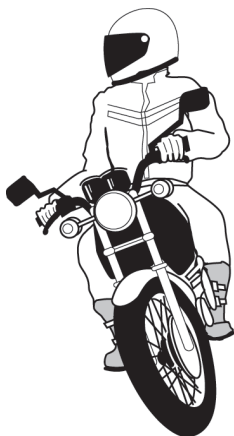

TEST YOURSELF 3

When riding, you should:

- A. Turn your head and shoulders to look through turns.
- B. Keep your arms straight.
- C. Keep your knees away from the gas tank.
- D. Turn just your head and eyes to look where you are going.

Answer - page 41

KEEPING YOUR DISTANCE

The best protection you can have is distance — a “cushion of space” — all around your motorcycle. If someone else makes a mistake, distance permits you:

- **Time to react.**
- **Space to maneuver.**

Lane Positions

In some ways the size of the motorcycle can work to your advantage. Each traffic lane gives a motorcycle three paths of travel, as indicated in the illustration.

Your lane position should:

- **Increase** your ability to see and be seen.
- **Avoid** others’ blind spots.
- **Avoid** surface hazards.
- **Protect** your lane from other drivers.
- **Communicate** your intentions.
- **Avoid** wind blast from other vehicles.
- **Provide** an escape route.

Select the appropriate path to maximize your space cushion and make yourself more easily seen by others on the road.

14 RIDE WITHIN YOUR ABILITIES

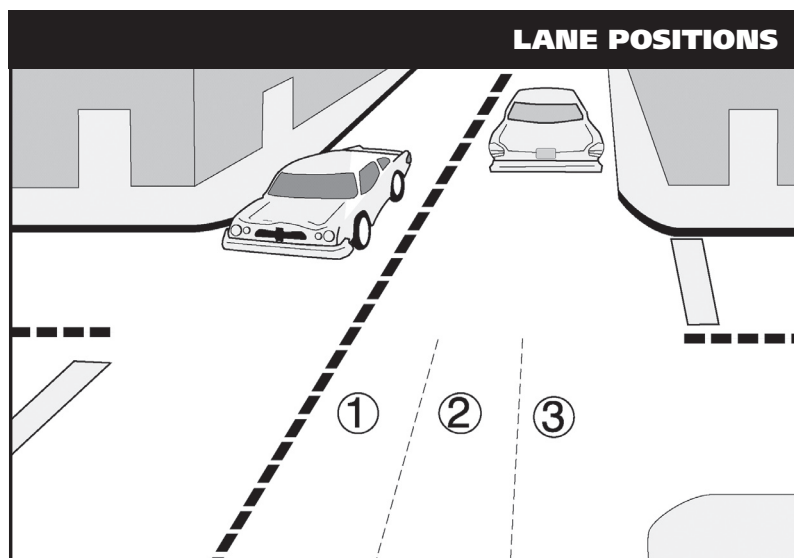

In general, there is no single best position for riders to be seen and to maintain a space cushion around the motorcycle. No portion of the lane need be avoided — including the center.

Position yourself in the portion of the lane where you are most likely to be seen and you can maintain a space cushion around you. Change position as traffic situations change. Ride in path 2 or 3 if vehicles and other potential problems are on your left only. Remain in path 1 or 2 if hazards are on your right only. If vehicles are being operated on both sides of you, the center of the lane, path 2, is usually your best option.

The oily strip in the center portion that collects drippings from cars is usually no more than two feet wide. Unless the road is wet, the average center strip permits adequate traction to ride on safely. You can operate to the left or right of the grease strip and still be within the center portion of the traffic lane. Avoid riding on big buildups of oil and grease usually found at busy intersections or toll booths.

Following Another Vehicle

“Following too closely” could be a factor in crashes involving motorcyclists. In traffic, motorcycles need as much distance to stop as cars. Normally, a **minimum of two seconds** distance should be maintained behind the vehicle ahead.

To gauge your following distance:

- **Pick out a marker**, such as a pavement marking or lamppost, on or near the road ahead.
- **When the rear bumper** of the vehicle ahead passes the marker, count off the seconds: “one-thousand-one, one-thousand-two.”
- **If you reach the marker** before you reach “two,” you are following too closely.

A two-second following distance leaves a minimum amount of space to stop or swerve if the driver ahead stops suddenly. It also permits a better view of potholes and other hazards in the road.

A larger cushion of space is needed if your motorcycle will take longer

FOLLOWING

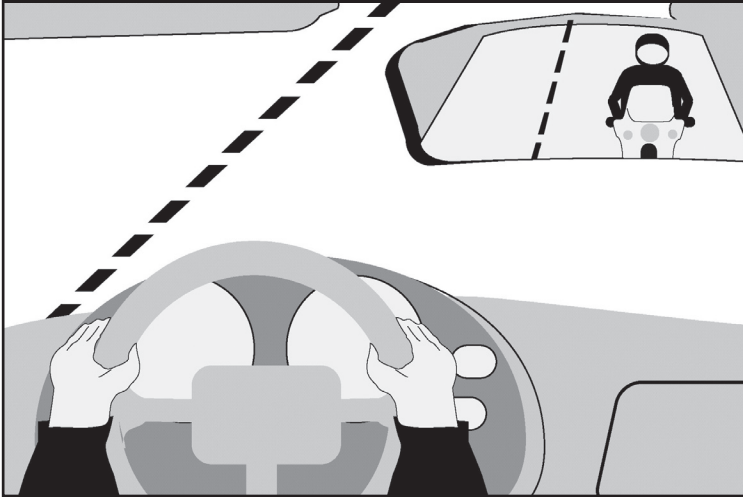

than normal to stop. If the pavement is slippery, if you cannot see through the vehicle ahead, or if traffic is heavy and someone may squeeze in front of you, open up a three-second or more following distance.

Keep well behind the vehicle ahead even when you are stopped. This will make it easier to get out of the way if someone bears down on you from behind. It will also give you a cushion of space if the vehicle ahead starts to back up for some reason.

When behind a car, ride where the driver can see you in the rearview mirror. Riding in the center portion of the lane should put your image in the middle of the rearview mirror — where a driver is most likely to see you.

Riding at the far side of a lane may permit a driver to see you in a sideview mirror. But remember that most drivers don't look at their sideview mirrors nearly as often as they check the rearview mirror. If the traffic situation allows, the center portion of the lane is usually the best place for you to be seen by the drivers ahead and to prevent lane sharing by others.

Being Followed

Speeding up to lose someone following too closely only ends up with someone tailgating you at a higher speed.

A better way to handle tailgaters is to get them in front of you. When someone is following too closely, change lanes and let them pass. If you can't do this, slow down and open up extra space ahead of you to allow room for both you and the tailgater to stop. This will also encourage them to pass. If they don't pass, you will have given yourself and the tailgater more time and space to react in case an emergency does develop ahead.

Passing and Being Passed

Passing and being passed by another vehicle is not much different than with a car. However, visibility is more critical. Be sure other drivers see you, and that you see potential hazards.

16 RIDE WITHIN YOUR ABILITIES

Passing

1. **Ride in the left portion** of the lane at a safe following distance to increase your line of sight and make you more visible. Signal and check for oncoming traffic. Use your mirrors and turn your head to look for traffic behind.
2. **When safe**, move into the left lane and accelerate. Select a lane position that doesn't crowd the car you are passing and provides space to avoid hazards in your lane.
3. **Ride through the blind spot** as quickly as possible.
4. **Signal again**, and complete mirror and headchecks before returning to your original lane and then cancel the signal.

Remember, passes must be completed within posted speed limits, and only where permitted. Know your signs and road markings!

Being Passed

When you are being passed from behind or by an oncoming vehicle, stay in the center portion of your lane. Riding any closer to them could put you in a hazardous situation.

Avoid being hit by:

- **The other vehicle** — A slight mistake by you or the passing driver could cause a sideswipe.
- **Extended mirrors** — Some drivers forget that their mirrors hang out farther than their fenders.
- **Objects thrown from windows** — Even if the driver knows you're there, a passenger may not see you and might toss something on you or the road ahead of you.
- **Blasts of wind from larger vehicles** — They can affect your control. You have more room for error if you are in the middle portion when hit by this blast than if you are on either side of the lane.

Do not move into the portion of the lane farthest from the passing vehicle. It might invite the other driver to cut back into your lane too early.

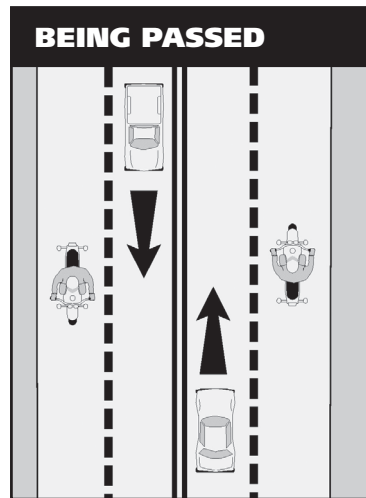
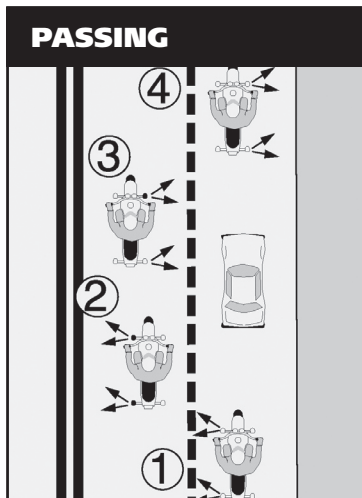

Lane Sharing

Cars and motorcycles need a full lane to operate safely. Lane sharing is usually prohibited.

Riding between rows of stopped or moving cars in the same lane can leave you vulnerable to the unexpected. A hand could come out of a window; a door could open; a car could turn suddenly. Discourage lane sharing by others. Keep a center-portion position whenever drivers might be tempted to squeeze by you. Drivers are most tempted to do this:

- **In heavy**, bumper-to-bumper traffic.
- **When they** want to pass you.
- **When you** are preparing to turn at an intersection.
- **When you** are moving into an exit lane or leaving a highway.

Merging Cars

Drivers on an entrance ramp may not see you on the highway. Give them

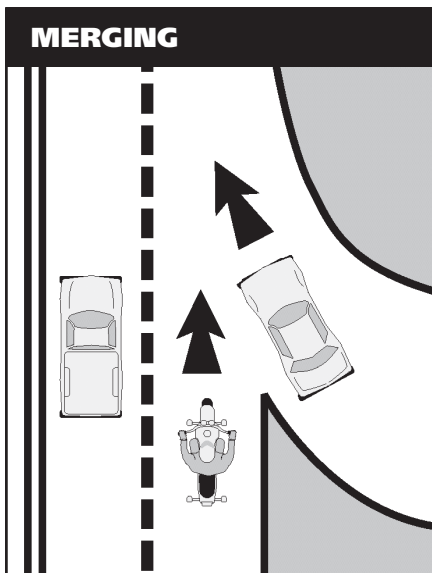

plenty of room. Change to another lane if one is open. If there is no room for a lane change, adjust speed to open up space for the merging driver.

Cars Alongside

Do not ride next to cars or trucks in other lanes if you do not have to. You might be in the blind spot of a car in the next lane, which could switch into your lane without warning. Cars in the next lane also block your escape if you come upon danger in your own lane. Speed up or drop back to find a place clear of traffic on both sides.

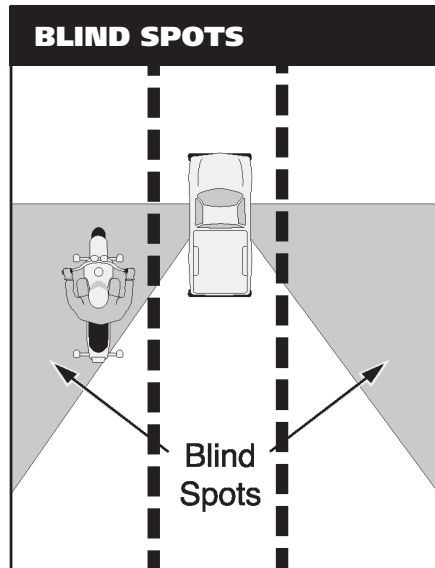

TEST YOURSELF

4

Usually, a good way to handle tailgaters is to:

- Change lanes and let them pass.
- Use your horn and make obscene gestures.
- Speed up to put distance between you and the tailgater.
- Ignore them.

Answer - page 41

18 RIDE WITHIN YOUR ABILITIES

SEE

Good experienced riders remain aware of what is going on around them. They improve their riding strategy by using MSF's SEESM strategy, a three-step process used to make appropriate judgments, and apply them correctly in different traffic situations:

- **Search**
- **Evaluate**
- **Execute**

Let's examine each of these steps.

Search

Search aggressively ahead, to the sides and behind to avoid potential hazards even before they arise. How assertively you search, and how much time and space you have, can eliminate or reduce harm. Focus even more on finding potential escape routes in or around intersections, shopping areas and school and construction zones.

Search for factors such as:

- **Oncoming traffic** that may turn left in front of you.
- **Traffic** coming from the left and right.
- **Traffic** approaching from behind.
- **Hazardous** road conditions.

Be especially alert in areas with limited visibility. Visually "busy" surroundings could hide you and your motorcycle from others.

Evaluate

Think about how hazards can interact to create risks for you. Anticipate potential problems and have a plan to reduce risks.

- **Road and surface characteristics**

— Potholes, guardrails, bridges, telephone poles and trees won't move into your path but may influence your riding strategy.

- **Traffic control devices** — Look for traffic signals, including regulatory signs, warning signs, and pavement markings, to help you evaluate circumstances ahead.

- **Vehicles and other traffic** — May move into your path and increase the likelihood of a crash.

Think about your time and space requirements in order to maintain a margin of safety. You must leave yourself time to react if an emergency arises.

Execute

Carry out your decision.

To create more space and minimize harm from any hazard:

- **Communicate** your presence with lights and/or horn.
- **Adjust your speed** by accelerating, stopping or slowing.
- **Adjust your position** and/or direction.

Apply the old adage "one step at a time" to handle two or more hazards. Adjust speed to permit two hazards to separate. Then deal with them one at a time as single hazards. Decision-making becomes more complex with three or more hazards. Evaluate the consequences of each and give equal distance to the hazards.

In potential high-risk areas, such as intersections, shopping areas and school and construction zones, cover the clutch and both brakes to reduce the time you need to react.

TEST YOURSELF 5

To reduce your reaction time, you should:

- A. Ride slower than the speed limit.
- B. Cover the clutch and the brakes.
- C. Shift into neutral when slowing.
- D. Pull in the clutch when turning.

Answer - page 41

INTERSECTIONS

The greatest potential for conflict between you and other traffic is at intersections. An intersection can be in the middle of an urban area or at a driveway on a residential street — anywhere traffic may cross your path of travel. Over one-half of motorcycle/car crashes are caused by drivers entering a rider's right-of-way. Cars that turn left in front of you, including cars turning left from the lane to your right, and cars on side streets that pull into your lane, are the biggest dangers. Your use of SEE [p. 17] at intersections is critical.

There are no guarantees that others see you. Never count on "eye contact" as a sign that a driver will yield. Too often, a driver looks right at a motorcyclist and still fails to "see" him or her. The only eyes that you can count on are your own. If a car can enter your path, assume that it will. Good riders are always "looking for trouble" — not to get into it, but to stay out of it.

Increase your chances of being seen at intersections. Ride with your headlight on and in a lane position that provides the best view of oncoming traffic. Provide a space cushion around the motorcycle that permits you to take evasive action.

SMALL INTERSECTIONS

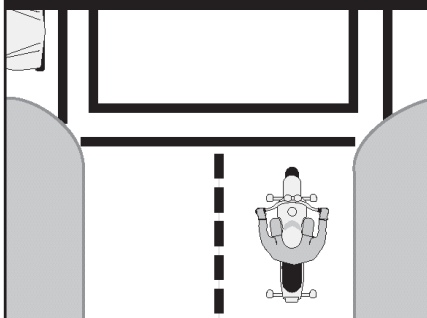

RIDE WITHIN YOUR ABILITIES 21

STOP SIGNS

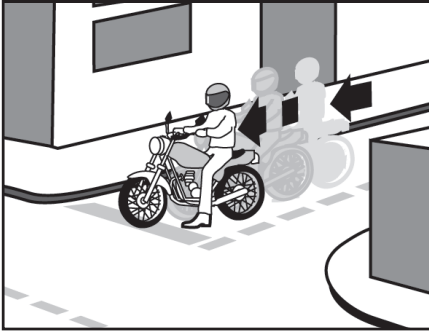

If you have a stop sign or stop line, stop there first. Then edge forward and stop again, just short of where the cross-traffic lane meets your lane. From that position, lean your body forward and look around buildings, parked cars or bushes to see if anything is coming. Just make sure your front wheel stays out of the cross lane of travel while you're looking.

Passing Parked Cars

When passing parked cars, stay toward the left of your lane. You can avoid problems caused by doors opening, drivers getting out of cars or people stepping from between cars. If oncoming traffic is present, it is usually best to remain in the center-lane position to maximize your space cushion.

A bigger problem can occur if the driver pulls away from the curb without

PARKED CARS

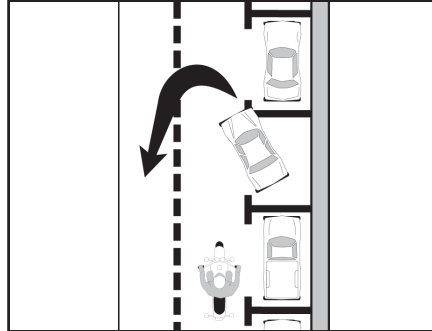

checking for traffic behind. Even if he does look, he may fail to see you.

In either event, the driver might cut into your path. Slow down or change lanes to make room for someone cutting in.

Cars making a sudden U-turn are the most dangerous. They may cut you off entirely, blocking the whole roadway and leaving you with no place to go. Since you can't tell what a driver will do, slow down and get the driver's attention. Sound your horn and continue with caution.

Parking at the Roadside

Park at a 90° angle to the curb with your rear wheel touching the curb.

PARKING AT CURBS

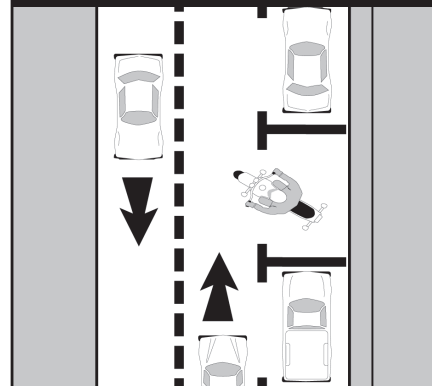

TEST YOURSELF 6

Making eye contact with other drivers:

- A. Is a good sign they see you.
- B. Is not worth the effort it takes.
- C. Doesn't mean that the driver will yield.
- D. Guarantees that the other driver will yield to you.

Answer - page 41

22 RIDE WITHIN YOUR ABILITIES

INCREASING CONSPICUITY

In crashes with motorcyclists, drivers often say that they never saw the motorcycle. From ahead or behind, a motorcycle's outline is much smaller than a car's. Also, it's hard to see something you are not looking for, and most drivers are not looking for motorcycles. More likely, they are looking through the skinny, two-wheeled silhouette in search of cars that may pose a problem to them.

Even if a driver does see you coming, you aren't necessarily safe. Smaller vehicles appear farther away and seem to be traveling slower than they actually are. It is common for drivers to pull out in front of motorcyclists, thinking they have plenty of time. Too often, they are wrong.

However, you can do many things to make it easier for others to recognize you and your motorcycle.

Clothing

Most crashes occur in broad daylight. Wear bright-colored clothing to increase your chances of being seen. Remember, your body is half of the visible surface area of the rider/motorcycle unit.

Bright orange, red, yellow or green jackets or vests are your best bets for being seen. Your helmet can do more than protect you in a crash. Brightly colored helmets can also help others see you.

Any bright color is better than drab or dark colors. Reflective, bright-colored clothing (helmet and jacket or vest) is best.

Reflective material on a vest and on the sides of the helmet will help drivers

coming from the side to spot you. Reflective material can also be a big help for drivers coming toward you or from behind.

Headlight

The best way to help others see your motorcycle is to keep the headlight on — **at all times** (new motorcycles sold in the USA since 1978 automatically have the headlights on when running). Studies show that, during the day, a motorcycle with its light on is twice as likely to be noticed. Use low beam at night and in fog.

Signals

The signals on a motorcycle are similar to those on a car. They tell others what you plan to do.

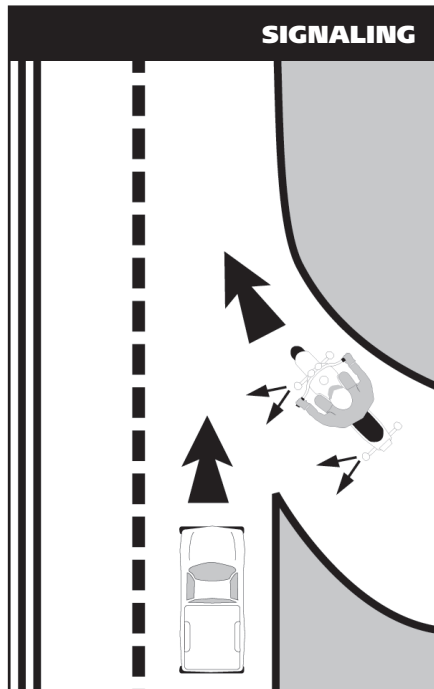

However, due to a rider's added vulnerability, signals are even more important. Use them anytime you plan to change lanes or turn. Use them even when you think no one else is around. It's the car you don't see that's going to give you the most trouble. Your signal lights also make you easier to spot. That's why it's a good idea to use your turn signals even when what you plan to do is obvious.

When you enter a freeway, drivers approaching from behind are more likely to see your signal blinking and make room for you.

Turning your signal light on before each turn reduces confusion and frustration for the traffic around you. Once you turn, make sure your signal is off or a driver may pull directly into your path, thinking you plan to turn again. Use your signals at every turn so drivers can react accordingly. Don't make them guess what you intend to do.

Brake Light

Your motorcycle's brake light is usually not as noticeable as the brake lights on a car — particularly when your taillight is on. (It goes on with the headlight.) If the situation will permit, help others notice you by flashing your brake light before you slow down. It is especially important to flash your brake light before:

- **You slow more quickly** than others might expect (turning off a high-speed highway).

- **You slow where** others may not expect it (in the middle of a block or at an alley).

If you are being followed closely, it's a good idea to flash your brake light before you slow. The tailgater may be watching you and not see something ahead that will make you slow down. This will hopefully discourage them from tailgating and warn them of hazards ahead they may not see.

Using Your Mirrors

While it's most important to keep track of what's happening ahead, you can't afford to ignore situations behind. Traffic conditions change quickly. Knowing what's going on behind is essential for you to make a safe decision about how to handle trouble ahead.

Frequent mirror checks should be part of your normal searching routine. Make a special point of using your mirrors:

- **When you are stopped** at an intersection. Watch cars coming up from behind. If the drivers aren't paying attention, they could be on top of you before they see you.
- **Before you change lanes.** Make sure no one is about to pass you.
- **Before you slow down.** The driver behind may not expect you to slow, or may be unsure about where you will slow. For example, you signal a turn and the driver thinks you plan to turn at a distant intersection, rather than at a nearer driveway.

24 RIDE WITHIN YOUR ABILITIES

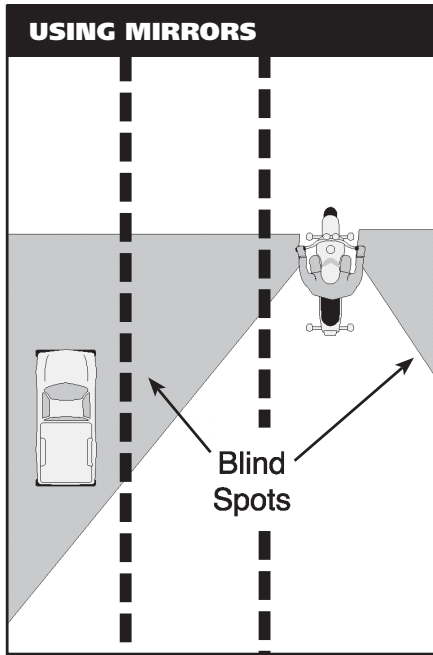

Some motorcycles have rounded (convex) mirrors. These provide a wider view of the road behind than do flat mirrors. They also make cars seem farther away than they really are. If you are not used to convex mirrors, get familiar with them. (*While you are stopped, pick out a parked car in your mirror. Form a mental image of how far away it is. Then, turn around and look at it to see how close you came.*) Practice with your mirrors until you become a good judge of distance. Even then, allow extra distance before you change lanes.

Head Checks

Checking your mirrors is not enough. Motorcycles have "blind spots" like cars. Before you change lanes, turn your head, and look to the side for other vehicles.

On a road with several lanes, check the far lane and the one next to you. A driver in the distant lane may head for the same space you plan to take.

Frequent head checks should be your normal scanning routine, also. Only by knowing what is happening **all around** you are you fully prepared to deal with it.

Horn

Be ready to use your horn to get someone's attention quickly.

It is a good idea to give a quick beep before passing anyone that may move into your lane.

Here are some situations:

- **A driver** in the lane next to you is driving too closely to the vehicle ahead and may want to pass.
- **A parked car** has someone in the driver's seat.
- **Someone is in the street**, riding a bicycle or walking.

In an emergency, press the horn button loud and long. Be ready to stop or swerve away from the danger.

Keep in mind that a motorcycle's horn isn't as loud as a car's — therefore, use it, but don't rely on it. Other strategies, like having time and space to maneuver, may be appropriate along with the horn.

Riding at Night

At night it is harder for you to see and be seen. Picking your headlight or taillight out of the car lights around you is not easy for other drivers. To compensate, you should:

- **Reduce Your Speed** — Ride even slower than you would during the day — particularly on roads you don't know well. This will increase your chances of avoiding a hazard.
- **Increase Distance** — Distances are harder to judge at night than during the day. Your eyes rely upon shadows and light contrasts to determine how far away an object is and how fast it is coming. These contrasts are missing or distorted under artificial lights at night. Open up a three-second following distance or more. And allow more distance to pass and be passed.
- **Use the Car Ahead** — The headlights of the car ahead can give you a better view of the road than even your high beam can. Taillights bouncing up and down can alert you to bumps or rough pavement.
- **Use Your High Beam** — Get all the light you can. Use your high beam whenever you are not following or meeting a car. Be visible: Wear reflective materials when riding at night.
- **Be Flexible About Lane Position.** Change to whatever portion of the lane is best able to help you see, be seen and keep an adequate space cushion.

TEST YOURSELF

7

Reflective clothing should:

- A. Be worn at night.
- B. Be worn during the day.
- C. Not be worn.
- D. Be worn day and night

Answer - page 41

CRASH AVOIDANCE

No matter how careful you are, there will be times when you find yourself in a tight spot. Your chances of getting out safely depend on your ability to react quickly and properly. Often, a crash occurs because a rider is not prepared or skilled in crash-avoidance maneuvers.

Know when and how to stop or swerve, two skills critical in avoiding a crash. It is not always desirable or possible to stop quickly to avoid an obstacle. Riders must also be able to swerve around an obstacle. Determining which skill is necessary for the situation is important as well.

Studies show that most crash-involved riders:

- **Underbrake** the front tire and overbrake the rear.
- **Did not** separate braking from swerving or did not choose swerving when it was appropriate.

The following information offers some good advice.

Quick Stops

To stop quickly, apply both brakes at the same time. Don't be shy about using the front brake, but don't "grab" it, either. Squeeze the brake lever firmly and progressively. If the front wheel locks, release the front brake immediately then reapply it firmly. At the same time, press down on the rear brake. If you accidentally lock the rear brake on a good traction surface, you can keep it locked until you have completely stopped; but, even with a locked rear wheel, you can control the motorcycle on a straightaway if it is upright and going in a straight line.

26 RIDE WITHIN YOUR ABILITIES

STOPPING DISTANCE

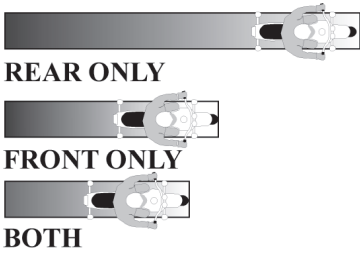

Always use both brakes at the same time to stop. The front brake can provide 70% or more of the potential stopping power.

If you must stop quickly while turning or riding a curve, the best technique is to straighten the bike upright first and then brake. However, it may not always be possible to straighten the motorcycle and then stop. If you must brake while leaning, apply light brakes and reduce the throttle. As you slow, you can reduce your lean angle and apply more brake pressure until the motorcycle is

straight and maximum brake pressure is possible. You should “straighten” the handlebars in the last few feet of stopping. The motorcycle should then be straight up and in balance.

Swerving or Turning Quickly

Sometimes you may not have enough room to stop, even if you use both brakes properly. An object might appear suddenly in your path. Or the car ahead might squeal to a stop. The only way to avoid a crash may be to turn quickly, or swerve around it.

A swerve is any sudden change in direction. It can be two quick turns, or a rapid shift to the side. Apply a small amount of pressure to the handgrip located on the side of your intended direction of escape. This will cause the motorcycle to lean quickly. The sharper the turn(s), the more the motorcycle must lean.

Keep your body upright and allow the motorcycle to lean in the direction of the turn while keeping your knees

SWERVE, THEN BRAKE

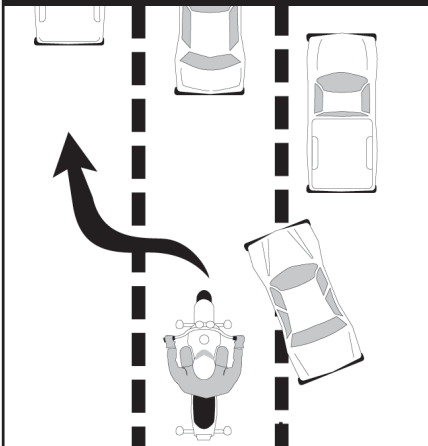

BRAKE, THEN SWERVE

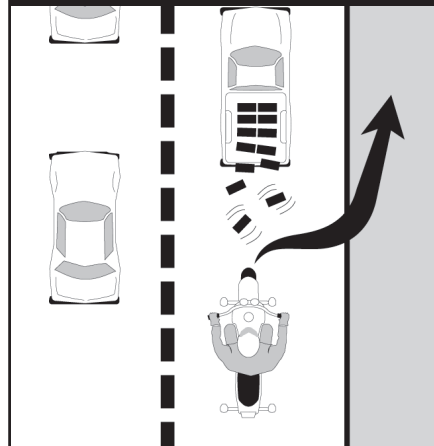

against the tank and your feet solidly on the footrests. Let the motorcycle move underneath you. Make your escape route the target of your vision. Press on the opposite handgrip once you clear the obstacle to return you to your original direction of travel. To swerve to the left, press the left handgrip, then press the right to recover. To swerve to the right, press right, then left.

IF BRAKING IS REQUIRED, SEPARATE IT FROM SWERVING. Brake before or after — never while swerving.

Cornering

A primary cause of single-vehicle crashes is motorcyclists running wide in a curve or turn and colliding with the roadway or a fixed object.

Every curve is different. Be alert to whether a curve remains constant, gradually widens, gets tighter or involves multiple turns.

Ride within your skill level and posted speed limits.

Your best path may not always follow the curve of the road.

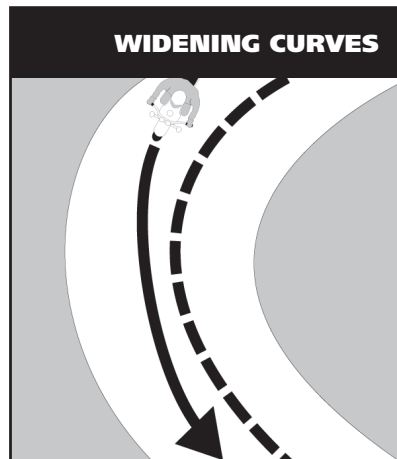
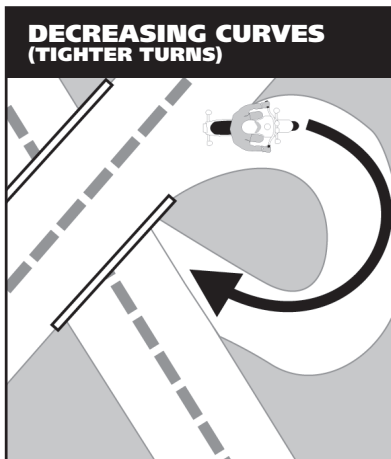
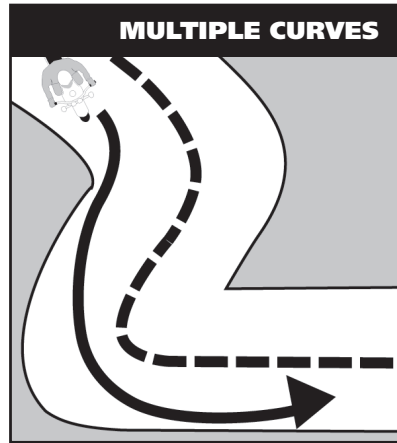
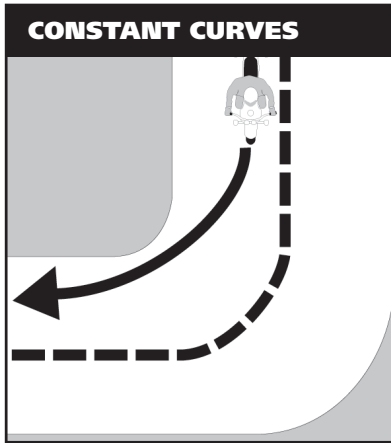

28 RIDE WITHIN YOUR ABILITIES

Change lane position depending on traffic, road conditions and curve of the road. If no traffic is present, start at the outside of a curve to increase your line of sight and the effective radius of the turn. As you turn, move toward the inside of the curve, and as you pass the center, move to the outside to exit.

Another alternative is to move to the center of your lane before entering a curve — and stay there until you exit. This permits you to spot approaching traffic as soon as possible. You can also adjust for traffic “crowding” the center line, or debris blocking part of your lane.

TEST YOURSELF

8

The best way to stop quickly is to:

- A. Use the front brake only.
- B. Use the rear brake first.
- C. Throttle down and use the front brake.
- D. Use both brakes at the same time.

Answer - page 41

HANDLING DANGEROUS SURFACES

Your chance of falling or being involved in a crash increases whenever you ride across:

- **Uneven surfaces or obstacles.**
- **Slippery surfaces.**
- **Railroad tracks.**
- **Grooves and gratings.**

Uneven Surfaces and Obstacles

Watch for uneven surfaces such as bumps, broken pavement, potholes or small pieces of highway trash.

Try to avoid obstacles by slowing or going around them. If you must go over the obstacle, first determine if it is possible. Approach it at as close to a 90° angle as possible. Look where you want to go to control your path of travel. If you have to ride over the obstacle, you should:

- **Slow down** as much as possible before contact.
- **Make sure** the motorcycle is straight.

OBSTACLES

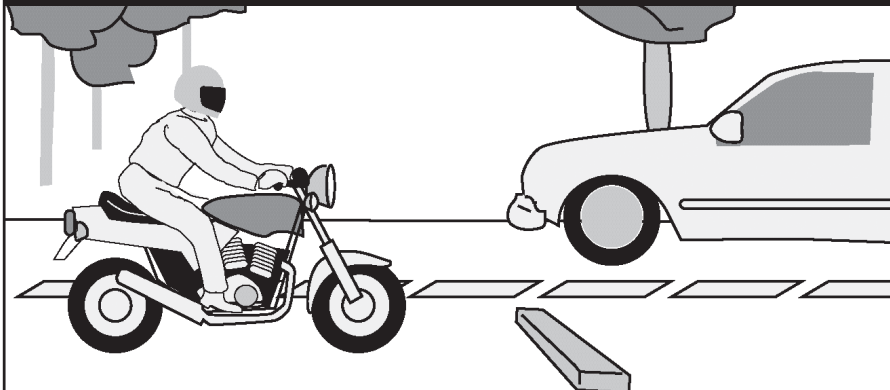

- **Rise slightly** off the seat with your weight on the footrests to absorb the shock with your knees and elbows, and avoid being thrown off the motorcycle.
- **Just before contact**, roll on the throttle slightly to lighten the front end.

If you ride over an object on the street, pull off the road and check your tires and rims for damage before riding any farther.

Slippery Surfaces

Motorcycles handle better when ridden on surfaces that permit good traction. Surfaces that provide poor traction include:

- **Wet pavement**, particularly just after it starts to rain and before surface oil washes to the side of the road.
- **Gravel roads**, or where sand and gravel collect.
- **Mud, snow, and ice.**
- **Lane markings (painted lines)**, steel plates and manhole covers, especially when wet.

To ride safely on slippery surfaces:

- **Reduce Speed** — Slow down before you get to a slippery surface to lessen your chances of skidding. Your motorcycle needs more distance to stop. And it is particularly important to reduce speed before entering wet curves.
- **Avoid Sudden Moves** — Any sudden change in speed or direction can cause a skid. Be as smooth as possible when you speed up, shift gears, turn or brake.
- **Use Both Brakes** — The front brake is still effective, even on a slippery surface. Squeeze the brake

lever gradually to avoid locking the front wheel. Remember, gentle pressure on the rear brake.

- **The center of a lane** can be hazardous when wet. When it starts to rain, ride in the tire tracks left by cars. Often, the left tire track will be the best position, depending on traffic and other road conditions as well.
- **Watch for oil spots** when you put your foot down to stop or park. You may slip and fall.
- **Dirt and gravel** collect along the sides of the road — especially on curves and ramps leading to and from highways. Be aware of what's on the edge of the road, particularly when making sharp turns and getting on or off freeways at high speeds.
- **Rain dries and snow melts faster** on some sections of a road than on others. Patches of ice tend to develop in low or shaded areas and on bridges and overpasses. Wet surfaces or wet leaves are just as slippery. Ride on the least slippery portion of the lane and reduce speed.

Cautious riders steer clear of roads covered with ice or snow. If you can't avoid a slippery surface, keep your motorcycle straight up and proceed as *slowly* as possible. If you encounter a large surface so slippery that you must coast, or travel at a walking pace, consider letting your feet skim along the surface. If the motorcycle starts to fall, you can catch yourself. Be sure to keep off the brakes. If possible, squeeze the clutch and coast. Attempting this maneuver at anything other than the slowest of speeds could prove hazardous.

30 RIDE WITHIN YOUR ABILITIES

CROSSTRACKS—RIGHT

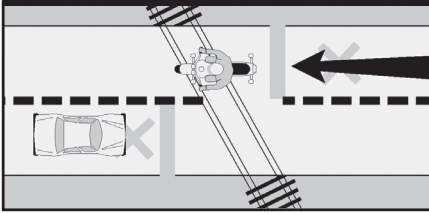

CROSSTRACKS—WRONG

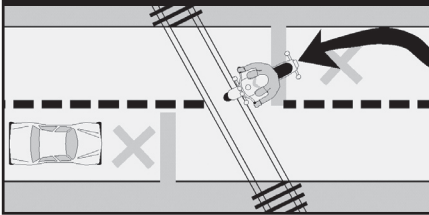

Railroad Tracks, Trolley Tracks and Pavement Seams

Usually it is safer to ride straight within your lane to cross tracks. Turning to take tracks head-on (at a 90° angle) can be more dangerous — your path may carry you into another lane of traffic.

PARALLEL TRACKS—RIGHT

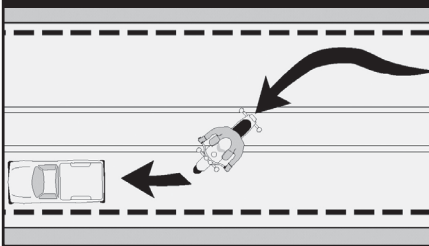

PARALLEL TRACKS—WRONG

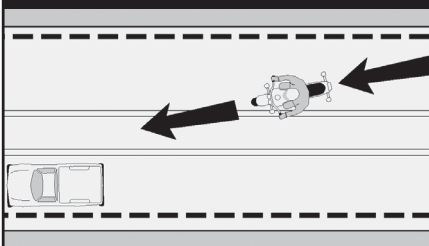

For track and road seams that run parallel to your course, move far enough away from tracks, ruts, or pavement seams to cross at an angle of at least 45°. Then, make a deliberate turn. Edging across could catch your tires and throw you off balance.

Grooves and Gratings

Riding over rain grooves or bridge gratings may cause a motorcycle to weave. The uneasy, wandering feeling is generally not hazardous. Relax, maintain a steady speed and ride straight across. Crossing at an angle forces riders to zigzag to stay in the lane. The zigzag is far more hazardous than the wandering feeling.

GRATE CROSSINGS—RIGHT

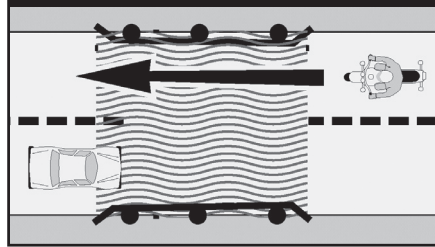

GRATE CROSSINGS—WRONG

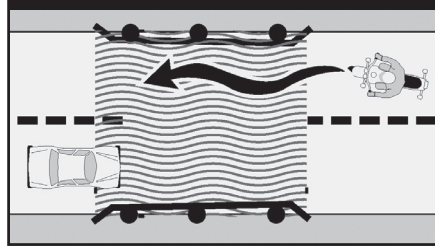

TEST YOURSELF

9

When it starts to rain it is usually best to:

- A. Ride in the center of the lane.
- B. Pull off to the side until the rain stops.
- C. Ride in the tire tracks left by cars.
- D. Increase your speed.

Answer - page 41

MECHANICAL PROBLEMS

You can find yourself in an emergency the moment something goes wrong with your motorcycle. In dealing with any mechanical problem, take into account the road and traffic conditions you face. Here are some guidelines that can help you handle mechanical problems safely.

Tire Failure

You will seldom hear a tire go flat. If the motorcycle starts handling differently, it may be a tire failure. This can be dangerous. You must be able to tell from the way the motorcycle reacts. If one of your tires suddenly loses air, react quickly to keep your balance. Pull off and check the tires.

If the front tire goes flat, the steering will feel "heavy." A front-wheel flat is particularly hazardous because it affects your steering. You have to steer well to keep your balance.

If the rear tire goes flat, the back of the motorcycle may jerk or sway from side to side.

If either tire goes flat while riding:

- **Hold handgrips** firmly, ease off the throttle, and keep a straight course.
- **If braking is required**, however, gradually apply the brake of the tire that isn't flat, if you are sure which one it is.
- **When the motorcycle slows**, edge to the side of the road, squeeze the clutch and stop.

Stuck Throttle

Twist the throttle back and forth several times. If the throttle cable is stuck, this may free it. If the throttle stays stuck, immediately operate the engine cut-off switch and pull in the clutch at the same time. This will remove power from the rear wheel, though engine sound may not immediately decline. Once the motorcycle is "under control," pull off and stop.

After you have stopped, check the throttle cable carefully to find the source of the trouble. Make certain the throttle works freely before you start to ride again.

Wobble

A "wobble" occurs when the front wheel and handlebars suddenly start to shake from side to side at any speed. Most wobbles can be traced to improper loading, unsuitable accessories or incorrect tire pressure. If you are carrying a heavy load, lighten it. If you can't, shift it. Center the weight lower and farther forward on the motorcycle. Make sure tire pressure, spring preload, air shocks and dampers are at the settings recommended for that much weight. Make sure windshields and fairings are mounted properly.

Check for poorly adjusted steering; worn steering parts; a front wheel that is bent, misaligned, or out of balance; loose wheel bearings or spokes; and worn swingarm bearings. If none of these is determined to be the cause, have the motorcycle checked out thoroughly by a qualified professional.

32 RIDE WITHIN YOUR ABILITIES

Trying to “accelerate out of a wobble” will only make the motorcycle more unstable. Instead:

- **Grip the handlebars firmly**, but don’t fight the wobble.
- **Close the throttle gradually** to slow down. Do not apply the brakes; braking could make the wobble worse.
- **Move your weight** as far forward and down as possible.
- **Pull off the road** as soon as you can to fix the problem.

TEST YOURSELF 10

If your motorcycle starts to wobble:

- A. Accelerate out of the wobble.
- B. Use the brakes gradually.
- C. Grip the handlebars firmly and close the throttle gradually.
- D. Downshift.

Answer - page 41

Drive Train Problems

The drive train for a motorcycle uses either a chain, belt, or drive shaft to transfer power from the engine to the rear wheel. Routine inspection, adjustment, and maintenance makes failure a rare occurrence. A chain or belt that slips or breaks while you’re riding could lock the rear wheel and cause your motorcycle to skid.

If the chain or belt breaks, you’ll notice an instant loss of power to the rear wheel. Close the throttle and brake to a stop in a safe area.

On models with a drive shaft, loss of oil in the rear differential can cause the rear wheel to lock, and you may not be able to prevent a skid.

Engine Seizure

When the engine “locks” or “freezes” it is usually low on oil. The engine’s moving parts can’t move smoothly against each other, and the engine overheats. The first sign may be a loss of engine power or a change in the engine’s sound. Squeeze the clutch lever to disengage the engine from the rear wheel. Pull off the road and stop. Check the oil. If needed, oil should be added as soon as possible or the engine will seize. When this happens, the effect is the same as a locked rear wheel. Let the engine cool before restarting.

ANIMALS

Naturally, you should do everything you safely can to avoid hitting an animal. If you are in traffic, however, remain in your lane. Hitting something small is less dangerous to you than hitting something big — like a car.

Motorcycles seem to attract dogs. If you are chased, downshift and approach the animal slowly. As you approach it, accelerate away and leave the animal behind. Don’t kick at an animal. Keep control of your motorcycle and look to where you want to go.

For larger animals (deer, elk, cattle) brake and prepare to stop — they are unpredictable.

TEST YOURSELF 11

If you are chased by a dog:

- A. Kick it away.
- B. Stop until the animal loses interest.
- C. Swerve around the animal.
- D. Approach the animal slowly, then speed up.

Answer - page 41

FLYING OBJECTS

From time to time riders are struck by insects, cigarettes thrown from cars or pebbles kicked up by the tires of the vehicle ahead. If you are wearing face protection, it might get smeared or cracked, making it difficult to see. Without face protection, an object could hit you in the eye, face or mouth. Whatever happens, keep your eyes on the road and your hands on the handlebars. When safe, pull off the road and repair the damage.

GETTING OFF THE ROAD

If you need to leave the road to check the motorcycle (or just to rest for a while), be sure you:

- **Check the roadside** — Make sure the surface of the roadside is firm enough to ride on. If it is soft grass, loose sand or if you're just not sure about it, slow way down before you turn onto it.
- **Signal** — Drivers behind might not expect you to slow down. Give a clear signal that you will be slowing down and changing direction. Check your mirror and make a head check before you take any action.
- **Pull off the road** — Get as far off the road as you can. It can be very hard to spot a motorcycle by the side of the road. You don't want someone else pulling off at the same place you are.
- **Park carefully** — Loose and sloped shoulders can make setting the side or center stand difficult.

CARRYING PASSENGERS AND CARGO

Only experienced riders should carry passengers or large loads. The extra weight changes the way the motorcycle handles, balances, speeds up and slows down. Before taking a passenger or a heavy load on the street, practice away from traffic.

Equipment

To carry passengers safely:

- **Equip and adjust** your motorcycle to carry passengers.
- **Instruct the passenger** before you start.
- **Adjust your riding** technique for the added weight.

Equipment should include:

- **A proper seat** — large enough to hold both of you without crowding. You should not sit any farther forward than you usually do.
- **Footrests** — for the passenger. Firm footing prevents your passenger from falling off and pulling you off, too.
- **Protective equipment** — the same protective gear recommended for operators.

Adjust the suspension to handle the additional weight. You will probably need to add a few pounds of pressure to the tires if you carry a passenger. (Check your owner's manual for appropriate settings.) While your passenger sits on the seat with you, adjust the mirrors and headlight according to the change in the motorcycle's angle.

34 RIDE WITHIN YOUR ABILITIES

Instructing Passengers

Even if your passenger is a motorcycle rider, provide complete instructions before you start. Tell your passenger to:

- **Get on** the motorcycle only after you have started the engine.
- **Sit as far forward** as possible without crowding you.
- **Hold firmly** to your waist, hips, belt, or to the bike's passenger handholds.
- **Keep both feet** on the footrests, even when stopped.
- **Keep legs away** from the muffler(s), chains or moving parts.
- **Stay directly behind you**, leaning as you lean.
- **Avoid unnecessary** talk or motion.

Also, tell your passenger to tighten his or her hold when you:

- **Approach** surface problems.
- **Are about to start** from a stop.
- **Warn that you** will make a sudden move.

Riding With Passengers

Your motorcycle will respond more slowly with a passenger on board. The heavier your passenger, the longer it may take to slow down and speed up — especially on a light motorcycle.

TEST YOURSELF 12

Passengers should:

- A. Lean as you lean.
- B. Hold on to the motorcycle seat.
- C. Sit as far back as possible.
- D. Never hold onto you.

Answer - page 41

- **Ride a little slower**, especially when taking curves, corners or bumps.
- **Start slowing earlier** as you approach a stop.
- **Open up a larger cushion** of space ahead and to the sides.
- **Wait for larger gaps** to cross, enter or merge in traffic.

Warn your passenger of special conditions — when you will pull out, stop quickly, turn sharply or ride over a bump. Turn your head slightly to make yourself understood, but keep your eyes on the road ahead.

Carrying Loads

Most motorcycles are not designed to carry much cargo. Small loads can be carried safely if positioned and fastened properly.

- **Keep the Load Low** — Fasten loads securely, or put them in saddlebags. Piling loads against a sissybar or frame on the back of the seat raises the motorcycle's center of gravity and disturbs its balance.
- **Keep the Load Forward** — Place the load over, or in front of, the rear axle. Tankbags keep loads forward, but use caution when loading hard or sharp objects. Make sure the tankbag does not interfere with handlebars or controls. Mounting loads behind the rear axle can affect how the motorcycle turns and brakes. It can also cause a wobble.
- **Distribute the Load Evenly** — Load saddlebags with about the same weight. An uneven load can cause the motorcycle to drift to one side.

- **Secure the Load** — Fasten the load securely with elastic cords (bungee cords or nets). Elastic cords with more than one attachment point per side are more secure. A tight load won't catch in the wheel or chain, causing it to lock up and skid. Rope tends to stretch and knots come loose, permitting the load to shift or fall.
- **Check the Load** — Stop and check the load every so often to make sure it has not worked loose or moved.

GROUP RIDING

If you ride with others, do it in a way that promotes safety and doesn't interfere with the flow of traffic.

Keep the Group Small

Small groups make it easier and safer for car drivers who need to get around them. A small number isn't separated as easily by traffic or red lights. Riders won't always be hurrying to catch up. If your group is larger than four or five riders, divide it up into two or more smaller groups.

Keep the Group Together

- **Plan** — The leader should look ahead for changes and signal early so "the word gets back" in plenty of time. Start lane changes early to permit everyone to complete the change.
- **Put Beginners Up Front** — Place inexperienced riders just behind the leader. That way the more experienced riders can watch them from the back.
- **Follow Those Behind** — Let the tailender set the pace. Use your mirrors to keep an eye on the person behind. If a rider falls behind, everyone should slow down a little to stay with the tailender.

- **Know the Route** — Make sure everyone knows the route. Then, if someone is separated they won't have to hurry to keep from getting lost or taking a wrong turn. Plan frequent stops on long rides.

Keep Your Distance

Maintain close ranks but at the same time keep a safe distance to allow each rider in the group time and space to react to hazards. A close group takes up less space on the highway, is easier to see and is less likely to be separated. However, it must be done properly.

Don't Pair Up — Never operate directly alongside another rider. There is no place to go if you have to avoid a car or something on the road. To talk, wait until you are both stopped.

Staggered Formation — This is the best way to keep ranks close yet maintain an adequate space cushion. The leader rides in the left side of the lane, while the second rider stays one second behind in the right side of the lane.

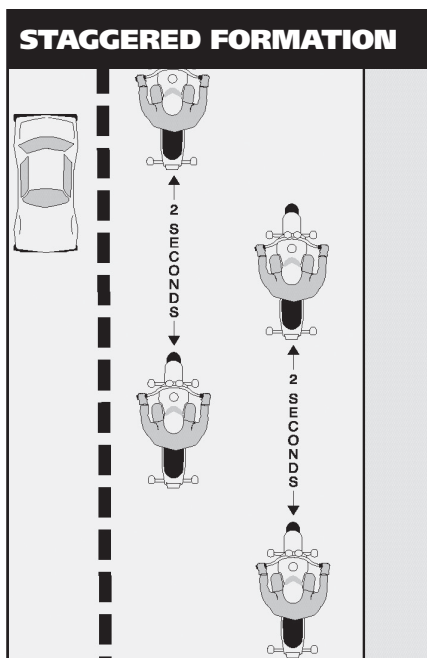

36 RIDE WITHIN YOUR ABILITIES

A third rider maintains in the left position, two seconds behind the first rider. The fourth rider would keep a two-second distance behind the second rider. This formation keeps the group close and permits each rider a safe distance from others ahead, behind and to the sides.

- **Passing in Formation** — Riders in a staggered formation should pass one at a time.
- **First, the lead rider should pull out** and pass when it is safe. After passing, the leader should return to the left position and continue riding at passing speed to open room for the next rider.
- **After the first rider passes safely**, the second rider should move up to the left position and watch for a safe chance to pass. After passing, this rider should return to the right position and open up room for the next rider.

Some people suggest that the leader should move to the right side after passing a vehicle. This is not a good idea. It encourages the second rider to pass and cut back in before there is a large enough space cushion in front of the passed vehicle. It's simpler and safer to wait until there is enough room ahead of the passed vehicle to allow each rider to move into the same position held before the pass.

Single-File Formation — It is best to move into a single-file formation when riding curves, turning, entering or leaving a highway.

TEST YOURSELF 13

When riding in a group, inexperienced riders should position themselves:

- A. Just behind the leader.
- B. In front of the group.
- C. At the tail end of the group.
- D. Beside the leader.

Answer - page 41

GROUP PASSING (STAGE 1)

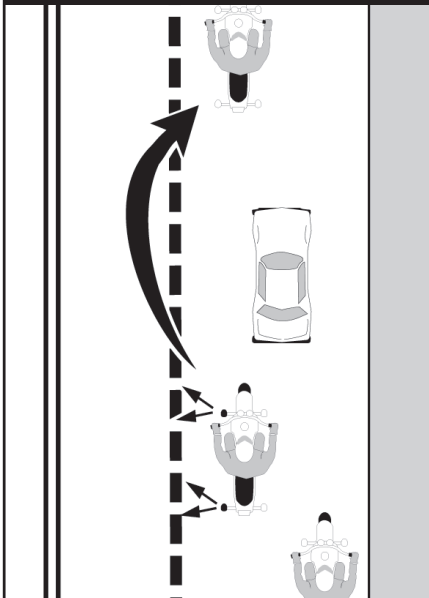

GROUP PASSING (STAGE 2)

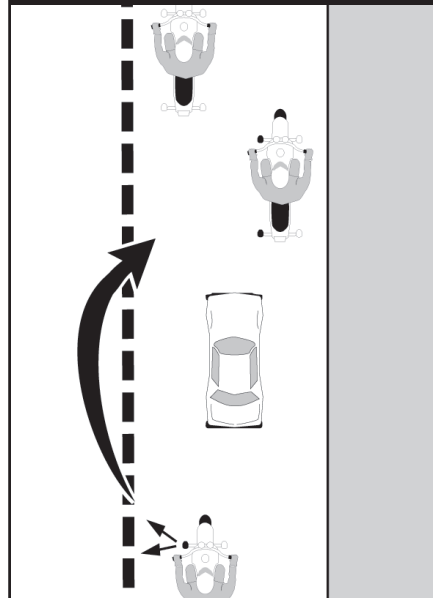

Riding a motorcycle is a demanding and complex task. Skilled riders pay attention to the riding environment and to operating the motorcycle, identifying potential hazards, making good judgments and executing decisions quickly and skillfully. Your ability to perform and respond to changing road and traffic conditions is influenced by how fit and alert you are. Alcohol and other drugs, more than any other factor, degrade your ability to think clearly and to ride safely. As little as one drink can have a significant effect on your performance.

Let's look at the risks involved in riding after drinking or using drugs. What to do to protect yourself and your fellow riders is also examined.

WHY THIS INFORMATION IS IMPORTANT

Alcohol is a major contributor to motorcycle crashes, particularly fatal crashes. Studies show that 40% to 45% of all riders killed in motorcycle crashes had been drinking. Only one-third of those riders had a blood alcohol concentration above legal limits. The rest had only a few drinks in their systems — enough to impair riding skills. In the past, drug levels have been harder to distinguish or have not been separated from drinking violations for the traffic records. But riding “under the influence” of either alcohol or drugs poses physical and legal hazards for every rider.

Drinking and drug use is as big a problem among motorcyclists as it is among automobile drivers. Motorcyclists, however, are more likely to be killed or severely injured in a crash. Injuries occur in 90% of motorcycle crashes and 33% of automobile crashes that involve abuse of substances. On a yearly basis, 2,100 motorcyclists are killed and about 50,000 seriously injured in this same type of crash. These statistics are too overwhelming to ignore.

By becoming knowledgeable about the effects of alcohol and other drugs you will see that riding and substance abuse don't mix. Take positive steps to protect yourself and prevent others from injuring themselves.

ALCOHOL AND OTHER DRUGS IN MOTORCYCLE OPERATION

No one is immune to the effects of alcohol or drugs. Friends may brag about their ability to hold their liquor or perform better on drugs, but alcohol or drugs make them less able to think clearly and perform physical tasks skillfully. Judgment and the decision-making processes needed for vehicle operation are affected long before legal limitations are reached.

Many over-the-counter, prescription and illegal drugs have side effects that increase the risk of riding. It is difficult to accurately measure the involvement of particular drugs in motorcycle crashes. But we do know what effects various drugs have on the processes involved in riding a motorcycle. We also know that the combined effects of alcohol and other drugs are more dangerous than either is alone.

ALCOHOL IN THE BODY

Alcohol enters the bloodstream quickly. Unlike most foods and beverages, it does not need to be digested. Within minutes after being consumed, it reaches the brain and begins to affect the drinker. The major effect alcohol has is to slow down and impair bodily functions — both mental and physical. Whatever you do, you do less well after consuming alcohol.

38 BEING IN SHAPE TO RIDE

Blood Alcohol Concentration

Blood Alcohol Concentration or BAC is the amount of alcohol in relation to blood in the body. Generally, alcohol can be eliminated in the body at the rate of almost one drink per hour. But a variety of other factors may also influence the level of alcohol retained. The more alcohol in your blood, the greater the degree of impairment.

Three factors play a major part in determining BAC:

- **The amount** of alcohol you consume.
- **How fast** you drink.
- **Your body** weight.

Other factors also contribute to the way alcohol affects your system.

Your sex, physical condition and food intake are just a few that may cause your BAC level to be even higher. But the full effects of these are not completely known. **Alcohol may still accumulate in your body even if you are drinking at a rate of one drink per hour.** Abilities and judgment can be affected by that one drink.

A 12-ounce can of beer, a mixed drink with one shot of liquor, and a 5-ounce glass of wine all contain the same amount of alcohol.

The faster you drink, the more alcohol accumulates in your body. If you drink two drinks in an hour, at the end of that hour, at least one drink will remain in your bloodstream.

Without taking into account any other factors, these examples illustrate why time is a critical factor when a rider decides to drink.

A person drinking:

– Seven drinks over the span of three hours would have at least four (7 – 3 = 4) drinks remaining in their system at the end of the three hours. They would need at least another four hours to eliminate the four remaining drinks before they consider riding.

ALCOHOL CONTENT

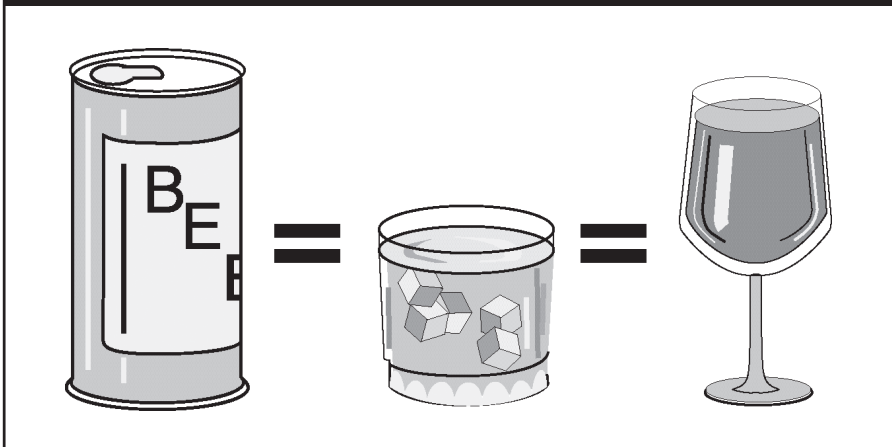

– Four drinks over the span of two hours would have at least two ($4 - 2 = 2$) drinks remaining in their system at the end of the two hours. They would need at least another two hours to eliminate the two remaining drinks before they consider riding.

There are times when a larger person may not accumulate as high a concentration of alcohol for each drink consumed. They have more blood and other bodily fluids. But because of individual differences it is better not to take the chance that abilities and judgment have not been affected. Whether or not you are legally intoxicated is not the real issue. Impairment of judgment and skills begins well below the legal limit.

ALCOHOL AND THE LAW

In all states, an adult with a BAC of 0.08% or above is considered intoxicated. For operators under the age of 21, lower BAC limits (0.00 to 0.02%, depending on state) apply. It doesn't matter how sober you may look or act. The breath or urine test is what usually determines whether you are riding legally or illegally.

Your chances of being stopped for riding under the influence of alcohol are increasing. Law enforcement is being stepped up across the country in response to the senseless deaths and injuries caused by drinking drivers and riders.

Consequences of Conviction

Years ago, first offenders had a good chance of getting off with a small fine and participation in alcohol-abuse classes. Today the laws of most states impose stiff penalties on drinking operators. And those penalties are mandatory, meaning that judges must impose them.

If you are convicted of riding under the influence of alcohol or drugs, you may receive any of the following penalties:

- **License Suspension** — Mandatory suspension for conviction, arrest or refusal to submit to a breath test.
- **Fines** — Severe fines are another aspect of a conviction, usually levied with a license suspension.
- **Community Service** — Performing tasks such as picking up litter along the highway, washing cars in the motor-vehicle pool or working at an emergency ward.
- **Costs** — Additional lawyer's fees to pay, lost work time spent in court or alcohol-education programs, public transportation costs (while your license is suspended) and the added psychological costs of being tagged a "drunk driver."

MINIMIZE THE RISKS

Your ability to judge how well you are riding is affected first. Although you may be performing more and more poorly, you think you are doing better and better. The result is that you ride confidently, taking greater and greater risks. Minimize the risks of drinking and riding by taking steps before you drink. Control your drinking or control your riding.

Make an Intelligent Choice

Don't Drink — Once you start, your resistance becomes weaker.

Setting a limit or pacing yourself are poor alternatives at best. Your ability to exercise good judgment is one of the first things affected by alcohol. Even if you have tried to drink in moderation, you may not realize to what extent your skills have suffered from alcohol's fatiguing effects.

40 BEING IN SHAPE TO RIDE

Or Don't Ride — If you haven't controlled your drinking, you must control your riding.

- **Leave the motorcycle** — so you won't be tempted to ride. Arrange another way to get home.
- **Wait** — If you exceed your limit, wait until your system eliminates the alcohol and its fatiguing effects.

STEP IN TO PROTECT FRIENDS

People who have had too much to drink are unable to make a responsible decision. It is up to others to step in and keep them from taking too great a risk. No one wants to do this — it's uncomfortable, embarrassing and thankless. You are rarely thanked for your efforts at the time. But the alternatives are often worse.

There are several ways to keep friends from hurting themselves:

- **Arrange a safe ride** — Provide alternative ways for them to get home.
- **Slow the pace of drinking** — Involve them in other activities.
- **Keep them there** — Use any excuse to keep them from getting on their motorcycle. Serve them food and coffee to pass the time. Explain your concerns for their risks of getting arrested or hurt or hurting someone else. Take their key, if you can.
- **Get friends involved** — Use peer pressure from a group of friends to intervene.

It helps to enlist support from others when you decide to step in. The more people on your side, the easier it is to be

firm and the harder it is for the rider to resist. While you may not be thanked at the time, you will never have to say, "If only I had ..."

FATIGUE

Riding a motorcycle is more tiring than driving a car. On a long trip, you'll tire sooner than you would in a car. Avoid riding when tired. Fatigue can affect your control of the motorcycle.

- **Protect yourself** from the elements — Wind, cold, and rain make you tire quickly. Dress warmly. A windshield is worth its cost if you plan to ride long distances.
- **Limit your distance** — Experienced riders seldom try to ride more than about six hours a day.
- **Take frequent rest breaks** — Stop and get off the motorcycle at least every two hours.
- **Don't drink or use drugs** — Artificial stimulants often result in extreme fatigue or depression when they start to wear off. Riders are unable to concentrate on the task at hand.

TEST YOURSELF

14

If you wait one hour per drink for the alcohol to be eliminated from your body before riding:

- A. You cannot be arrested for drinking and riding.
- B. Your riding skills will not be affected.
- C. Side effects from the drinking may still remain.
- D. You will be okay as long as you ride slowly.

Answer - page 41

Safe riding requires knowledge and skill. Licensing tests are the best measurement of the skills necessary to operate safely in traffic. Assessing your own skills is not enough. People often overestimate their own abilities. It's even harder for friends and relatives to be totally honest about your skills. Licensing exams are designed to be scored more objectively.

To earn your license, you must pass a knowledge test and an on-cycle skill test. Knowledge test questions are based on information, practices and ideas from this manual. They require that you know and understand road rules and safe riding practices. An on-cycle skill test will either be conducted in an actual traffic environment or in a controlled, off-street area.

Knowledge Test

(Sample Questions)

1. It is MOST important to flash your brake light when:

- A. Someone is following too closely.
- B. You will be slowing suddenly.
- C. There is a stop sign ahead.
- D. Your signals are not working.

2. The FRONT brake supplies how much of the potential stopping power?

- A. About one-quarter.
- B. About one-half.
- C. About three-quarters.
- D. All of the stopping power.

3. To swerve correctly:

- A. Shift your weight quickly.
- B. Turn the handlebars quickly.
- C. Press the handlegrip in the direction of the turn.
- D. Press the handlegrip in the opposite direction of the turn.

4. If a tire goes flat while riding and you must stop, it is usually best to:

- A. Relax on the handlegrips.
- B. Shift your weight toward the good tire.
- C. Brake on the good tire and steer to the side of the road.
- D. Use both brakes and stop quickly.

5. The car below is waiting to enter the intersection. It is best to:

- A. Make eye contact with the driver.
- B. Reduce speed and be ready to react.
- C. Maintain speed and position.
- D. Maintain speed and move right.

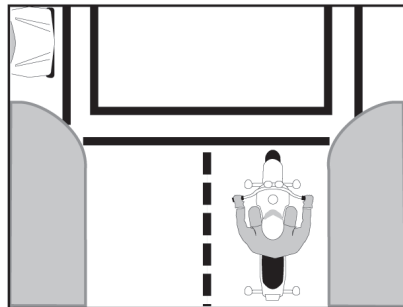

42 EARNING YOUR LICENSE

On-Motorcycle Skill Test

Basic vehicle control and crash-avoidance skills are included in on-motorcycle tests to determine your ability to handle normal and hazardous traffic situations.

You may be tested for your ability to:

- **Know your motorcycle** and your riding limits.
- **Accelerate, brake and turn safely.**
- **See, be seen** and communicate with others.
- **Adjust speed** and position to the traffic situation.

- **Stop, turn and swerve quickly.**
- **Make critical decisions** and carry them out.

Examiners may score on factors related to safety such as:

- **Selecting** safe speeds to perform maneuvers.
- **Choosing** the correct path and staying within boundaries.
- **Completing** normal and quick stops.
- **Completing** normal and quick turns or swerves.

Answers to Test Yourself (previous pages)

1-C, 2-D, 3-D, 4-A, 5-B,
6-C, 7-D, 8-D, 9-C, 10-C,
11-D, 12-A, 13-A, 14-C

Answers to Knowledge Test (left):

1-B, 2-C, 3-C, 4-C, 5-B

Diagrams and drawings used in this manual are for reference only and are not to correct scale for size of vehicles and distances.

The Rider Skill Test

Safe motorcycle riding depends largely on your knowledge and skills. The skills for motorcycling require a lot of practice. If you have just learned to handle a motorcycle and have very little riding experience, then the most important part of learning to ride is still ahead.

You may wish to take a Georgia Motorcycle Safety Program rider education course that offers a license waiver. For more information about locations and schedules, visit www.dds.ga.gov/training.

The Rider Skills Test (RST) is used for both two-wheeled (RST-2W) and three-wheeled vehicles (RST-3W). The following pages highlight the testing patterns for both the two-wheel and three-wheel test.

Both tests consist of four riding evaluations that measure your control of the motorcycle and your hazard-response skills. The final two exercises involve speeds of about 15 miles per hour.

You will be scored on time / distance standards as well as path violations. The test may be ended early for point accumulation, committing an unsafe act, or failure to understand or follow instructions.

When you report for your test, you should have:

- **An approved helmet and protective goggles.**
- **For safety, it is suggested to wear long sleeves, long pants, gloves, and sturdy footwear.**
- **You must furnish a street-legal motorcycle for the test and pass a safety inspection of the motorcycle by the license examiner before the riding test is given.**

PLEASE NOTE: You have the right to cancel the test at any time. Inform the examiner that you do not wish to continue the test. The examiner will explain the conditions for taking the test later.

The examiner also has the right to stop the test if you (a) fail to demonstrate basic control skills, (b) accumulate more than the maximum number of penalty points allowed, (c) commit any unsafe act (d) fail to understand or follow directions, or (e) fall or drop the motorcycle. If any of these instances occur, the test will be discontinued.

Finally, all testing may be suspended due to inclement weather, equipment failure or other circumstances beyond the control of you or the examiner.

44 THE NEW RIDER SKILL TEST - 2W

Rider Skills Test for Two-Wheels

Evaluation #1

Cone Weave & Normal Stop

Directions:

From the start point ride to the right of the first cone, to the left of the second, and so on.

After passing the last cone turn left and ride toward the opposite side of the course. Make a smooth, non-skidding stop with your front tire inside the box.

Points will accumulate if you:

- Stall during the exercise
- Put a foot down or hit/skip a cone during the weave
- Skid when coming to a stop
- Fail to stop with your front tire within the borders of the box

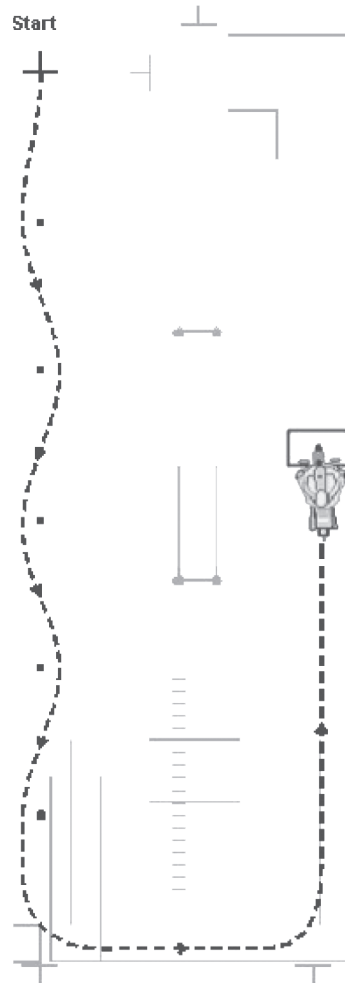

**Rider Skills Test for Two-Wheels
(continued).**

Evaluation #2

Turn From a Stop & U-Turn

Directions

From the start point make a right turn between the boundary lines.

After completing the turn, diagonally cross to the opposite side of the course and make a left U-Turn inside the painted box at the far end of the course. Do not touch the solid (24') line for motorcycles 600cc or more, or the dashed (20') line for motorcycles less than 600cc

Stop with your front tire inside the box

Points will accumulate if you:

- Stall during the exercise
- Put a foot down
- Touch or cross a boundary line

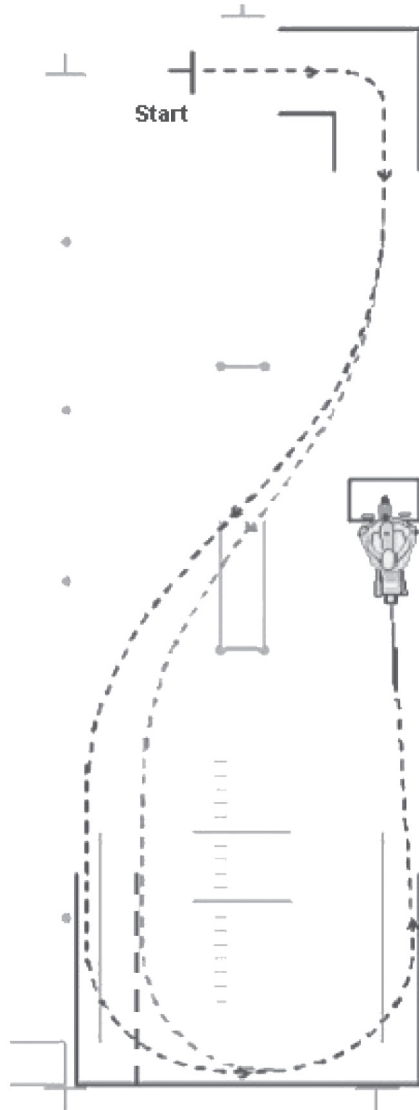

**Rider Skills Test for Two-Wheels
(continued).**

Evaluation #3
Quick Stop

Directions

From the start point accelerate straight up the path. Stabilize your speed between 12-20 mph by the time you reach the first line. Maintain a steady speed.

When your front tire crosses the second line, stop as fast as you safely can using both brakes.

This test will be timed in order to determine your speed

Points will accumulate if you:

- Stall during the exercise
- Fail to stop within the established guidelines

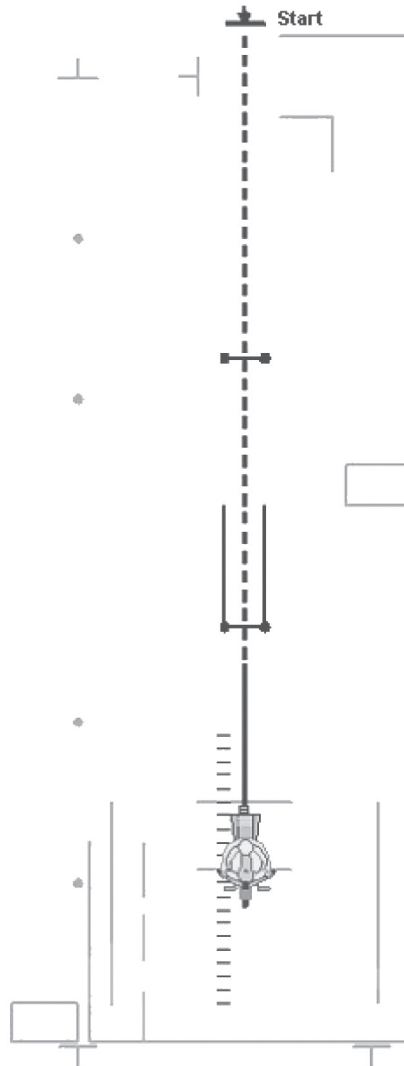

Rider Skills Test for Two-Wheels
(continued).

Evaluation #4

Obstacle Swerve

Directions

From the start point accelerate straight up the path. Stabilize your speed between 12-20 mph by the time you reach the first line. Maintain a steady speed.

When your front tire passes the second line, swerve to the left or right as directed.

This test will be timed in order to determine your speed

Points will accumulate if you:

- Stall during the exercise
- Touch or cross the obstacle line or sideline with either tire
- Swerve in the wrong direction

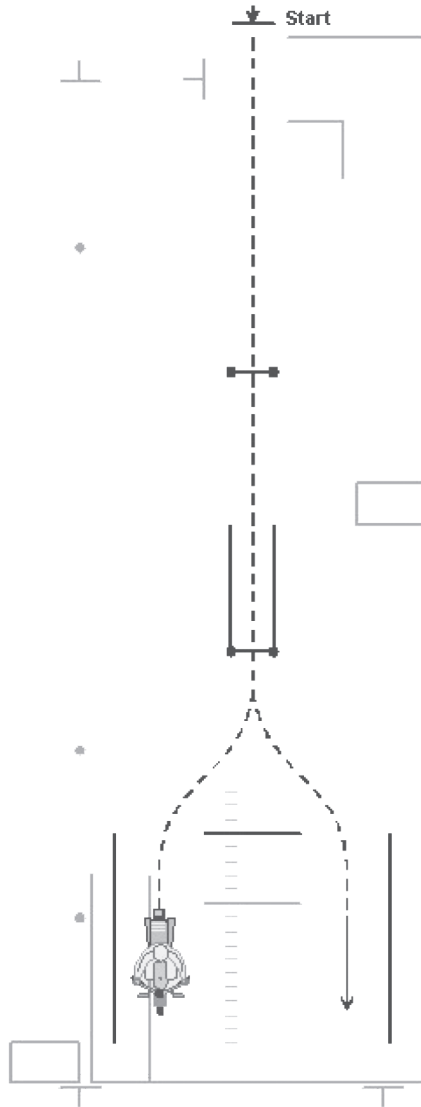

Rider Skills Test for Three-Wheels

Evaluation #1

Left Turn & Normal Stop

Directions

From the start point ride straight ahead and make a sharp left turn between the boundary lines and the single cone marker.

Then ride toward the opposite end of the course. Make a smooth, non-skidding stop with your front tire inside the box. (Left front tire on vehicles with two front tires).

Points will accumulate if you:

- Stall during the exercise
- Touch or cross a boundary line
- Hit or skip the boundary cone
- Skid when coming to a stop
- Fail to stop with your front tire within the borders of the box

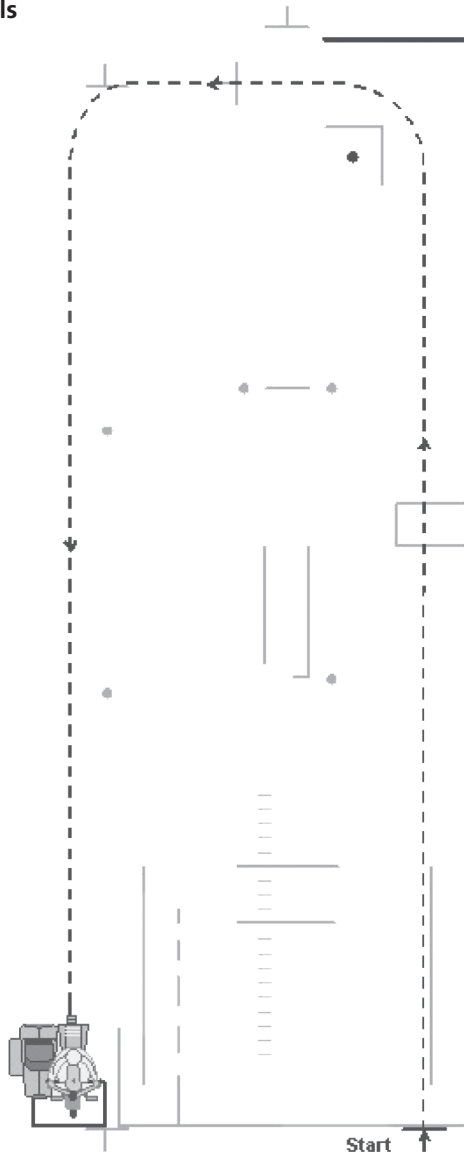

Rider Skills Test for Three-Wheels (continued).

Evaluation #2

Cone Weave & Turn From a Stop

Directions

From the start point ride to the left of the first cone, to the right of the second and to the left of the third.

After passing the last cone turn right at the end of the course and stop at the Start "T" facing the other side of the course. Then make a right hand turn between the boundary lines and the cone.

Make a smooth, non-skidding stop with your front tire inside the box

Points will accumulate if you:

- Stall during the exercise
- Hit or skip a cone during the weave
- Touch or cross a boundary line
- Hit or skip the boundary cone

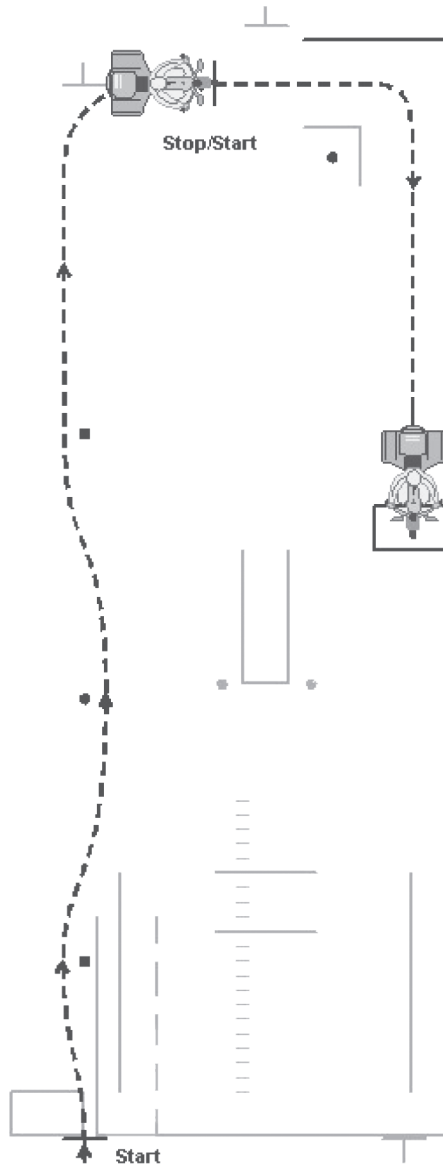

Rider Skills Test for Three-Wheels**(continued).**

Evaluation #3

Quick Stop

Directions

From the start point accelerate straight up the path. Stabilize your speed between 12-20 mph by the time you reach the first set of cones. Maintain a steady speed.

When your front tire crosses the second set of cones, stop as fast as you safely can using both brakes.

This test will be timed in order to determine your speed

Points will accumulate if you:

- Stall during the exercise
- Fail to stop within the established guidelines

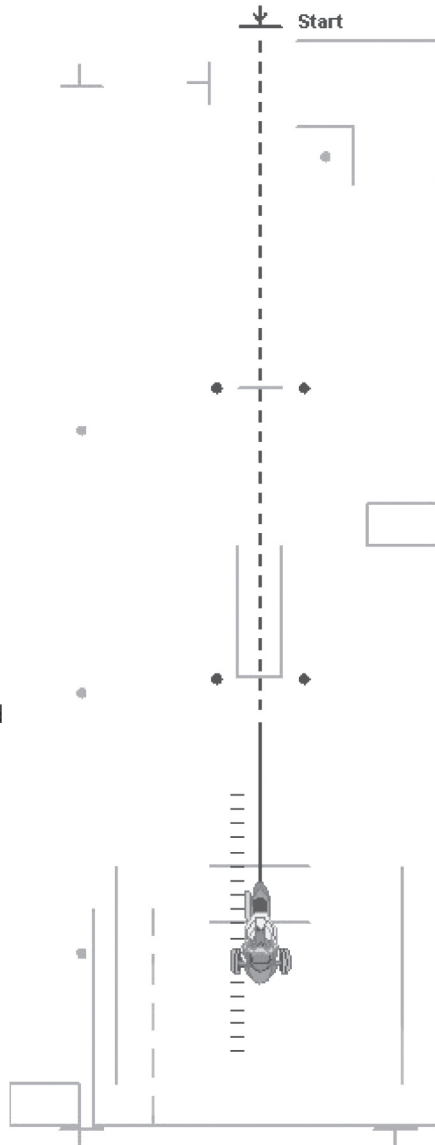

52 REQUIREMENTS

INSURANCE

Georgia law prohibits any person from operating a motorcycle, or authorizing another person to operate a motorcycle, unless the owner has liability insurance or is classified as a self-insurer, as required by law.

Proof of insurance must be carried at all times while operating a motorcycle, and displayed to a law enforcement officer upon request.

MOTORCYCLE OPERATOR LICENSE REQUIREMENTS

A Class M license, a Class MP learner's permit, or an M endorsement on another class of license is required to legally operate a motorcycle or motor-driven cycle in Georgia. Every motor vehicle having a saddle for the use of the rider and designed to travel on not more than three wheels in contact with the ground, but excluding a tractor and moped, are defined as motorcycles. Georgia law places types of motorcycles (including scooters, motorbikes and minibikes) into classification. All are considered motor-driven cycles.

CLASS M - LICENSE REQUIREMENTS

- 1. Must be 17 years of age & have parental consent if under 18.**
- 2. Must successfully complete a motorcycle examination, which includes a special road signs test, a special road rules test and an actual driving test on a motorcycle.**
- 3. Must pass a visual acuity test. If the vision test was administered & passed during the year, the eye test may be waived.**
- 4. If the applicant meets the established requirements for a Class M license, and possesses a Class C or combination of other classes of permits, that license must be surrendered and a photographic license containing the Class M endorsement will be issued. The applicant will not be given a refund for the remaining period of validity of the other license, but such endorsements would run concurrently with the Class M endorsement.**
- 5. Other licensing requirements as prescribed by the Department of Driver Services.**
- 6. Safety equipment as required by law.**

If you need additional information on license requirements, fees, renewals, expirations, organ donor program or other information concerning drivers license you should refer to the Georgia Drivers Manual or you can call (678) 413-8400, (678) 413-8500, (678) 413-8600, or toll free at (866) 754-3687 if calling from outside metro Atlanta.

You may also refer to the list of Customer Service Centers in the back of this manual.

CLASS MP - LEARNERS PERMIT

All applicants must pass an eye test and an examination of motorcycle knowledge. An issued Class MP instruction permit is valid for 6 months, after which time the applicant may return to the issuing station and take a road test.

It is not mandatory for a Class MP license applicant to obtain a Class MP Learners Permit before taking the Class MP examination. Restrictions for a Class MP instruction or learners permit are the following.

- 1. Must be at least 17 years old and have parental consent if under 18 (NOTE: if the applicant is at least 16 years old and has completed a DDS-approved Driver Education course, he or she may apply for their MP at the age of 16. The Georgia Motorcycle Safety Program courses do not satisfy the driver education requirement. See www.dds.ga.gov for more information.)**
- 2. Motorcycle operation in daylight hours only.**
- 3. No passengers allowed.**
- 4. No limited access roadways (interstates or expressways).**
- 5. Other licensing requirements as prescribed by the Department of Driver Services.**
- 6. Safety equipment as prescribed by law.**

SAFETY GEAR

Helmet: Protective headgear is required by law in Georgia. All helmets shall meet the minimum standards as established by the Georgia Department of Public Safety. Your helmet should be comfortable and must be securely strapped on.

54 REQUIREMENTS

Eye Protective Devices: Georgia law states that no person may operate or ride upon a motorcycle if it is not equipped with a windshield unless he or she is wearing an eye-protective of a type approved by the Georgia Department of Public Safety. Contact lenses are not acceptable as protective glasses.

Footwear: The operator and any passengers riding a motorcycle must wear some type of footwear other than socks. Commonsense overrules riding with sandals and slippers. The best footwear is high-topped leather boots.

Protective Clothing: Clothing should be adequate to reduce injury in case of a spill or accident. Long sleeves, regular trousers (rather than shorts), and gloves will help reduce skin abrasions. The heavier the clothing, the more protection, leather provides the best protection. When riding at night it is safest to wear light colored clothing (white, yellow, orange) which will make you much more visible to other motorists.



Tips for New Riders**Get licensed: Real Riding...Real Skills**

Unlicensed riders tend to crash more. But a license won't protect you completely. It's an attitude thing. Serious riders know that real riding takes real skills to ride legally and sober. A license is the first step.

Get trained: Real Riding...Real Skills

Friends are great...except when it comes to training. They may be well-intentioned and try to show you how to ride but to survive today's streets you need professional instruction. The Georgia Motorcycle Safety Program is ready to help. Our Basic Course is designed for folks with no experience and introduces the exciting world of motorcycling. Hey, it also may help with getting licensed. Successful graduates not only learn street survival skills but they can earn their motorcycle license too.

For riders with more experience (and maybe a bit lax in getting their motorcycle license) the GMSP offers an Experienced Course that can help get a rider their motorcycle license. Watch our website (www.dds.ga.gov) for details on locations and dates.

Get in Gear: Real Riding...Real Skills

Riding gear that is. Along with a helmet, consider gloves, a jacket, riding pants, sturdy footwear

And when the weather turns ugly, a good rain suit (made for motorcycling) can keep you comfortable and focused on the road ahead, not on that annoying drip down your back.

Get Out: Real Riding...Real Skills.

You are not alone. The road is a busy place that will challenge you every minute and requires all your attention. You and your motorcycle are the smallest on the road and other drivers may not see you. So stay out of their blind zones and expect them to make their own errors. Make sure you and your bike are ready for the riding tasks. Proper maintenance and proper gear can help reduce your risk.

56 SIGNS, SIGNALS, AND MARKINGS

Georgia law requires that all drivers, including bicyclists, obey official highway signs and traffic control signals unless otherwise directed by a police officer or emergency worker.

Road Signs

Shapes of Signs

The State of Georgia uses seven basic shapes of signs to convey traffic control instructions. Drivers should know signs by their shapes and colors so that they may recognize them from a distance and begin reacting.



An **Octagon** (eight-sided shape) always means stop. When you come to it, you must make a complete stop at a marked stop line. If there is no stop line, stop before the crosswalk on your side of the intersection. If there is no crosswalk, stop at a point from which you can best see oncoming traffic. You must not start again until all pedestrians have finished crossing on the side of the roadway you are traveling on, and you have yielded the right-of-way to closely approaching traffic.



Triangle signs means yield. You must slow down to a speed that is reasonable for existing conditions and stop if necessary. If you must stop, do so at a marked stop line, if it exists. After slowing or stopping, you must yield the right-of-way to other vehicles in the intersection or approaching closely on another roadway or auxiliary road leading into a major highway.



Round signs means you are approaching a railroad crossing. This sign is posted a few hundred feet in front of the tracks and alerts you to slow down, look, listen and prepare to stop. If necessary, roll down a window and listen carefully for an approaching train. If the train is approaching, stop! Do not try to calculate whether you can “make it” across the track. Never try to beat a train through the intersection. Passing is prohibited at all railroad crossings.



Diamond shaped signs warns of existing or possible hazards on roadways or adjacent areas. They are yellow with black words indicating the potential hazard, or black symbols visually describing the potential hazard.



Pentagon shaped signs means you are approaching a school zone and/or school crossing. When used, they will be erected not less than 150 feet nor more than 700 feet in advance of the school grounds or school crossing. (Warning signs can sometimes be fluorescent green in color.)



Horizontal Rectangle signs are generally used as guide signs. They show locations, directions, or other special information.



Vertical Rectangle signs are generally used for regulatory signs, which tell you what you must do. You must obey them in the same manner as traffic laws.

58 SIGNS, SIGNALS, AND MARKINGS

Regulatory Signs

Regulatory signs tell drivers what they may or may not do. Drivers, including bicyclists, must obey them in the same manner as traffic laws. Remember, a red circle with a red slash from upper left to lower right means “No.” The picture within the circle shows what is prohibited.



This marks a one-way road. If you are facing this sign traffic is coming toward you. You must not continue down the road.



Motorist is approaching a one-way highway or ramp.



You may travel only in the direction of the arrow.



Traffic is required to keep to the right of medians or obstructions.



You cannot turn around to go in the opposite direction at this intersection.



You cannot make a right turn at this intersection.





55 miles per hour is the maximum speed limit permitted in this area.



You are approaching an area where a reduced speed limit has been established.



When two or more traveling lanes are available in the direction you are traveling, slower traffic should travel in the right (outside) lane(s).



A right turn on red is prohibited, even after coming to a complete stop.



You are approaching a school zone. A reduced speed limit is in effect when the yellow lights are flashing.



Bicycles are prohibited from entering this roadway.



Trucks are prohibited from entering this roadway.

60 SIGNS, SIGNALS, AND MARKINGS

Warning Signs

Warning signs are usually yellow with black markings. (Warning signs can also be fluorescent green with black markings.) They alert you to conditions that are immediately ahead. There may be road hazards, changes in traffic direction or some other potentially hazardous situation that requires action on your part.



Sharp turn to the right.



Curve to the right.



Sharp turn to the right and then sharp turn to the left.



Winding road ahead.



Side road enters highway ahead.



Side road enters highway ahead at an angle.



Another road crosses the highway ahead.



The road you are traveling on ends straight ahead. Slow down and prepare to yield or stop before turning right or left.



The bridge ahead allows room for only two lanes of traffic. Approach with caution.



There is a dip in the road ahead. Slow down!



There is a bump in the road ahead. Slow down!



Shoulder of the road is soft. Drive on the shoulder only in emergencies.



**DIVIDED
HIGHWAY**

Divided highway begins. Prepare to change lanes or shift lane position.



**DIVIDED
HIGHWAY
ENDS**

Divided highway ends. Prepare to change lanes or shift lane position.



**TWO WAY
TRAFFIC**

Warning that you are leaving a separated one-way highway and will soon be driving on a two-way highway.



**LOW
CLEARANCE**

Approaching a low underpass. Do not enter if your vehicle or cargo exceeds the maximum height indicated on the sign.



MERGE

Traffic merging from the right. Prepare to allow traffic to safely merge.



HILL

Steep hill ahead. Slow down and be ready to shift to lower gear to control speed and protect brakes from damage.

62 SIGNS, SIGNALS, AND MARKINGS



Presence of traffic signals at intersection ahead. Slow down!



There is a stop sign ahead. Begin to slow down.



There is a yield sign ahead. Slow down and prepare to stop if necessary.



This sign is on the left side of the highway and marks the beginning of a no passing zone. Any passing maneuver must be completed before reaching this sign.



Number of lanes reduced ahead.



Roadway slippery when wet. Remember, the first half-hour of rain is most hazardous.



These signs alert drivers in advance of areas where animals, people, and vehicles may be crossing.

Construction and Maintenance Warning Signs

Warning signs for construction and maintenance projects are used to alert you to dangers ahead and give you enough time in which to adjust your speed accordingly. These signs are orange with black markings.



64 SIGNS, SIGNALS, AND MARKINGS

Service Signs

As you travel along Georgia's highways, the following blue and white signs will give directions to service facilities.



Roadside Park and Rest Area



Guide Signs

Guide signs may indicate what road you are on, and how to get to your destination. Many guide signs are rectangular, but some have other shapes. There are several different kinds of guide signs — route markers, information, destination, distance, and location signs. These signs may be accompanied by a "To" sign or an arrow, indicating the highway, facility, or location that can be reached by following the signs. Here are some examples:





The numbers on these signs designate specific exits.



Intersection of U.S. Route 47 & Ga. Highway 38. These roads are going to cross or meet the highway you are traveling on.



This sign is used to mark an officially designated bicycle route. Be cautious of bicyclists while traveling on this road.



Milepost markers are placed each mile along the edge of the roadway from one end of the state to the other. Zero always starts at the south or west border where a route begins.



The crossbuck is placed at all railroad crossings. Yield to any approaching trains. Slow down, look and listen before crossing. A sign below the crossbuck indicates the number of tracks. A complete stop is required when a red light is flashing.



Caution - a vehicle displaying this emblem is a slow-moving vehicle. A slow-moving vehicle is defined as any vehicle moving less than 25 miles per hour. They are required by law to display this emblem.











This sign means there is a public parking area in the direction of the arrow.

66 SIGNS, SIGNALS, AND MARKINGS

Traffic Signals and Signs

Traffic signals are placed at intersections to control the orderly movement of traffic and to prevent accidents. Drivers (including bicyclists) and pedestrians must obey these signals except when an officer is directing traffic. If a traffic signal is not functioning at all at an intersection, all drivers must treat the intersection as if a stop sign is posted for all directions. If a traffic signal is malfunctioning and flashing, drivers must proceed based on the color of the flashing signal they are facing: if the driver is facing a yellow flashing signal, the driver may proceed with caution; if the driver is facing a red flashing signal, the driver must stop and wait until it is safe to proceed.

	A red light means you must make a complete stop before entering the crosswalk or intersection and wait until the light turns to green before proceeding.
	A yellow light warns the light is changing from green to red. Slow down and prepare to stop.
	A green light means you may proceed if it is safe to do so after stopping for pedestrians and yielding to vehicles within the intersection.
	A green arrow means you may proceed carefully only in the direction the arrow is pointing after stopping for pedestrians and yielding to vehicles within the intersection. In this case you may go straight ahead only.
	A green arrow, in this case, means you may turn in the direction of the arrow after stopping for pedestrians and yielding to vehicles within the intersection.
	A yellow arrow may appear after a green arrow and warns you to clear the intersection.
	A red flashing light means you must stop completely (treat as you would a stop sign). Proceed with caution only after yielding the right-of-way to pedestrians and to other vehicles at the intersection.
	A yellow flashing light means you must slow down and exercise caution before proceeding through the intersection.

Lane Control Signals

Some roadways are designed to accommodate different traffic demands during the day through the use of a reversible lane system. Appropriate travel lanes on a roadway utilizing a reversible lane system are indicated as follows:



No travel allowed in this lane in the direction you are going.



"Steady" - clear the lane
"Flashing" - left turn permitted



Travel in lane

Overhead Lane Signs



Left turn only



Straight or left turn only



Right turn only

Pedestrian Signals



Leave the curb to cross street



Do not leave curb



"Flashing" - do not leave curb but complete crossing

68 SIGNS, SIGNALS, AND MARKINGS

Pavement Markings

Pavement markings, like highway signs, are used to warn and direct drivers to regulate traffic.

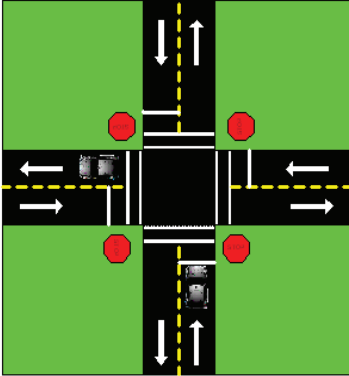

Stop Lines

Stop lines are white lines painted across the pavement at intersections indicating the point beyond which your vehicle should not cross if you are stopping for a traffic control device. In urban areas the line is usually located about four feet before the crosswalk. Drivers must come to a complete stop at the stop line, when present, not at the actual stop sign or traffic signal.

Crosswalk Lines

These white lines are painted across, or partially across the pavement. Sometimes they will be painted in a ladder pattern. When pedestrians are in the crosswalks, they have the right-of-way over motor vehicles. Crosswalks are sometimes in the middle of a block in residential areas, and in some cases, a pedestrian crossing signal is located at the white line.

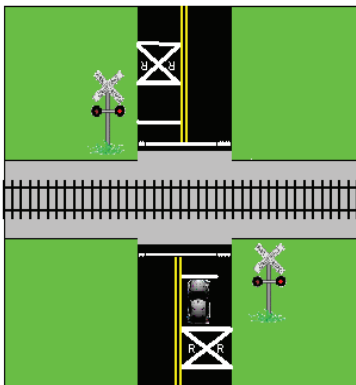

Railroad Crossings

When a road is crossed by a railroad crossing, the pavement is usually marked with a large X and two R's. At railroad crossings, a yellow line is always placed on the right side of the center line to prevent passing. The crossing is sometimes equipped with control arms and/or emergency lights, to warn drivers of approaching trains. The driver of the vehicle must stop if warning signals indicate a train is approaching.

Center Lines

These are used to separate traffic moving in opposite directions on paved roadways. Broken yellow lines are used when there are only two lanes.

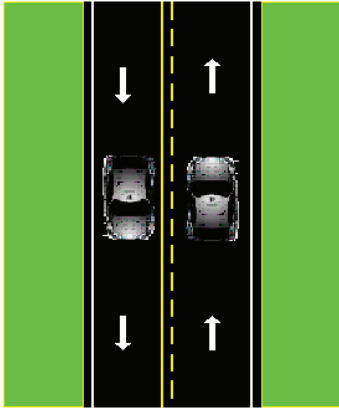

No Passing Lines

These single, solid yellow lines on two-lane roads indicate zones where passing is prohibited. These single, solid yellow lines will be located on the right of the broken yellow line when they apply to the lane in which you are traveling. In some instances, both yellow lines will be solid, indicating it is not safe for passing in either direction.

Edgelines

These are the solid white lines along the side of the pavement. They serve as safety guides, especially at night when it is difficult to see the edge of the road. A yellow edge line may be used on the left side to warn of narrow or raised medians.

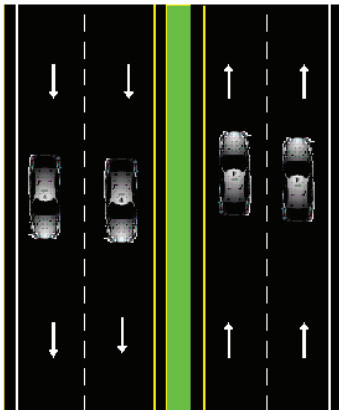

Lane Lines

These are the white dashes that mark the individual lanes of travel on streets and highways having more than one lane for traffic moving in the same direction.

When there are four or more lanes with traffic moving in opposite directions, two solid yellow lines mark the center of the roadway. You may cross these lines only to make a left turn into or from an alley, private road, driveway, or another street. When traveling on a multi-lane road, stay in the right lane except to pass other vehicles traveling in the same direction.

70 SIGNS, SIGNALS, AND MARKINGS

Turn Lanes

This lane, bordered by solid yellow and/or broken yellow lines, is in the center of streets and highways to make left turns. A motorist desiring to turn left should proceed to the turn lane just prior to making a left turn. Georgia law prohibits the use of this lane for any purpose other than making a left turn. You may enter this lane no more than 300 feet from the location of the left turn.

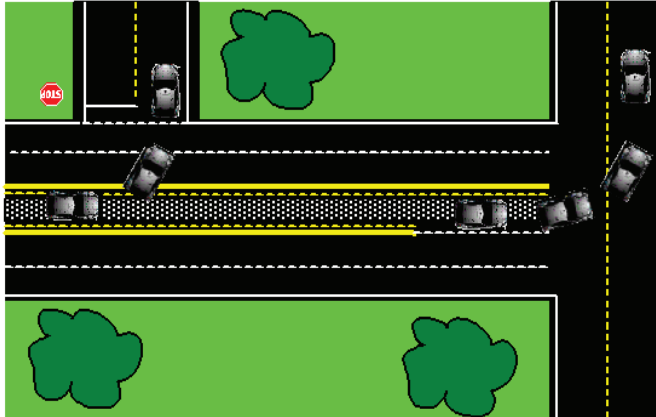

When a turning lane is provided for vehicles traveling in both directions, you should use extreme caution before entering the turning lane to make a left turn. There may be a vehicle traveling in the opposite direction also entering the turning lane to make a left turn. This is especially problematic in congested areas.

Bicycle Lanes

These are solid white lines typically located between the farthest right traffic lane and the curb or edge of the roadway. If there is a right-turn-only lane present, the bicycle lane will be located to the left of the right-turn-only lane in order to safely accommodate bicycles traveling straight through the intersection. Bicycle lanes may also be marked with painted symbols of a bicycle. Drivers of motor vehicles are prohibited from driving or parking in the bicycle lane, except to cross over it to make a turn. When crossing over a bicycle lane to make a turn, motorists must yield to bicyclists that are present.

Roundabouts

Roundabouts are sometimes used at intersections instead of stops signs. The purpose of a roundabout is to allow the intersection to handle heavier traffic flow without the need for a signal or a four-way stop. When entering a roundabout, traffic laws concerning right-of-way still apply. You must yield to other traffic that is already in the roundabout. You will always enter a roundabout to the right, and continue circling to the right until you have reached the roadway onto which you want to turn. When reaching the desired road, you will always turn right.

Traffic Striping

These markings, created by diagonal yellow lines, are on streets and highways indicating that the road is narrowing or there is an obstruction on the roadway. The area is similar to a triangle with solid yellow diagonal lines within the outside lines. Always keep to the right of these markings.

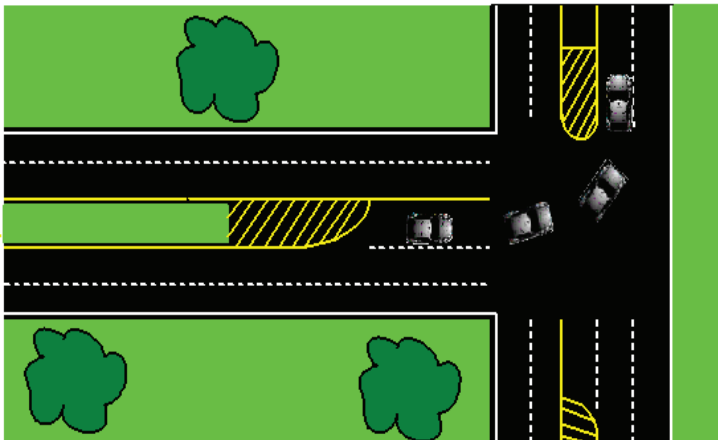

72 CUSTOMER SERVICE CENTERS

Contact the Georgia Motorcycle Program at (678) 413-8400 in Atlanta or 1-866-754-3687 outside of Atlanta.

To register for training courses online visit www.dds.ga.gov/training

*Albany	2062 Newton Road
Americus	506 W. Lamar Street
Athens	1505 US 29 North
Atlanta	445 Capitol Avenue
*Augusta	3423 Mike Padgett Hwy
Between	1010 Heritage Parkway
*Blairsville	149 Chase Drive
Blue Ridge	159 Industrial Blvd.
*Brunswick	153 Perry Lane Road
*Calhoun	402 Belwood Road
*Canton	220 Brown Industrial Pkwy, #200
*Carrollton	512 Old Newnan Road
*Cartersville	1300 Joe Frank Harris Parkway
Cedartown	1626 Rockmart Highway
Colquitt	308 East Crawford Street
*Columbus	8397 Macon Road
Conyers	2206 East View Parkway
*Cordele	409 S. Midway Road
Covington	8134 Geiger Street
*Cumming	4055 County Way
Cuthbert	608 B Blakely Street
*Dalton	235 Wagner Drive
*Decatur	2801 Candler Road, Suite 82
*Douglas	348 Thomas Frier Sr Drive
*Dublin	620 County Farm Road
Elberton	45 Forest Avenue
Evans	4408 Evans to Locks
Fayetteville	278 McElroy Road
Forest Park	5036 Highway 85
*Gainesville	1010 Aviation Blvd.
Greensboro	1180 C. Weldon Smith Drive
*Griffin	1313 Arthur K. Bolton Pkwy
Helena	Highway 341
*Hinesville	2301 Airport Road
Jackson	149 Riverview Park Road
Kingsland	333 S. Ashley Street
LaGrange	900 Dallis Street