



Xerox WorkCentre  
5632/5638/5645/5655/5665/5675/5687  
Multifunction Systems  
Information Assurance Disclosure Paper  
Version 2.0

**Prepared by:**

Larry Kovnat  
Xerox Corporation  
1350 Jefferson Road  
Rochester, New York 14623



©2009 Xerox Corporation. All rights reserved. Xerox and the sphere of connectivity design are trademarks of Xerox Corporation in the United States and/or other countries.

Other company trademarks are also acknowledged.

Document Version: 2.01 (April 2010).

# Table of Contents

<b>1. Introduction.....</b>	<b>5</b>
1.1. Purpose .....	5
1.2. Target Audience.....	5
1.3. Disclaimer .....	5
<b>2. Device Description .....</b>	<b>6</b>
2.1. Security-relevant Subsystems.....	6
2.2. Controller.....	8
2.3. Fax Card .....	14
2.4. Scanner .....	14
2.5. Graphical User Interface (GUI) .....	14
2.6. Marking Engine (also known as the Image Output Terminal or IOT) .....	15
2.7. System Software Structure .....	15
2.8. Logical Access [Multifunction models only].....	17
<b>3. System Access.....</b>	<b>22</b>
3.1. Authentication Model.....	22
3.2. Login and Authentication Methods.....	24
3.3. System Accounts.....	25
3.4. Diagnostics.....	26
<b>4. Security Aspects of Selected Features .....</b>	<b>30</b>
4.1. Audit Log.....	30
4.2. Xerox Standard Accounting.....	33
4.3. Automatic Meter Reads .....	33
4.4. Encrypted Partitions .....	33
4.5. Image Overwrite .....	34
<b>5. Responses to Known Vulnerabilities .....</b>	<b>35</b>
5.1. Security @ Xerox ( <a href="http://www.xerox.com/security">www.xerox.com/security</a> ) .....	35
<b>6. APPENDICES .....</b>	<b>36</b>
6.1. Appendix A – Abbreviations.....	36
6.2. Appendix B – Supported MIB Objects.....	38
6.3. Appendix C –Standards.....	41

6.4. Appendix E – References .....43

# 1. Introduction

The WorkCentre 5632/5638/5645/5655/5665/5675/5687 Multifunction Systems are among the latest versions of Xerox copier and multifunction devices for the general office.

## 1.1. Purpose

The purpose of this document is to disclose information for the WorkCentre products with respect to device security. *Device Security*, for this paper, is defined as how image data is stored and transmitted, how the product behaves in a networked environment, and how the product may be accessed, both locally and remotely. Please note that the customer is responsible for the security of their network and the WorkCentre products do not establish security for any network environment.

The purpose of this document is to inform Xerox customers of the design, functions, and features of the WorkCentre products relative to Information Assurance (IA).

This document does NOT provide tutorial level information about security, connectivity, PDLs, or WorkCentre products features and functions. This information is readily available elsewhere. We assume that the reader has a working knowledge of these types of topics. However, a number of references are included in the Appendix.

## 1.2. Target Audience

The target audience for this document is Xerox field personnel and customers concerned with IT security.

## 1.3. Disclaimer

The information in this document is accurate to the best knowledge of the authors, and is provided without warranty of any kind. In no event shall Xerox Corporation be liable for any damages whatsoever resulting from user's use or disregard of the information provided in this document including direct, indirect, incidental, consequential, loss of business profits or special damages, even if Xerox Corporation has been advised of the possibility of such damages.

## 2. Device Description

WorkCentre products consist of two basic modules: a digital copier module that provides conventional copy functions and features, and a Network Controller that provides the capability to connect the copier to a LAN. CopyCentre models of these products are available which provide copy-only features and do not include a Network Controller.



Figure 2-1 WorkCentre Multifunction System

### 2.1. Security-relevant Subsystems

#### 2.1.1. Physical Partitioning

The security-relevant subsystems of the product are physically partitioned as shown in Figure 2-2-2.

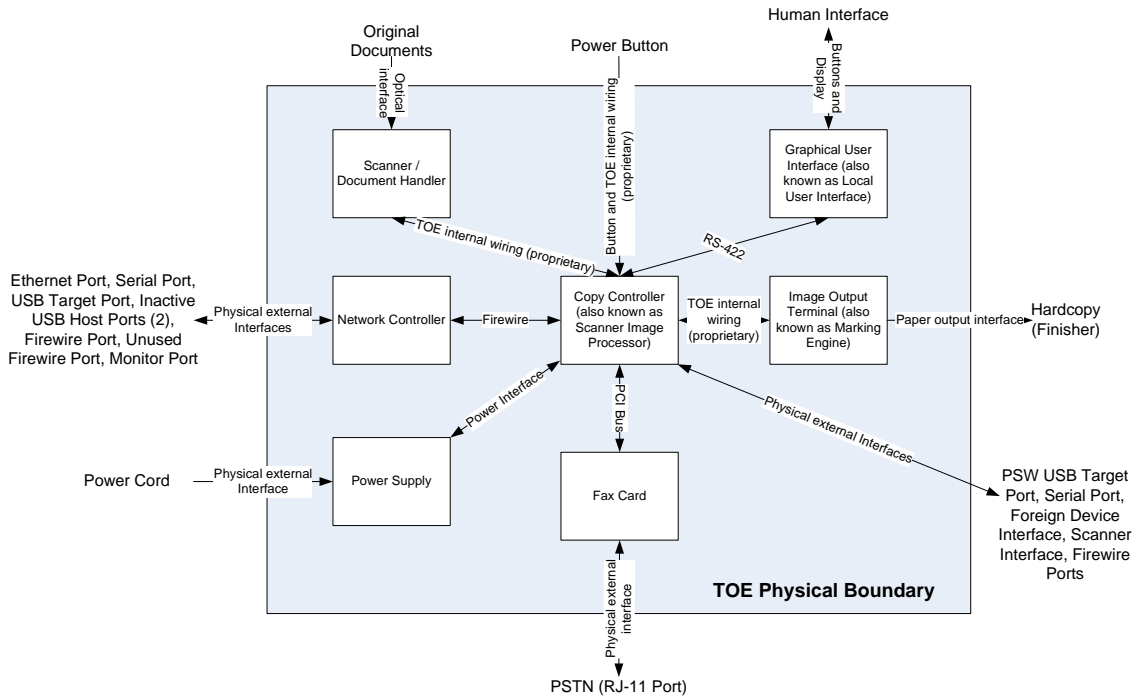

Figure 2-2-2 TOE System Partitioning, multi-board controller configuration (65, 75 and 87 ppm models)

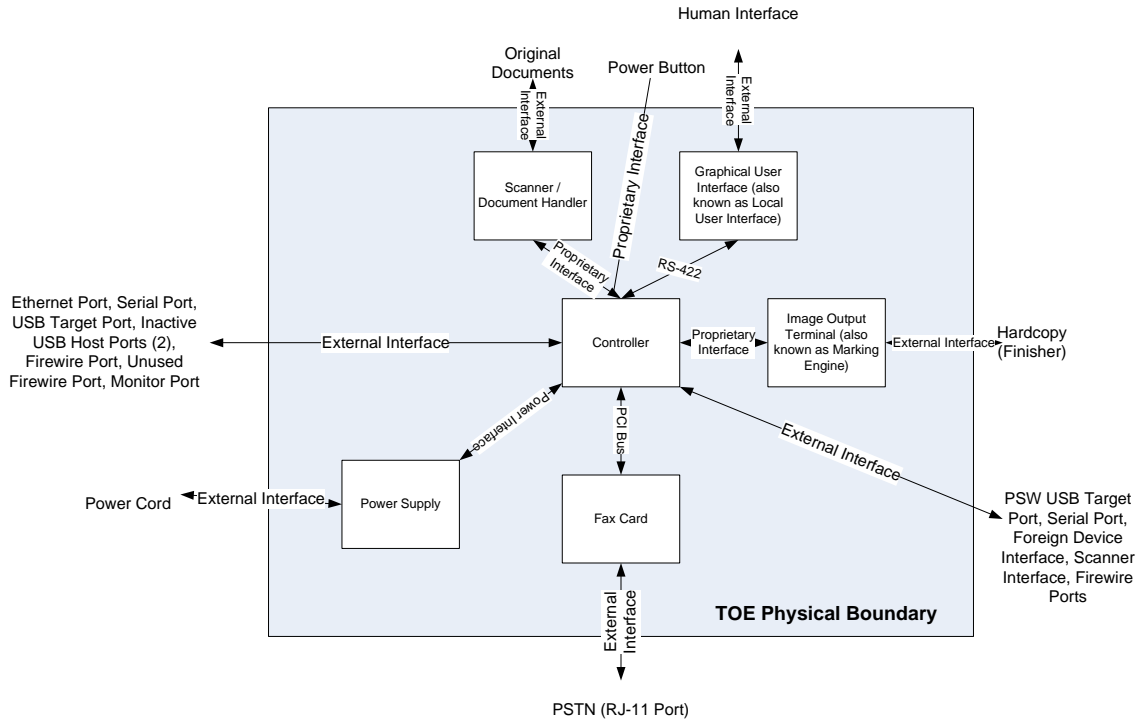

Figure 2-2-3 TOE System Partitioning, single-board Controller configuration (32, 38, 45 and 55ppm models)

## 2.1.2. Security Functions allocated to Subsystems

Security Function	HLD Subsystem
Image Overwrite	Network Controller Copy Controller Graphical User Interface
System Authentication	Network Controller Copy Controller Graphical User Interface
Network Authentication	Network Controller Graphical User Interface
Security Audit	Network Controller
Cryptographic Operations	Network Controller
User Data Protection – SSL	Network Controller
User Data Protection – IP Filtering	Network Controller
User Data Protection – IPSec	Network Controller
Network Management Security	Network Controller
Fax Flow Security	Fax Card Network Controller Copy Controller Graphical User Interface
Security Management	Network Controller Copy Controller Graphical User Interface

Table 2-1 Security Functions allocated to Subsystems

## 2.2. Controller

There are two controller configurations in this family. To reduce cost in the 32, 38, 45 and 55ppm models, the Copy Controller and Network Controller have been consolidated into one physical printed wiring board, referred to as the single-board controller (SBC) configuration. In the 65, 75 and 87ppm models, the copy controller and the network controller remain as two separate printed wiring boards. This configuration is referred to as the multi-board controller (MBC) configuration.

The software architecture in both configurations is the same. In the 65, 75 and 87 models, the copy controller software and network controller software communicate using RPC calls over a Firewire physical interface. In the 32, 38, 45 and 55ppm models, the copy controller software and network controller software execute on a common processor within separate and unshared memory spaces and continue to communicate with RPC calls.

### 2.2.1. Copy Controller (CC)

#### 2.2.1.1. Purpose

The Copy Controller provides all of the functions necessary to implement a digital copier, and works together with the Fax card to implement embedded fax functionality. The Copy Controller contains the image path, which uses proprietary hardware and algorithms to process the scanned images into high-quality reproductions. Among other



common copier functions, the CC works with the EPC DRAM to enable electronic pre-collation, sometimes referred to as scan-once/print-many. When producing multiple copies of a document, the scanned image is processed and buffered in the EPC DRAM in a proprietary format. The buffered bitmaps are then read from EPC DRAM and sent to the Image Output Terminal (IOT) for marking on hardcopy output. For long documents, the production of hardcopy may begin before the entire original is scanned, achieving a level of concurrency between the scan and mark operations.

The Copy Controller works with the Graphical User Interface (GUI) assembly to provide System Configuration functions. A System Administrator PIN must be entered at the GUI in order to access these functions.

**2.2.1.2. Hardware [32/38/45/55ppm models]**

Name	Size	Purpose / Explanation
Processor	NA	PowerQUICC III MPC8545 1200MHz
DRAM	1 GB	System workspace and temporary image store. Subsequent jobs will overwrite the current document so there is no long-term retention of image data in this memory.
Flash ROM	128 MB	All operating system and application executable control code resides here (e.g. boot loader, scanner, paper path, xerographic, high capacity feeder, disk finisher). No user image data is stored in this memory.
NVRAM	128 KB	This non-volatile memory has no image data stored in it. It contains: Device set points for xerographic image quality, paper path timing, and other process control. If auditron is enabled, user PIN numbers and copy tracking data.

Table 2-2 Copy/Network Controller Hardware Components

**2.2.1.3. Hardware [65/75/87ppm models]**

Name	Size	Purpose / Explanation
Processor	NA	AMD SC520 100MHz
EPC DRAM	128 – 512 MB	The EPC DRAM is used to buffer image data as the Marking Engine receives it. Subsequent jobs will overwrite the current document so there is no long-term retention of image data in this memory.
SRAM	32 MB	SRAM is used to store setup and user information associated with copy jobs.
Flash ROM	16 MB	All operating system and application executable control code resides here (e.g. boot loader, scanner, paper path, xerographic, high capacity feeder, disk finisher). No user image data is stored in this memory.
NVRAM	128 KB	This non-volatile memory has no image data stored in it. It contains: Device set points for xerographic image quality, paper path timing, and other process control. If auditron is enabled, user PIN numbers and copy tracking data.

Table 2-3 Copy Controller Hardware Components

### 2.2.1.4. External Connections

32/38/45/55ppm models:

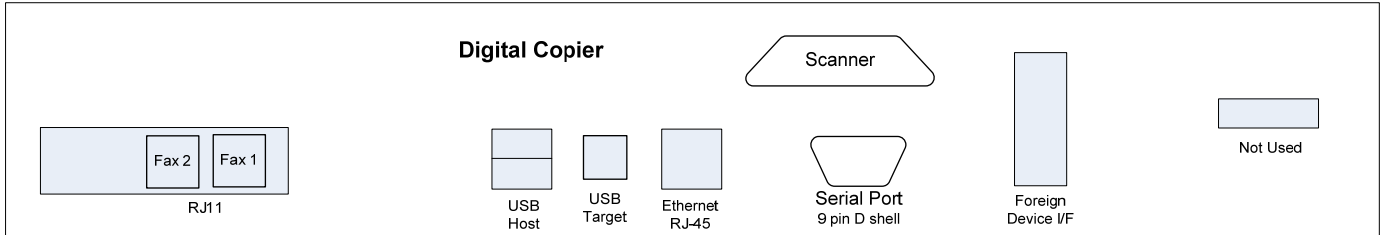

Figure 2-4 Physical Map of Copy Controller external connections [32/38/45/55 ppm models]

65/75/87 ppm models:

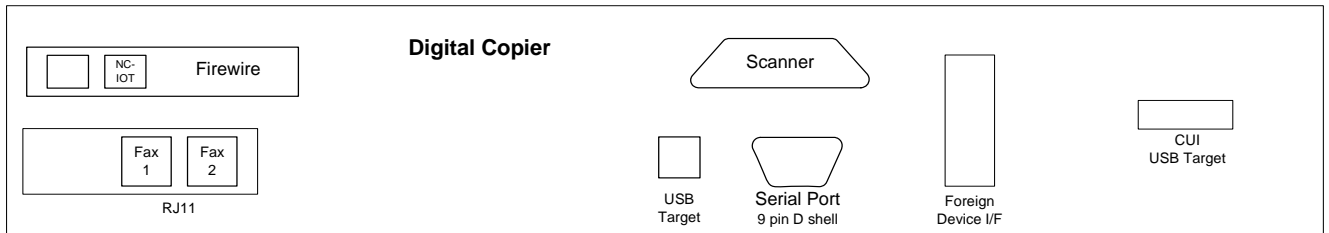

Figure 2-5 Physical Map of Copy Controller external connections [65/75/87 ppm models]

Interface	Description / Usage
PSW USB Target Port	Diagnostics and service
CUI USB Target Port	Allows connection between the GUI and Network Controller
Digital Copier Serial Port	Engineering development debug; default state is disabled
FAX line 1, RJ-11	Supports FAX Modem T.30 protocol only
FAX line 2, RJ-11	Supports FAX Modem T.30 protocol only
Foreign Device Interface	Allows connection of optional access control hardware
Scanner	Proprietary connection between the Scan Module and the Copy Controller
FireWire	Dedicated connection between the Network Controller and Copy Controller.
FireWire spare	Inactive
S2X	Scanning accelerator (65/75/87 models only)

**Table 2-4 Copy Controller external connections**

**2.2.1.5. Internal Interfaces**

The interfaces between the Copy Controller and other subsystems (see **Error! Reference source not found.**) are logically internal to the DEVICE. All of these interfaces are also physically internal to the DEVICE except for the connection to the Network Controller, which uses an externally-cabled Firewire connection. Proprietary protocols are implemented on all internal interfaces.

**2.2.2. Network Controller (NC)**

**2.2.2.1. Purpose**

The Network Controller provides both network and direct-connect external interfaces, and enables print, email, network scan, internet FAX, and LanFAX functionality. Network scanning, Internet fax, and LanFAX, are optional features. An Image Overwrite Security kit is available which enables both Immediate and On-Demand overwrite of any temporary image data created on the NC disk. The Network Controller also incorporates an open-source web server (Apache) that exports a Web User Interface (WebUI) through which users can submit jobs and check job and machine status, and through which System Administrators can remotely administer the machine. The Network Controller is sometimes referred to as the Electronic Subsystem (ESS).

An optional interface card is available that allows direct host-based printing over USB target and Parallel connections. This card is installed in one of two available PCI slots in the NC.

The Network Controller is equipped with a 1.0GHz AMD Duron microprocessor.

The Network Controller (NC) runs RedHat Linux, kernel v. 2.4.20+. (Note: This baseline may be updated as indicated by the '+' sign. See Section **Error! Reference source not found.**) Unnecessary services such as rsh, telnet and finger are disabled in the OS. FTP is used in client-only mode by the optional Network Scanning feature for the filing of scanned images and the retrieval of Scan Templates; however the NC does not contain an FTP server.

**2.2.2.2. Hardware [65/75/87ppm models only]**

Name	Size	Purpose / Explanation
Processor	NA	AMD Athlon 1.4 GHz
DRAM	256 MB – 512 MB	The executable software is loaded from disk and runs in this memory. It is also used for temporary storage of data files and images. This information is not backed up and is lost when the power to the copier is removed. Upon power-on the Network Controller DRAM is put through a memory test which performs an overwrite function. Cryptographic session keys are stored in DRAM for the duration of the current boot cycle. The keys are destroyed by powering off, or by a reboot. Note: IPSec shared secret and SNMPv3 shared passwords are stored on the NC disk and are persistent across power cycles/reboots.
Boot PROM	512 KB	This read-only Flash memory contains the code necessary to boot or alt-boot the system. A power-on self test is performed and the bootstrap OS is loaded. The area never contains any user image or document data.
S2X kit	384 MB	Image data buffer to support rotation/compression etc. There is no long term retention of image data. Subsequent jobs overwrite the data and all images are lost at power off or reboot. (65/75/87

		models only.)
Network Controller Hard Disk	80 GB	<p>This device contains numerous types of data:</p> <ul style="list-style-type: none"> <li>- All executable code (operating system, PDL interpreters, network protocols, document scheduler, etc.).</li> <li>- Spooled documents in PDL format from the network, as well as Network Scan jobs prior to export. Spooled jobs are buffered in /tmp/spool (2GB partition) and Network Scan jobs are buffered in /tmp/scan_spool (9GB partition).</li> <li>- Server IDs, server password, user IDs, user passwords, and file locations (for Network Scanning).</li> <li>- All MIB Objects.</li> <li>- All resident fonts. (Please note that a Font Management Utility is available to permanently download fonts to the hard disk.)</li> </ul> <p>The hard disk employs a UNIX-like format. When a job is completed, its reference in the directory table is deleted. If Immediate Image Overwrite is enabled, the sectors containing job image data are overwritten using a 3-pass overwrite algorithm. On-Demand Image Overwrite allows the user to overwrite the entire spooling area of the hard disk. Both IIO and ODIO are available in the Image Overwrite Security Option Kit.</p> <p>/tmp/spool and /tmp/scan_spool remain at 2GB and 9GB partitions respectively when Image Overwrite is installed.</p>

**Table 2-5 Network Controller Hardware Components**

### 2.2.2.3. External Connections [65/75/87ppm models only]

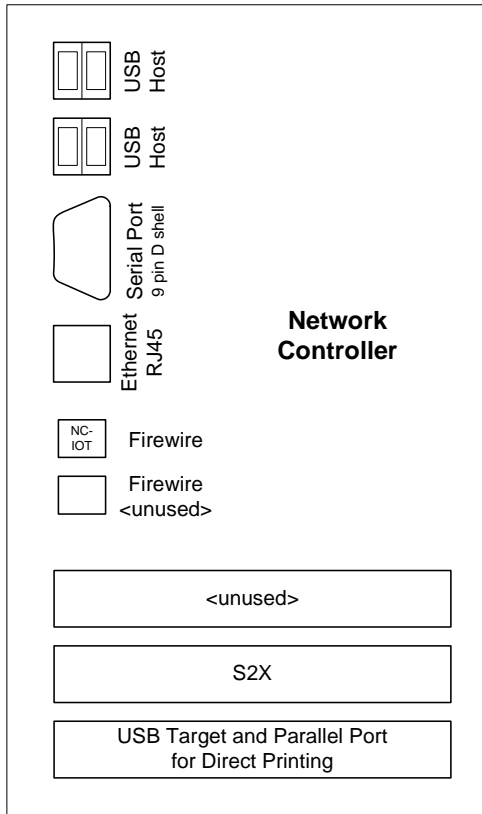

Figure 2-6 Physical Connections located on the Network Controller at lower rear of the machine

Interface	Description / Usage
10/100 MB Ethernet RJ-45 Network Connector (Network Controller)	Network Connectivity
Network Controller Serial Port (Network Controller)	Diagnostic use & Engineering development debug
USB Target (Network Controller)	Optional interface allows direct printing
USB Host Ports (Network Controller)	Inactive
Parallel Port mini-Centronics (Network Controller)	Optional interface allows direct printing
FireWire	Dedicated connection between the Network Controller and Copy Controller.
S2X	Scanning accelerator (65/75/87 models only)

Table 2-6 Network Controller external interfaces

### 2.2.2.4. Internal Interfaces

The NC communicates with the CC across a proprietary interface over an externally-cabled Firewire connection. The NC communicates with the GUI, scanner, FAX card and Hardcopy Marking subsystems through the CC.

## 2.3. Fax Card

### 2.3.1. Purpose

The embedded FAX service uses the installed embedded fax card to send and receive images over the telephone interface. The FAX card plugs into a PCI slot on the copy controller.

### 2.3.2. Hardware

The Fax Card is a printed wiring board assembly containing processor, memory, and fax modem. It connects to the CC via PCI bus. The Fax Card is responsible for implementing the T.30 fax protocol and for managing all of the fax-specific features of the product. The fax telephone lines are connected directly to the Fax Card via RJ-11 connectors.

Name	Size	Purpose / Explanation
Processor	NA	Motorola Coldfire MCF5307-90MHz Processor
SDRAM	80 MB	Scratch pad RAM for executing code. No user image data is stored in this memory. This memory is initialized to a known state on every power up.
Flash ROM	4 MB	Contains the executable code.
Flash NVRAM	64 MB to 256 MB	User document Image data are stored in this non-volatile memory. Destination phone numbers are also stored here. Received jobs can be stored in user mailboxes. Send jobs may be held for delayed send.
MODEM #1	NA	Conexant FM336 Fax modem
MODEM #2	NA	Requires installation of extended card with additional FM336

Table 2-7 Fax Card Hardware Components

## 2.4. Scanner

### 2.4.1. Purpose

The purpose of the scanner is to provide mechanical transport of hardcopy originals and to convert hardcopy originals to electronic data.

### 2.4.2. Hardware

The scanner converts the image from hardcopy to electronic data. An optional document handler moves originals into a position to be scanned. The scanner provides enough image processing for signal conditioning and formatting. The scanner does not store scanned images. All other image processing functions are in the copy controller.

The scanner has 1MB of non-volatile executable code and 128KB of scratchpad RAM.

### 2.4.3. Control and Data Interfaces

Scanned images are transmitted from the scanner to the copy controller across a proprietary interface.

## 2.5. Graphical User Interface (GUI)

### 2.5.1. Purpose

The GUI detects soft and hard button actuations, and provides text and graphical prompts to the user. The GUI is sometimes referred to as the Local UI (LUI) to distinguish it from the WebUI, which is exported by the web service

that runs in the Network Controller. Images are not transmitted to or stored in the GUI. The Start hard button is located on the GUI panel.

### 2.5.2. Hardware

Name	Size	Purpose / Explanation
Processor	NA	Motorola "Dragonball" 68VZ328-33, 33MHZ
DRAM	32 MB	Used for display buffers of the user interface. No user image data is stored in this volatile memory. Specifically, cryptographic secrets are not entered via the GUI. This memory is initialized to a known state on every power up.
Flash ROM	16 MB	Contains the executable code, language dependent strings and icons that are displayed. Up to 20 languages are stored in 1 SIMM. Language selection may be restricted to the SA only. Code can be upgraded via the PSW (Portable Service Workstation) or Customer Administration Tools (CAT) or by copying from a master SIMM.
Display	NA	Monochrome Liquid Crystal Display, 640 x 240 pixels

Table 2-8 UI Hardware Components

### 2.5.3. Control and Data Interfaces

The GUI communicates with the copy controller across a proprietary interface.

## 2.6. Marking Engine (also known as the Image Output Terminal or IOT)

### 2.6.1. Purpose

The Marking Engine performs copy/print paper feeding and transport, image marking and fusing, and document finishing. Images are not stored at any point in these subsystems.

### 2.6.2. Hardware

The marking engine is comprised of paper supply trays and feeders, paper transport, laser scanner, xerographics, and paper output and finishing.

### 2.6.3. Control and Data Interfaces

Images and control signals are transmitted from the copy controller to the marking engine across a proprietary interface.

## 2.7. System Software Structure

### 2.7.1. Open-source components

Open-source components in the connectivity layer implement high-level protocol services. The security-relevant connectivity layer components are:

- Apache 1.3.27, with mod\_ssl integrated (http and https)
- OpenSSL 0.9.7a (SSL)
- SAMBA 3.0.22 (SMB)
- Netsnmp 5.0.9 (SNMPv3)

### 2.7.2. OS Layer in the Network Controller

The OS layer includes the operating system, network and physical I/O drivers. The baseline for the product launch version of the Network Controller<sup>2</sup> operating system is Red Hat Linux 8.0, kernel version 2.4.20+. Red Hat designates the specific distribution for Xerox in the version number extension represented by the '+' field. At product launch this was 2.4.20-31.9.1.4xerox. Xerox may issue security patches consistent with Flaw Remediation, in which case the Xerox portion of the version number will be incremented.

The crypto library for IPSec is provided by Frees/Wan version 1.99.

IP Filtering is accomplished by IPTables version 1.2.6a-2.

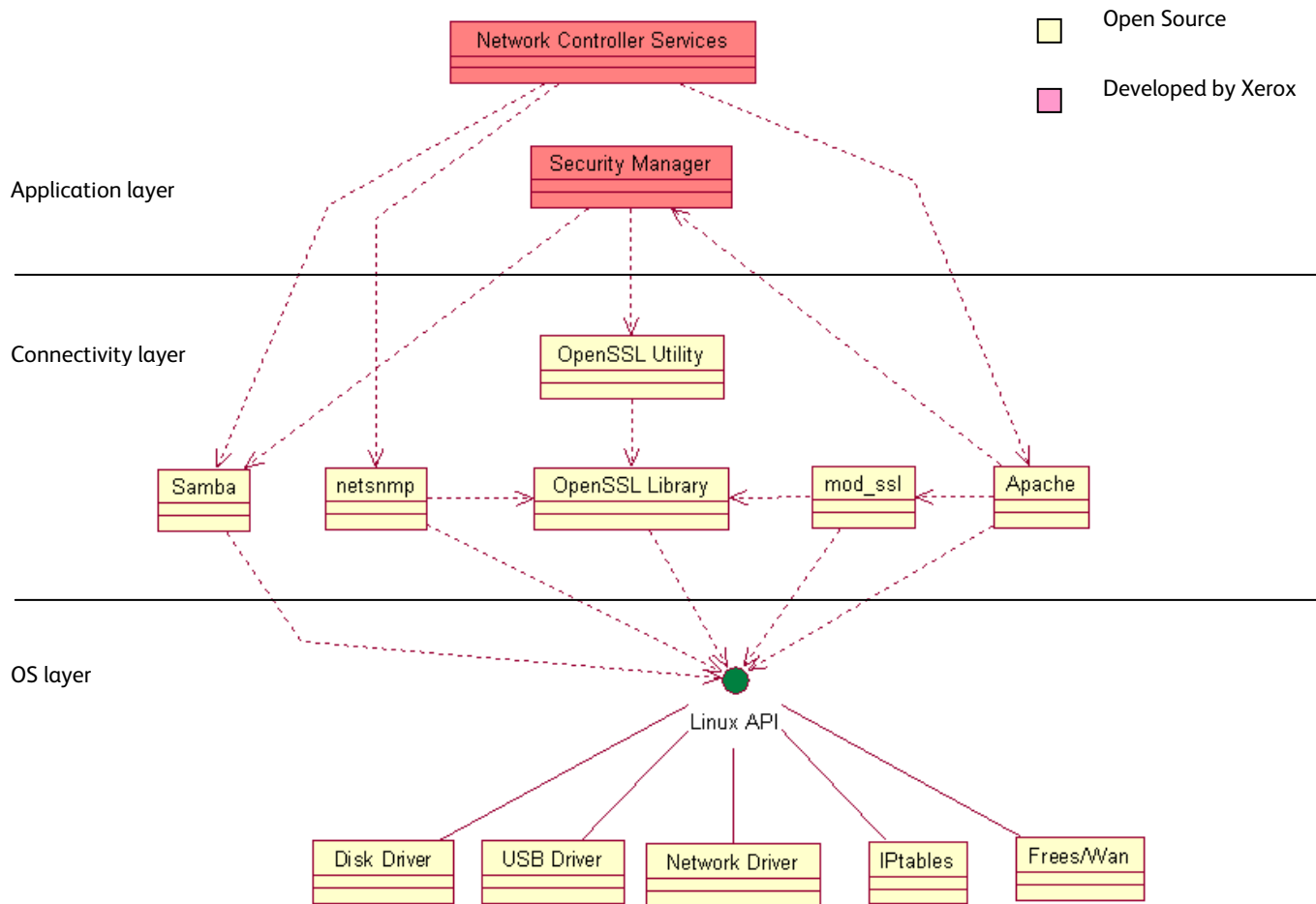

Figure 2-7 Network Controller Operating System layer components

### 2.7.3. Network Protocols

Figure 2-5 is an interface diagram depicting the protocol stacks supported by the device, annotated according to the DARPA model.

<sup>2</sup> A proprietary executive with no networking capability provides the operating environment for the copy controller.



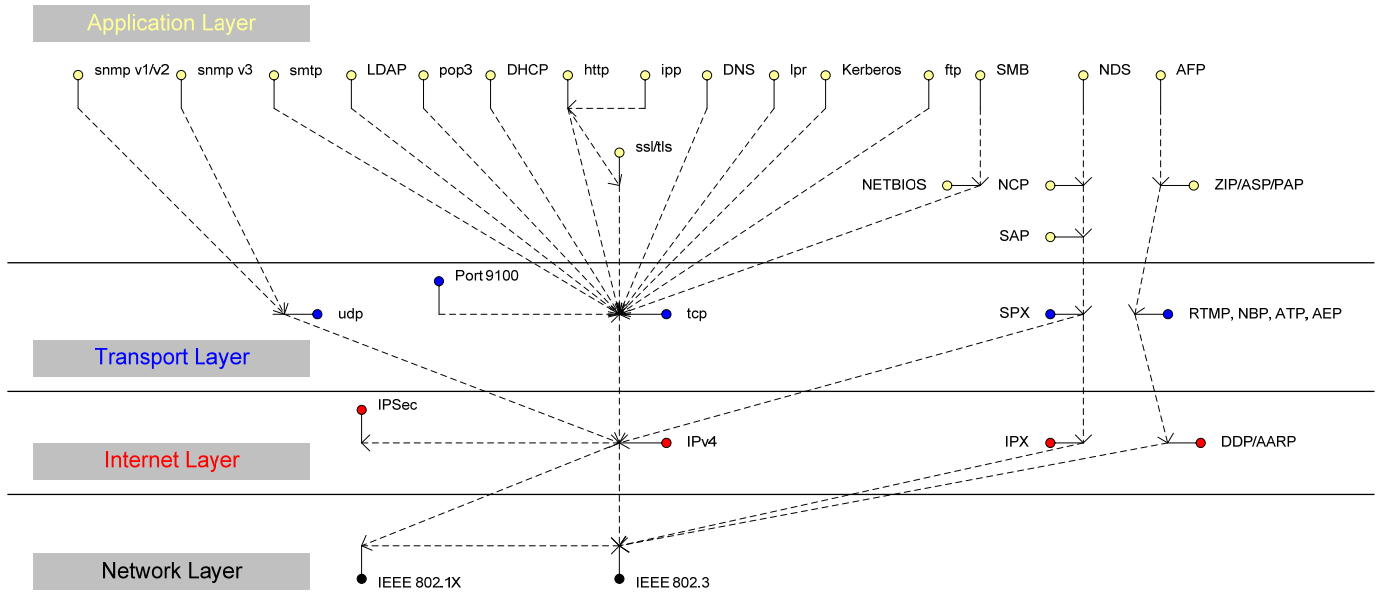

Figure 2-5 Network Controller protocol stacks

## 2.8. Logical Access [Multifunction models only]

### 2.8.1. Network Protocols

The supported network protocols are listed in Appendix D and are implemented to industry standard specifications (i.e. they are compliant to the appropriate RFC) and are well-behaved protocols. There are no 'Xerox unique' additions to these protocols.

#### 2.8.1.1. IPSec

The device supports IPSec tunnel mode. The print channel can be secured by establishing an IPSec association between a client and the device. A shared secret is used to encrypt the traffic flowing through this tunnel. SSL must be enabled in order to set up the shared secret.

When an IPSec tunnel is established between a client and the machine, the tunnel will also be active for administration with SNMPv2 tools (HP Open View, etc.), providing security for SNMP SETs and GETs with an otherwise insecure protocol. SNMP Traps may not be secure if either the client or the device has just been rebooted. IP Filtering can be useful to prevent SNMP calls from non-IPSec clients.

Once an IPSec channel is established between two points, it stays open until one end reboots or goes into power saver,. Only network clients and servers will have the ability to establish an IPSec tunnel with the machine. Thus device-initiated

operations (like scanning) cannot assume the existence of the tunnel unless a print job (or other client initiated action) has been previously run since the last boot at either end of the connection.

## 2.8.2. Ports

The following table summarizes all potential open ports and subsequent sections discuss each port in more detail.

Default Port #	Type	Service name
25	TCP	SMTP
53	UDP	DNS
68	UDP	BOOTP/DHCP
80	TCP	HTTP
88	UDP	Kerberos
110	TCP	POP-3 client
137	UDP	NETBIOS- Name Service
138	UDP	NETBIOS-Datagram Service; SMB filing and Scan template retrieval
139	TCP	NETBIOS; SMB filing and Scan template retrieval
161	UDP	SNMP
162	UDP	SNMP trap
389	UDP	LDAP
396	TCP	Netware
427	UDP	SLP
443	TCP	SSL
515	TCP	LPR
631	TCP	IPP
1900	UDP	SSDP
3003	TCP	http/SNMP reply
9100	TCP	raw IP

Please note that there is no ftp port in this list. ftp is only used to export scanned images and to retrieve Scan Job Templates, and will open port 21 on the remote device. An ftp port is never open on the Network Controller itself.

### 2.8.2.1. Port 25, SMTP

This unidirectional port is open only when Scan to E-mail or Internet Fax (I-Fax) is exporting images to an SMTP server. SMTP messages & images are transmitted to the SMTP server from the device.

### 2.8.2.2. Port 53, DNS

Designating a DNS server will allow the device to resolve domain names. This can be configured via the WebUI.

### 2.8.2.3. Port 68, DHCP

This port is used only when performing DHCP, and is not open all of the time. To permanently close this port, DHCP must be explicitly disabled. This is done in User Tools via the Local User Interface or via the TCP/IP page in the Properties tab on the WebUI.

### 2.8.2.4. Port 80, HTTP

The embedded web pages communicate to the machine through a set of unique APIs and do not have direct access to machine information:

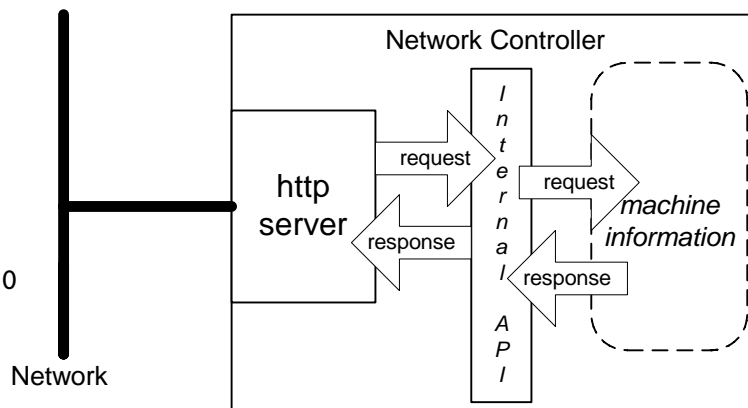

The HTTP port can only access the HTTP server residing in the Network Controller. The embedded HTTP server is Apache. The purpose of the HTTP server is to:

- Give users information of the status of the device;
- View the job queue within the device and delete jobs;
- Allow users to download print ready files and program Scan to File Job Templates;
- Allow remote administration of the device. Many settings that are on the Local UI are replicated in the device's web pages. Users may view the properties of the device but not change them without logging into the machine with administrator privileges.

The HTTP server can only host the web pages resident on the hard disk of the device. It does not and cannot act as a proxy server to get outside of the network the device resides on. Hence the server cannot access any networks (or web servers) outside of the customer firewall.

When the device is configured with an IP address, it is as secure as any device inside the firewall. The web pages are accessible only to authorized users of the network inside the firewall.

This service (and port) may be disabled in User Tools via the Local User Interface or via the TCP/IP page in the Properties tab on the WebU. Please note that when this is disabled, IPP Port 631 is also disabled.

HTTP may be secured by enabling Secure Sockets Layer.

#### 2.8.2.4.1. Proxy Server

The device can be configured to communicate through a proxy server. Features that can make use of a proxy server include the Automatic Meter Read feature, scanning to a remote repository, or retrieving scan templates from a remote template pool.

#### 2.8.2.5. Port 88, Kerberos

This port is only open when the device is communicating with the Kerberos server to authenticate a user, and is only used only to authenticate users in conjunction with the Network Scanning feature. To disable this port, authentication must be disabled, and this is accomplished via the Local User Interface.

This version of software has Kerberos 5.1.1 with DES (Data Encryption Standard) and 64-bit encryption. The Kerberos code is limited to user authentication, and is used to authenticate a user with a given Kerberos server as a valid user on the network. Please note that the Kerberos server (a 3<sup>rd</sup> party device) needs to be set up for each user. Once the user is authenticated, the Kerberos software has completed its task. This code will not and cannot be used to encrypt or decrypt documents or other information.

This feature is based on the Kerberos program from the Massachusetts Institute of Technology (MIT). The Kerberos network authentication protocol is publicly available on the Internet as freeware at <http://web.mit.edu/kerberos/www/>. Xerox has determined that there are no export restrictions on this version of the software. However, there are a few deviations our version of Kerberos takes from the standard Kerberos implementation from MIT. These deviations are:

- 1) The device does not keep a user's initial authentication and key after the user has been authenticated. In a standard Kerberos implementation, once a user is authenticated, the device holds onto the authentication for a programmed timeout (the usual default is 12 hours) or until the user removes it (prior to the timeout period). In the Xerox implementation, all traces of authentication of the user are removed once they have been authenticated to the device. The user can send any number of jobs until the user logs off the system, either manually or through system timeout.
- 2) The device ignores clock skew errors. In a standard implementation of Kerberos, authentication tests will fail if a device clock is 5 minutes (or more) different from the Kerberos server. The reason for this is that given enough time, someone could reverse engineer the authentication and gain access to the network. With the 5-minute timeout, the person has just 5 minutes to reverse engineer the authentication and the key before it becomes invalid. It was determined during the implementation of Kerberos for our device that it would be too difficult for the user/SA to keep the device clock in sync with the Kerberos server, so the Xerox instantiation of Kerberos has the clock skew check removed. The disadvantage is that this gives malicious users unlimited time to reverse engineer the user's key. However, since this key is only valid to access the Network Scanning features on a device, possession of this key is of little use for nefarious purposes.
- 3) The device ignores much of the information provided by Kerberos for authenticating. For the most part, the device only pays attention to information that indicates whether authentication has passed. Other information that the server may return (e.g. what services the user is authenticated for) is ignored or disabled in the Xerox implementation. This is not an issue since the only service a user is being authenticated for is access to an e-mail directory. No other network services are accessible from the Local UI.

Xerox has received an opinion from its legal counsel that the device software, including the implementation of a Kerberos encryption protocol in its network authentication feature, is not subject to encryption restrictions based on Export Administration Regulations of the United States Bureau of Export Administration (BXA). This means that it can be exported

from the United States to most destinations and purchasers without the need for previous approval from or notification to BXA. At the time of the opinion, restricted destinations and entities included terrorist-supporting states (Cuba, Iran, Libya, North Korea, Sudan and Syria), their nationals, and other sanctioned entities such as persons listed on the Denied Parties List. Xerox provides this information for the convenience of its customers and not as legal advice. Customers are encouraged to consult with legal counsel to assure their own compliance with applicable export laws.

#### **2.8.2.6. Port 110, POP-3 Client**

This unidirectional port is used when receiving an Internet Fax (I-Fax) or E-Mail. These jobs may only be printed, and the port is only open if I-Fax is enabled and while receiving the job. It is not configurable.

#### **2.8.2.7. Ports 137, 138, 139, NETBIOS**

For print jobs, these ports support the submission of files for printing as well as support Network Authentication through SMB. Port 137 is the standard NetBIOS Name Service port, which is used primarily for WINS. Port 138 supports the CIFS browsing protocol. Port 139 is the standard NetBIOS Session port, which is used for printing. Ports 138 and 139 may be configured in either (1) User Tools via the Local User Interface, or (2) in the Properties tab of the device's web pages, but Port 137 can only be configured via the web.

For Network Scanning features, ports 138 and 139 are used for both outbound (i.e. exporting scanned images and associated data) and inbound functionality (i.e. retrieving Scan Templates). In both instances, these ports are only open when the files are being stored to the server or templates are being retrieved from the Template Pool. For these features, SMB protocol is used.

#### **2.8.2.8. Ports 161, 162, SNMP**

These ports support the SNMPv1, SNMPv2c, and SNMPv3 protocols. Please note that SNMP v1 does not have any password or community string control. SNMPv2 relies on a community string to keep unwanted people from changing values or browsing parts of the MIB. This community string is transmitted on the network in clear text so anyone sniffing the network can see the password. Xerox strongly recommends that the customer change the community string upon product installation. SNMP is configurable, and may be explicitly enabled or disabled in the Properties tab of the device's web pages. SNMP traffic may be secured if an IPsec tunnel has been established between the agent (the device) and the manager (i.e. the user's PC).

The device supports SNMPv3, which is an encrypted version of the SNMP protocol that uses a shared secret. Secure Sockets Layer must be enabled before configuring the shared secret needed for SNMPv3.

#### **2.8.2.9. Port 389, LDAP**

This is the standard LDAP port used for address book queries in the Scan to Email feature.

#### **2.8.2.10. Port 396, Netware**

This configurable port is used when Novell Netware is enabled to run over IP.

#### **2.8.2.11. Port 427, SLP**

When activated, this port is used for service discovery and advertisement. The device will advertise itself as a printer and also listen for SLP queries using this port. It is not configurable. This port is explicitly enabled / disabled in the Properties tab of the device's web pages.

#### **2.8.2.12. Port 443, SSL**

This is the default port for Secure Sockets Layer communication. This port can be configured via the device's web pages. SSL must be enabled before setting up either SNMPv3 or IPsec or before retrieving the audit log (see Sec. **Error! Reference source not found.**). SSL must also be enabled in order to use any of the Web Services (Scan Template Management, Automatic Meter Reads, or Network Scanning Validation Service).

SSL should be enabled so that the device can be securely administered from the web UI. If the optional scanning feature has been purchased, SSL can be used to secure the filing channel to a remote repository.

SSL uses X.509 certificates to establish trust between two ends of a communication channel. When storing scanned images to a remote repository using an https: connection, the device must verify the certificate provided by the remote repository. A Trusted Certificate Authority certificate should be uploaded to the device in this case.

To securely administer the device, the user's browser must be able to verify the certificate supplied by the device. A certificate signed by a well-known Certificate Authority (CA) can be downloaded to the device, or the device can generate a self-signed certificate. In the first instance, the device creates a Certificate Signing Request (CSR) that can be downloaded and forwarded to the well-known CA for signing. The signed device certificate is then uploaded to the device. Alternatively, the device will generate a self-signed certificate. In this case, the generic Xerox root CA certificate must be downloaded from the device and installed in the certificate store of the user's browser.

The device supports only server authentication.

#### **2.8.2.13. Port 515, LPR**

This is the standard LPR printing port, which only supports IP printing. It is a configurable port, and may be explicitly enabled or disabled in User Tools via the Local User Interface or in the Properties tab of the device's web pages.

#### **2.8.2.14. Port 631, IPP**

This port supports the Internet Printing Protocol. It is not configurable. This is disabled when the http server is disabled.

#### **2.8.2.15. Port 1900, SSDP**

This port behaves similarly to the SLP port. When activated, this port is used for service discovery and advertisement. The device will advertise itself as a printer and also listen for SSDP queries using this port. It is not configurable. This port is explicitly enabled / disabled in the Properties tab of the device's web pages.

#### **2.8.2.16. Port 3003, http/SNMP reply**

This port is used when the http server requests device information. The user displays the Web User Interface (WebUI) and goes to a page where the http server must query the device for settings (e.g. Novell network settings). The http server queries the machine via an internal SNMP request (hence this port can only open when the http server is active). The machine replies back to the http server via this port. It sends the reply to the loopback address (127.0.0.0), which is internally routed to the http server. This reply is never transmitted on the network. Only SNMP replies are accepted by this port, and this port is active when the http server is active (i.e. if the http server is disabled, this port will be closed). If someone attempted to send an SNMP reply to this port via the network, the reply would have to contain the correct sequence number, which is highly unlikely, since the sequence numbers are internal to the machine.

#### **2.8.2.17. Port 9100, raw IP**

This allows downloading a PDL file directly to the interpreter. This port has limited bi-directionality (via PDL back channel) and allows printing only. This is a configurable port, and may be disabled in either (1) User Tools via the Local User Interface, or (2) in the Properties tab of the device's web pages.

### **2.8.3. IP Filtering**

The devices contain a static host-based firewall that provides the ability to prevent unauthorized network access based on IP address and/or port number. Filtering rules can be set by the SA using the WebUI. An authorized SA can create rules to (Accept / Reject / Drop) for ALL or a range of IP addresses. In addition to specifying IP addresses to filter, an authorized SA can enable/disable all traffic over a specified transport layer port.

## 3. System Access

### 3.1. Authentication Model

The authentication model allows for both local and network authentication and authorization. In the local and network cases, authentication and authorization take place as separate processes: a user must be authenticated before being authorized to use the services of the device.

If the device is set for local authentication, user account information will be kept in a local accounts database (see the discussion in Chapter 4 of Xerox Standard Accounting) and the authentication process will take place locally. The system administrator can assign authorization privileges on a per user basis. User access to services will be provided based on the privileges set for each user in the local accounts database.

When the device is set for network authentication, the user's network credentials will be used to authenticate the user at the network domain controller. User's can be entered into groups created at the domain controller. At this time support is provided for a System Administrator group. Any user listed in the System Administrator group will be granted sys admin privileges at the device. Use of network credentials for system administrator login provides more security than the legacy model based on a sys admin PIN, allowing for better tracking of sys admin logins by individual users.

Figure 3-1 provides a schematic view of the authentication and authorization subsystem. Use of the local accounts database or the network can be set independently for both authentication and authorization, meaning that it is possible to enable network authentication and local authorization, or vice versa. Usually the device will be set for both authentication and authorization to take place against the same database, either local or network.

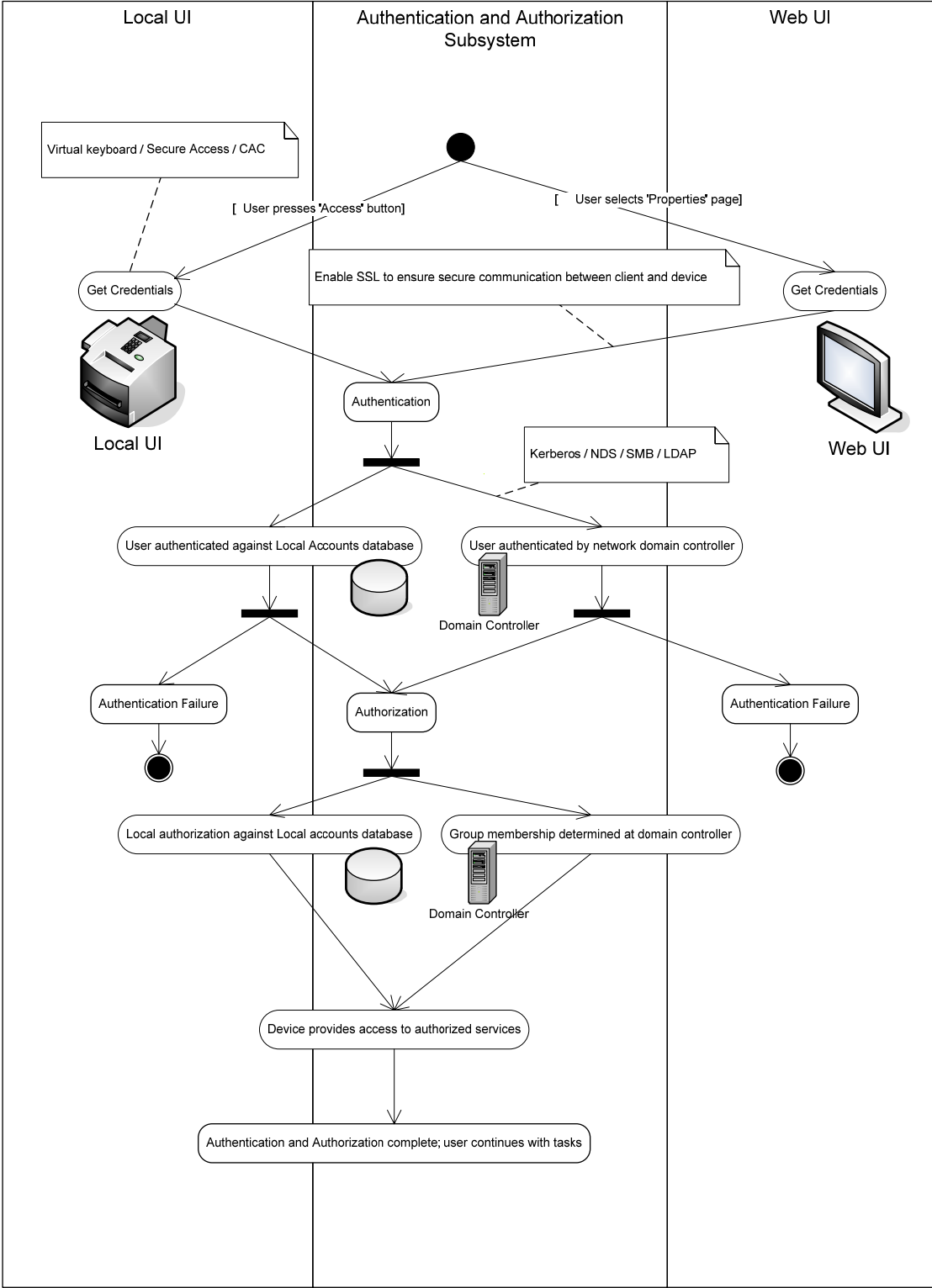

Figure 3-1 Authentication and Authorization schematic

## 3.2. Login and Authentication Methods

There are a number of methods for different types of users to be authenticated. In addition, the connected versions of the product also log into remote servers. A description of these behaviors follows.

### 3.2.1. System Administrator Login [All product configurations]

Users must authenticate themselves to the device. To access the User Tools via the Local UI, a numerical PIN is required. The customer can set the PIN to anywhere from 3 to 12 digits in length. This PIN is stored in the Copy Controller NVM and is inaccessible to the user. Xerox strongly recommends that this PIN be changed from its default value immediately upon product installation. The PIN should be set to a minimum of 8 characters in length and changed at least once per month. Longer PINs can be changed less frequently; a 9-digit PIN would be good for a year. The same PIN is used to access the Administration screens in the Web UI.

### 3.2.2. User authentication

Users may authenticate to the device using Kerberos, LDAP, SMB Domain, or NDS authentication protocols. Once the user is authenticated to the device, the user may proceed to use the Network Scanning features listed above.

The WebUI allows an SA to set up a default authentication domain and as many as 10 additional alternate authentication domains. The device will attempt to authenticate the user at each domain server in turn until authentication is successful, or the list is exhausted.

#### 3.2.2.1. Kerberos Authentication (Solaris or Windows 2000/Windows 2003)

This is an option that must be enabled on the device, and is used in conjunction with all Network Scanning features (Scan to File, Scan to E-mail and Scan to Fax Server). The authentication steps are:

- 1) A User enters a user name and password at the device in the Local UI. The device sends an authentication request to the Kerberos Server.
- 2) The Kerberos Server responds with the encrypted credentials of the user attempting to sign on.
- 3) The device attempts to decrypt the credentials using the entered password. The user is authenticated if the credentials can be decrypted.
- 4) The device then logs onto and queries the LDAP server trying to match an email address against the user's Login Name
- 5) If the LDAP Query is successful, the user's email address is placed in the From: field. Otherwise, the user's login name along with the system domain is used in the From: field.
- 6) The user may then add recipient addresses by accessing the Address Book on the LDAP server. Please see the User Manual for details. Each addition is a separate session to the LDAP server.

#### 3.2.2.2. SMB Authentication (Windows NT 4 or Windows 2000/Windows 2003)

This is also an option that may be enabled on the device, and is used in conjunction with all Network Scanning features (Scan to File, Scan to E-mail and Scan to Fax Server). The authentication steps vary somewhat, depending on the network configuration. Listed below are 3 network configurations and the authentication steps.

Basic Network Configuration: Device and Domain Controller are on the same Subnet

Authentication Steps:

- 1) The device broadcasts an authentication request that is answered by the Domain Controller.
- 2) The Domain Controller responds back to the device whether or not the user was successfully authenticated.

If (2) is successful, steps 3 – 5 proceed as described in steps 4 – 6 of the Kerberos section.

Device and Domain Controller are on different Subnets, SA defines IP Address of Domain Controller

Authentication Steps:

- 1) The device sends an authentication request directly to the Domain Controller through the router using the IP address of the Domain Controller.
- 2) The Domain Controller responds back to the device through the router whether or not the user was successfully authenticated.

If (2) is successful, steps 3 – 5 proceed as described in 4 - 6 of Kerberos section.



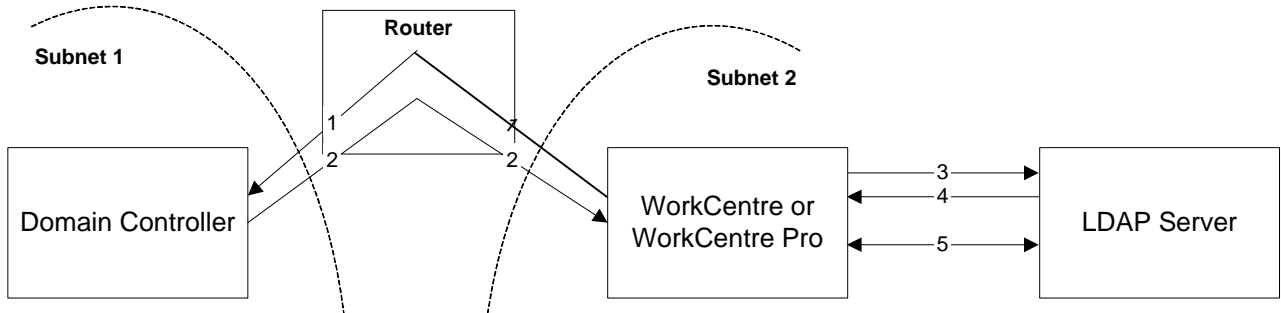

Device and Domain Controller are on different Subnets, SA defines Hostname of Domain Controller  
 Authentication Steps:

- 1) The device sends the Domain Controller hostname to the DNS Server.

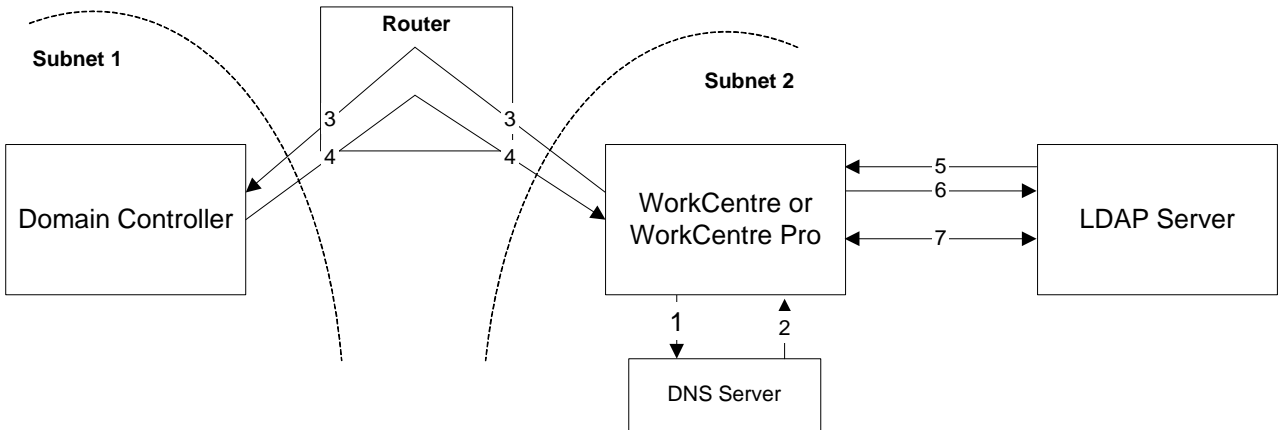

- 2) The DNS Server returns the IP Address of the Domain Controller
  - 3) The device sends an authentication request directly to the Domain Controller through the router using the IP address of the Domain Controller.
  - 4) The Domain Controller responds back to the device through the router whether or not the user was successfully authenticated.
- If (4) is successful, steps 5 – 7 proceed as described in steps 4 - 6 of the Kerberos section.

### 3.2.2.3. DDNS

The implementation in the device does not support any security extensions.

## 3.3. System Accounts

### 3.3.1. Printing [Multifunction models only]

The device may be set up to connect to a print queue maintained on a remote print server. The login name and password are sent to the print server in clear text. IPsec should be used to secure this channel.

### 3.3.2. Network Scanning [Multifunction models only]

Network Scanning may require the device to log into a server. The instances where the device logs into a server are detailed in the following table. Users may also need to authenticate for scanning. This authentication is detailed in subsequent sections.

#### 3.3.2.1. Device log on

Scanning feature	Device behavior
Scan to File, Public Template	The device logs in to the scan repository as set up by the SA in User Tools.
Scan to E-mail, I-Fax	<p>The device logs into an LDAP Server as set up by the SA in User Tools. It will only log into the Server when a user attempts to use the scan-to-email feature. At the time the LDAP server must be accessed, the device will log into the LDAP server.</p> <p>The device uses simple authentication on the LDAP server. A network username and password must be assigned to the device. The device logs in as a normal user, with read only privileges. User credentials are not used for this authentication step, and are never transmitted over the network.</p>
Scan to Fax Server	The device logs in to the Fax Server as set up by the SA in User Tools on the Local UI or from the Properties tab on the WebUI.

Please note that when the device logs into any server the device username and password are sent over the network in clear text unless SSL has been enabled or IPSec has been configured to encrypt the traffic.

#### 3.3.2.2. Scan Template Management

This is a web service that allows the SA to manage templates stored in a remote template pool. The connection to the remote pool can be secured with SSL.

## 3.4. Diagnostics

### 3.4.1. Service [All product configurations]

To access onboard diagnostics from the local user interface, Xerox service representatives must enter a unique 4-digit password. This PIN is the same for all product configurations and cannot be changed. For additional security, a Xerox authorized service representative can enable a “secure diagnostics” mode. In this mode, the service representative must enter two PINs to access onboard diagnostics. When enabling the secure diagnostics mode for the first time, the service representative should change the PIN to something known only to him or his local team. On subsequent logins, the secure diagnostics PIN must be entered followed by the standard diagnostics PIN in order to gain access to the diagnostics menu.

### 3.4.2. Alternate Boot via Network Controller Serial Port

Alternate Boot (Alt-boot) is a means for the Portable Service Workstation (PSW) to directly connect to the Network Controller. The primary purpose of Alternate Boot is to provide the capability to boot the Network Controller in case of hard disk failure, to perform system diagnostics, and load Network Controller software, independent of other sub-systems.

To enter this mode a user must strike any key on the PSW within 10 seconds of power on. If the 10 seconds times out, then the normal boot sequence occurs and the serial port acts as a typical tty (see next section). However, if this mode is entered, a Xerox unique serial protocol is used to communicate to the alt-boot code. All commands are DOS-type menu driven (i.e. type in a number to start a command). If a PSW is connected, the application on the PSW cannot be accessed without logging on with a password (see next section).

If the PSW is used and is successfully logged on, then the Ethernet port is used to download executable files. The serial port is used for commands and status. Again, please refer to the PSW section for details.

### 3.4.3. tty Mode

When the Network Controller has completed booting a login line will be displayed. This mode is a typical tty window, and is password protected. This password changes with each major software release. The password is stored on the Network Controller hard disk in an encrypted format similarly to how UNIX encrypts and stores passwords. Through this port a user can gain information and access to any files or information stored in the Network Controller DRAM or Network Controller hard disk. However, this mode is only used by a CSE if directed by a Field Engineer when all other diagnostics fail to solve a problem. The written repair procedures that direct the CSE never employ this mode.

### 3.4.4. Diagnostics via Portable Service Workstation (PSW) Port

When connected to the PSW Port, the PSW provides an extensive suite of diagnostic functions for use by the Xerox Customer Service Engineer (CSE). The over-the-wire protocol is Xerox proprietary. This port cannot process any other protocol except this proprietary protocol used for machine diagnosis. Also, the PSW must have an application loaded to connect to and communicate with the device.

Customer documents or files cannot be accessed during a diagnostic session, nor are network servers accessible through this port.

#### 3.4.4.1. Access

The Xerox Service Technician must be authenticated twice:

1. The first password, called the *PSW Lock Facility*, is obtained by calling a Xerox service location and providing the CSE employee number and the serial number of the PSW. The password is then given to the Xerox Service Technician, and is valid for 90 days. When the password expires, the Xerox Service Technician must call in again. This password is unique to the client application running on that particular PSW, and is required to log onto the PSW prior to initiating communications with the machine.
2. Once the application is running, the PSW supplies the second password (different from the first) to authenticate the session to the device. This embedded password is automatically passed from the application to the machine, and is never seen by anyone. It is hardcoded in the software of the Marking Engine and the PSW application, and is common to all products. It is not encrypted. Many of the diagnostic routines will require this password in order to function.

#### 3.4.4.2. Communication Protocol

The communication process uses a Xerox proprietary protocol. Each packet passing back and forth will have a unique identifier (session key) with it for authentication and tracking purposes. All protocols are API based – very little information is directly transferred. For example, in order to run any given diagnostic test, the ‘Start Test XXX’ command is sent to the Marking Engine. The Marking Engine runs the test and responds with a ‘Test XXX passed (or failed)’ reply. This is illustrated in the following diagram:

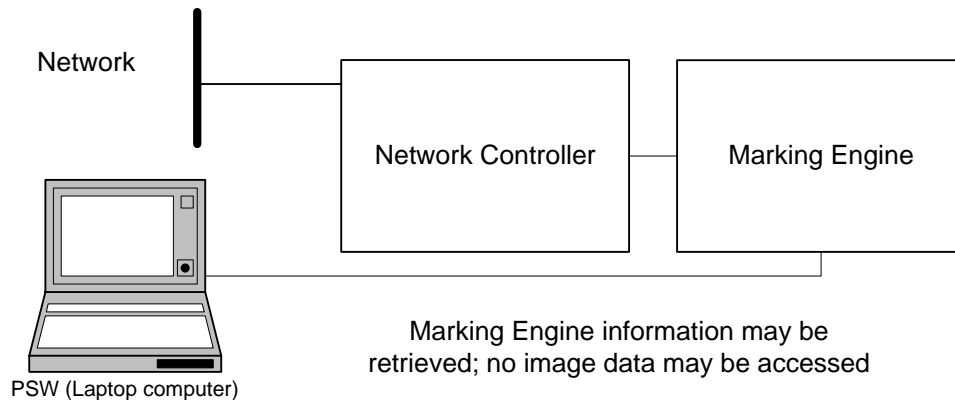

### 3.4.4.3. Network Diagnostics executed from the PSW

The PSW allows the technician to execute certain Network diagnostic tests by connecting directly to the serial port on the Network Controller. These tests are executed with the device disconnected from the customer's LAN.

The tests that are available are echo tests for the various protocols (e.g. IP, IPX), where the Network Controller sends a dummy message to itself to test the transmit and receive capabilities of its own connectivity stacks. Each protocol is tested individually and each test must be invoked separately. The diagnostic sequence is as follows:

- 1) After the PSW and Marking Engine have established a connection, the PSW must send the expected synchronization message to the machine.
- 2) The Marking Engine will respond with an acknowledge message containing its serial number.
- 3) The PSW will send a request for Diagnostic service and a password.
- 4) Assuming the password is authentic, the Marking Engine will either execute a Marking Engine diagnostic, or else forward the diagnostic request to the Network Controller. If this is a network diagnostic, the Network Controller will execute the diagnostic and report results back to the Marking Engine.
- 5) The Marking Engine will report diagnostic results back to the PSW.

### 3.4.4.4. Accessible Data

The only files that are accessible are various log files (fault log, internal event log, complete job log, configuration log and a debug log). The customer's network is accessible for diagnostic purposes only. However, there is one diagnostic routine (Get Network Connectivity Data), where the device will collect data about the network it is on and transmit the data. The CSE is expected to seek permission from the customer before connecting the device to the LAN and performing this diagnostic.

This Novell test will only collect information for devices on the local network. It will not provide information for any devices across a router. The following data will be stored on the Network Controller:

- Frame Type (local network devices only)
- Server Name
- Server internal network number
- Server node (Media Access Control) address
- Server NOS version number
- Hop count to device (local net)

The IP test will collect data from all responding IP routers and lpd hosts. The following data will be stored on the Network Controller:

- Network Controller Interface where host discovered (Ethernet, Token Ring, etc.)
- Device subnet mask
- Device IP address
- Device Media Access Control (MAC) address

The Novell test will NOT collect:

- Print Queue Name
- Attached to File Server status
- Attached to Print Queue status

The IP test will NOT collect:

- Device Name
- Gateway IP address

- Destination Network number
- Hop count to device

### 3.4.5. Summary

As stated above, accessibility of customer documents, files or network resources is impossible via the PSW. In the extremely unlikely event that someone did spoof the Xerox proprietary protocols, only diagnostic activities can be executed.

# 4. Security Aspects of Selected Features

[Multifunction models only]

## 4.1. Audit Log

The device maintains a security audit log. Recording of security audit log data can be enabled or disabled by the SA. The audit log is implemented as a circular log containing a maximum of 15000 event entries, meaning that once the maximum number of entries is reached, the log will begin overwriting the earliest entry. Only an SA will be authorized to download the log from the device. The log may only be exported over an https: connection, so SSL must be set up before retrieving the log. The log is exported in MS-Excel comma-separated file format. The log does not clear when it is disabled, and will persist through power cycles.

The following table lists the events that are recorded in the log:

Tagged index	Event ID	Event description	Entry Data
1	1	System startup	Device name Device serial number
2	2	System shutdown	Device name Device serial number
3	3	ODIO Standard started	Device name Device serial number
4	4	ODIO Standard complete	Device name Device serial number Overwrite Status
5	5	Print job	Job name User Name Completion Status IIO status Accounting User ID Accounting Account ID
6	6	Network scan job	Job name User Name Completion Status IIO status Accounting User ID Accounting Account ID total-number-net-destination net-destination.
7	7	Server fax job	Job name User Name Completion Status IIO status

Tagged index	Event ID	Event description	Entry Data
			Accounting User ID Accounting Account ID Total-fax-recipient-phone-numbers fax-recipient-phone-numbers net-destination.
<a href="#">8</a>	8	IFAX	Job name User Name Completion Status IIO status Accounting User ID Accounting Account ID total-number-of-smtp-recipients smtp-recipients
<a href="#">9</a>	9	Email job	Job name User Name Completion Status IIO status Accounting User ID Accounting Account ID total-number-of-smtp-recipients smtp-recipients
<a href="#">10</a>	10	Audit Log Disabled	Device name Device serial number
<a href="#">11</a>	11	Audit Log Enabled	Device name Device serial number
<a href="#">14</a>	14	Lan Fax Job	Job name User Name Completion Status IIO status Accounting User ID Accounting Account ID Total-fax-recipient-phone-numbers fax-recipient-phone-numbers
<a href="#">16</a>	16	ODIO Full started	Device name Device serial number
<a href="#">17</a>	17	ODIO Full complete	Device name Device serial number Overwrite Status
<a href="#">20</a>	20	Scan to Mailbox job	Job name or Dir name User Name Completion Status IIO status
<a href="#">21</a>	21	Delete File/Dir	Job name or Dir name User Name Completion Status IIO status
<a href="#">24</a>	30	SA login	Device name Device serial number Completion Status (Success or Failed)
<a href="#">25</a>	31	User Login	UserName Device name Device serial number Completion Status (Success or Failed)
<a href="#">26</a>	32	Service Login	Service name Device name Device serial number

Tagged index	Event ID	Event description	Entry Data
			Completion status (Success or Failed).
<a href="#">27</a>	33	Audit log download	UserName Device name Device Serial Number Completion status (Success or Failed).
<a href="#">28</a>	34	IIO feature status	UserName Device name Device serial number IIO Status (enabled or disabled)
<a href="#">29</a>	35	SA pin changed	UserName Device name Device serial number Completion status
<a href="#">30</a>	36	Audit log Transfer	UserName Device name Device serial number Completion status
<a href="#">31</a>	37	SSL	UserName Device name Device serial number Completion status (Enabled/Disabled).
<a href="#">32</a>	38	X509 certificate	UserName Device name Device serial number Completion Status (Created/uploaded/Downloaded).
<a href="#">33</a>	39	IP sec	UserName Device name Device serial number Completion Status (Configured/enabled/disabled).
<a href="#">34</a>	40	SNMPv3	UserName Device name Device serial number Completion Status (Configured/enabled/disabled).
<a href="#">35</a>	41	IP Filtering Rules	UserName Device name Device serial number Completion Status (Configured/enabled/disabled).
<a href="#">36</a>	42	Network Authentication	UserName Device name Device serial number Completion Status (Enabled/Disabled)
<a href="#">37</a>	43	Device clock	UserName Device name Device serial number Completion Status (time changed/date changed)
<a href="#">38</a>	44	SW upgrade	Device name Device serial number Completion Status (Success, Failed)
<a href="#">39</a>	45	Cloning	Device name Device serial number Completion Status (Success, Failed)
<a href="#">40</a>	46	Secure scanning	Device name Device serial number Completion Status (Certificate Validation success, certificate validation failed)
<a href="#">41</a>	47	Secure authentication	Device name Device serial number



Tagged index	Event ID	Event description	Entry Data
			Completion status (completed w errors).
<a href="#">44</a>	50	Process crash	Device name Device serial number Process name
<a href="#">45</a>	51	ODIO scheduled	Device name Device serial number ODIO type (Full or Standard) Scheduled time ODIO status (Started/Completed/canceled) Completion Status (Success/Failed/Canceled)

## 4.2. Xerox Standard Accounting

Xerox Standard Accounting (XSA), intended primarily for use as an accounting service, can be used as an internal authorization service. XSA tracks copy, scan (including filing and email), print and fax usage by individual user<sup>4</sup>. The system administrator can enable/disable the feature via the LUI or Web UI, add or delete users, and set usage limits by service for each user. If XSA is enabled, a walk-up user must enter a valid XSA ID before being allowed access to the device. The device will confirm that the entered XSA ID matches an authorized user, and that the usage limits for the selected service have not been exceeded. In this sense, XSA acts as an authorization service. The system administrator can limit access to device services by setting the usage limits on specific services to zero for users that should not have rights to use the feature. After each job is performed, the user's balance is updated by the number of impressions or scans performed. Services become unavailable to the user when the usage limits are exceeded. When XSA is enabled in the print driver or on the Web UI, before a print job is submitted, an XSA ID must also be entered. The ID is sent to the Network controller for validation. If the submitted ID is valid, the job will print, and the user's balance will be updated by the number of impressions performed. If the submitted ID is invalid, the job is deleted and an error sheet is printed in its place.

On demand, the SA will be able to download a report that shows activity for all of the users. The SA can add, modify or remove users and their allocations at any point.

An end user will be able to review their balances by entering a User ID at the LUI or web UI.

## 4.3. Automatic Meter Reads

Automatic Meter Reads (AMR) is a service that allows devices to electronically report meter readings back to Xerox. The Systems Administrator sets up the attributes for the AMR service via the web UI, including registering the device with the Xerox AMR server. Once enabled, the device will poll the Xerox AMR server daily over the network. The server will check whether it is time in the monthly billing cycle to update the meter readings. If so, the server will request reads from the device, and the device will then respond by sending the meter reads back to the server.

This communication process means that the device initiates all communication between it and Xerox. Only device ID and meter read information is transferred. The information is sent in clear text.

The device can be set to communicate via a proxy server on the customer's network. The proxy server address is set up using the WebUI.

## 4.4. Encrypted Partitions

<sup>4</sup> On color machines XSA can track color copy or color print usage.

The network controller disk is encrypted using the AES algorithm with a 128-bit key. The key is generated dynamically on each boot, and is kept only in volatile memory.

## 4.5. Image Overwrite

The Image Overwrite Security Option provides both Immediate Image Overwrite (IIO) and On-Demand Image Overwrite (ODIO) functions. Immediately before a job is considered complete, IIO will overwrite any temporary files associated with print, network scan, internet fax, network fax, or e-mail jobs that had been created on the Network Controller Hard Disk. The ODIO feature can be executed at any time by the SA and will overwrite the entire document image partitions of the Network Controller Hard disk. ODIO may also be scheduled to run at regular times. A standard ODIO will overwrite all image data from memory and disks except for Jobs and Folders stored in the Reprint Saved Jobs feature; Jobs stored in the Scan to Mailbox feature (if installed); Fax Dial Directories (if fax card is installed); and Fax Mailbox contents (if fax card is installed). A full ODIO will overwrite all image data from memory and disks as well as the items excluded from a standard ODIO.

### 4.5.1. Algorithm

The overwrite mechanism for both IIO and ODIO conforms to the U.S. Department of Defense Directive 5200.28-M (Section 7, Part 2, paragraph 7-202<sup>5</sup>, and is common to all WorkCentre Pros. The algorithm for the Image Overwrite feature is:

- Step 1: Pattern #1 is written to the sectors containing temporary files (IIO) or to the entire spooling area of the disks (ODIO). (hex value 0x35 (ASCII "5")).
- Step 2: Pattern #2 is written to the sectors containing temporary files (IIO) or to the entire spooling area of the disks (ODIO). (hex value 0xCA (ASCII compliment of 5)).
- Step 3: Pattern #3 is written to the sectors containing temporary files (IIO) or to the entire spooling area of the disks (ODIO). (hex value 0x97 (ASCII "ú")).
- Step 4: 10 % of the overwritten area is sampled to ensure Pattern #3 was properly written. The 10 % sampling is accomplished by sampling a random 10 % of the overwritten area.

### 4.5.2. User Behavior

This feature is available as the Image Overwrite Security Option Kit (please see your Xerox Sales representative for pricing and ordering details). This kit provides overwrite functionality for the Network Controller Hard Disk in this set of products. Once enabled, IIO is invoked automatically immediately prior to the completion of a print, network scan, internet fax, network fax, or e-mail job. If IIO completes successfully, status is displayed in the Job Queue. However, if IIO fails, a popup will appear on the Local UI recommending that the user run ODIO, and a failure sheet will be printed. ODIO may be invoked either from the Local UI in Tools Pathway or from the CentreWare Internet Services Web UI. Network functions will be delayed until the overwrite is completed. Copying is unavailable while the overwrite itself is underway, but copies may be made while the Network Controller is booting. Upon completion and verification of the ODIO process, a confirmation sheet is printed which indicates the status of the overwrite. The completion status can be successful, failed, cancelled, or timed-out. Please note that invocation of ODIO will cause currently processing print jobs to be aborted. However, scan jobs will not be aborted and so ODIO might fail. The user should insure that all scan jobs have been completed before invoking ODIO. Please refer to the customer documentation for a description on how failures are logged.

### 4.5.3. Overwrite Timing

The ODIO overwrite time is dependent on the type of hard disk in the product. The overwrite and reset average time is 10 minutes, but longer times are possible. IIO is performed as a background operation, with no user-perceivable reduction in copy, print or scan performance.

---

<sup>5</sup>[http://www.dtic.mil/whs/directives/corres/archives/520028m\\_0173/p520028m.pdf](http://www.dtic.mil/whs/directives/corres/archives/520028m_0173/p520028m.pdf)

# 5. Responses to Known Vulnerabilities

## 5.1. Security @ Xerox ([www.xerox.com/security](http://www.xerox.com/security))

Xerox maintains an evergreen public web page that contains the latest security information pertaining to its products. Please see [www.xerox.com/security](http://www.xerox.com/security).

## 6. APPENDICES

### 6.1. Appendix A – Abbreviations

<b>ADF</b>	Automatic Document Feeder
<b>AHA</b>	Advanced Hardware Architecture, a proprietary compression
<b>API</b>	Application Programming Interface
<b>AMR</b>	Automatic Meter Reads
<b>ASIC</b>	Application-Specific Integrated Circuit. This is a custom integrated circuit that is unique to a specific product.
<b>CAT</b>	Customer Administration Tool
<b>CCITT</b>	Comite Consultatif International de Telegraphique et Telephonique (International Telegraph and Telephone Consultative Committee) [now ITU-T]
<b>CSE</b>	Customer Service Engineer
<b>DADF/DADH</b>	Duplex Automatic Document Feeder/Handler
<b>DC</b>	Digital Copier
<b>DHCP</b>	Dynamic Host Configuration Protocol
<b>DNS</b>	Domain Name Server. A centralized database that maps host names to static IP addresses.
<b>DDNS</b>	Dynamic Domain Name Server. Maps host names to dynamic static IP addresses.
<b>DRAM</b>	Dynamic Random Access Memory
<b>EGP</b>	Exterior Gateway Protocol
<b>EPC</b>	Electronic PreCollation
<b>GB</b>	Gigabyte
<b>HP</b>	Hewlett-Packard
<b>HTTP</b>	Hypertext transfer protocol
<b>IBM</b>	International Business Machines
<b>ICMP</b>	Internet Control Message Protocol
<b>IETF</b>	Internet Engineering Task Force
<b>IFAX</b>	Internet Fax
<b>IIO</b>	Immediate Image Overwrite
<b>IIT</b>	Image Input Terminal (the scanner)
<b>IT</b>	Information Technology
<b>IOT</b>	Image Output Terminal (the marking engine)
<b>IP</b>	Internet Protocol
<b>IPSec</b>	Internet Protocol Security
<b>IPX</b>	Internet Protocol Exchange
<b>ITU</b>	International Telecommunications Union
<b>LAN</b>	Local Area Network
<b>LDAP</b>	Lightweight Directory Access Protocol

<b>LDAP Server</b>	Lightweight Directory Access Protocol Server. Typically the same server that is used for email. It contains information about users such as name, phone number, and email address. It can also include a users login alias.
<b>LED</b>	Light Emitting Diode
<b>LPR</b>	Line Printer Request
<b>LZ</b>	Lempel Ziv (a type of compression)
<b>MAC</b>	Media Access Control
<b>MIB</b>	Management Information Base
<b>n/a</b>	not applicable
<b>NC</b>	<b>Network Controller</b>
<b>NDPS</b>	Novell Distributed Print Services
<b>NETBEUI</b>	NETBIOS Extended User Interface
<b>NETBIOS</b>	Network Basic Input/Output System
<b>NOS</b>	Network Operating System
<b>NVRAM</b>	Non-Volatile Random Access Memory
<b>NVM</b>	Non-Volatile Memory
<b>ODIO</b>	On-Demand Image Overwrite
<b>PCL</b>	Printer Control Language
<b>PDL</b>	Page Description Language
<b>PIN</b>	Personal Identification Number
<b>PROM</b>	Programmable Read-Only Memory
<b>PWBA</b>	Printed Wire Board Assembly
<b>PSW</b>	Portable Service Workstation
<b>PWS</b>	alternative acronym for Portable Service Workstation
<b>RFC</b>	Required Functional Capability
<b>ROM</b>	Read Only Memory
<b>ROS</b>	Raster Output Scanner
<b>SA</b>	System Administrator
<b>SIMM</b>	Single In-line Memory Module
<b>SLP</b>	Service Location Protocol
<b>SNMP</b>	Simple Network Management Protocol
<b>SRAM</b>	Static Random Access Memory
<b>SSDP</b>	Simple Service Discovery Protocol
<b>SSL</b>	Secure Sockets Layer
<b>TCP</b>	Transmission Control Protocol
<b>TIFF</b>	Tagged Image File Format
<b>UI</b>	User Interface
<b>URL</b>	Uniform Resource Locator
<b>UDP</b>	User Datagram Protocol
<b>WebUI</b>	Web User Interface – the web pages resident in the WorkCentre Pro. These are accessible through any browser using the machine’s IP address as the URL.
<b>XCFI</b>	Xerox Common Management Interface
<b>XSA</b>	Xerox Standard Accounting

## 6.2. Appendix B – Supported MIB Objects

**NOTES :**

- (1) The number of objects shown per MIB group represents the number of objects defined by the IETF standard for that MIB group. It does not represent the instantiation of the MIB group which may contain many more objects.
- (2) Some MIB objects defined within Input and Output groups of the Printer MIB (*RFC 1759*) have a MAX-ACCESS of RW. However, the Printer MIBv2 defines a MIB-ACCESS of RO for these MIB objects within the Input and Output groups and all machines assessed support RO access. Therefore, RO access to these MIB objects is considered IETF compliant.
- (3) It is assumed that mandatory IETF string-related MIB objects shall contain meaningful data; not blank strings
- (4) The "(C)" notation indicates that the previously stated item is a true caveat condition. The "(I)" notation indicates that the previous stated item should be regarded as information only.
- (5) MIB objects that CANNOT be populated with meaningful data (e.g. a machine may not have paper level sensors, hence, can only support "0" or "-3 for more than 1 sheet" for prtInputCurrentLevel) will be considered a caveat, denoted as "(C)".
- (6) The Printer MIB requires a few groups from RFC 1213 and RFC 1514 to be supported. Therefore, this assessment will indicate that these groups are "supported" as long as the basic MIB structures have been implemented.

**Support Definitions**

Term	Definition
"supported"	all MIB objects exists and are populated w/ meaningful data that is consistent w/ the hardware installed within the machine.
"supported w/ caveats"	all MIB objects exists, however, 2 major bugs or less may exists w/ some of the objects that were not fixed
"not supported"	MIB objects do not exist/implementation was not planned
"not fully supported"	MIB objects exists, HOWEVER, are NOT populated w/ meaningful data OR provide only default values OR contain 3 or more major bugs
"optional, **"	optional group that is NOT required by the RFC, however, an implementation may exist; some MIB objects may not be populated w/ meaningful data

SNMP version / Network Transport support	WorkCentre/WorkCentre Pro
SNMPv1 (RFC 1157)	supported
SNMPv2P (RFCs 140x)	not supported
SNMPv2C (RFCs 190x)	supported
SNMPv3 (RFCs 1902, 2572, 2574)	supported
SNMP over UDP (IP)	supported
SNMP over IPX (Netware)	supported
SNMP over NETBEUI (Microsoft Networking)	not supported (implemented but never delivered)

RFC 1759 - Printer MIB Group	WorkCentre/WorkCentre Pro
RFC 1213 - System group	supported
RFC 1213 - Interface group	supported
RFC 1514 - Storage group	supported
RFC 1514 - Device group	supported
General group [7 objects]	supported
Covers group [3 objects]	supported w/ caveats = Finisher cover is shown as open when only the Front Door is open due to detection limitation of status condition
Localization group [4 objects]	supported w/ caveats = only US English language supported
Responsible Party group [2 objects] - OPTIONAL	supported
System Resources group [4 objects]	supported
Input group [12 objects]	supported
Extended Input group [7 objects] - OPTIONAL	supported
Input Media group [4 objects] - OPTIONAL	supported
Output group [6 objects]	supported w/ caveats = only "-3" (i.e. can accept 1 or more sheets) can be supported for the Top Tray (C)
Extended Output group [7 objects] - OPTIONAL	supported
Output Dimensions group [5 objects] OPTIONAL	supported
Output Features group [6 objects] - OPTIONAL	supported
Marker group [15 objects]	supported
Marker Supplies group [9 objects] - OPTIONAL	supported
Marker Colorant group [5 objects] - OPTIONAL	supported
Media Path group [11 objects]	supported
Channels group [8 objects]	supported
Interpreter group [12 objects]	supported
Console group [4 objects]	supported w/ caveats = prtConsoleDisable is hardcoded to enabled(3), prtConsoleLocalization hardcoded to 1
Console Display Buffer group [2 objects]	supported w/ caveats = limited local UI messaging captured within table (C), local UI button selection messages are not captured within table
Console Display Light group [5 objects]	supported w/ caveats = only the Power Saver LED is supported, the other LEDs were not implemented because they represent local UI menu activations (I)
Alert Table group [8 objects]	supported
Alert Time group [1 object] - OPTIONAL	supported

RFC 1514 – Host Resources MIB group	WorkCentre/WorkCentre Pro
System group [7 objects]	supported
Storage group [8 objects]	supported
Devices group [6 objects]	supported w/ caveats = hrDeviceStatus for xcmHrDeviceScanner does not work, hrDeviceErrors for xcmHrDeviceScanner does not work, all other device error counts AND hrDeviceStatus are not supported ☹
Processor Table [2 objects]	supported
Network Interface Table [1 object]	supported
Printer Table [2 objects]	supported
Disk Storage Table [4 objects]	supported
Partition Table [5 objects]	supported
File System Table [9 objects]	supported w/ caveats = hrFSLastFullBackupDate & hrFSLastPartialBackupDate are not supported ☹
Software Running group [7 objects] – OPTIONAL	optional, not supported
Software Running Performance group [2 objects] – OPTIONAL	optional, not supported
Software Installed group [7 objects] – OPTIONAL	optional, not supported

RFC 1213 - MIB-II for TCP/IP group	WorkCentre/WorkCentre Pro
System group [7 objects]	supported
Interfaces group [23 objects]	supported w/ caveats = ifInUnknownProtos does not work
Address Translation group [3 objects]	supported, but this group has been DEPRICATED by the IETF
IP group [42 objects]	supported
ICMP group [26 objects]	supported
TCP group [19 objects]	supported
UDP group [6 objects]	supported
EGP group [20 objects]	not applicable because Exterior Gateway Protocol not supported by machine

RFC 1213 - MIB-II for TCP/IP group	WorkCentre/WorkCentre Pro
Transmission group [0 objects]	not applicable because the group has not yet been defined by the IETF
SNMP group [28 objects]	supported
System Object Resources Table/objects per RFC 1907 [8 objects]	supported

Additional Capabilities / Application Support	WorkCentre/WorkCentre Pro
ability to change GET, SET, TRAP PDU community names	supported, default values : GET="public", SET="private", TRAP="SNMP_trap"
Printer MIB traps	supported = printerV1Alert, printerV2Alert
SNMP Generic Traps	supported = coldStart, warmStart, authenticationFailure
Vendor-specific Traps	supported = xcmJobV1AlertNew, xcmJobV2AlertNew for job monitoring alerts
set trap destination address(es) for any 3rd party Net Mgmt apps.	supported via Web UI
polling for IETF status objects using any 3rd party Net Mgmt apps.	supported
walking IETF MIB tree structure using any 3rd party Net Mgmt app. (e.g. HP OpenView, etc.) / shareware program	supported
New type 2 enumerations from next generation Host Resources MIB supported	optional, not support because Host Resources MIBv2 has NOT entered the standards track
New type 2 enumerations from next generation Printer MIB supported	supported
New Printer MIBv2 objects implemented	optional, not support because Printer MIBv2 has NOT entered the standards track
IETF AppleTalk MIB (RFC ?) implemented	not supported
Job monitoring via MIBs	supported via Xerox MIBs
Vendor-specific MIBs implemented	supported = Network Connectivity, Job Monitoring, Scan-to-File, and Scan-to-LAN FAX features supported via Xerox MIBs
Vendor-specific MIBs provided to customer	supported w/ caveat = planned support within 2 - 3Q00 via Xerox web site, URL = www.xerox.com
Vendor-specific client application(s) provided	CentreWare Services
required Windows2000 MIB objects supported	supported
Embedded Web Server support	supported
Xerox PrinterMap application support	supported
Xerox PrintXchange support	supported
Novell Distributed Print Services support	supported = w/ Xerox NDPS Gateway solution w/ improved device status
Dazell Output Management Environment	supported
HP OpenView snap-in module	supported
CA Unicenter snap-in module	supported
IBM/Tivoli NetView snap-in module	supported



## 6.3. Appendix C –Standards

### Network Controller Hardware

PCI Specification (PCI Local Bus Specification Revision 2.1)  
 100 Megabit Ethernet (IEEE 802.3)  
 Universal Serial Bus 1.1  
 Parallel (IEEE 1284)  
 IEEE 1394a (FireWire)

### Network Controller Software

Function	RFC/Standard
Internet Protocol	950
Internet standard subnetting procedure	919
Broadcasting internet datagrams	922
IP Version 6	2460
IP Version 6 Addressing Architecture	2373
ICMP Version 6 Protocol	2463
Transition Mechanisms for IPv6 Hosts and Routers	1933
Transmission Control Protocol (TCP)	793
User Datagram Protocol	768
Standard for the transmission of IP datagrams over Ethernet networks	894
Standard for the transmission of IP datagrams over IEEE802 networks	1042
ICMP – ICMP Echo, ICMP Time, ICMP Echo Reply, and ICMP Destination Unreachable message.	792
Reverse Address Resolution Protocol (RARP)	903
Bootstrap Protocol (BOOTP)	951
Clarifications and Extensions for the Bootstrap Protocol (BOOTP)	1542
X.500 Distinguished Name RFC references	1779, 2253, 2297, 2293
SLP	2608
Dynamic Host Configuration Protocol (DHCP)	2131
DHCP Options and BOOTP Vendor Extensions	2132
X.509 Certificate RFC references	2247, 2293, 2459, 2510, 2511, 3280
Hyper Text Transfer Protocol version 1.1 (HTTP)	2616
Line Printer Daemon (LPR/LPD)	1179
File Transfer Protocol (FTP)	959
SNMPv1	1157
SNMPv2	1901, 1905, 1906, 1908, 1909
SNMPv3	1902, 2572, 2574
Structure of Management Information (SMI) for SNMPv1	1155, 1212
Structure of Management Information (SMI) for SNMPv2	1902, 1903, 1904
IETF MIBs: MIB II	1213
Host Resources	1514
RFC 1759 (Printer), Printer MIB V2	1759
SNMP Traps	1215

Function	RFC/Standard
Document Printing Application (DPA)	10175
Appletalk	Inside Appletalk, Second Edition

**Printing Description Languages**

Postscript Language Reference, Third Edition  
PCL6 (PCL5E 5SI emulation)  
PCL6 (PCLXL 5M emulation)  
TIFF 6.0  
JPEG  
Portable Document Format Reference Manual Version 1.3

## 6.4. Appendix E – References

Kerberos FAQ

<http://www.nrl.navy.mil/CCS/people/kenh/kerberos-faq.html>

IP port numbers

<http://www.iana.org/assignments/port-numbers>

