

Overview and Quick Start

Introduction to phone exterior

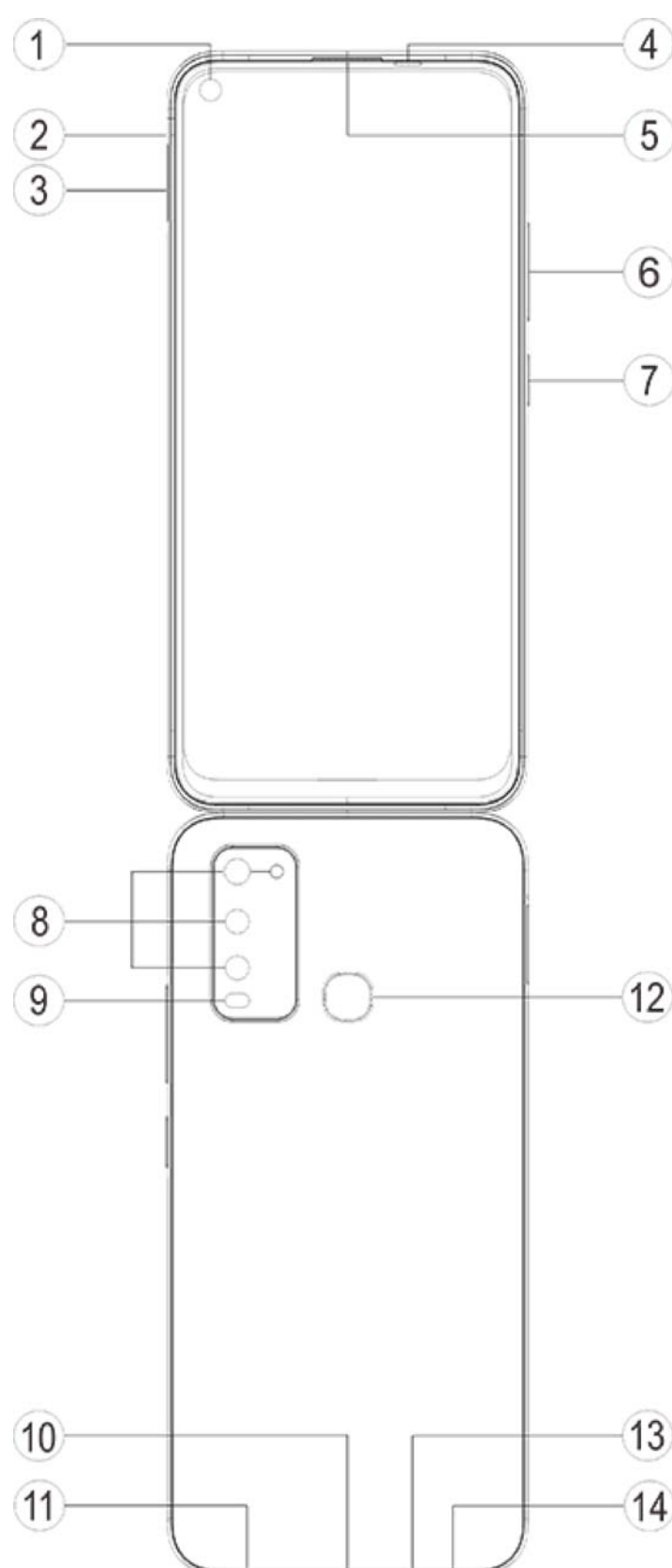

1.Front camera; 2.Pin port; 3.Card tray; 4.Ambient light sensor & Proximity sensor; 5.Receiver; 6.Volume button; 7.Power button; 8.Rear camera; 9.Rear flash; 10.USB port; 11.Speaker; 12.Fingerprint sensor; 13.Microphone; 14.Earphone jack.

Introduction to keys and widgets

Ambient light sensor: Automatically detect the intensity of the ambient light, and adjust the brightness of the screen with the ambient light.

Proximity sensor: When making phone calls, this sensor automatically detects the distance between you and your phone. If you're too close to your phone, it will switch off your screen to avoid unintentional triggering of certain functions. The sensor is inactive in headset and handsfree mode. It is normal for the light at the top of the screen to flash briefly when dialing or calling. This indicates the screen's infrared is working.

Volume buttons: You can adjust the volume using the volume button.

Front camera/Triple rear cameras: You can take photos and record videos.

Receiver: You can hear the caller through the receiver when on the phone.

Power button: Long press the Power button in power off mode to turn on the mobile phone. Long press the button in boot mode to turn off the phone or reboot the phone.

⚠Note

When the phone can not be used normally, simultaneously long press [**Power button**] and [**Volume button -**] more than 10 seconds to force the device to restart .



Fingerprint sensor: The button has the fingerprint recognition function, which can be used to unlock the phone instead of the password.

Card tray: Install/Remove the cards.

Pin port: Insert the pin into the pin jack on the side body, and press it inwards to eject the card tray.

Microphone: Transfer sound when you make calls.

Rear flash: Flashlight source.

Speaker: Playing sound.

USB port: You can connect your phone to other devices such as a charger or computer using a data cable.

Earphone jack: You can connect headphones to your phone using the headphone jack.

Installation and Preparation

Procedure for installing SIM / SD card

This phone supports hot swapping of Nano card (SIM1/SIM2)/Micro SD card. When the phone is on, it can automatically recognize a Nano card (SIM1/SIM2)/Micro SD card when you insert the card in. This phone supports Nano card (SIM1/SIM2)/Micro SD.

1. Insert the pin into the SIM pin port on the side body, and press it inwards to eject the SIM card tray; Remove the card tray.

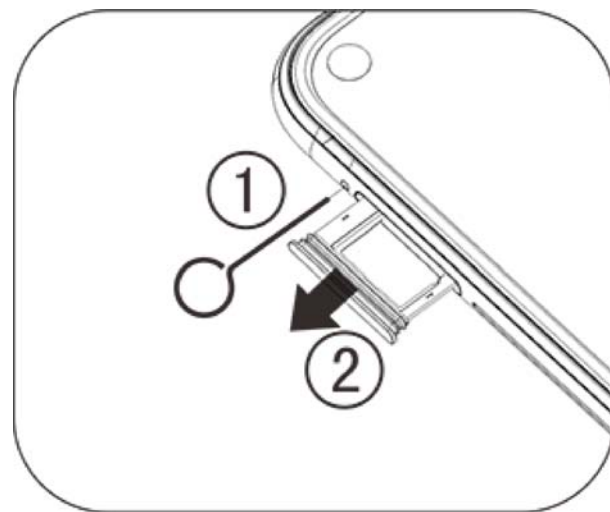

2. Make the metal face of the Nano card (SIM1/SIM2) or Micro SD card face downward, with the oblique angle corresponding to that of card tray. Put the Nano card (SIM1/SIM2) or Micro SD card into the card slot according to the direction indicated by arrows of the diagram.

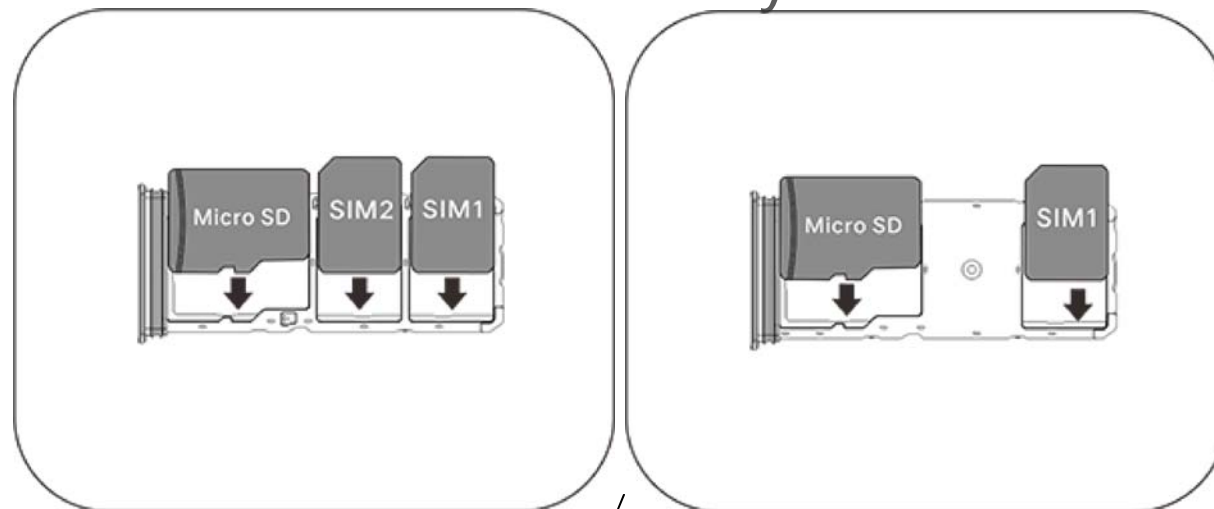

3. Touch screen facing up, follow the direction of the arrow to install the tray (with Nano card or Micro SD) into the phone.

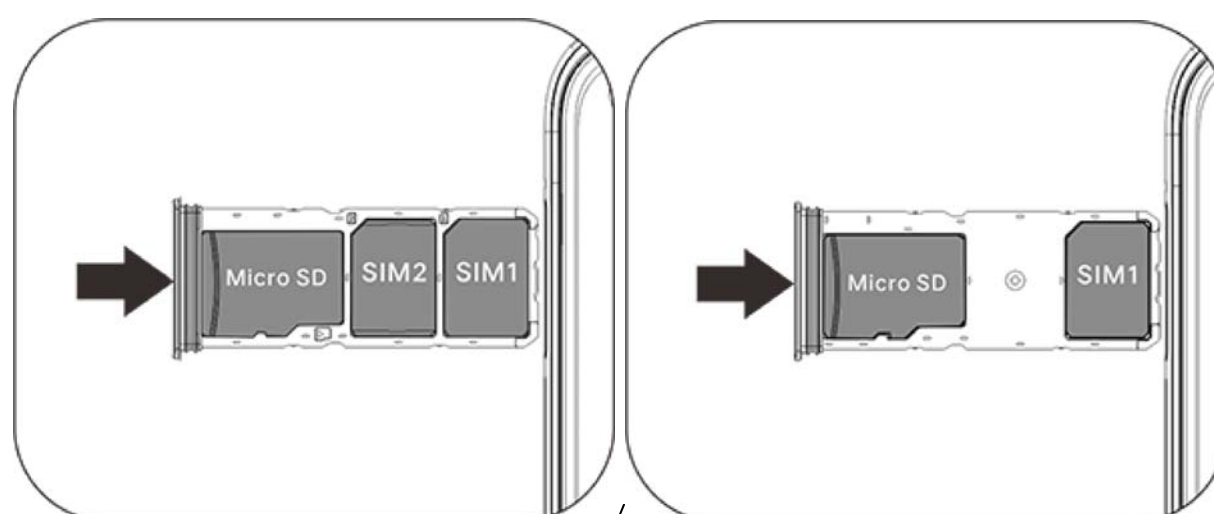

Note



1. Due to different needs across countries, some phones may be single or dual SIM. The instructions do not cover every difference between models.
2. The back cover is not removable, so as not to damage the machine.
3. Put SIM/SD card into card tray, then mount card tray into the phone. It is forbidden to insert SIM/SD card to the phone directly.
4. You are suggested not to cut your SIM card by yourself. If the Nano card (SIM1/SIM2) does not match, please go to the carrier to change a standard Nano card.
5. The phone uses a "Dual card dual standby single-pass" design, which means the two cards in the phone cannot be used in the same time for voice service nor data connection service. When one of the two cards is in voice communication, the other card cannot be used to answer any calls. If there is an incoming call to the other card, the caller may hear messages such as "The number you called is not at service", "The subscriber you dialed can not be connected for the moment, please redial later". When one of the two cards is in data connection state, the other card can use the data connection service. For this reason the above phone "Dual card dual standby single-pass" design caused, regardless of the operator's network status. Single-channel is adopted because the phone uses single-chip design, which can significantly improve the battery life and energy efficiency. The user is encouraged to consult local operators to enable services like "Missed call reminder", "Incoming call reminder" and "Secretarial service" to avoid the issue of missing calls without alerts under the aforesaid conditions.

Connect headphones

Insert the headphone plug into the headphone jack on the phone, ensuring that the headphone plug is fully inserted.

Charge phone

Insert one end of the data cable into the USB port on the phone and the other end into the charger or a compatible device. The phone will start to charge. After charging is complete, disconnect the phone from the charger or the compatible device and remove the charger from the socket.

Note

Please use the data cable and charger that came with the phone.

Antenna

This phone is equipped with a built-in antenna. Please do not touch the antenna when it is transmitting or receiving signals. Touching the antenna may affect communication quality, cause the phone to operate using a power level higher than needed as well as shorten the battery life. The antenna is located inside the circle marked with dotted lines. Please do not cover this area when holding the phone, as shown in the picture below:

A. GPS/Wi-Fi/Bluetooth antenna; B. Upper main antenna; C. Lower main antenna.



Note

The pictures used in these instructions are for reference only and may differ from your phone. Please be subject to your phone.



Screen lock and unlock















The phone will lock automatically after being idle for a certain time. You can set the duration of auto lock. You can also tap the [Power button] to lock the screen manually.

The methods used to unlock different screen locks, quickly start up applications may differ. You can follow the prompts on the screen to finish operations by using different gestures, and enjoy the pleasure of discovery.

Status bar icons and notifications

Meaning of status icons

The status bar at the top of the screen provides some basic status information of the phone, including signal strength, system time and battery power.

	Signal strength
	SIM card has no signal
	Airplane mode turned on
	Connected to Wi-Fi
2G/G/E	2G Network type icon*
3G/H/H+	3G Network type icon*
4G	4G Network type icon*
	Bluetooth activated
	Vibration mode enabled
	Silent mode enabled
	Do not disturb mode enabled
	You have a new message
	Alarm on
	Battery power
	Charging
	You have a missed call
	Location services are already turned on
	Downloading

Note

Network symbol is displayed to indicate current operators and network settings.

View notifications

When you receive a new event notification, its content will be displayed on the status bar. You can slide down the status bar and tap the notification to view details. You can slide left / right on the notification to remove it.



Shortcut Center on the home screen

You can swipe down from the top of the screen to reveal the home screen shortcut center.

In Shortcut Center, you can tap an icon to quickly turn on/off the function corresponding to that icon.

Launcher and Themes

Home screen editing

As more applications are installed, the number of your screens increases automatically. You can slide from left to right or right to left to switch between screens.

Edit home screen layout

In the standby interface, press and hold an icon, a widget or a blank area to rearrange the home screen. How to operate:

(1) Move: Hold down the application or widget and then drag it to the desired location. To move it to another screen, drag it to the screen.

(2) Merge: Hold down the application, drag it on top of another application and release finger. The two applications will be merged into a folder. You can continue to drag other applications to the folder.

(3) Tap the folder to expand it and then tap the folder name to rename it. You can also adjust the layout of apps in the folder.

Remove widgets/Delete third-party applications

Press and hold a third-party app or widget and select Remove or Uninstall in the pop-up window.

Themes



Change

Take the example of changing themes to introduce download methods. Select your desired theme under "**Themes**" interface and click "**Download**", then click "**Apply**" after download to change the current theme. After the theme has been changed, the lockscreen wallpaper, desktop wallpaper and Home screen icon style will be changed to that of the new theme by default. You can also configure the settings so that wallpapers do not change with the theme. Methods: Under the interface of "**Themes**", click "**Local** > ⚙️", switch of "**Change home screen wallpaper based on theme**" or "**Change lock screen wallpaper based on theme**".

Settings

Wi-Fi

Connected Wi-Fi

You can enable or disable Wi-Fi under "**Settings > Wi-Fi**". Choose a network connection after enabling Wi-Fi. If a Wi-Fi network is encrypted then   is displayed and you need to enter the password. When your phone is connected to a Wi-Fi network, the signal strength of the Wi-Fi network  will be displayed in the status bar at the top of the screen. The more bars you see, the stronger the signal. If there is no Wi-Fi network available, or you have disabled Wi-Fi, your phone will try to connect to the Internet via a cellular data network. Once your phone is connected to a Wi-Fi network, it will connect to the network automatically when in range.

Add network

If you want to add a Wi-Fi network that is not in the list of available networks, please choose "**Add network**" and enter networkname. You need to know the network name, password and security type before connecting to it.

Advanced

For advanced settings on a Wi-Fi network, you can tap "**Advanced**".

Mobile network

You can set the current network usage status under "**Settings > Mobile network**".

Data network

When the cellular data connection is activated, you can use network-related applications such as Browser and Email via a data network. Your operator may impose charges on the service, please consult your operator for more details.

SIM settings

1. **SIM1/SIM2:** You can modify the settings of SIM1/SIM2 in "**Dual SIMs and Mobile Network**" interface after you put to SIM cards in the phone. After startup of the device, both cards can stand by.
2. **Network Mode:** You can choose different network mode based on the type of SIM card.
3. **Data roaming:** With this feature enabled, you can connect to data service when in international roaming. Please be aware that enabling data roaming may cause considerable roaming charges.
4. **Carrier:** When you are out of range of your SIM card carriers, you can only make calls via local carriers that have roaming agreements with your SIM card carriers. You can set available carriers here. You may need to pay extra fees for the mobile services provided by these carriers.



5. **Access point name(APN):** You can set APN based on the type of you SIM card. Usually these features does not need your setting, as they are defaulted before delivery. If your SIM card has enough money loaded, then you can use these features out of box; you can connect to the Internet soon as you enabled the "**Data network**" feature. If you by accident have the features incorrectly set or the APN removed, all you need is simple tap "**Reset to default**". Cellular data networks may vary depending on the type of SIM card. Please choose the proper APN based on the local traffic plan. Please consult the network operator for details.
6. **Edit SIM:** Tap "**Edit SIM**" to edit the name of SIM card.

Other Networks and Connections

● Airplane mode

1. In the "**Settings>Other Networks and Connections**" interface, you can enable or disable the "**Airplane mode**".
2. You can swipe down from the top of the screen to reveal the home screen shortcut center. Then you can tap the "**Airplane mode**" to enable or disable this function.

⚠Note

Open the "**Airplane mode**" can save battery power.

● Personal Hotspot

1. **Hotspot configuration:** You can manually change the default network, security and password settings (You are recommended to keep the default settings).
2. **Data limit per use:** you can set the network single data limit.
3. **Number of connections allowed:** you can set the number of network allowed to connect.
4. **Other sharing mode:** Share phone network via Bluetooth/Share phone network via USB, please refer to "**Help**" to check the specific operations.

● VPN

An organization's internal VPN allows you to communicate private information securely over a public network. For example, you may need to configure a VPN to access your work emails. You can tap "**VPN**" to configure the VPN. You have to set a screen lock pattern or password before setting up this function.

● Bluetooth

You can then send data including files, contacts, pictures and music via Bluetooth.

● Smart Mirroring

1. **Local file mirroring:** This function allows you to mirror media files on your phone to be played on your device.
The phone will automatically connect to your frequently used device, or you can tap "**Search for supported devices**" to start searching, and the devices found will be displayed in the device list. After successfully connecting to a device, you can select the content you want to mirror.

⚠Note

You can tap "**Search for supported devices >?**" in the popup to check the step-by-step guidance using a TV as an example.

2. **Screen Mirroring:** Content on your phone screen can be displayed on your device synchronously. You can directly touch the screen controls on your phone to proceed.
After enabling "**Screen Mirroring**" on your phone, tap "**Search for supported devices**" to start



searching. The devices found will be displayed in the device list. After successfully connecting to a device, the content on your phone screen will display on the device.

Note

You can go to "**User guide** " to check the step-by-step guidance using a TV as an example.

● **OTG**

OTG is short for On-The-Go, OTG technology realizes data transfer among storage devices.eg. Connect digital camera to the printer, connect both devices' USB interface, we can print the photo by OTG. OTG enables you to connect external storage device with your phone. Enable "**OTG**", then you can operate pictures, videos and music files in your storage device.

Status bar and notification

Enter "**Settings > Status bar and notification**" interface, turn on the switch, and relevant prompts will be showed on the status bar.

Display and Brightness

You can adjust the system settings such as screen brightness, auto-lock time of the phone.

Note

You must enable network access on the phone before using some functions.

Home screen, lock screen and wallpaper

You can adjust the detailed settings of the phone's lock screen, home screen, and wallpaper.

Lock screen settings

You can use the built-in lock screen styles or download new styles that you like.

Home screen settings

You can adjust the detailed settings related to the home screen (such as Circular sliding screen and Dynamic icon).

Theme/Wallpaper

You can use the built-in themes/wallpapers or download and use new themes/wallpapers that you like.

Note

You must enable network access on the phone before using some functions.



Dynamic Effects

A variety of animation styles are provided under the corresponding feature. You can select and apply your favorite style.

Sound and vibration

You can set your preferred sounds profile in "**Settings > Sound and vibration**".

Jovi

You can go to a function from the Jovi interface and learn the usage of each function or adjust the detailed settings of some functions to your preference.

System navigation

Selecting "**Navigation gestures**" will hide the navigation keys; selecting "**Navigation keys**" will show the navigation keys. You can set the navigation key according to your preference at "**Settings > System navigation**".

Location

You can set for location function under "**Settings > Location**". After opening the function, apps such as Maps and Camera as well as third-party location-based apps can collect and use location data. When you do not need location data, you can disable function to save battery power.

Note

The location service will use the larger network traffic that is recommended for you to use the Wi-Fi network.

Ultra Game Mode

You can add games to Game Box manually so they can use Game Box functions. Tap the add button to select games.



Shortcuts and Accessibility

● Smart motion

You can go to "**Smart motion**" to configure the smart motion.
Ways to check Smart motion: Click menu button, refer to pop-up feature tips.

● Smart click

Open "**Smart click**", when the screen goes black, press and hold [Volume buttons -] to open self-customizable feature, this setting can't be used while the music is playing .

● Easy Touch

When "**Easy Touch**" is enabled, you can adjust the detailed settings as you like.

● Task timer

You can make detailed settings for "**Task timer**" in "**Task timer**". When you have set "**Scheduled power on/off**", your phone will turn on or off at the set time. When the set time has been reached, your phone will ask you to confirm whether you want to power off. You can choose "**Cancel**" to stop the phone from turning off. If no specific instructions are received, the phone will turn off after 60 seconds.

● One-handed

You can go to "**One-handed**" to configure this function. You can tap the switch to select whether to display one handed interface for corresponding options.

● Accessible

Using the screen reader, the zoom gesture, the screen color corrector and other accessibility functions can help you make better use of your phone.

System management

● About phone

Go to "**About phone**", You can learn a variety of information related to the phone.

For legal information, go to "**About phone > Legal Information > Regulatory compliance**".

● Customer service

You can find the phone manual, service centers, E-warranty card and other information here to make better use of your phone.

⚠Note

Before using this function, please enable network access on your phone.

● RAM and storage space



Go to "**RAM and storage space**" interface, you can check the memory usage of the storage devices, as well as format the storage devices. All data will be cleared after the phone storage has been formatted. Please make sure that you have backed up important data before formatting.

● Recent apps

After going to "**Recent apps**" and enabling "**Blur display**", you can select the recent apps to be displayed blurred in the background, or choose to enable or disable the "**Blur the display of private content**"(This option only shows when "**Blur display**" is on.).

● Global search

In "**Global search**",and then you can set the search scope .

● Download management

You can view the apps being downloaded or already downloaded to your phone.

● Smart Split

The split screen makes you handle two apps easily at the same time. On the interfaces of some apps, an incoming message will show as a floating icon. Tap the icon and the screen will split into two, and the two apps will display at the same time.

● Date and time

You can go to "**Date and time**" to configure your phone's date and time.

⚠Note

Please turn on network connection before using the "**Auto**" function.

● Language & Input

You can set the system language in "**Language & Input**". Tap "**Languages**" to choose a language. Tap "**Region**", select the appropriate.

● Backup & Reset

Backup data / Restore data: You can tap "**Backup data / Restore data**" to back up or restore your data via vivoCloud/Google server.

Reset network settings: This operation will reset all network settings, including Wi-Fi/Mobile data network/Bluetooth.

Reset all settings: The phone will be restored to factory default settings, but no data or media files will be deleted.

Erase all data: This will erase all data from your phone's System space, all settings will be restored to factory default. Before using this function, back up important data on your phone to a storage device.

Security & Privacy

Here is a collection of functional settings for the security of the phone, such as system security and privacy security. You can adjust the settings according to your personal needs.

More security settings



SIM card lock settings: You can lock SIM card to protect your privacy. When this function is enabled, each time you turn on the phone or swapping of SIM card, you need to enter a password to use the phone.

Credential storage: Some of the functions require credential files . You can use this function to install or clear credential files.

1.**Trusted credentials:** You can view trusted credential files and disable or enable them as needed.

2.**User credentials:** View the credentials you have added and delete any as needed.

3.**Install from phone storage and SD card :** You can choose to install trusted credential files from the phone storage.

4.**Clear credentials:** Clear user-installed certificate file.

Digital Wellbeing & parental controls

You can check the usage of the device here and adjust the settings of some functions to reduce the interference the device causes to you. You can also set up Parental Control to control and manage the use of the phone by your child.

Battery

You can go to "**Settings > Battery**" and set a mode according to the current status of your phone to help you save battery life while meeting your usage requirements.

Applications and Permissions

● App manager

All and services installed on your phone will be listed, you can adjust the detailed settings as you like.

● Permission management

You can use this function to manage and set app permissions

● System app settings

You can adjust the system app settings to your liking by going to "**System app settings**".

Google

You can adjust some of the functional configurations provided by Google here. Tap  on the home screen to learn about detailed solutions to related problems.



In Standby Mode, you can find entertainment, social media and other apps in the Google folder on the home screen. You may need to log in to your Google account to access some of the apps.

Accounts & Sync

Add account

To add an account, tap "**Add account**" and choose the account. You can choose to add multiple accounts.

vivo account

You need to register and log into a vivo account to use some functions on the phone. You can only log into one vivo account at a time.

Auto-sync

When "**Auto-sync**" is activated, applications can synchronize data automatically.

Note

Please turn on network connection before using this function. Auto-sync will consume power and incur data usage. It is suggested that you turn off this function after you have finished syncing.

System update

You can use "**System update**" to easily and quickly upgrade your phone system. First, enable Wi-Fi or data network. Then go to "**Settings**" and tap "**System update**". The phone will automatically detect new software version, which you can simply download and install.

Note

A recovery or system update that is not performed by Vivo may cause security risks. It is recommended that you back up important data to a storage device before upgrading. System update consume a large amount of data, you're suggested to use Wi-Fi.

App Clone

Enter into "**App Clone**", and turn on the switch of installed Apps that support such function. When the switch is on, a clone App will be generated on the screen.

Copy the application as "**II·xxx**", to distinguish the original application. This function allows you to log in with another account. No need to switch your accounts in one app.

Note

1. Uninstalling or closing the original app will also delete the cloned app and its data.
2. Double application may increase data usage, please clean up in time with iManager.
3. In view of the actual use of scenes and third-party application restrictions, this feature only supports applications logging in



with account, other applications currently don't support this function.

4. App clone could only be used on vivo's original desktop, and may not work well on other types of desktop.

Developer options

"**Developer options**" is used by Android developers. Enabling set options under "**Developer options**" may lead to crash or abnormality to your apps or device. Please use it with caution. Before use PC tool to manage the device, please enable "**USB debugging**". "**USB debugging**" switch is under "**Developer options**" menu. Steps to call up "**Developer options**" menu:

1. Enter "**Settings > System management > About phone**".
2. Click seven times at "**Software version**".
3. "**Developer options**" menu will be appeared in "**Settings > System management**".

Phone and Contacts

Calls

Smart contacts search and dial

You can dial a number using the dialpad or go to the contacts list, search for a contact and then call the number. Search methods:

1. Enter corresponding numbers for the first several letters of the name of the contact person.
2. Enter corresponding numbers for all letters of the name of the contact person.
3. Enter the contact's number.

Redial a number in call history

If you have called a contact person, in the interface of dial plate, click at the contact persons showed in the call history above the dial plate, and you can call back; You can slide down the dialpad to hide it so as to view more call logs.

Note

This action can be performed for other functions. For details, please see [Call](#) in "**Phone and Contacts > More operations**".

Dial from contacts list

You can tap  in the bottom left-hand corner of the dialpad to display the "**Contacts**" list and select a contact to call.

During calls

During a call, options will be displayed on the screen so that you can perform different actions.

Pause call



You can tap "**On hold**" to pause the current call and tap again to resume it. When a call is on hold, the cost of the call is the same as when not on hold.

Speaker

During a call, you can tap "**Speaker**" to turn on the speakerphone. You can also tap this key to change the answering method to normal answering (Using the handset earpiece) or answering with the speaker.

Adjust call volume

You can press the [Volume button] to adjust the call volume.

Turn off screen

You can press the [Power button] to turn the screen off or on. When the screen is turned off, call quality is not affected. Turning the screen off saves battery power and prevents accidental actions when touching the screen.

Calling in the background

1. You can press the [Home button] to make the call run in the background. You can then perform other actions while on the phone, such as searching for contacts. If you need to go back to the call interface, tap the green status bar at the top of the screen.
2. You can also answer or make other calls when in the middle of a call. Before using this function, please go to "**Settings > Applications and Permissions > System app settings > Call settings > Call waiting**" and enable the function.

Make or answer another call

1. If there is another incoming call, you will hear short beep sounds, and the caller information and call options will be displayed on the screen. You can choose to "**Hold & Accept**". If you answer the call, the previous call will be put on hold.
2. If you want to call another number, tap "**Add call**" and choose a contact number. When you dial the number, the previous call will be put on hold.

Note

You can tap "**Swap**" to switch between the two calls. When you talk on one line, the other line is put on hold.

Call settings

You can go to "**Settings > Applications and Permissions > System app settings > Phone**" to configure calls.

Rejection

If you do not wish to receive text messages or incoming calls from a particular contact, you can configure settings to block them.

Reject incoming calls with an SMS message

You can edit the text message to be sent to the caller when you reject the call.

SIM card



1. **Call waiting:** When this function is enabled, the network will notify the phone to send reminder sounds when there is another incoming call. You can decide whether to answer the call. When this function is disabled, the phone will not send reminder sounds when there is another incoming call, and the caller will hear a busy signal (Some networks might notify the caller that you are engaged). If you have enabled the call forwarding function, the call will be forwarded to another phone.
2. **Call forwarding:** When this function is enabled, incoming calls will be forwarded to another phone. You can choose from four options for call forwarding.
3. **Call barring:** When this function is enabled, the phone's incoming and outgoing calls will be restricted. You can set restriction conditions and levels according to your needs. You need to enter the password when enabling this function.
4. **Voicemail:** When this function is enabled, you can receive voicemail messages when the phone is turned off, when you are out of the service area or when it is inconvenient to answer calls. You will receive message reminders when you have new voicemail messages. You can tap and hold the number 1 on the dialpad to go to voicemail.
5. **Fixed Dialing Numbers:** When this function is enabled, you can only dial numbers in the "**FDN list**". The FDN list is saved on the SIM card. You need to enter PIN2 to configure the setting.
6. **Show my caller ID:** When enabled, your phone number will be displayed on the phone that receives your call.

Note

This function is provided by the carrier for users to save, forward and listen to voicemail messages. You can apply at the carrier's for a voicemail number and password. For details, please consult your carrier.

Contacts

You can tap "**Contacts**" on the home screen to display the "**Contacts**" list.

New contact

You can tap **+** in the top right-hand corner of the list to create a new contact. You will be asked whether to save the contact to the phone or SIM card .

Edit contact

Tap a contact to enter the "**Details**" interface, then tap "**Edit**" in the top right-hand corner.

Groups

You can classify contacts, add them to different "**Groups**" and send text messages to all the contacts in a group. Go to the "**Contacts**" interface and tap "**Groups**". You can then perform the following actions in the "**Groups**" list.

1. You can add a contact to a group in the following ways:
 - (1) Tap "**Not in groups**" and then select the group when enter the "**Details**" interface.
 - (2) Go to the group, tap **+**, mark one or multiple contacts in the contacts list, then tap "**Add**".
2. Remove contact from group: In a group, tap "**Remove member**" in the bottom right-hand corner, then mark one or multiple contacts to remove the contacts from the group.
3. Send SMS to group: In a group, tap "**Send SMS to group**" in the bottom left-hand corner to send a text message to all the contacts in the group.

Note

You can only add contacts stored on the phone to a "**Groups**".

Settings

Enter the "**Contacts**>" interface, you can have detailed settings.

1. **Import/Export contacts:** You can export contacts from the phone to a storage device to backup your contacts.



2. **Merge duplicate contacts:** Tap "**Merge duplicate contacts**". If contact A and B share exactly the same name and number, tap "**Merge**" to delete one of the duplicate contacts; if contact A and B share the same name or the same number, select the contacts and tap "**Merge**" to keep one contact with the data of the other contact integrated into it.

3. **Show contacts with numbers only:** After you enable this function, only the contacts with phone numbers will be displayed in the contact list.

4. **The contact list displays phone numbers:** After you enable this function, the phone number will be displayed in the contact list.

Note

You can only use "**Merge duplicate contacts**" for contacts that are stored in the same location.



More operations

Search for contact using index

If the contacts list is long, you can use the index at the right of the list to search for a contact quickly. The contacts are divided into groups according to the initial letter of their surnames. You can tap a letter in the index to go to the corresponding group.



Call

When in the "**Contacts**" list interface, you can call a contact in the following ways:

1. Slip one contact person from the right to the left, and click .
2. Tap the contact, go to the "**Details**" interface, then tap  corresponding to the contact.

Send text message

When in the "**Contacts**" list interface, you can send a text message to a contact in the following ways:

1. Slip one contact person from the right to the left, and click .
2. Tap the contact, go to the "**Details**" interface, then tap  corresponding to the contact.

Messages and Email

Messages

When in the standby mode, go to the "**Messages**" interface and choose a message to view it.

Compose message

When composing a message, you can perform actions on the message in the following ways:





1. Add recipient:

(1) Enter the recipient's number in the "**To**" input field.

(2) Search for a contact using intelligent matching. The method for intelligent matching is similar to that for intelligent searching using the dialpad. For details, please see [Smart contacts search and dial](#)



in "**Phone and Contacts**". The matched contact will be displayed at the bottom of the input field. You can tap to add it as a recipient.

- (3) Tap  next to the input field and select one or more contacts from recent contacts, contacts, groups or favorites. Select a contact, tap  to delete the contact.
2. Add picture, video or audio: Tap  All pictures, voices and videos supported by the cell phone can be sent in the way of short message.
3. Send as multimedia message: When composing the message, tap " >**Theme** ", then enter content and tap send.

Search messages

In the "**Messages**" list, you can enter a message to search in search bar.

Forward message

1. When viewing a message, tap and hold the message, then tap "... >**Forward**" in the pop-up box.
2. When viewing a message, tap "**Edit**" in the top right-hand corner of the screen, select one or more messages, then tap "**Forward**".

Call the contacts from the message

In the interface of "**Messages**" list, slip one message from the right to the left and click , and you can call the contact person who have sent the message.

Save contact from message session

In the interface of "**Messages**" list, long press one contact person, click "**Add to Contacts**" in the pop-up box.

Email

Add account

You need to log in to an email account before using email. Enter your email address and password, and tap "**Sign in**" to access your inbox.

You can add multiple email accounts in the following ways:

1. In the "**Email**" screen, tap , tap a logged in account, and then tap "**Add an email account**" in the pop-up.
2. In the "**Me**" screen, tap "**Add an email account**".

Settings

In the "**Me**" screen, tap a logged in account to adjust the detailed settings of this account. Tap "**Settings**" to adjust the settings of your mailbox.

Delete email

You can delete an email in the following ways:

1. In the inbox list screen, press and hold the email you want to delete and tap "**Delete**";
2. In the read email content screen, tap ;
3. The deleted email will be moved to "**Trash**". If you wish to delete the email permanently, please delete it again in "**Trash**".



Tools

Calculator

Enter "**Calculator>Calculate**" interface. Tap numbers and functions just like you would with a standard calculator. The standard calculator is displayed by default. You can hold the phone horizontally to display the scientific calculator.

In "**Calculator>Exchange rate**", you can convert an amount of money from one currency into another according to the latest foreign exchange rates.

Notes

In the "**Notes**" screen or notes list interface, tap "**New Note**".

Share or Save note

In the view notes screen, tap  to choose to share/save the note.

Deleting notes

You can delete a note in the following ways:

1. Long press a note, then tap "**Delete**" in the pop-up window.
2. In the "**Notes**" screen, tap "**Edit**", mark one or more notes, and then tap "**Delete**".
3. Tap  in the view notes interface.

Recorder

The recorder allows you to use the built-in microphone and use the phone as a portable recording device. Enter "**Recorder**" interface. You can then perform the following operations on the recorder:

Tap  to start recording. Tap  to pause recording, and tap  to stop and save recording.

Play recording

Choose a recording file, then tap  to play/pause.

Drag the slider on the progress bar to go forwards or backwards.

Deleting recordings

1. Long press a recording file, then tap "**Delete**" in the pop-up window.
2. Tap "**Edit**", select the recording files you want to delete, and then tap "**Delete**".



Share recording

Long press a recording file, then tap "**Share**" in the pop-up window.

Set recording as ringtone

Long press a recording file, then tap "**More >Set as ringtone**" in the pop-up window to set it as the ringtone.

Compass

You can check out directions, longitude, latitude, and the horizontal line with the compass. Before using the function, please make sure your phone is in horizontal condition and away from electromagnetic interference, to ensure accuracy.

Note



1. Please turn on network connection and location service before checking your current location.
2. When under severe interference, the compass will be switched to the calibration window; the compass will resume after calibration.
3. The digital compass can only be used to assist navigation. Please do not use it to determine an accurate location, proximity, distance or directions.

FM Radio

In the standby mode, enter the "**Tools > FM Radio**" interface, connect headphones, then tap  to activate the recorder.

Search

You can search for channels in the following ways:

1. Tap  /  to search for the channel closest to the left/right of the current channel.
2. Tap  to enter the "**All channels**" list. Tap "**Search**" to start searching. You can choose whether to save and update favorite channels during searching.



Delete channel

You can delete a channel in the following ways:

1. Tap  to enter the "**All channels**" list. Long press a channel, then choose "**Delete channel**" in the pop-up window.
2. Tap "**Edit**", mark one or more channels, then tap "**Delete**".

Favorites

You can save your favorite channels in the following ways:

1. If the current channel is not saved as a favorite, tap  in the bottom of the screen to add it to favorites.
2. Tap  to enter the "**All channels**" list. Choose a channel and tap  to save as a favorite.

Do not save to Favorites

You can cancel a favorite in the following ways:

1. In the "**FM Radio**" interface, long press a favorite channel, then choose "**Do not save to**



Favorites" in the pop-up window.

2. Tap  to enter the "**All channels**" list. Choose a channel and tap  to Cancel favorites.





i Manager

From the iManager home page, tap  to go to the "**Settings**", where you can adjust the detailed settings of iManager and view more relevant information.

You can tap any function as you need on the home screen of iManager to enter the Execute or Settings interface, providing you with a safe, green mobile life.

Clock

The clock consists of four functions:

1. **Alarm:** You can tap  to add several alarm clocks. In the interface of alarm clock, click at , You can finish detailed settings according to your habits.
2. **World Clock:** You can tap  to add times for different cities.
3. **Stopwatch:** Click  to start timing, and click  to time respectively.
4. **Timer:** You can use the timer as a countdown clock.

Calendar

Tap "**Calendar**" on the home screen to enter the "**Calendar**" interface. You can perform the following operations.

Events

Select a day and click the  to create new activities. Once the time is up, the cell phone will remind you. To delete an activity, tap "**Event**", and then long press the content you want to delete.

Settings

Enter the "**Calendar**>" interface, you can have detailed settings.

How to take a screenshot

1. Take a quick screenshot: Simultaneously hold down the [Volume button-] and the [Power button] to take a screenshot. The phone will save what is displayed on the screen.
2. **S-capture:** Tap "**S-capture**" in the Shortcut Center on the home screen to enable the S-capture function. Please follow the onscreen instructions.



Instructions for connecting to USB

Connect to your computer using a USB cable, slide down to show the notification bar, select "**Files**" and then you can manage the files on your phone using the computer.

Windows

1. With Windows 7 and above, users do not need to install any drivers. You can double click "**Computer**" (Win 7) or "**This Computer**" (Win 10) on the desktop to view your device, and then double-click it to copy and manage the files on your phone.
2. With Windows XP, users need to install the MTP driver. Go to www.vivo.com on your computer, select the "**Service**" tab, and type "**USB**" in the search box to find the link for the MTP driver. Download and install the driver to manage the files on your phone using your computer.

Note

To use the function properly, computers running Windows XP need to install Windows Media Player 11 or above.

Mac

1. Mac OS users need to download "AndroidFileTransfer.dmg" to manage the phone files.
2. Visit vivo official website www.vivo.com, select "**Service**" page, and click on "**USB**" download the Mac system MTP management tool. After the download is completed, you can open it to use the computer to manage the phone files.

Linux

Manage the phone files using mtpfs software:

1. Install tool "sudo apt-get install mtp-tools mtpfs";
2. Create new directory "sudo mkdir /media/mtp";
3. Modify the directory permission "sudo chmod 755 /media/mtp";
4. Install device "sudo mtpfs -o allow_other /media/mtp", then you can manage the phone files in the file manager;
5. Unload device "sudo umount /media/mtp".

During installation, do not disconnect the USB data cable between the phone and the computer. If it cannot be used after being installed, please restart the computer or reinstall.

Weather

Add city

Tap  to go to "**City management**", and then tap  in the upper right corner to add more cities.

Auto-location

The current city will be located when "**Auto-location**" is on at "**City management**" window.

View weather condition

When several cities are added, you can view weather conditions of those cities by sliding the screen to the right or left.



Change the order of cities

Click  to enter "**City management**", hold down , and drag the city up and down, you can adjust the order of cities.

Deleted city

At "**City management**", long press the city, and click "**Delete**" at the pop-up box.

Note

Please turn on network connection before using "**Auto-location**".

EasyShare

EasyShare neither consumes data nor requires a Wi-Fi connection. You can send/receive files via this function.

An introduction to some features

Phone Clone : You can use "  > **Phone Clone** " to quickly import data from your old phone to this phone without data consumption.

Web Share: This function supports data transfer between the phone and a computer. You can go to the "  > **Web Share** " page and follow the instructions shown.

Play Store

After logging in, you can find the latest Android apps, games, movies, music and other amazing content. You can search for and download any content according to your personal needs.

Note

Please connect to the Internet and log in to your Google account before use.

vivo.com

You can learn more about vivo and our products in "**Home/Shop**". You can also provide your feedback on the "**Support**" page and find solutions to common problems.

Note

Before using this function, please enable network access on your phone.



Multimedia

Music

You do not need to add song manually. The mobile phone will scan for songs on the storage device automatically when turned on and add them to "**Music**".

Lists

After tapping "**Music > Lists**" on the home screen, you can tap "**Create playlist**" to customize a song list containing your favorite songs.

1. You can add song to custom playlists in the following ways:

Go to the "**Songs**" list, tap and hold a song and tap "**Add to playlist**" in the pop-up window.

2. Edit song list: Go into a custom song list, press "**Manage songs**", mark one or more songs, then tap "**Add to the playlist/Remove**".

3. Delete song list: Tap and hold a custom song list, then tap "**Delete**" in the pop-up window.

Deleting a custom song list will not delete any songs.

Settings

Enter the ☰ interface, you can have detailed settings.

Video

You do not need to add videos manually. When you boot the phone, it will automatically scan the videos saved in storage devices and add them to "**Videos**". Tap "**Video**" on Home to access the "**Videos**" list interface, and tap a video to play it. During the video play process, you can lightly tap the screen to show or hide control buttons, which allow you to modify the video settings.

Camera

1. Use the camera to take photos and videos so that you can record the wonderful moments in your life anytime.

2. Go to "**Camera**" interface and you can zoom the camera frame in/out and adjust the focal length in the following ways:

(1) Use two fingers to zoom in/out on the screen;

(2) The camera can automatically focus on objects and displays a rectangular box to indicate focus area. You can also tap the screen to manually set the focus position and lock the focused area onto the objects you want to highlight.

Albums



You can view the photos and videos you have captured and the various images stored on your storage devices. Photos and videos taken by the camera of your phone will be stored in "**File Manager > Local files > DCIM > Camera**" folder; To find photos already moved to your File Safe, go to "**File Manager > File safe > Pictures**".

Note

Picture location information is only available for pictures which include geographical location information.

Slideshow

1. Go to "**Photo**", open a photo/video, tap "**More > Slideshow**".
2. Go to "**Albums**", open a photo/video in a folder, tap "**More > Slideshow**".

Share and delete

1. In the "**Photo**" screen, tap "**Edit**" or press and hold a photo/video to enter the editing mode; select multiple photos or videos, and tap "**Share**" or "**Delete**";
2. In the "**Albums**" screen, go to a folder, tap "**Edit**" or press and hold a photo/video to enter the editing mode; select multiple photos or videos, and tap "**Share**" or "**Delete**".

Edit image

In the "**Photo**" or "**Albums**" screen, open an image to view, tap the view image screen to show/hide buttons and edit the image.

File Manager

Enter the "**File Manager > Local files**" interface. You can organize the folders. Tap and hold a file/file folder to operate.

Device Maintenance

About maintenance

It is important to understand mobile phone maintenance and servicing thoroughly so that you can use your phone safely and effectively and extend its service life as much as possible. For details on maintenance and troubleshooting, please refer to "Important Information and Warranty Card".

Phone and accessories

This phone uses the Android operating system.



There are two industry standards for the earphone interface. Using the two standards together will result in low volume or noise due to incompatible hardware. If sound is normal when you insert your earphones into the vivo mobile phone, but the abnormal sounds described above occur when your earphones are inserted into other phones or audio devices, then your earphones are not compatible with the device interface. If this occurs, long press the key in the MIC shell of the earphones.

Ultra high volume may cause damage to your hearing.

Using your earphones at high volumes for long periods of time when listening to music or making calls may result in ear discomfort or damage to your hearing.

When using the earphones while walking or moving around, please ensure that the earphone cord will not become tangled with your arms or nearby objects.

Electrostatic energy may build up in the earphones when used in dry environments. Your ears may suffer electrostatic shocks. Before connecting the earphones to the mobile phone, you can wash your hands or touch unpainted metal objects to discharge the electrostatic energy.

The phone is not waterproof. Keep your phone and its accessories dry. Rain, humid air, liquids and water may contain minerals which can corrode the electronic circuit.

Dust may damage your mobile phone. Do not use or store your phone in dusty or dirty places.

Do not use or store the phone in a very hot environment. High temperatures may shorten the lifespan of the phone, damage the battery or deform or melt certain plastic parts.

Do not use or store the phone in a very cold environment. This generates moisture in the mobile phone when its temperature returns to normal, damaging the circuit board.

Avoid dropping, hitting or shaking the phone. Mishandling your mobile phone may cause the screen to crack or damage the internal circuit board and its intricate structure.

Do not use chemical solvents or detergents to clean your phone. To clean your phone, wipe the phone's shell gently using a soft cotton cloth dampened with water or neutral soap.

Use a clean and dry soft cloth to clean the lenses (Such as the lens of the camera) and the display screen.

Do not use paint to coat the phone. Paint may obstruct parts and affect the phone's normal operation.

If you encounter any crashes or errors when using the phone, please follow the instructions as follows: for the phone can not remove the battery, please simultaneously long press [Power button] and [Volume button -] for 10 seconds or more, the phone will be forced to restart (when the phone restarts, release the hand), by this way you can solve the common faults.

A backup should be made for data that you need to keep (Such as contacts and important information).

Unplug the charger from the power socket when it is not in use. Do not keep the battery connected to the charger for extended periods when it is fully charged, as overcharging may shorten the lifespan of the battery.

Help

If you encounter any problems when using your phone, contact your network carrier or contact vivo after-sales service center. Please enter "**Settings > System management > Customer service > Service Center**" interface to find service hotline.



Supported file formats

Video recordings	mp4
Pictures	png 、 jpg 、 bmp 、 gif
Sound recordings	m4a
Music	mp3、 ogg 、 wav 、 midi 、 flac 、 ape 、 wma 、 m4a 、 aac、 amr、 awb、 mp2
Video	avi、 mp4、 3gp、 wmv

