

Human Salvage

Computer and
instruments aid
rehabilitation

(photo, right)

SOLID-STATE MICROWAVES

Design procedure for
using varactors

MUSCLE VOLTAGE MOVES HAND

Needs four-stage
transistor amplifier

PULSE-WIDTH MODULATOR

Achieving precision
without high cost

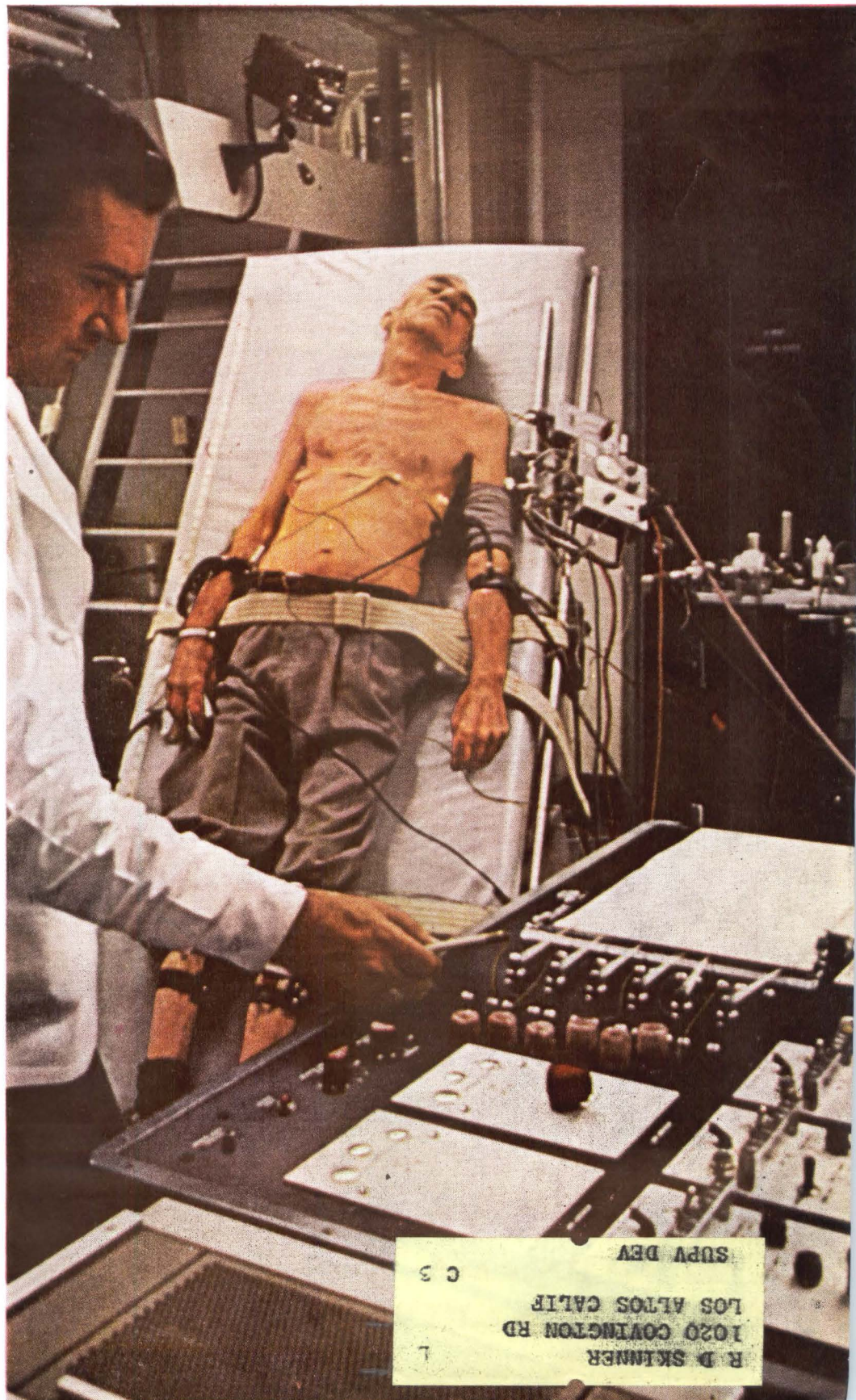

R. D. SKINNER
1020 COVINGTON RD
LOS ALAMOS CALIF
C 3
SUPV DEV



HERMETICALLY SEALED
NOW to MIL-T-27B

VARIABLE INDUCTORS

HIGH-Q plus HIGHEST STABILITY

IMMEDIATE DELIVERY FROM STOCK

For almost a third of a century UTC has pioneered in the development of transformers, electric wave filters, high Q coils, magamps and similar iron core components. Highest engineering talent plus the most complete facilities for research and testing has made UTC the leading

supplier in the industry for both stock and custom built components. UTC Variductors (stock variable inductors) have served as a simple solution to tuned circuit for almost 20 years . . . for oscillators, equalizers, filters, tuned radio circuits, etc.

NEW! - VERNIER

HVV VARIDUCTOR™ HERMETICALLY SEALED

**NARROW
 RANGE**

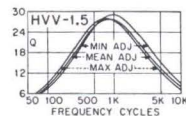

INDUCTANCE - HYS	HVV-1.5
MAX ADJ.	
MEAN ADJ.	
MIN ADJ.	

The HVV Variductors have been designed to emphasize extremely high stability with temperature, level, shock and vibration commensurate with the highest obtainable Q. They are ideal for precise matching to other components such as capacitors with standard 10% tolerance. Units are provided with a vernier adjustment variation of $\pm 10\%$ through 900° rotation of adjustment screw on top of case. Setting is positive. There are 12 units in the stock line with mean inductances ranging from .006 Hy to 150 Hys. Specific mean inductances other than stock items are available on special order. Manufactured and guaranteed to MIL-T-27B, MIL type TF4RX20YY. Drawn metal case: 1 1/8" long, 25/32" wide, 1-7/32" high (including adjustment screw); weight: 2 ounces. Effective Q over a wide frequency range and variation of inductance with applied AC voltage are illustrated for a typical unit. Patent pending.

HVC VARIDUCTOR™ HERMETICALLY SEALED

**WIDE
 RANGE**

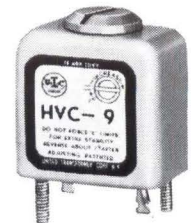

HVC units are usable over a wide frequency range and have high stability with temperature and voltage change. Nominal inductance values of 12 stock units in series range from .006 Hy to 150 Hys. The variable inductance range of each unit is +200%, -70% of nominal value through 900° rotation of adjusting screw on top of case. Setting is positive. Case size and weight is the same as HVV. U.S. Patent No. 2,879,489.

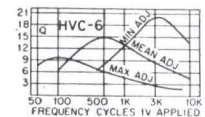

TVC VARIDUCTOR™

TVC Variductors are identical to the HVC units, but provide taps at 30% and 50% of total turns. Different taps are available on special order. U.S. Patent No. 2,879,489.

**WIDE
 RANGE**

VIC VARIDUCTOR™ COMMERCIAL GRADE

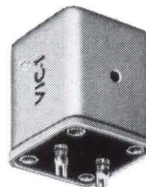

Nominal inductance values of 22 stock items in this series range from .0085 Hy to 130 Hys. Mean inductance may be varied +85%, -45% through 600° rotation of adjustment screw in side of case. Rugged die cast case: 1-11/13" long, 1 1/4" wide, 1-7/16" high; weight 5 1/2 ounces.

**AND "SPECIAL" CUSTOM BUILT UNITS
 TO YOUR SPECIFICATIONS**

Write for catalog of over
 1,200 UTC HIGH RELIABILITY
 STOCK ITEMS
 IMMEDIATELY AVAILABLE
 from your local distributor.



UNITED TRANSFORMER CORP.

150 VARICK STREET, NEW YORK 13, N. Y.

PACIFIC MFG. DIVISION: 3630 EASTHAM DRIVE, CULVER CITY, CALIF.
 EXPORT DIVISION: 13 EAST 40th STREET, NEW YORK 16, N. Y. CABLE: "ARLAB"

W. W. MacDONALD, Editor
Telephone Area Code 212 (971-2645)

J. M. CARROLL, Managing Editor (2293)

SENIOR EDITORS

Samuel Weber (2371)
George W. Sideris (3444)

SENIOR ASSOCIATE EDITORS

Michael F. Wolff (2600)
John F. Mason (2666)

ASSOCIATE EDITORS

Michael F. Tomaino (2071)
William P. O'Brien (2297)
George J. Flynn (2188)
George V. Novotny (3151)
Leon H. Dulberger (3446)
Alexander A. McKenzie (2685)

ASSISTANT EDITORS

Stephen B. Gray (2245)
Barry A. Briskman (2306)
Dan Smith (2467)
Joel A. Strasser (2127)

REGIONAL EDITORS

Harold C. Hood,
1125 W. 6th St., Los Angeles 90017, Calif.
(213-482-5450)
Laurence D. Shergalis,
John Hancock Bldg., 255 California St.,
San Francisco 94111, Calif. (415-362-4600)
Thomas Maguire
McGraw-Hill Bldg., 607 Boylston St.,
Boston 02116, Mass. (617-262-1160)
Cletus M. Wiley,
Blair Bldg., 645 N. Michigan Ave.,
Chicago 60611, Ill. (312-664-5800)

ART DIRECTOR

Howard R. Berry (2430)

ASSISTANT ART DIRECTOR

John C. Wright, Jr. (3430)

EDITORIAL ASSISTANTS

Lorraine Rossi, Virginia T. Bastian,
Lynn Emery, Ann Mella, Lorraine Werner,
Alice M. O'Brien, Sharon Parks,
Claire Benell, Kay Fontana

FOREIGN NEWS BUREAU

DIRECTOR, John Wilhelm, (2532);
Lawrence Mihlon (2997), Alyne Elias
(2998)

LONDON—John Shinn, Derek Barlow,
Nicholas Landon, 34 Dover St., London
W.1, England

BONN—Bruce Bendow, Richard Mikton,
Silke McQueen, Mittelstrasse 39, Bad
Godesberg, Germany

BRUSSELS—27 Rue Ducarle, Brussels,
Belgium

PARIS—Robert Farrell, Arthur Erikson,
17 Ave. Matignon, 3rd Fl., Paris 8,
France

MILAN—Marc A. Messina, Via Manzoni
No. 12, Milan, Italy

MEXICO CITY—Wesley Perry, Jr.,
Lafragua 4-314, Mexico 1 D.F. Mexico

RIO DE JANEIRO—Leslie Warren, Rua
Mexico 3-S/1507 1509, Rio de Janeiro,
Brazil

MOSCOW—Stewart Ramsey,
Kutuzovsky Prospekt 19, Apt. 28-29,
Moscow, USSR

TOKYO—Richard Halloran, Charles Cohen,
John Yamaguchi, Toranomon Sangyo
Bldg., 1 Kotohiracho Shiba, Minato-Ku,
Tokyo, Japan

CIRCULATION MANAGER

Hugh J. Quinn (2310)

C. C. RANDOLPH, Publisher (2016)

electronics

A MCGRAW-HILL WEEKLY 75 CENTS

SENSITIVE INSTRUMENTS and IBM data-processing equipment are used at the Texas Institute for Rehabilitation and Research, Houston, to get fast, frequent checks on patients and produce a quickly retrievable health record. *Interrelated changes among physiological parameters are useful to diagnosticians and result in more efficient management of long-term illness and injury. See p 10*

COVER

MEDICAL HUMANETICS. The hospital of tomorrow, in operation today in Texas, uses advanced diagnostic equipment and computer analysis in rehabilitating disease or injury-crippled patients. *Researchers call the new approach to treating the patient in mind and body "medical humanetics"*

10

BRITISH AIR-TRAFFIC CONTROL. By 1968, the British plan to have two multicomputer centers in operation, winnowing radar reports to direct control of air traffic over the British Isles. *For now, radar will report to computers; in the future, the computers may control radar so their beams can search, track and command planes*

14

SOLID-STATE MICROWAVE GENERATORS. To get high microwave power using only solid-state components it is necessary to start with high power and low frequency and multiply using tuned circuits. The varactor is widely used in these circuits but its nonlinearity creates design problems. *This step-by-step design procedure shows how to cope with them.*

By D. O. Fairley, Lenkurt Electric 23

INEXPENSIVE PULSE-WIDTH MODULATION. Like most pwm circuits, this one linearly charges and discharges a capacitor. But it avoids using precision components and power supplies. *It uses instead a precision high-speed comparator and a two-mode ramp generator.*

By H. Schmid and B. Grindle, General Electric 29

CAPACITANCE CHARGES FOR SPACE SYSTEMS. Plasma engines, pulsed lasers and some thermonuclear devices all require charging a capacitor bank periodically. *Use of high-power silicon controlled rectifiers saves weight and power when the ratio of charging period to supply frequency is high.*

By F. Ellern, Republic Aviation 32

Published weekly, with Electronics Buyers' Guide as part of the subscription, by McGraw-Hill Publishing Company, Inc. Founder: James H. McGraw (1860-1948).

Title ® registered U.S. Patent Office; © copyright 1963 by McGraw-Hill Publishing Co., Inc. All rights reserved, including the right to reproduce the contents of this publication, in whole or in part.

Executive, editorial, circulation and advertising offices: McGraw-Hill Building, 330 West 42nd Street, New York, N. Y., 10036. Telephone Area Code 212 971-3333. Teletype TWX N. Y. 212-640-4646. Cable McGrawhill, N. Y. PRINTED IN ALBANY, N. Y.; second class postage paid at Albany, N. Y.

OFFICERS OF THE PUBLICATIONS DIVISION: Shelton Fisher, President; Vice Presidents: Joseph H. Allen, Operations; John R. Callahan, Editorial; Ervin E. DeGraff, Circulation; Donald C. McGraw, Jr., Advertising Sales; Angelo R. Venezian, Marketing.

OFFICERS OF THE CORPORATION: Donald C. McGraw, President; Hugh J. Kelly, Harry L. Waddell, L. Keith Goodrich, Executive Vice Presidents; John L. McGraw, Treasurer; John J. Cooke, Vice President and Secretary.

Subscriptions are solicited only from those actively engaged in the field of the publication. Position and company connection must be indicated on orders. Subscription rates: United States and Possessions and Canada, \$6.00 one year, \$9.00 two years, \$12.00 three years. All other countries \$20.00 one year. Single copies, United States and Possessions and Canada 75¢. Single copies all other countries \$1.50.

THE PUBLISHER, UPON WRITTEN REQUEST TO OUR NEW YORK OFFICE FROM ANY SUBSCRIBER, AGREES TO REFUND THAT PART OF THE SUBSCRIPTION PRICE APPLYING TO COPIES NOT YET MAILED.

Subscribers: Please send change of address notices, subscription orders or complaints to Fulfillment Manager, Electronics, at the address below. Change of address notices should provide old as well as new address, including postal zone number if any. If possible, attach address label from recent issue. Allow one month for change to become effective.

Postmaster: Please send Form 3579 to Fulfillment Manager, Electronics, P. O. Box 430, Hightstown, New Jersey, 08520.



Audited Paid Circulation



Contents continued

MUSCLE VOLTAGE MOVES ARTIFICIAL HAND. Muscles in stumps of amputated limbs generate electric potentials that can be used to control the movement of artificial limbs. Signals are sent to a transistor differential amplifier, band-pass amplifier and integrator; an output relay controls voltage fed to a 1/60-hp motor. By G. W. Horn, Consulting Engineer 34

ACTIVE THIN-FILM DEVICES. Active thin-film components can now handle most circuit needs up to 10 Mc, should be in operational use in a few years. Two weeks from now, ECCANE meeting will also hear how an oxide layer can store charges and control transistors 41

COMMUNICATIONS. While the Russians may be aiming at telepathic links on the moon, we figure good old vhf will do the job. Other news at Paris conference: The French have an interferometer antenna that covers a two-octave bandwidth 42

POWER-SUPPLY TROUBLE. The lack of suitable electrical and propulsion power plants means interplanetary trips are at least 20 years away. Besides, no money has been committed for the flight 42

DEPARTMENTS

Crosstalk. A Huge Amorphous Mass 5
Comment. Heat Flow Patterns. Thermal Resistance 6
Electronics Newsletter. Pentagon May Pay for Civilian Product Studies 17
Meetings Ahead. Scintillation and Semiconductor Counter Symposium 18
Washington This Week. Senate Committee Wants Defense Contracts Channeled Into Distressed Areas 20
Research and Development. Vocal Analog Synthesizes Speech 46
Components and Materials. Bright Future Seen for Organics 51
Production Techniques. Pulses Control Soldering Quality 57
New Products. Printed-Circuit Readouts Feature Modular Design 63
Literature of the Week 70
People and Plants. Esterline Angus Elects V-P's 72
Index to Advertisers 81

New from Sprague!

**GERMANIUM
P-N-P 2N2962**

**Extends High-Efficiency
ECDC® Transistor Performance to
VHF POWER RANGE**

- High Voltage—40 Volts
- High f_T —800 mc (typ.)
- Isolated Mounting Stud offers Design Freedom



TYPE	V_{CES}	$P_G @ 160 \text{ mc}$	$P_O @ 160 \text{ mc}$
2N2962	40 V	6 db	.5 W
2N2963	40 V	5 db	.5 W
2N2964	30 V	6 db	.5 W
2N2965	30 V	5 db	.5 W

For application engineering assistance, write to Transistor Division, Sprague Electric Co., Concord, N. H. For technical data, write for Engineering Bulletins 30,452 and 30,454 to Technical Literature Service, Sprague Electric Co., 35 Marshall St., North Adams, Mass.

SPRAGUE COMPONENTS

TRANSISTORS
CAPACITORS
RESISTORS
MICROCIRCUITS
INTERFERENCE FILTERS

PULSE TRANSFORMERS
PIEZOELECTRIC CERAMICS
PULSE-FORMING NETWORKS
TOROIDAL INDUCTORS
ELECTRIC WAVE FILTERS

CERAMIC-BASE PRINTED NETWORKS
PACKAGED COMPONENT ASSEMBLIES
BOBBIN and TAPE WOUND MAGNETIC CORES
SILICON RECTIFIER GATE CONTROLS
FUNCTIONAL DIGITAL CIRCUITS



*Sprague' and '®' are registered trademarks of the Sprague Electric Co.

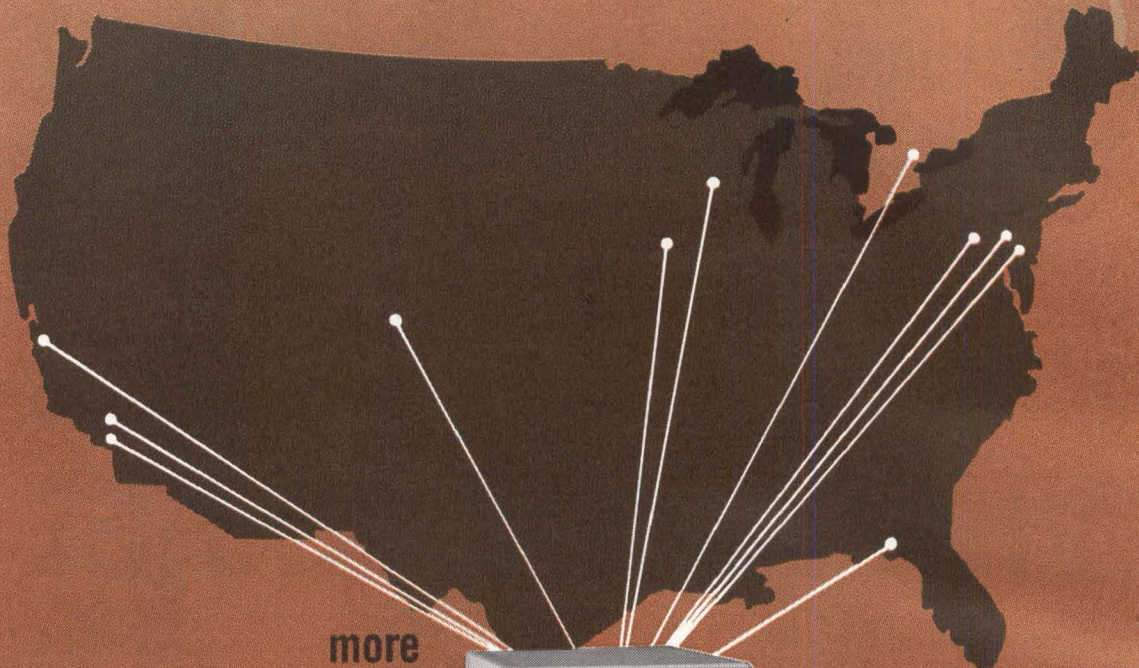

more
than
two years
of proof
in the
nation's
top
standards
labs:



- dc through 12.4 GC
- 10 to 1500 watts
- guaranteed 1% accuracy through 1000 watts
- easy to use, fast

TODAY'S MOST ACCURATE CALORIMETER!

Sierra's 290C Calorimeter, incorporating ac wattmeter, calorimeter and heat exchanger in one rack, plus separate dual loads, measures power 30 to 1000 watts with 1% limit of error... and a probable accuracy better than 0.5%. And it lets you measure power 10 to 1500 watts with 2% to 3% accuracy. Operation is in a null balance mode for *accuracy*, direct-reading mode for *speed*, and differential mode for *convenience*.

Readout in the direct-reading mode is 60 seconds or less, and the 290C Calorimeter is extremely easy to use.

Call your Sierra representative or write direct for full details on the 290C and other power measuring instrumentation representing today's most significant advances in the state of the art. Sierra Model 290C Calorimeter, \$4,500.

DUAL WATER LOADS FOR THE 290C

Model	Frequency	Max. VSWR	Price
286B	dc-4 GC	1.25	\$1600
NEW —287A-SC	4-5.8 GC	1.1	1600
287A-C	5.8-8.2 GC	1.1	1600
287A-XB	7-10 GC	1.1	1550
287A-X	8.2-12.4 GC	1.1	1500

PHILCO
A SUBSIDIARY OF Ford Motor Company.



SIERRA ELECTRONIC DIV.

8080 Bohannon Drive • Menlo Park, 1, California
Area Code 415 • DAVenport 6-2060

Sales representatives in all principal areas

8080

A Huge Amorphous Mass

INFORMATION RETRIEVAL has already generated considerable activity within the electronics industry and it is likely to generate even more. We are in favor of any worthwhile activity that will stimulate development, production and sale of electronic equipment. But sometimes it is necessary to speak out against a proposal that could do the industry more harm than good.

Such a proposal, if we understand it correctly, is H.R. 1946, introduced in Congress by Representative Roman C. Pucinski (D.-Ill). The bill would amend title IX of the National Defense Education Act of 1958 to provide for an all-inclusive Science Information Data Processing Center to be located at one place, in Chicago.

We believe Mr. Pucinski's proposal is a good one in principle but a bad one in practice, and that if it were implemented its almost inevitable failure could set the whole IR business back a decade or more.

There is abundant evidence that the performance of an IR system diminishes with increasing size and, especially, with breadth of coverage. A single, centralized national system probably could not deliver acceptable performance. Also, the effectiveness of such a system rises in proportion to the specialized subject knowledge of the operators. It seems unlikely that the Federal government could attract to any one place, and hold, the number and quality of experts in many diverse fields necessary to operate the system successfully.

Most civilian effort in IR has been supported by the Office of Scientific Information Services of the National Science Foundation, but this support has so far been for research, not implementation. We urge, like Pucinski, that substantial Federal support of implementation be made a matter of public policy, and that the National Defense Education Act of 1958 be so amended. But right there is where we appear to part company.

The Office of Science Information Services might well be given overall responsibility. However, we believe that the role of OSIS should be limited to setting policy and providing secretariat services for a national effort. The actual IR function should be organized on a field-of-interest basis, with the responsibility for maintaining each field-of-interest system assigned to the professional society, university, research institute or other civilian agency most capable of undertaking the work. In this way, public money will advance the public interest, not only by subsidizing a national IR system but also by helping to support worthy institutions.

Each individual IR center should be located near a principal academic community for that discipline. The centers should be linked by the most modern



digital communications network. Thus a requestor would have at his fingertips the keys to several efficient centers, each serving a discipline that impinges on his query rather than having to address his inquiry to a huge amorphous mass whose accuracy might be questionable and whose effectiveness could be dubious.

Let's beef up existing developmental IR systems in special fields of interest and fill in the gaps. Then integrate them with a modern communications system. The communications center could, indeed, be in a city such as Chicago.

Coming In Our October 18 Issue

ULTRASONICS. A leading authority on ultrasonics, W. P. Mason, of Bell Telephone Labs, will report next week on the state of the ultrasonic art.

This is no ordinary review of the applications for ultrasonics in detection, communications, manufacturing and research. Mason orients his report toward the latest and most significant advances—present and promising—in materials, components and techniques.

These developments are not only improving transducers for equipment such as sonar and ultrasonic cleaners. They are also influencing the design of radar and other equipments requiring such components as filters, delay lines and oscillators. For example, the problem of attenuation in delay lines may soon be eliminated by piezoelectric semiconductor amplifiers.

Among other interesting and useful articles next week will be:

- A self-modulation technique for klystrons. A simple tuned circuit can replace an external modulator and power supply
- Ways to combine tunnel diodes and charge-storage diodes into nanosecond logic circuits with improved characteristics
- Cook-book design methods for determining resistance values in transistor switches. With the equations, worst-case d-c design can be calculated
- Radar that uses a color-tv picture tube to show the ppi map and moving targets in contrasting colors.

now
available
for
immediate
delivery:

**JERROLD
RF SWEEP
EQUIPMENT
...the industry's
finest!**



**Model 900B
Super Sweep Generator**

Wide plus narrow band in one versatile instrument. Handles all IF, VHF, UHF sweep requirements. Sweep widths from 10kc to 400mc. Frequency range from 500kc to 1,200mc. Built-in crystal-controlled harmonic markers, dc or ac scope preamplifier, precision attenuator. **\$1,980.00**



**Model LA-5100
rf Log Amplifier**

Accurate within ± 1 db over 80db dynamic range. Frequency range 500kc to 100mc. Lets you make exact measurements of attenuation in networks, filters, amplifiers with dynamic ranges down to 85 db. Total rf response displayed in precise log ratio on standard dc-coupled scope. **\$795.00**

Model 900A Wide-Band Sweeper

Sweep widths from 100kc to 400mc. Frequency range from 500kc to 1,200mc. **\$1,260.00**

Model 707 Ultra-Flat Sweeper

Flatness of ± 0.05 db in highest single octave. Plug-in oscillator heads. **\$840.00**

All for immediate delivery. Prices f.o.b. Philadelphia. Write for complete technical data on these and other Jerrold rf test instruments.



Industrial Products
Division,
Philadelphia 32, Pa.

A subsidiary of THE JERROLD CORPORATION

COMMENT

HEAT FLOW PATTERNS

Today I saw the . . . August 23 *ELECTRONICS*. I am quite pleased both with the outcome of the cover and with the *Components and Materials* rewrite inside, Phosphors Trace Heat Flow Patterns (p 40). . . .

Apparently you . . . judged accurately that interest would be high. The first paper, first session, was presented to a nearly full hall of very interested people at WESCON. For nearly two hours after the presentation, I was talking to interested persons outside the hall. . . .

Again, thank you for an efficient reporting job. It is certainly a pleasure to deal with a situation and people where everything works without errors, like well-oiled machinery.

HENRY D. FRAZIER

Rolling Hills Estates, California

THERMAL RESISTANCE

I am especially interested in some of Harold Bauman's comments with regard to MIL-SPECS (p 4, June 14). There appear to be about 130 current MIL-SPECS on transistors, of which 42 are JAN types (reference: June 1963 D.A.T.A. Transistor Tabulation). Our own file indicates 84 types, as in Canada we do not get any of the single-service specifications unless we specifically request them. Anyway, of these 84, only one (2N539) included a test for thermal *time constant*, although a great many, nearly half, included a test for thermal *resistance*. . . .

I agree roughly with his statement that I_{cbo} for a germanium transistor doubles for each increase of 10 deg, close enough. To be more specific, we find that $I_T = kT^{1.7}e^{-8800/T}$, where T is in deg K. This assumes that only the bulk diffusion current is significant, which is probably quite true for a clean surface at any normally encountered temperature. In the case of silicon, the diffusion current is negligible up to about 175 deg C, and again assuming a clean surface across the junction, we find that the measured reverse current is principally the charge generation current, given by $I_T = kT^{1.5}e^{-7020/T}$, where T is in deg K as before.

An accurate plot of these two curves shows that actually, at room temperature, the current increases *faster* than double for every 10 deg C in both germanium and silicon. The calculated increase between 20 and 30 deg C may be of interest: germanium, 2.72; silicon, 2.32. . . . Experimental measurements on a number of transistors, both germanium and silicon, tend to show slightly lower values than those quoted above, probably due to surface effects.

It may be of interest to know that this multiplication figure decreases as the temperature increases, and is exactly 2 at about 90 deg C for germanium and 55 deg C for silicon. . . .

In his article, Mr. Bauman draws typical calibration curves assuming that the variation is linear over the range 25-60 deg C. These extremes give currents in the approximate ratio of 1:23 for germanium. Assuming a linear relationship, this gives an increase of 22 units for a 35-deg C change in temperature. The calculated current at 40 deg C would then be $1 + 15/35 \times 22 = 10.4$. It is actually 4.2!

Conversely, if the measured current were 10.4, his linear approximation would say that $T_j = 40$ deg C, whereas it would actually be almost exactly 52 deg C. For a case temperature of 37 deg C, and say 9.8 watts dissipation (as in his example), we have: thermal resistance (linear approximation) = $(40-37)/9.8 = 0.31$ deg C/w; thermal resistance (more accurate calculation) = $(52-37)/9.8 = 1.53$ deg C/w. Quite a difference!

Even though I do not agree with all that Mr. Bauman says, I must admit that it has been very interesting analyzing his article (Practical Way to Measure Transistor Thermal Resistance, p 66, Feb. 15), and by going into the subject as thoroughly as I have, I have certainly learned a few things that I might not otherwise have.

SIDNEY V. SOANES

Research Department
Ferranti-Packard Electric Ltd.
Toronto, Ontario, Canada

TELEMETRY GROUND STATION

May I compliment you on your *New Products* treatment of the Bendix Pacific Correlated Data Systems DDS-1000 PCM ground station (p 65, Sept. 13).

However, the address indicated is no longer used by The Bendix Corporation. Instead, all reader inquiries should be directed to Bendix-Pacific Division, The Bendix Corporation, 11600 Sherman Way, North Hollywood.

W. S. LEITCH

Bendix-Pacific Division
The Bendix Corporation
North Hollywood, California

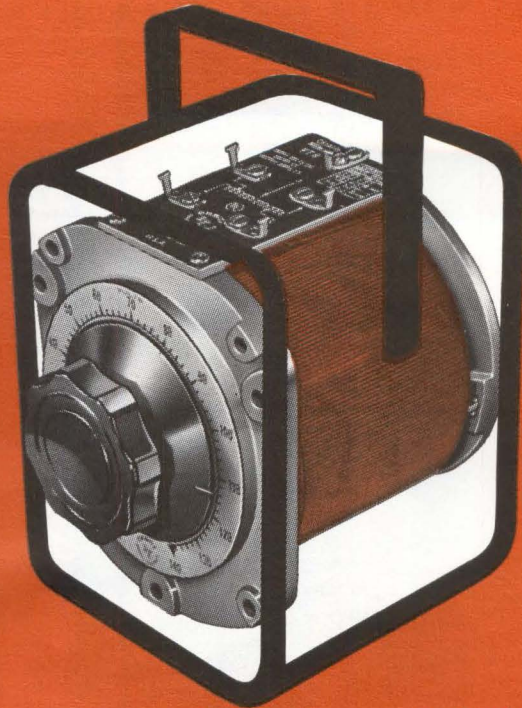

select from
44 cased models of OHMITE "v.t."[®] variable transformers

ALL AVAILABLE FROM STOCK

Input Volts	Maximum Amps.	Output Volts	Feature or Connection	Stock No.
120	1.4	0-132	Fixed Mtg.	VT2E
120	1.75	0-132	Portable	VT2F
120	1.6	0-120	Fixed Mtg.	VT2NE
120	2.0	0-120	Portable	VT2NF
120	2.8	0-140	Fixed Mtg.	VT4E
120	3.5	0-140	Portable	VT4F
120	3.5	0-140	VT4F w/gnd. in. & out.	VT4FC
120	3.8	0-120	Fixed Mtg.	VT4NE
120	4.75	0-120	Portable	VT4NF
120	4.75	0-120	VT4NF w/gnd. in. & out.	VT4NFC
120	6.0	0-140	Fixed Mtg.	VT8E
120	7.5	0-140	Portable	VT8F
120	7.5	0-140	VT8F w/gnd. in. & out.	VT8FC
120	6.0	0-120/140	Deluxe Portable	VT8G
120	6.0	0-120/140	VT8G w/gnd. in. & out.	VT8GC
120	8.0	0-120	Fixed Mtg.	VT8NE
120	10.0	0-120	Portable	VT8NF
120	10.0	0-120	VT8NF w/gnd. in. & out.	VT8NFC
120	20.0	0-120/140	Basic Case	VT20B
120	25.0	0-120	Basic Case	VT20NB
120	16.0	0-120/140	Fixed Mtg.	VT20E
120	20.0	0-140	Portable	VT20FC
120	16.0	0-120/140	Portable	VT20GC
120	20.0	0-120	Fixed Mtg.	VT20NE
120	25.0	0-120	Portable	VT20NFC

Input Volts	Maximum Amps.	Output Volts	Feature or Connection	Stock No.
WITH METERS				
120	6.0	0-120/140	w/voltmeter, gnd. conn.	VT8GCV
120	6.0	0-120/140	w/volt. & ammtr., gnd. conn.	VT8GCVA
120	6.0	0-120/140	w/volt. & wattmtr., gnd. conn.	VT8GCVW
120	10.0	0-120	w/voltmeter, gnd. conn.	VT8NFCV
120	10.0	0-120	w/volt. & ammtr., gnd. conn.	VT8NFCVA
120	10.0	0-120	w/volt. & wattmtr., gnd. conn.	VT8NFCVW
120	16.0	0-120/140	w/voltmeter, gnd. conn.	VT20GCV
120	16.0	0-120/140	w/volt. & ammtr., gnd. conn.	VT20GCVA
120	16.0	0-120/140	w/volt. & wattmtr., gnd. conn.	VT20GCVW
120	25.0	0-120	w/voltmeter, gnd. conn.	VT20NFCV
120	25.0	0-120	w/volt. & ammtr., gnd. conn.	VT20NFCVA
120	25.0	0-120	w/volt. & wattmtr., gnd. conn.	VT20NFCVW
TWO-IN-TANDEM ASSEMBLIES				
240	20.0	0-240/280	Series Conn.	VT20-2B
240	25.0	0-240	Series Conn.	VT20N-2B
120	20.0	0-120/140	Open Delta Conn., 3-Phase	VT20-2B
120	25.0	0-120	Open Delta Conn., 3-Phase	VT20N-2B
THREE-IN-TANDEM ASSEMBLIES				
240	6.0	0-240/280	"Y" Conn., 3-Phase	VT8-3E
240	20.0	0-240/280	"Y" Conn., 3-Phase	VT20-3B
240	25.0	0-240	"Y" Conn., 3-Phase	VT20N-3B

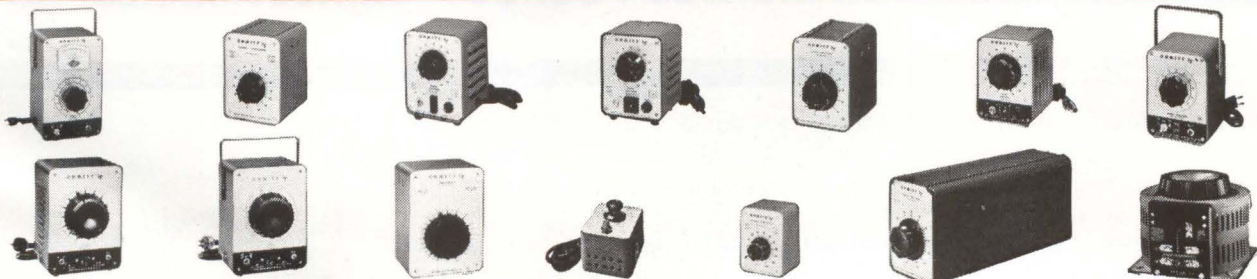

From this Ohmite selection which ranges from a small 1.4-amp unit in a simple case for fixed mounting to a portable 25-amp unit with dual meters, you can satisfy almost any normal application. But if you have a very special requirement, don't hesitate to contact Ohmite's custom-design department. It can engineer case arrangements for the most unusual service. A wide range of standard, uncased units are also available, as well as special designs made to your order. Write for Catalog 500A on Ohmite "v.t."[®] variable transformers—the industry's fast-growing line.



OHMITE
 MANUFACTURING COMPANY
 3610 Howard Street, Skokie, Illinois 60076
 Phone: (312) ORchard 5-2600

RHEOSTATS • POWER RESISTORS • PRECISION RESISTORS • VARIABLE TRANSFORMERS • TANTALUM CAPACITORS • TAP SWITCHES • RELAYS • R.F. CHOKES • SEMICONDUCTOR DIODES



MICRO SWITCH Precision Switches

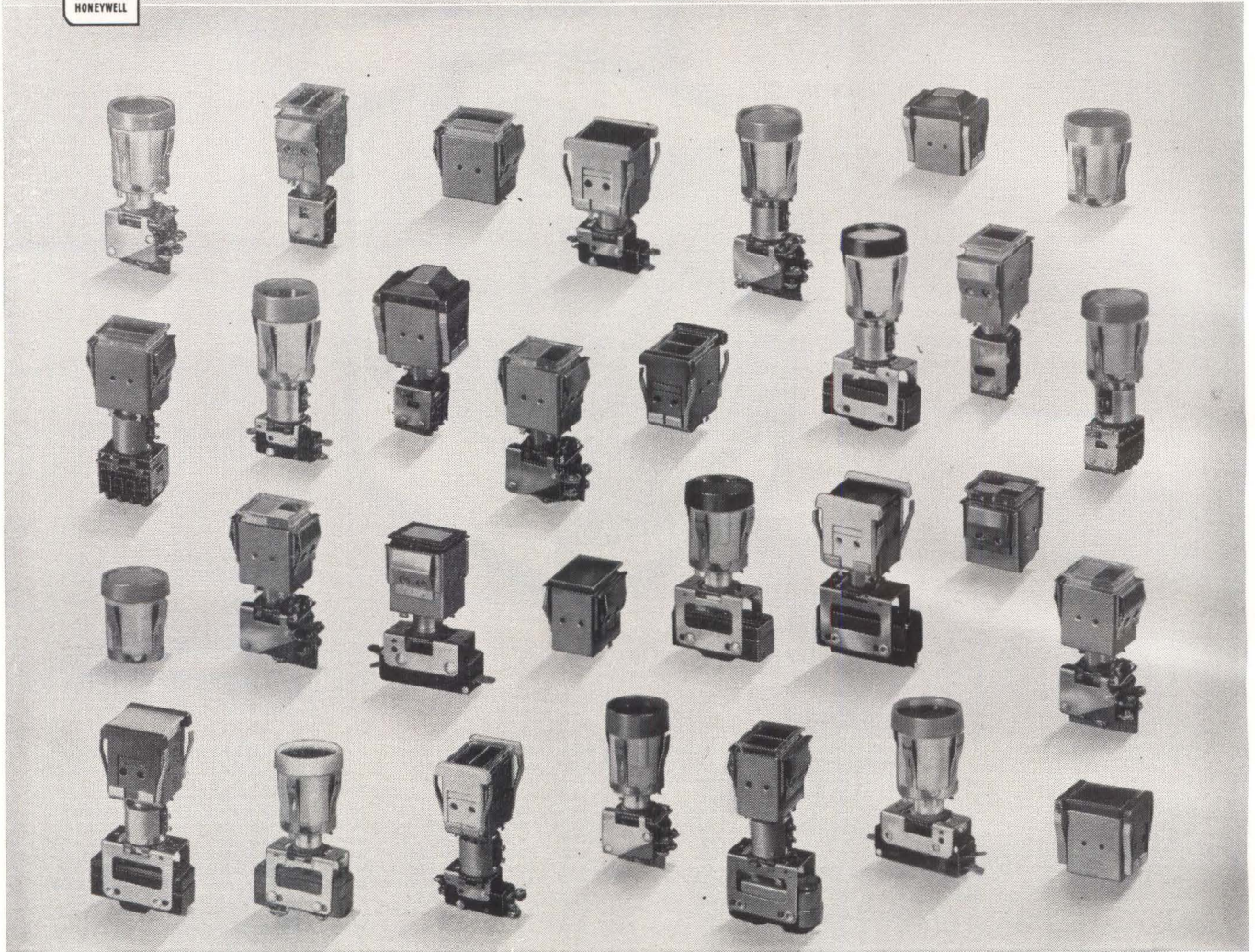

Unlimited control and display opportunities

WITH MICRO SWITCH LIGHTED PUSHBUTTON ASSEMBLIES



Series 2 Lighted Pushbuttons introduce new custom answers for a wide variety of design problems. A broad selection of components and modular, snap-on assemblies provide unlimited possibilities.

Choice of round or rectangular displays for shape coding; four separate lamps in each unit allowing four-color display; variety of screen and hardware colors; 7, 15 or 20 amp. switch units, in sub-miniature or hermetically sealed assemblies; circuitry and electrical ratings you require; momentary or maintained switching action, with or without remote control.

For engineering assistance, call our Branch Office (see Yellow Pages), or write for Catalog 67.

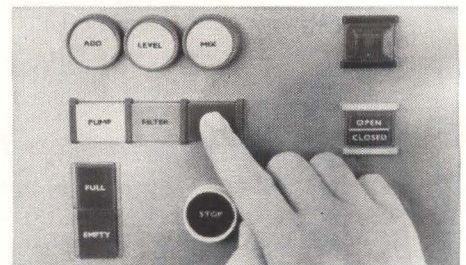

MICRO SWITCH

FREEMONT, ILLINOIS

A DIVISION OF HONEYWELL

IN CANADA: HONEYWELL CONTROLS LIMITED, TORONTO 17, ONTARIO

HONEYWELL INTERNATIONAL—SALES AND SERVICE OFFICES IN ALL PRINCIPAL CITIES OF THE WORLD. MANUFACTURING IN UNITED STATES, UNITED KINGDOM, CANADA, NETHERLANDS, GERMANY, FRANCE, JAPAN.

NEW! LOW COST, STANDARDIZED SEMICONDUCTOR BASES

Semiconductor News - FROM ELECTRICAL INDUSTRIES

...featuring super-ruggedized, high reliability E-I Compression Seals

New additions to the ELECTRICAL INDUSTRIES standard line of semiconductor bases provide the engineer with a quick, economical solution to design problems. These new components feature high-strength E-I Compression Seals, and all MIL types

equal or exceed government specifications. If you have a design problem involving any type of glass-to-metal hermetic sealing, ask ELECTRICAL INDUSTRIES for recommendations on your specific requirements—call or write today!

BASES FOR HIGH POWER TRANSISTORS

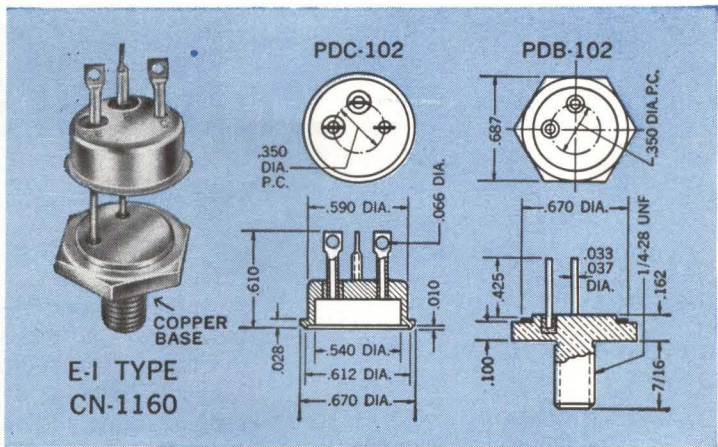
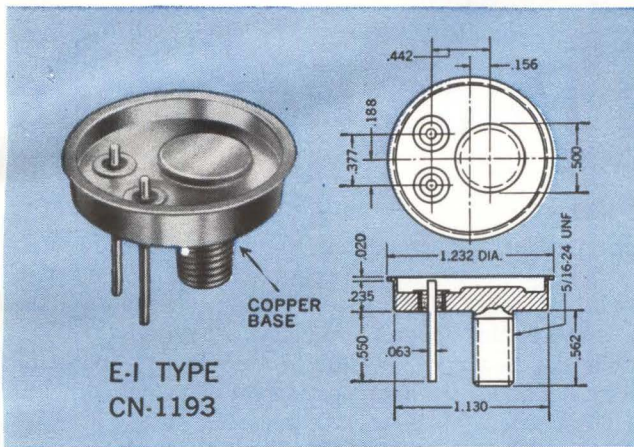

STANDARD SEMICONDUCTOR BASES

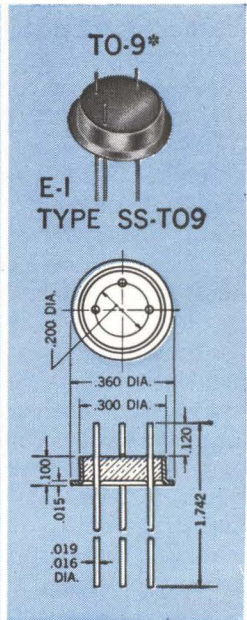
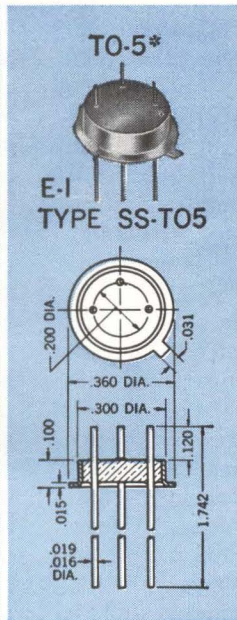
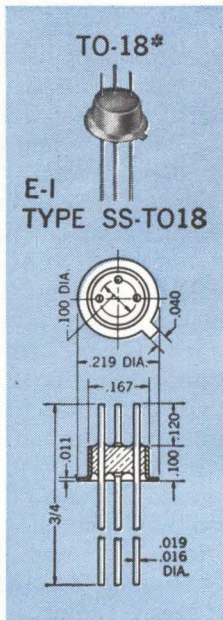
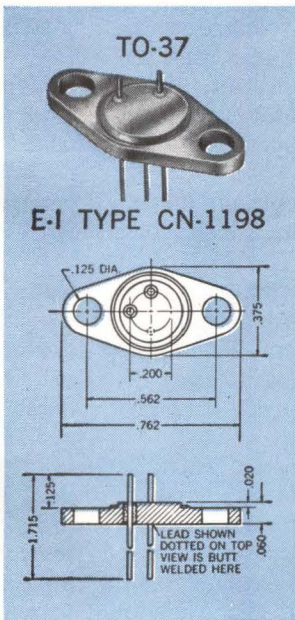
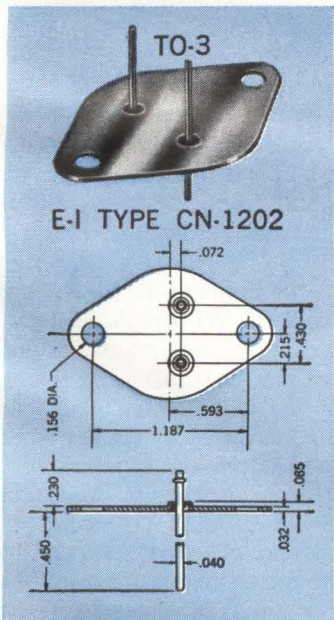

*Also Available with Dumet Leads

Division of Philips Electronics & Pharmaceutical Industries Corporation



ELECTRICAL INDUSTRIES

MURRAY HILL, NEW JERSEY - Telephone: 464-3200 (Area Code 201)

PATENTED IN THE U.S.A., NO. 3,035,372; IN CANADA, NO. 523,390; AND IN THE UNITED KINGDOM, NO. 734,583.

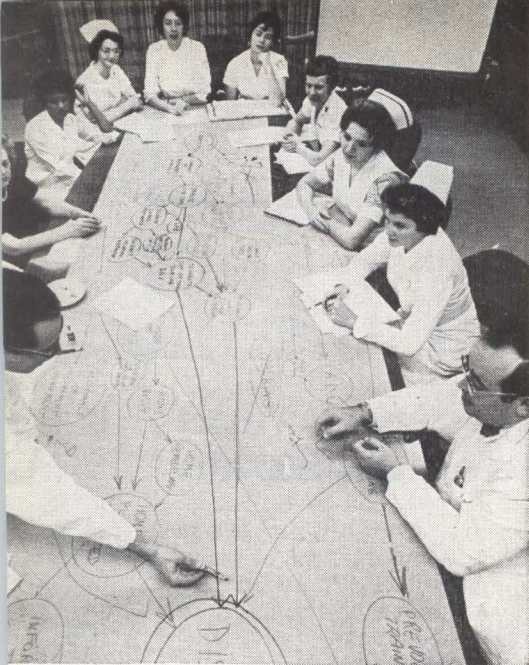

MEDI-PERT SESSION plans patient's rehabilitation. This is one technique the Institute has borrowed from industry



EX-PATIENTS serve as computer operators and programmers. Next month, an IBM 1410 will replace the IBM 1401 now used

Computers Pace Progress

Advanced diagnostic methods help salvage disease-wasted lives

By **HAROLD C. HOOD**
Regional Editor, Los Angeles

HOUSTON—Visitors to the Texas Institute for Rehabilitation and Research here are getting a preview of the "hospital of tomorrow." They seldom leave without feeling that TIRR's staff of 260, using digital computers and other electronic tools, are making giant strides toward overcoming the disabling effects of long-term illness and catastrophic injury.

Most of the 600 in-patients and 400 out-patients treated yearly at the Institute have been stricken with such serious illnesses as polio, cystic fibrosis, strokes, muscular dystrophy, and congenital defects, or have suffered spinal injuries causing partial or complete paralysis. Others have lost limbs from automobile accidents and other mishaps.

All cases are treated with the same basic approach—"medical humanetics." This phrase, coined at TIRR, refers to the integration of medical, psychological, and social factors for the optimum treatment

and rehabilitation of the patient.

Hospital Computers—Use of computers in hospitals and clinics throughout the country is not new. Mayo Clinic analyzes electroencephalograms and the blood chemistry of mentally disturbed patients with computers. At Yale, scientific computers are helping researchers unravel mysteries associated with certain diseases of the eye, such as glaucoma. Installations of computers in city hospitals for diagnostic purposes are being reported in increasing numbers.

But TIRR is probably unique in the number of functions which have been relegated to its IBM 1401 and ancillary equipment. Areas into which computer usage has been extended include patient diagnosis, monitoring of illness, scheduling of services, medical record keeping, and fiscal control.

Information on patients, which is digitized and recorded on punched cards, falls into four general categories:

- Routine descriptive data such as date of admission, age, weight, height, marital status, educational level, occupation, etc.

- Data descriptive of the course of each patient's illness, such as results of laboratory tests, treatment

rendered, running records of physiological parameters including temperature, respiration rate, blood pressure and heart sounds

- Case history data gleaned from interrogation into the patient's past illnesses, accidents, etc.

- Information resulting from special biomathematical and biostatistical procedures, such as multiple correlations and time-series analysis.

Combined with highly sensitive, modern instrumentation, this painstaking tabulation of data makes possible fast and frequent checks on patients and produces a new kind of quickly retrievable health record.

Knowing the Patient—Hard-driving, 41-year-old Dr. William A. Spencer, director of TIRR and named as one of "America's ten outstanding young men" by the U. S. Junior Chamber of Commerce in 1954 for his work in polio rehabilitation, points out that TIRR's instruments and records enable its staff physicians to review accurately what happens to a patient and to generalize from one patient or group of patients to help the next individual.

"This could be done by the country doctor with his little black bag when medical skills were rudimentary and the data few."

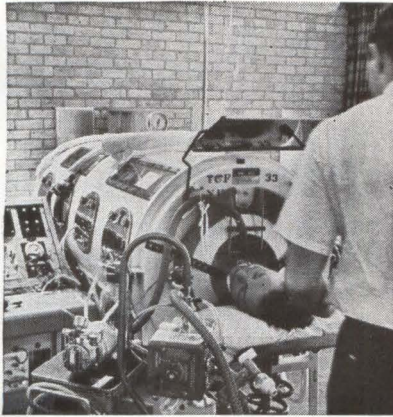

FOUR-CHANNEL RECORDER monitors temperature, pulse rate, respiration and blood pressure of patient in iron lung. He was completely disabled by cerebral aneurism

INSTITUTE'S DIRECTOR, Dr. William Spencer (right) and colleagues study real-time data transmitted from bedside of patient. Direct-line physiograph handles wide variety of diagnostic equipment inputs

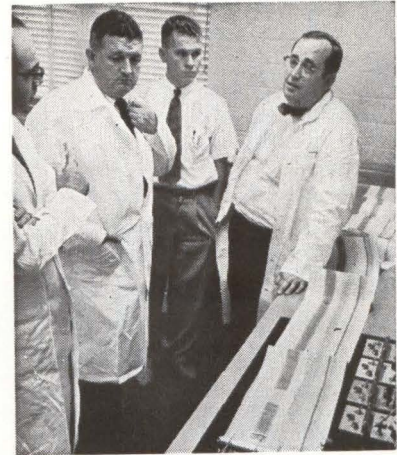

IMPEDANCE PNEUMOGRAPH for measuring respiration rate. Electrodes on either side of patient's chest pick up variations in impedance caused by breathing

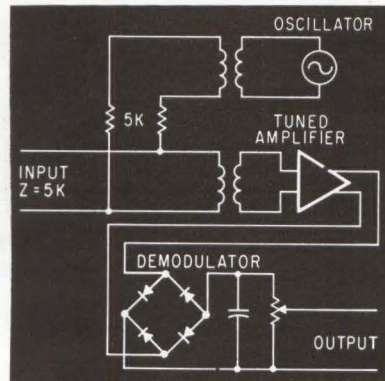

in Medical Humanetics

"The country doctor had the advantage of knowing his patients personally and observing them within the context of their families. But with the advent of our many new drugs, new tools for medical practice, and better understanding of the causes of physical disorders, help was needed to interrelate the vastly increased amount of data. Computer analysis techniques are providing this help."

High Cost, High Reward — Dr. Spencer admits that this type of intensive-care, research-oriented operation is expensive. Operating costs for the \$1.3 million facility are running at \$2.2 million per year, whereas the average hospital holds its annual costs to about one-third capital investment.

"But if our work here means that illnesses can be treated more effectively, and will enable us to make critical judgments about the care of the aged and the chronically ill, the use of our hospitals, and the training of young physicians and other health personnel, then the cost is certainly not exorbitant," he says.

An example of this optimization of medical treatment by means of computer-generated information at TIRR was the discovery that, in the treatment of spinal fusion, patients

should be immobilized for exactly 12 weeks. The analyses of physiological data from several patients indicated that this period provided the best conditions for recovery and did not introduce any of the problems of overtreatment or prolonged immobilization.

In another computer-supported study, the centers of gravity of various parts of amputees' bodies are being determined from measurements of length, width and weight in an effort to design prosthetic devices which do not alter the individual's equilibrium.

Studies for NASA—Similarities in the physiologies of bed-fast patients and of future space travelers, destined to be confined in cramped quarters over long periods of time, was a factor in the recent award of a \$66,950 study contract to TIRR by NASA. Included in the study will be the development and testing of instrumentation systems for applications to space exploration.

Because of its proximity to NASA's Manned Spacecraft Center, its familiarity with advanced computer analysis techniques, its well-equipped biochemical laboratories and special dietary capabilities, TIRR appears to be a good

choice. Sophisticated new sensor and electrode techniques are being evaluated, signal conditioning devices applicable to space travel will be tested, and principles of transduction of physiological or medical events will be investigated.

The Institute is expected to provide NASA with an applied research facility and consulting capability and to integrate the basic findings of other research centers into needs of the manned space program. NASA data collecting and processing equipment has already been installed at TIRR in connection with an "immobilization" or bed-rest phase of the study expected to provide controlled experimental conditions. One part of the study will deal with the analysis of results of the introduction of a variable, such as exercise, after the immobilization period.

Associated with the Baylor University College of Medicine, TIRR is providing medical students with invaluable educational tools. Real-time physiological data is transmitted by direct wire from multiple-channel bedside recorders at the Institute to medical school laboratories half a mile away. Here the data is reproduced on recording physiographs; and students can view the patient by closed circuit tv.

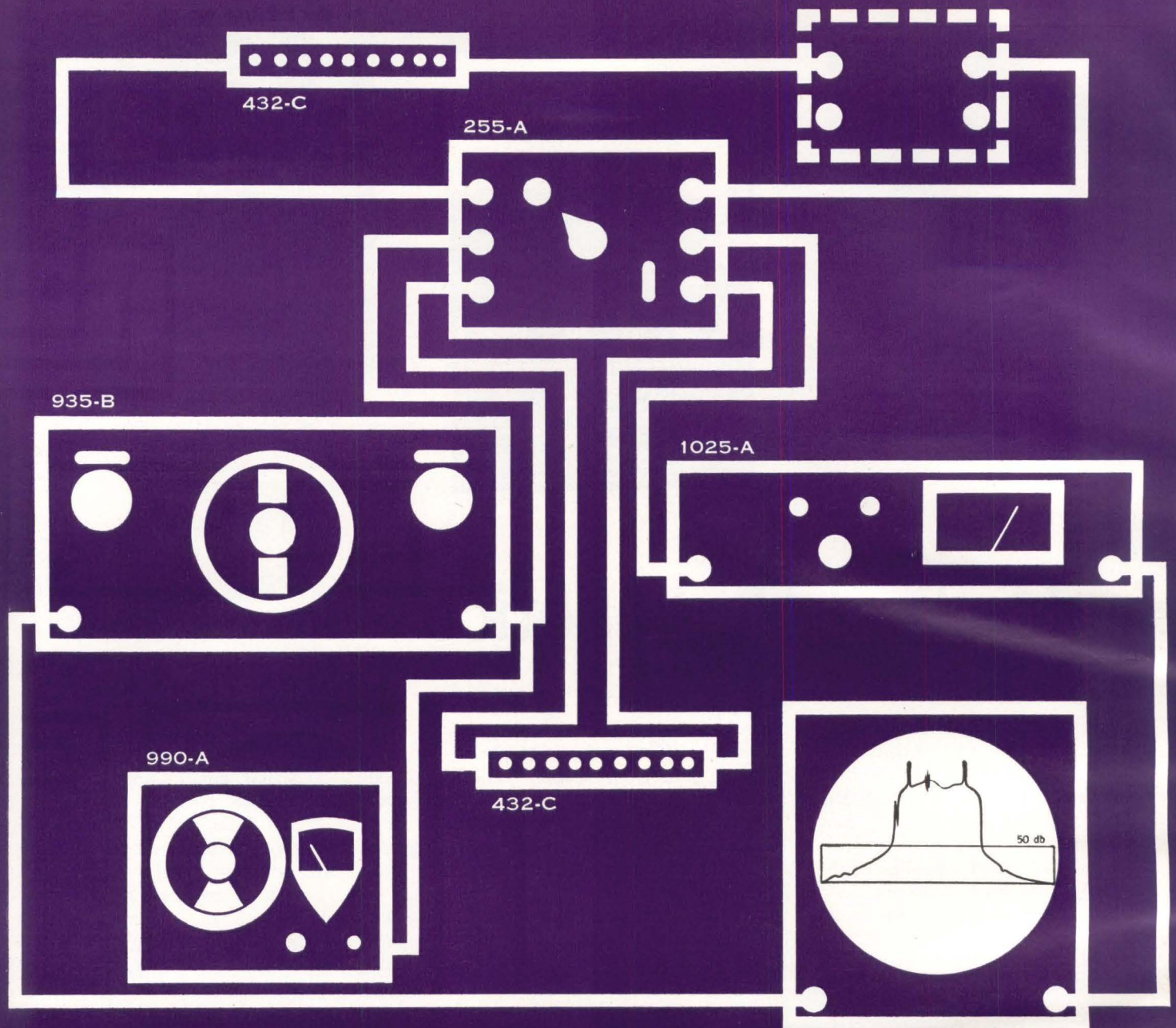

Swept, Marked, Logged, Calibrated... by **KAY**

A sharp filter, swept and marked in frequency (fixed and variable) by 935-B and 990-A on the log amplitude display of the 1025-A, with calibrated level line set by the 432-C, switched in by the 255-A.

935-B Sweeping Oscillator

50 cps to 220 mc
Audio Video, VHF

Price: \$1295.00

990-A CW Oscillator

4.5 to 220 mc
1.0V rms, AGC'd

Price: \$373.00

1025-A Log Amplifier

200 kc to 220 mc
80 db Dynamic Range

Price: \$795.00

432-C Attenuator

DC to 500 mc
0 to-101 db in 1-db steps

Price: \$110.00

Write for complete catalog information

KAY
ELECTRIC COMPANY

Maple Ave, Pine Brook, Morris County, New Jersey
Dept. E-10 • Capital 6-4000

255-A Coaxial Electronic Switch

DC to 500 mc
70 db "off" at 200'mc

Price: \$295.00

CIRCLE 12 ON READER SERVICE CARD

**“Will the most sensitive,
most stable,
most reliable
low current SCR
please stand up!”**



Now you can eliminate the possibility of premature firing... turn on the SCR when you want it in lower power switching and control applications. The G-E C5 SCR requires no more than 200 μ A trigger current at 25°C. The C7 requires only 20 μ A. Both devices have guaranteed upper and lower limits on gate voltage to trigger. The narrow spread in gate triggering requirements permits the design of simple, yet reliable, triggering circuits. The long term stability of blocking voltage, leakage current and, most important, the sensitive gate characteristics are well documented by extensive life test data.

For applications that do not require the sensitivity or low blocking currents of the C5 and C7, G. E. also offers the 2N1595 series. For complete details, including spec sheets, see your G-E Semiconductor District Sales Manager. Or write Section 16J118, Rectifier Components Department, General Electric Company, Auburn, New York.

MAXIMUM ALLOWABLE RATINGS

	C5	C7 (2N2344-2N2348)	2N1595-2N1599
PRV/VBO	25-400	25-200	50-400 volts
RMS Forward Current	1.6	1.6	1.6 amperes
Peak One Cycle Surge Current (i_{surge})	18	15	15 amperes
Storage Temperature	← -65°C to +150°C →		
Operating Temperature	-65°C to +125°C	-65°C to +100°C	-65°C to +150°C

GENERAL  ELECTRIC



KEYBOARD of computer that simulates actions of 100 pilots is used in British atc experiments



ALPHANUMERIC indicator driven by Elliott 502 computer updates airport controller's information

Multicomputers to Rule English Sky

British will hitch new radars to the computers for air traffic control

By **DEREK BARLOW**
McGraw-Hill World News

LONDON—An integrated military and civil air-traffic-control (atc) system is to be operational in Britain by 1968. It will use linked multi-computer systems installed at two atc centers in Northern and Southern England to provide information coverage of the U. K. and its approaches. The two computers, each with 20 to 30 million components, will process all flight information and radar data, and will provide special displays to both radar controllers and air traffic controllers.

The system is still experimental, but already civil radars suitable for data extraction are being installed and new military radars linked in. Under construction are broadband microwave links to feed radar surveillance data to the atc centers. The centers are to be operational before 1967 and the data processing system by 1968.

Even more exciting are future systems under consideration. At an R&D symposium at the Royal Radar Establishment, Malvern, computer control of radar-beam scanning was proposed by a government engineer and by W. Hersch, of E. M. I. Electronics.

Instantaneous position of the beam would be controlled from pulse to pulse and radar prf varied

by the computer. The radar would spend most of the time tracking aircraft, not searching empty airspace. Beam-positioning flexibility allows four operating modes: surveillance, tracking, tracking command and interrogation.

In surveillance, the radar systematically searches the entire airspace and stores in the computer memory positional coordinates and velocity vectors of each aircraft detected. In tracking, the computer decides how frequently speed of each aircraft must be updated. Updating the rate controls the beam position so each aircraft is updated according to its importance in the traffic pattern. Thus data rate is no longer fixed by scanner rotation rate but is adjusted by the computer.

In tracking command, pulse-position-modulated signals go over the radar beam to the aircraft tracked. Command signals could be fed directly to the aircraft's autopilot.

Britain's ATC System—In the atc system under development, digital techniques will be used to automatically accept, store and update aircraft flight data. Another section of the system will track automatically all aircraft in the area from primary and secondary radar information. The system's third task is to display data from remote radars, provide for intertrace marking and digitally labeled situation-plan presentations, and to provide crt tabular data displays.

In the labeled-plan display alphanumerics can be written at 20 μ sec/character to annotate over 256

tracks. Category selection allows the viewer to choose aircraft type and heights.

The crt tabular display will present processed flight-plan information and radar data on a time sharing basis with facilities for strobing each display line and providing intermarking between the tabular plan-position displays.

Experiments Underway—While system guidelines are already laid down, experiments are underway to fill in details. A rundown follows.

System Reliability—To provide in the multicomputer concept the redundancy needed for flexibility and reliability, the system developers, Automatic Telephone and Electric Co., propose a central pool of storage and computer equipment. Each computer has a fast-access, medium-size instruction and working store and can transfer data to stores and other parts of the system. The computers operate "highway" system for high-speed long-distance signaling between subsystems. Transfer demands from the computers control random highway usage. Particular time slots are allocated to particular transfers.

Routining computers detect faults. Upon detection, a special program from a magnetic drum goes into the routining computers. The special programs, in a central store, can go into various computers as required so that effects of multiple faults only reduce the system operating rate and do not destroy system facilities.

Radar—Circular polarization and pulse compression are being actively investigated. The aim is to improve resolution and make 10-cm radar's all-weather performance as good as longer-wavelength systems operating at longer lengths.

A pulse-compression system being developed by Marconi Ltd. raises pulse powers without increasing transmitter peak power. Applied to the receiver, it improves discrimination. Transmitter frequency is swept within the 10- μ sec long-period transmitter pulse. A dispersive delay line then selectively delays the frequencies within the swept pulse. Delaying the leading edge of the pulse until the back edge is received shortens the output pulse to 0.1 μ sec and raises effective peak power. Gain is improved 17 db on rain signals and aircraft echoes are not reduced.

Displays—Tabular displays developed by Marconi's and Associated Electrical Industries Ltd. use high-speed electronic beam writing on a crt from a digital store.

Three-dimensional systems are under development. E.M.I. Electronics would picture on a crt a faint perspective view of a transparent cube representing the airspace. Aircraft positions, obtained from a computer store, appear as spots within the cube. Airways and other geographical features are also traced by the crt beam.

An experimental Standard Telephone and Cable system at Shannon airport is electromechanical. Projection indicators for each aircraft show height, air-lane position and flight attitude of aircraft.

Flight-Plan Processing—Due for experimental installation next fall is a system based on an Elliott 502 computer driving some 9,000 miniature alphanumeric indicators. Teleprinted flight plans, stored in the memory, are displayed at the airport atc console. If a conflict appears, the controller can try out solutions on the computer, which updates the display when a solution is found.

In another flight-plan presentation system, by General Precision Systems Ltd., a matrix of styli energized by an encoder prints flight plans on paper strips and delivers them to the controller.

X-Ray Vidicon

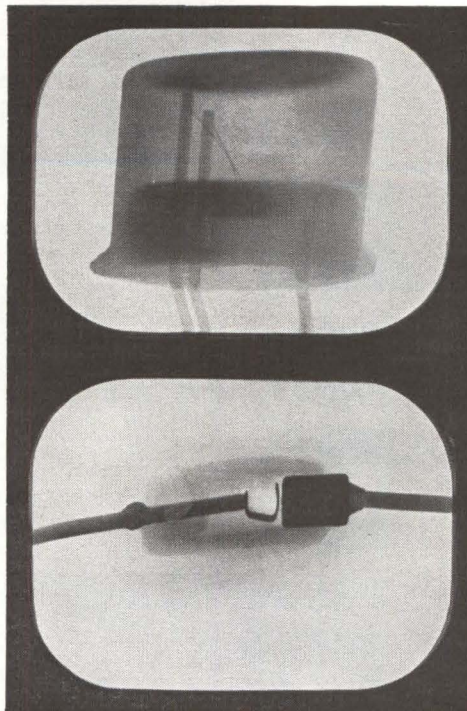

X-ray TV image of metal-clad transistor and encapsulated diode—a typical non-destructive testing application.



High quality—static and in-motion—X-ray TV images . . .

The New ML-589 DYNAMICON is a 1" x-ray-sensitive vidicon camera tube which is capable of providing high contrast images with detail resolution down to 0.0005", and penetrameter sensitivities up to 2%, when used with an adequate CCTV system and x-ray source. Magnifications to 50X are easily obtainable. ML-589 is particularly suited for non-destructive testing and biological applications, permitting both static and in-motion examinations of small encapsulated components and materials such as plastics, ceramics, steel, aluminum, and rubber.

For complete details write The Machlett Laboratories, Inc., Springdale, Conn. An affiliate of Raytheon Co.





BRUSH DIRECT WRITING
RECORDING SYSTEM IN USE
AT NASA LABORATORIES*

**Brush uses Allen-Bradley
Hot Molded Resistors
because their reliability
is established by years
of experience**

■ To insure consistently accurate readout of their recorder, Brush insists upon the ultimate in component reliability. For this reason, Allen-Bradley hot molded resistors are their standard for their direct writing recording system.

The complete reliability of A-B hot molded resistors is proved by an "in service" record of more than ten billion resistors *without a single instance of catastrophic failure*. This has been made possible through Allen-Bradley's exclusive hot molding process that results in such complete uniformity—from one billion resistance units to the next—that long term resistor performance can be accurately predicted. Their stable characteristics and conservative ratings are your assurance of faultless performance even in super-critical applications.

Performance experience is the reason for the constantly growing family of electronic engineers who have standardized on A-B hot molded resistors. You can only benefit by following such qualified leaders. Publication 6024 gives detailed information on these and other A-B quality electronic components. So please write: Allen-Bradley Co., 110 W. Greenfield Ave., Milwaukee, Wis. 53204. In Canada: Allen-Bradley Canada Ltd., Galt, Ontario,

*At NASA, a Brush Recorder was used to design a control system which would bypass the pilot and project the plane into prolonged zero gravity flight.

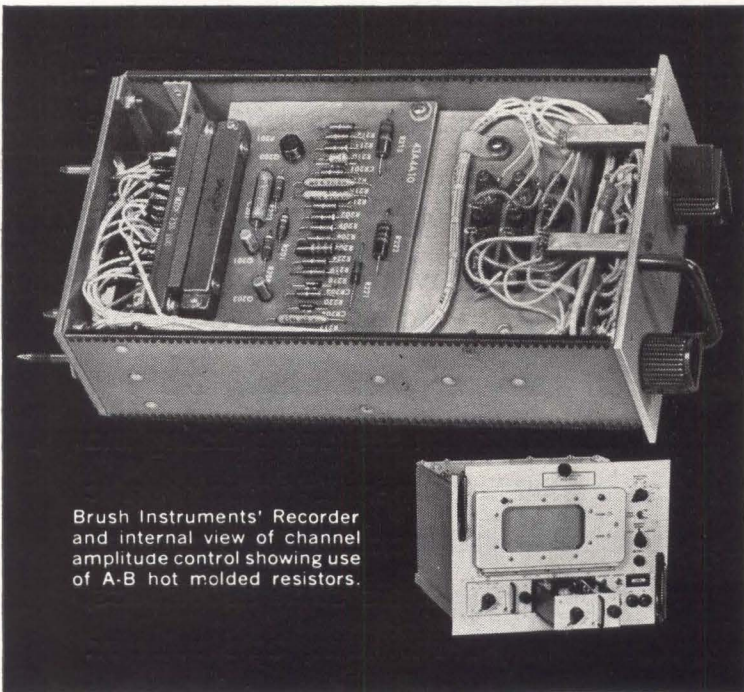

Brush Instruments' Recorder and internal view of channel amplitude control showing use of A-B hot molded resistors.

TYPE TR 1/10 WATT		MIL TYPE RC 06
TYPE CB 1/4 WATT		MIL TYPE RC 07
TYPE EB 1/2 WATT		MIL TYPE RC 20
TYPE GB 1 WATT		MIL TYPE RC 32
TYPE HB 2 WATTS		MIL TYPE RC 42

HOT MOLDED FIXED RESISTORS are available in all standard EIA and MIL-R-11 resistance values and tolerances, *plus* extended ranges below and above standard limits.

ALLEN-BRADLEY
QUALITY ELECTRONIC COMPONENTS

DOD Weighs a Sweetener

DOD MAY TAKE some of the sting out of cutbacks in defense procurement by sweetening its rules on civilian market research. Present regulations allow contractors to charge for long-range studies of military to civilian conversion, but not for studies aimed at determining the civilian market potential of a device or technique developed as a byproduct of defense R&D.

An amendment to section 15 of the Armed Services Procurement Regulations now under consideration would change this, a Pentagon spokesman told ELECTRONICS early this week.

At a recent gathering in Boston, where reports of the liberalization first circulated, defense marketing executives were told it could provide companies with the incentive to remain in the defense business.

"Too good to be true," said an industry official in the Boston area, where defense cutbacks and stretch-outs are hitting hard.

Contractors should settle for this help from DOD, one speaker said, instead of pushing for such things as higher profits and return on equity, less reporting and scrutinizing.

House Committee Trims NASA's Space R&D Funds

WASHINGTON—The House Appropriations Committee has chopped the \$5.7-billion budget NASA requested for this year to \$5.1-billion. This is \$250.8-million lower than Congress has authorized for the space program. The bulk of the cuts were made in space R&D. The committee voted \$3.9 billion for this, \$425.7 million lower than requested and \$193.6 million below what had been authorized.

Expressing concern over the rise in government-financed R&D, the committee also eliminated all money for new programs presented by the National Science Foundation. It approved a \$323.2-million budget

Apollo Price Tag Too High?

BOSTON—D. Brainerd Holmes, until recently director of NASA's Manned Space Flight Program, last week disputed the \$40-billion price tag put on the man-to-the-moon program. His own estimate would be \$20 billion, although "this could be doubled to \$40 billion if the management is not good." Holmes, now senior vice president of Raytheon, spoke here at a meeting of the Government Contracts Management Association.

He also denied that Apollo is a crash program, saying it has been fund-limited from the start and would cost more if it were either slowed down or speeded up.

for NSF, some \$265.8-million lower than requested. The committee also cut \$245,000 from a \$1,025,000 request of the Office of Science and Technology, trimmed \$700,000 from the FCC's \$16.5-million request, and lopped \$64.5-million from the Federal Aviation Agency's \$815.1-million request.

New Laser System Tracks Target Angles

BALTIMORE—Optical equivalent of a bistatic tracking radar is being evaluated at Westinghouse's Air Arm division. The system consists of a pulsed-laser transmitter and an optical receiver. At present, it can measure line-of-sight angles in azimuth and elevation to a target with a single pulse; prf is 40 pps. In the experimental system, transmitter and receiver are separate units; each is aimed at the target by an operator. The transmitter illuminates the target and the receiver determines target angle from the reflection. Operation can be made automatic by coupling the two units by a tracking servo, Westinghouse said. With modifications, the system could

also be used for ranging. Range is more than 1 mile.

Nike-X Program Gets \$213-Million Boost

WESTERN ELECTRIC has been awarded a \$213,385,000 incentive-type contract for continued R&D on the Nike-X. The contract—covering development and testing of the three-stage Nike Zeus, the Sprint, and phased-array radar—is the largest single missile contract ever awarded by the Army, says the Pentagon. Subcontractors include Avco, Cornell Aeronautical Laboratories, Douglas Aircraft, GE, Martin, Sperry Rand, Raytheon, andsylvania.

Laser-Operated Display Called Practical

NEW YORK—A practical laser-operated display unit will be developed within a few years, predicts A. D. Rugeri, of Rome Air Development Center. At the East Coast Symposium of the Society for Information

Display last week, he said a laser beam would be used in place of the cathode-ray beam in something like a huge crt, with a room-sized screen.

Two techniques are under consideration active-screen, where the laser indexes only, and passive-screen, where the laser provides scanning and illumination. Biggest problem is how to deflect the laser beam. So far, using electro-optical techniques, deflections are only a fraction of a degree.

Research Head Hits Reliability Program

PALO ALTO, CALIF.—John R. Pierce, director of research-communications, Bell Telephone Labs, deplored the “nonsense” in the field of reliability, at the AIAA meeting last week. Statistics, redundancy and special reliability programs, he said, won't take the place of good

components. Uniform, well-controlled, realistic tests are essential before a component can be considered part of a reliable system. Avoid novelty, except where necessary, he advised. The trouble with our space effort, he claims, is that it is goal-oriented rather than fact-oriented. The lag in satellite communication is due to the uninspiring nature of the problems, he added.

Optical Scanner Speeds Credit-Card Accounting

IBM has developed an optical scanner designed to channel the rising flood of credit-card sales (more than \$1 billion a year in the petroleum field alone) into a smooth-flowing accounting operation. Into the IBM 1282 optical reader card punch are fed card-stock copies of sales forms received from the field. The 1282 can read preprinted information, ac-

count numbers imprinted by credit cards, and dollar amounts entered on the sales slip as small horizontal pencil marks, and transfer this data to punched cards for high-speed data processing. The 1281, which can process either 80 or 51-column cards up to 200 a minute, sells for \$72,000 and rents for \$1,550 a month. Deliveries are scheduled for the first quarter of 1965.

Phonon Emission Hints Tunable Laser Possible

NEW PHENOMENON that might lead to continuously tunable optical masers has been observed at Bell Telephone Labs. L. F. Johnson, R. E. Dietz and H. J. Guggenheim report the simultaneous emission of phonons in optical maser oscillations from nickel-doped magnesium fluoride. This is believed unique since all known solid-state optical masers utilize purely electronic transitions in solids.

Because the phonon portion of the emission spectrum is a smoothly varying function of wavelength, such a maser theoretically should be continuously tunable over a frequency range that constitutes an appreciable part of the emission spectrum, Johnson told ELECTRONICS. There is no basis, however, for thinking the phonon emission is coherent he said. Details of the report appear in the current Physical Review Letters

MEETINGS AHEAD

SOCIETY OF MOTION PICTURE-TELEVISION ENGINEERS CONVENTION, SMPTE; Somerset Hotel, Boston, Mass., Oct. 13-18.

AUDIO ENGINEERING SOCIETY FALL CONVENTION—EXHIBIT, AES; Barbizon-Plaza Hotel, New York, Oct. 14-18.

NEW YORK CONFERENCE ON ELECTRONIC RELIABILITY, IEEE; United Engineering Center, N. Y., N. Y., Oct. 18.

EAST COAST CONFERENCE ON AEROSPACE-NAVIGATIONAL ELECTRONICS, IEEE-PTGANE; Emerson Hotel, Baltimore, Md., Oct. 21-23.

NATIONAL ELECTRICAL MANUFACTURERS ASSOCIATION ANNUAL MEETING, NEMA; Edgewater Beach Hotel, Chicago, Ill., Oct. 21-24.

NATIONAL ELECTRONICS CONFERENCE, IEEE, IIT, Northwestern University, University of Illinois; McCormick Place, Chicago, Ill., Oct. 28-30.

ELECTRON DEVICES MEETING, IEEE; Sheraton Park Hotel, Washington, D. C., Oct. 31-Nov. 1.

17TH NORTHEAST ELECTRONICS RESEARCH-ENGINEERING MEETING, New England Sections IEEE; Commonwealth Armory and Somerset Hotel, Boston, Mass., Nov. 4-6.

RADIO FALL MEETING, IEEE, EIA; Hotel Manger, Rochester, N. Y., Nov. 11-13.

FALL JOINT COMPUTER CONFERENCE, AFIPS, IEEE, ACM; Las Vegas Convention Center, Las Vegas, Nev., Nov. 12-14.

MAGNETISM-MAGNETIC MATERIALS ANNUAL CONFERENCE, AIP, IEEE-PTGMTT; Chalfonte-Haddon Hall, Atlantic City, N. J., Nov. 12-15.

NUMERICAL CONTROL PRESIDENTS' CONFERENCE, NCS; Hotel Plaza, N. Y., N. Y., Nov. 14-15.

TECHNICAL WRITING WORKSHOP, University of California Extension Center; San Francisco, Calif., Nov. 18-19.

ENGINEERING IN MEDICINE AND BIOLOGY ANNUAL CONFERENCE, IEEE, ISA; Lord Baltimore Hotel, Baltimore, Md., Nov. 18-20.

ADVANCE REPORT

SCINTILLATION AND SEMICONDUCTOR COUNTER SYMPOSIUM, IEEE, AEC, NBS; Hotel Shoreham, Washington, D. C., Feb. 26-28, 1964; Dec. 1 is deadline for submitting abstracts to W. E. Higinbotham, Chairman, Program Committee, Brookhaven National Laboratory, Upton, Long Island, N. Y. Topics include photomultipliers and image tubes, scintillators and scintillator combinations, semiconductor and special detectors, circuitry and applications, multi-dimensional data acquisition, presentation track imaging complex detector and data processing systems, radiation detection in space.

Mitre Steps Up Size of NMCS Staff

MITRE is planning to increase its staff over the next nine months in support of the Defense Communications Agency's National Military Command System (p 20, April 26). The 1964 contract is expected to be about \$1 million. C. A. Zraket, formerly director of Mitre's system planning, research, and advanced planning, will head the new group in Washington, D. C.

Weathermen Nix Nimbus

WASHINGTON—In the wake of last week's cancellation of the operational Nimbus satellite system, gravity-gradient stabilization (p 16, Aug. 23) is now seen as a leading contender for attitude control of a new satellite that will replace Nimbus. Weather Bureau dropped Nimbus because of its \$80-million annual cost and short, one-year life span. Construction of the Nimbus ground station at Nova Scotia was also suspended. Cancellation of the program came after more than \$100 million had been pumped into it, \$45.6 million by the Weather Bureau.

Atomic power and redundancy will probably be included in the new operational satellite, to be designed by NASA to operate at low cost for more than three years. The gravity stabilizer would have to be a three-axis system because of weather satellites' gridding requirements. As an interim system, however, the Weather Bureau will use the modified, wheel-configured Tيروس (p 7, May 31), to be operational within two years. Two Nimbus R&D satellites are not affected by the decision.

Coding Doppler Return Avoids Enlarging System

PALO ALTO, CALIF.—Increases in spectrum bandwidth at orbital velocity of 25,000 feet sec and 600,000-foot altitude indicate that doppler navigators should have a complex frequency tracker or a larger antenna, it was brought out at last week's AIAA meeting here. Both are undesirable in spacecraft; antenna size becomes impractical, complexity raises weight. There is also loss of peak power amplitude.

R. G. McManus and J. C. Rand, of Raytheon, reported on an alternative that showed promise in flight tests of a breadboard system. They alter spectral bandwidth by modulating transmitter frequency, thus coding the ground return. Recommended modulation waveform is a linear sawtooth modified by superimposing a slight parabolic component. Signal band width was reduced about 40 to 50 times.

Economist Calls R&D Key to Electronics Growth

BOSTON—Preliminary results of a study by the McGraw-Hill Economics department indicate electronic industry sales will grow by 40 percent in the next seven years, Douglas Greenwald, chief economist, reported to the Financial Executives Institute this week. He estimated 1963 sales at \$16 billion.

Pointing out that two thirds of the industry's 1962 sales were in products developed since 1952, he urged that financial executives of electronics companies not judge R&D's values by concepts applicable to slower-moving industries.

In electronics, Greenwald said, they should familiarize themselves with research trends, form an alliance with research personnel and "go aloft with the scientist rather than holding him down"

Pocket Transceiver Answers Telephone

NEW YORK—A remote-telephone extension that allows a telephone subscriber to use his phone even when he is a mile away was demonstrated last week by the Chromalloy Corp. When the phone rings, a stationary transceiver under the telephone buzzes a pocket-size transceiver carried by the user. By pressing a button, he can signal a mechanical arm to release the telephone's cradle buttons, putting the stationary transceiver in operation. Chromalloy would not comment on price except to say the device would be within the range of present telephone accessories.

IN BRIEF

UNITED AIRCRAFT is developing a computer-controlled processor for manufacturing microelectronic circuit devices, under a \$630,000 Air Force contract. A laser beam and high-intensity electron beams will provide the prime energy sources.

ONR SATELLITE, scheduled for launch early next year by NASA, will seek evidence to confirm the existence of a "horn" cutting across the Van Allan radiation belt and penetrating the earth's atmosphere near the North Pole.

TV CHANNEL 37 (608 to 614 Mc) has been reserved by FCC for exclusive use of radio astronomy until the beginning of 1974. Canada and Mexico will be asked to make similar reservations.

MARTIN received a \$27,739,662 Army contract for additional engineering services for the Pershing weapons system.

FAIRCHILD crash-data recorders for Lockheed C-141 jet transport were ordered by the Air Force. The contract calls for 206 of the recorder systems at a total cost of \$753,033.

PERKIN-ELMER has been awarded a \$276,500 NASA contract for five Aerobee rocket camera and experimental instrument packages to study nightglow and nebular emission.

GENERAL PRECISION has received \$1.6-million Navy contract for radar navigation systems for anti-submarine, attack and carrier-based early warning aircraft.

RAYTHEON has received contracts totaling \$12.4 million for work on the Hawk missile system.

GT-1, the first Gemini-Titan launch vehicle, is completing factory check-out at the Martin Ga. plant in Baltimore and will be delivered to Cape Canaveral within 30 days. McDonnell delivered the first capsule last week to the Cape.

SYSTRON-DONNER has received a \$1.8-million Army contract for guidance system components for the Lance missile. The Lance series is expected to total \$20 to \$23 million for Systron-Donner over the next nine years.

ITT is planning a \$30-million expansion program in Europe.

Senate Report Wants Contracts Channeled Into Distress Areas

Shift in government buying to favor electronics contractors and R&D firms in less prosperous areas of the country will be coming in the next two years if Hubert H. Humphrey (D-Minn.), Senate majority whip, has his way. As chairman of a Senate Small Business Committee subcommittee, Humphrey has just issued a report recommending new procurement policies to "balance the pattern of defense spending."

Bluntly, this means keeping more electronic, missile and R&D contracts from going to the West Coast. He says the shift in that kind of procurement to the West Coast has cost Ohio, Indiana, Illinois, Michigan and Wisconsin \$6.1 billion a year in defense contracts, resulting in "the loss of hundreds of thousands of jobs and the growth of new distressed areas."

Humphrey's recommendations include: set aside all of particular procurement contracts for a distressed region, not just a portion; send task forces to help midwestern and other universities get more R&D contracts; place more subcontracts in distressed areas by requiring prime contractors to report names and locations of their subcontractors; require special clearance before allowing new bases and government facilities outside distressed areas; allow government purchasing agents to buy at "point of origin" to give firms in distressed areas a break in competition with sources of supply nearer the point of delivery.

Early next year, defense officials are expected to testify on these proposals before Humphrey's subcommittee.

Satellites to Seek Breaches Of A-Test Ban

First two Vela Hotel weapons-detection satellites are being readied for launch aboard an Atlas Agena from Cape Canaveral. Ten of the satellites will be launched this fall and early next year, to provide a system for detecting possible violations in outer space of the nuclear test-ban treaty. Each 485-lb satellite will carry 17 solar-powered radiation detection instruments: 6 gamma, 10 x-ray and 1 neutron detector. They will go into 60,000-mile orbits and will be separated from each other by 140 degrees.

Air Force is now beginning to set up the space telemetry network. The first data-receiving station for the Vela Hotel satellites is being built on one of the Seychelle Islands in the Indian Ocean.

NASA Rakes Industry for Mercury Work

In a major review of Project Mercury at the Manned Spacecraft Center in Houston, industry was raked harshly by NASA for sloppy workmanship on space projects. NASA says industry delivered spare parts that were 50 percent defective, space capsules with more than 500 defects, improperly soldered electronic parts and so on. On the average, 10 components malfunctioned on each of the six Mercury capsules, NASA reported. NASA says that space reliability needs are higher than for any program ever undertaken, and that industry must improve workmanship. The Houston meeting came on the heels of a new incentive contracting policy (ELECTRONICS, p 20, Oct. 4) aimed at upgrading contractor performance.

SST Hearings Get Underway

Senate Aviation Subcommittee will explore, in hearings starting October 16, the technical problems and economic risks involved in development of a supersonic transport plane. Major issue is how much industry should pay of the \$1-billion development cost. Several new automatic flight control systems are being considered for the SST (ELECTRONICS, p 7, June 14, 1963).

Solid state and stable to 20 ppm!

—for calibration, test and measurement applications
requiring extreme stability, accuracy, regulation and resolution



New

FLUKE MODEL 313A VOLTAGE CALIBRATOR

PARTIAL SPECIFICATIONS

COMPLETELY SOLID STATE

OUTPUT VOLTAGE: 0 to 50 VDC or 0 to 5 VDC

OUTPUT CURRENT: 0 to 2.0 amperes

STABILITY: $\pm 0.002\%$ per hour; $\pm 0.0025\%$ per day; $\pm 0.005\%$ per month

RIPPLE: less than 50 microvolts RMS

TEMPERATURE RANGES: 0°C to 55°C operating; -40°C to 60° storage

DIMENSIONS: 5 1/4" high x 19" wide x 18" deep

PRICE: \$1,295 f.o.b. factory

*Price and specifications
subject to change
without notice.*



ON REQUEST, complete MODEL 313A specification data and latest short form catalog digest. Be sure your file is up to date on the full line of FLUKE differential voltmeters, power supplies, other precision instruments, components, and Montronics standard frequency equipment.

The Model 313A is an efficient, solid state voltage calibrator with better than 20 ppm short-term stability and 5 ppm line and load regulation. Output voltage is controlled by six in-line front panel decade switches, or can be remotely controlled by a variable resistance connected between two rear panel terminals. May be continuously short-circuited without damage. Normal operation is restored upon removal of overload, indicated by front panel warning light. Panel meter may be switched to monitor either voltage or current. Mechanical construction utilizes plug-in printed circuit boards for ease of calibration and maintenance. All heat-producing components are isolated from control circuitry.

Like all FLUKE test and measurement equipment, the Model 313A is engineered for ease of operation, long life and low cost maintainability. Your FLUKE representative will be happy to present full specifications, review operating and service advantages, or arrange a demonstration. JOHN FLUKE MFG. CO., INC., P. O. Box 7428, Seattle 33, Washington. PR 6-1171. TWX, 206-879-1864. TLX, 852. Cable, FLUKE.

FLUKE

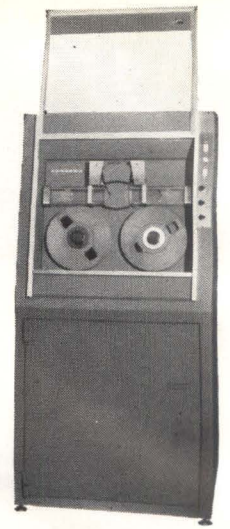
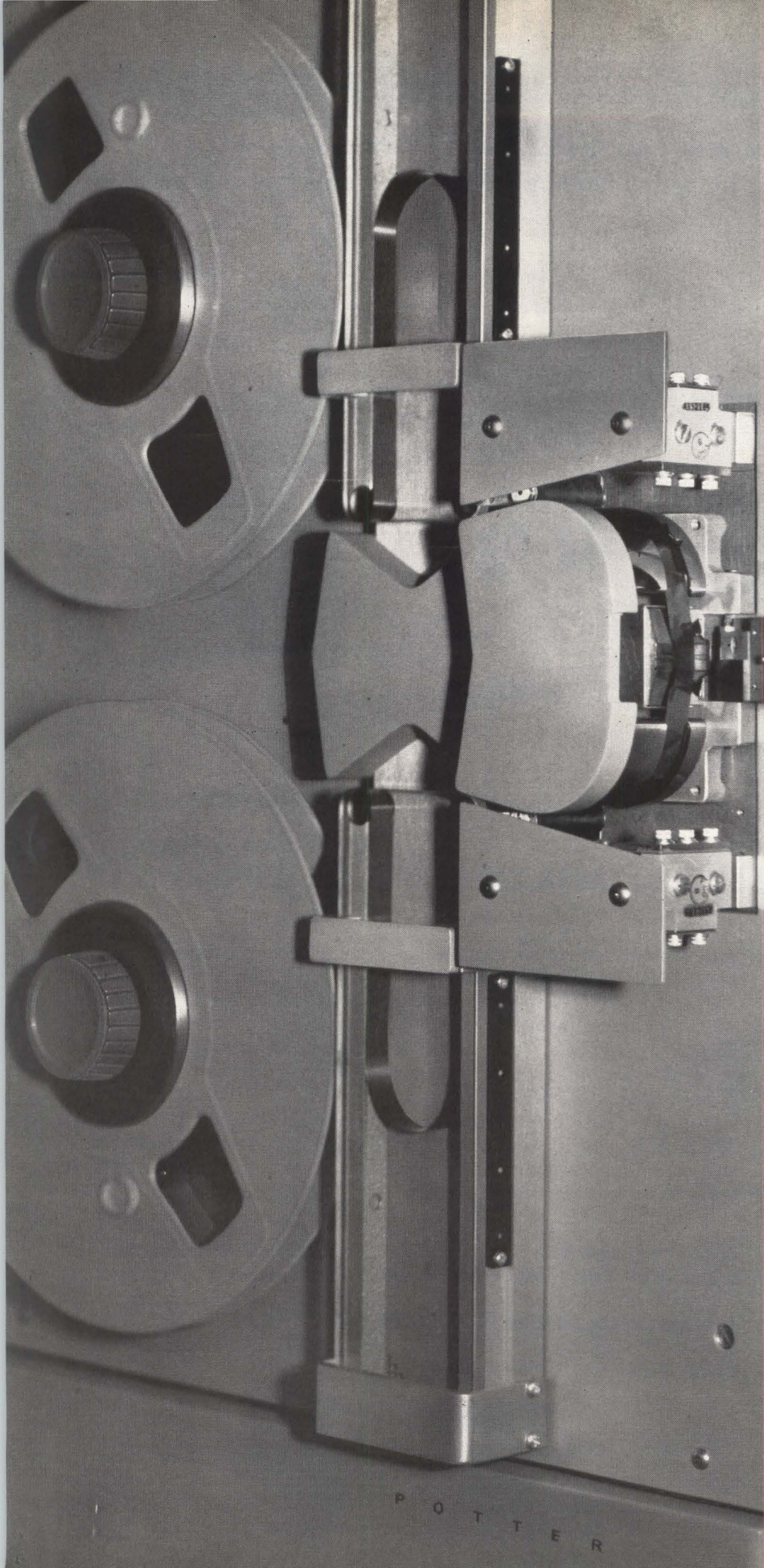

A very big transport in a 2-foot package

This is Potter's MT-24, a new vacuum column, digital magnetic tape transport which is already proving big in the field. Packed into its mere 24" height (or length if you prefer to mount it sideways) is all the dependability and performance of tape drives costing over twice as much. Here are the facts:

PERFORMANCE — Read/write tape speeds from 3 to 36 ips, data transfer to 28.8 kc, 200 commands per second. (50 ips and 40 kc performance available in the MT-36 companion unit at very little increase in price!)

RELIABILITY — Use of thoroughly field tested components in combination with new vacuum column construction has resulted in improved transport dependability. Reliability warranted 1 in 10^8 bits read.

COMPATIBILITY — The MT-24 is compatible with IBM's 7330, with packing densities of 200, 556, and 800 bpi. One inch tape and other computer formats are readily accommodated.

ECONOMY — MT-24 (and MT-36) costs less per effective bit transferred than any other transport on the market . . . and with greater operating dependability and data transfer reliability than tape drives costing more than twice as much.

Potter is shipping MT-24's NOW. Delivery within 4 weeks. Want details? Write — Sales Manager.

POTTER
INSTRUMENT CO., INC.
151 Sunnyside Boulevard, Plainview, New York

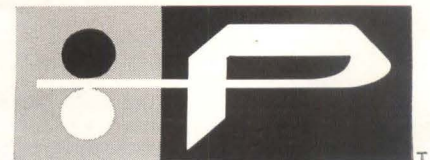

T.M.

CIRCLE 22 ON READER SERVICE CARD

MULTIPLIER TUNING requires spectrum analyzer or selective receiver and each stage should be tuned separately before cascading

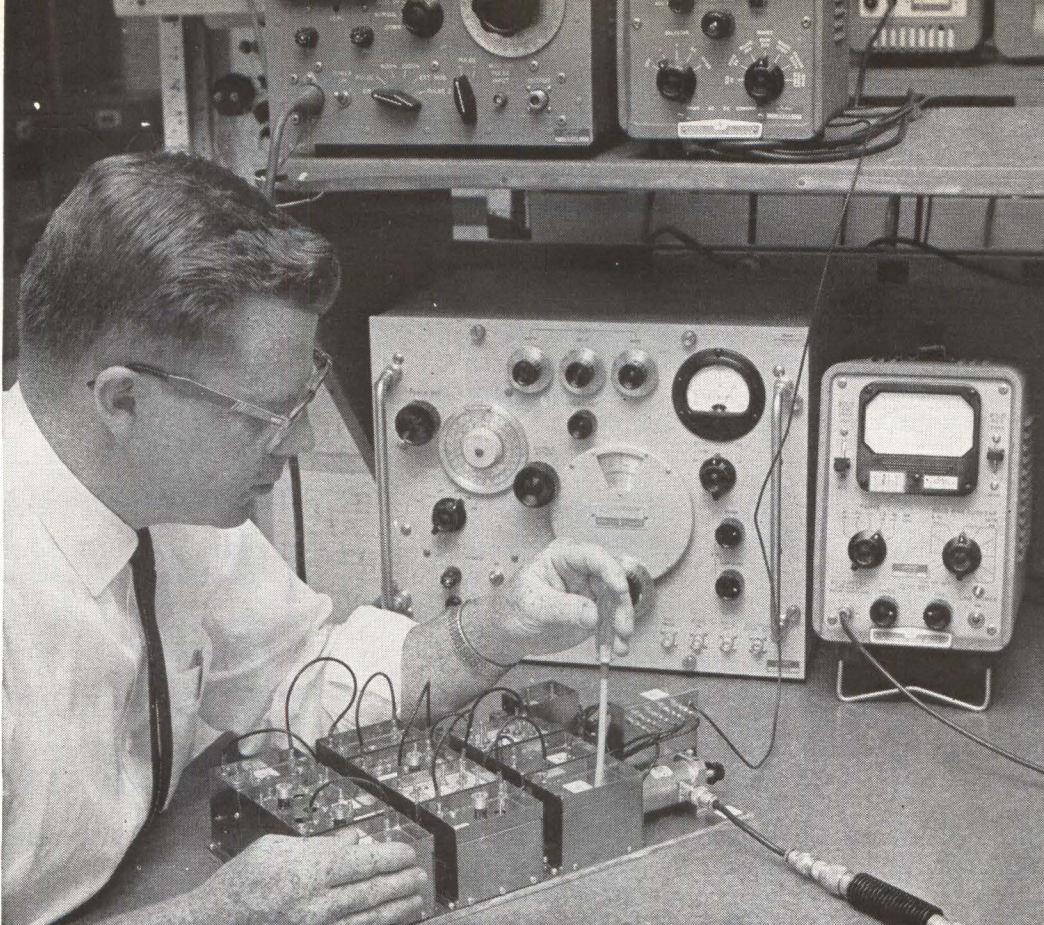

By **D. O. FAIRLEY**,
Lenkurt
Electric Co., Inc.,
San Carlos, Calif.

Solid-State Microwave Generators

New look in microwave generators is solid-state. Varactor diodes allow frequency multiplication to Gc bands without prohibitive power loss, may replace klystrons for some applications

A STRAIGHTFORWARD approach to high-power high-frequency generators is to start with high power and low frequency and multiply, using tuned circuits and keeping circuit losses as low as possible. The variable capacitance diode—or varactor—is particularly useful in such circuits, but its nonlinearity leads to special design problems.

Electrical circuits containing nonlinear reactances are analogous to mechanical problems of forced vibrations with a nonlinear restoring force. For a simple system consisting of a mass M , nonlinear spring, small damping factor, and applied periodic force, the differential equation is

$$M \frac{d^2x}{dt^2} + B \frac{dx}{dt} + F(x) = F_0 \cos \omega t$$

where x is displacement and $F(x)$ is restoring force.

A procedure for solution where $F(x) = Kx - \delta x^3$ is to approximate successively using an assumed function $x = a \cos \omega t$ for the first approximation.¹

Results for a specific set of system constants and various driving forces are shown in Fig. 1. No generalization of the problem can be made since each set of system constants gives a new set of curves and—because of the nonlinearity—solutions to the differential equation are not additive.

The solution² using the even restoring function $F(x) = Kx - \delta x^2$ which would correspond to an abrupt junction varactor is similar to that shown in Fig. 1. The shapes of the curves have been experimentally verified.³

The notable aspect of the curves is that large driving forces produce a multivalued function. In general, any curve with more than one value is unstable; in

this case the circuit has two possible amplitudes for a given frequency.

For a frequency multiplier using a nonlinear reactance, the problem is further complicated in that a single differential equation will not suffice to represent the circuit. A set of equations is required to deal with coupling between input, output and idler circuits (if present). Analysis of the varactor⁴ without regard to any particular circuit, however, has led to asymptotic operational limits for abrupt junction varactors that can be used in circuit design.

Idler Terminations—Conversion efficiency improvement with idler terminations in multipliers of order greater than two has been shown mathematically and verified empirically.^{7, 8, 9} Mathematically output power at the n th harmonic is proportional to some power of the $(n-1)$ th, $(n-2)$ th, etc., currents through the diode. Reactive terminations maximize these currents through resonance and limit power dissipation to the spreading resistance of the diode. Table I shows the necessary idler currents for high-order multiplier circuits.⁹

Diode Selection—The optimum operating point on a diode's capacitance-voltage characteristic is determined by its voltage breakdown (V_b), specified capacitance and spreading resistance.

For an abrupt junction diode operating to the limit of forward conduction, the optimum bias point^{4, 8} is approximately $V_b/3$. Experiments have shown that $V_b/3$ is a reasonable bias for both abrupt and graded junction diodes.

High-frequency operation requires a diode with a high cutoff frequency, which dictates low spreading resistance and low capacitance. Multiplier efficiency falls off rapidly if the ratio of cutoff frequency (at the operating capacitance) to output frequency becomes less than ten.^{10, 11}

The low capacitance required for high frequency is incompatible with high-power operation. Power-handling capability is proportional to diode capacitance and its breakdown voltage squared. A compromise is usually made that will allow a reasonably high cutoff frequency and a large enough breakdown voltage to handle the expected power. The circuit design value of the average capacitance then corresponds to $V_b/3$.

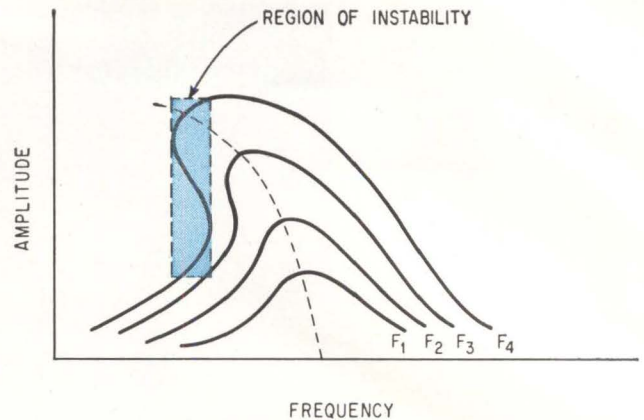

ELECTRICAL CIRCUITS containing a nonlinear reactance show a double-valued characteristic if the driving signal becomes too large—Fig. 1

Bias—Thus a specific operating point is desirable and can be obtained through either fixed or self-bias or a combination. Fixed bias is provided by a low-impedance voltage source through an r-f choke or bypass capacitor, self-bias by charge build-up across an RC circuit from rectified current. One useful combination bias is a large resistance in series with the fixed bias source. Self-bias developed across this resistance is adjusted with the fixed-bias source. The series resistance prevents accidental high currents through the diode from the source. For high-power operation, fixed bias alone does not seem workable. No protection for the diode is provided without a series resistance.

Multiplier Circuits—In lumped circuits operating at high power in the lower uhf range, a shunt diode configuration is recommended. The circuit allows direct heat sink connection for maximum heat transfer.

A basic circuit for doublers, triplers, and quadruplers is shown in Fig. 2A. The circuit is doubly resonant for doublers and triply resonant for triplers and quadruplers.

For the doubler,¹² with the element values as shown in Table II, the average capacitance of the diode is chosen at $V_b/3$ to be C_0 . Series inductance L_0 resonates the diode's capacitance at the geometric mean frequency of input and output, which is $\omega\sqrt{2}$. An input trap prevents second harmonic power from reach-

Idler Terminations in High-Order Multipliers—TABLE I

Multiplier	Required idler order for high efficiency
3	2
4	2
5	2, 3 or 2, 4
6	2, 3 or 2, 4
7	2, 3
8	2, 4
10	2, 3, 5
16	2, 3, 4, 8
32	2, 4, 8, 16

Element Values for Standard Lumped Multiplier—TABLE II

Element	Doubler	Tripler	Quadrupler
C_0	C_d	$2C_d$	$2C_d$
L_0	$1/2\omega^2C_0$	$1/4\omega^2C_0$	$1/4\omega^2C_0$
C_1	$4C_0/3$	$9C_0/10$	$16C_0/45$
L_1	$3L_0/2$	$40L_0/9$	$45L_0/4$
C_n	$2C_0/3$	$C_0/6$	$4C_0/45$
L_n	$3L_0/4$	$24L_0/9$	$45L_0/16$

A COMBINED OPERATION

The nature of the semiconductor beast is to be a low-power, low frequency, low-input-impedance device. Yet the advantages of solid-state devices are so attractive that device manufacturers and circuit designers have never stopped trying to push the limits upward.

Varactor diodes used in resonant multiplier circuits to produce all-solid-state microwave generators are a late example of the combined approach. Solid-state generators can now deliver 200 mw at 3.2 Gc or 15 watts at 100 Mc. There is still a long way to go but the numbers are already satisfactory for many microwave applications

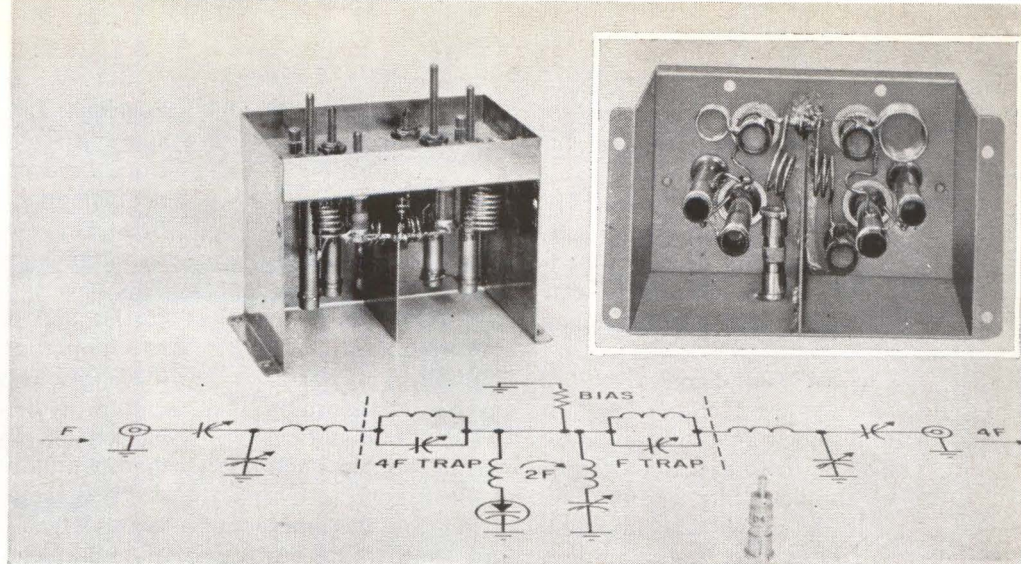

FREQUENCY quadrupler and schematic

ing the generator; an output trap prevents the fundamental frequency power from reaching the load. The input circuit will be series resonant at ω and the output circuit will be series resonant at 2ω . The double resonance leaves only a pure resistance to be matched to the generator and load. In addition, the inductance in series with the diode presents a high impedance to other harmonics.

For tripler and quadrupler operation, the shunt arm of the circuit is modified as shown in Fig. 2B to be two arms, both of which are resonant at the second harmonic idler frequency. Since each arm is resonant, the series combination is also resonant and an idler path is provided around the loop. The series traps are again chosen such that the complete circuit is resonant at both input and output frequencies.

Two alternatives are available in the modified shunt arm of the circuit. Both arms are identical in value but one capacitor can be a diode and the other an idler tuning adjustment; for high-power operation both arms could have diodes. If both arms contain diodes, one of the coils should be tuned to provide an idler adjustment. If it is impractical to tune one of the coils, an additional trimmer capacitance should be included.

Tuning procedure for the lumped multiplier is.

- (1) Temporarily impress the bias voltage upon the diode through a resistor or choke
- (2) Using a low level signal generator at the in-

put, tune the input and output traps for a null at their respective frequencies at the output

- (3) Tune the idler circuit (if used) for a null at its frequency
- (4) Restore the bias circuit to its intended configuration and impress full drive power on the input
- (5) Tune the matching networks for maximum output power
- (6) Retune the idler slightly for maximum power and stable response. Retuning the input and output traps should not be necessary.

Matching Networks—Because of the nonlinearity of the multiplier circuits, the exact value of the input and output resistance to be matched is unknown. From qualitative reasoning, however, a value greater than the spreading resistance is to be expected for the input, since a portion of the input power must be dissipated in the load. As the frequency increases and the diode Q is reduced, then the input resistance should approach the spreading resistance of the diode. (Also, the conversion efficiency should approach zero.) Input and output resistances for an abrupt junction varactor when driven between the limits of breakdown and forward conduction have been calculated.^{4, 8}

As a starting point, the matching networks can be designed to match the spreading resistance of the diode—with adjustment capable of matching a larger

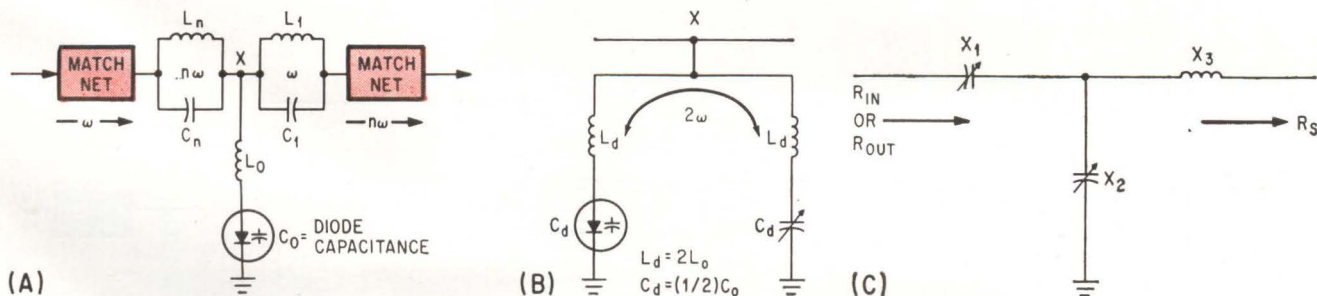

LUMPED DOUBLER circuit (A) uses resonant circuits to block $n\omega$ from input and ω from output. Doubler is converted to tripler or quadrupler by substituting circuit (B) for L_0 and diode at point X. Matching network (C) fits a wide range of multiplier circuits—Fig. 2

value—and then adjusted for optimum power and efficiency. This technique has produced acceptably good results.

The matching network¹³ shown in Fig. 2C has advantages in this situation. Because of its three-elements, the coil need not be precisely chosen; a wide range of real impedances can be matched and a d-c block is inherent in the circuit.

Coaxial Multipliers—Even-order multipliers in coaxial circuits are facilitated by the inverse relationships in resonant lines at even integer harmonic frequencies. The circuits described are a coaxial doubler and quadrupler using a series-diode configuration.

In the simple coaxial doubler of Fig. 3A, the input $\lambda/4$ short stub is an open to ω and a short to 2ω ; the output $\lambda/4$ open stub is an open to 2ω and a short to ω . The matching networks simultaneously cancel the varactor susceptance and match the input and output resistances. Bias is provided by a large resistance attached to the center conductor and passing through the outer conductor of the coaxial line.

A coaxial quadrupler is shown in Fig. 3B, with current paths for the fundamental, second harmonic idler and fourth harmonic output frequency as shown. The $\lambda/4$ short-circuited stub (at the input frequency) provides an open circuit for the fundamental and a short circuit for the second and fourth harmonics; the $\lambda/4$ open stub provides a short circuit to the fundamental and an open circuit to the fourth harmonic; the $\lambda/8$ open stub provides a short circuit to the second harmonic and an open circuit to the fourth harmonic. Thus, input current is not allowed to flow through the load, output current cannot pass back to the source, and a shorting path is provided for the second harmonic idler current on either side of the varactor. Matching networks cancel the susceptance and match diode resistance at the input and output frequencies.

In both the doubler and quadrupler circuits, the $\lambda/4$ short and open stubs can be set independently of the varactor used. The $\lambda/8$ stub in the quadrupler is then used for idler tuning. In most cases, the impedance of the input and output circuits is within the matching range of a double stub tuner. Tuning procedure for the coaxial multipliers is similar to that given for lumped circuits. Using the basic coaxial circuits described, stripline multipliers have also been built successfully.

Spurious Enhancement—If a carrier signal and a spurious signal separated by some frequency difference from the carrier are both impressed upon a nonlinear doubler, the output will contain twice the carrier frequency (which is desired) and a new spurious signal having the same spacing from this new carrier. This new spurious signal is the sum of the original carrier and original spurious signal. Also, the relative amplitude of the original carrier with respect to the spurious signal will have been degraded at the output of the doubler. This is known as spurious enhancement. Thus the doubler is actually a better mixer than a multiplier.

The generalized expression for spurious enhancement, which is approximately correct for all types of multipliers, is

$$\text{Spurious Enhancement} = 20 \log R \text{ (db)}$$

where R is the multiplication ratio.

There is no way of avoiding the production of spurious signals in a multiplier chain. The first multiplier in the chain will produce the spurious signal that will be closest to the carrier and this frequency spacing will be maintained to the output. If the desired spurious rejection at the output is X db, the filtering through the multiplier is Y db, and the spurious enhancement is Z db, then the suppression (or filtering) required out of the first multiplier is $(X - Y + Z)$ db.

Relaxation Modes—One of the difficulties in the development of solid-state generators has been the suppression of relaxation modes of oscillation in the high-power multipliers of a chain. The relaxation oscillation establishes itself in the varactor bias circuit under the large signal conditions and severely modulates the desired harmonic of the input voltage.

The oscillation is believed to be caused by a negative resistance in the diode I-V characteristic, which is induced by the r-f drive on the diode. The magnitude of the effect depends on the amplitude of the r-f drive voltage and the particular diode (or diodes) in the multiplier. Since the amplitude of the r-f driving signal itself depends on the circuit tuning, the difficulty is usually found during tuneup, making this a more difficult process.

Several theories about the negative resistance effect have been offered.^{14, 15, 16, 17}

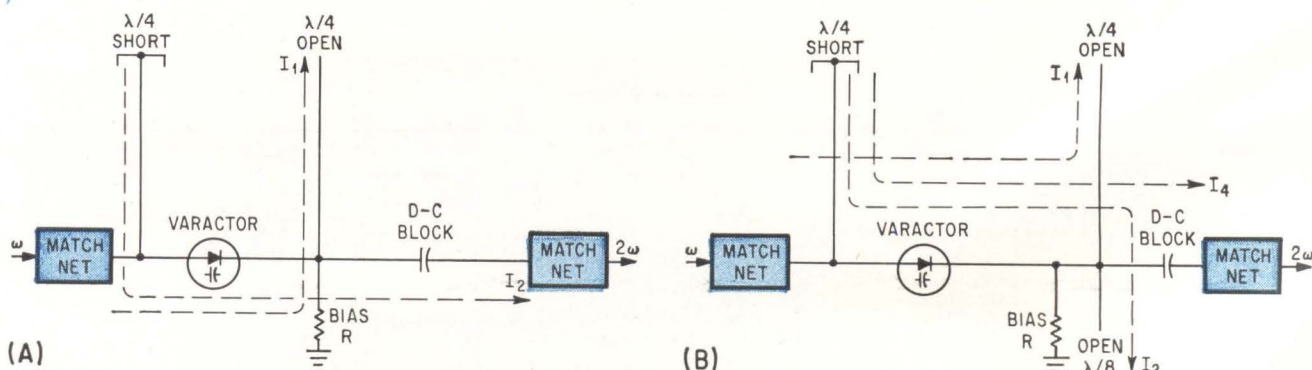

COAXIAL DOUBLER (A) and quadrupler (B) use open and shorted stubs as tuned circuits to provide input and output isolation—Fig. 3

The problem of spurious oscillation is increased by cascading. If the effect occurs in an early stage, spurious enhancement of the sidebands generated by the relaxation oscillations takes place in successive stages; a major portion of the developed harmonic power will then be contained in the output as noise, and will have a spectrum similar to white noise.

Careful tuning will eliminate the sidebands or will reduce them sufficiently. A combination of fixed and self-bias helps; changing the value of bias resistor may also help.

Hysteresis—Parametric multipliers show a hysteresis tuning effect. Optimum output is obtained when tuning from one direction but not from the other. The effect seems to be greater for high-power operation and can also be observed when adjusting the varactor bias circuit.

Spontaneous detuning is believed due to the change in average diode capacitance with respect to r-f drive. Since the diode forms part of a resonant circuit, any tuning change results in a voltage change across the diode, which changes its capacitance and produces further detuning. In the reverse direction, the same sequence cannot occur and therefore the tuning characteristic exhibits hysteresis.

A similar effect occurs with regard to the input power level for a given tuning condition. In addition to the hysteresis seen when power is increased and decreased, the performance of the multiplier goes through a definite peak and exhibits power sensitivity. Increasing the input any further degrades the output. On the other hand, unless sufficient input is present, the conversion efficiency will be poor.

A jump effect is sometimes noted simultaneously with hysteresis under high drive. This is a direct result of the nonlinearity of the diode.

Bias Noise—Noise may sometimes be present due to pickup in the bias circuit. This can be eliminated by filtering or by shielding the bias leads.

Output Frequency—The output frequency fixes the cascaded multiplying ratio if the design is limited to doublers, triplers and quadruplers. Multiplying ratios are given in Table III.

For an output at 8 Gc and a 200 Mc limit on active amplification, the minimum multiplying ratio would be about 40 and the maximum about 80. From Table III the desirable multiplication ratios would be either 48 or 64: cascades of $3 \times 4 \times 4$ or $4 \times 4 \times 4$. The 48 multiplier would have a higher multiplying efficiency while the 64 would relax amplifier and oscillator requirements.

Output Power—Output power is a function of individual multiplier efficiencies and available power at the input frequency. Efficiency of each multiplier may be calculated or obtained from empirical data. Table IV presents a large number of solid-state results.

Using the circuits described, with presently available diodes, conversion losses for doublers range from 1 to 6 db from vhf to the shf band, 2 to 9 db for triplers, and 3 to 12 db for quadruplers. The curves of Fig. 4 show average results for these circuits. For

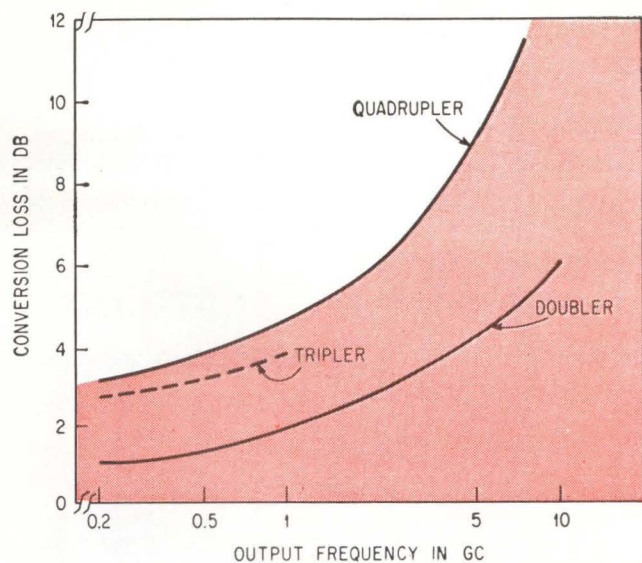

CONVERSION loss chart for varactor multipliers can be used as first approximation in cascade multiplier design—Fig. 4

Multiplying Ratios for Fewest Diodes in Doubler, Tripler, and Quadrupler Cascades—TABLE III

Output in Gc. (0.1 to 0.2 Gc Input)	Mult. Ratio	Fewest Mult. Factors
0.2 to 0.4	2	2
0.3 to 0.6	3	3
0.4 to 0.8	4	4
0.6 to 1.2	6	2×3
0.8 to 1.6	8	2×4
0.9 to 1.8	9	3×3
1.2 to 2.4	12	3×4
1.6 to 3.2	16	4×4
1.8 to 3.6	18	$2 \times 3 \times 3$
2.4 to 4.8	24	$2 \times 3 \times 4$
2.7 to 5.4	27	$3 \times 3 \times 3$
3.2 to 6.4	32	$2 \times 4 \times 4$
3.6 to 7.2	36	$3 \times 3 \times 4$
4.8 to 9.6	48	$3 \times 4 \times 4$
6.4 to 12.8	64	$4 \times 4 \times 4$

MULTIPLIER CASCADE DESIGN

- (1) Select overall multiplication ratio and the individual multiplier ratios from Table III
- (2) Use Fig. 4 to determine power requirements of the individual multipliers
- (3) Provide an amplifier to supply required input power
- (4) Design the individual multipliers and tune independently for the necessary characteristics
- (5) Cascade the circuits and tune to system specifications

the $3 \times 4 \times 4$ multiplier with 8-Gc output, total expected conversion loss is about 22 db.

Bandwidth—Multiplier bandwidth is more a function of the circuit than the diode. A high-efficiency doubler has at least four separate tuned circuits corresponding

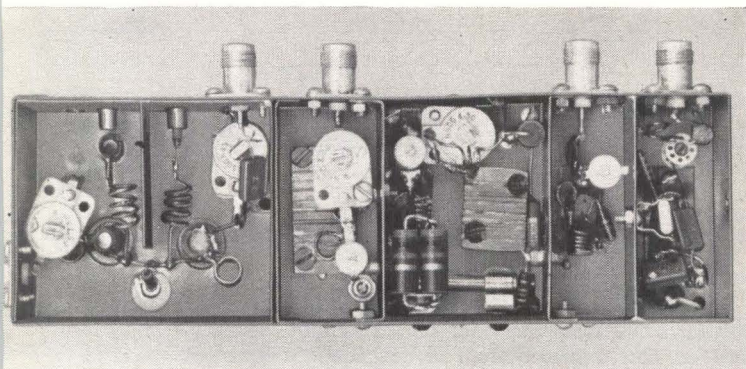

TYPICAL solid-state circuit consisting of crystal oscillator, amplifier and varactor-diode tripler to produce 700 mw at 400 Mc

Solid-State Results: Parametric Multipliers—TABLE IV

Output in Mc	Mult. Ratio	Watts Out	Conversion Loss in db	Diode
Lumped Design				
100	2	15.0	1.9	PC 117-47 (2)
144	3	0.5	4.2	PC 117-47
200	2	8.0	2.7	PC 116-22 (2)
300	2	1.5	1.25	MA 4347 E
400	2	6.0	1.3	PC 116-22 (2)
400	4	7.0	4.3	PC 117-47 (2)
400	3	0.7	3.2	PC 115-10
553-1/3	4	0.21	5.8	D 4252 C
576	4	1.0	4.3	MA 4348 D
Coaxial Design				
800	2	3.2	1.9	MA 4348 F
1,600	2	0.5	3.4	MA 4348 C
1,600	4	2.0	4.8	MA 4348 F
1,600	4	0.21	5.3	MA 4348 E
2,300	4	0.2	5.5	MA 4358 C
3,200	2	0.96	3.6	MA 4348 B
3,200	4	0.2	10.0	MA 4348 C
6,400	4	0.18	9.8	D 4262 D
6,400	4	0.16	10.9	D 4260 C
6,400	4	0.015	11.2	D 4221 H

REFERENCES

(1) J. J. Stoker, "Nonlinear Vibrations," Interscience Publishers, Inc., New York, 1960.
 (2) L. Pipes, "Applied Mathematics for Engineers & Physicists," McGraw-Hill, New York, 1946.
 (3) J. C. McDade, "Jump Phenomena in Varactor Diode Circuits," Diamond Ordnance Fuze Laboratories, TR-1008, Jan. 1962.
 (4) P. Penfield, Jr. and R. P. Rafuse, "Varactor Applications," The MIT Press, MIT, Cambridge, Mass., 1962.
 (5) N. Houlding, "Measurement of Varactor Quality," *The Microwave Journal*, Jan. 1960.
 (6) A. Bakanowski, N. Cranna and A. Uhlir, "Diffused Silicon Nonlinear Capacitors," *IRE Trans Electron Devices*, Oct. 1959.
 (7) B. L. Diamond, "Idler Circuits in Varactor Frequency Multipliers," SM Thesis, MIT, Cambridge, Mass., Feb. 1961.
 (8) G. Leuttgenau, J. Williams and H. Miyahiro, "A Practical Approach to the Design of Parametric Frequency Multipliers," *Wescon*, San Francisco, Sept. 1961.
 (9) F. P. Storke, "High Order Harmonic Generation with

to diode resonance and input and output matching. A tripler or quadrupler with idler has five. To broaden the bandwidth of a single multiplier, the Q of the tuned circuits must be lowered or the circuits stagger tuned. Reducing Q causes a loss in efficiency. Stagger tuning increases circuit complexity but may be the only way to fulfill the design. In addition, cascading multipliers results in further bandwidth narrowing, as in synchronously tuned amplifiers.

Thus a parametric multiplier cascade is essentially a narrow-band device, unless great sacrifices in efficiency and input power are acceptable. For cascades including three or more multipliers and a driving amplifier, bandwidths of one percent are typical.

Stability—Output frequency stability seems to be purely a function of the controlling oscillator. In general, if the oscillator frequency lies above 100 Mc, a fifth overtone crystal is normally used and a stability of one or two parts in 10^5 is obtainable over temperature ranges of 50 C without oven control. Bias and tank circuits must be carefully compensated to achieve this stability.

Cascading—To allow individual multipliers to be separately tuned and then cascaded, all units should be designed for input and output impedances of 50 ohms. This will minimize sensitivity to cable length and will simplify system tuning and repair. If system requirements are so severe that the additional circuit losses and space are intolerable, temporary matching networks can be used for tuning and then removed. With ingenuity, this can be done in both lumped and coaxial multipliers even in compact cascades.

An additional problem sometimes exists when harmonics generated in a preceding stage upset the resonant balance of a stage. Bandpass filters between units eliminate this interaction. A low-pass filter may also suffice unless the interfering signal is due to divider action on the part of the preceding multiplier.

The recommended procedure for tuning a multiplier cascade is:

- (1) Tune each unit individually at the expected power input
- (2) Add units from the lower frequency up and retune at each step
- (3) If trouble is experienced, retune individual units
- (4) Use a spectrum analyzer or selective receiver at each step to insure signal purity.

Varactor Diodes, 1962 *Int. Solid-State Cir. Conf.*, Phila. Pa., Feb. 1962.
 (10) A. Uhlir, Jr., "Selection of Varactors for Power Harmonic Generation," Microwave Associates Report, May 3 1961.
 (11) T. Hyltin and K. Kotzebue, "A Solid-State Microwave Source from Reactance Diode Harmonic Generators," *IRE Trans Microwave Theory and Techniques*, Jan. 1961.
 (12) Alan T. Fisher, "Capacity Diode Parametric Performance and Circuit Design by a Finite Current Method," Redstone Arsenal Report No. DG-7R-1-59, Jan. 1959.
 (13) H. B. Yin, "Calculating Bandwidths for Matching Networks," *Electronic Industries*, July 1960.
 (14) K. Siegal, "Anomalous Reverse Current in Varactor Diodes," *Proc IRE*, 48, p 1159, June 1960.
 (15) L. Hefni, "The Negative Resistances in Junction Diodes," *Proc IRE*, 49, p 1427, Sept. 1961.
 (16) J. C. McDade, "RF Induced Negative Resistance in Junction Diodes," *Proc IRE*, 49, p 957 May 1960.
 (17) J. C. McDade, "Explanation of One Type of RF Induced Negative Resistance in Junction Diodes," *Proc IRE*, 50, p 91, Jan. 1962.

By **HERMANN SCHMID**
BLAINE GRINDLE
 Light Military
 Electronics Dept.,
 General Electric Co.,
 Johnson City, N. Y.

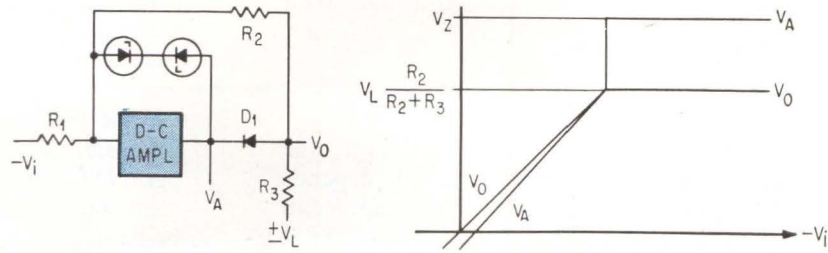

PRECISION LIMITER and voltage graph—Fig. 1

Pulse-Width Modulator

Offers Precision Performance

Transistor input switches, integrator, comparator and flip flop provide amplitude modulation of the controlled-width pulse, accurate to better than one part in 1,000 at a 1-kc repetition frequency

A NEW CIRCUIT for pulse-width modulation has been developed that offers precision performance without the need of precision resistors, precision capacitors or stable power supplies. Applicable to analog computers, analog-to-digital converters and telemetry, the circuit can operate with a relatively low-gain ($G = 1,000$) d-c amplifier, and performs to an accuracy of better than 1 part in 1,000 at a 1-kc repetition frequency over an input range of $+10$ v to -10 v.

A pulse-width modulator is a device that accepts a d-c voltage as input and provides as output a pulse whose duration is proportional to the input amplitude. Most conventional pulse-width modulators use a closed-loop circuit with a voltage or current switch and a low-pass filter in the feedback to obtain high accuracy.¹⁻⁵ These devices require highly sophisticated d-c operational amplifiers with high gain and low drift. The feedback loop of these circuits create stability problems and the low-pass filter severely limits the bandwidth.

Another class of pulse-width modulators developed for telemetering application^{6,7} uses a method of linearly charging and discharging a capacitor. The main design objective in this application is to minimize the bandwidth of the transmitted data, which is done

by operating with a variable repetition frequency (delta-sigma modulation). In pulse-time analog computers⁸⁻¹⁰ and pulse-time hybrid computers, however, the repetition frequency must be constant and synchronized with some central reference; therefore, the capacitor-charging type of pulse-width modulator is not applicable.

The modulator described uses the method of linearly charging and discharging a capacitor, but in combination with a precision high-speed comparator and a two-mode ramp generator, which improves performance with relatively simple circuits.

Considerations—The time required for a linear voltage ramp, starting at zero, to reach a certain value X is directly proportional to the magnitude of X . A pulse-width modulator can thus be built if a linear voltage ramp is compared with a d-c voltage representing the input variable X . The precision of this modulation process is a function of the linearity of the ramp, and of the accuracy and speed of the comparator.

One of the most accurate comparators is the precision limiter (Fig. 1). When the magnitude of the input voltage V_i approaches the magnitude of the limiting or comparison voltage V_L , the current i_1 through diode D_1 approaches zero, increasing the diode impedance.

With more impedance in the feedback path, the closed-loop gain of the d-c amplifier increases; the amplifier output voltage V_A becomes larger, and cuts off the diode still more. This in turn causes an even higher feedback impedance, and so on. A regenerative process continues until V_A reaches the Zener breakdown voltage V_Z of the diodes across the amplifier. The output voltage V_o of this limiting circuit is determined by the current i_2 through the feedback resistor R_2 . With current i_1 equal to zero, i_2 must equal cur-

HOW CAN IT BE USED?

This circuit requires neither precision resistors nor precision capacitors nor stabilized power supplies. This fact, plus high circuit performance and relative circuit simplicity, make the modulator an excellent building block for analog computers, analog-to-digital interface equipment and control circuits

rent i_3 , and if V_L is constant, V_o is also constant. With no additional load, the output voltage of the limiter

$$V_o = V_L \frac{R_2}{R_2 + R_3}$$

When the gain of the d-c amplifier is large, the precision with which V_o is determined usually depends only on the tolerance of the resistors R_2 and R_3 ; a magnitude of error in the order of ± 0.01 percent is feasible. However, the precision limiter is not fast. The amplifier output voltage V_A (Fig. 1), needs as much as 100 microseconds to rise from the value V_o to V_Z . In a 10-volt computing system, and with a one-kilocycle voltage ramp, this would constitute an error of 10 percent of full scale. To overcome this speed limitation, diode D_1 in the precision limiter is replaced by a transistor amplifier.

The pulse-width modulator in Fig. 2A¹² generates a linear ramp V_S which is compared with the input voltage V_X . When V_S equals V_X the comparator provides an output pulse, resetting the flip-flop that was set with the negative-going edge of the RESET pulse.

This pulse-width modulator offers excellent performance under room-temperature conditions. However, it is difficult to maintain the high accuracy when the temperature changes from -55 deg C to $+125$ deg C, as experienced in military environment. It is particularly difficult to maintain the slope of the ramp constant unless the integrating capacitor and resistor are highly stable or put into an oven. The linear ramp is reset by shorting a transistor across the integrating capacitor. This causes transient settling problems in the operation, which require careful circuit layout and close control of the RESET pulse. Also, transients and ripple on V_X are transmitted through the modulator with unity gain. Finally, summing into the modulator creates bias and impedance problems.

Circuit Description—Most of these problems are overcome with the pulse-width modulator shown in Fig. 2B. It consists of input switches, integrator, comparator and a conventional set-reset flip-flop.

The input switches are conventional transistor voltage switches,¹³ either shunt or series-shunt type. For operating temperatures below 60 deg C, germanium alloy-junction transistors are preferred; for higher temperatures, silicon transistors are required.

The integrator is a conventional transistor d-c operational amplifier with the appropriate input resistor and feedback capacitor. The effective drift current I_D of the amplifier, with respect to time and temperature, must be smaller than 0.1 percent of the maximum input current I_i . With a 10,000-ohm input resistor, $I_{i \max}$ is 1 ma; thus, I_D must be less than $1 \mu\text{a}$ over the desired temperature range. For a $+20$ to $+60$ deg C range, this is within the capability of a differential d-c amplifier, such as the Philbrick P65. However, due to the two-mode operation of the modulator, the amplifier needs only a gain of about 1,000. Therefore, a relatively simple d-c amplifier can be used.

The comparator is basically a one-stage current amplifier and a one-stage voltage amplifier. The two transistors are connected into the feedback path of the integrator in such a way that the integrator sees only

a diode. When comparator input current I_c becomes zero, the comparator provides a fast change of its output signal.

Circuit Operation—The operation of this modulator is divided into two discrete modes, each lasting for a period T . The T_1/T_2 control signal (Fig. 3A) connects the modulator alternately into the two modes by energizing switch S_1 .

With S_1 in position *a*, the output voltage of the integrator V_A increases with a slope proportional to the input voltage V_X (Fig. 3B). At the end of period T_1 , the voltage V_A is $V_A = kV_X$.

With S_1 in position *b*, the output voltage of the integrator decreases with a slope proportional to the reference voltage V_R . When V_A becomes equal to the bias voltage V_B , the comparator provides an output signal that opens switch S_2 and resets the flip-flop. Switch S_2 disconnects V_R from the integrator and maintains V_A at V_B . The output of the flip-flop, which was set when the T_1/T_2 control signal changed from plus to zero, is the output of the modulator. The time required for the process of decreasing V_A from kV_X to V_B is $t = kV_X/V_R$.

The output signal of the modulator (Fig. 3C) has a pulse ON time of t and a repetition period of $2T$. The maximum modulation of the output signal is thus limited to 50 percent of the repetition period.

Mathematics—The following analysis proves that the performance of the modulator is independent of the variation of the integrating time constant RC .

During period T_1 , the output voltage of the d-c amplifier is

$$V_{A1}(t) = \frac{1}{RC} \int_0^{T_1} V_X dt = \frac{V_X}{RC} t$$

and at the end of T_1

$$V_A(T_1) = \frac{V_X}{RC} T_1$$

During period T_2 , the output voltage of the d-c amplifier is

$$\begin{aligned} V_{A2}(t) &= \frac{V_X}{RC} T_1 - \frac{1}{RC} \int_0^{\tau} V_R dt \\ &= \frac{V_X}{RC} T_1 - \frac{V_R}{RC} \tau \end{aligned}$$

and at the end of the period

$$V_A(\tau) = \frac{V_X}{RC} T_1 - \frac{V_R}{RC} \tau$$

When V_{A2} equals zero, the equation above can be solved for the pulse time

$$\tau = \frac{V_X}{V_R} T_1$$

This equation does not contain the value RC ; thus, the operation of the modulator is independent of variations in RC .

Performance—The performance of any pulse-width modulator is, at best, a compromise between static and dynamic performance. Within limits, static accuracy can always be traded for speed of operation, or

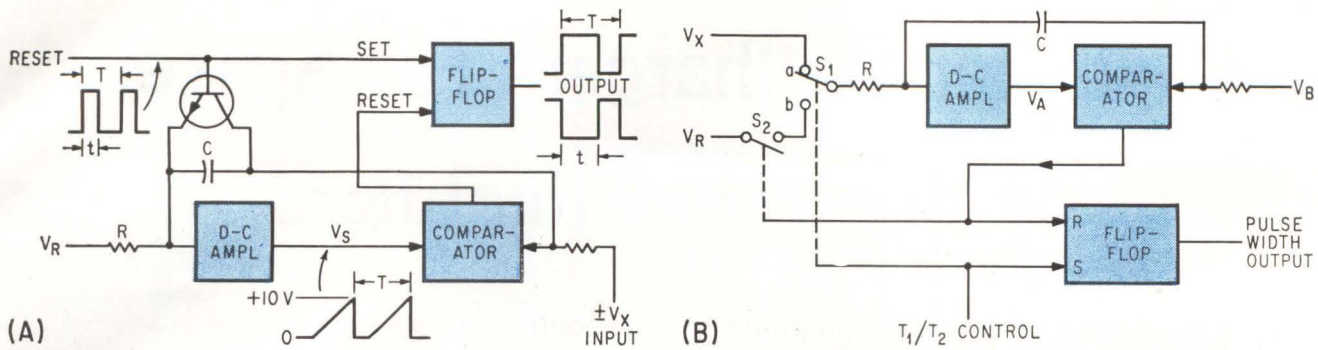

CONVENTIONAL pulse-width modulator, consisting of a ramp generator and a comparator (A); improved pulse-width modulator (B)—Fig. 2

conversely, by changing the frequency of the control signal T_1/T_2 .

Static accuracy is a measure of how well the circuit produces the desired output with an input that does not vary with time. Factors affecting static accuracy are

- Offset voltage of the input switches. This can be made less than 1 mv out of 10 volts, or 0.01 percent.
- Comparator error about 0.02 percent; this is largely a timing error due to variations in component characteristics with temperature.
- Drift in the d-c amplifier is the largest error component. Better performance is always possible with an amplifier having smaller drift.
- Switching-time errors at the input and in the flip-flop. Individual switching times can be made less than $0.1 \mu\text{sec}$. The cumulative effect of all switching is about 0.02 percent.
- Combined effect of all other errors, including noise and jitter, is about 0.02 percent.

This error analysis assumes perfect inputs. The total error, verified by laboratory tests, is less than 0.1 percent of full scale at a repetition rate of 1 kc. Static accuracy is a function of carrier frequency. Greater accuracy up to a maximum of ± 0.01 percent could be obtained with a lower frequency of operation. The

dynamic range of this modulator; that is, the ratio between the maximum output voltage and the minimum output voltage, is 10,000:1, 1,000:1 and 100:1 at carrier frequencies of 1, 10, and 100 kc, respectively.

When the input voltage V_X changes as a function of time, the pulse width output signal from the modular must also change as a function of time. The pulse-width modulator is a device whose operation is based on the sampling theorem. In such a circuit, there is a linear phase-shift but no noticeable amplitude variations as the input signal frequency changes from zero to one-tenth of the repetition frequency. If the frequency is raised still further, the output pulse train becomes unstable and finally breaks down altogether. The bandwidth of the pulse-width modulator is, therefore, limited to approximately one-tenth of the repetition frequency.

The proposed pulse width modulator has operated with repetition frequencies up to 100 kc, where it maintained an accuracy of ± 1 percent of full scale.

There is, however, one limiting factor. The modulator, in its present form with the Philbrick P65 differential amplifier, will not maintain its accuracy over the full military temperature range. The accuracy deteriorates from 0.1 percent between $+20$ and 60 deg C to 0.25 deg between -20 and $+100$ deg C and to 1 percent between $+55$ and $+125$ deg C. To overcome this limitation, it is suggested a simpler d-c amplifier with a gain of 1,000 be designed. Such an amplifier should be considerably smaller and can thus be oven-controlled to minimize drift.

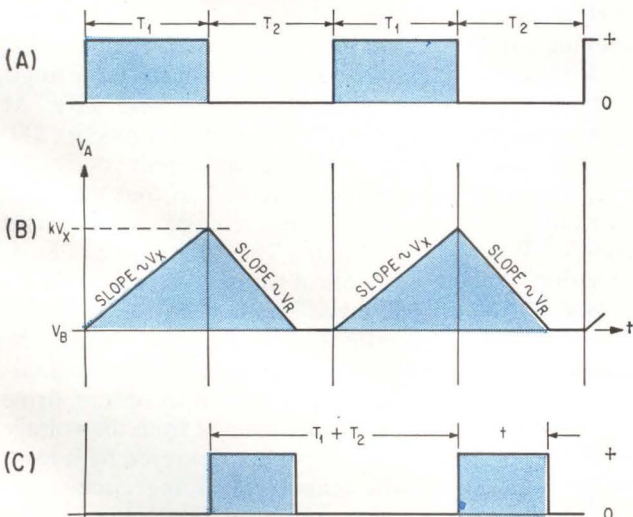

MODULATOR WAVEFORMS: T_1/T_2 control signal (A); output of d-c amplifier (B); modulator output (C)—Fig. 3

REFERENCES

- (1) E. A. Goldberg, High-Accuracy Time Division Multiplier, *RCA Review*, Volume B, Sept. 1952.
- (2) M. L. Lilamond, A Time-Division Multiplier, *IRE PGEC*, March 1956.
- (3) D. C. Kalbfell, An Electronic Analog Multiplier, *IRE PGEC*, June 1957.
- (4) H. Schmid, A Transistorized Four-Quadrant Time-Division Multiplier With 0.1% Accuracy, *IRE PGEC*, March 1958.
- (5) E. Kettel, An Accurate Multiplier Divider, *IRE PGEC*, June 1961.
- (6) H. Inose, et al., New Modulation Technique Simplifies Circuits, *Electronics*, Jan. 25, 1963.
- (7) H. Inose, et al., A Telemetering System By Code Modulation, *IRE PGSET*, Sept. 1962.
- (8) W. R. Seegmiller, Hydapt For Flight Control, Winter 1963 AIEE General Meeting, NY City, Jan. 27-Feb. 1.
- (9) H. Schmid, Linear Segment Function Generator, *IRE PGEC*, Dec. 1962.
- (10) H. Schmid, A Transistorized, All-Electronic Cosine-Sine Function Generator, Proceedings of WESCON, Los Angeles, August, 1958.
- (11) H. Koerner and G. A. Korn, New Operational-Amplifier Techniques For Precision Switching and Function Generation, University of Arizona ACL—Memorandum No. 5.
- (12) H. Schmid, Four-Quadrant All-Electronic Pulse Time Multiplier, General Electric Company, TIS 62APJ43.

Capacitance Chargers For Space Employ Controlled Rectifiers

Development of reliable high-power silicon controlled rectifiers makes possible light, highly efficient charging circuits that are particularly advantageous where the ratio of charging period to supply frequency period is high

By FELIX ELLERN, Power Conversion Systems Division, Republic Aviation Corp., Farmingdale, N. Y.

RECENTLY, a conventional charger for a 30-kw plasma pinch engine, fed from a 1,000-cps supply into a 360- μ f capacitor whose discharging rate was 80 cps, required a 70-pound inductor and a 40-pound transformer. Its losses were estimated at 2,500 watts. The circuit of Fig. 1 reduces the size of this inductor to 7 pounds by shaping the input voltage in a special manner and making use of a silicon controlled rectifier (SCR).

The input voltage waveshape is modified so that the current waveshape will consist of a series of rectified sine curves at a frequency of f_2 , Fig. 2A. Current waveform (1) will provide the same power-transfer efficiency as that of (2). However, the relative increase in frequency allows the use of lower inductance. Maximum transfer efficiency occurs when inductive reactance equals capacitive reactance. If the supply frequency is f_2 and it takes n half cycles to charge the capacitor, the ratio of the resonating frequency to the discharge frequency is

$$\frac{f_2}{f_1} = \frac{\frac{1}{t_2}}{\frac{1}{T}} = \frac{\frac{1}{t_2}}{\frac{1}{n t_2}} = n$$

where t_2 is half the supply voltage

period and T is the charging period. This ratio will also determine the inductance required in the SCR circuit L_2 compared to that of a conventional circuit L_1

$$n = \frac{\frac{1}{\sqrt{L_2 C}}}{\frac{1}{\sqrt{L_1 C}}} = \sqrt{\frac{L_1}{L_2}}$$

However, $L = KN^2$ where N is the number of turns and K is a proportionality factor of the inductor, hence

$$\frac{N_1}{N_2} = n$$

If it is assumed that the number of turns is proportional to weight W then

$$\frac{W_1}{W_2} = \sqrt{\frac{L_1}{L_2}} = n$$

where W_2 is the weight for the SCR inductor and W_1 the weight of the original inductor. Assuming equal diameters of conductors for the two cores, the weight is reduced by a factor of n . Thus, if the weight were the only consideration, the larger the charging period for a given input frequency the more advantageous the SCR charger becomes. When larger diameter conductors with lower resistances are used in the

larger inductor the weight advantage increases in favor of the SCR method. For equal size conductors, the resistance of the inductor is directly proportional to the number of turns used so that the effective resistance decreases for the SCR charger. Also, the overall efficiency is increasing by a considerable amount since at slow discharge rates the inductor contributes the major part of the losses.

SCR Charger—The new constant-current charging circuit uses active control elements such as silicon controlled rectifiers with their high efficiency-controlling capabilities. Basically they are switches operating similarly to mercury switching tubes. Little power is required to switch large loads. Like the mercury switch, the SCR is switched off when the current through it decreases to zero.

In this application, regulation is achieved by a shift in the firing angle of the supply voltage (Fig. 2B). At first this firing angle approaches 180 deg. After each supply cycle the angle is decreased so that the input current surge remains at a constant amplitude. The circuit used, Fig. 1, is identical to that of a conventional full-wave rectifier bridge with two rectifiers of the bridge replaced by SCR's and an appropriate firing circuit. The magnitude of the firing angle is determined from the voltage on the capacitor delivered by a feedback loop to the firing circuits.

For a conventional charger, the actual current waveshape obtained is shown in Fig. 3A. The current

USES IN SPACE

Many actual and proposed systems for use aboard space craft involve charging a capacitor bank periodically. These systems include plasma engines, pulsed lasers and some thermonuclear devices. Here is a way to do it efficiently while conserving both weight and power

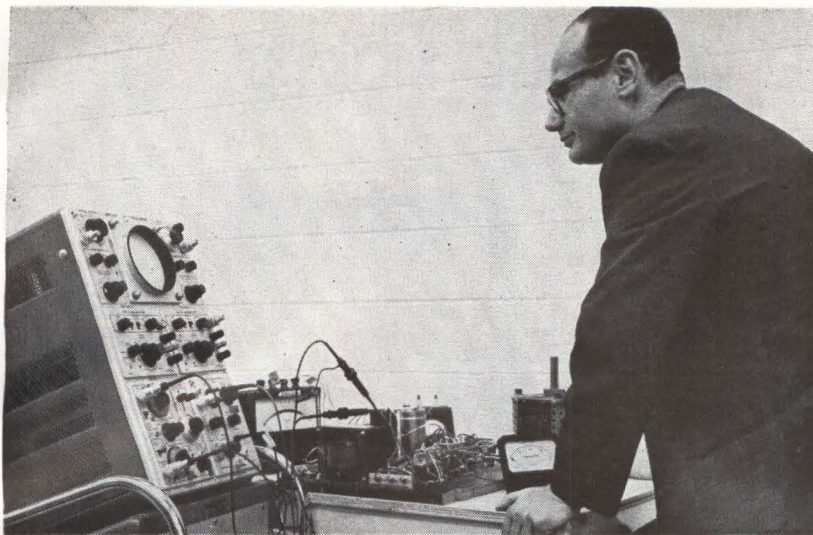

BREAD-BOARD LAYOUT of 100 watt SCR charger

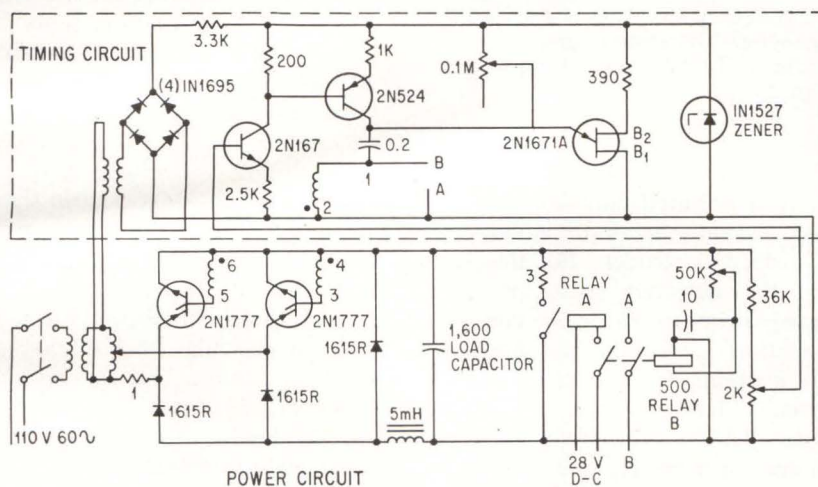

CONTROLLED RECTIFIERS replace diodes of full-wave rectifier bridge circuit, provide a-c charging of load capacitor. Voltage on the capacitor determines magnitude of SCR firing angle through a feedback loop, thus providing a constant-current source—Fig. 1

spikes have a long duty cycle that reduces efficiency. This duty cycle will be considerably improved with a three-phase supply but its actual efficiency proportional to its duty cycle ratio, may be calculated to be 0.38 that of the SCR charger. The relative losses, however, are 2.6 times as great if the equivalent resistance were the same in both chargers. However, the total resistance of conventional resonant charging circuit is more than twice that of the SCR circuit due to the much larger inductor so that the efficiency in the SCR circuit will be the same or greater.

Results—Using the full-wave SCR single-phase charger of Fig. 1 produced the typical voltage and current waveforms of Fig. 3B. The period is 0.09 second, the voltage

before discharge is 120 volts and the output is 103.5 watts. The voltage, increasing in linear steps, indicates that the current pulses are identical and equal to an average peak of about 8.6 amperes.

The resistance of the source including transformer and Variac is 2.3 ohms. The resistance of the coil is 0.03 ohm. The rectifiers contribute 0.4 ohm, the capacitors 0.3 ohm. An additional 1-ohm resistance is used to measure the current by voltmeter, so that the total equivalent source resistance is 3.3 ohms and the total equivalent load resistance is 0.73 ohm.

The size of the inductor needed without SCR's can be calculated to be 0.62 henry. With SCR's it shrinks to 5 mh. The weight is reduced by approximately 90 percent.

The actual losses in the circuit

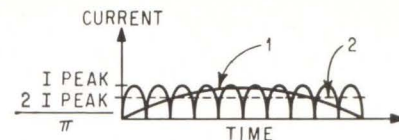

(A)

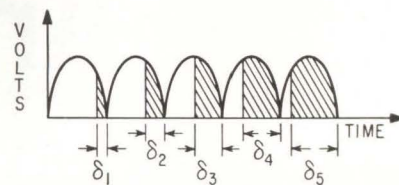

(B)

HALF-SINE waveform (A1) has an average value that approaches the ideal (A2). Shaded area is voltage applied to charging capacitors, SCR firing angle varies in proportion to this voltage (B)—Fig. 2

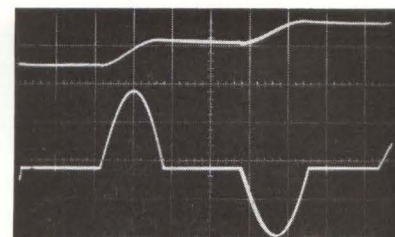

(A)

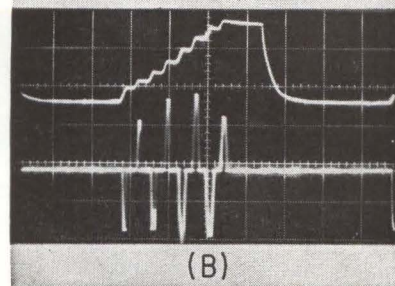

(B)

CONVENTIONAL charger waveforms, voltage, top, and current, bottom, (A); SCR charger waveforms (voltage, top, and current, bottom) provide increased efficiency due to reduced duty cycle—Fig. 3

are only due to rectifiers, capacitor and resistance of the inductor which is 0.73 ohm. The effective value of the current is 3.8 amperes and the losses are 10.5 watts. Excluding the losses in the capacitor itself (common to both chargers), the losses are only 4.5 watts.

The author thanks Prof. Dov Hazony of Case Institute and H. Jacobs and D. Rigney for suggestions and discussion.

BIBLIOGRAPHY

P. M. Mostov, J. L. Neuringer and D. S. Rigney, Optimum Charging Efficiency for Space System, *Proc IRE*, p 941, 48, No. 5, May 1961.

GE SCR Manual, Second edition, p 171.

MUSCLE VOLTAGE MOVES

Artificial Hand

MYOELECTRIC control of prostheses offers advantages over conventional mechanical or transducer control of artificial limbs. Muscular effort generates the electromyographic (emg) signal without the exercise of physical force. Only mental concentration is required. In the type of device to be described, the amputee needs only to think of closing his missing hand, whereupon the artificial hand closes electro-mechanically. Physical movement of the stump, relative to the prosthetic device, can be used to modify or refine the movement.

Muscle potentials, termed emg signals, can be detected at the surface of the body using small plane electrodes pressed against the skin covering the desired muscle. The nature of the emg signal is a carrier that is amplitude modulated by the integrated activity of the whole muscle. A typical emg signal, recorded during a sequence of strong and light muscle effort and relaxation, is shown in Fig. 1.

Detected Signal—The total electri-

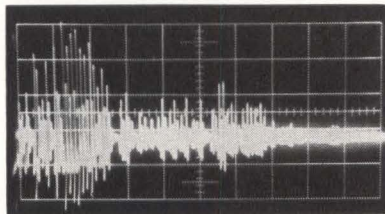

FILTERED typical emg signal corresponding to strong grasp, light grasp and relaxation of muscle—Fig. 1

cal activity at a given time is randomly distributed along the muscle mass and only a sample is detected by surface electrodes. For this reason, the detected signal is only roughly proportional to the contraction effort. Similarly, the emg signal fluctuates, even at constant muscular tension, around a mean value. There is crosstalk between the emg of a muscle and that of its antagonist, the magnitude varying among patients and with the siting of the pickup electrodes. The crosstalk is generally 10 to 15 db below the desired signal from the active muscle.

Myoelectric signals are always present in a stump muscle even when the amputation is many years old. A muscle affected by polio or other paralyzing disease produces emg signals, even when the muscle is so weak that it cannot operate against gravity. Since the amplitude is often larger in polio patients than in normal subjects, emg-controlled orthotic aids may be particularly applicable to the relief of paralyzed patients.

Characteristics—Myoelectric signals are complex pulse potentials of 10 to 1,000 microvolts with durations between 1 and 10 milliseconds when recorded from the body surface. Individual muscular fiber discharge is about 1 millisecond in duration. However, the pulses overlap in the muscle bundle to produce lower frequency components.

Interference arises from stray electromagnetic fields, especially power lines, and myoelectric tissue noise (some 10 μV in amplitude), involuntary contractions and electrode-skin contact instability.

ELECTROMEDICAL CHALLENGE

Despite some unfamiliar terminology, most of the words that are uniquely descriptive have been retained in this article by the editors. The prefix **myo** is a combining form meaning muscle and the electromyographic (emg) signal is a muscle-initiated electrical impulse that makes possible the actuation of the prosthesis, or prosthetic device, which in this case is an artificial hand. An orthotic (from the Greek **straight**) aid in medical terminology concerns correction of a deformity. The availability of a usable electric signal from even a polio damaged muscle may come as a revelation to most electronics engineers—and should set them thinking

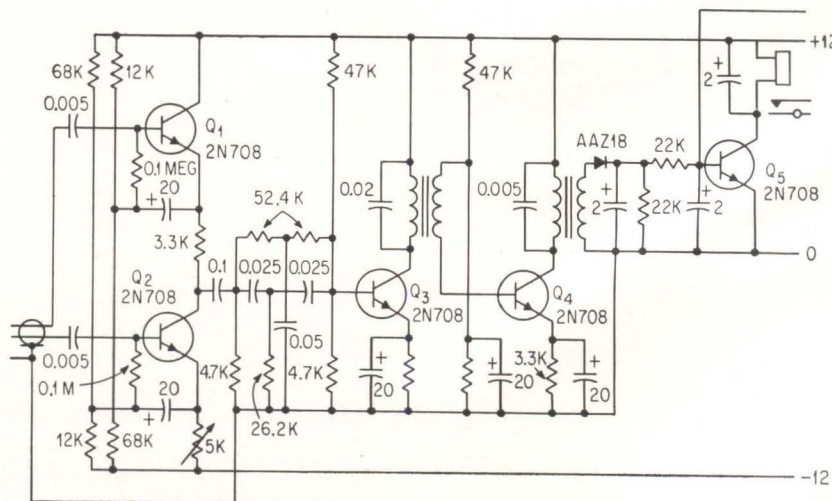

MYOELECTRIC amplifier accepts muscle signal through differential amplifier. Processed, integrated signal operates a relay—Fig. 2

Electromyographic signal produced by muscle movement controls grasp of prosthetic fingers

By **G. W. HORN**, Consulting Engineer
Mandello Lario, Como, Italy

The input amplifier should have a front-end impedance in excess of 1,000 ohms and should preferably match skin resistance that varies between 50,000 to 100,000 ohms when dry to less than 5,000 to 10,000 ohms when lightly sandpapered and coated with an electrode jelly.

Limiting overall bandwidth increases signal-noise ratio. Preliminary tests showed that beyond 1 kc useful myoelectric signals were insignificant whereas noise was added. Limitation of the lower cutoff frequency to 100 cycles results in information loss but this condition may be tolerable under conditions of severe power-line noise. The more significant harmonic content of the emg signal falls between 100 and 1,000 cycles.

Equipment Design—By designing the input of the amplifier as a differential stage spurious signals can be reduced. An extraneous potential picked up by the two skin electrodes is in phase and if the amplifier is perfectly symmetrical, no output results. The desired out-of-phase signal is passed to the following amplifier. Transistor amplifiers are less subject to spurious-signal pickup.

Even after filtering and amplification, the emg signal is raw and irregular, requiring further electronic transformations. A 100-ms iterative integration improves discrimination between different signal levels, achieved by summing over a discrete time interval. However, the concomitant time lag affects tracking performance. A smoothing transformation of the rectified emg signal provides a steady, slowly varying input to the control system, but by itself introduces signal attenuation and degrades system capability to discriminate between different activity levels.

Fluctuations in emg signal after filtering and rectification are a source of trouble. With a long time constant, response is sluggish. When the time constant is too short, the actuator vibrates with signal fluctuations. Backlash between the control signal and actuator response has solved this difficulty.

Amplifier—The diagram of a suitable transistor amplifier is shown in Fig. 2. Transistors Q_1 and Q_2 act as a differential input amplifier. Feedback from emitters to bases raises input impedance between the electrodes to about a megohm. Using matched transistors, a common mode rejection of 5,000 is possible. A band-pass amplifier (Q_3 and Q_4) employs stagger-tuned interstage transformers to obtain a 100-1,000 cycle bandwidth. Attenuation at 50 cycles is almost 45 db down and the amplifier response falls 18 db at 2 kc. An optional T-pad can be used to reject the second harmonic of power-line interference.

After amplification, the emg signal is integrated in the detector stage. If a predetermined level is attained, the output relay closes. This device gives a proportional output as well as a binary response corresponding to the state of contraction of the muscle.

Practically, the binary output is more useful, because the emg signal, as a sample of total muscle electrical activity, is itself more binary in nature. Obtaining a proportional servo motion is possible but probably only with central logic blocks responsive to several emg signals from different muscles.

Working Model—To test the control system, a conventional hand prosthesis (illustrated) was used, only the thumb and first two fingers being driven by a 1/60-hp motor

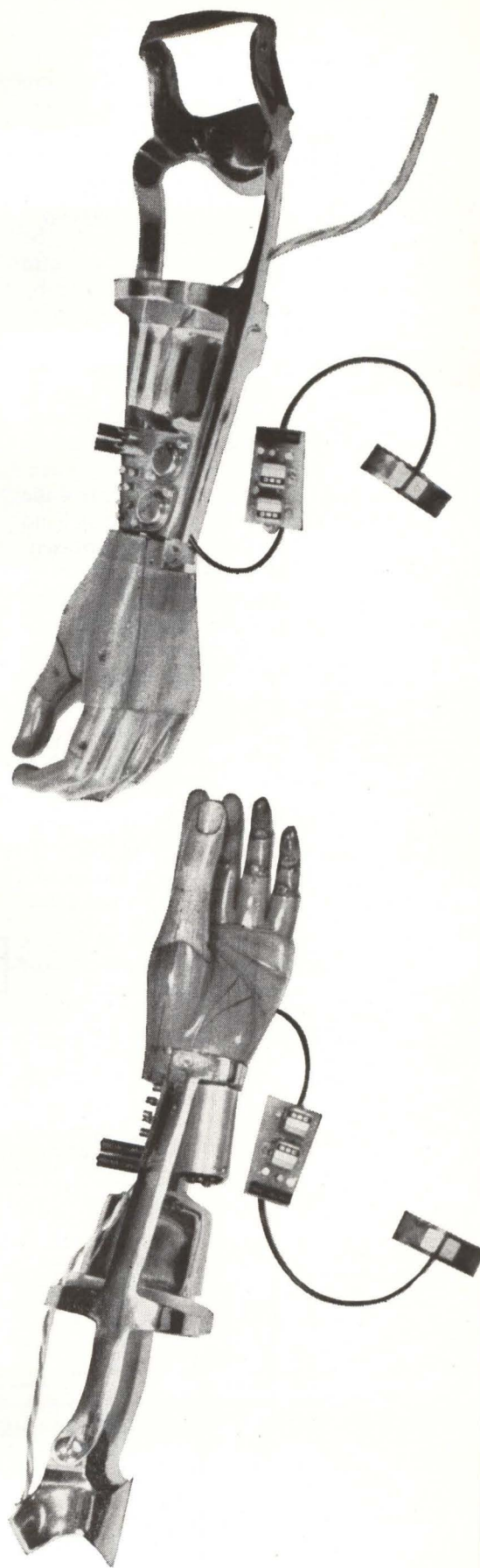

EXPOSED views of prosthetic hand with cosmetic glove and socket removed to show servoamplifier, potentiometer rotative control, and motor assembly; emg pickup electrodes are attached to adhesive strap

through a reduction gear and set of levers. The other two fingers are passively positionable in an infinite number of arbitrary positions. The motor and mechanical system are placed close to the wrist and the emg pickup electrodes are arranged on a small leather strap to be tightened on the patient's forearm stump or, alternatively, attached by adhesive strapping to the skin over the muscle.

Electrical functions of the prosthesis are shown in block form in Fig. 3. The output circuit for control-motor excitation is designed to use minimum power with the system at rest. The patient can control the grasping force of his artificial hand through R_c , (Fig. 4), a pressure-sensitive variable resistor. This transducer is actuated by the patient's contracting and pressing the stump against it. The schematic diagram in Fig. 4 shows additional detail. In

the absence of emg signal, a voluntary positioning of the prosthesis active fingers is possible through a potentiometer controlled by axial rotation of the stump in the socket. The servo action is determined by mutual position of the control and follow-up potentiometers.

The position servo and emg control cannot operate at the same time. As the patient contracts the muscle that closes the prosthesis, emg takes control, disconnecting the position servo. As he relaxes the muscle to open the prosthesis and release the grasped object, the position servo again takes control allowing the patient to reposition his fingers.

Practical use of the prosthesis is improved by introducing some backlash into the control system such that a considerable effort must be made to initiate the grasp, which is then maintained by a lesser effort.

Control binary (Q_6 and Q_7) is triggered on through a diode and reset by Q_8 for which the conduction threshold is determined by the setting of R_1 . Amplitude of the emg signal must override the threshold S_2 causing the binary to shift state and close the prosthesis. Once triggered, the control binary cannot flip back, even if signal amplitude falls back under R_2 , so long as it remains higher than R_1 . Transistor Q_8 conducts only when the signal falls under R_1 , resetting the binary and causing the prosthesis to open. The adjustable settings for thresholds R_2 and R_1 determine the effort necessary to close the hand and to maintain the grip.

Motor current is supplied by a couple of complementary transistors, Q_{15} and Q_{16} , driven by Q_{13} and Q_{14} . The stage is driven by differential amplifier Q_{11} and Q_{12} . Transistors Q_9 and Q_{10} are biased so that zero voltage appears at Q_{11} and Q_{12} bases when the system is at balance. Transistors Q_9 and Q_{10} inputs are supplied by the control and follow-up potentiometers. When the control binary, driven by an emg level above R_2 triggers on, transistor Q_{11} bias is shifted so Q_{15} conducts heavily and the motor rotates. With muscle relaxed, the signal disappears, the control binary resets and the system switches back to position servo.

Battery drain is negligible at rest, but increases to 0.6 amp at maximum grasp. Miniature alkaline silver-zinc cells provide current.

The author is indebted to A. Variolo, president of the Italian Orthotics and Prosthetics Association, for stimulating and helpful discussions.

BIBLIOGRAPHY

- H. Groth, J. Lyman, G. Weltman, Practical Transducer Problems in Electro-Mechanical Control of Arm Prostheses, University of California, Biotechnical Laboratory Report, June 1962.
- N. Bergen, C. R. Huppert, The Use of Electrical and Mechanical Muscular Forces for the Control of an Electric Prosthesis, American Occupational Therapy, p 16, 3.
- A. Nightingale, C. K. Battye, J. Whillis, The Use of Myo-Electric Currents in the Operation of Prostheses, J. Bone Joint Surg., p 506, 37B.
- A. E. Kobrinsky, S. V. Bolkoivin, L. M. Voskabrnikova, D. M. Ioffe, E. P. Polyan, Ya. L. Slavitskii, A. Yu. Sysin, A. S. Jacobson, Problems of Automatic Control, Proc. Automatic Control Conference, Moscow 1960, p 1119, Butterworth Pub., London.
- G. Horn, L'Automazione della Funzione Pressile, Automazione e Automatismi (Inst. Ital. per l'Automazione, Milano) 2, 1963.
- G. Horn, Elettronica e Automazione negli Apparecchi di Protesi Ortopedica, Scienza e Tecnica Ortopedica in Italia e all'Estero (Ass. Naz. Produttori Presidi Ortopedici, Treviso), 80/81, 1963.

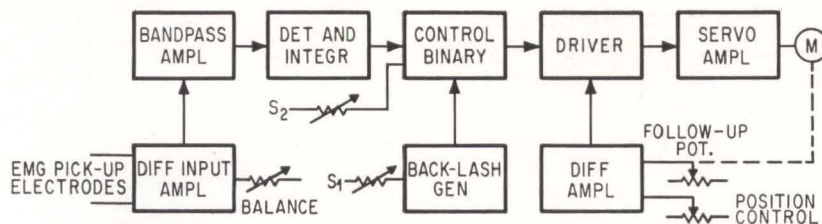

ELECTRICAL functions of the prosthetic device are summarized in block form—Fig. 3

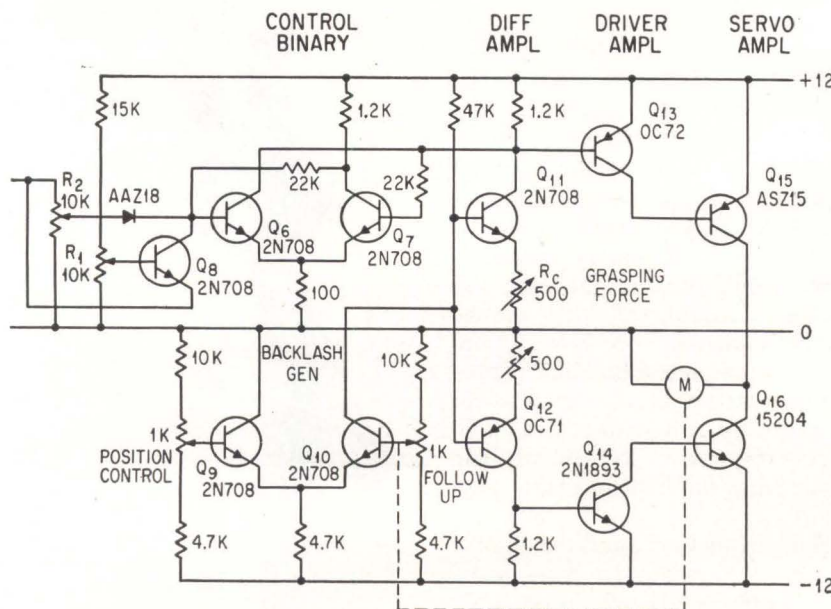

CONTROL amplifier drives servomotor that operates fingers of artificial hand—Fig. 4

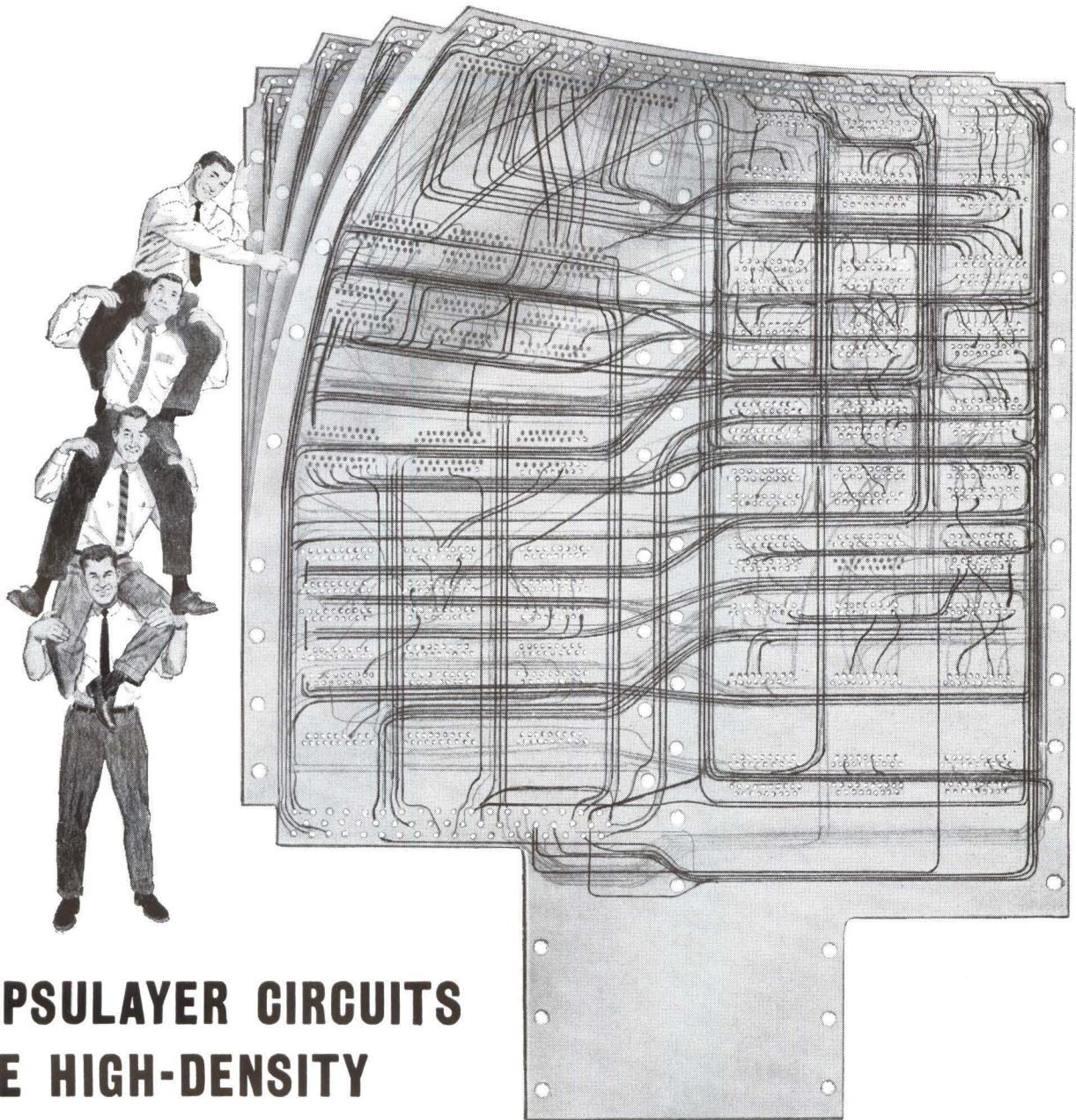

ENCAPSULAYER CIRCUITS SOLVE HIGH-DENSITY DESIGN PROBLEMS

"Encapsulayer" is Photocircuits' multilayer printed circuit—an advanced new technique embodying great technical advantages. Thin printed circuit layers are stacked over each other—laminated together in registry to make one integral board. Plated-through holes provide interconnections between layers, interlinking all layers' circuitry with each other and board surface. Some advantages?

- Problems of conductor cross-over, spacing, and routing are sharply minimized—space required for component or module interconnection circuitry is reduced.
- Expanded printed circuit design freedom—much more than possible with conventional circuits. Encapsulayer circuits are dip-solderable and are able to meet severe environmental requirements.

CIRCLE 37 ON READER SERVICE CARD

- Hole spacing on .050" centers is possible; shielding or ground layers can be put directly into board; and the number of layers is virtually unlimited.

Simplifying wiring of complex sub-assemblies at reasonable cost—Encapsulayer provides maximum reliability in the smallest space—another Photocircuits value engineering first.

 **Photocircuits**
CORPORATION
Glen Cove, New York • Anaheim, California

CIRCLE 38 ON READER SERVICE CARD →

Geometry. Performance. Price.

There are dozens of rack-and-panel connectors that give you either geometry, performance, or price—maybe even two out of three. Only Amphenol Blue Ribbons, though, give you all three. That explains their popularity.

THE THREE BASICS

These are the three fundamental considerations behind every rack-and-panel connector application:

Geometry. The connector must fit the package. It must be small enough to serve unobtrusively in miniaturized equipment; large and rugged enough to handle the heavy duty jobs; and at the same time, accommodate the necessary number of interconnections.

Performance. Not only must a rack-and-panel connector mate perfectly. It also has to carry current with a minimum of resistance. And it must perform again and again in a wide range of environments.

Price. A truly great rack-and-panel connector should be a bargain. That is, the connector should deliver top value per purchase dollar.

LET'S TALK GEOMETRY

Blue Ribbons come in two series . . . small (26 series) and smaller (57 series . . . called Micro-Ribbons). Series 26 units pack 32 contacts into a $3\frac{1}{4}$ " x $\frac{3}{4}$ " body with 8, 16, and 24 contact units available in proportionately smaller bodies. Micro-Ribbons come with 14, 24, 36, and 50 contacts and are, con-

tact for contact, one-third the size of the 26 series. All are rated 5 amps.

Unlike pins and sockets, Blue Ribbon contacts join with a wedge-like mating action. Once united, resilient spring action binds male and female together.

The advantages are fourfold:

1. Extremely low insertion and withdrawal forces combined with high contact pressure when mated;
2. Remarkably low contact resistance because of large contact surfaces;
3. Self-wiping action of contacts assures a clean mating surface after every insertion; and
4. No pin bending or socket jamming.

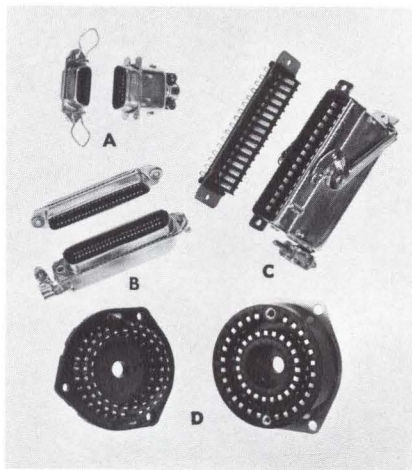

Four Blue Ribbon connector types:

(A) Micro-Ribbon 14-contact pair in cable-to-chassis housing; (B) Micro-Ribbon 50-contact pair with cable-to-chassis housing; (C) Blue Ribbon 36-contact pair in latch-type housing with end cable outlet; (D) Circular Blue Ribbon pair.

14 MILLIVOLTS DROP

Performance? Blue Ribbons behave like champs after thousands of mating cycles in salt spray. Electrical and mechanical changes are barely measurable.

Contact resistance, for example, is normally in the order of 14-millivolts drop at 5 amps.

Reliability? Over 5 billion contacts have been used by the maintenance-conscious telephone industry—without a single reported failure! (Confidentially, we think there must have been a failure someplace, but nobody told us about it.)

ACCEPTANCE

Competition, oversupply, and panic have forced many electronic component prices down, often to profitless levels.

Blue Ribbon prices are down, too. But for a different reason. Blue Ribbon prices have resulted directly from the acceptance that this unique connector has built up since its introduction nearly fifteen years ago.

EASY TO BUY

You can get Blue Ribbon (or Micro-Ribbon) connectors as fast as one of our sales offices or stocking distributors can arrange shipment.

If you'd like to know more about Blue Ribbon connectors, just write to: Dick Hall, Vice President, Marketing, Amphenol Connector Division, 1830 S. 54th Avenue, Chicago 50, Illinois.



Amphenol Division / Amphenol-Borg Electronics Corporation

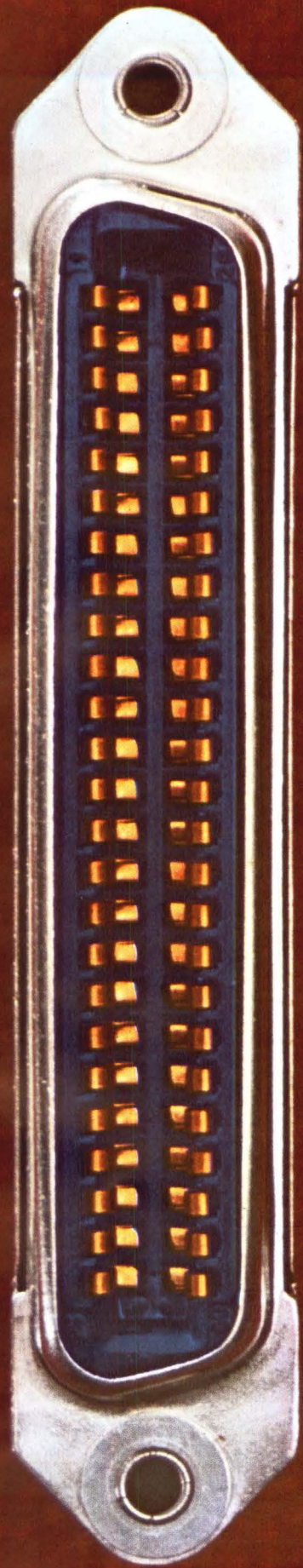



A Foreword by
Dr. Walter East
 President, Electro Instruments, Inc.

It has been largely out of a need for precise results that the aircraft, missile and spacecraft industries have taken the lead in the use of electronic measurement and control systems.

Industries which have lagged behind in their employment probably have felt the added precision wasn't worth the system's price tag.

Many businesses, I fear, have overlooked the fact *speed* alone is often a good dollar-and-cents reason for modernizing measurement and control systems. One of our more interesting "case histories," I think, is the experience of the glass manufacturer whose story is told below.

I am continually cautioning our own people not

to use the word "system" too glibly. It sounds like something complex—and expensive. Actually, of course, a "system" for measuring can be quite simple. Witness the clock, the automobile speedometer, your furnace thermostat.

Our Aim—Save You Money!

We manufacture and sell instruments and equipment for measuring everything under the sun. We make simple, inexpensive systems; we make complicated, expensive ones.

But you'll find our Sales Engineers are real "down to earth" people. They don't go around recommending systems with costs out of all proportion to the savings they make possible.

I mentioned last month that we like to offer the challenge: "You name it, we'll find a way to measure it." Maybe I should have added "on the budget you have in mind"!

Classic Jobs of Measurement

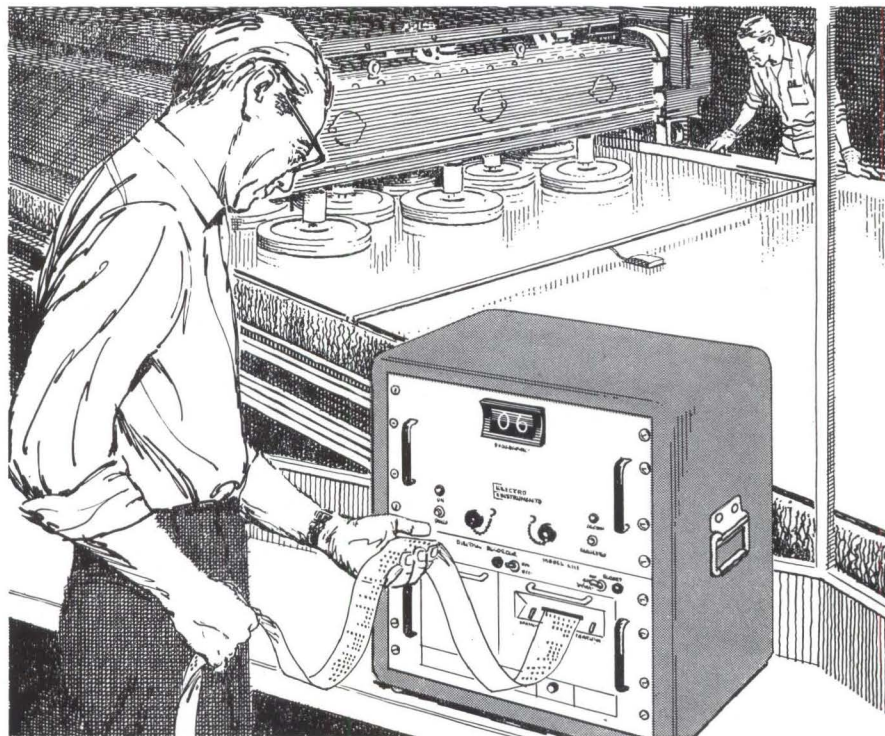

"Heart" of new glass scanning system was Electro Instruments' Digital Recorder.

Performed by Electro Instruments

Electronic Scanning Slashes Time, Labor of Grading Glass . . . and manufacturer discovers output can be worth more money.

Glass, like steel, is poured and rolled to thickness while molten. After cooling, it is polished. Degree of polish will determine its quality, and will establish its market worth.

One manufacturer actually counted pits and blemishes, then determined grade by means of a tedious system of mathematical hand plotting.

A consultation with Electro Instruments led to the development of an automatic system, based around a light source and a photosensitive instrument. These could be connected to an EI instrument to count pits electronically, simultaneously compute grade of glass, and visually display results. An additional output allowed information to be automatically graphed by an Electro Instruments' X-Y recorder.

More Accurate Grading, Too!

The whole process of grading glass thus could be drastically speeded up at this manufacturer's plant. A secondary benefit was greater accuracy in grading. Oddly enough, older measurement methods had resulted in substantial output being downgraded, and the glass priced below its true worth!

Unique Use of X-Y Recorder Saves Company over \$20,000

An odd one—involving measuring equipment but no measuring job! Operator at a major plant once had to hand-space ceramic wafers on a processing tray. Bid for automating job was \$24,000. An EI X-Y recorder, with tray mounted to recorder in place of plotting pen, was found to be all that was needed for the job. The enterprising EI Sales Engineer saved the company involved more than \$20,000!

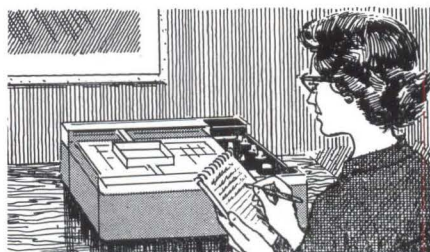

Electro Instruments offers the world's most carefully designed X-Y Recorders.



Electro Instruments, Inc.
 8611 Balboa Avenue, San Diego 12, California

ELECTRO INTERNATIONAL, INC., ANNAPOLIS, MARYLAND • TRANSFORMER ENGINEERS, SAN GABRIEL, CALIFORNIA

CIRCLE 40 ON READER SERVICE CARD

October 11, 1963 electronics

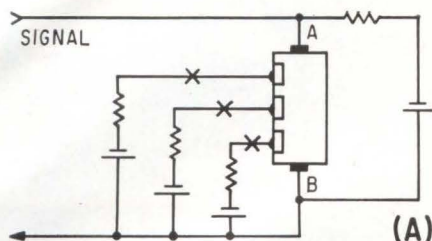

MULTILAYER DIODE can be used as analog-to-digital converter (A), reports Westinghouse's Vasil Uzunoglu. Oxide between transistor emitter and base controls gain (B)

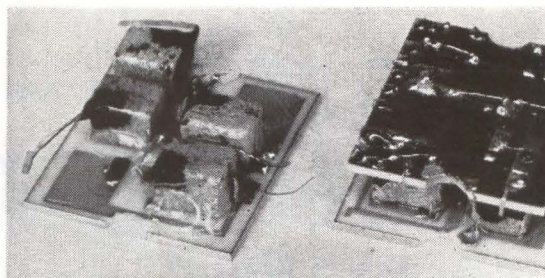
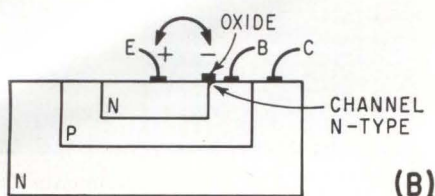

SERVO AMPLIFIER built with hybrid circuits

Active Thin-Film Device Problems Fade

ECCANE also to hear how oxide layer can control transistors

ACTIVE THIN-FILM devices can now be fabricated to meet most low-power circuit requirements at speeds up to 10 Mc, according to Charles Feldman, of Melpar, Inc. In fact, operational thin-film circuits using both active and passive elements are now just three to five years away, he estimates.

Feldman will be one of several speakers at the East Coast Conference on Aerospace and Navigational Electronics who see thin film circuits as the answer to space radiation and temperature problems. ECCANE will be held in Baltimore Oct. 21-23.

Among devices Melpar is developing is a new thin-film varistor. The device is a metal-boron-metal sandwich. Melpar uses aluminum as the metal, but other metals can be used.

Field-effect devices used as variable resistors and variable capacitors can be fabricated from cadmium selenide, silicon oxide, neodymium oxide and a wide variety of other materials. Melpar's field-effect devices are majority carrier, polycrystalline, nonjunction, large-energy-gap devices—a combination that makes for high temperature (500 C), radiation-resistant molecular circuits.

Radiation Resistance—Melpar's thin-film flip-flops have been tested in gamma fields up to 10^8 roentgens per second without changing state. Feldman claims semiconductor flip-flops would be damaged in radiation fields 1,000 times lower. Preliminary checks of some capacitors are now being made under neutron bombardment. The work is being done for the Bureau of Naval Weapons.

Martin Karp, of Alpha Microelectronics, will cite some of the chief advantages thin-films have over semiconductors including radiation resistance, higher temperature tolerances, lack of feedback and high power handling capacity with speeds of up to 50 Mc in passive devices. A custom digital computer made with 5,000 resistors in 300 circuits on 1.8×1.8 -in. substrates will be used as an example.

Servo Amplifier—A 5-w hybrid microelectronic servo amplifier built at General Precision Aerospace (ELECTRONICS, p 48, Feb. 15) will be described by P. Smith, N. Mahoney, H. M. Pollack and M. Genser. The group now says units delivering 15 watts can be built in the same size and weight (0.3 cu. in., 0.5 oz.), and that the present unit, mounted in a suitable heat sink, has successfully driven two 5-w motors in parallel.

Transistor Memory—Placing oxide layers between the emitter and base

of a transistor to control gain will be described by Vasil Uzunoglu, of Westinghouse Electric. Such devices (see figure) may provide memory elements with long storage times.

The oxide can be considered as a capacitor shunted by a resistor over 10^{12} ohms. Thus, it has a very long storage time, and a pulse applied to the transistor operating in its linear region will change the gain, depending upon pulse amplitude. This new state will last as long as the charge stored on the oxide remains. Typical storage times are as high as 25 minutes.

Diodes with oxide-coated junctions can be used as biasing elements on the transistors. Applying different voltages on the oxide and one of the layers can change the reverse current flow of the junction and thus adjust the transistor input impedance. Typical units, used in transistors, changed the impedance level over 500 percent within 6 volts of bias variation.

A multilayer diode (ELECTRONICS, p 38, March 8) used as an analog-to-digital converter will also be described by Uzunoglu. Each junction has a negative-resistance region. Depending on incoming signal strength, any one of the diodes or a certain number of them, will be actuated. Indicators can be used in series with the diodes to convert analog data to digital. Suitable pulses applied at terminals A-B of the multilayer diode (see illustration) reset the devices.

New from Sprague!

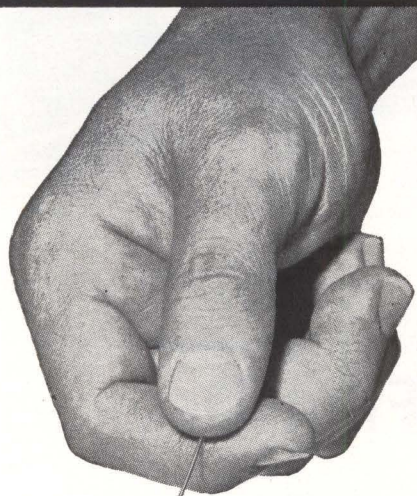

**Improved Type 150D
Solid-Electrolyte
TANTALEX®
CAPACITORS**

PERFORMANCE CHARACTERISTICS NEVER BEFORE POSSIBLE

- Dissipation factor cut by 1/2 for 20 volt and higher ratings!
- Higher permissible a-c ripple currents!
- Lower impedance at high frequency!
- Lower leakage currents!
- Better capacitance stability!
- New ratings to 100 vdc!

For complete technical data on Improved Type 150D Capacitors, write for Engineering Bulletin 3520E to Technical Literature Service, Sprague Electric Co., 35 Marshall Street, North Adams, Massachusetts.



45C-140-83

Telepathy Maybe

For now, lunar-mission planners figure on hardware, not software

PARIS—While the revelation that Russians might achieve telepathic communications on the moon (ELECTRONICS, p 17, Oct. 4) stirred up the International Astronautical Conference last week, other reports showed that hardware development to do the job electronically was quite well in hand.

Translunar communications, said one speaker, is a "relatively simple problem." Near earth, reported M. G. Chatelain, of North American Aviation, voice would be transmitted at vhf with omnidirectional antennas like discones, biconical horns or scimitar arrays. At 4,000 n. mi out, frequency would shift to S band (1 to 3 Gc) using high-gain antennas like parabolic reflectors or end-fire arrays.

To talk to each other on the moon, astronauts would use vhf again. However, the moon's small diameter cuts line-of-sight range, its surface dielectric constant seems less favorable for wave propagation and ionization at the surface may bar over-the-horizon transmission. To solve these problems, Chatelain suggested inflatable passive-reflector lunar satellites or a belt of reflecting dipoles in orbit around the moon.

On earth reentry, he said, blackout might be solved by using a frequency scanner and tracker to find an optimum frequency window in the plasma sheath. Transmitter and receiver would automatically switch to the window frequency.

Antennas—H. R. Warren, of De-Havilland Aircraft, described an unusual communications-satellite an-



HELICAL ANTENNAS for experimental CSF width, give accuracy of 100 microradians

tenna that has a frontal area less than 16 sq ft, but gives a gain of about 36 db at 2 to 3 Mc. It is a stacked end-fire parasitic array made of storable, tubular, extendible "stems." The construction, like a steel tape measure, also can be used for vlf dipoles as long as 2,000 ft.

Helical antennas used in CSF's experimental interferometer at Nancy cover a two-octave bandwidth. With no base change, said M. M. Bellenger, the interferometer functions at 136-137 Mc and at 400-401 Mc. Expected accuracy at 136 Mc is 100 microradians, the limit imposed by ionospheric refraction. Precision would be higher at 400 Mc.

Satellites—Eugene Burns, of Space Technology Laboratories, proposed a satellite that would provide data

Power Lag Postpones

Besides the lack of suitable power plants, there's no money

PALO ALTO, CALIF.—Although studies show flights around Mars and Venus are possible in the 1970's, manned interplanetary space flight is



interferometer cover two-octave band-

for a mineralogical map of the moon by recording the infrared emission at 8 to 25 microns. It would carry a modified Perkin-Elmer SG-4 spectrometer, using a liquid-helium-cooled, doped-germanium, photoconductive detector.

In guidance and control sessions, J. D. Welch's description of General Electric's self-contained spacecraft navigation system was rated a standout. It combines inertial navigation for the accelerating phase of a space mission and electro-optical tracking for nonaccelerating flight. The multimode image-tube tracker uses coaxial dual-field-of-view optics working with a tv picture tube. The electrostatic gyros for inertial guidance are strapped to the tracker and used by it for angle readout and angle memory when taking fixes on stars and planets.

Mars Flight

still at least 20 years away, said scientists last week at the American Institute of Aeronautics and Astronautics.

The biggest problem, aside from the fact that the money required for such a flight has not been programmed, is the lag in development of suitable nuclear engines and nuclear-electric systems. Nor do the

NEW from DEI

FOR PRECISION...

SIMPLICITY...

STABILITY...

AN ADVANCED
PCM
SIMULATOR



- Accurately Calibrated Clock
- Simplified Programming and Operation
- Zero Referenced Output
- Up to One Megabit for all Formats

Another new digital product from Defense Electronics, Inc. for calibration and checkout of PCM telemetry systems and components is the PTS-2A Simulator . . . available NOW!

It is versatile enough to simulate signals—from 1 bit to 1 million bits per second—ordinarily received from satellites and space vehicles yet sufficiently flexible to permit exercising PCM telemetry stations.

PRECISE calibration of the bit-rate (up to 1 mc) is achieved through a stable, accurate internal clock (within 0.1%) with thumbwheel control and exponential "push button" range selection.

SIMPLIFIED operation and rapid selection of code and word length is afforded through use of three-position bit-switches.

STABLE bit-rate is assured by a temperature-controlled, servo-stabilized bit-rate oscillator.

The all solid-state PTS-2A features true linear phase plug-in filter cards for exact simulation of transmitted waveform, inputs for superimposing jitter and noise in the output and a front-panel frame pulse output for synchronization of an oscilloscope. A modular, detachable power supply . . . and color-coded, keyed digital cards facilitate maintenance.

Write for DEI bulletin PTS-2A . . . or call:



DEI
SERVING
GOVERNMENT
AND INDUSTRY

Defense Electronics, Inc.

Main Office:

5455 Randolph Rd. Phone: 301-WH 6-2600

Rockville, Md. TWX: 301-949-6788

Regional Office: Sherman Oaks, Calif. Phone: 873-4322

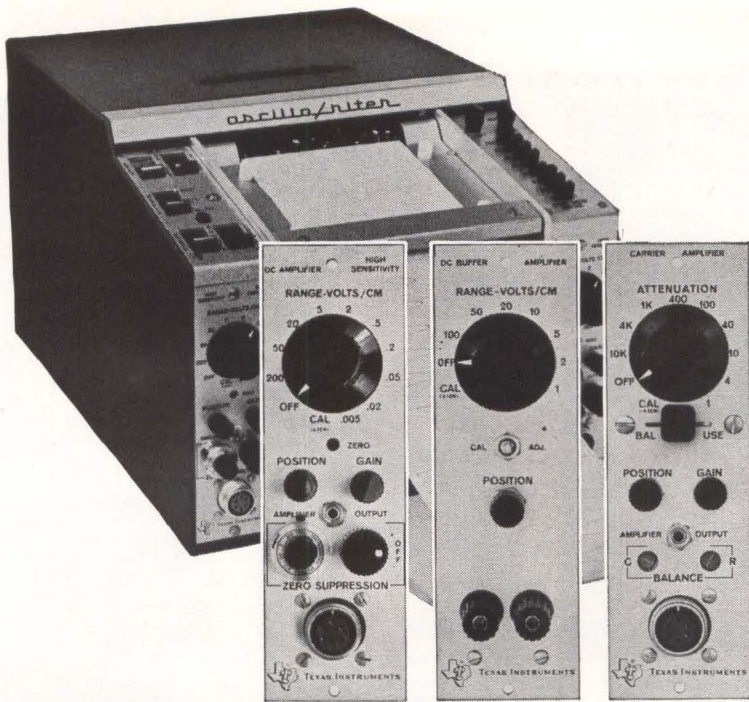

Interchange-ability with plug-in oscillo/riter* recorder amplifiers

TI offers amplifiers to fit any medium frequency application . . . all types simply plug in the front panel. Choose from an impedance matching buffer amplifier, a high gain d-c unit, a high performance carrier amplifier, a medium gain differential amplifier, and other special purpose types.

Oscillo/riter recorders offer interchange-ability in chart paper, too. For convenience and ease of ready

reference, choose Z-fold charts, they read like a book, stack out of the way; or get economy with the standard roll chart furnished with each recorder.

Oscillo/riter recorders offer more pushbutton convenience than any other medium frequency recorder. Basic price with buffer amplifiers is \$1195.

Write for complete information.

*trademark of Texas Instruments Incorporated

INDUSTRIAL
PRODUCTS
GROUP



TEXAS INSTRUMENTS
INCORPORATED
P. O. BOX 66027 HOUSTON 6, TEXAS

SENSING • RECORDING • TESTING • DIGITIZING INSTRUMENTS
THE INSTRUMENTS OF TEXAS INSTRUMENTS

613

CIRCLE 44 ON READER SERVICE CARD

**HELP YOUR POST OFFICE
TO SERVE YOU BETTER
BY
MAILING EARLY IN THE DAY
NATIONWIDE IMPROVED MAIL SERVICE
PROGRAM**

launch power plants exist.

Requirements for flyby trips, 613 631 days long, to Mars or Venus in 1970-72, were studied by Philco's Aeronutronic division. In his report on the study, called Empire, Frank P. Dixon said booster development should have started in early 1963. The 1970 date will most probably be missed, which means a wait until the mid-1980's for favorable planetary positions.

It was also pointed out that at the time Empire would need heavy funding, the Apollo program would be in full swing, creating a funding problem.

Empire Electronics—On the trip, the navigator would get updated ephemeris from a network of ground tracking stations. He would establish vehicle attitudes and determine trajectory with a self-contained stellar tracker. Principal guidance sensor for planetary approach would be optical.

Earth-vehicle communications antennas would be stabilized by sun and earth trackers. Redundant S-band antennas with 40-db gain and 4-kc bandwidth are recommended. The communications system planned, a minimum system for voice and digital data, needs about 200 watts of power.

Power Supplies—A Mars or Venus spacecraft requires about 40 kw, in flight, including 5 to 8 kw per man for life support, 6 to 9 kw for telemetry and radio, 2½ to 5 kw for scientific experiments.

Eugene Zwick, of NAA's Rocketdyne division, surveyed power plants and saw none in existence that would satisfy the requirements. Photovoltaic systems weigh 500 lb/kw, too heavy; solar thermoelectric systems weigh 50 lb/kw and are large and inefficient; the amount of radioisotope material needed for a 40-kw thermoelectric system isn't available; the goal of 20 lb/kw in the Snap 70 reactor-thermoelectric system is, for now at least, foiled by high-temperature materials problems; solar dynamic systems require large mirrors to focus the sun's rays, don't produce enough power (3 to 15 kw in various models) and face mechanical problems; reactor temperatures of 2,000 C needed for efficient thermionic systems are not yet available.

Reliability of Mallory XT Tantalum Capacitors proved by 10,260,000 piece-hours of testing

The original high temperature wet slug tantalum capacitor, the Mallory XT series has compiled a unique record of reliability in tests made in our own laboratories, by independent laboratories and by military equipment manufacturers. Here are typical results:

In 10,260,000 piece-hours of testing* **standard production capacitors**, the mean time between failure is presently 960,000 hours.

Independent tests over a two year period show that Mallory XT capacitors have *twice* the anticipated mean time to failure of other tantalum capacitors.

Ten-year shelf life tests prove that even after extremely long storage, Mallory XT capacitors meet original specification limits of d-c leakage.

Seal tests by independent laboratories indicate that the leak rate of the glass-to-metal hermetic seal used in Mallory XT capacitors is 1×10^{-11} standard cc. These capacitors are being used in airborne military equipment where stringent specifications for seal reliability must be met.

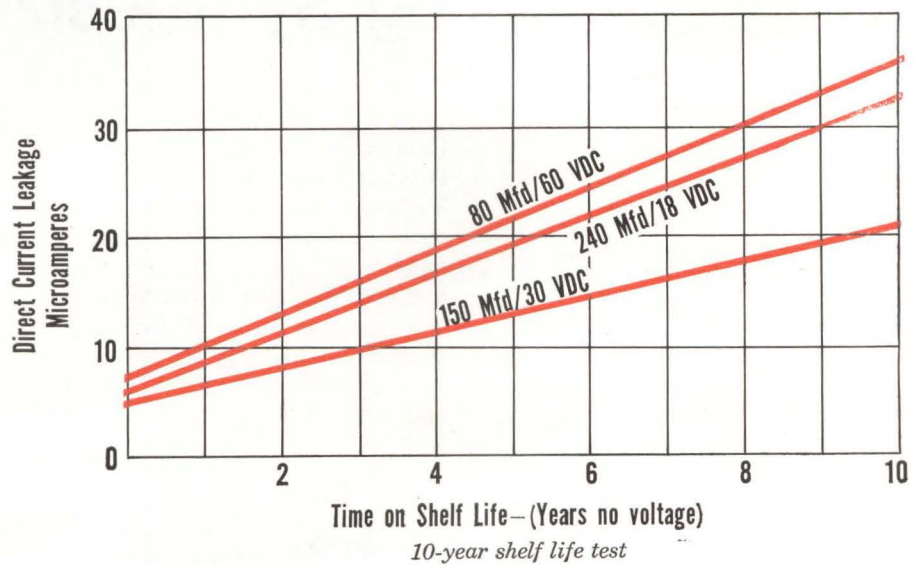

The XT line has been in continuous production by Mallory for nearly 15 years . . . for the past five years operating under the Signal Corps RIQAP plan. For each production lot, individual records of quality control test data are kept for a five-year period.

The XT series includes 175°C and 200°C ratings in many configurations, including a broad range of MIL types and new radiation-resistant models. For complete data and a consultation, write to Mallory Capacitor Company, Indianapolis 6, Indiana—a division of P. R. Mallory & Co. Inc.

*Test conditions at rated voltage at 85°C and 175°C

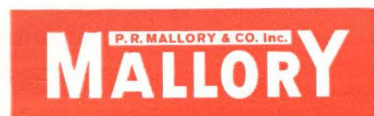

Type	Temp. Range	Capacity Range	WVDC (85°C)
XTM	-55 to +175°C	4 — 14 mfd	340— 8V
XTK	-55 to +175°C	2 — 70 mfd	340— 8V
XTH	-55 to +200°C	7 — 240 mfd	630—18V
XTL	-55 to +200°C	3.5— 120 mfd	630—18V
XTV	-55 to +200°C	12 —2200 mfd	630—12V

WET SLUG, FOIL AND SOLID TANTALUM CAPACITORS

Vocal Analog Synthesizes Speech

System produces intelligible sounds from hand-drawn curves

SPEECH SYNTHESIS instrument that can reconstruct artificial speech from hand-drawn patterns has been built by the Electronics Research

Laboratory of Melpar's Research Division. Called EVA for Electronic Vocal Analog, the research-oriented tool consists of a programmable function generator and a controllable formant synthesizer. It was designed for the basic study of speech production, for evaluating various speech recognition concepts, and also studying various config-

urations of the compression system.

Adapted from a similar machine developed at Sweden's Royal Institute of Technology by Gunnar Fant, the EVA system uses a grid on which up to 12 parameters of speech can be plotted with conductive ink. The carriage electrifies the traces with voltages that vary according to the position of the traces on the grid. The twelve analog voltages are then fed to a speech synthesizer and there combined to produce intelligible sounds.

The hand-drawn parameter curves can be erased and altered between passes, thus allowing study of the effects of a change in any one parameter. Among the basic parameters are pitch, or frequency of larynx vibrations, also the formant frequencies or natural resonances of the vocal tract, amplitude of nasology, amplitude of fricative sounds, amplitude of source excitations, and frequency of nasal poles.

Purpose of the research involving EVA is to establish the invariant rules regarding production of speech, paving the way to the development of a phonetic typewriter, or "speakwrite", which would type out any vocal messages dictated to it.

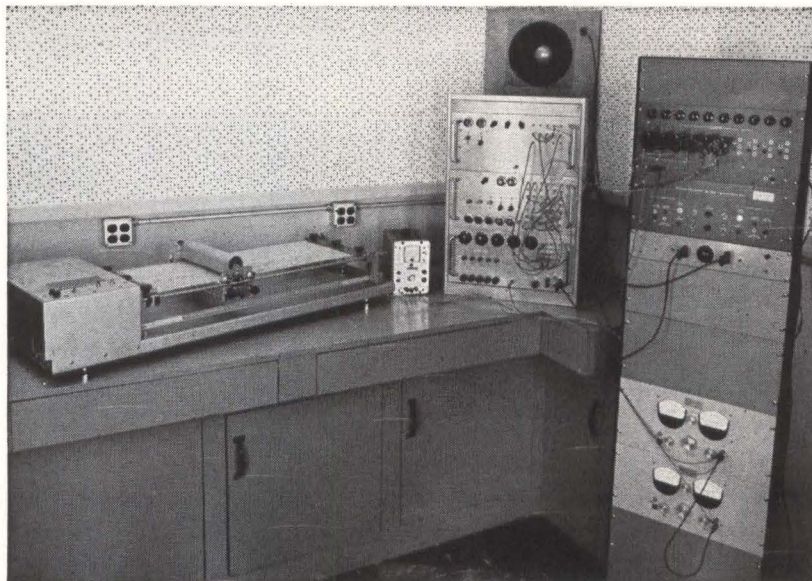

ELECTRONIC VOICE ANALOG system includes programmable function generator, left, controllable formant synthesizer, center, and associated circuits, right

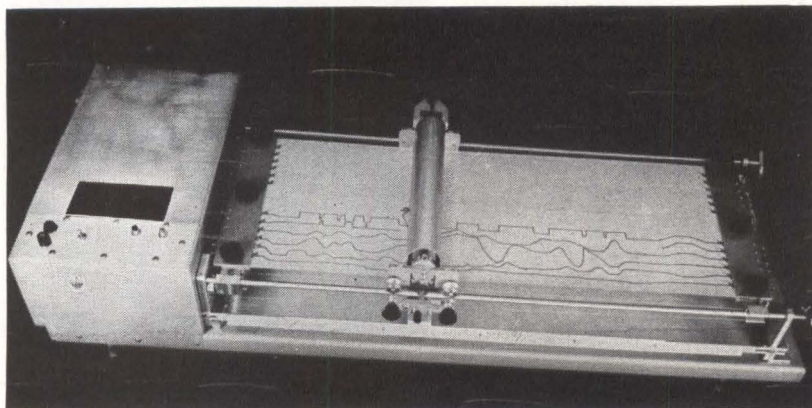

FUNCTION GENERATOR has Mylar plate on which patterns representing speech parameters are hand-drawn in conducting ink. Voltage-fed resistive rollers, center, pass over traces and generate analog signals

Function Generator—The programmable function generator, shown in the photographs, consists of a carriage-like mechanism, moving along a Mylar sheet. On the Mylar sheet are drawn the speech parameters to be reproduced, using a special ink that has high conductivity and is easily removed.

The moveable carriage consists of a resistive roller element, kept in contact with the conductive parametric traces. With a potential applied to the resistive element, each conductive trace assumes the potential at its point of contact with the roller. The playback unit thus converts the hand-drawn curves into



SILICONE

What you can do with General Electric's RTV silicone compounds

to insulate, seal and mold from -150°F to 500°F



Encapsulate it. Fluid RTV silicone rubber penetrates deep into transformer coils. RTV has excellent dielectric strength and practically no shrinkage. Cure time at room temperature can be varied from minutes to hours.

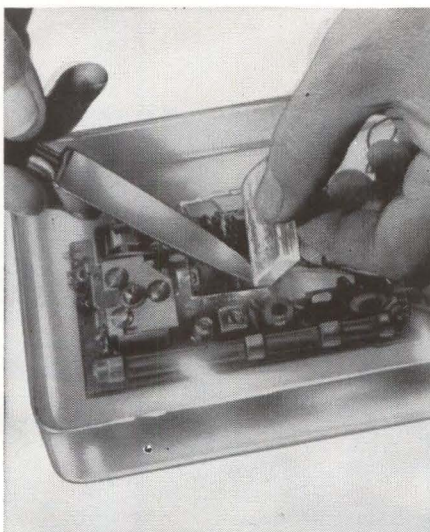

Pot it. Transparent or opaque, G-E silicones provide a resilient protection against moisture, ozone, thermal and mechanical shock. Flows freely around complicated parts, can be cut away to replace internal components.

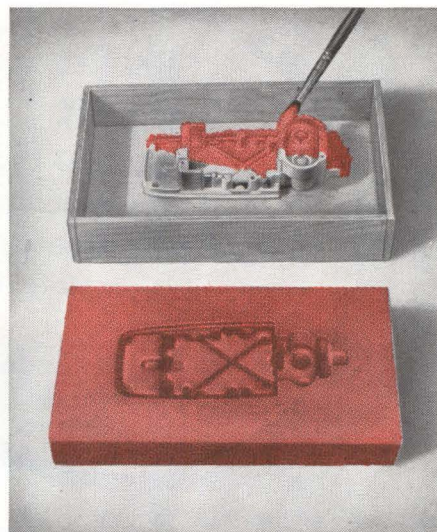

Duplicate it. Flexible RTV is often used to make molds for prototypes and short run production. This part requires deep undercutting, but duplicate parts flex free easily. RTV's tensile strength is as high as 850 psi.

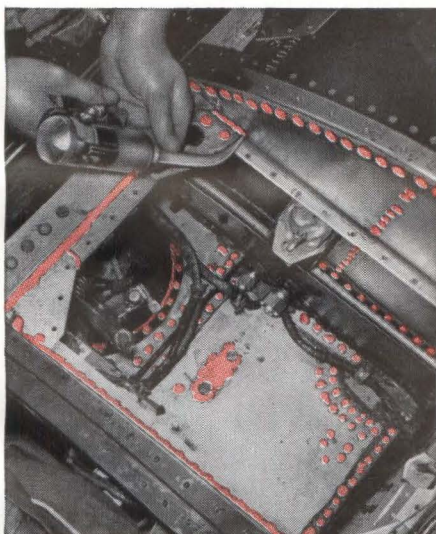

Seal it. Bondable RTV (when surface is properly primed) seals against moisture and vibration, ozone and chemicals. Can be used for sheet metal fabrication, shock mounts, gasketing. Viscosities range from pourable to paste.

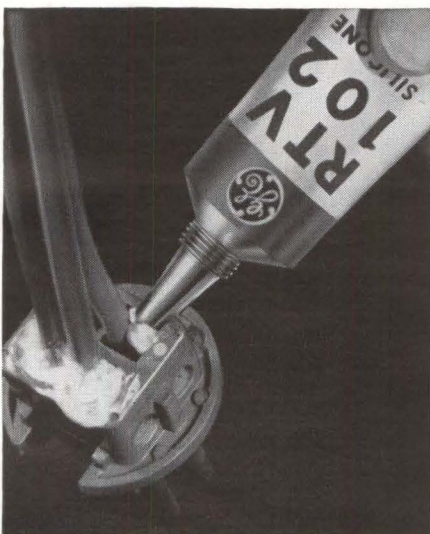

Insulate it. Adhesive/sealant RTV-102 requires no mixing of catalyst, can be used to insulate open wiring, for on-the-spot caulking, gluing and soldering. RTVs are virtually ageless, will not stress-crack or weather.



Manufacture it. RTV adhesive/sealants are fast working assembly tools, eliminate prefabricated parts or more costly, time consuming techniques. Here an RTV adhesive laminates flexible mica strips to form cylindrical ducts.

If you would like a free sample of one of the nine General Electric RTV silicones for evaluation, write on your letterhead, describing your application. For additional information, check reader service card. Section N1095 Silicone Products Dept., General Electric Company, Waterford, New York.

GENERAL  ELECTRIC

IT'S ONLY LACING TAPE— WHY ALL THIS GUDEBROD QUALITY CONTROL?



WHAT'S THE ADVANTAGE OF GUDEBROD FLAT BRAIDED LACING TAPE?

When tying round lacing cord there is a tendency for the cord to create a sharp cutting edge which may knife through the insulation, the cord itself or the worker's hands.

With Gudebrod Flat Braided Lacing Tape the stress is distributed over the flat surface. Firm, flat contact is made, cold flow is eliminated, hands are safe.

Even a minor detail such as lacing tape becomes important when your electronic equipment must meet exacting specifications. So that you can specify Gudebrod Flat Braided Lacing Tapes with complete confidence Gudebrod goes to great lengths to back up its guarantee of quality. The lot number on every package of Gudebrod Tape assures that it has been made under strict control. Close tolerances have been met on such characteristics as slip resistance, fray resistance, tensile strength, finish, fungus resistance, and many others. Where MIL-T-713A Specifications apply, Gudebrod Tape meets or exceeds the requirements.

Whatever your lacing needs—Teflon*, Dacron*, nylon, glass—for general use, for burn proof requirements, for high temperature, for fungus resistance, Gudebrod makes a tape or will produce one. And you'll know that knots will not slip, harnesses will stay tied and assemblies remain firm. Workers prefer Gudebrod Tape, too, because it does not cut either insulation or hands.

If you want to inspect a sample, want more information, get in touch with your Gudebrod representative, or write to the Electronics Division.

*Du Pont registered trademarks

equivalent electronic signals controlling a speech synthesizer; the carriage movement corresponds to time, and the distance along the resistance roller is a function of frequency or of amplitude.

The moving carriage can be slowed down considerably, allowing the study of the microstructure of speech. In addition, any parameter can be easily erased and changed to study its effect on intelligibility.

Formant Synthesizer—The controllable formant synthesizer is basically an electrical analog of the human vocal mechanism. Action of the vocal chords is simulated by a glottal pulse generator, shaped to conform to the energy content typical of that produced by a human. The energy is then transmitted through circuits that simulate the poles of the transfer function of the vocal tract. Repetition rate of the glottal pulses, as well as the frequencies of the poles (or formants) are typical of the functions under control of the function generator when speech is being produced.

The formant synthesizer allows control of 16 possible variables, including the frequencies of pitch and the formants. An additional feature is the ability to control the spectral shape of the glottal excitation pulse in order to vary the personality of the speech.

Space Reflector Unfolds

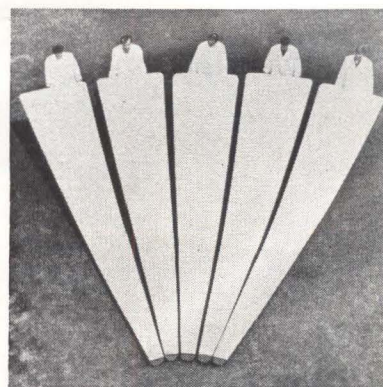

ELECTROFORMED petals for a 45-ft, 2,000-sq ft unfurlable reflector that will provide from 50 to 250 kilowatts of solar power to a space power conversion system, have been made in a feasibility study by Electro-Optical Systems, Pasadena, Calif. The parabolic reflector will weigh less than one pound per square foot of reflecting area



GUDEBROD BROS. SILK CO., INC.

FOUNDED IN 1870

Electronics Division

12 SOUTH 12TH STREET, PHILADELPHIA, PENNSYLVANIA 19107

Scanning Electronic Eye

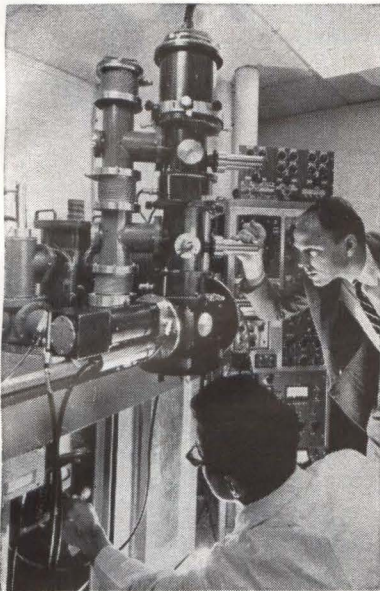

CLAIMED to be the first successful scanning electron microscope in the U. S., this new instrument at Westinghouse Research Laboratories, Pittsburgh, develops an electron-microscope image by sweeping the object with a 0.1-micron electron beam. Area viewed can be as small as 15 millionths of a square inch; image is obtained by generating secondary electrons at the scanned surface and converting these into light by a scintillating crystal, then back to electric pulses and then to display crt. Resolution is from 250 to 1,000 lines per frame

New Digitizers Track Flying Particles

TWO NEW devices for studying the traces of collisions between nuclear particles are nearing completion at Brookhaven National Laboratory. Called flying-spot digitizers, the machines will help analyze pictures of particle tracks left in bubble chambers. They are being built to help handle the large number of track photographs that will be produced by the Laboratory's new 80-inch bubble chamber; present methods are too slow.

The digitizer uses a 15-micron beam of light, split into two, with one half scanning the bubble-chamber film, and the other half scanning a grating to act as a position reference. Photocells behind both the film and the grating convert the light intensity into voltage, and the resulting signals are passed on to a computer for analysis.

Mort
Mann
can
show
you...



Sales Engineer, North Atlantic Industries

how to measure in-phase, quadrature and angle while sweeping frequency to 100 kc

North Atlantic's latest addition to the PAV line of Phase Angle Voltmeters* enables you to make measurements while frequency is varying over half-decades without recalibration. The VM-301 Broadband Phase Angle Voltmeter* provides complete coverage from 10 cps to 100 kc, and incorporates plug-in filters to reduce the effects of harmonics in the range of 50 cps to 10 kc with only 16 sets of filters. Vibration analysis and servo analysis are only two of the many applications for this unit. Abridged specifications are listed below:

Voltage Range.....	1 mv to 300 volts full scale
Voltage Accuracy.....	2% full scale
Phase Dial Range.....	0° to 90° with 0.1° resolution (plus 4 quadrants)
Phase Accuracy.....	0.3°
Input Impedance.....	10 megohms, 30μf for all ranges (signal and reference inputs)
Reference Level Range.....	0.15 to 130 volts
Harmonic Rejection.....	50 db
Nulling Sensitivity.....	less than 2 microvolts
Size.....	19" x 7" x 10" deep
Price.....	\$1750.00 plus \$120.00 per set of filters

North Atlantic's sales representative in your area can tell you all about this unit as well as other Phase Angle Voltmeters* for both production test and ground support applications. Send for our data sheet today.

*Trademark



NORTH ATLANTIC industries, inc.
TERMINAL DRIVE, PLAINVIEW, L. I., NEW YORK • Overbrook 1-8600

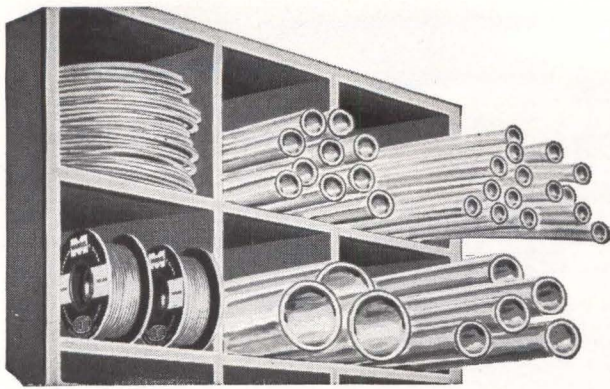

JUST SAY WHEN

You want insulating tubings for regular production *when you want them*—not weeks later! That's why we stock miles and miles of the dependable FLEXITE Extruded Tubings at our factory and at other points across the country—for immediate delivery!

FLEXITE HT-105C EXTRUDED VINYL TUBING

This strong, flexible vinyl tubing has excellent dielectric strength, heat stability, and oil and fungus resistance. It is U/L-approved up to 105°C and qualified to MIL-I-631C, Grade C, specifications.

FLEXITE E EXTRUDED VINYL TUBING

Highly flexible tubing for use at temperatures down to -55°C, as in aeronautical applications. Performs to MIL-I-22076 and MIL-I-7444B specs. Both of the above tubings are available in sizes from #24 to 1½", in clear and in standard colors—on spools or in coils.

Quality
Approved

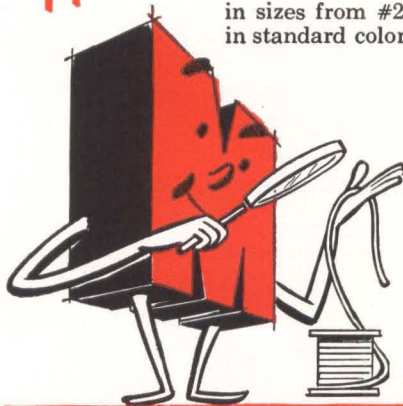

Send for samples, data and prices of these FLEXITE Vinyl Tubings

A letterhead request will bring the complete Market Sample File of insulating tubings & sleeveings.

FLEXITE®

EXTRUDED PLASTIC TUBINGS

L. FRANK **MARKEL** & SONS
SINCE 1922

Norristown, Pennsylvania



SOURCE for
EXCELLENCE

Eisler

A NAME TO REMEMBER IN
MACHINERY FOR ELECTRONICS

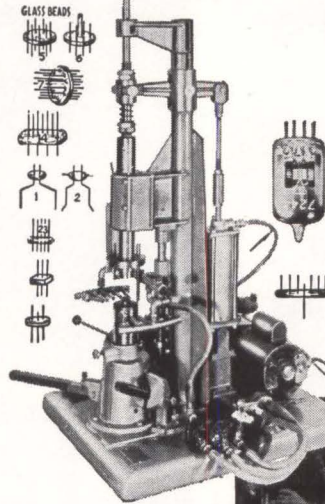

At left: No. 105-BST1 single position Button Stem and Wafer making machine—Fully automatic. Designed for small production runs on special tube parts or for laboratory use. Produces button stems up to 1¼" diameter. Machine can be supplied with up to 24 positions.

Illustrated below: An Eisler precision Vertical Spot Welder designed exclusively for welding of electronic components. Available in sizes from ½ to 7½ KVA.

Write us today
for full
particulars!



EISLER ENGINEERING CO., INC.

Charles Eisler Jr., President

751 So. 13th St., Newark 3, N.J.

CIRCLE 200 ON READER SERVICE CARD

Simplify
WIRE
ASSEMBLY

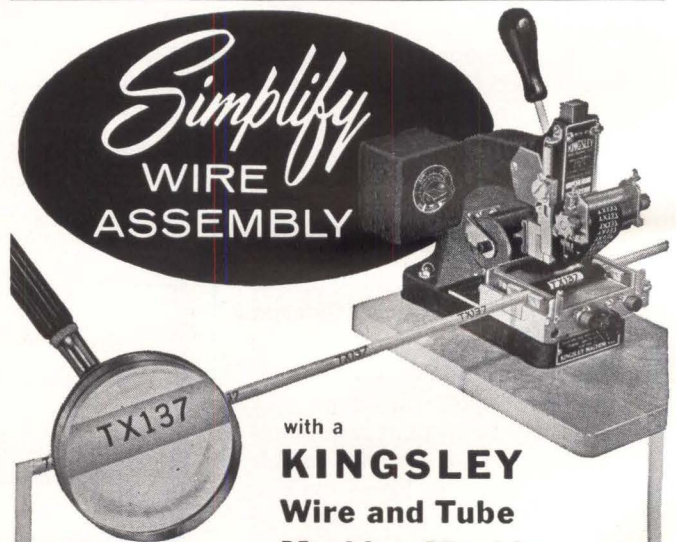

with a
KINGSLEY
Wire and Tube
Marking Machine

Now you can mark each wire or piece of plastic tubing with its own individual circuit number.. quickly.. economically – right in your own plant!

Cut costs and speed production with the same machine that has proved so successful in the aircraft/missile field.

Write for details.

KINGSLEY MACHINES

850 Cahuenga • Hollywood 38, Calif.

CIRCLE 201 ON READER SERVICE CARD

October 11, 1963 electronics

Bright Future Seen for Organics

They strike out as semiconductors, but open up designs for new functions

By **MICHAEL F. TOMAINO**
Associate Editor

NEW YORK—Investigations of organic materials have taken a 180-degree turn. Rather than trying to squeeze semiconductor properties out of organics, these materials are now being exploited for the generation of coherent radiation, piezoelectricity, optical phenomena, acoustical interactions, infrared transistions, and dielectrics.

Last week, at Electrochemical Society Symposium, Texas Instruments' R. R. Neiman and R. E. Johnson dusted off some "old hat" concepts about organic materials. They clarified some rather far-fetched ideas some electronics people have about organics. Most important, they presented an exciting picture of some areas opening up in electronics that are now close to fruition.

Authors of paper on organic materials for electronic applications define organic materials as any material that contains at least one carbon atom. Thus they include metal-organics and chelates.

Little Hope—The Texans believe that organic structures now offer little hope of being used successfully as semiconducting materials. Their reasoning: organics have low mobilities, apparent absence of *n*-type carriers, and our lack of knowledge of doping these materials.

Why then are they and other workers sticking to organics?

They say organic materials are easy to prepare. Large numbers of materials are available. Many or-

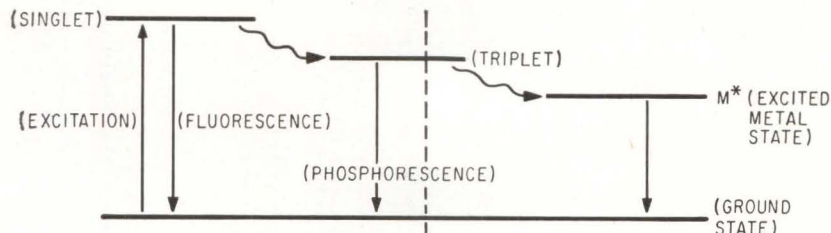

ENERGY level diagram. Organic portion of molecule offers an extremely wide pump band for excitation of rare-earth atoms. The light-induced triplet state in organic compounds is analogous to a three-level maser or laser scheme

ganics have different properties, and they offer potential of precise control over material properties by substituent group synthesis.

The latter is the foremost reason for considering organics, speakers say. Organics offer the molecular tuning which is one of the bright hopes for electronic materials.

The authors looked at the opposite side of the coin. Organics are difficult to purify to the degree necessary for device operation. They are difficult to manipulate. They are difficult to understand.

Useful materials for electronics are usually assessed upon the availability of high-purity materials, consistent and reliable electrical measurements on single-crystal samples, and a detailed understanding of electron-transport mechanisms.

It is now difficult to obtain the purities usually discussed in semiconductor operations. The technology of making contacts to organic materials is almost completely unknown. Knowledge of electrical properties has been slow in coming.

Why, then, do organics warrant serious consideration in electronics?

Bright Hope—The key to this question, authors say, lie in several areas. The generation of coherent radiation. Their use as piezoelectric or piezoresistive elements, optical phenomena, and their use as circuit elements.

Texas Instruments workers believe that organic materials can be exploited for all these applications. They recommend that increased efforts should be directed in all these areas. Aeronautical Systems Division, USAF, has gone all out for these recommendations. The Air Force now has two important programs under contract to investigate organics. Programs are with Texas Instruments and RCA.

Workers at both firms believe that the use of rare-earth chelates as laser materials have a decided edge over other materials. The organic portion of the molecule offers an extremely wide pump band for the excitation of the rare-earth atom, according to TI. They say that the chelates will assume a prominent place in optical maser devices. Workers at General Telephone Laboratories have shown laser action in europium benzoylacetate, for instance. These rare-earth chelates have longer decay time than corresponding inorganic salts. Chelates have narrow linewidth, high quantum efficiency.

Beam-type masers utilize transitions in the millimeter wavelength region. The light-induced triplet state in organic compounds bears a formal analogy to a three-level maser or laser scheme. Maser action could be possible in such organic compounds as the nitrines. Hope is offered for many new laser



**MAKE IT
TRACK SIGNALS
OVER AN 8 TO 1
FREQUENCY
BAND**

**Briefs on the Kind of Assignments
You Can Expect at SES-West**

What's unique about this broadband tracking antenna? Almost everything. The lightweight reflector and feed support boom—polyurethane foam over an eggcrate-like frame, metalized by flame spraying. Lens-corrected feed horn with an 11 to 1 bandwidth—reflector-feed combination uses constant bandwidth techniques to minimize change in crossover level with frequency. Performance thought impossible a few months ago—tracks signals over an 8 to 1 frequency band!

We're proud of this advancement—and of the men at SES-West who achieved it.

SES-West is a "Quick Reaction" facility developing systems and hardware that are on the forefront

of our nation's defense technology. Job assignments are as vital and varied as the unique projects we handle. You put your ideas to work on projects in advanced antenna development, arms control, space vehicle guidance, RF systems, reconnaissance, microwaves.

Expansions in size and scope continue at SES-West—creating exceptional opportunities for you. See listing on next page.



SYLVANIA ELECTRONIC SYSTEMS-WEST
DEPT. 20 P.O. Box 188, Mountain View, California
An Equal Opportunity Employer

CURRENT OPENINGS AT SES-WEST (a partial listing)

ENGINEERS

ANTENNA

Develop advanced medium- and high-gain antennas for SES-West Electronic Defense Systems. Interesting and varied work on both portable and fixed position antennas. Background desired: MS with emphasis on antenna design or BSEE—3-5 years experience.

TRANSMISSION FACILITIES

Design compact powerful transmitters with needle-sharp frequency control; lightweight transmitters closely integrating transmitter and receiver functions; and ultra-sensitive receiving systems. BSEE required.

OPERATIONAL ANALYSIS

Challenging assignments in theoretical systems. Work with physicists, statisticians, mathematicians in developing and evaluating electronic warfare concepts and tactical field problems. BSEE required.

RECEIVER

Design and develop high performance receivers in the range from 0.5 m.c. to 40 kmc and beyond, making extensive use of solid state devices. Engineering responsibility for developmental sub-systems from planning through equipment delivery.

BSEE Required. Advanced Degree and Experience Desirable.

SES-West is located on the beautiful San Francisco peninsula, in an ideal geographical, cultural and social climate. Excellent facilities for SES-West-sponsored advanced courses at nearby Stanford, Cal, and other Bay Area Universities.

For complete information on these and other openings contact: *H.J. Sheppard*. Your inquiry will be treated in confidence and given immediate consideration.



SYLVANIA ELECTRONIC SYSTEMS-WEST

DEPT. 20 P.O. Box 188,
Mountain View, California

An Equal Opportunity Employer

frequencies. The Raman-effect lasers, discovered by Hughes, also offer the possibility of new laser frequencies.

Neiman and Johnson considered piezoelectrics. They said that organics could be used as crystal filters or could act as inductors. Ease of growth on substrates make organics suitable for truly integrated circuits sought by the Air Force. Organic piezoelectrics, include benzophenone, acetone oxime and hexamethylene tetramine.

Color Changes—Going into optical phenomena, color changes produced by exposure of organics to light offer possibilities for many applications: switches, computer elements, microfilms, ultraviolet-sensitive glasses, and display systems.

Organics, particularly hexamethylene tetramine (HMTA), may possess real advantages over inorganic crystals for linear optical-electro effects (LOEE). This is due to their ease of growth and in some cases their higher melting points. The LOEE can be used for light-modulation devices.

Conductive plastics can be used as interconnections in electronic devices. There is increasing evidence that organic as well as inorganic thin films may contribute to metal-insulator-metal device technology. Free radicals of organics can be used as microwave detectors. Mims has shown that chirped radar signals can be detected by electron spin echoes. This method is similar to a two-level maser. A suitable material, could be the free radical, diphenylpicrylhydrazyl TI says.

At RCA, S. E. Harrison, G. E. Heilmeier and G. Warfield also point out that explorations into the organics may give new insights to the life processes with may depend upon electronic motion.

The study of the mechanisms of energy transfer and charge flow in organics may shed light on the operation of biologically important compounds. The electronic structure of both materials are similar.

Rolled Metal Strips

Compete with Thin Films

LONDON—Nickel-iron alloys, cold rolled down to a thickness of 1.5

microns, show properties akin to evaporated films for electronic applications, according to researchers at Britain's General Post Office Research Station, Dollis Hill, London. Advantages of thin-film devices manufactured by this technique are compactness and versatility—since there is no cumbersome substrate—and the capacity of using any alloy—at present, only alloys that evaporate at temperatures low enough not to damage substrates can be used for thin-film devices.

Although theoretical calculations show that rolled metal strip should not show anisotropic characteristics at thicknesses above 0.5 microns, the thinnest strip made so far—1.5 microns—is definitely anisotropic, although switching speed is not comparable with evaporated devices. GPO Researchers predict, however, that switching speed will increase as thickness is decreased.

Manufacturing processes have limited thickness so far, because dust captured during rolling operations makes the final product "like a lace curtain." Further attempts—using glove-boxes and clean-rooms—are planned, and strips of 0.5-micron thicknesses should be possible.

Device Lasts ½ Second In Titan Exhaust Flames



THE LIFE expectancy of this Fairchild 3S-G transducer is approximately one-half second. Before it is consumed in the heat of Aerozone 50 and nitrogen tetroxide—igniting to separate the first and second stages of Titan II—the high frequency response pressure transducer will report on the shock pressure encountered during the separation firing. By analyzing this data, in conjunction with other information, the performance of the Gemini

INSTANT LOADING



INSTANT DEVELOPING with new Beattie-Coleman Oscillotrons using the new Polaroid® Land FILM PACK

The added convenience of the new Polaroid Land Film Pack is now available with the new Beattie-Coleman Mark II or K-5 Oscillotron, or as a retrofit. Combines these many advantages:

- Fast film-pack loading. No threading.
- Easier removal of film. No door to open. Pulls out smoothly through slot.
- Picture develops in 10 seconds; outside camera. Easier stripping of print.
- Film lies flat in focal plane for maximum accuracy of registration.
- Compact. 1¼ lbs. lighter.
- Variable ratio — 1:0.5 — 1:1.
- 13 multiple exposures on one frame.
- Vertical or horizontal format.
- Non-reversed, direct view of CRT.
- Data recording optional.
- Immediate delivery.

"Polaroid"® by Polaroid Corporation



OSCILLOTRON® 'SCOPE CAMERAS

1004 N. Olive St., Anaheim, California
Phone (714) 774-4503

launch vehicle's 100,000-pound-thrust second stage—and its adherence to the programmed flight plan—can accurately be determined.

Microprobe Finds Failure Modes at Micron Level

CHICAGO—Use of an electron microprobe analyzer as a technique for studying failure modes of components was outlined by Paul Pietrowsky of Autonetics. Talk was given at the Symposium on Physics of Failure. Meeting, held last week, was sponsored by ITT Research Institute and Rome Air Development Center.

The electron microprobe analyzer scans increments as short as one micron. It has tracked complex atomic dispersions of gold and nickel inside switching diodes. Instrument used in Autonetics' work was manufactured by Applied Research Laboratory, Glendale, California. Objective of the study was to determine how the analyzer could be used to study semiconductor devices and device process technology.

The scanning beam instrument can investigate an area which is the size of the device itself. Vast amount of data can be collected in a relatively short time. The large area display reveals information which would be time consuming to obtain by point analysis techniques.

In another paper, delivered at same meeting, H. Stuart Dodge of Burroughs pointed out that electrical flaws cause about one failure in every three semiconductor failures. Mechanical faults account for about 65 percent of failures. Most failures are detected at early qualification stages. Lifetimes are predicted and potential trouble makers are eliminated before they cause failures.

A fundamental failure mechanism in thin metal-dielectric-metal structure is observable as a generated voltage. This galvanic-diffusion effect was discussed by J. J. Wortman and R. M. Burger of Research Triangle Institute. Authors suggest several measures can be taken to minimize this effect, including use of gold and platinum electrodes, use of thick electrodes, dense dielectrics, low temperature operation, use of efficient getters in hermetic enclosures, and adjustment of electric field polarities.

ELECTRICAL ENGINEERS

Melpar's Engineering Division has immediate need for engineers in the areas noted below. These openings include positions of major responsibility for Senior Engineers as well as unusual opportunities for advancement for recent graduates.

MICROWAVE RECEIVER DESIGN

Specific problems include parametric amplifiers, varactor techniques, microwave filters, ultrastable programmable oscillators and dual and triple channel balanced receivers for monopulse and guard antenna gating.

SYSTEMS DESIGN

For the logic design of digital equipment, specifying necessary digital/analog interface equipment, the analysis of real-time flight simulation systems and the design of analog computer systems for flight simulators.

ANTENNA DESIGN

Working with modern techniques of achieving narrow beam, low side-lobe, d/f antennas in the microwave region. Must have a strong theoretical background.

PROGRAMMING

To write and debug programs for fixed-point real-time computers to be used with special purpose digital and analog equipment for the real time simulation of aircraft.

For further details,
write in strictest confidence to:

John A. Haverfield

Manager, Professional Placement

MELPAR INC.

(A Subsidiary of Westinghouse
Air Brake Company)

3428 Arlington Boulevard
Falls Church, Virginia
(a suburb of Washington, D. C.)

an equal opportunity employer

HERE IS THE WORLD'S SMALLEST MOTOR
YET IT'S SO POWERFUL . . .

MITSUMI MICRO MOTOR

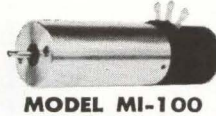

MODEL MI-100

Less than 20mm in diameter, the new Mitsumi Micromotor provides a startling efficiency of over 50%, the barrier which miniature motors are not allowed to pass.

A novel construction principle helped to make this accomplishment possible. The form is more simplified by setting all the terminals at one position. Because the entire mechanism is given full protection against irregular revolution and above all, electrical noise is entirely eliminated, you may call this the most perfect micromotor yet devised. Please write for complete information on Mitsumi Micromotor, and we will send you specifications and data.



MITSUMI PARTS
MITSUMI ELECTRIC CO., LTD.

TOKYO • OSAKA • NEW YORK

CIRCLE 202 ON READER SERVICE CARD

99.6%*

of the 63,000 electronics engineers and procurement specialists who received the 1963-64 **electronics Buyers' Guide** use it personally when specifying electronic components and materials. **Better budget space for the next electronics Buyers' Guide** / a McGraw-Hill publication.

*Survey of August, 1963

Telrex

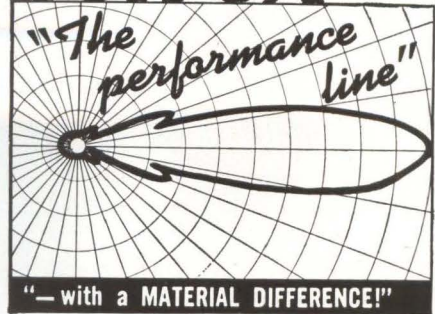

The Choice of the Discriminating Communication Engineer . . . the Man who Never Settles for Anything Less than THE-VERY-BEST!

telrex "BEAMED-POWER" ANTENNAS and ANTENNA SYSTEMS

Provide optimum performance and reliability per element, per dollar. Antennas from 500 Kc to 1500 Mc. Free PL88 condensed data and pricing catalog, describes military and commercial antennas, systems, accessories, Towers, Masts, Rotators, "Baluns" and transmission line data.



Asbury Park 41, New Jersey, U.S.A.
CIRCLE 203 ON READER SERVICE CARD

OPTICAL BENCHES AND ACCESSORIES



SECOND HARMONIC GENERATOR CONVERTS RED LASER LIGHT TO BLUE.

COVER PICTURE FROM **ELECTRONICS** MAY 10, 1963

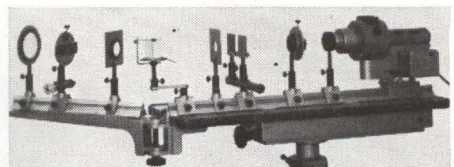

STRAIGHTNESS TO **0.1 mm**

FOR A DESCRIPTION OF THIS EQUIPMENT ASK FOR OUR FREE CATALOG NO. 80E.

KLINGER SCIENTIFIC APPARATUS
83-45 Parsons Blvd., Jamaica 32, N. Y.
Tel: 212 OLympia 7-0335



The men you hire tomorrow

are the kids you help today

Contributions made to United Funds or Community Chests are really an investment. An investment in *your* future. United Fund agencies take the edge off hunger and misery, sure, but they go way beyond that. They do an awful lot for youngsters—providing recreational facilities, finding homes for the homeless, steering puzzled teen-agers onto the right road. So it makes good sense to give the United Way. Your company can make a contribution, and you can make it convenient for your employees to join in through payroll payments. This once-a-year appeal cuts down on the confusion and duplication of separate drives, too. So give United. Could be, the kids you help today will be helping your business tomorrow.

**One gift works many
wonders/GIVE THE
UNITED WAY**

PHOTO BY PHIL BATH

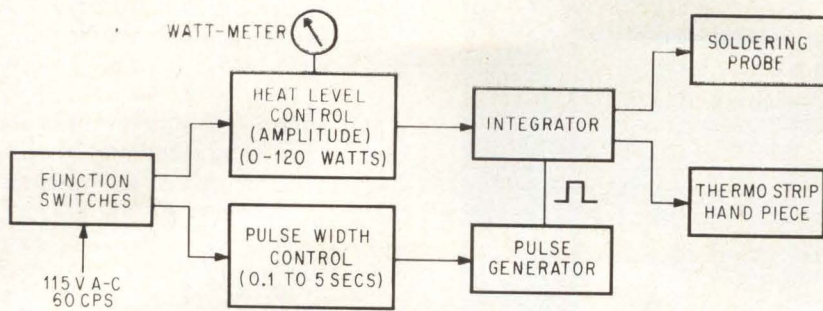

BLOCK PROGRAM of power supply. Pulse width (time duration) and heat level (current amplitude) are continuously variable



SOLID STATE supply provides adjustable current pulses to probe. A foot switch controls the supply but machine turns off at a predetermined time

Pulses Control Soldering Quality

Programmed control for resistance soldering assures good connections

PULSED resistance - soldering equipment developed by Electro-Miniature Corp., of Hackensack,

N.J., enables inexperienced persons to make solder joints in miniature equipment with speed and reliability.

According to R. E. Wolfé, chief engineer, the equipment has made some 140,000 satisfactory solder joints with an increase in production speed of 50 percent.

The company has been using the resistance solderer to make terminal connections on miniature connectors for slip rings used in inertial guidance platforms and for soldering in the slip-ring assembly itself.

The soldering equipment also does double-duty as a thermo-stripper for wire insulation.

Furnace Seals Integrated Circuits



FINAL ASSEMBLY and packaging of integrated circuits manufactured by the Westinghouse Molecular Electronics Division, Elkridge, Md.: The Kovar alloy frames in the petri dishes are placed in the carbon casts on the workbench. Glass, Kovar alloy leads, and metallic or ceramic bases are then added. Weights from the boxes at lower right are placed on top. The entire assembly is fed into the inert gas furnace, top right, where the glass fuses to form an hermetic seal. Called Flat-Packs these circuits are functional blocks.

Operation—In resistance soldering, an operator would normally apply a current-carrying probe to the part being soldered until a solder preform melted. Heat is generated by the resistance of the part, such as a terminal pin, or in the chassis near the joint. The probe has two conductors, separated by a gap. The part being soldered completes the electrical path through the gap.

In Electro-Miniature's system, a similar probe is used. However, the power supply is programmed so the operator need not judge timing or solder flow to make a satisfactory connection. Current-pulse amplitude and width are predetermined and set up on the power supply's control panel. The pulse can be as long as 5 seconds.

All the operator need do is apply the probe to the part being soldered and start the soldering-pulse cycle with a foot switch.

Programming is done by a quality-control man experienced in soldering. He determines current

NOW!

RECORD VOLTS, OHMS, MILLIAMPS

with ONE RECORDER

... NO EXTRAS!



ONLY
\$595
COMPLETE

New Bausch & Lomb V.O.M.-5 RECORDER

... an all-new, complete 5-inch strip-chart recorder that breaks all precedent in the field ... brings you the finest features of potentiometric recorders for one low price. Compare these exclusive advantages, all these "extras" at no extra cost, with any other recorder in its class.

- Six voltage ranges, 10 millivolts to 500 volts D.C.—full scale deflection.
- Six linear ohms scales, 1-to-100,000 ohms full scale, with zener diode D.C. supply.
- Five D.C. current ranges—10 microamperes to 100 milliamperes.
- Off balance input impedance—over 10 megohms.
- Five chart speeds, 400-to-1 range.
- Event marker, with interchangeable pens.
- Function switch with mechanical pen letdown.
- Operates in flat, 30° tilt, or wall-mounted position.
- Compact—only 4¾" x 14½" x 11¾".
- Portable—only 16 lbs.

And more. Lots more! Mail the coupon now for the whole story on this new 5-speed recorder with versatility-plus!

BAUSCH & LOMB

**BAUSCH & LOMB
INCORPORATED**
61446 Bausch Street
Rochester 2, N. Y.

Please demonstrate the V.O.M.-5 Recorder at my convenience.

Send Recorder Catalog D-2032.

Name Title

Company

Address

City Zone State

time and amplitude required for an optimum joint in a particular type of connection. Values can be preset within 1-percent accuracy. The control system is shown in the block diagram.

Application — One application for the equipment is soldering 70 size-28 conductors to a subminiature slip-ring assembly. Connector terminals are as close as 0.05 inch. The company says there have been no problems of solder running between pins or excessive heat conduction to other sections of the connector.

The units are assembled on a fix-

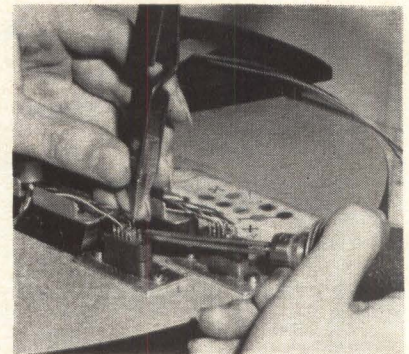

MINIATURE CONNECTORS are easily soldered with preformed solder and programmed heat supply. Heat is developed by the flow of current through the connector terminal

ture with solder preforms and terminal pins in place. The operator inserts the connector wire into the hollow pin as soon as the solder flows.

The company adds that if changes or repairs should be needed in the assemblies, parts can be unsoldered quickly and without excessive heat by setting the controls to melt the solder in the joint.

Additional probes are provided for thermally stripping wire insulation.

Multiblade Saws Cut Wafering Heat

WORCESTER, MASS. — Multiblade wafering machine built here by Norton Co. is being tested in semi-

conductor plants in U. S., Europe, and Japan as a new approach to slicing of semiconductor crystals.

Principal advantage over annular saws may be in minimization of heat-caused surface damage to semiconductor material. The question of surface damage is relatively an unexplored field.

According to Thomas Bushman, of Norton Co.'s Machine Tool division, virtually no heat is generated and 25 microns is deepest penetration of damage detected so far from multiblade wafering machine.

The technique has its roots in the drag saws used in the marble-cutting industry. The machine goes through one inch of semiconductor material in six hours, instead of the typical one inch per minute for annular saws. But multiple cuts are being made. Blue-tempered steel blades work their way back and forth through a slurry composed of 9.5-micron grains of silicon carbide mixed with oil. As far as can be determined, the steel blades never touch the silicon or other semiconductor material.

Developers admit the technique is not as accurate as conventional saws in size and parallelism of cut, but point out that a lapping has to be done later anyway. Success of technique will probably depend on extensive studies now being undertaken in semiconductor laboratories to determine relative depth-of-damage caused by cutting methods.

Another application for the multiblade saws, now being investigated, is the fabrication of ferrite waffles for waffle-type computer memories, compact, high-speed memory devices recently developed by Bell Telephone Laboratories.

Indexing Machines Mold Plastic Parts

AUTOMATIC MOLDING process was outlined by George B. Rheinfrank, Jr., of Glasskyd Department of American Cyanamid Co., Perrysburg, Ohio, last week at the Cleveland Meeting of the Society of Plastic Engineers. The machine is designed for molding Glasskyd alkyd compounds, used in electrical and

NEW SOLID-BACK AIRCRAFT TERMINAL BOARDS FROM GEN-PRO

HAVE MOLDED-IN STUDS, MEET MS-27212

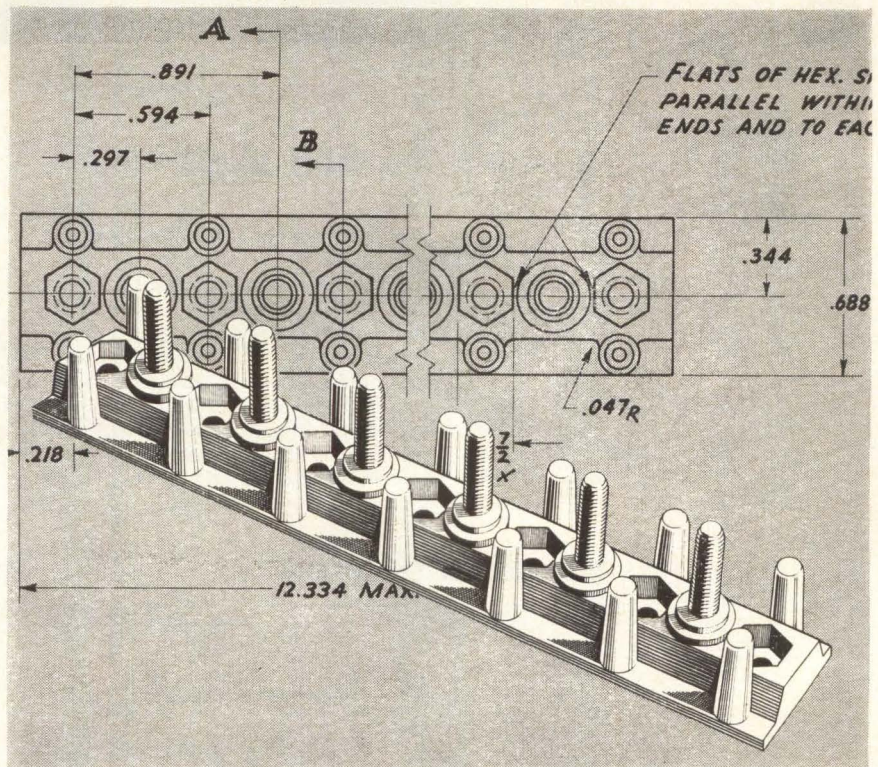

MS-27212 Supersedes MS-25123

Developed by Gen-Pro in conjunction with the USAF, this new aircraft terminal board is designed for high reliability in modern airframes, aerospace vehicles, ground support equipment, telemetering and other critical applications. Molded-in stainless steel inserts and solid-back construction eliminate the need for insulating strips and prevent any possible short-circuiting between mounting screws and studs. Boards are precision-molded of GDI-30F glass-filled diallyl phthalate for high strength and resistance to shock, flame and moisture. The material has an operating temperature of 475°F. To build greater safety and reliability into your designs, specify Gen-Pro aircraft terminal boards—available for immediate delivery.

Write to Military Marketing Manager today for descriptive literature



GENERAL PRODUCTS CORPORATION ■ UNION SPRINGS, N.Y.

The Nation's Leading Producer of Military Terminal Boards
TWX No. 315-999-1455 • Phone: (area code 315) TT 9-7367

Space Navigation Systems Engineers:

THINKING INTERPLANETARY?

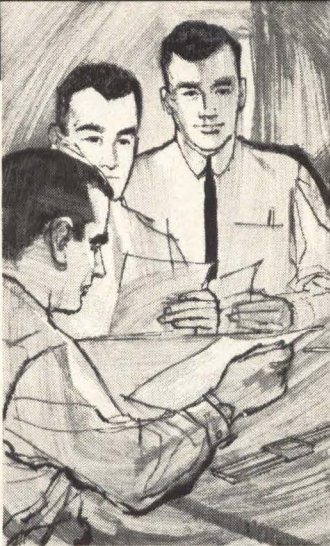

so are we!

Engineers and Scientists at Honeywell in Florida are actively engaged in the design and development of airborne and spaceborne navigation systems for such programs as X-20A, Centaur, Gemini and many others of great complexity. Are you qualified to make a significant contribution to our systems capabilities? We offer the inquisitive, imaginative engineer the growth and responsibility which comes only from working with an aggressive, engineering-oriented firm.

INERTIAL SYSTEMS DESIGN ENGINEERS

Will examine the state of the art for the broad application of inertial, electro-optical, and manually operated optical sensors for navigation and control of manned and unmanned spacecraft. Will conduct preliminary design studies of guidance techniques for such craft. Experience desirable in Guidance and Control Systems Design, configuration and error analysis, system test or evaluation, circuit theory, optical and inertial sensors or servo theory.

SYSTEMS ANALYSIS ENGINEERS

Will analyze systems performance, conduct servo analysis and solve trajectory problems using analog/digital computers and construct mathematical models. Knowledge of advanced calculus, vector analysis, classical mechanics, Bode diagrams, root locus plots and Laplace transforms highly desirable.

SYSTEMS INTEGRATION ENGINEERS

Will integrate components into the inertial guidance system and the system into the vehicle and solve problems of interface, such as grounding, signal isolation, and hardware and digital computer interface. Knowledge of inertial navigation, gyros and accelerometers is required.

Qualified Applicants are invited to visit

our facilities, meet our people and discover for themselves the many added advantages of working and living here on Florida's Suncoast. A brief note, describing your education, experience and specific area of work interest, addressed to **O. L. Keese, Honeywell 13350 U. S. Highway 19, St. Petersburg, Florida**, will bring a prompt, confidential reply.

Honeywell

An Equal Opportunity Employer

"A Good Place to Live... A Good Place to Work"

To investigate professional openings in other Honeywell facilities, send resume to F. F. Laing, Honeywell, Minneapolis 8, Minnesota.



electronic applications.

The machine consists of a cold plunger section, used to inject a cold slug of Glasskyd alkyd-glass fibre compounds and a press with a rotary indexing table carrying four molds 90 degrees apart. Six-station machines have also been built.

Process—The injection piston forces a 1-lb slug of molding compound from the loading well into an injection chamber heated to 150 deg F. At this temperature, the rope-shaped molding compounds become relatively fluid and remain stable for 24 hours. Rheinfrank added that the machine can be further automated by adding automatic feeding equipment.

When the mold rotates to the injection station, the injection cylinder advances until its nozzle engages the mold orifice. The compound is injected during an interval of 1/2 to 3 seconds at 5,000 to 8,000 psi. The mold is held closed by an air-intensified clamp. Injection pressure is then lowered to a holding pressure of 1,000 to 2,000 psi permitting cure of material at the mold gate. The resulting sealed cavity prevents escape of the injected compound.

Automatic withdrawal of the injection cylinder from the mold completes the injection cycle. Cure is initiated with injection of the compound into the mold cavity. Immediate release of full clamping pressure is followed by automatic mold rotation to the next station. Cure is completed when the mold reaches the third station. During cure only 200 to 400-psi hold pressure is needed to keep the mold closed.

Molded parts are automatically ejected at the fourth station. The closed, empty mold is then ready to start a new cycle. Total time to complete the entire cycle may run as low as 24 seconds. The rope-shaped alkyd molding compounds need not be accurately weighed before loading into the injection chamber. Waste of the compound is reduced since the cull is completely eliminated. Automation is easy since weighing of material before loading is not necessary.

This cold plunger process is patented by the American Cyanamid Company, but royalty free licenses will be granted to interested fabricators.

HIGH QUALITY GAS LASERS

CAN BE

INEXPENSIVE!

Yes, you can buy a gas laser system for several thousand dollars!

BUT MUST YOU?

Semi-Elements NEW SEOG* MKIB Gas Laser System available now at \$750.00 provides these characteristics:

WAVELENGTHS: Visible and Infrared, 6328A, 11,513A, 33912A.

POWER: 1 to 2 Milliwatt Output.

ADJUSTABILITY: Reflector angle, adjusts to 0.1 arc second resolution, with precision adjustment of the resonator over 2 cm in length.

EXCITER: New simplified controls.

WARRANTY: Plasma Tubes are warranted for 300 hours continuous operation (most will operate 500 hours). Optical purity of end windows and Brewster angle accurate to within $1/2^\circ$ and alignment accurate to within $1/4^\circ$ in respect to each other. Windows are flat to 1/10 of wavelength. Quality of Reflecting Mirrors accurate to within 1/20 of wavelength.

Other Semi-Elements Gas Laser Models available up to \$15,000

The World's LARGEST Supplier of Single Crystals

Write or call for Literature

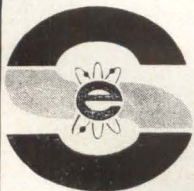

emi-elements, inc.

Saxonburg Boulevard, Saxonburg, Pa.
Phone: 412-352-1548

CIRCLE 204 ON READER SERVICE CARD

electronics October 11, 1963

Now SYSTEMS & SUBSYSTEMS COMPONENTS for INPUT-OUTPUT EQUIPMENT

INVAC Corporation announces for the first time its completely solid state on-line and off-line equipment for special punched paper tape applications.

This off-the-shelf equipment provides for system flexibility . . . military applications — low RFI — uses photoelectric principle to eliminate electrical contacts.

Fast delivery assured — large or small quantities. For additional information write or call: Area Code 617 899-2380.

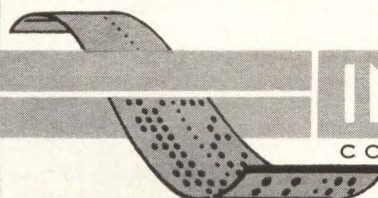
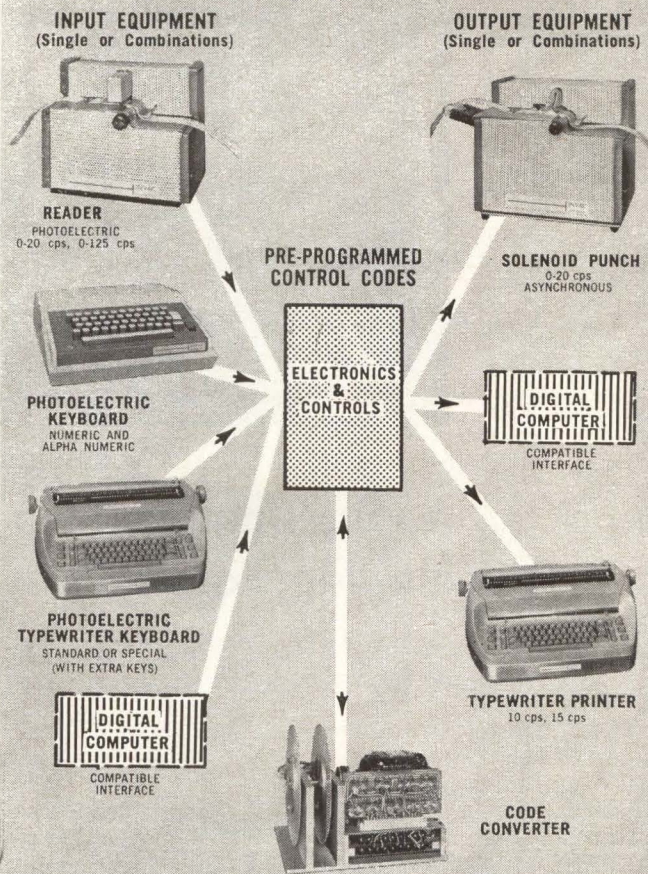

INVAC
CORPORATION

26 FOX ROAD • WALTHAM 54, MASS.

Area Code 617 - 899-2380

CIRCLE 61 ON READER SERVICE CARD

61

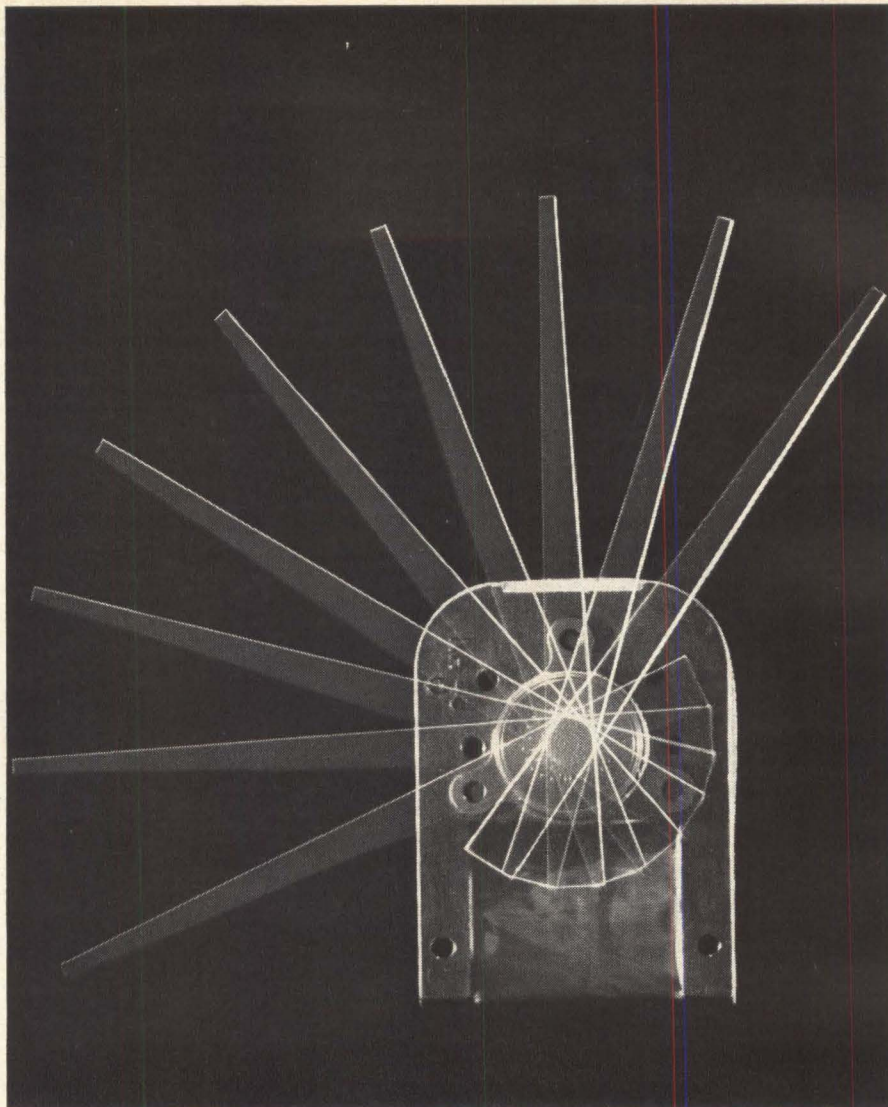

Sigma's Cyclonome® Stepping Motor—

An uncomplicated approach to accurate positioning, counting, synchronizing, converting

From Sigma comes an electro-magnetic drive that delivers torque in precise 18° steps...

- ... up to 1,000 steps per second
- ... up to 5 inch-ounces of torque
- ... with no standby power to maintain high holding torque
- ... with only one moving part (no catches, ratchets, escapements)

... with size as small as 1 cubic inch.
... and requiring only the simplest input circuitry.

Engineers are already applying the Cyclonome stepping motor in chart and tape drives, in analog-digital converting, in impulse counting, in step servos, in remote positioning, in timing.

If you position, count or convert, the Cyclonome stepping motor can benefit you.

Our application engineers will be glad to work with you. Or perhaps you would first prefer to read more about the Sigma Cyclonome. If so, send for a copy of The Cyclonome Technical Bulletin. Write to Department 11.

SIGMA DIVISION  **SIGMA INSTRUMENTS INC**
Assured Reliability With Advanced Design/Braintree 85, Mass.

What is a Stepping Motor?

A stepping motor is like a synchronous motor in principle, except that its rotor does not revolve smoothly and continuously when the motor is energized. Instead, on command from the input, the rotor travels an incremental step,

stops instantly and locks magnetically in position. When a signal of opposite polarity is applied, the rotor advances another precise step, delivering torque in exact proportion to and at the same rate as the input.

Printed-Circuit Readouts Feature Modular Design

Optical technique increases readability, reduces eye fatigue

MODEL 4W modular readouts provide rapid, error-free, high-contrast display of numerals and other symbols. Using twelve transparent lucite plates arranged one behind the other, units increase readability of digital display and minimize eye fatigue. Display symbols are engraved on lucite plates that are individually edge illuminated by miniature lamps. Energizing any of the 12 lamps causes the associated symbol to glow, while a Polaroid filter covering the readout reduces incident light reflections and contributes to figure definition and brilliance.

Construction of the 4W readouts

allows the characters furthest from the front to be clearly seen without interference from nearer engravings. This is accomplished by shaping and positioning each character to minimize overlap and by forming the characters by impressing a series of dots into the lucite plates rather than forming characters by continuous engraving. The depth and diameter of each dot is designed to achieve greatest possible light transfer.

Any number of readouts may be arranged on a printed-circuit board to provide lengthy displays. Units plug in and out simply as shown in the photo. Readout lamps are mounted in the digital unit on two easily-removed printed-circuit cards that hold six lamps each. Lamps require 6, 14 or 28 volts and are therefore suited for transistor circuits. Normal lamp life is 5,000 hours representing 2½ years at

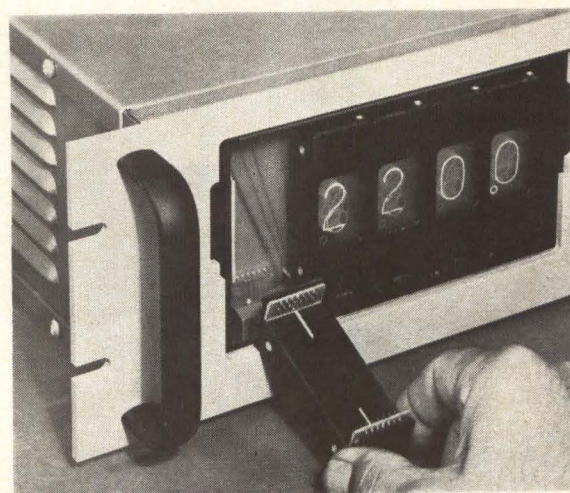

8 hours per day, 5 days per week. 10,000 hour and 50,000 hour lamps are also available. Price: \$15 to \$25 each, depending upon quantity. Non-Linear Systems, Inc., P.O. Box 728, Del Mar, California.

CIRCLE 301 READER SERVICE CARD

Chamber Cools Photomultipliers

THERMOELECTRICALLY refrigerated chamber permits operation of multiplier phototubes in a controlled-temperature environment.

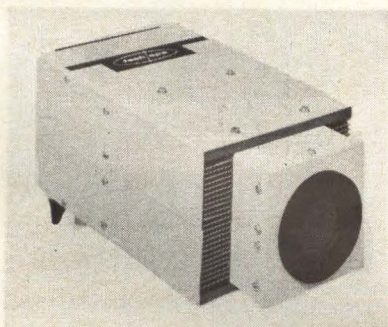

Believed by the manufacturer to be the first device of its kind to be offered on a standard product basis, the unit allows the operating temperatures of tube photocathodes to be selected in the range from 20 C to -10 C and stabilized to ± 0.25 C for extended periods. A thermally-insulated window prevents dewing of the tube face and a cylindrical mu-metal shield that surrounds the tube envelope is arranged for operation at the tube's cathode potential. Total power consumption is less than 100 watts, permitting convenient portable operation. Technical Operations Research, Burlington, Mass. (302)

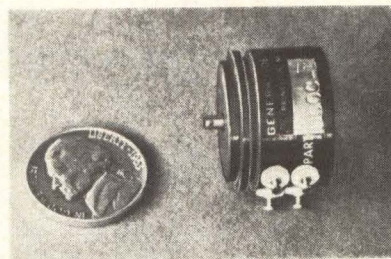

Tiny Switch Provides High-Speed Programming

SUBMINIATURE multi-channel programming switch designed for military and commercial applications provides a multitude of accurately related switching functions with shaft rotation. In addition to greatly reduced size, unit features low driving torque, low contact noise and dynamic resistance and

NEW DI-ACRO 24-INCH BOX FINGER BRAKE

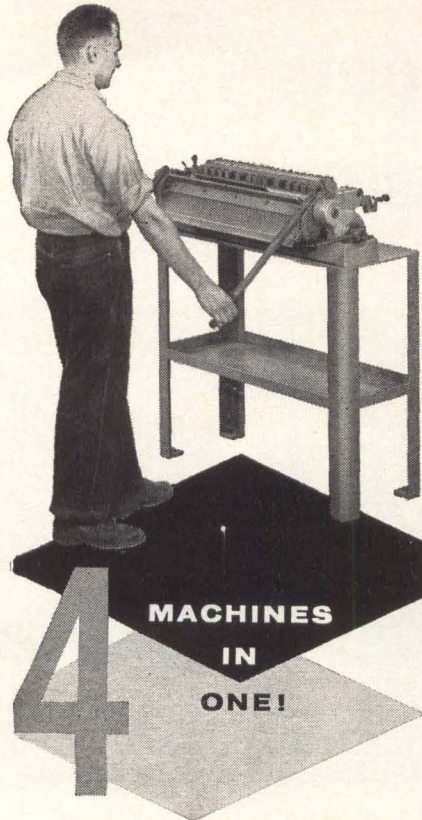

UNDERCUT FINGERS

and one inch clearance permit forming chassis with up to 1/2-inch flange and clearing reverse bends from front of machine. Micrometer Gauge instantly positions material for forming to die accuracy in experimental labs, model shops, short-run production.



A NEW
12-inch
Brake with

16 gauge steel capacity is available for forming smaller parts.

For free illustrated folder see your nearest Di-Acro distributor or write to us.



DI-ACRO CORPORATION
4310 Eighth Avenue Lake City, Minnesota



1. BOX AND CABINET FORMER... forms all widths from 1/4" to 24" by 1/4" steps.



2. BAR FOLDER... folds or hems up to 16 gauge mild sheet steel across full width.



3. RADIUS FORMER... forms radii by positioning forming edge or with special radius fingers.



4. OPEN END FORMER... forms open end shapes by replacing box fingers with open end finger.

high timing accuracy for its size. Called Programmite, the switch is capable of reliable operation for long periods of time over a wide speed range and is particularly adaptable to high-speed programming applications where contact bounce must be avoided. Although available in a variety of standard and special configurations, the unit shown in the photo is a 3-pole commutating switch capable of up to 50 on-off functions per pole, per rotation. Prices of production quantities are less than \$100 each. General Devices, Inc., P.O. Box 253, Princeton, N.J.

CIRCLE 303, READER SERVICE CARD

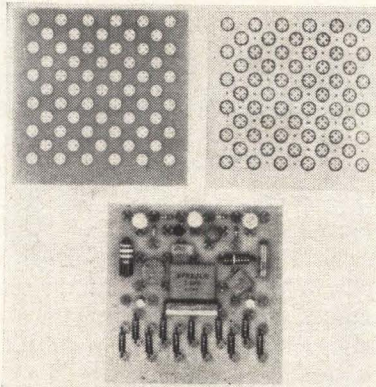

Circuit Boards Use Four-Hole Etched Pads

STANDARD prefabricated circuit boards employing four-hole etched pads, with or without ground plane combinations, provide a quality and effective method of packaging a complete high or low frequency circuit. Standard and miniature sizes ranging from 1 by 2 to 4 by 8 in. are available in a glass epoxy, paper epoxy and phenolic materials. Transparent facsimile lay-out sheets are supplied to match each stock size board. Price range: \$2.32 to \$4.63. Availability: from stock in phenolic materials, 20 days for epoxy materials. Aero Circuits Co., Box 209, Fairfield, Conn. (304)

Conductor Ribbon Designed for H-F Use

ANNOUNCEMENT is made of Silver-Stepped, a silver-plated copper conductor ribbon in sizes to 1/8 in. wide

MULTI- CONDUCTOR MULTI- COLOR CABLES...

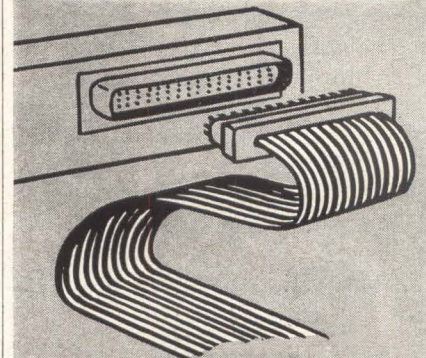
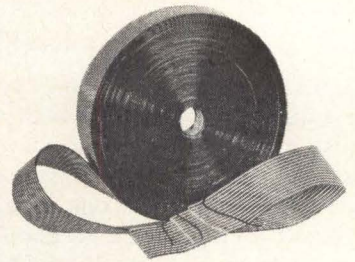

SPECTRA-STRIP®

Efficiency in wiring... Always reliable, complete flexibility, easily identifiable, so easy to handle, neat, low in weight, controlled capacitances... always an experienced staff to assist you. Gauges #10 to #30 AWG, to 1000 Conductors... Receive more of everything in cables and harnesses.

Write for information regarding SPECTRA-STRIP CABLES to:



P.O. BOX 415—Tel: 714-537-4530
TWX: 714-530-0313
GARDEN GROVE, CALIF.

CIRCLE 205 ON READER SERVICE CARD

October 11, 1963 electronics

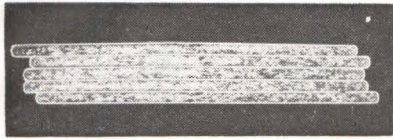

and as thin as 1½ mils. The ribbon, with uniform cross sectional characteristics, fully plated edges, and at popular prices, should permit the electronic designer a new approach to many silver-coated conductor problems. Some of the applications lie in high temperature conductors, laminated flat tape conductors, high-frequency coaxial cable designs, drain wires and flexible cordage. Substitution of such materials can effect savings as much as 30 percent in silver alone when substituted for silver-coated stranded fine wire. Steel Heddle Mfg. Co., Philadelphia, Pa.

CIRCLE 305, READER SERVICE CARD

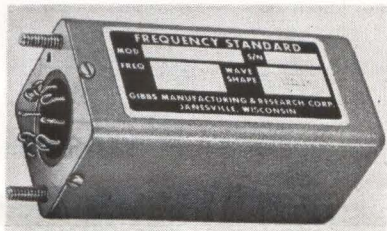

Crystal Oscillator Is Small and Light

CRYSTAL OSCILLATOR replacement for tuning forks and other less stable devices is announced. It offers high stability at very low cost. The 439 series has output frequencies available from 10 kc to 100 kc; calibration tolerance of ± 50 ppm; and a stability of ± 10 ppm/week over an ambient operating range of - 40 C to + 60 C. Gibbs Mfg. and Research Corp., 450 North Main St., Janesville, Wisc. (306)

Bulk Tape Eraser Cleans Up Noise

NOW AVAILABLE is the Magneraser Senior, which completely erases tapes on the reel with a once-around revolution of the reel. It is designed for use with audio, computer, teletimeter, and machine-control tapes; and with 8, 16, and 35-mm sound strips. It completely erases the most severely overloaded tapes, and ac-

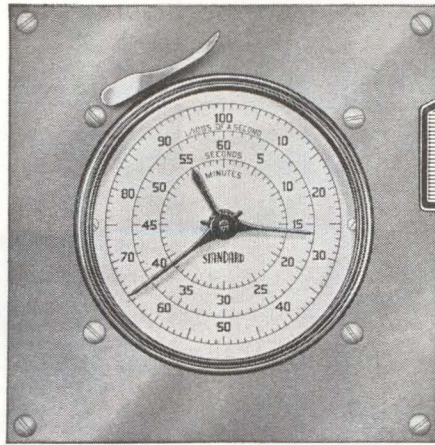

THE ONE TIMER WITH ALL THE FEATURES

- Portable, Panel or Wall Mounting
- Scale Divisions from 1/1000 sec. to 1/5 sec.
- Totalize from .360 sec. to 60 min.
- Accuracy range from ± .0002 to ± .1 sec.

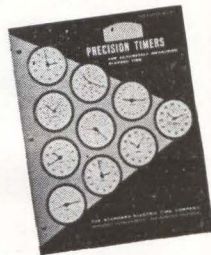

Since 1932 Standard Electric Time Company has been developing and manufacturing units for the precise measurement of elapsed time. Accuracy, rugged construction and long life are Standard features.

For full details request free 20 page catalog No. 257.

THE STANDARD ELECTRIC TIME COMPANY
89 LOGAN STREET • SPRINGFIELD, MASSACHUSETTS

CIRCLE 206 ON READER SERVICE CARD

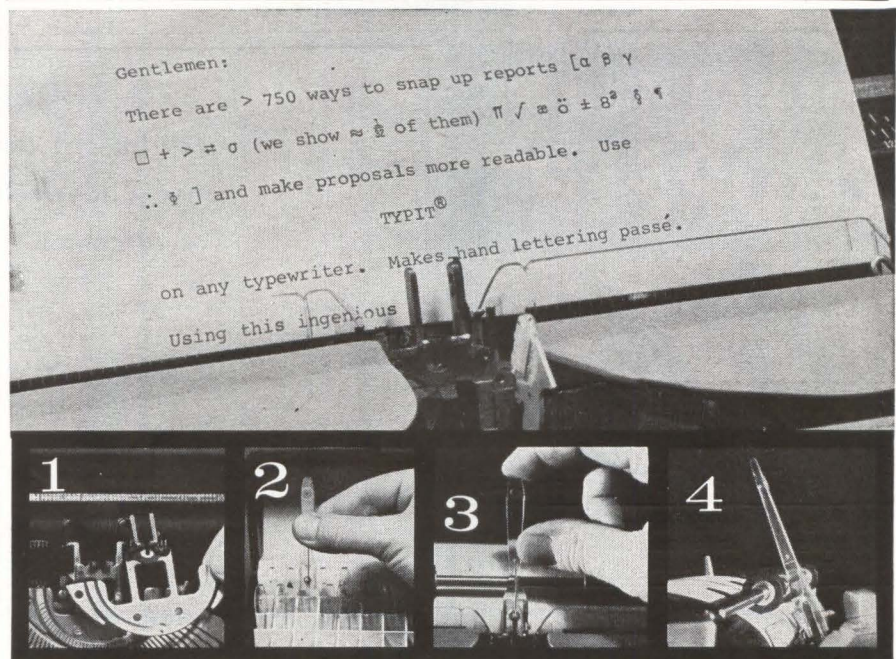

- 1 Have TYPIT® installed
- 2 Select the symbol
- 3 Insert the symbol
- 4 Strike any key:
type the symbol

NOW LEARN ABOUT

TYPIT® manufactured by mechanical enterprises, inc.
3127-A Colvin Street, Alexandria, Va.
Gentlemen:

Send: Catalog Representative
Name _____ Title _____
Company _____
Address _____
City _____ Zone _____ State _____

BUSS Sub-Miniature PIGTAIL TRON FUSES

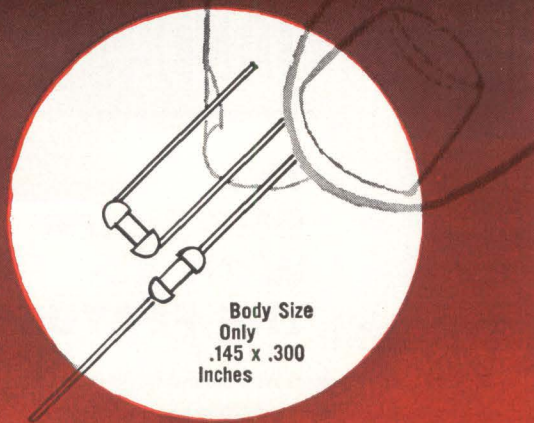

Body Size
Only
.145 x .300
Inches

Tron fuses are so small they can be used as an integral part of circuit—to protect miniaturized devices—or gigantic multi-circuit electronic devices, without sacrifice of space.

They are hermetically sealed for potting without danger of sealing material affecting operation and have high resistance to shock or vibration. Operate without exterior venting. May be teamed with other components in replaceable unit.

BUSS

Write for BUSS
Bulletin SFB.

BUSSMANN MFG. DIVISION, McGraw-Edison Co., St. Louis 7, Mo.

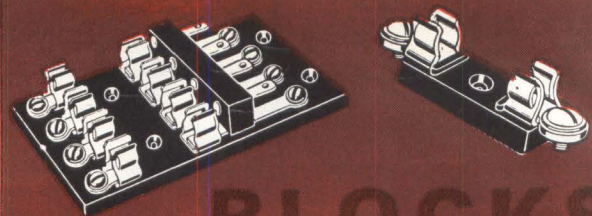

BLOCKS for BUSS FUSES

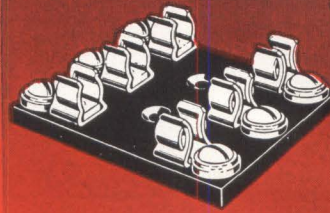

All Types Available for
Every Application . . .

Single pole, multiple pole, small base, full base, molded base, bakelite base, porcelain base for fuse from 1/4 x 3/8 inches up to 1/2 x 2 inches. Also signal fuse blocks and special blocks of all types.

Send us your requirements—we have the block you need or can engineer it for you.



BUSS

Write for BUSS
Bulletin SFB.

BUSSMANN MFG. DIVISION, McGraw-Edison Co., St. Louis 7, Mo.

BUSS : the complete line of fuses .

CIRCLE 207 ON READER SERVICE CARD

CIRCLE 207 ON READER SERVICE CARD

SOLID STATE ELECTRONIC CHOPPERS

ACTUAL SIZE

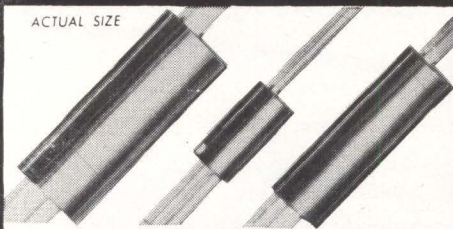

MODEL 50

MODEL 60

MODEL 70

HIGH SPEED
LOW POWER
LONG LIFE

MICROMINIATURE
NON-MECHANICAL
INERTIALESS

LINEAR
STABLE
RUGGED

The transistor chopper (or modulator) is a solidly encapsulated unit designed to alternately connect and disconnect a load from a signal source. It may also be used as a demodulator to convert an a.c. signal to d.c. It is capable of linearly switching or chopping voltages over a wide dynamic range which extends down to a fraction of a millivolt and up to 150 volts.

These units are practically immune to the effects of shock and vibration making them ideal for military, space vehicle and portable applications. The transistor chopper has an inherently long life and is not subject to contact bounce, wear, pitting or burning.

WRITE OR PHONE FOR BULLETINS

SOLID STATE ELECTRONICS CORP.
15321 RAYEN STREET
SEPULVEDA, CALIFORNIA
EMpire 4-2271 • STate 5-4473



TO ORDER REPRINTS

Fill in, cut out coupon below

insert in envelope and mail to:

electronics Reprint Dept.

330 W. 42nd Street, New York, N. Y. 10036

REPRINT ORDER FORM

(To help expedite mailing of your reprints please send cash, check or money order with your order.)

For Reprints of the latest Special Report:

Radio Frequency Interference

Send me Reprints of Key No. **R-39** 1-10 copies 75¢ each, 11-24 copies 60¢ each, 25 or more 50¢ each.

For Reprints of previous **Special Reports** or **Feature Articles** fill in below:

Send me Reprints of Key No.(s) @ ¢ each.

(For prices, see Reader Service Card.)

*For orders of **Bulk Reprints** of other editorial articles in this issue or past issues:

Send me Reprints of page No.(s) of issue date

of article entitled

*Minimum bulk order 100 copies. You will be advised of costs by return mail.

Name

Number of Street

City, Zone No., State

CIRCLE 49 ON READER SERVICE CARD

tually lowers background noise levels 3 to 6 db less than some new (unused) tapes. There are no missed spots, no partial erasure, no track overlap, and no reel turnover for ¼-in. tapes on plastic or aluminum reels. The eraser saves wear and tear on heads, pressure pads, tape guides and clutches. Single spindle position accommodates 3, 5, 7, and 10½-in. reels without spindle shifting. Price is \$24.95. Amplifier Corp. of America, 398 Broadway, N. Y. 13, N.Y.

CIRCLE 307, READER SERVICE CARD



racy is equal to the power line frequency accuracy; ± 1 digit in the measuring mode and 0, - 1 digit in the controlling mode. Price is \$129. NHL, P. O. Box 1051, Bristol, Conn. (308)

Digital Device Measures Time Interval

DIGITAL timing device 2000D can be used to measure or control time interval. It features in-line digital presentation of both elapsed and preset time. The built-in time base is available with resolutions of 1 sec to 1/1000 minute. Total time that can be measured on the 1-sec version is greater than 27 hr. Accu-

Transistor Develops Very High Beta

MODEL SST 610 is a three-terminal device containing a matched pair of hermetically-sealed *npn* diffused-mesa silicon transistors in a composite configuration permitting attainment of very-high current gain with high stability and re-

liability. Unit has features that include: Current gain (Beta) of 5,000, current range from 1 ma to 500 ma, dissipation of 1 watt at 25 C case temperature, low saturation voltage at high collector current, temperature range from -55 C to ± 150 C and high collector-emitter and

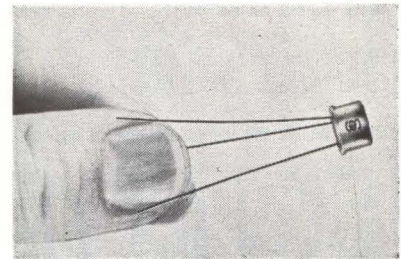

emitter-base voltage. Applications include high gain and input impedance, low-level amplifiers, negative feedback stabilization, buffer amplifiers, sensitive switches and relays. Model SST 610 is designed to meet MIL-S-19500B specifications. Solid State Electronics Co., 15321 Rayen St., Sepulveda, California. (309)

..... of unquestioned high quality

BUSS Sub-Miniature FUSE-HOLDER COMBINATION



A light weight, protective device for space-tight applications in multiple circuit apparatus. Fuse has transparent window for visual inspection of element. Fuse may be mounted alone or used in holder on printed circuit boards.

HWA holder can also be panel mounted with or without use of knob. Knob makes holder water proof for front of panel.

BUSS

For full details write for BUSS bulletin SFB

BUSSMANN MFG. DIVISION, McGraw-Edison Co., St. Louis 7, Mo.

CIRCLE 207 ON READER SERVICE CARD



If you should have a special problem in electrical protection...

... we welcome your request either to quote or to help in designing or selecting the special type of fuse or fuse mounting best suited to your particular conditions.

Submit description or sketch, showing type of fuse to be used, number of circuits, type of terminal, etc. If your protection problem is still in the engineering state, tell us current, voltage, load characteristics, etc. Be sure to get the latest information BEFORE final design is crystallized.

At any time our staff of fuse engineers is at your service to help solve your problems in electrical protection.

BUSS

Just call or write:

BUSSMANN MFG. DIVISION, McGraw-Edison Co., St. Louis 7, Mo.

CIRCLE 207 ON READER SERVICE CARD

specify the new Bendix Products

AVNET

contact Avnet for best service

Pygmy* types PT, SP; Pygmy crimp types PTCE, PTSE; MS, MS-E, MS-R, QWLD, SR rack and panel

on-time delivery of emergency

BENDIX

and prototype connector needs

Reg. T.M. Bendix Corp.



call your Local Avnet Headquarters

AVNET

The Avnet System, coast to coast

CIRCLE 208 ON READER SERVICE CARD

FASTENERS FROM

GRC

DIE CAST ZINC ALLOY



Wing Nuts



Cap Nuts



Thumb Nuts



Thumb & Wing Screws



MOLDED NYLON & DELRIN

Screws



Hex Nuts



Washers



Screw Insulators

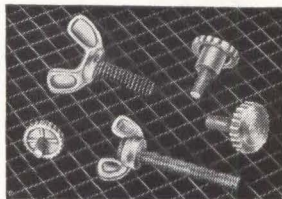

WING & THUMB SCREWS

Wing Screws have generous washer-type shoulders, patented recessed finger-grip wings.

Thumb Screws have exclusive wide heads for firm, comfortable grip: plain or shoulder type.

Produced in one high speed automatic operation, GRC's exclusive methods assure uniformity, smooth, rustproof & corrosion resistant surfaces and lowest cost.

GRC's special automatic methods of die casting in zinc alloy and molding in engineering thermoplastics guarantee:

- High quality
- Uniform accuracy
- Low cost
- Wide range of stock styles, types, sizes and threads

WRITE, WIRE, PHONE NOW for samples & GRC's new detailed Industrial fastener catalog.



GRIES

GRIES REPRODUCER CORP.

World's Foremost Producers of Small Die Castings
151 Beechwood Ave. • New Rochelle, N. Y.

Phone: (914) New Rochelle 3-8600

LITERATURE OF THE WEEK

COOLING DEVICES Dynacool Mfg. Co., P.O. Box 132, West Hurley, N. Y., has published a six-page brochure illustrating and describing a complete line of cooling devices for the industry. Prices are included.

CIRCLE 401, READER SERVICE CARD

CRYSTAL CAN RELAY C. P. Clare & Co., 3101 Pratt Blvd., Chicago, Ill. Crystal can relay reliability manual 710 is now available. (402)

SOLID-STATE RELAYS Hi-G, Inc., Bradley Field, Windsor Locks, Conn. Catalog SS-1 contains data on operational and environmental characteristics of the series 2000 solid-state relays. (403)

LOG-VOLTMETER-CONVERTER Houston Instrument Corp., 4950 Terminal Ave., Bellaire 101, Texas, has published an 8-page bulletin on the model HLVC-150 log-voltmeter-converter. (404)

PRECISION FACE PLATES Precision Optics Division, Pennsylvania Optical Co., Reading, Pa. Bulletin 201 describes products and facilities for producing a wide variety of precision face plates for image orthicons, readout tubes, crt's and other electronic applications. (405)

SERVO AMPLIFIERS Feedback Controls, Inc., 8 Erie Drive, Natic, Mass. A series of solid-state servo amplifiers for industrial applications are described in a technical data sheet. (406)

CERAMIC CAPACITORS The Scionics Corp., 8900 Winnetka Ave., Northridge, Calif. A series of data sheets describe a complete line of microminiature ceramic capacitors. (407)

DIGITAL SYMBOL GENERATOR Digital Equipment Corp., 146 Main St., Maynard, Mass. Brochure describes symbol generator type 33, which automatically translates digital words into symbol format information. (408)

CIRCUIT DESIGN AIDS Magnetics Inc., Butler, Pa. A 10-page booklet has been prepared to aid circuit design engineers who are interested in inverters, magnetic amplifiers, and transformers. (409)

DELAY LINES The Gudeman Co. of California, Inc., 7473 Avenue 304, Visalia, Calif. Catalog sheet describes miniature lumped constant delay lines with packaging densities up to 60 sections per cu. in. (410)

METAL FILM RESISTORS Pyrofilm Resistor Co., Inc., 3 Saddle Road, Cedar Knolls, N. J., has issued a data sheet describing a line of ultra-stable Pyromet series oxide-protected film resistors. (411)

PRECISION SWITCHES Haydon Switch, Inc., 1500 Meriden Road, Waterbury, Conn., has completed a new Catalog No. 7 covering hermetically-sealed and high-temperature precision switches and switch assemblies. (412)

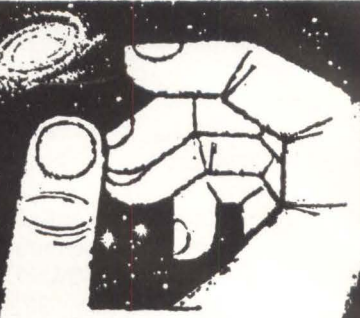

How high is your goal?

Ours are out of sight in the labyrinth of space. But your opportunities are a tangible reality, here and now at North American's Space and Information Systems Division. Trained, creative engineering minds, attuned to the research, development and production of manned spacecraft, large booster systems, inflatable winged recovery systems and missile weapon systems will find fertile fields to grow in at S&ID.

ADVANCED INTELLIGENCE SYSTEMS

This group is engaged in developing advanced intelligence systems concepts, in evolving techniques applicable to advanced design, and performing analytical studies to ascertain preliminary configuration of these systems.

Several creative research and engineering positions, as well as high level supervisory positions, are available in the following areas:

DATA COLLECTION SYSTEMS

Sensor and multi-sensor systems, both conventional (photo, infrared, radar, electronic devices, T.V. etc.) and nonconventional (seismic devices).

SYSTEMS SYNTHESIS

Evolving complete systems concepts, from data collection to data transfer and display. Emphasis on data collection for aerospace and ground operations (mobile and fixed).

If you have experience in systems synthesis, reconnaissance intelligence, sensor systems, or indicator analysis and have a technical degree (preferably advanced) please contact:

Mr. P. K. MALLOT
DEPARTMENT 020
ENGINEERING AND
SCIENTIFIC EMPLOYMENT
12214 LAKEWOOD BLVD.
DOWNEY, CALIFORNIA

All qualified applicants will receive consideration for employment without regard to race, creed, color, or national origin.

SPACE AND INFORMATION SYSTEMS DIVISION

NORTH AMERICAN AVIATION



NEXUS

HAS PROUDLY PRESENTED

industry's first

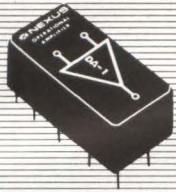

DA-1, miniature, fully encapsulated, full performance (Gain of 10,000) SOLID STATE OPERATIONAL AMPLIFIER available from stock — 0.9 cu. in. — \$105 list

industry's smallest



MCA-1, full performance (Gain of 20,000) SOLID STATE OPERATIONAL AMPLIFIER Operation to 85°C • All silicon—0.3 cu. in. — \$195 list

industry's least expensive

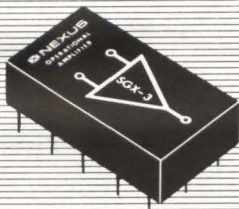

SGX-3, full performance (Min. Gain of 10,000) SOLID STATE OPERATIONAL AMPLIFIER Operation to 55°C — 1.5 cu. in. — \$40 list

AND NOW PRESENTS

industry's most potent

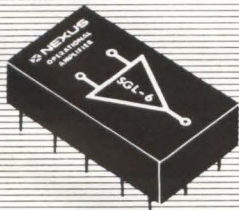

SGL-6, ±20 MA @ ±10 Volt Output (Typical Gain of 500,000) SOLID STATE OPERATIONAL AMPLIFIER Completely protected against input & output overload — 1.5 cu. in. — \$80 list
Many other types available. Call or write

NEXUS
RESEARCH LABORATORY, INC.
19 Needham St., Dedham, Mass., Tel. 617 326-8414

CIRCLE 210 ON READER SERVICE CARD
electronics October 11, 1963

MICROWAVE TERMINATIONS SM Electronics, P.O. Box 397, La Canada, Calif. Bulletin describes liquid nitrogen-cooled matched microwave terminations useful for evaluating the equivalent noise temperature of low noise receivers and antenna systems. (413)

COOLING UNITS Lear Siegler, Inc., 241 South Abbe Road, Elyria, O. Cooling units for space, airborne electronics and ground guidance are described in a six-page brochure. (414)

MAGNETIC TAPE HEAD The Nortronics Co., Inc., 8101 10th Ave. North, Minneapolis 27, Minn. Data sheet on 4-track, 4-channel magnetic tape head for ¼-in. tape is released. (415)

DIGITAL LOGIC MODULES Wyle Laboratories, 128 Maryland St., El Segundo, Calif. Condensed Catalog F describes a comprehensive line of solid-state logic cards and accessory equipment such as power supplies and mounting cases. (416)

SENSING DEVICES Victory Engineering Corp., 122-48 Springfield Ave., Springfield, N. J. Catalog SB-53 is designed to serve as an engineer's guide to a line of thermistors, varistors and related products for civilian and military applications. (417)

INTEGRATED MICROWAVE COMPONENTS Microlab, 570 West Mt. Pleasant Ave., Livingston, N. J. A 20-page brochure illustrates the Microlab/Bogart capabilities in the area of integrated microwave components. (418)

ZENER DIODES General Instrument Corp., 65 Gouverneur St., Newark 4, N. J. A complete 36-page catalog and specifications on all EIA registered Zener diodes is now available as an aid to design engineers. (419)

SOLDERING IRONS Caig Laboratories Inc., 46 Stanwood Road, New Hyde Park, L. I., N. Y. Bulletin E-501 covers a line of Ersa miniature, precision 10-20-30 w, 6 v soldering irons. (420)

WELDING EQUIPMENT Ewald Instruments, Route 7, Kent, Conn. Catalog S2 on welding equipment for small parts, covers miniature and bench welding heads, stored energy power supplies, a-c precision and non-synchronous timer power supplies and special portable welders. (421)

SNAP-ACTION SWITCHES Cherry Electrical Products Corp., 1650 Old Deerfield Road, Highland Park, Ill. A 24-page catalog of snap-action switches provides complete engineering drawings, specifications and operating characteristics. (422)

HEAT SINKS PinFin, Inc., 681 Main St., Waltham, Mass. Brochure describing heat sinks is available to design engineers interested in maximum heat dissipation while conserving space and weight. (423)

TIMING DEVICES Eagle Signal, division of E. W. Bliss Co., 202 20th St., Moline, Ill. Bulletin 851 covers electronic timing devices for military and aerospace programs. A glossary of terminology is included. (424)

CAPACITORS General Electric Co., Schenectady 5, N.Y. Bulletin GET-2984A describes porous anode liquid electrolyte Tantalitic capacitors. (425)

specify the new circuit breakers by Mechanical Products, Inc.

AVNET

contact The Avnet System for best service & on-time delivery

the line includes breakers with both standard commercial and Mil Spec part nos. Mechanical Products' circuit breakers meet requirements of MIL C-5809 and MIL C-7079.

for MP circuit breakers

MECHANICAL PRODUCTS

call your Local Avnet Headquarters

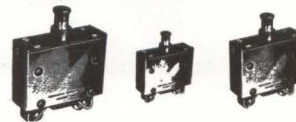

Westbury, L. I.; Chicago; Phoenix; Burlington, Mass.; Syracuse, N. Y.;

LOCAL

Salt Lake City; Bellevue, Wash.; San Diego, L. A.; Sunnyvale, Cal.

CIRCLE 209 ON READER SERVICE CARD

A NEW Catalog

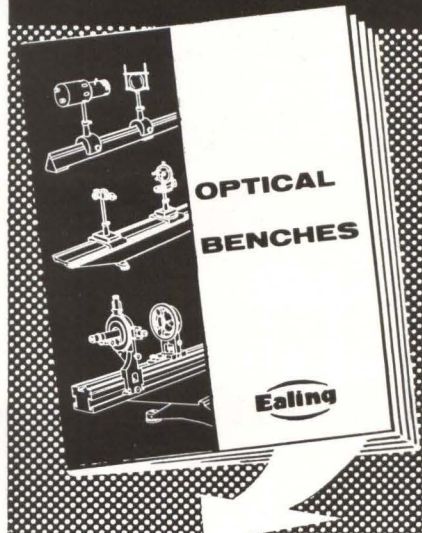

THE Ealing CORPORATION

2245 Massachusetts Ave.,
Cambridge, Massachusetts 02140
Telephone: 617-491-1515

CIRCLE 71 ON READER SERVICE CARD 71

Esterline Angus Elects V-P's



Edwin H. Baldrige



Hugh C. Cameron



Robert L. Adams

THREE KEY FIGURES in the recent acquisition of two companies by Esterline Angus Instrument Co., Inc., Indianapolis, have been elected vice presidents by the board of directors. They are Edwin H. Baldrige, Hugh C. Cameron and Robert L. Adams.

Baldrige continues as treasurer and a director of the company. Cameron remains in charge of sales. Adams continues to hold executive responsibility for engineering, research and development.

The fiscal, sales and engineering responsibilities of all three men were greatly increased when Esterline Angus purchased the assets of Lumen, now known as Lumen Electronics, a division of Esterline Angus Instrument Co., Inc., and the graphic recording line of instruments from Weston Instruments and Electronics, a division of Daystrom, Inc.

IRC Establishes New Division

INTERNATIONAL RESISTANCE Company has established an Instrumentation & Systems division to design, manufacture, and market electromechanical/electronic subsystems and associated equipment and circuitry.

The new organization was formed by integrating the firm's Control Components division with its recently merged Frontier Electronics and Plastic Products divisions. It will be located in Philadelphia.

O. C. Kebernick, formerly manager of Plastic Products, has been appointed division general manager. Marketing activities will be managed by Terry Halpern, former head of Control Components. Chief engineer is Patrick Lannan who held a similar position in Frontier Electronics.



Univac Promotes McDonald

R. E. MCDONALD, general manager of Univac Operations in the Twin Cities, has been named a vice president of the Univac division of Sperry Rand Corporation in an announcement made by Louis T. Rader, president.

"This new position has been established in recognition of the in-

creasingly important role that our Twin Cities facilities play in the profitable growth of the Univac division", Rader said.

As vice president and general manager, Univac Operations, McDonald will continue as chief operating officer of Univac's extensive research, development and production facilities in the Twin Cities area and will assume added responsibilities with respect to overall Univac objectives.

ITT Division Hires Steeg

APPOINTMENT of Carl W. Steeg, Jr., as director of new product planning and development at ITT Industrial Laboratories, Ft. Wayne, Ind., division of International Telephone and Telegraph Corp., is announced.

Steeg comes from RCA, where he managed aerospace communications and controls programs.

O'Donnell Accepts Kollsman Post

CHARLES J. O'DONNELL has been appointed vice president of operations for the Kollsman Instrument Corp., Elmhurst, N. Y., subsidiary of Standard Kollsman Industries Inc. He will be in charge of all activities of the Instrument division at Elmhurst and the Guidance, Display and Armaments division at Syosset, N. Y.

O'Donnell was formerly general manager of the Belock Instrument Corp., College Point, N. Y.

Precision Line Names Lyon

PRECISION LINE INC., Maynard, Mass., has appointed William W. Lyon chief engineer in charge of design, development and production of precision, ultra-precision, and trimmer potentiometers and

related electronic components.

For the past few years Lyon was engineering manager for New England Instrument, Waltham-Natick, Mass.



Franklin Joins GI Sickles Division

S. EDWARD FRANKLIN has joined the F. W. Sickles division of General Instrument Corporation in Chicopee, Mass., as vice president in charge of operations. He will be responsible for all phases of manufacturing and related operations, as well as design engineering, in the division.

The division, with headquarters plant at Chicopee, manufactures uhf tv tuners and other radio-tv components, as well as devices for military end use.

Franklin comes to his new post from Canadian Aviation Electronics Ltd., where he was vice president of manufacturing, in charge of both commercial and military products.

Rixon Reassigns Executives

J. L. HOLLIS, president and board chairman of Rixon Electronics, Inc., Silver Spring, Md., has announced that C. J. Harrison, senior vice president, engineering and operations, and L. Lerner, vice president for engineering, are assuming new responsibilities.

Harrison has been appointed administrative vice president, a newly established key management posi-

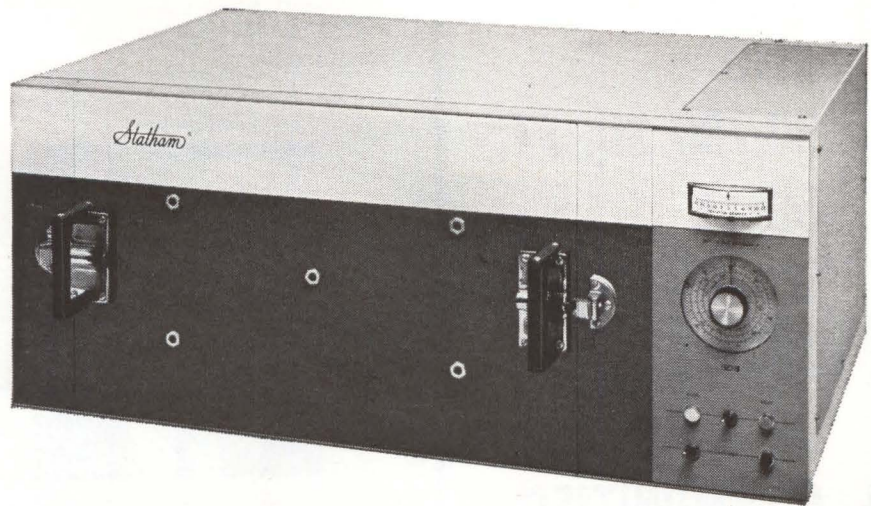

PRECISION TEMPERATURE TEST CHAMBER 2.6 Cu. Ft. Capacity

The new Statham Model SD8 is a 2.6 cu. ft. bench-type chamber designed for precise temperature testing of electronic components from -100°F to $+525^{\circ}\text{F}$. It has a control accuracy of $\pm \frac{1}{4}^{\circ}\text{F}$, and true proportional control of heater power by all solid-state circuitry. □ For high performance and convenience, liquid CO_2 is used for cooling. □ The design advances in the Model SD8 result in the elimination of the conventional heater power relay and cycling about control point. Heater life is extended by the smooth regulation of heater power from zero to 100 percent. Dual resistance temperature sensors eliminate stabilizing drift. Their fast response permits sensitive proportional gain control for tight temperature control. □ Automatic cyclic timers are available for use with the Statham SD8.

More Accurate, Easier to Use Temperature Selection and Readout

Model SD8 features 24 lineal inches of calibrated set-point scale, with temperature readout by means of a deviation meter calibrated in one-degree increments. This expanded scale approach provides a level of accuracy and readability not attainable in conventional chambers.

WRITE FOR SPECIFICATIONS



Statham Instruments, Inc.
12401 West Olympic Blvd.
Los Angeles 64

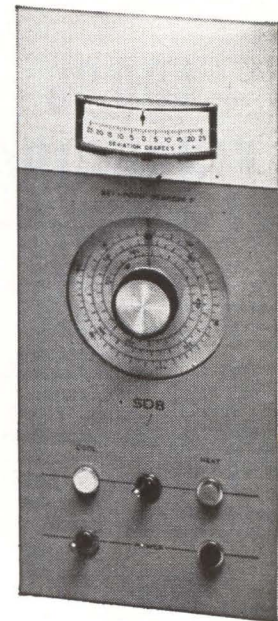

**TWO
50,700 SQ. FT.
SHELL
BUILDINGS
FOR SALE
OR LEASE IN
COMMUNITIES
GIVEN TOP
RANKING BY
PROJECT
DECISION**

These two shell buildings are under construction in communities selected by Appalachian Power Company for their many advantages to industry. One is in Pulaski, Va.; the other is in Princeton, W. Va. Industries already located in these two towns include textiles, furniture manufacturing, aeronautical equipment, plastics and chemicals. Excellent colleges are nearby. So is an ample supply of good labor and superb recreational facilities. Both sites are served by railways, interstate highways and airlines.

**100%
FINANCING**

Each of these shell buildings provides more than 50,000 sq. ft. of manufacturing and office space. Built by Appalachian Power Co. under its Project Decision program, they will be finished to your specifications. These buildings may be either leased or purchased. Should you wish to lease, 100% financing is available through local development organizations. For complete data and specifications, write or phone **Jack Lloyd, Area Development Director, Appalachian Power Co., Roanoke, Va. Diamond 4-1411, Ext. 231.**



tion, and Lerner has been named vice president for engineering and manufacturing.



**McRann Moves Up
At Telemetrics**

ELECTION of Robert McRann to the newly created post of vice president, operations of Telemetrics, Inc., Gardena, Calif., is announced. Telemetrics is a subsidiary of Technical Measurement Corp., North Haven, Conn.

In his new position, McRann will be responsible for all manufacturing, planning, and materiel control. Before this, he had served as director of operations.

**Astropower Elects
Vice President**

WILLIAM R. MONROE has been elected vice president of engineering of Astropower, Inc., Newport Beach, Calif. He was formerly chief electronics engineer at General Dynamics in San Diego.

As vice president, Monroe will direct the Astropower audio information display project, the electronics, electromechanical, optical and mechanical-ordnance engineering sections and the hydro engineering group. Astropower is a subsidiary of Douglas Aircraft Co.

**Hurletron Incorporated
Promotes Crew**

DAVID O. CREW has been named vice president and manager of operations of Hurletron Inc., Chicago, Ill. He will be responsible for coordinating operations of the company's three plants at Whittier, Calif.; Danville and Wheaton, Ill.

Crew joined Hurletron in 1962 as manager of the Wheaton plant.

PEOPLE IN BRIEF

Jack Rosenberg, formerly with Hughes Aircraft, named chief engineer for the Manufacturing div. of Wyle Laboratories. **G. Sherwood Smith** promoted to div. mgr. for Technical Dynamics. **Robert J. Stahl** advances to mgr. of product planning for Sylvania Electric Products Inc. **T. C. Parker**, ex-Northrop Corp., appointed director of engineering of Telemetrics, Inc. **James H. Smith** moves up to product mgr., advanced developments, of Dalmo Victor Co. **Robert L. Tanner**, v-p of TRG, Inc., elected to the board of directors. Promotions in the Microwave Tube div. of Hughes Aircraft Co.: **William M. Mueller** to mgr. of mfg. and **Bruce A. Highstrete** to mgr. of R&D. **Leonard L. Rosenfeld** elevated to mgr. of mfg. for The Jerrold Corp. **Richard W. Vieser** advances to g-m of the Chatham div. of Tung-Sol Electric Inc. **Manfred Eimer**, previously with Jet

Propulsion Laboratory, joins Space-General Corp. as director of engineering. **Robert P. Greene** raised to exec v-p of Ovenaire, Inc. GE ups **Robert L. Casselberry** to mgr. of planning for standard products at its Communication Products dept. in Lynchburg, Va. **Edward P. Burns**, formerly with Burmac Electronics, named chief of magnetics engineering at Manson Laboratories. **I. T. Burney**, with Westinghouse since 1951, appointed mfg. mgr. of its Cryogenic Systems dept. **Robert L. Ashley**, former president of Silicon Transistor Corp., joins Thompson Ramo Wooldridge Inc. electronics group as director of marketing. **E. I. Little**, previously with Molecular Research, Inc., now material mgr. at Lockheed Propulsion Co. **Jackson W. Granholm** leaves Mellonics Audio-Visual Inc. to become v-p of Informatics, Inc.



Investment Opportunity

The hand holding the hammer will someday make products for you.

Long years of training will have to go into making those chubby fingers productive. Much care, much love, much planning and money.

But no matter how lean and hard and skillful they become, it will signify little if the fruits of their skill are produced in anything but a free society.

You have an investment in those hands. To protect your investment, you can join with other leading American businessmen to promote the Treasury's Payroll Savings Plan for United States Savings Bonds. The Treasury Department's Plan works for soundness in

our economy, strength in our defenses, and thriftiness and self-reliance in our thinking.

When you bring the Payroll Savings Plan into your plant—when you encourage your employees to enroll—you are investing in the hands of tomorrow's tool makers and tool users. You are investing in America's next generation of machine operators, mechanics, metal workers—in all of America's skilled labor force. You are investing in America's future. In freedom itself.

Don't pass this investment opportunity by. Call your State Savings Bonds Director. Or write today to the Treasury Department, U.S. Savings Bonds Division, Washington 25, D.C.



in your plant...promote the PAYROLL SAVINGS PLAN for U.S. SAVINGS BONDS



The U. S. Government does not pay for this advertisement. The Treasury Department thanks, for their patriotism, The Advertising Council and this magazine.

electronics

WEEKLY QUALIFICATION FORM FOR POSITIONS AVAILABLE

ATTENTION: ENGINEERS, SCIENTISTS, PHYSICISTS

This Qualification Form is designed to help you advance in the electronics industry. It is unique and compact. Designed with the assistance of professional personnel management, it isolates specific experience in electronics and deals only in essential background information.

The advertisers listed here are seeking professional experience. Fill in the Qualification Form below.

STRICTLY CONFIDENTIAL

Your Qualification form will be handled as "Strictly Confidential" by ELECTRONICS. Our processing system is such that your form will be forwarded within 24 hours to the proper executives in the companies you select. You will be contacted at your home by the interested companies.

WHAT TO DO

1. Review the positions in the advertisements.
2. Select those for which you qualify.
3. Notice the key numbers.
4. Circle the corresponding key number below the Qualification Form.
5. Fill out the form completely. Please print clearly.
6. Mail to: Classified Advertising Div., ELECTRONICS, Box 12, New York, N. Y. 10036. (No charge, of course).

COMPANY	SEE PAGE	KEY #
ATOMIC PERSONNEL INC. Philadelphia, Penna.	66*	1
BENDIX CORPORATION Kansas City Division Kansas City, Missouri	77	2
CHEMSTRAND COMPANY Pensacola, Florida	66*	3
CORPORATE SYSTEMS CENTER United Aircraft Corp., Farmington, Conn.	62*	4
GENERAL DYNAMICS/ELECTRONICS Rochester, New York	67*	5
HONEYWELL St. Petersburg, Florida	60	6
MELPAR INC. Sub. of Westinghouse Air Brake Co. Falls Church, Virginia	54	7
PAN AMERICAN WORLD AIRWAYS INC. Guided Missiles Range Division Patrick Air Force Base, Florida	77	8
SNELLING & SNELLING Boston, Mass.	66*	9
SPACE AND INFORMATION SYSTEMS Div. of North American Aviation Inc., Downey, California	70	10
SYLVANIA ELECTRONICS SYSTEMS—WEST Mountain View, California	52, 53	11

* These advertisements appeared in the October 4th issue

(cut here)

electronics WEEKLY QUALIFICATION FORM FOR POSITIONS AVAILABLE

(cut here)

(Please type or print clearly. Necessary for reproduction.)

Personal Background

NAME

HOME ADDRESS

CITY ZONE STATE

HOME TELEPHONE

Education

PROFESSIONAL DEGREE(S)

MAJOR(S)

UNIVERSITY

DATE(S)

FIELDS OF EXPERIENCE (Please Check)

101163

- | | | |
|--|--|---------------------------------------|
| <input type="checkbox"/> Aerospace | <input type="checkbox"/> Fire Control | <input type="checkbox"/> Radar |
| <input type="checkbox"/> Antennas | <input type="checkbox"/> Human Factors | <input type="checkbox"/> Radio—TV |
| <input type="checkbox"/> ASW | <input type="checkbox"/> Infrared | <input type="checkbox"/> Simulators |
| <input type="checkbox"/> Circuits | <input type="checkbox"/> Instrumentation | <input type="checkbox"/> Solid State |
| <input type="checkbox"/> Communications | <input type="checkbox"/> Medicine | <input type="checkbox"/> Telemetry |
| <input type="checkbox"/> Components | <input type="checkbox"/> Microwave | <input type="checkbox"/> Transformers |
| <input type="checkbox"/> Computers | <input type="checkbox"/> Navigation | <input type="checkbox"/> Other |
| <input type="checkbox"/> ECM | <input type="checkbox"/> Operations Research | <input type="checkbox"/> |
| <input type="checkbox"/> Electron Tubes | <input type="checkbox"/> Optics | <input type="checkbox"/> |
| <input type="checkbox"/> Engineering Writing | <input type="checkbox"/> Packaging | <input type="checkbox"/> |

CATEGORY OF SPECIALIZATION

Please indicate number of months experience on proper lines.

	Technical Experience (Months)	Supervisory Experience (Months)
RESEARCH (pure, fundamental, basic)
RESEARCH (Applied)
SYSTEMS (New Concepts)
DEVELOPMENT (Model)
DESIGN (Product)
MANUFACTURING (Product)
FIELD (Service)
SALES (Proposals & Products)

CIRCLE KEY NUMBERS OF ABOVE COMPANIES' POSITIONS THAT INTEREST YOU

1 2 3 4 5 6 7 8 9 10 11 12 13 14 15

ENGINEERING OPPORTUNITIES

In The Booming Heart of America
BENDIX, KANSAS CITY!

ELECTRONIC DESIGN ENGINEERS

BSEE or Physics with experience in any of the following fields: Digital circuits, logical design, semiconductor circuit design, or microwave design. Engineers are assigned complete project responsibilities for one or more complex systems and will maintain liaison from conception through design and production, to final delivery to the customer.

COMPONENTS ENGINEERS

EE or Physics degree with minimum of 2 years' experience in the application of one or more of the following: Semiconductors, relays, switches, motors, gas filled tubes, or other electronic components. As a specialist you will work as a consultant with engineering design groups, quality engineers, purchasing and manufacturing personnel on component problems.

ELECTRONIC TEST EQUIPMENT DESIGN ENGINEERS

To develop, design and supervise construction of special electronic test instruments, and to direct the technical activities of others in the organization. These positions require familiarity with test equipment problems and inspection techniques. Past association with military electronic equipment or experience in precision measurement of production items would assist you in qualifying for these positions. EE degree required.

ELECTRONIC PROCESS ENGINEERS

For these positions we prefer experienced engineers with a degree or equivalent experience in light product tooling and machining methods or electronic encapsulation packaging. Responsibilities include determining manufacturing processes, procedures, approving tool designs and capital equipment and facilities planning.

YOUR FUTURE AT BENDIX!

The Kansas City Division of Bendix, long-term prime contractor for the AEC, offers a pleasant, stimulating environment for professional growth. Kansas City is also a delightful place to live; visitors frequently call it America's most beautiful city. Living costs are moderate, recreational, cultural and educational facilities are plentiful. Choice suburban living only minutes away; no traffic problems. For prompt attention, address your confidential inquiry to:

MR. D. M. BOWEN
Technical Personnel Representative

BENDIX CORPORATION
Box 303-NA
Kansas City 41, Mo.

An Equal Opportunity Employer



KANSAS CITY DIVISION

SYSTEMS ENGINEERS

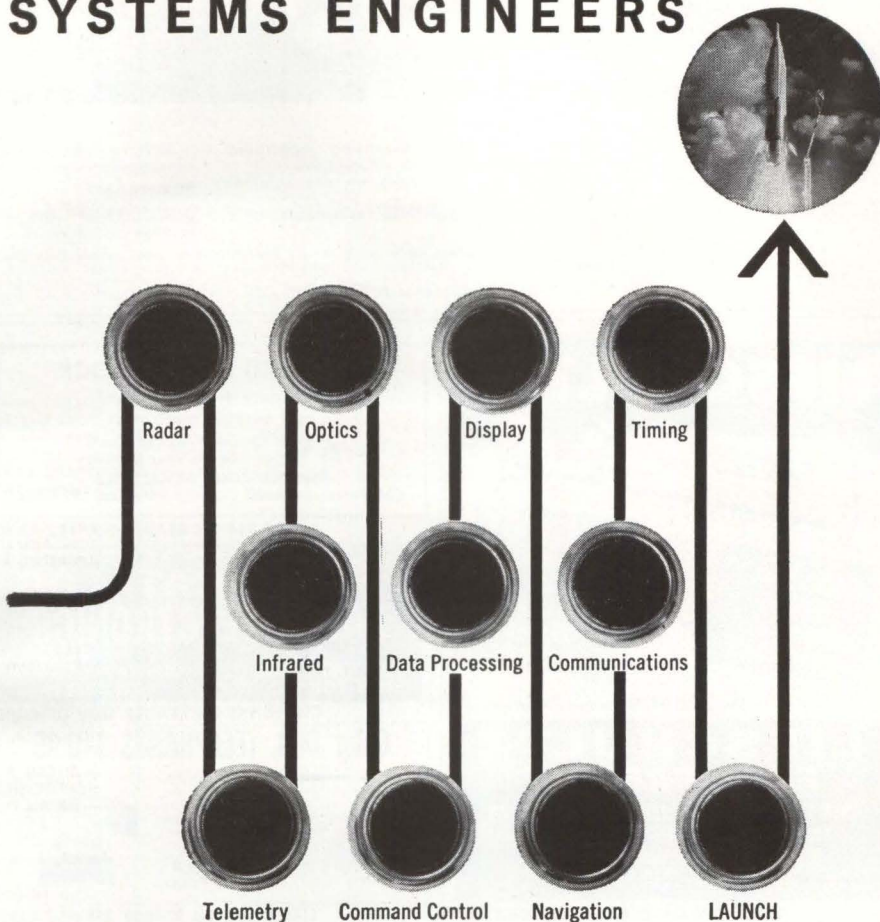

to reach "GO"

... vital decisions must be made between the drawing board concept of a range instrumentation system for a specific launch, and the final countdown at the Atlantic Missile Range.

The Systems Engineers of Pan Am's Guided Missiles Range Division are entrusted with these important assignments. They must develop systems studies for each new concept, prepare specifications, provide technical direction of contracted instrumentation for the Air Force, and phase it into operational status.

These varied programs encompass three major disciplines:

data acquisition, utilizing CW and pulse radar, optics, infrared, telemetry, and navigation.

data handling, including real-time transmission and computation, post-flight data processing, and data display.

data support, covering RFI, timing, command control and communications engineering.

Decision-making engineers with a minimum of 3 years applicable experience are invited to consider these important systems engineering positions.

For further information, write in confidence to Dr. Charles Carroll, Dept. 28K-2



GUIDED MISSILES RANGE DIVISION

PAN AMERICAN WORLD AIRWAYS, INC.
P. O. BOX 4465, PATRICK AIR FORCE BASE, FLORIDA
AN EQUAL OPPORTUNITY EMPLOYER

DISPLAYED RATE

The advertising rate is \$27.25 per inch for advertising appearing on other than a contract basic. Contract rates quoted on request. AN ADVERTISING INCH is measured 7/8 inch vertically on one column, 3 columns—30 inches—to a page. EQUIPMENT WANTED or FOR SALE ADVERTISEMENTS acceptable only in Displayed Style.

UNDISPLAYED RATE

\$2.70 a line, minimum 3 lines. To figure advance payment count 5 average words as a line. BOX NUMBERS count as one line additional in undisplayed ads. DISCOUNT of 10% if full payment is made in advance for four consecutive insertions of undisplayed ads (not including proposals.)

The publisher cannot accept advertising in the Searchlight Section, which lists the names of the manufacturers of resistors, capacitors, rheostats, and potentiometers, or other names designed to describe such products.

Send NEW ADS or inquiries to Classified Adv. Div. of Electronics P. O. Box 12, N. Y., N. Y. 10036

LIFSCHULTZ

FASTEST...

4th DAY between Chicago and West Coast

2nd DAY between Chicago—Milwaukee and Eastern Terminals

Specialists in Shipment of Electronics Products

LIFSCHULTZ

FAST FREIGHT

NEW YORK — CHICAGO — PHILADELPHIA — BOSTON
 HOLYOKE — BALTIMORE — BLOOMFIELD, N. J.
 NEW HAVEN — PROVIDENCE — MILWAUKEE
 LOS ANGELES — SAN FRANCISCO

CIRCLE 950 ON READER SERVICE CARD

Available! Ultra-Modern

Air Cond. One Story

19,400 Sq. Ft. Bldg.

SUBURBAN PHILA., PA.

5 Acres. Near Penna. Turnpike
 N. E. Ext. Tailgate loading. All utilities. Fully sprinklered.

BINSWANGER

1420 Walnut St., Phila. 2, Pa. • PE 5-0202

CIRCLE 951 ON READER SERVICE CARD

MICROWAVE ANTENNAS

Parabolic, 6 foot dia., Andrews, Spun Aluminum. 1700-2400 MCs Complete with mounting bracket, Di-pole, de-icers, etc. Unused—Crated—Cheap. One Hundred Available.

SIERRA-WESTERN ELECTRIC
 1401 Middle Harbor Road
 Oakland, Cal. Telo. 832-3527

CIRCLE 952 ON READER SERVICE CARD

INVENTORY DISPOSAL SALE

ONE TIME ONLY

Dual channel Edin DC amplifier and recorder. Du-Mont 322A dual beam oscilloscope, GR strobosc and strobolux, 4 Mod S L&N Micromax strip chart recorders, Dual channel Esterline-Angus strip chart recorder—LOT FOR \$1050.00. Also included at no charge—3 MH temperature controllers and 4 Foxboro strip chart recorders. E & R DEVELOPMENT CO., 15226 Greville Avenue, Lawndale, California.

CIRCLE 953 ON READER SERVICE CARD

SMALL AD but BIG STOCK
 of choice test equipment and surplus electronics
 Higher Quality—Lower Costs
 Get our advice on your problem

ENGINEERING ASSOCIATES
 434 Patterson Road — Dayton 19, Ohio

CIRCLE 954 ON READER SERVICE CARD

TUBES & COMPONENT

FREE...CATALOG

BARRY ELECTRONICS

512 BROADWAY 212-Walker 5-7000
 NEW YORK 12, N.Y. TWX-571-0484

CIRCLE 955 ON READER SERVICE CARD

Color DIAL TELEPHONES \$10.95

Factory rebuilt Western Electric in white, beige, ivory, pink, green, or blue. If 4 prong plug is required add \$2.00. Fully guaranteed. Write for free list. All shipments FOB.

SURPLUS SAVING CENTER
 Waymart Dept. E-101133 Penna.



CIRCLE 956 ON READER SERVICE CARD

OPTICAL BENCHES

\$13. to \$13,000. New Catalog

THE Ealing CORP.

2250 Massachusetts Avenue, Cambridge, Mass., 02140

CIRCLE 957 ON READER SERVICE CARD

ELECTRON TUBES

KLYSTRONS • ATR & TR • MAGNETRONS
 SUBMINIATURES • C.R.T. • T.W.T. • 5000-6000 SERIES

• SEND FOR NEW CATALOG A2 •
A & A ELECTRONICS CORP.
 1063 PERRY ANNEX
 WHITTIER, CALIF.
 AN 92865 OR 943-2829

CIRCLE 958 ON READER SERVICE CARD

POTTING APPLICATORS

MANUAL AND DISPOSABLE

6cc 12cc 30cc

FOR POTTING, ENCAPSULATING, AND SEALING OF MINIATURE COMPONENTS

PHILIP FISHMAN CO.
 7 CAMERON ST., WELLESLEY 81, MASS.



CIRCLE 959 ON READER SERVICE CARD

FOR SALE

For sale: Used Model 3490 Triplet Transistor Analyzer. \$250.00. Excellent condition. Tennelec Instrument, Box 964, Oak Ridge, Tennessee.

“SEARCHLIGHT”

IS

Opportunity Advertising

—to help you get what you want—to help you sell what you no longer need.

Take Advantage Of It

“THINK SEARCHLIGHT FIRST”
 For Every Business Want

SEARCHLIGHT EQUIPMENT LOCATING SERVICE

No Cost or Obligation

This service is designed to help you, the reader of SEARCHLIGHT SECTION, to locate used or rebuilt equipment not currently advertised.

HOW TO USE: Check the ads in this SEARCHLIGHT SECTION to see if what you want is advertised. If not, print clearly the specifications of the equipment and/or components wanted on the coupon below, or on your own letterhead.

THIS IS A SERVICE TO OUR READERS. THIS PUBLICATION DOES NOT BUY, SELL OR STOCK EQUIPMENT OR MATERIALS OF ANY TYPE. Your requirements will be brought promptly to the attention of the used equipment dealers advertising in this section. You will receive replies directly from them.

Obviously, the list of such advertisers is limited by comparison with the over 57,000 subscribers to ELECTRONICS, all directly engaged in the electronics industry. A small 'EQUIPMENT WANTED' advertisement in the SEARCHLIGHT SECTION will bring your needs to the attention of ALL who read ELECTRONICS. The cost is low . . . just \$27.25 per advertising inch—7/8" x 2-3/16"

SEARCHLIGHT EQUIPMENT LOCATING SERVICE

CLASSIFIED ADVERTISING
 c/o Electronics
 P. O. Box 12, N. Y., N. Y., 10036

Please help us to locate the following used equipment:

.....

.....

NAME

TITLE

COMPANY

STREET

CITYZONE

STATE 10/11/63

ELECTRONIC

WAR TERMINATION INVENTORIES

WRITE OR WIRE FOR INFORMATION ON OUR COMPLETE LINE OF SURPLUS ELECTRONIC COMPONENTS. ALL PRICES NET F.O.B. PASADENA, CALIFORNIA

C&H

SALES CO.

2176-E East Colorado St.
Pasadena 8, California
Murray 1-7393

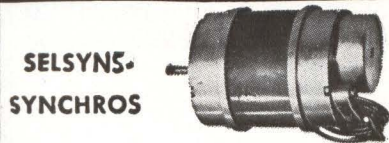

SELSYN- SYNCHROS

ICT cont. Trans 90/55V 60 cy.....	\$27.50
IDG Diff. Gen. 90/90V 60 cy.....	34.50
IF Syn. Mtr. 115/90V 60 cy.....	34.50
IG Gen. 115V 60 cy.....	34.50
IHDG	37.50
1HCT	37.50
1SF Syn. Mtr. 115/90V 400 cy.....	12.50
23TR4 torque receiver.....	34.50
23TR6 torque receiver.....	37.50
23CT6 control transformer.....	37.50
23CX6 control transmitter.....	37.50
23TX6 torque transmitter.....	37.50
7DG differential generator.....	37.50
2J1F1 Gen. 115/57.5V 400 cy.....	7.50
2J1F3 Gen. 115/57.5V 400 cy.....	7.50
2J1FA1 Gen. 115/57.5V 400 cy.....	7.50
2J1G1 57.5/57.5V 400 cy.....	7.50
2J1H1 Diff. Gen. 57.5V 400 cy.....	17.50
2J5D1 Cont. Trans. 105/55V 60 cy.....	17.50
2J5F1 Cont. Trans. 105/55V 60 cy.....	17.50
2J5H1 Gen. 115/105V 60 cy.....	17.50
2J15M1 Gen. 115/57.5V 400 cy.....	34.50
5CT Cont. Trans. 90/55V 60 cy.....	34.50
5D Diff. Mtr. 90/90V 60 cy.....	34.50
5DG Diff. Gen. 115/90 VAC 60 cy.....	34.50
5F Syn. Gen. 115/90VAC 60 cy.....	34.50
5HCT Cont. Trans. 90/55V 60 cy.....	37.50
5SDG Diff. Gen. 90/90V 400 cy.....	12.50
6DG Diff. Gen. 90/90V 60 cy.....	25.00
6G Syn. Gen. 115/90VAC 60 cy.....	34.50
7G Syn. Gen. 115/90VAC 60 cy.....	42.50
C56701 Type 11-4 Rep. 115V 60 cy.....	20.00
C69405-2 Type 1-1 Transm. 115V 60 cy.....	20.00
C69406 Syn. Transm. 115V 60 cy.....	20.00
C69406-1 Type 11-2 Rep. 115V 60 cy.....	20.00
C78248 Syn. Transm. 115V 60 cy.....	12.50
C78410 Repeater 115V 60 cy.....	20.00
FPE 49-7 Diehl servo motor, 115 volts, 60 cycle, 10 watts.....	30.00

SIMPLE DIFFERENTIAL WITH BALL-BEARING SUN GEARS

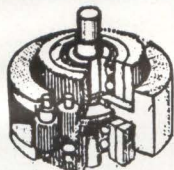

The 1:1 reverse ratio spur gears are 48-tooth, 32 pitch brass with 3/16" available face. On one side, the shaft is 23.64" dia. for 11/16" and has a pin hole, then increases in dia. to .377" for the remaining 3/16" of length. On the other side, the shaft is .377 dia. 1/4" lg. 2-13/16" dia. is required to clear the body. Stock no. A6-115each \$15.00

RCA 6032 IMAGE-CONVERTER TUBE
Combined with suitable optical systems, this 3-electrode tube permits viewing of scene with infrared radiation. Scene to be viewed is imaged by optical objective upon semi-transparent photocathode. Spectral resp., S-1; good response up to about 1200A. Max. ratings, absolute, grid #2, 20,000VDC or peak AC, grid #1, 2700.
\$9.95 ppd.

MINOR SWITCH 10-position, 3-pole, with stopper & reset coil 6-12 V. D.C. off-normal non-bridging wiper, wt.: 1 lb \$9.95

GENERAL ELECTRIC FULL WAVE BRIDGE GERMANIUM RECTIFIER
input 117 volt AC, output 115 volt DC at 10 amperes approximate dimensions: 4 3/4" x 4 3/4" x 7 1/2" long, weight: 3 1/2 lbs.
\$9.95 each

VARIAC TYPE V20
input 120 volt AC, 50/60 cycles output range 0-140 volts, 20 amperes.
PRICE \$37.50 each

POWERSTAT TYPE 20
input 120 volt AC, 50/60 cycle output range 0-140 volts AC, 3 amperes.
PRICE \$9.95 each

POWERSTAT TYPE 116
input 120 volts, 50/60 cycle output range 0-140 volts AC, 7.5 amperes.
PRICE \$16.95 each

8-DAY ELAPSED-TIME SURPLUS AIRCRAFT CLOCK



Here is an accurate time-control center that'll help you win your next rallye. It not only tells you the date and time of day right to the second, it's a stop watch that gives you elapsed time in seconds, minutes, and hours! The 24-hour clock simplifies adding and subtracting elapsed time for your navigator. Manufactured by Elgin Watch Co. to exacting military specifications, it will remain accurate in spite of road bumps and vibrations. Uses no electrical connections. Does the job of high-cost equipment. Jeweled/Sweep Second Hand/Luminous Hands and Numerals/25-Hour Dial/Black Face and Plastic Case/3/8" Mounting.
Cost the Government \$185.00
Only \$39.95 Postpaid

SPERRY VERTICAL GYRO

Part #673073, Motorola 115 volts, 3 phase, 400 cycle, 8 watts, 20,000 RPM. 3-minute runup, synchro pickoffs, roll 360°, pitch 85°. Synchro excitation 26 volts, 400 cycle, 150 m.a. Vertical accuracy ± 1/2°. Weight 3 1/2 lbs. Approx. dim. 5 3/4" L., 4 1/2" W., 4 1/2" H. Price \$35.00

VARIABLE SPEED BALL DISC INTEGRATORS

(All Shafts Ball Bearing Supported)

No. 145 Forward & Reverse 2 1/2"-0-2 1/4" Input shaft spline gear 12 teeth 9/32" dia. 3/4" long. Output shaft 15/64" dia. x 15/32" long. Control shaft 11/32" x 3/8" long. Cast aluminum construction. Approx. size 3" x 3" x 2 3/4" \$17.50

No. 146 Forward & Reverse 4-0-4. Input shaft 5/16" dia. x 3/4" long; Output shaft 15/64" dia x 9/16" long. Control shaft 11/64" dia. x 11/16" long. Cast aluminum construction. Approx. size 4 1/2" x 4 1/2" x 4" \$18.50 ea.

SMALL DC MOTORS

(approx. size over 3/8" x 1/4" dia.)

5067043 Delco 12 VDC PM 1" x 1" x 2", 10,000 rpm. \$7.50

5067126 Delco PM, 27 VDC, 125 RPM, Governor Controlled 15.00 ea.

5069600 Delco PM 27.5 VDC 250 rpm 12.50

#5069625 120 rpm, mfr. Delco, 27 VDC governor controlled \$15.00

5069230 Delco PM 27.5 VDC 145 rpm 15.00

5068750 Delco 27.5 VDC 160 rpm w. brake 6.50

5068571 Delco PM 27.5 VDC 10,000 rpm (1x1x2") 5.00

5069790 Delco PM, 27 VDC, 100 RPM, Governor Controlled 15.00 ea.

#5069800 575 rpm, mfr. Delco, 27 VDC, PM reversible governor controlled, equipped with 27 VDC clutch \$17.50

5072735 Delco 27 VDC 200 rpm governor controlled. 15.00

5BA10A118 GE 24 VDC 110 rpm 10.00

5BA10A137 GE 27 VDC 250 rpm reversible 10.00

5BA10AJ52 27 VDC 145 rpm reversible 12.50

5BA10AJ50, G.E., 12 VDC, 140 rpm 15.00

5BA10FJ401B, G.E. 28 VDC, 215 rpm, 10 oz. in., 7 amp. contains brake 15.00

5BA10FJ421, G.E. 26 VDC, 4 rpm, reversible, 6 oz. in., .65 amp 15.00

400 CYCLE PM GENERATOR

115/200 volts A.C. 1- or 3-phase, 200 watts. 4,000 r.p.m. Approx. dimensions: 4 3/4" dia.; 3" long; 1/2" shaft, AN connector. \$75.00

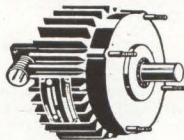

9KVA 400-CYCLE GENERATOR

120/208 volts, 3-phase power factor 1.0 CCW rotation. Approx. 13 1/2" lg. x 8" dia. 4000 rpm, mfg. Bendix Aviation P/N 1633-1A.

\$150.00

MINNEAPOLIS-HONEYWELL RATE GYRO (Control Flight)



Part no. JG7005A, 115 volts A.C., 400 cycle, single phase potentiometer take off resistance 530 ohms. Speed 21,000 r.p.m. Angular momentum 2 1/2" million, CM²/sec. Weight 2 lbs. Dimensions 4-7/32 x 3-29/32 x 3-31/64. Price \$22.50

400 CYCLE, 3 PHASE GENERATOR

BY MASTER ELECTRIC Type AG, frame 364Y, 7.5 kw, 3428 rpm, pf .95 Star connected 120/208 3 phase, 22 amps. Delta connected 120 volt single phase 6 amps. Self excited. Complete with control box, voltage regulator, AC voltmeter and frequency meter. Shaft 1" dia., 2" long; overall dim. of unit: 21" x 18" x 20".
Price \$395.00 each

SENSITIVE INTEGRATING GYROS

This is the famous HIG Gyro which is being used in missile guidance systems, radar stabilization and fine control systems. Government cost approximately \$1500.
PRICE \$50.00

OIL CAPACITORS

1 MFD. 25,000 V. DC Westinghouse inter-teen type FP style 1313854.

\$39.95 each

10 or more, \$35.00 each.

HONEYWELL VERTICAL GYRO MODEL JG7044A17



115 volts, 400 cycles, single phase, 35 watts. Pitch and roll potentiometer pickoffs 890 ohms, 40 volts max. AC or DC. Speed 20,000 rpm, ang. momentum 12,500,000 gm-cm²/sec. Erection system 27 VAC.

400 cycles, time 5 min. to 1/2°; caging mechanism operates on 24 VDC. \$49.50

24 VOLT DC POWER SUPPLY

Input: 115/440 volts A C, 60 cycle, single phase.
Output: 24 volts D C at 25 amperes tapped primary and secondary to vary voltage unit contains 0-30 volt D C meter and 0-30 amp meter, circuit breaker, filtered, selenium type rectifier approx. dim: 16" wide, 18" long, 8 1/2" high, approx wt.: 70 lbs.
PRICE \$49.50 each

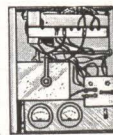

AUTOTRACK ANTENNA MOUNT

TYPE SCR 584, MP 61B

360 degree azimuth, 210 degree elevation sweep with better than 1 mil. accuracy. Missile velocity acceleration and slewing rates. Amplidyne and servo control. Will handle up to 20 ft. dish. Supplied complete with control chassis. In stock—immediate delivery. Used world over by NASA, ABMA, USAF.

AIRBORNE AUTOTRACK MOUNT

Gimbaled mount, compl. w/all servos & drives for full sweep. \$475.

SCR 584 RADARS AUTOMATIC TRACKING 3 CM & 10 CM

Our 584s in like new condition, ready to go, and in stock for immediate delivery. Ideal for telemetry research and development, missile tracking, satellite tracking, balloon tracking, weather forecasting, anti-aircraft defense tactical air support. Used on Atlantic Missile Range, Pacific Missile Range, N.A.S.A. Wallops Island, A.B.M.A. Desc. MIT Rad. Lab. Compl. inst. bk. available \$25.00 ea. Series, Vol. 1, pps. 207-210, 228, 284-286.

PULSE MODULATORS

MIT MODEL 9 PULSER

1 MEGAWATT—HARD TUBE

Output 25 kv 40 amp. Duty cycle, .002. Pulse lengths .25 to 2 microsec. Also .5 to 5 microsec. and .1 to .5 msec. Uses 6C21. Input 115v 60 cycle AC. Mfr. GE. Complete with driver and high voltage power supply. Ref: MIT Rad. Lab. Series Vol. 5 pps. 152-160.

500KW THYRATRON PULSER

Output 22kv at 28 amp. Rep. rates: 2.25 microsec. 300 pps, 1.75 msec 550 pps, .4 msec 2500 pps. Uses 5C22 hydrogen thyatron. Complete with driver and high voltage power supply. Input 115v 60 cy AC.

2 MEGAWATT PULSER

Output 30 kv at 70 amp. Duty cycle .001. Rep rates: 1 microsec 600 pps, 1 or 2 msec 300 pps. Uses 5948 hydrogen thyatron. Input 120/208 VAC 60 cycle. Mfr. GE. Complete with high voltage power supply.

15KW PULSER—DRIVER

Biased multivibrator type pulser generator using 3E29. Output 3kv at 5 amp. Pulse length .5 to 5 microsec, easily adj. to .1 to .5 msec. Input 115v 60 cy AC. \$475. Ref: MIT Rad. Lab. Series Vol. 5 pps. 157.

MIT MODEL 3 PULSER

Output: 144 kv (12 kv at 12 amp.) Duty ratio: .001 max. Pulse duration: .5, .20 and 2 microsec. Input: 115 v 400 to 2000 cps and 24 vdc. \$325 ea. Full desc. Vol. 5 MIT Rad. Lab. series pg. 140.

MICROWAVE SYSTEMS

300 TO 2400MC RF PKG.

300 to 2400MC CW. Tuneable. Transmitter 10 to 30 Watts. Output. As new \$475.

X BAND DOPPLER SYSTEM

AN/APN-102 G.P.L. ANT/RCYR/XMTR PKG. 4 Beam Pulsed Janus Planar Array—New \$1600.

AN/TPS-ID RADAR

500 kw 1220-1359 mcs. 160 nautical mile search range P.P.I. and A Scopes. MTL thyatron mod. 5J26 magnetron. Complete system.

10 CM. WEATHER RADAR SYSTEM

Raytheon, 275 KW output S Band. Rotating yoke P.P.I. Weather Band. 4, 20 and 80 mile range. 360 degree azimuth scan. Supplied brand new complete with instruction books and installation drawings. Price \$975 complete.

AN/APS-15B 3 CM RADAR

Airborne radar, 40 kw output using 725A magnetron. Model 3 pulser. 30-in. parabola stabilized antenna. PPI scope. Complete system. \$1200 each. New.

10KW 3 CM. X BAND RADAR

Complete RF head including transmitter, receiver, modulator. Uses 2442 magnetron. Fully described in MIT Rad. Lab. Series Vol. I, pps 616-625 and Vol. II, pps. 171-185 \$375. Complete System. \$750.

AN/APS-27 X BAND RADAR

Complete 100 kw output airborne system with AMTI, 5C22 thr. mod. 4J52 magnetron, PPI, 360 deg az sweep, 60 deg. elev. sweep, gyro stabilizer, hi-gain rcr. Complete with all plugs and cables \$2800.

M-33 AUTO-TRACK RADAR SYSTEM

X band with plotting board, automatic range tracking, etc. Complete in 2 van complex incl. 1 megawatt acquisition radar.

AN/APS-45 HEIGHT FINDER

Airborne system, 40,000 ft. altitude display on PPI & RHL. 9375 mcs. 400kw output using QK-172 magnetron, 5622 thyatron.

L BAND RF PKG.

20 KW peak 990 to 1040 MC. Pulse width .7 to 1.2 microsec. Rep rate 180 to 420 pps. Input 115 vac. Incl. Receiver \$1200.

200MC RF PKG

175 to 225 mc. Output: 200 to 225 kw. 5 microsec 60 pps. Input: 115v 60 cycle AC. \$750.

QUARTZ DELAY LINE

500 Microsecs, 30 MC. 1000 OHMS Termination Resistance—with Calib. Curve. Price \$275 each.



Radio-Research Instrument Co.

550 5th Ave. New York 36, N.Y.
Tel. JUdson 6-4691

CIRCLE 961 ON READER SERVICE CARD

Advertisement

Unique Relay Catalog Now Available

NEW YORK, N. Y. Sept., 1963. Universal Relay Corp., 42 White St., New York 13, N. Y. announces the publication of their latest 32 page catalog. Universal's normal inventory includes over 2,000,000 relays in approximately 30,000 types. In most cases stock is sufficient to give immediate delivery of production quantities. This catalog is not just a listing of items available "on order" but it is an indication of in-stock items (either as complete units or as ready-to-assemble components). Average shipment is made within 48 hours. Where coils and frames require assembly, or relays require special testing or adjustment, shipments are made within one week to ten days.

Universal is completely equipped to assemble, adjust and thoroughly test any type of relay. A personal interest is taken in every order. This interest is maintained as the order is processed and continues even after the customer receives the merchandise, until he makes sure that it satisfies his needs. All merchandise is guaranteed, subject to customers' inspection and approval and may be returned within 30 days for replacement or credit. Catalog E-763 may be obtained by writing directly to:

UNIVERSAL RELAY CORP.
42 White St., New York 13, N. Y.
Telephone 212 WA 5-6900

CIRCLE 962 ON READER SERVICE CARD

FOR INFORMATION

about Classified Advertising

contact the McGraw-Hill office nearest you

- ATLANTA, 30309 I. HILL—R. JOHNSON
1375 Peachtree St., N.E.
875-0523 (Area Code 404)
- BOSTON, 02116 J. WREDE
McGraw-Hill Bldg., Copley Square
COngress 2-1160 (Area Code 617)
- CHICAGO, 60611 WM. HIGGINS—G. AMBROZE
645 No. Michigan Avenue
MOhawk 4-5800 (Area Code 313)
- CLEVELAND, 44113 R. HARTER
55 Public Square
SUperior 1-7000 (Area Code 216)
- DALLAS, 75201 F. LeBEAU
1712 Commerce St., Vaughn Bldg.
Riverside 7-9721 (Area Code 214)
- DENVER, 80202 J. PATTEN
1700 Broadway, Tower Bldg.
255-2981 (Area Code 303)
- DETROIT, 48226 T. JAMES
856 Penobscot Building
962-1793 (Area Code 313)
- HOUSTON, 77025 K. GEORGE
Prudential Bldg., Holcombe Blvd.
Riverside 8-1280 (Area Code 713)
- LOS ANGELES, 90017 R. MCGINNIS
1125 West Sixth Street
HUntley 2-5450 (Area Code 213)
- NEW YORK, 10036 D. HAWKSBY—H. BUCHANAN
500 Fifth Avenue
971-3596 (Area Code 212)
- PHILADELPHIA, 19103 WM. SULLIVAN—R. LEWIS
Six Penn Center Plaza
LOcut 8-4330 (Area Code 215)
- PITTSBURGH, 15222 J. CROWE
4 Gateway Center
391-1314 (Area Code 412)
- ST. LOUIS, 63105 J. A. HARTLEY
7751 Carondelet Avenue
PARKview 5-7285 (Area Code 314)
- SAN FRANCISCO, 94111 J. A. HARTLEY
255 California Street
DOUglas 2-4600 (Area Code 415)

LEGAL NOTICE

STATEMENT OF OWNERSHIP, MANAGEMENT AND CIRCULATION
(Act of October 23, 1962, Section 4369, Title 39, United States Code)

1. Date of filing: October 1, 1963.
2. Title of publication: ELECTRONICS.
3. Frequency of issue: Weekly.
4. Location of known office of publication: 330 West 42nd St., City, County and State of New York—10036.
5. Location of the headquarters or general business offices of the publishers: 330 West 42nd St., City, County and State of New York—10036.
6. Names and addresses of publisher, editor, and managing editor: Publisher, Charles C. Randolph—330 West 42nd St., New York, N. Y.—10036; Editor, W. W. McDonald—330 West 42nd St., New York, N. Y.—10036; Managing Editor, John M. Carroll—330 West 42nd St., New York, N. Y.—10036.
7. The owner is McGraw-Hill Publishing Company, Inc., 330 West 42nd St., New York 10036, N. Y. Stockholders holding 1% or more of stock are: Donald C. McGraw, Elizabeth McGraw Webster, Donald C. McGraw, Jr. & Harold W. McGraw, Jr., Trustees under Indenture of Trust m/b James H. McGraw, dated 1/14/21 as modified; Donald C. McGraw & Harold W. McGraw, Trustees under an Indenture of Trust m/b James H. McGraw, dated 7/1/37 as amended; Donald C. McGraw, individually; Estate of Mildred W. McGraw (Donald C. McGraw and Catharine McGraw Reck, Executors) all of 330 West 42nd St., New York 10036, N. Y.; Richard Mehren, Paul Mehren & George Byrnes, as Trustees of Grace W. Mehren Trust No. 2, 633 Rancho Road, Monrovia, California; Douglas & Co. (Affiliated Fund), 140 Broadway, New York, N. Y.
8. Known bondholders, mortgages, and other security holders owning or holding 1 percent or more of total amount of bonds, mortgages or other securities: None.
9. Paragraphs 7 and 8 include, in cases where the stockholder or security holder appears upon the books of the company as trustee or in any other fiduciary relation, the name of the person or corporation for whom such trustee is acting, also the statements in the two paragraphs show the affiant's full knowledge and belief as to the circumstances and conditions under which stockholders and security holders who do not appear upon the books of the company as trustees, hold stock and securities in a capacity other than that of a bona fide owner. Names and addresses of individuals who are stockholders of a corporation which itself is a stockholder or holder of bonds, mortgages or other securities of the publishing corporation have been included in paragraphs 7 and 8 when the interests of such individuals are equivalent to 1 percent or more of the total amount of the stock or securities of the publishing corporation.
10. This item must be completed for all publications except those which do not carry advertising other than the publisher's own and which are named in sections 132.231, 132.232, and 132.233, Postal Manual (Sections 4355a, 4355b, and 4356 of Title 39, United States Code).

	Average No. Copies Each Issue During Preceding 12 Months	Single Issue Nearest to Filing Date
A. Total No. Copies Printed (Net Press Run).....	62495	63404
B. Paid Circulation		
1. To term subscribers by mail, carrier delivery or by other means.....	57596	58200
2. Sales through agents, news dealers or otherwise
C. Free Distribution (including samples) by mail, carrier delivery, or by other means.....	4287	4733
D. Total No. of Copies Distributed (Sum of lines B1, B2 and C).....	61883	62933
I certify that the statements made by me above are correct and complete.		
MCGRAW-HILL PUBLISHING COMPANY, INC. By JOHN J. COOKE, Vice President & Secretary		

Mr. Used Equipment Dealer:

When you advertise in the Searchlight Section . . . You have hired your most persuasive salesman:

He's efficient . . . He thrives on long hours . . . His territory is the entire nation . . . and overseas . . . He doesn't see buyers of used and new surplus equipment: They see him—regularly. They depend on him.

He is Searchlight—The section of this publication where wise dealers advertise and list their stocks for sale.

SEARCHLIGHT SECTION

Classified Advertising Div.

Post Office Box 12
New York, N. Y., 10036

INDEX TO ADVERTISERS

Allen-Bradley Co. 16	Machlett Laboratories Inc., The 15
• Amphenol-Borg Electronics	Mallory and Co., Inc., P. R. 45
Corp. Connector Division 38, 39	• Markel & Sons, L. Frank 50
Appalachian Power Co. 74	Mechanical Enterprises, Inc. 67
• Avnet Electronics Corp: 70, 71	Melpar Inc. 54
	• Microswitch
Bausch & Lomb, Inc. 58	Division of Honeywell 8
Beattie-Coleman Inc. 54	Mitsumi Electric Co., Ltd. 55
• Bussman Mfg. Co. Div. of	
McGraw Edison Co. 68, 69	Nexus Research Laboratory, Inc. 71
	• North Atlantic Industries, Inc. 49
• Defense Electronics, Inc. 43	
Di Acro Corp. 64	• Ohmite Mfg. Co. 7
Ealing Corp., The 71	Photocircuits Corp. 37
Eisler Engineering Co., Inc. 50	Potter Instrument Co., Inc. 22
Electrical Industries, Inc. 9	
• Electro Instruments Inc. 40	
	Radio Corporation of America
Fairchild Semiconductor Corp. 82	3rd cover
Fluke Mfg. Co., Inc., John 21	4th cover
General Electric Co.	• Semi-Elements, Inc. 61
Rectifier Components Dept. 13	Sierra Electronic
Silicone Products Dept. 47	Div. of Philco 4
• General Products Corp. 59	• Sigma Instruments, Inc. 62
Gries Reproducer Corp. 70	Solid State Electronics Corp. 68
Gudebrod Bros. Silk Co., Inc. 48	Space and Information Systems
	Div. North American Aviation
Honeywell 60	Spectra-Strip Wire & Cable Corp. 64
	Sprague Electric Co. 3, 42
Invac Corp. 61	Standard Electric Time Co., The
	Statham Instruments, Inc. 73
Jerrold Electronics Corp. 6	Sylvania Electronic Systems 52, 53
Kay Electric Co. 12	Telrex Laboratories 55
Kingsley Machines 50	Texas Instruments Incorporated
Klinger Scientific Apparatus 55	Industrial Products Group 44
	• United Transformer Corp. 2nd cover

CLASSIFIED ADVERTISING	
F. J. Eberle, Business Mgr. (2557)	
EMPLOYMENT OPPORTUNITIES	77
NOTICES	
Legal	80
EQUIPMENT	
(Use or Surplus New)	
For Sale	78-80

CLASSIFIED ADVERTISERS INDEX	
• A & A Electronics	78
Barry Electronics	78
Bendix Corporation	77
Binswanger	78
• C & H Sales Company	79
E & R Development Company	78
Ealing Corp.	78
• Engineering Associates	78
Fishman Co., Philip	78
Lifschultz Fast Freight	78
Pan American World Airways Inc.,	
Guided Missiles Range Div.	77
• Radio Research Instrument Co.	80
Sierra Western Electric	78
Surplus Saving Center	78
• Universal Relay Corp	80

• See advertisement in the July 25, 1963 issue of electronics Buyers' Guide for complete line of products or services.

This Index and our Reader Service Numbers are published as a service. Every precaution is taken to make them accurate, but electronics assumes no responsibilities for errors or omissions.

electronics



AUDITED PAID CIRCULATION

JAMES T. HAUPTLI (2210)
Advertising Sales Manager

HENRY M. SHAW (3485)
Market Research Manager

electronics Buyers' Guide

R. S. QUINT (2335)
General Manager

RICHARD J. TOMLINSON (3191)
Business Manager

THEODORE R. GEIPEL (2044)
Production Manager

NEW YORK TELEPHONE: Dial Direct:
971 plus number in parenthesis,
Area Code 212

ADVERTISING REPRESENTATIVES

ATLANTA, GA. 30009
Michael H. Miller, Robert C. Johnson
1375 Peachtree St. N.E.,
Trinity 5-0523 (area code 404)

BOSTON, MASS. 02116
William S. Hodgkinson
McGraw-Hill Building, Copley Square,
Congress 2-1160 (area code 617)

CHICAGO, ILL. 60611
Harvey W. Wernecke,
Robert M. Denmead
645 North Michigan Avenue,
Mohawk 4-5800 (area code 312)

CLEVELAND, OHIO 44113
Paul T. Fegley
55 Public Square, Superior 1-7000
(area code 216)

DALLAS, TEXAS 75201
Frank Le Beau
The Vaughn Bldg.,
1712 Commerce St.
Riverside 7-9721 (area code 214)

DENVER, COLO. 80202
John W. Patten
Tower Bldg., 1700 Broadway,
Alpine 5-2981 (area code 303)

HOUSTON, TEXAS 77025
Kenneth George
Prudential Bldg., Halcombe Blvd.,
Riverside 8-1280 (area code 713)

LOS ANGELES, CALIF. 90017
Ashley P. Hartman, John G. Zisch,
1125 W. 6th St., Huntley 2-5450
(area code 213)

NEW YORK, N. Y. 10036
Donald H. Miller (212) 971 3615
George F. Werner (212) 971 3617
Donald R. Furth (212) 971 3616
500 Fifth Avenue

PHILADELPHIA, PA. 19103
Warren H. Gardner, William J. Boyle
6 Penn Center Plaza,
LOcust 8-4330 (area code 215)

SAN FRANCISCO, CALIF. 94111
Richard C. Alcorn
255 California Street,
Douglas 2-4600 (area code 415)

LONDON W1:
Edwin S. Murphy Jr.
34 Dover St.

FRANKFURT/Main:
Matthee Herfurth
85 Westendstrasse

GENEVA:
Michael R. Zeynel
2 Place du Port

TOKYO:
George Olcott,
1, Kotohiracho, Shiba, Minato-ku

AVAILABLE FROM DISTRIBUTOR STOCKS

EPITAXIAL MICROLOGIC

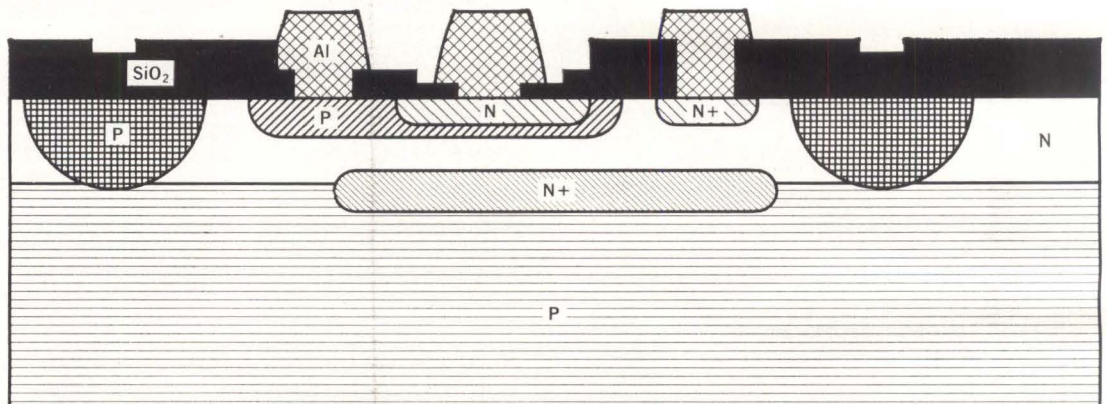

SILICON PLANAR EPITAXIAL MICROLOGIC CROSS-SECTION

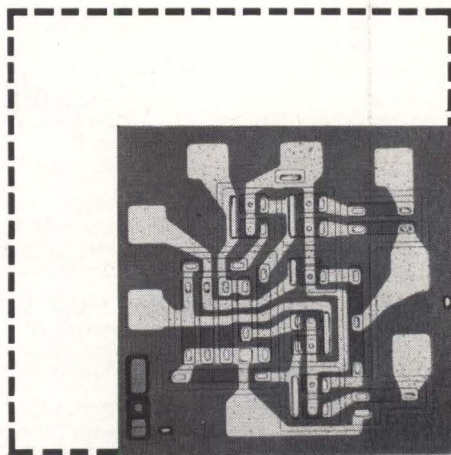

New Planar epitaxial construction doubles both switching speeds and DC noise immunity in Fairchild's Micrologic family of digital integrated microcircuits. In addition, the new elements offer an increase of more than 30% in logic level separation throughout the temperature range. Circuit designers can take advantage of epitaxial Micrologic to improve performance in both pulsed and linear circuits. In a pulsed circuit, the results are faster switching speeds, increased useful current range and improved DC level control. Linear circuits benefit from increases in both frequency range and current range. The functions of elements in epitaxial Micrologic and the original Micrologic family are identical. Epitaxial units can directly replace units now in use, doubling both speed and worst case noise margins. No design changes are needed. The photograph to the left is an epitaxial "S" element chip. The dotted line indicates size of the original Micrologic "S" element chip. Although smaller in area, the epitaxial chip is made thicker with no change in electrical characteristics, adding to the ruggedness of the device. Epitaxial Micrologic is available directly from distributor stocks. Write for data sheets and application notes.

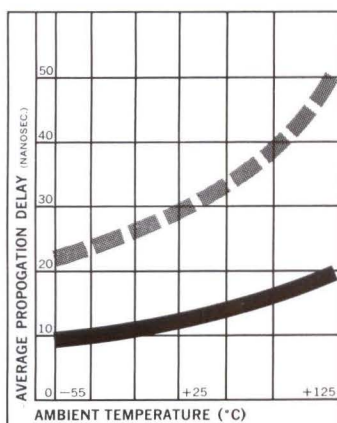

FASTER SPEED

Propagation delay is lower and less affected by temperature than in the original Micrologic family, resulting in faster operating speeds in digital systems.

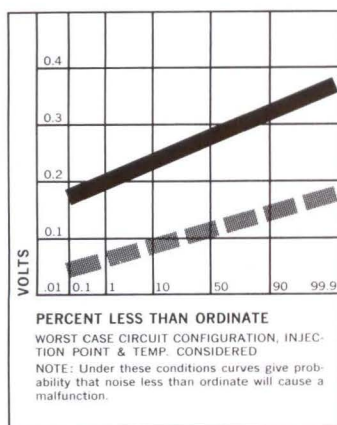

GREATER NOISE IMMUNITY

Epitaxial construction provides a wider guardband against malfunction due to ambient circuit noise.

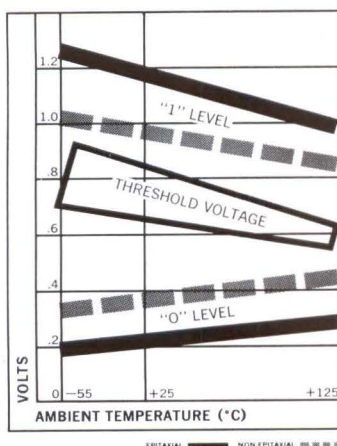

IMPROVED LOGIC LEVELS

Logic level separation in all elements has been increased more than 30 per cent.

FAIRCHILD
SEMICONDUCTOR



RCA-A15288 PENCIL TRIODE

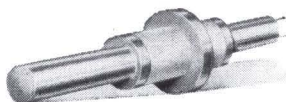

MORE TUBE POWER FOR MINIATURIZED MICROWAVE DESIGNS

Increased power per unit weight—that's the challenge successfully met by the RCA-A15288. An excellent example of recent advances in Microwave tube design, this tiny pencil triode can provide 1 Kw of useful peak power output at 5 Gc as a plate-pulsed oscillator.

For use in telemetry, altimeters, and UHF transceivers, the ceramic-metal RCA-A15288 is designed to operate at altitudes up to 25,000 feet at 3.5 Kv without pressurization. Furthermore, the coaxial arrangement of electrodes around the RCA-A15288 heater practically eliminates tube characteristic

changes caused by heater-voltage variations.

If your design involves miniaturized Microwave equipment for application in the 5 Gc region, consider the RCA-A15288. It offers exceptional reliability in vibration and shock environments. Heater power requirement is a low 1.6 watts; warm-up time is 4 seconds.

For information on how the RCA-A15288 can be used in your design circuits, see your RCA Industrial Field Representative, or write: Manager, Microwave Marketing, RCA Electronic Components and Devices, Harrison, New Jersey.

RCA-A15288

Plate-Pulsed Oscillator at 5 Gc	Typical Operation
Peak Positive Plate Supply Voltage	2,500 volts
DC Plate Current	0.0022 amp
DC Grid Current	0.0015 amp
Grid Resistor	2,000 ohms
Useful Power Output at Peak of Pulse	1,000 watts
Pulse Duration	1.0 μ sec
Pulse Repetition Rate	1,000 pps
Plate Efficiency	20%

RCA FIELD OFFICES:

OEM SALES: Newark 2, N. J., 32-36 Green St., (201) 485-3900 • Chicago 54, Ill., Suite 1154, Merchandise Mart Plaza, (312) 527-2900 • Los Angeles 22, Calif., 6801 E. Washington Blvd., (213) RA 3-8361 • GOVERNMENT SALES: Harrison, N. J., 415 South Fifth St., (201) 485-3900 • Dayton 2, Ohio, 224 N. Wilkinson St., (513) BA 6-2366 • Washington 6, D. C., 1725 "K" St., N.W., (202) FE 7-8500 • INTERNATIONAL SALES: RCA International Division, Clark, New Jersey, (201) 382-1000



THE MOST TRUSTED NAME IN ELECTRONICS