

User's Guide

Part I

Life Scope *TR*

Bedside Monitor

BSM-6301/BSM-6501/BSM-6701

BSM-6000 series
BSM-6301A
BSM-6301K
BSM-6501A
BSM-6501K
BSM-6701A
BSM-6701K

In order to use this product safely and fully understand all its functions, read this manual before using the product.

Keep this manual near the instrument or in the reach of the operator and refer to it whenever the operation is unclear.

This product stores personal patient information. Manage the information appropriately.

Patient names on the screen shots and recording examples in this manual are fictional and any resemblance to any person living or dead is purely coincidental.

The contents of this manual are subject to change without notice.

If you have any comments or suggestions on this manual, please contact us at: www.nihonkohden.com

Copyright Notice

The entire contents of this manual are copyrighted by Nihon Kohden. All rights are reserved. No part of this document may be reproduced, stored, or transmitted in any form or by any means (electronic, mechanical, photocopied, recorded, or otherwise) without the prior written permission of Nihon Kohden.

Trademark



The mark printed on the SD card that is used in this instrument is a trademark. The company name and model name are trademarks and registered trademarks of each company.

CE **Rx**
0086 **Only**

Contents

GENERAL HANDLING PRECAUTIONS	i
WARRANTY POLICY	ii
EMC RELATED CAUTION	ii
Conventions Used in this Manual and Instrument	v
Warnings, Cautions and Notes	v
Text Conventions	v
Explanations of the Symbols in this Manual and Instrument	vi
Related Documentation	x
Safety Standards	x
Safety Information.....	xi
Periodic Inspection.....	xi

Section 1 **General..... 1.1**

Introduction	1.2
General	1.2
Applications	1.3
Features	1.3
Measurement Parameters and Applicable Units	1.5
Composition.....	1.7
Network Composition.....	1.8
Panel Description.....	1.9
MU-631R Main Unit	1.9
Front Panel	1.9
Left Side Panel	1.10
Right Side Panel.....	1.10
Rear Panel.....	1.11
MU-651R/MU-671R Main Unit.....	1.12
Front Panel	1.12
Left Side Panel	1.13
Right Side Panel.....	1.13
Rear Panel.....	1.14
AY-631P/633P/651P/653P/660P/661P/663P/671P/673P Input Unit.....	1.15
Front Panel	1.15
Using MULTI Sockets for CO Monitoring.....	1.15
Using the Output Signal from the ECG/BP OUT Socket	1.16
Left Side Panel	1.17
Right Side Panel.....	1.17
Rear Panel.....	1.18
AA-672P/AA-674P Smart Expansion Unit.....	1.18
Front Panel	1.18
Using MULTI Sockets for CO Monitoring.....	1.19
Right Side Panel.....	1.19
BSM-1700 series Bedside Monitor.....	1.19
QF series Interface and IF series Communication Cable	1.20

RY-910PA Remote Controller..... 1.21

Basic Operating Concepts 1.22

 Screen Displays..... 1.22

 Using Touch Screen Keys 1.28

 Keys on the Bedside Monitor..... 1.30

 Using the Remote Control 1.31

 Using the Mouse..... 1.31

 Using the Data Acquisition Unit 1.32

 Using the MENU Window 1.33

Section 2 Preparation 2.1

Preparation Flowchart..... 2.2

Installation Conditions..... 2.3

Inserting and Removing the Battery Pack 2.5

 Battery Handling and Operation 2.5

 Safety Information 2.5

 Battery Pack Handling Procedures..... 2.6

 When Not Using the Monitor or Battery Pack..... 2.6

 Inserting and Removing the Battery Packs 2.6

 Inserting the Battery Pack 2.7

 Removing the Battery Pack 2.8

Inserting and Removing the AY-600P series Input Unit or
BSM-1700 series Bedside Monitor 2.9

 Inserting the Input Unit 2.9

 Removing the Input Unit 2.10

 When the Transport Function is Enabled..... 2.10

Preparing the Optional Recorder 2.11

 Installing the Recorder Module..... 2.11

 Loading Recording Paper 2.11

Preparing the Remote Control 2.13

 Installing the Batteries 2.13

 Setting the Remote Control Channel..... 2.14

 Attaching the Remote Control Channel Label to the Bedside Monitor 2.14

 Assigning Functions to the Customized Keys..... 2.14

Power..... 2.15

 Turning the Power On 2.15

 Check Before Turning On the Power 2.15

 Turning the Power On..... 2.16

 Check After Turning On the Power and During Monitoring..... 2.17

 Power and Battery Status Indications..... 2.18

 When the “BATTERY WEAK” Message Appears 2.20

 Charging the Battery Pack..... 2.20

 Monitor Status on Power Interruption 2.21

 Turning the Power Off 2.21

 Check After/Before Turning the Power Off..... 2.22

Section 3	<i>Necessary Settings Before Monitoring</i>	3.1	1
	Changing Date and Time	3.2	2
	Changing Sound Volume Settings	3.3	3
	Changing the Screen Brightness	3.4	4
	Changing Waveform Display Settings	3.5	5
	Admitting/Discharging Patient.....	3.7	6
	Displaying the ADMIT DISCHARGE Window	3.7	7
	Stored Data Status and Screen Transition for Admitting Patient.....	3.9	8
	Selecting Patient Type	3.11	9
	Entering the Patient Information	3.12	10
	Entering the Patient ID	3.12	11
	Entering the Patient Name	3.13	
	Entering the Date of Birth and Age	3.15	
	Entering the Height and Weight.....	3.16	
	Entering the Gender.....	3.17	
	Entering the Pacemaker Use.....	3.17	
	Admitting a Patient.....	3.19	
	Discharging a Patient.....	3.21	
	Suspended Alarms after Admission or Discharge	3.24	
	Using Transport Function in a Monitor Network	3.25	
	Input Unit	3.25	
	Transport Function.....	3.25	
	Data and Settings that can be Transferred between Bedside Monitors	3.26	
	Necessary Settings Before Use.....	3.27	
	Sending Data to a CNS-6201 or CNS-9701 Central Monitor.....	3.28	
	Authenticating a Patient when the Input Unit is Moved from One Monitor to Another	3.29	
	When Using Data in the Input Unit	3.29	
	When Using Data in the Main Unit	3.31	
	When Monitoring as a New Patient	3.32	
	When the Patient Information are the Same in the Input Unit and Main Unit.....	3.34	
	Preparing for Removing the Input Unit	3.34	
	Enabling the Input Unit	3.36	
	WLAN Transport	3.37	
	Preparation.....	3.38	
	Starting WLAN Transport.....	3.38	
	Ending WLAN Transport.....	3.40	
	Using Transport Function with a Defibrillator	3.41	
	Precautions for Transport Function with a Defibrillator	3.41	
	Receiving Data from the Defibrillator.....	3.42	
	Bed ID	3.42	
	Data that can be Received from the Defibrillator.....	3.42	
	Receiving Data from the Defibrillator.....	3.43	
Section 4	<i>Home Screen</i>	4.1	
	Safety Precautions for Monitoring.....	4.3	
	Using an Electrosurgical Unit	4.3	

- Using a Defibrillator 4.3
- Overview 4.4
 - Home Screen..... 4.4
 - Review Windows..... 4.4
 - Sync Sound 4.4
 - Adjusting the Sync and Alarm Sound Volume 4.4
 - Changing Settings and Performing Other Tasks During Monitoring 4.4
 - Site Mode 4.5
 - Recording/Printing on the Home Screen 4.5
 - Interbed Monitoring..... 4.6
- Home Screen 4.7
 - Settings for the Home Screen 4.8
 - Waveform Sweep Mode and Speed 4.8
 - Waveform Display on the Home Screen..... 4.8
 - Pacing Mark Position on the ECG Waveform 4.8
 - ST Waveform and Reference ST Recall Waveform Display on the Home Screen On or Off 4.8
 - Blood Pressure Waveform Display Mode 4.9
 - IBP Waveform Display Area on the Home Screen 4.9
 - PPV or SPV Display on the Home Screen 4.9
 - Pulse Rate Display on the Home Screen 4.9
 - Current Average CO and PCWP Values Display on the Home Screen 4.10
 - Trendgraph/OCRG Display on the Home Screen On or Off 4.10
 - Scale Setting for the Trendgraph on the Home Screen 4.10
 - Parameter Colors 4.10
 - Waveform Sensitivity 4.10
 - Cascade ECG Waveform..... 4.10
 - Displaying Other Windows from the Home Screen..... 4.11
- Displaying OCRG..... 4.12
- Freezing Waveforms 4.13
- Displaying the LARGE NUMERICS Screen..... 4.14
- Using the Timer..... 4.17
- Car Seat Challenge 4.19
- Using Sleep Mode 4.21
 - Turning Sleep Mode On..... 4.22
 - Turning Sleep Mode Off..... 4.22

Section 5 Alarm Function..... 5.1

- Overview of Alarms..... 5.4
 - What is an Alarm 5.4
 - Alarm Level..... 5.5
 - Alarm Escalation 5.5
 - Alarm Priority..... 5.5
 - Alarm Sound/Alarm Indicator 5.5
 - Alarm Messages on the Screen 5.5
- Silencing/Suspending Alarms..... 5.6
- Alarm Master 5.7
- Automatic Recording 5.7

Alarm Setting	5.8	1
Canceling the Technical Alarm	5.9	
Adjusting Alarm Sound Volume	5.9	2
Alarm Activation after Power On.....	5.9	
ALARM HISTORY Window	5.9	3
Interbed Alarm	5.9	
Alarm Types	5.10	4
Vital Signs Alarms	5.10	
Arrhythmia Alarms	5.10	5
Technical Alarms	5.12	
ECG Related Alarms	5.12	6
Respiration Related Alarms.....	5.12	7
CO ₂ Related Alarms	5.12	
Microcap [®] /Micropod [™] Related Alarms	5.13	8
SpO ₂ Related Alarms	5.13	
NIBP Related Alarms	5.14	9
IBP Related Alarms	5.14	
Temperature Related Alarms.....	5.14	10
BIS Related Alarms	5.15	
CO Related Alarms	5.15	11
Gas Related Alarms	5.16	
O ₂ Related Alarms.....	5.16	
VENT Related Alarms	5.16	
TOF Related Alarms.....	5.17	
CCO (APCO) Related Alarms	5.17	
CCO Related Alarms.....	5.17	
PiCCO Related Alarm	5.17	
FLOW/Paw Related Alarms.....	5.18	
EEG Related Alarms	5.18	
tcPO ₂ /tcPCO ₂ Related Alarms.....	5.18	
rSO ₂ Related Alarm	5.19	
Other Alarms	5.19	
Messages	5.20	
ECG Related Messages	5.20	
Respiration Related Messages.....	5.20	
CO ₂ Related Messages	5.21	
SpO ₂ Related Messages	5.21	
NIBP Related Messages	5.22	
IBP Related Message.....	5.22	
BIS Related Messages	5.22	
O ₂ Related Messages.....	5.22	
CO Related Messages	5.23	
Gas Related Messages	5.23	
CCO (APCO) Related Messages	5.24	
FLOW/Paw Related Messages.....	5.24	
EEG Related Messages	5.24	
Microcap [®] /Micropod [™] Related Messages	5.24	
Other Messages	5.25	
Alarm Indications	5.26	
Overview.....	5.26	

- Individual Alarm Indications..... 5.27
 - Vital Signs Alarms 5.28
 - Arrhythmia Alarms 5.33
 - Technical Alarms 5.33
 - Other Alarms 5.41
 - Interbed Alarms 5.42
- Alarm Control Marks..... 5.42
 - Individual Vital Signs Alarm Off Marks 5.42
- Flow of Alarm Function..... 5.43
- Silencing and Suspending Alarms 5.44
 - Overview..... 5.44
 - Silencing an Alarm 5.44
 - Suspending Alarms 5.44
 - Silencing Alarms After Alarm Occurrence 5.47
 - Silencing an Alarm 5.47
 - Canceling Alarm Silence 5.47
 - Suspending Alarms Before Alarm Occurrence..... 5.47
 - Suspending Alarms 5.47
 - Suspending All Alarms Indefinitely 5.48
 - Suspending All Alarms and NIBP STAT and Auto Measurement Indefinitely 5.51
- Turning Automatic Alarm Recording On/Off..... 5.53
- Setting Alarms 5.54
 - Overview..... 5.54
 - Alarm Limits Ranges 5.54
 - Vital Signs Alarms 5.55
 - Arrhythmia Alarms 5.61
 - Setting Vital Signs Alarms Individually..... 5.63
 - Automatically Setting All Upper and Lower Alarm Limits..... 5.64
 - Automatic Setting Range..... 5.64
 - Setting All Vital Signs Alarms to a Preset Pattern (Alarm Master)..... 5.66
 - Setting Arrhythmia Alarms Individually 5.67
 - Setting All Arrhythmia Alarms to a Preset Pattern (Alarm Master) 5.69
- Interbed Alarm 5.71

Section 6 *Review Windows* 6.1

- General 6.3
 - Transport..... 6.4
 - Review Recording..... 6.5
- Event Bar 6.6
 - Changing the Displayed Event Types 6.7
 - Changing the Time Scale of the Event Bar and Review Window..... 6.7
 - Scrolling the Event Bar and Review Window 6.8
- Trend Window 6.9
 - GRAPH 1, GRAPH 2, GRAPH 3 Page 6.9
 - Displaying the GRAPH 1, GRAPH 2 or GRAPH 3 Page 6.11
 - Selecting Parameters for the Trendgraph Display..... 6.13
 - Changing the Trendgraph Scale 6.14

Changing the Trendgraph Display Format	6.15	1
Scrolling the Trendgraph	6.16	
Recording the Trendgraph	6.16	2
Printing the Trendgraph	6.17	
TABLE 1, TABLE 2, TABLE 3 Page	6.19	3
Displaying the TABLE 1, TABLE 2 or TABLE 3 Page	6.20	
Scrolling the Trend Table	6.21	4
Selecting Parameters for the Trend Table Display	6.21	
Selecting the Measurement Interval	6.22	5
Recording a Trend Table	6.23	
Printing a Trend Table	6.24	6
NIBP TREND Page	6.26	7
Displaying the NIBP TREND Page	6.27	
Scrolling the NIBP Trend Table	6.28	8
Selecting Parameters for the NIBP Trend Display	6.28	
Recording a NIBP Trend Table	6.29	9
Printing a NIBP Trend Table	6.30	
HEMO TREND Page	6.32	10
Displaying the HEMO TREND Page	6.32	
Scrolling the Hemodynamics Table	6.33	11
Explanation of the Hemodynamics Table	6.34	
Recording a Hemodynamics Table	6.35	
Printing a Hemodynamics Table	6.36	
LUNG TREND Page	6.37	
Displaying the LUNG TREND Page	6.37	
Explanation of the Lung Trend Table	6.38	
Recording the Lung Trend Table	6.39	
Printing a Lung Trend Table	6.40	
Arrhythmia Recall Window	6.41	
General	6.41	
Arrhythmia List	6.41	
Displaying the Arrhythmia Recall Window	6.43	
Selecting the Arrhythmia Types to be Saved as a Recall File	6.44	
Scrolling the Arrhythmia Recall Files	6.44	
Displaying the Actual Size Waveform of the Selected Arrhythmia Recall File	6.45	
Arrhythmia Waveform Annotation	6.45	
Recording or Printing the Arrhythmia Recall Waveform	6.45	
Recording on the ARRHYTHM HISTORY Window	6.46	
Printing on the ARRHYTHM HISTORY Window	6.47	
Recording on the Actual Size ECG Waveform Window	6.48	
Printing on the Actual Size ECG Waveform Window	6.49	
Alarm History Window	6.50	
Displaying the ALARM HISTORY Window	6.50	
Scrolling the Alarm History Files	6.51	
Recording the Alarm History File	6.51	
Full Disclosure Window	6.53	
Displaying the FULL DISC Window	6.53	
Scrolling the Full Disclosure Waveform	6.55	
Selecting the Parameters to be Saved for Full Disclosure	6.56	

- Recording or Printing the Full Disclosure Waveform 6.57
 - Recording the Full Disclosure Waveform..... 6.57
 - Printing the Full Disclosure Waveform..... 6.58
- Recording or Printing the Enlarged ECG Waveform..... 6.60
 - Recording the Enlarged ECG Waveform 6.60
 - Printing the Enlarged ECG Waveform 6.61
- ST Level Recall Window 6.63
 - Displaying the ST Window 6.64
 - Scrolling the ST Level Recall File 6.65
 - Displaying the ST Point..... 6.65
 - Displaying the ST Recall Waveform on the Home Screen..... 6.66
 - Saving as Reference ST Recall File 6.67
 - Displaying the Reference ST Recall Waveform on the Home Screen 6.68
 - Printing the ST Level Recall File..... 6.69
- OCRG Window 6.71
 - Displaying the OCRG Window..... 6.71
 - Selecting the OCRG Trendgraph Type..... 6.73
 - Changing the Trendgraph Scale for Heart Rate and SpO₂ and Sensitivity for Respiration 6.74
 - Recording or Printing the OCRG Trend 6.75
 - Recording the OCRG Trend 6.75
 - Printing the OCRG Trend..... 6.76
- aEEG Window..... 6.78
 - Displaying the aEEG Window 6.78
 - Changing Time Scale for aEEG..... 6.80
 - Scrolling aEEG Traces..... 6.81
 - Recording or Printing the aEEG 6.81
 - Recording the aEEG 6.81
 - Printing the aEEG..... 6.83

Section 7 12 Lead Analysis/12 Lead Windows 7.1

- 12 Lead Analysis Window 7.2
 - Preparation Flowchart 7.2
 - Displaying the 12 LEAD ANALYSIS Window 7.3
 - Entering the Patient’s Date of Birth and Gender..... 7.4
 - Displaying the PATIENT INFO Window 7.4
 - Entering the Date of Birth and Age 7.4
 - Entering the Gender 7.4
 - Performing 12 Lead ECG Interpretation 7.5
 - Recording or Printing the 12 Lead ECG Waveform 7.6
 - Recording the 12 Lead ECG Waveforms..... 7.6
 - Printing the 12 Lead ECG Waveforms..... 7.7
- 12 LEAD Window 7.9
 - Displaying the 12 LEAD Window 7.9
 - 12 LEAD Page 7.10
 - Scrolling the 12 Lead Data File 7.10
 - Recording the 12 Lead Data 7.10
 - ANALYSIS WAVE Page 7.11

Recording or Printing the 12 Lead Waveform	7.12	1
Recording the 12 Lead Waveform	7.12	
Printing the 12 Lead Waveform	7.13	2
REPORT Page.....	7.14	
Recording or Printing the 12 Lead Interpretation Results.....	7.14	3
Recording the 12 Lead Interpretation Results.....	7.14	
Printing the 12 Lead Interpretation Results	7.15	4
AVERAGE WAVE Page	7.16	
Printing the Averaged ECGs	7.16	5
Section 8 Drug/Lung Function Windows	8.1	7
DRUG Window.....	8.2	
Drug Titration Initial Settings.....	8.3	8
Flow Rate Equations.....	8.3	
Displaying the DRUG Window	8.5	9
Selecting the Drug	8.7	
Assigning a Drug Name and Dosage Unit to DRUG A to D.....	8.8	10
Changing the Settings	8.10	
Changing the Drug Amount, Solution Amount, Dosage, Flow Rate and Weight.....	8.10	11
Changing the Dose Step	8.11	
Unit and Setting Range	8.11	
Drug Amount, Dosage and Step	8.11	
Solution Amount, Flow Rate and Weight	8.12	
LUNG FUNCTION Window.....	8.13	
Displaying the LUNG FUNCTION Window	8.13	
Entering the Data.....	8.15	
Explanation of the DATA ENTRY Items	8.15	
Checking the Calculation Results.....	8.16	
Explanation of the CALCULATION RESULTS.....	8.16	
Adding the Calculation Results to the LUNG TREND Table	8.17	
Displaying the LUNG TREND Table.....	8.17	
Recording the Calculation Results and Entered Data	8.18	
Section 9 Interbed Window	9.1	
Registering Interbed Beds	9.3	
Removing an Interbed Bed.....	9.3	
Displaying the Numeric Data of All Interbed Beds	9.4	
Displaying the Interbed Bed Data	9.5	
Interbed Alarm	9.7	
Interbed Alarm Setting.....	9.8	
Section 10 Recording	10.1	
Overview of Recording.....	10.2	
Recording Modes	10.3	
Manual Waveform Recording/Printing	10.5	

Recording/Printing on the 12 LEAD ANALYSIS Window.....	10.5
Recording/Printing on the Review Windows other than 12 Lead Window.....	10.5
Recording/Printing on the 12 LEAD Window.....	10.5
Recording on the LUNG FUNCTION Window.....	10.5
Recording/Printing OCRG.....	10.5
Recording on the CO Window.....	10.6
Recording on the TOF Window.....	10.6
Recording on the CCO Window.....	10.6
Recording on the FLOW Window.....	10.6
Recording on the EEG Window.....	10.6
Recording on the ANALOG Window.....	10.6
Periodic Recording.....	10.7
Alarm Recording.....	10.8
Recording Mode Annotations.....	10.10
Recording Priority.....	10.11
Recording Sensitivity.....	10.11
Recording Speed.....	10.11
Feeding the Paper after Recording.....	10.11
Recording Related Message.....	10.12
Recorded/Printed Data.....	10.12
Changing the Recording Speed.....	10.13
Changing the Recording Pattern.....	10.14
Manually Recording/Printing Waveforms.....	10.15
Recording Waveforms on the Optional Recorder.....	10.15
Recording Waveforms on the Bedside Monitor with No Recorder.....	10.16
Manual Printing on the Network Printer.....	10.16
Setting Periodic Recording.....	10.17
Changing Settings for Automatic Periodic Recording.....	10.18
Printing on a Network Printer.....	10.19
Section 11 Reference.....	11.1
Clock Accuracy.....	11.2
Periodical Replacement Schedule.....	11.3
Repair Parts Availability Policy.....	11.3

GENERAL HANDLING PRECAUTIONS

This device is intended for use only by qualified medical personnel.

Use only Nihon Kohden approved products with this device. Use of non-approved products or in a non-approved manner may affect the performance specifications of the device. This includes, but is not limited to, batteries, recording paper, pens, extension cables, electrode leads, input boxes and AC power.

Please read these precautions thoroughly before attempting to operate the instrument.

1. To safely and effectively use the instrument, its operation must be fully understood.

2. When installing or storing the instrument, take the following precautions.

- (1) Avoid moisture or contact with water, extreme atmospheric pressure, excessive humidity and temperatures, poorly ventilated areas, and dust, saline or sulphuric air.
- (2) Place the instrument on an even, level floor. Avoid vibration and mechanical shock, even during transport.
- (3) Avoid placing in an area where chemicals are stored or where there is danger of gas leakage.
- (4) The power line source to be applied to the instrument must correspond in frequency and voltage to product specifications, and have sufficient current capacity.
- (5) Choose a room where a proper grounding facility is available.

3. Before Operation

- (1) Check that the instrument is in perfect operating order.
- (2) Check that the instrument is grounded properly.
- (3) Check that all cords are connected properly.
- (4) Pay extra attention when the instrument is combined with other instruments to avoid misdiagnosis or other problems.
- (5) All circuitry used for direct patient connection must be doubly checked.
- (6) Check that battery level is acceptable and battery condition is good when using battery-operated models.

4. During Operation

- (1) Both the instrument and the patient must receive continual, careful attention.
- (2) Turn power off or remove electrodes and/or transducers when necessary to assure the patient's safety.
- (3) Avoid direct contact between the instrument housing and the patient.

5. To Shutdown After Use

- (1) Turn power off with all controls returned to their original positions.
- (2) Remove the cords gently; do not use force to remove them.
- (3) Clean the instrument together with all accessories for their next use.

6. The instrument must receive expert, professional attention for maintenance and repairs. When the instrument is not functioning properly, it should be clearly marked to avoid operation while it is out of order.

7. The instrument must not be altered or modified in any way.

8. Maintenance and Inspection

- (1) The instrument and specified parts must undergo regular maintenance inspection at the interval which is specified after the GENERAL HANDLING PRECAUTIONS section.
- (2) If stored for extended periods without being used, make sure prior to operation that the instrument is in perfect operating condition.

- (3) Technical information such as parts list, descriptions, calibration instructions or other information is available for qualified user technical personnel upon request from your Nihon Kohden representative.
9. **When the instrument is used with an electrosurgical instrument, pay careful attention to the application and/or location of electrodes and/or transducers to avoid possible burn to the patient.**
10. **When the instrument is used with a defibrillator, make sure that the instrument is protected against defibrillator discharge. If not, remove patient cables and/or transducers from the instrument to avoid possible damage.**

WARRANTY POLICY

Nihon Kohden Corporation (NKC) shall warrant its products against all defects in materials and workmanship for one year from the date of delivery. However, consumable materials such as recording paper, ink, stylus and battery are excluded from the warranty.

NKC or its authorized agents will repair or replace any products which prove to be defective during the warranty period, provided these products are used as prescribed by the operating instructions given in the operator's and service manuals.

No other party is authorized to make any warranty or assume liability for NKC's products. NKC will not recognize any other warranty, either implied or in writing. In addition, service, technical modification or any other product change performed by someone other than NKC or its authorized agents without prior consent of NKC may be cause for voiding this warranty.

Defective products or parts must be returned to NKC or its authorized agents, along with an explanation of the failure. Shipping costs must be pre-paid.

This warranty does not apply to products that have been modified, disassembled, reinstalled or repaired without Nihon Kohden approval or which have been subjected to neglect or accident, damage due to accident, fire, lightning, vandalism, water or other casualty, improper installation or application, or on which the original identification marks have been removed.

In the USA and Canada other warranty policies may apply.

CAUTION

United States law restricts this product to sale by or on the order of a physician.

EMC RELATED CAUTION

This equipment and/or system complies with IEC 60601-1-2 International Standard for electromagnetic compatibility for medical electrical equipment and/or system. However, an electromagnetic environment that exceeds the limits or levels stipulated in IEC 60601-1-2, can cause harmful interference to the equipment and/or system or cause the equipment and/or system to fail to perform its intended function or degrade its intended performance. Therefore, during the operation of the equipment and/or system, if there is any undesired deviation from its intended operational performance, you must avoid, identify and resolve the adverse electromagnetic effect before continuing to use the equipment and/or system.

The following describes some common interference sources and remedial actions:

1. Strong electromagnetic interference from a nearby emitter source such as an authorized radio station or cellular phone:
Install the equipment and/or system at another location. Keep the emitter source such as cellular phone away from the equipment and/or system, or turn off the cellular phone.
2. Radio-frequency interference from other equipment through the AC power supply of the equipment and/or system:
Identify the cause of this interference and if possible remove this interference source. If this is not possible, use a different power supply.
3. Effect of direct or indirect electrostatic discharge:
Make sure all users and patients in contact with the equipment and/or system are free from direct or indirect electrostatic energy before using it. A humid room can help lessen this problem.
4. Electromagnetic interference with any radio wave receiver such as radio or television:
If the equipment and/or system interferes with any radio wave receiver, locate the equipment and/or system as far as possible from the radio wave receiver.
5. Interference of lightning:
When lightning occurs near the location where the equipment and/or system is installed, it may induce an excessive voltage in the equipment and/or system. In such a case, disconnect the AC power cord from the equipment and/or system and operate the equipment and/or system by battery power, or use an uninterruptible power supply.
6. Use with other equipment:
When the equipment and/or system is adjacent to or stacked with other equipment, the equipment and/or system may affect the other equipment. Before use, check that the equipment and/or system operates normally with the other equipment.
7. Use of unspecified accessory, transducer and/or cable:
When an unspecified accessory, transducer and/or cable is connected to this equipment and/or system, it may cause increased electromagnetic emission or decreased electromagnetic immunity. The specified configuration of this equipment and/or system complies with the electromagnetic requirements with the specified configuration. Only use this equipment and/or system with the specified configuration.
8. Use of unspecified configuration:
When the equipment and/or system is used with the unspecified system configuration different than the configuration of EMC testing, it may cause increased electromagnetic emission or decreased electromagnetic immunity. Only use this equipment and/or system with the specified configuration.
9. Measurement with excessive sensitivity:
The equipment and/or system is designed to measure bioelectrical signals with a specified sensitivity. If the equipment and/or system is used with excessive sensitivity, artifact may appear by electromagnetic interference and this may cause mis-diagnosis. When unexpected artifact appears, inspect the surrounding electromagnetic conditions and remove this artifact source.

Caution - continued

10. Use with radiation therapy equipment:

When the equipment and/or system is used in a radiotherapy room, it may cause failure or malfunction due to electromagnetic radiation or corpuscular radiation. When you bring the equipment and/or system into a radiotherapy room, constantly observe the operation. Prepare countermeasures in case of failure or malfunction.

If the above suggested remedial actions do not solve the problem, consult your Nihon Kohden representative for additional suggestions.

BSM-6301 and BSM-6501 (JA-690PA or JA-694PA data acquisition unit, QE-910P BIS processor, AE-918P neuro unit, JP-911P IBP interface isolation cable, QI-320PA or QI-420PA wireless LAN station and QI-670P interface are not connected) comply with International Standard IEC 60601-1-2: 2001 and Amendment 1: 2004 which requires CISPR11, Group 1, Class B. Class B EQUIPMENT is equipment suitable for use in domestic establishments and in establishments directly connected to a low voltage power supply network which supplies buildings used for domestic purposes.

BSM-6301, BSM-6501 (JA-690PA or JA-694PA data acquisition unit, QE-910P BIS processor, AE-918P neuro unit, JP-911P IBP interface isolation cable, QI-320PA or QI-420PA wireless LAN station or QI-670P interface is connected) and BSM-6701 comply with International Standard IEC 60601-1-2: 2001 and Amendment 1: 2004 which requires CISPR11, Group 1, Class A. Class A EQUIPMENT is equipment suitable for use in industrial or light industrial establishments and commercial environment.

BSM-6301 and BSM-6501 (when ZS-900P is connected) are CLASS A equipment if the equipment complies with IEC 60601-1-2: 2001 36 201.1.5 in the countries which do not have national wireless rule.

WARNING

The bioelectric impedance measurement sensor of a minute ventilation rate-adaptive implantable pacemaker may be affected by cardiac monitoring and diagnostic equipment which is connected to the same patient. If this occurs, the pacemaker may pace at its maximum rate and give incorrect data to the monitor or diagnostic equipment. If this occurs, disconnect the monitor or diagnostic equipment from the patient or change the setting on the pacemaker by referring to the pacemaker's manual. For more details, contact your pacemaker representative or Nihon Kohden representative.

The CE mark is a protected conformity mark of the European Community. Products with the CE mark comply with the requirements of the Medical Device Directive 93/42/EEC.

NOTE about Waste Electrical and Electronic Equipment (WEEE) directive 2002/96/EC

For the member states of the European Union only:

The purpose of WEEE directive 2002/96/EC is, as a first priority, the prevention of waste electrical and electronic equipment (WEEE), and in addition, the reuse, recycling and other forms of recovery of such wastes so as to reduce the disposal of waste.

Contact your Nihon Kohden representative for disposal.

Conventions Used in this Manual and Instrument

Warnings, Cautions and Notes

Warnings, cautions and notes are used in this manual to alert or signal the reader to specific information.

WARNING

A warning alerts the user to possible injury or death associated with the use or misuse of the instrument.

CAUTION

A caution alerts the user to possible injury or problems with the instrument associated with its use or misuse such as instrument malfunction, instrument failure, damage to the instrument, or damage to other property.

NOTE

A note provides specific information, in the form of recommendations, prerequisites, alternative methods or supplemental information.

























Text Conventions



- Names of hard keys on the main unit are enclosed in square brackets: [Menu]
- Messages that are displayed on the screen are enclosed in quotation marks: "CHECK ELECTRODES"
- Names of items that are displayed on the screen are enclosed in angle brackets: <SENSITIVITY>

Explanations of the Symbols in this Manual and Instrument

The following symbols found in this manual/instrument bear the respective descriptions as given.

MU-631R/MU-651R/MU-671R Main Unit





Symbol	Description	Symbol	Description
	“On” only for a part of instrument		Output terminal
	“Off” only for a part of instrument		Equipotential terminal
	Alternating current		Serial number
	Battery charging		Date of manufacture
	Out of paper		BIS READY label (QE-910P BIS processor/BISx processor can be connected)
	Record		Battery slot 1/Battery slot 2 (MU-631R only)
	Alarm silence	ZS	ZS socket
	Attention, consult operator’s manual		CSA mark*
	NIBP		MR unsafe*
	NIBP interval		The CE mark** is a protected conformity mark of the European Community. Products marked with this symbol comply with the requirements of the Medical Device Directive 93/42/EEC.
	NIBP start		
	NIBP stop		
	Menu		Products marked with this symbol** comply with the European WEEE directive 2002/96/EC and require separate waste collection. For Nihon Kohden products marked with this symbol, contact your Nihon Kohden representative for disposal.
	Home		
	Data input/output		

Symbol	Description	Symbol	Description
	SD card slot	Rx Only	CAUTION: United States law restricts this product to sale by or on the order of a physician.*
	Network socket		

* The CSA mark, MR unsafe mark and RX only mark only apply to the MU-631RA/MU-651RA/MU-671RA.

** The CE mark and WEEE mark only apply to the MU-631RK/MU-651RK/MU-671RK.





AY-600P Series Input Unit

Symbol	Description	Symbol	Description
	Defibrillation-proof type CF applied part		Date of manufacture
	Output terminal	CE 0086	The CE mark is a protected conformity mark of the European Community. Products marked with this symbol comply with the requirements of the Medical Device Directive 93/42/EEC.
	Attention, consult operator's manual		
	Serial number		



BSM-1700 Series Bedside Monitor

Refer to the BSM-1700 series bedside monitor operator's manual.



AA-672P/AA-674P Smart Expansion Unit

Symbol	Description	Symbol	Description
	Defibrillation-proof type CF applied part		Date of manufacture
	Attention, consult operator's manual	CE 0086	The CE mark is a protected conformity mark of the European Community. Products marked with this symbol comply with the requirements of the Medical Device Directive 93/42/EEC.
	Serial number		



QI-631P Interface

Symbol	Description	Symbol	Description
	Serial interface (RS-232C socket)		Attention, consult operator's manual
	External display (RGB socket)		





QI-632P Interface

Symbol	Description	Symbol	Description
	Input/output terminal (USB socket and Multi-link socket)		Attention, consult operator's manual
	Output terminal (Alarm socket)		



QI-634P Interface

Symbol	Description	Symbol	Description
	Input/output terminal (USB socket and Multi-link socket)		Attention, consult operator's manual





QI-671P Interface

Symbol	Description	Symbol	Description
	Input/output terminal (Multi-link socket)		External display (RGB socket)
IOIOI	Serial interface (RS-232C socket)		Attention, consult operator's manual
	Output (Alarm socket)		





QI-672P Interface

Symbol	Description	Symbol	Description
	Input/output terminal (USB socket and Multi-link socket)		Attention, consult operator's manual















WS-671P Recorder Module

Symbol	Description	Symbol	Description
	Attention, consult operator's manual		The CE mark is a protected conformity mark of the European Community. Products marked with this symbol comply with the requirements of the Medical Device Directive 93/42/EEC.
	Serial number		
	Date of manufacture		

SB-671P Battery Pack

Symbol	Description	Symbol	Description
	Date of manufacture		Products marked with this symbol comply with environmental protection use period of 10 years according to the ST/J11364 “Marking for Control of Pollution Caused by Electronic Information Products” of the People’s Republic of China Electronic Industry Standard.
	Recycle mark		
	Products marked with this symbol require separate waste collection according to EU battery directive 2006/66/EC.		The CE mark is a protected conformity mark of the European Community. Products marked with this symbol comply with the requirements of the Medical Device Directive 93/42/EEC.

On screen

Symbol	Description	Symbol	Description
	Alarm silence		Accessing to SD card
	Alarm suspended		Checking SD card
	All alarms off or vital sign alarm limit off		SD card failure
	Non-paced		Adjust setting/Scroll data
	QRS/pulse sync mark		Zoom in/Zoom out
	Respiration sync mark		Left end/Right end
	Battery status		Touch panel calibration
	Cascade display		

Related Documentation

The BSM-6301A/K, BSM-6501A/K and BSM-6701A/K bedside monitors come with the following manuals in addition to the operator's manual.

Administrator's Guide

Describes how to install the bedside monitor. It also explains about the password protected settings on the SYSTEM SETUP window and SYSTEM CONFIGURATION screen which only an administrator can change.

User's Guide, Part I

Gives supplemental information on the operation of the bedside monitor.

User's Guide, Part II

Describes the features and settings of the monitoring parameters.

Service Manual

Describes information on servicing the bedside monitor. Only qualified service personnel can service the bedside monitor.

Safety Standards

The safety standard of this bedside monitor is classified as follows:

Type of protection against electrical shock: CLASS I EQUIPMENT (AC Powered)

Internally Powered EQUIPMENT (BATTERY Powered)

Degree of protection against electrical shock

Defibrillator-proof type CF applied part:

AY-631P, AY-633P, AY-651P, AY-653P, AY-661P, AY-663P, AY-671P and AY-673P:

ECG, Respiration (impedance and thermistor method), IBP, Temperature, SpO₂, SpO₂-2, CO₂, O₂, NIBP, BIS, CCO (APCO)

AY-660P: ECG, Respiration (impedance method), IBP, Temperature, SpO₂, CO₂, NIBP

AA-672P, AA-674P, JA-694P: Respiration (thermistor method), IBP, Temperature, SpO₂-2, CO₂, O₂, BIS, CCO (APCO)

BSM-1700 series: ECG, Respiration (impedance method), IBP, Temperature, SpO₂, SpO₂-2, CO₂, NIBP, BIS

CF applied part:

AY-631P, AY-633P, AY-651P, AY-653P, AY-661P, AY-663P, AY-671P, AY-673P, AA-672P, AA-674P, JA-694P and BSM-1700 series: CO

Degree of protection against harmful ingress of water:

IPX0 (non-protected)

Degree of safety of application in the presence of FLAMMABLE ANAESTHETIC MIXTURE WITH AIR, OR WITH OXYGEN OR NITROUS OXIDE:

Equipment not suitable for use in the presence of FLAMMABLE ANAESTHETIC MIXTURE WITH AIR, OR WITH OXYGEN OR NITROUS OXIDE

Mode of operation:

CONTINUOUS OPERATION

Safety Information

This User's Guide only contains safety information related to operation. Full information is in the BSM-6000A/K series Bedside Monitor Operator's Manual (code number: 0614-900685U).

Periodic Inspection

If the periodic inspection is not performed, degradation or loss of function may go unnoticed and lead to misdiagnosis.

Service personnel should perform the periodic inspection at least once every year. Make sure that the bedside monitor operates properly and replace the consumables.

If you found abnormalities as a result of inspection and the bedside monitor is suspected to be faulty, attach an "Unusable" or "Repair request" label to the bedside monitor and contact your Nihon Kohden representative. For inspection, refer to the Service Manual.

Section 1 General

Introduction.....	1.2
General.....	1.2
Applications.....	1.3
Features.....	1.3
Measurement Parameters and Applicable Units.....	1.5
Composition.....	1.7
Network Composition.....	1.8
Panel Description.....	1.9
MU-631R Main Unit.....	1.9
Front Panel.....	1.9
Left Side Panel.....	1.10
Right Side Panel.....	1.10
Rear Panel.....	1.11
MU-651R/MU-671R Main Unit.....	1.12
Front Panel.....	1.12
Left Side Panel.....	1.13
Right Side Panel.....	1.13
Rear Panel.....	1.14
AY-631P/633P/651P/653P/660P/661P/663P/671P/673P Input Unit.....	1.15
Front Panel.....	1.15
Using MULTI Sockets for CO Monitoring.....	1.15
Using the Output Signal from the ECG/BP OUT Socket.....	1.16
Left Side Panel.....	1.17
Right Side Panel.....	1.17
Rear Panel.....	1.18
AA-672P/AA-674P Smart Expansion Unit.....	1.18
Front Panel.....	1.18
Using MULTI Sockets for CO Monitoring.....	1.19
Right Side Panel.....	1.19
BSM-1700 series Bedside Monitor.....	1.19
QF series Interface and IF series Communication Cable.....	1.20
RY-910PA Remote Controller.....	1.21
Basic Operating Concepts.....	1.22
Screen Displays.....	1.22
Using Touch Screen Keys.....	1.28
Keys on the Bedside Monitor.....	1.30
Using the Remote Control.....	1.31
Using the Mouse.....	1.31
Using the Data Acquisition Unit.....	1.32
Using the MENU Window.....	1.33

Introduction

General

The Life Scope TR BSM-6301A/K, BSM-6501A/K and BSM-6701A/K bedside monitors are for one patient. You can combine the monitor with other units and options depending on the measurement parameters and use the monitor in a wide range of sites such as the operating rooms and intensive care unit (ICU).

You can also connect this monitor to a network to communicate with a central monitor and other bedside monitors.

The BSM-6301A/K bedside monitor has a 10.4 inch TFT color display, BSM-6501A/K has a 12.1 inch TFT color display, and BSM-6701A/K has a 15 inch TFT color display. All models can display 15 waveforms on the screen.

For simplicity, the suffix A/G/K will be omitted in this manual.

WARNING

Do not diagnose a patient based on only part of the monitoring data on the bedside monitor or only on the data acquired by the bedside monitor. Overall judgement must be performed by a physician who understands the features, limitations and characteristics of the bedside monitor by reading this user's guide thoroughly and by reading the biomedical signals acquired by other instruments.

WARNING

Do not use the same monitor for more than one patient at the same time. Do not connect different sensors from different patients to the same monitor.

NOTE

- Upgrade the main unit and each optional unit to the Nihon Kohden recommended software version. Only use the specified configuration of units. If more than one BSM-6000 series bedside monitor is used in the same facility, make sure the bedside monitors have the same software version. If BSM-6000 series monitors with different software versions are used together, correct system operation cannot be guaranteed.
- The ALARM CAP function is available on the following bedside monitors, central monitors and multiple patient receivers.
 - BSM-6000A series software version 04-01 or later
 - BSM-9101A software version 13-03 or later
 - CNS-9701A software version 01-95 or later
 - ORG-9100A/ORG-9110A software version 03-06 or later
 - ORG-9700A software version 03-06 or later

For details on ALARM CAP function, refer to manual for each instrument of the above and Section 3 of the BSM-6000 series Administrator's Guide.

- Be sure to have the administrator change settings for system operation to modify purposes of system use or relocate the system, or have any changes checked by the administrator. Inappropriate changes may result in unsuitable monitoring or a missed alarm.

Applications

This system monitors biological information on a patient in an operating room, recovery room, ICU, CCU, HCU, NICU or emergency room.

Features

- **Components**
You can connect an input unit, smart expansion unit, interface and other options to the main unit.
- **Use of MULTI sockets**
The MULTI sockets allow you to flexibly connect different parameters.
- **Touch screen display**
The wide angle TFT color display can display measurement values and up to 15 waveforms. You can operate the monitor by touching the screen.
- **Use of remote control (Section 2)**
The remote control allows operation at a distance.
- **Telemetry system (Administrator's Guide)**
When the optional ZS-900P* transmitter is connected to the bedside monitor, waveform(s) and parameter data from the bedside monitor can be sent to a cardiac telemetry system or to a central monitor via a multiple patient receiver. (Available waveforms and parameter data depend on the receiving monitor. CO, O₂ and anesthetic gas data cannot be transmitted.)
* ZS-900P is not available for BSM-6000A series.
- **Available network connection (Administrator's Guide)**
You can connect this system via a 10/100BASE-T LAN cable to a network to communicate with the central monitor and other devices.
- **Available backup battery**
When an SB-671P battery pack (option) is installed in the monitor, there is a sudden power failure or during patient transfer, the monitor can be operated continuously on battery power.
- **Home screen (Administrator's Guide)**
You can change the home screen display according to the needs of your facility.
- **Trendgraphs and OCRG display on the home screen (Administrator's Guide)**
The home screen displays trendgraphs of measured values and waveforms so you can easily identify changes in the patient condition. When a neonate is monitored, OCRG can also be displayed instead of trendgraphs.

1. GENERAL

- **Review information (Section 6)**
This system provides the capability to display review information as trends, arrhythmia recall and full disclosure waveforms.
- **Thermal array recorder (Section 10)**
You can install a WS-671P recorder module (option) to record up to three waveforms and reports.
- **Multi arrhythmia analysis mode (User's Guide Part II, Section 1)**
The multi arrhythmia analysis mode allows you to analyze arrhythmia more accurately.
- **ECG window (User's Guide Part II, Section 1)**
This system displays QRS waveforms of the normal waveform as the dominant QRS, allowing you to check analysis accuracy.
- **12 lead analysis (Section 7)**
When the 10-electrode ECG is monitored, you can display standard 12 lead ECG. 12 lead interpretation is provided.
- **Function keys (Administrator's Guide)**
You can register frequently used operations to function key.
- **Different site setting (Administrator's Guide)**
You can set different settings for different sites (OR, ICU and NICU).
- **Transport function (Section 3)**
The data of the bedside monitor can be saved and sent to another bedside monitor by using a BSM-1700 series bedside monitor, or an AY-600P series input unit with a QM-600P memory unit. If the source monitor and destination monitor are in the same central monitor network, you can observe the transported patient continuously from the central monitor.

When a QI-670P interface is mounted on the bedside monitor, waveforms and numeric data can be received from a TEC-5600 series or TEC-8300 series defibrillator.

Standard components

- MU-631R, MU-651R, MU-671R main unit
- QI-631P, QI-632P, QI-634P, QI-671P, QI-672P interface
- BSM-1700 bedside monitor
- AY-631P, AY-633P, AY-651P, AY-653P, AY-660P*, AY-661P*, AY-663P*, AY-671P, AY-673P input unit
- AA-672P, AA-674P smart expansion unit
- WS-671P recorder module
- SB-671P battery pack

* These are not available for BSM-6000A series.

NOTE

When AY-660P input unit is used, the AA-672P or AA-674P smart expansion unit cannot be used.

Measurement Parameters and Applicable Units

Measurement Parameters		Applicable Units			
		AY-600P series Input Unit	BSM-1700 series Bedside Monitor	QI-632P QI-634P QI-671P QI-672P Interface	Other Units
ECG		OK	OK	–	–
Respiration	Impedance method	OK	OK	–	–
	Thermistor method	OK* ¹	–	–	–
CO ₂	Mainstream	OK	OK	–	–
	Sidestream	–	–	OK	<ul style="list-style-type: none"> • AG-400R CO₂ unit*⁴ • AG-920R multigas unit • GF-110PA multigas unit • GF-120PA multigas/flow unit*⁴ • GF-210R multigas unit • GF-220R multigas/flow unit*⁴
SpO ₂		OK	OK	–	–
NIBP		OK	OK	–	–
IBP		OK	OK	–	–
Temperature	TEMP socket	OK	OK	–	–
	MULTI socket	OK* ¹	–	–	–
BIS	MULTI socket	OK	OK	–	<ul style="list-style-type: none"> • YJ-671P BISx connection cable • QE-910P BIS processor/BISx
	Multi-link socket	–	–	OK	External instrument
Cardiac output		OK* ¹	OK	OK	–
Anesthetic gas* ²		–	–	OK	<ul style="list-style-type: none"> • AG-920R multigas unit • GF-110PA multigas unit • GF-210R multigas unit
Anesthetic gas and FLOW/Paw* ³		–	–	OK	<ul style="list-style-type: none"> • GF-120PA multigas/flow unit*⁴ • GF-220R multigas/flow unit*⁴
O ₂		OK* ¹	–	–	–
Ventilation		–	–	OK	External instrument
TOF		–	–	OK	External instrument
CCO (APCO)		OK* ¹	–	–	JP-600P APCO/IBP processor* ⁴
CCO		–	–	OK	External instrument
EEG		–	–	OK	AE-918P neuro unit
tcPO ₂ /tcPCO ₂		–	–	OK	External instrument
Analog input		–	–	OK	External instrument
Anesthesia		–	–	OK	External instrument
rSO ₂		–	–	OK	External instrument

*¹ These parameters cannot be measured by the MULTI sockets on the AY-660P input unit, but can be measured by the MULTI sockets on the JA-694PA data acquisition unit.

*² RR, CO₂ (Sidestream), O₂, N₂O, AGENT and MAC can be measured.

*³ RR, CO₂ (Sidestream), O₂, N₂O, AGENT, MAC and FLOW/Paw can be measured.

*⁴ These devices are not available for BSM-6000A series.

1. GENERAL

Differences Between the Input Unit Models

Input Unit Model	AY-631P	AY-633P	AY-651P	AY-653P	AY-660P*1	AY-661P*1 AY-671P	AY-663P*1 AY-673P	BSM-1733	BSM-1753	BSM-1763*1	BSM-1773
No. of MULTI sockets	1	3	1	3	1	1	3	3			
Available parameters using MULTI sockets	RESP (Thermistor), CO ₂ , SpO ₂ , IBP, TEMP, BIS, CO, O ₂ , CCO (APCO)				CO ₂ , IBP	RESP (Thermistor), CO ₂ , SpO ₂ , IBP, TEMP, BIS, CO, O ₂ , CCO (APCO)		ECG, respiration in impedance method, SpO ₂ , NIBP, temperature (up to 2 channels), IBP (up to 3 channels), ETCO ₂ , FiCO ₂ , cardiac output, SpO ₂ -2, BIS			
No. of TEMP sockets	2				1	2		2			
ECG measurement using 10 electrodes	Yes				No	Yes		Yes			
12 lead analysis	Yes				No	Yes		Yes			
SpO ₂ probe	Masimo		Nellcor		Nihon Kohden*2			Masimo	Nellcor	Nihon Kohden	
Dual SpO ₂	Yes*3		Yes*4		Yes*5	Yes*6		Yes*3	Yes*4	Yes*6	
NIBP PWTT measurement	No				Yes			No		Yes	
Smart expansion unit	Yes				No	Yes		No			
Analog ECG								Yes			
Analog BP								Yes			
HT output								Yes			

*1 These are not available for BSM-6000A series.

*2 When the probe is not connected to the SpO₂ socket, Masimo or Nellcor probe can be used with IF-925P or IF-919P communication cable.

*3 IF-925P communication cable is required.

*4 IF-919P communication cable is required.

*5 Dual SpO₂ is available when the MULTI socket on the JA-694PA data acquisition unit is used.

*6 JL-500P1 or JL-500P2 SpO₂ adapter is required.

Composition

BSM-6000 series Bedside Monitor

Main Unit

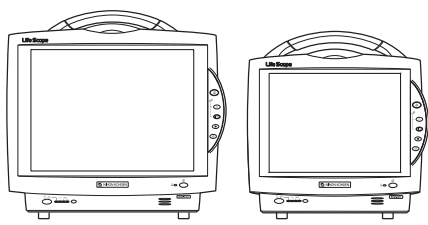

MU-671R MU-651R



MU-631R

Bedside Monitor



BSM-1700 series

Input Unit

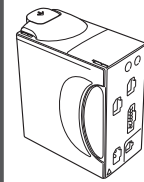
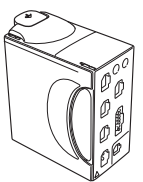
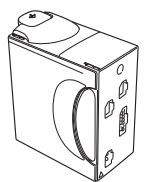
AY-631P/651P/
661P*/671P AY-633P/653P/
663P*/673P AY-660P*

Smart Expansion Unit

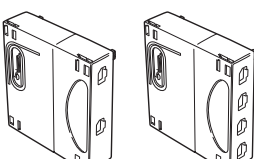

AA-672P AA-674P

Interface

For MU-631R

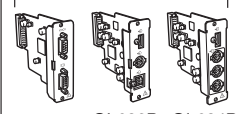

QI-631P QI-632P QI-634P

For MU-651R, MU-671R

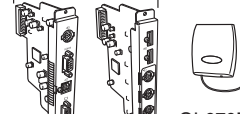

QI-671P QI-672P



QI-670P*

Recorder Module

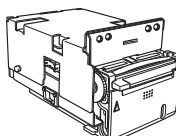

WS-671P

Battery Pack



SB-671P

Remote Controller



RY-910PA

Mouse



Bar Code Reader



Hyper Isolation Transformer



HIT-100

Transmitter

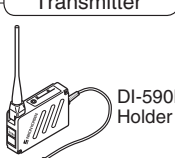

DI-590P
Holder
ZS-900P*

APCO/IBP Processor



JP-600P

CO₂ Unit



AG-400R

Multigas Unit



AG-920R

Multigas Unit/Multigas/Flow Unit



DH-220P
Mount Adapter
DH-223P
Unit Mount
GF-110PA/GF-120PA*
GF-210R/GF-220R*

BIS Processor

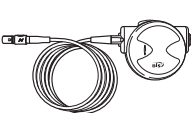

QE-910P

Data Acquisition Unit

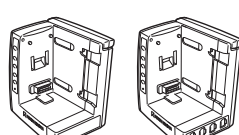

JA-690PA JA-694PA

QI-600P Interface Unit
YS-096P2/096P3
Unit Connection Cable
YS-096P5 Multi-link Cable
DH-691P Base
DH-692P Holder
DH-693P Adapter

Wireless LAN Station



QI-320PA/QI-420PA

Neuro Unit

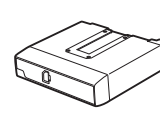

AE-918P

Interface/Communication Cable

QF-801P/901P/902P/903P/904P/905P*/907P/908P/909P/911P*/921P**
IF-912P/913P/914P/916P/917P/918P*/919P/920P*/922P/923P/925P/
927P/928P/930P/931P*/932P/933P*/934P*/935P/936P*/937P/938P/
939P/942P/943P/944P/945P*/946P/948P/950P*/951P*/952P**

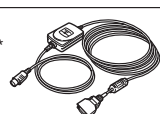

Example is QF-904P

Other

KC-600P Cart
KG-951P Wall Mount Kit
KG-600P Counter Top Mount
DH-600P Handle

* Not available for BSM-6000A series.
** Only available for BSM-6000A series.

Network Composition

In a central monitor network, on a central monitor, you can see data of any bed in the network.

The data that can be displayed on the bedside monitor or central monitor depends on the type of bedside or central monitor used.

The number of central monitors and bedside monitors that can be connected to a central monitor network and the network communication method depends on the type of monitor used. For details, refer to the Network and System Installation Guide.

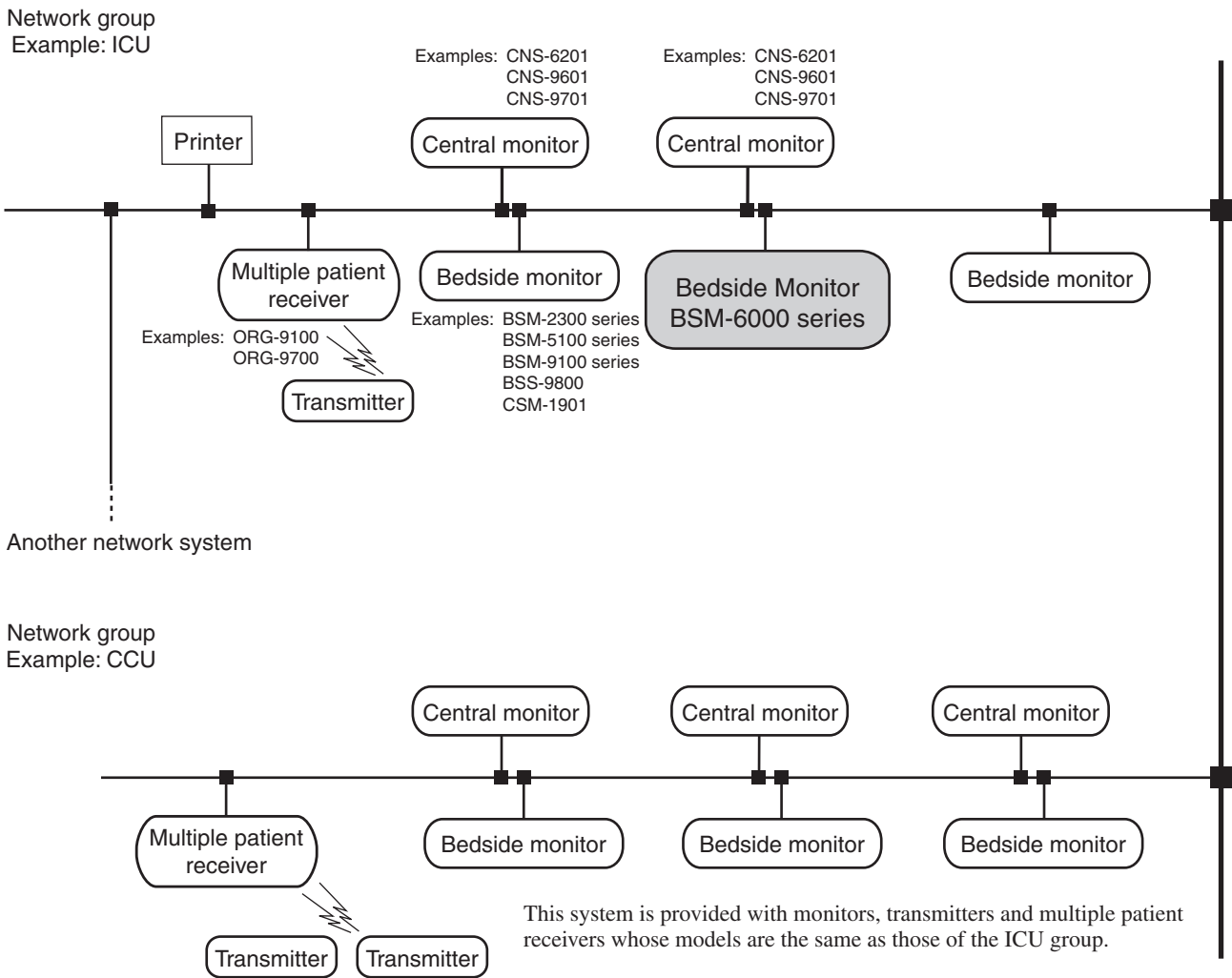

WARNING

Install all network devices, including printer and hubs, outside the patient environment (IEC 60601-1-1). If they are installed inside the patient environment, the patient or operator may receive electrical shock or injury. For installation, contact your Nihon Kohden representative.

WARNING

Check the software version number of the monitor before connecting it to the network. Different software versions have different communication methods. More than one communication method in a network may cause communication failure. For details, refer to the Network and System Installation Guide.

Panel Description

MU-631R Main Unit

Front Panel

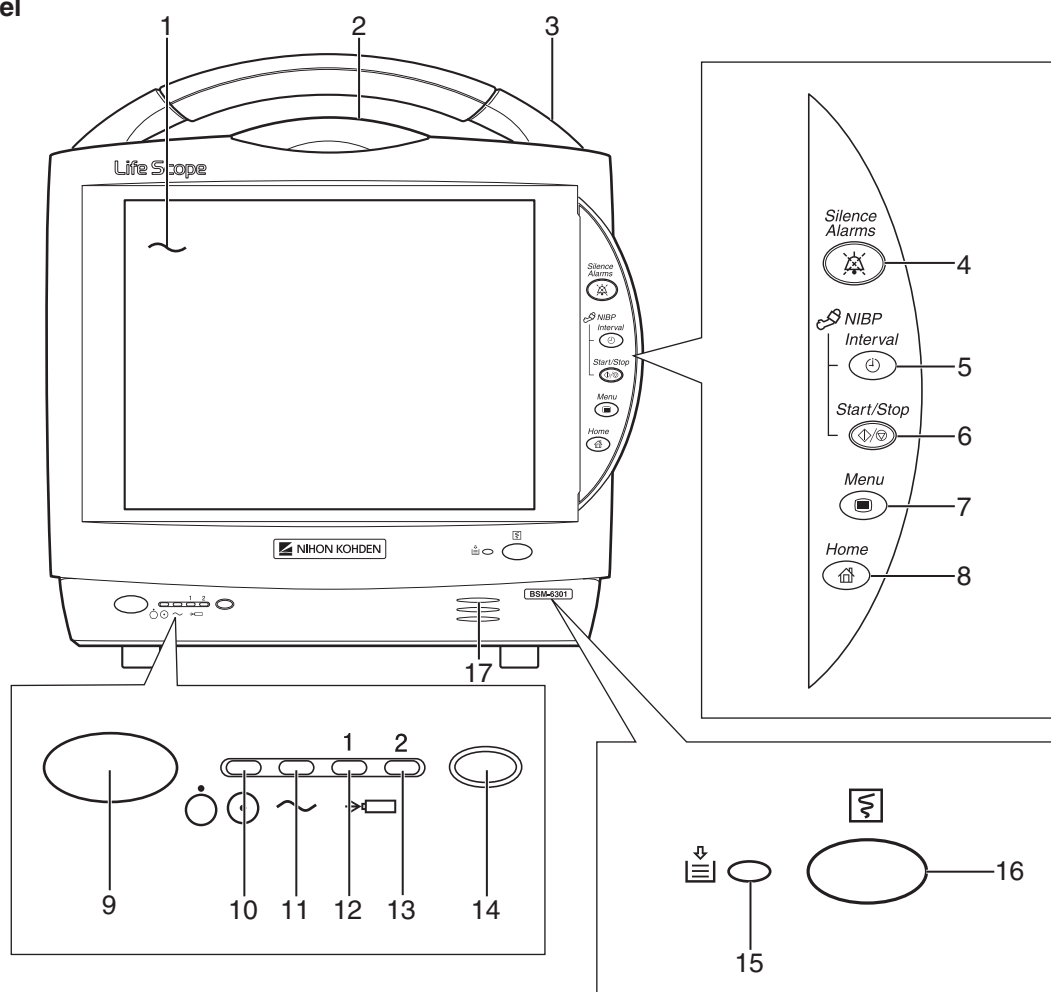

1 Touch screen

Displays monitoring data. Touching a key or data on the screen changes the displayed screen and settings.

2 Alarm indicator

Red or yellow lamp blinks, or yellow or cyan lamps lights according to the alarm settings. Green lamp blinks in synchronization with the patient's QRS or pulse.

3 Handle

For carrying the monitor.

4 Silence Alarms key

Silences the alarm sound.

5 NIBP Interval key

Selects NIBP measurement mode. Pressing this key changes the mode.

6 NIBP Start/Stop key

Starts NIBP measurement in selected mode. Pressing the key during measurement stops measurement.

7 Menu key

Displays the MENU window.

8 Home key

Closes all opened windows and displays the home screen.

9 Power switch

Press to turn the monitor power on. When turning the monitor power off, press and hold for more than three seconds.

10 Power lamp

Lights when the monitor power is turned on.

11 AC power lamp

Lights when the power cord is connected between the AC SOURCE socket and AC outlet.

12 Battery lamp 1

Indicates a battery status of the battery in the battery slot 1.

13 Battery lamp 2

Indicates a battery status of the battery in the battery slot 2.

14 Remote control sensor

Receives an infrared signal from the remote control.

15 ERROR lamp (option)

Blinks when out of paper. Lights when the recorder door is open.

16 RECORD/STOP key (option)

Press to start or stop recording.

17 Speaker

For alarms and sync sound.

1. GENERAL

Left Side Panel

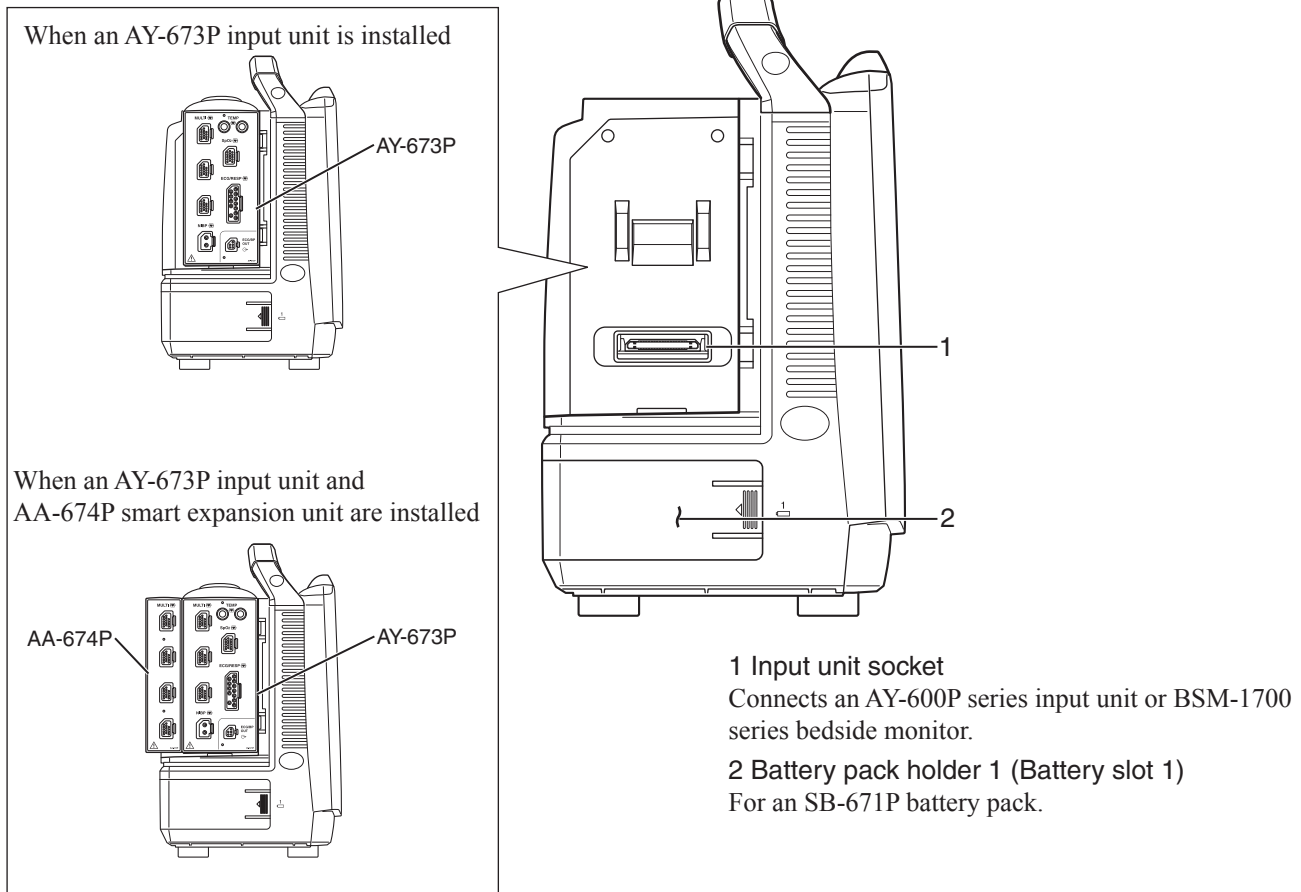

Right Side Panel

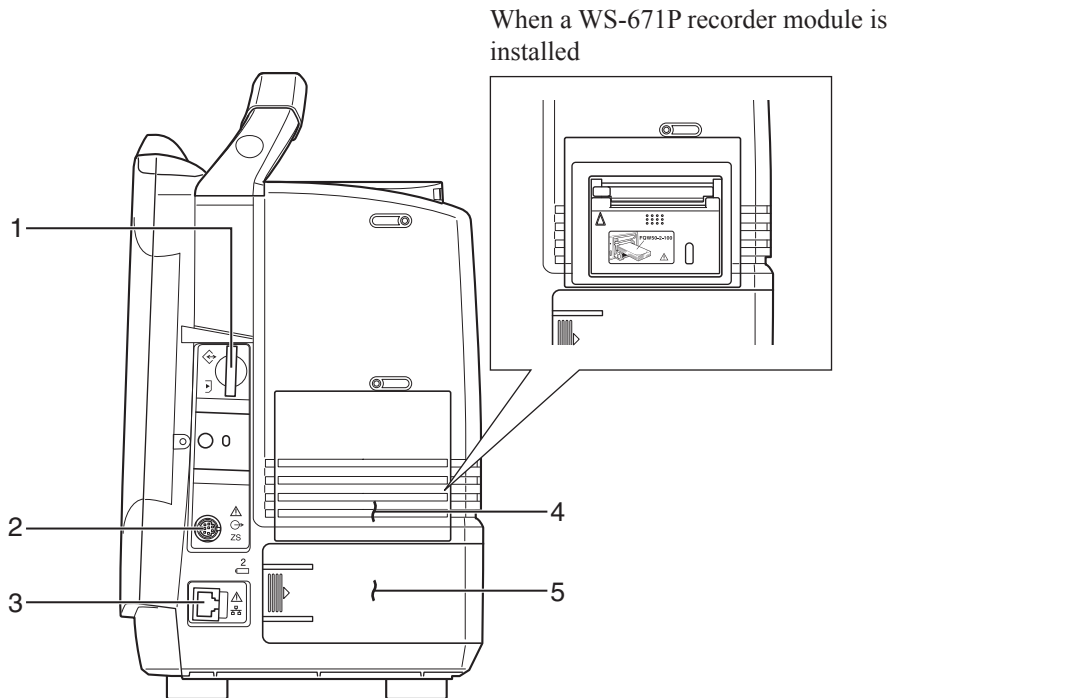

Rear Panel

Example shows QI-631P and QI-632P interfaces installed.

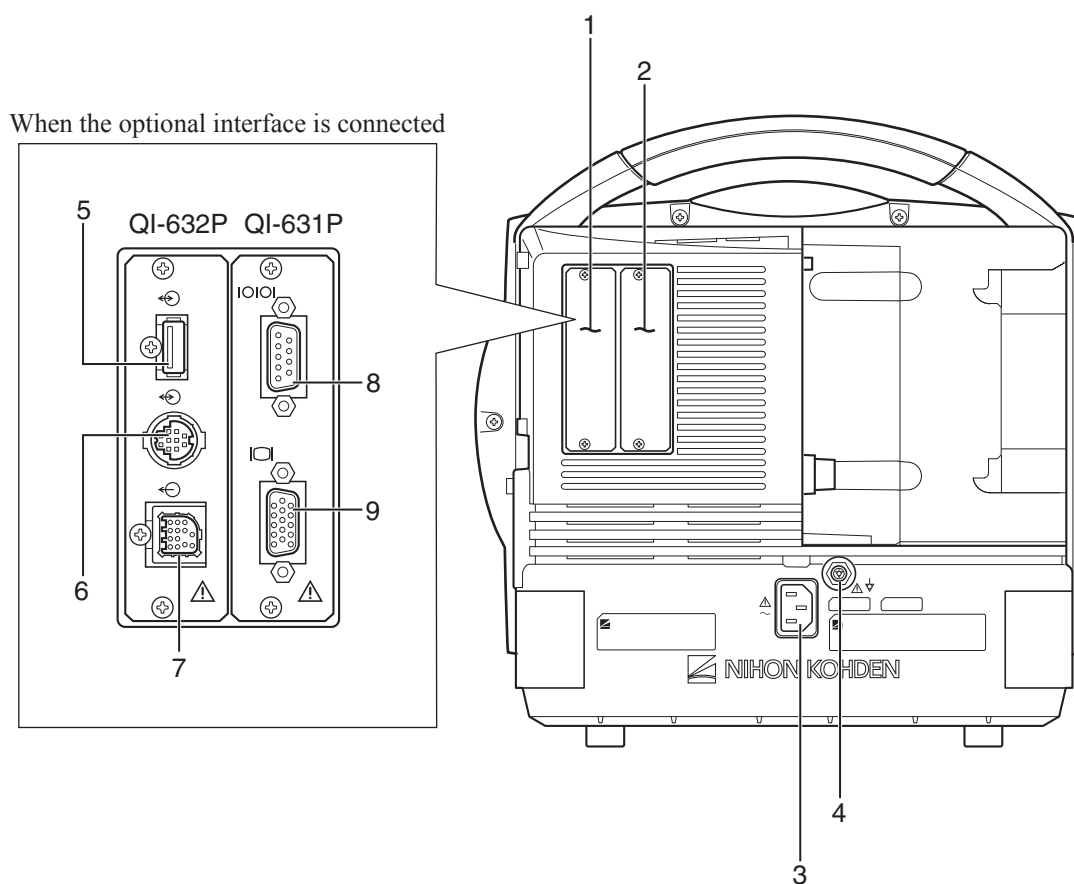

1 QI-632P/QI-634P interface socket
Connects a QI-632P or QI-634P interface.

2 QI-631P interface socket
Connects a QI-631P interface.

3 AC SOURCE power cord socket
For the AC power cord.

4 Equipotential grounding terminal
For an equipotential grounding lead.

5 USB socket (QI-632P/QI-634P)
Connects a mouse or bar code reader.

6 Multi-link socket (QI-632P/QI-634P)
Connects a QF series interface, IF series communication cable or multi-link cable of an external unit.

7 Alarm socket (QI-632P)
Connects a YJ-672P nurse call cable.

8 RS-232C socket (QI-631P)
Connects a YJ-672P nurse call cable.

9 RGB socket (QI-631P)
Outputs an RGB video signal. Connects to a slave display.

1. GENERAL

MU-651R/MU-671R Main Unit

Front Panel

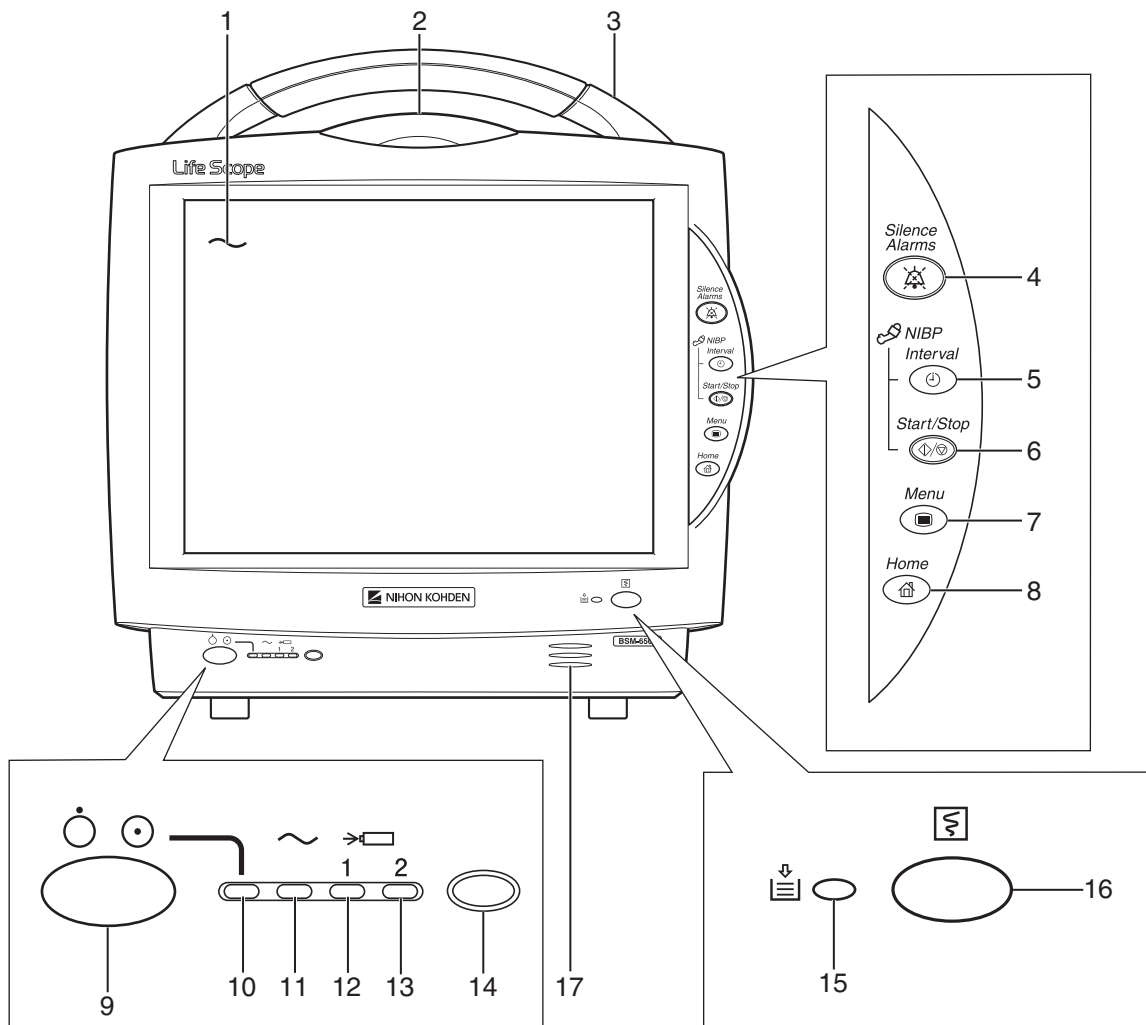

1 Touch screen

Displays monitoring data. Touching a key or data on the screen changes the displayed screen and settings.

2 Alarm indicator

Red or yellow lamp blinks, or yellow or cyan lamps lights according to the alarm settings. Green lamp blinks in synchronization with the patient's QRS or pulse.

3 Handle

For carrying the monitor.

4 Silence Alarms key

Silences the alarm sound.

5 NIBP Interval key

Selects NIBP measurement mode. Pressing this key changes the mode.

6 NIBP Start/Stop key

Starts NIBP measurement in selected mode. Pressing the key during measurement stops measurement.

7 Menu key

Displays the MENU window.

8 Home key

Closes all opened windows and displays the home screen.

9 Power switch

Press to turn the monitor power on. When turning the monitor power off, press and hold for more than three seconds.

10 Power lamp

Lights when the monitor power is turned on.

11 AC power lamp

Lights when the power cord is connected between the AC SOURCE socket and AC outlet.

12 Battery lamp 1

Indicates a battery status of the battery in the battery slot 1.

13 Battery lamp 2

Indicates a battery status of the battery in the battery slot 2.

14 Remote control sensor

Receives an infrared signal from the remote control.

15 ERROR lamp (option)

Blinks when out of paper. Lights when the recorder door is open.

16 RECORD/STOP key (option)

Press to start or stop recording.

17 Speaker

For alarms and sync sound.

Left Side Panel

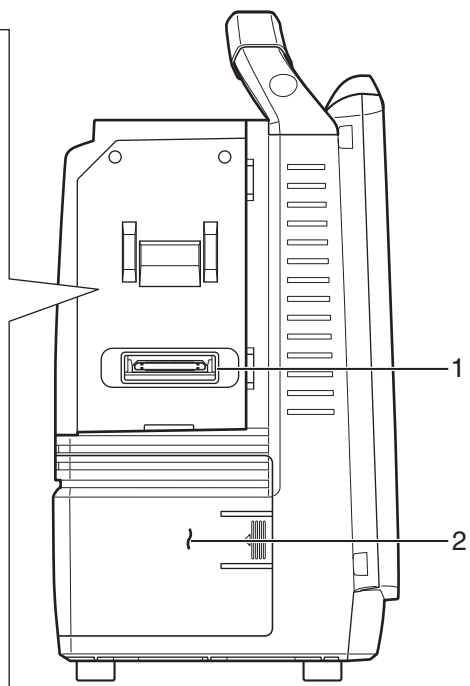
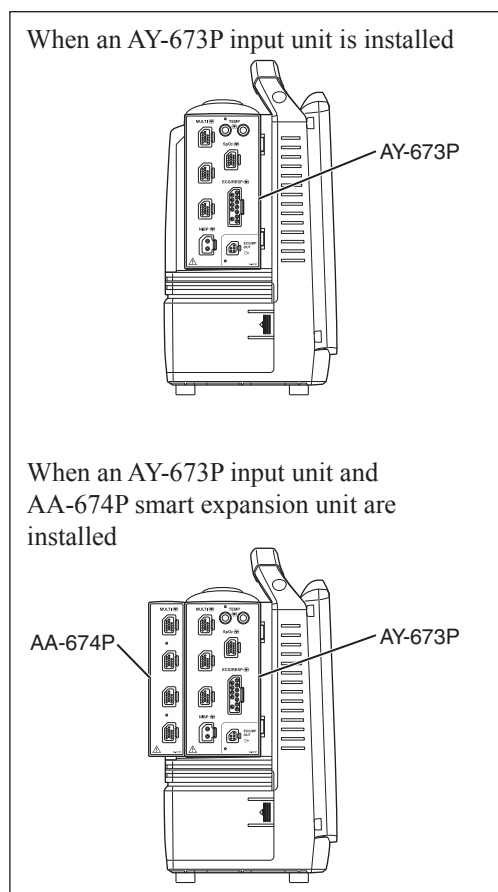

- 1 Input unit socket**
Connects an AY-600P series input unit or BSM-1700 series bedside monitor.
- 2 Battery pack holder**
For an SB-671P battery pack.

Right Side Panel

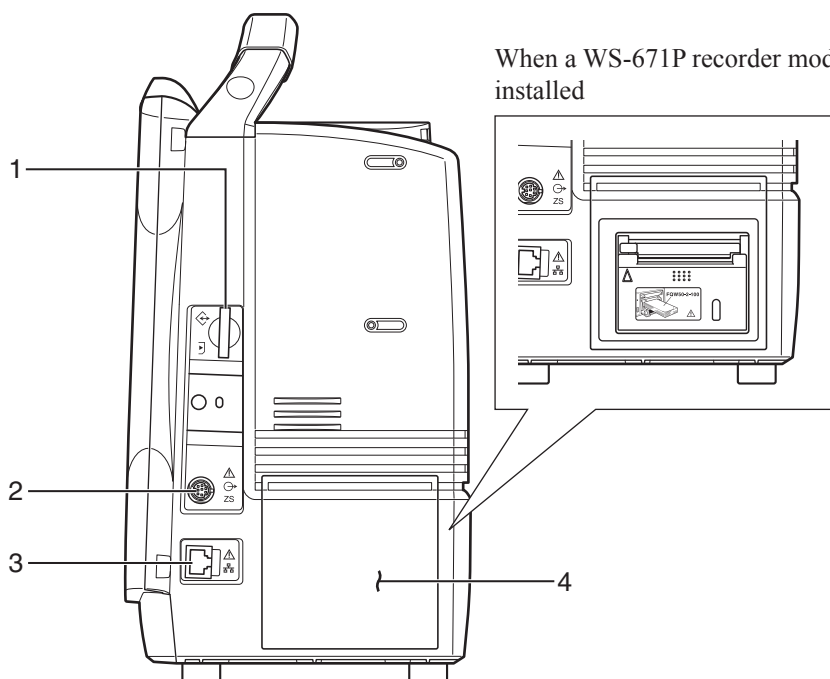

- 1 SD card slot**
For an SD card or program card.
- 2 ZS socket**
For a ZS-900P* transmitter.
* The ZS-900P transmitter is not available for the BSM-6000A series.
- 3 Network socket**
Connects to a monitoring network via a network separation unit.
- 4 Recorder module holder**
For a WS-671P recorder module.

1. GENERAL

Rear Panel

When the optional interface is connected

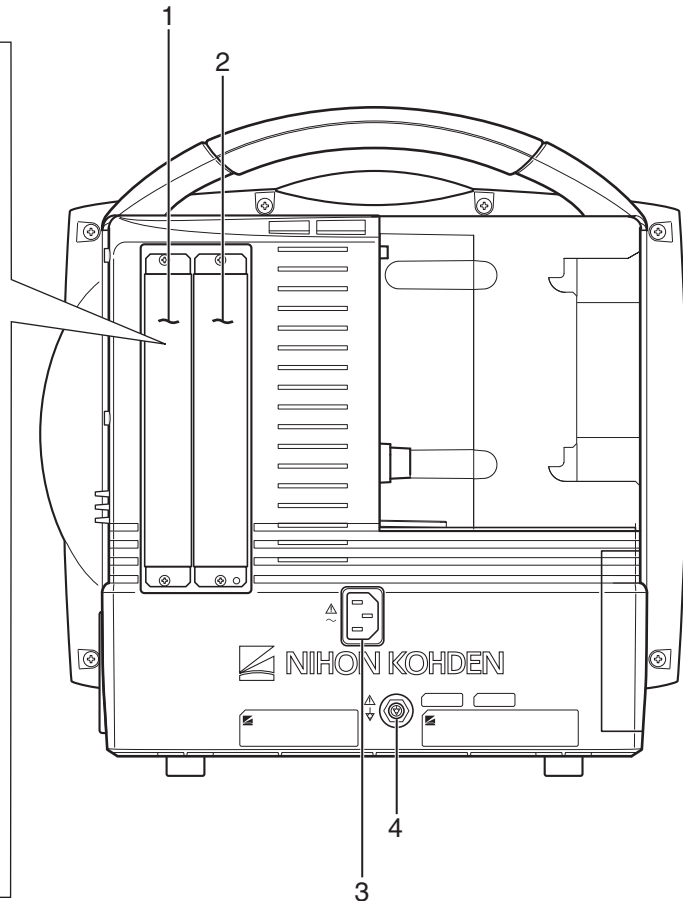
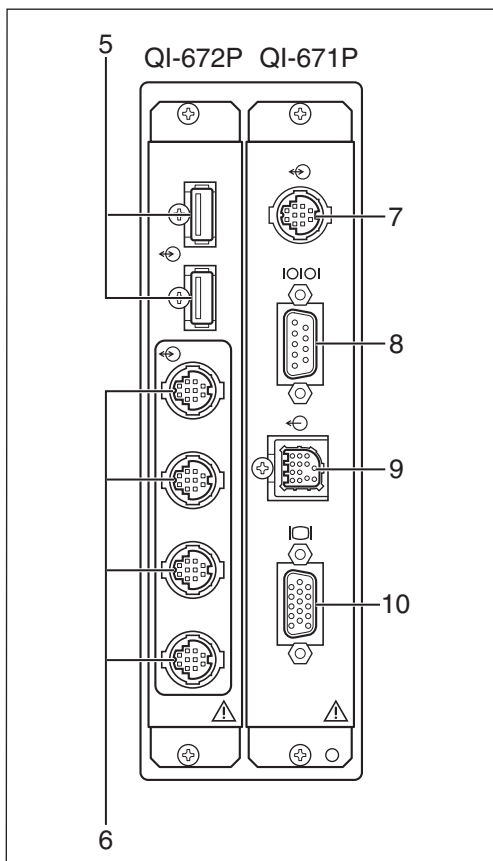

1 QI-672P interface socket

Connects a QI-672P interface.

2 QI-671P interface socket

Connects a QI-671P interface.

3 AC SOURCE power cord socket

For the AC power cord.

4 Equipotential grounding terminal

For an equipotential grounding lead.

5 USB sockets

Connects to a mouse or bar code reader.

6 Multi-link sockets

Connects a QF series interface, IF series communication cable or multi-link cable of an external unit.

7 Multi-link sockets

Connects a QF series interface, IF series communication cable or multi-link cable of an external unit.

8 RS-232C socket

Not available.

9 Alarm socket

Connects a YJ-672P nurse call cable.

10 RGB socket

Outputs an RGB video signal. Connects to a dual display or slave display.

AY-631P/633P/651P/653P/660P/661P/663P/671P/673P Input Unit

Front Panel

One MULTI socket

Example is AY-671P input unit.

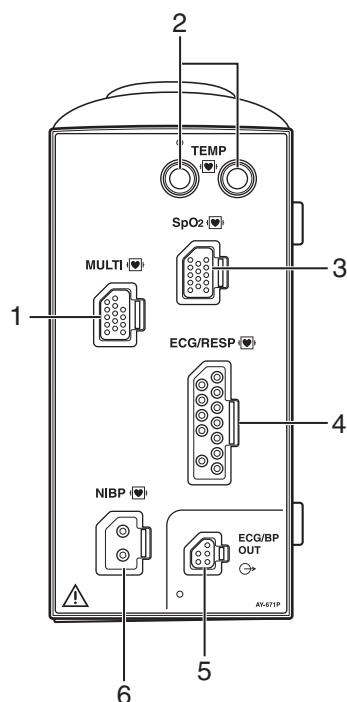

Three MULTI sockets

Example is AY-673P input unit.

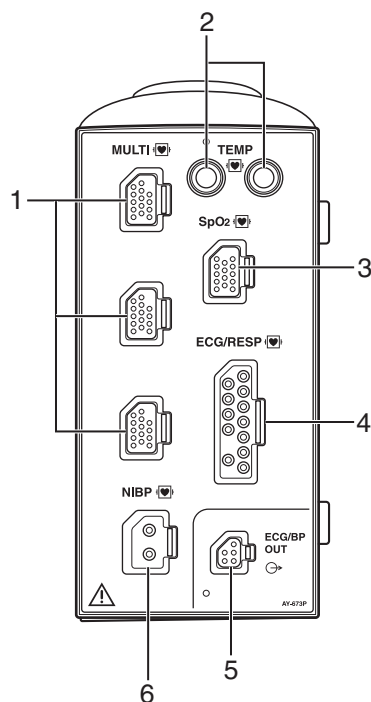

AY-660P: One TEMP socket, one MULTI socket, no ECG/BP OUT socket

AY-631P/AY-651P/AY-661P/AY-671P: One MULTI socket

AY-633P/AY-653P/AY-663P/AY-673P: Three MULTI sockets

NOTE

- AY-660P, AY-661P and AY-663P input units are not available for BSM-6000A series.
- With the MULTI socket on the AY-660P input unit, either IBP or CO₂ can be monitored.

1 MULTI socket

Connects to the connection cord of the parameter to be monitored (IBP, temperature, CO, CO₂, SpO₂-2 (AY-661P, AY-663P, AY-671P or AY-673P only), O₂, respiration by thermistor method, BIS or CCO (APCO)). The type of parameter is automatically recognized.

2 TEMP socket

Connects to the temperature probe cable.

3 SpO₂ socket

Connects to the SpO₂ connection cord.

4 ECG/RESP socket

Connects to the ECG connection cord.

5 ECG/BP OUT socket

Outputs 100 mmHg/V IBP waveform and 1 mV/V ECG waveform by using the YJ-910P or YJ-920P ECG/BP output cable. These analog signals can be used as the synchronization signal for other equipment, such as IABP.

6 NIBP socket

Connects to the air hose.

WARNING

Connect only the specified instrument to the monitor and follow the specified procedure. Failure to follow this warning may result in electrical shock or injury to the patient and operator, and cause fire or instrument malfunction.

Using MULTI Sockets for CO Monitoring

WARNING

When performing defibrillation during cardiac output monitoring, never touch the CO connection cord. The discharged energy may cause electrical shock or injury.

NOTE

CO monitoring using the MULTI socket does not comply with the defibrillator proof type CF.

1. GENERAL

Using the Output Signal from the ECG/BP OUT Socket

CAUTION

When using the output signal from the monitor as the synchronization signal for other equipment such as an IABP (intra-aortic balloon pump) or defibrillator:

- Set the timing of the IABP by checking the waveform on the IABP screen.
- Check the condition of the bedside monitor at all times. The output signal may become unstable.
- Check that the delay time of the output signal is within the range of the connected equipment.

CAUTION

Only a Nihon Kohden defibrillator can use the output signal from the monitor as a synchronization signal. Check that the delay time of the output signal (heart rate trigger 20 ms maximum) is within the range of the connected defibrillator.

NOTE

- When using an IBP waveform as a synchronization signal for other equipment, connect the IBP line to the MULTI socket. The IBP waveform that is used for the synchronization signal depends on the "IBP ANALOG OUT" setting in the SYSTEM SETUP window.
 - When "IBP ANALOG OUT" is set to FIXED POSITION:
The IBP line connected to the top MULTI socket is used.
 - When "IBP ANALOG OUT" is set to HIGHEST PRIORITY LABEL:
When more than one IBP waveform is acquired, the IBP waveform of the highest priority label is used.
IBP label priority:
ART > ART2 > RAD > DORS > AO > FEM > UA > LVP > P1 > P2 > P3 > P4 > P5 > P6 > P7
- The output signal from the ECG/BP OUT socket may become unstable in the following conditions.
 - Electrode is dry or detached.
 - Electrode lead is damaged or disconnected from the electrode.
 - Electrode lead is pulled.
 - AC interference or EMG noise superimposed.
 - Air bubbles or blood clog in the circuit for monitoring IBP.
 - Cord or cable is disconnected or damaged.
- All instruments which are to be connected to the ECG/BP OUTPUT socket must use a YJ-910P or YJ-920P ECG/BP output cable and comply with the IEC 60601-1 safety standard for medical equipment.
- When using an IABP, set <CALCULATION METHOD> on the OTHER page of the PRESS window to "PEAK" to improve measurement accuracy.

Output Signal Delay Time

Output Signal	Delay Time
ECG	maximum 20 ms
IBP	maximum 40 ms
Heart rate trigger	maximum 20 ms

Left Side Panel

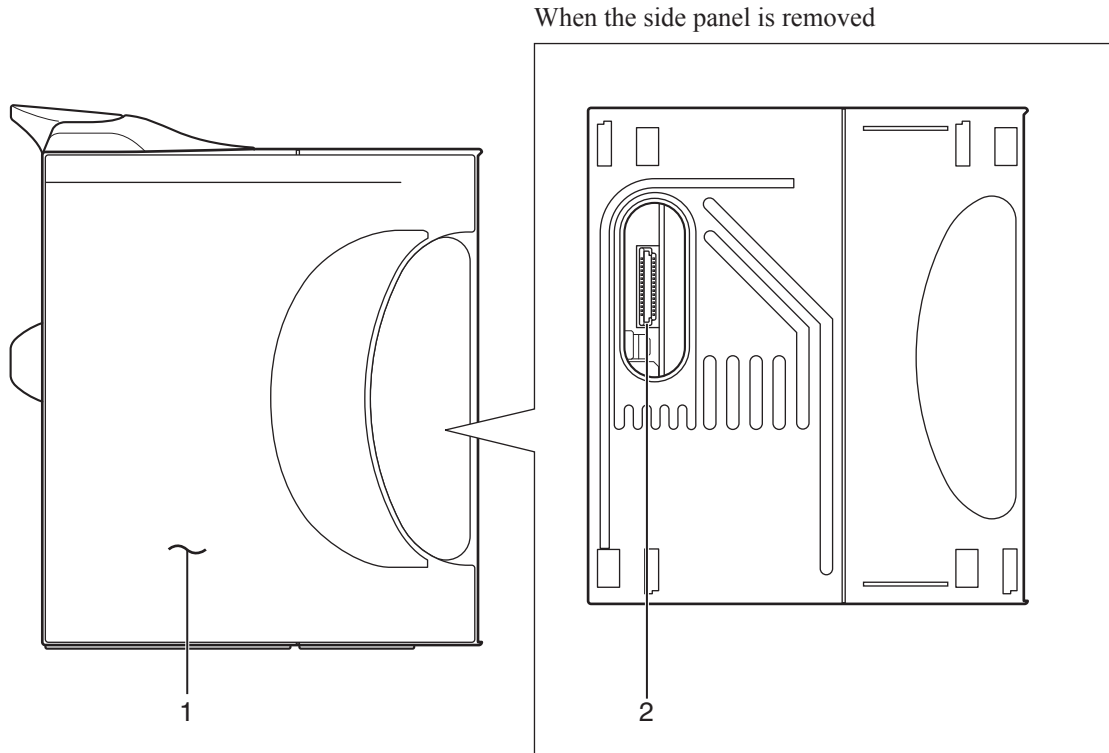

- 1 Side panel
Remove to attach an AA-672P or AA-674P smart expansion unit.
- 2 Smart expansion unit socket
Connects an AA-672P or AA-674P smart expansion unit.

Right Side Panel

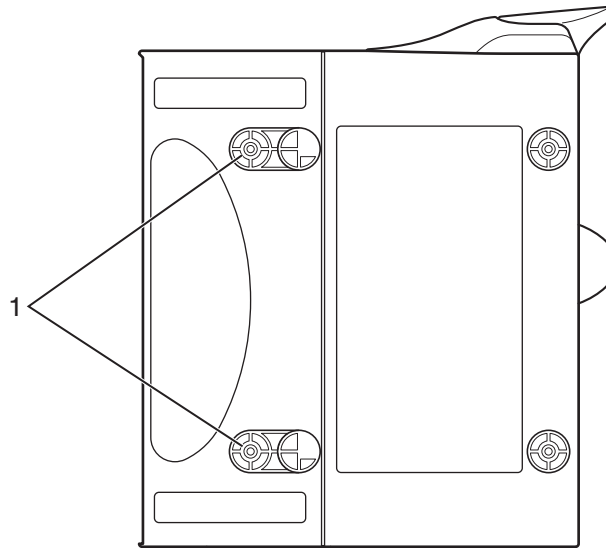

- 1 Tabs
Match the tabs on the input unit to the slots on the bedside monitor.

1. GENERAL

Rear Panel

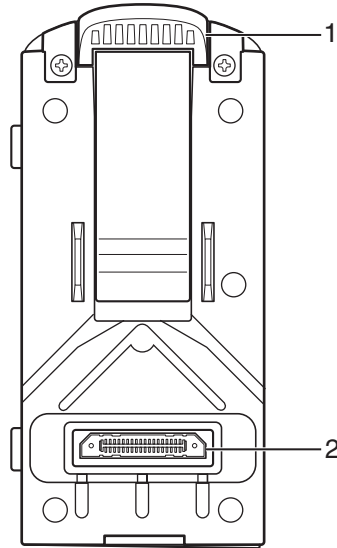

- 1 Lock release lever
Lift up the lever to remove the input unit from the bedside monitor.
- 2 Input unit socket
For connecting a bedside monitor.

AA-672P/AA-674P Smart Expansion Unit

NOTE

AA-672P or AA-674P smart expansion unit cannot be used with AY-660P input unit.

Front Panel

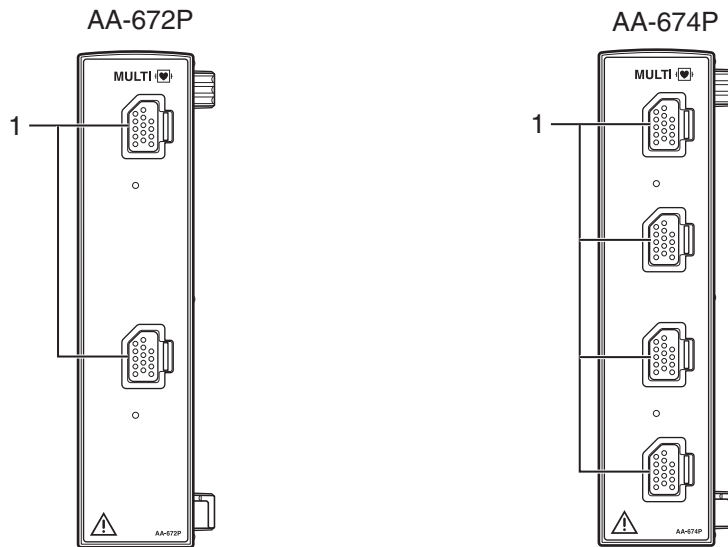

- 1 MULTI socket
Connect to the connection cord of the parameter to be monitored (Respiration by thermistor method, CO₂, SpO₂-2 (only when an AY-661P, AY-663P, AY-671P or AY-673P input unit is used), IBP, temperature, CO, O₂, BIS or CCO (APCO)). The type of parameter is automatically recognized.

Using MULTI Sockets for CO Monitoring

WARNING

When performing defibrillation during cardiac output monitoring, never touch the CO connection cord. The discharged energy may cause electrical shock or injury.

NOTE

CO monitoring using the MULTI socket does not comply with the defibrillator proof type CF.

Right Side Panel

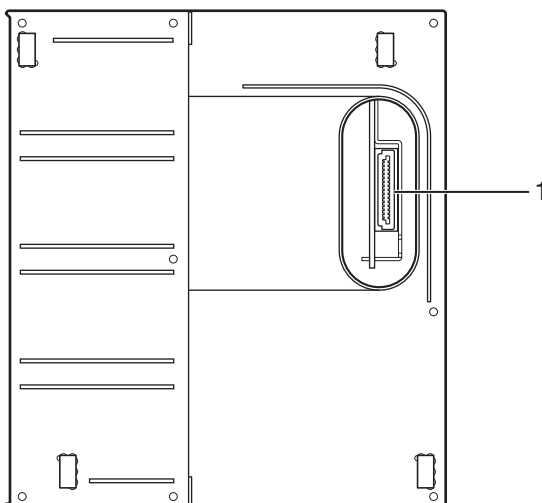

1 Connector

Connects an AY-631P, AY-633P, AY-651P, AY-653P, AY-661P, AY-663P, AY-671P or AY-673P input unit.

BSM-1700 series Bedside Monitor

Refer to the manuals of the BSM-1700 series bedside monitor.

1. GENERAL

QF series Interface and IF series Communication Cable

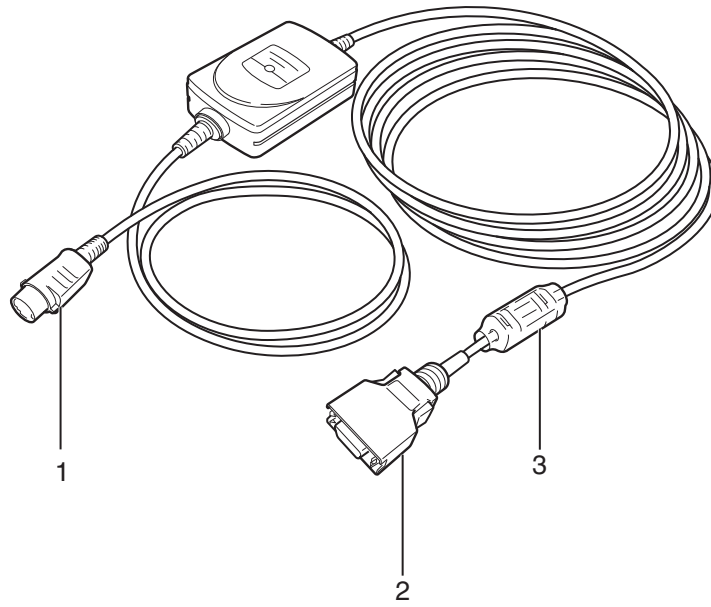

- 1 Multi-link connector
Connect to the multi-link socket on the bedside monitor.
- 2 External device connector
Connect to an external device.
- 3 Ferrite core

RY-910PA Remote Controller

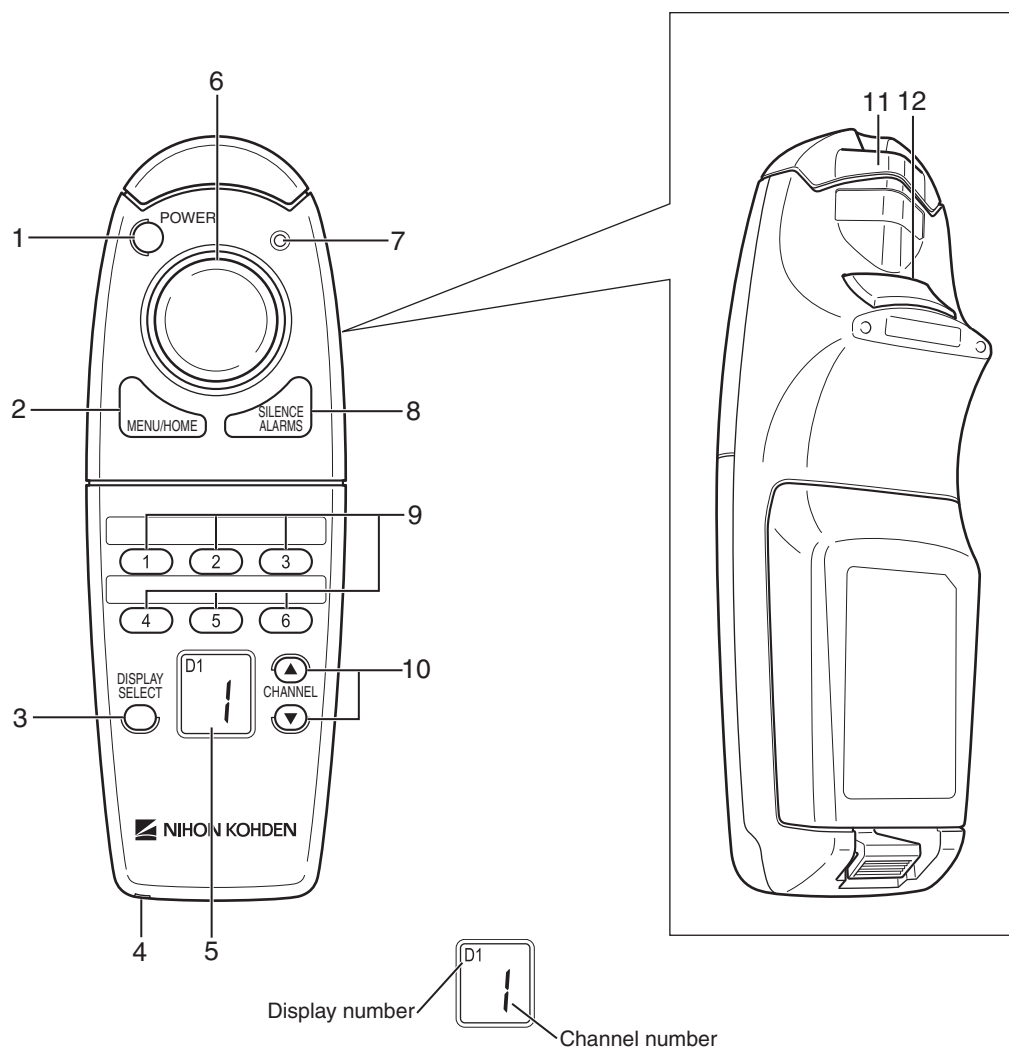

1 Power button

When the power cord is connected between the bedside monitor and AC outlet, turns the monitor power on or off.

2 MENU/HOME key

Opens the MENU window. Closes the window and displays the home screen when a window is opened.

3 DISPLAY SELECT key

Not available.

4 Strap hole

Use a strap to prevent dropping the remote control.

5 Display

Displays the channel number and the display number.

6 Selection knob

Move this knob up/down/left/right to move the cursor or mouse pointer on the screen.

7 LED

Lights when the pointer on the screen is moved by the selection knob. Blinks when a key on the remote control is pressed.

8 SILENCE ALARMS key

Silences the alarm sound.

9 Customized keys

Windows and functions can be assigned to each key for shortcut key operations.

10 CHANNEL keys

Select the monitor when a channel is assigned to the monitor.

11 Transmitter

Signal is transmitted from here. Point the transmitter to the remote control sensor on the bedside monitor when operating the monitor with the remote control.

12 ENTER key

Registers the setting selected on the screen.

Basic Operating Concepts

Screen Displays

Following are the screens and windows available on the Life Scope TR bedside monitor. For details about the individual screens and windows, see the appropriate section.

The shadow of the previous screen may remain for a few minutes after changing the screen.

Normally, the home screen is displayed. All screens, except for the LARGE NUMERICS screen, SYSTEM CONFIGURATION screen, 12 LEAD ANALYSIS window, DRUG window, INTERBED window and the MEASURE page of the CO window, return to the home screen when there is no key operation for about 3 minutes.

Home screen

Home

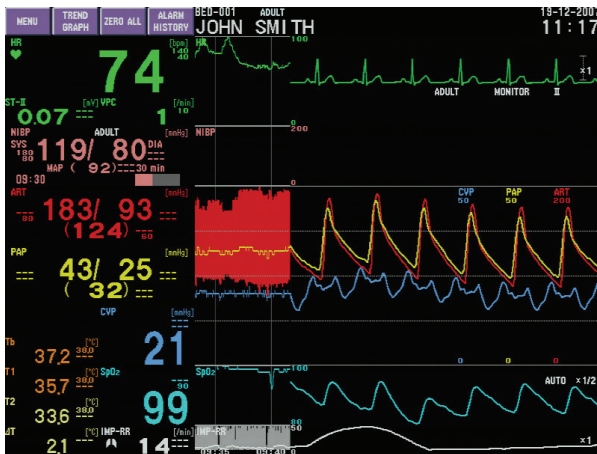

- The home screen can be displayed anytime by pressing the [Home] key on the bedside monitor.
- Displays waveforms and data of the monitoring parameters.
- Touching the patient name displays the ADMIT page for changing patient information.
- Touching the parameter data displays the parameter setting window.

MENU window

Menu

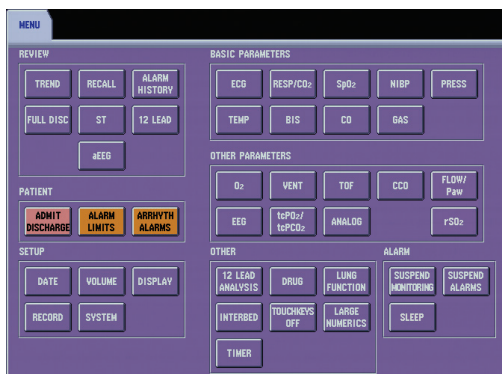

The MENU window can be displayed anytime by pressing the [Menu] key on the bedside monitor. From the MENU window, you can display any window except the home screen.

Review windows

- TREND GRAPH page for displaying 24 hour trend graphs of up to 6 selected parameters.
- TREND TABLE page for displaying table of parameter data.
- NIBP TREND page for displaying vital signs data with NIBP measurement.
- HEMO TREND page for displaying hemodynamics data when CO is measured.
- LUNG TREND page for displaying lung function measurement data.

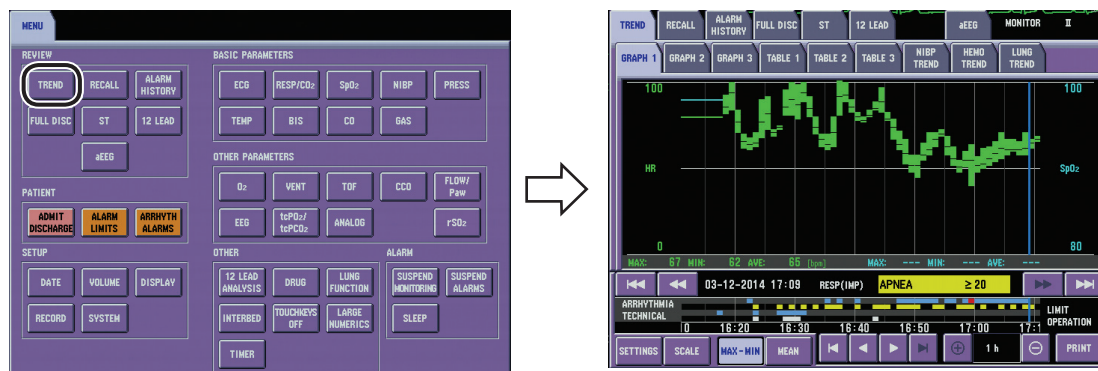

ARRHYTHM RECALL window for displaying arrhythmia recall data.

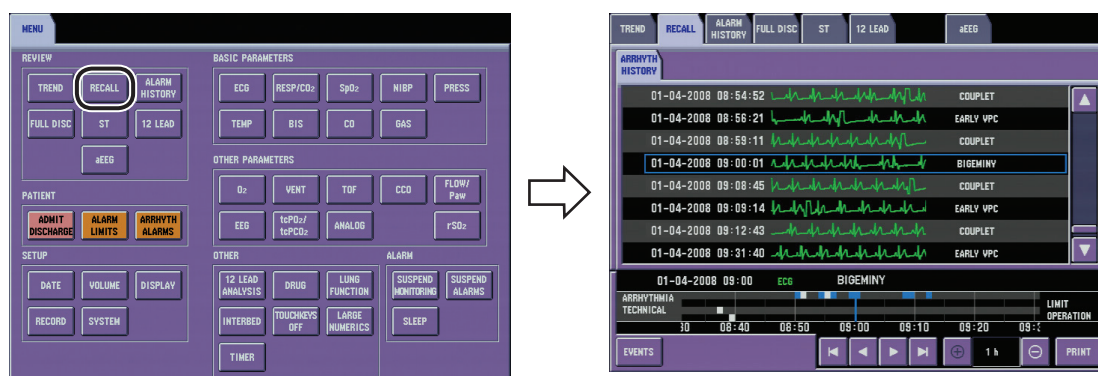

ALARM HISTORY window for displaying vital sign data at alarm occurrence.

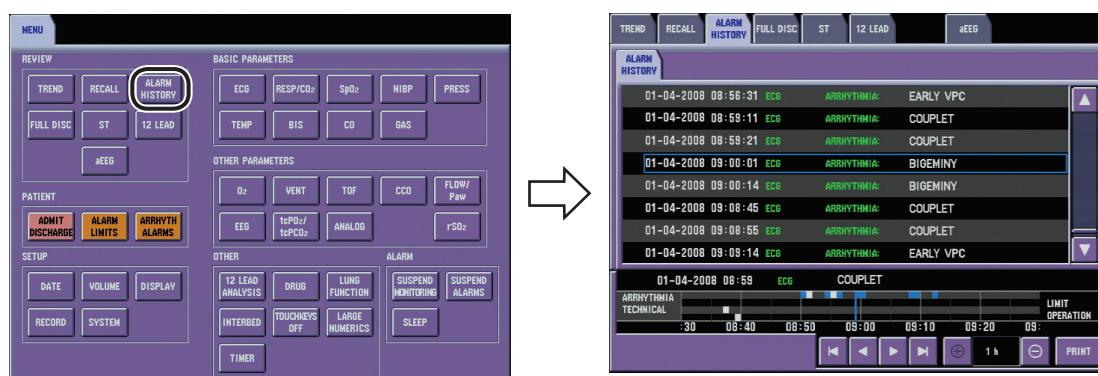

FULL DISC window for displaying full disclosure waveforms. Up to 5 parameters can be saved.

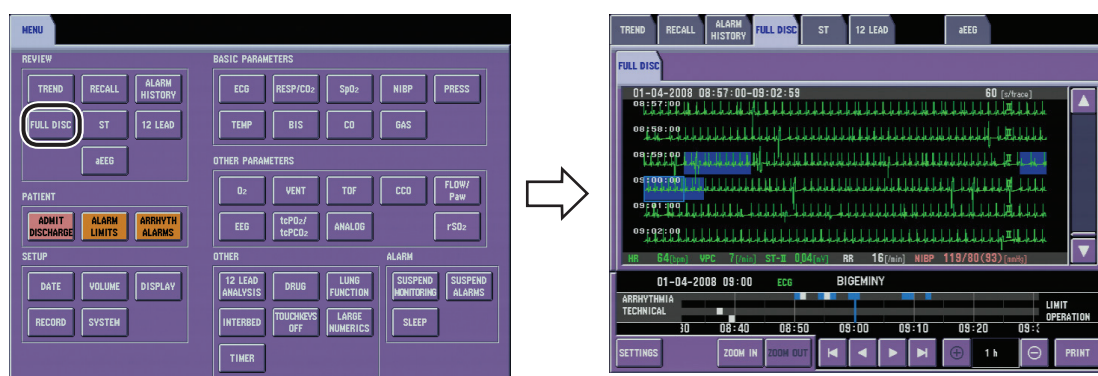

1. GENERAL

ST window for displaying ST level recall waveforms. ST measurement condition can be changed.

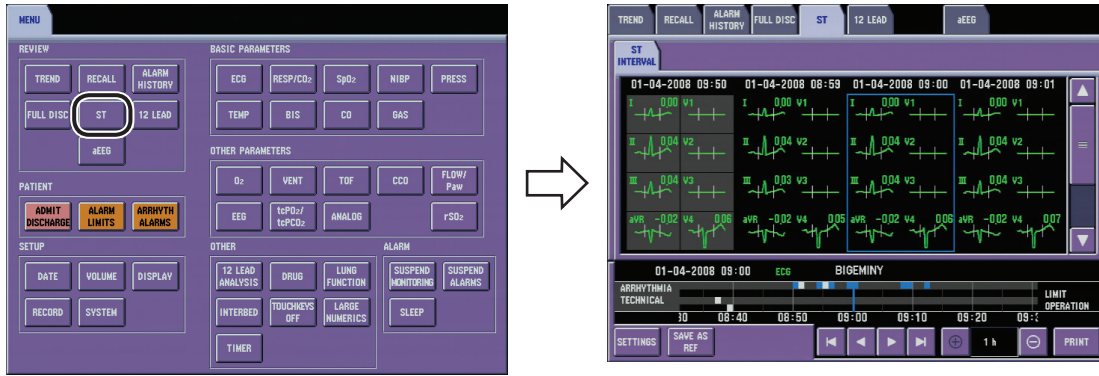

12 LEAD window for displaying 12 lead ECG interpretation and analysis results. On BSM-6000A series, this is not available when the site mode is NICU and 12 LEAD ANALYSIS is set to Off in the SYSTEM CONFIGURATION screen.

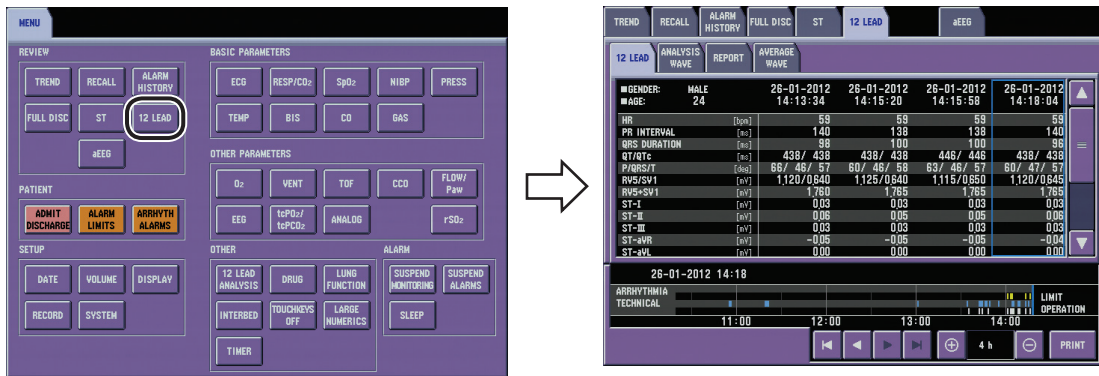

OCRG window for displaying OCRG trendgraph. Only available when the site mode is NICU.

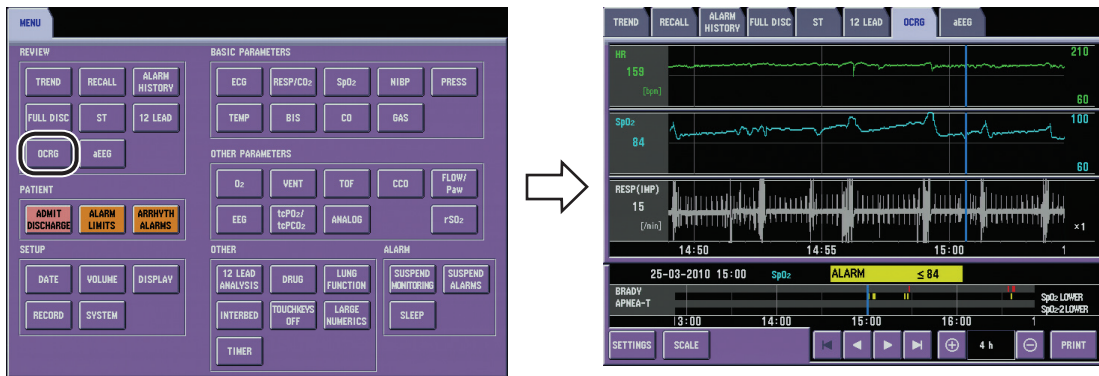

aEEG window for displaying aEEG traces. Not available for BSM-6301A/K.

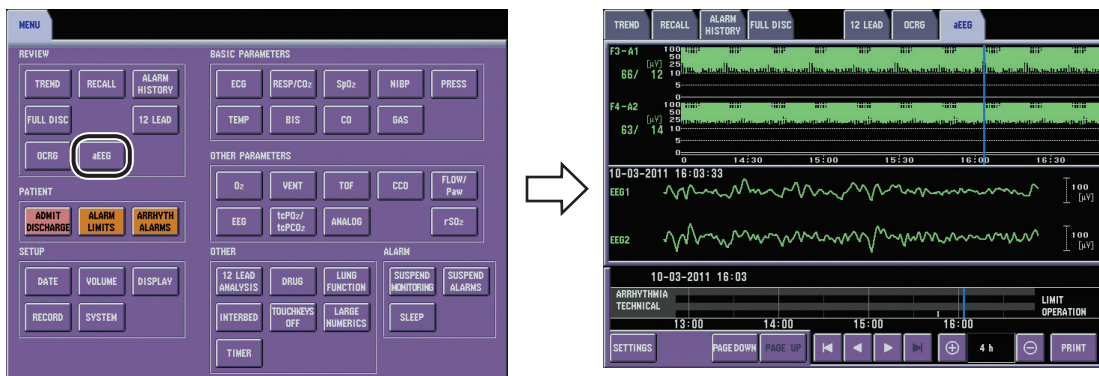

Patient windows

ADMIT DISCHARGE window for admitting/discharging a patient. Data can be deleted on this window.

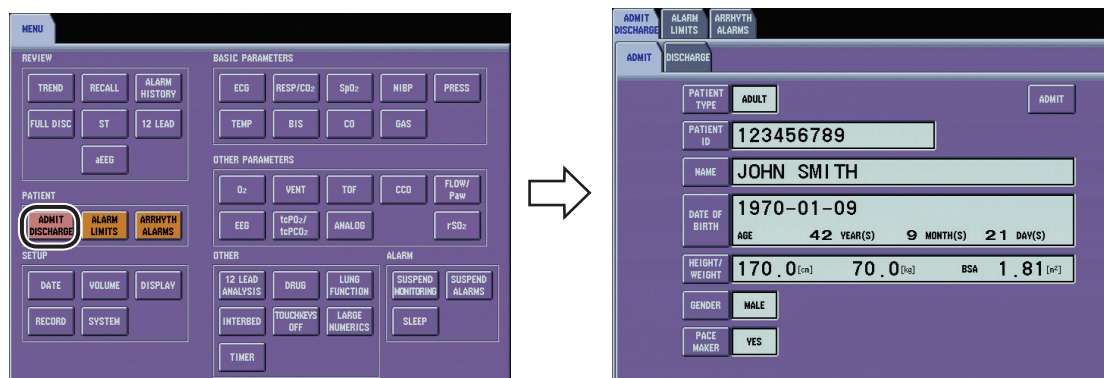

ALARM LIMITS window for setting vital signs alarm and ARRRHYTHM ALARMS window for setting arrhythmia alarms.

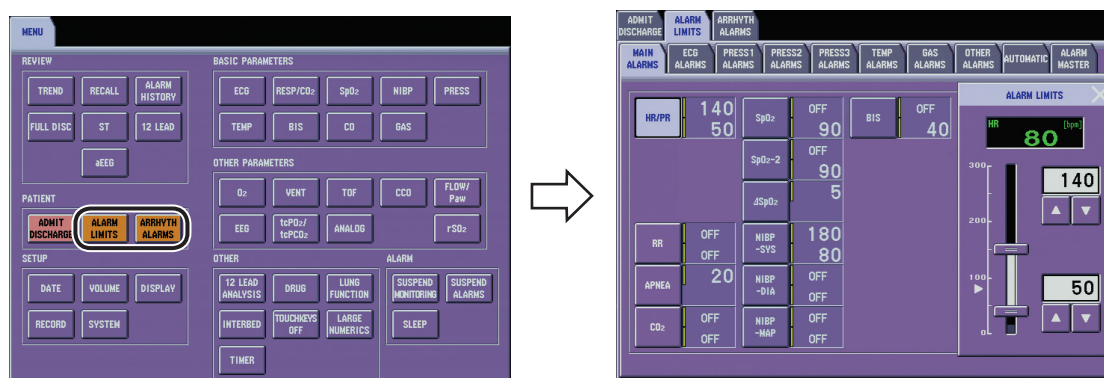

Parameter setting windows

For changing parameter monitoring settings. Example is ECG window. FLOW/Paw is not available for BSM-6000A series.

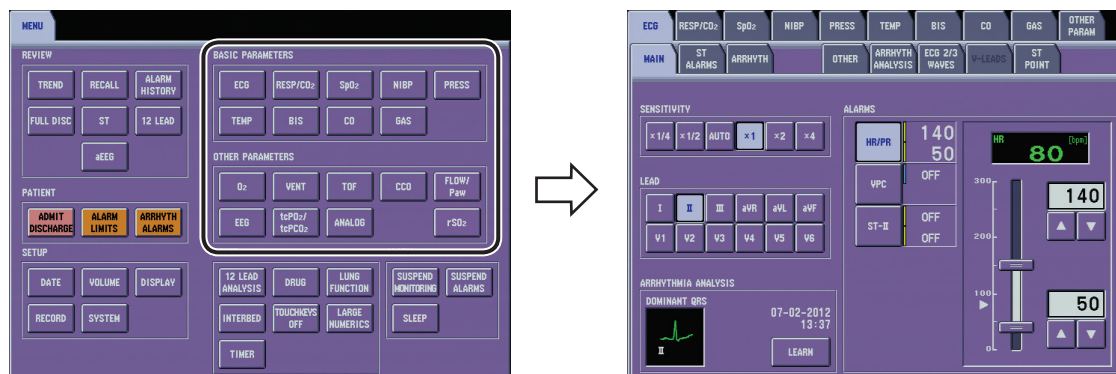

Setup windows

- DATE window for changing date and time
- VOLUME window for changing alarm and sync sound volume
- DISPLAY window for setting number of ECG waveforms on the home screen, PRESS waveform display type, waveform sweep speed, and respiration/CO₂ waveform sweep speed
- RECORD window for setting recording parameters
- SYSTEM window for checking assigned functions to the remote control keys

1. GENERAL

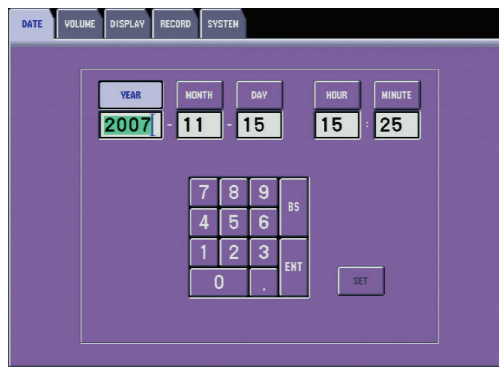
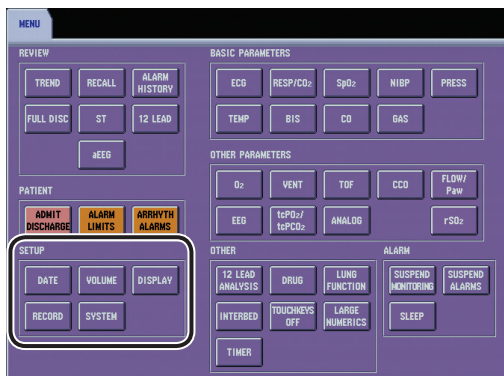

Other windows

12 LEAD ANALYSIS window for displaying simultaneous 12 lead ECG. 12 lead ECG interpretation can be performed. On BSM-6000A series, this is not available when the site mode is NICU and 12 LEAD ANALYSIS is set to Off in the SYSTEM CONFIGURATION screen.

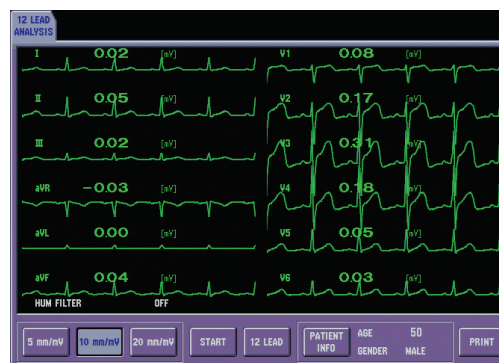
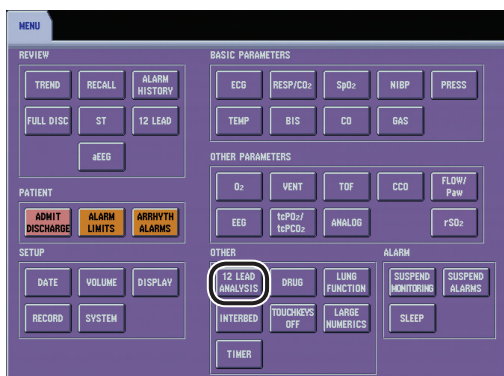

DRUG window for registering drug and units, calculating drug and displaying the table of the selected drug titration.

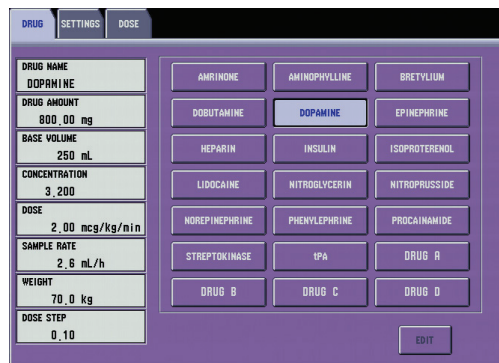
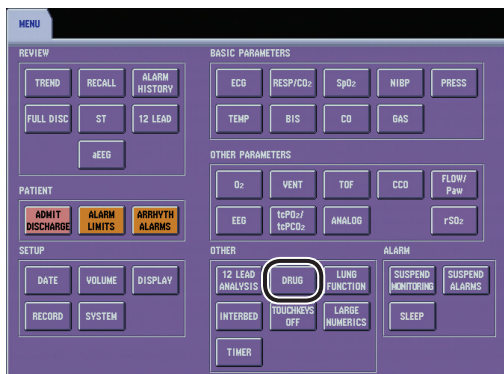

LUNG FUNCTION window for calculating the respiration dynamics.

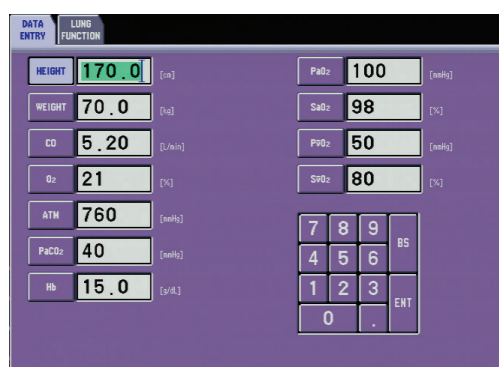
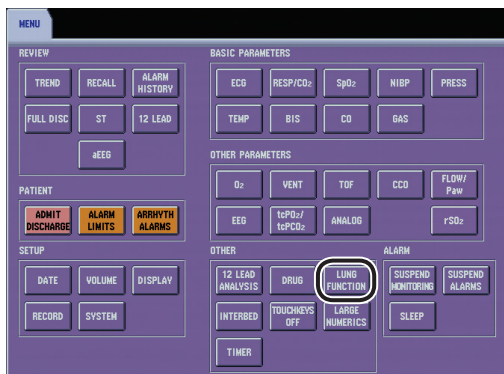

INTERBED window for displaying interbed beds when the monitor is connected to a network.

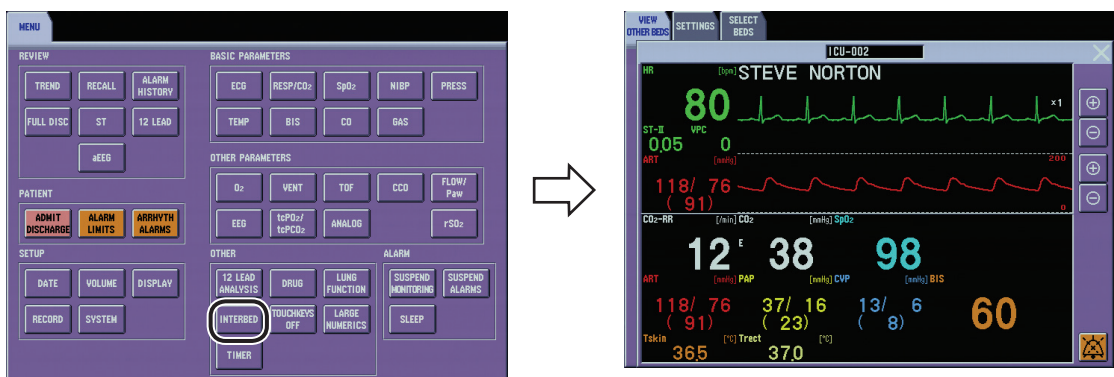

TOUCH KEYS OFF window for turning touch screen function off.

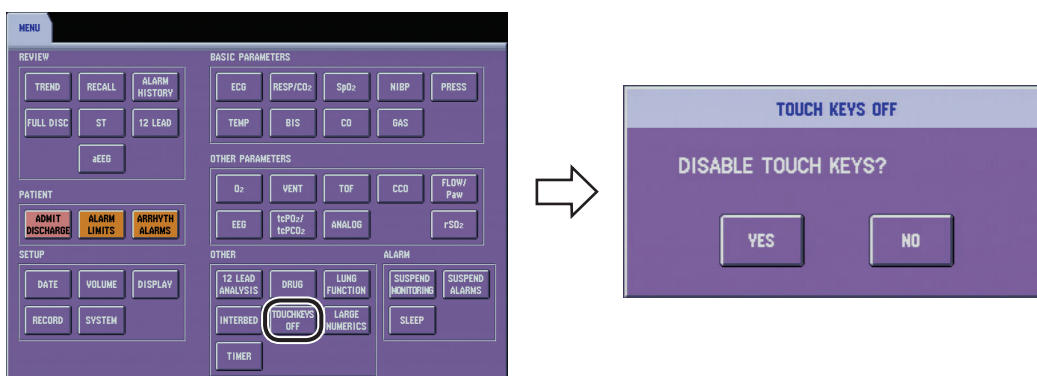

LARGE NUMERICS window for displaying numeric data.

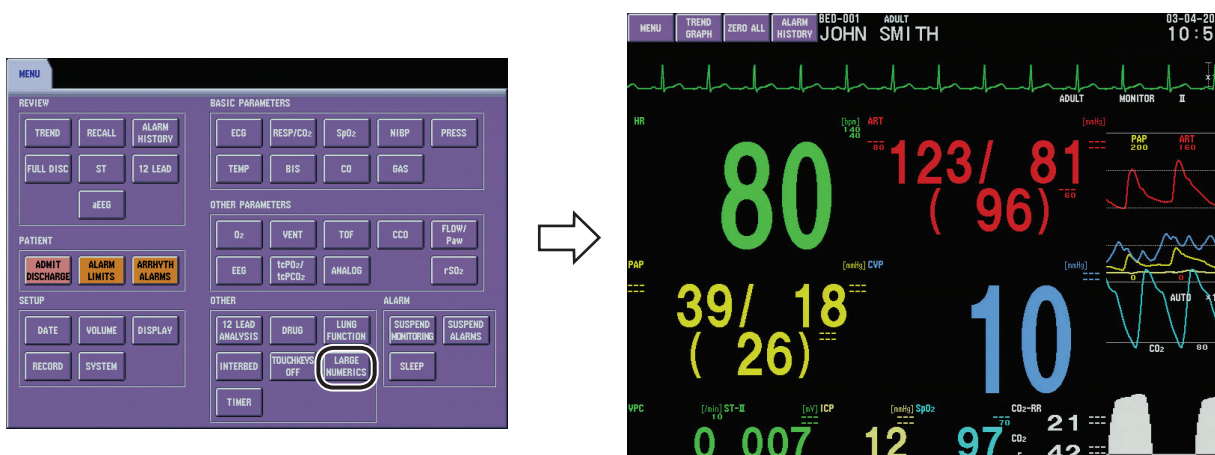

TIMER window for counting up the elapsed time.

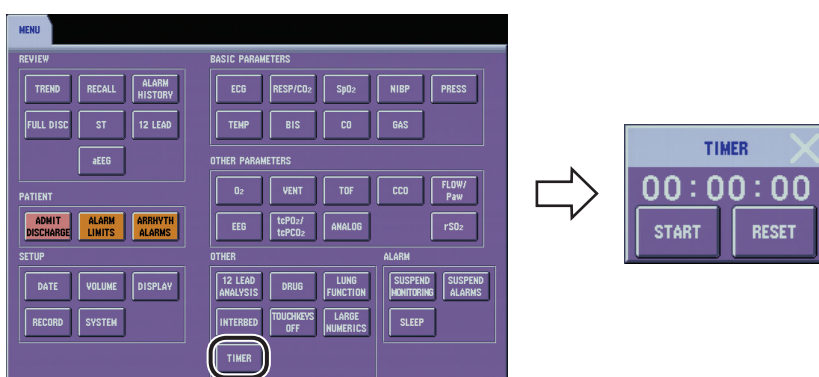

1. GENERAL

CAR SEAT CHALLENGE window for measuring a neonate’s lower heart rate limit, lower SpO₂ limit and apnea time for a set duration. This is only available on BSM-6000A series when the site mode is NICU.

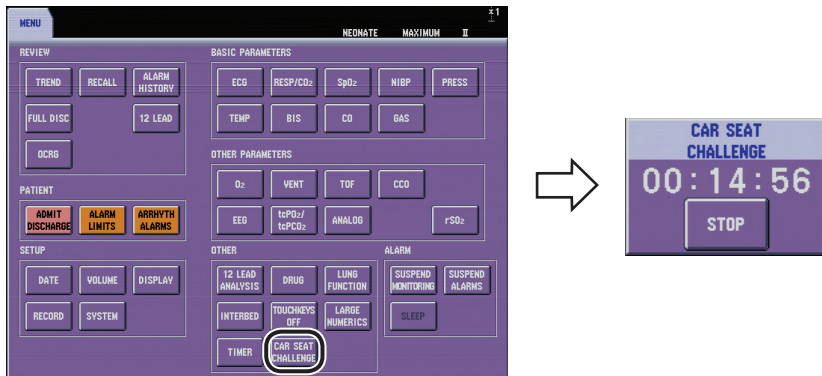

SLEEP window for turning sleep mode on.

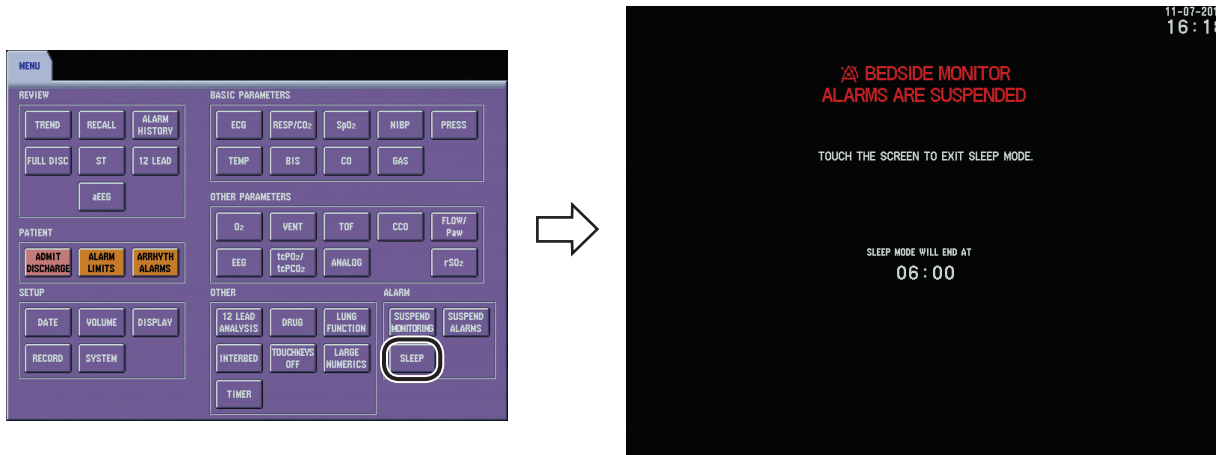

Using Touch Screen Keys

Any window can be opened and settings can be changed by touching the keys and items on the screen with your finger. Touching the key on the screen displays the window. You can use the scroll bar on the screen to scroll data on the window.

There is a pip sound when a key or screen is touched, or the scroll bar on the screen is used.

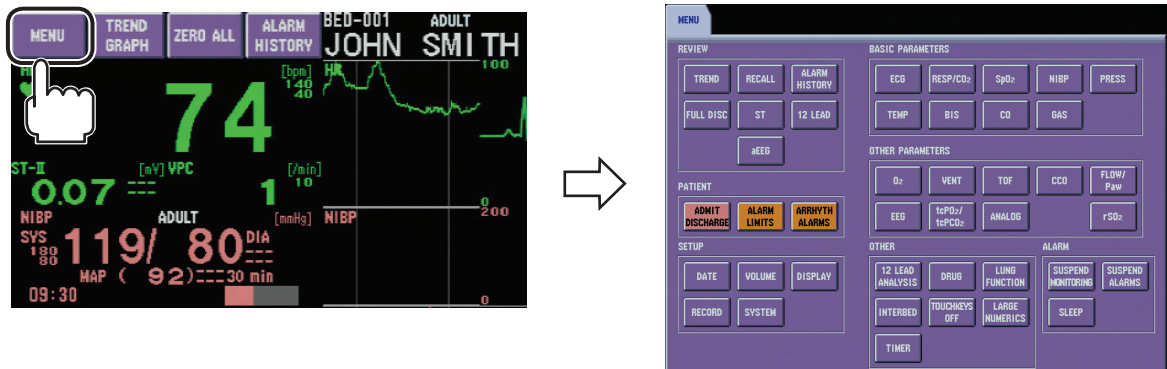

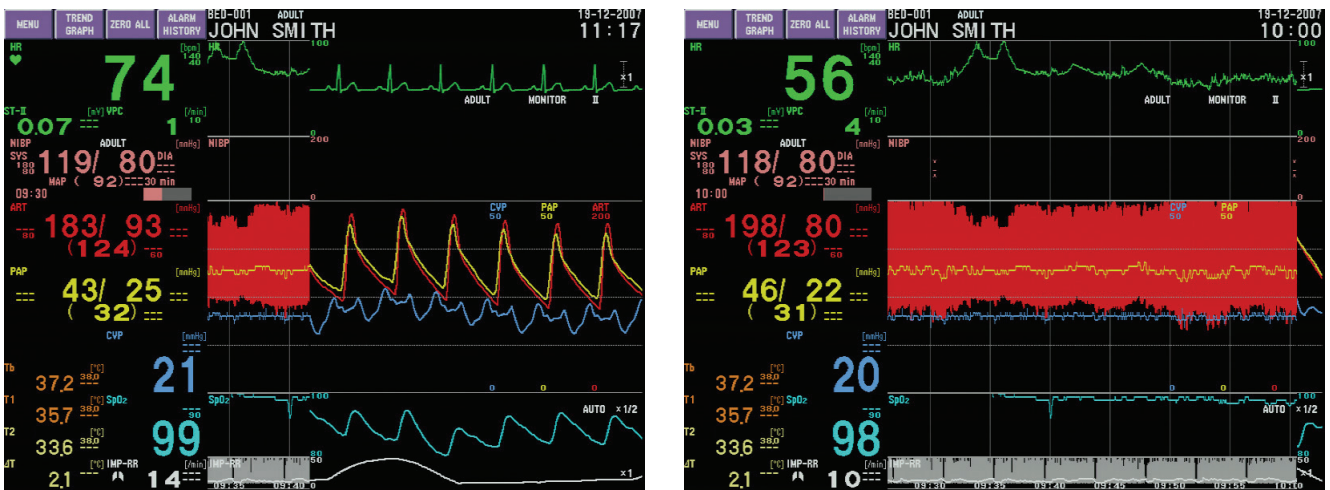
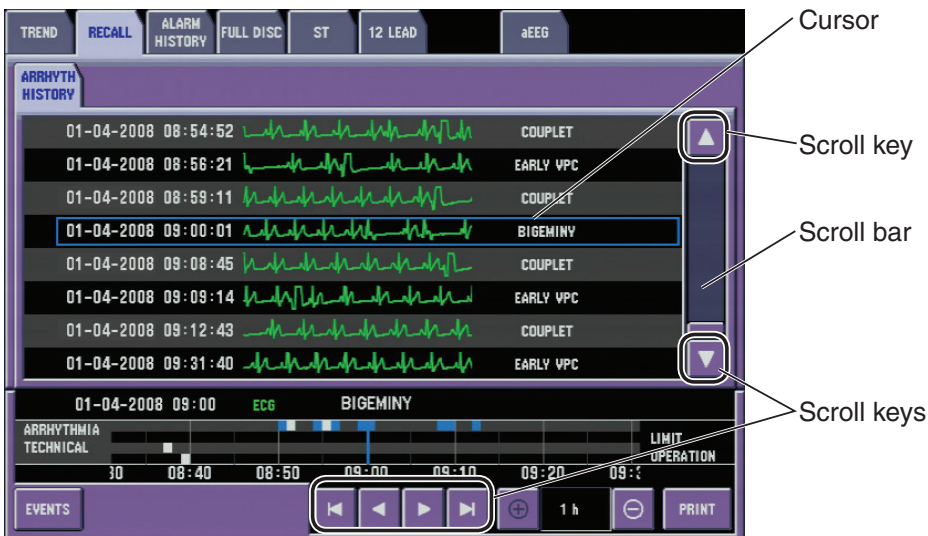
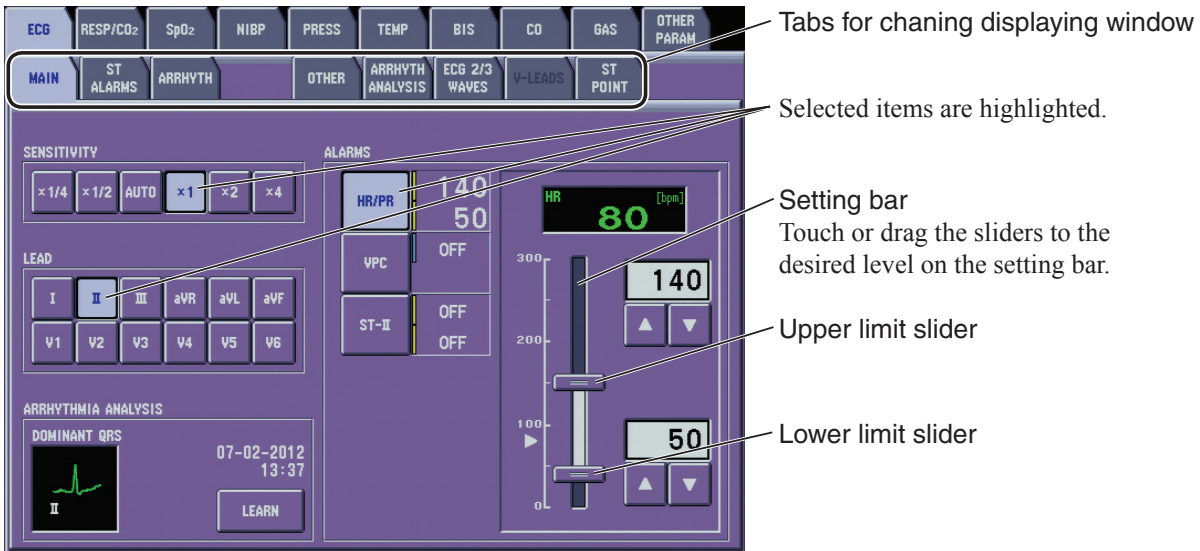

The time width of the trendgraph on the home screen can be adjusted by touching the right edge of the trendgraph and dragging it left or right.

1. GENERAL

Keys on the Bedside Monitor

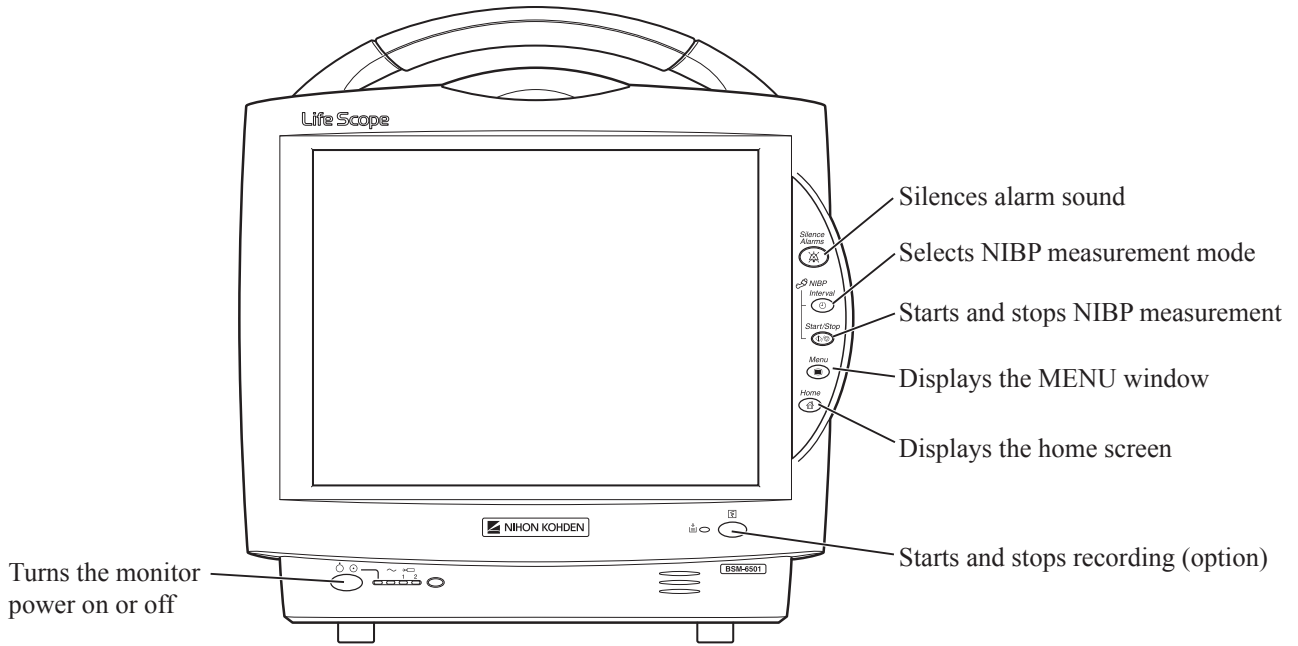

Using the Remote Control

Use the RY-910PA remote controller to operate the monitor from a distance. A pointer appears on the screen when the monitor is operated by the remote control. The remote control channel can be assigned to the monitor to prevent operating a different monitor. Point the remote control at the remote control sensor on the bedside monitor.

Press the keys on the remote control to open/close a window. Move the selection knob up/down/left/right to scroll the data or select a setting and press the [ENTER] key to register the setting.

There is a pip sound when a key on the remote control is pressed or the selection knob is moved to scroll the data.

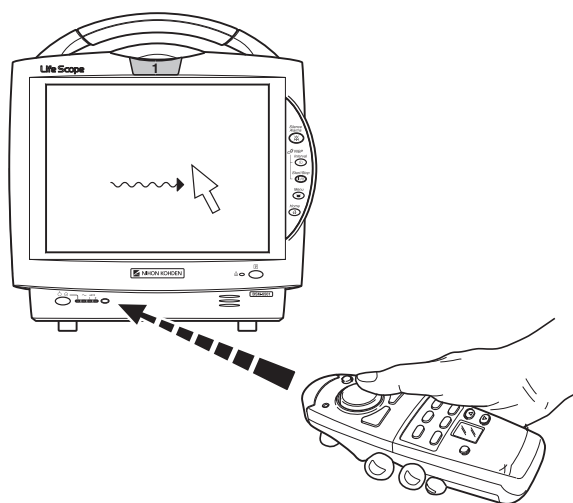

NOTE

- Watch the monitor screen and check the operation when using the remote control to avoid wrong operation.
- Make sure that the remote control is handled appropriately.

Using the Mouse

When connecting a QI-632P, QI-634P or QI-672P interface, use the mouse to move the pointer on the screen and click the left button to select and register the setting.

There is a pip sound when the mouse is clicked.

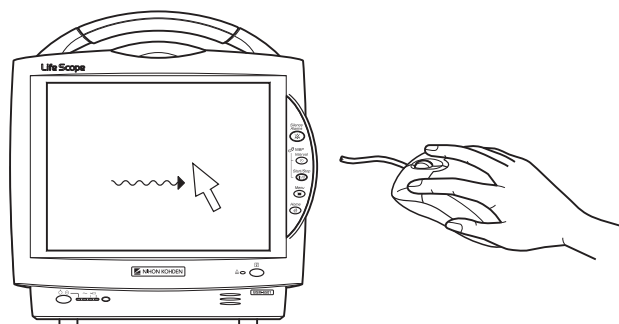

1. GENERAL

Using the Data Acquisition Unit

With the JA-690PA or JA-694PA data acquisition unit, you can use an input unit that is separate from the bedside monitor. With the keys on the data acquisition unit, you can operate the bedside monitor remotely. For details, refer to the JA-690PA or JA-694PA data acquisition unit manual.

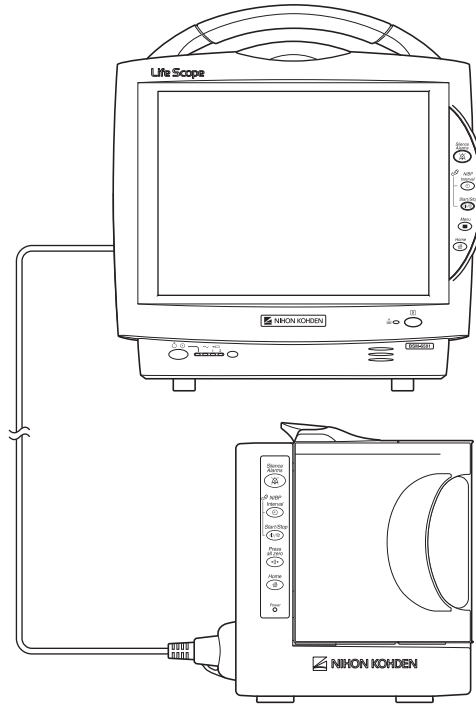

Using the MENU Window

The MENU window can be displayed anytime by pressing the [Menu] key on the bedside monitor. From the MENU window, you can display any window except the home screen. The MENU window layout differs according to the selected site. Refer to “SITE Window” in Administrator’s Guide, Section 2.

For details on each window, refer to the section specified below.

When the site mode is OR or ICU

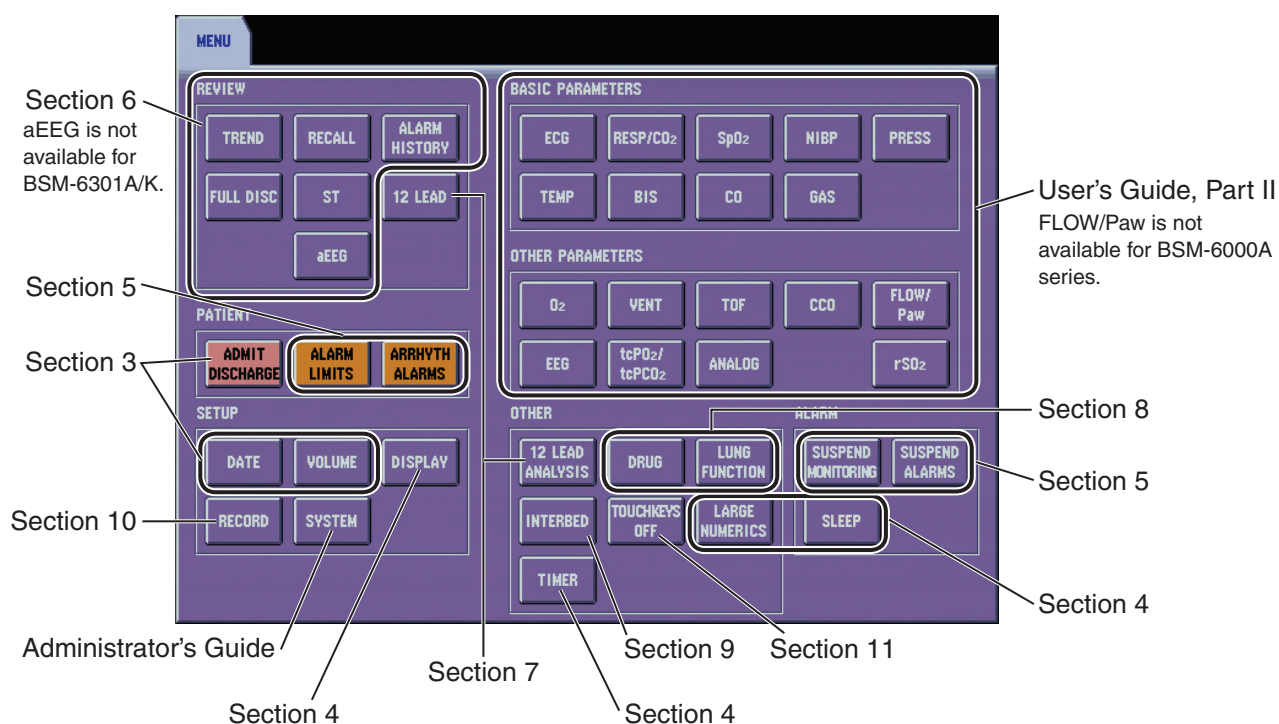

For the alarm off key on the MENU window, refer to “Silencing and Suspending Alarms” in Section 5.

When the site mode is NICU

- The OCRG key is added in the <REVIEW> box. Refer to Section 6.
- On BSM-6000A series, the CAR SEAT CHALLENGE key is added in the <OTHER> box. Refer to Section 4.
- On BSM-6000A series, the 12 LEAD and 12 LEAD ANALYSIS keys are not available when 12 LEAD ANALYSIS is set to Off in the SYSTEM CONFIGURATION screen. Refer to Section 2 of the Administrator’s Guide.

Section 2 Preparation

Preparation Flowchart	2.2
Installation Conditions	2.3
Inserting and Removing the Battery Pack	2.5
Battery Handling and Operation	2.5
Safety Information	2.5
Battery Pack Handling Procedures	2.6
When Not Using the Monitor or Battery Pack	2.6
Inserting and Removing the Battery Packs	2.6
Inserting the Battery Pack	2.7
Removing the Battery Pack	2.8
Inserting and Removing the AY-600P series Input Unit or BSM-1700 series Bedside Monitor	2.9
Inserting the Input Unit	2.9
Removing the Input Unit	2.10
When the Transport Function is Enabled	2.10
Preparing the Optional Recorder	2.11
Installing the Recorder Module	2.11
Loading Recording Paper	2.11
Preparing the Remote Control	2.13
Installing the Batteries	2.13
Setting the Remote Control Channel	2.14
Attaching the Remote Control Channel Label to the Bedside Monitor	2.14
Assigning Functions to the Customized Keys	2.14
Power	2.15
Turning the Power On	2.15
Check Before Turning On the Power	2.15
Turning the Power On	2.16
Check After Turning On the Power and During Monitoring	2.17
Power and Battery Status Indications	2.18
When the “BATTERY WEAK” Message Appears	2.20
Charging the Battery Pack	2.20
Monitor Status on Power Interruption	2.21
Turning the Power Off	2.21
Check After/Before Turning the Power Off	2.22

Preparation Flowchart

You may not need to do all these.

1. Install the monitor. Refer to Administrator's Guide.
2. Prepare battery pack, remote control and recorder. Refer to Section 2 in this manual.
3. Check or change any initial settings on the SYSTEM CONFIGURATION screen. Changing these settings during monitoring interrupts monitoring. Refer to Administrator's Guide, Section 2.
4. Check or change any initial settings on the SYSTEM SETUP window. These settings are the password protected settings which only an administrator can change. Refer to Administrator's Guide, Section 3.
5. Check or change the necessary settings before monitoring in Section 3 in this manual.
 - Date and time
 - Sound volume
 - Screen brightness
 - Waveform display settings
6. Enter the information of the new patient. Refer to "Admitting/Discharging Patient" in Section 3 in this manual.
7. Check or change all alarm items for the patient. Refer to Section 5 in this manual. The alarm settings return to the master settings when the monitor power is off for more than 30 minutes and <SHOW ADMIT CONFIRMATION WINDOW> is turned off in the SYSTEM CONFIGURATION screen or the patient is admitted or discharged.
8. Check or change settings for the review windows, such as trendgraphs, tables and arrhythmia recall files. Refer to Section 6 in this manual.
9. Check or change recording settings. Refer to Section 10 in this manual.
10. Prepare the equipment (electrodes, transducers, probes, etc.) for monitoring individual parameters and check or change the settings for each parameter. Refer to User's Guide, Part II.

Installation Conditions

Put the monitor on a stable and flat stand or on an optional KC-600P cart, KG-600P counter top mount or KG-951P wall mount kit in a suitable location where the screen is easy to see and does not reflect light. Follow the cautions below.

The monitor must be installed by qualified personnel. Details are in Administrator's Guide.

WARNING

Never use the monitor in the presence of any flammable anesthetic gas or high concentration oxygen atmosphere. Failure to follow this warning may cause explosion or fire.

WARNING

Connect only the specified instrument to the monitor and follow the specified procedure. Failure to follow this warning may result in electrical shock or injury to the patient and operator, and cause fire or instrument malfunction.

CAUTION

Avoid collision when moving the monitor on a cart. Strong impact may damage the monitor.

CAUTION

Avoid a location where the monitor is sprinkled with liquids. Avoid direct sprinkling, spray or moist air from a nebulizer or a humidifier.

CAUTION

The display screen is made of glass. Strong impact may damage it.

CAUTION

Avoid locations where the monitor may receive strong electromagnetic interference such as radio or TV stations, cellular phones or mobile two-way radios.

CAUTION

If fluids are accidentally spilled on the monitor, take the monitor out of service and check for damage.

CAUTION

Avoid exposing the monitor to direct sunlight.

CAUTION

Do not use the monitor in an ambulance. The monitor may not function properly in a moving vehicle.

CAUTION

Do not place blankets or cloth over the monitor. It may affect monitoring.

2. PREPARATION

CAUTION

Do not place the monitor in a dusty area.

CAUTION

Connect the power cord to an AC outlet which can supply enough AC current to the monitor. The monitor cannot function properly with low current.

CAUTION

Do not use an electrical blanket. It may affect monitoring.

CAUTION

When there is any problem on the monitor, turn off the power immediately and disconnect the power cord from the AC outlet. Take the monitor out of service and check for damage.

CAUTION

Avoid placing the monitor near a heater or humidifier.

CAUTION

Do not place the monitor in an MRI examination room. The monitor may not function properly, or noise from the monitor may interfere with the MRI.

CAUTION

Make sure that there is more than 5 cm of space between the monitor and the wall for adequate ventilation. When the monitor is surrounded, make sure that there is about 10 cm of space above the monitor for ventilation so that the operating temperature does not exceed 40°C (104°F).

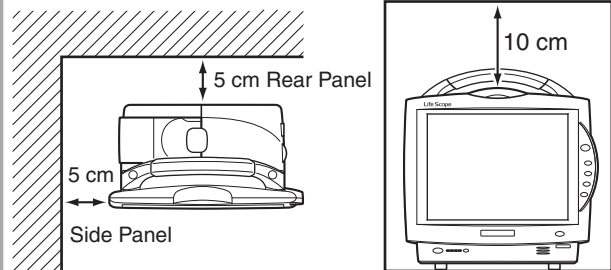

Inserting and Removing the Battery Pack

Battery Handling and Operation

Safety Information

WARNING

Do not do the following to the battery pack. It may cause leakage, overheating, explosion and fire.

- Short-circuit the + and – terminals on the battery pack.
- Put the battery pack into fire or heat the battery pack.
- Disassemble or modify the battery pack.
- Give strong impact to or deform the battery pack.
- Use the battery pack on unspecified instruments.
- Charge the battery pack on unspecified instruments.
- Install the battery pack with the wrong polarity.
- Leave the battery pack in the reach of patients.

WARNING

If the battery pack is damaged and the substance inside the battery contacts the eyes or skin, wash immediately and thoroughly with water and see a physician. Never rub your eyes, because you may lose your eyesight.

WARNING

- Do not immerse the battery pack in water. The battery pack may heat up and rust and the substance inside the battery pack may leak.
- Do not leave the battery pack unused for more than about two years. The battery pack may leak.

CAUTION

Do not expose the battery pack to direct sunlight or leave in a high temperature place. The lifetime of the battery pack may be shortened, the performance of the battery pack may be degraded and the battery may leak.

CAUTION

Do not use a battery pack with a damaged cover. The operator may receive electrical shock.

CAUTION

Do not leave the battery pack near the patient or in reach of children.

CAUTION

Do not subject the battery pack to a strong mechanical shock.

CAUTION

Do not tilt the monitor when removing the battery pack from the monitor. If the lock release lever is lifted while the monitor is tilted, the battery pack falls out of the monitor and may injure the patient or operator.

CAUTION

Use the battery pack between 10°C (50°F) and 40°C (104°F). Temperatures out of this range affect the working of the battery.

CAUTION

Do not use a battery pack which is past the expiration date written on the label.

CAUTION

Before disposing of the battery pack, check with your local solid waste officials for details in your area for recycling options or proper disposal. The battery pack is recyclable. At the end of its useful life, under various state and local laws, it may be illegal to dispose of this battery pack into the municipal waste stream.

NOTE

Be careful when handling the fully charged battery pack. The battery pack heats up to about 60°C (140°F).

Battery Pack Handling Procedures

- Always place a battery pack in the monitor. This charges it so that you will always have a fully charged battery pack ready.
- Fully recharge the battery pack before using it for the first time or after storing it for over a month. When the battery is not used, it self-discharges.
- Replace the battery pack with a new one every year. This is because the battery is a chemical product which gradually deteriorates whether or not it is used.
- Store the battery packs under the following conditions.

Temperature: -20 to +60°C (-4 to +140°F) (within 30 days)

-20 to +45°C (-4 to +113°F) (within 90 days)

-20 to +35°C (-4 to +95°F) (more than 90 days)

Humidity: 20 to 85% RH (noncondensing)

When Not Using the Monitor or Battery Pack

- When the monitor is not used for a long time, remove the battery pack. When a charged or discharged battery pack is left inside the monitor with the power cord unplugged, the battery self-discharges and deteriorates.
- When a battery pack is not used, fully charge it before storage. When a battery pack is not used for over one month, fully charge it once every six months.

Inserting and Removing the Battery Packs

This monitor can hold two battery packs. Insert the battery pack to the battery slot 1 or/and battery slot 2.

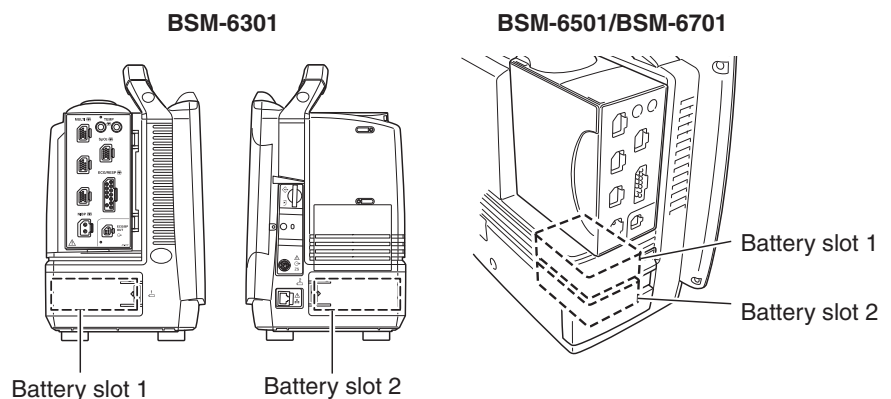

NOTE

- Only use the SB-671P battery pack.
- The procedure for inserting and removing the battery packs is the same for BSM-6301 and BSM-6501/BSM-6701 bedside monitors even though the battery slot positions and battery cover shapes are different.

Inserting the Battery Pack

1. Remove the battery cover by pressing the tab on the battery cover and slide the cover off.

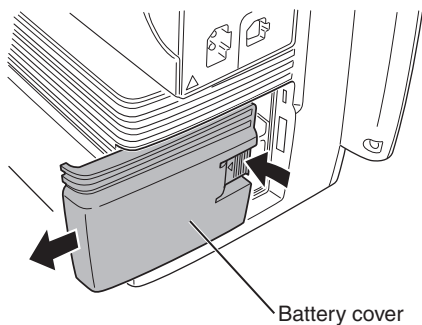

2. Insert the battery pack in the battery slot with the label (black) facing up.

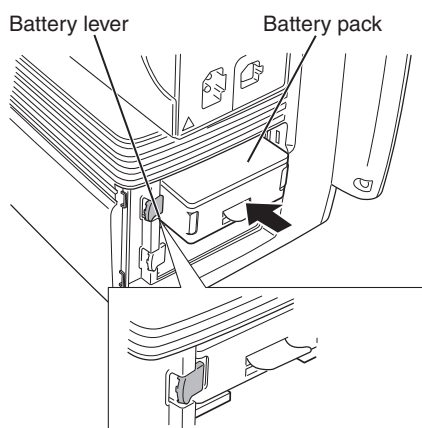

3. Attach the battery cover.

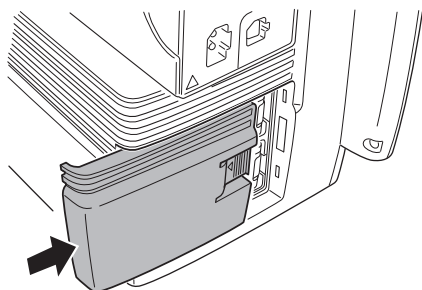

2. PREPARATION

Removing the Battery Pack

CAUTION

Do not tilt the monitor when removing the battery pack from the monitor. If the lock release lever is lifted while the monitor is tilted, the battery pack falls out of the monitor and may injure the patient or operator.

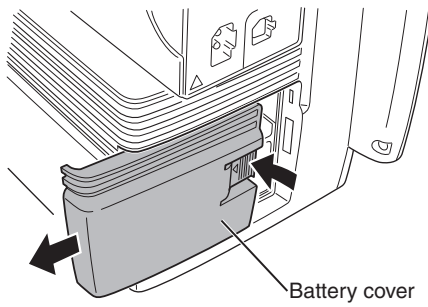

1. Remove the battery cover by pressing the tab on the battery cover and slide the cover off.

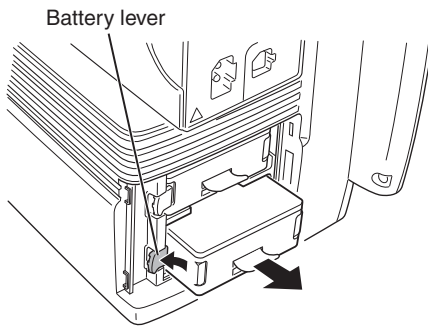

2. Press the battery lever and release the lock.
3. Pull out the battery pack from the battery slot.

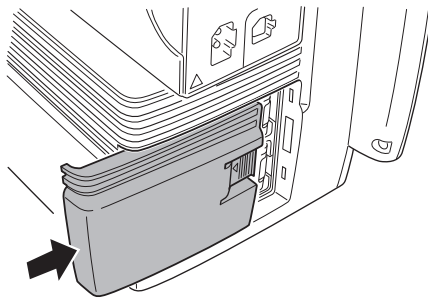

4. Attach the battery cover.

Inserting and Removing the AY-600P series Input Unit or BSM-1700 series Bedside Monitor

2

The AY-600P series input unit or BSM-1700 series bedside monitor can be inserted to or removed from the monitor. When the patient is changed or moved to a different location, insert or remove the input unit or BSM-1700 series bedside monitor.

The following procedure is for the AY-600P series input unit. For details on inserting and removing the BSM-1700 series bedside monitor, refer to the BSM-1700 series bedside monitor operator's manual.

Inserting the Input Unit

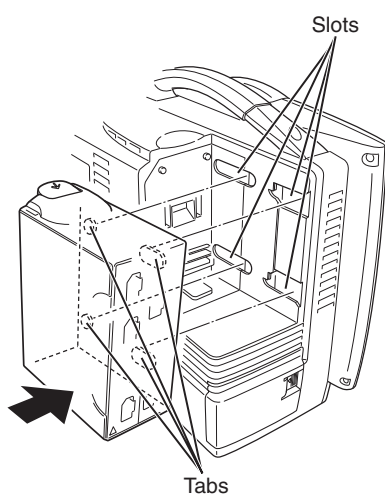

1. Put the input unit into the rear of the monitor so that the four tabs go into the four slots.

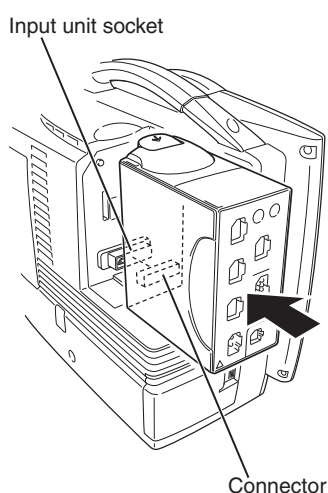

2. Slide the input unit all the way into the monitor until it clicks into place.

2. PREPARATION

Removing the Input Unit

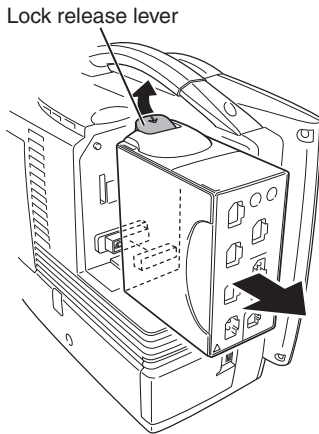

CAUTION

When inserting or removing the input unit from the monitor, be careful not to drop it.

Slide out the input unit while pulling up the lock release lever.

When the Transport Function is Enabled

CAUTION

When removing the input unit from the monitor when the transport function is enabled, perform the removal procedure of the input unit on the REMOVE tab of the ADMIT DISCHARGE window before removing the input unit. Otherwise, the data in the input unit may be lost.

When Connected to the Network

CAUTION

Do not remove the input unit while the data is being sent to the central monitor. The data may be lost.

CAUTION

When the patient is discharged and there is no need to send the patient data to the central monitor, discharge the patient on the central monitor before removing the input unit. When the input unit is unintentionally removed or inserted when not using transport function, data that was sent to the central monitor in the past may be lost.

NOTE

When the patient is discharged and there is no need to send the patient data to the central monitor, removing the input unit from the bedside monitor is not necessary.

Preparing the Optional Recorder

Installing the Recorder Module

Install the optional WS-671P recorder module in the monitor by referring to the WS-671P recorder module Installation Guide.

CAUTION for Handling the Recording Paper

- Do not allow paper to contact pastes, adhesive agents, oil-based felt pen tips or diazo process (ditto/spirit) copying paper. These discolor the paper surface.
- Do not allow paper to contact any materials made of vinyl chloride, plastic eraser, adhesive tape, fluorescent felt tip pen, or cinnabar seal ink because these discolor the recorded waveforms and data.
- Do not apply strong pressure to the paper. Rubbing or scratching discolors the paper surface.
- Do not allow paper to contact saline solution. The paper discolors and if the saline solution gets on the thermal head, there will be dots missing from the recorded data.
- Avoid high humidity, high temperature, direct sunlight and direct fluorescent light when storing recording paper. Otherwise the paper may discolor. Store the recording paper in a dry, cool place.
- When using glue on the recording paper, use glue which consists of starch, polyvinyl alcohol, gum arabic, or carboxymethyl.

Loading Recording Paper

CAUTION for Loading the Recording Paper

- Correctly load the recording paper as specified. Otherwise, recording may not be performed properly.
- Do not touch the recording head with any hard material. When the head is tapped with hard material, the head may crack and the heater element wire may short-circuit.
- Clean the head surface with the provided head cleaner pen before loading new paper. After a period of usage, paper dust may accumulate between the paper and the head surface, and good printing cannot be obtained.

NOTE

Only use the specified recording paper, FQW50-2-100.

The out of paper lamp on the bedside monitor lights and the “INSERT REC PAPER” message appears on the screen when there is no paper.

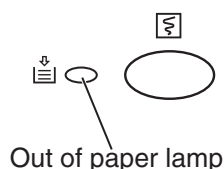

2. PREPARATION

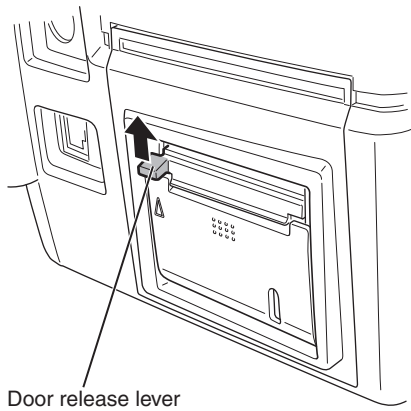

Door release lever

1. Move the recorder door release lever in the direction of the arrow (△) to release the lock.

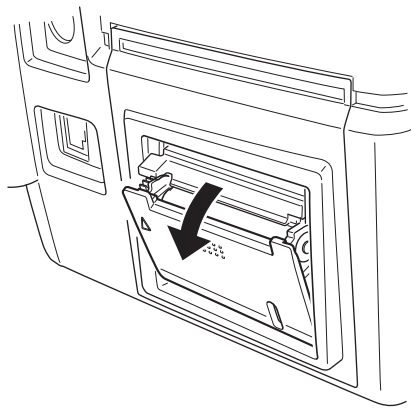

2. Open the recorder door.

CAUTION

Do not touch the thermal head inside the recorder module. The thermal head may be damaged by static electricity or become dirty and cause printing failure.

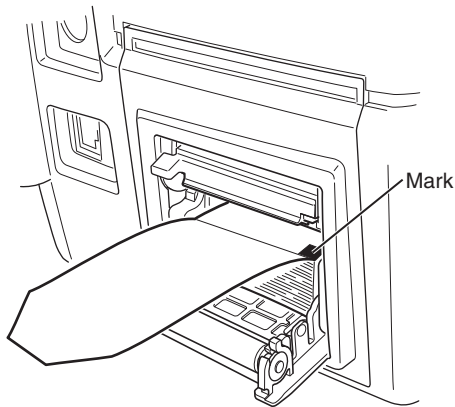

3. Set the recording paper inside the recorder module so that the detection mark (small black square on corner) of the paper is on the right side.

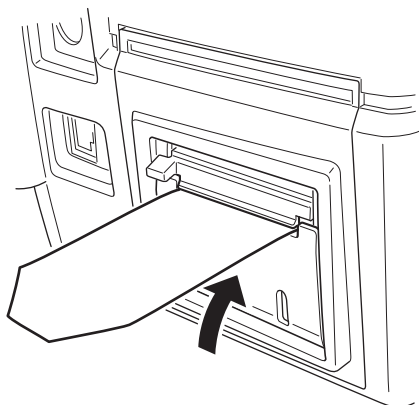

4. Draw out one page of paper toward you and close the recorder door.

If the out of paper lamp is still lit, the recorder door is not closed properly.

Preparing the Remote Control

The monitor has a remote control sensor for receiving signals from the remote control.

When the monitor cannot operate by remote control or the remote control distance becomes short, the battery may be deteriorated. Change the battery with new one. Use two AAA alkaline batteries and change the two batteries at the same time.

Installing the Batteries

WARNING

- Keep the batteries away from fire. They may explode.
- Keep the batteries away from patients.
- Never short-circuit the + and – terminals on the battery. It may cause overheating and fire.
- Do not damage, disassemble, drop or give impact to the battery.

WARNING

If the battery is damaged and the substance inside the battery contacts the eyes or skin, wash immediately and thoroughly with water and see a physician. Never rub your eyes, because you may lose your eyesight.

NOTE

When not using the remote control for a long time, remove the batteries from the remote control.

1. Remove the battery cover on the rear panel of the remote control as shown.

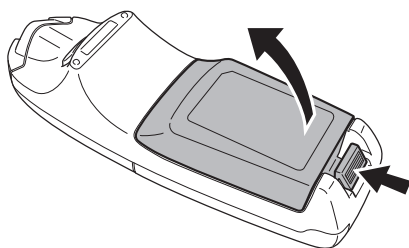

2. Insert two new AAA alkaline batteries into the remote control observing the correct + and – position.

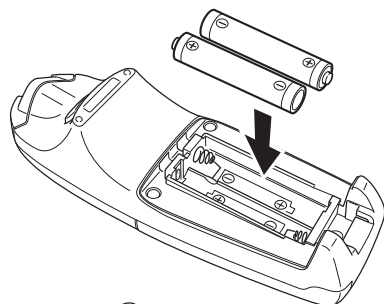

3. Reattach the battery cover.

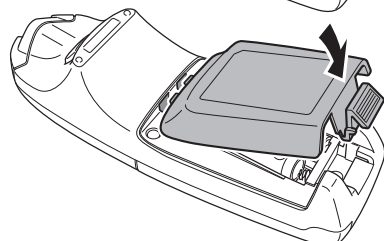

2. PREPARATION

NOTE

- Remove the battery from the remote controller when not using the battery.
- Check with your local solid waste officials for details in your area for recycling options or proper disposal.
- Take care not dropping or losing the remote controller.

Setting the Remote Control Channel

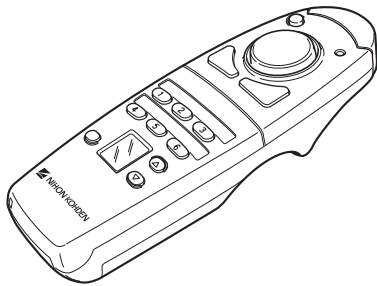

One remote control can operate up to nine monitors by changing channel. The remote control channel must be set to the correct monitor.

The infrared light emitted from the remote control has wide directivity and reflects the ceiling and wall and may operate the other devices.

The remote control channel must be set by the administrator. The procedure is described in the Administrator's Guide.

CAUTION

- Set the remote control channel on the monitor to prevent the remote control from operating a different monitor.
- When several monitors are installed close together, check that the remote control operates only the desired monitor. If the remote control operates a different monitor, recheck the channel setting.

Attaching the Remote Control Channel Label to the Bedside Monitor

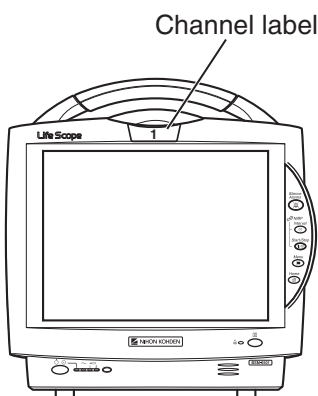

After setting the remote control channel on the monitor, attach the remote control channel label to the display.

Assigning Functions to the Customized Keys

The window or operation can be assigned to each key on the remote control for the shortcut key operation. There are six customized keys on the remote control. The function is assigned on the SYSTEM SETUP window. Refer to Section 3 of the Administrator's Guide.

Power

The monitor can operate on either battery pack or AC power.

When the power cord is plugged into an AC outlet and the power switch on the front panel is turned on, the monitor operates on AC power.

When a SB-671P battery pack is inserted into the battery slot and the power cord is disconnected or there is a sudden power failure, the monitor automatically switches to battery power.

When the battery pack is not used and there is a sudden power failure, the patient data and settings are stored for about 30 minutes after power off when <DATA TRANSPORT USING INPUT UNIT> is set to DISABLE and <SHOW ADMIT CONFIRMATION WINDOW> is turned off in the SYSTEM CONFIGURATION screen.

When <DATA TRANSPORT USING INPUT UNIT> is set to ENABLE, the patient data and settings are always stored.

The battery pack is charged when the power cord is plugged into an AC outlet and the AC current is supplied to the monitor. The battery pack is also charged during monitoring.

When the monitor is operated on battery power, the brightness of the screen can be reduced to save battery power.

The monitor can operate for about 90 minutes (BSM-6301/BSM-6501) or 60 minutes (BSM-6701) with a new fully charged battery pack when:

- Used in normal temperature.
- Recorder is stopped.
- No alarm occurs.
- Monitoring ECG, respiration (impedance) and SpO₂.
- <POWER SAVING MODE> on the SYSTEM SETUP window is set to ON.
- <SYNC SOUND VOLUME> on the VOLUME window is set to OFF.
- NIBP measurement interval is 15 minutes.
- QI-671P and QI-672P interfaces or QI-631P and QI-632P or QI-634P interfaces are installed in the monitor.
- The input unit is an AY-600P series input unit and not a BSM-1700 series bedside monitor.

Turning the Power On

Check Before Turning On the Power

Check the following items before turning on the power.

- Enough electrodes and electrode leads are ready.
- Cleaned and sterilized sensors and transducers are ready.

2. PREPARATION

- Power cord is connected properly.
- Equipotential grounding lead is connected properly when equipotential grounding is required.
- All cables are connected properly.
- Enough recording paper in the recorder (when using an optional recorder).
- Fully charged battery pack is installed in the monitor in case of a sudden power failure.
- No scratches, damage or dirt on the monitor.
- No damage to the keys and panels.
- No damage to the power cord.
- No damage to the electrode leads, transducers, probes and cables.
- The monitor is not in a wet place.

Turning the Power On

CAUTION

When the monitor is turned on, check that a single beep sounds and the red, yellow, cyan and green alarm indicator lamps blink once. This shows that the alarm is functioning properly.

NOTE

- The sound volume when the monitor power is turned on is the volume set on <ALARM VOLUME> of the VOLUME window.
- It takes a few minutes for the LCD screen to reach full brightness.
- The shadow of the previous screen may remain for a few minutes after changing screens.
- There may be some dots on the LCD screen which are always on or always off, but it does not affect monitoring. This is normal for all LCD screens.
- Even though the position of symbol marks for the lamps are different on BSM-6301 and BSM-6501/BSM-6701 bedside monitors, the function and the position of lamps are the same.
- The patient data and settings are deleted when the monitor power is off for more than 30 minutes and <SHOW ADMIT CONFIRMATION WINDOW> is turned off in the SYSTEM CONFIGURATION screen.

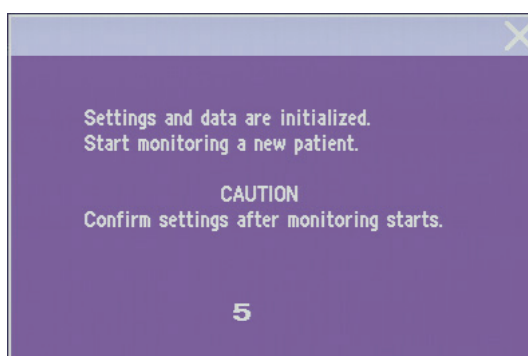

When <DATA TRANSPORT USING INPUT UNIT> is set to ENABLE, the patient data and settings are always stored.

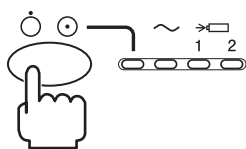

Press the [Power] switch on the front panel to turn the power on. The power can also be turned on by pressing the [POWER] button on the remote control. The power lamp and the AC power lamp light and self check starts. When the check is complete, the home screen appears.

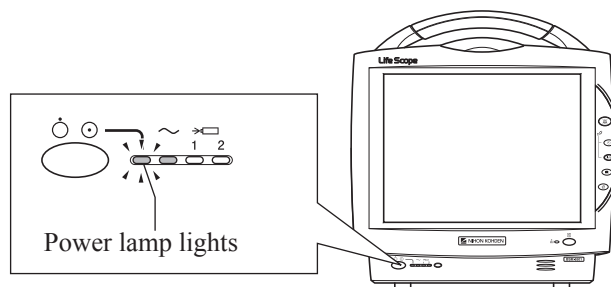

If the power lamp does not light, check the power cord connection.

When the monitor power is turned on, alarms are suspended while the monitor is waiting for the electrodes and probe to be attached to the patient. The monitoring starts when the connection cord is connected to the socket on the monitor and the electrodes or probe are attached to the patient. The alarm activates when one of the following occurs:

- ECG, SpO₂ or IBP is monitored or NIBP is measured and a value is displayed (when AUTO is selected for <ALARM ACTIVATION DELAY> on the ALARM window of the SYSTEM SETUP window).
- ECG, SpO₂ or IBP is continuously monitored for the selected time (when 1 min, 2 min or 3 min is selected for <ALARM ACTIVATION DELAY>).
- NIBP is measured (when 1 min, 2 min or 3 min is selected for <ALARM ACTIVATION DELAY>).

If the monitor power is turned off and on again within 60 seconds, the monitoring continues.

Check After Turning On the Power and During Monitoring

To start monitoring safely and properly, check the following items after turning on the power. If any problem is detected, take the proper countermeasure according to the troubleshooting and maintenance sections.

- There is no fire, smoke or smell.
- The monitor is not too hot.
- The power lamp and other lamps light.
- Alarm indicators (red, yellow, cyan and green lamps) blink once and a beep sounds.
- The start up screen appears and the home screen appears.
- No error message is displayed on the screen.
- The time on the screen is correct.
- The monitor does not affect surrounding equipment.
- The data and waveforms are displayed properly.
- Keys and switches operate properly.
- The touch keys function properly and the key clicking sound is generated.
- Alarm functions properly.
- Alarm sound can be heard.

2. PREPARATION

- Alarm sound volume setting is appropriate.
- There is no trouble in recording (when using an optional recorder).
- Sound can be heard from the monitor.

NOTE

After turning the monitor on and when admitting a patient on the monitor, make sure that the time displayed at the upper right of the screen is correct. When the date or time is changed during monitoring, the date and time of all stored data is also changed and may not match the date and time on the printout.

When the monitor is connected to a network

The time on this monitor is automatically adjusted to match the time of the network as long as the monitor is connected to the network. The date and time on all monitors in the network are set to the same setting.

Power and Battery Status Indications

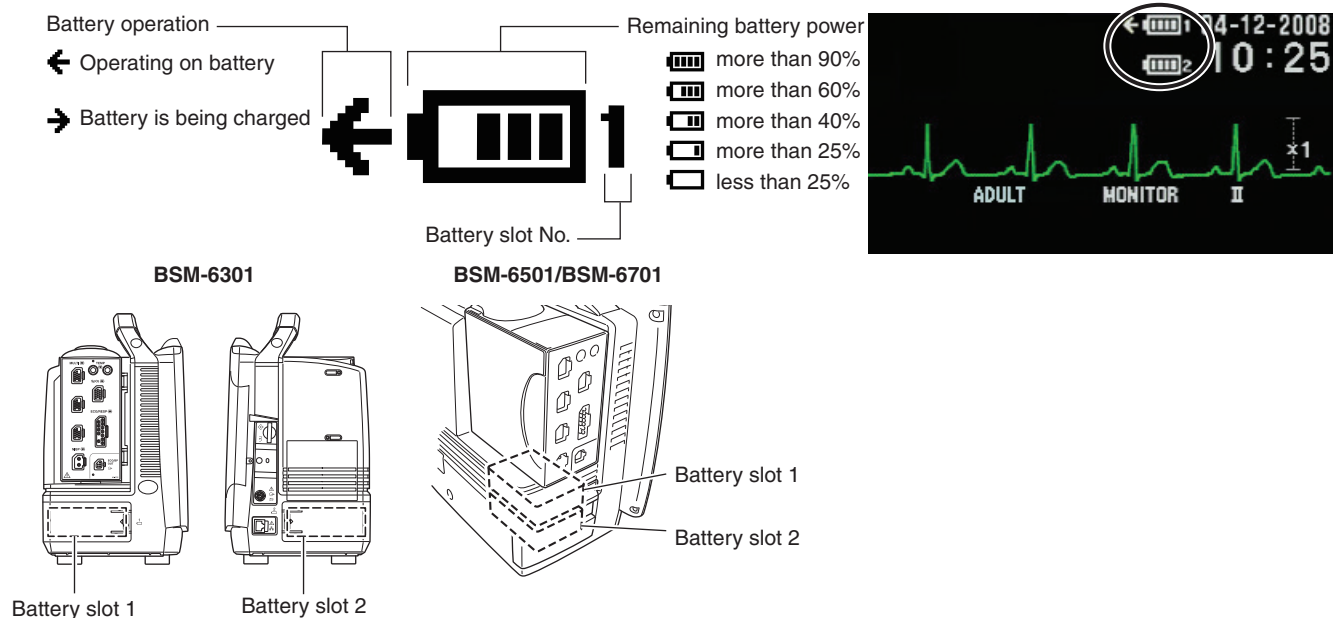

Power and battery status are indicated by four lamps on the bedside monitor. A discharged battery pack is also indicated by battery marks, screen message and alarm.

NOTE

- When charging the battery pack with the monitor power turned off, check that the power lamp and battery charging lamp light. If the lamps do not light even when the power cord is connected and the battery pack is inserted, turn the power on, check that the battery charging lamp is blinking or lit, then turn the power off.
- Even though the position of symbol marks for the lamps are different on BSM-6301 and BSM-6501/BSM-6701 bedside monitors, the function and the position of lamps are the same.

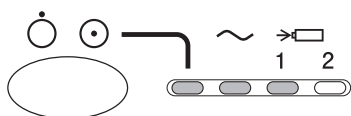

- Operating on AC power and battery pack is fully charged or there is no battery
Power lamp: Lit
AC power lamp: Lit
Battery lamp 1: Lit or off
Battery lamp 2: Lit or off

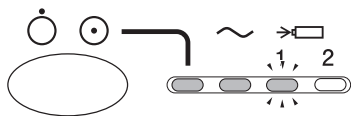

- Operating on AC power and battery pack is being charged
Power lamp: Lit
AC power lamp: Lit
Battery lamp 1: Slow blinking (once every 2 seconds) or off
Battery lamp 2: Slow blinking (once every 2 seconds) or off

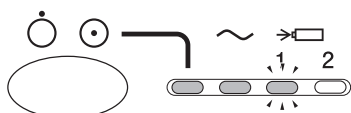

- Operating on AC power when battery pack is damaged
Power lamp: Lit
AC power lamp: Lit
Battery lamp 1: Rapid blinking (4 times per second) or off
Battery lamp 2: Rapid blinking (4 times per second) or off
Screen indication: "BATTERY ERROR" message
Alarm indication: Continuous "bing bong" sound (when NK1 is selected for <ALARM SOUND TYPE> on the ALARM window of the SYSTEM SETUP window) and blinking yellow alarm indicator lamp

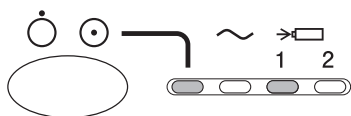

- Operating on battery power
Power lamp: Lit
AC power lamp: Off
Battery lamp 1: Lit* or off
Battery lamp 2: Lit* or off
* When two battery packs are used and when the battery pack which is not used is fully charged

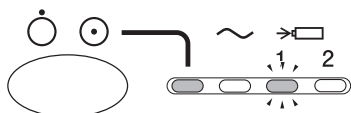

- Operating on battery power and battery pack is damaged
Power lamp: Lit
AC power lamp: Off
Battery lamp 1: Rapid blinking (4 times per second) or off
Battery lamp 2: Rapid blinking (4 times per second) or off
Screen indication: "BATTERY ERROR" message
Alarm indication: Continuous "bing bong" sound (when NK1 is selected for <ALARM SOUND TYPE> on the ALARM window of the SYSTEM SETUP window) and blinking yellow alarm indicator lamp

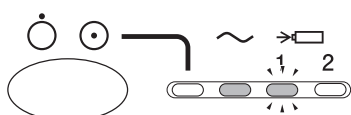

- No monitoring and charging battery pack
Power lamp: Off
AC power lamp: Lit
Battery lamp 1: Slow blinking (once every 2 seconds) or off
Battery lamp 2: Slow blinking (once every 2 seconds) or off

When the “BATTERY WEAK” Message Appears

Operate the monitor on AC power and/or replace the battery pack when the “BATTERY WEAK” message appears.

When the “BATTERY WEAK” message appears, the remaining battery power is less than 25%. The yellow alarm lamp lights with a continuous “bing bong” sound.

If no AC or battery power is supplied to the monitor, there is no measurement and patient data such as trend data may be lost.

Charging the Battery Pack

The battery pack can be charged by the monitor. It takes about 10 hours to charge one battery pack during monitoring and 6 hours to charge two battery packs when not monitoring.

NOTE

The new battery pack is not charged. Charge the battery pack before use.

The monitor can operate for about 90 minutes (BSM-6301/BSM-6501) or 60 minutes (BSM-6701) with a new fully charged battery pack when:

- Used in normal temperature.
- Recorder is stopped.
- No alarm occurs.
- Monitoring ECG, respiration (impedance) and SpO₂.
- <POWER SAVING MODE> on the SYSTEM SETUP window is set to ON.
- <SYNC SOUND VOLUME> on the VOLUME window is set to OFF.
- NIBP measurement interval is 15 minutes.
- QI-671P and QI-672P interfaces or QI-631P and QI-632P or QI-634P interfaces are installed in the monitor.
- The input unit is an AY-600P series input unit and not a BSM-1700 series bedside monitor.

CAUTION

When charging the battery pack, keep the ambient temperature at approximately 20°C to maintain the optimal battery operation time. If the battery pack is charged at less than 10°C (50°F) or more than 30°C (86°F), the maximum battery operation time will be 20% to 30% less than the optimal operation time.

Charging in the Monitor

Normal charging

During AC operation, the battery pack is automatically charged without interrupting monitoring. It takes approximately 10 hours of continuous charging to fully charge a battery pack.

Fast charging

It takes 6 hours of continuous charging to fully charge two battery packs when not monitoring. When installing two battery packs, the monitor can charge the two battery packs at the same time.

After continuous charging, the monitor automatically switches to trickle charging mode to keep the battery pack fully charged. Trickle charging is necessary because the battery pack can self-discharge even when it is not in use.

NOTE

Do not disconnect the power cord from the monitor during battery charging.

Monitor Status on Power Interruption

When there is a power failure or sudden power interruption, the monitor status is as follows.

- When a battery pack is installed in the monitor, the BSM-6301 and BSM-6501 operate for about 90 minutes and the BSM-6701 operates for about 60 minutes on battery power.
- When the monitor has no battery pack installed or the battery pack is discharged, the monitor turns off. When the AC power is restored, the monitor turns on automatically. The patient data and settings are stored for about 30 minutes after power off when <DATA TRANSPORT USING INPUT UNIT> is set to DISABLE and <SHOW ADMIT CONFIRMATION WINDOW> is turned off in the SYSTEM CONFIGURATION screen.

When <DATA TRANSPORT USING INPUT UNIT> is set to ENABLE, the patient data and settings are always stored.

When there is a power failure or sudden power interruption, immediately connect the monitor to the emergency power source. It is recommended to always keep the battery pack in the monitor.

Turning the Power Off

NOTE

- Even though the position of symbol marks for the lamps are different on BSM-6301 and BSM-6501/BSM-6701 bedside monitors, the function and the position of lamps are the same.
- Do not disconnect the power cord while the monitor power is on. Data may be lost.

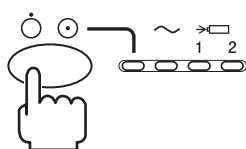

Press the [Power] switch on the front panel for more than three seconds to turn the power off. The screen becomes dark and the power lamp on the front panel turns off. The power can also be turned off by pressing the [POWER] button on the remote control.

2. PREPARATION

Check After/Before Turning the Power Off

Check the following items for the next use.

- Previous patient data is deleted.
- Temporarily changed settings are changed back to the previous settings.
- There is no dirt, damage or scratches on the monitor.
- The sensors, probes, transducers, and cables are cleaned and sterilized.
- Accessories are cleaned and stored properly.
- There are enough consumables, such as recording paper, and disposable electrodes for the next use.
- Battery pack is fully charged.
- The power switch on the monitor is turned off and the power cord is disconnected from the monitor.
- The monitor is not in a wet place.
- Dead batteries are disposed of properly.
- The medical waste is disposed of properly.
- The monitor is stored properly.

Section 3 *Necessary Settings Before Monitoring*

Changing Date and Time.....	3.2
Changing Sound Volume Settings.....	3.3
Changing the Screen Brightness.....	3.4
Changing Waveform Display Settings.....	3.5
Admitting/Discharging Patient.....	3.7
Displaying the ADMIT DISCHARGE Window.....	3.7
Stored Data Status and Screen Transition for Admitting Patient.....	3.9
Selecting Patient Type.....	3.11
Entering the Patient Information.....	3.12
Entering the Patient ID.....	3.12
Entering the Patient Name.....	3.13
Entering the Date of Birth and Age.....	3.15
Entering the Height and Weight.....	3.16
Entering the Gender.....	3.17
Entering the Pacemaker Use.....	3.17
Admitting a Patient.....	3.19
Discharging a Patient.....	3.21
Suspended Alarms after Admission or Discharge.....	3.24
Using Transport Function in a Monitor Network.....	3.25
Input Unit.....	3.25
Transport Function.....	3.25
Data and Settings that can be Transferred between Bedside Monitors.....	3.26
Necessary Settings Before Use.....	3.27
Sending Data to a CNS-6201 or CNS-9701 Central Monitor.....	3.28
Authenticating a Patient when the Input Unit is Moved from One Monitor to Another.....	3.29
When Using Data in the Input Unit.....	3.29
When Using Data in the Main Unit.....	3.31
When Monitoring as a New Patient.....	3.32
When the Patient Information are the Same in the Input Unit and Main Unit.....	3.34
Preparing for Removing the Input Unit.....	3.34
Enabling the Input Unit.....	3.36
WLAN Transport.....	3.37
Preparation.....	3.38
Starting WLAN Transport.....	3.38
Ending WLAN Transport.....	3.40
Using Transport Function with a Defibrillator.....	3.41
Precautions for Transport Function with a Defibrillator.....	3.41
Receiving Data from the Defibrillator.....	3.42
Bed ID.....	3.42
Data that can be Received from the Defibrillator.....	3.42
Receiving Data from the Defibrillator.....	3.43

Changing Date and Time

When the power is on, the current time is displayed in the upper right corner of the screen.

NOTE

- When the date or time is changed during monitoring, the date and time of all stored data is also changed and might not match the date and time on the printout.
- While the transport function is enabled and sending data to the central monitor, the date and time cannot be changed.

1. Display the DATE window.

Press the [Menu] key → DATE key.

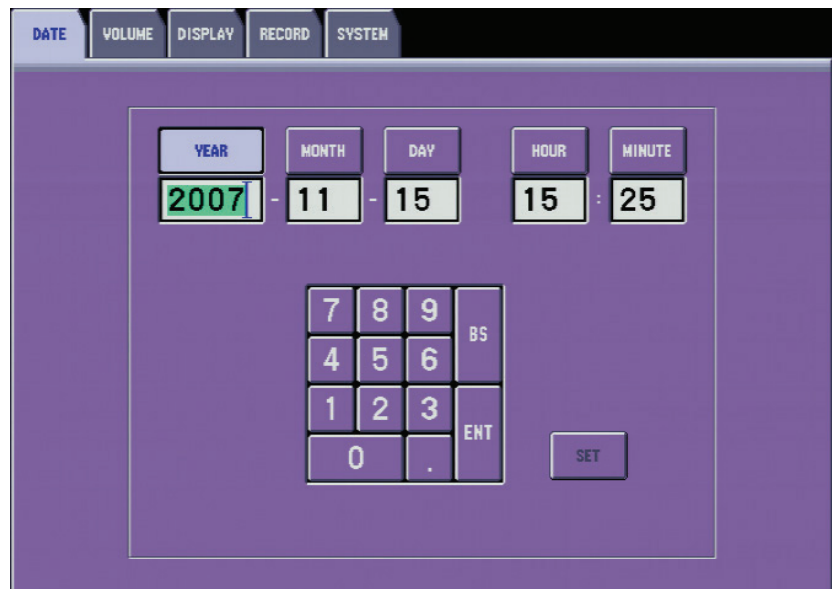

The DATE window can also be displayed by touching the time on the upper right corner of the home screen.

2. Touch the YEAR, MONTH, DAY, HOUR or MINUTE key.
3. Touch the desired number(s) using the numeric keypad.
4. Repeat steps 2 and 3 to enter other items.
5. Touch the SET key. The SET key must be touched before changing windows. Otherwise the setting changes back to the previous setting.

When the set date is incorrect, the “OUT OF RANGE” message appears on the screen. Enter the correct date.

6. Press the [Home] key to return to the home screen.

Changing Sound Volume Settings

On the VOLUME window, you can select sync sound on or off and adjust the sync sound volume and alarm sound volume.

The following settings can be changed on the SYSTEM SETUP window. Refer to Section 3 of the Administrator's Guide.

- NIBP completion sound on or off
- NIBP completion sound volume
- Alarm minimum volume
- Key click sound volume
- Interbed alarm volume

1. Display the VOLUME window.

Press the [Menu] key → VOLUME key.

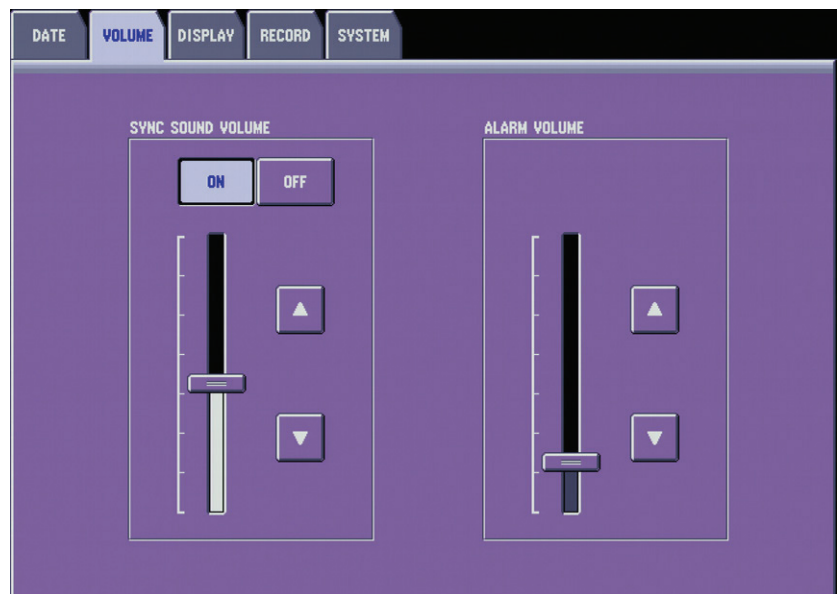

2. Change any settings.

- Select ON or OFF in <SYNC SOUND VOLUME> box to set sync sound volume on or off.
- To change the sync sound volume, touch the ▲ or ▼ key or drag the slider to the desired level on the setting bar in <SYNC SOUND VOLUME> box. At the lowest volume setting, the sync sound is not audible. When ON is selected, there is a beeping sound.
- To change the alarm sound volume, touch the ▲ or ▼ key to adjust the setting or drag the slider to the desired level on the setting bar in <ALARM VOLUME> box. At the lowest volume setting, the alarm is still audible.

NOTE

Set the alarm volume depending on the monitoring environment. When you drag the slider or touch the key to the lowest level, the alarm sound goes to the minimum volume.

3. After changing settings, press the [Home] key to return to the home screen.

Changing the Screen Brightness

When operating on battery power, the brightness is automatically set to minimum.

1. Display the BRIGHT page.
Press the [Menu] key → DISPLAY key → BRIGHT tab.

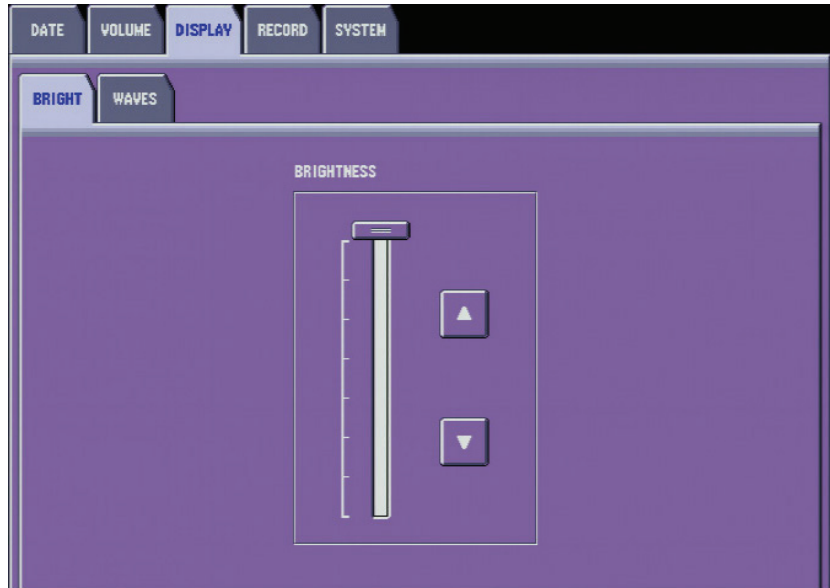

2. Touch the desired place on the setting bar in <BRIGHTNESS> box. Use the ▲ or ▼ key or drag the slider to the desired level on the setting bar to adjust the setting.
3. Press the [Home] key to return to the home screen.

Changing Waveform Display Settings

The following items can be set for the home screen configuration.

- Blood pressure waveform display mode
- Number of ECG waveforms
- Respiration/CO₂ waveform sweep speed
- Waveform sweep speed (except for respiration, CO₂ and EEG waveform)
- Waveform display on the home screen

1. Display the WAVES page.

Press the [Menu] key → DISPLAY key → WAVES tab.

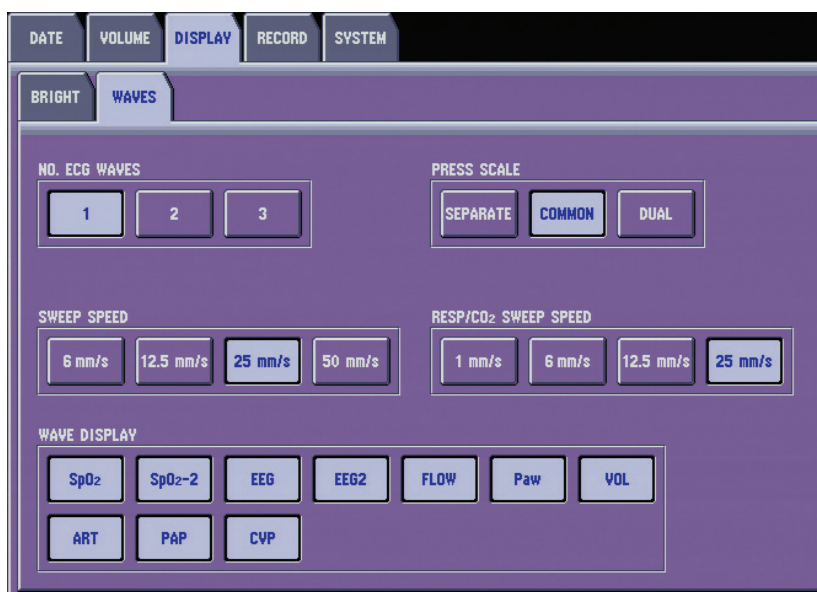

2. Change settings.

To change the number of ECG waveforms, select 1, 2 or 3 in the <NO. ECG WAVES> box.

To change the blood pressure waveform display mode, select one of the following in <PRESS SCALE> box.

SEPARATE: Blood pressure waveforms are displayed separately on different scales.

COMMON: Blood pressure waveforms are displayed on the same scale.

DUAL: Blood pressure waveforms are separated into arterial blood pressures and other type of blood pressures. The arterial blood pressures are labeled ART, ART-2, RAD, DORS, AO, FEM, UA, LVP and P1 to P7.

To change the sweep speed of waveforms other than respiration, CO₂ and EEG waveforms, select a speed in the <SWEEP SPEED> box.

To change the respiration/CO₂ waveform sweep speed, select from one of four speeds in the <RESP/CO₂ SWEEP SPEED> box.

3. NECESSARY SETTINGS BEFORE MONITORING

To change the waveform display of the following parameters on the home screen, select a parameter in the <WAVE DISPLAY> box. Available parameters are SpO₂, SpO₂-2, FLOW, Paw, VOL, EEG, EEG2 and IBP.

NOTE

- The SpO₂-2 key is available only when an AY-660P, AY-661P, AY-663P, AY-671P or AY-673P input unit, or BSM-1763 or BSM-1773 bedside monitor is used. The BSM-1763 bedside monitors is not available in the US.
- When both BIS and EEG are monitored, both EEG waveforms are displayed.
- FLOW, Paw and VOL keys are not available for BSM-6000A series.

3. Press the [Home] key to return to the home screen.

Admitting/Discharging Patient

Before admitting a new patient, you must first delete all data of a previous patient. Refer to “Discharging Patient” section.

CAUTION

When admitting a new patient, first delete all data of the previous patient. Otherwise, the data of the previous patient and new patient will be mixed together.

NOTE

After turning the monitor on and when admitting a patient on the monitor, make sure that the time displayed at the upper right of the screen is correct. If the date or time is changed during monitoring, the date and time of all stored data is also changed and may not match the date and time on the printout.

When <DATA TRANSPORT USING INPUT UNIT> setting on the DATA MANAGEMENT window of the SYSTEM CONFIGURATION window is set to ENABLE, the TRANSPORT DATA tab appears on the ADMIT DISCHARGE window. Use this tab when removing the AY-600P series input unit or BSM-1700 series bedside monitor. Refer to Section 2 “Preparation” for details.

Screen examples in this section are for BSM-6000K series.

Displaying the ADMIT DISCHARGE Window

1. Display the MENU window by doing one of the following.
 - Press the [Menu] key on the monitor.
 - Press the [MENU/HOME] key on the remote control.
 - Touch the MENU function key on the screen.

3. NECESSARY SETTINGS BEFORE MONITORING

2. Touch the ADMIT DISCHARGE key to display the ADMIT DISCHARGE window.

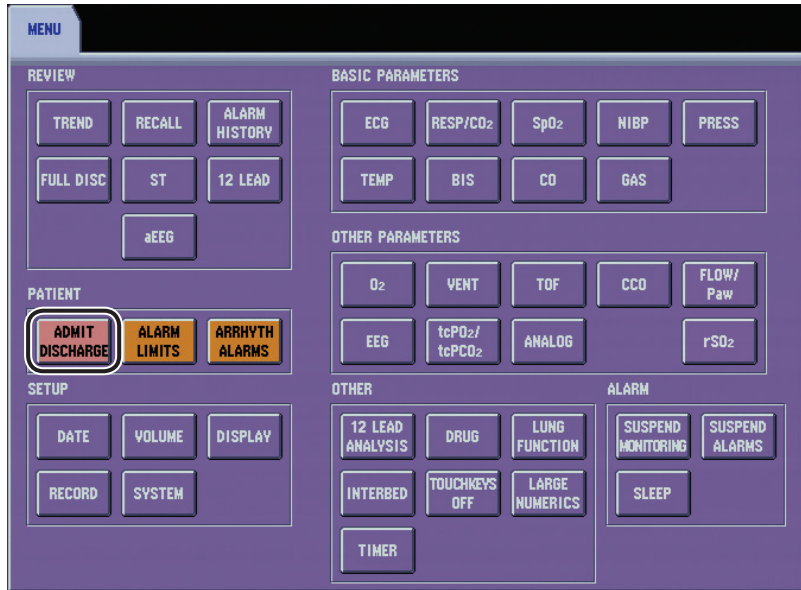

The ADMIT DISCHARGE window can also be displayed by the following ways.



- Touch the patient name area at the upper part of the home screen.
- When <ADMIT MODE> is set to MANUAL, the STANDBY window appears after discharging a patient. The STANDBY window depends on the <STANDBY MODE> setting in the SYSTEM CONFIGURATION screen. When <STANDBY MODE> is set to Off, the ADMIT key appears on the STANDBY window. When <STANDBY MODE> is set to On, the MONITOR key appears on the STANDBY window. You can start monitoring a patient immediately after touching the MONITOR key.

3. Admit or discharge a patient.

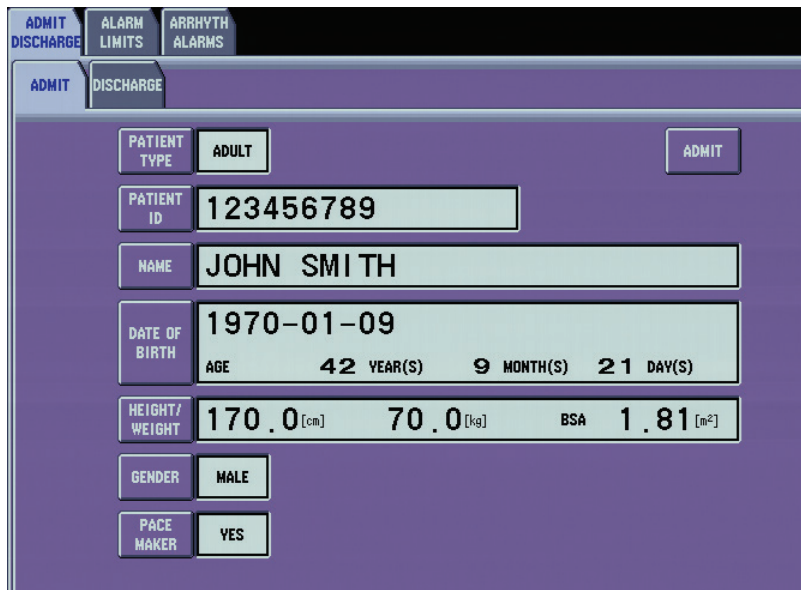

4. Close the window.
 - Press the [Home] key on the monitor or data acquisition unit.
 - Press the [MENU/HOME] key on the remote control.
 - Touch the HOME function key on the screen.
 - Touch the waveform or current trendgraph display area on the home screen.

Stored Data Status and Screen Transition for Admitting Patient

When <DATA TRANSPORT USING INPUT UNIT> is set to ENABLE on the DATA MANAGEMENT window of the SYSTEM CONFIGURATION screen, the patient data and settings are always stored in the QM-600P memory unit in the input unit or the BSM-1700 series bedside monitor. For details, refer to the “Using Transport Function” section.

When <DATA TRANSPORT USING INPUT UNIT> is set to DISABLE on the DATA MANAGEMENT window of the SYSTEM CONFIGURATION screen, the stored data status at power on depends on the settings on the DATA MANAGEMENT window of the SYSTEM CONFIGURATION screen, whether the previous patient is discharged, and whether the power is off for more than 30 minutes.

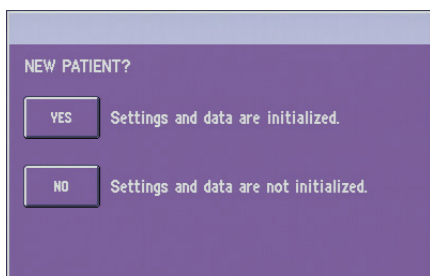

When <ADMIT MODE> is set to AUTO and <SHOW ADMIT CONFIRMATION WINDOW> is turned on on the DATA MANAGEMENT window of the SYSTEM CONFIGURATION screen, the ADMIT CONFIRMATION window appears when the monitor power is turned on. Touch the YES key to monitor a new patient. Touch the NO key to continue monitoring the same patient.

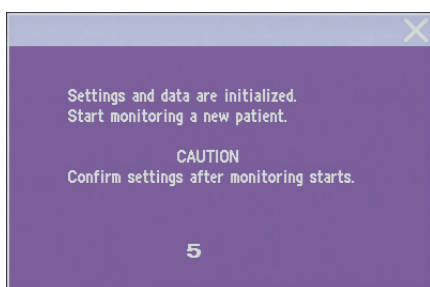

When <ADMIT MODE> is set to AUTO and <SHOW ADMIT CONFIRMATION WINDOW> is turned off on the DATA MANAGEMENT window of the SYSTEM CONFIGURATION screen and the monitor is turned off for more than 30 minutes, the patient data and settings are deleted and monitoring starts about 5 seconds after power on. After turning the power on, admit the patient by doing the procedure in the “Admitting a Patient” section.

When <ADMIT MODE> is set to AUTO and <SHOW ADMIT CONFIRMATION WINDOW> is turned off on the DATA MANAGEMENT window of the SYSTEM CONFIGURATION screen and the power is turned off for less than 30 minutes, the previous patient data and settings are kept and monitoring of the same patient resumes. To monitor a new patient after turning the power on again, admit the patient by doing the procedure in the “Admitting a Patient” section.

3. NECESSARY SETTINGS BEFORE MONITORING

When <ADMIT MODE> is set to MANUAL and <SHOW ADMIT CONFIRMATION WINDOW> is turned on on the DATA MANAGEMENT window of the SYSTEM CONFIGURATION screen and the previous patient was not discharged before turning the power off, the ADMIT CONFIRMATION window appears when the power is turned on again. Touch the YES key to monitor a new patient. Touch the NO key to continue monitoring the same patient.

When <ADMIT MODE> is set to MANUAL and <SHOW ADMIT CONFIRMATION WINDOW> is turned on on the DATA MANAGEMENT window of the SYSTEM CONFIGURATION screen and the patient was discharged before turning the power off, the DISCHARGED message and the STANDBY window appear when the power is turned on again. The STANDBY window depends on the <STANDBY MODE> setting in the SYSTEM CONFIGURATION screen. Touch the ADMIT key to display the ADMIT page of ADMIT DISCHARGE window and admit the patient by doing the procedure in the “Admitting a Patient” section. Touch the MONITOR key to start monitoring a patient immediately.

When <ADMIT MODE> is set to MANUAL and <SHOW ADMIT CONFIRMATION WINDOW> is turned off on the DATA MANAGEMENT window of the SYSTEM CONFIGURATION screen, the monitor is turned off for more than 30 minutes and the patient was not discharged before turning the power off, the patient data and settings are deleted and monitoring starts about 5 seconds after power on. You should admit the patient by doing the procedure in the “Admitting a Patient” section.

When <ADMIT MODE> is set to MANUAL and <SHOW ADMIT CONFIRMATION WINDOW> is turned off on the DATA MANAGEMENT window of the SYSTEM CONFIGURATION screen, the monitor power is off for less than 30 minutes and the patient was not discharged before turning the power off, the patient data and settings are kept and monitoring of the previous patient resumes. To monitor a new patient after the power is turned on, admit the patient by doing the procedure in the “Admitting a Patient” section.

When <ADMIT MODE> is set to MANUAL and <SHOW ADMIT CONFIRMATION WINDOW> is turned off on the DATA MANAGEMENT window of the SYSTEM CONFIGURATION screen and the patient was discharged before turning the power off, the DISCHARGED message and the STANDBY window appear when the power is turned on again. The STANDBY window depends on the <STANDBY MODE> setting in the SYSTEM CONFIGURATION screen. Touch the ADMIT key to display the ADMIT page of ADMIT DISCHARGE window and admit the patient by doing the procedure in the “Admitting a Patient” section. Touch the MONITOR key to start monitoring a patient immediately.

Selecting Patient Type

Select the patient type. The alarm settings, scale settings and other settings change to the default settings according to the patient type.

NOTE

The patient type setting and QRS detection type setting (on the ECG window) are independent of each other.

1. Display the ADMIT page on the ADMIT DISCHARGE window. For details on how to display the ADMIT DISCHARGE window, refer to the “Displaying the ADMIT DISCHARGE Window” in this section.

The screenshot shows the ADMIT DISCHARGE window with the following fields and values:

PATIENT TYPE	ADULT	ADMIT
PATIENT ID	123456789	
NAME	JOHN SMITH	
DATE OF BIRTH	1970-01-09	
AGE	42 YEAR(S)	9 MONTH(S) 21 DAY(S)
HEIGHT/WEIGHT	170.0 [cm]	70.0 [kg] BSA 1.81 [m ²]
GENDER	MALE	
PACE MAKER	YES	

2. Touch the PATIENT TYPE key. The PATIENT TYPE window is displayed.

The screenshot shows the PATIENT TYPE window with the following options and a caution message:

PATIENT TYPE

ADULT CHILD NEONATE

<CAUTION>
Settings will be changed according to patient type.

3. Select the patient type. A confirmation message appears.

The selected alarm master is displayed. Refer to Administrator's Guide, Section 3.

The screenshot shows the PATIENT TYPE window with the following options and a confirmation message:

PATIENT TYPE

ADULT CHILD NEONATE

<CAUTION>
Settings will be changed according to patient type.

ALARM MASTER CHILD
Child Master1

Change patient type to Child?

YES NO

4. Touch the YES key to change the patient type.
Touch the NO key to cancel changing.

3. NECESSARY SETTINGS BEFORE MONITORING

Entering the Patient Information

Enter a patient ID, name, birth date, height, weight, gender and pacemaker use.

Entering the Patient ID

The patient ID can be entered with the screen keyboard, bar code reader or from the central monitor. Up to 16 alphanumeric characters can be entered. The patient ID can only be displayed on the PATIENT ID window. The patient ID is necessary to identify the patient on the central monitor network.

Entering the Patient ID Using the Keyboard

1. Touch the PATIENT ID key to display the PATIENT ID window.

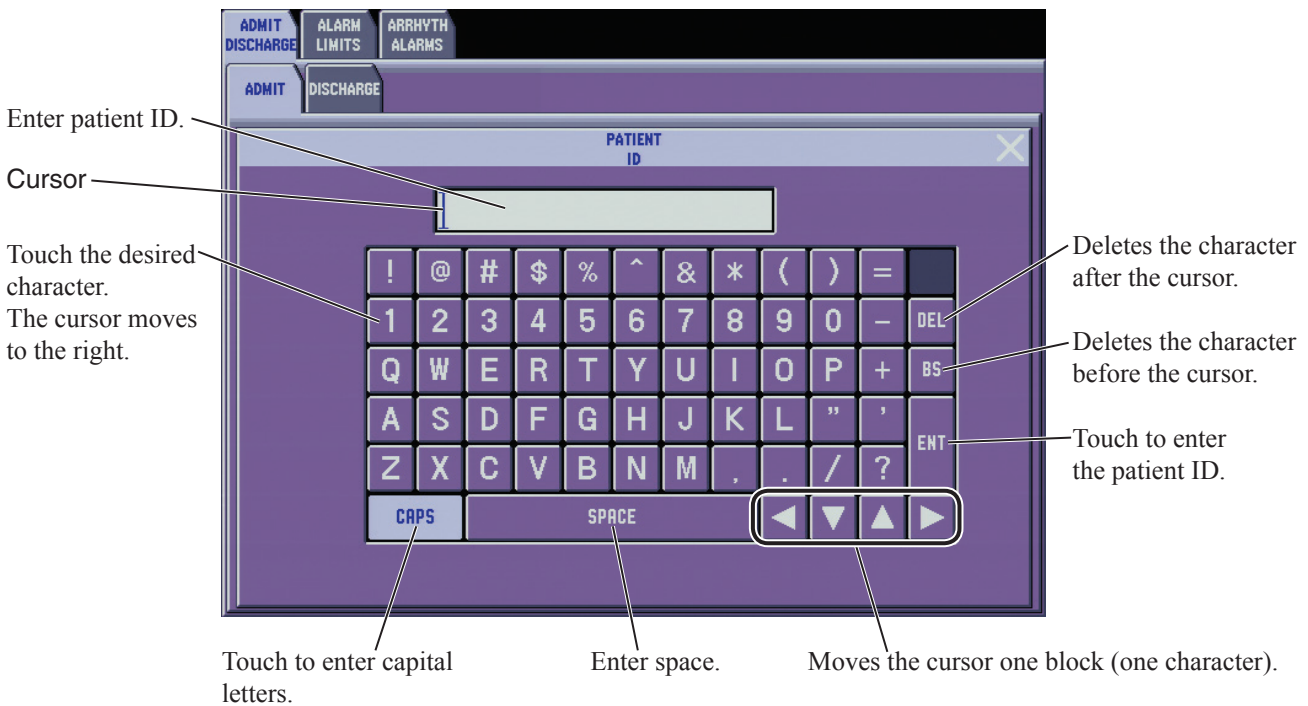

2. Enter the patient ID by using the keyboard keys.
3. Touch the ENT key.
4. Touch the  key to close the PATIENT ID window.

Entering the Patient ID Using the Bar Code Reader

1. Touch the Patient ID key to display the PATIENT ID window.

NOTE

Patient ID can be entered from the home screen.

2. Scan the bar code of the patient. The PATIENT ID window closes.
3. Confirm that the patient ID is displayed on the PATIENT INFO page.

Entering the Patient Name

There are two methods to enter the patient name. You can use both methods together.

KEYBOARD: Use the keyboard keys displayed on the window.
Up to 15 alphanumeric characters can be entered.

FREE: Any character or image you have drawn on the free writing area appears as the patient name.

When the monitor is connected to a monitor network, the FREE window is not available. When the patient name is entered from the FREE window and the monitor is then connected to a network, the patient name on the bedside monitor is deleted and the patient name entered on the central monitor appears on the bedside monitor.

Entering the Patient Name Using the Keyboard

1. Touch the NAME tab. The NAME window appears.

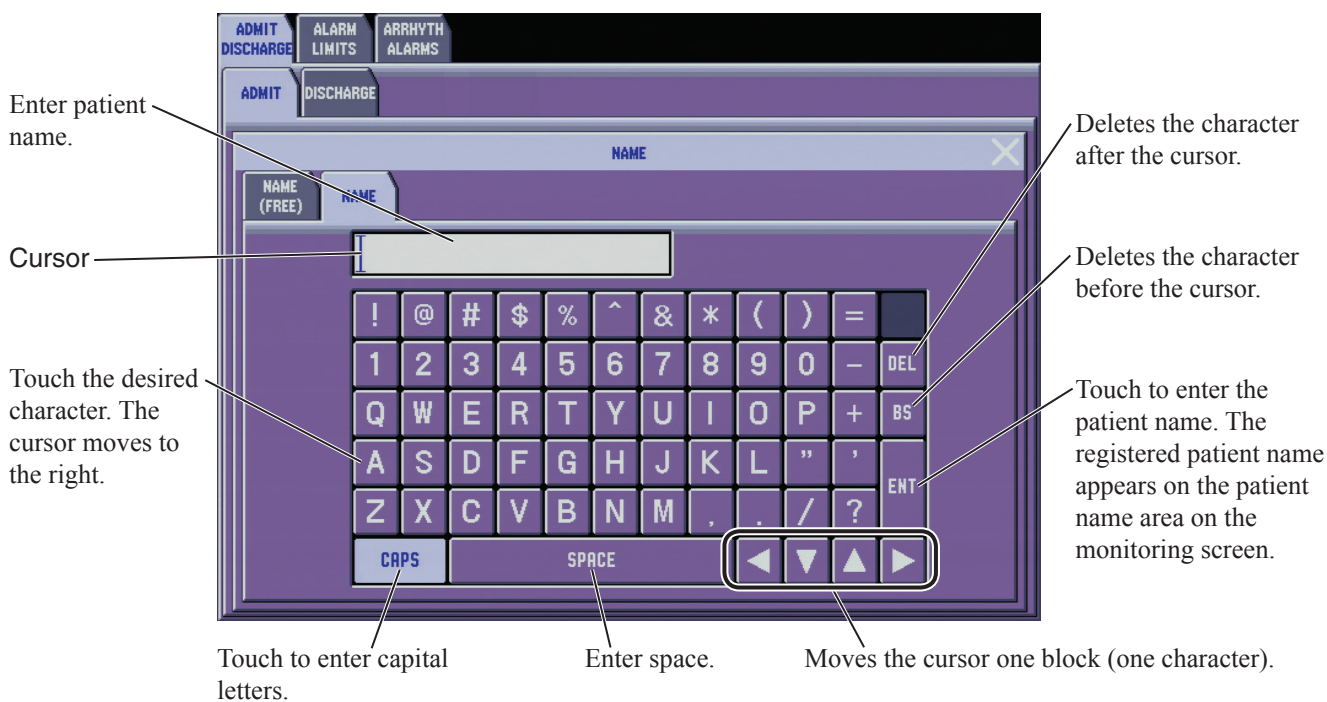

2. Enter the patient name by using the keyboard keys.
3. Touch the ENT key. The patient name appears in the patient name area on the home screen.
4. Touch the  key to close the NAME window.

3. NECESSARY SETTINGS BEFORE MONITORING

Entering the Patient Name Using Free Function

1. Touch the NAME (FREE) tab. The free writing area appears.
2. Write the patient name with your finger or touch pen in the free writing area.

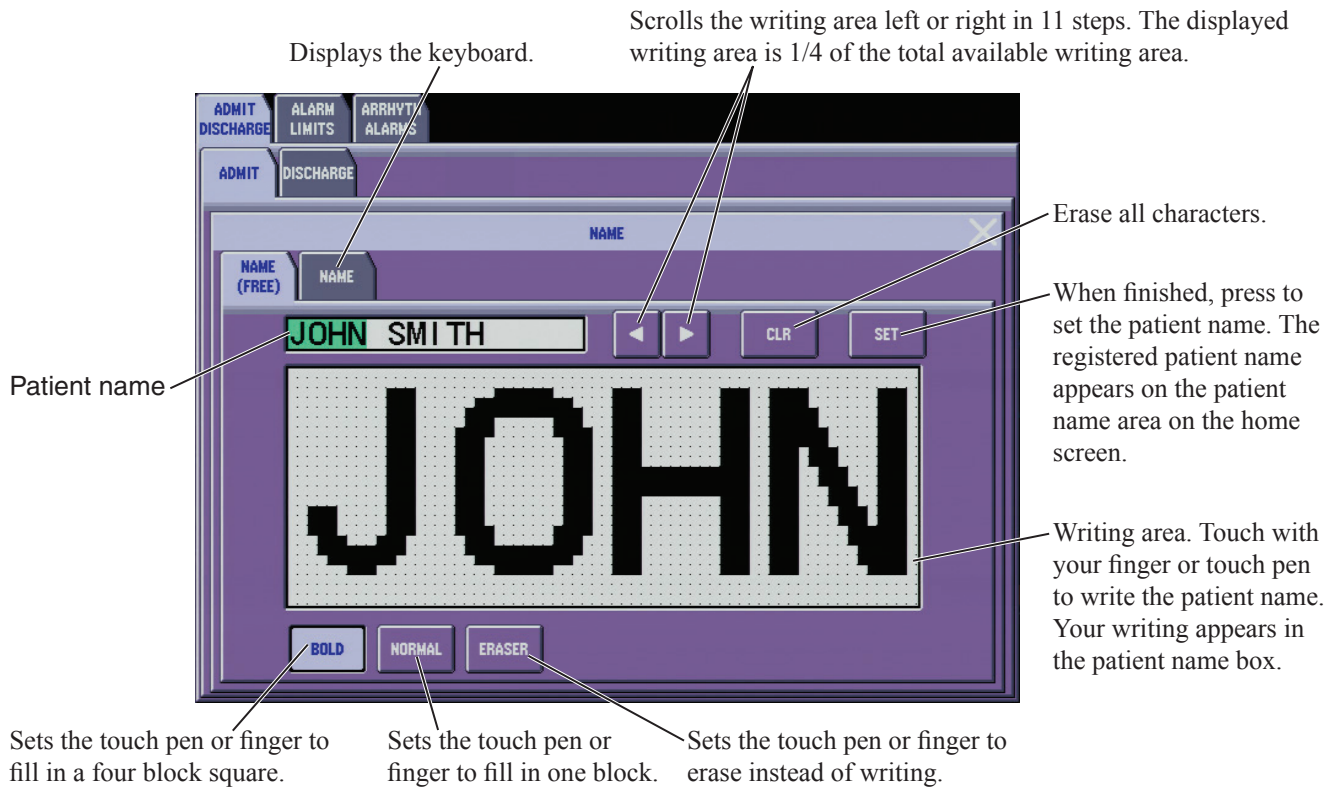

You can enter any character by drawing it. You can also edit names which were previously entered by keyboard. For example, you can make European language characters by drawing accent marks over English characters.

3. Touch the SET key. The patient name appears in the patient name area on the home screen.

Entering the Date of Birth and Age

CAUTION

When the date of birth or age is not entered, 12 lead ECG interpretation is performed with the patient as 35 years old.

3

1. Touch the DATE OF BIRTH key to display the DATE OF BIRTH window.

2. Touch YEAR, MONTH or DAY key or touch the box under the YEAR, MONTH or DAY key to enter year, month and day.
3. Enter the numbers by using the number keys.
4. Touch the ENT key. The number is entered under the YEAR, MONTH or DAY box.
5. Touch the SET key. When the year, month and day are entered, age is automatically calculated and appears at the AGE area on the DATE OF BIRTH window.
6. Touch the key to close the DATE OF BIRTH window.

3. NECESSARY SETTINGS BEFORE MONITORING

Entering the Height and Weight

The height unit (cm or inches) and weight unit (kg or pound) can be set on the SYSTEM CONFIGURATION screen. Refer to Administrator's Guide, Section 2.

1. Touch the HEIGHT/WEIGHT key to display the HEIGHT AND WEIGHT window.



2. Touch the HEIGHT or WEIGHT key or the box beside the HEIGHT or WEIGHT key to enter height and weight.
3. Enter the numbers by using the number keys.
4. Touch the ENT key. When the height and weight are entered, BSA is automatically calculated and appears at the BSA area on the DATE OF BIRTH window.
5. Touch the  key to close the HEIGHT AND WEIGHT window.

Entering the Gender

CAUTION

When the gender is not specified, 12 lead ECG interpretation is performed with the patient as male.

3

1. Touch the GENDER key to display the GENDER window.

The screenshot shows a patient admission form with the following fields: PATIENT TYPE (ADULT), PATIENT ID (empty), NAME (JOHN SMITH), DATE BIRTH (empty), HEIGHT (empty), WEIGHT (empty), GENDER (empty), and PACE MAKER (empty). A GENDER window is open, displaying three buttons: MALE, FEMALE, and -. The window also has a close button (X) in the top right corner.

2. Touch the MALE or FEMALE key. Touch the - key when the patient sex is unknown.
3. Touch the key to close the GENDER window.

Entering the Pacemaker Use

1. Touch the PACE MAKER key to display the PACE MAKER window.

The screenshot shows the same patient admission form as above. A PACE MAKER window is open, displaying two buttons: YES and NO. The window also has a close button (X) in the top right corner.

2. Touch the YES or NO key.

3. NECESSARY SETTINGS BEFORE MONITORING

3. Touch the  key to close the PACE MAKER window.

The pacing spike detection can be turned on or off on the OTHER page of the ECG window. The setting is linked between the ADMIT page of the ADMIT DISCHARGE window and the OTHER page of the ECG window.



When the pacing spike detection set to off, the non-paced mark () is displayed on the upper part of the screen.

WARNING

Turn the pacing pulse detection* to ON when monitoring a pacemaker patient. Otherwise the pacemaker pulse is not rejected. However, even when the pacing pulse detection is set to ON, the pacemaker pulse might not be rejected. When the pacemaker pulse is not rejected, the pacemaker pulse is detected as QRS and false heart rate may be indicated or critical arrhythmia such as asystole may be overlooked. Keep pacemaker patients under close observation.

WARNING

Even when the pacing pulse detection is set to ON, the pacemaker pulse can be overlooked or detected as QRS. You cannot confirm the pacemaker operation only from the detected pacemaker pulse.

* For the pacemaker pulse rejection capability of BSM-6000 series bedside monitor, refer to the “Specifications - ECG” in operator’s manual.

NOTE

When you monitor a premature baby or infant and the monitor miscounts the narrow width QRS, set this to NO.

Admitting a Patient

3

WARNING

Check the alarm settings when admitting a new patient and whenever the patient condition changes and change the alarm settings if necessary. The alarm settings return to the alarm master settings on the SYSTEM SETUP window when:

- A patient is admitted or discharged.
- <SHOW ADMIT CONFIRMATION WINDOW> is set to “Off” in the SYSTEM CONFIGURATION screen and 30 minutes elapse after monitor power off.
- “PATIENT TYPE” is changed on the ADMIT DISCHARGE window.

CAUTION

When admitting a new patient, first delete all data of the previous patient. Otherwise, the data of the previous patient and new patient will be mixed together.

After having entered patient information, you have to take the procedure for admission.

- Upon admission, the following data is deleted.
 - Data on the review windows
 - Data on the 12 LEAD ANALYSIS window
 - Data on the DRUG window
 - Data on the LUNG FUNCTION window
 - PCWP value on the CO window
 - Thermodilution curve on the CO window
 - CO table on the MEASURE page of the CO window
 - Current trendgraph on the home screen
 - CSA/DSA graph
- Alarm settings are initialized to the alarm master value.
- Arrhythmia analysis on or off setting is initialized to the master setting.
- QRS detection type is initialized to the master setting.
- NIBP measurements are deleted, the interval at which to measure NIBP is initialized to the interval master value and the initial cuff inflation pressure is initialized to the master setting.

3. NECESSARY SETTINGS BEFORE MONITORING

1. Display the ADMIT page on the ADMIT DISCHARGE window. For details on how to display the ADMIT DISCHARGE window, refer to the “Displaying the ADMIT DISCHARGE Window” in this section.
2. Touch the ADMIT key to admit the patient. The confirmation message appears.

The screenshot shows the 'ADMIT DISCHARGE' window with the 'ADMIT' tab selected. The patient information is as follows:

PATIENT TYPE	ADULT
PATIENT ID	123456789
NAME	JOHN SMITH
DATE OF BIRTH	1970-01-09
AGE	42 YEAR(S) 9 MONTH(S) 21 DAY(S)
HEIGHT/WEIGHT	170.0 [cm] 70.0 [kg] BSA 1.81 [m ²]
GENDER	MALE
PACE MAKER	YES

An 'ADMIT' button is located in the top right corner of the form.

3. Touch the OK key to admit the patient.

The screenshot shows the 'ADMIT DISCHARGE' window with the 'ADMIT' tab selected. A confirmation dialog box titled 'ADMIT' is overlaid on the screen. The dialog box contains the following text:

Check alarm settings for new patient.
Delete review data and initialize the following settings to the MASTER settings?

- Alarm settings
- Arrhythmia analysis On/Off
- QRS detection type
- NIBP interval

ALARM MASTER ADULT
Adult Master1

Buttons for 'OK' and 'CANCEL' are at the bottom of the dialog box.

If the CANCEL key is touched, the procedure for admission is cancelled, the previous data is not deleted and the settings are not initialized.

When admission is complete, the ADMIT DISCHARGE window closes and the admitted patient name appears on the upper left of the screen.

Discharging a Patient

When monitoring the patient is no longer required, discharge the patient on the DISCHARGE* page.

* For BSM-6000A series, DISCHARGE tab is NEXT CASE tab when the site setting is OR.

CAUTION

When admitting a new patient, first delete all data of the previous patient. Otherwise, the data of the previous patient and new patient will be mixed together.

When monitoring the patient is no longer required, delete the data on the DISCHARGE page. The alarm settings, arrhythmia analysis on or off and QRS detection type return to the alarm master settings, and the NIBP measurement mode returns to the INTERVAL MASTER setting on the SYSTEM SETUP window.

After having discharged the patient, you have to take the procedure for discharge.

- Upon discharge, the following data is deleted.
 - Patient information
 - Data on the review windows
 - Data on the 12 LEAD ANALYSIS window
 - Data on the DRUG window
 - Data on the LUNG FUNCTION window
 - PCWP value on the CO window
 - Thermodilution curve on the CO window
 - CO table on the MEASURE page of the CO window
 - Current trendgraph on the home screen
 - CSA/DSA graph
- Patient type setting returns to the master setting.
- Alarm settings are initialized to the alarm master value.
- Arrhythmia analysis on or off setting is initialized to the master setting.
- QRS detection type is initialized to the master setting.
- NIBP measurements are deleted, the interval at which to measure NIBP is initialized to the interval master value and the initial cuff inflation pressure is initialized to the master setting.

3. NECESSARY SETTINGS BEFORE MONITORING

1. Display the DISCHARGE page on the ADMIT DISCHARGE window.
For details on how to display the ADMIT DISCHARGE window, refer to the “Displaying the ADMIT DISCHARGE Window” in this section. The message confirming the data deletion appears.

When DISCHARGE is assigned to one of the function keys at the upper left of the screen, the DISCHARGE page of the ADMIT DISCHARGE window can be displayed by touching the DISCHARGE function key.

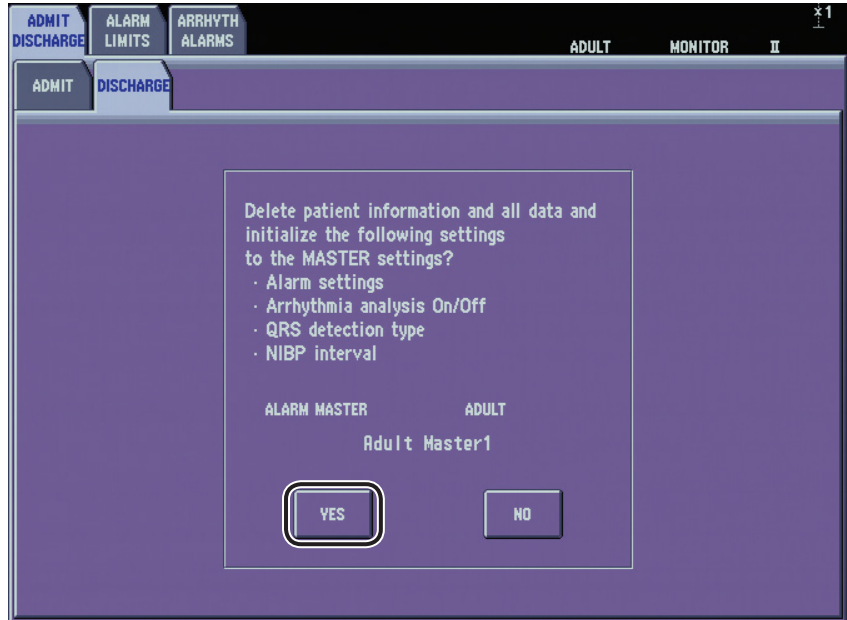

2. Touch the YES key to discharge the patient.

If the NO key is touched, discharging is cancelled, the previous data is not deleted and the settings are not initialized.

When discharging the patient is complete, the ADMIT DISCHARGE window closes and the “DISCHARGED” message and the STANDBY window appear. The patient name is deleted from the upper left of the screen.

The STANDBY window depends on the <STANDBY MODE> setting in the SYSTEM CONFIGURATION screen. Touch the ADMIT key to display the ADMIT page of ADMIT DISCHARGE window and admit the patient. Touch the MONITOR key to start monitoring a patient immediately.

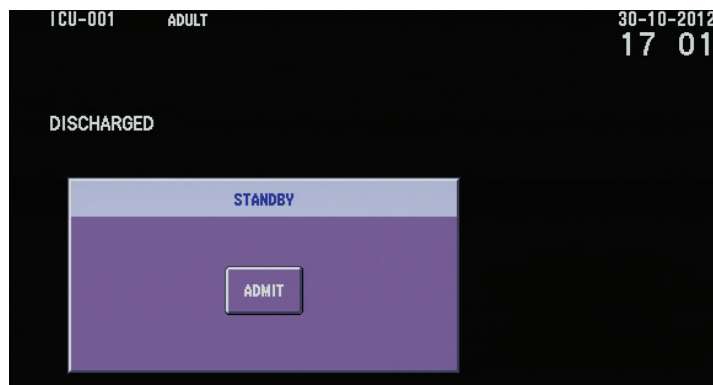

When <ADMIT MODE> is set to AUTO, do steps 3 to 4.

3. Check the following items to confirm that all data are deleted.
 - Patient name on the home screen is deleted.
 - The message on the DISCHARGE page is dimmed.
 - ALARMS SUSPENDED message appears and alarms are suspended on the monitor.

Patient name is deleted. ALARMS SUSPENDED message appears.



The message is dimmed.

4. Press the [Home] key to return to the home screen.

3. NECESSARY SETTINGS BEFORE MONITORING

Suspended Alarms after Admission or Discharge

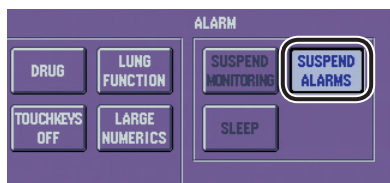

The alarm function is suspended between patient discharge and admission and during monitoring preparation to avoid generating any unnecessary alarms. Alarm function resumes when the SUSPEND ALARMS key is touched or the following monitoring conditions are continuously met.

Setting of <ALARM ACTIVATION DELAY> on the SYSTEM SETUP window	Condition
AUTO	<p>Alarm function activates when ECG, SpO₂ or IBP* is monitored or NIBP** is measured and a value is displayed.</p> <p>* When SYS > DIA, the difference between these two values is 3 mmHg and this status continues for more than 3 seconds.</p> <p>** When SYS, DIA or MAP value is measured.</p> <p>The alarm function is also recovered when the heart rate is 0.</p>
1 min	<p>When one of the following requirements is met.</p> <p>1 ECG, SpO₂ or IBP is continuously monitored for the selected time.</p> <p>2 NIBP is measured (SYS, DIA or MAP value is measured).</p> <p>3 Heart rate becomes 0.</p>
2 min	
3 min	

Using Transport Function in a Monitor Network

Input Unit

In this “Using Transport Function in a Monitor Network” section, the “input unit” means the AY-600P series input unit which a QM-600P memory unit is installed and the BSM-1700 series bedside monitor unless otherwise specified.

Transport Function

You can use the transport function with the input unit when <DATA TRANSPORT USING INPUT UNIT> on the DATA MANAGEMENT window of the SYSTEM CONFIGURATION screen is set to ENABLE. When using the BSM-1700 series bedside monitor as an input unit, also set <DATA TRANSPORT USING INPUT UNIT> to On on the BSM-1700 series.

You can transport the input unit or AY-600P series input unit mounted on the JA-690PA or JA-694PA data acquisition unit together with the patient to another monitor, connect the input unit to another BSM-6000 series or BSM-9101 bedside monitor, and continue to monitor the patient data at the destination bed without interruption.

When <USE SETTINGS IN INPUT UNIT> on the DATA MANAGEMENT window of the SYSTEM CONFIGURATION is turned on on the destination monitor, the settings on the source monitor are applied to the destination monitor. Select “On” or “Off” according to the operating environment.

If the source monitor and destination monitors are in the same central monitor network, you can observe the transported patient continuously from the central monitor.

CAUTION

When installing the monitor, change the time zone setting to the same setting as the other bedside monitors and central monitors. If the time zone setting is not the same, the data which was in the input unit before transport is deleted when using the transport function with the input unit.

NOTE

- A QM-600P memory unit must be installed in the AY-600P series input unit to use the transport function.
- If the BSM-6000 series bedside monitors have different software version, transport function cannot be used.
- If the BSM-6000 series bedside monitor has software version 02-03 or later, transport function using a BSM-9101 bedside monitor is available.

3. NECESSARY SETTINGS BEFORE MONITORING

- When “On” is selected for <USE SETTINGS IN INPUT UNIT> on the DATA MANAGEMENT window of the SYSTEM CONFIGURATION screen and the data is transported from the source monitor whose arrhythmia type is set to STANDARD to the destination monitor whose arrhythmia type is set to EXTENDED, the “STANDARD” settings of the source monitor are copied to the destination monitor. However, depending on the other various settings, the “STANDARD” settings may be changed. Check the arrhythmia alarm settings before monitoring on the destination monitor.
- If the BSM-6000 series bedside monitor has software version 02-01 or later, transport function not using the central monitor network is available.
- If the BSM-6000 series bedside monitor has software version 02-02 or later, transport function using the central monitor network is available.

Data and Settings that can be Transferred between Bedside Monitors

The following data and settings are saved in the input unit and can be transferred to another bedside monitor. Review data of the past 24 hours can be saved.

Settings

- Patient information (patient ID, name, date of birth, height, weight and gender)
- Pacing detection On/Off
- QRS detection type
- Arrhythmia analysis On/Off
- Vital sign upper/lower alarm limits settings
- Arrhythmia alarms settings
- Parameters to be saved for full disclosure and ECG lead settings of TRACE 1 and TRACE 2

NOTE

When “Off” is selected for <USE SETTINGS IN INPUT UNIT> on the DATA MANAGEMENT window of the SYSTEM CONFIGURATION screen on the destination monitor, only the patient information, pacing detection On/Off and QRS detection type settings are applied to the destination monitor. To apply all the above settings to the destination monitor, <USE SETTINGS IN INPUT UNIT> must be turned on.

Review data

- Data on the TREND windows
- Data on the RECALL window (except for AF)
- Data on the ALARM HISTORY window
- Full disclosure waveform (First trace of ECG and the four other waveforms selected on the FULL DISC window)
- Data on the ST window
- Data on the 12 LEAD window

NOTE

- PCCO, ScvO₂, SVV, EDV, EDVI, ESV, ESVI, EF, PPV, SPV, O₂ LEV, HAL LEV, ISO LEV, ENF LEV, DES LEV, SEV LEV, HRV and CF data on the GRAPH 1 to GRAPH 3 pages and TABLE 1 to TABLE 3 pages of the TREND window cannot be saved in the input unit and cannot be sent.
- EEG (monitored with the AE-918P neuro unit), SEF, MDF, PPF and TP data cannot be saved in the input unit and cannot be sent.
- The oldest file is deleted when the maximum number of files is saved.
- To display data on the FULL DISC window, select the same parameters for the waveforms to be saved on both the source monitor and the destination monitor.
- Data on the aEEG and OCRG windows cannot be transported.

Necessary Settings Before Use**CAUTION**

If the patient data in the input unit has different measuring units from the data in the main unit, an INPUT UNIT ERROR dialog box to delete the data in the input unit appears. If you do not want to delete the data in the input unit, touch the CANCEL key and remove the input unit from the main unit.

The unit settings must be the same on the input unit and main unit to use the transport function. Refer to “UNITS Window” in Section 2 of the Administrator’s Guide.

To save data in the input unit and transport data, set <DATA TRANSPORT USING INPUT UNIT> on the DATA MANAGEMENT window of the SYSTEM CONFIGURATION screen to ENABLE.

To apply settings on the source monitor to the destination monitor, set <USE SETTINGS IN INPUT UNIT> on the DATA MANAGEMENT window of the SYSTEM CONFIGURATION screen to ON. Refer to “DATA MANAGEMENT window” in Section 2 of the Administrator’s Guide.

NOTE

On BSM-6000A series, if <CRISIS VITAL ALARM MANAGEMENT> on the SYSTEM CONFIGURATION screen is turned on and “ALARM PRIORITY” of the following parameters is set to CRISIS on the destination monitor, the alarm settings on the destination monitor have priority and the source monitor settings are not applied to the destination monitor.

Parameters:

HR/PR UPPER, HR/PR LOWER, RR UPPER, RR LOWER, APNEA, SpO₂ UPPER, SpO₂ LOWER, SpO₂-2 UPPER, SpO₂-2 LOWER, CO₂ (E) UPPER, CO₂ (E) LOWER, arrhythmia alarms

3. NECESSARY SETTINGS BEFORE MONITORING

Sending Data to a CNS-6201 or CNS-9701 Central Monitor

The review data listed in the “Data and Settings that can be Transferred between Bedside Monitors” section, except for the data on the LUNG TREND page of TREND window and the ALARM HISTORY window, can be sent to the central monitor.

WARNING

When using transport function in the monitor network, patient data may be mixed together or lost in the following cases:

- Transport function and wireless LAN are used at the same time.
- The network cable is connected or disconnected from the bedside monitor or the input unit is removed while the bedside monitor power is off.

WARNING

When you send data from the bedside monitor to the central monitor, use a 10BASE-T or 100BASE-TX switching hub. If you use another type of hub, the network may lose connection and the patient cannot be monitored on the central monitor.

CAUTION

Do not remove the input unit while the data is being sent to the central monitor. The data may be lost.

CAUTION

When the patient is discharged and there is no need to send the patient data to the central monitor, discharge the patient on the central monitor before removing the input unit. When the input unit is unintentionally removed or inserted when not using transport function, data that was sent to the central monitor in the past may be lost.

NOTE

If the central monitor is CNS-9701, it must have software version 01-77 or later. Any version of CNS-6201 is compatible with transport function.

If the input unit is removed from a monitor and connected to a monitor in a central monitor network, the “SENDING DATA” message appears while the data is being sent.

Authenticating a Patient when the Input Unit is Moved from One Monitor to Another

When the transport function is enabled, the patient data must be authenticated to continue or start monitoring when the input unit is inserted into the monitor or the data acquisition unit with the input unit is connected to the monitor. Authenticate the patient on the SELECT PATIENT DATA window and select whether to:

- Use the patient information and data in the input unit,
- Use the patient information and data in the main unit (the data saved in the main unit), or
- Start monitoring as a new patient.

WARNING

When the input unit is connected to the monitor, make sure to authenticate the patient on the SELECT PATIENT DATA window. Otherwise, monitoring cannot be started.

WARNING

Check the patient information and data range on the SELECT PATIENT DATA window. Otherwise, the patient may be incorrectly identified.

WARNING

Check the alarm settings after patient authentication. The alarm settings depend on the <USE SETTINGS IN INPUT UNIT> On/Off setting on the DATA MANAGEMENT window of the SYSTEM CONFIGURATION screen of the destination monitor.

When Using Data in the Input Unit

When the input unit is connected to the monitor, the SELECT PATIENT DATA (INPUT UNIT) window appears.

The screenshot shows the 'SELECT PATIENT DATA (INPUT UNIT)' window. It displays patient information from the input unit, including Patient ID (000-000-2), Name (MARY SMITH), Date of Birth (1955-01-30), Height/Weight (170.0 [cm], 65.0 [kg]), Age (58 YEAR(S), 4 MONTH(S)), and Gender (FEMALE). Below this, it shows the data range: 'Data range: 18-06-2013 11:43 to 18-06-2013 11:43'. The window prompts the user to 'Confirm the patient information.' and provides instructions: 'Touch YES to use patient data from the input unit.' and 'Touch NO to delete patient data in the input unit.' There are 'YES' and 'NO' buttons at the bottom. A note at the bottom reads 'CONFIRM ALARM SETTINGS PRIOR TO MONITORING PATIENT.'

Patient information in the input unit

Data range of the review data in the input unit

Confirm the patient information and data range on the SELECT PATIENT DATA (INPUT UNIT) window and touch the YES key to use the data in the input unit and delete the data in the main unit. You can edit the patient information if necessary.

When the NO key is touched, the SELECT PATIENT DATA (MAIN UNIT) window appears.

3. NECESSARY SETTINGS BEFORE MONITORING

If an AY-600P series input unit without a QM-600P memory unit is connected to the monitor, the SELECT PATIENT DATA (MAIN UNIT) window with the “Data cannot be transferred to another bed with this input unit.” message appears.

SELECT PATIENT DATA (MAIN UNIT)				
Patient information in the main unit:				
PATIENT ID	000-000-1	NAME	JOHN SMITH	
DATE OF BIRTH	1960-01-31	HEIGHT/WEIGHT	180.0 [cm]	80.0 [kg]
AGE	53 YEAR(S)	4 MONTH(S)	GENDER	MALE

Data range: 18-06-2013 11:44 to 18-06-2013 11:47

Confirm the patient information.

Touch YES to use patient data from bedside monitor.
Touch NO to delete patient data in bedside monitor.

CONFIRM ALARM SETTINGS PRIOR TO MONITORING PATIENT.

Data cannot be transferred to another bed with this input unit.

If this message appears, replace the input unit with another AY-600P series input unit which a QM-600P memory unit is installed or the BSM-1700 series bedside monitor which <DATA TRANSPORT USING INPUT UNIT> is set to On. Or, do the procedure in the “When Using Data in the Main Unit” section to use the data in the main unit.

CAUTION

If the patient data in the input unit has different measuring units from the data in the main unit, an INPUT UNIT ERROR dialog box to delete the data in the input unit appears. If you do not want to delete the data in the input unit, touch the CANCEL key and remove the input unit from the main unit.

NOTE

- The unit settings must be the same on the input unit and main unit to use the transport function in the monitor network. If the unit settings differ, an INPUT UNIT ERROR dialog box with the “The patient data in the input unit has different measuring units from the data in the main unit. The data in the input unit will be deleted.” message appears. Touch the OK key to display the SELECT PATIENT DATA (MAIN UNIT) window and select whether to use the data in the main unit. Refer to the “When Using Data in the Main Unit” section. If you do not want to delete the data in the input unit, remove the input unit from the main unit.
- If the data in the input unit is damaged, an INPUT UNIT ERROR window appears. Touch the OK key to display the SELECT PATIENT DATA (MAIN UNIT) window and select whether to use the data in the main unit. Refer to the “When Using Data in the Main Unit” section.

- If the input unit and main unit have different software versions, an INPUT UNIT ERROR dialog box with the “The input unit software version is incompatible with the main unit. The data in the input unit will be deleted” message appears. Touch the OK key to display the SELECT PATIENT DATA (MAIN UNIT) window and select whether to use the data in the main unit. Refer to the “When Using Data in the Main Unit” section. If you do not want to delete the data in the input unit, remove the input unit from the main unit.



When Using Data in the Main Unit

1. When the input unit is connected to the monitor, the SELECT PATIENT DATA (INPUT UNIT) window appears. Touch the NO key to display the SELECT PATIENT DATA (MAIN UNIT) window.
2. Confirm the patient information and data range on the SELECT PATIENT DATA (MAIN UNIT) window and touch the YES key to use the data in the main unit. The data in the input unit is deleted and the data is saved in the main unit and input unit when monitoring starts.

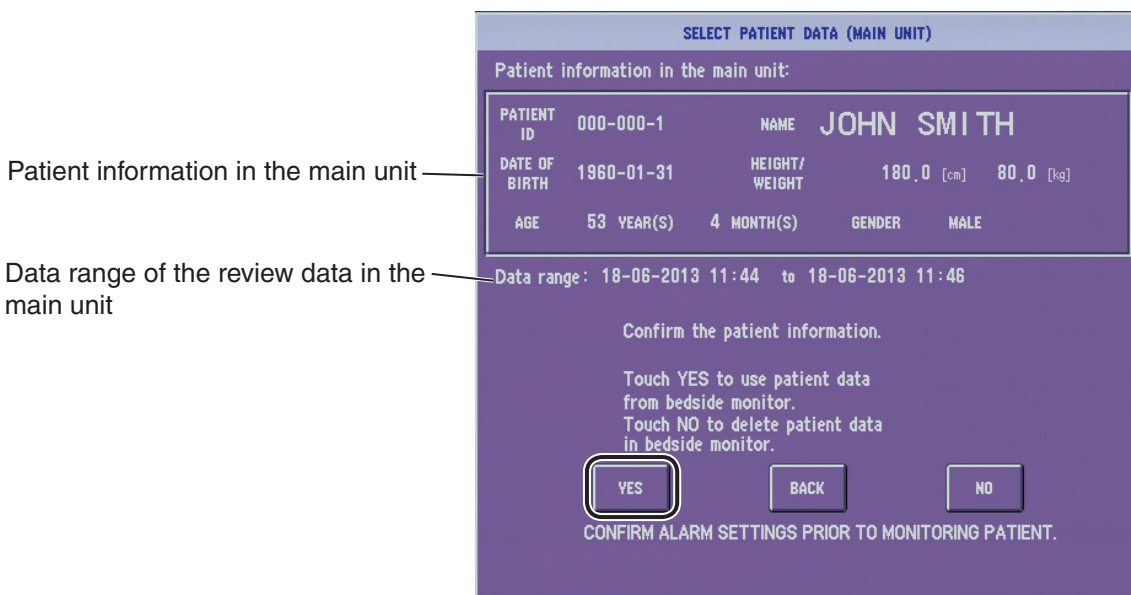

When the NO key is touched, the data in the main unit and input unit are deleted.

3. NECESSARY SETTINGS BEFORE MONITORING

When <ADMIT MODE> on the DATA MANAGEMENT window of the SYSTEM CONFIGURATION screen is set to AUTO, monitoring starts. Admit the patient by doing the procedure in the “Admitting a Patient” section.

When <ADMIT MODE> on the DATA MANAGEMENT window of the SYSTEM CONFIGURATION screen is set to MANUAL, the “DISCHARGED” message and the STANDBY window appear. The STANDBY window depends on the <STANDBY MODE> setting in the SYSTEM CONFIGURATION screen. Touch the ADMIT key to display the ADMIT page of ADMIT DISCHARGE window and admit the patient. Touch the MONITOR key to start monitoring a patient immediately.

When the BACK key on the SELECT PATIENT DATA (MAIN UNIT) window is touched, the window returns to the SELECT PATIENT DATA (INPUT UNIT) window. The BACK key only appears when there is data in the input unit.

When Monitoring as a New Patient

1. When the input unit is connected to the monitor, the SELECT PATIENT DATA (INPUT UNIT) window appears. Touch the NO key to display the SELECT PATIENT DATA (MAIN UNIT) window.

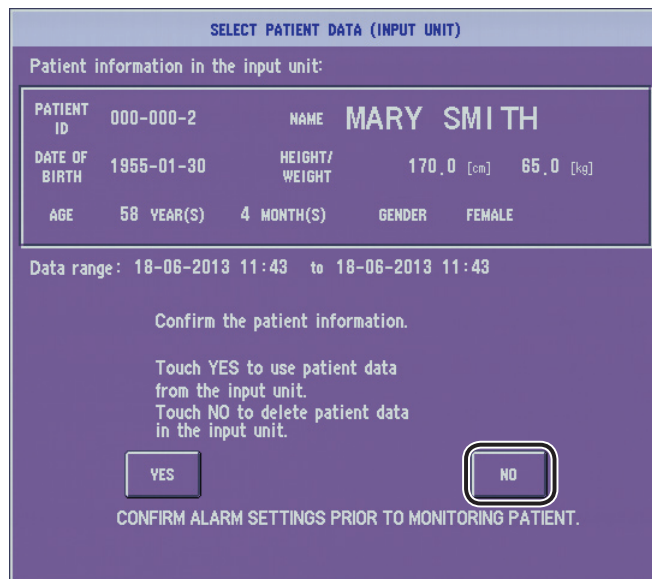

SELECT PATIENT DATA (INPUT UNIT)			
Patient information in the input unit:			
PATIENT ID	000-000-2	NAME	MARY SMITH
DATE OF BIRTH	1955-01-30	HEIGHT/WEIGHT	170.0 [cm] 65.0 [kg]
AGE	58 YEAR(S) 4 MONTH(S)	GENDER	FEMALE

Data range: 18-06-2013 11:43 to 18-06-2013 11:43

Confirm the patient information.

Touch YES to use patient data from the input unit.
Touch NO to delete patient data in the input unit.

CONFIRM ALARM SETTINGS PRIOR TO MONITORING PATIENT.

3. NECESSARY SETTINGS BEFORE MONITORING

2. Touch the NO key to delete the data in the input unit and main unit, and start monitoring as a new patient.

SELECT PATIENT DATA (MAIN UNIT)

Patient information in the main unit:

PATIENT ID	000-000-1	NAME	JOHN SMITH		
DATE OF BIRTH	1960-01-31	HEIGHT/WEIGHT	180.0 [cm]	80.0 [kg]	
AGE	53 YEAR(S)	4 MONTH(S)	GENDER	MALE	

Data range: 18-06-2013 11:44 to 18-06-2013 11:46

Confirm the patient information.

Touch YES to use patient data from bedside monitor.
Touch NO to delete patient data in bedside monitor.

CONFIRM ALARM SETTINGS PRIOR TO MONITORING PATIENT.

When <ADMIT MODE> on the DATA MANAGEMENT window of the SYSTEM CONFIGURATION screen is set to AUTO, monitoring starts. Admit the patient by doing the procedure in the “Admitting a Patient” section.

When <ADMIT MODE> on the DATA MANAGEMENT window of the SYSTEM CONFIGURATION screen is set to MANUAL, the “DISCHARGED” message and the STANDBY window appear. The STANDBY window depends on the <STANDBY MODE> setting in the SYSTEM CONFIGURATION screen. Touch the ADMIT key to display the ADMIT page of ADMIT DISCHARGE window and admit the patient. Touch the MONITOR key to start monitoring a patient immediately.

When the BACK key on the SELECT PATIENT DATA (MAIN UNIT) window is touched, the window returns to the SELECT PATIENT DATA (INPUT UNIT) window. The BACK key only appears when there is data in the input unit.

3. NECESSARY SETTINGS BEFORE MONITORING

When the Patient Information are the Same in the Input Unit and Main Unit

If the patient information in the input unit and main unit are the same, the SELECT PATIENT DATA (INPUT UNIT) window appears.

SELECT PATIENT DATA (INPUT UNIT)					
Patient information in the input unit:					
PATIENT ID	000-000-1	NAME	JOHN SMITH		
DATE OF BIRTH	1960-01-31	HEIGHT/WEIGHT	180.0 [cm]	80.0 [kg]	
AGE	53 YEAR(S)	4 MONTH(S)	GENDER	MALE	
Data range: 17-06-2013 15:41 to 18-06-2013 11:40					
Confirm the patient information.					
<input type="button" value="OK"/>					
CONFIRM ALARM SETTINGS PRIOR TO MONITORING PATIENT.					

Touch the OK key and continue monitoring. The data in the input unit is used.

Preparing for Removing the Input Unit

When the transport function is enabled, perform the following procedure before removing the input unit from the monitor.

WARNING

The monitor cannot start monitoring when the input unit is not ready. When the preparation for removing the input unit from the source monitor is complete, immediately insert the input unit into the destination monitor. If not transporting the patient, activate the standby state.

CAUTION

When removing the input unit from the monitor when the transport function is enabled, perform the removal procedure of the input unit on the REMOVE tab of the ADMIT DISCHARGE window before removing the input unit. Otherwise, the data in the input unit may be lost.

NOTE

If you removed the input unit but you will not transfer the patient, reinsert the input unit into the source monitor and enable the input unit.

1. Display the REMOVE tab.

Press the [Menu] key → ADMIT DISCHARGE key → TRANSPORT DATA* tab → REMOVE tab.

* For BSM-6000A series, TRANSPORT DATA tab is X-PORT DATA tab.

For details on how to display the ADMIT DISCHARGE window, refer to the “Displaying the ADMIT DISCHARGE Window”.

When TRANSPORT DATA is assigned to one of the function keys at the upper left of the screen, the TRANSPORT DATA page of the ADMIT DISCHARGE window can be displayed by touching the TRANSPORT DATA function key.

NOTE

- When the patient is discharged and there is no need to send the patient data to the central monitor, removing the input unit from the bedside monitor is not necessary.
 - If the QM-600P memory unit is not installed in the input unit or the memory unit or the BSM-1700 series bedside monitor is damaged, the following message appears when the REMOVE page is displayed: “This input unit has no memory unit or the memory unit is damaged. Data cannot be transferred to another bed with this input unit.”.
2. Touch the YES key to save data in the input unit and remove the input unit. When the NO key is touched, it returns to the home screen.

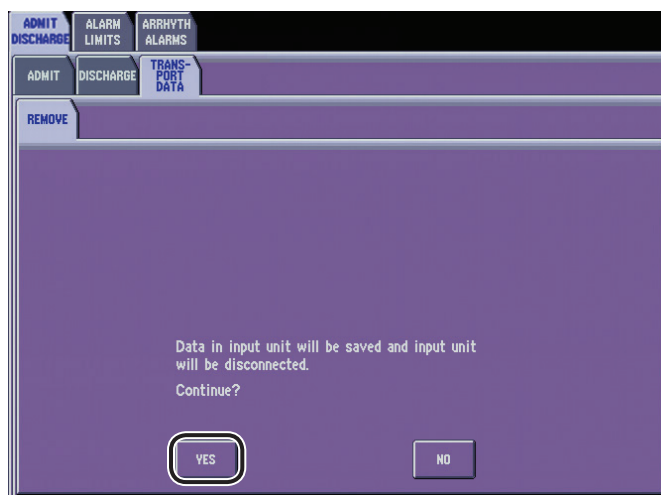

The “PLEASE WAIT” message appears while the monitor is preparing for the input unit removal. When preparation is complete, the “Remove the input unit.” message appears.

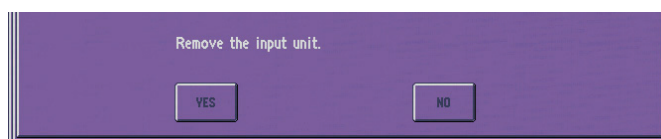

3. Remove the input unit from the monitor (or data acquisition unit).

3. NECESSARY SETTINGS BEFORE MONITORING

Enabling the Input Unit

When the transport function is enabled and preparation for removing the input unit is complete on the monitor or when you remove the input unit without performing the removal procedure, the input unit is disabled and the “CONNECT INPUT UNIT” message and the STANDBY window appear.

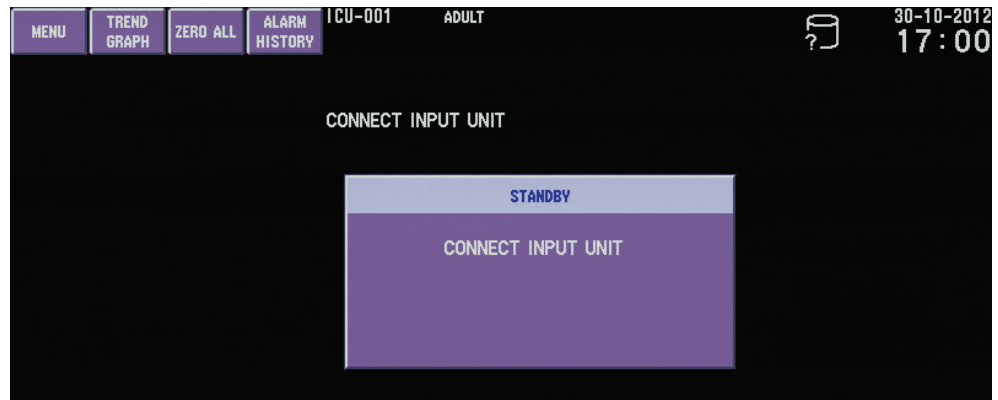

When the input unit is disabled, the measurement values and waveforms are not displayed on the home screen and the data cannot be saved in the monitor. Authenticating the patient and changing the patient information are also not available.

NOTE

When the input unit is disabled, only the drug calculation results, interbed data, review data before disabling the input unit can be displayed.

To enable the input unit, connect the input unit to the monitor and authenticate the patient on the SELECT PATIENT DATA window. Refer to the “Authenticating a Patient when the Input Unit is Moved from One Monitor to Another” earlier in this section.

WARNING

The monitor cannot start monitoring when the input unit is not ready. When the preparation for removing the input unit from the source monitor is complete, immediately insert the input unit into the destination monitor. If not transporting the patient, activate the standby state.

WLAN Transport

NOTE

WLAN transport is not available on BSM-6000K series bedside monitors.

With WLAN transport, BSM-1700 series bedside monitors (transport monitors) are automatically detected and registered so manual registration and setting changes are not needed. And on the central monitor, you do not need to register the bed as a monitored bed. This makes it easier to monitor a patient during transport from one monitor to a different monitor in the network.

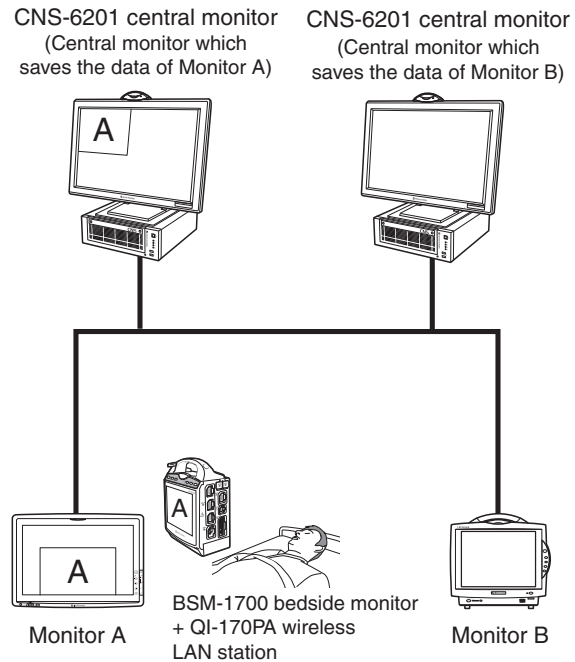

At the start of WLAN transport, when a BSM-1700 series bedside monitor is transported from Monitor A, the patient's registered bed automatically changes from Monitor A to the BSM-1700 series bedside monitor. On the central monitor, patient data can be continuously monitored on the same window as before transport, and the monitoring screen of the BSM-1700 series bedside monitor appears on the Monitor A window.

To end WLAN transport, mount the BSM-1700 series bedside monitor onto Monitor B and authenticate the patient on Monitor B. When authentication is performed on Monitor B, the monitored bed on the central monitor returns to Monitor A and the central monitor shows an empty Monitor A screen.

3. NECESSARY SETTINGS BEFORE MONITORING

Preparation

Prepare the WLAN environment. Refer to the installation guide of the wireless LAN system.

- WLAN transport can only be used with the following combination of instruments.

Central monitor

- CNS-6201 central monitor (Op No. 01A) Ver. 03-40 or later

Host monitor

- BSM-6000A series bedside monitor Ver. 07-01 or later

- CSM-1901 bedside monitor (Op No. 01A) Ver. 01-21 or later

Input unit

- BSM-1700 series bedside monitor (Op No. 33A, 53A and 73A) Ver. 01-15 or later with a QI-170P wireless LAN station

- Change the transport setting on this bedside monitor.
 - Set <DATA TRANSPORT USING INPUT UNIT> on the DATA MANAGEMENT window of the SYSTEM CONFIGURATION screen to ENABLE. (Transport settings of all instruments which use WLAN transport must be set to Enable.) Refer to “DATA MANAGEMENT Window” in Section 2 of the administrator’s guide.
- Change the WLAN transport settings on the BSM-1700 series bedside monitor. For details, refer to the administrator’s guide of BSM-1700 series bedside monitor.
 - Set <DATA TRANSPORT USING INPUT UNIT> on the DATA MANAGEMENT window of the SYSTEM CONFIGURATION screen to ENABLE.
 - Set <WLAN TRANSPORT> to ON on the DATA MANAGEMENT window of the SYSTEM CONFIGURATION screen.
 - Set <WLAN> to ON on the WLAN window of the BSM-1700 series bedside monitor.

Starting WLAN Transport

The REMOVE page opens on the first host monitor when the BSM-1700 series bedside monitor is disconnected.

1. Touch the YES key.

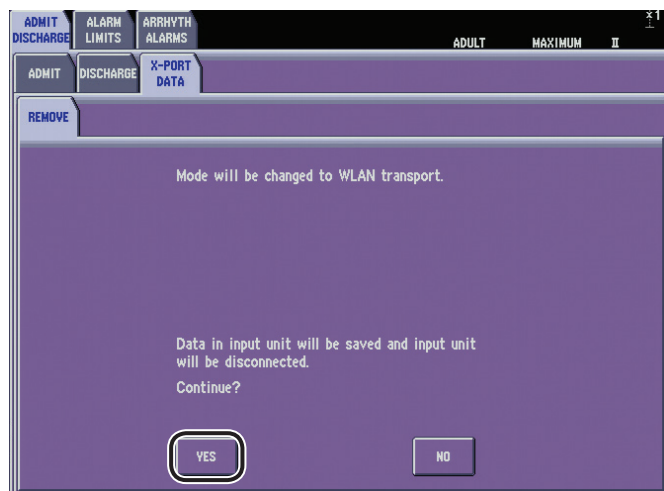

“Mode will be changed to WLAN transport.” and “Remove the input unit.” messages appear.

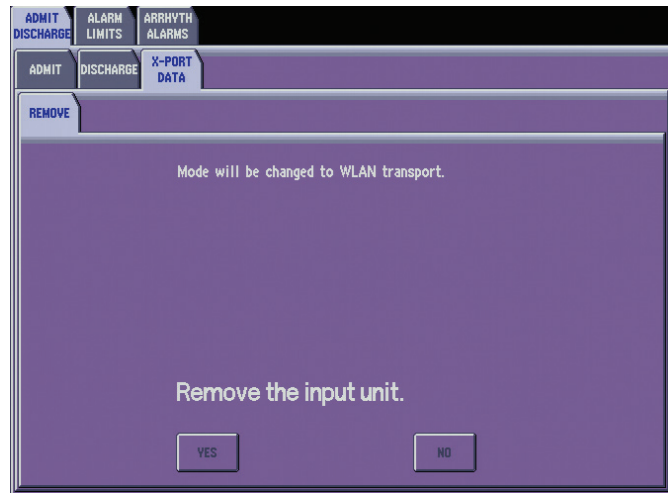

2. Remove the input unit from the first host monitor (or data acquisition unit). A “PLEASE WAIT” message appears and WLAN communication is initiated.



When WLAN communication is established, a WLAN transport window appears on the first host monitor, and a WLAN transport icon appears on the BSM-1700 series bedside monitor and on the central monitor.

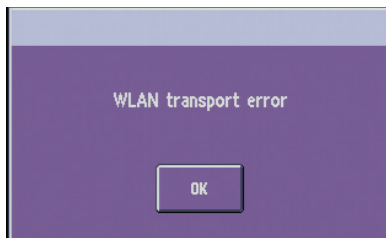

If communication is unstable, WLAN transport cannot be started and a pop-up error appears.

3. NECESSARY SETTINGS BEFORE MONITORING

3. Check that numeric data and waveforms appear on the first host monitor.

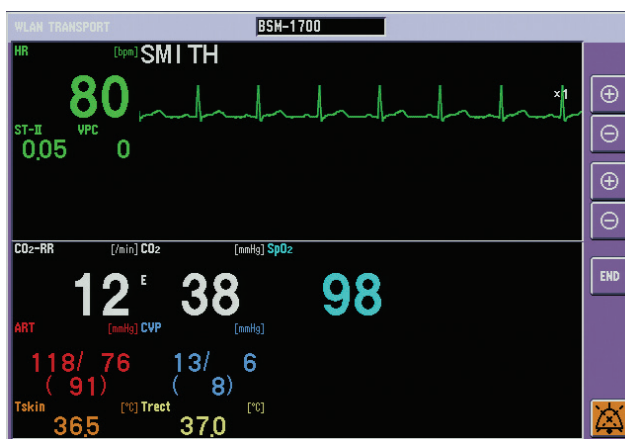

Ending WLAN Transport

When Ending WLAN Transport after Patient Transport

Mount the BSM-1700 series bedside monitor onto the destination monitor and select the patient data. Refer to “Authenticating a Patient when the Input Unit is Moved from One Monitor to Another” section.

If a New Patient Needs the First Host Monitor during WLAN Transport

Connect another input unit to the first host monitor during patient transport and select the patient data. Refer to “Authenticating a Patient when the Input Unit is Moved from One Monitor to Another” section.

When Ending WLAN Transport before Completion

Touch the END key on the first host monitor.

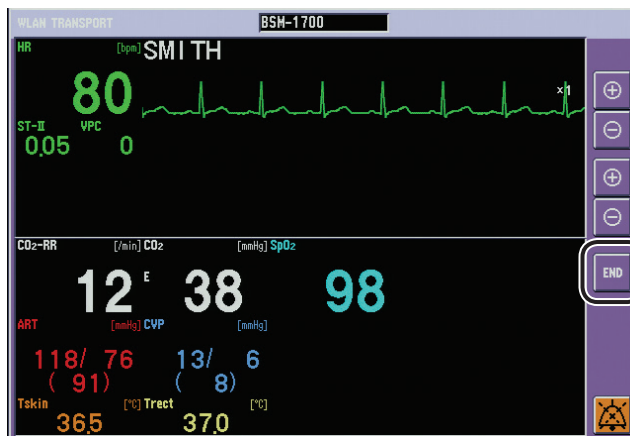

To end the WLAN transport on the BSM-1700 bedside monitor or central monitor, refer to the operator’s manual.

NOTE

The following also ends WLAN transport.

- Discharge the patient from the central monitor or BSM-1700 series bedside monitor.
- Turning off the first host monitor, BSM-1700 series bedside monitor, or central monitor during WLAN transport.

Using Transport Function with a Defibrillator

When a QI-670P interface is mounted on the bedside monitor, waveforms and numeric data can be received from a TEC-5600 series or TEC-8300 series defibrillator. Data from the defibrillator can be reviewed on the Review window.

Refer to the defibrillator operator's manual together with this manual.

One of the following interfaces is also required when connecting a QI-670P interface.

BSM-6301: QI-632P or QI-634P interface

BSM-6501: QI-672P interface

BSM-6701: QI-672P interface

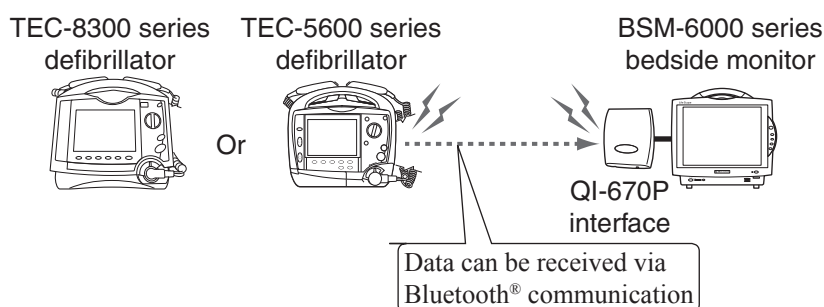

Precautions for Transport Function with a Defibrillator

NOTE

- Transport function with a defibrillator can be used with BSM-6000 series bedside monitor software version 05-41 or later. For the compatible defibrillator software versions, refer to the defibrillator operator's manual.
- While receiving data, do not turn off the bedside monitor or disconnect the USB cable of the QI-670P interface from the bedside monitor. The bedside monitor may be damaged or data may be lost.
- The filter setting of the waveform cannot be received from the defibrillator.
- Data communication with the QI-670P interface is only for TEC-5600 series and TEC-8300 series defibrillators.
- If a QI-670P interface that was connected to this bedside monitor is reconnected to a different bedside monitor, all data in the interface is deleted.
- If the time setting on the bedside monitor and defibrillator are different, the time of the received data is adjusted to the time on the bedside monitor.
- Do not use the QI-670P interface at the same time as a QI-320PA or QI-420PA wireless LAN station.
- The received data from the defibrillator cannot be transferred to the central monitor.

3. NECESSARY SETTINGS BEFORE MONITORING

Receiving Data from the Defibrillator

To prevent mixing data of different patients, defibrillator data can only be received while the bedside monitor is monitoring a patient who has been admitted on the bedside monitor.

Bed ID

Each bedside monitor has a bed ID. Before receiving data, you must select the bedside monitor's bed ID on the defibrillator. If there is more than one bedside monitor, check that the bed ID is not duplicated. If the bed ID is changed, restart the bedside monitor.

Data that can be Received from the Defibrillator

The bedside monitor can receive two hours of defibrillator data via the QI-670P interface.

- Trend data
(Data on the GRAPH, TABLE and NIBP TREND pages)
- Alarm history
(upper and lower limit alarm (HR, ST and VPC), arrhythmia alarm (ASYSTOLE, VF, VT, VPC RUN, TACHYCARDIA, BRADYCARDIA, COUPLET, EARLY VPC, BIGEMINY, FREQ VPC and VPC))
- Full disclosure waveforms

Review Window

The data from the defibrillator is displayed on the review window with a different background color.

Example: TREND window (Trend graph)

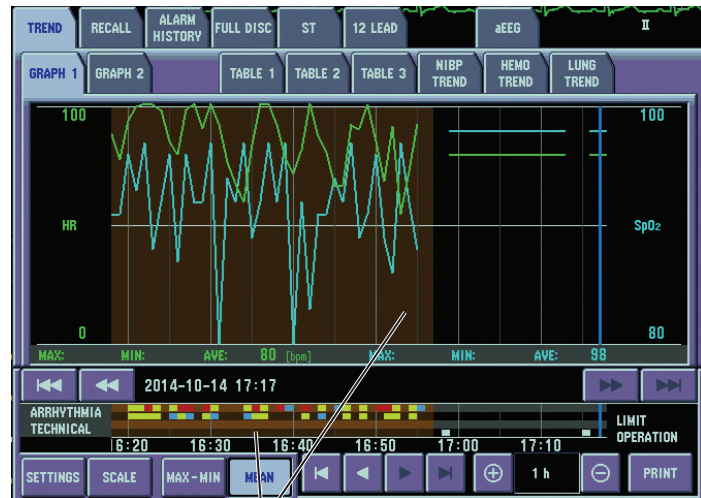

Data from the defibrillator

Data from the defibrillator cannot be printed with the recorder module or network printer.

Receiving Data from the Defibrillator

You must enter this bedside monitor's identification number on the defibrillator before receiving data.

1. On the defibrillator, prepare to send data to the bedside monitor. Refer to the defibrillator operator's manual.

When the preparation on the defibrillator is complete, the RECEIVE TEC DATA window appears on the bedside monitor for 30 seconds.

Identification number
Enter this identification number on the
DATA SEND window of the defibrillator.

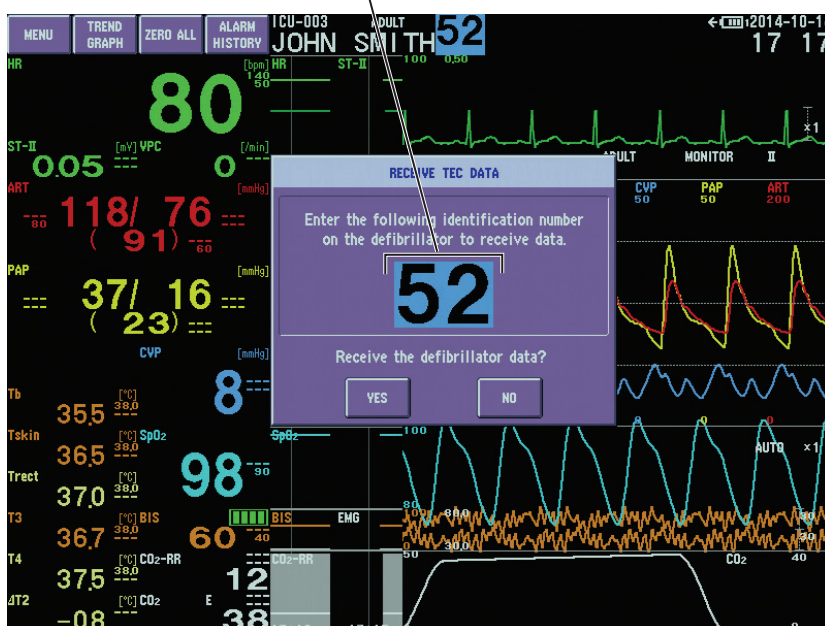

2. Enter the identification number on the RECEIVE TEC DATA window on the DATA SEND window of the defibrillator.

NOTE

If the RECEIVE TEC DATA window disappears from the bedside monitor screen before you can enter the identification number on the defibrillator, redo step 1.

3. Before receiving data from the defibrillator, check that the destination monitor is this bedside monitor.
4. Touch the YES key on the RECEIVE TEC DATA window of the bedside monitor. Data receiving starts.

A "RECEIVING TEC DATA" message is displayed on the bedside monitor while data is being received. The message disappears after the data is received.

Section 4 Home Screen

Safety Precautions for Monitoring.....	4.3
Using an Electrosurgical Unit	4.3
Using a Defibrillator	4.3
Overview.....	4.4
Home Screen	4.4
Review Windows	4.4
Sync Sound.....	4.4
Adjusting the Sync and Alarm Sound Volume.....	4.4
Changing Settings and Performing Other Tasks During Monitoring	4.4
Site Mode	4.5
Recording/Printing on the Home Screen.....	4.5
Interbed Monitoring	4.6
Home Screen.....	4.7
Settings for the Home Screen	4.8
Waveform Sweep Mode and Speed.....	4.8
Waveform Display on the Home Screen	4.8
Pacing Mark Position on the ECG Waveform.....	4.8
ST Waveform and Reference ST Recall Waveform Display on the Home Screen On or Off	4.8
Blood Pressure Waveform Display Mode	4.9
IBP Waveform Display Area on the Home Screen	4.9
PPV or SPV Display on the Home Screen.....	4.9
Pulse Rate Display on the Home Screen.....	4.9
Current Average CO and PCWP Values Display on the Home Screen.....	4.10
Trendgraph/OCRG Display on the Home Screen On or Off.....	4.10
Scale Setting for the Trendgraph on the Home Screen	4.10
Parameter Colors	4.10
Waveform Sensitivity.....	4.10
Cascade ECG Waveform	4.10
Displaying Other Windows from the Home Screen	4.11
Displaying OCRG	4.12
Freezing Waveforms	4.13
Displaying the LARGE NUMERICS Screen	4.14
Using the Timer	4.17
Car Seat Challenge	4.19
Using Sleep Mode	4.21
Turning Sleep Mode On	4.22
Turning Sleep Mode Off	4.22

4. HOME SCREEN

This section explains how to monitor the patient's waveforms and data.

Before monitoring the patient:

- Prepare the patient and equipment according to Sections 2 to 3, 5 to 9, Administrator's Guide, Sections 1 to 3 and User's Guide Part II. When using an optional recorder module, also see Section 10.
- Before monitoring a new patient, follow the flowchart in Section 2.
- Read the safety precautions in the "Safety Precautions for Monitoring" section.

In this section:

- "Overview" gives general information for all monitoring.
- "Displaying OCRG" explains about displaying OCRG.
- "Freezing Waveforms" explains how to freeze waveforms.
- "Using Sleep Mode" explains how to use sleep mode.
- "Displaying LARGE NUMERICS screen" explains about displaying large numeric data.
- "Using the Timer" explains how to use the timer.

Safety Precautions for Monitoring

Before beginning monitoring, observe the following safety precautions and the safety precautions in User's Guide Part II for ECG and other parameters.

4

Using an Electrosurgical Unit

WARNING

Electrosurgical units (ESU) emit a lot of RF interference. If the monitor is used with an ESU, RF interference may affect the monitor operation.

WARNING

Locate the monitor as far as possible from the ESU. Locate them on opposite sides of the operating table, if possible.

WARNING

Connect the monitor and ESU to different AC outlets located as far as possible from each other.

WARNING

When the monitor is used with an electrosurgical unit (ESU), firmly attach the entire area of the ESU return plate. Otherwise, the current from the ESU flows into the electrodes of the monitor, causing electrical burn where the electrodes are attached. For details, refer to the ESU manual.

Using a Defibrillator

WARNING

Before defibrillation, all persons must keep clear of the bed and must not touch the patient or any equipment connected to the patient. Failure to follow this warning may cause electrical shock or injury.

If the ECG waveform on the screen is too unstable to synchronize with the patient's heart beat because of the following reason(s), remove the cause(s) of an alarm, message, or unstable ECG, and then use a stable ECG lead for synchronization.

- ECG electrode is detached or broken. Lead wire is detached or broken.
- Lead wire moves. AC interference, EMG noise or noise from ESU is superimposed.
- Connection cable is broken or has a short circuit. Connector has poor contact.

Overview

Home Screen

When you first begin monitoring, a home screen appears. The home screen displays waveforms and numeric data for ECG and other parameters. Any time you press the [Home] key, the home screen appears.

The parameters on the home screen depend on the measured parameters.

When the monitor power is turned on, alarms are suspended while the monitor is waiting for the electrodes and probe to be attached to the patient. Monitoring starts when the connection cord is connected to the socket on the monitor and the electrodes or probe is attached to the patient.

NOTE

When <DATA TRANSPORT USING INPUT UNIT> is set to DISABLE, and <SHOW ADMIT CONFIRMATION WINDOW> is turned off in the SYSTEM CONFIGURATION screen, the stored data remains in memory for about 30 minutes after the power is turned off. After 30 minutes, the stored data is lost. When <DATA TRANSPORT USING INPUT UNIT> is set to ENABLE, the patient data and settings are always stored.

Review Windows

The trend, arrhythmia recall, alarm history, full disclosure, ST level recall, 12 lead, OCRG and aEEG windows display the stored data. For details about the review windows, refer to Section 6.

Sync Sound

During monitoring, a continuous “pip” sounds in synchronization with either the QRS or pulse waveform. QRS is the default setting. Refer to “Changing the Sync Sound Source” in Section 1, 4 or 6 of the User’s Guide Part II to change the source of the sync sound.

Adjusting the Sync and Alarm Sound Volume

The sync sound volume and alarm sound volume can be adjusted on the VOLUME window. At the lowest setting, the alarm sound is audible but the sync sound is not audible. Refer to “Changing Sound Volume Settings” in Section 3.

Changing Settings and Performing Other Tasks During Monitoring

Every screen except the SYSTEM CONFIGURATION screen always displays at least one real-time ECG waveform and the numeric data of monitoring parameters. This lets you monitor the patient continuously without interruption while you do other tasks, such as changing settings, printing reports, or viewing trendgraphs.

The screen returns to the home screen when there is no key operation for about 3 minutes.

Site Mode

The site mode can be selected from OR, ICU and NICU according to the environment. The default settings, including alarm upper and lower limit settings, differ according to the site. For details, refer to the Administrator's Guide, Section 2.

The keys displayed on the MENU window differ for each site mode.

OR: The "BYPASS" key is displayed. The "OCRG" key is not displayed.

ICU: The "BYPASS" and "OCRG" keys are not displayed.

NICU: The "BYPASS" and "ST" keys are not displayed. On BSM-6000A series, the 12 LEAD and 12 LEAD ANALYSIS keys are not available when 12 LEAD ANALYSIS is set to Off in the SYSTEM CONFIGURATION screen. Refer to Section 2 of the Administrator's Guide.

When "ALL ALARMS OFF" is selected for ALARMS OFF TYPE on the ALARM window of the SYSTEM SETUP window, the "ALL ALARMS OFF" key is displayed instead of the "BYPASS" or "SUSPEND MONITORING" key on the MENU window. Refer to "Alarm Window" in the Administrator's Guide, Section 3.

For details on the functions of the "BYPASS", "SUSPEND MONITORING" and "ALL ALARMS OFF" keys, refer to "Silencing and Suspending Alarms" in Section 5.

Recording/Printing on the Home Screen

When the optional WS-671P recorder module is installed in the monitor, the waveforms on the home screen can be recorded. ECG and up to two parameters selected on the RECORD window are recorded when the  [Record] key is pressed. When RECORD WAVE is assigned to one of the function keys at the upper left corner of the screen, touching the RECORD WAVE function key also records ECG and parameters.

When PRINT WAVE is assigned to one of the function keys at the upper left corner of the screen, all monitoring waveforms and numeric data can be printed on the network printer when the function key is touched.

For details, refer to Section 10 "Recording".

Interbed Monitoring

When the bedside monitor is connected to a central monitor, the bedside monitor data can be sent to the central monitor. Up to 20 beds in the network can be registered as “interbed” beds and monitoring data of the selected interbed bed can be displayed on the INTERBED window. When an alarm occurs at an interbed bed, the highlighted bed name appears on the upper right corner of the home screen. The interbed alarm can also be silenced from this bedside monitor. Refer to Section 9 “Interbed Window”.

Home Screen

When you first begin monitoring, a home screen appears. To return to the home screen from another window or screen, press the [Home] key.

When a window is displayed and there is no operation for about 3 minutes, the screen automatically returns to the home screen.

The home screen is automatically laid out according to the measured parameters. The layout changes when a measuring parameter changes.

The settings for monitoring parameters can be changed individually on the parameter window. For details about individual parameters, see the User's Guide Part II.

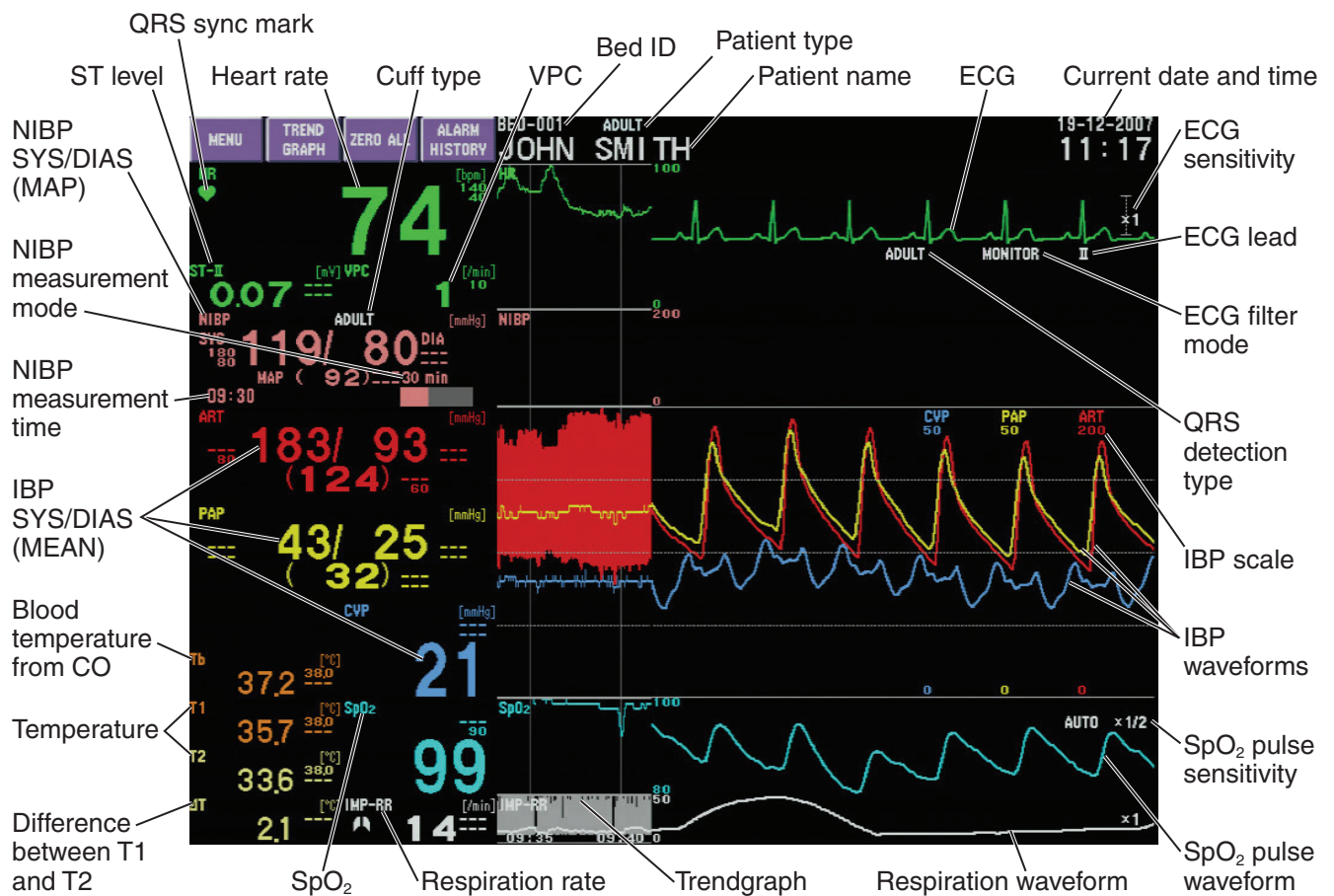

The respiration rate can only be detected from one parameter. When CO₂, respiration and anesthetic gas are monitored at the same time, the respiration rate is detected in the following priority.

Gas > FLOW > CO₂ > thermistor respiration > impedance respiration

When <DISPLAY IMP-RR AS SECOND PARAMETER> on the OTHER page of the RESP/CO₂ window is set to ON, the respiration rate is detected from two parameters. Refer to the User's Guide Part II, Section 2.

4. HOME SCREEN

You can “freeze” (stop sweeping) the waveforms on the home screen. By freezing the waveforms, you can observe one part of a waveform in detail. The numerical data on the screen are not frozen. For details, refer to the “Freezing Waveforms” section.

The latest 30 minute parameter data can be displayed as a trendgraph on the home screen. This trendgraph can be dragged by touching the right edge of the trendgraph and moving it right or left.

An OCRG can be displayed on the home screen instead of a trendgraph. Refer to the “Displaying OCRG” section.

The timer can be displayed on the home screen. Refer to the “Using the Timer” section.

Settings for the Home Screen

Waveform Sweep Mode and Speed

The waveform displaying mode (fixed or moving) on the home screen can be set on the SYSTEM window of the SYSTEM SETUP window. Refer to “SYSTEM Window” in the Administrator’s Guide, Section 3.

The sweep speed of waveforms other than respiration/CO₂ and EEG waveforms on the home screen can be selected from one of four speeds: 6, 12.5, 25 or 50 mm/s at <SWEEP SPEED> on the DISPLAY window.

The respiration and CO₂ waveform sweep speed on the home screen can be selected from one of four speeds: 1, 6, 12.5 or 25 mm/s at <RESP/CO₂ SWEEP SPEED> on the DISPLAY or RESP/CO₂ window.

Waveform Display on the Home Screen

Waveform display of the following parameters on the home screen can be selected in the <WAVE DISPLAY> setting on the WAVES page of the DISPLAY window. Available parameters are SpO₂, SpO₂-2, FLOW, Paw, VOL, EEG, EEG2, ART, PAP and CVP.

Pacing Mark Position on the ECG Waveform

The position of the pacing mark on the ECG waveform displays on the home screen and ECG window can be selected on the PARAMETERS window of the SYSTEM SETUP window. Refer to “PARAMETERS Window” in the Administrator’s Guide, Section 3.

ST Waveform and Reference ST Recall Waveform Display on the Home Screen On or Off

The ST waveforms, reference ST recall waveforms, selected monitoring ECG leads and ST levels display on the home screen are set in the <ST WAVE ON HOME SCREEN> and <ST REF WAVE ON HOME SCREEN> settings on the ST window of the REVIEW window.

Blood Pressure Waveform Display Mode

There are three ways of displaying blood pressure waveforms. This can be changed at <PRESS SCALE> on the DISPLAY window or PRESS window. Refer to “Changing Waveform Display Settings” in Section 3 when changing the press scale on the DISPLAY window or refer to the “Selecting the IBP Waveform Display Mode” in the User’s Guide Part II, Section 6 when changing the press scale on the PRESS window.

SEPARATE: Blood pressure waveforms are displayed separately on different scales.

COMMON: Blood pressure waveforms are displayed on the same scale.

DUAL: Blood pressure waveforms are separated into arterial blood pressures and other type of blood pressures. The arterial blood pressures are labeled ART, ART2, RAD, DORS, AO, FEM, UA, LVP and P1 to P7.

IBP Waveform Display Area on the Home Screen

The IBP waveform display area on the home screen can be selected on the SYSTEM window of the SYSTEM SETUP window. Refer to “SYSTEM Window” in the Administrator’s Guide, Section 3.

PPV or SPV Display on the Home Screen

The PPV or SPV display on the home screen can be selected on the OTHER page of PRESS window. Refer to the “Displaying PPV or SPV on the Home Screen” in the User’s Guide Part II.

Pulse Rate Display on the Home Screen

When using an AY-661P, AY-663P, AY-671P or AY-673P input unit or BSM-1763 or BSM-1773 bedside monitor, the pulse rates display in SpO₂ areas and SpO₂-2 area and the Δ SpO₂ display in SpO₂-2 area on the home screen can be set to on or off on the NUMERIC DISPLAY page of the SpO₂ window. When using an AY-660P input unit, only the pulse rate can be set to on or off. Refer to the “Displaying Pulse Rate and Δ SpO₂ on the Home Screen” in the User’s Guide Part II, Section 4-1.

When using an AY-651P or AY-653P input unit or BSM-1753 bedside monitor, the pulse rates display in the SpO₂ areas and SpO₂-2 area and the Δ SpO₂ display in the SpO₂-2 area on the home screen can be set to on or off on the NUMERIC DISPLAY page of the SpO₂ window. Refer to the “Displaying Pulse Rate and Δ SpO₂ on the Home Screen” in the User’s Guide Part II, Section 4-2.

When using an AY-631P or AY-633P input unit or BSM-1733 bedside monitor, the pulse rate and perfusion index (PI) display in SpO₂ area and SpO₂-2 area and the Δ SpO₂ display in SpO₂-2 area on the home screen can be set to on or off. Refer to the “Displaying Pulse Rate, Δ SpO₂ and Perfusion Index (PI) on the Home Screen” in the User’s Guide Part II, Section 4-3.

Current Average CO and PCWP Values Display on the Home Screen

Current average CO and PCWP values and the measured time are displayed on the home screen. The data dims after 15 minutes and disappears from the home screen after 24 hours. When data is added to the hemodynamics trend table in the HEMO TREND page of the TREND window, the data disappears from the home screen.

Trendgraph/OCRG Display on the Home Screen On or Off

The trendgraph and OCRG display on the home screen is set at <CURRENT TREND> setting on the DISPLAY page of the SYSTEM window in the SYSTEM SETUP window. Refer to “SYSTEM Window” in the Administrator’s Guide, Section 3.

NORMAL: Trendgraph display on the home screen
OCRG 1 cm/min: OCRG display with the horizontal scale 1 cm/min
OCRG 3 cm/min: OCRG display with the horizontal scale 3 cm/min
OFF: No trendgraph/OCRG display on the home screen

Scale Setting for the Trendgraph on the Home Screen

The scale for the trendgraph on the home screen is the same as the setting on the TREND GRAPH window.

Parameter Colors

The parameter colors are set on the COLOR window of the SYSTEM SETUP window. Refer to “COLOR Window” in the Administrator’s Guide, Section 3.

Waveform Sensitivity

Waveform sensitivity can be changed on the parameter window. Refer to the User’s Guide Part II.

Cascade ECG Waveform

The ECG waveform can be cascaded. Refer to “DISPLAY Window” in the Administrator’s Guide, Section 3.

Displaying Other Windows from the Home Screen

Touching the following items on the home screen displays the following windows.

- Numeric value: Parameter setting window
- Patient name: ADMIT DISCHARGE window
- Time: DATE window
- Function key: Window assigned to the function key

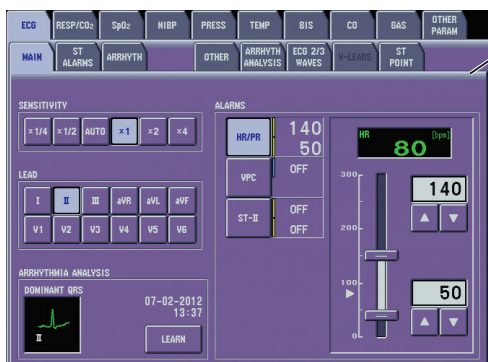
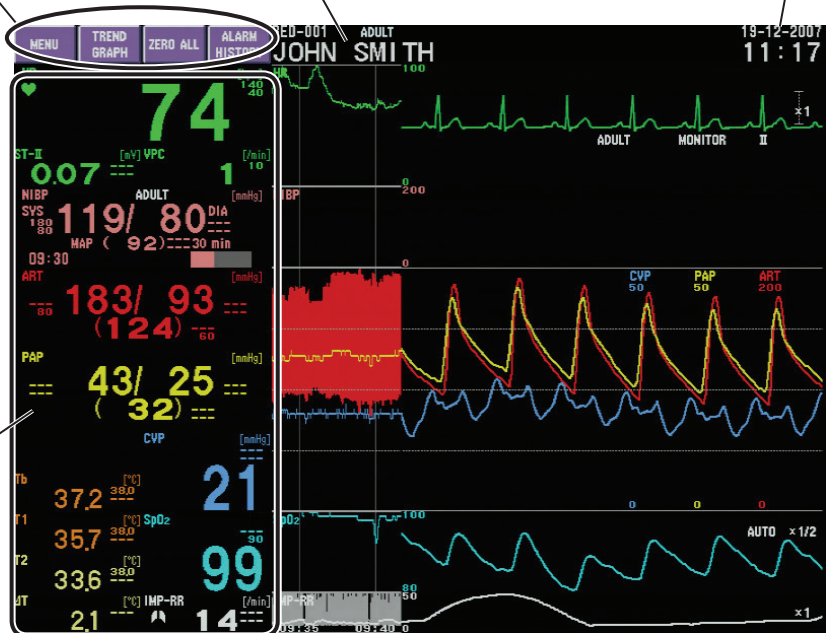
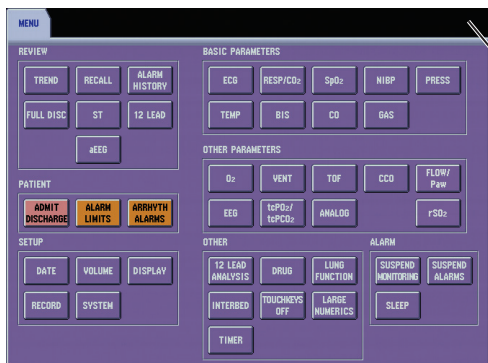

Displaying OCRG

An OCRG (oxygen-cardio-respirogram) can be displayed on the home screen instead of a trendgraph.

The OCRG only displays HR and SpO₂ trendgraphs and compressed respiration waveform. If another parameter is monitored, only the numeric data and waveform for that parameter are displayed on the home screen.

To display OCRG on the home screen, set <CURRENT TREND> to either OCRG 1 cm/min or OCRG 3 cm/min on the DISPLAY page of the SYSTEM SETUP window. Refer to “SYSTEM Window” in the Administrator’s Guide, Section 3.

When the optional WS-671P recorder module is installed in the monitor, OCRG can be recorded. To record OCRG at any time, assign RECORD OCRG to one of the function keys at the upper left corner of the screen. The OCRG on the home screen is recorded when the RECORD OCRG function key is pressed. Refer to “KEYS Window” in the Administrator’s Guide, Section 3.

To record OCRG periodically, set <PERIODIC REC INTERVAL (min)> on the RECORD window to 5 (OCRG) or 15 (OCRG). The OCRG is recorded at 5 or 15 minute intervals. Refer to “Setting Periodic Recording” in Section 10.

The OCRG on the home screen can be printed on the network printer. To print OCRG, assign PRINT OCRG key to one of the function keys. Refer to “KEYS Window” in the Administrator’s Guide, Section 3.

OCRG 1 cm/min

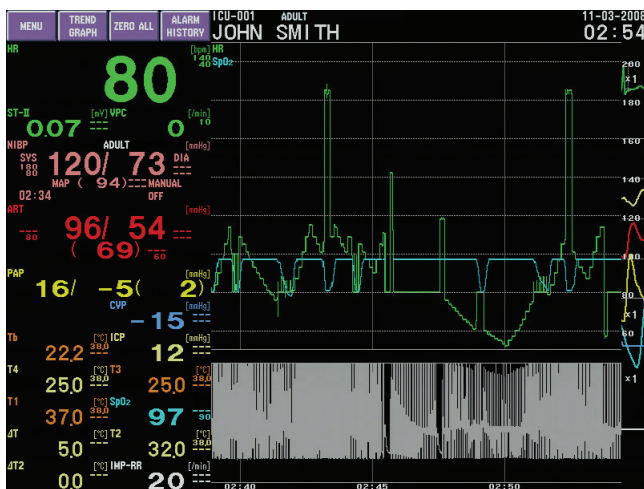

OCRG 3 cm/min

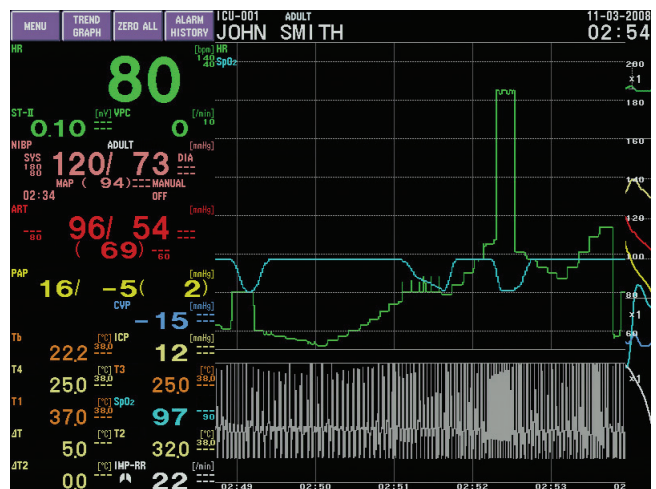

Freezing Waveforms

Normally, the waveforms continuously sweep across the screen. You can also “freeze” (stop sweeping) the waveforms. By freezing the waveforms, you can observe one part of a waveform in detail. The numerical data on the screen are not frozen.

To freeze waveforms, the freeze function must be assigned to one of the function keys in the upper left corner of the screen. Refer to “KEYS Window” in the Administrator’s Guide, Section 3.

When the freeze function is assigned to a function key, waveforms on the home screen can be frozen any time by touching the FREEZE key.

When the waveforms are frozen, the “FREEZE” message appears with the frozen time.

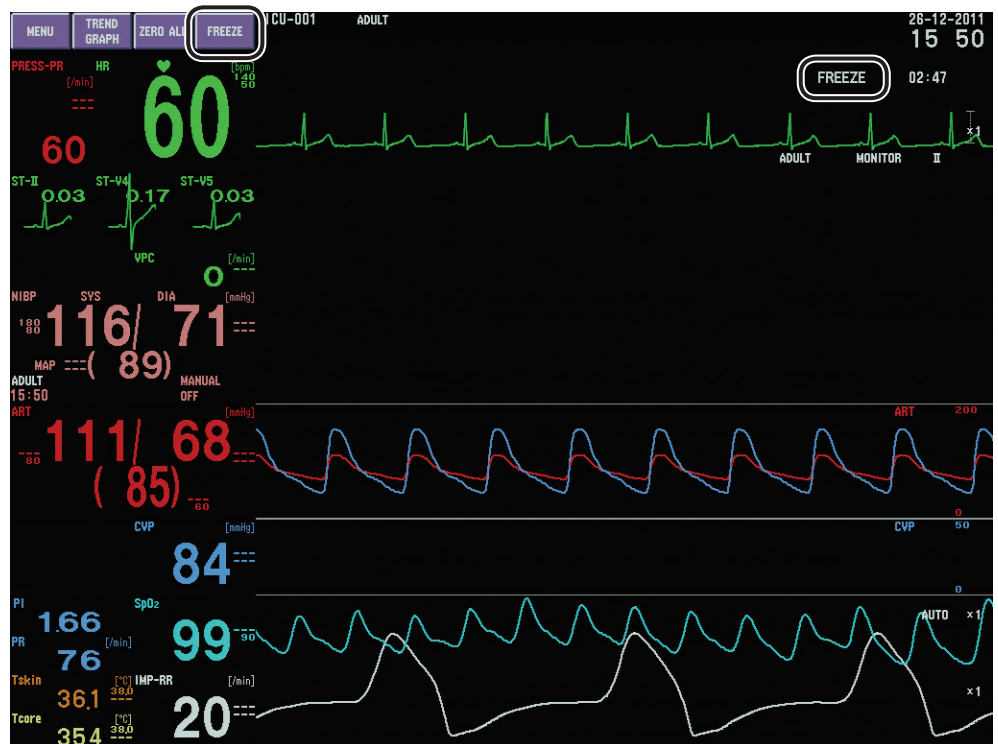

The waveforms are unfrozen automatically when:

- 3 minutes pass.
- The interbed window appears. (<AUTO INTERBED DISPLAY> on the Settings page of the INTERBED window must be set to ON. Refer to Section 9 “Interbed Window”.)

To unfreeze the waveforms manually:

- Touch any key on the screen.
- Press any key on the bedside monitor.

When the waveforms are unfrozen by pressing a hard key, the function of that hard key is also performed. For example, if the [NIBP Start/Stop] key is pressed, NIBP measurement in manual mode is performed.

Displaying the LARGE NUMERICS Screen

The numeric data of all monitoring parameters are enlarged on the LARGE NUMERICS screen. This window is useful for viewing at a distance.

Two types of the LARGE NUMERICS screen are provided. For the difference, refer to the next page. You can select either type on the DISPLAY page of the SYSTEM SETUP window. Refer to “SYSTEM Window” in the Administrator’s Guide, Section 3.

When respiration by impedance method, respiration by thermistor method, CO₂ and anesthetic gas are monitored at the same time, the respiration rate data on the LARGE NUMERICS screen is detected in the following priority.

Gas > CO₂ > respiration by thermistor > respiration by impedance

1. Press the [Menu] key. The MENU window appears.

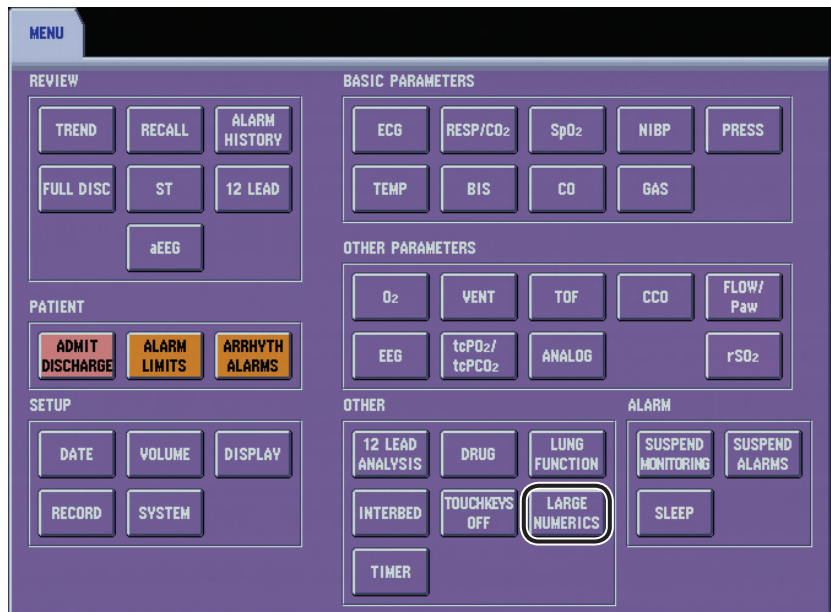

2. Touch the LARGE NUMERICS key. The LARGE NUMERICS screen appears.

2 x 2

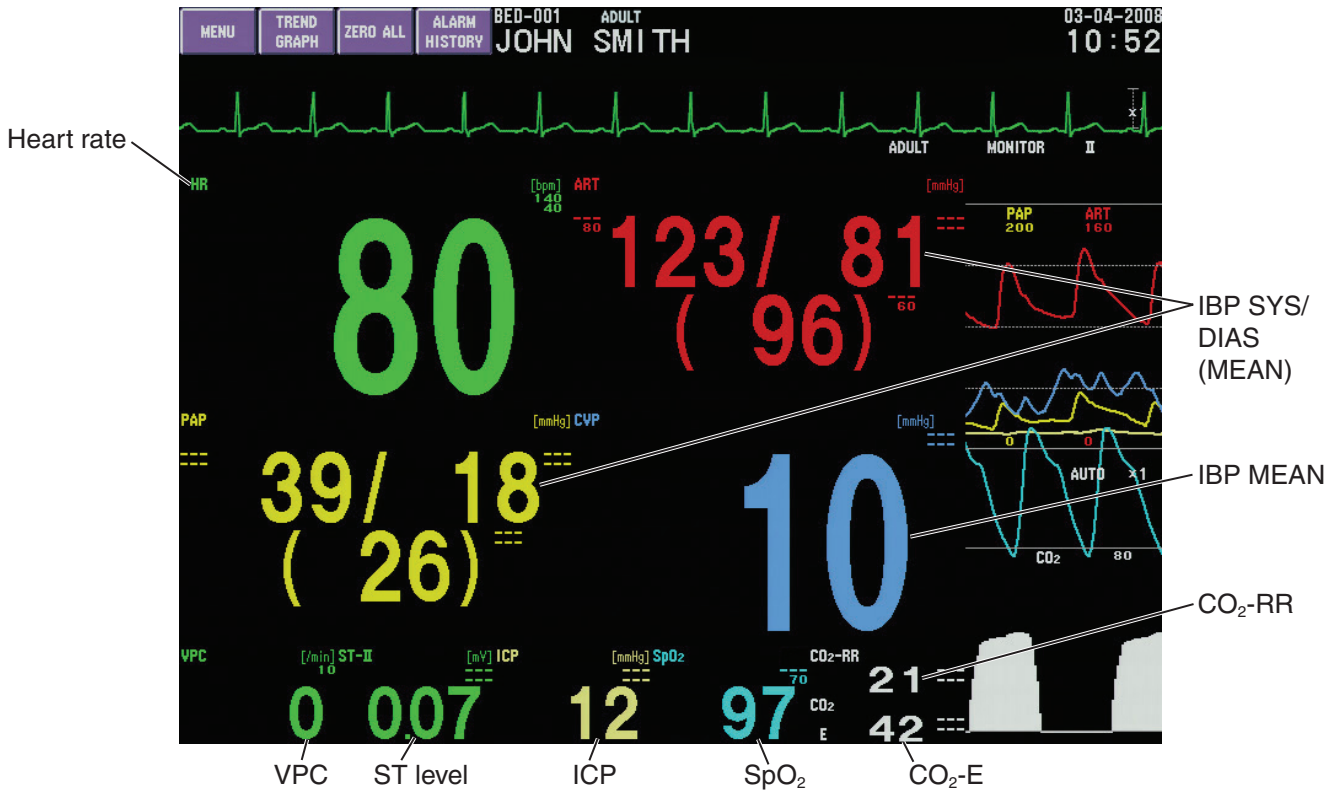

4

3 x 4

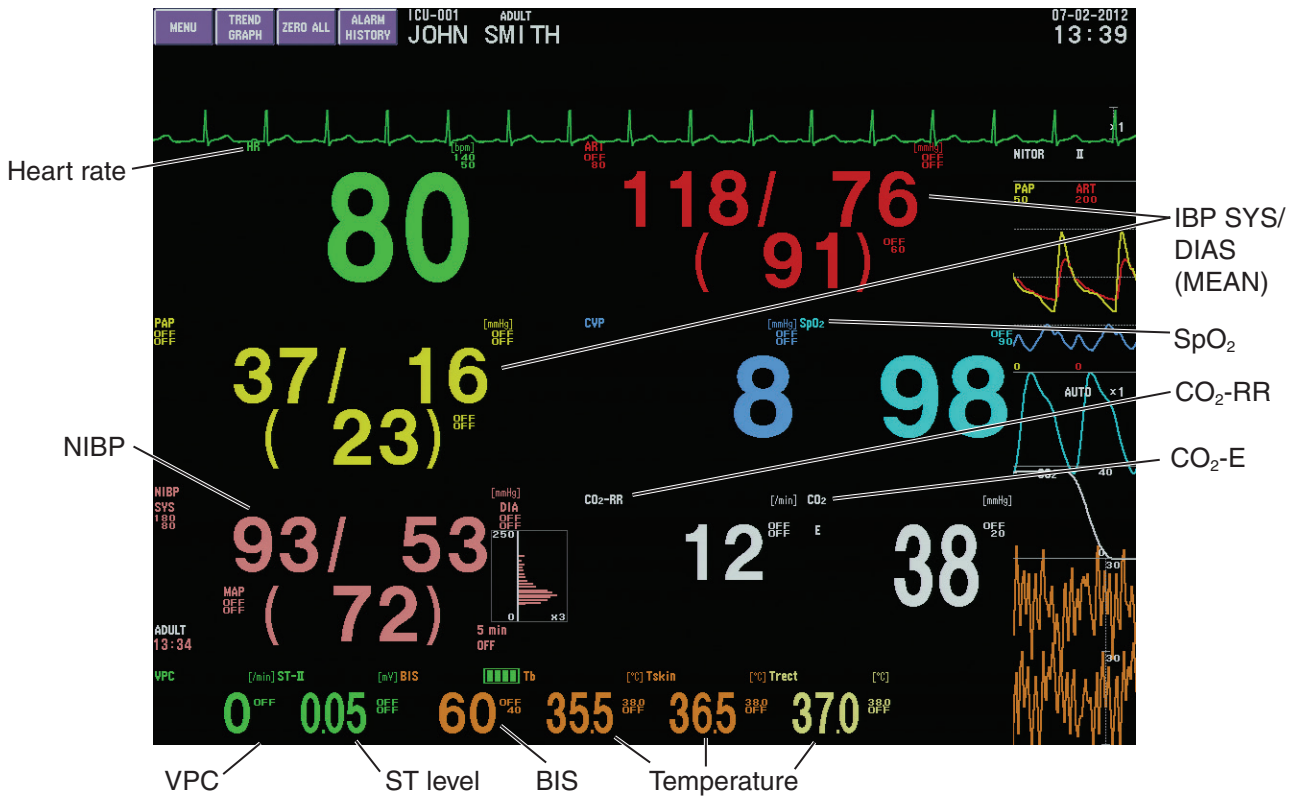

4. HOME SCREEN

The NIBP oscillation graph is displayed when:

- DISPLAY OSCILLATION GRAPH is set to ON on the OTHER page of the NIBP window
- Only a few parameters are monitored

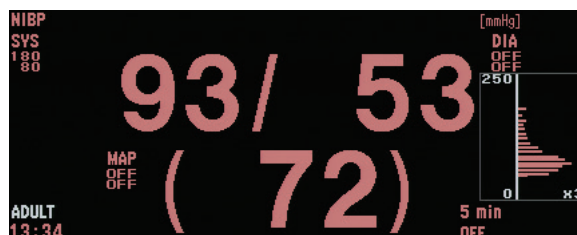

Touching the numeric value displays the parameter setting window.

On the LARGE NUMERICS screen, the trendgraph can be dragged by touching the right edge of the trendgraph and moving it right or left.

3. Press the [Home] key to return to the home screen.

Using the Timer

A timer window can be displayed on the home screen.

1. Press the [Menu] key. The MENU window appears.

4



2. Touch the TIMER key. The TIMER window appears on the home screen.

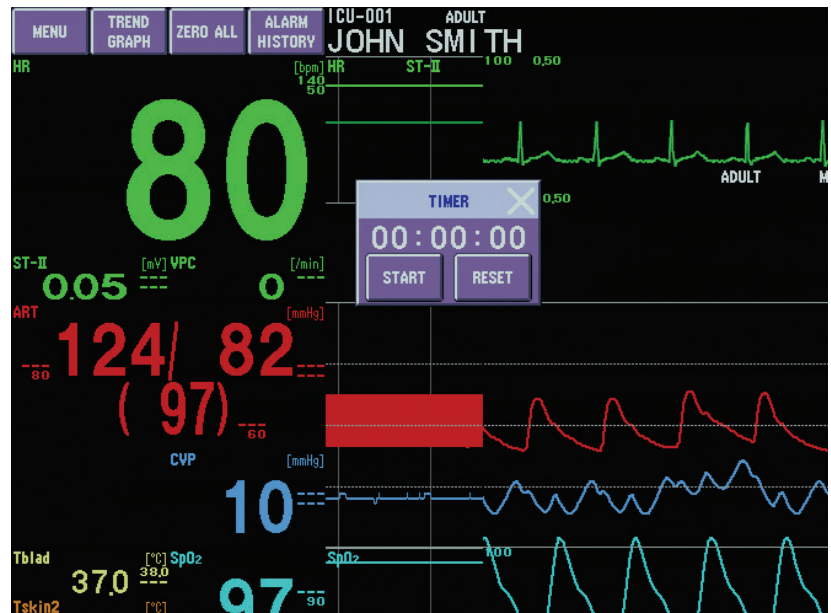

When TIMER is assigned to one of the function keys at the upper left of the screen or one of the function keys on the remote control keys, the TIMER window can be displayed by touching the TIMER function key. Refer to “KEYS Window” in Section 3 of the Administrator’s Guide to assign a function to the function key.

4. HOME SCREEN



3. Touch the START key on the TIMER window. It counts up to 99:59:59.
4. Touch the STOP key to stop the timer. To restart the timer, touch the START key.
5. When stop using the timer, touch the RESET key to reset the timer. The time returns to 00:00:00.
6. Touch  to close the TIMER window.

When ALL ALARMS OFF or BYPASS is assigned to one of the function keys at the upper left of the home screen and the ALL ALARMS OFF or BYPASS function key is touched, the TIMER window appears on the home screen and it starts counting up automatically.

Car Seat Challenge

The American Academy of Pediatrics recommends car seat challenge for all neonates born before 37 weeks gestation to ensure that the neonate is able to sit in a car seat safely without any episodes of oxygen desaturation apnea or bradycardia.

The CAR SEAT CHALLENGE window measures neonate's lower heart rate limit, lower SpO₂ limit and apnea time for a set duration. This is only available on BSM-6000A series bedside monitors when the site mode is NICU.

1. Press the [Menu] key. The MENU window appears.

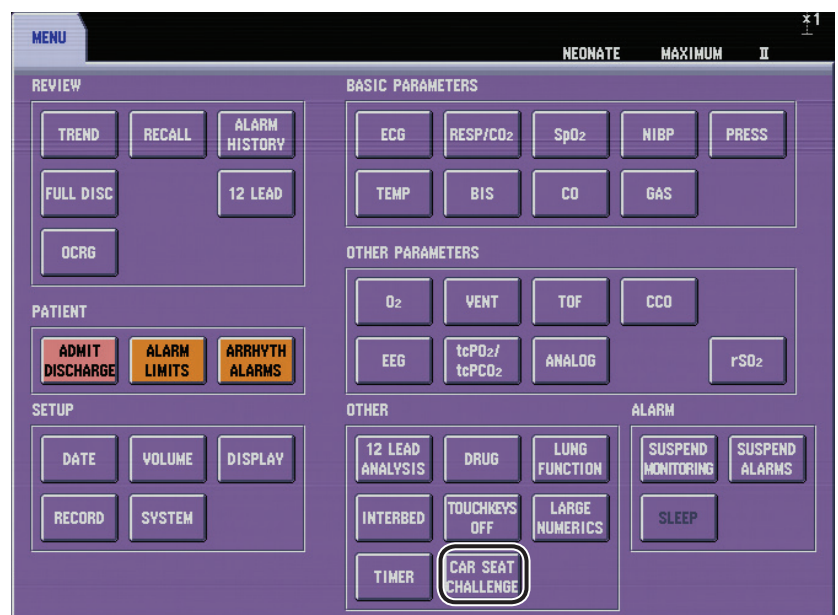

2. Touch the CAR SEAT CHALLENGE key. The TEST window is displayed.



4. HOME SCREEN

3. Set the test duration and touch the START key.



To stop the test, touch the STOP key.

4. After the set duration, the RESULT window appears.

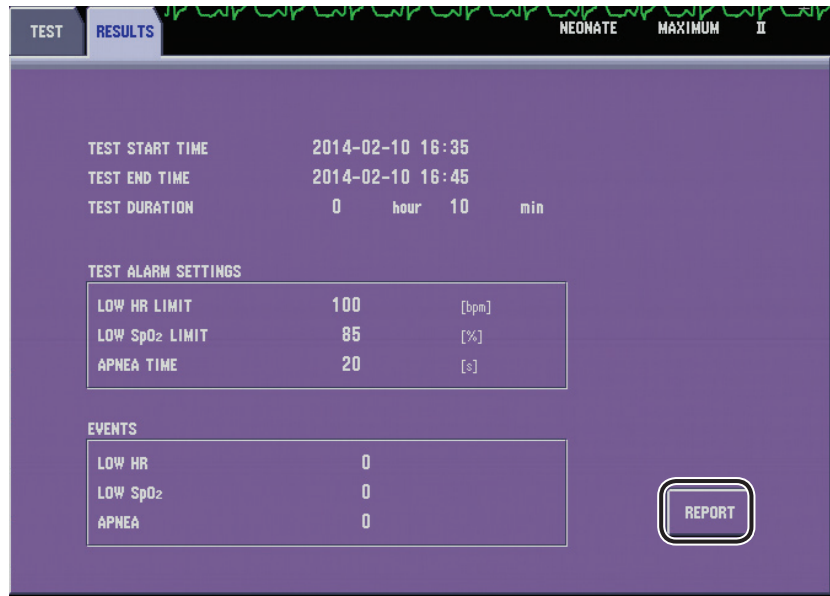

5. Touch the REPORT key to print the report. The REPORT SETTINGS window is displayed.

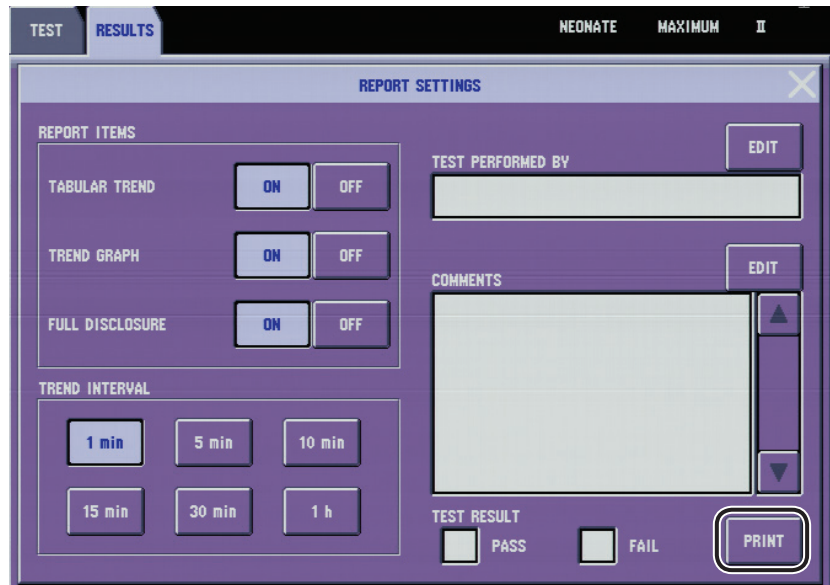

6. Touch the Print key. The test results are printed on the network printer.

Using Sleep Mode

4

In sleep mode, the screen is darkened and sync sound is turned off. The sleep mode is available only when the site mode is set to ICU or NICU and ZS-900P* transmitter is connected or the bedside monitor is connected to the central monitor network. To change the site mode, refer to “SITE Window” in the Administrator’s Guide, Section 2.

* The ZS-900P transmitter is not available for BSM-6000A series.

Use this mode when you want to prevent the monitor from disturbing the patient, such as during sleep.

When <EXIT SLEEP MODE ON CRISIS ALARM> on the SLEEP window of the SYSTEM SETUP window is set to:

YES: Sleep mode is turned off and the home screen appears when a CRISIS level alarm occurs.

NO: Sleep mode continues even when an alarm occurs.

When the time is set in <SLEEP MODE WILL END AT> box on the SLEEP window of the SYSTEM SETUP window, the monitor exits the sleep mode on the set clock time.

When the communication between the bedside monitor and central monitor is interrupted, the bedside monitor exits sleep mode.

Refer to the Administrator’s Guide, Section 3.

WARNING

When using sleep function, monitor the patient on the central monitor or telemetry system. Otherwise, the bedside monitor alarm may be overlooked. When <EXIT SLEEP MODE ON CRISIS ALARM> check box on the ALARM page of the SYSTEM SETUP window is OFF, bedside monitor alarms and sync sound appear on the central monitor but do not appear on the bedside monitor during sleep mode.

4. HOME SCREEN

Turning Sleep Mode On

1. Press the [Menu] key. The MENU window appears.

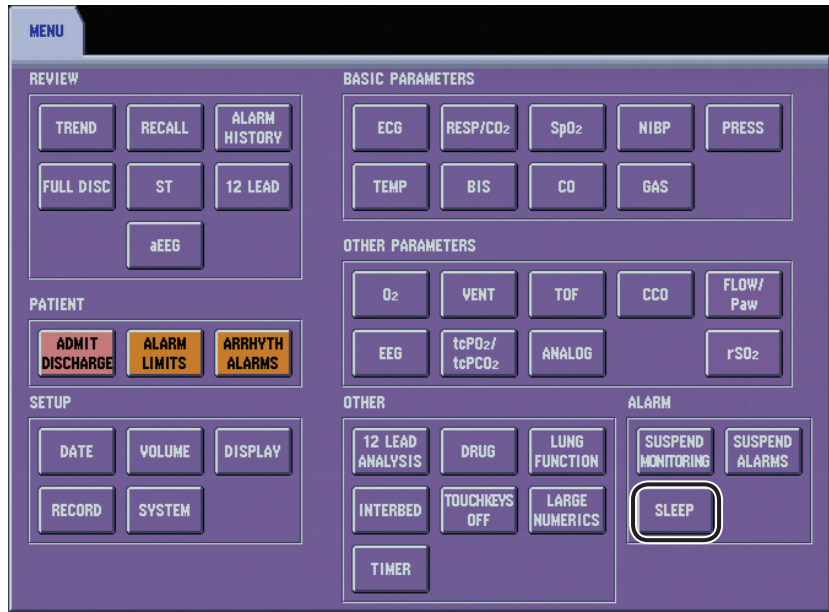

2. Touch the SLEEP key to set the sleep mode.

When SLEEP is assigned to one of the function keys at the upper left of the screen or one of the function keys on the remote control keys, the SLEEP window can be displayed by touching the SLEEP function key. Refer to “KEYS Window” in Section 3 of the Administrator’s Guide to assign a function to the function key.

During the sleep mode, the following screen is displayed.

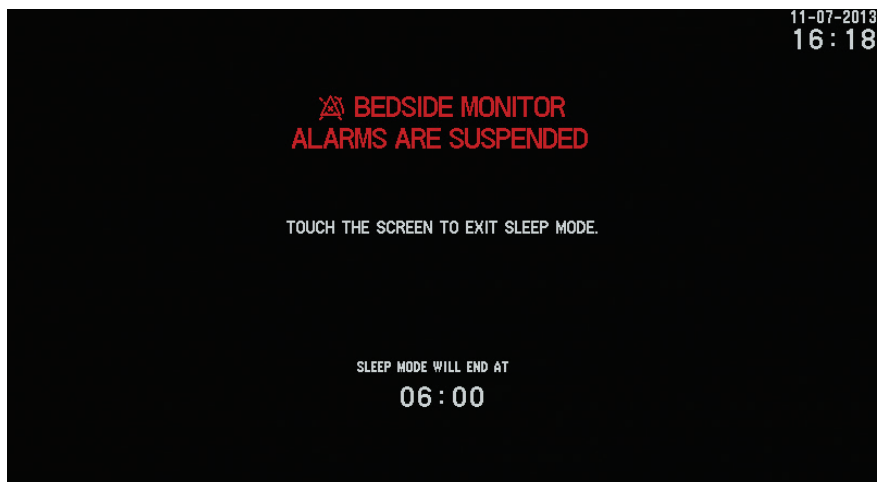

Turning Sleep Mode Off

Touch the screen or press any hard key.

When the sleep mode is turned off by pressing a hard key, the function of that hard key is also performed. For example, if the [NIBP Start/Stop] key is pressed, NIBP measurement in manual mode is performed.

Section 5 Alarm Function

Overview of Alarms	5.4
What is an Alarm	5.4
Alarm Level	5.5
Alarm Escalation	5.5
Alarm Priority.....	5.5
Alarm Sound/Alarm Indicator	5.5
Alarm Messages on the Screen.....	5.5
Silencing/Suspending Alarms	5.6
Alarm Master	5.7
Automatic Recording	5.7
Alarm Setting.....	5.8
Canceling the Technical Alarm	5.9
Adjusting Alarm Sound Volume	5.9
Alarm Activation after Power On	5.9
ALARM HISTORY Window.....	5.9
Interbed Alarm.....	5.9
Alarm Types	5.10
Vital Signs Alarms	5.10
Arrhythmia Alarms.....	5.10
Technical Alarms	5.12
ECG Related Alarms.....	5.12
Respiration Related Alarms	5.12
CO ₂ Related Alarms	5.12
Microcap [®] /Micropod [™] Related Alarms	5.13
SpO ₂ Related Alarms	5.13
NIBP Related Alarms	5.14
IBP Related Alarms.....	5.14
Temperature Related Alarms	5.14
BIS Related Alarms.....	5.15
CO Related Alarms	5.15
Gas Related Alarms	5.16
O ₂ Related Alarms.....	5.16
VENT Related Alarms.....	5.16
TOF Related Alarms	5.17
CCO (APCO) Related Alarms	5.17
CCO Related Alarms	5.17
PiCCO Related Alarm	5.17
FLOW/Paw Related Alarms	5.18
EEG Related Alarms.....	5.18
tcPO ₂ /tcPCO ₂ Related Alarms.....	5.18
rSO ₂ Related Alarm.....	5.19
Other Alarms	5.19
Messages	5.20

ECG Related Messages.....	5.20
Respiration Related Messages	5.20
CO ₂ Related Messages.....	5.21
SpO ₂ Related Messages.....	5.21
NIBP Related Messages.....	5.22
IBP Related Message	5.22
BIS Related Messages.....	5.22
O ₂ Related Messages	5.22
CO Related Messages.....	5.23
Gas Related Messages.....	5.23
CCO (APCO) Related Messages.....	5.24
FLOW/Paw Related Messages	5.24
EEG Related Messages.....	5.24
Microcap [®] /Micropod [™] Related Messages.....	5.24
Other Messages.....	5.25
Alarm Indications.....	5.26
Overview	5.26
Individual Alarm Indications	5.27
Vital Signs Alarms.....	5.28
Arrhythmia Alarms.....	5.33
Technical Alarms.....	5.33
Other Alarms.....	5.41
Interbed Alarms.....	5.42
Alarm Control Marks	5.42
Individual Vital Signs Alarm Off Marks.....	5.42
Flow of Alarm Function.....	5.43
Silencing and Suspending Alarms.....	5.44
Overview	5.44
Silencing an Alarm	5.44
Suspending Alarms.....	5.44
Silencing Alarms After Alarm Occurrence.....	5.47
Silencing an Alarm	5.47
Canceling Alarm Silence.....	5.47
Suspending Alarms Before Alarm Occurrence.....	5.47
Suspending Alarms.....	5.47
Suspending All Alarms Indefinitely.....	5.48
Suspending All Alarms and NIBP STAT and Auto Measurement Indefinitely.....	5.51
Turning Automatic Alarm Recording On/Off	5.53
Setting Alarms	5.54
Overview	5.54
Alarm Limits Ranges.....	5.54
Vital Signs Alarms.....	5.55
Arrhythmia Alarms.....	5.61
Setting Vital Signs Alarms Individually	5.63
Automatically Setting All Upper and Lower Alarm Limits	5.64
Automatic Setting Range	5.64
Setting All Vital Signs Alarms to a Preset Pattern (Alarm Master)	5.66
Setting Arrhythmia Alarms Individually.....	5.67
Setting All Arrhythmia Alarms to a Preset Pattern (Alarm Master).....	5.69
Interbed Alarm.....	5.71

This section explains:

- An overview of alarms.
- Alarm types.
- Alarm indications.
- Silencing an alarm.
- Suspending all alarms before occurrence.
- Setting individual alarms, turning automatic alarm recording on or off and all other functions for alarms.

Overview of Alarms

WARNING

A physician must be within the range where he/she can hear the alarm sound of the bedside monitor while monitoring a patient on the bedside monitor. If the physician cannot hear the alarm sound, critical changes on the patient may be overlooked.

WARNING

Do not diagnose a patient based on only the alarm information of the bedside monitor. An alarm may not be indicated due to alarm level or alarm on/off setting and critical changes on the patient may be overlooked.

WARNING

Check the alarm settings when admitting a new patient and whenever the patient condition changes and change the alarm settings if necessary. The alarm settings return to the alarm master settings on the SYSTEM SETUP window when:

- A patient is admitted or discharged.
- <SHOW ADMIT CONFIRMATION WINDOW> is set to “Off” in the SYSTEM CONFIGURATION screen and 30 minutes elapse after monitor power off.
- “PATIENT TYPE” is changed on the ADMIT DISCHARGE window.

WARNING

If more than one medical equipment is used together in the same facility, make sure all equipments have the same alarm default settings (alarm master). If the medical equipments have different alarm default settings and when initialized, the alarm settings differ with the other equipments and alarm cannot be managed appropriately in the facility. If using different alarm default settings according to areas or wings in the facility, manage the alarms appropriately.

WARNING

When an alarm occurs:

- Check the patient first and take necessary measure to ensure patient’s safety.
- Remove the cause of the alarm.
- Check the alarm settings on the bedside monitor and change the alarm settings if necessary.

What is an Alarm

When the monitor detects an abnormal patient condition, it can generate an alarm sound, screen indication and alarm lamp indication. When the optional recorder module is installed in the monitor, ECG waveforms and data can be recorded at an alarm occurrence. You can set each individual alarm condition. There are four types of alarms: vital signs, arrhythmias, technical and interbed alarms, and three levels of alarm: crisis, warning and advisory. The different alarm types are fully explained in the “Alarm Types” section and different alarm levels are explained in the “Alarm Indications” section.

NOTE

When the transport function is enabled or admit a new patient, check the alarm settings.

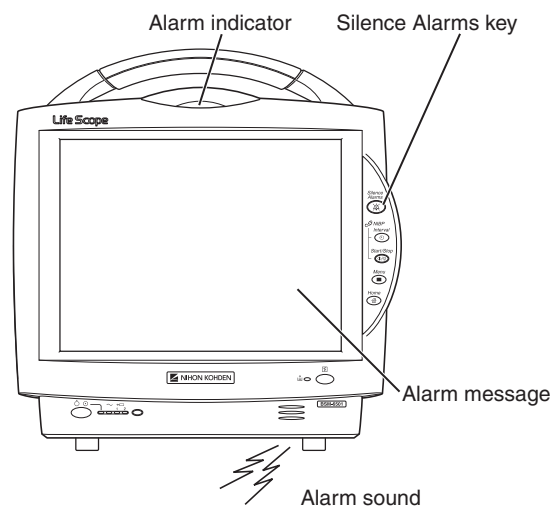
**Alarm Level**

There are three alarm levels.

CRISIS: Patient is in critical condition and the patient's life may be at risk. Immediate action must be taken. Electrodes or probe off, or incorrect lead or other cable connections may also cause this alarm.

WARNING: Patient is in critical condition. Prompt action should be taken. Electrodes or probe off, or incorrect lead or other cable connections may also cause this alarm.

ADVISORY: Electrodes, probe, cuff, lead and other cable connections or settings on the monitor are not appropriate for accurate measurement. Prompt action should be taken.

Alarm Escalation

If the APNEA, SpO₂, ECG CHECK ELECTRODES, CANNOT ANALYZE or SpO₂ CHECK PROBE alarm occurs and no action is taken for a selected duration, the alarm level can be escalated. If an SpO₂ value drops below a set level for a selected duration, the alarm level can also be escalated. Refer to Section 3 of the Administrator's Guide.

Alarm Priority**Alarm Sound/Alarm Indicator**

When several alarms occur at the same time, only the alarm with the highest alarm level is indicated.

Alarm Messages on the Screen

When several alarms (arrhythmia, vital sign and technical alarms) with the same alarm level occur, the alarm messages for each alarm are alternately displayed on the home screen. The message display position depends on the alarm level.

Only one interbed ID can be displayed at a time on the home screen. When more than one interbed alarm occurs, the alarm messages for each alarming interbed ID are alternately displayed in the alarm level color when the <INTERBED ALARMS TO DISPLAY> is set to ALL, CRISIS AND WARNING, or CRISIS.

Silencing/Suspending Alarms

You can temporarily silence current alarm sounds and indications for a 1, 2 or 3 minute period. Refer to the “Silencing and Suspending Alarms” later in this section. You can also silence an interbed alarm from this bedside monitor but the alarm silence time depends on the setting on the alarmed bed. For interbed alarms, refer to Section 9 “Interbed Window”.

WARNING

During alarm suspension (“ALARMS SUSPENDED” or “ALL ALARMS OFF” message displayed), all alarms are turned off. Be careful when you suspend the alarm.

WARNING

Do not turn all alarms off with the ALL ALARMS OFF or BYPASS key when there is no medical staff around the patient or when the patient is connected to a ventilator.

The BYPASS key is only available in OR mode. The site mode is set on the SYSTEM SETUP window. Refer to Administrator’s Guide, Section 3.

Either the SUSPEND MONITORING, SUSPEND ALARMS or ALL ALARMS OFF/BYPASS key is displayed on the MENU window. The key to be displayed on the MENU window is set on the SYSTEM SETUP window. Refer to Administrator’s Guide, Section 3.

The SUSPEND MONITORING, SUSPEND ALARMS or BYPASS key can be assigned to one of the function keys. Refer to Administrator’s Guide, Section 3.

When the monitor connected to the central monitor network, the bedside monitor alarm can be silenced by touching the Silence Alarms key on the central monitor. For details, refer to the central monitor Operator’s Manual.

Alarm Master

For fast and easy alarm setup, a group of alarm items can be set all together at one time. For example, there may be typical alarm settings at your hospital, or you may have certain alarm settings for certain patients. There is one alarm master for vital signs and one alarm master for arrhythmias. The alarm masters are set by the administrator on the MASTER window of the SYSTEM SETUP window.

Even when alarms are set by an alarm master, individual alarm settings can still be changed on the ALARM LIMITS and ARRHYTHM ALARMS windows or the alarm setting window of each parameter window. See the “Setting Alarms” section.

WARNING

If more than one medical equipment is used together in the same facility, make sure all equipments have the same alarm default settings (alarm master). If the medical equipments have different alarm default settings and when initialized, the alarm settings differ with the other equipments and alarm cannot be managed appropriately in the facility. If using different alarm default settings according to areas or wings in the facility, manage the alarms appropriately.

Automatic Recording

When the optional recorder module is installed in the monitor, you can set the monitor to automatically record ECG waveforms and data when an alarm occurs. See the “Turning Automatic Alarm Recording On/Off” section.

If a higher level alarm occurs during another alarm recording, the present alarm recording is canceled and the higher level alarm is recorded.

From the bedside monitor, the alarm recording cannot be recorded on the recorder of the connected central monitor.

Alarm Setting

Usually, alarms are set before monitoring, but alarms can be set or changed anytime without interrupting monitoring.

All alarm settings return to the alarm master settings of the SYSTEM SETUP window when:

- The monitor power is off for more than 30 minutes when <SHOW ADMIT CONFIRMATION WINDOW> is turned off in the SYSTEM CONFIGURATION screen.
- The patient is admitted or discharged.
- “PATIENT TYPE” is changed on the ADMIT DISCHARGE window.

To set a parameter alarm to off, set the upper and lower limits to OFF.

WARNING

Check the alarm settings when admitting a new patient and whenever the patient condition changes and change the alarm settings if necessary. The alarm settings return to the alarm master settings on the SYSTEM SETUP window when:

- A patient is admitted or discharged.
- <SHOW ADMIT CONFIRMATION WINDOW> is set to “Off” in the SYSTEM CONFIGURATION screen and 30 minutes elapse after monitor power off.
- “PATIENT TYPE” is changed on the ADMIT DISCHARGE window.

WARNING

If more than one medical equipment is used together in the same facility, make sure all equipments have the same alarm default settings (alarm master). If the medical equipments have different alarm default settings and when initialized, the alarm settings differ with the other equipments and alarm cannot be managed appropriately in the facility. If using different alarm default settings according to areas or wings in the facility, manage the alarms appropriately.

CAUTION

When the alarm limit is set to OFF, there will be no alarm for that limit. Be careful when you set the alarm limit to OFF.

CAUTION

When the alarm is turned OFF for an arrhythmia, there will be no alarm for that arrhythmia type. There is no message or mark to indicate that a certain arrhythmia alarm is turned off. Therefore, be careful when you turn off an arrhythmia alarm.

CAUTION

When the ZS-900P transmitter is attached to the bedside monitor, check the alarm, arrhythmia and monitoring settings on the central monitor or telemetry system. The transmitter does not transmit the alarm, arrhythmia and monitoring setting information.

Canceling the Technical Alarm

When you remove a sensor cable, probe cable, input unit or the BSM-1700 series bedside monitor from the monitor and press the [Silence Alarms] key, the technical alarm can be canceled. Touching the SUSPEND MONITORING, SUSPEND ALARMS, BYPASS and ALL ALARMS OFF keys also cancel the technical alarm.

Adjusting Alarm Sound Volume

The alarm sound volume can be adjusted on the VOLUME window. Refer to “Changing Sound Volume Settings” in Section 3.

Alarm Activation after Power On

CAUTION

After the monitor power is turned on, parameter-related alarms do not function until the parameters are monitored.

When the monitor power is turned on, alarms are suspended while the monitor is waiting for the electrodes and probe to be attached to the patient. The monitoring starts when the connection cord is connected to the socket on the monitor and the electrodes or probe are attached to the patient. The alarm activates when one of the following occurs:

- ECG, SpO₂ or IBP is monitored or NIBP is measured and a value is displayed (when AUTO is selected for <ALARM ACTIVATION DELAY> on the ALARM window of the SYSTEM SETUP window).
- ECG, SpO₂ or IBP is continuously monitored for the selected time (when 1 min, 2 min or 3 min is selected for <ALARM ACTIVATION DELAY>).
- NIBP is measured (when 1 min, 2 min or 3 min is selected for <ALARM ACTIVATION DELAY>).

ALARM HISTORY Window

The vital sign data is saved as a file on a vital sign or arrhythmia alarm occurrence. These data can be viewed on the ALARM HISTORY window. Refer to “Alarm History Window” in Section 6.

Interbed Alarm

When an alarm occurs on an interbed bed, the interbed alarm occurs on this bedside monitor. For details, refer to “Interbed Alarm” later in this section.

Alarm Types

Alarms are divided into 4 categories: vital signs, arrhythmia, technical and interbed alarms. The alarm name is displayed on the screen when an alarm occurs. For the vital signs and arrhythmia alarms, waveforms and data can be recorded in automatic alarm recording when an optional recorder module is installed in the monitor.

For the alarm types which are not classified into alarm levels, only the message is displayed.

Vital Signs Alarms

Vital sign alarm occurs when the parameter value exceeds the upper or lower alarm limit.

Arrhythmia Alarms

Arrhythmia Name	Description
ASYSTOLE	Longer than 3 to 10 seconds (selectable) with no QRS complex.
VF	Ventricular fibrillation longer than 4 seconds.
VT	Ventricular tachycardia. 3 to 9 (selectable) or more consecutive VPCs when heart rate exceeding the VT heart rate limit (16 to 300 beats/min selectable).
EXT TACHY* ¹	Extreme tachycardia exceeding the EXTREME TACHY limit.
EXT BRADY* ¹	Extreme bradycardia dropping below the EXTREME BRADY limit.
V BRADY* ¹	Ventricular bradycardia. 3 or more consecutive VPCs when heart rate drops below the V BRADY heart rate limit (15 to 299 beats/min selectable).
VPC RUN	VPC short run. 3 to 8 (selectable) consecutive VPCs when heart rate exceeds the VPC RUN heart rate limit (16 to 300 beats/min selectable* ²). or The selected number* ² of consecutive VPCs when heart rate drops below the VT heart rate limit.
SV TACHY* ¹	Supraventricular tachycardia. 3 to 9 (selectable) or more consecutive normal QRS of regular R-R interval when heart rate exceeding the SV TACHY heart rate limit (16 to 300 beats/min selectable).
TACHYCARDIA	Heart rate above the upper heart rate limit.
BRADYCARDIA	Heart rate below the lower heart rate limit.
PAUSE* ¹	1 to 3 seconds (selectable) with no QRS.
V RHYTHM* ¹	Ventricular rhythm. 3 or more consecutive VPCs.
COUPLET	VPC couplet (paired VPCs). 2 consecutive VPCs.
EARLY VPC	Early VPC including R-on-T type. VPC with a time interval from the preceding normal QRS complex of less than approximately one-third of the normal R-R interval, at heart rate dropping below 120* ³ beats/min.

Arrhythmia Name	Description
MULTIFORM* ¹	Two different shaped VPCs within the last 3 minutes.
BIGEMINY	Ventricular bigeminy. 3 or more consecutive pairs of VPC and normal QRS. A dominant rhythm of N-V-N-V-N-V (N = normal beat, V = ventricular beat)
TRIGEMINY* ¹	Ventricular trigeminy. A dominant rhythm of N-N-V-N-N-V.
FREQ VPC	Frequent VPCs. VPC rate (VPCs/min) reaching or exceeding the preset limit of 1 to 99 VPCs/min (selectable).
VPC	Ventricular premature contraction.
AF* ⁴	Atrial fibrillation longer than 2 minutes.
IRREGULAR RR* ¹	Consistently irregular R-R intervals.
PROLONGED RR* ¹	R-R interval 1.75 times longer than the dominant R-R interval.
NO PACER PULSE* ^{1*5}	No QRS and pacing pulse within the bradycardia limit. Oversensing.
PACER NON-CAPTURE* ^{1*5}	No QRS from the preceding pacing pulse for the preset time interval (40 to 480 ms selectable). Non-capture.

*¹ These arrhythmias become available when “EXTENDED” is selected for <ARRHYTHMIA TYPE> on the SYSTEM SETUP screen.

*² This number is set in the VT alarm setting.

*³ 120 beats/min when <QRS DETECTION TYPE> is set to ADULT, 150 beats/min when <QRS DETECTION TYPE> is set to CHILD or NEONATE.

*⁴ Not available for BSM-6000K series. Available only when <ARRHYTHMIA TYPE> on the ECG page of the SYSTEM SETUP window is set to EXTENDED, and <AF DETECTION> on the ECG page of the SYSTEM SETUP window is set to On. For the SYSTEM SETUP window settings, refer to the Administrator’s Guide.

*⁵ Available only when DETECT in the <PACING> box is set to ON.

WARNING

It is not possible to obtain 100% accurate detection of every arrhythmia.

WARNING

Do not use AF detection for children or neonates. The monitor might not correctly detect AF in children or neonates.

WARNING

The monitor requires a minimum of 2 minutes of continuous analysis before AF can be detected. Detection may take up to 2.5 minutes.

5. ALARM FUNCTION

When an arrhythmia alarm is generated, even if the patient recovers quickly from the arrhythmia, the alarm status continues for a short time. The time depends on the alarm level.

- CRISIS: 30 s
- WARNING: 20 s
- ADVISORY: 10 s

Technical Alarms

ECG Related Alarms

Alarm Name	Description
ECG CHECK ELECTRODES	Electrode loose or disconnected.
ECG CHECK ELECTRODE --	Specified electrode loose or disconnected.
ECG MODULE ERROR	Module malfunction.

Respiration Related Alarms

Alarm Name	Description
RESP CHECK SENSOR	The respiration pickup is damaged.
RESP CONNECTOR OFF	The respiration pickup is disconnected from the monitor (thermistor).

CO₂ Related Alarms

Alarm Name	Description
CHECK CO ₂ CELL* ¹	The respiration circuit has fluid or fluid prevents measurement.
	The respiration circuit has fluid and CO ₂ cannot be measured.
CO ₂ APNEA	Apnea exceeded the apnea alarm limit.
CO ₂ CELL OFF* ¹	The airway adapter is disconnected.
CO ₂ CHANGE ABSORBENT	The CO ₂ absorption agent must be replaced. (Sidestream method only)
CO ₂ CHANGE ADAPTER	The CO ₂ adapter is damaged. (Mainstream method only)
CO ₂ CHECK SENSOR* ²	Insufficient sensor light. (Mainstream method only)
CO ₂ CHECK EXTERNAL DEVICE	The AG-400R CO ₂ unit is disconnected from the bedside monitor.
CO ₂ CONNECTOR OFF	CO ₂ connection cord is disconnected from the socket during measurement. (Mainstream method only)
CO ₂ DEVICE ERROR	CO ₂ unit failure. (Sidestream method only)
CO ₂ LINE BLOCK	The airway adapter, FilterLine or exhaust gas adapter is clogged. (Sidestream method only)
CO ₂ NO FILTERLINE	The FilterLine is not properly connected to the CO ₂ unit or an unspecified sampling tube is used. (Sidestream method only)
CO ₂ SENSOR ERROR	CO ₂ sensor is damaged. (Mainstream method only)

*¹ These alarms are displayed when <AVAILABLE ALARM TYPES> is set to ALL on the SYSTEM SETUP window.

*² This alarm is displayed when <AVAILABLE ALARM TYPES> is set to MAIN on the SYSTEM SETUP window.

Microcap®/Micropod™ Related Alarms

Alarm Name	Description
CO ₂ CHECK EXTERNAL DEVICE	The external instrument is disconnected from the bedside monitor.
CO ₂ DEVICE ERROR	The external instrument or interface failure.
	Communication error between the external instrument and bedside monitor.
CO ₂ LINE BLOCK	The airway adapter, filterline or exhaust gas tube is clogged and CO ₂ cannot be measured.
CO ₂ NO FILTERLINE	The filterline is not connected to the external instrument or unspecified tube is connected.

5

SpO₂ Related Alarms

Alarm Name	Description
SpO ₂ -2 ALARM	Alarm on the pulse oximeter. (when using an IF-919P or IF-925P only)
SpO ₂ /SpO ₂ -2 CANNOT DETECT PULSE	Pulse cannot be detected.
SpO ₂ /SpO ₂ -2 CHANGE PROBE	SpO ₂ probe or connection cord is damaged.
SpO ₂ /SpO ₂ -2 CHECK PROBE	Finger probe is not attached to the patient firmly or the amount of transmitted light is too small to measure.
SpO ₂ /SpO ₂ -2 CHECK PROBE SITE	The probe is not attached at the appropriate site or the probe is past its expiration date.
SpO ₂ /SpO ₂ -2 CONNECTOR OFF	The SpO ₂ connection cord is disconnected from the SpO ₂ socket during monitoring.
	The probe cable is disconnected from the SpO ₂ connection cord. (when using a Nellcor or a Masimo probe only)
	The probe is not connected to the patient cable correctly. (when using a Masimo probe only)
	The monitor cannot identify the connected probe. (when using a Masimo probe only)
SpO ₂ /SpO ₂ -2 LIGHT INTERFERENCE	Too much light on probe.
SpO ₂ /SpO ₂ -2 MODULE ERROR	SpO ₂ hardware malfunction.
SpO ₂ /SpO ₂ -2 NO PROBE	The probe is not connected to the SpO ₂ connection cord.

NIBP Related Alarms

Alarm Name	Description
NIBP AIR LEAK	Cuff pressure does not change after inflation.
NIBP CANNOT DETECT PULSE	Measurement cannot be performed because the patient's pulse wave is small, the cuff or hose leaks air, the cuff hose is obstructed or the cuff is not connected.
NIBP CHECK INTERVAL SETTING	NIBP is measured at 1 minute intervals for more than 30 minutes.
NIBP CONNECTOR OFF	NIBP hose is disconnected from the cuff socket during monitoring.
NIBP CUFF OCCLUSION	Cuff pressure does not decrease after measurement has completed.
NIBP HIGH CUFF PRESS	Enormous pressure was applied by the pressure of the cuff.
NIBP MEAS TIME OUT	The measuring time exceeded the specified time.
NIBP MODULE ERROR	NIBP module malfunction.
NIBP SAFETY CIRCUIT RUNNING	Instrument automatically stopped inflating.
NIBP SYSTOLIC OVER	Systolic value is outside the measurable range.

IBP Related Alarms

Alarm Name	Description
PRESS CHECK SENSOR	Blood pressure transducer is disconnected from the IBP connection cord or the IBP connection cord is damaged.
PRESS CONNECTOR OFF	IBP connection cord is disconnected from the socket during measurement.
PRESS THIS LABEL IS ALREADY REGISTERED	More than one IBP connection cord with the same label are used.

Temperature Related Alarms

Alarm Name	Description
TEMP CHECK SENSOR	Temperature sensor is disconnected from the TEMP socket or temperature connection cord is disconnected from the MULTI socket, or the probe or connection cord is damaged.
TEMP CONNECTOR OFF	Temperature connection cord is disconnected from the socket during monitoring.
TEMP THIS LABEL IS ALREADY REGISTERED	More than one temperature probe with the same label are used.

BIS Related Alarms

Alarm Name	Description
BIS CHECK EXTERNAL DEVICE	The BIS monitor is disconnected from the bedside monitor. (when using a BIS monitor only)
BIS CHECK SENSOR	The BIS sensor is detached from the patient. (when using a BIS processor or a BISx only)
	The BIS sensor is disconnected from the PIC Plus patient interface cable. (when using a BIS processor or a BISx only)
	The PIC Plus patient interface cable is disconnected from the BIS processor. (when using a BIS processor or a BISx only)
	The impedance between the BIS sensor and skin is too high. (when using a BIS processor or a BISx only)
BIS CONNECTOR OFF	The BIS processor is disconnected from the connection cord or the connection cord is disconnected from the monitor. (when using a BIS processor or a BISx only)
BIS MODULE FAILURE	Faulty BIS processor. (when using a BIS processor or a BISx only)
BIS SENSOR ERROR	The BIS sensor failure. (when using a BIS processor or a BISx only)
BIS SENSOR EXPIRED	BIS sensor is past its expiration date. (when using a BIS processor or a BISx only)

CO Related Alarms

Alarm Name	Description
CO CHECK SENSOR	Tb sensor is disconnected from the CO connection cord or the CO connection cord is damaged.
CO CONNECTOR OFF	CO connection cord is disconnected from the socket during monitoring.

Gas Related Alarms

Alarm Name	Description
GAS APNEA	Apnea exceeded the apnea alarm limit.
GAS CHECK EXTERNAL DEVICE	Measure switch on the unit is turned off.
	The connection cable is disconnected from the monitor.
	An error occurs in the communication between the unit and monitor.
	The power cord is disconnected. (GF-210R/220R only)
<GAS MEASUREMENT> on the GAS window is OFF. (GF-110PA/120PA and GF-210R/220R only)	
GAS CHECK SAMPLE LINE	The sampling gas inlet on the water trap or sampling gas outlet on the rear panel of the unit is pressurized. (AG-920R only)
GAS CHECK WATER TRAP	The water trap is not attached properly. The sampling line is not connected properly.
	An unspecified sampling line is used. (GR-210R/220R only)
GAS CHECK WATERTRAP AND SAMPLE LINE	The water trap is clogged.
	The sampling line is clogged.
	The exhaust gas tube is clogged.
GAS DEVICE ERROR	Faulty unit.
GAS LINE BLOCK	The water trap is clogged.
	The sampling line is clogged.
	The exhaust gas tube is clogged.
GAS MIXED GAS	Two anesthetic agents are detected at the same time when the vaporizer is changed.
	Wrong agent is delivered to the vaporizer.
	Two anesthetic agents are detected when two vaporizers operated at the same time.
GAS OVERHEAT	Faulty fan. (GF-210R/220R only)

O₂ Related Alarms

Alarm Name	Description
O ₂ CONNECTOR OFF	The FiO ₂ connection cord is disconnected from the socket during monitoring.
O ₂ CHECK SENSOR	The FiO ₂ sensor is disconnected from the FiO ₂ connection cord or the FiO ₂ connection cord is damaged.

VENT Related Alarms

Alarm Name	Description
VENT ALARM	Alarm on the ventilator.
VENT CHECK EXTERNAL DEVICE	The ventilator is disconnected from the bedside monitor.
	Communication error between the bedside monitor and ventilator.

TOF Related Alarms

Alarm Name	Description
TOF ALARM	There is an error on the TOF-watch® SX.
TOF CHECK EXTERNAL DEVICE	The TOF-watch® SX is disconnected from the bedside monitor.
	Communication error between the bedside monitor and TOF-watch® SX.

CCO (APCO) Related Alarms

Alarm Name	Description
CCO CHECK SENSOR	The FloTrac sensor is disconnected from the APCO/IBP processor.
	The specified FloTrac sensor is not used.
	The cable or sensor is damaged.
	APCO/IBP processor internal system failure.
CCO CHECK WAVEFORM	The arterial waveform is not accurate enough for measuring CCO.
	The arterial waveform is not accurate enough for a long period.
	The IBP line is not appropriate.
	The arterial systolic pressure is too high or arterial diastolic pressure is too low.
CCO CONNECTOR OFF	The APCO/IBP processor is disconnected from the monitor.
	The APCO/IBP processor is damaged.
CCO MODULE FAILURE	Faulty APCO/IBP processor.
CCO SVV: HIGHLY VARIABLE PULSE RATE	The pulse rate changes greatly from the arrhythmia, etc. The SVV value might not be reliable.

CCO Related Alarms

Alarm Name	Description
CCO ALARM	Alarm on the CCO monitor.
CCO CHECK EXTERNAL DEVICE	The CCO monitor is disconnected from the bedside monitor.
	Communication error between the bedside monitor and external device.

PiCCO Related Alarm

Alarm Name	Description
PCCO CHECK EXTERNAL DEVICE	The PiCCO monitor is disconnected from the bedside monitor.
	Communication error between the bedside monitor and external device.

FLOW/Paw Related Alarms

Alarm Name	Description
FLOW APNEA	Apnea exceeded the apnea alarm limit.
FLOW CHECK EXTERNAL DEVICE	Measure switch on the unit is turned off.
	The connection cable is disconnected from the monitor.
	An error occurs in the communication between the unit and monitor.
	The power cord is disconnected. (GF-220R)
	<FLOW/Paw MEASUREMENT> on the FLOW/Paw window is OFF.
FLOW CONNECTOR OFF	Faulty flow tube.
	The flow tube is disconnected from the unit.
FLOW DEVICE ERROR	Faulty unit.

EEG Related Alarms

Alarm Name	Description
EEG CHECK ELECTRODES	The electrode is dry or not attached to the patient.
	The electrode lead is disconnected from the EEG connection cord.
	Contact between the electrode lead clip and electrode is poor (when using disposable electrodes).
	The electrode lead is damaged.
	Abnormal electrode polarization.
	The electrode impedance is too high.
	The EEG connection cord is disconnected then connected.
EEG CHECK EXTERNAL DEVICE	The neuro unit is disconnected from the bedside monitor.
EEG CONNECTOR OFF	The EEG connection cord is disconnected from the neuro unit.
	The EEG connection cord is damaged.

tcPO₂/tcPCO₂ Related Alarms

Alarm Name	Description
tcPO ₂ /PCO ₂ ALARM	Alarm on the transcutaneous monitor.
tcPO ₂ /PCO ₂ CHECK EXTERNAL DEVICE	The transcutaneous monitor is disconnected from the bedside monitor.
	Communication error between the bedside monitor and transcutaneous monitor.

rSO₂ Related Alarm

Alarm Name	Description
rSO ₂ CHECK EXTERNAL DEVICE	The cerebral/somatic oximeter is disconnected from the bedside monitor
	Communication error between the bedside monitor and cerebral/somatic oximeter.

Other Alarms

5

Alarm Name	Description
--- ALARM	Alarm concerning the --- (parameter name)
BATTERY ERROR	Battery problems.
BATTERY WEAK	Battery pack is fully discharged.
CHECK INPUT UNIT BATTERY	The battery pack is not inserted correctly in the BSM-1700 series bedside monitor.
CLOCK IC FAILURE	The clock IC is damaged.
COMMUNICATION LOSS	LAN cable problems or incorrect network settings.
DATA SEND ERROR	Sending data to the central monitor failed when using the transport function.
HIS SYNC ERROR	The settings for HL7 are not correct.
	The entered patient ID is not correct.
INPUT UNIT DISCONNECT	The input unit or the BSM-1700 series bedside monitor is disconnected from the monitor when the transport function is enabled.
INPUT UNIT FAILURE	Communication error between the input unit or the BSM-1700 series bedside monitor and main unit.
	The QM-600P memory unit in the input unit or the BSM-1700 series bedside monitor is damaged.
	The data is sent to a bedside monitor or central monitor which has a different time zone setting and data in the input unit or the BSM-1700 series bedside monitor is deleted.
MPU MODULE ERROR	MPU circuit malfunction.
	The monitor simulates the temperature signal of 27°C and 37°C inside the monitor. Monitoring this simulated signal periodically (every 128 ms), the monitor self-diagnoses the temperature signal processor part of the monitor. When the monitor could not cover the 0 to 45°C measurement range, a "MPU MODULE ERROR" message is displayed.
MULTILINK CONFIG ERROR	Communication failure between QF series interface or IF series communication cable and monitor.
MULTILINK POWER ERROR	Multi-link power supply failure.
PARAMETER NOT AVAILABLE	Connected cord or cable of the parameter is not available on the monitor.
PRINT ERROR	Printing failed.
TEC DATA RECEIVE ERROR	Sending data is canceled on the defibrillator.
	Communication distance is too far.
	Radio waves interference
TEC INTERFACE ALREADY CONNECTED	Two QI-670P interfaces are connected.

Alarm Name	Description
TEC INTERFACE DISCONNECTED	USB cable of the QI-670P interface is disconnected from the monitor.
TEC INTERFACE ERROR	Communication error between the QI-670P interface and monitor. QI-670P interface error
--- THIS PARAMETER IS ALREADY REGISTERED	More than the specified number of channels are used for a parameter.
TRANSMITTER CONNECTOR OFF	The connection cord of the transmitter is disconnected from the monitor.

Messages

The following messages are monitoring information and are not considered alarms.

ECG Related Messages

Message	Description
ARRHYTHMIA ANALYSIS OFF	Arrhythmia analysis is turned off.
CANNOT ANALYZE*	Noise interference for more than 30 seconds and heart rate cannot be counted and arrhythmia cannot be analyzed.
ECG AUTO LEAD CHANGE	Monitoring lead is being changed by auto lead change function.
ECG LEARNING	Learning QRS for arrhythmia analysis.
ECG LOW mV	The QRS amplitude is too small.
ECG NOISE*	The baseline is not stable due to respiration or body movement.
	EMG noise is superimposed.
	The electrode is pulled by the lead.
	The electrode is dry.
	The contact between the lead and electrode is poor.
	High electrode impedance.
	An electric blanket is used.
Equipment which emits strong electromagnetic interference is nearby. e.g. ESU, cellular phone.	
Equipotential grounding is not acquired.	
ECG PACING	Paced QRS is detected. (This message appears only when PACING DETECT is set to ON.)

* When <ARRHYTHMIA ANALYSIS> on the ECG window is set to ON, a “CANNOT ANALYZE” message appears instead of “ECG NOISE”. If the “CANNOT ANALYZE” message is displayed for more than 30 seconds, the message changes to an alarm.

Respiration Related Messages

Message	Description
RESP OFF	Respiration monitoring in impedance mode is turned off.

CO₂ Related Messages

Message	Description
CO ₂ CAL??	Zero calibration is not performed when using a TG-950P, TG-970P or TG-980P CO ₂ sensor kit.
CO ₂ CAL COMPLETE	Calibration is complete. (Sidestream method only)
CO ₂ CAL ERROR	Calibration failed. (Sidestream method only)
CO ₂ PLEASE WAIT	Measurement of the sensitivity calibration is completed and calculation is started. (Sidestream method only)
CO ₂ PURGING	Purging to remove clogging of the sampling path. (Sidestream method only)
CO ₂ WARMING UP	The CO ₂ unit is warming up. (Sidestream method only)
CO ₂ ZERO CALIBRATING	Zero calibration is being performed. (Sidestream method only)
CO ₂ CALIBRATING	Zero calibration is being performed when using a TG-900P or TG-920P CO ₂ sensor kit.
	Calibration is being performed. (Sidestream method only)
OUT OF RANGE*	CO ₂ measurement value exceeds the measurement range.
UNSPECIFIED ACCURACY*	Temperature or pressure exceeds the operating environment.

* These messages are displayed when AVAILABLE ALARM TYPES is set to ALL on the SYSTEM SETUP window.

SpO₂ Related Messages

Message	Description
SpO ₂ /SpO ₂ -2 CANNOT DETECT PULSE	Pulse cannot be detected.
SpO ₂ /SpO ₂ -2 CHECK PROBE SITE	The probe is not attached to the appropriate site or the probe is damaged.
SpO ₂ /SpO ₂ -2 DETECTING PULSE*	Searching for the correct pulse wave. Auto gain control is being done. When the message is displayed for more than 20 seconds, the detected pulse is too small to measure.
SpO ₂ /SpO ₂ -2 LOW QUALITY SIGNAL	Pulse waveform is not stable.
SpO ₂ /SpO ₂ -2 WEAK PULSE	Poor peripheral circulation.

* When this message is displayed for more than 30 seconds, the message changes to the "CANNOT DETECT PULSE" alarm.

NIBP Related Messages

Message	Description
NIBP INFLATION PRESS LOW	Insufficient cuff inflation pressure.
NIBP INFLATION TIME PASSED	Venous puncture cuff inflation time is passed.
NIBP MEASURING NIBP	Start venous puncture during NIBP.
NIBP PLEASE WAIT	Measurement and cuff inflation started before the cuff is deflated enough.
NIBP REMEASURING	Remeasuring NIBP.
NIBP ZEROING	NIBP zero balance adjustment is performed. If the message does not disappear, the monitor has a malfunction.
NIBP WEAK PULSE	Patient's pulse is small.

IBP Related Message

Message	Description
PRESS OUT OF RANGE	The measured value is outside the measurable range.
PRESS ZERO CALIBRATING	Zero balance adjustment is performed.
PRESS ZERO IMBALANCE	Zero balance is not adjusted.
PRESS ZERO OUT OF RANGE	Cannot adjust zero balance.
PRESS ZERO UNSTABLE	Unstable zero balance.
PRESS ZEROING COMPLETE	Zero balance adjustment is complete.

BIS Related Messages

Message	Description
BIS HIGH IMPEDANCE	The impedance between the BIS sensor and skin is too high. (when using a BIS processor or a BISx only)
BIS CHECKING IMPEDANCE	The impedance of the BIS sensor is being checked. (when using a BIS processor or a BISx only)
BIS NOISE	Noise interference. (when using a BIS processor or a BISx only)

O₂ Related Messages

Message	Description
O ₂ CAL??	Calibration is not performed.
O ₂ CALIBRATING	Calibration is performed.

CO Related Messages

Message	Description
CO BASELINE DRIFT	Baseline is not stable.
CO CHECK Ti TEMP*	The injectate temperature is not measured.
CO DETECTING BASELINE	Searching for the baseline of the blood temperature.
CO INJECT	Injectate is not injected.
CO INJECTION TIME OUT	The injectate is not injected within the specified time.
CO MEASURING CO	Measuring the CO value.
CO OUT OF RANGE	Measured value is outside the measurable range.
CO Tb TEMP ERROR	The blood temperature is out of range.
CO THERMODILUTION CURVE ERROR	Returned to the baseline of the thermodilution curve too late. Possible endocardial shunt.
CO Ti TEMP ERROR	The injectate is not cooled.

* On BSM-6000K series bedside monitor, when <<“CHECK Ti TEMP” MESSAGE> on the OTHER PARAM window of the SYSTEM SETUP window is turned off, this message does not appear. Refer to “OTHER PARAM Page” in Section 3 of the Administrator’s Guide.

Gas Related Messages

Message	Description
GAS CALIBRATING	Air or gas calibration is being performed.
GAS CAL COMPLETE	Air or gas calibration is complete. (GF-110P/120P and GF-210R/220R only)
GAS CAL ERROR	The sampling line or exhaust gas tube is clogged. Contaminated air due to leaking prevented air calibration.
	The pressure in the gas cylinder is less than 0.1 MPa. (AG-920R and GF-110PA/120PA only)
	Correct gas is not used for calibration. (AG-920R and GF-110PA/120PA only)
GAS OUT OF RANGE	The measured value is outside the measurable range.
	The measurement sensitivity has shifted.
GAS PURGING	Purging to remove clogging from the sampling line. (AG-920R only)
GAS UNSPECIFIED ACCURACY	The measured value is outside the accuracy range. (AG-920R only)
	The measurement sensitivity has shifted. (AG-920R only)
GAS WARMING UP	The unit is still warming up.

CCO (APCO) Related Messages

Message	Description
CCO CHECK PATIENT INFORMATION	The patient's gender, age and/or BSA are not entered.
	The patient's gender, age and/or BSA are out of range.
CCO UNSTABLE	The arterial waveform is not accurate enough for measuring CCO.
	The IBP line is not appropriate.
	The arterial systolic pressure is too high or arterial diastolic pressure is too low.
	The patient's pulse is getting low.
CCO ZERO IMBALANCE	Zero balance is not adjusted.
CCO ZERO UNSTABLE	The circuit is not exposed to air during zero balance adjustment.
	The pressure of zero balance is unstable.
CCO ZEROING COMPLETE	Zero balance adjustment is complete.

FLOW/Paw Related Messages

Message	Description
FLOW CAL COMPLETE	Zero calibration is complete.
FLOW CAL ERROR	There was vibration during calibration and zeroing failed.
	Nearby device was generating a strong noise during calibration and zeroing failed.
FLOW OUT OF RANGE	The measured value is outside the measurable range.
FLOW ZERO CALIBRATING	Zero calibration is being performed.

EEG Related Messages

Message	Description
EEG CALIBRATING	The CAL key on the EEG window is touched to display the calibration waveforms.
EEG CHECKING IMPEDANCE	Checking electrode impedance.
EEG HIGH IMPEDANCE	The electrode impedance is too high.
EEG RESETTING BASELINE	The RESET key on the EEG window is touched to return all EEG waveforms to the baseline position.

Microcap®/Micropod™ Related Messages

Message	Description
CO ₂ PURGING	Purging to remove clog from the sampling path.
CO ₂ WARMING UP	The external instrument is warming up. Measurement is not possible.
CO ₂ ZERO CALIBRATING	Auto zero balance adjustment is being performed.

Other Messages

Message	Description
ALARM SILENCE	Alarm is suspended.
ALARMS SUSPENDED	The [Silence Alarms] key was pressed before alarm occurrence.
ALARMS SUSPENDED: X min	Remaining suspended time.
ALL ALARMS OFF	All alarms are OFF.
CALIBRATING	Monitor is calibrated.
CLOSE PAPER MAGAZINE	Recorder door is open.
CONNECT INPUT UNIT	The input unit or the BSM-1700 series bedside monitor is not connected to the main unit and the monitor is not ready for monitoring when the transport function is enabled.
FREEZE	Waveforms are frozen.
INSERT REC PAPER	No recording paper.
Bed name INTERBED ALARM	Alarm occurred on an interbed bed of the bed name.
INVALID CARD	Invalid SD card is inserted.
HIS SYNC ERROR	Incorrect HL7 settings
	Incorrect patient ID
Lost communication with instruments (such as a central monitor) in the network.	<AVAILABLE ALARM TYPES> is set to ALL or <ARRHYTHMIA TYPE> is set to EXTENDED on this monitor and the monitor is connected to the network. One or more instruments in the network have software version which does not support extended arrhythmia and communication is lost.
	The <PROTOCOL> is set to 1ST GEN. (BSM-6000A series only)
MONITOR OFF	Monitor cannot access to interbed bed.
PRINTING	Printing now.
RECEIVING TEC DATA	Receiving data from the defibrillator.
SENDING DATA	The input unit or the BSM-1700 series bedside monitor is removed from a bedside monitor and connected to another bedside monitor in a central monitor network. The data of the source bedside monitor is sent to the central monitor.
SIMULATED DATA	The displayed data is simulated data.
UPDATING DATA	Changing the parameter on the trend screen.

Alarm Indications

Overview

The monitor can indicate alarms both visually and audibly:

- Alarm sound
- Alarm message or highlighted numeric data on the screen
- Alarm indicator: red blinking, yellow blinking or cyan or yellow lit LED

Alarm control marks indicating that various alarm functions are turned off are also displayed.

There are two color display modes. The color mode and colors are set on the SYSTEM SETUP window. Refer to Administrator's Guide, Section 3.

PARAMETER: Different colors can be set for each parameter. When an alarm occurs, the alarmed parameter data is highlighted.

ALARM: The same color is set for all parameters. When an alarm occurs, the alarmed parameter color changes according to the alarm level set on the SYSTEM SETUP window.

CRISIS: red

WARNING: yellow

ADVISORY: cyan

or,

CRISIS: red

WARNING: orange

ADVISORY: yellow

The alarm indicator on the monitor indicates three alarm levels: crisis, warning and advisory. The lamp blinks or lights according to the alarm level. The colors are set on the SYSTEM SETUP window.

CRISIS: Blinking red

WARNING: Blinking yellow

ADVISORY: Lights in cyan or yellow

Alarm Latching Function

BSM-6000A series bedside monitors have an alarm latching function. If alarm latching is enabled, human intervention is required to end the alarm. When alarm latching is enabled, audible and visual alarms continue until the operator acknowledges the alarm by silencing or suspending alarms on the bedside monitor or central monitor. Refer to Section 3 of the Administrator's Guide.

Individual Alarm Indications

The alarm level for the HR/PR (upper and lower), VPC, ST, RR (upper and lower), APNEA, CO₂(E) (upper and lower), CO₂(I), SpO₂ (upper and lower), SpO₂-2*¹ (upper and lower), ΔSpO₂, BIS, NIBP, PRESS, TEMP, ΔT, ΔT2, O₂(E), O₂(I), N₂O(E), N₂O(I), HAL(E), HAL(I), ISO(E), ISO(I), ENF(E), ENF(I), DES(E), DES(I), SEV(E), SEV(I), MV*², Ppeak*², PEEP*², SEF, TP, CCO*², CCI*², ECG CHECK ELECTRODES, CANNOT ANALYZE, SpO₂ CHECK PROBE, and arrhythmia (ASYSTOLE, VF, VT, V BRADY, EXT TACHY, EXT BRADY, SV TACHY, VPC RUN, TACHYCARDIA, BRADYCARDIA, COUPLET, EARLY VPC, MULTIFORM, V RHYTHM, PAUSE, BIGEMINY, TRIGEMINY, VPC, IRREGULAR RR, PACER NON-CAPTURE, PROLONGED RR, NO PACER PULSE) alarms can be selected on the SYSTEM SETUP window. Refer to Administrator's Guide, Section 3.

*¹ Available only when an AY-661P, AY-663P, AY-671P or AY-673P input unit or BSM-1763 or BSM-1773 bedside monitor is used.

*² These alarms are not available for BSM-6000A series.

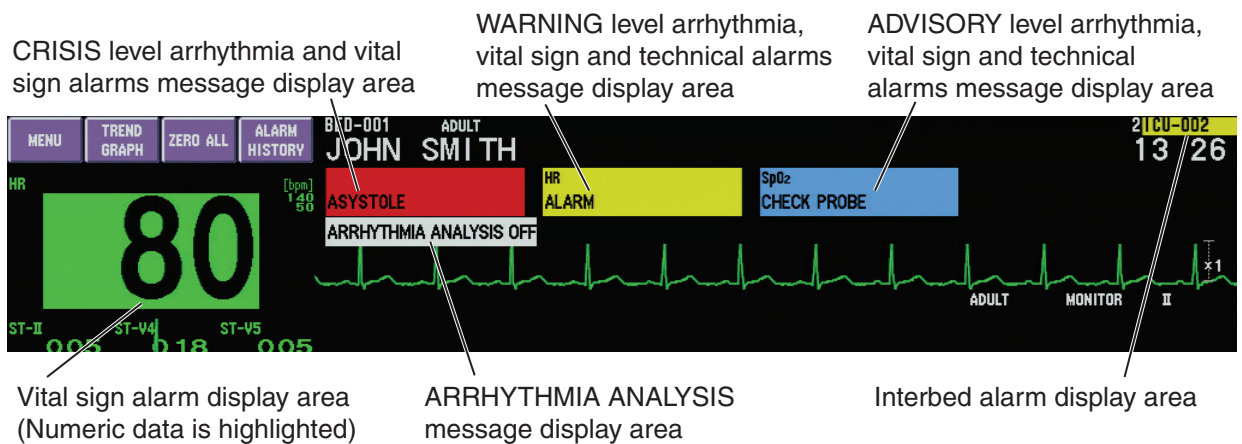

ARRHYTHMIA ANALYSIS message is not highlighted when the site setting is NICU.

5. ALARM FUNCTION

Vital Signs Alarms

Alarm	Alarm level	Alarm sound	Alarm display	Sound/display duration	Alarm indicator LED
UPPER/ LOWER HR*/PR	CRISIS	NK1 (Continuous pip sound), NK2 (Continuous ping sound) or IEC standard (ceg-gC)	Blinking highlighted numeric data	During detection	Blinking red
	WARNING	NK1 (Continuous bing bong sound), NK2 (Continuous ding ding sound) or IEC standard (ceg)	Highlighted numeric data		Blinking yellow
	ADVISORY	NK1 and NK2 (Single beep every 20 or 120 seconds) or IEC standard (ec)	Highlighted numeric data		Lights in cyan/ yellow
VPC	CRISIS	NK1 (Continuous pip sound), NK2 (Continuous ping sound) or IEC standard (ceg-gC)	Blinking highlighted numeric data	During detection	Blinking red
	WARNING	NK1 (Continuous bing bong sound), NK2 (Continuous ding ding sound) or IEC standard (ceg)	Highlighted numeric data		Blinking yellow
	ADVISORY	NK1 and NK2 (Single beep every 20 or 120 seconds) or IEC standard (ec)	Highlighted numeric data		Lights in cyan/ yellow
ST	CRISIS	NK1 (Continuous pip sound), NK2 (Continuous ping sound) or IEC standard (ceg-gC)	Blinking highlighted numeric data	During detection	Blinking red
	WARNING	NK1 (Continuous bing bong sound), NK2 (Continuous ding ding sound) or IEC standard (ceg)	Highlighted numeric data		Blinking yellow
	ADVISORY	NK1 and NK2 (Single beep every 20 or 120 seconds) or IEC standard (ec)	Highlighted numeric data		Lights in cyan/ yellow
UPPER/ LOWER RR	CRISIS	NK1 (Continuous pip sound), NK2 (Continuous ping sound) or IEC standard (ceg-gC)	Blinking highlighted numeric data	During detection	Blinking red
	WARNING	NK1 (Continuous bing bong sound), NK2 (Continuous ding ding sound) or IEC standard (ceg)	Highlighted numeric data		Blinking yellow
	ADVISORY	NK1 and NK2 (Single beep every 20 or 120 seconds) or IEC standard (ec)	Highlighted numeric data		Lights in cyan/ yellow
APNEA	CRISIS	NK1 (Continuous pip sound), NK2 (Continuous ping sound) or IEC standard (ceg-gC)	Highlighted “APNEA ALARM” message	During detection	Blinking red
	WARNING	NK1 (Continuous bing bong sound), NK2 (Continuous ding ding sound) or IEC standard (ceg)	Highlighted “APNEA ALARM” message		Blinking yellow
	ADVISORY	NK1 and NK2 (Single beep every 20 or 120 seconds) or IEC standard (ec)	Highlighted “APNEA ALARM” message		Lights in cyan/ yellow
UPPER SpO ₂ , UPPER SpO ₂ -2* ² , ΔSpO ₂	CRISIS	NK1 (Continuous pip sound), NK2 (Continuous ping sound) or IEC standard (ceg-gC)	Blinking highlighted numeric data	During detection	Blinking red
	WARNING	NK1 (Continuous bing bong sound), NK2 (Continuous ding ding sound) or IEC standard (ceg)	Highlighted numeric data		Blinking yellow
	ADVISORY	NK1 and NK2 (Single beep every 20 or 120 seconds) or IEC standard (ec)	Highlighted numeric data		Lights in cyan/ yellow

*1 When arrhythmia analysis is turned on, the “TACHYCARDIA” or “BRADYCARDIA” message also appears.

*2 Available only when an AY-661P, AY-663P, AY-671P or AY-673P input unit or BSM-1763 or BSM-1773 bedside monitor is used.

Alarm	Alarm level	Alarm sound	Alarm display	Sound/display duration	Alarm indicator LED
LOWER SpO ₂ , LOWER SpO ₂ -2*	CRISIS	NK1 (Continuous pip sound), NK2 (Continuous ping sound) or IEC standard (ceg-gC)	Blinking highlighted numeric data	During detection	Blinking red
	WARNING	NK1 (Continuous bing bong sound), NK2 (Continuous ding ding sound) or IEC standard (ceg)	Highlighted numeric data		Blinking yellow
NIBP	CRISIS	NK1 (Continuous pip sound), NK2 (Continuous ping sound) or IEC standard (ceg-gC)	Blinking highlighted numeric data	During detection	Blinking red
	WARNING	NK1 (Continuous bing bong sound), NK2 (Continuous ding ding sound) or IEC standard (ceg)	Highlighted numeric data		Blinking yellow
	ADVISORY	NK1 and NK2 (Single beep every 20 or 120 seconds) or IEC standard (ec)	Highlighted numeric data		Lights in cyan/yellow
PRESS	CRISIS	NK1 (Continuous pip sound), NK2 (Continuous ping sound) or IEC standard (ceg-gC)	Blinking highlighted numeric data	During detection	Blinking red
	WARNING	NK1 (Continuous bing bong sound), NK2 (Continuous ding ding sound) or IEC standard (ceg)	Highlighted numeric data		Blinking yellow
	ADVISORY	NK1 and NK2 (Single beep every 20 or 120 seconds) or IEC standard (ec)	Highlighted numeric data		Lights in cyan/yellow
TEMP, ΔT, ΔT2	CRISIS	NK1 (Continuous pip sound), NK2 (Continuous ping sound) or IEC standard (ceg-gC)	Blinking highlighted numeric data	During detection	Blinking red
	WARNING	NK1 (Continuous bing bong sound), NK2 (Continuous ding ding sound) or IEC standard (ceg)	Highlighted numeric data		Blinking yellow
	ADVISORY	NK1 and NK2 (Single beep every 20 or 120 seconds) or IEC standard (ec)	Highlighted numeric data		Lights in cyan/yellow
UPPER/ LOWER CO ₂ (E)	CRISIS	NK1 (Continuous pip sound), NK2 (Continuous ping sound) or IEC standard (ceg-gC)	Blinking highlighted numeric data	During detection	Blinking red
	WARNING	NK1 (Continuous bing bong sound), NK2 (Continuous ding ding sound) or IEC standard (ceg)	Highlighted “CO ₂ (E) ALARM” message		Blinking yellow
CO ₂ (I)	CRISIS	NK1 (Continuous pip sound), NK2 (Continuous ping sound) or IEC standard (ceg-gC)	Blinking highlighted numeric data	During detection	Blinking red
	WARNING	NK1 (Continuous bing bong sound), NK2 (Continuous ding ding sound) or IEC standard (ceg)	Highlighted “CO ₂ (I) ALARM” message		Blinking yellow
O ₂ (E)	CRISIS	NK1 (Continuous pip sound), NK2 (Continuous ping sound) or IEC standard (ceg-gC)	Blinking highlighted numeric data	During detection	Blinking red
	WARNING	NK1 (Continuous bing bong sound), NK2 (Continuous ding ding sound) or IEC standard (ceg)	Highlighted numeric data		Blinking yellow
	ADVISORY	NK1 and NK2 (Single beep every 20 or 120 seconds) or IEC standard (ec)	Highlighted numeric data		Lights in cyan/yellow

* Available only when an AY-661P, AY-663P, AY-671P or AY-673P input unit or BSM-1763 or BSM-1773 bedside monitor is used.

5. ALARM FUNCTION

Alarm	Alarm level	Alarm sound	Alarm display	Sound/display duration	Alarm indicator LED
O ₂ (I)	CRISIS	NK1 (Continuous pip sound), NK2 (Continuous ping sound) or IEC standard (ceg-gC)	Blinking highlighted numeric data	During detection	Blinking red
	WARNING	NK1 (Continuous bing bong sound), NK2 (Continuous ding ding sound) or IEC standard (ceg)	Highlighted numeric data		Blinking yellow
N ₂ O(E)	CRISIS	NK1 (Continuous pip sound), NK2 (Continuous ping sound) or IEC standard (ceg-gC)	Blinking highlighted numeric data	During detection	Blinking red
	WARNING	NK1 (Continuous bing bong sound), NK2 (Continuous ding ding sound) or IEC standard (ceg)	Highlighted numeric data		Blinking yellow
	ADVISORY	NK1 and NK2 (Single beep every 20 or 120 seconds) or IEC standard (ec)	Highlighted numeric data		Lights in cyan/yellow
N ₂ O(I)	CRISIS	NK1 (Continuous pip sound), NK2 (Continuous ping sound) or IEC standard (ceg-gC)	Blinking highlighted numeric data	During detection	Blinking red
	WARNING	NK1 (Continuous bing bong sound), NK2 (Continuous ding ding sound) or IEC standard (ceg)	Highlighted numeric data		Blinking yellow
HAL(E)	CRISIS	NK1 (Continuous pip sound), NK2 (Continuous ping sound) or IEC standard (ceg-gC)	Blinking highlighted numeric data	During detection	Blinking red
	WARNING	NK1 (Continuous bing bong sound), NK2 (Continuous ding ding sound) or IEC standard (ceg)	Highlighted numeric data		Blinking yellow
	ADVISORY	NK1 and NK2 (Single beep every 20 or 120 seconds) or IEC standard (ec)	Highlighted numeric data		Lights in cyan/yellow
HAL(I)	CRISIS	NK1 (Continuous pip sound), NK2 (Continuous ping sound) or IEC standard (ceg-gC)	Blinking highlighted numeric data	During detection	Blinking red
	WARNING	NK1 (Continuous bing bong sound), NK2 (Continuous ding ding sound) or IEC standard (ceg)	Highlighted numeric data		Blinking yellow
ISO(E)	CRISIS	NK1 (Continuous pip sound), NK2 (Continuous ping sound) or IEC standard (ceg-gC)	Blinking highlighted numeric data	During detection	Blinking red
	WARNING	NK1 (Continuous bing bong sound), NK2 (Continuous ding ding sound) or IEC standard (ceg)	Highlighted numeric data		Blinking yellow
	ADVISORY	NK1 and NK2 (Single beep every 20 or 120 seconds) or IEC standard (ec)	Highlighted numeric data		Lights in cyan/yellow
ISO(I)	CRISIS	NK1 (Continuous pip sound), NK2 (Continuous ping sound) or IEC standard (ceg-gC)	Blinking highlighted numeric data	During detection	Blinking red
	WARNING	NK1 (Continuous bing bong sound), NK2 (Continuous ding ding sound) or IEC standard (ceg)	Highlighted numeric data		Blinking yellow

Alarm	Alarm level	Alarm sound	Alarm display	Sound/display duration	Alarm indicator LED
ENF(E)	CRISIS	NK1 (Continuous pip sound), NK2 (Continuous ping sound) or IEC standard (ceg-gC)	Blinking highlighted numeric data	During detection	Blinking red
	WARNING	NK1 (Continuous bing bong sound), NK2 (Continuous ding ding sound) or IEC standard (ceg)	Highlighted numeric data		Blinking yellow
	ADVISORY	NK1 and NK2 (Single beep every 20 or 120 seconds) or IEC standard (ec)	Highlighted numeric data		Lights in cyan/yellow
ENF(I)	CRISIS	NK1 (Continuous pip sound), NK2 (Continuous ping sound) or IEC standard (ceg-gC)	Blinking highlighted numeric data	During detection	Blinking red
	WARNING	NK1 (Continuous bing bong sound), NK2 (Continuous ding ding sound) or IEC standard (ceg)	Highlighted numeric data		Blinking yellow
DES(E)	CRISIS	NK1 (Continuous pip sound), NK2 (Continuous ping sound) or IEC standard (ceg-gC)	Blinking highlighted numeric data	During detection	Blinking red
	WARNING	NK1 (Continuous bing bong sound), NK2 (Continuous ding ding sound) or IEC standard (ceg)	Highlighted numeric data		Blinking yellow
	ADVISORY	NK1 and NK2 (Single beep every 20 or 120 seconds) or IEC standard (ec)	Highlighted numeric data		Lights in cyan/yellow
DES(I)	CRISIS	NK1 (Continuous pip sound), NK2 (Continuous ping sound) or IEC standard (ceg-gC)	Blinking highlighted numeric data	During detection	Blinking red
	WARNING	NK1 (Continuous bing bong sound), NK2 (Continuous ding ding sound) or IEC standard (ceg)	Highlighted numeric data		Blinking yellow
SEV(E)	CRISIS	NK1 (Continuous pip sound), NK2 (Continuous ping sound) or IEC standard (ceg-gC)	Blinking highlighted numeric data	During detection	Blinking red
	WARNING	NK1 (Continuous bing bong sound), NK2 (Continuous ding ding sound) or IEC standard (ceg)	Highlighted numeric data		Blinking yellow
	ADVISORY	NK1 and NK2 (Single beep every 20 or 120 seconds) or IEC standard (ec)	Highlighted numeric data		Lights in cyan/yellow
SEV(I)	CRISIS	NK1 (Continuous pip sound), NK2 (Continuous ping sound) or IEC standard (ceg-gC)	Blinking highlighted numeric data	During detection	Blinking red
	WARNING	NK1 (Continuous bing bong sound), NK2 (Continuous ding ding sound) or IEC standard (ceg)	Highlighted numeric data		Blinking yellow
MV*	CRISIS	NK1 (Continuous pip sound), NK2 (Continuous ping sound) or IEC standard (ceg-gC)	Blinking highlighted numeric data	During detection	Blinking red
	WARNING	NK1 (Continuous bing bong sound), NK2 (Continuous ding ding sound) or IEC standard (ceg)	Highlighted numeric data		Blinking yellow
	ADVISORY	NK1 and NK2 (Single beep every 20 or 120 seconds) or IEC standard (ec)	Highlighted numeric data		Lights in cyan/yellow

* Not available for BSM-6000A series.

5. ALARM FUNCTION

Alarm	Alarm level	Alarm sound	Alarm display	Sound/display duration	Alarm indicator LED
PEEP*	CRISIS	NK1 (Continuous pip sound), NK2 (Continuous ping sound) or IEC standard (ceg-gC)	Blinking highlighted numeric data	During detection	Blinking red
	WARNING	NK1 (Continuous bing bong sound), NK2 (Continuous ding ding sound) or IEC standard (ceg)	Highlighted numeric data		Blinking yellow
	ADVISORY	NK1 and NK2 (Single beep every 20 or 120 seconds) or IEC standard (ec)	Highlighted numeric data		Lights in cyan/yellow
Ppeak*	CRISIS	NK1 (Continuous pip sound), NK2 (Continuous ping sound) or IEC standard (ceg-gC)	Blinking highlighted numeric data	During detection	Blinking red
	WARNING	NK1 (Continuous bing bong sound), NK2 (Continuous ding ding sound) or IEC standard (ceg)	Highlighted numeric data		Blinking yellow
	ADVISORY	NK1 and NK2 (Single beep every 20 or 120 seconds) or IEC standard (ec)	Highlighted numeric data		Lights in cyan/yellow
SEF	CRISIS	NK1 (Continuous pip sound), NK2 (Continuous ping sound) or IEC standard (ceg-gC)	Blinking highlighted numeric data	During detection	Blinking red
	WARNING	NK1 (Continuous bing bong sound), NK2 (Continuous ding ding sound) or IEC standard (ceg)	Highlighted numeric data		Blinking yellow
	ADVISORY	NK1 and NK2 (Single beep every 20 or 120 seconds) or IEC standard (ec)	Highlighted numeric data		Lights in cyan/yellow
TP	CRISIS	NK1 (Continuous pip sound), NK2 (Continuous ping sound) or IEC standard (ceg-gC)	Blinking highlighted numeric data	During detection	Blinking red
	WARNING	NK1 (Continuous bing bong sound), NK2 (Continuous ding ding sound) or IEC standard (ceg)	Highlighted numeric data		Blinking yellow
	ADVISORY	NK1 and NK2 (Single beep every 20 or 120 seconds) or IEC standard (ec)	Highlighted numeric data		Lights in cyan/yellow
CCO*	CRISIS	NK1 (Continuous pip sound), NK2 (Continuous ping sound) or IEC standard (ceg-gC)	Blinking highlighted numeric data	During detection	Blinking red
	WARNING	NK1 (Continuous bing bong sound), NK2 (Continuous ding ding sound) or IEC standard (ceg)	Highlighted numeric data		Blinking yellow
	ADVISORY	NK1 and NK2 (Single beep every 20 or 120 seconds) or IEC standard (ec)	Highlighted numeric data		Lights in cyan/yellow
CCI*	CRISIS	NK1 (Continuous pip sound), NK2 (Continuous ping sound) or IEC standard (ceg-gC)	Blinking highlighted numeric data	During detection	Blinking red
	WARNING	NK1 (Continuous bing bong sound), NK2 (Continuous ding ding sound) or IEC standard (ceg)	Highlighted numeric data		Blinking yellow
	ADVISORY	NK1 and NK2 (Single beep every 20 or 120 seconds) or IEC standard (ec)	Highlighted numeric data		Lights in cyan/yellow

* Not available for BSM-6000A series.

Arrhythmia Alarms

Alarm	Alarm level	Alarm sound	Alarm display	Sound/display duration	Alarm indicator LED
ASYSTOLE VF VT	CRISIS	NK1 (Continuous pip sound), NK2 (Continuous ping sound) or IEC standard (ceg-gC)	Blinking highlighted message	During detection	Blinking red
VPC RUN COUPLET EARLY VPC FREQ VPC EXT TACHY* ¹ EXT BRADY* ¹ V BRADY* ¹ SV TACHY* ¹ PAUSE*	CRISIS	NK1 (Continuous pip sound), NK2 (Continuous ping sound) or IEC standard (ceg-gC)	Blinking highlighted message	During detection	Blinking red
	WARNING	NK1 (Continuous bing bong sound), NK2 (Continuous ding ding sound) or IEC standard (ceg)	Highlighted message		Blinking yellow
	ADVISORY	NK1 and NK2 (Single beep every 20 or 120 seconds) or IEC standard (ec)	Highlighted message		Lights in cyan/yellow
MULTIFORM* ¹ V RHYTHM* ¹ BIGEMINY TRIGEMINY* ¹ AF* ² IRREGULAR RR* ¹ PROLONGED RR* ¹ NO PACER PULSE* ¹ PACER NON-CAPUTRE* ¹	CRISIS	NK1 (Continuous pip sound), NK2 (Continuous ping sound) or IEC standard (ceg-gC)	Blinking highlighted message	At detection	Blinking red
	WARNING	NK1 (Continuous bing bong sound), NK2 (Continuous ding ding sound) or IEC standard (ceg)	Highlighted message		Blinking yellow
	ADVISORY	NK1 and NK2 (Single beep every 20 or 120 seconds) or IEC standard (ec)	Highlighted message		Lights in cyan/yellow

*¹ Available only when ARRHYTHMIA TYPE on the ECG page of the SYSTEM SETUP window is set to EXTENDED.

*² Not available for BSM-6000K series. Available only when <ARRHYTHMIA TYPE> on the ECG page of the SYSTEM SETUP window is set to EXTENDED, and <AF DETECTION> on the ECG page of the SYSTEM SETUP window is set to On. For the SYSTEM SETUP window settings, refer to the Administrator's Guide.

Technical Alarms

ECG related alarms

Alarm	Alarm level	Alarm sound	Alarm display	Sound/display duration	Alarm indicator LED
ECG CHECK ELECTRODES	WARNING	NK1 (Continuous bing bong sound), NK2 (Continuous ding ding sound) or IEC standard (ceg)	Highlighted numeric data and message	During detection	Blinking yellow
ECG CHECK ELECTRODE -- ECG MODULE ERROR	ADVISORY	NK1 and NK2 (Single beep every 20 or 120 seconds) or IEC standard (ec)	Highlighted message		Lights in cyan/yellow

5. ALARM FUNCTION

CO₂ related alarms

Mainstream method

Alarm	Alarm level	Alarm sound	Alarm display		Sound/ display duration	Alarm indicator LED
			Home screen	When a window is open		
CHECK CO ₂ CELL* ¹	WARNING	NK1 (Continuous bing bong sound), NK2 (Continuous ding ding sound) or IEC standard (ceg)	Highlighted message		During detection	Blinking yellow
	ADVISORY	NK1 and NK2 (Single beep every 20 seconds) or IEC standard (ec)	Highlighted message			Lights in cyan/yellow
CO ₂ CELL OFF* ¹	ADVISORY	NK1 and NK2 (Single beep every 20 or 120 seconds) or IEC standard (ec)	Highlighted message		During detection	Lights in cyan/yellow
CO ₂ CHANGE ADAPTER						
CO ₂ CHECK SENSOR* ²						
CO ₂ CONNECTOR OFF						
CO ₂ SENSOR ERROR						

*¹ These alarms are displayed when AVAILABLE ALARM TYPES is set to ALL on the SYSTEM SETUP window.

*² This alarm is displayed when AVAILABLE ALARM TYPES is set to MAIN on the SYSTEM SETUP window.

Sidestream method

Alarm	Alarm level	Alarm sound	Alarm display		Sound/ display duration	Alarm indicator LED
			Home screen	When a window is open		
CO ₂ CHANGE ABSORBENT	WARNING	NK1 (Continuous bing bong sound), NK2 (Continuous ding ding sound) or IEC standard (ceg)	Highlighted message		During detection	Blinking yellow
CO ₂ LINE BLOCK						
CO ₂ CHECK EXTERNAL DEVICE	ADVISORY	NK1 and NK2 (Single beep every 20 or 120 seconds) or IEC standard (ec)	Highlighted message		During detection	Lights in cyan/yellow
CO ₂ DEVICE ERROR						
CO ₂ NO FILTERLINE						

Respiration related alarm

Alarm	Alarm level	Alarm sound	Alarm display		Sound/ display duration	Alarm indicator LED
			Home screen	When a window is open		
RESP CONNECTOR OFF	ADVISORY	NK1 and NK2 (Single beep every 20 or 120 seconds) or IEC standard (ec)	Highlighted message		During detection	Lights in cyan/yellow
RESP CHECK SENSOR						

SpO₂ related alarms

Alarm	Alarm level	Alarm sound	Alarm display		Sound/ display duration	Alarm indicator LED
			Home screen	When a window is open		
SpO ₂ /SpO ₂ -2 CHANGE PROBE SpO ₂ /SpO ₂ -2 CHECK PROBE	WARNING	NK1 (Continuous bong bong sound), NK2 (Continuous ding ding sound) or IEC standard (ceg)	Highlighted message		During detection	Blinking yellow
SpO ₂ -2 ALARM SpO ₂ /SpO ₂ -2 CANNOT DETECT PULSE SpO ₂ /SpO ₂ -2 CHECK PROBE SITE SpO ₂ /SpO ₂ -2 CONNECTOR OFF SpO ₂ /SpO ₂ -2 LIGHT INTER-FERENCE SpO ₂ /SpO ₂ -2 MODULE ERROR SpO ₂ /SpO ₂ -2 NO PROBE	ADVISORY	NK1 and NK2 (Single beep every 20 or 120 seconds) or IEC standard (ec)	Highlighted message		During detection	Lights in cyan/yellow

5. ALARM FUNCTION

NIBP related alarms

Alarm	Alarm level	Alarm sound	Alarm display		Sound/ display duration	Alarm indicator LED
			Home screen	When a window is open		
NIBP CUFF OCCLUSION NIBP SAFETY CIRCUIT RUNNING	WARNING	NK1 (Continuous bing bong sound), NK2 (Continuous ding ding sound) or IEC standard (ceg)	Highlighted message		During detection	Blinking yellow
NIBP AIR LEAK NIBP CANNOT DETECT PULSE NIBP CHECK INTERVAL SETTING NIBP MEAS TIME-OUT NIBP MODULE ERROR NIBP SYSTOLIC OVER	ADVISORY	NK1 and NK2 (Single beep every 20 or 120 seconds) or IEC standard (ec)	Highlighted message		During detection	Lights in cyan/yellow

IBP related alarms

Alarm	Alarm level	Alarm sound	Alarm display		Sound/ display duration	Alarm indicator LED
			Home screen	When a window is open		
PRESS* CHECK SENSOR PRESS* CONNECTOR OFF PRESS* THIS LABEL IS ALREADY REGISTERED	ADVISORY	NK1 and NK2 (Single beep every 20 or 120 seconds) or IEC standard (ec)	Highlighted message		During detection	Lights in cyan/yellow

* The labels are displayed for BP.

Temperature related alarms

Alarm	Alarm level	Alarm sound	Alarm display		Sound/ display duration	Alarm indicator LED
			Home screen	When a window is open		
TEMP CHECK SENSOR TEMP CONNECTOR OFF TEMP THIS LABEL IS ALREADY REGISTERED	ADVISORY	NK1 and NK2 (Single beep every 20 or 120 seconds) or IEC standard (ec)	Highlighted message		During detection	Lights in cyan/yellow

BIS related alarms

Alarm	Alarm level	Alarm sound	Alarm display		Sound/ display duration	Alarm indicator LED
			Home screen	When a window is open		
BIS CHECK EXTERNAL DEVICE BIS CHECK SENSOR BIS MODULE FAILURE BIS SENSOR ERROR BIS SENSOR EXPIRED BIS THIS PARAMETER IS ALREADY REGISTERED	ADVISORY	NK1 and NK2 (Single beep every 20 or 120 seconds) or IEC standard (ec)	Highlighted message		During detection	Lights in cyan/yellow

5

CO related alarms

Alarm	Alarm level	Alarm sound	Alarm display		Sound/ display duration	Alarm indicator LED
			Home screen	When a window is open		
CO CHECK SENSOR CO CONNECTOR OFF	ADVISORY	NK1 and NK2 (Single beep every 20 or 120 seconds) or IEC standard (ec)	Highlighted message		During detection	Lights in cyan/yellow

5. ALARM FUNCTION

Gas related alarms

Alarm	Alarm level	Alarm sound	Alarm display		Sound/ display duration	Alarm indicator LED
			Home screen	When a window is open		
GAS APNEA GAS CHECK SAMPLE LINE GAS LINE BLOCK GAS MIXED GAS	WARNING	NK1 (Continuous bing bong sound), NK2 (Continuous ding ding sound) or IEC standard (ceg)	Highlighted message		During detection	Blinking yellow
GAS CHECK WATER TRAP AND SAMPLE LINE GAS CHECK EXTERNAL DEVICE GAS CHECK WATERTRAP GAS DEVICE ERROR GAS OVERHEAT	ADVISORY	NK1 and NK2 (Single beep every 20 or 120 seconds) or IEC standard (ec)	Highlighted message		During detection	Lights in cyan/yellow

O₂ related alarms

Alarm	Alarm level	Alarm sound	Alarm display		Sound/ display duration	Alarm indicator LED
			Home screen	When a window is open		
O ₂ CHECK SENSOR O ₂ CONNECTOR OFF	ADVISORY	NK1 and NK2 (Single beep every 20 or 120 seconds) or IEC standard (ec)	Highlighted message		During detection	Lights in cyan/yellow

VENT related alarm

Alarm	Alarm level	Alarm sound	Alarm display		Sound/ display duration	Alarm indicator LED
			Home screen	When a window is open		
VENT ALARM VENT CHECK EXTERNAL DEVICE	ADVISORY	NK1 and NK2 (Single beep every 20 or 120 seconds) or IEC standard (ec)	Highlighted message		During detection	Lights in cyan/yellow

TOF related alarm

Alarm	Alarm level	Alarm sound	Alarm display		Sound/ display duration	Alarm indicator LED
			Home screen	When a window is open		
TOF ALARM TOF CHECK EXTERNAL DEVICE	ADVISORY	NK1 and NK2 (Single beep every 20 or 120 seconds) or IEC standard (ec)	Highlighted message		During detection	Lights in cyan/yellow

5

CCO (APCO) related alarm

Alarm	Alarm level	Alarm sound	Alarm display		Sound/ display duration	Alarm indicator LED
			Home screen	When a window is open		
CCO CHECK SENSOR CCO CHECK WAVEFORM CCO CONNECTOR OFF CCO MODULE FAILURE CCO SVV: HIGHLY VARIABLE PULSE RATE	ADVISORY	NK1 and NK2 (Single beep every 20 or 120 seconds) or IEC standard (ec)	Highlighted message		During detection	Lights in cyan/yellow

CCO and CCO/S \bar{v} O₂ related alarm

Alarm	Alarm level	Alarm sound	Alarm display		Sound/ display duration	Alarm indicator LED
			Home screen	When a window is open		
CCO ALARM CCO CHECK EXTERNAL DEVICE	ADVISORY	NK1 and NK2 (Single beep every 20 or 120 seconds) or IEC standard (ec)	Highlighted message		During detection	Lights in cyan/yellow

5. ALARM FUNCTION

PiCCO related alarm

Alarm	Alarm level	Alarm sound	Alarm display		Sound/ display duration	Alarm indicator LED
			Home screen	When a window is open		
PCCO CHECK EXTERNAL DEVICE	ADVISORY	NK1 and NK2 (Single beep every 20 or 120 seconds) or IEC standard (ec)	Highlighted message		During detection	Lights in cyan/yellow

FLOW/Paw related alarms

Alarm	Alarm level	Alarm sound	Alarm display		Sound/ display duration	Alarm indicator LED
			Home screen	When a window is open		
FLOW APNEA	WARNING	NK1 (Continuous bing bong sound), NK2 (Continuous ding ding sound) or IEC standard (ceg)	Highlighted message		During detection	Blinking yellow
FLOW CONNECTOR OFF	ADVISORY	NK1 and NK2 (Single beep every 20 or 120 seconds) or IEC standard (ec)	Highlighted message		During detection	Lights in cyan/yellow
FLOW CHECK EXTERNAL DEVICE						
FLOW DEVICE ERROR						

EEG related alarms

Alarm	Alarm level	Alarm sound	Alarm display		Sound/ display duration	Alarm indicator LED
			Home screen	When a window is open		
EEG CHECK ELECTRODES	ADVISORY	NK1 and NK2 (Single beep every 20 or 120 seconds) or IEC standard (ec)	Highlighted message		During detection	Lights in cyan/yellow
EEG CHECK EXTERNAL DEVICE						
EEG CONNECTOR OFF						

tcPO₂/tcPCO₂ related alarms

Alarm	Alarm level	Alarm sound	Alarm display		Sound/ display duration	Alarm indicator LED
			Home screen	When a window is open		
tcPO ₂ /PCO ₂ ALARM	ADVISORY	NK1 and NK2 (Single beep every 20 or 120 seconds) or IEC standard (ec)	Highlighted message		During detection	Lights in cyan/yellow
tcPO ₂ /PCO ₂ CHECK EXTERNAL DEVICE						

rSO₂ related alarm

Alarm	Alarm level	Alarm sound	Alarm display		Sound/ display duration	Alarm indicator LED
			Home screen	When a window is open		
rSO ₂ CHECK EXTERNAL DEVICE	ADVISORY	NK1 and NK2 (Single beep every 20 or 120 seconds) or IEC standard (ec)	Highlighted message		During detection	Lights in cyan/yellow

Other Alarms

Alarm	Alarm level	Alarm sound	Alarm display	Sound/display duration	Alarm indicator LED
BATTERY ERROR	WARNING	NK1 (Continuous bing bong sound), NK2 (Continuous ding ding sound) or IEC standard (ceg)	Highlighted message	During detection	Blinking yellow
BATTERY WEAK					
CHECK INPUT UNIT BATTERY					
MULTI LINK CONFIG ERROR					
MULTI LINK POWER ERROR	ADVISORY	NK1 and NK2 (Single beep every 20 or 120 seconds) or IEC standard (ec)	Highlighted message	During detection	Lights in cyan/yellow
COMMUNICATION LOSS					
DATA SEND ERROR					
HIS SYNC ERROR					
INPUT UNIT DISCONNECT					
INPUT UNIT FAILURE					
MPU MODULE ERROR					
PARAMETER NOT AVAILABLE					
PRINT ERROR					
TEC DATA RECEIVE ERROR					
TEC INTERFACE ALREADY CONNECTED					
TEC INTERFACE DISCONNECTED					
TEC INTERFACE ERROR					
--- THIS PARAMETER IS ALREADY REGISTERED					
TRANSMITTER CONNECTOR OFF					

Interbed Alarms

The interbed alarm indication depends on the <INTERBED ALARMS TO DISPLAY> setting on the INTERBED page of the SYSTEM SETUP window. When set to ALL, CRISIS AND WARNING, or CRISIS, the highlighted bed name is displayed on the upper right corner of the home screen and three ping sounds at detection. When set to NONE, only the bed ID of the alarmed bed is indicated at the upper right corner of the home screen. For details, refer to the Administrator’s Guide, Section 3.

Alarm Control Marks

When certain alarm functions are not available, an alarm control mark and the message is displayed in the upper part of the screen.



Alarm is silenced by pressing the [Silence Alarms] key on the bedside monitor or [SILENCE ALARMS] key on the remote control. Remaining minutes appears.



Alarms are suspended for a certain period.



Alarms are suspended infinitely or vital sign alarm limit is set to off.

Individual Vital Signs Alarm Off Marks

The vital sign alarm off mark can be displayed at every parameter which has the vital signs alarm limit set to OFF. The upper/lower alarm limits can also be displayed at each parameter.

Set this setting at <LIMIT DISPLAY> of the ALARM window on the SYSTEM SETUP window. See Administrator’s Guide, Section 3. The default setting is VALUES.

When <LIMIT DISPLAY> is set to VALUES, for BSM-6000A series, when the limit is set to OFF, “OFF” is displayed. For BSM-6000K series, when the limit is set to OFF, “---” is displayed.

BSM-6000A series



BSM-6000K series



LIMIT DISPLAY set to VALUES



LIMIT DISPLAY set to MARK BRIGHT



LIMIT DISPLAY set to MARK DIM

Flow of Alarm Function

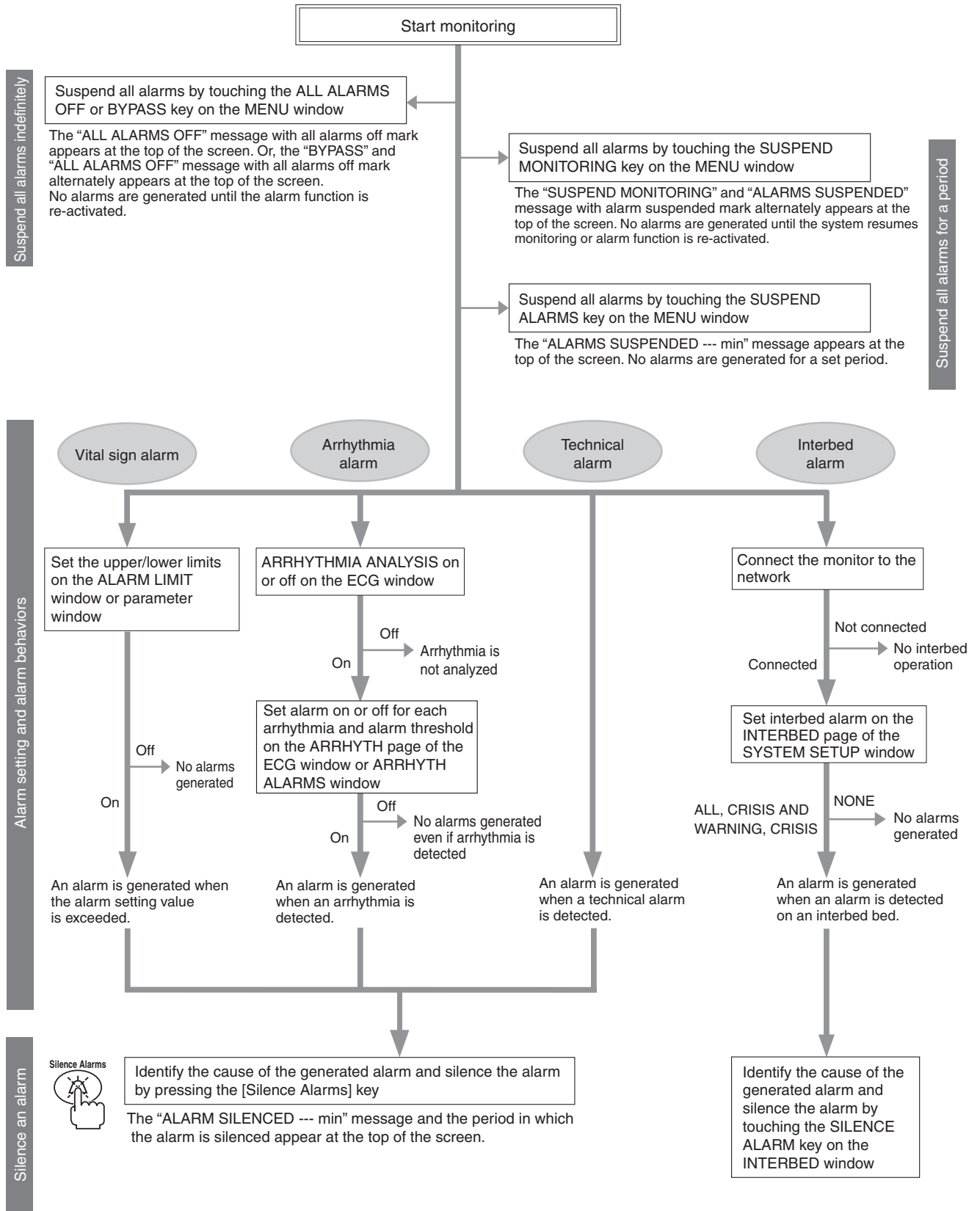



Silencing and Suspending Alarms

Overview

Silencing an Alarm

When an alarm occurs, you can silence the alarm sound and indications for one, two or three minutes by pressing the  [Silence Alarms] key on the bedside monitor or remote control. When a vital signs alarm or arrhythmia alarm is silenced, the alarm resumes after the alarm silence ends. When a vital signs alarm other than NIBP or arrhythmia alarm is silenced, the alarm resumes after the alarm silence ends. When a technical alarm other than the following alarms is silenced, the alarm indication does not resume after the alarm silence ends. If the following alarms are silenced, the alarm resumes after the alarm silence ends.

- BATTERY ERROR
- BATTERY WEAK
- CO₂ CHANGE ABSORBENT
- CO₂ LINE BLOCK
- ECG CANNOT ANALYZE
- EXTERNAL DEVICE ALARM
- GAS CHECK SAMPLE LINE
- GAS LINE BLOCK
- MULTILINK CONFIG ERROR
- MULTILINK POWER ERROR
- NIBP CUFF OCCLUSION
- NIBP SAFETY CIRCUIT RUNNING
- SpO₂ CHANGE PROBE

When several alarms occur together and the  [Silence Alarms] key is pressed, all alarms are silenced. To cancel vital sign or arrhythmia alarm silence, press the  [Silence Alarms] key. <SILENCE ALARMS TIME> is set on the ALARM window of the SYSTEM SETUP window. Refer to Administrator's Guide, Section 3.

When the Monitor is Connected to the Central Monitor

When the bedside monitor is connected to a central monitor network, all alarms are temporarily silenced by touching the Silence Alarms key on the central monitor. Refer to the central monitor operator's manual for details.

Suspending Alarms

All alarms can also be suspended before they occur. During alarm suspension, all alarms are off. This monitor has three types of alarm suspension according to the site mode.

Monitor Operation	Example of How This Function is Used	Key to Press	How the Alarm Function Comes Back
Suspends all alarms for 1, 2 or 3 minutes	For electrode replacement.	[SUSPEND ALARMS] key on the bedside monitor or remote control	When 1, 2 or 3 minutes set on the <SUSPEND ALARMS TIME> elapse.
			When the [SUSPEND ALARMS] key is pressed again.
Suspends all alarms and NIBP STAT/SIM and auto measurement indefinitely	When the patient is being examined.	SUSPEND MONITORING key on the screen	When the SUSPEND MONITORING key is touched again.
	When the patient is connected to a heart-lung machine or being examined.		When the condition set for the <ALARM ACTIVATION DELAY> is met. * ¹
		BYPASS key on the screen (OR mode only)	When the BYPASS key is touched again.
Suspends all alarms indefinitely	When you want to turn off an unnecessary alarm in such situations as when the patient's vital signs are obviously out of normal range and the medical staff are aware that the patient is in an alarm condition and are currently treating the patient.	ALL ALARMS OFF key on the screen	When the ALL ALARMS OFF key is touched again.

*¹ Setting of <ALARM ACTIVATION DELAY> on the SYSTEM SETUP window

Setting	Condition
AUTO	Alarm function activates when ECG, SpO ₂ or IBP* ² is monitored or NIBP* ³ is measured and a value is displayed. * ² When SYS > DIA, the difference between these two values is 3 mmHg and this status continues for more than three seconds. * ³ When SYS, DIA or MAP value is measured. The alarm function is also recovered when the heart rate is 0.
1 min 2 min 3 min	When one of the following requirements is met. 1 ECG, SpO ₂ or IBP is continuously monitored for the selected time. 2 NIBP is measured (SYS, DIA or MAP value is measured). 3 Heart rate becomes 0.

The BYPASS key is only available in OR mode. The site mode is set on the SYSTEM CONFIGURATION screen. Refer to Administrator's Guide, Section 2.

Either the SUSPEND MONITORING, SUSPEND ALARMS, ALL ALARMS OFF/BYPASS key is displayed on the MENU window. The key to be displayed on the MENU window is set on the ALARM window of the SYSTEM SETUP window. Refer to Administrator's Guide, Section 3.

The SUSPEND MONITORING, SUSPEND ALARMS or BYPASS key can be assigned to one of the function keys. Refer to Administrator's Guide, Section 3.

For the interbed alarm, refer to Section 9 "Interbed Window".

The alarm off key on the MENU window

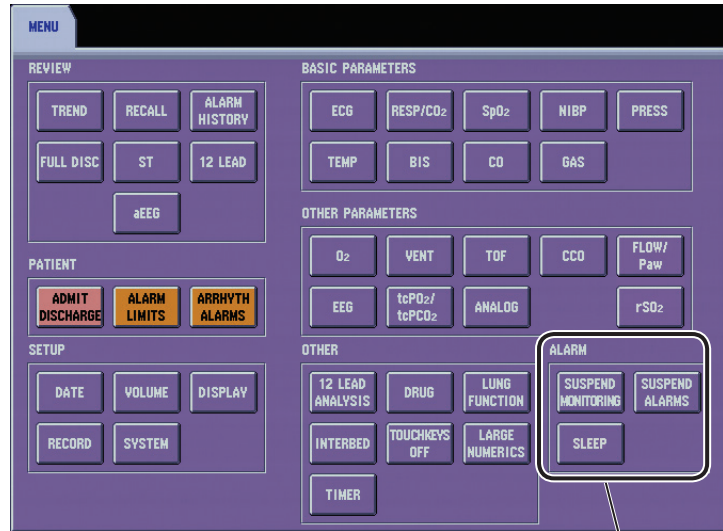

Alarm off keys

ALARM INACTIVATION Setting	ICU/NICU Site	OR Site
SUSPEND ALARMS		
ALL ALARMS OFF		<p>ALARMS OFF TYPE: BYPASS</p> <p>ALARMS OFF TYPE: ALL ALARMS OFF</p>

Alarm off function

SUSPEND MONITORING key

Use this key to temporarily stop patient monitoring for examination. When this key is touched, all alarms and NIBP STAT/SIM and auto measurements are suspended. Alarms resume when the SUSPEND MONITORING key is touched again or when the <ALARM ACTIVATION DELAY> condition is met.

SUSPEND ALARMS key

Use this key to suspend all alarms for the time set in <SUSPEND ALARMS TIME>.

BYPASS key

Use this key when the patient is connected to a heart-lung machine. When this key is touched, all alarms and NIBP STAT/SIM and auto measurements are indefinitely suspended. Touch the BYPASS key and touch the YES key on the confirmation window. Alarms resume when the BYPASS key is touched again.

ALL ALARMS OFF key

Use this key to suspend all alarms indefinitely. Touch the ALL ALARMS OFF key and touch the YES key on the confirmation window. Alarms resume when the ALL ALARMS OFF key is touched again.

Silencing Alarms After Alarm Occurrence

During alarm silence,

- the “ALARM SILENCED” message, the suspended mark and the remaining minutes are displayed
- the alarm sound is silenced

The alarm silence time can be set to either 1, 2 or 3 minutes at <SILENCE ALARMS TIME> on the ALARM window of the SYSTEM SETUP window. Refer to Administrator’s Guide, Section 3. The default setting is 2 minutes.

If another alarm occurs during alarm silence, the alarm sound, indication and recording occur as usual. The alarm silence does not affect alarms which occur after the  [Silence Alarms] key is pressed. (A new occurrence of the silenced alarm condition is treated as a different alarm.)

Silencing an Alarm

Press the  [Silence Alarms] key. The “ALARMS SILENCED” message and the alarm silenced mark and the minutes remaining in the alarm silence are displayed on the screen.

**Canceling Alarm Silence**

Vital sign and arrhythmia alarm silence can be cancelled by pressing the  [Silence Alarms] key. The alarm silence mark disappears and all alarms are resumed. Parameter alarm and other alarm silence cannot be canceled.

Suspending Alarms Before Alarm Occurrence**Suspending Alarms**

By touching the SUSPEND ALARMS key, all alarms for the patient are suspended for 1, 2 or 3 minutes. The alarm silence time can be set to either 1, 2 or 3 minutes at <SILENCE ALARMS TIME> on the ALARM window of the SYSTEM SETUP window. Refer to Administrator’s Guide, Section 3. The default setting is 2 minutes.

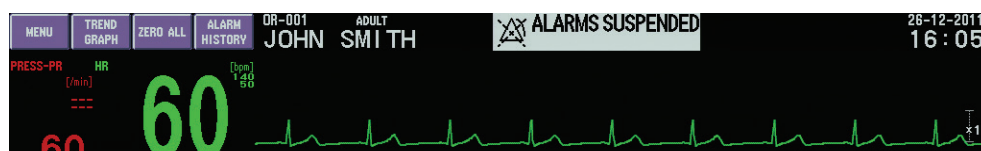

5. ALARM FUNCTION

During alarm suspension, all alarms are suspended and

- the “ALARMS SUSPENDED” message is displayed
- the alarm sound is silenced
- all alarm recording is suspended.

Resuming Alarms

Alarms resume when the set minutes elapses or when the  [Silence Alarms] key is pressed again.

Suspending All Alarms Indefinitely

Using the BYPASS Key

You can suspend all alarms and NIBP STAT/SIM and auto measurements for an indefinite time by touching the BYPASS key on the MENU window.

The BYPASS key is displayed on the MENU window when the site mode is OR and BYPASS is selected at <ALARMS OFF TYPE> on the ALARM window of the SYSTEM SETUP window. Refer to Administrator’s Guide, Section 3.

WARNING

Do not turn all alarms off with the ALL ALARMS OFF or BYPASS key when there is no medical staff around the patient or when the patient is connected to a ventilator.

1. Press the [Menu] key. The MENU window appears.

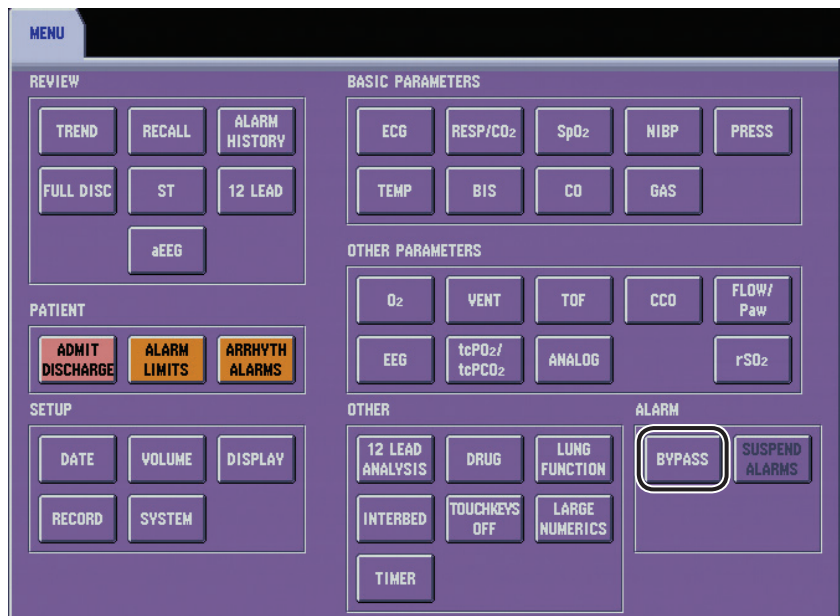

2. Touch the BYPASS key. The following window appears for confirmation.

When BYPASS is assigned to one of the function keys at the upper left of the screen, touching the BYPASS function key also opens the following window.



NOTE

If the  [Silence Alarms] key is pressed when this window is displayed, the BYPASS function is cancelled and the alarm is silenced or suspended.

3. Touch the YES key. To cancel it, touch the NO key.

The “BYPASS” and “ALL ALARMS OFF” messages appear on the screen.



When the <ALARM INDICATOR LIT> on the ALARM window of the SYSTEM SETUP window is set to ON, the red lamp of the alarm indicator lights when all alarms are indefinitely suspended with the BYPASS key.

When BYPASS is assigned to one of the function keys at the upper left of the screen, touching the BYPASS function key displays the TIMER window. It starts counting up automatically so that elapsed time can be checked. Refer to “Using the Timer” in Section 4 for details on the timer.

To resume alarms, touch the “BYPASS” key (or the BYPASS function key) again. Alarms can only resume by touching the “BYPASS” key.

To resume NIBP measurement in STAT or Auto mode, press the  [NIBP START/STOP] key. Refer to User’s Guide, Part II, Section 5.

5. ALARM FUNCTION

Using the ALL ALARMS OFF Key

In any site mode, you can suspend all alarms for an indefinite time by touching the ALL ALARMS OFF key on the MENU window. When you start monitoring or during monitoring, you can use this function to temporarily turn all alarms off. The ALL ALARMS OFF key is displayed on the MENU window when it is selected at <ALARMS OFF TYPE> on the ALARM window of the SYSTEM SETUP window. Refer to Administrator's Guide, Section 3.

WARNING

Do not turn all alarms off with the ALL ALARMS OFF or BYPASS key when there is no medical staff around the patient or when the patient is connected to a ventilator.

1. Press the [Menu] key. The MENU window appears.

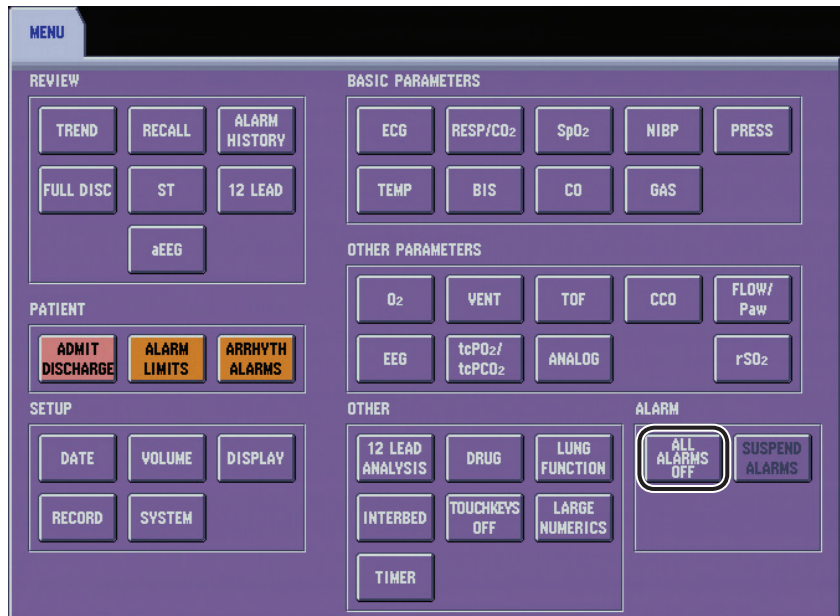

2. Touch the ALL ALARMS OFF key. The following window appears for confirmation.

When ALL ALARMS OFF is assigned to one of the function keys at the upper left of the screen, touching the ALL ALARMS OFF function key also opens the following window.



NOTE

If the  [Silence Alarms] key is pressed when this window is displayed, the ALL ALARMS OFF function is cancelled and the alarm is silenced or suspended.

3. Touch the YES key. To cancel it, touch the NO key.

The “ALL ALARMS OFF” message appears on the screen.



When the <ALARM INDICATOR LIT> on the ALARM window of the SYSTEM SETUP window is set to ON, the red lamp of the alarm indicator lights when all alarms are indefinitely suspended with the ALL ALARMS OFF key.

When ALL ALARMS OFF is assigned to one of the function keys at the upper left of the screen, touching the ALL ALARMS OFF function key displays the TIMER window. It starts counting up automatically so that elapsed time can be checked. Refer to “Using the Timer” in Section 4 for details on the timer.

To resume alarms, touch the ALL ALARMS OFF key (or the ALL ALARMS OFF function key) again. Alarms can only resume by touching the ALL ALARMS OFF key.

Suspending All Alarms and NIBP STAT and Auto Measurement Indefinitely

You can suspend all alarms and NIBP STAT/SIM and auto measurements for an indefinite time by touching the SUSPEND MONITORING key.

The SUSPEND MONITORING key is displayed on the MENU window when the SUSPEND ALARMS is selected at <ALARM INACTIVATION> on the ALARM window of the SYSTEM SETUP window. Refer to Administrator’s Guide, Section 3.

5. ALARM FUNCTION

1. Press the [Menu] key. The MENU window appears.

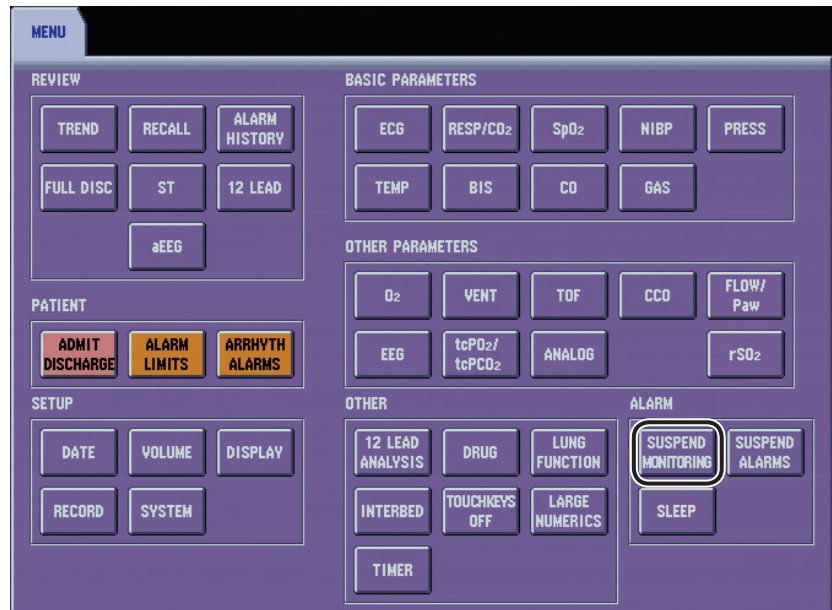

2. Touch the SUSPEND MONITORING key. The following window appears for confirmation.



3. Touch the YES key. To cancel it, touch the NO key.

The “SUSPEND MONITORING” and “ALARMS SUSPENDED” messages appear on the screen alternately.



To resume alarms, touch the “SUSPEND MONITORING” key again. Alarms can only resume by touching the “SUSPEND MONITORING” key.

To resume NIBP measurement in STAT or Auto mode, press the \diamond/\odot [NIBP START/STOP] key. Refer to User’s Guide, Part II, Section 5.

Turning Automatic Alarm Recording On/Off

If <ALARM RECORDING> on the RECORD window is set to ON and an alarm occurs, waveforms beginning 8 seconds before and ending 12 seconds after the alarm are automatically recorded. If this setting is OFF, you can still record waveforms manually.

Recording is only available when the optional recorder module is installed in the monitor.

You can select which waveform(s) to record by changing the recording pattern. See Section 10.

To cancel recording while an automatic vital signs alarm is being recorded, press the  [Record] key.

NOTE

When an arrhythmia alarm is turned OFF on the ARRHYTHM ALARMS or ARRHYTHM ALARMS window of the ECG window, there will be no alarm recording for that arrhythmia type even when <ALARM RECORDING> is set to ON on the RECORD window.

To set automatic vital signs alarm recording on or off:

1. Display the OTHER page on the RECORD window.
Press the [Menu] key → RECORD key → OTHER tab.
2. Touch the ON or OFF key in <ALARM RECORDING> box to set alarm recording on or off.

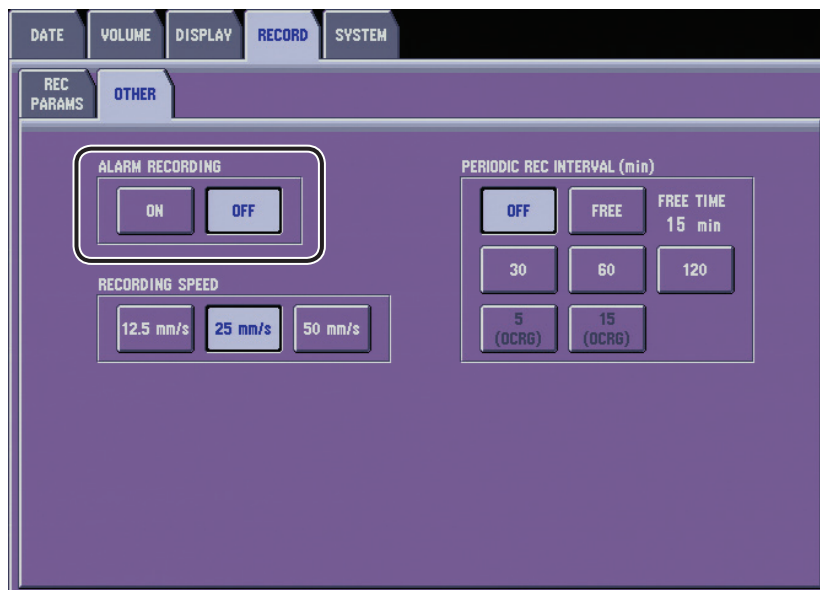

3. Press the [Home] key to return to the home screen.

Setting Alarms

Overview

There are three ways to set alarm limits and on/off settings:

- Set all alarm limits at the same time on one window.
- Set a group of alarm items all together to a preset pattern using an alarm master.
- Set the alarms for individual parameters separately from the ECG, RESP/CO₂, SpO₂, NIBP, PRESS, TEMP, BIS, CO, GAS, O₂, CCO, FLOW/Paw and EEG windows. See User’s Guide Part II.

Vital signs alarm limits can be set on two different windows: the ALARM LIMITS window and the alarm setting page for the individual parameter. When you change an alarm setting on one window, the same setting on the other window is also automatically changed.

Arrhythmia alarm limits can be set on two different windows: the ARRHYTHM ALARMS window and the ARRHYTHM window of the ECG window. When you change an alarm setting on one window, the same setting on the other window is also automatically changed.

The alarm settings return to the master settings when the monitor power is off for more than 30 minutes and <SHOW ADMIT CONFIRMATION WINDOW> is turned off in the SYSTEM CONFIGURATION screen or the patient is admitted or discharged.

To set NIBP alarm limits for neonate, the cuff for neonates must be connected to the NIBP socket on the monitor.

Alarm Limits Ranges

The following tables show the setting ranges for each alarm. Any upper and lower limit can also be set to off.

Master: Returns to this master setting when the monitor power is off for more than 30 minutes and <SHOW ADMIT CONFIRMATION WINDOW> is turned off in the SYSTEM CONFIGURATION screen or the patient is admitted or discharged.

WARNING

Change the anesthetic alarm settings by referring to anesthetic agent reference information.

CAUTION

When the alarm limit is set to OFF, there will be no alarm for that limit. Be careful when you set the alarm limit to OFF.

Vital Signs Alarms

If the upper limit is set to a value above the maximum, or the lower limit is set to a value below the minimum, the alarm for that upper/lower limit is automatically set to OFF.

Window	Page	Setting Item	Settings Range		Step	Default Setting	Backup
ALARM LIMITS	MAIN ALARMS	HR/PR (When SYNC SOURCE is set to ECG)	Upper	OFF, 16 to 300* ¹ * ⁴ * ⁵	1	ADULT: 140 beats/min CHILD: 170 beats/min NEONATE: 200 beats/min	Master
			Lower	OFF, 15 to 299* ² * ⁴ * ⁵		ADULT: 50 beats/min CHILD: 75 beats/min NEONATE: 100 beats/min	
		HR/PR (When SYNC SOURCE is set to SpO ₂ or PRESS)	Upper	OFF, 31 to 300* ¹ * ⁴ * ⁵		ADULT: 140 beats/min CHILD: 170 beats/min NEONATE: 200 beats/min	
			Lower	OFF, 30 to 299* ² * ⁴ * ⁵		ADULT: 50 beats/min CHILD: 75 beats/min NEONATE: 100 beats/min	
		RR	Upper	OFF, 2 to 150 counts/min* ⁴ * ⁵	2	OFF	
			Lower	OFF, 0 to 148 counts/min* ⁴ * ⁵			
		APNEA	Upper	OFF, 5 to 40 s* ⁴ * ⁵	5	20 s	
		CO ₂	Upper	OFF, 2 to 99 mmHg* ⁴ * ⁵	1	OFF	
				OFF, 0.2 to 13.0 kPa* ⁴ * ⁵	0.1		
		Lower	OFF, 1 to 98 mmHg* ⁴ * ⁵	1	OFF		
			OFF, 0.1 to 12.9 kPa* ⁴ * ⁵	0.1			
		SpO ₂	Upper	OFF, 51 to 100%SpO ₂ * ⁴ * ⁵	1	ADULT, CHILD: OFF NEONATE: 95%SpO ₂	
			Lower	OFF, 50 to 99%SpO ₂ * ⁴ * ⁵		ADULT, CHILD: 90%SpO ₂ NEONATE: 85%SpO ₂	
		SpO ₂₋₂ * ³	Upper	OFF, 51 to 100%SpO ₂ * ⁴ * ⁵		ADULT, CHILD: OFF NEONATE: 95%SpO ₂	
			Lower	OFF, 50 to 99%SpO ₂ * ⁴ * ⁵		ADULT, CHILD: 90%SpO ₂ NEONATE: 85%SpO ₂	
		ΔSpO ₂	Upper	OFF, 1 to 50%SpO ₂		5%SpO ₂	
BIS	Upper	OFF, 1 to 100	OFF				
	Lower	OFF, 0 to 99	40				

*¹ When EXT TACHY alarm setting is ON, HR setting range is 16 (or 31) to EXT TACHY limit, OFF.

*² When EXT BRADY alarm setting is ON, HR setting range is EXT BRADY limit to 299, OFF.

*³ Available only when an AY-661P, AY-663P, AY-671P or AY-673P input unit or BSM-1763 or BSM-1773 bedside monitor is used.

*⁴ On BSM-6000A series, if <CRISIS VITAL ALARM MANAGEMENT> on the SYSTEM CONFIGURATION screen is turned on and "ALARM PRIORITY" is set to CRISIS, the alarm setting is set to the alarm master setting.

*⁵ On BSM-6000A series, if <ALARM CAP> on the SYSTEM CONFIGURATION screen is turned on, the alarm setting is affected by the "ALARM CAP" setting.

5. ALARM FUNCTION

Window	Page	Setting Item	Settings Range		Step	Default Setting	Backup
ALARM LIMITS	MAIN ALARMS	NIBP-SYS	Upper	OFF, 15 to 260 mmHg	5	ADULT: 180 mmHg CHILD: 140 mmHg NEONATE: 100 mmHg	Master
				OFF, 1.5 to 35.0 kPa	0.5	ADULT: 24.0 kPa CHILD: 18.5 kPa NEONATE: 13.5 kPa	
			Lower	OFF, 10 to 255 mmHg	5	ADULT: 80 mmHg CHILD: 65 mmHg NEONATE: 50 mmHg	
				OFF, 1.0 to 34.5 kPa	0.5	ADULT: 10.5 kPa CHILD: 8.5 kPa NEONATE: 6.5 kPa	
		NIBP-DIA	Upper	OFF, 15 to 260 mmHg	5	OFF	
				OFF, 1.5 to 35.0 kPa	0.5		
			Lower	OFF, 10 to 255 mmHg	5	OFF	
				OFF, 1.0 to 34.5 kPa	0.5		
		NIBP-MAP	Upper	OFF, 15 to 260 mmHg	5	OFF	
				OFF, 1.5 to 35.0 kPa	0.5		
			Lower	OFF, 10 to 255 mmHg	5	OFF	
				OFF, 1.0 to 34.5 kPa	0.5		
	ECG ALARMS	HR/PR	Upper	OFF, 16 to 300 beats/min*1*2	1	ADULT: 140 beats/min CHILD: 170 beats/min NEONATE: 200 beats/min	
				Lower		OFF, 15 to 299 beats/min*1*2	ADULT: 50 beats/min CHILD: 75 beats/min NEONATE: 100 beats/min
		VPC*3	Upper	OFF, 1 to 99 beats/min	OFF		
		ST-I to ST-V6	Upper	OFF, -1.99 to 2.00 mV	0.01	OFF	
				OFF, -19.9 to 20.0 mm	0.1		
		Lower	OFF, -2.00 to 1.99 mV	0.01	OFF		
	OFF, -20.0 to 19.9 mm		0.1				
	PRESS1 ALARMS	P1-SYS to P7-SYS	Upper	OFF, -48 to 300 mmHg	2	OFF	
				OFF, -6.0 to 40.0 kPa	0.5		
			Lower	OFF, -50 to 298 mmHg	2	OFF	
				OFF, -6.5 to 39.5 kPa	0.5		
		P1-DIA to P7-DIA	Upper	OFF, -48 to 300 mmHg	2	OFF	
OFF, -6.0 to 40.0 kPa				0.5			
Lower			OFF, -50 to 298 mmHg	2	OFF		
			OFF, -6.5 to 39.5 kPa	0.5			
P1-MEAN to P7-MEAN		Upper	OFF, -48 to 300 mmHg	2	OFF		
			OFF, -6.0 to 40.0 kPa	0.5			
	Lower	OFF, -50 to 298 mmHg	2	OFF			
		OFF, -6.5 to 39.5 kPa	0.5				

*1 On BSM-6000A series, if <CRISIS VITAL ALARM MANAGEMENT> on the SYSTEM CONFIGURATION screen is turned on and “ALARM PRIORITY” is set to CRISIS, the alarm setting is set to the alarm master setting.

*2 On BSM-6000A series, if <ALARM CAP> on the SYSTEM CONFIGURATION screen is turned on, the alarm setting is affected by the “ALARM CAP” setting.

*3 Only when the ARRHYTHMIA ANALYSIS is set to ON.

Window	Page	Setting Item	Settings Range	Step	Default Setting	Backup		
ALARM LIMITS	PRESS2 ALARMS	ART-SYS*, ART2-SYS, RAD-SYS, AO-SYS, FEM-SYS	Upper	OFF, -48 to 300 mmHg	2	OFF	Master	
				OFF, -6.0 to 40.0 kPa	0.5			
			Lower	OFF, -50 to 298 mmHg	2	ADULT: 80 mmHg CHILD: 66 mmHg NEONATE: 50 mmHg		
				OFF, -6.5 to 39.5 kPa	0.5	ADULT: 10.5 kPa CHILD: 9.0 kPa NEONATE: 6.5 kPa		
		ART-DIA*, ART2-DIA, RAD-DIA, AO-DIA, FEM-DIA	Upper	OFF, -48 to 300 mmHg	2	OFF		
				OFF, -6.0 to 40.0 kPa	0.5			
			Lower	OFF, -50 to 298 mmHg	2	OFF		
				OFF, -6.5 to 39.5 kPa	0.5			
		ART-MEAN*, ART2-MEAN, RAD-MEAN, AO-MEAN, FEM-MEAN	Upper	OFF, -48 to 300 mmHg	2	OFF		
				OFF, -6.0 to 40.0 kPa	0.5			
			Lower	OFF, -50 to 298 mmHg	2	ADULT: 60 mmHg CHILD: 46 mmHg NEONATE: 30 mmHg		
				OFF, -6.5 to 39.5 kPa	0.5	ADULT: 8.0 kPa CHILD: 6.0 kPa NEONATE: 4.0 kPa		
		DORS-SYS	Upper	OFF, -48 to 300 mmHg	2	ADULT: OFF CHILD: 200 mmHg NEONATE: OFF		
				OFF, -6.0 to 40.0 kPa	0.5	ADULT: OFF CHILD: 26.5 kPa NEONATE: OFF		
			Lower	OFF, -50 to 298 mmHg	2	ADULT: 80 mmHg CHILD: 66 mmHg NEONATE: 50 mmHg		
				OFF, -6.5 to 39.5 kPa	0.5	ADULT: 10.5 kPa CHILD: 9.0 kPa NEONATE: 6.5 kPa		
			DORS-DIA	Upper	OFF, -48 to 300 mmHg	2		OFF
					OFF, -6.0 to 40.0 kPa	0.5		OFF
			Lower	OFF, -50 to 298 mmHg	2	OFF		
				OFF, -6.5 to 39.5 kPa	0.5	OFF		
		DORS-MEAN	Upper	OFF, -48 to 300 mmHg	2	ADULT: OFF CHILD: 186 mmHg NEONATE: OFF		
				OFF, -6.0 to 40.0 kPa	0.5	ADULT: OFF CHILD: 25.0 kPa NEONATE: OFF		
			Lower	OFF, -50 to 298 mmHg	2	ADULT: 60 mmHg CHILD: 46 mmHg NEONATE: 30 mmHg		
				OFF, -6.5 to 39.5 kPa	0.5	ADULT: 8.0 kPa CHILD: 6.0 kPa NEONATE: 4.0 kPa		

* On BSM-6000A series, if <ALARM CAP> on the SYSTEM CONFIGURATION screen is turned on, the alarm setting is affected by the "ALARM CAP" setting.

5. ALARM FUNCTION

Window	Page	Setting Item	Settings Range		Step	Default Setting	Backup
ALARM LIMITS	PRESS2 ALARMS	UA-SYS	Upper	OFF, -48 to 300 mmHg	2	OFF	Master
				OFF, -6.0 to 40.0 kPa	0.5		
			Lower	OFF, -50 to 298 mmHg	2	OFF	
				OFF, -6.5 to 39.5 kPa	0.5		
		UA-DIA	Upper	OFF, -48 to 300 mmHg	2	OFF	
				OFF, -6.0 to 40.0 kPa	0.5		
			Lower	OFF, -50 to 298 mmHg	2	OFF	
				OFF, -6.5 to 39.5 kPa	0.5		
		UA-MEAN, UV-MEAN	Upper	OFF, -48 to 300 mmHg	2	OFF	
				OFF, -6.0 to 40.0 kPa	0.5		
			Lower	OFF, -50 to 298 mmHg	2	OFF	
				OFF, -6.5 to 39.5 kPa	0.5		
	PRESS3 ALARMS	PAP-SYS*, RVP-SYS, LVP-SYS	Upper	OFF, -48 to 300 mmHg	2	OFF	
				OFF, -6.0 to 40.0 kPa	0.5		
			Lower	OFF, -50 to 298 mmHg	2	OFF	
				OFF, -6.5 to 39.5 kPa	0.5		
		PAP-DIA*, RVP-DIA, LVP-DIA	Upper	OFF, -48 to 300 mmHg	2	OFF	
				OFF, -6.0 to 40.0 kPa	0.5		
			Lower	OFF, -50 to 298 mmHg	2	OFF	
				OFF, -6.5 to 39.5 kPa	0.5		
		PAP-MEAN*, CVP-MEAN*, RAP-MEAN, RVP-MEAN, LAP-MEAN, LVP-MEAN, ICP-MEAN, ICP2-MEAN to ICP4-MEAN	Upper	OFF, -48 to 300 mmHg	2	OFF	
				OFF, -6.0 to 40.0 kPa	0.5		
			Lower	OFF, -50 to 298 mmHg	2	OFF	
				OFF, -6.5 to 39.5 kPa	0.5		
TEMP ALARMS	T1 to T4, Tskin, Tskin2, Tskin3, Trect, Tcore, Tnaso, Teso, Ttymp	Upper	OFF, 0.1 to 45.0°C	0.1	ADULT: 38.0°C CHILD: 38.5°C NEONATE: 39.0°C		
			OFF, 33.0 to 113.0°F	1.0	ADULT: 100°F CHILD: 101°F NEONATE: 102°F		
		Lower	OFF, 0.0 to 44.9°C	0.1	OFF		
			OFF, 32.0 to 112.0°F	1.0			
		Tblad, Taxil	Upper	OFF, 0.1 to 45.0°C	0.1	ADULT: 38.0°C CHILD: 38.5°C NEONATE: 39.0°C	
				OFF, 33.0 to 113.0°F	1.0	ADULT: 100°F CHILD: 101°F NEONATE: 102°F	
	Lower		OFF, 0.0 to 44.9°C	0.1	OFF		
			OFF, 32.0 to 112.0°F	1.0			
	Tb	Upper	OFF, 15.1 to 45.0°C	0.1	ADULT: 38.0°C CHILD: 38.5°C NEONATE: 39.0°C		
			OFF, 51.0 to 113.0°F	1.0	ADULT: 100°F CHILD: 101°F NEONATE: 102°F		
		Lower	OFF, 15.0 to 44.9°C	0.1	OFF		
			OFF, 50.0 to 112.0°F	1.0			

* On BSM-6000A series, if <ALARM CAP> on the SYSTEM CONFIGURATION screen is turned on, the alarm setting is affected by the “ALARM CAP” setting.

Window	Page	Setting Item	Settings Range		Step	Default Setting	Backup
ALARM LIMITS	TEMP ALARMS	$\Delta T, \Delta T2$	Upper	OFF, 0.1 to 45.0°C	0.1	OFF	Master
				OFF, 1.0 to 113.0°F	1.0		
	RR	Upper	OFF, 2 to 150 counts/min ^{*1*2}	2	OFF		
		Lower	OFF, 0 to 148 counts/min ^{*1*2}		OFF		
	APNEA	Upper	OFF, 5 to 40 s ^{*1*2}	5	20 s		
	CO ₂ (E)	Upper	OFF, 2 to 99 mmHg ^{*1*2}	1	OFF		
			OFF, 0.2 to 13.0 kPa ^{*1*2}	0.1			
		Lower	OFF, 1 to 98 mmHg ^{*1*2}	1	OFF		
			OFF, 0.1 to 12.9 kPa ^{*1*2}	0.1			
	CO ₂ (I)	Upper	OFF, 1 to 99 mmHg	1	ADULT OR: 3 mmHg ADULT ICU/NICU: OFF CHILD: 3 mmHg NEONATE: OFF		
			OFF, 0.1 to 13.0 kPa	0.1	ADULT OR: 0.4 kPa ADULT ICU/NICU: OFF CHILD: 0.4 kPa NEONATE: OFF		
	O ₂ (E)	Upper	OFF, 11 to 100%	1	OFF		
		Lower	OFF, 10 to 99%		OFF		
	O ₂ (I)	Upper	OFF, 19 to 100%	1	OFF		
		Lower	18 to 99%		18%		
	N ₂ O(E)	Upper	OFF, 1 to 100%	1	OFF		
		Lower	OFF, 0 to 99%		OFF		
	N ₂ O(I)	Upper	OFF, 1 to 100%	1	80%		
		Lower	OFF, 0 to 99%		OFF		
	HAL(E)	Upper	OFF, 0.1 to 7.0%	0.1	OFF		
		Lower	OFF, 0.0 to 6.9%		OFF		
	HAL(I)	Upper	OFF, 0.1 to 7.0%	0.1	4.0%		
		Lower	OFF, 0.0 to 6.9%		OFF		
	ISO(E)	Upper	OFF, 0.1 to 7.0%	0.1	OFF		
		Lower	OFF, 0.0 to 6.9%		OFF		
	ISO(I)	Upper	OFF, 0.1 to 7.0%	0.1	5.0%		
		Lower	OFF, 0.0 to 6.9%		OFF		
	ENF(E)	Upper	OFF, 0.1 to 7.0%	0.1	OFF		
		Lower	OFF, 0.0 to 6.9%		OFF		
	ENF(I)	Upper	OFF, 0.1 to 7.0%	0.1	5.0%		
		Lower	OFF, 0.0 to 6.9%		OFF		
	SEV(E)	Upper	OFF, 0.1 to 7.0%	0.1	OFF		
		Lower	OFF, 0.0 to 6.9%		OFF		
SEV(I)	Upper	OFF, 0.1 to 7.0%	0.1	6.0%			
	Lower	OFF, 0.0 to 6.9%		OFF			
DES(E)	Upper	OFF, 0.1 to 20.0%	0.1	OFF			
	Lower	OFF, 0.0 to 19.9%		OFF			
DES(I)	Upper	OFF, 0.1 to 20.0%	0.1	12.0%			
	Lower	OFF, 0.0 to 19.9%		OFF			

*1 On BSM-6000A series, if <CRISIS VITAL ALARM MANAGEMENT> on the SYSTEM CONFIGURATION screen is turned on and "ALARM PRIORITY" is set to CRISIS, the alarm setting is set to the alarm master setting.

*2 On BSM-6000A series, if <ALARM CAP> on the SYSTEM CONFIGURATION screen is turned on, the alarm setting is affected by the "ALARM CAP" setting.

5. ALARM FUNCTION

Window	Page	Setting Item	Settings Range		Step	Default Setting	Backup
ALARM LIMITS	OTHER ALARMS	MV*	Upper	OFF, 0.1 to 30.0 L/min	0.1	ADULT: 10.0 L/min CHILD: 6.0 L/min NEONATE: OFF	Master
			Lower	OFF, 0.0 to 29.9 L/min	0.1	ADULT, CHILD: 2.0 L/min NEONATE: OFF	
		Ppeak*	Upper	OFF, 1 to 100 cmH ₂ O	1	ADULT, CHILD: 40 cmH ₂ O NEONATE: OFF	
			Lower	OFF, 0 to 99 cmH ₂ O		ADULT: OFF CHILD: 8 cmH ₂ O NEONATE: OFF	
		PEEP*	Upper	1 to 50, OFF cmH ₂ O	1	ADULT, CHILD: 10 cmH ₂ O NEONATE: OFF	
			Lower	OFF, 0 to 49 cmH ₂ O		ADULT: OFF CHILD: 2 cmH ₂ O NEONATE: OFF	
		SEF	Upper	OFF, 1.0 to 60.0 Hz	0.5	OFF	
			Lower	OFF, 0.5 to 59.5 Hz		OFF	
		TP	Upper	OFF, 0.02 to 9.99 nW	0.01	OFF	
			Lower	OFF, 0.01 to 9.98 nW		OFF	
		CCO*	Upper	OFF, 1.1 to 20.0 L/min	0.1	OFF	
			Lower	OFF, 1.0 to 19.9 L/min		OFF	
		CCI*	Upper	OFF, 1.1 to 20.0 L/min/m ²	0.1	OFF	
			Lower	OFF, 1.0 to 19.9 L/min/m ²		OFF	

* These parameters are not available for BSM-6000A series.

Arrhythmia Alarms

Window	Page	Setting Item	Settings Range	Step	Default Setting	Backup
ARRHYTHM ALARMS	ARRHYTH	ASYSTOLE	ON fixed 3 to 10 s	1	ADULT, CHILD: 5 s NEONATE: 3 s	Master
		VF	ON fixed	–	ON	
		VT	ON fixed	–	ON	
		EXT TACHY* ¹	ON, OFF	–	BSM-6000A: ON BSM-6000K: OFF	
			upper heart rate alarm limit to 300	1	ADULT: 160 bpm CHILD: 190 bpm NEONATE: 220 bpm	
		EXT BRADY* ¹	ON, OFF	–	BSM-6000A: ON BSM-6000K: OFF	
			15 to lower heart rate alarm limit	1	ADULT: 40 bpm CHILD: 60 bpm NEONATE: 80 bpm	
		V BRADY* ¹	ON, OFF	–	ADULT OR: OFF ICU/NICU: ON CHILD, NEONATE: OFF	
			15 to 299 bpm	1	ADULT, CHILD: 50 bpm NEONATE: 60 bpm	
		VPC RUN	ON, OFF	–	ADULT OR: OFF ICU/NICU: ON CHILD, NEONATE: OFF	
			16 to 300 bpm	1	ADULT, CHILD: 100 bpm NEONATE: 140 bpm	
			3 to 8 beats	1	3 beats	
		SV TACHY* ¹	ON, OFF	–	OFF	
			16 to 300 bpm	1	ADULT, CHILD: 170 bpm NEONATE: 210 bpm	
		PAUSE* ¹	ON, OFF	–	ON	
			1.0 to 3.0 s	0.1	ADULT, CHILD: 3.0 s NEONATE: 1.5 s	
		V RHYTHM* ¹	ON, OFF	–	ADULT OR: OFF ICU/NICU: ON CHILD, NEONATE: OFF	
COUPLET	ON, OFF	–	OFF			
EARLY VPC	ON, OFF	–	OFF			
MULTIFORM* ¹	ON, OFF	–	OFF			

5. ALARM FUNCTION

Window	Page	Setting Item	Settings Range	Step	Default Setting	Backup
ARRHYTHM ALARMS	ARRHYTH	BIGEMINY	ON, OFF	–	OFF	Master
		TRGEMINY* ¹	ON, OFF	–	OFF	
		AF* ²	ON, OFF	–	ADULT: ON CHILD, NEONATE: OFF	
		IRREGULAR RR* ¹	ON, OFF	–	OFF	
		PROLONGED RR* ¹	ON, OFF	–	OFF	
		NO PACER PULSE* ¹	ON, OFF	–	OFF	
		PACER NON-CAPTURE* ¹	ON, OFF 40 to 480 ms	– 4	OFF 400 ms	

*¹ Available only when ARRHYTHMIA TYPE on the ECG page of the SYSTEM SETUP window is set to EXTENDED.

*² Not available for BSM-6000K series. Available only when <ARRHYTHMIA TYPE> on the ECG page of the SYSTEM SETUP window is set to EXTENDED, and <AF DETECTION> on the ECG page of the SYSTEM SETUP window is set to On. For the SYSTEM SETUP window settings, refer to the Administrator's Guide.

Setting Vital Signs Alarms Individually

CAUTION

When the alarm limit is set to OFF, there will be no alarm for that limit. Be careful when you set the alarm limit to OFF.

1. Display the ALARM LIMITS window.
Press the [Menu] key → ALARM LIMITS key.

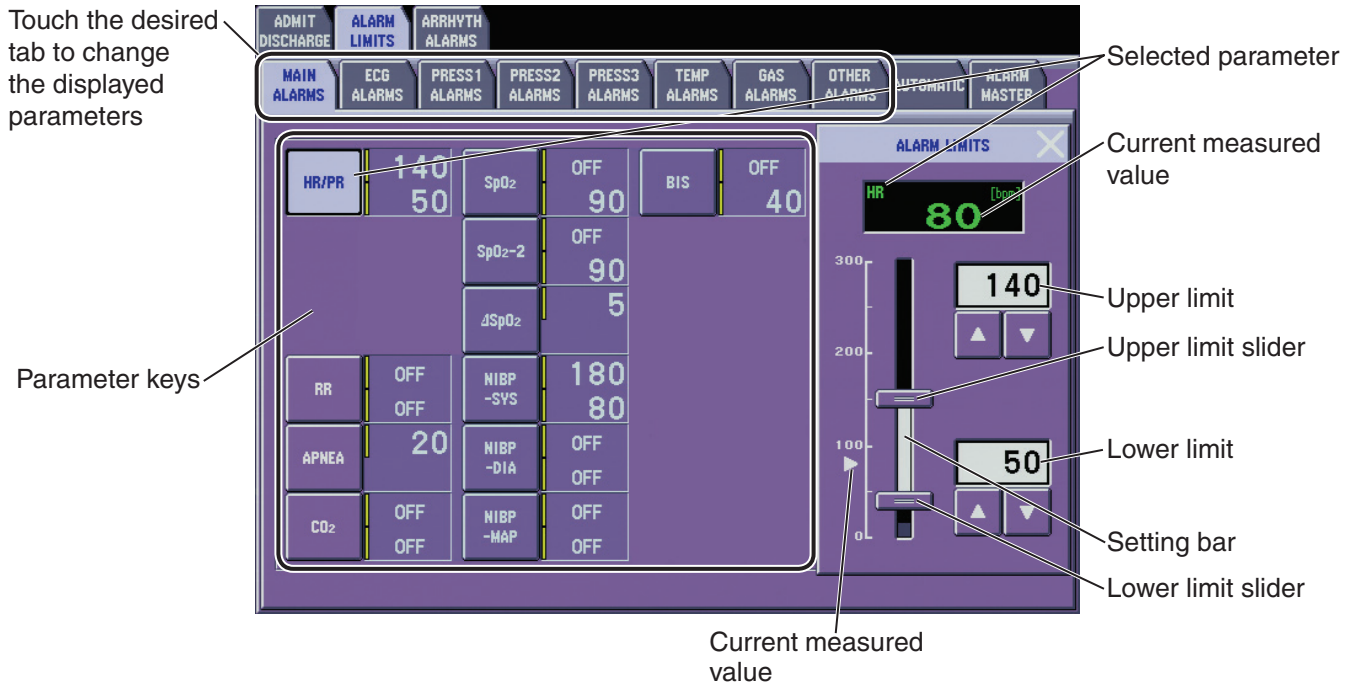

2. Touch the parameter key for the limit you want to change. To change the displaying parameters, use the tabs to change the parameters.
3. Touch and drag the sliders to the desired level on the setting bar. Use the ▲ or ▼ to adjust the setting.

If the upper limit is set to a value above the maximum or the lower limit is set to a value below the minimum, the alarm is set to OFF.

4. Repeat steps 2 and 3 to change alarm settings for other parameters.
5. Press the [Home] key to return to the home screen.

Automatically Setting All Upper and Lower Alarm Limits

You can automatically set all upper and lower alarm limits with respect to the current measuring values. This function allows you to suitably set alarm limits according to a patient.

NOTE

You cannot automatically set any parameters not currently measured or assigned with invalid values.

Automatic Setting Range

Parameter		Upper limit value	Lower limit value	Unit
ECG	HR	HR×1.25	HR×0.75	beat/min
PR		PR×1.25	PR×0.75	count/min
ST		ST+0.5	ST-0.5	mV
Resp	RR	RR×1.25+4	RR×0.75-4	count/min
	APNEA	(60/RR)×2	—	s
NIBP	SYS, DIA, MAP	NIBP×1.25+10	NIBP×0.75-10	mmHg
SpO ₂	SpO ₂ , SpO ₂ -2	—* ¹	SpO ₂ -5	%SpO ₂
IBP (ART, ART2, RAD, DORS, AO, FEM, UA, PAP, RVP, LVP, P1 to 7)	SYS, DIA, MEAN	IBP×1.25+10	IBP×0.75-10	mmHg
IBP (UV, CVP, RAP, LAP, ICP, ICP2 to 4)	MEAN	IBP×1.25+5	IBP×0.75-5	mmHg
Temp (Tb, Tskin, Tskin2, Tskin3, Trect, Tcore, Tnaso, Teso, Ttym, Tblad, Taxil, T1 to 4)		TEMP+0.5	TEMP-0.5	°C
ΔT		ΔT+0.5	—	°C
O ₂	O ₂ (I)	O ₂ (I)×1.1	O ₂ (I)×0.9	%
	O ₂ (E)	O ₂ (E)×1.25	O ₂ (E)×0.75	
CO ₂	CO ₂ (I)	CO ₂ (I)×1.25	—	mmHg
	ETCO ₂	ETCO ₂ ×1.25	ETCO ₂ ×0.75	
N ₂ O	N ₂ O (I)	N ₂ O (I)×1.2+5	N ₂ O (I)×0.8-5	%
	N ₂ O (E)	N ₂ O (E)×1.2+5	N ₂ O (E)×0.8-5	
HAL	HAL (I)	HAL (I)×1.1+0.5	HAL (I)×0.9-0.5	
	HAL (E)	HAL (E)×1.1+0.5	HAL (E)×0.9-0.5	
ISO	ISO (I)	ISO (I)×1.1+0.5	ISO (I)×0.9-0.5	
	ISO (E)	ISO (E)×1.1+0.5	ISO (E)×0.9-0.5	
ENF	ENF (I)	ENF (I)×1.1+0.5	ENF (I)×0.9-0.5	
	ENF (E)	ENF (E)×1.1+0.5	ENF (E)×0.9-0.5	
SEV	SEV (I)	SEV (I)×1.1+0.5	SEV (I)×0.9-0.5	
	SEV (E)	SEV (E)×1.1+0.5	SEV (E)×0.9-0.5	
DES	DES (I)	DES (I)×1.2+0.5	DES (I)×0.8-0.5	
	DES (E)	DES (E)×1.2+0.5	DES (E)×0.8-0.5	
MV* ²		MV×1.25	MV×0.75	L/min
Ppeak* ²		Ppeak×1.25	Ppeak×0.75	cmH ₂ O
PEEP* ²		PEEP×1.25	PEEP×0.75	
BIS		Off	40	—
EEG	SEF	SEF×1.25+2.0	SEF×0.75-2.0	Hz
	TP	TP×1.25+0.20	TP×0.75-0.20	nW

*¹ Not automatically set (the upper limit value is greater than the lower limit value).

*² These parameter alarms are not available on BSM-6000A series.

1. Display the AUTOMATIC page.
 Press the [Menu] key → ALARM LIMITS key → AUTOMATIC tab.
 The “Automatically set all parameters based on current data?” message appears.

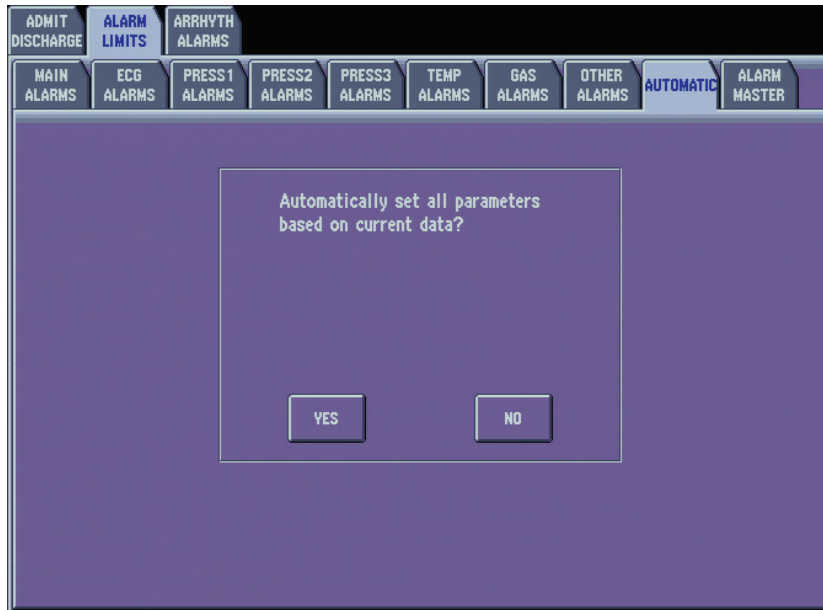

5

2. Touch “YES”. All upper and lower alarm limits are replaced by the values according to current measurements.

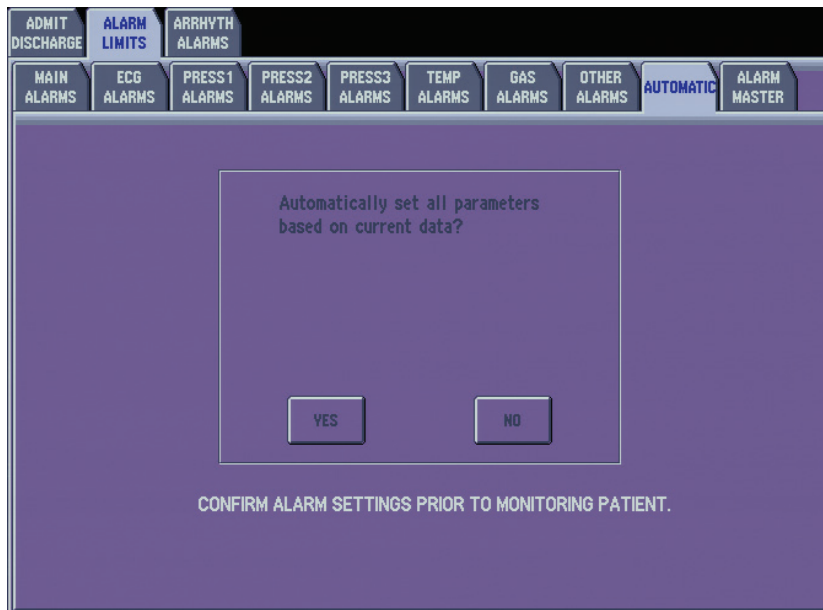

NOTE

Check for valid automatic settings.

3. Press the [Home] key to return to the home screen.

Setting All Vital Signs Alarms to a Preset Pattern (Alarm Master)

For fast and easy alarm setup, a group of alarm items can be set all together to one group of preset settings. This is called an alarm master. This is useful, for example, if there are typical alarm settings at your hospital, or you have certain alarm settings for certain patients.

You can also change individual alarm settings after setting all alarms with an alarm master.

The alarm masters are set by the administrator on the MASTER window of the SYSTEM SETUP window.

1. Display the ALARM MASTER page.

Press the [Menu] key → ALARM LIMITS key → ALARM MASTER tab.
The “APPLY SETTINGS FROM MASTER?” message appears.

When the <NUMBER OF MASTER SETTINGS> is set to “1”

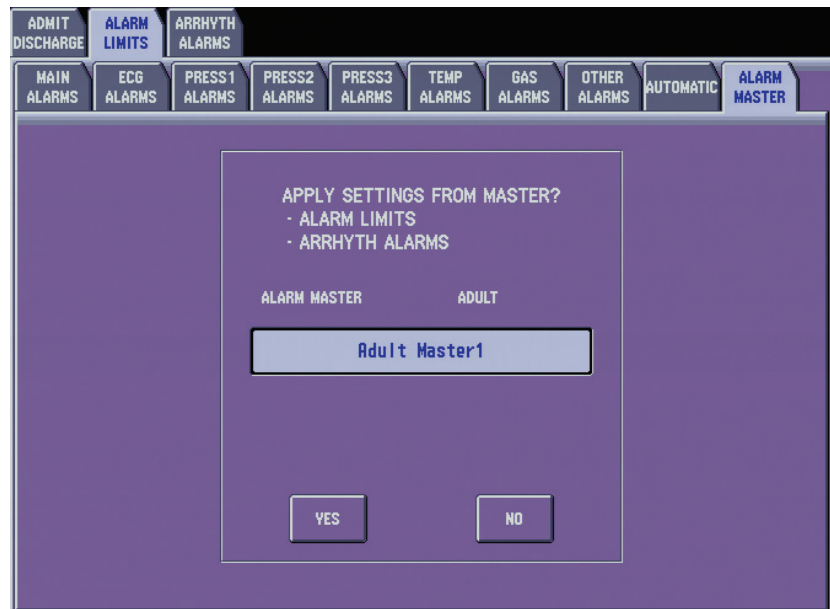

When the <NUMBER OF MASTER SETTINGS> is set to “3”

Select a master to apply.

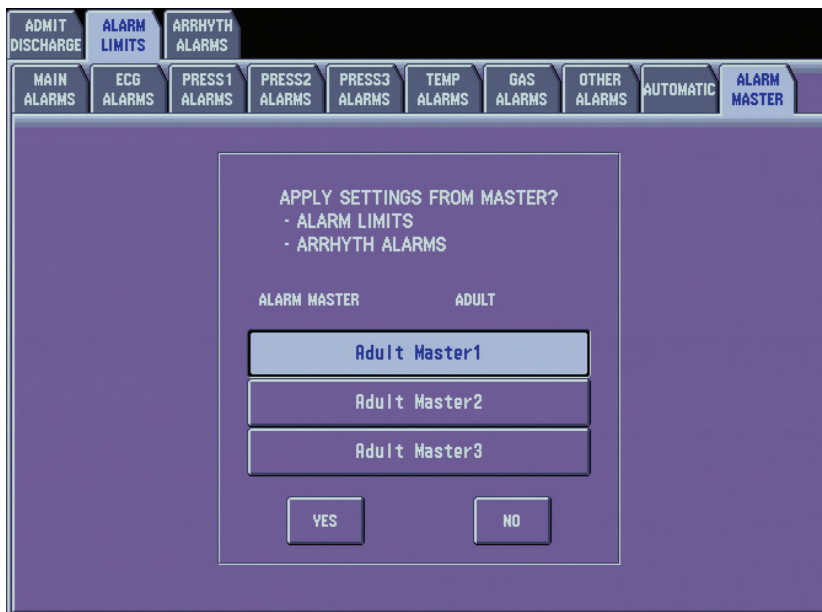

5

2. Touch the YES key to apply all settings of the alarm master. The master setting is applied to the both vital sign upper/lower limit alarm and arrhythmia alarm settings.

Touch the NO key to cancel applying the alarm master settings.

3. Press the [Home] key to return to the home screen.

Setting Arrhythmia Alarms Individually

There are two patterns of arrhythmia analysis, EXTENDED or STANDARD. Select the arrhythmia type in the SYSTEM SETUP window. Refer to Administrator's Guide, Section 3.

For details about arrhythmia monitoring, refer to "Monitoring Arrhythmia" in User's Guide Part II, Section 1.

WARNING

For arrhythmia monitoring, set <ARRHYTHMIA ANALYSIS> on the ECG window to ON. Otherwise, there is no sound or indication for arrhythmia alarms (except for ASYSTOLE).

CAUTION

When the alarm is turned OFF for an arrhythmia, there will be no alarm for that arrhythmia type. There is no message or mark to indicate that a certain arrhythmia alarm is turned off. Therefore, be careful when you turn off an arrhythmia alarm.

NOTE

- If arrhythmia type is changed to “EXTENDED” and the bedside monitor is connected via network to a central monitor that has old software, the “Lost communication with instruments in the network” message appears on the bedside monitor and the bedside monitor cannot be monitored on the central monitor.
- On BSM-6000A series bedside monitor, if Protocol is changed to “2ND GEN” and the bedside monitor is connected via network to a central monitor that has old software, the “Lost communication with instruments in the network” message appears on the bedside monitor and the bedside monitor cannot be monitored on the central monitor.

1. Display the ARRHYTH page.

Press the [Menu] key → ARRHYTH ALARMS key → ARRHYTH tab.

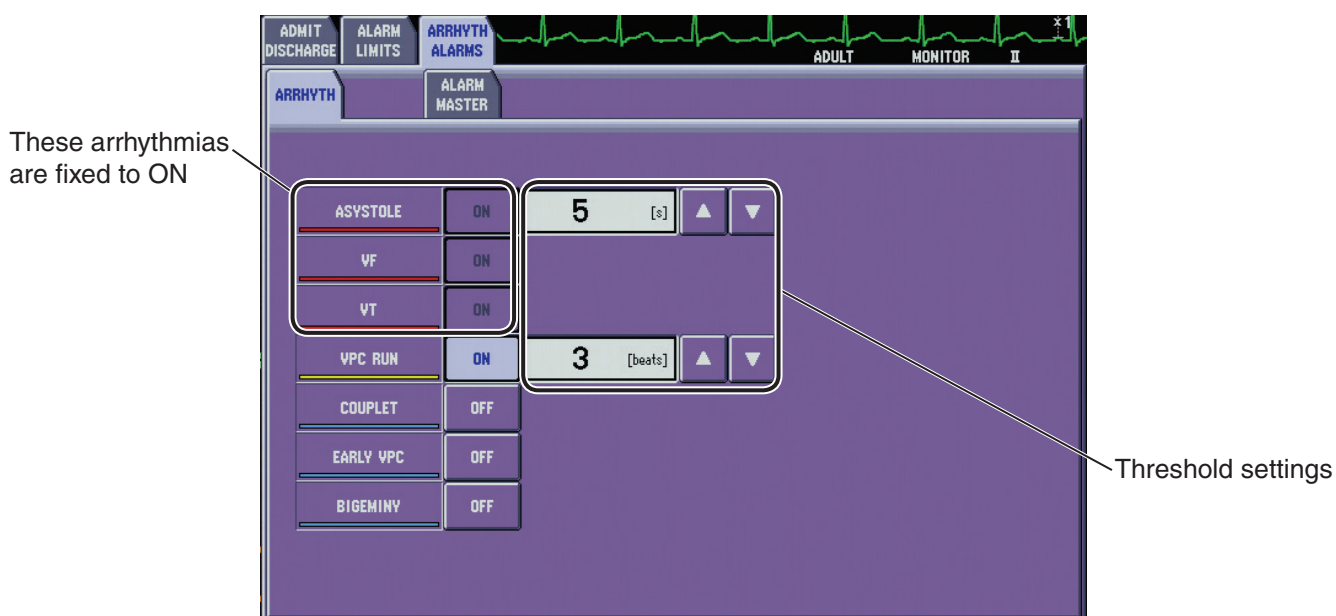

2. Touch the ON or OFF key for each arrhythmia type to set it on or off.

3. For “ASYSTOLE”, “VPC RUN” and “FREQ VPC”, set the detecting condition with the ▲ or ▼ key.

NOTE

For BSM-6000A series bedside monitors:

- Items can be turned on or off but thresholds are fixed and cannot be changed. The thresholds are set by the administrator on the MASTER window of the SYSTEM SETUP window.
- Arrhythmia alarm whose priority is set to CRISIS on the ALARM window of the SYSTEM SETUP window cannot be set to OFF. Refer to Section 3 of the Administrator’s Guide.
- When the “EXT TACHY” or “EXT BRADY” alarm is set to OFF, the heart rate limit range is 15 to 300 beat/min or OFF.

When EXTENDED is selected for the arrhythmia type in the SYSTEM SETUP window, touch the threshold to display the ARRHYTH window and adjust the setting.

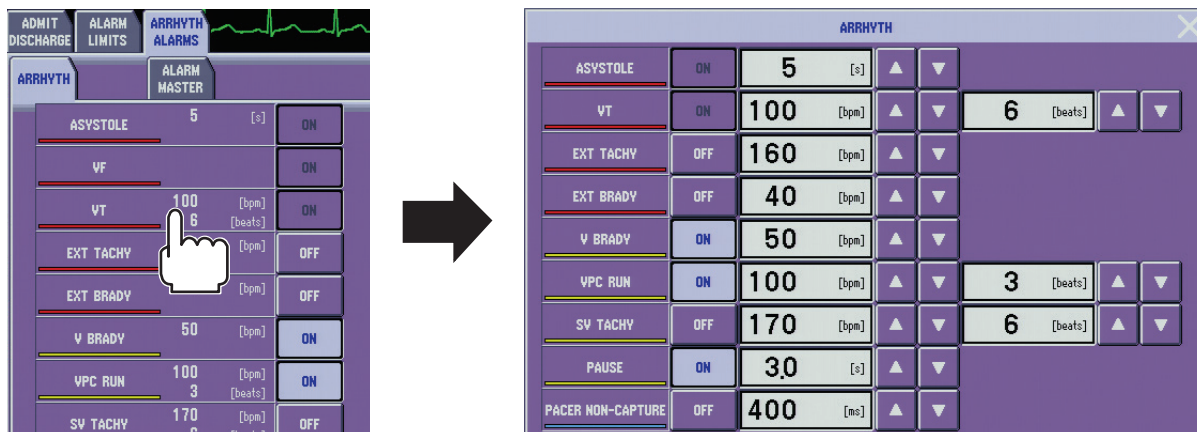

4. Press the [Home] key to return to the home screen.

Setting All Arrhythmia Alarms to a Preset Pattern (Alarm Master)

For fast and easy alarm setup, a group of alarm items can be set all together to one group of preset settings. This is called an alarm master. This is useful, for example, if there are typical alarm settings at your hospital, or you have certain alarm settings for certain patients.

You can also change individual alarm settings, as described in previous pages, after setting all alarms with an alarm master.

The alarm masters are set by the administrator on the MASTER window of the SYSTEM SETUP window.

WARNING

For arrhythmia monitoring, set <ARRHYTHMIA ANALYSIS> on the ECG window to ON. Otherwise, there is no sound or indication for arrhythmia alarms (except for ASYSTOLE).

CAUTION

When the alarm is turned OFF for an arrhythmia, there will be no alarm for that arrhythmia type. There is no message or mark to indicate that a certain arrhythmia alarm is turned off. Therefore, be careful when you turn off an arrhythmia alarm.

1. Display the ALARM MASTER page.
Press the [Menu] key → ARRHYTHM ALARMS key → ALARM MASTER tab.
The “APPLY SETTING FROM MASTER?” message appears.

5. ALARM FUNCTION

When the <NUMBER OF MASTER SETTINGS> is set to “1”

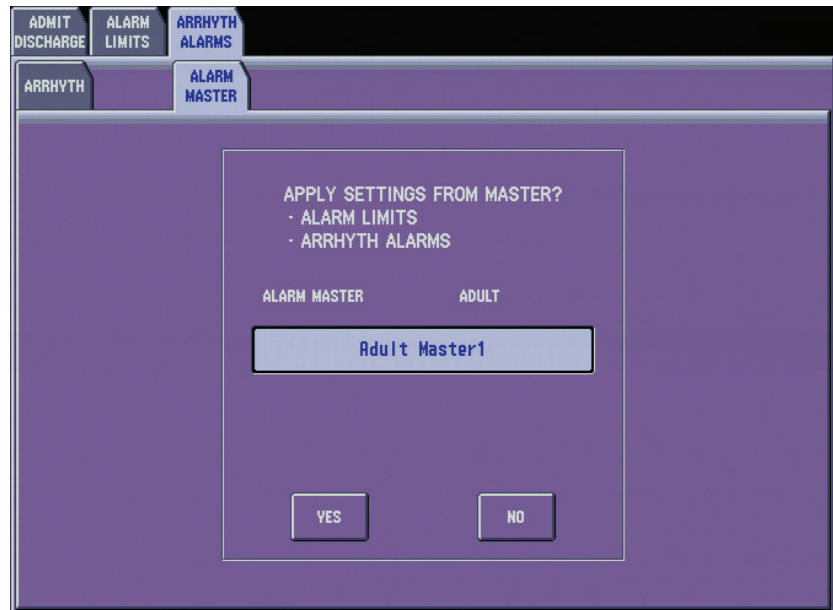

When the <NUMBER OF MASTER SETTINGS> is set to “3”

Select a master setting to apply.

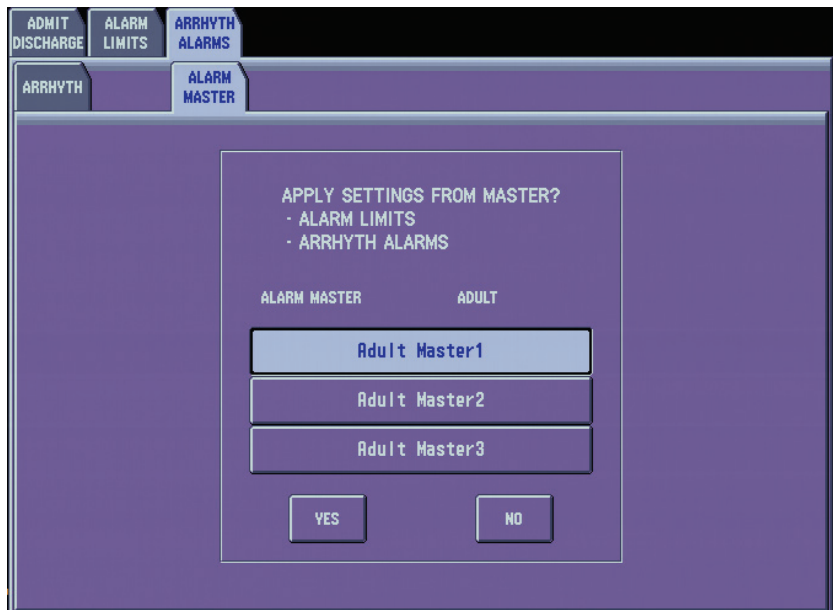

2. Touch the YES key to apply all settings of the alarm master. The master setting is applied to the both vital sign upper/lower limit alarm and arrhythmia alarm settings.

Touch the NO key to cancel applying the alarm master settings.







3. Press the [Home] key to return to the home screen.

Interbed Alarm

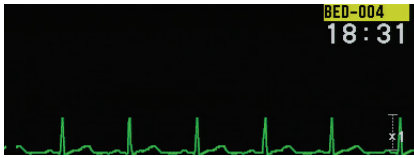
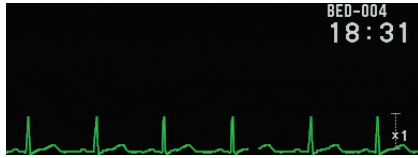
When the bedside monitor is connected to a central monitor network, the bedside monitor can display monitoring data and alarms of up to 20 other beds in the network on the INTERBED window if the other beds are registered as “interbed” bed. When an interbed alarm occurs, the monitor acts as follows. The monitor action depends on the INTERBED ALARMS TO DISPLAY setting on the SYSTEM SETUP window. Refer to Section 9 of this manual and Section 3 of the Administrator’s Guide for details.

NOTE

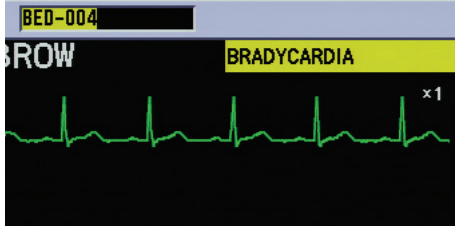
- Parameters which cannot be measured on this monitor are displayed as “ALARM”.
- The interbed alarm for another bed is lower level than any other alarm for this bed. Therefore, the interbed alarm might not be indicated during an alarm for this bed.

INTERBED ALARMS TO DISPLAY Setting		ALL, CRISIS AND WARNING, CRISIS	NONE
Alarm Indicator		Off	
Alarm Sound		Three continuous ping sounds (only when the alarm is detected)	No sound
Home Screen	The bed ID of interbed alarm bed is displayed in the upper right corner. When two or more alarms are detected, the bed IDs alternate.	The bed ID is highlighted in the alarm priority color.* ¹ 	The bed ID is displayed in white. 
	After  is touched.	Bed ID: remain highlighted	Bed ID: remain in white font
Multiple Beds Window	Interbed alarm message is displayed	The bed ID and interbed alarm message is highlighted in the alarm priority color.* ^{1*2} 	
	After  is touched.	Bed ID: displayed in white Alarm: remain highlighted	
Individual Bed Window	The alarm message and bed ID are highlighted in the alarm priority color. When the vital sign alarm occurs, the measurement value is also highlighted.	The bed ID and alarm message is highlighted in the alarm priority color.* ^{1*2} 	
	After  is touched.	Bed ID: displayed in white Alarm: remain highlighted	

*¹ The alarm priority is displayed as set on the interbed bed. The alarm priority color is set at <ALARM PRIORITY COLOR> on the DISPLAY/SOUND page of the ALARM window of the SYSTEM SETUP screen. Refer to “ALARM Window” in Section 3 of the Administrator’s Guide.

*² When the alarm of crisis or warning level occur, the message blinks.

Section 6 Review Windows

General.....	6.3
Transport	6.4
Review Recording	6.5
Event Bar.....	6.6
Changing the Displayed Event Types.....	6.7
Changing the Time Scale of the Event Bar and Review Window	6.7
Scrolling the Event Bar and Review Window.....	6.8
Trend Window	6.9
GRAPH 1, GRAPH 2, GRAPH 3 Page.....	6.9
Displaying the GRAPH 1, GRAPH 2 or GRAPH 3 Page.....	6.11
Selecting Parameters for the Trendgraph Display	6.13
Changing the Trendgraph Scale.....	6.14
Changing the Trendgraph Display Format.....	6.15
Scrolling the Trendgraph	6.16
Recording the Trendgraph.....	6.16
Printing the Trendgraph.....	6.17
TABLE 1, TABLE 2, TABLE 3 Page.....	6.19
Displaying the TABLE 1, TABLE 2 or TABLE 3 Page.....	6.20
Scrolling the Trend Table	6.21
Selecting Parameters for the Trend Table Display	6.21
Selecting the Measurement Interval.....	6.22
Recording a Trend Table.....	6.23
Printing a Trend Table.....	6.24
NIBP TREND Page	6.26
Displaying the NIBP TREND Page.....	6.27
Scrolling the NIBP Trend Table.....	6.28
Selecting Parameters for the NIBP Trend Display	6.28
Recording a NIBP Trend Table	6.29
Printing a NIBP Trend Table	6.30
HEMO TREND Page.....	6.32
Displaying the HEMO TREND Page	6.32
Scrolling the Hemodynamics Table	6.33
Explanation of the Hemodynamics Table	6.34
Recording a Hemodynamics Table.....	6.35
Printing a Hemodynamics Table.....	6.36
LUNG TREND Page.....	6.37
Displaying the LUNG TREND Page	6.37
Explanation of the Lung Trend Table	6.38
Recording the Lung Trend Table.....	6.39
Printing a Lung Trend Table.....	6.40
Arrhythmia Recall Window.....	6.41
General.....	6.41
Arrhythmia List	6.41

Displaying the Arrhythmia Recall Window	6.43
Selecting the Arrhythmia Types to be Saved as a Recall File	6.44
Scrolling the Arrhythmia Recall Files	6.44
Displaying the Actual Size Waveform of the Selected Arrhythmia Recall File	6.45
Arrhythmia Waveform Annotation	6.45
Recording or Printing the Arrhythmia Recall Waveform	6.45
Recording on the ARRHYTH HISTORY Window	6.46
Printing on the ARRHYTH HISTORY Window	6.47
Recording on the Actual Size ECG Waveform Window	6.48
Printing on the Actual Size ECG Waveform Window	6.49
Alarm History Window	6.50
Displaying the ALARM HISTORY Window	6.50
Scrolling the Alarm History Files	6.51
Recording the Alarm History File	6.51
Full Disclosure Window	6.53
Displaying the FULL DISC Window	6.53
Scrolling the Full Disclosure Waveform	6.55
Selecting the Parameters to be Saved for Full Disclosure	6.56
Recording or Printing the Full Disclosure Waveform	6.57
Recording the Full Disclosure Waveform	6.57
Printing the Full Disclosure Waveform	6.58
Recording or Printing the Enlarged ECG Waveform	6.60
Recording the Enlarged ECG Waveform	6.60
Printing the Enlarged ECG Waveform	6.61
ST Level Recall Window	6.63
Displaying the ST Window	6.64
Scrolling the ST Level Recall File	6.65
Displaying the ST Point	6.65
Displaying the ST Recall Waveform on the Home Screen	6.66
Saving as Reference ST Recall File	6.67
Displaying the Reference ST Recall Waveform on the Home Screen	6.68
Printing the ST Level Recall File	6.69
OCRG Window	6.71
Displaying the OCRG Window	6.71
Selecting the OCRG Trendgraph Type	6.73
Changing the Trendgraph Scale for Heart Rate and SpO ₂ and Sensitivity for Respiration	6.74
Recording or Printing the OCRG Trend	6.75
Recording the OCRG Trend	6.75
Printing the OCRG Trend	6.76
aEEG Window	6.78
Displaying the aEEG Window	6.78
Changing Time Scale for aEEG	6.80
Scrolling aEEG Traces	6.81
Recording or Printing the aEEG	6.81
Recording the aEEG	6.81
Printing the aEEG	6.83

General

You can review saved data on the following review windows. You can expand the memory of the monitor from 128 MB to 1 GB with the optional QM-601P memory card.

The parentheses show the capacity when the QM-601P memory card is installed in the monitor.

- TREND window
 - GRAPH page: Displays the trendgraph of the past 24 hours (72 hours).
 - TABLE page: Displays the vital sign data of the past 24 hours (72 hours).
 - NIBP TREND page: Displays vital sign data at the NIBP measurement. Up to 512 files (1,024 files) can be saved.
 - HEMO TREND page: Displays the hemodynamic data when CO is measured. Up to 512 files (1,024 files) can be saved.
 - LUNG TREND page: Displays data acquired at the lung function measurement. Up to 128 files (128 files) can be saved.
- RECALL window: Displays arrhythmia waveforms of 4 seconds before and 4 seconds after the arrhythmia detection. Up to 8,192 files (16,384 files) can be saved.
- ALARM HISTORY window: Displays the table of vital sign alarms and arrhythmia alarms. Up 8,192 files (16,384 files) can be saved.
- FULL DISC window: Displays and up to 24 hours (72 hours) of compressed and expanded waveforms of up to 5 parameters.
- ST window: Displays the ST level waveforms of the past 24 hours (72 hours). All monitoring ECG can be saved.
- 12 LEAD window: Displays the 12 lead analysis result data of up to 6 files (18 files). Refer to the Section 7 “12 LEAD/12 LEAD ANALYSIS Windows”.
- OCRG window: Displays the OCRG trendgraph of the past 24 hours (72 hours).
- aEEG window: Displays 2 aEEG traces of the past 24 hours (72 hours). aEEG is only available when EEG is monitored with AE-918P neuro unit with software version 02-01 or later.

NOTE

- When <DATA TRANSPORT USING INPUT UNIT> is set to DISABLE, and <SHOW ADMIT CONFIRMATION WINDOW> is turned off in the SYSTEM CONFIGURATION screen, the stored data remains in memory for about 30 minutes after the power is turned off. After 30 minutes, the stored data is lost. When <DATA TRANSPORT USING INPUT UNIT> is set to ENABLE, the patient data and settings are always stored.
- When changing the review window, the data at the cursor on the original window is displayed on the second window. For example, when the FULL DISC window is called up from the ALARM HISTORY window, the full disclosure is displayed with the time of the file selected on the ALARM HISTORY window.
- The oldest file is deleted when the maximum number of files are saved.
- Do not disconnect the power cord while the monitor power is on. Data may be lost.
- aEEG window is not available on BSM-6301A/K.

Transport

* A QM-600P memory unit must be installed to use the transport function.

The data of the bedside monitor can be saved and sent to another bedside monitor by using a BSM-1700 series bedside monitor or an AY-600P series input unit*. For details, refer to “Using Transport Function” in Section 3.

NOTE

- When using the BSM-1700 series bedside monitor or the AY-600P series input unit* and data transport function is enabled:
 - Data for up to 24 hours is saved.
 - The saved data is kept in the main unit and the BSM-1700 series bedside monitor or AY-600P series input unit* even when 30 minutes elapse after monitor power off.
- The time of the data in the BSM-1700 series bedside monitor or AY-600P series input unit* is adjusted to the time of the main unit.
- To display data on the FULL DISC window, select the same parameters for the waveforms to be saved on both the source monitor and the destination monitor.
- The following items cannot be saved in the BSM-1700 series bedside monitor or AY-600P series input unit* and cannot be sent.
 - PCCO, ScvO₂, SVV, EDV, EDVI, ESV, ESVI, EF, PPV, SPV, O₂ LEV, HAL LEV, ISO LEV, ENF LEV, DES LEV, SEV LEV, HRV and CF data on the GRAPH 1 to GRAPH 3 pages and TABLE 1 to TABLE 3 pages of the TREND window
 - EEG (monitored with the AE-918P neuro unit), SEF, MDF, PPF and TP data
- To display data on the FULL DISC window, select the same parameters for the waveforms to be saved on both the source monitor and the destination monitor.
- Data on the aEEG and OCRG windows cannot be transported.
- Data on the LUNG TREND page of TREND window, ALARM HISTORY window, aEEG window and OCRG window cannot be sent to the central monitor.

The following review data are saved in the AY-600P series input unit or BSM-1700 series bedside monitor and can be sent to the CNS-9701 central monitor when the monitor is connected to the central monitor network.

Review Window		Data Saved in Memory Unit	Data Transport to CNS
TREND - GRAPH		Available	Available
TREND - TABLE		Available	Available
TREND - NIBP TREND		Available	Available
TREND - HEMO TREND		Available	Available
TREND - LUNG TREND		Available	Not available
RECALL		Available	Available
ALARM HISTORY		Available	Not available
FULL DISC	Compressed waveform	Available*	Available*
	Actual waveform	Available*	Available*
ST		Available	Available
OCRG		Not available	Not available
aEEG		Not available	Not available
12 LEAD - 12 LEAD		Available	Available
12 LEAD - ANALYSIS WAVE		Available	Available
12 LEAD - REPORT		Available	Available
12 LEAD - AVERAGE WAVE		Available	Available

* First trace of ECG and the four other waveforms selected on the FULL DISC window.

Review Recording

Available review recordings are listed below. For details of recording, refer to the Section 10 "Recording".

Review Window	Recording		Printing	
	Record Page	Record All	Print Page	Print All
TREND - GRAPH	Available	Not available	Available	Not available
TREND - TABLE	Available	Available	Available	Available
TREND - NIBP TREND	Available	Available	Available	Available
TREND - HEMO TREND	Available	Available	Available	Available
TREND - LUNG TREND	Available	Available	Available	Available
RECALL	Available	Not available	Available	Not available
ALARM HISTORY	Available	Available	Not available	Not available
FULL DISC	Compressed waveform	Available	Available	Not available
	Actual waveform	Available	Available	Not available
ST	Not available	Not available	Available	Not available
OCRG	Available	Available	Available	Available
aEEG	Available	Not available	Available	Not available
12 LEAD - 12 LEAD	Available	Not available	Not available	Not available
12 LEAD - ANALYSIS WAVE	Available	Not available	Available	Not available
12 LEAD - REPORT	Available	Not available	Available	Not available
12 LEAD - AVERAGE WAVE	Not available	Not available	Available	Not available

Event Bar

An event bar near the bottom of the review window shows events during displayed review time. The event bar and review window are synchronized. They have the same time scale and scroll together.

You can display up to four types of events.

- Arrhythmia alarms
- Technical alarms
- Vital sign alarms
- Monitoring operations: silence alarm, suspend alarms, all alarms off, bypass, and suspend monitoring



Event bar

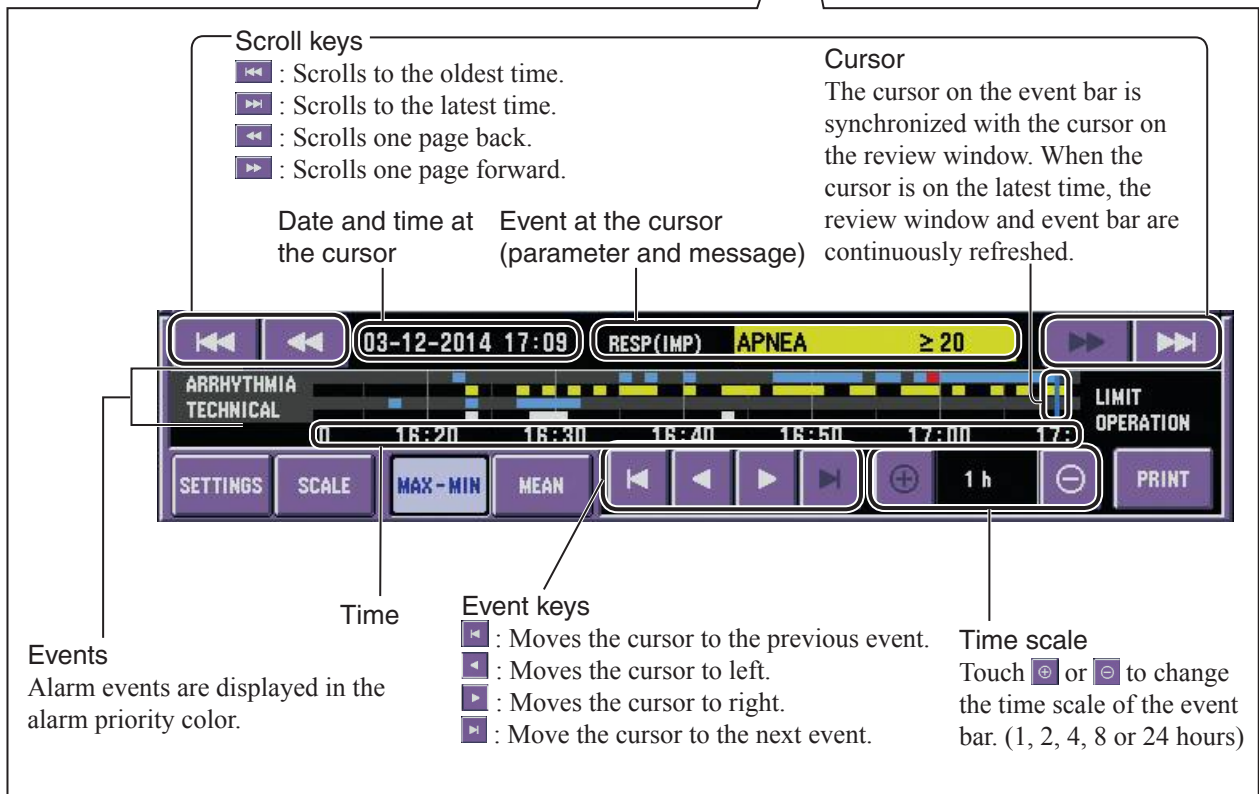

Changing the Displayed Event Types

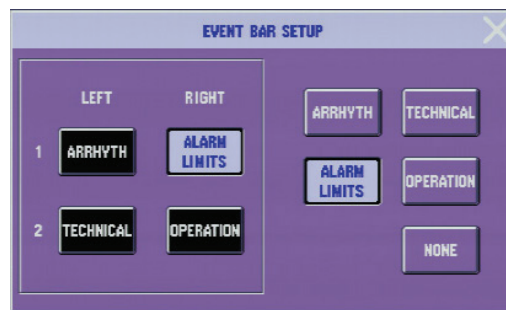

You can change the types of events which are displayed in the event bar.

1. Touch an event name. You can change the types of events which are displayed in the event bar. The EVENT BAR SETUP window appears.



2. You can change the types of events which are displayed in the event bar. Select the top to bottom on the event bar where you want to display an event type. Then select an event type from the right side. Use the NONE key to not assign any event.
3. Repeat step 2 to select other items.
4. Touch the  key to close the window.

Changing the Time Scale of the Event Bar and Review Window

Touch the  or  key to change the time scale of the event bar and review windows. (1, 2, 4, 8 or 24 hours)

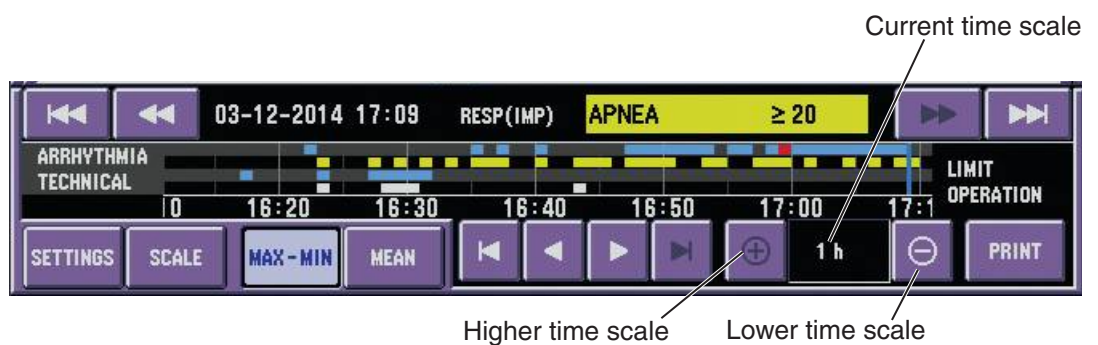

Scrolling the Event Bar and Review Window

You can scroll the event bar and review window backward or forward or jump to earlier or later events. The movement of the review window and event bar is synchronized.

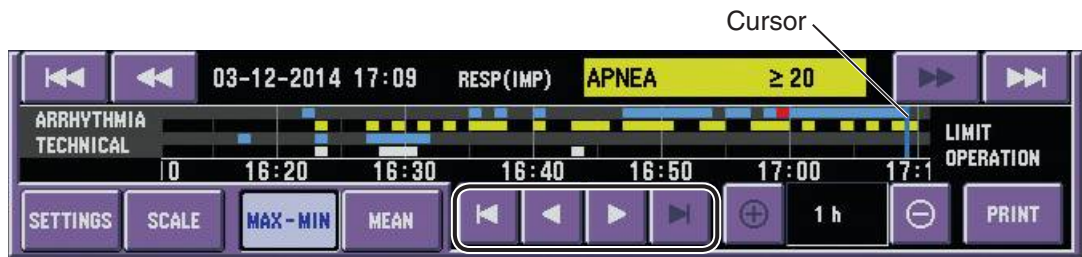

◀ : Moves the cursor to the previous event.

◀ : Moves the cursor left.

▶ : Moves the cursor right.

▶ : Moves the cursor to the next event.

You can also move the cursor by touching the event display area. The touched area becomes the center of the event bar and cursor location.

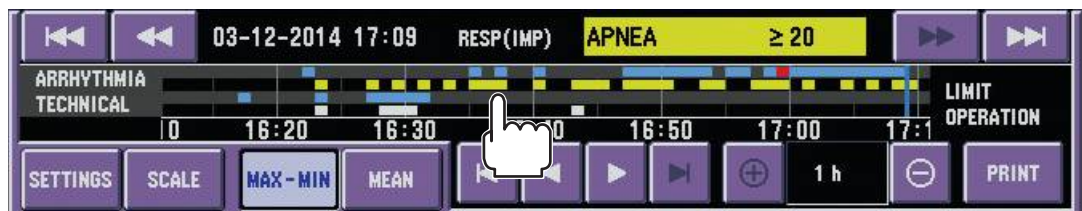

Trend Window

The TREND window has nine pages: GRAPH 1, GRAPH 2 and GRAPH 3, TABLE 1, TABLE 2 and TABLE 3, NIBP TREND, HEMO TREND and LUNG TREND pages.

GRAPH 1, GRAPH 2, GRAPH 3 Page

The GRAPH 1, GRAPH 2 and GRAPH 3 pages displays monitoring parameter data of up to 6 selected parameters of the past 24 hours as a graph. With the optional QM-601P memory card, data of past 72 hours can be saved.

The trendgraph can be recorded on the optional recorder or printed on the network printer.

The maximum, mean and minimum values of all monitoring parameters are automatically acquired every 1 minute for the trendgraph. The acquired values are 1 minute averaged data. The frequency of data display depends on the selected trend time.

1, 2, 4 or 8 hours: 1 minute

24 hours: 3 minutes

The following table shows the available trend parameters, screen displays and scales.

Parameter	Description	Vertical Scale Range
HR	Heart rate (beats/min)	0 to 300
PR	Pulse rate (beats/min)	0 to 300
VPC	VPC rate (count/min)	0 to 100
RR	Respiration rate (count/min)	0 to 150
ST	ST level (mV, mm)	-2.0 to 2.0 (mV) -20.0 to 20.0 (mm)
APNEA-T	Apnea time (Total time in one data segment, in seconds)	0 to 180
APNEA-F	Apnea frequency (Total number of apnea occurrences in one data segment)	0 to 12
NIBP	NIBP (mmHg, kPa)	0 to 300 (mmHg) 0 to 40.0 (kPa)
CO ₂ (E)	CO ₂ partial pressure (mmHg, kPa)	0 to 150 (mmHg) 0 to 20.0 (kPa)
CO ₂ (I)		0 to 100 (mmHg) 0 to 13.0 (kPa)
O ₂ (E), O ₂ (I)	Oxygen concentration (%)	0 to 100
SpO ₂ , SpO ₂ -2	Saturated oxygen from pulse oximeter (%SpO ₂)	0 to 100
PI (SpO ₂), PI (SpO ₂ -2)	Masimo: Perfusion index (%) Nihon Kohden: Pulse-amplitude index (%)	0.01 to 100
Tb (CO)	Blood temperature (°C, °F)	0 to 45.0 (°C) 0 to 115.0 (°F)
PRESS*1	IBP (mmHg, kPa)	0 to 300 (mmHg) 0 to 40.0 (kPa)
PPV	Pulse pressure variability (%)	0 to 50

6. REVIEW WINDOWS

Parameter	Description	Vertical Scale Range
SPV	Systolic pressure variability (%)	0 to 50
TEMP*1	Temperature (°C, °F)	0 to 45.0 (°C) 0 to 115.0 (°F)
N ₂ O(E), N ₂ O(I)	Nitrogen oxide concentration from gas monitoring (%)	0 to 100
AGENT*1(E), AGENT*1(I)	Agent concentration from gas monitoring (%)	0.0 to 20.0
BIS	Bispectral Index	0 to 100
SQI (BIS)	Signal quality indicator (%)	0.0 to 100.0
SR	Suppression ratio (%)	0.0 to 100.0
EMG	Electromyelogram (dB)	0.00 to 80.0
PWTT	Pulse wave transit time (s)	0 to 500
CCO	Continuous cardiac output (L/min)	0.00 to 20.00
CCI	Continuous cardiac output index (L/min/m ²)	0.00 to 20.00
SV	Stroke volume (mL)	0 to 300
SVI	Stroke volume index (mL/m ²)	0 to 200
SvO ₂	Mixed venous oxygen saturation (%)	0 to 100
ScvO ₂	Central venous oxygen saturation (%)	0 to 100
EDV	End diastolic volume (mL)	0 to 800
CF	Calibration factor	0 to 10.0
SVR	Systemic vascular resistance (dyn•s/cm ⁵ , kPa•s/L)	0 to 3000 (dyn•s/cm ⁵) 0 to 300.0 (kPa•s/L)
SVRI	Systemic vascular resistance index (dyn•s•m ² /cm ⁵ , kPa•s•m ² /L)	0 to 30000 (dyn•s•m ² /cm ⁵) 0 to 3000.0 (kPa•s•m ² /L)
SVV	Stroke volume variation (%)	0 to 50
HRV	Heart rate variability (%)	0 to 100
PCCO	Pulse contour cardiac output (L/min)	0.00 to 20.00
PCCI	Pulse contour cardiac output index (L/min/m ²)	0.00 to 20.00
DO ₂ *2	Oxygen delivery (mL/min)	0 to 1200
DO ₂ I*2	Oxygen delivery index (mL/min/m ²)	0 to 1200
VO ₂ *2	Oxygen consumption (mL/min)	0 to 500
VO ₂ I*2	Oxygen consumption index (mL/min/m ²)	0 to 500
TOFrat	TOF ratio (%)	0 to 200
TOFcnt	TOF counts (Times)	0 to 4
PTC	Post tetanic counts (Times)	0 to 15
MV*2	Minute volume (L/min)	0 to 30.0
TVe*2	Expiratory tidal volume (mL)	0 to 2000
C*2	Compliance (mL/cmH ₂ O/L/s, mL/hPa)	0 to 200
R*2	Airway resistance (cmH ₂ O/L/s, hPa/L/s)	0 to 100
Re*2	Expiratory airway resistance (cmH ₂ O/L/s, hPa/L/s)	0 to 100
Ri*2	Inspiratory airway resistance (cmH ₂ O/L/s, hPa/L/s)	0 to 100
Ppeak*2	Peak airway pressure (cmH ₂ O, hPa)	0 to 150
Pmean*2	Mean airway pressure (cmH ₂ O, hPa)	0 to 150
PEEP*2	Positive end expiratory pressure (cmH ₂ O, hPa)	0 to 150
tcPO ₂ *2	Transcutaneous oxygen partial pressure (mmHg, kPa)	0 to 800 (mmHg) 0 to 100.0 (kPa)
tcPCO ₂ *2	Transcutaneous carbon dioxide partial pressure (mmHg, kPa)	0 to 120 (mmHg) 0 to 16.0 (kPa)
rSO ₂ 1 to rSO ₂ 4	Regional saturation of oxygen	0 to 100

*1 The label appears.

*2 These parameters are not available for BSM-6000A series.

NOTE

- When <DATA TRANSPORT USING INPUT UNIT> is set to DISABLE, and <SHOW ADMIT CONFIRMATION WINDOW> is turned off in the SYSTEM CONFIGURATION screen, the stored data remains in memory for about 30 minutes after the power is turned off. After 30 minutes, the stored data is lost. When <DATA TRANSPORT USING INPUT UNIT> is set to ENABLE, the patient data and settings are always stored.
- Do not disconnect the power cord while the monitor power is on. Data may be lost.
- PCCO, ScvO₂, SVV, EDV, EDVI, ESV, ESVI, EF, PPV and SPV data on the GRAPH 1 to GRAPH 3 pages of the TREND window cannot be saved in the BSM-1700 series bedside monitor or AY-600P series input unit and cannot be sent.

Displaying the GRAPH 1, GRAPH 2 or GRAPH 3 Page

1. Press the [Menu] key to display the MENU window.

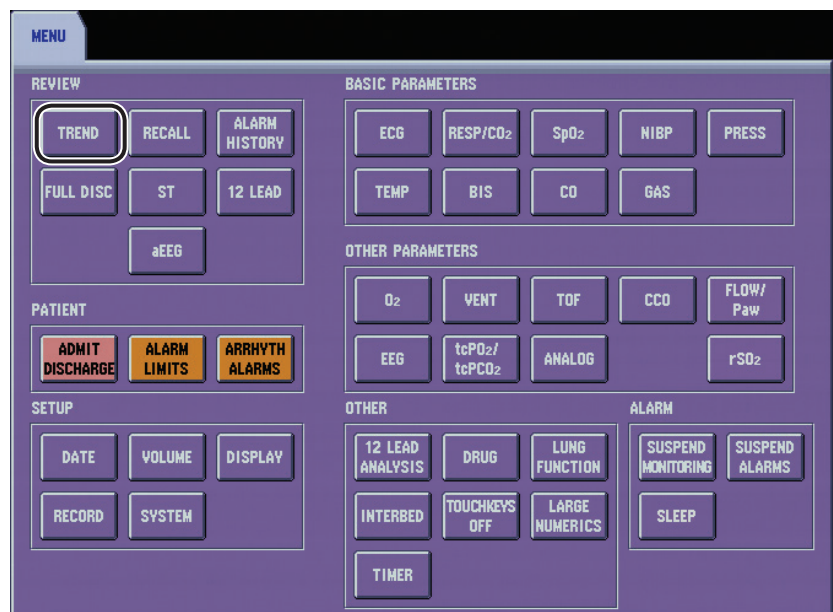

2. Touch the TREND key. The TREND window appears.

When TREND GRAPH is assigned to one of the function keys at the upper left of the screen or one of the function keys on the remote control keys, the trendgraph window can be displayed by touching the TREND GRAPH function key. Refer to “KEYS Window” in Administrator’s Guide, Section 3 to assign a function to the function key.

6. REVIEW WINDOWS

3. Touch the GRAPH 1, GRAPH 2 or GRAPH 3 tab. The graph page appears.

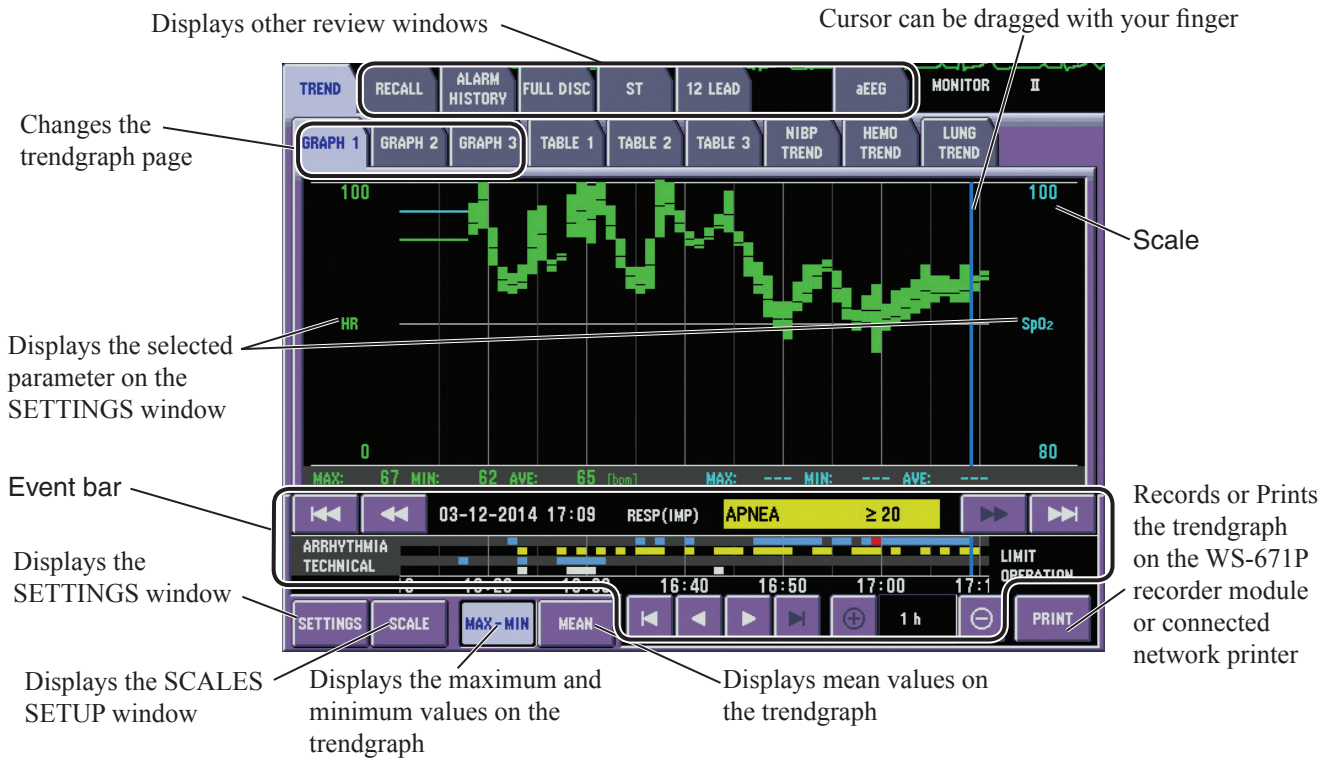

You can select up to 6 parameters for displaying the trendgraphs on GRAPH 1, GRAPH 2 and GRAPH 3 page on the SETTINGS window, the scale on the SCALE window and the display format by touching the MAX-MIN or MEAN key on under the event bar.

For details on the event bar, refer to the previous “EVENT BAR” section.

To return to the home screen, press the [Home] key.

Selecting Parameters for the Trendgraph Display

You can change the parameters of the trendgraph.



1. Touch the SETTINGS key on the GRAPH 1, GRAPH 2 or GRAPH 3 page. The SETTINGS window appears.

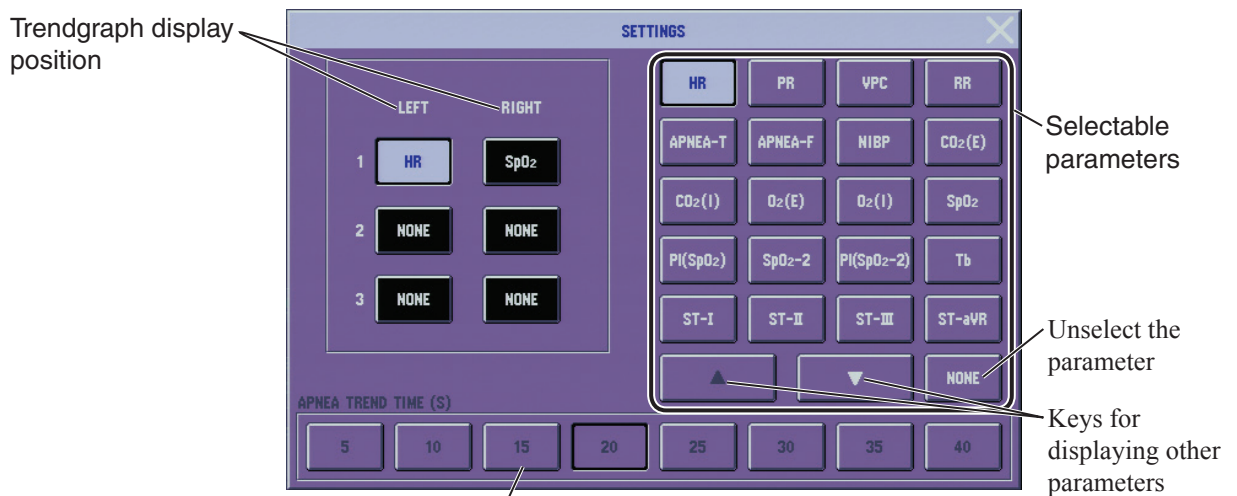

2. Select the display position of the trendgraph. The parameter selected for the “LEFT” is displayed on the left side of the page.



For setting threshold for the apnea trendgraph

3. Select the parameter by touching the desired parameter key. Use the  or  key to display other parameters. Use the NONE key to unselect the parameter.

You can change the time threshold for the apnea trendgraph by touching the desired time in <APNEA TREND TIME> box.

4. Touch the  key to close the window.

Changing the Trendgraph Scale

You can change the trendgraph scale for each parameter.



1. Touch the SCALE key on the GRAPH 1, GRAPH 2 or GRAPH 3 page. The SCALE SETUP window appears.

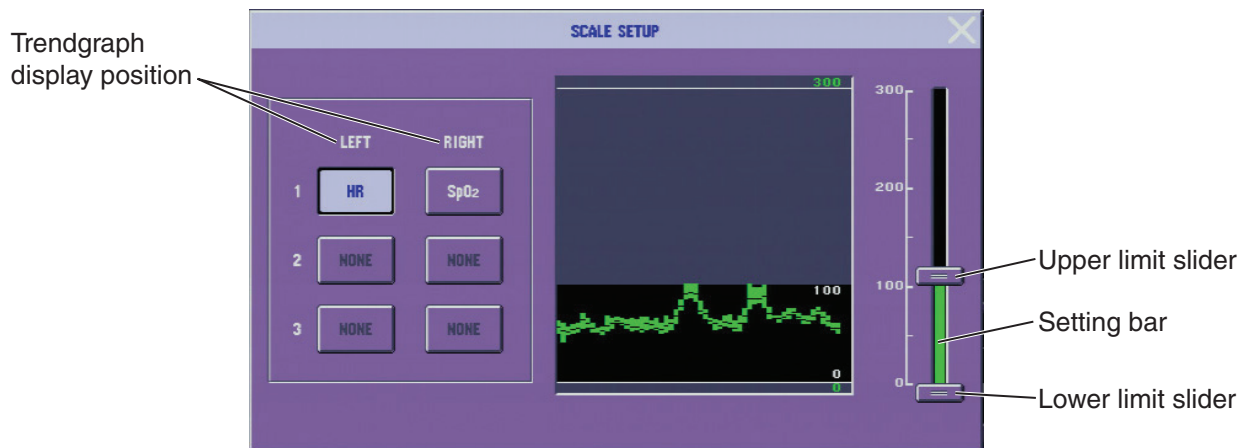

2. Select the display position of the trendgraph. The scale selected for the “LEFT” is displayed on the left side of the page.
3. Touch and drag the sliders to the desired level on the setting bar.
4. Touch the  key to close the window.

Changing the Trendgraph Display Format

You can change the display format of the trendgraph by touching the MAX-MIN or MEAN key under the event bar. The same format is used for the GRAPH 1, GRAPH 2, GRAPH 3 page and the trendgraph on the home screen. The MAX-MIN key displays maximum and minimum values on the trendgraph. The MEAN key displays mean value on the trendgraph.





MAX-MIN

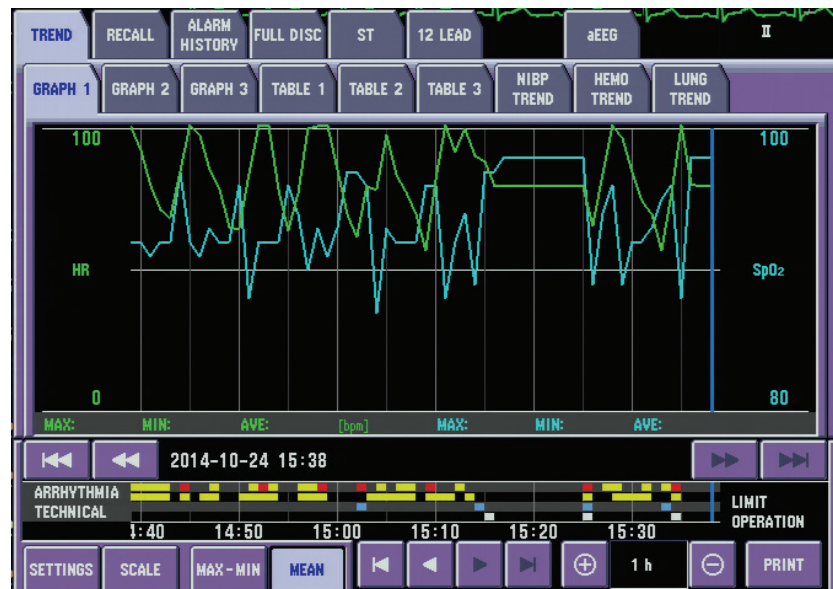





MEAN



Scrolling the Trendgraph

The trendgraph can be scrolled by touching the , ,  or  scroll keys above the event bar. The event bar scrolls together with the trendgraph.



-  : Scrolls to the oldest time.
-  : Scrolls to the latest time.
-  : Scrolls one page back.
-  : Scrolls one page forward.

Recording the Trendgraph

The trendgraph displayed on the GRAPH 1, GRAPH 2 or GRAPH 3 page can be recorded on the optional recorder.

1. Display the trendgraph you want to record on the GRAPH 1, GRAPH 2 or GRAPH 3 page.



2. Touch the PRINT key. The PRINT window appears.

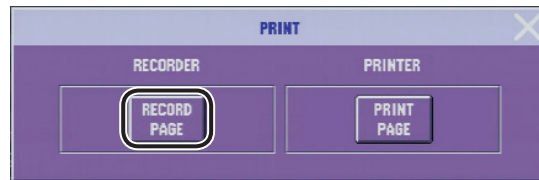

3. Touch the RECORD PAGE key in <RECORDER> box. Recording starts.

To stop recording, press the [Record] key.

4. Touch the [X] key to close the window.

Recording example

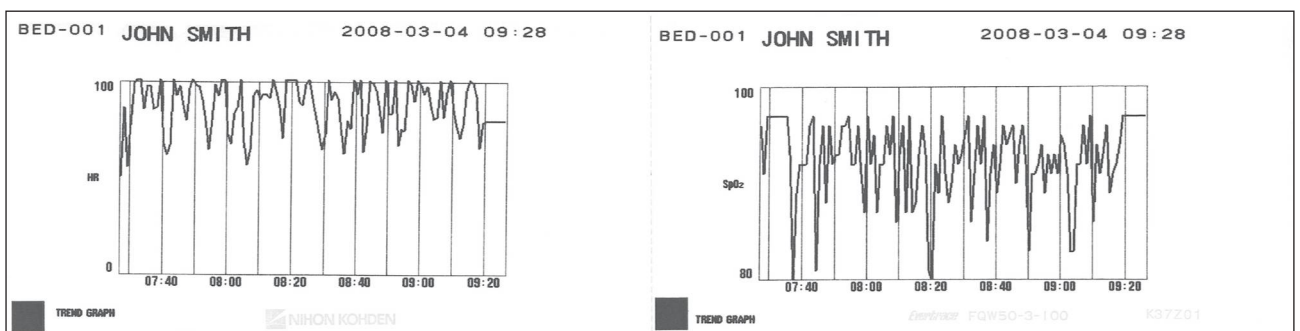

Printing the Trendgraph

The trendgraphs displayed on the GRAPH 1, GRAPH 2 or GRAPH 3 page can be printed when the monitor is connected to a network printer.

1. Display the trendgraph you want to print on the GRAPH 1, GRAPH 2 or GRAPH 3 page.



6. REVIEW WINDOWS

2. Touch the PRINT key. The PRINT window appears.

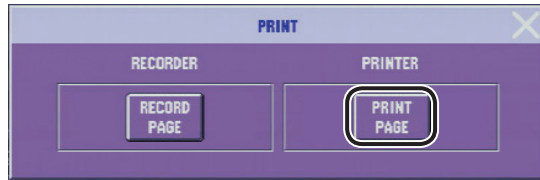

3. Touch the PRINT PAGE key in <PRINTER> box. Printing starts.
4. Touch the  key to close the window.

Printing example

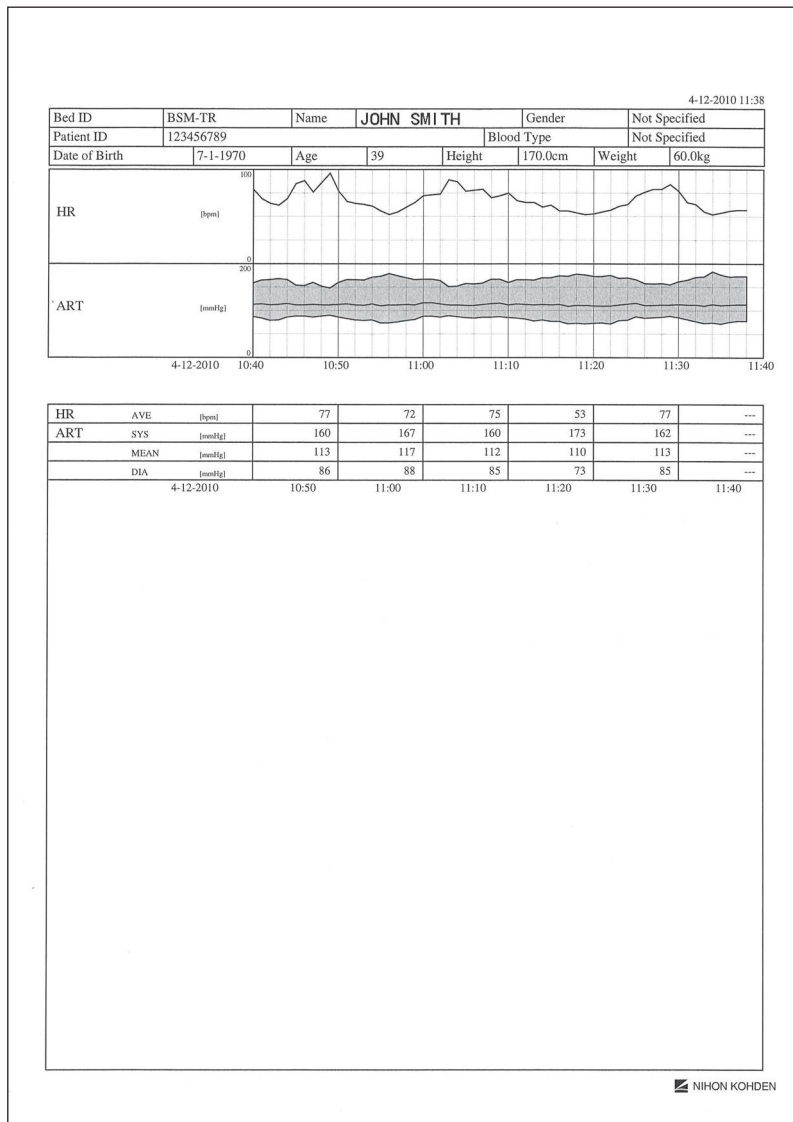

TABLE 1, TABLE 2, TABLE 3 Page

The TABLE 1, TABLE 2 and TABLE 3 pages displays monitoring parameter data of up to 15 selected parameters of the past 24 hours as a table and you can change the display interval. One page shows 7 measurements. Each measurement appears in a separate column. With the optional QM-601P memory card, data of past 72 hours can be saved.

The trend table of selected time period can be recorded on the optional recorder or printed on the network printer.

The following table shows the available trend parameter and screen display.

Parameter	Description
HR	Heart rate (beats/min)
PR	Pulse rate (beats/min)
VPC	VPC rate (count/min)
RR	Respiration rate (count/min)
ST	ST level (mV, mm)
NIBP-SYS	Systolic non-invasive blood pressure (mmHg, kPa)
NIBP-DIA	Diastolic non-invasive blood pressure (mmHg, kPa)
NIBP-MAP	Mean non-invasive blood pressure (mmHg, kPa)
NIBP-PR	Pulse rate measured from non-invasive blood pressure (count/min)
CO ₂ (E), CO ₂ (I)	CO ₂ partial pressure (mmHg, kPa)
O ₂ (E), O ₂ (I)	Oxygen concentration (%)
SpO ₂ , SpO ₂ -2	Saturated oxygen from pulse oximeter (%SpO ₂)
PI (SpO ₂), PI (SpO ₂ -2)	Masimo: Perfusion index (%) Nihon Kohden: Pulse-amplitude index (%)
Tb (CO)	Blood temperature (°C, °F)
PRESS* ¹	IBP (mmHg, kPa)
PPV	Pulse pressure variability (%)
SPV	Systolic pressure variability (%)
TEMP* ¹	Temperature (°C, °F)
AGENT* ¹ (E), AGENT* ¹ (I)	Agent concentration from gas monitoring (%)
BIS	Bispectral index
SQI (BIS)	Signal quality indicator (%)
SR	Suppression ratio (s)
EMG	Electromyogram (dB)
CCO	Continuous cardiac output (L/min)
CCI	Continuous cardiac output index (L/min/m ²)
SV	Stroke volume (mL)
SVI	Stroke volume index (mL/m ²)
SvO ₂	Mixed venous oxygen saturation (%)
ScvO ₂	Central venous oxygen saturation (%)
EDV	End diastolic volume (mL)
EDVI	End diastolic volume index (mL/m ²)
ESV	End systolic volume (mL)
ESVI	End systolic volume index (mL/m ²)
EF	Ejection fraction (%)
CF	Calibration factor

Parameter	Description
SVR	Systemic vascular resistance (dyn•s/cm ⁵ , kPa•s/L)
SVRI	Systemic vascular resistance index (dyn•s•m ² /cm ⁵ , kPa•s•m ² /L)
SVV	Stroke volume variation (%)
HRV	Heart rate variability (%)
PCCO	Pulse contour cardiac output (L/min)
PCCI	Pulse contour cardiac output index (L/min/m ²)
DO ₂ * ²	Oxygen delivery (mL/min)
DO ₂ I* ²	Oxygen delivery index (mL/min/m ²)
VO ₂ * ²	Oxygen consumption (mL/min)
VO ₂ I* ²	Oxygen consumption index (mL/min/m ²)
TOFrat	TOF ratio (%)
TOFcnt	TOF counts (times)
PTC	Post tetanic counts (times)
MV* ²	Minute volume (L/min)
TVE* ²	Expiratory tidal volume (mL)
C* ²	Compliance (mL/cmH ₂ O, mL/hPa)
R* ²	Airway resistance (cmH ₂ O/L/s, hPa/L/s)
Re* ²	Expiratory airway resistance (cmH ₂ O/L/s, hPa/L/s)
Ri* ²	Inspiratory airway resistance (cmH ₂ O/L/s, hPa/L/s)
Ppeak* ²	Peak airway pressure (cmH ₂ O, hPa)
Pmean* ²	Mean airway pressure (cmH ₂ O, hPa)
PEEP* ²	Positive end expiratory pressure (cmH ₂ O, hPa)
tcPO ₂ * ²	Transcutaneous oxygen partial pressure (mmHg, kPa)
rSO ₂	Regional saturation of oxygen
O ₂ LEV	Oxygen consumption (L)
HAL LEV	Halothane consumption (mL)
ISO LEV	Isoflurane consumption (mL)
ENF LEV	Enflurane consumption (mL)
DES LEV	Desflurane consumption (mL)
SEV LEV	Sevoflurane consumption (mL)

*¹ The label appears.

*² These parameters are not available for BSM-6000A series.

NOTE

- When <DATA TRANSPORT USING INPUT UNIT> is set to DISABLE, and <SHOW ADMIT CONFIRMATION WINDOW> is turned off in the SYSTEM CONFIGURATION screen, the stored data remains in memory for about 30 minutes after the power is turned off. After 30 minutes, the stored data is lost. When <DATA TRANSPORT USING INPUT UNIT> is set to ENABLE, the patient data and settings are always stored.
- Do not disconnect the power cord while the monitor power is on. Data may be lost.
- PCCO, ScvO₂, SVV, EDV, EDVI, ESV, ESVI, EF, PPV and SPV data on the GRAPH 1 to GRAPH 3 pages of the TREND window cannot be saved in the BSM-1700 series bedside monitor or AY-600P series input unit and cannot be sent.

Displaying the TABLE 1, TABLE 2 or TABLE 3 Page

1. Press the [Menu] key to display the MENU window.

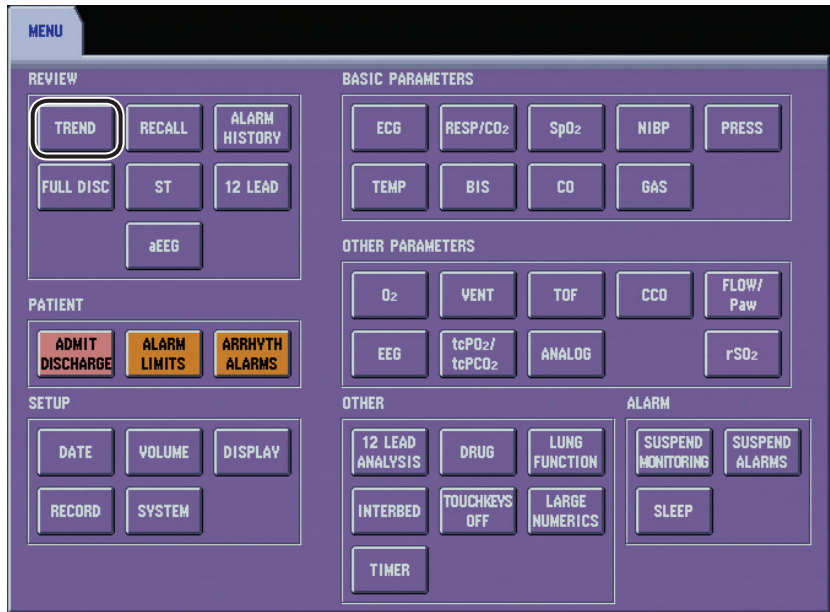

2. Touch the TREND key. The TREND window appears.

When TREND DATA is assigned to one of the function keys at the upper left of the screen or one of the function keys on the remote control keys, the trend table window can be displayed by touching the TREND TABLE function key. Refer to “KEYS Window” in Administrator’s Guide, Section 3 to assign a function to the function key.

3. Touch the TABLE 1, TABLE 2 or TABLE 3 tab. The table page appears.

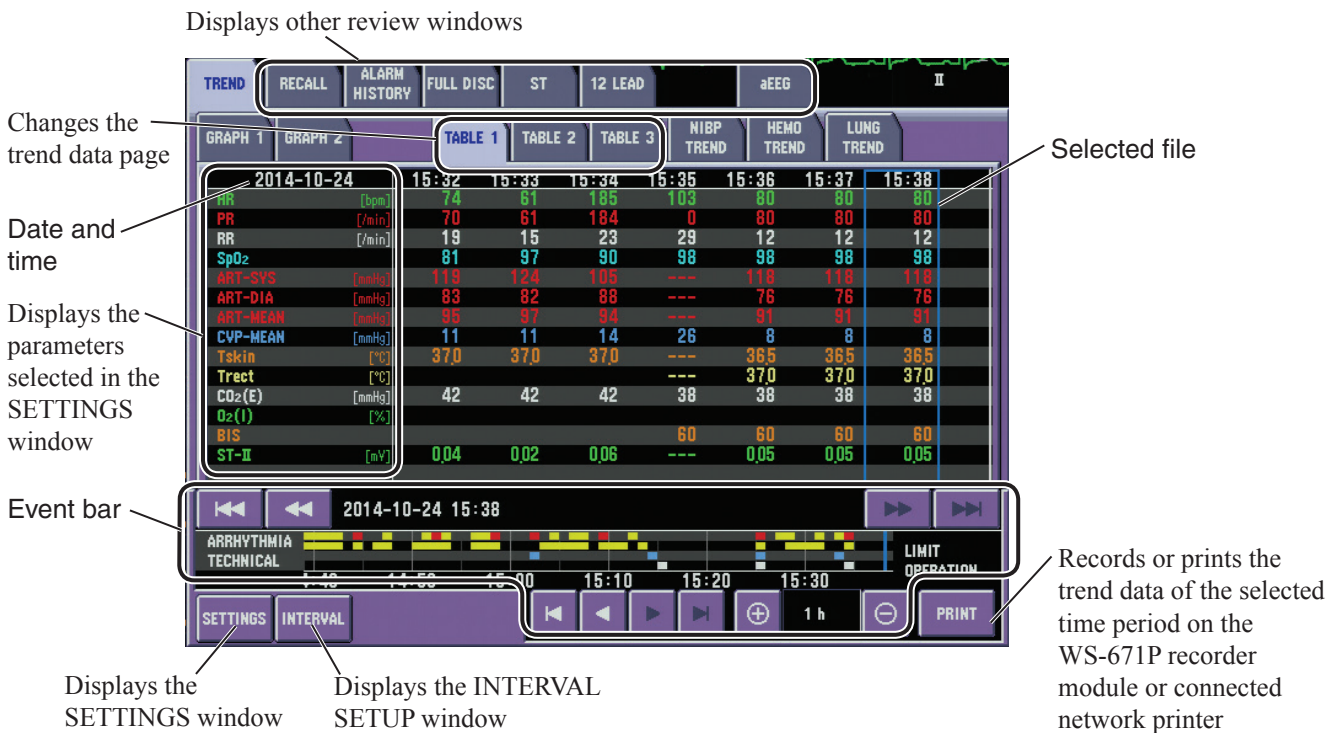

For details on the event bar, refer to the “EVENT BAR” section.

To return to the home screen, press the [Home] key.

Scrolling the Trend Table

Use the vertical scroll bar on the window to scroll the trend table.

The trend table can be scrolled by touching the ▲ or ▼ key on the scroll bar.

Selecting Parameters for the Trend Table Display

1. Touch the SETTINGS key on the TABLE 1, TABLE 2 or TABLE 3 page. The PARAMETER SETUP window appears.

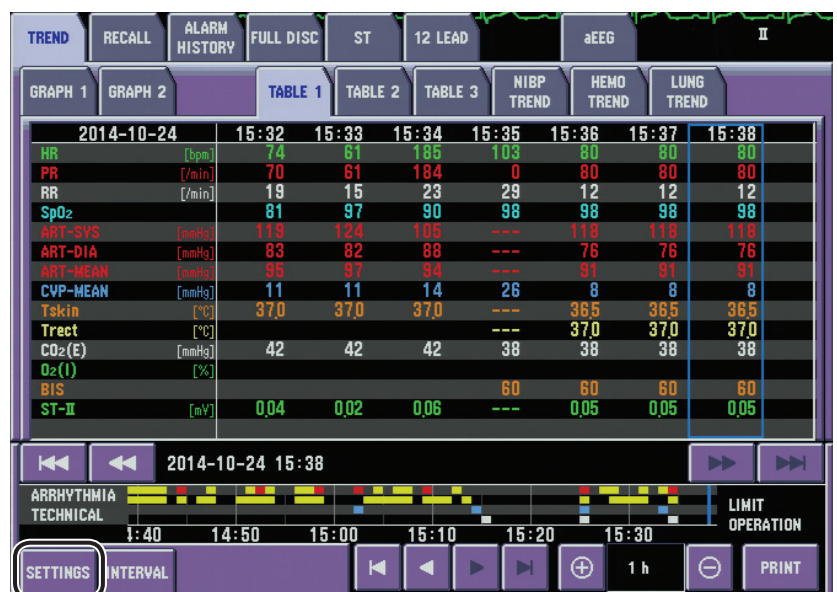

2. Select the display position from the left column. Select the parameter from the right column. The selected parameter appears in the display order on the left column.

6. REVIEW WINDOWS

Selected parameters in the display order.
Up to 15 parameters can be selected

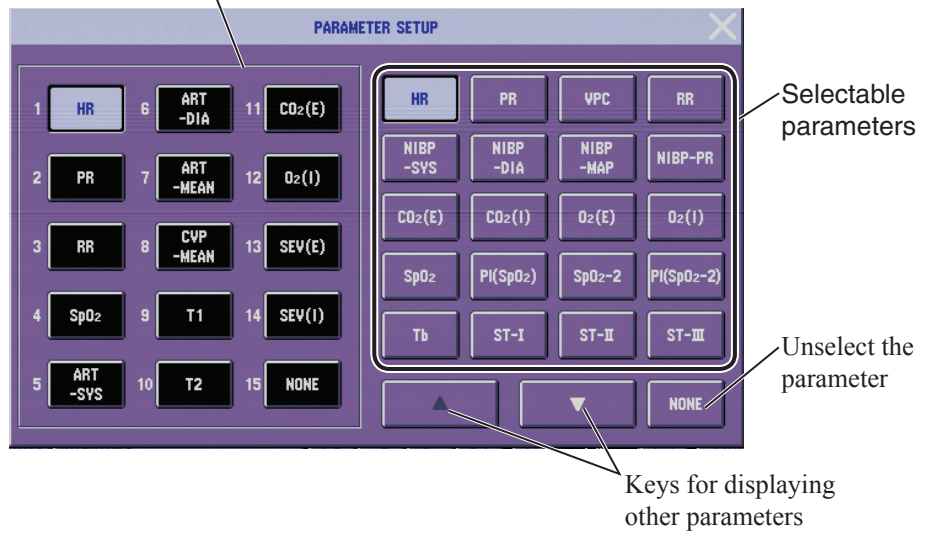

3. Repeat step 2 to select other parameters.
4. Touch the  key to close the window.

Selecting the Measurement Interval

1. Touch the INTERVAL key on the TABLE 1, TABLE 2 or TABLE 3 page.
The INTERVAL SETUP window appears.

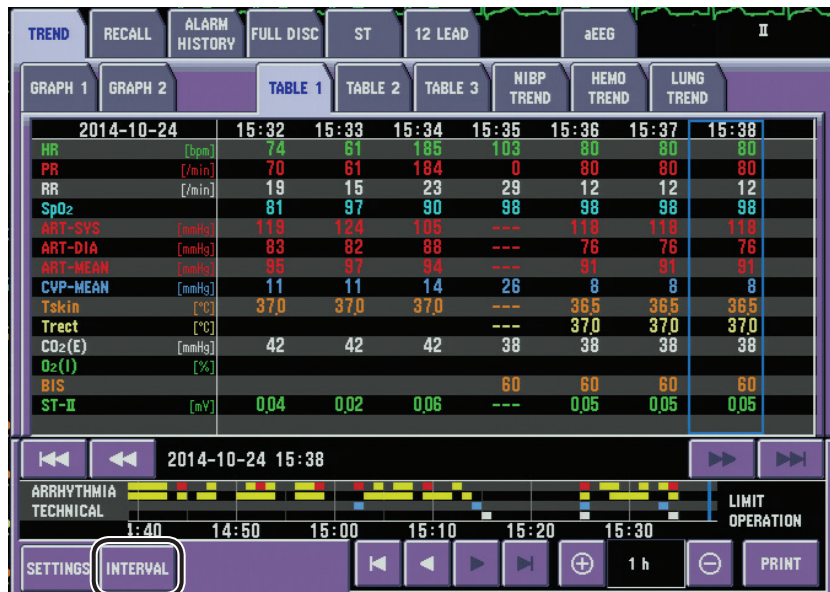

2. Select the measurement interval for the trend table on the INTERVAL SETUP window.

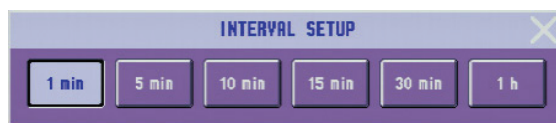

3. Touch the  key to close the window.

Recording a Trend Table

You can record the trend table of the selected time period with the optional recorder.

1. Touch the PRINT key. The PRINT window appears.

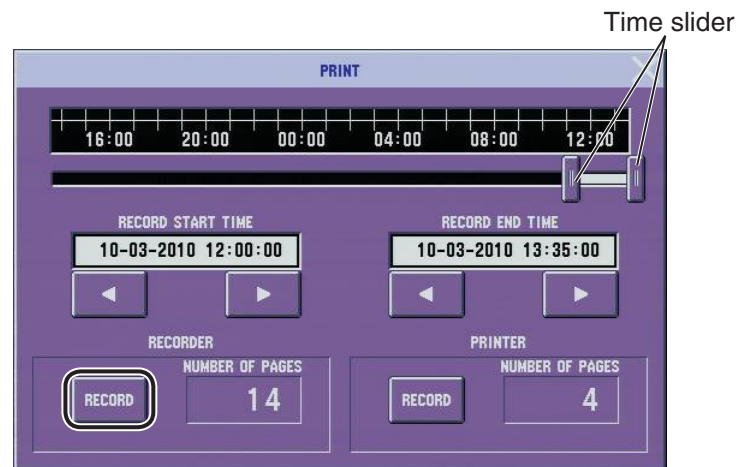

2. Set the RECORD START TIME and RECORD END TIME with the ◀ or ▶ key or time slider.

The initial RECORD START TIME and RECORD END TIME depend on the REVIEW setting on the RECORDER page of the SYSTEM SETUP window. For details, refer to “RECORDER page” in Section 3 of the Administrator’s Guide.

3. Check the number of pages and touch the RECORD key in <RECORDER> box.

To stop recording, press the ☒ [Record] key.

4. Touch the ☒ key to close the window.

Recording example

BED-001 JOHN SMITH		2008-03-04 09:30						
	03-03-2008	17:27	17:28	17:29	17:30	17:31	17:32	17:33
HR	[bpm]		80	80	80	80	80	80
PR	[b/min]		80	80	80	80	80	80
RR	[b/min]		12	12	12	12	12	12
SpO2			98	98	98	98	98	98
ART-SYS	[mmHg]		---	---	---	---	---	118
ART-DIA	[mmHg]		---	---	---	---	---	76
ART-MEAN	[mmHg]		---	---	---	---	---	91
CVP-MEAN	[mmHg]		---	---	---	---	---	8
TEMP	[°C]							
TEMP2	[°C]							
CO2-E	[mmHg]		38	38	38	38	38	38
O2-I	[%]							
SEV-E	[%]							
SEV-I	[%]							

TREND DATA NIHON KOKKEN

Printing a Trend Table

You can print the trend table of the selected time period with a network printer.

1. Touch the PRINT key. The PRINT window appears.

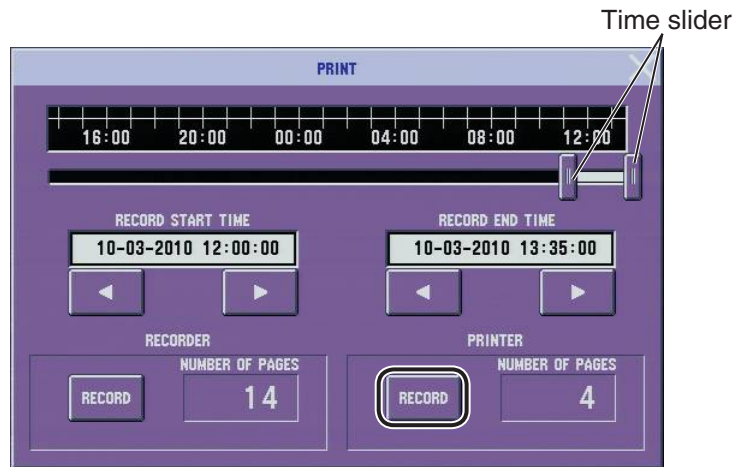

2. Set the RECORD START TIME and RECORD END TIME with the ◀ or ▶ key or time slider.

The initial RECORD START TIME and RECORD END TIME depend on the REVIEW setting on the RECORDER page of the SYSTEM SETUP window. For details, refer to “RECORDER page” in Section 3 of the Administrator’s Guide.

3. Check the number of pages and touch the RECORD key in <PRINTER> box. The “PRINTING” message appears on the screen and the table is printed.
4. Touch the ✕ key to close the window.

Printing example

4-9-2010 16:33											
Bed ID	BSM-TR	Name	JOHN SMITH				Gender	Not Specified			
Patient ID	123456789										
Date of Birth	7-1-1970	Age	39		Height	170.0cm		Weight	60.0kg		
4-9-2010		16:20	16:21	16:22	16:23	16:24	16:25	16:26			
HR	[bpm]	80	80	80	80	80	80	80			
PR	[/min]	80	80	80	80	80	80	80			
RR	[/min]	12	12	12	12	12	12	12			
SpO ₂		98	98	98	98	98	98	98			
ART-SYS	[mmHg]	118	118	118	118	118	118	118			
ART-DIA	[mmHg]	76	76	76	76	76	76	76			
ART-MEAN	[mmHg]	91	91	91	91	91	91	91			
CVP-MEAN	[mmHg]	8	8	8	8	8	8	8			
T1	[°C]	---	---	---	---	---	---	---			
T2	[°C]	---	---	---	---	---	---	---			
CO ₂ (E)	[mmHg]	38	38	38	38	38	38	38			
O ₂ (I)	[%]	---	---	---	---	---	---	---			
SEV (E)	[%]	---	---	---	---	---	---	---			
SEV (I)	[%]	---	---	---	---	---	---	---			

NIBP TREND Page

The NIBP TREND page displays monitoring parameter data of up to 15 selected parameters as a table. Data for all parameters is automatically entered into the table every time NIBP is measured.

One page shows 7 measurements. Each measurement appears in a separate column. Up to 512 data can be registered to the NIBP trend table. If more than 512 measurements are made, the oldest measurement data is deleted.

The NIBP trend table of selected time period can be recorded on the optional recorder or printed on the network printer. With the optional QM-601P memory card, data of up to 1,024 files can be saved.

The following table shows the available trend parameter and screen display.

Parameter	Description
HR	Heart rate (beats/min)
PR	Pulse rate (beats/min)
VPC	VPC rate (count/min)
RR	Respiration rate (count/min)
ST	ST level (mV, mm)
NIBP-SYS	Systolic non-invasive blood pressure (mmHg, kPa)
NIBP-DIA	Diastolic non-invasive blood pressure (mmHg, kPa)
NIBP-MAP	Mean non-invasive blood pressure (mmHg, kPa)
NIBP-PR	Pulse rate measured from non-invasive blood pressure (count/min)
CO ₂ (E), CO ₂ (I)	CO ₂ partial pressure (mmHg, kPa)
O ₂ (E), O ₂ (I)	Oxygen concentration (%)
SpO ₂ , SpO ₂ -2	Saturated oxygen from pulse oximeter (%SpO ₂)
PI (SpO ₂), PI (SpO ₂ -2)	Masimo: Perfusion index (%) Nihon Kohden: Pulse-amplitude index (%)
Tb (CO)	Blood temperature (°C, °F)
PRESS* ¹	IBP (mmHg, kPa)
PPV	Pulse pressure variability (%)
SPV	Systolic pressure variability (%)
TEMP* ¹	Temperature (°C, °F)
AGENT* ¹ (E), AGENT* ¹ (I)	Agent concentration from gas monitoring (%)
BIS	Bispectral index
SQI (BIS)	Signal quality indicator (%)
SR	Suppression ratio (s)
EMG	Electromyogram (dB)
CCO	Continuous cardiac output (L/min)
CCI	Continuous cardiac output index (L/min/ m ²)
SV	Stroke volume (mL)
SVI	Stroke volume index (mL/m ²)
SvO ₂	Mixed venous oxygen saturation (%)
ScvO ₂	Central venous oxygen saturation (%)
EDV	End diastolic volume (mL)
EDVI	End diastolic volume index (mL/m ²)
ESV	End systolic volume (mL)
ESVI	End systolic volume index (mL/m ²)

Parameter	Description
EF	Ejection fraction (%)
CF	Calibration factor
SVR	Systemic vascular resistance (dyn•s/cm ⁵ , kPa•s/L)
SVRI	Systemic vascular resistance index (dyn•s•m ² /cm ⁵ , kPa•s•m ² /L)
SVV	Stroke volume variation (%)
HRV	Heart rate variability (%)
PCCO	Pulse contour cardiac output (L/min)
PCCI	Pulse contour cardiac output index (L/min/m ²)
DO ₂ * ²	Oxygen delivery (mL/min)
DO ₂ I* ²	Oxygen delivery index (mL/min/m ²)
VO ₂ * ²	Oxygen consumption (mL/min)
VO ₂ I* ²	Oxygen consumption index (mL/min/m ²)
TOFrat	TOF ratio (%)
TOFcnt	TOF counts (times)
PTC	Post tetanic counts (times)
MV* ²	Minute volume (L/min)
TVe* ²	Expiratory tidal volume (mL)
C* ²	Compliance (mL/cmH ₂ O, mL/hPa)
R* ²	Airway resistance (cmH ₂ O/L/s, hPa/L/s)
Re* ²	Expiratory airway resistance (cmH ₂ O/L/s, hPa/L/s)
Ri* ²	Inspiratory airway resistance (cmH ₂ O/L/s, hPa/L/s)
Ppeak* ²	Peak airway pressure (cmH ₂ O, hPa)
Pmean* ²	Mean airway pressure (cmH ₂ O, hPa)
PEEP* ²	Positive end expiratory pressure (cmH ₂ O, hPa)
tcPO ₂ * ²	Transcutaneous oxygen partial pressure (mmHg, kPa)
rSO ₂	Regional saturation of oxygen
O ₂ LEV	Oxygen consumption (L)
HAL LEV	Halothane consumption (mL)
ISO LEV	Isoflurane consumption (mL)
ENF LEV	Enflurane consumption (mL)
DES LEV	Desflurane consumption (mL)
SEV LEV	Sevoflurane consumption (mL)

*¹ The label appears.

*² These parameters are not available for BSM-6000A series.

NOTE

- When <DATA TRANSPORT USING INPUT UNIT> is set to DISABLE, and <SHOW ADMIT CONFIRMATION WINDOW> is turned off in the SYSTEM CONFIGURATION screen, the stored data remains in memory for about 30 minutes after the power is turned off. After 30 minutes, the stored data is lost. When <DATA TRANSPORT USING INPUT UNIT> is set to ENABLE, the patient data and settings are always stored.
- Do not disconnect the power cord while the monitor power is on. Data may be lost.

Displaying the NIBP TREND Page

1. Press the [Menu] key to display the MENU window.

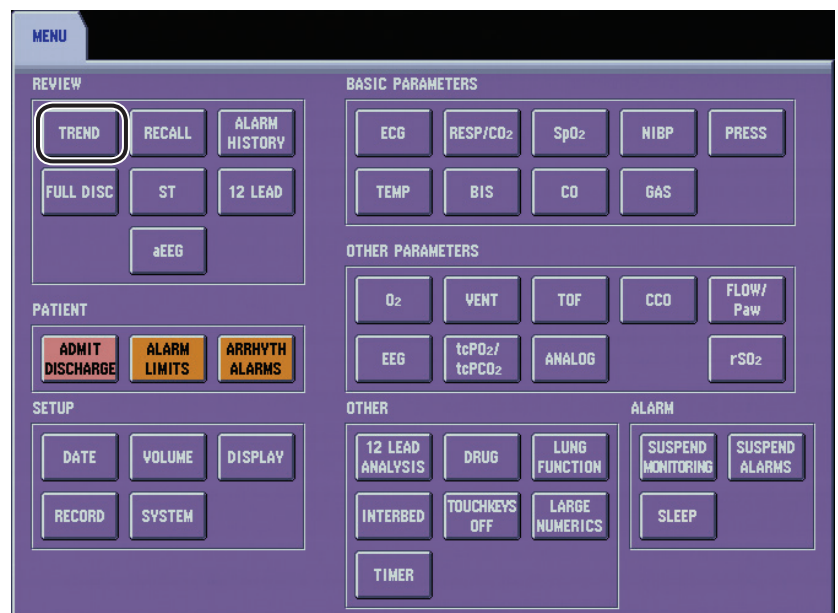

2. Touch the TREND key. The TREND window appears.
3. Touch the NIBP TREND tab. The NIBP TREND page appears.

When NIBP TREND is assigned to one of the function keys at the upper left of the screen or one of the function keys on the remote control keys, the NIBP TREND page can be displayed by touching the NIBP TREND function key. Refer to “KEYS Window” in Administrator’s Guide, Section 3 to assign a function to the function key.

6. REVIEW WINDOWS

Displays other review windows

Date and time

Displays the selected parameters in the SETTINGS window

Event bar

Selected file

Records or prints the NIBP data of the selected time period on the WS-671P recorder module or connected network printer

Displays the SETTINGS window

NOTE

The HR on the NIBP TREND page is the HR at the completion of NIBP measurement. The HR on the TABLE page and NIBP TREND page may be different.

For details on the event bar, refer to the previous “EVENT BAR” section.

To return to the home screen, press the [Home] key.

Scrolling the NIBP Trend Table

Use the vertical scroll bar on the window to scroll the NIBP trend table. The trend table can be scrolled by touching the ▲ or ▼ key on the scroll bar.

Selecting Parameters for the NIBP Trend Display

1. Touch the SETTINGS key on the NIBP TREND page. The PARAMETER SETUP window appears.

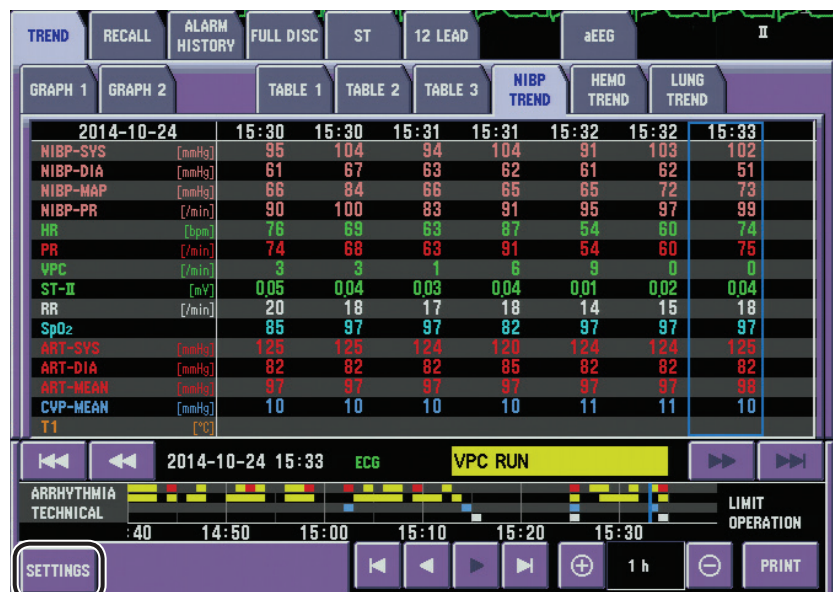

2. Select the display position from the left column. Select the parameter from the right column. The selected parameter appears in the display order on the left column.

Selected parameters in the display order. Up to 15 parameters can be selected.

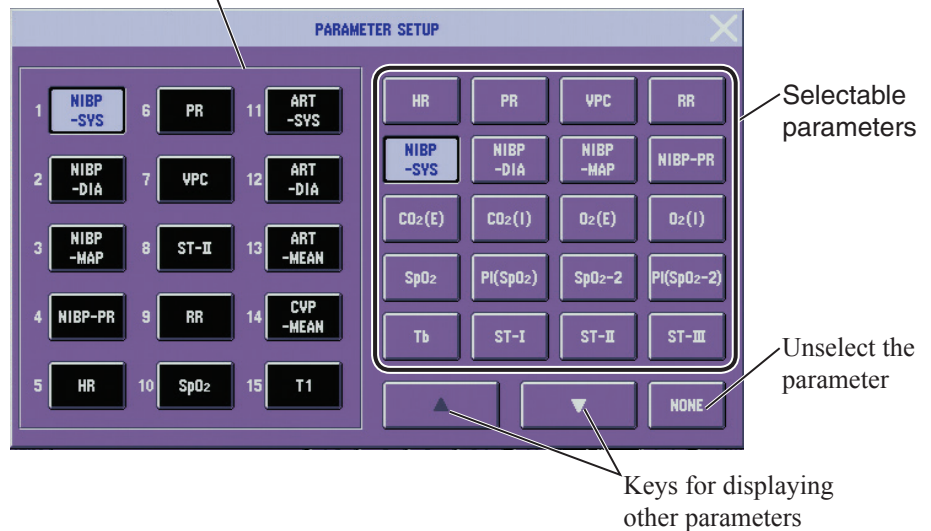

3. Repeat step 2 to select other parameters.
4. Touch the  key to close the window.

Recording a NIBP Trend Table

You can record the NIBP trend table of the selected time period with the optional recorder.

1. Touch the PRINT key. The PRINT window appears.

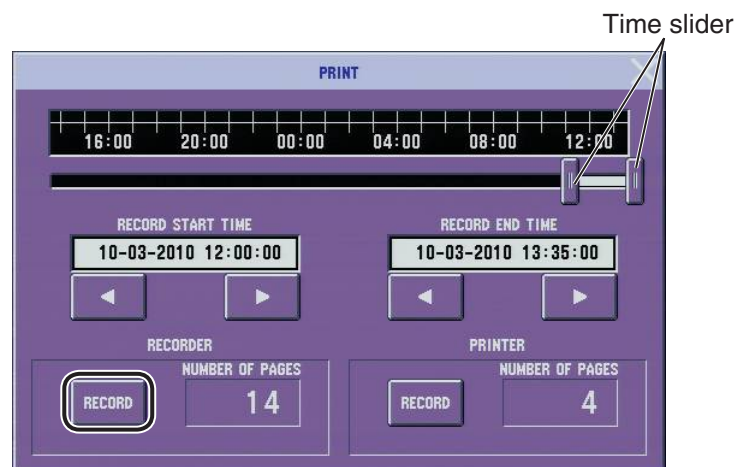

2. Set the RECORD START TIME and RECORD END TIME with the  or  key or time slider.

The initial RECORD START TIME and RECORD END TIME depend on the REVIEW setting on the RECORDER page of the SYSTEM SETUP window. For details, refer to “RECORDER page” in Section 3 of the Administrator’s Guide.

6. REVIEW WINDOWS

3. Check the number of pages and touch the RECORD key in <RECORDER> box.

To stop recording, press the [Record] key.

4. Touch the [Close] key to close the window.

Recording example

BED-001 JOHN SMITH		2008-03-04 09:33							
		03-03-2008	18:29	18:30	18:33	18:34	18:35	18:38	18:42
NIBP-SYS	(mmHg)		134	110	119	112	103	103	85
NIBP-DIA	(mmHg)		57	66	75	73	64	66	61
NIBP-MAP	(mmHg)		100	93	95	91	89	70	71
NIBP-PR	(min)		45	49	52	53	54	54	55
HR	(bpm)		80	80	80	80	80	80	80
PR	(min)		80	80	80	80	80	80	80
VPC	(min)		0	0	0	0	0	0	0
ST-II	(mV)		0.07	0.07	0.07	0.07	0.07	0.07	0.07
RR	(min)		21	21	21	21	21	21	21
SpO₂									
ART-SYS	(mmHg)		123	123	123	123	123	123	123
ART-DIA	(mmHg)		81	81	81	81	81	81	81
ART-MEAN	(mmHg)		96	96	96	96	96	96	96
CVP-MEAN	(mmHg)		4	4	4	4	4	4	4
TEMP	(°C)		37.0	37.0	37.0	37.0	37.0	37.0	37.0

Printing a NIBP Trend Table

You can print the NIBP trend table of the selected time period with a network printer.

1. Touch the PRINT key. The PRINT window appears.

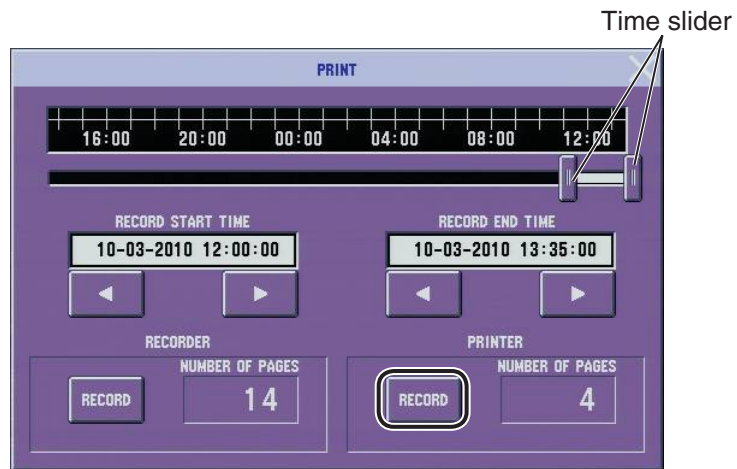

2. Set the RECORD START TIME and RECORD END TIME with the [Left Arrow] or [Right Arrow] key or time slider.

The initial RECORD START TIME and RECORD END TIME depend on the REVIEW setting on the RECORDER page of the SYSTEM SETUP window. For details, refer to “RECORDER page” in Section 3 of the Administrator’s Guide.

3. Check the number of pages and touch the RECORD key in <PRINTER> box. The “PRINTING” message appears on the screen and the table is printed.
4. Touch the [Close] key to close the window.

Printing example

4-9-2010 16:50										
Bed ID	BSM-TR	Name	JOHN SMITH			Gender	Not Specified			
Patient ID	123456789					Blood Type	Not Specified			
Date of Birth	7-1-1970	Age	39		Height	170.0cm	Weight	60.0kg		
4-9-2010		16:48	16:49	16:49	16:50	16:50				
NIBP-SYS	[mmHg]	119	122	109	98	103				
NIBP-DIA	[mmHg]	72	74	64	62	65				
NIBP-MAP	[mmHg]	80	83	76	76	79				
NIBP-PR	[mm]	83	87	72	80	83				
HR	[bpm]	58	53	56	60	48				
PR	[min]	56	53	36	44	44				
VPC	[min]	0	0	3	7	5				
ST-II	[mV]	+0.01	+0.01	+0.01	+0.01	+0.01				
RR	[min]	14	13	15	14	12				
SpO ₂		---	---	---	---	---				
ART-SYS	[mmHg]	174	173	180	181	182				
ART-DIA	[mmHg]	80	78	65	72	72				
ART-MEAN	[mmHg]	114	113	107	111	112				
CVP-MEAN	[mmHg]	6	6	5	5	6				
T1	[°C]	---	---	---	---	---				

HEMO TREND Page

The hemodynamics table can be created when CO or CCO is monitored and the acquired data is registered to this table. To register the acquired CO data to the hemodynamics table, refer to “Adding Acquired Data to the Hemodynamics Table on the TREND Window” in User’s Guide Part II, Section 9.

Up to 512 data can be registered to the hemodynamics table. If more than 512 measurements are made, the oldest measurement data is deleted.

With the optional QM-601P memory card, data of up to 1,024 files can be saved.

The hemodynamics table of selected time period can be recorded on the optional recorder or printed on the network printer.

NOTE

- When <DATA TRANSPORT USING INPUT UNIT> is set to DISABLE, and <SHOW ADMIT CONFIRMATION WINDOW> is turned off in the SYSTEM CONFIGURATION screen, the stored data remains in memory for about 30 minutes after the power is turned off. After 30 minutes, the stored data is lost. When <DATA TRANSPORT USING INPUT UNIT> is set to ENABLE, the patient data and settings are always stored.
- Do not disconnect the power cord while the monitor power is on. Data may be lost.

Displaying the HEMO TREND Page

1. Press the [Menu] key to display the MENU window.

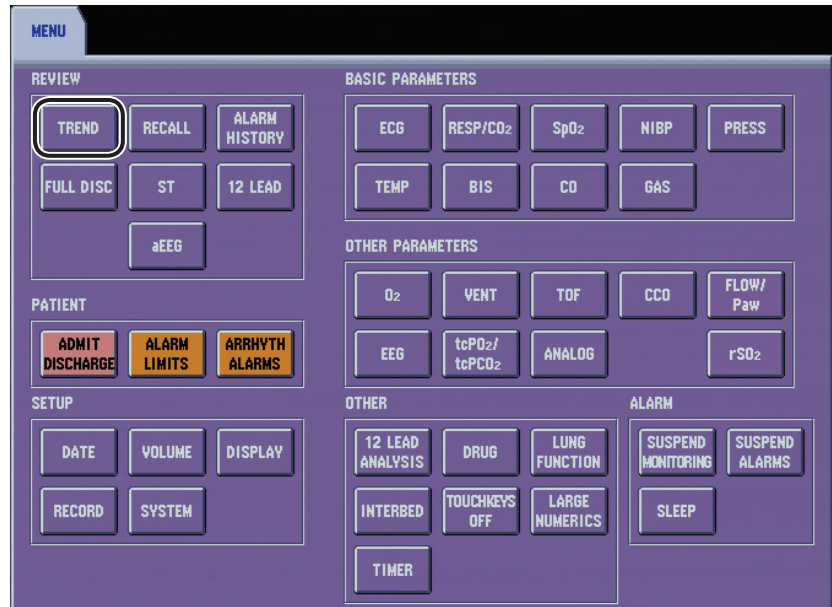

2. Touch the TREND key. The TREND window appears.

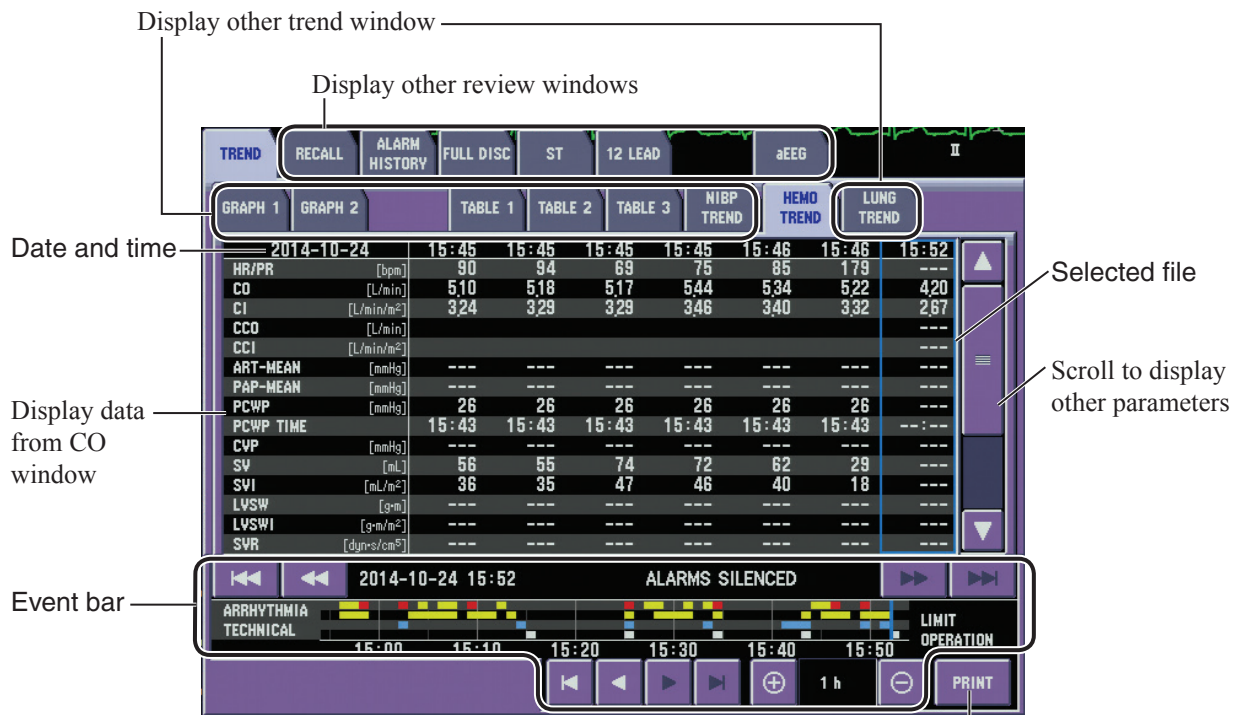

Records or prints the hemodynamic data of the selected time period on the WS-671P recorder module or connected network printer

3. Touch the HEMO TREND tab. The HEMO TREND page appears.

When HEMO TREND is assigned to one of the function keys at the upper left of the screen or one of the function keys on the remote control keys, the HEMO TREND page can be displayed by touching the HEMO TREND function key. Refer to “KEYS Window” in Administrator’s Guide, Section 3 to assign a function to the function key.

For details on the event bar, refer to the previous “EVENT BAR” section.

To return to the home screen, press the [Home] key.

Scrolling the Hemodynamics Table

Use the vertical scroll bar on the window to scroll the hemodynamic table.

The hemodynamics table can be scrolled by touching the ▲ or ▼ key on the scroll bar.

6. REVIEW WINDOWS

Explanation of the Hemodynamics Table

Label	Name	Unit	Explanation and Equation
HR/PR	Heart rate/pulse rate	beats/min	Heart rate at the time the CO is measured. When using the APCO/IBP processor, pulse rate is registered.
CO	Cardiac output	L/min	—
CI	Cardiac index	L/min/m ²	CI = CO/BSA
CCO	Continuous cardiac output	L/min	—
CCI	Continuous cardiac output index	L/min/ m ²	CCI = CCO/BSA
ART-MEAN	Arterial mean pressure	mmHg, kPa	Values registered at the time the CO is measured.
PAP-MEAN	Pulmonary arterial mean pressure		
PCWP	Pulmonary capillary wedge pressure		
PCWP TIME	Pulmonary capillary wedge pressure measurement time		
CVP	Central venous mean pressure	mmHg, kPa	
SV	Stroke volume	mL	SV = (CO × 1000)/HR
SVI	Stroke volume index	mL/m ²	SVI = (CI × 1000)/HR
LVSW*	Left ventricular stroke work	g•m	LSW = {SV × (AMP – PCWP)} × 0.0136
LVSWI*	Left ventricular stroke work index	g•m/m ²	LSWI = {SVI × (AMP – PCWP)} × 0.0136
SVR	Systemic vascular resistance	dyn•s/cm ⁵	SVR = {(AMP – CVP) × 80}/CO
SVRI	Systemic vascular resistance index	dyn•s•m ² /cm ⁵ , kPa•s•m ² /L	SVRI = {(AMP – CVP) × 80}/CI
SVV	Stroke volume variation	%	—
PVR*	Pulmonary vascular resistance	dyn•s/cm ⁵	PVR = {(PAMP – PCWP) × 80}/CO
PVRI	Pulmonary vascular resistance index	dyn•s•m ² /cm ⁵ , kPa•s•m ² /L	PVRI = {(PAMP – PCWP) × 80}/CI
RVSW	Right ventricular stroke work	g•m	RSW = {13.6 × CO × (PAMP – CVP)}/HR
RVSWI	Right ventricular stroke work index	g•m/m ²	RSWI = {13.6 × CO × (PAMP – CVP)}/(HR × BSA)
ScvO ₂	Central venous oxygen saturation	%	—

* When PCWP is not measured, “- -” appears.

Recording a Hemodynamics Table

You can record the hemodynamics table of the selected time period with the optional recorder.

1. Touch the PRINT key. The PRINT window appears.

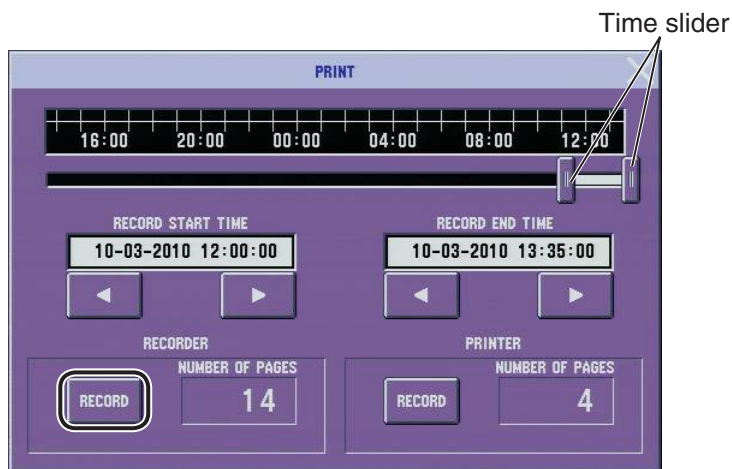

2. Set the RECORD START TIME and RECORD END TIME with the ◀ or ▶ key or time slider.

The initial RECORD START TIME and RECORD END TIME depend on the REVIEW setting on the RECORDER page of the SYSTEM SETUP window. For details, refer to “RECORDER page” in Section 3 of the Administrator’s Guide.

3. Check the number of pages and touch the RECORD key in <RECORDER> box.

To stop recording, press the [Record] key.

4. Touch the ✕ key to close the window.

Recording example

14-06-2011 14:40 14:45 14:50 14:57 15:00 15:04 15:07							
HR/PR	[1/min]	81	80	81	80	83	80 80
CO	[L/min]		5.21		5.21	5.34	5.20
CI	[L/min/m ²]		2.63		2.60	2.69	2.62
CCO	[L/min]	5.30		5.60		5.60	
CCI	[L/min/m ²]	2.70		2.90		2.80	
ART-MEAN	[mmHg]	71	74	71	73	74	70 71
PAP-MEAN	[mmHg]	19	20	20	21	20	21 20
PCWP	[mmHg]	---	---	---	8	8	8 8
PCWP TIME		---	---	---	14:57	14:57	15:03 15:03
CVP	[mmHg]	10	11	11	10	10	11 11
SV	[mL]	66	65	72	65	66	66 65
SVI	[mL/m ²]	33	32	36	32	34	33 32

14-06-2011 15:37							
LVSF	[%]	---	---	---	57	60	56 55
LVSFI	[g/m ²]	---	---	---	29	30	28 28
SVFI	[g/m ²]	821	867	828	867	914	893 923
SVFI	[g/m ²]	1823	1915	1639	1916	1810	1750 1827
PVRI	[dynes/cm ²]	---	---	---	199	171	194 194
PVRI	[dynes/cm ²]	---	---	---	385	339	385 365
RVSW	[g]	8.0	7.9	8.7	9.7	9.1	9.0 7.9
RVSWI	[g/m ²]	4.0	4.0	4.4	4.9	4.6	4.5 4.0

Printing a Hemodynamics Table

You can print the hemodynamics table of the selected time period with a network printer.

1. Touch the PRINT key. The PRINT window appears.

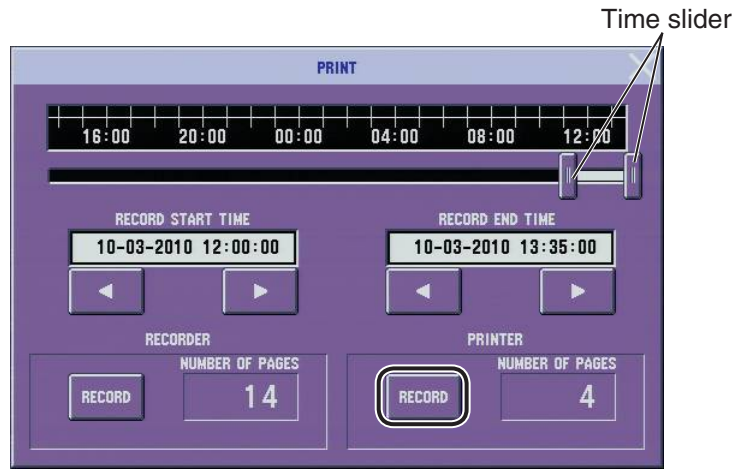

2. Set the RECORD START TIME and RECORD END TIME with the ◀ or ▶ key or time slider.

The initial RECORD START TIME and RECORD END TIME depend on the REVIEW setting on the RECORDER page of the SYSTEM SETUP window. For details, refer to “RECORDER page” in Section 3 of the Administrator’s Guide.

3. Check the number of pages and touch the RECORD key in <PRINTER> box. The “PRINTING” message appears on the screen and the table is printed.
4. Touch the [X] key to close the window.

Printing example

14-6-2011 15:28												
Bod ID	[ICU-001]	Name	JOHN SMITH			Gender	Male	Patient ID	123456789			
DATE	TIME	14-6-2011	14-6-2011	14-6-2011	14-6-2011	14-6-2011	14-6-2011	14-6-2011	14-6-2011	14-6-2011	14-6-2011	
HR/PR	[bpm]	80	81	80	81	80	83	80	80	85	80	
CO	[l/min]	5.27	---	5.21	---	5.21	---	5.34	5.20	---	5.23	
CI	[l/min/m ²]	2.66	---	2.63	---	2.63	---	2.69	2.62	---	2.64	
CCO	[l/min]	---	5.30	---	5.80	---	5.60	---	---	5.70	---	
CCI	[l/min/m ²]	---	2.70	---	2.90	---	2.80	---	---	2.90	---	
ART-SYS	[mmHg]	109	109	111	109	109	110	108	106	110	111	
ART-DIA	[mmHg]	56	55	59	56	56	58	54	56	57	60	
ART-MEAN	[mmHg]	72	71	74	71	73	74	70	71	74	75	
PAP-SYS	[mmHg]	28	26	28	27	28	26	27	28	27	26	
PAP-DIA	[mmHg]	16	16	16	16	16	16	16	16	17	16	
PAP-MEAN	[mmHg]	21	19	20	20	21	20	21	20	20	19	
PCWP	[mmHg]	---	---	---	---	8	8	8	8	8	8	
PCWP TIME	[mm]	---	---	---	---	14:58	14:58	15:04	15:04	15:04	15:04	
CVP	[mmHg]	10	10	11	11	11	10	11	11	10	11	
SV	[ml]	65	66	65	72	65	68	66	65	67	65	
SVI	[ml/m ²]	33	33	32	36	32	34	33	32	34	33	
LVSW	[g/min]	---	---	---	---	57	60	56	55	59	59	
LVSWI	[g/min/m ²]	---	---	---	---	29	30	28	28	30	30	
SVR	[dyne/cm ²]	941	921	909	826	907	914	883	923	896	878	
SVRI	[dyne/cm ² /m ²]	1863	1823	1915	1639	1915	1810	1750	1827	1779	1838	
PVRI	[dyne/cm ²]	---	---	---	---	199	171	194	184	168	168	
PVRI	[dyne/cm ² /m ²]	---	---	---	---	385	239	385	365	333	333	
RVSW	[g/min]	9.8	8.0	7.9	8.7	9.7	9.1	9.0	7.9	9.1	7.1	
RVSWI	[g/min/m ²]	4.9	4.0	4.0	4.4	4.9	4.6	4.5	4.0	4.5	3.5	

NHON KOHLEN

LUNG TREND Page

The lung trend table can be created when patient's respiration dynamics are calculated on the LUNG FUNCTION window. The files of up to 128 data can be registered to the lung trend table.

The lung trend table of selected time period can be recorded on the optional recorder.

NOTE

- When <DATA TRANSPORT USING INPUT UNIT> is set to DISABLE, and <SHOW ADMIT CONFIRMATION WINDOW> is turned off in the SYSTEM CONFIGURATION screen, the stored data remains in memory for about 30 minutes after the power is turned off. After 30 minutes, the stored data is lost. When <DATA TRANSPORT USING INPUT UNIT> is set to ENABLE, the patient data and settings are always stored.
- Do not disconnect the power cord while the monitor power is on. Data may be lost.

Displaying the LUNG TREND Page

1. Press the [Menu] key to display the MENU window.

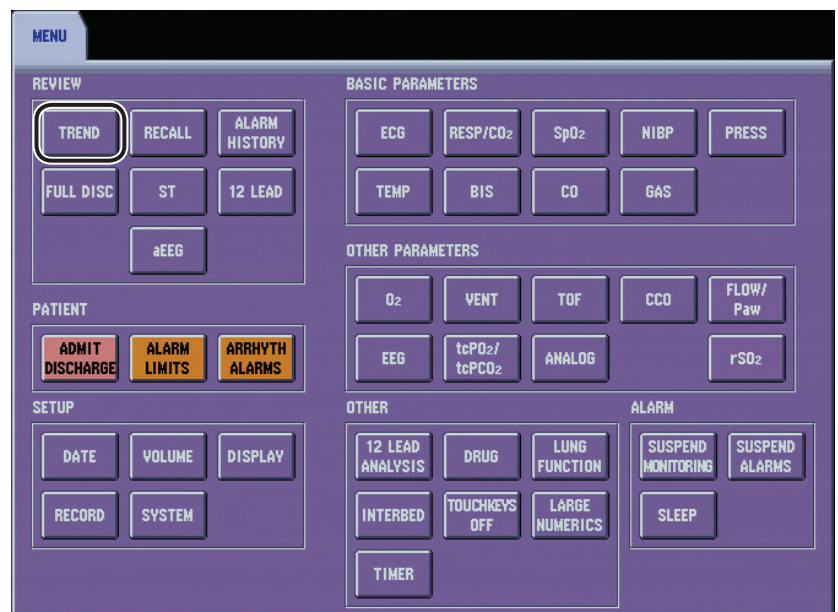

2. Touch the TREND key. The TREND window appears.
3. Touch the LUNG TREND tab. The LUNG TREND page appears.

When LUNG TREND is assigned to one of the function keys at the upper left of the screen or one of the function keys on the remote control keys, the LUNG TREND page can be displayed by touching the LUNG TREND function key. Refer to “KEYS Window” in Administrator’s Guide, Section 3 to assign a function to the function key.

6. REVIEW WINDOWS

Displays other review windows

Date and time

Displays data from LUNG FUNCTION window

Selected file

Event bar

Records the lung trend data of the selected time period on the WS-671P recorder module

	2014-10-24	15:51	15:51	15:51	15:51	15:51	15:51	15:51
BSA	[m ²]	1.57	1.57	1.57	1.57	1.57	1.57	1.57
CI	[L/min/m ²]	3.19	3.19	3.19	3.19	3.19	3.19	3.19
AaDO ₂	[mmHg]	-380.07	-380.07	-380.07	-380.07	-380.07	-380.07	-380.07
CaO ₂	[mL/dL]	34.10	33.43	33.76	34.10	33.43	33.76	34.10
DO ₂	[mL/min]	1704.75	1671.25	1688.00	1704.75	1671.25	1688.00	1704.75
DO ₂ I	[mL/min/m ²]	1086.82	1065.46	1076.14	1086.82	1065.46	1076.14	1086.82
C \bar{v} O ₂	[mL/dL]	26.96	26.96	26.96	26.96	26.96	26.96	26.96
avDO ₂	[mL/dL]	7.14	6.47	6.81	7.14	6.47	6.81	7.14
VO ₂	[mL/min]	357.00	323.50	340.25	357.00	323.50	340.25	357.00
VO ₂ I	[mL/min/m ²]	227.60	206.24	216.92	227.60	206.24	216.92	227.60
O ₂ ER	[%]	20.94	19.36	20.16	20.94	19.36	20.16	20.94
PaO ₂ /O ₂	[mmHg]	1428.57	1428.57	1428.57	1428.57	1428.57	1428.57	1428.57
Qs/Qt	[%]	-13.39	-2.75	-8.07	-13.39	-2.75	-8.07	-13.39

For details on the event bar, refer to the previous “EVENT BAR” section.

To return to the home screen, press the [Home] key.

To add the calculation results to the lung trend table, refer to “Adding the Calculation Result to the LUNG TREND Table” in Section 8.

Explanation of the Lung Trend Table

Label	Name	Unit
BSA	Body surface area	m ²
CI	Cardiac index	L/min/m ²
AaDO ₂	Alveolar arterial oxygen tension difference	mmHg
CaO ₂	Arterial oxygen content	mL/dL
DO ₂	Oxygen delivery	mL/min
DO ₂ I	Oxygen delivery index	mL/min/m ²
C \bar{v} O ₂	Venous oxygen content	mL/dL
avDO ₂	Arteriovenous oxygen difference	mL/dL
VO ₂	Oxygen consumption	mL/min
VO ₂ I	Oxygen consumption index	mL/min/m ²
O ₂ ER	Oxygen extraction ratio	%
PaO ₂ /O ₂	Oxygenation ratio	mmHg
Qs/Qt	Shunt fraction	%

Recording the Lung Trend Table

You can record the lung trend table of the selected time period with the optional recorder.

1. Touch the PRINT key. The PRINT window appears.

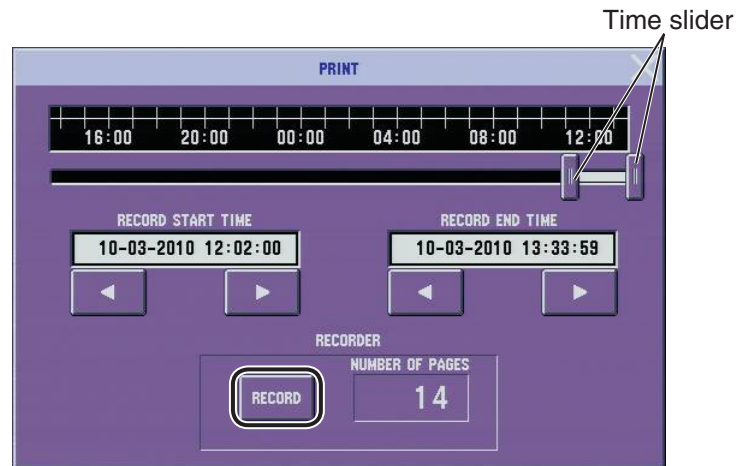

2. Set the RECORD START TIME and RECORD END TIME with the ◀ or ▶ key or time slider.

The initial RECORD START TIME and RECORD END TIME depend on the REVIEW setting on the RECORDER page of the SYSTEM SETUP window. For details, refer to “RECORDER page” in Section 3 of the Administrator’s Guide.

3. Check the number of pages and touch the RECORD key in <RECORDER> box.

To stop recording, press the [Record] key.

4. Touch the [X] key to close the window.

Recording example

CALCULATION RESULTS		DATA ENTRY	
BSA	1.81 [m ²]	HEIGHT	170.0 [cm]
CI	2.87 [L/min/m ²]	WEIGHT	70.0 [kg]
AaDO ₂	-380.07 [mmHg]	CO	5.20 [L/min]
CaO ₂	33.76 [mL/dL]	Q _z	21 [%]
DO ₂	1755.52 [mL/min]	ATM	350 [cmHg]
DO ₂ I	870.06 [mL/min/m ²]	PaCO ₂	120 [mmHg]
CvO ₂	26.96 [mL/dL]	Hb	25.0 [g/dL]
QvDO ₂	6.81 [mL/dL]	PaO ₂	300 [mmHg]
VO ₂	353.86 [mL/min]	SpO ₂	98 [%]
VO ₂ I	195.53 [mL/min/m ²]	PvO ₂	50 [mmHg]
O ₂ ER	20.16 [%]	SpO ₂	80 [%]
PaO ₂ /O ₂	1428.67 [mmHg]		
QS/QT	-8.07 [%]		

ICU-001 JOHN SMITH 2008-03-07 13:32

LUNG FUNCTION *Genesee* FQW50-3-100 K37201

Printing a Lung Trend Table

You can print the lung trend table of the selected time period with a network printer.

1. Touch the PRINT key. The PRINT window appears.

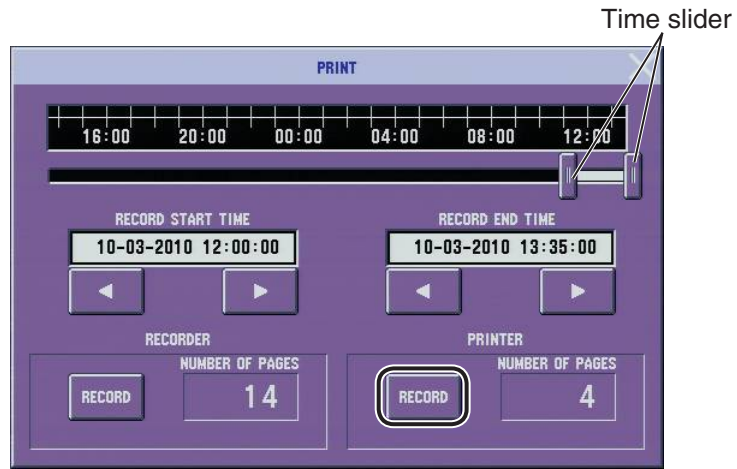

2. Set the RECORD START TIME and RECORD END TIME with the ◀ or ▶ key or time slider.

The initial RECORD START TIME and RECORD END TIME depend on the REVIEW setting on the RECORDER page of the SYSTEM SETUP window. For details, refer to “RECORDER page” in Section 3 of the Administrator’s Guide.

3. Check the number of pages and touch the RECORD key in <PRINTER> box. The “PRINTING” message appears on the screen and the table is printed.
4. Touch the [X] key to close the window.

Printing example

Bed ID	ICU-001	Name	JOHN SMITH			Gender	Not Specified			Patient ID		
DATE	14-9-2010	14-9-2010	14-9-2010	14-9-2010	14-9-2010	14-9-2010	14-9-2010	14-9-2010	14-9-2010	14-9-2010	14-9-2010	14-9-2010
TIME	8:25	8:25	8:25	8:25	8:25	8:25	8:25	8:25	8:25	8:25	8:25	8:25
BSA	(m ²)	1.69	1.69	1.69	1.69	1.69	1.69	1.69	1.69	1.69	1.69	1.69
CI	(L/min/m ²)	3.07	3.01	3.07	3.13	2.95	2.89	3.07	3.07	3.01	3.01	3.01
AaDO ₂	(mmHg)	-380.07	-380.07	-380.07	-380.07	-380.07	-380.07	-380.07	-380.07	-383.40	-383.40	-383.40
CaO ₂	(ml/dL)	33.76	33.76	33.76	33.76	33.76	33.76	33.76	33.76	33.76	33.76	34.10
DO ₂	(ml/min)	1755.52	1721.76	1755.52	1789.28	1688.00	1654.24	1755.52	1755.52	1721.76	1721.76	1738.84
DO ₂ I	(ml/minute)	1035.74	1015.82	1035.74	1055.66	995.90	975.98	1035.74	1035.74	1015.82	1015.82	1025.90
CO	(ml/dL)	32.99	32.99	32.99	32.99	32.99	32.99	32.99	32.99	32.99	32.99	32.99
avDO ₂	(ml/dL)	0.77	0.77	0.77	0.77	0.77	0.77	0.77	0.77	0.77	0.77	1.11
VO ₂	(ml/min)	40.30	39.52	40.30	41.07	38.75	37.97	40.30	40.30	39.52	39.52	56.61
VO ₂ I	(ml/minute)	23.78	23.32	23.78	24.23	22.86	22.40	23.78	23.78	23.32	23.32	33.40
O ₂ ER	(%)	2.30	2.30	2.30	2.30	2.30	2.30	2.30	2.30	2.30	2.30	3.26
PaO ₂ /O ₂	(mmHg)	1428.57	1428.57	1428.57	1428.57	1428.57	1428.57	1428.57	1428.57	1500.00	1500.00	1500.00
QS/Qt	(%)	-190.50	-190.50	-190.50	-190.50	-190.50	-190.50	-190.50	-190.50	-202.19	-202.19	-332.82

Arrhythmia Recall Window

General

An ECG waveform of 4 seconds before and 4 seconds after the arrhythmia detection is saved as an arrhythmia recall file. Up to 8,192 files can be created. When more than 8,192 files are created, the oldest file is automatically deleted.

With the optional QM-601P memory card, data of up to 16,384 files can be saved.

To create arrhythmia recall files:

- <ARRHYTHMIA ANALYSIS> on the ECG window must be set to ON. Refer to “Monitoring Arrhythmia” in User’s Guide Part II, Section 1.
- The type of arrhythmias you want to save as files must be selected on the ARRHYTHMIA EVENT SETUP window. Refer to “Selecting the Arrhythmia Types to be Saved as a Recall File” section.

NOTE

- When <DATA TRANSPORT USING INPUT UNIT> is set to DISABLE, and <SHOW ADMIT CONFIRMATION WINDOW> is turned off in the SYSTEM CONFIGURATION screen, the stored data remains in memory for about 30 minutes after the power is turned off. After 30 minutes, the stored data is lost. When <DATA TRANSPORT USING INPUT UNIT> is set to ENABLE, the patient data and settings are always stored.
- Do not disconnect the power cord while the monitor power is on. Data may be lost.

The Arrhythmia Recall window displays the recall files. Up to 8 files can be displayed on one page. The actual size arrhythmia waveform can be displayed by touching a recall file.

Arrhythmia List

The arrhythmias are listed in the priority of highest to lowest. When several arrhythmias occur at the same time, only the arrhythmia of the highest priority is saved as the recall file.

Arrhythmia Name	Description
ASYSTOLE	Longer than 3 to 10 seconds (selectable) with no QRS complex.
VF	Ventricular fibrillation longer than 4 seconds.
VT	Ventricular tachycardia. 3 to 9 (selectable) or more consecutive VPCs when heart rate exceeding the VT heart rate limit (16 to 300 beats/min selectable).
EXT TACHY*1	Extreme tachycardia exceeding the EXTREME TACHY limit.
EXT BRADY*1	Extreme bradycardia dropping below the EXTREME BRADY limit.

Arrhythmia Name	Description
V BRADY* ¹	Ventricular bradycardia. 3 or more consecutive VPCs when heart rate drops below the V BRADY heart rate limit (15 to 299 beats/min selectable).
VPC RUN	VPC short run. 3 to 8 (selectable) consecutive VPCs when heart rate exceeds the VPC RUN heart rate limit (16 to 300 beats/min selectable* ²). or The selected number* ² of consecutive VPCs when heart rate drops below the VT heart rate limit.
SV TACHY* ¹	Supraventricular tachycardia. 3 to 9 (selectable) or more consecutive normal QRS of regular R-R interval when heart rate exceeding the SV TACHY heart rate limit (16 to 300 beats/min selectable).
TACHYCARDIA	Heart rate above the upper heart rate limit.
BRADYCARDIA	Heart rate below the lower heart rate limit.
PAUSE* ¹	1 to 3 seconds (selectable) with no QRS.
V RHYTHM* ¹	Ventricular rhythm. 3 or more consecutive VPCs.
COUPLET	VPC couplet (paired VPCs). 2 consecutive VPCs.
EARLY VPC	Early VPC including R-on-T type. VPC with a time interval from the preceding normal QRS complex of less than approximately one-third of the normal R-R interval, at heart rate dropping below 120* ³ beats/min.
MULTIFORM* ¹	Two different shaped VPCs within the last 3 minutes.
BIGEMINY	Ventricular bigeminy. 3 or more consecutive pairs of VPC and normal QRS. A dominant rhythm of N-V-N-V-N-V (N = normal beat, V = ventricular beat)
TRIGEMINY* ¹	Ventricular trigeminy. A dominant rhythm of N-N-V-N-N-V.
FREQ VPC	Frequent VPCs. VPC rate (VPCs/min) reaching or exceeding the preset limit of 1 to 99 VPCs/min (selectable).
VPC	Ventricular premature contraction.
AF* ⁴	Atrial fibrillation longer than 2 minutes.
IRREGULAR RR* ¹	Consistently irregular R-R intervals.
PROLONGED RR* ¹	R-R interval 1.75 times longer than the dominant R-R interval.
NO PACER PULSE* ¹ * ⁵	No QRS and pacing pulse within the bradycardia limit. Oversensing.
PACER NON-CAPTURE* ¹ * ⁵	No QRS from the preceding pacing pulse for the preset time interval (40 to 480 ms selectable). Non-capture.

*¹ These arrhythmias become available when “EXTENDED” is selected for <ARRHYTHMIA TYPE> on the SYSTEM SETUP screen.

*² This number is set in the VT alarm setting.

*³ 120 beats/min when <QRS DETECTION TYPE> is set to ADULT, 150 beats/min when <QRS DETECTION TYPE> is set to CHILD or NEONATE.

*⁴ Not available for BSM-6000K series. Available only when <ARRHYTHMIA TYPE> on the ECG page of the SYSTEM SETUP window is set to EXTENDED, and <AF DETECTION> on the ECG page of the SYSTEM SETUP window is set to On. For the SYSTEM SETUP window settings, refer to the Administrator’s Guide.

*⁵ Available only when DETECT in the <PACING> box is set to ON.

Displaying the Arrhythmia Recall Window

1. Press the [Menu] key to display the MENU window.

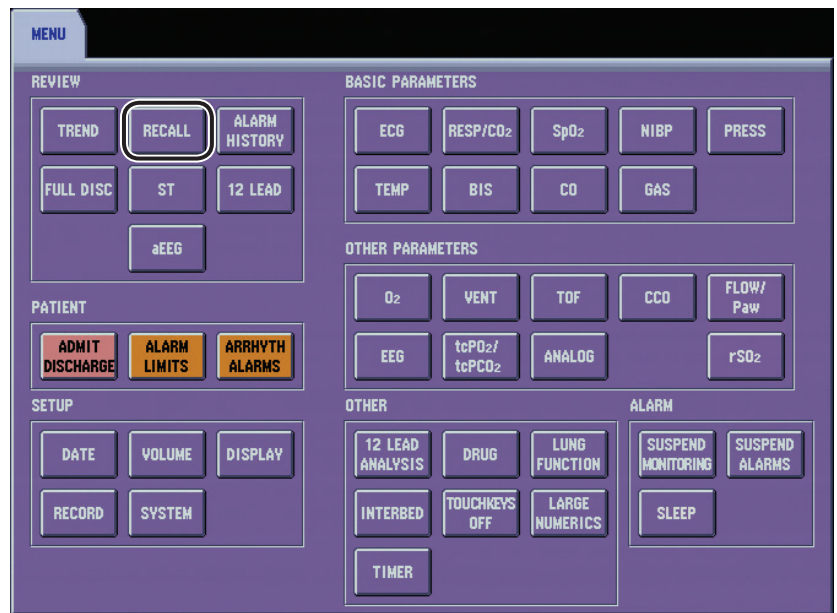

2. Touch the RECALL key to display the Arrhythmia Recall window.

When RECALL is assigned to one of the function keys at the upper left of the screen or one of the function keys on the remote control keys, the ARRHYTHM HISTORY page can be displayed by touching the RECALL function key. Refer to “KEYS Window” in Administrator’s Guide, Section 3 to assign a function to the function key.

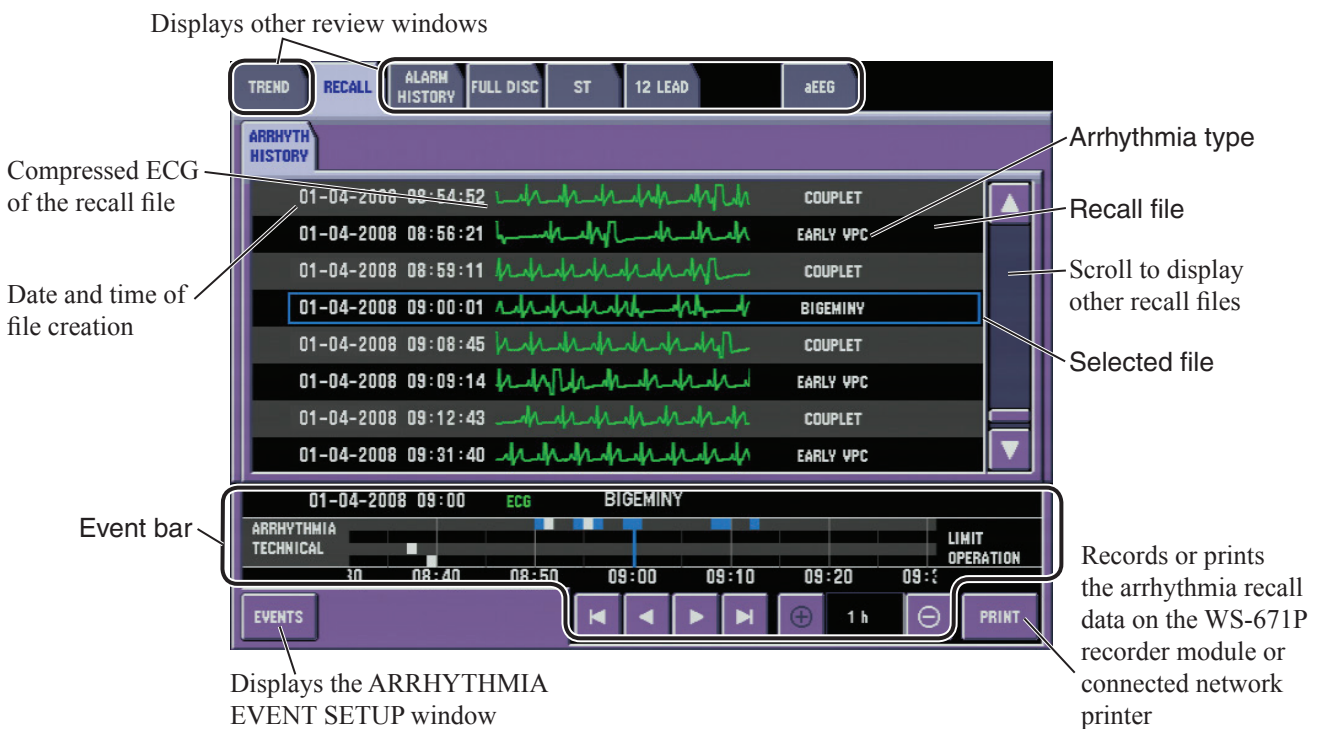

When there is no recall file, the “NO DATA” message is displayed.

For details on the event bar, refer to the previous “EVENT BAR” section.

To return to the home screen, press the [Home] key.

Selecting the Arrhythmia Types to be Saved as a Recall File

Select the arrhythmia types to create files for. You can select individual arrhythmia types separately or select all arrhythmia types together.

There are two patterns of arrhythmia analysis, EXTENDED or STANDARD. Select the arrhythmia type in the SYSTEM SETUP window. Refer to Administrator's Guide, Section 3.

1. Touch the EVENTS key on the ARRHYTHM HISTORY page. ARRHYTHMIA EVENT SETUP window appears.



Selected arrhythmia type is highlighted

When ARRHYTHMIA TYPE is STANDARD

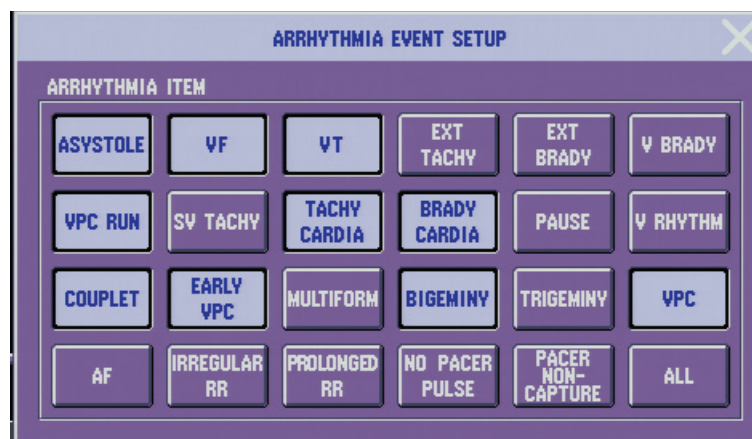

When ARRHYTHMIA TYPE is EXTENDED



AF is not available for BSM-6000K series.

2. Select the arrhythmia type individually.

To set all arrhythmia types together, touch the ALL key.

3. Touch the  key to close the window.

Scrolling the Arrhythmia Recall Files

Use the vertical scroll bar on the window to scroll the arrhythmia recall file. The arrhythmia recall file can be scrolled by touching the  or  key on the scroll bar.

Displaying the Actual Size Waveform of the Selected Arrhythmia Recall File

The ARRHYTHM HISTORY window displays the actual size ECG of the selected recall file with the ECG of one before and one after the selected file.

1. Touch the **▲** or **▼** key to select the arrhythmia recall waveform which you want to display in actual size.
2. Touch the center key. The arrhythmia waveform is displayed in the actual size.

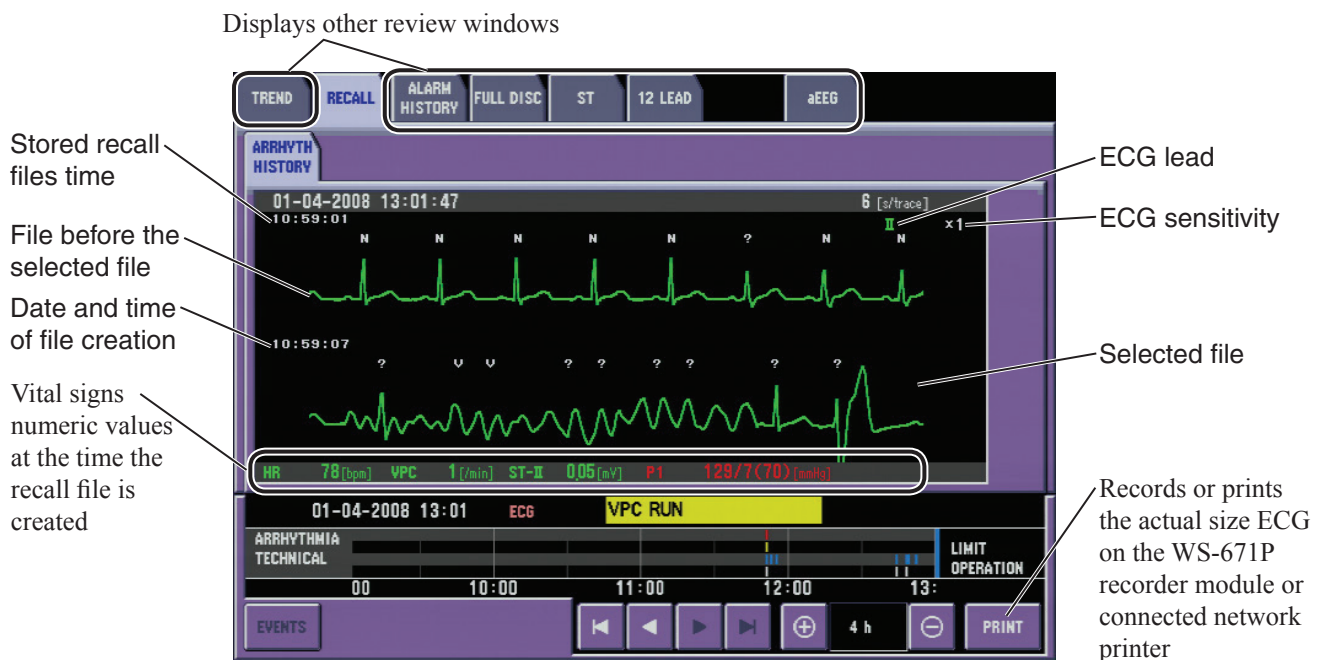

Arrhythmia Waveform Annotation

Each beat of a stored arrhythmia waveform is automatically classified and annotated as follows.

QRS Annotation	Description
N	Normal QRS complex
V	Ventricular premature contraction
P	Paced QRS
?	Impossible to classify or during learning
—	Noise

Recording or Printing the Arrhythmia Recall Waveform

The selected arrhythmia waveform can be recorded by the optional recorder or connected network printer. The recording can be performed on both the file window and waveform window.

Recording on the ARRHYTH HISTORY Window

1. Select the arrhythmia recall file you want to record.

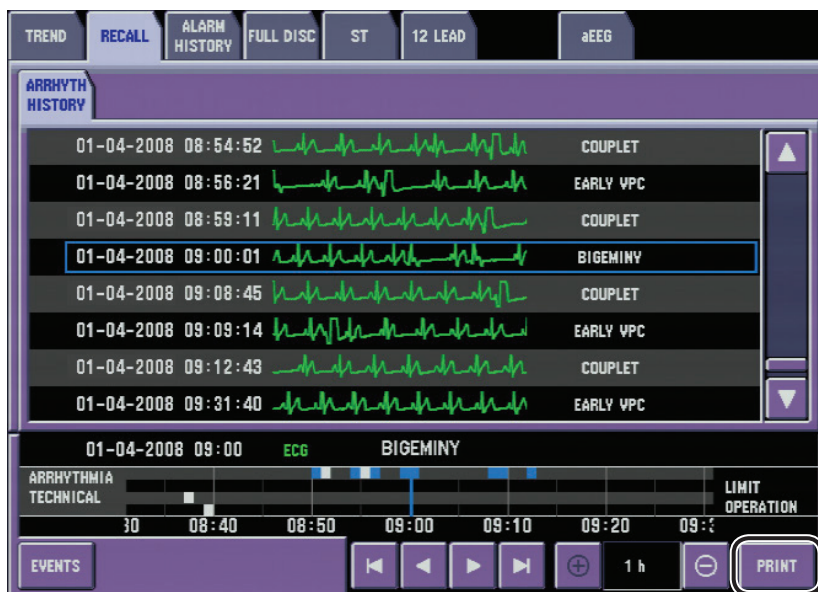

2. Touch the PRINT key. The PRINT window appears.

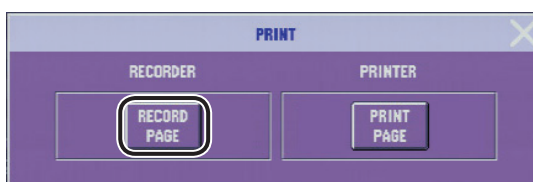

3. Touch the RECORD PAGE key in <RECORDER> box. Recording starts.

To stop recording, press the [Record] key.

4. Touch the [Close] key to close the window.

The arrhythmia waveform is recorded as displayed on the ARRHYTH HISTORY page.

Recording example



Printing on the ARRHYTHM HISTORY Window

1. Select the arrhythmia recall waveform you want to print.

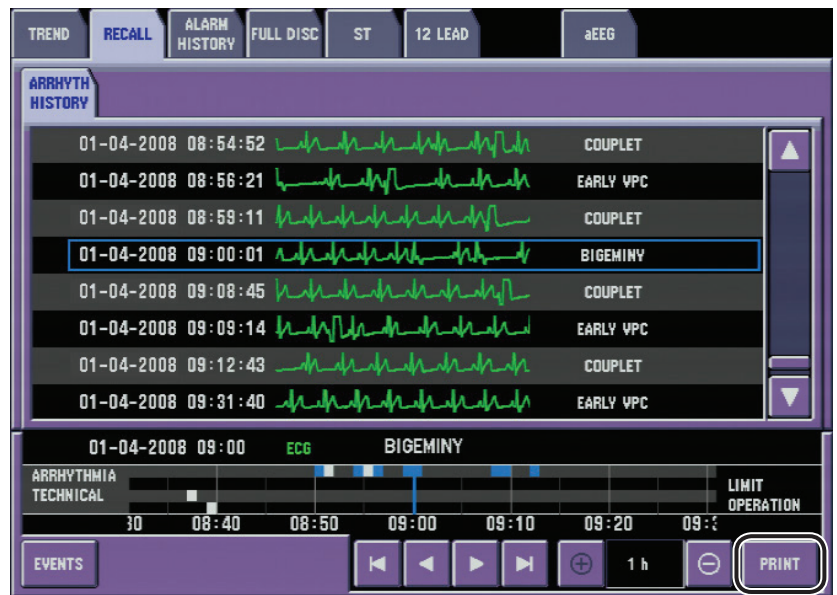

2. Touch the PRINT key. The PRINT window appears.

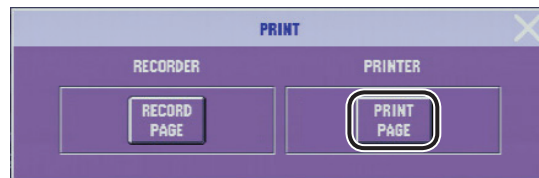

3. Touch the PRINT PAGE key in <PRINTER> box. Printing starts.
4. Touch the key to close the window.

The arrhythmia waveform is printed as displayed on the ARRHYTHM HISTORY page.

Printing example

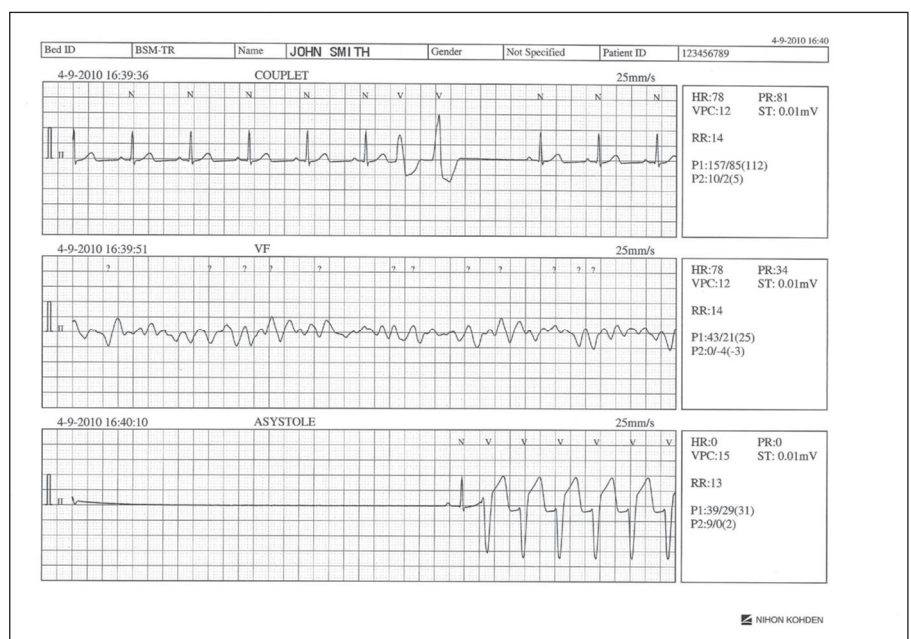

Recording on the Actual Size ECG Waveform Window

1. Select the arrhythmia recall waveform you want to record.

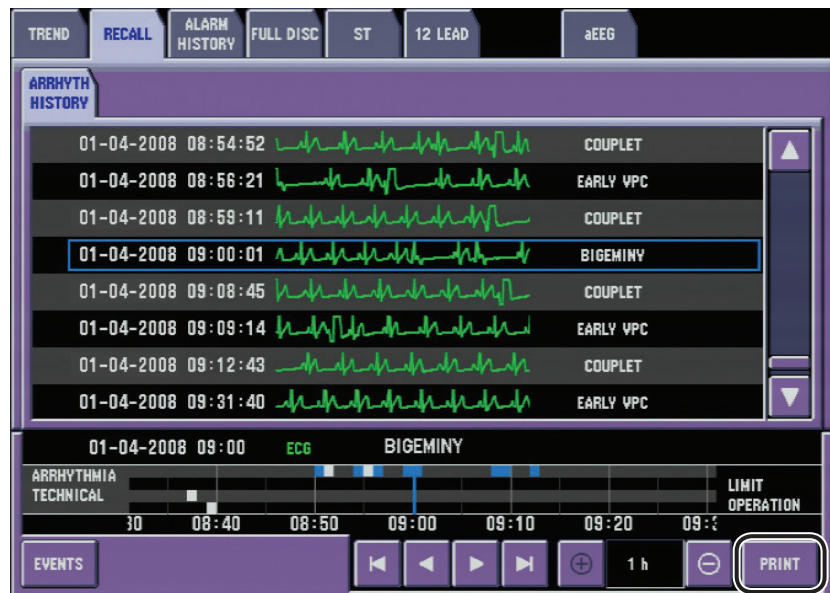

2. Touch the PRINT key. The window opens.

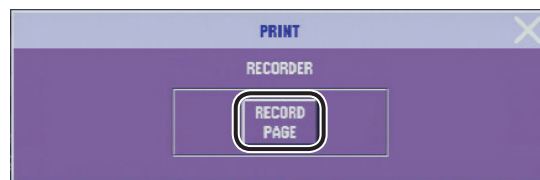

3. Touch the RECORD PAGE key. Recording starts.

To stop recording the table, press the  [Record] key.

4. Touch the  key to close the window.

The 12 seconds of arrhythmia waveforms can be recorded.

Printing on the Actual Size ECG Waveform Window

1. Select the arrhythmia recall waveform you want to record.

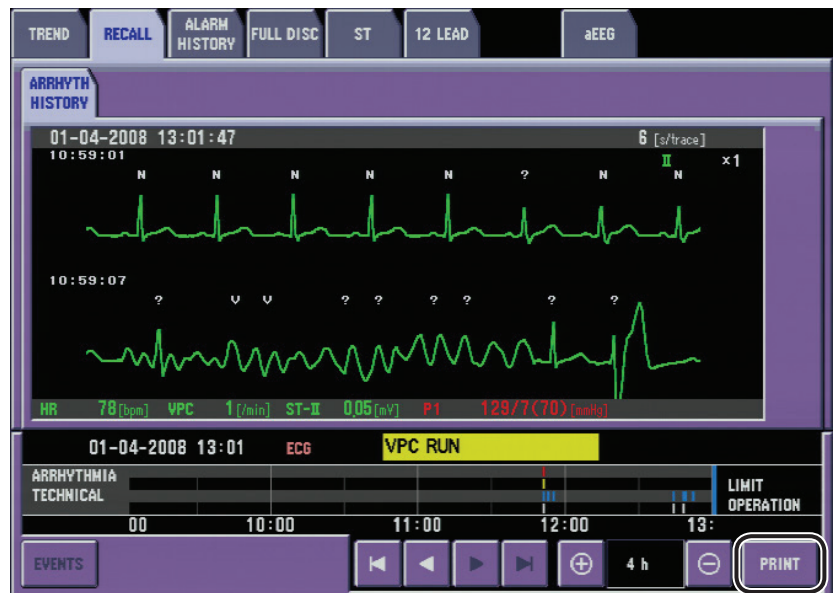

2. Touch the PRINT key. The PRINT window opens.

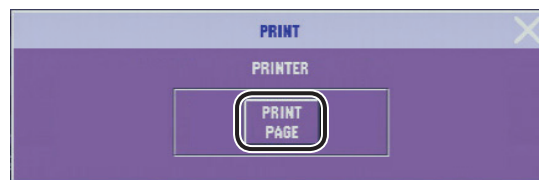

3. Select the PRINT PAGE key. Printing starts.
4. Touch the  key to close the window.

The 8 seconds of selected arrhythmia waveform and the previous and the next waveforms are printed.

Alarm History Window

Alarm data can be listed on the ALARM HISTORY window. Up to 8,192 files can be saved and up to 8 data can be displayed on the ALARM HISTORY window. The alarm history is created anytime when an alarm occurs.

With the optional QM-601P memory card, data of up to 16,384 files can be saved.

When the FULL DISC window is displayed from the ALARM HISTORY window, the waveforms of the selected alarm file on the ALARM HISTORY window can be displayed.

The alarm history file displayed on the ALARM HISTORY window can be recorded on the optional recorder or printed on the network printer.

NOTE

- When <DATA TRANSPORT USING INPUT UNIT> is set to DISABLE, and <SHOW ADMIT CONFIRMATION WINDOW> is turned off in the SYSTEM CONFIGURATION screen, the stored data remains in memory for about 30 minutes after the power is turned off. After 30 minutes, the stored data is lost. When <DATA TRANSPORT USING INPUT UNIT> is set to ENABLE, the patient data and settings are always stored.
- Do not disconnect the power cord while the monitor power is on. Data may be lost.

Displaying the ALARM HISTORY Window

1. Press the [Menu] key to display the MENU window.

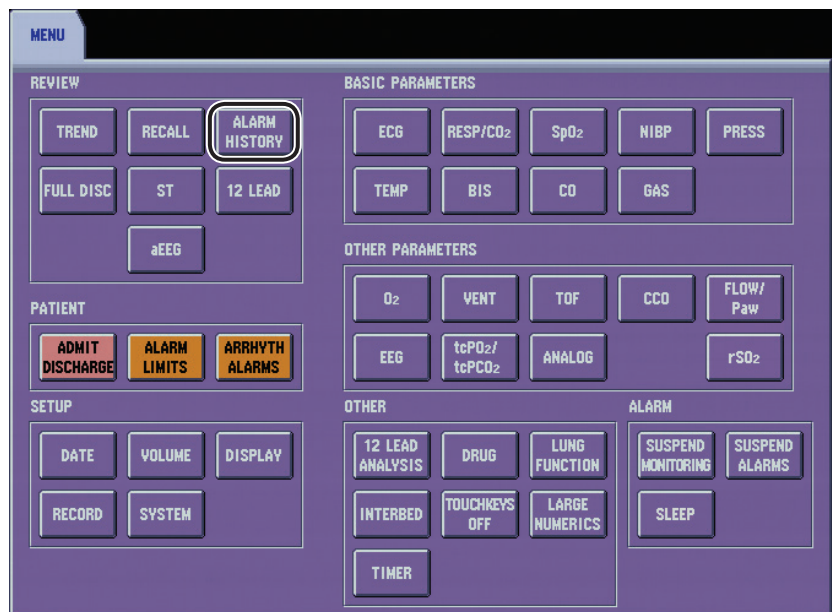

2. Touch the ALARM HISTORY key to display the ALARM HISTORY window.

When ALARM HISTORY is assigned to one of the function keys at the upper left of the screen or one of the function keys on the remote control keys, the ALARM HISTORY window can be displayed by touching the ALARM HISTORY function key. Refer to “KEYS Window” in Administrator’s Guide, Section 3 to assign a function to the function key.

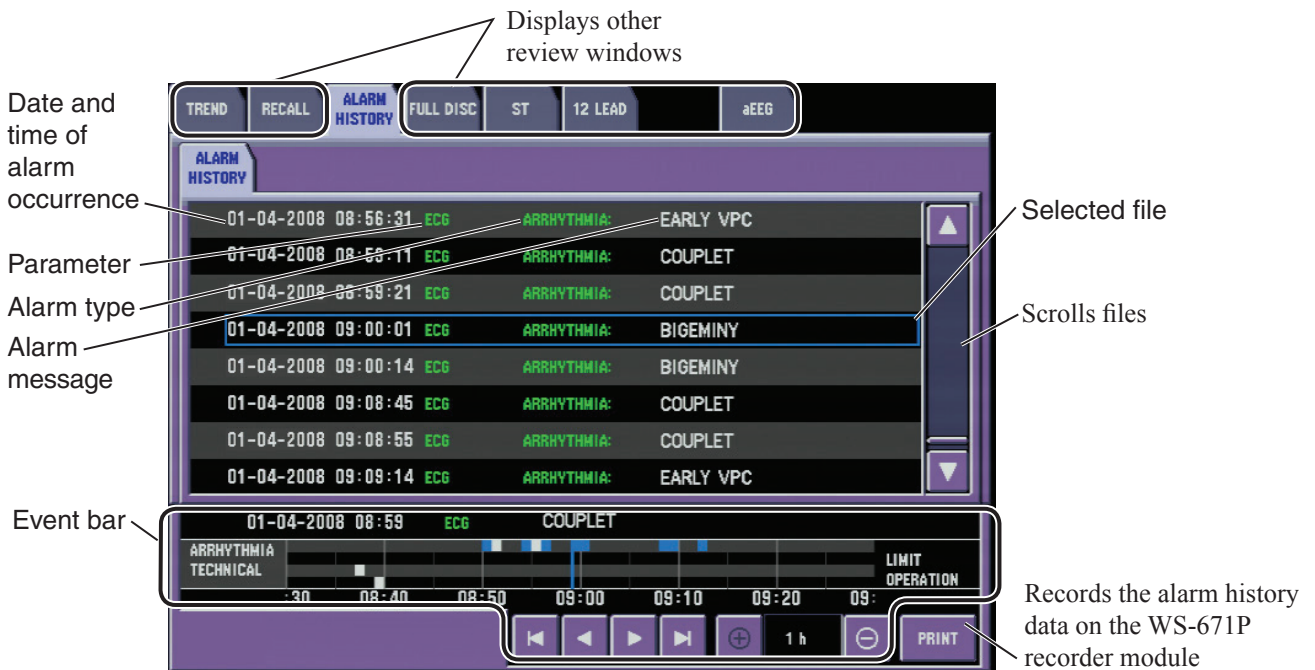

For details on the event bar, refer to the previous “EVENT BAR” section.

To return to the home screen, press the [Home] key.

Scrolling the Alarm History Files

Use the vertical scroll bar on the window to scroll the alarm history file. The alarm history file can be scrolled by touching the ▲ or ▼ key on the scroll bar.

Recording the Alarm History File

You can record the alarm history file of the selected time period with the optional recorder.

1. Touch the PRINT key. The PRINT window appears.

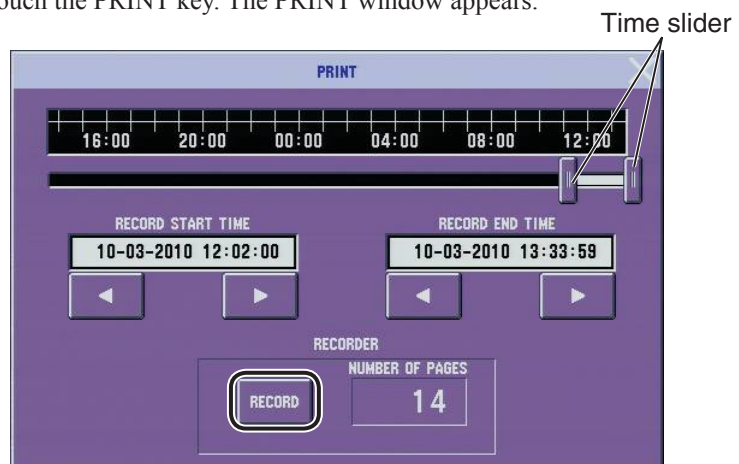

6. REVIEW WINDOWS

2. Set the RECORD START TIME and RECORD END TIME with the  or  key or time slider.

The initial RECORD START TIME and RECORD END TIME depend on the REVIEW setting on the RECORDER page of the SYSTEM SETUP window. For details, refer to “RECORDER page” in Section 3 of the Administrator’s Guide.

3. Check the number of pages and touch the RECORD key in <RECORDER> box.

To stop recording, press the  [Record] key.

4. Touch the  key to close the window.

Recording example

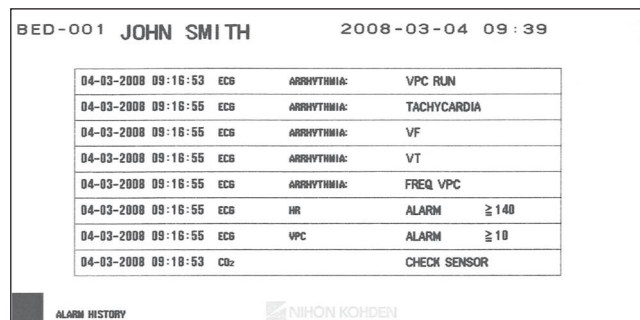

BED-001 JOHN SMITH		2008-03-04 09:39	
04-03-2008 09:16:53	ECG	ARRHYTHMIA:	VPC RUN
04-03-2008 09:16:55	ECG	ARRHYTHMIA:	TACHYCARDIA
04-03-2008 09:16:55	ECG	ARRHYTHMIA:	VF
04-03-2008 09:16:55	ECG	ARRHYTHMIA:	VT
04-03-2008 09:16:55	ECG	ARRHYTHMIA:	FREQ VPC
04-03-2008 09:16:55	ECG	HR	ALARM ≥ 140
04-03-2008 09:16:55	ECG	VPC	ALARM ≥ 10
04-03-2008 09:18:53	CO ₂		CHECK SENSOR

ALARM HISTORY 

Full Disclosure Window

ECG and up to 4 other parameter full disclosure of 24 hours can be saved. With the optional QM-601P memory card, data of past 72 hours can be saved. The full disclosure waveforms can be reviewed, scrolled and recorded, in either compressed or expanded form.

NOTE

- When <DATA TRANSPORT USING INPUT UNIT> is set to DISABLE, and <SHOW ADMIT CONFIRMATION WINDOW> is turned off in the SYSTEM CONFIGURATION screen, the stored data remains in memory for about 30 minutes after the power is turned off. After 30 minutes, the stored data is lost. When <DATA TRANSPORT USING INPUT UNIT> is set to ENABLE, the patient data and settings are always stored.
- Do not disconnect the power cord while the monitor power is on. Data may be lost.
- When using a transport function, select the same parameters for the waveforms to be saved on both the source monitor and the destination monitor to display data on the full disclosure window.

The FULL DISC window displays one minute full disclosure waveform on each line. The 12 second actual size waveform selected by the cursor on the full disclosure is displayed on the actual size ECG window.

Displaying the FULL DISC Window

1. Press the [Menu] key to display the MENU window.

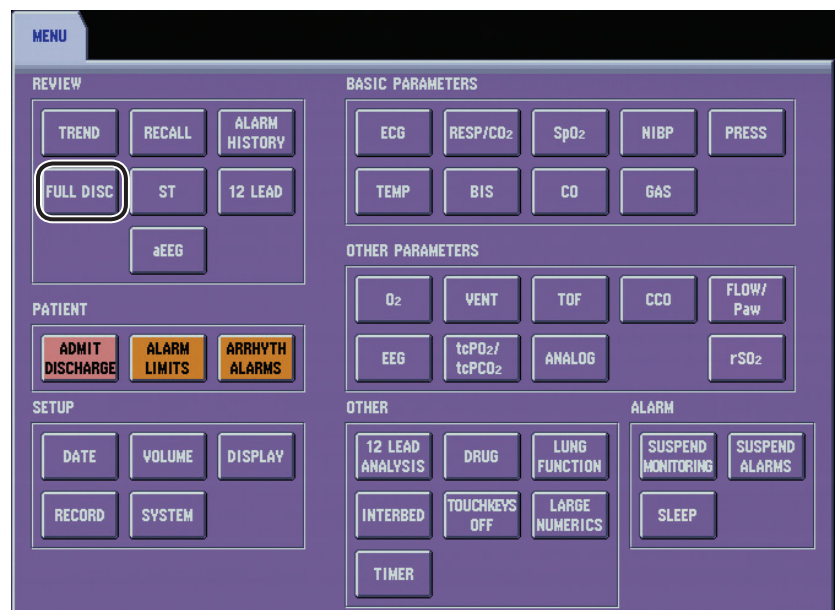

2. Touch the FULL DISC key to display the FULL DISC window.

6. REVIEW WINDOWS

When FULL DISC is assigned to one of the function keys at the upper left of the screen or one of the function keys on the remote control keys, the FULL DISC page can be displayed by touching the FULL DISC function key.

Refer to “KEYS Window” in Administrator’s Guide, Section 3 to assign a function to the function key.

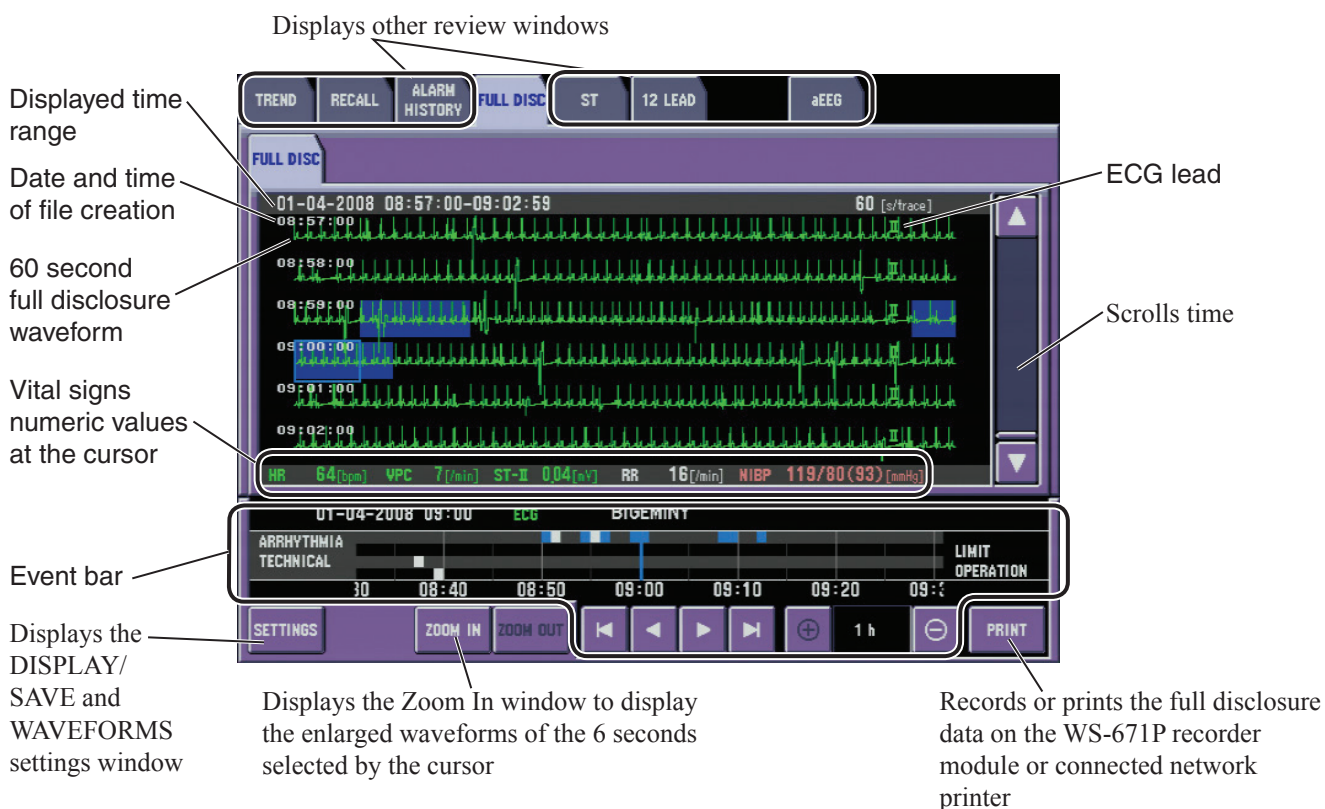

For details on the event bar, refer to the previous “EVENT BAR” section.

To return to the home screen, press the [Home] key.

NOTE

It may take some time for the data to be displayed.

When there is no full disclosure waveform, the “NO DATA” message is displayed.

The full disclosure is refreshed every minute.

When the FULL DISC window is called up from the ARRHYTHM RECALL window, the full disclosure is displayed with the time of the ARRHYTHM RECALL window.

When the FULL DISC window is called up from the ALARM HISTORY window, the full disclosure is displayed with the time of the file selected on the ALARM HISTORY window.

To display the enlarged waveform of the compressed waveform, touch the part on the FULL DISC window where you want to see the enlarged waveform and touch the ZOOM IN key. To return to the compressed waveform window, press the ZOOM OUT key.

Touch the waveforms to display the 6 seconds of enlarged waveforms. Touch again to restore the previous display.

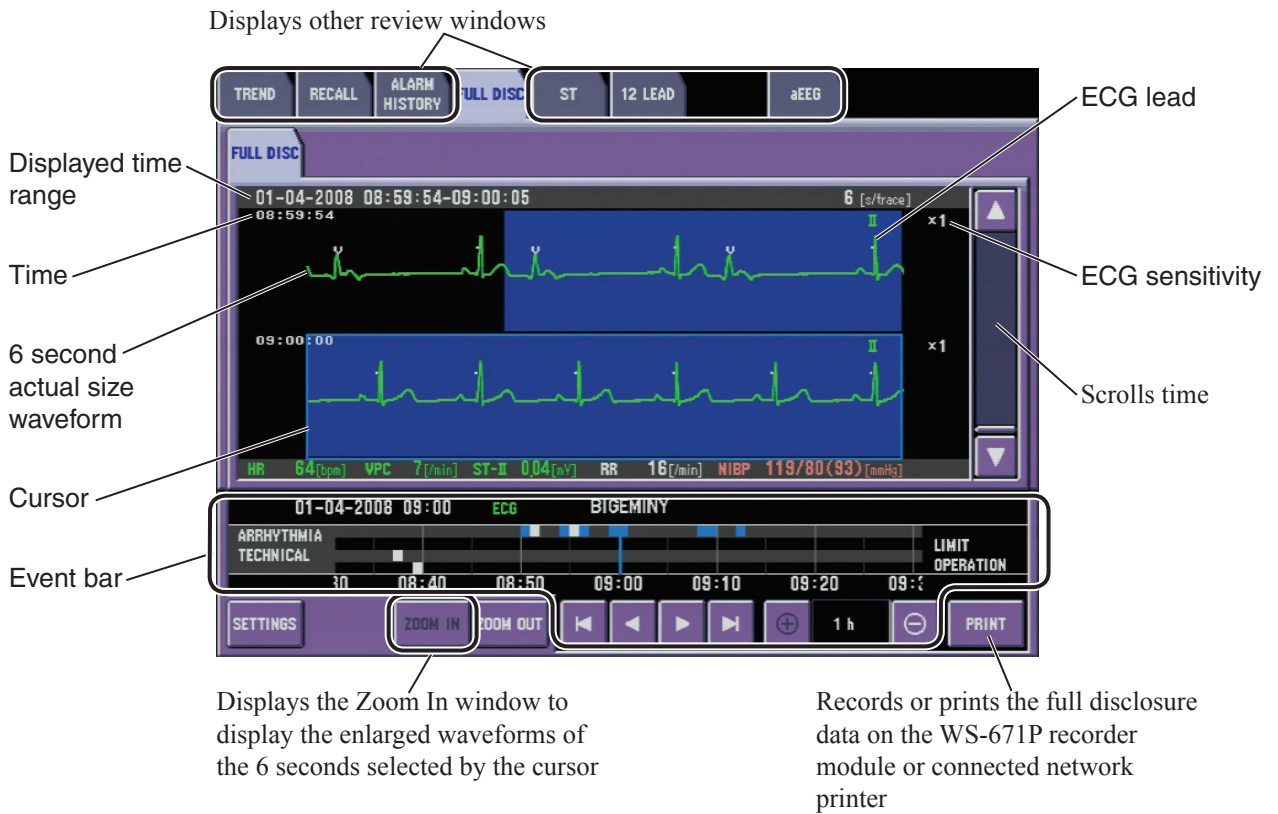

Scrolling the Full Disclosure Waveform

Use the vertical scroll bar on the window to scroll the full disclosure waveform. The full disclosure waveform can be scrolled by touching the ▲ or ▼ key on the scroll bar. The cursor can also be dragged with your finger.

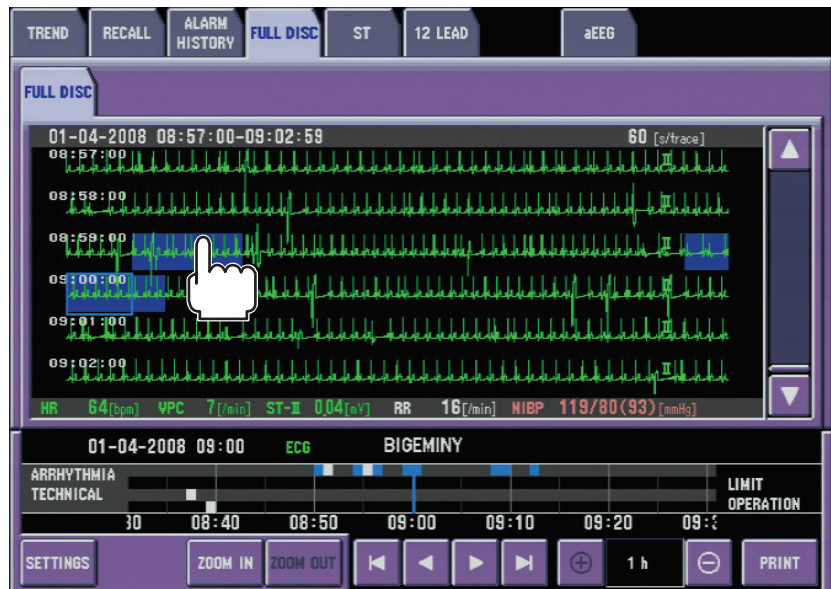

Selecting the Parameters to be Saved for Full Disclosure

ECG and up to 4 other parameters can be saved for the full disclosure. You can select the parameters to be displayed on the FULL DISC window from the saving parameters.

NOTE

- When the saved parameters are changed, the data for the parameter which is no longer saved is deleted.
- The IBP parameters must be correctly labeled. Otherwise, the IBP waveform may distort.
- This setting is independent from the setting on the central monitor or network server. Even when a parameter is selected to be saved on the bedside monitor, that parameter must also be selected to be saved on the central monitor/server. Otherwise the full disclosure for that parameter cannot be displayed on the central monitor.

1. Touch the SETTINGS key to display the SETTINGS window.

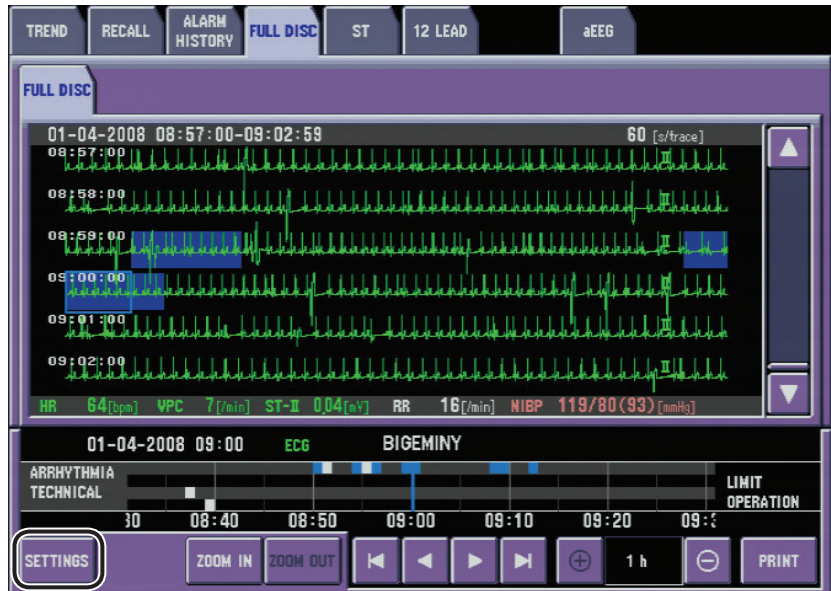

2. Touch the WAVEFORMS tab. The WAVEFORM window appears.
3. Select the parameters you want to save the full disclosure data for.

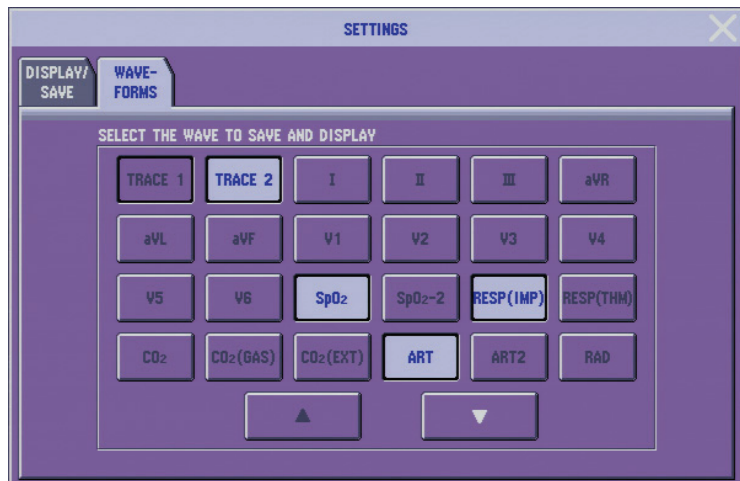

- To select the parameters to be displayed on the FULL DISC window, touch the DISPLAY/SAVE tab.

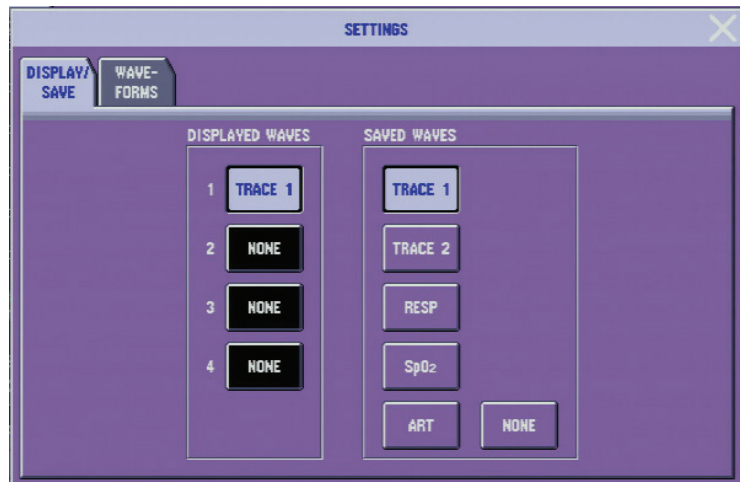

- Select the position from <DISPLAYED WAVES> box and select the parameter to save from <SAVED WAVES> box. Use the NONE key to unselect the parameter.
- Repeat step 4 to select other parameters.
- Touch the  key to close the window.

Recording or Printing the Full Disclosure Waveform

The displayed or saved full disclosure waveform can be recorded on the optional recorder and connected network printer.

Recording the Full Disclosure Waveform

- Display the full disclosure waveform you want to record.

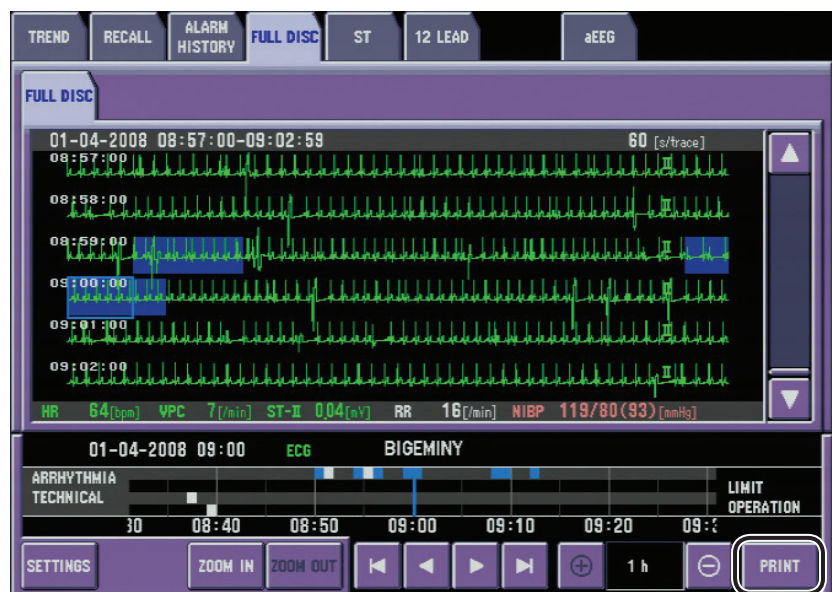

6. REVIEW WINDOWS

2. Touch the PRINT key. The PRINT window appears.



3. Touch the RECORD PAGE key in <RECORDER> box. Recording starts.

To stop recording, press the [Record] key.

4. Touch the [Close] key to close the window.

Recording example

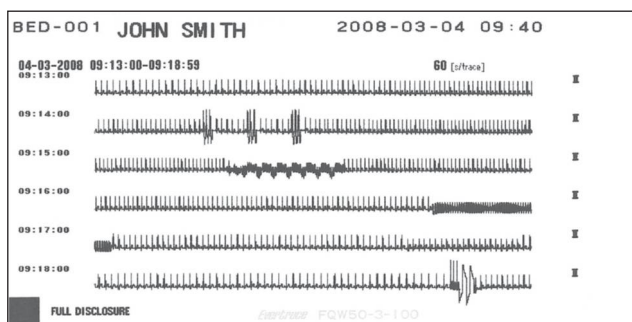

Printing the Full Disclosure Waveform

1. Display the full disclosure waveform you want to print.

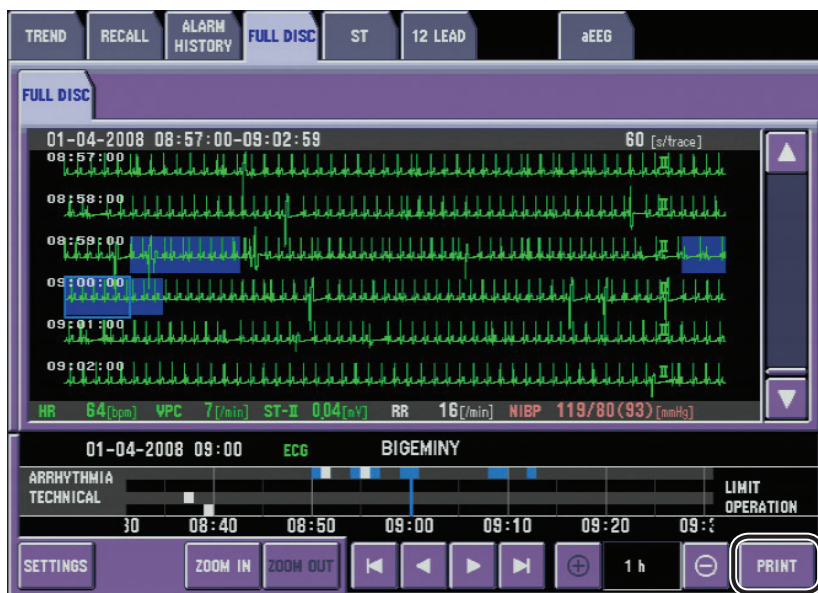

2. Touch the PRINT key. The PRINT window appears.

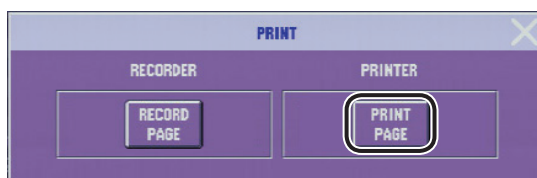

3. Touch the PRINT PAGE key in <PRINTER> box.

4. Touch the  key to close the window.

Printing example

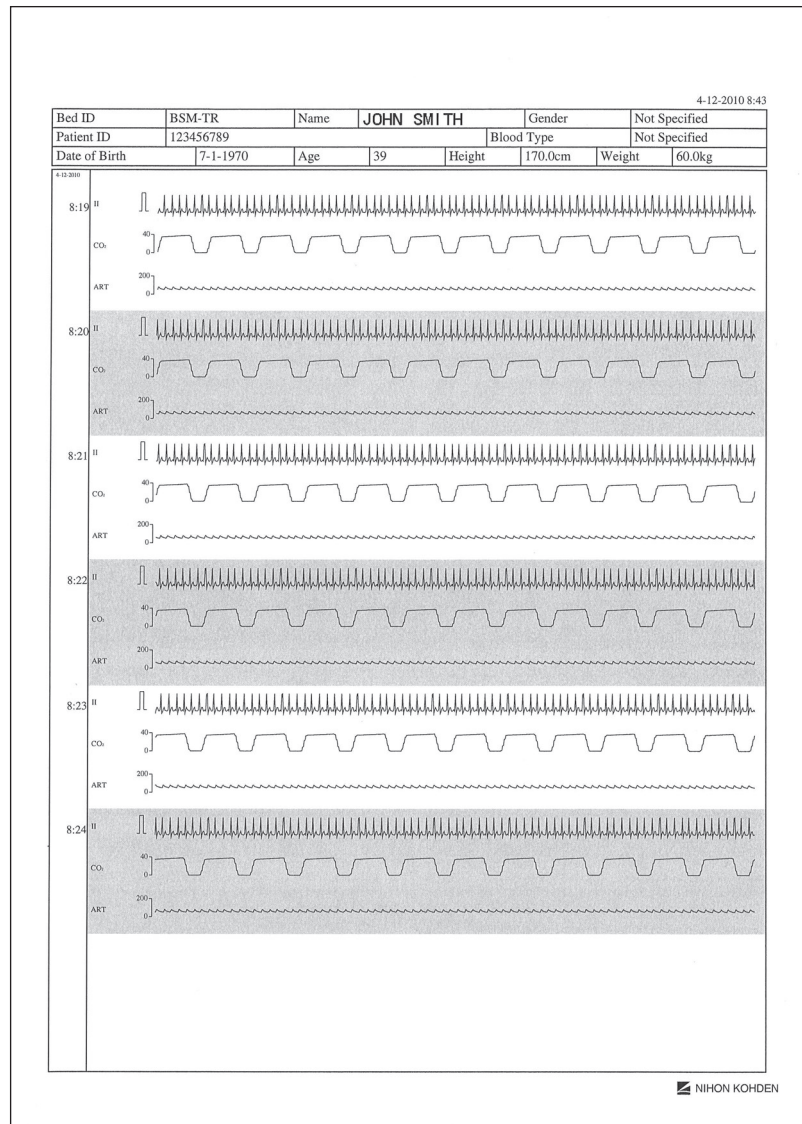

Recording or Printing the Enlarged ECG Waveform

The displayed enlarged waveform can be recorded or printed on the optional recorder or connected network printer.

Recording the Enlarged ECG Waveform

1. Display the enlarged waveform you want to record by touching the ZOOM IN key.

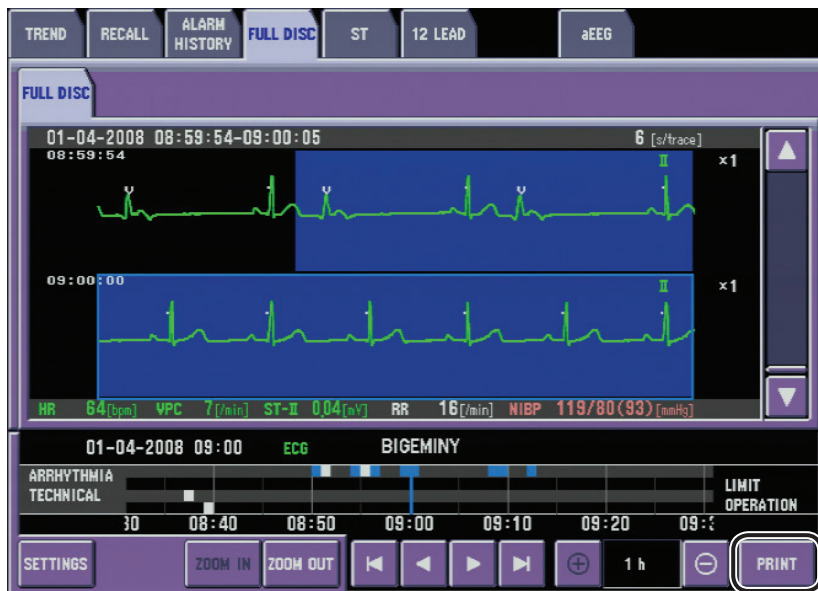

2. Touch the PRINT key. The PRINT window appears.

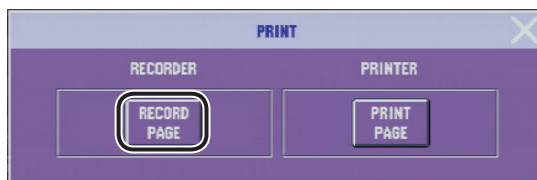

3. Touch the RECORD PAGE key in <RECORDER> box. Recording starts.

To stop recording, press the  [Record] key.

4. Touch the  key to close the window.

Recording example

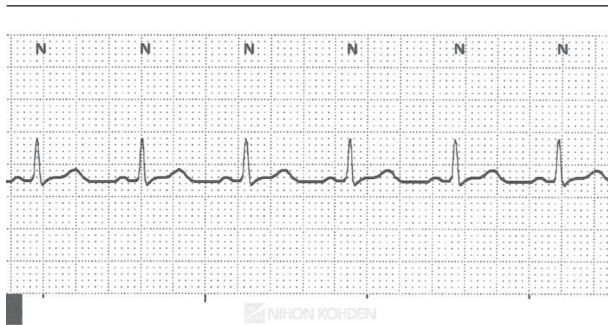
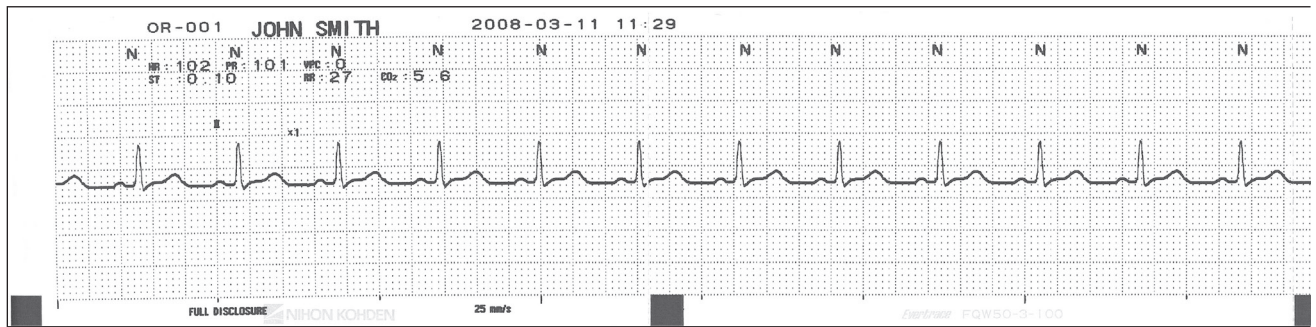

6

Printing the Enlarged ECG Waveform

1. Display the enlarged waveform you want to print by touching the ZOOM IN key.

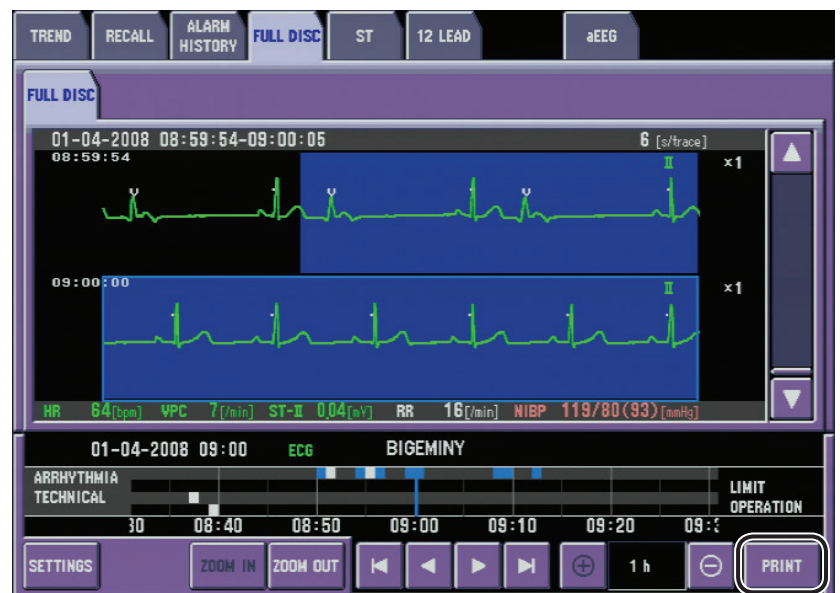

2. Touch the PRINT key. The PRINT window appears.

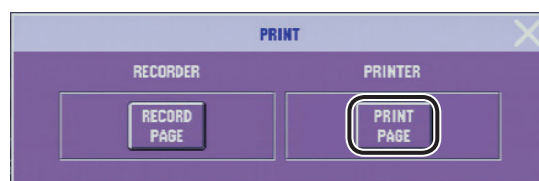

3. Touch the PRINT PAGE key in <PRINTER> box. Printing starts.
4. Touch the  key to close the window.

Printing example

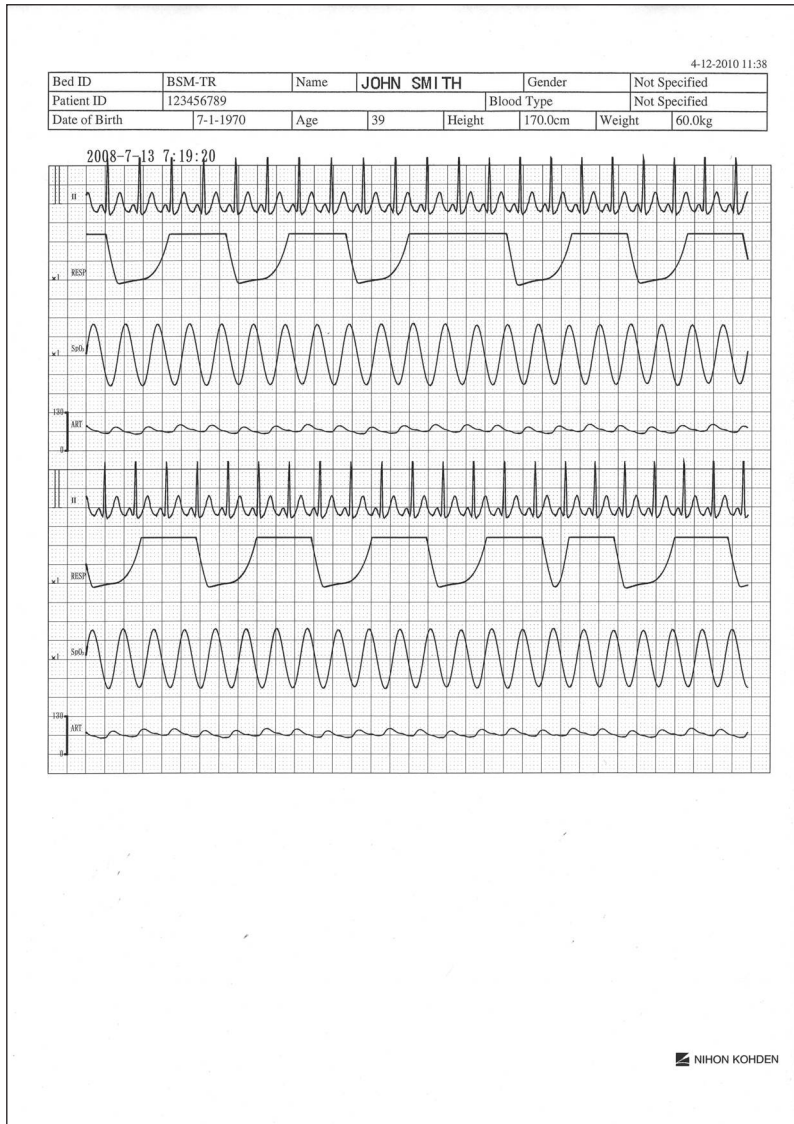

ST Level Recall Window

The ST recall waveform and ST level of all monitoring ECG leads for up to 24 hours can be saved. With the optional QM-601P memory card, data of past 72 hours can be saved.

The ST recall window displays 3 files of ST level recall waveforms.

The ST level recall can be printed when the monitor is connected to a network printer.

The ST level alarm limits can be set on the ST ALARM page of the ECG window. Refer to “Changing the ST Alarm Limits” in User’s Guide Part II, Section 1. You can set all alarms, including the ST of all leads alarm limits, on the ALARM LIMITS window. Refer to Section 5 in this manual.

The ST level unit (mV or mm) can be set on the SYSTEM CONFIGURATION screen. Refer to “UNITS Window” in Administrator’s Guide, Section 2.

NOTE

- The ST window is not available when the patient type is neonate and <NEONATE ST MEASUREMENT> on the PARAMETERS window of the SYSTEM SETUP window is set to OFF.
- Although the ST algorithm has been tested for accuracy of the ST analysis result, the significance of the ST level changes need to be determined only by a physician.
- When <DATA TRANSPORT USING INPUT UNIT> is set to DISABLE, and <SHOW ADMIT CONFIRMATION WINDOW> is turned off in the SYSTEM CONFIGURATION screen, the stored data remains in memory for about 30 minutes after the power is turned off. After 30 minutes, the stored data is lost. When <DATA TRANSPORT USING INPUT UNIT> is set to ENABLE, the patient data and settings are always stored.
- Do not disconnect the power cord while the monitor power is on. Data may be lost.

Displaying the ST Window

1. Press the [Menu] key to display the MENU window.

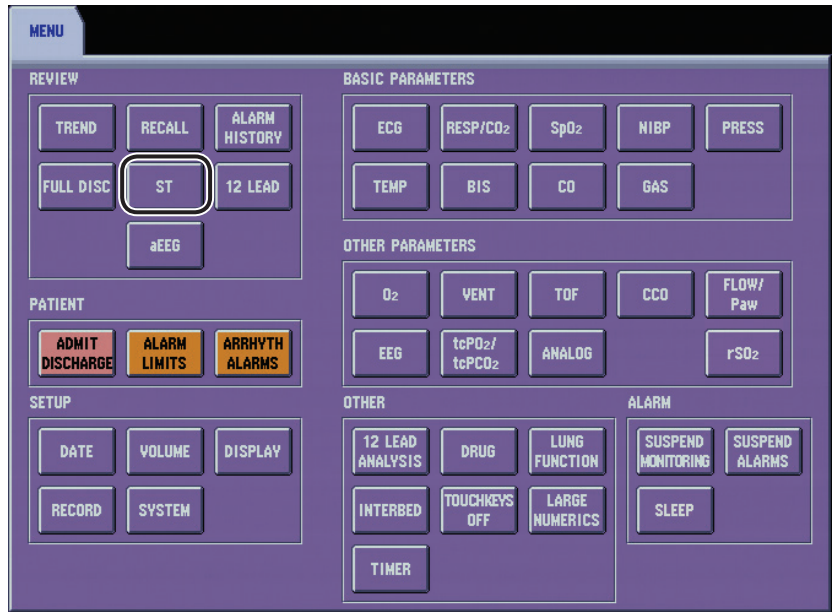

2. Touch the ST key to display the ST DISPLAY window.

When ST TREND is assigned to one of the function keys at the upper left of the screen or one of the function keys on the remote control keys, the ST INTERVAL page can be displayed by touching the ST function key. Refer to “KEYS Window” in Administrator’s Guide, Section 3 to assign a function to the function key.

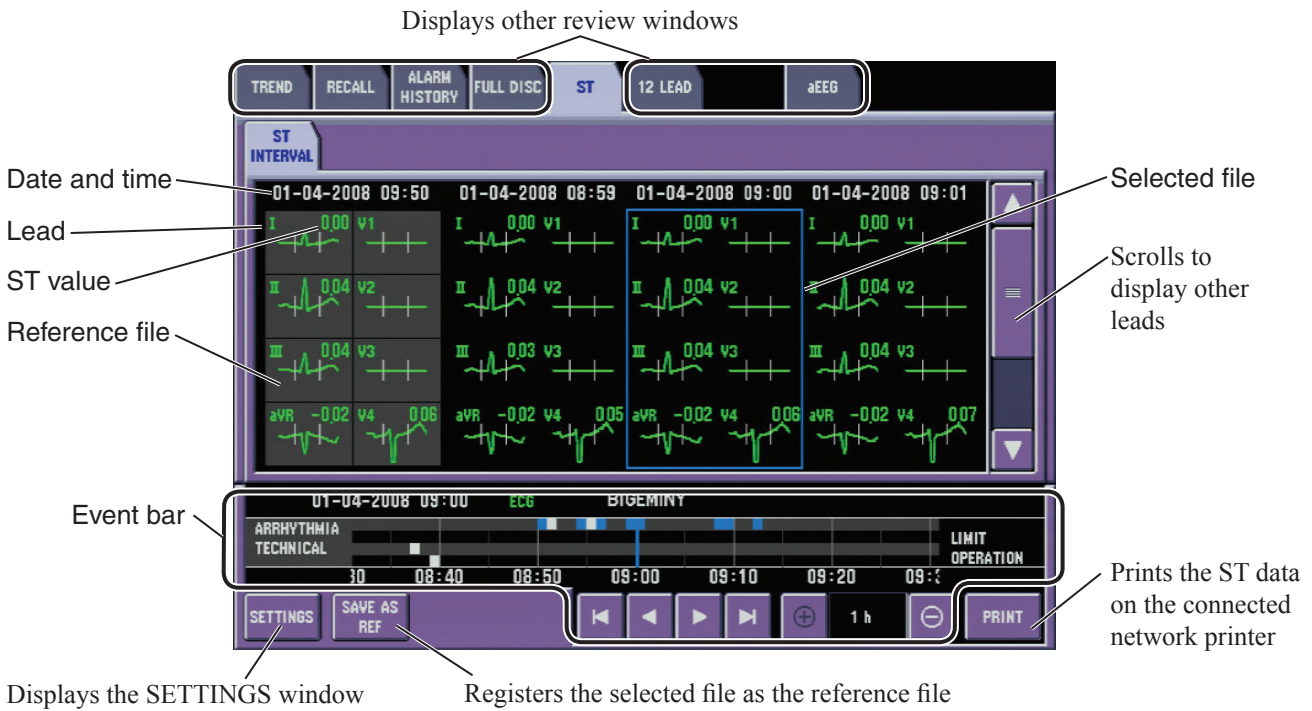

When there is no ST level recall waveforms, the “NO DATA” message is displayed.

For details on the event bar, refer to the previous “EVENT BAR” section. To return to the home screen, press the [Home] key.

Scrolling the ST Level Recall File

Use the vertical scroll bar on the window to scroll the ST level recall file.

The ST level recall file can be scrolled by touching the ▲ or ▼ key on the scroll bar.

Displaying the ST Point

When the ST point setting is set to ON, the ST point can be displayed on the ST level recall waveform.

1. Touch the SETTINGS key on the ST window to display the SETTINGS window.

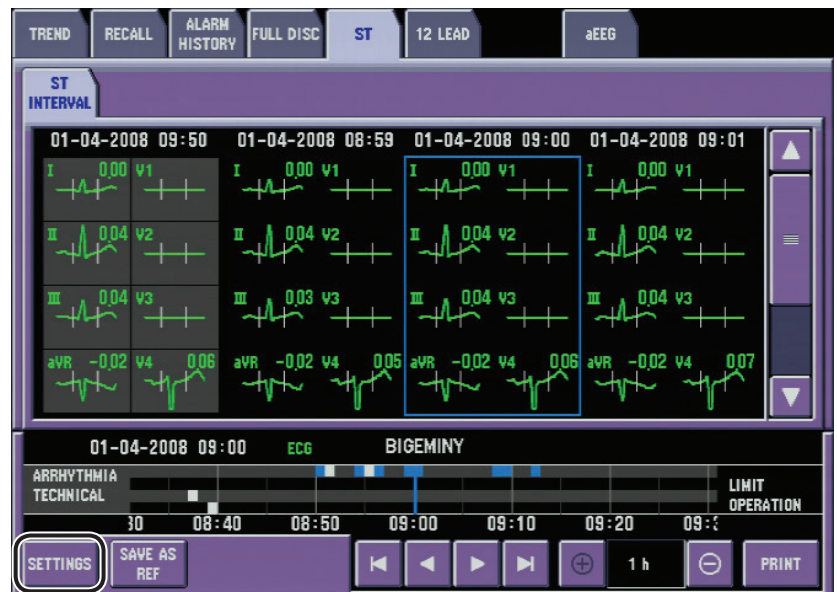

2. Touch the ON or OFF key in the <ST POINT> box to select on or off.

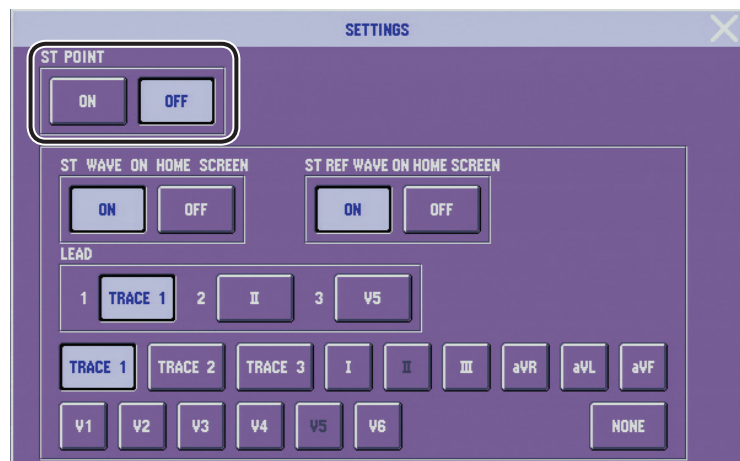

3. Touch the ✕ key to close the window.

Displaying the ST Recall Waveform on the Home Screen

The ST recall waveform and ST level of selected monitoring ECG leads are displayed on the home screen. Up to 3 waveforms can be displayed.

1. Touch the SETTINGS key on the ST window to display the SETTINGS window.



2. Touch the ON or OFF key in the <ST WAVE ON HOME SCREEN> box to select on or off.

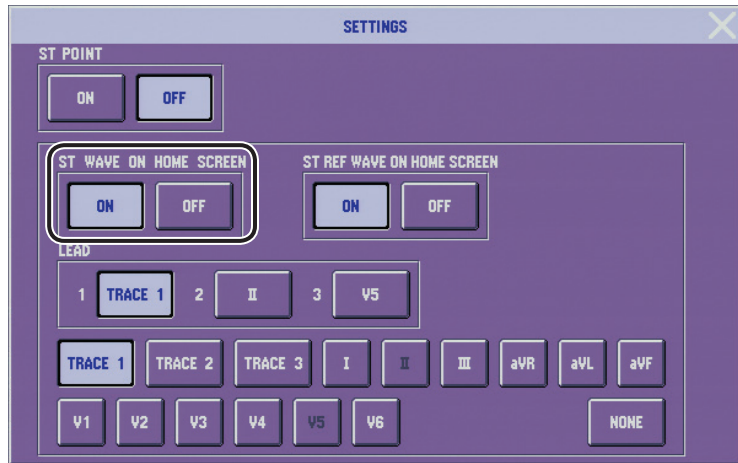

When set to ON, select the lead for each of the 3 ST recall waveforms on the home screen.

3. Touch the  key to close the window.

Saving as Reference ST Recall File

Save the file used as the reference ST waveforms.

1. Select a file to save as a reference file and touch the SAVE AS REF key. A “SAVE AS REFERENCE?” message appears.



2. Touch the YES key to save it as a reference.

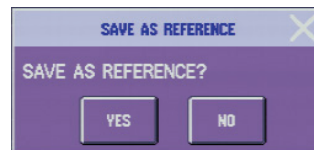

To not save it as a reference file, touch the NO key.

3. Touch the key to close the window.

Displaying the Reference ST Recall Waveform on the Home Screen

When <ST WAVE ON HOME SCREEN> is set to ON, the ST level and up to 3 waveforms saved as reference ST recall waveforms can be displayed on the home screen.

1. Touch the SETTINGS key on the ST window to display the SETTINGS window.



2. Touch the ON or OFF key in the <ST REF WAVE ON HOME SCREEN> box.

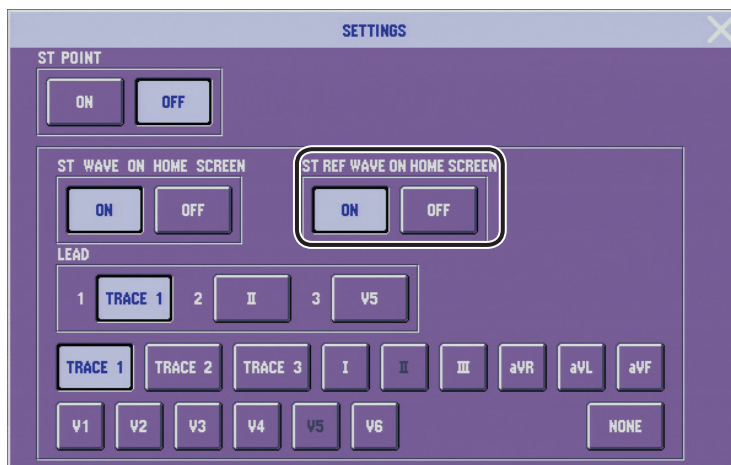

When set to ON, select the lead for each of the 3 reference ST recall waveforms on the home screen.

3. Touch the  key to close the window.

Printing the ST Level Recall File

The displayed ST recall files and the previous three ST recall files can be printed when the monitor is connected to a network printer.

1. Touch the PRINT key. The PRINT window appears.

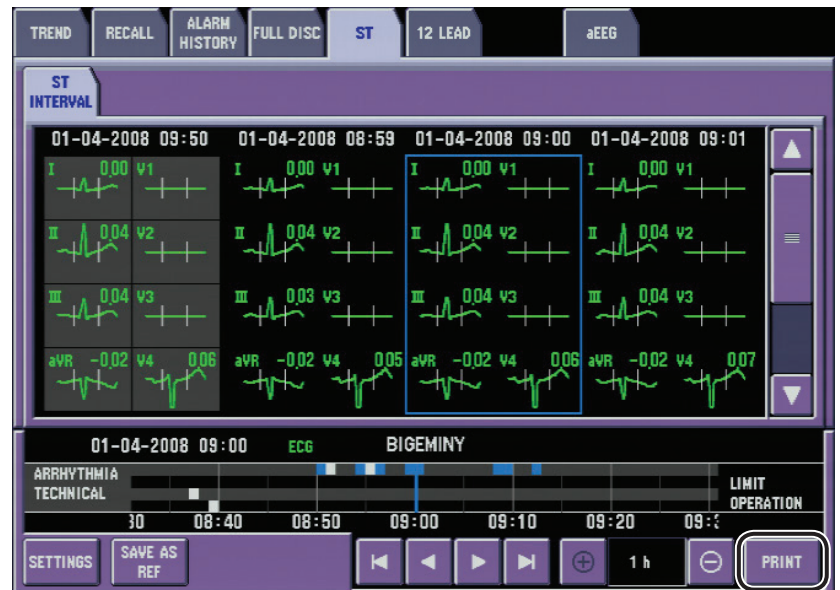

2. Touch the PRINT PAGE key in the <PRINTER> box. Printing starts.

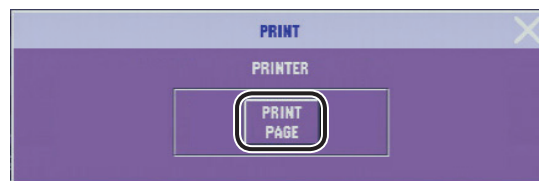

3. Touch the  key to close the window.

Printing example

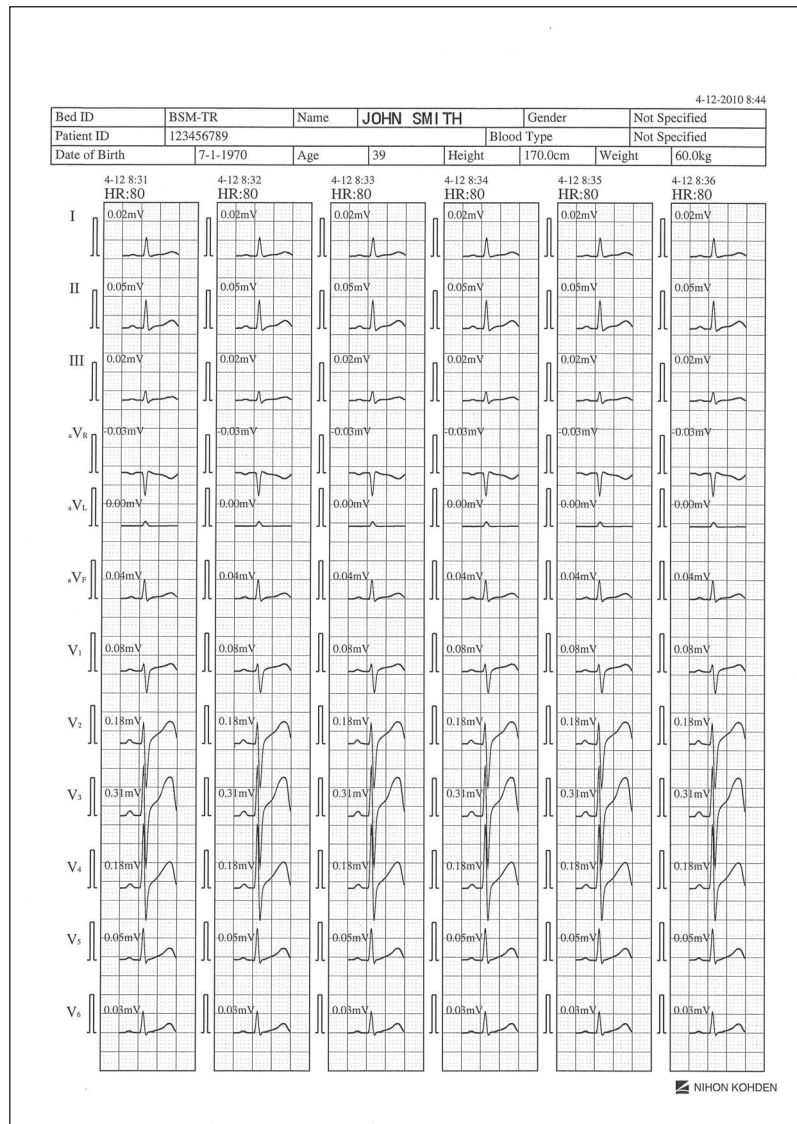

OCRG Window

The OCRG window displays heart rate and SpO₂ acquired every 1 minute for the trendgraph and compressed respiration waveform of the past 24 hours. With the optional QM-601P memory card, data of past 72 hours can be saved.

NOTE

- When <DATA TRANSPORT USING INPUT UNIT> is set to DISABLE, and <SHOW ADMIT CONFIRMATION WINDOW> is turned off in the SYSTEM CONFIGURATION screen, the stored data remains in memory for about 30 minutes after the power is turned off. After 30 minutes, the stored data is lost. When <DATA TRANSPORT USING INPUT UNIT> is set to ENABLE, the patient data and settings are always stored.
- Do not disconnect the power cord while the monitor power is on. Data may be lost.
- The OCRG window is available only when the site mode is NICU. Refer to “SITE Window” in Administrator’s Guide, Section 2 to change the site.
- Data on the OCRG window cannot be transported.

The following table shows the available trend parameters, screen displays and scales.

Parameter	Description	Vertical Range
HR	Heart rate (beats/min)	210-60, 160-80, 220-100
SpO ₂	Saturated oxygen from pulse oximeter (%SpO ₂)	100-60, 100-80
RESP (IMP)	Respiration measured by impedance method	×1/4, ×1/2, ×1, ×2, ×4

Displaying the OCRG Window

1. Press the [Menu] key to display the MENU window.

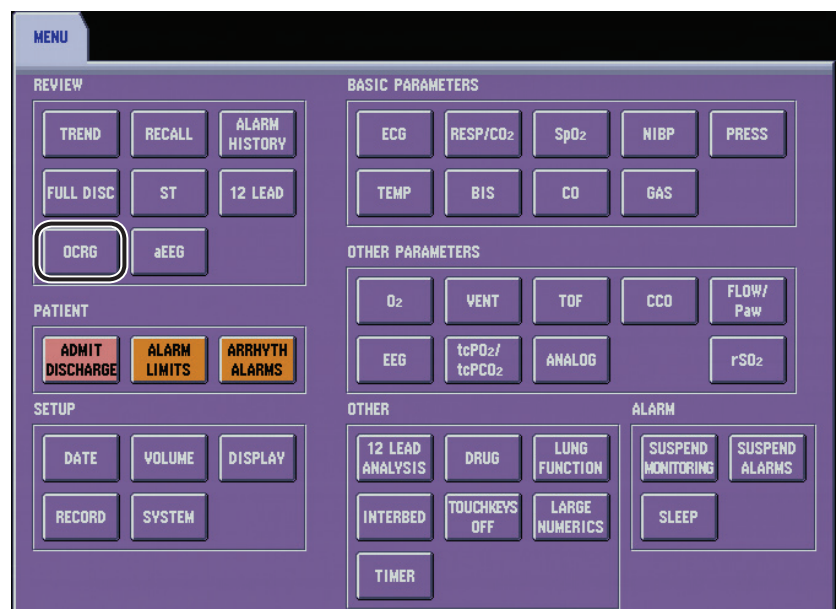

6. REVIEW WINDOWS

2. Touch the OCRG key to display the OCRG window.

When OCRG is assigned to one of the function keys at the upper left of the screen or one of the function keys on the remote control keys, the OCRG page can be displayed by touching the OCRG function key. Refer to “KEYS Window” in Administrator’s Guide, Section 3 to assign a function to the function key.

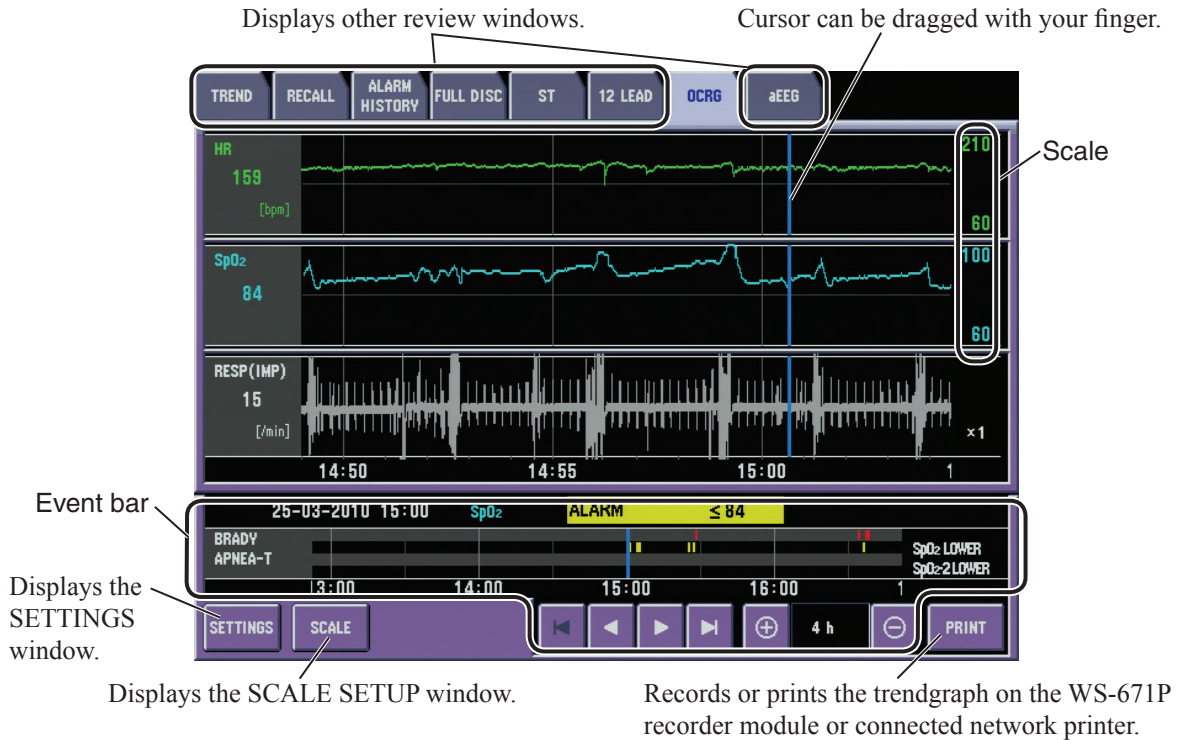

For details on the event bar, refer to the previous “EVENT BAR” section.

To return to the home screen, press the [Home] key.

Selecting the OCRG Trendgraph Type

Select the OCRG trendgraph type displayed on the home screen.

1. Touch the SETTINGS key on the OCRG window to display the SETTINGS window.

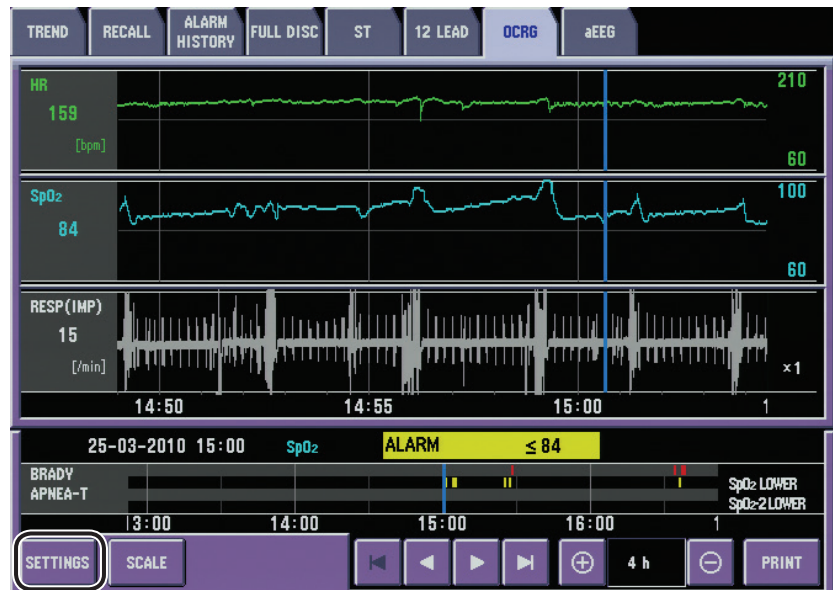

2. Select the 1 cm/min or 3 cm/min key in the <SETTINGS> box.

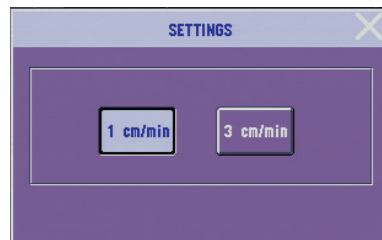

1 cm/min: OCRG display with the horizontal scale 1 cm/min

3 cm/min: OCRG display with the horizontal scale 3 cm/min

Changing the Trendgraph Scale for Heart Rate and SpO₂ and Sensitivity for Respiration

You can change the trendgraph scale for heart rate and SpO₂ and sensitivity for respiration.

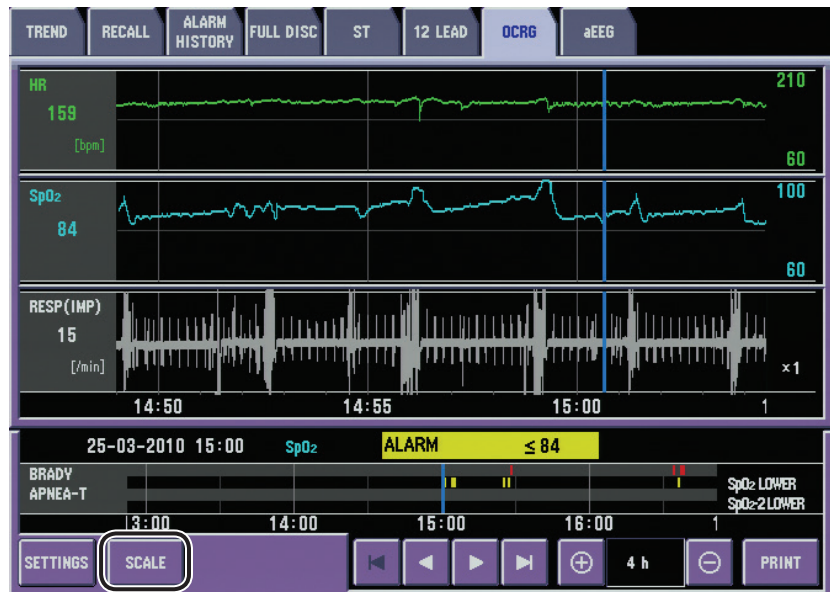

1. Touch the SCALE key on the OCRG window to display the SCALE SETUP window.

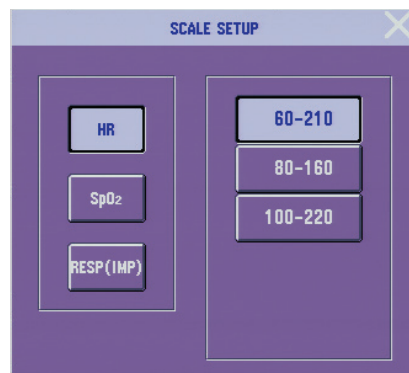

2. Touch the HR, SpO₂ or RESP(IMP) key on the left and select the scale on the right.
3. Touch the key to close the window.

Recording or Printing the OCRG Trend

The OCRG trend displayed on the OCRG window can be recorded or printed on the optional recorder or connected network printer.

Recording the OCRG Trend

1. Display the OCRG trend you want to record on the OCRG window.

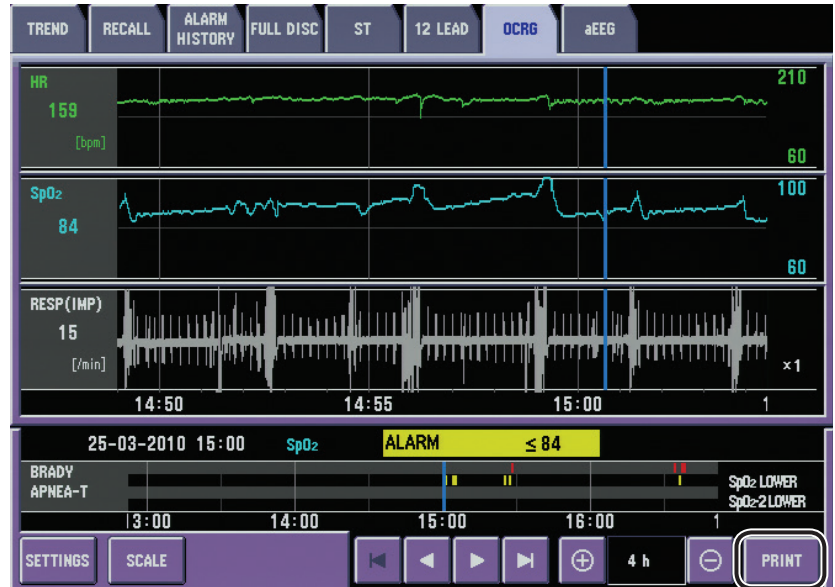

2. Touch the PRINT key. The PRINT window appears.

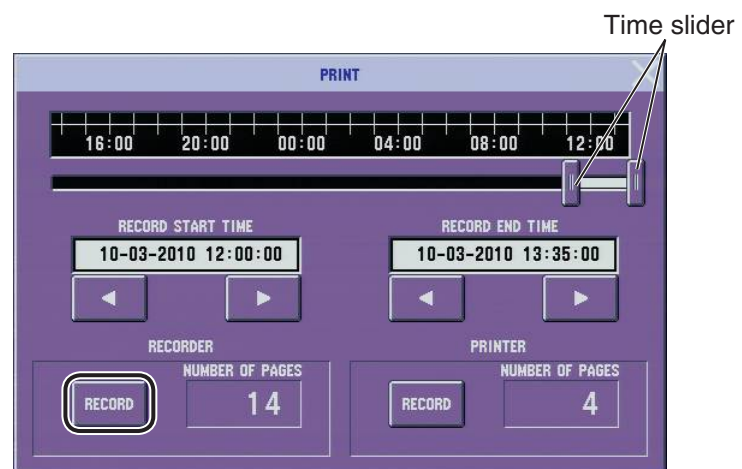

3. Set the RECORD START TIME and RECORD END TIME with the ◀ or ▶ key or time slider.

The initial RECORD START TIME and RECORD END TIME depend on the REVIEW setting on the RECORDER page of the SYSTEM SETUP window. For details, refer to “RECORDER page” in Section 3 of the Administrator’s Guide.

4. Check the number of pages and touch the RECORD key in <RECORDER> box.

To stop recording, press the [⏏] [Record] key.

The OCRG trend is recorded as displayed on the OCRG window.

6. REVIEW WINDOWS

5. Touch the  key to close the window.

Recording example

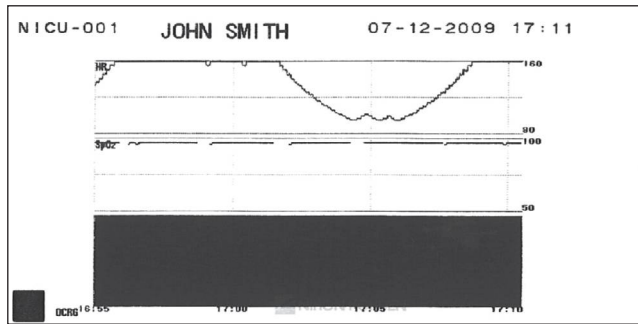

Printing the OCRG Trend

1. Display the OCRG trend you want to print on the OCRG window.

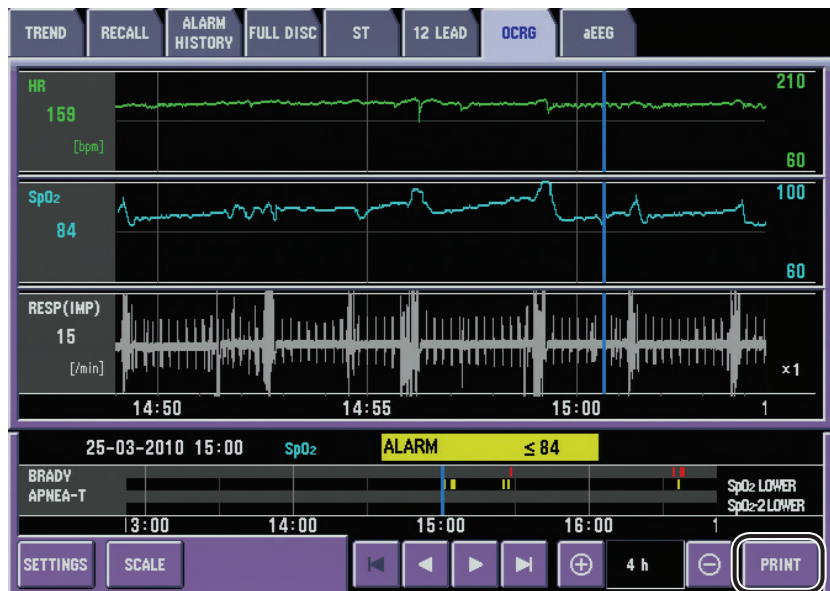

2. Touch the PRINT key. The PRINT window appears.

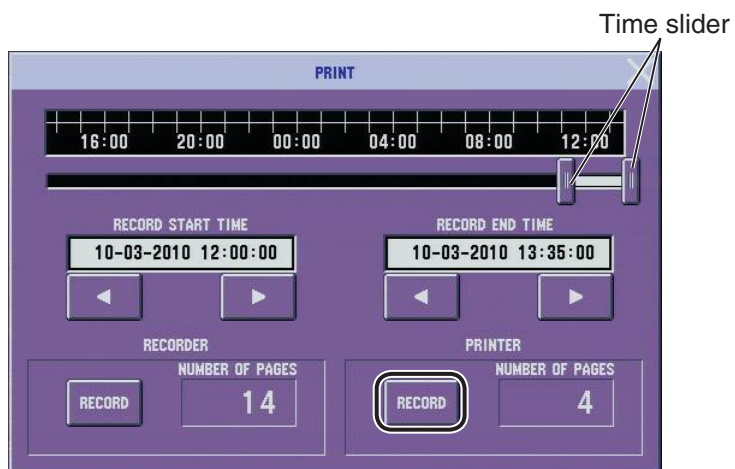

- Set the RECORD START TIME and RECORD END TIME with the ◀ or ▶ key or time slider.

The initial RECORD START TIME and RECORD END TIME depend on the REVIEW setting on the RECORDER page of the SYSTEM SETUP window. For details, refer to “RECORDER page” in Section 3 of the Administrator’s Guide.

- Check the number of pages and touch the RECORD key in the <PRINTER> box. The “PRINTING” message appears on the screen and the OCRG trend is printed as displayed on the OCRG window.
- Touch the ✕ key to close the window.

Printing example

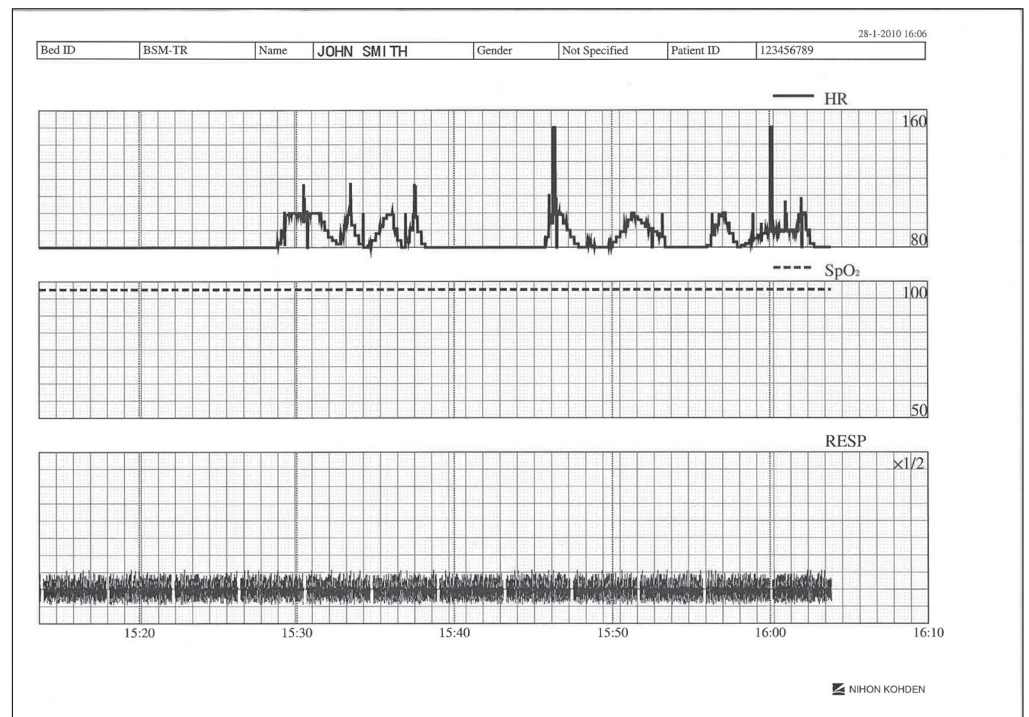

aEEG Window

The aEEG window displays two aEEG traces on the aEEG window of the past 24 hours. With the optional QM-601P memory card, data of past 72 hours can be saved.

To display aEEG, EEG must be monitored with an AE-918P neuro unit with software version 02-01 or later.

The displayed aEEG traces can be recorded with the WS-671P recorder module. The aEEG traces can also be printed on the network printer when the monitor is connected to a network.

NOTE

- aEEG window is not available on BSM-6301A/K.
- When <DATA TRANSPORT USING INPUT UNIT> is set to DISABLE, and <SHOW ADMIT CONFIRMATION WINDOW> is turned off in the SYSTEM CONFIGURATION screen, the stored data remains in memory for about 30 minutes after the power is turned off. After 30 minutes, the stored data is lost. When <DATA TRANSPORT USING INPUT UNIT> is set to ENABLE, the patient data and settings are always stored.
- The oldest data is deleted when the maximum number of data are created.
- Data on the aEEG window cannot be transported.

Displaying the aEEG Window

1. Press the [Menu] key to display the MENU window.

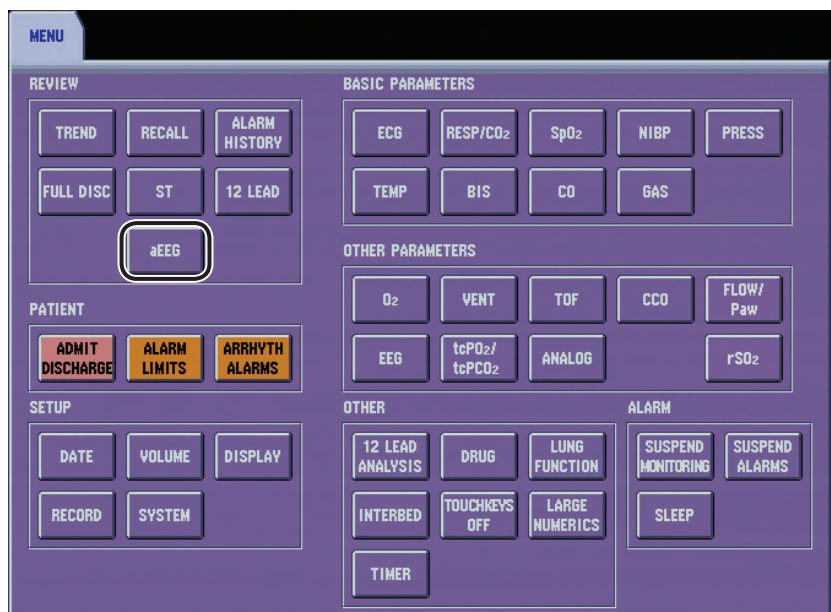

2. Touch the aEEG key to display the aEEG window.

When aEEG is assigned to one of the function keys at the upper left of the screen or one of the function keys on the remote control keys, the aEEG page can be displayed by touching the aEEG function key. Refer to “KEYS Window” in Administrator’s Guide, Section 3 to assign a function to the function key.

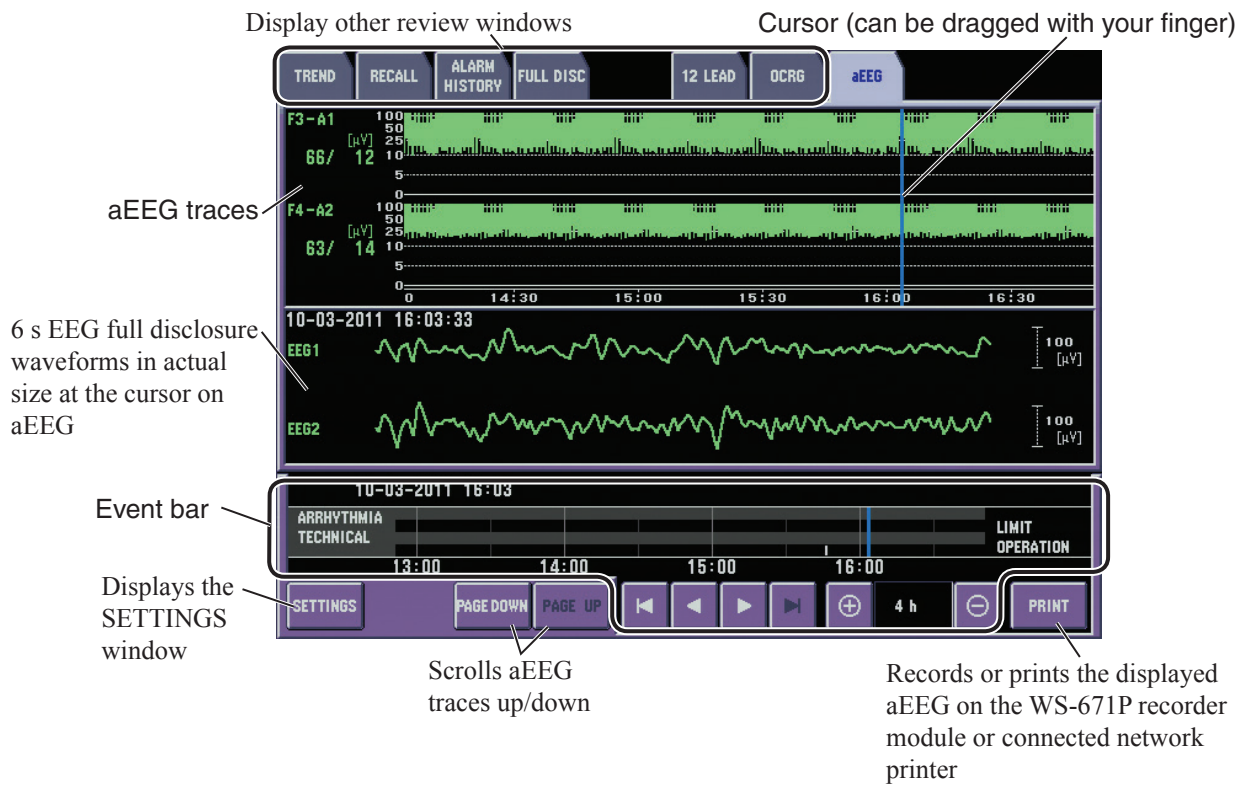

For details on the event bar, refer to the previous “EVENT BAR” section.

To return to the home screen, press the [Home] key.

Changing Time Scale for aEEG

This function changes the time scale to display aEEG.

1. Touch the SETTINGS key on the aEEG window to display the SETTINGS window.

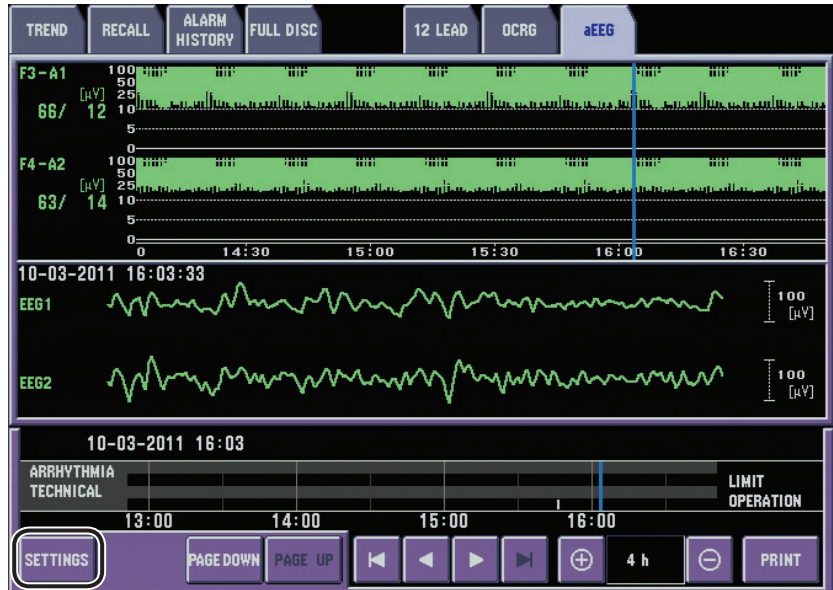

2. Select the 1, 3, 6, 9 or 12 cm/h key in the <SETTINGS> box.

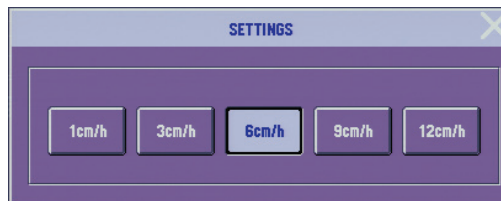

Scrolling aEEG Traces

You can scroll the aEEG traces up or down. To display the target data, touch the appropriate position on the screen or use the PAGE DOWN or PAGE UP key.

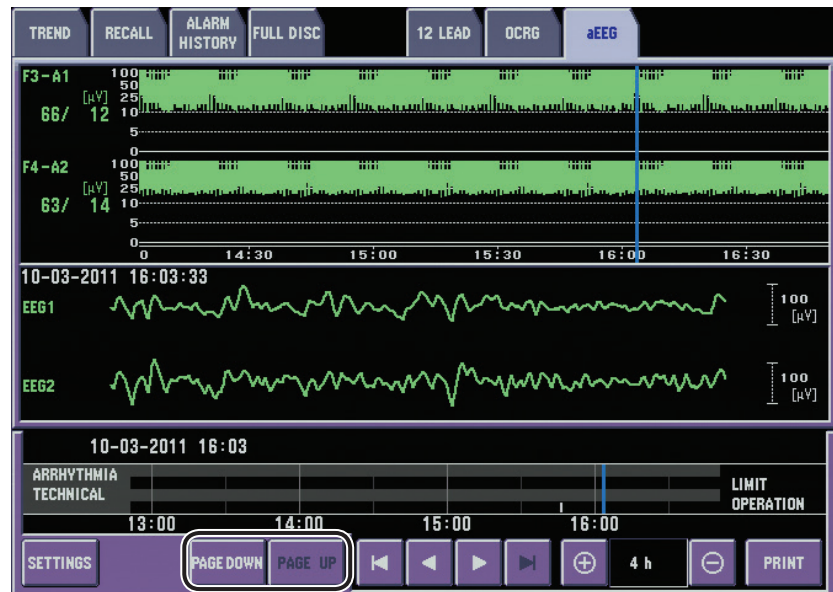

6

Recording or Printing the aEEG

Recording the aEEG

The aEEG displayed on the aEEG window can be recorded or printed on the optional recorder or connected network printer.

1. Display the aEEG you want to record on the aEEG page.

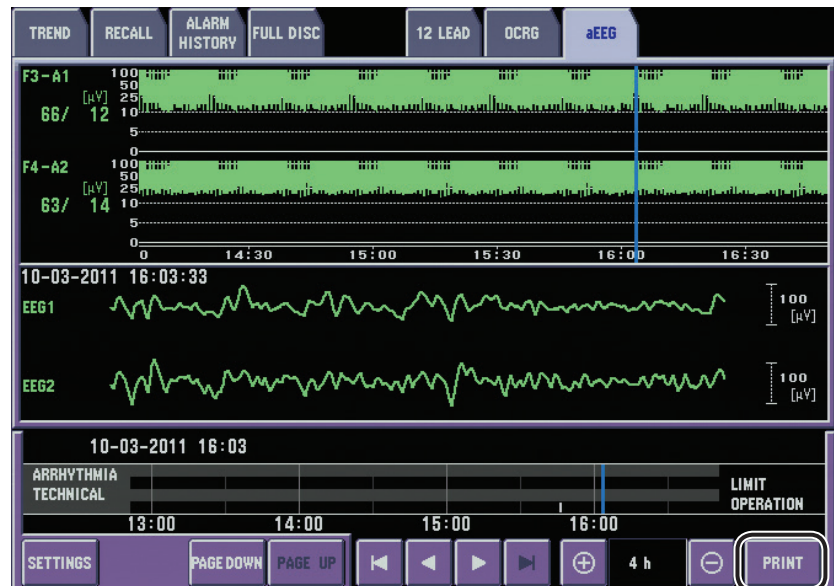

6. REVIEW WINDOWS

2. Touch the PRINT key. The PRINT window appears.

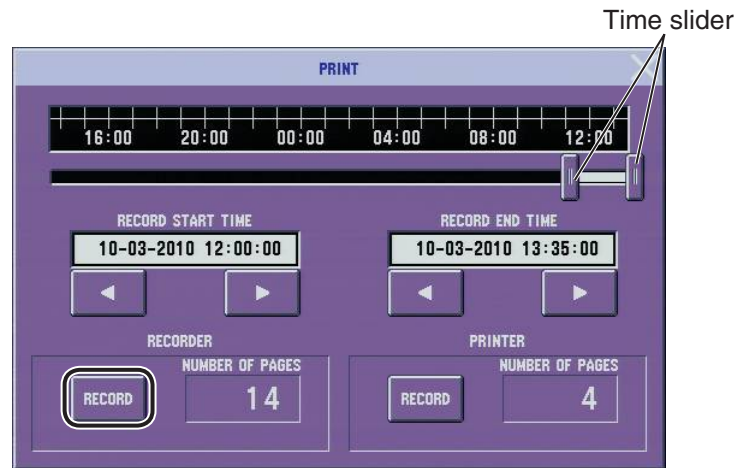

3. Set the RECORD START TIME and RECORD END TIME with the ◀ or ▶ key or time slider.

The initial RECORD START TIME and RECORD END TIME depend on the REVIEW setting on the RECORDER page of the SYSTEM SETUP window. For details, refer to “RECORDER page” in Section 3 of the Administrator’s Guide.

4. Check the number of pages and touch the RECORD key in <RECORDER> box.

To stop recording, press the [⏏] [Record] key.

The aEEG is recorded as displayed on the aEEG window.

5. Touch the [X] key to close the window.

Recording example

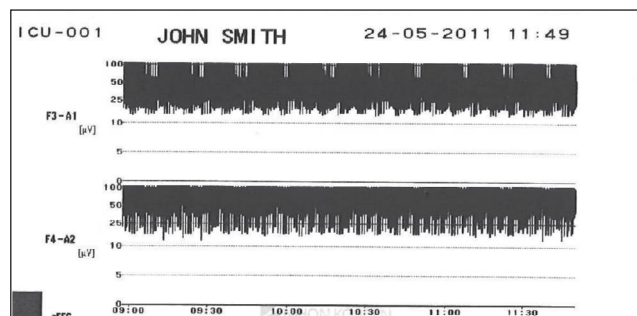

Printing the aEEG

1. Display the aEEG you want to print on the aEEG window.

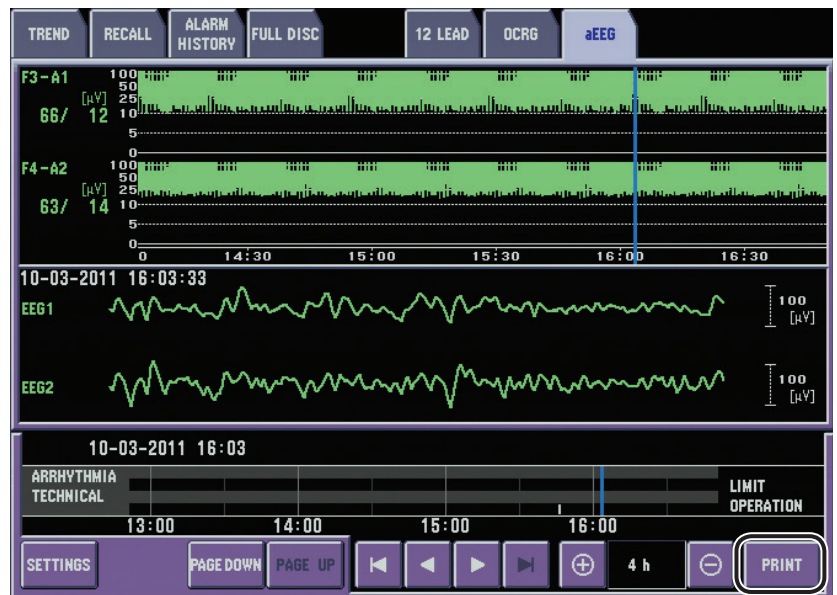

2. Touch the PRINT key. The PRINT window appears.

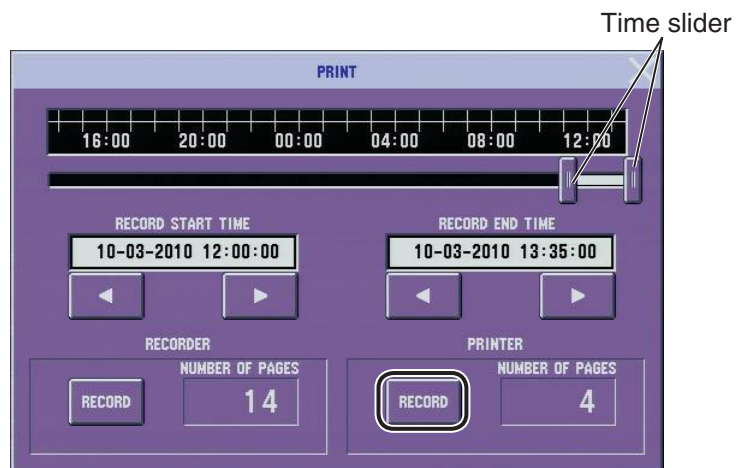

3. Set the RECORD START TIME and RECORD END TIME with the ◀ or ▶ key or time slider.

The initial RECORD START TIME and RECORD END TIME depend on the REVIEW setting on the RECORDER page of the SYSTEM SETUP window. For details, refer to “RECORDER page” in Section 3 of the Administrator’s Guide.

4. Check the number of pages and touch the RECORD key in the <PRINTER> box. The “PRINTING” message appears on the screen and the aEEG is printed as displayed on the aEEG window.
5. Touch the ☒ key to close the window.

Printing example

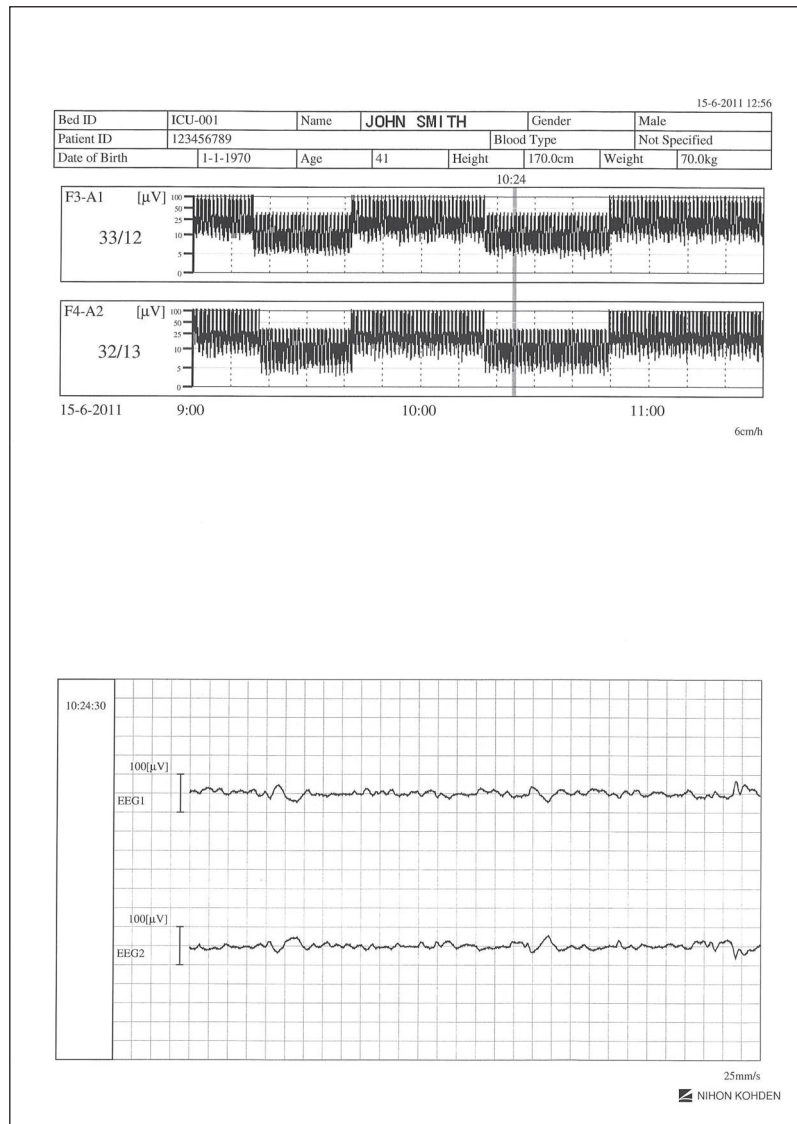

Section 7 12 Lead Analysis/12 Lead Windows

12 Lead Analysis Window.....	7.2
Preparation Flowchart	7.2
Displaying the 12 LEAD ANALYSIS Window.....	7.3
Entering the Patient's Date of Birth and Gender	7.4
Displaying the PATIENT INFO Window	7.4
Entering the Date of Birth and Age	7.4
Entering the Gender.....	7.4
Performing 12 Lead ECG Interpretation.....	7.5
Recording or Printing the 12 Lead ECG Waveform.....	7.6
Recording the 12 Lead ECG Waveforms	7.6
Printing the 12 Lead ECG Waveforms	7.7
12 LEAD Window.....	7.9
Displaying the 12 LEAD Window.....	7.9
12 LEAD Page.....	7.10
Scrolling the 12 Lead Data File	7.10
Recording the 12 Lead Data	7.10
ANALYSIS WAVE Page.....	7.11
Recording or Printing the 12 Lead Waveform.....	7.12
Recording the 12 Lead Waveform.....	7.12
Printing the 12 Lead Waveform	7.13
REPORT Page	7.14
Recording or Printing the 12 Lead Interpretation Results	7.14
Recording the 12 Lead Interpretation Results	7.14
Printing the 12 Lead Interpretation Results.....	7.15
AVERAGE WAVE Page.....	7.16
Printing the Averaged ECGs	7.16

12 Lead Analysis Window

NOTE

- The 12 LEAD ANALYSIS window is not available when an AY-660P input unit is used.
- On BSM-6000A series, the 12 LEAD ANALYSIS window is not available when the site mode is NICU and 12 LEAD ANALYSIS is set to Off in the SYSTEM CONFIGURATION screen. Refer to “SITE Window” in the Administrator’s Guide of Section 2.

When ECG is monitored with 10 electrodes, simultaneous 12 lead ECG can be displayed on the 12 LEAD ANALYSIS window. When ECG is monitored with 6 electrodes, simultaneous 8 lead ECG can be displayed.

The ECG waveforms on the 12 LEAD ANALYSIS window can be analyzed by the 12 lead ECG interpretation program (ECAPS 12C) and analysis result and clinical findings can be displayed on the screen. For details about the analysis and the clinical findings, refer to the ECAPS 12C program user’s guide. Up to 6 lead ECG interpretation result can be saved on the monitor.

ECG waveforms displayed on the 12 LEAD ANALYSIS window, 12 LEAD page, ANALYSIS WAVE page and REPORT page in 12 LEAD window can be recorded on the recorder.

When the monitor is connected to the CNS-9300 series or CNS-9701 central monitor network, the ECG waveforms displayed on the 12 LEAD ANALYSIS window, the 12 lead ECG interpretation result and the averaged ECG can be sent to the central monitor and printed on the central monitor printer.

When the monitor is connected to the CNS-9701 central monitor with QP-974P program kit, the 12 lead ECG interpretation result and ECG waveforms are automatically sent to the central monitor and can be reviewed and printed on the central monitor.

When the monitor is connected to a network printer, the ECG waveforms displayed on the 12 LEAD ANALYSIS window can be printed on the network printer.

Preparation Flowchart

1. Display the PATIENT INFO page on the 12 LEAD ANALYSIS window and check that the age and gender are correct. To correct the age and gender, refer to “Entering the Patient’s Date of Birth and Gender” in this section.
2. Check that the electrodes are attached to the patient and leads are connected appropriately.
3. Display the 12 LEAD ANALYSIS window and check that ECGs on the window are stable. Refer to the next “Displaying the 12 LEAD ANALYSIS Window” section.

Displaying the 12 LEAD ANALYSIS Window

1. Press the [Menu] key. The MENU window appears.

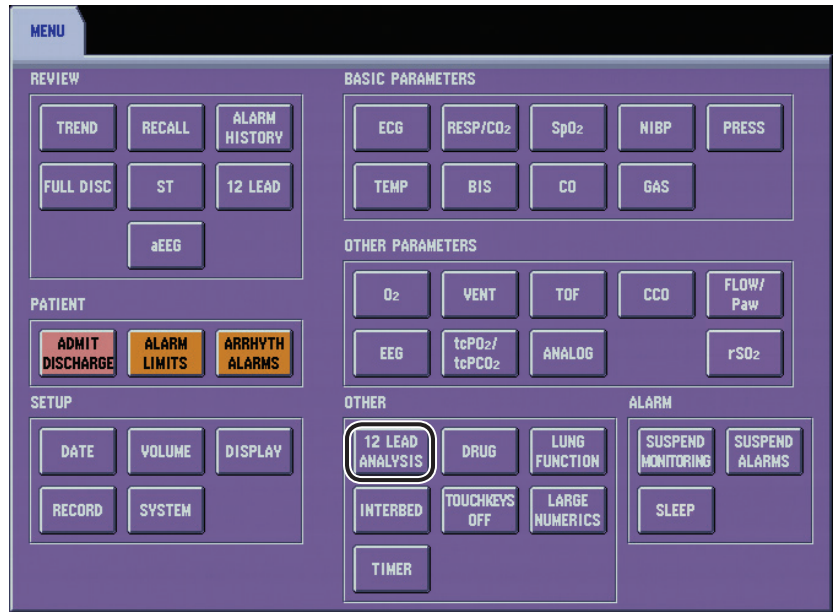

2. Touch the 12 LEAD ANALYSIS key. The 12 LEAD ANALYSIS window appears.

When 12 LEAD ANALYSIS is assigned to one of the function keys at the upper left of the screen, touching the 12 LEAD ANALYSIS function key also opens the 12 LEAD ANALYSIS window.

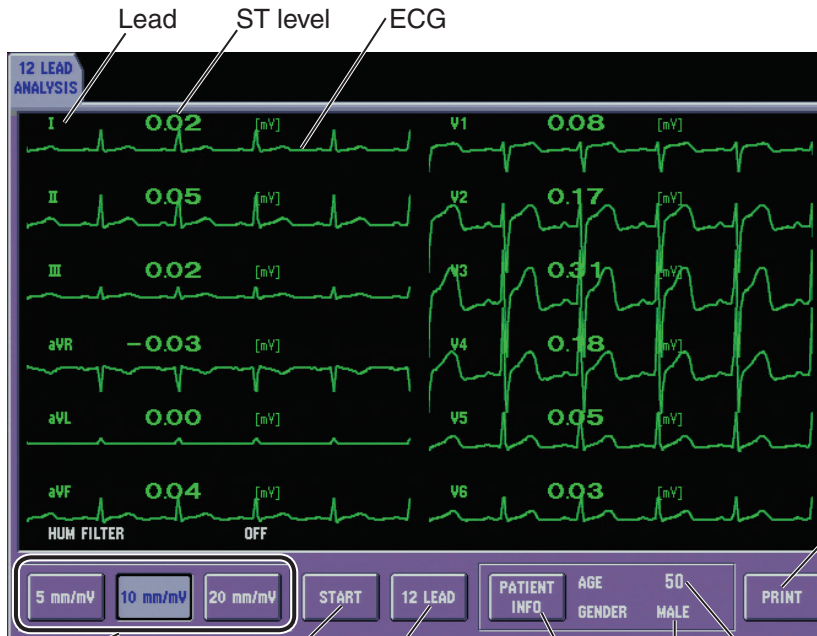

You can change the sensitivity of the ECG waveforms

Starts analysis

Displays 12 LEAD window

You can change the patient's date of birth and gender

Patient's gender

Patient's age

Prints the displayed ECGs on the WS-671P recorder module or connected network printer

3. Press the [Home] key to return to the home screen.

Entering the Patient's Date of Birth and Gender

Displaying the PATIENT INFO Window

1. Touch the PATIENT INFO key on the 12 LEAD ANALYSIS window. The PATIENT INFORMATION window appears.

2. Touch the close button (X), to close the window.

Entering the Date of Birth and Age

CAUTION

When the date of birth or age is not entered, 12 lead ECG interpretation is performed with the patient as 35 years old.

1. Touch the YEAR, MONTH and DAY key to enter year, month and day respectively.
2. Enter the numbers by using the numeric keypad, then touch the ENT key.
3. Touch the SET key. When the year, month and day are entered, age is automatically calculated and appears in the age area.

Entering the Gender

CAUTION

When the gender is not specified, 12 lead ECG interpretation is performed with the patient as male.

Touch the MALE, FEMALE or - (Unknown) key in <GENDER> box.

Performing 12 Lead ECG Interpretation

WARNING

Do not use 12 lead ECG interpretation results and measured values from the Mason-Likar modification for diagnosis because the limb electrode placement is not the same as the standard 12 lead ECG. This may cause wrong diagnosis since 12 lead ECG interpretation of this monitor is based on the standard 12 lead ECG.

CAUTION

- The 12 lead ECG interpretation is performed for acquired ECG waveforms only and does not reflect all conditions of the patient. The results of the analysis might not correspond to the judgement of a physician.
- Overall judgement must be performed by the physician, referring to the analysis result, clinical findings and other examination results. After the physician's overall judgement, the analysis results should be signed or initialed by the physician.

CAUTION

When the gender is not specified, 12 lead ECG interpretation is performed with the patient as male.

CAUTION

When the date of birth or age is not entered, 12 lead ECG interpretation is performed with the patient as 35 years old.

NOTE

- When electrodes are not attached to the limbs, the analysis result concerning the ECG axis (such as axis deviation) may differ from the analysis with electrodes attached to limbs.
- Noise is rejected from the analyzed waveforms by the 50/60 Hz filter, but noise other than these frequencies might not be rejected.

Touch the START key to start analyzing ECGs. The "SAVING. PLEASE WAIT" message appears and 10 second ECG of all leads are acquired and analyzed.

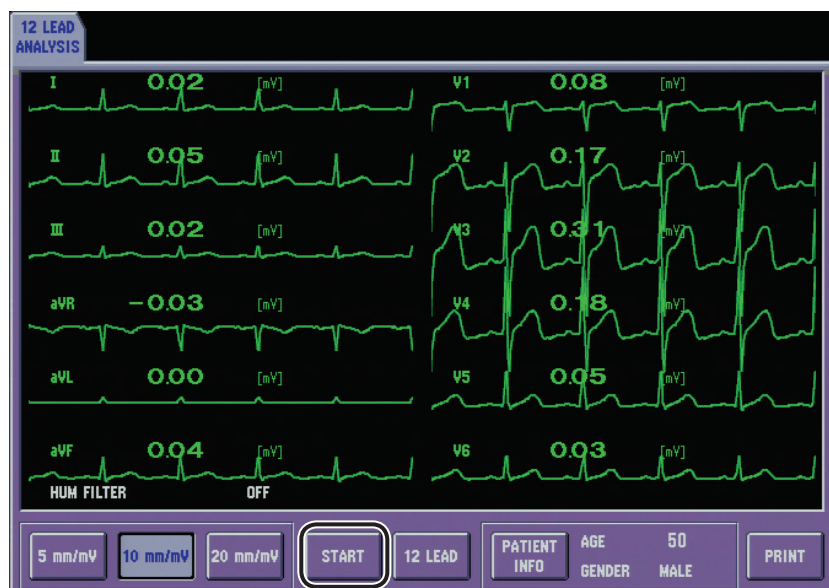



When analyzing is complete, the “ANALYZING. PLEASE WAIT” message disappears and the 12 LEAD window is displayed.

Recording or Printing the 12 Lead ECG Waveform

Recording the 12 Lead ECG Waveforms

10 second ECG waveform used for analysis can be recorded on the optional recorder.

1. Touch the PRINT key. The window appears.

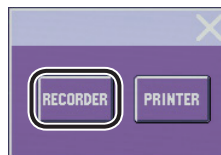

2. Touch the RECORDER key. Recording starts.

To stop recording, press the  [Record] key.

3. Touch the  key to close the window.

Recording example

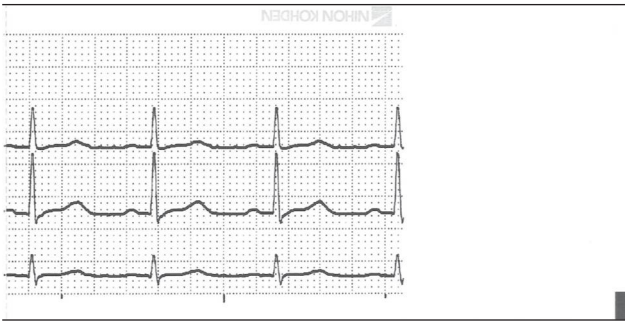
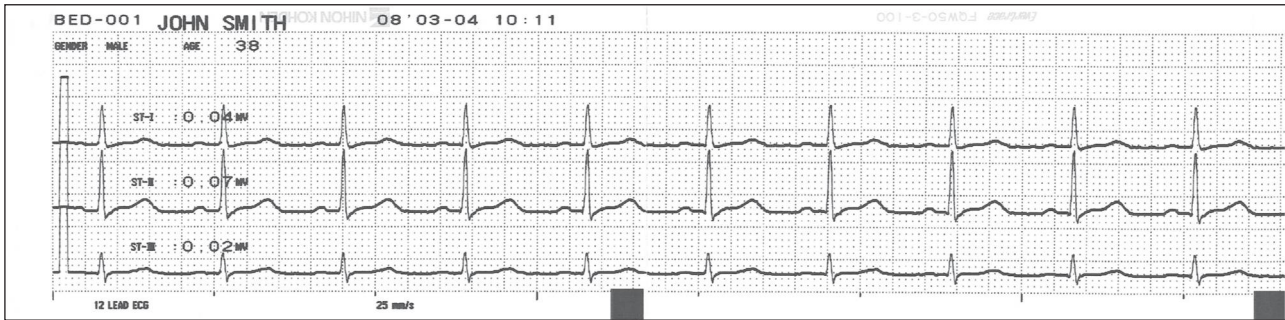

7

Printing the 12 Lead ECG Waveforms

10 second 12 lead ECG waveform used for analysis can be printed when the monitor is connected to a network printer or the monitor is connected to a CNS-9300 series or CNS-9701 central monitor network.

1. Touch the PRINT key. The window appears.



2. Touch the PRINTER key. Printing starts.
3. Touch the  key to close the window.

7. 12 LEAD ANALYSIS/12 LEAD WINDOWS

Printing example

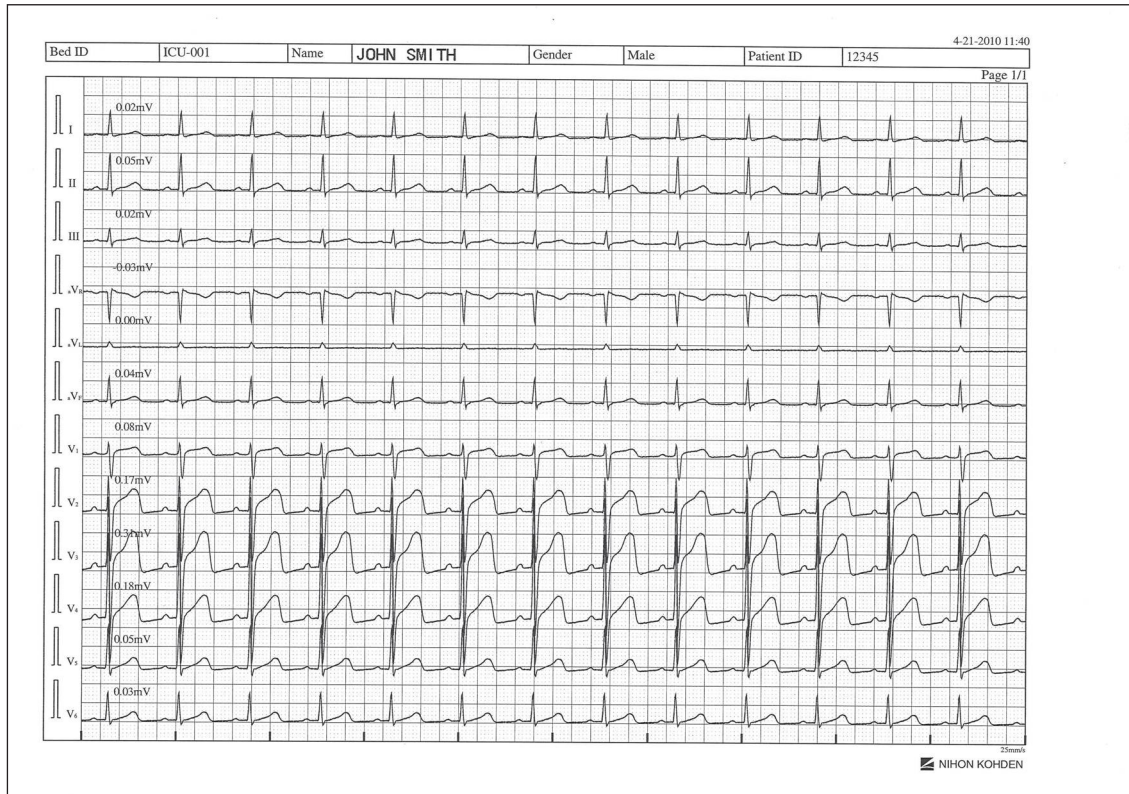

12 LEAD Window

The 12 LEAD window has the following pages related to 12 LEAD ANALYSIS window.

- 12 LEAD page for displaying the 12 lead analysis result data
- ANALYSIS WAVE page for displaying ECG waveforms used for analysis
- REPORT page for displaying clinical findings
- AVERAGE WAVE page for displaying averaged ECG waveforms

NOTE

- When <DATA TRANSPORT USING INPUT UNIT> is set to DISABLE, and <SHOW ADMIT CONFIRMATION WINDOW> is turned off in the SYSTEM CONFIGURATION screen, the stored data remains in memory for about 30 minutes after the power is turned off. After 30 minutes, the stored data is lost. When <DATA TRANSPORTS USING INPUT UNIT> is set to ENABLE, the patient data and settings are always stored.
- On BSM-6000A series, the 12 LEAD window is not available when the site mode is NICU and 12 LEAD ANALYSIS is set to Off in the SYSTEM CONFIGURATION screen. Refer to “SITE Window” in the Administrator’s Guide of Section 2.

7

Displaying the 12 LEAD Window

1. Press the [Menu] key to display the MENU window.

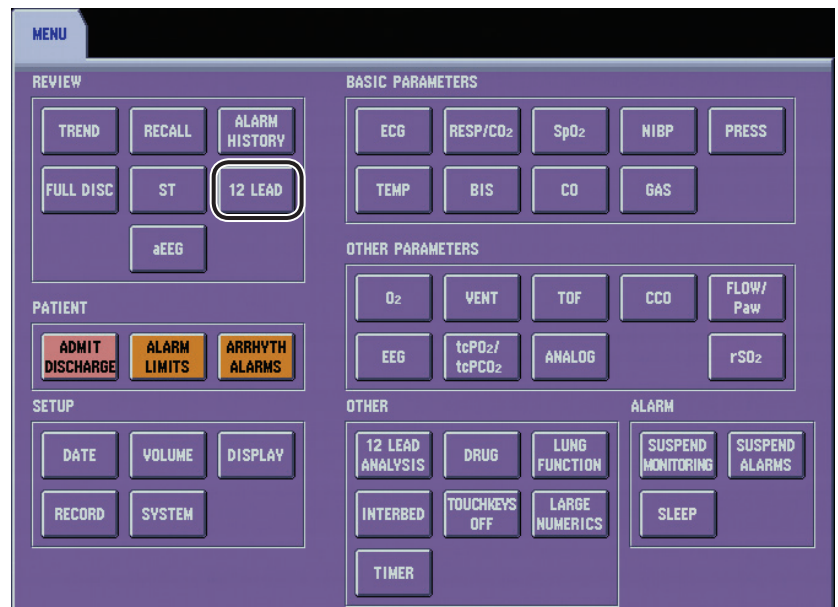

2. Touch the 12 LEAD key. The 12 LEAD window appears.
3. Press the [Home] key to return to the home screen.

12 LEAD Page

To see the 12 lead analysis result data, touch the 12 LEAD tab. Up to 6 files can be saved and up to 4 files can be displayed on the 12 LEAD page.

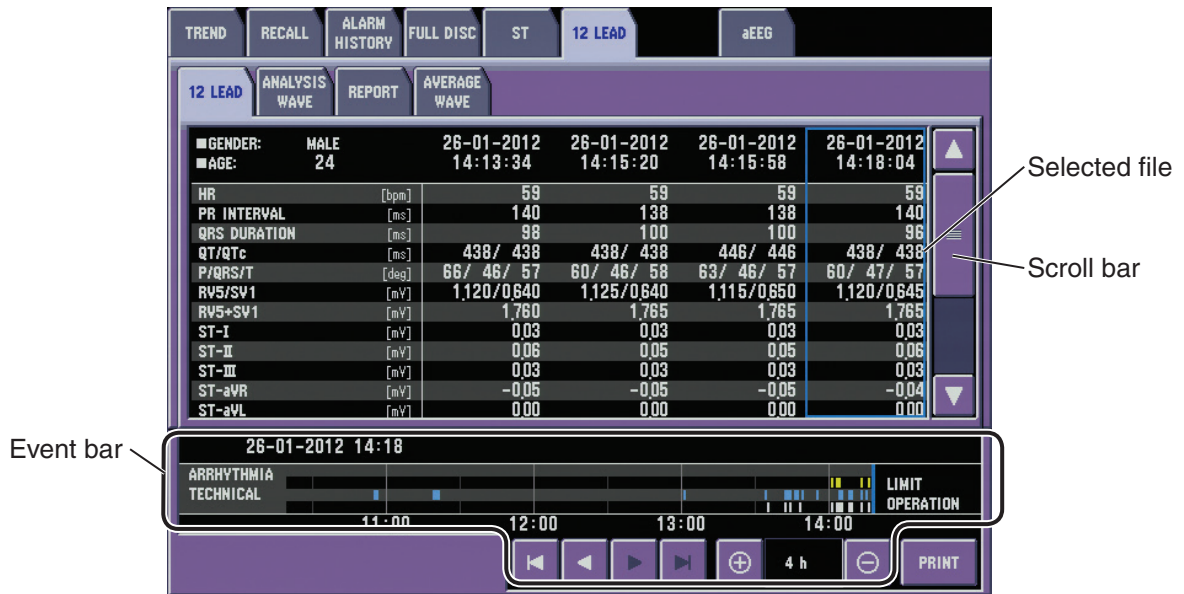

When 12 LEAD is assigned to one of the function keys at the upper left of the screen, the 12 LEAD page can be displayed by touching the 12 LEAD function key. Refer to “KEYS Window” in Administrator’s Guide, Section 3 to assign a function to the function key.

For the event bar description, refer to “Event Bar” in Section 6.

Scrolling the 12 Lead Data File

The 12 lead analysis result data table can be scrolled by touching the ▲ or ▼ key on the vertical scroll bar.

Recording the 12 Lead Data

The displayed 12 lead data can be recorded on the optional recorder.

1. Display the 12 lead data you want to record.

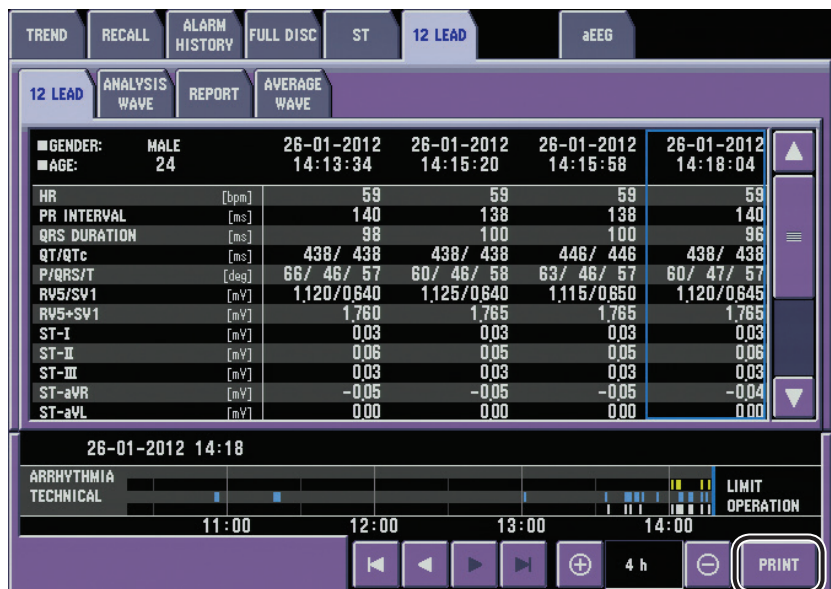

2. Touch the PRINT key. The window appears.



3. Touch the RECORD PAGE key. Recording starts.
4. Touch the  key to close the window.

Recording example

OR-001 JOHN SMITH 26-01-2012 14:26					OR-001 JOHN SMITH 26-01-2012 14:26				
#GENDER:	MALE	26-01-2012	26-01-2012	26-01-2012	26-01-2012				
#AGE:	24	14:13:34	14:15:20	14:15:59	14:18:04				
HR	[bpm]	59	59	59	59				
PR INTERVAL	[ms]	140	138	138	140				
QRS DURATION	[ms]	98	100	100	96				
QT/QTc	[ms]	438/ 438	438/ 438	446/ 446	438/ 438				
P/RS/T	[deg]	66/ 46/ 57	60/ 46/ 58	63/ 46/ 57	60/ 47/ 57				
RV5+SV1	[mV]	1120/0640	1125/0640	1115/0650	1120/0645				
RV5+SV1	[mV]	1760	1765	1765	1765				
ST-I	[mV]	003	003	003	003				
ST-II	[mV]	006	005	005	006				
ST-III	[mV]	003	003	003	003				

ST-IVR	[mV]	-005	-005	-005	-004
ST-IVL	[mV]	000	000	000	000
ST-IVF	[mV]	004	004	004	004
ST-V1	[mV]	011	011	011	011
ST-V2	[mV]	025	025	024	024
ST-V3	[mV]	037	037	037	037
ST-V4	[mV]	024	024	024	024
ST-V5	[mV]	007	007	007	007
ST-V6	[mV]	006	006	006	006

ANALYSIS WAVE Page

To see the 12 lead analysis result, touch the ANALYSIS WAVE tab. About 2 seconds of the ECG of each lead and 10 seconds of rhythm waveform (lead II) used for the analysis are displayed.

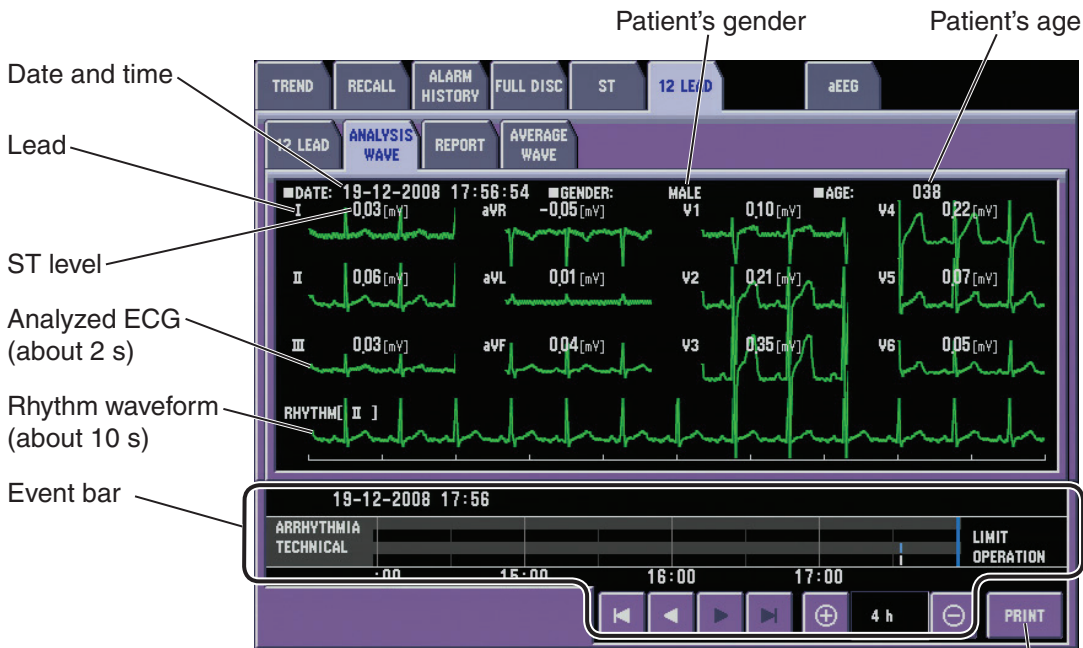

Records or prints the displayed ECGs on the WS-671P recorder module or connected network printer



Recording or Printing the 12 Lead Waveform

Recording the 12 Lead Waveform

Analyzed 10 second ECG waveform can be recorded on the optional recorder. The rhythm waveform cannot be recorded.

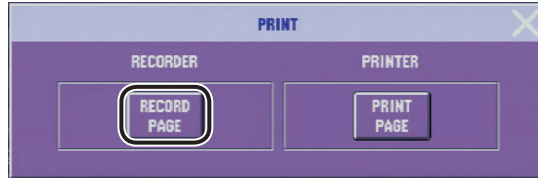
1. Touch the PRINT key. The PRINT window appears.



2. Touch the RECORD PAGE key in <RECORDER> box. Recording starts. To stop recording, press the  [Record] key.
3. Touch the  key to close the window.

Recording example

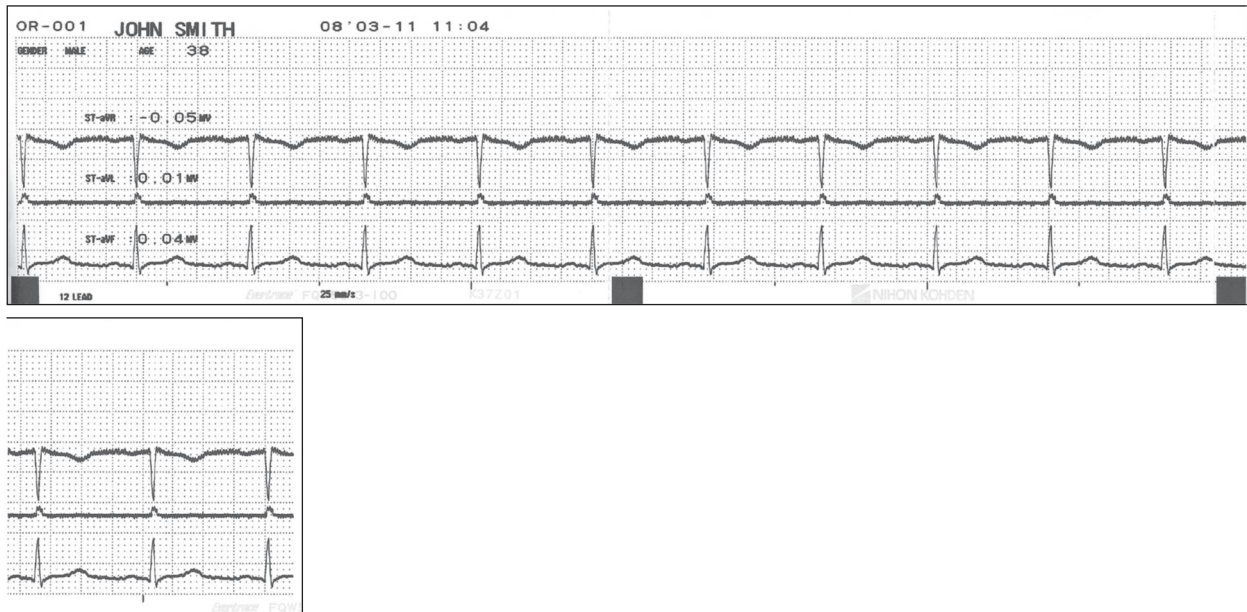

Printing the 12 Lead Waveform

Analyzed 10 second 12 lead ECG waveform used for analysis can be printed when the monitor is connected to a network printer.

1. Touch the PRINT key. The PRINT window appears.

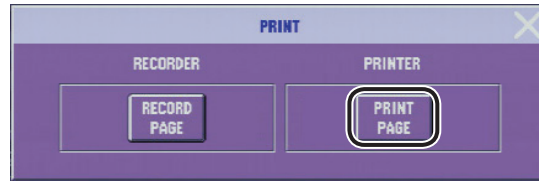

2. Touch the PRINT PAGE key in <PRINTER> box. Printing starts.
3. Touch the  key to close the window.

Printing example

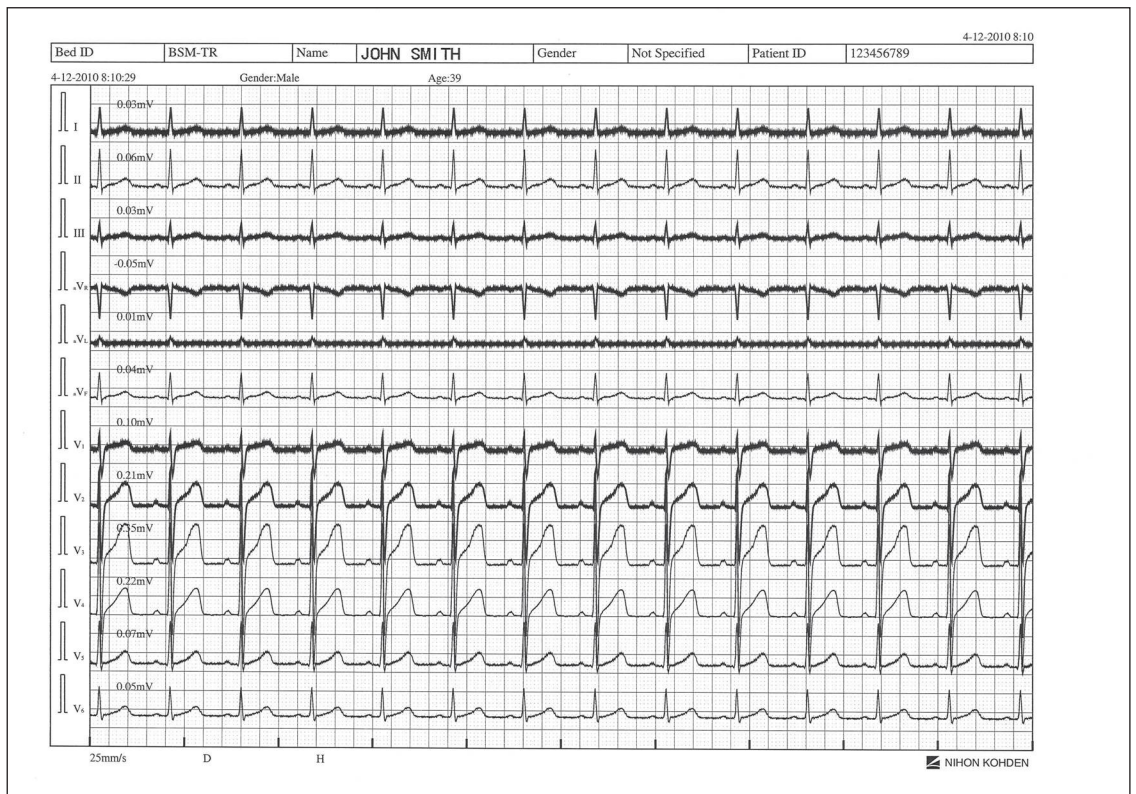

REPORT Page

To see analysis results, touch the REPORT tab. The REPORT page appears. For details about the findings, refer to the ECAPS 12C program user’s guide.

When the analysis result on the REPORT window is recorded or printed, the recorded/printed data must be examined by a physician. After the physician’s overall judgement, the “UNCONFIRMED REPORT” message on the recording/printing paper must be crossed out and signed by the physician.

Up to six analysis results can be saved in the monitor. When another analysis is performed, the older data is deleted. If necessary, record or print the analysis result before performing another analysis on the 12 LEAD ANALYSIS window.

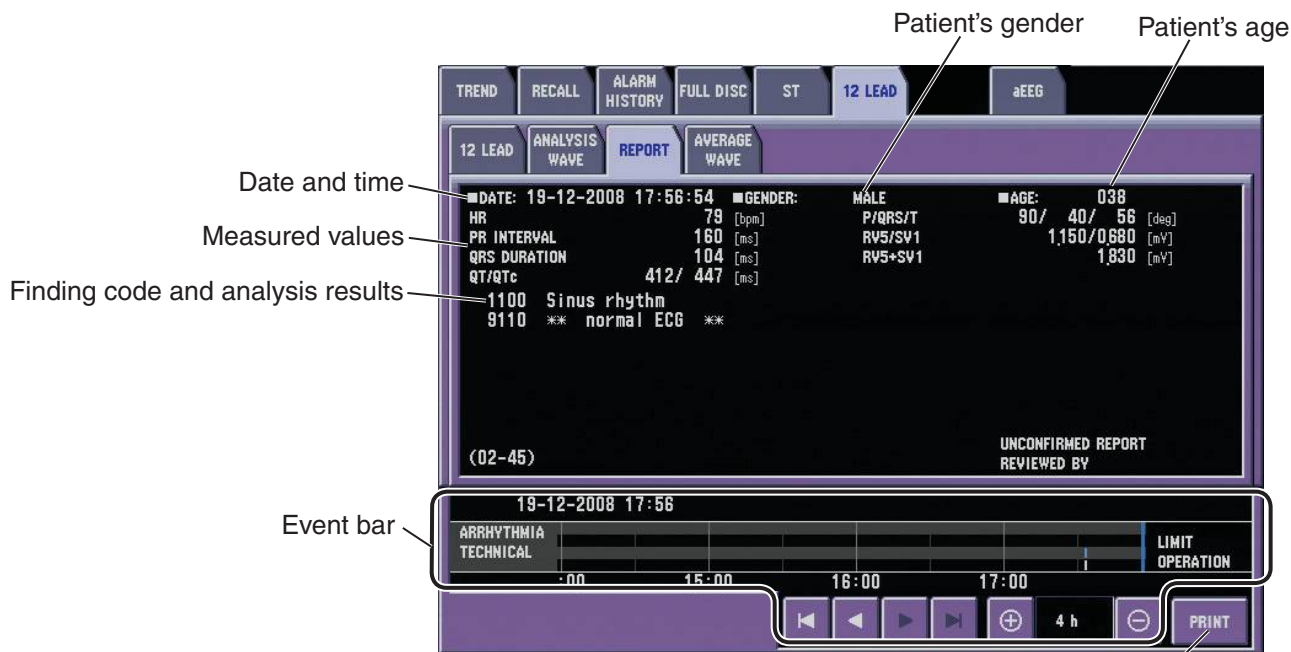

Records or prints the displayed ECGs on the WS-671P recorder module or connected network printer

When the analysis is not performed, “NO DATA” message appears.

Recording or Printing the 12 Lead Interpretation Results

Recording the 12 Lead Interpretation Results

The 12 lead interpretation results are recorded as display on the REPORT page.

1. Touch the PRINT key. The PRINT window appears.

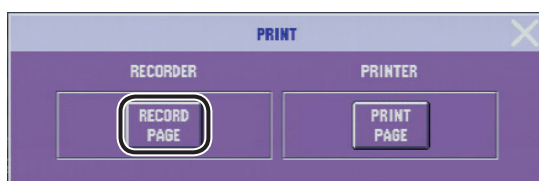

2. Touch the RECORD PAGE key in <RECORDER> box. Recording starts.

To stop recording, press the [Record] key.

3. Touch the [X] key to close the window.

Recording example

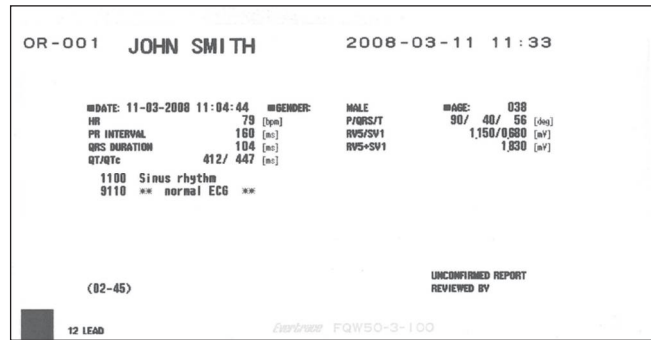

Printing the 12 Lead Interpretation Results

1. Touch the PRINT key. The PRINT window appears.

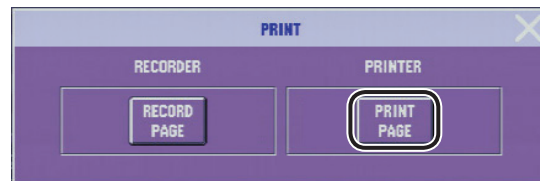

2. Touch the PRINT PAGE key in <PRINTER> box. Printing starts.

To stop printing, press the [Record] key.

3. Touch the [X] key to close the window.

Printing example

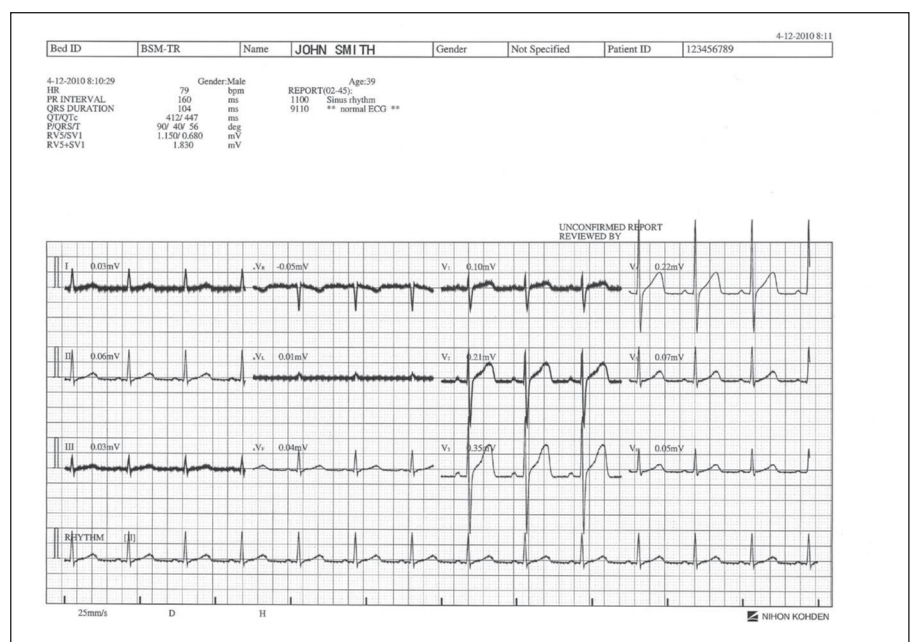

AVERAGE WAVE Page

To see the averaged ECGs, touch the AVERAGE WAVE tab. The cursors appear to indicate the P wave start and end points, QRS start and end points and T wave end points. The averaged ECGs can only be printed on the network printer.

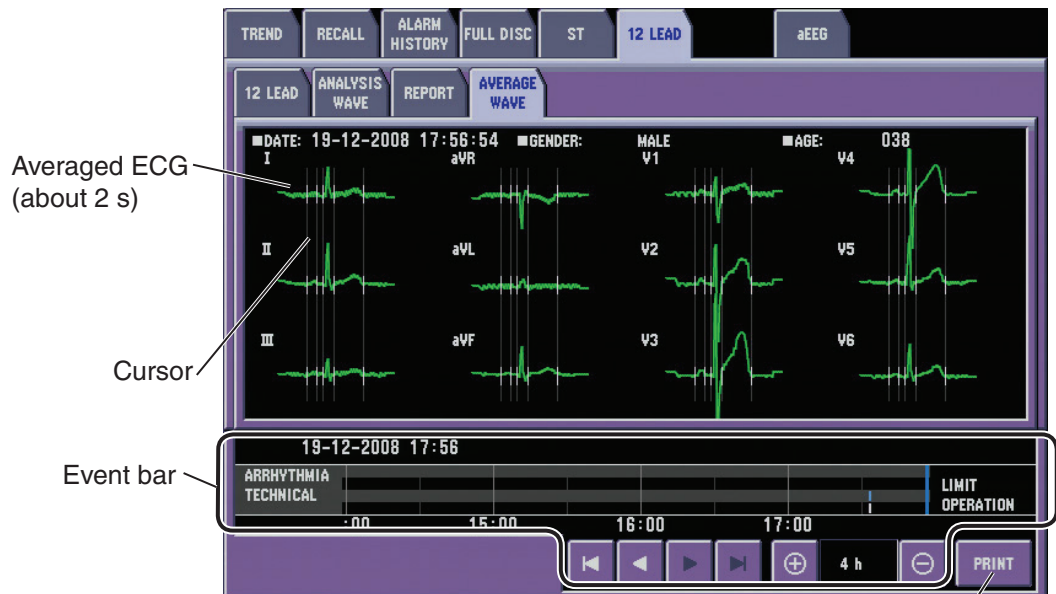



Prints the displayed ECGs on the connected network printer

Printing the Averaged ECGs

The averaged ECGs, analysis results and findings are printed.

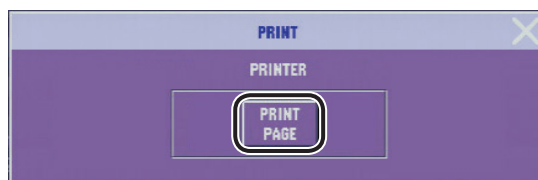
1. Touch the PRINT key. The PRINT window appears.



2. Touch the PRINT PAGE key in <PRINTER> box. Printing starts.
3. Touch the  key to close the window.

Printing example

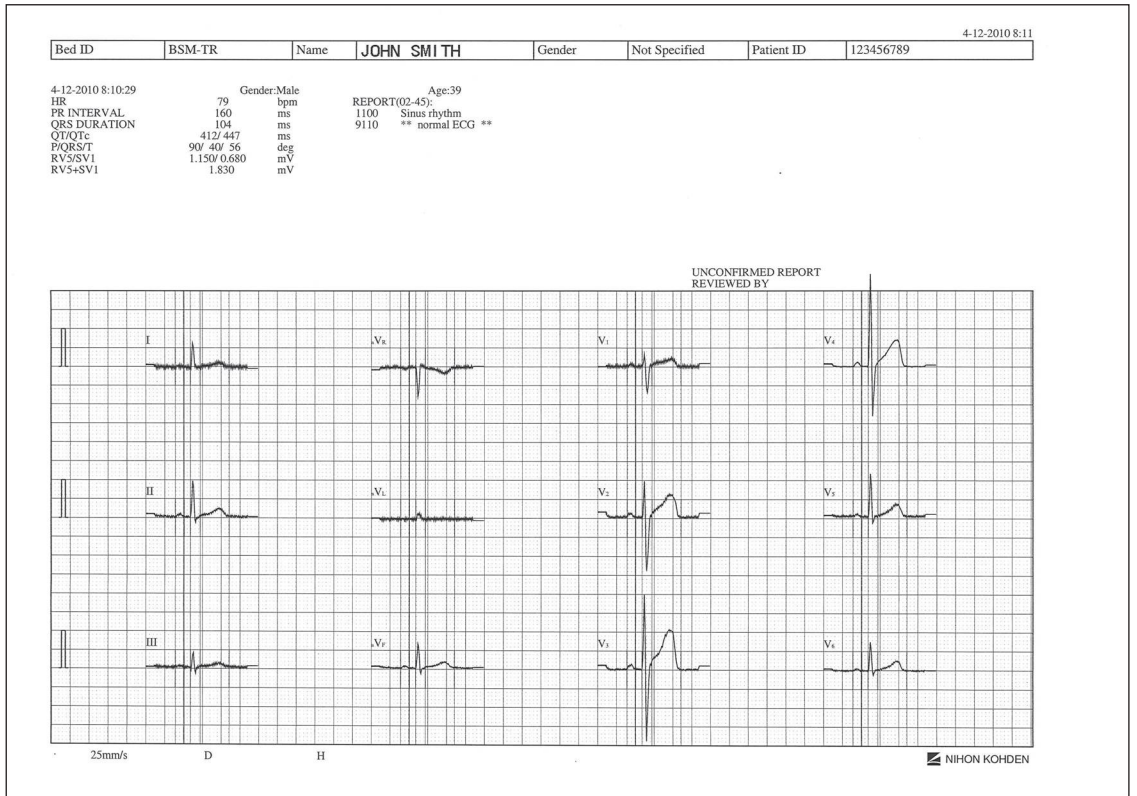

Section 8 Drug/Lung Function Windows

DRUG Window	8.2
Drug Titration Initial Settings	8.3
Flow Rate Equations	8.3
Displaying the DRUG Window	8.5
Selecting the Drug	8.7
Assigning a Drug Name and Dosage Unit to DRUG A to D	8.8
Changing the Settings	8.10
Changing the Drug Amount, Solution Amount, Dosage, Flow Rate and Weight	8.10
Changing the Dose Step	8.11
Unit and Setting Range	8.11
Drug Amount, Dosage and Step	8.11
Solution Amount, Flow Rate and Weight	8.12
LUNG FUNCTION Window	8.13
Displaying the LUNG FUNCTION Window	8.13
Entering the Data	8.15
Explanation of the DATA ENTRY Items	8.15
Checking the Calculation Results	8.16
Explanation of the CALCULATION RESULTS	8.16
Adding the Calculation Results to the LUNG TREND Table	8.17
Displaying the LUNG TREND Table	8.17
Recording the Calculation Results and Entered Data	8.18

DRUG Window

On the DRUG window, you can calculate the flow rates and dosages for medication titrations. The flow rate is calculated from the following equation. The dosage can also be calculated when the flow rate is known.

$$\text{Flow rate} = \frac{\text{Dosage} \times \text{Patient Weight} \times \text{Solution Amount}}{\text{Drug Amount}}$$

There are three windows for the drug calculation. On the DOSE window, you can see the table of the selected drug titration. The drug name and unit are selected on the DRUG window. On the SETTING window, you can change drug amount (AMOUNT), solution amount (VOLUME), dosage (DOSE), flow rate (SAMPLE RATE), patient weight and dose step. The settings on the DRUG and SETTING windows are used for the drug calculation and you can see the calculation result on the DOSE window. The dosage and flow rate calculated from the setting on the SETTING window are highlighted in blue.

The screenshot shows the DRUG window interface with the following components:

- DRUG SETTINGS:**
 - DRUG NAME: AMRINONE
 - DRUG AMOUNT: 500.00 mg
 - BASE VOLUME: 250 mL
 - CONCENTRATION: 2
 - DOSE: 20.00 mcg/kg/min
 - SAMPLE RATE: 42.0 mL/h
 - WEIGHT: 70.0 kg
 - DOSE STEP: 0.01
- TITRATION TABLE:**

DOSE	SAMPLE RATE	DOSE	SAMPLE RATE
19.91	41.8	20.01	42.0
19.92	41.8	20.02	42.0
19.93	41.9	20.03	42.1
19.94	41.9	20.04	42.1
19.95	41.9	20.05	42.1
19.96	41.9	20.06	42.1
19.97	41.9	20.07	42.1
19.98	42.0	20.08	42.2
19.99	42.0	20.09	42.2
20.00	42.0	20.10	42.2
- DOSE STEP CONTROLS:** Buttons for 0.01, 0.05, 0.10, 1.00, 10.00, and a PRINT button.

Annotations in the image:

- "Drug name selected on the DRUG window" points to AMRINONE.
- "Value calculated from the settings on the SETTING window" points to the highlighted 20.00 in the DOSE column.
- "Titration table" points to the table of values.
- "Set on the SETTING window" points to the DOSE STEP 0.01.
- "Select the dose step" points to the 0.01 button.
- "Prints the titration table and the drug on the recorder or network printer" points to the PRINT button.

NOTE

- When using the DRUG window for the first time after shipment or after settings are initialized, you must set the drug names and other settings.
- When the patient weight is changed on the ADMIT page of the ADMIT DISCHARGE window, the titration is automatically recalculated with the new weight.

17 drugs and drug amount, solution amount, dosage and dose step for each drug are preset on the monitor. The dosage and flow rate are calculated from the equations listed in the "Flow Rate Equations" section. You can set four other drugs on the DRUG window and change the settings on the EDIT window.

Drug Titration Initial Settings

Drug Name	Drug Amount	Solution Amount	Dosage	Step
AMRINONE	500 mg	250 mL	5.00 µg/kg/min	0.10
AMINOPHYLLINE	500 mg	250 mL	0.50 mg/h	0.10
BRETYLIUM	2000 mg	250 mL	1.00 mg/min	0.10
DOBUTAMINE	250 mg	250 mL	2.50 µg/kg/min	0.10
DOPAMINE	800 mg	250 mL	2.00 µg/kg/min	0.10
EPINEPHRINE	4 mg	250 mL	1.00 µg/min	0.10
HEPARIN	25000 units	250 mL	1000 units/h	50
INSULIN	100 units	100 mL	1.00 units/h	0.10
ISOPROTERENOL	2 mg	250 mL	1.00 µg/kg/min	0.10
LIDOCAINE	2000 mg	250 mL	2.00 mg/min	0.10
NITROGLYCERIN	50 mg	250 mL	100 µg/min	0.10
NITROPRUSSIDE	50 mg	250 mL	0.50 µg/kg/min	0.10
NOREPINEPHRINE	4 mg	250 mL	2.00 µg/min	0.10
PHENYLEPHRINE	300 mg	250 mL	100 µg/min	0.10
PROCAINAMIDE	2000 mg	250 mL	2.00 mg/min	0.10
STREPTOKINASE	750000 IU	250 mL	30000 IU/h	5000
TPA	100 mg	200 mL	20.00 mg/h	0.10
DRUG A to D	500 mg	250 mL	1.00 µg/kg/min	0.01

Flow Rate Equations

Dosage Unit	Drug Name	Equation
mg/h	AMINOPHYLLINE TPA	Flow rate (mL/h) = $\frac{\text{Dosage (mg/h)} \times \text{Solution amount (mL)}}{\text{Drug amount (mg)}}$
mg/min	BRETYLIUM LIDOCAINE PROCAINAMIDE	Flow rate (mL/h) = $\frac{\text{Dosage (mg/min)} \times \text{Solution amount (mL)} \times 60}{\text{Drug amount (mg)}}$
µg/min	EPINEPHRINE ISOPROTERENOL NOREPINEPHRINE PHENYLEPHRINE	Flow rate (mL/h) = $\frac{\text{Dosage (µg/min)} \times \text{Solution amount (mL)} \times 60}{\text{Drug amount (mg)} \times 1000}$
µg/kg/min	AMRINONE DOPAMINE DOBUTAMINE NITROGLYCERINE NITROPRUSSIDE	Flow rate (mL/h) = $\frac{\text{Dosage (µg/kg/min)} \times \text{Weight (kg)} \times \text{Solution amount (mL)} \times 60}{\text{Drug amount (mg)} \times 1000}$
units/h	HEPARIN INSULIN	Flow rate (mL/h) = $\frac{\text{Dosage (units/h)} \times \text{Solution amount (mL)}}{\text{Drug amount (units)}}$
IU/h	STREPTOKINASE	Flow rate (mL/h) = $\frac{\text{Dosage (IU/h)} \times \text{Solution amount (mL)}}{\text{Drug amount (IU)}}$

8. DRUG/LUNG FUNCTION WINDOWS

For DRUG A to D, when using the same dosage unit as above, the same equation is used. When using other units, refer to the table below.

Dosage Unit	Equation
mg/kg/min	Flow rate (mL/h) = $\frac{\text{Dosage (mg/kg/min)} \times \text{Weight (kg)} \times \text{Solution amount (mL)} \times 60}{\text{Drug amount (mg)}}$
mg/kg/h	Flow rate (mL/h) = $\frac{\text{Dosage (mg/kg/h)} \times \text{Weight (kg)} \times \text{Solution amount (mL)}}{\text{Drug amount (mg)}}$
µg/h	Flow rate (mL/h) = $\frac{\text{Dosage (µg/h)} \times \text{Solution amount (mL)}}{\text{Drug amount (mg)} \times 1000}$
µg/kg/h	Flow rate (mL/h) = $\frac{\text{Dosage (µg/kg/h)} \times \text{Weight (kg)} \times \text{Solution amount (mL)}}{\text{Drug amount (mg)} \times 1000}$
units/kg/h	Flow rate (mL/h) = $\frac{\text{Dose speed (units/kg/h)} \times \text{Weight (kg)} \times \text{Base amount (mL)}}{\text{Drug amount (units)}}$
IU/kg/h	Flow rate (mL/h) = $\frac{\text{Dose speed (IU/kg/h)} \times \text{Weight (kg)} \times \text{Base amount (mL)}}{\text{Drug amount (IU)}}$

Displaying the DRUG Window

1. Press the [MENU] key to display the MENU window.

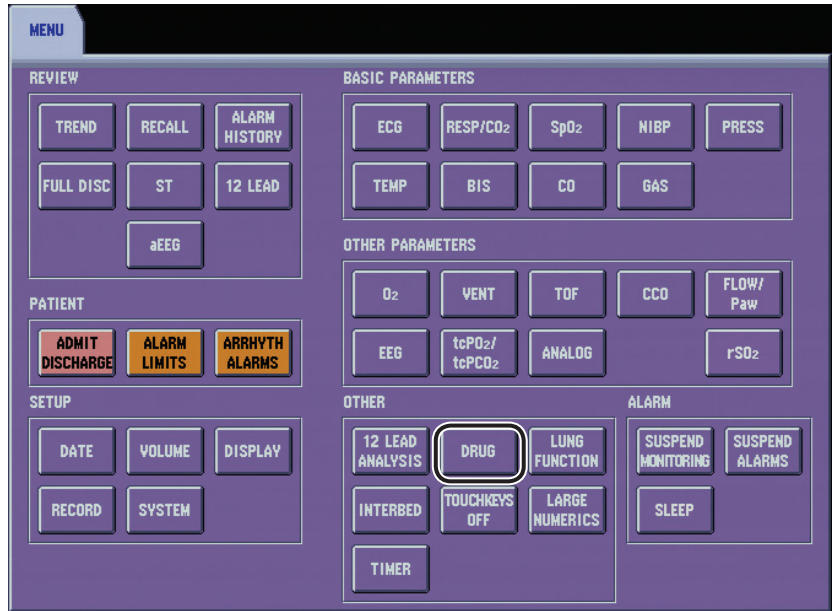

2. Touch the DRUG key. The DRUG window appears.

When DRUG is assigned to one of the function keys at the upper left of the screen, touching the DRUG function key also opens the DRUG window.



Displays EDIT window for entering drug name and dose unit.

8. DRUG/LUNG FUNCTION WINDOWS

- To display the SETTINGS window, touch the SETTINGS tab.

Touch a key to enter value.

Use the numeric keypad to enter values. Touch the ENT key to register the entered value.

To display the DOSE window, touch the DOSE tab.

DOSE	SAMPLE RATE	DOSE	SAMPLE RATE
19.91	41.8	20.01	42.0
19.92	41.8	20.02	42.0
19.93	41.9	20.03	42.1
19.94	41.9	20.04	42.1
19.95	41.9	20.05	42.1
19.96	41.9	20.06	42.1
19.97	41.9	20.07	42.1
19.98	42.0	20.08	42.2
19.99	42.0	20.09	42.2
20.00	42.0	20.10	42.2

Touching the PRINT key prints the titration table and the drug data on the left.

Recording example

ICU-001 JOHN SMITH 2008-03-07 13:30

DRUG NAME	DOSE	SAMPLE RATE	DOSE	SAMPLE RATE
AMRINONE	19.10	40.1	20.10	42.2
500.00 mg	19.20	40.3	20.20	42.4
250 mL	19.30	40.5	20.30	42.6
2	19.40	40.7	20.40	42.8
20.00 mcg/kg/min	19.50	41.0	20.50	43.0
42.0 mL/h	19.60	41.2	20.60	43.3
70.0 kg	19.70	41.4	20.70	43.5
0.10	19.80	41.6	20.80	43.7
	19.90	41.8	20.90	43.9
	20.00	42.0	21.00	44.1

DRUG *Zenith* FQW50-3-100 K37Z01

- Press the [Home] key to return to the home screen.

Selecting the Drug

1. Display the DRUG window.
Press the [Menu] key → DRUG key → DRUG tab.

When DRUG is assigned to one of the function keys, touching the DRUG function key also opens the DRUG window.

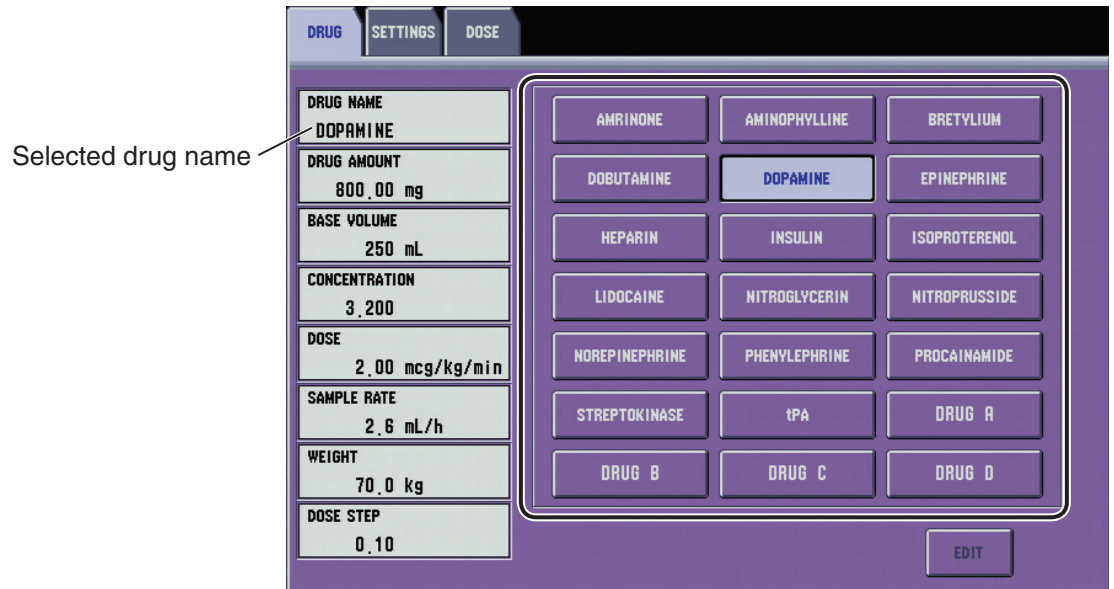

2. Select the drug by touching the drug name key. When the drug is selected, drug amount, solution amount (BASE VOLUME), dosage (DOSE) and step (DOSE STEP) set for that drug and concentration and flow rate (SAMPLE RATE) which are automatically calculated appear on the window.

NOTE

- DOPAMINE, DOBUTAMINE, NITROGLYCERIN and NITROPRUSSIDE need patient weight to calculate the flow rate. For these drugs, enter the patient weight on the ADMIT page of the ADMIT DISCHARGE window or the SETTINGS window of the DRUG window.
- For the DRUG A to D, assign the drug name and set the unit on the DRUG window and set the drug amount, solution amount, dosage and step on the SETTINGS window.

Assigning a Drug Name and Dosage Unit to DRUG A to D

When using a drug other than the 17 preset drugs, you can assign a drug name and dosage unit to DRUG A to D. When the dosage unit is set, the flow rate unit is automatically set. When using this function, you must also set the drug amount, solution amount (BASE VOLUME), dosage (DOSE) and step (DOSE STEP) so that the dosage and flow rate (SAMPLE RATE) can be calculated.

1. Display the DRUG NAME window.
Press the [Menu] key → DRUG key → DRUG tab.

When DRUG is assigned to one of the function keys, touching the DRUG function key also opens the DRUG window.

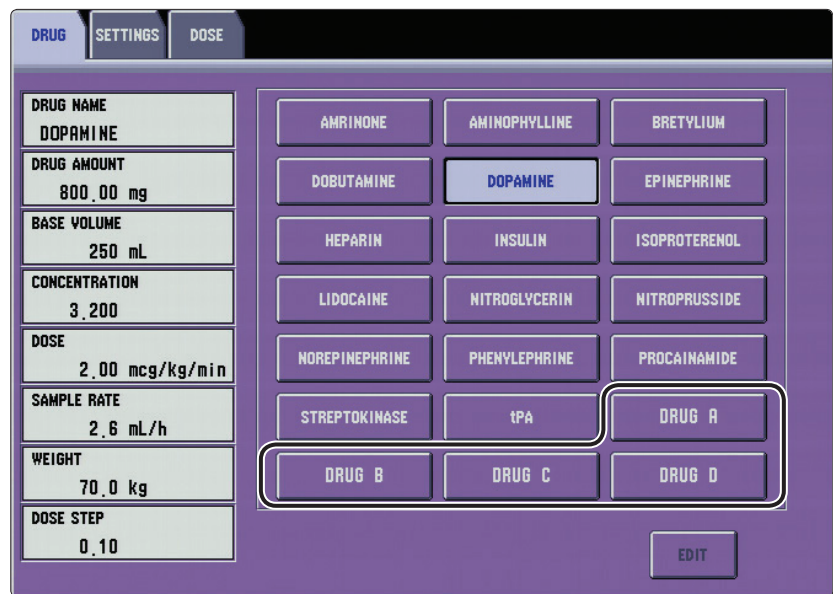

2. Select DRUG A, B, C or D key to assign a drug name.
3. Touch the EDIT key. The keyboard for entering drug name appears.



4. Enter the drug name. Up to 16 alphanumeric characters can be entered. Touch the ENT key to register the entered name.
5. Select the unit. When the dosage unit is set, the flow rate unit is automatically set as follows.

Dosage Unit	Drug Amount Unit
mg/h	mg
mg/min	
mg/kg/h	
mg/kg/min	
µg/h	
µg/min	
µg/kg/h	
µg/kg/min	
units/h	units
IU/h	IU

Changing the Settings

The following items can be changed for the drug calculation. When the settings are changed, the dosage and flow rate are automatically recalculated.

- Drug amount
- Solution amount (Base volume)
- Dosage (Dose)
- Flow rate (Sample rate)
- Weight
- Step (Dose step)

NOTE

- Enter the data in the units displayed on the window.
- When using the drug which is assigned to DRUG A to D, you must set the unit on the DRUG window before changing the setting on the SETTINGS window.

Changing the Drug Amount, Solution Amount, Dosage, Flow Rate and Weight

1. Display the SETTINGS window.
Press the [Menu] key → DRUG key → SETTINGS tab.

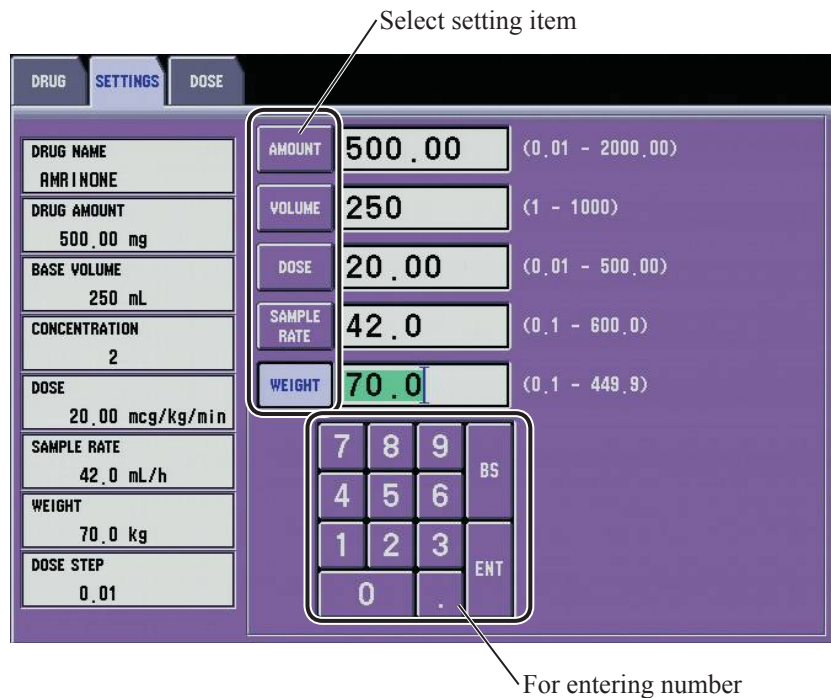

2. Select the item you want to change the setting for by touching the item name key.
3. Change the setting.
Use the numeric keypad on the window, then touch the ENT key.

Changing the Dose Step

1. Display the DOSE window.
Press the [Menu] key → DRUG key → DOSE tab.

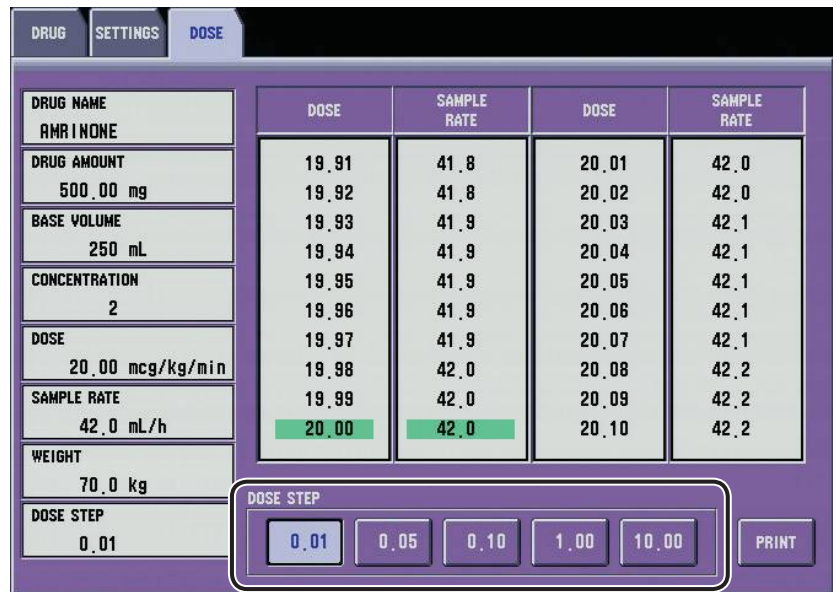

2. Select the setting from <DOSE STEP> box.

Unit and Setting Range

Drug Amount, Dosage and Step

Drug Name	Drug Amount		Dosage		Step
	Unit	Setting Range	Unit	Setting Range	Setting Range
AMRINONE	mg	0.01 to 1500000	µg/kg/min	0.01 to 1500000	0.01, 0.05, 0.10, 1.00, 10.00
AMINOPHYLLINE			mg/h		
BRETYLIUM			mg/min		
DOBUTAMINE			µg/kg/min		
DOPAMINE			µg/kg/min		
EPINEPHRINE			µg/min		
HEPARIN	units		units/h		10, 50, 100, 500
INSULIN			units/kg/h		
ISOPROTERENOL	mg		µg/min		0.01, 0.05, 0.10, 1.00, 10.00
LIDOCAINE			mg/min		
NITROGLYCERIN	mg		µg/kg/min		
NITROPRUSSIDE			µg/kg/min		
NOREPINEPHRINE			µg/min		
PHENYLEPHRINE			µg/min		
PROCAINAMIDE			mg/min		
ISOPROTERENOL					
STREPTOKINASE	IU	IU/h	5000, 10000, 50000		
		IU/kg/h			
TPA	mg	mg/h	0.01, 0.05, 0.10, 1.00, 10.00		

8. DRUG/LUNG FUNCTION WINDOWS

For DRUG A to D

Dosage		Drug Amount		Step			
Unit	Setting Range	Unit	Setting Range	Setting Range			
mg/h	0.01 to 1500000	mg	0.01 to 1500000	0.01, 0.05, 0.10, 1.00, 10.00			
mg/min							
mg/kg/h							
mg/kg/min							
µg/h							
µg/min							
µg/kg/h							
µg/kg/min							
units/h					units	IU	10, 50, 100, 500
units/kg/h							
IU/h		IU		5000, 10000, 50000			
IU/kg/h							

Solution Amount, Flow Rate and Weight

Item	Unit	Drug Amount Unit
Solution Amount	mL	1 to 1000
Flow Rate	mL/h	0.1 to 1000
Weight	kg	0 to 449.9

LUNG FUNCTION Window

There are two windows in the LUNG FUNCTION window. The DATA ENTRY window calculates the patient's respiration dynamics and the LUNG FUNCTION window displays the calculation result. The following data required for this calculation is automatically acquired from the monitoring parameters when the window is opened.

- Patient's height and weight entered on the ADMIT page of the ADMIT DISCHARGE window
- CCO value (When CCO is measured, the CCO value is used as the CO value)
- O₂ when O₂ or anesthetic gas is monitored

The calculation result displayed on the LUNG FUNCTION page can be recorded on the optional recorder.

8

Displaying the LUNG FUNCTION Window

1. Press the [Menu] key to display the MENU window.

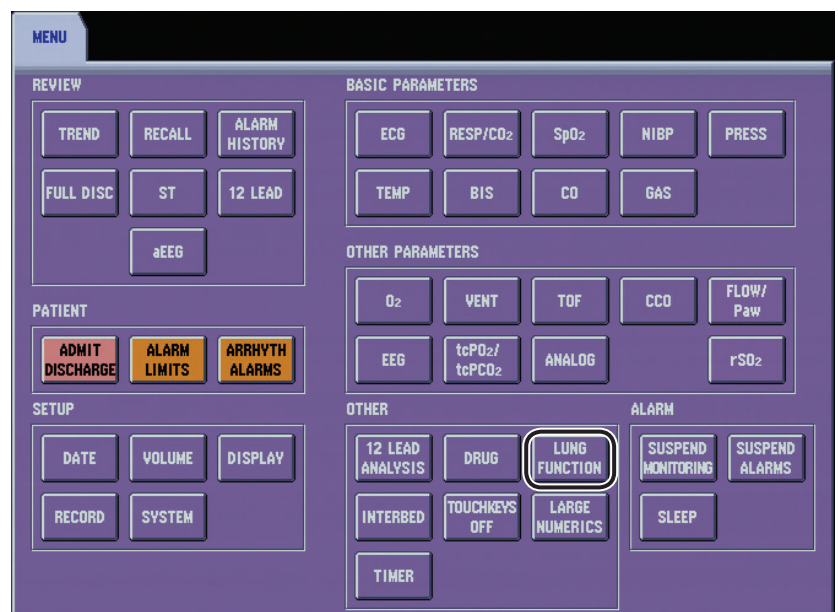

8. DRUG/LUNG FUNCTION WINDOWS

2. Touch the LUNG FUNCTION key. The DATA ENTRY page appears.

When LUNG FUNCTION is assigned to one of the function keys at the upper left of the screen, touching the LUNG FUNCTION function key also opens the DATA ENTRY page.

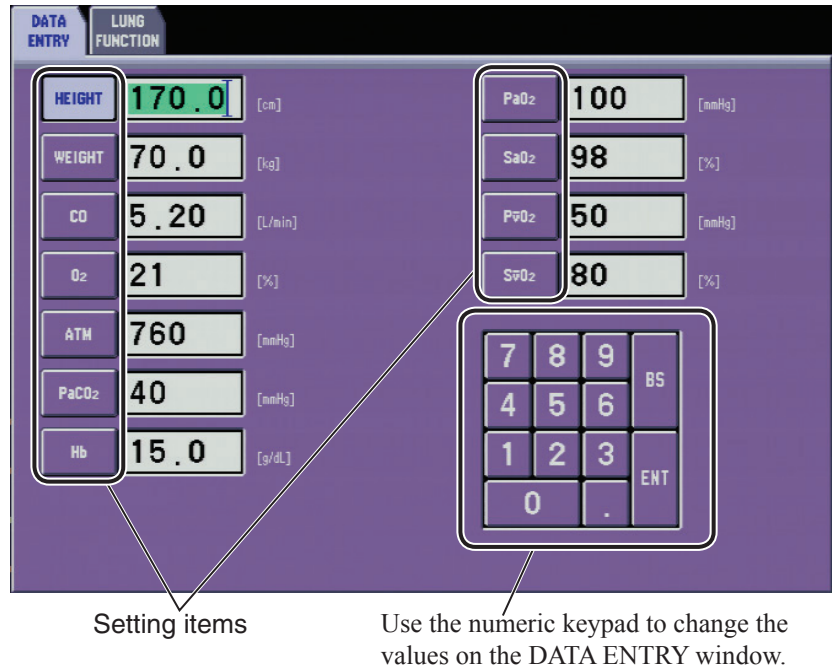

3. Touch the LUNG FUNCTION tab. The LUNG FUNCTION page appears.



4. Press the [Home] key to return to the home screen.

Entering the Data

Explanation of the DATA ENTRY Items

Item Name	Unit	Setting Range
Height	cm/inch	0.1 to 299.9
Weight	kg/pound	0.1 to 449.9
CO	L/min	0.01 to 20.0
O ₂	%	1 to 100
Atmospheric pressure	mmHg/kPa	235 to 795
PaCO ₂	mmHg/kPa	0 to 200
Hb	g/dL, mmol/L	0.1 to 50.0
PaO ₂	mmHg/kPa	0 to 800
SaO ₂	%	1 to 100
P \bar{V} O ₂	mmHg/kPa	1 to 100
S \bar{V} O ₂	%	0 to 99

8

1. Display the DATA ENTRY page.

Press the [Menu] key → LUNG FUNCTION key → DATA ENTRY tab.

When LUNG FUNCTION is assigned to one of the function keys, touching the LUNG FUNCTION function key also opens the DATA ENTRY window.

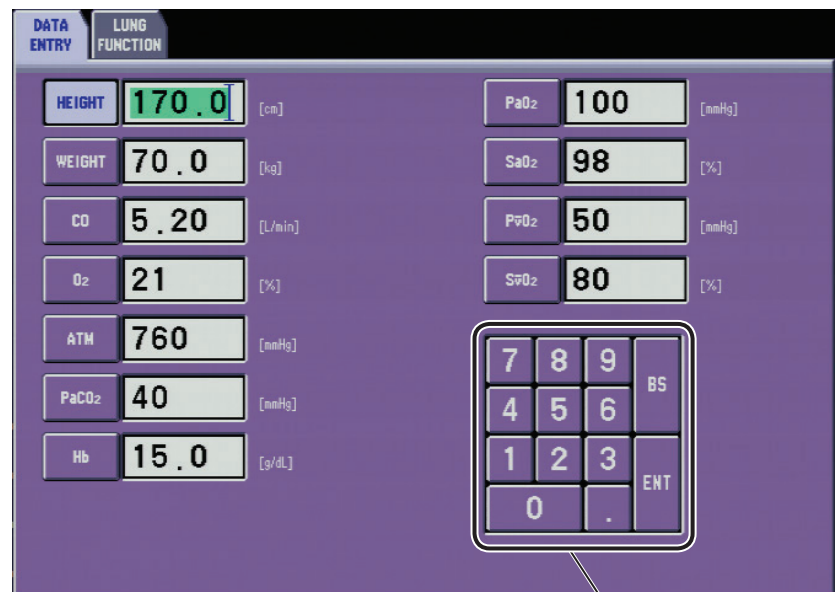

Numeric keypad

2. If necessary, change values using the numeric keypad. Select the item you want to change the settings by touching the item name key.
3. Change the value using the numeric keypad on the window, then touch the ENT key.
4. Repeat step 2 and 3 to select other parameters.

When height or weight is changed, the same setting on the ADMIT page of the ADMIT DISCHARGE window and windows which use height and weight are also changed. The respiration dynamics are recalculated according to the entered values.

Checking the Calculation Results

1. Display the LUNG FUNCTION page.

Press the [Menu] key → LUNG FUNCTION key → LUNG FUNCTION tab.

The screenshot shows the LUNG FUNCTION page with two main sections: CALCULATION RESULTS and DATA ENTRY. The CALCULATION RESULTS section is highlighted with a white border and contains the following data:

CALCULATION RESULTS	
BSA	1.81 [m ²]
CI	2.87 [L/min/m ²]
AaDO ₂	1.83 [mmHg]
CaO ₂	20.01 [mL/dL]
DO ₂	1040.42 [mL/min]
DO ₂ I	574.91 [mL/min/m ²]
CvO ₂	16.24 [mL/dL]
avDO ₂	3.77 [mL/dL]
VO ₂	196.20 [mL/min]
VO ₂ I	108.41 [mL/min/m ²]
O ₂ ER	18.86 [%]
PaO ₂ /O ₂	476.19 [mmHg]
Qs/Qt	9.75 [%]

The DATA ENTRY section contains the following data:

DATA ENTRY	
HEIGHT	170.0 [cm]
WEIGHT	70.0 [kg]
CO	5.20 [L/min]
O ₂	21 [%]
ATM	760 [mmHg]
PaCO ₂	40 [mmHg]
Hb	15.0 [g/dL]
PaO ₂	100 [mmHg]
SaO ₂	98 [%]
PvO ₂	50 [mmHg]
SvO ₂	80 [%]

On the right side of the screen, there are three buttons: "ADD TO LUNG TREND" (with an "ADD" button below it), "SHOW LUNG TREND" (with a "SHOW" button below it), and "RECORD" (with a "RECORD" button below it).

2. Check the calculation results.

Explanation of the CALCULATION RESULTS

Label	Name	Unit
BSA	Body surface area	m ²
CI	Cardiac index	L/min/m ²
AaDO ₂	Alveolar arterial oxygen tension difference	mmHg, kPa
CaO ₂	Arterial oxygen content	mL/dL
DO ₂	Oxygen delivery	mL/min
DO ₂ I	Oxygen delivery index	mL/min/m ²
CvO ₂	Venous oxygen content	mL/dL
avDO ₂	Arteriovenous oxygen difference	mL/dL
VO ₂	Oxygen consumption	mL/min
VO ₂ I	Oxygen consumption index	mL/min/m ²
O ₂ ER	Oxygen extraction ratio	%
PaO ₂ /O ₂	Oxygenation ratio	mmHg, kPa
Qs/Qt	Shunt fraction	%

Adding the Calculation Results to the LUNG TREND Table

1. Display the LUNG FUNCTION page.
Press the [Menu] key → LUNG FUNCTION key → LUNG FUNCTION tab.



2. Touch the ADD key on the LUNG FUNCTION page to add the calculation results to the table on the LUNG TREND page in the TREND window.

Displaying the LUNG TREND Table

1. Display the LUNG FUNCTION page.
Press the [Menu] key → LUNG FUNCTION key → LUNG FUNCTION tab.



2. Touch the SHOW key on the LUNG FUNCTION window to display the table on the LUNG TREND page in the TREND window.

Recording the Calculation Results and Entered Data

The calculation results and entered data displayed on the LUNG FUNCTION page can be recorded on the optional recorder.

1. Display the LUNG FUNCTION page.
Press the [Menu] key → LUNG FUNCTION key → LUNG FUNCTION tab.



2. Touch the RECORD key. The recording starts.

To stop recording the table, press the [⏏] [Record] key.

3. Touch the [X] key to close the window.

Recording example

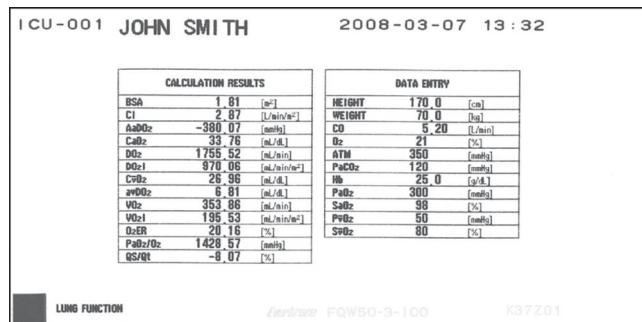

Section 9 Interbed Window

Registering Interbed Beds.....	9.3
Removing an Interbed Bed.....	9.3
Displaying the Numeric Data of All Interbed Beds.....	9.4
Displaying the Interbed Bed Data.....	9.5
Interbed Alarm.....	9.7
Interbed Alarm Setting	9.8

9. INTERBED WINDOW

When the bedside monitor is connected to a central monitor network, the bedside monitor data can be sent to the central monitor. The bedside monitor can display monitoring data of up to 20 other beds in the network on the INTERBED window. If you have previously registered other beds as interbed beds on the INTERBED window, an alarmed interbed bed ID appears on the home screen and alarm sounds on this bedside monitor.

To use the interbed function, the following must be set.

- Register the beds to be managed by the interbed function on this monitor.
- Set <INTERBED ALARMS TO DISPLAY> on the INTERBED page of the SYSTEM SETUP window to ALL, CRISIS AND WARNING, or CRISIS. Refer to Section 3, Administrator's Guide.
- Set <AUTO INTERBED DISPLAY> on the SETTINGS window of the INTERBED window to ON to automatically display the VIEW OTHER BEDS window of the alarmed bed when an alarm occurs on that bed.

WARNING

Do not monitor a patient's vital signs only by the interbed function. The patient must be monitored on the interbed bed or central monitor.

WARNING

When an alarm occurs:

- Check the patient first and take necessary measure to ensure patient's safety.
- Remove the cause of the alarm.
- Check the alarm settings on the bedside monitor and change the alarm settings if necessary.

NOTE

The monitor must be connected to a network to use the interbed function.

Registering Interbed Beds

To view another bed, you must register the bed as an interbed bed. Only registered beds can be viewed. You can register up to 20 interbed beds. Any bed in the monitor network can be registered as an interbed bed.

When registering an interbed bed, the power of the bedside monitor to be registered must be turned on.

1. Display the SELECT BEDS window.
Press the [Menu] key → INTERBED key → SELECT BEDS tab.

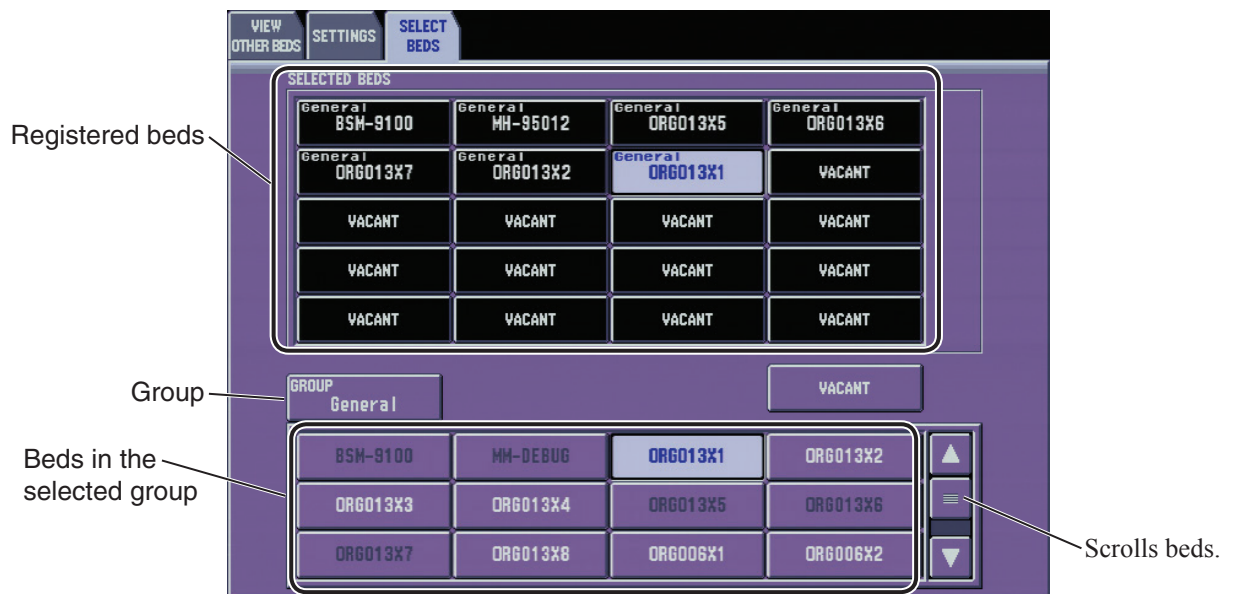

2. In the <SELECTED BEDS> box, select the position to register the interbed bed.
3. Touch the GROUP key to select the group to which the desired bed belongs and select the bed from the bed list. The beds which are already registered as interbed beds cannot be selected.
4. Check that the selected bed appears in the <SELECTED BEDS> box.

Removing an Interbed Bed

1. In the <SELECTED BEDS> box, select the interbed bed to be removed.
2. Touch the VACANT key.

Displaying the Numeric Data of All Interbed Beds

The numeric data of all registered interbed beds can be displayed on the VIEW OTHER BEDS window. There are two display patterns for this window.

Display the VIEW OTHER BEDS window.

Press the [Menu] key → INTERBED key → VIEW OTHER BEDS tab.

To see more parameters on the VIEW OTHER BEDS window, register beds only in the top two rows of the SELECT BEDS window.

SELECTED BEDS			
General	General	General	General
BSM-9100	MH-95012	ORGD13X5	ORGD13X6
ORGD13X7	ORGD13X2	ORGD13X1	VACANT
VACANT	VACANT	VACANT	VACANT
VACANT	VACANT	VACANT	VACANT
VACANT	VACANT	VACANT	VACANT

When any beds are registered in the bottom three rows on the SELECT BEDS window, only HR and SpO₂ are displayed on the VIEW OTHER BEDS window.

- When no interbed beds are registered in the bottom three rows on the SELECT BEDS window, the heart rate, SpO₂, blood pressure, CO₂, BIS and temperature of the interbed beds are displayed on the VIEW OTHER BEDS window.

VIEW OTHER BEDS	SETTINGS	SELECT BEDS		
ICU-002	ICU-003	ICU-004	ICU-005	
STEVE NORTNICHOL	BRUABBY BROWN	WALTER ABB		
HR 80 SpO ₂ 97	HR 80 SpO ₂ 98	HR 108 SpO ₂ 93	HR 113 SpO ₂ 97	
ART 125/81 (97)	PAP 37/16 (23)	ART 125/81 (97)	ART 123/81 (97)	
CO ₂ (E) 42	CO ₂ (E) 38 BIS 60	CO ₂ (E) 38 BIS 60	CO ₂ (E) 42	
Tblad 370	Tskin 365	Tskin 365	Tskin2 370	
ICU-006	ICU-007	ICU-008	ICU-009	
DORA ORWELKATHY	BENETIM GRANT	SARAH RASK		
SpO ₂ -PR 80 SpO ₂ 98	HR 88 SpO ₂ 96	HR 61 SpO ₂ 93	HR 77 SpO ₂ 97	
NIBP 113/72 (75)	P1 123/81 (96)	CVP 18/7 (11)	ART 125/81 (97)	
Tskin 365	IMP-RR 22 T1 250	CO ₂ (E) 42 BIS 60	CO ₂ (E) 42	

- When interbed beds are registered in the bottom three rows on the SELECT BEDS window, only the heart rate and SpO₂ of the interbed beds are displayed on the VIEW OTHER BEDS window.

VIEW OTHER BEDS	SETTINGS	SELECT BEDS		
ICU-002	ICU-003	ICU-004	ICU-005	
STEVE NORTNICHOL	BRUABBY BROWN	WALTER ABB		
HR 70 SpO ₂ 97	HR 70 SpO ₂ 97	HR 80 SpO ₂ 97	HR 67 SpO ₂ 97	
ICU-006	ICU-007	ICU-008	ICU-009	
DORA ORWELKATHY	BENETIM GRANT	SARAH RASK		
HR 67 SpO ₂ 97	HR 85 SpO ₂ 97	HR 79 SpO ₂ 97	HR 70 SpO ₂ 97	
ICU-010	ICU-011			
JOB LAMBERRALPH SHIE				
HR 80 SpO ₂ 97	HR 70			

Touching a patient name opens the individual bed window. Refer to the next “Displaying the Interbed Bed Data” section for details.

Displaying the Interbed Bed Data

On the individual bed window of the INTERBED window, heart rate and ECG waveform of the first trace are always displayed. Other numerical data and one waveform from the following list can be displayed. Other parameters cannot be displayed.

Numeric Data

- Heart rate
- VPC
- ST
- Respiration rate
- CO₂
- SpO₂
- NIBP
- BIS
- T1
- T2
- O₂
- P1
- P2
- P3

Waveform

- Respiration/CO₂/FLOW
- SpO₂
- P1
- P2
- P3

NOTE

When the instrument which is registered to the interbed bed is turned off or not connected to the network correctly, the "MONITOR OFF" message is displayed and measurement value and alarm are not displayed.

9. INTERBED WINDOW

1. Display the VIEW OTHER BEDS window.

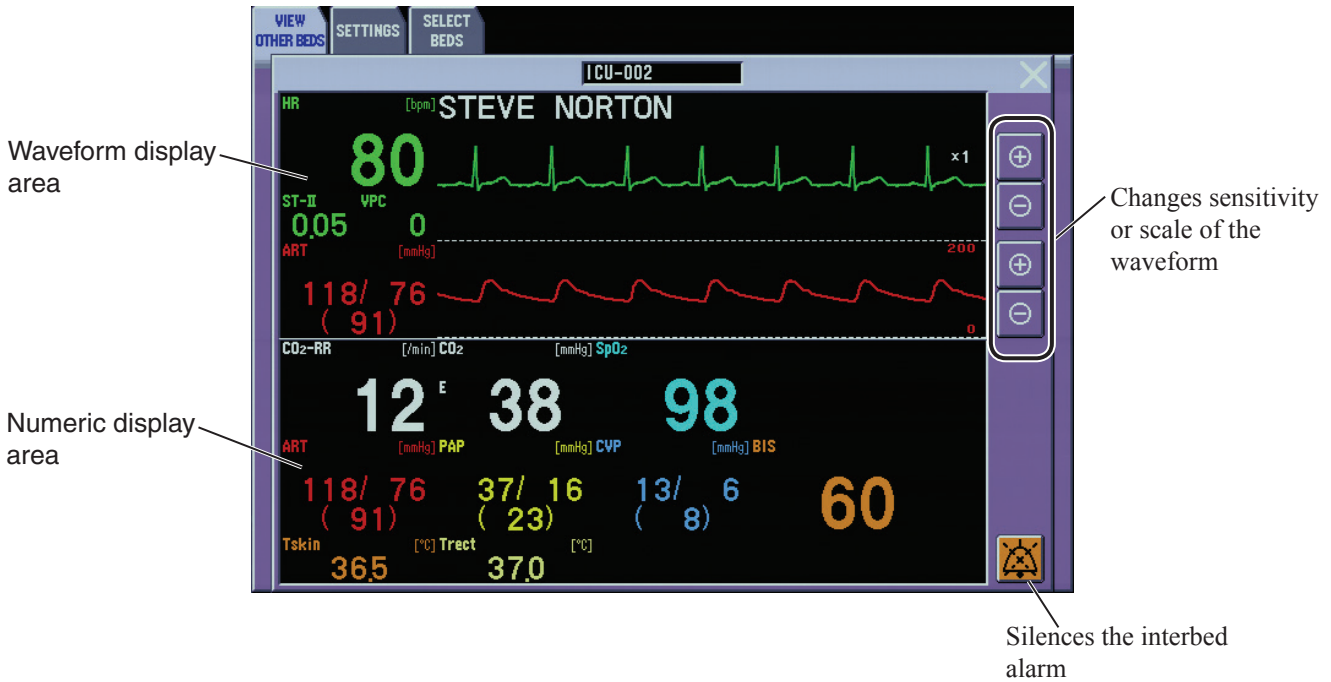

Press [Menu] key → INTERBED key → VIEW OTHER BEDS tab.



2. Touch the desired bed on the VIEW OTHER BEDS window to display the individual bed window.
To change beds, touch the  key to close the window and select the desired bed.

To change the second waveform, touch the numeric data of the parameter you want to display for the waveform in the numeric display area.

To not display the second waveform, touch the numeric value of the second parameter in the waveform display area.

You can also change the waveform sensitivity or scale by using the  and  keys.

Even when ECG is not monitored, pulse rate is displayed on the screen when IBP or SpO₂ is monitored.

Interbed Alarm

When an alarm occurs on an interbed bed, a highlighted bed name appears at the top right corner of the home screen. This interbed alarm message does not indicate the type of alarm. The VIEW OTHER BEDS window can be automatically displayed when an alarm occurs and <AUTO INTERBED DISPLAY> is set to ON.

WARNING

When an alarm occurs:

- Check the patient first and take necessary measure to ensure patient's safety.
- Remove the cause of the alarm.
- Check the alarm settings on the bedside monitor and change the alarm settings if necessary.

NOTE

When the alarm function is turned off by “all alarms off” or “alarm suspended” on the interbed bed, the interbed alarm does not occur on this bedside monitor.

Only one interbed ID can be displayed at a time on the home screen. When more than one interbed alarm occurs, the alarm message appears and the alarming interbed IDs are alternately displayed one at a time.

On the INTERBED window, the bed ID and patient name of the alarmed bed is highlighted.

NOTE

The interbed alarm for another bed is lower level than any other alarm for this bed. Therefore, the interbed alarm might not be indicated during an alarm for this bed.

You can silence the interbed alarm by touching the  key on the individual bed window of the INTERBED window. Silencing the interbed alarm on this monitor also silences the alarm on the alarmed bed itself. The alarm silence indication on the alarmed bed depends on the alarmed bed specifications. The alarm silence time depends on the setting on the alarmed bed.

NOTE

When several interbed alarms occur, all interbed alarms are silenced by touching the  key on the individual bed window of the INTERBED window.

The interbed alarm can only be suspended on the alarmed bed.

Interbed Alarm Setting

CAUTION

The interbed window only appears on the home screen when an interbed alarm occurs and <AUTO INTERBED DISPLAY> is set to ON.

1. Display the SETTINGS window.
Press the [Menu] key → INTERBED key → SETTINGS tab.

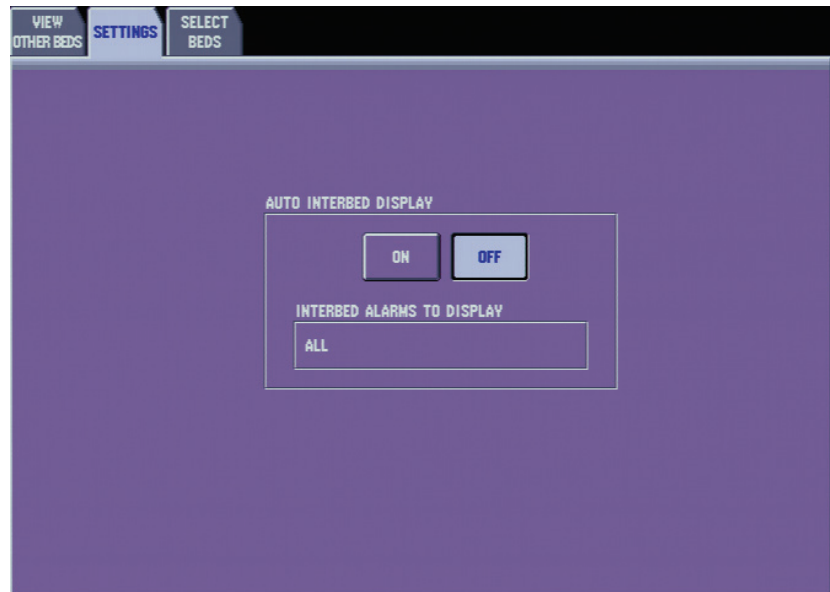

2. Select ON or OFF in the <AUTO INTERBED DISPLAY> box. When this is set to ON, the VIEW OTHER BEDS window is automatically displayed when an alarm occurs.
3. Press the [Home] key to return to the home screen.

Section 10 Recording

Overview of Recording	10.2
Recording Modes	10.3
Manual Waveform Recording/Printing	10.5
Recording/Printing on the 12 LEAD ANALYSIS Window	10.5
Recording/Printing on the Review Windows other than 12 Lead Window	10.5
Recording/Printing on the 12 LEAD Window	10.5
Recording on the LUNG FUNCTION Window	10.5
Recording/Printing OCRG	10.5
Recording on the CO Window	10.6
Recording on the TOF Window	10.6
Recording on the CCO Window	10.6
Recording on the FLOW Window	10.6
Recording on the EEG Window	10.6
Recording on the ANALOG Window	10.6
Periodic Recording	10.7
Alarm Recording	10.8
Recording Mode Annotations	10.10
Recording Priority	10.11
Recording Sensitivity	10.11
Recording Speed	10.11
Feeding the Paper after Recording	10.11
Recording Related Message	10.12
Recorded/Printed Data	10.12
Changing the Recording Speed	10.13
Changing the Recording Pattern	10.14
Manually Recording/Printing Waveforms	10.15
Recording Waveforms on the Optional Recorder	10.15
Recording Waveforms on the Bedside Monitor with No Recorder	10.16
Manual Printing on the Network Printer	10.16
Setting Periodic Recording	10.17
Changing Settings for Automatic Periodic Recording	10.18
Printing on a Network Printer	10.19

Overview of Recording

A variety of waveforms and data can be recorded by the optional recorder.

When the bedside monitor with no recorder is connected to a central monitor network, waveforms and data of the bedside monitor can be recorded manually on the central monitor recorder from the bedside monitor.

When the bedside monitor is connected to a network printer, real-time waveforms, data on the review windows and 12 lead ECG interpretation and analyzed waveforms can be printed. Refer to the “Printing on a Network Printer” section.

This section provides an overview of recording.

The “Changing the Recording Pattern” section explains how to change the recording pattern for all recordings except for the review data recordings.

The “Manually Recording/Printing Waveforms” section explains how to manually record waveforms at any time.

The “Setting Periodic Recording” section explains necessary settings for performing automatic periodic recording.

Some recording procedures are explained in other sections.

- To record trendgraphs and tables, see Section 6.
- To record arrhythmia recall files, see Section 6.
- To record alarm history, see Section 6.
- To record full disclosure, see Section 6.
- To record ST level recall files, see Section 6.
- To record OCRG, see Section 6.
- To record aEEG, see Section 6.
- To record 12 lead ECG interpretation result, see Section 7.
- To record 12 lead analysis waveform, see Section 7.
- For alarm recording, see Section 5.
- To record CO data on the CO window, see Section 9, User’s Guide Part II.
- To record TOF measurement results on the TOF window, see Section 13, User’s Guide Part II.
- To record AP waveform on the CCO window, see Section 14, User’s Guide Part II.
- To record FLOW data and loops on the FLOW window, see Section 15, User’s Guide Part II.
- To record EEG waveforms with the numeric values on the EEG window, see Section 16, User’s Guide Part II.
- To record analog waveforms on the ANALOG window, see Section 18, User’s Guide Part II.

To load recording paper, see “Loading Recording Paper” in Section 2.

Recording Modes

The following recording modes are available.

Recording mode	Recorded data	Length/time of recorded data	Operations/conditions/settings for recording	Recorded annotation
Real time/ delayed waveform recording*	Up to three waveforms selected on the RECORD window with numerical data	Time set at <MANUAL RECORD TIME> on the SYSTEM SETUP window	[Record] key is pressed or RECORD WAVE function key is touched	MANUAL
			Select second and third parameters for waveform recording on the RECORD window	
Trend graph recording	Trendgraph on the window	Trendgraph displayed on the window	RECORD PAGE key on the PRINT window of the GRAPH 1, 2 or 3 window is touched	TREND GRAPH
Trend table recording	Table on the window	Data of selected time period	RECORD key on the PRINT window of the TABLE 1, 2 or 3 window is touched	TREND DATA
NIBP trend recording	Table on the window	Data of selected time period	RECORD key on the PRINT window of the NIBP TREND window is touched	NIBP TREND
Hemo trend recording	Table on the window	Data of selected time period	RECORD key on the PRINT window of the HEMO TREND window is touched	HEMO- DYNAMICS TREND
Lung trend recording	Table on the window	Data of selected time period	RECORD key on the PRINT window of the LUNG TREND window is touched	LUNG TREND
Arrhythmia recall recording	Acquired arrhythmia waveform	12 seconds	RECORD PAGE key on the PRINT window of the RECALL window is touched	RECALL
	Arrhythmia waveform on the window	Data displayed on the window		
Alarm history recording	Alarm history on the window	Data of selected time period	RECORD key on the PRINT window of the ALARM HISTORY window is touched	ALARM HISTORY
Full disclosure recording	Full disclosure data on the window	Full disclosure waveform on the window	RECORD PAGE key on the PRINT window of the FULL DISC window is touched	FULL DISC- LOSURE
	Actual size waveform on the window (when ZOOM IN key is touched)	12 seconds		
OCRG recording	OCRG on the window	Data displayed on the window	RECORD PAGE key on the PRINT window of the OCRG window is touched	OCRG
aEEG recording	aEEG on the window	Data displayed on the window	RECORD PAGE key on the PRINT window of the aEEG window is touched	aEEG
Recording on the 12 LEAD ANALYSIS WAVE page	ECG waveforms on the 12 LEAD ANALYSIS window	10 seconds	RECORDER key on the PRINT window of the 12 LEAD ANALYSIS window is touched	12 LEAD ECG
Recording on the 12 LEAD window	Table on the 12 LEAD window	Data displayed on the window	RECORD PAGE key on the PRINT window of the 12 LEAD window is touched	12 LEAD
	ECG waveforms on the ANALYSIS WAVE page	10 seconds of ECG waveforms	RECORD PAGE key on the PRINT window of the 12 LEAD window is touched	
	Analysis result on the REPORT page	Data displayed on the window	RECORD PAGE key on the PRINT window of the 12 LEAD window is touched	

10. RECORDING

Recording mode	Recorded data	Length/time of recorded data	Operations/conditions/settings for recording	Recorded annotation
Recording on the LUNG FUNCTION window**	CALCULATION RESULTS and DATA ENTRY data on the window	Data displayed on the window or all saved data	RECORD key on the LUNG FUNCTION window is touched	LUNG FUNCTION
Recording on the CO window**	Up to 5 CO data on the window	Data displayed on the window	RECORD key on the CO window is touched	CO TABLE
Recording on the TOF window	TOF measurement results on the TOF window	Data displayed on the window	RECORD key on the TOF window is touched	TOF
Recording on the CCO window	AP waveform on the CCO window	1 page	RECORD WAVE key on the CCO window is touched	CCO
Recording on the FLOW window	FLOW data and loops on the FLOW window	1 page	RECORD key on the FLOW window is touched	P-V LOOP or F-V LOOP
Recording on the EEG window	EEG waveforms and numeric values on the EEG window	1 page	RECORD key or RECORD ALL WAVES key on the EEG window is touched	EEG
Recording on the ANALOG window	Analog waveforms on the ANALOG window	1 page	RECORD key on the ANALOG window is touched	ANALOG
Recording on the DOSE window	The table and settings displayed on the DOSE window	Data displayed on the window	RECORDER key on the PRINT DRUG CALC window of the DOSE window is touched	DRUG
Recording OCRG	OCRG on the home screen	1 page	RECORD OCRG function key on the home screen is touched	OCRG
Vital signs alarm recording	Up to three waveforms selected on the RECORD window and vital sign data at an alarm occurrence	From 8 seconds before to 12 seconds after alarm occurrence	<ALARM RECORDING> on the RECORD window must be set to ON	ALARM
			Alarm for vital signs parameter must be turned on	
Alarm for arrhythmia must be turned on				
Select second and third parameters for waveform recording on the RECORD window				
Arrhythmia alarm recording	Up to three waveforms selected on the RECORD window and vital sign data at an alarm occurrence	From 8 seconds before to 12 seconds after alarm occurrence	<ALARM RECORDING> on the RECORD window must be set to ON	
			Alarm for arrhythmia must be turned on	
			<ARRHYTHMIA ANALYSIS> on the ECG window must be set to ON	
Periodic recording	Up to three waveforms selected on the RECORD window with numerical data	10 seconds	<PERIODIC REC INTERVAL> on the RECORD window must be set to a time interval (FREE, 30, 60 or 120)	TIMER
	OCRG trendgraph (HR, SpO ₂ and compressed respiration waveform)	2 pages	<PERIODIC REC INTERVAL> on the RECORD window must be set to either 5 (OCRG) or 15 (OCRG)	OCRG

* Real time or delayed recording can be selected on the SYSTEM SETUP window. Refer to Administrator's Guide, Section 3. When the bedside monitor with no optional recorder is connected to a central monitor network, waveforms and data of the bedside monitor can be recorded manually from the bedside monitor on the central monitor recorder by pressing the [Record] key. In this case, only real time recording is available.

** CO data and lung function data recording is only available on the optional WS-671P recorder module.

Manual Waveform Recording/Printing

Up to three waveforms selected on the RECORD window are recorded. For details, refer to the “Manually Recording/Printing Waveforms” section.

With recorder: Recorded on the optional recorder whenever the  [Record] key or RECORD WAVE function key is touched.

No recorder: Not available.

Bedside monitor connected to central monitor network:

Recorded on the central monitor recorder whenever the  [Record] key on the bedside monitor is touched. In this case, ECG and the parameter selected for the second waveform are recorded.

Bedside monitor connected to a network printer:

Printed on the network printer whenever the PRINTER key on PRINT window is touched.

Recording/Printing on the 12 LEAD ANALYSIS Window

12 lead ECG waveforms on the 12 LEAD window can be recorded. For details, refer to “12 LEAD ANALYSIS Window” in Section 7.

With recorder: Recorded on the optional recorder when the RECORDER key on the PRINT window of the 12 LEAD ANALYSIS window is touched.

No recorder: Not available.

Bedside monitor connected to a CNS-9300 series or CNS-9701 central monitor:

Printed on the central monitor printer when the PRINTER key on the PRINT window of the 12 LEAD ANALYSIS window is touched.

Bedside monitor connected to a network printer:

Printed on the network printer when the PRINTER key on the PRINT window of the 12 LEAD ANALYSIS window is touched.

Recording/Printing on the Review Windows other than 12 Lead Window

For details, refer to Section 6.

Recording/Printing on the 12 LEAD Window

For details, refer to Section 7.

Recording on the LUNG FUNCTION Window

The lung function data displayed on the LUNG FUNCTION window can be recorded on the optional WS-671P recorder module. For details, refer to “Recording the Calculation Results and Entered Data” in Section 8.

Recording/Printing OCRG

OCRG on the home screen can be recorded. Periodic OCRG recording is also available. See the “Periodic Recording” section below.

With recorder: Recorded on the optional recorder when the RECORD OCRG function key on the home screen is touched.

No recorder: Not available.

Bedside monitor connected to a network printer:

Printed on the network printer when the PRINT OCRG key on the home screen is touched.

Recording on the CO Window

The CO data displayed on the CO window can be recorded on the optional WS-671P recorder module. Recording starts after a few seconds and a blinking  mark appears on the upper right corner of the screen. CO can only be recorded on the optional recorder. For details, refer to Section 9 of User's Guide Part II.

Recording on the TOF Window

Measurement results displayed on the TOF window can be recorded on the optional WS-671P recorder module. For details, refer to Section 13 of User's Guide Part II.

With recorder: Recorded on the optional recorder when the RECORD key on the TOF window is touched.

No recorder: Not available.

Recording on the CCO Window

The AP waveform displayed on the CCO window can be recorded on the optional WS-671P recorder module. For details, refer to Section 14 of User's Guide Part II.

With recorder: Recorded on the optional recorder when the RECORD WAVE key on the CCO window is touched.

No recorder: Not available

Recording on the FLOW Window

The FLOW data and loops can be recorded on the optional WS-671P recorder module. For details, refer to Section 15 of User's Guide Part II.

With recorder: Recorded on the optional recorder when the RECORD key on the FLOW window is touched.

No recorder: Not available.

Recording on the EEG Window

The EEG waveforms with the numeric values can be recorded on the optional WS-671P recorder module. For details, refer to Section 16 of User's Guide Part II.

With recorder: Recorded on the optional recorder when the RECORD key or RECORD ALL WAVES key on the EEG window is touched.

No recorder: Not available.

Recording on the ANALOG Window

The analog waveform displayed on the ANALOG window can be recorded on the optional WS-671P recorder module. For details, refer to Section 18 of User's Guide Part II.

With recorder: Recorded on the optional recorder when the RECORD key on the ANALOG window is touched.

No recorder: Not available

Periodic Recording

There are two types of recording data for periodic recording.

- Up to three waveforms with numerical data:
Up to three waveforms selected on the RECORD window and vital signs data are recorded automatically at the set interval.
- OCRG:
The trendgraphs of HR and SpO₂ and compressed respiration waveform are recorded at 5 or 15 minute intervals.

Periodic recording is only available on the optional recorder.

Set the following items on the RECORD window.

- Periodic recording time interval. When OFF is selected, periodic recording is turned off.
To periodically record OCRG, select either the 5 (OCRG) or 15 (OCRG).
- Recording pattern (not necessary when recording the OCRG)

Recording examples

10

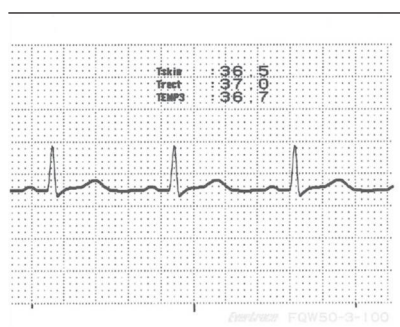
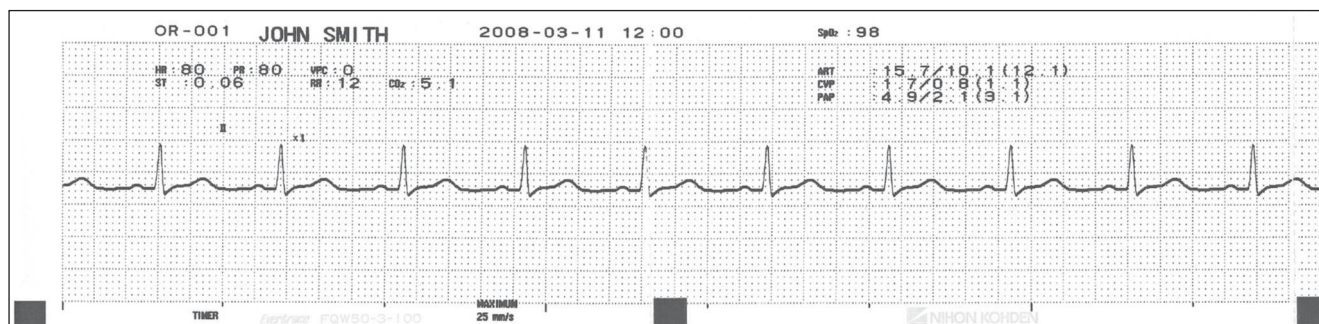

OCRG recording

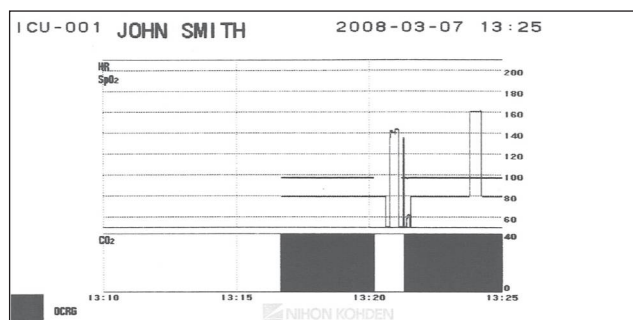

10. RECORDING

Alarm Recording

When a vital sign alarm or arrhythmia alarm occurs, up to three waveforms selected on the RECORD window and vital sign data are automatically recorded. The recorded waveforms are from 8 seconds before to 12 seconds after the alarm occurrence. The alarm recording is only available on the optional recorder.

Set alarm recording on or off on the RECORD window. For details, refer to Section 5.

CAUTION

Alarm recording is not performed when:

- Alarm is suspended.
- Alarm recording is set to Off.

Recording examples

Arrhythmia alarm recording

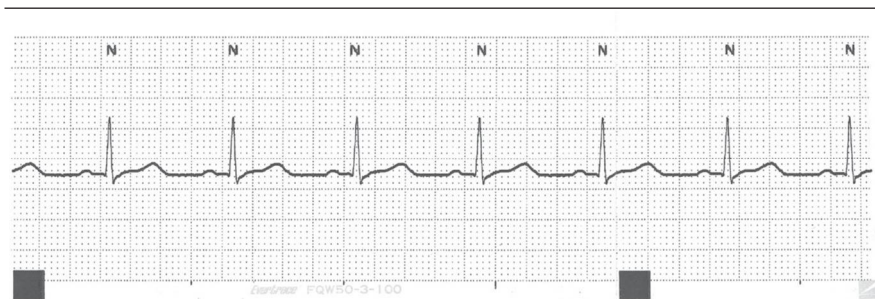
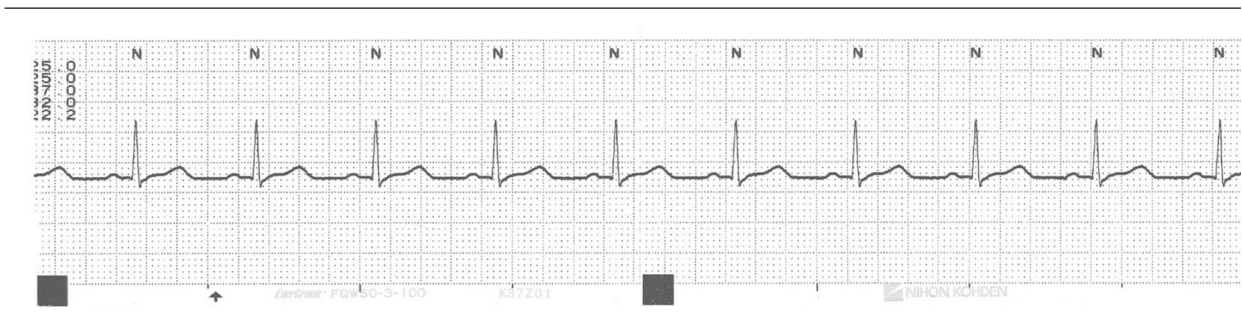
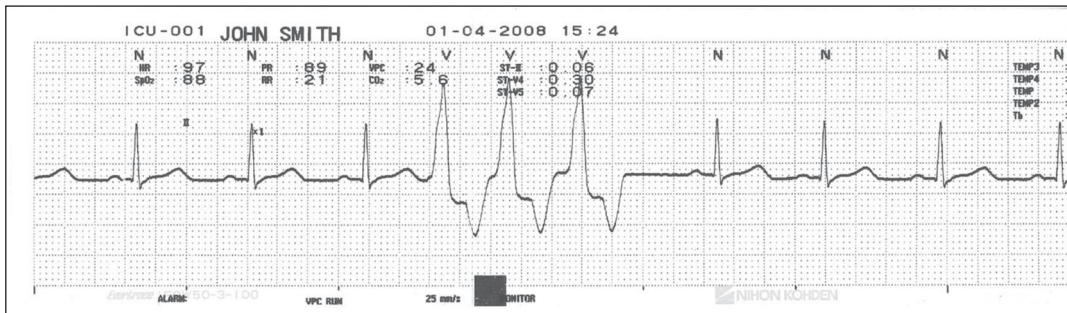

Upper/lower limit alarm recording

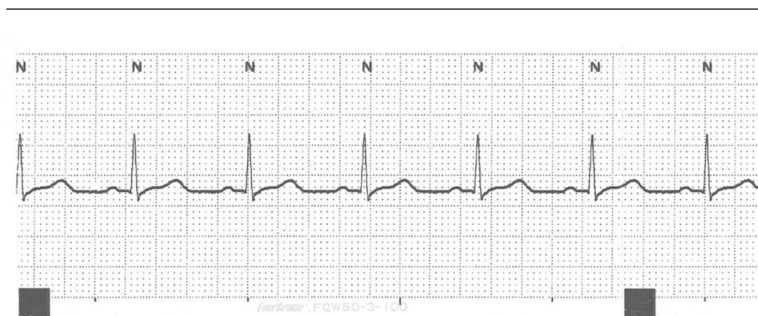
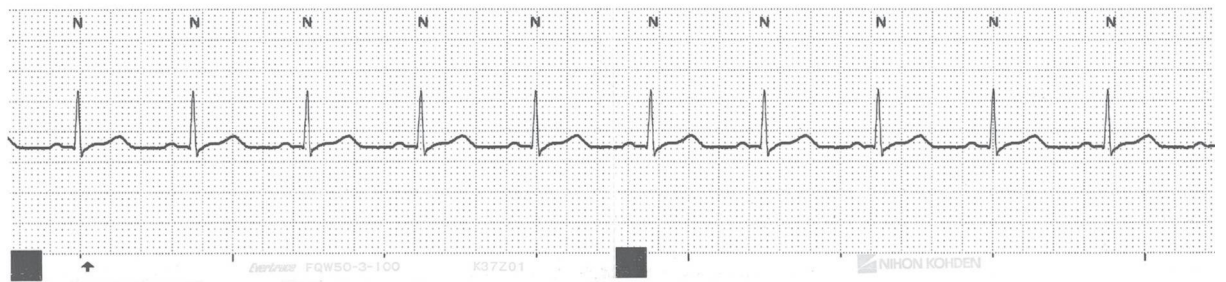
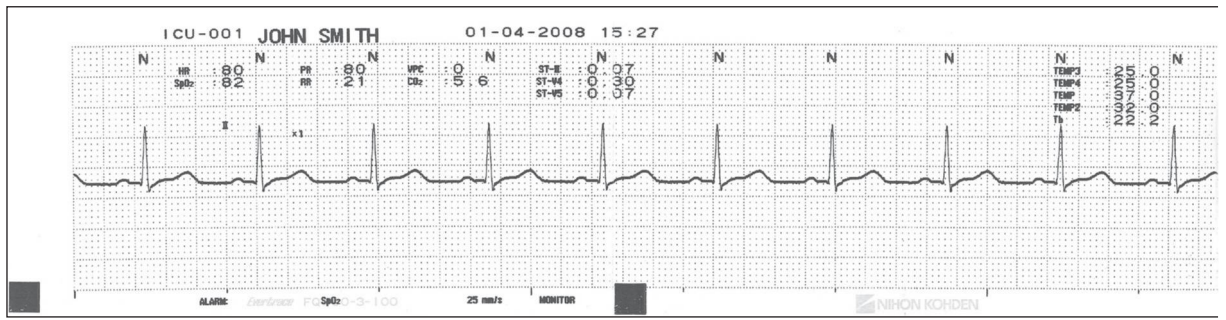

Recording Mode Annotations

One of the following annotations is recorded on each page of the recording paper as shown below.

TIMER:	Automatic periodic recording. Refer to the “Setting Periodic Recording” section.
ALARM:	Automatic recording at a vital sign or arrhythmia alarm occurrence. Refer to “Turning Automatic Alarm Recording On/Off” in Section 5.
TREND GRAPH:	Trendgraph recording. Refer to “Trend Window” in Section 6.
TREND DATA:	Trend table recording. Refer to “Trend Window” in Section 6.
NIBP TREND:	NIBP trend recording. Refer to “Trend Window” in Section 6.
HEMO TREND:	Hemo trend recording. Refer to “Trend Window” in Section 6.
LUNG TREND:	Lung trend recording. Refer to “Trend Window” in Section 6.
RECALL:	Arrhythmia waveform recording. Refer to “Arrhythmia Recall Window” in Section 6.
ALARM HISTORY:	Alarm history recording. Refer to “Alarm History Window” in Section 6.
FULL DISCLOSURE:	Full disclosure recording. Refer to “Full Disclosure Window” in Section 6.
ST:	ST level recall recording. Refer to “ST Level Recall Window” in Section 6.
OCRG:	OCRG recording on the OCRG window. Refer to “OCRG Window” in Section 6.
aEEG:	aEEG recording on the aEEG window. Refer to “aEEG Window” in Section 6.
12 LEAD ECG:	OCRG recording on the home screen. ECG waveforms displayed on the ANALYSIS WAVE page of the 12 LEAD window are recorded. Refer to “12 LEAD Window” in Section 7.
DRUG:	Titration table and settings displayed on the DOSE window is recorded. Refer to “DRUG Window” in Section 8.
LUNG FUNCTION:	Calculation results and entered data displayed on the LUNG FUNCTION page are recorded. Refer to “LUNG FUNCTION Window” in Section 8.
MANUAL:	Manual recording.
CO TABLE:	Hemodynamics data and thermodilution curves table on the CO window are recorded. Refer to Section 9 “Cardiac Output Monitoring” in the User’s Guide Part II.
TOF:	Measurement results displayed on the TOF window is recorded. Refer to Section 13 “TOF Monitoring” in the User’s Guide Part II.

CCO:	AP waveform recording. Refer to Section 14 “CCO Monitoring” in the User’s Guide Part II.
P-V LOOP, F-V LOOP:	FLOW data and loops displayed on the FLOW window is recorded. Refer to Section 15 “FLOW/Paw Monitoring” in the User’s Guide Part II.
EEG:	EEG waveform recording. Refer to Section 16 “EEG Monitoring” in the User’s Guide Part II.
ANALOG:	Analog waveform recording. Refer to Section 18 “ANALOG Monitoring” in the User’s Guide Part II.

Recording Priority

If more than one recording mode is activated at the same time, only the highest priority mode is used.

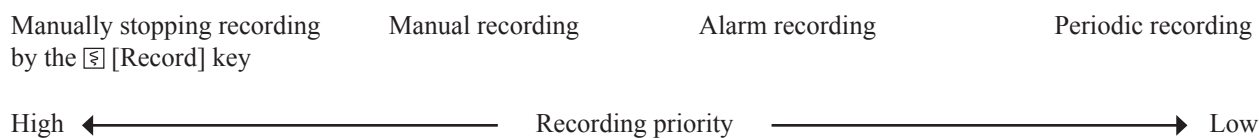

10

During alarm recording, if a higher priority alarm occurs, the current recording is canceled and the higher priority alarm is recorded for 20 seconds.

During any type of recording, if a lower or equal priority alarm recording or any other type of recording occurs, the lower or equal priority recording is not performed; only the current recording is performed.

Recording Sensitivity

The sensitivity of the waveforms recorded on the recording paper is the same as the sensitivity of the waveforms displayed on the screen.

To change the sensitivity, change the sensitivity setting on the parameter setting window as described in the User’s Guide Part II.

Recording Speed

The recording speed can be set at <RECORDING SPEED> on the RECORD window. Refer to “Changing the Recording Speed” in this section.

Feeding the Paper after Recording

The paper can be automatically fed after recording. Refer to “RECORD Window” in Section 3 of the Administrator’s Guide.

Recording Related Message

The following messages appears in the following conditions.

When out of recording paper

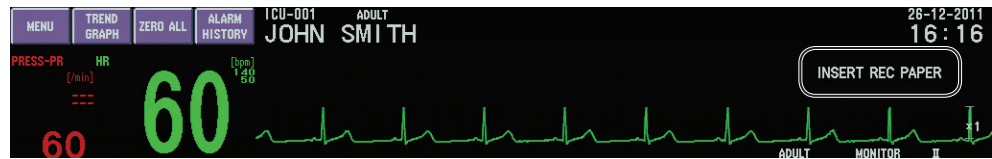

When the recorder door is open

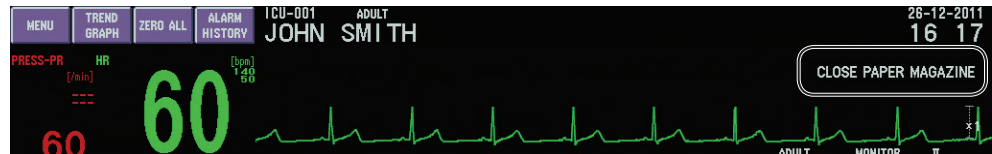

Recorded/Printed Data

The following data can be printed.

Printed Items	Example
Patient name	John Smith
Bed ID	BED-001
Date and time	11-07-2002 10:30
Reason for recording	TIMER, ALARM, etc.
Sensitivity	×2
Paper speed	25 mm/s
ECG related message	MONITOR* ¹
Heart rate (beats/min)	HR: 100
ECG lead	II
Number of VPCs	VPC: 10
ST level	-0.04 mV
Pulse rate (beats/min)	PR: 80
SpO ₂ (%SpO ₂)	SpO ₂ : 98
NIBP: SYS/DIA (MEAN) (mmHg), measurement time	NIBP: 132/61 (80) [mmHg] 17:24
Respiration rate (resp/min)	RR: 14
CO ₂ (mmHg)	CO ₂ : 40
IBP: SYS/DIA (MEAN) (mmHg)	ART: 132/61 (80)
Temperature (°C/°F)	Tskin: 36.4
O ₂ (I) (%)	O ₂ (I): 12
Anesthetic gas	FiISO: 3.0
Arrhythmia name	COUPLET
Waveform annotation* ²	N, V, P etc.

*¹ Selected setting for FILTERS on the ECG window is recorded. Refer to User's Guide, Part II. When the "CHECK ELECTRODES" alarm occurs, "CHECK ELECTRODES" is recorded instead of the FILTERS setting.

*² Recorded when the recording mode is MANUAL, ALARM or RECALL and <ARRHYTHMIA ANALYSIS> on the ECG window is set to ON.

Changing the Recording Speed

Recording speed can be selected from 12.5, 25 or 50 mm/s for recording with the optional recorder.

Recording speed and waveform sweep speed on the screen can be set separately.

1. Display the OTHER page.

Press the [Menu] key → RECORD key → OTHER tab.

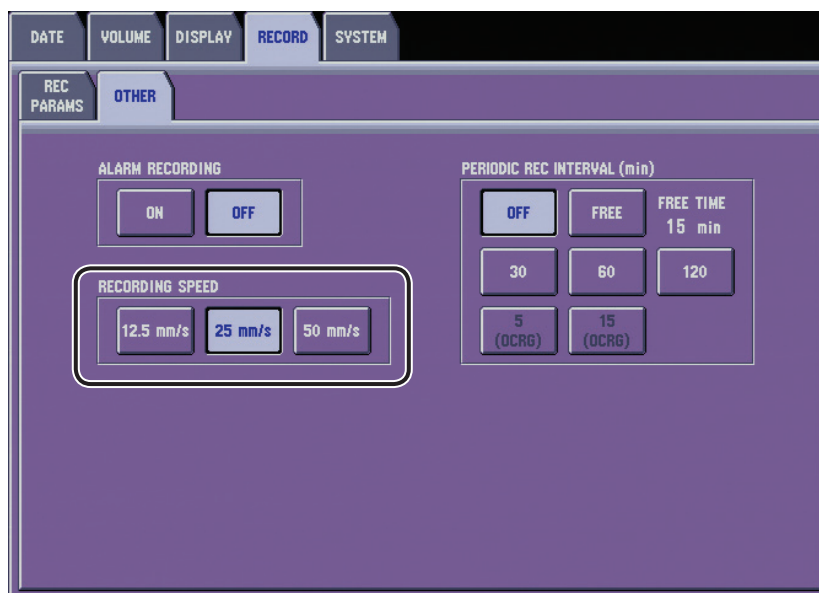

2. Select the speed by touching the speed key in the <RECORDING SPEED> box.
3. Press the [Home] key to return to the home screen.

Changing the Recording Pattern

Up to two parameter waveforms can be selected for a recording pattern.

The selected recording pattern applies to all recording except recording on the review windows, CO window and OCRG. ECG (TRACE 1) is the default setting.

1. Display the REC PARAMS page.
Press the [Menu] key → RECORD key → REC PARAMS tab.

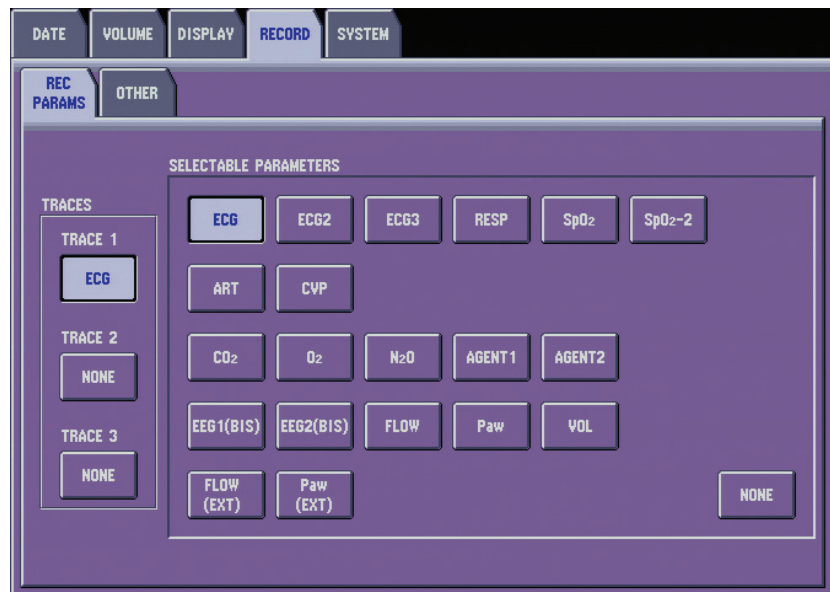

FLOW, Paw and VOL are not available for BSM-6000A series.

2. Select the trace in the <TRACES> box and select the parameter by touching the parameter key in the <SELECTABLE PARAMETERS> box. Select the NONE key to not assign any parameter.
3. Press the [Home] key to return to the home screen.

Manually Recording/Printing Waveforms

Recording Waveforms on the Optional Recorder

Waveforms and data can be recorded manually on the recorder module.

There are four settings:

- Recording pattern: This setting determines which of the measured parameter waveforms is recorded. See the “Changing the Recording Pattern” in this section.
- Real-time or delay mode: In DELAY mode, recording begins with the waveforms acquired 8 seconds before recording starts. In REAL TIME mode, recording begins with the waveforms acquired when recording starts. To select real-time or delayed manual recording mode, refer to “RECORD window” in Administrator’s Guide, Section 3.
- Recording length: CONTINUOUS, 10, 20 or 30 seconds can be selected for the recording length on the SYSTEM SETUP window. Refer to “RECORD window” in Administrator’s Guide, Section 3.
- Recording speed: The recording speed is set at <RECORDING SPEED> on the RECORD window.

1. If necessary, select the recording pattern on the RECORD window. Refer to the “Changing the Recording Pattern” in this section.
2. To start recording, press the  [Record] key.

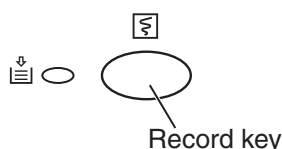

When RECORD WAVE is assigned to one of the function keys at the upper left of the screen, touching the RECORD WAVE function key also starts manual recording. Refer to “KEYS Window” in Section 3 of the Administrator’s Guide to assign a function to the function key.

3. To stop recording, press the  [Record] key again.

Recording example

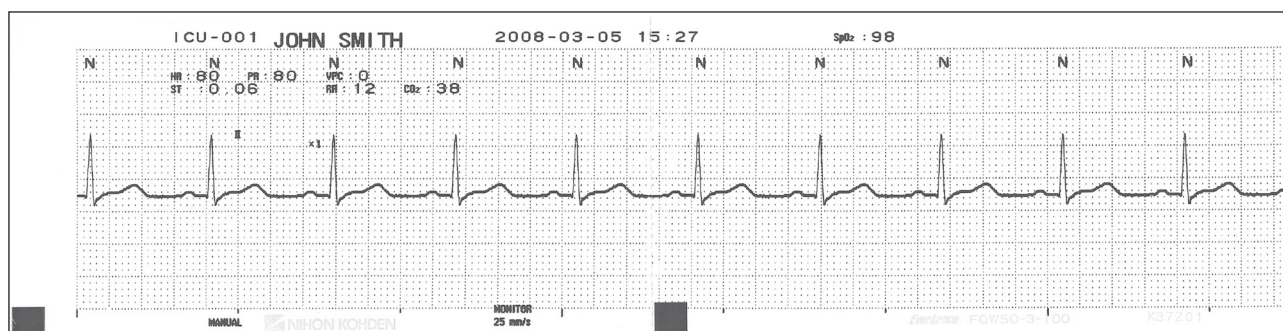

Recording Waveforms on the Bedside Monitor with No Recorder

When the bedside monitor with no optional recorder is connected to a central monitor network, waveforms and data can be recorded manually from the bedside monitor on the central monitor recorder. Three waveforms selected for the TRACE 1, TRACE 2 and TRACE 3 are recorded with the recording length selected on the bedside monitor. When CONTINUOUS is selected for the recording length, 30 seconds is automatically selected.

1. If necessary, select the recording pattern on the RECORD window. Refer to the “Changing the Recording Pattern” in this section.
2. To start recording, press the  [Record] key.

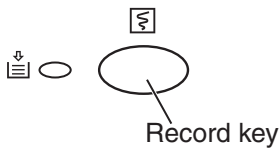

NOTE

Even if RECORD WAVE is assigned to one of the function keys at the upper left of the screen, touching the RECORD WAVE function key does not start recording on the central monitor recorder.

Manual Printing on the Network Printer

When the bedside monitor is connected to a network printer, all monitoring waveforms and numeric data can be printed on the network printer. The waveforms from 7 seconds before to 3 seconds after PRINT key on the window is touched are printed.

The OCRG can also be printed on the network printer. The OCRG displayed on the home screen can be printed when the PRINT OCRG function key is touched.

To print the OCRG, the print function must be assigned to one of the function keys in the upper left corner of the screen. Refer to “KEYS Window” in Administrator’s Guide, Section 3.

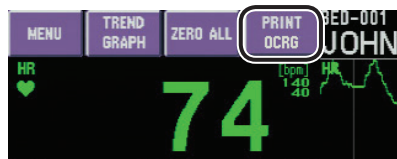

For details about printing on the network printer, refer to the “Printing on a Network Printer” in this section.

Setting Periodic Recording

You can select one of the two types of recording data:

- Up to three waveforms with numerical data
- OCRG

From the bedside monitor, automatic periodic recording cannot be performed on the central monitor recorder.

Up to three waveforms with numerical data

A 10 second waveform can be automatically recorded at preset intervals of 30, 60, 120 minutes or a free interval that you can set to any length.

Recording starts at the nearest half-hour for 30 min interval, at the nearest hour for 60 or 120 min interval and at the next FREE interval for FREE recording.

For example, if you start automatic periodic recording at 9:20 with a 30 min interval, periodic recording will be performed at 9:30, 10:00, 10:30 and so on. If you start at 9:20 with a 120 min interval, periodic recording will be performed at 10:00, 12:00, 14:00 and so on. If you start at 9:20 with a FREE interval of 65 min, periodic recording will be performed at 10:25, 11:30, 12:35 and so on.

OCRG

The trendgraphs of HR and SpO₂ and compressed respiration waveform are recorded. The OCRG is recorded every 5 minutes when the 5 (OCRG) is selected in <PERIODIC REC INTERVAL> box on the RECORD window, and every 15 minutes when the 15 (OCRG) is selected. To select the 5 (OCRG) or the 15 (OCRG), OCRG must be selected for <CURRENT TREND> on the SYSTEM window of the SYSTEM SETUP window. Refer to Administrator's Guide, Section 3.

The OCRG recording has two pages. The first page contains HR and SpO₂ trendgraphs and the second page contains compressed respiration waveform.

Changing Settings for Automatic Periodic Recording

There are two settings:

- Periodic recording on/off: Recording interval must be selected on the RECORD window to automatically record waveform and data at periodic interval. To record OCRG, select the 5 (OCRG) or the 15 (OCRG).
- Free time interval: You can set the desired interval for automatic periodic recording at <PERIODIC FREE INTERVAL> on the SYSTEM SETUP window. FREE selection is from 1 to 120 minutes (1 min/step). Default setting is 15 min. See “RECORD Window” in Administrator’s Guide, Section 3.

1. Display the OTHER page.
Press the [Menu] key → RECORD key → OTHER tab.



2. Select the recording interval at the <PERIODIC REC INTERVAL> box. Select the OFF key when not performing periodic recording.

To record OCRG every 5 minutes, select the 5 (OCRG) key. To record OCRG every 15 minutes, select the 15 (OCRG) key.

3. Press the [Home] key to return to the home screen.

Printing on a Network Printer

When the bedside monitor is connected to a network printer, the following printing is available. To print on the network printer, the printer properties (IP address, printer type and paper size) must be set on the RECORD window of the SYSTEM SETUP window. Refer to Administrator's Guide, Section 3.

NOTE

Printing cannot be canceled once it is started.

- Real-time waveform printing:
Prints the waveforms from 7 seconds before to 3 seconds after the PRINT PAGE key on the PRINT window is touched. Refer to the "Manually Recording/Printing Waveforms" in this section.
- Printing data on the review windows:
Prints the displayed trendgraphs when the PRINT PAGE key on the PRINT window of the TREND GRAPH page is touched.

The data of selected time period can be printed when RECORD key on the PRINT window of the TREND TABLE, NIBP TREND, HEMO TREND or LUNG TREND page is touched.

The displayed 8 seconds of arrhythmia recall waveform and the one file before and after of arrhythmia recall waveform is printed when the PRINT PAGE key on the PRINT window of the RECALL window is touched.

The compressed or actual size full disclosure waveform selected by the cursor can be printed when the PRINT PAGE key on the PRINT window of the FULL DISC window is touched.

The displayed ST recall files and the previous three ST recall files are printed when the PRINT PAGE key on the PRINT window of the ST window is touched.

- Printing on the 12 LEAD ANALYSIS window:
When <RECORDING SPEED> on the RECORD window is set to 25 mm/s, 10 seconds of 12 lead ECG on the 12 LEAD ANALYSIS window can be printed when the PRINTER key on the PRINT window is touched.

When <RECORDING SPEED> on the RECORD window is set to 50 mm/s, 2 pages of 12 lead ECG on the 12 LEAD ANALYSIS window can be printed when the PRINTER key on the PRINT window is touched.

10. RECORDING

- **Printing on the 12 LEAD window:**
10 seconds of 12 lead ECG on the ANALYSIS WAVE page, 2.2 second ECG, 10 second rhythm waveform and analysis report on the REPORT page and averaged waveforms on the AVERAGE WAVE page can be printed when the PRINT PAGE key on the PRINT window of the 12 LEAD window is touched.
- **Printing OCRG on the OCRG window:**
The displayed OCRG on the OCRG window can be printed when the RECORD key on the PRINT window is touched.
- **Printing aEEG on the aEEG window:**
The displayed aEEG on the aEEG window can be printed when the RECORD key on the PRINT window is touched.
- **Printing on the DRUG window:**
The titration table and drug data on the DOSE window can be printed when the PRINTER key on the PRINT window of the DOSE window is touched.
- **Printing OCRG on the home screen:**
When the PRINT OCRG is assigned to one of the function keys, the OCRG on the home screen can be printed on the network printer.
- **Printing on the CAR SEAT CHALLENGE window:**
The car seat challenge results can be printed when the PRINT key on the REPORT SETTINGS window is touched.

Section 11 Reference

Clock Accuracy	11.2
Periodical Replacement Schedule.....	11.3
Repair Parts Availability Policy	11.3

Clock Accuracy

At an operating temperature of 25°C (77°F), the accuracy of the clock IC of this monitor is about ± 2 min 30 s per month.

At storage temperatures between -20 and +60°C (-4 and +140°F), the accuracy of the clock IC of this monitor is about ± 6 min per month.

Periodically check that the time in the upper right corner of the monitor screen is correct.

To change the time setting, refer to “Changing Date and Time” in Section 4.

NOTE

When the date or time is changed during monitoring, the date and time of all stored data is also changed and may not match the date and time on the printout.

When the monitor is connected to a network

The time on this monitor is automatically adjusted to match the time of the network as long as the monitor is connected to the network. The date and time on all monitors in the network are set to the same setting.

Periodical Replacement Schedule

To maintain the performance of the instrument, the following parts must be periodically replaced.

Description	Code No./ Supply Code	Expected Life Span
MU-631R/MU-651R/MU-671R Main Unit		
Battery pack (option)	SB-671P	Approx. 1 year
WS-671P Recorder Module (option)		
Thermal array head, AJ048-8E802	662311	Approx. 370 stacks of recording paper After 370 stacks of recording paper, the thermal array head is deteriorated and the recording becomes thin.
Motor Assy (Paper drive motor)	CD-0004	Approx. 9,000 stacks of recording paper (continuous recording) After 9,000 stacks of recording paper, the paper drive motor is deteriorated and cannot feed the recording paper.
Platen roller, Ø 8	6114-135436	Approx. 6 years When the platen roller is deteriorated, the paper cannot be fed.
Retainer ring, G-3	675369	Must be replaced with a new one when the platen roller is replaced.

Repair Parts Availability Policy

Nihon Kohden Corporation (NKC) shall stock repair parts (parts necessary to maintain the performance of the instrument) for a period of 8 years from the date of delivery. In that period, NKC or its authorized agents will repair the instrument. This period may be shorter than 8 years if the board or part necessary for the faulty section is not available.



NIHON KOHDEN CORPORATION
 1-31-4 Nishiiochiai, Shinjuku-ku Tokyo 161-8560, Japan
 Phone +81 3-5996-8036
 Fax +81 3-5996-8100

NIHON KOHDEN ITALIA S.r.l.
 Via Fratelli Bronzetti 28, 24124 Bergamo, Italy
 Phone +39 035-219543
 Fax +39 035-232546

North and South America

NIHON KOHDEN AMERICA, INC.
 15353 Barranca Parkway, Irvine, CA 92618, U.S.A.
 Toll-free +1-800-325-0283
 Phone +1 949-580-1555
 Fax +1 949-580-1550

NIHON KOHDEN MEXICO S.A. DE C.V.
 Insurgentes Sur 730, Piso 9 Oriente, Col. Del Valle
 C.P. 03100, Delegacion Benito Juarez, Mexico, D.F.
 Phone +52 55-8851-5550
 Fax +52 55-8851-5580

NIHON KOHDEN DO BRASIL LTDA.
 Rua Diadema, 89, 1º andar, conjuntos 11 a 17, bairro Mauá
 no Município de São Caetano do Sul, Estado de São Paulo
 CEP 09580-670, Brasil
 Phone +55 11-3044-1700
 Fax +55 11-3044-0463

Europe

 European Representative

NIHON KOHDEN EUROPE GmbH
 Raiffeisenstrasse 10, D-61191 Rosbach, Germany
 Phone +49 6003-827-0
 Fax +49 6003-827-599

NIHON KOHDEN DEUTSCHLAND GmbH
 Raiffeisenstrasse 10, D-61191 Rosbach, Germany
 Phone +49 6003-827-0
 Fax +49 6003-827-599

NIHON KOHDEN FRANCE SARL
 8, rue Francois Delage, 94 230 Cachan, France
 Phone +33 1-49-08-05-50
 Fax +33 1-49-08-93-32

NIHON KOHDEN IBERICA S.L.
 C/Ulises 75A, E-28043 Madrid, Spain
 Phone +34 917-161-080
 Fax +34 913-004-676

NIHON KOHDEN UK LTD.
 Trident Court 118, 1 Oakcroft Road
 Chessington, Surrey KT9 1BD, UK
 Phone +44 20-8391-6800
 Fax +44 20-8391-6809

Asia

**SHANGHAI KOHDEN
 MEDICAL ELECTRONIC INSTRUMENT CORP.**
 567 Huancheng Bei Road
 Shanghai Comprehensive Industrial Development Zone
 Shanghai 201401, China
 Phone +86 21-5743-6998
 Fax +86 21-5743-6939

NIHON KOHDEN SINGAPORE PTE LTD
 1 Maritime Square, #10-34 HarbourFront Centre
 Singapore 099253
 Phone +65 6376-2210
 Fax +65 6376-2264

NIHON KOHDEN INDIA PVT. LTD.
 308, Tower A, Spazedge, Sector 47, Sohna Road
 Gurgaon-122 002 Haryana, India
 Toll-free +91 1800-103-8182
 Phone +91 124-493-1000
 Fax +91 124-493-1029

NIHON KOHDEN MIDDLE EAST FZE
 JAFZA One Tower A, 19th floor, Office No. 1912
 Jebel Ali Free Zone, P.O. Box 261516, Dubai, U.A.E.
 Phone +971 4-884-0080
 Fax +971 4-880-0122

NIHON KOHDEN KOREA, INC.
 5F Miso Bldg.
 890-47 Daechi-dong, Gangnam-gu, Seoul, 135-280 Korea
 Phone +82 2-3273-2310
 Fax +82 2-3273-2352

Contact information is accurate as of July 2016. Visit www.nihonkohden.com for the latest information.

The model and serial number of your instrument are identified on the rear or bottom of the unit.
 Write the model and serial number in the spaces provided below. Whenever you call your representative concerning
 this instrument, mention these two pieces of information for quick and accurate service.

Model _____

Serial Number _____

Your Representative
