



# Compressed Air Purity (Quality) Testing Validation to ISO 8573 Classifications or Indicative Testing?

A White Paper By Mark White -  
Compressed Air Treatment Applications Manager



ENGINEERING YOUR SUCCESS.  
[www.parker.com/gsf](http://www.parker.com/gsf)

# Compressed Air Quality Testing

Compressed air is widely used throughout industry, with over 90% of manufacturing industries globally using compressed air in one form or another. To be a safe, reliable and cost effective utility, compressed air must be treated. Many facilities use international standards to specify the purity (quality) of compressed air they require for their applications and this will dictate the compressed air treatment equipment installed. Once the compressed air treatment equipment is installed and operating, users often require ‘proof’ the specified air purity (quality) is being achieved.

The international standards used to specify air purity (quality) are very specific on how to test a compressed air system accurately for contamination, specifically, the sampling methodology and the test equipment to be used for validation of air purity (quality).

*The purpose of this document is to provide an overview of what is required to test compressed air for validation purposes and to highlight the methods and equipment that are used for ‘indicative’ purposes only.*

## ISO Compressed Air Purity Standards

ISO 8573-1 is the international standard for compressed air purity (quality). Introduced in 1991 and now in its 3<sup>rd</sup> edition, the standard is used extensively to define the quality of compressed air used for a variety of applications in all manner of manufacturing industries.

## ISO 8573-1 and the Compressed Air User

The ISO 8573-1 standard allows users to select a ‘classification’ for particulate, water and oil, with each classification having defined limits of contamination, except for class 0 which is user or equipment supplier definable (Class 0 must be more stringent than class 1 and within the limits of accurate measurement shown in ISO8573 parts 2 to 9).

## ISO 8573-1 and Compressed Air Treatment Equipment Manufacturers

ISO 8573-1 standard is also used by manufacturers of compressed air treatment equipment to show the quality of compressed air delivered downstream of their compressed air treatment equipment.



**Example Of An Air Purity Specification Using Latest ISO 8573-1 Classifications**

**Required air purity at point of use #1**  
ISO 8573-1:2010 Class 1:2:1

# Validation / Verification of Air Quality

Validation of compressed air purity to the classifications shown in ISO 8573-1 requires the user (or tester) to follow additional standards as ISO 8573-1 is only one part of a series of nine separate standards.

ISO 8573-1 can not be used in isolation as can be seen from the following extracts from the document:

*“This part of ISO 8573 is supplemented by other parts that provide measurement methods for a wide range of contaminants.”*

*“The following referenced documents are indispensable for the application of this document.”*

## The Nine Parts that make up the ISO 8573 Series



# ISO 8573 Series - Part 1

Often, those referring to ISO 8573-1 are only familiar with the classification tables from the document and it should be noted that within the standard document there are three individual classification tables, one for solid particulate, one for water and one for total oil. However, for many years the compressed air industry (compressor manufacturers and air treatment manufacturers) have combined the three tables into a single table for ease of use.

ISO 8573-1:2010 CLASS	Particulate			Mass Concentration mg/m <sup>3</sup>	Vapour Pressure Dewpoint	Water Liquid g/m <sup>3</sup>	Oil Total Oil (aerosol liquid and vapour) mg/m <sup>3</sup>
	Maximum number of particulates per m <sup>3</sup>						
	0.1 - 0.5 micron	0.5 - 1 micron	1 - 5 micron				
0	As specified by the equipment user or supplier and more stringent than Class 1						
1	≤ 20,000	≤ 400	≤ 10	—	≤ -70°C	—	0.01
2	≤ 400,000	≤ 6,000	≤ 100	—	≤ -40°C	—	0.1
3	—	≤ 90,000	≤ 1,000	—	≤ -20°C	—	1
4	—	—	≤ 10,000	—	≤ +3°C	—	5
5	—	—	≤ 100,000	—	≤ +7°C	—	—
6	—	—	—	≤ 5	≤ +10°C	—	—
7	—	—	—	5 - 10	—	≤ 0.5	—
8	—	—	—	—	—	0.5 - 5	—
9	—	—	—	—	—	5 - 10	—
X	—	—	—	> 10	—	> 10	> 10

Many who refer to and use the ISO 8573-1 standard do not purchase a full copy, instead relying solely on marketing literature for reference. In doing so, the additional information contained in the ISO 8573-1 document is omitted.

The omitted information is extremely important as it references other parts of the ISO 8573 series (parts 2 to 9) which are specific to testing of the different contaminants.

## For Example:

### ISO 8573-1 Section 5.2 Particle Classes states:

*“The particle purity classes are identified and defined in Table 1. Measurements shall be made in accordance with ISO 8573-4 and, when required, ISO 8573-8.”*

### ISO 8573-1 Section 5.3 Humidity and liquid water classes states:

*“The humidity and liquid water purity classes are identified and defined in Table 2. Measurements shall be made in accordance with ISO 8573-3 and, when required, ISO 8573-9.”*

### ISO 8573-1 Section 5.4 Oil classes states:

*“The total oil purity classes are identified and defined in Table 3. Measurements for liquid oil and aerosols of oil shall be made in accordance with ISO 8573-2. It is considered that, for classes 3, 4 and X, the oil vapour content is not expected to significantly affect the total concentration; therefore, the measurement of vapour is optional. Where it is deemed necessary to measure the oil vapour, then ISO 8573-5 shall be used.”*

ISO 8573-1 is therefore stating that if a user wishes to test their compressed air system and classify it in accordance with ISO 8573-1, then the test methods and equipment shown in ISO 8573 parts 2 to 9 must be used.

ISO 8573-1 is commonly used to specify compressed air purity (quality), however it is not used correctly when it comes to the testing of compressed air and the validation of actual air purity (quality). The reason for this is that ISO 8573 parts 2 to 9 are rarely ever used.

# Why are ISO 8573 parts 2 to 9 rarely used?

ISO 8573 parts 2 to 9 have been developed to provide the most accurate measurement of the main contaminants found in a compressed air system. To test in accordance with the standards first requires the tester to purchase nine different standard documents and this is rarely done due to cost.

Once purchased, there are additional costs as the standards are very specific about test methodology (required to ensure a representative contamination sample enters the test equipment) and the test equipment itself (required to ensure accuracy of results). Both the sampling instruments and the test equipment have a considerable cost associate with them.

Additionally, the sampling instrument is specific to each test point in a compressed air system (based upon pipe diameter, flow, etc.). Typically, the sample instrument will need to be custom made for that position in the system and will require modification to the system piping. Often, many sample points are required, all adding to the overall cost of testing.

Many of the sampling & test methods are very complex and do not provide instant results. They often require additional laboratory based equipment and the involvement of specialist, trained personnel, all of which adds to the cost of testing and validating in accordance with ISO 8573 parts 2 to 9.

Many users are now requesting 'continuous' monitoring of air purity. A number of test equipment manufacturers market products which claim to be in accordance with the ISO 8573 standards whilst delivering continuous monitoring, however with the exception of dewpoint, accurate, continuous monitoring for total oil, particulate and micro-organism count is not currently possible, requiring laboratory based equipment which tests samples 'offline'.

There are also service providers who claim they test a compressed air system in accordance with the ISO 8573 standards, however on closer inspection, they do not follow the methodology highlighted in ISO 8573 parts 2 to 9 nor do they use the correct test equipment.

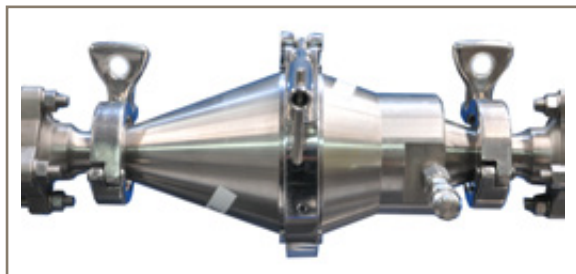

# Common Practice

It is typical for testing to be carried out at so called 'sample points' which are simply a 'T piece' fitted into the compressed air distribution piping or at the pressure gauge on an air receiver.

Whilst convenient and low cost, the problem with these sample points are:

- Air velocity at the test equipment is different (usually higher) than in the compressed air flow being sampled
- Contaminant concentration is no longer identical to the concentration in the compressed air flow being sampled (often significantly higher)
- Inaccuracy with the measurements taken
- Not in accordance with the sampling methods highlighted in ISO 8573 parts 2 to 9

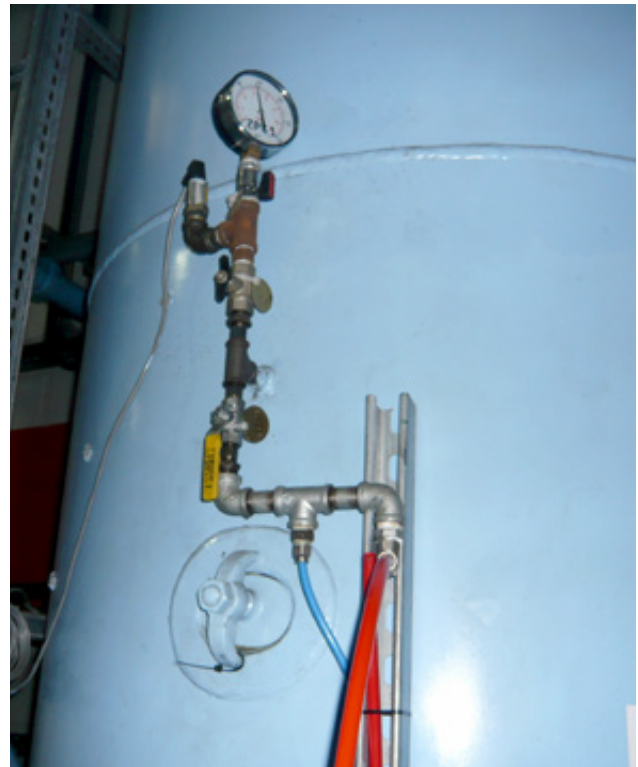

## Important Notes:

- ***If this type of sampling method is used to test a compressed air system, then the results cannot be used to classify or validate the compressed air purity in accordance with ISO 8573-1.***
- ***Classifications to ISO 8573-1 can only be claimed if the correct sampling method and test equipment are used.***

# Testing in Accordance with ISO 8573 Series

To accurately test a compressed air system for contamination, following the test methodology (the sampling method) shown in ISO 8573 parts 2 to 9 is just as important as using the correct test equipment.

ISO 8573 parts 2 to 9 typically recommends either a full flow or iso-kinetic (partial) flow sampling method.

This document will first of all provide a simplified overview of the test methodology required for accurate sampling of compressed air contamination

It will then cover the test equipment required to test and validate compressed air purity in accordance with the ISO 8573 series of standards.

## **Important Note:**

*This document should not be viewed as a replacement for the individual standard documents and any organisation or individual wishing to carry out validation testing should always purchase the full standard from ISO.*



---

## Sampling Methodology

Using the correct sampling method is a key factor to ensure accuracy when measuring contaminants in a compressed air system, as failure to sample correctly will lead to inaccurate results.

ISO 8573 Parts 2 to 9 typically recommends using either a 'Full Flow' sampling methodology or a 'Partial Flow Iso-kinetic' sampling methodology.

# Sampling Methodology - Full Flow

Compressed air sampling points will typically be located in the compressor room (downstream of purification equipment) and at each compressed air usage point (again, typically downstream of point of use purification equipment).

The diameter of the compressed air piping and the compressed air flow rate at each sample point will therefore differ between the compressor room and each point of use.

The equipment used to test compressed air purity (quality) will have a maximum compressed air sample rate and pressure.

## Full flow sampling shall be used when:

- The flow of compressed air at the sampling point is less than or equal to the maximum flow rate of the test equipment being used
- The test equipment can measure at the system operating pressure
- When the standard allows it (not all parts of ISO 8573 allow for full flow sampling)

## Example of Full Flow Sampling Set-up

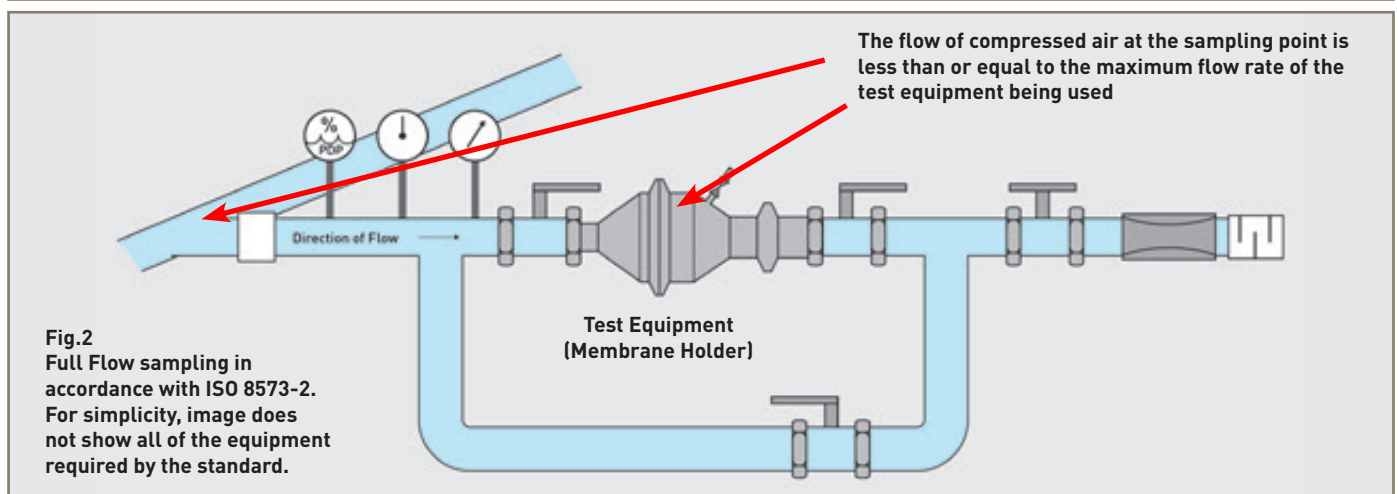
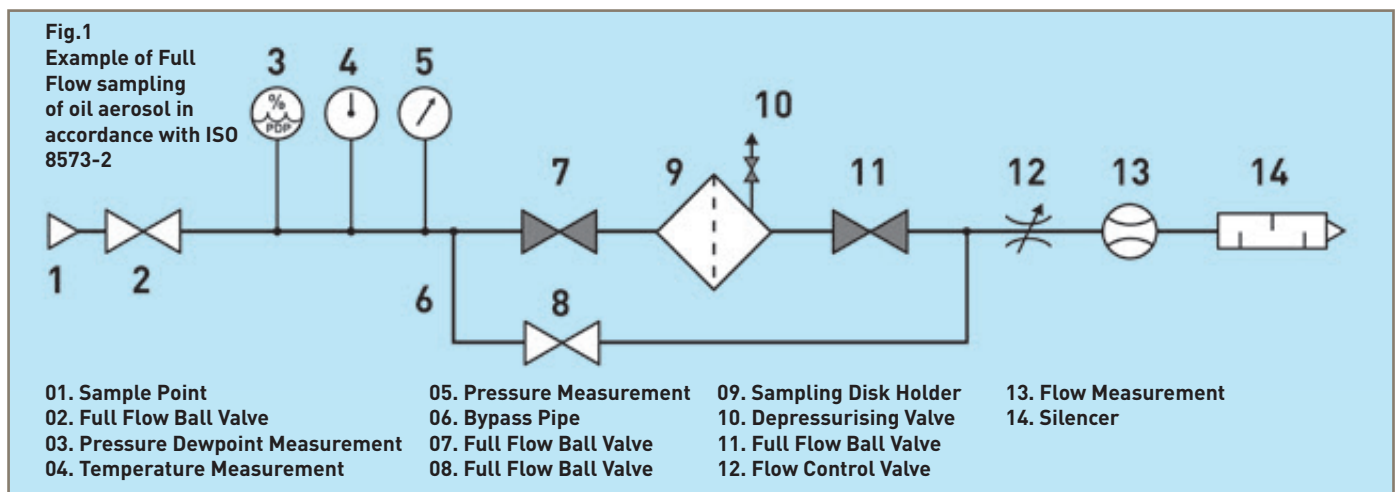



# Sampling Methodology - Partial Flow

In most instances, the equipment being used to test compressed air purity will have a maximum compressed air sample rate and or operating pressure below the flow rate or pressure of the sample point, therefore full flow sampling is not suitable as to do so would lead to inaccurate measurements.

**Partial flow Iso-kinetic sampling must therefore be used when:**

- The compressed air flow rate at the sampling point exceeds the maximum flow rate of the test equipment
- When the standard recommends it over full flow sampling

Using the partial flow Iso-kinetic sampling methodology ensures the air velocity and therefore contaminant concentration and distribution in the test equipment is as close to or identical to the contaminant distribution and concentration in the main compressed air flow at the sample point.

*For oil aerosol, solid particulate counting and micro-biological testing, partial flow iso-kinetic sampling will be required for validation to the highest ISO 8573-1 classifications.*

Partial flow iso-kinetic sampling typically requires modification of the compressed air piping. Sampling must be taken at a 90° elbow using a correctly selected iso-kinetic sample probe. Refer to relevant parts of ISO 8573 parts 2 to 9 for design details.

## Example of Partial Flow Iso-kinetic Sampling Set-up

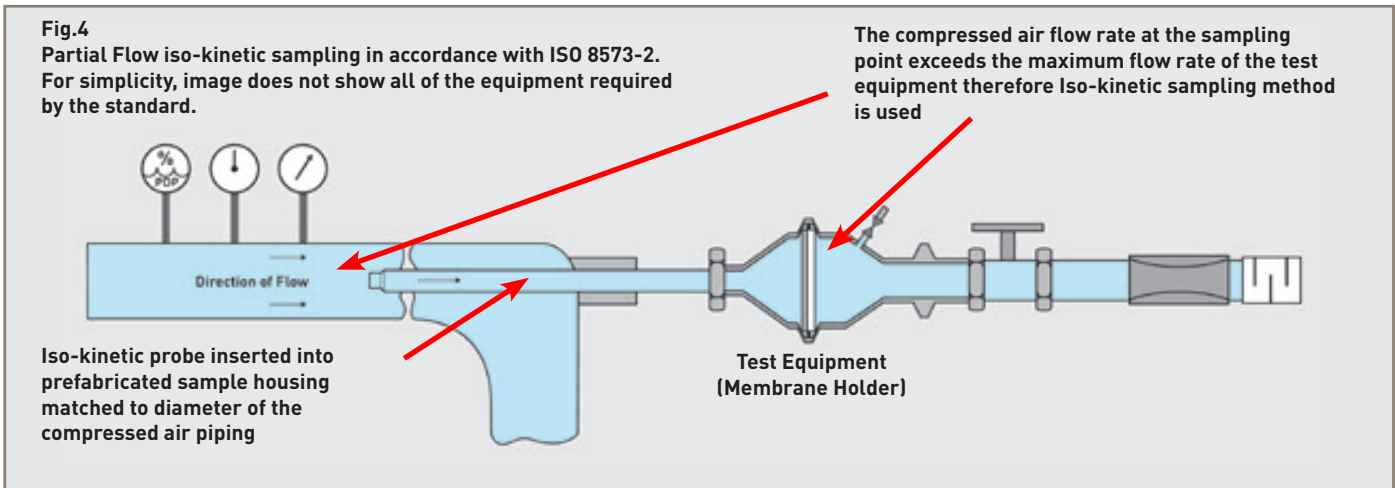
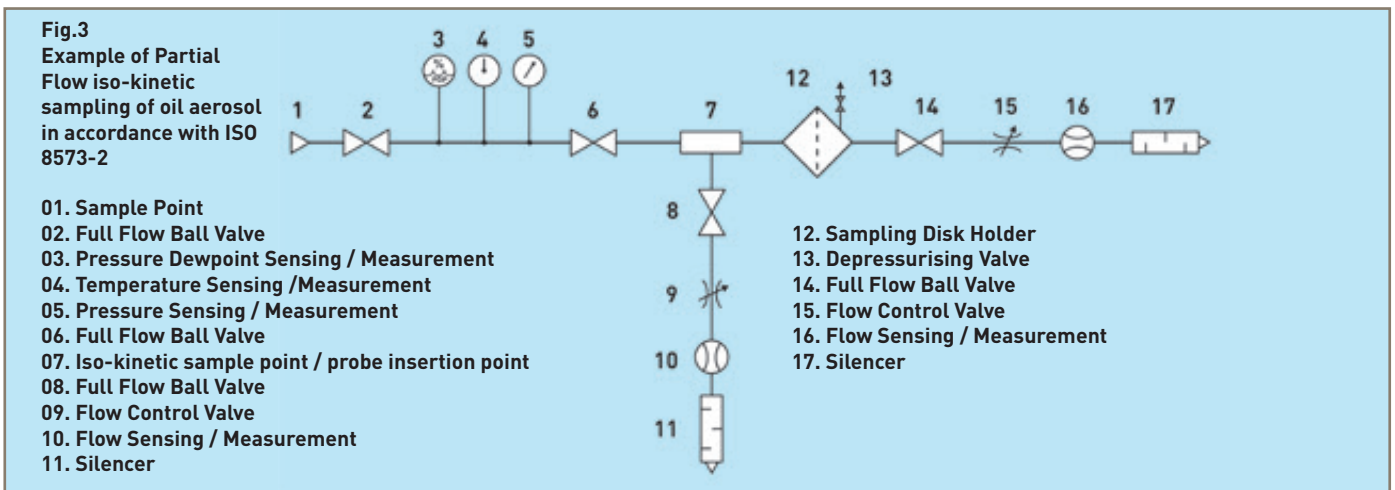

# Complying with the ISO 8573 Series of Standards

Once the correct sampling method has been determined for accurate contaminant measurement, selection of test equipment should be made.

## System Testing in Accordance with ISO 8573 Parts 2 – 9 (Test Equipment)

As previously mentioned, each part of ISO 8573 from part 2 to part 9 is specific to a contaminant and each document is reviewed periodically by a 'Technical Committee' made up of global industry experts, trade associations and governing bodies. A standard comes up for review and is updated typically every 5 years (but not always). One can identify the last year a standard was updated by its revision date which is stated in the document title - for example, ISO 8573-4:2019 shows that this document was updated and released in the year 2019.

Part of the review process is to look at new test equipment and / or test methods. If the technical committee review finds new test equipment with the potential to deliver equally accurate results from a simplified test methodology or even deliver greater accuracy, then the methodology or equipment will be tested, validated and if proven, included in the relevant part of ISO 8573.

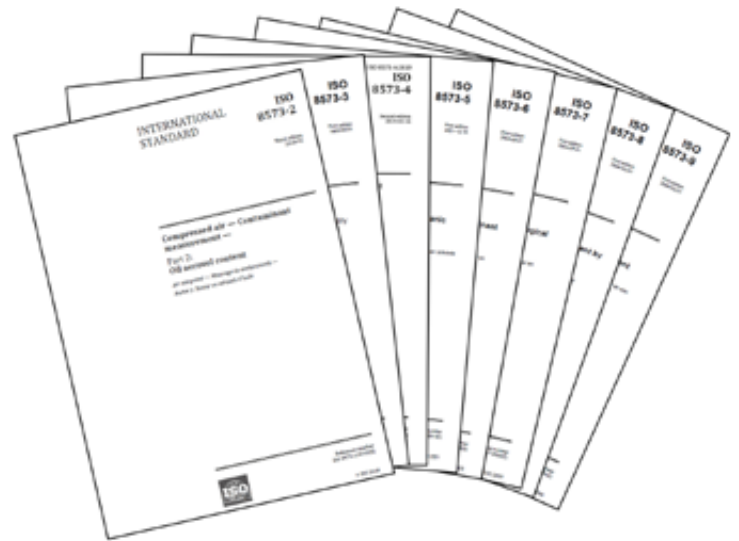

## Important Notes:

***As a rule, if the piece of test equipment being considered for use is not included in ISO 8573 parts 2 to 9, it isn't accurate enough to measure compressed air contamination to the levels shown in ISO 8573-1.***

***Most importantly, if the test equipment isn't in a standard, then it cannot be used to validate compressed air purity in accordance with ISO 8573-1 classifications.***

# Overview of Key Parts of ISO 8573

When validation of ISO 8573-1 purity classifications is required downstream of compressed air treatment equipment, 4 parts of the ISO 8573 series would be typically be used (for the accurate measurement of solid particles, water vapour and total oil).

## Most Commonly used parts of ISO 8573 series (in addition to ISO 8573-1)

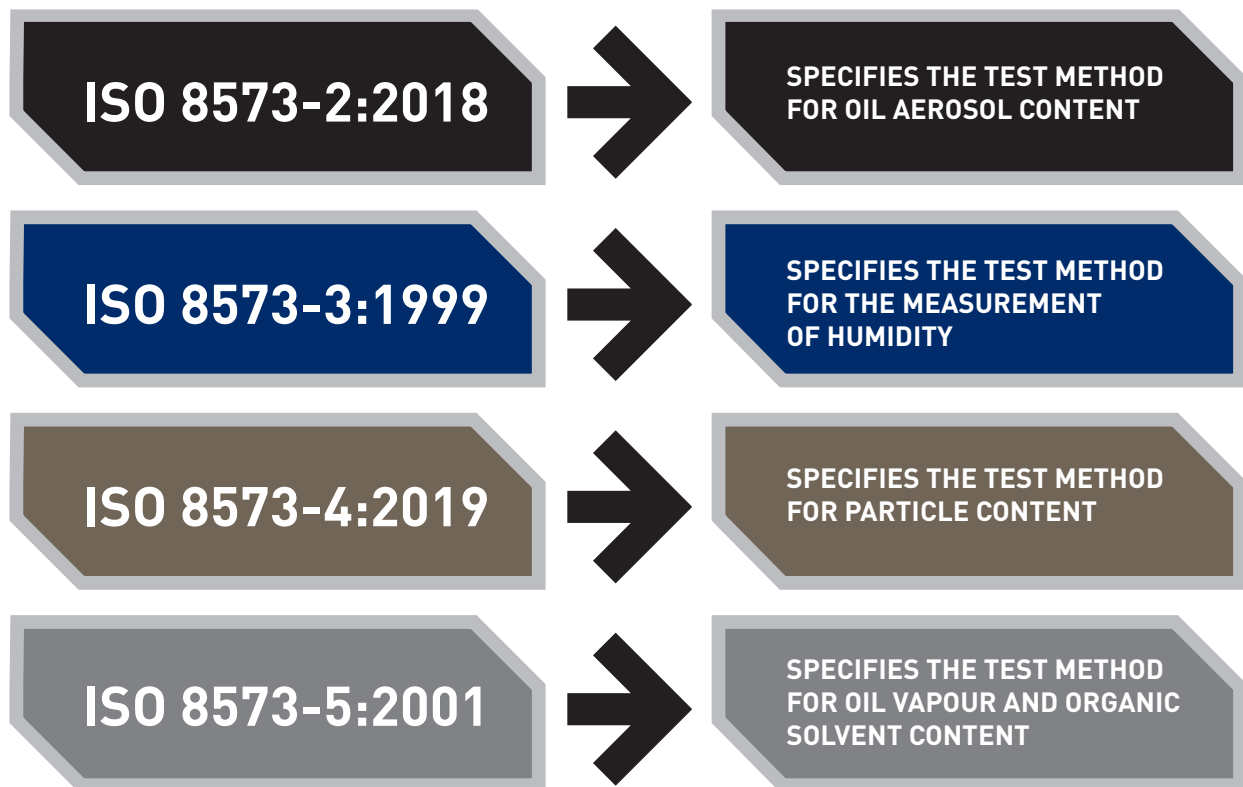

## Critical Applications

For critical applications in the food, beverage and pharmaceutical industries where confirmation of sterility or a count of CFU's (Colony Forming Units) is required, an additional part of the ISO 8573 series must also be used in conjunction with particulate testing procedures highlighted above.



Pages 12 to 17 of this document will highlight the methodology that must be followed and the test equipment required to test and classify (validate) compressed air purity in accordance with ISO 8573-1. These pages should not be viewed as a replacement for the individual standard documents which should be purchased by any organisation or individual wishing to carry out validation testing.

# ISO 8573-2:2018 Oil Aerosol

## Sampling methods stated in the standard are:

- Sample Method A - Full Flow
- Sample Method B1 - Full Flow
- Sample Method B2 - Partial Flow Iso-kinetic

## Sampling Equipment stated in the standard

- Method A Full Flow - Coalescing Filter
- Method B1 Full Flow - 3 Layer\* Membrane Filter
- Method B2 Partial Flow - 3 Layer\* Membrane Filter
- \* or more layers if required

Sample methods B1 & B2 are the most accurate and are required to test a compressed air system downstream of filtration equipment to see if its air purity (quality) is in accordance with ISO 8573-1:2010.

Sampling - Method B1

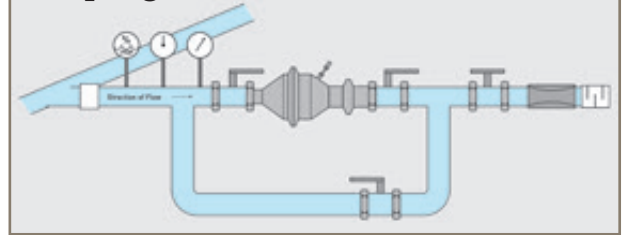

Sampling - Method B2

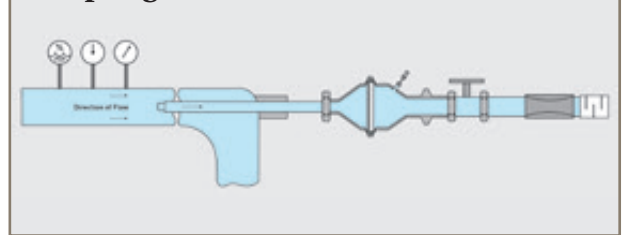

## Obtaining Results using Methods B1 & B2 as shown in ISO 8573-2

### Membrane collection & solvent extraction process

1. Take sample
2. Membrane removal
3. Solvent extraction of oil from membrane
4. Sample solvent with infrared spectrometer or Gas Chromatograph
5. Calculate results

**Infrared Spectrum**

This type of testing is not “real time” and currently there are no “real time” measurement devices available that offer the accuracy required to classify compressed air in accordance with ISO 8573-1 for total oil.

**Method B1 - Test Equipment Required:**

1. Clean Piping / Fittings / Valves
2. Dewpoint Hygrometer
3. Pressure Gauge
4. Temperature Gauge
5. Membrane holder & membranes
6. Solvent extraction equipment
7. Infrared spectrometer or Gas Chromatograph

**Method B2 - Test Equipment Required:**

8. Clean Piping / Fittings / Valves
9. Dewpoint Hygrometer
10. Pressure Gauge
11. Temperature Gauge
12. Iso-kinetic sample probes / sampling rig
13. Membrane holder & membranes
14. Solvent extraction equipment
15. Infrared spectrometer or Gas Chromatograph

**Iso-kinetic sample points and probes. These must be matched to diameter of piping at sample point therefore a number will be required**

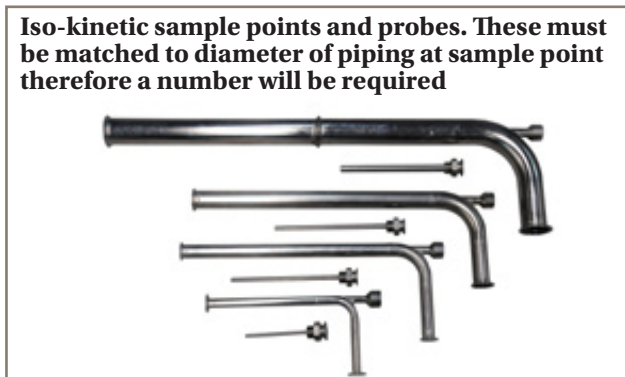

**Stainless Steel Membrane Holder**

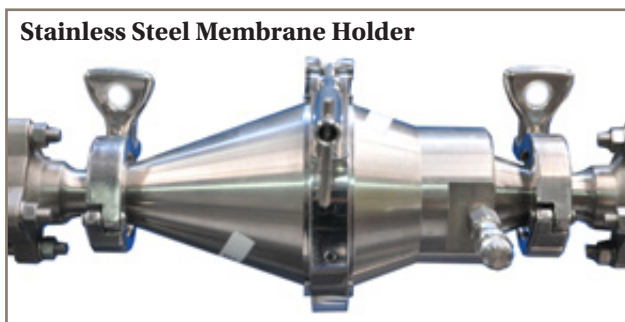

**Membranes placed in membrane holder**



**Iso-kinetic sampling rig including membrane holder**

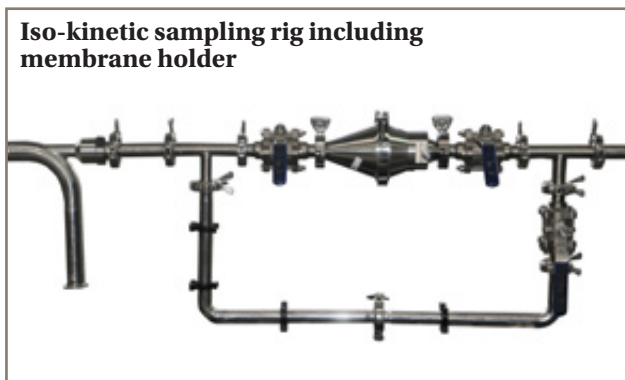

**Solvent extraction of oil from membrane in fume cupboard**



**Solvent Extraction**

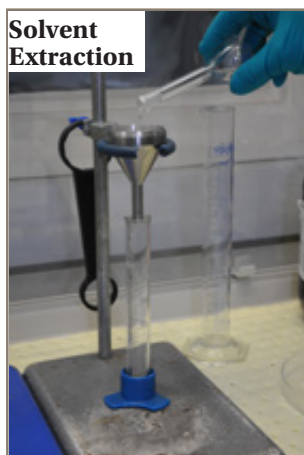

**Analysis of solvent to determine oil aerosol content using FTIR (Fourier-transform infrared spectrometer)**

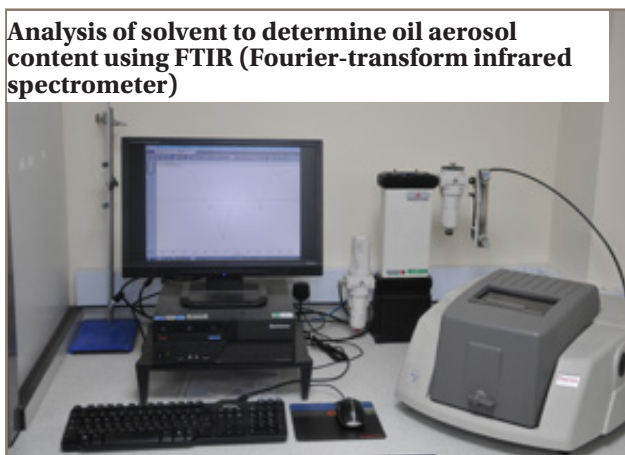

**Important Notes:**

*To validate to ISO 8573-1:2010 for total oil, ISO 8573-5 oil vapour testing is also required. The results of the two tests must be added together to provide a total oil level.*

# ISO 8573-3:1999 Humidity (Dewpoint)

## Sampling methods stated in the standard are:

- Sample Method - Full Flow
- Sample Method - Partial Flow Bypass Tube

## Full flow measurement

The probe is inserted in the main air flow stream, but protected against free water and other contaminants and used within the stated lower and upper limits of flow velocity for the measurement system.

## Partial flow measurement

The probe is installed in a small bypass tube. In this way the flow velocity to which the probe is exposed may be controlled. In portable equipment, the probe is integral to the equipment and connected to the main sampling point via piping of appropriate material.

## Partial flow - Test Equipment Required:

1. Hygrometer
2. Bypass Tube / Flow meter / Regulator

Chilled mirror hygrometers are often found to offer the highest dewpoint accuracy (measuring at pressure), however these can be expensive, delicate instruments. Typically, hygrometers using an electrical sensing method based upon resistance, capacitance or conductivity are used on-site as these offer the best balance between cost, accuracy, durability and portability. Many compressed air dryers also have this type of hygrometer built into controllers / energy management systems.

## Important Notes:

Humidity (Dewpoint) can be measured either at atmospheric pressure (giving a reading of Atmospheric Dewpoint or ADP) or at system pressure (giving a reading of Pressure Dewpoint or PDP). Any Humidity (Dewpoint) reading taken must state if it is either ADP or PDP.

Taking a humidity (dewpoint) measurement generally does not require any additional equipment other than the hygrometer, nor does it necessitate modification of the system piping, i.e. for iso-kinetic sampling. Dewpoint sampling will require the use of PTFE or stainless steel sample tubing for measuring low dewpoint's i.e.  $-70^{\circ}\text{C}$  PDP due to the permeability of certain piping materials.

Example of a typical hygrometer sensor



Hygrometer sensor in partial flow bypass tube



Example of a chilled mirror hygrometer



Example of a typical hygrometer using electrical sensing method based upon capacitance, resistance or conductivity



# ISO 8573-4:2019 Particulate

## Sampling methods stated in the standard are:

The method of measurement to be used depends upon the size range of the particles in the compressed air.

1. Sample disc and sizing / counting by light optical microscopy ( $\geq 5.0$ )
2. Sample disc and sizing / counting by scanning electron microscope ( $\geq 0.005$  micron)
3. Optical particle sizing and counting instrument ( $\geq 0.06$  to  $\leq 100$  micron)

As methods 1 & 2 are relatively time consuming, sampling method 3 is the most commonly used.

## Testing with particle sizing and counting instruments

As the test equipment sampling flow rates for this type of equipment are often very low, it is probable that full flow sampling will not be possible, and sampling will be performed using iso-kinetic (partial flow) sampling techniques.

## Particle sizing and counting instruments

This type of instrument will use 'light scattering measurement principle for single particle measurements.' Typically, the technology will be an optical aerosol spectrometer (OAS) or an optical particle counter (OPC). Selection will be based upon the particle size and concentration the user wishes to measure. The two technologies have differing particle size ranges and concentrations.

- Optical aerosol spectrometer (OAS)  $\geq 0,06$  to  $\leq 100$  micron
- Optical particle counter (OPC)  $\geq 0,1$  to  $\leq 10$  micron

OAS instruments are generally more tolerant of high particle concentrations and larger particle sizes and are typically used for sampling of untreated compressed air.

Laser based OPCs are ideal for detecting small particle sizes in low concentration, and are typically used for sampling of compressed air downstream of purification equipment.

## Partial flow - Test Equipment Required:

4. Iso-kinetic sample probes / sampling rig
5. Optical Particle Counter (OPC)

## Important Notes:

This is the method and equipment required for accurate testing of compressed air to the purities specified in ISO 8573-1 Class 0, 1 or 2 for particulate.

Not all OPC's can measure in the particle size bands required for ISO 8573-1 classification. Always ensure the Optical Particle Counter used can measure in the following particle size bands:

## Measurement Range / Bands Required by Test Equipment

0.1 – 0.5  $\mu\text{m}$  / 0.5 – 1  $\mu\text{m}$  / 1 – 5  $\mu\text{m}$

## Partial flow iso-kinetic sampling required for accurate particle measurement

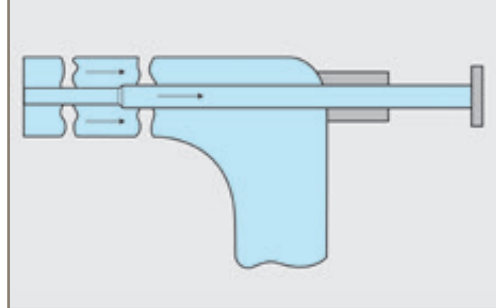

## Example of an Optical Aerosol Spectrometer (OAS)



## Example of an Optical Particle Counter (OPC)



# ISO 8573-5:2001 Oil Vapour

## Sampling method stated in the standard is:

The sample shall be free from interfering contaminants for example water vapour and oil aerosol. The sampling and analysis of the oil vapour shall be performed using a constant flow rate. The temperature and velocity range shall be within the ranges specified by the manufacturer of the test equipment. The probe shall be installed in a small extraction tube, which conducts an air sample from the main pipe into the measurement chamber, where the measurement shall be made under system pressure.

## Test Equipment Required:

1. Sampling rig
2. Membrane holder & membranes
3. Stainless steel sampling tube and adsorbent
4. Solvent extraction equipment
5. Gas Chromatograph

## Important Notes:

The standard states, for the purposes of this part of ISO 8573, chemical detector tubes may be employed to provide an initial indication of the presence of oil vapour. Once identified, the gas chromatography method shall be used for accuracy.

### Sampling methodology & equipment required for accurate measurement of oil vapour

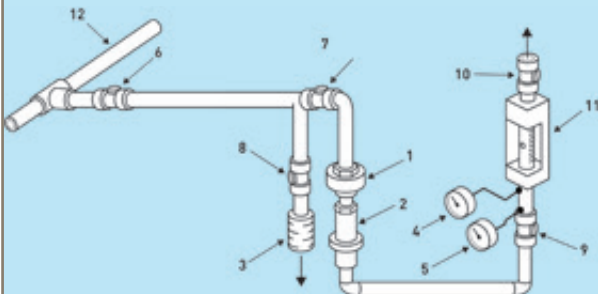

- |                        |                                   |
|------------------------|-----------------------------------|
| 01. Membrane Holder    | 02. Stainless Steel Sampling Tube |
| 03. Silencer           | 04. Pressure Gauge                |
| 05. Temperature Gauge  | 06. Shut Off Valve                |
| 07. Shut Off Valve     | 08. Shut Off Valve                |
| 09. Flow Control Valve | 10. Flow Control Valve            |
| 11. Flow Meter         | 12. Main Pipe                     |

### Example of an ATD Thermal Desorption tube (used for lower limit detection)



### Example of Gas Chromatograph (GC) required to analyse oil vapour samples collected in the thermal desorption tubes



### Example of carbon desorption tube





# ISO 8573-7:2003 Viable Microbiological Contaminant Content

## Sampling method stated in the standard is:

- Sample Method – Partial Flow Iso-kinetic

*Sampling method shall be iso-kinetic using the method given in ISO 8573-4*

Air is first tested in accordance with ISO 8573-4 for solid particles. Next samples are taken using a slit sampler as a particle analyser is unable to distinguish the difference between a particle and a micro-organism.

The slit sampler passes compressed air over an agar plate. The plate is then taken to a laboratory, incubated and checked for growth.

The purpose of the test is to determine if the air is sterile or non-sterile and if required to provide a count of colony forming units (CFU's).

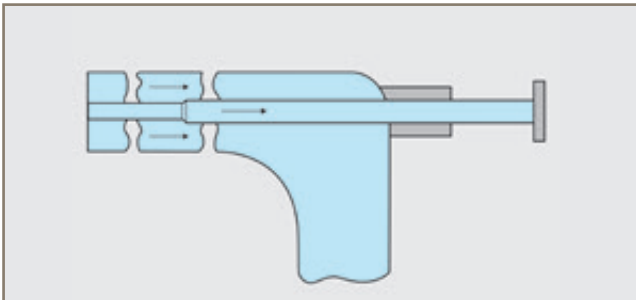

## Partial flow - Test Equipment Required:

1. Sampling rig (including flow meter)
2. Iso-kinetic sample probes / piping
3. Sampling rig
4. Slit sampler & Agar Plates
5. Incubator (or access to a laboratory)



Agar plate with micro-biological growth from compressed air sample



# Indicative Testing

If the sampling methodology shown in ISO 8573 parts 2 to 9 is not followed, then classification to ISO 8573-1 and validation of air purity is not possible. If the test equipment to be used is not listed in ISO 8573 parts 2 to 9 then classification to ISO 8573-1 and validation of air purity is not possible.

Any testing not carried out fully in accordance with ISO 8573 parts 2 to 9 is therefore referred to as “Indicative Testing”.

## Indicative Testing - Using the Test Results

Whilst indicative testing cannot be used for air purity validation purposes, it can still provide usable information for compressed air users. Certain industries may be required to show some level of testing has been carried on their compressed air system and at a specific frequency to show compliance (for example Food / Beverage / Pharmaceutical industries).

In most instances, the cost and complexity of purchasing the test equipment and following the sampling methodology required to validate in accordance with ISO 8573 parts 2 to 9 precludes full validation from being available or cost effective. Therefore, indicative testing can be carried out to highlight any changes that may be happening to the air purity at critical points of use. Using the results from indicative testing will allow a user to record and look for major changes to contamination levels and take appropriate action when necessary.

## Test Equipment Selection

When selecting equipment to test a compressed air system for contamination, it is important to understand if the results the equipment will provide are suitable for ISO 8573-1 classification (and air purity validation) or are for indicative purposes only.

This flow chart can assist when making equipment selection.

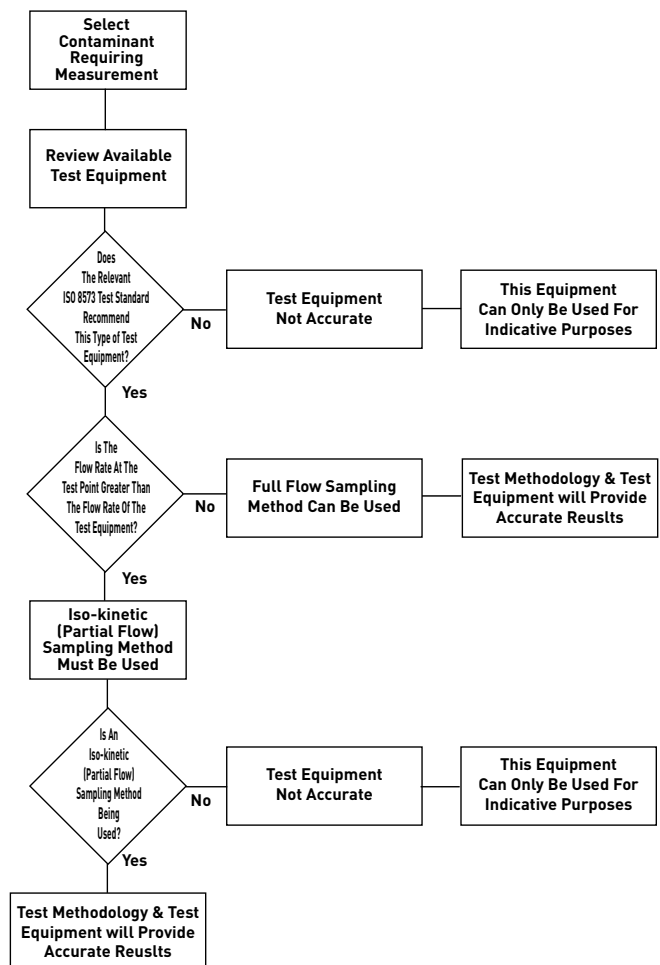

# Test Equipment for Indicative Testing

When using test equipment and / or test methodology not recommended by the ISO 8573 series of standards, it is advisable to understand the measurement limits and / or limitations of the equipment or sampling methodology being used. The following will provide an overview of commonly available test equipment used for indicative testing of compressed air systems.

Equipment Type	For the Measurement of	Sampling Method
Particle Counter	Particle Count	T-Piece in piping, regulated for flow and pressure T-Piece in piping supplying iso-kinetic Probe
Hygrometer	Pressure Dewpoint or Atmospheric Dewpoint	T-Piece in piping, direct to hygrometer T-Piece in piping, regulated for flow and pressure
Chemical Detector Tubes	Water Content	T-Piece in piping, regulated for flow and pressure
Photo Ionisation Detector (PID) based Digital Oil Analyser	Oil Vapour	T-Piece in piping, regulated for flow and pressure T-Piece in piping supplying iso-kinetic Probe
Chemical Detector Tubes (Impactor)	Oil Aerosol	T-Piece in piping, regulated for flow and pressure
Chemical Detector Tubes (Adsorbent)	Oil Vapour	T-Piece in piping, regulated for flow and pressure

## Important Note:

*None of the equipment / sampling methods mentioned above are suitable for the validation of compressed air purity in accordance with the classifications shown in ISO 8573-1.*

# Particle Counters (Solid Particulates)

Particle counters listed in and able to measure in accordance with ISO 8573-4 can be very expensive, delicate pieces of test equipment and are often only suited for laboratory test conditions.

There are of course many different types of portable particle counters available and some of these may seem to be affordable and cost effective alternatives. However, most were originally designed to measure ambient air in clean rooms, not sample pressurised compressed air systems. They often don't measure down to the levels shown in the ISO 8573-1 classification table (typically only down as low as 0.2 or 0.3 micron and / or not in the 3 distinct channels required). Many also require the air to be expanded to atmospheric pressure which again affects results.

Particle counting downstream of filtration equipment is common due to the relatively low cost of these types of particle counter, and it is the so called 'validation testing' of filters that causes the greatest number of issues between compressed air users and equipment providers. Compressed air treatment equipment such as coalescing and dry particulate filters are often highlighted by testers as 'failed' (not achieving their specified air purity) when in fact the filter is not at fault, the fault lies with the test equipment, the test methodology and the understanding of the person carrying out the tests. For example:

- Particle counters and not always kept clean and purged before use
- The equipment calibration regime is not always up to date
- Many operators do not understand how the particle analyser functions (i.e. what it is measuring and what can affect the measurements) and can therefore misinterpret the results
- Some pieces of test equipment show cumulative counts, for example, it will count everything below 5 micron, then everything below 3 micron, then everything below 1 micron which requires the user to subtract the lower readings (leading to double or triple counting and high particle counts)
- In addition to solid particles, a particle counters can also include aerosols of liquid, condensation and micro-organisms in their results
- Test equipment does not always measure in the 3 bands that is required by ISO 8573-1, therefore testers will incorrectly try to 'reallocate' particle counts into the ISO bands, skewing results
- Test points are often downstream of filtration not immediately at the outlet of the final filter, allowing particles from piping and fittings to be included in the count
- Test points fittings and valves are often the source of many particle contaminants and will be included in the particle count
- With the exception of absolute rated sterile air filters, general purpose and high efficiency dry particulate filters are at best 99.9999% efficient, meaning the greater the particulate concentration at the inlet of the filter, the higher the concentration downstream of the filter
- Many filters are located in the compressor room, testing is carried out at the point of use. Particle counts will therefore include contaminants picked up from the distribution piping (compressed air purity is only stated at the last compressed air filter outlet)
- Point of use filters for critical applications often have piping downstream made from materials which can add to the particulate count (always use new, cleaned piping downstream of final filters for critical applications)
- Testing after filter servicing (element change) will typically yield higher particle counts as the process of unscrewing the filter bowl to change the filter element will produce particles. Atmospheric particles an also enter the filter internals, increasing particle count for a short time
- Compressed air system usage can impact particle counts and must be factored into testing
- Knocking the piping can dislodge particles and increase particle count

# Hygrometers (Dewpoint)

## Digital Hygrometers

Whilst spectroscopic and chilled mirror (condensation) hygrometers can be very expensive, digital hygrometers using capacitance, resistance or conductivity sensing are now available and offer an excellent balance between accuracy, response time and affordability.

Dewpoint is the one contaminant than can be cost effectively measured in “real time”. Whilst for true compliance with ISO 8573-3 the measurement should sampled using the test methodology highlighted within the standard, dewpoint can in fact be measured at most points in the system with reasonable accuracy using a “t-piece”.



# Chemical Detector Tubes (Dewpoint)

## Chemical Detector Tubes

Chemical detector tubes for water are typically only suitable for measuring depressurised air and will provide an indication of  $\text{mg H}_2\text{O}/\text{m}^3$ . To obtain a Pressure Dewpoint (PDP) figure, the result must first be converted to an equivalent atmospheric dewpoint (ADP) and then converted into a pressure dewpoint.

As the dewpoint of compressed air is constantly changing (due to changing ambient conditions and the way compressed air dryers function), by the time the readings and calculations are performed, the PDP of the compressed air in the system will have changed.

Chemical detector tubes are therefore best suited for measuring the moisture content of ‘stored’ compressed air, for example in a diving bottle and not for measuring in a dynamic compressed air system.



# Digital Oil Analysers (Oil Vapour)

There are a number of digital oil analysers available that are marketed as suitable for measurement of Total Oil in compressed air & classification in accordance with ISO 8573-1, however this type of equipment is not shown in the recommended equipment list of ISO 8573-2 and ISO 8573-5.

Digital oil analyser's typically use Photo Ionisation Detectors (also known as PID's). A Photo Ionisation Detector uses an ultraviolet (UV) light source to remove an electron from any hydrocarbons and VOC's in the compressed air and create charged ions. The charged ions land on a collector electrode, and the detector measures electrical current in proportion to the concentration of VOCs present, shown as a value in mg/m<sup>3</sup> on the instruments display.

The compressed air is directed to the PID sensor directly or via a zero air generator (catalyst). The purpose of the zero air generator is to provide a reference gas that periodically 'resets' the zero measurement reference in the detector.

By design, PID's provide measurement of oil vapour only, they do not provide measurement for liquid oil or oil aerosols and are therefore unable to give a reading for total oil as required by ISO 8573-1. As oil aerosol typically represents the majority of oil present, PID based instruments will drastically underestimate the total amount of oil present.

## Limitations of Photo Ionisation Devices (PID's) include:

- Often marketed as a device for measuring oil content in compressed air, implying total oil content, when in fact they are only designed to specifically measure oil vapour
- They do not measure total oil (liquid / aerosol / vapour) in accordance with ISO 8573-1, therefore they cannot provide an ISO 8573-1 air purity classification
- Due to their accuracy, they are not included in the ISO 8573 series of standards as a recognised piece of test equipment and therefore cannot be used to provide an ISO 8573-1 air purity classification
- In some instances, they may measure hydrocarbons & VOC's with less than 6 carbon atoms (<C6) affecting the reliability of the results
- Fluctuations in measurement accuracy is high – between  $\pm 30\%$  accuracy at low levels (0.01mg/m<sup>3</sup>) to  $\pm 10\%$  accuracy at higher levels (2.5mg/m<sup>3</sup>)
- Due to the accuracy fluctuations, there is the potential for an ISO 8573-1 Class 2 value to appear as Class 1 and vice versa
- They must only be used on filtered, dry compressed air supplies, never directly downstream of an oil-free compressor
- The measuring device regulates pressure (typically down to 2.5 bar g) which can change the air temperature of the sample and therefore impact accuracy)
- The accuracy of a PID can be affected by ambient temperature, direct sunlight and localised radiation sources (e.g. radio waves)
- The partial flow measurement method used by most PID's is not true iso-kinetic sampling which can impact the accuracy of the test results
- The zero air catalyst which forms part of the detection system operates at temperatures between 130°C & 240°C, outside of this range, the unit will not provide any results
- Changes in sample flow rate can affect measurements
- PID's can also be affected by the presence of oil aerosols, water aerosols, particles and micro-organisms

## Use of PID based digital oil analysers

As the accuracy of the PID based measurement devices preclude them from the ISO 8573-5 standard, they should only be used for 'indicative testing' of **oil vapour** (like the chemical detector tubes mentioned in ISO 8573-5 which are used for checking purposes before more accurate sampling is undertaken). PID based measurement devices should never be used to determine the ISO 8573-1 classifications for total oil in a compressed air supply as they will not comply and are not allowed by the standard.

# Chemical Detector Tubes (Oil)

Many air purity test kits use chemical detector tubes. These are commonly used to test compressed air systems; however, they have many limitations.

## Limitations of Chemical Oil Detector Tubes include:

- Measurement range - The measurement range of many tubes are outside of the total oil levels shown in ISO 8573-1 for Class 1 and / or Class 2
- Oil Mist - Many detector tubes only measure oil mist (aerosols) and not oil vapour.
- ISO 8573-1 classification - This requires measurement of total oil (liquid / aerosol / vapour) which chemical detector tubes are unable to provide
- Results are subjective, many are based upon subtle colour changes whilst others are based upon coloured dots (impactors)
- Accuracy - A NIOSH study stated that when used correctly, the typical accuracy for detector tubes was around +/-25%.
- Temperature - Tubes are typically calibrated at 20°C, ambient and compressed air temperatures over or under 20°C can affect results
- Pressure - Compressed air pressure must be regulated, changing the oil concentration in the compressed air
- Sampling method - The air flow at the sampling point is typically higher than the sampling flow of the tube, requiring regulation of flow and pressure which provides a nonrepresentative sample into the tube and leads to accuracy errors
- Other chemicals - Detector tubes are primarily designed to detect mineral oils and other chemicals in the lubricant being sampled, for example additives such as anti-foaming agents, coolants, etc. which are common in compressor lubricants can cause false readings or not be detected at all

## Important Notes:

**ISO 8573-5 mentions the use of chemical detector tubes (extract below):**

### 5 Test Methods

*Selection of the available test methods depends on the range of oil vapour content in the compressed air*

- *Gas chromatography is applicable for oil vapour in the range of 0.001mg/m<sup>3</sup> to 10mg/m<sup>3</sup>.*
- *Chemical indicator tubes are to be used as a preliminary method only, for checking purposes and as an initial investigation, after which the gas chromatography method shall be employed.*

In summary, chemical detector tubes are a low cost, quick way of checking for the presence of bulk oil, however they lack the measurement range and are too inaccurate for ISO 8573-1 classification purposes, use incorrect sampling methods, are affected by lubricant additives, do not detect total oil (liquid, aerosol / vapour) and are not a recognised ISO 8573 measurement method and should therefore be used for indication only not classification to ISO 8573-1.

### Accurate Measurement of Total Oil

In ISO 8573-1, the specification for oil is for 'Total Oil' (liquid oil, oil aerosols and oil vapour). To accurately test for total oil requires the separate measurement of oil aerosol and oil vapour using ISO 8573-2 & ISO 8573-5 respectively. The results of the two tests are then added together to provide the value for total oil.

For accurate oil detection, solvent extraction methods are required (as stated in ISO 8573-2 and ISO 8573-5) plus access to an infrared spectrophotometer and gas chromatograph.

# Service Providers / Experts & Consultants

There are many companies / individuals who offer a “product testing or validation service”. However, when the wrong methodology and / or test equipment is used, the results are usually (incorrectly) interpreted as a failure of the compressed air treatment equipment.

Unfortunately, there are currently no training courses available or examinations to take that would allow a person to show competency when it comes to understanding and testing in accordance with the ISO 8573 series of standards. Therefore, care must be taken when selecting a service provider.

The following may help during the selection of a suitable service provider:

- First ask the prospective service provider if they are validating the air purity to ISO 8573-1 classifications or just providing indicative testing

## **If claiming validation of air purity to ISO 8573-1**

- Ask to see *their* copies of the ISO 8573 standards they are going to use - many of those carrying out the testing and claiming it is in accordance with the ISO 8573 standards do not reference or even own copies of the standards
- Ask to see method statements / equipment lists
- Ask questions regarding the test procedures they follow, the number of samples and have them show how this correlates back to a particular ISO 8573 standard and a section in that standard - make sure they are able to confidently advise you on the use of the standards
- Ensure that they understand the accuracy of the different types of equipment available - ask them to show you where the piece of test equipment to be used is shown in an ISO 8573 standard document
- Ask why they selected that type of test equipment and ensure the type selected is the correct one shown in the standard for the classification levels being validated
- Ensure that they are using the correct sampling methodology - ask about sample points and sample methodology, have them show you the sample equipment they are going to use and where it appears in a particular part of the ISO 8573 standard document

**If the answers provided to the questions are not satisfactory, then the testing being provided is probably indicative testing and the results should only be used to look for major changes in contaminant levels**



# Performance Validated Compressed Air Treatment Equipment

As the cost and complexity of testing and validating compressed air purity in accordance with ISO standards is prohibitive, Parker can provide a cost-effective alternative.

Parker compressed air filters & Parker compressed air dryers are a complete range of compressed air treatment products with 3<sup>rd</sup> party validated performance and backed up by an air quality guarantee.

The Parker OIL-X range of compressed air filters and Parker adsorption dryer ranges have been designed to provide compressed air purity (quality) that meets or exceeds every classification shown in all editions of ISO 8573-1.

Filtration & dryer performance has also been independently 3<sup>rd</sup> party verified by Lloyds Register.

Parker Filtration & Parker Dryer 3 <sup>rd</sup> Party Performance Testing and Validation						
Purification Equipment	ISO 8573-1 Performance Validation	ISO 12500-4 ISO 8573-9	ISO 12500-1 ISO 8573-2	ISO 8573-3 ISO 7183	ISO 8573-4	ISO 8573-5
OIL-X Grade WS Water Separators	✓	✓				
OIL-X GRADE AO/AA Coalescing Filters	✓		✓		✓	
CDAS / OFAS / ATEX / FBP / MX / MXLE Adsorption Dryers	✓			✓		
OIL-X Grade OVR Oil Vapour Reduction Filters						✓
OIL-X GRADE AO/AA Dry Particulate Filters	✓				✓	

# Parker Compressed Air Filtration Products with 3rd Party Performance Validation

## **OIL-X Grade WS Water Separators**

Water separator performance has been tested in accordance with ISO 12500-4 and ISO 8573-9.

## **OIL-X Grade A0 / AA Coalescing Filters**

Coalescing filter performance has been tested in accordance with ISO 12500-1, ISO 8573-2 and ISO 8573-4.

## **OIL-X Grade A0 / AA Dry particulate filters**

Dry particulate filter performance has been tested in accordance with ISO 8573-4.

## **OIL-X Grade OVR Oil Vapour Reduction Filters**

Oil vapour removal filter performance has been tested in accordance with ISO 8573-5.

In addition to performance validation, the materials used in the construction of the above product ranges are suitable for use in food and beverage manufacturing facilities. FDA Title 21 compliance and EC1935-2004 exemption certificates are available on request.

---



**OIL-X  
Coalescing &  
Dry Particulate Filters**



**OVR  
Oil Vapour  
Reduction Filters**

# Parker Compressed Air Drying Products with 3<sup>rd</sup> Party Performance Validation

## Adsorption Dryers

CDAS / OFAS / FBP / CDAS HL ATEX / MX / MXLE dryer performance has been tested in accordance with ISO 7183, the international standard for compressed air dryer testing

In addition to performance validation, the materials used in the construction of the FBP, MX & MXLE dryer product ranges are suitable for use in food and beverage manufacturing facilities. FDA Title 21 compliance and EC1935-2004 exemption certificates are available on request.

CDAS HL ATEX & MX ATEX are suitable for use in ATEX hazardous environments and certified to ATEX Group II Category 2 GD



**CDAS**  
Clean Dry Air System



**OFAS**  
Oil Free Air System



**CDAS HL ATEX**  
Clean Dry Air System



**FBP**  
OIL Free Air System



**MX**  
Adsorption  
Dryer



**MXLE**  
Low Energy  
Adsorption Dryer

# Summary

To classify or validate the air purity (quality) of compressed air in accordance with ISO 8573-1, the test methods and test equipment shown in ISO 8573-1 parts 2 to 9 must be used. If not, results are indicative only and cannot be used for classification or validation purposes.

## Validation of ISO 8573-1 Classification Downstream of Purification Equipment Requires:

### Particles (ISO 8573-4)

- Iso-kinetic sampling equipment or full flow sampling equipment (for very small flow rates)
- Particle counting with OPC (Optical Particle Counter) accurately measuring in the bands (0.1 ~ 0.5  $\mu\text{m}$  / 0.5 ~ 1  $\mu\text{m}$  / 1 ~ 5  $\mu\text{m}$ )

### Micro-organisms (ISO 8573-7)

- Iso-kinetic sampling equipment
- Flow / Pressure / Temperature / Dewpoint Measuring Equipment
- Slit sampler for distribution of air sample over agar plates
- Agar plates
- Incubator to grow live samples
- Lab based analysis of agar plates

### Dewpoint (ISO 8573-5)

- Full flow sampling equipment or Partial Flow with bypass tube
- Digital hygrometer

Example of an Optical Particle Counter (OPC)



Chilled mirror hygrometer



Slit Sampler



### Total Oil

Measurement of total oil to the levels shown in ISO 8573-1:2010 Class 0 or ISO 8573-1:2010 Class 1 requires two separate tests. One for oil aerosol (ISO 8573-2) and one for oil vapour (ISO 8573-5). The results are then added together for total oil.

### Oil Aerosol (ISO 8573-2)

- Iso-kinetic sampling equipment or full flow sampling equipment (for very small flow rates)
- Membrane holder and membranes for membrane capture of oil aerosol
- Solvent for solvent extraction of oil from membranes
- Lab based analysis with Infrared spectrophotometer

### Oil Vapour (ISO 8573-5)

- Full flow sampling equipment (regulated)
- Adsorbent capture tubes for adsorbent capture of oil vapour
- Solvent for solvent extraction of oil from adsorbent materials
- Lab based analysis with Gas Chromatograph

**Iso-kinetic sample points and probes. These must be matched to diameter of piping at sample point therefore a number will be required**



**Iso-kinetic sampling rig including membrane holder for compliance with ISO 8573-2 testing**

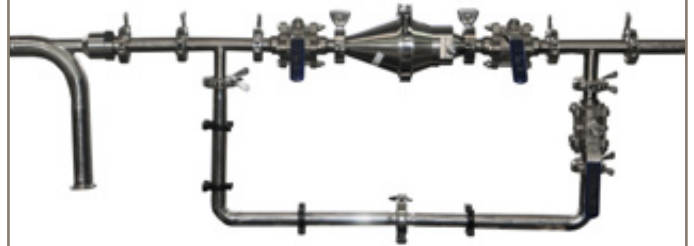

**Example of an ATD Thermal Desorption tube (used for lower limit detection) ISO 8573-5**



**Analysis of solvent to determine oil aerosol content using FTIR (Fourier-transform infrared spectrometer)**

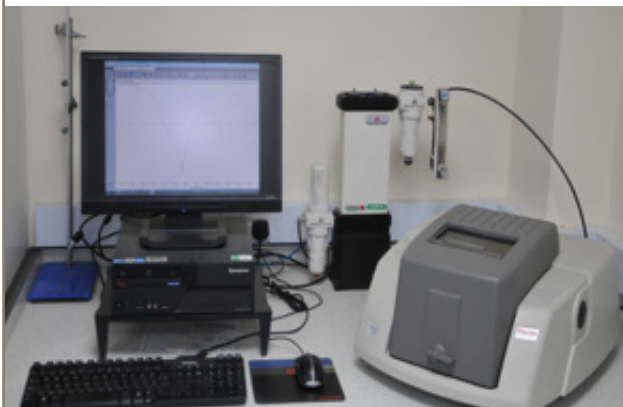

**Example of Gas Chromatograph (GC) required to analyse oil vapour samples collected in the thermal desorption tubes**



# Summary

On-site testing fully in accordance with ISO 8573 is often not possible due to the complexity of the test method and the expense of test equipment and other analysis equipment required (installing multiple iso-kinetic sampling points in the compressor room and at each point of use can also be very costly).

As testing of a compressed air system is often carried out using simple sample points and / or with test equipment not recommended in ISO 8573 parts 2 to 9, the testing is referred to as 'Indicative Testing'.

## Examples of indicative testing:

- Not using iso-kinetic sampling methods when required
- Use of flow regulators / pressure regulators which change the pressure / air velocity / temperature / contaminant concentration of a sample
- Total Oil testing using PID based digital oil analyser
- Total Oil testing using chemical detector tubes
- Particulate testing using particle counters that do not count in required particle bands
- Particle testing using particle analysers that do not measure down to lowest particle size required by the ISO 8573-1 standard
- Measuring water vapour with chemical detector tubes



## Important Note:

- ***The international Standards Organisation (ISO) does not provide a facility for manufacturers to gain equipment compliance with a standard nor does it test, validate or endorse any type of test equipment.***

### Indicative testing

It must be stressed that indicative testing:

- Is any testing not in accordance with the sampling methodology shown in ISO 8573 parts 2 to 9 (does not typically use iso-kinetic sampling)
- Is any testing that does not use the test equipment shown in ISO 8573 parts 2 to 9
- Will not allow the tester / user to show compliance with ISO 8573-1 air purity classifications

ISO 8573-1:2010 CLASS	Maximum number of particulates per m <sup>3</sup>			Particulate	Vapour pressure	Liquid g/m <sup>3</sup>	Oil
	0.1 - 0.5 micron	0.5 - 1 micron	1 - 5 micron	Mass Concentration	Dewpoint		Total Oil (aerosol liquid and vapour)
				mg/m <sup>3</sup>			mg/m <sup>3</sup>
0	As specified by the equipment user or supplier and more stringent than Class						
1	≤ 20,000	≤ 400	≤ 10	—	≤ -70°C	—	0.01
2	≤ 400,000	≤ 2,000	≤ 100	—	≤ -40°C	—	0.1
3	—	≤ 90,000	≤ 1,000	—	≤ -20°C	—	1
4	—	—	≤ 10,000	—	≤ 0°C	—	5
5	—	—	≤ 100,000	—	≤ +7°C	—	—
6	—	—	—	≤ 5	≤ +10°C	—	—
7	—	—	—	5 - 10	—	≤ 0.5	—
8	—	—	—	—	—	0.5 - 5	—
9	—	—	—	—	—	5 - 10	—
X	—	—	—	> 10	—	> 10	> 10

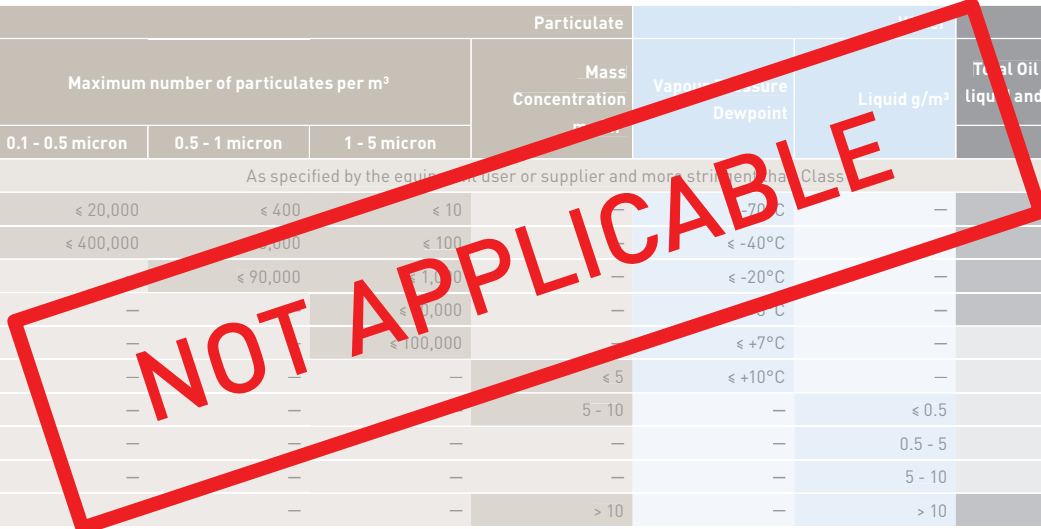

- Is not accurate
- Provides results that are not suitable for product performance validation
- Provides results that are not suitable for air purity validation
- Only provides results suitable for trend analysis (major changes in test results from one test to another may indicate a problem that would warrant further investigation)

## Performance Validated Compressed Air Treatment Products

As the cost and complexity of testing and validating compressed air purity in accordance with ISO standards is prohibitive, Parker can provide a cost-effective alternative.

Parker domnick hunter compressed air filters & Parker Zander compressed air dryers are a complete range of compressed air treatment products with 3<sup>rd</sup> party validated performance and backed up by an air quality guarantee.

### References, Data & Support:

International Standards Organisation (ISO) Publications: ISO 8573-1 / ISO 8573-2/ ISO 8573-3/ ISO 8573-4/ ISO 8573-5/ ISO 8573-6/ ISO 8573-7/ ISO 8573-8/ ISO 8573-9

British Compressed Air Society (BCAS)

Matthew Andrews (responsible for image creation)

David McMillan, CEng FIMechE - Engineering Services & Approvals Manager (Member of ISO TC118/SC4/WG1 - Compressed Air Purity Specification and Compressed Air Treatment Equipment - Working Groups)

Stuart Graham, MIET, DiPCAM - Research Group Senior Engineer (responsible for ISO 8573-2 & ISO 8573-4 testing)

Matthew Pearson, BEng (Hons), DiPCAM - Senior Engineer (responsible for ISO 8573-5 testing)

Ben Birch, BSc (Hons), DipCAM - Research Scientist (responsible for ISO 8573-7 testing)

# Parker Worldwide

## Europe, Middle East, Africa

**AE – United Arab Emirates,**  
Dubai

Tel: +971 4 8127100  
parker.me@parker.com

**AT – Austria,** St. Florian

Tel: +43 (0)7224 66201  
parker.austria@parker.com

**AZ – Azerbaijan,** Baku

Tel: +994 50 2233 458  
parker.azerbaijan@parker.com

**BE/NL/LU – Benelux,**

Hendrik Ido Ambacht  
Tel: +31 (0)541 585 000  
parker.nl@parker.com

**BG – Bulgaria,** Sofia

Tel: +359 2 980 1344  
parker.bulgaria@parker.com

**BY – Belarus,** Minsk

Tel: +48 (0)22 573 24 00  
parker.poland@parker.com

**CH – Switzerland,** Etoy

Tel: +41 (0)21 821 87 00  
parker.switzerland@parker.com

**CZ – Czech Republic,** Klecany

Tel: +420 284 083 111  
parker.czechrepublic@parker.com

**DE – Germany,** Kaarst

Tel: +49 (0)2131 4016 0  
parker.germany@parker.com

**DK – Denmark,** Ballerup

Tel: +45 43 56 04 00  
parker.denmark@parker.com

**ES – Spain,** Madrid

Tel: +34 902 330 001  
parker.spain@parker.com

**FI – Finland,** Vantaa

Tel: +358 (0)20 753 2500  
parker.finland@parker.com

**FR – France,** Contamine s/Arve

Tel: +33 (0)4 50 25 80 25  
parker.france@parker.com

**GR – Greece,** Piraeus

Tel: +30 210 933 6450  
parker.greece@parker.com

**HU – Hungary,** Budaörs

Tel: +36 23 885 470  
parker.hungary@parker.com

**IE – Ireland,** Dublin

Tel: +353 (0)1 466 6370  
parker.ireland@parker.com

**IL – Israel**

Tel: +39 02 45 19 21  
parker.israel@parker.com

**IT – Italy,** Corsico (MI)

Tel: +39 02 45 19 21  
parker.italy@parker.com

**KZ – Kazakhstan,** Almaty

Tel: +7 7273 561 000  
parker.easteurope@parker.com

**NO – Norway,** Asker

Tel: +47 66 75 34 00  
parker.norway@parker.com

**PL – Poland,** Warsaw

Tel: +48 (0)22 573 24 00  
parker.poland@parker.com

**PT – Portugal**

Tel: +351 22 999 7360  
parker.portugal@parker.com

**RO – Romania,** Bucharest

Tel: +40 21 252 1382  
parker.romania@parker.com

**RU – Russia,** Moscow

Tel: +7 495 645-2156  
parker.russia@parker.com

**SE – Sweden,** Spånga

Tel: +46 (0)8 59 79 50 00  
parker.sweden@parker.com

**SK – Slovakia,** Banská Bystrica

Tel: +421 484 162 252  
parker.slovakia@parker.com

**SL – Slovenia,** Novo Mesto

Tel: +386 7 337 6650  
parker.slovenia@parker.com

**TR – Turkey,** Istanbul

Tel: +90 216 4997081  
parker.turkey@parker.com

**UA – Ukraine,** Kiev

Tel: +48 (0)22 573 24 00  
parker.poland@parker.com

**UK – United Kingdom,** Warwick

Tel: +44 (0)1926 317 878  
parker.uk@parker.com

**ZA – South Africa,** Kempton Park

Tel: +27 (0)11 961 0700  
parker.southafrica@parker.com

## North America

**CA – Canada,** Milton, Ontario

Tel: +1 905 693 3000

**US – USA,** Cleveland

Tel: +1 216 896 3000

## Asia Pacific

**AU – Australia,** Castle Hill

Tel: +61 (0)2-9634 7777

**CN – China,** Shanghai

Tel: +86 21 2899 5000

**HK – Hong Kong**

Tel: +852 2428 8008

**IN – India,** Mumbai

Tel: +91 22 6513 7081-85

**JP – Japan,** Tokyo

Tel: +81 (0)3 6408 3901

**KR – South Korea,** Seoul

Tel: +82 2 559 0400

**MY – Malaysia,** Shah Alam

Tel: +60 3 7849 0800

**NZ – New Zealand,** Mt Wellington

Tel: +64 9 574 1744

**SG – Singapore**

Tel: +65 6887 6300

**TH – Thailand,** Bangkok

Tel: +662 186 7000

**TW – Taiwan,** Taipei

Tel: +886 2 2298 8987

## South America

**AR – Argentina,** Buenos Aires

Tel: +54 3327 44 4129

**BR – Brazil,** Sao Jose dos Campos

Tel: +55 800 727 5374

**CL – Chile,** Santiago

Tel: +56 2 623 1216

**MX – Mexico,** Toluca

Tel: +52 72 2275 4200



**EMEA Product Information Centre**

**Free phone: 00 800 27 27 5374**

(from AT, BE, CH, CZ, DE, DK, EE, ES, FI, FR, IE, IL, IS, IT, LU, MT, NL, NO, PL, PT, RU, SE, SK, UK, ZA)

**US Product Information Centre**

**Toll-free number: 1-800-27 27 537**

[www.parker.com/gsf](http://www.parker.com/gsf)