

Technical note

Measuring the level of solid materials

Finding the right technology



Measuring the Level of Solid Materials

1.0 Solids measurement characteristics

Solids and liquid media have different characteristics and measuring the level of solids can be challenging. This technical note outlines the most important areas for consideration when measuring level on bulk solids.

Due to the material properties, solids surfaces are usually uneven with irregular shapes, and there are often high levels of dust. Along with these challenges, solid materials often have low dielectric constants making them more difficult to measure.

When selecting a measuring device, it is important to understand the purpose of the measurement. There are different process characteristics to consider that may, or may not, require special features in the level device of choice.

1.1 Uneven surface

All level measurement instruments are affected by the uneven surfaces in solids applications. The material characteristics, speed of emptying and filling cycles, silo shape and size, and complexity of the surface shape, will determine the level measurement requirement, and influence the preferred installation location and choice of technology. In many cases several devices are recommended to achieve a reliable measurement.

Guided wave radar is less affected by uneven surfaces since the microwave signal is more compact and guided by the probe. The signal is then reflected from the contact point on the surface.

Non-contacting radar is more affected by uneven surfaces since some of the signal is not reflected directly back and instead may be re-directed away from the device. The device gathers several smaller echoes concentrated from the radar footprint of the surface and then merges them into a single echo that represents an average of the measured area. The benefit of the non-contacting radar merging smaller echoes is that the level reading will be a better representation of the actual level, since the result is based on more than a single point from the surface. The radar signal becomes more concentrated as antenna size increases. Although the overall surface area measured is reduced, the return signal is strengthened.

When installing solids switches, it is important to consider where the level will be changing, to achieve a reliable and accurate point level detection. It is preferred to install the switch from the top or the side.

1.2 Dielectrics and bulk density

Materials with very low dielectric constant and low density may attenuate the measurement signal so that it becomes insufficient.

The dielectric constant of many solids is fairly low. For the radar technology, this is a key indicator of the amount of signal that will be reflected back to the gauge and thereby the possible measuring range. For level switches, the capacitance technology is affected by the bulk solid dielectric constant. Both radar and capacitance technologies can handle low dielectrics with ease.

Radar is unaffected by bulk density, while many solids switches are. The bulk density is therefore an important selection parameter when choosing technology for point level measurement.

1.3 Filling

The mounting location in relation to the filling location is important for most measuring technologies. The closer a device is mounted to the filling point, the larger the risk is that the device will be affected. A continuous measurement device mounted in direct relation with the filling location, will lead to an inconclusive measurement. Solids switches should not be mounted into the filling stream since this can lead to mechanical damage of the sensor.

There are cases where the material is blown into a silo through a pneumatic process. Dust and the stream from the filling can disturb the measurement to a large extent. It is recommended to locate the devices in accordance with best practices presented in this technical note.

Figure 1. Filling of Dusty Solid Material

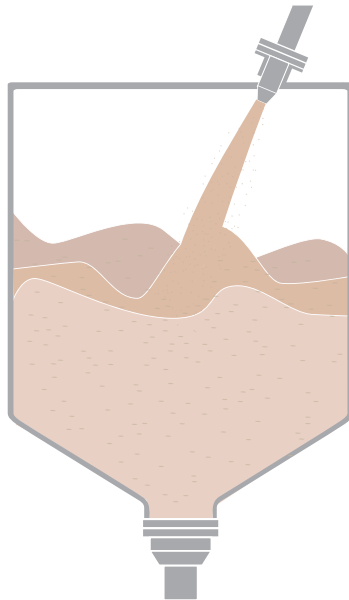

1.4 Dust

There is often a considerable amount of dust created during the fill cycle of solid materials. The amount of dust depends on the type of filling and the material.

Both radar gauges and level switches can handle dust in the vapor space without being disturbed. Other technologies such as ultrasonic and laser devices are less suitable since their signal is significantly impacted by dust.

Although a heavy layer of dust on a radar antenna can block the signal in applications where the dust is especially sticky, this can be compensated for by alternatives such as non-stick antenna materials and air-purging. Some switches can be prone to caking, if too much dust gets stuck in undesired locations, while other switches have built-in solutions to handle extreme conditions.

Figure 2. Dusty Application

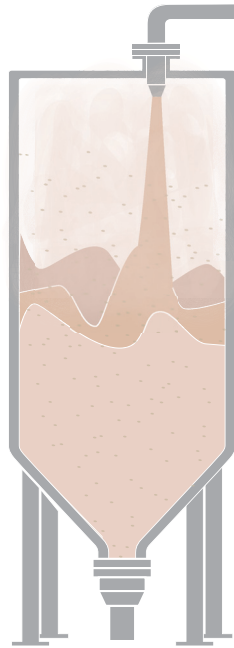

1.5 Condensation

In some solids applications there is condensation, and since the vessel ceiling is normally the coldest spot, this is a common area to find it. Unfortunately, this is typically the location of top-down measurement devices such as radar, so the effects it has on the technology must be taken into consideration.

If the signal is dampened by heavy condensation at the antenna, it often helps to insulate the nozzle. This minimizes the temperature disparity between the internal and ambient temperature. Installing the antenna so it is inside the vessel helps reduce the chance of condensation.

Condensation can also tie up dust and create a layer on the wetted parts, which may cause problems if no action is taken. Guided wave radar is not affected by condensation and is a good choice for extreme cases, although build-up on the probe could affect readings. Signal quality diagnostics can monitor this. Non-contacting radars may need air purging to cope with condensation related issues; see “[Antenna requirements](#)” on page 10 for more information.

1.6 Open air applications

Open air applications include measurements on piles and distance control between conveyor belts and the pile. These types of applications have different properties compared to standard bins or silos. There are no walls or roof to install instruments onto, so the biggest challenge is to find an installation point. Protection from external factors - like wind and rain - can also be a challenge. Non-contacting radar is recommended in open air applications, as the devices are not affected by outdoor conditions.

Figure 3. Open Air Application

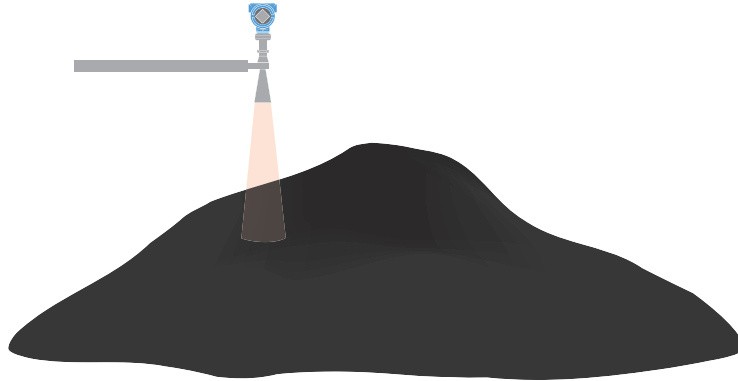

2.0 Solids continuous level measurement

The main benefit of a continuous level measurement is having continuous access to information, which allows for better materials tracking and control.

In solids level measurement there are often fast level changes and low dielectrics. Having a continuous insight into the process enables process optimization, reduced interruptions and a higher level of safety.

Radars usually provide appropriate solutions for small to medium sized silos where the filling rate can be high and the environment can be rough, but also in large silos for inventory management.

Table 1. Continuous Level Measurement Product Selection

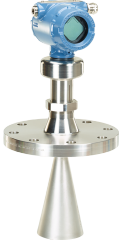
	Guided wave radar	Non-contacting radar
	 Rosemount 5300	 Rosemount 5408
Silo height	3-98 ft. (1-30 m)	Maximum 131 ft. (40 m)
Minimum mounting requirements	1 in.	2, 3, 4, and 8 in.
Power	2-wire	2-wire
Material restriction	DC > 1.1 up to 39 ft. (12 m) with Probe End Projection activated DC > 1.4	Up to 131 ft. (40 m) depending on antenna type and product category. See Table 4 on page 11 for further details.
Protocol	4-20 mA, HART®, FOUNDATION™ Fieldbus, Modbus®, WirelessHART®	4-20 mA, HART, WirelessHART, FOUNDATION Fieldbus
Features	Direct Switch Technology, Probe End Projection, Signal Quality Metrics	Solids signal processing, air purging, FMCW technology, All-PTFE solutions, Signal Quality Metrics

2.1 Guided Wave Radar

Guided wave radar is used in many different applications. It is especially well suited for smaller vessels with diameter <33 ft. (10 m) containing powders and small granular materials and where the installation area is restricted. As vessel height increases, wear on the probe becomes more of a factor in the suitability of its use.

The main benefits of guided wave radar are:

- Handles high filling and emptying speeds
- Enhanced signal strength for more reliable and robust measurements with Direct Switch Technology
- Handles long ranges and low DC down to 1.1 with Probe End Projection
- Signal Quality Metrics will aid in detection of dirty probes

Some of the limitations to consider for guided wave radar are:

- Sensitive to pull forces
- Wear on probe
- Inferred level/volume from one single point

Mounting considerations

Always install the probe in an empty silo and regularly inspect the probe for damage. For silos taller than 98 ft. (30 m), consult your Emerson representative.

Position

Mount the probe as far away as possible from filling and emptying ports. This will minimize load and wear and will help to avoid disturbances from the incoming product.

Figure 4. Position Recommendations

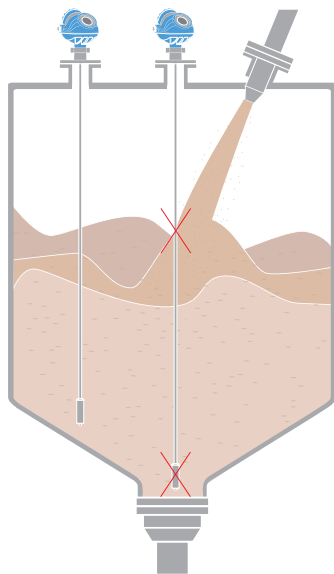

Installing the probe at about $\frac{1}{3}$ to $\frac{1}{2}$ of the silo radius is recommended to compensate for measurement errors caused by cone-shaped surface formation during centered filling. The minimum recommended probe distance to tank wall or disturbing objects is 20 in. (50 cm), unless the wall is comprised of smooth metal, then the distance is 4 in. (10 cm). In any case, the probe should not be able to touch the wall of the tank during operation.

Nozzle

A short nozzle is recommended. The maximum recommended nozzle height is nozzle diameter + 4 in. (100 mm). When nozzles are more than 4 in. (100 mm) in height, a long stud is recommended to prevent the probe from contacting the nozzle. Avoid 10 in. (250 mm)/DN250 or larger diameter nozzles, especially in applications with low dielectric constants.

Figure 5. Nozzle Recommendations

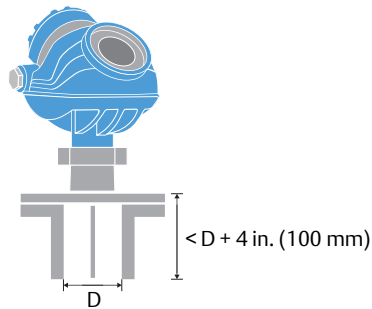

Special silos

In the case of non-metallic silos, a guided wave radar should be mounted with a metal plate of at least 14 in. (350 mm) in diameter. Use metal shielding for the conduit connections. In the case of bunkers with a concrete roof, a Rosemount 5303 should be installed flush with the inner roof surface or in a nozzle insert.

Figure 6. Installation in Concrete Silos with Metal Shielding

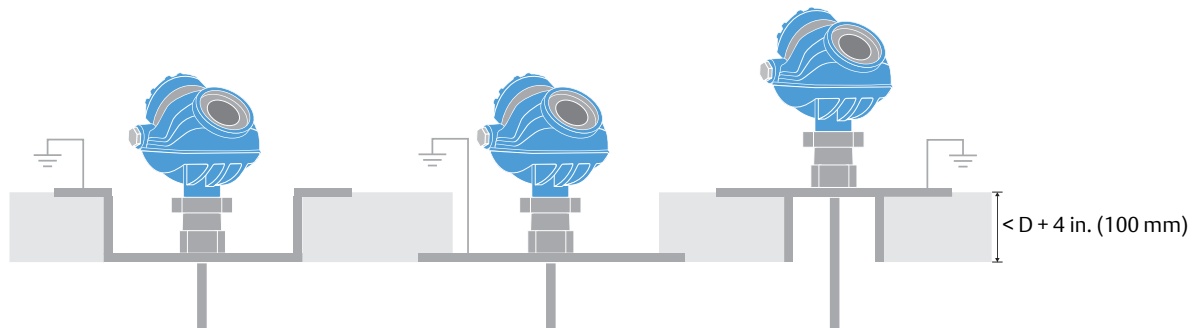

Electrostatic discharges

In some applications, such as plastic pellets, electrostatic charges can build up and eventually discharge. While the Rosemount 5300 electronics can tolerate some static charge, providing a good earth ground for the electronics by anchoring the end of the probe to the vessel will create ground paths for discharge away from the electronics. If the product can build up static electricity, the probe should be properly grounded ($R < 1$ Ohm).

Probe anchoring

The best practice is to have a free-hanging probe, but an anchored probe is sometimes needed for application reasons. The probe end should not be fixed for 98 ft. (30 m) or longer probes. The probe must be slack when anchoring the probe to reduce the risk of probe breakage. Select a probe longer than the required measuring range so there is a sag in the middle of the probe greater than or equal to 1.5 in. per 10 ft. (1 cm per m) of the probe length.

Figure 7. Probe Anchoring

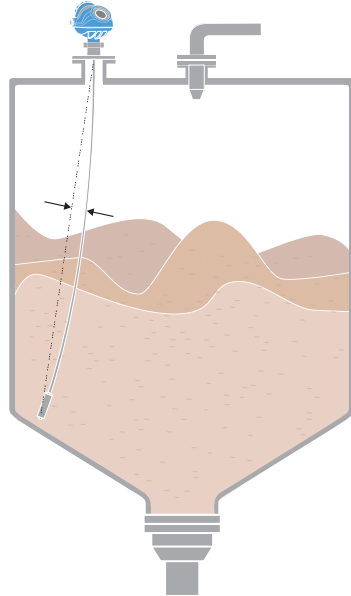

Probe End Projection

Probe End Projection is a function in the Rosemount 5303 that allows for measurements when the surface pulse is too weak to be detected. This commonly occurs when the material dielectric constant is very low, especially in combination with a long distance to the surface, or electromagnetic interference. When the dielectric constant of the material being measured is low, only a portion of the electrical signal is reflected off the top of the material. The rest of the signal continues down the probe. When the signal reaches the end of the probe, there is a strong reflection. Since the microwave signal propagates more slowly in the material than it does in air, this echo is seen at a distance further down than the actual probe end. The actual probe length, the probe end reflection echo location, and the dielectric of the material, can be used to calculate the level of the material, when the initial reflection from the top of the material is not strong enough to make a direct reading. This function is recommended for solids with a dielectric constant less than or equal to two (e.g. perlite at 1.7, plastic pellets at 1.2).

Probe End Projection is easily configured by using the guided setup in either Rosemount Radar Master, AMS, or a handheld communicator. For best performance, complete the Guided Probe End Projection Setup with an empty tank and then, without overwriting the empty tank calibration, a second time with a filled tank.

Figure 8. Probe End Projection

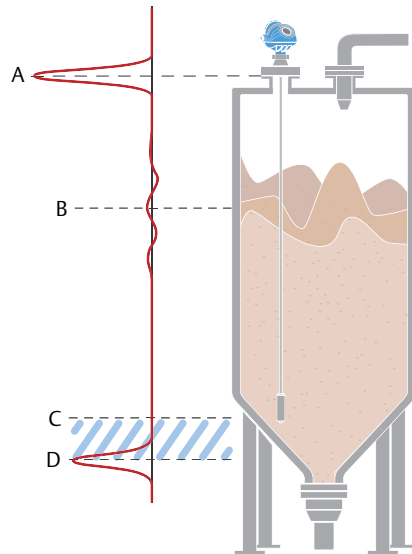

A. Reference

B. Surface

C. Physical probe end

D. Displaced probe end echo

Pull force

The flexible single lead probe is recommended for solids. It is available in two versions to handle different loads and lengths. Yield strength is the amount of force the probe can withstand before any deformation occurs.

Figure 9. Pull Force

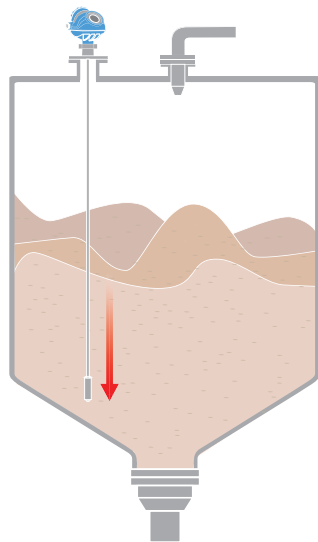

It is important to keep the following in mind when planning for installation:

- The silo roof must be able to withstand maximum probe tensile load.
- The tensile load depends on the silo size, material density, and the friction coefficient. Forces increase with the buried length, the vessel width and probe diameter.
- Forces on probes are generally increased two to ten times when probes are anchored to the vessel.

Table 2. Tensile Load for Unanchored 0.16 in. (4 mm) Flexible Single Lead Probe, lb (kN)

Material	Probe length 49 ft. (15 m)		Probe length 115 ft. (35 m)	
	Tank Ø = 10 ft. (3 m)	Tank Ø = 39 ft. (12 m)	Tank Ø = 10 ft. (3 m)	Tank Ø = 39 ft. (12 m)
Wheat	670 (3)	1120 (5)	1800 (8)	4500 (20) ⁽¹⁾
Plastic pellets	340 (1.5)	670 (3)	810 (3.6)	2360 (10.5)
Fly ash	770 (3.4)	1690 (7.5)	1980 (8.8)	5980 (26.6) ⁽¹⁾
Coal dust	540 (2.4)	1190 (5.3)	1390 (6.2)	4230 (18.8) ⁽¹⁾
Cement	900 (4)	2020 (9)	2470 (11)	7310 (32.5) ⁽¹⁾

1. Exceeds the yield strength limit of 2698 lb (12kN).

Table 3. Tensile Load for Unanchored 0.24 in. (6 mm) Flexible Single Lead Probe, lb (kN)

Material	Probe length 49 ft. (15 m)		Probe length 115 ft. (35 m)	
	Tank Ø = 10 ft. (3 m)	Tank Ø = 39 ft. (12 m)	Tank Ø = 10 ft. (3 m)	Tank Ø = 39 ft. (12 m)
Wheat	900 (4)	1690 (7.5)	2810 (12.5)	6740 (30) ⁽¹⁾
Plastic pellets	450 (2)	920 (4.1)	1190 (5.3)	350 (15.6)
Fly ash	1130 (5)	2520 (11.2)	2950 (13.1)	8990 (40) ⁽¹⁾
Coal dust	790 (3.5)	1780 (7.9)	2070 (9.2)	6320 (28.1)
Cement	1350 (6)	2920 (13)	3600 (16)	10790 (48) ⁽¹⁾

1. Exceeds the yield strength limit of 6519 lb (29 kN).

2.2 Non-contacting radar

Non-contacting radar is used on a large variety of applications. It has no restrictions with respect to the weight of the material so it can be used in applications where guided wave radar may not be appropriate because of pull forces or concerns about probe breakage. As a radar device, it reacts quickly to level changes, so it is also appropriate for process applications and small vessels.

Based on Frequency Modulated Continuous Wave (FMCW) technology, it transmits a continuous radar signal with the frequency changing over time to create a signal sweep. This technology enables greater measurement accuracy and reliability, which can be applied to a broader range of applications. In a measurement situation, temperature variations, dust or pressure changes do not affect accuracy.

The main benefits of non-contacting radar are:

- Narrow beam
- Small vessel intrusion
- Internal obstructions
- 2-wire
- Process seal antenna provides an all-PTFE solution
- Signal Quality Metrics to predict maintenance requirement for dust build-up
- Dedicated Solids algorithm, calculating average level from footprint instead of a single point
- Easy to install and configure

Some of the limitations to consider for non-contacting radar are:

- May need air purging

Mounting considerations

Position

A non-contacting radar should not be mounted in the center of the silo or very close to the tank wall. General best practice is to mount the non-contacting radar at $\frac{2}{3}$ tank radius from tank wall. The inlet stream of the product will interfere with readings if it is in the path of the radar beam.

Figure 10. Position Recommendations

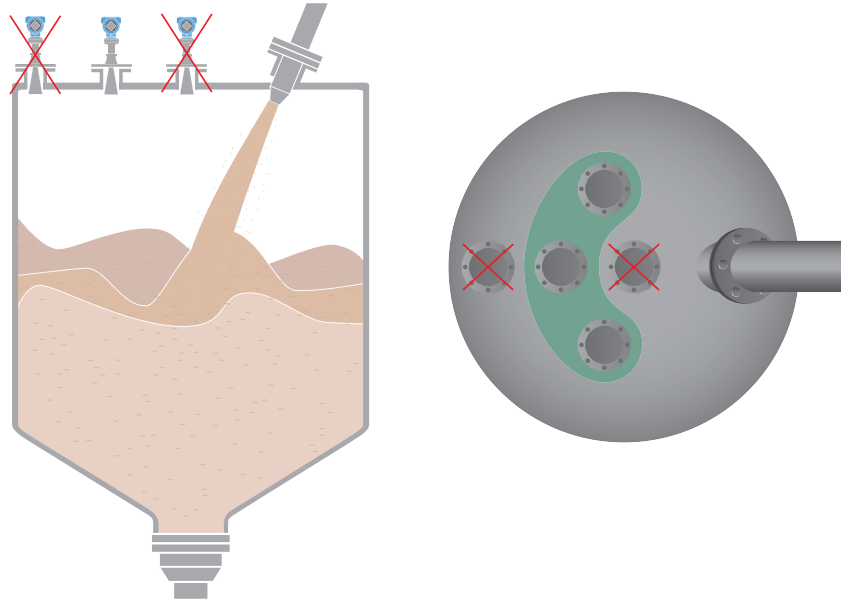

Antenna requirements

The antenna types available for non-contacting radar are: cone antenna, parabolic antenna, and process seal antenna. They require different tank connections and considerations to minimize potential disturbances from the nozzle as displayed in Figure 11. A shorter nozzle typically results in a stronger surface reflection. This is applicable to all antenna types.

Figure 11. Tank Connection Requirements for Rosemount 5408 Antenna Types

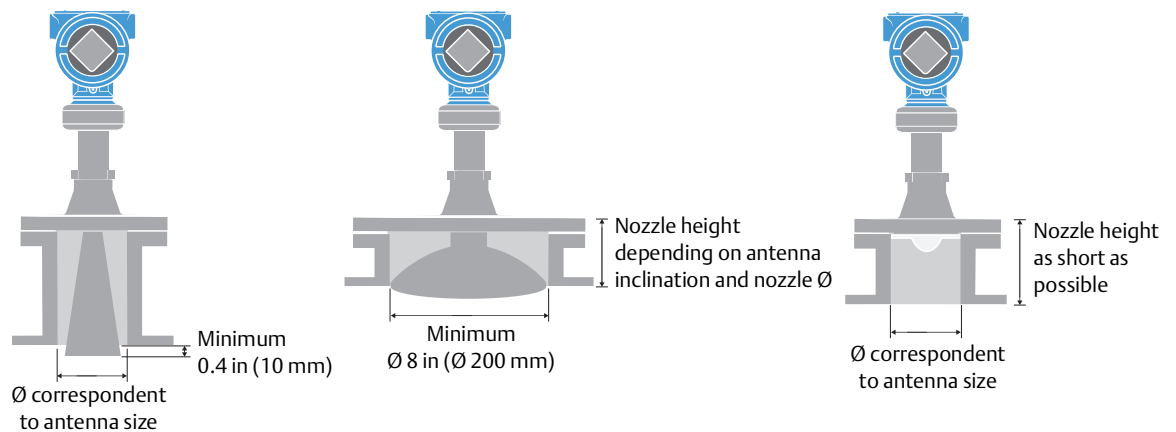

The cone antenna should be installed perpendicular to the ground, and is suitable for many applications, including closed vessels, and tall nozzles.

The process seal antenna with all PTFE wetted parts, is an all-around antenna for use in a large variety of applications. It can be used in hygienic applications, aggressive and corrosive media, dust, heavy condensation, and build-up.

The parabolic antenna inclination is adjustable. General best practice is to initially align the parabolic antenna perpendicular to the ground as well. Refer to the Rosemount 5408 Level Transmitter [Reference Manual](#) for further information. A parabolic antenna is a good alternative for long measuring ranges in combination with low reflective media, such as solids materials.

Measuring range

The recommended measuring range for Rosemount 5408 varies depending on antenna type and product dielectric constant. [Table 4](#) provides detailed measuring range information.

Table 4. Recommended Measuring Range for Solids, ft. (m)

Rosemount 5408 antenna	Light powder ⁽¹⁾	Light granulates and pellets ⁽²⁾	Heavy powder ⁽³⁾	Grains ⁽⁴⁾	Larger particles ⁽⁵⁾
2-in. (DN50) cone/process seal ⁽⁶⁾	16 (5)	33 (10)	82 (25)	82 (25)	98 (30)
3-in. (DN80) cone/process seal ⁽⁶⁾	49 (15)	66 (20)	98 (30)	98 (30)	130 (40)
4-in. (DN100) process seal ⁽⁶⁾					
4-in. (DN100) cone ⁽⁶⁾	66 (20)	98 (30)	130 (40)	130 (40)	130 (40)
8-in. (DN200) parabolic ⁽⁷⁾	115 (35)	130 (40)	130 (40)	130 (40)	130 (40)

1. Plastic powder, etc. (Dielectric constant: 1.2)
2. Plastic pellets, etc. (Dielectric constant: 1.35)
3. Lime powder, cement, sand, etc. (Dielectric constant: 1.5)
4. Kernels, brans, etc. (Dielectric constant: 1.5)
5. Wood chips/pellets, etc. (Dielectric constant: 1.7)
6. Cone and process seal antennas are the preferred choice for most solid applications. For specific recommendations in dusty applications, see “[Dust management](#)” on page 11.
7. Recommended for longer measuring ranges, typically > 66 ft (20 m).

The figures given in [Table 4](#) should be considered as guidelines; the total measuring range may differ depending on other contributing application conditions such as product filling, how the product piles up, silo diameter vs. angle of repose, internal obstacles within the silo, dust, condensation, antenna build-up, etc.

Dust management

Dust is often present in solids applications. Non-contacting radar may not be affected by the dust in the vapor space, but dust can be sticky and create a layer on the antenna. If this layer becomes too thick, it may affect the measurement. This is best managed by using air purging.

The easiest way to determine if air purging is needed is to open the manhole hatch and see if there is a thick layer of dust on it. If so, air purging is most likely needed.

In the absence of air supply, the process seal antenna provides an all PTFE solution — ideal for aggressive media, and is resistant to dust and/or condensation.

Figure 12. Dust Management by Using Air Purging or an All-PTFE Solution

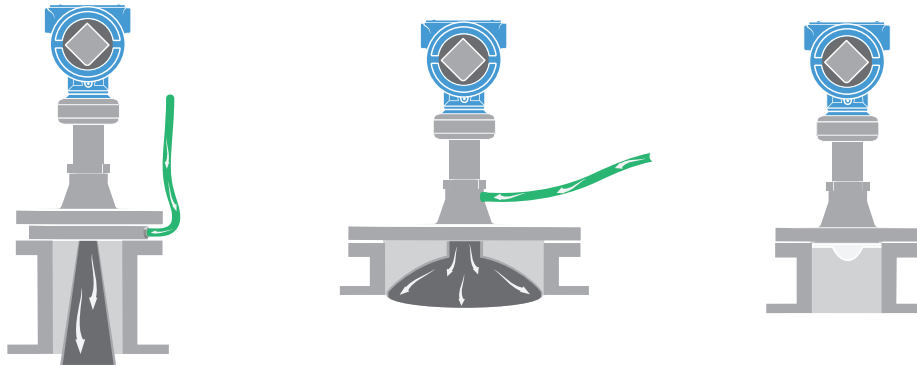

Solids software setup

Solids applications are generally difficult to measure so Emerson has developed a special solids mode in the device database. An algorithm calculates the average level of the solids surface, by merging the measured area into one result. Follow a standard configuration and check the “solids” check box in the tank environment window to activate the special solids mode. Although additional adjustments are not needed in most cases, there are some situations where it is necessary. Consult your Emerson representative for further details on how to proceed if additional adjustments are needed.

3.0 Point level detection - Solids switches

Limit detection is required in most silos, vessels, and containers to avoid overflowing and overspills, or run-dry/empty situations, both of which can lead to unnecessary downtime.



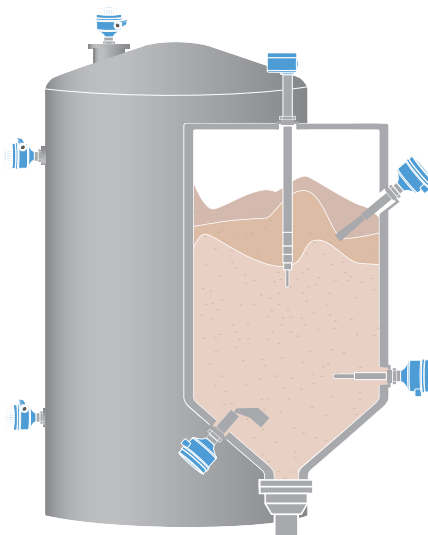

Point level measurement devices are often installed as a high-level alarm for overflow prevention, and low-level alarm or empty detection for silos, hoppers, and vessels. They can be used for simple process control in heavy or very light materials, and handle extreme conditions such as high temperatures, pressure, mechanical stress, and tensile forces.

Figure 13. Solid Switches Used for Point Level Detection



Solids switches are used as a simple, low maintenance technology for indicating the presence of solids media. They are simple to use and install, they are robust and reliable, insensitive to dust, electrical charge and adhesion, which makes them suitable for increased safety, reduced maintenance and downtime costs. There are several types of technologies available, presented in Table 5, to fit the broad variety of solids applications and characteristics in different industries.

Table 5. Point Level Detection Technologies

	Rotating paddles	Vibrating forks	Vibrating rod	Capacitance probe
				
	Rosemount 2501	Rosemount 2511/2521	Rosemount 2535	Rosemount 2555
Immersion lengths	Up to 394 in (10 000 mm)	Up to 787 in (20 000 mm)	Up to 157 in (4 000 mm)	Up to 787 in (20 000 mm)
Temperature	Up to 2012 °F (1100 °C)	Up to 302 °F (150 °C)	Up to 302 °F (150 °C)	Up to 932 °F (500 °C)
Sensitivity (Density/ Dielectric constant)	For media ≥ 0.9 lb/ft ³ (15 g/l)	Standard version For media ≥ 1.8 lb/ft ³ (30 g/l) Enhanced version For media ≤ 0.3 lb/ft ³ (5 g/l)	For media ≥ 1.2 lb/ft ³ (20 g/l)	For dielectric constant ≥ 1.5
Handles granulates/powders	Yes	Yes	Yes	Yes
Prone to caking	Yes	No	No	Yes
Abrasive material	Yes	Yes	Yes	Yes
Grain size	N/A	Maximum 0.39 in. (10 mm)	N/A	N/A
Maximum mechanical load	Configuration dependent	500 N	Sensitive	10 kN
Output	Relay	Relay, 3-wire PNP	Relay, 3-wire PNP	Relay

3.1 Mounting considerations

All types of solids switches can be mounted in a vertical, horizontal, or oblique position, and can be used in addition to other measurement devices. All technologies come with many different lengths and extension options, which will affect the recommended installation location.

Figure 14. Solids Switches Mounting Positions

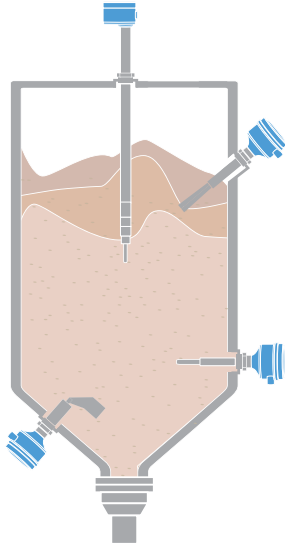

3.2 Caking

Fine powders, smaller particles, or grains, can lump together and create larger particles or parts of mass that get stuck in undesired locations. This is called caking, and can lead to shutdowns and increased overall downtime, which result in decreased profitability.

Figure 15. Caking

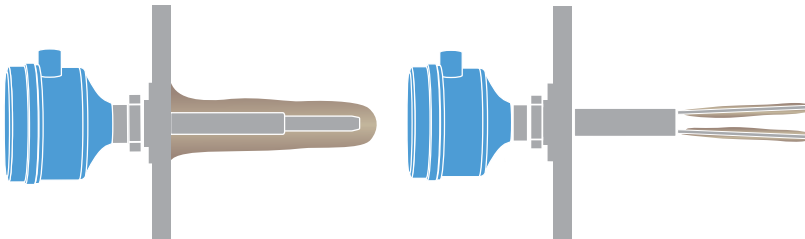

When handling bulk solids, the material characteristics and process environment will influence the stored material. Caking is most often created due to a combination of lighter materials and a humid environment, but can also appear under pressure. Therefore, it is important to consider what type of media is being stored when measuring the presence or absence of solids material at a specific point. If the process is prone to caking, point level devices such as rotating paddles, vibrating rod, or capacitance probe are recommended.

Vibrating fork, vibrating rod, and rotating paddles create vibration or movement, which leads to the smaller particles falling off the device. These devices are therefore a suitable solution where minor caking is a risk. Even though capacitance probes are more prone to build-ups than the other technologies, it is a better solution for larger amount of build-up and caking, due to its active shield technology.

3.3 Bridging

Bridging is a phenomenon that occurs when the media inside a silo or vessel builds up around a point level device and causes grounding, which creates a false signal that indicates the presence of a media.

Figure 16. Bridging

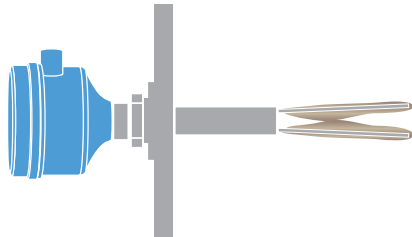

Vibrating forks are most prone to bridging. If the collected particle size becomes greater than the distance between the forks, it can get stuck, and the device will indicate the presence of a media even when there is none.

Vibrating rod and rotating paddles create vibration or movement, which leads to the smaller particles falling off the device. This makes both devices a suitable solution where bridging can occur. For larger amounts of build-up the capacitance probe is the best option due to its active shield technology, making it immune to bridging.

3.4 Rotating paddles

The simple electromechanical measuring principle is suitable for bulk goods, powders, and wet solids materials and withstands heavy loads and extreme temperatures. It can be used for full, demand, or empty detection for all bulk media in all types of vessels, silos, and hoppers. It is a simple, robust, and reliable technology that is insensitive to dust, electrical charge, adhesion, extreme temperature, and pressure.

The main benefits of rotating paddles are:

- Self-diagnosis – device fault alarm
- Adjustable switching delay prevents false switching
- Patented mechanical hysteresis for extended product lifetime
- Unaffected by dust, electrostatic charging and caking
- Withstands heavy loads and high temperatures
- Rotatable housing for easy installation
- Mechanically stable shaft bearing design
- Robust die-cast housing with IP66 protection

Some of the limitations to consider for rotating paddles are:

- Measures level at one specific point
- Overpressure maximum 145 psi (10 bar)

Installation consideration

Rotating paddles can be used with a tube, horizontal tube, rope, angled, or short extension, together with a regular vane, boot shaped vane, and double or single sided hinged vane, depending on the application. [Figure 17](#) shows various examples of the recommended installations for rotating paddles.

Figure 17. Rotating Paddles Installation Examples

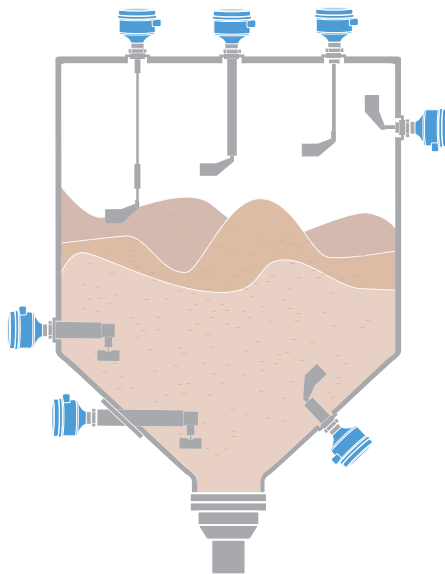

The length and type of extension that can be used will be dependent on the installation location and sometimes on the process temperature. Some of the extensions are suitable for all types of installation angles and are available in longer editions, while others are more limited. Table 6 provides an overview of all extension types.

Table 6. Type of Probes for Rotating Paddles

	Standard shaft	Standard rope extension	Reinforced rope extension	Horizontal tube extension	Tube extension
Mounting position	<ul style="list-style-type: none"> ■ From top (vertical) ■ From side (horizontal) ■ Angular towards bottom ■ Angular towards top 	<ul style="list-style-type: none"> ■ From top (vertical) ■ Angled from top 	<ul style="list-style-type: none"> ■ From top (vertical) ■ Angled from top 	<ul style="list-style-type: none"> ■ From side (horizontal) 	<ul style="list-style-type: none"> ■ From top (vertical) ■ From side (horizontal) ■ Angular towards bottom ■ Angular towards top
Immersion length	2.76 to 39.4 in. (70 to 1000 mm)	9.84 to 157 in. (250 to 4000 mm)	19.69 to 394 in. (500 to 10 000 mm)	4.92 to 23.6 in. (125 to 600 mm)	5.9 to 23.6 in. (150 to 600 mm)
Process temperature	2012 °F (1100 °C)	2012 °F (1100 °C)	1112 °F (600 °C)	484 °F (250 °C)	1112 °F (600 °C)

3.5 Vibrating forks

Vibrating fork technology is suitable for dry bulk solids and fine-grained, powdered media with good flow properties, in storage and process vessels, silos, and hoppers. It is a robust technology, available with standard or high sensitivity and is easy to operate. It has flexible options via configurable specifications for different applications. With an adjustable switching delay, false switching can be prevented.

The main benefits of vibrating forks are:

- Able to withstand high mechanical loads due to short extension length
- Adjustable sensitivity
- Adjustable switching delay prevents false switching
- Approvals suitable for use in hazardous/explosive and dusty environments
- Polished forks applicable for use in food and beverage applications
- Reliable, simple, and maintenance free measurement principle
- All wetted parts made from stainless steel
- Robust die-cast housing with IP66 protection

Some of the limitations to consider for vibrating forks are:

- Process temperatures up to 302 °F (150 °C)
- Smallest process connection is 1 1/2 in.
- Prone to bridging or poor flowing media (i.e. flour)

Installation consideration

Vibrating forks are available as short, cable, tube extension, or remote sensor, and in different fork lengths, to suit most applications. It is important to install the vibrating fork in the right orientation when put in an inclined or horizontal position. The tines must be perpendicular to the tank wall, with the long sides facing the wall.

Figure 18. Vibrating Fork Installation Examples

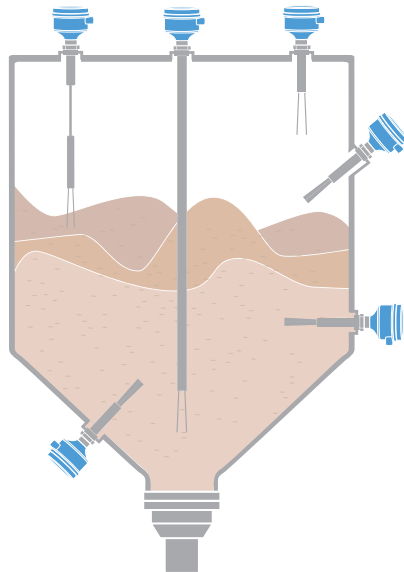

Based on where you want to install a vibrating fork and what you will use it for, different types and lengths of extensions are suitable. For instance, a full and an emptying detector can sometimes be installed at the same location but will have different designs. Where and how the forks can be installed is shown in [Table 7](#) for standard models, and in [Table 8](#) and [Table 9](#) for models with enhanced sensitivity.

Table 7. Type of Probes for Rosemount 2511 Vibrating Fork

	Short – short probe length	Tube – extended probe length
Mounting position	<ul style="list-style-type: none"> ■ From top (vertical) ■ Angled from top ■ From side (horizontal) ■ Angular towards bottom ■ Angular towards top 	<ul style="list-style-type: none"> ■ From top (vertical) ■ Angled from top ■ Side angled (towards bottom)
Immersion lengths	6.68 in. (170 mm)	11.8 to 157 in. (300 to 4000 mm)
Sensitivity/Media density	Setting B: > 1.8 lb/ft ³ (30 g/l) Setting A: > 9.3 lb/ft ³ (150 g/l)	Setting B: > 1.8 lb/ft ³ (30 g/l) Setting A: > 9.3 lb/ft ³ (150 g/l)
Grain size	Maximum 0.31 in (8 mm)	Maximum 0.31 in. (8 mm)
Output	PNP, Relay DPDT	PNP, Relay DPDT
Process pressure	232 psi (16 bar)	232 psi (16 bar)
Maximum mechanical load	500 N (on forks)	500 N (on forks)
Mechanical load (torque)	N/A	250 Nm

Table 8. Type of Probes for Rosemount 2521 Vibrating Fork with Short Fork Length

	Short – short fork length	Tube extension – short fork length	Remote – short fork length	Cable extension – short fork length
Mounting position	<ul style="list-style-type: none"> ■ From top (vertical) ■ Angled from top ■ From side (horizontal) ■ Angular towards bottom ■ Angular towards top 	<ul style="list-style-type: none"> ■ From top (vertical) ■ Angled from top ■ Side angled (towards bottom) 	<ul style="list-style-type: none"> ■ From top (vertical) ■ Angled from top ■ From side (horizontal) ■ Angular towards bottom ■ Angular towards top 	<ul style="list-style-type: none"> ■ From top (vertical)
Immersion length	6.5 in. (165 mm)	11.8 to 157 in. (300 to 4000 mm)	6.5 in. (165 mm)	29.6 to 787 in. (750 to 20 000 mm)
Sensitivity / Media density	Setting B: > 3.1 lb/ft ³ (50 g/l) Setting A: > 9.3 lb/ft ³ (150 g/l)	Setting B: > 3.1 lb/ft ³ (50 g/l) Setting A: > 9.3 lb/ft ³ (150 g/l)	Setting B: > 3.1 lb/ft ³ (50 g/l) Setting A: > 9.3 lb/ft ³ (150 g/l)	Setting B: > 3.1 lb/ft ³ (50 g/l) Setting A: > 9.3 lb/ft ³ (150 g/l)
Output	PNP, Relay SPDT	PNP, Relay SPDT	PNP, Relay SPDT	PNP, Relay SPDT
Mechanical load (torque)	600 Nm	300 Nm	300 Nm	N/A

Table 9. Type of Probes for Rosemount 2521 Vibrating Fork with Long Fork Length

	Short – long fork length	Tube extension – long fork length	Remote – long fork length	Cable extension – long fork length
Mounting position	<ul style="list-style-type: none"> ■ From top (vertical) ■ Angled from top ■ From side (horizontal) ■ Angular towards bottom ■ Angular towards top 	<ul style="list-style-type: none"> ■ From top (vertical) ■ Angled from top ■ Side angled (towards bottom) 	<ul style="list-style-type: none"> ■ From top (vertical) ■ Angled from top ■ From side (horizontal) ■ Angular towards bottom ■ Angular towards top 	<ul style="list-style-type: none"> ■ From top (vertical)
Immersion length	Standard version 9.25 in. (235 mm) Enhanced version 9.84 in. (260 mm)	11.8 to 157 in. (300 to 4000 mm)	9.25 in. (235 mm)	29.6 to 787 in. (750 to 20 000 mm)
Sensitivity / Media density	Standard version Setting B: > 1.2 lb/ft ³ (20 g/l) Setting A: > 4.6 lb/ft ³ (75 g/l) Enhanced version Setting B: > 0.3 lb/ft ³ (5 g/l) Setting A: > 1.2 lb/ft ³ (20 g/l)	Standard version Setting B: > 1.2 lb/ft ³ (20 g/l) Setting A: > 4.6 lb/ft ³ (75 g/l) Enhanced version Setting B: > 0.3 lb/ft ³ (5 g/l) Setting A: > 1.2 lb/ft ³ (20 g/l)	Standard version Setting B: > 1.2 lb/ft ³ (20 g/l) Setting A: > 4.6 lb/ft ³ (75 g/l) Enhanced version Setting B: > 0.3 lb/ft ³ (5 g/l) Setting A: > 1.2 lb/ft ³ (20 g/l)	Standard version Setting B: > 1.2 lb/ft ³ (20 g/l) Setting A: > 4.6 lb/ft ³ (75 g/l) Enhanced version Setting B: > 0.3 lb/ft ³ (5 g/l) Setting A: > 1.2 lb/ft ³ (20 g/l)
Output	Relay SPDT	Relay SPDT	Relay SPDT	Relay SPDT
Mechanical load (torque)	600 Nm	300 Nm	300 Nm	N/A

3.6 Vibrating rod

Vibrating rods are particularly suited for full, demand, and empty detection of light bulk solids, fine grains and powders that cause less mechanical load, in storage and process vessels, silos, and hoppers. It handles light solids and powders with ease and is suitable for use in hazardous and dusty environments. Its simple design makes it reliable, maintenance-free and less prone to clogging.

The main benefits of vibrating rods are:

- Grain size does not matter
- Not affected by bridging
- Approvals suitable for use in hazardous/explosive and dusty environments
- All wetted parts made from stainless steel
- Good resistance to caking; reliable and maintenance free
- Small process connections
- Robust die-cast housing with IP66 protection

Some of the limitations to consider for vibrating rods are:

- Not suitable for heavy mechanical loads
- Process temperatures up to 302 °F (150 °C)

Installation consideration

Vibrating rod level switches are available with a short or tube extension to cover the needs of full, demand, and emptying detection in different installation locations.

Figure 19. Vibrating Rod Installation Examples

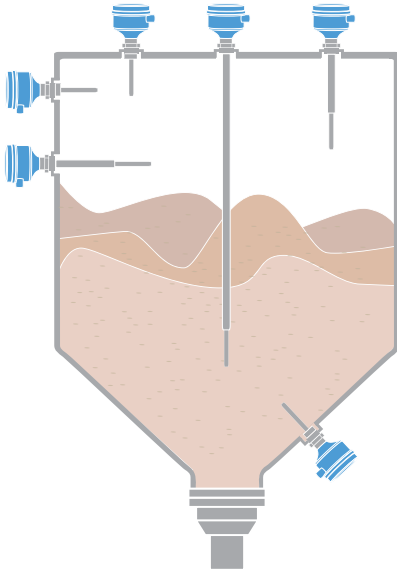

The length and type of the vibrating rod will affect where you can install the level switch. Shorter rods are more flexible; see [Table 10](#) for more details.

Table 10. Type of Probes for Rosemount 2535 Vibrating Rod

	Short	Extended tube
Mounting position	<ul style="list-style-type: none"> ■ From top (vertical) ■ From side (horizontal) ■ Angular towards bottom ■ Angular towards top 	<ul style="list-style-type: none"> ■ From top (vertical)
Immersion lengths	5.12 in. (130 mm)	7.9 to 157 in. (200 to 4000 mm)

3.7 Capacitance probe

Capacitance probes operate by measuring the capacitance between the probe and container wall. When solids media covers the probe, the capacitance increases, and the signal will switch to its “covered state”. When media is not present, it decreases, and turns to its “uncovered state”.

They are robust and suitable for bulk goods and powdered or wet solids media in metal, plastic, and inside coated tanks or vessels and silos, concrete made basins, downpipes, or hoppers. Capacitance probes can be used for full, demand, or empty detection and are designed for low dielectric media and extreme conditions such as high temperatures, high mechanical stress, and high tensile forces.

The main benefits of capacitance probe are:

- Active Shield Technology protects against media build-up or caking to ensure complete reliability
- Withstand heavy loads and high temperatures
- Approvals suitable for use in hazardous/explosive and dusty environments
- Detects change in product quality and mixture
- Automatic calibration
- Easy to use local operator interface and display
- Continuous self-diagnostic probe
- Electronics housing made of plastic or die-cast aluminum, protection class IP67
- Measurement of media with low dielectric constants (from 1.5)

Some of the limitations to consider for capacitance probe are:

- Sensitive to strong vibrations
- Not compatible with NAMUR

Active Shield Technology

Build-up on the capacitance probe causes grounding, and signals that a solids level is present, even if it is not, by creating an electrical field between the tip of the probe and the vessel wall. The electrical field will always take the easiest path to the wall, so if there is caking or build-up on the probe the electrical field will go through the caking to the wall, as illustrated in [Figure 20](#), creating false presence of a level.

Figure 20. Build-Up Causing a False Level Measurement

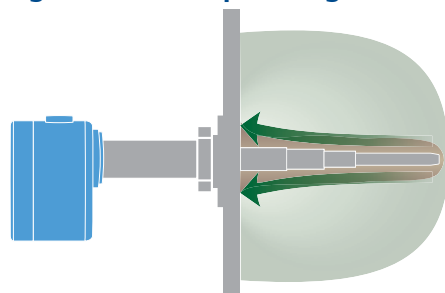

Active Shield Technology uses an additional electrode which generates an electrical field that acts as an inner shield and forces the electric field around the build-up, which makes it resistant to caking, coating, and build-up (see [Figure 21](#)).

Figure 21. Active Shield Technology

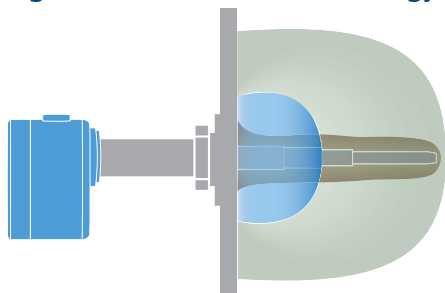

Installation considerations

Capacitance probes are available in three categories: standard, heavy duty, and high temperature options. Each category then has a rod and a rope extension option.

Figure 22. Capacitance Probe Installation Example

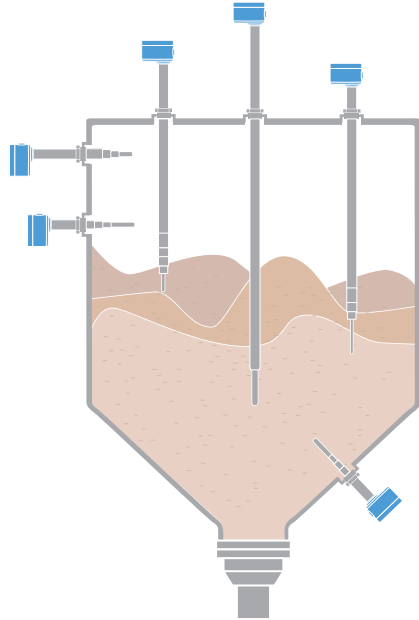

Each design has a very separate purpose, which makes it important to understand what product is suitable for a specific application. What differentiates the options from each other is listed [Table 11](#) and [Table 12](#).

Table 11. Types of Extensions for Rosemount 2555 Capacitance Probe with Rod Probe

	Standard - Rod	Heavy duty - Rod	High temperature - Rod
Mounting position	<ul style="list-style-type: none"> ■ From top (vertical) ■ From side (horizontal) ■ Angular towards bottom ■ Angular towards top 	<ul style="list-style-type: none"> ■ From top (vertical) ■ From side (horizontal) ■ Angular towards bottom ■ Angular towards top 	<ul style="list-style-type: none"> ■ From top (vertical) ■ From side (horizontal) ■ Angular towards bottom ■ Angular towards top
Immersion length	7.9 to 98.4 in. (450 to 2500 mm)	11.8 to 98.4 in. (300 to 2500 mm)	12.6 to 98.4 in. (320 to 2500 mm)
Process pressure	362 psi (25 bar)	362 psi (25 bar)	145 psi (10 bar)
Process temperature	-40 to 464 °F (-40 to 240 °C)	-40 to 464 °F (-40 to 240 °C)	-40 to 932 °F (-40 to 500 °C)
Lateral load (torque)	Maximum 20 Nm for Ø 0.39 in. (10 mm) Maximum 125 Nm for Ø 0.87 in. (22 mm)	Maximum 90 Nm for Ø 0.87 in. (22 mm) Maximum 525 Nm for Ø 1.3 in. (33 mm)	Maximum 20 Nm for Ø 0.87 in. (22 mm) Maximum 525 Nm for Ø 1.3 in. (33 mm)
Mechanical load (torque)	125 Nm (20 Nm)	525 Nm (90 Nm)	525 Nm (90 Nm)

Table 12. Types of Extensions for Rosemount 2555 Capacitance Probe with Rope Probe

	Standard - Rope	Heavy duty - Rope	High temperature - Rope
Mounting position	■ From top (vertical)	■ From top (vertical)	■ From top (vertical)
Immersion length	17.7 to 787 in. (450 to 20 000 mm)	21.7 to 787 in. (550 to 20 000 mm)	22.4 to 787 in. (570 to 20 000 mm)
Process pressure	362 psi (25 bar)	362 psi (25 bar)	145 psi (10 bar)
Process temperature	-40 to 464 °F (-40 to 240 °C)	-40 to 464 °F (-40 to 240 °C)	-40 to 932 °F (-40 to 500 °C)
Mechanical load (torque)	Maximum 4 kNm	Maximum 40 kNm	Maximum 10 kNm

4.0 Summary

Measuring level in solids application can be tricky. The characteristics often involves uneven surfaces, rapid level changes, low dielectrics and bulk densities, together with dust and condensation. Having high quality level measurement devices will reduce maintenance and downtime, resulting in higher profitability. It will also increase worker safety.

Continuous level measurement enables continuous access to information about the content in your application, to provide a reliable, robust, and safe operation. Most challenges can be compensated for with dedicated solutions, depending on the specific application characteristics. Guided wave radar handles measurement of media with very low dielectric constant and long ranges, but can be sensitive to pull forces, while non-contacting radar is suitable in most applications.

Point level detection is installed for high or low-level alarm to avoid overfilling or dry runs, and can be used as a simple process control to increase utilization, uptime, and safety in most applications. Point level devices can be prone to caking and bridging, but these challenges can be solved by the right choice of technology. Rotating paddles, vibrating forks, vibrating rod and capacitance probes can each be used in most applications, and the combination of technologies will cover even the toughest conditions.

Global Headquarters

Emerson Automation Solutions

6021 Innovation Blvd.

Shakopee, MN 55379, USA

+1 800 999 9307 or +1 952 906 8888

+1 952 949 7001

RFQ.RMD-RCC@Emerson.com

North America Regional Office

Emerson Automation Solutions

8200 Market Blvd.

Chanhassen, MN 55317, USA

+1 800 999 9307 or +1 952 906 8888

+1 952 949 7001

RMT-NA.RCCRFQ@Emerson.com

Latin America Regional Office

Emerson Automation Solutions

1300 Concord Terrace, Suite 400

Sunrise, FL 33323, USA

+1 954 846 5030

+1 954 846 5121

RFQ.RMD-RCC@Emerson.com

Europe Regional Office

Emerson Automation Solutions Europe GmbH

Neuhofstrasse 19a P.O. Box 1046

CH 6340 Baar

Switzerland

+41 (0) 41 768 6111

+41 (0) 41 768 6300

RFQ.RMD-RCC@Emerson.com

Asia Pacific Regional Office

Emerson Automation Solutions

1 Pandan Crescent

Singapore 128461

+65 6777 8211

+65 6777 0947

Enquiries@AP.Emerson.com

Middle East and Africa Regional Office

Emerson Automation Solutions

Emerson FZE P.O. Box 17033

Jebel Ali Free Zone - South 2

Dubai, United Arab Emirates

+971 4 8118100

+971 4 8865465

RFQ.RMTMEA@Emerson.com

 [Linkedin.com/company/Emerson-Automation-Solutions](https://www.linkedin.com/company/Emerson-Automation-Solutions)

 [Twitter.com/Rosemount_News](https://twitter.com/Rosemount_News)

 [Facebook.com/Rosemount](https://www.facebook.com/Rosemount)

 [Youtube.com/user/RosemountMeasurement](https://www.youtube.com/user/RosemountMeasurement)

 [Google.com/+RosemountMeasurement](https://www.google.com/+RosemountMeasurement)

Emerson Terms and Conditions of Sale are available upon request.
The Emerson logo is a trademark and service mark of Emerson Electric Co. Rosemount is a mark of one of the Emerson family of companies.
All other marks are the property of their respective owners.
© 2020 Emerson. All rights reserved.