



HP AMP



---

# Table of contents

<b>1 HP AMP Help .....</b>	<b>1</b>
<b>2 Get started .....</b>	<b>3</b>
Printer parts .....	4
Control panel features .....	5
Control panel lights and display icons status .....	7
Print reports from control panel .....	9
Load media .....	10
Change the default paper size detected by printer .....	14
Paper basics .....	15
Open the HP printer software (Windows) .....	18
Use the HP Smart app to print, scan, and troubleshoot from an iOS, Android, or Windows 10 device .....	19
Sleep mode .....	20
Quiet Mode .....	21
Auto-Off .....	22
<b>3 Print .....</b>	<b>23</b>
Print documents .....	24
Print photos .....	26
Print using the HP Smart app .....	27
Print envelopes .....	28
Print using the maximum dpi .....	29
Print with mobile devices .....	31
Tips for print success .....	32
<b>4 Use Bluetooth audio system .....</b>	<b>35</b>
Audio control panel .....	36
Pair and connect your device to the audio system .....	37
Respond to calls from audio control panel .....	39
Print and audio interaction .....	40

<b>5 Use Web Services .....</b>	<b>41</b>
What are Web Services? .....	42
Set up Web Services .....	43
Print with HP ePrint .....	37
Remove Web Services .....	45
<b>6 Scan using HP Smart .....</b>	<b>47</b>
Scan from a Windows 10 device .....	48
Scan from an Android or iOS device .....	49
<b>7 Manage cartridges .....</b>	<b>51</b>
Check estimated ink levels .....	52
Order ink supplies .....	53
HP Instant Ink .....	54
Replace cartridges .....	55
Use single cartridge mode .....	57
Cartridge warranty information .....	58
Tips for working with cartridges .....	59
<b>8 Connect your printer .....</b>	<b>61</b>
Connect your printer to a wireless network with a router .....	62
Connect wirelessly to the printer without a router .....	65
Connect your printer by using the HP Smart app .....	69
Wireless settings .....	70
Connect your printer to your computer with a USB cable (non-wireless connection) .....	71
Change from a USB connection to a wireless network .....	72
Advanced printer management tools (for wireless printers) .....	73
Tips for setting up and using a wireless printer .....	75
<b>9 Solve a problem .....</b>	<b>77</b>
Jams and paper-feed issues .....	78
Cartridge issues .....	82
Printing issues .....	84
Network and connection issues .....	92
Get help from the HP Smart app .....	94
Printer hardware issues .....	95
Control panel error codes and status .....	96
Bluetooth audio system issues .....	100
HP support .....	101

<b>Appendix A Technical information .....</b>	<b>103</b>
HP Company notices .....	104
Specifications .....	105
Regulatory notices .....	107
Environmental product stewardship program .....	113
<b>Index .....</b>	<b>121</b>



---

# 1 HP AMP Help

Learn how to use your HP AMP.

- [Get started on page 3](#)
- [Print on page 23](#)
- [Use Bluetooth audio system on page 35](#)
- [Use Web Services on page 41](#)
- [Manage cartridges on page 51](#)
- [Connect your printer on page 61](#)
- [Technical information on page 103](#)
- [Solve a problem on page 77](#)





---

## 2 Get started

- [Printer parts](#)
- [Control panel features](#)
- [Control panel lights and display icons status](#)
- [Print reports from control panel](#)
- [Load media](#)
- [Change the default paper size detected by printer](#)
- [Paper basics](#)
- [Open the HP printer software \(Windows\)](#)
- [Use the HP Smart app to print, scan, and troubleshoot from an iOS, Android, or Windows 10 device](#)
- [Sleep mode](#)
- [Quiet Mode](#)
- [Auto-Off](#)

## Printer parts

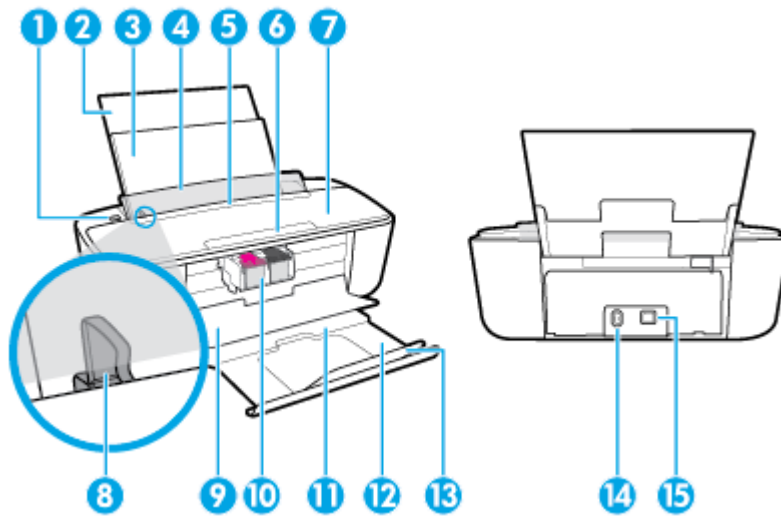

1	USB charging port
2	Input tray extender
3	Input tray
4	Input tray shield
5	Control panel
6	Audio control panel
7	Bluetooth audio system
8	Paper-width guide
9	Cartridge access door
10	Cartridges
11	Output tray
12	Output tray extender (also referred to as the tray extender)
13	Paper catch
14	Power connection
15	USB port

# Control panel features

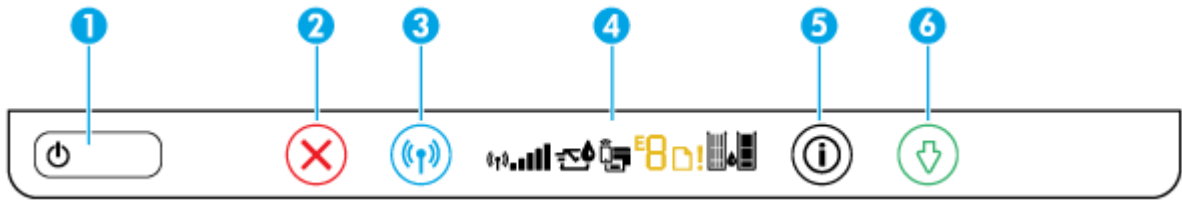

## Overview of buttons and lights











Feature	Description
1	<b>Power</b> button: Turns the printer on or off.
2	<b>Cancel</b> button: Stops the current operation.
3	<b>Wireless</b> button: Turns on or off the printer wireless capabilities. <b>Wireless</b> button light: Indicates whether the printer is connected to a wireless network.
4	<b>Control panel display</b> : Indicates wireless status and signal strength, HP Instant Ink status, Wi-Fi Direct status, warnings or errors, and ink levels. <b>NOTE:</b> HP Instant Ink service is not available in all countries. To check availability, visit <a href="http://hpinstantink.com">hpinstantink.com</a> .
5	<b>Information</b> button: Prints out a printer information page on its current status. <b>Information</b> button light: If the light is blinking in white and the <b>Wi-Fi Direct</b> icon on the display is blinking fast at the same time, press the <b>Information</b> button to confirm a connection.
6	<b>Resume</b> button: Resumes a job after a disruption (for example, after loading paper or clearing a paper jam). <b>Resume</b> button light: Indicates the printer is in a warning or error state. For more information, see <a href="#">Control panel error codes and status on page 96</a> .

## Control panel display icons



Icon	Description
	<b>Wireless</b> status icons: Show the status of a wireless connection. The wireless status icons consist of three icons, the <b>Wireless</b> icon (  ) , the <b>Wireless Attention</b> icon (  ) , and the <b>Signal Bars</b> icon (  ).

Icon	Description
	<p><b>HP Instant Ink</b> icon: Indicates the HP Instant Ink service status.</p> <ul style="list-style-type: none"> <li>• If the <b>HP Instant Ink</b> icon is visible, the printer is enrolled in the HP Instant Ink service and tracking ink usage to determine when to order more ink.</li> <li>• If the <b>Information</b> button is yellow (possibly blinking), it indicates an HP Instant Ink warning or error. Press the <b>Information</b> button to print an information page, check the HP Instant Ink section for diagnostic results, and then follow the instructions on the page.</li> </ul> <p><b>NOTE:</b> HP Instant Ink service is not available in all countries. To check availability, visit <a href="http://hpinstantink.com">hpinstantink.com</a>.</p>
	<p><b>Wi-Fi Direct</b> icon: Indicates the current Wi-Fi Direct status.</p> <ul style="list-style-type: none"> <li>• If the <b>Wi-Fi Direct</b> icon is on, Wi-Fi Direct is on and ready for use.</li> <li>• If the <b>Wi-Fi Direct</b> icon is off, Wi-Fi Direct is off. To turn it on, press and hold the <b>Power</b> button (  ) for three seconds to turn on all the button lights on the control panel, and then press and hold the <b>Wireless</b> button (  ) and the <b>Resume</b> button (  ) together for three seconds.</li> <li>• If the <b>Wi-Fi Direct</b> icon is blinking fast in sync with the blinking <b>Error</b> icon for three seconds, and then stays on, Wi-Fi Direct has reached the maximum of five connections.</li> <li>• If the <b>Wi-Fi Direct</b> icon is blinking fast in sync with the blinking <b>Error</b> icon for three seconds, and then turns off, Wi-Fi Direct is disabled by your network administrator.</li> </ul>
	<p>Error number icons: Indicate the printer is in an error state. For more information, see <a href="#">Control panel error codes and status on page 96</a>.</p>
	<p><b>Paper Error</b> icon: Indicates a paper-related error.</p>
	<p><b>Error</b> icon: Indicates a warning or an error.</p>
	<p><b>Ink Level</b> icons: The left ink icon shows the estimated ink level of the tri-color cartridge, and the right icon shows the estimated ink level of the black cartridge.</p> <p><b>NOTE:</b> Ink level warnings and indicators provide estimates for planning purposes only. When you receive a low-ink warning message, consider having a replacement cartridge available to avoid possible printing delays. You do not need to replace cartridges until the print quality becomes unacceptable.</p>

# Control panel lights and display icons status



## Power button light



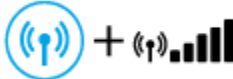

Status	Description
On	The printer is on.
Off	The printer is powered off.
Dimmed	The printer is in Sleep mode. The printer automatically enters Sleep mode after five minutes of inactivity.
Blinking	The printer is processing a job. To cancel the job, press the <b>Cancel</b> button (✗).
Blinking fast	If the cartridge access door is open, close it. If the cartridge access door is closed and the light is blinking fast, the printer is in an error state that you can resolve by following the onscreen messages from the computer. If you do not see any onscreen messages, try printing a document to generate an onscreen message.

## Wireless button light and icons

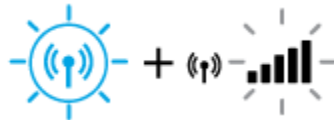
- The **Wireless** button light and the wireless status icons on the control panel display work together to indicate the status of a wireless connection.

Status	Description
The <b>Wireless</b> button light is on in blue. The <b>Wireless</b> icon and the <b>Signal Bars</b> icon are on.	The printer is connected to a wireless network.
	
The <b>Wireless</b> button light is dim (not fully off), and the <b>Wireless</b> status icons are off.	The wireless capability of the printer is off. To turn on the wireless capability, press the <b>Wireless</b> button (Ⓜ).
	
The <b>Wireless</b> button light is on and blinking, the <b>Wireless</b> icon is on, and the signal bars are cycling.	The printer is in the Auto Wireless Connect setup mode through the HP printer software.
	
The <b>Wireless</b> button light is on and blinking, the <b>Wireless</b> icon is on, and the signal bars are blinking together in sync with the <b>Wireless</b> button light.	The printer is in the Wi-Fi Protected Setup (WPS) progress mode.
	

Status	Description
<p>The <b>Wireless</b> button light blinks fast for three seconds and then turns off. At the same time, the <b>Wireless</b> icon and the <b>Wireless Attention</b> icon on the display blink fast for three seconds and then turn off.</p>	<p>The wireless capability of the printer is disabled.</p> <p>Change the wireless settings. For more information, see <a href="#">Wireless settings on page 70</a>.</p>
<p>During the wireless setup, the <b>Wireless</b> button light is blinking, the <b>Wireless</b> icon and the <b>Wireless Attention</b> icon are on, and the signal bars are cycling.</p>	<p>There is no wireless signal.</p> <ul style="list-style-type: none"> <li>– Make sure your wireless router or access point is powered on.</li> <li>– Move the printer closer to the wireless router.</li> </ul>
	<p>One of the following might have occurred.</p> <ul style="list-style-type: none"> <li>– The printer has a problem connecting to the wireless network.</li> <li>– An error occurs or an overlap session is detected when using WPS.</li> </ul>
<p>The <b>Wireless</b> button light is blinking, the <b>Wireless</b> icon is on, and the <b>Wireless Attention</b> icon is blinking in sync with the <b>Wireless</b> button light.</p>	<p>Press and hold the <b>Power</b> button (⏻) for three seconds to turn on all the button lights on the control panel, and then press the <b>Wireless</b> button (📶) and the <b>Information</b> button (ⓘ) together to run the wireless test, and then review the test report for information on how to solve the problem.</p>
	

# Print reports from control panel



**NOTE:** Before printing reports, press and hold the **Power** button (⏻) for three seconds to turn on all the button lights on the control panel, and then follow the instructions in the table.

Printer report	How to print	Description
Printer Status Report	Press and hold the <b>Cancel</b> button (✖) for three seconds.	Printer Status Report provides the current printer information, cartridge status, or recent events. It can also help troubleshooting printer problems.
Wireless Network Test Report and Network Configuration Page	Press the <b>Wireless</b> button (📶) and the <b>Information</b> button (ℹ) at the same time.	Wireless Network Test Report shows the diagnostics results for the status of the wireless network, wireless signal strength, detected networks, and more.  Network Configuration Page shows the network status, hostname, network name, and more.
Wireless Quick Start Guide	Press and hold the <b>Information</b> button (ℹ) for three seconds.	Wireless Quick Start Guide provides the step-by-step instructions to help you set up the wireless connection.
Wi-Fi Direct Guide	Press the <b>Information</b> button (ℹ) and <b>Resume</b> button (⏪) at the same time.	Wi-Fi Direct Guide provides the instructions to help you set up and use Wi-Fi Direct.
Web Services Reports	Press the <b>Information</b> button (ℹ) and <b>Cancel</b> button (✖) at the same time.	Depending on Web Services status, Web Services Reports provide different instructions to help you turn on Web Services, set up Web Services, or fix connection issues, and more.

## Load media

Select a paper size to continue.

### To load full-size paper

1. Raise the input tray and input tray extender.



2. Insert a stack of paper into the input tray with the short edge down and the print side up, and slide the stack of paper down until it stops.

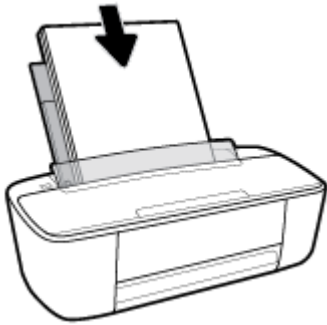

3. Slide the paper-width guide to the right until it stops at the edge of the paper.

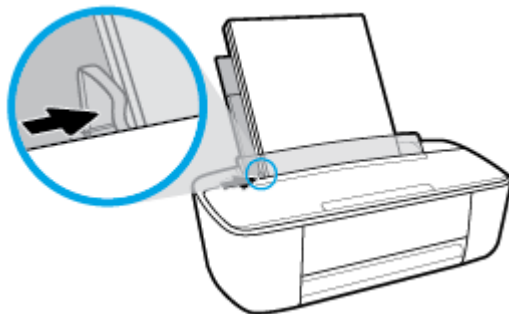



4. Pull out the output tray and the output tray extender, and then lift the paper catch.



### To load small-size paper

1. Raise the input tray and input tray extender.



2. Insert a stack of photo paper into the far-right side of the input tray with the short edge down and the print side up, and slide the stack of paper down until it stops.

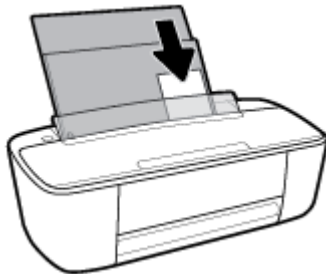

3. Slide the paper-width guide to the right until it stops at the edge of the paper.

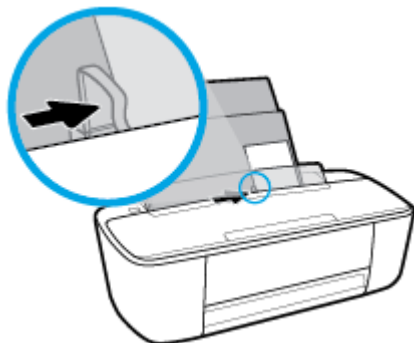

4. Pull out the output tray and the output tray extender, and then lift the paper catch.



### To load envelopes

1. Raise the input tray and input tray extender.



2. Insert one or more envelopes into the far-right side of the input tray and slide the stack of envelopes down until it stops. The side to be printed on should face up.

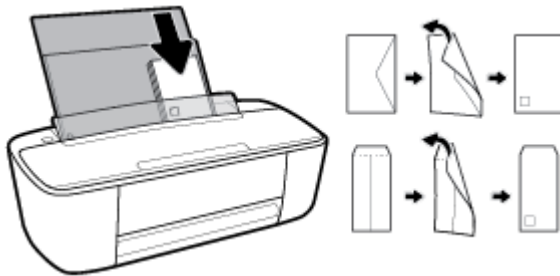

3. Slide the paper-width guide to the right against the stack of envelopes until it stops.

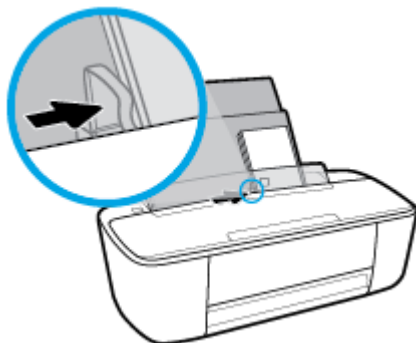

4. Pull out the output tray and the output tray extender, and then lift the paper catch.



## Change the default paper size detected by printer

The printer can automatically detect whether the input tray has paper loaded and detect whether the loaded paper is large, small, or medium width. You can change the default large, medium, or small paper size detected by the printer.

### To change the default paper size detected by the printer

1. Open the embedded web server (EWS). For more information, see [Open the embedded web server on page 73](#).
2. Click the **Settings** tab.
3. In the **Preferences** section, click **Tray and Paper Management**, and then select the desired option.
4. Click **Apply**.

## Paper basics

The printer is designed to work well with most types of office paper. It is best to test a variety of print paper types before buying large quantities. Use HP paper for optimum print quality. Visit the HP website at [www.hp.com](http://www.hp.com) for more information about HP paper.



HP recommends plain papers with the ColorLok logo for printing everyday documents. All papers with the ColorLok logo are independently tested to meet high standards of reliability and print quality, and produce documents with crisp, vivid color, bolder blacks, and that dry faster than ordinary plain papers. Look for papers with the ColorLok logo in a variety of weights and sizes from major paper manufacturers.

This section contains the following topics:

- [Recommended papers for printing](#)
- [Order HP paper supplies](#)

## Recommended papers for printing

If you want the best print quality, HP recommends using HP papers that are specifically designed for the type of project you are printing.

Depending on your country/region, some of these papers might not be available.

### Photo printing

- **HP Premium Plus Photo Paper**

HP Premium Plus Photo Paper is HP's highest-quality photo paper for your best photos. With HP Premium Plus Photo Paper, you can print beautiful photos that are instant-dry so you can share them right off the printer. It is available in several sizes, including A4, 8.5 x 11 inches (216 x 279 mm), 4 x 6 inches (10 x 15 cm), and 5 x 7 inches (13 x 18 cm), and in two finishes - glossy or soft gloss (semi-gloss). Ideal for framing, displaying, or gifting your best photos and special photo projects. HP Premium Plus Photo Paper delivers exceptional results with professional quality and durability.

- **HP Advanced Photo Paper**

This glossy photo paper features an instant-dry finish for easy handling without smudging. It resists water, smears, fingerprints, and humidity. Your prints have a look and feel comparable to a store-processed photo. It is available in several sizes, including A4, 8.5 x 11 inches (216 x 279 mm), 4 x 6 inches (10 x 15 cm), and 5 x 7 inches (13 x 18 cm). It is acid-free for longer lasting documents.

- **HP Everyday Photo Paper**

Print colorful, everyday snapshots at a low cost, using paper designed for casual photo printing. This affordable photo paper dries quickly for easy handling. Get sharp, crisp images when you use this paper with any inkjet printer. It is available in glossy finish in several sizes, including A4, 8.5 x 11 inches (216 x 279 mm), 5 x 7 inches (13 x 18 cm), and 4 x 6 inches (10 x 15 cm). It is acid-free for longer lasting documents.

- **HP Photo Value Packs**

HP Photo Value Packs conveniently package original HP ink cartridges and HP Advanced Photo Paper to save you time and take the guesswork out of printing affordable, lab-quality photos with your HP printer. Original HP inks and HP Advanced Photo Paper have been designed to work together so your photos are long lasting and vivid, print after print. Great for printing out an entire vacation's worth of photos or multiple prints to share.

### Business documents

- **HP Premium Presentation Paper 120g Matte or HP Professional Paper 120 Matte**

This paper is a heavy two-sided matte paper perfect for presentation, proposals, reports, and newsletters. It is heavyweight for an impressive look and feel.

- **HP Brochure Paper 180g Glossy or HP Professional Paper 180 Glossy**

These papers are glossy-coated on both sides for two-sided use. They are the perfect choice for near-photographic reproductions and business graphics for report covers, special presentations, brochures, mailers, and calendars.

- **HP Brochure Paper 180g Matte or HP Professional Paper 180 Matte**

These papers are matte-coated on both sides for two-sided use. They are the perfect choice for near-photographic reproductions and business graphics for report covers, special presentations, brochures, mailers, and calendars.

### Everyday printing

All the papers listed for everyday printing feature ColorLok Technology for less smearing, bolder blacks, and vivid colors.

- **HP Bright White Inkjet Paper and Color Inkjet Paper**

HP Bright White Inkjet Paper and Color Inkjet Paper deliver high-contrast colors and sharp text. They are opaque enough for two-sided color usage with no show-through, making them ideal for newsletters, reports, and flyers.

- **HP Multipurpose and All-in-One Printing Paper**

HP Multipurpose and All-in-One Printing Paper is a high-quality multifunction paper. It produces documents that look and feel more substantial than documents printed on standard multipurpose or copy paper. It is acid-free for longer lasting documents.

- **HP Office, Copy, and Copy & Print Paper**

These varieties of HP paper high-quality multifunction paper are suitable for copies, drafts, memos, and other everyday documents. They are acid-free for longer lasting documents.

- **HP Office Recycled Paper**

HP Office Recycled Paper is a high-quality multifunction paper made with 30% recycled fiber.

### Order HP paper supplies

The printer is designed to work well with most types of office paper. Use HP paper for optimum print quality.

To order HP papers and other supplies, go to [www.hp.com](http://www.hp.com). At this time, some portions of the HP website are available in English only.

HP recommends plain papers with the ColorLok logo for printing and copying of everyday documents. All papers with the ColorLok logo are independently tested to meet high standards of reliability and print quality, and produce documents with crisp, vivid color, bolder blacks and shorter dry-time than ordinary plain papers. Look for papers with the ColorLok logo in a variety of weights and sizes from major paper manufacturers.

## Open the HP printer software (Windows)

After installing the HP printer software, double-click the printer icon on the desktop or do one of the following to open the printer software:

- **Windows 10:** From the computer desktop, click **Start**, select **HP** from the app list, and then select the icon with the printer name.
- **Windows 8.1:** Click the down arrow in lower left corner of the Start screen, and then select the printer name.
- **Windows 8:** Right-click an empty area on the Start screen, click **All Apps** on the app bar, and then select the printer name.
- **Windows 7, Windows Vista, and Windows XP:** From the computer desktop, click **Start**, select **All Programs**, click **HP**, click the folder for the printer, and then select the icon with the printer name.



# Use the HP Smart app to print, scan, and troubleshoot from an iOS, Android, or Windows 10 device

HP Smart (formerly known as HP All-in-One Printer Remote) helps you to set up, scan, print, share, and manage your HP printer. You can share documents and images through email, text messages, and popular cloud and social media services (such as iCloud, Google Drive, Dropbox, and Facebook). You can also set up new HP printers, as well as monitor and order supplies.

---

 **NOTE:** The HP Smart app might not be available in all languages. Some features might not be available with all printer models.

---

## To install the HP Smart app

- ▲ The HP Smart app is supported on iOS, Android, and Windows 10 devices. To install the app on your device, go to [123.hp.com](https://123.hp.com) and follow the onscreen instructions to access your device's app store.

## To open the HP Smart app on a Windows 10 computer

- ▲ After installing the HP Smart app, from the device desktop, click **Start**, and then select **HP Smart** from the app list.

## Connect to your printer

- ▲ Make sure that the printer is turned on and is connected to the same network as your device. Then HP Smart will automatically detect the printer.

## Get more information about the HP Smart app

For basic instructions on how to print, scan, and troubleshoot using HP Smart, see [Print using the HP Smart app on page 27](#), [Scan using HP Smart on page 47](#) and [Get help from the HP Smart app on page 94](#).

For more information about using HP Smart for printing, scanning, accessing printer features, and troubleshooting issues, go to:

- **iOS/Android:** [www.hp.com/go/hpsmart-help](https://www.hp.com/go/hpsmart-help)
- **Windows:** [www.hp.com/go/hpsmartwin-help](https://www.hp.com/go/hpsmartwin-help)

## Sleep mode

Power usage is reduced while in Sleep mode.

After initial setup of printer, the printer will enter Sleep mode after 5 minutes of inactivity.

To change the time to Sleep mode

1. Open the embedded web server (EWS). For more information, see [Open the embedded web server on page 73](#).
2. Click the **Settings** tab.
3. In the **Power Management** section, click **Energy Save Mode**, and select the desired option.
4. Click **Apply**.

# Quiet Mode

Quiet Mode slows down printing to reduce overall noise without affecting print quality. Quiet Mode only works for printing with **Normal** print quality on plain paper. To reduce printing noise, turn on Quiet Mode. To print at normal speed, turn Quiet Mode off. Quiet Mode is off by default.

---

 **NOTE:** In Quiet Mode, if you print on plain paper with the **Draft** or **Best** print quality, or if you print photos or envelopes, the printer works in the same way as when Quiet Mode is off.

---

## To turn Quiet Mode on or off from the printer software (Windows)

1. Open the HP printer software. For more information, see [Open the HP printer software \(Windows\) on page 18](#).
2. Click the **Quiet Mode** tab.
3. Select **On** or **Off**.
4. Click **Save Setting**.

## To turn Quiet Mode on or off from the printer software (OS X and macOS)

1. Open HP Utility.



---

**NOTE:** HP Utility is located in the **HP** folder in the **Applications** folder.

---

2. Select the printer.
3. Click **Quiet Mode**.
4. Select **On** or **Off**.
5. Click **Apply Now**.

## To turn Quiet Mode on or off from the embedded web server (EWS)

1. Open the EWS. For more information, see [Open the embedded web server on page 73](#).
2. Click the **Settings** tab.
3. In the **Preferences** section, select **Quiet Mode**, and then select **On** or **Off**.
4. Click **Apply**.

## Auto-Off

This feature turns the printer off after 2 hours of inactivity to help reduce energy use. **Auto-Off turns the printer off completely, so you must use the Power button to turn the printer back on.** If your printer supports this energy saving feature, Auto-Off is automatically enabled or disabled depending on printer capabilities and connection options. Even when Auto-Off is disabled, the printer enters Sleep mode after 5 minutes of inactivity to help reduce energy use.

- Auto-Off is enabled when the printer is turned on, if the printer does not have network or fax capability, or is not using these capabilities.
- Auto-Off is disabled when a printer's wireless or Wi-Fi Direct capability is turned on or when a printer with fax, USB, or Ethernet network capability establishes a fax, USB, or Ethernet network connection.

---

# 3 Print

- [Print documents](#)
- [Print photos](#)
- [Print using the HP Smart app](#)
- [Print envelopes](#)
- [Print using the maximum dpi](#)
- [Print with mobile devices](#)
- [Tips for print success](#)

# Print documents

Before printing documents, make sure you have paper loaded in the input tray and the output tray is open. For more information about loading paper, see [Load media on page 10](#).

## To print a document (Windows)

1. From your software, select **Print**.
2. Make sure your printer is selected.
3. Click the button that opens the **Properties** dialog box.

Depending on your software application, this button might be called **Properties**, **Options**, **Printer Setup**, **Printer Properties**, **Printer**, or **Preferences**.

4. Select the appropriate options on the **Printing Shortcuts** or **Printing Shortcut** tab.

To change other print settings, click the other tabs.

For more printing tips, see [Printer settings tips on page 33](#).



---

**NOTE:** If you change the paper size, ensure that you have loaded the correct paper in the input tray.

5. Click **OK** to close the **Properties** dialog box.
6. Click **Print** or **OK** to begin printing.

## To print documents (OS X and macOS)

1. From the **File** menu in your software, choose **Print**.
2. Make sure your printer is selected.
3. Set the print options.

If you do not see options on the Print dialog, click **Show Details**.

- Choose the appropriate paper size in the **Paper Size** pop-up menu.



---

**NOTE:** If you change the paper size, ensure that you have loaded the correct paper.

- Select the orientation.
  - Enter the scaling percentage.
4. Click **Print**.

## To print on both sides of the page (Windows)

1. From your software, select **Print**.
2. Make sure your printer is selected.
3. Click the button that opens the **Properties** dialog box.

Depending on your software application, this button might be called **Properties**, **Options**, **Printer Setup**, **Printer Properties**, **Printer**, or **Preferences**.

4. On the **Printing Shortcuts** or **Printing Shortcut** tab, select the **Two-sided (Duplex) Printing** shortcut.  
To change other print settings, click the other tabs.  
For more printing tips, see [Printer settings tips on page 33](#).



**NOTE:** If you change the paper size, ensure that you have loaded the correct paper in the input tray.

5. After you print the first side, follow the onscreen instructions to reload the paper, and then click **Continue**.
6. Click **OK** to print.

#### To print on both sides of the page (OS X and macOS)

1. From the **File** menu in your software, choose **Print**.
2. In the Print dialog, choose **Paper Handling** from the pop-up menu and set **Page Order** to **Normal**.
3. Set **Pages to Print** to **Odd Only**.
4. Click **Print**.
5. After all of the odd numbered pages have printed, remove the document from the output tray.
6. Reload the document so that the end that came out of the printer is now going into the printer and the blank side of the document is facing toward the front of the printer.
7. In the Print dialog, return to the **Paper Handling** pop-up menu and set the page order to **Normal** and the pages to print to **Even Only**.
8. Click **Print**.

# Print photos

Before printing photos, make sure you have photo paper loaded in the input tray and the output tray is open. For more information about loading paper, see [Load media on page 10](#).

## To print a photo on photo paper (Windows)

1. From your software, select **Print**.
2. Make sure your printer is selected.
3. Click the button that opens the **Properties** dialog box.

Depending on your software application, this button might be called **Properties**, **Options**, **Printer Setup**, **Printer Properties**, **Printer**, or **Preferences**.

4. Select the appropriate options on the **Printing Shortcuts** or **Printing Shortcut** tab.

To change other print settings, click the other tabs.

For more printing tips, see [Printer settings tips on page 33](#).



---

**NOTE:** If you change the paper size, ensure that you have loaded the correct paper in the input tray.

5. Click **OK** to return to the **Properties** dialog box.
6. Click **OK**, and then click **Print** or **OK** in the **Print** dialog box.



---

**NOTE:** After the printing is finished, remove unused photo paper from the input tray. Store the photo paper so it does not start to curl, which could reduce the quality of your printout.

## To print a photo from the computer (OS X and macOS)

1. From the **File** menu in your software, choose **Print**.
2. Make sure your printer is selected.
3. Set the print options.

If you do not see options on the Print dialog, click **Show Details**.

- Choose the appropriate paper size in the **Paper Size** pop-up menu.



---

**NOTE:** If you change the paper size ensure that you have loaded the correct paper.

- Select the orientation.
4. From the pop-up menu, choose **Paper Type/Quality**, and then choose the following settings:
    - **Paper Type:** The appropriate photo paper type
    - **Quality:** Select the option that provides the best quality or maximum dpi.
    - Click the **Color Options** disclosure triangle, and then choose the appropriate **Photo Fix** option.
      - **Off:** applies no changes to the image.
      - **On:** automatically focuses the image; moderately adjusts image sharpness.
  5. Select any other print settings you want, and then click **Print**.



# Print using the HP Smart app

This section provides basic instructions for using the HP Smart app to print from your Android, iOS, or Windows 10 device. For more information about using the HP Smart app, go to:

- **iOS/Android:** [www.hp.com/go/hpsmart-help](http://www.hp.com/go/hpsmart-help)
- **Windows:** [www.hp.com/go/hpsmartwin-help](http://www.hp.com/go/hpsmartwin-help)

## To print from a Windows 10 device

1. Load paper in the input tray. For more information, see [Load media on page 10](#).
2. Open HP Smart. For more information, see [Use the HP Smart app to print, scan, and troubleshoot from an iOS, Android, or Windows 10 device on page 19](#).
3. On the HP Smart Home screen, make sure your printer is selected.

---

 **TIP:** If you want to select a different printer, click or tap the Printer icon on the toolbar at the left side of the screen, and then select **Select a Different Printer** to view all available printers.

---

4. At the bottom of the Home screen, click or tap **Print**.
5. Select **Print Photo**, locate a photo you want to print, and then click or tap **Select Photos to Print**.  
Select **Print Document**, locate a PDF document you want to print, and then click or tap **Print**.
6. Select the appropriate options. To view more settings, click or tap **More settings**. For more information about printing settings, see [Printer settings tips on page 33](#).
7. Click or tap **Print** to begin printing.

## To print from an Android or iOS device

1. Open the HP Smart app.
2. Tap the Plus icon if you need to change to a different printer, or add a new printer.
3. Tap a printing option (for example, **Print Photos** or **Print Facebook Photos**, etc.). You can print photos and documents from your device, cloud storage, or social media sites.
4. Select the photo or document you want to print.
5. Tap **Print**.

# Print envelopes

Before printing envelopes, make sure you have envelopes loaded in the input tray and the output tray is open. You can load one or more envelopes into the input tray. Do not use shiny or embossed envelopes or envelopes that have clasps or windows. For more information about loading envelopes, see [Load media on page 10](#).



**NOTE:** For specific details on how to format text for printing on envelopes, consult the help files in your word application.

---

## To print an envelope (Windows)

1. From your software, select **Print**.
2. Make sure your printer is selected.
3. Click the button that opens the **Properties** dialog box.

Depending on your software application, this button might be called **Properties**, **Options**, **Printer Setup**, **Printer Properties**, **Printer**, or **Preferences**.

4. Select appropriate options from the **Paper/Quality** and **Layout** tabs and **Advanced Options** dialog box.
  - From the **Paper type** or **Media** drop-down list, select the appropriate paper type.
  - From the **Paper sizes** or **Paper Size** drop-down list, select the appropriate envelope size.
  - Select **Portrait** or **Landscape** orientation.

For more printing tips, see [Printer settings tips on page 33](#).

5. Click **OK**, and then click **Print** or **OK** in the **Print** dialog box.

## To print envelopes (OS X and macOS)

1. From the **File** menu in your software, choose **Print**.
2. Make sure your printer is selected.
3. Select the appropriate envelope size from the **Paper Size** pop-up menu.

If you do not see options on the Print dialog, click **Show Details**.



**NOTE:** If you change the paper size, ensure that you have loaded the correct paper.

---

4. From the pop-up menu, choose **Paper Type/Quality**, and verify the paper type setting is set to **Plain Paper**.
5. Click **Print**.

# Print using the maximum dpi

Use maximum dots per inch (dpi) to print high-quality, sharp images on photo paper.

Printing in maximum dpi takes longer than printing with other settings and requires a large amount of disk space.

For a list of supported print resolutions, visit the product support website at [www.support.hp.com](http://www.support.hp.com).

## To print in maximum dpi mode (Windows)

1. From your software, select **Print**.
2. Make sure your printer is selected.
3. Click the button that opens the **Properties** dialog box.

Depending on your software application, this button might be called **Properties, Options, Printer Setup, Printer Properties, Printer,** or **Preferences**.

4. Select the appropriate options.

### Windows 10, Windows 8.1, and Windows 8

- Click **Paper/Quality** tab. From the **Paper sizes** drop-down list, select the appropriate paper size. From the **Paper type** drop-down list, select the appropriate paper type.
- Click the **Advanced** tab. Select **Print in Max DPI**.

### Windows 7, Windows Vista, and Windows XP

- Click **Paper/Quality** tab. From the **Media** drop-down list, select the appropriate paper type.
- Click the **Advanced** button. Select the appropriate paper size from the **Paper Size** drop-down list. In the **Printer Features** area, select **Yes** from the **Print in Max DPI** drop-down list. Then click **OK** to close the **Advanced Options** dialog box.

For more printing tips, see [Printer settings tips on page 33](#).

5. Confirm the paper orientation on the **Layout** tab, and then click **OK** to print.

## To print using maximum dpi (OS X and macOS)

1. From the **File** menu in your software, choose **Print**.
2. Make sure your printer is selected.
3. Set the print options.

If you do not see options on the Print dialog, click **Show Details**.

- Choose the appropriate paper size in the **Paper Size** pop-up menu.



**NOTE:** If you change the paper size ensure that you have loaded the correct paper.

- Select the orientation.
4. From the pop-up menu, choose **Paper Type/Quality**, and then choose the following settings:

- **Paper Type:** The appropriate paper type
  - **Quality: Maximum dpi**
5. Select any other print settings that you want, and then click **Print**.

# Print with mobile devices

## Print from mobile devices

You can print documents and photos directly from your mobile devices, including iOS, Android, Windows Mobile, Chromebook and Amazon Kindle.

---

 **NOTE:** You can also use the HP Smart app to print from mobile devices. For more information, see [Print using the HP Smart app on page 27](#).

---

### To print from mobile devices

1. Make sure your printer is connected to the same network as your mobile device.

 **TIP:** If you want to print without connecting to a router, use Wi-Fi Direct to print from mobile device. For more information, see [Connect wirelessly to the printer without a router on page 65](#).

---

2. Enable printing on your mobile device:

- **iOS:** Use the **Print** option from the **Share** menu ()

---

 **NOTE:** Devices running iOS 4.2 or later have AirPrint preinstalled.

---

- **Android:** Download the HP Print Service Plugin (supported by most Android devices) from the Google Play Store and enable it on your device.

---

 **NOTE:** Devices running Android 4.4 or later are supported by the HP Print Service Plugin. Devices running Android 4.3 or earlier can print using the HP ePrint app, available in the Google Play Store.

---

- **Windows Mobile:** Tap **Print** from the **Device** menu.

---

 **NOTE:** If your printer is not listed, you might need to do a one-time setup of the printer using the **Add Printer** wizard.

---

- **Chromebook:** Download and install the **HP Print for Chrome** app from the Chrome Web Store to enable both Wi-Fi and USB printing.
- **Amazon Kindle Fire HD9 and HDX:** The first time you select **Print** on your device, the HP Print Service Plugin is automatically downloaded to enable mobile printing.

---

 **NOTE:** For detailed information about enabling printing from your mobile devices, visit the HP Mobile Printing website ( [www.hp.com/go/mobileprinting](http://www.hp.com/go/mobileprinting) ). If a local version of this website is not available in your country/region or language, you might be directed to the HP Mobile Printing website in another country/region or language.

---

3. Make sure the loaded paper matches the paper settings of the printer (see [Load media on page 10](#) for more information). Accurately setting the paper size for the paper that is loaded enables your mobile device to know what paper size it is printing.

## Tips for print success

- [Ink tips](#)
- [Paper loading tips](#)
- [Printer settings tips](#)

To print successfully, the HP cartridges should be functioning properly with sufficient ink, the paper should be loaded correctly, and the printer should have the appropriate settings.

Print settings do not apply to copying or scanning.

### Ink tips

- Use original HP cartridges.
- Install both the black and tri-color cartridges correctly.  
For more information, see [Replace cartridges on page 55](#).
- Check the estimated ink levels in the cartridges to make sure there is sufficient ink.  
For more information, see [Check estimated ink levels on page 52](#).
- If the print quality is not acceptable, see [Printing issues on page 84](#) for more information.



---

**NOTE:** Original HP cartridges are designed and tested with HP printers and papers to help you easily produce great results, time after time.

HP cannot guarantee the quality or reliability of non-HP supplies. Product service or repairs required as a result of using a non-HP supply will not be covered under warranty.

If you see a 'Non-HP Cartridge' message displayed from the printer software and you believe you purchased original HP cartridges, go to: [www.hp.com/go/anticounterfeit](http://www.hp.com/go/anticounterfeit).

---

### Paper loading tips

- Load a stack of paper (not just one page). All of the paper in the stack should be in the same size and type to avoid a paper jam.
- Load the paper with side to be printed on facing up.
- Ensure that paper loaded in the input tray lays flat, and the edges are not bent or torn.
- Adjust the paper-width guide in the input tray to fit snugly against all paper. Make sure the paper-width guide does not bend the paper in the input tray.

For more information, see [Load media on page 10](#).

## Printer settings tips

### Printer settings tips (Windows)

- To change default print settings, open the HP printer software, click **Print**, and then click **Set Preferences**. For information how to open the printer software, see [Open the HP printer software \(Windows\) on page 18](#).
- You can use printing shortcuts to save time setting desired printing preferences. A printing shortcut stores the settings that are appropriate for a particular type of job, so that you can set all the options with a single click. To use a shortcut, go to the **Printing Shortcuts** or **Printing Shortcut** tab, select the desired shortcut, and then click **OK**.

To add a new printing shortcut, select an existing shortcut similar to the one you want to create, set the desired printing preferences in the **Printing Shortcuts** or **Printing Shortcut** tab, click **Save As** and enter a name, and then click **OK**.

To delete a printing shortcut, select it, and then click **Delete**.



---

**NOTE:** You cannot delete the default printing shortcuts.

---

- To understand paper and paper tray settings:
  - **Paper sizes** or **Paper Size:** Select the paper size you loaded in the input tray.
  - **Paper type** or **Media:** Select the paper type you are using.
- To understand color or black and white settings:
  - **Color:** Uses ink from all cartridges for full color prints.
  - **Black & White** or **Black Ink Only:** Uses the black ink only for normal or lower quality black and white prints.
  - **High Quality Grayscale:** Uses ink from both the color and black cartridges to produce a wider range of black and grey tones for high quality black and white prints.
- To understand print quality settings:

The print quality is measured in print resolution dots per inch (dpi). Higher dpi produces clearer and more detailed prints, but slows print speed and might use more ink.

  - **Draft:** Lowest dpi typically used when ink levels are low or when high quality prints are not needed.
  - **Normal:** Suitable for most print jobs.
  - **Best:** Better dpi than **Normal**.
  - **Print in Max DPI:** Highest dpi setting available for print quality.
  - **HP Real Life Technologies:** This feature smooths and sharpens images and graphics for improved print quality.
- To understand page and layout settings:
  - **Orientation:** Select **Portrait** for vertical prints or **Landscape** for horizontal prints.
  - **Print on Both Sides Manually:** Manually flip the pages after one side of the paper prints out so that you can print on both sides of the paper.

- **Flip on Long Edge:** Select it if you want to flip pages by the long edge of the paper when printing on both sides of the paper.
- **Flip on Short Edge:** Select it if you want to flip pages by the short edge of the paper when printing on both sides of the paper.
- **Booklet Layout** or **Booklet:** Allows you to print a multiple-page document as a booklet. It places two pages on each side of a sheet that can then be folded into a booklet in half size of the paper.
  - **Left binding** or **Booklet-LeftBinding:** The binding side after folded into a booklet appears at the left side. Select this option if your reading habit is from left to right.
  - **Right binding** or **Booklet-RightBinding:** The binding side after folded into a booklet appears at the right side. Select this option if your reading habit is from right to left.
- **Page Borders:** Allows you to add borders to the pages if you print the document with two or more pages per sheet.
- **Pages per Sheet Layout:** Helps you specify the order of the pages if you print the document with more than two pages per sheet.
- **Pages to Print:** Allows you to print the odd pages only, print the even pages only, or print all pages.
- **Reverse page order** or **Page Order:** Allows you to print pages from front to back or in reverse order.

#### Printer settings tips (OS X and macOS)

- On the Print dialog, use the **Paper Size** pop-up menu to select the size of paper loaded in the printer.
- On the Print dialog, choose the **Paper Type/Quality** pop-up menu and select the appropriate paper type and quality.
- To print a black and white document using only black ink, choose the **Paper Type/Quality** from the pop-up menu and choose **Grayscale** from the Color pop-up menu.



---

## 4 Use Bluetooth audio system

- [Audio control panel](#)
- [Pair and connect your device to the audio system](#)
- [Respond to calls from audio control panel](#)
- [Print and audio interaction](#)

Using the Bluetooth audio system, you can enjoy music from your mobile phone, tablet, laptop, or other Bluetooth devices. With the built-in microphone on the audio system, you can also answer calls from your Bluetooth mobile device. The audio system can be paired with up to two Bluetooth devices at the same time.

## Audio control panel

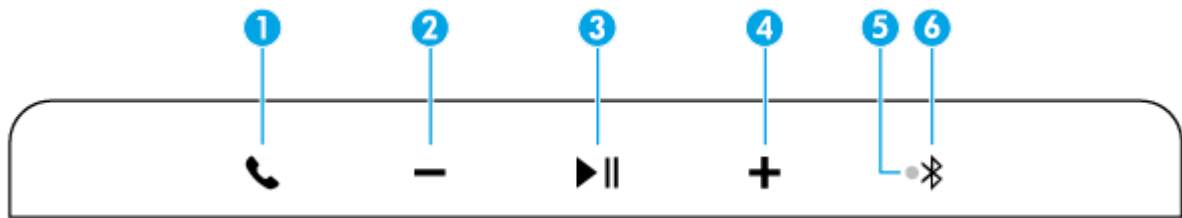

Feature	Description
1	<b>Phone</b> button: Handles an incoming call when the audio system and your mobile device are paired. For more information, see <a href="#">Respond to calls from audio control panel on page 39</a> .
2	<b>Volume down</b> button: Press or press and hold to decrease the audio system volume.
3	<b>Play/Pause</b> : Plays or pauses the audio from the audio system. Mutes or unmutes the microphone during a call.
4	<b>Volume up</b> button: Press or press and hold to increase the audio system volume.
5	<b>Bluetooth</b> light: <ul style="list-style-type: none"><li>• <b>Off light</b>—Bluetooth is off. The audio system is on standby if the power is on.</li><li>• <b>Blinking light</b>—The audio system is attempting to connect to a device.</li><li>• <b>Solid on blue light</b>—The audio system is connected to a paired device.</li><li>• <b>Dim light</b>—There is a print job coming and the audio is paused temporarily.</li></ul>
6	<b>Bluetooth</b> button: <ul style="list-style-type: none"><li>• Press to turn Bluetooth on or off.</li><li>• Press and hold the button for about eight seconds to clear previous pairings from the audio system memory.</li></ul>

# Pair and connect your device to the audio system

- [First-time setup](#)
- [Pair and connect another device to the audio system](#)
- [Reconnect to the audio system](#)

## First-time setup

Before playing audio or answering calls with the audio system, you need pair and connect your Bluetooth device to the audio system.

### To pair and connect your device to the audio system for the first time

The first time you turn on the printer, the audio system is ready to pair and connect your first device. Make sure your device is within 10 m of the printer.

1. Press the **Bluetooth** button () on the audio control panel.

The audio system emits a series of tones and the **Bluetooth** light starts to blink. These indicate the audio system is discoverable.

2. On your device, turn on Bluetooth, search for available Bluetooth devices, and then select **HP AMP** from the list to pair.
3. After pairing is complete and your device is connected to the audio system, the audio system emits an announcement that the device is connected, and the **Bluetooth** light stays on.

The audio system stays connected with your device. If there is no audio streaming from your device within about 10 minutes, the audio system turns off the amplifier to save energy.

---

 **NOTE:** If the **Bluetooth** light turns off after three minutes, it has not paired or connected with your device. Press the **Bluetooth** button and try pairing your device again.

---

## Pair and connect another device to the audio system

The audio system can be paired with two Bluetooth devices at the same time. After the first device is successfully paired with the audio system, you can pair another device with the audio system.

### To pair and connect another device to the audio system

1. Turn off Bluetooth on your first device.
2. Press the **Bluetooth** button () on the audio control panel again.

The **Bluetooth** light starts to blink and the audio system becomes discoverable again.

3. On your second device, turn on Bluetooth, search for available Bluetooth devices, and then select **HP AMP** from the list to pair.
4. After pairing is complete and your second device is connected to the audio system, the audio system emits an announcement that the device is connected, and the **Bluetooth** light stays on.
5. On your first device, turn on Bluetooth, select **HP AMP** from the list to reconnect to the audio system.



---

**NOTE:** When the audio system is connected to two devices at the same time, it responds to the device which plays audio first while both devices are streaming audio to the audio system.

---







## Reconnect to the audio system

Up to eight paired Bluetooth devices can be stored in the printer memory. When turned on, the audio system attempts to reconnect with previously paired devices. It keeps searching for about 12 to 15 seconds, and then stays discoverable in three minutes. If the audio system is reconnected with a previously paired device, the **Bluetooth** light stays on.

## Respond to calls from audio control panel

The audio system has a built-in microphone. You can answer call without disconnecting from the audio system when you are streaming audio from your mobile device to the audio system.

When a call is coming in, the audio system pauses the audio before ringing. When you hang up, the audio starts where it left off.

Situation	On audio control panel
1 <sup>st</sup> incoming call	<ul style="list-style-type: none"><li>• <b>Pick up call:</b> Press the <b>Phone</b> button (  ).</li><li>• <b>Reject call:</b> Press and hold the <b>Phone</b> button (  ) until ringing stops.</li></ul>
On call	<ul style="list-style-type: none"><li>• <b>Mute microphone:</b> Press the <b>Play/Pause</b> button (  ).</li><li>• <b>Unmute microphone:</b> Press the <b>Play/Pause</b> button (  ) again.</li><li>• <b>End call:</b> Press the <b>Phone</b> button (  ).</li><li>• <b>Switch call back to phone:</b> Press and hold the <b>Phone</b> button (  ) until call is switched.</li></ul>
2 <sup>nd</sup> incoming call	<ul style="list-style-type: none"><li>• You will hear a tone, indicating there is a second call coming.</li><li>• The first call will not be interrupted by the second call.</li></ul>

# Print and audio interaction

## Print and call control

When your mobile device is paired with the audio system, there is an incoming call, and the printer receives a print job, check the following for how call and print are handled:

- If the call comes first, you want to answer the call from the audio system, then the print job is paused and processed after the call ends.
- If the call comes first, you reject the call from the audio system, then the print job is processed.
- If the print job comes first, then the print job is processed. The audio system turns off Bluetooth and disconnects from your mobile device. The audio system is not able to respond to call.

The audio system turns off Bluetooth during printing. After the print job is complete, the audio system turns on Bluetooth and reconnects to your mobile device.

## Print and audio streaming control

When your mobile device is paired with the audio system, and the printer receives a print job, check the following for how print and audio streaming are handled:

- If there is no audio playing, audio streaming is paused and the print job is processed first. After the print job is complete, audio streaming is turned on.
- If there is audio playing, the audio fades out and is paused. Then the print job is processed. After the print job is complete, the audio starts where it left off.

---

# 5 Use Web Services

- [What are Web Services?](#)
- [Set up Web Services](#)
- [Print with HP ePrint](#)
- [Remove Web Services](#)

## What are Web Services?

The printer offers innovative, web-enabled solutions that can help you quickly access the Internet, obtain documents, and print them faster and with less hassle—and all without using a computer.



---

**NOTE:** To use these web features, the printer must be connected to the Internet (using wireless connection). You cannot use these web features if the printer is connected using a USB cable.

---

### HP ePrint

- HP ePrint is a free service from HP that allows you to print to your HP ePrint-enabled printer anytime, from any location. It's as simple as sending an email to the email address assigned to your printer when you enable Web Services on the printer. No special drivers or software are needed. If you can send an email, you can print from anywhere, using HP ePrint.

Once you have signed up for an account on [HP Connected](#) (might not be available in all countries/regions), you can sign in to view your HP ePrint job status, manage your HP ePrint printer queue, control who can use your printer's HP ePrint email address to print, and get help for HP ePrint.



# Set up Web Services

Before you set up Web Services, make sure your printer is connected to the Internet using a wireless connection.

## To set up Web Services

1. Open the embedded web server (EWS). For more information, see [Open the embedded web server on page 73](#).
2. Click the **Web Services** tab.
3. In the **Web Services Settings** section, click **Setup**, click **Continue**, and follow the onscreen instructions to accept the terms of use.
4. If prompted, choose to allow the printer to check for and install printer updates.

---

 **NOTE:** If a printer update is available, the printer downloads and installs the update, and then restarts. Repeat the instructions from step 1 to set up Web Services.

 **NOTE:** If prompted for proxy settings and if your network uses proxy settings, follow the onscreen instructions to set up a proxy server. If you do not have the proxy details, contact your network administrator or the person who set up the network.

---

5. When the printer is connected to the server, the printer prints an information page. Follow the instructions on the information page to finish the setup.

# Print with HP ePrint



HP ePrint allows you to print to your HP ePrint-enabled printer anytime, from any location.

Before you can use HP ePrint, make sure the printer is connected to an active network providing Internet access.

## To print a document using HP ePrint

1. Make sure you have set up Web Services.

For more information, see [Set up Web Services on page 43](#).

2. Press and hold the **Power** button () for three seconds to turn on all the button lights on the control panel, press the **Information** button () and **Cancel** button () at the same time to print an information page, and then find the email address for your printer from the page.

3. Email your document to the printer.

- a. On your computer or mobile device, open your email application.



---

**NOTE:** For information about using the email application on your computer or mobile device, see the documentation provided with the application.

---

- b. Create a new email and attach the document to print.

- c. Send the email to the printer email address.

The printer prints the attached document.



---

### NOTE:

- Enter only the HP ePrint email address in the "To" field. Do not enter any additional email addresses in the other fields. The HP ePrint server does not accept email print jobs if there are multiple addresses in the "To" field or any address in the "Cc" field."
  - The email will be printed once it is received. As with any email, there is no guarantee when or whether it will be received. You can check the print status on [HP Connected](#) (might not be available in all countries/regions).
  - Documents printed with HP ePrint may appear different from the original. Style, formatting, and text flow may differ from the original document. For documents that need to be printed with a higher quality (such as legal documents), we recommend that you print from the software application on your computer, where you will have more control over what your printout looks like.
-

## Remove Web Services

To remove Web Services, complete the following steps:

1. Open the embedded web server (EWS). For more information, see [Open the embedded web server on page 73](#).
2. Click the **Web Services** tab, and then click **Remove Web Services** in the **Web Services Settings** section.
3. Click **Remove Web Services**.
4. Click **Yes** to remove Web Services from your printer.



---

## 6 Scan using HP Smart

- [Scan from a Windows 10 device](#)
- [Scan from an Android or iOS device](#)

This section provides basic instructions for using the HP Smart app to scan from your Android, iOS, or Windows 10 device. For more information about using the HP Smart app, go to:

- **iOS/Android:** [www.hp.com/go/hpsmart-help](http://www.hp.com/go/hpsmart-help)
- **Windows:** [www.hp.com/go/hpsmartwin-help](http://www.hp.com/go/hpsmartwin-help)

# Scan from a Windows 10 device

## To scan a document or photo using the device camera

If your device has a camera, you can use the HP Smart app to scan a printed document or photo with the device camera. You can then use HP Smart to edit, save, print or share the image.

1. Open HP Smart. For more information, see [Use the HP Smart app to print, scan, and troubleshoot from an iOS, Android, or Windows 10 device on page 19](#).
2. Select **Scan**, and then select **Camera**.
3. Put a document or photo in front of the camera, and then click or tap the round button at the bottom of the screen to take an image.
4. Adjust boundaries if needed. Click or tap the Apply icon.
5. Make other adjustments if necessary:
  - Click or tap **Add** to add more documents or photos.
  - Click or tap **Edit** to rotate or crop the document or image, or adjust its contrast, brightness, saturation, or angle.
6. Select the file type you want, and then click or tap the Save icon to save it or click or tap the Share icon to share it with others.

## To edit a previously scanned document or photo

HP Smart provides editing tools, such as crop or rotate, so that you can use to adjust a previously scanned document or photo on your device.

1. Open HP Smart. For more information, see [Use the HP Smart app to print, scan, and troubleshoot from an iOS, Android, or Windows 10 device on page 19](#).
2. Select **Scan**, and then select **Import Local**.
3. Select the document or photo that you want to adjust, and then click or tap **Open**.
4. Adjust boundaries if needed. Click or tap the Apply icon.
5. Make other adjustments if necessary:
  - Click or tap **Add** to add more documents or photos.
  - Click or tap **Edit** to rotate or crop the document or image, or adjust its contrast, brightness, saturation, or angle.
6. Select the file type you want, and then click or tap **Save** or **Share** to save the file or share it with others.

# Scan from an Android or iOS device

## To scan from an Android or iOS device

1. Open the HP Smart app.
2. Tap the Plus icon if you need to change to a different printer, or add a new printer.
3. Tap the scanning option you want to use.
  - If you select to scan using the camera, the built-in camera will open. Scan your photo or document using the camera.
  - If you select to scan using the printer scanner, tap the Settings icon to select the input source and change the scan settings, and then tap the Scan icon.



**NOTE:** Be sure to select the correct input source if your printer supports scan from both the document feeder and scanner glass.

---

4. When you have finished adjusting the scanned document or photo, save, share, or print it.





---

# 7 Manage cartridges

This section contains the following topics:

- [Check estimated ink levels](#)
- [Order ink supplies](#)
- [HP Instant Ink](#)
- [Replace cartridges](#)
- [Use single cartridge mode](#)
- [Cartridge warranty information](#)
- [Tips for working with cartridges](#)

## Check estimated ink levels

You can easily check the ink supply level to determine how soon you might need to replace a cartridge. The ink supply level shows an estimate of the amount of ink remaining in the cartridges.



---

**NOTE:**

- If you have installed a refilled or remanufactured cartridge, or a cartridge that has been used in another printer, the ink level indicator might be inaccurate or unavailable.
- Ink level warnings and indicators provide estimates for planning purposes only. When you receive a low-ink warning message, consider having a replacement cartridge available to avoid possible printing delays. You do not have to replace the cartridges until the print quality is unacceptable.
- Ink from the cartridges is used in the printing process in a number of different ways, including in the initialization process, which prepares the printer and cartridges for printing, and in printhead servicing, which keeps print nozzles clear and ink flowing smoothly. In addition, some residual ink is left in the cartridge after it is used. For more information, see [www.hp.com/go/inkusage](http://www.hp.com/go/inkusage).



**NOTE:** If you have enrolled in the HP Instant Ink service, the printer automatically checks the ink levels and orders new ink when necessary. For more information about HP Instant Ink, go to [hpinstantink.com](http://hpinstantink.com).

---

You can check the estimated ink levels from the printer software or from the printer control panel.

### To check the ink levels from the printer control panel

- The **Ink Level** icons on the printer display show an estimate of ink remaining in the cartridges.

### To check the ink levels from the HP printer software (Windows)

1. Open the HP printer software. For more information, see [Open the HP printer software \(Windows\) on page 18](#).
2. In the printer software, click the **Estimated Levels** tab.

### To check the ink levels from the HP printer software (OS X and macOS)

1. Open HP Utility.



---

**NOTE:** HP Utility is located in the **HP** folder in the **Applications** folder.

---

2. Select the HP AMP from the list of devices at the left of the window.
3. Click **Supplies Status**.  
The estimated ink levels appear.
4. Click **All Settings** to return to the **Information and Support** pane.

# Order ink supplies

Before ordering cartridges, locate the correct cartridge number.

## To locate the cartridge number on the printer

- The cartridge number is located inside the cartridge access door.



## To locate the cartridge number from the printer software (Windows)

1. Open the HP printer software. For more information, see [Open the HP printer software \(Windows\) on page 18](#).
2. In the printer software, click **Shop**, click **Shop For Supplies Online**, and then follow the onscreen instructions.

## To find the print cartridge reorder numbers (OS X and macOS)

1. Open HP Utility.



---

**NOTE:** HP Utility is located in the **HP** folder in the **Applications** folder.

---

2. Click **Supplies Info**.

The print cartridge ordering numbers appear.

3. Click **All Settings** to return to the **Information and Support** pane.

To order original HP supplies for the HP AMP, go to [www.hp.com/buy/supplies](http://www.hp.com/buy/supplies). If prompted, choose your country/region, and then follow the prompts to find the right cartridges for your printer.



---

**NOTE:** Ordering cartridges online is not supported in all countries/regions. If it is not available in your country/region, you may still view supplies information and print a list for reference when shopping at a local HP reseller.

---

## HP Instant Ink

Your printer is eligible for the HP Instant Ink replacement service, which can reduce your printing costs and save you time. After you enroll in the service, your printer automatically keeps track of your ink levels and orders more ink for you when the ink is running low. HP ships the new cartridges straight to your door before your ink runs out, so you'll always have ink on hand when you need it. Additionally, the cartridges that you receive contain more ink than HP XL cartridges, so you'll need to replace cartridges less frequently. To learn more about how HP Instant Ink can save you time and money, go to [hpinstantink.com](https://hpinstantink.com).



---

**NOTE:** HP Instant Ink service is not available in all countries. To check availability, visit [hpinstantink.com](https://hpinstantink.com).

# Replace cartridges

## To replace the cartridges

1. Check that power is on.
2. Remove the cartridge.
  - a. Open the cartridge access door and wait for the print carriage to move to the center of the printer.



- b. Press down to release the cartridge, and then pull it toward you out of the slot.

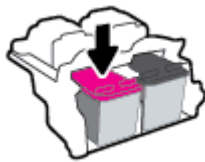

3. Insert a new cartridge.
  - a. Remove the cartridge from the packaging.

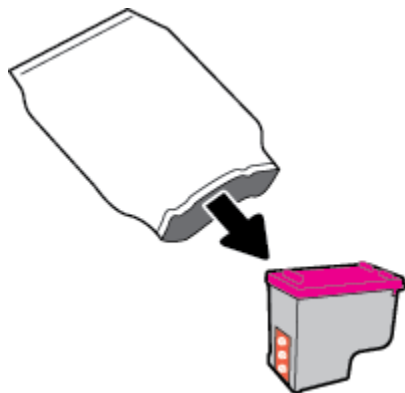

- b. Remove the plastic tape using the pull tab.

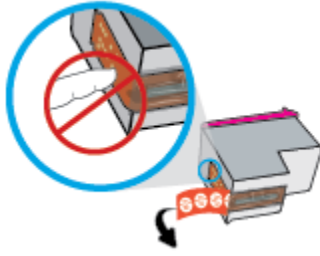

 **NOTE:** Do not touch the electrical contacts on the cartridge.

- c. Slide the cartridge into the slot at a slight upward angle, and then push up on the cartridge until it clicks into place.

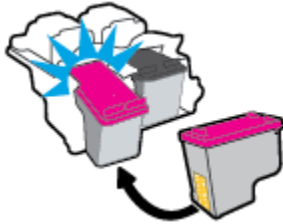

- d. Close the cartridge access door.



## Use single cartridge mode

Use the single cartridge mode to operate the printer with only one cartridge. The single cartridge mode is initiated when one of the following occurs.

- There is only one cartridge installed in the carriage.
- A cartridge is removed from the carriage if there are two cartridges installed previously.



**NOTE:** If the printer enters the single cartridge mode when two cartridges are installed in the printer, verify that the protective piece of plastic tape has been removed from each cartridge. When the plastic tape covers the cartridge contacts, the printer cannot detect that the cartridge is installed. If there is no plastic tape on the cartridges, try cleaning the cartridge contacts. For information about cleaning cartridge contacts, see [Cartridge issues on page 82](#).

---

### To exit the single cartridge mode

- Install both the black and tri-color cartridges in the printer.

## Cartridge warranty information

The HP cartridge warranty is applicable when the cartridge is used in its designated HP printing device. This warranty does not cover HP cartridges that have been refilled, remanufactured, refurbished, misused, or tampered with.

During the warranty period, the cartridge is covered as long as the HP ink is not depleted and the end of warranty date has not been reached. The end of warranty date, in YYYY/MM/DD format, may be found on the cartridge as indicated:

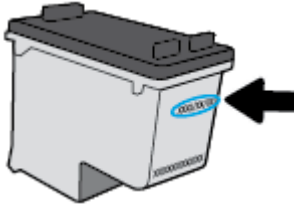

For a copy of the HP Limited Warranty Statement, see the printed documentation that came with the printer.



## Tips for working with cartridges

Use the following tips to work with cartridges:

- To protect the cartridges from drying out, always turn the printer off using the **Power** button, and wait until the **Power** button light goes out.
- Do not open or untape cartridges until you are ready to install them. Leaving tape on the cartridges reduces ink evaporation.
- Insert the cartridges into the correct slots. Match the color and icon of each cartridge to the color and icon for each slot. Make sure the cartridges snap into place.
- Align the printer for best print quality. See [Printing issues on page 84](#) for more information.
- When the **Estimated Cartridge Levels** screen in the printer software shows one or both cartridges in a low state, consider getting replacement cartridges to avoid possible printing delays. You do not need to replace the cartridges until print quality becomes unacceptable. See [Replace cartridges on page 55](#) for more information.
- If you remove a cartridge from the printer for any reason, try to replace it again as soon as possible. If a cartridge is left unprotected outside the printer, its nozzles might dry out and clog up.





---

## 8 Connect your printer

- [Connect your printer to a wireless network with a router](#)
- [Connect wirelessly to the printer without a router](#)
- [Connect your printer by using the HP Smart app](#)
- [Wireless settings](#)
- [Connect your printer to your computer with a USB cable \(non-wireless connection\)](#)
- [Change from a USB connection to a wireless network](#)
- [Advanced printer management tools \(for wireless printers\)](#)
- [Tips for setting up and using a wireless printer](#)

## Connect your printer to a wireless network with a router

 **TIP:** To print Wireless Quick Start Guide, press and hold **Power** button () for three seconds to turn on all the button lights on the control panel, and then press and hold the **Information** button () for three seconds.

- [Connect your printer to a wireless network using Wi-Fi Protected Setup \(WPS\)](#)
- [Connect your printer to a wireless network using HP printer software](#)

## Connect your printer to a wireless network using Wi-Fi Protected Setup (WPS)

Before you can connect your printer to a wireless network using WPS, make sure you have following:

- A wireless 802.11b/g/n network that includes a WPS-enabled wireless router or access point.

 **NOTE:** The printer only supports connections using 2.4GHz.

- A computer connected to the wireless network that you intend to connect the printer to. Be sure you have installed the HP printer software on the computer.

If you have a WPS router with a WPS push button, follow the **Push Button method**. If you are not certain your router has a push button, follow the **PIN method**.

### To use the Push Button Configuration (PBC) method





1. Press and hold the **Wireless** button () on the printer for more than three seconds to start WPS push mode. The **Wireless** light starts blinking.
2. Press the WPS button on your router.



 **NOTE:** The product begins a timer for approximately two minutes while a wireless connection is established.

If the printer connects successfully, the blue **Wireless** light stops blinking and remains on.

## To use the PIN method

1. Press and hold the **Power** button () for three seconds to turn on all the button lights on the control panel, press the **Wireless** button () and **Information** button () at the same time to print the network configuration page, and then locate a WPS PIN.
2. Press and hold the **Wireless** button () from the printer control panel for more than three seconds. The wireless light starts blinking.
3. Open the configuration utility or software for the wireless router or wireless access point, and then enter the WPS PIN.

---

 **NOTE:** For more information about using the configuration utility, see the documentation provided with the router or wireless access point.

---

Wait for about two minutes. If the printer connects successfully, the blue **Wireless** light stops blinking and remains on.

## Connect your printer to a wireless network using HP printer software

To connect the printer to an integrated wireless WLAN 802.11 network, you will need the following:

- A wireless 802.11b/g/n network that includes a wireless router or access point.

---

 **NOTE:** The printer only supports connections using 2.4GHz.

---

- A computer connected to the wireless network that you intend to connect the printer to.
- Network name (SSID).
- WEP key or WPA Passphrase (if needed).

### To connect your printer using HP printer software (Windows)

1. Depending on whether you have installed the HP printer software or not, do one of the following:

#### If you have not installed the HP printer software on your computer

- a. Visit [123.hp.com](http://123.hp.com) to download and install the printer software.

---

 **NOTE:** During the software installation, a USB cable might be required for temporary connection between the printer and the computer. Do not connect the USB cable until the printer software prompts to do so.

---

- b. When you are prompted, select **Wireless**, and then follow the onscreen instructions.

#### If you have the HP printer software installed on your computer

- a. Open the printer software. For more information, see [Open the HP printer software \(Windows\) on page 18](#).
- b. In the printer software, click **Tools**.

- c. Click **Device Setup & Software**.
  - d. Click **Connect a new device**, click **Wireless**, and then follow the onscreen instructions.
2. After the printer connects successfully, the blue **Wireless** light stops blinking and remains on.

#### To connect your printer using HP printer software (OS X and macOS)

1. Depending on whether you have installed the HP printer software or not, do one of the following:

##### If you have not installed the HP printer software on your computer

- ▲ Visit [123.hp.com](https://123.hp.com) to download and install the printer software.

##### If you have the HP printer software installed on your computer

- a. Double-click HP Utility in the **HP** folder in the **Applications** folder.
  - b. On the menu bar at the top of the screen, choose **Setup New Device** from the Devices menu, and then follow the onscreen instructions.
2. After the printer connects successfully, the blue **Wireless** light stops blinking and remains on.

# Connect wirelessly to the printer without a router

With Wi-Fi Direct, you can print wirelessly from a computer, smart phone, tablet, or other wireless-capable device—without connecting to an existing wireless network.

## Guidelines for using Wi-Fi Direct

- Make sure your computer or mobile device has the necessary software.
  - If you are using a computer, make sure you have installed the printer software provided with the printer.  
  
If you have not installed the HP printer software on the computer, connect to Wi-Fi Direct first and then install the printer software. Select **Wireless** when prompted by the printer software for a connection type.
  - If you are using a mobile device, make sure you have installed a compatible printing app. For more information, visit the HP Mobile Printing website at [www.hp.com/go/mobileprinting](http://www.hp.com/go/mobileprinting). If a local version of this website is not available in your country/region or language, you might be directed to the HP Mobile Printing website in another country/region or language.
- Make sure Wi-Fi Direct for your printer is turned on.
- Up to five computers and mobile devices can use the same Wi-Fi Direct connection.
- Wi-Fi Direct can be used while the printer is also connected either to a computer using a USB cable or to a network using a wireless connection.
- Wi-Fi Direct cannot be used to connect a computer, mobile device, or printer to the Internet.

## To turn Wi-Fi Direct on or off

On the printer control panel, press and hold the **Power** button (⏻) for three seconds to turn on all the button lights, and then press and hold the **Wireless** button (📶) and the **Resume** button (⏪) together for three seconds.

- When Wi-Fi Direct is turned on, the **Wi-Fi Direct** icon on the display stays on. To find the Wi-Fi Direct name and password, press the **Information** button (ℹ️) to print a printer information page.

---

 **NOTE:** When you turn on Wi-Fi Direct the first time, the printer automatically prints a Wi-Fi Direct guide. The guide provides instructions about how to use Wi-Fi Direct. After that, you can press and hold the **Power** button (⏻) for three seconds to turn on all the button lights on the control panel, and then press the **Information** button (ℹ️) and the **Resume** button (⏪) together to print the Wi-Fi Direct guide. The guide may not be available in all languages.

---

- When Wi-Fi Direct is turned off, the **Wi-Fi Direct** icon on the display is off.
- For more information about the Wi-Fi Direct icon status, see [Control panel display icons on page 5](#).

## To print from a wireless-capable mobile device that supports Wi-Fi Direct

Make sure you have installed the latest version of HP Print Service Plugin on your mobile device. You can download this plugin from the Google Play application store.

1. Make sure you have turned on Wi-Fi Direct on the printer.
2. Turn on Wi-Fi Direct on your mobile device. For more information, see the documentation provided with the mobile device.
3. From your mobile device, select a document from a print enabled application, and then select the option to print the document.

The list of available printers appears.

4. From the list of available printers, choose the Wi-Fi Direct name shown such as DIRECT-\*\*-HP AMP (where \*\* are the unique characters to identify your printer). And then print your document.
  - If the Wi-Fi Direct connection security for the printer is **Automatic** (the default setting), the mobile device will connect to the printer automatically and send the print job.
  - If the Wi-Fi Direct connection security for the printer is set to **Manual**, do one of the following to connect to the printer and print.
    - If the **Wi-Fi Direct** icon on the printer display is blinking in sync with the white blinking **Information** light, press the **Information** button () within 60 seconds. After your mobile connects to the printer, the **Wi-Fi Direct** icon stops blinking and stays on.
    - If the printer prints out a page with a PIN code, follow the instruction on the page.

---

 **TIP:** You can change the Wi-Fi Direct connection security setting for the printer from the embedded web server (EWS). For more information, see [Open the embedded web server on page 73](#).

---

## To print from a wireless-capable mobile device that does not support Wi-Fi Direct

Make sure you have installed a compatible printing app on your mobile device. For more information, visit the HP Mobile Printing website at [www.hp.com/go/mobileprinting](http://www.hp.com/go/mobileprinting). If a local version of this website is not available in your country/region or language, you might be directed to the HP Mobile Printing website in another country/region or language.

1. Make sure you have turned on Wi-Fi Direct on the printer.
2. Turn on the Wi-Fi connection on your mobile device. For more information, see the documentation provided with the mobile device.

---

 **NOTE:** If your mobile device does not support Wi-Fi, you are not able to use Wi-Fi Direct.

---

3. From the mobile device, connect to a new network. Use the process you normally use to connect to a new wireless network or hotspot. Choose the Wi-Fi Direct name from the list of wireless networks shown such as DIRECT-\*\*-HP AMP (where \*\* are the unique characters to identify your printer).

Enter the Wi-Fi Direct password when prompted.

4. Print your document.



## To print from a wireless-capable computer (Windows)

1. Make sure you have turned on Wi-Fi Direct on the printer.
2. Turn on the computer's Wi-Fi connection. For more information, see the documentation provided with the computer.



**NOTE:** If your computer does not support Wi-Fi, you are not able to use Wi-Fi Direct.

3. From the computer, connect to a new network. Use the process you normally use to connect to a new wireless network or hotspot. Choose the Wi-Fi Direct name from the list of wireless networks shown such as DIRECT-\*\*-HP AMP (where \*\* are the unique characters to identify your printer).

Enter the Wi-Fi Direct password when prompted.

4. Proceed to step 5 if the printer has been installed and connected to the computer over a wireless network. If the printer has been installed and connected to your computer with a USB cable, follow the steps below to install the printer software using the Wi-Fi Direct connection.
  - a. Depending on your operating system, do one of the following:
    - **Windows 10:** From the computer desktop, click **Start**, select **HP** from the app list, and then select the icon with the printer name.
    - **Windows 8.1:** Click the down arrow in lower left corner of the Start screen, and then select the printer name.
    - **Windows 8:** Right-click an empty area on the Start screen, click **All Apps** on the app bar, and then select the printer name.
    - **Windows 7, Windows Vista, and Windows XP:** From the computer desktop, click **Start**, select **All Programs**, click **HP**, click the folder for the printer, and then select the icon with the printer name.
  - b. In the printer software, click **Tools**.
  - c. Click **Device Setup & Software**, and then select **Connect a new device**.
  - d. When the **Connection Options** software screen appears, select **Wireless**.  
Select your HP printer from the list of detected printers.
  - e. Follow the onscreen instructions.
5. Print your document.

## To print from a wireless-capable computer (OS X and macOS)

1. Make sure you have turned on Wi-Fi Direct on the printer.
2. Turn on Wi-Fi on the computer.  
For more information, see the documentation provided by Apple.
3. Click the Wi-Fi icon and choose the Wi-Fi Direct name, such as DIRECT-\*\*-HP AMP (where \*\* are the unique characters to identify your printer).  
If Wi-Fi Direct is turned on with security, enter the password when prompted.
4. Add the printer.

- a. Open **System Preferences** .
- b. Depending on your operating system, click **Printers & Scanners** .
- c. Click + below the list of printers at the left.
- d. Select the printer from the list of detected printers (the word “Bonjour” is listed the right column beside the printer name), and click **Add**.

# Connect your printer by using the HP Smart app

## To set up using the HP Smart app

You can use the HP Smart to set up the printer on your wireless network. The HP Smart app is supported on iOS, Android, and Windows devices. For information about this app, see [Use the HP Smart app to print, scan, and troubleshoot from an iOS, Android, or Windows 10 device on page 19](#).

1. If you are using an iOS or Android mobile device, make sure that Bluetooth is turned on. (HP Smart uses Bluetooth to make the setup process faster and easier on iOS and Android mobile devices.)



---

**NOTE:** HP Smart uses Bluetooth for printer setup only. Printing using Bluetooth is not supported.

---

2. Open the HP Smart app.
3. **Windows:** On the home screen, click or tap **Setup a new printer** and follow the onscreen instructions to add a printer to your network.

**iOS/Android:** On the home screen, tap the Plus icon and then tap **Add Printer**. Follow the onscreen instructions to add a printer to your network.

## Wireless settings

You can set up and manage your printer wireless connection and perform a variety of network management tasks. This includes printing information about network settings, turning the wireless function on or off, and changing wireless settings.

### To turn on or off the wireless capability of the printer

Press the **Wireless** button () to turn on or off the printer wireless capabilities.

- If the printer has an active connection to a wireless network, the blue **Wireless** light is solid on, and the printer display shows the **Wireless** icon and the **Signal Bars** icon.
- If wireless is turned off, the **Wireless** light is off.
- For more information about the wireless status, see [Control panel lights and display icons status on page 7](#).
- To print the wireless network test report and network configuration page, see [Print reports from control panel on page 9](#).

### To change wireless settings (Windows)

This method is available if you have already installed the printer software.



---

 **NOTE:** This method requires a USB cable. Do not connect the USB cable until prompted to do so.

---

1. Open the HP printer software. For more information, see [Open the HP printer software \(Windows\) on page 18](#).
2. In the printer software, click **Tools**.
3. Click **Device Setup & Software**.
4. Select **Reconfigure Wireless Settings**. Follow the onscreen instructions.

### To restore network settings to default settings

- Press and hold the **Power** button () for three seconds to turn on all the button lights on the control panel, and then press and hold the **Wireless** button () and the **Cancel** button () from the printer control panel together for three seconds.

# Connect your printer to your computer with a USB cable (non-wireless connection)

The printer supports a rear USB 2.0 High Speed port for connection to a computer.

## To connect the printer with the USB cable

1. Visit [123.hp.com](http://123.hp.com) to download and install the printer software.



---

**NOTE:** Do not connect the USB cable to the printer until you are prompted to do so.

---

2. Follow the onscreen instructions. When you are prompted, connect the printer to the computer by selecting **USB** on the **Connection Options** screen.
3. Follow the onscreen instructions.

If the printer software has been installed, the printer will operate as a plug-and-play device.

## Change from a USB connection to a wireless network

If you first set up your printer and installed the software with a USB cable, directly connecting the printer to your computer, you can easily change to a wireless network connection. You will need a wireless 802.11b/g/n network that includes a wireless router or access point.

---

 **NOTE:** The printer only supports connections using 2.4GHz.

---

Before changing from a USB connection to a wireless network, make sure that:

- The printer is connected to your computer with the USB cable until you are prompted to disconnect the cable.
- The computer is connected to the wireless network that you intend to install the printer on.

### Change from a USB connection to a wireless network (Windows)

1. Open the HP printer software. For more information, see [Open the HP printer software \(Windows\) on page 18](#).
2. In the printer software, click **Tools**.
3. Click **Device Setup & Software**.
4. Select **Convert a USB connected printer to wireless**. Follow the onscreen instructions.

### To change from a USB connection to a wireless connection (OS X and macOS)

1. Remove the USB cable from the printer.
2. Restore the printer to its network defaults. For more information, see [Wireless settings on page 70](#).
3. Download the most recent version of HP Easy Start from 123.hp.com.
4. Open HP Easy Start and follow the onscreen instructions to connect your printer.

### To change from a USB connection to a wireless network using the HP Smart app on a Windows 10 computer (Windows)

1. Before you proceed, make sure your computer and printer meet the following requirements:
  - Your printer is currently connected to your computer through USB.
  - Your computer is currently connected to a wireless network.
2. Open the HP Smart app. For information about how to open the app on a Windows 10 computer, see [Use the HP Smart app to print, scan, and troubleshoot from an iOS, Android, or Windows 10 device on page 19](#).
3. Make sure your printer is selected.

---

 **TIP:** If you want to select a different printer, click the Printer icon on the toolbar at the left side of the screen, and then select **Select a Different Printer** to view all available printers.

---

4. Click **Learn More** when you see “Make printing easier by connecting your printer wirelessly” on top of the home page of the app.

# Advanced printer management tools (for wireless printers)

When the printer is connected to a network, you can use the embedded web server (EWS) to view status information, change settings, and manage the printer from your computer.

 **NOTE:** You can open and use the EWS without being connected to the Internet. However, some features are not available.



 **NOTE:** To view or change some settings, you might need a password.

- [Open the embedded web server](#)
- [About cookies](#)

## Open the embedded web server

You can use one of the following ways to open the embedded web server.

### To open the embedded web server through a network





1. From the printer control panel, press and hold the **Power** button () for three seconds to turn on all the button lights, and then press the **Wireless** button () and the **Information** button () at the same time to print the wireless network test report and network configuration page.
2. Find out the IP address or hostname of the printer from the network configuration page.
3. In a supported web browser on your computer, type the IP address or hostname assigned to the printer.

For example, if the IP address is 192.168.0.12, type the following address into a web browser: `http://192.168.0.12`.

### To open the embedded web server from the HP printer software (Windows)

1. Open the printer software. For more information, see [Open the HP printer software \(Windows\) on page 18](#).
2. Click **Print**, and then click **Printer Home Page (EWS)**.

### To open the embedded web server through Wi-Fi Direct

1. If the **Wi-Fi Direct** icon on the printer display is off, press and hold the **Power** button () for three seconds to turn on all the button lights, and then press and hold the **Wireless** button () and the **Resume** button () together for three seconds to turn it on. To find the Wi-Fi Direct name and password, press the **Information** button () to print a printer information page.
2. From your wireless computer, turn wireless on, search for and connect to the Wi-Fi Direct name, for example: DIRECT-\*\*-HP AMP. Enter the Wi-Fi Direct password when prompted.
3. In a supported web browser on your computer, type the following address: `http://192.168.223.1`.

## About cookies

The embedded web server (EWS) places very small text files (cookies) on your hard drive when you are browsing. These files let the EWS recognize your computer the next time you visit. For example, if you have configured the EWS language, a cookie helps remember which language you have selected so that the next time you access the EWS, the pages are displayed in that language. Some cookies (such as the cookie that stores customer-specific preferences) are stored on the computer until you clear them manually.

You can configure your browser to accept all cookies, or you can configure it to alert you every time a cookie is offered, which allows you to decide which cookies to accept or refuse. You can also use your browser to remove unwanted cookies.



**NOTE:** Depending on your printer, if you disable cookies, you also disable one or more of the following features:

---

- Starting where you left the application (especially useful when using setup wizards)
- Remembering the EWS browser language setting
- Personalizing the EWS Home page

For information about how to change your privacy and cookie settings and how to view or delete cookies, see the documentation available with your web browser.



# Tips for setting up and using a wireless printer

Use the following tips to set up and use a wireless printer:

- When setting up the wireless networked printer, make sure your wireless router or access point is powered on. The printer searches for wireless routers, then lists the detected network names on the computer.
- If your computer is connected to a Virtual Private Network (VPN), you need to disconnect from the VPN before you can access any other device on your network, including the printer.
- Learn more about configuring your network and the printer for wireless printing. [Click here to go online for more information.](#)
- Learn how to find your network security settings. [Click here to go online for more information.](#)
- Learn about the HP Print and Scan Doctor. [Click here to go online for more information.](#)



---

**NOTE:** This utility is only available for Windows operating system.

---

- Learn how to change from a USB to wireless connection. [Click here to go online for more information.](#)
- Learn how to work with your firewall and antivirus programs during printer setup. [Click here to go online for more information.](#)



---

# 9 Solve a problem

This section contains the following topics:

- [Jams and paper-feed issues](#)
- [Cartridge issues](#)
- [Printing issues](#)
- [Network and connection issues](#)
- [Get help from the HP Smart app](#)
- [Printer hardware issues](#)
- [Control panel error codes and status](#)
- [Bluetooth audio system issues](#)
- [HP support](#)

# Jams and paper-feed issues

What do you want to do?

## Clear a paper jam

[Solve paper jam issues.](#)

Use an HP online troubleshooting wizard.

Instructions for clearing paper jams and resolving issues with paper or the paper feed.

 **NOTE:** The HP online troubleshooting wizards may not be available in all languages.

## Read general instructions in the Help for clearing paper jams

 **NOTE:** Paper jams can occur in several areas. Clear paper jam from the input tray first. It helps to clear the paper path and make clearing jams from other areas easier. Then continue to the next area until all paper jams are located and cleared.

### To clear a paper jam from the input tray

1. Remove all the paper from the input tray, including both loose and jammed paper.
2. Lift and hold the input tray shield, use a flashlight to check for any jammed paper or foreign objects in the paper path, and then remove any jammed paper or foreign objects you find.

To avoid tearing any whole sheets of paper, pull the paper with both hands gently.

 **NOTE:** The input tray shield can prevent foreign debris from falling into the paper path and causing serious paper jams. Do not take down the input tray shield.



3. Press the **Cancel** button (✘). The printer tries to clear the jam automatically.

### To clear a paper jam from the output tray

1. Remove all the paper from the output tray, including both loose and jammed paper.

2. Use a flashlight to check for any jammed paper or foreign objects in the output tray area, and then remove any jammed paper or foreign objects you find.

To avoid tearing any whole sheets of paper, pull the paper with both hands gently.



#### To clear a paper jam from the cartridge access area

1. Press the **Cancel** button (✘) to try to clear the jam automatically. If this does not work, complete the following steps to clear the jam manually.
2. Open the cartridge access door.



3. Wait until the carriage is idle and silent.
4. Press the **Power** button (⏻) to turn off the printer. Then disconnect the power cord and any other cables from the rear of the printer.

---

**⚠ CAUTION:** To avoid the risk of electrical shock, you must unplug the power cord to move the carriage by hand and reset the paper feed mechanism.

---

5. Use a flashlight to check for any jammed paper or foreign objects in the cartridge access area, and then remove any jammed paper or foreign objects you find.

To avoid tearing any whole sheets of paper, pull the paper with both hands gently.



6. If the carriage is in the center of the printer, slide it to the right, and then remove any paper or objects blocking the carriage path.
7. Close the cartridge access door.



8. Reconnect the power cord and any other cables to the rear of the printer, and then press the **Power** button (⏻) to turn on the printer.

After clearing jammed paper in all areas, reload paper into the input tray. Press the **Resume** button (⏪) on the control panel to continue the current job.

## Clear a print carriage jam

[Resolve a print carriage jam.](#)

Use an HP online troubleshooting wizard.

If something is blocking the print carriage or it does not move easily, get step-by-step instructions.



**NOTE:** The HP online troubleshooting wizards may not be available in all languages.

## Read general instructions in the Help for clearing a print carriage jams

- ▲ Remove any objects, such as paper, that are blocking the print carriage.



**NOTE:** Do not use any tools or other devices to remove jammed paper. Always use caution when removing jammed paper from inside the printer.

## Learn how to avoid paper jams

To help avoid paper jams, follow these guidelines.

- Do not overfill the input tray.
- Remove printed papers from the output tray frequently.
- Ensure that paper loaded in the input tray lays flat, and the edges are not bent or torn.
- Do not combine different paper types and paper sizes in the input tray; the entire stack of paper in the input tray must be the same size and type.
- Adjust the paper-width guide in the input tray to fit snugly against all paper. Make sure the paper-width guide does not bend the paper in the input tray.
- Do not force paper too far down in the input tray.
- Do not add paper while the printer is printing. If the printer is about to run out of paper, wait until the out of paper message appears before adding paper.

## Solve paper-feed problems

What kind of problem are you having?

- **Paper is not picked up from the input tray**
  - Make sure paper is loaded in the input tray. For more information, see [Load media on page 10](#).
  - Adjust the paper-width guide in the input tray to fit snugly against all paper. Make sure the paper-width guide does not bend the paper in the input tray.
  - Make sure paper in the input tray is not curled. Uncurl paper by bending it in the opposite direction of the curl.
- **Pages are skewing**
  - Make sure the paper is loaded in the far-right side of the input tray and the paper-width guide is fit against the left side of the paper.
  - Load paper into the printer only when it is not printing.
- **Multiple pages are being picked up**
  - Adjust the paper-width guide in the input tray to fit snugly against all paper. Make sure the paper-width guide does not bend the paper in the input tray.
  - Make sure the input tray is not overloaded with paper.
  - Make sure the pieces of the loaded paper are not sticking together.
  - Use HP paper for optimum performance and efficiency.

# Cartridge issues

## Identify whether a cartridge has a problem

To identify whether a cartridge has a problem, check the status of the **Ink Alert** light and the corresponding **Ink Level** icon. For more information, see [Control panel error codes and status on page 96](#).

If you get a cartridge problem message from the printer software that states at least one of the cartridges has a problem, do the following to identify whether a cartridge has a problem.

1. Remove the black cartridge and then close the cartridge access door.
  - If the **Ink Level** icon for the tri-color cartridge blinks, the tri-color cartridge has a problem.
  - If the **Ink Level** icon for the tri-color cartridge does not blink, the tri-color cartridge does not have a problem.
2. Install the black cartridge back in the printer, remove tri-color cartridge, and then close the cartridge access door.
  - If the **Ink Level** icon for the black cartridge blinks, the black cartridge has a problem.
  - If the **Ink Level** icon for the black cartridge does not blink, the black cartridge does not have a problem.

## Fix cartridge problems

If an error occurs after a cartridge is installed, or if a message indicates a cartridge problem, try removing the cartridges, verifying the protective piece of plastic tape has been removed from each cartridge, and then reinserting the cartridges. If this does not work, clean the cartridge contacts. If the problem is still not resolved, replace the cartridges. For information about replacing cartridges, see [Replace cartridges on page 55](#).

### To clean cartridge contacts

**⚠ CAUTION:** The cleaning procedure should take only a few minutes. Make sure that the cartridges are reinstalled in the printer as soon as possible. It is not recommended to leave the cartridges outside the printer longer than 30 minutes. If cartridges are left unprotected outside the printer, their nozzles might dry out and clog up.

1. Check that power is on.
2. Open the cartridge access door and wait for the print carriage to move to the center of the printer.





3. Remove the cartridge indicated in the error message.

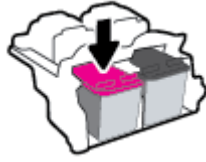

4. Clean the cartridge contacts and printer contacts.

- a. Hold the cartridge by its sides with the bottom pointing up and locate the electrical contacts on the cartridge.

The electrical contacts are the small gold-colored dots on the cartridge.

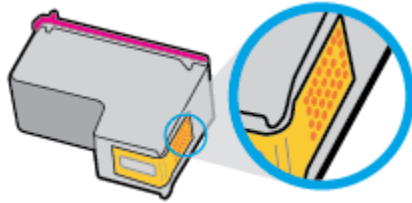

- b. Wipe only the contacts with a dry swab or lint-free cloth.

---

**CAUTION:** Be careful to wipe only the contacts, and do not smear any of the ink or other debris elsewhere on the cartridge.

---

- c. On the inside of the printer, locate the contacts for the cartridge.

The printer contacts are the set of gold-colored bumps positioned to meet the contacts on the cartridge.

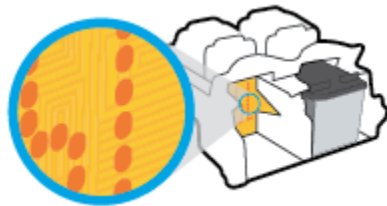

- d. Use a dry swab or lint-free cloth to wipe the contacts.
5. Reinstall the cartridge.
  6. Close the cartridge access door.
  7. Check if the error message has gone away. If you still receive the error message, turn the printer off, and then on.

---

**NOTE:** If one cartridge is causing problems, you can remove it and use the single cartridge mode to operate the printer with only one cartridge.

---

# Printing issues

What do you want to do?

## Fix problems with page not printing (unable to print)

<a href="#">HP Print and Scan Doctor</a>	The HP Print and Scan Doctor is a utility that will try to diagnose and fix the issue automatically. <b>NOTE:</b> This utility is only available for Windows operating system.
<a href="#">Troubleshoot problems with print jobs not printing.</a>	Use an HP online troubleshooting wizard. Get step-by-step instructions if the printer is not responding or printing.



**NOTE:** The HP Print and Scan Doctor and the HP online troubleshooting wizards may not be available in all languages.

## Read general instructions in the Help for unable to print issues

### To resolve print issues (Windows)

Make sure that the printer is turned on and that there is paper in the input tray. If you are still unable to print, try the following in order:

1. Check for error messages from the printer software and resolve them by following the onscreen instructions.
2. If your computer is connected to the printer with a USB cable, disconnect and reconnect the USB cable. If your computer is connected to the printer with a wireless connection, confirm that the connection is working.
3. Verify that the printer is not paused or offline.

### To verify that the printer is not paused or offline

- a. Depending upon your operating system, do one of the following:
  - **Windows 10:** From the Windows **Start** menu, select **Windows System** from the app list, select **Control Panel**, and then click **View devices and printers** under **Hardware and Sound**.
  - **Windows 8.1 and Windows 8:** Point to or tap the upper-right corner of the screen to open the Charms bar, click the **Settings** icon, click or tap **Control Panel**, and then click or tap **View devices and printers**.
  - **Windows 7:** From the Windows **Start** menu, click **Devices and Printers**.
  - **Windows Vista:** From the Windows **Start** menu, click **Control Panel**, and then click **Printers**.
  - **Windows XP:** From the Windows **Start** menu, click **Control Panel**, and then click **Printers and Faxes**.
- b. Either double-click the icon for your printer or right-click the icon for your printer and select **See what's printing** to open the print queue.

- c. On the **Printer** menu, make sure there are no check marks next to **Pause Printing** or **Use Printer Offline**.
  - d. If you made any changes, try to print again.
4. Verify that the printer is set as the default printer.

#### To verify that the printer is set as the default printer

- a. Depending upon your operating system, do one of the following:
    - **Windows 10:** From the Windows **Start** menu, select **Windows System** from the app list, select **Control Panel**, and then click **View devices and printers** under **Hardware and Sound**.
    - **Windows 8.1 and Windows 8:** Point to or tap the upper-right corner of the screen to open the Charms bar, click the **Settings** icon, click or tap **Control Panel**, and then click or tap **View devices and printers**.
    - **Windows 7:** From the Windows **Start** menu, click **Devices and Printers**.
    - **Windows Vista:** From the Windows **Start** menu, click **Control Panel**, and then click **Printers**.
    - **Windows XP:** From the Windows **Start** menu, click **Control Panel**, and then click **Printers and Faxes**.
  - b. Make sure the correct printer is set as the default printer.

The default printer has a check mark in a black or green circle next to it.
  - c. If the wrong printer is set as the default printer, right-click the correct printer and select **Set as Default Printer**.
  - d. Try using your printer again.
5. Restart the print spooler.

#### To restart the print spooler

- a. Depending upon your operating system, do one of the following:

##### Windows 10

- i. From the Windows **Start** menu, select **Windows Administrative Tools** from the app list, and then select **Services**.
- ii. Right-click the **Print Spooler**, and then click **Properties**.
- iii. On the **General** tab, next to **Startup type**, make sure that **Automatic** is selected.
- iv. If the service is not already running, under **Service status**, click **Start**, and then click **OK**.

##### Windows 8.1 and Windows 8

- i. Point to or tap the upper-right corner of the screen to open the Charms bar, and then click the **Settings** icon.
- ii. Click or tap **Control Panel**, and then click or tap **System and Security**.
- iii. Click or tap **Administrative Tools**, and then double-click or double-tap **Services**.

- iv. Right-click or touch and hold **Print Spooler**, and then click **Properties**.
- v. On the **General** tab, next to **Startup type**, make sure that **Automatic** is selected.
- vi. If the service is not already running, under **Service status**, click or tap **Start**, and then click or tap **OK**.

#### Windows 7

- i. From the Windows **Start** menu, click **Control Panel, System and Security**, and then **Administrative Tools**.
- ii. Double-click **Services**.
- iii. Right-click the **Print Spooler**, and then click **Properties**.
- iv. On the **General** tab, next to **Startup type**, make sure that **Automatic** is selected.
- v. If the service is not already running, under **Service status**, click **Start**, and then click **OK**.

#### Windows Vista

- i. From the Windows **Start** menu, click **Control Panel, System and Maintenance, Administrative Tools**.
- ii. Double-click **Services**.
- iii. Right-click the **Print Spooler service**, and then click **Properties**.
- iv. On the **General** tab, next to **Startup type**, make sure that **Automatic** is selected.
- v. If the service is not already running, under **Service status**, click **Start**, and then click **OK**.

#### Windows XP

- i. From the Windows **Start** menu, right click **My Computer**.
  - ii. Click **Manage**, and then click **Services and Applications**.
  - iii. Double-click **Services**, and then select **Print Spooler**.
  - iv. Right-click **Print Spooler**, and click **Restart** to restart the service.
- b. Make sure the correct printer is set as the default printer.  
The default printer has a check mark in a black or green circle next to it.
  - c. If the wrong printer is set as the default printer, right-click the correct printer and select **Set as Default Printer**.
  - d. Try using your printer again.
- 6. Restart the computer.
  - 7. Clear the print queue.

#### To clear the print queue

- a. Depending upon your operating system, do one of the following:

- **Windows 10:** From the Windows **Start** menu, select **Windows System** from the app list, select **Control Panel**, and then click **View devices and printers** under **Hardware and Sound**.
  - **Windows 8.1 and Windows 8:** Point to or tap the upper-right corner of the screen to open the Charms bar, click the **Settings** icon, click or tap **Control Panel**, and then click or tap **View devices and printers**.
  - **Windows 7:** From the Windows **Start** menu, click **Devices and Printers**.
  - **Windows Vista:** From the Windows **Start** menu, click **Control Panel**, and then click **Printers**.
  - **Windows XP:** From the Windows **Start** menu, click **Control Panel**, and then click **Printers and Faxes**.
- b. Double-click the icon for your printer to open the print queue.
  - c. On the **Printer** menu, click **Cancel all documents** or **Purge Print Document**, and then click **Yes** to confirm.
  - d. If there are still documents in the queue, restart the computer and try printing again after the computer has restarted.
  - e. Check the print queue again to make sure it is clear, and then try to print again.

#### To resolve print issues (OS X and macOS)

1. Check for error messages and resolve.
2. Disconnect and reconnect the USB cable.
3. Verify that the product is not paused or offline.

#### To verify that the product is not paused or offline

- a. In **System Preferences**, click **Printers & Scanners**.
- b. Click the **Open Print Queue** button.
- c. Click a print job to select it.

Use the following buttons to manage the print job:

- **Delete:** Cancel the selected print job.
  - **Hold:** Pause the selected print job.
  - **Resume:** Continue a paused print job.
  - **Pause Printer:** Pause all print jobs in the print queue.
- d. If you made any changes, try to print again.
4. Restart the computer.

## Fix print quality issues

[Step-by-step instructions for resolving most print quality issues.](#)

Troubleshoot print quality issues online.

## Read general instructions in the Help for resolving print quality issues



**NOTE:** To protect the cartridges from drying out, always turn the printer off using the **Power** button, and wait until the **Power** button light goes out.

### To improve print quality (Windows)

1. Make sure you are using original HP cartridges.
2. Check the paper type.

For best print quality, use high quality HP paper, or papers that adhere to the ColorLok® standard. For more information, see [Paper basics on page 15](#).

Always make sure the paper you are printing on is flat. For best results when printing images, use HP Advanced Photo Paper.

Store specialty paper in its original packaging inside a resealable plastic bag on a flat surface in a cool, dry place. When you are ready to print, remove only the paper you plan to use immediately. When you have finished printing, return any unused photo paper to the plastic bag. This prevents the photo paper from curling.

3. Check the printer software to make sure you have selected the appropriate paper type from the **Media** drop-down list and print quality from the **Quality Settings** drop-down list.

In the printer software, click **Print**, and then click **Set Preferences** to access the print properties.

4. Check the estimated ink levels to determine if the cartridges are low on ink.

For more information, see [Check estimated ink levels on page 52](#). If the cartridges are low on ink consider replacing them.

5. Align the cartridges.

#### To align the cartridges

- a. Load letter or A4 unused plain white paper into the input tray.
- b. Open the printer software. For more information, see [Open the HP printer software \(Windows\) on page 18](#).
- c. In the printer software, click **Print** and then click **Maintain Your Printer** to access the printer toolbox.

The printer toolbox appears.

- d. Click **Align Cartridges** on the **Device Services** tab.

The printer prints an alignment page.

- e. Follow the onscreen instructions to align the cartridges. Recycle or discard the cartridge alignment sheet later.

6. Print a diagnostics page if the cartridges are not low on ink.

### To print a diagnostics page

- a. Load letter or A4 unused plain white paper into the input tray.
- b. Open the printer software. For more information, see [Open the HP printer software \(Windows\) on page 18](#).
- c. In the printer software, click **Print** and then click **Maintain Your Printer** to access the printer toolbox.
- d. Click **Print Diagnostic Information** on the **Device Reports** tab to print a diagnostics page.
- e. Examine the color blocks on the diagnostics page.

If any of the color blocks show white lines, are faded, or are missing completely, continue to the next step.

**Figure 9-1** Color blocks without defects

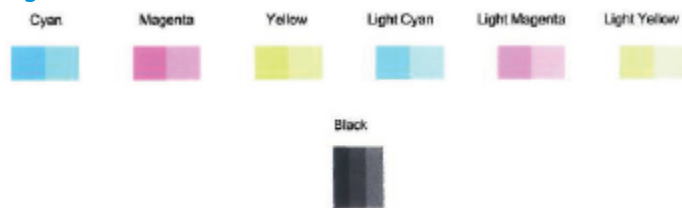

**Figure 9-2** Example of color blocks with defects



7. Clean the cartridges.

### To clean the cartridges

- a. Load letter or A4 unused plain white paper into the input tray.
- b. Open the printer software. For more information, see [Open the HP printer software \(Windows\) on page 18](#).
- c. In the printer software, click **Print** and then click **Maintain Your Printer** to access the printer toolbox.
- d. Click **Clean Cartridges** on the **Device Services** tab. Follow the onscreen instructions.

## To improve print quality (OS X and macOS)

1. Make sure you are using original HP cartridges.
2. Check the paper type.

For best print quality, use high quality HP paper, or papers that adhere to the ColorLok® standard. For more information, see [Paper basics on page 15](#).

Always make sure the paper you are printing on is flat. For best results when printing images, use HP Advanced Photo Paper.

Store specialty paper in its original packaging inside a resealable plastic bag on a flat surface in a cool, dry place. When you are ready to print, remove only the paper you plan to use immediately. When you have finished printing, return any unused photo paper to the plastic bag. This prevents the photo paper from curling.

3. Make sure you have selected the appropriate paper type and print quality in the **Print** dialog.
4. Check the estimated ink levels to determine if the cartridges are low on ink.  
Consider replacing the print cartridges if they are low on ink.
5. Align the printhead.

### To align the printhead from the software

- a. Load Letter or A4 plain, white paper in the input tray.
- b. Open HP Utility.



---

**NOTE:** HP Utility is located in the **HP** folder in the **Applications** folder.

---

- c. Select your printer from the list of devices at the left of the window.
  - d. Click **Align**.
  - e. Click **Align** and follow the onscreen instructions.
  - f. Click **All Settings** to return to the **Information and Support** pane.
6. Print a test page.

### To print a test page

- a. Load Letter or A4 plain, white paper in the input tray.
- b. Open HP Utility.



---

**NOTE:** HP Utility is located in the **HP** folder in the **Applications** folder.

---

- c. Select your printer from the list of devices at the left of the window.
  - d. Click **Test Page**.
  - e. Click the **Print Test Page** button, and follow the onscreen instructions.
7. If the diagnostic page shows streaks or missing portions of the text or colored boxes, clean the printhead automatically.



### To automatically clean the printhead

- a. Load Letter or A4 plain, white paper in the input tray.
- b. Open HP Utility.



**NOTE:** HP Utility is located in the **HP** folder in the **Applications** folder.

---

- c. Select your printer from the list of devices at the left of the window.
- d. Click **Clean Printheads**.
- e. Click **Clean**, and follow the onscreen instructions.



**CAUTION:** Clean the printhead only when necessary. Unnecessary cleaning wastes ink and shortens the life of the print head.



**NOTE:** If print quality still seems poor after you complete cleaning, try aligning the printhead. If print quality problems persist after cleaning and aligning, contact HP support.

---

- f. Click **All Settings** to return to the **Information and Support** pane.

## Network and connection issues

What do you want to do?

### Fix wireless connection

Choose one of the following troubleshooting options.

<a href="#">HP Print and Scan Doctor</a>	The HP Print and Scan Doctor is a utility that will try to diagnose and fix the issue automatically. <b>NOTE:</b> This utility is only available for Windows operating system.
Use an HP online troubleshooting wizard	<ul style="list-style-type: none"><li>• <a href="#">Troubleshoot your wireless problem</a>, whether your printer has never been connected or it was connected and is no longer working.</li><li>• <a href="#">Troubleshoot a firewall or antivirus issue</a>, if you suspect that it is preventing your computer from connecting to the printer.</li></ul>

 **NOTE:** The HP Print and Scan Doctor and the HP online troubleshooting wizards may not be available in all languages.

### Read general instructions in the Help for wireless troubleshooting

- ▲ From the printer control panel, press and hold the **Power** button (⏻) for three seconds to turn on all the button lights, and then press the **Wireless** button (📶) and the **Information** button (ⓘ) at the same time to print the wireless network test report and network configuration page.

### Find network settings for wireless connection

Choose one of the following troubleshooting options.

<a href="#">HP Print and Scan Doctor</a>	The HP Print and Scan Doctor is a utility that can tell you the network name (SSID) and password (network key). <b>NOTE:</b> This utility is only available for Windows operating system.
<a href="#">Use an HP online troubleshooting wizard</a>	Learn how to find your network name (SSID) and wireless password.



 **NOTE:** The HP Print and Scan Doctor and the HP online troubleshooting wizards may not be available in all languages.

### Fix Wi-Fi Direct connection

<a href="#">Use an HP online troubleshooting wizard</a>	Troubleshoot your Wi-Fi Direct problem or learn how to configure Wi-Fi Direct.
---	--

 **NOTE:** The HP online troubleshooting wizards may not be available in all languages.

## Read general instructions in the Help for Wi-Fi Direct troubleshooting

1. Make sure that the **Wi-Fi Direct** icon on the printer control panel is on. If it is off, press and hold the **Power** button (  ) for three seconds to turn on all the button lights, and then press and hold the **Wireless** button (  ) and the **Resume** button (  ) together for three seconds to turn it on.
2. From your wireless computer or mobile device, turn on the Wi-Fi connection, and then search for and connect to the Wi-Fi Direct name of your printer.

If you are using a mobile device that does not support Wi-Fi Direct, make sure you have installed a compatible printing app. For more information, visit the HP Mobile Printing website at [www.hp.com/go/mobileprinting](http://www.hp.com/go/mobileprinting). If a local version of this website is not available in your country/region or language, you might be directed to the HP Mobile Printing website in another country/region or language.



---

**NOTE:** If your mobile device does not support Wi-Fi, you are not able to use Wi-Fi Direct.

---

3. If the Wi-Fi Direct connection security for the printer is set to **Manual**, do one of the following to connect to the printer.
  - Make sure to enter the correct Wi-Fi Direct password or PIN code when prompted.
  - If the **Wi-Fi Direct** icon on the printer display is blinking in sync with the white blinking **Information** light, make sure to press the **Information** button (  ) within one minute to connect before timeout.
4. Make sure that the number of Wi-Fi Direct connections has not reached the maximum of five devices.

## Get help from the HP Smart app

The HP Smart app provides alerts for printer issues (jams and other problems), links to help content, and options to contact support for additional assistance.

# Printer hardware issues

## Close cartridge access door

- Cartridge door must be closed to begin printing.



## The printer shuts down unexpectedly

- Check the power and power connections.
- Make sure the power cord of the printer is connected firmly to a functioning power outlet.



**NOTE:** When Auto-Off is enabled, the printer will automatically turn off after two hours of inactivity to help reduce energy use. For more information, see [Auto-Off on page 22](#).









## Resolve printer failure



- Turn the printer off, then on. If that does not resolve the problem, contact HP.

# Control panel error codes and status

## Control panel error codes



- If the Error number icons on the printer display changes to a number, blinking together with the letter E at the left side, it indicates the printer is in an error state. The letter E and the number work as error codes.

Light behavior	Cause and Solution
<p>The letter E, the number 1, the <b>Error</b> icon, and the <b>Paper Error</b> icon are all blinking. The <b>Cancel</b> button light and the <b>Resume</b> button light are on.</p> 	<p>The printer receives a printing job, starts feeding paper, and detects that the paper width for the printing job is bigger than the width of the loaded paper.</p> <p>Press either the <b>Resume</b> button (  ) or the <b>Cancel</b> button (  ) to cancel the printing job and eject paper.</p> <p>To avoid the paper size mismatch problem, do one of the following before printing.</p> <ul style="list-style-type: none"><li>– Change the paper size setting for the printing job to match the paper loaded.</li><li>– Remove all paper from the input tray, and then load paper that matches the paper size setting for the printing job.</li></ul> <p><b>TIP:</b> You can change the default paper size automatically detected by the printer. For more information, see <a href="#">Change the default paper size detected by printer on page 14</a>.</p>
<p>The letter E, the number 2, the <b>Error</b> icon, and the <b>Paper Error</b> icon are all blinking. The <b>Cancel</b> button light and the <b>Resume</b> button light are on.</p> 	<p>The printer receives a multipage printing job, detects that the paper length for the printing job does not match the length of the loaded paper, and then prints out the first page of the job with errors.</p> <ul style="list-style-type: none"><li>– To cancel the printing job, press the <b>Cancel</b> button (  ).</li><li>– To continue printing the remaining pages, press the <b>Resume</b> button (  ). The remaining pages will have the same errors as the first page.</li></ul> <p><b>TIP:</b> You can change the default paper size automatically detected by the printer. For more information, see <a href="#">Change the default paper size detected by printer on page 14</a>.</p>
<p>The letter E, the number 3, and the <b>Error</b> icon are all blinking. The <b>Cancel</b> button light and the <b>Resume</b> button light are on.</p> 	<p>The carriage inside the printer has stalled.</p> <p>Open the cartridge access door and make sure the carriage is not obstructed. Move the carriage to the right, close the cartridge access door, and then press the <b>Resume</b> button (  ) to continue printing. See <a href="#">Jams and paper-feed issues on page 78</a> for more information.</p>

Light behavior	Cause and Solution
<p>The letter E, the number 4, the <b>Error</b> icon, and the <b>Paper Error</b> icon are all blinking. The <b>Cancel</b> button light and the <b>Resume</b> button light are on.</p> 	<p>There is a paper jam.</p> <p>Clear the jam, and then press the <b>Resume</b> button (  ) to continue printing.</p> <p>For more information, see <a href="#">Jams and paper-feed issues on page 78</a>.</p>
<p>The letter E, the number 6, and the <b>Error</b> icon are blinking.</p> 	<p>The printer is in an error state.</p> <ol style="list-style-type: none"> <li>1. Turn off the printer.</li> <li>2. Unplug the power cord.</li> <li>3. Wait a minute, and then plug the power cord back in.</li> <li>4. Turn on the printer.</li> </ol> <p>If the problem persists, contact HP.</p>

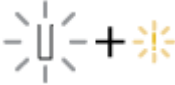
## Control panel ink error status

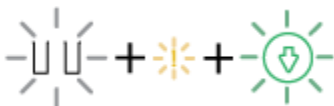
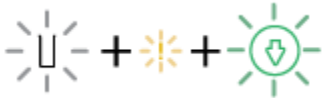
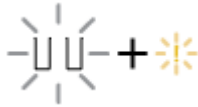

- | Light behavior  | Cause and Solution  |
|---|---|
| <p>One of the <b>Ink Level</b> icons without segment and the <b>Error</b> icon are blinking. The <b>Resume</b> button light is off.</p>  | <p>One of the following might have occurred.</p> <ul style="list-style-type: none"> <li>– The corresponding cartridge is missing.</li> </ul> <p>If one of the cartridges is missing, the printer enters single cartridge mode. To exit the single cartridge mode, insert the corresponding cartridge. For more information about the single cartridge mode, see <a href="#">Use single cartridge mode on page 57</a>.</p> <ul style="list-style-type: none"> <li>– The corresponding cartridge is installed improperly, or still has plastic tape on it.</li> </ul> <p>Remove the corresponding cartridge, make sure there is no plastic tape on it, and then reinsert the cartridge securely. For more information, see <a href="#">Replace cartridges on page 55</a>.</p> |

Light behavior	Cause and Solution
<p>Both <b>Ink Level</b> icons without segment and the <b>Error</b> icon are blinking. The <b>Resume</b> button light is off.</p>	<p>One of the following might have occurred.</p> <ul style="list-style-type: none"> <li>– Both cartridges are missing.</li> <li>– Both cartridges are installed improperly, or still have plastic tape on them.</li> <li>– Both cartridges are incompatible or damaged.</li> </ul> <p>Try the following solutions to solve the problem.</p> <ul style="list-style-type: none"> <li>– If there is no cartridge installed in the printer, install the cartridges.</li> <li>– If both cartridges are installed in the printer, remove the cartridges, make sure there is no plastic tape on them, and then reinsert the cartridges securely.</li> <li>– Make sure that you are using the correct HP cartridges for your printer.</li> <li>– If the error persists, replace the cartridges. For information about how to replace cartridges, see <a href="#">Replace cartridges on page 55</a>.</li> </ul>
<p>One of the <b>Ink Level</b> icons without segment and the <b>Error</b> icon are blinking. The <b>Resume</b> button light is on.</p>	<p>One of the following might have occurred.</p> <ul style="list-style-type: none"> <li>– The counterfeit or previously used cartridge is installed.</li> <li>– The corresponding cartridge is very low on ink.</li> </ul> <p>Try the following solutions to solve the problem.</p> <ul style="list-style-type: none"> <li>– If the corresponding cartridge is newly installed, it might be counterfeit or previously used. Refer to the message in the HP printer software for more information.</li> <li>– If the corresponding cartridge is not newly installed, it is very low on ink. Press the <b>Resume</b> button (  ) to continue printing, and replace the cartridge when the print quality is no longer acceptable. For information about how to replace cartridges, see <a href="#">Replace cartridges on page 55</a>.</li> </ul>
<p>Both <b>Ink Level</b> icons without segment and the <b>Error</b> icon are blinking. The <b>Resume</b> button light is on.</p>	<p>One of the following might have occurred.</p> <ul style="list-style-type: none"> <li>– The counterfeit or previously used cartridges are installed.</li> <li>– Both of the cartridges are very low on ink.</li> </ul> <p>Try the following solutions to solve the problem.</p> <ul style="list-style-type: none"> <li>– If the cartridges are newly installed, they might be counterfeit or previously used. Refer to the message in the HP printer software for more information.</li> <li>– If the cartridges are not newly installed, they are very low on ink. Press the <b>Resume</b> button (  ) to continue printing, and replace the cartridges when the print quality is no longer acceptable. For information about how to replace cartridges, see <a href="#">Replace cartridges on page 55</a>.</li> </ul>



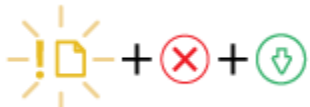

## Control panel paper error status

Light behavior	Cause and Solution
<p>The <b>Error</b> icon and the <b>Paper Error</b> icon are on.</p> 	<p>There is no paper in the input tray.</p> <p>Load paper in the input tray.</p> <p>For information about how to load paper, see <a href="#">Load media on page 10</a>.</p>
<p>The <b>Error</b> icon and the <b>Paper Error</b> icon are blinking. The <b>Cancel</b> button light and the <b>Resume</b> button light are on.</p> 	<p>The printer receives a printing job, and detects that there is no paper in the input tray.</p> <ul style="list-style-type: none"><li>- To cancel the printing job, press the <b>Cancel</b> button (  ).</li><li>- To continue printing, load paper, and then press the <b>Resume</b> button (  ).</li></ul> <p>For information about how to load paper, see <a href="#">Load media on page 10</a>.</p>

# Bluetooth audio system issues

## The audio system indicates a connection but is not playing music

- Ensure the device you want to hear is connected to the audio system and playing music.
- Ensure the audio system is not muted and the audio system volume is turned up.
- Your Bluetooth device might be out of range. Try moving it closer to the audio system.
- Move your device away from any device that generates electromagnetic interference, such as another Bluetooth device, cordless phone, microwave oven, or wireless router.
- Turn off and turn on the audio system.

## Cannot pair the audio system with my Bluetooth device

- Ensure your audio system is discoverable (The **Bluetooth** light is blinking).
- Ensure Bluetooth is enabled on your device.
- Ensure you have selected the printer name in the Bluetooth device list on your device and the connection has been confirmed by your device.
- Your Bluetooth device might be out of range. Try moving it closer to the audio system.
- If possible, turn off all other nearby Bluetooth devices or disable their Bluetooth functionality.
- Turn off and turn on the printer, and then pair and connect your device. For more information, see [Pair and connect your device to the audio system on page 37](#).
- Press and hold the **Bluetooth** button (  ) for about eight seconds to disconnect from all devices and clear previous pairings from the audio system memory. Then pair and connect your device again. For more information, see [Pair and connect your device to the audio system on page 37](#).

## HP support

For the latest product updates and support information, visit the product support website at [www.support.hp.com](http://www.support.hp.com). HP online support provides a variety of options for help with your printer:



**Drivers & downloads:** Download software drivers and updates, as well as product manuals and documentation that came in the box with your printer.



**HP support forums:** Visit HP Support Forums for answers to common questions and issues. You can view questions posted by other HP customers, or sign in and post your own questions and comments.



**Troubleshooting:** Use HP online tools to detect your printer and find recommended solutions.

## Contact HP

If you need help from an HP technical support representative to solve a problem, visit the [Contact Support website](#). The following contact options are available at no cost for in-warranty customers (HP agent-assisted support for out-of-warranty customers may require a fee):



Chat with an HP support agent online.



Call an HP support agent.

When contacting HP support, be prepared to provide the following information:

- Product name (Located on the printer, such as HP AMP)
- Product number (located inside the cartridge access door)



- Serial number (located on the back or bottom of the printer)

## Register printer

By taking just a few quick minutes to register, you can enjoy quicker service, more efficient support, and product support alerts. If you did not register your printer while installing the software, you can register now at <http://www.register.hp.com>.

## Additional warranty options

Extended service plans are available for the HP AMP at additional costs. Go to [www.support.hp.com](http://www.support.hp.com), select your country/region and language, then explore the extended warranty options available for your printer.

---

# A Technical information

The technical specifications and international regulatory information for the HP AMP are provided in this section.

For additional specifications, see the printed documentation that came with the HP AMP.

This section contains the following topics:

- [HP Company notices](#)
- [Specifications](#)
- [Regulatory notices](#)
- [Environmental product stewardship program](#)

## HP Company notices

The information contained herein is subject to change without notice.

All rights reserved. Reproduction, adaptation, or translation of this material is prohibited without prior written permission of HP, except as allowed under the copyright laws. The only warranties for HP products and services are set forth in the express warranty statements accompanying such products and services. Nothing herein should be construed as constituting an additional warranty. HP shall not be liable for technical or editorial errors or omissions contained herein.

© Copyright 2017 HP Development Company, L.P.

Microsoft and Windows are either registered trademarks or trademarks of Microsoft Corporation in the United States and/or other countries.

Bluetooth is a trademark owned by its proprietor and used by HP Inc. under license.

# Specifications

Technical specifications for the HP AMP are provided in this section. For more product specifications, see the Product Data Sheet at [www.support.hp.com](http://www.support.hp.com).

## System requirements

- For information about software and system requirements or future operating system releases and support, visit the HP online support website at [www.support.hp.com](http://www.support.hp.com).

## Environmental specifications

- Recommended operating temperature range: 15°C to 30°C (59°F to 86°F)
- Allowable operating temperature range: 5°C to 40°C (41°F to 104°F)
- Humidity: 15% to 80% RH non-condensing; 28°C maximum dewpoint
- Nonoperating (Storage) temperature range: -40°C to 60°C (-40°F to 140°F)
- In the presence of high electromagnetic fields, it is possible the output from the HP AMP may be slightly distorted
- HP recommends using a USB cable less than or equal to 3 m (10 feet) in length to minimize injected noise due to potential high electromagnetic fields

## Input tray capacity

- Plain paper sheets (80 g/m<sup>2</sup> [20lb]): Up to 60
- Envelopes: Up to 5
- Index cards: Up to 20
- Photo paper sheets: Up to 20

## Output tray capacity

- Plain paper sheets (80 g/m<sup>2</sup> [20lb]): Up to 25
- Envelopes: Up to 5
- Index cards: Up to 20
- Photo paper sheets: Up to 20

## Paper size

- For a complete list of supported media sizes, see the printer software.

## Paper weights

- Plain Paper: 60 to 90 g/m<sup>2</sup> (16 to 32 lb bond)
- Envelopes: 75 to 90 g/m<sup>2</sup> (20 to 24 lb bond envelope)
- Cards: Up to 200 g/m<sup>2</sup> (110 lb index maximum)
- Photo Paper: Up to 300 g/m<sup>2</sup> (145 lb bond)

### **Print specifications**

- Print speeds vary according to the complexity of the document
- Method: drop-on-demand thermal inkjet
- Language: PCL3 GUI

### **Print resolution**

- For a list of supported print resolutions, visit the product support website at [www.support.hp.com](http://www.support.hp.com).

### **Cartridge yield**

- Visit [www.hp.com/go/learnaboutsupplies](http://www.hp.com/go/learnaboutsupplies) for more information on estimated cartridge yields.

### **Acoustic information**

- If you have Internet access, you can access acoustic information from the [HP website](#).



# Regulatory notices

The printer meets product requirements from regulatory agencies in your country/region.

This section contains the following topics:

- [Regulatory model identification number](#)
- [FCC statement](#)
- [VCCI \(Class B\) compliance statement for users in Japan](#)
- [Notice to users in Japan about the power cord](#)
- [Notice to users in Korea](#)
- [Noise emission statement for Germany](#)
- [European Union Regulatory Notice](#)
- [Visual display workplaces statement for Germany](#)
- [Declaration of conformity](#)
- [Regulatory wireless statements](#)

## Regulatory model identification number

For regulatory identification purposes, your product is assigned a Regulatory Model Number. The Regulatory Model Number for your product is SNPRH-1701. This regulatory number should not be confused with the marketing name (HP AMP, etc.) or product numbers (T8X39A, etc.).

## FCC statement

The United States Federal Communications Commission (in 47 CFR 15.105) has specified that the following notice be brought to the attention of users of this product.

This equipment has been tested and found to comply with the limits for a Class B digital device, pursuant to Part 15 of the FCC Rules. These limits are designed to provide reasonable protection against harmful interference in a residential installation. This equipment generates, uses and can radiate radio frequency energy and, if not installed and used in accordance with the instructions, may cause harmful interference to radio communications. However, there is no guarantee that interference will not occur in a particular installation. If this equipment does cause harmful interference to radio or television reception, which can be determined by turning the equipment off and on, the user is encouraged to try to correct the interference by one or more of the following measures:

- Reorient or relocate the receiving antenna.
- Increase the separation between the equipment and the receiver.
- Connect the equipment into an outlet on a circuit different from that to which the receiver is connected.
- Consult the dealer or an experienced radio/TV technician for help.

For further information, contact: Manager of Corporate Product Regulations, HP Inc. 1501 Page Mill Road, Palo Alto, CA 94304, U.S.A.

Modifications (part 15.21)

The FCC requires the user to be notified that any changes or modifications made to this device that are not expressly approved by HP may void the user's authority to operate the equipment.

This device complies with Part 15 of the FCC Rules. Operation is subject to the following two conditions: (1) this device may not cause harmful interference, and (2) this device must accept any interference received, including interference that may cause undesired operation.

## VCCI (Class B) compliance statement for users in Japan

この装置は、クラス B 情報技術装置です。この装置は、家庭環境で使用することを目的としていますが、この装置がラジオやテレビジョン受信機に近接して使用されると、受信障害を引き起こすことがあります。取扱説明書に従って正しい取り扱いをして下さい。

VCCI-B

## Notice to users in Japan about the power cord

製品には、同梱された電源コードをお使い下さい。

同梱された電源コードは、他の製品では使用出来ません。

## Notice to users in Korea

B급 기기

(가정용 방송통신기자재)

이 기기는 가정용(B급) 전자파적합기기로서 주로 가정에서 사용하는 것을 목적으로 하며, 모든 지역에서 사용할 수 있습니다.

## Noise emission statement for Germany

Geräuschemission

LpA < 70 dB am Arbeitsplatz im Normalbetrieb nach DIN 45635 T. 19

## European Union Regulatory Notice



Products bearing the CE marking comply to applicable EU Directives and related European Harmonised Standards. The full Declaration of Conformity can be found at the following website:

[www.hp.eu/certificates](http://www.hp.eu/certificates) (Search with the product model name or its Regulatory Model Number (RMN), which may be found on the regulatory label.)

The point of contact for regulatory matters is HP Deutschland GmbH, HQ-TRE, 71025, Boeblingen, Germany.

## Products with wireless functionality

### EMF

- This product meets international guidelines (ICNIRP) for exposure to radio frequency radiation.

If it incorporates a radio transmitting and receiving device that in normal use, a separation distance of 20 cm ensures that radio frequency exposure levels comply with EU requirements.

### Wireless functionality in Europe

- For products with 802.11 b/g/n or Bluetooth radio:
  - This product operates on radio frequency between 2400 MHz and 2483.5 MHz, with a transmit power of 20 dBm (100 mW) or less.
- For products with 802.11 a/b/g/n radio:
  -  **CAUTION:** IEEE 802.11x wireless LAN with 5.15-5.35 GHz frequency band is restricted for **indoor use only** in all European Union member states, EFTA (Iceland, Norway, Liechtenstein) and most other European countries (e.g. Switzerland, Turkey, Republic of Serbia). Using this WLAN application outdoor might lead to interference issues with existing radio services.
  - This product operates on radio frequencies between 2400 MHz and 2483.5 MHz, and between 5170 MHz and 5710 MHz, with a transmit power of 20 dBm (100 mW) or less.

## Visual display workplaces statement for Germany

### GS-Erklärung (Deutschland)

Das Gerät ist nicht für die Benutzung im unmittelbaren Gesichtsfeld am Bildschirmarbeitsplatz vorgesehen. Um störende Reflexionen am Bildschirmarbeitsplatz zu vermeiden, darf dieses Produkt nicht im unmittelbaren Gesichtsfeld platziert werden.

## Declaration of conformity



### DECLARATION OF CONFORMITY according to ISO/IEC 17050-1 and EN 17050-1

DoC #: SNPRH-1701- R1 Original/en

**Manufacturer's Name:** HP Inc.  
**Manufacturer's Address:** Hewlett Packard Singapore (Pte) Ltd, 138 Depot Road, Singapore 109683

**declare, under its sole responsibility that the product**

**Product Name and Model:**<sup>2)</sup> HP AMP  
**Regulatory Model Number:**<sup>1)</sup> SNPRH-1701  
**Product Options:** All

**conforms to the following Product Specifications and Regulations:**

**Safety**

IEC 60950-1:2005 +A1:2009 +A2:2013  
EN 60950-1:2006 +A11:2009 +A1:2010 +A12:2011  
+A2:2013  
EN 62479:2010  
EN 62311:2008

**EMC**

CISPR 32:2012 / EN55032:2012 Class B  
CISPR 24:2010 / EN55024:2010  
EN 61000-3-2:2014  
EN 61000-3-3:2013  
FCC CFR 47 Part 15 Class B  
ICES-003, Issue 6 Class B  
EN 301 489-1 V1.9.2:2011  
EN 301 489-17 V2.2.1:2012

**Spectrum**

EN 300 328 V1.9.1:2015

**Ecodesign**

Regulation (EC) No. 1275/2008  
ENERGY STAR® Qualified Imaging Equipment Operational Mode (OM) Test Procedure  
EN 50564:2011  
IEC 62301:2011

**RoHS**

EN 50581:2012

The product herewith complies with the requirements of the R&TTE Directive 1999/5/EC, the Ecodesign Directive 2009/125/EC, the RoHS Directive 2011/65/EU and carries the **CE** marking accordingly.

This device complies with part 15 of the FCC Rules. Operation is subject to the following two conditions:

(1) This device may not cause harmful interference, and (2) this device must accept any interference received, including interference that may cause undesired operation.

**Additional Information:**

- 1) This product is assigned a Regulatory Model Number which stays with the regulatory aspects of the design. The Regulatory Model Number is the main product identifier in the regulatory documentation and test reports, this number should not be confused with the marketing name or the product numbers.
- 2) This product was tested in a typical HP environment.
- 3) This product uses a radio module with Regulatory Model Number SDG0B-1392+Bluetooth as needed to meet technical regulatory requirements for the countries/regions where this product will be sold.

Singapore  
01-03-2017

Hou-Meng Yik, Manager  
HP Singapore Inkjet Printing Solutions

**Local contact for regulatory topics only:**

EU: HP Deutschland GmbH, HP HQ-TRE, 71025 Boeblingen, Germany  
U.S.: HP Inc., 1501 Page Mill Road, Palo Alto 94304, U.S.A. 650-857-1501

<http://www.hp.eu/certificates>

## Regulatory wireless statements

This section contains the following regulatory information pertaining to wireless products:

- [Exposure to radio frequency radiation](#)
- [Notice to users in Brazil](#)
- [Notice to users in Canada](#)
- [Notice to users in Taiwan](#)
- [Notice to users in Mexico](#)
- [Notice to users in Japan](#)
- [Notice to users in Korea](#)

### Exposure to radio frequency radiation

---

**⚠ CAUTION:** The radiated output power of this device is far below the FCC radio frequency exposure limits. Nevertheless, the device shall be used in such a manner that the potential for human contact during normal operation is minimized. This product and any attached external antenna, if supported, shall be placed in such a manner to minimize the potential for human contact during normal operation. In order to avoid the possibility of exceeding the FCC radio frequency exposure limits, human proximity to the antenna shall not be less than 20 cm (8 inches) during normal operation.

---

### Notice to users in Brazil

Este equipamento opera em caráter secundário, isto é, não tem direito à proteção contra interferência prejudicial, mesmo de estações do mesmo tipo, e não pode causar interferência em sistemas operando em caráter primário.

### Notice to users in Canada

Under Industry Canada regulations, this radio transmitter may only operate using an antenna of a type and maximum (or lesser) gain approved for the transmitter by Industry Canada. To reduce potential radio interference to other users, the antenna type and its gain should be so chosen that the equivalent isotropically radiated power (e.i.r.p.) is not more than that necessary for successful communication.

This device complies with Industry Canada licence-exempt RSS standard(s). Operation is subject to the following two conditions: (1) this device may not cause interference, and (2) this device must accept any interference, including interference that may cause undesired operation of the device.

**WARNING! Exposure to Radio Frequency Radiation** The radiated output power of this device is below the Industry Canada radio frequency exposure limits. Nevertheless, the device should be used in such a manner that the potential for human contact is minimized during normal operation.

To avoid the possibility of exceeding the Industry Canada radio frequency exposure limits, human proximity to the antennas should not be less than 20 cm (8 inches).

Conformément au Règlement d'Industrie Canada, cet émetteur radioélectrique ne peut fonctionner qu'avec une antenne d'un type et d'un gain maximum (ou moindre) approuvé par Industrie Canada. Afin de réduire le brouillage radioélectrique potentiel pour d'autres utilisateurs, le type d'antenne et son gain doivent être choisis de manière à ce que la puissance isotrope rayonnée équivalente (p.i.r.e.) ne dépasse pas celle nécessaire à une communication réussie.

Cet appareil est conforme aux normes RSS exemptes de licence d'Industrie Canada. Son fonctionnement dépend des deux conditions suivantes : (1) cet appareil ne doit pas provoquer d'interférences nuisibles et (2) doit accepter toutes les interférences reçues, y compris des interférences pouvant provoquer un fonctionnement non souhaité de l'appareil.

AVERTISSEMENT relatif à l'exposition aux radiofréquences. La puissance de rayonnement de cet appareil se trouve sous les limites d'exposition de radiofréquences d'Industrie Canada. Néanmoins, cet appareil doit être utilisé de telle sorte qu'il doive être mis en contact le moins possible avec le corps humain.

Afin d'éviter le dépassement éventuel des limites d'exposition aux radiofréquences d'Industrie Canada, il est recommandé de maintenir une distance de plus de 20 cm entre les antennes et l'utilisateur.

## Notice to users in Taiwan

低功率電波輻射性電機管理辦法

第十二條

經型式認證合格之低功率射頻電機，非經許可，公司、商號或使用者均不得擅自變更頻率、加大功率或變更設計之特性及功能。

第十四條

低功率射頻電機之使用不得影響飛航安全及干擾合法通信；經發現有干擾現象時，應立即停用，並改善至無干擾時方得繼續使用。

前項合法通信，指依電信法規定作業之無線電通信。低功率射頻電機須忍受合法通信或工業、科學及醫藥用電波輻射性電機設備之干擾。

## Notice to users in Mexico

La operación de este equipo está sujeta a las siguientes dos condiciones: (1) es posible que este equipo o dispositivo no cause interferencia perjudicial y (2) este equipo o dispositivo debe aceptar cualquier interferencia, incluyendo la que pueda causar su operación no deseada.

Para saber el modelo de la tarjeta inalámbrica utilizada, revise la etiqueta regulatoria de la impresora.

## Notice to users in Japan

この機器は技術基準適合証明又は工事設計認証を受けた無線設備を搭載しています。

## Notice to users in Korea

해당 무선설비는 전파혼신 가능성이 있으므로 인명안전과 관련된 서비스는 할 수 없음

(무선 모듈이 탑재된 제품인 경우)

# Environmental product stewardship program

HP is committed to providing quality products in an environmentally sound manner. Design for recycling has been incorporated into this product. The number of materials has been kept to a minimum while ensuring proper functionality and reliability. Dissimilar materials have been designed to separate easily. Fasteners and other connections are easy to locate, access, and remove using common tools. High priority parts have been designed to access quickly for efficient disassembly and repair. For more information, visit HP's Commitment to the Environment website at:

[www.hp.com/hpinfo/globalcitizenship/environment](http://www.hp.com/hpinfo/globalcitizenship/environment)

- [Eco-Tips](#)
- [European Union Commission Regulation 1275/2008](#)
- [Paper](#)
- [Plastics](#)
- [Safety data sheets](#)
- [Recycling program](#)
- [HP inkjet supplies recycling program](#)
- [Power consumption](#)
- [Disposal of waste equipment by users](#)
- [Waste disposal for Brazil](#)
- [Chemical substances](#)
- [Declaration of the Presence Condition of the Restricted Substances Marking \(Taiwan\)](#)
- [The Table of Hazardous Substances/Elements and their Content \(China\)](#)
- [Restriction of hazardous substance \(Ukraine\)](#)
- [Restriction of hazardous substance \(India\)](#)
- [Restriction on hazardous substances statement \(Turkey\)](#)
- [EPEAT](#)
- [SEPA Ecolabel User Information \(China\)](#)
- [China Energy Label for Printer, Fax and Copier](#)

## Eco-Tips

HP is committed to helping customers reduce their environmental footprint. Please visit the HP Environmental Programs and Initiatives website for more information on HP's environmental initiatives.

[www.hp.com/hpinfo/globalcitizenship/environment/](http://www.hp.com/hpinfo/globalcitizenship/environment/)

## European Union Commission Regulation 1275/2008

For product power data, including the power consumption of the product in networked standby if all wired network ports are connected and all wireless network ports are activated, please refer to section P14 'Additional Information' of the product IT ECO Declaration at [www.hp.com/hpinfo/globalcitizenship/environment/productdata/itecodesktop-pc.html](http://www.hp.com/hpinfo/globalcitizenship/environment/productdata/itecodesktop-pc.html).

## Paper

This product is suited for the use of recycled paper according to DIN 19309 and EN 12281:2002.

## Plastics

Plastic parts over 25 grams are marked according to international standards that enhance the ability to identify plastics for recycling purposes at the end of product life.

## Safety data sheets

Safety Data Sheets, product safety and environmental information are available at [www.hp.com/go/ecodata](http://www.hp.com/go/ecodata) or on request.

## Recycling program

HP offers an increasing number of product return and recycling programs in many countries/regions, and partners with some of the largest electronic recycling centers throughout the world. HP conserves resources by reselling some of its most popular products. For more information regarding recycling of HP products, please visit:

[www.hp.com/recycle](http://www.hp.com/recycle)

## HP inkjet supplies recycling program

HP is committed to protecting the environment. The HP Inkjet Supplies Recycling Program is available in many countries/regions, and lets you recycle used print cartridges and ink cartridges free of charge. For more information, go to the following website:

[www.hp.com/hpinfo/globalcitizenship/environment/recycle/](http://www.hp.com/hpinfo/globalcitizenship/environment/recycle/)

## Power consumption

HP printing and imaging equipment marked with the ENERGY STAR® logo is certified by the U.S. Environmental Protection Agency. The following mark will appear on ENERGY STAR certified imaging products:



Additional ENERGY STAR certified imaging product model information is listed at: [www.hp.com/go/energystar](http://www.hp.com/go/energystar)



## Disposal of waste equipment by users



This symbol means do not dispose of your product with your other household waste. Instead, you should protect human health and the environment by handing over your waste equipment to a designated collection point for the recycling of waste electrical and electronic equipment. For more information, please contact your household waste disposal service, or go to <http://www.hp.com/recycle>.

## Waste disposal for Brazil



Não descarte o produto eletrônico em lixo comum

Este produto eletrônico e seus componentes não devem ser descartados no lixo comum, pois embora estejam em conformidade com padrões mundiais de restrição a substâncias nocivas, podem conter, ainda que em quantidades mínimas, substâncias impactantes ao meio ambiente. Ao final da vida útil deste produto, o usuário deverá entregá-lo à HP. A não observância dessa orientação sujeitará o infrator às sanções previstas em lei.

Após o uso, as pilhas e/ou baterias dos produtos HP deverão ser entregues ao estabelecimento comercial ou rede de assistência técnica autorizada pela HP.

Para maiores informações, inclusive sobre os pontos de recebimento, acesse:

[www.hp.com.br/reciclar](http://www.hp.com.br/reciclar)

## Chemical substances

HP is committed to providing our customers with information about the chemical substances in our products as needed to comply with legal requirements such as REACH (*Regulation EC No 1907/2006 of the European Parliament and the Council*). A chemical information report for this product can be found at: [www.hp.com/go/reach](http://www.hp.com/go/reach).

## Declaration of the Presence Condition of the Restricted Substances Marking (Taiwan)

### 限用物質含有情況標示聲明書

#### Declaration of the Presence Condition of the Restricted Substances Marking

單元 Unit	限用物質及其化學符號					
	Restricted substances and its chemical symbols					
	鉛 Lead (Pb)	汞 Mercury (Hg)	鎘 Cadmium (Cd)	六價鉻 Hexavalent chromium (Cr <sup>6+</sup> )	多溴聯苯 Polybrominated biphenyls (PBB)	多溴二苯醚 Polybrominate d diphenyl ethers (PBDE)
外殼和紙匣 (External Casings and Trays)	0	0	0	0	0	0
電線 (Cables)	0	0	0	0	0	0
印刷電路板 (Printed Circuit Boards)	—	0	0	0	0	0
列印引擎(Print Engine)	—	0	0	0	0	0
列印機組件 (Print Assembly)	—	0	0	0	0	0
噴墨印表機墨水匣 (Print Supplies)	0	0	0	0	0	0
列印機配件 (Print Accessory)	—	0	0	0	0	0

備考 1. “超出 0.1 wt %” 及 “超出 0.01 wt %” 係指限用物質之百分比含量超出百分比含量基準值。

Note 1: “Exceeding 0.1 wt %” and “exceeding 0.01 wt %” indicate that the percentage content of the restricted substance exceeds the reference percentage value of presence condition.

備考 2. “0” 係指該項限用物質之百分比含量未超出百分比含量基準值。

Note 2: “0” indicates that the percentage content of the restricted substance does not exceed the percentage of reference value of presence.

備考 3. “—” 係指該項限用物質為排除項目。

Note 3: The “—” indicates that the restricted substance corresponds to the exemption.

若要存取產品的最新使用指南或手冊，請前往 [www.support.hp.com](http://www.support.hp.com)。選取搜尋您的產品，然後依照畫面上的指示繼續執行。

To access the latest user guides or manuals for your product, go to [www.support.hp.com](http://www.support.hp.com). Select **Find your product**, and then follow the onscreen instructions.

## The Table of Hazardous Substances/Elements and their Content (China)

产品中有害物质或元素的名称及含量

根据中国《电器电子产品有害物质限制使用管理办法》



部件名称	有害物质					
	铅 (Pb)	汞 (Hg)	镉 (Cd)	六价铬 (Cr(VI))	多溴联苯 (PBB)	多溴二苯醚 (PBDE)
外壳和托盘	0	0	0	0	0	0
电线	0	0	0	0	0	0
印刷电路板	X	0	0	0	0	0
打印系统	X	0	0	0	0	0
显示器	X	0	0	0	0	0
喷墨打印机墨盒	0	0	0	0	0	0
驱动光盘	X	0	0	0	0	0
扫描仪	X	0	0	0	0	0
网络配件	X	0	0	0	0	0
电池板	X	0	0	0	0	0
自动双面打印系统	0	0	0	0	0	0
外部电源	X	0	0	0	0	0

本表格依据 SJ/T 11364 的规定编制。

0：表示该有害物质在该部件所有均质材料中的含量均在 GB/T 26572 规定的限量要求以下。

X：表示该有害物质至少在该部件的某一均质材料中的含量超出 GB/T 26572 规定的限量要求。

此表中所有名称中含“X”的部件均符合欧盟 RoHS 立法。

注：环保使用期限的参考标识取决于产品正常工作的温度和湿度等条件。

## Restriction of hazardous substance (Ukraine)

### Технічний регламент щодо обмеження використання небезпечних речовин (Україна)

Обладнання відповідає вимогам Технічного регламенту щодо обмеження використання деяких небезпечних речовин в електричному та електронному обладнанні, затвердженого постановою Кабінету Міністрів України від 3 грудня 2008 № 1057

## Restriction of hazardous substance (India)

This product, as well as its related consumables and spares, complies with the reduction in hazardous substances provisions of the "India E-waste Rule 2016." It does not contain lead, mercury, hexavalent chromium, polybrominated biphenyls or polybrominated diphenyl ethers in concentrations exceeding 0.1

weight % and 0.01 weight % for cadmium, except where allowed pursuant to the exemptions set in Schedule 2 of the Rule.

## Restriction on hazardous substances statement (Turkey)

Türkiye Cumhuriyeti: EEE Yönetmeliğine Uygundur

## EPEAT

Most HP products are designed to meet EPEAT. EPEAT is a comprehensive environmental rating that helps identify greener electronics equipment. For more information on EPEAT go to [www.epeat.net](http://www.epeat.net). For information on HP's EPEAT registered products go to [www.hp.com/hpinfo/globalcitizenship/environment/pdf/epeat\\_printers.pdf](http://www.hp.com/hpinfo/globalcitizenship/environment/pdf/epeat_printers.pdf).

## SEPA Ecolabel User Information (China)

### 中国环境标识认证产品用户说明

噪声大于 63.0 dB(A) 的办公设备不宜放置于办公室内，请在独立的隔离区域使用。

如需长时间使用本产品或打印大量文件，请确保在通风良好的房间内使用。

如您需要确认本产品处于零能耗状态，请按下电源关闭按钮，并将插头从电源插座断开。

您可以使用再生纸，以减少资源耗费。

## China Energy Label for Printer, Fax and Copier

### 复印机、打印机和传真机能源效率标识实施规则

依据“复印机、打印机和传真机能源效率标识实施规则”，该打印机具有中国能效标识。标识上显示的能效等级和操作模式值根据“复印机、打印机和传真机能效限定值及能效等级”标准（“GB 21521”）来确定和计算。

#### 1. 能效等级

产品能效等级分 3 级，其中 1 级能效最高。能效限定值根据产品类型和打印速度由标准确定。能效等级则根据基本功耗水平以及网络接口和内存等附加组件和功能的功率因子之和来计算。

#### 2. 能效信息

##### 喷墨打印机

- 操作模式功率

睡眠状态的能耗按照 GB 21521 的标准来衡量和计算。该数据以瓦特 (W) 表示。

- 待机功率

待机状态是产品连接到电网电源上功率最低的状态。该状态可以延续无限长时间，且使用者无法改变此状态下产品的功率。对于“成像设备”产品，“待机”状态通常相当于“关闭”状态，但也可能相当于“准备”状态或者“睡眠”状态。该数据以瓦特 (W) 表示。

- 睡眠状态预设延迟时间

出厂前由制造商设置的时间决定了该产品在完成主功能后进入低耗模式（例如睡眠、自动关机）的时间。该数据以分钟表示。

- 附加功能功率因子之和

网络接口和内存等附加功能的功率因子之和。该数据以瓦特 (W) 表示。

标识上显示的能耗数据是根据典型配置测量得出的数据，此类配置包含登记备案的打印机依据复印机、打印机和传真机能源效率标识实施规则所选的所有配置。因此，该特定产品型号的实际能耗可能与标识上显示的数据有所不同。

要了解规范的更多详情，请参考最新版的 GB 21521 标准。



---

# Index

## A

- audio system
  - audio control panel 35
  - pair and connect 35
  - print and audio 35
  - reconnect 35
  - respond to call 35

## B

- buttons, control panel 5

## C

- carriage
  - clear carriage jams 80
- control panel
  - buttons 5
  - features 5
  - status icons 5
- customer support
  - warranty 102

## E

- embedded web server
  - opening 73
- environment
  - Environmental product stewardship program 113
  - environmental specifications 105

## J

- jams
  - clear 78

## M

- multi-feeds, troubleshoot 81

## N

- network connection
  - wireless connection 62

## networks

- view and print settings 9

## O

- operating systems supported 105

## P

- paper
  - clear jams 78
  - HP, order 16
  - skewed pages 81
  - troubleshoot feeding 81
- paper-feed problems, troubleshoot 81
- power
  - troubleshoot 95
- print
  - specifications 106
  - troubleshoot 95
- printer software (Windows)
  - opening 18

## R

- recycle
  - ink cartridges 114
- regulatory notices 107
  - regulatory model identification number 107
  - wireless statements 111

## S

- skew, troubleshoot
  - print 81
- specifications
  - system requirements 105
- status icons 5
- system requirements 105

## T

- technical information
  - environmental specifications 105
  - print specifications 106
- trays
  - clear paper jams 78
  - troubleshoot feeding 81
- troubleshoot
  - audio system 100
  - HP Smart 94
  - multiple pages are picked 81
  - paper not picked up from tray 81
  - paper-feed problems 81
  - power 95
  - print 95
  - skewed pages 81

## V

- view
  - network settings 9

## W

- warranty 102
- Windows
  - system requirements 105

