

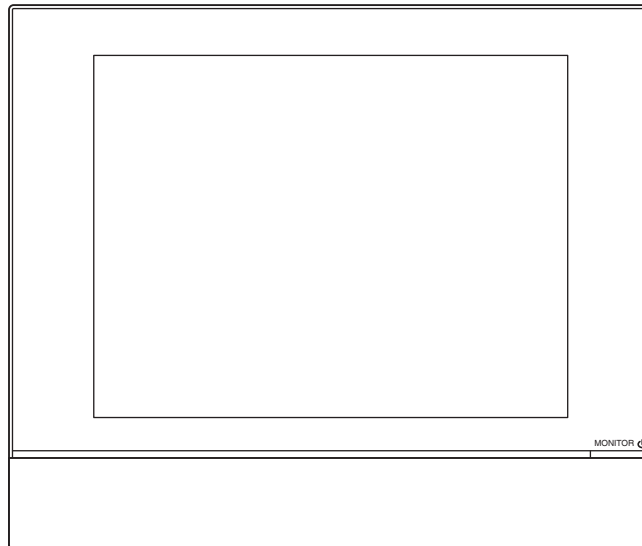

intelligent **Manager**

Model

DCM601A71
DCM601A72
DCM601A73
DCM002A71
DCM008A71



Disclosure

To the User in USA

Part 15 of FCC

Note: This equipment has been tested and found to comply with the limits for a Class B digital device, pursuant to part 15 of the FCC Rules. These limits are designed to provide reasonable protection against harmful interference in a residential installation. This equipment generates, uses and can radiate radio frequency energy and, if not installed and used in accordance with the instructions, may cause harmful interference to radio communications. However, there is no guarantee that interference will not occur in a particular installation. If this equipment does cause harmful interference to radio or television reception, which can be determined by turning the equipment off and on, the user is encouraged to try to correct the interference by one or more of the following measures:

- Reorient or relocate the receiving antenna.
- Increase the separation between the equipment and receiver.
- Connect the equipment into an outlet on a circuit different from that to which the receiver is connected.
- Consult the dealer or an experienced radio/TV technician for help.

FCC CAUTION

Changes or modifications not expressly approved by the party responsible for compliance could void the user's authority to operate the equipment.

To the User in CANADA

Canadian ICES-003

This Class B digital apparatus complies with Canadian ICES-003.
Cet appareil numérique de la classe B est conforme à la norme NMB-003 du Canada.



Safety Considerations

Read these **SAFETY CONSIDERATIONS** carefully before operating the controller.





Train the customer to operate and maintain the controller.





Inform customers that they should store this User's Manual with the Installation Manual for future reference.

Meanings of **WARNING**, **CAUTION** and **NOTE** Symbols:





 WARNING	Indicates a potentially hazardous situation which, if not avoided, could result in death or serious injury.
 CAUTION	Indicates a potentially hazardous situation which, if not avoided, may result in minor or moderate injury. It may also be used to alert against unsafe practices.
 NOTE	Indicates situation that may result in equipment or property-damage only accidents.

• The following pictograms are used in this manual.



	Never do.		Always follow the instructions given.
	Keep wet hands away.		Keep water and moisture away.

 WARNING	
	<ul style="list-style-type: none"> • Do not modify or repair the controller. Consult your Daikin dealer for any modification or for repairs.
	<ul style="list-style-type: none"> • Do not relocate or reinstall the controller by yourself. Improper installation may result in electric shocks or fire. Consult your Daikin dealer to relocate or for any reinstallation.
	<ul style="list-style-type: none"> • Do not use flammable materials (e.g., hairspray or insecticide) near the controller. Do not clean the product with organic solvents such as paint thinner. The use of organic solvents may cause cracking, damaging the product, causing electric shocks, or fire.
	<ul style="list-style-type: none"> • Consult the dealer if the controller was submerged under water due to a natural disaster, such as a flood or hurricane. Do not operate the controller if it was submerged under water or a malfunction, electric shock, or fire can occur.

CAUTION

	<ul style="list-style-type: none">• Never disassemble the controller. Touching the interior parts may result in electric shocks or fire. Consult your Daikin dealer for internal inspections and adjustments.
	<ul style="list-style-type: none">• Do not allow children to play with the controller to avoid causing damage to the product.
	<ul style="list-style-type: none">• Do not touch the controller buttons with wet fingers. Touching the buttons with wet fingers can cause an electric shock.
	<ul style="list-style-type: none">• Do not wash the controller. Doing so may cause electric leakage and result in electric shocks or fire.
	<ul style="list-style-type: none">• Never let the controller to get wet. Water can cause damage to the controller, and may cause an electric shock or fire.

NOTE

	<ul style="list-style-type: none">• Never press the button of the controller with a hard, pointed object. The controller may be damaged.
	<ul style="list-style-type: none">• Never pull or twist the electric wire of the controller. It may cause the unit to malfunction.
	<ul style="list-style-type: none">• Do not wipe the controller operation panel with benzine, thinner, chemical dustcloth, etc. The panel may get discolored or the coating peeled off. If it is heavily dirty, soak a cloth in water-diluted neutral detergent, squeeze it well and wipe the panel clean. And wipe it with another dry cloth.

Contents

Safety Considerations	2
System Overview	8
1. About the iTM (intelligent Touch Manager)	8
1-1 Main Features.....	8
1-2 System Configuration	9
1-3 What is a Management Point/Area?	10
• What is a management point?	10
• What is an area?.....	10
1-4 Touch Panel Operation Method	12
1-5 Dialog Operation.....	16
• Text /Password input dialog operation	16
• Time input dialog operation.....	19
• Numerical input dialog operation	20
Quick Reference	22
2. Simple Operations	22
2-1 Displaying the List of Areas and Management Points	22
2-2 Displaying Areas and Management Points	22
2-3 Starting/Stopping Areas and Management Points.....	23
2-4 Setting up the Operation Mode for an Indoor Unit	24
2-5 Setting up the Setpoint, Fan Speed, and Airflow Direction for an Indoor Unit	25
2-6 Enabling/Disabling Remote Controller.....	27
2-7 Setting up the Operation Mode and Ventilation Amount for Ventilator	28
2-8 Performing Operations with the Menu List Screen	28
• Checking the schedule.....	29
• Checking settings such as Area Name, Detailed Info., and Icon	30
• Checking settings such as Mgmt. Point Name, Detailed Info., and Icon	30
• Setting up the time	31
• Checking the history	32
Names and Functions	33
3. Names and Functions of Each Part	33
3-1 Front Panel and Side View.....	33

4. Detailed Screen Description	35
4-1 Setup Screen Structure	35
4-2 Standard View (Icon) Screen	37
• Detailed Setup Screen	40
• Detailed Information Screen	46
4-3 Standard View (List) Screen	47
4-4 Layout View (Optional) Screen	50
4-5 Menu List Screen.....	52
• Automatic Ctrl. Tab	52
• System Settings Tab	54
• Operation Mgmt. Tab.....	56
• Energy Navigator Tab.....	57
4-6 Information Screen	58
• Legend Tab	58
• Contact Tab.....	60
 Using Standard Functions.....	 61
5. Setting up the Automatic Control.....	61
5-1 Setting up a Schedule.....	61
• Setting up a schedule program	61
• Detailed screen and button descriptions.....	72
5-2 Setting up the Timer Extension Function.....	97
5-3 Setting up the Auto Changeover.....	99
• Creating and editing an Auto Changeover group.....	101
• Setting up the changeover conditions.....	103
• Applying the Auto Changeover function.....	105
5-4 Checking an Emergency Stop	107
 6. System Settings	 109
6-1 Setting up an Area.....	109
• Creating and deleting an area.....	109
• Moving an area	113
• Registering a management point or area to an area	114
• Naming and setting up the detailed information of an area	117
• Setting up the interval for sequential start/stop.....	118
• Setting up icons	119
• Saving and loading the area data CSV file	120
6-2 Setting up a Management Point	121

6-3	Setting up and Changing the Password.....	123
6-4	Setting up Maintenance and Checking.....	125
6-5	Setting up and Changing the Locale.....	126
6-6	Setting up and Changing the Time	128
6-7	Setting up and Changing the Screensaver	129
6-8	Setting up and Changing the Hardware Settings.....	130
6-9	Setting up and Changing the Confirm Operation.....	131
6-10	Calibrating the Touch Panel	132
6-11	Backing up	133
6-12	Viewing the Version Information.....	134
7.	Data Management	135
7-1	Checking and Outputting History.....	135
7-2	Outputting Function Settings	137
	Operating Optional Functions.....	147
8.	Setting up Automatic Control Functions	147
8-1	Setting up the Setback.....	147
8-2	Setting up the Interlocking Control.....	153
	• Interlocking Control Restrictions	156
	• Setting up an interlocking program	158
	• Detailed screen and button descriptions.....	166
8-3	Setting up the Emergency Stop.....	188
	• Releasing the Emergency Stop	191
8-4	Setting up the Temperature Limit.....	192
8-5	Setting up the Sliding Temperature Function	197
8-6	Setting up the Heating Mode Optimization Function	203
9.	System Settings	205
9-1	Network Settings	205
9-2	Web Access Settings and Remote Management	208
	• Registering Web users.....	209
	• Logging in/out to/from a PC	212
	• Web Remote Management Screen.....	213
9-3	Setting up the E-Mail Error Report	216
	• Setting up the Mail Server.....	216
	• Setting up the recipient E-mail address and sending an E-mail	219

Operating Optional Maker Functions	223
10. Power Proportional Distribution	223
10-1 Power Proportional Distribution Function	223
• Setting up the data collection period.....	223
• Collecting data and outputting the Power Proportional Distribution results	224
11. Energy Navigator.....	226
11-1 Energy Navigator Function	226
• Energy Budget/Actual Management.....	229
• Equipment operation management (Deviation from the operation plan).....	249
• Data output function.....	265
iTM integrator Explanation	273
12. iTM integrator.....	273
12-1 iTM integrator	273
• Detailed screen and button descriptions.....	274
• Cautions when using the iTM integrator	282
Maintenance.....	286
13. Maintenance.....	286
13-1 Resetting the Filter Sign	286
13-2 Maintaining the LCD display	287
Useful Information.....	288
14. Troubleshooting.....	288
14-1 Before Having the Product Serviced	288
14-2 Turning ON/OFF the Internal Battery.....	299
14-3 Error Information Function.....	300
15. Hardware Specifications.....	302
15-1 iTM Hardware Specifications.....	302
15-2 Peripheral Equipment Specifications	303
15-3 Copyright and Trademarks.....	303
Appendix	304

System Overview

1. About the iTM (intelligent Touch Manager)

1-1 Main Features

- iTM is an advanced central controller operated by using a 10.4" touch panel. It allows you to easily monitor as well as operate air conditioners and generic equipment connected to the iTM from the touch panel.
- One iTM can monitor and control a maximum of 64 groups of indoor units (128 units), including Ventilator. The iTM can be expanded with up to seven iTM plus adaptors, which similarly to the iTM, can connect a maximum of 64 groups of indoor units (128 units); that is, with one iTM you can control and monitor a maximum of 512 groups of indoor units (1024 units).

A group of indoor units refers to the following:

(1) One indoor unit without remote controller

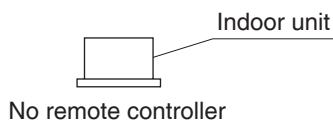

(2) One indoor unit controlled with one or two remote controllers

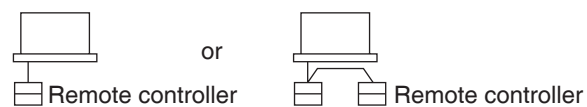

(3) Up to 16 indoor units controlled as group with one or two remote controllers

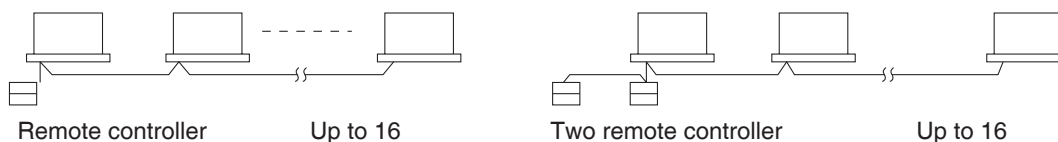

- The iTM allows you to define privileges for Users and Managers, so that you can set up and manage them according to their respective privileges. Furthermore, by connecting the iTM with computers in a LAN, you can set up Web Remote Management and allow a maximum of 4 managers and 16 users to simultaneously access the iTM, and if a connection to the Internet is available, then, you can monitor and operate the iTM remotely, via the Internet.
- The iTM allows you to schedule the operation of each air conditioner in detail.
You can set up an annual schedule by setting up a schedule by the day of the week and defining Special Days such as extra holidays.
Changes by the season are achieved by setting up a validity period to programs.
- By using optional functions, you can display the floor plan of individual buildings and the like as background on the iTM monitoring screen, and monitor and operate by viewing the actual layout of the air conditioners.
- You can use Interlocking Control to start/stop air conditioners in conjunction with other equipment or Setback function to save energy.
- You can use Power Proportional Distribution function (option software) to distribute the electric bill among tenants or the Energy Navigator function (option software) to manage the energy consumption systematically.
- By connecting a USB memory to the iTM, you can output billing data, budget/actual energy consumption data, function settings, history data, etc. to a CSV file.

NOTE

- Periodical data saving is recommended in order to prevent loss of your important data due to an accidental problem.

1-2 System Configuration

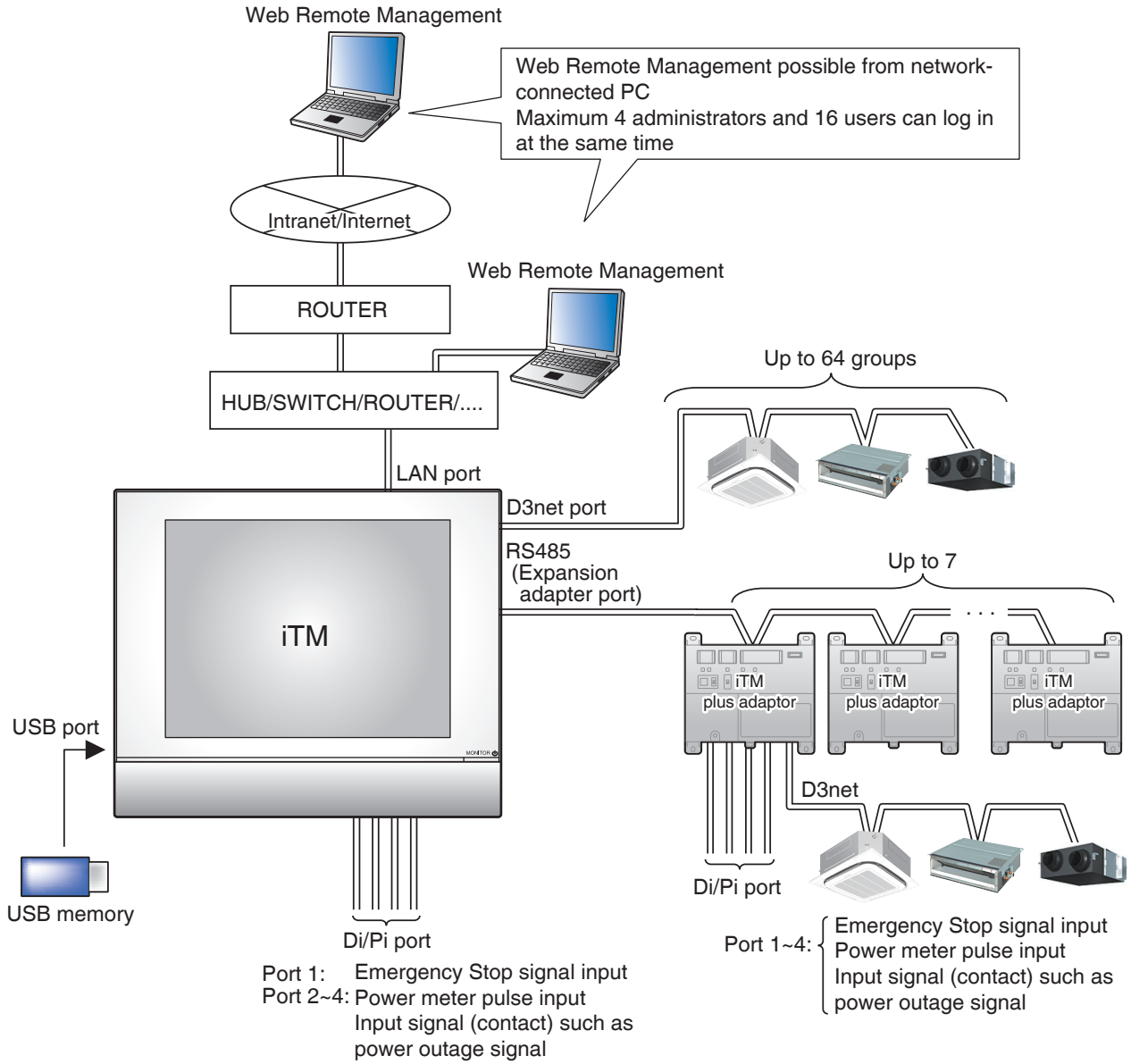

1-3 What is a Management Point/Area?

What is a management point?

A management point is the target equipment monitored and operated using the iTM.

The types of management points that can be controlled by iTM are as follows:

Indoor, Ventilator, Dio, Analog, Pulse, and Outdoor, Chiller

What is an area?

An area is a hierarchical group into which management points, monitored and operated by the iTM, are classified. You can populate an area with member areas and management points. An All area, to which you cannot manually register or delete members from, is provided by default.

Maximum number of areas that can be created: 650 (All excluded)

Example: All Area Area ● Management point

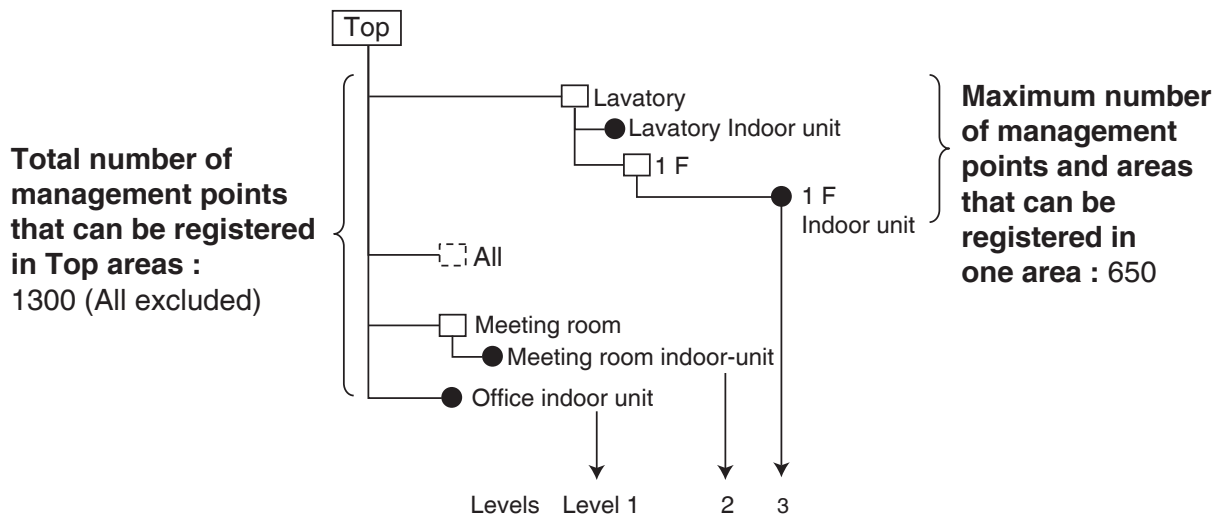

Maximum number of hierarchal levels that can be created: 10 levels

NOTE

Registered management points are automatically registered in the folder for the corresponding management point type set up under All.

You can register a management point in two or more areas. However, you cannot register the same management point two or more times in one area. You cannot register the same area in two or more areas either.

Example: Area ● Management point

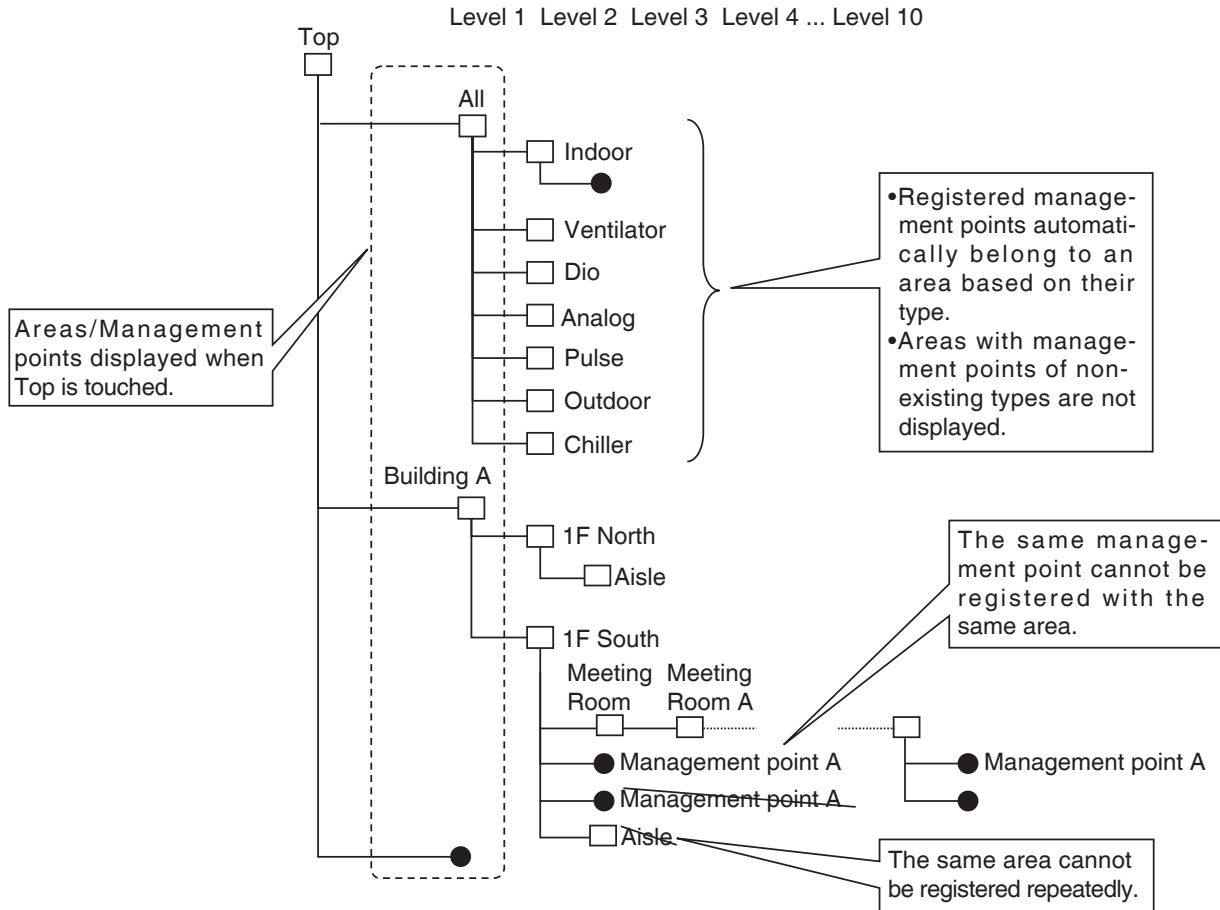

1-4 Touch Panel Operation Method

Operation is possible by touching the panel with your fingers or a touch pen. Be sure not to use sharp edged items as this could damage the touch screen permanently.

<Standard View (Icon) Screen>

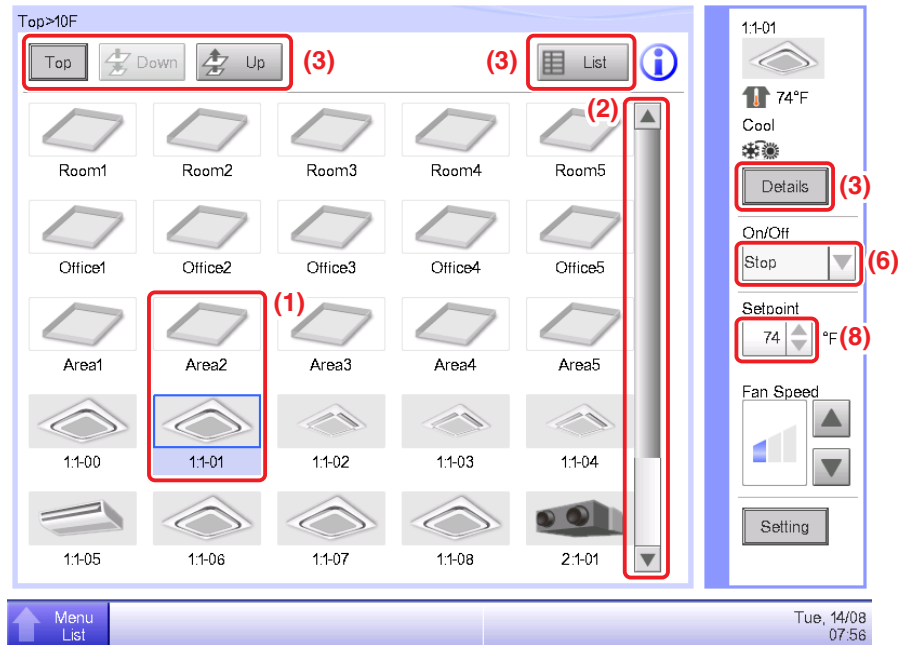

<Detailed Setup dialog>

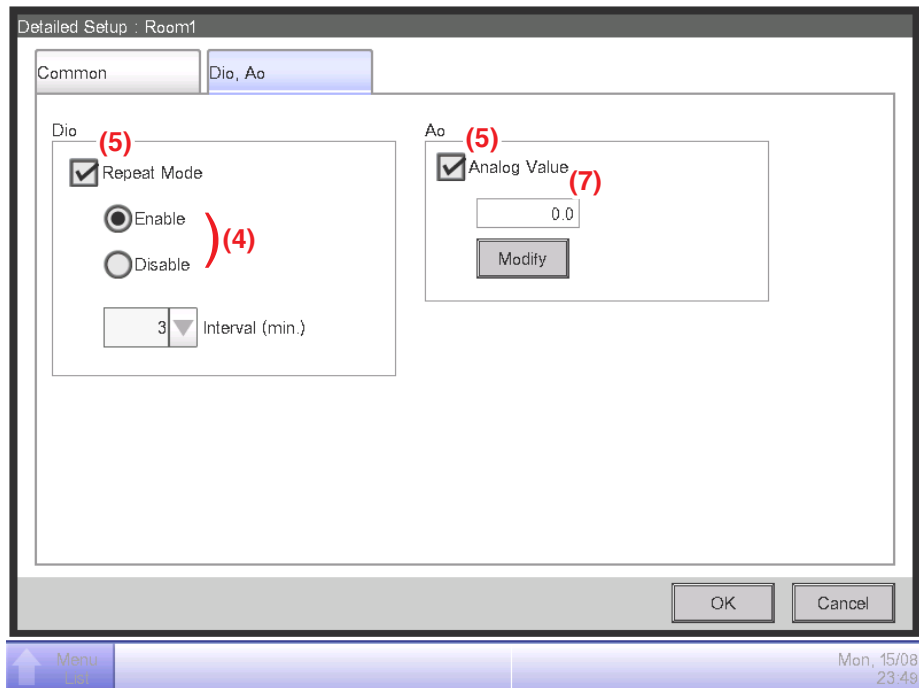

The following describes how the text on each component, displayed on screen, looks like in normal state, when it is selected (it has been touched), or is grayed out. (* For components not shown in the Standard view above, see the respective detailed description page.)

(1) Icon of centrally monitored management point/area

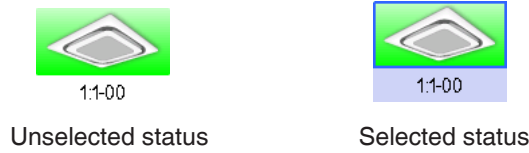

(2) List, scroll bars, and sorting

Type	Name	M...
Indoor	1.1-00	Off
Indoor	1.1-01	Off
Indoor	1.1-02	Off
Indoor	1.1-03	Off
Indoor	1.1-04	Off
Indoor	1.1-05	Off

List image

- Scroll bars appear when there are hidden lines and columns.
- To display hidden lines and columns, press ▲▼, or slide the scroll bars.
- To display truncated column text, slide the column separation.
- When sorting is enabled, touch the header to sort the column according to the sequence shown in the figure below

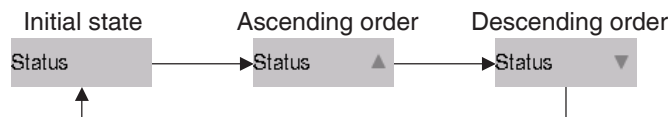

(3) Button

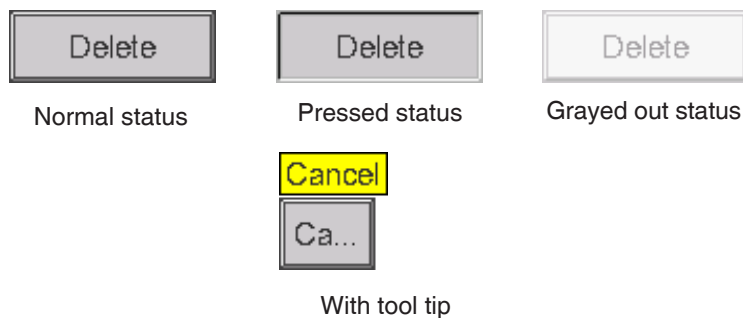

NOTE

- Components such as buttons and check boxes are grayed out when not all the conditions for operating the particular function/option for the management point/area are satisfied. Operation, such as touch and select a grayed out component, is not possible.
- “...” is displayed on buttons and the like when the label text is truncated due to space availability.
To display the label text completely, touch the component for a while. A tool tip with the complete text will appear.

(4) Radio button



(5) Check box

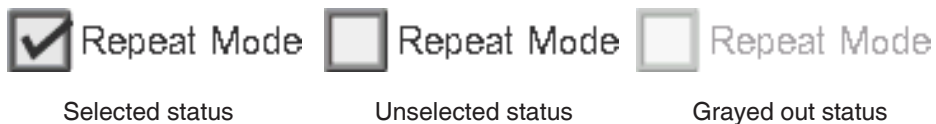

(6) Combo box

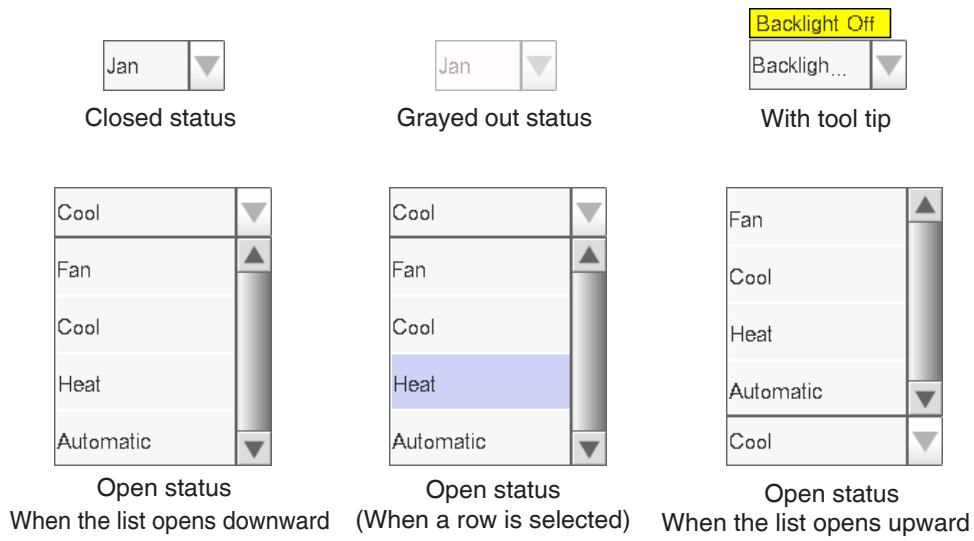

(7) Text box

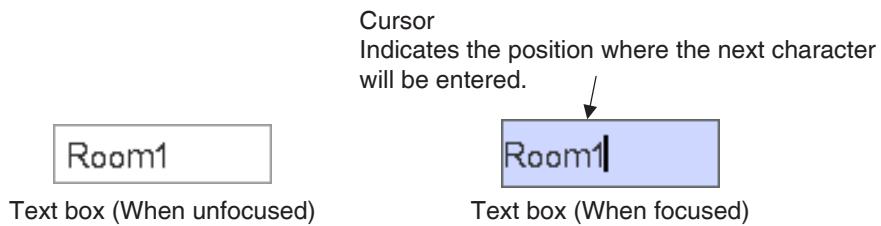

(8) Spin box

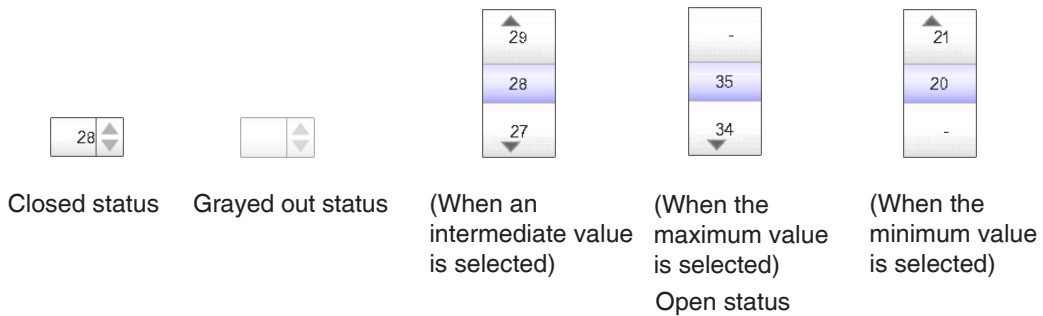

1-5 Dialog Operation

Text /Password input dialog operation

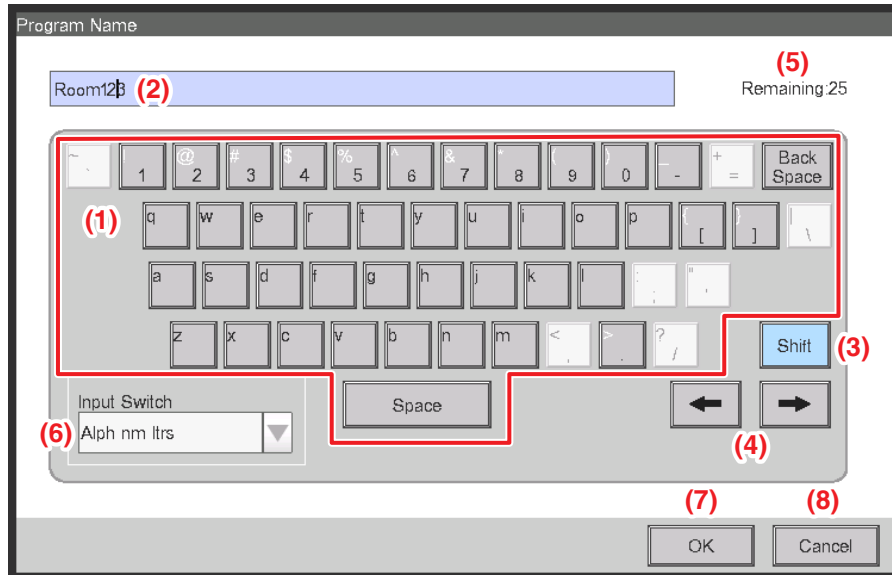

(1) Character key buttons

Key buttons for entering characters.

(2) Input area text box

Displays the entered characters. For the Password input dialog, it displays asterisks (*).

(3) Shift key toggle button

Toggles between upper and lower case.

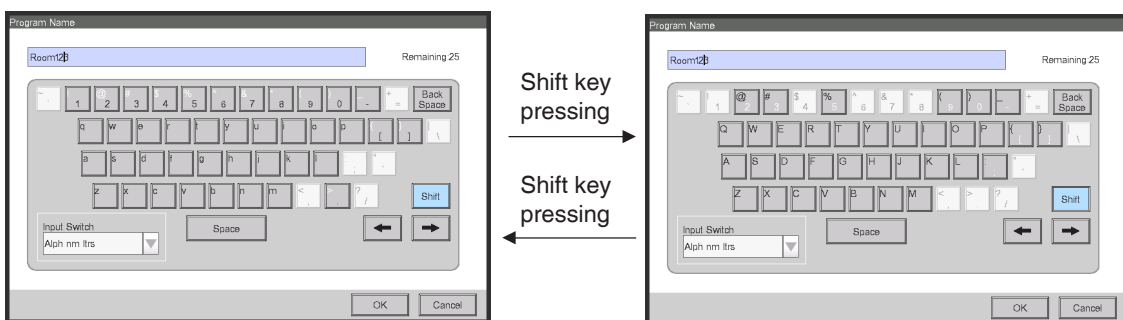

(4) Right and left arrow buttons

Moves right and left the cursor in the input area text box.

(5) Character input range label

Displays three types of information regarding the number of characters that can be entered.

Remaining: Indicates the difference between the number of characters entered and the maximum permitted by the function

Exceeded: Indicates the number of characters entered in excess from the maximum permitted

Missing: Indicates the number of characters still necessary to comply with the minimum required

(6) Keyboard switch combo box

Toggles the keyboard between Special and Alph nm ltrs.

Special: Sets the keyboard to special keyboard

Alph nm ltrs: Sets the keyboard to alphanumeric keyboard

Not displayed for the Password input dialog.

To toggle between upper and lower case, use the Shift key.

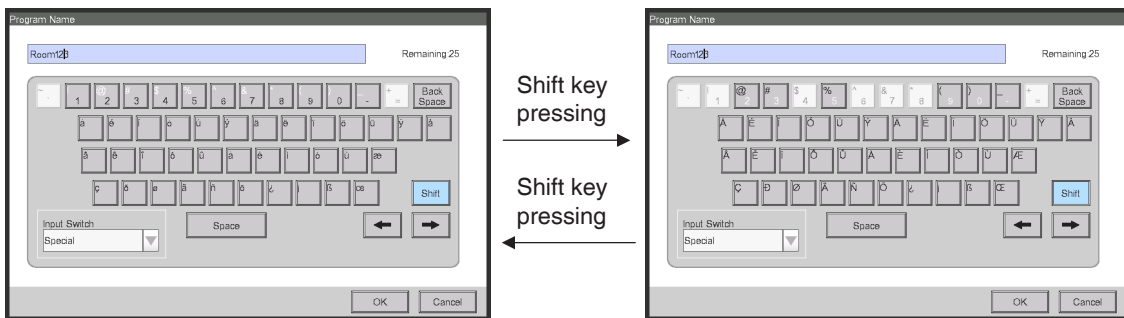

(7) OK button

Touching this button commits the input.

(8) Cancel button

Touching this button cancels the edit and closes the screen.

NOTE

- Grayed out characters are unavailable for input.
- When Chinese, Japanese or Korean is set as the iTM display language, a button to display the input list appears. Touch the button to display a list of frequently used words and select the word to input. Select a word and commit the selection by pressing the OK button. The selected word is displayed in the input area text box. Not displayed for the Password input dialog.



Time input dialog operation

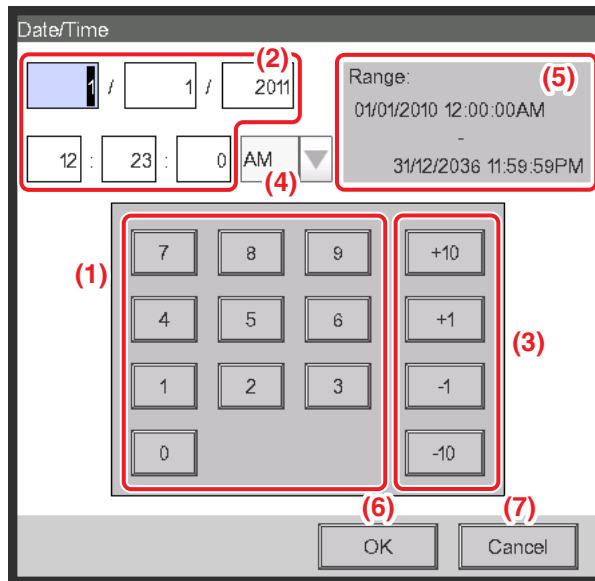

(1) Number key button

Key buttons for entering numeric values.

(2) Input area text box

Displays the entered numeric values. Touch the text box and enter the required numeric value. The input area text box changes the display pattern among “year month day hour minute second”, “year month day”, and “hour minute” depending on the entered data.

(3) Up/Down button

Increases or decreases the numeric value selected in the input area text box (2) by +1, +10, -1, or -10.

(4) AM/PM setting combo box

Specifies whether the time is AM or PM when time is indicated using 12-hour clock. This combo box is not displayed when 24-hour clock is set in the System Settings.

(5) Input range label

Displays the range of values that can be entered.

(6) OK button

Touching this button commits the input.

(7) Cancel button

Touching this button cancels the edit and closes the screen.

Numerical input dialog operation

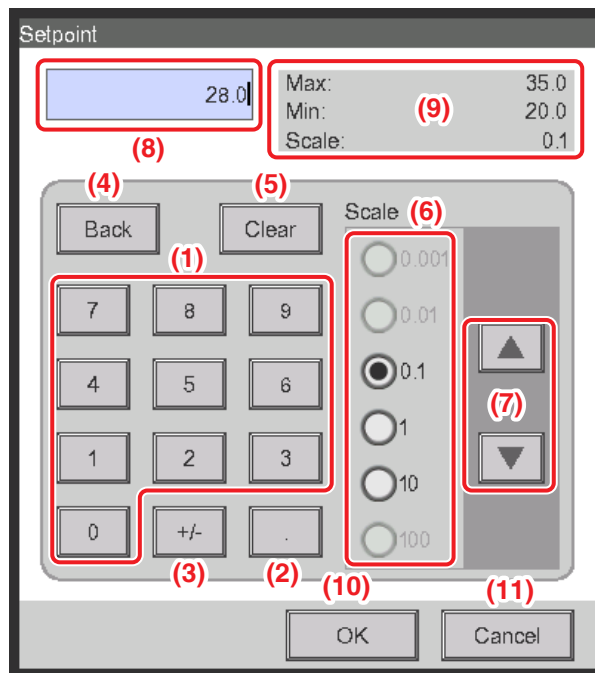

(1) Number key button

Key buttons for entering numeric values.

(2) Decimal point key button

Press this button to enter a decimal point.

(3) +/- key button

Press this button to change the sign of a numeric value. Adds a minus sign before a positive value while for a negative value, deletes the minus sign and makes the value positive.

(4) Back button

Deletes one digit at a time from the last number displayed in the input area text box.

(5) Clear button

Completely deletes the numeric value displayed in the input area text box.

(6) Up/Down step radio button

Specifies the step by which the Up/Down button increases/decreases when pressed. You can only select buttons with higher step values than the minimum step defined for the value to be input, see frame (9).

(7) Up/Down button

Increases or decreases the numeric value by the step specified in the Up/Down step radio button.

(8) Input area text box

Displays the entered numeric values. You can input up to 10 characters.

(9) Input range label

Displays the range of values that can be entered.

(10) OK button

Touching this button commits the input.

(11) Cancel button

Touching this button cancels the edit and closes the screen.

Quick Reference

2. Simple Operations

2-1 Displaying the List of Areas and Management Points

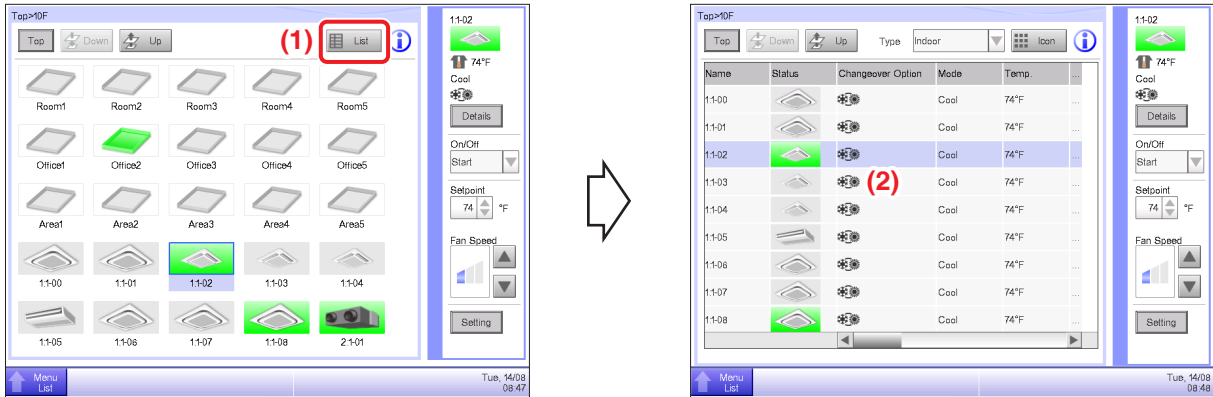

(1) Touch the **List** button.

(2) The List View screen with the area and indoor unit names, the operation mode, setpoint, and fan speed information appears.

(For detailed operation, see page 47.)

2-2 Displaying Areas and Management Points

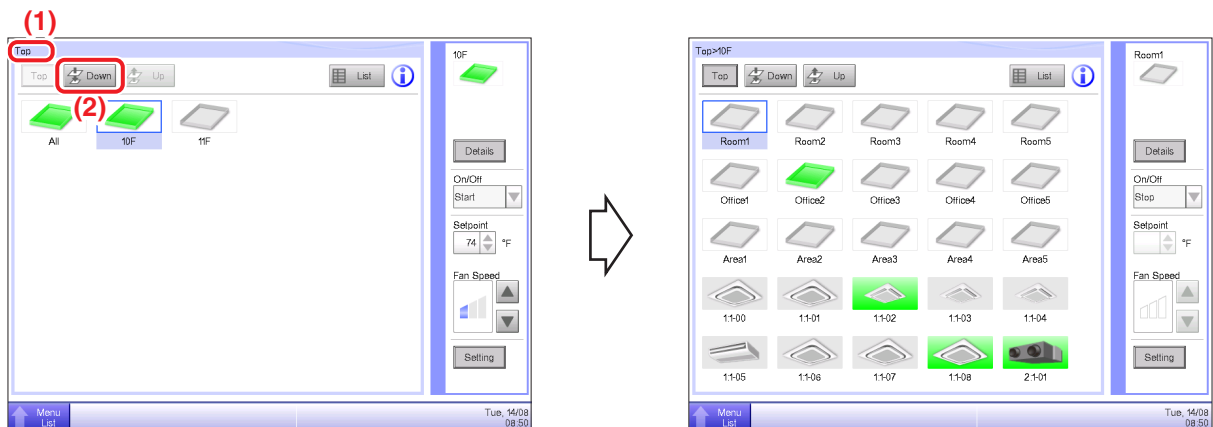

(1) Displays the hierarchical level of the current area and indoor unit.

(2) Touch the **Down** button to move into the selected area and display the areas and management points included there.

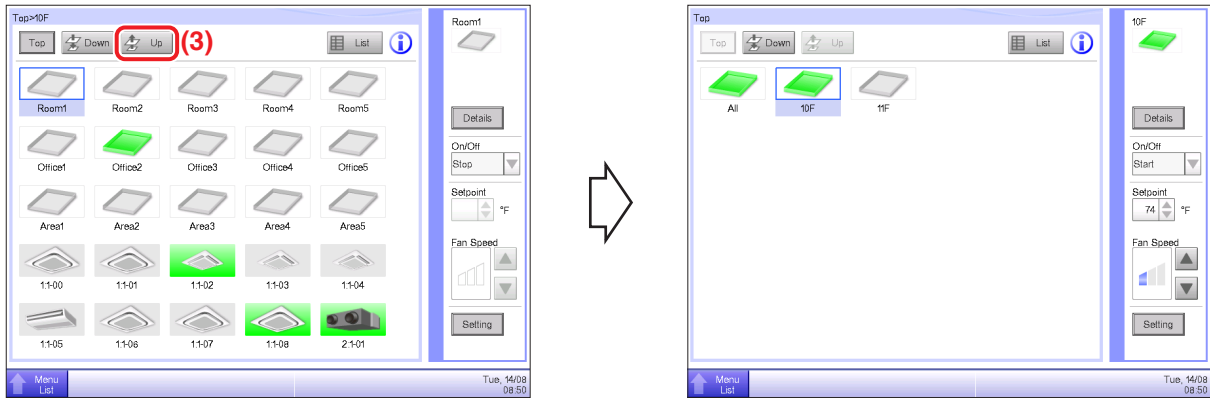

- (3) Touch the **Up** button to move one level up from the currently selected one.
 (For detailed operation, see page 37.)

2-3 Starting/Stopping Areas and Management Points

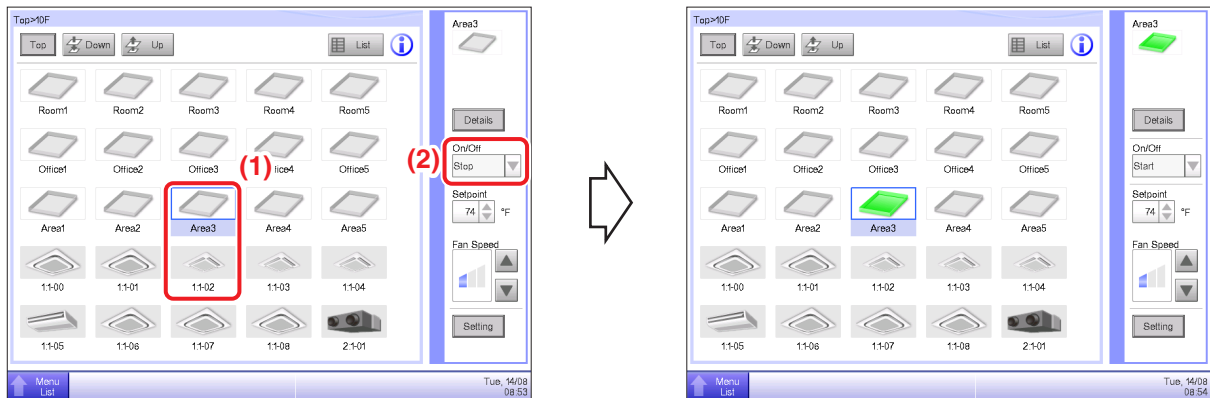

- (1) Select the area or management point you want to start or stop.
 (2) Selecting “Start” in the **On/Off** combo box starts the selected area or management point while selecting “Stop” stops the selected area or management point. The icon turns green or red (depending on the system settings) when the selected area or management point has been started while the icon turns gray when it is stopped.

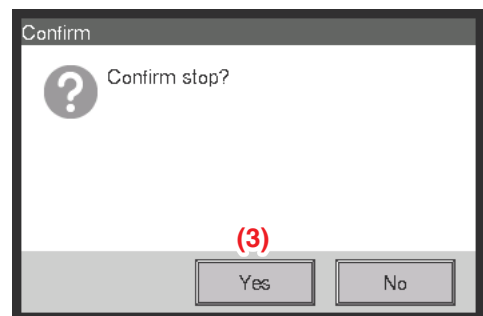
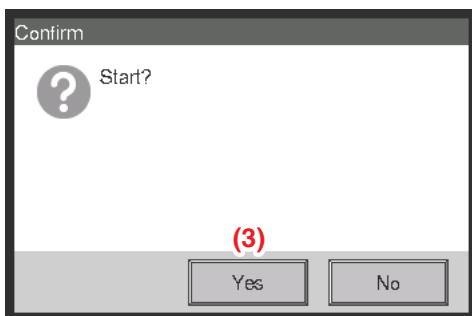

- (3) When Confirm is “enabled” in the system settings, a confirmation dialog appears accordingly. Press the **Yes** button to commit. (For detailed operation, see page 131.)

2-4 Setting up the Operation Mode for an Indoor Unit

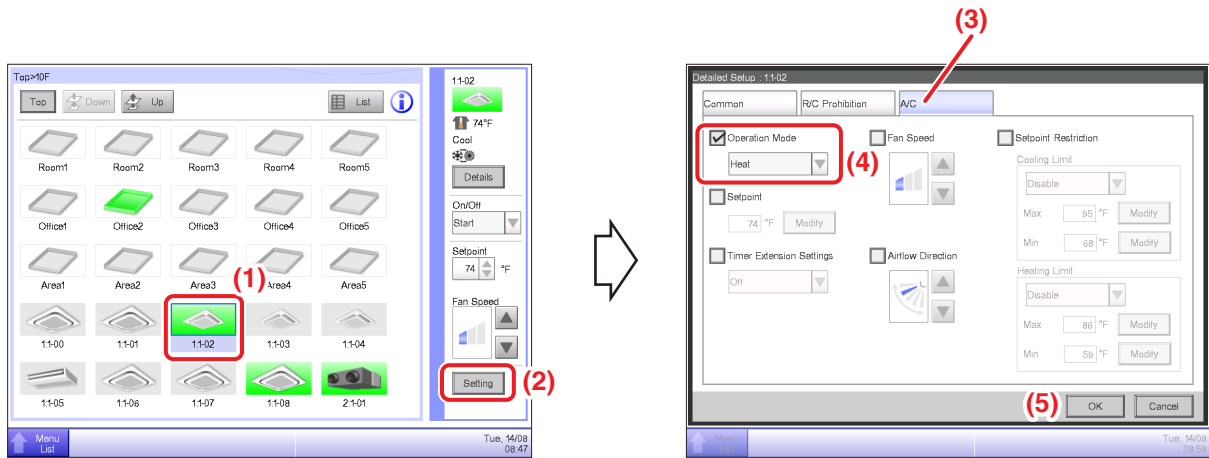

- (1) Select the indoor unit for which you want to set up the operation mode.
 - (2) Touch the **Setting** button and display the Detailed Setup screen.
 - (3) Select the **A/C** tab.
 - (4) Select the **Operation Mode** check box and select Fan, Cool, Heat, Dependent, Automatic, or Dry from the combo box.
 - (5) Touch the **OK** button to commit and close the screen.
- (For detailed operation, see page 42.)

2-5 Setting up the Setpoint, Fan Speed, and Airflow Direction for an Indoor Unit

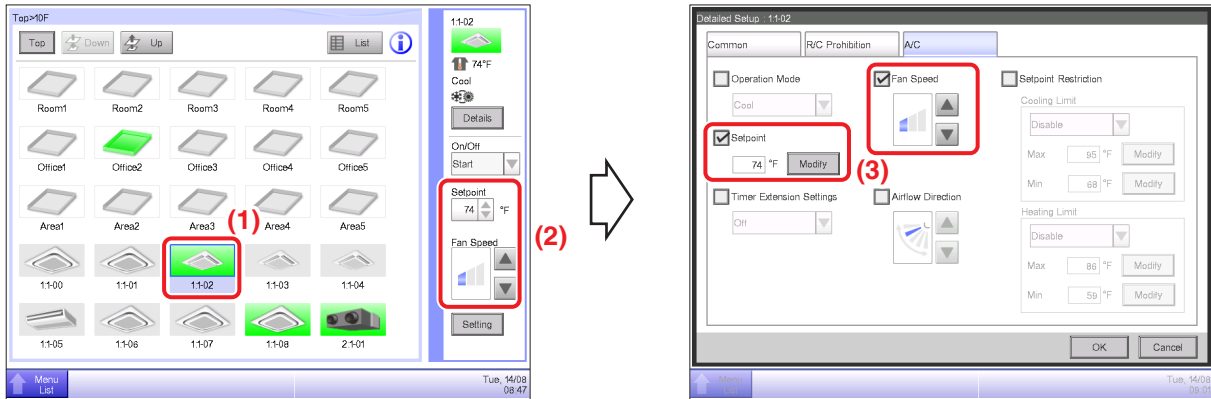

- (1) Select the indoor unit for which you want to set up the setpoint, fan speed, and airflow direction.
- (2) Set up the setpoint in the **Setpoint** spin box, and the **Fan Speed** using the ▲▼ buttons.



(Low)



(Middle)



(High)

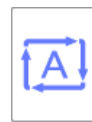

(Automatic)

NOTE

Available fan speed settings depend on the indoor unit.

- (3) You can also set up the setpoint and fan speed in the Detailed Setup screen. (For the operation to display the Detailed Setup screen, see (4) To set up the airflow direction.)

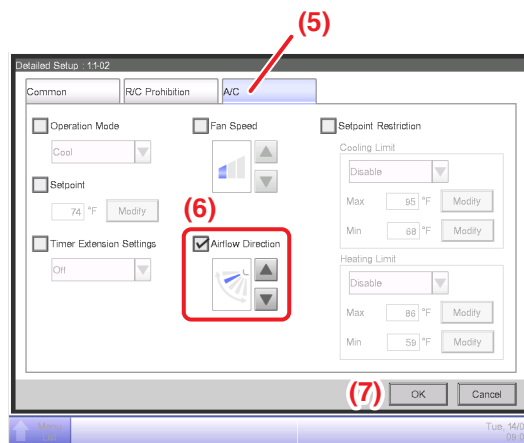
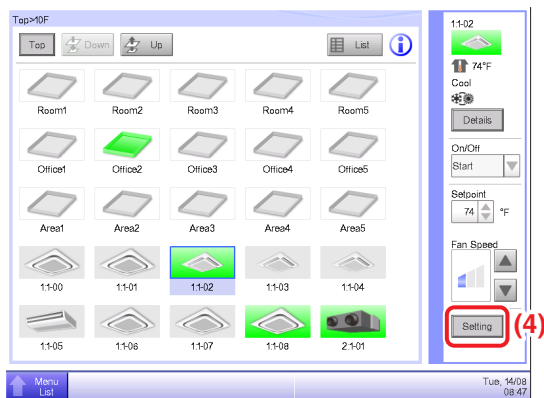

(4) To set up the airflow direction, touch the **Setting** button and display the Detailed Setup screen.

(5) Select the **A/C** tab.

(6) Select the **Airflow Direction** check box and set up the Airflow Direction using the ▲▼ buttons.



<Airflow direction 0> <Airflow direction 1> <Airflow direction 2> <Airflow direction 3> <Airflow direction 4> <Swing>

(7) Touch the **OK** button to commit and close the screen. (For detailed operation, see page 42.)

2-6 Enabling/Disabling Remote Controller

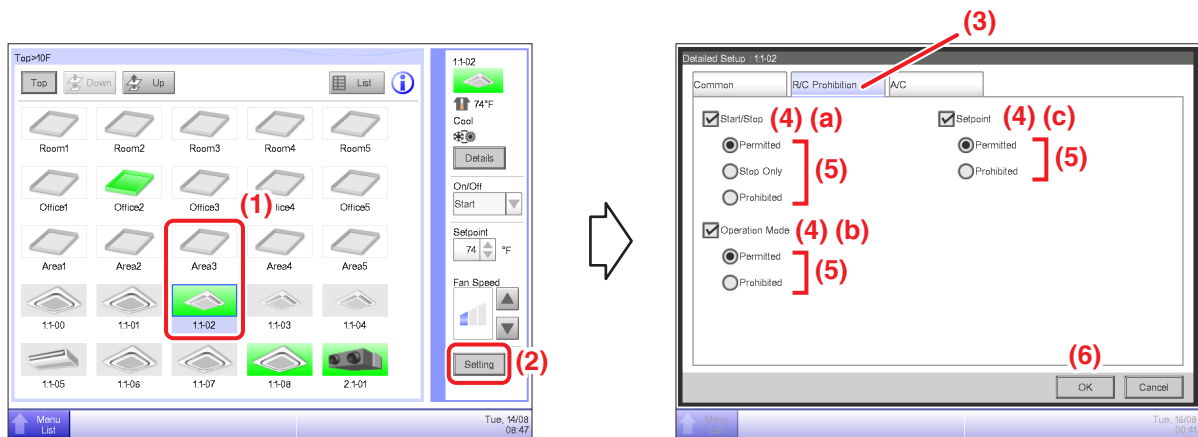

- (1) Select the area or management point for which you want enable/disable remote controller.
 - (2) Touch the **Setting** button and display the Detailed Setup screen.
 - (3) Select the **R/C Prohibition** tab.
 - (4) You can permit/prohibit the following remote controller operations: (a) start/stop, (b) set up the operation mode, and (c) set up the setpoint.
 - (5) Select the check box of the operation you want to set up and select its detail from the radio button.
 - (6) Touch the **OK** button to commit and close the screen.
- (For detailed operation, see page 41.)

2-7 Setting up the Operation Mode and Ventilation Amount for Ventilator

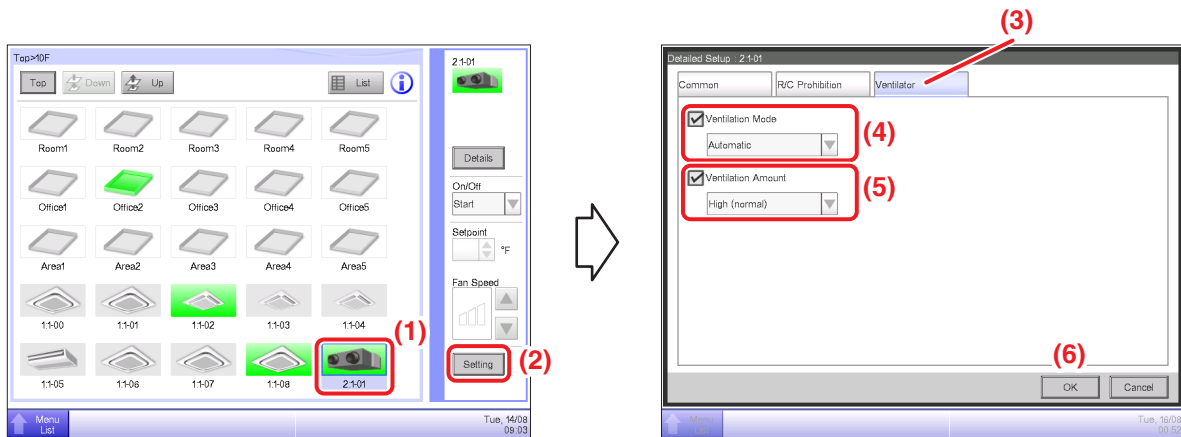

- (1) Select the Ventilator for which you want to set up the operation mode and ventilation amount.
 - (2) Touch the **Setting** button and display the Detailed Setup screen.
 - (3) Select the **Ventilator** tab.
 - (4) Select the check box for **Ventilation Mode** and select Automatic, ERVentilation, or Bypass from the combo box.
 - (5) Select the check box for **Ventilation Amount** and select Auto(normal), Low(normal), High(normal), Auto(fresh up), Low(fresh up), or High(fresh up) from the combo box.
 - (6) Touch the **OK** button to commit and close the screen.
- (For detailed operation, see page 44.)

2-8 Performing Operations with the Menu List Screen

The Menu List screen allows you to check schedules, set up areas/management points, set up the time, check history, etc.

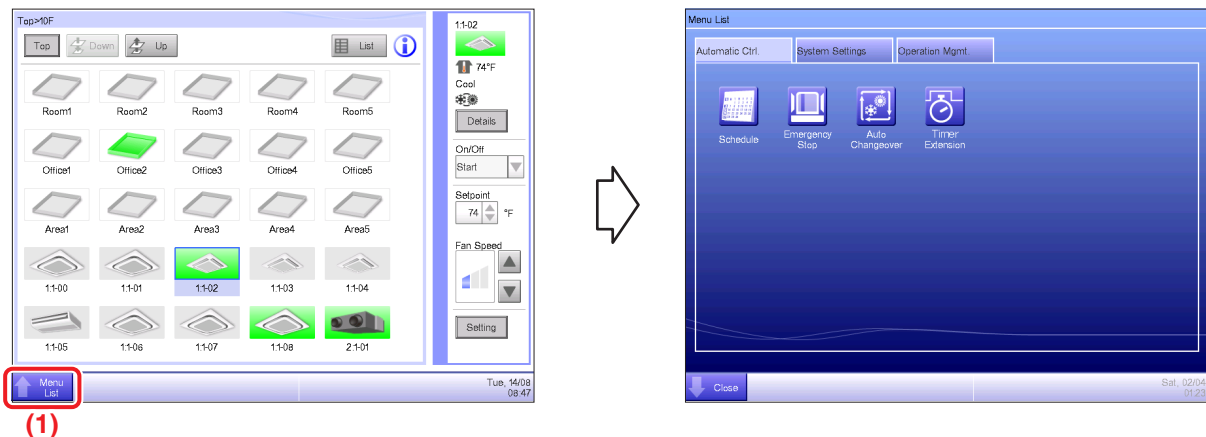

- (1) Touch the **Menu List** button and display the Menu List screen.
- (For detailed operation, see page 52.)

Checking the schedule

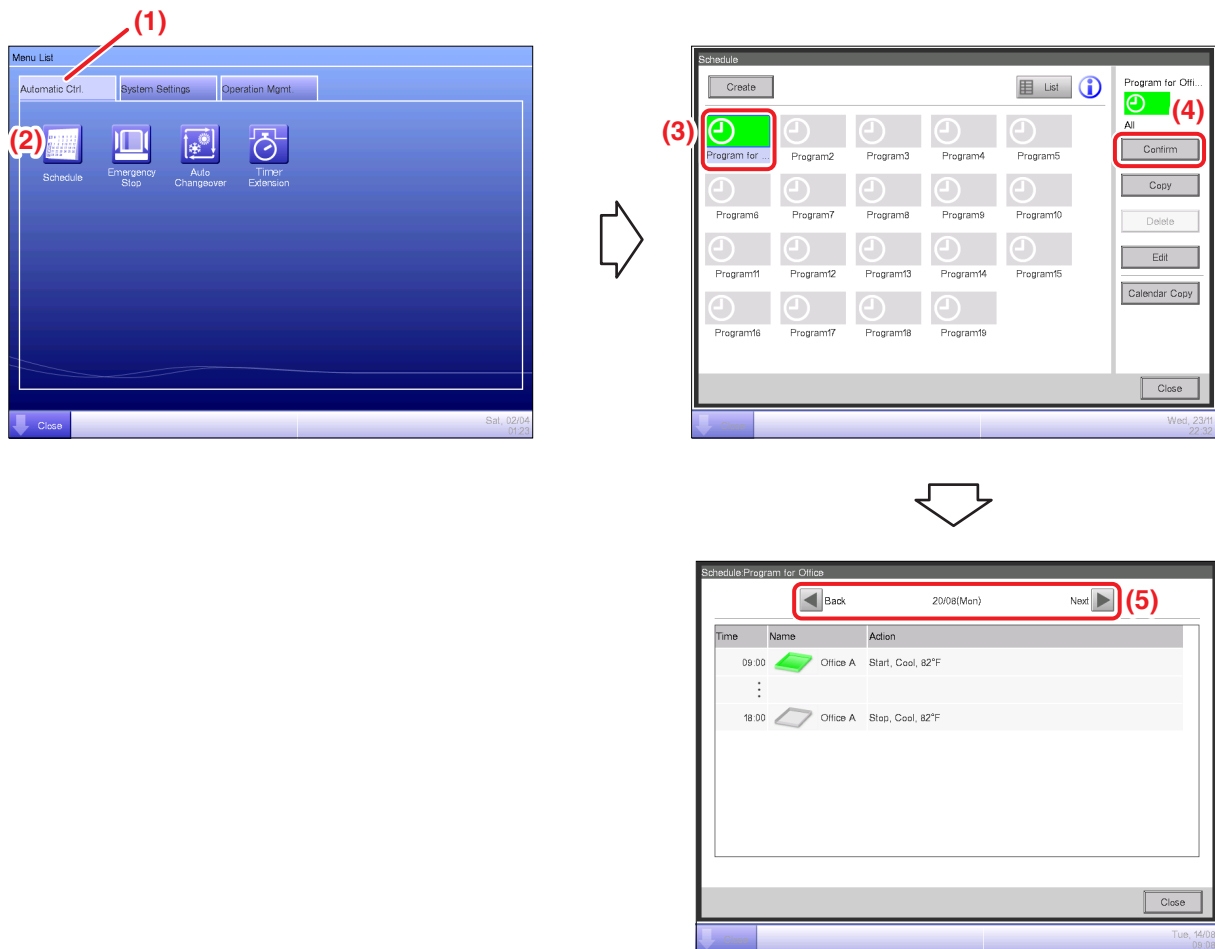

- (1) Select the **Automatic Ctrl.** tab on the Menu List screen.
 - (2) Touch the **Schedule** button and display the Schedule screen.
 - (3) Select the schedule program to check.
 - (4) Touch the **Confirm** button on the Schedule screen and display the Confirm screen.
 - (5) Select the date for which you want to check the schedule.
- (For detailed operation, see page 72.)

Checking settings such as Area Name, Detailed Info., and Icon

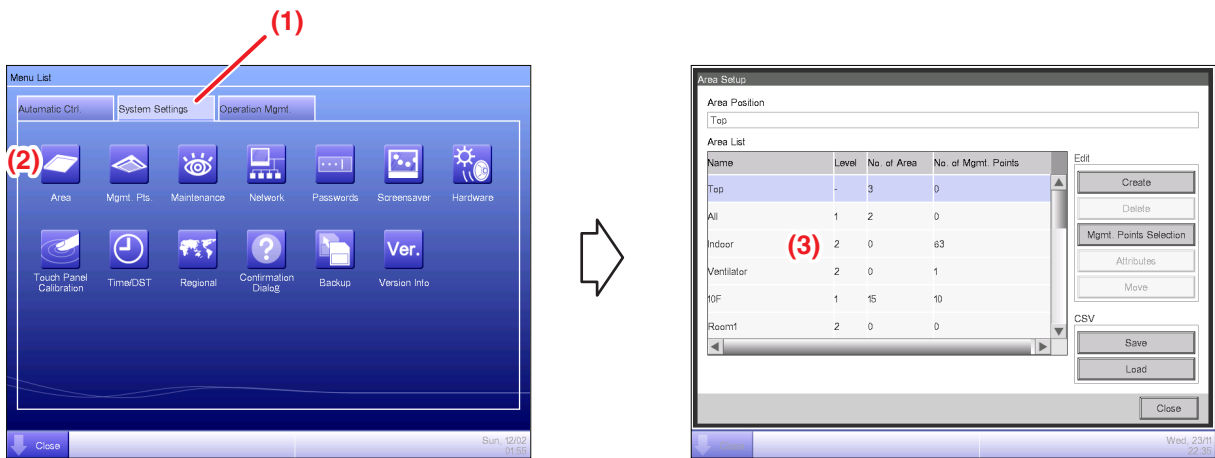

(1) Select the **System Settings** tab on the Menu List screen.

(2) Touch the **Area** button and display the Area Setup screen.

(3) Check settings in the Area List

(For detailed operation, see page 117.)

Checking settings such as Mgmt. Point Name, Detailed Info., and Icon

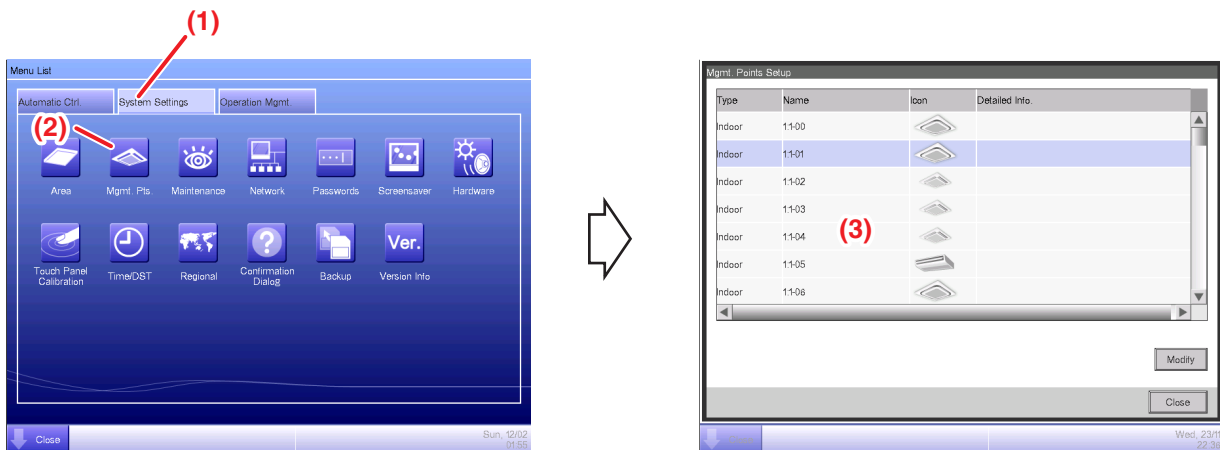

(1) Select the **System Settings** tab on the Menu List screen.

(2) Touch the **Mgmt. Pts.** button and display the Mgmt. Points Setup screen.

(3) Check settings in the Mgmt. member list.

(For detailed operation, see page 121.)

Setting up the time

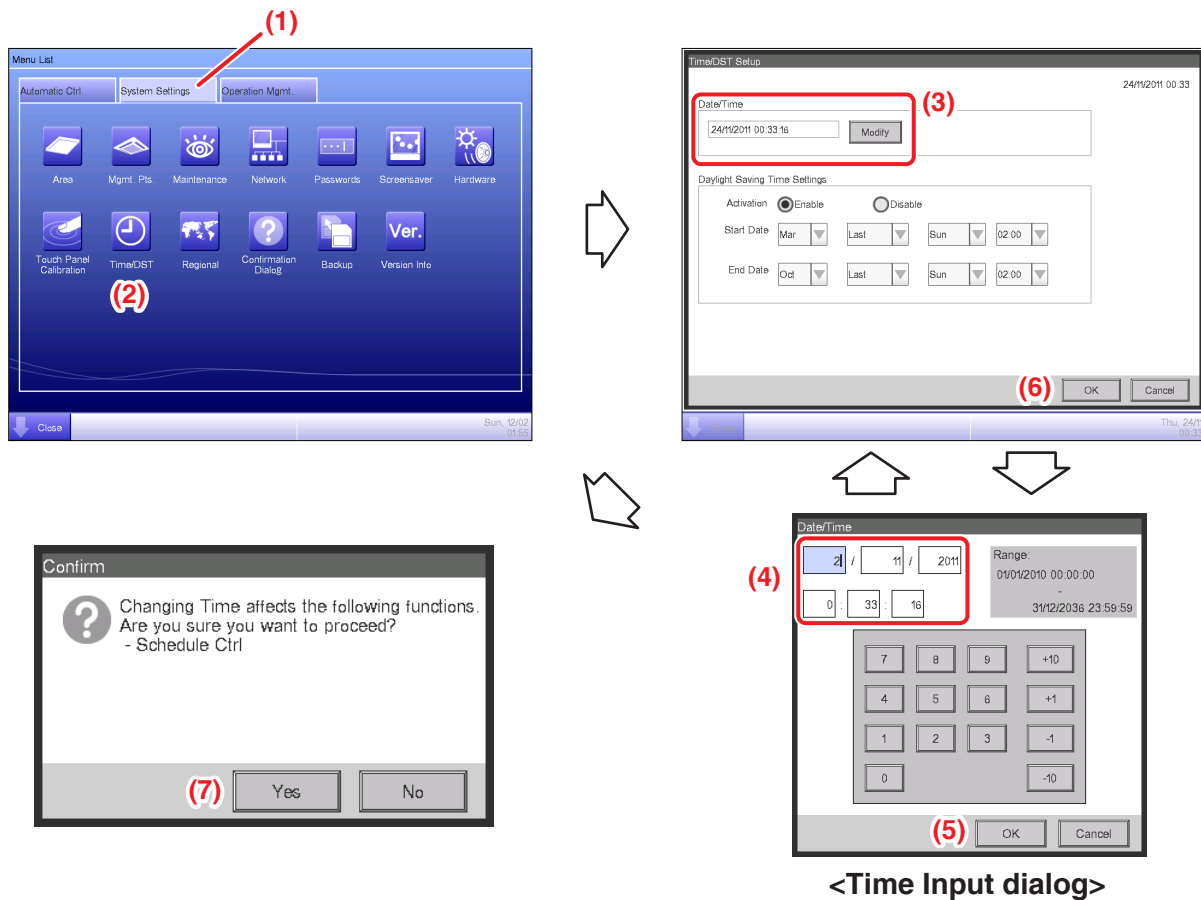

- (1)** Select the **System Settings** tab on the Menu List screen.
 - (2)** Touch the **Time/DST** button and display the Time/DST Setup screen.
 - (3)** On the screen, the current time is displayed. To change, touch the **Modify** button.
 - (4)** Enter the time in the Time Setup dialog that appears.
 - (5)** Touch the **OK** button.
 - (6)** Touch the **OK** button on the Time Setup dialog.
 - (7)** Touch the **Yes** button on the Confirm dialog that appears and close the screen.
- (For detailed operation, such as setting the daylight saving time, see page 128.)

Checking the history

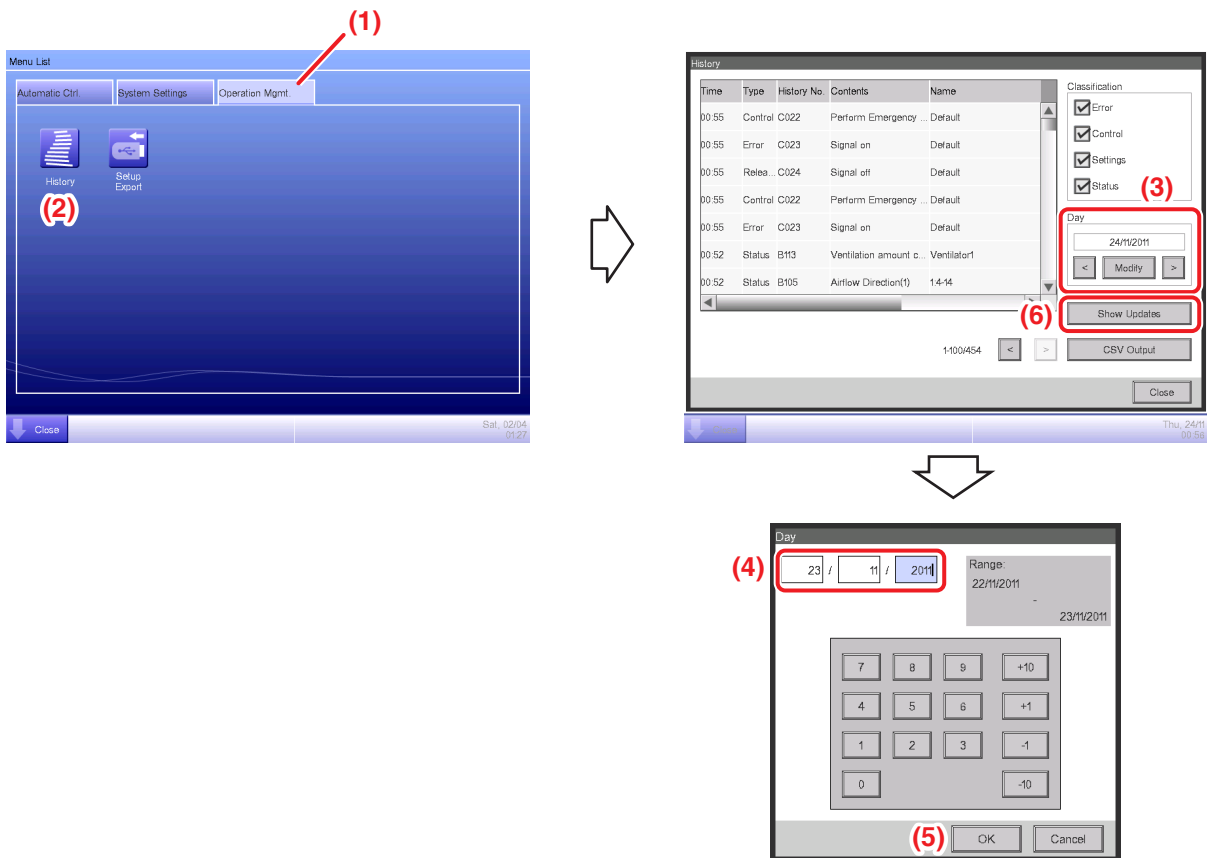

- (1) Select the **Operation Mgmt.** tab on the Menu List screen.
- (2) Touch the **History** button and display the History screen.
- (3) You can use the < and > buttons to specify the date for which you want to check the history. Alternatively, you can display the Time Setup dialog by touching the **Modify** button and specify the date there.
- (4) Enter the time in the Time Setup dialog.
- (5) Touch the **OK** button.
- (6) Touching the **Show Updates** button displays the list of setup execution dates and time.
(For detailed operation, such as outputting to CSV, see page 135.)

Names and Functions

3. Names and Functions of Each Part

3-1 Front Panel and Side View

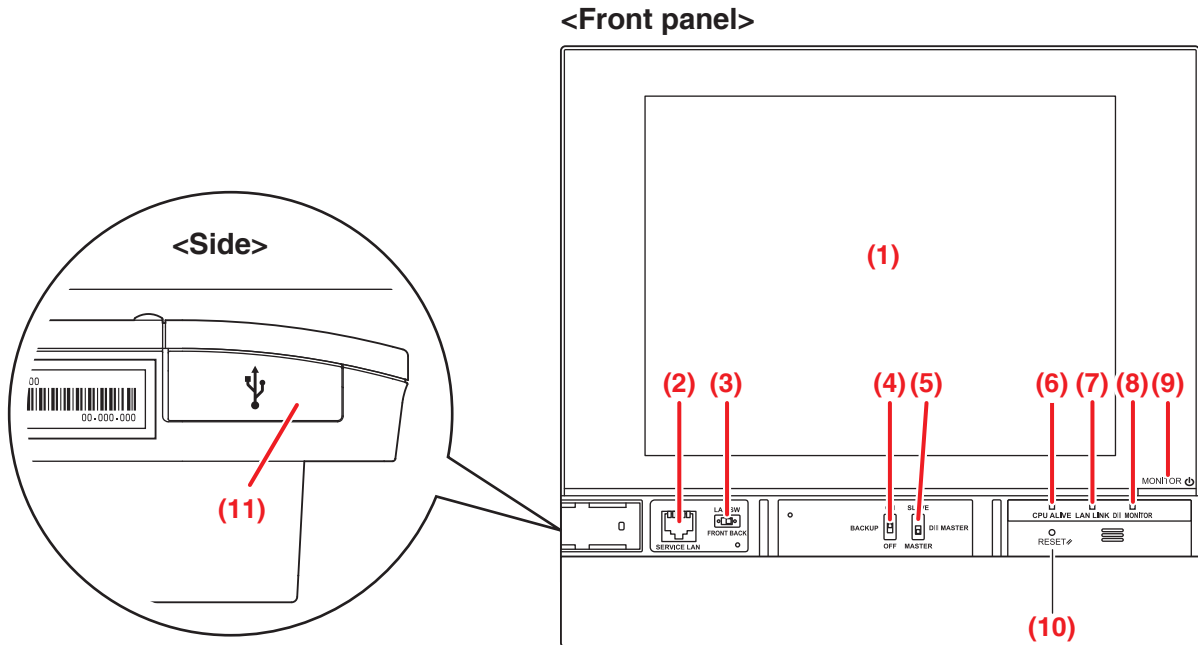

(1) MONITOR

LCD touch panel for monitoring and performing operations.

(2) SERVICE LAN

Socket for LAN connection. When using, (3) LAN SW must be set to FRONT.

(3) LAN SW

Switch for toggling between the LAN socket on the rear and (2) SERVICE LAN socket.

(4) BACKUP

Power ON/OFF switch for settings backup.

(5) DIII MASTER

Switch for setting up “MASTER” and “SLAVE”.

(6) CPU ALIVE (Green)

LED indicating the CPU operational status. The CPU is operating normally if this LED is flashing.

On: Installation error

Off: Hardware error

(7) LAN LINK (Green)

This LED is On when the LAN port is connected to a network. It indicates the LAN connection is operating correctly.

(8) DIII MONITOR (Yellow)

This LED flashes during DIII-NET transmissions.

(9) MONITOR key/LED (Orange/Green)

Switch for turning ON/OFF the monitor.

The LED color changes as follows each time the key is pressed.

Off: The power is turned off

On (Orange): The monitor is turned off

On (Green): The monitor is turned on

(10) RESET//

Restart switch.

(11) USB socket cover (side)

Socket for USB memory connection.

NOTE

Do not use the socket for any purpose other than connecting a USB memory.

4. Detailed Screen Description

4-1 Setup Screen Structure

Standard functions

Icon View	Displays the operational status of areas and indoor units.	(See page 37.)
List View	Displays the operational status of areas and indoor units as a list.	(See page 47.)
Menu List Screen	Displays the list of menu items.	(See page 52.)
Schedule	Sets up weekly and annual schedules.	(See page 61.)
Weekly Schedule	Sets up a weekly schedule for each day.	(See page 62.)
Annual Schedule	Sets up schedules for special days, such as extra holidays.	(See page 69.)
Timer Extension	Sets up the off-timer to prevent failure to turn off indoor units.	(See page 97.)
Auto Changeover	Sets up the automatic change between cool and heat modes.	(See page 99.)
Emergency Stop	Sets up the emergency stop at fire alarms.	(See page 107.)
Area Setup	Creates and sets up areas.	(See page 109.)
Mgmt. Pts. Setup	Creates and sets up management points.	(See page 121.)
Passwords	Sets up passwords, such as the administrator password.	(See page 123.)
Maintenance	Places indoor units under maintenance.	(See page 125.)
Regional	Changes the date format and unit of temperature to those appropriate for the locale.	(See page 126.)
Language	Sets the language to use.	(See page 126.)
Time/DST Setup	Sets the current time and the daylight saving time.	(See page 128.)
Screensaver	Sets up the screensaver.	(See page 129.)
Hardware	Sets up the luminance for the screen and volume for the touch sound.	(See page 130.)
Confirmation Dialog	Enables or disables the display of a confirmation dialog at start/stop.	(See page 131.)
Touch Panel Calibration	Corrects the contact points of the touch panel.	(See page 132.)
Backup	Function for backing up and restoring iTM data.	(See page 133.)
Version Information	Displays version information for the iTM.	(See page 134.)
History	Function for checking and exporting history, such as that of error occurrences.	(See page 135.)
Setup Export	Settings for exporting the entire setup information.	(See page 137.)

Optional functions

Icon View	Displays the operational status of areas and indoor units.	(See page 37.)
List View	Displays the operational status of areas and indoor units as a list.	(See page 47.)
Layout View	Displays the areas and operational statuses of indoor units on the relevant floor plan.	(See page 50.)
Menu List Screen	Displays the list of menu items.	(See page 52.)
Setback Setup	Function for keeping the indoor temperature within the setpoint and limit the energy consumption during absence.	(See page 147.)
Interlocking Control	Function for starting/stopping management points in conjunction with other equipment.	(See page 153.)
Emergency Stop	Sets up an arbitrary emergency stop program.	(See page 188.)
Temperature Limit	Function for keeping the room temperature within a certain range.	(See page 192.)
Sliding Temperature	Function for controlling the indoor unit's setpoint in accordance with the outdoor temperature.	(See page 197.)
Heating Mode Optimization	Function for automatically starting/stopping management points when operating in Heating mode for the purpose of preventing further temperature rise.	(See page 203.)
Network	Sets up the network IP address and the like.	(See page 205.)
Web Access Users	Sets up users of the Web Remote Management.	(See page 208.)
Setting of e-mail	Sets up e-mail transmission at error occurrence and the like.	(See page 216.)
Power Proportional Distribution	Function for distributing power to each tenant.	(See page 223.)
Energy Navigator	Function for managing the budget/actual energy consumption.	(See page 226.)

4-2 Standard View (Icon) Screen

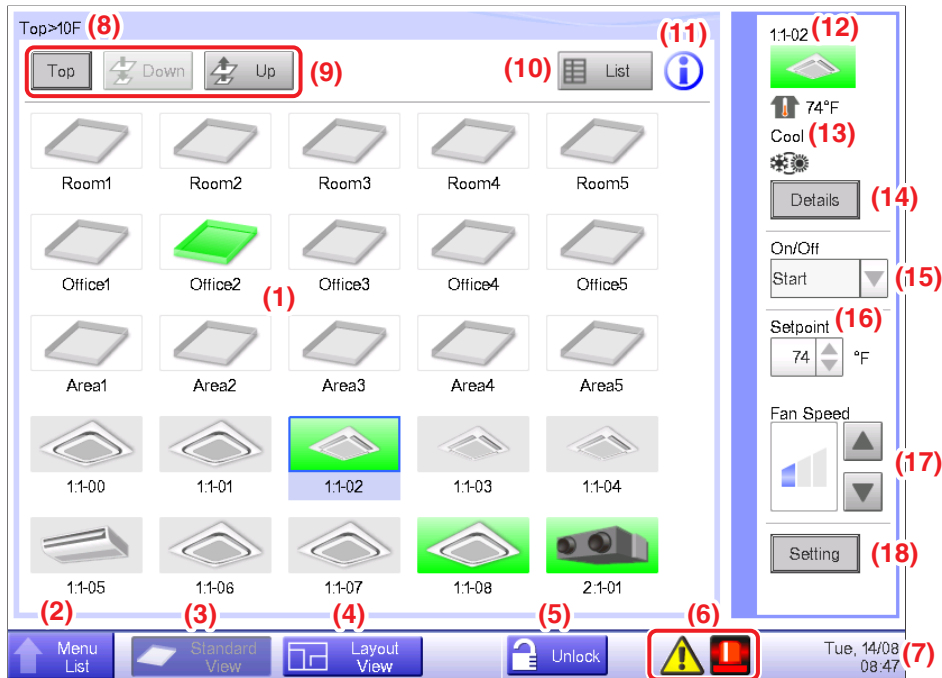

(1) Area/Management Point view area

Displays area and management point icons.

(2) Menu List switch button

Switches to the Menu List screen, which consists of Automatic Ctrl., System Settings, Operation Mgmt. and Energy Navigator (optional) tabs.

The button changes to Close while the Menu List screen is being displayed.

(3) Standard View switch button

Switches from the Layout View screen (optional) to the Standard View screen.

(4) Layout View switch button

Switches the screen to the Layout View screen (optional), which displays indoor units in a floor plan.

NOTE

Displayed only when the Layout View option is enabled.

(5) Lock/Unlock button

Locks/Unlocks the screen. The button is grayed out when the screen lock is disabled.

(6) Group monitoring icon

A Error detection Reports error when any of the following faults is detected.



(Red)

Flashing indicator: System error

Text: System error occurred. Touch this icon to check and restore.



(Yellow)

Flashing indicator: Unit/Limit Error

Text: Error occurred. Touch this icon to check.



(Blue)

Lit indicator: Communication error

B Emergency Stop Reports emergency stop.



Emergency Stop

Text: Emergency stop occurred. Touch this icon to release.



Waiting for Release

Text: Emergency stop occurred. Touch this icon to release.

*A balloon is displayed when the target unit entered into waiting for release status automatically, without the icon being touched even once. The balloon is not displayed if the target unit was put into waiting for release status manually, by touching the icon.



OFF

C Energy Save Displays the Energy Save status.



Enabled



Suspended



Under Control

(7) Time

Displays the current time.

(8) Area hierarchy indicator

Displays the hierarchical level of the currently displayed area.

(9) Top, Down, and Up buttons

Top button: Displays the area and management points at the Top.

Down button: Moves into the selected area and displays the areas and management points there.

Up button: Moves up one hierarchical level from that of the currently displayed area and displays the areas and management points there.

(10) List switch button

Toggles the Standard View screen between Icon View and List View.

(11) Information button

Displays the legend for an icon or contact information for inquiries regarding the system.

(12) Selected area/management point information indicator

Displays the name, icon, and filter sign of the selected area or management point.

(13) Room Temp/Operation Mode/Changeover Option indicator

Displays the room temperature and settings of the selected management point. Not displayed for areas.

NOTE

When the selected management point is in error, it displays the error code.

(14) Details button

Displays the Detailed Setup screen for the selected area or indoor unit.

(15) On/Off Combo box

Starts/Stops the selected area or management point.

NOTE

When the optional Setback function is enabled, it displays Start, SB Low, SB High, or Stop.

(16) Setpoint spin box

Sets up the temperature for the indoor unit of the selected area, or the selected indoor unit.

(17) Fan Speed button

Sets up the fan speed for the indoor unit of the selected area, or the selected indoor unit.

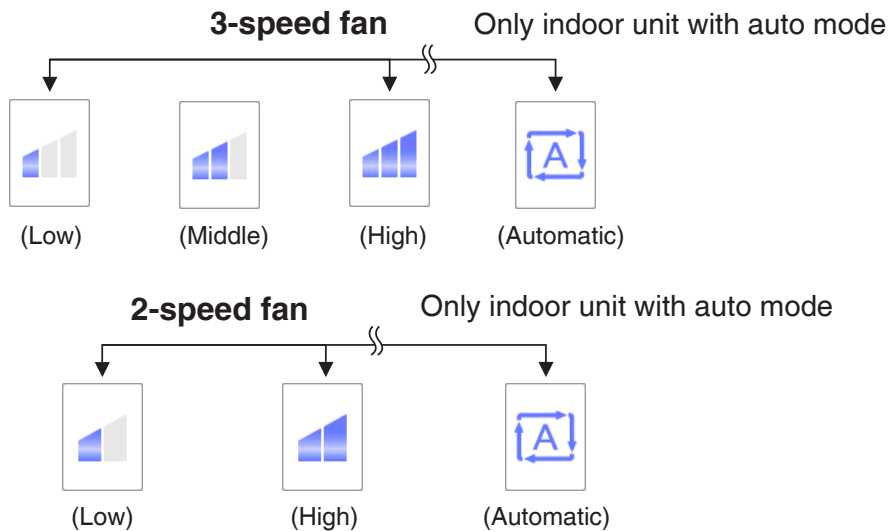

(18) Setting button

Displays the Detailed Setup screen for the selected area or management point.

Detailed Setup Screen

The Detailed Setup screen appears when you touch the **Setting** button (18) (see page 37 and page 47) on the Standard View screen. Necessary tab is displayed in accordance with the selected management points/areas. Set up the Common, R/C Prohibition, Ventilator, and Dio. Ao tabs as required. To change the settings on each tab, select the relevant check boxes. To commit the settings, touch the OK button.

For items for which manual setup is prohibited, you can only reset the filter sign.

• Common Tab

Sets up items common to the indoor unit, Ventilator, Dio and area.

Change settings by selecting the relevant check boxes.

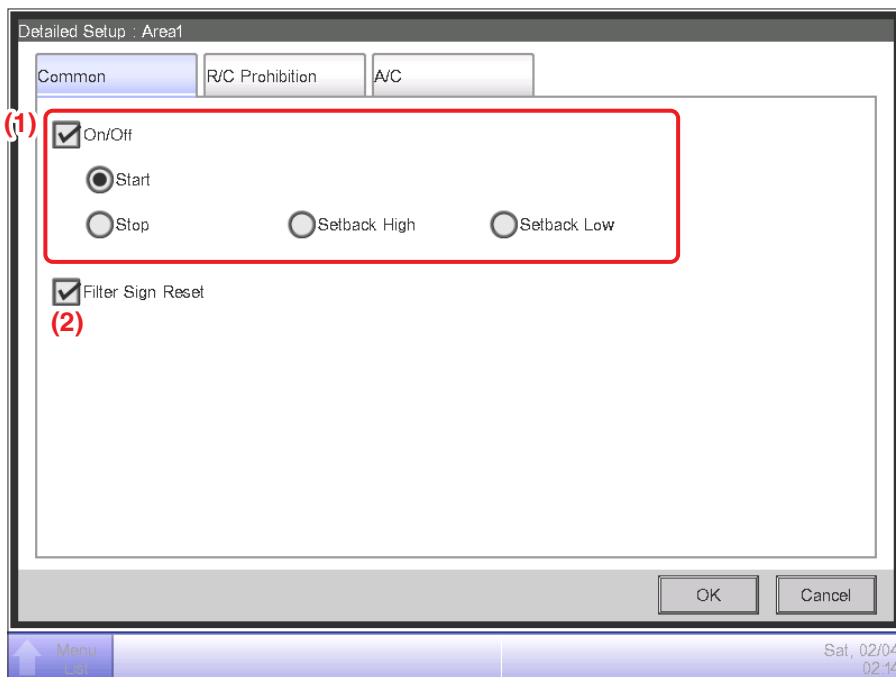

(1) On/Off

Starts/Stops the area or management point.

Furthermore, when the optional Setback function is enabled, you can set it up to High or Low.

(2) Filter Sign Reset

Resets the filter sign for the indoor unit.

Displayed only when there are filter signs.

- **R/C Prohibition Tab**

Enables/disables remote controller of the indoor unit, Ventilator and area.

Change settings by selecting the relevant check boxes.

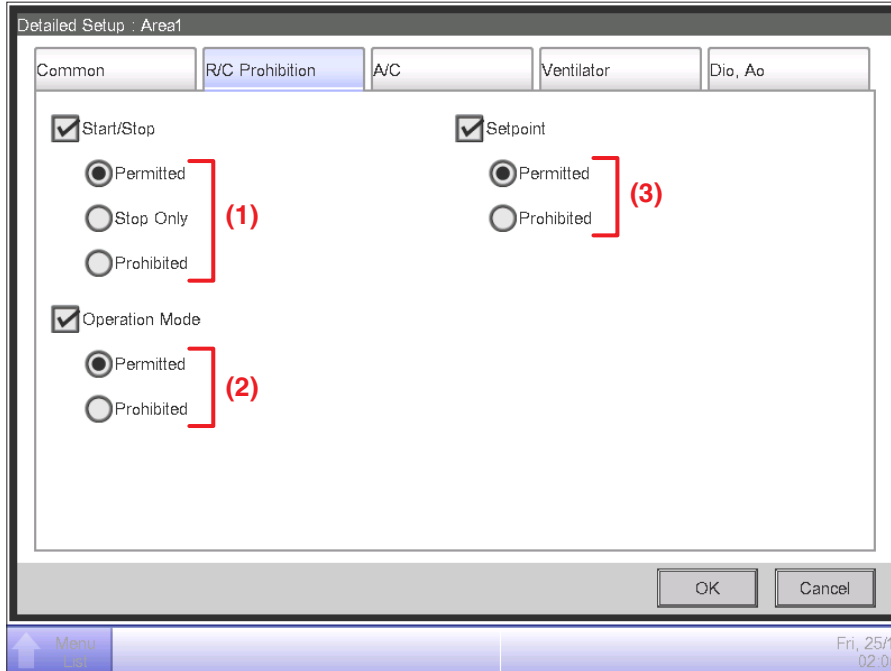

(1) Start/Stop

Sets up whether starting/stopping the management point from the remote controller will be enabled or disabled.

Permitted: Enabled.

Stop Only: Only stopping is enabled.

Prohibited: Disabled.

(2) Operation Mode

Sets up whether changing the operation mode from the remote controller will be enabled or disabled.

Permitted: Enabled.

Prohibited: Disabled.

(3) Setpoint

Sets up whether changing the management points' setpoint from the remote controller will be enabled or disabled.

Permitted: Enabled.

Prohibited: Disabled.

• **A/C Tab**

Sets up the indoor unit.

Change settings by selecting the relevant check boxes. The range of values and items you can set up will depend on the selected equipment.

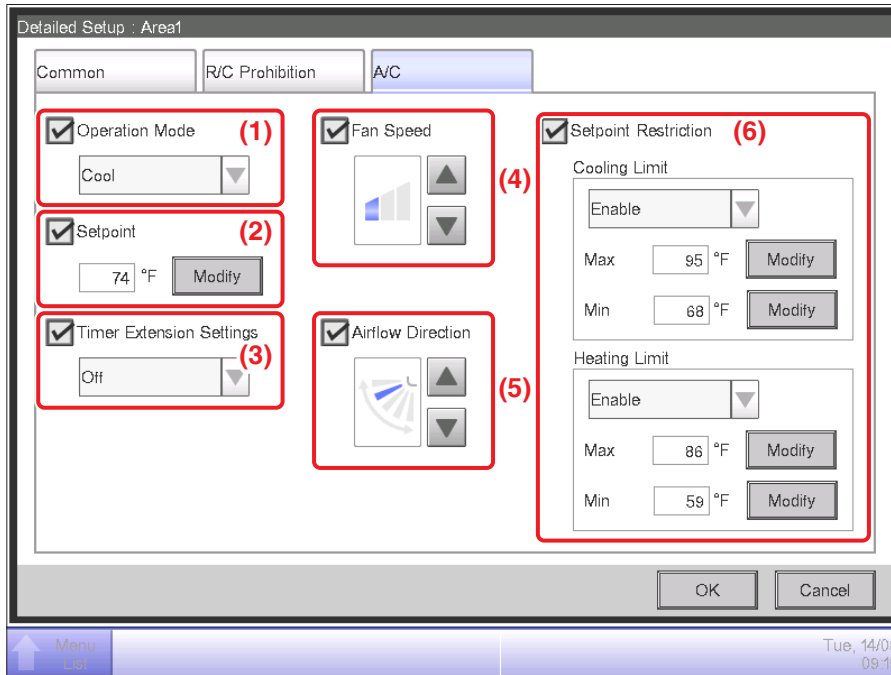

(1) Operation Mode

Changes the operation mode.

Select and set up a value from Fan, Cool, Heat, Dependent, Automatic, and Dry.

NOTE

- Dependent means either Cool or Heat. This is because the operation mode follows the Cool or Heat operation mode set up in the air conditioner with Changeover option.
- Setting up "Dry" in an indoor unit with Changeover option does not change the operation mode of indoor units without Changeover option that belong to the same Outdoor Unit group and are operating in Cool or Dry mode.

(2) Setpoint

Sets up the temperature.

(3) Timer Extension Settings

Enables or disables the Timer Extension function.

(4) Fan Speed

Sets up the fan speed.



(Low)



(Middle)



(High)



(Automatic)

(5) Airflow Direction

Sets up the fan direction.



<Airflow direction 0>



<Airflow direction 1>



<Airflow direction 2>



<Airflow direction 3>



<Airflow direction 4>



<Swing>

(6) Setpoint Restriction

Use this setting when limiting the setpoint range that can be set up from the remote controller.

Cooling Limit: Sets up the setpoint range for the indoor unit in cooling mode. Enable or disable, and enter the maximum and minimum temperatures.

Heating Limit: Sets up the setpoint range for the indoor unit in heating mode. Enable or disable, and enter the maximum and minimum temperatures.

- **Ventilator Tab**

Sets up the Ventilator.

Change settings by selecting the relevant check boxes.

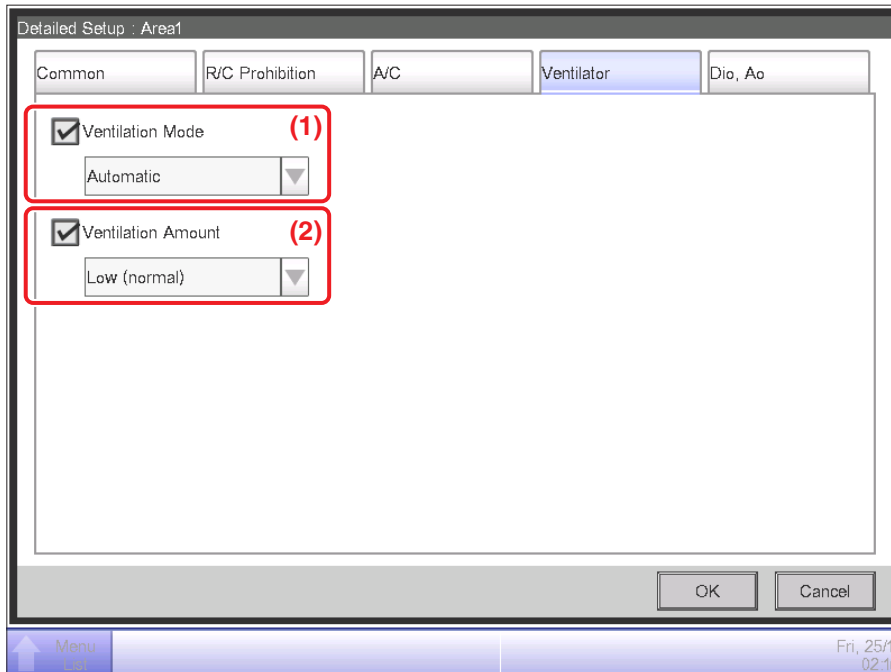

(1) Ventilation Mode

Select and set up a ventilation mode from Automatic, ERVentilation, and Bypass.

NOTE

This setting may not be available depending on the model.

(2) Ventilation Amount

Select and set up a ventilation amount from Auto (normal), Low (normal), High (normal), Auto (fresh up), Low (fresh up), and High (fresh up).

NOTE

This setting may not be available depending on the model.

- **Dio, Ao Tab**

Sets up the Dio and Ao.

Change settings by selecting the relevant check boxes.

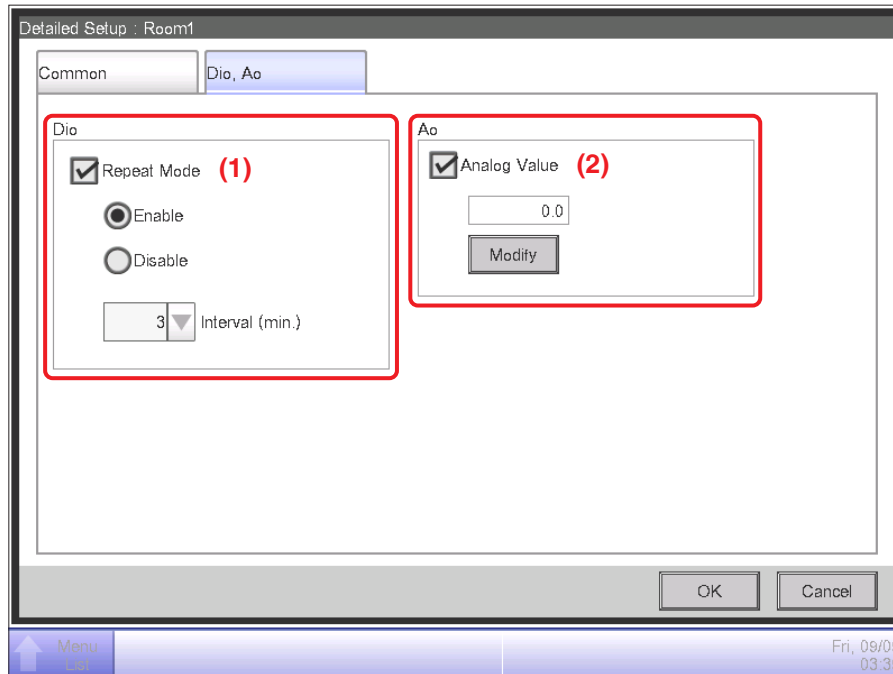

(1) Dio

Enable/disable Repeat Mode for Dio, and select and set up a repetition interval in the 1 to 10-minute range, in increments of 1 minute.

If starting or stopping the Dio fails when the Repeat Mode is enabled, the attempt to start/stop Dio is repeated at the specified repetition interval.

(2) Ao

Sets up the analog value for Ao. You can set up a value within the specified upper and lower limits, and accuracy.

Detailed Information Screen

The Detailed Information screen appears when you touch the **Details** button (14) (see page 37 and page 47) on the Standard View screen.

The screenshot shows a window titled "Detailed information" with the following fields and values:

- (1) Name: 1:1-00
- (2) ID: 178
- (3) Detailed Type: Indoor
- (4) Port No.: 1
- (5) Address: 1-00
- Detailed Info. (6): (Empty text box)
- Properties (7):
 - Area:
 - Top>All>Indoor
 - Top>10F
 - Top>10F>Area1
 - Thermostat Status [OFF]

At the bottom right of the window is a "Close" button. The bottom of the screen shows a navigation bar with a "Menu" button and a status bar displaying "Tue, 16/08 01:15".

(1) Name field

Displays the name of the area or management point.

(2) ID field

Displays the ID of the area or management point.

(3) Detailed Type field

Displays the type of the area or management point.

(4) Port No. field

Displays the port number to which the management point is connected.

NOTE

Not displayed for areas.

(5) Address field

Displays the address of the management point.

NOTE

Not displayed for areas.

(6) Detailed Info. field

Displays detailed information of the area or management point.

(7) Properties field

Displays information such as attributes, status, and setting details of the area or management point.

4-3 Standard View (List) Screen

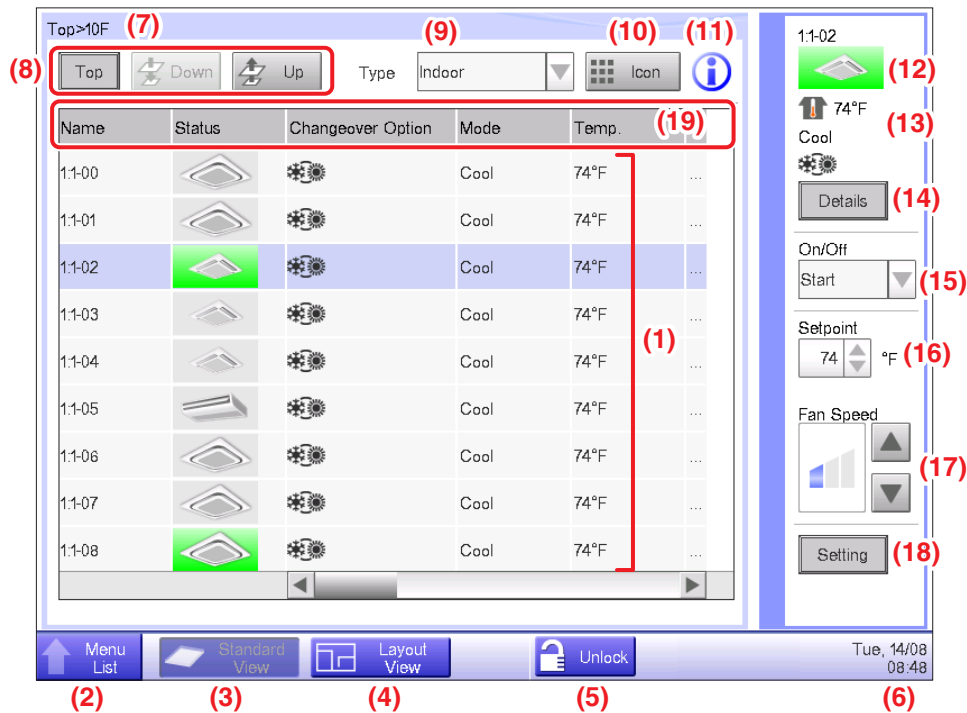

(1) Area/Management Point view area

Displays information on the areas and management points of the hierarchical level displayed in the area hierarchy indicator.

(2) Menu List switch button

Switches to the Menu List screen, which consists of Automatic Ctrl., System Settings, Operation Mgmt. and Energy Navigator (optional) tabs.

(3) Standard View switch button

Switches from the Layout View screen (optional) to the Standard View screen.

(4) Layout View switch button

Switches the screen to the Layout View screen (optional), which displays indoor units in a floor plan.

NOTE

Displayed only when the Layout View option is enabled.

(5) Lock/Unlock button

Locks/Unlocks the screen. The button is grayed out when the screen lock is disabled.

(6) Time

Displays the current time.

(7) Area hierarchy indicator

Displays the hierarchical level of the currently displayed area.

(8) Top, Down, and Up buttons

Top button: Displays the area and management points at the Top.

Down button: Moves into the selected area and displays the areas and management points there.

Up button: Moves up one hierarchical level from that of the currently displayed area and displays the areas and management points there.

(9) Type combo box

Selects the type of areas and management points to display in the Area/Management Point view area.

Types available for selection are: All, Indoor, Ventilator, Chiller, Outdoor, Dio, Analog, and Pulse.

(10) Icon switch button

Switches the screen to a view in which settings of areas and management points are displayed using icons.

(11) Information button

Displays the legend for an icon or contact information for inquiries regarding the system.

(12) Selected area/management point status

Displays the name, icon, and filter sign of the selected area or management point.

(13) Room Temp/Operation Mode/Changeover Option indicator

Displays the room temperature and settings of the selected indoor unit. Not displayed for areas.

NOTE

When the selected indoor unit is in error, it displays only the error code.

(14) Details button

Displays the Detailed Information screen for the selected area or management point.

(15) On/Off combo box

Starts/Stops the selected area or management point.

NOTE

When the optional Setback function is enabled, it displays Start, SB Low, SB High, or Stop.

(16) Setpoint spin box

Sets up the temperature for the indoor unit of the selected area, or the selected indoor unit.

(17) Fan Speed button

Sets up the fan speed for the indoor unit of the selected area, or the selected indoor unit.



(Low)



(Middle)



(High)



(Automatic)

(18) Setting button

Displays the Detailed Setup screen for the selected area or management point.

(19) Header

Each time you touch an item header, the displayed entries are sorted according to the contents of that item.

4-4 Layout View (Optional) Screen

The Layout View screen is displayed only when the Layout option is enabled.

The Layout View screen appears when you touch the **Layout View** switch button (4) (see page 37 and page 47) on the Standard View screen.

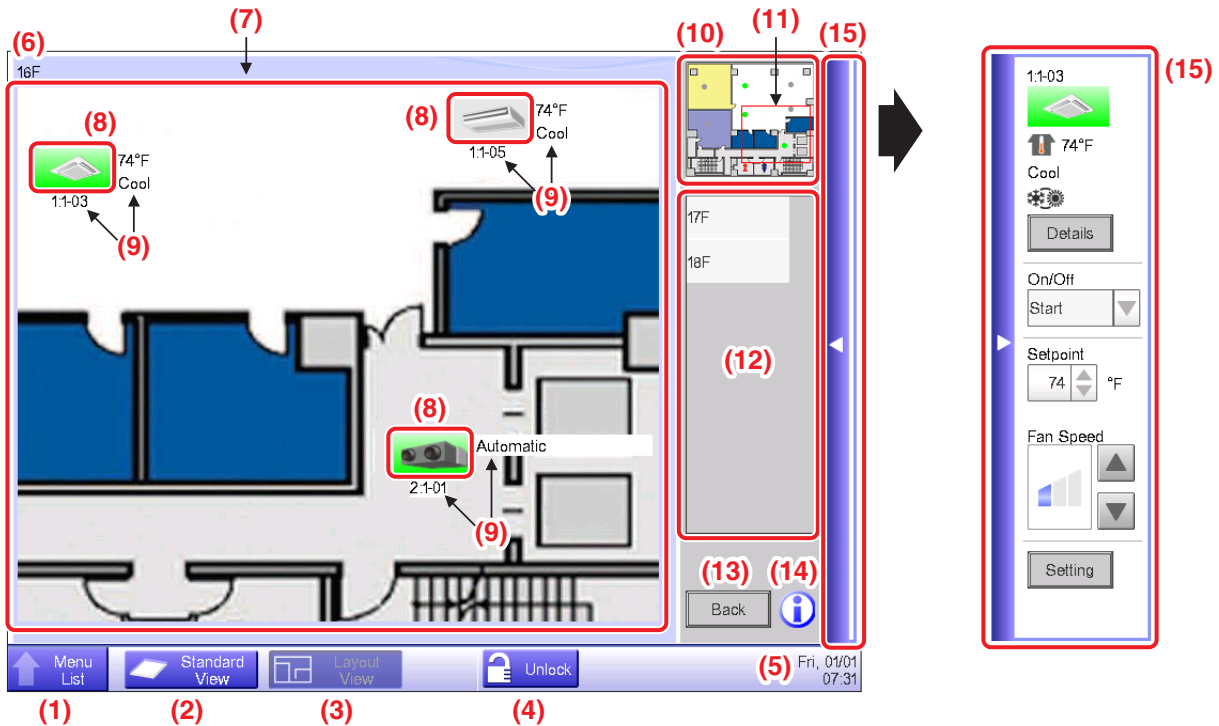

(1) Menu List switch button

Switches to the Menu List screen, which consists of Automatic Ctrl., System Settings, Operation Mgmt. and Energy Navigator (optional) tabs.

(2) Standard View switch button

Switches from the Layout View to the Standard View screen

(3) Layout View switch button

Displayed when the button is pressed while the Layout View is being displayed.

(4) Lock/Unlock button

Locks/Unlocks the screen. Not displayed when screen lock is not enabled.

(5) Time

Displays the current time.

(6) Title

Displays the name of the displayed screen.

(7) Background

Displays the background image set up to the screen.

(8) Icon (Area, Management Point)

Displays area and management point icons.

(9) Info

Displays auxiliary information of the area or management point.

(10) View panel

Displays the entire background image.

(11) Scope

Indicates the portion of the background image that is displayed as background on the screen. To move, touch the scope and drag.

(12) Layout selection list

The title selected in this list is the displayed layout.

(13) Back button

Displays the previous screen again.

(14) Information button

Displays the legend for an icon or contact information for inquiries regarding the system.

(15) Operation Window bar

Touching the bar displays the Operation Window. To close, touch the bar again.

The operating procedure of the Operation Window is the same as that of the Standard View screen.

See the descriptions for the Standard View screen (page 37, page 47).

4-5 Menu List Screen

The Menu List screen appears when you touch the **Menu List** button (2) on the Standard View screen (see page 37, page 47) or the **Menu List** button (1) on the Layout View screen (see page 50). It consists of the following tabs: Automatic Ctrl., System Settings, Operation Mgmt., Energy Navigator (only when the option is enabled).

Automatic Ctrl. Tab



NOTE

For an optional function, its button is hidden unless the option is enabled.

(1) Schedule

Allows you to set up weekly as well as annual schedules including special holidays by setting up the time to start/stop air conditioners by the day of the week, for example.

(2) Interlocking Control (Optional function)

This function starts/stops management points registered with the iTM in an interlocked manner, for example.

(3) Emergency Stop (Optional function)

This function immediately stops registered management points in emergencies, such as, fire.

(4) Auto Changeover

This function automatically toggles between cooling and heating.

(5) Temp. Limit (Optional function)

This function keeps the room temperature within a certain range.

(6) Sliding Temp. (Optional function)

This function controls the indoor unit's setpoint in accordance with the outdoor temperature to keep the difference between the outdoor and indoor temperatures within a certain range.

It only works in Cool mode.

(7) HMO (Optional function)

This function automatically starts/stops the indoor unit when it is operating in Heat mode.

This function avoids unnecessary rise in the room temperature.

(8) Timer Extension

This function sets up the time to stop the indoor unit and prevent the failure to turn it off.

(9) Temp. Setback (Optional function)

This function keeps the room temperature within the setpoint and limits the energy consumption during absence.

System Settings Tab



NOTE

For an optional function, its button is hidden unless the option is enabled.

(1) Area

Creates areas and registers management points to the areas, as well as sets up various area settings. You can set up to 10 hierarchical levels.

(2) Mgmt. Pts.

Changes the name, detailed information, and icon of management points.

(3) Maintenance

Sets up a management point maintenance.

(4) Network

Sets up the network IP addresses as well as Web Servers.

(5) E-mail (Optional function)

Sets up mail addresses to which e-mails will be sent in the event of an error, as well as mail servers.

(6) Web Access Users

Sets up Web users for Web Remote Management.

(7) Passwords

Sets up the password for managers as well as that for unlocking screens.

(8) Screensaver

Changes the screensaver as well as cancels the screensaver in the event of an error.

(9) Hardware

Sets up the brightness for the screen as well as the volume for the touch panel tone and buzzer.

(10) Touch Panel Calibration

Corrects the contact points of the touch panel.

(11) Time/DST

Sets up the current time and the daylight saving time.

(12) Regional

Sets up the language to use, date and time format, unit of temperature, icon color, etc.

(13) Confirmation Dialog

Enables or disables the display of a confirmation dialog box at start/stop.

(14) Backup

Outputs the iTM backup data to a USB memory.

(15) Version Info

Displays the iTM version information and details of optional software.

Operation Mgmt. Tab



NOTE

For an optional function, its button is hidden unless the option is enabled.

(1) History

Displays history such as that of errors, status changes, control information, etc. You can also output history to a USB memory in CSV format.

(2) PPD (Optional function)

This function calculates and displays the proportional distribution to each air conditioner of the total amount of power used by air conditioners, obtained from measurement.

(3) Setup Export

This function outputs setting information such as schedule control and interlocking control to a USB memory in CSV format, in one date file.

Energy Navigator Tab

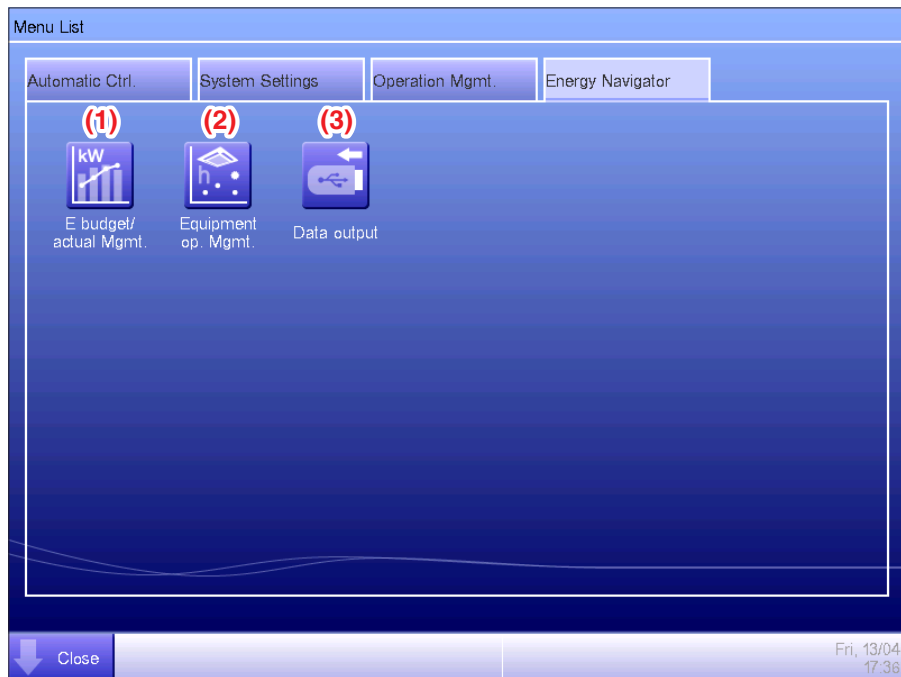

NOTE

This is an optional function, the tab is displayed only when the option enabled.

(1) E budget/actual Mgmt.

This function displays the state of the actual consumption over the planned energy consumption per year/month on a graph and the like. You can also compare this year's actual consumption with that of last year's.

(2) Equipment op. Mgmt.

This function shows equipment operating out of the planned hours or, air conditioners operating at a temperature different from the setpoint based on the operation plan.

(3) Data output

This function outputs measured data in CSV format.

4-6 Information Screen

The Information screen appears when you touch the **Information** button (11) on the Standard View screen (see page 37, page 47) or the **Information** button (14) on the Layout View screen (see page 50). The Information screen consists of the Legend and Contact tabs.



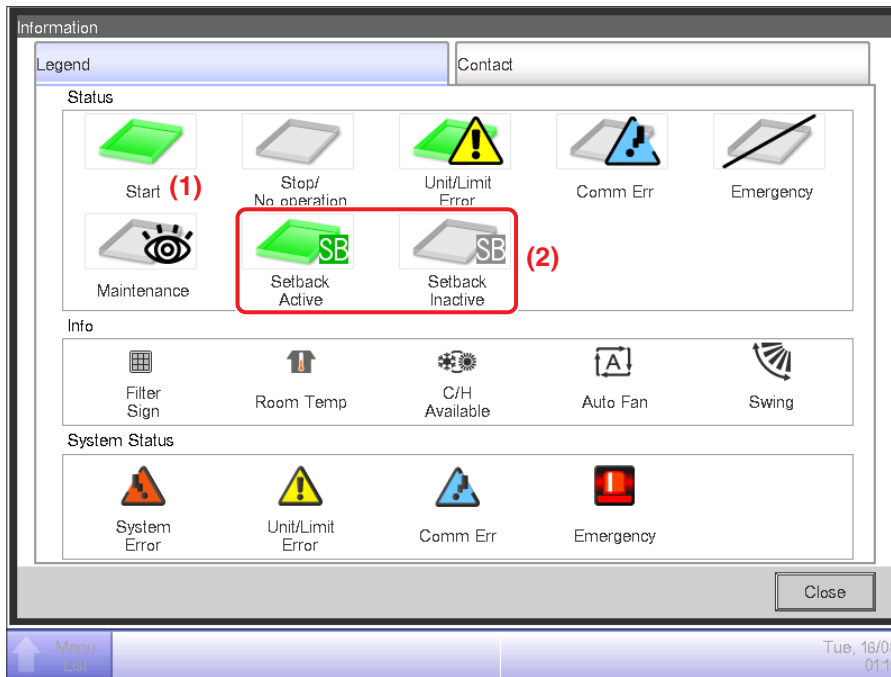





Legend Tab

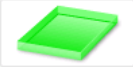











(1) The icon color is displayed in the color set up in the System Settings.

(2) No icon is displayed for a disabled function. (For example, Setback.)

• Icon View in Each Status

	Start (*1)	Setback Active	Setback Inactive	Stop/No operation
Area				
	When there is at least one management point in the area that is start (*1)	When there is at least one management point in the area where Setback is active	When there is at least one management point in the area where Setback is inactive	<ul style="list-style-type: none"> • When all management points in the area are Stop/No operation • When there are no management points in the area
Management point				

	Unit/Limit Error (*2)	Communication error	Emergency Stop	Maintenance
Area	 			
	When there is at least one management point in error in the area (Error sign is displayed over start, Stop/No operation icon)	When there is at least one management point with communication error in the area	When there is at least one management point in emergency stop in the area	When all management points are in maintenance in the area
Management point	 			

(*1) The icon color is displayed in the color configured in the System Settings.
 (*2) For outdoor units, no Equipment error icon is displayed even if an error is detected.

NOTE

• Priority order of management point icons

When two or more statuses overlap, that with the highest priority is displayed with an icon.
 “Start/Stop/Setback Active/Setback Inactive/No operation” < “Unit/Limit Error” < “Communication error” < “Maintenance” < “Emergency stop”

• Priority order of area icons

When the area includes two or more management points with different statuses, that with the highest priority is displayed with an icon.
 “Maintenance” < “Stop/No operation” < “Setback Inactive” < “Setback Active” < “Start” < “Communication error” < “Unit/Limit Error” < “Emergency Stop”

Contact Tab

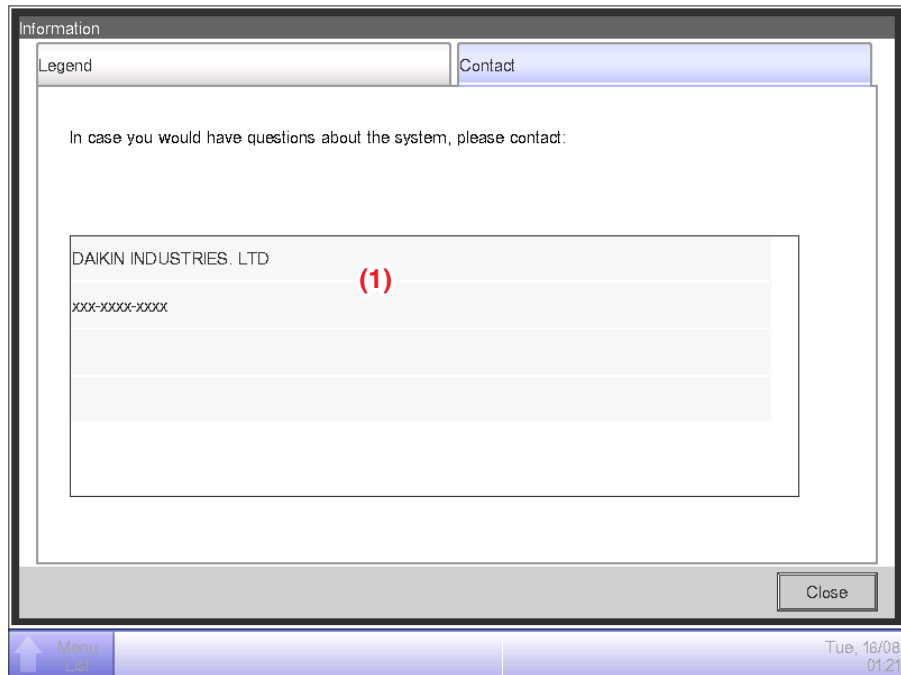

(1) Displays contact information set up by the service person.

Using Standard Functions

5. Setting up the Automatic Control

5-1 Setting up a Schedule

The schedule control function in iTM allows you to operate designated management points and areas according to a schedule program. There are two types of schedule: a weekly schedule where settings are by day of the week, and an annual schedule where you can specify special days. You can also specify a validity period for a schedule and make it valid only for a certain period of time.

The following tables show items you can control using this function.

Target	On/Off	On/Off (Pre-cool/ Pre-heat)	On/Off (Setback)	Operation Mode
Indoor unit	○	○	○	○
Ventilator	○	×	×	×
Chiller	○	×	×	○
Dio	○	×	×	×
Ao	×	×	×	×
Area	○	○	○	○

Target	Fan Speed	Setpoint	Setpoint shift	Ventilation mode	Ventilation amount
Indoor unit	○	○	○	×	×
Ventilator	×	×	×	○	○
Chiller	×	○	×	×	×
Dio	×	×	×	×	×
Ao	×	×	×	×	×
Area	○	○	○	○	○

Target	Remote Controller Enable/Disable			Timer Extension	Analog value	Setpoint range restriction
	Start/Stop	Setpoint	Operation mode setup			
Indoor unit	○	○	○	○	×	○
Ventilator	○	×	×	×	×	×
Chiller	○	○	○	×	×	×
Dio	×	×	×	×	×	×
Ao	×	×	×	×	○	×
Area	○	○	○	○	○	○

Setting up a schedule program

The following describes how to create and set up a schedule program based on the model case below.

Name of schedule program: **Program for Office**

Target: **Office A** (area comprising indoor units only)

Every week, from Monday to Friday: **9:00 to 18:00 Setpoint 82°F Cool On**

Every week, Saturday and Sunday: **Holiday Off**

Every month, 3rd Saturday only: **9:00 to 18:00 Setpoint 82°F Cool On**

- **Creating the Weekly Schedule**

Create the weekly schedule: **Cool Office A to setpoint 82°F Monday to Friday, from 9:00 to 18:00.**

Touch the Schedule button on the Automatic Ctrl. tab of the Menu List screen and display the Schedule screen (see page 52).

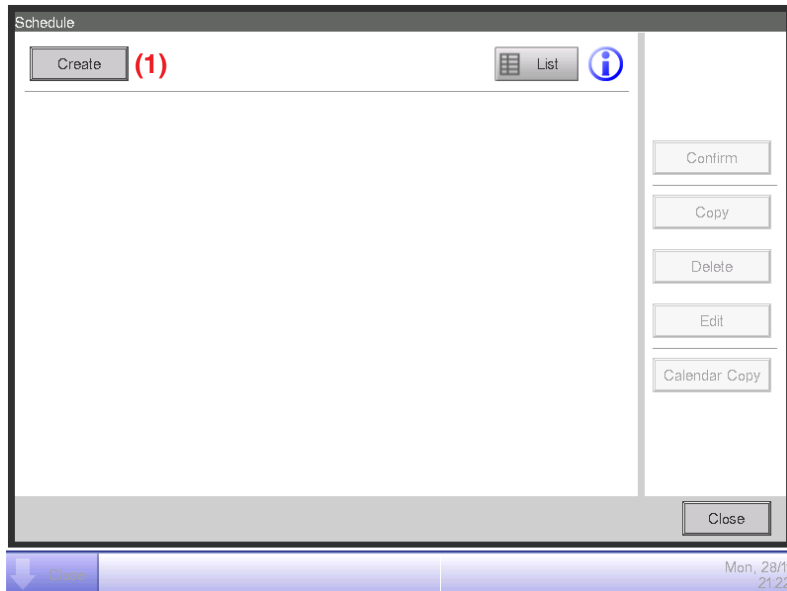

1. Setting up the schedule program name

Touch the **Create** button (1) and display the Schedule Edit screen.

The Schedule Edit screen consists of four tabs. Set up by switching the tabs as necessary.

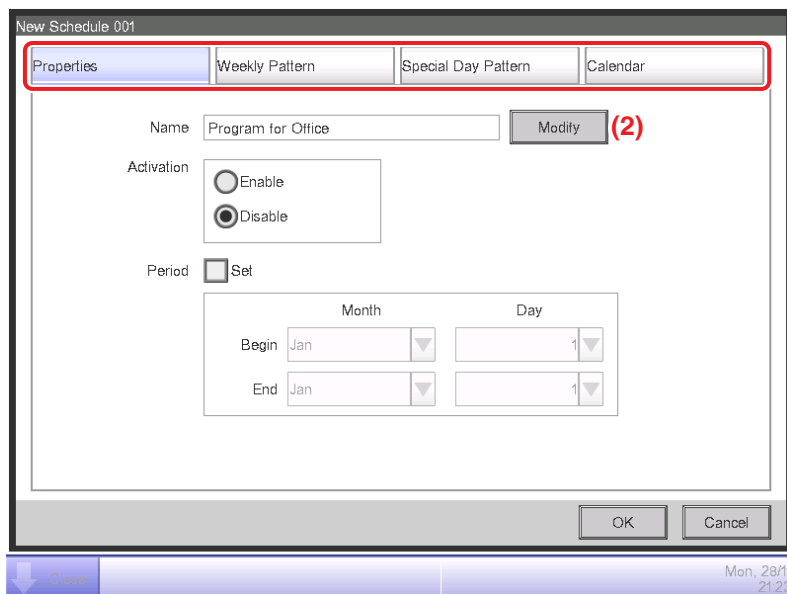

Touch the **Modify** button (2) on the Properties tab to display the Input dialog for entering the program name. Enter **“Program for Office”**.

2. Setting up the operation start time on Monday

Touch to display the Weekly Pattern tab.

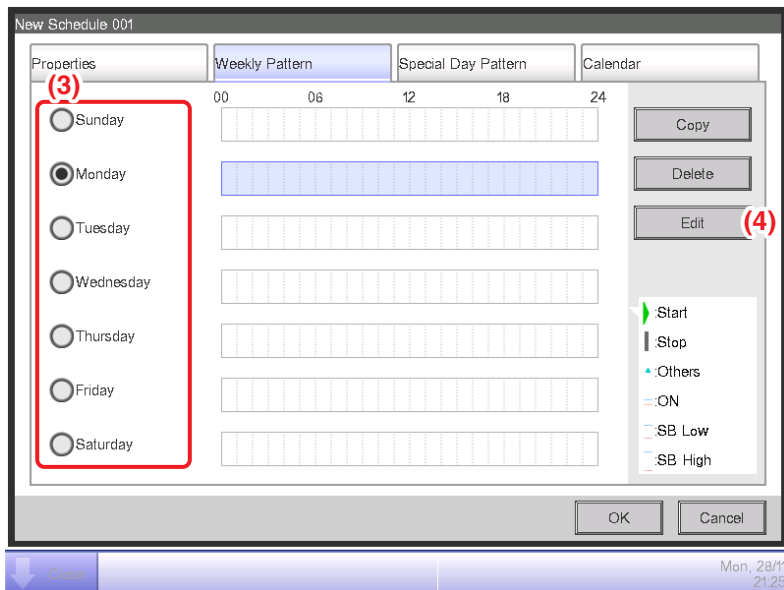

Select Monday using the **Day of the week** radio button (3) .

Touch the **Edit** button (4) to display the Event List screen.

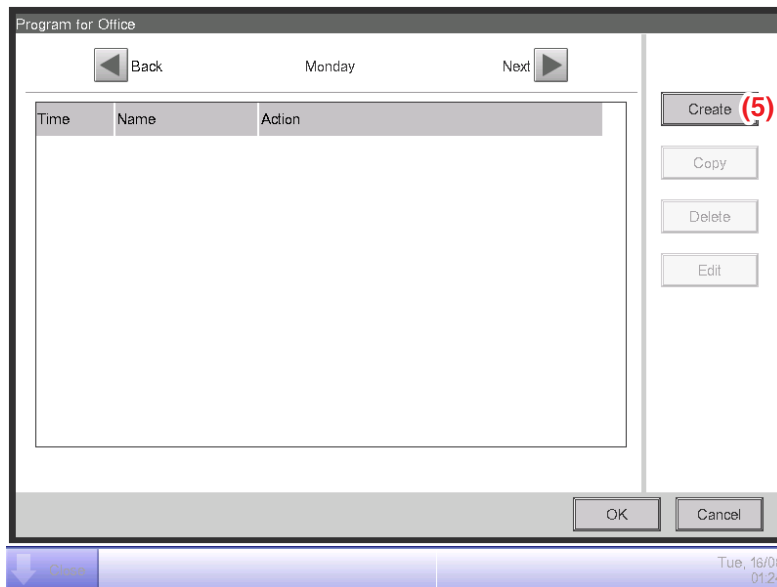

Touch the **Create** button (5) to display the Events: New program screen.

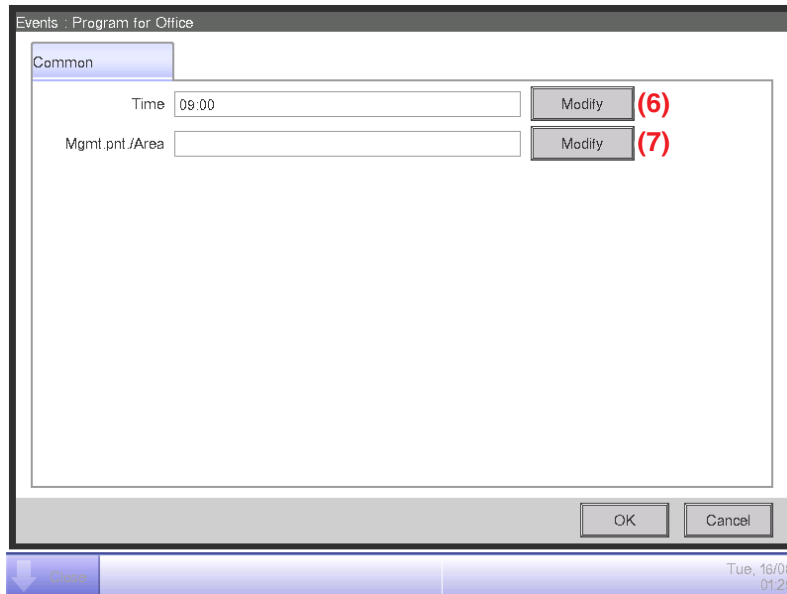

Touch the **Modify** button (6) and display the Time input dialog to specify the operation start time.

Enter “9:00 (AM9:00 when using 12-hour clock)” and touch the OK button to return.

3. Setting up the target

Touch the **Modify** button (7) to display the Mgmt. Point/Area dialog.

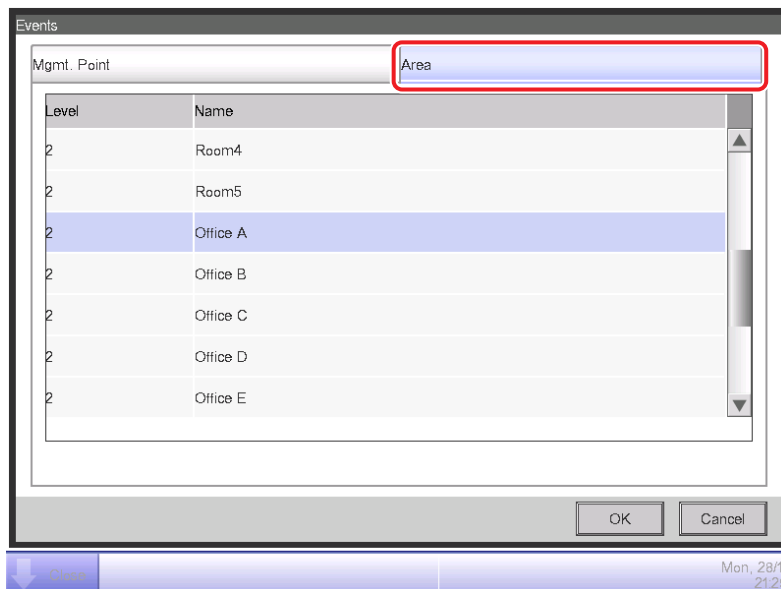

The Mgmt. Point/Area dialog consists of two tabs: Mgmt. Point and Area.

Touch and display the Area tab. Select “**Office A**” from the list, and touch the OK button to return. For the procedure for creating areas, see page 109.

4. Setting up the operation mode and setpoint

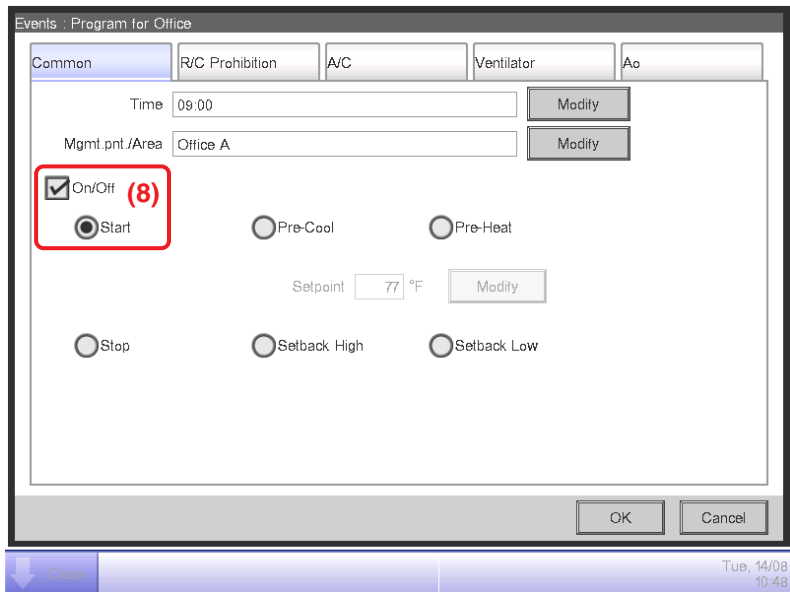

Select the **On/Off** check box (8) and then, the **Start** radio button.

To set up the operation mode and setpoint, touch and display the **A/C** tab.

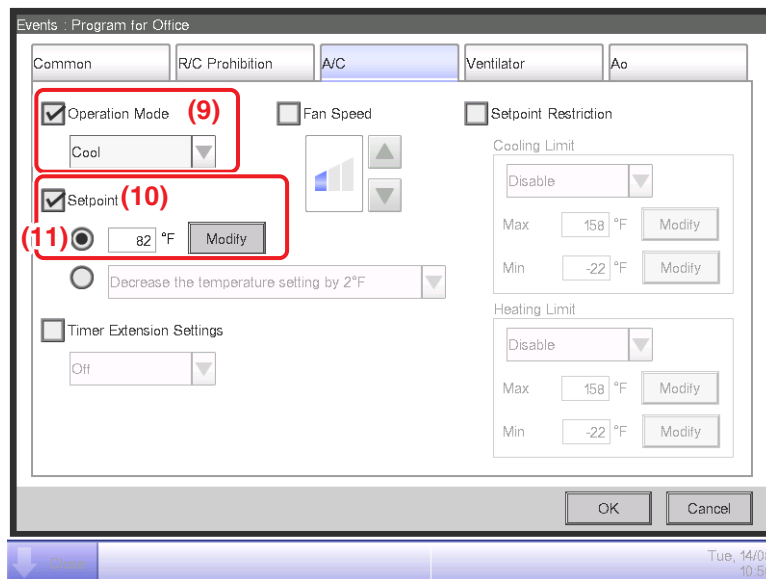

Select the **Operation Mode** check box (9) and then, “**Cool**” from the combo box.

Select the **Setpoint** check box (10) and then, the **Setpoint** radio button (11). Touch the **Modify** button. Enter “82” in the Numerical Input dialog and touch the **OK** button to return to the **A/C** tab (Events screen).

Touch the OK button and return to the Event List screen.

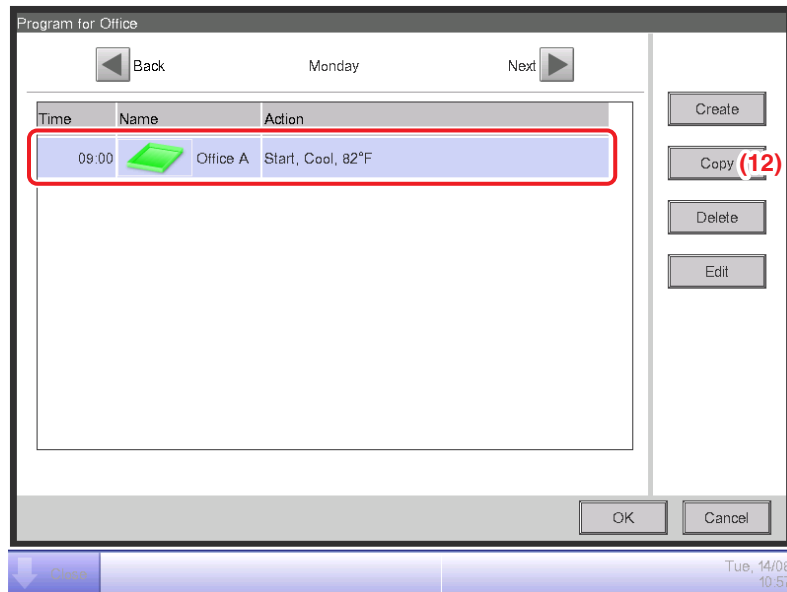

The set up event details appears in the list.

The step above finishes the setup of the event: **Start cooling Office A to setpoint 82°F from 9:00 on Monday.**

5. Setting up the operation stop time

Select the event: **Start cooling Office A to setpoint 82°F from 9:00 on Monday** created in step 4, then touch the **Copy (12)** to display the Events screen.

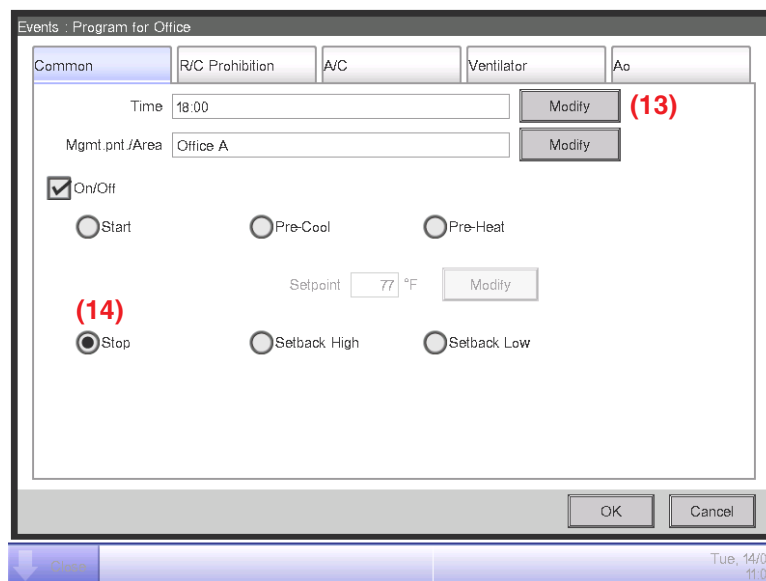

An exact copy of the selected event will appear.

Touch the **Modify** button (13) and enter the operation stop time “**18:00 (PM6:00 when using 12-hour clock)**” in the Time Setup dialog. Touch the OK button to return.

Select the **Stop** radio button (14).

Touch the OK button and return to the Event List screen.

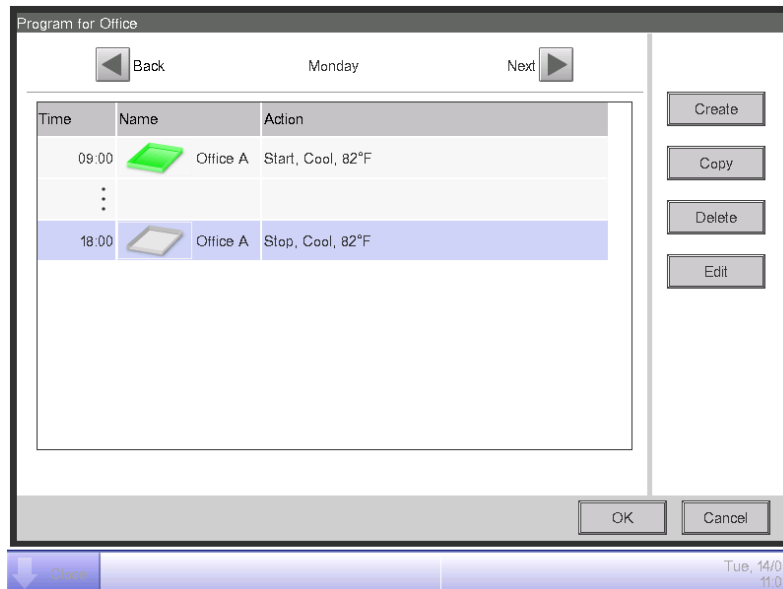

The step above finishes the creation of the schedule: **Cool Office A to setpoint 82°F from 9:00 to 18:00 on Monday.**

Touch the OK button and return to the Schedule Edit screen.

6. Setting up schedule for Tuesday to Friday

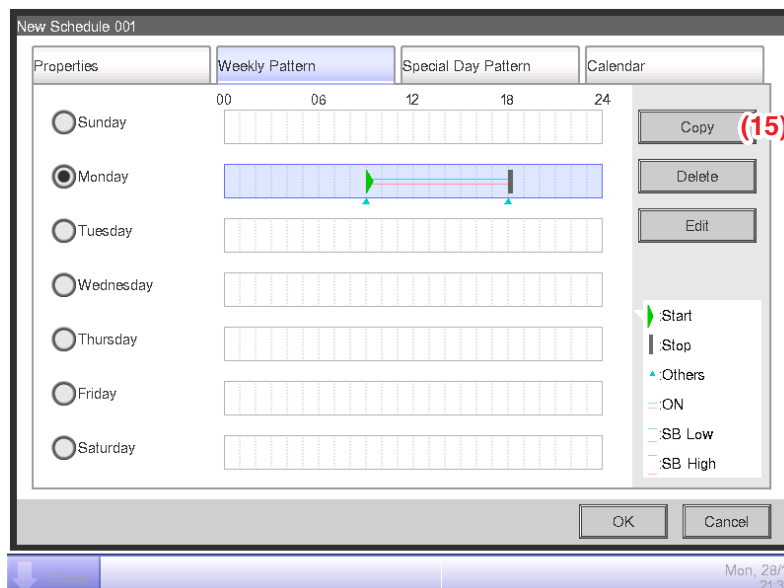

Copy the event set up for Monday to the other days of the week.

Select Monday, then touch the **Copy** button (15) to display the Copy to Selection screen.

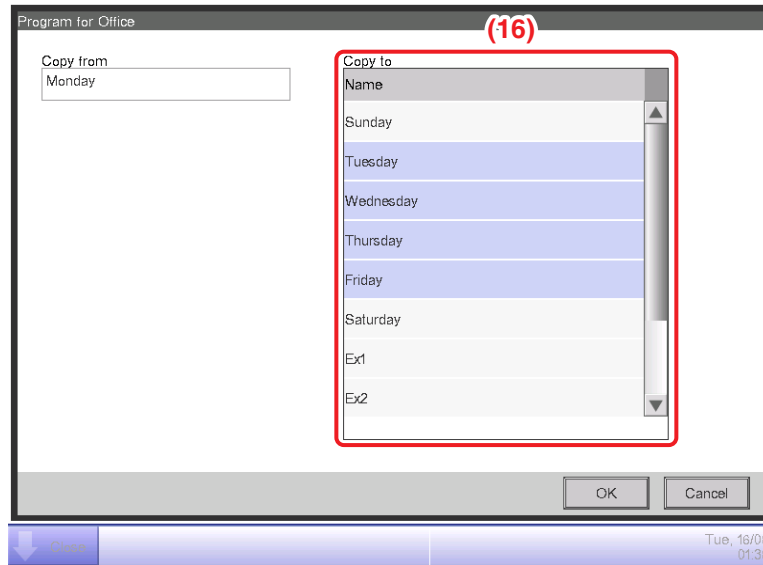

Select the copy destination from the list (16). Select Tuesday, Wednesday, Thursday, and Friday. Touch the OK button to overwrite the events and return to the Schedule Edit screen.

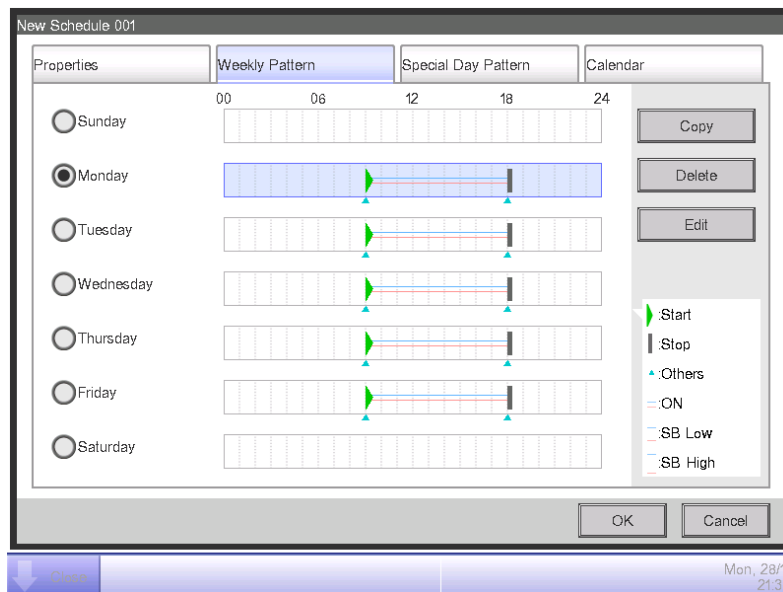

The step above finishes the creation of the weekly schedule: **Cool Office A to setpoint 82°F Monday to Friday, from 9:00 to 18:00.**

- **Creating the Schedule for Special Days**

Set up the schedule only for the 3rd Saturday of every month (special day).

Touch the Special Day Pattern tab on the Schedule Edit screen.

1. Setting up the name of the special day

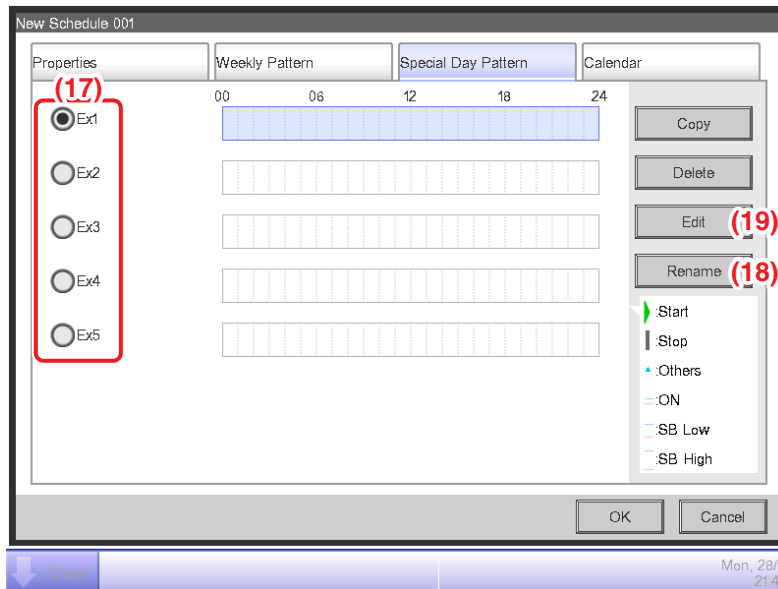

Select Ex1 in (17). Touch the **Rename** button (18) to display the Name Input dialog.

Enter “**Working day**” for name and touch the OK button to rename the special day.

2. Setting up the operation start/stop times, operation mode, and setpoint

Touch the **Edit** button (19) and set up the event details.

Follow the same procedure as for creating the weekly schedule and set up the schedule for “**cooling Office A area to setpoint 82°F from 9:00 to 18:00**”.

3. Setting up the Special Day (3rd Saturday of every month) in the Calendar

Touch the Calendar tab on the Schedule Edit screen.

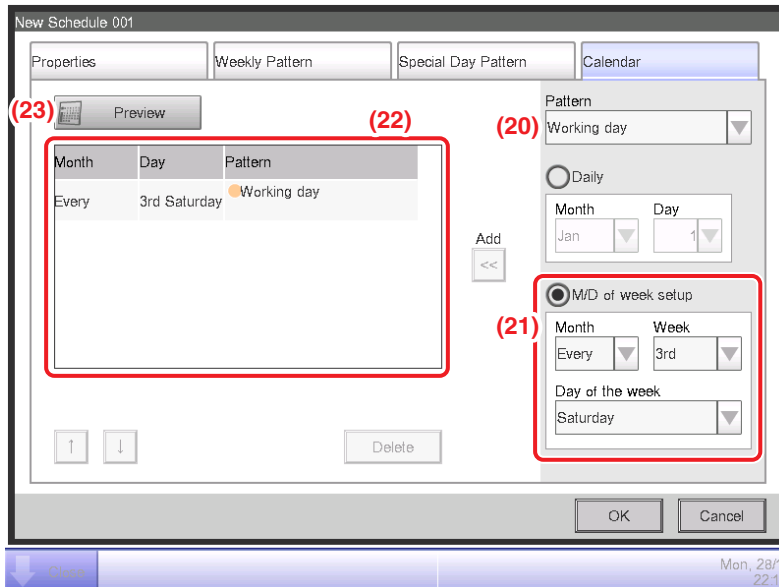

Select the created “**Working day**” from the **Pattern** combo box (20).

Select the **M/D of week setup** radio button (21) and select the day to set up in the combo box.

To set “3rd Saturday of every month”, select as follows:

Month: **Every** Week: **3rd** Day of the week: **Saturday**

Touch the Add button to register the special day pattern. It appears in (22).

To preview the calendar with the special day pattern, touch the **Preview** button (23).

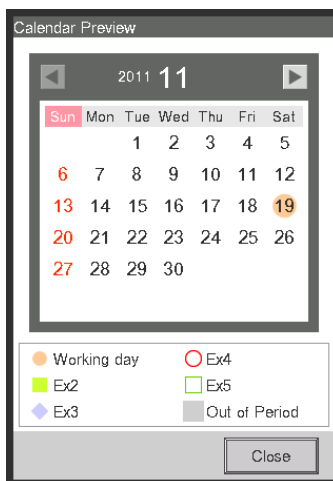

Touch the Close button and return to the Schedule Edit screen.

The step above finishes the creation of the special day schedule: **Cool Office A area to setpoint 82°F from 9:00 to 18:00 on the 3rd Saturday of every month.**

The “**Program for Office**” is now finished since both the weekly and special day schedules have been created.

- **Enabling the Schedule Program**

Enable the created **“Program of Office”**.

Touch the Properties tab on the Schedule Edit screen.

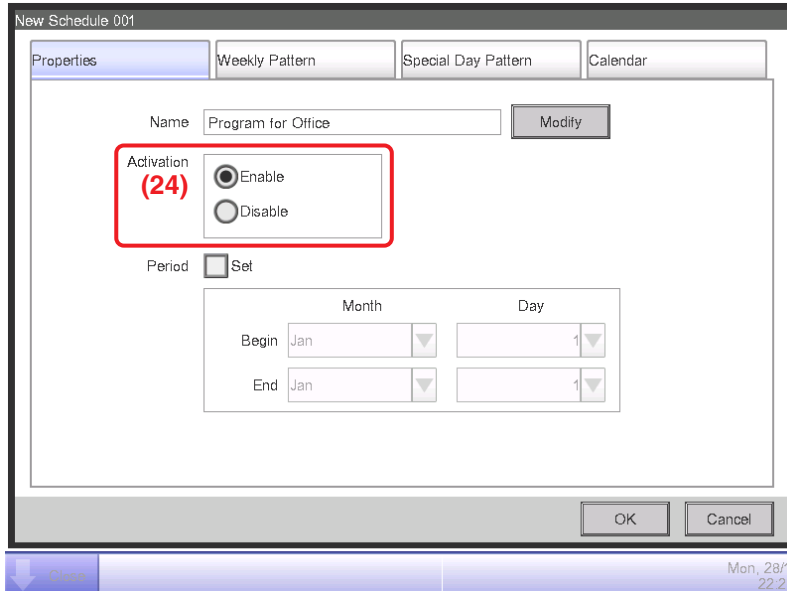

Select the **Enable** radio button (24) and enable the **“Program for Office”**.

This completes the creation of the schedule program.

Touch the OK button to save and return to the main Schedule screen.

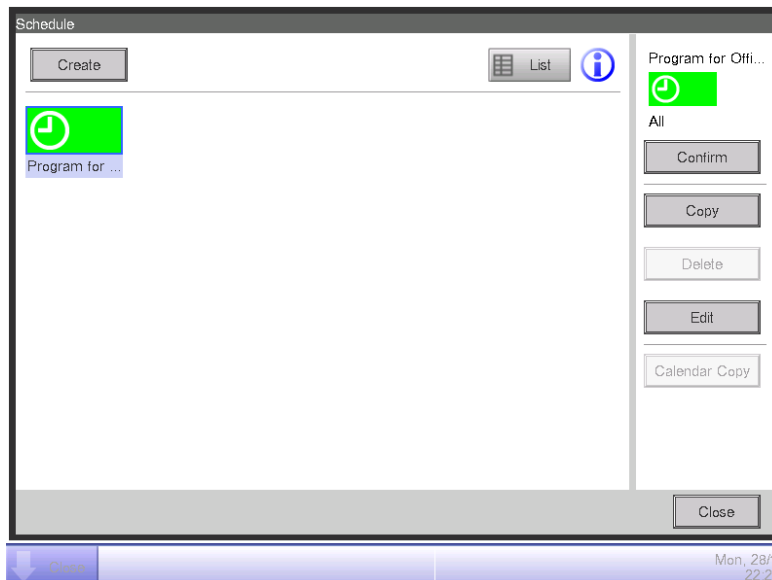

Check that the created **“Program for Office”** is displayed on the main screen.

Touch the Close button to close the screen.

Detailed screen and button descriptions

• Main Schedule Screen (Icon view)

This screen is displayed when you touch the Schedule button on the Automatic Ctrl. tab of the Menu List screen.

It is also displayed when you touch the Icon button on the main Schedule screen (List screen).

This screen allows you to check, create, edit, and delete schedule programs as well as copy a calendar.

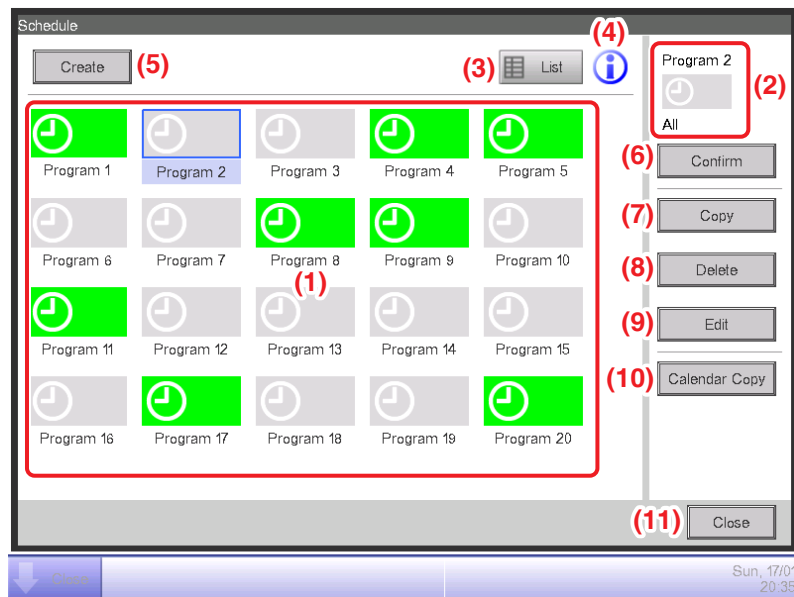

(1) Schedule Info view area

Displays registered schedule programs.

(2) Selected schedule view area

Displays information of the program selected in the Schedule Info view area.

(3) List button

Switches the screen to the List view.

(4) Legend button

Displays the Legend screen.

(5) Create button

Displays the Schedule Edit screen for creating a new schedule program.

You can create a maximum of 100 schedule programs.

(6) Confirm button

Displays the Schedule Confirmation screen that allows you to check the setting details of the program selected in the Schedule Info view area.

(7) Copy button

Copies the program selected in the Schedule Info view area and displays it on the Schedule Edit screen.

(8) Delete button

Deletes the program selected in the Schedule Info view area. Touching the button displays a deletion confirmation dialog.

(9) Edit button

Displays the Schedule Edit screen that allows you to edit the program selected in the Schedule Info view area.

(10) Calendar Copy button

Displays the Calendar Copy screen that allows you to copy the calendar of the program selected in the Schedule Info view area.

(11) Close button

Closes the screen.

- **Main Schedule Screen (List View)**

This screen is displayed when you touch the List button on the main Schedule screen (Icon view).

This screen allows you to check, create, edit, and delete schedule programs as well as copy a calendar.

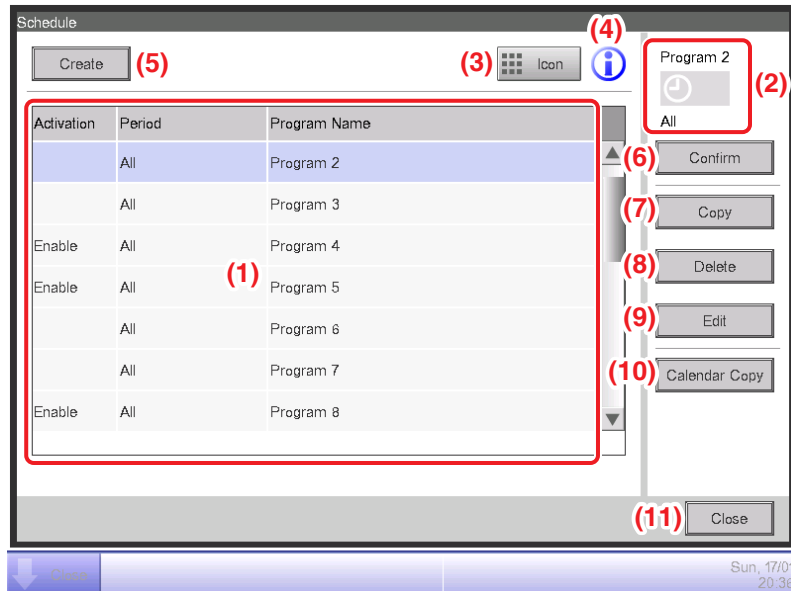

(1) Schedule Info view area

Displays a list of registered schedule programs in order of its registration.

(2) Selected schedule view area

Displays information of the program selected in the Schedule Info view area.

(3) Icon button

Switches the screen to Icon view.

(4) Legend button

Displays the Legend screen.

(5) Create button

Displays the Schedule Edit screen for creating a new schedule program.

You can create a maximum of 100 schedule programs.

(6) Confirm button

Displays the Schedule Confirmation screen that allows you to check the setting details of the program selected in the Schedule Info view area.

(7) Copy button

Copies the program selected in the Schedule Info view area and displays it on the Schedule Edit screen.

(8) Delete button

Deletes the program selected in the Schedule Info view area. Touching the button displays a deletion confirmation dialog.

(9) Edit button

Displays the Schedule Edit screen that allows you to edit the program selected in the Schedule Info view area.

(10) Calendar Copy button

Displays the Calendar Copy screen that allows you to copy the calendar of the program selected in the Schedule Info view area.

(11) Close button

Closes the screen.

• **Legend Screen**

This screen is displayed when you touch the Legend button on the main Schedule screen.
 Displays legends for icons available in the main Schedule screen (Icon view).

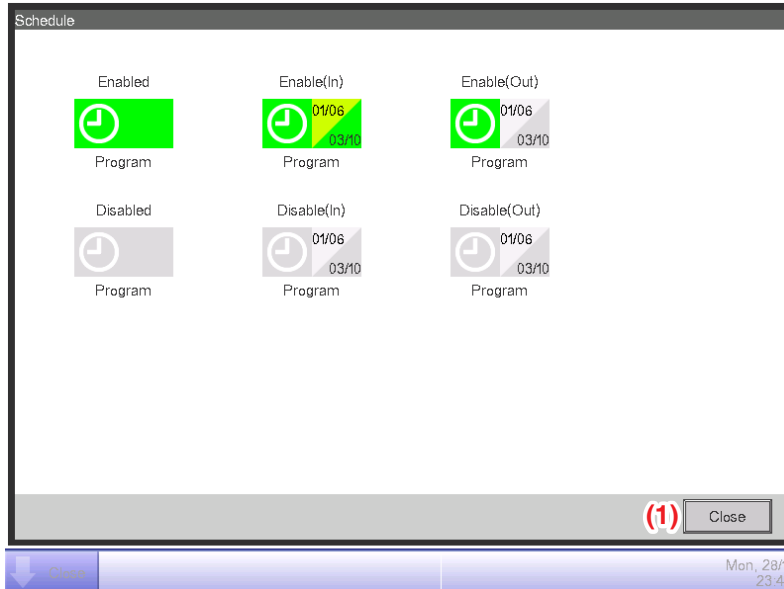

- <Displayed information>
- Icon of scheduled program
 - Validity period of scheduled program (Upper Left: Start date, Lower right: End date).
- Name

		Icon type	
Disabled	Without validity period		Program
	With validity period	Within validity period	Program
		Out of validity period	Program
Enabled	Without validity period		Program
	With validity period	Within validity period	Program
		Out of validity period	Program

Displays legends for the Icon view.

(1) Close button

Closes the screen.

- **Schedule Confirmation Screen**

This screen is displayed when you touch the Confirm button on the main Schedule screen.

It allows you to check the setting details of schedule programs with the Schedule Settings list.

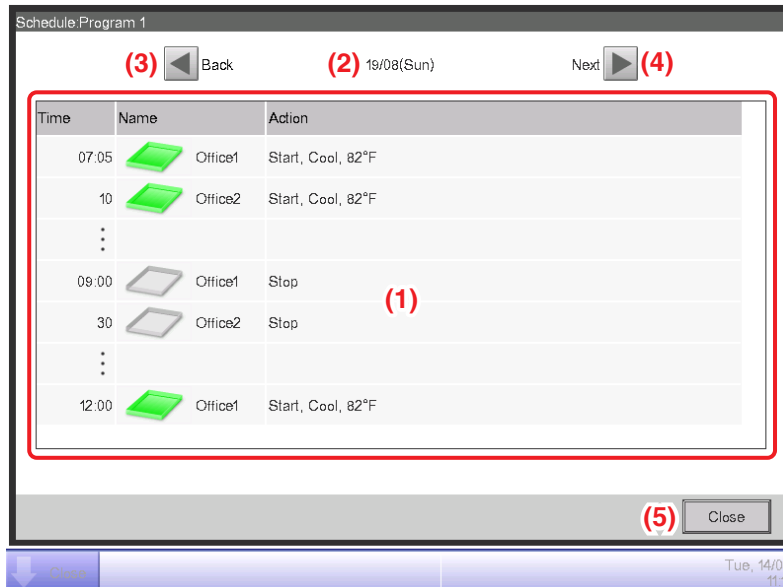

(1) Schedule Settings list

Displays the list of events for the date indicated in the Date area (2) for the selected schedule program.

(2) Date area

Displays the date and day of the week for which the events are displayed.

(3) Back button

Changes the content displayed in the Schedule Settings list to that of the previous day.

(4) Next button

Changes the content displayed in the Schedule Settings list to that of the next day. You can specify up to the next 7 days.

(5) Close button

Closes the screen.

- **Properties Tab (Schedule Edit Screen)**

This screen is displayed when you touch the Create, Copy, or Edit button on the main Schedule screen.

It allows you to set up the name, validity period, and enable/disable the schedule program.

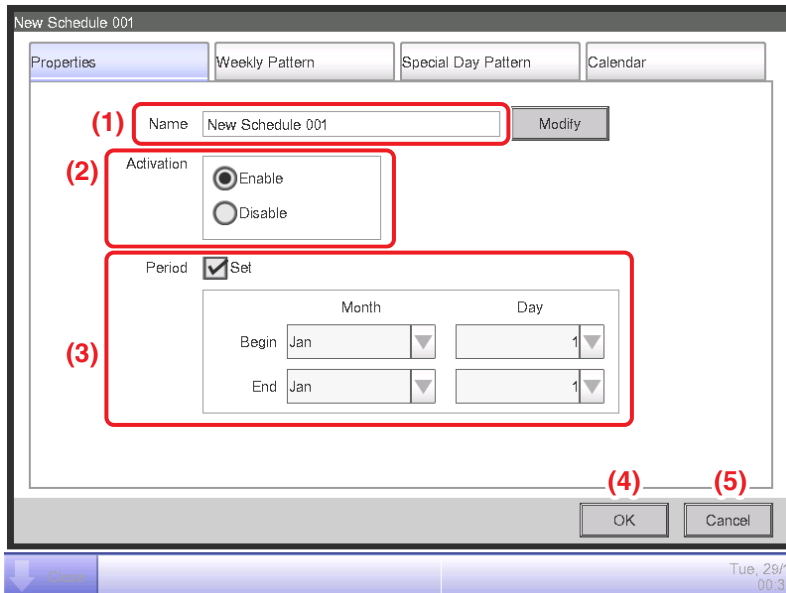

(1) Name text field

Displays the schedule program name.

To change, touch the Modify button. Enter the new name in the Text Input dialog that appears.

Set up a name using 1 to 32 characters, irrespective of single or double byte.

Duplicate names are not permitted.

(2) Activation radio button

Enables/disables the schedule program.

(3) Period check box, combo box

Selecting the check box enables the combo box for entering the validity period.

Select the start date and end date from the combo box. The selectable range for each combo box is as follows:

Month: Jan, Feb, Mar, Apr, May, Jun, Jul, Aug, Sep, Oct, Nov, Dec

Day: 1 to 31 (Non-existing days cannot be selected)

(4) OK button

Saves the edit and closes the screen.

(5) Cancel button

Cancels the edit and closes the screen. Touching the button displays a confirmation dialog.

- **Weekly Pattern Tab (Schedule Edit Screen)**

This screen is displayed when you touch the Weekly Pattern tab on the Schedule Edit screen. It allows you to set up a weekly schedule.

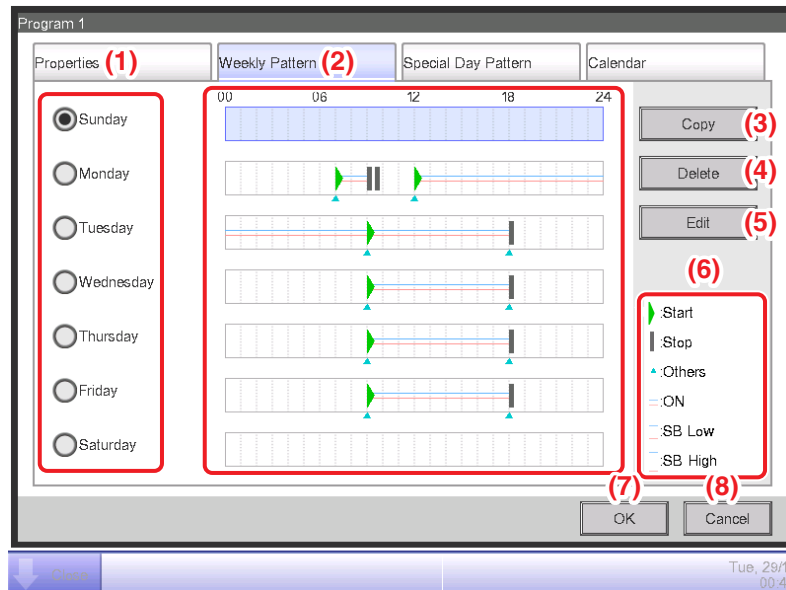

(1) Day of the week radio button

Selects the day of the week to edit.

(2) Schedule Settings view area

Displays the schedule set to each day of the week.

(3) Copy button

Displays the Copy to Selection screen for selecting the destination, to which the schedule set for the day of the week, selected with the radio button, will be copied.

(4) Delete button

Deletes the schedule set to the day of the week selected with radio button. Touching the button displays a deletion confirmation dialog.

(5) Edit button

Displays the Event List screen that allows you to edit the schedule set up for the day of the week selected with the radio button.

(6) Legend view area

Displays legends available in the Schedule Settings view area.

SB Low and SB High are displayed only when the optional setback function is enabled.

(7) OK button

Saves the edit and closes the screen.

(8) Cancel button

Cancels the edit and closes the screen. Touching the button displays a confirmation dialog.

- **Special Day Pattern Tab (Schedule Edit Screen)**

This screen is displayed when you touch the Special Day Pattern tab on the Schedule Edit screen.

It allows you to set up the schedule for a special day.

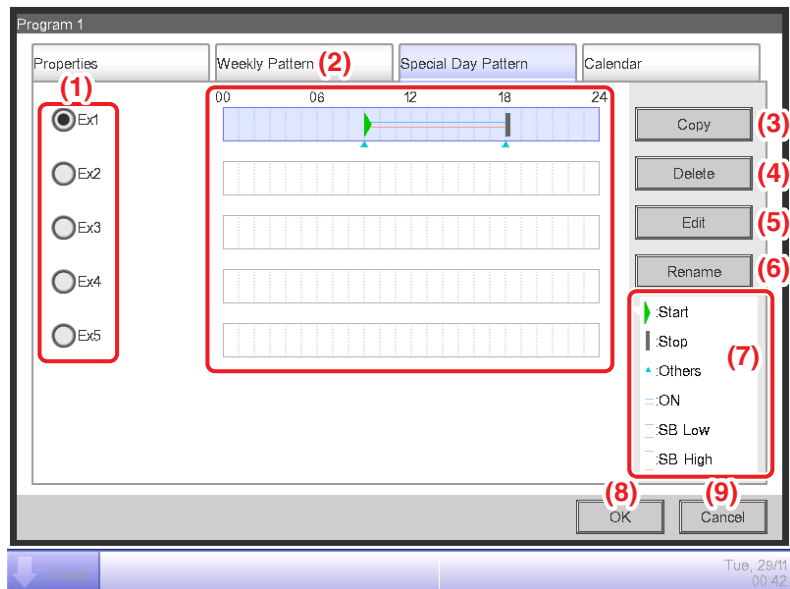

(1) Special Day radio button

Selects the special day to edit.

You can set up to 5 types of special day.

(2) Schedule Settings view area

Displays the schedule set to each special day.

(3) Copy button

Displays the Copy to Selection screen that allows you to select the destination, to which the schedule set for the special day, selected with the radio button, will be copied.

(4) Delete button

Deletes the schedule set to the special day selected with radio button. Touching the button displays a deletion confirmation dialog.

(5) Edit button

Displays the Event List screen that allows you to edit the schedule set for the special day selected with the radio button.

(6) Rename button

Changes the name of the special day.

Touching the button displays the Text Input dialog.

Specify a name for the special day using 1 to 15 characters, irrespective of single or double byte.

Duplicate names are not permitted.

(7) Legend view area

Displays legends available in the Schedule Settings view area.

SB Low and SB High are displayed only when the optional setback function is enabled.

(8) OK button

Saves the edit and closes the screen.

(9) Cancel button

Cancels the edit and closes the screen. Touching the button displays a confirmation dialog.

• **Calendar Tab (Schedule Edit Screen)**

This screen is displayed when you touch the Calendar tab on the Schedule Edit screen. It allows you to register special day schedules in the calendar.

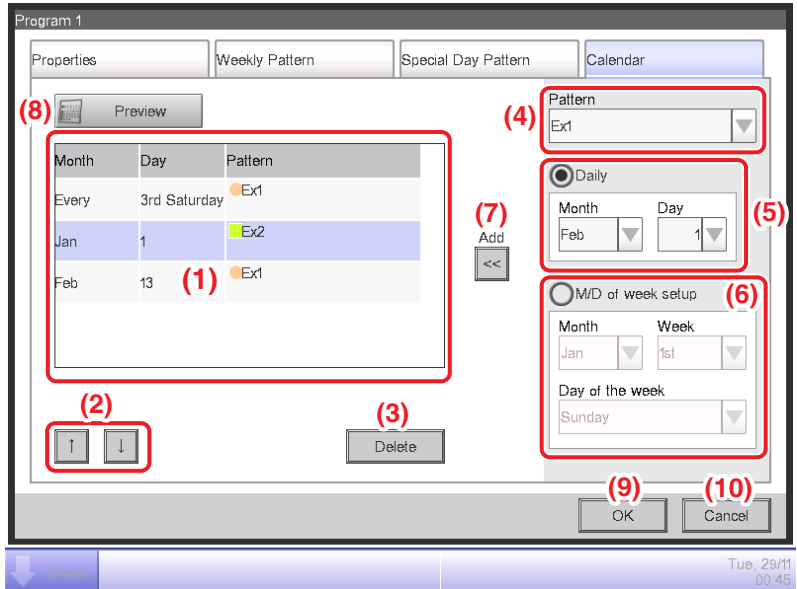

(1) Calendar Settings list

Displays the list of registered special day patterns.

You can register a maximum of 40 special day patterns in one calendar.

(2) Order button

Moves up and down the order of the special day pattern selected in the Calendar Settings list.

(3) Delete button

Deletes the special day pattern selected in the Calendar Settings list.

(4) Pattern combo box

Selects the type of the special day to register.

(5) Daily radio button

Sets up the special day setting pattern with the Daily combo box.

The selectable range in each combo box is as follows:

Month: Jan, Feb, Mar, Apr, May, Jun, Jul, Aug, Sep, Oct, Nov, Dec, Every

Day: 1 to 31 (Non-existing days cannot be selected)

(6) M/D of week setup radio button

Sets up the special day setting pattern with the M/D of week setup combo box.

The selectable range in each combo box is as follows:

Month: Jan, Feb, Mar, Apr, May, Jun, Jul, Aug, Sep, Oct, Nov, Dec, Every

Week: 1st, 2nd, 3rd, 4th, Last

Day of the week: Sunday, Monday, Tuesday, Wednesday, Thursday, Friday, Saturday

(7) Add button

Registers the set up special day pattern.

(8) Preview button

Previews the calendar with the registered special day in the Calendar Settings list.

(9) OK button

Saves the edit and closes the screen.

(10) Cancel button

Cancels the edit and closes the screen. Touching the button displays a confirmation dialog.

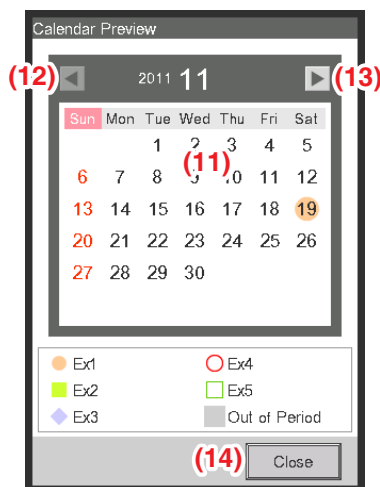

<Calendar Preview>

(11) Calendar view area

Previews the calendar with the special day.

(12) ◀ button

Moves the view to the month previous to that displayed in the Calendar view area.

(13) ▶ button

Moves the view to the month next to that displayed in the Calendar view area. You can specify up to the next one year.

(14) Close button

Closes the screen.

NOTE

- If a special day set using the Date setup and Month/Day of the week setup combo boxes overlap, the special day set using the Date setup combo box takes precedence when setting the calendar.
- If two or more special days set using the Date setup combo box overlap (for example, single day designation overlaps with a period designation) the latter (lower in the list) takes precedence.
- If two or more special days set using the Month/Day setup combo box overlap, the latter (lower in the list) takes precedence.
- Setting up a Special Day overrides the weekly schedule set up on that day.

- **Calendar Copy Screen**

This screen is displayed when you touch the Calendar Copy button on the main Schedule screen. It allows you to copy the Special Day Calendar set up in a schedule program to another schedule program.

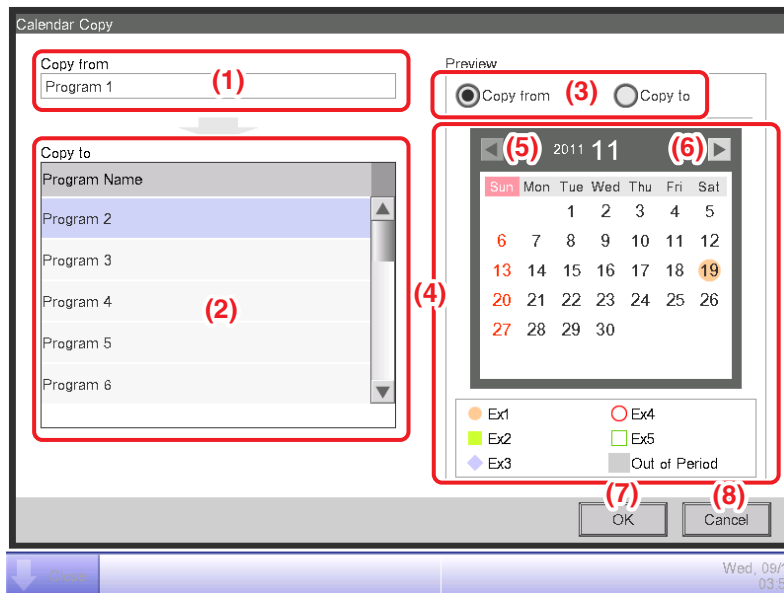

(1) Copy from text area

Displays the name of the schedule program source of the copy.

(2) Copy to list

Displays a list of schedule program names from which to select the destination of the copy.

(3) Preview radio button

Selects the schedule to be displayed in the Calendar view area.

You can select the schedule program source of the copy or a schedule program destination of the copy.

(4) Calendar view area

Displays the schedule program selected with the Preview radio button.

(5) ◀ button

Moves the view to the month previous to that displayed in the Calendar view area.

(6) ▶ button

Moves the view to the month next to that displayed in the Calendar view area. You can specify up to the next one year.

(7) OK button

Saves the edit and closes the screen.

(8) Cancel button

Cancels the edit and closes the screen.

- **Event List Screen**

This screen is displayed when you touch the Edit button on the Weekly Pattern tab or Special Day Pattern tab of the Schedule Edit screen.

It lists events registered in the weekly schedule/special day schedule.

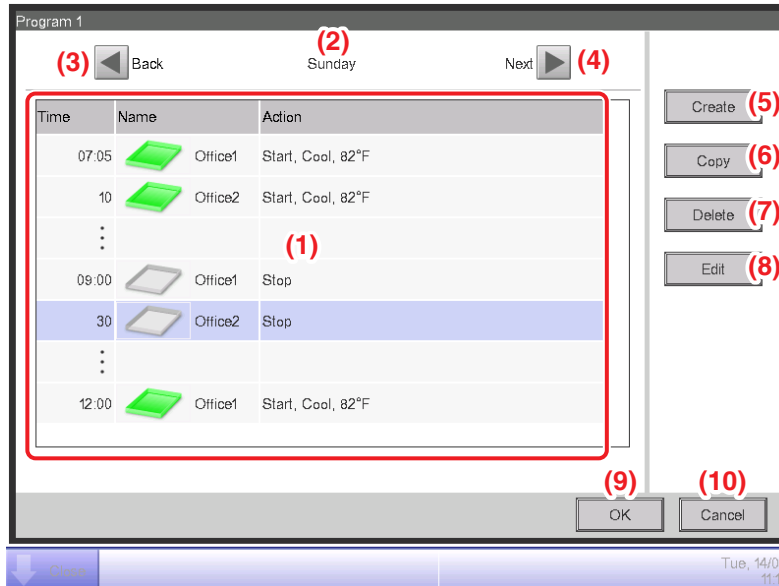

(1) Event list

Displays the list of events set to each day of the week/special day.

(2) Day of the week view area

Displays the day of the week/special day selected in the Schedule Edit screen.

(3) Back button

Moves the Event list view to that of the previous day of the week/special day.

(4) Next button

Moves the Event list view to that of the next day of the week/special day.

(5) Create button

Displays the Events screen that allows you to register new events.

You can register a maximum of 20 events in one schedule.

(6) Copy button

Displays the Event screen with a copy of the event selected in the Event list.

(7) Delete button

Deletes the event selected in the Event list. Touching the button displays a deletion confirmation dialog.

(8) Edit button

Displays the Event screen with the event selected in the Event list for editing.

(9) OK button

Saves the edit and closes the screen.

(10) Cancel button

Cancels the edit and closes the screen.

- **Copy to Selection Screen**

This screen is displayed when you touch the Copy button on the Weekly Pattern tab or Special Day Pattern tab of the Schedule Edit screen.

It allows you to copy events set up for a day of the week/special day to another day of the week/special day.

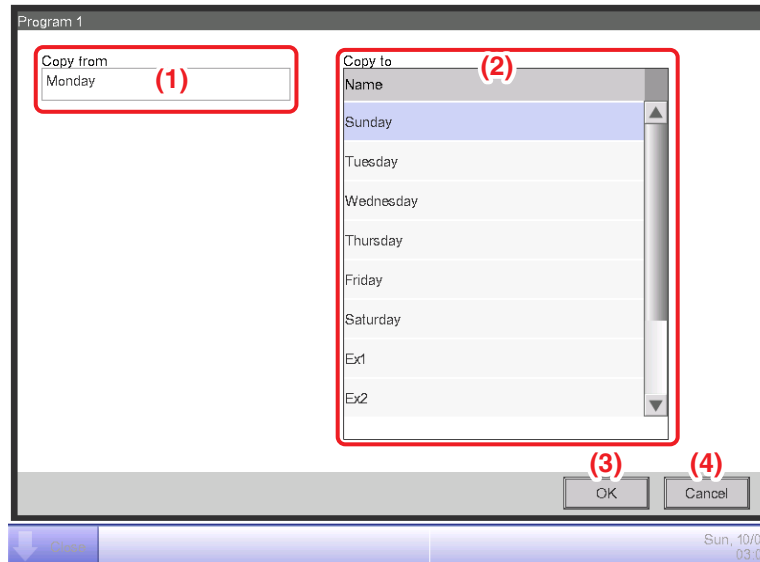

(1) Copy from text field

Displays the name of day of the week/special day selected in the Schedule Edit screen.

(2) Copy to list

Displays a list of days of the week/special days from which to select the destination of the copy.

(3) OK button

Saves the edit and closes the screen.

(4) Cancel button

Cancels the edit and closes the screen.

• **Common Tab (Events Screen)**

This screen is displayed when you touch the Create or Edit button on the Event List screen. It allows you to set up the event's operating time, target management point/area, as well as the start/stop action for the event.

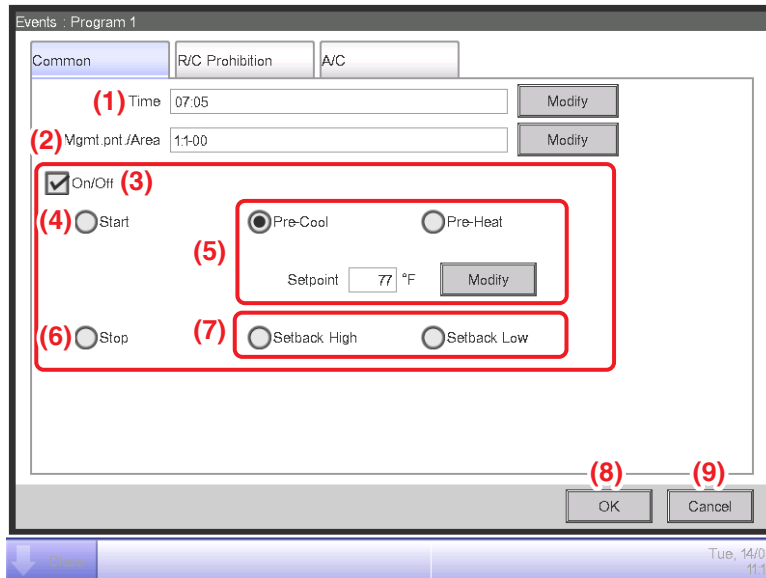

(1) Time setting area

Sets the event's operating time. Touch the Modify button and enter the time in the Time Input dialog that appears.

The range of values you can enter is 00:00 to 23:59 (AM00:00 to PM11:59 when using 12-hour clock).

(2) Mgmt. Pnt./Area setting area

Sets up the management points or areas to control (target).

Touch the Modify button and select one from the list in the Event dialog that appears.

<Management Points Selection dialog>

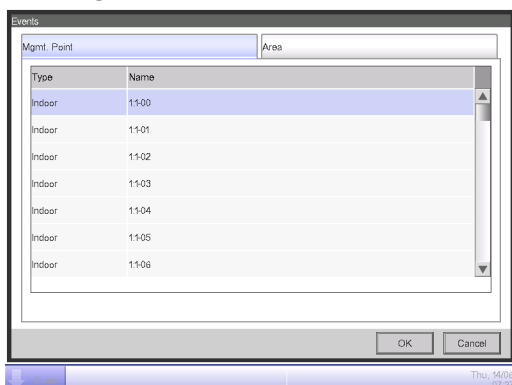

<Area Selection dialog>

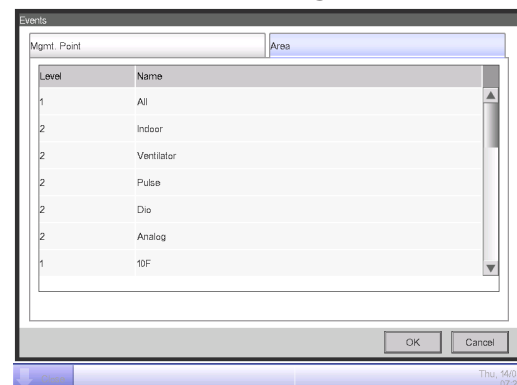

(3) On/Off setting area

Select the On/Off check box to start/stop the target.

(4) Start radio button

Select to start the target.

(5) Pre-Cool, Pre-Heat radio button

Select either of the two radio buttons when using the Pre-Cool/Pre-Heat function.

Touch the Modify button and enter the setpoint in the Numerical Input dialog that appears. The range of values you can enter is 60 to 90, in increments of 1°F.

These radio buttons are displayed only when the target is an indoor unit or area.

When Pre-Cool/Pre-Heat function is set up, the following confirmation dialog will appear as the operation mode and setpoint set up in the A/C tab of the Events screen will be disabled. Touch the Yes button to commit the setting.

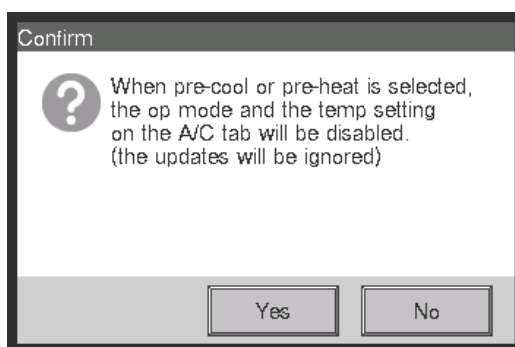

NOTE

- Pre-cool/Pre-heat function is a function that starts the air conditioners earlier than the time set up in the schedule to make the room temperature reach the setpoint at the set time. The function calculates the time to automatically start the air conditioners from the suction temperature and setpoint. The start time is adjusted accordingly as the function learns from repeated use.
- When Pre-Cool/Pre-Heat is set up for an area, the operation mode, the setpoint set up in the Pre-Cool/Pre-Heat settings, and the order to start are sent to the management points in the area at the set time. Be sure to exclude management points you do not want to operate at set times or management points you do not want to modify their operation mode or setpoint from the area.
- Pre-Cool/Pre-Heat is not possible if the Setback function is being used.

Restrictions for use of the pre-cool/heat function

Please note the following restrictions when using the pre-cool/heat function.

The pre-cool/heat function is executed according to the settings as of 0:00 on the day of execution. Therefore, if you scheduled pre-cool/heat on the day intended for execution, the schedule will not be executed as intended but the normal schedule will be executed on the day.

To execute pre-cool/heat as intended, make the settings before the day of execution.

- When changing the settings

The changed settings become effective at 0:00 of the next day. Even if you change or delete the schedule on the day of execution, the schedule identified at 0:00 will be executed.

-
- When changing the date setting of iTM

If the time setting of iTM is changed and the date setting is accordingly changed, pre-cool/heat already scheduled on the changed date will be ignored and the normal schedule will be executed.

- When restarting iTM

If iTM is restarted, pre-cool/heat scheduled on the day of restart will be ignored and the normal schedule will be executed.

- Execution of pre-cool/heat during 0:00 to 2:59

If you set pre-cool/heat to be executed during 0:00 to 2:59, the pre-cool/heat setting will be ignored and the normal schedule will be executed.

- When the daylight saving time starts or ends

Pre-cool/heat may not be executed or may be executed twice depending on the time setting.

- When using an air conditioner without changeover option

Even if you set pre-cool/heat to an air conditioner without changeover option, the setting will be executed according to the operation mode of an air conditioner with changeover option.

(6) Stop radio button

Select to stop the target.

(7) Setback High, Setback Low radio buttons

Select either of the two radio buttons when setting up the Setback function.

These radio buttons are displayed only when the optional Setback function is enabled.

(8) OK button

Saves the edit and closes the screen.

(9) Cancel button

Cancels the edit and closes the screen.

- **R/C Prohibition Tab (Events Screen)**

This screen is displayed when you touch the R/C Prohibition tab on the Events screen. It allows you to enable/disable remote controller.

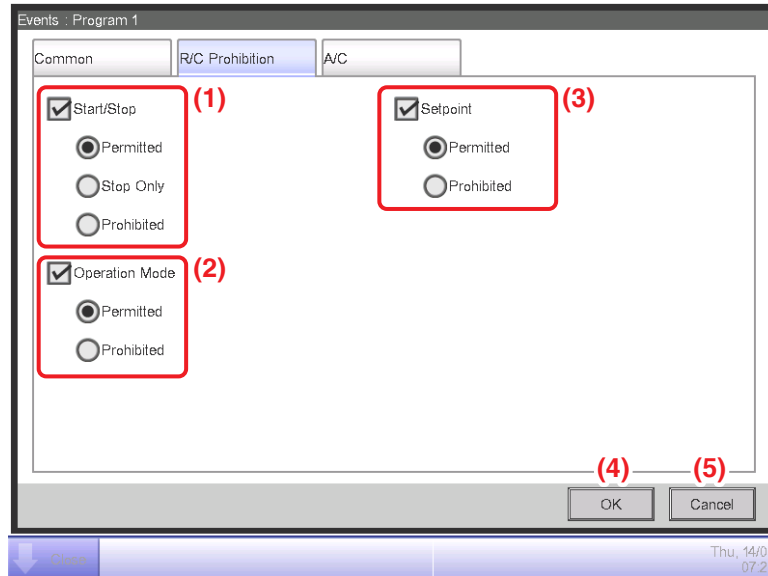

Select the check box of the items to set up and select the setting from the radio buttons.

(1) R/C Start/Stop permission/prohibition setting area

Restricts starting/stopping from the remote controller.

Select the setting from Permitted, Stop Only, and Prohibited.

(2) R/C Operation Mode permission/prohibition setting area

Restricts changing the operation mode from the remote controller.

Select the setting from Permitted and Prohibited.

This setting area is not displayed when the target is Ventilator.

(3) R/C Setpoint permission/prohibition setting area

Restricts changing the setpoint from the remote controller.

Select the setting from Permitted and Prohibited.

This setting area is not displayed when the target is Ventilator.

(4) OK button

Saves the edit and closes the screen.

(5) Cancel button

Cancels the edit and closes the screen.

• **A/C Tab (Events Screen)**

This screen is displayed when you touch the A/C tab on the Events screen. It allows you to set up the air conditioner actions.

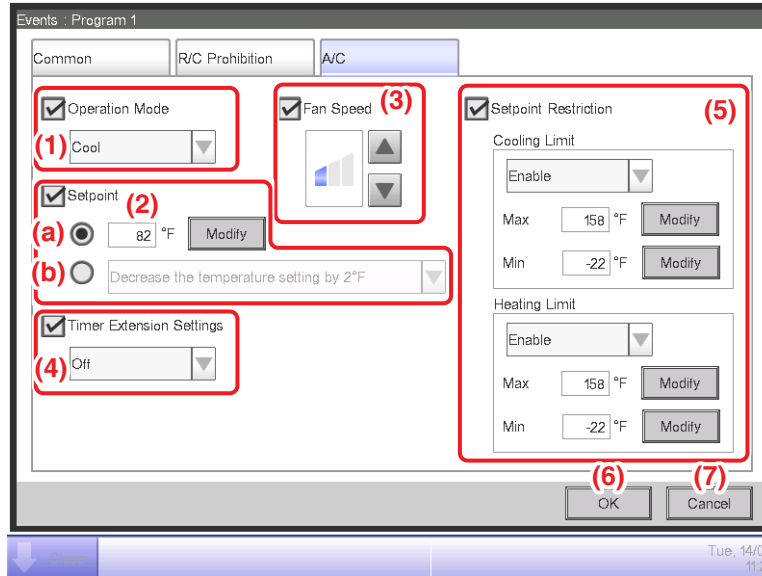

Select the check box of the items to set up and select/enter the setting using the combo box/Modify button.

(1) Operation Mode setting area

Sets up the operation mode.

Select the setting from Fan, Cool, Heat, Dependent, Automatic, and Dry.

Only options applicable to the target are displayed.

(2) Setpoint setting area

Sets up the setpoint.

To set up, select either the (a) Setpoint radio button or (b) Setpoint shift radio button.

If you selected Setpoint, touch the Modify button and enter the temperature in the Numerical Input dialog that appears. The range of values you can enter is –22 to 158°F, in increments of 1°F.

If you selected Setpoint shift, select the amount to shift using the combo box.

Select the amount to shift the temperature from Decrease the temperature settings by 7°F, Decrease the temperature settings by 6°F, Decrease the temperature settings by 5°F, Decrease the temperature settings by 4°F, Decrease the temperature settings by 3°F, Decrease the temperature settings by 2°F, Decrease the temperature settings by 1°F, Increase the temperature settings by 1°F, Increase the temperature settings by 2°F, Increase the temperature settings by 3°F, Increase the temperature settings by 4°F, Increase the temperature settings by 5°F, Increase the temperature settings by 6°F, and Increase the temperature settings by 7°F.

NOTE

- Setpoint shift is a function that allows you to set up the setpoint with respect to the current setpoint.
“Decrease the temperature settings” increases the setpoint for Cool mode, while for Heat mode, it decreases the setpoint by the specified shift amount.
“Increase the temperature settings” decreases the setpoint for Cool mode, while for Heat mode, it increases the setpoint by the specified shift amount.
- Setpoint shift does not work when the operation mode is Fan, Automatic or Dry.

(3) Fan Speed setup area

Sets up the fan speed.

Touching the ▲ button increases the fan speed by one level while touching the ▼ button decreases the fan speed by one level.

The fan speed you can set depends on the target.

(4) Timer Extension setup area

Sets up the function that prevents failure to turn off the indoor unit.

Select whether to enable (On) or disable (Off) the function using the combo box.

(5) Setpoint Restriction setup field

Sets up the setpoint restriction.

Respectively enable or disable the setpoint restrictions for cooling and heating using the combo boxes.

Touch the respective Modify buttons and enter the maximum and minimum values in the Numerical Input dialog that appears.

The range of values you can enter is the same as that for the Setpoint (2) but the entered values should be such that they do not invert the upper and lower limits.

This field is not displayed when the Setpoint Restriction function is disabled for the target indoor unit's management point.

(6) OK button

Saves the edit and closes the screen.

(7) Cancel button

Cancels the edit and closes the screen.

- **Ventilator Tab (Events Screen)**

This screen is displayed when you touch the Ventilator tab on the Events screen.

Sets up the Ventilator actions.

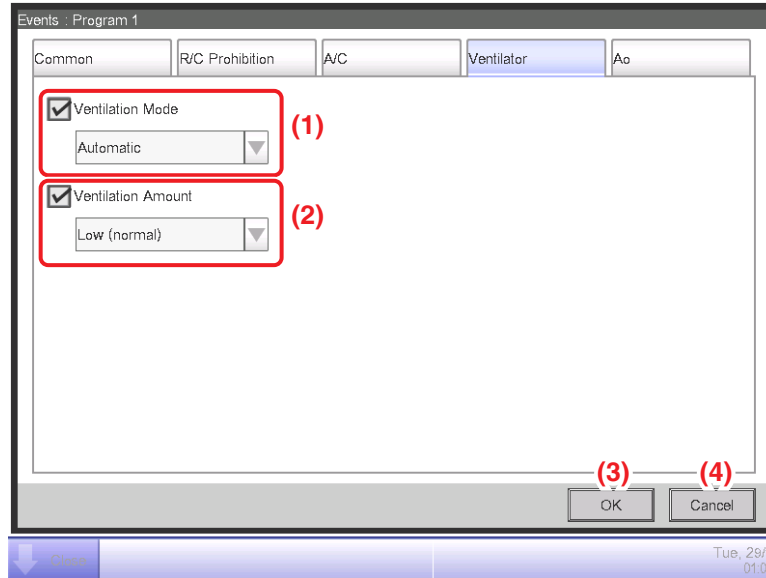

Select the check box of the items to set up and select the setting from the combo box.

(1) Ventilation Mode setting area

Sets up the ventilation mode.

Select the setting from Automatic, ERVentilation, and Bypass.

(2) Ventilation Amount setting area

Sets up the ventilation amount.

Select the setting from Auto (normal), Low (normal), High (normal), Auto (fresh up), Low (fresh up), and High (fresh up).

(3) OK button

Saves the edit and closes the screen.

(4) Cancel button

Cancels the edit and closes the screen.

- **Ao Tab (Events Screen)**

This screen is displayed when you touch the Ao tab on the Events screen.

It allows you to set up the Ao actions.

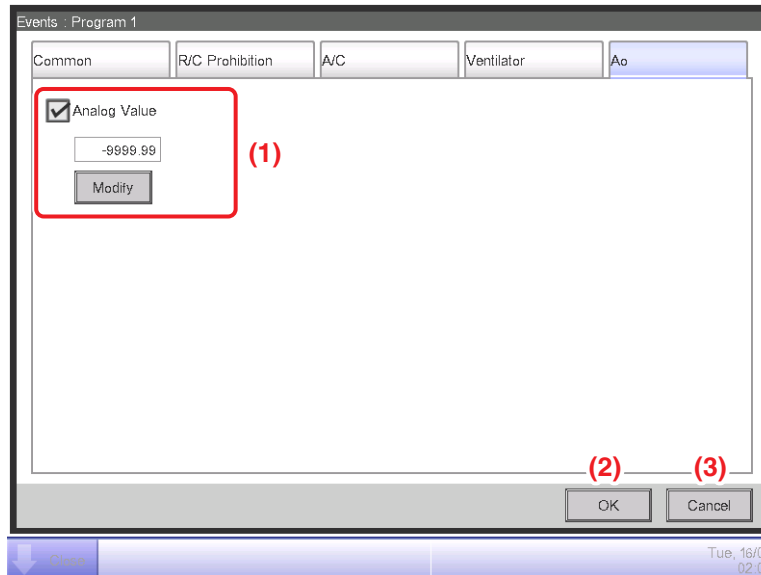

Select the check box of the item to set up, and enter the setting using the Modify button.

(1) Analog Value setting area

Sets up an analog value.

Touch the Modify button and enter the analog value in the Numerical Input dialog that appears.

The range of values you can enter must be within the upper and lower limits, and with the accuracy defined in the Ao's management point.

(2) OK button

Saves the edit and closes the screen.

(3) Cancel button

Cancels the edit and closes the screen.

5-2 Setting up the Timer Extension Function

Using this function, you can prevent failure to turn off the indoor unit by automatically stopping the indoor unit after a certain period of time from the operation start.

If this function is enabled, the indoor units are stopped when Duration elapses from the time they were started.

The following describes how to set this function up.

NOTE

- Once the iTM unit is turned off, all the Timer Extension Function setup will be OFF.
- When the indoor unit encounters the communication error or maintenance has been started, the counted Duration will be cleared.

1. Touch the Timer Extension button on the Automatic Ctrl. tab of the Menu List screen and display the Timer Extension screen (see page 52).

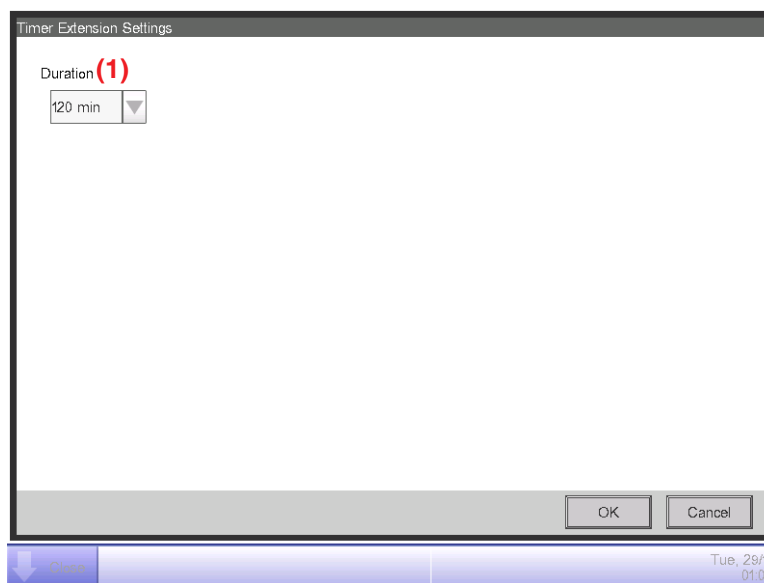

2. Select the time to wait to stop from the **Duration** combo box **(1)**. You can select a value between 30 to 180 minutes, in increments of 30 minutes.
3. When finished, touch the OK button to save and close the screen.
4. The Timer Extension function can be enabled/disabled from the A/C tab displayed in the Detailed Setup screen of the Standard screen, the Events screen of Schedule screen, and Action Setup screen of the Interlocking Control screen.
For details, see the relevant page.

Cautions when Using Simultaneously with Other Control Functions

1. Start/Stop of air conditioners by the Heating Mode Optimization function does not affect the operation of this function.
2. If the Pre-Cool/Pre-Heat function is simultaneously set up, the air conditioners may be stopped before the time set up by this function, preventing the temperature to reach the setpoint at the set time.

Example: 1. Duration is set to 30 minutes.

2. Pre-Cool/Pre-Heat is enabled to achieve 68°F at 9:00 by schedule.
3. The air conditioners are automatically started at 8:15 by the Pre-Cool/Pre-Heat function.
4. This function stops the air conditioners at 8:45. Therefore, the air conditioners are stopped by 9:00, the time set in the schedule.

5-3 Setting up the Auto Changeover

The Auto Changeover function allows you to automatically toggle the operation mode of air conditioners that do not support the “Automatic” mode, depending on the change in the room temperature. Furthermore, this functions automatically changes the setpoint when it changes the operation mode.

If this function is enabled, the function assesses the control conditions from the representative room temperature and representative setpoint every 5 minutes and toggles the operation mode when the conditions for toggling are satisfied. No assessment is performed in the 30 minutes that follows an operation mode change to cooling. However, if the setpoint is changed, an assessment is performed immediately, and then, once every 5 minutes.

The assessment of the control condition is performed according to the following four patterns depending on the thermal difference settings. If the thermal difference setting is 0 to 4°F, the operation mode is changed to keep the thermal preservation range constant at 6°F.

When the thermal difference is 5°F or more

- When **Representative suction temperature – Representative setpoint (Heat) > Thermal difference**, operation mode is changed from Heat to Cool
- When **Representative setpoint (Cool) – Representative suction temperature > Thermal difference**, operation mode is changed from Cool to Heat

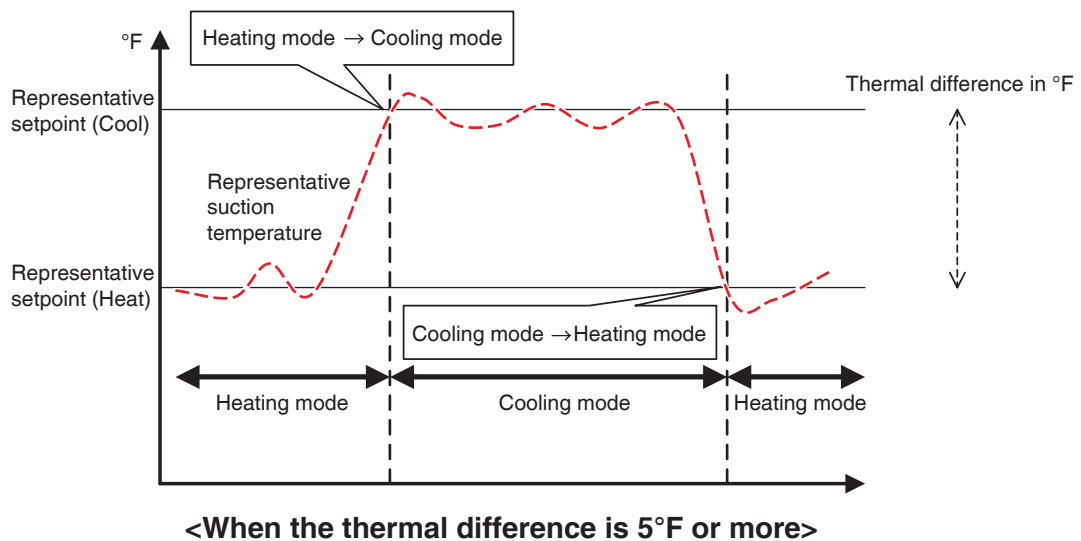

When the thermal difference is 3, 4°F

- When **Representative suction temperature – Representative setpoint (Heat) > Thermal difference + 1**, operation mode is changed from Heat to Cool
- When **Representative setpoint (Cool) – Representative suction temperature > Thermal difference + 1**, operation mode is changed from Cool to Heat

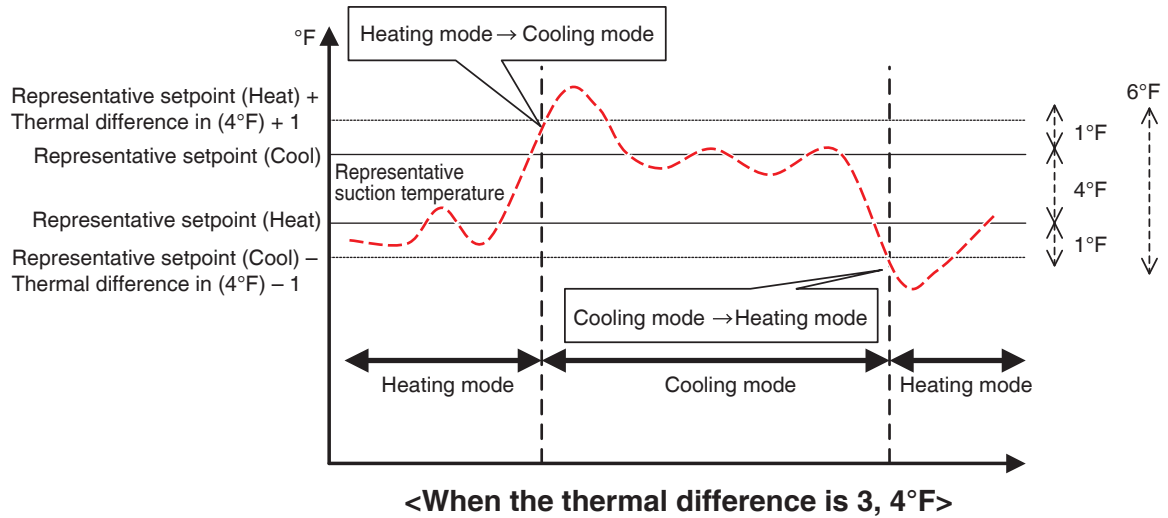

When the thermal difference is 1, 2°F

- When **Representative suction temperature – Representative setpoint (Heat) > Thermal difference + 2**, operation mode is changed from Heat to Cool
- When **Representative setpoint (Cool) – Representative suction temperature > Thermal difference + 2**, operation mode is changed from Cool to Heat

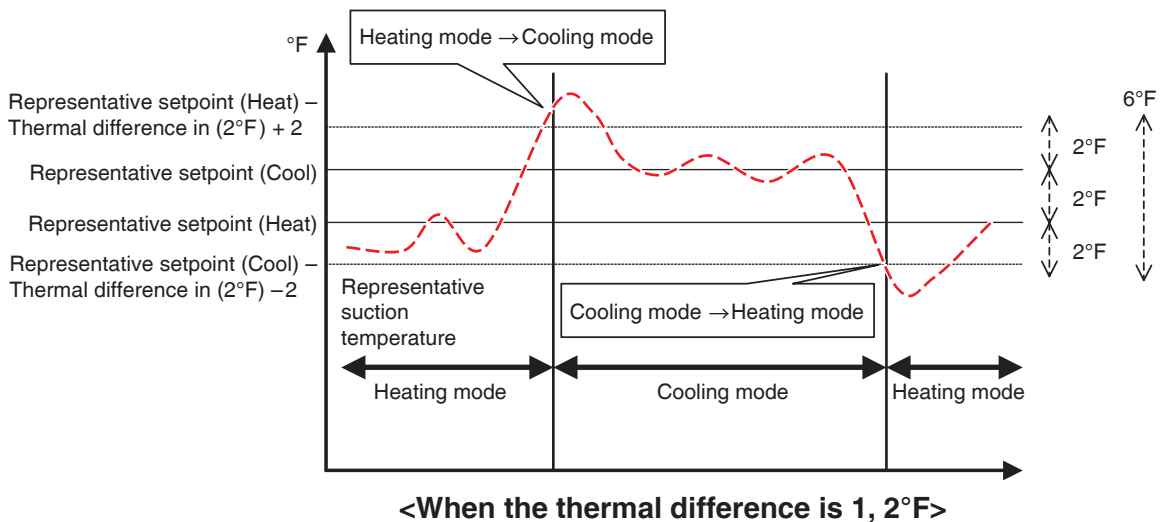

When the thermal difference is 0°F

- When **Representative suction temperature – Representative setpoint (Heat) > Thermal difference + 3**, operation mode is changed from Heat to Cool
- When **Representative setpoint (Cool) – Representative suction temperature > Thermal difference + 3**, operation mode is changed from Cool to Heat

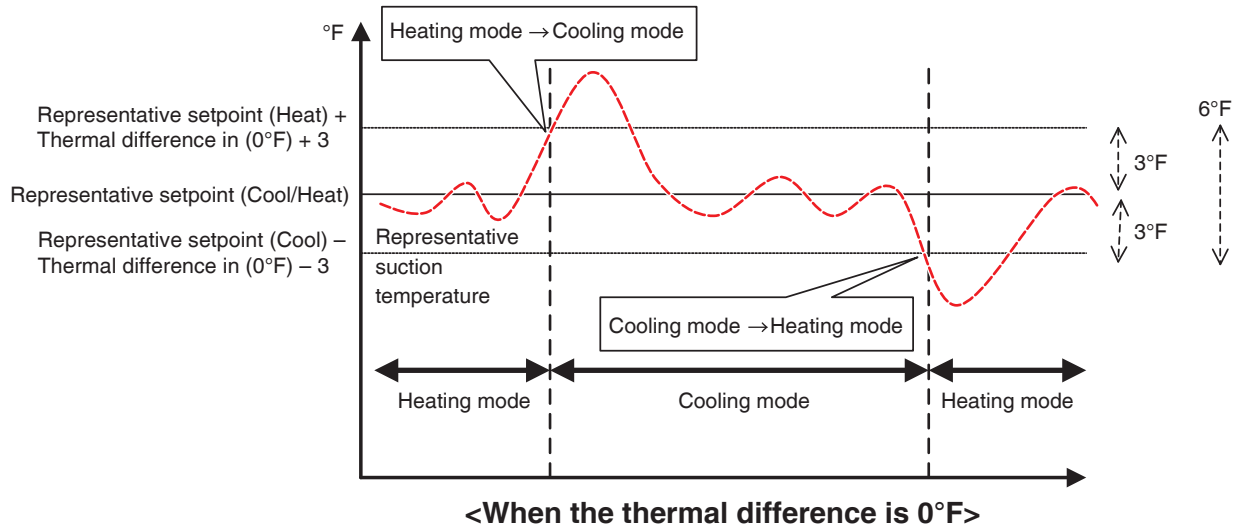

The following describes how to create and set up an Auto Changeover group.

Creating and editing an Auto Changeover group

1. Touch the Auto Changeover button on the Automatic Ctrl. tab of the Menu List screen and display the Automatic Changeover settings screen (see page 52).

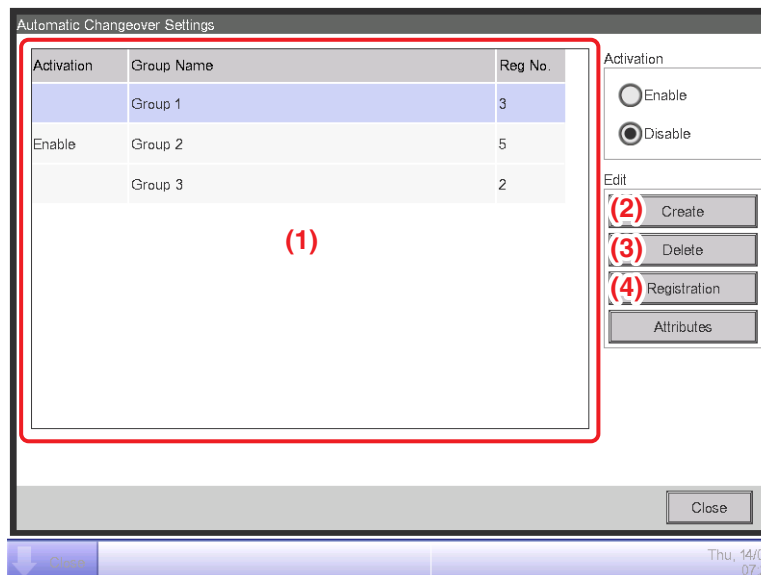

2. **(1)** is a list of registered Auto Changeover groups. To create a new group, touch the **Create** button **(2)** and enter the group name in the Name Setup dialog that appears. Duplicate names are not permitted. You can create up to 512 groups.

3. To delete a group, select the group and touch the **Delete** button (3).
4. To add or delete management points to/from a group, select the group to edit and touch the **Registration** button (4) to display the Registration: Auto Changeover Group screen.

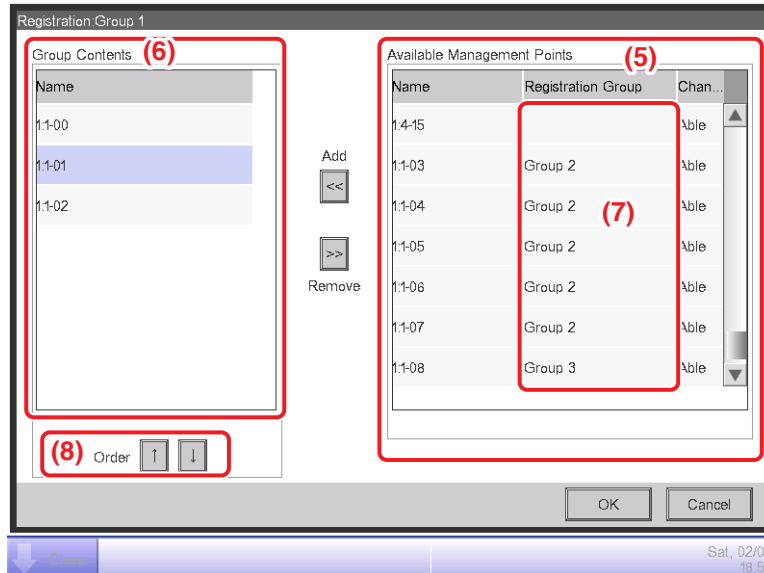

5. From the list of available management points (5), select the management point to register. Touch the Add button to move it to (6) and register it in the group. You can register up to 64 management points in a group. You cannot register the same management point in two or more groups. Select a management point that is not registered in any group, based on the affiliation information displayed in (7). Selecting a management point from (6) and touching the Remove button cancels its registration. To change the registration order within a group, move it up/down using the **Order** buttons (8). When finished, touch the OK button to save and return to the Automatic Changeover settings screen.

NOTE

- You can only register indoor unit management points. When registering indoor units to a group, try to register only those located in the same physical space.
- When registering indoor units without Changeover option to a group, register them with a group of indoor units including indoor units with Changeover option and using the same refrigerant circuit to avoid switching to an unexpected operation mode.

Setting up the changeover conditions

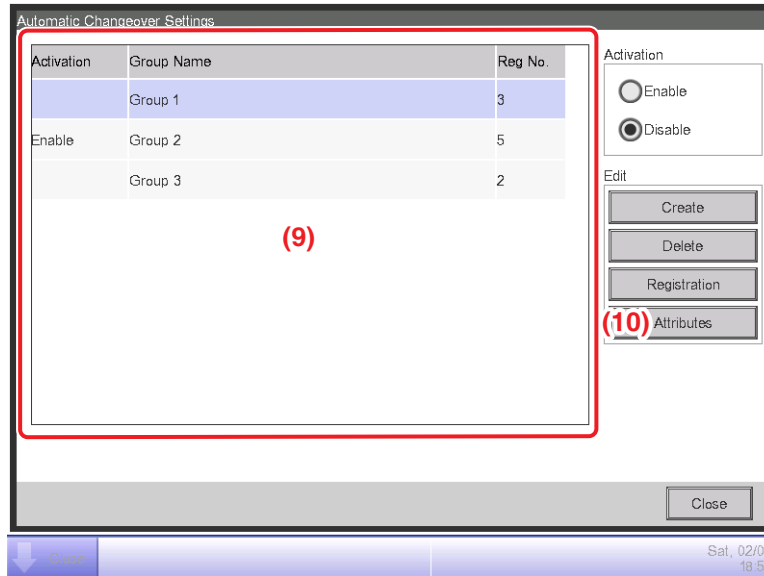

1. Select a group in (9) and touch the **Attributes** button (10) to display the Attributes dialog box.

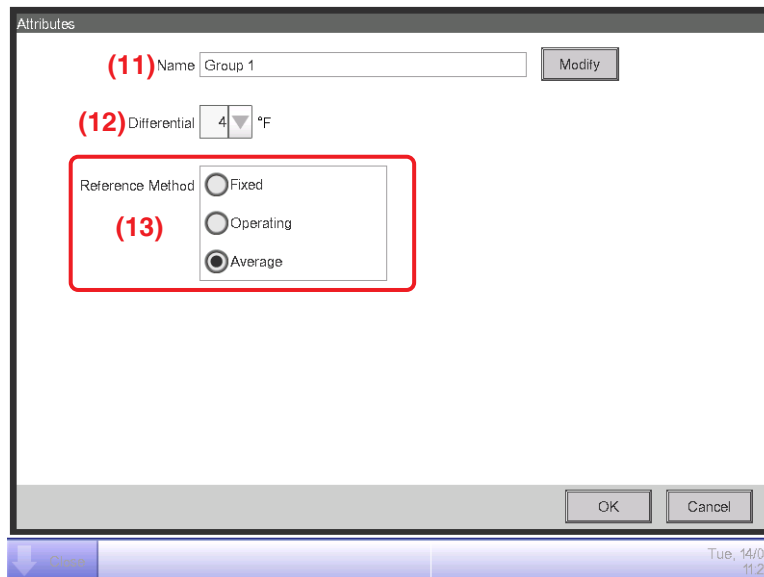

2. Touching the **Modify** button in (11) displays the Name Setup dialog where you can change the group name.

-
3. In the **Differential** combo box (12), select the thermal difference. The range of values you can set is 0 to 13°F, in increments of 1°F.

“Differential” is the tolerance for the indoor unit’s setpoint. When the difference between the room temperature and the representative setpoint exceeds this thermal difference, the operation mode changes.

When the operation mode changes from cooling to heating, the setpoint is decreased by this thermal difference.

When the operation mode changes from heating to cooling, the setpoint is increased by this thermal difference.

Example: If the indoor unit’s setpoint: 72°F and differential: 7°F, when operation changes to cooling because the indoor temperature exceeds 79°F, the setpoint changes to 79°F.

4. Select one from the three methods below for assessing the indoor temperature and setpoint for the group in (13). Average is selected by default.

Fixed: Uses the room temperature information and setpoint of the indoor unit registered at the top of the group as representative room temperature and representative setpoint. In this mode, information of the indoor unit registered at the top is used even when that indoor unit is stopped. However, this function does not work if the operation mode of that indoor unit is other than Cool, Heat, or Automatic, is Communication error, or Maintenance.

Operating: Searches for an indoor unit in the group operating in Cool, Heat, or Automatic mode, and uses the indoor temperature information and setpoint of that indoor unit as the representative indoor temperature and setpoint. The order in which an operating indoor unit is searched is the order in which the management point is registered with the group. If none of the indoor units in the group satisfies the condition, the indoor unit registered at the top, as in the Fixed method is referenced. In this mode, an indoor unit stopped by the Heating Mode Optimization is considered operating.

Average: Uses the average room temperature information and average setpoint of indoor units of the group operating in Cool, Heat, or Automatic mode as representative room temperature and representative setpoint. If none of the indoor units in the group satisfies the condition, the indoor unit registered at the top, as in the Fixed method is referenced. In this mode, an indoor unit stopped by the Heating Mode Optimization is considered operating.

NOTE

The operation mode at the time the automatic control starts is assessed as follows.

- If Average room temperature \leq Average setpoint, then the indoor unit is considered to be working in Heat mode.
- If Average room temperature $>$ Average setpoint, then the indoor unit is considered to be working in Cool mode.

5. When finished, touch the OK button to save and return to the Automatic Changeover settings screen.

Applying the Auto Changeover function

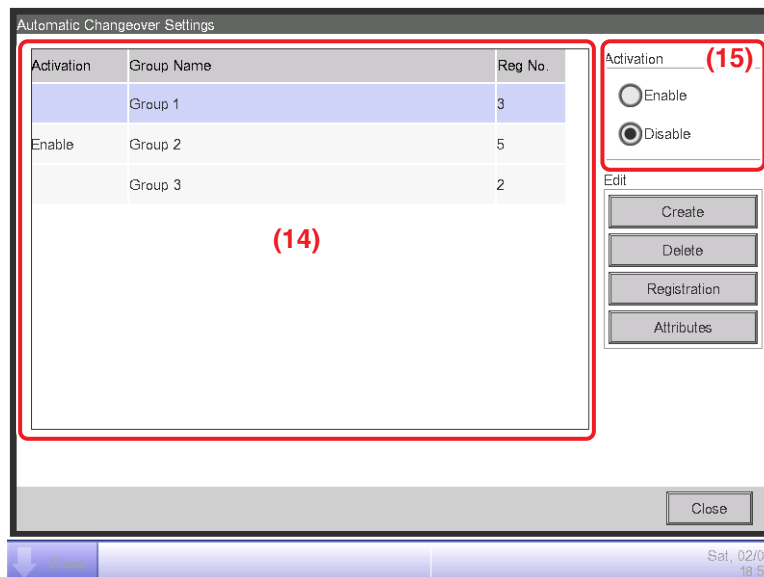

To enable the Auto Changeover function for the group selected in (14), select the **Activation** radio button (15). To disable, select Disable.

Cautions when Using Simultaneously with Other Control Functions

1. If the cooling setpoint is lowered by the Sliding Temperature function when this function is set up simultaneously with the Sliding Temperature function for the same indoor unit, the heating setpoint when the indoor unit changes to heating by this function may be significantly low.

Example: When the lower limit of the setpoint is 68°F for the Sliding Temperature function and the thermal difference is 7°F for this function

1. Heating is started with setpoint at 68°F.
2. When the room temperature becomes 75°F, this function changes the operation mode to Cool.
3. When operation mode changes to Cool, the Sliding Temperature function changes the setpoint according to the outdoor temperature.

-
4. If the outdoor temperature decreases, the setpoint is lowered up to 68°F by the Sliding Temperature function.

When the room temperature further decreases to 60°F, this function changes the operation mode to Heat. At that time, the setpoint becomes 60°F. At the beginning, heating was started with setpoint at 68°F, however, the setpoint became 60°F as a result of the change heat → cool → heat.

2. When this function is simultaneously used with the schedule and interlocking control functions, this function may not work as intended with the settings.

Example: When the method for referencing room temperature and setpoint is set up to Fixed and the thermal difference to 7°F

1. Heating starts with setpoint for the indoor unit reference of indoor temperature and setpoint set at 68°F.
2. The operation mode of that indoor unit is changed to Cool using the remote controller.
3. When the room temperature becomes 68°F or higher, the operation mode of the indoor unit of the Auto Changeover group is changed to Cool and the setpoint set to 68°F. If the operation mode had not been changed using the remote controller, the indoor unit works in Heat mode until the room temperature becomes 75°F, and the setpoint should have changed to 75°F when the operation mode changed to Cool but it didn't.

5-4 Checking an Emergency Stop

When an emergency such as fire occurs, the iTM automatically stops all management points and sounds the buzzer in conjunction with devices such as fire alarms. The iTM recovers all management points automatically when all disaster prevention signals disappear.

When the emergency stop is a result of an operating mistake during maintenance, you can recover the iTM forcibly.

The following describes how to interpret the Emergency Stop view and release an emergency stop.

NOTE

- If the optional function is enabled, you can divide the emergency stop by arbitrary disaster prevention zones (see page 188).
- If the optional function is disabled, all air conditioners are stopped at once.

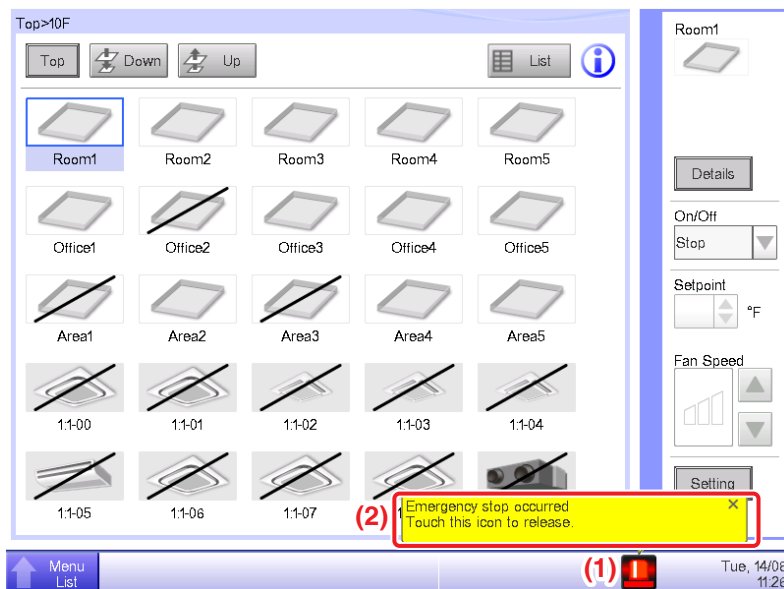

1. When an emergency stop occurs, an Emergency Stop icon appears in (1) and the buzzer sounds. Simultaneously, the message “Emergency Shutdown. Touch this icon to release.” appears in (2).
2. Touching the icon (1) displays the Emergency Stop Release dialog.

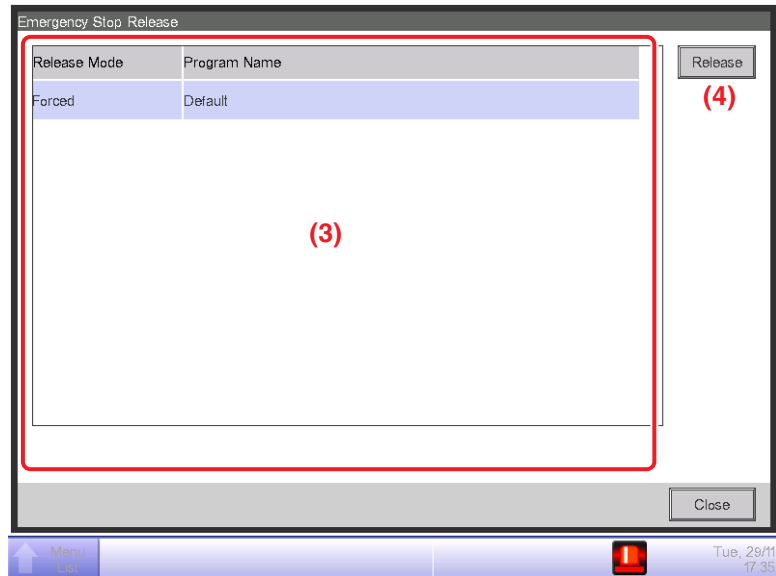

3. **(3)** is the list of emergency stop programs. Select the program to release and touch the **Release** button **(4)**. (Only “Default” is displayed for programs if the optional function is disabled.) To confirm and release the emergency stop, touch the Yes button on the Confirm dialog that appears.

NOTE

To create an arbitrary Emergency Stop program, the optional function must be enabled.

6. System Settings

6-1 Setting up an Area

The following describes how to create, delete, and move an area, as well as register a management point to an area. It also includes descriptions on how to name and set up the detailed settings and icon, as well as how to sequentially start/stop areas in association with the above.

The procedures are as follows.

Creating and deleting an area

1. Touch the Area button on the System Settings tab of the Menu List screen and display the Area Setup screen (see page 54).

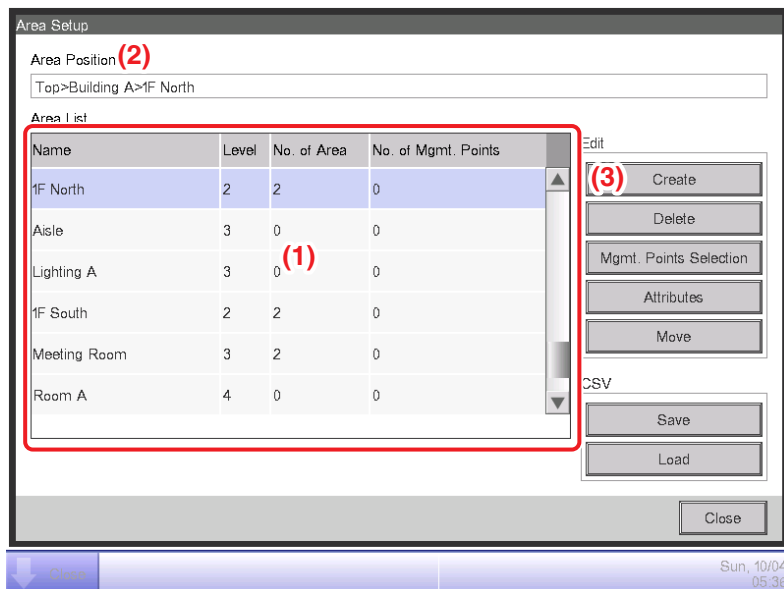

2. (1) on the Area Setup screen is the list of areas displayed as a tree structure organized in descending order. Select the higher level area (for example, 1F North) into which to create the new one. (2) indicates the position of the currently displayed area (for example, Top>Building A>1F North).
3. Touch the **Create** button (3). Enter the name of the new area (for example, Lavatory) in the Name Input dialog that appears and touch the OK button.

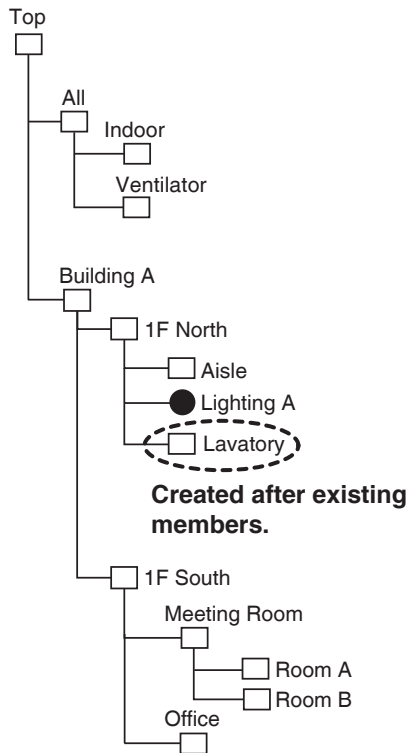

<Area Setup screen>

4. The area created in step 3 (for example, Lavatory) is added to the area selected in step 2 (for example, 1F North) as a member.

NOTE

A newly created area is created under existing management points and areas.

You will not be able to create new areas in the following cases.

- The number of areas exceeds 650.
- The area selected in the Area List is a 10th hierarchical level area.
- The management points and areas included in the selected area total 650.
- The selected area is All or an area immediately under All.
- The name is the same as that of another area. (However, the name may overlap with that of an Indoor, Ventilator, Dio, Analog, Pulse, Outdoor, or Chiller unit predefined in the All area.)

Example: To delete the Meeting Room

□ Area ● Management point

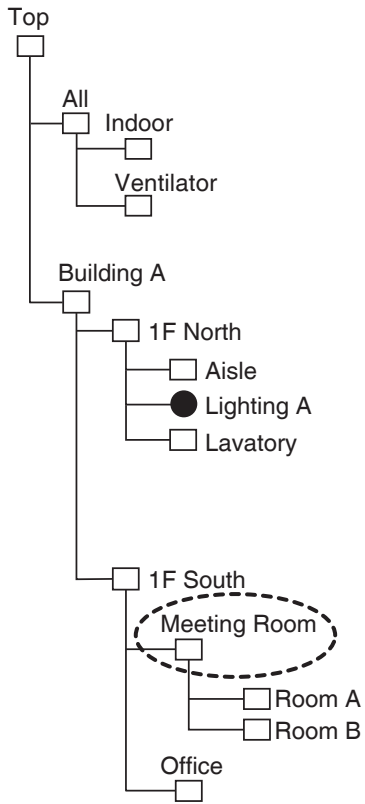

<Area Setup Screen>

Area Setup

Area Position
Top>Building A>1F South>Meeting Room

Name	Level	No. of Area	No. of Mgmt. Points
Lavatory	3	0	0
1F South	2	2	0
Meeting Room	3	2	0
Room A	4	0	0
Room B	4	0	0
Office	3	0	0

Edit

Create

(4) Delete

Mgmt. Points Selection

Attributes

Move

CSV

Save

Load

Close

5. To delete an area, select the area to delete (for example, Meeting Room) and touch the **Delete** button (4). Touching the YES button on the deletion confirmation dialog that appears deletes the selected area.

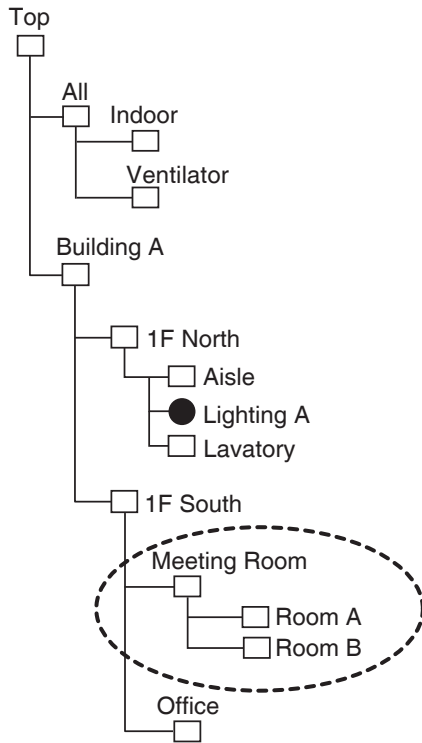

<Area Setup Screen>

Area Setup

Area Position

Area List

Name	Level	No. of Area	No. of Mgmt. Points
1F North	2	3	0
Aisle	3	0	0
Lighting A	3	0	0
Lavatory	3	0	0
1F South	2	1	0
Office	3	0	0

Edit

Create
Delete
Mgmt. Points Selection
Attributes
Move

CSV

Save
Load

Close

Sun, 10/04 05:45

6. (1) is the list of currently registered areas. The area deleted in step 5 (for example, Meeting Room) and the areas included in it (for example, Room A/B) are also deleted.

NOTE

Top, All and areas immediately under All cannot be deleted.

Moving an area

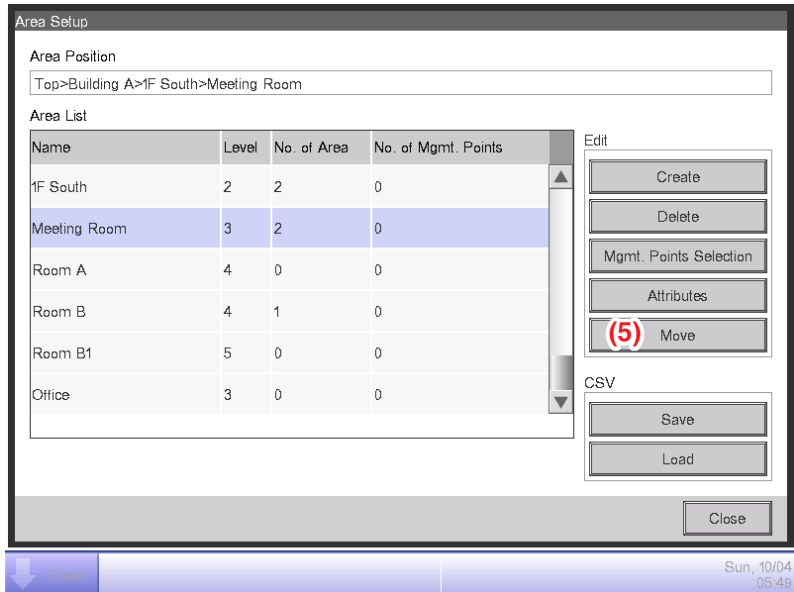

1. To move an area, select the area you want to move (for example, Meeting Room) and touch the **Move** button (5) to display the Area Move screen.

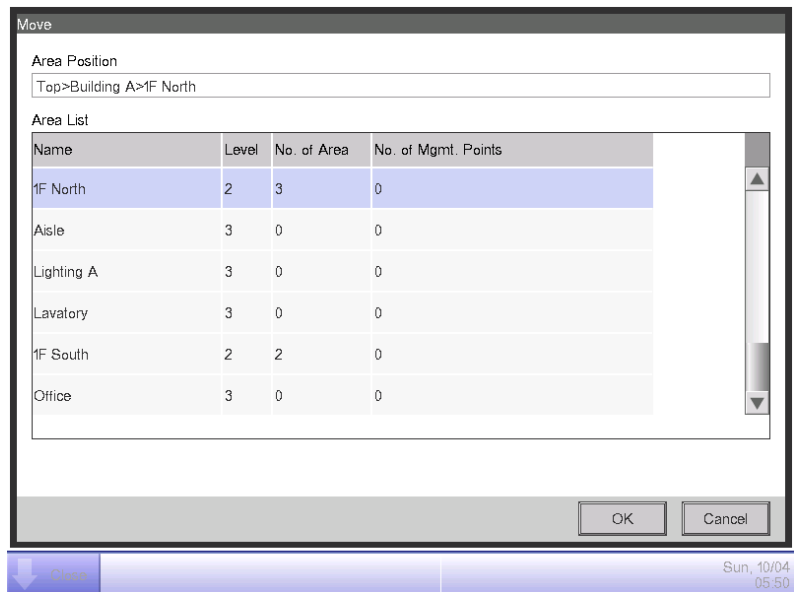

NOTE

The area to move and lower level areas (for example, Meeting Room, Room A, Room B, and Room B1) are not displayed. Furthermore, areas where a move makes the number of members exceed the maximum are not displayed.

2. Select the destination area (for example, 1F North) on the Area Move screen and touch the OK button.

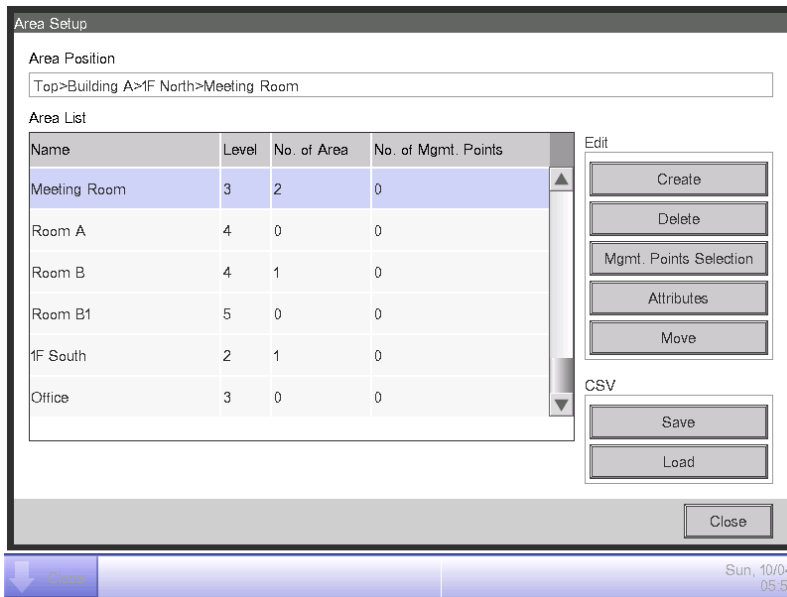

3. The moved area (for example, Meeting Room) is displayed under the area selected in step 2 (for example, 1F North).

NOTE

Top, All and areas immediately under All cannot be moved. You cannot move an area into these areas either.

Registering a management point or area to an area

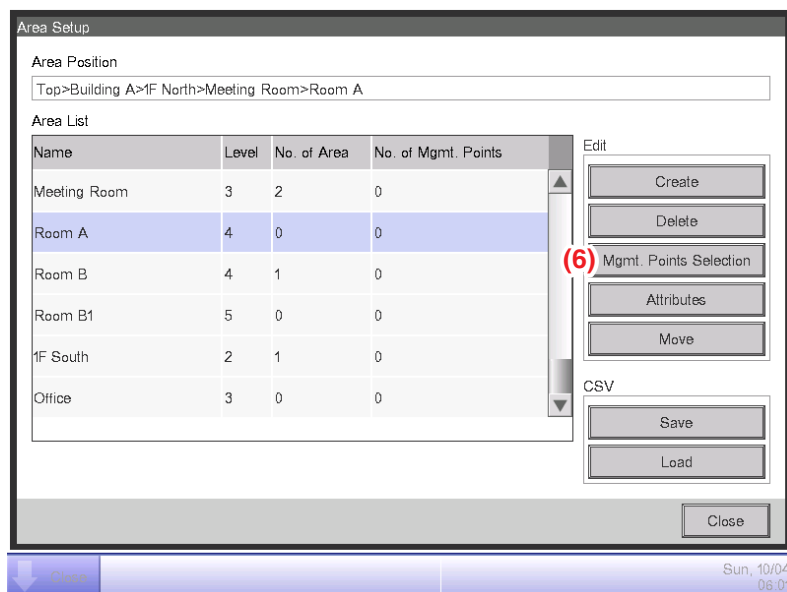

1. On the Area Setup screen, select the area to which you want to register a member and touch the **Mgmt. Points Selection** button (6) to display the Area Member Registration screen.

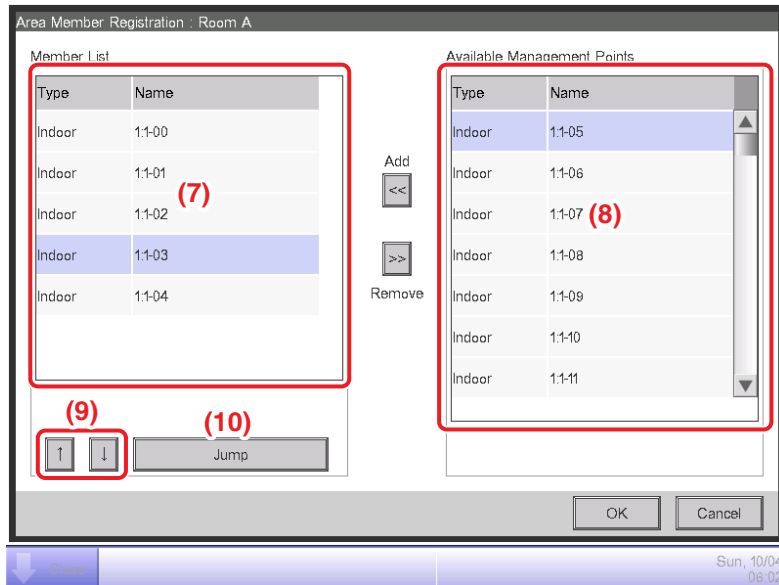

2. The list (7) displays management points and areas directly under the area being edited in the order they were registered. The list (8) displays non-registered management points. Select the management point you want to register (multiple selection possible). To register, move them using the Add button. To change the display order, change the order in which (7) is displayed using the ↑↓ buttons (9). To delete a member, select it from (7) and then touch the Remove button.

NOTE

The Add button cannot be used in the following cases.

- The displayed area is All or an area immediately under All.
- The area includes 650 or more members.
- The number of management points exceeds 1300.

The Remove button cannot be used in the following cases.

- The displayed area is All or an area immediately under All.
- An area is selected.

3. The **Jump** button (10) for changing the order of members displayed in (7) at once. Selecting a management point or area (multiple selection possible) to move and touching the **Jump** button (10) displays the Order Setup screen.

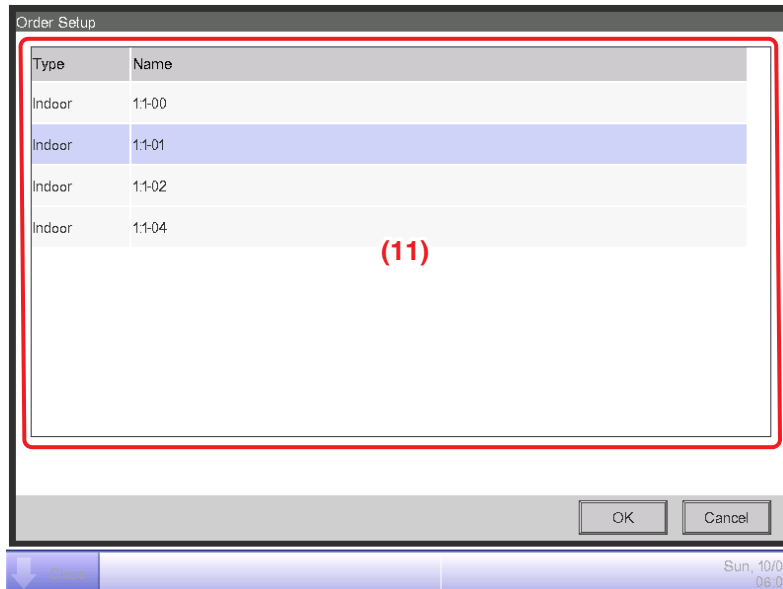

4. (11) is the list of management points and areas that were not selected in the Area Member Registration screen. Select the destination to move to and touch the OK button. The management points/areas selected in the Order Setup screen in step 3 move to the area under that selected in the Area Member Registration screen as indicated below.

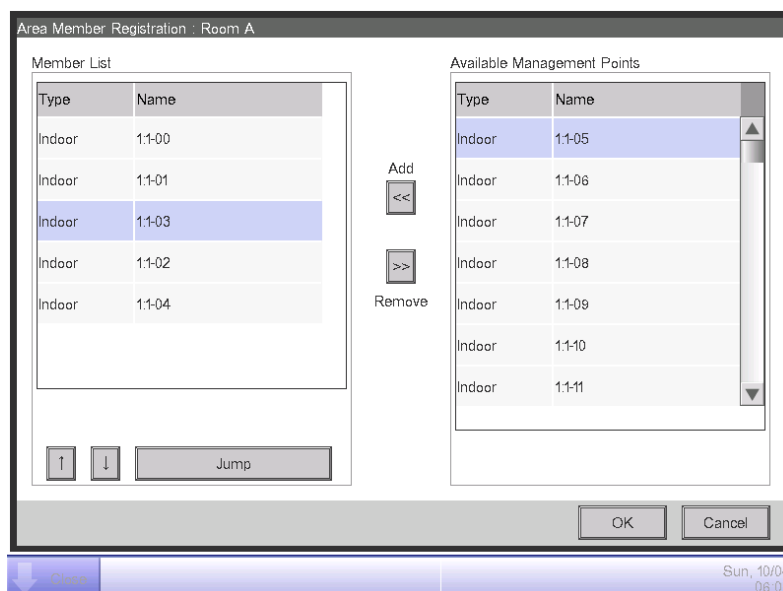

Naming and setting up the detailed information of an area

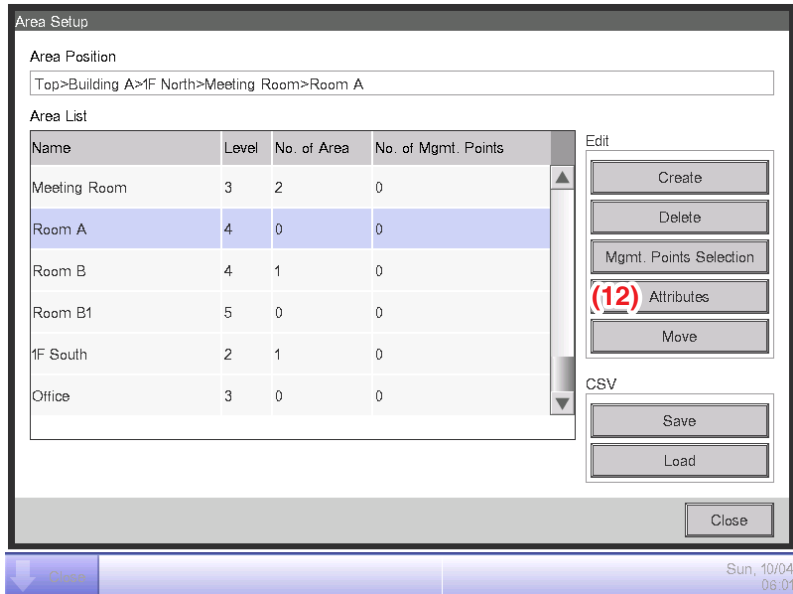

1. Select the area to name and set up the detailed information from the Area Setup screen and touch the **Attributes** button (12) to display the Area Attribute Setup screen.

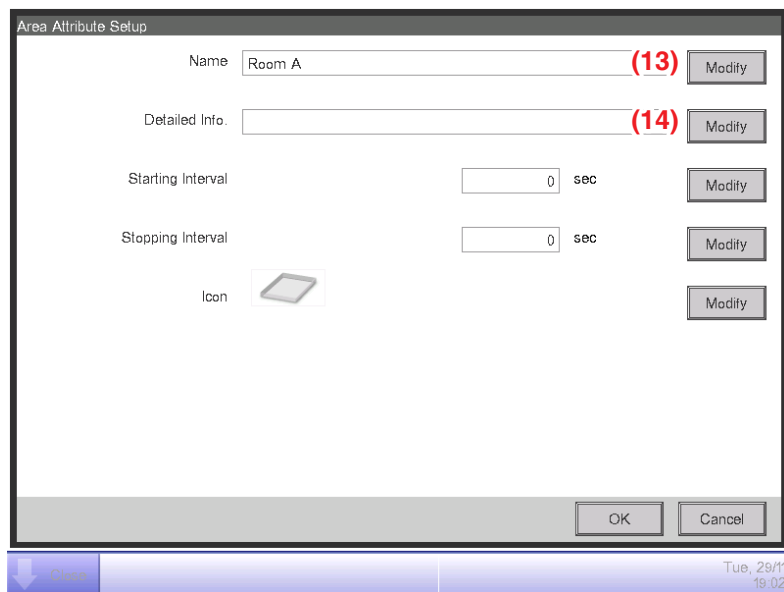

2. Touch the **Modify** buttons (13) and (14). Set up the name and detailed information in the Text Input dialog box that appears.

Setting up the interval for sequential start/stop

This function prevents all management points to be started or stopped at once when start/stop is ordered for an area by sequentially starting or stopping its member management points and areas in the order they are listed in the Area Member Registration screen.

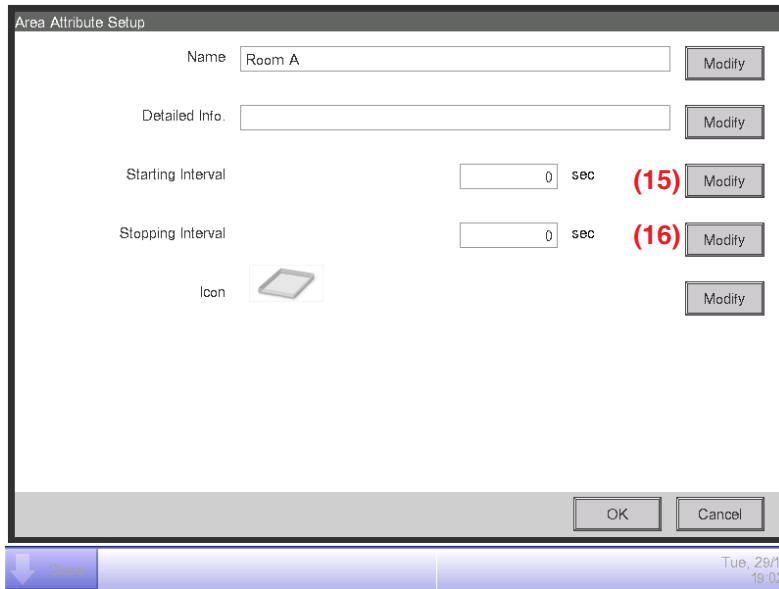

1. Touch the **Modify** buttons **(15)** and **(16)** on the Area Attribute Setup screen. Enter the interval for starting or stopping in the Numerical Input dialog box that appears. The range of values you can specify is 0 to 180 seconds.

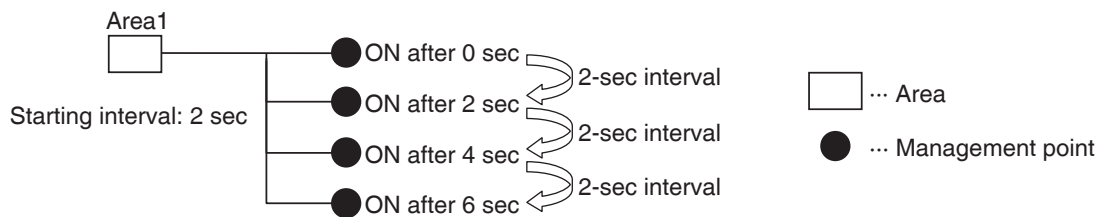

Setting up icons

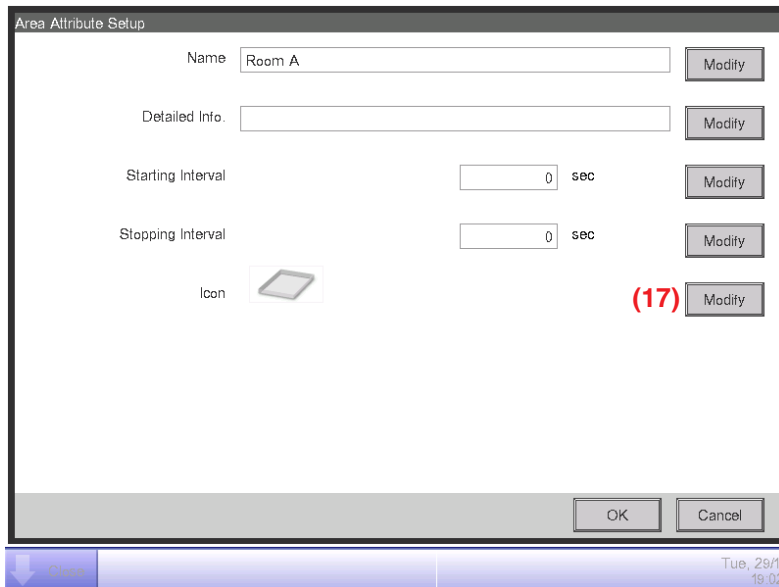

1. Touch the **Modify** button (17) on the Area Attribute Setup screen to display the Icon Setup screen.

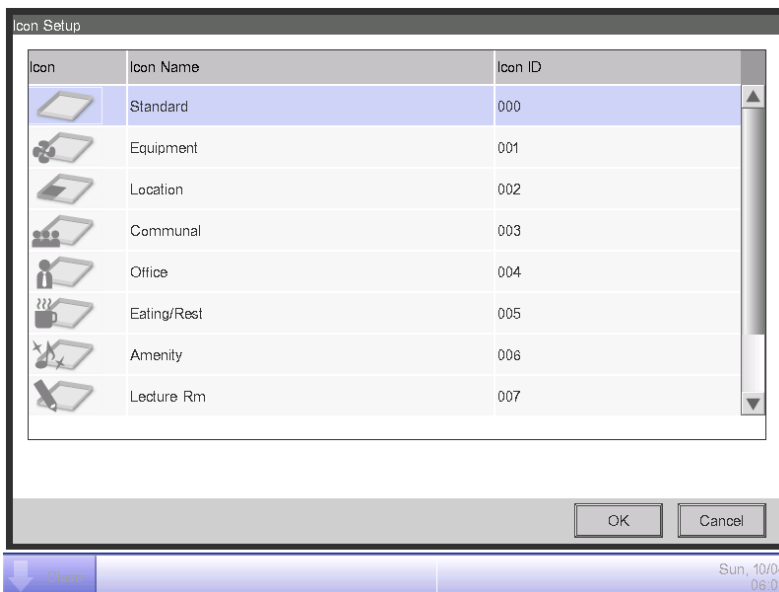

2. Select an icon from the displayed icon list and touch the OK button to set it up.

Saving and loading the area data CSV file

You can save the area settings in a USB memory as a CSV file (AreaData.csv). You can also load a CSV file from a USB memory. Make sure the file is named “AreaDate.csv” as it is the only readable fail name.

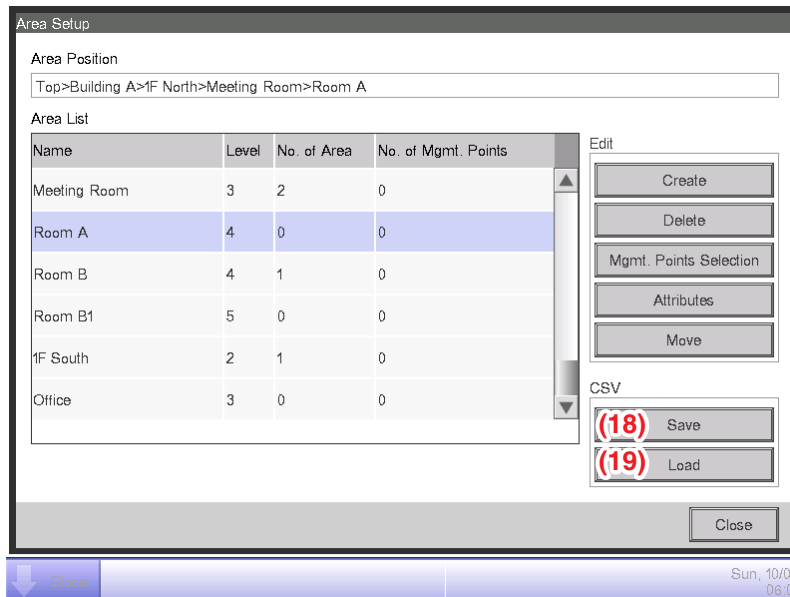

1. To save, connect a USB memory to the iTM unit and touch the **Save** button (18) on the Area Setup screen. A confirmation dialog with the message “Do you want to save area data in CVS format? Max Time : 15 sc” will appear. Touch the Yes button to save. When successfully saved, the message “File has been saved.” will appear.
2. To load, connect the USB memory with the CSV file file in the iTM unit and touch the **Load** button (19) on the Area Setup screen. A confirmation dialog with the message “Loaded data will delete existing data. Max Time : 15 sc” will appear. Touching the Yes button will start loading the data. When the CSV file to load is corrupt, an error screen is displayed. Correct the errors sequentially from the top.

The format of the CSV file used for saving and loading Area Data is as follows.

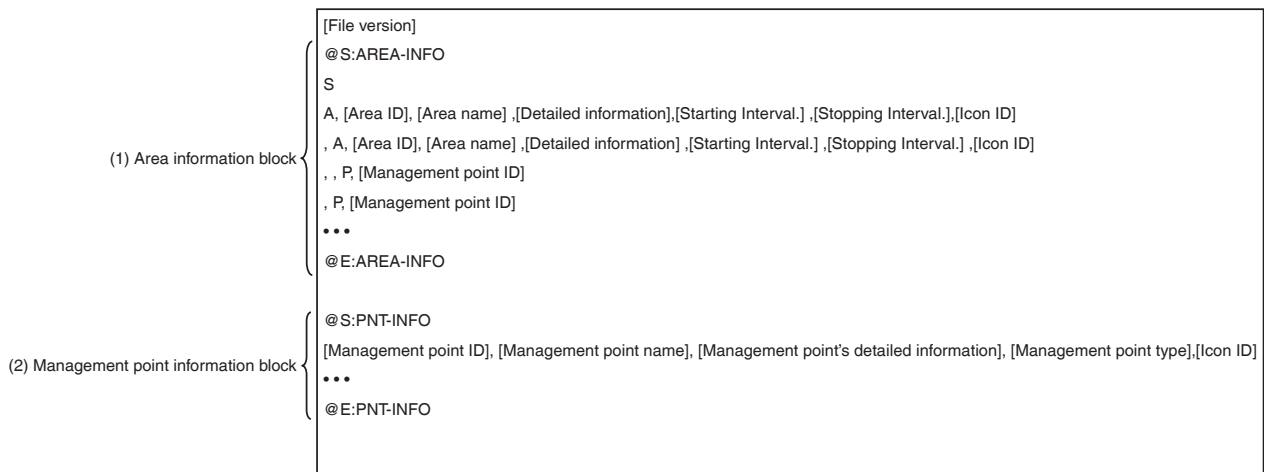

6-2 Setting up a Management Point

Changes the name, detailed information, and icon of management points.

The following describes how to set this up.

1. Touch the Mgmt.Pts. button on the System Settings tab of the Menu List screen and display the Mgmt. Points Setup screen (see page 54).

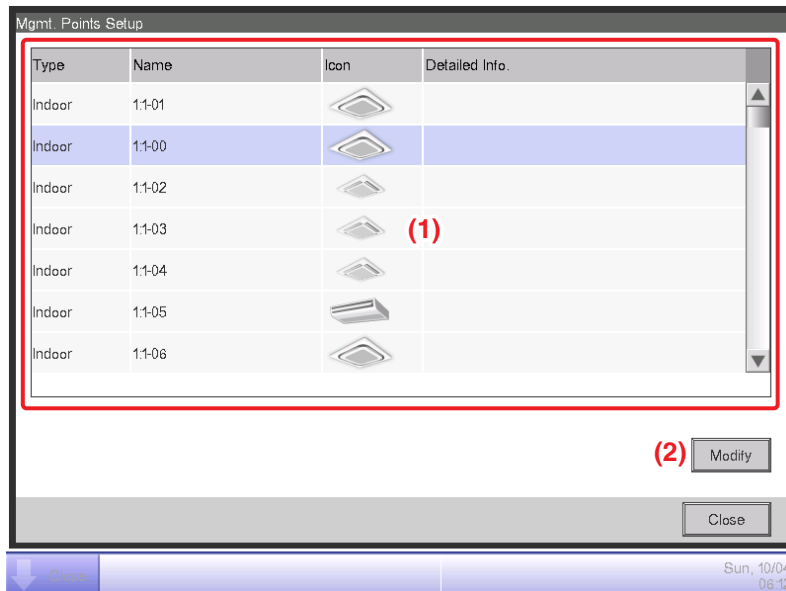

2. (1) is the list of management points. Select a management point and touch the **Modify** button (2) to display the Mgmt. Points Attributes Setup screen.

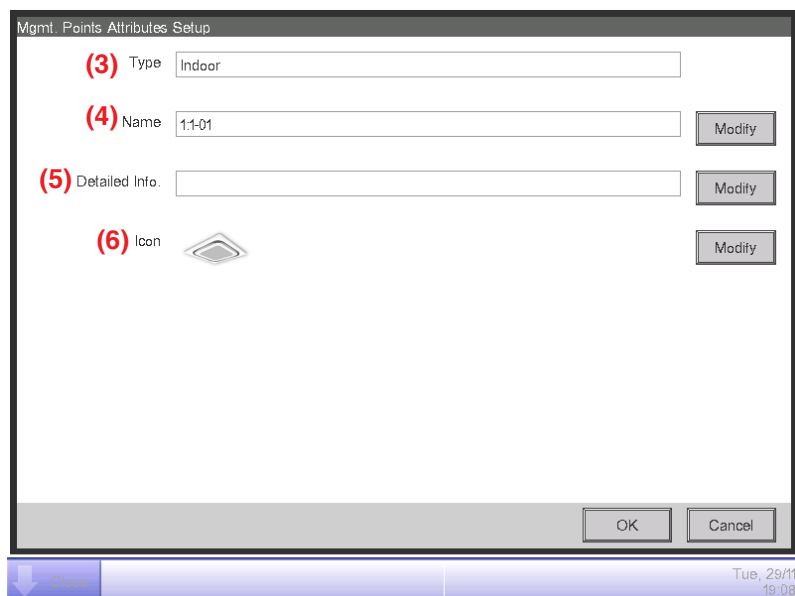

-
3. The Type of the management point is displayed in (3). However, you cannot change it here. Touch the Modify button (4) for the management point name. Enter the new name in the Text Input dialog box that appears. The number of characters you can enter is 1 to 12, irrespective of single or double byte. If the entered name is duplicated, a dialog with the message “Same Mgmt. Point name is already registered” appears and it is rejected. Touch the Modify button (5) for Detailed Info. Enter the detailed information in the Text Input dialog that appears. The maximum number of characters you can enter is 50, irrespective of single or double byte. You can omit entering detailed information if there is nothing to enter.
4. To set up the icon (6), touch the Modify button and display the Icon Setup screen.

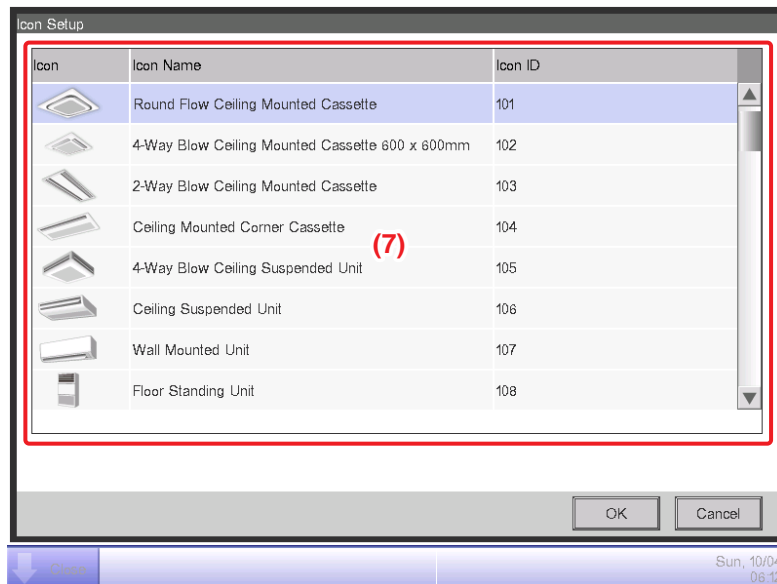

Select an icon from (7) and touch the OK button to set it up. Return to the Mgmt. Points Attributes Setup screen to check the whole view and touch the OK button to close the screen.

6-3 Setting up and Changing the Password

You can set up and change the password for the administrator as well as that for unlocking screens. If administrator password is enabled, touching the button for switching to the Menu List view on the Standard View or the optional Layout View screen displays the Password dialog, so that a user who does not know the administrator password cannot display the Menu List view.

If screen lock is enabled, touching the Unlock button on the Standard View or the optional Layout View screen locks the screen and no other operation than unlocking will be allowed.

To unlock, you must touch the Lock button and display the Password dialog to enter the password for unlocking the screen.

NOTE

- When administrator password and screen lock are simultaneously enabled, entering the administrator password after touching the Menu List switch button unlocks the screen and displays the Menu List screen.
- You can overwrite the Enable/Disable setting of the screen lock using the Web Remote Management function (optional)

The following describes how to set this function up.

1. Touch the Passwords button on the System Settings tab of the Menu List screen and display the Passwords screen (see page 54).

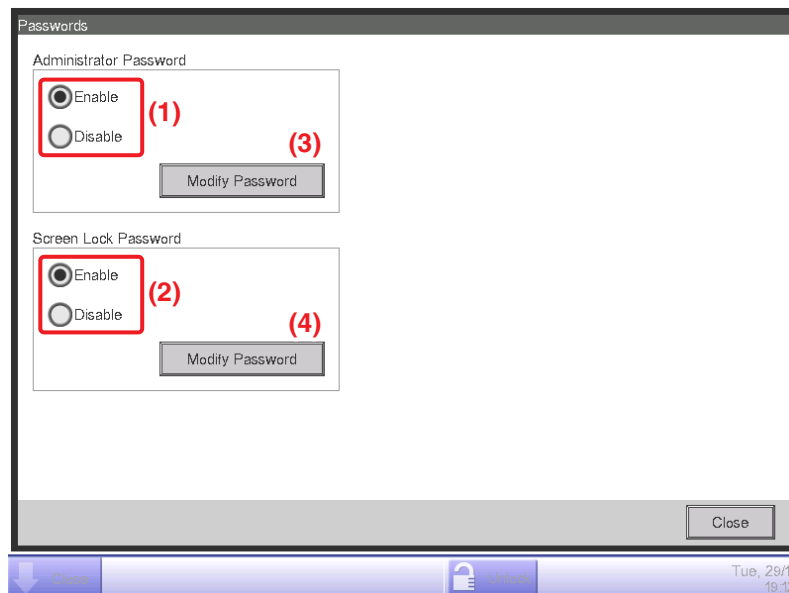

2. To enable the Administrator Password, select Enable in (1). To disable, select Disable. Selecting Enable displays the Password dialog box for entering a new password. Set a password using 1 to 15 alphanumeric characters. The dialog will appear again. Enter the password again for confirmation. Touch the OK button to save and close the screen.

3. To enable the Screen Lock, select Enable in **(2)**. To disable, select Disable.

Selecting Enable displays the Password dialog for entering a new password. Set a password using 1 to 15 alphanumeric characters.

The dialog will appear again. Enter the password again for confirmation. Touch the OK button to save and close the screen.

4. To change the administrator password or the screen lock password, touch the respective **Modify Password** button, **(3)** or **(4)**.

Enter the current password in the Password dialog for entering the existing password.

Thereafter, enter the new password twice. Touch the OK button to save and close the screen.

6-4 Setting up Maintenance and Checking

You can set a specific management point to “maintenance” or release it from “maintenance”.

A management point set to “maintenance” cannot be controlled from the iTM, that is, it cannot receive input signals such as orders of operation, automatic control, status monitoring, etc. However, emergency stop is possible.

The following describes how to set this function up.

1. Touch the Maintenance button on the System Settings tab of the Menu List screen and display the Maintenance Settings screen (see page 54).

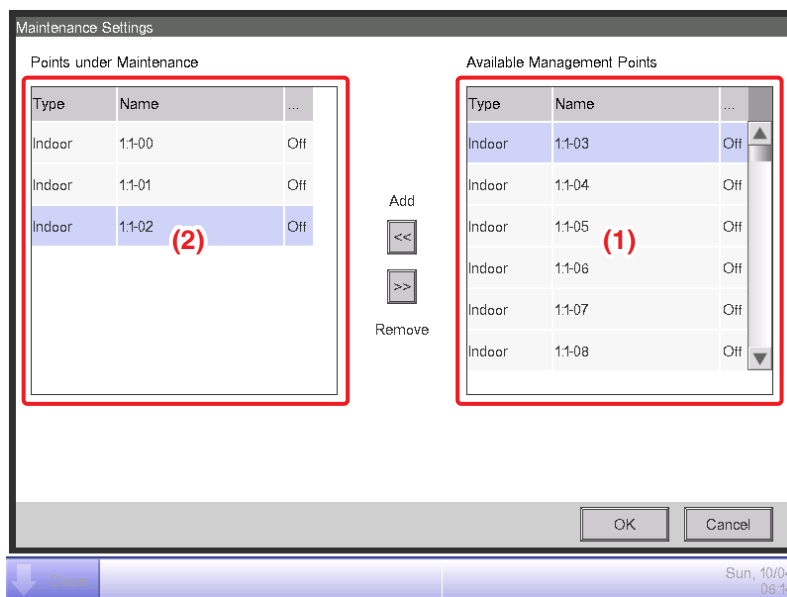

2. To set to maintenance, select a management point from (1) and touch the Add button to move it to (2). The management point is set to maintenance. Touch the OK button to save and close the screen.
3. To release from maintenance, select a management point from (2) and touch the Remove button to move it to (1). The management point is released from maintenance.

When finished, touch the OK button to save and close the screen.

6-5 Setting up and Changing the Locale

You can set up/change the display language used in the iTM unit.

1. Touch the Regional button on the System Settings tab of the Menu List screen and display the Locale screen (see page 54).

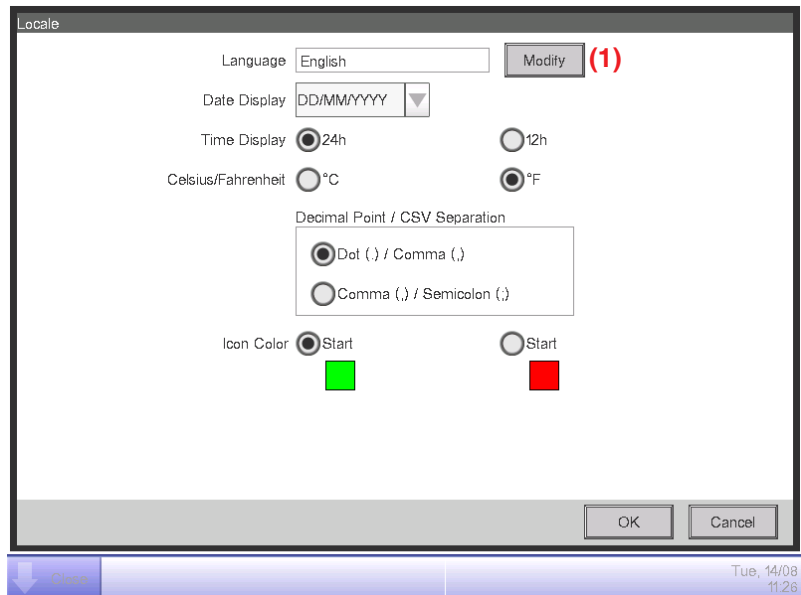

2. Select the display language. Touch the **Modify** button (1) and open the Language screen.

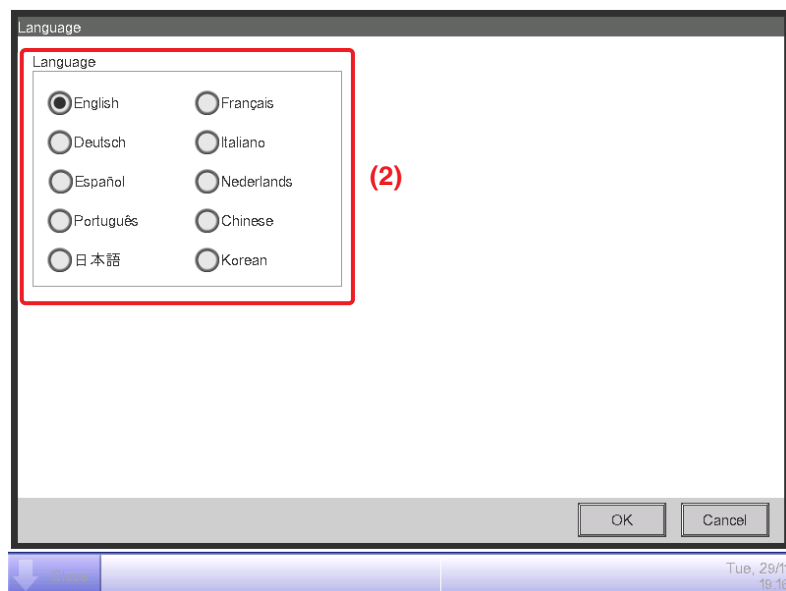

3. Select the language to use from (2). Touch the OK button to save and return to the Locale screen.

4. Set up the display format and unit.

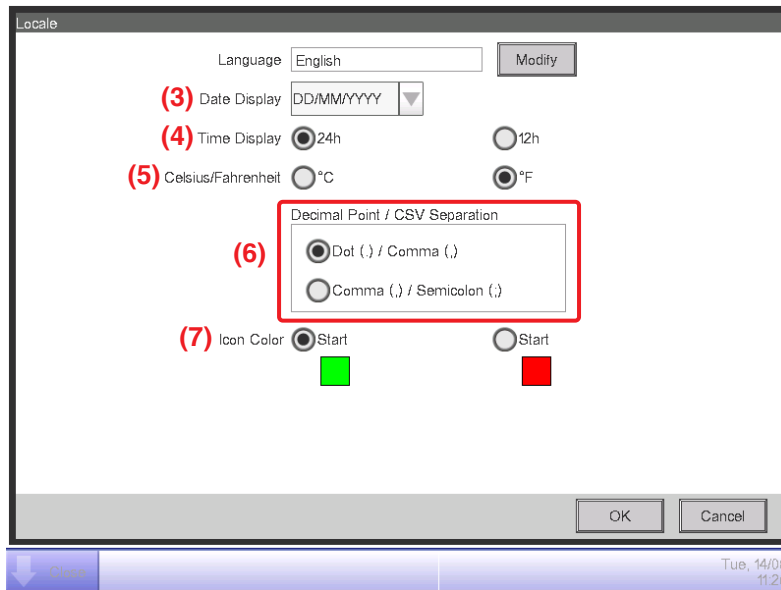

Set up the date display format using the **Date Display** combo box (3).

You can select from DD/MM/YYYY, MM/DD/YYYY, and YYYY/MM/DD.

Select the time display format using the **Time Display** radio button (4).

Select the temperature unit from Fahrenheit and Celsius using the **Celsius/Fahrenheit** radio button (5).

Select the decimal point and separator for the CSV file using the **Decimal Point/CSV Separation** radio buttons (6).

Select the icon color for operating management points using the **Icon Color** radio button (7).

When finished, touch the OK button to save and close the screen.

NOTE

When the unit of temperature is changed between Celsius and Fahrenheit, the change should be followed by a restart by the Restart switch.

6-6 Setting up and Changing the Time

You can set up and change the current time and daylight saving time.

1. Touch the Time/DST button on the System Settings tab of the Menu List screen and display the Time/DST screen (see page 54).

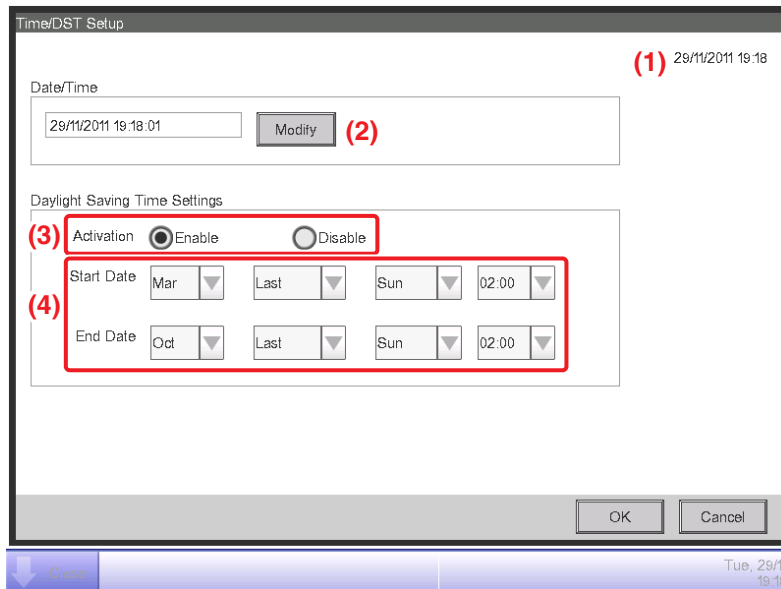

2. (1) displays the current time. To change, touch the **Modify** button (2). Enter the time in the Time Input dialog box that appears. Touch the OK button and close the screen.

Entering an inappropriate value displays an error dialog where you will be able to enter the correct value.

3. When using daylight saving time, enable it in (3) and select the start and end dates from the combo boxes (4). When not using daylight saving time, select Disable.

The selectable ranges are as follows.

Start month: Jan – Dec

End month: Jan – Dec

Start week: 1st – 4th, Last

End week: 1st – 4th, Last

Start day of the week: Sun – Sat

End day of the week: Sun – Sat

Start Time: 1 – 4

End Time: 2 – 4

4. When finished, touch the OK button. The following Confirm dialog appears. After confirming, touch the Yes button to save and close the screen.

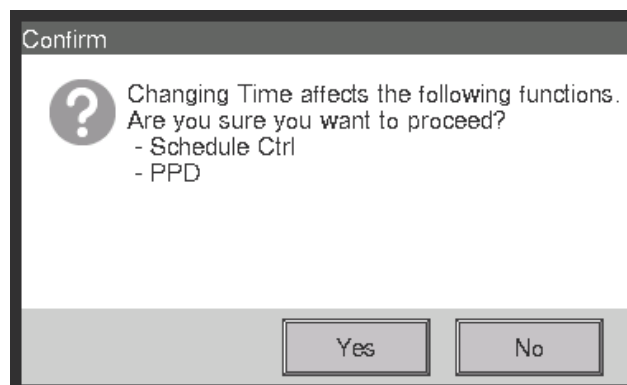

6-7 Setting up and Changing the Screensaver

You can set up or change the screensaver, as well as set up or change the setting for turning the screen off.

1. Touch the Screensaver button on the System Settings tab of the Menu List screen and display the Screensaver Settings screen (see page 54).

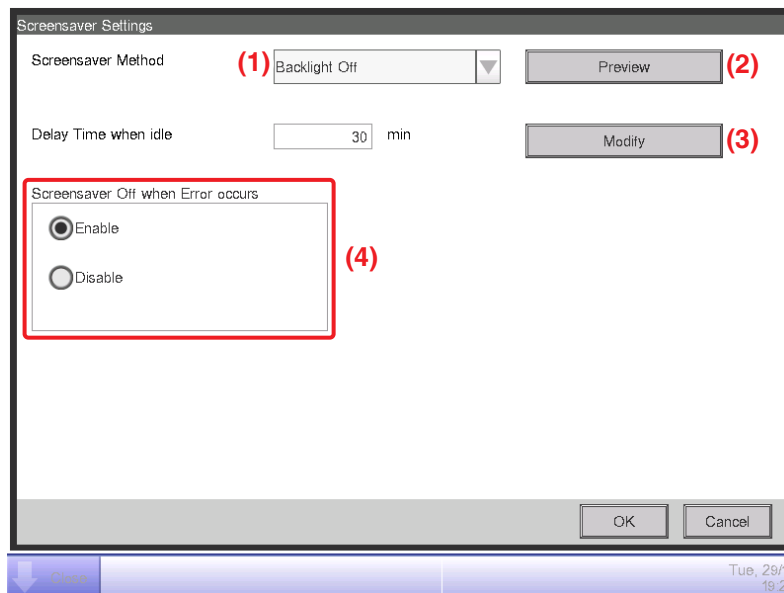

2. Enable/disable and set up the screensaver type using the **Screensaver Method (1)** combo box. Select from Disable, Backlight Off, Screen1, Screen2, and Screen3. Selecting Backlight Off will turn off the screen when the idle time set in step 3 elapses. Touch the **Preview** button (2) to preview the selected screensaver. Touch the screen to return to the Screensaver screen.
3. Touch the **Modify** button (3) and enter the idle time until displaying the screensaver or turning off the screen. You can specify an idle time of 1 to 60 minutes.
4. To automatically stop the screensaver, sound the buzzer, and display the Error Notification icon when an error occurs while the screensaver is being displayed or when the emergency stop occurred, select the **Screensaver Off when Error occurs** radio button (4). To continue displaying the screensaver, select Disable.
5. Touch the OK button to save and close the screen.

6-8 Setting up and Changing the Hardware Settings

You can set and change settings such as the luminance of the iTM unit's screen and buzzer volume.

1. Touch the Hardware button on the System Settings tab of the Menu List screen and display the Hardware Settings screen (see page 54).

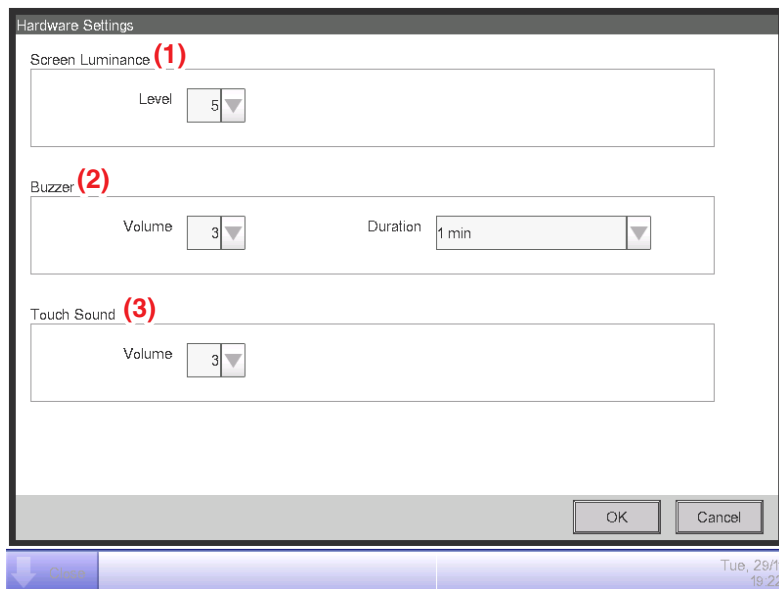

2. In the **Screen Luminance** combo box (1), select and set the luminance level for the iTM screen to a value between 1 and 8.
3. In the **Buzzer** combo box (2), select and set the volume for the buzzer that will sound at error or emergency stop to a value between 0 and 5. Also select and set a sound duration from 1 min, 3 min, 5 min, and Continuous.
4. In the **Touch Sound** combo box (3), select and set the volume for the touch sound, the sound when the screen is touched to a value between 0 and 5.
5. Touch the OK button to save and close the screen.

6-9 Setting up and Changing the Confirm Operation

You can set up and change the setting for displaying or not the dialog box that confirms the start/stop operation performed from the iTM Standard View screen.

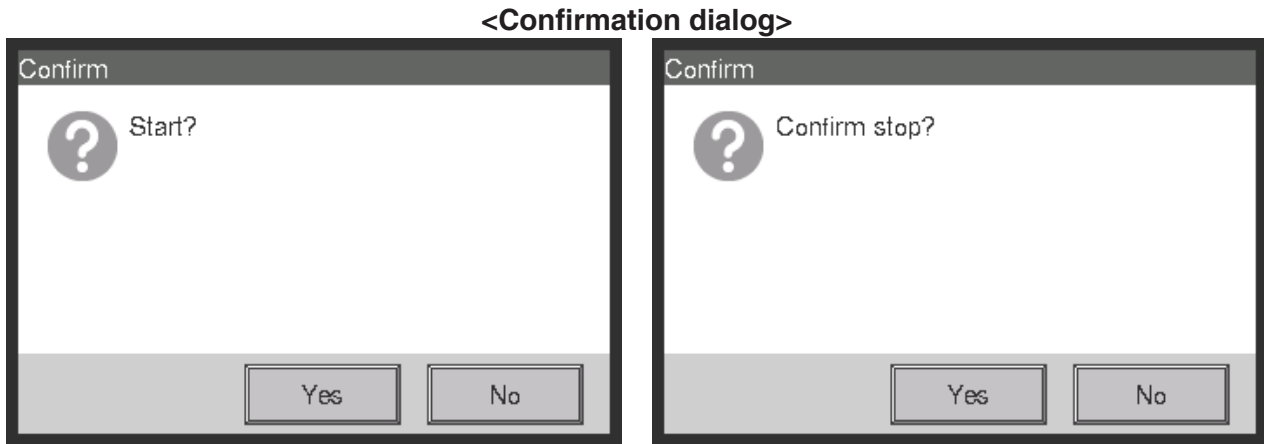

1. Touch the Confirmation Dialog button on the System Settings tab of the Menu List screen to display the Confirmation Dialog screen (see page 54).

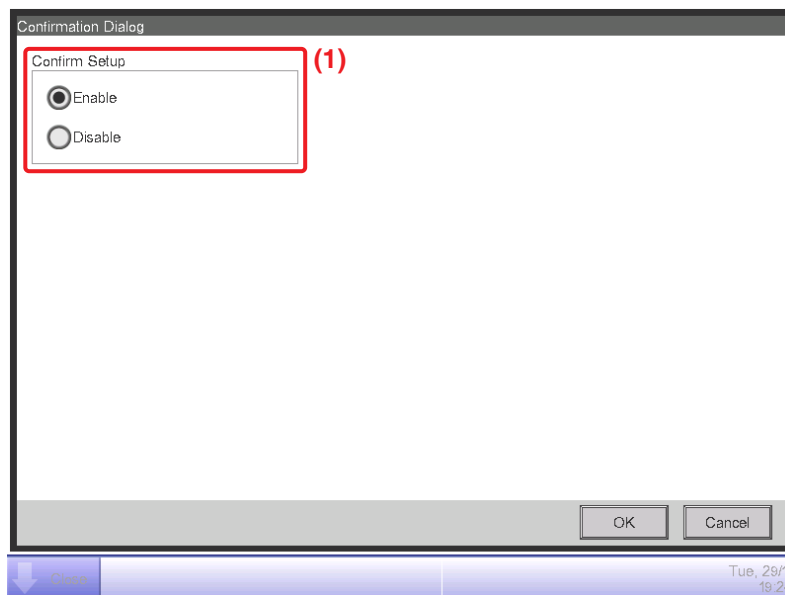

2. Select Enable for the **Confirm Setup** radio button **(1)** to display the Confirm dialog, and Disable to not display.
3. Touch the OK button to save and close the screen.

6-10 Calibrating the Touch Panel

You can calibrate the touch panel. To calibrate more accurately, use a touch pen.

1. Touch the Touch Panel Calibration button on the System Settings tab of the Menu List screen to display the touch panel calibration screen (see page 54).

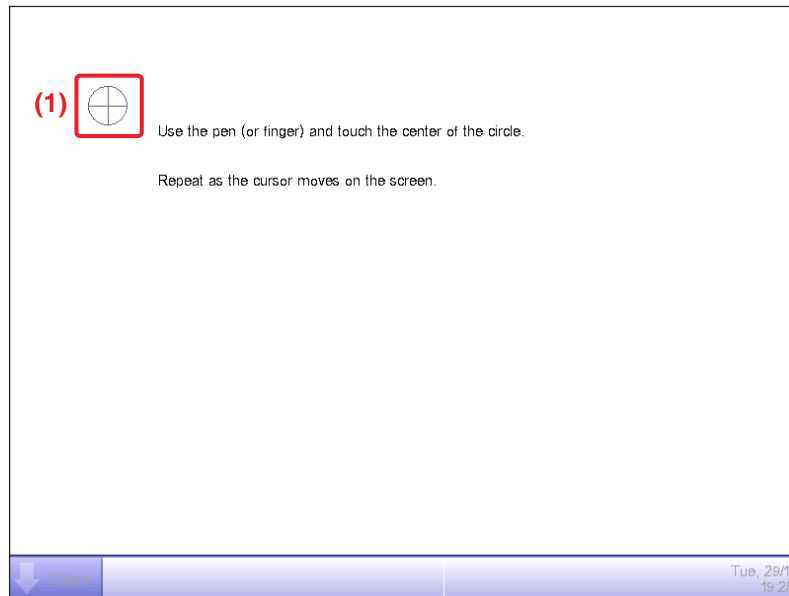

2. A **cross (1)** will appear 5 times on the screen. Touch the center of each cross in order. You can start the calibration again by touching a point far from the cross.
3. The calibration is complete when you touched the cross 5 times. Touch anywhere on the screen to close.

NOTE

If the screen is not touched for 30 seconds after the calibration is complete, the correction is canceled and the screen returns to the Menu List screen.

6-11 Backing up

You can back up various iTM data to a USB memory. You cannot perform any operation from the iTM unit screen during backup. However, functions will be working normally.

You can copy the backed up data to a computer for the purpose of management.

Use a USB memory of 32 GB or less. The iTM supports USB2.0.

1. Touch the Backup button on the System Settings tab of the Menu List screen (see page 54).

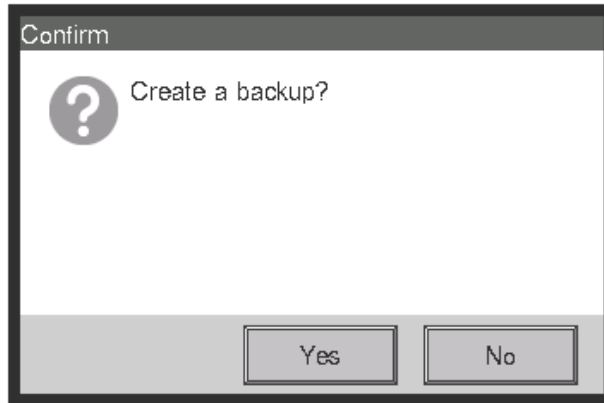

2. When the dialog that confirms the start of the backup is displayed, connect the USB memory to the iTM unit and touch the Yes button.

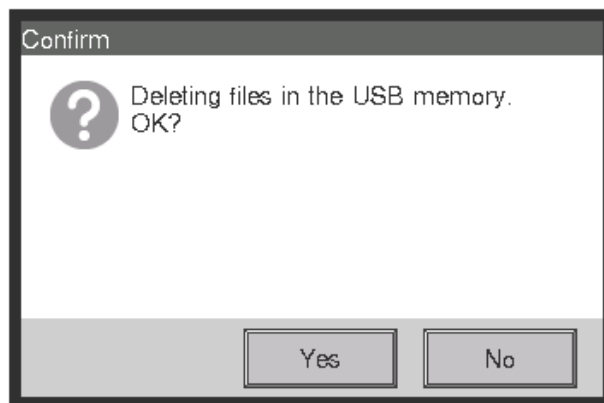

3. All files on the connected USB memory will be deleted. Touch the Yes button on the Confirm dialog that appears to commit and start the backup.
4. Backup takes up to 30 minutes per 1 GB. Backup is complete when the message "Backup is complete." appears. Touch the Close button to close the screen.

6-12 Viewing the Version Information

You can display the version information of the software installed in the iTM. The information displayed is as indicated below.

1. Touch the Version Info button on the System Settings tab of the Menu List screen to display the Version Information screen (see page 54).

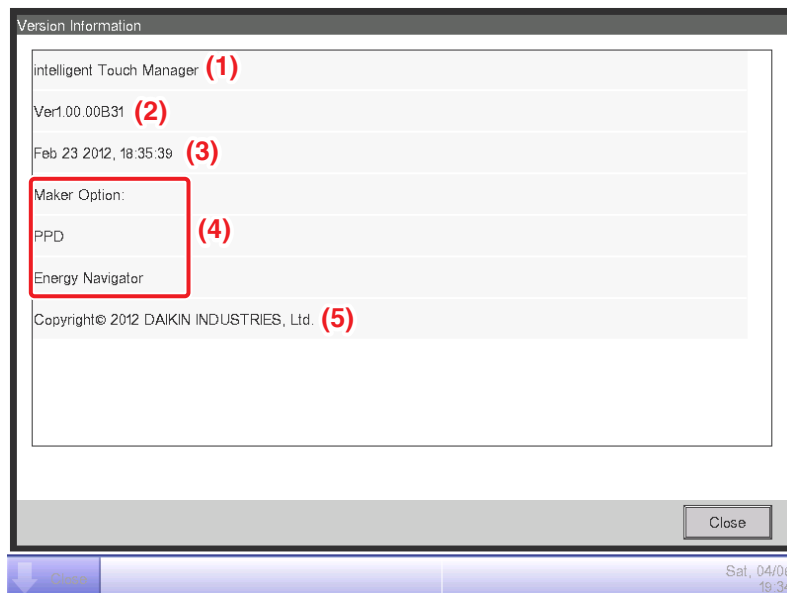

2. The information above consists of:
 - (1) Product name
 - (2) Software version
 - (3) Date and time the software was created
 - (4) Available options
 - (5) Copyright
3. Touch the Close button to close the screen.

7. Data Management

7-1 Checking and Outputting History

The iTM automatically saves various status changes and equipment errors as history. You can leverage that information for maintenance and bug fix by displaying the history or outputting as data.

The following describes how to display the history and output it in CSV file format.

1. Touch the History button on the Operation Mgmt. tab of the Menu List screen and display the History screen (see page 56).

NOTE

A Wait dialog is displayed while the history is being acquired.

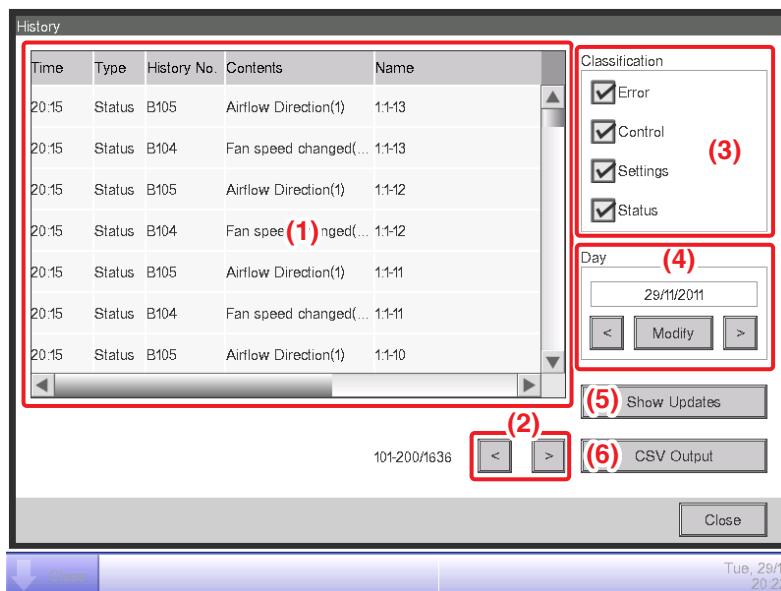

2. (1) displays the latest 100 history records.

Touch the < button in (2) to display the previous 100 history records and touch the > button to display the next 100 history records.

The screen consists of the following columns from the left: Time, Type, History No., Contents, Name, Instructed by, Port, Address, ID, and Code.

NOTE

Depending on the communication environment, "Source" may not display correctly.

The type of history to be displayed can be selected in the **Classification** area (3). (1) displays the history records of the selected types.

The **Day** field (4) specifies the date for which the history records will be displayed. When opened, the current date is specified. To display the history records of a specific date, touch the **Modify** button and enter the date in the Date Input dialog that appears.

Furthermore, touch the < button to display the history records of the previous day, and touch the > button to display the history records of the next day.

Touching the **Show Updates** button (5) displays in (1) the latest 100 history records of the type specified in (3) as well as the date specified in (4).

3. Touch the **CSV Output** button (6) to display the History Output screen.

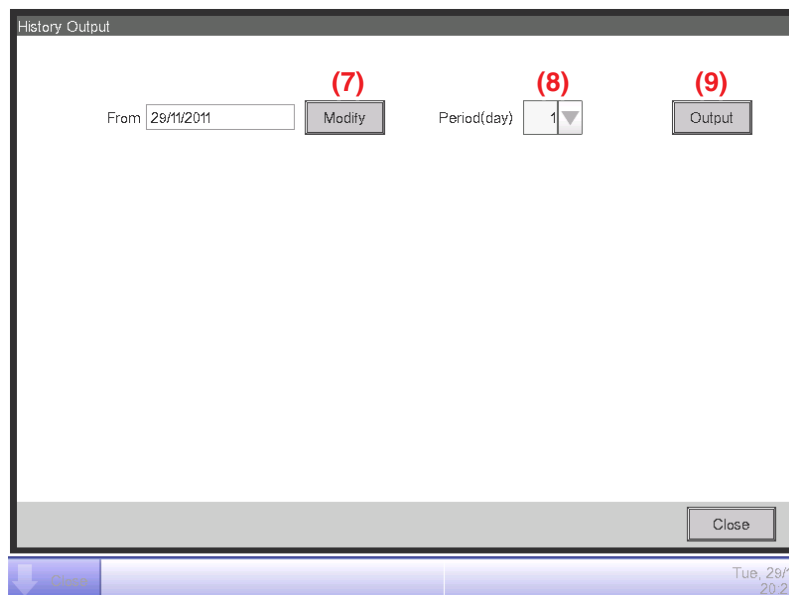

4. Touch the **Modify** button (7) and display the Time Input dialog to specify the output start date of the CSV file. Set the output period in days in the **Period (day)** combo box (8). You can select up to 7 days.

Touching the **Output** button (9) displays a confirmation dialog. Connect a USB memory to the iTM unit and touch the Yes button.

Output is complete when the message "File has been saved." appears.

Touch the Close button to close the screen.

7-2 Outputting Function Settings

The iTM includes various functions, and each of them needs settings. You can output them to a CSV file using the batch settings output function and load it to a computer to check the current values in a list. The following describes how to output the settings.

See below for settings you can output using this function.

<Batch settings output details>

For information on how to interpret the output file, see the tables on the next pages.

Function	Output content
Schedule	Settings of programs registered with the Schedule Control.
Interlocking Control	Settings of programs registered with the Interlocking Control.
Emergency Stop	Settings of programs registered with the Emergency Stop.
Auto Changeover	Settings of programs registered with the Auto Changeover.
Temperature Limit	Settings of groups registered with the Temperature Limit.
Sliding Temperature	Settings of groups registered with Sliding Temperature.
HMO	Settings of management points registered with HMO.
Setback	Recovery temperature and setback temperature settings.
Power Proportional Distribution	Excluded time settings of the past 13 months.

1. Touch the Setup Export button on the Operation Mgmt. tab of the Menu List screen (see page 56).

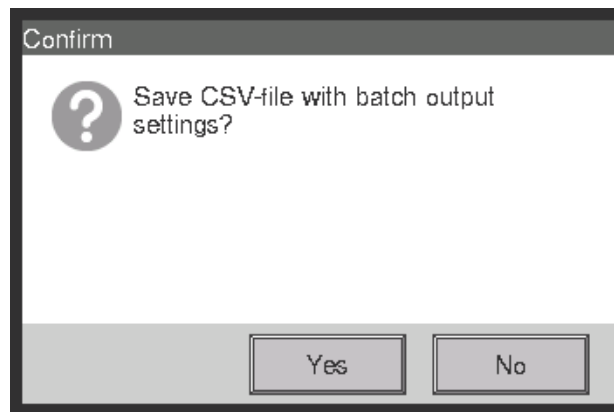

2. A confirmation dialog with the message “Save CSV-file with batch output settings?” appears. Connect a USB memory to the iTM unit and touch the Yes button. Outputting to the USB memory takes up to 2 minutes per 1MB.
3. Output is complete when the message “File has been saved.” appears. Touch the Close button to close the screen.

<Schedule Control CSV file format>

Shaded data are fixed strings (However, language support is provided)

A	B	C	D
Blank			
Controller Name	Controller name		
Export Date	Output date		
iTM Version	iTM version		
Program Name	Program name		
Enable/Disable	Program enabled/disabled Enable/ Disable		
Period	Validity period of the program "All" is output when the Schedule is enabled for all term		
Sun			
Time	P/A	Name	Action
Event time	Area/Mgmt. Point	Area/Mgmt. point name	Event action
Ditto	Ditto	Ditto	Ditto
;	;	;	;
Mon			
Time	P/A	Name	Action
;	;	;	;
Tue			
Time	P/A	Name	Action
;	;	;	;
Wed			
Time	P/A	Name	Action
;	;	;	;
Thu			
Time	P/A	Name	Action
;	;	;	;
Fri			
Time	P/A	Name	Action
;	;	;	;
Sat			
Time	P/A	Name	Action
;	;	;	;

A	B	C	D
Name of the Special day 1			
Time	P/A	Name	Action
;	;	;	;
Name of the Special day 2			
Time	P/A	Name	Action
;	;	;	;
Name of the Special day 3			
Time	P/A	Name	Action
;	;	;	;
Name of the Special day 4			
Time	P/A	Name	Action
;	;	;	;
Name of the Special day 5			
Time	P/A	Name	Action
;	;	;	;
Special Day			
Name of the Special day 1			
Date or Month/Day of the week setting of Special day 1 • Month/day			
;			
Name of the Special day 2			
Date or Month/Day of the week setting of Special day 2			
;			
Name of the Special day 3			
Date or Month/Day of the week setting of Special day 3			
;			
Name of the Special day 4			
Date or Month/Day of the week setting of Special day 4			
;			
Name of the Special day 5			
Date or Month/Day of the week setting of Special day 5			
;			

A	B	C	D	..
Calendar Preview				
+:Week				
Date	1	2	3	..
Year Month				
Ditto	;	;	;	;
Ditto	;	;	;	;
Ditto	;	;	;	;
Ditto	;	;	;	;
Ditto	;	;	;	;
Ditto	;	;	;	;
Ditto	;	;	;	;
Ditto	;	;	;	;
Ditto	;	;	;	;
Ditto	;	;	;	;
Ditto	;	;	;	;
Ditto	;	;	;	;
Ditto	;	;	;	;
Blank				
Program Name				
;				



The settings of the second or subsequent program will be output following above.

<Interlocking Control CSV file format>

Shadowed data are fixed strings (However, language support is provided)

A	B	C
Blank		
Controller Name	Controller name	
Export Date	Output date	
iTM Version	iTM version	
Program Name	Program name	
Enable/Disable	Program enabled/disabled Enable/Disable	
Input		
Mgmt. Point	Detection Conditions	Timer (min.)
Management point name	Detection Target	Continuous completion time
Ditto	Ditto	Ditto
;	;	;
Output 1		
Detection Conditions	Input condition for interlocked output	
Start/Stop Interval (sec.)	Sequential start/stop interval	
P/A	Name	Action
Area/Mgmt. Point	Area/Management point name	Management point/area action For details on the information displayed, see the display text for event actions described in the Interlocking Control Functional Specifications.
Ditto	Ditto	Ditto
;	;	;
Output 2		
Detection Conditions	Same as Output 1	
Start/Stop Interval (sec.)	Same as Output 1	
P/A	Name	Action
Same as Output 1	Same as Output 1	Same as Output 1
;	;	;
Blank		
Program Name	Program name	
;	;	;



The settings of the second or subsequent program will be output following above.

<Emergency Stop Control CSV file format>

Shadowed data are fixed strings (However, language support is provided)

A	B
Blank	
Controller Name	Controller name
Export Date	Output date
iTM Version	iTM version
Program Name	Program name
Enable/Disable	Program enabled/disabled Enable/Disable
Input	
Release Mode	Release mode Automatic/Manual
Mgmt. Point	
Input signal's management point name	
Ditto	
;	
Output	
Specification method	Output method Listed Points/Unlisted Points
Mgmt. Point	
Name of the registered management point	
Ditto	
;	
Blank	
Program Name	Program name
;	



The settings of the second or subsequent program will be output following above.

*Default program outputs only the name of default program and enable/disable, at the end of the registered program.

<Auto Changeover CSV file format>

Shadowed data are fixed strings (However, language support is provided)

A	B
Blank	
Controller Name	Controller name
Export Date	Output date
iTM Version	iTM version
Group Name	Group name
Enable/Disable	Control enable/disable Enable/Disable
Differential	Thermal difference
Reference	Representative temperature determination method Fixed/Operating/Average
Mgmt. Point	
Name of management point included in the group	
Ditto	
;	
Blank	
Group Name	Group name
Enable/Disable	
;	



The settings of the second or subsequent program will be output following above.

<Temperature Limit CSV file format>

Shadowed data are fixed strings (However, language support is provided)

A	B
Blank	
Controller Name	Controller name
Export Date	Output date
iTM Version	iTM version
Group Name	Group name
Enable/Disable	Control enable/disable Enable/Disable
Lower Limit	Lower limit of indoor temperature
Upper Limit	Upper limit of indoor temperature
Mgmt. Point	
Name of management point included in the group	
Ditto	
;	
;	
Blank	
Group Name	Group name
;	



The settings of the second or subsequent program will be output following above.

<Sliding Temperature CSV file format>

Shaded data are fixed strings (However, language support is provided)

A	B
Blank	
Controller Name	Controller name
Export Date	Output date
iTM Version	iTM version
Group Name	Group name
Enable/Disable	Control enable/disable Enable/Disable
Outdoor temp. Mgmt. Point	Name of the outdoor temperature management point
Outdoor Temperature Range	Outdoor temperature range Upper limit - Lower limit
Setpoint Range	Setpoint range Upper limit - Lower limit
Mgmt. Point	
Name of management point included in the group	
Ditto	
;	
;	
Blank	
Group Name	Group name
;	



The settings of the second or subsequent program will be output following above.

<HMO CSV file format>

Shaded data are fixed strings (However, language support is provided)

A	B
Blank	
Controller Name	Controller name
Export Date	Output date
iTM Version	iTM version
Mgmt. Point	Enable/Disable
Management point name	Control enable/disable for the management point on the left Enable/Disable
Ditto	Ditto
;	;
;	;

<Power Proportional Distribution CSV file format>

Shaded data are fixed strings (However, language support is provided)

A	B	C	D
Blank						
Controller Name	Controller name					
Export Date	Output date					
iTM Version	iTM version					
Excluded Time						
Week	Enable/Disable	Excluded Time				
Sun	Excluded Time enable/disable Enable/ Disable	Set up excluded time				
Mon	Ditto	Ditto				
Tue	Ditto	Ditto				
Wed	Ditto	Ditto				
Thu	Ditto	Ditto				
Fri	Ditto	Ditto				
Sat	Ditto	Ditto				
Exceptions to Excluded Time						
+:Normal #:Exceptions to Excluded Time						
Date	1	2	3	..	30	31
Year Month (The format follows the System Settings)	(Example: +)*	(Example: +)	(Example: +)	(Example: +)	(Example: +)	
Ditto	(Example: #)*	(Example: #)	(Example: +)	(Example: +)	(Example: +)	(Example: +)
Ditto	;	;	;	;	;	;
Ditto	;	;	;	;	;	;
Ditto	;	;	;	;	;	;
Ditto	;	;	;	;	;	;
Ditto	;	;	;	;	;	;
Ditto	;	;	;	;	;	;
Ditto	;	;	;	;	;	;
Ditto	;	;	;	;	;	;
Ditto	;	;	;	;	;	;
Ditto	;	;	;	;	;	;
Ditto	;	;	;	;	;	;
Ditto	;	;	;	;	;	;
Ditto	;	;	;	;	;	;

*The following symbols indicate whether the “Special Calculation Days” setting is applied or not.

#: Applied

+: Not applied

<Setback Control CSV file format>

Shadowed data are fixed strings (However, language support is provided)

A	B
Blank	
Controller Name	Controller name
Export Date	Output date
iTM Version	iTM version
Cool Recovery Temp	Cool Recovery Temp
Heat Recovery Temp	Heat Recovery Temp
High: Relative Setup Setpoint	Setback High: Relative Setup Setpoint
High: Relative Setback Setpoint	Setback High: Relative Setback Setpoint
Low: Relative Setup Setpoint	Setback Low: Relative Setup Setpoint
Low: Relative Setback Setpoint	Setback Low: Relative Setback Setpoint

Operating Optional Functions

8. Setting up Automatic Control Functions

8-1 Setting up the Setback

Setback is a function that keeps an air conditioned room at an acceptable temperature range when no one is in by easing the air conditioning and saving energy during that time to decrease the discomfort returning the room.

This lowering of the lower limit of the room temperature during absence is called “Setback” while increase of the upper limit of the room temperature during absence is called “Setup”. The two combined are generally referred to as “Setback”.

The indoor unit is stopped when it is not necessary for keeping the room temperature within the set lower and upper limits of the temperature. This status is called “setback inactive”.

For setback, there are two setpoints: Setback High and Setback Low. Set one or both depending on your needs.

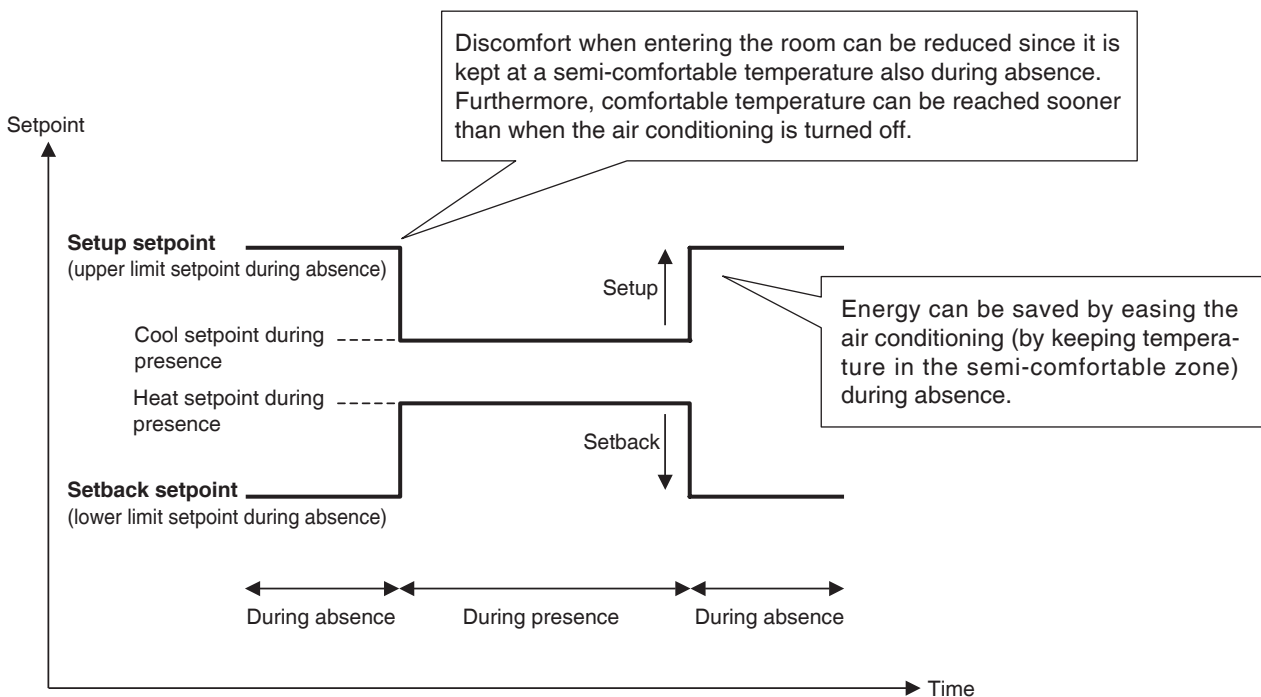

Indoor units and areas where this function is enabled are controlled as follows.

When the target is operating in Cool, Auto(Cool), or Dependent(Cool) mode

1. While the room temperature is lower than “Setpoint + Relative Setup Setpoint”, the indoor unit is stopped.
2. Room temperature is continuously monitored, and when it exceeds the “Setpoint + Relative Setup Setpoint”, the indoor unit is started again.

- Thereafter, when the room temperature becomes lower than the “Setpoint + Relative Setup Setpoint” by the recovery temperature, the indoor unit is stopped. However to avoid continual ON/OFF (hunting) of the indoor unit, it is not stopped until after 30 minutes.

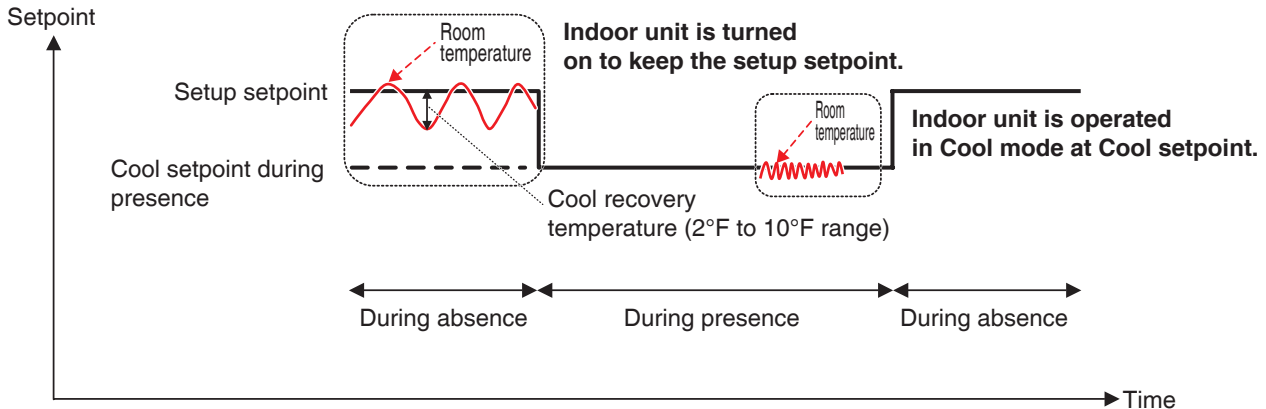

When the target is operating in Heat, Auto(Heat), or Dependent (Heat) mode

- While the room temperature is higher than “Setpoint – Relative Setback Setpoint”, the indoor unit is stopped.
- Room temperature is continuously monitored, and when it becomes lower than the “Setpoint – Relative Setback Setpoint”, the indoor unit is started again.
- Thereafter, when the room temperature exceeds the “Setpoint – Relative Setback Setpoint” by the recovery temperature, the indoor unit is stopped. However to avoid continual ON/OFF (hunting) of the indoor unit, it is not stopped until after 30 minutes.

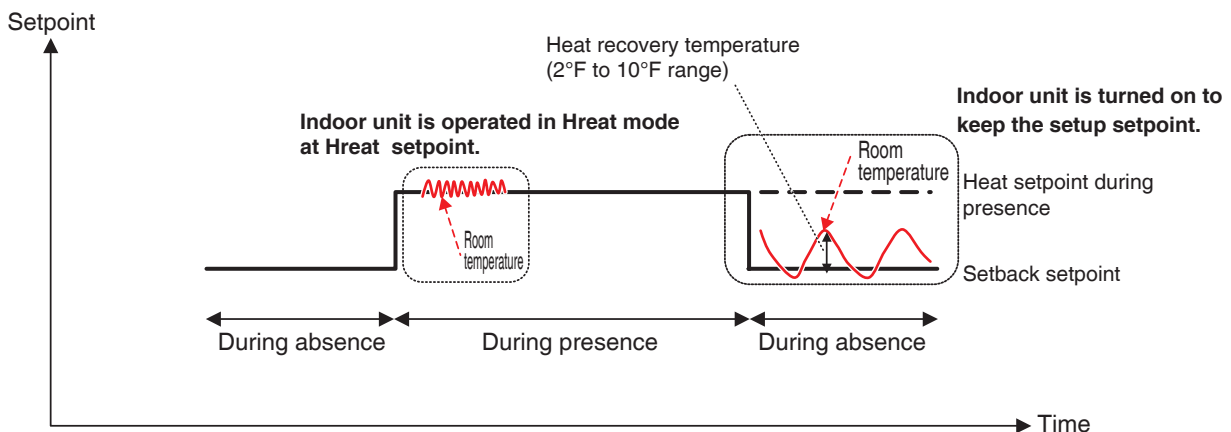

When the target is operating in Fan or Dry mode

The indoor unit operates normally while people are present.

When no one is in, the indoor unit is put into Setback Inactive status and subsequent start/stop is not performed.

When the operation mode of an indoor unit being controlled is changed to Fan or Dry

Subsequent start/stop is not performed and remains in the status when it was changed (Setback Active or Setback Inactive).

NOTE

- When an indoor unit where setback is active is stopped using remote controller, the unit stops but the setback control continues.
- If an indoor unit receives a start/stop order from the iTM unit or Schedule function while setback is active, the setback is canceled.
- The setback control will continue even if an indoor unit is stopped by the Timer Extension function when setback is active.

The following describes how to set this up.

1. Touch the Temp. Setback button on the Automatic Ctrl. tab of the Menu List screen and display the Setback Setup screen (see page 52).

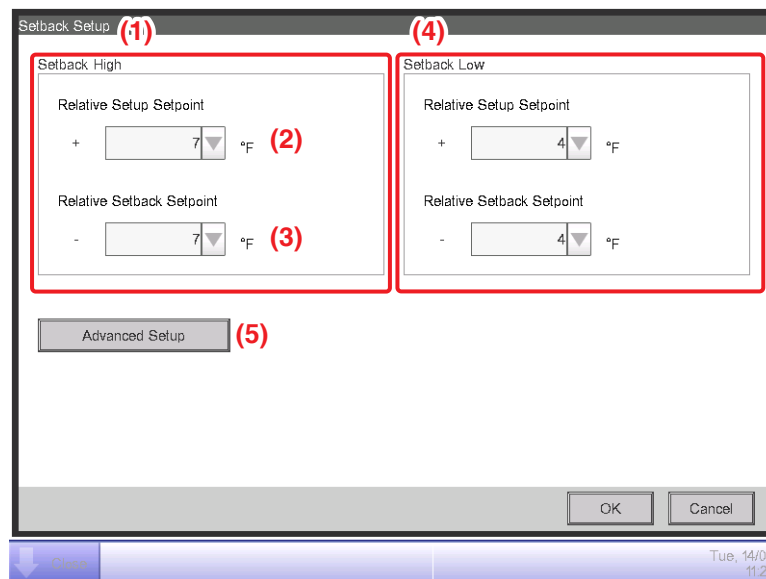

2. Set up the relative setpoints for Setback High in (1).

Select the relative setup setpoint in the **Relative Setup Setpoint** combo box (2).

Select the relative setback setpoint in the **Relative Setback Setpoint** combo box (3).

The range of values you can select from is 2 to 12°F in increments of 1°F for both setup and setback.

3. Set up the relative setpoints for Setback Low in (4).

Proceed in the same way as in step 2. However, you will not be able to set relative setpoints for Setback Low exceeding those of Setback High.

-
4. To set the recovery temperature, touch the **Advanced Setup** button (5) and display the Advance Setup screen.

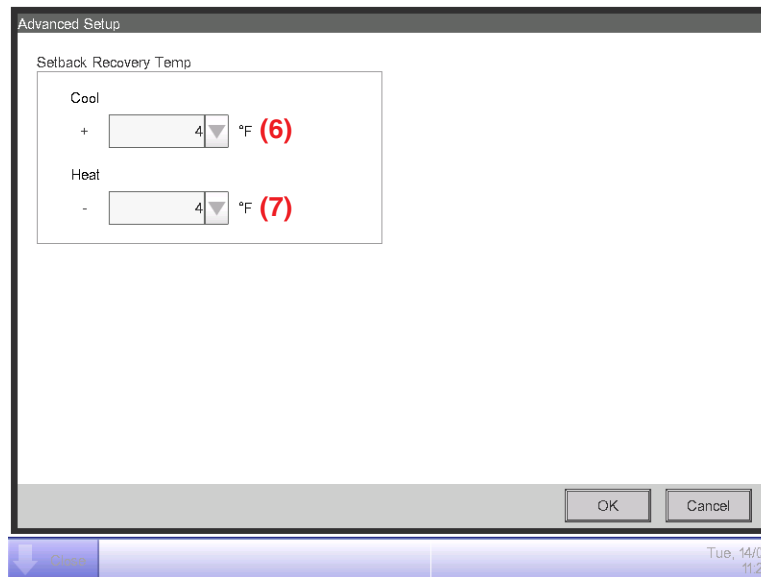

Select the recovery temperature for cooling in the **Cool Recovery Temp** combo box (6).

Select the recovery temperature for heating in the **Heat Recovery Temp** combo box (7).

The range of values you can select from is 2 to 10°F, in increments of 1°F.

When finished, touch the OK button to return to the Setback Setup screen.

5. The Setback function can be enable/disable from the Common tab in the Detailed Setup screen of the Standard screen, the Events screen of the Schedule screen, and Action Setup screen of the Interlocking Control screen.

For details, see the relevant page.

Relationship with Other Functions

1. Relationship with Automatic Control Functions

Function	Operation when Setback (Low or High) is active in the indoor unit
Schedule	You can set up Setback as action for the indoor unit.
Pre-Cool/ Pre-Heat	Pre-Cool/Pre-Heat is unavailable when the indoor unit is in Setback status. If Setback is ordered after the indoor unit has been operating in Pre-Cool or Pre-Heat mode, the indoor unit is put into setback status.
Interlocking Control	[Input] Setback active ⇒ Considered ON Setback inactive ⇒ Considered OFF [Output] You can set up Setback (Low or High) as action for the indoor unit.
Emergency Stop	An indoor unit can be immediately stopped by Emergency Stop even if Setback is active.
Auto Changeover	The Auto Changeover function also works when Setback is active. However, if Differential is set to 0°F for Auto Changeover, the 2°F Relative Setup Setpoint or -2°F Relative Setback Setpoint may not work even if set because the Auto Changeover temperature is setpoint ± 3°F. Furthermore, since a 30 minute guard timer is set up to prevent hunting, the function may also not work even if a higher value than the Relative Setback Setpoint or Relative Setup Setpoint is set.
Temperature Limit	Since Temperature Limit is a function that works when the indoor unit is stopped, it does not interfere with the Setback function.
Sliding Temperature	For both Setback Low and Setback High, the setback temperature is changed in accordance with the change in the setpoint by the Sliding Temperature function. The following expressions for calculating the setback temperatures are used both before and after the setpoint is changed by the Sliding Temperature function. Setup temperature = Setpoint + Relative Setup Setpoint Setup temperature = Setpoint – Relative Setback Setpoint
HMO	The HMO function does not work when Setback is active.
Timer Extension	If Timer Extension is enabled, the indoor unit is stopped or put into Setback Inactive depending on its operational status after the time set by the Timer Extension function has elapsed.

2. Relationship with Data Management Functions

Function	Operation when Setback (Low or High) is active in the indoor unit
Power Proportional Distribution	When Setback active ⇒ Power is proportionally distributed considering the indoor unit is operating. When Setback inactive ⇒ Power is proportionally distributed considering the indoor unit is stopped.

3. Effect on Other Automatic Control Functions

		Use of Switch as trigger	Use of On/Off status for assessment
Central Monitoring		-	○ • Setback Active ⇒ Treated as ON • Setback Inactive ⇒ Treated as OFF
Automatic Control	Schedule	-	-
	Pre-Cool/Pre-Heat	-	-
	Interlocking	○ • Start order by Setback ⇒ Treated as start trigger • Stop order by Setback ⇒ Treated as stop trigger	-
	Emergency Stop	-	-
	Auto Changeover	-	○ • Setback Active ⇒ Not treated as ON • Setback Inactive ⇒ Treated as OFF
	Temperature Limit	-	○ • Setback Active ⇒ Treated as ON • Setback Inactive ⇒ Not treated as OFF
	Sliding Temperature	-	-
	HMO	-	○ • Setback Active ⇒ Not treated as ON • Setback Inactive ⇒ Treated as OFF
	Timer Extension	○ • Start order by Setback ⇒ Not treated as start trigger • Stop order by Setback ⇒ Treated as stop trigger	○ • Setback Active ⇒ Not treated as ON • Setback Inactive ⇒ Treated as OFF
Data Management	Power Proportional Distribution	-	○ • Setback Active ⇒ Treated as ON • Setback Inactive ⇒ Treated as OFF
	Energy Navigator (Timer Extension sampling)	-	○ • Setback Active ⇒ Not treated as ON • Setback Inactive ⇒ Treated as OFF
	Operation time trend	-	○ • Setback Active ⇒ Treated as ON • Setback Inactive ⇒ Treated as OFF
	Start/Stop count trend	○ • Start order by Setback ⇒ Treated as start trigger • Stop order by Setback ⇒ Treated as stop trigger	-

8-2 Setting up the Interlocking Control

Interlocking Control is a function that allows you to control two or more management points and/or areas based on the status of an arbitrary management point. By using this function, you can start/stop multiple facilities in conjunction with access/exit to/from a room or key management, or implement free cooling.

This function monitors the change in status of the management point type specified in the input and considers the conditions are cleared when the status specified as the required condition continues for a specified time, and outputs the specified actions to the target management points or areas.

The management point types and conditions to detect that can be specified as input, as well as the relationship between the conditions to detect and required conditions are as indicated in the tables below.

Management point type		Switch	Equipment error	Analog upper/lower limit error	Operation mode	Analog value
	Target management point					
Indoor unit	Indoor unit	○	○	×	○	×
Ventilator	Ventilator	○	○	×	×	×
Chiller	Chiller	○	○	×	○	×
Dio	D3Dio	○	○	×	×	×
	External Dio					
	BACnet Dio					
	D3Di					
External Di	External Di	○	○	×	×	×
	Di					
	BACnet Di					
Analog (Ai)	External Ai Internal Ai BACnet Ai	×	×	○	×	○

Condition to detect	Required condition	
	Required duration	Status
Switch	Specify the time during which the required condition is continuously cleared in the 0 to 30 minute range, in increments of 1 minute.	Specify which will be considered condition cleared: On or error, or Off or normal. * On/Off, or error/normal must be set on the management point side.
Equipment error		
Analog upper/lower limit error		
Operation mode		Specify which operation mode clears the condition
Analog value	Specify the time during which the required condition is continuously cleared in the 1 to 30 minute range, and in increments of 1 minute.	Specify the analog value that clears the condition as an expression

Example: If required duration is set to “15 minutes”, whether the “condition has been cleared” is assessed only after 15 minutes, and not when the monitored target reached the specified status.

The figure below shows the example of an assessment when the required condition is “On” and required duration, “15 minutes”.

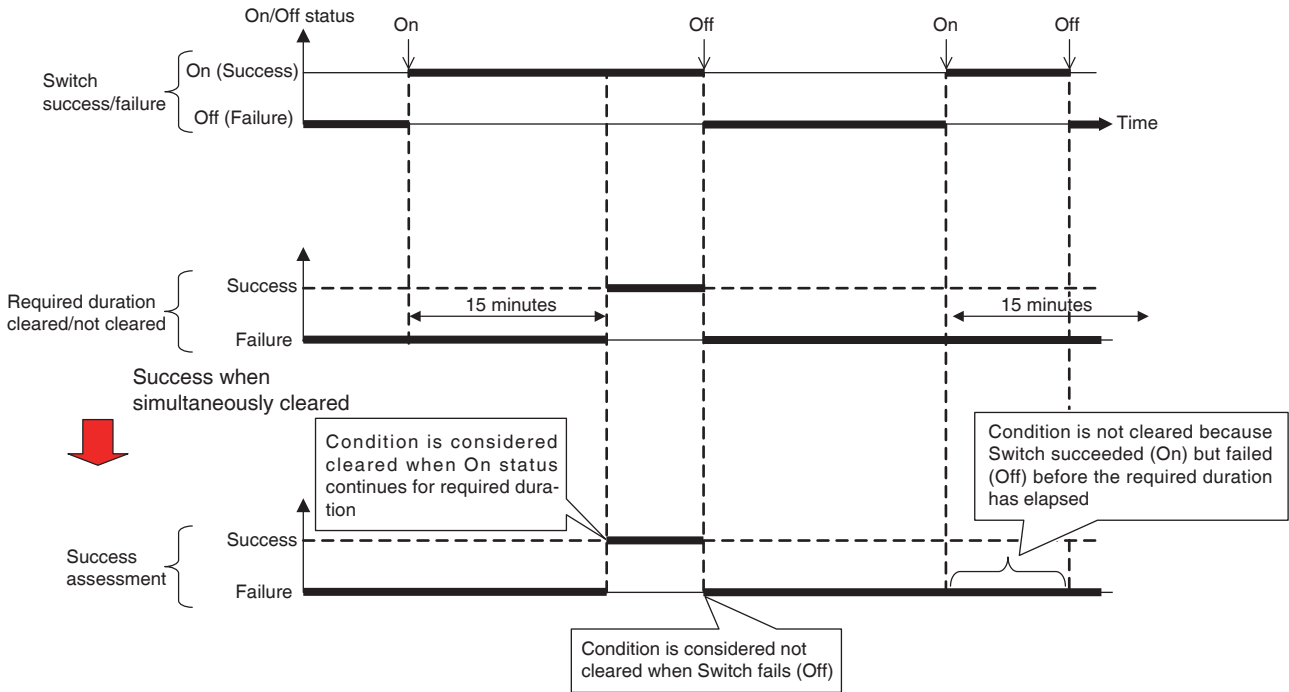

You can register up to two outputs to one interlocking program. In this way, you can set up different outputs (for example, start and stop) for the same input depending on the condition cleared.

The relationship between the targets that the outputs can control and possible actions is as indicated in tables below.

Target (management point type)	Target management point	On/Off	On/Off (Setback)	Ventilation amount/ Ventilation mode	Operation mode
Indoor unit	Indoor unit	○	○	×	○
Ventilator	Ventilator	○	×	○	×
Chiller	Chiller	○	×	×	○
Dio	D3Dio, External Dio BACnet Dio	○	×	×	×
Analog (Ao)	External Ao BACnet Ao	×	×	×	×
Area	All	○	○	○	○

Target (management point type)	Target management point	Fan Speed	Setpoint	Setpoint shift	Switch by remote controller enabled/ disabled
Indoor unit	Indoor unit	○	○	○	○
Ventilator	Ventilator	×	×	×	○
Chiller	Chiller	×	○	×	○
Dio	D3Dio, External Dio BACnet Dio	×	×	×	×
Analog (Ao)	External Ao BACnet Ao	×	×	×	×
Area	All	○	○	○	○

Target (management point type)	Target management point	Setpoint by remote controller enabled/ disabled	Operation mode by remote controller enabled/ disabled	Timer Extension	Analog value
Indoor unit	Indoor unit	○	○	○	×
Ventilator	Ventilator	×	×	×	×
Chiller	Chiller	○	○	×	×
Dio	D3Dio, External Dio BACnet Dio	×	×	×	×
Analog (Ao)	External Ao BACnet Ao	×	×	×	○
Area	All	○	○	○	○

Interlocking Control Restrictions

- **Handling of communication error**

The input condition is either a “valid” or “invalid” status of the target (input management point). When a communication error occurs, the status is handled as “unfixed” because it cannot be assessed. The changes in a status before and after “unfixed” (“valid (invalid) → unfixed” or “unfixed → valid (invalid)”) are not considered triggers of cleared conditions. However, a valid status change is treated as trigger if it occurred before becoming “unfixed” or after returning from “unfixed.”

- **Handling of start**

The initial status of a target (input management point) when started is handled as “unfixed”. Similarly to the case above, the changes in status before and after “unfixed” are not viewed as triggers of success.

- **Handling of maintenance**

This function does not work when the management point target of condition detection or control is in maintenance.

- **Inconsistent settings**

The system will not output any warning even if an inconsistent or inadequate setting is specified for this function. Be sure to carefully check by yourself before using.

- **Condition cleared immediately after program setup**

If the input changes while the program is being edited or when toggling from disabled to enabled, a condition may be considered cleared depending on the timing. Do not change settings when input is about to change.

• **Timing-dependent interlocking control**

In cases where two inputs change simultaneously, for example, the function may temporarily work unexpectedly depending on the timing.

Example:

Setting example	
Program 1, Input: 1-00, 1-01, Output 1:	At least one input becomes valid → 1-02 On
Program 1, Input: 1-00, 1-01, Output 2:	inputs become valid → 1-02 Off

When input 1-00 and input 1-01 simultaneously change from OFF to ON, the controller may detect two statuses as indicated in the figure below.

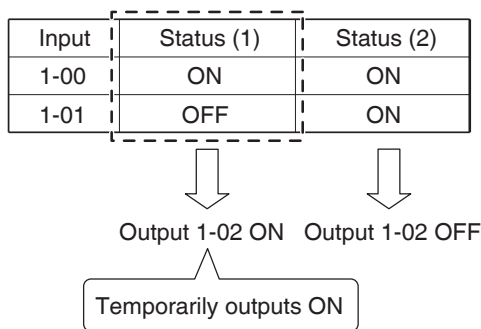

If another condition is cleared while the interlocking control for an already cleared condition is being executed, the latter does not trigger any interlocked control.

Example: When the required condition is “Any turned ON”, control is executed as indicated in the figure below.

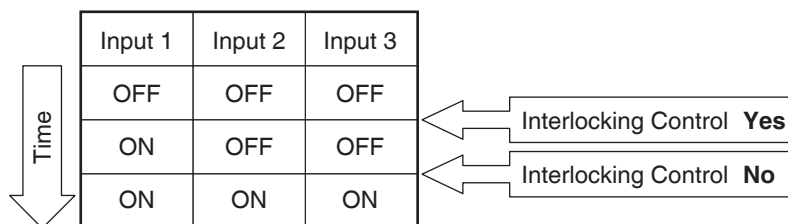

Setting up an interlocking program

The following describes how to program and set up an interlocking program based on the model case below.

- **Turn On the Ventilator when any of the indoor units for Office B goes On.**
- **Turn Off the Ventilator when all indoor units for Office B go Off.**

Interlocking program name: **Ventilator control program**

Target: **Office B (area consisting of indoor unit “a”, indoor unit “b”, and Ventilator “c”)**

Control program: **(Output1)** When either indoor unit “a” or indoor unit “b” goes on, turn on Ventilator “c”.

The required duration is “10 minutes”.

(Output2) When both indoor unit “a” and indoor unit “b” go off, turn off Ventilator “c”.

• **Creating the Interlocking Program**

Touch the Interlocking Control button on the Automatic Ctrl. tab of the Menu List screen and display the main Interlocking Control screen (see page 52).

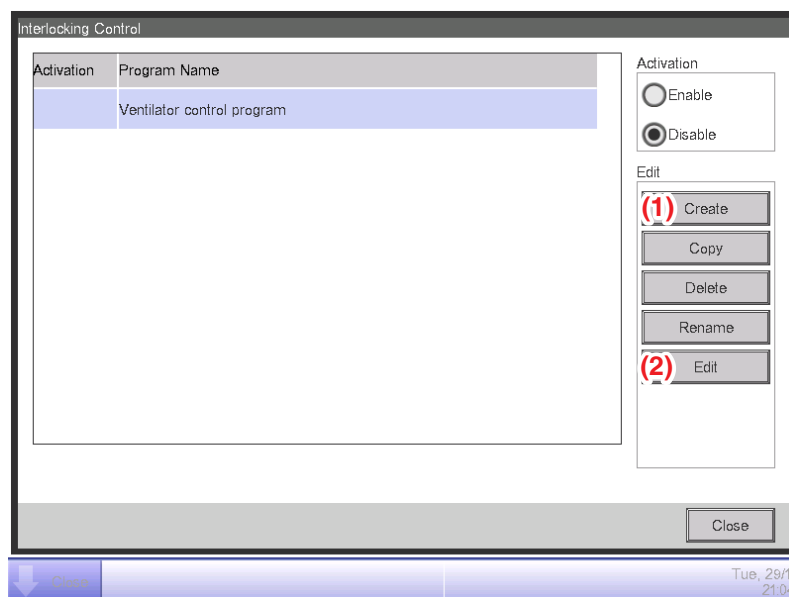

1. **Setting up the interlocking program name**

Touch the **Create** button (1) and enter the program name in the Name Input dialog that appears. Enter **“Ventilator control program”**.

Select the **“Ventilator control program”** registered in the list and touch the **Edit** button (2) to display the Interlock Program Setup screen.

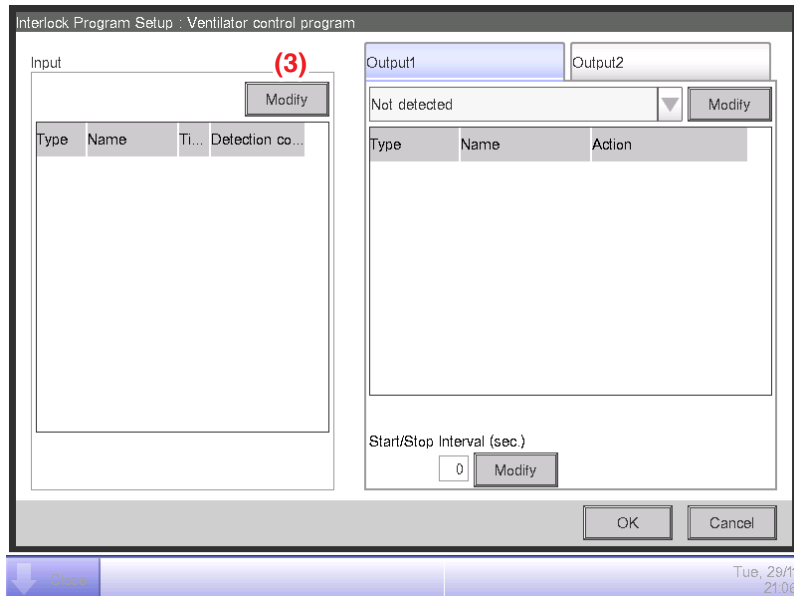

2. Setting up the condition to detect

Touch the **Modify** button (3) and display the Interlock Program Input screen.

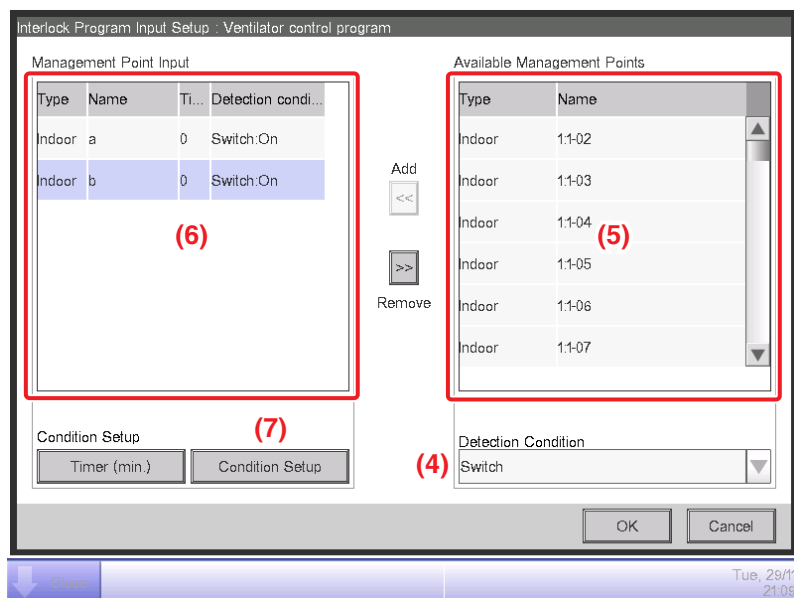

Selecting **“Switch”** in the **Detection Condition** combo box (4) displays a list of management points (5) for which On/Off can be registered as the condition to be detected.

Selecting the indoor unit **“a”** and touching the Add button registers it in (6).

Similarly, register the indoor unit **“b”**.

3. Setting up the required conditions

Select the indoor unit **“a”** from the list (6) and touch the **Condition Setup** button (7) to display the Condition Setup screen.

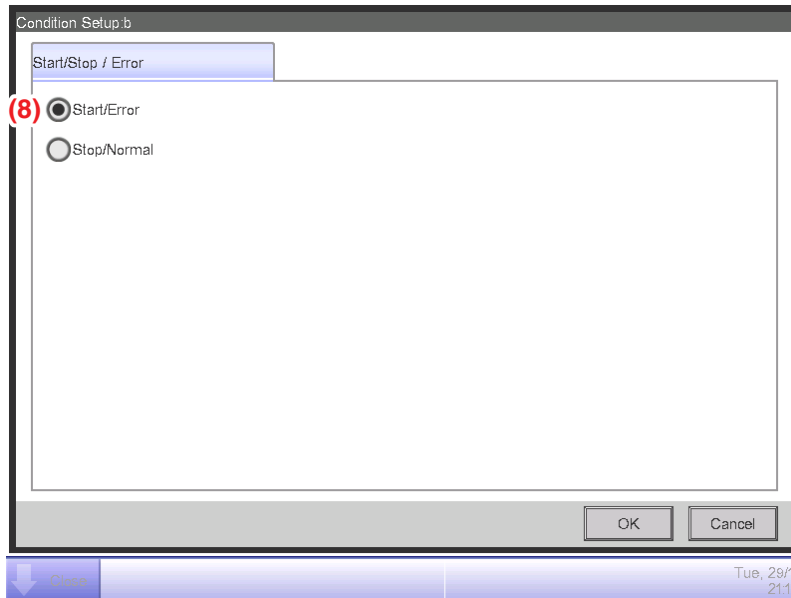

Select “**Start/Error**” (8) and touch the OK button to return to the Interlock Program Input screen. Similarly, set up the indoor unit “b”.

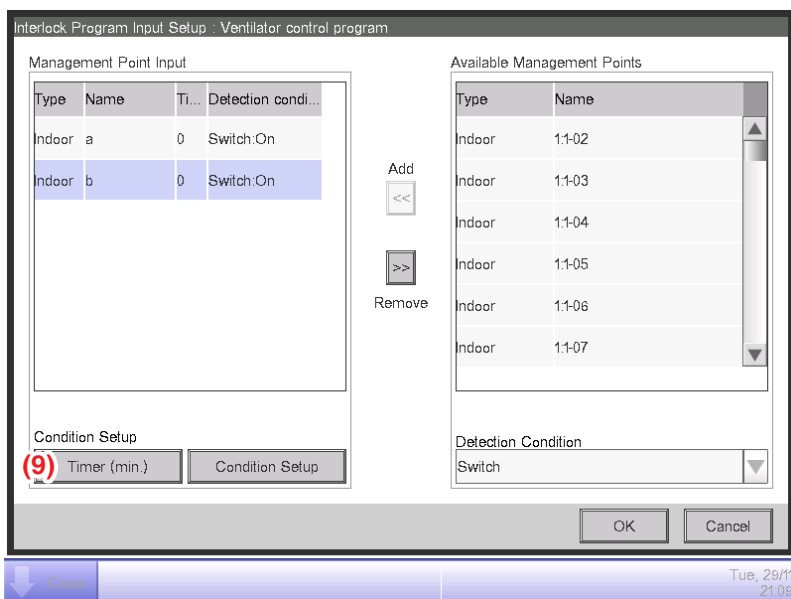

Select the indoor unit “a” and touch the **Timer (min.)** button (9) and enter “10” for required duration in the Numerical Input dialog that appears.

Touch the OK button and return to the Interlock Program Setup screen.

Similarly, set up the indoor unit “b”.

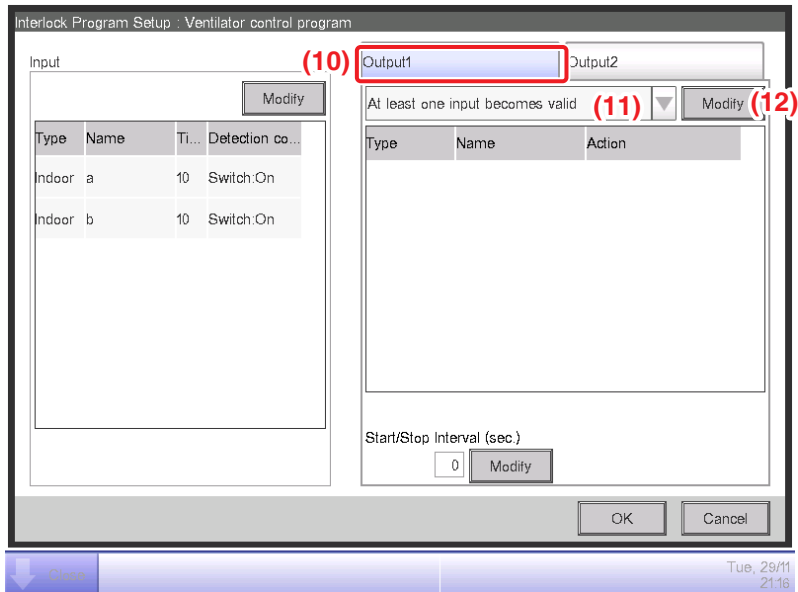

Check that the **Output1** tab (10) is displayed and

Select “**At least one input becomes valid**” in the **Input condition** combo box (11).

The step above finishes the setup of the required conditions, “**which is either indoor unit “a” or “b” to be On for 10 minutes**”.

4. Setting up the target

Touch the **Modify** button (12) and display the Interlock Program Output Setup screen.

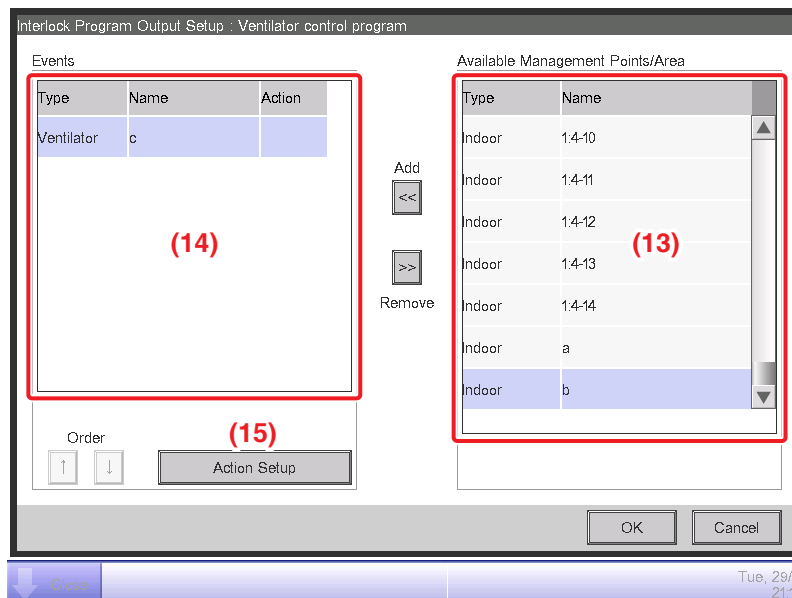

(13) is the list of management points and areas that can be registered.

Select Ventilator “c” and touch the Add button to register it as target of the output event in (14).

5. Setting up the output actions

Select the Ventilator “c” registered in (14) and touch the **Action Setup** button (15). The Action Setup screen appears.

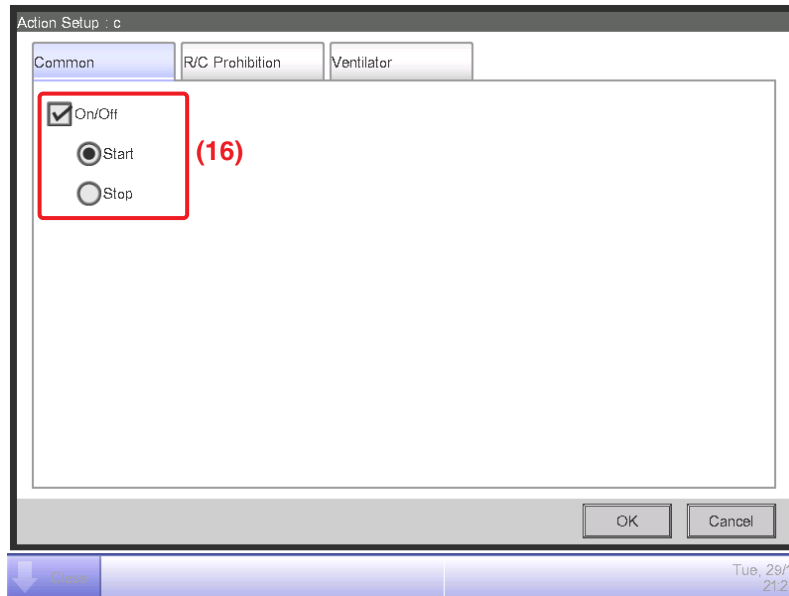

Select the **On/Off** check box **(16)** on the Common tab and then, select the **Start** radio button. Touch the OK button and return to the Interlock Program Output Setup screen.

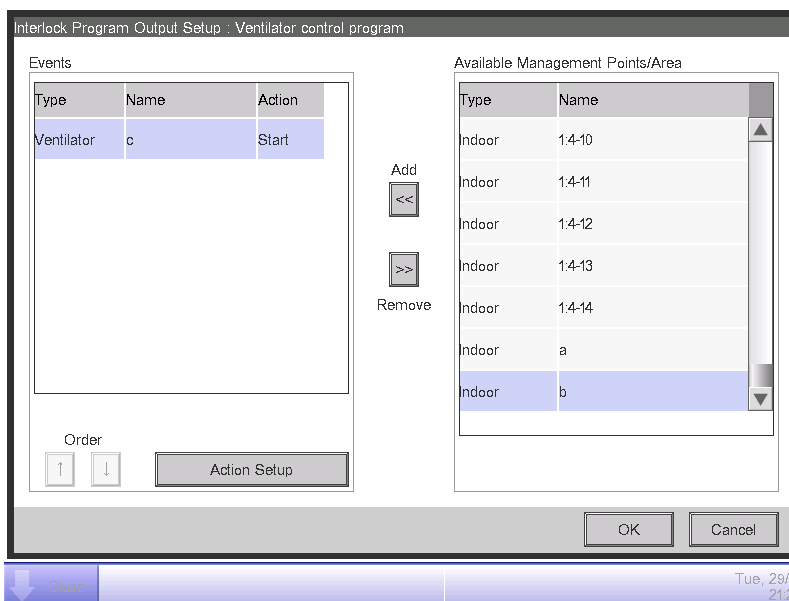

Touch the OK button and return to the Interlock Program Setup screen.

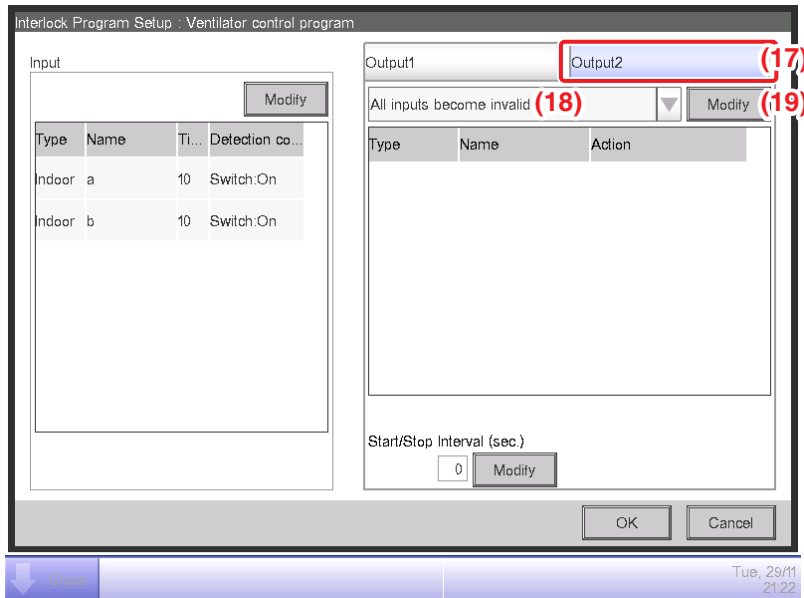

The step above finishes the setup of **Output1** for the program, “**which turns on Ventilator “c” when either indoor unit “a” or “b” is On for 10 minutes**”.

- **Setting up Output2**

Set up a different output action for the same condition to detect and target.

Select the **Output2** tab (17) and then, “**All inputs become invalid**” in the **Input condition** combo box (18).

Touch the **Modify** button (19) and display the Interlock Program Output Setup screen.

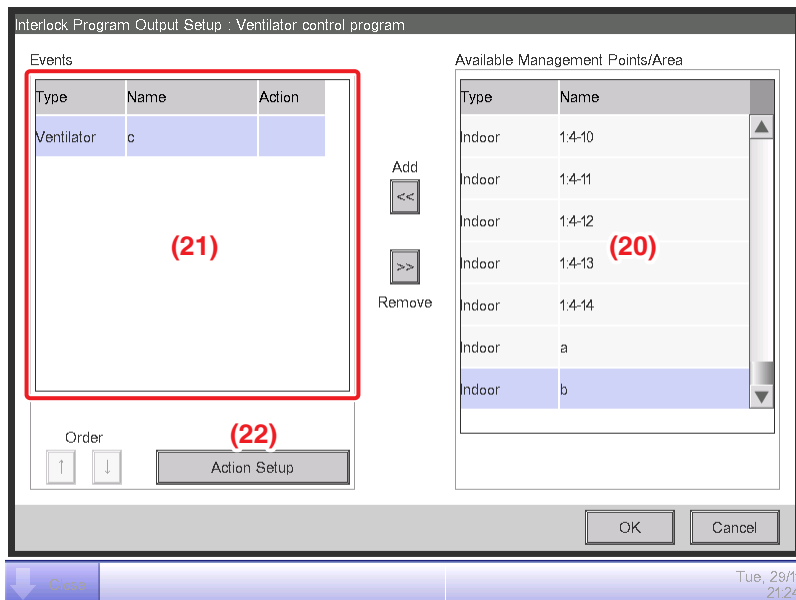

Select Ventilator “**c**” from (20) and touch the Add button to register it as target of the output event in (21).

Select the Ventilator “**c**” registered in (21) and touch the **Action Setup** button (22) to display the Action Setup screen.

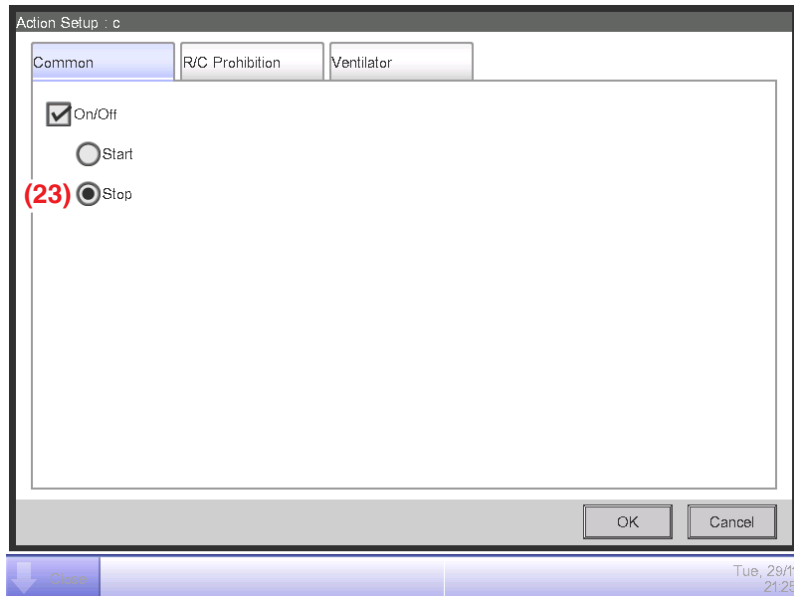

Select the **Stop** radio button **(23)** and touch the OK button to return to the Interlock Program Output Setup screen.

Likewise touch the OK button on the Interlock Program Output Setup screen and return to the Interlock Program Setup screen.

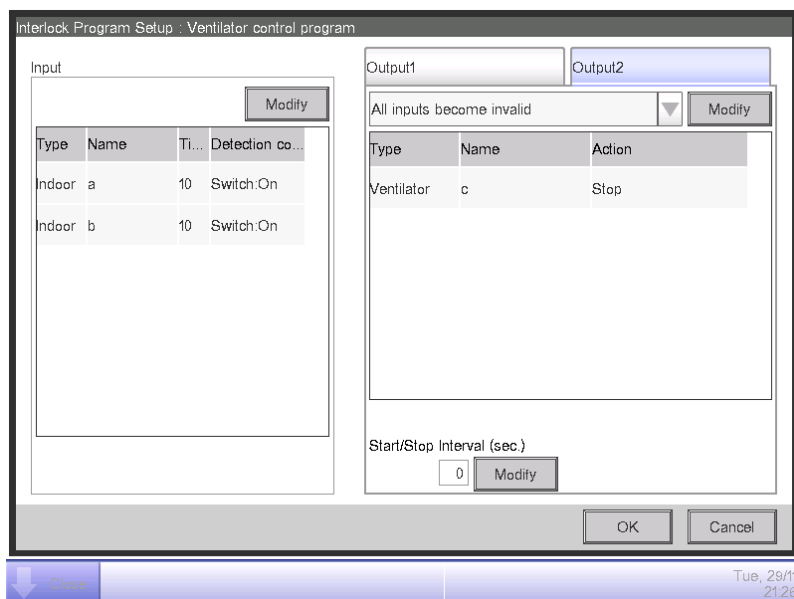

The step above finishes the setup of **Output2** for the program, “**which turns off Ventilator “c” when both indoor units “a” and “b” go off**”.

The “**Ventilator control program**” is now complete.

Touch the OK button and return to the main Interlocking Control screen.

- **Enabling the Interlocking Program**

Enable the created interlocking program.

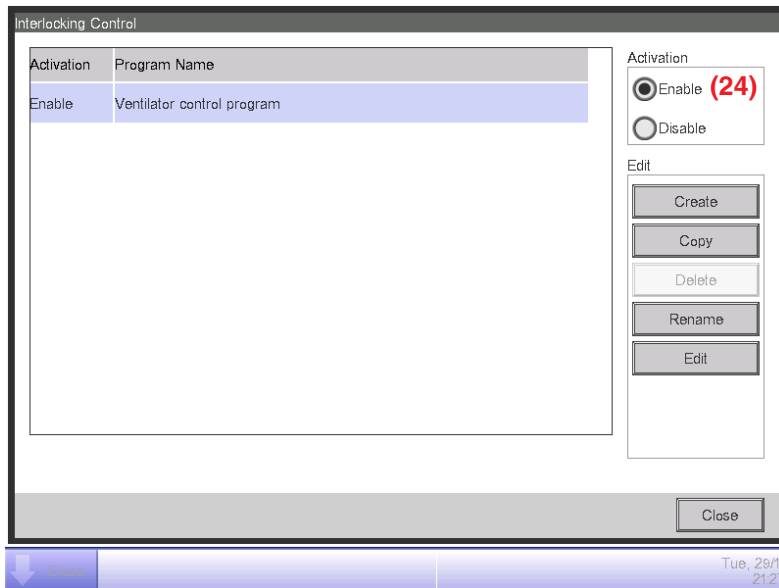

Select “**Ventilator control program**” and select the **Enable** radio button (24).

Check that the Activation column of the list is set to Enable and touch the Close button to close the screen.

Detailed screen and button descriptions

• Main Interlocking Control Screen

This screen is displayed when you touch the Interlocking Control button on the Automatic Ctrl. tab of the Menu List screen (see page 52).

This screen allows you to create and delete interlocking programs, as well as enable/disable the interlocking programs.

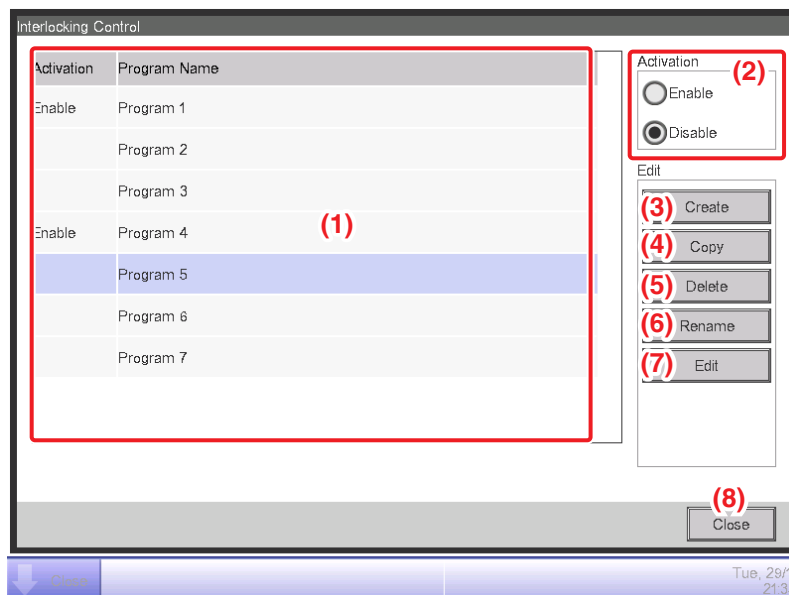

(1) Interlocking program list

Displays registered interlocking programs.

(2) Enable/Disable radio button

Enables and disables an interlocking program.

(3) Create button

Creates a new interlocking program. Touching the button displays the Name Input dialog.

The maximum number of interlocking programs you can create is 500.

Set up a name using 1 to 32 characters, irrespective of single or double byte.

Duplicate names are not permitted.

(4) Copy button

Copies the program selected in the interlocking program list. Touching the button displays the Name Input dialog.

(5) Delete button

Deletes the program selected in the interlocking program list. Touching the button displays a deletion confirmation dialog.

(6) Rename button

Renames the program selected in the interlocking program list. Touching the button displays the Text Input dialog.

(7) Edit button

Displays the Interlock Program Setup screen that allows you to edit the program selected in the interlocking program list.

(8) Close button

Closes the screen.

• **Interlock Program Setup Screen**

This screen is displayed when you touch the Edit button on the main Interlocking Control screen. Sets up details for the interlocking program.

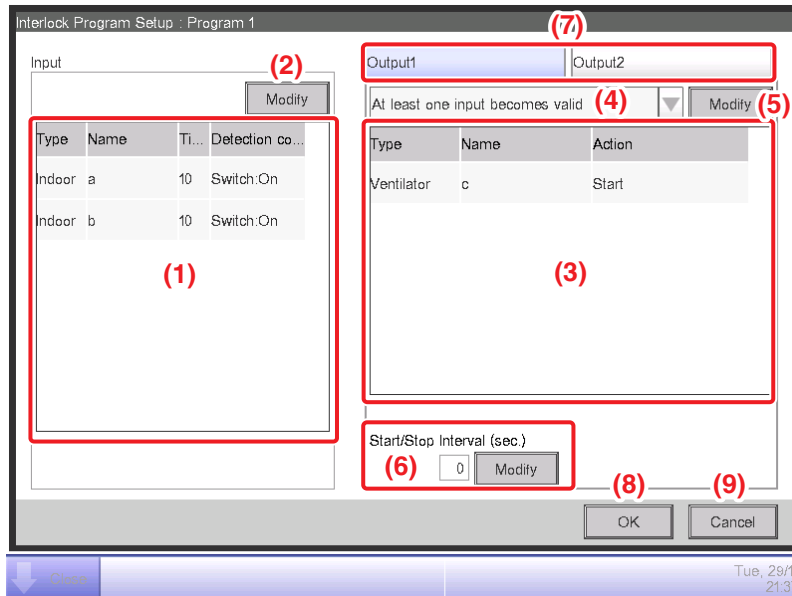

(1) Input list

Displays the input conditions of the interlocking program

(2) Modify button (Input)

Displays the Interlock Program Input screen that allows you to set the input conditions for interlocking.

(3) Output list

Displays the outputs of the interlocking program.

(4) Input condition combo box

Selects the input conditions for an interlocking program output.

Select an input condition from: Not detected, At least one input becomes valid, All inputs become valid, At least one input becomes invalid, and All inputs become invalid.

(5) Modify button (Output)

Displays the Interlock Program Output Setup screen that allows you to set up the event to be output by the interlocking program.

(6) Sequential Start/Stop interval [sec.] field

Sets up the delay for the outputs. When sending a switch order to multiple management points, you can set up an interval for outputting the orders.

Touch the Modify button and enter the time in the Numerical Input dialog that appears.

The range of values you can enter is 0 to 60, in increments of 1.

(7) Output1/Output2 selection tab

Toggles between settings for Output1 and Output2. You can set up to two outputs to one interlocking program.

(8) OK button

Saves the edit and closes the screen.

(9) Cancel button

Cancels the edit and closes the screen.

• **Interlock Program Input Setup Screen**

This screen is displayed when you touch the Modify button on the Interlock Program Setup screen.

Sets up the inputs to the interlocking program.

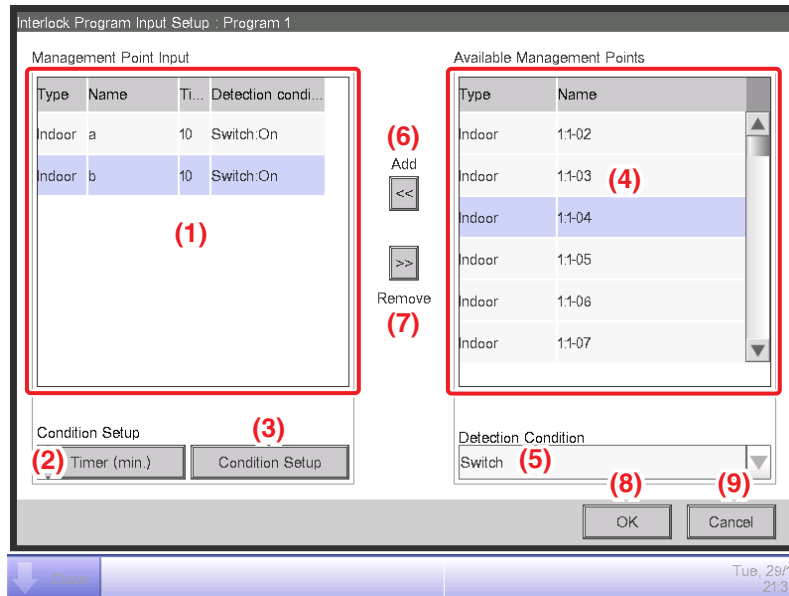

(1) Management Point Input list

Displays a list of management points monitored as inputs to the interlocking program.

(2) Timer (min.) button

Displays the Numerical Input dialog that allows you to set the required duration.

The range of values you can enter is 0 to 30, in increments of 1. (1 to 30 for analog values)

(3) Condition Setup button

Displays the Condition Setup screen that allows you to set up the conditions required for the management point selected in the Management Point Input list.

(4) Available Management Points list

Displays a list of management points that can be selected as input for the condition to detect selected in the Detection Condition combo box.

(5) Detection Condition combo box

Selects the condition to detect at an available management point in the Available Management Points list.

Select a condition to detect from: Switch, Equipment error, Analog upper limit error, Analog lower limit error, Operation mode, and Analog value condition.

(6) Add button

Registers an available management point selected in the Available Management Points list to the Management Point Input list.

You can register up to 50 management points to monitor. However, you cannot register areas.

(7) Remove button

Removes the management point selected in the Management Point Input list from monitoring.

(8) OK button

Saves the edit and closes the screen.

(9) Cancel button

Cancels the edit and closes the screen.

- **Condition Setup Screen**

This screen is displayed when you touch the Condition Setup button on the Interlock Program Setup screen.

Sets up the conditions to be required to the input.

The screen consists of three tabs: Start/Stop / Error, Operation Mode, and Analog Value, each detecting different conditions. The screen opens on the tab that corresponds to the type of the monitored management point.

- **Start/Stop / Error Tab (Condition Setup Screen)**

This screen is displayed when you touch the Start/Stop / Error tab on the Condition Setup screen.

Sets up the conditions required for Switch, Equipment error, Analog upper limit error, or Analog lower limit error to be detected.

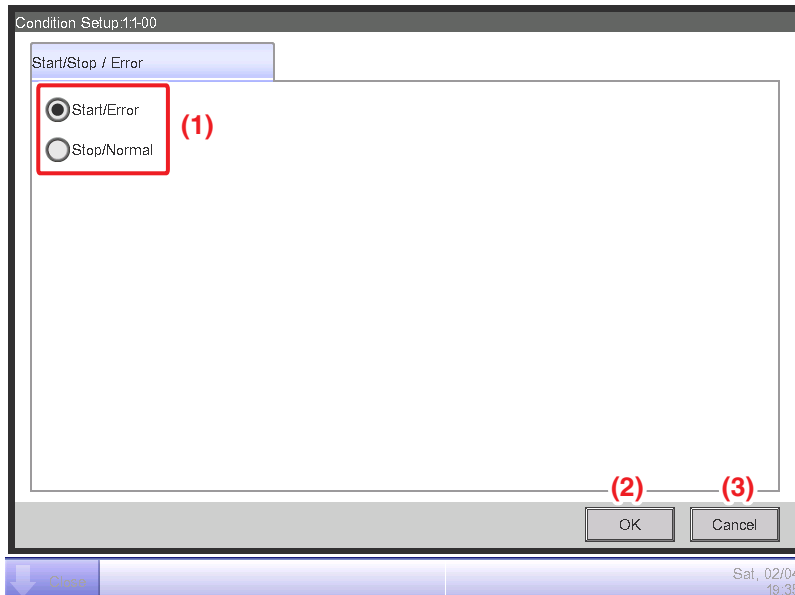

(1) Required condition radio button

Select either Start/Error or Stop/Normal as the required condition.

(2) OK button

Saves the edit and closes the screen.

(3) Cancel button

Cancels the edit and closes the screen.

- **Operation Mode Tab (Condition Setup Screen)**

This screen is displayed when you touch the Operation Mode tab on the Condition Setup screen. Sets up the conditions required for the operation mode to be detected.

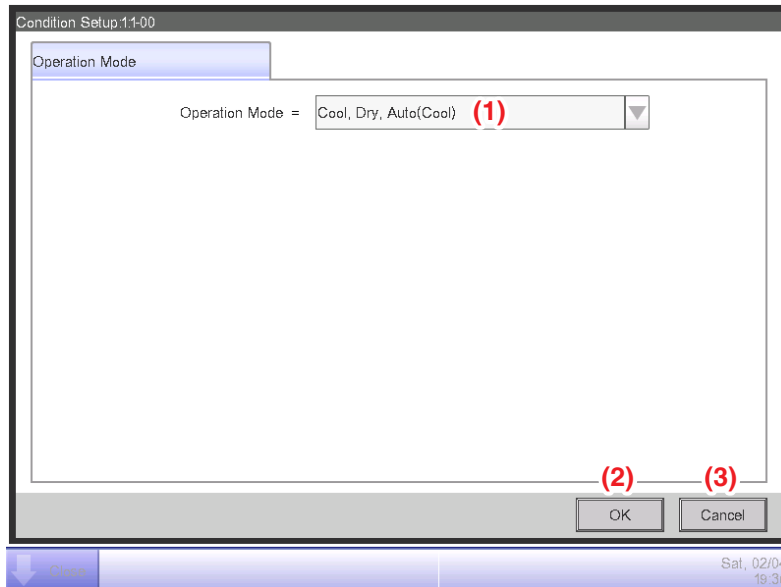

(1) Operation Mode combo box

Select the operation mode required for clearing the condition.

Select an operation mode from: “Cool, Dry, Auto(Cool)”, “Heat, Auto(Heat)”, and “Fan”.

(2) OK button

Saves the edit and closes the screen.

(3) Cancel button

Cancels the edit and closes the screen.

- **Analog Value Tab (Condition Setup Screen)**

This screen is displayed when you touch the Analog Value tab on the Condition Setup screen. Sets up the analog value requirement for the condition to be detected.

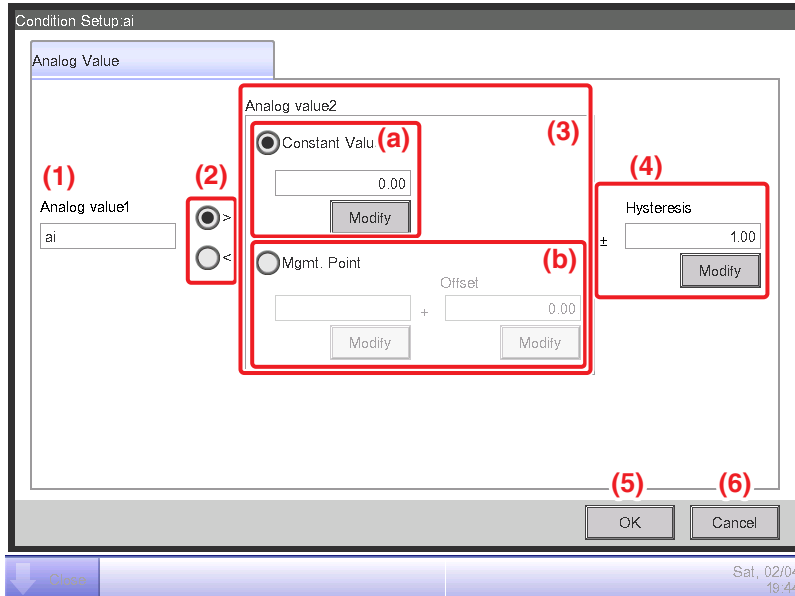

(1) Analog Value1 field

Displays the name of the management point selected in the Management Point Input list.

(2) Inequality Sign Selection radio button

Select the inequality sign to be used in the analog value condition from “>” and “<”.

(3) Analog Value2 field

Sets up the right side of the analog value condition.

(a) Constant Value area

Select this area when specifying a constant value on the right side.

Touch the Modify button and enter a value in the Numerical Input dialog that appears.

For the range of values you can enter, see page 178.

(b) Mgmt. Point area

Select this area when specifying the right side using a management point and offset.

Touch the Modify button under Mgmt. Point and display the Management Points Selection screen and select one from the list.

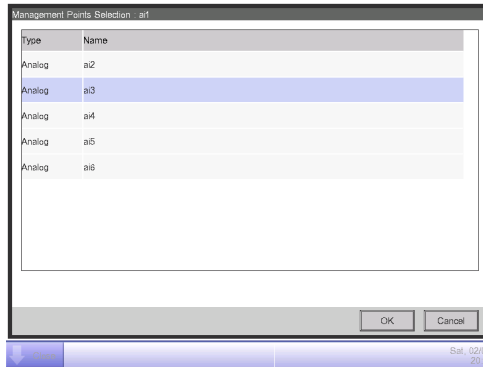

Touch the Modify button under Offset and display the Numerical Input dialog to enter the offset.
For the range of values you can enter, see page 178.

(4) Hysteresis area

Sets up the range of the dead zone.

Touch the Modify button and enter the range in the Numerical Input dialog that appears.

For the range of values you can enter, see page 178.

(5) OK button

Saves the edit and closes the screen.

(6) Cancel button

Cancels the edit and closes the screen.

• **Setting up an Analog Value Condition**

An analog value can be used as a condition to detect when using free cooling or, when starting/stopping the air conditioners only while the room temperature is within a set range.

The condition may be a comparison against a constant value or a comparison between analog values. Furthermore, “>” and “<” can be used to allow for range specification.

When the condition is cleared, the input is considered valid and when the condition is not cleared, the input is considered invalid.

Whether input is valid or invalid is assessed every minute.

In addition, you can set a hysteresis around the valid/invalid border value to prevent hunting.

In case that the condition is set between analog values, the conditions can only be set to the management points with the same analog type (temperature/general-purpose).

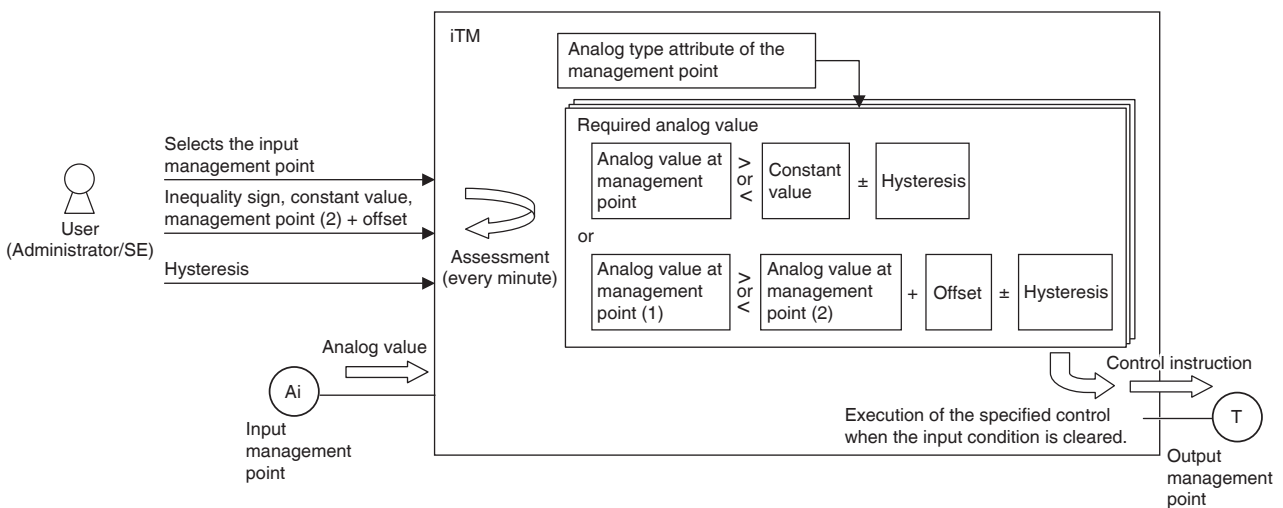

The following shows an example of how an analog value condition is assessed.

- The value at the management and constant value are compared as follows.

Example: [Analog value at the management point > Constant value + Hysteresis]

Analog value at the management point > Constant value + Hysteresis	Success
Analog value at the management point < Constant value – Hysteresis	Failure
Except above	Not assessed (Previous assessment kept)

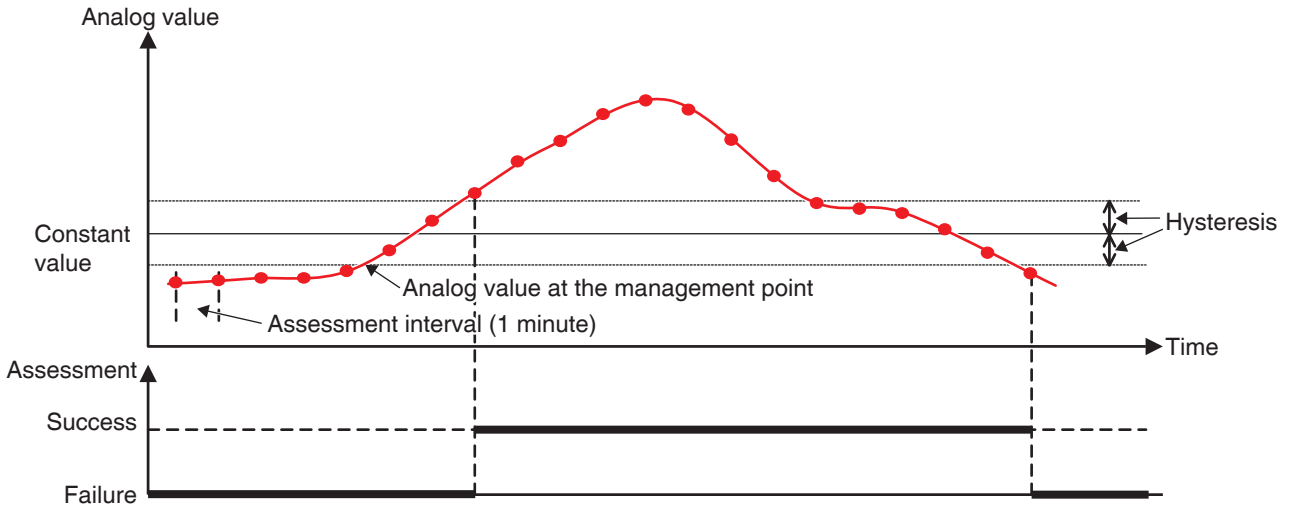

Example: [Analog value at the management point < Constant value + Hysteresis]

Analog value at the management point < Constant value – Hysteresis	Success
Analog value at the management point > Constant value + Hysteresis	Failure
Except above	Not assessed (Previous assessment kept)

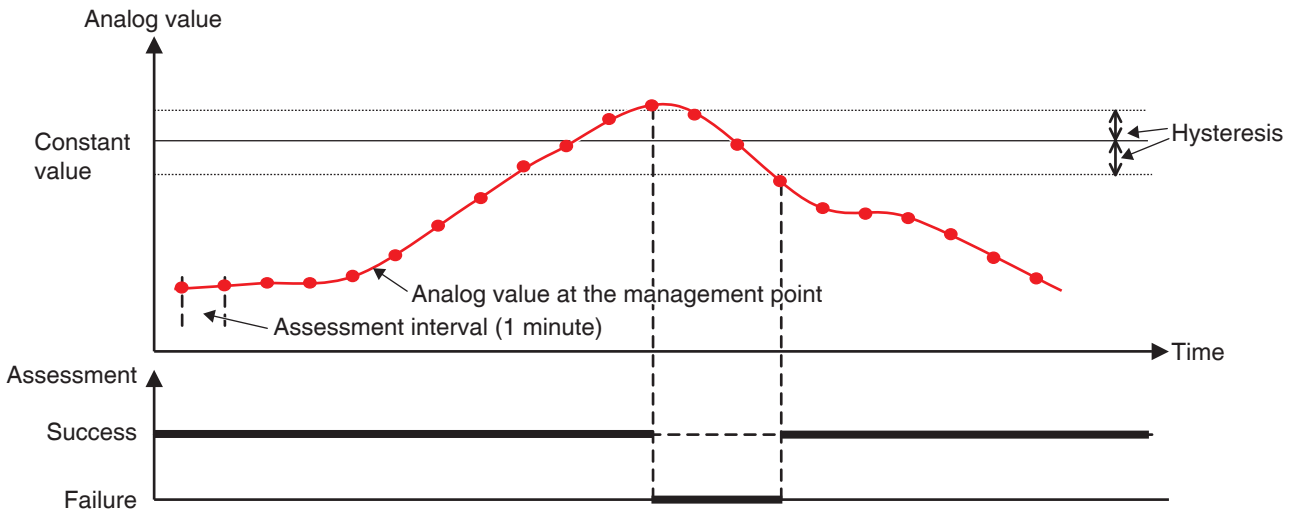

Range condition can be defined by combining the two cases above.

- Similarly, two analog values are compared as follows.

Example: [Analog value at the management point > Analog value at the management point + Offset ± Hysteresis]

Analog value at management point (1) > Analog value at management point (2) + Offset + Hysteresis	Success
Analog value at management point (1) < Analog value at management point (2) + Offset - Hysteresis	Failure
Except above	Not assessed (Previous assessment kept)

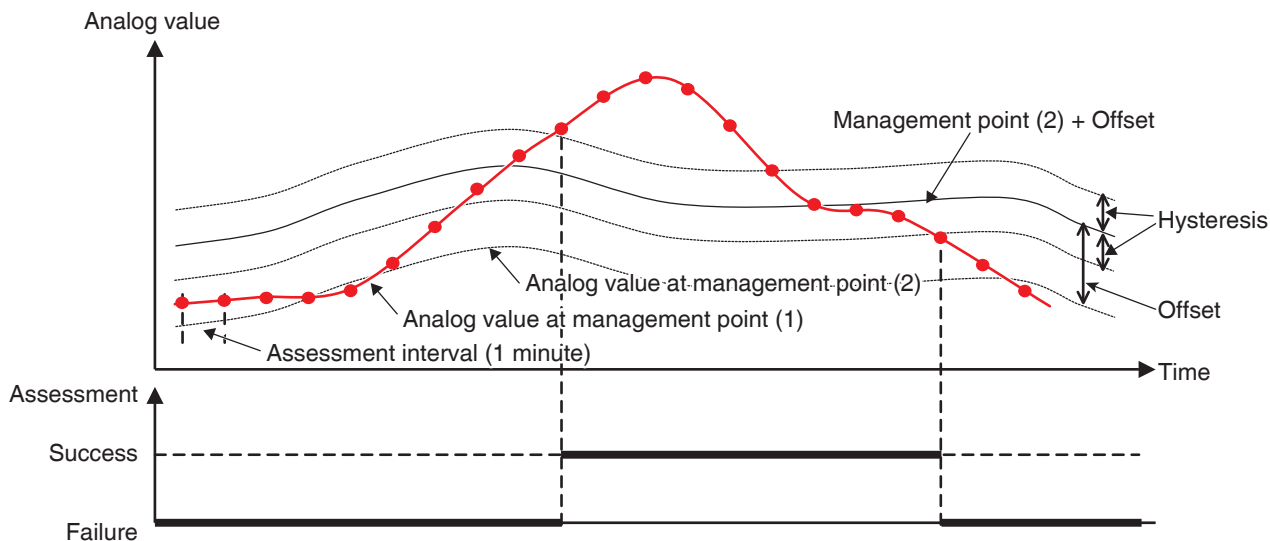

Example: [Analog value at the management point < Analog value at the management point + Offset ± Hysteresis]

Analog value at management point (1) < Analog value at management point (2) + Offset - Hysteresis	Success
Analog value at management point (1) > Analog value at management point (2) + Offset + Hysteresis	Failure
Except above	Not assessed (Previous assessment kept)

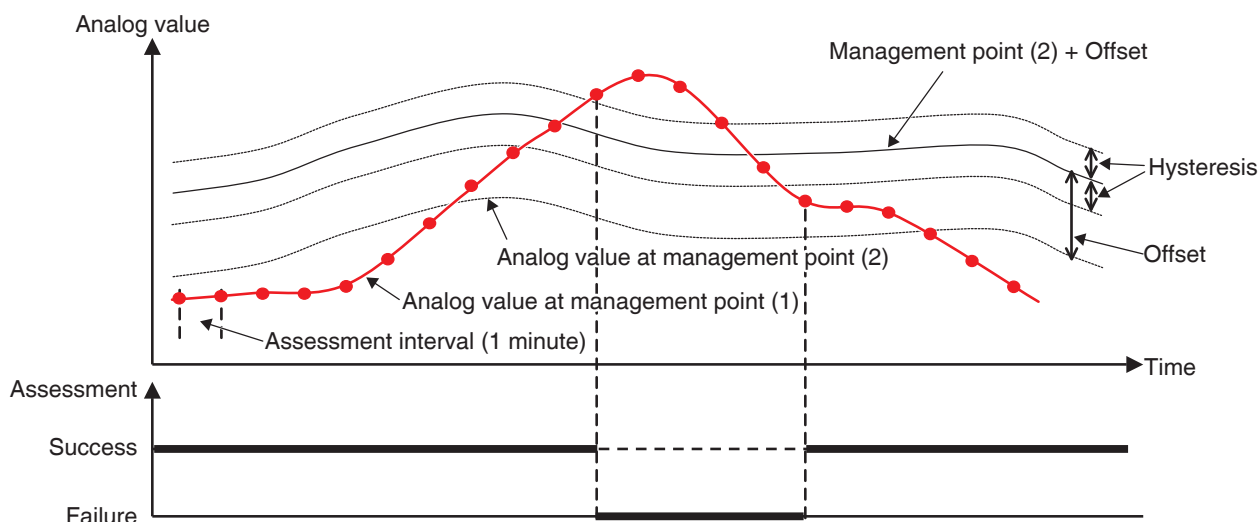

Range condition can be defined by combining the two cases above.

NOTE

- The setup of analog value conditions assumes expert users familiar with the system; therefore, be careful as no warning will be output even if a set up (for example, room temperature > 392°F) is inappropriate.
- If an abnormal value is entered due to an analog sensor malfunction, the analog value condition may be always cleared (or not cleared). When using an analog value condition, the creation of a separate interlocking program for analog upper/lower limit error is recommended.

• Setup Items for Condition Setup Screen

The setting items and range of values you can set in each tab are as indicated in the table below.

Setting location	Item	Setting details	Possible range (○: Visible, ×: Invisible, Between () : Numerical range)						
			Condition to detect	Equipment error	Analog upper/lower limit error	Operation mode	Analog value condition Single		
Start/Stop / Error tab	Required condition for Start/Stop / Error	Start/Error Stop/Normal	○ ○	○ ○	○ ○	○ ○	○ ○	○ ○	
	Operation Mode tab	Operation Mode	Cool, Dry, Auto(Cool) Heat, Auto(Heat) Fan	× × ×	× × ×	× × ×	○ ○ ○	× × ×	× × ×
Analog Value tab		Analog Value 1	Example: Outdoor Temp 1	×	×	×	○	○	○
	Inequality Sign Selection	>		×	×	×	○	○	○
		<		×	×	×	○	○	○
	Const Value	Temperature	Example: 0.0°C Example: 32°F	×	×	×	○	○	○ (-512.0-512.0) *1*2*4 Step: 0.1 ○ (-890-954) *1*2*4 Step: 1
		Generic	Example: 0.00	×	×	×	○	○	○ (-9999.99-9999.99) *1*4 Step: 0.01
	Analog Value2	Mgmt. Point	Offset	×	×	×	○	○	○ *3
			Temperature	Example: 0.0	×	×	○	○	○ (-512.0-512.0) *1*2*3 Step: 0.1 ○ (-922-922) *1*2*3 Step: 1
	Hysteresis	Generic	Temperature	Example: 0.00	×	×	○	○	○ (-9999.99-9999.99) *1*3 Step: 0.01 ○ (0.0-512.0) *1*2 Step: 0.1
			Temperature	Example: 1.0	×	×	○	○	○ (0-922) *1*2 Step: 1 ○ (0.00-9999.99) *1 Step: 0.01

*1 Displayed in accordance with the analog type of the selected management point.
 *2 Displayed in °C or °F depending on the unit selected in the System Settings.
 *3 Grayed out when Const Value is selected.
 *4 Grayed out when Mgmt. Point is selected.

• Interlock Program Output Setup Screen

This screen is displayed when you touch the Modify button on the Interlock Program Setup screen.

Sets events that will be output by the interlocking program.

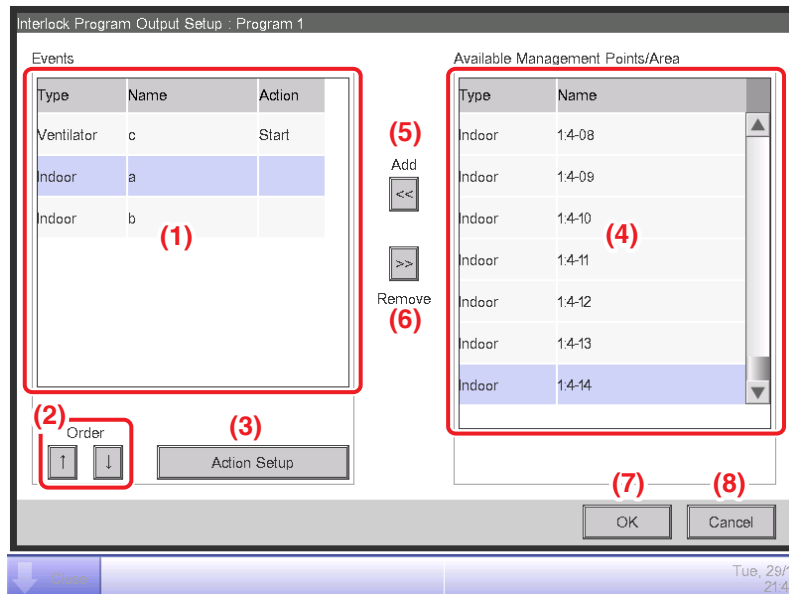

(1) Events list

Displays a list of management points/areas to which events are output.

(2) Order button

Moves up and down the output event selected in the Events list.

(3) Action Setup button

Displays the Action Setup screen that allows you to set up the action to be performed by the output event selected in the Events list.

(4) Available Management Points/Area list

Displays a list of management points/areas to which events can be output.

(5) Add button

Registers an available management point or area selected in the Available Management Points/Area list to the Events list as a target of event output.

You can register up to 25 management points or 1 area as target of an event output.

You cannot simultaneously register management points and areas in one interlocking program.

(6) Remove button

Removes the management point or area selected in the Events list.

(7) OK button

Saves the edit and closes the screen.

(8) Cancel button

Cancels the edit and closes the screen.

- **Action Setup Screen**

This screen is displayed when you touch the Action Setup button on the Interlock Program Output Setup screen.

Sets the actions that will be performed by an output event of the interlocking program.

This screen consists of five tabs: Common, R/C Prohibition, A/C, Ventilator, and Ao, each outputting different event actions. The screen opens on the tab that corresponds to the type of the selected management point/area.

- **Common Tab (Action Setup Screen)**

This screen is displayed when you touch the Common tab on the Action Setup screen.

Sets up actions for common items.

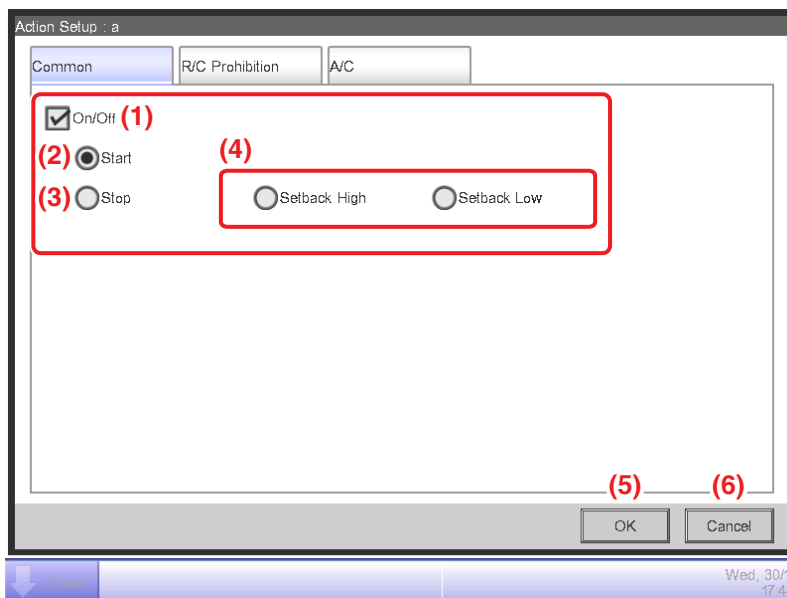

(1) On/Off area

Select the On/Off check box to start/stop the target.

(2) Start radio button

Select to start the target.

(3) Stop radio button

Select to stop the target.

(4) Setback High, Setback Low radio buttons

Select either of the two radio buttons when using the Setback function.

These radio buttons are displayed only when the optional Setback function is enabled.

(5) OK button

Saves the edit and closes the screen.

(6) Cancel button

Cancels the edit and closes the screen.

- **R/C Prohibition Tab (Action Setup Screen)**

This screen is displayed when you touch the R/C Prohibition tab on the Action Setup screen.

Enables or disables the remote controller. This tab is not displayed when the R/C Prohibition function is disabled.

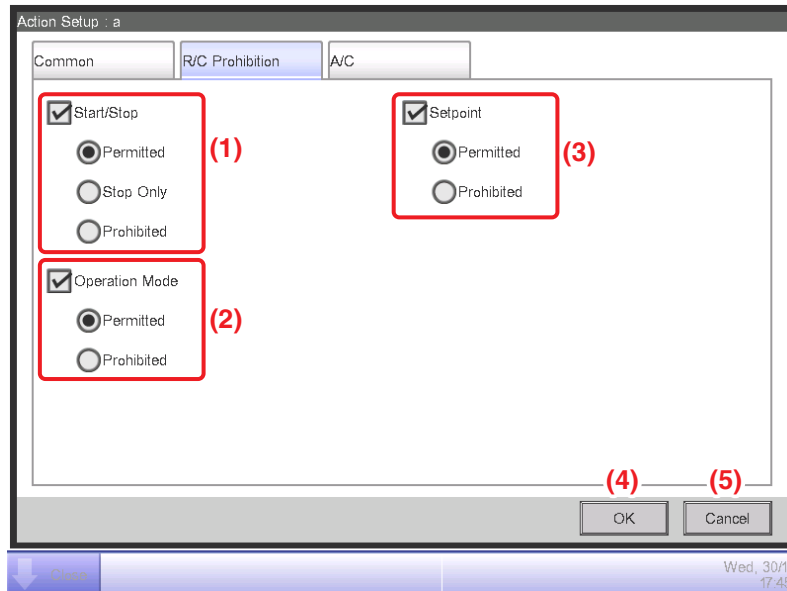

Select the check box of the items to set up and select the setting using the radio buttons.

(1) Start/Stop area

Permits/Prohibits starting/stopping from the remote controller.

Select the setting from Permitted, Stop Only, and Prohibited.

(2) Operation Mode area

Permits/Prohibits changing the operation mode from the remote controller.

Select the setting from Permitted and Prohibited.

This setting area is not displayed when the target is Ventilator

(3) Setpoint area

Permits/Prohibits changing the setpoint from the remote controller.

Select the setting from Permitted and Prohibited.

This setting area is not displayed when the target is Ventilator.

(4) OK button

Saves the edit and closes the screen.

(5) Cancel button

Cancels the edit and closes the screen.

• **A/C Tab (Action Setup Screen)**

This screen is displayed when you touch the A/C tab on the Action Setup screen.

Sets up the air conditioner actions.

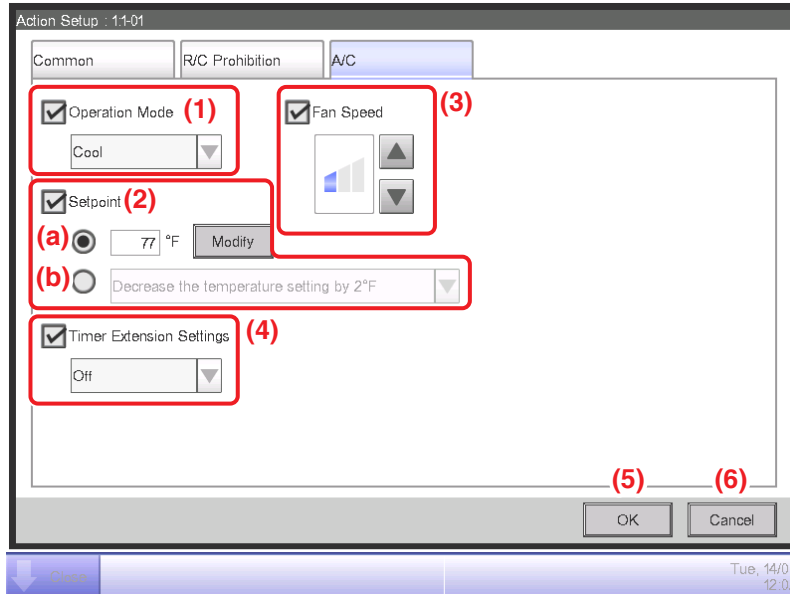

Select the check box of the items to set up and select the setting from the combo box.

(1) Operation Mode setting area

Sets up the operation mode.

Select the setting from Fan, Cool, Heat, Dependent, Automatic, and Dry.

Only options applicable to the target are displayed.

Some items may become unavailable depending on the selected operation mode.

(2) Setpoint setting area

Sets up the setpoint.

To set up, select either the **(a)** Setpoint radio button or **(b)** Setpoint shift radio button.

If you selected Setpoint, touch the Modify button and enter the temperature in the Numerical Input dialog that appears. The range of values you can enter is -22 to 158°F, in increments of 1°F.

If you selected Setpoint shift, select the amount to shift using the combo box.

Select the amount to shift the temperature from Decrease the temperature settings by 7°F, Decrease the temperature settings by 6°F, Decrease the temperature settings by 5°F, Decrease the temperature settings by 4°F, Decrease the temperature settings by 3°F, Decrease the temperature settings by 2°F, Decrease the temperature settings by 1°F, Increase the temperature settings by 1°F, Increase the temperature settings by 2°F, Increase the temperature settings by 3°F, Increase the temperature settings by 4°F, Increase the temperature settings by 5°F, Increase the temperature settings by 6°F, and Increase the temperature settings by 7°F.

(3) Fan Speed setup area

Sets up the fan speed.

Touching the ▲ button increases the fan speed by one level while touching the ▼ button decreases the fan speed by one level.

The fan speed you can set depends on the target.

(4) Timer Extension Settings area

Sets up the function that prevents failure to turn off the indoor unit.

Select whether to enable (On) or disable (Off) the function using the combo box.

(5) OK button

Saves the edit and closes the screen.

(6) Cancel button

Cancels the edit and closes the screen.

- **Ventilator Tab (Action Setup Screen)**

This screen is displayed when you touch the Ventilator tab on the Action Setup screen.

Sets up the Ventilator actions.

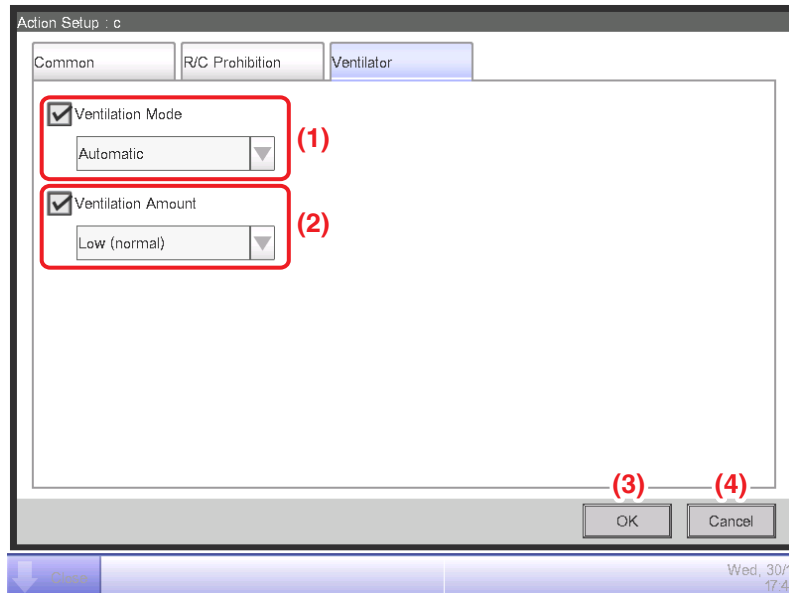

Select the check box of the items to set up and select the setting from the combo box.

(1) Ventilation Mode setting area

Sets up the ventilation mode.

Select the setting from Automatic, ERVentilation, and Bypass.

(2) Ventilation Amount setting area

Sets up the ventilation amount.

Select the setting from Auto (normal), Low (normal), High (normal), Auto (fresh up), Low (fresh up), and High (fresh up).

(3) OK button

Saves the edit and closes the screen.

(4) Cancel button

Cancels the edit and closes the screen.

- **Ao Tab (Action Setup Screen)**

This screen is displayed when you touch the Ao tab on the Action Setup screen.

Sets up the Ao actions.

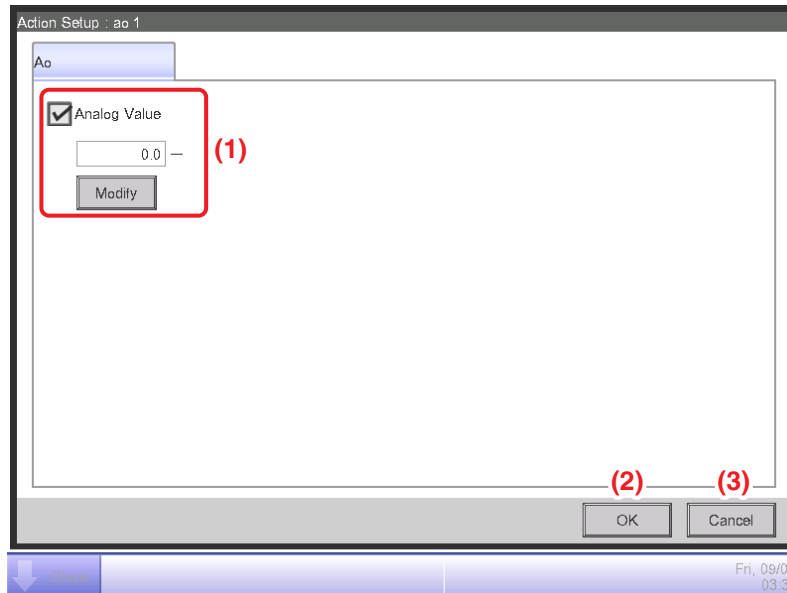

Select the check box of the items to set up and enter the setting using the Modify button.

(1) Analog Value setting area

Sets up an analog value.

Touch the Modify button and enter the analog value in the Numerical Input dialog that appears.

The range of values you can enter must be within the upper and lower limits, and with the accuracy defined in the Ao's management point.

(2) OK button

Saves the edit and closes the screen.

(3) Cancel button

Cancels the edit and closes the screen.

• Setup Items for Action Setup Screen

The setting items and range of values you can set in each tab are as indicated in the table below.

Setting location	Item	Setting details	Possible range [○: Visible, △: Conditionally visible, x: Invisible, Between () : Numerical range]					Area	Remarks		
			Management point type								
			Indoor unit	Ventilator	Chiller	Dio	Analog (Ao)				
Common tab	On/Off	Start	○	○	○	○	x	○			
		Pre-Cool							Schedule setup only		
		Pre-Heat									
		Stop	○	○	○	○	x	○			
		Setback high	△*1	x	x	x	x	△*1			
		Setback Low	△*1	x	x	x	x	△*1			
	Pre-Cool/Pre-Heat Setpoint	Celsius	Example: 25.0°C						Schedule setup only		
		Fahrenheit	Example: 77°F								
	Filter Sign								Only Detailed Setup for centralized monitoring		
	R/C Prohibition tab	R/C Prohibition	Start/Stop	Permitted	○	○	○	x	x	○	
Stop Only			○	○	○	x	x	○			
Operation Mode		Prohibited	○	○	○	x	x	○			
		Permitted	○	x	○	x	x	○			
Setpoint		Permitted	○	x	○	x	x	○			
		Prohibited	○	x	○	x	x	○			
Events Screen	Operation Mode	Fan	○	x	x	x	x	○			
		Cool	○	x	○	x	x	○			
		Heat	○	x	○	x	x	○			
		Dependent	○	x	x	x	x	○			
		Automatic	○	x	x	x	x	○			
		Dry	△*2	x	x	x	x	△*2			
		Setpoint	Celsius	Example: 30°C	○ (-30.0-70.0°C) *7*9	x	○ (-30.0-70.0°C) *7	x	x	○ (-30.0-70.0°C) *7*9	
	Example: 90°F			○ (-22-158°F) *7*9	x	○ (-22-158°F) *7	x	x	○ (-22-158°F) *7*9		
	Shift Amount		Celsius	Decrease the temperature settings by 4°C	○*7*8	x	x	x	x	○*7*8	
				Decrease the temperature settings by 3°C	○*7*8	x	x	x	x	○*7*8	
				Decrease the temperature settings by 2°C	○*7*8	x	x	x	x	○*7*8	
				Decrease the temperature settings by 1°C	○*7*8	x	x	x	x	○*7*8	
				Increase the temperature settings by 1°C	○*7*8	x	x	x	x	○*7*8	
				Increase the temperature settings by 2°C	○*7*8	x	x	x	x	○*7*8	
				Increase the temperature settings by 3°C	○*7*8	x	x	x	x	○*7*8	
				Increase the temperature settings by 4°C	○*7*8	x	x	x	x	○*7*8	
		Fahrenheit	Decrease the temperature settings by 7°F	○*7*8	x	x	x	x	○*7*8		
			Decrease the temperature settings by 6°F	○*7*8	x	x	x	x	○*7*8		
			Decrease the temperature settings by 5°F	○*7*8	x	x	x	x	○*7*8		
			Decrease the temperature settings by 4°F	○*7*8	x	x	x	x	○*7*8		
			Decrease the temperature settings by 3°F	○*7*8	x	x	x	x	○*7*8		
			Decrease the temperature settings by 2°F	○*7*8	x	x	x	x	○*7*8		
			Decrease the temperature settings by 1°F	○*7*8	x	x	x	x	○*7*8		
			Increase the temperature settings by 1°F	○*7*8	x	x	x	x	○*7*8		
	Fan Speed	Low	○	x	x	x	x	○			
		Middle	○	x	x	x	x	○			
		High	○	x	x	x	x	○			
		Auto	○	x	x	x	x	○			
Airflow Direction		Airflow direction 0							Only Detailed Setup for centralized monitoring		
		Airflow direction 1									
		Airflow direction 2									
	Airflow direction 3										
	Airflow direction 4										
Timer Extension	Swing										
	ON	○	x	x	x	x	○				
	OFF	○	x	x	x	x	○				

Setting location	Item		Setting details	Possible range [○: Visible, △: Conditionally visible, x: Invisible, Between () : Numerical range]					Remarks		
				Management point type						Area	
				Indoor unit	Ventilator	Chiller	Dio	Analog (Ao)			
A/C tab	Setpoint Restriction	Cooling Limit	Enable/Disable	Enable						Only Detailed Setup for centralized monitoring, Schedule	
			Disable								
		MAX	Celsius	Example: 32°C							
			Fahrenheit	Example: 90°F							
		MIN	Celsius	Example: 16°C							
			Fahrenheit	Example: 60°F							
	Heating Limit	Enable/Disable	Enable								
			Disable								
		MAX	Celsius	Example: 32°C							
			Fahrenheit	Example: 90°F							
		MIN	Celsius	Example: 16°C							
			Fahrenheit	Example: 60°F							
Events Screen	Ventilator tab	Ventilation Amount	Auto (normal)	x	△*3*4	x	x	x	○	When Ventilation Mode is disabled for the selected Ventilator management point, the tab itself is hidden.	
			Low (normal)	x	△*3	x	x	x	○		
			High (normal)	x	△*3	x	x	x	○		
			Auto (fresh up)	x	△*3*4*5	x	x	x	○		
			Low (fresh up)	x	△*3*5	x	x	x	○		
			High (fresh up)	x	△*3*5	x	x	x	○		
	Ventilation Mode	Automatic	x	△*3	x	x	x	○			
		ERVentilation	x	△*3	x	x	x	○			
		Bypass	x	△*3	x	x	x	○			
Dio tab	Repeat Mode	Enable/Disable	Enable						Only Detailed Setup for centralized monitoring		
		Disable									
	Interval	1									
		2									
		3									
		4									
		5									
		6									
		7									
		8									
		9									
10											
A/C tab	Analog	Example: 0.00	x	x	x	x	○*6	○(-9999.99-9999.99, w/o unit)			

*1 Not displayed when Setback Control is disabled.
*2 Not displayed when Operation Mode (Dry) is disabled.
*3 Not displayed when Ventilation Mode is disabled.
*4 Not displayed when Ventilation Amount/Auto Air Volume is disabled.
*5 Not displayed when Ventilation fresh up is disabled.
*6 The value will be displayed in set unit, upper/lower limit range, displayed accuracy.
*7 Displayed in °C or °F depending on the unit selected in the System Settings.
*8 Grayed out when Setpoint is selected.
*9 Grayed out when Setpoint shift is selected.

8-3 Setting up the Emergency Stop

The iTM includes the Emergency Stop as standard function (see page 107).

The Emergency Stop is a control function envisioned primarily as a measure against fire. Based on the emergency stop program, this function stops the management points set up as output when the input signal set up as the emergency stop signal is received.

The Default program stops all D3 units registered as management point when an emergency stop signal is received.

The Default program cannot be edited, except from toggling enable and disable.

If the optional Emergency Stop Control function is enabled, you can create your own emergency stop program.

The following describes how to create and set up an emergency stop program.

1. Touch the Emergency Stop button on the Automatic Ctrl. tab of the Menu List screen and display the Emergency Stop Control screen (see page 52).

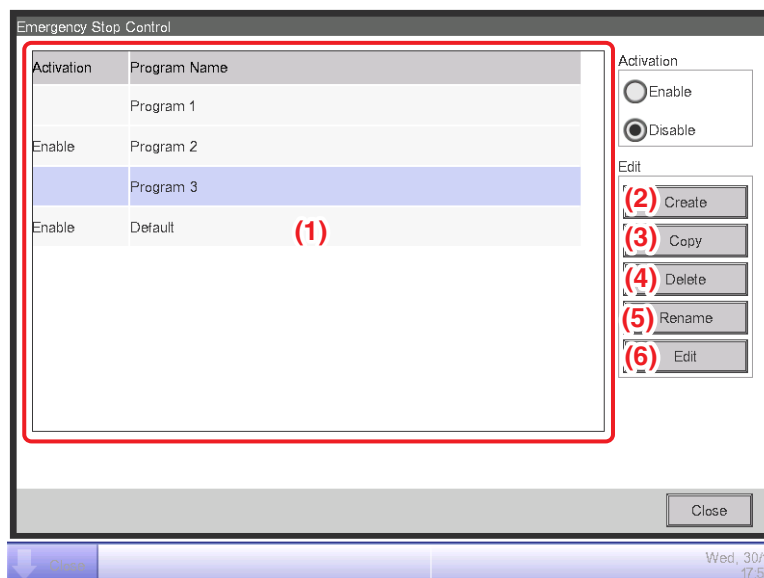

2. (1) is the list of emergency stop programs. Perform the intended operation by touching the relevant button on the right.

(2) Create button

Creates a new program. You can create up to 32 emergency stop programs (including the Default program).

(3) Copy button

Copies the selected program for editing.

(4) Delete button

Deletes the selected program.

(5) Rename button

Displays the Name Setup dialog where you can rename the selected program.

(6) Edit button

Allows you to edit a program.

3. Touching the Create, Copy, or Rename button displays the Name Setup dialog that allows you to enter the program name. You can name the program using up to 20 characters. Enter a name and touch the OK button to close the screen. The program is added to the list **(1)**. Then, touch the **Edit** button **(6)** and display the Emergency Stop Program Settings screen.

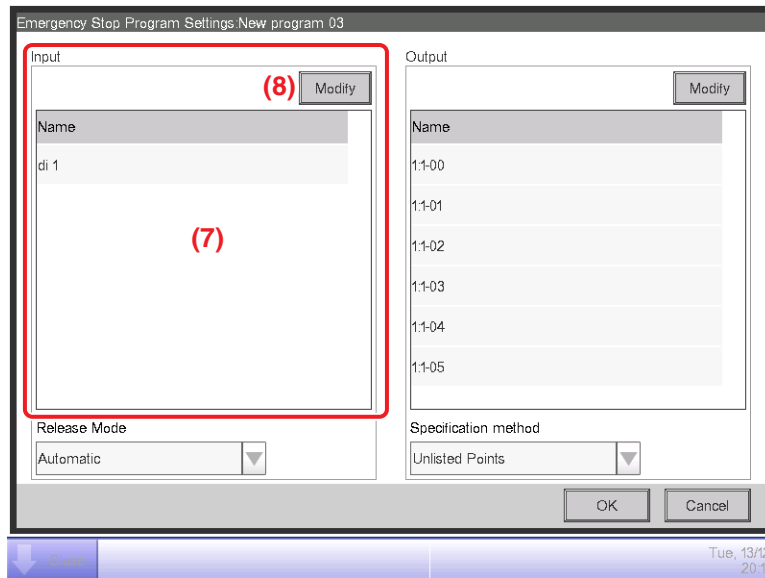

4. **(7)** is the list of management points input as emergency stop signal. Touch the **Modify** button **(8)** and display the Management Points Selection screen.

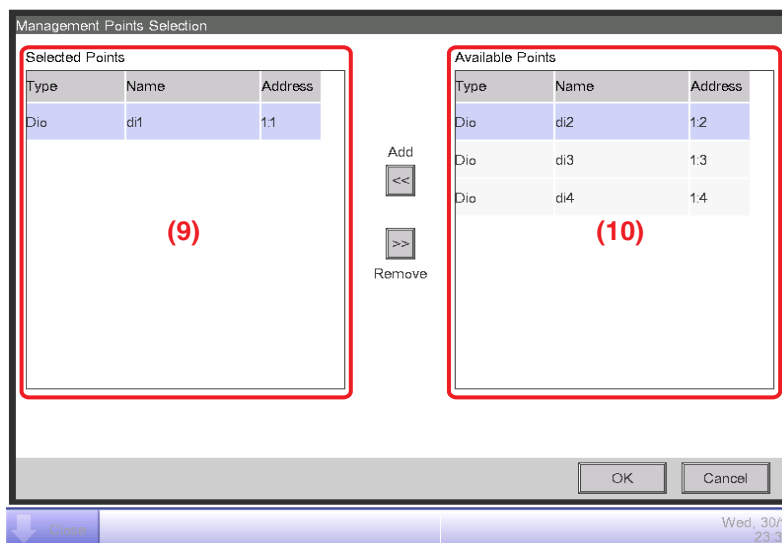

5. **(9)** is the list of registered management points while **(10)** is the list of management points that can be registered.

To add a management point, select one from (10) and touch the Add button. To remove a management point, select one from (9) and touch the Remove button.

You can register up to 6 management points to monitor.

When finished, touch the OK button to save and return to the Emergency Stop Program Settings screen.

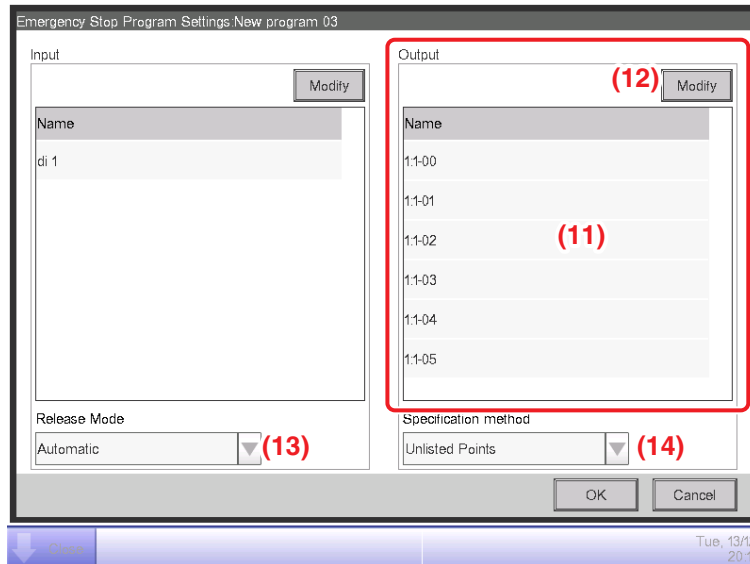

6. (11) is the list of management points target of the Emergency Stop. Touch the **Modify** button (12) and register management points, as in step 5.

7. Using the **Release Mode** combo box (13), select the method of releasing the emergency stop program from Automatic and Manual.

Using the **Specification method** combo box (14), select whether the the Output list (11) is the list of emergency stop targets or the list of those excluded.

NOTE

The management points, which was newly registered after creating the emergency stop program, can be used as follows.

- On the program which uses the list (11) as the list of emergency stop targets, it cannot be stopped emergently.
- On the program which uses the list (11) as the list of those excluded, it can be stopped emergently.

When finished, touch the OK button to save and return to the Emergency Stop Control screen.

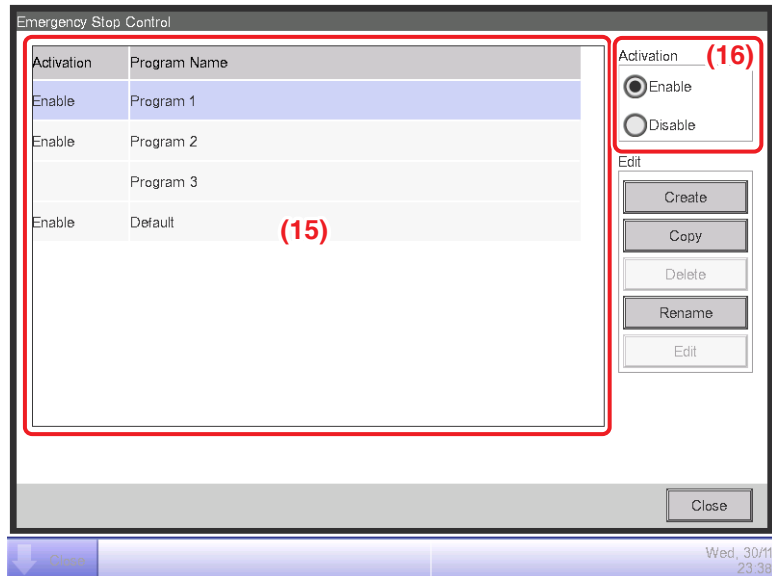

8. Select the program in (15) and enable or disable the program in (16).
When finished, touch the Close button and close the screen.

Releasing the Emergency Stop

For the Default program, canceling the emergency stop signal input automatically releases the emergency stop. (Forcible release possible.)

Programs created in this chapter can be manually released. When a program is set to manual release, touching the Release button on the Emergency Stop Release dialog (see page 108) displays a confirmation dialog. After checking, touch the Yes button and release the Emergency Stop.

8-4 Setting up the Temperature Limit

Temperature Limit is a function that keeps the room temperature within an upper and lower limits by automatically starting the cooling or heating when the room temperature exceeds the set upper limit or drops below the set lower limit. Using this function, you can prevent condensation and overheating in products stored in an unmanned room.

This function performs the following every 5 minutes for each indoor unit registered with a Temperature Limit group you have created and have this function enabled.

- When Off and room temperature > upper limit room temperature, sends the order to cool.
- When Off and room temperature < lower limit room temperature, sends the order to heat.
- When cooling is On by this function and room temperature < upper limit temperature -7°F , or room temperature < cool setpoint, sends the order to stop.
- When heating is On by this function and room temperature > lower limit room temperature $+7^{\circ}\text{F}$, or room temperature > heat setpoint, sends the order to stop.

NOTE

- Assessments following an order to start cooling or heating are not performed until after a period of 30 minutes. However, assessments are performed immediately and then, every 5 minutes when they follow a group member or group attribute change.

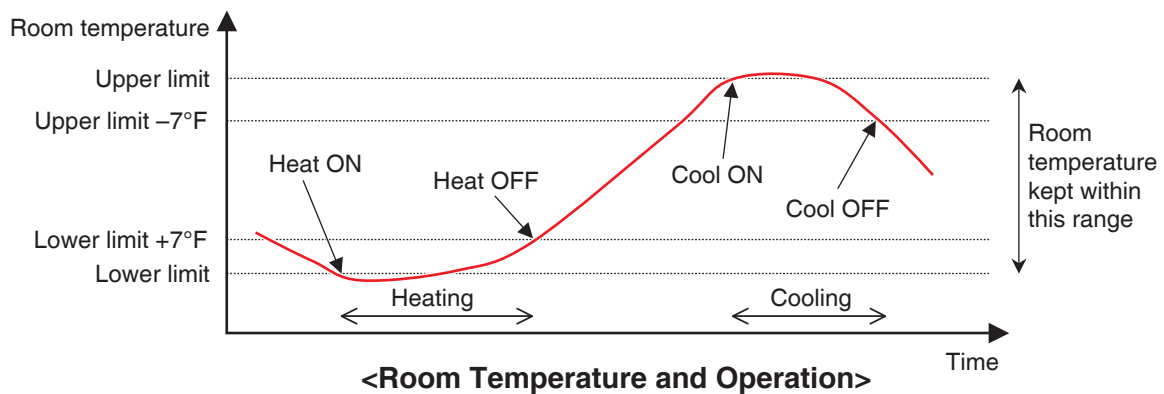

However, in the following situations, the above is not performed:

- The indoor unit is On by an order from another function, such as the Schedule Control or Interlocking Control function.
- The indoor unit received an order to start from another function while in operation by an order from this function.
- The suction temperature for the indoor unit cannot be acquired.

NOTE

- Be careful since an indoor unit that has been started by this function will remain On if the suction temperature cannot be acquired.

The following describes how to set this up.

1. Touch the Temp. Limit button on the Automatic Ctrl. tab of the Menu List screen and display the Temperature Limit screen (see page 52).

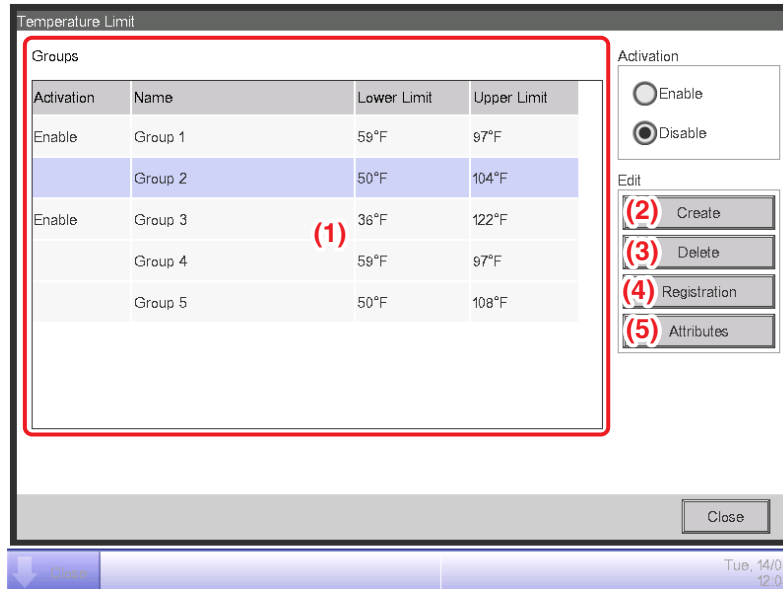

2. (1) is the list of Temperature Limit groups. Perform the intended operation by touching the relevant button on the right.

(2) Create button

Creates a new group and displays the Name Setup dialog that allows you to enter the name. Duplicate names are not permitted. You can create up to 8 Temperature Limit groups. Touch the OK button to save and close the screen. The created group is added to the list.

(3) Delete button

Deletes the selected group.

(4) Registration button

Displays the Registration screen that allows you to register/delete the selected management point as member.

(5) Attributes button

Displays the Attribute screen that allows you to rename the selected group, set up the upper limit/lower limit room temperatures, etc.

3. Display the Registration screen and register the group members.

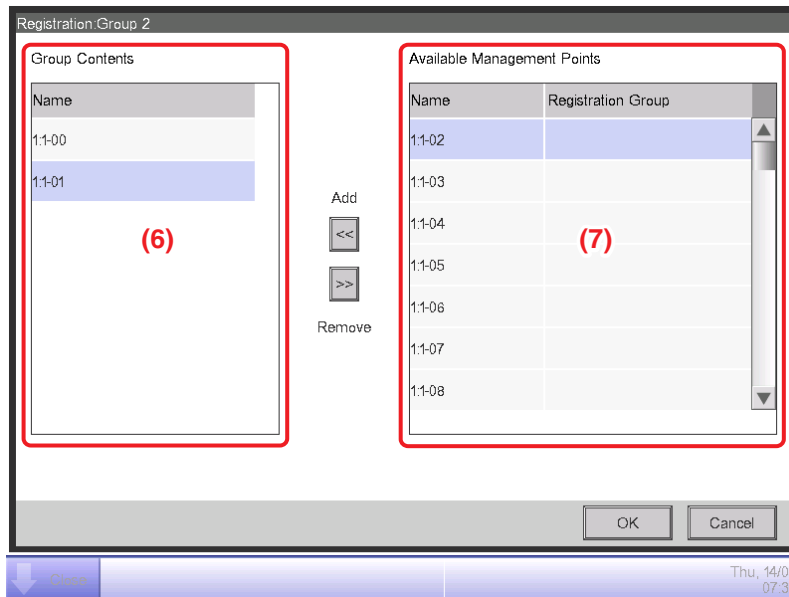

(6) is the list of registered management points registered with the group while (7) is the list of management points that can be registered.

To add a management point, select one from (7) and touch the Add button. To remove a management point, select one from (6) and touch the Remove button.

The management points you can register are limited to indoor units. You can register up to 512 indoor units in one group. You cannot register the same indoor unit in multiple groups.

When finished, touch the OK button to save and return to the Temperature Limit screen.

NOTE

- For indoor units without the Changeover option, make sure an indoor unit that uses the same refrigerant and has Changeover option is registered in the same group.
- Indoor units to be subject to the same control can be registered in the same group even if they are not located in the same space.

4. Display the Attributes screen and set up the group attributes.

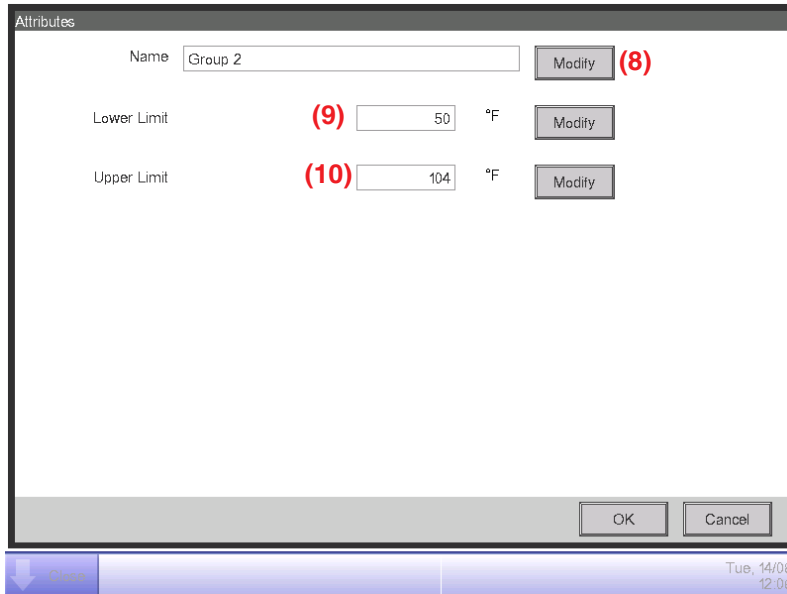

Touch the **Modify** button (8) to display the Text Input dialog where you can change the group name.

Enter the lower limit room temperature in (9) and the upper limit room temperature in (10) using the Numerical Input dialog.

In Upper Limit, you can specify a temperature in the 90°F to 122°F range, in increments of 1°F, while in Lower Limit, you can specify a temperature in the 36°F to 60°F range, in increments of 1°F.

When finished, touch the OK button to save and return to the Temperature Limit screen.

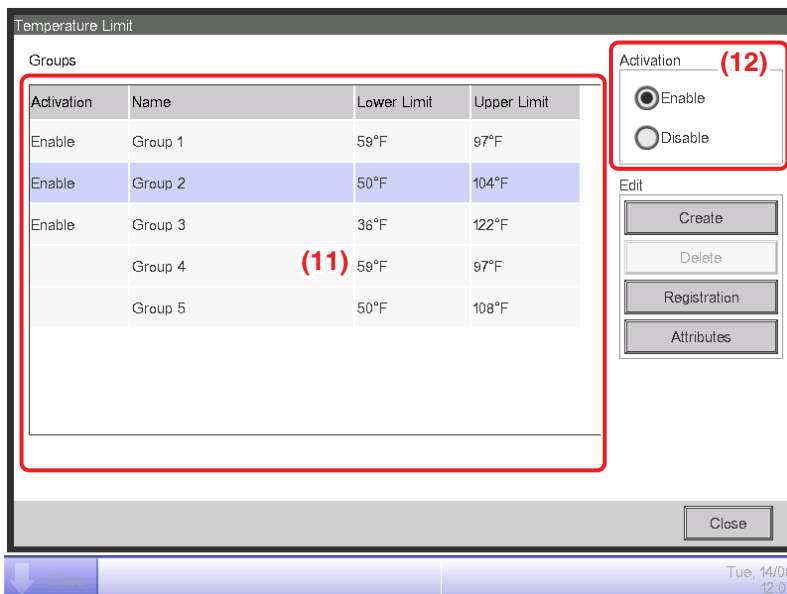

5. To enable the Temperature Limit function for the group selected in (11), select the Enable in the Activation radio button area (12) button. To disable, select the Disable button.

When finished, touch the Close button and close the screen.

Cautions when Using Simultaneously with Other Control Functions

1. This function cannot control indoor units with the Heating Mode Optimization function enabled.
2. If the Timer Extension function is set up for an indoor unit where this function is enabled, the indoor unit may be started again by this function after being stopped by the Timer Extension function.
3. When used together with the Sliding Temperature function, the indoor unit may be repeatedly started and stopped every 5 minutes (hunting) depending on the setpoint.

Example: When the setpoint for Sliding Temperature calculated from the outdoor temperature is 90°F and the upper limit for this function is 90°F.

1. When the room temperature exceeds 90°F, this function orders cooling to start.
2. The cool setpoint is set to 90°F by the Sliding Temperature function.
3. When the room temperature drops below 90°F, since room temperature < cool setpoint, this function orders cooling to stop.
4. The room temperature exceeds 90°F, and this function orders cooling to start. (Back to 1.)

When Using this Function

Use the target indoor units with automatic recovery from power failure set to “OFF”.

Be sure to consult a service person before using.

8-5 Setting up the Sliding Temperature Function

Sliding Temperature is a function that changes the indoor unit setpoint in accordance with the changes in the outdoor temperature so that the difference between the outdoor and indoor temperatures is not excessive in rooms with direct access to/from outside the building. This function works only when the indoor unit is working in Cool mode.

The setpoint of an indoor unit registered with a Sliding Temperature group you have created and have this function enabled may change every 5 minutes depending on the outdoor temperature measured at the Ai management point.

The outdoor temperature and setpoint are linked through the following expressions:

- When the outdoor temperature is higher than the upper limit outdoor temperature
Setpoint = Upper limit setpoint
- When the outdoor temperature is lower than the lower limit outdoor temperature
Setpoint = Lower limit setpoint
- When the outdoor temperature is within the range specified by the upper and limits of the outdoor temperature

$$\text{Setpoint} = (\text{Outdoor temperature} - \text{Lower limit outdoor temperature}) \times (\text{Upper limit setpoint} - \text{Lower limit setpoint}) / (\text{Upper limit outdoor temperature} - \text{Lower limit outdoor temperature}) + \text{Lower limit setpoint}$$

NOTE

- The value of the calculated setpoint is round off.

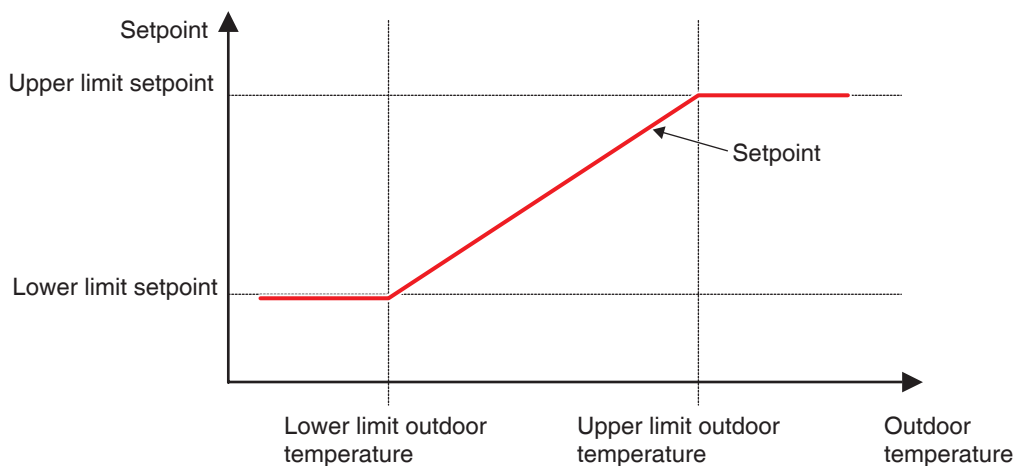

Relationship between Outdoor Temperature and Setpoint

The following describes how to set this up.

1. Touch the Sliding Temp. button on the Automatic Ctrl. tab of the Menu List screen and display the Sliding Temperature Settings screen (see page 52).

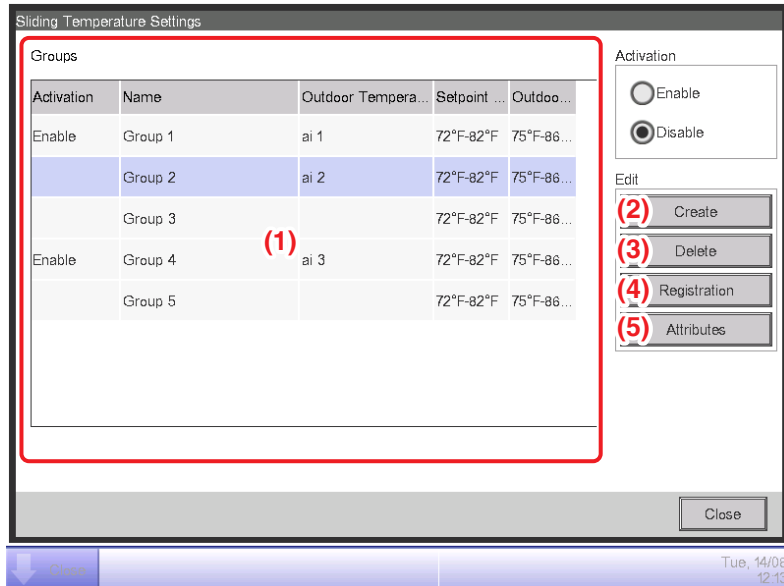

2. **(1)** is the list of Sliding Temperature groups. Perform the intended operation by touching the relevant button on the right.

(2) Create button

Creates a new group and displays the Name Setup dialog that allows you to enter the name. Duplicate names are not permitted. You can create up to 8 Temperature Limit groups. Touch the OK button and close the screen. The created group is added to the list.

(3) Delete button

Deletes the selected group.

(4) Registration button

Displays the Registration screen that allows you to register/delete group members.

(5) Attributes button

Displays the Attribute screen that allows you to rename the selected group, set up the upper limit/lower limit outdoor temperatures and/or setpoints, etc.

3. Display the Registration screen and register the group members.

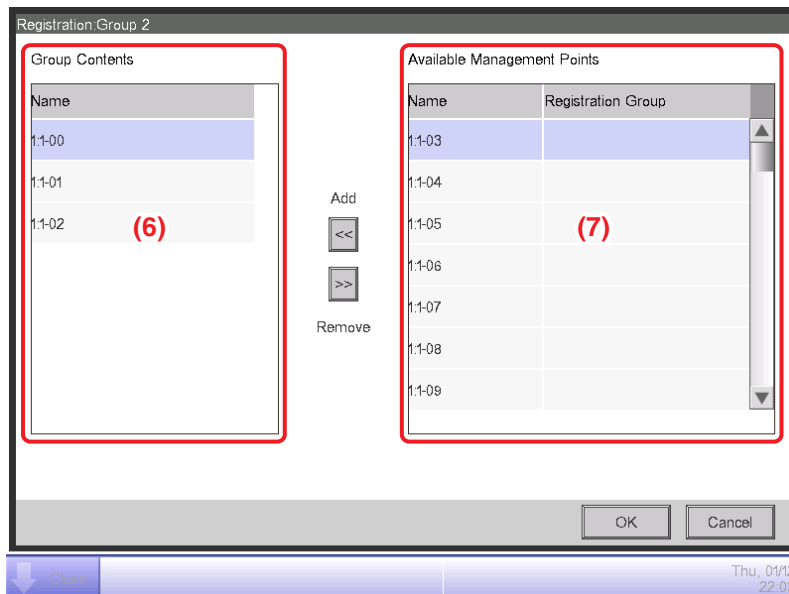

(6) is the list of registered management points registered with the group while (7) is the list of management points that can be registered.

To add a management point, select one from (7) and touch the Add button. To remove a management point, select one from (6) and touch the Remove button.

The management points you can register are limited to indoor units. You can register up to 512 indoor units in one group. You cannot register the same indoor unit in multiple groups.

When finished, touch the OK button to save and return to the Sliding Temperature Settings screen.

NOTE

Indoor units to be subject to the same control can be registered in the same group even if they are not located in the same space.

4. Display the Attribute screen and set up the group attributes.

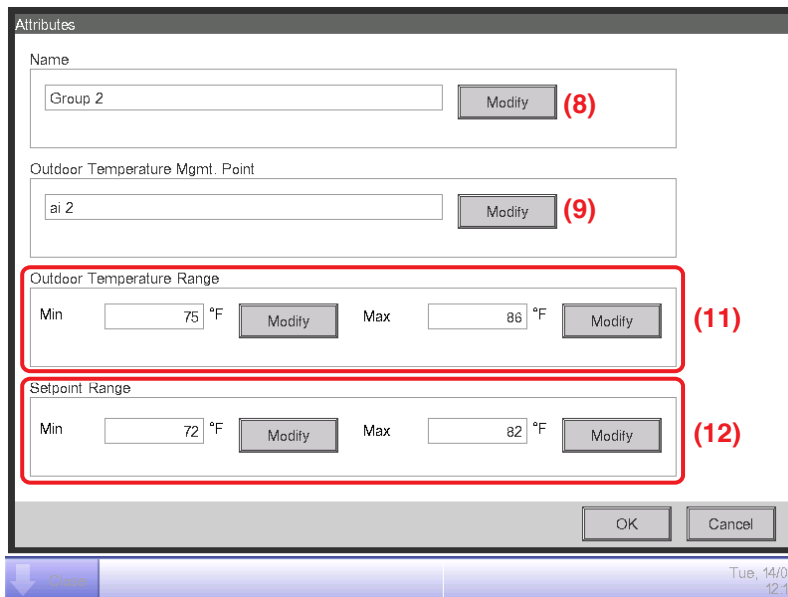

Touching the **Modify** button (8) displays the Text Input dialog where you can change the group name.

Touching the **Modify** button (9) displays the Analog Input screen where you can register the Ai management point at which the outdoor temperature will be measured.

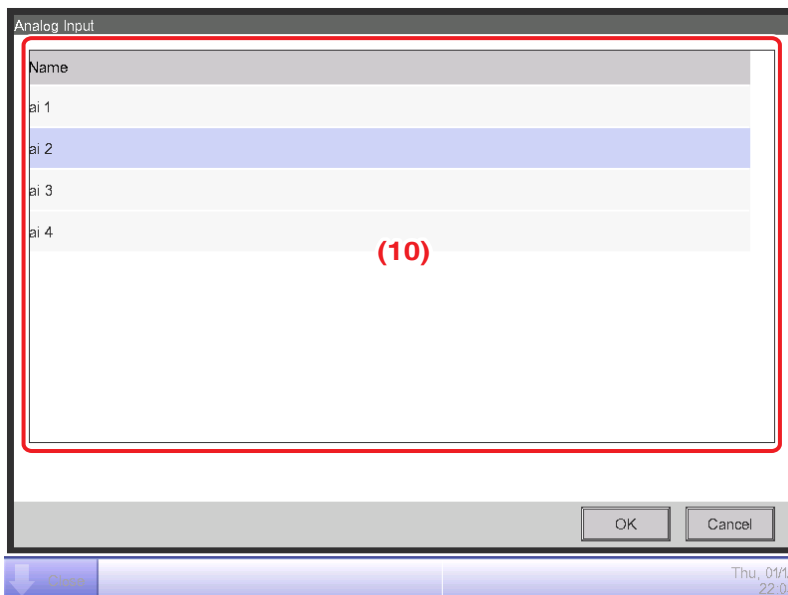

Select the Ai management point you want to register from the list (10). You can register the same Ai management point in multiple groups.

Touch the OK button to save and return to the Attribute screen.

Using the Numerical Input dialog, enter the upper and lower limit outdoor temperatures in (11).

Using the Numerical Input dialog, enter the upper and lower limit setpoints in (12).

For upper limit outdoor temperature, you can set a temperature in the 64°F to 93°F range, in increments of 1°F, while for lower limit outdoor temperature, you can set a temperature in the 60°F to 90°F range, in increments of 1°F.

When finished, touch the OK button to save and return to the Sliding Temperature Settings screen.

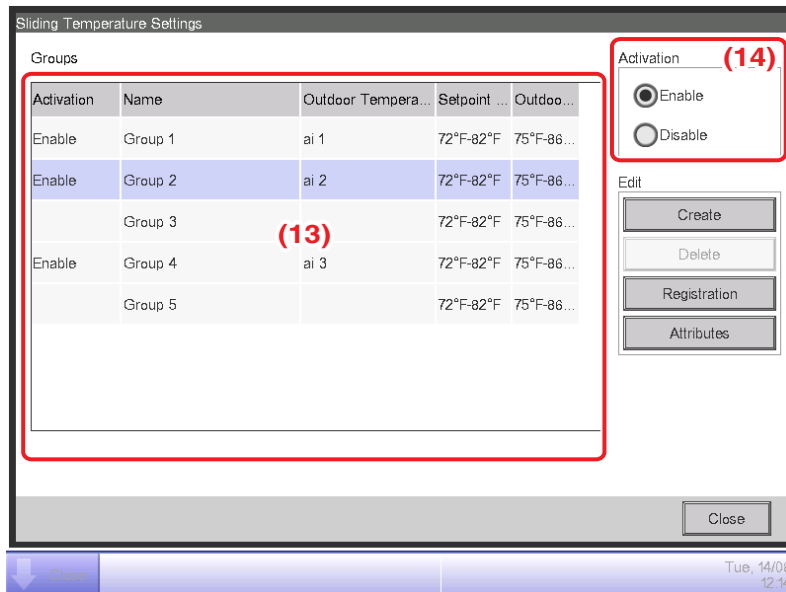

5. To enable the Sliding Temperature function for the group selected in (13), select the Enable button in the Activation radio button area (14). To disable, select the Disable button.

When finished, touch the Close button and close the screen.

Cautions when Using Simultaneously with Other Control Functions

1. If a setpoint is changed from another function while this function is in control, the setpoint is once changed by the other function but changed again by this function.
2. When used together with the Auto Changeover function, if the cool setpoint is lowered by this function, the setpoint when the operation mode is changed to heating by the Auto Changeover function may be unexpectedly low.

Example: When the lower limit setpoint is 68°F for this function and the Differential for the Auto Changeover function is 7°F.

1. Heating is started with setpoint at 68°F.
 2. When the room temperature becomes 75°F, the Auto Changeover function changes the operation mode to Cool.
 3. When operation mode changes to Cool, this function changes the setpoint according to the outdoor temperature.
 4. If the outdoor temperature decreases, the setpoint is lowered up to 68°F by this function.
 5. When the room temperature further decreases and becomes 60°F, the Auto Changeover function changes the operation mode to Heat. The setpoint at that time becomes 60°F.
3. Pre-Cool and Pre-Heat cannot be used when this function is set up.
 4. When used together with the Temperature Limit function, the indoor unit may be repeatedly started and stopped every 5 minutes (hunting) depending on the setpoint.

Example: When the setpoint for this function calculated from the outdoor temperature is 90°F and the upper limit for the Temperature Limit function is 90°F.

1. When the room temperature exceeds 90°F, the Temperature Limit function orders cooling to start.
2. This function sets the cooling setpoint to 90°F.
3. When the room temperature drops below 90°F, since room temperature < cool setpoint, the Temperature Limit function orders cooling to stop.
4. The room temperature exceeds 90°F, and the Temperature Limit function orders cooling to start. (Back to 1.)

8-6 Setting up the Heating Mode Optimization Function

Heating Mode Optimization is a function that stops the indoor unit while its operating status indication is kept unchanged to prevent unnecessary temperature rise during heating and unpleasant drafts.

This function performs the following every 5 minutes for each indoor unit with this function enabled.

- When heating and suction temperature $>$ setpoint $+2^{\circ}\text{F}$, stops the indoor unit. However, the iTM display will continue to indicate On. (Display of the remote controller will indicate Off.)
- While stopped by this function, if suction temperature $<$ setpoint -2°F , starts the indoor unit.
- While stopped by this function, if Heating Mode Optimization is changed from “Enabled” to “Disabled” in the Heating Mode Optimization Settings screen, starts the indoor unit.
- While stopped by this function, if the operation mode is changed to other than heating, starts the indoor unit.

If suction temperature could not be acquired from an indoor unit controlled by this function, the above described assessment is not performed. The operational status at that point is kept and the attempt to acquire the suction temperature continues every 5 minutes until it succeeds.

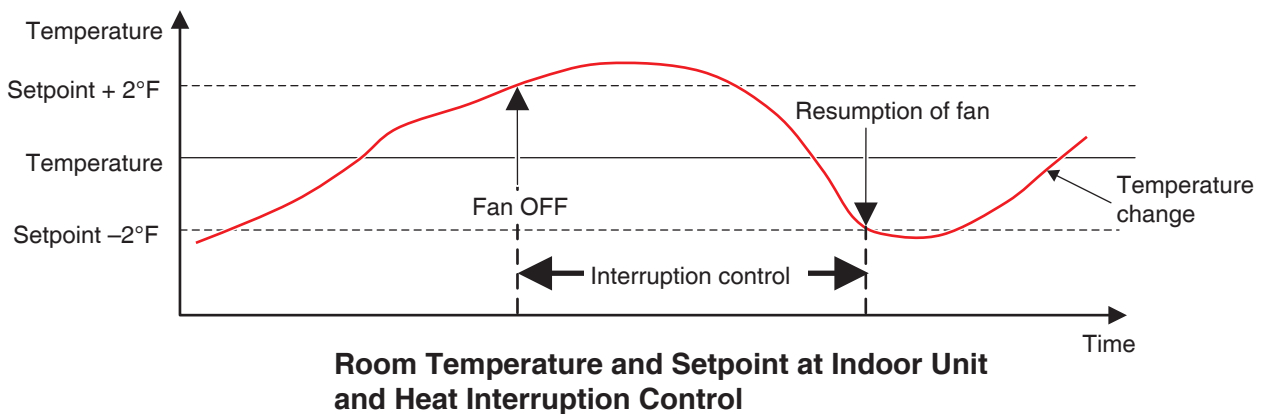

The following describes how to set this up.

1. Touch the HMO button on the Automatic Ctrl. tab of the Menu List screen and display the Heating Mode Optimization Settings screen (see page 52).

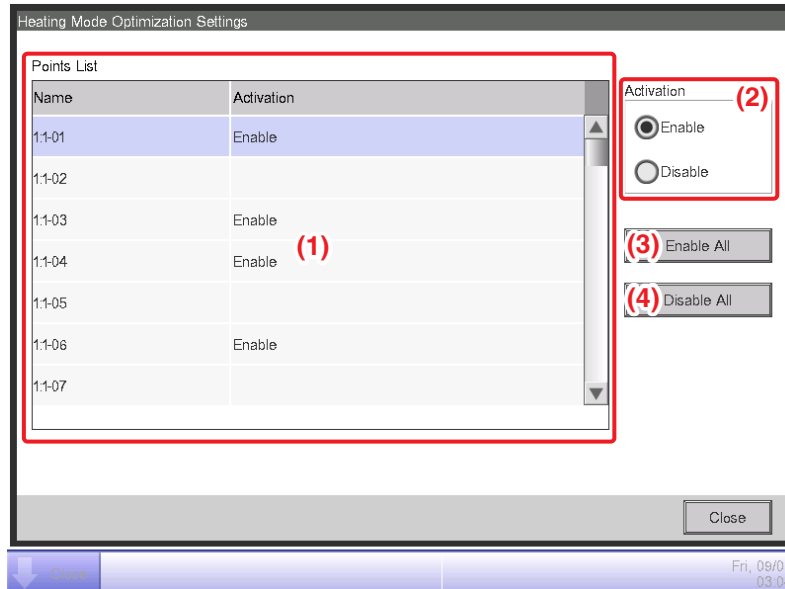

2. Select an indoor unit from list (1) displaying the names of indoor units and whether this function is enabled or disabled, and then select Enable or Disable in (2).
Touching the **Enable All** button (3) enables all listed indoor units.
Touching the **Disable All** button (4) disables all listed indoor units.

When finished, touch the Close button and close the screen.

Cautions when Using Simultaneously with Other Control Functions

1. Start/stop of indoor units by this function becomes the input condition for the Interlocking Control function.
2. Since indoor units stopped by this function are recognized as operating by the iTM, they are also not recognized as “stopped” by other functions such as Central Monitoring, Timer Extension, History, etc.
3. When an indoor unit stopped by this function is started by remote controller, it is stop at the next room temperature assessment if the room temperature exceeds the setpoint in 2°F or more.
4. Indoor units stopped by this function are treated as Stopped for Power Proportional Distribution and the current consumed while stopped, calculated as Idle Power.
5. This function cannot stop indoor units in operation by the Temperature Limit function.

9. System Settings

9-1 Network Settings

With iTM, you can operate it remotely via the Internet, or receive notification via E-mail in the case of an error. To use these functions, you must set up the network on the iTM unit.

The following describes how to set this up.

1. Touch the Network button on the System Settings tab of the Menu List screen and display the Network screen (see page 54).

Network

(1) Controller Name: intelligent Touch Manager [Modify]

(2) Host Name: localhost [Modify]

(3) IP Address: 192.168.0.1 [Modify]

(4) Subnet Mask: 255.255.255.0 [Modify]

(5) Default Gateway: 0.0.0.0 [Modify]

(6) Preferred DNS: 0.0.0.0 [Modify]

(7) Alternate DNS: 0.0.0.0 [Modify]

Web Server

OK Cancel

Sat, 20/08 00:49

Controller Name

intelligent Touch Manager Remaining 3s

OK Cancel

<Text Input dialog>

IP Address

192 168 0 .

OK Cancel

<IP Address Input dialog>

2. The current settings are displayed. Touch the Modify button and change the settings in the Input dialog that appears. For information necessary for the settings, consult your network administrator.

- (1) Controller name
- (2) Host name
- (3) IP address
- (4) Subnet mask
- (5) Default gateway address
- (6) Preferred DNS address
- (7) Alternate DNS address

3. Set the Web server port number.

Network

Controller Name	intelligent Touch Manager	Modify
Host Name	localhost	Modify
IP Address	192.168.0.1	Modify
Subnet Mask	255.255.255.0	Modify
Default Gateway	0.0.0.0	Modify
Preferred DNS	0.0.0.0	Modify
Alternate DNS	0.0.0.0	Modify

(8)

Web Server

OK Cancel

Clear Sat, 20/08 00:49

Touch the **Web Server** button (8) and display the Web Server screen to set the port number.

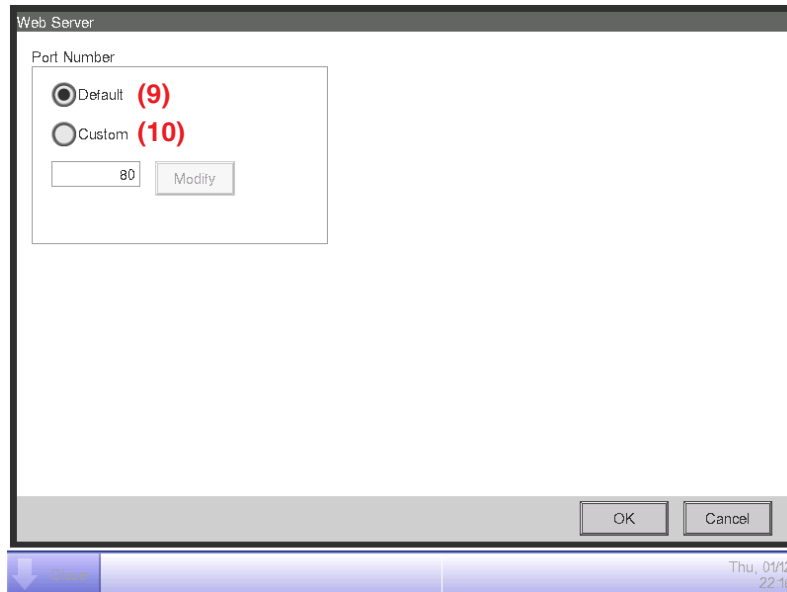

Select **(9)** to use the default port 80.

Selecting **(10)** displays the port number 8080. Touching the Modify button allows you change the settings in the Numerical Input dialog that appears.

Touch the OK button to save and close the screen.

4. When finished, touch the OK button. A confirmation dialog appears.

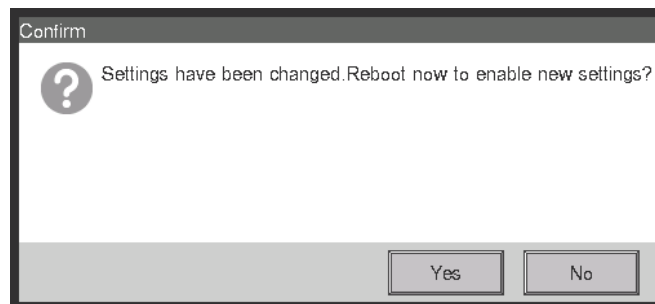

5. A restart confirmation message will be displayed. Touch the Yes button to reflect the setting and restart the iTM.

NOTE

The following numbers are not available as a port number.
8082, 17821, 20000-20010

9-2 Web Access Settings and Remote Management

An iTM with network setting can be accessed via the Internet for remote operation from a PC. You can register multiple Web users with different ranges of operations permitted in accordance with their privileges.

The PC requirements for using this function are as indicated in the table below.

Function	Requirement
PC for Web Remote Management	OS: Windows XP Professional SP3 (32 bit) Windows VISTA Business SP2 (32 bit) Windows 7 Professional SP1 (32 bit, 64 bit) CPU: Equivalent to Intel Core 2 Duo 1.2GHz or higher Memory: 2 GB or more Free HDD space: 10 GB or more Network: 100Base-TX or higher Display resolution: 1024 x 768 or higher
Network	100Base-TX Real transfer rate: 115 kbps or higher
Supported security software	McAfee 2011 Norton 2011 Virus Buster 2011
Flash Player *1	Version 11.1
Web browser *1	Internet Explorer 8, 9 Firefox 10.0

*1 For Flash Player and Web browser, operation is guaranteed only for the specified versions.

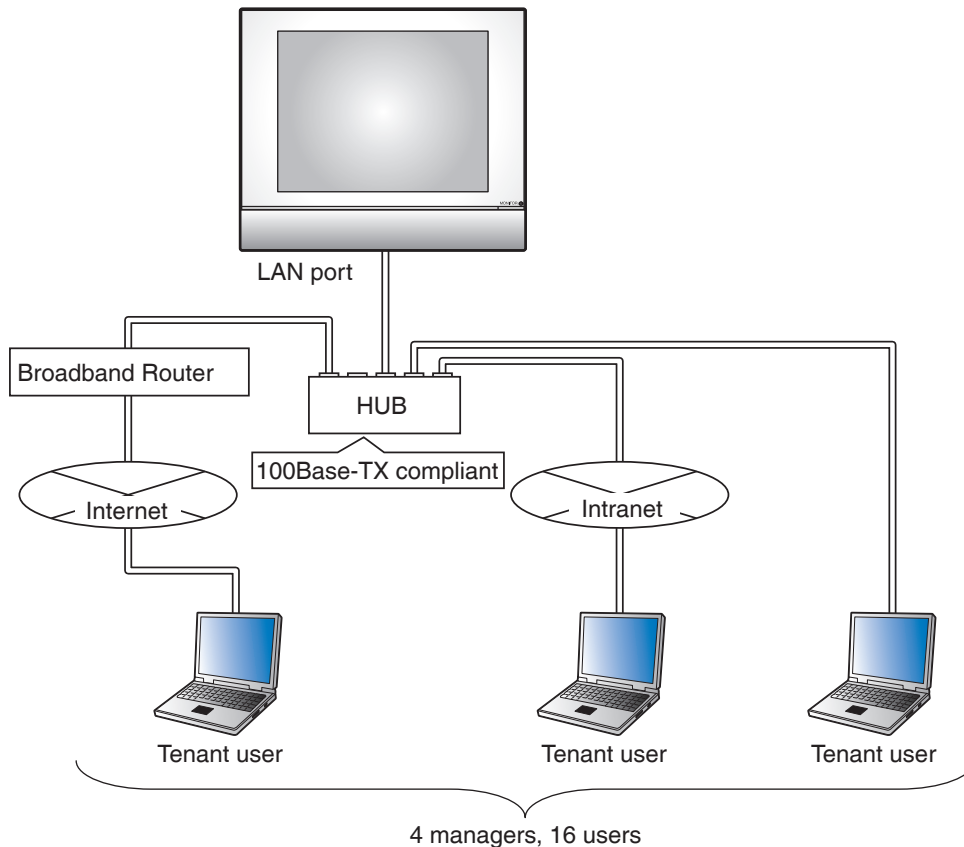

The following describes how to create users and operate.

Registering Web users

Register Web users that can access the Web. There are two types of Web users: managers and users, and the operations permitted to users can be limited by settings. The maximum number of managers you can register is 4 while that for users is 60. Simultaneous access is allowed to a maximum of 4 managers and 16 users.

1. Touch the Web Access Users button on the System Settings tab of the Menu List screen and display the Web Access Users Settings screen (see page 54).

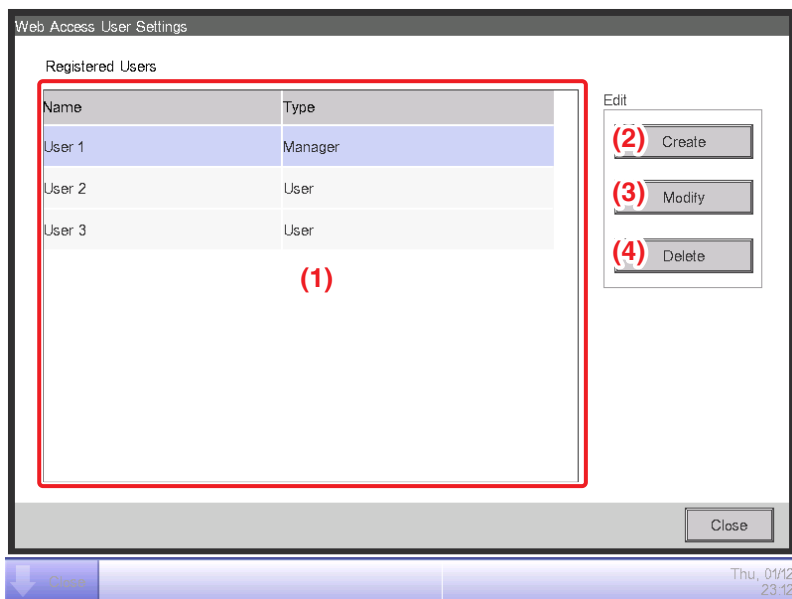

(1) is the list of registered Web users.

The **Create** button (2) allows you to create new users.

The **Modify** button (3) allows you to edit the settings of the selected user.

The **Delete** button (4) allows you to delete the selected user.

2. Touch the **Create** button (2) or **Modify** button (3) and display the User Setup screen.

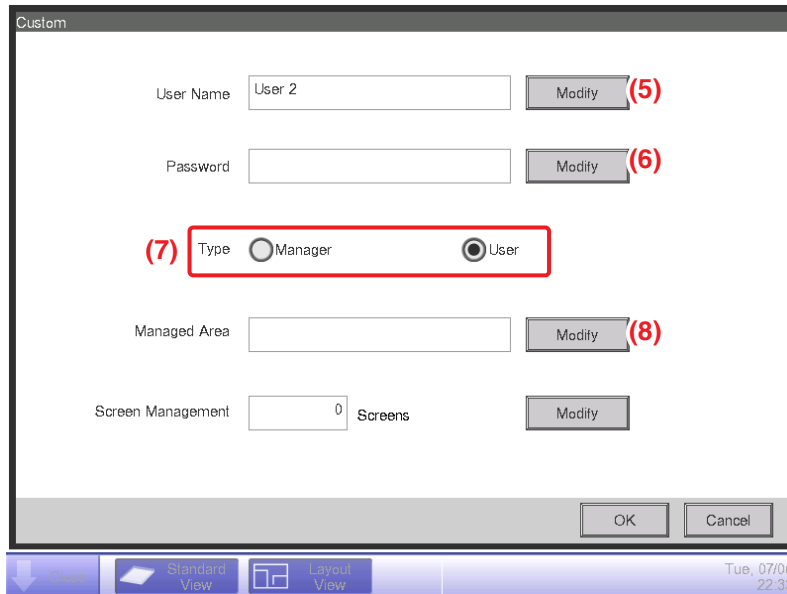

To enter the user name, touch the **Modify** button (5) and display the Text Input dialog. Specify a name using 1 to 15 characters, irrespective of single or double byte.

To set the login password, touch the **Modify** button (6) and display the Password Input dialog. Enter the same password twice for confirmation. Set a password using 0 to 15 alphanumeric characters.

Select the type of user in (7).

In the case of a user, set up the Managed Area and Managed Screen for the purpose of registering the target the user can manage.

3. Touch the **Modify** button (8) and display the Managed Area screen.

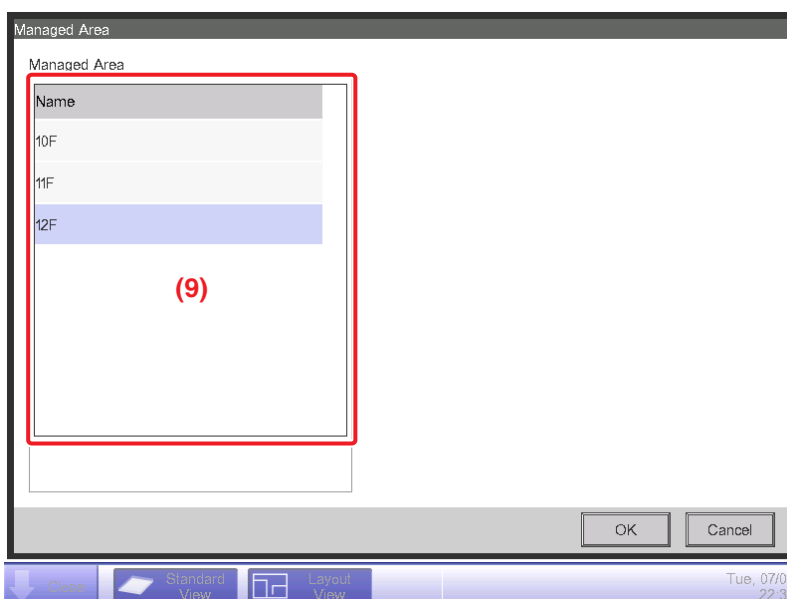

(9) is the list of areas that can be registered. Select one area and touch the OK button to save the settings and return to the User Setup screen.

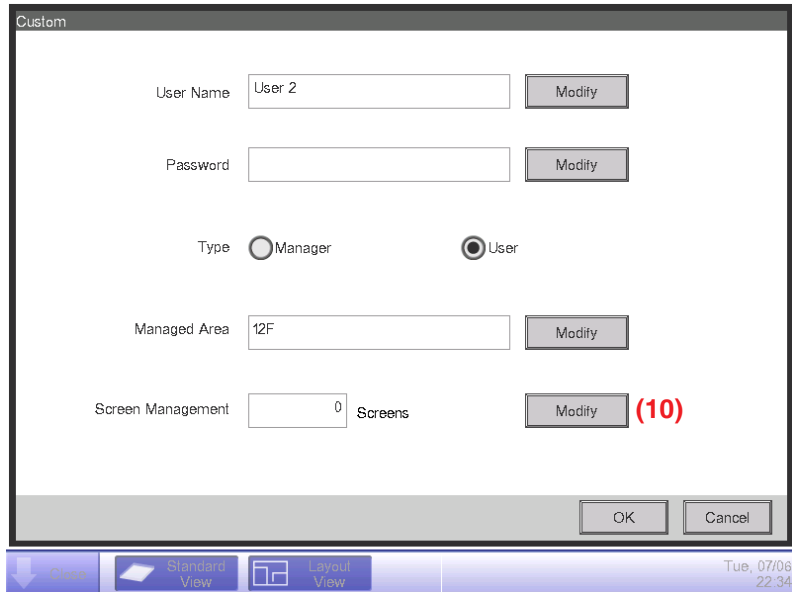

4. Touch the **Modify** button (10) and display the Screen Management screen.

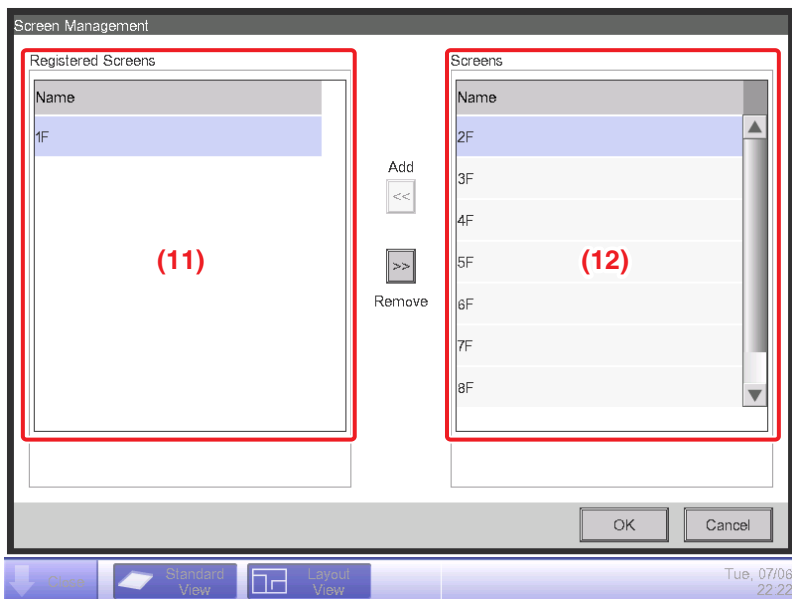

(11) is the list of Registered Screens while (12) is the list of Screens that can be registered.

Selecting a screen from (12) and touching the Add button registers the screen. You can only register one Layout View.

Selecting a registered screen from (11) and touching the Remove button cancels its registration.

When finished, touch the OK button to save the settings and return to the User Setup screen.

Touching the OK button on the User Setup screen saves the settings and registers the Web user.

NOTE

- Setting up Managed Area and Screen Management is unnecessary for Managers.
- The user name and the password cannot contain special characters.

Logging in/out to/from a PC

1. The Login screen appears when you access the iTM by launching the Web browser on a PC and entering the IP address of an iTM unit with network settings ([http:// iTM IP address](http://iTM IP address)).

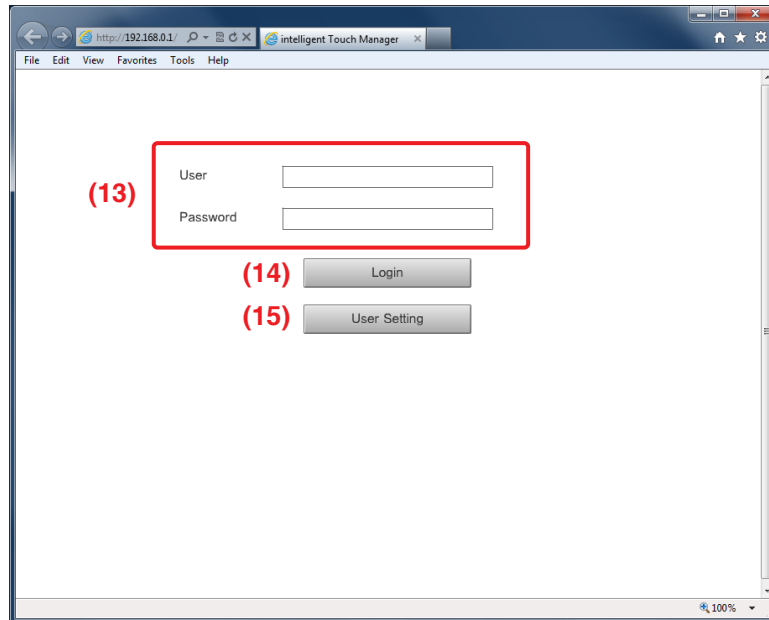

The display language of the Login screen follows the iTM unit locale setting.

Enter the user name and password in (13) and click the **Login** button (14). The Web Remote Management screen (Icon view) appears if authentication is successful.

2. Entering the user name and password, and clicking the **User Setting** button (15) displays the User Setup screen where you can change the login password and set the locale.

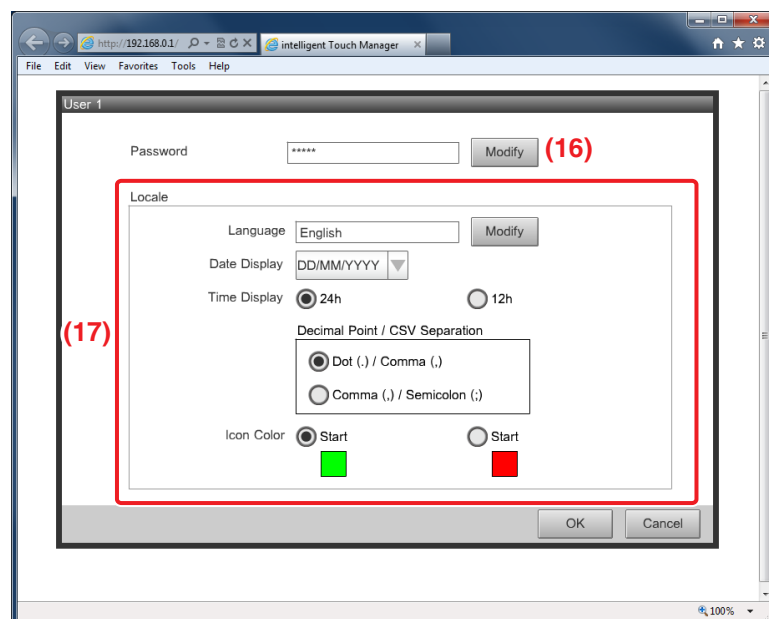

The **Modify** button (16) allows you to change the login password.

(17) is for setting the locale to be used by the PC. The information you can set is the same as that of the iTM unit locale setting. Set by seeing page 126.

3. To log off, click the Logoff button on the Web Remote Management screen. Click the Yes button on the confirmation screen that appears and log off.

Web Remote Management Screen

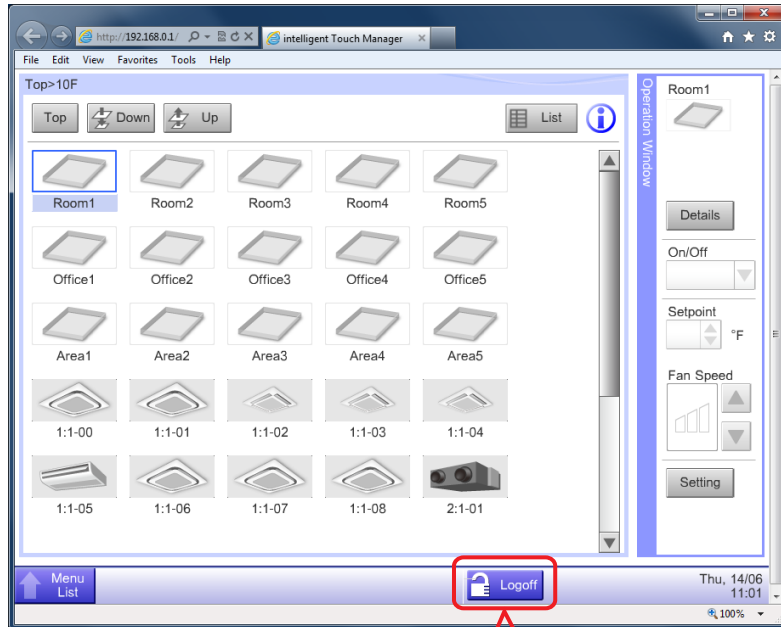

Logoff button

The operation after login is basically the same as from the iTM unit. For the operating procedure, see the relevant page.

Users can only use functions he/she is permitted in the User Setup. Furthermore, even a manager cannot open the same function setup screen as that being used by another manager.

Web user A has the Interlocking Control screen open

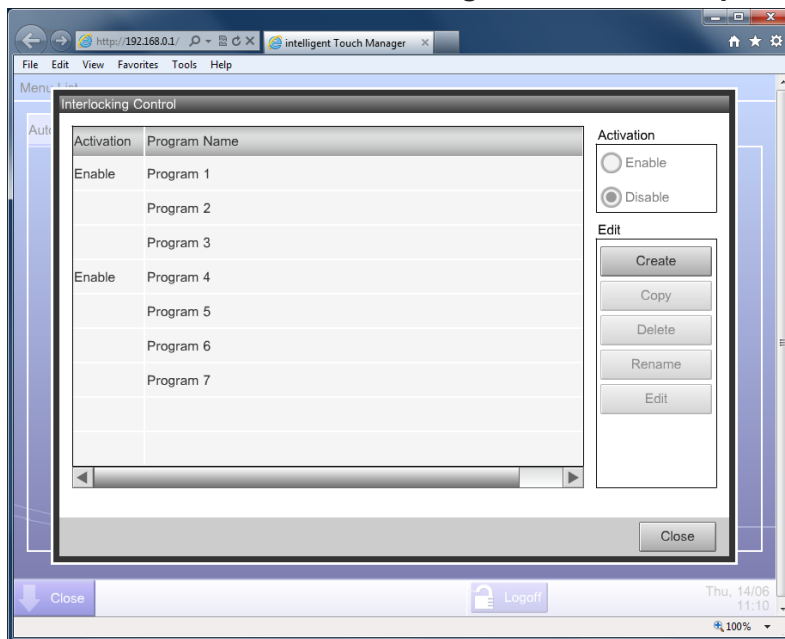

Information dialog is displayed when the Web user B presses the Interlock button.

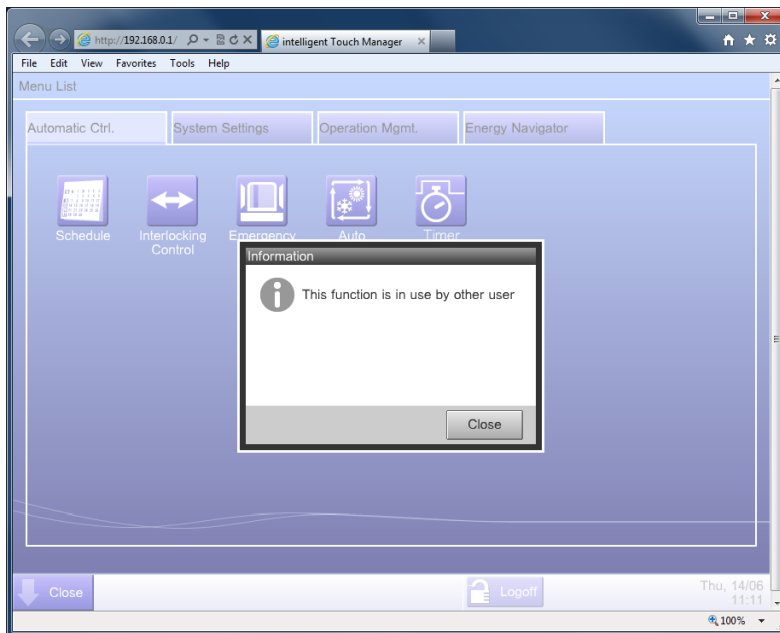

NOTE

- Operations that use USB memory in the iTM unit (output of settings and data) use the hard disk drive of the PC.
- This function cannot be used to input data from a file. It can be used only for outputting the following function data:
 - PPD · Energy Navigator · History · Setup Export
- Batch output settings file output with this function is output as a zip compressed files. (Default file name: SetupExport.zip)
- This function does not support the screen lock function.
- Functions specific to the iTM unit (for example, screensaver) are not available through this function.
- This function allows for opening and closing the Operation Window displayed on the Standard View (List) screen.
- If network is disconnected during logging in, it will take maximum 4 minutes until you can log in next time.

9-3 Setting up the E-Mail Error Report

An iTM with network setting can send E-mails with date of occurrence, error code, and other information to E-mail addresses set in advance when an error such as equipment error or analog upper/lower limit error occurs in a management point.

NOTE

An SMTP server and a terminal for receiving E-mails are necessary in addition to the iTM unit.

The following describes how to set this up.

Setting up the Mail Server

Touch the E-mail button on the System Settings tab of the Menu List screen and display the E-mail Settings screen (see page 54).

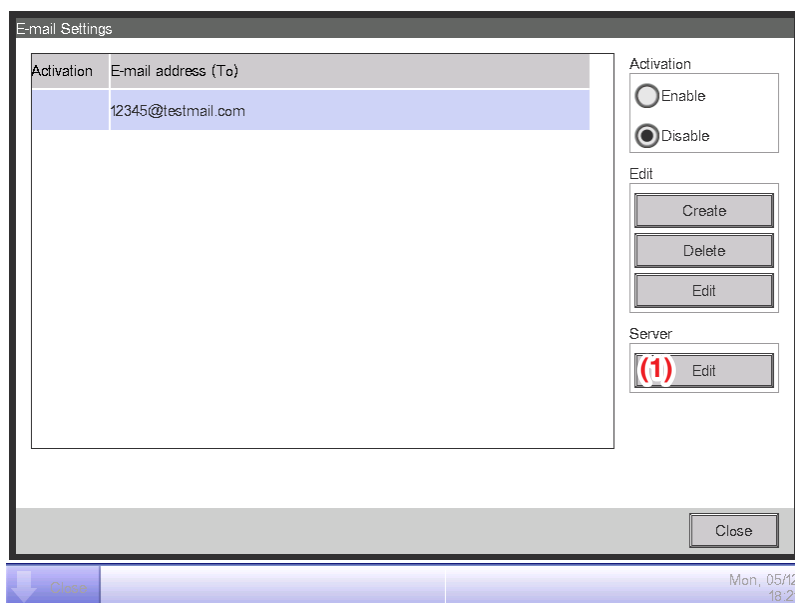

Touch the **Edit** button **(1)** and display the Server dialog. The dialog consists of two tabs: Transmission and E-mail Server. Switch and set up each of the tabs. When finished, touch the OK button to save and return to the E-mail Settings screen.

• **Transmission Tab**

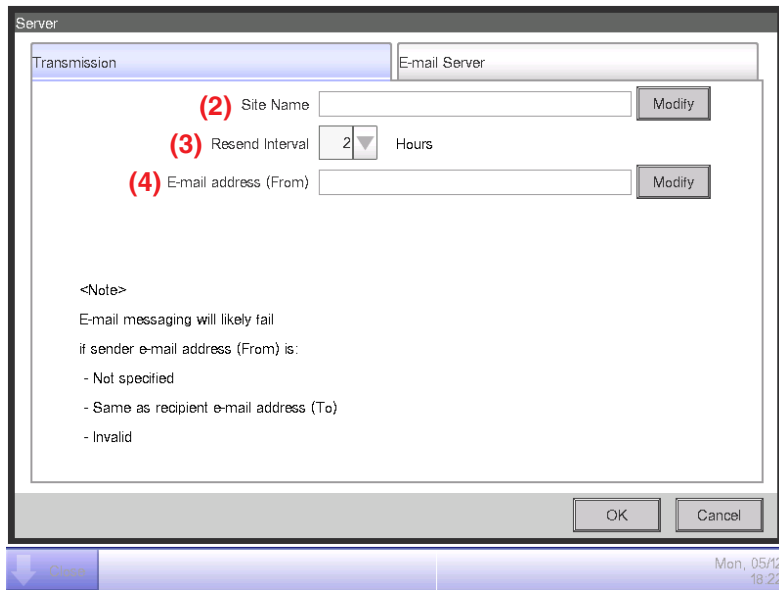

Set the site name in (2). Touch the Modify button and enter a name of up to 20 characters in the Site Name Setup dialog that appears. The site name will be used as subject of the E-mails.

Select the E-mail resending interval in the combo box (3). You may select an interval of 1 to 72 hours, in increments of 1 hour. If after sending the E-mail once, the error remains even after the time set here elapses, the E-mail is resent.

Set the sender address in (4). Touch the Modify button and enter an address of up to 128 characters in the From Address Setup dialog that appears.

- **E-mail Server Tab**

The screenshot shows a configuration window titled "Server" with a sub-tab "E-mail Server". The window is divided into several sections:

- SMTP Server:** Contains two input fields: "Address" (containing "SMTP Server Address") and "Port" (containing "25"). Each field has a "Modify" button to its right.
- Authentication:** Contains a "Method" dropdown menu currently set to "POP Before SMTP".
- POP Server:** Contains four input fields: "Address" (containing "POP Server Address"), "Port" (containing "110"), "User ID" (containing "User ID"), and "Password" (containing "*****"). Each field has a "Modify" button to its right.

At the bottom of the window, there are "OK" and "Cancel" buttons. Below the window, a status bar shows a "Close" button and the date/time "Mon, 05/12 18:26".

Displays information of the server that will send the E-mails. Set each item using the Modify button or combo box. For information necessary for the settings, consult your network administrator.

- (5) URL or IP address of the SMTP Server
- (6) Port number of the SMTP Server
- (7) Authentication method for outgoing E-mails: Select one from No Authentication, POP Before SMTP, and SMTP-AUTH
- (8) URL or IP address of the POP Server to be used in the POP Before SMTP authentication
- (9) Port number of the POP Server to be used in the POP Before SMTP authentication
- (10) User ID for the POP Server or SMTP authentication
- (11) Password for the POP Server or SMTP authentication

Setting up the recipient E-mail address and sending an E-mail

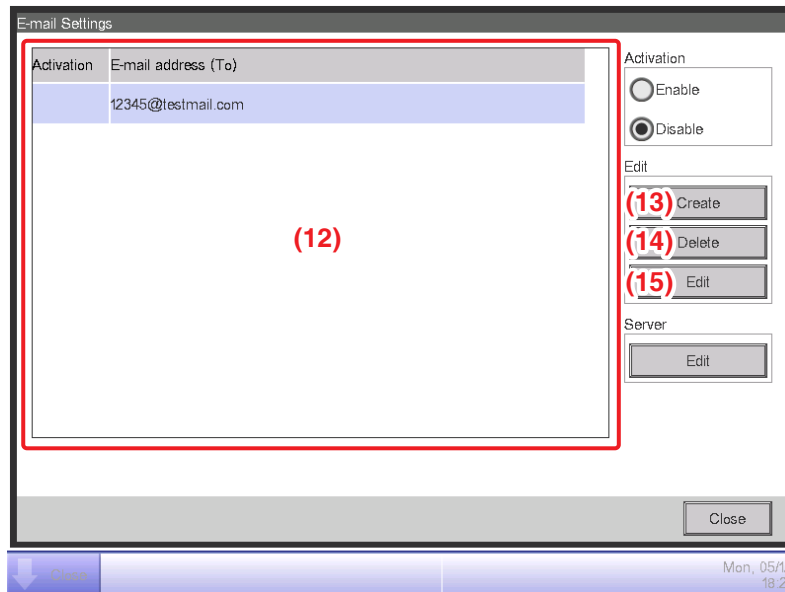

(12) is the list of registered recipient E-mail addresses. Perform the intended operation by touching the relevant button on the right.

(13) Create button

Creates a new E-mail address. Touch the button and enter an address of up to 128 characters in the E-mail Address Setup dialog that appears.

(14) Delete button

Deletes the selected E-mail address.

(15) Edit button

Edits the selected E-mail address. Touch the button and display the Edit dialog. The dialog consists of two tabs: Mgmt. Points Selection and E-mail Address. Set both up as necessary.

• **Mgmt. Points Selection Tab**

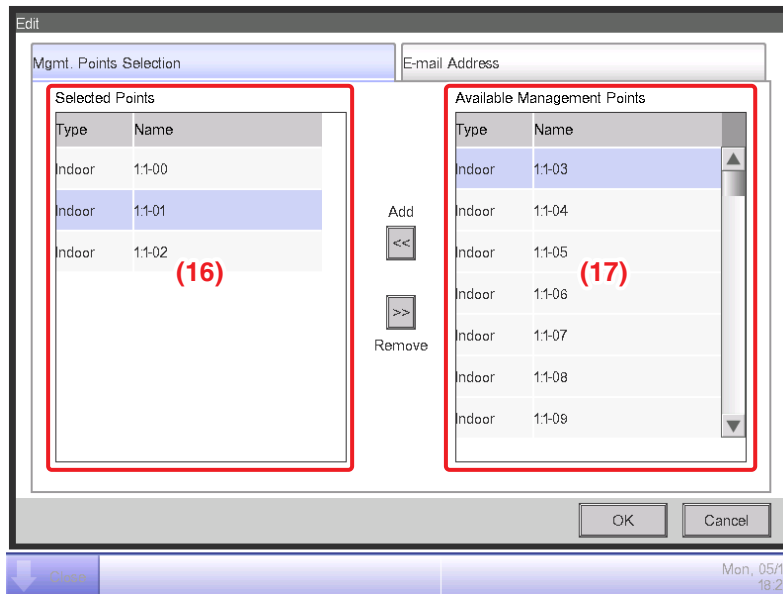

(16) is the list of management points registered as target of error monitoring while (17) is the list of management points that can be registered. To register, select a management point that will be target of monitoring from (17) and touch the Add button. You can register up to 512 management points. Selecting a management point from (16) and touching the Remove button cancels its registration.

• **E-mail Address Tab**

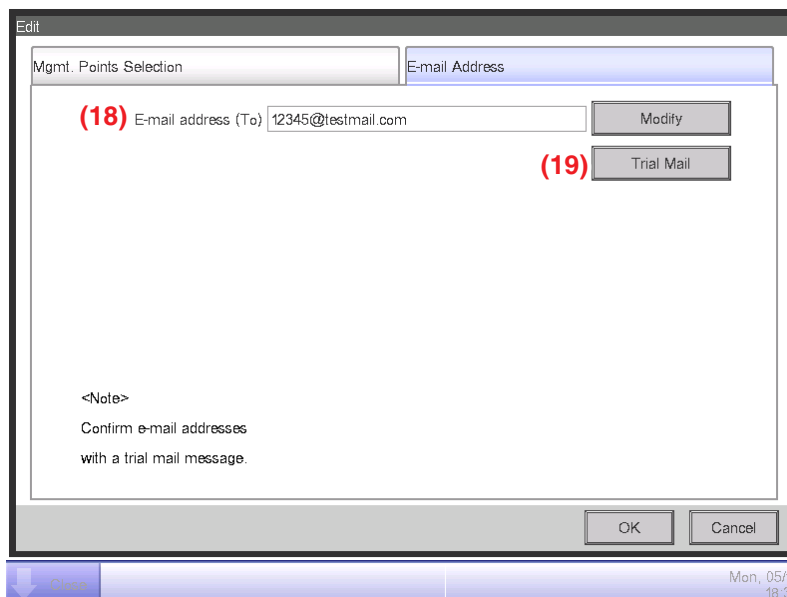

(18) is the current E-mail address. To change, touch the Modify button and enter the E-mail address in the E-mail Address Setup dialog that appears. Touching the **Trial Mail** button (19) displays the Trial Mail dialog.

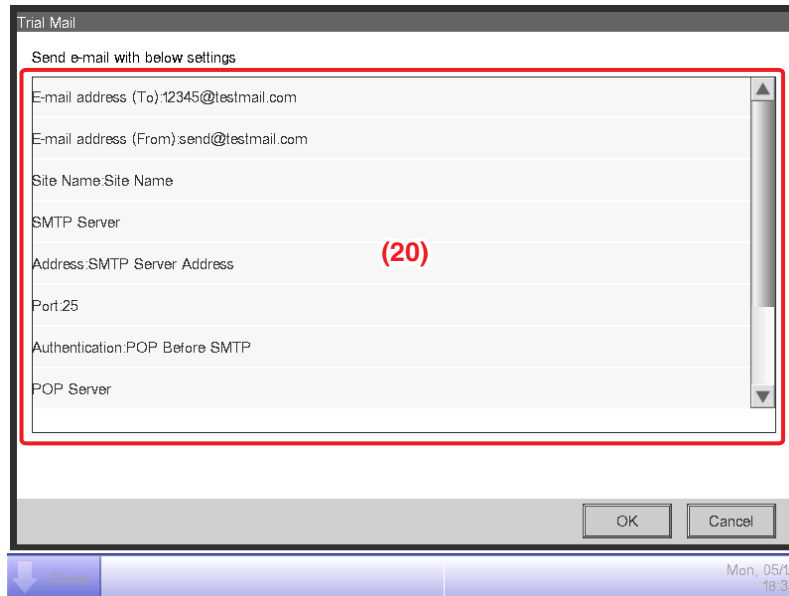

(20) displays the current settings whose details are as indicated in Table 1 below.

Item	Displayed information	Remarks	
To E-mail address	E-mail Address (To):[address]		
From E-mail address	E-mail Address (From):[address]		
Site Name	Site Name:[name]		
SMTP Server	Title	SMTP Server	
	Address	Address:[address]	
	Port number	Port:[port]	
Authentication	Authentication method	Authentication:[method]	[method] is one among [No Authentication], [POP Before SMTP], and [SMTP-AUTH]
	Title	POP Server	Displayed when [method] is [POP Before SMTP].
	POP Server Address	Address:[address]	
	POP Server Port No.	Port:[port]	
	User ID	User ID:[ID]	Displayed when [method] is other than [No Authentication].

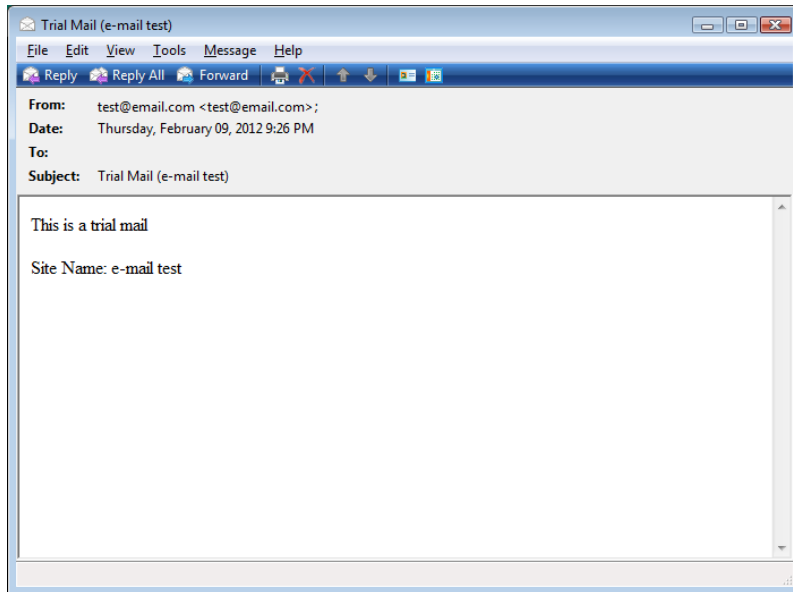

Touching the OK button sends the trial e-mail and returns the screen to the Edit tab.
When finished, touch the OK button to save and close the screen.

Operating Optional Maker Functions

10. Power Proportional Distribution

10-1 Power Proportional Distribution Function

Power Proportional Distribution is a function that proportionally distributes the total power used by the air conditioners in a rental building and the like, measured using an electricity meter among the tenants. The proportional distribution calculation can also be exported to a CSV file.

To use this function, you must set up groups for proportional distribution, input devices, etc. as well as run a trial on a PC in advance. Consult your service person.

Proportional distribution cannot be calculated if the controller is turned off. Do not turn off the controller if calculating proportional distribution.

This chapter describes operations to be performed on the iTM unit.

Setting up the data collection period

Touch the PPD button on the Operation Mgmt. tab of the Menu List screen and display the Power Proportional Distribution screen (see page 56).

Name	Used Powe...	Idle Power (kWh)
1.1-00	0.000	0.000
1.1-01	0.000	0.000
1.1-02	0.000	0.000
1.1-03	0.000	0.000
1.1-04	0.000	0.000
1.1-05	0.000	0.000

Set the data collection period in (1).

Select the **Period** radio button (a) to set the collection start and end dates.

Touch the Modify button for Start date and End date, and enter the dates in the respective Date Input dialog that appears.

The range of dates you can enter is between the 1st of the same month of the previous year and the previous day of the day you opened the dialog. The order of the start date and end date must not be inverted.

Select the **Month** radio button **(b)** to set the Account Date. The data collection period is determined as the month from the Account Date of the previous month.

For example, if the date on the iTM unit is October 20th, and Account Date is set to the 20th, then proportional distribution is calculated for the period from September 20th to October 19th.

Touch the Modify button and enter the Account Date. You can enter a value in the 1 to 31 range. However, if the specified counting date does not exist in the month, the counting period will be automatically adjusted to match the calendar dates.

(2) is the button for making advanced settings that are normally unused.

Collecting data and outputting the Power Proportional Distribution results

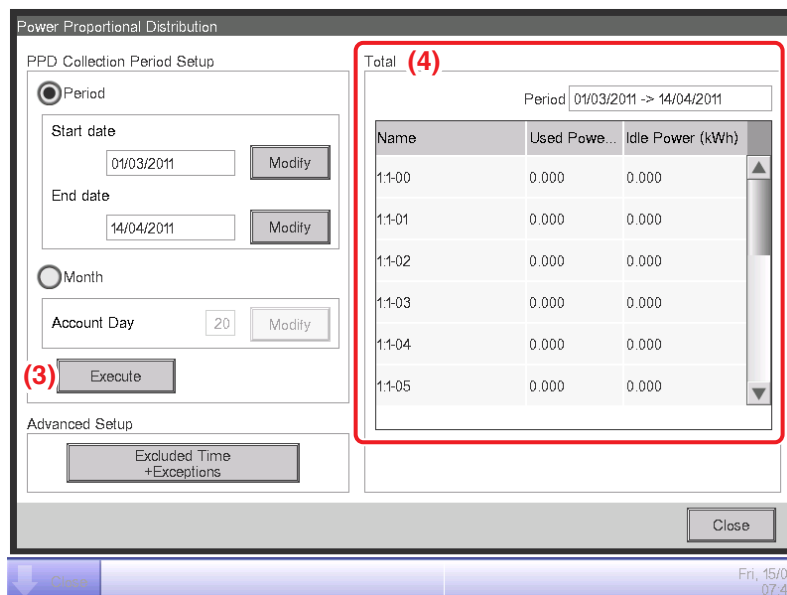

Touching the **Execute** button **(3)** displays a confirmation dialog. Connect the USB memory to the iTM unit and touch the Yes button to start data collection and CSV file output.

Data collection may take up to 30 minutes. When data collection finishes, a list of the periods and results of the data collection appears in **(4)**.

If the USB memory is not connected, data is collected and the collection results displayed but no file is output.

11. Energy Navigator

11-1 Energy Navigator Function

Recently, the laws and regulations related to energy reduction and CO₂ reduction of many countries are being strengthened. For that reason, for properties, it is necessary to know how much energy they consume, or their progress with regard to an energy consumption plan to comply with the laws, and make improvements to reduce the energy consumption if necessary.

Equipment administrators and energy administrators are required to systematically manage equipment by analyzing the operational status of the equipment and devising energy reduction plans, defining equipment operation guidelines to save energy, etc.

Energy Navigator Overview

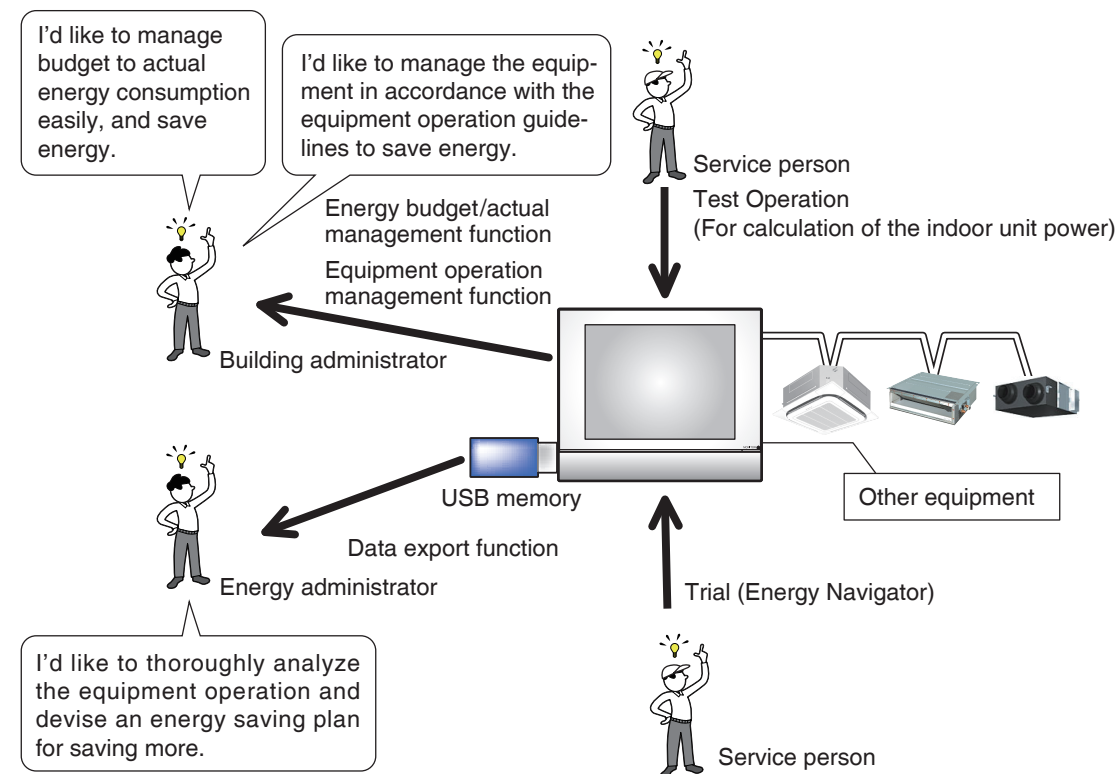

The Energy Navigator is a function for supporting the management of budget and actual energy consumption and/or equipment management. It includes the following three functions.

- **Energy budget/actual management function**
- **Equipment operation management (deviation from the operation plan)**
- **Data output function**

By using these functions together with power meters and the trial power proportional distribution, you can support various needs and use scenarios. For details, consult a service person.

Start position for a user who wants to check the actual energy consumption and operational status of the equipment in the iTM implementation year, and start managing the equipment operation the next year.

Start position for a user who wants to manage the equipment operation immediately after iTM implementation.

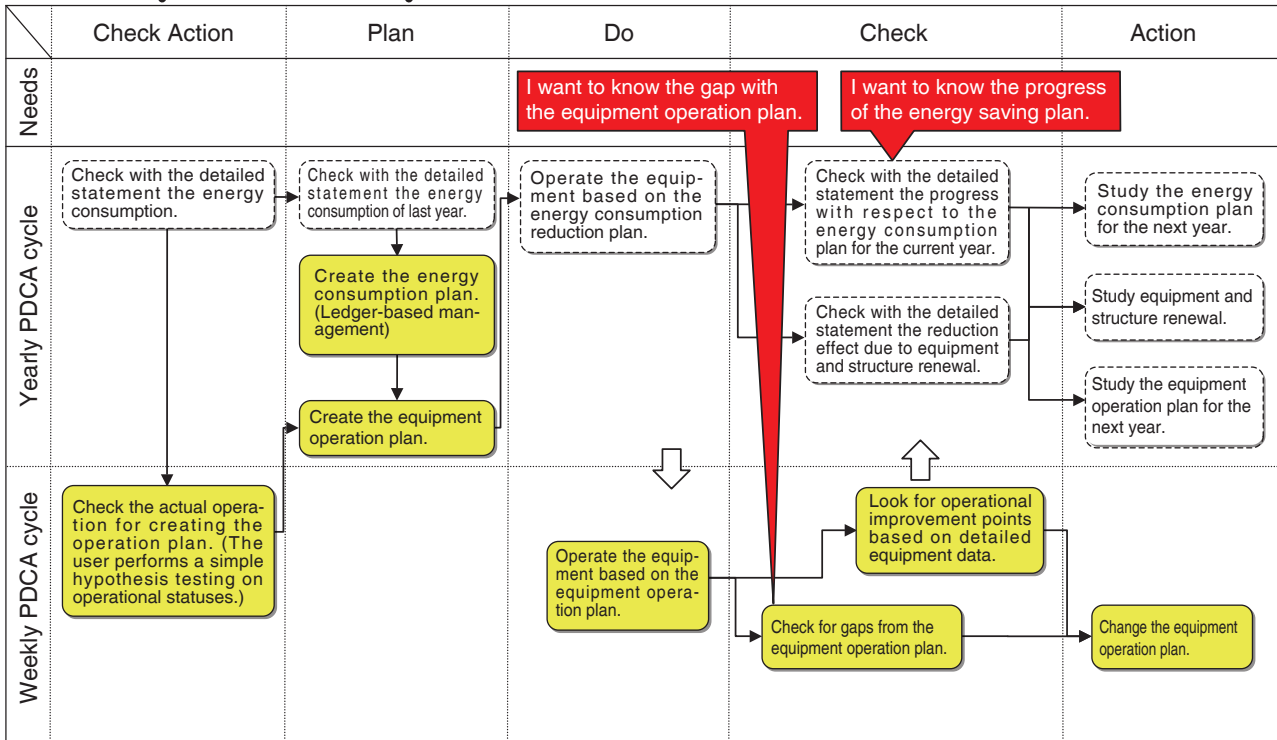

Start position for a user who wants to check the actual energy consumption and operational status of the equipment in the iTM implementation year, and start managing the energy consumption the next year.

Start position for a user who wants to manage the energy consumption immediately after iTM implementation.

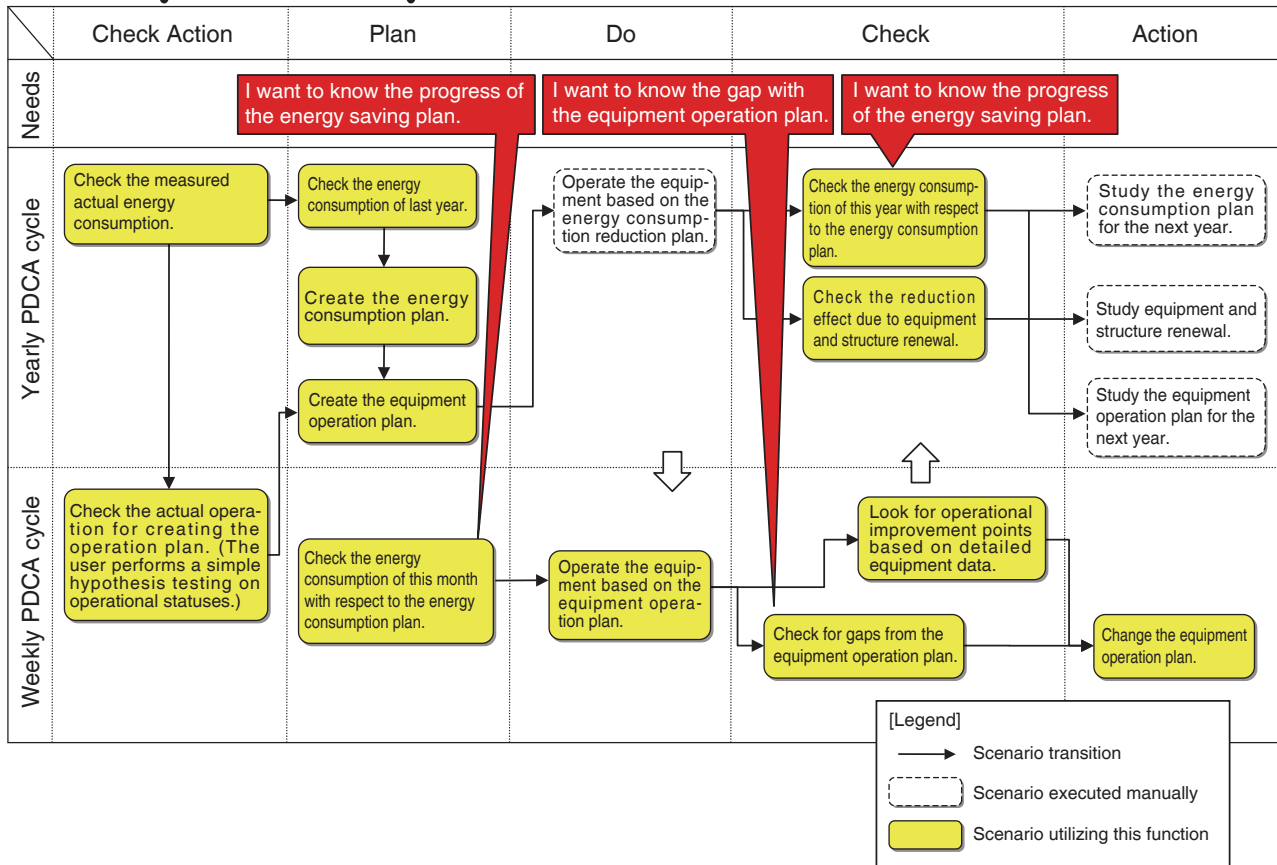

This chapter describes the functions, their settings, and how to use them.

NOTE

Prior trial is necessary for using this function. Consult a service person before use.

Energy Budget/Actual Management

This functions can calculate the level of achievement of the energy consumption plan from the actual energy consumption and the estimated consumption when the plan is fully achieved, as well as plot the budget and actual energy consumption in yearly/monthly graphs for easy management. Furthermore, it can compare last year's actual energy consumption with this year's actual energy consumption.

Functions you can use depend on the availability of power meters and availability of an energy consumption plan, as indicated in the tables below.

Engineering details		Energy budget/actual management function			
Availability of meters	Availability of energy consumption plan	(Monthly) Energy consumption estimation function	Energy budget/actual visualization function		
			Annual energy budget/actual visualization function	Monthly energy budget/actual visualization function	Year-to-year energy comparison function
Yes	Yes	○	○	○	○
Yes	No	×	△	△	○
No	Yes	×	○ (Budget/actual can be visualized by manually entering the actual energy consumption)	×	○ (Available by manually entering the actual energy consumption)
No	No	×	△	×	○ (Available by manually entering the actual energy consumption)

Engineering details		Energy budget/actual management function				
Availability of meters	Availability of energy consumption plan	Energy consumption plan registration function	Actual energy consumption registration function	Energy Group registration function	Energy type/Energy conversion factor registration function	
					Energy type registration function	Energy conversion factor registration function
Yes	Yes	○	○	○	○	○
Yes	No	○	○	○	○	○
No	Yes	○	○	○ (Creation of group to which to manually enter the actual energy consumption)	○	○
No	No	○	○	○ (Creation of group to which to manually enter the actual energy consumption)	○	○

○: Available
 △: Some functions available
 ×: Unavailable

The steps of energy budget/actual management are as follows:

Set up the energy type target of energy budget/actual management



Set up the management point group (energy group) target of energy budget/actual management



Set up an energy consumption plan



Register actual energy consumption



Check budget to actual energy consumption using graph

The following describes how to set this up and use.

- **Setting up the Energy Type and Energy Group**

Set up the energy type and energy group target of the energy budget/actual management.

Display the Energy Navigator tab of the Menu List screen (see page 57).

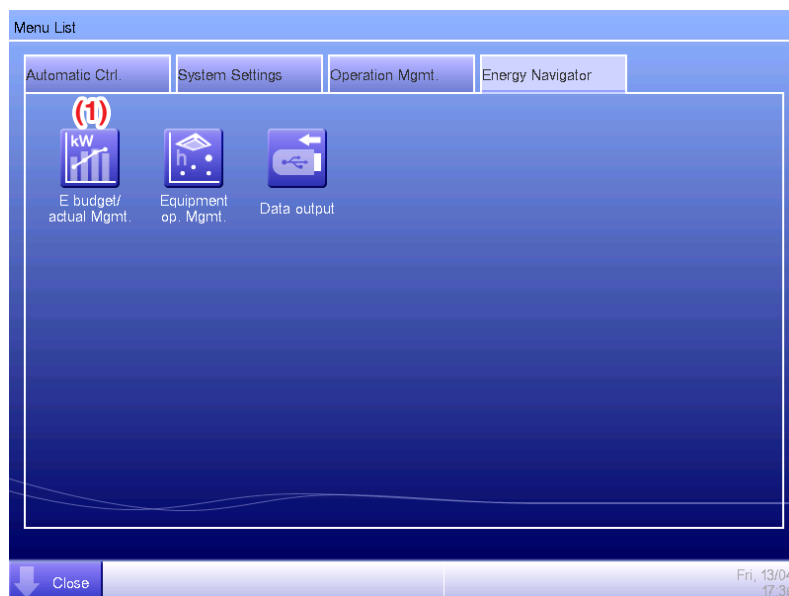

Touch the **E budget/actual Mgmt.** button **(1)** and display the Energy budget/actual management screen.

The Energy budget/actual management screen consists of three tabs: Yearly budget/actual mgmt., Month budget/actual mgmt., and Compared to previous (F)Year.

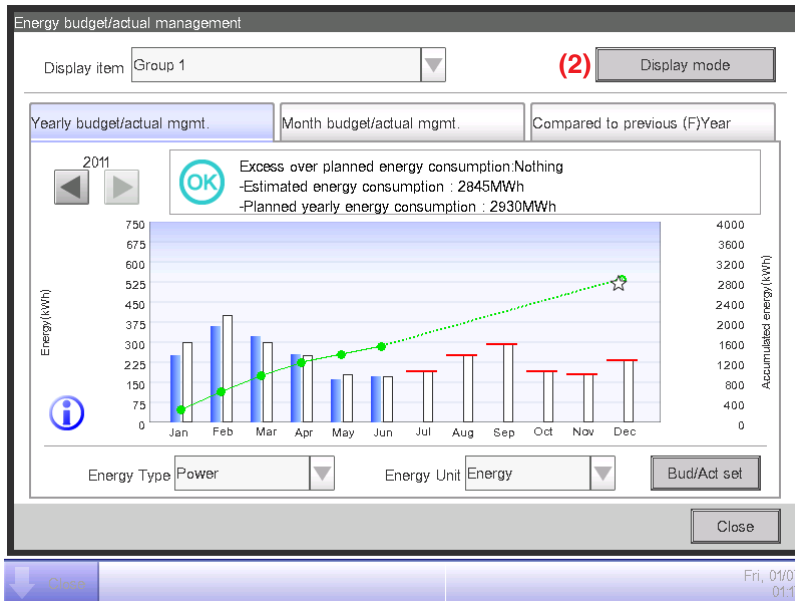

Touch the **Display mode** button (2) and display the Display mode screen. The Display mode button is available on all tabs.

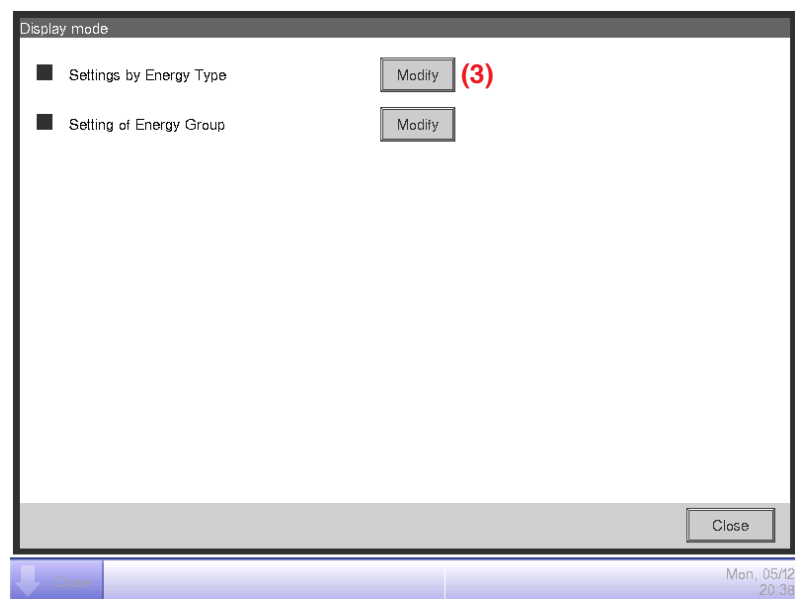

Touch the **Modify** button (3) and display the Energy Type screen.

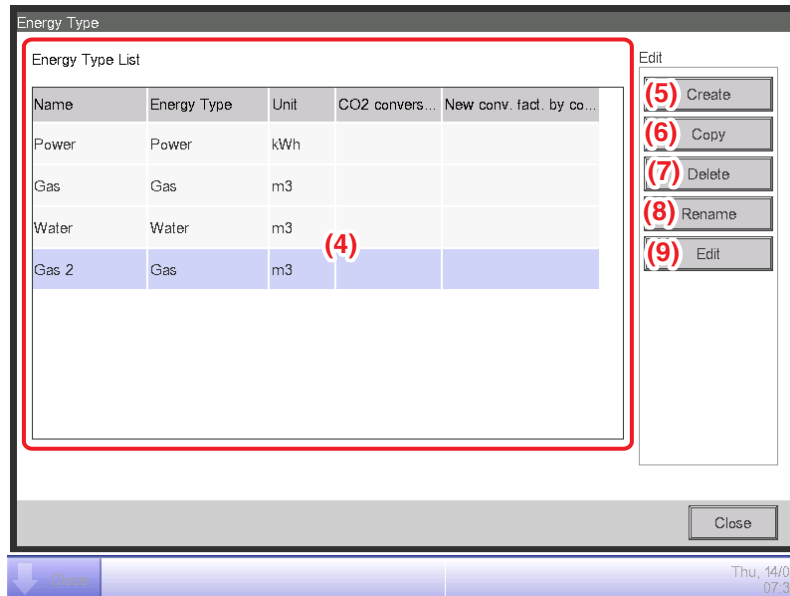

Set up the energy type for which to plot the energy budget/actual management graph.

(4) is the list of registered energy types.

Perform the intended operation by touching the relevant button on the right.

(5) Create button

Creates a new energy type. You can register up to 30 energy types including the power, gas and water registered by default.

Enter a name in the Name Input dialog that appears. Touch the OK button to register the name in **(4)** as a new energy type.

You can name the energy type using up to 16 characters.

(6) Copy button

Creates a new energy type by copying the selected energy type.

Enter a name in the Name Input dialog that appears. Touch the OK button to register the name in **(4)**.

You can name the energy type using up to 16 characters.

(7) Delete button

Deletes the selected energy type.

(8) Rename button

Renames the selected energy type.

Enter a name in the Name Input dialog that appears. Touch the OK button to change the name.

You can name the energy type using up to 16 characters.

You cannot change the name of energy types registered by default.

(9) Edit button

Displays the Energy Type/CO₂ Conversion Factor screen that allows you to edit the selected energy type.

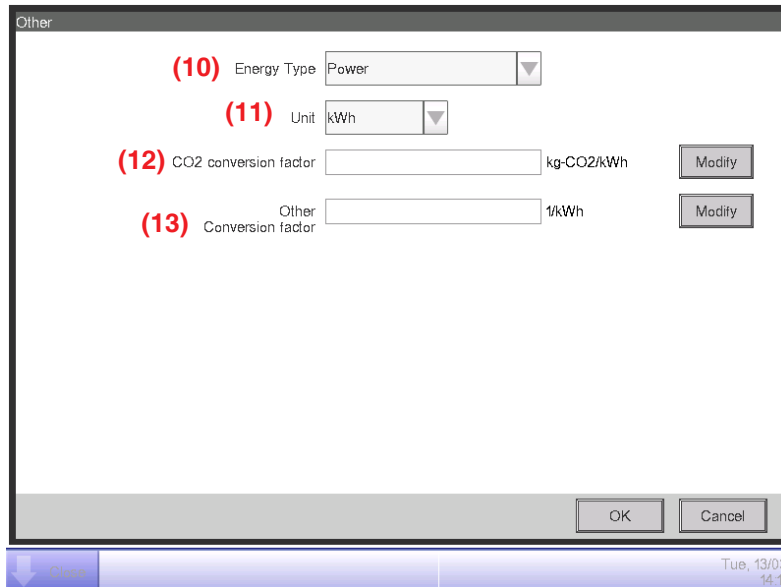

Sets up details for the selected energy type.

In the combo box **(10)**, select the energy type from Power, Gas and Water.

Select the unit **(11)** from the candidate corresponding to the selected Energy Type **(10)** in the combo box. The unit is fixed for each Energy Type: it is kWh for power, and m³ for gas and water.

Set the CO₂ Conversion factor in **(12)**.

Touch the Modify button and enter the conversion factor in the Numerical Input dialog that appears. You can enter a value in the 0 to 9999.999 range, in increments of 0.001. The unit is displayed in accordance with the unit selected in **(10)**.

If the new energy conversion type is registered in the Energy Conversion Type screen, enter the new conversion factor in **(13)**.

Touch the Modify button and enter the conversion factor in the Numerical Input dialog that appears. You can enter a value in the 0 to 9999.999 range, in increments of 0.001. The unit is displayed in accordance with the unit selected in **(10)**.

Touch the OK button to save the settings and return to the Energy Type screen.

When finished, touch the OK button to save the settings and return to the Display mode screen.

NOTE

For information on registration of new conversion types, consult a service person.

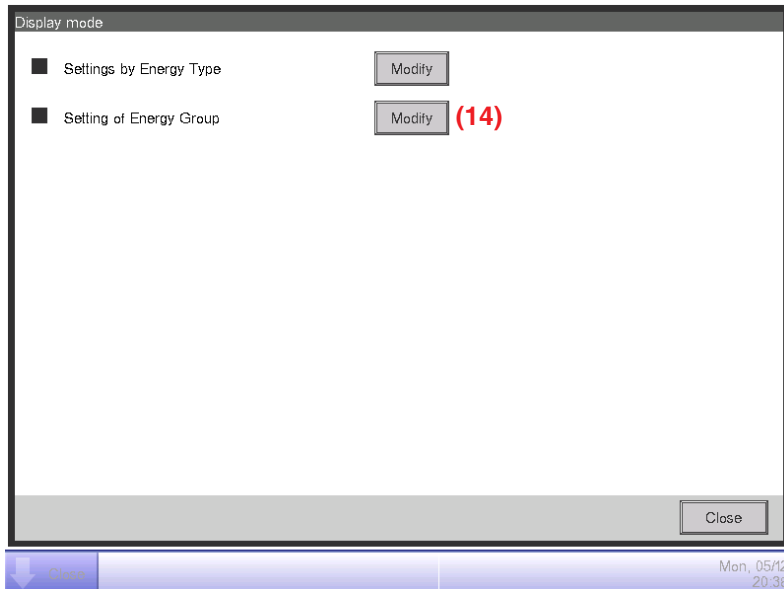

Touch the **Modify** button (14) and display the Energy Group screen.

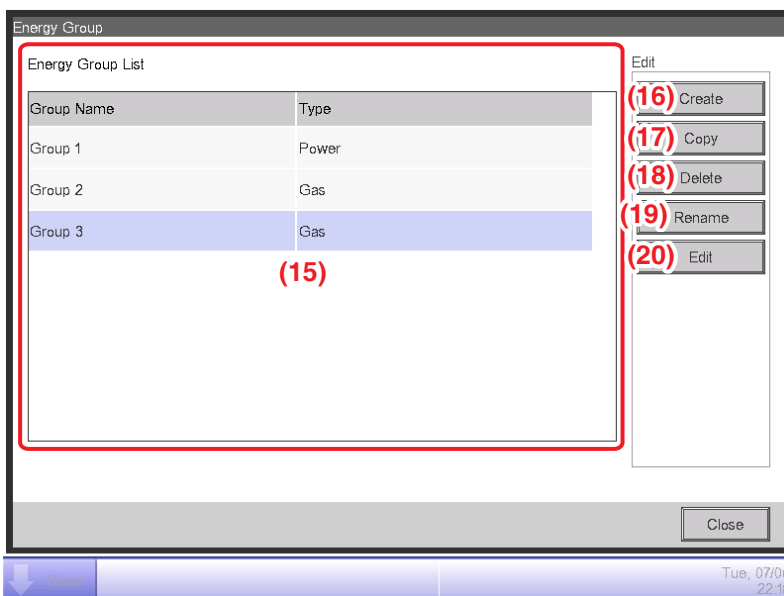

Set up the Energy Group target of energy budget/actual management.

(15) is the list of Energy Groups.

Perform the intended operation by touching the relevant button on the right.

(16) Create button

Creates a new Energy Group. You can create up to 30 Energy Groups.

Enter a name in the Name Input dialog that appears. Touch the OK button to register the name in (15) as a new Energy Group.

You can name the Energy Group using up to 16 characters.

(17) Copy button

Creates a new Energy Group by copying the selected group.

Enter a name in the Name Input dialog that appears. Touch the OK button to register the name in **(15)**.

You can name the Energy Group using up to 16 characters.

(18) Delete button

Deletes the selected Energy Group.

(19) Rename button

Renames the selected Energy Group.

Enter a name in the Name Input dialog that appears. Touch the OK button to change the name.

You can name the Energy Group using up to 16 characters.

(20) Edit button

Displays the Energy Group Setup screen that allows you to set up the selected group.

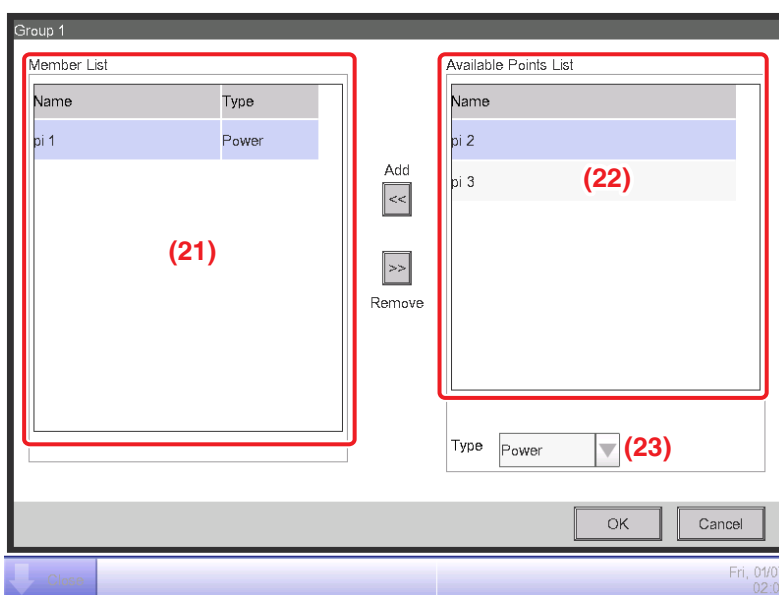

Set the management point from which to acquire the data to be used in energy budget/actual management.

In an Energy Group, you can only register Pi management points. You can register up to 100 per group. Furthermore, you can register Pi management points including multiple energy types. You can also register multiple Pi management points in one Energy Group.

(21) is the list of registered management points.

Select a management point from the list of available management points **(22)** and using the **Type** combo box **(23)**, select its type from Power, Gas and Water. You can select an energy type registered in the Energy Type screen.

Touch the Add button to register in **(21)**.

Selecting an energy type from **(21)** and touching the Remove button cancels its registration.

Touch the OK button to save the settings and return to the Energy Group screen.

When finished, touch the OK button to save the settings and return to the Display Mode screen.

Touch the Close button on the Display Mode screen to close the screen and return to the Energy budget/actual management screen.

- **Setting up an Energy Consumption Plan and Registering the Actual Energy Consumption**
Set up the energy consumption plan (planned value) and actually consumed energy (actual value).

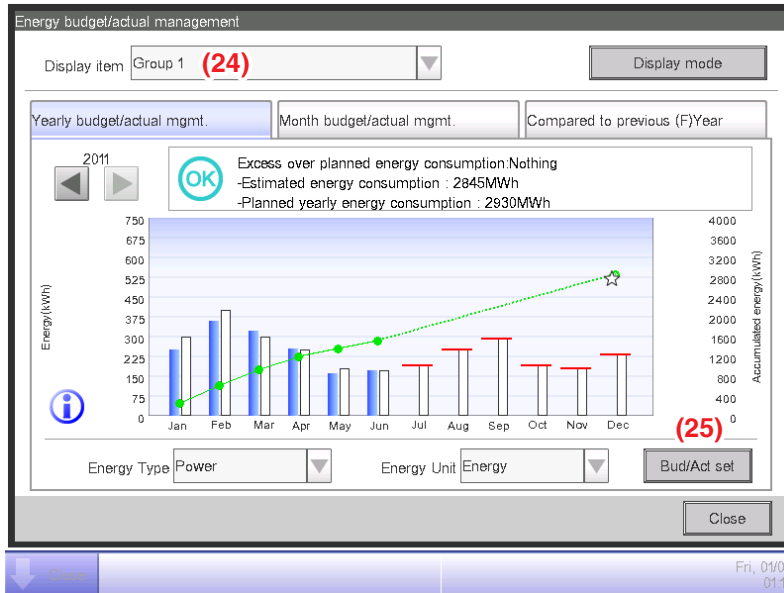

You can select a registered Energy Group using the **Display item** combo box (24) available on each tab of the Energy budget/actual management screen.

Select the Energy Group to which to set the energy consumption plan and register the actually consumed energy, and touch the **Bud/Act set** button (25) to display the Bud/Act set screen.

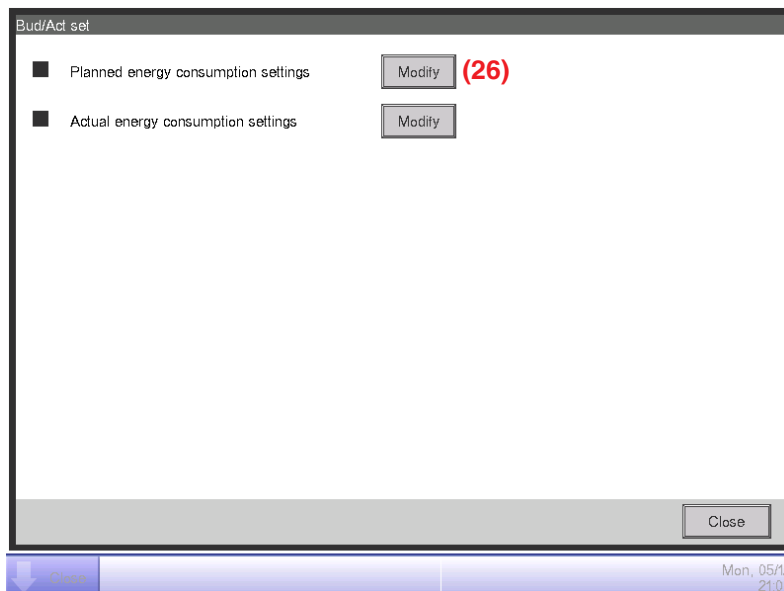

Touch the **Modify** button (26) and display the Planned Energy Consumption Setup screen.

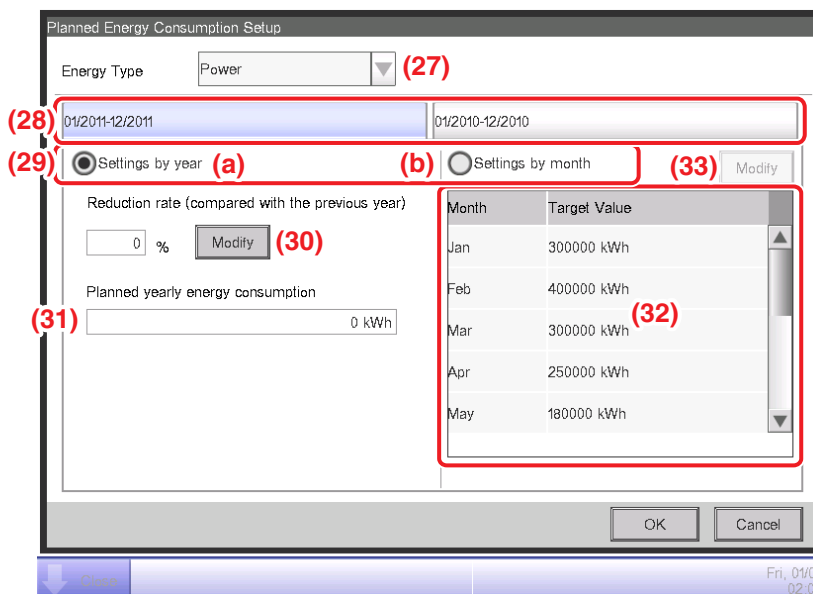

Set up the energy consumption plan for the Energy Group selected in the Energy budget/actual management screen.

In the **Energy Type** combo box (27), select the energy type for which to set the energy consumption plan from Power, Gas and Water. You can select from the energy types included in the selected Energy Group.

By switching this year and last year with the **Year** tab (28), set the objective of each year. This year is the period between the collection start month that includes the present and the end month of that year, while last year is the previous year.

Select the unit for the objective setting in (29). Select either (a) **Settings by year** or (b) **Settings by month**.

When the objective is (a) by year, touch the **Modify** button (30) and enter the reduction rate with respect to the previous year in the Numerical Input dialog that appears. The annual energy consumption plan is displayed in (31) in accordance with the value in (30).

When the objective is (b) by month, a list for setting the objective for the 12 months from the collection start month appears in (32). Select one month at a time and enter the objective for each month in the Numerical Input dialog that appears when you touch the **Modify** button (33). You can enter a value in the 0 to 2000000 range, in increments of 0.1.

When finished, touch the OK button to save the settings and return to the Bud/Act set screen.

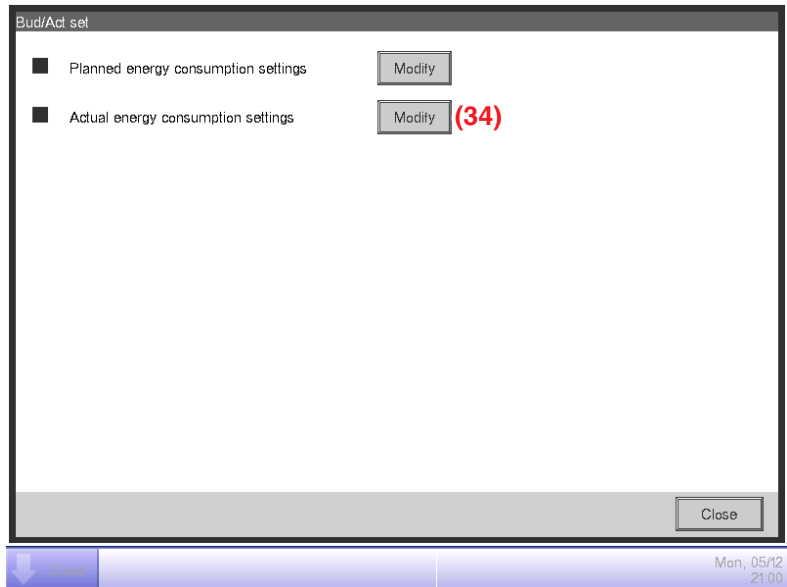

Touch the **Modify** button (34) and display the Actual Energy Consumption Setup screen.

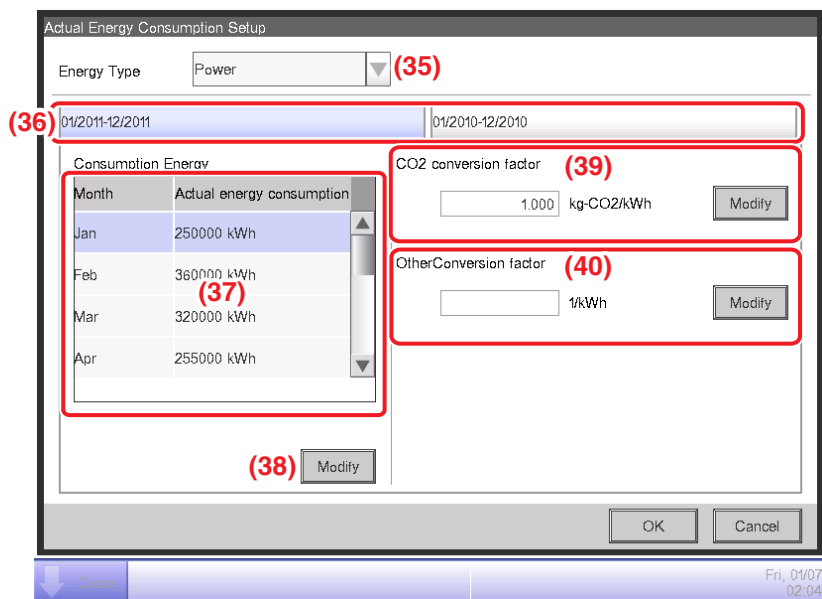

Register the actual energy consumption for the Energy Group selected in the Energy budget/ actual management screen.

In the **Energy Type** combo box (35), select the energy type for which to enter the actual energy consumption from Power, Gas and Water. You can select from the energy types included in the selected Energy Group.

By switching this year and last year with the **Year** tab (36), enter the actual values for each year. This year is the period between the collection start month that includes the present and the end month of that year, while last year is the previous year.

A list for setting the actual value for the 12 months from the collection start month appears in (37). Select one month at a time and enter the actual value for each month in the Numerical Input dialog that appears when you touch the **Modify** button (38).

The actual values which measured by Pi management points cannot be modified.

You can enter a value in the 0 to 2000000 range, in increments of 0.1.

The CO₂ conversion factor for the energy consumption appears in (39). The unit displayed depends on the selected energy type. Touch the Modify button and enter the conversion factor in the Numerical Input dialog that appears.

You can enter a value in the 0 to 9999.999 range, in increments of 0.001.

(40) appears a new energy conversion type is registered in the Energy Conversion Type screen. The displayed unit will depend on the energy type ([Unit registered in the new conversion type]/ kWh). Enter the conversion factor if necessary.

You can enter a value in the 0 to 9999.999 range, in increments of 0.001.

When finished, touch the OK button to save the settings and return to the Bud/Act set screen.

• **Checking the Budget to Actual Energy Consumption**

Assess the level of achievement by comparing the value set in the energy consumption plan and the actual energy consumption, and display it graphically.

Furthermore, display the estimated consumption when the plan is fully achieved and the objective for achieving the plan by calculating from the current actual value.

The Energy budget/actual management screen consists of three tabs: Yearly budget/actual mgmt., Month budget/actual mgmt., and Compared to previous (F)Year. Check with each tab the budget to actual energy consumption.

Touch the E budget/actual Mgmt. button on the Energy Navigator tab of the Menu List screen. (See page 57.)

Yearly budget/actual mgmt.Tab (Energy budget/actual management Screen)

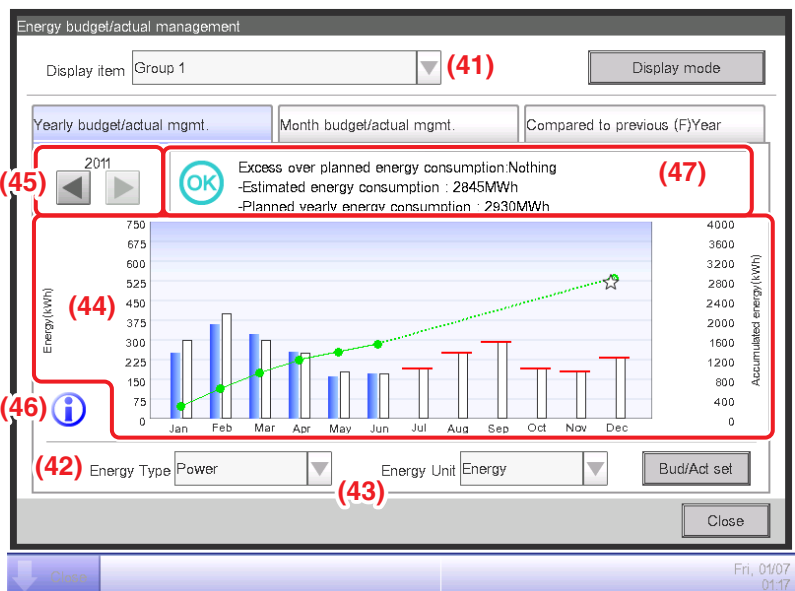

This screen displays the yearly budget to actual energy consumption status for the Energy Group selected in the **Display item** combo box (41).

Set the energy type to plot in the **Energy Type** combo box (42).

Select from Power, Gas and Water.

Only when the unit of energy is CO₂ or new conversion type, you will be able to select the “total” of CO₂ emitted by all types of energy.

Selecting the unit of energy to display in the graph from Energy, CO₂, and new conversion type in the **Energy Unit** combo box (43) plots the graph in (44).

In the graph, the horizontal axis represents each month of the year from the collection start month, the left vertical axis the monthly energy consumption, and the right vertical axis the accumulated energy consumption.

To switch the displayed year, use (45).

Touching the **Legend** button (46) displays an explanation of each graph component.

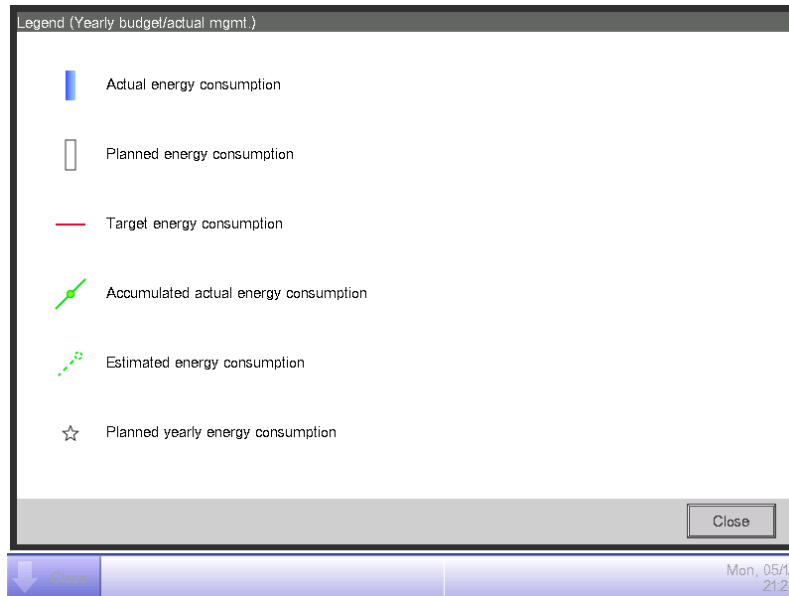



(47) displays icons along with messages in accordance with the level of achievement of the energy consumption plan.

Also, touching a month on the graph displays the actual energy consumption, planned value, and target value for that month in a tool tip.

When the screen is displaying the last year

Classification		Displayed information	
		Icon	Message
When both actual energy consumption and planned energy consumption exist	Accumulated energy consumption – Planned accumulated energy consumption >0		Excess over planned energy consumption: .% (...kWh) – Accumulated energy consumption:kWh – Planned yearly energy consumption:kWh
	Accumulated energy consumption – Planned accumulated energy consumption ≤0		Excess over planned energy consumption:Nothing – Accumulated energy consumption:kWh – Planned yearly energy consumption:kWh
When only the actual energy consumption exists (When energy consumption plan is not set)		–	Accumulated energy consumption:kWh
When neither actual energy consumption nor planned energy consumption exists		–	(No messages are displayed)

When the screen is displaying the this year

Classification		Displayed information	
		Icon	Message
When both estimated energy consumption and planned energy consumption exist	Estimated energy consumption - Planned accumulated energy consumption >0		Excess over planned energy consumption: .% (...kWh) – Estimated energy consumption:kWh – Planned yearly energy consumption:kWh
	Estimated energy consumption – Planned accumulated energy consumption ≤0		Energy consumption plan achieved:Nothing – Estimated energy consumption:kWh – Planned yearly energy consumption:kWh
When only the estimated energy consumption exist (When energy consumption plan is not set)		–	Estimated energy consumption:kWh
When neither estimated energy consumption nor planned energy consumption exists		–	(No messages are displayed)

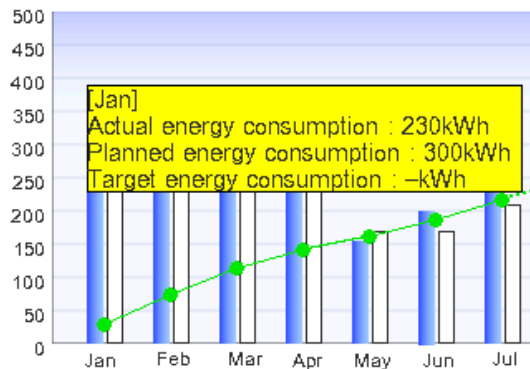

NOTE

Results may not be displayed when there are missing actual and/or planned values.

Month budget/actual mgmt. Tab (Energy budget/actual management Screen)

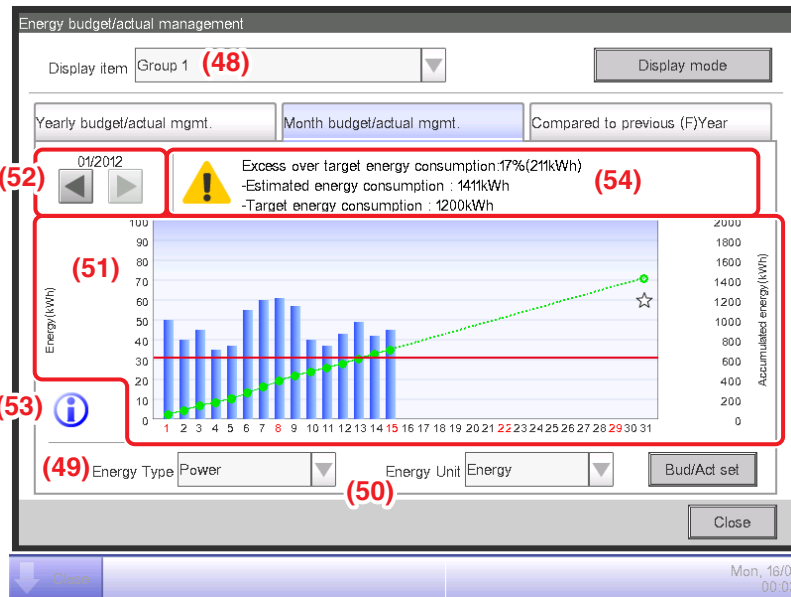

This screen displays the monthly budget to actual energy consumption status for the Energy Group selected in the **Display item** combo box (48).

Select the energy type to plot in the **Energy Type** combo box (49).

Select from Power, Gas and Water.

Only when the unit of energy is CO₂ or new conversion type, you will be able to select the “total” of CO₂ emitted by all types of energy.

Selecting the unit of energy to display in the graph from Energy, CO₂, and new conversion type in the **Energy Unit** combo box (50) plots the graph in (51).

In the graph, the horizontal axis represents each day of the month from the collection start day to the collection end day, the left vertical axis the daily energy consumption, and the right vertical axis the accumulated daily energy consumption.

Use (52) to switch the displayed month between the current and previous month.

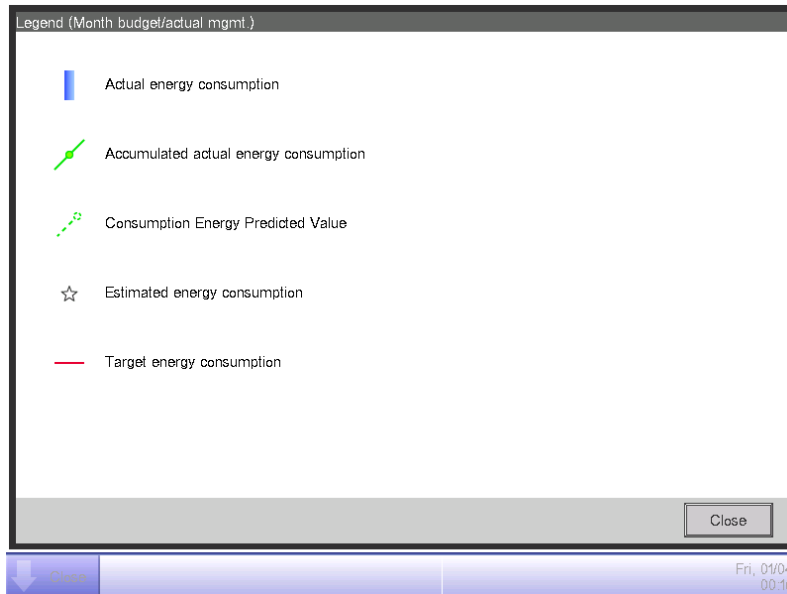

Touching the **Legend** button (53) displays an explanation of each graph component.





(54) displays icons along with messages in accordance with the level of achievement of the energy consumption plan.

Also, touching a day on the graph displays the actual energy consumption for that day in a tool tip.

When the screen is displaying the current month

Level of achievement	Icon	Message for the level of achievement
Safe		If this trend continues, the target can be achieved. – Estimated energy consumption:kWh – Target energy consumption:kWh
Caution		Excess over target energy consumption: Nothing: .% (...kWh) – Estimated energy consumption:kWh – Target energy consumption:kWh
Danger		Target energy consumption already exceeded. – Estimated energy consumption:kWh – Target energy consumption:kWh

When the screen is displaying a past month

Classification	Classification information	Message
	Icon	
Accumulated energy consumption – Planned accumulated energy consumption >0		Excess over target energy consumption: .% (...kWh) – Accumulated energy consumption:kWh – Target energy consumption:kWh
Accumulated energy consumption – Planned accumulated energy consumption ≤0		Target energy consumption is achieved. – Accumulated energy consumption:kWh – Target energy consumption:kWh

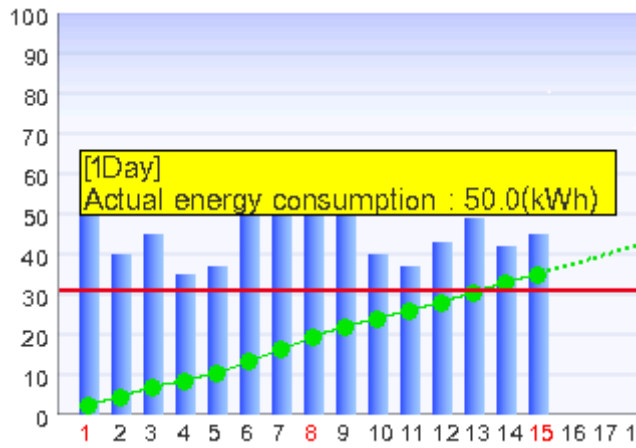

NOTE

Results may not be displayed when there are missing actual and/or planned values.

Compared to previous (F)Year Tab (Energy budget/actual management Screen)

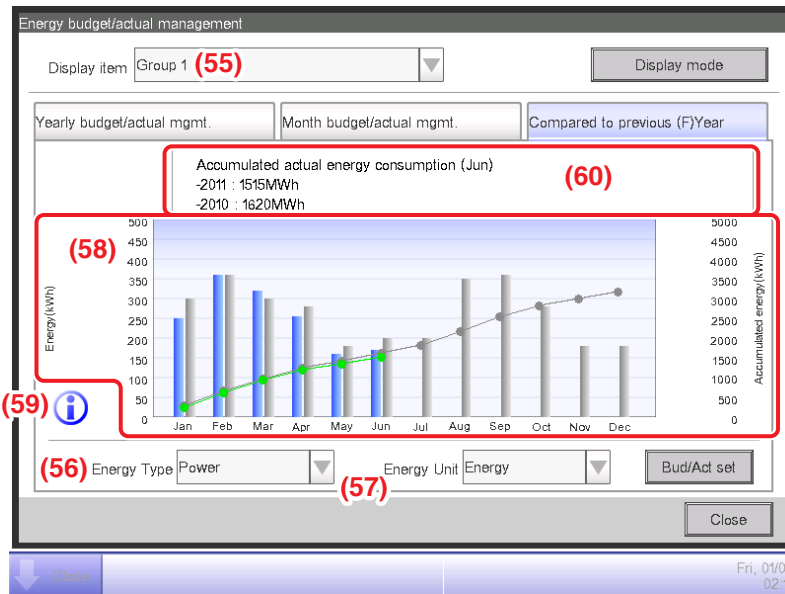

This screen displays the energy consumption of the current year against the previous year on a monthly basis for the Energy Group selected in the **Display item** combo box (55).

Select the energy type to plot in the **Energy Type** combo box (56).

Select from Power, Gas and Water.

Only when the unit of energy is CO₂ or new conversion type, you will be able to select the “total” of CO₂ emitted by all types of energy.

Selecting the unit of energy to display in the graph from Energy, CO₂, and new conversion type in the **Energy Unit** combo box (57) plots the graph in (58).

In the graph, the horizontal axis represents each month of the year from the collection start month, the left vertical axis the energy consumption of each month for the energy type selected in the Yearly budget/actual mgmt. tab of the Energy budget/actual management screen, and the right vertical axis, similarly to the left axis, the accumulated energy consumption corresponding to each month of the Yearly budget/actual mgmt. tab.

By using this graph, you can easily figure out the result of this year’s energy saving measures with regard to last year’s.

Touching the **Legend** button (59) displays an explanation of each graph component.

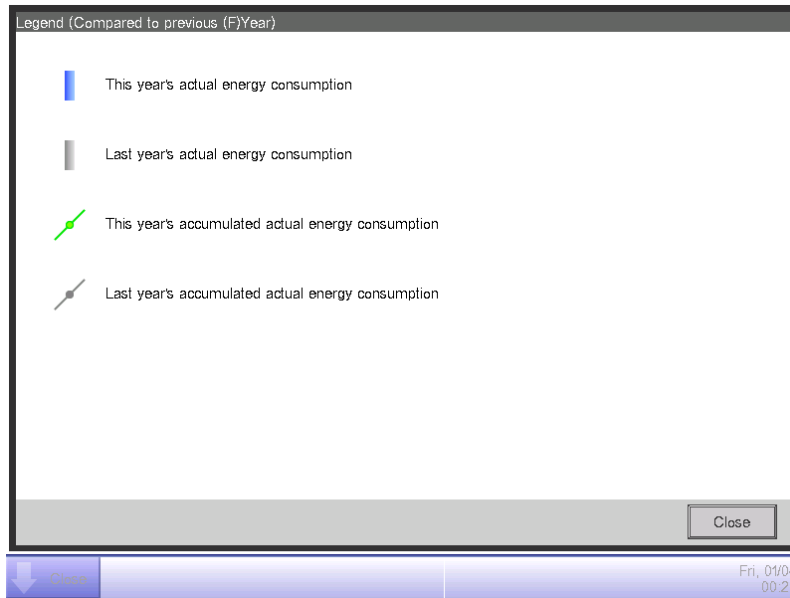

(60) displays messages in accordance with the level of achievement of the energy consumption plan.

Also, touching a month on the graph displays the actual energy consumption for that month and the previous year's actual value in a tool tip.

Message
Accumulated actual energy consumption
- kWh
- kWh

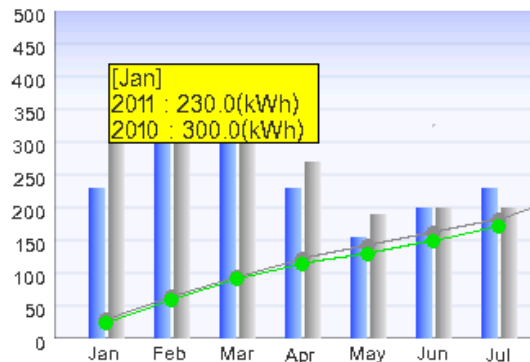

NOTE

Results may not be displayed when there are missing actual and/or planned values.

Equipment operation management (Deviation from the operation plan)

You can define operation rules for the purpose of saving energy and then, sample management points deviating from those rules.

This is a function for extracting and plotting/listing equipment operating at periods of time they were supposed to be stopped, air conditioners operating at a different setpoint than defined in the air conditioners operation plan, etc.

Functions you can use depend on whether trial power proportional distribution is enabled or not, or the availability of operation rules, as indicated in the tables below.

Engineering details		Equipment operation management		
Trial Power Proportional Distribution	Operation rules	Operation rule creation function	Sampling period/target setup function	
			Sampling period setup function	Sampling target setup function
Yes	Yes	○	○	○
Yes	No	○	○	○
No	Yes	○	○	○
No	No	○	○	○

Engineering details		Equipment operation management	
Trial Power Proportional Distribution	Operation rules	Failure to turn off sampling function	
		Failure to turn off sampling result display function	Detailed display function
Yes	Yes	○	○
Yes	No	△ (Sampling possible by default rule)	○
No	Yes	△ (Displays power consumed during failure to turn off, based on CT value.) *1	○
No	No	△ (Displays power consumed during failure to turn off, based on CT value.) *1 (Sampling possible by default rule)	○

Engineering details		Equipment operation management	
Trial Power Proportional Distribution	Operation rules	Setpoint gap sampling function	
		Setpoint gap sampling function	Detailed display function
Yes	Yes	○	○
Yes	No	△ (Sampling possible by default rule)	○
No	Yes	△ (Displays power consumption when there is setpoint gap, based on CT value.) *1	○
No	No	△ (Displays power consumption when there is setpoint gap, based on CT value.) *1 (Sampling possible by default rule)	○

*1 CT value is the power calculated from the outdoor unit's current. For details, consult a service person.

○: Available

△: Some functions available

×: Unavailable

Two operation rules are provided by default. Customize them as necessary for your use as their contents can be changed and/or deleted.

- Failure to turn off

Day of the week: Monday to Sunday, No special day settings/Operating hours: 9:00 to 21:00 (AM9:00 to PM9:00 when 12-hour clock is used)/Setpoint: None

- Setpoint gap

Day of the week: Monday to Sunday, No special day settings/Operating hours: 9:00 to 21:00 (AM9:00 to PM9:00 when 12-hour clock is used)/Setpoint: Cool 75°F, Heat 75°F

The following describes how to set this up and use.

- **Setting up the Equipment Operation Rules**

Set up the equipment operation rules.

Display the Energy Navigator tab on the Menu List screen (see page 57).

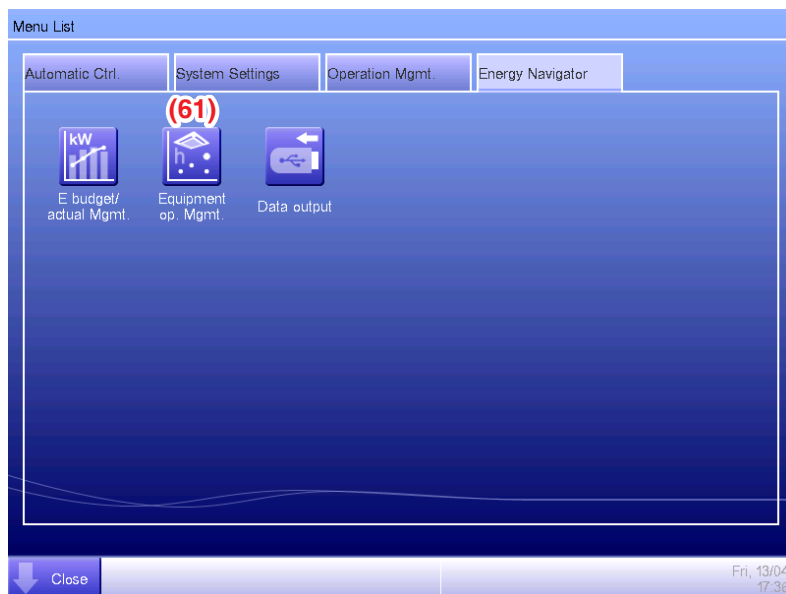

Touch the **Equipment op. Mgmt.** button (61) and display the Equipment operation management screen. The Equipment operation management screen consists of two tabs: Failure to turn off and Setpoint gap.



Touch the **Oper. Rules** button (62) and display the Operation Rule screen. The Oper. Rules button is available on both tabs.

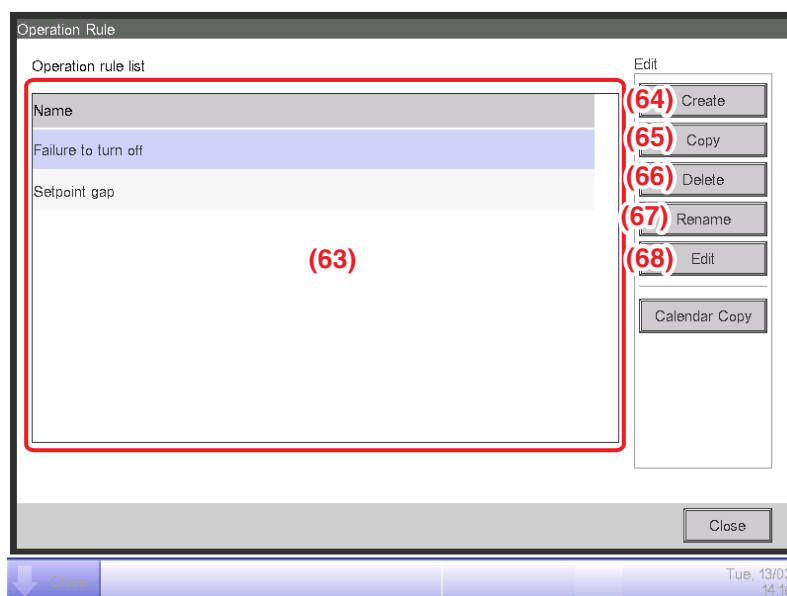

(63) is the list of registered operation rules. Perform the intended operation by touching the relevant button on the right.

(64) Create button

Creates a new operation rule. You can create up to 10 operation rules including those registered by default.

Enter a name in the Name Input dialog that appears. Touch the OK button to register the name in (63).

You can name the operation rule using up to 16 characters.

(65) Copy button

Creates a new operation rule by copying the selected rule.

Enter a name in the Name Input dialog that appears. Touch the OK button to register the name in **(63)**.

You can name the operation rule using up to 16 characters.

(66) Delete button

Deletes the selected operation rule.

(67) Rename button

Renames the selected operation rule.

Enter a name in the Name Input dialog that appears. Touch the OK button to change the name.

You can name the operation rule using up to 16 characters.

(68) Edit button

Displays the Operation Rule Setup screen that allows you to set up the selected operation rule.

The Operation Rule Setup screen consists of three tabs: Weekly Pattern, Special Day Pattern, and Calendar. Set up each of them by switching.

NOTE

Changing the operation rules deletes the data sampled up to that point.

The following pages describe how to set up each tab.

Weekly Pattern Tab (Operation Rule Setup Screen)

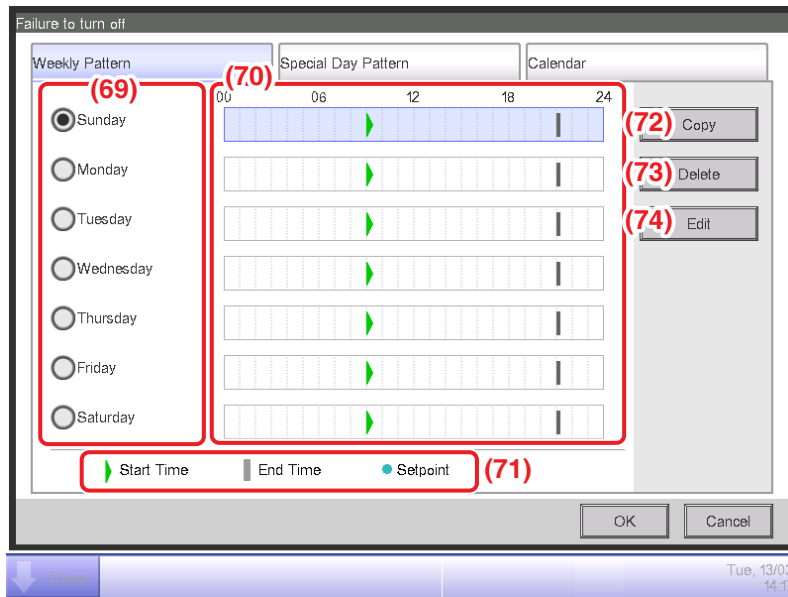

Set up a weekly equipment operation rule. Enter to all days of the week to which you want to set up a rule.

Select the day of the week to edit from (69).

(70) is the content of operation rules. (71) displays the legend.

Touch the **Copy** button (72) to copy the operation rule of the currently selected day of the week and paste it to the day of the week selected in the Copy to Selection screen. The operation rule in the destination of the copy is overwritten.

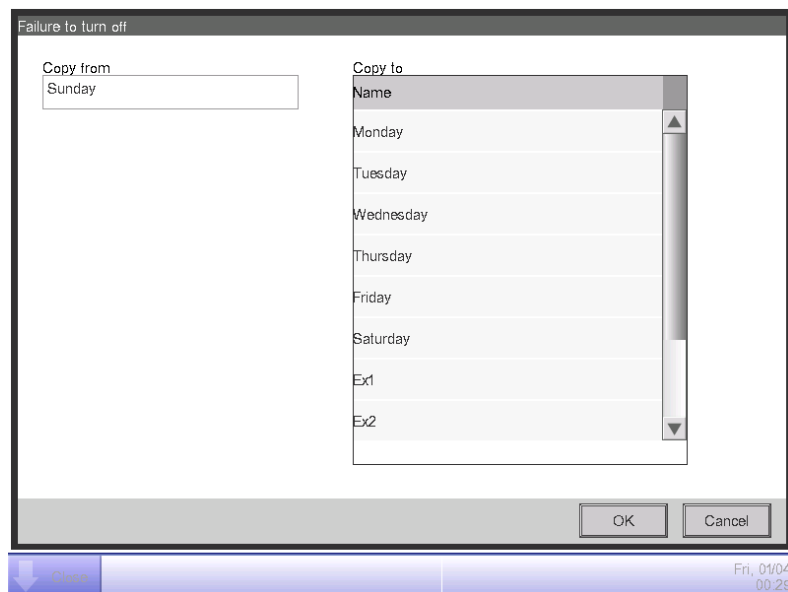

Touching the **Delete** button (73) deletes the selected day of the week operation rule.
 Touching the **Edit** button (74) displays the Operation Rule screen that allows you to edit the selected day of the week operation rule.

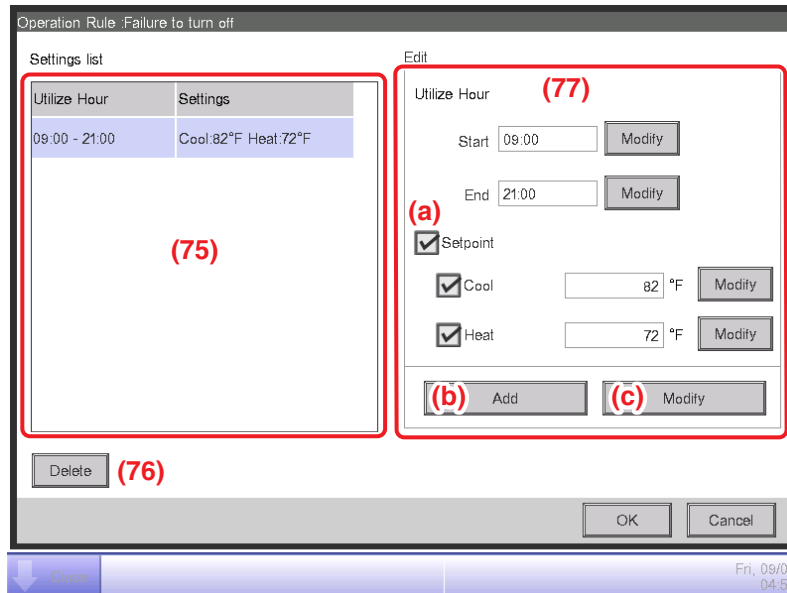

(75) is the list of registered operation rules with operating hours and setpoint details.
 Selecting an operation rule and touching the **Delete** button (76) deletes the selected operation rule.

Utilize Hours and Setpoints in (77).

Enter the Start Time and End Time in Utilize Hours. Touch the Modify button and enter the times in the Time Setup dialog that appears.

You can set up in the 00:00 to 24:00 (AM00:00 to PM12:00 when using 12-hour clock) range, and in increments of 15 minutes. If the entered value is not a multiple of 15 minutes, a dialog is displayed and the value rounded to a multiple of 15 minutes.

In addition, you cannot set hours spanning two days.

Select the check box (a) if applying a setpoint to the utilize hours.

You can set temperatures for both cooling and heating. To enter a temperature, select the check box and touch the Modify button to display the Numerical Input dialog.

You can enter values in the -22 to 158°F range, in increments of 1°F.

Touch the **Add** button (b) to add the new setting to (75).

You can set up to 10 operating hours to one operation rule.

To change the settings, you can select an existing operation rule from (75), enter new settings for it in (77), and then touch the **Modify** button (c).

Touch the OK button to save the settings and return to the Operation Rule Setup screen.

Special Day Pattern Tab (Operation Rule setup Screen)

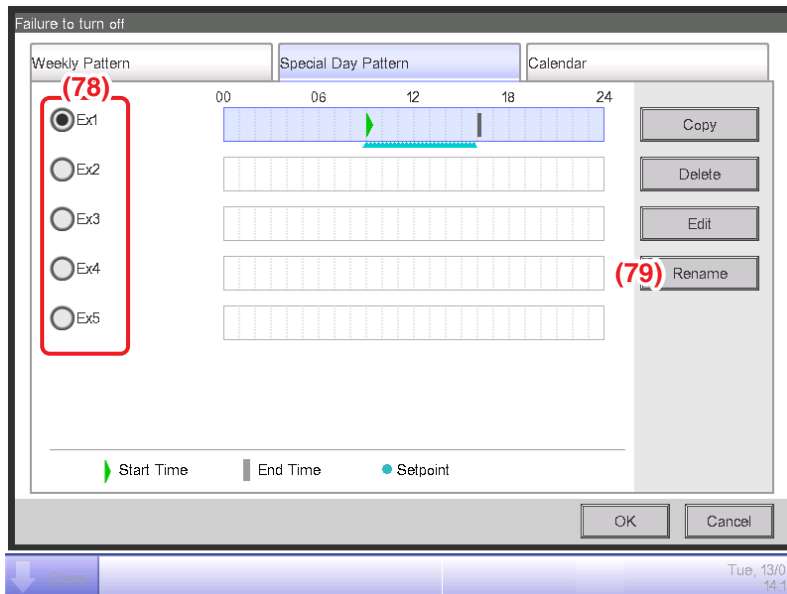

Sets up operation rules for special days, apart from the weekly operation rule. You can set up to 5 types of special day patterns.

Select the special day to edit in (78).

The subsequent steps and screen interpretation are the same as for the Weekly Pattern. Set up the operation rule using the same steps.

Touch the **Rename** button (79) to display the Name Input dialog where you can change the name of the selected special day.

Calendar Tab (Operation Rule Setup Screen)

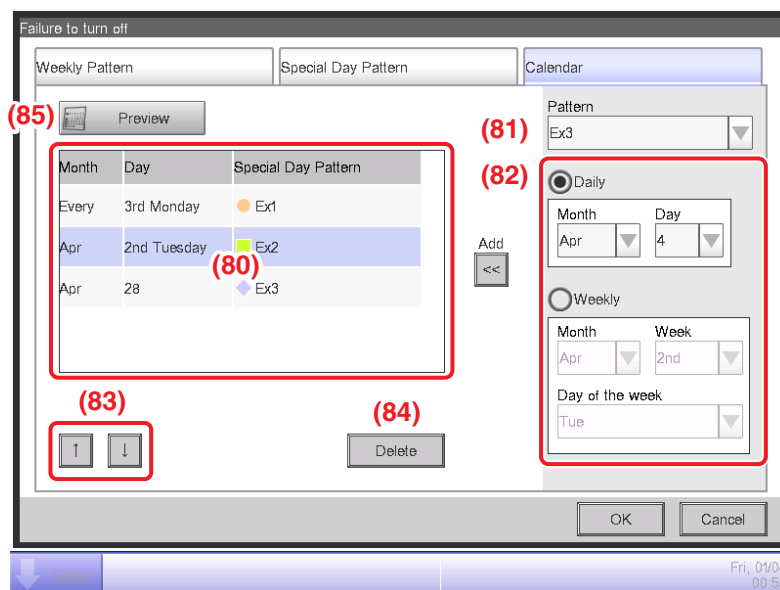

Registers the special day pattern created in the Special Day Pattern tab to the calendar. You can set up to 40 special day patterns.

(80) is the list of already registered special day patterns.

Select the special day pattern to register in the **Pattern** combo box (81) and set the day to which you want to register in (82). You can select a Date or a Month/Day of the week to set.

If a Date and Month/Day of the week overlap, the Month/Day of the week takes precedence.

The range of values you can specify in the respective combo boxes are as follows.

Month: Jan, Feb, Mar, Apr, May, Jun, Jul, Aug, Sep, Oct, Nov, Dec, and Every.

Day: 1 to 31. However, non-existing days cannot be selected.

Week: 1st, 2nd, 3rd, 4th, and Last

Day of the week: Sunday, Monday, Tuesday, Wednesday, Thursday, Friday, and Saturday

Touch the Add button to register the special day pattern to the calendar.

To change the order of the special day patterns in the list, move up and down using the ↑↓ buttons (83).

Selecting a special day pattern from the list and touching the **Delete** button (84) deletes the selected setting.

Touching the **Preview** button (85) allows you to check in calendar format the registration status for one year, from the current day.

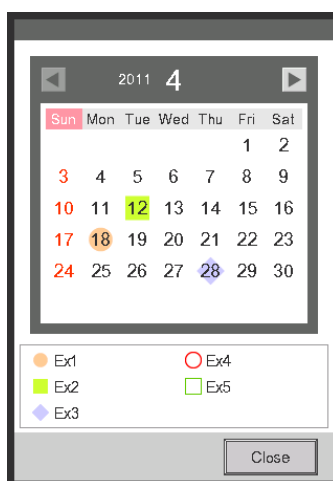

Close the calendar and touch the OK button on the Operation Rule Setup screen to save the settings and return to the Operation Rule screen.

Copying the Special Day Calendar

You can copy the calendar with special day settings among operation rules. Display the Operation Rule screen.

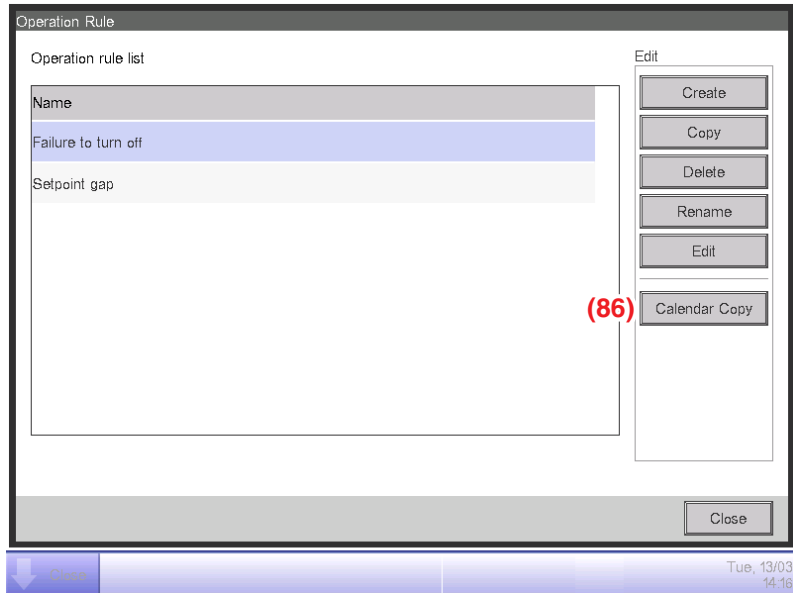

Select the operation rule where the calendar to copy is registered and touch the **Calendar Copy** button (86) to display the Calendar Copy screen.

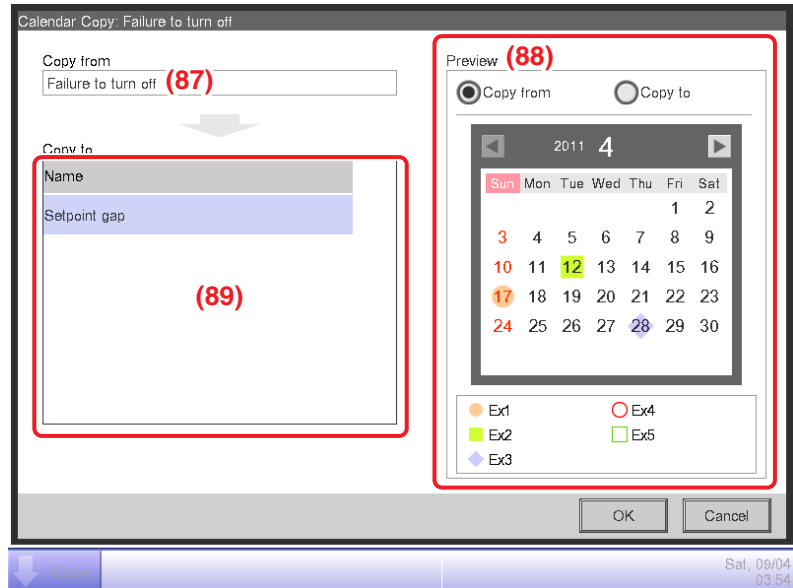

The name of the selected operation rule is displayed in (87).

In (88), you can preview the operation rule calendar of both the source and destination of the copy. Check by switching the button.

To paste, select the operation rule to copy to in (89) and touch the OK button. This will overwrite any calendar setting in the operation rule destination of the copy.

When the setup on the Operation Rule screen is finished, touch the OK button to save and return to the Equipment operation management screen.

Cautions when Using Simultaneously with Other Control Functions

1. Automatic control functions that work when there is no one in the room (such as Setback, Temperature Limit, Pre-Cool/Pre-Heat) are exempt from the operation rules during their operating hours.
2. Automatic control functions that work when there are people in the room (Auto Changeover, HMO, Timer Extension, Sliding Temperature, Schedule, Interlocking Control) are subject to the operation rules during their operating hours.
3. The operation rules do not apply to management points under maintenance.

- **Checking the Equipment Operational Status**

Executes a sampling and displays management points operating out of the set up operation rules. The checking results can also be output to a CSV file.

Selecting a sampling period, the sampling targets and applicable operation rules, and executing a sampling displays a graph and a list.

Specify the sampling target by area. Sub areas and management points included in the area will become targets.

There are two modes for displaying the sampling results: area sampling and management point sampling.

In area sampling mode, results are sampled by area and only sub areas included in the selected area are displayed.

In the management point sampling mode, the management points (including management points of sub areas) included in the selected area are displayed.

The sampled information is presented in two tabs: Failure to turn off tab where management points that were operating when they should be stopped are sampled, and Setpoint gap tab where indoor units with gaps between the actual setpoint and the setpoint that should be set are sampled.

NOTE

Failure to turn off and setpoint gap times are sampled per period.

* 1 period ... 15 minutes obtained by dividing 1 hour by 4.

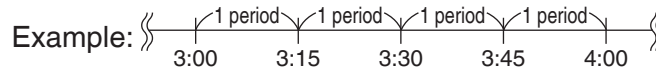

- Failure to turn off time

The equipment has been in operation the whole period though according to the operation rule, it should be stopped.

- Setpoint gap time

The equipment has been in operation the whole period and the energy gap between the average setpoint (actual value) and setpoint (operation rule) is positive.

However, if the operation during the period is due to multiple operation modes, sampling is not performed.

Touch the Equipment op. Mgmt. button on the Energy Navigator tab of the Menu List screen and display the Equipment operation management screen. (See page 57.)

Failure to turn off Tab (Equipment operation management Screen)

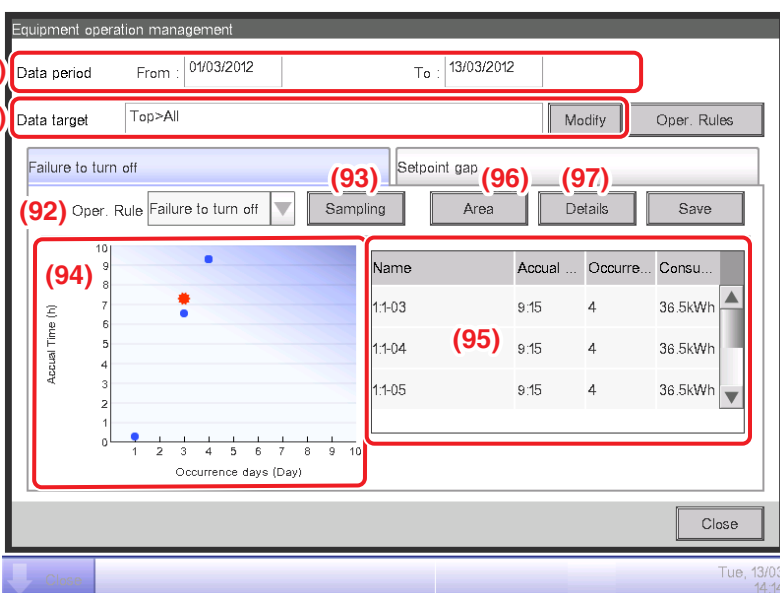

Name	Accual ...	Occurre...	Consu...
1.1-03	9:15	4	36.5kWh
1.1-04 (95)	9:15	4	36.5kWh
1.1-05	9:15	4	36.5kWh

The sampling period is displayed in (90). It runs from 15 days before to the current day.

Set the Data target in (91). Touching the Modify button displays the list of areas registered with the system in the Data Target Setup screen. Select the targets from the screen and touch the OK button to save.

In the **Oper. Rule** combo box (92), select an operation rule from those registered and touch the **Sampling** button (93).

The graph corresponding to the sampling result is displayed in (94).

<Interpreting the Graph>

- The horizontal axis represents the number of days on which failure to turn off occurred. When displayed by area, the total days on which the management points included in the area were not turned off is displayed.
- The vertical axis represents the total time.
- Management points and areas where failure to turn off occurred are displayed with a blue ●.
- Management points and areas selected in the list are displayed with an orange ✖.
- If the number of management points and areas where failure to turn off occurred exceeds 50, the top 50 are displayed.

(95) is the list of sampling results. The list displays the name of the management points and areas, the number of days on which failure to turn off occurred, the accrual time, and the amount of energy consumed.

If the number of management points and areas where failure to turn off occurred exceeds 50, the 50 with the most occurrence days and duration are displayed.

Both (94) and (95) display results by management point by default. To display by area, touch the **Area** button (96). The button becomes **Mgmt. Point** while in Area view. Touching the button, changes the view to Mgmt. Point.

Selecting a management point from the list in Mgmt. Point view and touching the **Detail** button (97) displays the Detail View Screen.

The Detail View Screen consists of two tabs: Operation status and Date of occurrence.

NOTE

Graph and list display only the sampled indoor unit management points.

Operation status Tab (Detailed View Screen)

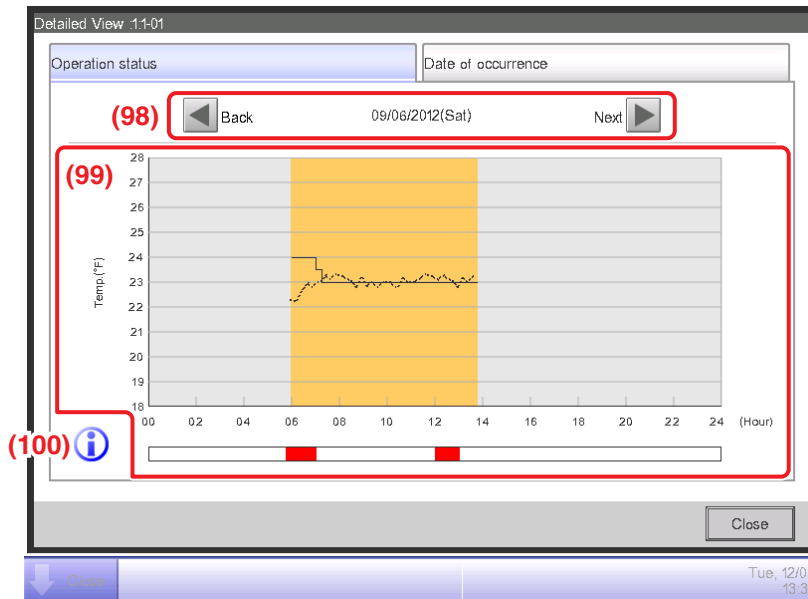

Set the date for which to display the details in (98). The From date of the Date period is displayed by default. You can change the date by touching the Next and Back buttons.

(99) is the operational status graph. The horizontal axis represents time and the vertical axis, the temperature.

Touching the **Legend** button (100) displays an explanation of each graph component.

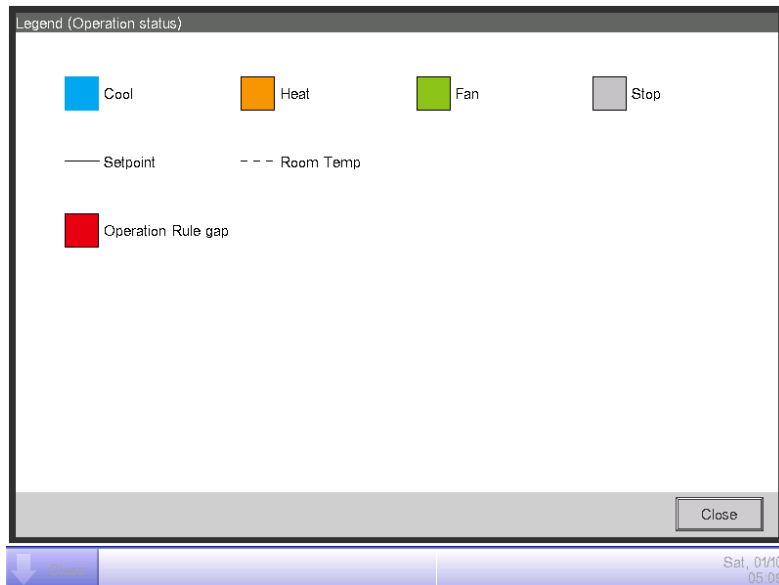

NOTE

The setpoint is not displayed when the operation mode is Fan or Dry.

Date of occurrence. Tab (Detailed View Screen)

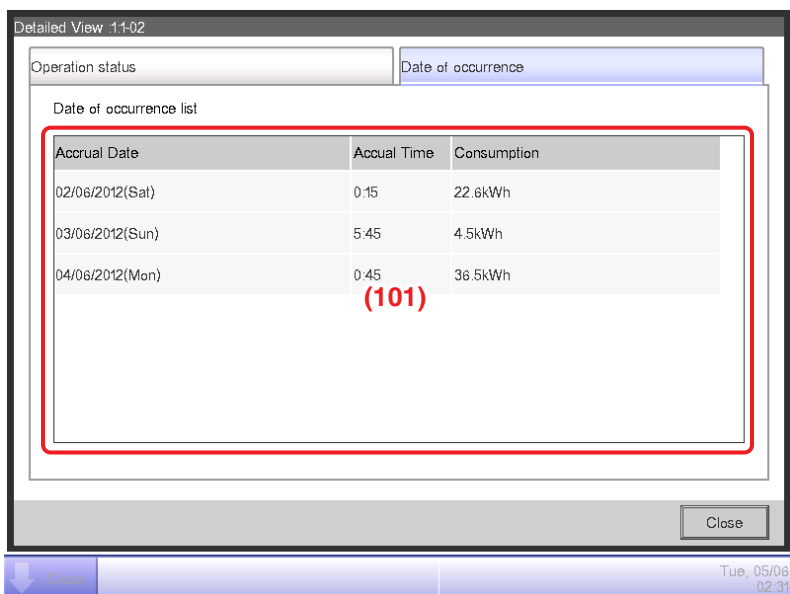

(101) is the list of dates on which deviations from the operation rule found in the selected management points.

The list displays the accrual dates, accrual time, and amount of energy consumed.

When finished checking, touch the Close button to close the screen and return to the Equipment operation management screen.

Setpoint gap Tab (Equipment operation management Screen)

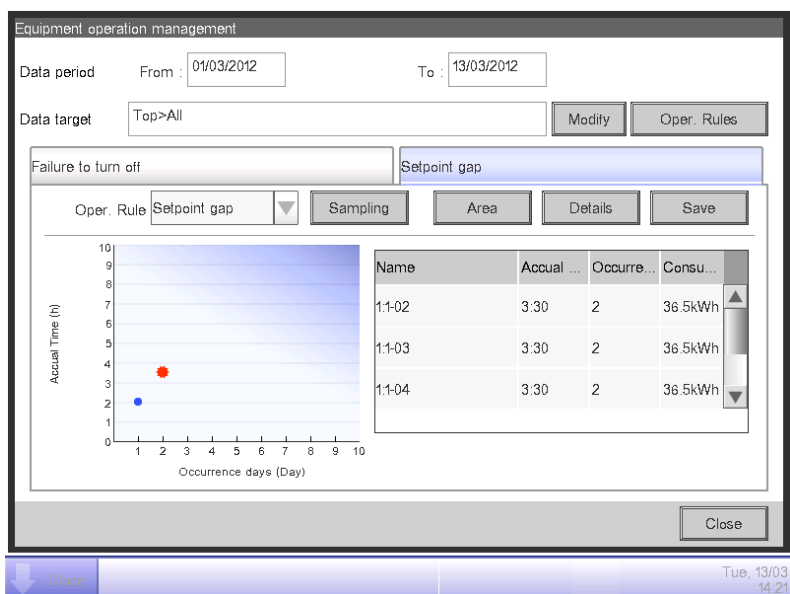

Similarly to the Failure to turn off tab, this screen displays the operational status for the set sampling period, sampling targets and operation rules.

The screen interpretation and steps are the same as for the Failure to turn off tab (see page 259).

When finished sampling and checking, touch the Close button and close the screen.

- **Outputting Sampling Data to a CSV File**

The conditions and results of sampling the failure to turn off and setpoint gap can be output as a CSV file.



Connecting a USB memory to the iTM unit and touching the **Save** button (102) saves the data sampled using the conditions displayed on the current screen to a CSV file.

The name of the file to be output change depending on the source tab. Top 50 management point/area will be output.

Failure to turn off tab: MngPointData-TurnOffXX.csv

Setpoint gap tab: MngPointData-SetPointXX.csv

(A number between 01 and 99 is automatically assigned to XX to prevent overwriting the files.)

When save is complete, a dialog appears. Touch the OK button and close the screen.

The contents of the output data and file format are as follows.

<MngPointData-TurnOffXXX.csv File Format>

Shadowed data are fixed strings
(However, language support is provided)

A	B	C	D
Blank			
Controller Name	Controller name (Example: Building A)		
Export Date	Output date (Example: 2012/09/02 12:00) (The format for date and time follow the System Settings)		
iTM Version	iTM version (Example: 1.0)		
Data period	Data period (Example: 2012/09/02 - 2012/09/30)		
Data target	Name (Example: All>1F)		
Mgmt. pnt/Area	Area/Mgmt. pnt (Example: Mgmt. pnt)		
Blank			
Administering Rules Name	Administering Rules Name		
Month	Day	Special Day Pattern	
Jan	3rd Wed	Special Day 1	
:	:	:	
Weekly Pattern or Special Day Pattern	Day of the week (Example: Monday, Tuesday, Wednesday, Thursday) or Special Day		
Time Zone	Setpoint (Cool) [°F]	Setpoint (Heat) [°F]	
:	:	:	:
Blank			
Mgmt.point name/ Area Name	Occurrence days [Day]	Accrual Time	Consumption [kwh]
:	:	:	:

<MngPointData-SetPointXXX.csv File Format>

Shadowed data are fixed strings
(However, language support is provided)

A	B	C	D
Blank			
Controller Name	Controller name (Example: Building A)		
Export Date	Output date (Example: 2012/09/02 12:00) (The format for date and time follow the System Settings)		
iTM Version	iTM version (Example: 1.0)		
Data period	Data period (Example: 2012/09/02 - 2012/09/30)		
Mgmt. pnt/Area	Area/Mgmt .pnt (Example: Mgmt. pnt)		
Blank			
Administering Rules Name	Administering Rules Name		
Month	Day	Special Day Pattern	
Jan	3rd Wed	Special Day 1	
:	:	:	
Weekly Pattern or Special Day Pattern	Day of the week (Example: Monday, Tuesday, Wednesday, Thursday) or Special Day		
Time Zone	Setpoint (Cool) [°F]	Setpoint (Heat) [°F]	
:	:	:	:
Blank			
Mgmt.point name/ Area Name	Occurrence days [Day]	Accrual Time	Consumption [kwh]
:	:	:	:

Data output function

The iTM can output measurement data other than those corresponding to the Energy Navigator function in CSV format for users who want to conduct sophisticated analyses.

Data regarding management points and areas with occurrences of failure to turn off and setpoint gap can be output from the Equipment operation management screen.

This chapter describes the steps to output energy budget/actual management data as well as data of an arbitrary management point.

Display the Energy Navigator tab on the Menu List screen (see page 57).



Touch the **Data output** button (103) and display the Data output screen. The Data output screen consists of two tabs: Energy Data and Mgmt. Point Data

- **Energy data Tab (Data output Screen)**

Outputs energy budget/actual management information.

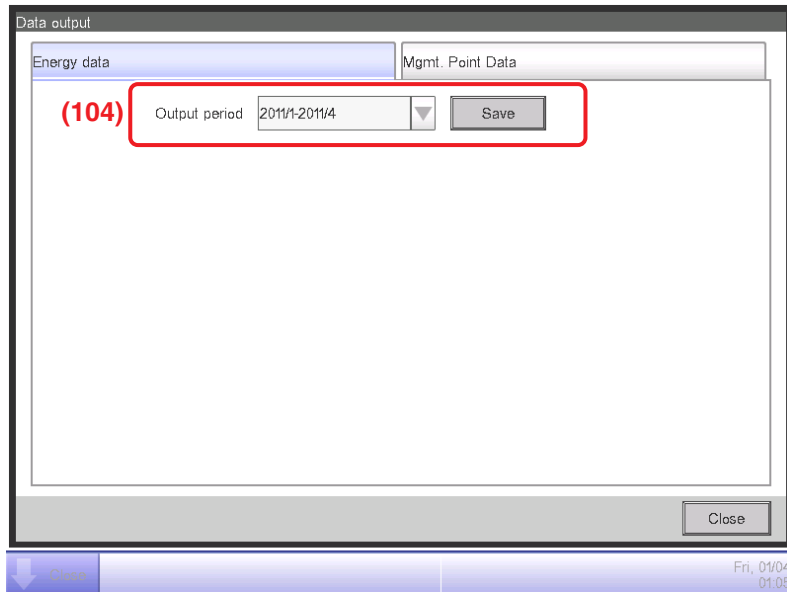

In the **Output period** combo box **(104)**, select the data to output from This year and Last year. Connect a USB memory to the iTM unit and touch the Save button. Touching the OK button on the confirmation dialog that appears starts the output.

Files are output by the name "EnergyDataXX.csv". (A number between 01 and 99 is automatically assigned to XX to prevent overwriting the files.)

When save is complete, a dialog appears. Touch the OK button and close the screen.

The contents of the output data and format are as follows.

- Energy Groups are output in the order they are registered.
- Energy Types are output in the order of: Power ⇒ Gas ⇒ Water ⇒ CO₂ ⇒ New conversion factor name.
- Files within the same energy type are output per unit of energy and in the order of: Energy ⇒ CO₂ ⇒ New conversion factor name.

<Energy Data CSV File Format>

Shaded data are fixed strings (However, language support are provided)

A	B	C	D	...	
Blank					
Controller Name	Controller name (Example: Building A)				
Export Date	Output date (Example: 2012/09/02 12:00) (The format for date and time follow the System Settings)				
iTM Version	iTM version (Example: 1.0)				
Export Year	Output year				
Blank					
Group Name	Energy group name				
Energy Type	Power				
Energy Unit	Energy				
Estimated energy consumption or Actual energy consumption [kWh/m ³]*	150000 (Actual value displayed when data is of the past)				
Planned yearly energy consumption [kWh/m ³]*	140000 ("-" displayed when data is of the past or there are no planned values)				
Month	Data collection start month (Example : 2012/04)			...	Data collection end month (Example : 2013/04)
Actual energy consumption [kWh/m ³]*					
Planned energy consumption [kWh/m ³]*					
Target energy consumption [kWh/m ³]*					
Energy Unit	CO ₂				
Month	Data collection start month (Example : 2012/04)			...	Data collection end month (Example : 2013/04)
Actual energy consumption [kg-CO ₂]*					
Energy Unit	[New conversion factor name]				
Month	Data collection start month (Example : 2012/04)			...	Data collection end month (Example : 2013/04)
Actual energy consumption [New Conversion Type Unit]*					
Month	Data collection start month (Example : 2012/04)			...	Data collection end month (Example : 2013/04)
Management point name 1 [kWh/m ³]* (Displays only management point registered with an Energy Group and matching Energy Type)	10000			...	15000
	⋮				
Energy Type	Gas				
	⋮				
Energy Type	CO ₂				
Month	Data collection start month (Example : 2012/04)			...	Data collection end month (Example : 2013/04)
CO ₂ [kg-CO ₂]*	14000				
Energy Type	[New conversion factor name]				
Month	Data collection start month (Example : 2012/04)			...	Data collection end month (Example : 2013/04)
[New Conversion Type Name] factor [New Conversion Type Unit]*					
Group Name	Energy group name				

As many as registered Energy Types

As many as registered Energy Groups.
(Not output when no Energy Group is registered)

↙ Continued on next table

*Converted and displayed according to Energy Type and Energy amount.

A	B	AF
Blank			
Group Name	Energy group name		
Month	Month (Example: 2012/04)		
Energy Type	Power		
Energy Unit	Energy		
Estimated energy consumption or Actual energy consumption [kWh/m ³]*	150000 (Actual value displayed when data is of the past)		
Target energy consumption [kWh/m ³]*	140000 ("—" displayed when data is of the past)		
Day	1st		Actual energy consumption
Actual energy consumption [kWh/m ³]*	1000	1500
Energy Unit	CO ₂		
Day	1st		Actual energy consumption
CO ₂ [kg-CO ₂]*	1000	1500
Energy Unit	[New conversion factor name]		
Day	1st		Actual energy consumption
Actual energy consumption [New Conversion Type Unit]*	1000	1500
Day	1st (Example : 2012/04/01)		Actual energy consumption (Example : 2012/04/30)
Management point name 1 [kWh/m ³]* (Displays only management point registered with an Energy Group and matching Energy Type)	1000	1500
⋮	⋮	⋮	⋮
Energy Type	Gas		
	...		
Energy Unit	CO ₂		
Day	1st		Actual energy consumption
CO ₂ [kg-CO ₂]*	1000	1500
Energy Type	[New conversion factor name]		
Day	1st		Actual energy consumption
[New Conversion Type Name] factor [New Conversion Type Unit]*	1000	1500
Month	Month (Example: 2012/04)		
	⋮		
Group Name	Energy group name		
	⋮		

As many as registered Energy Types.

As many times as the number of months from collection start to collection end, or to the current month.

As many as registered Energy Groups.
(Not output when no Energy Group is registered)

*Converted and displayed according to Energy Type and Energy amount.

- **Mgmt. Point Data Tab (Data output Screen)**

Outputs data of an arbitrary management point.

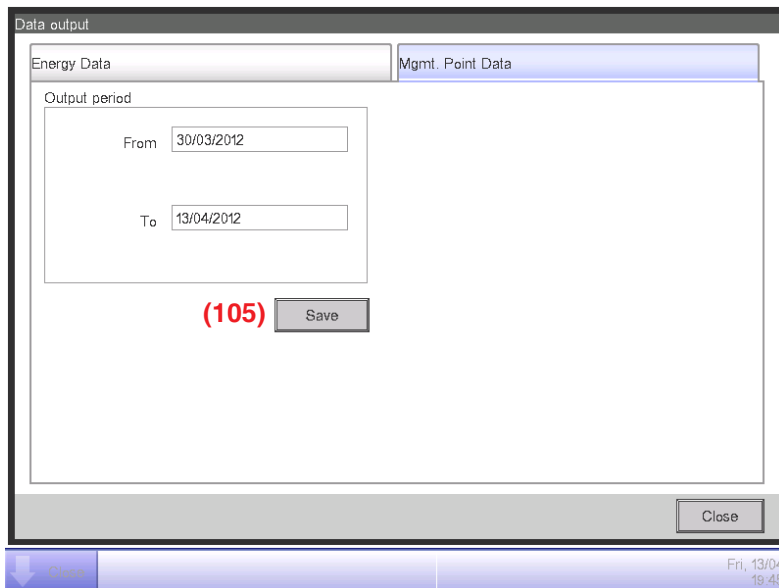

Connect a USB memory to the iTM unit and touch the **Save** button (105). Touching the OK button on the confirmation dialog that appears starts the export.

Files are output to the MngPointData folder created on the first level of the USB memory. File names are appended with month and year, so that they look like MngPointData201201.csv. When save is complete, a dialog appears. Touch the OK button and close the screen.

The contents of the output data and format are as follows.

- The data are output in the order of the management point name.
- Date, time, and data of each management point are output as hourly data.
- The types of management points that can be output are: indoor unit, Ventilator, Di, Dio, Pi, and Ai.

<Management Point Data CSV File Format>

Shadowed data are fixed strings (However, language support is provided)

A	B	C	D
Blank				
Controller Name	Controller name (Example: Building A)			
Export Date	Output date (Example: 2012/09/02 12:00) (The format for date and time follow the System Settings)			
iTM Version	iTM version (Example: 1.0)			
Output Period	Output period (Example: 2012/11/01 - 2012/11/30)			
Blank				
Mgmt. point name	Management point name to output			
Mgmt. point classification	Management point type to output			
Date	Time	Item 1 *	Item 2 *
Output date (Example: 2012/11/01)	Output time (Example: 10:00)			
⋮	⋮	⋮	⋮	⋮
Blank				

As many as the number of dates included in the Output period.

As many as the number of management points to be output.

*Output item varies for each management point type.
For output items, see the tables below.

[Indoor Unit (DIII)]

Output indoor Unit (DIII) data items

No.	Item	Collection method	Unit	Valid output range
1	Setpoint (Average)	Average 1-minute value in 1-hour (data collection time)	°C * °F *	0≤Value≤50.0 * 32≤Value≤122 *
2	Setpoint (Maximum Value)	Maximum 1-minute value in 1-hour (data collection time)	°C * °F *	0≤Value≤50.0 * 32≤Value≤122 *
3	Setpoint (Minimum Value)	Minimum 1-minute value in 1-hour (data collection time)	°C * °F *	0≤Value≤50.0 * 32≤Value≤122 *
4	Suction Temperature (Average)	Average 1-minute value in 1-hour (data collection time)	°C * °F *	-50.0≤Value≤120.0 * -58≤Value≤248 *
5	Suction Temperature (Maximum Value)	Maximum 1-minute value in 1-hour (data collection time)	°C * °F *	-50.0≤Value≤120.0 * -58≤Value≤248 *
6	Suction Temperature (Minimum Value)	Minimum 1-minute value in 1-hour (data collection time)	°C * °F *	-50.0≤Value≤120.0 * -58≤Value≤248 *
7	Operation time of cooling (Total)	Accumulated indoor unit's operation time in Cooling mode, in minutes	Minutes	0≤Value≤60
8	Operation time of heating (Total)	Accumulated indoor unit's operation time in Heating mode, in minutes	Minutes	0≤Value≤60
9	Operation time of fan (Total)	Accumulated indoor unit's Ventilation mode operation time, in minutes	Minutes	0≤Value≤60
10	Start/Stop count	Number of times indoor unit has been in operation.	Times	0≤Value≤9999

*Room temperature is output in Celsius or Fahrenheit depending on the System Settings.

[Ventilator]

Output Ventilator data items

No.	Item	Collection method	Unit	Valid output range
1	Operation time (Total)	Accumulated Ventilator operation time, in minutes	Minutes	0≤Value≤60
2	Start/Stop count	Number of times Ventilator has been in operation.	Times	0≤Value≤9999

[DIII chiller]

Items to be output by DIII chiller

The data is rounded to within the output effective range if it is outside the range.

No.	Item	Collection method	Unit	Valid output range
1	Operation time of heating (Total)	Accumulated operating time (in minutes) of the DIII chiller in heating mode	Minutes	0≤Value≤60
2	Operation time of cooling (Total)	Accumulated operating time (in minutes) of the DIII chiller in cooling mode	Minutes	0≤Value≤60
3	Start/Stop count	Number of times DIII chiller has been in operation.	Times	0≤Value≤9999
4	Inlet Water Temp. (Average)	Average 1-minute value in 1-hour (data collection time)	°C * °F *	-50.0≤Value≤120.0 * -58≤Value≤248 *
5	Inlet Water Temp. (Maximum)	Maximum 1-minute value in 1-hour (data collection time)	°C * °F *	-50.0≤Value≤120.0 * -58≤Value≤248 *
6	Inlet Water Temp. (Minimum)	Minimum 1-minute value in 1-hour (data collection time)	°C * °F *	-50.0≤Value≤120.0 * -58≤Value≤248 *
7	Outlet Water Temp. (Average)	Average 1-minute value in 1-hour (data collection time)	°C * °F *	-50.0≤Value≤120.0 * -58≤Value≤248 *
8	Outlet Water Temp. (Maximum)	Maximum 1-minute value in 1-hour (data collection time)	°C * °F *	-50.0≤Value≤120.0 * -58≤Value≤248 *
9	Outlet Water Temp. (Minimum)	Minimum 1-minute value in 1-hour (data collection time)	°C * °F *	-50.0≤Value≤120.0 * -58≤Value≤248 *

*Room temperature is output in Celsius or Fahrenheit depending on the System Settings.

[Di/Dio]

Output Di/Dio data items

No.	Item	Collection method	Unit	Valid output range
1	Operation time (Total)	Accumulated Di/Dio operation time, in minutes	Minutes	0≤Value≤60
2	Start/Stop count	Number of times Di/Dio has been in operation.	Times	0≤Value≤9999

[Pi]

Output Pi data items

No.	Item	Collection method	Unit	Valid output range
1	Meter value (Total)	Hourly (data collection time) total	-	0≤Value≤999999.99

[Ai]

Output Ai data items

No.	Item	Collection method	Unit	Valid output range
1	Analog value (Average)	Average 1-minute value in 1-hour (data collection time)	-	-100000.0≤Value≤100000.0

iTM integrator Explanation

12. iTM integrator

12-1 iTM integrator

An iTM integrator can control a maximum of five intelligent Touch Managers. In this way, you can monitor, operate, and set up a system with up to 2560 management points from a single screen.

You can also set a manager password to the iTM integrator as in the iTM to restrict unwanted operations by outsiders.

Furthermore, similarly to the iTM, you can also remotely operate the iTM integrator from a PC via a network.

By connecting the iTM integrator to each iTM, you can monitor, operate, and set up in the same way as with the iTM unit. However, the following are functions specific to the iTM unit and cannot be set up by accessing from the iTM integrator:

- Screen lock, locale setting, hardware setup
- Touch panel calibration, screensaver
- Backup/restore

Each iTM works individually. Therefore, you do not need to stop the entire system for an expansion work, for example.

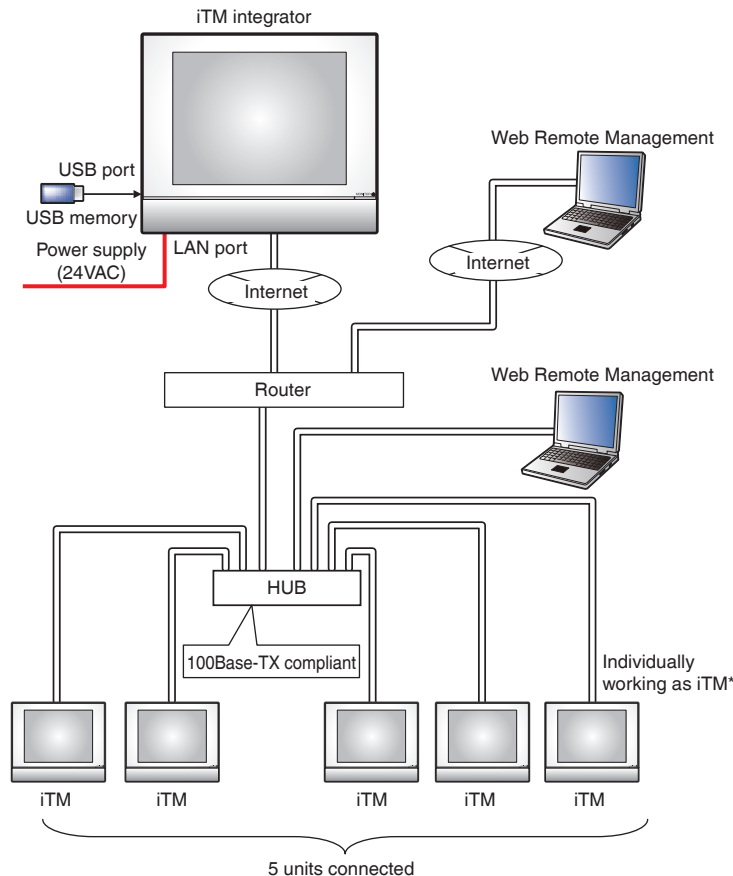

This chapter describes the iTM integrator screens and points to have in mind when using the iTM integrator.

Detailed screen and button descriptions

- Standard View Screen (iTM integrator unit)

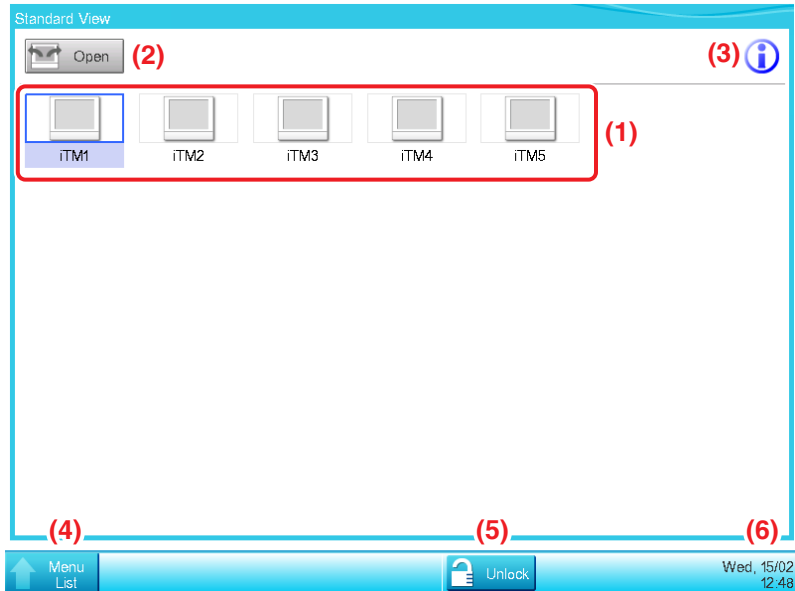

(1) Icon View

Displays the connected iTMs using icons.

(2) Open button

Accesses the iTM selected in the Icon view and displays its Standard View (Icon) screen.

(3) Information button

Displays the legend for the Icon view and contact information for inquiries regarding the iTM integrator.

(4) Menu List switch button

Switches the Menu List screen among the System Settings and Operation Mgmt. tabs.

(5) Lock/Unlock button

Locks/Unlocks the screen. The button is disappeared when the screen lock is disabled.

(6) Date/Time Display area

Displays the date and time in the iTM integrator.

- **Standard View Screen (Accessed iTM)**

This screen is displayed when you touch the **Open** button (2) on the iTM integrator Standard view screen and access an iTM.

The Unlock/Lock button that is usually displayed on the iTM unit is not displayed. The iTM integrator can access an iTM unit even if its screen is locked.

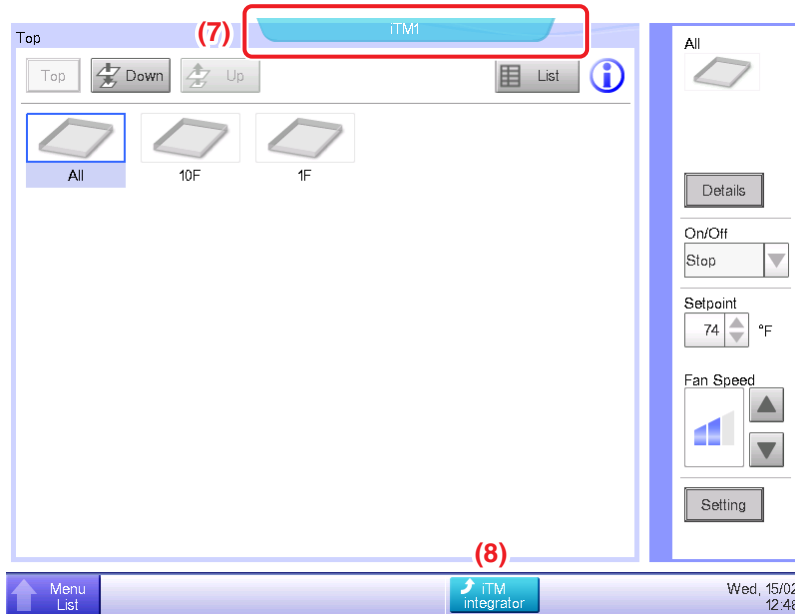

(7) Controller name tag

Displays the name of the iTM accessed from the iTM integrator and whose screen is being displayed.

(8) iTM integrator button

Returns to the iTM integrator Standard view screen.



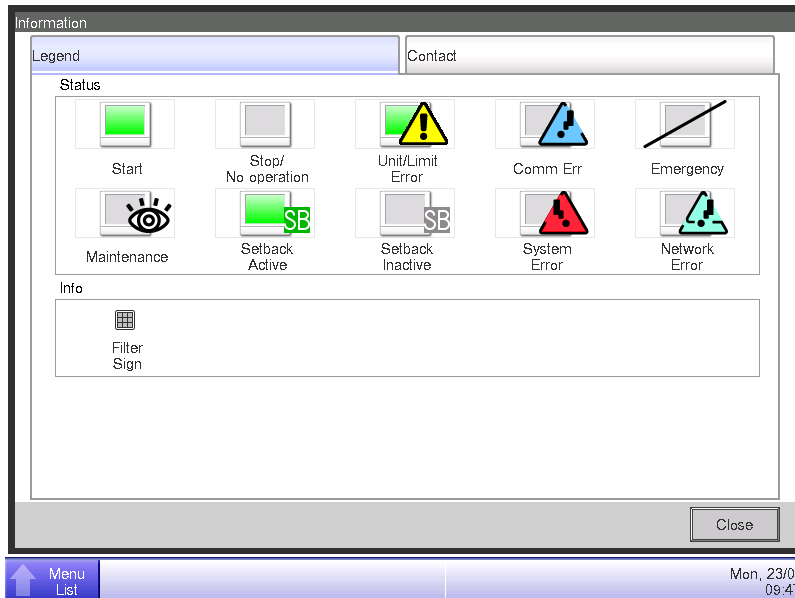

- **Legend Tab (Information Screen)**





This screen is displayed when you touch the Information button on the iTM integrator Standard view screen.



It displays the legend of icons used in the Standard view screen.

• Icon View in Each Status

	Maintenance	Stop/No operation	Setback Inactive	Setback Active	Start (*1)
Icon					
	When all management points connected to the iTM are in maintenance	<ul style="list-style-type: none"> When all management points connected to the iTM are Stop/No operation When no management point is connected to the controller 	When there is at least one management point with inactive setback	When there is at least one management point with active setback	When there is at least one management point connected to the iTM that is operating *1

	Communication Error	Unit/Limit Error	System Error	Emergency Stop	Network Error
Icon					
	When there is at least one management point connected to the iTM with communication error	When there is at least one management point connected to the iTM with error (Error sign is displayed over the Operating, Stop/No operation)	When there is a system error in iTM *2	When there is at least one management point connected to the iTM in emergency stop	<ul style="list-style-type: none"> When there is communication error between the iTM integrator and iTM When two iTM integrators are connected to a single iTM When the version is not compatible

*1 The icon color is displayed in the color set up in the System Settings.

*2 An error of the proportional distribution system is judged as restored when the balloon has disappeared.

NOTE

- When the statuses of management points connected to the iTM vary, that with the highest priority is displayed with an icon. The order of priority is as follows:
 "Maintenance" < "Stop/No operation" < "Setback Inactive" < "Setback Active" < "Operating"
 < "Communication Error" < "Unit/Limit Error" < "System error" < "Emergency Stop" < "Network Error"

- **Contact Tab (Information Screen)**

This screen is displayed when you touch the Contact tab on the Information screen.

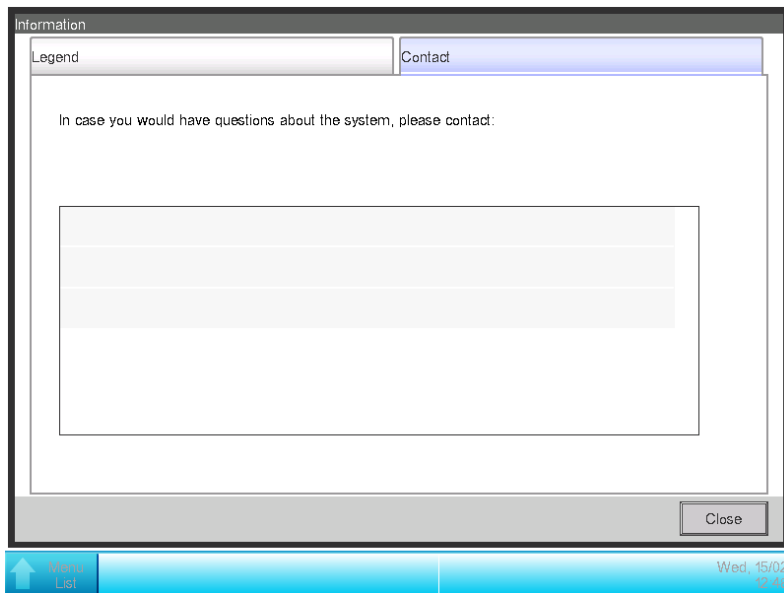

Displays contact information set up by the service person.

NOTE

Contact information displayed here are contacts regarding iTM integrator. Please note that they are not contacts regarding iTM unit.

- **Operation Mgmt. Tab (Menu List Screen)**

This screen is displayed when you touch the Menu List switch button on the iTM integrator Standard view.

The setup method is the same as that of the iTM unit. See “4-5 Menu List Screen”.

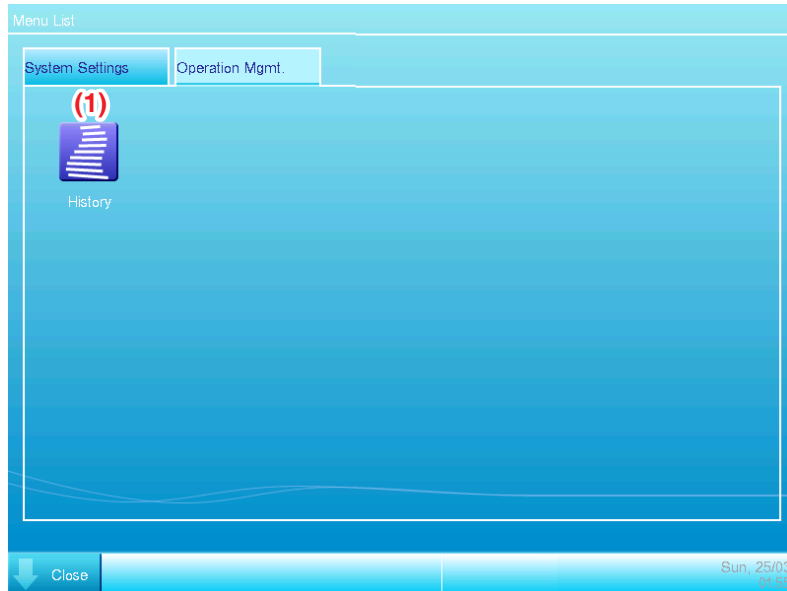

(1) History button

Sets up history management of error occurrence, status change, control information, etc. for the iTM integrator.

NOTE

Settings described here are iTM integrator settings. Please note that they are different from those of the iTM unit.

- **System Settings Tab (Menu List Screen)**

This screen is displayed when you touch the System Settings tab on the iTM integrator Menu List screen.

The setup method is the same as that of the iTM unit. See “4-5 Menu List Screen”.

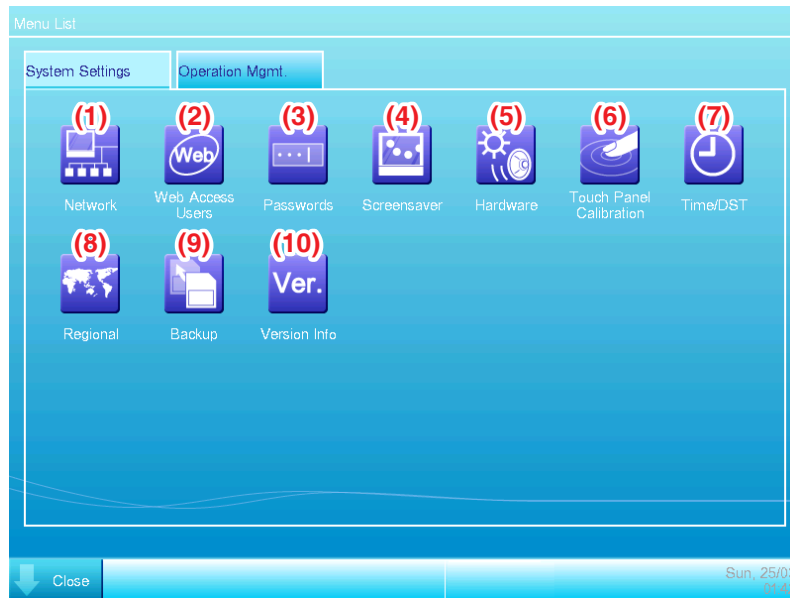

(1) Network button

Sets up the network IP addresses as well as Web Servers.

(2) Web Access Users button

Sets up Web users for Web Remote Management.

In iTM integrator, only managers are permitted. The maximum number of managers that can be registered is 4.

(3) Passwords button

Sets up the password for unlocking.

(4) Screensaver button

Changes the screensaver as well as cancels the screensaver during errors.

(5) Hardware button

Sets up the luminance of the screen as well as the volume for the touch sound and buzzer.

(6) Touch Panel Calibration button

Corrects the touch panel calibration.

(7) Time/DST button

Sets up the current time and the daylight saving time.

(8) Regional button

Sets up the language to use, date and time format, decimal point and delimiter, and icon color to be used in the iTM integrator.

NOTE

The unit of temperature follows the locale of the accessed iTM unit.

(9) Backup button

Exports the iTM integrator backup data to USB memory.

(10) Version Info button

Displays the iTM integrator version information.

NOTE

Settings described here are iTM integrator settings. Please note that they are different from those of the iTM unit.

Cautions when using the iTM integrator

Operation and setup of the iTM integrator unit, and remote operation and setup by accessing to an iTM from the iTM integrator are basically equivalent to the operation and setup performed in the iTM unit. For details, see their respective pages.

The following describes functions specific to the iTM integrator and cautions when using it.

iTM integrator and iTM Version

To control iTM using iTM integrator, the iTM integrator must be installed with a software version compatible with the software of the iTMs to control.

If the software is not compatible, iTM issues a communication error with a record of the cause in the history. Consult a service person.

Access to iTM

Simultaneous access to an iTM unit via iTM integrator is allowed to 5 users.

However, multiple users cannot simultaneously open the same setup screen.

History function

The history displayed from the Operation Mgmt. tab of the iTM integrator Menu List screen is the history of the iTM integrator unit (can save up to 10,000 records).

To check the history of each iTM, access the target iTM from the iTM integrator Standard view screen and display history from the iTM's Menu List screen.

To output iTM integrator history data, output it to a USB memory connected to the iTM integrator.

Locale

The iTM integrator's System Settings allows you to set up the language to use, date and time format, decimal point and delimiter, and icon color. These settings also apply when displaying the screen of an iTM accessed from the iTM integrator.

However, these settings are iTM integrator's settings and not of the accessed iTM. The locale of the accessed iTM unit remain as respectively set up and will not change as a result of an operation from the iTM integrator.

The unit of temperature follows the locale of the accessed iTM unit (the view on the iTM integrator cannot be changed either).

Emergency Stop and Error Information

When an emergency stop/system error/equipment error/monitoring error has occurred in any iTM connected to the iTM integrator, a buzzer will sound if the buzzer is set to ON in System Setting of iTM integrator.

The steps for releasing and checking an emergency stop or error Information are the same as for the iTM unit.

If any event has occurred in iTM, one of the balloons below will be displayed as a prompt.



Data input/output

Similarly to when operating on the iTM unit, you can input/output various data even when accessing the iTM from the iTM integrator. In this case, input/output is performed using a USB memory connected to the iTM integrator unit.

Data you can import/export are as follows:

- Setup export
- History
- Power proportional distribution data (optional)
- Energy Navigator data (optional)

The output files are named in a similar way as when output by the iTM unit. However, the iTM integrator automatically creates and saves the output file in a folder named with the iTM controller name and its IP address, [controller name]_[IP address], to indicate the iTM (i) that output the file, and manage files per iTM.

However, how the folder is created and the file saved may vary depending on the USB memory's internal status. See the following table.

USB memory's internal status		Creation and save method
No target folder in USB memory's root directory	No file with the same name in USB memory	Create new target folder and save
	File with the same name in USB memory	Delete file of the same name, create new target folder and save
Target folder present in USB memory's root directory		Save in the existing folder

iTM unit settings change

iTM unit screen switching, or restart, etc. may occur as a result of iTM settings change from the iTM integrator. See the following table.

Setting contents	Timing	Result
iTM restart causing settings change	When restart starts	The iTM unit restarts
Area deletion	When the "Yes" button is pressed on the deletion confirmation dialog	Displays the top screen of the Standard Icon view of the iTM screen. If a setup screen is open, the settings in progress are canceled.
Area member registration	When the "OK" button is pressed on the Registration screen	
Area attributes change	When the "OK" button is pressed on the Area Attribute Setup screen	
Area move	When the "OK" button is pressed on the Area Move screen	
Management point setup	When the "OK" button is pressed on the Mgmt. Points Attributes Setup screen	
Centralized Monitoring Setup change	When the "OK" button is pressed on the Centralized Monitoring Setup screen	
Confirm Setup change	When the "OK" button is pressed on the Confirm Setup screen	
Changeover Option change	When the "OK" button is pressed on the Changeover Option screen	

Disconnection of communication with iTM

The iTM integrator accesses the iTM via a network. Therefore, communication with iTM may be disconnected. Furthermore, communication may be disconnected due to power interruption in the iTM unit, or initialization due to settings change.

If communication is disconnected when a screen of the accessed iTM is open on the iTM integrator, the messages described in the following table are displayed.

Reason	Timing	Message
iTM restart causing settings change	When iTM is shut down	<Controller name> Communication disconnected. Wait a moment to access again.
iTM power interruption	When iTM power goes down	
Communication down due to network causes	When communication goes down	
Area deletion	When the "Yes" button is pressed on the deletion confirmation dialog	<Controller name> System settings changed. Please access again.
Area member registration	When the "OK" button is pressed on the Registration screen	
Area attributes change	When the "OK" button is pressed on the Area Attribute Setup screen	
Area move	When the "OK" button is pressed on the Area Move screen	
Area CSV input	When the "Yes" button on the confirmation dialog is pressed and saving is successful	
Management point setup	When the "OK" button is pressed on the Mgmt. Points Attributes Setup screen	
iTM unit's locale change	When the "OK" button is pressed on the Locale screen	
Centralized Monitoring Setup change	When the "OK" button is pressed on the Centralized Monitoring Setup screen	
Confirm Setup change	When the "OK" button is pressed on the Confirm Setup screen	
Changeover Option change	When a Changeover Option is changed	

Web user

Web Remote Management from the iTM integrator is permitted to managers only, and the maximum number of managers you can register is 4.

Maintenance

13. Maintenance

13-1 Resetting the Filter Sign

Reset filter sign after cleaning the air conditioner with the sign ON.



1. Select **(1)** with the filter sign ON on the Standard View screen and touch the **Setting** button **(2)** to display the Detailed Setup screen.

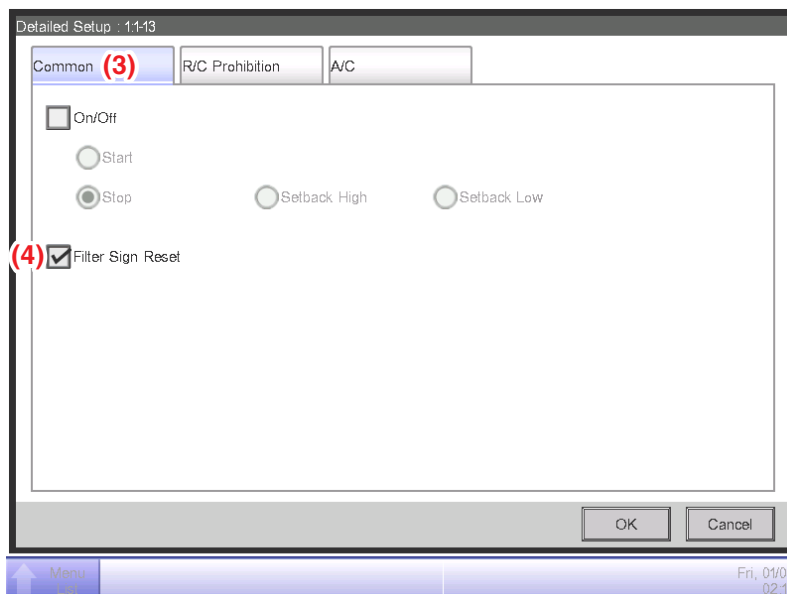

-
2. Touch the **Common** tab (3) of the Detailed Setup screen and display the Common screen. Select the **Filter Sign Reset** check box (4) to enable the reset. Touch the OK button and close the screen.

NOTE

Not selectable when there are no filter signs.

13-2 Maintaining the LCD display

When the surface of the LCD of the iTM or the iTM unit is dirty, wipe the dirt off with a piece of soft cloth soaked in a diluted neutral detergent and wrung sufficiently.



CAUTION

- Do not use strongly acid detergent and organic solvents such as alcohol, paint thinner, or benzene. The print may fade, or wear out and discolor.
- Forcibly rubbing with hard cloth may damage the LCD display. Always use soft cloth to remove dirt.
- Leaving the LCD display with water droplets and/or dirt may stain the LCD or peel off the coating.

Useful Information

14. Troubleshooting

14-1 Before Having the Product Serviced

■ The display of the iTM has gone out.

- Check the MONITOR button LED on the unit.

If it is lit in orange, the monitor is turned off. Press the MONITOR button and turn the monitor on. The LED lights on in green.

- When Backlight Auto Off is set in the screensaver settings of the iTM, the screen goes off if left untouched for a certain period of time.

Touch the screen with your finger. The display will come back on.

■ The backlight does not go out although Backlight Auto is set to OFF.

- Backlight Auto Off is a function that automatically turns the display OFF when the screen is left untouched for a certain period of time.

The display does not go out automatically when it is displaying “Configure/Details”, “System Settings”, etc.

■ The iTM cannot be operated or monitoring does not work.

- Move the sliding front cover. Then, remove the screwed cover and press the RESET button at the bottom right of the iTM.

Pressing this switch restarts the iTM.

(Pressing this switch does not erase area/management point settings, schedules, etc.)

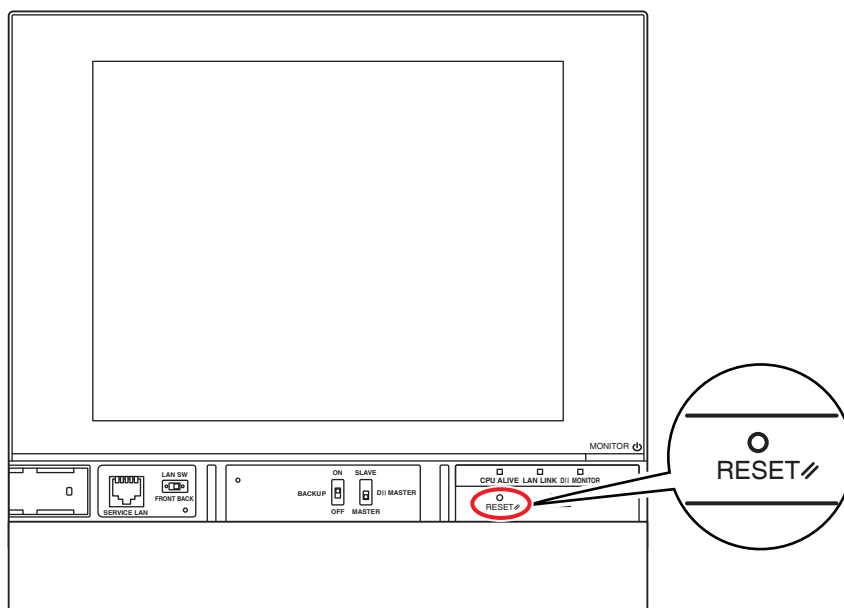

■ The power supply to iTM needs to be shut off.

- Turn on/off the earth leakage breaker to turn on/off the power supply to iTM.

iTM does not have a power on/off switch.

**CAUTION**

- Do not press the switch with excessive force. Doing so may damage the components and cause malfunction.
- If electronic components in the iTM are charged with static electricity, it may cause malfunction.

Be sure to discharge the static electricity accumulated in your body before attempting any operation. To discharge yourself, touch a grounded metal object (control panel, etc.).

- When operating on the Standard View screen, touch sound is heard even when an area not allocated for a button is pressed.
 - The iTM screen is designed to sound wherever it is touched. This is normal.
- The screen flickers at a regular interval.
 - The Standard View screen of the iTM is refreshed every 3 seconds to reflect the air conditioners current status. The screen flickers each time it is refreshed, but this is normal.
- The operation performed by touching the iTM screen takes some time to be reflected on the screen view.
 - Depending on the status of the communication with the connected air conditioners, update of the screen view may take some time. Please wait a few seconds.
- LCD display
 - LCD displays are produced using high precision technology but there may be some dots that never go on, or dots that are permanently on. Furthermore, the LCD display may generate unevenness due to temperature change and the like. However, these are phenomena inherent to LCD panels, and are not faults.
- An indoor unit filter sign is ON on the Standard View screen.
 - The filter sign does not go off even when the air conditioner filter has been cleaned and the cleaning sign has been reset using remote controller.

The filter sign on the Standard View screen is designed to go off only when the cleaning signs for all of the air conditioners in the group are reset.

Check for any air conditioner in the group with the cleaning sign ON apart from the cleaned air conditioner.

■ An air conditioner is not working.

- The air conditioner may be stopped by Interlocking Control. Check the Interlocking Control settings.

Under the following conditions, the air conditioner 1-01 will not work.

(1-00 and 1-01 are both started but thereafter, 1-01 is stopped by Interlocking Control.)

1-00 1-01 schedule starts indoor units 1-00 and 1-01.

When indoor unit 1-00 is ON, 1-01 is stopped by Interlocking Control.

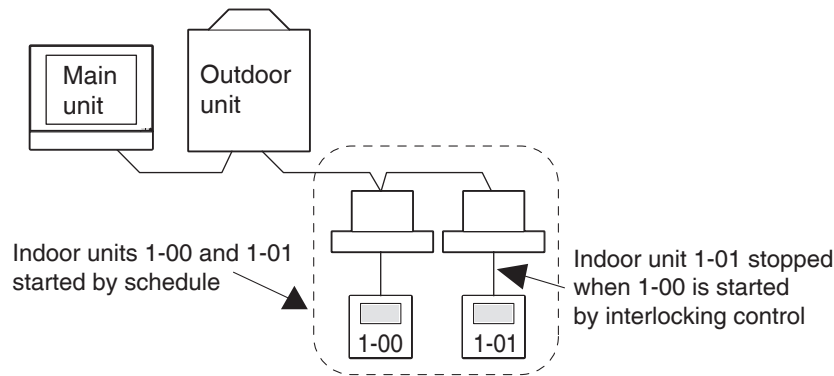

In the case above, Interlocking Control stops 1-01 though it was started by Schedule. ⇒ It looks as if it is not working.

When setting up a schedule or interlocking control, carefully consider interaction with other schedule programs and interlocking programs.

■ Other equipment stops when an indoor unit and the like are started from iTM. (Unexpected behavior)

- Check interlocking control settings.

Interlocking Control function may be set to stop other equipment when an indoor unit is put into operation.

Check the settings as indicated below.

1. Check interlocking control settings using the batch settings output function.

For details of the batch settings output function, see page 137.

2. Check control state of the relevant equipment in the history.

For details of History function, see page 135.

■ An indoor unit cannot be started using remote controller.

- Remote controller may be disabled.

An indoor unit may not be started/stopped, or its operation mode, set temperature changed depending on the remote controller operation settings.

Check remote controller operation settings from the Standard View screen (List View) or R/C Prohibition tab of the Detailed Setup screen.

For details of remote controller operation settings, see page 41.

■ An area or indoor unit cannot be operated from the Standard View screen.

- Check the Standard View screen for the “Emergency Stop” icon, as shown in the figure below.

“Emergency Stop” is displayed in the following cases:

An emergency stop order has been received by the central control device (centralized management controller, ON/OFF controller, etc), including the iTM. If an emergency stop order is received, all air conditioners connected to the iTM will stop by default. Furthermore, operating air conditioners from a central control device or remote controller is impossible while an emergency stop order is present.

The “Emergency Stop” icon will disappear and operation from the iTM will become possible when the emergency stop order stops.

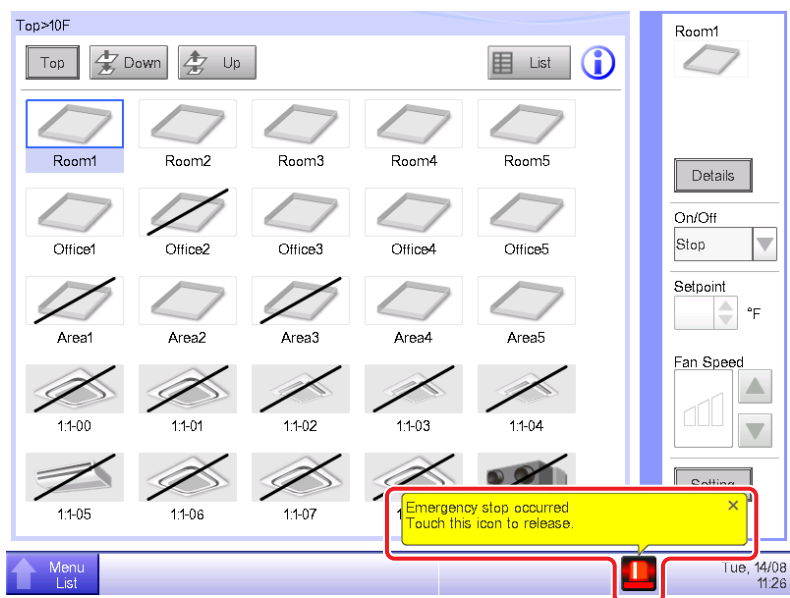

■ Starting/stopping air conditioners is not possible from the Standard View screen.

- Check the monitoring screen for the “Central controlled” sign, as shown in the figure below.

In “Central controlled”, iTM is left for monitoring only if a higher level central device (Interface for use in BAC net, etc.) is given priority.

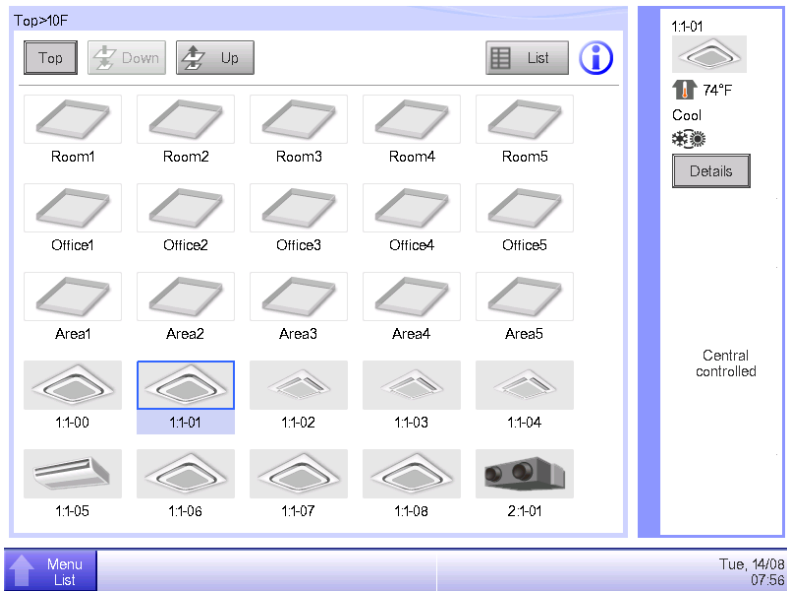

■ The Setting button is not available for touch on the Standard View screen.

- “Prohibit Manual Operation” may be set up for the selected management point.

If “Manual Disable” is displayed in the List View as shown in the figure below, “Prohibit Manual Operation” is set up.

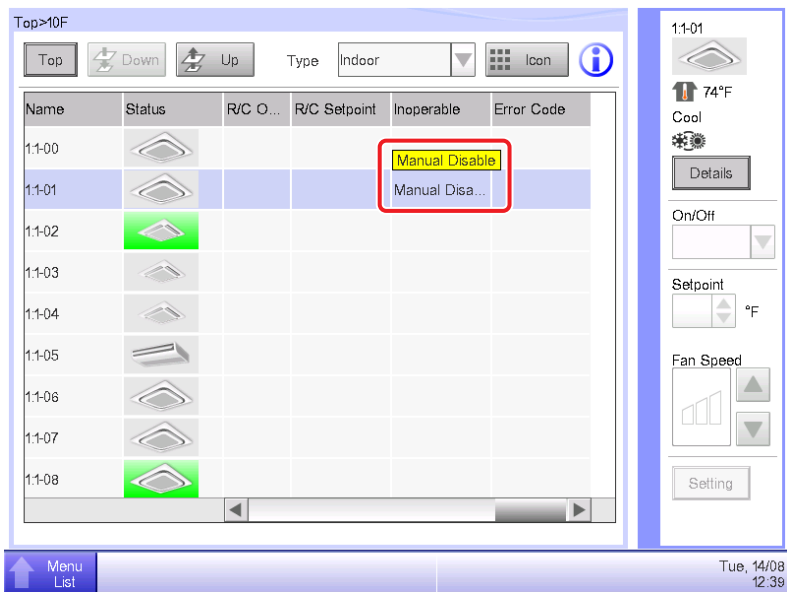

■ R/C Prohibition is not displayed.

The Setpoint Restriction is not displayed in the Area/Management Point List on the System Settings screen.

- When a higher level central device (Interface for use in BACnet, etc.) is connected, R/C Prohibition and Setpoint Restriction become unavailable. Furthermore, when there are two iTMs connected, R/C Prohibition and Setpoint Restriction are unavailable for the iTM set as sub.

■ Air conditioners cannot be started or stopped as the iTM went out of order when remote controller operation is disabled.

- Turn off the circuit breaker of the iTM power supply as an emergency measure until a service person looks into the trouble. By doing so, operating the air conditioners from the remote controller will become possible in about 5 minutes.

If there are other central control devices than the iTM connected, turn off the power to all central control devices once.

■ Communication error is displayed for indoor units and the like.

- The status of indoor units may not display (communication error) immediately after a start that follows an iTM restart, etc.

Please wait; conditions will become normal in about 10 minutes at most.

■ File output to a USB memory fails.

iTM provides multiple functions such as Backup and Setup Export for outputting files to a connected USB memory.

Check the following items if file output to a USB memory fails.

- Free space of the destination USB memory is not enough.
Check free space of the USB memory. (5 GB or more is recommended)
- The destination USB memory is write protected.
Unlock the write protection before use.
For how to unlock, see the instruction manual or etc, of the USB memory used.
- The destination USB memory contains a file of the same name.
Move the file contained in the USB memory to a computer.
Change the name of the file contained in the USB memory.
Delete the file contained in the USB memory. (Confirm that deleting the file does not cause a problem.)
- The USB memory is not connected to iTM.
Connect the USB memory to iTM and output the file again.
- The USB memory is disconnected during file output.
Do not disconnect the USB memory during file output.
Connect the USB memory to iTM and output the file again.

■ The screen for the Web access function is not displayed correctly.

- Network settings may be at fault.

Correct network settings are necessary for using the Web access function.

For details of network settings, see page 205.

- Screen may not display correctly if old content is stored in the browser's cache.

When accessing iTM with a PC, the following message is displayed if old content is stored in the browser's cache.

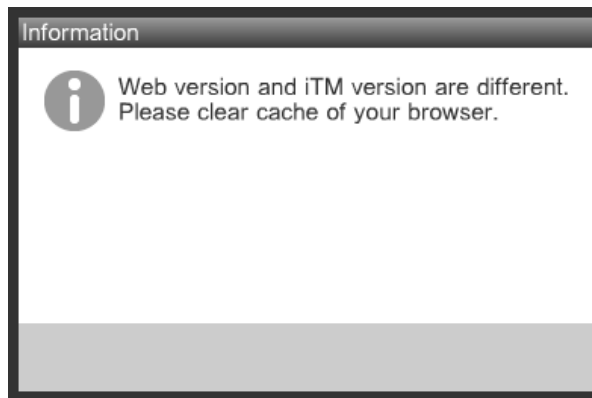

Clear the browser's cache using the procedure below.

<With Internet Explorer>

1. Select [Tools] – [Internet options] from the menu bar.

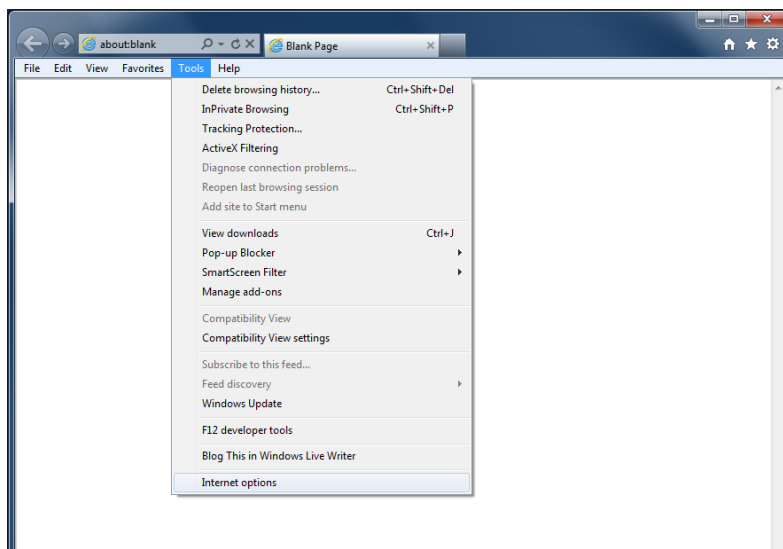

2. On the **[General]** tab, click the **[Delete]** button under **[Browsing history]**.

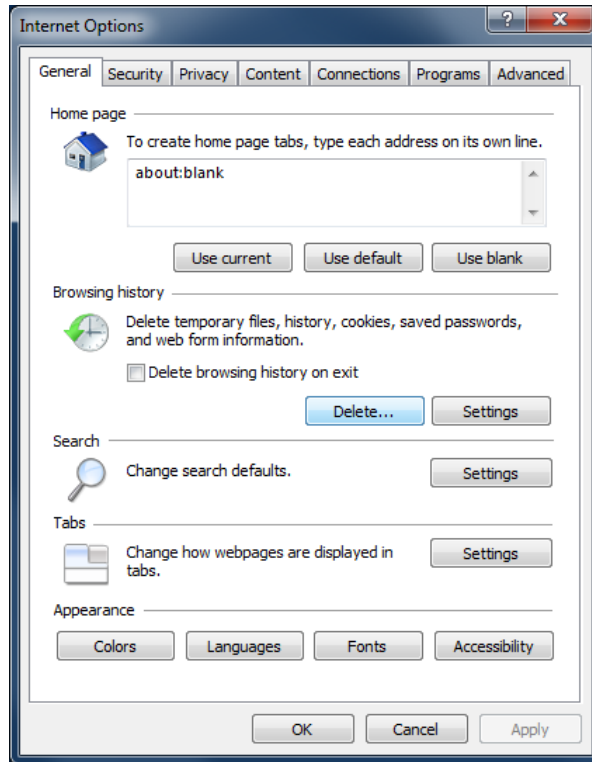

3. Select **[Temporary Internet files]**, **[Cookies]** and **[History]**, and then click the **[Delete]** button.

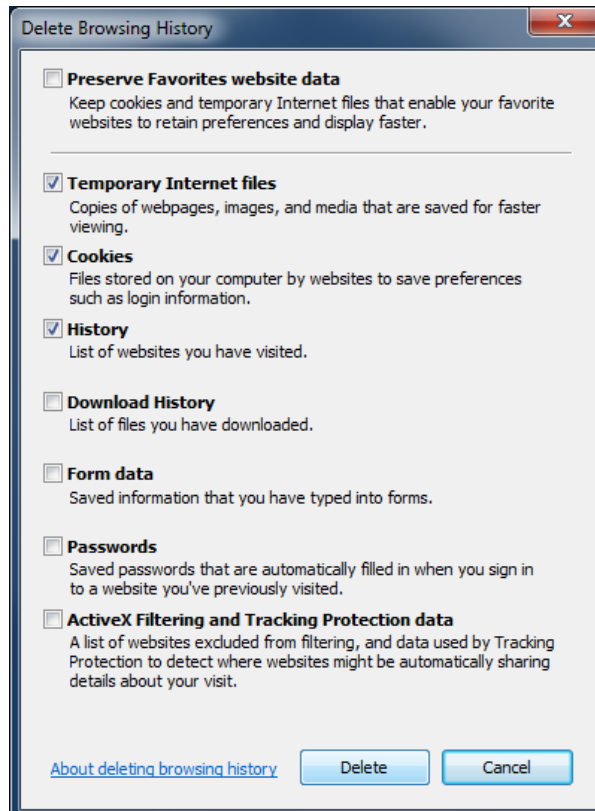

<Screen does not display correctly even after clearing the Internet Explorer's cache>

1. Select **[Tools]** – **[Internet options]** from the menu bar.

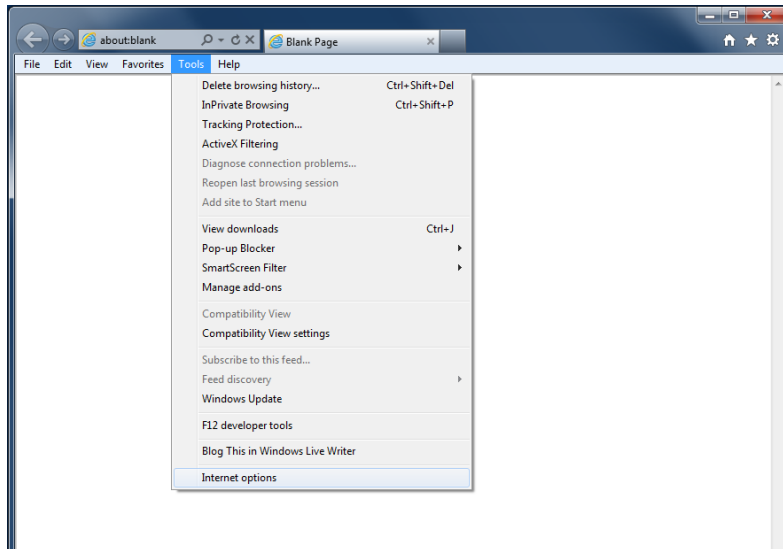

2. On the **[General]** tab, click the **[Settings]** button under **[Browsing history]**.

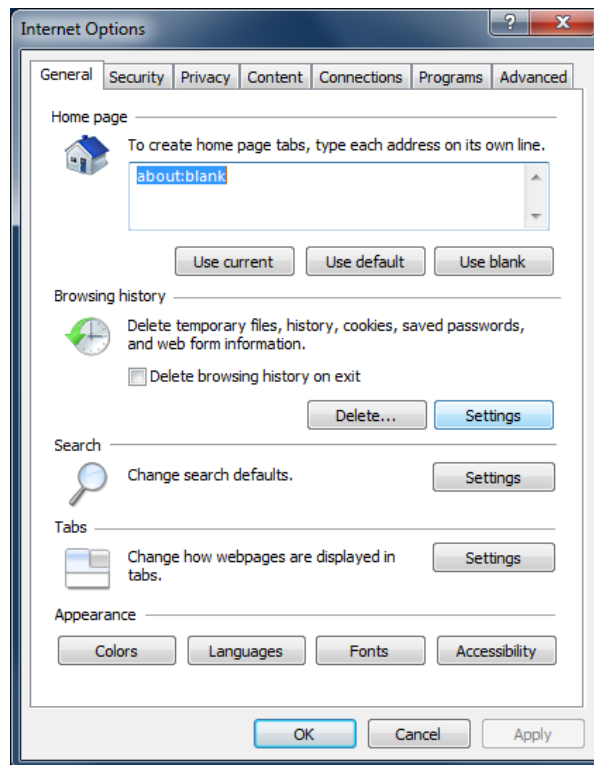

-
3. Select the **[Every time I visit the webpage]** radio button under Check for newer versions of stored pages, and click the **[OK]** button.

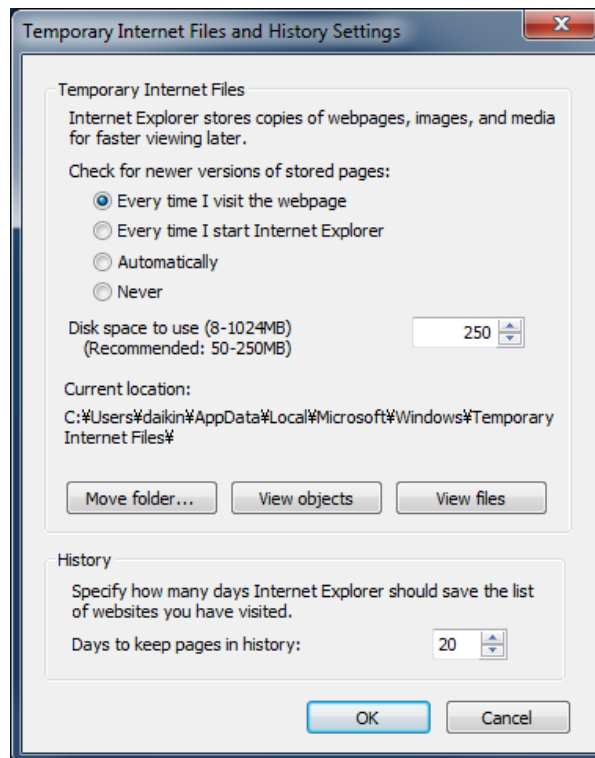

<With Firefox>

1. Select **[Tools]** – **[Clear Recent History]** from the menu bar.

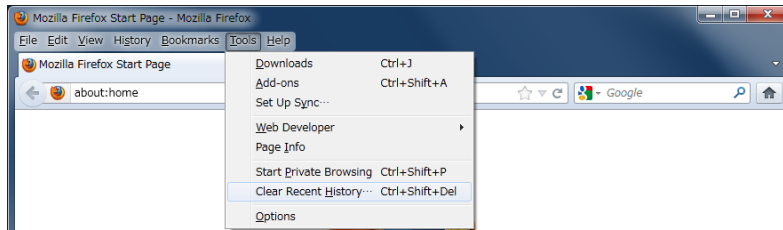

2. Select **[Everything]** from Time range to clear and **[Cookies]**, **[Cache]**, **[Active Logins]** and **[Site Preferences]** from Details, then click the **[Clear Now]** button.

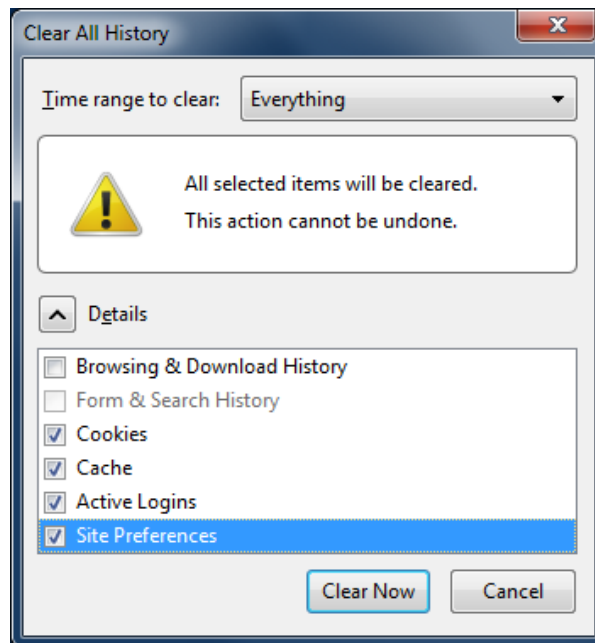

14-2 Turning ON/OFF the Internal Battery

The iTM is equipped with an internal battery to feed the clock during power failures and shutdown. The internal battery is turned ON/OFF by using the **BACKUP** switch (1). The BACKUP switch is located beneath the screwed cover that appears when the unit's sliding front cover is moved. (See figure below.) Normally, it is set to ON.

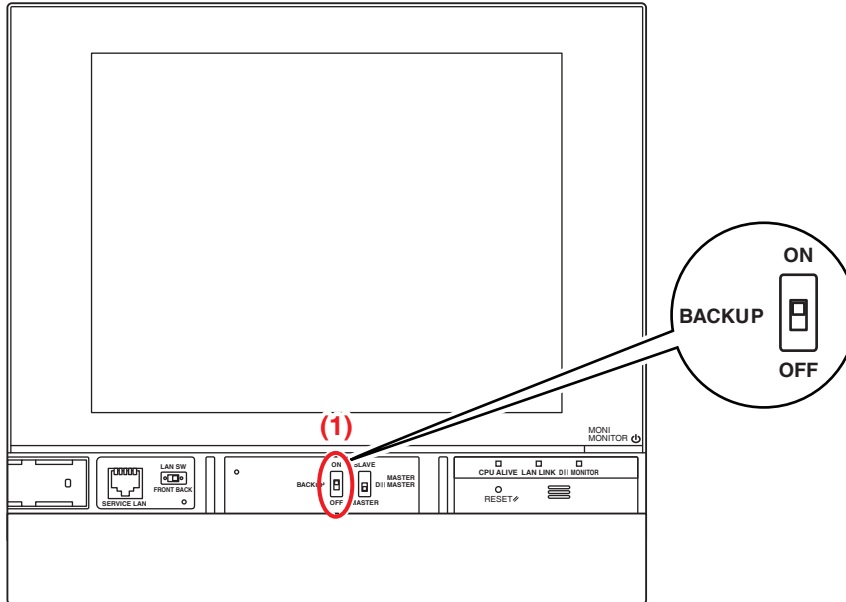

When Turning OFF the Unit for a Long Time

When leaving the controller turned OFF for a long time (6 months or more), set the BACKUP switch to OFF.

(Setting this switch to OFF does not erase area/management point settings, schedules, etc.)

- If power is not supplied to the iTM for a long time, the battery may discharge completely.
- When starting to use the iTM again, set the BACKUP switch to ON.



CAUTION



- Do not touch other switches.
- Do not turn the switch ON/OFF with excessive force. Doing so may damage the components and cause malfunction.
- If electronic components in the iTM are charged with static electricity, it may cause malfunction. Be sure to discharge the static electricity accumulated in your body before attempting any operation.

To discharge yourself, touch a grounded metal object (control panel, etc.).

14-3 Error Information Function

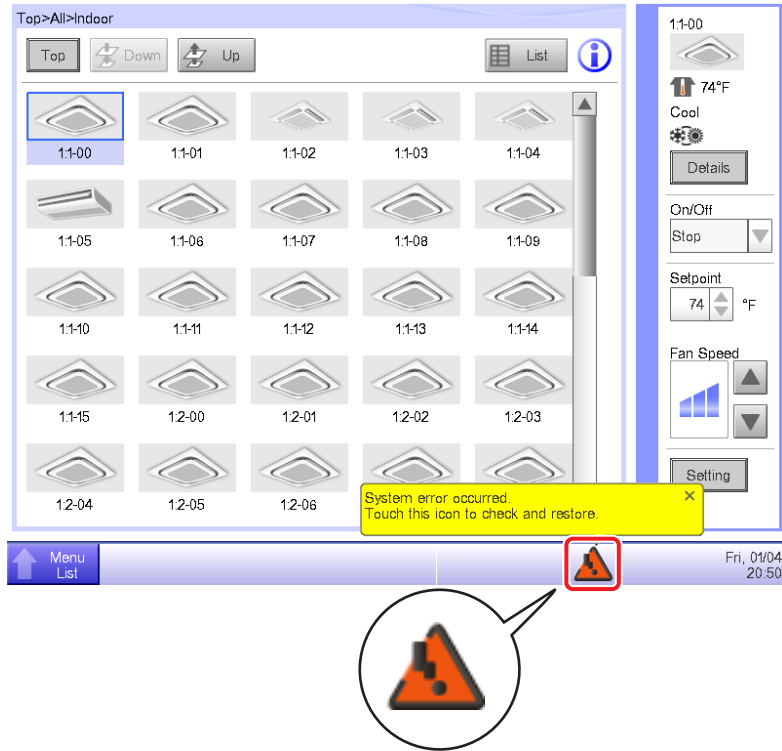
When an error occurs, the management point where the error occurred can be checked from the group monitoring icon indicating error displayed on the Standard View screen.



1. When an error is detected, it is notified by a flashing  or , and displaying a balloon. If set up, the buzzer will also sound.



Flashing: System error

(Red)

Text: System error occurred. Touch this icon to check and restore.



Flashing: Unit/Limit Error

(Yellow)

Text: Error occurred. Touch this icon to check.



ON: Communication error * Neither will the buzzer sound nor a message appear.

(Blue)

Touching the icon displays the Error Information dialog.

NOTE

Touching the icon when privilege restriction is set up displays the Password Input dialog.
Entering the correct password displays the Error Information dialog.

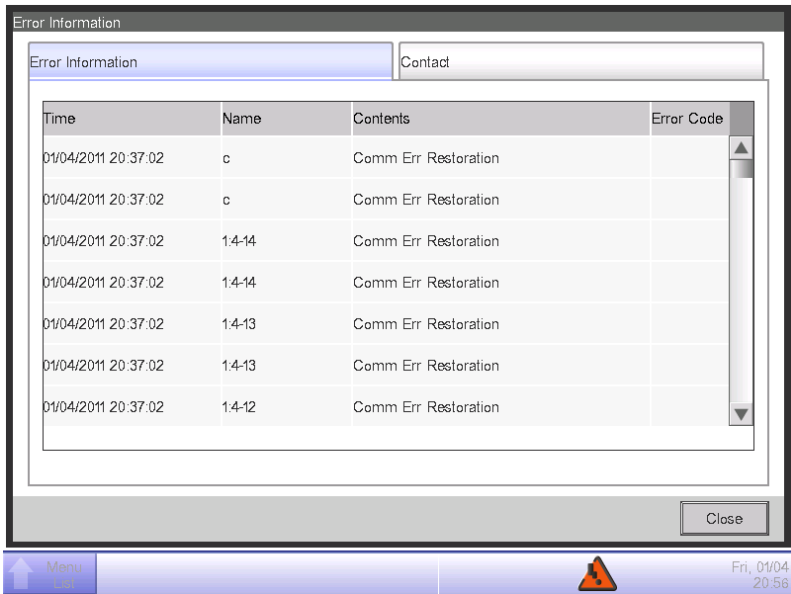

2. The Error Information dialog displays a list of errors.

The information provided in the list is as follows:

Time: The time the error occurred

Name: The name of the management point/system where the error occurred

Contents: The content of the error

Error Code: The error code

Contact an authorized dealer registered in the following Contact screen.

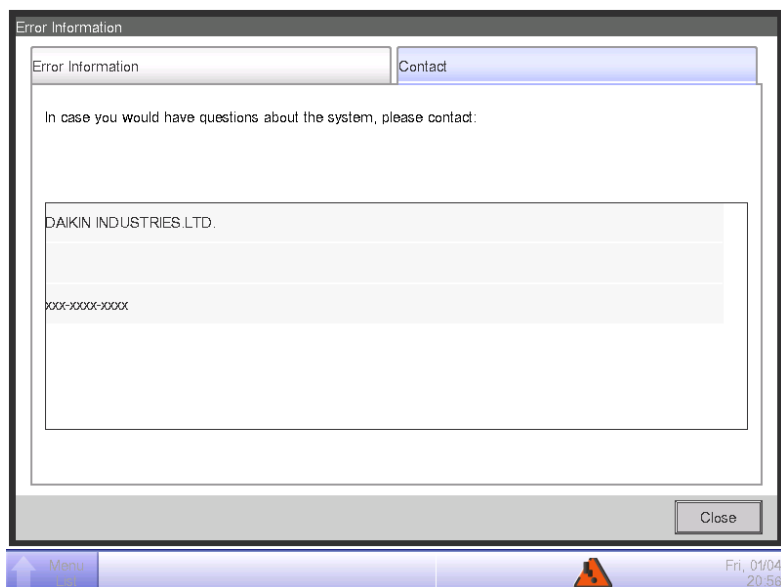

NOTE

Once listed system error such as equipment error/Analog error/power proportional distribution (Optional) will not be displayed again.

15. Hardware Specifications

15-1 iTM Hardware Specifications

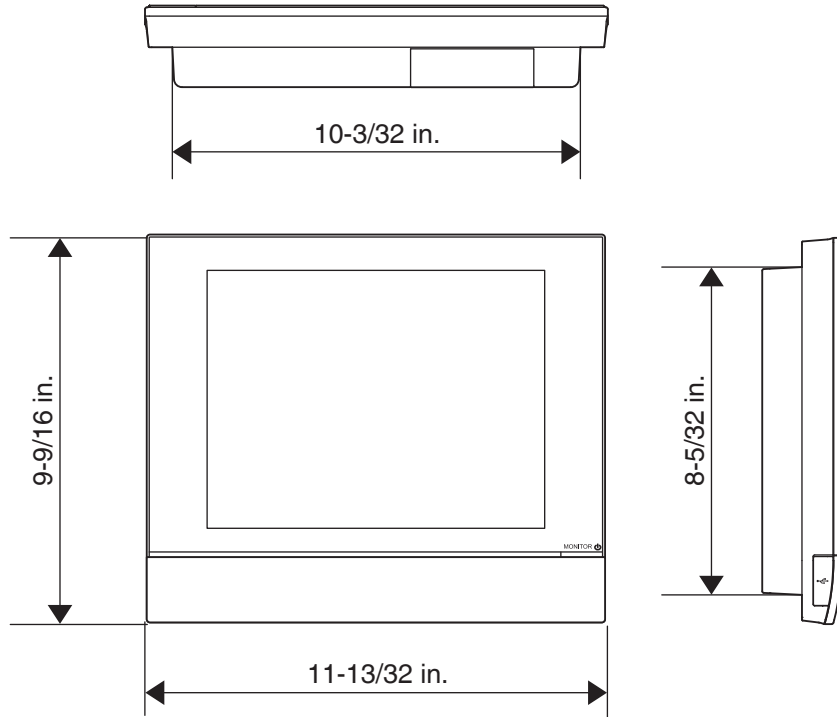

Power	24VAC 60Hz
Power consumption	23 W
Emergency stop input	Always "a" contact Contact current approximately 10 mA
Size	11-13/32 × 9-9/16 × 1-31/32 (W × H × D)
Weight (Mass)	5.3 Lbs
Time accuracy	Within -195.7 to 79.1 sec/month
Operating temperature range	32 - 104°F
Operating humidity range	85% or less

15-2 Peripheral Equipment Specifications

Function	Required Specification
PC for Web Remote Management	OS: Windows XP Professional SP3 (32 bit) Windows Vista Business SP2 (32 bit) Windows 7 Professional SP1 (32 bit, 64 bit) CPU: Equivalent to Intel Core 2 Duo 1.2GHz or higher Memory: 2 GB or more Free HDD space: 10 GB or more Network: 100Base-TX or higher Display resolution: 1024 × 768 or higher
Network	100Base-TX Real transfer rate: 115 kbps or higher
USB memory	USB2.0 Memory capacity: 8 GB (Free space: 5 GB) or more, 32 GB recommended. ==Recommended product (Operation confirmed)== Kingston Data Traveler Generation 3 (G3) 32 GB
Supported security software	McAfee 2011 Norton 2011 Virus Buster 2011
Flash Player	Version 11.1
Web browser	Internet Explorer 8, 9 Firefox 10.0

15-3 Copyright and Trademarks

- SDHC Logo is a trademark of SD-3C, LLC.



- The real-time OS “eT-Kernel,” the network protocol “PrCONNECT/Pro,” the file system “PrFILE2,” and the USB stack “PrUSB” installed on this product are products of eSOL Co., Ltd.
- Fugue © 1999-2011 Kyoto Software Research, Inc. All rights reserved.
- The TrueType font used by this product is a product of Ricoh Company, Ltd.

Appendix

■ iTM Monitoring Control Functions

Setting location		Number of settings	
Central Monitoring	Area	Number of areas that can be created	Up to 650 (All excluded)
		Total number of management points that can be registered in areas	Up to 1300
		Number of management points that can be registered in one area	Up to 650
		Number of hierarchical levels	Up to 10
	Management point * The total of all management points is 650.	Indoor unit management point	Up to 512
		Outdoor unit management point	Up to 80
		External management point	Up to 512 (Total of External management point, BACnet management point and Internal.Ai)
		BACnet management point	
		Unit's port management point	Up to 32
		Internal Pi management point	Up to 80
	Layout View screen	Number of images that can be used in a layout	Up to 60
		Number of icons that can be placed in one image	Up to 100
	History	Number of records that can be saved	Up to 100,000 (iTM) Up to 10,000 (iTM integrator) * Including the number of internal development records. The internal development records cannot be viewed.
	Automatic Control function	Schedule function	Number of schedule programs
Number of schedule patterns			Weekly: 7 patterns Special day: 5 patterns
Number of events			Up to 20 per schedule
Yearly calendar		Calendar view	1 year
		Maximum number of calendars that can be registered	40
Interlocking Control function		Number of interlocking programs	Up to 500
		Number of management points that can be used as input	Up to 50
		Number of events for Output1	Up to 25
		Number of events for Output2	Up to 25
Emergency Stop function		Number of emergency stop programs	Up to 32 (Including the Default program)
		Number of management points that can be registered in one group	Up to 650
		Number of management points that can be used in an emergency stop signal	Up to 6
Auto Changeover function		Number of groups that can be created	Up to 512
		Number of management points that can be registered in one group	Up to 64
Temperature Limit function		Number of groups that can be created	Up to 8
		Number of management points that can be registered in one group	Up to 512
Sliding Temperature function		Number of groups that can be created	Up to 8
		Number of management points that can be registered in one group	Up to 512
		Number of Ai management points that can be registered in one group	Up to 1
HMO function	Number of management points that can be controlled with HMO	Up to 512	
Timer Extension function	Timer Extension times	Selectable from 30 Min, 60 Min, 90 Min, 120 Min, 150 Min, 180 Min	

Setting location			Number of settings	
Automatic Control function	Setback function	Relative Setup Setpoint	Selectable from 2 to 12 for both Setback High and Setback Low	
		Relative Setback Setpoint		
		Recovery setpoint	Selectable in the range Cool Recovery Temperature: 2 to 10 Heat Recovery Temperature: 2 to 10	
Data management function	Power Proportional Distribution Function	Maximum number of Power Proportional Distribution groups	Up to 80	
		Number of input ports that can be registered in one group	Up to 80	
		Number of management points that can be registered in one group	Up to 512	
		Special PPD calculation range	For the last year from the day the screen is opened	
	PPD data output	Data retention days	Up to 13 months	
	Excluded Time setting	Excluded Time periods	Weekly: 7 patterns	
	Energy Navigator function	Energy Budget /Actual Management	Planned energy consumption	Reduction rate of 0 to 100 with respect to previous year can be entered Input planned annual energy consumption Input planned monthly energy consumption for January to December
			Actual energy consumption registration	Conversion factor of 0 to 9999.999 can be entered
			Number of Energy Groups	Up to 30
		Number of Pi management points that can be registered in one group	Up to 100	
		Number of energy types that can be registered	Up to 30	
		Energy conversion factor registration	1 for each energy type	
		Number of operation rules that can be created	Up to 10	
		Operation rule patterns	Weekly: 7 patterns	
			Special day: 5 patterns	
		Detailed operation rules	10 patterns	
Sampling period		15 days		
Timer Extension sampling period		15 days		
Setpoint gap sampling period	15 days			
Data export	For the last year from data collection start month			
Month of year setting	1 to 12			
Eco Mode function	Setpoint shift control	Temperature shift range	Decrease the temperature settings by 1 to 7°F Increase the temperature settings 1 to 7°F	

Setting location			Number of settings	
Remote access function	Web Remote Management function	Number of Web Users that can be registered	Up to 4 Managers Up to 60 Users	
		E-Mail Error Report function	SMTP Server settings	SMTP server address: 0 to 128 characters SMTP server port No.: 1 to 65535 Authentication method: No Authentication POP before SMTP SMTP-AUTH POP server address: 0 to 128 characters POP server port No.: 1 to 65535 User ID: 0 to 64 characters Password: 0 to 64 characters can be set
	Condition for transmission		Recipients: Up to 512 management points Resend interval: 1 to 72 hours Site name: 0 to 20 characters	
	E-mail		Up to 10 To E-mail addresses Up to 10 From E-mail addresses	
	System functions	System Settings function	Passwords	Administrator password
Screen unlock password				1 to 15 characters
Management point, area settings			See Central Monitoring.	
Time/DST Setup			Date/Time	From 2010/1/1 0:0:0 to 2036/12/31 23:59:59
			Daylight Saving Time Settings	Start Date: Month Jan to Dec The Week 1st to 4th, Last Day of the week Mon to Sun Time 1:00 to 4:00 End Date: Month Jan to Dec The Week 1st to 4th, Last Day of the week Mon to Sun Time 2:00 to 4:00
Network			Host name	1 to 63 characters
			IP Address	1 to 223, 0 to 255, 0 to 255, 0 to 255
			Subnet Mask	0 to 255, 0 to 255, 0 to 255, 0 to 255
			Default Gateway	1 to 223, 0 to 255, 0 to 255, 0 to 255
			Preferred DNS	or
			Alternate DNS	0, 0, 0, 0
	Web Server Port Number	1024 to 65535		
Controller Name	1 to 64 characters			
History records	See Central Monitoring.			

Setting location				Number of settings
System functions	Locale function	Language	Available languages	Ten languages are available: English, French, German, Italian, Spanish, Dutch, Portuguese, Chinese, Japanese, Korean
		Time Zone Settings	Available time zones	30
		Date Display	Available date formats	Three patterns available: "DD/MM/YYYY", "MM/DD/YYYY", "YYYY/MM/DD"
		Decimal point	CSV separator	"." "," or ".",""
		Unit of temperature	Temperature symbol	°C, °F
		Icon color	Icon color	Red, green
	Changeover function		Number of management points to which it is possible to set the Changeover option	Up to 512
	Controller Setup		Error detection level	Regard/Not regard Warning as Error level
			Operation mode (Dry)	Dry enable/disable
	Hardware		Luminance	8 levels, between 1 and 8
			Buzzer volume	6 levels, between 0 and 5
			Buzzer duration	Four patterns: 1 min, 3 min, 5 min, Continuous
			Touch volume	6 levels, between 0 and 5
	Management data registration		See Central Monitoring.	
	Screensaver		Screensaver settings	Disable, Backlight off, Screensaver1 to 3
			Idle time	1 to 60 minutes
Screen Saver OFF on error			Enable/Disable	
Contact Information		Contact entries	Up to 3 lines	

DAIKIN AC (AMERICAS), INC.

1645 Wallace Drive, Suite 110
Carrollton, TX 75006 USA

info@daikinac.com
www.daikinac.com

DAIKIN INDUSTRIES, LTD.

Head office:

Umeda Center Bldg., 2-4-12, Nakazaki-Nishi,
Kita-ku, Osaka, 530-8323 Japan

Tokyo office:

JR Shinagawa East Bldg., 2-18-1, Konan,
Minato-ku, Tokyo, 108-0075 Japan