



Cisco 800 Series Integrated Services Routers Software Configuration Guide

First Published: January 01, 2009

Last Modified: July 22, 2014

Americas Headquarters

Cisco Systems, Inc.
170 West Tasman Drive
San Jose, CA 95134-1706
USA
<http://www.cisco.com>
Tel: 408 526-4000
800 553-NETS (6387)
Fax: 408 527-0883

Text Part Number: OL-31704-02



CONTENTS

Preface

Preface xxv

Audience xxv

Document Organization xxv

Document Conventions xxvii

Related Documentation xxviii

Obtaining Documentation and Submitting a Service Request xxix

CHAPTER 1

Product Overview 1

Information About Cisco 800 Series ISRs 1

Cisco 860 Series ISRs 1

Features of Cisco 860 Series ISRs 2

4-port 10/100 FE LAN Switch of Cisco 860 Series ISRs 2

Security Features for Cisco 860 Series ISRs 2

802.11n Wireless LAN Option for Cisco 860 Series ISRs 2

Features of Cisco 860VAE Series ISRs 2

General Features of Cisco 860 VAE Series Routers 2

Interfaces of Cisco 860 VAE Series ISRs 4

IOS Images for Cisco 860 VAE Series ISRs 5

Cisco 880 Series ISRs 5

Models of Cisco 880 Series ISRs 5

Common Features of Cisco 880 Series ISRs 7

4-port 10/100 FE LAN Switch of Cisco 880 Series ISRs 7

802.11n Wireless LAN Option of Cisco 880 Series ISRs 7

Real-Time Clock of Cisco 880 Series ISRs 7

Security Features of Cisco 880 Series ISRs 8

Voice Features of Cisco 880 Series ISRs 8

Cisco 890 Series ISRs 8

8-port 10/100 FE LAN Switch of Cisco 890 Series ISRs	9
802.11n Wireless LAN Option of Cisco 890 Series ISRs	9
Real-Time Clock of Cisco 890 Series ISRs	9
Security Features of Cisco 890 Series ISRs	9
Cisco 810 Series ISRs	10
Features of Cisco 812 Series ISRs	10
3G Features of Cisco 812 Series ISR	10
WLAN Features of Cisco 812 Series ISR	11
Dual Radio of Cisco 812 Series ISR	11
Cleanair Technology of Cisco 812 Series ISR	11
Dynamic Frequency Selection of Cisco 812 Series ISR	11
Platform Features of Cisco 812 Series ISR	11
TFTP with Ethernet WAN Interface Feature of Cisco 812 Series ISR	12
SKU Information for Cisco 812 Series ISR	12
Features of Cisco 819 Series ISRs	12
3G Features of Cisco 819 Series ISRs	12
WLAN Features of Cisco 819 Series ISRs	13
4G LTE Features of Cisco 819 Series ISRs	13
Platform Features of Cisco 819 Series ISRs	13
Security Features of Cisco 819 Series ISRs	13
SKU Information for Cisco 819 Series ISRs	14
Licensing for Cisco 800 Series ISRs	14
Selecting Feature Sets for Cisco 800 Series ISRs	14

CHAPTER 2
Basic Router Configuration 15

Basic Router Configuration	15
Interface Ports	15
Default Configuration	17
Information Needed for Configuration	19
Configuring Command-Line Access	21
Configuring Global Parameters	22
Configuring WAN Interfaces	23
Configuring a Fast Ethernet WAN Interface	23
Configuring the Media Type	24
Configuring a Gigabit Ethernet WAN Interface	25

Configuring a V.92 Modem Interface	26
Configuring a VDSL2 WAN Interface	28
Configuring ADSL or VDSL on Cisco 860VAE and 880VA Multimode ISRs	30
Overview of Cisco 860VAE, 886VA, and 887VA Multimode ISRs	30
ADSL2/2+ Annex M Mode on Over POTS VDSL2/ADSL Multimode Annex A SKUs	31
Configuring Seamless Rate Adaption	31
Configuring UBR+	32
Configuring ADSL Mode	32
Configuring ADSL Auto Mode	32
Configuring CPE and Peer for ADSL Mode	33
Configuring the ATM CPE side	34
Configuring the ATM Peer side	35
ADSL Configuration Example	36
Verifying ADSL Configuration	38
Verifying CPE to Peer Connection for ADSL	39
Configuring VDSL Mode	39
Configuring VDSL Auto Mode	39
Configuring CPE and Peer for VDSL Mode	40
Configuring the VDSL CPE Side	40
Configuring the VDSL Peer Side	41
VDSL Configuration Example	42
Verifying VDSL Configuration	43
Verifying CPE to Peer Connection for VDSL	44
Enabling ADSL2/2+ Annex M Mode on Over POTS VDSL2/ADSL Multimode Annex A SKUs	44
Configuring ADSL2/2+ Annex M mode on Over POTS VDSL2/ADSL Multimode Annex A SKUs.	44
Enabling Seamless Rate Adaption	45
Example Configuration: Seamless Rate Adaption	46
Configuring UBR+	47
UBR+ Example	48
Troubleshooting	48
Configuring the Training Log Using the CLI	49
Capturing the Training Log	49
Halting the Training Log Capture	49

Displaying the Training Log Status and File Location	49
Configuring a G.SHDSL WAN Interface in ATM mode	50
Configuration Example: Configuring a G.SHDSL WAN Interface	53
Verifying G.SHDSL WAN Interface Configuration	53
Configuring a G.SHDSL WAN Interface in EFM mode	54
Configuring the Cellular Wireless WAN Interface	54
Prerequisites for Configuring the 3G Wireless Interface	54
Restrictions for Configuring the Cellular Wireless Interface	55
Data Account Provisioning	56
Verifying Signal Strength and Service Availability	56
Configuring a GSM Modem Data Profile	57
CDMA Modem Activation and Provisioning	58
Configuring a Cellular Interface	60
Configuring DDR	61
Configuring Data Dedicated Transmission Mode (DDTM)	64
Examples for Configuring Cellular Wireless Interfaces	64
Basic Cellular Interface Configuration	64
Tunnel over Cellular Interface Configuration	65
Configuring Dual SIM for Cellular Networks on Cisco 819 Series ISR	66
Configuring Router for Image and Config Recovery Using Push Button for Cisco 819 Series ISR Router	67
Output When Button Is Not Pushed: Example	68
Output When Button Is Pushed: Example	69
Push Button in WLAN AP	69
Configuring WAN Mode on Cisco 860VAE ISRs	69
Enabling WAN Mode	69
Displaying WAN Mode Configuration	70
Configuring the Fast Ethernet LAN Interfaces	72
Configuring the Wireless LAN Interface	72
Configuring a Loopback Interface	72
Configuration Example: Configuring a Loopback Interface	73
Verifying Configuration	73
Configuring Static Routes	74
Example	75
Verifying Static Routing Configuration	75

Configuring Dynamic Routes	75
Configuring Routing Information Protocol	75
Example Configuration: Configuring Dynamic Routing Protocol	77
Verifying RIP Configuration	77
Configuring Enhanced Interior Gateway Routing Protocol	77
Example Configuration: EIGRP	78
Verifying EIGRP Configuration	79

CHAPTER 3**Configuring Ethernet CFM and Y.1731 Performance Monitoring on Layer 3 Interfaces 81**

Configuring a Network Interface Device on the L3 Interface	81
Configuring the NID	82
Configuration Example	83
Verifying the NID Configuration	83
Troubleshooting the NID Configuration	84
Ethernet Data Plane Loopback	84
Restrictions for Configuring Ethernet Data Plane Loopback	85
Configuring External Ethernet Data Plane Loopback	86
Configuration Examples for Ethernet Data Plane Loopback	88
Verifying the Ethernet Data Plane Loopback Configuration	88
Troubleshooting the Ethernet Data Plane Loopback Configuration	89
CFM Support on Routed Port and Port MEP	90
Restrictions for Configuring Ethernet CFM	90
Configuring Ethernet CFM (Port MEP)	91
Configuration Example for Ethernet CFM (Port MEP)	93
Verifying the Ethernet CFM Configuration on a Port MEP	93
Configuring Ethernet CFM (Single-Tagged Packets)	95
Configuration Example for Ethernet CFM (Single-Tagged Packets)	97
Verifying the Ethernet CFM Configuration for Single-Tagged Packets	97
Configuring Ethernet CFM (Double-Tagged Packets)	99
Configuration Example for Ethernet CFM (Double-Tagged Packets)	102
Verifying the Ethernet CFM Configuration for Double-Tagged Packets	102
Troubleshooting Ethernet CFM Configuration	104
Support for Y.1731 Performance Monitoring on Routed Port (L3 Subinterface)	105
Frame Delay	105
Restrictions for Configuring Two-Way Delay Measurement	105

Configuring Two-Way Delay Measurement	106
Configuration Examples for Two-Way Delay Measurement	107
Verifying Two-Way Delay Measurement Configuration	108
Troubleshooting Two-Way Delay Measurement Configuration	110

CHAPTER 4**Configuring Power Management 113**

Monitoring Power Usage with EnergyWise	113
Configuring Power-over-Ethernet	113
Enabling/Disabling Power-over-Ethernet	113
Verifying the Power-over-Ethernet Configuration on the Interface	114

CHAPTER 5**Configuring Security Features 115**

Authentication, Authorization, and Accounting	115
Configuring AutoSecure	116
Configuring Access Lists	116
Access Groups	117
Configuring Cisco IOS Firewall	117
Configuring Cisco IOS IPS	118
URL Filtering	118
Configuring VPN	119
Configuring a VPN over an IPSec Tunnel	121
Configuring the IKE Policy	121
Configuring Group Policy Information	123
Applying Mode Configuration to the Crypto Map	124
Enabling Policy Lookup	124
Configuring IPSec Transforms and Protocols	125
Configuring the IPSec Crypto Method and Parameters	126
Applying the Crypto Map to the Physical Interface	127
Creating a Cisco Easy VPN Remote Configuration	128
Configuring a Site-to-Site GRE Tunnel	131

CHAPTER 6**Configuring Backup Data Lines and Remote Management 135**

Configuring Backup Interfaces	136
Configuring Cellular Dial-on-Demand Routing Backup	137
Configuring DDR Backup Using Dialer Watch	137

Configuring DDR Backup Using Floating Static Route	139
Cellular Wireless Modem as Backup with NAT and IPsec Configuration	140
Configuring Dial Backup and Remote Management Through the Console or Auxiliary Port	143
Example for specifying an IP address for the ATM interface through PPP and IPCP address negotiation and dial backup	147
Configuring Data Line Backup and Remote Management Through the ISDN S/T Port	149
Configuring ISDN Settings	152
Configuring Aggregator and ISDN Peer Router	154
Configuring Gigabit Ethernet Failover Media	155
Configuring Auto-Detect	156
Configuring Third-Party SFPs	157
Example for Configuring Third-Party SFPs	160

CHAPTER 7**Configuring Ethernet Switches 161**

Switch Port Numbering and Naming	161
Restrictions for the FE Switch	162
Ethernet Switches	162
VLANs and VLAN Trunk Protocol	162
Inline Power	162
Layer 2 Ethernet Switching	162
802.1x Authentication	162
Spanning Tree Protocol	163
Cisco Discovery Protocol	163
Switched Port Analyzer	163
IGMP Snooping	163
Storm Control	164
Overview of SNMP MIBs	164
BRIDGE-MIB for Layer 2 Ethernet Switching	164
MAC Address Notification	165
Configuring Ethernet Switches	165
Configuring VLANs	166
VLANs on the FE and GE Switch Ports	166
VLANs on the GE Port and GE ESW Port of Wireless APs	167
Configuring Layer 2 Interfaces	168
Configuring 802.1x Authentication	168

Configuring Spanning Tree Protocol	168
Configuring MAC Table Manipulation	169
Configuring Cisco Discovery Protocol	169
Configuring the Switched Port Analyzer	170
Configuring Power Management on the Interface	170
Configuring IP Multicast Layer 3 Switching	170
Configuring IGMP Snooping	170
Configuring Per-Port Storm Control	171
Configuring Separate Voice and Data Subnets	171
Managing the Switch	171

CHAPTER 8**Configuring Voice Functionality 173**

Voice Ports	173
Analog and Digital Voice Port Assignments	174
Voice Port Configuration	174
Call Control Protocols	174
SIP	174
MGCP	175
H.323	175
Dial Peer Configuration	175
Other Voice Features	175
Real-Time Transport Protocols	175
Dual Tone Multi Frequency Relay	176
CODECs	176
SCCP-Controlled Analog Ports with Supplementary Features	176
Fax Services	177
Fax Pass-Through	177
Cisco Fax Relay	177
T.37 Store-and-Forward Fax	177
T.38 Fax Relay	177
Unified Survival Remote Site Telephony	177
Verification of Voice Configuration	178

CHAPTER 9**Configuring the Serial Interface 179**

Configuring the Serial Interface	179
----------------------------------	-----

Legacy Protocol Transport	180
Configuring Serial Interfaces	181
Cisco HDLC Encapsulation	181
PPP Encapsulation	181
Multilink PPP	182
Keepalive Timer	183
Frame Relay Encapsulation	183
LMI on Frame Relay Interfaces	184
Configuring Serial Interfaces	184
Configuring a Synchronous Serial Interface	185
Specifying a Synchronous Serial Interface	185
Specifying Synchronous Serial Encapsulation	185
Configuring PPP	186
Configuring Bisync	186
Configuring Compression of HDLC Data	186
Using the NRZI Line-Coding Format	187
Enabling the Internal Clock	188
Inverting the Transmit Clock Signal	188
Setting Transmit Delay	189
Configuring DTR Signal Pulsing	189
Ignoring DCD and Monitoring DSR as Line Up/Down Indicator	190
Specifying the Serial Network Interface Module Timing	190
Specifying the Serial Network Interface Module Timing	191
Configuring Low-Speed Serial Interfaces	191
Half-Duplex DTE and DCE State Machines	191
Half-Duplex DTE State Machines	192
Half-Duplex DCE State Machines	193
Placing a Low-Speed Serial Interface in Constant-Carrier Mode	195
Tuning Half-Duplex Timers	196
Changing Between Synchronous and Asynchronous Modes	196
Changing Between Synchronous and Asynchronous Modes	197
Examples for Interface Enablement Configuration	198
Examples for Low-Speed Serial Interface	198
Examples for Synchronous or Asynchronous Mode	198
Example for Half-Duplex Timers	199

CHAPTER 10

Configuring Wireless Devices	201
Wireless Device Overview	201
Software Modes for Wireless Devices	201
Management Options for Wireless Device	202
Root Access Point	202
Central Unit in an All-Wireless Network	203
Cisco ScanSafe	204
TFTP support with Ethernet WAN interface	205
LEDs for Cisco 819 Series ISRs	205
Basic Wireless Configuration for Cisco 800 Series ISR	208
Starting a Wireless Configuration Session	208
Closing the Session	210
Configuring Wireless Settings	211
Cisco Express Setup	211
Cisco IOS Command Line Interface	211
Configuring the Radio	211
Configuring Wireless Security Settings	212
Configuring Authentication	212
Configuring WEP and Cipher Suites	212
Configuring Wireless VLANs and Assigning SSIDs	213
Configuring Wireless Quality of Service	215
Configuring the Access Point in Hot Standby Mode	215
Upgrading to Cisco Unified Software	216
Preparing for the Upgrade	216
Secure an IP Address on the Access Point	216
Example Configuration: Secure an IP Address on the Access Point	216
Confirm that the Mode Setting is Enabled	216
Performing the Upgrade	217
Troubleshooting an Upgrade or Reverting the AP to Autonomous Mode	217
Downgrading the Software on the Access Point	218
Recovering Software on the Access Point	218
Related Documentation	218
Configuring Radio Settings	220
Enabling the Radio Interface	220

Wireless Device Roles in a Radio Network	221
Configuring the Wireless Device Roles in a Radio Network	222
Configuring Dual-Radio Fallback	223
Radio Tracking	223
Fast Ethernet Tracking	223
MAC-Address Tracking	224
Overview of Radio Data Rates	224
Configuring Radio Data Rates	225
Configuration Example: Configuring Radio Data Rates	227
Configuring MCS Rates	227
Configuration Example: MCS Rates	229
Configuring Radio Transmit Power	229
Limiting the Power Level for Associated Client Devices	230
Configuring Radio Channel Settings	231
Configuring Wireless Channel Width	232
Enabling and Disabling World Mode	233
Enabling World Mode	233
Disabling and Enabling Short Radio Preambles	234
Disabling Short Radio Preambles	234
Transmit and Receive Antennas	235
Configuring Transmit and Receive Antennas	235
Disabling and Enabling Aironet Extensions	236
Disabling Aironet Extensions	237
Ethernet Encapsulation Transformation Method	238
Configuring the Ethernet Encapsulation Transformation Method	238
Enabling and Disabling Public Secure Packet Forwarding	239
Configuring Public Secure Packet Forwarding	239
Configuring Protected Ports	240
Beacon Period and the DTIM	241
Configuring the Beacon Period and the DTIM	241
RTS Threshold and Retries	242
Configuring RTS Threshold and Retries	242
Maximum Data Retries	243
Configuring the Maximum Data Retries	243
Configuring the Fragmentation Threshold	244

Configuring the Fragment Threshold	244
Enabling Short Slot Time for 802.11g Radios	245
Performing a Carrier Busy Test	245
Configuring VoIP Packet Handling	245
Configuring WLAN	246
Configuring WLAN Using the Web-based Interface	246
Connecting to the Web-based WLAN Interface	246
Address for Accessing Web-based Interface	247
DHCP Server Configuration	247
Subnet	247
Displaying Device Information	247
Displaying Connection Statistics	247
Configuring Access to the Web-based Interface	247
Configuring Basic Wireless Settings	248
Configuring Security	249
Configuring MAC Filtering	249
Configuring Advanced Wireless Settings	249
Station Information	252
Configuring the Password for Connecting to the Web-based Interface	252
Saving the Wireless LAN Configuration to a File	253
Loading a Wireless LAN Configuration File	253
Restoring the Default Configuration	253
Configuring WLAN Using the CLI-based Interface	253
WLAN CLI Interface	253
Displaying Command Information for WLAN CLI	254
Example : Displaying Command Information for WLAN CLI	254
Connecting to the WLAN CLI Interface	254
Example: Configuring a Loopback Interface	254
Example: Accessing WLAN CLI Using Telnet Through the Loopback Interface	255
Exiting from the WLAN CLI Interface	255
Setting the IP Address for the Web-based Interface	255
Enabling and Disabling WLAN	256
Configuring the Main SSID	256
Configuring Guest SSIDs	257

Enabling and Disabling Guest SSIDs	258
Hiding an Access Point	258
Enabling and Disabling Client Isolation	259
Enabling and Disabling WMM Advertise	260
Enabling and Disabling Wireless Multicast Forwarding (WMF)	261
Configuring the Global Maximum Number of Clients	262
Configuring the Maximum Number of Clients for an SSID	262
Configuring Authentication Options	263
Configuring Encryption Options	267
Configuring the MAC Address Filter Access List	270
Configuring the MAC Address Filter Mode	271
Configuring Radio Channel	271
Configuring 802.11n Options	272
Configuring the 54g Mode	274
Configuring the 54g Preamble Type	275
Configuring the 54g Rate	276
Configuring 54g Protection	277
Configuring the Multicast Rate	277
Configuring the Basic Rate	278
Configuring the Fragmentation Threshold	279
Configuring the RTS Threshold	280
Configuring the DTIM Interval	280
Configuring the Beacon Interval	281
Configuring the Radio Transmit Power	281
Configuring WMM Options	282
Displaying Current CLI Values and Keywords	283
Displaying Current Channel and Power Information	284
Displaying Current Associated Clients	286
Displaying the SSID to BSSID Mapping	287
Displaying the Tx/Rx Statistics	288
Displaying the BVI 1 Interface Details	288
Displaying Dot11Radio 0 Interface Information	289
Example: Displaying Dot11Radio 0 Interface Information	290
Displaying Brief Details for All Interfaces	290
Displaying CPU Statistics	290

Example: Displaying CPU Statistics	291
Showing a Summary of Memory Usage	291
Pinging an Address	292
Changing the Administrator Password	292
Configuring the Number of Lines on Screen	293
Administering the Wireless Device	293
Securing Access to the Wireless Device	293
Disabling the Mode Button Function	293
Displaying the mode-button status	294
Preventing Unauthorized Access to Your Access Point	294
Protecting Access to Privileged EXEC Commands	295
Configuring Default Password and Privilege Level	295
Setting or Changing a Static Enable Password	295
Configuration Example: Changing a Static Enable Password	296
Protecting Enable and Enable Secret Passwords with Encryption	296
Configuration Example: Enable Secret Passwords	298
Configuring Username and Password Pairs	298
Configuring Multiple Privilege Levels	299
Configuring Multiple Privilege Levels	301
Controlling Access Point Access with RADIUS	301
RADIUS Configuration	302
Configuring RADIUS Login Authentication	302
Defining AAA Server Groups	303
Configuration Example: AAA Group	305
Configuring RADIUS Authorization for User Privileged Access and Network Services	306
Displaying the RADIUS Configuration	307
Controlling Access Point Access with TACACS+	307
Default TACACS+ Configuration	307
Configuring TACACS+ Login Authentication	308
Configuring TACACS+ Authorization for Privileged EXEC Access and Network Services	309
Displaying the TACACS+ Configuration	310
Administering the Access Point Hardware and Software	310
Administering the Wireless Hardware and Software	310

Resetting the Wireless Device to the Factory Default Configuration	311	
Rebooting the Wireless Device	311	
Monitoring the Wireless Device	311	
Managing the System Time and Date	312	
Understanding Simple Network Time Protocol	312	
Configuring SNTP	312	
Time and Date Manual Configuration	313	
Example Configuration : Time and Date	315	
Configuring a System Name and Prompt	315	
Configuring a System Name	316	
Understanding DNS	316	
Creating a Banner	319	
Configuring a Message-of-the-Day Login Banner	319	
Example: Configuring a MOTD Banner	320	
Configuring a Login Banner	320	
Example Configuration: Login Banner	321	
Administering Wireless Device Communication	321	
Configuring Ethernet Speed and Duplex Settings	321	
Configuring the Access Point for Wireless Network Management	322	
Configuring the Access Point for Local Authentication and Authorization	323	
Configuring the Authentication Cache and Profile	324	
Example Configuration: Authentication Cache and Profile	325	
Configuring the Access Point to Provide DHCP Service	327	
Setting up the DHCP Server	327	
Monitoring and Maintaining the DHCP Server Access Point	329	
Configuring the Access Point for Secure Shell	330	
Understanding SSH	330	
Configuring SSH	330	
Client ARP Caching	331	
Understanding Client ARP Caching	331	
Configuring Client ARP Caching	331	
Configuring Multiple VLAN and Rate Limiting for Point-to-Multipoint Bridging	332	
CHAPTER 11	Configuring PPP over Ethernet with NAT	333
	Overview	334

PPPoE	334
NAT	335
Configuration Tasks	335
Configure the Virtual Private Dialup Network Group Number	335
Configure Ethernet WAN Interfaces	336
Configure the Dialer Interface	337
Configure Network Address Translation	339
Configuration Example	342
Verifying Your Configuration	343

CHAPTER 12

Configuring PPP over ATM with NAT	345
Overview	345
Configure the Dialer Interface	347
Configure the ATM WAN Interface	349
Configure DSL Signaling Protocol	350
Configuring ADSL	350
Verifying the Configuration	351
Configure Network Address Translation	352
Configuration Example	355
Verifying Your Configuration with NAT	356

CHAPTER 13

Environmental and Power Management	357
Environmental and Power Management	357
Cisco EnergyWise Support	358

CHAPTER 14

4G LTE Wireless WAN	359
4G LTE Support on Cisco 800 Series ISRs	359
How to Configure Cisco 800 Series 4G LTE ISRs	360
Configuration Examples for Cisco 800 Series 4G LTE ISRs	360
Example: Basic Cellular Configuration	360
Example: Dialer-Watch Configuration without External Dialer Interface	360
Example: Dialer-Persistent Configuration with External Dialer Interface	361
Example: GRE Tunnel over Cellular Interface Configuration	361
Modem Firmware Upgrade	362
Troubleshooting	362

3G Support on Cisco 880G series ISRs 362

CHAPTER 15**Configuring a LAN with DHCP and VLANs 363**

Configuring a LAN with DHCP and VLANs 363

DHCP 364

VLANs 364

Configuring DHCP and VLANs 364

Configuring DHCP 364

Configuration Example: DHCP 366

Verifying Your DHCP Configuration 366

Configuring VLANs 367

Assigning a Switch Port to a VLAN 368

Verifying Your VLAN Configuration 368

CHAPTER 16**Configuring a VPN Using Easy VPN and an IPSec Tunnel 371**

Configuring a VPN Using Easy VPN and an IPSec Tunnel 371

Configuring the IKE Policy 373

Configuring Group Policy Information 375

Applying Mode Configuration to the Crypto Map 376

Enabling Policy Lookup 377

Configuring IPSec Transforms and Protocols 378

Configuring the IPSec Crypto Method and Parameters 379

Applying the Crypto Map to the Physical Interface 380

Creating an Easy VPN Remote Configuration 381

Verifying Your Easy VPN Configuration 383

Configuration Examples for VPN and IPSec 383

CHAPTER 17**Configuring Cisco Multimode G.SHDSL EFM/ATM 385**

CHAPTER 18**Configuring VDSL2 Bonding and Single-Wire Pair 387**

Restrictions 387

Configuring Bonding in Auto Mode 388

Configuring Bonding in VDSL2 Mode 388

Configuring a Single-Wire Pair on Line 0 389

Configuring a Single-Wire Pair on Line 1 390

Configuration Examples 391

CHAPTER 19**Configuring Cisco IOx 393**

Configuring Cisco IOx 393

Configuration Examples 395

Developer Mode with Ethernet 395

 Stationary with Ethernet 396

 Mobile with Cellular 397

Cellular IP Address Type 398

Accessing the Web Interface of Local Manager 400

Configuring NTP Server 401

Configuring IOS NAT for Applications Installed using BRIDGE and NAT Networking

 Modes 401

Configuring Guest Serial 402

Upgrading Cisco IOx 403

Troubleshooting 403

CHAPTER 20**Deployment Scenarios 413**

About the Deployment Scenarios 413

Enterprise Small Branch 414

Internet Service and IPSec VPN with 3G 415

SMB Applications 416

Enterprise Wireless Deployments with LWAPP 417

Enterprise Small Branch Office Deployment 418

CHAPTER 21**Troubleshooting Cisco 800 Series Routers 419**

Getting Started 419

Before Contacting Cisco or Your Reseller 419

ADSL Troubleshooting 420

SHDSL Troubleshooting 420

VDSL2 Troubleshooting 420

show interfaces Troubleshooting Command 421

ATM Troubleshooting Commands 423

 ping atm interface Command 423

 show atm interface Command 424

debug atm Commands	425
Guidelines for Using Debug Commands	425
debug atm errors Command	425
debug atm events Command	426
debug atm packet Command	426
Software Upgrade Methods	428
Recovering a Lost Password	428
Change the Configuration Register	428
Reset the Router	429
Reset the Password and Save Your Changes	431
Reset the Configuration Register Value	432
Cisco Configuration Professional Express	433

APPENDIX A

Cisco IOS Software Basic Skills	435
Configuring the Router from a PC	435
Understanding Command Modes	436
Getting Help	438
Enable Secret Passwords and Enable Passwords	439
Entering Global Configuration Mode	440
Using Commands	440
Abbreviating Commands	441
Undoing Commands	441
Command-Line Error Messages	441
Saving Configuration Changes	442
Summary	442

APPENDIX B

Concepts	443
ADSL	443
SHDSL	444
Network Protocols	444
IP	444
Routing Protocol Options	444
RIP	445
Enhanced IGRP	445
PPP Authentication Protocols	445

PAP	446
CHAP	446
TACACS+	447
Network Address Translation	447
Easy IP (Phase 1)	447
Easy IP (Phase 2)	448
Network Interfaces	448
Ethernet	448
ATM for DSL	449
PVC	449
Dialer Interface	449
Dial Backup	450
Backup Interface	450
Floating Static Routes	450
Dialer Watch	450
QoS	450
IP Precedence	451
PPP Fragmentation and Interleaving	451
CBWFQ	451
RSVP	452
Low Latency Queuing	452
Access Lists	452
<hr/>	
APPENDIX C	ROM Monitor 453
	Entering the ROM Monitor 453
	ROM Monitor Commands 454
	ROM Monitor Commands for 860VAE ISRs 455
	ROM Monitor Command Descriptions 455
	Disaster Recovery with TFTP Download 456
	TFTP Download Command Variables 457
	Required Variables 457
	Optional Variables 457
	Using the TFTP Download Command 458
	Configuration Register 459
	Changing the Configuration Register Manually 459

Changing the Configuration Register Using Prompts 459

Console Download 460

 Error Reporting 461

ROM Monitor Debug Commands 461

Exiting the ROM Monitor 463



Preface

This preface describes the audience, organization, and conventions of this guide, and describes related documents that have additional information. It contains the following sections:

- [Audience, page xxv](#)
- [Document Organization, page xxv](#)
- [Document Conventions, page xxvii](#)
- [Related Documentation, page xxviii](#)
- [Obtaining Documentation and Submitting a Service Request, page xxix](#)

Audience

This guide provides an overview and explains how to configure the various features for the Cisco 810, Cisco 860, Cisco 880, and Cisco 890 series Integrated Services Routers (ISRs). Some information may not apply to your particular router model.

This guide is intended for Cisco equipment providers who are technically knowledgeable and familiar with Cisco routers and Cisco IOS software and features.

For warranty, service, and support information, see the “Cisco One-Year Limited Hardware Warranty Terms” section in the Readme First for the Cisco 800 Series Integrated Services Routers that was shipped with your router.

Document Organization

This document is organized into the following chapters:

Chapter	Description
Product Overview	Provides a brief description of the router models and the available software features.
Basic Router Configuration	Provides procedures for configuring the basic parameters of the router.

Chapter	Description
Configuring Ethernet CFM and Y.1731 Performance Monitoring on Layer 3 Interfaces, on page 81	Provides procedures for configuring the network interface device functionality, Ethernet data plane loopback, IEEE connectivity fault management, and Y.1731 performance monitoring.
Configuring Power Management	Provides the configuration of power management and Power-over-Ethernet (PoE).
Configuring Security Features	Provides procedures for implementing the security features that can be configured on the router.
Configuring Backup Data Lines and Remote Management	Provides procedures for configuring remote management functions and a backup data line connection.
Configuring Ethernet Switches	Provides an overview of the configuration tasks for the 4-port Fast Ethernet switch on the router.
Configuring Voice Functionality	Provides references to the procedures for voice configuration.
Configuring the Serial Interface	Provides information about WAN access and aggregation, Legacy protocol transport, and Dial Access Server.
Configuring Wireless Devices	Provides procedures for initial configuration of the wireless device, radio settings, WLAN, and administration of the wireless device.
Configuring PPP over Ethernet with NAT	Provides an overview of Point-to-Point Protocol over Ethernet (PPPoE) clients and network address translation (NAT)s that can be configured on the Cisco 860 and Cisco 880 series Integrated Services Routers (ISRs).
Configuring PPP over ATM with NAT	Provides an overview of Point-to-Point Protocol over Asynchronous Transfer Mode (PPPoA) clients and network address translation (NAT) that can be configured on the Cisco 860 and Cisco 880 series Integrated Services Routers (ISRs).
4G LTE Wireless WAN	Provides information about 4G LTE and 3G cellular networks.
Configuring a LAN with DHCP and VLANs	Describes how the routers can use the Dynamic Host Configuration Protocol (DHCP) to enable automatic assignment of IP configurations for nodes on these networks.
Configuring a VPN Using Easy VPN and an IPSec Tunnel	Provides an overview of the creation of Virtual Private Networks (VPNs) that can be configured on the Cisco 860 and Cisco 880 series Integrated Services Routers (ISRs).
Configuring Cisco Multimode G.SHDSL EFM/ATM	Describes the configuration of the Cisco Multimode 4-pair G.SHDSL.
Deployment Scenarios	Shows some typical deployment scenarios for the Cisco 860, Cisco 880, and Cisco 890 series ISRs.

Chapter	Description
Troubleshooting Cisco 800 Series Routers	Provides information to help isolate problems you might encounter.
Cisco IOS Software Basic Skills	Provides information for how to use Cisco IOS software to configure your router.
Concepts	Provides conceptual information that may be useful to Internet service providers or network administrators when they configure Cisco routers.
ROM Monitor	Provides information on how to use Cisco's ROM Monitor firmware.

Document Conventions

This document uses the following conventions:

Convention	Description
^ or Ctrl	Both the ^ symbol and Ctrl represent the Control (Ctrl) key on a keyboard. For example, the key combination ^D or Ctrl-D means that you hold down the Control key while you press the D key. (Keys are indicated in capital letters but are not case sensitive.)
bold font	Commands and keywords and user-entered text appear in bold font .
<i>Italic font</i>	Document titles, new or emphasized terms, and arguments for which you supply values are in <i>italic font</i> .
Courier font	Terminal sessions and information the system displays appear in <i>courier font</i> .
Bold Courier font	Bold Courier font indicates text that the user must enter.
[x]	Elements in square brackets are optional.
...	An ellipsis (three consecutive nonbolded periods without spaces) after a syntax element indicates that the element can be repeated.
	A vertical line, called a pipe, indicates a choice within a set of keywords or arguments.
[x y]	Optional alternative keywords are grouped in brackets and separated by vertical bars.
{x y}	Required alternative keywords are grouped in braces and separated by vertical bars.

Convention	Description
[x {y z}]	Nested set of square brackets or braces indicate optional or required choices within optional or required elements. Braces and a vertical bar within square brackets indicate a required choice within an optional element.
string	A nonquoted set of characters. Do not use quotation marks around the string or the string will include the quotation marks.
<>	Nonprinting characters such as passwords are in angle brackets.
[]	Default responses to system prompts are in square brackets.
!, #	An exclamation point (!) or a pound sign (#) at the beginning of a line of code indicates a comment line.

Reader Alert Conventions

This document uses the following conventions for reader alerts:



Note

Means *reader take note*. Notes contain helpful suggestions or references to material not covered in the manual.



Tip

Means *the following information will help you solve a problem*.



Caution

Means *reader be careful*. In this situation, you might do something that could result in equipment damage or loss of data.



Timesaver

Means *the described action saves time*. You can save time by performing the action described in the paragraph.



Warning

Means *reader be warned*. In this situation, you might perform an action that could result in bodily injury.

Related Documentation

In addition to this document, the Cisco 810, Cisco 860, Cisco 880, and Cisco 890 series ISR documentation set includes the following documents:

- *Readme First for the Cisco 800 Series Integrated Services Routers.*
- [Cisco 860, Cisco 880, and Cisco 890 Series Integrated Services Routers Hardware Installation Guide](#)
- [Regulatory Compliance and Safety Information for Cisco 800 Series and SOHO Series Routers](#)
- [Declarations of Conformity and Regulatory Information for Cisco Access Products with 802.11n Radios](#)
- [Software Activation on Cisco Integrated Services Routers and Cisco Integrated Service Routers G2](#)

You might also need to refer to the following documents:

- *Cisco System Manager Quick Start Guide*
- *Cisco IOS Release 12.4 Quality of Service Solutions Configuration Guide*
- *Cisco IOS Security Configuration Guide, Release 12.4*
- *Cisco IOS Security Configuration Guide, Release 12.4T*
- *Cisco IOS Security Command Reference, Release 12.4*
- *Cisco IOS Security Command Reference, Release 12.4T*
- *Cisco IOS Command Reference for Cisco Aironet Access Points and Bridges, versions 12.4(10b) JA and 12.3(8) JEC*
- *Cisco Aironet 1240AG Access Point Support Documentation*
- *Cisco 4400 Series Wireless LAN Controllers Support Documentation*
- *LWAPP Wireless LAN Controllers*
- *LWAPP Wireless LAN Access Points*
- *Cisco IOS Release 12.4 Voice Port Configuration Guide*
- *SCCP Controlled Analog (FXS) Ports with Supplementary Features in Cisco IOS Gateways*
- *Cisco Software Activation Conceptual Overview*
- *Cisco Software Activation Tasks and Commands*

Obtaining Documentation and Submitting a Service Request

For information on obtaining documentation, submitting a service request, and gathering additional information, see the monthly What's New in Cisco Product Documentation, which also lists all new and revised Cisco technical documentation, at:

<http://www.cisco.com/en/US/docs/general/whatsnew/whatsnew.html>

Subscribe to the What's New in Cisco Product Documentation as a Really Simple Syndication (RSS) feed and set content to be delivered directly to your desktop using a reader application. The RSS feeds are a free service and Cisco currently supports RSS version 2.0.



CHAPTER

1

Product Overview

This chapter provides an overview of the features available for the Cisco 810, Cisco 860, Cisco 880 and Cisco 890 series Integrated Services Routers (ISRs), and contains the following sections:

- [Information About Cisco 800 Series ISRs, page 1](#)
- [Cisco 860 Series ISRs, page 1](#)
- [Cisco 880 Series ISRs, page 5](#)
- [Cisco 890 Series ISRs, page 8](#)
- [Cisco 810 Series ISRs, page 10](#)
- [Licensing for Cisco 800 Series ISRs, page 14](#)

Information About Cisco 800 Series ISRs

The Cisco 860, Cisco 880, and Cisco 890 series ISRs provide Internet, VPN, voice, data, and backup capability to corporate teleworkers and remote and small offices of fewer than 20 users. These routers are capable of bridging and multiprotocol routing between LAN and WAN ports, and provide advanced features such as antivirus protection. In addition, the Cisco 860W, Cisco 880W, and Cisco 890W series ISRs incorporate an 802.11n wireless LAN option that allows the ISR to act as a wireless access point.

The Cisco 810 series ISRs provide Internet, VPN, data, and backup capability to corporate teleworkers and remote and small offices of fewer than 20 users and provides machine to machine connectivity. Under Cisco 810 series ISRs, there are two different series of routers available - Cisco 812 series ISRs and Cisco 819 series ISRs. The Cisco 812 ISRs support Gigabit Ethernet (GE), WAN connections over Cellular (3G) interface, and WLAN. The Cisco 819 ISRs are fixed-configuration data routers that provide four 10/100 Fast Ethernet (FE), 1 Gigabit Ethernet (GE), WAN connections over Serial and Cellular (3G, 4G) interfaces and WLAN.

Cisco 860 Series ISRs

The Cisco 860 series ISRs are fixed-configuration data routers that provide either a 10/100 Fast Ethernet (FE) or an ADSL2 over POTs WAN connection.

This section contains the following topics:

Features of Cisco 860 Series ISRs

The following features are supported on all Cisco 860 series ISRs:

4-port 10/100 FE LAN Switch of Cisco 860 Series ISRs

The 4-port 10/100 FE LAN switch provides four ports for connecting to 10/100BASE-T (10/100 Mbps) Fast Ethernet (FE) LANs or access points.

Security Features for Cisco 860 Series ISRs

The Cisco 860 Series ISRs provide the following security features:

- IPsec
- Firewall

802.11n Wireless LAN Option for Cisco 860 Series ISRs

The Cisco 861W ISR has an integrated 802.11b/g/n single radio module for wireless LAN connectivity. With this module, the router can then act as an access point in the local infrastructure.

Features of Cisco 860VAE Series ISRs

The following sections describe the features of the Cisco 860VAE series ISRs:

General Features of Cisco 860 VAE Series Routers

[Table 1: General Features of Cisco 860VAE Series ISRs](#), on page 2 describes the general features of Cisco 860VAE series routers.

Table 1: General Features of Cisco 860VAE Series ISRs

Feature	Benefit
Increased performance	<ul style="list-style-type: none"> • Performance enables customers to take advantage of broadband network speeds while running secure, concurrent data, voice, video, and wireless services.

Feature	Benefit
Security and QoS with secure routers	<ul style="list-style-type: none"> • IPSec & Easy VPN with 10 tunnels. • BGP. • MAC filtering and port security. • QoS features include LLQ and WFQ. • NBAR and DiffServ.
State-of-the-art xDSL	<ul style="list-style-type: none"> • State-of-the-art xDSL features, including latest ADSL2+/VDSL2 standards. • Improved interoperability vs. various DSLAMs deployed at WW SPs.
ScanSafe web filtering	<ul style="list-style-type: none"> • Protects network and staff from undesirable web content • Increases productivity by limiting time spent on recreational surfing • Optimizes network resources by reducing bandwidth congestion • Monitors online activity with comprehensive reporting
IPv6 support	<ul style="list-style-type: none"> • Supports latest IP addressing standards
WAN Diversity	<ul style="list-style-type: none"> • GE + DSL multimode VDSL2 and ADSL 1, 2, and 2+. • Multiple WAN options within the same box allow consistent configuration across diverse deployments.
Four-port 10/100-Mbps managed switch 1 GE port for secure routers	<ul style="list-style-type: none"> • Connection of multiple devices within a teleworker home or a small office, with the ability to designate a port as the network edge. • VLANs allow for secure segmentation of network resources.

Feature	Benefit
CON/AUX port	<ul style="list-style-type: none"> A single dual-purpose port provides direct connection to a console or external modem for management or backup access points.
Real-time clock	<ul style="list-style-type: none"> A built-in real-time clock maintains an accurate date and time for applications that require an accurate time stamp, such as logging and digital certificates.

Interfaces of Cisco 860 VAE Series ISRs

Table 2: Interfaces of the Cisco 860VAE Series ISRs, on page 4 describes the interfaces of the Cisco 860VAE series routers.

Table 2: Interfaces of the Cisco 860VAE Series ISRs

Interfaces	Models			
	866VAE	867VAE	866VAE-K9	867VAE-K9
4 FE ¹ switch ports	x	x	x	x
1 GE ² switch port	—	—	x	x
1 GE WAN port	x	x	x	x
1 VDSL/ADSL over POTS port	—	x	—	x
1 VDSL/ADSL over ISDN port	x	—	x	—

¹ FE = Fast Ethernet

² GE = Gigabit Ethernet



Note

The Cisco 866VAE, 867VAE, 866VAE-K9, and 867VAE-K9 routers each have two WAN ports. Only one of the two ports can be active at any given time.

IOS Images for Cisco 860 VAE Series ISRs

[Table 3: IOS Images of the Cisco 860VAE Series ISRs, on page 5](#) describes the IOS images included in Cisco 860VAE series routers.

Table 3: IOS Images of the Cisco 860VAE Series ISRs

IOS Image	Model		
	866VAE	867VAE	867VAE-K9
c860vae-ipbasek9-mz	x	x	—
c860vae-advsecurityk9-mz	—	—	x
c860vae-advsecurityk9_npe-mz	—	—	x

Cisco 880 Series ISRs

The Cisco 880 series ISRs are a family of fixed-configuration data and voice routers as described in the following sections:

Models of Cisco 880 Series ISRs

The Cisco 880 series ISRs have data and voice capabilities. Each router has one WAN port. In addition, routers supporting voice have either FXS (Foreign Exchange Station) or BRI voice ports. Data or voice backup ports are also available on most of the routers. The Cisco 880G routers come with a commercial third-generation (3G) wireless interface card that provides cellular backup. 802.11b/g/n option is available on all models.

[Table 4: Port Configurations of the Cisco 880 Series Data ISRs, on page 5](#) gives the port configurations of Cisco 880 series data ISRs.

Table 4: Port Configurations of the Cisco 880 Series Data ISRs

Model	WAN Port	Backup	
		Data ISDN	Data 3G
881 and 881W	FE	—	—
881-V	FE	—	—
881G and 881GW	FE	—	x
886 and 886W	ADSL2oPOTS	x	—

886G and 886GW	ADSL2oPOTS	—	x
887 and 887W	ADSL2oPOTS	x	—
887G and 887GW	ADSL2oPOTS	—	x
887-VA-V	VDSL2oPOTS	x	x
887V and 887VW	VDSL2oPOTS	x	—
887VG and 887VGW	VDSL2oPOTS	—	x
888 and 888W	G.SHDSL	x	—
888G and 888GW	G.SHDSL	—	x
888E and 888EW	EFM over G.SHDSL	x	—
C888EA-K9	Multimode	x	—

[Table 5: Port Configurations of Cisco 880 Series Voice ISRs](#), on page 6 gives the port configurations of Cisco 880 series voice ISRs.

Table 5: Port Configurations of Cisco 880 Series Voice ISRs

Model	WAN Port	FXS Voice Ports	Backup	
			PSTN FXO	PSTN BRI
C881SRST and C881SRSTW	FE	4	x	—
C888SRST and C888SRSTW	G.SHDSL	4	—	x
C888ESRST and C888ERSTW	EFM over G.SHDSL	4	—	4

[Table 6: Port Configurations of Cisco 880 Series Data and Voice ISRs](#), on page 6 gives the port configurations of Cisco 881-V, Cisco887VA-V, and Cisco 887VA-V-W series ISRs.

Table 6: Port Configurations of Cisco 880 Series Data and Voice ISRs

Model	WAN Port	FXS Voice Ports	PSTN BRI	WLAN	Backup	
					PSTN FXO	Data (ISDN)

C881-V	FE	4	2	—	1	—
C887VA-V	VDSL2/ADSL2	4	2	—	—	x
C887VA-V-W	VDSL2/ADSL2	4	2	x	—	x

The Cisco 887 VA-V and Cisco 881-V routers give you the flexibility to use the FXS or BRI voice ports (The Cisco 881-V router also supports a backup FX0 port), but the number of concurrent calls that the router supports is limited by the codec complexity configuration. The router supports less calls when the codec complexity setting is configured for high complexity. [Table 7: Number of Concurrent Calls Supported on Cisco 880 Series Data and Voice ISRs, on page 7](#) shows the number of concurrent calls that is supported on the router for each codec complexity setting. Configuring the codec complexity setting to support secure calls does not affect the numbers below.

Table 7: Number of Concurrent Calls Supported on Cisco 880 Series Data and Voice ISRs

Model	Flexible Complexity	Medium Complexity	High Complexity
C881-V	9	8	6
C887VA-V	8	8	6
C887VA-V-W	8	8	6

Common Features of Cisco 880 Series ISRs

Cisco 880 series ISRs support the following features:

4-port 10/100 FE LAN Switch of Cisco 880 Series ISRs

This switch provides four ports for connecting to 10/100BASE-T FE LANs, access points, or IP phones. In addition, an upgrade is available that gives Power over Ethernet (PoE) on two of the ports to provide power to access points or phones.

802.11n Wireless LAN Option of Cisco 880 Series ISRs

The Cisco 880W series ISRs have an integrated 802.11b/g/n single radio module for wireless LAN connectivity. With this module, the router can act as an access point in the local infrastructure.

Real-Time Clock of Cisco 880 Series ISRs

A real-time clock (RTC) provides date and time when the system is powered on. The RTC is used to verify the validity of the Certification Authority stored on the router.

Security Features of Cisco 880 Series ISRs

The Cisco 880 Series ISRs provide the following security features:

- Intrusion Prevention System (IPS)
- Dynamic Multipoint VPN (DMVPN)
- IPsec
- Quality of service (QoS)
- Firewall
- URL filtering

Voice Features of Cisco 880 Series ISRs

The Cisco 880 voice and data platforms (C880SRST, C880SRSTW, C881-V, C887 VA-V, and C887VA-V-W) support the following voice features:

- Signaling protocols: Session Initiation Protocol (SIP), Media Gateway Control Protocol (MGCP), and H323
- Real-time transfer protocol (RTP), Cisco RTP (cRTP), and secure RTP (SRTP) for these signaling protocols
- Fax passthrough, Cisco fax relay, T37 fax store-and-forward, and T.38 fax relay (including T.38 gateway-controlled MGCP fax relay)
- Dual tone multifrequency (DTMF) Relay—OOB and RFC2833
- Silence suppression/comfort noise
- G.711 (a-law and u-law), G.729A, G.729AB, G.729, G.729B, G.726
- Support of SRST failover to a Foreign Exchange Office (FXO) or BRI backup port connected to PSTN in case of WAN failure on C880SRST and C880SRSTW.
- Support for SRST and CME requires user license, but only a 5-user license is supported on C881-V, C887VA-V, and C887VA-V-W routers.
- Direct inward dialing (DID) on FXS

Cisco 890 Series ISRs

The Cisco 890 series ISRs are fixed-configuration data routers. These routers have a Gigabit Ethernet WAN port and data backup ports.

[Table 8: Port Configurations of the Cisco 890 Series ISRs, on page 9](#) gives the port configurations for the Cisco 890 Series ISRs.

Table 8: Port Configurations of the Cisco 890 Series ISRs

Model	WAN Port	Data Backup		
		FE	V.92	ISDN
891 and 891W	GE	x	x	—
892 and 892W	GE	x	—	x
892F and 892F-W	GE ³ or SFP ⁴	x	—	x

³ GE copper port.

⁴ SFP port supports GE with fiber. For a complete list of SFPs supported, see the Cisco 892F ISR data sheet on Cisco.com.

Some of the features supported on Cisco 890 series ISRs are given as follows:

8-port 10/100 FE LAN Switch of Cisco 890 Series ISRs

The 8-port 10/100 FE LAN switch provides eight ports for connecting to 10/100BASE-T FE LANs, access points, or IP phones. In addition, an upgrade is available that gives PoE on four of the ports to provide power to access points or phones.

802.11n Wireless LAN Option of Cisco 890 Series ISRs

The Cisco 890W series ISRs have integrated 802.11b/g/n and 802.11a/n dual radio modules for wireless LAN connectivity. With these modules, the router can act as an access point in the local infrastructure.

Real-Time Clock of Cisco 890 Series ISRs

A real-time clock (RTC) provides date and time when the system is powered on. The RTC is used to verify the validity of the Certification Authority stored on the router.

Security Features of Cisco 890 Series ISRs

Cisco 890 Series ISRs provide the following security features:

- Intrusion Prevention System (IPS)
- Dynamic Multipoint VPN (DMVPN)
- IPsec
- Quality of service (QoS)
- Firewall
- URL filtering

Cisco 810 Series ISRs

This section provides information about the features supported by Cisco 810 series ISRs. In Cisco 810 series ISRs, there are two different series of routers available - Cisco 812 series ISRs and Cisco 819 series ISRs.

This section contains the following topics:

Features of Cisco 812 Series ISRs

This section lists the software, platform, and security features supported by the Cisco 812 Series ISRs.

**Note**

The WAAS Express feature is not supported. This feature will be supported for 3G and 4G interfaces with later IOS releases.

3G Features of Cisco 812 Series ISR

The 3rd Generation (3G) is a generation of standards for mobile technology that facilitates growth, increased in bandwidth, and supports more diverse applications. The following 3G features are supported in Cisco 812 series ISR.

- Modem control and management
- Asynchronous transport (AT) command set
- Wireless Host Interface Protocol (WHIP)
- Control and Status (CNS) for out-of-band modem control and status
- Diagnostic Monitor (DM) logging
- Account provisioning
- Modem firmware upgrade
- SIM locking and unlocking
- MEP unlocking
- OMA-DM activation, voice-initiated data callback
- Dual SIM card slots
- Link persistence
- SMS Services
- Global Positioning System (GPS) Services
- 3G MIB

WLAN Features of Cisco 812 Series ISR

A Wireless Local Area Network (WLAN) implements a flexible data communication system frequently augmenting rather than replacing a wired LAN within a building or campus. WLANs use radio frequency to transmit and receive data over the air, minimizing the need for wired connections.

Cisco 812 ISR supports the following WLAN features:

Dual Radio of Cisco 812 Series ISR

The Cisco 802 Access Points (AP802) is an integrated access point on Cisco 812 ISRs. The access point is a wireless LAN transceiver that acts as the connection point between wireless and wired networks or as the center point of a standalone wireless network. In large installations, the roaming functionality provided by multiple access points enables wireless users to move freely throughout the facility while maintaining uninterrupted access to the network.

AP802 Dual Radio contains two different types of wireless radio that can support connections on both 2.4 Ghz used by 802.11b, 802.11g, and 802.11n and 5 Ghz used by 802.11a and 802.11n.

All the WLAN traffic for Cisco 812 ISR passes through the Ethernet WAN or 3G interface. The AP802 Dual Radio is supported on the following SKUs:

- C812G-CIFI+7-E-K9
- C812G-CIFI+7-N-K9
- C812G-CIFI-V-A-K9
- C812G-CIFI-S-A-K9

Cleanair Technology of Cisco 812 Series ISR

The CleanAir is a new wireless technology that intelligently avoids Radio Frequency (RF) to protect 802.11n performance. For more information, see [Cisco CleanAir Technology](#) . This feature is supported in all SKUs that has WLAN support.

Dynamic Frequency Selection of Cisco 812 Series ISR

The Dynamic Frequency Selection (DFS) is the process of detecting radar signals that must be protected against 802.11a interference and upon detection switching the 802.11a operating frequency to one that is not interfering with the radar systems. Transmit Power Control (TPC) is used to adapt the transmission power based on regulatory requirements and range information.

**Note**

The DFS functionality is disabled for FCC SKUs pending FCC certification. For more information, see [Dynamic Frequency Selection and IEEE 802.11h Transmit Power Control](#) .

Platform Features of Cisco 812 Series ISR

For the complete list of Cisco 812 ISR platform features, see [Platform Features](#).

TFTP with Ethernet WAN Interface Feature of Cisco 812 Series ISR

For more information on TFTP download, see [Disaster Recovery with TFTP Download](#) .

**Note**

The Cisco 812 ISR has a GE interface as the only Ethernet interface. Hence, the port number is automatically set at Rommon for TFTP connectivity.

SKU Information for Cisco 812 Series ISR

See the following link for SKUs available for Cisco 812 series ISR router:

<http://www.cisco.com/en/US/docs/routers/access/800/812/hardware/install/guide/overview.html#wp1057240>
SKU information for Cisco 812 series

Features of Cisco 819 Series ISRs

This section lists the software, platform, and security features supported by the Cisco 819 Series ISRs.

**Note**

The WAAS Express feature is not supported. This feature will be supported for 3G and 4G interfaces with later IOS releases.

3G Features of Cisco 819 Series ISRs

The following 3G features are supported by Cisco 819 series ISR routers .

- Modem control and management
- Asynchronous transport (AT) command set
- Wireless Host Interface Protocol (WHIP)
- Control and Status (CNS) for out-of-band modem control and status
- Diagnostic Monitor (DM) logging
- Account provisioning
- Modem firmware upgrade
- SIM locking and unlocking
- MEP unlocking
- OMA-DM activation
- Dual SIM card slots
- Link persistence
- SMS Services

- Global Positioning System (GPS) Services
- 3G MIB

WLAN Features of Cisco 819 Series ISRs

Cisco 819 series ISRs support the following WLAN features:

- Dual Radio
- CleanAir Technology
- Dynamic Frequency Selection

4G LTE Features of Cisco 819 Series ISRs

Cisco 819 series ISRs supports the following 4G LTE features:

- IPv4 bearer
- MIPv4, NEMOv4, RFC 3025
- IPv4 subnet behind LTE UE interface
- Evolved High-Rate Packet Data (EHRPD), which allows seamless handoff between 4G LTE and 3G services (C819(H)G-4G-V-K9 only)
- Seamless hand-off between LTE and EHRPD network (C819(H)G-4G-V-K9 only)
- Support for UMTS service as a fallback option from LTE service (C819(H)G-4G-A-K9 and C819(H)G-4G-G-K9 only)
- Seamless handoff between LTE and UMTS service (C819(H)G-4G-A-K9 and C819(H)G-4G-G-K9 only)
- Remote access to Qualcomm diagnostic monitor port
- OTA-DM including wireless configuration FOTA (C819(H)G-4G-V-K9 only)
- Mini USB type 2 connector for modem provisioning

Platform Features of Cisco 819 Series ISRs

For the complete list of Cisco 819 Series ISRs platform features, see [Platform Features for Cisco 819 ISRs](#).

Security Features of Cisco 819 Series ISRs

The Cisco 819 Series ISRs provide the following security features:

- Intrusion Prevention System (IPS)
- Dynamic Multipoint VPN (DMVPN)
- IPsec
- Quality of service (QoS)

- Firewall
- URL filtering

SKU Information for Cisco 819 Series ISRs

See the following link for SKUs available for Cisco 819 series ISRs:

<http://www.cisco.com/c/en/us/td/docs/routers/access/800/hardware/installation/guide/800HIG/prodoverview.html#pgfid-1146483>

Licensing for Cisco 800 Series ISRs

The Cisco 810, 860, Cisco 880, and Cisco 890 ISRs ship with licensed software installed. Software features may be upgraded and the software licenses may be managed through *Cisco Licensing Manager*. See [Software Activation On Cisco Integrated Services Routers and Cisco Integrated Service Routers G2](#) for details.

When you order a new router, you specify the software image and feature set that you want. The image and feature set are installed on your router before you receive it, so you do not need to purchase a software license. The router stores the software license file on the flash memory.



Note

The Cisco 860VAE does not require licenses.

Selecting Feature Sets for Cisco 800 Series ISRs

Some feature sets are bundled and offered with a software license that is installed on the hardware platforms. For a list of features available with a software license on the Cisco 810, Cisco 860, Cisco 880, and Cisco 890 platforms, see [Cisco 812 Data Sheet](#), [Cisco 819 Data Sheet](#), [Cisco 860 Data Sheet](#), [Cisco 880 Data Sheet](#), and [Cisco 890 Data Sheet](#). See [Cisco IOS Software Activation Tasks and Commands](#) for details about how to activate and manage the software licenses.



CHAPTER 2

Basic Router Configuration

This chapter provides procedures for configuring the basic parameters of your Cisco router, including global parameter settings, routing protocols, interfaces, and command-line access. It also describes the default configuration on startup.



Note

Individual router models may not support every feature described in this guide. Features that are not supported by a particular router are indicated whenever possible.

This chapter includes configuration examples and verification steps, as available.

For complete information on how to access global configuration mode, see the [Entering Global Configuration Mode](#) section.

- [Basic Router Configuration, page 15](#)

Basic Router Configuration

This chapter provides procedures for configuring the basic parameters of your Cisco router, including global parameter settings, routing protocols, interfaces, and command-line access. It also describes the default configuration on startup.



Note

Individual router models may not support every feature described in this guide. Features that are not supported by a particular router are indicated whenever possible.

This chapter includes configuration examples and verification steps, as available.

For complete information on how to access global configuration mode see [Entering Global Configuration Mode, page A-5](#).

Interface Ports

[Table 9: Supported Interfaces and Associated Port Labels for Cisco 860, 880 and 890 Series Router](#), on page 16 lists the interfaces that are supported for Cisco 860, 880 and 890 series routers and their associated port labels on the equipment.

Table 9: Supported Interfaces and Associated Port Labels for Cisco 860, 880 and 890 Series Router

Router	Interface	Port Label
LAN Ports		
Cisco 860, Cisco 880, and Cisco 890 series	Fast Ethernet LAN	LAN, FE0–FE3
	Wireless LAN	(no label)
Cisco 866VAE, 867VAE	Ethernet LAN	LAN, FE0-FE3
Cisco 866VAE-K9, 867VAE-K9	Ethernet LAN	LAN, GE0, FE0-FE3
WAN Ports		
Cisco 861, 861W, 881, 881W, 881G, 881GW, 881-V	Fast Ethernet WAN	WAN, FE4
Cisco 867, 867W	ADSL2oPOTS WAN	ADSLoPOTS
Cisco 886, 886W, 886G, 886GW	ADSL2oISDN WAN	ADSLoPOTS
Cisco 887, 887W	ADSL2oPOTS WAN	ADSLoPOTS
Cisco 887V, Cisco887VW, 887VG, 887VGW	VDSL2oPOTS WAN	VDSL oPOTS
Cisco 867VA, 887VA, 887VA-M, 887VA-V, 887VA-V-W	VDSL/ADSL oPOTS WAN	VDSL/ADSL oPOTS
Cisco 888, 888W	G.SHDSL WAN	G.SHDSL
Cisco 891, 892	Fast Ethernet WAN	FE8
	Gigabit Ethernet WAN	WAN GE 0
Cisco 866VAE, 867VAE	Gigabit Ethernet WAN	WAN GE0
Cisco 866VAE-K9, 867VAE-K9	Gigabit Ethernet WAN	WAN GE1
Cisco 866VAE, 866VAE-K9	VDSL/ADSL oISDN WAN	VDSL/ADSL OVER ISDN
Cisco 867VAE, 867VAE-K9	VDSL/ADSL oPOTS WAN	VDSL/ADSL OVER POTS

Table 10: Supported Interfaces and Port Labels for Cisco 810 Series ISR

Router	Interface	Port Label
Cisco 819 Series Router	4-port Fast Ethernet LAN	LAN, FE0–FE3
	Gigabit Ethernet WAN	GE WAN 0
	Serial	Serial
	Mini USB for 3G port Provisioning	3G RSVD
	Console/Aux port	CON/AUX
Cisco 812 Series Router	Gigabit Ethernet WAN	GE WAN 0
	Mini USB for 3G port Provisioning	3G RSVD
	Console/Aux port	CON/AUX

Default Configuration

When you first boot up your Cisco router, some basic configuration has already been performed. All of the LAN and WAN interfaces have been created, console and vty ports are configured, and the inside interface for Network Address Translation (NAT) has been assigned. Use the **show running-config** command to view the initial configuration, as shown in the following example, for a Cisco 881W.

```

Router# show running-config
User Access Verification
Password:
Router> en
Password:
Router# show running-config
Building configuration...
Current configuration : 986 bytes
!
version 12.4
no service pad
service timestamps debug datetime msec
service timestamps log datetime msec
no service password-encryption
!
hostname Router
!
boot-start-marker
boot-end-marker
!
enable secret 5 $1$g4y5$NxDm.0hON6YA51bcfGvN1
enable password ciscocisco
!
no aaa new-model
!
!
!
!
no ip routing
no ip cef
!

```

```
!
!
!
!
multilink bundle-name authe
!
!
archive
  log config
  hidekeys
!
!
!
!
!
interface FastEthernet0
!
interface FastEthernet1
  shutdown
!
interface FastEthernet2
  shutdown
!
interface FastEthernet3
  shutdown
!
interface FastEthernet4
  ip address 10.1.1.1 255.255.255.0
  no ip route-cache
  duplex auto
  speed auto
!
interface Vlan1
  no ip address
  no ip route-cache
  shutdown
!
interface wlan-ap0
  description Service Module interface to manage the embedded AP
  ip unnumbered Vlan1
  no cdp enable
  arp timeout 0
!
ip route 0.0.0.0 0.0.0.0 10.1.1.1
!
!
no ip http server
no ip http secure-server
!
!
!
!
control-plane
!
!
line con 0
  no modem enable
line aux 0
line vty 0 4
  password cisco
  login
  transport input telnet ssh
!
scheduler max-task-time 5000
!
webvpn cef
end
Router#
```

Information Needed for Configuration

Gather the following information, depending on your planned network scenario, before configuring your network:

- If you are setting up an Internet connection, gather the following information:
 - PPP client name that is assigned as your login name
 - PPP authentication type: Challenge Handshake Authentication Protocol (CHAP) or Password Authentication Protocol (PAP)
 - PPP password to access your ISP account
 - DNS server IP address and default gateways
- If you are setting up a connection to a corporate network, you and the network administrator must generate and share the following information for the WAN interfaces of the routers:
 - PPP authentication type: CHAP or PAP
 - PPP client name to access the router
 - PPP password to access the router
- If you are setting up IP routing:
 - Generate the addressing scheme for your IP network.
 - Determine the IP routing parameter information, including IP address and ATM permanent virtual circuits (PVCs). These PVC parameters are typically virtual path identifier (VPI), virtual circuit identifier (VCI), and traffic-shaping parameters.
 - Determine the number of PVCs that your service provider has given you, along with their VPIs and VCIs.
 - For each PVC, determine the type of AAL5 encapsulation supported. It can be one of the following:

AAL5SNAP—This can be either routed RFC 1483 or bridged RFC 1483. For routed RFC 1483, the service provider must provide you with a static IP address. For bridged RFC 1483, you may use DHCP to obtain your IP address, or you may obtain a static IP address from your service provider.

AAL5MUX PPP—With this type of encapsulation, you need to determine the PPP-related configuration items.

- If you plan to connect over an ADSL or G.SHDSL line:
 - Order the appropriate line from your public telephone service provider.

For ADSL lines—Ensure that the ADSL signaling type is DMT (also known as ANSI T1.413) or DMT Issue 2.

For G.SHDSL lines—Verify that the G.SHDSL line conforms to the ITU G.991.2 standard and supports Annex A (North America) or Annex B (Europe).

- If you are setting up 3G:

- You must have service availability on the Cisco 819 ISR from a carrier, and you must have network coverage where your router will be physically placed. For a complete list of supported carriers, see the data sheet at [Cisco 3G Wireless Connectivity Solutions](#).
- You must subscribe to a service plan with a wireless service provider and obtain a SIM card.
- You must install the SIM card before configuring the 3G Cisco 819 ISR. For instructions on how to install the SIM card, see Cisco 800 Series see [Configuring Cisco EHWIC and 880G for 3.7G \(HSPA+\)/3.5G \(HSPA\)](#)
- You must install the required antennas before you configure the 3G for Cisco 819 ISR. See [Table 11: Instructions for Installing Antenna](#), on page 20 for instructions on how to install the antennas:

Table 11: Instructions for Installing Antenna

Antenna	Instructions for Installig Antenna
3G-ANTM1919D	See Cisco Multiband Swivel-Mount Dipole Antenna (3G-ANTM1919D) .
3G-ANTM1916-CM	See Cisco Multiband Omnidirectional Ceiling Mount Antenna (3G-ANTM1916-CM)
3G-AE015-R (Antenna Extension)	See Cisco Single-Port Antenna Stand for Multiband TNC Male-Terminated Portable Antenna (Cisco 3G-AE015-R) .
3G-AE010-R (Antenna Extension)	See Cisco Single-Port Antenna Stand for Multiband TNC Male-Terminated Portable Antenna (Cisco 3G-AE015-R) . This document applies to both 3G-AE015-R and 3G-AE010-R. The only difference between these two products is the length of the cable.
3G-ANTM-OUT-OM	See Cisco 3G Omnidirectional Outdoor Antenna (3G-ANTM-OUT-OM) .
3G-ANTM-OUT-LP	See Cisco Multiband Omnidirectional Panel-Mount Antenna (3G-ANTM-OUT-LP) .
3G-ACC-OUT-LA	See Cisco 3G Lightning Arrestor (3G-ACC-OUT-LA) .
4G-ANTM-OM-CM	See Cisco 4G Indoor Ceiling-Mount Omnidirectional Antenna (4G-ANTM-OM-CM)

- ◦ You must check your LEDs for signal reception as described in [Table 2-1](#) .
- You should be familiar with the Cisco IOS software. See the Cisco IOS documentation beginning with Release 12.4(15)T or later for Cisco 3G support .

- To configure your 3G data profile, you will need the username, password, and access point name (APN) from your service provider:

After collecting the appropriate information, perform a full configuration on your router beginning with the tasks in [Configuring Command-Line Access](#), on page 21.

- If you plan to connect voice equipment, see [Cisco IOS Voice Port Configuration Guide](#) .
- If you need to obtain or change software licenses, see [Software Activation on Cisco Integrated Services Routers and Cisco Integrated Service Routers G2](#) .

Configuring Command-Line Access

To configure parameters to control access to the router, perform the following steps, beginning in global configuration mode:

SUMMARY STEPS

1. **line** [**aux** | **console** | **tty** | **vty**] *line-number*
2. **password** *password*
3. **login**
4. **exec-timeout** *minutes* [*seconds*]
5. **line** [**aux** | **console** | **tty** | **vty**] *line-number*
6. **password** *password*
7. **login**
8. **end**

DETAILED STEPS

	Command or Action	Purpose
Step 1	line [aux console tty vty] <i>line-number</i> Example: Router(config)# line console 0	Enters line configuration mode and specifies the type of line. This example specifies a console terminal for access.
Step 2	password <i>password</i> Example: Router(config-line)# password 5dr4Hepw3	Specifies a unique password for the console terminal line.
Step 3	login Example: Router(config-line)# login	Enables password checking at terminal session login.

	Command or Action	Purpose
Step 4	exec-timeout <i>minutes</i> [<i>seconds</i>] Example: Router(config-line)# exec-timeout 5 30	Sets the time interval that the EXEC command interpreter waits until user input is detected. The default is 10 minutes. Optionally, add seconds to the interval value. This example shows a timeout of 5 minutes and 30 seconds. Entering a timeout of 0 0 specifies never to time out.
Step 5	line [aux console tty vty] <i>line-number</i> Example: Router(config-line)# line vty 0 4	Specifies a virtual terminal for remote console access.
Step 6	password <i>password</i> Example: Router(config-line)# password aldf2ad1	Specifies a unique password for the virtual terminal line.
Step 7	login Example: Router(config-line)# login	Enables password checking at the virtual terminal session login.
Step 8	end Example: Router(config-line)# end	Exits line configuration mode, and returns to privileged EXEC mode.

Configuring Global Parameters

To configure selected global parameters for your router, perform these steps:

SUMMARY STEPS

1. **configure terminal**
2. **hostname** *name*
3. **enable secret** *password*
4. **no ip domain-lookup**

DETAILED STEPS

	Command or Action	Purpose
Step 1	configure terminal	Enters global configuration mode when using the console port.

	Command or Action	Purpose
	<p>Example:</p> <pre> </pre> <p>Example:</p> <pre>Router# configure terminal</pre>	<p>If you are connecting to the router using a remote terminal, use the following:</p> <pre>telnet router name or address Login: login id Password: ***** Router> enable</pre>
Step 2	<p>hostname <i>name</i></p> <p>Example:</p> <pre> </pre> <p>Example:</p> <pre>Router(config)# hostname Router</pre>	Specifies the name for the router.
Step 3	<p>enable secret <i>password</i></p> <p>Example:</p> <pre> </pre> <p>Example:</p> <pre>Router(config)# enable secret c1ny5ho</pre>	Specifies an encrypted password to prevent unauthorized access to the router.
Step 4	<p>no ip domain-lookup</p> <p>Example:</p> <pre> </pre> <p>Example:</p> <pre>Router(config)# no ip domain-lookup</pre>	Disables the router from translating unfamiliar words (typos) into IP addresses.

Configuring WAN Interfaces

Configure the WAN interface for your router using one of the following as appropriate:

Configuring a Fast Ethernet WAN Interface

To configure the Fast Ethernet interface on a Cisco 861 or 881 ISR, perform these steps, beginning in global configuration mode:

SUMMARY STEPS

1. **interface** type number
2. **ip address** ip-address mask
3. **no shutdown**
4. **exit**

DETAILED STEPS

	Command or Action	Purpose
Step 1	interface type number Example: <pre>Router(config)# interface fastethernet 4</pre>	Enters the configuration mode for a Fast Ethernet WAN interface on the router.
Step 2	ip address ip-address mask Example: <pre>Router(config-if)# ip address 192.168.12.2 255.255.255.0</pre>	Sets the IP address and subnet mask for the specified Fast Ethernet interface.
Step 3	no shutdown Example: <pre>Router(config-if)# no shutdown</pre>	Enables the Ethernet interface, changing its state from administratively down to administratively up.
Step 4	exit Example: <pre>Router(config-if)# exit</pre>	Exits configuration mode for the Fast Ethernet interface and returns to global configuration mode.

What to Do Next**Note**

Cisco IOS Release 15.1 (3) T introduces the batch command under the interface mode. You may notice a reduced CPU utilization when interface batching is enabled because packets are processed in batches resulting in more efficient cache usage.

Configuring the Media Type

Before configuring the Gigabit Ethernet interface on the Cisco 892F ISRs, you must first select the media type as either SFP or RJ45.

To configure the media type, perform the following steps, beginning in global configuration mode:

SUMMARY STEPS

1. **interface** type number
2. **media-type** {sfp | rj45}
3. **exit**

DETAILED STEPS

	Command or Action	Purpose
Step 1	interface type number Example: Router(config)# interface gigabitethernet 0	Enters the configuration mode for a Gigabit Ethernet WAN interface on the router.
Step 2	media-type {sfp rj45} Example: Router(config-if)# media-type sfp Example: OR Example: Router(config-if)# media-type rj45	Specifies an SFP physical connection. OR Specifies an RJ-45 physical connection.
Step 3	exit Example: Router(config-if)# exit	Exits configuration mode for the Gigabit Ethernet interface and returns to global configuration mode.

Configuring a Gigabit Ethernet WAN Interface

To configure the Gigabit Ethernet (GE) WAN interface on a Cisco 891, 892, or 860VAE ISR, perform these steps, beginning in global configuration mode:

SUMMARY STEPS

1. **interface** type number
2. **ip address** ip-address mask
3. **no shutdown**
4. **exit**

DETAILED STEPS

	Command or Action	Purpose
Step 1	interface type number Example: Router(config)# interface gigabitethernet 1	Enters the configuration mode for a Gigabit Ethernet WAN interface on the router.
Step 2	ip address ip-address mask Example: Router(config-if)# ip address 192.168.12.2 255.255.255.0	Sets the IP address and subnet mask for the specified Gigabit Ethernet interface.
Step 3	no shutdown Example: Router(config-if)# no shutdown	Enables the Ethernet interface, changing its state from administratively down to administratively up.
Step 4	exit Example: Router(config-if)# exit Example: Router(config)#	Exits configuration mode for the Gigabit Ethernet interface and returns to global configuration mode.

Configuring a V.92 Modem Interface

The Cisco 891 ISR has a V.92 modem backup interface. To configure this interface, perform these steps, beginning in global configuration mode:

SUMMARY STEPS

1. **interface** type number
2. **ip address ip-address mask**
3. **encapsulation** *ppp*
4. **dialer in-band**
5. **dialer string** *dial-string*
6. **dialer-group** *group-number*
7. **async mode dedicated**
8. **exit**

DETAILED STEPS

	Command or Action	Purpose
Step 1	<p>interface type number</p> <p>Example: </p> <p>Example: Router(config)# interface async 1</p>	Enters the configuration mode for a V.92 WAN interface (serial interface) on the router.
Step 2	<p>ip address ip-address mask</p> <p>Example: </p> <p>Example: Router(config-if)# ip address 192.168.12.2 255.255.255.0</p>	Sets the IP address and subnet mask for the specified V.92 interface.
Step 3	<p>encapsulation ppp</p> <p>Example: </p> <p>Example: Router(config-if)# encapsulation ppp</p>	Sets the encapsulation method to point-to-point protocol (PPP) for the serial interface.
Step 4	<p>dialer in-band</p> <p>Example: </p> <p>Example: Router(config-if)# dialer in-band</p>	Specifies that dial-on-demand routing (DDR) is supported.
Step 5	<p>dialer string dial-string</p> <p>Example: </p> <p>Example: Router(config-if)# dialer string 102</p>	Specifies the string (telephone number) to be used when placing a call from the interface.
Step 6	<p>dialer-group group-number</p> <p>Example: </p>	Configures the interface to belong to a specific dialing access group.

	Command or Action	Purpose
	Example: <pre>Router(config-if)# dialer-group 1</pre>	
Step 7	async mode dedicated Example: <pre> </pre> Example: <pre>Router(config-if)# async mode dedicated</pre>	Places the line into dedicated asynchronous mode using Serial Line Internet Protocol (SLIP) or PPP encapsulation.
Step 8	exit Example: <pre> </pre> Example: <pre>Router(config-if)# exit</pre> Example: <pre>Router(config)#</pre>	Exits configuration mode for the V.92 interface and returns to global configuration mode.

Configuring a VDSL2 WAN Interface

The VDSL2 WAN interface is used on the Cisco 887V ISR platforms. Note that the VDSL2 WAN interface uses Ethernet as the Layer 2 transport mechanism.

To configure VDSL2 on the Cisco 887V ISR, perform these steps, beginning in global configuration mode:

SUMMARY STEPS

1. **controller** *vdsl 0*
2. **interface** type number
3. **ip address** ip-address mask
4. **shutdown**
5. **no shutdown**
6. **exit**

DETAILED STEPS

	Command or Action	Purpose
Step 1	<p>controller <i>vdsl 0</i></p> <p>Example: </p> <p>Example: Router(config)# controller vdsl 0</p>	<p>Enters controller configuration mode and the controller number.</p> <p>Note There is no need to configure any VDSL2 parameters from CPE side. Any specific VDSL2 settings should be set on the DSLAM side.</p>
Step 2	<p>interface type number</p> <p>Example: </p> <p>Example: Router(config)# interface ethernet 0</p>	<p>Enters the configuration mode for Ethernet Layer 2 transport on the VDSL WAN interface on the router.</p>
Step 3	<p>ip address ip-address mask</p> <p>Example: </p> <p>Example: Router(config-if)# ip address 192.168.12.2 255.255.255.0</p>	<p>Sets the IP address and subnet mask for the interface.</p>
Step 4	<p>shutdown</p> <p>Example: </p> <p>Example: Router(config-if)# shutdown</p>	<p>Disables the interface, changing its state from administratively up to administratively down.</p>
Step 5	<p>no shutdown</p> <p>Example: </p> <p>Example: Router(config-if)# no shutdown</p>	<p>Enables the interface, changing its state from administratively down to administratively up.</p>
Step 6	<p>exit</p> <p>Example: </p>	<p>Exits configuration mode and returns to global configuration mode.</p>

	Command or Action	Purpose
	Example: Router(config-if)# exit	

Configuring ADSL or VDSL on Cisco 860VAE and 880VA Multimode ISRs

This section contains the following topics:

Overview of Cisco 860VAE, 886VA, and 887VA Multimode ISRs

The Cisco customer premise equipment (CPE) Cisco 866VAE, 867VAE, 866VAE-K9, 867VAE-K9, 886VA and 887VA integrated services routers (ISRs) support asymmetric digital subscriber line (ADSL) 1/2/2+ and very high speed digital subscriber line 2 (VDSL2) transmission modes, also called multimode.



Note

The 866VAE and 886VA support xDSL over ISDN. The 867VAE and 887VA support xDSL over a plain old telephone system (POTS).

The default CPE operating mode is auto. Auto mode means that the CPE trains up to the mode configured on the digital subscriber line access multiplexer (DSLAM), ADSL1/2/2+, or VDSL2.

The following examples assume the DSLAM is configured in either ADSL2+ mode or VDSL2 mode, and the CPE is configured in auto mode.

Figure 1: Example Topology, on page 30 shows an ATM WAN or Ethernet WAN network topography.

Figure 1: Example Topology

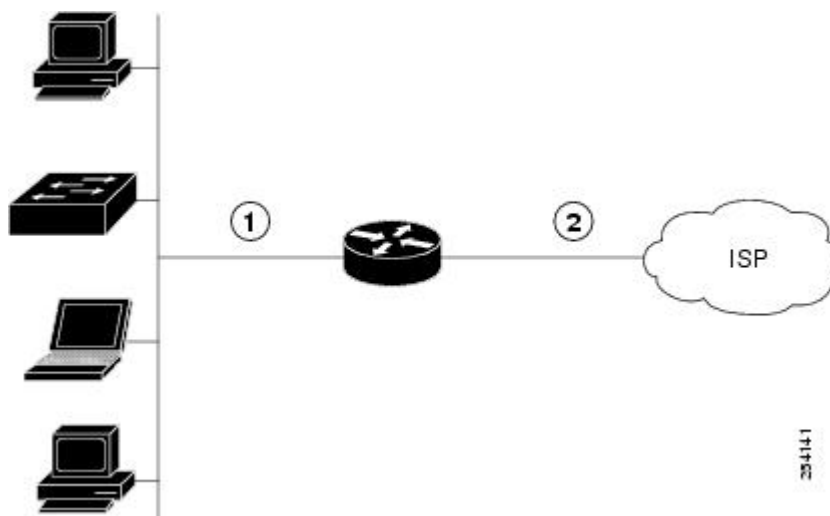

1	Fast Ethernet LAN interface or Gigabit Ethernet LAN interface	2	ATM WAN interface—ADSL 1/2/2+ mode or Ethernet WAN Interface—VDSL2 mode
---	--	---	--



Note A DSLAM in Layer 1 mode may be configured for auto mode. A DSLAM in Layer 2 mode must be configured for ATM mode or packet transfer mode (PTM).



Note Cisco 886VA and 887VA allow a maximum of four permanent virtual circuits (PVCs).



Note Cisco 866VAE, Cisco 867VAE, Cisco 866VAE-K9, and Cisco 867VAE-K9 ISRs allow a maximum of two PVCs.

ADSL2/2+ Annex M Mode on Over POTS VDSL2/ADSL Multimode Annex A SKUs

Annex M is an enhancement of the G.992.3 standard that doubles the upstream bandwidth by "borrowing" 32 additional tones from the downstream frequency range. This feature enables service providers to provision symmetric data rates for ADSL2 and ADSL2+ services with data rates up to 2 Mbps.

Cisco IOS Release 15.2(1)T adds support for enabling Annex M data structures on Cisco 887VA platforms and Annex A data structures on Cisco 887VA-M platforms. This feature allows both Annex A and Annex M structures to be run on the same platform with a performance tradeoff for the annex that is not optimized for the device. With this feature implementation, the modes supported on Annex A platforms are the same as the modes supported on Annex M platforms (887VA-M and EHWIC-1DSL-VA-M). When digital subscriber line access multiplexer (DSLAM) supports Annex M, Annex M mode takes precedence over Annex A mode.



Note Cisco 867VAE and 867VAE-K9 require Cisco IOS Release 15.1(4)M2 or 15.2(2)T or later to use this feature.

For information on configuring Annex M data structures on Annex A platforms, see the, [Enabling ADSL2/2+ Annex M Mode on Over POTS VDSL2/ADSL Multimode Annex A SKUs](#), on page 44.

Configuring Seamless Rate Adaption

ADSL connections can be dropped due to a number of reasons, such as crosstalk, changes in noise margin, temperature changes, or interference. ADSL2 addresses these problems by adapting the data rate in real-time. Seamless rate adaptation (SRA) enables the ADSL2 system to change the data rate of the connection during operation without any service interruption or bit errors.

**Note**

These features are not currently available on the 866VAE, 867VAE, 866VAE-K9, and 867VAE-K9.

For information on configuring SRA, see the [Enabling Seamless Rate Adaption](#), on page 45.

Configuring UBR+

UBR is typically used for data communications applications, such as file transfer and email. UBR is a best effort service and is the lowest class of service in the hierarchy. There are no guarantees to the actual bandwidth allowed. Therefore, UBR virtual circuits (VCs) are susceptible to a large number of cell drops or a high cell transfer delay as cells move from the source to the destination. UBR has no bounds on Cell Delay Variation Tolerance (CDVT) and is only a best effort service.

UBR+ is a special ATM service class developed by Cisco. UBR defines only peak cell rate (PCR); however, UBR+ defines a minimum guaranteed cell rate (MCR) and (on the switch) a cell delay variation tolerance (CDVT).

**Note**

On Cisco IOS versions 15.2(1)T and later, UBR+ is compatible with Cisco Multimode 886VA and 887VA routers.

**Note**

These features are not currently available on the 866VAE, 867VAE, 866VAE-K9, and 867VAE-K9.

For information on configuring UBR+, see the [Configuring UBR+](#), on page 47.

Configuring ADSL Mode

Configuration tasks

Perform the following tasks to configure ADSL mode:

Configuring ADSL Auto Mode

Perform these steps to configure the DSL controller to auto mode, starting in global configuration mode.

**Note**

Configure the DSLAM in ADSL 1/2/2+ mode prior to configuring the router.

SUMMARY STEPS

1. **enable**
2. **configure terminal**
3. controller vdsl slot
4. operating mode {**auto** | **adsl1** | **adsl2** | **adsl2+** | **vdsl2** | **ansi**}
5. **end**

DETAILED STEPS

	Command or Action	Purpose
Step 1	enable Example: <pre>Router> enable</pre>	Enables privileged EXEC mode. <ul style="list-style-type: none"> • Enter your password if prompted.
Step 2	configure terminal Example: <pre>Router# configure terminal</pre>	Enters global configuration mode.
Step 3	controller vdsl slot Example: <pre> </pre> Example: <pre>Router(config)# controller vdsl 0</pre>	Enters config mode for the VDSL controller.
Step 4	operating mode {auto adsl1 adsl2 adsl2+ vdsl2 ansi} Example: <pre> </pre> Example: <pre>Router(config-controller)# operating mode auto</pre>	Configures the operating mode. The default is auto and is recommended. Note When configured in auto, the operating mode does not appear in the show running command.
Step 5	end Example: <pre> </pre> Example: <pre>Router(config-controller)# end</pre> Example: <pre>Router#</pre>	Exits the configuration mode and enters EXEC mode. Note A reload is required after changing mode between adsl and vdsl for Cisco 866VAE, Cisco 867VAE, Cisco 866VAE-K9, and Cisco 867VAE-K9.

Configuring CPE and Peer for ADSL Mode

When configuring for ADSL, the ATM main interface or ATM sub-interface must be configured with a PVC and an IP address, perform a no shutdown command on the interface if needed.

Configuring the ATM CPE side

Perform the following steps to configure the ATM CPE side, starting in global configuration mode.

SUMMARY STEPS

1. interface type number
2. no shutdown
3. interface atm0.1 point-to-point
4. ip address ip-address mask
5. pvc [name] vpi/vci
6. protocol protocol {protocol-address [virtual-template] | inarp} [[no] broadcast | disable-check-subnet | [no] enable-check-subnet]
7. end

DETAILED STEPS

	Command or Action	Purpose
Step 1	interface type number Example: Router(config)# interface atm0	Enters configuration mode for the ATM WAN interface (ATM0).
Step 2	no shutdown Example: Router(config-if)# no shutdown	Enables the configuration changes to the ATM interface.
Step 3	interface atm0.1 point-to-point Example: Router(config-if)# interface ATM0.1 point-to-point Example: Router(config-subif)#	Enables ATM0.1 point-to-point interface.
Step 4	ip address ip-address mask Example: Router(config-subif)# ip address 30.0.0.1 255.255.255.0	Enters IP address and subnet mask.
Step 5	pvc [name] vpi/vci Example: Router(config-subif)# pvc 13/32	Creates or assigns a name to an ATM PVC and enters the ATM virtual circuit configuration mode.

	Command or Action	Purpose
Step 6	<p>protocol protocol {protocol-address [virtual-template] inarp} [[no] broadcast disable-check-subnet [no] enable-check-subnet]</p> <p>Example:</p> <pre>Router(config-if-atm-vc)# protocol ip 30.0.0.2 broadcast</pre>	Configures a static map for an ATM PVC.
Step 7	<p>end</p> <p>Example:</p> <pre>Router(config-if-atm-vc)# end Router#</pre>	Exits the configuration mode and enters EXEC mode.

Configuring the ATM Peer side

Perform the following steps to configure the ATM peer side, starting in global configuration mode.

SUMMARY STEPS

1. interface type number
2. no shutdown
3. interface atm0.1 point-to-point
4. ip address ip-address mask
5. pvc [name] vpi/vci
6. **protocol protocol {protocol-address [virtual-template] | inarp} [[no] broadcast | disable-check-subnet | [no] enable-check-subnet]**
7. end

DETAILED STEPS

	Command or Action	Purpose
Step 1	<p>interface type number</p> <p>Example:</p> <pre>Router(config)# interface atm0</pre>	Enters configuration mode for the ATM WAN interface (ATM0).
Step 2	<p>no shutdown</p> <p>Example:</p> <pre>Router(config-if)# no shutdown</pre>	Enables the configuration changes to the ATM interface.

	Command or Action	Purpose
Step 3	interface atm0.1 point-to-point Example: Router(config-if)# interface ATM0.1 point-to-point	Enables the ATM0.1 point-to-point interface.
Step 4	ip address ip-address mask Example: Router(config-subif)# ip address 30.0.0.2 255.255.255.0	Enters IP address and subnet mask.
Step 5	pvc [name] vpi/vci Example: Router(config-subif)# pvc 13/32	Creates or assigns a name to an ATM PVC and enters the ATM virtual circuit configuration mode.
Step 6	protocol protocol {protocol-address [virtual-template] inarp} [[no] broadcast disable-check-subnet [no] enable-check-subnet] Example: Router(config-if-atm-vc)# protocol ip 30.0.0.1 broadcast	Configures a static map for an ATM PVC.
Step 7	end Example: Router(config-if-atm-vc)# end	Exits the configuration mode and enters EXEC mode.

ADSL Configuration Example

The following example shows a typical ADSL2+ configuration set to auto mode. Outputs in bold are critical.

```

Router# show running
Building configuration...
Current configuration : 1250 bytes
!
! Last configuration change at 02:07:09 UTC Tue Mar 16 2010
!
version 15.1
no service pad
service timestamps debug datetime msec
service timestamps log datetime msec
no service password-encryption
!
hostname Router
!
boot-start-marker
boot-end-marker
!
!
```

```
no aaa new-model
memory-size iomem 10
ip source-route
!
!
!
ip cef
no ipv6 cef
!
!
!
license udi pid CISCO887-V2-K9 sn FHK1313227E
license boot module c880-data level advipservices
!
!
vtp domain cisco
vtp mode transparent
!
!
controller VDSL 0
!
vlan 2-4
!
!
!
!
interface Ethernet0
 no ip address
 shutdown
 no fair-queue
!
interface BRI0
 no ip address
 encapsulation hdlc
 shutdown
 isdn termination multidrop
!
interface ATM0
 no ip address
 no atm ilmi-keepalive
!
interface ATM0.1 point-to-point
 ip address 30.0.0.1 255.255.255.0
 pvc 15/32
  protocol ip 30.0.0.2 broadcast
!
!
interface FastEthernet0
!
interface FastEthernet1
!
interface FastEthernet2
!
interface FastEthernet3
!
interface Vlan1
 no ip address
!
ip forward-protocol nd
no ip http server
no ip http secure-server
!
!
!
!
!
!
control-plane
!
```

```

!
line con 0
  no modem enable
line aux 0
line vty 0 4
  login
  transport input all
!
exception data-corruption buffer truncate
end

```

Verifying ADSL Configuration

Verify that the configuration is set properly by using the `show controller vdsl 0` command from the privileged EXEC mode. Outputs in bold are critical.

```

Router# show controller vdsl 0
Controller VDSL 0 is UP
Daemon Status:
                Up
                XTU-R (DS)                XTU-C (US)
Chip Vendor ID:   'BDCM'                  'BDCM'
Chip Vendor Specific: 0x0000              0x6110
Chip Vendor Country: 0xB500              0xB500
Modem Vendor ID:  'CSCO'                  'BDCM'
Modem Vendor Specific: 0x4602              0x6110
Modem Vendor Country: 0xB500              0xB500
Serial Number Near: FHK1313227E 887-V2-K 15.1(20100
Serial Number Far:
Modem Version Near: 15.1(20100426:193435) [changahn
Modem Version Far:  0x6110
Modem Status:      TC Sync (Showtime!)
DSL Config Mode:   AUTO
Trained Mode:      G.992.5 (ADSL2+) Annex A
TC Mode:           ATM
Selftest Result:   0x00
DELT configuration: disabled
DELT state:        not running
Trellis:           ON
Line Attenuation:  1.0 dB                  1.4 dB
Signal Attenuation: 1.0 dB                  0.0 dB
Noise Margin:      6.8 dB                  13.6 dB
Attainable Rate:   25036 kbits/s           1253 kbits/s
Actual Power:      13.7 dBm                 12.3 dBm
Total FECS:        0                       0
Total ES:          0                       0
Total SES:         0                       0
Total LOSS:        0                       0
Total UAS:         0                       0
Total LPRS:        0                       0
Total LOFS:        0                       0
Total LOLS:        0                       0
Bit swap:          163                      7
Full inits:        32
Failed full inits: 0
Short inits:       0
Failed short inits: 0
Firmware           Source                 File Name (version)
-----
VDSL                embedded                VDSL_LINUX_DEV_01212008 (1)
Modem FW Version:   100426 1053-4.02L.03.A2pv6C030f.d22j
Modem PHY Version:  A2pv6C030f.d22j

```

	DS Channel1	DS Channel0	US Channel1	US Channel0
Speed (kbps):	0	24184	0	1047
Previous Speed:	0	24176	0	1047
Total Cells:	0	317070460	0	13723742
User Cells:	0	0	0	0
Reed-Solomon EC:	0	0	0	0
CRC Errors:	0	0	0	0
Header Errors:	0	0	0	0
Interleave (ms):	0.00	0.08	0.00	13.56

```
Actual INP:          0.00          0.00          0.00          1.80
Training Log : Stopped
Training Log Filename : flash:vdslllog.bin
```

Verifying CPE to Peer Connection for ADSL

Ping the peer to confirm that CPE to peer configuration is set up correctly.

```
Router# ping 30.0.0.2 rep 20
Type escape sequence to abort.
Sending 20, 100-byte ICMP Echos to 30.0.0.2, timeout is 2 seconds:
!!!!!!!!!!!!!!!!!!!!!!
Success rate is 100 percent (20/20), round-trip min/avg/max = 20/22/28 ms
Router#
```

Configuring VDSL Mode

Configuration tasks

Perform the following tasks to configure VDSL mode:

Configuring VDSL Auto Mode

Perform the following steps to configure the DSL controller to auto mode, starting in global configuration mode.



Note Configure the DSLAM in VDSL2 mode prior to configuring the router.

SUMMARY STEPS

1. controller vdsl slot
2. operating mode {auto | adsl1 | adsl2 | adsl2+ | vdsl2 | ansi}
3. end

DETAILED STEPS

	Command or Action	Purpose
Step 1	controller vdsl slot Example: Router(config)# controller vdsl 0	Enters config mode for the VDSL controller.
Step 2	operating mode {auto adsl1 adsl2 adsl2+ vdsl2 ansi} Example: Router(config-controller)# operating mode auto	Configures the operating mode. The default is auto and is recommended. Note When configured in auto, the operating mode does not appear in the show running command.

	Command or Action	Purpose
Step 3	end Example: <pre>Router(config-controller)# end Router#</pre>	Exits the configuration mode and enters EXEC mode. Note A reload is required after changing the mode on the Cisco 866VAE, Cisco 867VAE, Cisco 866VAE-K9, and Cisco 867VAE-K9.

Configuring CPE and Peer for VDSL Mode

When configuring VDSL, configure the ethernet 0 interface and perform a no shutdown command on the interface if needed. Start in the global configuration mode.

Configuring the VDSL CPE Side

Perform the following steps to configure the VDSL CPE side, starting in the global configuration mode.

SUMMARY STEPS

1. interface type number
2. ip address ip-address mask
3. no shutdown
4. end

DETAILED STEPS

	Command or Action	Purpose
Step 1	interface type number Example: <pre>Router(config)# interface ethernet0</pre>	Enters configuration mode for the Ethernet interface 0.
Step 2	ip address ip-address mask Example: <pre>Router(config-if)# ip address 90.0.0.1 255.255.255.0</pre>	Enters the IP address and subnet mask.
Step 3	no shutdown Example: <pre>Router(config-if)# no shutdown</pre>	Enables the configuration changes to the ip address and subnet mask.

	Command or Action	Purpose
Step 4	end Example: Router(config-if)# end	Exits the configuration mode and enters EXEC mode.

Configuring the VDSL Peer Side

Perform the following steps to configure the VDSL Peer side, starting in the global configuration mode.

SUMMARY STEPS

1. interface type number
2. ip address ip-address mask
3. no shutdown
4. end

DETAILED STEPS

	Command or Action	Purpose
Step 1	interface type number Example: Router(config)# interface ethernet0	Enters configuration mode for the Ethernet interface 0.
Step 2	ip address ip-address mask Example: Router(config-if)# ip address 90.0.0.2 255.255.255.0	Configures the IP address and subnet mask.
Step 3	no shutdown Example: Router(config-if)# no shutdown	Enables the configuration changes to the IP address and subnet mask.
Step 4	end Example: Router(config-if)# end	Exits the configuration mode and enters EXEC mode.

VDSL Configuration Example

The following example shows a typical output of a VDSL configuration. Outputs in bold are critical.

```

Router# show running
Building configuration...
Current configuration : 1250 bytes
!
! Last configuration change at 02:07:09 UTC Tue Mar 16 2010
!
version 15.1
no service pad
service timestamps debug datetime msec
service timestamps log datetime msec
no service password-encryption
!
hostname Router
!
boot-start-marker
boot-end-marker
!
!
no aaa new-model
memory-size iomem 10
ip source-route
!
!
!
!
ip cef
no ipv6 cef
!
!
!
license udi pid CISCO887-V2-K9 sn FHK1313227E
license boot module c880-data level advipservices
!
!
vtp domain cisco
vtp mode transparent
!
!
controller VDSL 0
!
vlan 2-4
!
!
!
!
interface Ethernet0
ip address 30.0.0.1 255.255.255.0
no fair-queue
!
interface BRI
no ip address
encapsulation hdlc
shutdown
isdn termination multidrop
!
interface ATM0
no ip address
shutdown
!
!
interface FastEthernet0
!
interface FastEthernet1
!

```



```

interface FastEthernet2
!
interface FastEthernet3
!
interface Vlan1
 no ip address
!
ip forward-protocol nd
no ip http server
no ip http secure-server
!
!
!
!
!
!
!
!
control-plane
!
!
line con 0
 no modem enable
line aux 0
line vty 0 4
 login
 transport input all
!
exception data-corruption buffer truncate
end

```

Verifying VDSL Configuration

Verify the configuration is set properly by using the `show controller vdsl 0` command from privileged EXEC mode. Outputs in bold are critical.

```

Router# show controller vdsl 0
Controller VDSL 0 is UP
Daemon Status:      Up
                   XTU-R (DS)           XTU-C (US)
Chip Vendor ID:    'BDCM'                'BDCM'
Chip Vendor Specific: 0x0000            0x0000
Chip Vendor Country: 0xB500            0xB500
Modem Vendor ID:   'CSCO'                'BDCM'
Modem Vendor Specific: 0x4602            0x0000
Modem Vendor Country: 0xB500            0xB500
Serial Number Near: FHK1313227E 887-V2-K 15.1 (20100
Serial Number Far:
Modem Version Near: 15.1 (20100426:193435) [changahn
Modem Version Far:  0x0000
Modem Status:      TC Sync (Showtime!)
DSL Config Mode:   AUTO
Trained Mode:      G.993.2 (VDSL2) Profile 12a
TC Mode:           PTM
Selftest Result:   0x00
DELT configuration: disabled
DELT state:        not running
Trellis:           ON                    OFF
Line Attenuation:  1.0 dB                 0.0 dB
Signal Attenuation: 1.0 dB                 0.0 dB
Noise Margin:      12.0 dB                 9.5 dB
Attainable Rate:   87908 kbits/s           50891 kbits/s
Actual Power:      13.5 dBm                8.9 dBm
Per Band Status:   D1    D2    D3    U0    U1    U2    U3
Line Attenuation(dB): 0.9  2.3  N/A  7.2  2.9  7.0  N/A
Signal Attenuation(dB): 0.9  2.3  N/A  N/A  2.3  6.6  N/A
Noise Margin(dB):    14.5  9.3  N/A  N/A  N/A  N/A  N/A
Total FECs:          0          0
Total ES:             0          0
Total SES:            0          0
Total LOSS:           0          0

```

```

Total UAS:          0          0
Total LPRS:         0          0
Total LOFS:         0          0
Total LOLS:         0          0
Bit swap:           1          0
Full inits:         33
Failed full inits:  0
Short inits:        0
Failed short inits: 0
Firmware           Source          File Name (version)
-----
VDSL                embedded          VDSL_LINUX_DEV_01212008 (1)
Modem FW Version:   100426_1053-4.02L.03.A2pv6C030f.d22j
Modem PHY Version:  A2pv6C030f.d22j
Speed (kbps):       0          84999          0          48968
Previous Speed:     0          24184          0          1047
Reed-Solomon EC:    0          0              0          0
CRC Errors:         0          0              0          0
Header Errors:      0          0              0          0
Interleave (ms):    0.00        6.00          0.00        0.00
Actual INP:         0.00        0.00          0.00        0.00
Training Log :      Stopped
Training Log Filename : flash:vdsllog.bin
Router#

```

Verifying CPE to Peer Connection for VDSL

Ping the peer to confirm that CPE to peer configuration is setup correctly.

```

Router# ping 30.0.0.2 rep 20
Type escape sequence to abort.
Sending 20, 100-byte ICMP Echos to 30.0.0.2, timeout is 2 seconds:
!!!!!!!!!!!!!!!!!!!!!!
Success rate is 100 percent (20/20), round-trip min/avg/max = 20/22/28 ms
Router#

```

Enabling ADSL2/2+ Annex M Mode on Over POTS VDSL2/ADSL Multimode Annex A SKUs



Note This feature requires Cisco IOS Release 15.2(1)T or a later.



Note Cisco 867VAE and 867VAE-K9 require Cisco IOS Release 15.1(4)M2 or 15.2(2)T or later to use this feature.

Configuring ADSL2/2+ Annex M mode on Over POTS VDSL2/ADSL Multimode Annex A SKUs.

SUMMARY STEPS

1. **enable**
2. **configure terminal**
3. **controller vdsl 0**
4. **operating mode {adsl1 | adsl2 annex a | annex m | adsl2+ annex a | annex m} | ansi | auto | vdsl2}**

DETAILED STEPS

	Command or Action	Purpose
Step 1	enable Example: Router> enable	Enables privileged EXEC mode. <ul style="list-style-type: none"> • Enter your password if prompted.
Step 2	configure terminal Example: Router# configure terminal	Enters global configuration mode.
Step 3	controller vdsl 0	Enters configuration mode for the VDSL controller.
Step 4	operating mode { adsl1 adsl2 annex a annex m adsl2+ annex a annex m ansi auto vdsl2 } Example: Router(config-controller)# operating mode adsl2+ annex m	adsl1—Configures operation in ITU G.992.1 Annex A full-rate mode. adsl2—Configures operation in ADSL2 operating mode-ITU G.992.3 Annex A, Annex L, and Annex M. If an Annex operating mode is not chosen, Annex A, Annex L, and Annex M are enabled. The final mode is decided by negotiation with the DSL access multiplexer (DSLAM). adsl2+—Configures operation in ADSL2+ mode-ITU G.992.5 Annex A and AnnexM. If an Annex A operating mode is not chosen, both Annex and Annex M is enabled. The final mode is decided by negotiation with DSLAM. ansi—Configures a router to operate in ANSI full-rate mode-ANSI T1.413. auto—Default setting. Configures the router so that the DSLAM automatically picks the DSL operating mode, in the sequence described in the "Usage Guidelines" section. All supported modes are enabled. vdsl2—Configures operation in ITU G.993.2 mode. annex a, m—(Optional) If the annex option is not specified, both Annex A and Annex M are enabled. The final mode is decided by negotiation with the Digital Synchronous Line Access Multiplexer (DSLAM).

Enabling Seamless Rate Adaption

To enable SRA, perform the following steps.

Note

SRA mode is disabled by default.

Note

SRA requires Cisco IOS Release 15.2(1)T or a later release.

**Note**

These features are not currently available on the Cisco 866VAE, 867VAE, 866VAE-K9, or 867VAE-K9.

SUMMARY STEPS

1. **enable**
2. **configure terminal**
3. **controller vdsl x/y/z**
4. **sra**

DETAILED STEPS

	Command or Action	Purpose
Step 1	enable Example: Router# enable	Enables privileged EXEC mode. • Enter your password if prompted.
Step 2	configure terminal Example: Router# configure terminal	Enters global configuration mode.
Step 3	controller vdsl x/y/z Example: Router(config)# controller vdsl 0/0/0	Enters controller configuration mode. Use the controller vdsl command in global configuration mode. This command does not have a no form. x—Defines the network module. y—Defines the slot number. z—Defines the port number.
Step 4	sra Example: router(config-controller)# sra	Enables SRA mode. Use the no form of the command to disable SRA.

Example Configuration: Seamless Rate Adaption

The following example enables SRA on a VDSL line:

```

!
!
!
router>enable
router# configure terminal

```

```

Enter configuration commands, one per line.  End with CNTL/Z
router(config)# controller vdsl 0
router(config-controller)# sra
router(config-controller)# end
router#
!
!
!

```

Configuring UBR+

Perform the following steps to configure UBR+.



Note

Cisco IOS Release 15.2(1)T or a later release is required to run UBR+ on Cisco 886VA, 887VA, and 887VA-M routers.



Note

These features are not currently available on the Cisco 866VAE, 867VAE, 866VAE-K9, or 867VAE-K9.

SUMMARY STEPS

1. **enable**
2. **configure terminal**
3. **ubr+ output-pcr output-mcr [input-pcr] [input-mcr]**

DETAILED STEPS

	Command or Action	Purpose
Step 1	enable Example: Router> enable	Enables privileged EXEC mode. <ul style="list-style-type: none"> • Enter your password if prompted.
Step 2	configure terminal Example: Router# configure terminal	Enters global configuration mode.
Step 3	ubr+ output-pcr output-mcr [input-pcr] [input-mcr] Example: Router(config-if-vc)# ubr+ 10000 3000 9000 1000	Configures unspecified bit rate (UBR) quality of service (QoS) and specifies the output peak cell rate and output minimum guaranteed cell rate for an ATM permanent virtual circuit (PVC), PVC range, switched virtual circuit (SVC), virtual circuit (VC) class, or VC bundle member. To remove the UBR+ parameters, use the no form of this command. output-pcr—The output peak cell rate (PCR) in kbps. output-mcr—The output minimum guaranteed cell rate in kbps. input-pcr—(Optional for SVCs only) The input PCR in kbps. If this value is omitted, the input-pcr equals the output-pcr.

	Command or Action	Purpose
		input-mcr—(Optional for SVCs only) The input minimum guaranteed cell rate in kbps. If this value is omitted, the input-mcr equals the output-mcr.

UBR+ Example

The following example configures UBR+ PVC on a DSL line:

```
interface atm 0/0
 pvc 4/100
 ubr+ 2304 2304
```

The following example specifies the output-pcr argument for an ATM PVC to be 100000 kbps and the output-mcr to be 3000 kbps:

```
pvc 1/32
ubr+ 100000 3000
```

The following example specifies the output-pcr, output-mcr, input-pcr, and input-mcr arguments for an ATM SVC to be 10000 kbps, 3000 kbps, 9000 kbps, and 1000 kbps, respectively:

```
svc lion nsap 47.0091.81.000000.0040.0B0A.2501.ABC1.3333.3333.05
ubr+ 10000 3000 9000 1000
```

Troubleshooting

There are no new commands for checking traffic on the Cisco 886VA and 887VA. Some helpful commands include the following **show** commands:

- show interface Ethernet0
- show interface ATM0
- show interface summary
- show controller vdsl 0
- show controller atm0
- show controller vdsl 0 datapath
- show atm pvc

The “[Cisco 860, Cisco 880, and Cisco 890 Series Integrated Services Routers Software Configuration Guide, Troubleshooting](#)” section may also be helpful.

Configuring the Training Log Using the CLI

When you initiate the training log capture using the **debug vdsl 0 training log** on the Cisco 866VAE, Cisco 867VAE, Cisco 866VAE-K9, and Cisco 867VAE-K9 ISRs, the training log file opens. Any messages that are generated are buffered locally and are written to the training log file at 5k bytes per interval. The messages are not written all at one time, as in previous software versions that supported the training log capture feature.

**Note**

A maximum log capacity of 8MB (approximately 1 hour of capture) exists on the Cisco 866VAE, Cisco 867VAE, Cisco 866VAE-K9, and Cisco 867VAE-K9 ISRs. Because of this capacity limitation, when the entire log collection exceeds 8MB, the log capture is automatically terminated.

**Note**

Cisco 866VAE, Cisco 867VAE, Cisco 866VAE-K9, and Cisco 867VAE-K9 ISRs do not support the continuous training log autostop feature.

Capturing the Training Log

By default the training log is saved to flash:vdsllog.bin.

To start the training log capture, use the **debug vdsl 0 training log** command.

```
Router# debug vdsl 0 training log
Router#
```

The following confirmation is displayed:

```
Training log generation started for VDSL 0
```

Halting the Training Log Capture

To stop the training log capture, use the **no debug vdsl 0 training log** command.

```
Router# no debug vdsl 0 training log
Router#
```

The following confirmation is displayed:

```
Training Log file for VDSL written to flash:vdsllog.bin
```

Displaying the Training Log Status and File Location

To display the training log status and file location, use the **show controller vdsl 0** command.

```
Router# show controller vdsl 0
Router#
```

The following confirmation is displayed:

```
Controller VDSL 0 is UP
```

```
Daemon Status:          NA
```

```
Chip Vendor ID:         XTU-R (DS)           XTU-C (US)
                        'BDCM'                'BDCM'
```

```

Chip Vendor Specific: 0x0000          0x938C
Chip Vendor Country: 0xB500          0xB500
Modem Vendor ID:     'CSCO'          'BDCM'
Modem Vendor Specific: 0x4602        0x938C
Modem Vendor Country: 0xB500        0xB500
Serial Number Near:  GMH1049001M 867VAE-K 15.1(20110
Serial Number Far:
Modem Version Near:  15.1(20110422:230431) [suguraja
Modem Version Far:  0x938C

Modem Status:          TC Sync (Showtime!)
DSL Config Mode:      AUTO
Trained Mode:         G.992.5 (ADSL2+) Annex A
TC Mode:              ATM
Selftest Result:     0x00
DELT configuration:   disabled
DELT state:          not running
Trellis:             ON              ON
Line Attenuation:    0.0 dB           0.0 dB
Signal Attenuation:  0.0 dB           0.0 dB
Noise Margin:        16.0 dB          14.6 dB
Attainable Rate:     28516 kbits/s    1222 kbits/s
Actual Power:        7.0 dBm          12.4 dBm
Total FECS:          3                0
Total ES:            0                0
Total SES:          0                0
Total LOSS:         0                0
Total UAS:          147              147
Total LPRS:         0                0
Total LOFS:         0                0
Total LOLS:         0                0
Bit swap:           0                0

Full inits:          1
Failed full inits:  0
Short inits:         0
Failed short inits: 0

```

```

Firmware      Source      File Name (version)
-----
VDSL          embedded   (0)

```

```

Modem FW Version: 23a
Modem PHY Version: A2pv6C032b.d23a

```

	DS Channel1	DS Channel0	US Channel1	US Channel0
Speed (kbps):	0	24543	0	1020
Previous Speed:	0	0	0	0
Total Cells:	0	87837567	0	3652502
User Cells:	0	0	0	0
Reed-Solomon EC:	0	3	0	0
CRC Errors:	0	0	0	0
Header Errors:	0	0	0	0
Interleave (ms):	0.00	15.00	0.00	3.76
Actual INP:	0.00	57.00	0.00	0.50

```

Training Log : Stopped
Training Log Filename : flash:vdsllog.bin

```

Configuring a G.SHDSL WAN Interface in ATM mode

Perform the following steps to configure G.SHDSL on the Cisco 888 ISR perform these steps, beginning in global configuration mode.

SUMMARY STEPS

1. **controller dsl** *slot/port*
2. **mode atm**
3. **line-term cpe**
4. **line-mode 4 wire standard**
5. **line-rate** {*auto* | *rate*}
6. **interface atm** *interface-number*
7. **ip-address** *ip-address*
8. **load-interval** *seconds*
9. **no atm ilmi-keepalive** [*seconds*]
10. **pvc** [*name*] *vpi/vci*
11. **protocol** *protocol protocol-address* **broadcast**
12. **encapsulation** [*encapsulation-type*]

DETAILED STEPS

	Command or Action	Purpose
Step 1	controller dsl <i>slot/port</i> Example: Router(config)# controller dsl 0	Enters controller configuration mode and the controller number.
Step 2	mode atm Example: Router(config-ctrl)# mode atm	Enables ATM encapsulation and creates logical ATM interface 0.
Step 3	line-term cpe Example: Router(config-ctrl)# line-term cpe	Enables CPE.
Step 4	line-mode 4 wire standard Example: Router(config-ctrl)# line-mode 4 wire standard	Enables 4 wire operation.
Step 5	line-rate { <i>auto</i> <i>rate</i> }	Specifies the DSL line rate for the SHDSL port. The range is 192 to 2312 kbps. The default is auto (negotiated between the SHDSL port and the DSLAM).
	Example: Router(config-ctrl)# line-rate 4608	Note If different DSL line rates are configured at opposite ends of the DSL uplink, the actual DSL line rate is always the lower rate. Note The maximum peak cell rate is 8 kbps less than the line rate.

	Command or Action	Purpose
Step 6	interface atm <i>interface-number</i> Example: Router(config-ctrl)# interface atm0	Enters ATM configuration mode for interface ATM 0.
Step 7	ip-address <i>ip-address</i> Example: Router(config-ctrl)# ip-address IP-address	Assigns an IP address to the DSL ATM interface.
Step 8	load-interval <i>seconds</i> Example: Router(config-ctrl)# load-interval 3	Assigns a load interval value.
Step 9	no atm ilmi-keepalive [<i>seconds</i>] Example: Router(config-ctrl)# no atm ilmi-keepalive0	Disables Integrated Local Management Interface (ILMI) keepalives. If you enable ILMI keepalives without specifying the number of seconds, the default time interval is 3 seconds.
Step 10	pvc [<i>name</i>] <i>vpi/vci</i> Example: Router(config-ctrl)# pvc 0/35	Enters atm-virtual-circuit (interface-atm-vc) configuration mode, and configures a new ATM PVC by assigning a name (optional) and VPI/VCI numbers. The default traffic shaping is UBR; the default encapsulation is AAL5+LLC/SNAP.
Step 11	protocol <i>protocol protocol-address</i> broadcast Example: Router(config-ctrl)# protocol ip 10.10.10.2 broadcast	Enables IP connectivity and creates a point-to-point IP address for the VC.
Step 12	encapsulation [<i>encapsulation-type</i>] Example: Router(config-ctrl)# encapsulation aal5snap	Configures the ATM adaptation layer (AAL) and encapsulation type. <ul style="list-style-type: none"> • Use the aal2 keyword for AAL2 • Use the aal5ciscoppp keyword for Cisco PPP over AAL5 • Use the aal5mux keyword for AAL5+MUX • Use the aal5nlpid keyword for AAL5+NLPID • Use the aal5snap keyword for AAL5+LLC/SNAP (the default)

Configuration Example: Configuring a G.SHDSL WAN Interface

The following configuration example shows a 4-wire standard G.SHDSL configuration.

```

!
controller DSL 0
 mode atm
 line-term cpe
 line-mode 4-wire standard
 dsl-mode shdsl symmetric annex B
 line-rate 4608
!
interface BRI0
 no ip address
 encapsulation hdlc
 shutdown
 isdn termination multidrop
!
!
interface ATM0
 ip address 10.10.10.1 255.255.255.0
 no atm ilmi-keepalive
 pvc 0/35
  protocol ip 10.10.10.2 broadcast
  encapsulation aal5snap
!
!
interface FastEthernet0
!
interface FastEthernet1
!
interface FastEthernet2
!
interface FastEthernet3
 shutdown
!
interface Vlan1
 ip address 2.15.15.26 255.255.255.0
!
ip forward-protocol nd
ip route 223.255.254.254 255.255.255.255 Vlan1
no ip http server
no ip http secure-server
!

```

Verifying G.SHDSL WAN Interface Configuration

To verify that you have properly configured the router, enter the show running command and look for controller DSL and interface ATM0 parameters.

```

Router# show running
Building configuration...

Current configuration : 1298 bytes
!
.....

!
controller DSL 0
 mode atm
 line-term cpe
 line-mode 4-wire standard
 dsl-mode shdsl symmetric annex B
 line-rate 4608
!
!
interface ATM0

```

```

ip address 10.10.10.1 255.255.255.0
no atm ilmi-keepalive
pvc 0/31
  protocol ip 10.10.10.5 broadcast
  encapsulation aal5snap
!
```

Configuring a G.SHDSL WAN Interface in EFM mode

To configure G.SHDSL on the Cisco 888E ISR, perform [Configuring Cisco G.SHDSL EFM HWICs in Cisco Routers](#) at:

http://www.cisco.com/en/US/docs/routers/access/interfaces/software/feature/guide/GSHDSL_EFM_HWICS.html

Configuring the Cellular Wireless WAN Interface

The Cisco 880 series and Cisco 810 series ISRs provide a third generation (3G) wireless interface for use over Global System for Mobile Communications (GSM) and code division multiple access (CDMA) networks. The interface is a 34-mm PCMCIA slot for Cisco 880 series.

Its primary application is WAN connectivity as a backup data link for critical data applications. However, the 3G wireless interface can also function as the primary WAN connection for the router.

To configure the 3G cellular wireless interface, follow these guidelines and procedures:

Prerequisites for Configuring the 3G Wireless Interface

The following are prerequisites to configuring the 3G wireless interface:

- You must have wireless service from a carrier, and you must have network coverage where your router will be physically placed. For a complete list of supported carriers, see the data sheet at:

http://www.cisco.com/en/US/prod/routers/networking_solutions_products_genericcontent0900aecd80601f7e.html

- You must subscribe to a service plan with a wireless service provider and obtain a SIM card (GSM modem only) from the service provider.
- You must check your LEDs for signal strength, as described in [Table 12: Front Panel LED Signal Strength Indications](#), on page 55.
- You should be familiar with the Cisco IOS software, beginning with Cisco NX-OS Release 4.1 or later. For Cisco 3G Wireless support, see the Cisco IOS documentation.
- To configure your GSM data profile, you need the following information from your service provider:
 - Username
 - Password
 - Access point name (APN)
- To configure your CDMA data profile for manual activation, you need the following information from your service provider:

- Master Subsidy Lock (MSL) number
- Mobile Directory number (MDN)
- Mobile Station Identifier (MSID)
- Electronic Serial Number (ESN)

Table 12: Front Panel LED Signal Strength Indications

LED	LED Color	Signal Strength
P3G RSSI ⁵	Amber	No service available and no RSSI detected
	Solid green	High RSSI (–69 dBm or higher)
	Fast (16 Hz) blinking green	Medium RSSI (–89 to –70 dBm)
	Slow (1 Hz) blinking green	Low to medium RSSI (–99 to –90 dBm), minimum level for a reliable connection
	Off	Low RSSI (less than –100 dBm)

⁵ 3G RSSI = 3G receive signal strength indication.

Restrictions for Configuring the Cellular Wireless Interface

The following restrictions apply to configuring the Cisco 3G wireless interface:

- A data connection can be originated only by the 3G wireless interface. Remote dial-in is not supported.
- Because of the shared nature of wireless communications, the experienced throughput varies depending on the number of active users or the amount of congestion in a given network.
- Cellular networks have higher latency than wired networks. Latency rates depend on the technology and carrier. Latency may be higher when there is network congestion.
- VoIP is not currently supported.
- Any restrictions that are part of the terms of service from your carrier also apply to the Cisco 3G wireless interface.
- Cisco 880G ISR does not support online insertion and removal (OIR) of 3G modems. To replace a modem with another modem of the same type, use the Cisco CLI to enter the shutdown command on the cellular interface before you replace the modems. =
- When a 3G modem is removed, the show interface cellular 0, show run, and show version command outputs still display cellular interface related information. The show interface command displays the following message, all other show commands have empty outputs.

```
3G Modem not inserted
```

- You can configure the cellular interface when the 3G modem is removed. However, the configuration is not effective until the 3G modem is inserted. The following message is shown when trying to configure the cellular interface while the modem is absent.

```
Router(config)# interface cellular 0
Warning: 3G Modem is not inserted
Configuration will not be effective until modem is inserted =
```

- Inserting a different type of modem than was previously removed requires configuration changes and you must reload the system.

Data Account Provisioning



Note To provision your modem, you must have an active wireless account with a service provider. A SIM card must be installed in a GSM 3G wireless card.

To provision your data account, follow these procedures:

Verifying Signal Strength and Service Availability

To verify the signal strength and service availability on your modem, use the following commands in privileged EXEC mode.



Note This feature requires Cisco IOS Release 15.2(1)T or a later.



Note Cisco 867VAE and 867VAE-K9 require Cisco IOS Release 15.1(4)M2 or 15.2(2)T or later to use this feature.

SUMMARY STEPS

1. **show cellular 0 network**
2. **show cellular 0 hardware**
3. **show cellular 0 connection**
4. **show cellular 0 radio**
5. **show cellular 0 profile**
6. **show cellular 0 security**
7. **show cellular 0 all**

DETAILED STEPS

	Command or Action	Purpose
Step 1	show cellular 0 network Example: Router# show cellular 0 network	Displays information about the carrier network, cell site, and available service.
Step 2	show cellular 0 hardware Example: Router# show cellular 0 hardware	Displays the cellular modem hardware information.
Step 3	show cellular 0 connection Example: Router# show cellular 0 connection	Displays the current active connection state and data statistics.
Step 4	show cellular 0 radio Example: Router# show cellular 0 radio	Shows the radio signal strength. Note The RSSI should be better than -90 dBm for steady and reliable connection.
Step 5	show cellular 0 profile Example: Router# show cellular 0 profile	Shows information about the modem data profiles created.
Step 6	show cellular 0 security Example: Router# show cellular 0 security	Shows the security information for the modem, such as SIM and modem lock status.
Step 7	show cellular 0 all Example: Router# show cellular 0 all	Shows consolidated information about the modem. The profiles that were created, the radio signal strength, the network security, and so on.

Configuring a GSM Modem Data Profile

To configure or create a new modem data profile, enter the **cellular 0 gsm profile create <profile number> <apn> <authentication> <username> <password>** command in privileged EXEC mode. See [Table 13: Modem Data Profile Parameters](#), on page 58 for details about the command parameters.

Example

```
Router# cellular 0 gsm profile create 3 apn.com chap GSM GSMPassword
```

Table 13: Modem Data Profile Parameters , on page 58 lists the modem data profile parameters.

Table 13: Modem Data Profile Parameters

<i>profile number</i>	Number for the profile that you are creating. You can create up to 16 profiles.
<i>apn</i>	Access point name. You must get this information from your service provider.
<i>authentication</i>	Type of authentication, for example, CHAP, PAP.
<i>username</i>	Username provided by your service provider.
<i>password</i>	Password provided by your service provider.

CDMA Modem Activation and Provisioning

Activation procedures may differ, depending upon your carrier. Consult your carrier, and perform one of the following procedures as appropriate:

- Manual activation
- Activation using over the air service provisioning

Table 14: CDMA Modem Activation and Provisioning, on page 58 lists the activation and provisioning processes supported by different wireless carriers.

Table 14: CDMA Modem Activation and Provisioning

Activation and Provisioning Process	Carrier
Manual Activation using MDN, MSID, MSL	Sprint
OTASP ⁶ Activation	Verizon Wireless
IOTA ⁷ for Data Profile refresh	Sprint

⁶ OTASP = Over the Air Service Provisioning.

⁷ IOTA = Internet Over the Air.

Manual Activation



Note

You must have valid mobile directory number (MDN), mobile subsidy lock (MSL), and mobile station identifier (MSID) information from your carrier before you start this procedure.

To configure a modem profile manually, use the following command, beginning in EXEC mode:

```
cellular 0 cdma activate manual mdn msid sid nid msl
```

Besides being activated, the modem data profile is provisioned through the Internet Over the Air (IOTA) process. The IOTA process is initiated automatically when you use the cellular cdma activate manual command.

The following is a sample output from this command:

```
router# cellular 0 cdma activate manual 1234567890 1234567890 1234 12 12345
NAM 0 will be configured and will become Active
Modem will be activated with following Parameters
MDN :1234567890; MSID :1234567890; SID :1234; NID 12:
Checking Current Activation Status
Modem activation status: Not Activated
Begin Activation
Account activation - Step 1 of 5
Account activation - Step 2 of 5
Account activation - Step 3 of 5
Account activation - Step 4 of 5
Account activation - Step 5 of 5
Secure Commit Result: Succeed
Done Configuring - Resetting the modem
The activation of the account is Complete
Waiting for modem to be ready to start IOTA
Beginning IOTA
router#
*Feb 6 23:29:08.459: IOTA Status Message Received. Event: IOTA Start, Result: SUCCESS
*Feb 6 23:29:08.459: Please wait till IOTA END message is received
*Feb 6 23:29:08.459: It can take up to 5 minutes
*Feb 6 23:29:27.951: OTA State = SPL unlock, Result = Success
*Feb 6 23:29:32.319: OTA State = Parameters committed to NVRAM, Result = Success
*Feb 6 23:29:40.999: Over the air provisioning complete; Result:Success
*Feb 6 23:29:41.679: IOTA Status Message Received. Event: IOTA End, Result: SUCCESS
```

The IOTA start and end must have “success” as the resulting output. If you receive an error message, you can run IOTA independently by using the cellular cdma activate iota command.

Your carrier may require periodic refreshes of the data profile. Use the following command to refresh the data profile:

cellular cdma activate iota

Activating with Over-the-Air Service Provisioning

To provision and activate your modem using Over-the-Air Service Provisioning (OTASP), use the following command, beginning in EXEC mode.

```
router # cellular 0 cdma activate otasp phone_number
```



Note

You need to obtain the phone number for use with this command from your carrier. The standard OTASP calling number is *22899.

The following is a sample output from this command:

```
router# cellular 0 cdma activate otasp *22899
Beginning OTASP activation
OTASP number is *22899
steelers_c881G#
OTA State = SPL unlock, Result = Success
router#
OTA State = PRL downloaded, Result = Success
OTA State = Profile downloaded, Result = Success
OTA State = MDN downloaded, Result = Success
OTA State = Parameters committed to NVRAM, Result = Success
Over the air provisioning complete; Result:Success
```

Configuring a Cellular Interface

To configure the cellular interface, enter the following commands, beginning in privileged EXEC mode.



Note

The PPP Challenge Handshake Authentication Protocol (CHAP) authentication parameters that you use in this procedure must be the same as the username and password provided by your carrier and configured only under the GSM profile. CDMA does not require a username or password.

SUMMARY STEPS

1. `configure terminal`
2. `interface cellular 0`
3. `encapsulation ppp`
4. `ppp chap hostname host`
5. `ppp chap password 0 password`
6. `asynchronous mode interactive`
7. `ip address negotiated`

DETAILED STEPS

	Command or Action	Purpose
Step 1	<code>configure terminal</code> Example: <code>Router# configure terminal</code>	Enters global configuration mode from the terminal.
Step 2	<code>interface cellular 0</code> Example: <code>Router (config)# interface cellular 0</code>	Specifies the cellular interface.
Step 3	<code>encapsulation ppp</code> Example: <code>Router (config-if)# encapsulation ppp</code>	Specifies PPP encapsulation for an interface configured for dedicated asynchronous mode or dial-on-demand routing (DDR).
Step 4	<code>ppp chap hostname host</code> Example: <code>Router (config-if)# ppp chap hostname host@wwan.ccs</code>	Defines an interface-specific Challenge Handshake Authentication Protocol (CHAP) hostname. This must match the username given by the carrier. Applies to GSM only.

	Command or Action	Purpose
Step 5	<p>ppp chap password 0 password</p> <p>Example:</p> <pre>Router (config-if)# ppp chap password 0 cisco</pre>	Defines an interface-specific CHAP password. This must match the password given by the carrier.
Step 6	<p>asynchronous mode interactive</p> <p>Example:</p> <pre>Router (config-if)# asynchronous mode interactive</pre>	Returns a line from dedicated asynchronous network mode to interactive mode, enabling the slip and ppp commands in privileged EXEC mode.
Step 7	<p>ip address negotiated</p> <p>Example:</p> <pre>Router (config-if)# ip address negotiated</pre>	Specifies that the IP address for a particular interface is obtained via PPP and IPCP address negotiation.

What to Do Next



Note

When the cellular interface requires a static IP address, the address may be configured as `ip address negotiated`. Through IP Control Protocol (IPCP), the network ensures that the correct static IP address is allocated to the device. If a tunnel interface is configured with the `ip address unnumbered cellular interface` command, the actual static IP address must be configured under the cellular interface, in place of `ip address negotiated`. For a sample cellular interface configuration, see the [Basic Cellular Interface Configuration, on page 64](#).

Configuring DDR

Perform these steps to configure dial-on-demand routing (DDR) for the cellular interface.

SUMMARY STEPS

1. **configure terminal**
2. **interface cellular 0**
3. **dialer in-band**
4. **dialer idle-timeout** *seconds*
5. dialer string string
6. dialer-group number
7. **exit**
8. dialer-list dialer-group protocol protocol-name {permit | deny | list *access-list-number* | access-group}
9. ip access-list access list number permit ip source address
10. line 3
11. script dialer regexp
12. **exit**
13. For GSM:
14. interface cellular 0
15. dialer string string

DETAILED STEPS

	Command or Action	Purpose
Step 1	configure terminal Example: Router# configure terminal	Enters global configuration mode.
Step 2	interface cellular 0 Example: Router (config)# interface cellular 0	Specifies the cellular interface.
Step 3	dialer in-band Example: Router (config-if)# dialer in-band	Enables DDR and configures the specified serial interface for in-band dialing.
Step 4	dialer idle-timeout <i>seconds</i> Example: Router (config-if)# dialer idle-timeout 30	Specifies the duration of idle time, in seconds, after which a line is disconnected.

	Command or Action	Purpose
Step 5	dialer string string Example: Router (config-if)# dialer string gsm	Specifies the number or string to dial. Use the name of the chat script here.
Step 6	dialer-group number Example: Router (config-if)# dialer-group 1	Specifies the number of the dialer access group to which a specific interface belongs.
Step 7	exit Example: Router (config-if)# exit	Enters the global configuration mode.
Step 8	dialer-list dialer-group protocol protocol-name {permit deny list <i>access-list-number</i> access-group} Example: Router (config)# dialer-list 1 protocol ip list 1	Creates a dialer list for traffic of interest and permits access to an entire protocol.
Step 9	ip access-list access list number permit ip source address Example: Router (config)# ip access list 1 permit any	Defines traffic of interest.
Step 10	line 3 Example: Router (config-line)# line 3	Specifies the line configuration mode. It is always 3.
Step 11	script dialer regexp Example: Router (config-line)# script-dialer gsm	Specifies a default modem chat script.
Step 12	exit Example: Router (config-line)# exit	Exits line configuration mode.
Step 13	For GSM: Example: chat-script script name "" "ATDT*99* profile number#" TIMEOUT timeout value CONNECT	Configures the line for GSM. Configures the line for CDMA. Defines the Attention Dial Tone (ATDT) commands when the dialer is initiated.

	Command or Action	Purpose
	<p>Example:</p> <p>For CDMA:</p> <p>Example:</p> <pre>chat-script script name "" "ATDT*777* profile number#" TIMEOUT timeout value CONNECT</pre> <p>Example:</p> <pre>Router (config)# chat-script gsm "" "ATDT*98*2#" TIMEOUT 60 "CONNECT"</pre>	
Step 14	<pre>interface cellular 0</pre> <p>Example:</p> <pre>Router (config)# interface cellular 0</pre>	Specifies the cellular interface.
Step 15	<pre>dialer string string</pre> <p>Example:</p> <pre>Router (config)# dialer string gsm</pre>	Specifies the dialer script (defined using the chat script command).

Configuring Data Dedicated Transmission Mode (DDTM)

On CDMA modems, data transmission is disrupted by incoming voice calls if data dedicated transmission mode (DDTM) is disabled. You can enable DDTM mode so the modem ignores incoming voice calls.

To enable DDTM on a CDMA modem, use the **cdma ddtm** command in configuration mode.

This command is enabled by default. You can disable this feature by using the **no cdma ddtm** command.



Note

When DDTM is enabled, only voice calls are blocked for the MC5728v modems. On the AC597E and MC5725 and MC 5727, incoming SMS messages are also blocked.

Examples for Configuring Cellular Wireless Interfaces

This section provides the following configuration examples:

Basic Cellular Interface Configuration

The following example shows how to configure a gsm cellular interface to be used as a primary WAN connection. It is configured as the default route.

```
chat-script gsm "" "ATDT*98*2#" TIMEOUT 60 "CONNECT"
```

```

!
interface Cellular0
 ip address negotiated
 encapsulation ppp
 dialer in-band
 dialer string gsm
 dialer-group 1
 async mode interactive
 ppp chap hostname cisco@wwan.ccs
 ppp chap password 0 cisco
 ppp ipcp dns request
!
ip route 0.0.0.0 0.0.0.0 Cellular0
!
!
access-list 1 permit any
dialer-list 1 protocol ip list 1
!
line 3
 exec-timeout 0 0
 script dialer gsm
 login
 modem InOut

```

The following example shows how to configure a cdma cellular interface to be used as a primary. It is configured as the default route.

```

chat-script cdma "" "ATDT#777" TIMEOUT 60 "CONNECT"
!
interface Cellular0
 ip address negotiated
 encapsulation ppp
 dialer in-band
 dialer string cdma
 dialer-group 1
 async mode interactive
 ppp chap password 0 cisco
!
ip route 0.0.0.0 0.0.0.0 Cellular0
!
!
access-list 1 permit any
dialer-list 1 protocol ip list 1
!
line 3
 exec-timeout 0 0
 script dialer cdma
 login
 modem InOut

```

Tunnel over Cellular Interface Configuration

The following example shows how to configure the static IP address when a tunnel interface is configured with the ip address unnumbered <cellular interface > command:

```

interface Tunnel2
 ip unnumbered Cellular0
 tunnel source Cellular0
 tunnel destination 128.107.248.254
interface Cellular0
 bandwidth receive 1400000
 ip address 23.23.0.1 255.255.0.0
 ip nat outside
 ip virtual-reassembly
 encapsulation ppp
 no ip mroute-cache
 dialer in-band
 dialer idle-timeout 0
 dialer string dial<carrier>
 dialer-group 1
 async mode interactive

```

```

no ppp lcp fast-start
ppp chap hostname <hostname>          *** gsm only ***
ppp chap password 0 <password>
ppp ipcp dns request
! traffic of interest through the tunnel/cellular interface
ip route 10.10.0.0 255.255.0.0 Tunnel2

```

Configuring Dual SIM for Cellular Networks on Cisco 819 Series ISR

The Dual SIM feature implements auto-switch and failover between two cellular networks on a Cisco 819 ISR. This feature is enabled by default with SIM slot 0 being the primary slot and slot 1 being the secondary (failover) slot.



Note

For instructions on how to configure the Dual SIM feature for 4G LTE cellular networks, see the [Cisco 4G LTE Software Installation Guide](#).

You can configure the Dual SIM feature using the following commands:

Command	Syntax	Description
gsm failovertimer	gsm failovertimer <1-7>	Sets the failover timer in minutes.
gsm sim authenticate	gsm sim authenticate <0,7> <pin> slot <0-1>	Verifies the SIM CHV1 code.
gsm sim max-retry	gsm sim max-retry <0-65535>	Specifies the maximum number of failover retries. The default value is 10.
gsm sim primary slot	gsm sim primary slot <0-1>	Modifies the primary slot assignment.
gsm sim profile	gsm sim profile <1-16> slot <0-1>	Configures the SIM profile.

Note the following:

- For auto-switch and failover to work, configure the SIM profile for slots 0 and 1 using the **gsm sim profile** command.
- For auto-switch and failover to work, configure the chat script without a specific profile number.
- If no SIM profile is configured, profile #1 is used by default.
- If no GSM failover timer is configured, the default failover timeout is 2 minutes.
- If no GSM SIM primary slot is configured, the default primary SIM is slot 0.

The following example shows you how to set the SIM switchover timeout period to 3 minutes:

```
router(config-controller)# gsm failovertimer 3
```

The following example shows you how to authenticate using an unencrypted pin:

```
router(config-controller)# gsm sim authenticate 0 1234 slot 0
```

The following example shows you how to set the maximum number of SIM switchover retries to 20:

```
router(config-controller)# gsm sim max-retry 20
```

The following example shows you how to set SIM slot 1 as the primary slot:

```
router(config-controller)# gsm sim primary slot 1
```

The following example shows you how to configure the SIM card in slot 0 to use profile 10:

```
router(config-controller)# gsm sim profile 10 slot 0
```

Perform the following commands to manually switch the SIM:

Command	Syntax	Description
cellular GSM SIM	cellular GSM SIM {lock unlock}	Locks or unlocks the SIM.
gsm sim	cellular <unit> gsm sim [lock unlock] <pin>	Locks or unlocks the gsm SIM.
gsm sim unblock	cellular <unit> gsm sim unblock <puk> <newpin>	Unblocks the gsm SIM.
gsm sim change-pin	cellular <unit> gsm sim change-pin <oldpin> <newpin>	Changes the PIN of the SIM.
gsm sim activate slot	cellular <unit> gsm sim activate slot <slot_no>	Activates the GSM SIM.

The following command forces the modem to connect to SIM1:

```
Router# cellular  
0  
  gsm sim activate  
  slot 1
```

Configuring Router for Image and Config Recovery Using Push Button for Cisco 819 Series ISR Router

A push button feature is available on the Cisco 819 ISR. The reset button on the front panel of the router enables this feature.

Perform the following steps to use this feature:

SUMMARY STEPS

1. Unplug power.
2. Press the reset button on the front panel of the router.
3. Power up the system while holding down the reset button.

DETAILED STEPS

-
- Step 1** Unplug power.
- Step 2** Press the reset button on the front panel of the router.
- Step 3** Power up the system while holding down the reset button.
The system LED blinks four times indicating that the router has accepted the button push.
-

What to Do Next

Using this button takes effect only during ROMMON initialization. During a warm reboot, pressing this button has no impact on performance. [Table 15: Push Button Functionality during ROMMON Initialization, on page 68](#) shows the high level functionality when the button is pushed during ROMMON initialization.

Table 15: Push Button Functionality during ROMMON Initialization

ROMMON Behavior	IOS Behavior
<ul style="list-style-type: none"> Boots using default baud rate. Performs auto-boot. Loads the *.default image if available on compact flash <p>Note If no *.default image is available, the ROMMON will boot up with the first Cisco IOS image on flash. Examples of names for default images: c800-universalk9-mz.SPA.default, c-800-universalk9_npe-mz.151T.default, image.default</p> <p>Note You can only have one configuration file with *.cfg option. Having more than one file will result in uncertain operational behavior.</p>	<p>If the configuration named *.cfg is available in nvram storage or flash storage, IOS will perform a backup of the original configuration and will boot up using this configuration.</p> <p>Note You can only have one configuration file with *.cfg option. Having more than one file will result in uncertain operational behavior.</p>

Use the show platform command to display the current bootup mode for the router. The following sections show sample outputs when the button is not pushed and when the button is pushed.

Output When Button Is Not Pushed: Example

```
router# show platform boot-record
Platform Config Boot Record :
=====
Configuration Register at boot time : 0x0
Reset Button Status at Boot Time   : Not Pressed
Startup-config Backup Status at Boot: No Status
Startup-config(backup file)location : No Backup
```

```
Golden config file at location      : No Recovery Detected
Config Recovery Status             : No Status
```

Output When Button Is Pushed: Example

```
router# show platform boot-record

Platform Config Boot Record :
=====
Configuration Register at boot time : 0x0
Reset Button Status at Boot Time    : Pressed
Startup-config Backup Status at Boot: Ok
Startup-config (backup file) location : flash:/startup.backup.19000716-225840-UTC
Golden config file at location      : flash:/golden.cfg
Config Recovery Status              : Ok
```

Push Button in WLAN AP

When the push button on the front panel is pressed, WLAN AP will perform both image and configuration recovery.

To perform image recovery, WLAN will go into the boot loader so that the user can download the image from the bootloader prompt.

To perform configuration recovery, WLAN AP will overwrite the contents of flash:/config.txt with the contents of flash:/cpconfig-ap802.cfg file if available in flash drive. Otherwise, flash:/config.txt will be deleted.

Configuring WAN Mode on Cisco 860VAE ISRs

The Cisco 866VAE, Cisco 867VAE, Cisco 866VAE-K9, and Cisco 867VAE-K9 routers can be configured to use either a GE interface or a DSL interface as a WAN link. DSL is the default WAN interface when the Cisco 866VAE, Cisco 867VAE, Cisco 866VAE-K9, and Cisco 867VAE-K9 routers boot.

After the router boots up, the desired WAN interface can be selected using the wan mode command. When WAN mode is configured as Ethernet, both ATM0 and Ethernet0 interfaces will be forced into shutdown state. Entering the **no shutdown** command on either of the DSL interfaces will be rejected with a message *WAN interface is Ethernet*. Similarly, when the WAN mode is DSL, the GE WAN interface will be put in shutdown state and the **no shutdown** command will be rejected with the message *WAN interface is DSL*.



Note

The routers do not support enabling both GE and DSL interfaces simultaneously.

Use the **wan mode dsl | ethernet** command to switch from DSL to Ethernet interfaces or vice versa.

This section contains the following information:

Enabling WAN Mode

Perform the following steps to select and enable WAN mode.

SUMMARY STEPS

1. **enable**
2. **show running-configuration**
3. **wan mode {dsl | ethernet}**
4. **exit**

DETAILED STEPS

	Command or Action	Purpose
Step 1	enable Example: Router> enable	Enables privileged EXEC mode. <ul style="list-style-type: none"> • Enter your password if prompted.
Step 2	show running-configuration Example: Router# show running-configuration	Displays the default entries on boot up.
Step 3	wan mode {dsl ethernet} Example: Router(config)# wan mode dsl	Selects the desired WAN mode.
Step 4	exit Example: Router(config)# exit Example: Router#	Exits configuration mode and returns to it would take the router back to privileged EXEC mode.

Displaying WAN Mode Configuration

Use the **show running-config** command to view the initial configuration, as shown in the following example for a Cisco 866VAE router.



Note Your Cisco router displays the WAN mode during the boot sequence after the initial configuration is complete.

```
Router#show running-config
Building configuration...
Current configuration : 1195 bytes
```

```
!  
! Last configuration change at 13:27:25 UTC Wed Feb 24 2010  
version 15.2  
no service pad  
service timestamps debug datetime msec localtime show-timezone  
service timestamps log datetime msec localtime show-timezone  
no service password-encryption  
!  
hostname Router  
!  
boot-start-marker  
boot-end-marker  
!  
!  
enable password lab  
!  
no aaa new-model  
wan mode ethernet  
no ipv6 cef  
!  
!  
!  
!  
ip cef  
!  
crypto pki token default removal timeout 0  
!  
!  
!  
!  
controller VDSL 0  
  shutdown  
!  
!  
!  
!  
interface ATM0  
  no ip address  
  shutdown  
  no atm ilmi-keepalive  
!  
interface ATM0.1 point-to-point  
  ip address 202.0.0.1 255.255.255.0  
  pvc 0/202  
  !  
!  
interface Ethernet0  
  no ip address  
  shutdown  
!  
interface FastEthernet0  
  no ip address  
!  
interface FastEthernet1  
  no ip address  
!  
interface FastEthernet2  
  no ip address  
!  
interface FastEthernet3  
  no ip address  
!  
interface GigabitEthernet0  
  ip address 1.0.0.1 255.255.255.0  
  duplex auto  
  speed auto  
!  
interface Vlan1  
  no ip address
```

```

!
ip forward-protocol nd
no ip http server
no ip http secure-server
!
!
!
!
control-plane
!
!
line con 0
  exec-timeout 0 0
  no modem enable
line aux 0
line vty 0 4
  login
  transport input all
!
scheduler allocate 60000 1000
!
end
Router#

```

Configuring the Fast Ethernet LAN Interfaces

The Fast Ethernet LAN interfaces on your router are automatically configured as part of the default VLAN and are not configured with individual addresses. Access is provided through the VLAN. You can also assign the interfaces to other VLANs. For more information about creating VLANs, see [Configuring Ethernet Switches, on page 161](#)

Configuring the Wireless LAN Interface

The Cisco 860, Cisco 880, and Cisco 890 series wireless routers have an integrated 802.11n module for wireless LAN connectivity. The router can then act as an access point in the local infrastructure. For more information about configuring a wireless connection, see [Configuring Wireless Devices](#)

Configuring a Loopback Interface

The loopback interface acts as a placeholder for the static IP address and provides default routing information. Perform these steps to configure a loopback interface, beginning in global configuration mode:

SUMMARY STEPS

1. **interface** *loopback number*
2. **ip address** *ip-address mask*
3. **exit**

DETAILED STEPS

	Command or Action	Purpose
Step 1	interface <i>loopback number</i>	Enters configuration mode for the loopback interface.

	Command or Action	Purpose
	Example: Router(config)# interface Loopback 0	number—number of the loopback interface.
Step 2	ip address <i>ip-address mask</i> Example: Router(config-if)# ip address 10.108.1.1 255.255.255.0	Sets the IP address and subnet mask for the loopback interface.
Step 3	exit Example: Router(config-if)# exit Example: Router(config)#	Exits configuration mode for the loopback interface and returns to global configuration mode.

Configuration Example: Configuring a Loopback Interface

The loopback interface in this sample configuration is used to support Network Address Translation (NAT) on the virtual-template interface. This configuration example shows the loopback interface configured on the Fast Ethernet interface with an IP address of 200.200.100.1/24, which acts as a static IP address. The loopback interface points back to virtual-template1, which has a negotiated IP address.

```

!
interface loopback 0
ip address 200.200.100.1 255.255.255.0 (static IP address)
ip nat outside
!
interface Virtual-Template1
ip unnumbered loopback0
no ip directed-broadcast
ip nat outside
!

```

Verifying Configuration

To verify that you have properly configured the loopback interface, enter the show interface loopback command. You should see verification output similar to the following example.

```

Router# show interface loopback 0
Loopback 0 is up, line protocol is up
  Hardware is Loopback
  Internet address is 200.200.100.1/24
  MTU 1514 bytes, BW 8000000 Kbit, DLY 5000 usec,
     reliability 255/255, txload 1/255, rxload 1/255
  Encapsulation LOOPBACK, loopback not set
  Last input never, output never, output hang never

```

```

Last clearing of "show interface" counters never
Queueing strategy: fifo
Output queue 0/0, 0 drops; input queue 0/75, 0 drops
5 minute input rate 0 bits/sec, 0 packets/sec
5 minute output rate 0 bits/sec, 0 packets/sec
  0 packets input, 0 bytes, 0 no buffer
    Received 0 broadcasts, 0 runts, 0 giants, 0 throttles
  0 input errors, 0 CRC, 0 frame, 0 overrun, 0 ignored, 0 abort
  0 packets output, 0 bytes, 0 underruns
  0 output errors, 0 collisions, 0 interface resets
  0 output buffer failures, 0 output buffers swapped out

```

Another way to verify the loopback interface is to ping it:

```

Router# ping 200.200.100.1
Type escape sequence to abort.
Sending 5, 100-byte ICMP Echos to 200.200.100.1, timeout is 2 seconds:
!!!!
Success rate is 100 percent (5/5), round-trip min/avg/max = 1/2/4 ms

```

Configuring Static Routes

Static routes provide fixed routing paths through the network. They are manually configured on the router. If the network topology changes, the static route must be updated with a new route. Static routes are private routes unless they are redistributed by a routing protocol.

Follow these steps to configure static routes, beginning in global configuration mode.

SUMMARY STEPS

1. `ip route prefix mask {ip-address | interface-type interface-number [ip-address]}`
2. `end`

DETAILED STEPS

	Command or Action	Purpose
Step 1	<p><code>ip route prefix mask {ip-address interface-type interface-number [ip-address]}</code></p> <p>Example:</p> <pre>Router(config)# ip route 192.168.1.0 255.255.0.0 10.10.10.2</pre>	<p>Specifies the static route for the IP packets.</p> <p>For details about this command and about additional parameters that can be set, see the Cisco IOS IP Routing Protocols Command Reference.</p>
Step 2	<p><code>end</code></p> <p>Example:</p> <pre>Router(config)# end</pre>	<p>Exits router configuration mode, and enters privileged EXEC mode.</p>

What to Do Next

For general information on static routing, see the [“Concepts” section on page B-1](#)

Example

In the following configuration example, the static route sends out all IP packets with a destination IP address of 192.168.1.0 and a subnet mask of 255.255.255.0 on the Fast Ethernet interface to another device with an IP address of 10.10.10.2. Specifically, the packets are sent to the configured PVC.

You do not need to enter the command marked “(default).” This command appears automatically in the configuration file generated when you use the **show running-config** command.

```
!  
ip classless (default)  
ip route 192.168.1.0 255.255.255.0 10.10.10.2!
```

Verifying Static Routing Configuration

To verify that you have properly configured static routing, enter the `show ip route` command and look for static routes signified by the “S.”

You should see verification output similar to the following:

```
Router# show ip route  
Codes: C - connected, S - static, R - RIP, M - mobile, B - BGP  
        D - EIGRP, EX - EIGRP external, O - OSPF, IA - OSPF inter area  
        N1 - OSPF NSSA external type 1, N2 - OSPF NSSA external type 2  
        E1 - OSPF external type 1, E2 - OSPF external type 2  
        i - IS-IS, su - IS-IS summary, L1 - IS-IS level-1, L2 - IS-IS level-2  
        ia - IS-IS inter area, * - candidate default, U - per-user static route  
        o - ODR, P - periodic downloaded static route  
Gateway of last resort is not set  
  10.0.0.0/24 is subnetted, 1 subnets  
C       10.108.1.0 is directly connected, Loopback0  
S* 0.0.0.0/0 is directly connected, FastEthernet0
```

Configuring Dynamic Routes

In dynamic routing, the network protocol adjusts the path automatically, based on network traffic or topology. Changes in dynamic routes are shared with other routers in the network.

The Cisco routers can use IP routing protocols, such as Routing Information Protocol (RIP) or Enhanced Interior Gateway Routing Protocol (EIGRP), to learn routes dynamically. You can configure either of these routing protocols on your router.

Configuring Routing Information Protocol

To configure the RIP routing protocol on the router, perform these steps, beginning in global configuration mode:

SUMMARY STEPS

1. **configure terminal**
2. **router rip**
3. **version {1 | 2}**
4. **network *ip-address***
5. **no auto-summary**
6. **end**

DETAILED STEPS

	Command or Action	Purpose
Step 1	configure terminal Example: Router# configure terminal	Enters global configuration mode.
Step 2	router rip Example: Router(config)# router rip	Enters router configuration mode, and enables RIP on the router.
Step 3	version {1 2} Example: Router(config-router)# version 2	Specifies use of RIP version 1 or 2.
Step 4	network <i>ip-address</i> Example: Router(config-router)# network 192.168.1.1	Specifies a list of networks on which RIP is to be applied, using the address of the network of each directly connected network.
Step 5	no auto-summary Example: Router(config-router)# no auto-summary	Disables automatic summarization of subnet routes into network-level routes. This allows subprefix routing information to pass across classfull network boundaries.
Step 6	end Example: Router(config-router)# end	Exits router configuration mode, and enters privileged EXEC mode.

What to Do Next

For general information on RIP, see the [“RIP” section on page B-3](#)

Example Configuration: Configuring Dynamic Routing Protocol

The following configuration example shows RIP version 2 enabled in IP network 10.0.0.0 and 192.168.1.0. To see this configuration, use the **show running-config** command from privileged EXEC mode.

```
!
Router# show running-config
router rip
  version 2
  network 10.0.0.0
  network 192.168.1.0
  no auto-summary
!
```

Verifying RIP Configuration

To verify that you have properly configured RIP, enter the **show ip route** command and look for RIP routes signified by “R.” You should see a verification output like the following example.

```
Router# show ip route
Codes: C - connected, S - static, R - RIP, M - mobile, B - BGP
       D - EIGRP, EX - EIGRP external, O - OSPF, IA - OSPF inter area
       N1 - OSPF NSSA external type 1, N2 - OSPF NSSA external type 2
       E1 - OSPF external type 1, E2 - OSPF external type 2
       i - IS-IS, su - IS-IS summary, L1 - IS-IS level-1, L2 - IS-IS level-2
       ia - IS-IS inter area, * - candidate default, U - per-user static route
       o - ODR, P - periodic downloaded static route
Gateway of last resort is not set
 10.0.0.0/24 is subnetted, 1 subnets
 C       10.108.1.0 is directly connected, Loopback0
 R       3.0.0.0/8 [120/1] via 2.2.2.1, 00:00:02, Ethernet0/0
```

Configuring Enhanced Interior Gateway Routing Protocol

To configure Enhanced Interior Gateway Routing Protocol (EIGRP), perform these steps, beginning in global configuration mode:

SUMMARY STEPS

1. **router eigrp** *as-number*
2. **network** *ip-address*
3. **end**

DETAILED STEPS

	Command or Action	Purpose
Step 1	router eigrp <i>as-number</i> Example: 	Enters router configuration mode and enables EIGRP on the router. The autonomous-system number identifies the route to other EIGRP routers and is used to tag the EIGRP information.

	Command or Action	Purpose
	<p>Example:</p> <pre>Router(config)# router eigrp 109</pre>	
Step 2	<p>network <i>ip-address</i></p> <p>Example:</p> <pre> </pre> <p>Example:</p> <pre>Router(config)# network 192.145.1.0</pre> <p>Example:</p> <pre>Router(config)# network 10.10.12.115</pre>	Specifies a list of networks on which EIGRP is to be applied, using the IP address of the network of directly connected networks.
Step 3	<p>end</p> <p>Example:</p> <pre> </pre> <p>Example:</p> <pre>Router(config-router)# end</pre> <p>Example:</p> <pre>Router#</pre>	Exits router configuration mode and enters privileged EXEC mode.

What to Do Next

For general information on EIGRP concepts, see the [“Enhanced IGRP” section on page B-3](#)

Example Configuration: EIGRP

The following configuration example shows the EIGRP routing protocol enabled in IP networks 192.145.1.0 and 10.10.12.115. The EIGRP autonomous system number is 109.

To see this configuration, use the **show running-config** command, beginning in privileged EXEC mode.

```
!
router eigrp 109
 network 192.145.1.0
 network 10.10.12.115
!
```

Verifying EIGRP Configuration

To verify that you have properly configured IP EIGRP, enter the `show ip route` command and look for EIGRP routes indicated by “D.” You should see verification output similar to the following:

```
Router# show ip route
Codes: C - connected, S - static, R - RIP, M - mobile, B - BGP
       D - EIGRP, EX - EIGRP external, O - OSPF, IA - OSPF inter area
       N1 - OSPF NSSA external type 1, N2 - OSPF NSSA external type 2
       E1 - OSPF external type 1, E2 - OSPF external type 2
       i - IS-IS, su - IS-IS summary, L1 - IS-IS level-1, L2 - IS-IS level-2
       ia - IS-IS inter area, * - candidate default, U - per-user static route
       o - ODR, P - periodic downloaded static route
Gateway of last resort is not set
 10.0.0.0/24 is subnetted, 1 subnets
 C    10.108.1.0 is directly connected, Loopback0
 D    3.0.0.0/8 [90/409600] via 2.2.2.1, 00:00:02, Ethernet0/0
```



Configuring Ethernet CFM and Y.1731 Performance Monitoring on Layer 3 Interfaces

This chapter provides procedures for configuring the network interface device functionality, Ethernet data plane loopback, IEEE connectivity fault management, and Y.1731 performance monitoring.

For configuring EVC Bridge Domain (BD) and the features it supports, see [Configuring Ethernet Virtual Connection Bridge Domain](#).

This chapter contains the following sections:

- [Configuring a Network Interface Device on the L3 Interface](#), page 81
- [Ethernet Data Plane Loopback](#), page 84
- [CFM Support on Routed Port and Port MEP](#), page 90
- [Support for Y.1731 Performance Monitoring on Routed Port \(L3 Subinterface\)](#), page 105

Configuring a Network Interface Device on the L3 Interface

Configuring a Network Interface Device (NID) enables support for the NID functionality on the router without including a NID hardware in the network. This feature combines the Customer-Premises Equipment (CPE) and the NID functionality into a physical device. The following are the advantages of configuring the NID functionality:

- Eliminates a physical device.
- Supports both the managed CPE feature set and the NID requirements.

**Note**

This feature is supported only if you have purchased the *advipservices* licensing module. For more information about managing software activation licenses on the Cisco ISR and Cisco ISR G2 platforms, see http://www.cisco.com/en/US/docs/routers/access/sw_activation/SA_on_ISR.html.

Configuring the NID

The following steps describe how to configure the NID:

SUMMARY STEPS

1. **enable**
2. **configure terminal**
3. **interface gigabitethernet *slot/port***
4. **port-tagging**
5. **encapsulation dot1q *vlan-id***
6. **set cos *cos-value***
7. **end**

DETAILED STEPS

	Command or Action	Purpose
Step 1	enable Example: Router>enable	Enables the privileged EXEC mode. Enter your password when prompted.
Step 2	configure terminal Example: Router#configure terminal	Enters the global configuration mode.
Step 3	interface gigabitethernet <i>slot/port</i> Example: Router(config)#interface gigabitethernet 0/2	Specifies an interface and enters the interface configuration mode.
Step 4	port-tagging Example: Router(config-if)#port-tagging	Inserts the VLAN ID into a packet header to identify which Virtual Local Area Network (VLAN) the packet belongs to.
Step 5	encapsulation dot1q <i>vlan-id</i> Example: Router(config-if-port-tagging)#encapsulation dot1q 10	Defines the encapsulation format as IEEE 802.1Q (dot1q), and specifies the VLAN identifier.

	Command or Action	Purpose
Step 6	set cos <i>cos-value</i> Example: Router(config-if-port-tagging)#set cos 6	Sets the Layer 2 class of service (CoS) value to an outgoing packet end.
Step 7	end Example: Router(config-if-port-tagging)#end	Exits the interface configuration mode.

Configuration Example

This configuration example shows how to configure the NID:

```
Router>enable
Router#configure terminal
Router(config)#interface gigabitethernet 0/2
Router(config-if)#port-tagging
Router(config-if-port-tagging)#encapsulation dot1q 10
Router(config-if-port-tagging)#set cos 6
Router(config-if-port-tagging)#end
```

Verifying the NID Configuration

Use the following commands to verify the port tagging sessions:

- **show run int**
- **ping**

Use the **show run int** command to display the port tagging sessions:

```
Router#show run int gi0/2
Building configuration...
Current configuration : 10585 bytes
!
interface GigabitEthernet0/2
 no ip address
 duplex auto
 speed auto
 port-tagging
 encapsulation dot1q 10
 set cos 6
 exit
end
!
interface GigabitEthernet0/2.1101
 encapsulation dot1Q 100
 ip address 132.1.101.4 255.255.255.0
!
interface GigabitEthernet0/2.1102
 encapsulation dot1Q 100
```

```
ip address 132.1.102.4 255.255.255.0
!
```

Use the **ping** command to verify the connectivity with port tagging configured:

```
Router#ping
 132.1.101.3
Type escape sequence to abort.
Sending 5, 100-byte ICMP Echos to 132.1.101.3, timeout is 2 seconds:
!!!!
Success rate is 100 percent (5/5), round-trip min/avg/max = 1/1/4 ms
router#
```

Troubleshooting the NID Configuration

[Table 16: debug Commands for NID Configuration](#), on page 84 lists the debug commands to troubleshoot the issues pertaining to the NID functionality.

The Cisco IOS Master Command List at

http://www.cisco.com/en/US/docs/ios/mcl/allreleasemcl/all_book.html

http://www.cisco.com/en/US/docs/ios/mcl/allreleasemcl/all_book.html provides more information about these commands.



Caution

Because debugging output is assigned high priority in the CPU process, it can diminish the performance of the router or even render it unusable. For this reason, use debug commands only to troubleshoot specific problems or during troubleshooting sessions with Cisco technical support staff.



Note

Before you run any of the debug commands listed in the following table, ensure that you run the **logging buffered debugging** command, and then turn off console debug logging using the **no logging console** command.

Table 16: debug Commands for NID Configuration

debug Command	Purpose
debug ethernet nid configuration	Enables debugging of configuration-related issues.
debug ethernet nid packet egress	Enables debugging of packet processing (VLAN tag push) on the egress side.
debug ethernet nid packet ingress	Enables debugging of packet processing (VLAN tag pop) on the ingress side.

Ethernet Data Plane Loopback

The Ethernet Data Plane Loopback feature provides a means for remotely testing the throughput of an Ethernet port. You can verify the maximum rate of frame transmission with no frame loss.



Note This feature is supported only if you have purchased the *advipservices* licensing module. For more information about managing software activation licenses on the Cisco ISR and Cisco ISR G2 platforms, see http://www.cisco.com/en/US/docs/routers/access/sw_activation/SA_on_ISR.html.



Note Internal Ethernet data plane loopback is not supported.

Figure 4-1 represents a sample topology to configure Ethernet data plane loopback.

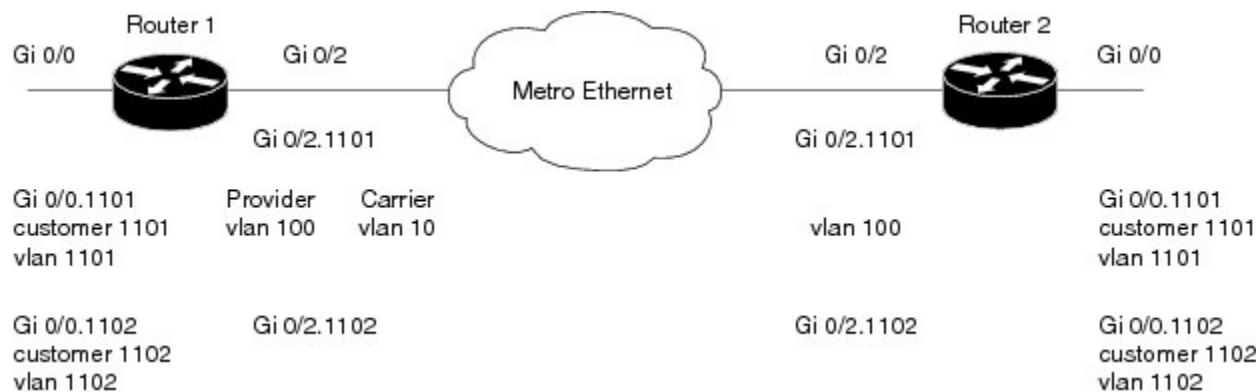

Restrictions for Configuring Ethernet Data Plane Loopback

Follow the guidelines and take note of the restrictions listed here when configuring Ethernet data plane loopback on a Layer 3 interface:

- Only external loopback (packets coming from the wire side) on the L3 dot1q subinterface and (untagged) main interface are supported.
- To perform a MAC swap, the destination address and source address must be swapped for the packets that are looped back. If the destination address is broadcast or multicast, the MAC address is used as the source address for the packets that are looped back.
- Loopback operations are supported at line rate.
- Untagged frames are not supported on a subinterface. However, the frames for *dot1q* and *qinq* are supported on a subinterface.
- *dot1ad* is not supported on the main interface. However, untagged frames are supported on the main interface.
- Single VLAN is supported as a filtering option for a subinterface, but VLAN list and VLAN range are not supported.
- Only MAC address is supported as a filtering option for the main interface.
- For the filtering option, the destination MAC cannot be combined with inner VLAN or outer VLAN.
- There is no support for L3 and L4 loopback. Source and destination IP address or source and destination ports will not be swapped.

- Connectivity Fault Management (CFM) packets are transparent to the data plane loopback configuration and cannot be looped back.
- Packets coming from the other side of the wire where loopback is configured and having the same destination MAC address are dropped.
- The broadcast and multicast IP addresses of the broadcast and multicast IP frames that are received cannot be used as the source IP address of the frame when it is sent back to the initiator. In such a case, the IP address of the subinterface is used as the source IP address of the frame when it is sent back to the initiator.

Configuring External Ethernet Data Plane Loopback

Configuring external Ethernet data plane loopback is permitted on a Layer 3 main interface and subinterfaces.

The following steps show how to configure external Ethernet data plane loopback on a subinterface using single and double tagging. (The procedure to configure external Ethernet data plane loopback on the main interface is similar to this procedure.)

SUMMARY STEPS

1. **enable**
2. **configure terminal**
3. **interface gigabitethernet *slot/port.sub-port***
4. Do one of the following:
 - **encapsulation dot1q *vlan-id***
 - **encapsulation dot1q *vlan-id* second-dot1q *inner vlan-id***
5. **ethernet loopback permit external**
6. **end**
7. **ethernet loopback start local interface gigabitethernet *slot/port.sub-port* external timeout *none***
8. **ethernet loopback stop local interface gigabitethernet *slot/port.sub-port* id *session-id***
9. **show ethernet loopback active**

DETAILED STEPS

	Command or Action	Purpose
Step 1	enable Example: Router>enable	Enables the privileged EXEC mode. Enter your password when prompted.

	Command or Action	Purpose
Step 2	<p>configure terminal</p> <p>Example:</p> <pre>Router#configure terminal</pre>	Enters the global configuration mode.
Step 3	<p>interface gigabitethernet <i>slot/port.sub-port</i></p> <p>Example:</p> <pre>Router(config)#interface gigabitethernet 0/2.1101</pre>	Specifies the subinterface and enters the subinterface configuration mode.
Step 4	<p>Do one of the following:</p> <ul style="list-style-type: none"> • encapsulation dot1q <i>vlan-id</i> • encapsulation dot1q <i>vlan-id</i> second-dot1q <i>inner vlan-id</i> <p>Example:</p> <pre>Router(config-subif)#encapsulation dot1q 100</pre> <p>OR</p> <p>Example:</p> <pre>Router(config-subif)#encapsulation dot1q 100 second-dot1q 1101</pre>	<p>Defines the encapsulation format as IEEE 802.1Q (dot1q), and specifies the VLAN identifier.</p> <p>For double tagging, use the second-dot1q keyword and the <i>inner vlan-id</i> argument to specify the VLAN tag.</p>
Step 5	<p>ethernet loopback permit external</p> <p>Example:</p> <pre>Router(config-subif)#ethernet loopback permit external</pre>	Configures Ethernet external loopback on the subinterface.
Step 6	<p>end</p> <p>Example:</p> <pre>Router(config-subif)#end</pre>	Exits the subinterface configuration mode.
Step 7	<p>ethernet loopback start local interface gigabitethernet <i>slot/port.sub-port</i> external timeout <i>none</i></p> <p>Example:</p> <pre>Router#ethernet loopback start local interface gigabitethernet 0/2.1101 external timeout none</pre>	<p>Starts Ethernet external loopback on a subinterface.</p> <p>Enter timeout as <i>none</i> to have no time out period for the loopback.</p>
Step 8	<p>ethernet loopback stop local interface gigabitethernet <i>slot/port.sub-port</i> id <i>session-id</i></p>	<p>Stops Ethernet external loopback on a sub-interface.</p> <p>Enter the value of the loopback session ID to specify the loopback session that you want to stop.</p>

	Command or Action	Purpose
	<p>Example:</p> <pre>Router#ethernet loopback stop local interface gigabitethernet 0/2.1101 id 1</pre>	
Step 9	<p>show ethernet loopback active</p> <p>Example:</p> <pre>Router#show ethernet loopback active</pre>	Displays information to verify if the loopback session has ended.

Configuration Examples for Ethernet Data Plane Loopback

This example shows how to configure Ethernet data plane loopback using single tagging:

```
Router>enable
Router#configure terminal
Router(config)#interface gigabitethernet 0/2.1101
Router(config-subif)#encapsulation dot1q 100
Router(config-subif)#ethernet loopback permit external
Router(config-subif)#end
```

This example shows how to configure Ethernet data plane loopback using double tagging:

```
Router>enable
Router#configure terminal
Router(config)#interface gigabitethernet 0/2.1101
Router(config-subif)#encapsulation dot1q 100 second-dot1q 1101
Router(config-subif)#ethernet loopback permit external
Router(config-subif)#end
```

This example shows how to start an Ethernet data plane loopback:

```
Router#ethernet loopback start local interface gigabitethernet 0/2.1101 external timeout
none
This is an intrusive loopback and the packets matched with the service will not be able to
pass through. Continue? (yes/[no]):
Enter yes to continue.
```

This example shows how to stop an Ethernet data plane loopback:

```
Router#ethernet loopback stop local interface gigabitethernet 0/2.1101 id 1
Router#*Oct 21 10:16:17.887: %E_DLB-6-DATAPLANE_LOOPBACK_STOP: Ethernet Dataplane Loopback
Stop on interface GigabitEthernet0/2 with session id 1
Router#show ethernet loopback active
Total Active Session(s): 0
Total Internal Session(s): 0
Total External Session(s): 0
```

Verifying the Ethernet Data Plane Loopback Configuration

Use the following commands to verify the Ethernet data plane loopback configuration:

- **show ethernet loopback permitted**
- **show ethernet loopback active**

Use the **show ethernet loopback permitted** command to view the loopback capabilities per interface:

```
Router#show ethernet loopback permitted
```

```
-----
Interface                               SrvcInst Direction
Dot1q/Dot1ad(s)                         Second-Dot1q(s)
-----
Gi0/2.1101                               N/A      External
100                                       1101
```

Use the **show ethernet loopback active** command to display the summary of the active loopback sessions on a subinterface:

```
Router#show ethernet loopback active
```

```
Loopback Session ID      : 1
Interface                 : GigabitEthernet0/2.1101
Service Instance         : N/A
Direction                 : External
Time out(sec)            : none
Status                    : on
Start time                : *10:17:46.930 UTC Mon Oct 21 2013
Time left                 : N/A
Dot1q/Dot1ad(s)          : 100
Second-dot1q(s)          : 1101
Source Mac Address       : Any
Destination Mac Address  : Any
Ether Type                : Any
Class of service         : Any
Llc-oui                   : Any
Total Active Session(s)  : 1
Total Internal Session(s): 0
Total External Session(s): 1
```

Use the **show ethernet loopback active** command to display the summary of the active loopback sessions on the main interface:

```
Router#show ethernet loopback permitted
```

```
Loopback Session ID      : 1
Interface                 : GigabitEthernet0/2
Service Instance         : N/A
Direction                 : External
Time out(sec)            : none
Status                    : on
Start time                : *10:14:23.507 UTC Mon Oct 21 2013
Time left                 : N/A
Dot1q/Dot1ad(s)          : 1-100
Second-dot1q(s)          : 1-1101
Source Mac Address       : Any
Destination Mac Address  : Any
Ether Type                : Any
Class of service         : Any
Llc-oui                   : Any
Total Active Session(s)  : 1
Total Internal Session(s): 0
Total External Session(s): 1
```

Troubleshooting the Ethernet Data Plane Loopback Configuration

[Table 17: debug Commands for Ethernet Data Plane Loopback Configuration](#), on page 90 lists the debug commands to troubleshoot issues pertaining to the Ethernet Data Plane Loopback feature. The Cisco IOS Master Command List at

http://www.cisco.com/en/US/docs/ios/mcl/allreleasemcl/all_book.html

http://www.cisco.com/en/US/docs/ios/mcl/allreleasemcl/all_book.html provides more information about these commands.

**Caution**

Because debugging output is assigned high priority in the CPU process, it can diminish the performance of the router or even render it unusable. For this reason, use debug commands only to troubleshoot specific problems or during troubleshooting sessions with Cisco technical support staff.

**Note**

Before you run any of the debug commands listed in the following table, ensure that you run the **logging buffered debugging** command, and then turn off console debug logging using the **no logging console** command.

Table 17: debug Commands for Ethernet Data Plane Loopback Configuration

debug Command	Purpose
debug elb-pal-pd all	Displays all the debugging information about the Ethernet data plane loopback configuration.
debug elb-pal-pd error	Displays debugging information about Ethernet data plane loopback configuration errors.
debug elb-pal-pd event	Displays debugging information about Ethernet data plane loopback configuration changes.

CFM Support on Routed Port and Port MEP

IEEE Connectivity Fault Management (CFM) is an end-to-end per-service Ethernet-layer Operations, Administration, and Maintenance (OAM) protocol. CFM includes proactive connectivity monitoring, fault verification, and fault isolation for large Ethernet metropolitan-area networks (MANs) and WANs.

**Note**

This feature is supported only if you have purchased the *advipservices* licensing module. For more information about managing software activation licenses on the Cisco ISR and Cisco ISR G2 platforms, see http://www.cisco.com/en/US/docs/routers/access/sw_activation/SA_on_ISR.html.

Restrictions for Configuring Ethernet CFM

- A specific domain must be configured. If it is not, an error message is displayed.
- Multiple domains (different domain names) having the same maintenance level can be configured. However, associating a single domain name with multiple maintenance levels is not permitted.

Configuring Ethernet CFM (Port MEP)

Complete these steps to configure and enable Ethernet CFM on a port Maintenance End Point (MEP):

SUMMARY STEPS

1. **enable**
2. **configure terminal**
3. **ethernet cfm ieee**
4. **ethernet cfm global**
5. **ethernet cfm domain** *domain-name level value*
6. **service** *service-name port*
7. **continuity-check interval** *value*
8. **end**
9. **configure terminal**
10. **interface gigabitethernet** *slot/port*
11. **ethernet cfm mep domain** *domain-name mpid mpid-value service service-name*
12. **end**

DETAILED STEPS

	Command or Action	Purpose
Step 1	enable Example: Router>enable	Enables the privileged EXEC mode. Enter your password when prompted.
Step 2	configure terminal Example: Router#configure terminal	Enters the global configuration mode.
Step 3	ethernet cfm ieee Example: Router(config)#ethernet cfm ieee	Enables the IEEE version of CFM.
Step 4	ethernet cfm global Example: Router(config)#ethernet cfm global	Enables CFM processing globally on the router.

	Command or Action	Purpose
Step 5	<p>ethernet cfm domain <i>domain-name level value</i></p> <p>Example:</p> <pre>Router(config-ecfm)#ethernet cfm domain carrier level 2</pre>	<p>Defines a CFM maintenance domain at a specified level, and enters the Ethernet CFM configuration mode.</p> <p>level can be any value from 0 to 7.</p>
Step 6	<p>service <i>service-name port</i></p> <p>Example:</p> <pre>Router(config-ecfm)#service carrier port</pre>	<p>Creates a service on the interface and sets the <i>config-ecfm-srv</i> submode.</p>
Step 7	<p>continuity-check interval <i>value</i></p> <p>Example:</p> <pre>Router(config-ecfm-srv)#continuity-check interval 100m</pre>	<p>Enables sending continuity check messages at the set interval.</p>
Step 8	<p>end</p> <p>Example:</p> <pre>Router(config-ecfm-srv)#end</pre>	<p>Returns the router to the privileged EXEC mode.</p>
Step 9	<p>configure terminal</p> <p>Example:</p> <pre>Router#configure terminal</pre>	<p>Enters the global configuration mode.</p>
Step 10	<p>interface gigabitethernet <i>slot/port</i></p> <p>Example:</p> <pre>Router(config)#interface gigabitethernet 0/2</pre>	<p>Specifies an interface and enters the interface configuration mode.</p>
Step 11	<p>ethernet cfm mep domain <i>domain-name mpid mpid-value service service-name</i></p> <p>Example:</p> <pre>Router(config-if)#ethernet cfm mep domain carrier mpid 44 service carrier</pre>	<p>Sets a port to a maintenance domain and defines it as an MEP.</p> <p>Note The values for domain and service must be the same as the values configured for CFM.</p>
Step 12	<p>end</p> <p>Example:</p> <pre>Router(config-if-ecfm-mep)#end</pre>	<p>Returns the router to the privileged EXEC mode.</p>

Configuration Example for Ethernet CFM (Port MEP)

This example shows how to configure Ethernet CFM on a port MEP:

```
Router>enable
Router#configure terminal
Router(config)#ethernet cfm ieee
Router(config)#ethernet cfm global
Router(config-ecfm)#ethernet cfm domain carrier level 2
Router(config-ecfm)#service carrier port
Router(config-ecfm-srv)#continuity-check interval 100m
Router(config-ecfm-srv)#end
Router#configure terminal
Router(config)#interface gigabitethernet
0/2
Router(config-if)#ethernet cfm mep domain
carrier
mpid 44 service
carrier
Router(config-if-ecfm-mep)#end
```

Verifying the Ethernet CFM Configuration on a Port MEP

Use the following commands to verify Ethernet CFM configured on a port MEP:

- **show ethernet cfm domain**
- **show ethernet cfm maintenance-points local**
- **show ethernet cfm maintenance-points remote**
- **ping ethernet mpid *mpid-value* domain *domain-name* service *service-name* cos *value***
- **traceroute ethernet mpid *mpid-value* domain *domain-name* service *service-name***
- **show ethernet cfm error configuration**

Use the **show ethernet cfm domain** command to view details about CFM maintenance domains:

```
Router#show ethernet cfm domain carrier
Domain Name: carrier
Level: 2
Total Services: 1
  Services:
  Type Id  Dir CC CC-int Static-rmep Crosscheck MaxMEP Source  MA-Name
  Port none Dwn Y  100ms Disabled Disabled  100   Static carrier
Router#
```

Use the **show ethernet cfm maintenance-points local** command to view the MEPs that are configured locally on a router. The following is a sample output of the **show ethernet cfm maintenance-points local** command:

```
Router#show ethernet cfm maintenance-points local

Local MEPs:
-----
MPID Domain Name                               Lvl  MacAddress      Type CC
Ofld Domain Id                                 Dir   Port            Id
      MA Name                                   SrvcInst        Source
      EVC name
-----
44   carrier                                     2    5657.a844.04fa  Port Y
No   carrier                                     Down  Gi0/2           none
     carrier                                          N/A            Static
```

N/A
 Total Local MEPs: 1
 Local MIPs: None

Use the **show ethernet cfm maintenance-points remote** command to display information about remote maintenance point domains or levels. In the following example, carrier, Provider, and customer are the maintenance point domains that are configured:

On router 1:
 Router1#**show ethernet cfm maintenance-points remote**

```

-----
MPID  Domain Name                MacAddress      IfSt  PtSt
  Lvl  Domain ID                    Ingress
  RDI  MA Name                      Type Id        SrvcInst
      EVC Name                      Age
      Local MEP Info
-----
43    carrier                      5657.a86c.fa92  Up    N/A
  2    carrier                      Gi0/2
  -    carrier                      Port none      N/A
      N/A
      MPID: 44 Domain: carrier MA: carrier
33    Provider                      5657.a86c.fa92  Up    Up
  5    Provider                      Gi0/2.100
  -    Provider                      Vlan 100      N/A
      N/A
      MPID: 34 Domain: Provider MA: Provider
3101  customer                      5657.a86c.fa92  Up    Up
  7    customer                      Gi0/2.1101
  -    customer1101                  S,C 100,1101  N/A
      N/A
      MPID: 4101 Domain: customer MA: customer1101
3102  customer                      5657.a86c.fa92  Up    Up
  7    customer                      Gi0/2.1102
  -    customer1102                  S,C 100,1102  N/A
      N/A
      MPID: 4102 Domain: customer MA: customer1102
Total Remote MEPs: 4
  
```

Use the **show ethernet cfm maintenance-points remote** command to view the details of a remote maintenance point domain:

On router 1:
 Router1#**show ethernet cfm maintenance-points remote domain carrier service carrier**

```

-----
MPID  Domain Name                MacAddress      IfSt  PtSt
  Lvl  Domain ID                    Ingress
  RDI  MA Name                      Type Id        SrvcInst
      EVC Name                      Age
      Local MEP Info
-----
43    carrier                      5657.a86c.fa92  Up    Up
  2    carrier                      Gi0/2
  -    carrier                      S,C 100,1101  N/A
      N/A
      MPID: 44 Domain: carrier MA: carrier
Total Remote MEPs: 1
  
```

On router 2:

Router2#**show ethernet cfm maintenance-points remote domain carrier service carrier**

```

-----
MPID  Domain Name                MacAddress      IfSt  PtSt
  Lvl  Domain ID                    Ingress
  RDI  MA Name                      Type Id        SrvcInst
      EVC Name                      Age
      Local MEP Info
-----
44    carrier                      5657.g945.04fa  Up    Up
  2    carrier                      Gi0/2
  
```

```

- carrier S,C 100,1101 N/A
  N/A 0s
  MPID: 43 Domain: carrier MA: carrier

```

Use the **ping** command to verify if Loopback Messages (LBM) and Loopback Replies (LBR) are successfully sent and received between the routers:

```
Router1#ping ethernet mpid 44 domain carrier service carrier cos 5
```

```

Type escape sequence to abort.
Sending 5 Ethernet CFM loopback messages to 5657.a86c.fa92, timeout is 5 seconds:!!!!!
Success rate is 100 percent (5/5), round-trip min/avg/max = 1/1/1 ms
Router1#

```

Use the **traceroute** command to send the Ethernet CFM traceroute messages:

```

Router#traceroute ethernet mpid 44 domain carrier service carrier
Type escape sequence to abort. TTL 64. Linktrace Timeout is 5 seconds
Tracing the route to 5657.a86c.fa92 on Domain carrier, Level 2, service carrier
Traceroute sent via Gi0/2
B = Intermediary Bridge
! = Target Destination
* = Per hop Timeout
-----
  Hops  Host                MAC Forwarded  Ingress  Ingr Action  Relay Action
        Host                Forwarded  Egress    Egr Action  Previous Hop
-----
! 1    5657.a86c.fa92  Gi0/2      Ingress    IngOk        RlyHit:MEP
        Not Forwarded                5657.g945.04fa
Router#

```

Configuring Ethernet CFM (Single-Tagged Packets)

Complete these steps to configure and enable Ethernet CFM for single-tagged packets:

SUMMARY STEPS

1. **enable**
2. **configure terminal**
3. **ethernet cfm ieee**
4. **ethernet cfm global**
5. **ethernet cfm domain *domain-name* level *value***
6. **service *service-name* vlan *vlan-id* direction down**
7. **continuity-check**
8. **interface gigabitethernet *slot/port***
9. **ethernet cfm mep domain *domain-name* mpid *mpid-value* service *service-name***
10. **interface gigabitethernet *slot/port.subinterface***
11. **encapsulation dot1q *vlan-id***
12. **end**

DETAILED STEPS

	Command or Action	Purpose
Step 1	enable Example: Router>enable	Enables the privileged EXEC mode. Enter your password when prompted.
Step 2	configure terminal Example: Router#configure terminal	Enters the global configuration mode.
Step 3	ethernet cfm ieee Example: Router(config)#ethernet cfm ieee	Enables the IEEE version of CFM.
Step 4	ethernet cfm global Example: Router(config)#ethernet cfm global	Enables CFM processing globally on the router.
Step 5	ethernet cfm domain <i>domain-name</i> level <i>value</i> Example: Router(config)#ethernet cfm domain customer level 7	Defines a CFM maintenance domain at a specified level, and enters the Ethernet CFM configuration mode. level can be any value from 0 to 7.
Step 6	service <i>service-name</i> vlan <i>vlan-id</i> direction down Example: Router(config-ecfm)#service customer1101 vlan 100 direction down	Enters the CFM service configuration mode. vlan —Specifies the VLAN.
Step 7	continuity-check Example: Router(config-ecfm-srv)#continuity-check	Enables sending continuity check messages.
Step 8	interface gigabitethernet <i>slot/port</i> Example: Router(config-ecfm-srv)#interface gigabitethernet 0/2	Specifies an interface and enters the interface configuration mode.
Step 9	ethernet cfm mep domain <i>domain-name</i> mpid <i>mpid-value</i> service <i>service-name</i>	Sets a port to a maintenance domain and defines it as an MEP.

	Command or Action	Purpose
	<p>Example:</p> <pre>Router(config-if)#ethernet cfm mep domain customer mpid 100 service customer1101</pre>	<p>Note The values for domain and service must be the same as the values that were configured for CFM.</p>
Step 10	<p>interface gigabitethernet slot/port.subinterface</p> <p>Example:</p> <pre>Router(config-if-ecfm-mep)#interface gigabitethernet 0/2.1</pre>	Specifies a subinterface and enters the subinterface configuration mode.
Step 11	<p>encapsulation dot1q vlan-id</p> <p>Example:</p> <pre>Router(config-subif)#encapsulation dot1q 100</pre>	Defines the encapsulation format as IEEE 802.1Q (dot1q), and specifies the VLAN identifier.
Step 12	<p>end</p> <p>Example:</p> <pre>Router(config-subif)#end</pre>	Returns the router to the privileged EXEC mode.

Configuration Example for Ethernet CFM (Single-Tagged Packets)

This example shows how to configure Ethernet CFM for single-tagged packets:

```
Router>enable
Router#configure terminal
Router(config)#ethernet cfm ieee
Router(config)#ethernet cfm global
Router(config)#ethernet cfm domain customer level 7
Router(config-ecfm)#service customer1101 vlan 100 direction down
Router(config-ecfm-srv)#continuity-check
Router(config)#interface gigabitethernet
0/2
Router(config-if)#ethernet cfm mep domain customer mpid 100 service
customer1101
Router(config-if-ecfm-mep)#interface gigabitethernet 0/2.1
Router(config-subif)#encapsulation dot1q 100
Router(config-subif)#end
```

Verifying the Ethernet CFM Configuration for Single-Tagged Packets

Use the following commands to verify Ethernet CFM configured for single-tagged packets:

- **show ethernet cfm domain**
- **show ethernet cfm maintenance-points local**
- **show ethernet cfm maintenance-points remote**

- **show ethernet cfm error configuration**

Use the **show ethernet cfm domain** command to display the maintenance point domains configured in the network. In the following example, the customer, enterprise, and carrier maintenance point domains are configured.

```
Router#show ethernet cfm domain
Domain Name: customer
Level: 7
Total Services: 1
  Services:
    Type Id  Dir CC CC-int Static-rmep Crosscheck MaxMEP Source MA-Name
    Vlan 100 Dwn Y 10s Disabled Disabled 100 Static customer1101
Domain Name: enterprise
Level: 6
Total Services: 1
  Services:
    Type Id  Dir CC CC-int Static-rmep Crosscheck MaxMEP Source MA-Name
    Vlan 110 Dwn Y 10s Disabled Disabled 100 Static custservice
Domain Name: carrier
Level: 2
Total Services: 1
  Services:
    Type Id  Dir CC CC-int Static-rmep Crosscheck MaxMEP Source MA-Name
    Vlan 200 Dwn Y 10s Disabled Disabled 100 Static carrier
Router#
```

Use the **show ethernet cfm maintenance-points local** command to view the local MEPs. The following is a sample output of the **show ethernet cfm maintenance-points local** command:

```
Router#show ethernet cfm maintenance-points local
-----
MPID Domain Name                               Lvl  MacAddress      Type  CC
Ofld Domain Id                               Dir  Port            Id
      MA Name                                 SrvcInst        Source
      EVC name
-----
100 customer                                   7    70ca.9b4d.a400  Vlan  Y
No  customer                                 Down  Gi0/2          100
      customer1101                          N/A    N/A            Static
      N/A
400 enterprise                                6    70ca.9b4d.a400  Vlan  I
No  enterprise                                Down  Gi0/1          110
      custservice                            N/A    N/A            Static
      N/A
44  carrier                                   2    70ca.9b4d.a400  Vlan  N
No  carrier                                 Down  Gi0/2          200
      carrier                                N/A    N/A            Static
      N/A
Total Local MEPs: 3
Local MIPs: None
Router#
```

Use the **show ethernet cfm maintenance-points remote** command to display information about remote maintenance point domains or levels.

The following example displays the continuity check messages exchanged between remote MEPs:
On router 1:

```
Router1#show ethernet cfm maintenance-points remote
-----
MPID Domain Name                               MacAddress      IfSt      PtSt
Lvl Domain                               Ingress
RDI MA                                     Type Id        SrvcInst
      EVC Name                               Age
      Local MEP Info
-----
110 customer                                   70ca.9b4d.a400  Up        Up
7  customer                                   Gi0/2
-  customer1101                               Vlan 100      N/A
```



```

N/A
MPID: 100 Domain: customer MA: customer1101 12s
410 enterprise 70ca.9b4d.a400 Up Up
6 enterprise Gi0/1
- custservice Vlan 110 N/A
N/A 12s
MPID: 400 Domain: enterprise MA: custservice
43 carrier 70ca.9b4d.a400 Up Up
2 carrier Gi0/2
- carrier Vlan 200 N/A
N/A 12s
MPID: 44 Domain: carrier MA: carrier
Total Remote MEPs: 3
Router1#
On router 2:
    
```

Router2#show ethernet cfm maintenance-points remote

MPID	Domain Name	MacAddress	IfSt	PtSt
Lvl	Domain	Ingress		
RDI	MA	Type Id	SrvcInst	
	EVC Name		Age	
	Local MEP Info			
100	customer	0026.99f7.0b41	Up	Up
7	customer	Gi0/2		
-	customer1101	Vlan 100	N/A	
	N/A		2s	
	MPID: 110 Domain: customer MA: customer1101			
400	enterprise	0026.99f7.0b41	Up	Up
6	enterprise	Gi0/1		
-	custservice	Vlan 110	N/A	
	N/A		2s	
	MPID: 410 Domain: enterprise MA: custservice			
44	carrier	0026.99f7.0b41	Up	Up
2	carrier	Gi0/2		
-	carrier	Vlan 200	N/A	
	N/A		2s	
	MPID: 43 Domain: carrier MA: carrier			
Total Remote MEPs: 3				

Router2#
 Use the **show ethernet cfm error configuration** command to view Ethernet CFM configuration errors (if any). The following is a sample output of the **show ethernet cfm error configuration** command:

Router#show ethernet cfm error configuration

CFM Interface	Type	Id	Level	Error type
Gi0/2	S,C	100	5	CFMLeak

Configuring Ethernet CFM (Double-Tagged Packets)

Complete these steps to configure and enable Ethernet CFM for double-tagged packets:

SUMMARY STEPS

1. **enable**
2. **configure terminal**
3. **ethernet cfm ieee**
4. **ethernet cfm global**
5. **ethernet cfm domain** *domain-name level 0 to 7*
6. **service** *service-name* **vlan** *vlan-id* **inner-vlan** *inner vlan-id* **direction down**
7. **continuity-check**
8. **interface gigabitethernet** *slot/port*
9. **ethernet cfm mep domain** *domain-name* **mpid** *mpid-value* **service** *service-name*
10. **interface gigabitethernet** *slot/port.subinterface*
11. **encapsulation dot1q** *vlan-id* **second-dot1q** *inner vlan-id*
12. **end**

DETAILED STEPS

	Command or Action	Purpose
Step 1	enable Example: Router>enable	Enables the privileged EXEC mode. Enter your password when prompted.
Step 2	configure terminal Example: Router#configure terminal	Enters the global configuration mode.
Step 3	ethernet cfm ieee Example: Router(config)#ethernet cfm ieee	Enables the IEEE version of CFM.
Step 4	ethernet cfm global Example: Router(config)#ethernet cfm global	Enables CFM processing globally on the router.
Step 5	ethernet cfm domain <i>domain-name level 0 to 7</i> Example: Router(config-ecfm)#ethernet cfm domain customer level 7	Defines a CFM maintenance domain at a specified level, and enters Ethernet CFM configuration mode. level can be any value from 0 to 7.
Step 6	service <i>service-name</i> vlan <i>vlan-id</i> inner-vlan <i>inner vlan-id</i> direction down	Enters the CFM service configuration mode. The following are the parameters:

	Command or Action	Purpose
	<p>Example:</p> <pre>Router(config-ecfm)#service customer1101 vlan 100 inner-vlan 30 direction down</pre>	<ul style="list-style-type: none"> • vlan—Specifies the VLAN. • inner-vlan—The inner-vlan keyword and the <i>inner vlan-id</i> argument specify the VLAN tag for double-tagged packets.
Step 7	<p>continuity-check</p> <p>Example:</p> <pre>Router(config-ecfm-srv)#continuity-check</pre>	Enables sending continuity check messages.
Step 8	<p>interface gigabitethernet slot/port</p> <p>Example:</p> <pre>Router(config-ecfm-srv)#interface gigabitethernet 0/2</pre>	Specifies an interface and enters the interface configuration mode.
Step 9	<p>ethernet cfm mep domain domain-name mpid mpid-value service service-name</p> <p>Example:</p> <pre>Router(config-if)#ethernet cfm mep domain customer mpid 100 service customer1101</pre>	<p>Sets a port to a maintenance domain and defines it as an MEP.</p> <p>Note The values for domain and service must be the same as the values configured for CFM.</p> <p>MPID—Specifies the maintenance endpoint identifier.</p>
Step 10	<p>interface gigabitethernet slot/port.subinterface</p> <p>Example:</p> <pre>Router(config-if-ecfm-mep)#interface gigabitethernet 0/2.1101</pre>	Specifies a subinterface and enters the subinterface configuration mode.
Step 11	<p>encapsulation dot1q vlan-id second-dot1q inner vlan-id</p> <p>Example:</p> <pre>Router(config-subif)#encapsulation dot1q 100 second-dot1q 30</pre>	<p>Defines the encapsulation format as IEEE 802.1Q (dot1q), and specifies the VLAN identifier.</p> <p>Use the second-dot1q keyword and the <i>inner vlan-id</i> argument to specify the VLAN tag.</p>
Step 12	<p>end</p> <p>Example:</p> <pre>Router(config-subif)#end</pre>	Returns the router to the privileged EXEC mode.

Configuration Example for Ethernet CFM (Double-Tagged Packets)

This example shows how to configure Ethernet CFM for double-tagged packets:

```
Router>enable
Router#configure terminal
Router(config)#ethernet cfm ieee
Router(config)#ethernet cfm global
Router(config-ecfm)#ethernet cfm domain customer level 7
Router(config-ecfm)#service customer1101 vlan 100 inner-vlan 30 direction down
Router(config-ecfm-srv)#continuity-check
Router(config-ecfm-srv)#interface gigabitethernet
0/2
Router(config-if)#ethernet cfm mep domain customer mpid 100 service customer1101
Router(config-if-ecfm-mep)#interface gigabitethernet 0/2.1101
Router(config-subif)#encapsulation dot1q 100 second-dot1q 30
Router(config-subif)#end
```

Verifying the Ethernet CFM Configuration for Double-Tagged Packets

Use the following commands to verify Ethernet CFM configured for double-tagged packets:

- **show ethernet cfm maintenance-points local**
- **show ethernet cfm maintenance-points remote**
- **ping ethernet mpid *mpid-value* domain *domain-name* service *service-name* cos *value***
- **tracertoe ethernet mpid *mpid-value* domain *domain-name* service *service-name***
- **show ethernet cfm error configuration**

Use the **show ethernet cfm maintenance-points local** command to view the local MEPs. The following is a sample output of the **show ethernet cfm maintenance-points local** command:

```
Router#show ethernet cfm maintenance-points local
-----
MPID Domain Name      MacAddress           IfSt      PtSt
  Lvl Domain ID      Ingress
  RDI MA Name        Type Id             SrcvInst
  EVC Name           Age
  Local MEP Info
-----
100 customer          8843.e154.6f01      Up        Up
  7 customer          Gi0/2.1101
  - customer1101     S, C 100, 30       N/A
  N/A
  MPID: 100 Domain: customer MA: customer1101
Router#
```

Use the **show ethernet cfm maintenance-points remote** command to display the remote maintenance point domains. In the following example, customer, carrier, and enterprise are the maintenance point domains that are configured:

On router 1:

```
Router1#show ethernet cfm maintenance-points remote
-----
MPID Domain Name      MacAddress           IfSt      PtSt
  Lvl Domain ID      Ingress
  RDI MA Name        Type Id             SrcvInst
  EVC Name           Age
  Local MEP Info
-----
```

```

-----
110 customer          8843.e154.6f01      Up                Up
  7 customer          Gi0/2.1101
  - customer1101     S, C 100, 30       N/A
  N/A                58s
  MPID: 100 Domain: customer MA: customer1101
43 carrier           8843.e154.6f01      Up                Up
  2 carrier           Gi0/2.2
  - carrier           S, C 50, 20        N/A
  N/A                58s
  MPID: 44 Domain: carrier MA: carrier
410 enterprise       8843.e154.6f01      Up                Up
  6 enterprise       Gi0/1.1
  - custservice      S, C 200, 70       N/A
  N/A                58s
  MPID: 400 Domain: enterprise MA: custservice
Router1#
    
```

On router 2:

Router2#show ethernet cfm maintenance-points remote

```

-----
MPID Domain Name      MacAddress           IfSt              PtSt
  Lvl Domain ID       Ingress
  RDI MA Name         Type Id             SrvcInst
  EVC Name            Age
  Local MEP Info
-----
100 customer          0026.99f7.0b41      Up                Up
  7 customer          Gi0/2.1101
  - customer1101     S, C 100, 30       N/A
  N/A                40s
  MPID: 110 Domain: customer MA: customer1101
44 carrier           0026.99f7.0b41      Up                Up
  2 carrier           Gi0/2.2
  - carrier           S, C 50, 20        N/A
  N/A                40s
  MPID: 43 Domain: carrier MA: carrier
400 enterprise       0026.99f7.0b41      Up                Up
  6 enterprise       Gi0/1.1
  - custservice      S, C 200, 70       N/A
  N/A                40s
  MPID: 410 Domain: enterprise MA: custservice
Router2#
    
```

Use the **ping** command to verify if Ethernet CFM loopback messages are successfully sent and received between the routers:

Router#ping ethernet mpid 100 domain customer service customer1101 cos 5

```

Type escape sequence to abort.
Sending 5 Ethernet CFM loopback messages to 8843.e154.6f01, timeout is 5 seconds:!!!!!
Success rate is 100 percent (5/5), round-trip min/avg/max = 1/1/1 ms
Router#
    
```

Use the **traceroute**

command to send the Ethernet CFM traceroute messages:

Router#traceroute ethernet mpid 100 domain customer service customer1101

Type escape sequence to abort. TTL 64. Linktrace Timeout is 5 seconds

Tracing the route to 8843.e154.6f01 on Domain customer, Level 7, service customer1101, vlan 100 inner-vlan 30

Traceroute sent via Gi0/2.1101

B = Intermediary Bridge

! = Target Destination

* = Per hop Timeout

```

-----
Hops  Host                MAC                Ingress           Ingr Action  Relay Action
      Host                Forwarded          Egress           Egr Action    Previous Hop
-----
! 1    8843.e154.6f01     Gi0/2.1101        IngOk          RlyHit:MEP
      Not Forwarded    5657.a86c.fa92
    
```

Use the **show ethernet cfm error configuration** command to view Ethernet CFM configuration errors (if any). The following is a sample output of the **show ethernet cfm error configuration** command:

```
Router#show ethernet cfm error configuration
-----
CFM Interface      Type  Id      Level  Error type
-----
Gi0/2              S,C   100,30   5      CFMLeak
Gi0/2              S,C   100,30   1      CFMLeak
```

Troubleshooting Ethernet CFM Configuration

Table 18: debug Commands for Ethernet CFM Configuration , on page 104 lists the debug commands to troubleshoot issues pertaining to the Ethernet CFM configuration.

The Cisco IOS Master Command List at

http://www.cisco.com/en/US/docs/ios/mcl/allreleasemcl/all_book.html

http://www.cisco.com/en/US/docs/ios/mcl/allreleasemcl/all_book.html provides more information about these commands.



Caution

Because debugging output is assigned high priority in the CPU process, it can diminish the performance of the router or even render it unusable. For this reason, use debug commands only to troubleshoot specific problems or during troubleshooting sessions with Cisco technical support staff.



Note

Before you run any of the debug commands listed in the following table, ensure that you run the **logging buffered debugging** command, and then turn off console debug logging using the **no logging console** command.

Table 18: debug Commands for Ethernet CFM Configuration

debug Command	Purpose
debug ethernet cfm all	Enables all Ethernet CFM debug messages.
debug ethernet cfm diagnostic	Enables low-level diagnostic debugging of Ethernet CFM general events or packet-related events.
debug ethernet cfm error	Enables debugging of Ethernet CFM errors.
debug ethernet cfm packets	Enables debugging of Ethernet CFM message packets.
debug ecfmpal all	Enables debug messages for all Ethernet CFM platform events.
debug ecfmpal api	Displays debug messages for all Ethernet CFM platform API events.

debug Command	Purpose
debug ecfmpal common	Displays debug messages for all Ethernet CFM platform common events.
debug ecfmpal ecfmpal	Enables debugging of all Ethernet CFM platform events.
debug ecfmpal epl	Enables debugging of all Ethernet CFM platform endpoint list (EPL) events.
debug ecfmpal isr	Enables debugging of all Ethernet CFM platform interrupt service request (ISR) events.

Support for Y.1731 Performance Monitoring on Routed Port (L3 Subinterface)

Y.1731 Performance Monitoring (PM) provides a standard Ethernet PM function that includes measurement of Ethernet frame delay, frame delay variation, frame loss, and frame throughput measurements specified by the ITU-T Y-1731 standard and interpreted by the Metro Ethernet Forum (MEF) standards group.



Note

This feature is supported only if you have purchased the *advipservices* licensing module. For more information about managing software activation licenses on the Cisco ISR and Cisco ISR G2 platforms, see http://www.cisco.com/en/US/docs/routers/access/sw_activation/SA_on_ISR.html.

Frame Delay

Ethernet frame delay measurement is used to measure frame delay and frame delay variations. Ethernet frame delay is measured using the Delay Measurement Message (DMM) method.

Restrictions for Configuring Two-Way Delay Measurement

Follow the guidelines and restrictions listed here when you configure two-way delay measurement:

- Y.1731 PM measurement works only for a point-to-point network topology.
- The granularity of the clock for delay measurement is in seconds and nanoseconds.
- CFM Y.1731 packets work with a maximum of two VLAN tags. The expected behavior is not observed with more VLAN tags. Also, CFM Y.1731 packets do not work with untagged cases.

Configuring Two-Way Delay Measurement

The following steps show how to configure two-way delay measurement. Both single and double tagging methods are included in the steps listed below.

SUMMARY STEPS

1. **enable**
2. **configure terminal**
3. **ip sla operation number**
4. Do one of the following:
 - **ethernet y1731 delay DMM domain value vlan vlan-id mpid value cos value source mpid value**
 - **ethernet y1731 delay DMM domain value vlan vlan-id inner-vlan inner vlan-id mpid value cos value source mpid value**
5. **aggregate interval seconds**
6. **exit**
7. **ip sla schedule operation number life value forever start-time value**
8. **end**

DETAILED STEPS

	Command or Action	Purpose
Step 1	enable Example: Router> enable	Enables the privileged EXEC mode. Enter your password when prompted.
Step 2	configure terminal Example: Router# configure terminal	Enters the global configuration mode.
Step 3	ip sla operation number Example: Router(config)# ip sla 1101	Enables the IP SLA configuration. <i>operation-number</i> —The IP SLA operation you want to configure.
Step 4	Do one of the following: <ul style="list-style-type: none"> • ethernet y1731 delay DMM domain value vlan vlan-id mpid value cos value source mpid value 	Configures a two-way delay measurement. Note Both single tagging and double tagging are supported. The following are the parameters: <ul style="list-style-type: none"> • delay—Specifies the delay distribution parameter.

	Command or Action	Purpose
	<ul style="list-style-type: none"> • ethernet y1731 delay DMM domain value vlan vlan-id inner-vlan inner vlan-id mpid value cos value source mpid value <p>Example:</p> <pre>Router(config-ip-sla)# ethernet y1731 delay DMM domain customer vlan 100 mpid 3101 cos 1 source mpid 4101 or Example: Router(config-ip-sla)# ethernet y1731 delay DMM domain customer vlan 100 inner-vlan 1101 mpid 3101 cos 1 source mpid 4101</pre>	<p>Note DMM is the only supported delay distribution parameter.</p> <ul style="list-style-type: none"> • vlan—Specifies the VLAN. • inner-vlan—The inner-vlan keyword and the <i>inner vlan-id</i> argument specify the VLAN tag for double-tagged packets. • cos—Specifies the CoS. The value can be any number between 0 and 7. <p>Note For double-tagged packets, the cos value corresponds to the value specified for the outer tag.</p> <ul style="list-style-type: none"> • mpid—Specifies the destination MPID. • source—Specifies the source MPID.
Step 5	<p>aggregate interval seconds</p> <p>Example:</p> <pre>Router(config-sla-y1731-delay)# aggregate interval 30</pre>	<p>Configures the Y.1731 aggregation parameter, where aggregate interval refers to the interval at which the packets are sent.</p> <p><i>seconds</i> —Specifies the length of time, in seconds.</p>
Step 6	<p>exit</p> <p>Example:</p> <pre>Router(config-sla-y1731-delay)# exit</pre>	<p>Exits the router configuration mode.</p>
Step 7	<p>ip sla schedule operation number life value forever start-time value</p> <p>Example:</p> <pre>Router(config)#ip sla schedule 1101 life forever start-time now</pre>	<p>Schedules the two-way delay measurement.</p> <ul style="list-style-type: none"> • life—Specifies a period of time (in seconds) to execute. The value can also be set as <i>forever</i> . • start-time—Specifies the time at which to start the entry. The options available are <i>after</i>, <i>hh:mm</i>, <i>hh:mm:ss</i>, <i>now</i>, and <i>pending</i> .
Step 8	<p>end</p> <p>Example:</p> <pre>Router(config)#end</pre>	<p>Exits the router configuration mode and returns to the privileged EXEC mode.</p>

Configuration Examples for Two-Way Delay Measurement

This example shows how to configure two-way delay measurement using single tagging:

```
router>enable
```

```

router#configure terminal
router(config)#ip sla
  1101
router(config-ip-sla)#ethernet y1731 delay DMM domain customer vlan 100 mpid 3101 cos 1
router(config-sla-y1731-delay)#aggregate interval 30
router(config-sla-y1731-delay)#exit
router(config)#ip sla schedule 1102 life forever start-time now
router(config)#end

```

This example shows how to configure two-way delay measurement using double tagging:

```

router>enable
router#configure terminal
router(config)#ip sla
  1101
router(config-ip-sla)#ethernet y1731 delay DMM domain customer vlan 100 inner-vlan 1101
mpid 3101 cos 1 source mpid 4101
router(config-sla-y1731-delay)#aggregate interval 30
router(config-sla-y1731-delay)#exit
router(config)#ip sla
  schedule 1101 life forever start-time now
router(config)#end

```

Verifying Two-Way Delay Measurement Configuration

Use the following commands to verify the performance-monitoring sessions:

- `show run | sec ip sla`
- `show ip sla summary`
- `show ip sla statistics entry-number`
- `show ip sla configuration entry-number`
- `show ethernet cfm pm session summary`
- `show ethernet cfm pm session detail session-id`
- `show ethernet cfm pm session db session-id`

The following are the sample outputs of the commands listed above:

```

Router#show run | sec ip sla
ip sla auto discovery
ip sla 1101
  ethernet y1731 delay DMM domain customer vlan 100 inner-vlan 1101 mpid 3101 cos
  1 source mpid 4101
ip sla schedule 1101 life forever start-time now
Router#show ip sla summary
IPSLAs Latest Operation Summary
Codes: * active, ^ inactive, ~ pending
ID          Type          Destination          Stats          Return          Last
          (ms)          Code                (ms)
-----
*1101      y1731-delay  Domain:customer V -   OK             27 seconds ag
          lan:100 CVlan:110
          1 Mpid:3101
Router#show ip sla statistics

IPSLAs Latest Operation Statistics
IPSLA operation id: 1101
Delay Statistics for Y1731 Operation 1101
Type of operation: Y1731 Delay Measurement
Latest operation start time: *10:43:12.930 UTC Mon Oct 21 2013
Latest operation return code: OK

```

```

Distribution Statistics:
Interval
Start time: *10:43:12.930 UTC Mon Oct 21 2013
Elapsed time: 15 seconds
Number of measurements initiated: 7
Number of measurements completed: 7
Flag: OK
Router#show ip sla configuration 1101
IP SLAs Infrastructure Engine-III
Entry number: 1101
Owner:
Tag:
Operation timeout (milliseconds): 5000
Ethernet Y1731 Delay Operation
Frame Type: DMM
Domain: customer
Vlan: 100
CVlan: 1101
Target Mpid: 3101
Source Mpid: 4101
CoS: 1
    Max Delay: 5000
    Request size (Padding portion): 64
    Frame Interval: 1000
    Clock: Not In Sync
Threshold (milliseconds): 5000
Schedule:
    Operation frequency (seconds): 30 (not considered if randomly scheduled)
    Next Scheduled Start Time: Start Time already passed
    Group Scheduled : FALSE
    Randomly Scheduled : FALSE
    Life (seconds): Forever
    Entry Ageout (seconds): never
    Recurring (Starting Everyday): FALSE
    Status of entry (SNMP RowStatus): Active
Statistics Parameters
    Frame offset: 1
    Distribution Delay Two-Way:
        Number of Bins 10
        Bin Boundaries: 5000,10000,15000,20000,25000,30000,35000,40000,45000,-1
    Distribution Delay-Variation Two-Way:
        Number of Bins 10
        Bin Boundaries: 5000,10000,15000,20000,25000,30000,35000,40000,45000,-1
    Aggregation Period: 30
History
    Number of intervals: 2
Router#show ethernet cfm pm session summary
Number of Configured Session : 150
Number of Active Session: 2
Number of Inactive Session: 148
Router#
Router(config)#show ethernet cfm pm session detail 0
Session ID: 0
Sla Session ID: 1101
Level: 7
Service Type: S,C
Service Id: 100,1101
Direction: Down
Source Mac: 5352.a824.04fr
Destination Mac: 5067.a87c.fa92
Session Version: 0
Session Operation: Proactive
Session Status: Active
MPID: 4101
Tx active: yes
Rx active: yes
RP monitor Tx active: yes
RP monitor Rx active: yes
Timeout timer: stopped
Last clearing of counters: *00:00:00.000 UTC Mon Jan 1 1900
DMMs:
    Transmitted: 117
DMRs:

```

```

Rcvd: 117
1DMs:
  Transmitted: 0
  Rcvd: 0
LMMs:
  Transmitted: 0
LMRs:
  Rcvd: 0
VSMs:
  Transmitted: 0
VSRs:
  Rcvd: 0
SLMs:
  Transmitted: 0
SLRs:
  Rcvd: 0
Test ID 0
Router1#
Router1#show ethernet cfm pm session db 0
-----
TX Time FWD          RX Time FWD          Frame Delay
TX Time BWD          RX Time BWD          Sec:nSec
Sec:nSec             Sec:nSec
-----
Session ID: 0
*****
3591340722:930326034      3591340663:866791722
3591340663:866898528      3591340722:930707484      0:274644
*****
3591340723:927640626      3591340664:864091056
3591340664:864182604      3591340723:927976302      0:244128
*****
3591340724:927640626      3591340665:864091056
3591340665:864167346      3591340724:927961044      0:244128
*****
3591340725:927671142      3591340666:864121572
3591340666:864213120      3591340725:928006818      0:244128
*****
3591340726:927655884      3591340667:864106314
3591340667:864197862      3591340726:927991560      0:244128
*****
3591340727:927732174      3591340668:864167346
3591340668:864533538      3591340727:928327236      0:228870
*****
3591340728:927655884      3591340669:864121572
3591340669:864197862      3591340728:928006818      0:274644
*****
3591340729:927671142      3591340670:864121572
3591340670:864197862      3591340729:927991560      0:244128
*****

```

Troubleshooting Two-Way Delay Measurement Configuration

Table 19: debug Commands for Two-Way Delay Measurement Configuration , on page 111 lists the debug commands to troubleshoot issues pertaining to the two-way delay measurement configuration.

The Cisco IOS Master Command List at

http://www.cisco.com/en/US/docs/ios/mcl/allreleasemcl/all_book.html

http://www.cisco.com/en/US/docs/ios/mcl/allreleasemcl/all_book.html provides more information about these commands.

**Note**

Because debugging output is assigned high priority in the CPU process, it can diminish the performance of the router or even render it unusable. For this reason, use debug commands only to troubleshoot specific problems or during troubleshooting sessions with Cisco technical support staff.

**Note**

Before you run any of the debug commands listed in the following table, ensure that you run the **logging buffered debugging** command, and then turn off console debug logging using the **no logging console** command.

Table 19: debug Commands for Two-Way Delay Measurement Configuration

debug Command	Purpose
debug eppal all	Enables debugging of all Ethernet performance monitoring (PM) events.
debug eppal api	Enables debugging of Ethernet PM API events.
debug eppal rx	Enables debugging of Ethernet PM packet-receive events.
debug eppal tx	Enables debugging of Ethernet PM packet-transmit events.



Configuring Power Management

This chapter provides information about configuring power management and Power-over-Ethernet (PoE) for router models that support these features. See specific router model documentation for information about supported features:

- [Monitoring Power Usage with EnergyWise, page 113](#)
- [Configuring Power-over-Ethernet, page 113](#)

Monitoring Power Usage with EnergyWise

Cisco EnergyWise monitors and manages the power usage of network devices and devices connected to the network. For information about using EnergyWise technology, see the configuration guides at the following site:

[Cisco EnergyWise Configuration Guides](#)

Configuring Power-over-Ethernet

Use the **power inline** command to enable/disable or the **show power inline** command to verify Power-over-Ethernet (PoE).

**Note**

Power-over-Ethernet is available for the C867VAE-POE-W-A-K9 model, using port FE0, with a 60-W power supply.

Enabling/Disabling Power-over-Ethernet

Use the **power inline** command to enable/disable Power-over-Ethernet (PoE) on the Fast Ethernet (FE) port 0. Beginning in privileged EXEC mode, perform these steps.

SUMMARY STEPS

- 1 **configure terminal**

```

2 interface fastethernet 0
3 power inline {auto | never}
4 end

```

DETAILED STEPS

SUMMARY STEPS

1. Router# **configure terminal**
2. Router(config)# **interface fastethernet 0**
3. Router(config-if)# **power inline {auto | never}**
4. Router(config-if)# **end**

DETAILED STEPS

	Command or Action	Purpose
Step 1	Router# configure terminal	Enters global configuration mode.
Step 2	Router(config)# interface fastethernet 0	The Fast Ethernet (FE) 0 interface. Note The C867VAE-POE-W-A-K9 supports Power-over-Ethernet on the FE0 interface only.
Step 3	Router(config-if)# power inline {auto never}	Use auto to configure the port to supply inline power automatically. Use never to disable inline power on the port.
Step 4	Router(config-if)# end Example: Router#	Exits configuration mode.

Verifying the Power-over-Ethernet Configuration on the Interface

Use the **show power inline** command to verify the power configuration on the FE0 port.

```

Router# show power inline
PowerSupply  SlotNum.  Maximum  Allocated  Status
-----
INT-PS      0      18.000   6.300     PS GOOD
Interface   Config  Device   Powered   PowerAllocated
-----
Fa0         auto   Cisco    On        6.300 Watts

```



Configuring Security Features

This chapter provides an overview of authentication, authorization, and accounting (AAA), which is the primary Cisco framework for implementing selected security features that can be configured on the Cisco 860 and Cisco 880 series Integrated Services Routers (ISRs).

This chapter contains the following sections:

- [Authentication, Authorization, and Accounting](#), page 115
- [Configuring AutoSecure](#), page 116
- [Configuring Access Lists](#), page 116
- [Configuring Cisco IOS Firewall](#), page 117
- [Configuring Cisco IOS IPS](#), page 118
- [URL Filtering](#), page 118
- [Configuring VPN](#), page 119

Authentication, Authorization, and Accounting

AAA network security services provide the primary framework through which you set up access control on your router. Authentication provides the method of identifying users, including login and password dialog, challenge and response, messaging support, and depending on the security protocol you choose, encryption. Authorization provides the method for remote access control, including one-time authorization or authorization for each service; per-user account list and profile; user group support; and support of IP, Internetwork Packet Exchange (IPX), AppleTalk Remote Access (ARA), and Telnet. Accounting provides the method for collecting and sending security server information used for billing, auditing, and reporting, such as user identities, start and stop times, executed commands (such as PPP), number of packets, and number of bytes.

AAA uses protocols such as RADIUS, TACACS+, or Kerberos to administer its security functions. If your router is acting as a network access server, AAA is the means through which you establish communication between your network access server and your RADIUS, TACACS+, or Kerberos security server.

For information about configuring AAA services and supported security protocols, see the following sections of http://www.cisco.com/en/US/docs/ios/sec_user_services/configuration/guide/12_4T/sec_securing_user_services_12.4t_book.html Cisco IOS Security Configuration Guide: Securing User Services, Release 12.4T :

- Configuring Authentication
- Configuring Authorization
- Configuring Accounting
- RADIUS and TACACS + Attributes
- Configuring Kerberos

Configuring AutoSecure

The AutoSecure feature disables common IP services that can be exploited for network attacks and enables IP services and features that can aid in the defense of a network when under attack. These IP services are all disabled and enabled simultaneously with a single command, which simplifies security configuration on your router. For a complete description of the AutoSecure feature, see [AutoSecure](#).

Configuring Access Lists

Access lists permit or deny network traffic over an interface based on source IP address, destination IP address, or protocol. Access lists are configured as standard or extended. A standard access list either permits or denies passage of packets from a designated source. An extended access list allows designation of both the destination and the source, and it allows designation of individual protocols to be permitted or denied passage.

For more complete information on creating access lists, see the “Access Control Lists (ACLs)” section in http://www.cisco.com/en/US/docs/ios/sec_data_plane/configuration/guide/12_4t/sec_data_plane_12_4t_book.html Cisco IOS Security Configuration Guide: Securing the Data Plane, Release 12.4T.

An access list is a series of commands with a common tag to bind them together. The tag is either a number or a name. Table below lists the commands used to configure access lists.

Table 20: Access List Configuration Commands

ACL Type	Configuration Commands
Numbered	
Standard	access-list 1-99 { permit deny } <i>source-addr</i> [<i>source-mask</i>]
Extended	access-list 100-199 { permit deny } <i>protocol</i> <i>source-addr</i> [<i>source-mask</i>] <i>destination-addr</i> [<i>destination-mask</i>]
Named	
Standard	ip access-list standard <i>name</i> deny { <i>source</i> <i>source-wildcard</i> any }

ACL Type	Configuration Commands
Extended	ip access-list extended <i>name</i> { permit deny } <i>protocol</i> { <i>source-addr</i> [<i>source-mask</i>] any } { <i>destination-addr</i> [<i>destination-mask</i>] any }

To create, refine, and manage access lists, see the “Access Control Lists (ACLs)” section in http://www.cisco.com/en/US/docs/ios/sec_data_plane/configuration/guide/12_4t/sec_data_plane_12_4t_book.html Cisco IOS Security Configuration Guide: Securing the Data Plane, Release 12.4T :

- Creating an IP Access List and Applying It to an Interface
- Creating an IP Access List to Filter IP Options, TCP Flags, Noncontiguous Ports, or TTL Values
- Refining an IP Access List
- Displaying and Clearing IP Access List Data Using ACL Manageability

Access Groups

An access group is a sequence of access list definitions bound together with a common name or number. This group is enabled for an interface during interface configuration. Use the following guidelines when creating access groups.

- The order of access list definitions is significant. A packet is compared against the first access list in the sequence. If there is no match (that is, if neither a permit nor a deny occurs), the packet is compared with the next access list, and so on.
- All parameters must match the access list before the packet is permitted or denied.
- There is an implicit “deny all” at the end of all sequences.

For information on configuring and managing access groups, see http://www.cisco.com/en/US/docs/ios/sec_data_plane/configuration/guide/12_4t/sec_data_plane_12_4t_book.html Cisco IOS Security Configuration Guide: Securing the Data Plane, Release 12.4T.

Configuring Cisco IOS Firewall

The Cisco IOS Firewall lets you configure a stateful firewall in which packets are inspected internally and the state of network connections is monitored. A stateful firewall is superior to static access lists because access lists can only permit or deny traffic based on individual packets, not based on streams of packets. Also, because Cisco IOS Firewall inspects the packets, decisions to permit or deny traffic can be made by examining application layer data, which static access lists cannot examine.

To configure a Cisco IOS Firewall, specify which protocols to examine by using the following command in interface configuration mode:

```
ip inspect name inspection-name protocol timeout seconds
```

When inspection detects that the specified protocol is passing through the firewall, a dynamic access list is created to allow the passage of return traffic. The timeout parameter specifies the length of time the dynamic

access list remains active without return traffic passing through the router. When the timeout value is reached, the dynamic access list is removed, and subsequent packets (possibly valid ones) are not permitted.

Use the same inspection name in multiple statements to group them into one set of rules. This set of rules can be activated elsewhere in the configuration by using the **ip inspect inspection-name {in | out}** command when you configure an interface at the firewall.

For additional information about configuring a Cisco IOS Firewall, see http://www.cisco.com/en/US/docs/ios/sec_data_plane/configuration/guide/12_4t/sec_data_plane_12_4t_book.html Cisco IOS Security Configuration Guide: Securing the Data Plane, Release 12.4T .

The Cisco IOS Firewall may also be configured to provide voice security in Session Initiated Protocol (SIP) applications. SIP inspection provides basic inspect functionality (SIP packet inspection and detection of pin-hole openings), as well protocol conformance and application security. For more information, see [Cisco IOS Firewall: SIP Enhancements: ALG and AIC](#) .

Configuring Cisco IOS IPS

Cisco IOS Intrusion Prevention System (IPS) technology is available on Cisco 880 series ISRs and enhances perimeter firewall protection by taking appropriate action on packets and flows that violate the security policy or represent malicious network activity.

Cisco IOS IPS identifies attacks using “signatures” to detect patterns of misuse in network traffic. Cisco IOS IPS acts as an in-line intrusion detection sensor, watching packets and sessions as they flow through the router, scanning each to match known IPS signatures. When Cisco IOS IPS detects suspicious activity, it responds before network security can be compromised, it logs the event, and, depending on configuration, it does one of the following:

- Sends an alarm
- Drops suspicious packets
- Resets the connection
- Denies traffic from the source IP address of the attacker for a specified amount of time
- Denies traffic on the connection for which the signature was seen for a specified amount of time

For additional information about configuring Cisco IOS IPS, see http://www.cisco.com/en/US/docs/ios/sec_data_plane/configuration/guide/12_4t/sec_data_plane_12_4t_book.html Cisco IOS Security Configuration Guide: Securing the Data Plane, Release 12.4T .

URL Filtering

Cisco 860 series and Cisco 880 series ISRs provide category based URL filtering. The user provisions URL filtering on the ISR by selecting categories of websites to be permitted or blocked. An external server, maintained by a third party, is used to check for URLs in each category. Permit and deny policies are maintained on the ISR. The service is subscription based, and the URLs in each category are maintained by the third-party vendor.

For additional information about configuring URL filtering, see http://www.cisco.com/en/US/docs/ios/sec_data_plane/configuration/guide/sec_url_filtering.html Subscription-based Cisco IOS Content Filtering guide .

Configuring VPN

A VPN connection provides a secure connection between two networks over a public network such as the Internet. Cisco 860 and Cisco 880 series ISRs support two types of VPNs; site-to-site and remote access. Site-to-site VPNs are used to connect branch offices to corporate offices, for example. Remote access VPNs are used by remote clients to log into a corporate network. Two examples are given in this section: remote access VPN and site-to-site VPN.

Remote Access VPN

The configuration of a remote access VPN uses Cisco Easy VPN and an IP Security (IPSec) tunnel to configure and secure the connection between the remote client and the corporate network. Figure below shows a typical deployment scenario.

Figure 2: Remote Access VPN Using IPSec Tunnel

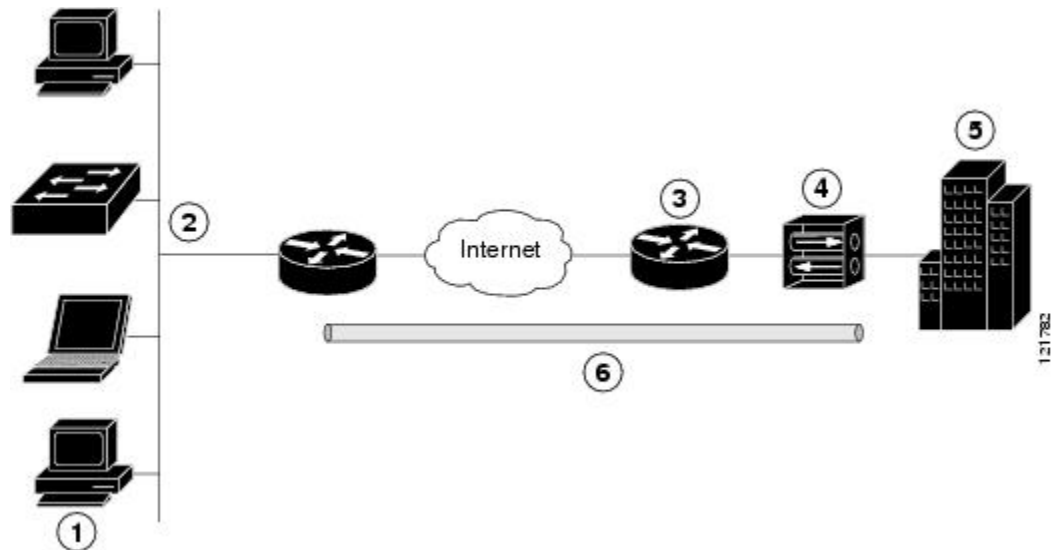

1	Remote networked users
2	VPN client—Cisco 880 series access router
3	Router—Providing the corporate office network access
4	VPN server—Easy VPN server; for example, a Cisco VPN 3000 concentrator with outside interface address 210.110.101.1
5	Corporate office with a network address of 10.1.1.1
6	IPSec tunnel

The Cisco Easy VPN client feature eliminates much of the tedious configuration work by implementing the Cisco Unity Client protocol. This protocol allows most VPN parameters, such as internal IP addresses, internal subnet masks, DHCP server addresses, Windows Internet Naming Service (WINS) server addresses, and split-tunneling flags to be defined at a VPN server, such as a Cisco VPN 3000 series concentrator that is acting as an IPsec server.

A Cisco Easy VPN server-enabled device can terminate VPN tunnels initiated by mobile and remote workers who are running Cisco Easy VPN Remote software on PCs. Cisco Easy VPN server-enabled devices allow remote routers to act as Cisco Easy VPN Remote nodes.

The Cisco Easy VPN client feature can be configured in one of two modes: client mode or network extension mode. Client mode is the default configuration and allows only devices at the client site to access resources at the central site. Resources at the client site are unavailable to the central site. Network extension mode allows users at the central site (where the VPN 3000 series concentrator is located) to access network resources on the client site.

After the IPsec server has been configured, a VPN connection can be created with minimal configuration on an IPsec client, such as a supported Cisco 880 series ISR. When the IPsec client initiates the VPN tunnel connection, the IPsec server pushes the IPsec policies to the IPsec client and creates the corresponding VPN tunnel connection.

Note

The Cisco Easy VPN client feature supports configuration of only one destination peer. If your application requires creation of multiple VPN tunnels, you must manually configure the IPsec VPN and Network Address Translation/Peer Address Translation (NAT/PAT) parameters on both the client and the server.

Cisco 860 and Cisco 880 series ISRs can also be configured to act as Cisco Easy VPN servers, letting authorized Cisco Easy VPN clients establish dynamic VPN tunnels to the connected network. For information on the configuration of Cisco Easy VPN servers see <http://www.cisco.com/c/en/us/support/docs/cloud-systems-management/configuration-professional/112037-easyvpn-router-config-ccp-00.html>.

Site-to-Site VPN

The configuration of a site-to-site VPN uses IPsec and the generic routing encapsulation (GRE) protocol to secure the connection between the branch office and the corporate network. Figure below shows a typical deployment scenario.

Figure 3: Site-to-Site VPN Using an IPsec Tunnel and GRE

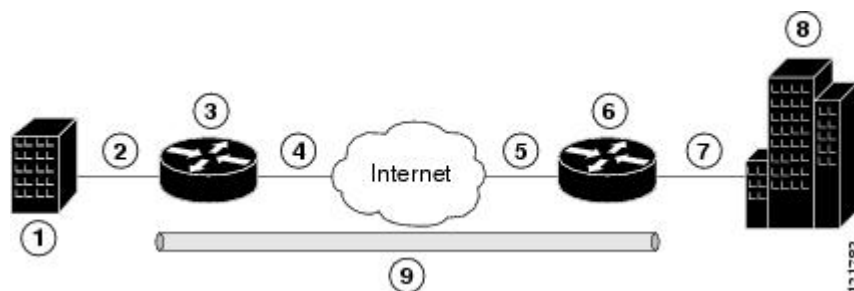

1	Branch office containing multiple LANs and VLANs
2	Fast Ethernet LAN interface—With address 192.165.0.0/16 (also the inside interface for NAT)

3	VPN client—Cisco 860 or Cisco 880 series ISR
4	Fast Ethernet or ATM interface—With address 200.1.1.1 (also the outside interface for NAT)
5	LAN interface—Connects to the Internet; with outside interface address of 210.110.101.1
6	VPN client—Another router, which controls access to the corporate network
7	LAN interface—Connects to the corporate network, with inside interface address of 10.1.1.1
8	Corporate office network
9	IPSec tunnel with GRE

For more information about IPSec and GRE configuration, see http://www.cisco.com/c/en/us/td/docs/ios-xml/ios/security/config_library/12-4t/secon-12-4t-library.html Cisco IOS Security Configuration Guide: Secure Connectivity, Release 12.4T .

Configuration Examples

Each example configures a VPN over an IPSec tunnel, using the procedure given in the [Configuring a VPN over an IPSec Tunnel, on page 121](#). The specific procedure for a remote access configuration is given, followed by the specific procedure for a site-to-site configuration.

The examples shown in this chapter apply only to the endpoint configuration on the Cisco 860 and Cisco 880 ISRs. Any VPN connection requires both endpoints be configured properly to function. See the software configuration documentation as needed to configure the VPN for other router models.

VPN configuration information must be configured on both endpoints. You must specify parameters, such as internal IP addresses, internal subnet masks, DHCP server addresses, and Network Address Translation (NAT).

Configuring a VPN over an IPSec Tunnel

Perform the following tasks to configure a VPN over an IPSec tunnel:

Configuring the IKE Policy

To configure the Internet Key Exchange (IKE) policy, perform these steps, beginning in global configuration mode:

SUMMARY STEPS

1. `crypto isakmp policy priority`
2. `encryption {des | 3des | aes | aes 192 | aes 256}`
3. `hash {md5 | sha}`
4. `authentication {rsa-sig | rsa-encr | pre-share}`
5. `group {1 | 2 | 5}`
6. `lifetime seconds`
7. `exit`

DETAILED STEPS

	Command or Action	Purpose
Step 1	<code>crypto isakmp policy priority</code> Example: <code>Router(config)# crypto isakmp policy 1</code>	Creates an IKE policy that is used during IKE negotiation. The priority is a number from 1 to 10000, with 1 being the highest. Also enters the Internet Security Association Key and Management Protocol (ISAKMP) policy configuration mode.
Step 2	<code>encryption {des 3des aes aes 192 aes 256}</code> Example: <code>Router(config-isakmp)# encryption 3des</code>	Specifies the encryption algorithm used in the IKE policy. The example specifies 168-bit data encryption standard (DES).
Step 3	<code>hash {md5 sha}</code> Example: <code>Router(config-isakmp)# hash md5</code>	Specifies the hash algorithm used in the IKE policy. The example specifies the Message Digest 5 (MD5) algorithm. The default is Secure Hash standard (SHA-1).
Step 4	<code>authentication {rsa-sig rsa-encr pre-share}</code> Example: <code>Router(config-isakmp)# authentication pre-share</code>	Specifies the authentication method used in the IKE policy. The example specifies a pre-shared key.
Step 5	<code>group {1 2 5}</code> Example: <code>Router(config-isakmp)# group 2</code>	Specifies the Diffie-Hellman group to be used in an IKE policy.
Step 6	<code>lifetime seconds</code> Example: <code>Router(config-isakmp)# lifetime 480</code>	Specifies the lifetime, in seconds, for an IKE security association (SA). Acceptable values are from 60 to 86400.
Step 7	<code>exit</code> Example: <code>Router(config-isakmp)# exit</code>	Exits ISAKMP policy configuration mode and returns to global configuration mode.

Configuring Group Policy Information

To configure the group policy, perform these steps, beginning in global configuration mode:

SUMMARY STEPS

1. **crypto isakmp client configuration group** {group-name | default}
2. **key** name
3. **dns** primary-server
4. **domain** name
5. **exit**
6. **ip local pool** {default | poolname} [low-ip-address [high-ip-address]]

DETAILED STEPS

	Command or Action	Purpose
Step 1	crypto isakmp client configuration group {group-name default} Example: Router(config)# crypto isakmp client configuration group rtr-remote	Creates an IKE policy group containing attributes to be downloaded to the remote client. Also enters the Internet Security Association Key and Management Protocol (ISAKMP) group policy configuration mode.
Step 2	key name Example: Router(config-isakmp-group)# key secret-password	Specifies the IKE pre-shared key for the group policy.
Step 3	dns primary-server Example: Router(config-isakmp-group)# dns 10.50.10.1	Specifies the primary Domain Name System (DNS) server for the group. Note To specify Windows Internet Naming Service (WINS) servers for the group, use the wins command.
Step 4	domain name Example: Router(config-isakmp-group)# domain company.com	Specifies group domain membership.
Step 5	exit Example: Router(config-isakmp-group)# exit Router(config)#	Exits ISAKMP group policy configuration mode and returns to global configuration mode.
Step 6	ip local pool {default poolname} [low-ip-address [high-ip-address]]	Specifies a local address pool for the group.

	Command or Action	Purpose
	Example: <pre>Router(config)# ip local pool dynpool 30.30.30.20 30.30.30.30</pre>	For details about this command and additional parameters that can be set, see Cisco IOS Dial Technologies Command Reference .

Applying Mode Configuration to the Crypto Map

To apply mode configuration to the crypto map, perform these steps, beginning in global configuration mode:

SUMMARY STEPS

1. `crypto map map-name isakmp authorization list list-name`
2. `crypto map tag client configuration address [initiate | respond]`

DETAILED STEPS

	Command or Action	Purpose
Step 1	crypto map map-name isakmp authorization list list-name Example: <pre>Router(config)# crypto map dynmap isakmp authorization list rtr-remote</pre>	Applies mode configuration to the crypto map and enables key lookup (IKE queries) for the group policy from an authentication, authorization, and accounting (AAA) server.
Step 2	crypto map tag client configuration address [initiate respond] Example: <pre>Router(config)# crypto map dynmap client configuration address respond</pre>	Configures the router to reply to mode configuration requests from remote clients.

Enabling Policy Lookup

To enable policy lookup through AAA, perform these steps, beginning in global configuration mode:

SUMMARY STEPS

1. **aaa new-model**
2. **aaa authentication login** {default | list-name} method1 [method2...]
3. **aaa authorization** {network | exec | commands level | reverse-access | configuration} {default | list-name} [method1 [method2...]]
4. **username name** {nopassword | password password | password encryption-type encrypted-password}

DETAILED STEPS

	Command or Action	Purpose
Step 1	aaa new-model Example: Router(config)# aaa new-model	Enables the AAA access control model.
Step 2	aaa authentication login {default list-name} method1 [method2...] Example: Router(config)# aaa authentication login rtr-remote local	Specifies AAA authentication of selected users at login, and specifies the method used. <ul style="list-style-type: none"> • This example uses a local authentication database. Note You could also use a RADIUS server. For details, see Cisco IOS Security Configuration Guide: Securing User Services, Release 12.4T and Cisco IOS Security Command Reference .
Step 3	aaa authorization {network exec commands level reverse-access configuration} {default list-name} [method1 [method2...]] Example: Router(config)# aaa authorization network rtr-remote local	Specifies AAA authorization of all network-related service requests, including PPP, and specifies the method of authorization. <ul style="list-style-type: none"> • This example uses a local authorization database. Note You could also use a RADIUS server. For details, see Cisco IOS Security Configuration Guide: Securing User Services, Release 12.4T and Cisco IOS Security Command Reference .
Step 4	username name {nopassword password password password encryption-type encrypted-password} Example: Router(config)# username username1 password 0 password1	Establishes a username-based authentication system.

Configuring IPSec Transforms and Protocols

A transform set represents a certain combination of security protocols and algorithms. During IKE negotiation, the peers agree to use a particular transform set for protecting data flow.

During IKE negotiations, the peers search in multiple transform sets for a transform that is the same at both peers. When a transform set is found that contains such a transform, it is selected and applied to the protected traffic as a part of both configurations.

To specify the IPSec transform set and protocols, perform these steps, beginning in global configuration mode:

SUMMARY STEPS

1. **crypto ipsec profile** *profile-name*
2. **crypto ipsec transform-set** *transform-set-name transform1 [transform2] [transform3] [transform4]*
3. **crypto ipsec security-association lifetime** {*seconds seconds* | *kilobytes kilobytes*}

DETAILED STEPS

	Command or Action	Purpose
Step 1	crypto ipsec profile <i>profile-name</i> Example: Router(config)# crypto ipsec profile prol	Configures IPSec profile to apply protection on the tunnel for encryption.
Step 2	crypto ipsec transform-set <i>transform-set-name transform1 [transform2] [transform3] [transform4]</i> Example: Router(config)# crypto ipsec transform-set vpn1 esp-3des esp-sha-hmac	Defines a transform set—an acceptable combination of IPSec security protocols and algorithms. See Cisco IOS Security Configuration Guide: Secure Connectivity, Release 12.4T for details about the valid transforms and combinations.
Step 3	crypto ipsec security-association lifetime { <i>seconds seconds</i> <i>kilobytes kilobytes</i> }	Specifies global lifetime values used when IPSec security associations are negotiated.
	Example: Router(config)# crypto ipsec security-association lifetime seconds 86400	

Configuring the IPSec Crypto Method and Parameters

A dynamic crypto map policy processes negotiation requests for new security associations from remote IPSec peers, even if the router does not know all the crypto map parameters (for example, IP address).

To configure the IPSec crypto method, perform these steps, beginning in global configuration mode:

SUMMARY STEPS

1. **crypto dynamic-map** *dynamic-map-name dynamic-seq-num*
2. **set transform-set** *transform-set-name [transform-set-name2...transform-set-name6]*
3. **reverse-route**
4. **exit**
5. **crypto map** *map-name seq-num [ipsec-isakmp] [dynamic dynamic-map-name] [discover] [profile profile-name]*

DETAILED STEPS

	Command or Action	Purpose
Step 1	crypto dynamic-map <i>dynamic-map-name dynamic-seq-num</i> Example: Router(config)# crypto dynamic-map dynmap 1	Creates a dynamic crypto map entry and enters crypto map configuration mode. See Cisco IOS Security Command Reference for more details about this command.
Step 2	set transform-set <i>transform-set-name [transform-set-name2...transform-set-name6]</i> Example: Router(config-crypto-map)# set transform-set vpn1	Specifies which transform sets can be used with the crypto map entry.
Step 3	reverse-route Example: Router(config-crypto-map)# reverse-route	Creates source proxy information for the crypto map entry. See Cisco IOS Security Command Reference for details.
Step 4	exit Example: Router(config-crypto-map)# exit	Exits crypto map configuration mode and returns to global configuration mode.
Step 5	crypto map <i>map-name seq-num [ipsec-isakmp] [dynamic dynamic-map-name] [discover] [profile profile-name]</i> Example: Router(config)# crypto map static-map 1 ipsec-isakmp dynamic dynmap	Creates a crypto map profile.

Applying the Crypto Map to the Physical Interface

The crypto maps must be applied to each interface through which IPSec traffic flows. Applying the crypto map to the physical interface instructs the router to evaluate all the traffic against the security associations database. With the default configurations, the router provides secure connectivity by encrypting the traffic

sent between remote sites. However, the public interface still allows the rest of the traffic to pass and provides connectivity to the Internet.

To apply a crypto map to an interface, perform these steps, beginning in global configuration mode:

SUMMARY STEPS

1. **interface** *type number*
2. **crypto map** *map-name*
3. **exit**

DETAILED STEPS

	Command or Action	Purpose
Step 1	interface <i>type number</i> Example: Router(config)# interface fastethernet 4	Enters the interface configuration mode for the interface to which the crypto map will be applied.
Step 2	crypto map <i>map-name</i> Example: Router(config-if)# crypto map static-map	Applies the crypto map to the interface. <ul style="list-style-type: none"> • See Cisco IOS Security Command Reference for more details about this command.
Step 3	exit Example: Router(config-crypto-map)# exit Router(config)#	Exits interface configuration mode and returns to global configuration mode.

What to Do Next

Where to Go Next

If you are creating a Cisco Easy VPN remote configuration, go to the [Creating a Cisco Easy VPN Remote Configuration](#), on page 128.

If you are creating a site-to-site VPN using IPSec tunnels and GRE, go to the [Configuring a Site-to-Site GRE Tunnel](#), on page 131.

Creating a Cisco Easy VPN Remote Configuration

The router acting as the Cisco Easy VPN client must create a Cisco Easy VPN remote configuration and assign it to the outgoing interface.

To create the remote configuration, perform these steps, beginning in global configuration mode:

SUMMARY STEPS

1. **crypto ipsec client ezvpn name**
2. **group group-name key group-key**
3. **peer {ipaddress | hostname}**
4. **mode {client | network-extension | network extension plus}**
5. **exit**
6. **crypto isakmp keepalive seconds**
7. **interface type number**
8. **crypto ipsec client ezvpn name [outside | inside]**
9. **exit**

DETAILED STEPS

	Command or Action	Purpose
Step 1	crypto ipsec client ezvpn name Example: <pre>Router(config)# crypto ipsec client ezvpn ezvpnclient</pre>	Creates a Cisco Easy VPN remote configuration, and enters Cisco Easy VPN remote configuration mode.
Step 2	group group-name key group-key Example: <pre>Router(config-crypto-ezvpn)# group ezvpnclient key secret-password</pre>	Specifies the IPsec group and IPsec key value for the VPN connection.
Step 3	peer {ipaddress hostname} Example: <pre>Router(config-crypto-ezvpn)# peer 192.168.100.1</pre>	Specifies the peer IP address or hostname for the VPN connection. <ul style="list-style-type: none"> • A hostname can be specified only when the router has a DNS server available for hostname resolution. Note Use this command to configure multiple peers for use as backup. If one peer goes down, the Easy VPN tunnel is established with the second available peer. When the primary peer comes up again, the tunnel is reestablished with the primary peer.
Step 4	mode {client network-extension network extension plus} Example: <pre>Router(config-crypto-ezvpn)# mode client</pre>	Specifies the VPN mode of operation.
Step 5	exit Example: <pre>Router(config-crypto-ezvpn)# exit</pre>	Exits Cisco Easy VPN remote configuration mode and returns to global configuration mode.

	Command or Action	Purpose
Step 6	crypto isakmp keepalive <i>seconds</i> Example: Router(config)# crypto isakmp keepalive 10	Enables dead peer detection messages. <ul style="list-style-type: none"> • <i>seconds</i>—Sets the time between messages. The range is from 10 to 3600.
Step 7	interface <i>type number</i> Example: Router(config)# interface fastethernet 4	Enters the interface configuration mode for the interface to which the Cisco Easy VPN remote configuration will be applied. Note For routers with an ATM WAN interface, this command would be interface atm 0 .
Step 8	crypto ipsec client ezvpn <i>name [outside inside]</i> Example: Router(config-if)# crypto ipsec client ezvpn ezvpnclient outside	Assigns the Cisco Easy VPN remote configuration to the WAN interface. <ul style="list-style-type: none"> • This command causes the router to automatically create the NAT or port address translation (PAT) and access list configuration needed for the VPN connection.
Step 9	exit Example: Router(config-crypto-ezvpn)# exit	Exits interface configuration mode and returns to global configuration mode.

What to Do Next

Configuration Example

The following configuration example shows a portion of the configuration file for the VPN and IPSec tunnel described in this chapter.

```

!
aaa new-model
!
aaa authentication login rtr-remote local
aaa authorization network rtr-remote local
aaa session-id common
!
username Cisco password 0 Cisco
!
crypto isakmp policy 1
  encryption 3des
  authentication pre-share
  group 2
  lifetime 480
!
crypto isakmp client configuration group rtr-remote
  key secret-password
  dns 10.50.10.1 10.60.10.1
  domain company.com
  pool dynpool
!
crypto ipsec transform-set vpn1 esp-3des esp-sha-hmac
!
crypto ipsec security-association lifetime seconds 86400

```



```

!
crypto dynamic-map dynmap 1
  set transform-set vpn1
  reverse-route
!
crypto map static-map 1 ipsec-isakmp dynamic dynmap
crypto map dynmap isakmp authorization list rtr-remote
crypto map dynmap client configuration address respond
crypto ipsec client ezvpn ezvpnclient
  connect auto
  group 2 key secret-password
  mode client
  peer 192.168.100.1
!
interface fastethernet 4
  crypto ipsec client ezvpn ezvpnclient outside
  crypto map static-map
!
interface vlan 1
  crypto ipsec client ezvpn ezvpnclient inside
!

```

Configuring a Site-to-Site GRE Tunnel

To configure a GRE tunnel, perform these steps, beginning in global configuration mode:

SUMMARY STEPS

1. **interface** *type number*
2. **ip address** *ip-address mask*
3. **tunnel source** *interface-type number*
4. **tunnel destination** *default-gateway-ip-address*
5. **crypto map** *map-name*
6. **exit**
7. **ip access-list** {**standard** | **extended**} *access-list-name*
8. **permit** *protocol source source-wildcard destination destination-wildcard*
9. **exit**

DETAILED STEPS

	Command or Action	Purpose
Step 1	interface <i>type number</i> Example: Router(config)# interface tunnel 1	Creates a tunnel interface and enters interface configuration mode.
Step 2	ip address <i>ip-address mask</i> Example: Router(config-if)# 10.62.1.193 255.255.255.252	Assigns an address to the tunnel.

	Command or Action	Purpose
Step 3	tunnel source <i>interface-type number</i> Example: <pre>Router(config-if)# tunnel source fastethernet 0</pre>	Specifies the source endpoint of the router for the GRE tunnel.
Step 4	tunnel destination <i>default-gateway-ip-address</i> Example: <pre>Router(config-if)# tunnel destination 192.168.101.1</pre>	Specifies the destination endpoint of the router for the GRE tunnel.
Step 5	crypto map <i>map-name</i> Example: <pre>Router(config-if)# crypto map static-map</pre>	Assigns a crypto map to the tunnel. Note Dynamic routing or static routes to the tunnel interface must be configured to establish connectivity between the sites.
Step 6	exit Example: <pre>Router(config-if)# exit</pre>	Exits interface configuration mode, and returns to global configuration mode.
Step 7	ip access-list { standard extended } <i>access-list-name</i> Example: <pre>Router(config)# ip access-list extended vpnstatic1</pre>	Enters ACL configuration mode for the named ACL that is used by the crypto map.
Step 8	permit <i>protocol source source-wildcard destination destination-wildcard</i> Example: <pre>Router(config-acl)# permit gre host 192.168.100.1 host 192.168.101.1</pre>	Specifies that only GRE traffic is permitted on the outbound interface.
Step 9	exit Example: <pre>Router(config-acl)# exit Router(config)#</pre>	Exits ACL configuration mode and returns to global configuration mode.

What to Do Next

Configuration Example

The following configuration example shows a portion of the configuration file for a VPN using a GRE tunnel scenario described in the preceding sections.

```

!
aaa new-model
!
aaa authentication login rtr-remote local
aaa authorization network rtr-remote local
aaa session-id common
!
username cisco password 0 cisco
!
interface tunnel 1
 ip address 10.62.1.193 255.255.255.252
 tunnel source fastethernet 0
 tunnel destination interface 192.168.101.1
 ip route 20.20.20.0 255.255.255.0 tunnel 1
crypto isakmp policy 1
 encryption 3des
 authentication pre-share
 group 2
!
crypto isakmp client configuration group rtr-remote
 key secret-password
 dns 10.50.10.1 10.60.10.1
 domain company.com
 pool dynpool
!
crypto ipsec transform-set vpn1 esp-3des esp-sha-hmac
!
crypto ipsec security-association lifetime seconds 86400
!
crypto dynamic-map dynmap 1
 set transform-set vpn1
 reverse-route
!
crypto map static-map 1 ipsec-isakmp dynamic dynmap
crypto map dynmap isakmp authorization list rtr-remote
crypto map dynmap client configuration address respond
!
! Defines the key association and authentication for IPsec tunnel.
crypto isakmp policy 1
 hash md5
 authentication pre-share
crypto isakmp key cisco123 address 200.1.1.1
!
!
! Defines encryption and transform set for the IPsec tunnel.
crypto ipsec transform-set set1 esp-3des esp-md5-hmac
!
! Associates all crypto values and peering address for the IPsec tunnel.
crypto map to_corporate 1 ipsec-isakmp
 set peer 200.1.1.1
 set transform-set set1
 match address 105
!
!
! VLAN 1 is the internal home network.
interface vlan 1
 ip address 10.1.1.1 255.255.255.0
 ip nat inside
 ip inspect firewall in ! Inspection examines outbound traffic.
 crypto map static-map
 no cdp enable
!
! FE4 is the outside or Internet-exposed interface
interface fastethernet 4
 ip address 210.110.101.21 255.255.255.0
 ! acl 103 permits IPsec traffic from the corp. router as well as
 ! denies Internet-initiated traffic inbound.
 ip access-group 103 in

```

```
ip nat outside
no cdp enable
crypto map to_corporate ! Applies the IPsec tunnel to the outside interface.
!
! Utilize NAT overload in order to make best use of the
! single address provided by the ISP.
ip nat inside source list 102 interface Ethernet1 overload
ip classless
ip route 0.0.0.0 0.0.0.0 210.110.101.1
no ip http server
!
!
! acl 102 associated addresses used for NAT.
access-list 102 permit ip 10.1.1.0 0.0.0.255 any
! acl 103 defines traffic allowed from the peer for the IPsec tunnel.
access-list 103 permit udp host 200.1.1.1 any eq isakmp
access-list 103 permit udp host 200.1.1.1 eq isakmp any
access-list 103 permit esp host 200.1.1.1 any
! Allow ICMP for debugging but should be disabled because of security implications.
access-list 103 permit icmp any any
access-list 103 deny ip any any ! Prevents Internet-initiated traffic inbound.
! acl 105 matches addresses for the IPsec tunnel to or from the corporate network.
access-list 105 permit ip 10.1.1.0 0.0.0.255 192.168.0.0 0.0.255.255
no cdp run
```



CHAPTER 6

Configuring Backup Data Lines and Remote Management

The Cisco 819 series and Cisco 880 Series Integrated Services Routers (ISRs) support backup data connectivity with a backup data line that enables them to mitigate WAN downtime.

**Note**

Voice backup is available on router models C881SRST and C888SRST. For information on configuring voice backup, see [Configuring Voice Functionality](#), on page 173

Cisco 880 ISRs also support remote management functions as follows:

- Through the auxiliary port on Cisco 880 series ISRs
- Through the ISDN S/T port on the Cisco 880 series ISRs

Cisco 819 ISRs support remote management functions through the auxiliary port on any Cisco 819 series ISRs.

**Note**

On Cisco 819 series and Cisco 880 series ISRs, the console port and the auxiliary port are on the same physical RJ-45 port; therefore, the two ports cannot be activated simultaneously. You must use the CLI to enable the desired function.

**Note**

Cisco 892F ISRs have a Gigabit Ethernet (GE) port that supports copper connections or a small-form-factor pluggable (SFP) port that supports fiber connections and can be configured for failover redundancy when the network goes down.

This chapter describes configuring backup data lines and remote management in the following sections:

- [Configuring Backup Interfaces](#), page 136
- [Configuring Cellular Dial-on-Demand Routing Backup](#), page 137
- [Configuring Dial Backup and Remote Management Through the Console or Auxiliary Port](#), page 143
- [Configuring Data Line Backup and Remote Management Through the ISDN S/T Port](#), page 149

- [Configuring Gigabit Ethernet Failover Media, page 155](#)
- [Configuring Third-Party SFPs, page 157](#)

Configuring Backup Interfaces

When the router receives an indication that the primary interface is down, the backup interface becomes enabled. After the primary connection has been restored for a specified period, the backup interface is disabled.

Even if the backup interface comes out of standby mode, the router does not enable the backup interface unless the router receives the traffic specified for that backup interface.

Table below shows the backup interfaces for Cisco 810, Cisco 880 and Cisco 890 series ISRs, along with their port designations. Basic configurations for these interfaces are given in the [Configuring WAN Interfaces, on page 23](#)

Table 21: Model Numbers and Data Line Backup Capabilities

Router Model Number	ISDN	3G	V.92
881G, 886G, 887G, 887VG, 888G	—	Yes	—
886, 886VA, 887, 887V, 888, 888E	Yes	—	—
891	—	—	Yes
892, 892F	Yes	—	—
819		Yes	

To configure your router with a backup interface, perform these steps, beginning in global configuration mode:

SUMMARY STEPS

1. **interface** *type number*
2. **backup interface** *interface-type interface-number*
3. **exit**

DETAILED STEPS

	Command or Action	Purpose
Step 1	interface <i>type number</i> Example: Router(config)# interface atm 0	Enters interface configuration mode for the interface for which you want to configure the backup. This interface can be a serial, ISDN, or asynchronous.

	Command or Action	Purpose
		The example shows the configuration of a backup interface for an ATM WAN connection.
Step 2	backup interface <i>interface-type</i> <i>interface-number</i> Example: <pre>Router(config-if)# backup interface bri 0</pre>	Assigns an interface as the secondary, or backup interface. This can be a serial interface or asynchronous interface. For example, a serial 1 interface could be configured to back up a serial 0 interface. The example shows a BRI interface configured as the backup interface for the ATM 0 interface.
Step 3	exit Example: <pre>Router(config-if)# exit Router(config)#</pre>	Exits the configuration interface mode.

Configuring Cellular Dial-on-Demand Routing Backup

To monitor the primary connection and initiate the backup connection over the cellular interface when needed, the router can use one of the following methods:

- Backup Interface—Backup interface that stays in standby mode until the primary interface line protocol is detected as down and then is brought up. See the [Configuring Backup Interfaces](#), on page 136.
- Dialer Watch—Backup feature that integrates dial backup with routing capabilities. See the [Configuring DDR Backup Using Dialer Watch](#), on page 137.
- Floating Static Route—Route through the backup interface has an administrative distance that is greater than the administrative distance of the primary connection route and therefore would not be in the routing table until the primary interface goes down. When the primary interface goes down, the floating static route is used. See the [Configuring DDR Backup Using Floating Static Route](#), on page 139.



Note

You cannot configure a backup interface for the cellular interface and any other asynchronous serial interface.

Configuring DDR Backup Using Dialer Watch

To initiate dialer watch, you must configure the interface to perform dial-on-demand routing (DDR) and backup. Use traditional DDR configuration commands, such as dialer maps, for DDR capabilities. To enable dialer watch on the backup interface and create a dialer list, use the following commands in interface configuration mode.

or

dialer group *dialer group number*

SUMMARY STEPS

1. **configure terminal**
2. **interface** *type number*
3. **dialer watch-group** *group-number*
4. **dialer watch-list** *group-number ip ip-address address-mask*
5. **dialer-list** *dialer-group protocol protocol-name {permit | deny | list access-list-number | access-group}*
6. **ip access-list** *access-list-number permit ip source address*
7. **interface cellular 0**
8. Do one of the following:
 - **dialer string** *string*
 - or
 - **dialer group** *dialer group number*

DETAILED STEPS

	Command or Action	Purpose
Step 1	configure terminal Example: Router# configure terminal	Enters global configuration mode.
Step 2	interface <i>type number</i> Example: Router (config)# interface ATM0	Specifies the interface.
Step 3	dialer watch-group <i>group-number</i> Example: Router(config-if)# dialer watch-group 2	Enables dialer watch on the backup interface.
Step 4	dialer watch-list <i>group-number ip ip-address address-mask</i> Example: Router(config-if)# dialer watch-list 2 ip 10.4.0.254 255.255.0.0	Defines a list of all IP addresses to be watched.

	Command or Action	Purpose
Step 5	<p>dialer-list <i>dialer-group</i> protocol <i>protocol-name</i> {permit deny list <i>access-list-number</i> access-group}</p> <p>Example:</p> <pre>Router(config)# dialer-list 2 protocol ip permit</pre>	Creates a dialer list for traffic of interest and permits access to an entire protocol.
Step 6	<p>ip access-list <i>access-list-number</i> permit <i>ip source address</i></p> <p>Example:</p> <pre>Router(config)# access list 2 permit 10.4.0.0</pre>	<p>Defines traffic of interest.</p> <p>Do not use the access list permit all command to avoid sending traffic to the IP network. This may result in call termination.</p>
Step 7	<p>interface cellular 0</p> <p>Example:</p> <pre>Router (config)# interface cellular 0</pre>	Specifies the cellular interface.
Step 8	<p>Do one of the following:</p> <ul style="list-style-type: none"> • dialer string <i>string</i> • or • dialer group <i>dialer group number</i> <p>Example:</p> <pre>Router (config-if)# dialer string cdma *** cdma *** OR Router (config-if)# dialer group 2 *** gsm ***</pre>	<p>CDMA only. Specifies the dialer script (defined using the chat script command).</p> <p>GSM only. Maps a dialer list to the dialer interface.</p>

Configuring DDR Backup Using Floating Static Route

To configure a floating static default route on the secondary interface, use the following commands, beginning in the global configuration mode.



Note

Make sure you have ip classless enabled on your router.

SUMMARY STEPS

1. **configure terminal**
2. **ip route** *network-number network-mask* {*ip address* | *interface*} [*administrative distance*] [**name name**]

DETAILED STEPS

	Command or Action	Purpose
Step 1	configure terminal Example: Router# configure terminal	Enters global configuration mode from the terminal.
Step 2	ip route network-number network-mask {ip address interface} [administrative distance] [name name] Example: Router (config)# ip route 0.0.0.0 Dialer 2 track 234	Establishes a floating static route with the configured administrative distance through the specified interface. A higher administrative distance should be configured for the route through the backup interface, so that the backup interface is used only when the primary interface is down.

Cellular Wireless Modem as Backup with NAT and IPsec Configuration

The following example shows how to configure the 3G wireless modem as backup with NAT and IPsec on either GSM or CDMA networks.

**Note**

The receive and transmit speeds cannot be configured. The actual throughput depends on the cellular network service.

```

Current configuration : 3433 bytes
!
version 12.4
no service pad
service timestamps debug datetime msec
service timestamps log datetime msec
no service password-encryption
!
hostname Router
!
boot-start-marker
boot-end-marker
!
!
no aaa new-model
!
!
!
!
crypto isakmp policy 1
  encr 3des
  authentication pre-share
crypto isakmp key gsm address 128.107.241.234          *** or cdma ***
!
!
crypto ipsec transform-set gsm ah-sha-hmac esp-3des  *** or cdma ***
!
crypto map gsm1 10 ipsec-isakmp                       *** or cdma1 ***
  set peer 128.107.241.234
  set transform-set gsm                               *** or cdma ***

```

```

    match address 103
    !
    !
    no ip dhcp use vrf connected
    ip dhcp excluded-address 10.4.0.254
    !
    ip dhcp pool gsm pool                               *** or cdm pool ***
        network 10.4.0.0 255.255.0.0
        dns-server 66.209.10.201 66.102.163.231
        default-router 10.4.0.254
    !
    !
    ip cef
    !
    no ipv6 cef
    multilink bundle-name authenticated
    chat-script gsm "" "atdt*98*1#" TIMEOUT 30 "CONNECT"    *** or cdma ***
    !
    !
    archive
        log config
        hidekeys
    !
    !
    controller DSL 0
        mode atm
        line-term cpe
        line-mode 4-wire standard
        line-rate 4608
    !
    !
    !
    interface ATM0
        no ip address
        ip virtual-reassembly
        load-interval 30
        no atm ilmi-keepalive
    !
    interface ATM0.1 point-to-point
        backup interface Cellular0
        ip nat outside
        ip virtual-reassembly
        pvc 0/35
        pppoe-client dial-pool-number 2
    !
    !
    interface FastEthernet0
    !
    interface FastEthernet1
    !
    interface FastEthernet2
    !
    interface FastEthernet3
    !
    interface Cellular0
        ip address negotiated
        ip nat outside
        ip virtual-reassembly
        encapsulation ppp
        no ip mroute-cache
        dialer in-band
        dialer idle-timeout 0
        dialer string gsm                                     *** or cdma ***
        dialer-group 1
        async mode interactive
        no ppp lcp fast-start
        ppp chap hostname chunahayev@wwan.ccs
        ppp chap password 0 B7uhestacr
        ppp ipcp dns request
        crypto map gsm1                                       *** or cdma1 ***
    !

```

```

interface Vlan1
  description used as default gateway address for DHCP clients
  ip address 10.4.0.254 255.255.0.0
  ip nat inside
  ip virtual-reassembly
!
interface Dialer2
  ip address negotiated
  ip mtu 1492
  ip nat outside
  ip virtual-reassembly
  encapsulation ppp
  load-interval 30
  dialer pool 2
  dialer-group 2
  ppp authentication chap callin
  ppp chap hostname cisco@dsl.com
  ppp chap password 0 cisco
  ppp ipcp dns request
  crypto map gsm1                                     *** or cdma1 ***
!
ip local policy route-map nat2cell interface Cellular0
ip forward-protocol nd
ip route 0.0.0.0 0.0.0.0 Dialer2 track 234
ip route 0.0.0.0 0.0.0.0 Cellular0 254
no ip http server
no ip http secure-server
!
!
ip nat inside source route-map nat2cell interface Cellular0 overload
ip nat inside source route-map nat2dsl interface Dialer2 overload
!
ip sla 1
  icmp-echo 209.131.36.158 source-interface Dialer2
  timeout 1000
  frequency 2
ip sla schedule 1 life forever start-time now
access-list 1 permit any
access-list 2 permit 10.4.0.0 0.0.255.255
access-list 3 permit any
access-list 101 permit ip 10.4.0.0 0.0.255.255 any
access-list 102 permit icmp any host 209.131.36.158
access-list 103 permit ip host 166.136.225.89 128.107.0.0 0.0.255.255
access-list 103 permit ip host 75.40.113.246 128.107.0.0 0.0.255.255
dialer-list 1 protocol ip list 1
dialer-list 2 protocol ip permit
!
!
route-map track-primary-if permit 10
  match ip address 102
  set interface Dialer2
!
route-map nat2dsl permit 10
  match ip address 101
  match interface Dialer2
!
route-map nat2cell permit 10
  match ip address 101
  match interface Cellular0
!
!
control-plane
!
!
line con 0
  no modem enable
line aux 0
line 3
  exec-timeout 0 0
  script dialer gsm                                     *** or cdma ***
  login
  modem InOut

```

```

no exec
line vty 0 4
 login
!
scheduler max-task-time 5000

!
webvpn cef
end
    
```

Configuring Dial Backup and Remote Management Through the Console or Auxiliary Port

When customer premises equipment, such as a Cisco 880 series ISR or Cisco 819 series ISR, is connected to an ISP, an IP address is dynamically assigned to the router, or the IP address may be assigned by the router peer through the centrally managed function. The dial backup feature can be added to provide a failover route in case the primary line fails. The Cisco 880 series ISRs can use the auxiliary port for dial backup and remote management.

Figure below shows the network configuration used for remote management access and for providing backup to the primary WAN line.

Figure 4: Dial Backup and Remote Management Through the Auxiliary Port

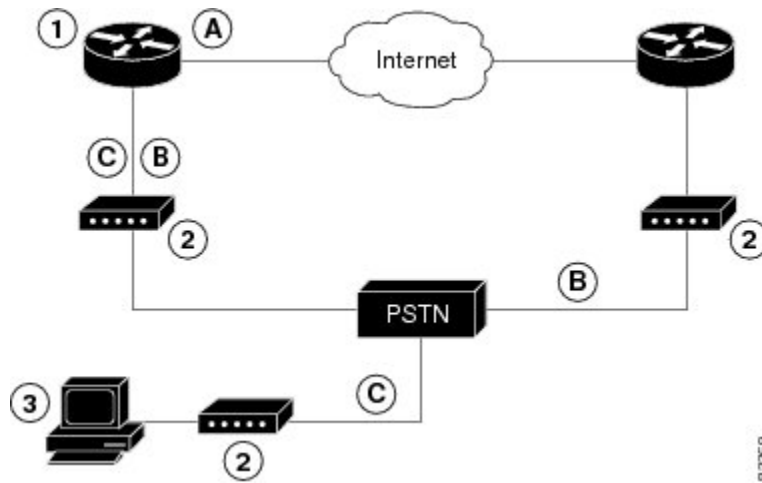

1	Cisco 880 series router	A	Main WAN link; primary connection to Internet service provider
2	Modem	B	Dial backup; serves as a failover link for Cisco 880 routers when the primary line goes down

3	PC	C	Remote management; serves as dial-in access to allow changes or updates to Cisco IOS configurations
---	----	---	---

To configure dial backup and remote management for these routers, perform these steps, beginning in global configuration mode:

SUMMARY STEPS

1. **ip name-server** *server-address*
2. **ip dhcp pool** *name*
3. **exit**
4. **chat-script** *script-name expect-send*
5. **interface** *type number*
6. **exit**
7. **interface** *type number*
8. **dialer watch-group** *group-number*
9. **exit**
10. **ip nat inside source** {**list** *access-list-number*} {**interface** *type number* | **pool** *name*} [**overload**]
11. **ip route** *prefix mask* [*ip-address* | *interface-type interface-number* [*ip-address*]]
12. **access-list** *access-list-number* {**deny** | **permit**} *source* [*source-wildcard*]
13. **dialerwatch-list** *group-number* {**ip***ip-address address-mask* | **delay route-check initial** *seconds*}
14. **line** [**aux** | **console** | **tty** | **vtty**] *line-number* [*ending-line-number*]
15. **modem enable**
16. **exit**
17. **line** [**aux** | **console** | **tty** | **vtty**] *line-number* [*ending-line-number*]
18. **flowcontrol** {**none** | **software** [**lock**] [**in** | **out**] | **hardware** [**in** | **out**]}

DETAILED STEPS

	Command or Action	Purpose
Step 1	ip name-server <i>server-address</i> Example: Router(config)# ip name-server 192.168.28.12	Enters your ISP DNS IP address. Tip You may add multiple server addresses if available.
Step 2	ip dhcp pool <i>name</i> Example: Router(config)# ip dhcp pool 1	Creates a DHCP address pool on the router and enters DHCP pool configuration mode. The <i>name</i> argument can be a string or an integer. Configure the DHCP address pool. For sample commands that you can use in DHCP pool configuration mode, see the

	Command or Action	Purpose
		Example for specifying an IP address for the ATM interface through PPP and IPCP address negotiation and dial backup, on page 147.
Step 3	exit Example: Router(config-dhcp)#exit	Exits config-dhcp mode and enters global configuration mode.
Step 4	chat-script script-name expect-send Example: Router(config)# chat-script Dialout ABORT ERROR ABORT BUSY "" "AT" OK "ATDT 5555102 T" TIMEOUT 45 CONNECT \c	Configures a chat script used in dial-on-demand routing (DDR) to give commands for dialing a modem and for logging in to remote systems. The defined script is used to place a call over a modem connected to the PSTN.
Step 5	interface type number Example: Router(config)# interface Async 1	Creates and enters configuration mode for the asynchronous interface. Configure the asynchronous interface. For sample commands that you can use in asynchronous interface configuration mode, see the Example for specifying an IP address for the ATM interface through PPP and IPCP address negotiation and dial backup, on page 147.
Step 6	exit Example: Router(config-if)# exit	Enters global configuration mode.
Step 7	interface type number Example: Router(config)# interface Dialer 3	Creates and enters configuration mode for the dialer interface.
Step 8	dialer watch-group group-number Example: Router(config-if)# dialer watch-group 1	Specifies the group number for the watch list.
Step 9	exit Example: Router(config-if)# exit	Exits the interface configuration mode.

	Command or Action	Purpose
Step 10	<p>ip nat inside source {list <i>access-list-number</i>} {interface <i>type number</i> pool <i>name</i>} [overload]</p> <p>Example:</p> <pre>Router(config)# ip nat inside source list 101 interface Dialer 3 overload</pre>	Enables dynamic translation of addresses on the inside interface.
Step 11	<p>ip route <i>prefix mask</i> {<i>ip-address</i> <i>interface-type interface-number</i> [<i>ip-address</i>]}</p> <p>Example:</p> <pre>Router(config)# ip route 0.0.0.0 0.0.0.0 22.0.0.2</pre>	Sets the IP route to point to the dialer interface as a default gateway.
Step 12	<p>access-list <i>access-list-number</i> {deny permit} <i>source</i> [<i>source-wildcard</i>]</p> <p>Example:</p> <pre>Router(config)# access-list 1 permit 192.168.0.0 0.0.255.255 any</pre>	Defines an extended access list that indicates which addresses need translation.
Step 13	<p>dialerwatch-list <i>group-number</i> {ip<i>ip-address address-mask</i> delay route-check initial <i>seconds</i>}</p> <p>Example:</p> <pre>Router(config)# dialer watch-list 1 ip 22.0.0.2 255.255.255.255</pre>	Evaluates the status of the primary link, based on the existence of routes to the peer. The address 22.0.0.2 is the peer IP address of the ISP.
Step 14	<p>line [aux console tty vty] <i>line-number</i> [<i>ending-line-number</i>]</p> <p>Example:</p> <pre>Router(config)# line console 0</pre>	Enters configuration mode for the line interface.
Step 15	<p>modem enable</p> <p>Example:</p> <pre>Router(config-line)# modem enable</pre>	Switches the port from console to auxiliary port function.
Step 16	<p>exit</p> <p>Example:</p> <pre>Router(config-line)# exit</pre>	Exits the configure interface mode.
Step 17	<p>line [aux console tty vty] <i>line-number</i> [<i>ending-line-number</i>]</p>	Enters configuration mode for the auxiliary interface.

	Command or Action	Purpose
	Example: Router(config)# line aux 0	
Step 18	flowcontrol {none software [lock] [in out] hardware [in out]} Example: Router(config)# flowcontrol hardware	Enables hardware signal flow control.

Example for specifying an IP address for the ATM interface through PPP and IPCP address negotiation and dial backup

The following configuration example specifies an IP address for the ATM interface through PPP and IPCP address negotiation and dial backup over the console port.

```

!
ip name-server 192.168.28.12
ip dhcp excluded-address 192.168.1.1
!
ip dhcp pool 1
  import all
  network 192.168.1.0 255.255.255.0
  default-router 192.168.1.1
!
! Need to use your own correct ISP phone number.
modemcap entry MY-USER_MODEM:MSC=&F1S0=1
chat-script Dialout ABORT ERROR ABORT BUSY "" "AT" OK "ATDT 5555102\T"
TIMEOUT 45 CONNECT \c
!
!
!
!
interface vlan 1
  ip address 192.168.1.1 255.255.255.0
  ip nat inside
  ip tcp adjust-mss 1452
  hold-queue 100 out
!
! Dial backup and remote management physical interface.
interface Async1
  no ip address
  encapsulation ppp
  dialer in-band
  dialer pool-member 3
  async default routing
  async dynamic routing
  async mode dedicated
  ppp authentication pap callin
!
interface ATM0
  mtu 1492
  no ip address
  no atm ilmi-keepalive
  pvc 0/35

```

Example for specifying an IP address for the ATM interface through PPP and IPCP address negotiation and dial backup

```

pppoe-client dial-pool-number 1
!
dsl operating-mode auto
!
! Primary WAN link.
interface Dialer1
ip address negotiated
ip nat outside
encapsulation ppp
dialer pool 1
ppp authentication pap callin
ppp pap sent-username account password 7 pass
ppp ipcp dns request
ppp ipcp wins request
ppp ipcp mask request
!
! Dialer backup logical interface.
interface Dialer3
ip address negotiated
ip nat outside
encapsulation ppp
no ip route-cache
no ip mroute-cache
dialer pool 3
dialer idle-timeout 60
dialer string 5555102 modem-script Dialout
dialer watch-group 1
!
! Remote management PC IP address.
peer default ip address 192.168.2.2
no cdp enable
!
! Need to use your own ISP account and password.
ppp pap sent-username account password 7 pass
ppp ipcp dns request
ppp ipcp wins request
ppp ipcp mask request
!
! IP NAT over Dialer interface using route-map.
ip nat inside source route-map main interface Dialer1 overload
ip nat inside source route-map secondary interface Dialer3 overload
ip classless
!
! When primary link is up again, distance 50 will override 80 if dial backup
! has not timed out. Use multiple routes because peer IP addresses are alternated
! among them when the CPE is connected.
ip route 0.0.0.0 0.0.0.0 64.161.31.254 50
ip route 0.0.0.0 0.0.0.0 66.125.91.254 50
ip route 0.0.0.0 0.0.0.0 64.174.91.254 50
ip route 0.0.0.0 0.0.0.0 63.203.35.136 80
ip route 0.0.0.0 0.0.0.0 63.203.35.137 80
ip route 0.0.0.0 0.0.0.0 63.203.35.138 80
ip route 0.0.0.0 0.0.0.0 63.203.35.139 80
ip route 0.0.0.0 0.0.0.0 63.203.35.140 80
ip route 0.0.0.0 0.0.0.0 63.203.35.141 80
ip route 0.0.0.0 0.0.0.0 Dialer1 150
no ip http server
ip pim bidir-enable
!
! PC IP address behind CPE.
access-list 101 permit ip 192.168.0.0 0.0.255.255 any
access-list 103 permit ip 192.168.0.0 0.0.255.255 any
!
! Watch multiple IP addresses because peers are alternated
! among them when the CPE is connected.
dialer watch-list 1 ip 64.161.31.254 255.255.255.255
dialer watch-list 1 ip 64.174.91.254 255.255.255.255
dialer watch-list 1 ip 64.125.91.254 255.255.255.255
!
! Dial backup will kick in if primary link is not available
! 5 minutes after CPE starts up.
dialer watch-list 1 delay route-check initial 300
dialer-list 1 protocol ip permit

```

```
!  
! Direct traffic to an interface only if the dialer is assigned an IP address.  
route-map main permit 10  
  match ip address 101  
  match interface Dialer1  
!  
route-map secondary permit 10  
  match ip address 103  
  match interface Dialer3  
!  
! Change console to aux function.  
line con 0  
  exec-timeout 0 0  
  modem enable  
  stopbits 1  
line aux 0  
  exec-timeout 0 0  
  ! To enable and communicate with the external modem properly.  
  script dialer Dialout  
  modem InOut  
  modem autoconfigure discovery  
  transport input all  
  stopbits 1  
  speed 115200  
  flowcontrol hardware  
line vty 0 4  
  exec-timeout 0 0  
  password cisco  
  login  
!  
scheduler max-task-time 5000  
end
```

Configuring Data Line Backup and Remote Management Through the ISDN S/T Port

Cisco 880 series routers can use the ISDN S/T port for remote management. [Figure 5: Data Line Backup Through CPE Splitter, DSLAM, and CO Splitter, on page 150](#) and [Figure 6: Data Line Backup Directly from Router to ISDN Switch, on page 151](#) show two typical network configurations that provide remote management access and backup for the primary WAN line. In [Figure 5: Data Line Backup Through CPE Splitter, DSLAM, and CO Splitter, on page 150](#), the dial backup link goes through a customer premises equipment (CPE) splitter, a digital subscriber line access multiplexer (DSLAM), and a central office (CO) splitter before connecting to

the ISDN switch. In [Figure 6: Data Line Backup Directly from Router to ISDN Switch](#), on page 151, the dial backup link goes directly from the router to the ISDN switch.

Figure 5: Data Line Backup Through CPE Splitter, DSLAM, and CO Splitter

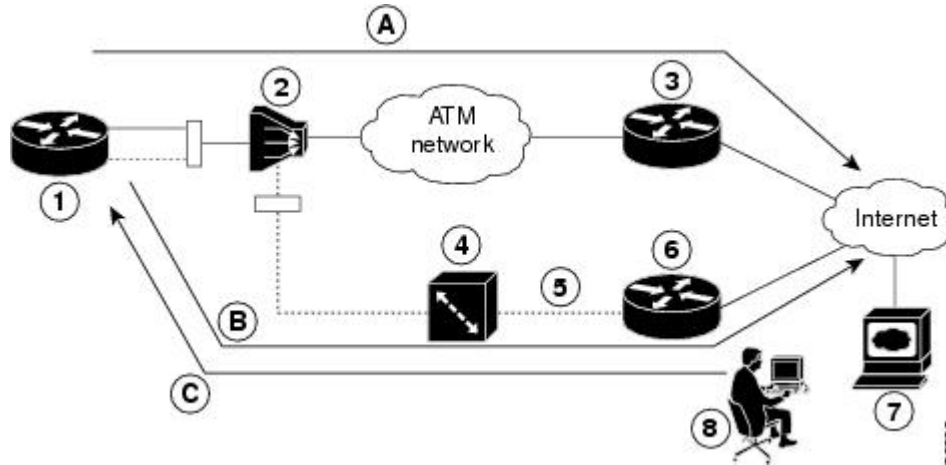

1	Cisco 880 series router	A	Primary DSL interface, FE interface (Cisco 881 router)
2	DSLAM	B	Dial backup and remote management through the ISDN interface (ISDN S/T port); serves as a failover link when the primary line goes down
3	ATM aggregator		
4	ISDN switch		
5	ISDN	C	Provides administrator with remote management capability through the ISDN interface when the primary DSL link is down; serves as dial-in access to allow changes or updates to Cisco IOS configuration
6	ISDN peer router		
7	Web server		
8	Administrator	—	—

Figure 6: Data Line Backup Directly from Router to ISDN Switch

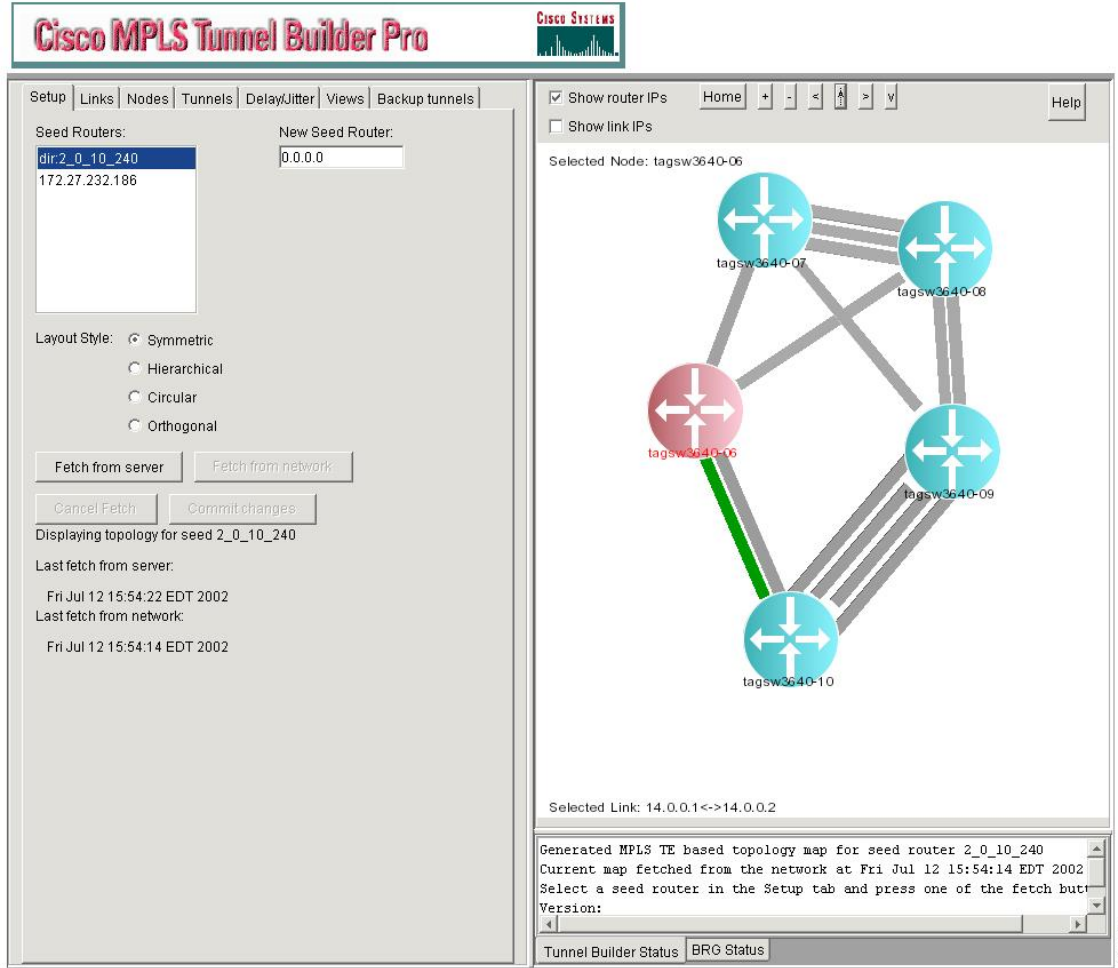

1	PC	A	Primary DSL interface
2	Cisco 880 series ISR	B	Dial backup and remote management through the ISDN interface (ISDN S/T port); serves as a failover link when the primary line goes down
3	DSLAM		
4	Aggregator		

5	ISDN switch	C	Provides administrator with remote management capability through the ISDN interface when the primary DSL link is down; serves as dial-in access to allow changes or updates to Cisco IOS configuration
6	Web server		
7	Administrator		

To configure dial backup and remote management through the ISDN S/T port of your router, perform the following procedures:

- [Configuring ISDN Settings, on page 152](#)
- [Configuring Aggregator and ISDN Peer Router, on page 154](#)

Configuring ISDN Settings



Note

Traffic of interest must be present to activate the backup ISDN line by means of the backup interface and floating static routes methods. Traffic of interest is not needed for the dialer watch to activate the backup ISDN line.

To configure your router ISDN interface for use as a backup interface, perform these steps, beginning in global configuration mode:

SUMMARY STEPS

1. **isdn switch-type** *switch-type*
2. **interface** *type number*
3. **encapsulation** *encapsulation-type*
4. **dialer pool-member** *number*
5. **isdn switch-type** *switch-type*
6. **exit**
7. **interface dialer** *dialer-rotary-group-number*
8. **ip address negotiated**
9. **encapsulation** *encapsulation-type*
10. **dialer pool** *number*
11. **dialer string** *dial-string#[:isdn-subaddress]*
12. **dialer-group** *group-number*
13. **exit**
14. **dialer-list** *dialer-group protocol protocol-name {permit | deny | list access-list-number | access-group}*

DETAILED STEPS

	Command or Action	Purpose
Step 1	isdn switch-type <i>switch-type</i> Example: Router(config)# isdn switch-type basic-net3	Specifies the ISDN switch type. The example specifies a switch type used in Australia, Europe, and the United Kingdom. For details on other supported switch types, see the Cisco IOS Dial Technologies Command Reference .
Step 2	interface <i>type number</i> Example: Router(config)# interface bri 0	Enters configuration mode for the ISDN BRI.
Step 3	encapsulation <i>encapsulation-type</i> Example: Router(config-if)# encapsulation ppp	Sets the BRI0 interface encapsulation type.
Step 4	dialer pool-member <i>number</i> Example: Router(config-if)# dialer pool-member 1	Specifies the dialer pool membership.
Step 5	isdn switch-type <i>switch-type</i> Example: Router(config-if)# isdn switch-type basic-net3	Specifies the ISDN switch type.
Step 6	exit Example: Router(config-if)# exit	Exits configuration interface mode and enters global configuration mode.
Step 7	interface dialer <i>dialer-rotary-group-number</i> Example: Router(config)# interface dialer 0	Creates a dialer interface (numbered 0 to 255) and enters interface configuration mode.
Step 8	ip address negotiated Example: Router(config-if)# ip address negotiated	Specifies that the IP address for the interface is obtained through PPP/PCP (IP Control Protocol) address negotiation. The IP address is obtained from the peer.

	Command or Action	Purpose
Step 9	encapsulation <i>encapsulation-type</i> Example: Router(config-if)# encapsulation ppp	Sets the encapsulation type to PPP for the interface.
Step 10	dialer pool <i>number</i> Example: Router(config-if)# dialer pool 1	Specifies the dialer pool to be used. In the example, the dialer pool 1 setting associates the dialer 0 interface with the BRI0 interface because the BRI0 dialer pool-member value is 1.
Step 11	dialer string <i>dial-string#[[:isdn-subaddress]]</i> Example: Router(config-if)# dialer string 384040	Specifies the telephone number to be dialed.
Step 12	dialer-group <i>group-number</i> Example: Router(config-if)# dialer group 1	Assigns the dialer interface to a dialer group (1–10).
Step 13	exit Example: Router(config-if)# exit	Exits dialer 0 interface configuration mode, and enters global configuration mode.
Step 14	dialer-list <i>dialer-group protocol protocol-name {permit deny list access-list-number access-group}</i> Example: Router(config)# dialer-list 1 protocol ip permit	Creates a dialer list for packets of interest to be forwarded through the specified interface dialer group. In the example, dialer-list 1 corresponds to dialer-group 1. For details about this command and additional parameters that can be set, see Cisco IOS Dial Technologies Command Reference .

Configuring Aggregator and ISDN Peer Router

The ISDN peer router is any router that has an ISDN interface and can communicate through a public ISDN network to reach your Cisco router ISDN interface. The ISDN peer router provides Internet access for your Cisco router during the ATM network downtime.

The aggregator is typically a concentrator router where your Cisco router ATM PVC terminates. In the following configuration example, the aggregator is configured as a PPPoE server.

```
! This portion of the example configures the aggregator.
vpdn enable
no vpdn logging
!
```



```

vpdn-group 1
  accept-dialin
  protocol pppoe
  virtual-template 1
!
interface Ethernet3
  description "4700ref-1"
  ip address 40.1.1.1 255.255.255.0
  media-type 10BaseT
!
interface Ethernet4
  ip address 30.1.1.1 255.255.255.0
  media-type 10BaseT
!
interface Virtual-Template1
  ip address 22.0.0.2 255.255.255.0
  ip mtu 1492
  peer default ip address pool adsl
!
interface ATM0
  no ip address
  pvc 1/40
  encapsulation aal5snap
  protocol pppoe
!
no atm limi-keepalive
!
ip local pool adsl 22.0.0.1
ip classless
ip route 0.0.0.0 0.0.0.0 22.0.0.1 50
ip route 0.0.0.0 0.0.0.0 30.1.1.2.80
! This portion of the example configures the ISDN peer.
isdn switch-type basic-net3
!
interface Ethernet0
  ip address 30.1.1.2 255.0.0.0
!
interface BRI0
  description "to 836-dialbackup"
  no ip address
  encapsulation ppp
  dialer pool-member 1
  isdn switch-type basic-net3
!
interface Dialer0
  ip address 192.168.2.2 255.255.255.0
  encapsulation ppp
  dialer pool 1
  dialer string 384020
  dialer-group 1
  peer default ip address pool isdn
!
ip local pool isdn 192.168.2.1
ip http server
ip classless
ip route 0.0.0.0 0.0.0.0 192.168.2.1
ip route 40.0.0.0 255.0.0.0 30.1.1.1
!
dialer-list 1 protocol ip permit!

```

Configuring Gigabit Ethernet Failover Media

Cisco 892F routers have a Gigabit Ethernet (GE) port that supports copper connections or a small-form-factor pluggable (SFP) port that supports fiber connections. Media can be configured for failover redundancy when the network goes down.

To assign primary and secondary failover media on the GE-SFP port, perform these steps, beginning in global configuration mode.

SUMMARY STEPS

1. **hostname** *name*
2. **enable secret** *password*
3. **interface gigabitethernet** *slot/port*
4. **media-type {sfp | rj45} auto-failover**
5. **exit**

DETAILED STEPS

	Command or Action	Purpose
Step 1	hostname <i>name</i> Example: Router(config)# hostname Router	Specifies the name for the router.
Step 2	enable secret <i>password</i> Example: Router(config)# enable secret crlny5ho	Specifies an encrypted password to prevent unauthorized access to the router.
Step 3	interface gigabitethernet <i>slot/port</i> Example: Router(config)# interface gigabitethernet 0/1	Enters interface configuration mode.
Step 4	media-type {sfp rj45} auto-failover Example: Router(config-if)# media-type sfp auto-failover Or Router(config-if)# media-type rj45 auto-failover	Configures the port with SFP as the primary media for automatic failover from SFP to RJ-45. Or Configures the port with RJ-45 as the primary media for automatic failover from RJ-45 to SFP.
Step 5	exit Example: Router(config-if)# exit Or Router(config)#	Exits interface configuration mode and returns to global configuration mode.

Configuring Auto-Detect

The Auto-Detect feature is enabled if media-type is not configured. This feature automatically detects which media is connected and links up. If both media are connected, whichever media comes up first is linked up.



Note The Auto-Detect feature only works with 1000 Base SFPs. This feature does not detect 100 Base SFPs.
To configure the Auto-Detect feature, perform the following steps, starting in global configuration mode:

SUMMARY STEPS

1. **interface gigabitethernet *slot/port***
2. **no media-type**
3. **exit**

DETAILED STEPS

	Command or Action	Purpose
Step 1	interface gigabitethernet <i>slot/port</i> Example: Router(config)# interface gigabitethernet 0/1	Enters interface configuration mode.
Step 2	no media-type Example: Router(config-if)# no media-type GigabitEthernet0/1: Changing media to UNKNOWN. You may need to update the speed and duplex settings for this interface.	Enables Auto-Detect. If a 1000Base SFP is plugged in, the speed and duplex are set automatically to 1000 and full. Speed and duplex options are not available. An RJ45 connection will only work with speed as 1000 and duplex as full. If an SFP is not plugged in, all speeds and duplexes are available for the RJ45 media. Note The Auto-Detect feature only works with 1000Base SFPs. This feature does not detect 100Base SFPs.
Step 3	exit Example: Router(config-if)# exit Router(config)#	Exits interface configuration mode and returns to global configuration mode.

Configuring Third-Party SFPs

Small Form-Factor Pluggables (SFPs) that are not Cisco certified are called third-party SFPs. Cisco approved means the SFPs have undergone rigorous testing with Cisco products and the SFPs are guaranteed to have 100% compatibility.

Third-party SFPs are manufactured by companies that are not on the Cisco-approved Vendor List (AVL). Currently, Cisco ISR G2 routers support only Cisco-approved SFPs. From Release 15.3(2)T, Cisco ISR G2 routers recognize third-party SFPs.



Note Cisco does not provide any kind of support for the third-party SFPs because they are not validated by Cisco.



Note

- Supports only 100BASE SFPs and 1000BASE SFPs under two speed configurations:
 - 100 Mbps speed for 100BASE SFPs
 - 1000 Mbps speed for 1000BASE SFPs
- Only the following routers and modules support third-party SFPs:
 - Cisco 2921 Integrated Services Router
 - Cisco 2951 Integrated Services Router
 - Cisco 3900 Integrated Services Router
 - Cisco 3900E Series Integrated Services Routers
 - Cisco 892-F Gigabit Ethernet Security Router
 - Cisco 898-EA Gigabit Ethernet Security Router
 - EHWIC-1GE-SFP

SUMMARY STEPS

1. **enable**
2. **configure terminal**
3. **service unsupported-transceiver**
4. **interface type** *slot/subslot/port number*
5. **media-type sfp**
6. **speed** *value*
7. **shutdown**
8. **no shutdown**
9. **exit**

DETAILED STEPS

	Command or Action	Purpose
Step 1	enable Example: Router> enable	Enables the privileged EXEC mode. Enter your password if prompted.

	Command or Action	Purpose
Step 2	configure terminal Example: Router# configure terminal	Enters the global configuration mode.
Step 3	service unsupported-transceiver Example: Router(config)# service unsupported-transceiver	Enables third-party SFP support.
Step 4	interface type slot/subslot/port number Example: Router(config)# interface ethernet 0/3/0	Selects an interface to configure.
Step 5	media-type sfp Example: Router(config-if)# media-type sfp	Changes media type to SFP.
Step 6	speed value Example: Router(config-if)# speed 100	Configures the speed of the interface. Note For 100BASE SFPs, configure the speed to 100 Mbps only. Similarly, for 1000BASE SFPs, configure the speed to 1000 Mbps only.
Step 7	shutdown Example: Router(config-if)# shutdown	Disables the interface, changing its state from administratively UP to administratively DOWN.
Step 8	no shutdown Example: Router(config-if)# no shutdown	Enables the interface, changing its state from administratively DOWN to administratively UP.
Step 9	exit Example: Router(config-if)# exit Router(config)#	Exits the configuration mode and returns the global configuration mode.

Example for Configuring Third-Party SFPs

This example shows how to configure a third-party SFP on a Cisco ISR G2 Series Router:

```
Router# configure terminal
Router(config-if)# service unsupported-transceiver
Router(config)# interface ethernet 0/3/0
Router(config-if)# media-type sfp
Router(config-if)# speed 100
Router(config-if)# shutdown
Router(config-if)# no shutdown
Router(config-if)# exit
Router(config)# exit
```



Configuring Ethernet Switches

This chapter gives an overview of configuration tasks for the following:

- 4-port Fast Ethernet (FE) switch on the Cisco 860, 880, and 890 integrated service routers (ISRs)
- Gigabit Ethernet (GE) switch on the Cisco 860VAE-K9
- Gigabit Ethernet (GE) switch that services the embedded wireless access point on the Cisco 860 and Cisco 880 series ISRs.

The FE switches are 10/100Base T Layer 2 Fast Ethernet switches. The GE switch is a 1000Base T Layer 2 Gigabit Ethernet switch. Traffic between different VLANs on a switch is routed through the router platform with the switched virtual interface (SVI).

Any switch port may be configured as a trunking port to connect to other Cisco Ethernet switches. An optional power module can be added to Cisco 880 series ISRs to provide inline power to two of the FE ports for IP telephones or external access points.

This chapter contains the following sections:

- [Switch Port Numbering and Naming, page 161](#)
- [Restrictions for the FE Switch, page 162](#)
- [Ethernet Switches, page 162](#)
- [Overview of SNMP MIBs, page 164](#)
- [Configuring Ethernet Switches, page 165](#)

Switch Port Numbering and Naming

The ports for Cisco 860, 880, and 890 ISRs are numbered as follows:

- The ports on the FE switch for the Cisco 860, 880, and 890 ISRs are numbered FE0 through FE3.
- The port on the GE switch for the 860VAE-K9 is numbered GE0.
- The port on the GE switch that services the embedded wireless access point on the Cisco 860 and Cisco 880 series ISRs is named and numbered Wlan-GigabitEthernet0.

Restrictions for the FE Switch

The following restrictions apply to the FE switch:

- Ports of an FE switch must not be connected to any Fast Ethernet onboard port of the router.
- On Cisco 880 series ISRs, inline power is supported only on FE switch ports FE0 and FE1. Inline power is not supported on Cisco 860 series ISRs.
- VTP pruning is not supported.
- FE switch can support up to 200 secure MAC addresses.

Ethernet Switches

To configure Ethernet switches, you should understand the following concepts:

VLANs and VLAN Trunk Protocol

For information on the concepts of VLANs and VLAN Trunk Protocol (VTP), see:

http://www.cisco.com/en/US/docs/ios/12_3t/12_3t4/feature/guide/gt1636nm.html#wp1047027

Inline Power

Inline power is not supported on the Cisco 860 series ISRs. On the Cisco 880 series ISRs, inline power can be supplied to Cisco IP phones or external access points on FE switch ports FE0 and FE1.

A detection mechanism on the FE switch determines whether it is connected to a Cisco device. If the switch senses that there is no power on the circuit, the switch supplies the power. If there is power on the circuit, the switch does not supply it.

You can configure the switch to never supply power to the Cisco device and to disable the detection mechanism.

The FE switch also provides support for powered devices compliant with IEEE 802.3af.

Layer 2 Ethernet Switching

For information on Layer 2 Ethernet Switching, see:

http://www.cisco.com/en/US/docs/ios/12_3t/12_3t4/feature/guide/gt1636nm.html#wp1048478

802.1x Authentication

For information on 802.1x Authentication, see:

http://www.cisco.com/en/US/docs/ios/12_3t/12_3t4/feature/guide/gt1636nm.html#wp1051006

**Note**

The **authentication** command under switch trunk interface mode is enabled for the NEAT feature. This is available with Cisco IOS Release 15.2T.

Spanning Tree Protocol

For information on Spanning Tree Protocol, see:

http://www.cisco.com/en/US/docs/ios/12_3t/12_3t4/feature/guide/gt1636nm.html#wp1048458

Cisco Discovery Protocol

Cisco Discovery Protocol (CDP) runs over Layer 2 (the data link layer) on all Cisco routers, bridges, access servers, and switches. CDP allows network management applications to discover Cisco devices that are neighbors of already known devices, in particular, neighbors running lower-layer, transparent protocols. With CDP, network management applications can learn the device type and the SNMP agent address of neighboring devices. This feature enables applications to send SNMP queries to neighboring devices.

CDP runs on all LAN and WAN media that support Subnetwork Access Protocol (SNAP). Each CDP-configured device sends periodic messages to a multicast address. Each device advertises at least one address at which it can receive SNMP messages. The advertisements also contain the time-to-live, or hold-time information, which indicates the length of time a receiving device should hold CDP information before discarding it.

Switched Port Analyzer

For information on Switched Port Analyzer, see:

http://www.cisco.com/en/US/docs/ios/12_3t/12_3t4/feature/guide/gt1636nm.html#wp1053663

IGMP Snooping

For information on IGMP Snooping, see:

http://www.cisco.com/en/US/docs/ios/12_3t/12_3t4/feature/guide/gt1636nm.html#wp1053727

IGMP Version 3

The Cisco 880 series ISRs support Version 3 of IGMP snooping.

IGMPv3 provides support for source filtering, which enables a multicast receiver host to signal to a router from which groups the receiver host is to receive multicast traffic, and from which sources this traffic is expected. Enabling the IGMPv3 feature with IGMP snooping on Cisco ISRs provides Basic IGMPv3 Snooping Support (BISS). BISS provides constrained flooding of multicast traffic in the presence of IGMPv3 hosts. This support constrains traffic to approximately the same set of ports as IGMPv2 snooping does with IGMPv2 hosts. The constrained flooding only considers the destination multicast address.

Storm Control

For information on storm control, see:

http://www.cisco.com/en/US/docs/ios/12_3t/12_3t4/feature/guide/gt1636nm.html#wp1051018

Overview of SNMP MIBs

Simple Management Network Protocol (SNMP) development and use is centered around the MIB. An SNMP MIB is an abstract database and it is a conceptual specification for information that a management application may read and modify in a certain form. This does not imply that the information is kept in the managed system in that same form. The SNMP agent translates between the internal data structures and formats of the managed system and the external data structures and formats defined for the MIB.

The SNMP MIB is conceptually a tree structure with conceptual tables. Cisco Layer 2 Switching Interface MIB is discussed in more detail in [BRIDGE-MIB for Layer 2 Ethernet Switching](#), on page 164. Relative to this tree structure, the term MIB is used in two ways. One definition of MIB is, it is actually a MIB branch, usually containing information for a single aspect of technology, such as a transmission medium or a routing protocol. A MIB used in this sense is more accurately called a MIB module, and is usually defined in a single document. The other definition of a MIB is a collection of such branches. Such a collection might comprise, for example, all the MIB modules implemented by a given agent, or the entire collection of MIB modules defined for SNMP.

A MIB is a tree where the leaves are individual items of data called objects. An object may be, for example, a counter or a protocol status. MIB objects are also sometimes called variables.

BRIDGE-MIB for Layer 2 Ethernet Switching

The Layer 2 Ethernet Switching Interface BRIDGE-MIB is supported in the Cisco 887, 880, and 890 platforms. The BRIDGE-MIB enables the user to know the Media Access Control (MAC) addresses and spanning tree information of the Ethernet switch modules. The user can query the MIB agent using the SNMP protocol and get the details of Ethernet switch modules, such as MAC addresses, of each interface and spanning protocol information.

The Bridge-MIB uses the following approaches to get the Layer 2 BRIDGE-MIB information:

- Community-string-based approach
- Context-based approach

In the community string based approach, one community string is created for each VLAN. Based on the query, the respective VLAN MIB is displayed.

To get the BRIDGE-MIB details, use the `snmp-server community public RW` command in the configuration mode.

```
Router(config)# snmp-server community public RW
```

Use the following syntax to query the SNMP BRIDGE-MIB details:

```
snmpwalk -v2c <ip address of the ISR, ...> public .1.3.6.1.2.1.17
snmpwalk -v2c <ip address of the ISR, ...> public@2 .1.3.6.1.2.1.17
snmpwalk -v2c <ip address of the ISR, ...> public@3 .1.3.6.1.2.1.17
```

**Note**

When you create a VLAN 'x', the logical entity public@x is added. If you query with public community, the Layer 3 MIB is displayed. When you query with public@x, the Layer 2 MIB for VLAN 'x' is displayed.

In the context based approach, the SNMP context mapping commands are used to display the values for Layer 2 interfaces. Each VLAN is mapped to a context. When the user queries with a context, the MIB displays the data for that specific VLAN, which is mapped to the context. In this approach, each VLAN is manually mapped to a context.

To get the BRIDGE-MIB details, use the following commands in the configuration mode:

```
Router(config)# Routersnmp-server group public v2c context bridge-group
Router(config)# snmp-server community public RW
Router(config)# snmp-server community private RW
Router(config)# snmp-server context bridge-group
Router(config)# snmp mib community-map public context bridge-group
```

Use the following syntax to query the SNMP BRIDGE-MIB details.

```
snmpwalk -v2c <ip address of the ISR, ...> public@1 .1.3.6.1.2.1.17 ?L2-MIB
snmpwalk -v2c <ip address of the ISR, ...> private .1.3.6.1.2.1.17?L3-MIB
```

**Note**

When you query with the public community, the Layer 2 MIB is displayed. Use a private group for Layer 3 MIB.

For more details to configure and retrieve the BRIDGE-MIB details, see:

http://www.cisco.com/en/US/tech/tk648/tk362/technologies_tech_note09186a0080094a9b.shtml#brgmib

MAC Address Notification

MAC address notification enables you to track users on a network by storing the MAC address activity on the switch. Whenever the switch learns or removes a MAC address, an SNMP notification can be generated and sent to the NMS. If you have many users coming and going from the network, you can set a trap interval time to bundle the notification traps and reduce network traffic. The MAC notification history table stores the MAC address activity for each hardware port for which the trap is enabled. MAC address notifications are generated for dynamic and secure MAC addresses; events are not generated for self addresses, multicast addresses, or other static addresses.

For more details to configure MAC address notification, see:

http://www1.cisco.com/en/US/docs/switches/lan/catalyst3550/software/release/12.2_25_see/configuration/guide/swadmin.html#wp1102213

Configuring Ethernet Switches

See the following sections for configuration tasks for Ethernet switches:

Configuring VLANs

This section provides information on how to configure VLANs. The Cisco 860 series ISRs support two VLANs and the 860VAE series ISRs support five VLANs. The Cisco 880 series ISRs support eight VLANs.



Note Cisco 866VAE-K9 and 867VAE-K9 routers have four Fast Ethernet (FE) switching ports and one Gigabit Ethernet (GE) switching port.

VLANs on the FE and GE Switch Ports

To configure VLANs, perform these steps, beginning in configuration mode.

SUMMARY STEPS

1. **interface** *type number*
2. **shutdown**
3. **switchport access vlan** *vlan_id*
4. **no shutdown**
5. **end**

DETAILED STEPS

	Command or Action	Purpose
Step 1	interface <i>type number</i> Example: Router(config)# Interface fastethernet0	Selects the Fast Ethernet port to configure.
Step 2	shutdown Example: Router(config-if)# shutdown	(Optional) Shuts down the interface to prevent traffic flow until configuration is complete.
Step 3	switchport access vlan <i>vlan_id</i> Example: Router(config-if)# switchport access vlan 2	Creates instances of additional VLANs. Allowable values of <i>vlan_id</i> are 2 to 4094, except for reserved values of 1002 to 1005.
Step 4	no shutdown Example: Router(config-if)# no shutdown	Enables the interface, changing its state from administratively down to administratively up.

	Command or Action	Purpose
Step 5	end Example: Router(config-if)# end	Exits configuration mode.

What to Do Next

For additional information, see the information at the following URL:

<http://www.cisco.com/en/US/docs/switches/lan/catalyst6500/ios/12.2SX/configuration/guide/layer2.html>

VLANs on the GE Port and GE ESW Port of Wireless APs

Because the GE port is an internal interface that services only the embedded access point of the router, it cannot be configured only with the **switchport access vlan X** command, where X is other than 1. It may, however, be configured in trunk mode. This may be done by performing the following steps, beginning in global configuration mode.

SUMMARY STEPS

1. **interface** *type number*
2. **switchport mode trunk**
3. **switchport access vlan** *vlan_id*

DETAILED STEPS

	Command or Action	Purpose
Step 1	interface <i>type number</i> Example: Router(config)# Interface gigabitethernet0	Selects the Gigabit Ethernet port to configure.
Step 2	switchport mode trunk Example: Router(config-if)# switchport mode trunk	Places the port in trunk mode.
Step 3	switchport access vlan <i>vlan_id</i> Example: Router(config-if)# switchport access vlan 2	(Optional) Once the port is in trunk mode, it may be assigned a VLAN number other than 1.

Configuring Layer 2 Interfaces

For information on how to configure Layer 2 interfaces, see the following URL:

http://www.cisco.com/en/US/docs/ios/12_3t/12_3t8/feature/guide/esw_cfg.html#wp1047041

The URL contains information on the following topics:

- Configuring a range of interfaces
- Defining a range macro
- Configuring Layer 2 optional interface features

Configuring 802.1x Authentication

For information on how to configure 802.1x port-based authentication, see:

http://www.cisco.com/en/US/docs/ios/12_4t/12_4t11/ht_8021x.html

The document contains information on the following topics:

- Understanding the default 802.1x configuration
- Enabling 802.1x authentication
- Configuring the switch-to-RADIUS-server communication
- Enabling periodic reauthentication
- Changing the quiet period
- Changing the switch-to-client retransmission time
- Setting the switch-to-client frame-retransmission number
- Enabling multiple hosts
- Resetting the 802.1x configuration to default values
- Displaying 802.1x statistics and status

Configuring Spanning Tree Protocol

For information on how to configure Spanning Tree Protocol, see:

http://www.cisco.com/en/US/docs/ios/12_3t/12_3t8/feature/guide/esw_cfg.html#wp1047906

The document contains information on the following topics:

- Enabling spanning tree
- Configuring spanning tree port priority
- Configuring spanning tree port cost
- Configuring the bridge priority of a VLAN

- Configuring the Hello Time
- Configuring the forward-delay time for a VLAN
- Configuring the maximum aging time for a VLAN
- Disabling spanning tree

Configuring MAC Table Manipulation

For information on how to configure MAC table manipulation, see:

http://www.cisco.com/en/US/docs/ios/12_3t/12_3t8/feature/guide/esw_cfg.html#wp1048223

The document contains information on the following topics:

- Enabling known MAC address traffic
- Creating a static entry in the MAC address table
- Configuring the aging timer
- Verifying the aging time

Port Security

The topic of enabling known MAC address traffic deals with port security. Port security can be either static or dynamic.

Static port security allows the user to specify which devices are allowed access through a given switch port. The specification is done manually by placing allowed device MAC addresses in the MAC address table. Static port security is also known as MAC address filtering.

Dynamic port security is similar. However, instead of specifying the MAC address of the devices, the user specifies the maximum number of devices that is allowed on the port. If the maximum number specified is more than the number of MAC addresses specified manually, the switch learns the MAC address automatically, up to the maximum specified. If the maximum number specified is less than the number of MAC addresses already specified statically, an error message is produced.

The following command is used to specify static or dynamic port security.

Command	Purpose
Router(config)# mac-address-table secure [<i>mac-address</i> maximum <i>maximum addresses</i>] fastethernet <i>interface-id</i> [vlan <i>vlan id</i>]	<i>mac-address</i> enables static port security. The maximum keyword enables dynamic port security.

Configuring Cisco Discovery Protocol

For information on how to configure Cisco Discovery Protocol (CDP), see:

http://www.cisco.com/en/US/docs/ios/12_3t/12_3t8/feature/guide/esw_cfg.html#wp1048365

The document contains information on the following topics:

- Enabling CDP
- Enabling CDP on an interface
- Monitoring and maintaining CDP

Configuring the Switched Port Analyzer

For information on how to configure a switched port analyzer (SPAN) session, see:

http://www.cisco.com/en/US/docs/ios/12_3t/12_3t8/feature/guide/esw_cfg.html#wp1048473

The document contains information on the following topics:

- Configuring the SPAN sources
- Configuring SPAN destinations
- Verifying SPAN sessions
- Removing sources or destinations from a SPAN session

Configuring Power Management on the Interface

For information on how to configure inline power for access points or Cisco IP phones, see:

http://www.cisco.com/en/US/docs/ios/12_3t/12_3t8/feature/guide/esw_cfg.html#wp1048551

Configuring IP Multicast Layer 3 Switching

For information on how to configure IP multicast Layer 3 switching, see:

http://www.cisco.com/en/US/docs/ios/12_3t/12_3t8/feature/guide/esw_cfg.html#wp1048610

The document contains information on the following topics:

- Enabling IP multicast routing globally
- Enabling IP protocol-independent multicast (PIM) on Layer 3 interfaces
- Verifying IP multicast Layer 3 hardware switching summary
- Verifying the IP multicast routing table

Configuring IGMP Snooping

For information on how to configure IGMP snooping, see:

http://www.cisco.com/en/US/docs/ios/12_3t/12_3t8/feature/guide/esw_cfg.html#wp1048777

The document contains information on the following topics:

- Enabling or disabling IGMP snooping
- Enabling IGMP immediate-leave processing

- Statically configuring an interface to join a group
- Configuring a multicast router port

IGMP Version 3

In support of the IGMPv3 feature in Cisco IOS Release 12.4(15)T, the **groups** and **count** keywords were added to the **show ip igmp snooping** command, and the output of the **show ip igmp snooping** command was modified to include global information about IGMP snooping groups. Use the **show ip igmp snooping** command with the **groups** keyword to display the multicast table learned by IGMP snooping for all VLANs, or the **show ip igmp snooping** command with the **groups** keyword, **vlan-id** keyword, and *vlan-id* argument to display the multicast table learned by IGMP snooping for a specific VLAN. Use the **show ip igmp snooping** command with the **groups** and **count** keywords to display the number of multicast groups learned by IGMP snooping.

Configuring Per-Port Storm Control

For information on how to configure per-port storm control, see:

http://www.cisco.com/en/US/docs/ios/12_3t/12_3t8/feature/guide/esw_cfg.html#wp1049009

The document contains information on the following topics:

- Enabling per-port storm-control
- Disabling per-port storm-control

Configuring Separate Voice and Data Subnets

For information on how to configure separate voice and data subnets, see:

http://www.cisco.com/en/US/docs/ios/12_3t/12_3t8/feature/guide/esw_cfg.html#wp1049866

Managing the Switch

For information on management of the switch, see:

http://www.cisco.com/en/US/docs/ios/12_3t/12_3t8/feature/guide/esw_cfg.html#wp1049978

The document contains information on the following topics:

- Adding Trap Managers
- Configuring IP Information
- Enabling Switch Port Analyzer
- Managing the ARP Table
- Managing the MAC Address Tables
- Removing Dynamic Addresses
- Adding Secure Addresses

- Configuring Static Addresses
- Clearing all MAC Address Tables



Configuring Voice Functionality

This chapter provides information about configuring voice functionality on the Cisco 880 Series Integrated Services Routers (ISRs). The following ISRs have voice gateway capability:

- C881SRST and C888SRST: 4 FXS ports and 1 voice backup port
 - The C881SRST ISR has an FXO voice backup port.
 - The C888SRST ISR has a BRI voice backup port.
- C881-V has 4FXS ports, 2 BRI ports, and 1 backup FXO port
- C887VA-V and C887VA-V-W has 4FXS ports and 2 BRI ports.
- [Voice Ports, page 173](#)
- [Call Control Protocols, page 174](#)
- [Dial Peer Configuration, page 175](#)
- [Other Voice Features, page 175](#)
- [Fax Services, page 177](#)
- [Unified Survival Remote Site Telephony, page 177](#)
- [Verification of Voice Configuration, page 178](#)

Voice Ports

Analog voice ports (Foreign Exchange Station (FXS) ports) connect routers in packet-based networks to 2-wire or 4-wire analog circuits in telephony networks. Two-wire circuits connect to analog telephone or fax devices, and four-wire circuits connect to PBXs.

Digital voice ports are ISDN basic rate interface (BRI) ports.

Analog and Digital Voice Port Assignments

Analog and digital voice port assignments vary by model number. [Table 22: Voice Port Assignments for Cisco 880 series ISRs](#), on page 174 lists the Cisco 880 series ISRs and their voice port assignments.

Table 22: Voice Port Assignments for Cisco 880 series ISRs

Model Number	Digital (BRI) Port Numbers	Analog (FXS) Port Numbers	Voice Backup Port Number
C881SRST	—	0–3	4 (FXO port)
C888SRST	—	0–3	4 (BRI port)
C881-V	2	4	1 (FXO port)
C887VA-V	2	4	—
C887VA-V-W	2	4	—

Voice Port Configuration

To configure analog and digital voice ports, see the following documents:

- [Configuring Analog Voice Ports](#)
- [Basic ISDN Voice Interface Configuration](#)

Call Control Protocols

SIP

Session Initiation Protocol (SIP) is a peer-to-peer, multimedia signaling protocol developed in the IETF (IETF RFC 2543). Session Initiation Protocol is ASCII-based. It resembles HTTP, and it reuses existing IP protocols (such as DNS and SDP) to provide media setup and teardown. See the [Cisco IOS SIP Configuration Guide](#) for more information.

For router configuration information under SIP, see the [Basic SIP Configuration](#) chapter of the Cisco IOS SIP Configuration Guide, Release 12.4T.

Cisco 880 Series ISR voice gateways provide voice security through SIP enhancements within the Cisco IOS Firewall. SIP inspect functionality (SIP packet inspection and detection of pin-hole openings) is provided, as well as protocol conformance and application security. The user is given more granular control on the policies and security checks applied to SIP traffic, and capability to filter out unwanted messages. For more information, see “[Cisco IOS Firewall: SIP Enhancements: ALG and AIC](#)”.

MGCP

Media Gateway Control Protocol (MGCP) RFC 2705 defines a centralized architecture for creating multimedia applications, including Voice over IP (VoIP). See the [Cisco IOS MGCP and Related Protocols Configuration Guide](#) for more information.

Cisco 880 series voice gateway ISRs are configured primarily as residential gateways (RGWs) under MGCP. For residential gateway configuration information, see the [Configuring an RGW](#) section of the [Basic MGCP Configuration](#) chapter of the [Cisco IOS MGCP and Related Protocols Configuration Guide](#).

H.323

International Telecommunications Union Recommendation H.323 defines a distributed architecture for creating multimedia applications, including Voice over IP.

For router configuration information, see the [Configuring H.323 Gateways](#) chapter of the [Cisco IOS H.323 Configuration Guide, Release 12.4T](#).

Dial Peer Configuration

Configuring dial peers is the key to implementing dial plans and providing voice services over an IP packet network. Dial peers are used to identify call source and destination endpoints and to define the characteristics applied to each call leg in the call connection. For router configuration information, see [Dial Peer Configuration on Voice Gateway Routers](#).

Other Voice Features

Real-Time Transport Protocols

Real-Time Transport Protocol (RTP) provides end-to-end network transport functions for applications that transmit real-time data.

Cisco Real-Time Transport Protocol (cRTP) uses the RTP protocol to forward Cisco-proprietary payload types.

Secure Real-Time Transport Protocol (SRTP) defines an RTP profile providing encryption, authentication, and replay protection.

RTP is used primarily with DTMF relay and is configured under dial peer configuration. For information on configuring RTP payload types, see the [Dual-Tone Multifrequency Relay](#) section of [Dial Peer Configuration on Voice Gateway Routers](#).

For information on configuring SRTP on SIP-controlled platforms, see the [Configuring SIP Support for SRTP](#) chapter of the [Cisco IOS SIP Configuration Guide, Release 4T](#).

For configuring RTP on MGCP-controlled platforms, see the [Configuring an RGW](#) section of the [Basic MGCP Configuration](#) chapter of the [Cisco IOS MGCP and Related Protocols Configuration Guide](#).

Dual Tone Multi Frequency Relay

Using Dual Tone Multi Frequency (DTMF) Relay the local VoIP gateway listens for DTMF digits and sends the digits uncompressed as either RTP packets or H.245 packets to the remote VoIP gateway. The remote VoIP gateway regenerates the DTMF digits. This methodology prevents digit loss due to compression. For information on configuring DTMF Relay, see the Dual-Tone Multifrequency Relay section of [Dial Peer Configuration on Voice Gateway Routers](#).

For information on configuring DTMF that is specific to call control protocols, see the following:

- [Configuring SIP DTMF Features](#)
- [Configuring DTMF Relay \(H.323\)](#)
- [Configuring Global MGCP Parameters](#)

CODECs

The following CODECs are supported by the Cisco 880 series voice gateway routers.

- G.711 (a-law and mu-law)
- G.726
- G.729, G.729A, G.729B, G.729AB

For information on CODECs, see the following:

- [Dial Peer Configuration Examples](#) appendix of [Dial Peer Configuration on Voice Gateway Routers](#).
- [Cisco IOS SIP Configuration Guide, Release 4T](#)
- [Cisco IOS H.323 Configuration Guide](#)

SCCP-Controlled Analog Ports with Supplementary Features

Cisco 880 series voice gateway ISRs support the Cisco Skinny Client Control Protocol (SCCP) that supplies supplementary features on analog voice ports that are controlled by Cisco Unified Communications Manager or by a Cisco Unified Communications Manager Express system. Supported features include:

- Audible message waiting indication
- Call forwarding options
- Call park/pickup options
- Call transfer
- Call waiting
- Caller ID
- 3-party conference calls
- Redial

- Speed dial options

For more information on the features supported and their configuration, see [SCCP Controlled Analog \(FXS\) Ports with Supplementary Features in Cisco IOS Gateways](#) .

Fax Services

The Cisco 880 series voice gateway ISRs support the following fax services:

Fax Pass-Through

Fax Pass-Through is the simplest way of transmitting faxes over IP, although it is not as reliable as Cisco Fax Relay. See the [Configuring Fax Pass-Through](#) chapter of the [Cisco IOS Fax, Modem, and Text Services over IP Configuration Guide](#) for more information.

Cisco Fax Relay

Cisco Fax Relay is a Cisco proprietary fax method that is turned on by default. Cisco Fax Relay allows the relay of a T.30 modulated signal across IP gateways in real-time on H.323 or SIP networks. See the [Configuring Cisco Fax Relay](#) chapter of the [Cisco IOS Fax, Modem, and Text Services over IP Configuration Guide](#) for more information.

T.37 Store-and-Forward Fax

The T.37 Store-and-Forward Fax mechanism allows a gateway to store and forward fax messages on H.323 or SIP networks. See the [Configuring T.37 Store-and-Forward Fax](#) chapter of the [Cisco IOS Fax, Modem, and Text Services over IP Configuration Guide](#) for more information.

T.38 Fax Relay

The T.38 Fax Relay provides an ITU-standard mechanism for real-time relay of fax signals. Gateway-controlled T.38 Fax Relay is available on MGCP networks. See the [Configuring T.38 Fax Relay](#) chapter of the [Cisco IOS Fax, Modem, and Text Services over IP Configuration Guide](#) for more information.

Unified Survival Remote Site Telephony

Cisco 880 Series voice gateway ISRs with Unified Survival Remote Site Telephony (SRST) include the following:

- Cisco C881SRST
- Cisco C888SRST

Unified SRST automatically detects a failure in the network and initializes the process of auto configuring the router. Unified SRST provides redundancy for the IP and FXS phones to ensure that the telephone system remains operational.

All the IP phones and analog phones connected to a telecommuter site are controlled by the headquarters office call control system, which uses Cisco Unified Communications Manager. During a WAN failure, the telecommuter router allows all the phones to reregister to the headquarter in SRST mode, allowing all inbound and outbound dialing to be routed off to the PSTN (on a backup Foreign Exchange Office (FXO) or BRI port). Upon restoration of WAN connectivity, the system automatically returns communication to the primary Cisco Unified Communications Manager cluster.

Direct Inward Dialing (DID) is supported on the Cisco 880 series SRST voice gateway ISRs.

For general Unified SRST information, see the [Cisco Unified SRST System Administrator Guide](#). Cisco Unified SRST is described in the [Overview](#) chapter.

- For information on how the H.323 and MGCP call control protocols relate to SRST, see the following sections of the [Overview](#) chapter in the [Cisco Unified SRST System Administrator Guide](#).

For SIP-specific SRST information, see the [Cisco Unified SRST System Administrator Guide](#). To configure SIP SRST features, see the [4.1 Features](#) chapter.

Verification of Voice Configuration

Use the following procedures to verify voice port configurations:

- [Verifying Analog and Digital Voice-Port Configurations](#)
- [Cisco IOS Voice Port Configuration Guide, Verify BRI Interfaces](#)

To verify, monitor, and maintain SRST, see [Monitoring and Maintaining Cisco Unified SRST](#).



Configuring the Serial Interface

This chapter describes configuring serial interface management.

- [Configuring the Serial Interface, page 179](#)
- [Legacy Protocol Transport, page 180](#)
- [Configuring Serial Interfaces, page 181](#)
- [Configuring Serial Interfaces, page 184](#)

Configuring the Serial Interface

The Cisco 819 Integrated Services Router (ISR) supports synchronous by default and asynchronous serial interface protocols.

Configuring the serial interface in the Cisco 819 ISR allows you to enable applications such as WAN access, legacy protocol transport, console server, and dial access server. It also allows remote network management, external dial-modem access, low-density WAN aggregation, legacy protocol transport, and high port-density support.

Serial interfaces enables the following features:

- WAN access and aggregation
- Legacy protocol transport
- Dial access server

Serial interfaces can be used to provide WAN access for remote sites. With support for serial speeds up to 8 Mbps, it is ideal for low- and medium-density WAN aggregation.

Figure 7: WAN Concentration



Legacy Protocol Transport

Serial and synchronous/asynchronous ports are ideally suited to transport legacy traffic across a TCP/IP network, facilitating network convergence. Legacy protocols supported by Cisco IOSR Software include:

- Synchronous Data Link Control (SDLC) Protocol
- Binary Synchronous Communications Protocol (Bisync)
- X.25 Protocol

Figure 8: Network Convergence

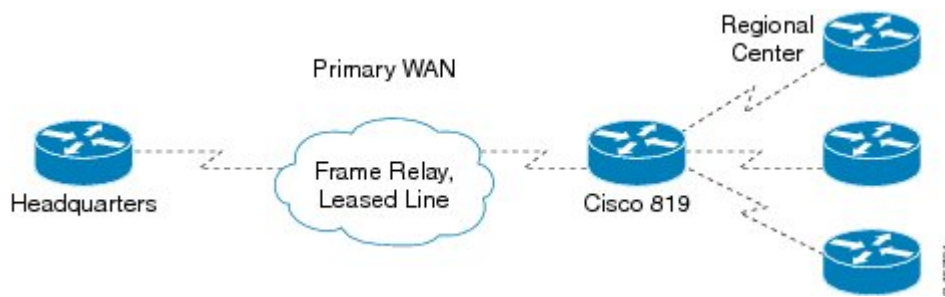

The Cisco 819 series ISRs use Cisco Smart Serial connectors. The supported cables are noted in the table below.

Table 23: Smart Serial Cabling for Cisco 819 ISRs

Product Number	Cable Type	Length	Connector Type
CAB-SS-V35MT	V.35 DTE	10 ft (3m)	Male
CAB-SS-V35FC 10 ft (3m) Female	V.35 DCE	10 ft (3m)	Female
CAB-SS-232MT	EIA/TIA-232 DTE	10 ft (3m)	Male
CAB-SS-232FC	EIA/TIA-232 DTE	10 ft (3m)	Female
CAB-SS-449MT	EIA/TIA-449 DTE	10 ft (3m)	Male
CAB-SS-449FC	EIA/TIA-449 DTE	10 ft (3m)	Female
CAB-SS-X21MT	X.21 DTE	10 ft (3m)	Male
CAB-SS-X21FC	X.21 DTE	10 ft (3m)	Female
CAB-SS-530MT	EIA/TIA-530 DTE	10 ft (3m)	Male
CAB-SS-530AMT	EIA/TIA-232 DTE	10 ft (3m)	Male

Configuring Serial Interfaces

When the router receives an indication that the primary interface is down, the backup interface becomes enabled. After the primary connection has been restored for a specified period, the backup interface is disabled.

Even if the backup interface comes out of standby mode, the router does not enable the backup interface unless the router receives the traffic specified for that backup interface.

To configure serial interfaces, you must understand the following concept:

Cisco HDLC Encapsulation

Cisco High-Level Data Link Controller (HDLC) is the Cisco proprietary protocol for sending data over synchronous serial links using HDLC. Cisco HDLC also provides a simple control protocol called Serial Line Address Resolution Protocol (SLARP) to maintain serial link keepalives. Cisco HDLC is the default for data encapsulation at Layer 2 (data link) of the Open System Interconnection (OSI) stack for efficient packet delineation and error control.

**Note**

Cisco HDLC is the default encapsulation type for the serial interfaces.

When the encapsulation on a serial interface is changed from HDLC to any other encapsulation type, the configured serial subinterfaces on the main interface inherit the newly changed encapsulation and they do not get deleted.

Cisco HDLC uses keepalives to monitor the link state, as described in the [Keepalive Timer](#), on page 183.

PPP Encapsulation

PPP is a standard protocol used to send data over synchronous serial links. PPP also provides a Link Control Protocol (LCP) for negotiating properties of the link. LCP uses echo requests and responses to monitor the continuing availability of the link.

**Note**

When an interface is configured with PPP encapsulation, a link is declared down and full LCP negotiation is re-initiated after five echo request (ECHOREQ) packets are sent without receiving an echo response (ECHOREP).

PPP provides the following Network Control Protocols (NCPs) for negotiating properties of data protocols that will run on the link:

- IP Control Protocol (IPCP) to negotiate IP properties
- Multiprotocol Label Switching control processor (MPLSCP) to negotiate MPLS properties
- Cisco Discovery Protocol control processor (CDPCP) to negotiate CDP properties
- IPv6CP to negotiate IP Version 6 (IPv6) properties
- Open Systems Interconnection control processor (OSICP) to negotiate OSI properties

PPP uses keepalives to monitor the link state, as described in the [Keepalive Timer](#), on page 183.

PPP supports the following authentication protocols, which require a remote device to prove its identity before allowing data traffic to flow over a connection:

- Challenge Handshake Authentication Protocol (CHAP)—CHAP authentication sends a challenge message to the remote device. The remote device encrypts the challenge value with a shared secret and returns the encrypted value and its name to the local router in a response message. The local router attempts to match the remote device's name with an associated secret stored in the local username or remote security server database; it uses the stored secret to encrypt the original challenge and verify that the encrypted values match.
- Microsoft Challenge Handshake Authentication Protocol (MS-CHAP)—MS-CHAP is the Microsoft version of CHAP. Like the standard version of CHAP, MS-CHAP is used for PPP authentication; in this case, authentication occurs between a personal computer using Microsoft Windows NT or Microsoft Windows 95 and a Cisco router or access server acting as a network access server.
- Password Authentication Protocol (PAP)—PAP authentication requires the remote device to send a name and a password, which are checked against a matching entry in the local username database or in the remote security server database.

Use the **ppp authentication** command in interface configuration mode to enable CHAP, MS-CHAP, and PAP on a serial interface.

**Note**

Enabling or disabling PPP authentication does not effect the local router's willingness to authenticate itself to the remote device.

Multilink PPP

Multilink Point-to-Point Protocol (MLPPP) is supported on the Cisco 819 ISR serial interface. MLPPP provides a method for combining multiple physical links into one logical link. The implementation of MLPPP combines multiple PPP serial interfaces into one multilink interface. MLPPP performs the fragmenting, reassembling, and sequencing of datagrams across multiple PPP links.

MLPPP provides the same features that are supported on PPP Serial interfaces with the exception of QoS. It also provides the following additional features:

- Fragment sizes of 128, 256, and 512 bytes
- Long sequence numbers (24-bit)
- Lost fragment detection timeout period of 80 ms
- Minimum-active-links configuration option
- LCP echo request/reply support over multilink interface
- Full T1 and E1 framed and unframed links

Keepalive Timer

Cisco keepalives are useful for monitoring the link state. Periodic keepalives are sent to and received from the peer at a frequency determined by the value of the keepalive timer. If an acceptable keepalive response is not received from the peer, the link makes the transition to the down state. As soon as an acceptable keepalive response is obtained from the peer or if keepalives are disabled, the link makes the transition to the up state.

**Note**

The **keepalive** command applies to serial interfaces using HDLC or PPP encapsulation. It does not apply to serial interfaces using Frame Relay encapsulation.

For each encapsulation type, a certain number of keepalives ignored by a peer triggers the serial interface to transition to the down state. For HDLC encapsulation, three ignored keepalives causes the interface to be brought down. For PPP encapsulation, five ignored keepalives causes the interface to be brought down. ECHOREQ packets are sent out only when LCP negotiation is complete (for example, when LCP is open).

Use the **keepalive** command in interface configuration mode to set the frequency at which LCP sends ECHOREQ packets to its peer. To restore the system to the default keepalive interval of 10 seconds, use the **keepalive** command with the **no** keyword. To disable keepalives, use the **keepalive disable** command. For both PPP and Cisco HDLC, a keepalive of 0 disables keepalives and is reported in the **show running-config** command output as **keepalive disable**.

When LCP is running on the peer and receives an ECHOREQ packet, it responds with an ECHOREP packet, regardless of whether keepalives are enabled on the peer.

Keepalives are independent between the two peers. One peer end can have keepalives enabled; the other end can have them disabled. Even if keepalives are disabled locally, LCP still responds with ECHOREP packets to the ECHOREQ packets it receives. Similarly, LCP also works if the period of keepalives at each end is different.

Frame Relay Encapsulation

When Frame Relay encapsulation is enabled on a serial interface, the interface configuration is hierarchical and comprises the following elements:

- The serial main interface comprises the physical interface and port. If you are not using the serial interface to support Cisco HDLC and PPP encapsulated connections, then you must configure subinterfaces with permanent virtual circuits (PVCs) under the serial main interface. Frame Relay connections are supported on PVCs only.
- Serial subinterfaces are configured under the serial main interface. A serial subinterface does not actively carry traffic until you configure a PVC under the serial subinterface. Layer 3 configuration typically takes place on the subinterface.
- When the encapsulation on a serial interface is changed from HDLC to any other encapsulation type, the configured serial subinterfaces on the main interface inherit the newly changed encapsulation and they do not get deleted.
- Point-to-point PVCs are configured under a serial subinterface. You cannot configure a PVC directly under a main interface. A single point-to-point PVC is allowed per subinterface. PVCs use a predefined circuit path and fail if the path is interrupted. PVCs remain active until the circuit is removed from either configuration. Connections on the serial PVC support Frame Relay encapsulation only.

**Note**

The administrative state of a parent interface drives the state of the subinterface and its PVC. When the administrative state of a parent interface or subinterface changes, so does the administrative state of any child PVC configured under that parent interface or subinterface.

To configure Frame Relay encapsulation on serial interfaces, use the **encapsulation (Frame Relay VC-bundle)** command.

Frame Relay interfaces support two types of encapsulated frames:

- Cisco (default)
- IETF

Use the **encap** command in PVC configuration mode to configure Cisco or IETF encapsulation on a PVC. If the encapsulation type is not configured explicitly for a PVC, then that PVC inherits the encapsulation type from the main serial interface.

**Note**

Cisco encapsulation is required on serial main interfaces that are configured for MPLS. IETF encapsulation is not supported for MPLS.

Before you configure Frame Relay encapsulation on an interface, you must verify that all prior Layer 3 configuration is removed from that interface. For example, you must ensure that there is no IP address configured directly under the main interface; otherwise, any Frame Relay configuration done under the main interface will not be viable.

LMI on Frame Relay Interfaces

The Local Management Interface (LMI) protocol monitors the addition, deletion, and status of PVCs. LMI also verifies the integrity of the link that forms a Frame Relay UNI interface. By default, **cisco** LMI is enabled on all PVCs.

If the LMI type is **cisco** (the default LMI type), the maximum number of PVCs that can be supported under a single interface is related to the MTU size of the main interface. Use the following formula to calculate the maximum number of PVCs supported on a card or SPA:

$$(MTU - 13)/8 = \text{maximum number of PVCs}$$

**Note**

The default setting of the **mtu** command for a serial interface is 1504 bytes. Therefore, the default numbers of PVCs supported on a serial interface configured with **cisco** LMI is 186.

Configuring Serial Interfaces

This section contains the following tasks:

Configuring a Synchronous Serial Interface

Synchronous serial interfaces are supported on various serial network interface cards or systems. This interface supports full-duplex operation at T1 (1.544 Mbps) and E1 (2.048 Mbps) speeds.

To configure a synchronous serial interface, perform the tasks in the following sections. Each task in the list is identified as either required or optional.

See the [Examples for Interface Enablement Configuration, on page 198](#) for examples of configuration tasks described in this chapter.

Specifying a Synchronous Serial Interface

To specify a synchronous serial interface and enter interface configuration mode, use one of the following commands in global configuration mode.

Command	Purpose
<code>Router(config)# interface serial 0</code>	Enters interface configuration mode.

Specifying Synchronous Serial Encapsulation

By default, synchronous serial lines use the High-Level Data Link Control (HDLC) serial encapsulation method, which provides the synchronous framing and error detection functions of HDLC without windowing or retransmission. The synchronous serial interfaces support the following serial encapsulation methods:

- HDLC
- Frame Relay
- PPP
- Synchronous Data Link Control (SDLC)
- SMDS
- Cisco Serial Tunnel (STUN)
- Cisco Bisync Serial Tunnel (BSTUN)
- X.25-based encapsulations

To define the encapsulation method, use the following command in interface configuration mode.

Command	Purpose
<code>Router(config-if)# encapsulation {hdlc frame-relay ppp sdhc-primary sdhc-secondary smds stun x25 bstun}</code>	Configures synchronous serial encapsulation.

**Note**

You cannot use the **physical-layer async** command for frame-relay encapsulation.

Encapsulation methods are set according to the type of protocol or application you configure in the Cisco IOS software.

- PPP is described in [Configuring Media-Independent PPP and Multilink PPP](#).
- The remaining encapsulation methods are defined in their respective books and chapters describing the protocols or applications. Serial encapsulation methods are also discussed in the [Cisco IOS Interface and Hardware Component Command Reference](#) **encapsulation** command.

By default, synchronous interfaces operate in full-duplex mode. To configure an SDLC interface for half-duplex mode, use the following command in interface configuration mode.

Command	Purpose
<code>Router(config-if) # half-duplex</code>	Configures an SDLC interface for half-duplex mode.

Binary synchronous communication (Bisync) is a half-duplex protocol. Each block of transmission is acknowledged explicitly. To avoid the problem associated with simultaneous transmission, there is an implicit role of primary and secondary stations. The primary sends the last block again if there is no response from the secondary within the period of block receive timeout.

To configure the serial interface for full-duplex mode, use the following command in interface configuration mode.

Command	Purpose
<code>Router(config-if) # full-duplex</code>	Specifies that the interface can run Bisync using switched RTS signals.

Configuring PPP

To configure PPP, refer to the [Configuring Media-Independent PPP and Multilink PPP](#).

Configuring Bisync

To configure the Bisync feature on the synchronous serial port adapters on Cisco 819 ISRs, refer to the [Block Serial Tunneling \(BSTUN\) Overview](#). All commands listed in this section apply to the synchronous serial port adapters on Cisco 891 ISRs. Any command syntax that specifies an interfacenumber supports the Cisco 891 ISRs **slot/port** syntax.

Configuring Compression of HDLC Data

You can configure point-to-point software compression on serial interfaces that use HDLC encapsulation. Compression reduces the size of a HDLC frame via lossless data compression. The compression algorithm used is a Stacker (LZS) algorithm.

Compression is performed in software and might significantly affect system performance. We recommend that you disable compression if CPU load exceeds 65 percent. To display the CPU load, use the **show process cpu EXEC** command.

If the majority of your traffic is already compressed files, you should not use compression.

To configure compression over HDLC, use the following commands in interface configuration mode.

SUMMARY STEPS

1. **encapsulation hdlc**
2. **compress stac**

DETAILED STEPS

	Command or Action	Purpose
Step 1	encapsulation hdlc Example: <code>Router(config-if)# encapsulation hdlc</code>	Enables encapsulation of a single protocol on the serial line.
Step 2	compress stac Example: <code>Router(config-if)# compress stac</code>	Enables compression.

Using the NRZI Line-Coding Format

The nonreturn-to-zero (NRZ) and nonreturn-to-zero inverted (NRZI) formats are supported on the Cisco 819 serial ports.

NRZ and NRZI are line-coding formats that are required for serial connections in some environments. NRZ encoding is most common. NRZI encoding is used primarily with EIA/TIA-232 connections in IBM environments.

The default configuration for all serial interfaces is NRZ format. The default is **no nrzi-encoding**.

To enable NRZI format, use one of the following commands in interface configuration mode.

SUMMARY STEPS

1. Do one of the following:
 - **nrzi-encoding**

DETAILED STEPS

	Command or Action	Purpose
Step 1	Do one of the following: <ul style="list-style-type: none"> • nrzi-encoding Example: <pre>Router(config-if)# nrzi-encoding Router(config-if)# nrzi-encoding [mark]</pre>	Enables NRZI encoding format. Enables NRZI encoding format for router.

Enabling the Internal Clock

When a DTE does not return a transmit clock, use the following interface configuration command on the router to enable the internally generated clock on a serial interface:

SUMMARY STEPS

1. **transmit-clock-internal**

DETAILED STEPS

	Command or Action	Purpose
Step 1	transmit-clock-internal Example: <pre>Router(config-if)# transmit-clock-internal</pre>	Enables the internally generated clock on a serial interface.

Inverting the Transmit Clock Signal

Systems that use long cables or cables that are not transmitting the TxC signal (transmit echoed clock line, also known as TXCE or SCTE clock) can experience high error rates when operating at the higher transmission speeds. For example, if the interface on the PA-8T and PA-4T+ synchronous serial port adapters is reporting a high number of error packets, a phase shift might be the problem. Inverting the clock signal can correct this shift. To invert the clock signal, use the following commands in interface configuration mode.

SUMMARY STEPS

1. **invert txclock**
2. **invert rxclock**

DETAILED STEPS

	Command or Action	Purpose
Step 1	invert txclock Example: Router(config-if)# invert txclock	Inverts the clock signal on an interface.
Step 2	invert rxclock Example: Router(config-if)# invert rxclock	Inverts the phase of the RX clock on the UIO serial interface, which does not use the T1/E1 interface.

Setting Transmit Delay

It is possible to send back-to-back data packets over serial interfaces faster than some hosts can receive them. You can specify a minimum dead time after transmitting a packet to remove this condition. This setting is available for serial interfaces on the MCI and SCI interface cards and for the HSSI or MIP. Use one of the following commands, as appropriate for your system, in interface configuration mode.

Command	Purpose
Router(config-if)# transmitter-delay <i>microseconds</i>	Sets the transmit delay on the MCI and SCI synchronous serial interfaces.
Router(config-if)# transmitter-delay <i>hdlc-flags</i>	Sets the transmit delay on the HSSI or MIP.

Configuring DTR Signal Pulsing

You can configure pulsing Data Terminal Ready (DTR) signals on all serial interfaces. When the serial line protocol goes down (for example, because of loss of synchronization), the interface hardware is reset and the DTR signal is held inactive for at least the specified interval. This function is useful for handling encrypting or other similar devices that use the toggling of the DTR signal to reset synchronization. To configure DTR signal pulsing, use the following command in interface configuration mode.

Command	Purpose
Router(config-if)# pulse-time <i>seconds</i>	Configures DTR signal pulsing.

Ignoring DCD and Monitoring DSR as Line Up/Down Indicator

By default, when the serial interface is operating in DTE mode, it monitors the Data Carrier Detect (DCD) signal as the line up/down indicator. By default, the attached DCE device sends the DCD signal. When the DTE interface detects the DCD signal, it changes the state of the interface to up.

In some configurations, such as an SDLC multidrop environment, the DCE device sends the Data Set Ready (DSR) signal instead of the DCD signal, which prevents the interface from coming up. To tell the interface to monitor the DSR signal instead of the DCD signal as the line up/down indicator, use the following command in interface configuration mode.

SUMMARY STEPS

1. `ignore-dcd`

DETAILED STEPS

	Command or Action	Purpose
Step 1	ignore-dcd Example: Router(config-if)# ignore-dcd	Configures the serial interface to monitor the DSR signal as the line up/down indicator.

What to Do Next



Caution

Unless you know for certain that you really need this feature, be very careful using this command. It will hide the real status of the interface. The interface could actually be down and you will not know just by looking at show displays.

Specifying the Serial Network Interface Module Timing

On Cisco 819 series ISRs, you can specify the serial Network Interface Module timing signal configuration. When the board is operating as a DCE and the DTE provides terminal timing (SCTE or TT), you can configure the DCE to use SCTE from the DTE. When running the line at high speeds and long distances, this strategy prevents phase shifting of the data with respect to the clock.

To configure the DCE to use SCTE from the DTE, use the following command in interface configuration mode.

SUMMARY STEPS

1. `dce-terminal-timing enable`

DETAILED STEPS

	Command or Action	Purpose
Step 1	dce-terminal-timing enable Example: Router(config-if)# dce-terminal-timing enable	Configures the DCE to use SCTE from the DTE.

Specifying the Serial Network Interface Module Timing

When the board is operating as a DTE, you can invert the TXC clock signal it gets from the DCE that the DTE uses to transmit data. Invert the clock signal if the DCE cannot receive SCTE from the DTE, the data is running at high speeds, and the transmission line is long. Again, this prevents phase shifting of the data with respect to the clock.

To configure the interface so that the router inverts the TXC clock signal, use the following command in interface configuration mode.

SUMMARY STEPS

1. **dte-invert-txc**

DETAILED STEPS

	Command or Action	Purpose
Step 1	dte-invert-txc Example: Router(config-if)# dte-invert-txc	Specifies timing configuration to invert TXC clock signal.

Configuring Low-Speed Serial Interfaces

This section describes how to configure low-speed serial interfaces and contains the following sections:

For configuration examples, see the [Examples for Low-Speed Serial Interface](#), on page 198.

Half-Duplex DTE and DCE State Machines

The following sections describe the communication between half-duplex DTE transmit and receive state machines and half-duplex DCE transmit and receive state machines.

Half-Duplex DTE State Machines

As shown in the figure below, the half-duplex DTE transmit state machine for low-speed interfaces remains in the ready state when it is quiescent. When a frame is available for transmission, the state machine enters the transmit delay state and waits for a time period, which is defined by the **half-duplex timer transmit-delay** command. The default is 0 milliseconds. Transmission delays are used for debugging half-duplex links and assisting lower-speed receivers that cannot process back-to-back frames.

Figure 9: Half-Duplex DTE Transmit State Machine

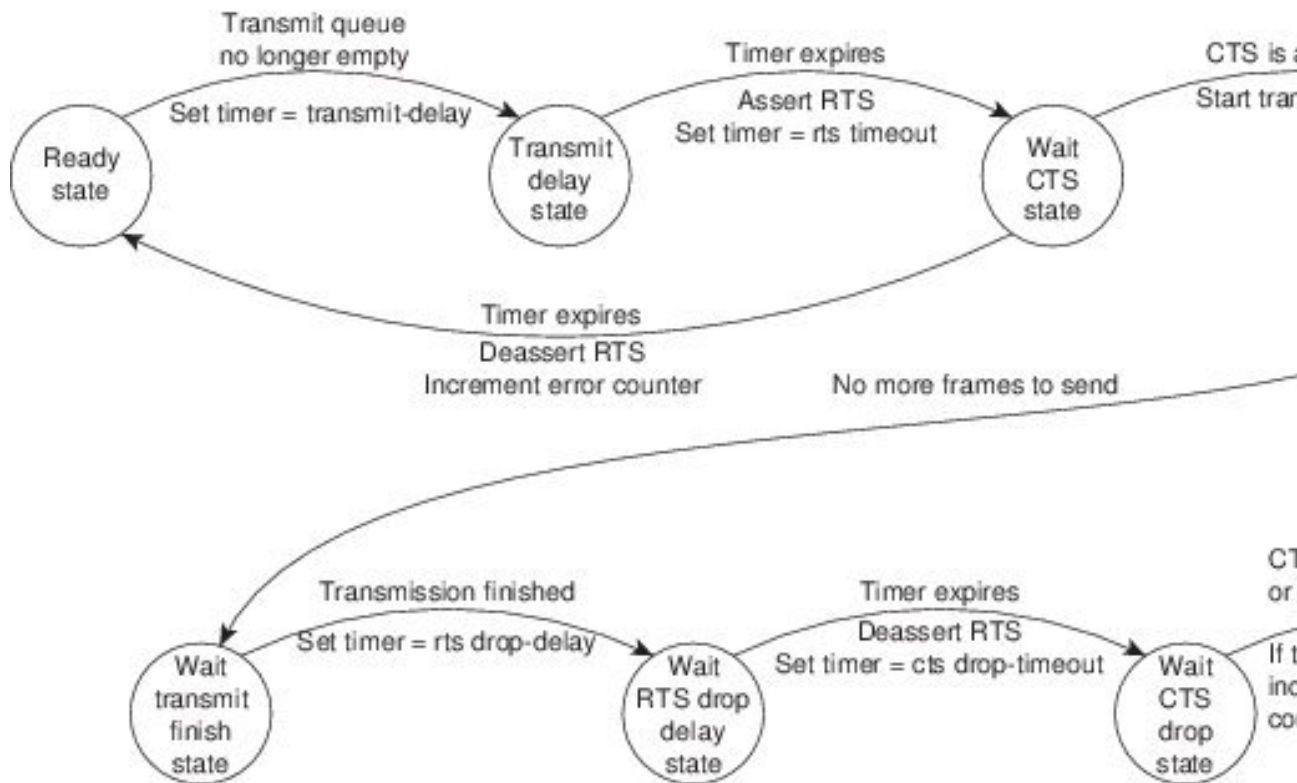

After idling for a defined number of milliseconds (ms), the state machine asserts a request to send (RTS) signal and changes to the wait-clear-to-send (CTS) state for the DCE to assert CTS. A timeout timer with a value set by the **half-duplex timer rts-timeout** command starts. The default is 3 ms. If the timeout timer expires before CTS is asserted, the state machine returns to the ready state and deasserts RTS. If CTS is asserted before the timer expires, the state machine enters the transmit state and sends the frames.

Once there are no more frames to transmit, the state machine transitions to the wait transmit finish state. The machine waits for the transmit FIFO in the serial controller to empty, starts a delay timer with a value defined by the **half-duplex timer rts-drop-delay** interface command, and transitions to the wait RTS drop delay state.

When the timer in the wait RTS drop delay state expires, the state machine deasserts RTS and transitions to the wait CTS drop state. A timeout timer with a value set by the **half-duplex timer cts-drop-timeout** interface command starts, and the state machine waits for the CTS to deassert. The default is 250 ms. Once the CTS

signal is deasserted or the timeout timer expires, the state machine transitions back to the ready state. If the timer expires before CTS is deasserted, an error counter is incremented, which can be displayed by issuing the **show controllers** command for the serial interface in question.

As shown in the figure below, a half-duplex DTE receive state machine for low-speed interfaces idles and receives frames in the ready state. A giant frame is any frame whose size exceeds the maximum transmission unit (MTU). If the beginning of a giant frame is received, the state machine transitions to the in giant state and discards frame fragments until it receives the end of the giant frame. At this point, the state machine transitions back to the ready state and waits for the next frame to arrive.

Figure 10: Half-Duplex DTE Receive State Machine

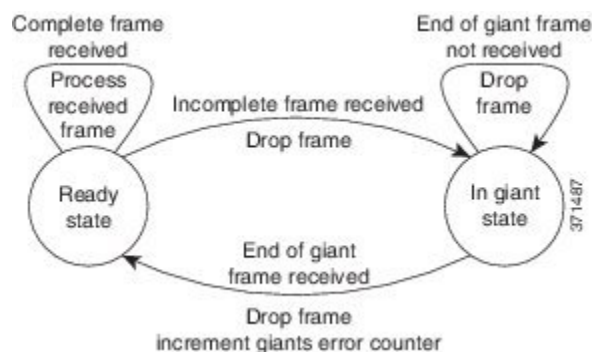

An error counter is incremented upon receipt of the giant frames. To view the error counter, use the **show interfaces** command for the serial interface in question.

Half-Duplex DCE State Machines

As shown in the figure below, for a low-speed serial interface in DCE mode, the half-duplex DCE transmit state machine idles in the ready state when it is quiescent. When a frame is available for transmission on the serial interface, such as when the output queues are no longer empty, the state machine starts a timer (based on the value of the **half-duplex timer transmit-delay** command, in milliseconds) and transitions to the transmit delay state. Similar to the DTE transmit state machine, the transmit delay state gives you the option of setting a delay between the transmission of frames; for example, this feature lets you compensate for a slow receiver that loses data when multiple frames are received in quick succession. The default **transmit-delay**

value is 0 ms; use the **half-duplex timer transmit-delay** interface configuration command to specify a delay value not equal to 0.

Figure 11: Half-Duplex DCE Transmit State Machine

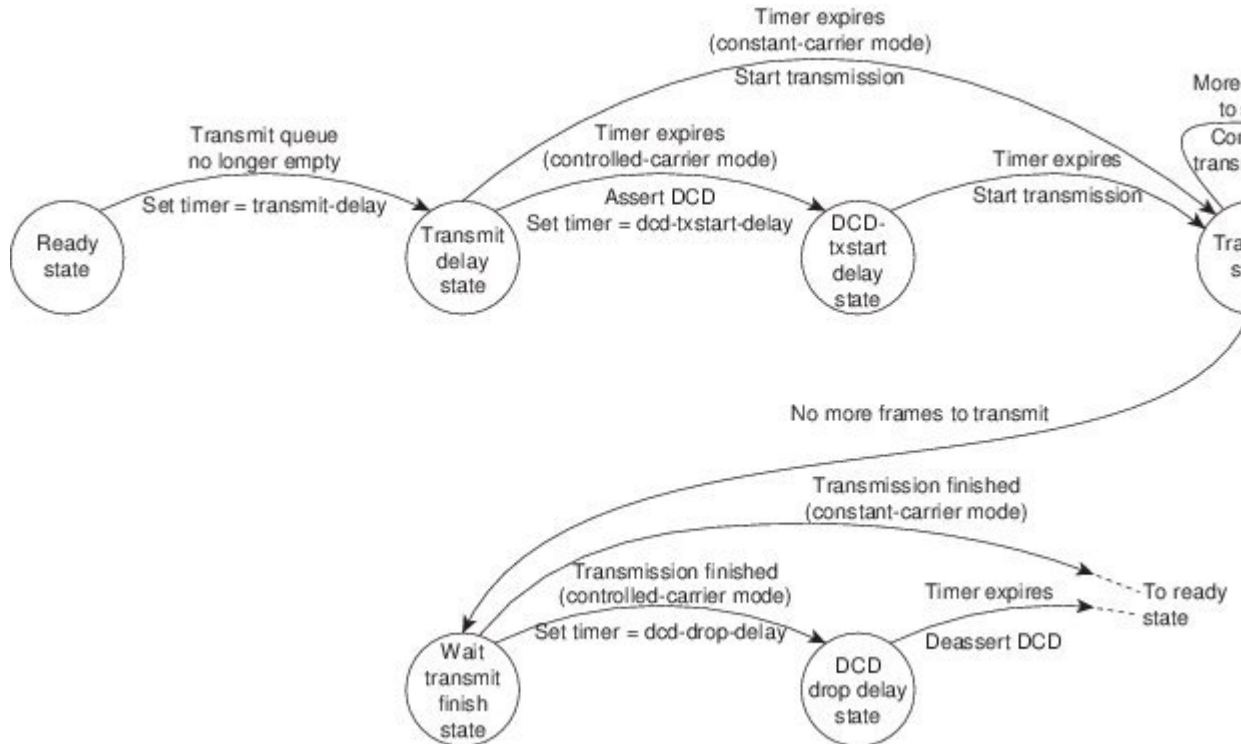

After the transmit delay state, the next state depends on whether the interface is in constant-carrier mode (the default) or controlled-carrier mode.

If the interface is in constant-carrier mode, it passes through the following states:

- 1 The state machine passes to the transmit state when the **transmit-delay** timer expires. The state machine stays in the transmit state until there are no more frames to transmit.
- 2 When there are no more frames to transmit, the state machine passes to the wait transmit finish state, where it waits for the transmit FIFO to empty.
- 3 Once the FIFO empties, the DCE passes back to the ready state and waits for the next frame to appear in the output queue.

If the interface is in controlled-carrier mode, the interface performs a handshake using the data carrier detect (DCD) signal. In this mode, DCD is deasserted when the interface is idle and has nothing to transmit. The transmit state machine transitions through the states as follows:

- 1 After the **transmit-delay** timer expires, the DCE asserts DCD and transitions to the DCD-txstart delay state to ensure a time delay between the assertion of DCD and the start of transmission. A timer is started based on the value specified using the **dcd-txstart-delay** command. (This timer has a default value of 100 ms; use the **half-duplex timer dcd-txstart-delay** interface configuration command to specify a delay value.)
- 2 When this delay timer expires, the state machine transitions to the transmit state and transmits frames until there are no more frames to transmit.

- 3 After the DCE transmits the last frame, it transitions to the wait transmit finish state, where it waits for transmit FIFO to empty and the last frame to transmit to the wire. Then DCE starts a delay timer by specifying the value using the **dcd-drop-delay** command. (This timer has the default value of 100 ms; use the **half-duplex timer dcd-drop-delay** interface configuration command to specify a delay value.)
- 4 The DCE transitions to the wait DCD drop delay state. This state causes a time delay between the transmission of the last frame and the deassertion of DCD in the controlled-carrier mode for DCE transmits.
- 5 When the timer expires, the DCE deasserts DCD and transitions back to the ready state and stays there until there is a frame to transmit on that interface.

As shown in the figure below, the half-duplex DCE receive state machine idles in the ready state when it is quiescent. It transitions out of this state when the DTE asserts RTS. In response, the DCE starts a timer based on the value specified using the **cts-delay** command. This timer delays the assertion of CTS because some DTE interfaces expect this delay. (The default value of this timer is 0 ms; use the **half-duplex timer cts-delay** interface configuration command to specify a delay value.)

Figure 12: Half-Duplex DCE Receive State Machine

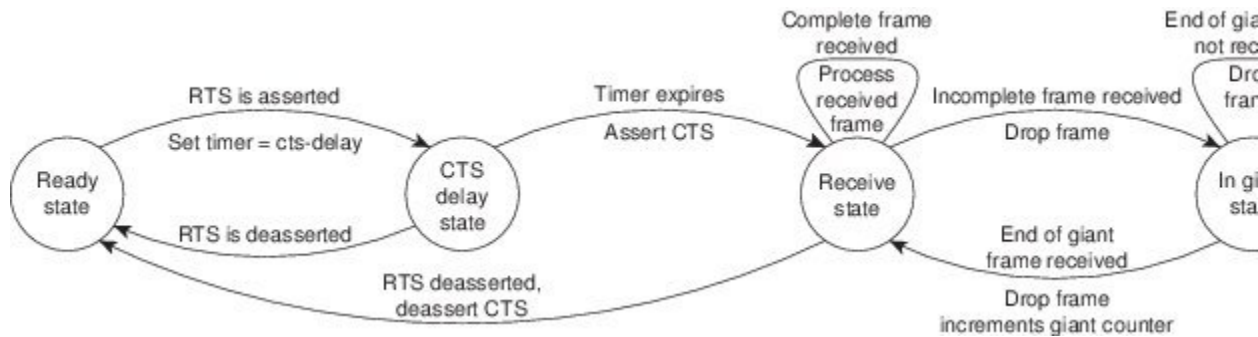

When the timer expires, the DCE state machine asserts CTS and transitions to the receive state. It stays in the receive state until there is a frame to receive. If the beginning of a giant frame is received, it transitions to the in giant state and keeps discarding all the fragments of the giant frame and transitions back to the receive state.

Transitions back to the ready state occur when RTS is deasserted by the DTE. The response of the DCE to the deassertion of RTS is to deassert CTS and go back to the ready state.

Placing a Low-Speed Serial Interface in Constant-Carrier Mode

To return a low-speed serial interface to constant-carrier mode from controlled-carrier mode, use the following command in interface configuration mode.

SUMMARY STEPS

1. **no half-duplex controlled-carrier**

DETAILED STEPS

	Command or Action	Purpose
Step 1	<p>no half-duplex controlled-carrier</p> <p>Example:</p> <pre>Router(config-if)# no half-duplex controlled-carrier</pre>	Places a low-speed serial interface in constant-carrier mode.

Tuning Half-Duplex Timers

To optimize the performance of half-duplex timers, use the following command in interface configuration mode.

Command	Purpose
<pre>Router(config-if)# half-duplex timer {cts-delay value cts-drop-timeout value dcd-drop-delay value dcd-txstart-delay value rts-drop-delay value rts-timeout value transmit-delay value }</pre>	Tunes half-duplex timers.

The timer tuning commands permit you to adjust the timing of the half-duplex state machines to suit the particular needs of their half-duplex installation.

Note that the **half-duplex timer** command and its options replaces the following two timer tuning commands that are available only on high-speed serial interfaces:

- **sdlc cts-delay**
- **sdlc rts-timeout**

Changing Between Synchronous and Asynchronous Modes

To specify the mode of a low-speed serial interface as either synchronous or asynchronous, use the following command in interface configuration mode.

SUMMARY STEPS

1. **physical-layer {sync | async}**

DETAILED STEPS

	Command or Action	Purpose
Step 1	physical-layer {sync async} Example: Router(config-if)# physical-layer sync	Specifies the mode of a low-speed interface as either synchronous or asynchronous.

Changing Between Synchronous and Asynchronous Modes

This command applies only to low-speed serial interfaces available on Cisco 2520 through Cisco 2523 routers.

**Note**

When you make a transition from asynchronous mode to synchronous mode in serial interfaces, the interface state becomes down by default. You should then use the **no shutdown** option to bring the interface up.

In synchronous mode, low-speed serial interfaces support all interface configuration commands available for high-speed serial interfaces, except the following two commands:

- **sdhc cts-delay**
- **sdhc rts-timeout**

When placed in asynchronous mode, low-speed serial interfaces support all commands available for standard asynchronous interfaces. The default is synchronous mode.

**Note**

When you use this command, it does not appear in the output of the **show running-config** and **show startup-config** commands because the command is a physical-layer command.

To return to the default mode (synchronous) of a low-speed serial interface on a Cisco 2520 through Cisco 2523 router, use the following command in interface configuration mode.

SUMMARY STEPS

1. **no physical-layer**

DETAILED STEPS

	Command or Action	Purpose
Step 1	no physical-layer Example: Router(config-if)# no physical-layer	Returns the interface to its default mode, which is synchronous.

Examples for Interface Enablement Configuration

The following example illustrates how to begin interface configuration on a serial interface. It assigns PPP encapsulation to serial interface 0.

```
interface serial 0
 encapsulation ppp
```

The same example on the router, assigning PPP encapsulation to port 0 in slot 1, requires the following commands:

```
interface serial 1/0
 encapsulation ppp
```

The following example shows how to configure the access server so that it will use the default address pool on all interfaces except interface 7, on which it will use an address pool called lass:

```
ip address-pool local
ip local-pool lass 172.30.0.1
 async interface
 interface 7
 peer default ip address lass
```

Examples for Low-Speed Serial Interface

The section includes the following configuration examples for low-speed serial interfaces:

Examples for Synchronous or Asynchronous Mode

The following example shows how to change a low-speed serial interface from synchronous to asynchronous mode:

```
interface serial 2
 physical-layer async
```

The following examples show how to change a low-speed serial interface from asynchronous mode back to its default synchronous mode:

```
interface serial 2
 physical-layer sync
or
```

```
interface serial 2
 no physical-layer
```

The following example shows some typical asynchronous interface configuration commands:

```
interface serial 2
 physical-layer async
 ip address 10.0.0.2 255.0.0.0
 async default ip address 10.0.0.1
 async mode dedicated
 async default routing
```

The following example shows some typical synchronous serial interface configuration commands available when the interface is in synchronous mode:

```
interface serial 2
  physical-layer sync
  ip address 10.0.0.2 255.0.0.0
  no keepalive
  ignore-dcd
  nrzi-encoding
  no shutdown
```

Example for Half-Duplex Timers

The following example shows how to set the cts-delay timer to 1234 ms and the transmit-delay timer to 50 ms:

```
interface serial 2
  half-duplex timer cts-delay 1234
  half-duplex timer transmit-delay 50
```



Configuring Wireless Devices

This chapter describes the procedures for initial configuration of the wireless device, radio settings, WLAN, and administration of the wireless devices. This chapter contains the following sub-sections:

- [Wireless Device Overview, page 201](#)
- [Basic Wireless Configuration for Cisco 800 Series ISR, page 208](#)
- [Configuring Radio Settings, page 220](#)
- [Configuring WLAN , page 246](#)
- [Administering the Wireless Device, page 293](#)

Wireless Device Overview

Wireless devices (commonly configured as access points) provide a secure, affordable, and easy-to-use wireless LAN solution that combines mobility and flexibility with the enterprise-class features required by networking professionals. When configured as an access point, the wireless device serves as the connection point between wireless and wired networks or as the center point of a stand-alone wireless network. In large installations, wireless users within radio range of an access point can roam throughout a facility while maintaining seamless, uninterrupted access to the network.

With a management system based on Cisco IOS software, wireless devices are Wi-Fi CERTIFIED™, 802.11a-compliant, 802.11b-compliant, 802.11g-compliant, and 802.11n-compliant wireless LAN transceivers.

Software Modes for Wireless Devices

The access point is shipped with an autonomous image and recovery image on the access point's flash. The default mode is autonomous; however, the access point can be upgraded to operate in Cisco Unified Wireless mode.

Each mode is described below:

- Autonomous mode—supports standalone network configurations, where all configuration settings are maintained locally on the wireless device. Each autonomous device can load its starting configuration independently, and still operate in a cohesive fashion on the network.

- Cisco Unified Wireless mode—operates in conjunction with a Cisco Unified Wireless LAN controller, where all configuration information is maintained within the controller. In the Cisco Unified Wireless LAN architecture, wireless devices operate in the lightweight mode using Lightweight Access Point Protocol (LWAPP), (as opposed to autonomous mode). The lightweight access point, or wireless device, has no configuration until it associates to a controller. The configuration on the wireless device can be modified by the controller only when the networking is up and running. The controller manages the wireless device configuration, firmware, and control transactions such as 802.1x authentication. All wireless traffic is tunneled through the controller.

For more information about Cisco Unified Wireless mode, see http://www.cisco.com/en/US/prod/collateral/wireless/ps5679/ps6548/prod_white_paper0900aecd804f19e3_ps6305_Products_White_Paper.html.

Management Options for Wireless Device

The wireless device runs its own version of Cisco IOS software that is separate from the Cisco IOS software operating on the router. You can configure and monitor the access point with several different tools:

- Cisco IOS software CLI
- Simple Network Management Protocol (SNMP)
- Web-browser Interface



Note

Avoid using the CLI and the web-browser tools concurrently. If you configure the wireless device using the CLI, the web-browser interface may display an inaccurate interpretation of the configuration.

Use the **interface dot11radio** command from **global** configuration mode to place the wireless device into the radio configuration mode. Network Configuration Examples

Set up the access point role in any of these common wireless network configurations. The access point default configuration is as a root unit connected to a wired LAN or as the central unit in an all-wireless network. Access points can also be configured as bridges and workgroup bridges. These roles require specific configurations, as defined in the following examples.

Root Access Point

An access point connected directly to a wired LAN provides a connection point for wireless users. If more than one access point is connected to the LAN, users can roam from one area of a facility to another without losing their connection to the network. As users move out of range of one access point, they automatically connect to the network (associate) through another access point. The roaming process is seamless and transparent

to the user. [Figure 13: Access Points as Root Units on a Wired LAN](#), on page 203 shows access points acting as root units on a wired LAN.

Figure 13: Access Points as Root Units on a Wired LAN

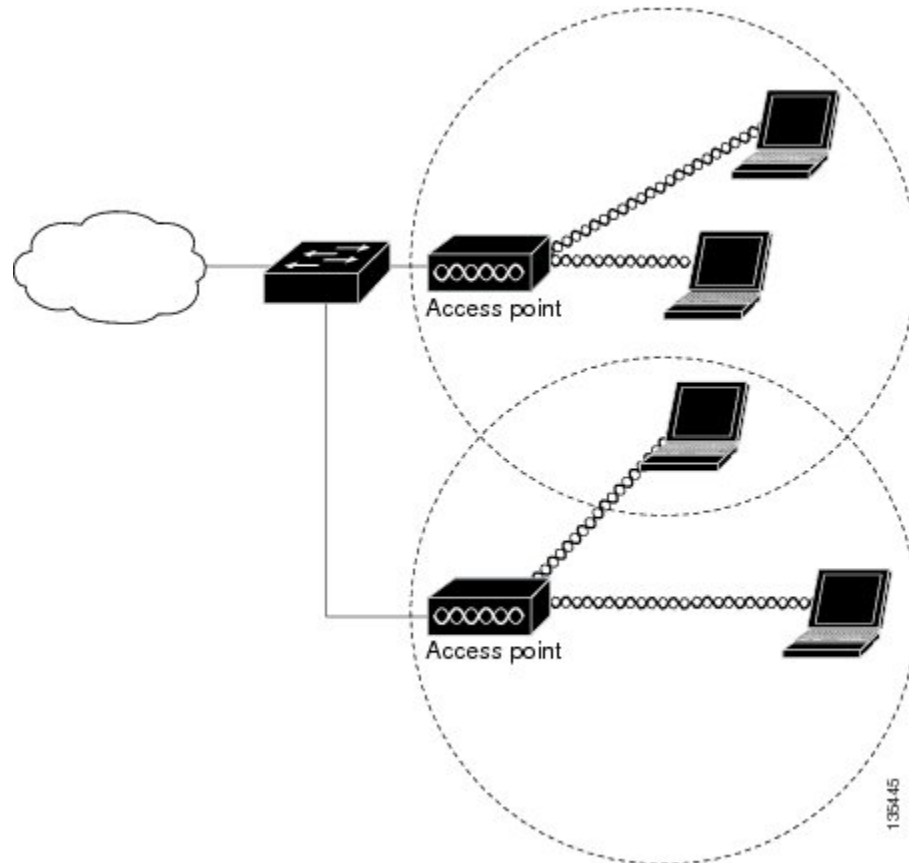

Central Unit in an All-Wireless Network

In an all-wireless network, an access point acts as a stand-alone root unit. The access point is not attached to a wired LAN; it functions as a hub linking all stations together. The access point serves as the focal point for

communications, increasing the communication range of wireless users. [Figure 14: Access Point as Central Unit in All-Wireless Network](#), on page 204 shows an access point in an all-wireless network.

Figure 14: Access Point as Central Unit in All-Wireless Network

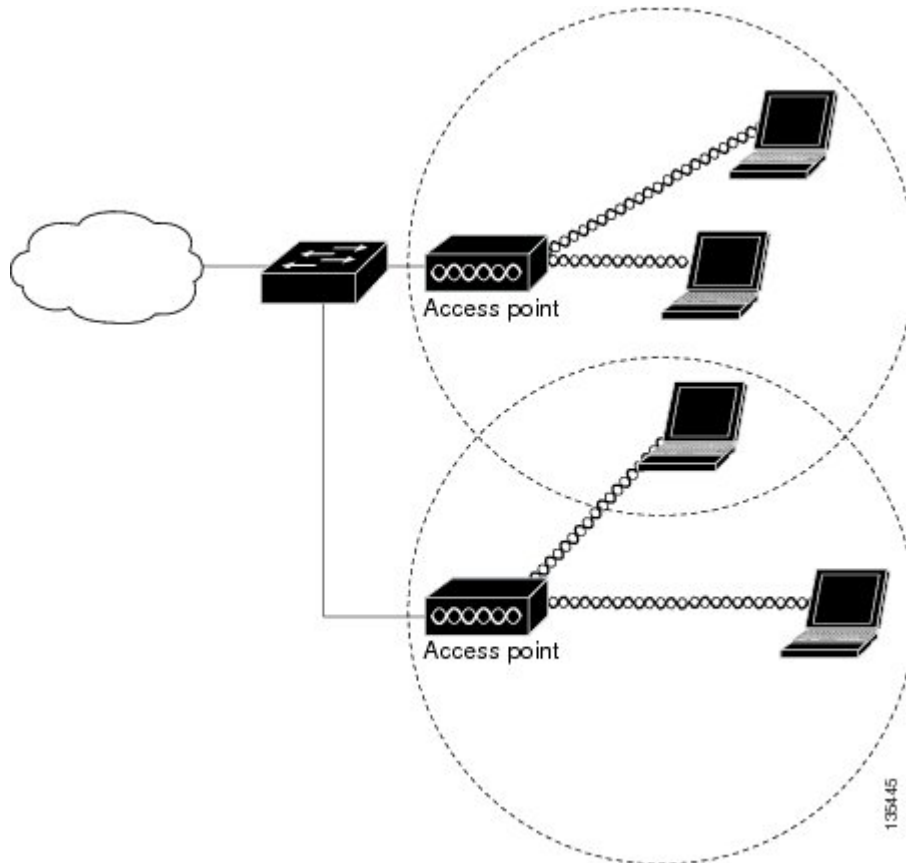

Cisco ScanSafe

The Cisco Integrated Services Router G2 (ISR G2) family delivers numerous security services, including firewall, intrusion prevention, and VPN. These security capabilities have been extended with Cisco ISR Web Security with Cisco ScanSafe for a web security and web filtering solution that requires no additional hardware or client software.

Cisco ISR Web Security with Cisco ScanSafe enables branch offices to intelligently redirect web traffic to the cloud to enforce granular security and acceptable use policies over user web traffic. With this solution, you can deploy market-leading web security quickly and can easily protect branch office users from web-based threats, such as viruses, while saving bandwidth, money, and resources.

For more information, see [Cisco ISR Web Security with Cisco ScanSafe Solution Guide](#).

TFTP support with Ethernet WAN interface

Trivial File Transfer Protocol (TFTP) is a file transfer protocol notable for its simplicity. It is generally used for automated transfer of configuration or boot files between machines in a local environment.

The Cisco 819H ISR supports TFTP with Ethernet WAN interface that supports data transfer rate of 10 Mbps.

For more information, see [Using the TFTP Download Command](#) .



Note

This feature is supported in all Cisco 819 ISRs that have ROMMON version 15.2(2r)T and above.



Note

TFTP download using switch port is supported in Cisco 819HGW SKUs only.

LEDs for Cisco 819 Series ISRs

The LED is located on the front panel of the router. [Table 24: 3G LED Descriptions for Cisco 819 Series ISRs](#), on page 205 describes the 3G LED for the Cisco 819 ISR.

Table 24: 3G LED Descriptions for Cisco 819 Series ISRs

LED	Color	Description
SYS	Yellow	FPGA download is complete.
	Green (blinking)	ROMMON is operational.
	Green (solid)	IOS is operational.
	Green (four blinks during bootup)	Reset button has been pushed during the bootup.
	Off	After powering up, when FPGA is being downloaded (in ROMMON).
ACT	Green	Network activity on FE Switch ports, GE WAN port, 3G cellular interface, and serial interfaces.
	Off	No network activity.

LED	Color	Description
WWAN	Green	Module is powered on and connected but not transmitting or receiving.
	Green (slow blinking)	Module is powered on and searching for connection.
	Green (fast blinking)	Module is transmitting or receiving.
	Off	Module is not powered.
GPS	Green (solid)	Standalone GPS.
	Green (slow blinking)	GPS is acquiring.
	Yellow (solid)	Assisted GPS.
	Yellow (slow blinking)	Assisted GPS is acquiring.
	Off	GPS is not configured.
RSSI	Green (solid)	Signal > -60 Very strong signal
	Green (four blinks and then a long pause)	Signal <= -60 to 74 Strong signal
	Green (two blinks and then a long pause)	Signal <= -75 to -89 Fair signal
	Green (one blink and then a long pause)	Signal <= -90 to -109 Marginal signal
	Off	Signal <= -110 Unusable signal

LED	Color	Description
SIM ^{8,9}	Green / Yellow (one green blink followed by two yellow blinks)	SIM in slot 0 active, SIM in slot 1 is not.
	Yellow / Green (one yellow blink followed by two greenblinks)	SIM in slot 1 active, SIM in slot 0 is not.
	Off / Green (two green blinks and then pause)	No SIM in slot 0, SIM present in slot 1.
	Green / Off (Slow single green blink and then pause)	SIM present in slot0, no SIM in slot 1.
	Off / Off	No SIM present in either slots.
3G	One blink green and then pause	For 1xRTT, EGPRS, GPRS service.
	Two blink green and then pause	For EVDO, EVDO/1xRTT, UMTS.
	Three blink green and then pause	For EVDO/1xRTT RevA, HSPA, HSUPA/HSDPA.
	Green (solid)	For HSPA PLUS.

⁸ Not applicable to Verizon and Sprint EVDO modems.

⁹ There is only one LED to indicate the status two SIMs. A one-blink pattern represents the status of the SIM in slot 0, followed by a two-blink pattern for the SIM in slot 1.

Use the following show commands to check the LED status for your router:

- **show platform led** (for all LEDs)
- **show controller cellular 0** (for 3G LEDs)

The following is a sample output from the show platform led command and shows the LED status:

```
Router# show platform led
LED STATUS:
=====
LEDS : SYSTEM   WWAN           RSSI           GPS
STATUS: GREEN   GREEN           GREEN (2 BLINK) OFF
LEDS : ACTIVITY SIM(slot0 / slot1) 3G
STATUS: OFF     GREEN / YELLOW  GREEN
LAN PORTS      : FE0      FE1      FE2      FE3
LINK/ENABLE LED : OFF      OFF      OFF      OFF
SPEED LED      : Unknown Unknown Unknown Unknown
PORT           : GE-WAN0
LINK/ENABLE LED : OFF
SPEED LED      : Unknown
```

The following is a sample output from the show controllers cellular command showing the 3G LED status:

```
Router# show controllers cellular 0
Interface Cellular0
```

Enter the following commands in global configuration mode on the router's Cisco IOS command-line interface (CLI).

SUMMARY STEPS

1. **interface wlan-ap0**
2. **ip address *subnet mask***
3. **no shut**
4. **interface vlan1**
5. **ip address *subnet mask***
6. **exit**
7. **exit**
8. **service-module wlan-ap 0 session**

DETAILED STEPS

	Command or Action	Purpose
Step 1	interface wlan-ap0 Example: Router(config)# interface wlan-ap0	Defines the router's console interface to the wireless device. <ul style="list-style-type: none"> • The interface is used for communication between the router's console and the wireless device. Note Always use port 0. <ul style="list-style-type: none"> • The following message appears: The wlan-ap 0 interface is used for managing the embedded AP. Please use the service-module wlan-ap 0 session command to console into the embedded AP.
Step 2	ip address <i>subnet mask</i> Example: Router(config-if)# ip address 10.21.0.20 255.255.255.0	Specifies the interface IP address and subnet mask. Note The IP address can be shared with the IP address assigned to the Cisco Integrated Services Router by using the ip unnumbered vlan1 command.
Step 3	no shut Example: Router(config-if)# no shut	Specifies that the internal interface connection will remain open.
Step 4	interface vlan1 Example: Router(config-if)# interface vlan1	Specifies the virtual LAN interface for data communication on the internal Gigabit Ethernet 0 (GE0) port to other interfaces. <ul style="list-style-type: none"> • All the switch ports inherit the default vlan1 interface on the Cisco 860 Series, Cisco 880 Series, and Cisco 890 Series ISRs.

	Command or Action	Purpose
Step 5	ip address <i>subnet mask</i> Example: <pre>Router(config-if)# ip address 10.10.0.30 255.255.255.0</pre>	Specifies the interface IP address and subnet mask.
Step 6	exit Example: <pre>Router(config-if)# exit</pre> Example: <pre>Router(config)#</pre>	Exits interface configuration mode and returns to global configuration mode.
Step 7	exit Example: <pre>Router(config)# exit</pre>	Exits the global configuration mode.
Step 8	service-module wlan-ap 0 session Example: <pre>Router# service-module wlan-ap0 session Trying 10.21.0.20, 2002 ... Open ap></pre>	Opens the connection between the wireless device and the router's console.

What to Do Next



Tip

To create a Cisco IOS software alias for the console to session into the wireless device, enter the **alias exec dot11radio service-module wlan-ap 0 session** command at the EXEC prompt. After entering this command, you automatically skip to the **dot11 radio** level in the Cisco IOS software.

Closing the Session

To close the session between the wireless device and the router's console, use control+shift+6 and x on the wireless device and enter **disconnect** command on the router and then press enter two times on the router.

Configuring Wireless Settings

**Note**

If you are configuring the wireless device for the first time, you must start a configuration session between the access point and the router before you attempt to configure the basic wireless settings. See the [Starting a Wireless Configuration Session](#), on page 208.

Configure the wireless device with either of the following tools, depending on the software you are using:

- [Cisco IOS Command Line Interface](#), on page 211—Autonomous software
- [Cisco Express Setup](#), on page 211—Unified Software

**Note**

To upgrade to Unified mode from the Autonomous mode, see [Upgrading to Cisco Unified Software](#), on page 216 for upgrade instructions. After upgrading to Cisco Unified Wireless software, use the web-browser tool to configure the device:

http://cisco.com/en/US/docs/wireless/access_point/12.4_10b_JA/configuration/guide/scg12410b-chap2-gui.html

Cisco Express Setup

To configure the Unified wireless device, use the web-browser tool and perform these steps

- 1 Establish a console connection to the wireless device and get the Bridge-Group Virtual Interface (BVI) IP address by entering the **show interface bvi1 Cisco IOS** command.
- 2 Open a browser window, and enter the BVI IP address in the browser-window address line. Press Enter. An Enter Network Password window appears.
- 3 Enter your username. *Cisco* is the default user name.
- 4 Enter the wireless device password. *Cisco* is the default password. The Summary Status page appears. For details about using the web-browser configuration page, see the following URL:

http://cisco.com/en/US/docs/wireless/access_point/12.4_10b_JA/configuration/guide/scg12410b-chap4-first.html#wp1103336

Cisco IOS Command Line Interface

To configure the Autonomous wireless device, use the Cisco IOS CLI tool and perform these tasks:

Configuring the Radio

Configure the radio parameters on the wireless device to transmit signals in autonomous or Cisco Unified mode. For specific configuration procedures, see [Configuring Radio Settings](#), on page 220.

Configuring Wireless Security Settings

This section includes the following configuration tasks:

Configuring Authentication

Authentication types are tied to the Service Set Identifiers (SSIDs) that are configured for the access point. To serve different types of client devices with the same access point, configure multiple SSIDs.

Before a wireless client device can communicate on your network through the access point, the client device must authenticate to the access point by using open or shared-key authentication. For maximum security, client devices should also authenticate to your network using MAC address or Extensible Authentication Protocol (EAP) authentication. Both authentication types rely on an authentication server on your network.

To select an authentication type, see *Authentication Types for Wireless Devices* at:

<http://www.cisco.com/en/US/docs/routers/access/wireless/software/guide/SecurityAuthenticationTypes.html>.

To set up a maximum security environment, see *RADIUS and TACACS+ Servers in a Wireless Environment* at:

http://www.cisco.com/en/US/docs/routers/access/wireless/software/guide/SecurityRadiusTacacs_1.html

To provide local authentication service or backup authentication service for a WAN link failure or a server failure, you can configure an access point to act as a local authentication server. The access point can authenticate up to 50 wireless client devices using Lightweight Extensible Authentication Protocol (LEAP), Extensible Authentication Protocol-Flexible Authentication via Secure Tunneling (EAP-FAST), or MAC-based authentication. The access point performs up to five authentications per second.

Configure the local authenticator access point manually with client usernames and passwords because it does not synchronize its database with RADIUS servers. You can specify a VLAN and a list of SSIDs that a client is allowed to use.

For details about setting up the wireless device in this role, see *Using the Access Point as a Local Authenticator* at:

<http://www.cisco.com/en/US/docs/routers/access/wireless/software/guide/SecurityLocalAuthent.html>

Configuring WEP and Cipher Suites

Wired Equivalent Privacy (WEP) encryption scrambles the data transmitted between wireless devices to keep the communication private. Wireless devices and their wireless client devices use the same WEP key to encrypt and decrypt data. WEP keys encrypt both unicast and multicast messages. Unicast messages are addressed to one device on the network. Multicast messages are addressed to multiple devices on the network.

Cipher suites are sets of encryption and integrity algorithms designed to protect radio communication on your wireless LAN. You must use a cipher suite to enable Wi-Fi Protected Access (WPA) or Cisco Centralized Key Management (CCKM).

Cipher suites that contain Temporal Key Integrity Protocol (TKIP) provide the greatest security for your wireless LAN. Cipher suites that contain only WEP are the least secure.

For encryption procedures, see *Configuring WEP and Cipher Suites* at:

<http://www.cisco.com/en/US/docs/routers/access/wireless/software/guide/SecurityCipherSuitesWEP.html>

Configuring Wireless VLANs and Assigning SSIDs

If you use VLANs on your wireless LAN and assign SSIDs to VLANs, you can create multiple SSIDs by using any of the four security settings defined in the [Table 25: Types of SSID Security](#), on page 213. A VLAN can be thought of as a broadcast domain that exists within a defined set of switches. A VLAN consists of a number of end systems, either hosts or network equipment (such as bridges and routers), that are connected by a single bridging domain. The bridging domain is supported on various pieces of network equipment, such as LAN switches that operate bridging protocols between them with a separate group of protocols for each VLAN.

For more information about wireless VLAN architecture, see *Configuring Wireless VLANs* at:

http://www.cisco.com/en/US/docs/routers/access/wireless/software/guide/wireless_vlans.html



Note

If you do not use VLANs on your wireless LAN, the security options that you can assign to SSIDs are limited because the encryption settings and authentication types are linked on the Express Security page.

You can configure up to 16 SSIDs on a wireless device in the role of an access point, and you can configure a unique set of parameters for each SSID. For example, you might use one SSID to allow guests limited access to the network and another SSID to allow authorized users access to secure data.

For more about creating multiple SSIDs, see *Service Set Identifiers* at:

<http://www.cisco.com/en/US/docs/routers/access/wireless/software/guide/ServiceSetID.html>.



Note

Without VLANs, encryption settings (WEP and ciphers) apply to an interface, such as the 2.4-GHz radio, and you cannot use more than one encryption setting on an interface. For example, when you create an SSID with static WEP with VLANs disabled, you cannot create additional SSIDs with WPA authentication because the SSIDs use different encryption settings. If the security setting for an SSID conflicts with the settings for another SSID, delete one or more SSIDs to eliminate the conflict.

Security Types

[Table 25: Types of SSID Security](#), on page 213 describes the four security types that you can assign to an SSID.

Table 25: Types of SSID Security

Security Type	Description	Security Features Enabled
No security	This is the least secure option. You should use this option only for SSIDs in a public space, and you should assign it to a VLAN that restricts access to your network.	None.

Security Type	Description	Security Features Enabled
Static WEP key	<p>This option is more secure than no security. However, static WEP keys are vulnerable to attack. If you configure this setting, you should consider limiting association to the wireless device based on MAC address, see <i>Cipher Suites and WEP</i> at: http://www.cisco.com/en/US/docs/routers/access/wireless/software/guide/SecurityCipherSuitesWEP.html. Or</p> <p>If your network does not have a RADIUS server, consider using an access point as a local authentication server. See <i>Using the Access Point as a Local Authenticator</i> for instructions: http://www.cisco.com/en/US/docs/routers/access/wireless/software/guide/SecurityLocalAuthent.html.</p>	Mandatory WEP. Client devices cannot associate using this SSID without a WEP key that matches the wireless device key.
EAP ¹⁰ authentication	<p>This option enables 802.1X authentication (such as LEAP¹¹, PEAP¹², EAP-TLS¹³, EAP-FAST¹⁴, EAP-TTLS¹⁵, EAP-GTC¹⁶, EAP-SIM¹⁷, and other 802.1X/EAP-based products)</p> <p>This setting uses mandatory encryption, WEP, open authentication plus EAP, network EAP authentication, no key management, and RADIUS server authentication port 1645.</p> <p>You are required to enter the IP address and shared secret for an authentication server on your network (server authentication port 1645). Because 802.1X authentication provides dynamic encryption keys, you do not need to enter a WEP key.</p>	<p>Mandatory 802.1X authentication. Client devices that associate using this SSID must perform 802.1X authentication.</p> <p>If radio clients are configured to authenticate using EAP-FAST, open authentication with EAP should also be configured. If you do not configure open authentication with EAP, the following warning message appears:</p> <pre>SSID CONFIG WARNING: [SSID]: If radio clients are using EAP-FAST, AUTH OPEN with EAP should also be configured.</pre>

Security Type	Description	Security Features Enabled
WPA ¹⁸	<p>This option permits wireless access to users who are authenticated against a database. Access is through the services of an authentication server. User IP traffic is then encrypted with stronger algorithms than those used in WEP.</p> <p>This setting uses encryption ciphers, TKIP¹⁹, open authentication plus EAP, network EAP authentication, key management WPA mandatory, and RADIUS server authentication port 1645.</p> <p>As with EAP authentication, you must enter the IP address and shared secret for an authentication server on your network (server authentication port 1645).</p>	<p>Mandatory WPA authentication. Client devices that associate using this SSID must be WPA capable.</p> <p>If radio clients are configured to authenticate using EAP-FAST, open authentication with EAP should also be configured. If you do not configure open authentication with EAP, the following warning message appears:</p> <pre>SSID CONFIG WARNING: [SSID]: If radio clients are using EAP-FAST, AUTH OPEN with EAP should also be configured.</pre>

¹⁰ EAP = Extensible Authentication Protocol.

¹¹ LEAP = Lightweight Extensible Authentication Protocol.

¹² PEAP = Protected Extensible Authentication Protocol.

¹³ EAP-TLS = Extensible Authentication Protocol—Transport Layer Security.

¹⁴ EAP-FAST = Extensible Authentication Protocol—Flexible Authentication via Secure Tunneling.

¹⁵ EAP-TTLS = Extensible Authentication Protocol—Tunneled Transport Layer Security.

¹⁶ EAP-GTC = Extensible Authentication Protocol—Generic Token Card.

¹⁷ EAP-SIM = Extensible Authentication Protocol—Subscriber Identity Module.

¹⁸ WPA = Wi-Fi Protected Access.

¹⁹ TKIP = Temporal Key Integrity Protocol.

Configuring Wireless Quality of Service

Configuring Quality of Service (QoS) can provide preferential treatment to certain traffic at the expense of other traffic. Without QoS, the device offers best-effort service to each packet, regardless of the packet contents or size. It sends the packets without any assurance of reliability, delay bounds, or throughput. To configure QoS for your wireless device, see *Quality of Service in a Wireless Environment* at:

<http://www.cisco.com/en/US/docs/routers/access/wireless/software/guide/QualityOfService.html>.

Configuring the Access Point in Hot Standby Mode

In hot standby mode, an access point is designated as a backup for another access point. The standby access point is placed near the access point that it monitors and is configured exactly like the monitored access point. The standby access point associates with the monitored access point as a client and sends Internet Access Point Protocol (IAPP) queries to the monitored access point through the Ethernet and radio ports. If the monitored access point fails to respond, the standby access point comes online and takes the monitored access point's place in the network.

Except for the IP address, the standby access point's settings should be identical to the settings on the monitored access point. If the monitored access point goes off line and the standby access point takes its place in the

network, matching settings ensure that client devices can switch easily to the standby access point. For more information, see *Hot Standby Access Points* at:

<http://www.cisco.com/en/US/docs/routers/access/wireless/software/guide/RolesHotStandby.html>.

Upgrading to Cisco Unified Software

To run the access point in Cisco Unified mode, upgrade the software by performing the following procedures:

Software Prerequisites

- Cisco 890 Series ISRs with embedded access points can be upgraded from autonomous software to Cisco Unified software, if the router is running the IP Base feature set and Cisco IOS 12.4(22)YB software.
- Cisco 880 Series ISRs with embedded access points can be upgraded from autonomous software to Cisco Unified software, if the router is running the advipservices feature set and Cisco IOS 12.4(20)T software.
- To use the embedded access point in a Cisco Unified Architecture, the Cisco Wireless LAN Configuration (WLC) must be running version 5.1 or later.

Preparing for the Upgrade

Perform the tasks in the following sections to prepare for the upgrade:

Secure an IP Address on the Access Point

Secure an IP address on the access point so it that can communicate with the WLC and download the Unified image upon boot up. The host router provides the access point DHCP server functionality through the DHCP pool. The access point then communicates with the WLC and setup option 43 for the controller IP address in the DHCP pool configuration.

Example Configuration: Secure an IP Address on the Access Point

The following example shows a sample configuration:

```
ip dhcp pool embedded-ap-pool
network 60.0.0.0 255.255.255.0
dns-server 171.70.168.183
default-router 60.0.0.1
option 43 hex f104.0a0a.0a0f (single WLC IP address(10.10.10.15) in hex format)
int vlan1
ip address 60.0.0.1 255.255.255.0
```

For more information about the WLC discovery process, see Cisco Wireless LAN Configuration Guide at: <http://www.cisco.com/en/US/docs/wireless/controller/4.0/configuration/guide/ccfig40.html>

Confirm that the Mode Setting is Enabled

To confirm that the mode setting is enabled, perform the following steps.

- 1 Ping the WLC from the router to confirm IP connectivity.
- 2 Enter the **service-module wlan-ap 0 session** command to establish a session into the access point.
- 3 Confirm that the access point is running an autonomous boot image.
- 4 Enter the show boot command on the access point to confirm that the mode setting is enabled.

```
Autonomous-AP# show boot
BOOT path-list:      flash:ap801-k9w7-mx.124-10b.JA3/ap801-k9w7-mx.124-10b.JA3
Config file:        flash:/config.txt
Private Config file: flash:/private-config
Enable Break:       yes
Manual Boot:        yes
HELPER path-list:
NVRAM/Config file
buffer size:        32768
Mode Button:        on
```

Performing the Upgrade

To upgrade the autonomous software to Cisco Unified software, follow these steps:

- 1 To change the access point boot image to a Cisco Unified upgrade image (also known as a *recovery image*), use the **service-module wlan-ap 0 bootimage unified** command, in global configuration mode.

```
Router# conf terminal
Router(config)# service-module wlan-ap 0 bootimage unified
Router(config)# end
```



Note If the **service-module wlan-ap 0 bootimage unified** command does not work successfully, check whether the software license is still eligible.



Note To identify the access point's boot image path, use the **show boot** command in privileged EXEC mode on the access point console.

- 2 To perform a graceful shutdown and reboot of the access point to complete the upgrade process, use the **service-module wlan-ap 0 reload** command in global configuration mode. Establish a session into the access point, and monitor the upgrade process.



Note See the [Cisco Express Setup, on page 211](#) for details about using the GUI configuration page to set up the wireless device settings.

Troubleshooting an Upgrade or Reverting the AP to Autonomous Mode

If the access point fails to upgrade from autonomous to Unified software, perform the following actions:

- Check to ensure the autonomous access point does not have the static IP address configured on the BVI interface before you boot the recovery image.
- Ping between the router/access point and the WLC to confirm communication.
- Check that the access point and WLC clock (time and date) are set correctly.

The access point may attempt to boot and fail or may become stuck in the recovery mode and fail to upgrade to the Unified software. If either one of this occurs, use the **service-module wlan-ap0 reset bootloader** command to return the access point to the bootloader for manual image recovery.

Downgrading the Software on the Access Point

To reset the access point boot to the last autonomous image, use the **service-module wlan-ap0 bootimage autonomous** command in global configuration mode. To reload the access point with the autonomous software image, use the **service-module wlan-ap 0 reload** command.

Recovering Software on the Access Point

To recover the image on the access point, use the **service-module wlan-ap0 reset bootloader** command in global configuration mode. This command returns the access point to the bootloader for manual image recovery.



Caution

Use this command with caution. It does not provide an orderly shutdown and consequently may impact file operations that are in progress. Use this command only to recover from a shutdown or a failed state.

Related Documentation

See the following documentation for additional autonomous and unified configuration procedures:

Table 26: Autonomous Cisco Documentation

Topic	Links
Wireless Overview	Wireless Device Overview , on page 201
Configuring the Radio	Configuring Radio Settings , on page 220
<i>Authentication Types for Wireless Devices</i>	This document describes the authentication types that are configured on the access point. http://www.cisco.com/en/US/docs/routers/access/wireless/software/guide/SecurityAuthenticationTypes.html
<i>RADIUS and TACACS+ Servers in a Wireless Environment</i>	This document describes how to enable and configure the RADIUS and TACACS+ and provides detailed accounting information and flexible administrative control over authentication and authorization processes. RADIUS and TACACS+ are facilitated through AAA ²⁰ and can be enabled only through AAA commands. http://www.cisco.com/en/US/docs/routers/access/wireless/software/guide/SecurityRadiusTacacs_1.html

Topic	Links
<i>Using the Access Point as a Local Authenticator</i>	<p>This document describes how to use a wireless device in the role of an access point as a local authenticator, serving as a standalone authenticator for a small wireless LAN, or providing backup authentication service. As a local authenticator, the access point performs LEAP, EAP-FAST, and MAC-based authentication for up to 50 client devices.</p> <p>http://www.cisco.com/en/US/docs/routers/access/wireless/software/guide/SecurityLocalAuthent.html</p>
<i>Cipher Suites and WEP</i>	<p>This document describes how to configure the cipher suites required for using WPA and CCKM²¹; WEP; and WEP features including AES²², MIC²³, TKIP, and broadcast key rotation.</p> <p>http://www.cisco.com/en/US/docs/routers/access/wireless/software/guide/SecurityCipherSuitesWEP.html</p>
<i>Hot Standby Access Points</i>	<p>This document describes how to configure your wireless device as a hot standby unit.</p> <p>http://www.cisco.com/en/US/docs/routers/access/wireless/software/guide/RolesHotStandby.html</p>
Configuring Wireless VLANs	<p>This document describes how to configure an access point to operate with the VLANs set up on a wired LAN.</p> <p>http://www.cisco.com/en/US/docs/routers/access/wireless/software/guide/wireless_vlans.html</p>
<i>Service Set Identifiers</i>	<p>In the role of an access point, a wireless device can support up to 16 SSIDs. This document describes how to configure and manage SSIDs on the wireless device.</p> <p>http://www.cisco.com/en/US/docs/routers/access/wireless/software/guide/ServiceSetID.html</p>
Administering the Access Point	<p>Administering the Wireless Device, on page 293</p>
Quality of Service	<p>This document describes how to configure QoS on your Cisco wireless interface. With this feature, you can provide preferential treatment to certain traffic at the expense of other traffic. Without QoS, the device offers best-effort service to each packet, regardless of the packet contents or size. It sends the packets without any assurance of reliability, delay bounds, or throughput.</p> <p>http://www.cisco.com/en/US/docs/routers/access/wireless/software/guide/QualityOfService.html</p>

Topic	Links
Regulatory Domains and Channels	This document lists the radio channels supported by Cisco access products in the regulatory domains of the world. http://www.cisco.com/en/US/customer/docs/routers/access/wireless/software/guide/RadioChannelFrequencies.html
System Message Logging	This document describes how to configure system message logging on your wireless device. http://www.cisco.com/en/US/docs/routers/access/wireless/software/guide/SysMsgLogging.html

²⁰ AAA = Authentication, Authorization, and Accounting.

²¹ CCKM = Cisco Centralized Key Management.

²² AES = Advanced Encryption Standard.

²³ MIC = Message Integrity Check.

Table 27: Cisco Unified Documentation

Network Design	Links
Why Migrate to the Cisco Unified Wireless Network?	http://www.cisco.com/en/US/solutions/ns175/networking_solutions_products_genericcontent0900aecd805299ff.html
<i>Wireless LAN Controller (WLC) FAQ</i>	http://www.cisco.com/en/US/products/ps6366/products_qanda_item09186a008064a991.shtml
<i>Cisco IOS Command Reference for Cisco Aironet Access Points and Bridges, versions 12.4(10b) JA and 12.3(8) JEC</i>	http://www.cisco.com/en/US/docs/wireless/access_point/12.4_10b_JA/command/reference/cr2410b.html
<i>Cisco Aironet 1240AG Access Point Support Documentation</i>	http://www.cisco.com/en/US/docs/wireless/access_point/1240/quick/guide/ap1240qs.html
<i>Cisco 4400 Series Wireless LAN Controllers Support Documentation</i>	http://www.cisco.com/en/US/products/ps6366/tsd_products_support_series_home.html

Configuring Radio Settings

This section describes how to configure radio settings for the wireless device and includes the following sub sections:

Enabling the Radio Interface

The wireless device radios are disabled by default.

**Note**

You must create a service set identifier (SSID) before you can enable the radio interface.

To enable the access point radio, follow these steps, beginning in privileged EXEC mode:

SUMMARY STEPS

1. **configure terminal**
2. **dot11 ssid *ssid***
3. **interface dot11radio {0}**
4. **ssid *ssid***
5. **no shutdown**
6. **end**
7. **copy running-config startup-config**

DETAILED STEPS

	Command or Action	Purpose
Step 1	configure terminal	Enters global configuration mode.
Step 2	dot11 ssid <i>ssid</i>	Enters the SSID. Note The SSID consists of up to 32 alphanumeric characters. SSIDs are case sensitive.
Step 3	interface dot11radio {0}	Enters interface configuration mode for the radio interface. The 2.4-GHz and 802.11g/n 2.4-GHz radios are radio 0.
Step 4	ssid <i>ssid</i>	Assigns the SSID that you created in Step 2 to the appropriate radio interface.
Step 5	no shutdown	Enables the radio port. Note Use the shutdown command to disable the radio port.
Step 6	end	Returns to privileged EXEC mode.
Step 7	copy running-config startup-config	(Optional) Saves your entries in the configuration file.

Wireless Device Roles in a Radio Network

The wireless device radio performs the following roles in the wireless network:

- Access point
- Access point (fallback to radioP shutdown)
- Root bridge

- Non-root bridge
- Root bridge with wireless clients
- Non-root bridge without wireless clients

You can also configure a fallback role for root access points. The wireless device automatically assumes the fallback role when its Ethernet port is disabled or disconnected from the wired LAN. The default fallback role for Cisco ISR wireless devices is shutdown, that is the wireless device shuts down its radio and disassociates all client devices.

Configuring the Wireless Device Roles in a Radio Network

To set the wireless device's radio network role and fallback role, follow these steps, beginning in privileged EXEC mode:

SUMMARY STEPS

1. **configure terminal**
2. **interface dot11radio {0}**
3. **station-role non-root {bridge | wireless-clients} root {access-point | ap-only | [bridge | wireless-clients] | [fallback | repeater | shutdown]} workgroup-bridge {multicast | mode { client | infrastructure} | universal *Ethernet-client-MAC-address* }**
4. **end**
5. **copy running-config startup-config**

DETAILED STEPS

	Command or Action	Purpose
Step 1	configure terminal	Enters global configuration mode.
Step 2	interface dot11radio {0}	Enters interface configuration mode for the radio interface. The 2.4-GHz and 802.11g/n 2.4-GHz radios are radio 0
Step 3	station-role non-root {bridge wireless-clients} root {access-point ap-only [bridge wireless-clients] [fallback repeater shutdown]} workgroup-bridge {multicast mode { client infrastructure} universal <i>Ethernet-client-MAC-address</i> }	<p>Sets the wireless device role.</p> <ul style="list-style-type: none"> • Sets the role to non-root bridge with or without wireless clients, to root access point or bridge, or to workgroup bridge. <p>Note The bridge mode radio supports point-to-point configuration only.</p> <p>Note The repeater and wireless-clients commands are not supported on Cisco 860 Series, Cisco 880 Series Integrated Services Routers.</p> <p>Note The scanner command is not supported on Cisco 860 Series Cisco 880 Series Integrated Services Routers.</p> <ul style="list-style-type: none"> • The Ethernet port is shut down when any one of the radios is configured as a repeater. Only one radio per access point may be configured as a workgroup bridge or repeater. A workgroup bridge can have a maximum of 25 clients, presuming that no other wireless clients are associated to the root bridge or access point.

	Command or Action	Purpose
Step 4	end	Returns to privileged EXEC mode.
Step 5	copy running-config startup-config	(Optional) Saves your entries in the configuration file.

What to Do Next



Note

When you enable the role of a device in the radio network as a bridge or workgroup bridge and enable the interface using the no shut command, the physical status and the software status of the interface will be up (ready) only if the device on the other end (access point or bridge) is up. Otherwise, only the physical status of the device will be up. The software status will be up when the device on the other end is configured and ready.

Configuring Dual-Radio Fallback

The dual-radio fallback features allows you to configure access points so that if the non-root bridge link connecting the access point to the network infrastructure goes down, the root access point link through which a client connects to the access point shut down. Shutting down the root access point link causes the client to roam to another access point. Without this feature, the client remains connected to the access point, but won't be able to send or receive data from the network.

You can configure dual-radio fallback in three ways:

Radio Tracking

You can configure the access point to track or monitor the status of one of its radios. If the tracked radio goes down or is disabled, the access point shuts down the other radio. If the tracked radio comes up, the access point enables the other radio.

To track radio 0, enter the following command:

```
# station-role root access-point fallback track d0 shutdown
```

Fast Ethernet Tracking

You can configure the access point for fallback when its Ethernet port is disabled or disconnected from the wired LAN. For guidance on configuring the access point for Fast Ethernet tracking, see the [Wireless Device Roles in a Radio Network](#), on page 221.



Note

Fast Ethernet tracking does not support the repeater mode.

To configure the access point for Fast Ethernet tracking, enter the following command:

```
# station-role root access-point fallback track fa 0
```

MAC-Address Tracking

You can configure the radio whose role is root access point to come up or go down by tracking a client access point, using its MAC address, on another radio. If the client disassociates from the access point, the root access point radio goes down. If the client reassociates to the access point, the root access point radio comes back up.

MAC-address tracking is most useful when the client is a non-root bridge access point connected to an upstream wired network.

For example, to track a client whose MAC address is 12:12:12:12:12:12, enter the following command:

```
# station-role root access-point fallback track mac-address 12:12:12:12:12:12 shutdown
```

Overview of Radio Data Rates

You use the data rate settings to choose the data rates that the wireless device uses for data transmission. The rates are expressed in megabits per second (Mb/s). The wireless device always attempts to transmit at the highest data rate set to **basic**, also known as **required** on the browser-based interface. If there are obstacles or interference, the wireless device steps down to the highest rate that allows data transmission. You can set each data rate to one of three states:

- **Basic** (the GUI labels Basic rates as Required)—Allows transmission at this rate for all packets, both unicast and multicast. At least one of the data rates of the wireless device must be set to basic.
- **Enabled**—The wireless device transmits only unicast packets at this rate; multicast packets are sent at one of the data rates set to basic.
- **Disabled**—The wireless device does not transmit data at this rate.



Note

At least one data rate must be set to **basic**.

You can use the data rate settings to set an access point to serve client devices operating at specific data rates. For example, to set the 2.4-GHz radio for 11 Mb/s service only, set the 11-Mb/s rate to **basic**, and set the other data rates to **disabled**. To set the wireless device to serve only client devices operating at 1 and 2 Mb/s, set 1 and 2 to **basic**, and set the rest of the data rates to **disabled**. To set the 2.4-GHz, 802.11g radio to serve only 802.11g client devices, set any orthogonal frequency division multiplexing (OFDM) data rate (6, 9, 12, 18, 24, 36, 48, 54) to **basic**. To set the 5-GHz radio for 54-Mb/s service only, set the 54-Mb/s rate to **basic**, and set the other data rates to **disabled**.

You can configure the wireless device to set the data rates automatically to optimize either the range or the throughput. When you enter **range** for the data rate setting, the wireless device sets the 1-Mb/s rate to **basic** and sets the other rates to **enabled**. The range setting allows the access point to extend the coverage area by compromising on the data rate. Therefore, if you have a client that cannot connect to the access point although other clients can, the client might not be within the coverage area of the access point. In such a case, using the range option will help extend the coverage area, and the client may be able to connect to the access point.

Typically, the trade-off is between throughput and range. When the signal degrades (possibly due to distance from the access point), the rates renegotiate in order to maintain the link (but at a lower data rate). A link that is configured for a higher throughput simply drops when the signal degrades enough that it no longer sustains a configured high data rate, or the link roams to another access point with sufficient coverage, if one is available. The balance between the two (throughput vs. range) is a design decision that must be made based on resources available to the wireless project, the type of traffic the users will be passing, the service level desired, and as always, the quality of the RF environment. When you enter **throughput** for the data rate setting, the wireless device sets all four data rates to **basic**.

**Note**

When a wireless network has a mixed environment of 802.11b clients and 802.11g clients, make sure that data rates 1, 2, 5.5, and 11 Mb/s are set to **required (basic)** and that all other data rates are set to **enable**. The 802.11b adapters do not recognize the 54 Mb/s data rate and do not operate if data rates higher than 11 Mb/s are set to **required** on the connecting access point.

Configuring Radio Data Rates

To configure the radio data rates, follow these steps, beginning in privileged EXEC mode:

SUMMARY STEPS

1. **configure terminal**
2. **interface dot11radio {0}**
3. **speed**
 - 802.11b, 2.4-GHz radio:

```
{[1.0] [11.0] [2.0] [5.5] [basic-1.0] [basic-11.0] [basic-2.0] [basic-5.5] | range | throughput}
```
 - 802.11g, 2.4-GHz radio:

```
{[1.0] [2.0] [5.5] [6.0] [9.0] [11.0] [12.0] [18.0] [24.0] [36.0] [48.0] [54.0] [basic-1.0] [basic-2.0] [basic-5.5] [basic-6.0] [basic-9.0] [basic-11.0] [basic-12.0] [basic-18.0] [basic-24.0] [basic-36.0] [basic-48.0] [basic-54.0] | range | throughput [ofdm] | default}
```
 - 802.11a 5-GHz radio:

```
{[6.0] [9.0] [12.0] [18.0] [24.0] [36.0] [48.0] [54.0] [basic-6.0] [basic-9.0] [basic-12.0] [basic-18.0] [basic-24.0] [basic-36.0] [basic-48.0] [basic-54.0] | range | throughput | ofdm-throughput | default}
```
 - 802.11n 2.4-GHz radio:

```
{[1.0] [11.0] [12.0] [18.0] [2.0] [24.0] [36.0] [48.0] [5.5] [54.0] [6.0] [9.0] [basic-1.0] [basic-11.0] [basic-12.0] [basic-18.0] [basic-24.0] [basic-36.0] [basic-48.0] [basic-5.5] [basic-54.0] [basic-6.0] [basic-9.0] [default] [m0-7] [m0.] [m1.] [m10.] [m11.] [m12.] [m13.] [m14.] [m15.] [m2.] [m3.] [m4.] [m5.] [m6.] [m7.] [m8-15] [m8.] [m9.] [ofdm] [only-ofdm] | range | throughput}
```
4. **end**
5. **copy running-config startup-config**

DETAILED STEPS

	Command or Action	Purpose
Step 1	<code>configure terminal</code>	Enters global configuration mode.
Step 2	<code>interface dot11radio {0}</code>	Enters interface configuration mode for the radio interface. The 2.4-GHz and the 802.11g/n 2.4-GHz radios are radio 0.
Step 3	<p><code>speed</code></p> <ul style="list-style-type: none"> 802.11b, 2.4-GHz radio: <code>{[1.0] [11.0] [2.0] [5.5] [basic-1.0] [basic-11.0] [basic-2.0] [basic-5.5] range throughput}</code> 802.11g, 2.4-GHz radio: <code>{[1.0] [2.0] [5.5] [6.0] [9.0] [11.0] [12.0] [18.0] [24.0] [36.0] [48.0] [54.0] [basic-1.0] [basic-2.0] [basic-5.5] [basic-6.0] [basic-9.0] [basic-11.0] [basic-12.0] [basic-18.0] [basic-24.0] [basic-36.0] [basic-48.0] [basic-54.0] range throughput [ofdm] default}</code> 802.11a 5-GHz radio: <code>{[6.0] [9.0] [12.0] [18.0] [24.0] [36.0] [48.0] [54.0] [basic-6.0] [basic-9.0] [basic-12.0] [basic-18.0] [basic-24.0] [basic-36.0] [basic-48.0] [basic-54.0] range throughput ofdm-throughput default}</code> 802.11n 2.4-GHz radio: <code>{[1.0] [11.0] [12.0] [18.0] [2.0] [24.0] [36.0] [48.0] [5.5] [54.0] [6.0] [9.0] [basic-1.0] [basic-11.0] [basic-12.0] [basic-18.0] [basic-24.0] [basic-36.0] [basic-48.0] [basic-5.5] [basic-54.0] [basic-6.0] basic-9.0] [default] [m0-7] [m0.] [m1.] [m10.] [m11.] [m12.] [m13.] [m14.] [m15.] [m2.] [m3.] [m4.] [m5.] [m6.] [m7.] [m8-15] [m8.] [m9.] [ofdm] [only-ofdm] range throughput}</code> 	<p>Sets each data rate to basic or enabled, or enters range to optimize range or enters throughput to optimize throughput.</p> <ul style="list-style-type: none"> (Optional) Enter 1.0, 2.0, 5.5, and 11.0 to set these data rates to enabled on the 802.11b, 2.4-GHz radio. <p>Enter 1.0, 2.0, 5.5, 6.0, 9.0, 11.0, 12.0, 18.0, 24.0, 36.0, 48.0, and 54.0 to set these data rates to enabled on the 802.11g, 2.4-GHz radio.</p> <p>Enter 6.0, 9.0, 12.0, 18.0, 24.0, 36.0, 48.0, and 54.0 to set these data rates to enabled on the 5-GHz radio.</p> <ul style="list-style-type: none"> (Optional) Enter basic-1.0, basic-2.0, basic-5.5, and basic-11.0 to set these data rates to basic on the 802.11b, 2.4-GHz radio. <p>Enter basic-1.0, basic-2.0, basic-5.5, basic-6.0, basic-9.0, basic-11.0, basic-12.0, basic-18.0, basic-24.0, basic-36.0, basic-48.0, and basic-54.0 to set these data rates to basic on the 802.11g, 2.4-GHz radio.</p> <p>Note If the client must support the basic rate that you select, it cannot associate to the wireless device. If you select 12-Mb/s or higher for the basic data rate on the 802.11g radio, 802.11b client devices cannot associate to the wireless device 802.11g radio. Enter basic-6.0, basic-9.0, basic-12.0, basic-18.0, basic-24.0, basic-36.0, basic-48.0, and basic-54.0 to set these data rates to basic on the 5-GHz radio.</p> <ul style="list-style-type: none"> (Optional) Enter range or throughput or <code>{[1.0] [11.0] [2.0] [5.5] [basic-1.0] [basic-11.0] [basic-2.0] [basic-5.5] range throughput}ofdm-throughput</code> (no ERP protection) to automatically optimize radio range or throughput. When you enter range, the wireless device sets the lowest data rate to basic and sets the other rates to enabled. When you enter throughput, the wireless device sets all data rates to basic. <p>(Optional) On the 802.11g radio, enter <code>speed throughput ofdm</code> to set all OFDM rates (6, 9, 12, 18, 24, 36, and 48) to basic (required) and to set all the CCK rates (1, 2, 5.5, and 11) to disabled. This setting disables 802.11b protection mechanisms and provides maximum throughput for 802.11g clients. However, it prevents 802.11b clients from associating to the access point.</p> <ul style="list-style-type: none"> (Optional) Enter default to set the data rates to factory default settings (not supported on 802.11b radios). <p>On the 802.11g radio, the default option sets rates 1, 2, 5.5, and 11 to basic, and sets rates 6, 9, 12, 18, 24, 36, 48, and 54 to enabled. These rate settings</p>

	Command or Action	Purpose
		<p>allow both 802.11b and 802.11g client devices to associate to the wireless device 802.11g radio.</p> <p>On the 5-GHz radio, the default option sets rates 6.0, 12.0, and 24.0 to basic, and ste rates 9.0, 18.0, 36.0, 48.0, and 54.0 to enabled.</p> <p>On the 802.11g/n 2.4-GHz radio, the default option sets rates 1.0, 2.0, 5.5, and 11.0 to enabled.</p> <p>On the 802.11g/n 5-GHz radio, the default option sets rates to 6.0, 12.0, and 24.0 to enabled.</p> <p>The modulation coding scheme (MCS) index range for both 802.11g/n radios is 0 to 15.</p>
Step 4	end	Returns to privileged EXEC mode.
Step 5	copy running-config startup-config	(Optional) Saves your entries in the configuration file.

Configuration Example: Configuring Radio Data Rates

This example shows how to configure data rates **basic-2.0** and **basic-5.5** from the configuration:

```
ap1200# configure terminal
ap1200(config)# interface dot11radio 0
ap1200(config-if)# speed basic-2.0 basic-5.5
ap1200(config-if)# end
```

Configuring MCS Rates

Modulation coding scheme (MCS) is a specification of PHY parameters consisting of modulation order (binary phase shift keying [BPSK], quaternary phase shift keying [QPSK], 16-quadrature amplitude modulation [16-QAM], 64-QAM) and forward error correction (FEC) code rate (1/2, 2/3, 3/4, 5/6). MCS is used in the wireless device 802.11n radios, which define 32 symmetrical settings (8 per spatial stream):

- MCS 0–7
- MCS 8–15
- MCS 16–23
- MCS 24–31

The wireless device supports MCS 0–15. High-throughput clients support at least MCS 0–7.

MCS is an important setting because it provides for potentially greater throughput. High-throughput data rates are a function of MCS, bandwidth, and guard interval. The 802.11a, b, and g radios use 20-MHz channel widths. [Table 28: Data Rates Based on MCS Settings, Guard Interval, and Channel Width](#), on page 228 shows potential data rates based on MCS, guard interval, and channel width.

Table 28: Data Rates Based on MCS Settings, Guard Interval, and Channel Width

MCS Index	Guard Interval = 800 ns	Guard Interval = 400 ns		
	20-MHz Channel Width Data Rate (Mb/s)	40-MHz Channel Width Data Rate (Mb/s)	20-MHz Channel Width Data Rate (Mb/s)	40-MHz Channel Width Data Rate (Mb/s)
0	6.5	13.5	7 2/9	15
1	13	27	14 4/9	30
2	19.5	40.5	21 2/3	45
3	26	54	28 8/9	60
4	39	81	43 1/3	90
5	52	109	57 5/9	120
6	58.5	121.5	65	135
7	65	135	72 2/9	152.5
8	13	27	14 4/9	30
9	26	54	28 8/9	60
10	39	81	43 1/3	90
11	52	108	57 7/9	120
12	78	162	86 2/3	180
13	104	216	115 5/9	240
14	117	243	130	270
15	130	270	144 4/9	300
The legacy rates are as follows: 5 GHz: 6, 9, 12, 18, 24, 36, 48, and 54 Mb/s 2.4 GHz: 1, 2, 5.5, 6, 9, 11, 12, 18, 24, 36, 48, and 54 Mb/s				

Configuration Example: MCS Rates

MCS rates are configured using the speed command.

The following example shows configuring speed setting for an 802.11g/n 2.4-GHz radio:

```
interface Dot11Radio0
no ip address
no ip route-cache
!
ssid 800test
!
speed basic-1.0 2.0 5.5 11.0 6.0 9.0 12.0 18.0 24.0 36.0 48.0 54.0 m0. m1. m2. m3. m4. m8.
m9. m10. m11. m12. m13. m14. m15.
```

Configuring Radio Transmit Power

Radio transmit power is based on the type of radio or radios installed in your access point and the regulatory domain in which it operates.

To set the transmit power on access point radios, follow these steps, beginning in privileged EXEC mode:

SUMMARY STEPS

1. **configure terminal**
2. **interface dot11radio {0}**
3. **power local**
4. **end**
5. **copy running-config startup-config**

DETAILED STEPS

	Command or Action	Purpose
Step 1	configure terminal Example: Router# configure terminal	Enters global configuration mode.
Step 2	interface dot11radio {0}	Enters interface configuration mode for the radio interface. The 2.4-GHz and the 802.11g/n 2.4-GHz radios are radio 0.
Step 3	power local Example: These options are available for the 2.4-GHz 802.11n radio (in dBm): Example: {8 9 11 14 15 17 maximum}	Sets the transmit power for the 2.4-GHz radios so that the power level is allowed in your regulatory domain. Note Use the no form of the power local command to return the power setting to maximum, the default setting.

	Command or Action	Purpose
Step 4	end	Returns to privileged EXEC mode.
Step 5	copy running-config startup-config	(Optional) Saves your entries in the configuration file.

Limiting the Power Level for Associated Client Devices

You can also limit the power level on client devices that associate to the wireless device. When a client device associates to the wireless device, the wireless device sends the maximum power level setting to the client.



Note

Cisco AVVID documentation uses the term Dynamic Power Control (DPC) to refer to limiting the power level on associated client devices.

To specify a maximum allowed power setting on all client devices that associate to the wireless device, follow these steps, beginning in privileged EXEC mode:

SUMMARY STEPS

1. **configure terminal**
2. **interface dot11radio {0}**
3. **power client**
4. **end**
5. **copy running-config startup-config**

DETAILED STEPS

	Command or Action	Purpose
Step 1	configure terminal	Enters global configuration mode.
Step 2	interface dot11radio {0}	Enters interface configuration mode for the radio interface. The 2.4-GHz and 802.11g/n 2.4-GHz radios are radio 0.
Step 3	<p>power client</p> <p>Example:</p> <pre>These options are available for 802.11n 2.4-GHz clients (in dBm): {local 8 9 11 14 15 17 maximum}</pre>	<p>Sets the maximum power level allowed on client devices that associate to the wireless device.</p> <ul style="list-style-type: none"> • Setting the power level to local sets the client power level to that of the access point. • Setting the power level to maximum sets the client power to the allowed maximum. <p>Note The settings allowed in your regulatory domain might differ from the settings listed here.</p>

	Command or Action	Purpose
Step 4	end	Returns to privileged EXEC mode.
Step 5	copy running-config startup-config	(Optional) Saves your entries in the configuration file.

What to Do Next

Use the no form of the **power client** command to disable the maximum power level for associated clients.



Note

Aironet extensions must be enabled to limit the power level on associated client devices. Aironet extensions are enabled by default.

Configuring Radio Channel Settings

The default channel setting for the wireless device radios is least congested. At startup, the wireless device scans for and selects the least-congested channel. For the most consistent performance after a site survey, however, we recommend that you assign a static channel setting for each access point. The channel settings on the wireless device correspond to the frequencies available in your regulatory domain. See the access point hardware installation guide for the frequencies allowed in your domain.

Each 2.4-GHz channel covers 22 MHz. Because the bands for channels 1, 6, and 11 do not overlap, you can set up multiple access points in the same vicinity without causing interference. The 802.11b and 802.11g 2.4-GHz radios use the same channels and frequencies.

The 5-GHz radio operates on 8 channels from 5180 to 5320 MHz, up to 27 channels from 5170 to 5850 MHz depending on regulatory domain. Each channel covers 20 MHz, and the bands for the channels overlap slightly. For best performance, use channels that are not adjacent (use channels 44 and 46, for example) for radios that are close to each other.



Note

The presence of too many access points in the same vicinity can create radio congestion that can reduce throughput. A careful site survey can determine the best placement of access points for maximum radio coverage and throughput.

The 802.11n standard allows both 20-MHz and 40-MHz channel widths consisting of two contiguous non-overlapping channels (for example, 2.4-GHz channels 1 and 6)

One of the 20-MHz channels is called the control channel. Legacy clients and 20-MHz high-throughput clients use the control channel. Only beacons can be sent on this channel. The other 20-MHz channel is called the extension channel. The 40-MHz stations may use this channel and the control channel simultaneously.

A 40-MHz channel is specified as a channel and extension, such as 1,1. In this example, the control channel is channel 1 and the extension channel is above it.

Configuring Wireless Channel Width

To set the wireless device channel width, follow these steps, beginning in privileged EXEC mode:

SUMMARY STEPS

1. `configure terminal`
2. `interface dot11radio {0 }`
3. `channel {frequency | least-congested | width [20 | 40-above | 40-below] | dfs}`
4. `end`
5. `copy running-config startup-config`

DETAILED STEPS

	Command or Action	Purpose
Step 1	<code>configure terminal</code>	Enters global configuration mode.
Step 2	<code>interface dot11radio {0 }</code>	Enters interface configuration mode for the radio interface. The 802.11g/n 2.4-GHz radio is radio 0
Step 3	<code>channel {frequency least-congested width [20 40-above 40-below] dfs}</code>	<p>Sets the default channel for the wireless device radio. To search for the least-congested channel on startup, enter <code>least-congested</code>.</p> <ul style="list-style-type: none"> • Use the <code>width</code> option to specify a bandwidth to use. This option is available for the Cisco 800 series ISR wireless devices and consists of three available settings: 20, 40-above, and 40-below: <ul style="list-style-type: none"> ◦ Choosing 20 sets the channel width to 20 MHz. ◦ Choosing 40-above sets the channel width to 40 MHz with the extension channel above the control channel. ◦ Choosing 40-below sets the channel width to 40 MHz with the extension channel below the control channel. <p>Note The channel command is disabled for 5-GHz radios that comply with European Union regulations on dynamic frequency selection (DFS). See the Enabling and Disabling World Mode, on page 233 for more information.</p>
Step 4	<code>end</code>	Returns to privileged EXEC mode.
Step 5	<code>copy running-config startup-config</code>	(Optional) Saves your entries in the configuration file.

Enabling and Disabling World Mode

You can configure the wireless device to support 802.11d world mode, Cisco legacy world mode, or world mode roaming. When you enable world mode, the wireless device adds channel carrier set information to its beacon. Client devices with world mode enabled receive the carrier set information and adjust their settings automatically. For example, a client device used primarily in Japan could rely on world mode to adjust its channel and power settings automatically when it travels to Italy and joins a network there. Cisco client devices detect whether the wireless device is using 802.11d or Cisco legacy world mode and automatically use the world mode that matches the mode used by the wireless device.

You can also configure world mode to be always on. In this configuration, the access point essentially roams between countries and changes its settings as required. World mode is disabled by default.

Enabling World Mode

To enable world mode, follow these steps, beginning in privileged EXEC mode:

SUMMARY STEPS

1. **configure terminal**
2. **interface dot11radio {0 }**
3. **world-mode {dot11d country_code code {both | indoor | outdoor} | world-mode roaming | legacy}**
4. **end**
5. **copy running-config startup-config**

DETAILED STEPS

	Command or Action	Purpose
Step 1	configure terminal	Enters global configuration mode.
Step 2	interface dot11radio {0 }	Enters interface configuration mode for the radio interface.
Step 3	world-mode {dot11d country_code code {both indoor outdoor} world-mode roaming legacy}	Enables world mode. <ul style="list-style-type: none"> • Enter the dot11d option to enable 802.11d world mode. <ul style="list-style-type: none"> ◦ When you enter the dot11d option, you must enter a two-character ISO country code (for example, the ISO country code for the United States is US). You can find a list of ISO country codes at the ISO website. ◦ After the country code, you must enter indoor, outdoor, or both to indicate the placement of the wireless device. • Enter the legacy option to enable Cisco legacy world mode. • Enter the world-mode roaming option to place the access point in a continuous world mode configuration.

	Command or Action	Purpose
		Note Aironet extensions must be enabled for legacy world mode operation, but Aironet extensions are not required for 802.11d world mode. Aironet extensions are enabled by default.
Step 4	<code>end</code>	Returns to privileged EXEC mode.
Step 5	<code>copy running-config startup-config</code>	(Optional) Saves your entries in the configuration file.

What to Do Next

Use the no form of the **world-mode** command to disable world mode.

Disabling and Enabling Short Radio Preambles

The radio preamble (sometimes called a header) is a section of data at the head of a packet that contains information that the wireless device and client devices need when sending and receiving packets. You can set the radio preamble to long or short:

- Short—A short preamble improves throughput performance.
- Long—A long preamble ensures compatibility between the wireless device and all early models of Cisco Aironet Wireless LAN Adapters. If these client devices do not associate to the wireless devices, you should use short preambles.

You cannot configure short or long radio preambles on the 5-GHz radio.

Disabling Short Radio Preambles

To disable short radio preambles, follow these steps, beginning in privileged EXEC mode:

SUMMARY STEPS

1. `configure terminal`
2. `interface dot11radio {0 }`
3. `no preamble-short`
4. `end`
5. `copy running-config startup-config`

DETAILED STEPS

	Command or Action	Purpose
Step 1	<code>configure terminal</code>	Enters global configuration mode.

	Command or Action	Purpose
Step 2	<code>interface dot11radio {0 }</code>	Enters interface configuration mode for the 2.4-GHz radio interface.
Step 3	<code>no preamble-short</code>	Disables short preambles and enables long preambles. Note Short preambles are enabled by default. Use the <code>preamble-short</code> command to enable short preambles if they are disabled.
Step 4	<code>end</code>	Returns to privileged EXEC mode.
Step 5	<code>copy running-config startup-config</code>	(Optional) Saves your entries in the configuration file.

What to Do Next

Transmit and Receive Antennas

You can select the antenna that the wireless device uses to receive and transmit data. There are four options for both the receive antenna and the transmit antenna:

- **Gain**—Sets the resultant antenna gain in decibels (dB).
- **Diversity**—This default setting tells the wireless device to use the antenna that receives the best signal. If the wireless device has two fixed (non-removable) antennas, you should use this setting for both receive and transmit.
- **Right**—If the wireless device has removable antennas and you install a high-gain antenna on the wireless device's right connector, you should use this setting for both receive and transmit. When you look at the wireless device's back panel, the right antenna is on the right.
- **Left**—If the wireless device has removable antennas and you install a high-gain antenna on the wireless device's left connector, you should use this setting for both receive and transmit. When you look at the wireless device's back panel, the left antenna is on the left.

See the following section for information on configuring transmit and receive antennas:

Configuring Transmit and Recieve Antennas

To select the antennas that the wireless device uses to receive and transmit data, follow these steps, beginning in privileged EXEC mode:

SUMMARY STEPS

1. `configure terminal`
2. `interface dot11radio {0 }`
3. `gain dB`
4. `antenna receive {diversity | left | right}`
5. `end`
6. `copy running-config startup-config`

DETAILED STEPS

	Command or Action	Purpose
Step 1	<code>configure terminal</code>	Enters global configuration mode.
Step 2	<code>interface dot11radio {0 }</code>	Enters interface configuration mode for the radio interface. The 802.11g/n 2.4-GHz radio is radio 0
Step 3	<code>gain dB</code>	Specifies the resultant gain of the antenna attached to the device. <ul style="list-style-type: none"> • Enter a value from –128 to 128 dB. If necessary, you can use a decimal in the value, such as 1.5. <p>Note The Cisco 860 and Cisco 880 ISRs are shipped with a fixed antenna that cannot be removed. The antenna gain cannot be configured on these models</p>
Step 4	<code>antenna receive {diversity left right}</code>	Sets the receive antenna to diversity, left, or right. <p>Note For best performance with two antennas, leave the receive antenna setting at the default setting, diversity. For one antenna, attach the antenna on the right and set the antenna for right.</p>
Step 5	<code>end</code>	Returns to privileged EXEC mode.
Step 6	<code>copy running-config startup-config</code>	(Optional) Saves your entries in the configuration file.

Disabling and Enabling Aironet Extensions

By default, the wireless device uses Cisco Aironet 802.11 extensions to detect the capabilities of Cisco Aironet client devices and to support features that require specific interaction between the wireless device and associated client devices. Aironet extensions must be enabled to support these features:

- Load balancing—The wireless device uses Aironet extensions to direct client devices to an access point that provides the best connection to the network on the basis of such factors as number of users, bit error rates, and signal strength.

- Message Integrity Check (MIC)—MIC is an additional WEP security feature that prevents attacks on encrypted packets called bit-flip attacks. The MIC, implemented on the wireless device and all associated client devices, adds a few bytes to each packet to make the packets tamper-proof.
- Load balancing—The wireless device uses Aironet extensions to direct client devices to an access point that provides the best connection to the network on the basis of such factors as number of users, bit error rates, and signal strength.
- Cisco Key Integrity Protocol (CKIP)—Cisco's WEP key permutation technique is based on an early algorithm presented by the IEEE 802.11i security task group. The standards-based algorithm, Temporal Key Integrity Protocol (TKIP), does not require Aironet extensions to be enabled.
- World mode (legacy only)—Client devices with legacy world mode enabled receive carrier set information from the wireless device and adjust their settings automatically. Aironet extensions are not required for 802.11d world mode operation.
- Limiting the power level on associated client devices—When a client device associates to the wireless device, the wireless device sends the maximum allowed power level setting to the client.

Disabling Aironet extensions disables the features listed above, but it sometimes improves the ability of non-Cisco client devices to associate to the wireless device.

Disabling Aironet Extensions

Aironet extensions are enabled by default. To disable Aironet extensions, follow these steps, beginning in privileged EXEC mode:

SUMMARY STEPS

1. **configure terminal**
2. **interface dot11radio {0 }**
3. **no dot11 extension aironet**
4. **end**
5. **copy running-config startup-config**

DETAILED STEPS

	Command or Action	Purpose
Step 1	configure terminal	Enters global configuration mode.
Step 2	interface dot11radio {0 }	Enters interface configuration mode for the radio interface. The 802.11g/n 2.4-GHz radio is radio 0.
Step 3	no dot11 extension aironet	Disables Aironet extensions.
Step 4	end	Returns to privileged EXEC mode.
Step 5	copy running-config startup-config	(Optional) Saves your entries in the configuration file.

What to Do Next

Use the dot11 extension aironet command to enable Aironet extensions if they are disabled.

Ethernet Encapsulation Transformation Method

When the wireless device receives data packets that are not 802.3 packets, the wireless device must format the packets to 802.3 by using an encapsulation transformation method. These are the two transformation methods:

- 802.1H—This method provides optimum performance for Cisco wireless products.
- RFC 1042—Use this setting to ensure interoperability with non-Cisco wireless equipment. RFC1042 does not provide the interoperability advantages of 802.1H but is used by other manufacturers of wireless equipment.

For information on how to configure the ethernet encapsulation transformation method, see the following section:

Configuring the Ethernet Encapsulation Transformation Method

To configure the encapsulation transformation method, follow these steps, beginning in privileged EXEC mode:

SUMMARY STEPS

1. **configure terminal**
2. **interface dot11radio {0 }**
3. **payload-encapsulation {snap | dot1h}**
4. **end**
5. **copy running-config startup-config**

DETAILED STEPS

	Command or Action	Purpose
Step 1	configure terminal	Enters global configuration mode.
Step 2	interface dot11radio {0 }	Enters interface configuration mode for the radio interface. The 802.11g/n 2.4-GHz radio is radio 0.
Step 3	payload-encapsulation {snap dot1h}	Sets the encapsulation transformation method to RFC 1042 (snap) or 802.1h (dot1h, the default setting).
Step 4	end	Returns to privileged EXEC mode.
Step 5	copy running-config startup-config	(Optional) Saves your entries in the configuration file.

Enabling and Disabling Public Secure Packet Forwarding

Public Secure Packet Forwarding (PSPF) prevents client devices that are associated to an access point from inadvertently sharing files or communicating with other client devices that are associated to the access point. PSPF provides Internet access to client devices without providing other capabilities of a LAN. This feature is useful for public wireless networks like those installed in airports or on college campuses.



Note

To prevent communication between clients associated to different access points, you must set up protected ports on the switch to which the wireless devices are connected. See the [Related Documentation, on page 218](#) for instructions on setting up protected ports.

To enable and disable PSPF using CLI commands on the wireless device, you use bridge groups. For a detailed explanation of bridge groups and instructions for implementing them, see the following link:

http://www.cisco.com/en/US/docs/ios/12_2/ibm/configuration/guide/bcftb_ps1835_TSD_Products_Configuration_Guide_Chapter.html

Configuring Public Secure Packet Forwarding

PSPF is disabled by default. To enable PSPF, follow these steps, beginning in privileged EXEC mode:

SUMMARY STEPS

1. **configure terminal**
2. **interface dot11radio {0}**
3. **bridge-group group port-protected**
4. **end**
5. **copy running-config startup-config**

DETAILED STEPS

	Command or Action	Purpose
Step 1	configure terminal	Enters global configuration mode.
Step 2	interface dot11radio {0}	Enters interface configuration mode for the radio interface. The 802.11g/n 2.4-GHz radio is radio 0.
Step 3	bridge-group group port-protected	Enables PSPF.
Step 4	end	Returns to privileged EXEC mode.
Step 5	copy running-config startup-config	(Optional) Saves your entries in the configuration file.

What to Do Next

Use the no form of the **bridge group** command to disable PSPF.

Configuring Protected Ports

To prevent communication between client devices that are associated to different access points on your wireless LAN, you must set up protected ports on the switch to which the wireless devices are connected.

To define a port on your switch as a protected port, follow these steps, beginning in privileged EXEC mode:

SUMMARY STEPS

1. **configure terminal**
2. **interface** *interface-id*
3. **switchport protected**
4. **end**
5. **show interfaces** *interface-id* **switchport**
6. **copy running-config startup-config**

DETAILED STEPS

	Command or Action	Purpose
Step 1	configure terminal	Enters global configuration mode.
Step 2	interface <i>interface-id</i>	Enters interface configuration mode. • Enter the type and number of the switch port interface to configure, such as <i>wlan-gigabitethernet0</i> .
Step 3	switchport protected	Configures the interface to be a protected port.
Step 4	end	Returns to privileged EXEC mode.
Step 5	show interfaces <i>interface-id</i> switchport	Verifies your entries.
Step 6	copy running-config startup-config	(Optional) Saves your entries in the configuration file.

What to Do Next

To disable protected port, use the **no switchport protected** command.

For detailed information on protected ports and port blocking, see the “Configuring Port-Based Traffic Control” chapter in Catalyst 3550 Multilayer Switch Software Configuration Guide, 12.1(12c)EA1. Click this link to browse to that guide:

http://www.cisco.com/en/US/docs/switches/lan/catalyst3550/software/release/12.1_12c_ea1/configuration/guide/3550scg.html

Beacon Period and the DTIM

The beacon period is the amount of time between access point beacons in kilomicroseconds (Kmicrosecs). One Kmicrosec equals 1,024 microseconds. The data beacon rate, always a multiple of the beacon period, determines how often the beacon contains a delivery traffic indication message (DTIM). The DTIM tells power-save client devices that a packet is waiting for them.

For example, if the beacon period is set at 100, its default setting, and if the data beacon rate is set at 2, its default setting, then the wireless device sends a beacon containing a DTIM every 200 Kmicrosecs.

The default beacon period is 100, and the default DTIM is 2.

See the following section for information on configuring beacon period and DTIM:

Configuring the Beacon Period and the DTIM

To configure the beacon period and the DTIM, follow these steps, beginning in privileged EXEC mode:

SUMMARY STEPS

1. **configure terminal**
2. **interface dot11radio {0}**
3. **beacon period *value***
4. **beacon dtim-period *value***
5. **end**
6. **copy running-config startup-config**

DETAILED STEPS

	Command or Action	Purpose
Step 1	configure terminal	Enters global configuration mode.
Step 2	interface dot11radio {0}	Enters interface configuration mode for the radio interface. The 802.11g/n 2.4-GHz radio is radio 0
Step 3	beacon period <i>value</i>	Sets the beacon period. <ul style="list-style-type: none"> • Enter a value in kilomicroseconds.
Step 4	beacon dtim-period <i>value</i>	Sets the DTIM. <ul style="list-style-type: none"> • Enter a value in kilomicroseconds.
Step 5	end	Returns to privileged EXEC mode.
Step 6	copy running-config startup-config	(Optional) Saves your entries in the configuration file.

RTS Threshold and Retries

The request to send (RTS) threshold determines the packet size at which the wireless device issues an RTS before sending the packet. A low RTS threshold setting can be useful in areas where many client devices are associating with the wireless device, or in areas where the clients are far apart and can detect only the wireless device and not detect each other. You can enter a setting ranging from 0 to 2347 bytes.

The maximum RTS retries is the maximum number of times the wireless device issues an RTS before stopping the attempt to send the packet over the radio. Enter a value from 1 to 128.

The default RTS threshold is 2347 for all access points and bridges, and the default maximum RTS retries setting is 32.

Configuring RTS Threshold and Retries

To configure the RTS threshold and maximum RTS retries, follow these steps, beginning in privileged EXEC mode:

SUMMARY STEPS

1. **configure terminal**
2. **interface dot11radio {0}**
3. **rts threshold *value***
4. **rts retries *value***
5. **end**
6. **copy running-config startup-config**

DETAILED STEPS

	Command or Action	Purpose
Step 1	configure terminal	Enters global configuration mode.
Step 2	interface dot11radio {0}	Enters interface configuration mode for the radio interface. The 2.4-GHz and the 802.11g/n 2.4-GHz radios are radio 0
Step 3	rts threshold <i>value</i>	Sets the RTS threshold. <ul style="list-style-type: none"> • Enter an RTS threshold from 0 to 2347.
Step 4	rts retries <i>value</i>	Sets the maximum RTS retries. <ul style="list-style-type: none"> • Enter a setting from 1 to 128.
Step 5	end	Returns to privileged EXEC mode.
Step 6	copy running-config startup-config	(Optional) Saves your entries in the configuration file.

What to Do Next

Use the no form of the `rts` command to reset the RTS settings to defaults.

Maximum Data Retries

The maximum data retries setting determines the number of attempts that the wireless device makes to send a packet before it drops the packet. The default setting is 32.

Configuring the Maximum Data Retries

To configure the maximum data retries, follow these steps, beginning in privileged EXEC mode:

SUMMARY STEPS

1. `configure terminal`
2. `interface dot11radio {0}`
3. `packet retries value`
4. `end`
5. `copy running-config startup-config`

DETAILED STEPS

	Command or Action	Purpose
Step 1	<code>configure terminal</code>	Enters global configuration mode.
Step 2	<code>interface dot11radio {0}</code>	Enters interface configuration mode for the radio interface. The 802.11g/n 2.4-GHz radio is radio 0.
Step 3	<code>packet retries value</code>	Sets the maximum data retries. <ul style="list-style-type: none"> • Enter a setting from 1 to 128. <p>Note Use the no form of the <code>packet retries</code> command to reset the setting to the default.</p>
Step 4	<code>end</code>	Returns to privileged EXEC mode.
Step 5	<code>copy running-config startup-config</code>	(Optional) Saves your entries in the configuration file.

What to Do Next

Configuring the Fragmentation Threshold

The fragmentation threshold determines the size at which packets are fragmented (sent as several pieces instead of as one block). Use a low setting in areas where communication is poor or where there is a great deal of radio interference. The default setting is 2346 bytes.

Configuring the Fragment Threshold

To configure the fragmentation threshold, follow these steps, beginning in privileged EXEC mode:

SUMMARY STEPS

1. `configure terminal`
2. `interface dot11radio {0}`
3. `fragment-threshold value`
4. `end`
5. `copy running-config startup-config`

DETAILED STEPS

	Command or Action	Purpose
Step 1	<code>configure terminal</code>	Enters global configuration mode.
Step 2	<code>interface dot11radio {0}</code>	Enters interface configuration mode for the radio interface. The 802.11g/n 2.4-GHz and 5-GHz radios are radio 0.
Step 3	<code>fragment-threshold value</code>	Sets the fragmentation threshold. <ul style="list-style-type: none"> • Enter a setting from 256 to 2346 bytes for the 2.4-GHz radio. • Enter a setting from 256 to 2346 bytes for the 5-GHz radio. <p>Note Use the no form of the fragment-threshold command to reset the setting to the default.</p>
Step 4	<code>end</code>	Returns to privileged EXEC mode.
Step 5	<code>copy running-config startup-config</code>	(Optional) Saves your entries in the configuration file.

What to Do Next

Enabling Short Slot Time for 802.11g Radios

You can increase throughput on the 802.11g 2.4-GHz radio by enabling short slot time. Reducing the slot time from the standard 20 microseconds to the 9-microsecond short slot time decreases the overall backoff, which increases throughput. Backoff, which is a multiple of the slot time, is the random length of time that a station waits before sending a packet on the LAN.

Many 802.11g radios support short slot time, but some do not. When you enable short slot time, the wireless device uses the short slot time only when all clients associated to the 802.11g 2.4-GHz radio support short slot time.

Short slot time is supported only on the 802.11g 2.4-GHz radio. Short slot time is disabled by default.

In radio interface mode, enter the short-slot-time command to enable short slot time:

```
ap(config-if)# short-slot-time
```

Use the no form of the short-slot-time command to disable short slot time.

Performing a Carrier Busy Test

You can perform a carrier busy test to check the radio activity on wireless channels. During the carrier busy test, the wireless device drops all associations with wireless networking devices for 4 seconds while it conducts the carrier test and then displays the test results.

In privileged EXEC mode, enter this command to perform a carrier busy test:

```
dot11 interface-number carrier busy
```

For interface-number, enter dot11radio 0 to run the test on the 2.4-GHz radio

Use the **show dot11 carrier busy** command to redisplay the carrier busy test results.

Configuring VoIP Packet Handling

You can improve the quality of VoIP packet handling per radio on access points by enhancing 802.11 MAC behavior for lower latency for the class of service (CoS) 5 (Video) and CoS 6 (Voice) user priorities.

To configure VoIP packet handling on an access point, follow these steps:

- 1 Using a browser, log in to the access point.
- 2 Click **Services** in the task menu on the left side of the web-browser interface.
- 3 When the list of Services expands, click **Stream**.
The Stream page appears.
- 4 Click the tab for the radio to configure.
- 5 For both CoS 5 (Video) and CoS 6 (Voice) user priorities, choose Low Latency from the Packet Handling drop-down menu, and enter a value for maximum retries for packet discard in the corresponding field.

The default value for maximum retries is 3 for the Low Latency setting. This value indicates how many times the access point will try to retrieve a lost packet before discarding it.

Figure 15: Packet Handling Configuration

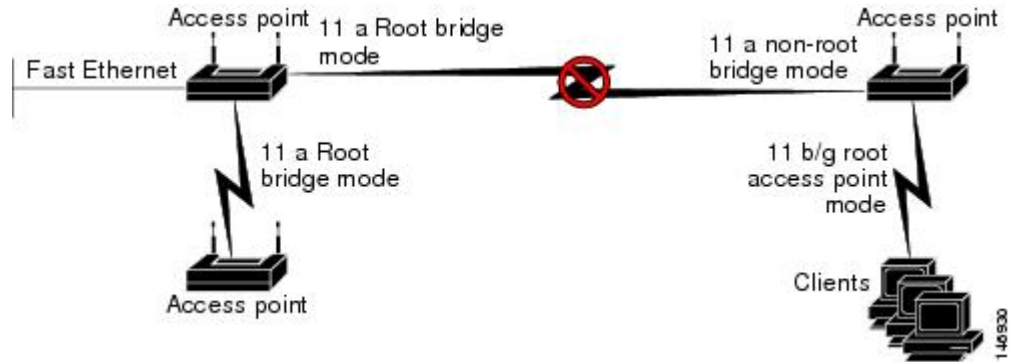

Note You may also configure the CoS 4 (Controlled Load) user priority and its maximum retries value.

6 Click **Apply**.

Configuring WLAN

This section describes the Wireless LAN (WLAN) configuration tasks for Cisco 810, 860, 880 and 890 series routers and contains the following sections:

Configuring WLAN Using the Web-based Interface

Use the web-based interface to display wireless LAN (WLAN) information and configure settings. For information about the CLI-based WLAN interface, see [Configuring WLAN Using the CLI-based Interface, on page 253](#).

Connecting to the Web-based WLAN Interface

To connect to the web-based WLAN interface, open the following address in a web browser: <http://10.10.10.2>

Log in using the default credentials:

User name: **admin**

Password: **admin**



Note When using the default WLAN credentials, the user is prompted to change the password when logging in for the first time.

Address for Accessing Web-based Interface

You can change the address for accessing the web-based interface. See [Configuring Access to the Web-based Interface](#), on page 247.

DHCP Server Configuration

By default, the DHCP server is not configured. Configure DHCP parameters using the Cisco IOS CLI on VLAN 1.

Subnet

Connect to the interface from a device within the LAN containing the router. The device must be within the subnet configured for accessing the router. The default subnet mask is 255.255.255.0.

Displaying Device Information

In the left pane, click **Device Info** -> **Summary** to open the Device Info page, displaying the following device information:

- Hardware and driver information for upgrading drivers or troubleshooting

Displaying Connection Statistics

In the left pane, click **Device Info** -> **Statistics** to open the Statistics - WLAN page, displaying statistics on packets received and packets transmitted. The page is automatically refreshed.

Configuring Access to the Web-based Interface

In the left pane, click **Device Info** -> **Network Interface** to open the Network Interface Setup page for configuring access to the web-based interface.

The page shows the IP address and subnet mask used to access the web-based interface. You can enter a new IP address and subnet mask for accessing the web-based interface. The default values are:

IP: **10.10.10.2**

Subnet Mask: **255.255.255.248**



Note

Enter IPv4 values only. IPv6 is not supported.



Note

Changing the IP address to a different subnet requires changing VLAN 1 to be in the same subnet also.



Note

You can access the web-based interface only from a device within the same subnet.

Configuring Basic Wireless Settings

In the left pane, click **Wireless** -> **Basic** to open the Wireless - Basic page, providing configuration options for the wireless LAN (WLAN).

Main SSID

The options in the top portion of the Wireless - Basic page apply to the main service set identification (SSID):

- **Enable Wireless**—Enables/disables the WLAN feature.
- **Hide Access Point**—Hiding the SSID provides a small measure of security in helping to prevent unauthorized users from accessing the network. When this feature is enabled, the WLAN access point SSID is not broadcast, making wireless snooping more difficult.
- **Clients Isolation**—Prevents a wireless client connected to a specific SSID from communicating with other wireless clients connected to the same SSID.
- **Disable WMM Advertise**—Disables the WiFi Multimedia (WMM) feature. The WMM feature prioritizes media traffic to improve media transmission.
- **Enable Wireless Multicast Forwarding (WMF)**—Enables the Wireless Multicast Forwarding (WMF) feature.
- **SSID**—Main SSID used for accessing the WLAN. Devices connected to the WLAN using the same SSID operate within the same domain. The main SSID can be disabled only by disabling WLAN completely.
- **BSSID**—MAC address for the main SSID. Each enabled SSID has a separate BSSID.
- **Max Clients**—Configures the maximum number of clients that can connect to the main SSID. Default value: 16 Recommended maximum: 16 Theoretical maximum: 128

Guest SSIDs

A table at the bottom of the Wireless - Basic page shows the guest SSIDs for connecting guest devices to the WLAN. For each guest SSID, you can configure options similar to those for the main SSID.

Default SSID Values

The following are the default SSID values:

- Main SSID: Cisco860
- Guest SSID 1: Cisco860_Guest1
- Guest SSID 2: Cisco860_Guest2
- Guest SSID 3: Cisco860_Guest3

**Note**

By default, the main SSID is enabled and guest SSIDs are disabled.

Configuring Security

In the left pane, click **Wireless** -> **Security** to open the Wireless - Security page, providing security settings for each access point.

Complete the following steps to configure security settings for an access point:

- 1 In the Select SSID drop-down list, select the SSID to configure.
- 2 Using the drop-down lists, select network authentication options for the SSID. Selecting an authentication type displays additional options specific to the authentication type.



Note By default, the network authentication is open and WEP encryption is disabled for each SSID.

- 3 Click **Apply/Save**.

Configuring MAC Filtering

In the left pane, click **Wireless** -> **MAC Filter** to open the Wireless - MAC Filter page, enabling you to restrict access to specific SSIDs according to device MAC addresses.

For each SSID, you can specify MAC addresses to allow or MAC addresses to deny. By default, the MAC restriction feature is disabled for all SSIDs.

Complete the following steps to configure MAC filtering for an SSID:

- 1 In the Select SSID drop-down list, select the SSID to configure.
- 2 To add a MAC address to the list, click **Add** and enter the address.
- 3 To remove a MAC address from the list, select the “Remove” check box for the address and click **Remove**.
- 4 Select a MAC restriction mode from these options:
 - Disabled—The feature is disabled.
 - Allow—Allow devices with the specified MAC addresses to connect.
 - Deny—Do not allow devices with the specified MAC addresses to connect.

Configuring Advanced Wireless Settings

In the left pane, click **Wireless** > **Advanced** to open the Wireless - Advanced page for configuring the advanced wireless LAN (WLAN) features described in [Table 29: Advanced WLAN](#), on page 249.

Table 29: Advanced WLAN

Option	Description
Band	Frequency band. This is preset to 2.4 GHz.
Channel	Radio channels. By default, the router sets the channel automatically. You can select a specific channel. The channel options depend on the geographic region.

Option	Description
Auto Channel Timer (min)	(Enabled when Channel is set to Auto) Minutes to wait before scanning again to determine the best channel. Range: 1 to 35791394 minutes.
802.11n/EWC	Enables/disables 802.11n support.
802.11n Rate	(802.11n/EWC must be set to Auto) Configures the rate for 802.11n.
802.11n Protection	(802.11n/EWC must be set to Auto) Configures RTS/CTS protection.
Support 802.11n Client Only	(802.11n/EWC must be set to Auto) Restricts support to 802.11n only.
RIFS Advertisement	(802.11n/EWC must be set to Auto) Enables/disables Reduced Inter-Frame Space (RIFS) Advertisement.
RX Chain Power Save	(802.11n/EWC must be set to Auto) Enables/disables the power save mode.
RX Chain Power Save Quiet Time	(802.11n/EWC must be set to Auto and RX Chain Power Save must be set to Enable) Time interval (seconds) to wait before going into the power save mode. Range: 0 to 2147483647 seconds.
RX Chain Power Save PPS	(802.11n/EWC must be set to Auto and RX Chain Power Save must be set to Enable) Packets per second (PPS) threshold. When the PPS is below the threshold, the router enters power save mode after the number of seconds configured in the "RX Chain Power Save Quiet Time" field. Range: 0 to 2147483647 packets per second.
54g Rate	(802.11n/EWC must be set to Disabled or 802.11n Rate must be set to "Use 54g Rate") Configures the 54g rate.

Option	Description
Multicast Rate	Transmit/Receive rate for multicast packets. Note If 802.11n/EWC is Disabled and “54g Mode” is set to “802.11b Only,” then the options will change.
Basic Rate	Data rate that wireless clients should support.
Fragmentation Threshold	Maximum packet size (bytes) before data is fragmented. Range: 256 to 2346 bytes.
RTS Threshold	RTS threshold value that will trigger the CTS protection mechanism. If an access point transmits a packet larger than the threshold, this will trigger the CTS protection mode. Range: 0 to 2347 bytes.
DTIM Interval	Delivery Traffic Indication Message (DTIM) interval information is included in beacon frames to inform clients of when next to expect buffered data from AP. The interval is specified as number of beacons. For example, if DTIM interval is set to 2, the client will wake-up/check for buffered data on AP at every second beacon. Range: 1 to 255 beacons.
Beacon Interval	Length of time between beacon transmissions. Range: 1 to 65535 milliseconds.
Global Max Clients	Upper limit for the maximum number of clients that can connect to an AP. The “Max Clients” setting for each SSID cannot exceed this limit. Range: 1 to 128 Default value: 16 Recommended maximum: 16 Theoretical maximum: 128
Transmit Power	Configures the transmit power level.
WMM (Wi-Fi Multimedia)	Enables/disables the WMM feature, a quality of service (QoS) feature of 802.11.
WMM No Acknowledgement	(WMM (Wi-Fi Multimedia) must be set to Enabled or Auto) Enables/disables the WMM No Acknowledgement feature.

Option	Description
WMM APSD	(WMM (Wi-Fi Multimedia) must be set to Enabled or Auto) Enables/disables the WMM Automatic Power Save Delivery feature. Note When WMM is in Auto mode, WMM APSD must be set to Enabled to enable a client to use Power Save Mode. When WMM is in Enabled mode, the client can use Power Save Mode regardless of whether WMM APSD is Enabled or Disabled.
54g Mode	(802.11n/EWC must be set to Disabled) Configures 54g mode.
54g Protection	(802.11n/EWC must be set to Disabled) Setting this field to Auto enables the RTS/CTS Protection mechanism.
Preamble Type	(802.11n/EWC must be set to Disabled. 54g Mode must be set to either "54g Auto" or "802.11b only".) Defines the length of the cyclic redundancy code (CRC) block used for AP-to-WLAN client communication.

Station Information

In the left pane, click **Wireless** -> **Station Info** to open the Wireless - Authenticated Stations page, displaying clients that have been authenticated for wireless LAN (WLAN) and the status of each client.

Configuring the Password for Connecting to the Web-based Interface

In the left pane, click **Management** to open the Access Control - Passwords page for configuring the administrative password.

The user name must be **admin**. You can follow the instructions on this page to change the password. The default password is **admin**.



Note The administrative account has unrestricted permission to configure the router.



Note To restore WLAN config to the default, delete the wlconfig.txt file from the flash memory, using the Cisco IOS CLI.

Saving the Wireless LAN Configuration to a File

In the left pane, click **Configuration** -> **Backup** to save a configuration file for the wireless configuration. The file is saved locally on the workstation being used to access the GUI. For information about loading the saved configuration from the local file, see [Loading a Wireless LAN Configuration File](#), on page 253.

Loading a Wireless LAN Configuration File

In the left pane, click **Configuration** -> **Update** to load a configuration file for the wireless LAN configuration from the workstation being used to access the GUI.

**Caution**

Loading a configuration file restarts the router, interrupting any current connections.

For information about saving a configuration file locally, see [Saving the Wireless LAN Configuration to a File](#), on page 253.

**Note**

A configuration file can be used to load a specific configuration onto several different routers.

Restoring the Default Configuration

In the left pane, click **Configuration** -> **Restore Default** to restore the wireless LAN configuration to default.

**Caution**

Restoring the default configuration restarts the router, interrupting any current connections.

Configuring WLAN Using the CLI-based Interface

Use the CLI-based interface to display wireless LAN (WLAN) information and configure settings. For information about the web-based WLAN interface, see [Configuring WLAN Using the Web-based Interface](#), on page 246.

See the following sections:

WLAN CLI Interface

The WLAN CLI interface is similar to the CLI interface for IOS.

When you enter the CLI interface, the prompt appears as follows:

```
ap#
```

Similarly to Cisco IOS, the prompt indicates the command mode. For example, using the **configure terminal** command to enter global configuration mode changes the prompt to:

```
ap(config)#
```

To exit from a specific mode, use the **exit** command.

For example:

```
ap(config)# exit
ap#
```

Displaying Command Information for WLAN CLI

Entering a question mark (?) displays information about available command options. This feature provides a simple access to information about commands and relevant command options.

Example : Displaying Command Information for WLAN CLI

In interface configuration mode, entering ? at the prompt displays the commands available in that mode:

```
ap(config-if)# ?
  exit                Exit from config-if mode
  ip                  Interface Internet Protocol config commands
  no                  Negate a command or set its defaults
  shutdown           Shutdown the interface
```

In SSID configuration mode, entering **encryption mode wep ?** displays the options available for configuring WEP encryption mode with the **encryption mode wep** command, as follows:

```
ap(config-ssid)# encryption mode wep ?
  current-key         Network Key to use
  encryption-strength Encryption strength
  key                 Set encryption keys
  <cr>
```

Three arguments (*current-key*, *encryption-strength*, and *key*) may be entered for the command. The <cr> option indicates that **encryption mode wep** is valid by itself without additional options. In this example, entering the command without additional arguments enables WEP encryption.

Connecting to the WLAN CLI Interface

To connect to the WLAN CLI interface, complete the following steps.

- 1 From the Cisco IOS command line, create a loopback interface, specifying any desired IP address. For information about creating a loopback interface in Cisco IOS, see the *Cisco IOS Master Commands List* : http://www.cisco.com/en/US/docs/ios/mcl/allreleasemcl/all_book.html
- 2 Connect by Telnet to the IP address specified for the loopback interface and port 2002.
- 3 Log in when prompted.
The router displays the WLAN CLI interface prompt.



Note

The default login credentials are: User name: **admin** Password: **admin** When logging in for the first time, the router prompts you to change the default password.

Example: Configuring a Loopback Interface

```
Router# configure terminal
Enter configuration commands, one per line. End with CNTL/Z.
Router(config)# interface loopback 0
Router(config-if)# ip address 1.1.1.1 255.255.255.0
Router(config-if)# end
```

Example: Accessing WLAN CLI Using Telnet Through the Loopback Interface

```
Router# telnet 1.1.1.1 2002
Trying 1.1.1.1, 2002 ... Open
Connecting to AP console, enter Ctrl-^ followed by x,
then "disconnect" to return to router prompt
ap#
```

Exiting from the WLAN CLI Interface

To exit from the WLAN CLI and return to the Cisco IOS CLI prompt, press **CTRL-SHIFT-6**, followed by **x**, then **"disconnect"**.

Setting the IP Address for the Web-based Interface

By default, the IP address used to access the web-based WLAN interface is 10.10.10.2.

To change the IP address of the bridge interface used to access the web-based interface, perform these steps.

SUMMARY STEPS

1. **configure terminal**
2. **interface BVI 1**
3. **ip address *IP-address subnet-mask***

DETAILED STEPS

	Command or Action	Purpose
Step 1	configure terminal Example: ap# configure terminal Example: ap(config)#	Enters configuration mode.
Step 2	interface BVI 1 Example: ap(config)# interface BVI 1	The interface number.
Step 3	ip address <i>IP-address subnet-mask</i> Example: ap(config-if)# ip address 10.10.10.2 255.255.255.248	Configures the new IP address and subnet mask. Note Use IPv4 addresses only. Tip You can display the configured IP address using the show interfaces BVI 1 command (see Displaying the BVI 1 Interface Details , on page 288).

	Command or Action	Purpose
--	-------------------	---------

Enabling and Disabling WLAN

By default, the WLAN feature is enabled.

To enable or disable WLAN, follow these steps from global configuration mode:

Use **shutdown** to disable WLAN and **no shutdown** to enable WLAN.

SUMMARY STEPS

1. **interface Dot11Radio 0**
2. **[no] shutdown**

DETAILED STEPS

	Command or Action	Purpose
Step 1	interface Dot11Radio 0 Example: ap(config)# interface Dot11Radio 0	Enters interface configuration mode.
Step 2	[no] shutdown Example: ap(config-if)# no shutdown	shutdown —Disables WLAN. no shutdown —Enables WLAN.

Configuring the Main SSID

To change the name of the main SSID, perform these steps.

SUMMARY STEPS

1. **configure terminal**
2. **dot11 ssid *SSID-name***

DETAILED STEPS

	Command or Action	Purpose
Step 1	configure terminal Example: ap# configure terminal Example: ap(config)#	Enters configuration mode.
Step 2	dot11 ssid <i>SSID-name</i> Example: ap(config)# dot11 ssid mainssid	<i>SSID-name</i> —The main SSID. The SSID may be up to 32 characters. In the example, the new SSID is called mainssid.

Configuring Guest SSIDs

To change the name of a guest SSID, perform these steps.

SUMMARY STEPS

1. **configure terminal**
2. **dot11 guest-ssid *guest-SSID-number SSID-name***

DETAILED STEPS

	Command or Action	Purpose
Step 1	configure terminal Example: ap# configure terminal Example: ap(config)#	Enters configuration mode.
Step 2	dot11 guest-ssid <i>guest-SSID-number SSID-name</i> Example: ap(config)# dot11 guest-ssid 1 guest1	<i>guest-SSID-number</i> —Specify 1, 2, or 3 to identify the guest SSID to configure. <i>SSID-name</i> —The new SSID. The SSID may be up to 32 characters.

	Command or Action	Purpose
		The example specifies a new SSID of guest1 for guest SSID number 1.

Enabling and Disabling Guest SSIDs

To enable or disable a guest SSID, follow these steps from global configuration mode:



Note

The main SSID cannot be disabled. However, guest SSIDs can be enabled/disabled. By default, guest SSIDs are disabled.

SUMMARY STEPS

1. `interface Dot11Radio 0`
2. `[no] guest-ssid guest-SSID-number SSID-name`

DETAILED STEPS

	Command or Action	Purpose
Step 1	<code>interface Dot11Radio 0</code> Example: <code>ap(config)# interface Dot11Radio 0</code>	Enters interface configuration mode.
Step 2	<code>[no] guest-ssid guest-SSID-number SSID-name</code> Example: <code>ap(config-if)# guest-ssid 1 guestssid1</code>	Enables the guest SSID specified by <i>guest-SSID-number</i> and <i>SSID-name</i> . <ul style="list-style-type: none"> • <i>guest-SSID-number</i>—Specify 1, 2, or 3 to identify the guest SSID to configure. • <i>SSID-name</i>—The name of the guest SSID. Entering the wrong SSID displays an error message. <p>Note The no form of the command disables the specified guest SSID.</p>

Hiding an Access Point

To hide or unhide an SSID, follow these steps from global configuration mode:

**Note**

Hiding the SSID (access point) provides a small measure of security in helping to prevent unauthorized users from accessing the network. When you hide the SSID, the SSID is not broadcasted, making wireless snooping more difficult.

SUMMARY STEPS

1. `dot11 {ssid | guest-ssid} [guest-SSID-number] SSID-name`
2. `[no] hide-ap`

DETAILED STEPS

	Command or Action	Purpose
Step 1	<p><code>dot11 {ssid guest-ssid} [guest-SSID-number] SSID-name</code></p> <p>Example:</p> <pre>ap(config)# dot11 guest-ssid 1 guestssid1</pre>	<p>Enters SSID configuration mode for a specific SSID. The <code>ap(config-ssid)</code> prompt indicates SSID configuration mode.</p> <ul style="list-style-type: none"> • ssid—The main SSID. • guest-ssid—A guest SSID. • <i>guest-SSID-number</i>—The guest SSID number. Use this only with the guest-ssid option. • <i>SSID-name</i>—The SSID name.
Step 2	<p><code>[no] hide-ap</code></p> <p>Example:</p> <pre>ap(config-ssid)# hide-ap</pre>	<p>Hides the SSID specified in the previous step.</p> <p>Note The no form of the command unhides the specified SSID.</p>

Enabling and Disabling Client Isolation

To enable or disable client isolation for a specific SSID, follow these steps from global configuration mode:

**Note**

Client isolation prevents a wireless client connected to a specific SSID from communicating with other wireless clients connected to the same SSID.

SUMMARY STEPS

1. `dot11 {ssid | guest-ssid} [guest-SSID-number] SSID-name`
2. `[no] isolate-clients`

DETAILED STEPS

	Command or Action	Purpose
Step 1	<p>dot11 {ssid guest-ssid} [guest-SSID-number] SSID-name</p> <p>Example:</p> <pre>ap(config)# dot11 guest-ssid 1 guestssid1</pre>	<p>Enters SSID configuration mode for a specific SSID. The ap(config-ssid) prompt indicates SSID configuration mode.</p> <ul style="list-style-type: none"> • ssid—The main SSID. • guest-ssid—A guest SSID. • <i>guest-SSID-number</i>—The guest SSID number. Use this only with the guest-ssid option. • <i>SSID-name</i>—The SSID name.
Step 2	<p>[no] isolate-clients</p> <p>Example:</p> <pre>ap(config-ssid)# isolate-clients</pre>	<p>Enables client isolation for the SSID specified in the previous step.</p> <p>The no form of the command disables client isolation for the specified SSID.</p>

Enabling and Disabling WMM Advertise

To enable or disable WiFi Multimedia (WMM) Advertise for a specific SSID, follow these steps from global configuration mode.

**Note**

The WiFi Multimedia (WMM) Advertise feature prioritizes media traffic to improve media transmission. WMM Advertise is enabled by default.

SUMMARY STEPS

1. **dot11** {ssid | guest-ssid} [guest-SSID-number] SSID-name
2. **[no] disable-wmm**

DETAILED STEPS

	Command or Action	Purpose
Step 1	<p>dot11 {ssid guest-ssid} [guest-SSID-number] SSID-name</p> <p>Example:</p> <pre>ap(config)# dot11 guest-ssid 1 guestssid1</pre>	<p>Enters SSID configuration mode for a specific SSID. The ap(config-ssid) prompt indicates SSID configuration mode.</p> <ul style="list-style-type: none"> • ssid—The main SSID. • guest-ssid—A guest SSID. • <i>guest-SSID-number</i>—The guest SSID number. Use this only with the guest-ssid option.

	Command or Action	Purpose
		<ul style="list-style-type: none"> • <i>SSID-name</i>—The SSID name.
Step 2	<p>[no] disable-wmm</p> <p>Example:</p> <pre>ap(config-ssid)# disable-wmm</pre>	<p>Disables the WMM Advertise feature for the SSID specified in the previous step.</p> <p>The no form of the command enables the WMM Advertise feature for the specified SSID.</p> <p>Note WMM Advertise is enabled by default.</p>

Enabling and Disabling Wireless Multicast Forwarding (WMF)

To enable or disable Wireless Multicast Forwarding(WMF) for a specific SSID, follow these steps from global configuration mode:



Note The WMF feature improves multicast traffic performance.

SUMMARY STEPS

1. **dot11 {ssid | guest-ssid} [guest-SSID-number] SSID-name**
2. **[no] wmf**

DETAILED STEPS

	Command or Action	Purpose
Step 1	<p>dot11 {ssid guest-ssid} [<i>guest-SSID-number</i>] <i>SSID-name</i></p> <p>Example:</p> <pre>ap(config)# dot11 guest-ssid 1 guestssid1</pre>	<p>Enters SSID configuration mode for a specific SSID. The ap(config-ssid) prompt indicates SSID configuration mode.</p> <ul style="list-style-type: none"> • ssid—The main SSID. • guest-ssid—A guest SSID. • <i>guest-SSID-number</i>—The guest SSID number. Use this only with the guest-ssid option. • <i>SSID-name</i>—The SSID name.
Step 2	<p>[no] wmf</p> <p>Example:</p> <pre>ap(config-ssid)# wmf</pre>	<p>Enables the WMF feature for the SSID specified in the previous step.</p> <p>The no form of the command disables the WMF feature for the specified SSID.</p>

Configuring the Global Maximum Number of Clients

To set the global maximum number of clients that can connect to an AP, follow these steps from global configuration mode:

SUMMARY STEPS

1. **configure terminal**
2. **global-max-clients** *number-of-clients*

DETAILED STEPS

	Command or Action	Purpose
Step 1	configure terminal Example: ap# configure terminal Example: ap(config)#	Enters configuration mode. Note To exit a configuration mode after completing configuration tasks, use the exit command .
Step 2	global-max-clients <i>number-of-clients</i> Example: ap(config)# global-max-clients 32	Configures the maximum number of clients that can connect to an AP. <i>number-of-clients</i> range: 1 to 128 clients

Configuring the Maximum Number of Clients for an SSID

To configure the maximum number of clients, follow these steps from global configuration mode:

SUMMARY STEPS

1. **dot11** {ssid | guest-ssid} [*guest-SSID-number*] *SSID-name*
2. **max-associations** *number-of-clients*

DETAILED STEPS

	Command or Action	Purpose
Step 1	dot11 {ssid guest-ssid} [<i>guest-SSID-number</i>] <i>SSID-name</i>	Enters SSID configuration mode for a specific SSID. The ap(config-ssid) prompt indicates SSID configuration mode.

	Command or Action	Purpose
	<p>Example:</p> <pre>ap(config)# dot11 guest-ssid 1 guestssid1</pre>	<ul style="list-style-type: none"> • ssid—The main SSID. • guest-ssid—A guest SSID. • <i>guest-SSID-number</i>—The guest SSID number. Use this only with the guest-ssid option. • <i>SSID-name</i>—The SSID name.
Step 2	<p>max-associations <i>number-of-clients</i></p> <p>Example:</p> <pre>ap(config-ssid)# max-associations 24</pre>	<p>Configures the maximum number of clients for the SSID specified in the previous step.</p> <p><i>number-of-clients</i>—Range is from 1 to 128 and the default value is 16.</p>

Configuring Authentication Options

Use the **authentication** command to configure authentication options for a specific SSID. By default, network authentication is Open.

To configure the authentication options, follow these steps from global configuration mode:

SUMMARY STEPS

1. **dot11** {**ssid** | **guest-ssid**} [*guest-SSID-number*] *SSID-name*
2. **authentication** *authentication-options*

DETAILED STEPS

	Command or Action	Purpose
Step 1	<p>dot11 {ssid guest-ssid} [<i>guest-SSID-number</i>] <i>SSID-name</i></p> <p>Example:</p> <pre>ap(config)# dot11 guest-ssid 1 guestssid1</pre>	<p>Enters SSID configuration mode for a specific SSID. The ap(config-ssid) prompt indicates SSID configuration mode.</p> <ul style="list-style-type: none"> • ssid—The main SSID. • guest-ssid—A guest SSID. • <i>guest-SSID-number</i>—The guest SSID number. Use this only with the guest-ssid option. • <i>SSID-name</i>—The SSID name.
Step 2	<p>authentication <i>authentication-options</i></p> <p>Example:</p> <pre>ap(config-ssid)# authentication open</pre>	<p>Configures authentication options for the SSID specified in the previous step. Table 30: Authentication Command Options, on page 264 describes options for the authentication command.</p> <p>The default authentication option is open.</p>

Command or Action	Purpose
-------------------	---------

What to Do Next

[Table 30: Authentication Command Options](#), on page 264 describes options for the **authentication** command:

Table 30: Authentication Command Options

Option	Syntax	Description
Open authentication	open	Configures open authentication.
Shared authentication	shared ap(config-ssid) # authentication shared	Configures shared authentication.
802.1x Options		
Authentication server port	802.1x auth-port <i>port-number</i> ap(config-ssid) # authentication 802.1x auth-port 2000	Defines the UDP port for the RADIUS authentication server. Range: 0 to 65535 Default: 1812
RADIUS key	802.1x key <i>encryption-key</i> ap(config-ssid) # authentication 802.1x key ABC123ABC1	Defines the per-server encryption key. Enter the server key in an unencrypted (cleartext) form.
RADIUS server address	802.1x server <i>server-IP-address</i> ap(config-ssid) # authentication 802.1x server 10.1.1.1	Specifies a RADIUS server.
WPA Authentication		
Authentication server port	WPA auth-port <i>port-number</i> ap(config-ssid) # authentication WPA auth-port 2000	Defines the UDP port for the RADIUS authentication server. Range: 0 to 65535 Default: 1812
RADIUS key	WPA key <i>encryption-key</i> ap(config-ssid) # authentication WPA key ABC123ABC1	Defines the per-server encryption key. Enter the server key in an unencrypted (cleartext) form.

Option	Syntax	Description
WPA Group Rekey Interval	WPA rekey-interval <i>seconds</i> ap(config-ssid)# authentication WPA rekey-interval 604800	Defines the authentication rekey interval in seconds. Range: 0 to 2147483647 (seconds) The example configures the rekey interval to one week (604800 seconds).
RADIUS server address	WPA server <i>server-IP-address</i> ap(config-ssid)# authentication WPA server 10.1.1.1	Specifies a RADIUS server.
WPA-PSK Authentication		
WPA/WAPI passphrase	WPA-PSK passphrase <i>password</i> ap(config-ssid)# authentication WPA-PSK passphrase MyPaSsWoRd	The passphrase for WPA-PSK. Enter a cleartext/unencrypted WPA passphrase. Range: 8 to 63 ASCII characters or 64 hexadecimal digits
WPA Group Rekey Interval	WPA-PSK rekey-interval <i>seconds</i> ap(config-ssid)# authentication WPA-PSK rekey-interval 604800	Defines the authentication rekey interval in seconds. Range: 0 to 2147483647 (seconds) The example configures the rekey interval to one week (604800 seconds).
WPA2 Authentication		
Authentication server port	WPA2 auth-port <i>port-number</i> ap(config-ssid)# authentication WPA2 auth-port 2000	Defines the UDP port for the RADIUS authentication server. Range: 0 to 65535 Default: 1812
RADIUS key	WPA2 key <i>encryption-key</i> ap(config-ssid)# authentication WPA2 key ABC123ABC1	Defines the per-server encryption key. Enter the server key in an unencrypted (cleartext) form.
WPA2 preauthentication	WPA2 preauth ap(config-ssid)# authentication WPA2 preauth ap(config-ssid)# no authentication WPA2 preauth	Enables WPA2 preauthentication. The no form of the command disables preauthentication.

Option	Syntax	Description
Network reauthorization interval	WPA2 reauth-interval <i>seconds</i> ap(config-ssid) # authentication WPA2 reauth-interval 604800	Defines the WPA2 reauthorization interval in seconds. Range: 0 to 2147483647 (seconds) The example configures the reauthorization interval to one week (604800 seconds).
WPA Group Rekey Interval	WPA2 rekey-interval <i>seconds</i> ap(config-ssid) # authentication WPA2 rekey-interval 604800	Defines the authentication rekey interval in seconds. Range: 0 to 2147483647 (seconds) The example configures the rekey interval to one week (604800 seconds).
RADIUS server address	WPA2 server <i>server-IP-address</i> ap(config-ssid) # authentication WPA2 server 10.1.1.1	Specifies a RADIUS server.
WPA2-PSK Authentication		
WPA/WAPI passphrase	WPA2-PSK passphrase <i>password</i> ap(config-ssid) # authentication WPA2-PSK passphrase MyPaSsWoRd	The passphrase for WPA2-PSK. Enter a cleartext/unencrypted WPA passphrase. Range: 8 to 63 ASCII characters or 64 hexadecimal digits
WPA-PSK Group Rekey Interval	WPA2-PSK rekey-interval <i>seconds</i> ap(config-ssid) # authentication WPA2-PSK rekey-interval 604800	Defines the authentication rekey interval in seconds. Range: 0 to 2147483647 (seconds) The example configures the rekey interval to one week (604800 seconds).
Mixed WPA2/WPA Authentication		
Authentication server port	Mixed-WPA2-WPA auth-port <i>port-number</i> ap(config-ssid) # authentication Mixed-WPA2-WPA auth-port 2000	Defines the UDP port for the RADIUS authentication server. Range: 0 to 65535 Default: 1812
RADIUS key	Mixed-WPA2-WPA key <i>encryption-key</i> ap(config-ssid)# authentication Mixed-WPA2-WPA key ABC123ABC1	Defines the per-server encryption key. Enter the server key in an unencrypted (cleartext) form.

Option	Syntax	Description
WPA2 preauthentication	Mixed-WPA2-WPA preauth ap(config-ssid)# authentication Mixed-WPA2-WPA preauth ap(config-ssid)# no authentication Mixed-WPA2-WPA preauth	Enables WPA2 preauthentication. The no form of the command disables preauthentication.
Network reauthorization interval	Mixed-WPA2-WPA reauth-interval ap(config-ssid)# authentication Mixed-WPA2-WPA reauth-interval 604800	Defines the WPA2 reauthorization interval in seconds. Range: 0 to 2147483647 (seconds) The example configures the reauthorization interval to one week (604800 seconds).
WPA Group Rekey Interval	Mixed-WPA2-WPA rekey-interval <i>seconds</i> ap(config-ssid)# authentication Mixed-WPA2-WPA rekey-interval 604800	Defines the authentication rekey interval in seconds. Range: 0 to 2147483647 (seconds) The example configures the rekey interval to one week (604800 seconds).
RADIUS server address	Mixed-WPA2-WPA server <i>server-IP-address</i> ap(config-ssid)# authentication Mixed-WPA2-WPA server 10.1.1.1	Specifies a RADIUS server.
Mixed WPA2/WPA-PSK Authentication		
Passphrase	Mixed-WPA2-WPA-PSK passphrase <i>password</i> ap(config-ssid)# authentication Mixed-WPA2-WPA-PSK passphrase MyPaSsWoRd	The preshared passphrase for WiFi protected access. Enter a clear WPA passphrase. Range: 8 to 63 ASCII characters or 64 hexadecimal digits
WPA Group Rekey Interval	WPA2-PSK rekey-interval <i>seconds</i> ap(config-ssid)# authentication Mixed-WPA2-WPA-PSK rekey-interval 604800	Defines the authentication rekey interval in seconds. Range: 0 to 2147483647 (seconds) The example configures the rekey interval to one week (604800 seconds).

Configuring Encryption Options

To configure the encryption options for a specific SSID, follow these steps from global configuration mode:

SUMMARY STEPS

1. **dot11** {ssid | guest-ssid} [*guest-SSID-number*] *SSID-name*
2. **encryption mode** *encryption-options*

DETAILED STEPS

	Command or Action	Purpose
Step 1	dot11 {ssid guest-ssid} [<i>guest-SSID-number</i>] <i>SSID-name</i> Example: ap(config)# dot11 guest-ssid 1 guestssid1	Enters SSID configuration mode for a specific SSID. The ap(config-ssid) prompt indicates SSID configuration mode. <ul style="list-style-type: none"> • ssid—The main SSID. • guest-ssid—A guest SSID. • <i>guest-SSID-number</i>—The guest SSID number. Use this only with the guest-ssid option. • <i>SSID-name</i>—The SSID name.
Step 2	encryption mode <i>encryption-options</i> Example: ap(config-ssid)# encryption mode wep	Configures encryption options for the SSID specified in the previous step. Table 31: Encryption Command Options, on page 268 describes options for the encryption mode command.

What to Do Next

[Table 31: Encryption Command Options, on page 268](#) describes options for the **encryption mode** command:

Table 31: Encryption Command Options

Option	Syntax	Description
WEP encryption options		

Option	Syntax	Description
Enable/Disable WEP encryption	<p>[no] encryption mode wep</p> <p>ap(config-ssid)# encryption mode wep</p> <p>ap(config-ssid)# no encryption mode wep</p>	<p>Enables WEP encryption. The no form of the command disables WEP encryption.</p> <p>Note The WEP encryption default setting depends on the authentication option selected. Open authentication—Default is disabled. Shared—Default is enabled; cannot disable. 802.1x—Default is enabled; cannot disable. WPA, WPA-PSK, WPA2, WPA2-PSK, Mixed WPA2/WPA, Mixed WPA2/WPA-PSK—Default is disabled; cannot enable.</p>
Encryption strength	<p>wep encryption-strength [64bit 128bit]</p> <p>ap(config-ssid)# encryption mode wep encryption-strength 64bit</p>	<p>Configures the WEP encryption strength.</p> <p>64bit—Specifies a 64-bit key.</p> <p>128bit—Specifies a 128-bit key.</p>
Current network key	<p>wep current-key <i>key-number</i></p> <p>ap(config-ssid)# encryption mode wep current-key 1</p>	<p>It is possible to configure four different network keys. This command determines which key to use currently.</p> <p><i>key-number</i> range: 1 to 4</p>
Network key	<p>wep key <i>key-number key</i></p> <p>ap(config-ssid)# encryption mode wep key 1 54321</p>	<p>Configures a network key.</p> <p><i>key-number</i> range: 1 to 4</p> <p><i>key</i>:</p> <ul style="list-style-type: none"> • For a 64-bit key: 5 ASCII characters or 10 hexadecimal digits • For a 128-bit key: 13 ASCII characters or 26 hexadecimal digits
WPA/WAPI Encryption Options		
AES	<p>aes</p> <p>ap(config-ssid)# encryption mode aes</p>	<p>Configures the encryption mode to AES.</p> <p>Note AES is supported only under WPA, WPA-PSK, WPA2, WPA2-PSK, Mixed WPA2/WPA, or Mixed WPA2/WPA-PSK.</p>

Option	Syntax	Description
TKIP+AES	<pre> tkip+aes ap(config-ssid) # encryption mode tkip+aes </pre>	<p>Configures the encryption mode to TKIP+AES.</p> <p>Note TKIP+AES is supported only under WPA, WPA-PSK, WPA2, WPA2-PSK, Mixed WPA2/WPA, or Mixed WPA2/WPA-PSK.</p>

Configuring the MAC Address Filter Access List

To add a MAC address to the access-list or to remove a MAC address from the access-list, follow these steps from global configuration mode :

SUMMARY STEPS

1. **dot11** {ssid | guest-ssid} [guest-SSID-number] SSID-name
2. [no] **access-list** MAC-address

DETAILED STEPS

	Command or Action	Purpose
Step 1	<pre> dot11 {ssid guest-ssid} [guest-SSID-number] SSID-name Example: ap(config) # dot11 guest-ssid 1 guestssid1 </pre>	<p>Enters SSID configuration mode for a specific SSID. The ap(config-ssid) prompt indicates SSID configuration mode.</p> <ul style="list-style-type: none"> • ssid—The main SSID. • guest-ssid—A guest SSID. • <i>guest-SSID-number</i>—The guest SSID number. Use this only with the guest-ssid option. • <i>SSID-name</i>—The SSID name.
Step 2	<pre> [no] access-list MAC-address Example: ap(config-ssid) # access-list AB:12:CD:34:EF:56 Example: ap(config-ssid) # no access-list AB:12:CD:34:EF:56 </pre>	<p>Adds the MAC address to the access list for the SSID specified in the previous step.</p> <p><i>MAC-address</i>—Hexadecimal characters in the following format: HH:HH:HH:HH:HH:HH</p> <p>Note The no form of the command removes a MAC address from the access list.</p>

Configuring the MAC Address Filter Mode

To select the MAC address access list mode, follow these steps from global configuration mode:

SUMMARY STEPS

1. `dot11 {ssid | guest-ssid} [guest-SSID-number] SSID-name`
2. `[no] mac-filter-mode [allow | deny]`

DETAILED STEPS

	Command or Action	Purpose
Step 1	<p><code>dot11 {ssid guest-ssid} [guest-SSID-number] SSID-name</code></p> <p>Example:</p> <pre>ap(config)# dot11 guest-ssid 1 guestssid1</pre>	<p>Enters SSID configuration mode for a specific SSID. The <code>ap(config-ssid)</code> prompt indicates SSID configuration mode.</p> <ul style="list-style-type: none"> • ssid—The main SSID. • guest-ssid—A guest SSID. • <i>guest-SSID-number</i>—The guest SSID number. Use this only with the guest-ssid option. • <i>SSID-name</i>—The SSID name.
Step 2	<p><code>[no] mac-filter-mode [allow deny]</code></p> <p>Example:</p> <pre>ap(config-ssid)# mac-filter-mode allow</pre> <p>Example:</p>	<p>Configures the mode for the MAC address filter feature.</p> <ul style="list-style-type: none"> • allow—To allow MAC addresses on the access list to connect: • deny—To deny MAC addresses on the access list from connecting:

Configuring Radio Channel

To configure channel options, follow these steps from global configuration mode:

SUMMARY STEPS

1. `interface Dot11Radio 0`
2. `channel {channel-number | least-congested} [timer minutes-before-next-scan]`

DETAILED STEPS

	Command or Action	Purpose
Step 1	interface Dot11Radio 0 Example: ap(config)# interface Dot11Radio 0	Enters radio interface mode, indicated by the ap(config-if) prompt.
Step 2	channel {<i>channel-number</i> least-congested} [timer <i>minutes-before-next-scan</i>] Example: ap(config-if)# channel least-congested timer 60	Configures a specific radio channel manually or selects automatic scanning; and configures the automatic scanning timer. <ul style="list-style-type: none"> • <i>channel-number</i>—Sets a specific channel. The channel-number range is 1 to 11 for American models, or 1 to 13 for European models • least-congested—Configures automatic scanning for the least congested channel, use the least-congested option and specify the number of minutes to wait before scanning again for the best channel. • <i>minutes-before-next-scan</i>—Sets the timer for automatic scanning. Range varies from 1 to 35791394.

Configuring 802.11n Options

To configure 802.11n options, follow these steps from global configuration mode:

SUMMARY STEPS

1. **interface Dot11Radio 0**
2. **[no] dot11n**
3. **dot11n rate**
4. **[no] dot11n protection**
5. **[no] dot11n n-client-only**
6. **[no] dot11n rifs**
7. **[no] dot11n [rx-pwr-save | rx-pwr-save quiet-time *seconds*] pps *pps-value*]**

DETAILED STEPS

	Command or Action	Purpose
Step 1	interface Dot11Radio 0 Example: ap(config)# interface Dot11Radio 0	Enters radio interface mode, indicated by the ap(config-if) prompt.

	Command or Action	Purpose
Step 2	[no] dot11n	Configures 802.11n radio options.
Step 3	dot11n rate	Configures the 802.11n rate: <ul style="list-style-type: none"> • <i>rate</i> range: 0 to 15. Table 32: Rate Options for 802.11n, on page 273 describes the 802.11n rates for each <i>rate</i> value. • 54g—Uses the 54g rate. • auto—Selects a rate automatically.
Step 4	[no] dot11n protection	Enables 802.11n protection.
Step 5	[no] dot11n n-client-only	Enables the 802.11n client-only mode, which limits the WLAN to clients using 802.11n: <p>Note When the 802.11n client-only option is enabled, clients are unable to connect to SSIDs with a WEP security setting. To enable the client to connect to the SSID, change the SSID security setting so that WEP is not configured. Alternatively, the client can connect to an SSID with non-WEP security settings.</p>
Step 6	[no] dot11n rifs	Enables Reduced Inter-Frame Space (RIFS) advertisement.
Step 7	[no] dot11n [rx-pwr-save rx-pwr-save quiet-time <i>seconds</i> pps <i>pps-value</i>]	Enables the RX Chain Power Save. <ul style="list-style-type: none"> • <i>seconds</i> —Sets the RX Chain Power Save quiet time (time interval to wait before going into power save mode): The range is from 0 to 2147483647. • <i>pps-value</i> — Sets the RX Chain Power Save packets per second (PPS) threshold. The range is from 0 to 2147483647 packets per second.

What to Do Next

[Table 32: Rate Options for 802.11n, on page 273](#) describes the rate options for 802.11n, as specified by rate in the **dot11n rate** command:

Table 32: Rate Options for 802.11n

Value	Rate
0	MCS index 0, 6.5 Mbps
1	MCS index 1, 13 Mbps
2	MCS index 2, 19.5 Mbps
3	MCS index 3, 26 Mbps

Value	Rate
4	MCS index 4, 39 Mbps
5	MCS index 5, 52 Mbps
6	MCS index 6, 58.5 Mbps
7	MCS index 7, 65 Mbps
8	MCS index 8, 13 Mbps
9	MCS index 9, 26 Mbps
10	MCS index 10, 39 Mbps
11	MCS index 11, 52 Mbps
12	MCS index 12, 78 Mbps
13	MCS index 13, 104 Mbps
14	MCS index 14, 117 Mbps
15	MCS index 15, 130 Mbps

Configuring the 54g Mode

To set the 54g mode, follow these steps from global configuration mode:

SUMMARY STEPS

1. `interface Dot11Radio 0`
2. `54g-mode [auto | dot11b-only | lrs | performance]`

DETAILED STEPS

	Command or Action	Purpose
Step 1	<code>interface Dot11Radio 0</code> Example: <code>ap(config)# interface Dot11Radio 0</code>	Enters radio interface mode, indicated by the ap(config-if) prompt.
Step 2	<code>54g-mode [auto dot11b-only lrs performance]</code>	Configures the 54g mode. <ul style="list-style-type: none"> • auto—54g auto mode. Accepts 802.11b, 802.11g, and 54g clients. This option provides the widest compatibility.

	Command or Action	Purpose
	<p>Example:</p> <pre>ap(config-if)# 54g-mode auto</pre>	<ul style="list-style-type: none"> • dot11b-only—Accepts only 802.11b clients. • lrs—54g Limited Rate Support (LRS). Intended for legacy 802.11b client support. • performance—54g Performance mode. Accepts only 54g clients, provides the fastest performance with 54g certified equipment.

Configuring the 54g Preamble Type

To set the 54g preamble type, follow these steps from global configuration mode:



Note

The preamble type can be set only when 802.11n is disabled (**no dot11n**) and 54g-mode is either **auto** or **dot11b-only**.

SUMMARY STEPS

1. `interface Dot11Radio 0`
2. `54g-mode {auto | dot11b-only} preamble {short | long}`

DETAILED STEPS

	Command or Action	Purpose
Step 1	<p><code>interface Dot11Radio 0</code></p> <p>Example:</p> <pre>ap(config)# interface Dot11Radio 0</pre>	Enters radio interface mode, indicated by the ap(config-if) prompt.
Step 2	<p><code>54g-mode {auto dot11b-only} preamble {short long}</code></p> <p>Example:</p> <pre>ap(config-if)# 54g-mode auto preamble long</pre> <p>Example:</p> <pre>ap(config-if)# 54g-mode dot11b-only preamble short</pre>	<p>Configures 54g preamble type.</p> <ul style="list-style-type: none"> • short—Short preamble. When there are no 802.11b clients, setting preamble type to short improves performance. • long—Long preamble. When there are both 802.11g and 802.11b clients, set preamble type to long. • 54g-mode must be either auto or dot11b-only.

Configuring the 54g Rate

To set the 54g transmission rate, follow these steps from global configuration mode:



Note The 54g rate can be set only when the 802.11n rate is configured to use 54g rate (**dot11n rate 54g**) or when 802.11n is disabled (**no dot11n**).

SUMMARY STEPS

1. **interface Dot11Radio 0**
2. **54g-rate {Mbps-rate |auto}**

DETAILED STEPS

	Command or Action	Purpose
Step 1	interface Dot11Radio 0 Example: ap(config)# interface Dot11Radio 0	Enters radio interface mode, indicated by the ap(config-if) prompt.
Step 2	54g-rate {Mbps-rate auto} Example: ap(config-if)# 54g-rate 54 Example:	Configures the rate for 54g mode. <ul style="list-style-type: none"> • <i>Mbps-rate</i>—specifies a rate in Mbps. The following values are possible: <ul style="list-style-type: none"> • 1 • 2 • 5.5 • 6 • 9 • 11 • 12 • 18 • 24 • 36 • 48 • 54 • auto—Sets the 54g rate automatically.

Configuring 54g Protection

To set 54g protection, follow these steps from global configuration mode:



Note 54g protection can be set only when 802.11n is disabled.

SUMMARY STEPS

1. `interface Dot11Radio 0`
2. `54g-protection`

DETAILED STEPS

	Command or Action	Purpose
Step 1	interface Dot11Radio 0 Example: <code>ap(config)# interface Dot11Radio 0</code>	Enters radio interface mode, indicated by the ap(config-if) prompt.
Step 2	54g-protection Example: <code>ap(config-if)# 54g-protection</code>	Enables 54g protection. <ul style="list-style-type: none"> • 54g-protection—Enables the RTS/CTS protection mechanism. • no 54g-protection—Disables 54g protection.

Configuring the Multicast Rate

To set the multicast transmission rate, follow these steps from global configuration mode:

SUMMARY STEPS

1. `interface Dot11Radio 0`
2. `multicast-rate {Mbps-rate | auto}`

DETAILED STEPS

	Command or Action	Purpose
Step 1	interface Dot11Radio 0 Example: <code>ap(config)# interface Dot11Radio 0</code>	Enters radio interface mode, indicated by the ap(config-if) prompt.
Step 2	multicast-rate {Mbps-rate auto} Example: <code>ap(config-if)# multicast-rate 54</code> Example: <code>ap(config-if)# multicast-rate auto</code>	Configures the multicast rate. <i>Mbps-rate</i> specifies a rate in Mbps. The following values are possible: <ul style="list-style-type: none"> • 1 • 2 • 5.5 • 6 • 9 • 11 • 12 • 18 • 24 • 36 • 48 • 54 auto —Sets the multicast rate automatically. Note When 802.11n is disabled (no dot11n) and 54g-mode is configured to 802.11b only (54g-mode dot11b-only), the only accepted rates are auto, 1, 2, 5.5, or 11 Mbps. Attempting to configure any other rate displays a warning message:

Configuring the Basic Rate

To set the basic transmission rate, which is the data rate that wireless clients should support, follow these steps from global configuration mode:

SUMMARY STEPS

1. **interface Dot11Radio 0**
2. **basic-rate {1 | 2 | all | default}**

DETAILED STEPS

	Command or Action	Purpose
Step 1	interface Dot11Radio 0 Example: <code>ap(config)# interface Dot11Radio 0</code>	Enters radio interface mode, indicated by the ap(config-if) prompt.
Step 2	basic-rate {1 2 all default} Example: <code>ap(config-if)# basic-rate 2</code> Example: <code>ap(config-if)# basic-rate all</code>	Configures the basic rate. <ul style="list-style-type: none"> • 1—1 and 2 Mbps • 2—1, 2, 5.5, 6, 11, 12, and 24 Mbps • all—All rates • default—1, 2, 5.5, and 11 Mbps

Configuring the Fragmentation Threshold

To set the fragmentation threshold, which is the maximum packet size (bytes) before data is fragmented, follow these steps from global configuration mode:

SUMMARY STEPS

1. **interface Dot11Radio 0**
2. **fragment-threshold** *threshold-in-bytes*

DETAILED STEPS

	Command or Action	Purpose
Step 1	interface Dot11Radio 0 Example: <code>ap(config)# interface Dot11Radio 0</code>	Enters radio interface mode, indicated by the ap(config-if) prompt.
Step 2	fragment-threshold <i>threshold-in-bytes</i> Example: <code>ap(config-if)# fragment-threshold 2346</code>	Configures the fragmentation threshold in bytes. <i>threshold-in-bytes</i> range: 256 to 2346 bytes Default value is 2346

Configuring the RTS Threshold

To set the request-to-send (RTS) threshold, follow these steps from global configuration mode:



Note If an access point transmits a packet larger than the threshold, it will trigger CTS (clear-to-send) protection mode.

SUMMARY STEPS

1. `interface Dot11Radio 0`
2. `rts-threshold threshold-in-bytes`

DETAILED STEPS

	Command or Action	Purpose
Step 1	interface Dot11Radio 0 Example: <code>ap(config)# interface Dot11Radio 0</code>	Enters radio interface mode, indicated by the ap(config-if) prompt.
Step 2	rts-threshold <i>threshold-in-bytes</i> Example: <code>ap(config-if)# rts-threshold 2347</code>	Configures the RTS threshold in bytes. <i>threshold-in-bytes</i> —Range is from 0 to 2347 bytes. Default value is 2347

Configuring the DTIM Interval

To set the Delivery Traffic Indication Message (DTIM) interval, follow these steps from global configuration mode:

SUMMARY STEPS

1. `interface Dot11Radio 0`
2. `dtim-interval number-of-beacons`

DETAILED STEPS

	Command or Action	Purpose
Step 1	interface Dot11Radio 0 Example: ap(config)# interface Dot11Radio 0	Enters radio interface mode, indicated by the ap(config-if) prompt.
Step 2	dtim-interval <i>number-of-beacons</i> Example: ap(config-if)# dtim-interval 255	Configures the DTIM interval that is included in beacon frames to inform clients of when next to expect buffered data from the AP. <i>number-of-beacons</i> —Range is 1 to 255 beacons. Default is 1

Configuring the Beacon Interval

To set the beacon interval, follow these steps from global configuration mode:

SUMMARY STEPS

1. **interface Dot11Radio 0**
2. **beacon-interval *number-of-milliseconds***

DETAILED STEPS

	Command or Action	Purpose
Step 1	interface Dot11Radio 0 Example: ap(config)# interface Dot11Radio 0	Enters radio interface mode, indicated by the ap(config-if) prompt.
Step 2	beacon-interval <i>number-of-milliseconds</i> Example: ap(config-if)# beacon-interval 65535	Configures the beacon interval. <i>number-of-milliseconds</i> —range is 1 to 65535 milliseconds (ms) and default value is 100 milliseconds.

Configuring the Radio Transmit Power

To set the radio transmit power for WLAN, follow these steps from global configuration mode:

SUMMARY STEPS

1. `interface Dot11Radio 0`
2. `tx-pwr power-percentage`

DETAILED STEPS

	Command or Action	Purpose
Step 1	interface Dot11Radio 0 Example: <code>ap(config)# interface Dot11Radio 0</code>	Enters radio interface mode, indicated by the ap(config-if) prompt.
Step 2	tx-pwr power-percentage Example: <code>ap(config-if)# tx-pwr 60</code>	Configures the transmit power, as a percentage of the maximum power. <i>power-percentage</i> —specifies the power percentage. The following values are possible: <ul style="list-style-type: none"> • 20 • 40 • 60 • 80 • 100

Configuring WMM Options

To configure WiFi Multimedia (WMM) options, follow these steps from global configuration mode :

SUMMARY STEPS

1. `interface Dot11Radio 0`
2. `[no] wmm [auto | no-ack | apsd]`

DETAILED STEPS

	Command or Action	Purpose
Step 1	interface Dot11Radio 0 Example: <code>ap(config)# interface Dot11Radio 0</code>	Enters radio interface mode, indicated by the ap(config-if) prompt.

	Command or Action	Purpose
Step 2	<p>[no] wmm [auto no-ack apsd]</p> <p>Example:</p> <pre>ap(config-if)# wmm</pre>	<p>Enable or Disables WMM.</p> <ul style="list-style-type: none"> • auto—Configures WMM auto mode: • no-ack—Configures no-acknowledgement for WMM • apsd—Enables Automatic Power Save Delivery (APSD) mode for WMM. <p>Note When WMM is in “Auto” mode, WMM APSD must be set to “Enabled” to enable a client to use Power Save Mode. When WMM is in “Enabled” mode, the client can use Power Save Mode regardless of whether WMM APSD is “Enabled” or “Disabled”.</p>

Displaying Current CLI Values and Keywords

Use the `show ap-config` command to display the current CLI values and keywords.

SUMMARY STEPS

1. `show ap-config`

DETAILED STEPS

	Command or Action	Purpose
Step 1	<p><code>show ap-config</code></p> <p>Example:</p> <pre>ap# show ap-config</pre>	Displays the current CLI values and keywords.

What to Do Next

Example Configuration: Displaying Current CLI Values and Keywords

This example displays current CLI values and keywords.

```
ap# show ap-config
global-max-clients 16
dot11 ssid Cisco860
no isolate-clients
no wmf
max-associations 16
no hide-ap
no disable-wmm
no mac-filter-mode
authentication open
no encryption mode wep
exit
```

```

dot11 guest-ssid 1 Cisco860_Guest1
no isolate-clients
no wmf
max-associations 16
no hide-ap
no disable-wmm
no mac-filter-mode
authentication open
no encryption mode wep
exit
dot11 guest-ssid 2 Cisco860_Guest2
no isolate-clients
no wmf
max-associations 16
no hide-ap
no disable-wmm
no mac-filter-mode
authentication open
no encryption mode wep
exit
dot11 guest-ssid 3 Cisco860_Guest3
no isolate-clients
no wmf
max-associations 16
no hide-ap
no disable-wmm
no mac-filter-mode
authentication open
no encryption mode wep
exit
interface Dot11Radio 0
no shutdown
ssid Cisco860
no guest-ssid 1 Cisco860_Guest1
no guest-ssid 2 Cisco860_Guest2
no guest-ssid 3 Cisco860_Guest3
dot11n
channel least-congested timer 15
dot11n rate auto
dot11n protection
no dot11n n-client-only
dot11n rifs
no dot11n rx-pwr-save
dot11n rx-pwr-save quiet-time 10
dot11n rx-pwr-save pps 10
54g-rate auto
multicast-rate auto
basic-rate default
fragment-threshold 2346
rts-threshold 2347
dtim-interval 1
beacon-interval 100
tx-pwr 100
wmm
no wmm no-ack
wmm apsd
exit
interface BVI 1
ip address 10.10.10.2 255.255.255.248
no shutdown
exit

```

Displaying Current Channel and Power Information

Use the **show controllers Dot11Radio 0** command to display the current channel and power information.

SUMMARY STEPS

1. **show controllers Dot11Radio 0**

DETAILED STEPS

	Command or Action	Purpose
Step 1	<p>show controllers Dot11Radio 0</p> <p>Example:</p> <p>ap# show controllers Dot11Radio 0</p>	Displays the current channel and power information.

What to Do Next

Example

```

ap# show controllers Dot11Radio 0
interface Dot11Radio0
Beacon Interval(ms)                : 100
DTIM Interval(beacon)              : 1
Power Control:                      On, HW
Current Channel:                    11
BSS Channel:                        11
BSS Local Max:                      30.0 dBm
BSS Local Constraint:              0.0 dB
Channel Width:                      20MHz
User Target:                        31.75 dBm
SROM Antgain 2G:                    2.0 dB
SROM Antgain 5G:                    2.0 dB
SAR:                                -
Current rate:                        [MCS15] ht mcs 15 Tx Exp 0 BW 20 sgi
Regulatory Limits:
Rate                               Chains 20MHz
DSSS                               1      19.0
OFDM                               1      13.50
MCS0_7                             1      13.50
VHT8_9SS1                          1      -
DSSS_MULTI1                        2      -
OFDM_CDD1                          2      10.50
MCS0_7_CDD1                        2      10.50
VHT8_9SS1_CDD1                     2      -
MCS0_7_STBC                        2      10.50
VHT8_9SS1_STBC                     2      -
MCS8_15                             2      10.50
VHT8_9SS2                          2      -
DSSS_MULTI2                        3      -
OFDM_CDD2                          3      -
MCS0_7_CDD2                        3      -
VHT8_9SS1_CDD2                     3      -
MCS0_7_STBC_SPEXP1                 3      -
VHT8_9SS1_STBC_SPEXP1              3      -
MCS8_15_SPEXP1                     3      -
VHT8_9SS2_SPEXP1                   3      -
MCS16_23                           3      -
VHT8_9SS3                          3      -
Core Index:                        0
Board Limits:
Rate                               Chains 20MHz
DSSS                               1      17.50
OFDM                               1      17.50
MCS0_7                             1      17.50
VHT8_9SS1                          1      -
DSSS_MULTI1                        2      17.50
OFDM_CDD1                          2      17.50
MCS0_7_CDD1                        2      17.50

```

```

VHT8_9SS1_CDD1          2      -
MCS0_7_STBC             2     17.50
VHT8_9SS1_STBC         2      -
MCS8_15                 2     17.50
VHT8_9SS2               2      -
DSSS_MULTTI2           3      -
OFDM_CDD2              3      -
MCS0_7_CDD2            3      -
VHT8_9SS1_CDD2         3      -
MCS0_7_STBC_SPEXP1     3      -
VHT8_9SS1_STBC_SPEXP1  3      -
MCS8_15_SPEXP1         3      -
VHT8_9SS2_SPEXP1       3      -
MCS16_23               3      -
VHT8_9SS3              3      -
Power Targets:
Rate                    Chains 20MHz
DSSS                    1     16.0
OFDM                    1     12.0
MCS0_7                  1     12.0
VHT8_9SS1               1      8.0
DSSS_MULTTI1           2      8.0
OFDM_CDD1              2      9.0
MCS0_7_CDD1            2      9.0
VHT8_9SS1_CDD1         2      8.0
MCS0_7_STBC            2      9.0
VHT8_9SS1_STBC         2      8.0
MCS8_15                 2      9.0
VHT8_9SS2               2      8.0
DSSS_MULTTI2           3      -
OFDM_CDD2              3      -
MCS0_7_CDD2            3      -
VHT8_9SS1_CDD2         3      -
MCS0_7_STBC_SPEXP1     3      -
VHT8_9SS1_STBC_SPEXP1  3      -
MCS8_15_SPEXP1         3      -
VHT8_9SS2_SPEXP1       3      -
MCS16_23               3      -
VHT8_9SS3              3      -
Maximum Power Target among all rates: 16.0 16.0
Last est. power           : 0.0 15.75
Power Target for the current rate : 16.0 16.0
Last adjusted est. power  : 0.0 15.75
Power Percentage          : 100
Channel Status:
No scan in progress.
current mac channel      11
target channel          11

```

Displaying Current Associated Clients

Use the **show dot11 associations** command to display the current associated clients.

SUMMARY STEPS

1. **show dot11 associations**

DETAILED STEPS

	Command or Action	Purpose
Step 1	show dot11 associations Example: ap# show dot11 associations	Displays the current associated clients.

What to Do Next**Example: Displaying Current Associated Clients**

```
ap# show dot11 associations
Authenticated      Associated      Authorized      Interface
AA:BB:CC:11:22:33  yes            no              Dot11Radio0
```

Displaying the SSID to BSSID Mapping

Each SSID has an associated BSSID. Use the **show dot11 bssid** command to display the SSID to BSSID mapping.

SUMMARY STEPS

1. **show dot11 bssid**

DETAILED STEPS

	Command or Action	Purpose
Step 1	show dot11 bssid Example: ap# show dot11 bssid	Displays the SSID to BSSID mapping.

What to Do Next**Example: Displaying the SSID to BSSID Mapping**

```
ap# show dot11 bssid
Interface      BSSID          Guest      SSID
Dot11Radio0   A4:93:4C:01:7A:9A  No         Cisco860
Dot11Radio0   A4:93:4C:01:7A:9B  Yes        Cisco860_Guest1
Dot11Radio0   A4:93:4C:01:7A:9C  Yes        Cisco860_Guest2
Dot11Radio0   A4:93:4C:01:7A:9D  Yes        Cisco860_Guest3
```

Displaying the Tx/Rx Statistics

Use the **show dot11 statistics** command to display the current transmit/receive (tx/rx) statistics for Dot11Radio 0 interface.

SUMMARY STEPS

1. **show dot11 statistics**

DETAILED STEPS

	Command or Action	Purpose
Step 1	show dot11 statistics Example: ap# show dot11 statistics	Displays the current tx/rx statistics for Dot11Radio 0 interface.

What to Do Next

Example: Displaying the Tx/Rx Statistics

```
ap# show dot11 statistics
          rx bytes  rx pkts  rx errs  rx drops  tx bytes  tx pkts  tx errs  tx drops
Dot11Radio0          0         0          0          0    12824         94          0          0
```

Displaying the BVI 1 Interface Details

Use the **show interfaces BVI 1** command to display BVI 1 interface details. Details include the IP address of the router.



Tip

After changing the IP address used for accessing the router, this command can be used to confirm the change. See [Setting the IP Address for the Web-based Interface](#), on page 255.

SUMMARY STEPS

1. **show interfaces BVI 1**

DETAILED STEPS

	Command or Action	Purpose
Step 1	show interfaces BVI 1 Example: ap# show interfaces BVI 1	Displays the current BVI 1 interface details.

What to Do Next**Example: Displaying the BVI 1 Interface Details**

This example displays BVI 1 interface details.

```
ap# show interfaces BVI 1
BVI1
    Link encap:Ethernet  HWaddr AA:11:BB:22:CC:33
    inet addr:10.10.10.2  Bcast:10.10.10.7  Mask:255.255.255.248
    UP BROADCAST RUNNING MULTICAST  MTU:1500  Metric:1
    RX packets:260  multicast:86  unicast:0  broadcast:174
    RX errors:0  dropped:0  overruns:0  frame:0
    TX packets:21  multicast:0  unicast:21  broadcast:0
    TX errors:0  dropped:0  overruns:0  carrier:0  collisions:0
    txqueuelen:0
    RX bytes:46642 (45.5 KiB)  TX bytes:1260 (1.2 KiB)
    RX multicast bytes:32164 (31.4 KiB)  TX multicast bytes:0 (0.0 B)
```

Displaying Dot11Radio 0 Interface Information

Use the **show interfaces Dot11Radio 0** command to display Dot11Radio 0 interface information.

SUMMARY STEPS

1. **show interfaces Dot11Radio 0**

DETAILED STEPS

	Command or Action	Purpose
Step 1	show interfaces Dot11Radio 0 Example: ap# show interfaces Dot11Radio 0	Displays the current Dot11Radio 0 interface information.

Example: Displaying Dot11Radio 0 Interface Information

This example displays Dot11Radio 0 interface information.

```
ap# show interfaces Dot11Radio 0
Dot11Radio0
    Link encap:Ethernet HWaddr AA:11:BB:22:CC:33
    UP BROADCAST RUNNING MULTICAST MTU:1500 Metric:1
    RX packets:0 multicast:0 unicast:0 broadcast:0
    RX errors:0 dropped:0 overruns:0 frame:160876
    TX packets:267 multicast:86 unicast:0 broadcast:181
    TX errors:0 dropped:0 overruns:0 carrier:0 collisions:0
    txqueuelen:1000
    RX bytes:0 (0.0 B) TX bytes:52150 (50.9 KiB)
    RX multicast bytes:0 (0.0 B) TX multicast bytes:0 (0.0 B)
    Interrupt:15 Base address:0x4000
```

Displaying Brief Details for All Interfaces

Use the `show ip interface brief` command to display brief details for all interfaces.

SUMMARY STEPS

1. `show ip interface brief`

DETAILED STEPS

	Command or Action	Purpose
Step 1	<code>show ip interface brief</code> Example: <code>ap# show ip interface brief</code>	Displays brief details for all interfaces.

What to Do Next

Example: Displaying Brief Details for All Interfaces

In the output, the Method column indicates whether the interface was user-configured or configured by DHCP.

```
ap# show ip interface brief
Interface          IP-Address      OK? Method Status Protocol
Dot11Radio0       unassigned     YES NVRAM  up      up
BVI1               10.10.10.2     YES NVRAM  up      up
```

Displaying CPU Statistics

Use the `show processes cpu` command to display CPU utilization statistics.

SUMMARY STEPS

1. `show processes cpu`

DETAILED STEPS

	Command or Action	Purpose
Step 1	<code>show processes cpu</code> Example: ap# <code>show processes cpu</code>	Displays CPU utilization statistics.

Example: Displaying CPU Statistics

```
ap# show processes cpu
CPU:  0% usr  0% sys  0% nic  90% idle  0% io  0% irq  9% sirq
```

Showing a Summary of Memory Usage

Use the `show memory summary` command to display details of current memory usage.

SUMMARY STEPS

1. `show memory summary`

DETAILED STEPS

	Command or Action	Purpose
Step 1	<code>show memory summary</code> Example: ap# <code>show memory summary</code>	Displays details of current memory usage.

What to Do Next**Example: Showing a Summary of Memory Usage**

```
ap# show memory summary
Total(kB) Used(kB) Free(kB)
Processor 88052 44212 43840
```

Pinging an Address

Use the **ping** command to test connectivity with a specific address.

SUMMARY STEPS

1. **ping** *{IP-address | hostname}*

DETAILED STEPS

	Command or Action	Purpose
Step 1	ping <i>{IP-address hostname}</i> Example: ap# ping 10.0.0.0	Tests connectivity to the specified IP address or host name. Entering the ping command with an address specified indicates the round trip time in milliseconds for several transmissions of a small datagram. Entering the ping command without specifying an address starts the interactive mode of the command, enabling you to enter the target address, the transmission repeat count, and the datagram size.

Changing the Administrator Password

Use the **password** command to change the administrator password.



Note

The default login credentials are: User name: **admin** Password: **admin** When logging in for the first time, the router prompts you to change the default password.

SUMMARY STEPS

1. **password** *old-password new-password confirm-password*

DETAILED STEPS

	Command or Action	Purpose
Step 1	password <i>old-password new-password confirm-password</i> Example: ap# password admin AbCdE123# AbCdE123#	Changes the administrator password. Note that the command requires entering the new password twice to confirm the exact text of the new password.

Configuring the Number of Lines on Screen

Use the **terminal length** command to configure the number of lines displayed on the screen.

SUMMARY STEPS

1. **terminal length** *number-of-lines*

DETAILED STEPS

	Command or Action	Purpose
Step 1	terminal length <i>number-of-lines</i> Example: ap# terminal length 40	Sets the number of lines displayed on the screen. <i>number-of-lines</i> range: 0 to 512 A value of 0 specifies that the display does not pause for scrolling.

What to Do Next

Administering the Wireless Device

This module describes the following wireless device administration tasks:

Securing Access to the Wireless Device

This section provides information about performing the following tasks to secure access to the wireless device:

Disabling the Mode Button Function



Caution

This command disables password recovery. If you lose the privileged EXEC mode password for the access point after entering this command, you must contact the Cisco Technical Assistance Center (TAC) to regain access to the access point CLI.



Note

To reboot the wireless device, use the `service-module wlan-ap reset` command from the router's Cisco IOS CLI. See the [Rebooting the Wireless Device, on page 311](#) for information about this command.

The mode button is enabled by default. To disable the access point's mode button, follow these steps, beginning in privileged EXEC mode:

SUMMARY STEPS

1. **configure terminal**
2. **no boot mode-button**
3. **end**

DETAILED STEPS

	Command or Action	Purpose
Step 1	configure terminal	Enters global configuration mode.
Step 2	no boot mode-button	Disables the access point's mode button.
Step 3	end	Returns to privileged EXEC mode. Note It is not necessary to save the configuration.

Displaying the mode-button status

You can check the status of the mode button by executing the `show boot` or `show boot mode-button` command in privileged EXEC mode. The status does not appear in the running configuration. The following example shows typical responses to the `show boot` and `show boot mode-button` commands:

```
ap# show boot
BOOT path-list: flash:/c1200-k9w7-mx-v123_7_ja.20050430/c1200-k9w7-mx.v123_7_ja.20050430
Config file: flash:/config.txt
Private Config file: flash:/private-config
Enable Break: no
Manual boot: no
Mode button: on
Enable IOS break: no
HELPER path-list:
NVRAM/Config file
  buffer size: 32768
ap# show boot mode-button
on
ap#
```

**Note**

As long as the privileged EXEC password is known, you can use the `boot mode-button` command to restore the mode button to normal operation.

Preventing Unauthorized Access to Your Access Point

You can prevent unauthorized users from reconfiguring the wireless device and viewing configuration information. Typically, you want the network administrators to have access to the wireless device while restricting access to users who connect through a terminal or workstation from within the local network.

To prevent unauthorized access to the wireless device, configure one of these security features:



Note The characters TAB, ?, \$, +, and [are invalid characters for passwords.

Protecting Access to Privileged EXEC Commands

A simple way of providing terminal access control in your network is to use passwords and assign privilege levels. Password protection restricts access to a network or network device. Privilege levels define what commands users can issue after they have logged in to a network device.



Note For complete syntax and usage information for the commands used in this section, see *Cisco IOS Security Command Reference for Release 12.4*

This section describes how to control access to the configuration file and privileged EXEC commands. It contains the following configuration information:

Configuring Default Password and Privilege Level

Table 33: Default Passwords and Privilege Levels , on page 295 shows the default password and privilege level configuration.

Table 33: Default Passwords and Privilege Levels

Privilege Level	Default Setting
Username and password	Default username is Cisco, and the default password is Cisco.
Enable password and privilege level	Default password is Cisco. The default is level 15 (privileged EXEC level). The password is encrypted in the configuration file.
Enable secret password and privilege level	Default enable password is Cisco. The default is level 15 (privileged EXEC level). The password is encrypted before it is written to the configuration file.
Line password	Default password is Cisco. The password is encrypted in the configuration file.

Setting or Changing a Static Enable Password

The enable password controls access to the privileged EXEC mode.



Note The **no enable password** command, in global configuration mode, removes the enable password, but you should use extreme care when using this command. If you remove the enable password, you are locked out of the privileged EXEC mode.

To set or change a static enable password, follow these steps, beginning in privileged EXEC mode:

SUMMARY STEPS

1. **configure terminal**
2. **enable password** *password*
3. **end**
4. **show running-config**
5. **copy running-config startup-config**

DETAILED STEPS

	Command or Action	Purpose
Step 1	configure terminal	Enters global configuration mode.
Step 2	enable password <i>password</i>	Defines a new password or changes an existing password for access to privileged EXEC mode. <ul style="list-style-type: none"> • The default password is Cisco. • <i>password</i>—A string from 1 to 25 alphanumeric characters. The string cannot start with a number, is case sensitive, and allows spaces but ignores leading spaces. The characters TAB, ?, \$, +, and [are invalid characters for passwords.
Step 3	end	Returns to privileged EXEC mode.
Step 4	show running-config	Verifies your entries.
Step 5	copy running-config startup-config	(Optional) Saves your entries in the configuration file.

What to Do Next

The enable password is not encrypted and can be read in the wireless device configuration file.

Configuration Example: Changing a Static Enable Password

The following example shows how to change the enable password to *11u2c3k4y5*. The password is not encrypted and provides access to level 15 (standard privileged EXEC mode access):

```
AP(config)# enable password 11u2c3k4y5
```

Protecting Enable and Enable Secret Passwords with Encryption

To configure encryption for enable and enable secret passwords, follow these steps, beginning in privileged EXEC mode:

**Note**

It is recommend that you use the **enable secret** command because it uses an improved encryption algorithm. If you configure the **enable secret** command, it takes precedence over the **enable password** command; the two commands cannot be in effect simultaneously.

SUMMARY STEPS

1. **configure terminal**
2.
 - **enable password** [level *level*] {*password* | *encryption-type encrypted-password*}
 - or
 - **enable secret** [level *level*] {*password* | *encryption-type encrypted-password*}
3. **service password-encryption**
4. **end**
5. **copy running-config startup-config**

DETAILED STEPS

	Command or Action	Purpose
Step 1	configure terminal	Enters global configuration mode.
Step 2	<ul style="list-style-type: none"> • enable password [level <i>level</i>] {<i>password</i> <i>encryption-type encrypted-password</i>} or • enable secret [level <i>level</i>] {<i>password</i> <i>encryption-type encrypted-password</i>} 	<p>Defines a new password or changes an existing password for access to privileged EXEC mode.</p> <p>or</p> <p>Defines a secret password, which is saved using a nonreversible encryption method.</p> <ul style="list-style-type: none"> • <i>level</i>—(Optional) Range is from 0 to 15. Level 1 is normal user EXEC mode privileges. The default level is 15 (privileged EXEC mode privileges). • <i>password</i>—A string from 1 to 25 alphanumeric characters. The string cannot start with a number, is case sensitive, and allows spaces but ignores leading spaces. By default, no password is defined. • <i>encryption-type</i>—(Optional) Only type 5. Cisco proprietary encryption algorithm, is available. If you specify an encryption type, you must provide an encrypted password—an encrypted password you copy from another access point wireless device configuration. <p>Note If you specify an encryption type and then enter a clear text password, you cannot reenter privileged EXEC mode. You cannot recover a lost encrypted password by any method.</p>
Step 3	service password-encryption	<p>(Optional) Encrypts the password when the password is defined or when the configuration is written.</p> <p>Encryption prevents the password from being readable in the configuration file.</p>
Step 4	end	Returns to privileged EXEC mode.

	Command or Action	Purpose
Step 5	<code>copy running-config startup-config</code>	(Optional) Saves your entries in the configuration file.

Configuration Example: Enable Secret Passwords

This example shows how to configure the encrypted password `1FaD0$Xyti5Rkls3LoyxzS8` for privilege level 2:

```
AP(config)# enable secret level 2 5 $1$FaD0$Xyti5Rkls3LoyxzS8
```

Configuring Username and Password Pairs

Configure username and password pairs, which are locally stored on the wireless device. These pairs are assigned to lines or interfaces, and they authenticate each user before the user can access the wireless device. If you have defined privilege levels, assign a specific privilege level (with associated rights and privileges) to each username and password pair.

To establish a username-based authentication system that requests a login username and a password, follow these steps, beginning in privileged EXEC mode:

SUMMARY STEPS

1. `configure terminal`
2. `username name [privilege level] {password encryption-type password }`
3. `login local`
4. `end`
5. `show running-config`
6. `copy running-config startup-config`

DETAILED STEPS

	Command or Action	Purpose
Step 1	<code>configure terminal</code>	Enters global configuration mode.
Step 2	<code>username name [privilege level] {password encryption-type password }</code>	Enters the username, privilege level, and password for each user. <ul style="list-style-type: none"> • <i>name</i>—Specifies the user ID as one word. Spaces and quotation marks are not allowed. • <i>level</i> —(Optional) Specifies the privilege level the user has after gaining access. The range is 0 to 15. Level 15 gives privileged EXEC mode access. Level 1 gives user EXEC mode access. • <i>encryption-type</i> —Enter 0 to specify that an unencrypted password will follow. Enter 7 to specify that a hidden password will follow.

	Command or Action	Purpose
		<ul style="list-style-type: none"> <i>password</i>—The password the user must enter to gain access to the wireless device. The password must be from 1 to 25 characters, can contain embedded spaces, and must be the last option specified in the username command.
Step 3	login local	Enables local password checking at login time. Authentication is based on the username specified in Step 2.
Step 4	end	Returns to privileged EXEC mode.
Step 5	show running-config	Verifies your entries.
Step 6	copy running-config startup-config	(Optional) Saves your entries in the configuration file.

What to Do Next



Note

You must have at least one username configured and you must have login local set to open a Telnet session to the wireless device. If you enter no username for the only username, you can be locked out of the wireless device.

Configuring Multiple Privilege Levels

By default, Cisco IOS software has two modes of password security: user EXEC and privileged EXEC. You can configure up to 16 hierarchical levels of commands for each mode. By configuring multiple passwords, you can allow different sets of users to have access to specified commands.

For example, for many users to have access to the **clear line** command, you can assign it level 2 security and distribute the level 2 password fairly widely. For more restricted access to the **configure** command, you can assign it level 3 security and distribute that password to a more restricted group of users.

This section includes this configuration information:

Setting the Privilege Level for a Command

To set the privilege level for a command mode, follow these steps, beginning in privileged EXEC mode:

SUMMARY STEPS

1. **configure terminal**
2. **privilege mode level level command**
3. **enable password level level password**
4. **end**
5.
 - **show running-config**
 - or
 - **show privilege**
6. **copy running-config startup-config**

DETAILED STEPS

	Command or Action	Purpose
Step 1	configure terminal	Enters global configuration mode.
Step 2	privilege mode level level command	<p>Sets the privilege level for a command.</p> <ul style="list-style-type: none"> • <i>mode</i> —Enter configure for global configuration mode, exec for EXEC mode, interface for interface configuration mode, or line for line configuration mode. • <i>level</i> —Range is from 0 to 15. Level 1 is for normal user EXEC mode privileges. Level 15 is the level of access permitted by the enable password. • <i>command</i> —Specifies the command to which access is restricted.
Step 3	enable password level level password	<p>Specifies the enable password for the privilege level.</p> <ul style="list-style-type: none"> • <i>level</i> —Range is from 0 to 15. Level 1 is for normal user EXEC mode privileges. • <i>password</i> —A string from 1 to 25 alphanumeric characters. The string cannot start with a number, is case sensitive, and allows spaces but ignores leading spaces. By default, no password is defined. <p>Note The characters TAB, ?, \$, +, and [are invalid characters for passwords.</p>
Step 4	end	Returns to privileged EXEC mode.
Step 5	<ul style="list-style-type: none"> • show running-config or • show privilege 	<p>Verifies your entries.</p> <p>The show running-config command displays the password and access level configuration.</p> <p>The show privilege command displays the privilege level configuration.</p>
Step 6	copy running-config startup-config	(Optional) Saves your entries in the configuration file.

Configuring Multiple Privilege Levels



Note

When you set a command to a privilege level, all commands whose syntax is a subset of that command are also set to that level. For example, if you set the **show ip route** command to level 15, the **show** commands and **show ip** commands are automatically set to privilege level 15 unless you set them individually to different levels. To return to the default privilege for a given command, use the **no privilege mode level level command** command in global configuration mode.

Logging Into and Exiting a Privilege Level

To log in to a specified privilege level or to exit to a specified privilege level, follow these steps, beginning in privileged EXEC mode:

SUMMARY STEPS

1. **enable level**
2. **disable level**

DETAILED STEPS

	Command or Action	Purpose
Step 1	enable level	Logs in to a specified privilege level. <i>level</i> — The privilege range is from 0 to 15.
Step 2	disable level	Exits to a specified privilege level.

Controlling Access Point Access with RADIUS

This section describes how to control administrator access to the wireless device by using Remote Authentication Dial-In User Service (RADIUS). For complete instructions on configuring the wireless device to support RADIUS, see the Cisco IOS Software Configuration Guide for Cisco Aironet Access Points.

RADIUS provides detailed accounting information and flexible administrative control over authentication and authorization processes. RADIUS is facilitated through authentication, authorization, and accounting (AAA) and can be enabled only through AAA commands.



Note

For complete syntax and usage information for the commands used in this section, see [“Cisco IOS Security Command Reference”](#).

RADIUS configuration tasks are described in the following sections:

RADIUS Configuration

RADIUS and AAA are disabled by default. To prevent a lapse in security, you cannot configure RADIUS through a network management application. When enabled, RADIUS can authenticate users who are accessing the wireless device through the CLI.

To configure AAA authentication, define a named list of authentication methods and then apply the list to various interfaces. The method list defines the types of authentication to be performed and the sequence in which they are performed; it must be applied to a specific interface before any defined authentication methods are performed. The only exception is the default method list (which is named `default`). The default method list is automatically applied to all interfaces except those that have a named method list explicitly defined.

A method list describes the sequence and authentication methods to be used to authenticate a user. You can designate one or more security protocols for authentication, thus ensuring a backup system for authentication in case the initial method fails. The software uses the first method listed to authenticate users. If that method fails to respond, the software selects the next authentication method in the method list. This process continues until there is successful communication with a listed authentication method or until all defined methods are exhausted. If authentication fails at any point in this cycle—that is, the security server or local username database responds by denying the user access—the authentication process stops, and no other authentication methods are attempted.

Configuring RADIUS Login Authentication

To configure login authentication, follow these steps, beginning in privileged EXEC mode. This procedure is required.

SUMMARY STEPS

1. **configure terminal**
2. **aaa new-model**
3. **aaa authentication login {default |list-name } method1 [method2...**
4. **line [console | tty | vty] line-number [ending-line-number**
5. **login authentication {default | list-name**
6. **end**
7. **show running-config**
8. **copy running-config startup-config**

DETAILED STEPS

	Command or Action	Purpose
Step 1	configure terminal	Enters global configuration mode.
Step 2	aaa new-model	Enables AAA.
Step 3	aaa authentication login {default list-name } method1 [method2...	Creates a login authentication method list. <ul style="list-style-type: none"> • To create a default list that is used when a named list is <i>not</i> specified in the login authentication command, use the default keyword followed by the

	Command or Action	Purpose
		<p>methods that are to be used in default situations. The default method list is automatically applied to all interfaces.</p> <ul style="list-style-type: none"> • <i>list-name</i>—A character string to name the list you are creating. • <i>method1...</i> —Specifies the actual method the authentication algorithm tries. The additional methods of authentication are used only if the previous method returns an error, not if it fails. <p>Select one of these methods:</p> <ul style="list-style-type: none"> • local—Use the local username database for authentication. You must enter username information in the database. Use the username password global configuration command. • radius—Use RADIUS authentication. You must configure the RADIUS server before you can use this authentication method. For more information, see the “Identifying the RADIUS Server Host” section of the “Configuring Radius and TACACS+ Servers” chapter in Cisco IOS Software Configuration Guide for Cisco Aironet Access Points.
Step 4	line [console tty vty] <i>line-number</i> [<i>ending-line-number</i>]	Enters line configuration mode, and configures the lines to which the authentication list applies.
Step 5	login authentication {default <i>list-name</i> }	<p>Applies the authentication list to a line or set of lines.</p> <ul style="list-style-type: none"> • If you specify default, use the default list that you created with the aaa authentication login command. • <i>list-name</i> —Specifies the list that you created with the aaa authentication login command.
Step 6	end	Returns to privileged EXEC mode.
Step 7	show running-config	Verifies your entries.
Step 8	copy running-config startup-config	(Optional) Saves your entries in the configuration file.

What to Do Next

Defining AAA Server Groups

You can configure the wireless device to use AAA server groups to group existing server hosts for authentication. Select a subset of the configured server hosts and use them for a particular service. The server group is used with a global server-host list, which lists the IP addresses of the selected server hosts.

Server groups can also include multiple host entries for the same server if each entry has a unique identifier (the combination of the IP address and UDP port number), allowing different ports to be individually defined

as RADIUS hosts providing a specific AAA service. If you configure two different host entries on the same RADIUS server for the same service (such as accounting), the second configured host entry acts as a failover backup to the first one.

You use the **server** group server configuration command to associate a particular server with a defined group server. You can either identify the server by its IP address or identify multiple host instances or entries by using the optional **auth-port** and **acct-port** keywords.

Configuring AAA Server Group

To define the AAA server group and associate a particular RADIUS server with it, follow these steps, beginning in privileged EXEC mode:

SUMMARY STEPS

1. **configure terminal**
2. **aaa new-model**
3. **radius-server host** {*hostname* | *ip-address* } [**auth-port** *port-number*] [**acct-port** *port-number*] [**timeout** *seconds*] [**retransmit** *retries*] [**key** *string*]
4. **aaa group server radius** *group-name*
5. **server** *ip-address*
6. **end**
7. **show running-config**
8. **copy running-config startup-config**

DETAILED STEPS

	Command or Action	Purpose
Step 1	configure terminal	Enters global configuration mode.
Step 2	aaa new-model	Enables AAA.
Step 3	radius-server host { <i>hostname</i> <i>ip-address</i> } [auth-port <i>port-number</i>] [acct-port <i>port-number</i>] [timeout <i>seconds</i>] [retransmit <i>retries</i>] [key <i>string</i>]	<p>Specifies the IP address or hostname of the remote RADIUS server host.</p> <ul style="list-style-type: none"> • auth-port <i>port-number</i>—(Optional) Specifies the user datagram protocol (UDP) destination port for authentication requests. • acct-port <i>port-number</i>—(Optional) Specifies the UDP destination port for accounting requests. • timeout <i>seconds</i> —(Optional) The time interval that the wireless device waits for the RADIUS server to reply before retransmitting. The range is 1 to 1000. This setting overrides the radius-server timeout global configuration command setting. If no timeout is set with the radius-server host command, the setting of the radius-server timeout command is used. • retransmit <i>retries</i>—(Optional) The number of times that a RADIUS request is resent to a server if that server is not responding or responding slowly. The range is 1 to 1000. If no retransmit value is set with the radius-server host command, the setting of the radius-server retransmit global configuration command is used.

	Command or Action	Purpose
		<ul style="list-style-type: none"> • <i>key string</i> —(Optional) Specifies the authentication and encryption key used between the wireless device and the RADIUS daemon running on the RADIUS server. <p>Note The key is a text string that must match the encryption key that is used on the RADIUS server. Always configure the key as the last item in the radius-server host command. Leading spaces are ignored, but spaces within and at the end of the key are used. If you use spaces in your key, do not enclose the key in quotation marks unless the quotation marks are part of the key.</p> <p>To configure the wireless device to recognize more than one host entry that is associated with a single IP address, enter this command as many times as necessary, making sure that each UDP port number is different. The wireless device software searches for hosts in the order in which you specify them. Set the timeout, retransmit, and encryption key values to use with the specific RADIUS host.</p>
Step 4	aaa group server radius <i>group-name</i>	Defines the AAA server-group with a group name. This command puts the wireless device in a server group configuration mode.
Step 5	server <i>ip-address</i>	Associates a particular RADIUS server with the defined server group. <ul style="list-style-type: none"> • Repeat this step for each RADIUS server in the AAA server group. • Each server in the group must be previously defined in Step 2.
Step 6	end	Returns to privileged EXEC mode.
Step 7	show running-config	Verifies your entries.
Step 8	copy running-config startup-config	(Optional) Saves your entries in the configuration file.

What to Do Next

Enable RADIUS login authentication: See the [“Configuring RADIUS Login Authentication”](#) section of the “Configuring Radius and TACACS+ Servers” chapter in *Cisco IOS Software Configuration Guide for Cisco Aironet Access Points* for information to enable RADIUS login authentication.

Configuration Example: AAA Group

In the following is example, the wireless device is configured to recognize two different RADIUS group servers (group1 and group2). Group1 has two different host entries on the same RADIUS server, which are configured for the same services. The second host entry acts as a failover backup to the first entry.

```
AP(config)# aaa new-model
AP(config)# radius-server host 172.20.0.1 auth-port 1000 acct-port 1001
AP(config)# radius-server host 172.10.0.1 auth-port 1645 acct-port 1646
AP(config)# aaa group server radius group1
AP(config-sg-radius)# server 172.20.0.1 auth-port 1000 acct-port 1001
AP(config-sg-radius)# exit
AP(config)# aaa group server radius group2
AP(config-sg-radius)# server 172.20.0.1 auth-port 2000 acct-port 2001
AP(config-sg-radius)# exit
```

Configuring RADIUS Authorization for User Privileged Access and Network Services

AAA authorization limits the services that are available to a user. When AAA authorization is enabled, the wireless device uses information retrieved from the user's profile, which is in the local user database or on the security server, to configure the user session. The user is granted access to a requested service only if the user profile allows it.

You can use the **aaa authorization** command in global configuration mode with the **radius** keyword to set parameters that restrict a user's network access to privileged EXEC mode.

The **aaa authorization exec radius** command sets these authorization parameters:

- Use RADIUS for privileged EXEC access authorization if authentication was performed by using RADIUS.
- Use the local database if authentication was not performed by using RADIUS.



Note

Authorization is bypassed for authenticated users who log in through the CLI, even if authorization has been configured.

Configuring RADIUS Authorization for User Privileged Access and Network Services

To specify RADIUS authorization for privileged EXEC access and network services, follow these steps, beginning in privileged EXEC mode:

SUMMARY STEPS

1. **configure terminal**
2. **aaa authorization network radius**
3. **aaa authorization exec radius**
4. **end**
5. **show running-config**
6. **copy running-config startup-config**

DETAILED STEPS

	Command or Action	Purpose
Step 1	configure terminal	Enters global configuration mode.
Step 2	aaa authorization network radius	Configures the wireless device for user RADIUS authorization for all network-related service requests.
Step 3	aaa authorization exec radius	Configures the wireless device for user RADIUS authorization to determine whether the user has privileged EXEC access. The exec keyword might return user profile information (such as autocommand information).
Step 4	end	Returns to privileged EXEC mode.

	Command or Action	Purpose
Step 5	show running-config	Verifies your entries.
Step 6	copy running-config startup-config	(Optional) Saves your entries in the configuration file.

What to Do Next

To disable authorization, use the **no aaa authorization {network | exec} method1** command in global configuration mode.

Displaying the RADIUS Configuration

To display the RADIUS configuration, use the **show running-config** command in privileged EXEC mode.

Controlling Access Point Access with TACACS+

This section describes how to control administrator access to the wireless device using Terminal Access Controller Access Control System Plus (TACACS+). For complete instructions on configuring the wireless device to support TACACS+, see *Cisco IOS Software Configuration Guide for Cisco Aironet Access Points*.

TACACS+ provides detailed accounting information and flexible administrative control over authentication and authorization processes. TACACS+ is facilitated through AAA and can be enabled only through AAA commands.



Note For complete syntax and usage information for the commands used in this section, see [Cisco IOS Security Command Reference](#).

These sections describe TACACS+ configuration information.

Default TACACS+ Configuration

TACACS+ and AAA are disabled by default.

To prevent a lapse in security, you cannot configure TACACS+ through a network management application. When enabled, TACACS+ can authenticate administrators who are accessing the wireless device through the CLI.

To configure AAA authentication, you define a named list of authentication methods and then apply the list to various interfaces. The method list defines the types of authentication to be performed and the sequence in which they are performed; it must be applied to a specific interface before any defined authentication methods are performed. The only exception is the default method list (which is named *default*). The default method list is automatically applied to all interfaces, except those that have a named method list explicitly defined.

A method list describes the sequence and authentication methods to be used to authenticate a user. You can designate one or more security protocols for authentication, thus ensuring a backup system for authentication in case the initial method fails. The software uses the first method listed to authenticate users. If that method fails to respond, the software selects the next authentication method in the method list. This process continues

until there is successful communication with a listed authentication method or until all defined methods are exhausted. If authentication fails at any point in this cycle—that is, the security server or local username database responds by denying the user access—the authentication process stops, and no other authentication methods are attempted.

Configuring TACACS+ Login Authentication

To configure login authentication, follow these steps, beginning in privileged EXEC mode. This procedure is required.

SUMMARY STEPS

1. **configure terminal**
2. **aaa new-model**
3. **aaa authentication login {default | list-name } method1 [method2...**
4. **line [console | tty | vty] line-number [ending-line-number**
5. **login authentication {default | list-name**
6. **end**
7. **show running-config**
8. **copy running-config startup-config**

DETAILED STEPS

	Command or Action	Purpose
Step 1	configure terminal	Enters global configuration mode.
Step 2	aaa new-model	Enables AAA.
Step 3	aaa authentication login {default list-name } method1 [method2...	<p>Creates a login authentication method list.</p> <ul style="list-style-type: none"> • To create a default list that is used when a named list is <i>not</i> specified in the login authentication command, use the default keyword followed by the methods that are to be used in default situations. The default method list is automatically applied to all interfaces. • <i>list-name</i> —A character string to name the list you are creating. • <i>method1...</i> —Specifies the actual method the authentication algorithm tries. The additional methods of authentication are used only if the previous method returns an error, not if it fails. <p>Select one of these methods:</p> <ul style="list-style-type: none"> • local—Use the local username database for authentication. You must enter username information into the database. Use the username password command in global configuration mode. • tacacs+—Use TACACS+ authentication. You must configure the TACACS+ server before you can use this authentication method.

	Command or Action	Purpose
Step 4	line [console tty vty] <i>line-number</i> [<i>ending-line-number</i>]	Enters line configuration mode, and configures the lines to which the authentication list applies.
Step 5	login authentication { default <i>list-name</i> }	Applies the authentication list to a line or set of lines. <ul style="list-style-type: none"> • If you specify default, use the default list created with the aaa authentication login command. • <i>list-name</i> —Specifies the list created with the aaa authentication login command.
Step 6	end	Returns to privileged EXEC mode.
Step 7	show running-config	Verifies your entries.
Step 8	copy running-config startup-config	(Optional) Saves your entries in the configuration file.

What to Do Next

To disable AAA, use the **no aaa new-model** command in global configuration mode. To disable AAA authentication, use the **no aaa authentication login** {*default* | *list-name*} *method1* [*method2*...] command in global configuration mode. To either disable TACACS+ authentication for logins or to return to the default value, use the **no login authentication** {**default** | *list-name*} command in line configuration mode.

Configuring TACACS+ Authorization for Privileged EXEC Access and Network Services

AAA authorization limits the services available to a user. When AAA authorization is enabled, the wireless device uses information retrieved from the user profile, which is located either in the local user database or on the security server, to configure the user session. The user is granted access to a requested service only if the information in the user profile allows it.

You can use the **aaa authorization** command in global configuration mode with the **tacacs+** keyword to set parameters that restrict a user network access to privileged EXEC mode.

The **aaa authorization exec tacacs+ local** command sets these authorization parameters:

- Use TACACS+ for privileged EXEC access authorization if authentication was performed by using TACACS+.
- Use the local database if authentication was not performed by using TACACS+.



Note

Authorization is bypassed for authenticated users who log in through the CLI even if authorization has been configured.

To specify TACACS+ authorization for privileged EXEC access and network services, follow these steps, beginning in privileged EXEC mode:

SUMMARY STEPS

1. `configure terminal`
2. `aaa authorization network tacacs+`
3. `aaa authorization exec tacacs+`
4. `end`
5. `show running-config`
6. `copy running-config startup-config`

DETAILED STEPS

	Command or Action	Purpose
Step 1	<code>configure terminal</code>	Enters global configuration mode.
Step 2	<code>aaa authorization network tacacs+</code>	Configures the wireless device for user TACACS+ authorization for all network-related service requests.
Step 3	<code>aaa authorization exec tacacs+</code>	Configures the wireless device for user TACACS+ authorization to determine whether the user has privileged EXEC access. The <code>exec</code> keyword might return user profile information (such as autocommand information).
Step 4	<code>end</code>	Returns to privileged EXEC mode.
Step 5	<code>show running-config</code>	Verifies your entries.
Step 6	<code>copy running-config startup-config</code>	(Optional) Saves your entries in the configuration file.

What to Do Next**Displaying the TACACS+ Configuration**

To display TACACS+ server statistics, use the `show tacacs` command in privileged EXEC mode.

Administering the Access Point Hardware and Software

This section contains information on performing the following tasks:

Administering the Wireless Hardware and Software

This section provides instructions for performing the following tasks:

Resetting the Wireless Device to the Factory Default Configuration

To reset the wireless device hardware and software to its factory default configuration, use the **service-module wlan-ap0 reset default-config** command in the router's Cisco IOS privileged EXEC mode.



Caution

Because you may lose data, use only the **service-module wlan-ap0 reset** command to recover from a shutdown or failed state.

Rebooting the Wireless Device

To perform a graceful shutdown and reboot the wireless device, use the **service-module wlan-ap0 reload** command in the router's Cisco IOS privileged EXEC mode. At the confirmation prompt, press **Enter** to confirm the action, or enter **n** to cancel.

When running in autonomous mode, the reload command saves the configuration before rebooting. If the attempt is unsuccessful, the following message displays:

```
Failed to save service module configuration.
```

When running in Lightweight Access Point Protocol (LWAPP) mode, the reload function is typically handled by the wireless LAN controller (WLC). If you enter the **service-module wlan-ap0 reload** command, you will be prompted with the following message:

```
The AP is in LWAPP mode. Reload is normally handled by WLC controller.
Still want to proceed? [yes]
```

Monitoring the Wireless Device

This section provides commands for monitoring hardware on the router for displaying wireless device statistics and wireless device status.

Use the **service-module wlan-ap0 statistics** command in privileged EXEC mode to display wireless device statistics. The following is sample output for the command:

```
CLI reset count = 0
CLI reload count = 1
Registration request timeout reset count = 0
Error recovery timeout reset count = 0
Module registration count = 10
```

The last IOS initiated event was a cli reload at *04:27:32.041 UTC Fri Mar 8 2007

Use the **service-module wlan-ap0 status** command in privileged EXEC mode to display the status of the wireless device and its configuration information. The following is sample output for the command:

```
Service Module is Cisco wlan-ap0
Service Module supports session via TTY line 2
Service Module is in Steady state
Service Module reset on error is disabled
Getting status from the Service Module, please wait..

Image path = flash:c8xx_19xx_ap-k9w7-mx.acregr/c8xx_19xx_ap-k9w7-mx.acre
```

```
gr
System uptime = 0 days, 4 hours, 28 minutes, 5 seconds

Router#d was introduced for embedded wireless LAN access points on Integrated Services Routers.
```

Managing the System Time and Date

You can manage the system time and date on the wireless device automatically, by using the Simple Network Time Protocol (SNTP), or manually, by setting the time and date on the wireless device.



Note

For complete syntax and usage information for the commands used in this section, see *Cisco IOS Configuration Fundamentals Command Reference for Release 12.4*.

This section provides the following configuration information:

Understanding Simple Network Time Protocol

Simple Network Time Protocol (SNTP) is a simplified, client-only version of NTP. SNTP can only receive the time from NTP servers; it cannot provide time services to other systems. SNTP typically provides time within 100 milliseconds of the accurate time, but it does not provide the complex filtering and statistical mechanisms of NTP.

You can configure SNTP to request and accept packets from configured servers or to accept NTP broadcast packets from any source. When multiple sources are sending NTP packets, the server with the best stratum is selected. Click this URL for more information on NTP and strata:

http://www.cisco.com/en/US/docs/ios/12_1/configfun/configuration/guide/fcd303.html#wp1001075
http://www.cisco.com/en/US/docs/ios/12_1/configfun/configuration/guide/fcd303.html#wp1001075

If multiple servers are at the same stratum, a configured server is preferred over a broadcast server. If multiple servers pass both tests, the first one to send a time packet is selected. SNTP chooses a new server only if the client stops receiving packets from the currently selected server, or if (according to the above criteria) SNTP discovers a better server.

Configuring SNTP

SNTP is disabled by default. To enable SNTP on the access point, use one or both of the commands listed in [Table 34: SNTP Commands](#), on page 312 in global configuration mode.

Table 34: SNTP Commands

Command	Purpose
sntp server {address hostname} [version number]	Configures SNTP to request NTP packets from an NTP server.
sntp broadcast client	Configures SNTP to accept NTP packets from any NTP broadcast server.

Enter the `sntp server` command once for each NTP server. The NTP servers must be configured to respond to the SNTP messages from the access point.

If you enter both the `sntp server` command and the `sntp broadcast client` command, the access point accepts time from a broadcast server but prefers time from a configured server, if the strata are equal. To display information about SNTP, use the `show sntp EXEC` command.

Time and Date Manual Configuration

If no other source of time is available, you can manually configure the time and date after restarting the system. The time remains accurate until the next system restart. We recommend that you use manual configuration only as a last resort. If you have an outside source to which the wireless device can synchronize, you do not need to manually set the system clock.

You have the options to configure the system clock, time zone and summer time.

Configuring Time and Date

To set the system clock manually, follow these steps, beginning in privileged EXEC mode:



Note

If you have an outside source on the network that provides time services, such as an NTP server, you do not need to manually set the system clock.

SUMMARY STEPS

1. `clock set hh:mm:ss day month year`
2. `clock timezone zone hours-offset minutes-offset`
3. `clock summer-time zone recurring [week day month hh:mm week day month hh:mm [offset]]`
4.
 - `clock summer-time zone date [month date year hh:mm month date year hh:mm [offset]]`
 - or
 - `clock summer-time zone date [date month year hh:mm date month year hh:mm [offset]]`
5. `end`
6. `show running-config`
7. `copy running-config startup-config`

DETAILED STEPS

	Command or Action	Purpose
Step 1	<code>clock set hh:mm:ss day month year</code> Example: <code>clock set hh:mm:ss month day year</code>	Manually sets the system clock by using one of these formats: <ul style="list-style-type: none"> • <code>hh:mm:ss</code>—Specifies the time in hours (24-hour format), minutes, and seconds. The time specified is relative to the configured time zone. • <code>day</code>—Specifies the day by date in the month. • <code>month</code>—Specifies the month by its full name. • <code>year</code>—Specifies the year in four digits (no abbreviation).

	Command or Action	Purpose
Step 2	clock timezone <i>zone hours-offset</i> <i>minutes-offset</i>	<p>Sets the time zone.</p> <p>Note The wireless device keeps internal time in universal time coordinated (UTC). Use this command only for display purposes and when the time is manually set.</p> <ul style="list-style-type: none"> • <i>zone</i>—Enter the name of the time zone to be displayed when standard time is in effect. The default is UTC. • <i>hours-offset</i>—Enter the hours offset from UTC. • <i>minutes-offset</i>—(Optional) Enter the minutes offset from UTC. The <i>minutes-offset</i> variable in the clock timezone command in global configuration mode is available for situations where a local time zone is a percentage of an hour different from UTC.
Step 3	clock summer-time <i>zone</i> recurring [<i>week day month</i> <i>hh:mm week day month hh:mm</i> [<i>offset</i>]]	<p>(Optional) Configures summer time to start and end on the specified days every year.</p> <p>The first part of the clock summer-time global configuration command specifies when summer time begins, and the second part specifies when it ends. All times are relative to the local time zone. The start time is relative to standard time. The end time is relative to summer time. If the starting month is after the ending month, the system assumes that you are in the southern hemisphere.</p> <p>Summer time is disabled by default. If you specify clock summer-time zone recurring without parameters, the summer time rules default to the United States rules.</p> <ul style="list-style-type: none"> • <i>zone</i> —Specifies the name of the time zone (for example, PDT) to be displayed when summer time is in effect. • <i>week</i> —(Optional) Specifies the week of the month (1 to 5 or last). • <i>day</i> —(Optional) Specifies the day of the week (for example, Sunday). • <i>month</i> —(Optional) Specifies the month (for example, January). • <i>hh:mm</i> —(Optional) Specifies the time (24-hour format) in hours and minutes. • <i>offset</i> —(Optional) Specifies the number of minutes to add during summer time. The default is 60.
Step 4	<ul style="list-style-type: none"> • clock summer-time <i>zone</i> date [<i>month date year</i> <i>hh:mm month date year</i> <i>hh:mm</i> [<i>offset</i>]] or • clock summer-time <i>zone</i> date [<i>date month year</i> <i>hh:mm date month year</i> <i>hh:mm</i> [<i>offset</i>]] 	<p>(Optional) Sets summer time if there is no recurring pattern. Configures summer time to start on the first date and end on the second date. The first part of the clock summer-time global configuration command specifies when summer time begins, and the second part specifies when it ends. All times are relative to the local time zone. The start time is relative to standard time. The end time is relative to summer time. If the starting month is after the ending month, the system assumes that you are in the southern hemisphere.</p> <p>Summer time is disabled by default.</p> <ul style="list-style-type: none"> • <i>zone</i>—Specifies the name of the time zone (for example, PDT) to be displayed when summer time is in effect. • <i>week</i> —(Optional) Specifies the week of the month (1 to 5 or last).

	Command or Action	Purpose
		<ul style="list-style-type: none"> • <i>day</i> —(Optional) Specifies the day of the week (for example, Sunday). • <i>month</i> —(Optional) Specifies the month (for example, January). • <i>hh:mm</i> —(Optional) Specifies the time (24-hour format) in hours and minutes. • <i>offset</i> —(Optional) Specifies the number of minutes to add during summer time. The default is 60.
Step 5	end	Returns to privileged EXEC mode.
Step 6	show running-config	Verifies your entries.
Step 7	copy running-config startup-config	(Optional) Saves your entries in the configuration file.

What to Do Next



Note

To display the time and date configuration, use the **show clock [detail]** command in privileged EXEC mode. The system clock keeps an *authoritative* flag that shows whether the time is authoritative (believed to be accurate). If the system clock has been set by a timing source such as NTP, the flag is set. If the time is not authoritative, it is used only for display purposes. Until the clock is authoritative and the *authoritative* flag is set, the flag prevents peers from synchronizing to the clock when the peers' time is invalid. The symbol that precedes the **show clock** display has this meaning:

Example Configuration : Time and Date

This example shows how to specify that summer time starts on the first Sunday in April at 02:00 and ends on the last Sunday in October at 02:00:

```
AP(config)# clock summer-time PDT recurring 1 Sunday April 2:00 last Sunday October 2:00
```

This example shows how to set summer time to start on October 12, 2000, at 02:00, and end on April 26, 2001, at 02:00:

```
AP(config)# clock summer-time pdt date 12 October 2000 2:00 26 April 2001 2:00
```

Configuring a System Name and Prompt

Configure the system name on the wireless device to identify it. By default, the system name and prompt are *ap*.

If you have not configured a system prompt, the first 20 characters of the system name are used as the system prompt. A greater-than symbol (>) is appended. The prompt is updated whenever the system name changes, unless you manually configure the prompt by using the **prompt** command in global configuration mode.

**Note**

For complete syntax and usage information for the commands used in this section, see [Cisco IOS Configuration Fundamentals Command Reference](#) and [Cisco IOS IP Addressing Services Command Reference](#).

This section contains the following configuration information:

Configuring a System Name

To manually configure a system name, follow these steps, beginning in privileged EXEC mode:

SUMMARY STEPS

1. **configure terminal**
2. **hostname *name***
3. **end**
4. **show running-config**
5. **copy running-config startup-config**

DETAILED STEPS

	Command or Action	Purpose
Step 1	configure terminal	Enters global configuration mode.
Step 2	hostname <i>name</i>	Manually configures a system name. The default setting is <i>ap</i> . Note When you change the system name, the wireless device radios are reset, and associated client devices disassociate and quickly re-associate. Note You can enter up to 63 characters for the system name. However, when the wireless device identifies itself to client devices, it uses only the first 15 characters in the system name. If it is important for client users to distinguish between devices, make sure that a unique portion of the system name appears in the first 15 characters.
Step 3	end	Returns to privileged EXEC mode.
Step 4	show running-config	Verifies your entries.
Step 5	copy running-config startup-config	(Optional) Saves your entries in the configuration file.

Understanding DNS

The DNS protocol controls the Domain Name System (DNS), a distributed database with which you can map hostnames to IP addresses. When you configure DNS on the wireless device, you can substitute the hostname for the IP address with all IP commands, such as **ping**, **telnet**, **connect**, and related Telnet support operations.

IP defines a hierarchical naming scheme that allows a device to be identified by its location or domain. Domain names are pieced together with periods (.) as the delimiting characters. For example, Cisco Systems, Inc. is a commercial organization that IP identifies by a *com* domain name, so its domain name is *cisco.com*. A specific device in this domain, such as the File Transfer Protocol (FTP) system, is identified as *ftp.cisco.com*.

To keep track of domain names, IP has defined the concept of a domain name server, which holds a cache (or database) of names mapped to IP addresses. To map domain names to IP addresses, you must first identify the hostnames, specify the name server that is present on your network, and enable the DNS.

This section contains the following configuration information:

Default DNS Configuration

[Table 35: Default DNS Configuration](#), on page 317 describes the default DNS configuration.

Table 35: Default DNS Configuration

Feature	Default Setting
DNS enable state	Disabled.
DNS default domain name	None configured.
DNS servers	No name server addresses are configured.

Setting Up DNS

To set up the wireless device to use the DNS, follow these steps, beginning in privileged EXEC mode:

SUMMARY STEPS

1. **configure terminal**
2. **ip domain-name** *name*
3. **ip name-server** *server-address1* [*server-address2* ... *server-address6*]
4. **ip domain-lookup**
5. **end**
6. **show running-config**
7. **copy running-config startup-config**

DETAILED STEPS

	Command or Action	Purpose
Step 1	configure terminal	Enters global configuration mode.
Step 2	ip domain-name <i>name</i>	Defines a default domain name that the software uses to complete unqualified hostnames (names without a dotted-decimal domain name). Do not include the initial period that separates an unqualified name from the domain name.

	Command or Action	Purpose
		At boot time, no domain name is configured. However, if the wireless device configuration comes from a BOOTP or DHCP server, then the default domain name might be set by the BOOTP or DHCP server (if the servers were configured with this information).
Step 3	ip name-server <i>server-address1</i> [<i>server-address2</i> ... <i>server-address6</i>	Specifies the address of one or more name servers to use for name and address resolution. You can specify up to six name servers. Separate server addresses with a space. The first server specified is the primary server. The wireless device sends DNS queries to the primary server first. If that query fails, the backup servers are queried.
Step 4	ip domain-lookup	(Optional) Enables DNS-based hostname-to-address translation on the wireless device. This feature is enabled by default. If your network devices require connectivity with devices in networks for which you do not control name assignment, you can dynamically assign device names that uniquely identify your devices by using the global Internet naming scheme (DNS).
Step 5	end	Returns to privileged EXEC mode.
Step 6	show running-config	Verifies your entries.
Step 7	copy running-config startup-config	(Optional) Saves your entries in the configuration file.

What to Do Next

If you use the wireless device IP address as its hostname, the IP address is used and no DNS query occurs. If you configure a hostname that contains no periods (.), a period followed by the default domain name is appended to the hostname before the DNS query is made to map the name to an IP address. The default domain name is the value set by the **ip domain-name** command in global configuration mode. If there is a period (.) in the hostname, Cisco IOS software looks up the IP address without appending any default domain name to the hostname.

To remove a domain name, use the **no ip domain-name** *name* command in global configuration mode. To remove a name server address, use the **no ip name-server** *server-address* command in global configuration mode. To disable DNS on the wireless device, use the **no ip domain-lookup** command in global configuration mode.

Displaying the DNS Configuration

To display the DNS configuration information, use the **show running-config** command in privileged EXEC mode.



Note

When DNS is configured on the wireless device, the show running-config command sometimes displays a server IP address instead of its name.

Creating a Banner

You can configure a message-of-the-day (MOTD) and a login banner. By default the MOTD and login banners are not configured. The MOTD banner appears on all connected terminals at login and is useful for sending messages that affect all network users (such as impending system shutdowns).

The login banner also appears on all connected terminals. It appears after the MOTD banner and appears before the login prompts appear.



Note

For complete syntax and usage information for the commands used in this section, see [Cisco IOS Configuration Fundamentals Command Reference](#).

This section contains the following configuration information:

Configuring a Message-of-the-Day Login Banner

You can create a single-line or multiline message banner that appears on the screen when someone logs into the wireless device.

To configure an MOTD login banner, follow these steps, beginning in privileged EXEC mode:

SUMMARY STEPS

1. **configure terminal**
2. **banner motd *c message c***
3. **end**
4. **show running-config**
5. **copy running-config startup-config**

DETAILED STEPS

	Command or Action	Purpose
Step 1	configure terminal	Enters global configuration mode.
Step 2	banner motd <i>c message c</i>	Specifies the message of the day. <ul style="list-style-type: none"> • <i>c</i> —Enter the delimiting character of your choice, such as a pound sign (#), and press the Return key. The delimiting character signifies the beginning and end of the banner text. Characters after the ending delimiter are discarded. • <i>message</i> —Enter a banner message up to 255 characters. You cannot use the delimiting character in the message.
Step 3	end	Returns to privileged EXEC mode.
Step 4	show running-config	Verifies your entries.

	Command or Action	Purpose
Step 5	<code>copy running-config startup-config</code>	(Optional) Saves your entries in the configuration file.

Example: Configuring a MOTD Banner

The following example shows how to configure a MOTD banner for the wireless device. The pound sign (#) is used as the beginning and ending delimiter:

```
AP(config)# banner motd
#
This is a secure site. Only authorized users are allowed.
For access, contact technical support.
#
AP(config)#
```

This example shows the banner that results from the previous configuration:

```
Unix> telnet 172.2.5.4
Trying 172.2.5.4...
Connected to 172.2.5.4.
Escape character is '^]'.
This is a secure site. Only authorized users are allowed.
For access, contact technical support.
User Access Verification
Password:
```

Configuring a Login Banner

You can configure a login banner to appear on all connected terminals. This banner appears after the MOTD banner and appears before the login prompt appears.

To configure a login banner, follow these steps, beginning in privileged EXEC mode:

SUMMARY STEPS

1. `configure terminal`
2. `banner login c message c`
3. `end`
4. `show running-config`
5. `copy running-config startup-config`

DETAILED STEPS

	Command or Action	Purpose
Step 1	<code>configure terminal</code>	Enters global configuration mode.
Step 2	<code>banner login c message c</code>	Specifies the login message. <ul style="list-style-type: none"> • <i>c</i>—Enter the delimiting character of your choice, such as a pound sign (#), and press the Return key. The delimiting character signifies the

	Command or Action	Purpose
		beginning and end of the banner text. Characters after the ending delimiter are discarded. <ul style="list-style-type: none"> • <i>message</i> —Enter a login message up to 255 characters. You cannot use the delimiting character in the message.
Step 3	end	Returns to privileged EXEC mode.
Step 4	show running-config	Verifies your entries.
Step 5	copy running-config startup-config	(Optional) Saves your entries in the configuration file.

Example Configuration: Login Banner

The following example shows how to configure a login banner for the wireless device using the dollar sign (\$) as the beginning and ending delimiter:

```
AP(config)# banner login
$
Access for authorized users only. Please enter your username and password.
$
AP(config)#
```

Administering Wireless Device Communication

This section provides information about performing the following tasks:

Configuring Ethernet Speed and Duplex Settings

The Ethernet speed and duplex are set to auto by default. To configure Ethernet speed and duplex, follow these steps, beginning in privileged EXEC mode:



Note

The speed and duplex settings on the wireless device Ethernet port must match the Ethernet settings on the port to which the wireless device is connected. If you change the settings on the port to which the wireless device is connected, change the settings on the wireless device Ethernet port to match.

SUMMARY STEPS

1. **configure terminal**
2. **interface fastethernet0**
3. **speed {10 | 100 | auto}**
4. **duplex {auto | full | half}**
5. **end**
6. **show running-config**
7. **copy running-config startup-config**

DETAILED STEPS

	Command or Action	Purpose
Step 1	configure terminal	Enters global configuration mode.
Step 2	interface fastethernet0	Enters configuration interface mode.
Step 3	speed {10 100 auto}	Configures the Ethernet speed. Note We recommend that you use auto, the default setting.
Step 4	duplex {auto full half}	Configures the duplex setting. Note We recommend that you use auto, the default setting.
Step 5	end	Returns to privileged EXEC mode.
Step 6	show running-config	Verifies your entries.
Step 7	copy running-config startup-config	(Optional) Saves your entries in the configuration file.

Configuring the Access Point for Wireless Network Management

You can enable the wireless device for wireless network management. The wireless network manager (WNM) manages the devices on your wireless LAN.

Enter the following command to configure the wireless device to interact with the WNM:

```
AP(config)# wlccp wnm ip address ip-address
```

Enter the following command to check the authentication status between the WDS access point and the WNM:

```
AP# show wlccp wnm status
```

Possible statuses are not authenticated, authentication in progress, authentication fail, authenticated, and security keys setup.

Configuring the Access Point for Local Authentication and Authorization

You can configure AAA to operate without a server by configuring the wireless device to implement AAA in local mode. The wireless device then handles authentication and authorization. No accounting is available in this configuration.



Note

You can configure the wireless device as a local authenticator for 802.1x-enabled client devices to provide a backup for your main server or to provide authentication service on a network without a RADIUS server. See the *Using the Access Point as a Local Authenticator* document on Cisco.com for detailed instructions on configuring the wireless device as a local authenticator. <http://www.cisco.com/en/US/docs/routers/access/wireless/software/guide/SecurityLocalAuthent.html>

To configure the wireless device for local AAA, follow these steps, beginning in privileged EXEC mode:

SUMMARY STEPS

1. **configure terminal**
2. **aaa new-model**
3. **aaa authentication login default local**
4. **aaa authorization exec local**
5. **aaa authorization network local**
6. **username name [privilege level] {password encryption-type password}**
7. **end**
8. **show running-config**
9. **copy running-config startup-config**

DETAILED STEPS

	Command or Action	Purpose
Step 1	configure terminal	Enters global configuration mode.
Step 2	aaa new-model	Enables AAA.
Step 3	aaa authentication login default local	Sets the login authentication to use the local username database. The default keyword applies the local user database authentication to all interfaces.
Step 4	aaa authorization exec local	Configures user AAA authorization to determine whether the user is allowed to run an EXEC shell by checking the local database.
Step 5	aaa authorization network local	Configures user AAA authorization for all network-related service requests.
Step 6	username name [privilege level] {password encryption-type password}	<p>Enters the local database, and establishes a username-based authentication system.</p> <p>Repeat this command for each user.</p> <ul style="list-style-type: none"> • <i>name</i>—Specifies the user ID as one word. Spaces and quotation marks are not allowed.

	Command or Action	Purpose
		<ul style="list-style-type: none"> • <i>level</i>—(Optional) Specifies the privilege level that the user has after gaining access. The range is 0 to 15. Level 15 gives privileged EXEC mode access. Level 0 gives user EXEC mode access. • <i>encryption-type</i>—Enter 0 to specify that an unencrypted password follows. Enter 7 to specify that a hidden password follows. • <i>password</i>—Specifies the password that the user must enter to gain access to the wireless device. The password must be from 1 to 25 characters long, can contain embedded spaces, and must be the last option specified in the username command. <p>Note The characters TAB, ?, \$, +, and [are invalid characters for passwords.</p>
Step 7	end	Returns to privileged EXEC mode.
Step 8	show running-config	Verifies your entries.
Step 9	copy running-config startup-config	(Optional) Saves your entries in the configuration file.

What to Do Next



Note To disable AAA, use the **no aaa new-model** command in global configuration mode. To disable authorization, use the **no aaa authorization {network | exec} method1** command in global configuration mode.

Configuring the Authentication Cache and Profile

The authentication cache and profile feature allows the access point to cache the authentication and authorization responses for a user so that subsequent authentication and authorization requests do not need to be sent to the AAA server.



Note On the access point, this feature is supported only for Admin authentication.

The following commands that support this feature are included in Cisco IOS Release 12.3(7):

- **cache expiry**
- **cache authorization profile**
- **cache authentication profile**
- **aaa cache profile**

**Note**

See [Cisco IOS Command Reference for Cisco Aironet Access Points and Bridges, Versions 12.4\(10b\)JA and 12.3\(8\)JEC](#) for information about these commands.

Example Configuration: Authentication Cache and Profile

The following is a configuration example for an access point configured for Admin authentication using TACACS+ with the authorization cache enabled. Although this example is based on a TACACS server, the access point could be configured for Admin authentication using RADIUS:

```

version 12.3
no service pad
service timestamps debug datetime msec
service timestamps log datetime msec
service password-encryption
!
hostname ap
!
!
username Cisco password 7 123A0C041104
username admin privilege 15 password 7 01030717481C091D25
ip subnet-zero
!
!
aaa new-model
!
!
aaa group server radius rad_eap
server 192.168.134.229 auth-port 1645 acct-port 1646
!
aaa group server radius rad_mac
server 192.168.134.229 auth-port 1645 acct-port 1646
!
aaa group server radius rad_acct
server 192.168.134.229 auth-port 1645 acct-port 1646
!
aaa group server radius rad_admin
server 192.168.134.229 auth-port 1645 acct-port 1646
cache expiry 1
cache authorization profile admin_cache
cache authentication profile admin_cache
!
aaa group server tacacs+ tac_admin
server 192.168.133.231
cache expiry 1
cache authorization profile admin_cache
cache authentication profile admin_cache
!
aaa group server radius rad_pmip
!
aaa group server radius dummy
!
aaa authentication login default local cache tac_admin group tac_admin
aaa authentication login eap_methods group rad_eap
aaa authentication login mac_methods local
aaa authorization exec default local cache tac_admin group tac_admin
aaa accounting network acct_methods start-stop group rad_acct
aaa cache profile admin_cache
all
!
!
aaa session-id common
!
!
!
bridge irb
!

```

```

!
interface Dot11Radio0
no ip address
no ip route-cache
shutdown
speed basic-1.0 basic-2.0 basic-5.5 6.0 9.0 basic-11.0 12.0 18.0 24.0 36.0 48.0 54.0
station-role root
bridge-group 1
bridge-group 1 subscriber-loop-control
bridge-group 1 block-unknown-source
no bridge-group 1 source-learning
no bridge-group 1 unicast-flooding
bridge-group 1 spanning-disabled
!
interface Dot11Radio1
no ip address
no ip route-cache
shutdown
speed basic-6.0 9.0 basic-12.0 18.0 basic-24.0 36.0 48.0 54.0
station-role root
bridge-group 1
bridge-group 1 subscriber-loop-control
bridge-group 1 block-unknown-source
no bridge-group 1 source-learning
no bridge-group 1 unicast-flooding
bridge-group 1 spanning-disabled
!
interface FastEthernet0
no ip address
no ip route-cache
duplex auto
speed auto
bridge-group 1
no bridge-group 1 source-learning
bridge-group 1 spanning-disabled
!
interface BVI1
ip address 192.168.133.207 255.255.255.0
no ip route-cache
!
ip http server
ip http authentication aaa
no ip http secure-server
ip http help-path http://www.cisco.com/warp/public/779/smbiz/prodconfig/help/eag
ip radius source-interface BVI1
!
tacacs-server host 192.168.133.231 key 7 105E080A16001D1908
tacacs-server directed-request
radius-server attribute 32 include-in-access-req format %h
radius-server host 192.168.134.229 auth-port 1645 acct-port 1646 key 7 111918160405041E00
radius-server vsa send accounting
!
control-plane
!
bridge 1 route ip
!
!
!
line con 0
transport preferred all
transport output all
line vty 0 4
transport preferred all
transport input all
transport output all
line vty 5 15
transport preferred all
transport input all
transport output all
!
end

```

Configuring the Access Point to Provide DHCP Service

By default, access points are configured to receive IP settings from a DHCP server on your network. You can also configure an access point to act as a DHCP server to assign IP settings to devices on both wired and wireless LANs.



Note

When you configure the access point as a DHCP server, it assigns IP addresses to devices on its subnet. The devices communicate with other devices on the subnet but not beyond it. If data needs to be passed beyond the subnet, you must assign a default router. The IP address of the default router should be on the same subnet as the access point configured as the DHCP server.

For detailed information on DHCP-related commands and options, see the DHCP part in [Cisco IOS IP Addressing Services Configuration Guide, Release 12.4](#) at:

http://www.cisco.com/en/US/docs/ios/ipaddr/configuration/guide/iad_dhcp_rdmp_ps6350_TSD_Products_Configuration_Guide_Chapter.html

http://www.cisco.com/en/US/docs/ios/ipaddr/configuration/guide/iad_dhcp_rdmp_ps6350_TSD_Products_Configuration_Guide_Chapter.html

The following sections describe how to configure the wireless device to act as a DHCP server:

Setting up the DHCP Server

To configure an access point to provide DHCP service and to specify a default router, follow these steps, beginning in privileged EXEC mode:

SUMMARY STEPS

1. **configure terminal**
2. **ip dhcp excluded-address** *low_address* [*high_address*]
3. **ip dhcp pool** *pool_name*
4. **network** *subnet_number* [**mask** | *prefix-length*]
5. **lease** {*days* [*hours*] [*minutes*] | **infinite**}
6. **default-router** *address* [*address2* ... *address 8*]
7. **end**
8. **show running-config**
9. **copy running-config startup-config**

DETAILED STEPS

	Command or Action	Purpose
Step 1	configure terminal Example: AP# <code>configure terminal</code>	Enters global configuration mode.

	Command or Action	Purpose
Step 2	ip dhcp excluded-address <i>low_address [high_address]</i>	Excludes the wireless device IP address from the range of addresses that the wireless device assigns. <ul style="list-style-type: none"> • Enter the IP address in four groups of characters, such as 10.91.6.158. • The wireless device assumes that all IP addresses in a DHCP address pool subnet are available for assigning to DHCP clients. You must specify the IP addresses that the DHCP server should not assign to clients. • (Optional) To enter a range of excluded addresses, enter the address at the low end of the range, followed by the address at the high end of the range.
Step 3	ip dhcp pool <i>pool_name</i>	Creates a name for the pool of IP addresses that the wireless device assigns in response to DHCP requests, and enters DHCP configuration mode.
Step 4	network <i>subnet_number</i> [mask <i>prefix-length</i>]	Assigns the subnet number for the address pool. The wireless device assigns IP addresses within this subnet. (Optional) Assigns a subnet mask for the address pool, or specifies the number of bits that compose the address prefix. The prefix is an alternative way of assigning the network mask. The prefix length must be preceded by a forward slash (/).
Step 5	lease { <i>days</i> [<i>hours</i>] [<i>minutes</i>] infinite }	Configures the duration of the lease for IP addresses assigned by the wireless device. <ul style="list-style-type: none"> • <i>days</i> —Lease duration in number of days. • <i>hours</i> —(Optional) Lease duration in number of hours. • <i>minutes</i> —(Optional) Lease duration in number of minutes. • infinite—Sets the lease duration to infinite.
Step 6	default-router <i>address</i> [<i>address2</i> ... <i>address 8</i>]	Specifies the IP address of the default router for DHCP clients on the subnet. Note One IP address is required; however, you can specify up to eight addresses in one command line.
Step 7	end	Returns to privileged EXEC mode.
Step 8	show running-config	Verifies your entries.
Step 9	copy running-config startup-config	(Optional) Saves your entries in the configuration file.

What to Do Next

Example Configuration: Setting up the DHCP Server

The following example shows how to configure the wireless device as a DHCP server, how to exclude a range of IP address, and how to assign a default router:

```
AP# configure terminal
AP(config)# ip dhcp excluded-address 172.16.1.1 172.16.1.20
AP(config)# ip dhcp pool wishbone
AP(dhcp-config)# network 172.16.1.0 255.255.255.0
AP(dhcp-config)# lease 10
AP(dhcp-config)# default-router 172.16.1.1
AP(dhcp-config)# end
```

Monitoring and Maintaining the DHCP Server Access Point

The following sections describe commands you can use to monitor and maintain the DHCP server access point:

show Commands

To display information about the wireless device as DHCP server, enter the commands in [Table 36: Show Commands for DHCP Server](#), on page 329, in privileged EXEC mode.

Table 36: Show Commands for DHCP Server

Command	Purpose
show ip dhcp conflict [address]	Displays a list of all address conflicts recorded by a specific DHCP Server. Enter the wireless device IP address to show conflicts recorded by the wireless device.
show ip dhcp database [url]	Displays recent activity on the DHCP database. Note Use this command in privileged EXEC mode.
show ip dhcp server statistics	Displays count information about server statistics and messages sent and received.

clear Commands

To clear DHCP server variables, use the commands in [Table 37: Clear Commands for DHCP Server](#), on page 329, in privileged EXEC mode.

Table 37: Clear Commands for DHCP Server

Command	Purpose
clear ip dhcp binding {address *}	Deletes an automatic address binding from the DHCP database. Specifying the address argument clears the automatic binding for a specific (client) IP address. Specifying an asterisk (*) clears all automatic bindings.

Command	Purpose
<code>clear ip dhcp conflict {address *}</code>	Clears an address conflict from the DHCP database. Specifying the address argument clears the conflict for a specific IP address. Specifying an asterisk (*) clears conflicts for all addresses.
<code>clear ip dhcp server statistics</code>	Resets all DHCP server counters to 0.

debug Command

To enable DHCP server debugging, use the following command in privileged EXEC mode:

```
debug ip dhcp server {events | packets | linkage}
```

Use the no form of the command to disable debugging for the wireless device DHCP server.

Configuring the Access Point for Secure Shell

This section describes how to configure the Secure Shell (SSH) feature.



Note

For complete syntax and usage information for the commands used in this section, see the “Secure Shell Commands” section in the *Cisco IOS Security Command Reference for Release 12.4*.

Understanding SSH

SSH is a protocol that provides a secure, remote connection to a Layer 2 or Layer 3 device. There are two versions of SSH: SSH version 1 and SSH version 2. This software release supports both SSH versions. If you do not specify the version number, the access point defaults to version 2.

SSH provides more security for remote connections than Telnet by providing strong encryption when a device is authenticated. The SSH feature has an SSH server and an SSH integrated client. The client supports the following user authentication methods:

For more information about SSH, see Part 5, “Other Security Features” in the *Cisco IOS Security Configuration Guide for Release 12.4*.



Note

The SSH feature in this software release does not support IP Security (IPsec).

Configuring SSH

Before configuring SSH, download the cryptographic software image from Cisco.com. For more information, see release notes for this release.

For information about configuring SSH and displaying SSH settings, see Part 6, “Other Security Features” in *Cisco IOS Security Configuration Guide for Release 12.4*, which is available at:

http://www.cisco.com/en/US/docs/ios/security/configuration/guide/12_4/sec_12_4_book.html

Client ARP Caching

You can configure the wireless device to maintain an address resolution protocol (ARP) cache for associated client devices. Maintaining an ARP cache on the wireless device reduces the traffic load on your wireless LAN. ARP caching is disabled by default.

This section contains this information:

Understanding Client ARP Caching

ARP caching on the wireless device reduces the traffic on your wireless LAN by stopping ARP requests for client devices at the wireless device. Instead of forwarding ARP requests to client devices, the wireless device responds to requests on behalf of associated client devices.

When ARP caching is disabled, the wireless device forwards all ARP requests through the radio port to associated clients. The client that receives the ARP request responds. When ARP caching is enabled, the wireless device responds to ARP requests for associated clients and does not forward requests to clients. When the wireless device receives an ARP request for an IP address not in the cache, the wireless device drops the request and does not forward it. In its beacon, the wireless device includes an information element to alert client devices that they can safely ignore broadcast messages to increase battery life.

When a non-Cisco client device is associated to an access point and is not passing data, the wireless device might not know the client IP address. If this situation occurs frequently on your wireless LAN, you can enable optional ARP caching. When ARP caching is optional, the wireless device responds on behalf of clients with IP addresses known to the wireless device but forwards out of its radio port any ARP requests addressed to unknown clients. When the wireless device learns the IP addresses for all associated clients, it drops ARP requests not directed to its associated clients.

Configuring Client ARP Caching

To configure the wireless device to maintain an ARP cache for associated clients, follow these steps, beginning in privileged EXEC mode:

SUMMARY STEPS

1. **configure terminal**
2. **dot11 arp-cache [optional]**
3. **end**
4. **show running-config**
5. **copy running-config startup-config**

DETAILED STEPS

	Command or Action	Purpose
Step 1	configure terminal	Enters global configuration mode.
Step 2	dot11 arp-cache [optional]	Enables ARP caching on the wireless device.

	Command or Action	Purpose
		(Optional) Use the optional keyword to enable ARP caching only for the client devices whose IP addresses are known to the wireless device.
Step 3	end	Returns to privileged EXEC mode.
Step 4	show running-config	Verifies your entries.
Step 5	copy running-config startup-config	(Optional) Saves your entries in the configuration file.

What to Do Next

Example: Configure ARP Caching

The following example shows how to configure ARP caching on an access point:

```
AP# configure terminal
AP(config)# dot11 arp-cache
AP(config)# end
```

Configuring Multiple VLAN and Rate Limiting for Point-to-Multipoint Bridging

This feature modifies the way that point-to-multipoint bridging can be configured to operate on multiple VLANs with the ability to control traffic rates on each VLAN.



Note

A rate-limiting policy can be applied only to Fast Ethernet ingress ports on non-root bridges.

In a typical scenario, multiple-VLAN support permits users to set up point-to-multipoint bridge links with remote sites, with each remote site on a separate VLAN. This configuration provides the capability for separating and controlling traffic to each site. Rate limiting ensures that no remote site consumes more than a specified amount of the entire link bandwidth. Only uplink traffic can be controlled by using the Fast Ethernet ingress ports of non-root bridges.

Using the class-based policing feature, you can specify the rate limit and apply it to the ingress of the Ethernet interface of a non-root bridge. Applying the rate at the ingress of the Ethernet interface ensures that all incoming Ethernet packets conform to the configured rate.



Configuring PPP over Ethernet with NAT

This chapter provides an overview of Point-to-Point Protocol over Ethernet (PPPoE) clients and network address translation (NAT) that can be configured on the Cisco 819, Cisco 860, Cisco 880, and Cisco 890 series Integrated Services Routers (ISRs).

- [Overview, page 334](#)
- [PPPoE, page 334](#)
- [NAT, page 335](#)
- [Configuration Tasks, page 335](#)
- [Configuration Example, page 342](#)

Overview

Multiple PCs can be connected to the LAN behind the router. Before the traffic from these PCs is sent to the PPPoE session, it can be encrypted, filtered, and so forth. [Figure 16: PPP over Ethernet with NAT](#) shows a typical deployment scenario with a PPPoE client and NAT configured on the Cisco router.

Figure 16: PPP over Ethernet with NAT

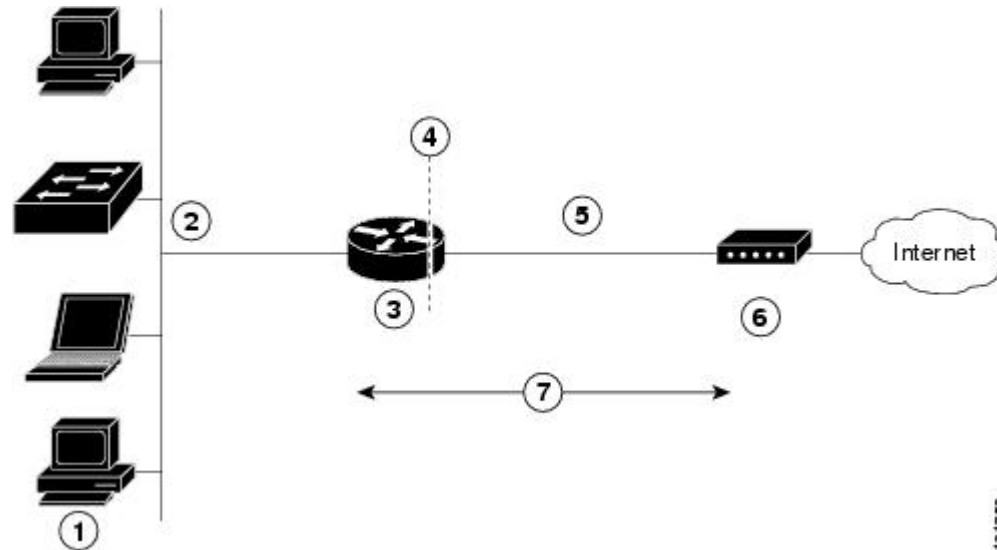

1	Multiple networked devices—Desktops, laptop PCs, switches
2	Fast Ethernet LAN interface (inside interface for NAT)
3	PPPoE client—Cisco 860, Cisco 880, or Cisco 890 ISRs
4	Point at which NAT occurs
5	Fast Ethernet WAN interface (outside interface for NAT)
6	Cable modem or other server that is connected to the Internet
7	PPPoE session between the client and a PPPoE server

PPPoE

The PPPoE client feature on the router provides PPPoE client support on Ethernet interfaces. A dialer interface must be used for cloning virtual access. Multiple PPPoE client sessions can be configured on an Ethernet interface, but each session must use a separate dialer interface and a separate dialer pool.

A PPPoE session is initiated on the client side by the Cisco 819, Cisco 860, or Cisco 880 ISRs. An established PPPoE client session can be terminated in one of two ways:

- By entering the `clear vpdn tunnel pppoe` command. The PPPoE client session is terminated, and the PPPoE client immediately tries to reestablish the session. This also occurs if the session has a timeout.
- By entering the `no pppoe-client dial-pool number` command to clear the session. The PPPoE client does not attempt to reestablish the session.

NAT

NAT (represented as the dashed line at the edge of the Cisco router) signifies two addressing domains and the inside source address. The source list defines how the packet travels through the network.

Configuration Tasks

Perform the following tasks to configure this network scenario:

An example showing the results of these configuration tasks is shown in the [Configuration Example, on page 342](#).

Configure the Virtual Private Dialup Network Group Number

Configuring a virtual private dialup network (VPDN) enables multiple clients to communicate through the router by way of a single IP address.

To configure a VPDN, perform the following steps, starting in global configuration mode:

SUMMARY STEPS

1. `vpdn enable`
2. `vpdn-group name`
3. `request-dialin`
4. `protocol {l2tp | pppoe}`
5. `exit`
6. `exit`

DETAILED STEPS

	Command or Action	Purpose
Step 1	<code>vpdn enable</code> Example: <code>Router(config)# vpdn enable</code>	Enables VPDN on the router.

	Command or Action	Purpose
Step 2	vpdn-group name Example: <pre>Router(config)# vpdn-group 1</pre>	Creates and associates a VPDN group with a customer or VPDN profile.
Step 3	request-dialin Example: <pre>Router(config-vpdn)# request-dialin</pre>	Creates a request-dialin VPDN subgroup, indicating the dialing direction, and initiates the tunnel.
Step 4	protocol {l2tp pppoe} Example: <pre>Router(config-vpdn-req-in)# protocol pppoe</pre>	Specifies the type of sessions the VPDN subgroup can establish.
Step 5	exit Example: <pre>Router(config-vpdn-req-in)# exit</pre>	Exits request-dialin VPDN group configuration mode.
Step 6	exit Example: <pre>Router(config-vpdn)# exit</pre>	Exits VPDN configuration mode and returns to global configuration mode.

Configure Ethernet WAN Interfaces

In this scenario, the PPPoE client (your Cisco router) communicates over a 10/100 Mbps-Ethernet interface on both the inside and the outside.

To configure the Fast Ethernet WAN interfaces, perform these steps, starting in global configuration mode:

SUMMARY STEPS

1. interface type number
2. **pppoe-client dial-pool-number** *number*
3. **no shutdown**
4. **exit**

DETAILED STEPS

	Command or Action	Purpose
Step 1	interface type number Example: <pre>Router(config)# interface fastethernet 4 or Router(config)# interface gigabitethernet 4</pre>	Enters interface configuration mode for WAN interface.
Step 2	pppoe-client dial-pool-number number Example: <pre>Router(config-if)# pppoe-client dial-pool-number 1</pre>	Configures the PPPoE client and specifies the dialer interface to use for cloning.
Step 3	no shutdown Example: <pre>Router(config-if)# no shutdown</pre>	Enables the Fast Ethernet interface and the configuration changes just made to it.
Step 4	exit Example: <pre>Router(config-if)# exit</pre>	Exits configuration mode for the Fast Ethernet interface and returns to global configuration mode.

What to Do Next**Ethernet Operations, Administration, and Maintenance**

Ethernet Operations, Administration, and Maintenance (OAM) is a protocol for installing, monitoring, and troubleshooting Ethernet metropolitan-area networks (MANs) and Ethernet WANs. It relies on a new, optional sublayer in the data link layer of the Open Systems Interconnection (OSI) model. The OAM features covered by this protocol are Discovery, Link Monitoring, Remote Fault Detection, Remote Loopback, and Cisco Proprietary Extensions.

For setup and configuration information about Ethernet OAM, see [Using Ethernet Operations, Administration, and Maintenance](#) at: [Carrier Ethernet Configuration Guide](#).

Configure the Dialer Interface

The dialer interface indicates how to handle traffic from the clients, including, for example, default routing information, the encapsulation protocol, and the dialer pool to use. The dialer interface is also used for cloning virtual access. Multiple PPPoE client sessions can be configured on a Fast Ethernet interface, but each session must use a separate dialer interface and a separate dialer pool.

To configure a dialer interface for one of the Fast Ethernet LAN interfaces on the router, complete the following steps, starting in global configuration mode:

SUMMARY STEPS

1. **interface dialer** *dialer-rotary-group-number*
2. **ip address negotiated**
3. **ip mtu** *bytes*
4. **encapsulation** *encapsulation-type*
5. **ppp authentication** *{protocol1 [protocol2...]}*
6. **dialer pool** *number*
7. **dialer-group** *group-number*
8. **exit**
9. **dialer-list***dialer-group protocol protocol-name {permit | deny | list access-list-number | access-group}*
10. **ip route***prefix mask {interface-type interface-number}*

DETAILED STEPS

	Command or Action	Purpose
Step 1	interface dialer <i>dialer-rotary-group-number</i> Example: Router(config)# interface dialer 0	Creates a dialer interface and enters interface configuration mode. • Range is from 0 to 255.
Step 2	ip address negotiated Example: Router(config-if)# ip address negotiated	Specifies that the IP address for the interface is obtained through PPP/IPCP (IP Control Protocol) address negotiation.
Step 3	ip mtu <i>bytes</i> Example: Router(config-if)# ip mtu 1492	Sets the size of the IP maximum transmission unit (MTU). • The default minimum is 128 bytes. The maximum for Ethernet is 1492 bytes.
Step 4	encapsulation <i>encapsulation-type</i> Example: Router(config-if)# encapsulation ppp	Sets the encapsulation type to PPP for the data packets being transmitted and received.
Step 5	ppp authentication <i>{protocol1 [protocol2...]}</i> Example: Router(config-if)# ppp authentication chap	Sets the PPP authentication method to Challenge Handshake Authentication Protocol (CHAP). For details about this command and additional parameters that can be set, see Cisco IOS Security Command Reference.

	Command or Action	Purpose
Step 6	<p>dialer pool <i>number</i></p> <p>Example:</p> <pre>Router(config-if)# dialer pool 1</pre>	Specifies the dialer pool that is used to connect to a specific destination subnetwork.
Step 7	<p>dialer-group <i>group-number</i></p> <p>Example:</p> <pre>Router(config-if)# dialer-group 1</pre>	<p>Assigns the dialer interface to a dialer group.</p> <ul style="list-style-type: none"> • Range is from 1 to 10. <p>Tip Using a dialer group controls access to your router.</p>
Step 8	<p>exit</p> <p>Example:</p> <pre>Router(config-if)# exit</pre>	Exits the dialer 0 interface configuration mode and returns to global configuration mode.
Step 9	<p>dialer-list<i>dialer-group</i> protocol<i>protocol-name</i> {permit deny list <i>access-list-number</i> access-group}</p> <p>Example:</p> <pre>Router(config)# dialer-list 1 protocol ip permit</pre>	<p>Creates a dialer list and associates a dial group with it. Packets are then forwarded through the specified interface dialer group.</p> <p>For details about this command and additional parameters that can be set, see Cisco IOS Dial Technologies Command Reference.</p>
Step 10	<p>ip route<i>prefix mask</i> {<i>interface-type</i> <i>interface-number</i>}</p> <p>Example:</p> <pre>Router(config)# ip route 10.10.25.2 255.255.255.255 dialer 0</pre>	Sets the IP route for the default gateway for the dialer 0 interface.

Configure Network Address Translation

Network Address Translation (NAT) translates packets from addresses that match a standard access list, using global addresses allocated by the dialer interface. Packets that enter the router through the inside interface, packets sourced from the router, or both are checked against the access list for possible address translation. You can configure NAT for either static or dynamic address translations.

To configure the outside Fast Ethernet WAN interface with dynamic NAT, perform these steps, beginning in global configuration mode:

SUMMARY STEPS

1. **ip nat pool** *name start-ip end-ip* {**netmask** *netmask* | **prefix-length** *prefix-length*}
2. Do one of the following:
 - **ip nat inside source** {**list** *access-list-number*} {**interface** *type number* | **pool** *name*} [**overload**]
 - Router(config)# ip nat inside source list 1 interface dialer 0 overload
 - Router(config)# ip nat inside source list acl1 pool pool1
3. interface *type number*
4. **ip nat** {**inside** | **outside**}
5. **no shutdown**
6. **exit**
7. interface *type number*
8. **ip nat** {**inside** | **outside**}
9. **no shutdown**
10. **exit**
11. **access-list** *access-list-number* {**deny** | **permit**} *source* [*source-wildcard*]

DETAILED STEPS

	Command or Action	Purpose
Step 1	ip nat pool <i>name start-ip end-ip</i> { netmask <i>netmask</i> prefix-length <i>prefix-length</i> } Example: Router(config)# ip nat pool pool1 192.168.1.0 192.168.2.0 netmask 255.255.252.0	Creates pool of global IP addresses for NAT.
Step 2	Do one of the following: <ul style="list-style-type: none"> • ip nat inside source {list <i>access-list-number</i>} {interface <i>type number</i> pool <i>name</i>} [overload] • Router(config)# ip nat inside source list 1 interface dialer 0 overload • Router(config)# ip nat inside source list acl1 pool pool1 	Enables dynamic translation of addresses on the inside interface. The first example shows the addresses permitted by the access list 1 to be translated to one of the addresses specified in the dialer interface 0 . The second example shows the addresses permitted by access list <i>acl1</i> to be translated to one of the addresses specified in the NAT pool <i>pool1</i> .
Step 3	interface <i>type number</i> Example: Router(config)# interface vlan 1	Enters configuration mode for the VLAN (on which the Fast Ethernet LAN interfaces [FE0–FE3] reside) to be the inside interface for NAT.

	Command or Action	Purpose
Step 4	ip nat {inside outside} Example: Router(config-if)# ip nat inside	Identifies the specified VLAN interface as the NAT inside interface.
Step 5	no shutdown Example: Router(config-if)# no shutdown	Enables the configuration changes just made to the Ethernet interface.
Step 6	exit Example: Router(config-if)# exit	Exits configuration mode for the Fast Ethernet interface and returns to global configuration mode.
Step 7	interface type number Example: Router(config)# interface fastethernet 4	Enters configuration mode for the Fast Ethernet WAN interface (FE4) to be the outside interface for NAT.
Step 8	ip nat {inside outside} Example: Router(config-if)# ip nat outside	Identifies the specified WAN interface as the NAT outside interface.
Step 9	no shutdown Example: Router(config-if)# no shutdown	Enables the configuration changes just made to the Ethernet interface.
Step 10	exit Example: Router(config-if)# exit	Exits configuration mode for the Fast Ethernet interface and returns to global configuration mode.
Step 11	access-list access-list-number {deny permit} source [source-wildcard] Example: Router(config)# access-list 1 permit 192.168.1.0 255.255.255.0	Defines a standard access list indicating which addresses need translation. Note All other addresses are implicitly denied.

What to Do Next



Note To use NAT with a virtual-template interface, you must configure a loopback interface. See [Basic Router Configuration](#) for information on configuring a loopback interface.

For complete information on the NAT commands, see the Cisco NX-OS Release 4.1 documentation set. For more general information on NAT concepts, see [Cisco IOS Software Basic Skills](#).

Configuration Example

The following configuration example shows a portion of the configuration file for the PPPoE scenario described in this chapter.

The VLAN interface has an IP address of 192.168.1.1 with a subnet mask of 255.255.255.0. NAT is configured for inside and outside



Note Commands marked by “(default)” are generated automatically when you run the **show running-config** command.

```

vpdn enable
vpdn-group 1
request-dialin
protocol pppoe
!
interface vlan 1
ip address 192.168.1.1 255.255.255.0
no ip directed-broadcast (default)
ip nat inside
interface FastEthernet 4
no ip address
no ip directed-broadcast (default)
ip nat outside
pppoe enable group global
pppoe-client dial-pool-number 1
no sh
!
interface dialer 0
ip address negotiated
ip mtu 1492
encapsulation ppp
ppp authentication chap
dialer pool 1
dialer-group 1
!
dialer-list 1 protocol ip permit
ip nat inside source list 1 interface dialer 0 overload
ip classless (default)
ip route 10.10.25.2 255.255.255.255 dialer 0
ip nat pool pool1 192.168.1.0 192.168.2.0 netmask 255.255.252.0
ip nat inside source list acl1 pool pool1
!

```

Verifying Your Configuration

Use the `show ip nat statistics` command in privileged EXEC mode to verify the PPPoE with NAT configuration. You should see verification output similar to the following example:

```
Router# show ip nat statistics
Total active translations: 0 (0 static, 0 dynamic; 0 extended)
Outside interfaces:
  FastEthernet4
Inside interfaces:
  Vlan1
Hits: 0 Misses: 0
CEF Translated packets: 0, CEF Punted packets: 0
Expired translations: 0
Dynamic mappings:
-- Inside Source
[Id: 1] access-list 1 interface Dialer0 refcount 0
Queued Packets: 0
```



Configuring PPP over ATM with NAT

This chapter provides an overview of Point-to-Point Protocol over Asynchronous Transfer Mode (PPPoA) clients and network address translation (NAT) that can be configured on the Cisco 860 and Cisco 880 series Integrated Services Routers (ISRs).

- [Overview, page 345](#)
- [Configure the Dialer Interface, page 347](#)
- [Configure the ATM WAN Interface, page 349](#)
- [Configure DSL Signaling Protocol, page 350](#)
- [Configure Network Address Translation, page 352](#)
- [Configuration Example, page 355](#)

Overview

Multiple PCs can be connected to the LAN behind the router. Before traffic from the PCs is sent to the PPPoA session, it can be encrypted, filtered, and so forth. PPP over ATM provides a network solution with simplified address handling and straight user verification like a dial network. [Figure 17: PPP over ATM with NAT, on](#)

page 346 shows a typical deployment scenario with a PPPoA client and NAT configured on the Cisco router. This scenario uses a single static IP address for the ATM connection.

Figure 17: PPP over ATM with NAT

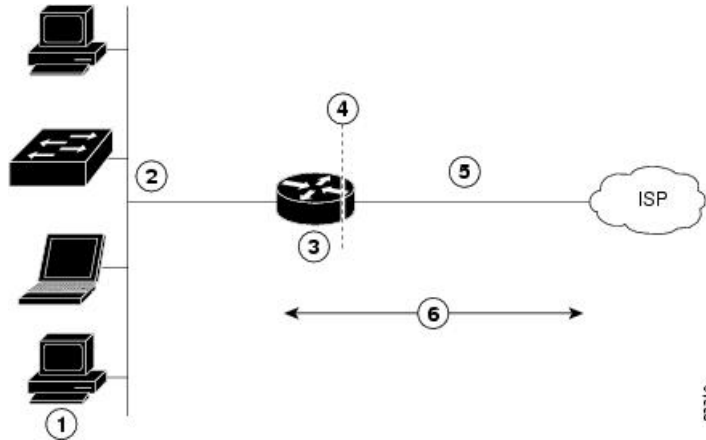

1	Small business with multiple networked devices—desktops, laptop PCs, switches
2	Fast Ethernet LAN interface (inside interface for NAT, 192.168.1.1/24)
3	PPPoA Client
4	Point at which NAT occurs
5	ATM WAN interface (outside interface for NAT)
6	PPPoA session between the client and a PPPoA server at the ISP

In this scenario, the small business or remote user on the Fast Ethernet LAN can connect to an Internet service provider (ISP) using the integrated xDSL WAN interface on the Cisco 860 and Cisco 880 series ISRs.

The Fast Ethernet interface carries the data packet through the LAN and off-loads it to the PPP connection on the ATM interface. The ATM traffic is encapsulated and sent over the xDSL interface. The dialer interface is used to connect to the ISP.

PPPoA

The PPPoA Client feature on the router provides PPPoA client support on ATM interfaces. A dialer interface must be used for cloning virtual access. Multiple PPPoA client sessions can be configured on an ATM interface, but each session must use a separate dialer interface and a separate dialer pool.

A PPPoA session is initiated on the client side by the Cisco 860 or Cisco 880 series router.

NAT

NAT (represented as the dashed line at the edge of the Cisco router) signifies two addressing domains and the inside source address. The source list defines how the packet travels through the network.

Configuration Tasks

Perform the following tasks to configure this network scenario:

- [Configure the Dialer Interface](#), on page 347
- [Configure the ATM WAN Interface](#), on page 349
- [Configure DSL Signaling Protocol](#), on page 350
- [Configure Network Address Translation](#), on page 352

An example showing the results of these configuration tasks is shown in the [Configuration Example](#), on page 355.

Configure the Dialer Interface

The dialer interface indicates how to handle traffic from the clients, including, for example, default routing information, the encapsulation protocol, and the dialer pool to use. It is also used for cloning virtual access. Multiple PPPoA client sessions can be configured on an ATM interface, but each session must use a separate dialer interface and a separate dialer pool.

Perform these steps to configure a dialer interface for the ATM interface on the router, starting in global configuration mode.

SUMMARY STEPS

1. **interface dialer** *dialer-rotary-group-number*
2. **ip address negotiated**
3. **ip mtu bytes**
4. **encapsulation** *encapsulation-type*
5. **ppp authentication** {*protocol1* [*protocol2...*]}
6. **dialer pool number**
7. **dialer-group** *group-number*
8. **exit**
9. **dialer-list** *dialer-group* **protocol** *protocol-name* {**permit** | **deny** | **list** *access-list-number* | **access-group**}
10. **ip route** *prefix mask* {*interface-type interface-number*}

DETAILED STEPS

	Command or Action	Purpose
Step 1	interface dialer <i>dialer-rotary-group-number</i> Example: Router(config)# interface dialer 0	Creates a dialer interface (numbered 0–255), and enters into interface configuration mode.

	Command or Action	Purpose
Step 2	ip address negotiated Example: Router(config-if)# ip address negotiated	Specifies that the IP address for the dialer interface is obtained through PPP/IPCP (IP Control Protocol) address negotiation.
Step 3	ip mtu bytes Example: Router(config-if)# ip mtu 4470	Sets the size of the IP maximum transmission unit (MTU). The default minimum is 128 bytes. The maximum for ATM is 4470 bytes.
Step 4	encapsulation encapsulation-type Example: Router(config-if)# encapsulation ppp	Sets the encapsulation type to PPP for the data packets being transmitted and received.
Step 5	ppp authentication {protocol1 [protocol2...]} Example: Router(config-if)# ppp authentication chap	Sets the PPP authentication method. The example applies the Challenge Handshake Authentication Protocol (CHAP). For details about this command and additional parameters that can be set, see the Cisco IOS Security Command Reference.
Step 6	dialer pool number Example: Router(config-if)# dialer pool 1	Specifies the dialer pool to use to connect to a specific destination subnetwork.
Step 7	dialer-group group-number Example: Router(config-if)# dialer-group 1	Assigns the dialer interface to a dialer group (1–10). Tip Using a dialer group controls access to your router.
Step 8	exit Example: Router(config-if)# exit	Exits the dialer 0 interface configuration.
Step 9	dialer-list dialer-group protocol protocol-name {permit deny list access-list-number access-group} Example: Router(config)# dialer-list 1 protocol ip permit	Creates a dialer list and associates a dial group with it. Packets are then forwarded through the specified interface dialer group. For details about this command and additional parameters that can be set, see the Cisco IOS Dial Technologies Command Reference.
Step 10	ip route prefix mask {interface-type interface-number}	Sets the IP route for the default gateway for the dialer 0 interface.

	Command or Action	Purpose
	Example: <pre>Router(config)# ip route 10.10.25.2 0.255.255.255 dialer 0</pre>	For details about this command and additional parameters that can be set, see the Cisco IOS IP Command Reference, Volume 1 of 4: Routing Protocols.

What to Do Next

Repeat these steps for any additional dialer interfaces or dialer pools needed.

Configure the ATM WAN Interface

Perform these steps to configure the ATM interface, beginning in global configuration mode.

SUMMARY STEPS

1. `interface type number`
2. `pvc vpi/vci`
3. `encapsulation {aal5auto | aal5autoppv virtual-template number [group group-name] | aal5ciscoppv virtual-template number | aal5mux protocol | aal5nlpid | aal5snap}`
4. `dialer pool-member number`
5. `no shutdown`
6. `exit`

DETAILED STEPS

	Command or Action	Purpose
Step 1	<code>interface type number</code> Example: <pre>Router(config)# interface atm 0</pre>	Enters interface configuration mode for the ATM interface (labeled ADSLoPOTS or G.SHDSL on the back of your router). Note This interface was initially configured during basic router configuration. See the Configuring WAN Interfaces, on page 23 .
Step 2	<code>pvc vpi/vci</code> Example: <pre>Router(config-if)# pvc 8/35</pre>	Creates an ATM PVC for each end node (up to ten) with which the router communicates. Enters ATM virtual circuit configuration mode. When a PVC is defined, AAL5SNAP encapsulation is defined by default. Use the encapsulation command to change this, as shown in Step 3 . The VPI and VCI arguments cannot be simultaneously specified as zero; if one is 0, the other cannot be 0. For details about this command and additional parameters that can be set, see the Cisco IOS Wide-Area Networking Command Reference.

	Command or Action	Purpose
Step 3	<p>encapsulation {aal5auto aal5autopp virtual-template <i>number</i> [group <i>group-name</i>] aal5ciscoppp virtual-template <i>number</i> aal5mux <i>protocol</i> aal5nlpid aal5snap}</p> <p>Example:</p> <pre>Router(config-if-atm-vc)# encapsulation aal5mux ppp dialer</pre>	<p>Specifies the encapsulation type for the PVC and points back to the dialer interface.</p> <p>For details about this command and additional parameters that can be set, see the Cisco IOS Wide-Area Networking Command Reference.</p>
Step 4	<p>dialer pool-member <i>number</i></p> <p>Example:</p> <pre>Router(config-if-atm-vc)# dialer pool-member 1</pre>	<p>Specifies the ATM interface as a member of a dialer profile dialing pool. The pool number must be in the range of 1–255.</p>
Step 5	<p>no shutdown</p> <p>Example:</p> <pre>Router(config-if-atm-vc)# no shutdown</pre>	<p>Enables interface and configuration changes just made to the ATM interface.</p>
Step 6	<p>exit</p> <p>Example:</p> <pre>Router(config-if)# exit</pre> <p>Example:</p> <pre>Router(config)#</pre>	<p>Exits configuration mode for the ATM interface.</p>

Configure DSL Signaling Protocol

DSL signaling must be configured on the ATM interface for connection to your ISP. The Cisco 887 and Cisco 867 ISRs support ADSL signaling over POTS and the Cisco 886 ISR supports ADSL signaling over ISDN. The Cisco 888 ISR supports G.SHDSL.

Configuring ADSL

The default configuration for ADSL signaling is shown in [Table 38: Default ADSL Configuration](#), on page 351.

Table 38: Default ADSL Configuration

Attribute	Description	Default Value
Operating mode	Specifies the operating mode of the digital subscriber line (DSL) for an ATM interface. <ul style="list-style-type: none"> • ADSL over POTS—ANSI or ITU full rate, or automatic selection. • ADSL over ISDN—ITU full rate, ETSI, or automatic selection. 	Auto
Loss of margin	Specifies the number of times a loss of margin may occur.	—
Training log	Toggles between enabling the training log and disabling the training log.	Disabled

If you wish to change any of these settings, use one of the following commands in global configuration mode.

- **dsl operating-mode** (from the ATM interface configuration mode)
- **dsl lom integer**
- **dsl enable-training-log**

See the Cisco IOS Wide-Area Networking Command Reference for details of these commands.

Verifying the Configuration

You can verify that the configuration is set the way you want by using the **show dsl interface atm** command from privileged EXEC mode.

```
Router# show dsl interface atm 0
ATM0
Alcatel 20190 chipset information
          ATU-R (DS)                               ATU-C (US)
Modem Status:      Showtime (DMTDSL_SHOWTIME)
DSL Mode:          ITU G.992.5 (ADSL2+) Annex A
ITU STD NUM:       0x03                             0x2
Chip Vendor ID:    'STMI'                           'BDCM'
Chip Vendor Specific: 0x0000                         0x6193
Chip Vendor Country: 0x0F                           0xB5
Modem Vendor ID:   'CSCO'                            '   '
Modem Vendor Specific: 0x0000                       0x0000
Modem Vendor Country: 0xB5                          0x00
Serial Number Near:
Serial Number Far:
Modem VerChip ID:      C196 (3)
DFE BOM:               DFE3.0 Annex A (1)
Capacity Used:         82%                           99%
Noise Margin:          12.5 dB                        5.5 dB
Output Power:          11.5 dBm                      12.0 dBm
Attenuation:           5.5 dB                         0.0 dB
FEC ES Errors:         0                             0
ES Errors:             1                             287
SES Errors:            1                             0
```

```

LOSES Errors:      1                      0
UES Errors:       0                      276233
Defect Status:    None                    None
Last Fail Code:   None
Watchdog Counter: 0x56
Watchdog Resets: 0
Selftest Result: 0x00
Subfunction:     0x00
Interrupts:      4147 (0 spurious)
PHY Access Err:  0
Activations:     3
LED Status:      ON
LED On Time:     100
LED Off Time:    100
Init FW:         init AMR-4.0.015_no_bist.bin
Operation FW:    AMR-4.0.015.bin
FW Source:       embedded
FW Version:      4.0.15

Speed (kbps):    DS Channel1    DS Channel0    US Channel1    US Channel0
Cells:           0                19999          0                1192
Reed-Solomon EC: 0                0              0                1680867
CRC Errors:      0                0              0                0
Header Errors:   0                0              0                326
Total BER:       0E-0            65535E-0
Leakage Average BER: 0E-0        65535E-255
Interleave Delay: 0                36             0                11
                ATU-R (DS)      ATU-C (US)
Bitswap:         enabled         enabled
Bitswap success: 0                0
Bitswap failure: 0                0
LOM Monitoring : Disabled
DMT Bits Per Bin
000: 0 0 0 0 F F F F F F F F F F F F
010: 0 0 3 0 F F F F F F F F F F F F
020: F F F F F F F F F F F F F F
....
DSL: Training log buffer capability is not enabled
Router#

```

Configure Network Address Translation

Network Address Translation (NAT) translates packets from addresses that match a standard access list, using global addresses allocated by the dialer interface. Packets that enter the router through the inside interface, packets sourced from the router, or both are checked against the access list for possible address translation. You can configure NAT for either static or dynamic address translations.

Perform these steps to configure the outside ATM WAN interface with dynamic NAT, beginning in global configuration mode:

SUMMARY STEPS

1. **ip nat pool** *name start-ip end-ip* {**netmask** *netmask* | **prefix-length** *prefix-length*}
2. Do one of the following:
 - **ip nat inside source** {**list** *access-list-number*} {**interface** *type number* | **pool** *name*} [**overload**]
 - **Example 1:**

```
Router(config)# ip nat inside source list 1 interface dialer
0 overload
```
 - **Example 2:**

```
Router(config)# ip nat inside source list acl1 pool pool1
```
3. **interface** *type number*
4. **ip nat** {**inside** | **outside**}
5. **no shutdown**
6. **exit**
7. **interface** *type number*
8. **ip nat** {**inside** | **outside**}
9. **no shutdown**
10. **exit**
11. **access-list** *access-list-number* {**deny** | **permit**} *source* [*source-wildcard*]

DETAILED STEPS

	Command or Action	Purpose
Step 1	<p>ip nat pool <i>name start-ip end-ip</i> {netmask <i>netmask</i> prefix-length <i>prefix-length</i>}</p> <p>Example:</p> <pre>Router(config)# ip nat pool pool1 192.168.1.0 192.168.2.0 netmask 255.255.255.0</pre>	Creates pool of global IP addresses for NAT.
Step 2	<p>Do one of the following:</p> <ul style="list-style-type: none"> • ip nat inside source {list <i>access-list-number</i>} {interface <i>type number</i> pool <i>name</i>} [overload] • Example 1: <pre>Router(config)# ip nat inside source list 1 interface dialer 0 overload</pre> • Example 2: <pre>Router(config)# ip nat inside source list acl1 pool pool1</pre> 	<p>Enables dynamic translation of addresses on the inside interface.</p> <p>The first example shows the addresses permitted by the access list <i>1</i> to be translated to one of the addresses specified in the dialer interface <i>0</i>.</p> <p>The second example shows the addresses permitted by access list <i>acl1</i> to be translated to one of the addresses specified in the NAT pool <i>pool1</i>.</p>

	Command or Action	Purpose
Step 3	<p>interface type number</p> <p>Example:</p> <pre>Router(config)# interface vlan 1</pre>	Enters configuration mode for the VLAN (on which the Fast Ethernet LAN interfaces [FE0–FE3] reside) to be the inside interface for NAT.
Step 4	<p>ip nat {inside outside}</p> <p>Example:</p> <pre>Router(config-if)# ip nat inside</pre>	Applies NAT to the Fast Ethernet LAN interface as the inside interface.
Step 5	<p>no shutdown</p> <p>Example:</p> <pre>Router(config-if)# no shutdown</pre>	Enables the configuration changes just made to the Ethernet interface.
Step 6	<p>exit</p> <p>Example:</p> <pre>Router(config-if)# exit</pre>	Exits configuration mode for the Fast Ethernet interface.
Step 7	<p>interface type number</p> <p>Example:</p> <pre>Router(config)# interface atm 0</pre>	Enters configuration mode for the ATM WAN interface (ATM0) to be the outside interface for NAT.
Step 8	<p>ip nat {inside outside}</p> <p>Example:</p> <pre>Router(config-if)# ip nat outside</pre>	Identifies the specified WAN interface as the NAT outside interface.
Step 9	<p>no shutdown</p> <p>Example:</p> <pre>Router(config-if)# no shutdown</pre>	Enables the configuration changes just made to the Ethernet interface.
Step 10	<p>exit</p> <p>Example:</p> <pre>Router(config-if)# exit</pre>	Exits configuration mode for the ATM interface.
Step 11	<p>access-list access-list-number {deny permit} source [source-wildcard]</p> <p>Example:</p> <pre>Router(config)# access-list 1 permit 192.168.1.0 255.255.255.0</pre>	<p>Defines a standard access list permitting addresses that need translation.</p> <p>Note All other addresses are implicitly denied.</p>

What to Do Next



Note If you want to use NAT with a virtual-template interface, you must configure a loopback interface. See [Basic Router Configuration](#) for information on configuring the loopback interface.

For complete information on NAT commands, see the Cisco NX-OS Release 4.1 documentation set.

Configuration Example

The following configuration example shows a portion of the configuration file for a client in the PPPoA scenario described in this chapter.

The VLAN interface has an IP address of 192.168.1.1 with a subnet mask of 255.255.255.0. NAT is configured for inside and outside.



Note Commands marked by “(default)” are generated automatically when you run the **show running-config** command.

```
!
interface Vlan1
 ip address 192.168.1.1 255.255.255.0
 ip nat inside
 ip virtual-reassembly (default)
!
interface ATM0
 no ip address
 ip nat outside
 ip virtual-reassembly
 no atm ilmi-keepalive
 pvc 8/35
 encapsulation aal5mux ppp dialer
 dialer pool-member 1
!
dsl operating-mode auto
!
interface Dialer0
 ip address negotiated
 ip mtu 1492
 encapsulation ppp
 dialer pool 1
 dialer-group 1
 ppp authentication chap
!
ip classless (default)
!
ip nat pool pool1 192.168.1.0 192.168.2.0 netmask 0.0.0.255
ip nat inside source list 1 interface Dialer0 overload
!
access-list 1 permit 192.168.1.0 0.0.0.255
dialer-list 1 protocol ip permit
ip route 10.10.25.2 0.255.255.255 dialer 0
!
```

Verifying Your Configuration with NAT

Use the `show ip nat statistics` command in privileged EXEC mode to verify the PPPoA client with NAT configuration. You should see verification output similar to the following example:

```
Router# show ip nat statistics
Total active translations: 0 (0 static, 0 dynamic; 0 extended)
Outside interfaces:
  ATM0
Inside interfaces:
  Vlan1
Hits: 0 Misses: 0
CEF Translated packets: 0, CEF Punted packets: 0
Expired translations: 0
Dynamic mappings:
-- Inside Source
  [Id: 1] access-list 1 interface Dialer0 refcount 0
Queued Packets: 0
```



CHAPTER 13

Environmental and Power Management

This chapter explains the environmental and power Management features.

- [Environmental and Power Management, page 357](#)
- [Cisco EnergyWise Support, page 358](#)

Environmental and Power Management

The Cisco 819 integrated services routers are equipped with sensors in the router body for monitoring the environment temperature and logging the temperature every 30 seconds. There are four sensors located on the four corners of the router chassis. There is an additional System Ambient sensor and a 3G sensor.

The corner sensors display the following message:

- Error message on the console—When the temperature ranges are outside the set temperature thresholds, the monitor displays an error message. Different temperature ranges are set for different SKUs of the router:
 - Cisco 819G (non-hardened): 0 to 60 degrees celcius
 - Cisco 819HG (hardened): -25 to 75 degrees celcius
- SNMP Traps—syslog messages are created when the temperature is outside the specified range.
- Server “call home” feature—The server callhome feature is already enabled to call Cisco TAC in the event of very high or low temperatures.

In addition to the corner sensors, the System Ambient and 3G sensors also log the temperature every 30 seconds onto bootflash memory.

Any time the temperature is above the high threshold, or lower than the low threshold, the temperature information will be saved in non-volatile memory region and is also displayed as part of this output.

Use the show environment command to check the temperature of the router. You can also use this command to display the power usage and the power consumption of the unit at the end.

The following is a sample output for the show environment command:

```
router# show environment
```

```

SYSTEM WATTAGE
=====
Board Power consumption is: 4.851 W
Power Supply Loss: 1.149 W
Total System Power consumption is: 6.000 W
REAL TIME CLOCK BATTERY STATUS
=====
Battery OK (checked at power up)
TEMPERATURE STATUS
=====
Sensor          Current          High/Low
Name            Temperature      Status           Threshold
-----
Sensor 1        36               Normal           60/0
Sensor 2        34               Normal           60/0
Sensor 3        40               Normal           60/0
Sensor 4        38               Normal           60/0
System Ambient Sensor 35       Normal           60/0
3G Modem Sensor 33               Normal           85/0
Environmental information last updated 00:00:26 ago

```

**Note**

If the modem temperature goes up to 85 degrees for non-hardened or 90 degrees for hardened version, a warning message appears. The router automatically shuts down if the temperature goes higher than 108 degrees.

Cisco EnergyWise Support

The Cisco 819 ISRs have hardware and software features for reducing power consumption. The hardware features include high-efficiency AC power supplies and electrical components with built-in power saving features, such as RAM select and clock gating. For more information, see [Cisco 819 Integrated Services Router Hardware Installation Guide](#).

The software features include Cisco EnergyWise, a power efficiency management feature that powers down unused modules and disable unused clocks to the modules and peripherals on the router.

The Cisco 819 ISRs must be running Cisco IOS Release 15.0(1)M or later to support EnergyWise. Detailed configuration procedures are included in

[Cisco EnergyWise Configuration Guide, EnergyWise Phase 1](#) and [Cisco EnergyWise Configuration Guide, EnergyWise Phase 2](#).



CHAPTER 14

4G LTE Wireless WAN

The Cisco Fourth-Generation Long-Term Evolution (4G LTE) Wireless WAN (WWAN) offers a highly secure, simplified, and cost-effective WAN alternative to DSL or Frame Relay. In areas where terrestrial broadband services (cable, DSL, or T1) are not available or are expensive, 4G LTE WWAN connectivity can be a viable alternative. The Cisco 819 Series 4G LTE ISRs, Cisco C880 Series 4G LTE ISRs, and Cisco C890 Series 4G LTE ISRs support 4G LTE and 3G cellular networks and Cisco 880G series ISRs support 3G cellular networks.

- [4G LTE Support on Cisco 800 Series ISRs, page 359](#)
- [3G Support on Cisco 880G series ISRs, page 362](#)

4G LTE Support on Cisco 800 Series ISRs

Effective with Cisco IOS Release 15.2(4)M1, the multimode 4G LTE feature is supported on Cisco 819 Series 4G LTE ISRs, Cisco C880 Series 4G LTE ISRs, and Cisco C890 Series 4G LTE ISRs also support 4G LTE feature effective with Cisco IOS Release 15.4(3)T. Cisco 819 Series 4G LTE ISRs, Cisco C880 Series 4G LTE ISRs, and Cisco C890 Series 4G LTE ISRs support the following modes:

- **4G LTE**—4G LTE mobile specification provides multi-megabit bandwidth, more efficient radio network, latency reduction, and improved mobility. LTE solutions target new cellular networks. These networks initially support up to 100 Mb/s peak rates in the downlink and up to 50 Mb/s peak rates in the uplink. The throughput of these networks is higher than the existing 3G networks.
- **3G Evolution High-Speed Packet Access (HSPA/HSPA+) Mode**—HSPA is a UMTS-based 3G network. It supports High-Speed Downlink Packet Access (HSDPA) and High-Speed Uplink Packet Access (HSUPA) data for improved download and upload speeds. Evolution High-Speed Packet Access (HSPA+) supports Multiple Input/Multiple Output (MIMO) antenna capability.
- **3G Evolution-Data Optimized (EVDO or DOrA) Mode**—EVDO is a 3G telecommunications standard for the wireless transmission of data through radio signals, typically for broadband Internet access. DOrA refers to EVDO Rev-A. EVDO uses multiplexing techniques including Code Division Multiple Access (CDMA), as well as Time Division Multiple Access (TDMA), to maximize both individual users' throughput and the overall system throughput.

How to Configure Cisco 800 Series 4G LTE ISRs

For instructions on how to configure the 4G LTE features on Cisco 819 Series 4G LTE ISRs, Cisco C880 Series 4G LTE ISRs, and Cisco C890 Series 4G LTE ISRs, see [Cisco 4G LTE Software Installation Guide](#).

Note

For Cisco 800 Series 4G LTE ISRs, use slot "0" for all commands.

Configuration Examples for Cisco 800 Series 4G LTE ISRs

The following examples show how to configure the cellular interface for Cisco 800 Series 4G LTE ISRs:

Example: Basic Cellular Configuration

The following example shows how to configure the cellular interface to be used as primary and is configured as the default route:

```
chat-script lte "" "AT!CALL1" TIMEOUT 20 "OK"
!
!
controller Cellular 0
!
!
interface Cellular0
ip address negotiated
encapsulation slip
load-interval 30
dialer in-band
dialer idle-timeout 0
dialer string lte
dialer-group 1
no peer default ip address
async mode interactive
routing dynamic
!
dialer-list 1 protocol ip permit
!
line 3
script dialer lte
modem InOut
no exec
transport input all
transport output all
!
```

Example: Dialer-Watch Configuration without External Dialer Interface

The following example shows how to configure the dialer-watch without external dialer interface. The bold text is used to indicate important commands that are specific to the dialer-watch:

```
chat-script lte "" "AT!CALL1" TIMEOUT 20 "OK"
interface Cellular0
ip address negotiated
encapsulation slip
dialer in-band
dialer string LTE
dialer watch-group 1
```

```

async mode interactive
!
dialer watch-list 1 ip 5.6.7.8 0.0.0.0
dialer watch-list 1 delay route-check initial 60
dialer watch-list 1 delay connect 1
!
ip route 0.0.0.0 0.0.0.0 cellular 0
line 3
script dialer LTE
modem InOut
no exec
transport input all
transport output all

```

Example: Dialer-Persistent Configuration with External Dialer Interface

The following example shows how to configure the dialer-persistent with external dialer interface. The bold text is used to indicate important commands that are specific to the dialer-persistent:

```

interface Cellular0
ip address negotiated
encapsulation slip
dialer in-band
dialer pool-member 1
async mode interactive
routing dynamic
interface Dialer1
ip address negotiated
encapsulation slip
dialer pool 1
dialer idle-timeout 0
dialer string lte
dialer persistent
dialer-group 1
!
dialer-list 1 protocol ip permit
ip route 0.0.0.0 0.0.0.0 dialer 1
line 3
script dialer lte
modem InOut
no exec
transport input all
transport output all

```

Example: GRE Tunnel over Cellular Interface Configuration

The following example shows how to configure the static IP address when a GRE tunnel interface is configured with ip address unnumbered cellular interface:



Note

The GRE tunnel configuration is supported only if the service providers provide a public IP address on the LTE interface.



Note

For service providers using a private IP address, the point-to-point static GRE tunnel cannot be set up with a private IP address at one end and a public IP address on the other end.

```

interface Tunnel2
ip unnumbered <internal LAN interface GE0/0 etc.>
tunnel source Cellular0
tunnel destination a.b.c.d

```

```

interface Cellular0
ip address negotiated
encapsulation slip
no ip mroute-cache
dialer in-band
dialer string lte
dialer-group 1
async mode interactive
! traffic of interest through the tunnel/cellular interface
ip route x.x.x.x 255.0.0.0 Tunnel2
! route for the tunnel destination via cellular
ip route a.b.c.d 255.255.255.255 cellular 0

```

Modem Firmware Upgrade

For instructions on how to upgrade the modem firmware for Cisco 800 Series 4G LTE ISRs, see the "Modem Firmware Upgrade" section in [Cisco 4G LTE Software Installation Guide](#).

Troubleshooting

For information on the troubleshooting procedures for Cisco 800 Series 4G LTE ISRs, see the "Troubleshooting" section in [Cisco 4G LTE Software Installation Guide](#).

3G Support on Cisco 880G series ISRs

The Cisco 880G series Integrated Services Routers (ISR) with embedded third-generation (3G) wireless WAN (WWAN) option provide collaborative business solutions for secure data communication to small businesses and enterprises.

The Cisco 880G series ISRS are available for the following 3G standards:

- GSM and UMTS models based on third-generation partner project (3GPP) that support HSPA+, HSPA, UMTS, EDGE, and GPRS.

For information on how to configure 3G HSPA or HSPA+ on Cisco 880G series ISRs, see the following links:

- http://www.cisco.com/en/US/docs/routers/access/1800/1861/software/feature/guide/mrwls_hspa.html
- http://www.cisco.com/en/US/docs/routers/access/1800/1861/software/feature/guide/mrwls_gsm.html

- CDMA models based on 3GPP2, that support EVDO, EVDO Rev A modes.

For information on how to configure EVDO on Cisco 880G series ISRs, see the following links:

- http://www.cisco.com/en/US/docs/routers/access/1800/1861/software/feature/guide/mrwls_evdo.html
- http://www.cisco.com/en/US/docs/routers/access/1800/1861/software/feature/guide/mrwls_cdma.html

For detailed information on supported Cisco 880G series models, see Cisco 880G series ISR data sheet at:

http://www.cisco.com/en/US/prod/collateral/routers/ps380/ps10082/data_sheet_c78-682548.html



CHAPTER 15

Configuring a LAN with DHCP and VLANs

The Cisco 819, Cisco 860 and Cisco 880 Integrated Services Routers (ISRs) support clients on both physical LANs and virtual LANs (VLANs).

- [Configuring a LAN with DHCP and VLANs, page 363](#)
- [Configuring DHCP and VLANs, page 364](#)

Configuring a LAN with DHCP and VLANs

The Cisco 819, Cisco 860 and Cisco 880 Integrated Services Routers (ISRs) support clients on both physical LANs and virtual LANs (VLANs). The routers can use the Dynamic Host Configuration Protocol (DHCP) to enable automatic assignment of IP configurations for nodes on these networks.

The figure below shows a typical deployment scenario with two physical LANs connected by the router and two VLANs.

Figure 18: Physical and Virtual LANs with DHCP Configured on the Cisco Router

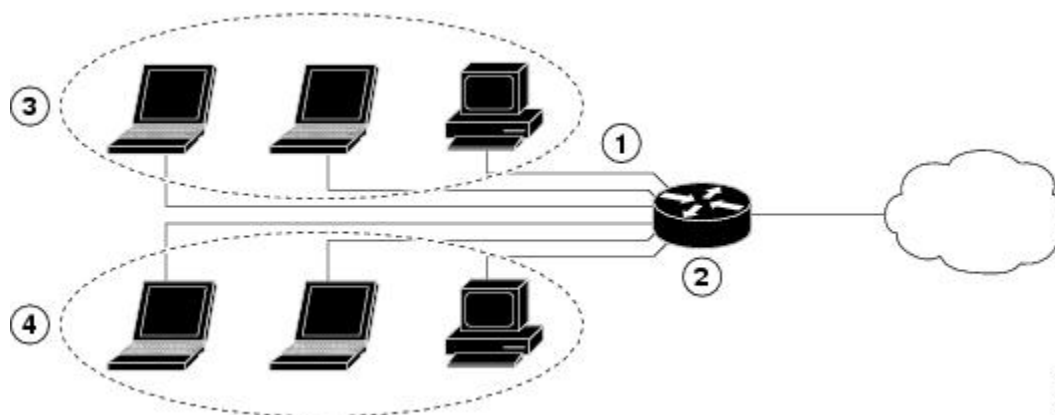

1	Fast Ethernet LAN (with multiple networked devices)
---	---

2	Router and DHCP server—Cisco 819, Cisco 860, or Cisco 880 ISR—connected to the Internet
3	VLAN 1
4	VLAN 2

DHCP

DHCP, which is described in RFC 2131, uses a client/server model for address allocation. As an administrator, you can configure your Cisco 800 series router to act as a DHCP server, providing IP address assignment and other TCP/IP-oriented configuration information to your workstations. DHCP frees you from having to manually assign an IP address to each client.

When you configure a DHCP server, you must configure the server properties, policies, and DHCP options.

Note

Whenever you change server properties, you must reload the server with the configuration data from the Network Registrar database.

VLANs

The Cisco 819, Cisco 860 and Cisco 880 routers support four Fast Ethernet ports on which you can configure VLANs.

VLANs enable networks to be segmented and formed into logical groups of users, regardless of the user's physical location or LAN connection.

Configuring DHCP and VLANs

Note

The procedures in this chapter assume you have already configured basic router features, as well as PPPoE or PPPoA with NAT. If you have not performed these configurations tasks, see the [Basic Router Configuration](#) and [Configuring a VPN Using Easy VPN and an IPSec Tunnel, on page 371](#) as appropriate for your router.

Configuring DHCP

Perform these steps to configure your router for DHCP operation, beginning in global configuration mode:

SUMMARY STEPS

1. **ip domain name** *name*
2. **ip name-server** *server-address1 [server-address2...server-address6]*
3. **ip dhcp excluded-address** *low-address [high-address]*
4. **ip dhcp pool** *name*
5. **network** *network-number [mask | prefix-length]*
6. **import all**
7. **default-router** *address [address2...address8]*
8. **dns-server** *address [address2...address8]*
9. **domain-name** *domain*
10. **exit**

DETAILED STEPS

	Command or Action	Purpose
Step 1	ip domain name <i>name</i> Example: Router(config)# ip domain smallbiz.com	Identifies the default domain that the router uses to complete unqualified hostnames (names without a dotted-decimal domain name).
Step 2	ip name-server <i>server-address1 [server-address2...server-address6]</i> Example: Router(config)# ip name-server 192.168.11.12	Specifies the address of one or more Domain Name System (DNS) servers to use for name and address resolution.
Step 3	ip dhcp excluded-address <i>low-address [high-address]</i> Example: Router(config)# ip dhcp excluded-address 192.168.9.0	Specifies IP addresses that the DHCP server should not assign to DHCP clients. In this example, we are excluding the router address.
Step 4	ip dhcp pool <i>name</i> Example: Router(config)# ip dhcp pool dpool1 Router(config-dhcp)#	Creates a DHCP address pool on the router and enters DHCP pool configuration mode. The <i>name</i> argument can be a string or an integer.
Step 5	network <i>network-number [mask prefix-length]</i> Example: Router(config-dhcp)# network 10.10.0.0 255.255.255.0	Defines subnet number (IP) address for the DHCP address pool, optionally including the mask.

	Command or Action	Purpose
Step 6	import all Example: Router(config-dhcp)# import all	Imports DHCP option parameters into the DHCP portion of the router database.
Step 7	default-router address [address2...address8] Example: Router(config-dhcp)#default-router 10.10.10.10	Specifies up to eight default routers for a DHCP client.
Step 8	dns-server address [address2...address8] Example: Router(config-dhcp)# dns-server 192.168.35.2	Specifies up to eight DNS servers available to a DHCP client.
Step 9	domain-name domain Example: Router(config-dhcp)#domain-name cisco.com	Specifies the domain name for a DHCP client.
Step 10	exit Example: Router(config-dhcp)# exit	Exits DHCP configuration mode and enters global configuration mode.

Configuration Example: DHCP

The following configuration example shows a portion of the configuration file for the DHCP configuration described in this chapter:

```
ip dhcp excluded-address 192.168.9.0
!
ip dhcp pool dpool1
import all
network 10.10.0.0 255.255.255.0
default-router 10.10.10.10
dns-server 192.168.35.2
domain-name cisco.com
!
ip domain name smallbiz.com
ip name-server 192.168.11.12
```

Verifying Your DHCP Configuration

Use the following commands to view your DHCP configuration:

- **show ip dhcp import**—Displays the optional parameters imported into the DHCP server database.

- **show ip dhcp pool**—Displays information about the DHCP address pools.
- **show ip dhcp server statistics**—Displays the DHCP server statistics, such as the number of address pools, bindings, and so forth.

```

Router# show ip dhcp import
Address Pool Name: dpool1
Router# show ip dhcp pool
Pool dpool1 :
  Utilization mark (high/low)      : 100 / 0
  Subnet size (first/next)         : 0 / 0
  Total addresses                   : 254
  Leased addresses                  : 0
  Pending event                    : none
  1 subnet is currently in the pool :
  Current index      IP address range      Leased addresses
  10.10.0.1          10.10.0.1 - 10.10.0.254             0
Router# show ip dhcp server statistics
Memory usage          15419
Address pools         1
Database agents       0
Automatic bindings    0
Manual bindings       0
Expired bindings      0
Malformed messages    0
Secure arp entries    0
Message               Received
BOOTREQUEST           0
DHCPDISCOVER          0
DHCPCREQUEST          0
DHCPDECLINE           0
DHCPRELEASE           0
DHCPIFORM             0
Message               Sent
BOOTREPLY             0
DHCPOFFER             0
DHCPACK               0
DHCPNAK               0
Router#

```

Configuring VLANs

Perform these steps to configure VLANs on your router, beginning in global configuration mode:

SUMMARY STEPS

1. **vlan *vlan_id***
2. **exit**

DETAILED STEPS

	Command or Action	Purpose
Step 1	vlan <i>vlan_id</i> Example: Router# config t Router(config)#vlan 2	Enters VLAN configuration mode.

	Command or Action	Purpose
Step 2	exit Example: Router (config-vlan) #exit	Updates the VLAN database, propagates it throughout the administrative domain, and returns to global configuration mode.

Assigning a Switch Port to a VLAN

Perform these steps to assign a switch port to a VLAN, beginning in global configuration mode:

SUMMARY STEPS

1. **interface** *switch port id*
2. **switchport access vlan** *vlan-id*
3. **end**

DETAILED STEPS

	Command or Action	Purpose
Step 1	interface <i>switch port id</i> Example: Router (config) #interface FastEthernet 2	Specifies the switch port that you want to assign to the VLAN.
Step 2	switchport access vlan <i>vlan-id</i> Example: Router (config-if) # switchport access vlan 2	Assigns a port to the VLAN.
Step 3	end Example: Router (config-if) #end	Exits interface mode and returns to privileged EXEC mode.

Verifying Your VLAN Configuration

Use the following commands to view your VLAN configuration.

- **show**—Entered from VLAN database mode. Displays summary configuration information for all configured VLANs.
- **show vlan-switch**—Entered from privileged EXEC mode. Displays detailed configuration information for all configured VLANs.

```
Router# vlan database
Router(vlan)# show
VLAN ISL Id: 1
  Name: default
  Media Type: Ethernet
  VLAN 802.10 Id: 100001
  State: Operational
  MTU: 1500
  Translational Bridged VLAN: 1002
  Translational Bridged VLAN: 1003
VLAN ISL Id: 2
  Name: VLAN0002
  Media Type: Ethernet
  VLAN 802.10 Id: 100002
  State: Operational
  MTU: 1500
VLAN ISL Id: 3
  Name: red-vlan
  Media Type: Ethernet
  VLAN 802.10 Id: 100003
  State: Operational
  MTU: 1500
VLAN ISL Id: 1002
  Name: fddi-default
  Media Type: FDDI
  VLAN 802.10 Id: 101002
  State: Operational
  MTU: 1500
  Bridge Type: SRB
  Translational Bridged VLAN: 1
  Translational Bridged VLAN: 1003
VLAN ISL Id: 1003
  Name: token-ring-default
  Media Type: Token Ring
  VLAN 802.10 Id: 101003
  State: Operational
  MTU: 1500
  Bridge Type: SRB
  Ring Number: 0
  Bridge Number: 1
  Parent VLAN: 1005
  Maximum ARE Hop Count: 7
  Maximum STE Hop Count: 7
  Backup CRF Mode: Disabled
  Translational Bridged VLAN: 1
  Translational Bridged VLAN: 1002
VLAN ISL Id: 1004
  Name: fddinet-default
  Media Type: FDDI Net
  VLAN 802.10 Id: 101004
  State: Operational
  MTU: 1500
  Bridge Type: SRB
  Bridge Number: 1
  STP Type: IBM
VLAN ISL Id: 1005
  Name: trnet-default
  Media Type: Token Ring Net
  VLAN 802.10 Id: 101005
  State: Operational
  MTU: 1500
  Bridge Type: SRB
  Bridge Number: 1
  STP Type: IBM
```

```

Router# show vlan-switch
VLAN Name                               Status      Ports
-----
1    default                               active     Fa0, Fa1, Fa3
2    VLAN0002                              active     Fa2
1002 fddi-default                          active
1003 token-ring-default                  active
1004 fddinet-default                    active
1005 trnet-default                      active
VLAN Type SAID      MTU   Parent RingNo BridgeNo  Stp  BrdgMode  Trans1  Trans2
-----
1    enet  100001  1500 -     -     -        -   -         1002   1003
2    enet  100002  1500 -     -     -        -   -         0      0
1002 fddi  101002  1500 -     -     -        -   -         1      1003
1003 tr   101003  1500 1005  0     -        -   srb       1      1002
1004 fdnet 101004  1500 -     -     1        -   ibm       0      0
1005 trnet 101005  1500 -     -     1        -   ibm       0      0

```



Configuring a VPN Using Easy VPN and an IPSec Tunnel

This chapter provides an overview of the creation of Virtual Private Networks (VPNs) that can be configured on the Cisco 819, Cisco 860, and Cisco 880 series Integrated Services Routers (ISRs).

- [Configuring a VPN Using Easy VPN and an IPSec Tunnel, page 371](#)
- [Configuring the IKE Policy, page 373](#)
- [Configuring Group Policy Information, page 375](#)
- [Applying Mode Configuration to the Crypto Map, page 376](#)
- [Enabling Policy Lookup, page 377](#)
- [Configuring IPSec Transforms and Protocols, page 378](#)
- [Configuring the IPSec Crypto Method and Parameters, page 379](#)
- [Applying the Crypto Map to the Physical Interface, page 380](#)
- [Creating an Easy VPN Remote Configuration, page 381](#)
- [Verifying Your Easy VPN Configuration, page 383](#)
- [Configuration Examples for VPN and IPSec, page 383](#)

Configuring a VPN Using Easy VPN and an IPSec Tunnel

Cisco routers and other broadband devices provide high-performance connections to the Internet, but many applications also require the security of VPN connections, which perform a high level of authentication and which encrypt the data between two particular endpoints.

Two types of VPNs are supported—site-to-site and remote access. Site-to-site VPNs are used to connect branch offices to corporate offices, for example. Remote access VPNs are used by remote clients to log in to a corporate network.

The example in this chapter illustrates the configuration of a remote access VPN that uses the Cisco Easy VPN and an IP Security (IPSec) tunnel to configure and secure the connection between the remote client and the corporate network. The figure below shows a typical deployment scenario.

Figure 19: Remote Access VPN Using IPSec Tunnel

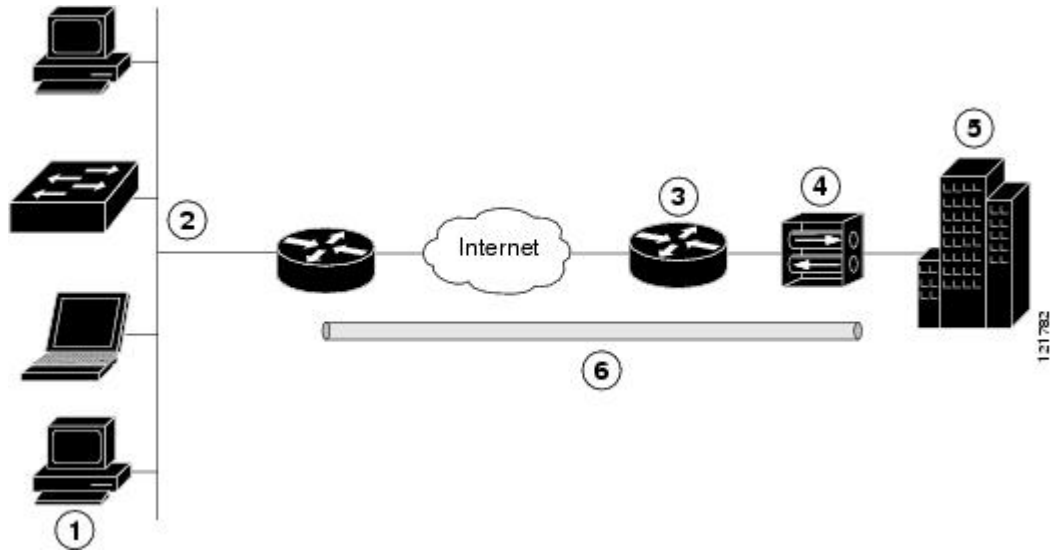

1	Remote, networked users
2	VPN client—Cisco 860 and Cisco 880 series ISRs
3	Router—Providing the corporate office network access
4	VPN server—Easy VPN server
5	Corporate office with a network address of 10.1.1.1
6	IPSec tunnel

Cisco Easy VPN

The Cisco Easy VPN client feature eliminates much of the tedious configuration work by implementing the Cisco Unity Client protocol. This protocol allows most VPN parameters, such as internal IP addresses, internal subnet masks, DHCP server addresses, WINS server addresses, and split-tunneling flags, to be defined at a VPN server that is acting as an IPSec server.

An Easy VPN server-enabled device can terminate VPN tunnels initiated by mobile and remote workers who are running Cisco Easy VPN Remote software on PCs. Easy VPN server-enabled devices allow remote routers to act as Easy VPN Remote nodes.

The Cisco Easy VPN client feature can be configured in one of two modes—client mode or network extension mode. Client mode is the default configuration and allows only devices at the client site to access resources

at the central site. Resources at the client site are unavailable to the central site. Network extension mode allows users at the central site to access network resources on the client site.

After the IPSec server has been configured, a VPN connection can be created with minimal configuration on an IPSec client, such as a supported Cisco 819, Cisco 860, and Cisco 880 series ISRs. When the IPSec client initiates the VPN tunnel connection, the IPSec server pushes the IPSec policies to the IPSec client and creates the corresponding VPN tunnel connection.

**Note**

The Cisco Easy VPN client feature supports configuration of only one destination peer. If your application requires creation of multiple VPN tunnels, you must manually configure the IPSec VPN and Network Address Translation/Peer Address Translation (NAT/PAT) parameters on both the client and the server.

Configuration Tasks

Perform the following tasks to configure your router for this network scenario:

- [Configuring the IKE Policy](#), on page 373
- [Configuring Group Policy Information](#), on page 375
- [Applying Mode Configuration to the Crypto Map](#), on page 376
- [Enabling Policy Lookup](#), on page 377
- [Configuring IPSec Transforms and Protocols](#), on page 378
- [Configuring the IPSec Crypto Method and Parameters](#), on page 379
- [Applying the Crypto Map to the Physical Interface](#), on page 380
- [Creating an Easy VPN Remote Configuration](#), on page 381

An example showing the results of these configuration tasks is provided in the [Configuration Examples for VPN and IPSec](#), on page 383.

**Note**

The procedures in this chapter assume that you have already configured basic router features as well as PPPoE or PPPoA with NAT, DHCP and VLANs. If you have not performed these configurations tasks, see [Basic Router Configuration](#), [Configuring PPP over Ethernet with NAT](#), [Configuring PPP over ATM with NAT](#), and [Configuring a LAN with DHCP and VLANs](#), on page 363 as appropriate for your router.

**Note**

The examples shown in this chapter refer only to the endpoint configuration on the Cisco 819, 860 and 880 series routers. Any VPN connection requires both endpoints to be configured properly to function. See the software configuration documentation as needed to configure the VPN for other router models.

Configuring the IKE Policy

To configure the Internet Key Exchange (IKE) policy, perform these steps, beginning in global configuration mode:

SUMMARY STEPS

1. `crypto isakmp policy priority`
2. `encryption {des | 3des | aes | aes 192 | aes 256}`
3. `hash {md5 | sha}`
4. `authentication {rsa-sig | rsa-encr | pre-share}`
5. `group {1 | 2 | 5}`
6. `lifetime seconds`
7. `exit`

DETAILED STEPS

	Command or Action	Purpose
Step 1	<code>crypto isakmp policy priority</code> Example: Router(config)# <code>crypto isakmp policy 1</code>	Creates an IKE policy that is used during IKE negotiation. The priority is a number from 1 to 10000, with 1 being the highest. Also enters the Internet Security Association Key and Management Protocol (ISAKMP) policy configuration mode.
Step 2	<code>encryption {des 3des aes aes 192 aes 256}</code> Example: Router(config-isakmp)# <code>encryption 3des</code>	Specifies the encryption algorithm used in the IKE policy. The example specifies 168-bit data encryption standard (DES).
Step 3	<code>hash {md5 sha}</code> Example: Router(config-isakmp)# <code>hash md5</code>	Specifies the hash algorithm used in the IKE policy. The example specifies the Message Digest 5 (MD5) algorithm. The default is Secure Hash standard (SHA-1).
Step 4	<code>authentication {rsa-sig rsa-encr pre-share}</code> Example: Router(config-isakmp)# <code>authentication pre-share</code>	Specifies the authentication method used in the IKE policy. The example specifies a pre-shared key.
Step 5	<code>group {1 2 5}</code> Example: Router(config-isakmp)# <code>group 2</code>	Specifies the Diffie-Hellman group to be used in an IKE policy.
Step 6	<code>lifetime seconds</code> Example: Router(config-isakmp)# <code>lifetime 480</code>	Specifies the lifetime, in seconds, for an IKE security association (SA). <ul style="list-style-type: none"> • Acceptable values are from 60 to 86400.

	Command or Action	Purpose
Step 7	exit Example: Router(config-isakmp)# exit	Exits ISAKMP policy configuration mode and returns to global configuration mode.

Configuring Group Policy Information

To configure the group policy, perform these steps, beginning in global configuration mode:

SUMMARY STEPS

1. **crypto isakmp client configuration group** {group-name | default}
2. **key name**
3. **dns primary-server**
4. **domain name**
5. **exit**
6. **ip local pool** {default | poolname} [low-ip-address [high-ip-address]]

DETAILED STEPS

	Command or Action	Purpose
Step 1	crypto isakmp client configuration group {group-name default} Example: Router(config)# crypto isakmp client configuration group rtr-remote Router(config-isakmp-group)#	Creates an IKE policy group containing attributes to be downloaded to the remote client. Also enters the Internet Security Association Key and Management Protocol (ISAKMP) group policy configuration mode.
Step 2	key name Example: Router(config-isakmp-group)# key secret-password	Specifies the IKE pre-shared key for the group policy.
Step 3	dns primary-server Example: Router(config-isakmp-group)# dns 10.50.10.1	Specifies the primary Domain Name System (DNS) server for the group. Note To specify Windows Internet Naming Service (WINS) servers for the group, use the wins command.

	Command or Action	Purpose
Step 4	domain <i>name</i> Example: Router(config-isakmp-group)# domain company.com	Specifies group domain membership.
Step 5	exit Example: Router(config-isakmp-group)# exit Router(config)#	Exits ISAKMP policy configuration mode and returns to global configuration mode.
Step 6	ip local pool { default <i>poolname</i> } [<i>low-ip-address</i> <i>high-ip-address</i>] Example: Router(config)# ip local pool dynpool 30.30.30.20 30.30.30.30	Specifies a local address pool for the group. For details about this command and additional parameters that can be set, see Cisco IOS Dial Technologies Command Reference .

Applying Mode Configuration to the Crypto Map

To apply mode configuration to the crypto map, perform these steps, beginning in global configuration mode:

SUMMARY STEPS

1. **crypto map** *map-name* **isakmp authorization list** *list-name*
2. **crypto map** *tag* **client configuration address** [**initiate** | **respond**]

DETAILED STEPS

	Command or Action	Purpose
Step 1	crypto map <i>map-name</i> isakmp authorization list <i>list-name</i> Example: Router(config)# crypto map dynmap isakmp authorization list rtr-remote	Applies mode configuration to the crypto map and enables key lookup (IKE queries) for the group policy from an authentication, authorization, and accounting (AAA) server.

	Command or Action	Purpose
Step 2	crypto map tag client configuration address [initiate respond] Example: <pre>Router(config)# crypto map dynmap client configuration address respond</pre>	Configures the router to reply to mode configuration requests from remote clients.

Enabling Policy Lookup

To enable policy lookup through AAA, perform these steps, beginning in global configuration mode:

SUMMARY STEPS

1. **aaa new-model**
2. **aaa authentication login {default | list-name} method1 [method2...]**
3. **aaa authorization {network | exec | commands level | reverse-access | configuration} {default | list-name} [method1 [method2...]]**
4. **username name {nopassword | password password | password encryption-type encrypted-password}**

DETAILED STEPS

	Command or Action	Purpose
Step 1	aaa new-model Example: <pre>Router(config)# aaa new-model</pre>	Enables the AAA access control model.
Step 2	aaa authentication login {default list-name} method1 [method2...] Example: <pre>Router(config)# aaa authentication login rtr-remote local</pre>	Specifies AAA authentication of selected users at login, and specifies the method used. <ul style="list-style-type: none"> • This example uses a local authentication database. <p>Note You could also use a RADIUS server for this. For details, see Cisco IOS Security Configuration Guide and Cisco IOS Security Command Reference.</p>
Step 3	aaa authorization {network exec commands level reverse-access configuration} {default list-name} [method1 [method2...]] Example: <pre>Router(config)# aaa authorization network rtr-remote local</pre>	Specifies AAA authorization of all network-related service requests, including PPP, and specifies the method of authorization. <ul style="list-style-type: none"> • This example uses a local authorization database.

	Command or Action	Purpose
		Note You could also use a RADIUS server for this. For details, see the Cisco IOS Security Configuration Guide and Cisco IOS Security Command Reference .
Step 4	username <i>name</i> { nopassword password <i>password</i> password <i>encryption-type</i> <i>encrypted-password</i> } Example: <pre>Router(config)# username Cisco password 0 Cisco</pre>	Establishes a username-based authentication system.

Configuring IPSec Transforms and Protocols

A transform set represents a certain combination of security protocols and algorithms. During IKE negotiation, the peers agree to use a particular transform set for protecting data flow.

During IKE negotiations, the peers search in multiple transform sets for a transform that is the same at both peers. When such a transform set is found, it is selected and applied to the protected traffic as a part of both peer configurations.

To specify the IPSec transform set and protocols, perform these steps, beginning in global configuration mode:

SUMMARY STEPS

1. **crypto ipsec transform-set** *transform-set-name transform1* [*transform2*] [*transform3*] [*transform4*]
2. **crypto ipsec security-association lifetime** {**seconds** *seconds* | **kilobytes** *kilobytes*}

DETAILED STEPS

	Command or Action	Purpose
Step 1	crypto ipsec transform-set <i>transform-set-name transform1</i> [<i>transform2</i>] [<i>transform3</i>] [<i>transform4</i>] Example: <pre>Router(config)# crypto ipsec transform-set vpn1 esp-3des esp-sha-hmac</pre> Example:	Defines a transform set—an acceptable combination of IPSec security protocols and algorithms. See Cisco IOS Security Command Reference for details about the valid transforms and combinations.
Step 2	crypto ipsec security-association lifetime { seconds <i>seconds</i> kilobytes <i>kilobytes</i> } Example: <pre>Router(config)# crypto ipsec security-association lifetime seconds 86400</pre>	Specifies global lifetime values used when IPSec security associations are negotiated.

What to Do Next

**Note**

With manually established security associations, there is no negotiation with the peer, and both sides must specify the same transform set.

Configuring the IPSec Crypto Method and Parameters

A dynamic crypto map policy processes negotiation requests for new security associations from remote IPSec peers, even if the router does not know all the crypto map parameters (for example, IP address).

To configure the IPSec crypto method, perform these steps, beginning in global configuration mode:

SUMMARY STEPS

1. **crypto dynamic-map** *dynamic-map-name dynamic-seq-num*
2. **set transform-set** *transform-set-name [transform-set-name2...transform-set-name6]*
3. **reverse-route**
4. **exit**
5. **crypto map** *map-name seq-num [ipsec-isakmp] [dynamic dynamic-map-name] [discover] [profile profile-name]*

DETAILED STEPS

	Command or Action	Purpose
Step 1	crypto dynamic-map <i>dynamic-map-name dynamic-seq-num</i> Example: Router(config)# crypto dynamic-map dynmap 1 Router(config-crypto-map)#	Creates a dynamic crypto map entry and enters crypto map configuration mode. See Cisco IOS Security Command Reference for details about this command.
Step 2	set transform-set <i>transform-set-name [transform-set-name2...transform-set-name6]</i> Example: Router(config-crypto-map)# set transform-set vpn1	Specifies which transform sets can be used with the crypto map entry.
Step 3	reverse-route Example: Router(config-crypto-map)# reverse-route	Creates source proxy information for the crypto map entry.

	Command or Action	Purpose
Step 4	exit Example: <pre>Router(config-crypto-map)# exit Router(config)#</pre>	Exits crypto map configuration mode and returns to global configuration mode.
Step 5	crypto map <i>map-name seq-num [ipsec-isakmp] [dynamic dynamic-map-name] [discover] [profile profile-name]</i> Example: <pre>Router(config)# crypto map static-map 1 ipsec-isakmp dynamic dynmap</pre>	Creates a crypto map profile.

Applying the Crypto Map to the Physical Interface

The crypto maps must be applied to each interface through which IP Security (IPSec) traffic flows. Applying the crypto map to the physical interface instructs the router to evaluate all the traffic against the security associations database. With the default configurations, the router provides secure connectivity by encrypting the traffic sent between remote sites. However, the public interface still allows the rest of the traffic to pass and provides connectivity to the Internet.

To apply a crypto map to an interface, perform these steps, beginning in global configuration mode:

SUMMARY STEPS

1. **interface** *type number*
2. **crypto map** *map-name*
3. **exit**

DETAILED STEPS

	Command or Action	Purpose
Step 1	interface <i>type number</i> Example: <pre>Router(config)# interface fastethernet 4 Router(config-if)#</pre>	Enters the interface configuration mode for the interface to which the crypto map applies.
Step 2	crypto map <i>map-name</i>	Applies the crypto map to the interface.

	Command or Action	Purpose
	Example: Router(config-if)# crypto map static-map	See Cisco IOS Security Command Reference for details about this command.
Step 3	exit Example: Router(config-crypto-map)# exit Router(config)#	Exits interface configuration mode and returns to global configuration mode.

Creating an Easy VPN Remote Configuration

The router acting as the IPSec remote router must create an Easy VPN remote configuration and assign it to the outgoing interface.

To create the remote configuration, perform these steps, beginning in global configuration mode:

SUMMARY STEPS

1. **crypto ipsec client ezvpn *name***
2. **group *group-name* key *group-key***
3. **peer {*ipaddress* | *hostname*}**
4. **mode {*client* | *network-extension* | *network extension plus*}**
5. **exit**
6. **interface *type number***
7. **crypto ipsec client ezvpn *name* [*outside* | *inside*]**
8. **exit**

DETAILED STEPS

	Command or Action	Purpose
Step 1	crypto ipsec client ezvpn <i>name</i> Example: Router(config)# crypto ipsec client ezvpn ezvpnclient Router(config-crypto-ezvpn)#	Creates a Cisco Easy VPN remote configuration, and enters Cisco Easy VPN remote configuration mode.

	Command or Action	Purpose
Step 2	<p>group <i>group-name</i> key <i>group-key</i></p> <p>Example:</p> <pre>Router(config-crypto-ezvpn)# group ezvpnclient key secret-password Router(config-crypto-ezvpn)#</pre>	Specifies the IPSec group and IPSec key value for the VPN connection.
Step 3	<p>peer {<i>ipaddress</i> <i>hostname</i>}</p> <p>Example:</p> <pre>Router(config-crypto-ezvpn)# peer 192.168.100.1 Router(config-crypto-ezvpn)#</pre>	Specifies the peer IP address or hostname for the VPN connection. Note A hostname can be specified only when the router has a DNS server available for hostname resolution.
Step 4	<p>mode {client network-extension network extension plus}</p> <p>Example:</p> <pre>Router(config-crypto-ezvpn)# mode client Router(config-crypto-ezvpn)#</pre>	Specifies the VPN mode of operation.
Step 5	<p>exit</p> <p>Example:</p> <pre>Router(config-crypto-ezvpn)# exit Router(config)#</pre>	Exits Cisco Easy VPN remote configuration mode and returns to global configuration mode.
Step 6	<p>interface <i>type number</i></p> <p>Example:</p> <pre>Router(config)# interface fastethernet 4 Router(config-if)#</pre>	Enters the interface configuration mode for the interface to which the Cisco Easy VPN remote configuration applies. Note For routers with an ATM WAN interface, this command would be interface atm 0 .
Step 7	<p>crypto ipsec client ezvpn name [outside inside]</p> <p>Example:</p> <pre>Router(config-if)# crypto ipsec client ezvpn ezvpnclient outside Router(config-if)#</pre>	Assigns the Cisco Easy VPN remote configuration to the WAN interface. This command causes the router to automatically create the NAT or port address translation (PAT) and access list configuration needed for the VPN connection.
Step 8	<p>exit</p> <p>Example:</p> <pre>Router(config-crypto-ezvpn)# exit Router(config)#</pre>	Exits interface configuration mode and returns to global configuration mode.

Verifying Your Easy VPN Configuration

```
Router# show crypto ipsec client ezvpn
Tunnel name :ezvpnclient
Inside interface list:vlan 1
Outside interface:fastethernet 4
Current State:IPSEC_ACTIVE
Last Event:SOCKET_UP
Address:8.0.0.5
Mask:255.255.255.255
Default Domain:cisco.com
```

Configuration Examples for VPN and IPsec

The following configuration example shows a portion of the configuration file for the VPN and IPsec tunnel described in this chapter.

```
!
aaa new-model
!
aaa authentication login rtr-remote local
aaa authorization network rtr-remote local
aaa session-id common
!
username Cisco password 0 Cisco
!
crypto isakmp policy 1
  encryption 3des
  authentication pre-share
  group 2
  lifetime 480
!
crypto isakmp client configuration group rtr-remote
  key secret-password
  dns 10.50.10.1 10.60.10.1
  domain company.com
  pool dynpool
!
crypto ipsec transform-set vpn1 esp-3des esp-sha-hmac
!
crypto ipsec security-association lifetime seconds 86400
!
crypto dynamic-map dynmap 1
  set transform-set vpn1
  reverse-route
!
crypto map static-map 1 ipsec-isakmp dynamic dynmap
crypto map dynmap isakmp authorization list rtr-remote
crypto map dynmap client configuration address respond
crypto ipsec client ezvpn ezvpnclient
  connect auto
  group 2 key secret-password
  mode client
  peer 192.168.100.1
!
interface fastethernet 4
  crypto ipsec client ezvpn ezvpnclient outside
  crypto map static-map
!
interface vlan 1
```

```
crypto ipsec client ezvpn ezvpnclient inside  
!
```



Configuring Cisco Multimode G.SHDSL EFM/ATM

This chapter provides a link to a document that describes the configuration of the Cisco Multimode 4-pair G.SHDSL Ethernet in the first mile (EFM)/Asynchronous Transfer Mode (ATM) WAN port. This functionality is provided by the Cisco C888-EA-K9 fixed Integrated Services Router (ISR).

The following guide describes this functionality for multiple products, including enhanced high-speed WAN interface cards (EHWICs) and the C888-EA-K9 router:

Configuring Cisco Multimode G.SHDSL EFM/ATM in Cisco ISR G2 is available at the following location:

http://www.cisco.com/en/US/docs/routers/access/interfaces/software/feature/guide/GSHDSL_EFM_ATM_HWICS.html





Configuring VDSL2 Bonding and Single-Wire Pair

Very-high-bit-rate digital subscriber line 2 (VDSL2) bonding combines two copper wire pairs to increase the capacity or extend the copper network's reach. For a customer, this means enhanced data rate and operation on longer loops. A single-wire pair enables you to configure profile 8a through 17a and ADSL on line 0, and profile 8a through 30a on line 1. VDSL2 bonding and single-wire pair are supported on **C897VAB-K9** series router.

This chapter contains the following sections:

- [Restrictions, page 387](#)
- [Configuring Bonding in Auto Mode, page 388](#)
- [Configuring Bonding in VDSL2 Mode, page 388](#)
- [Configuring a Single-Wire Pair on Line 0, page 389](#)
- [Configuring a Single-Wire Pair on Line 1, page 390](#)
- [Configuration Examples, page 391](#)

Restrictions

The following restrictions are applicable to VDSL2 bonding on the Cisco 800 Series Routers:

- VDSL2 bonding is supported only on the C897VAB-K9 Series Router.
- Even though C897VAB-K9 is a bonding SKU, bonding is not the default configuration. The ADSL mode and VDSL single-wire mode are supported in the default configuration. You should enable bonding using the **line-mode bonding** command.
- The **no line-mode bonding** and **default line-mode bonding** commands change the configuration to 'single-wire' on Line 0, which is the default configuration.
- The line-mode configuration is removed from the router whenever you change the operating mode. You have to run the command again in the new operating mode to configure bonding.

Configuring Bonding in Auto Mode

You can configure bonding either in **auto** mode or **VDSL2**. The default configuration is **auto**.

Perform the following tasks to configure bonding in **auto** mode:

SUMMARY STEPS

1. **configure terminal**
2. **controller VDSL *slot***
3. **operating mode *mode***
4. **line-mode bonding**
5. **exit**

DETAILED STEPS

	Command or Action	Purpose
Step 1	configure terminal Example: router#configure terminal	Enters global configuration mode when using the console port.
Step 2	controller VDSL <i>slot</i> Example: router(config)# controller vdsl 0	Enters controller configuration mode.
Step 3	operating mode <i>mode</i> Example: router(config)# operating mode auto	Specifies the operating mode. The operating mode is auto .
Step 4	line-mode bonding Example: router(config-controller)# line-mode bonding	Enables bonding mode in CPE.
Step 5	exit Example: router(config-controller)# exit	Exits controller configuration mode.

Configuring Bonding in VDSL2 Mode

Perform the following tasks to configure bonding in VDSL2 mode:

SUMMARY STEPS

1. **configure terminal**
2. **controller VDSL *slot***
3. **operating mode *mode***
4. **line-mode bonding**
5. **exit**

DETAILED STEPS

	Command or Action	Purpose
Step 1	configure terminal Example: router#configure terminal	Enters global configuration mode when using the console port.
Step 2	controller VDSL <i>slot</i> Example: router(config)# controller vdsl 0	Enters controller configuration mode.
Step 3	operating mode <i>mode</i> Example: router(config)# operating mode vdsl2	Specifies the operating mode. The operating mode is VDSL2.
Step 4	line-mode bonding Example: router(config-controller)# line-mode bonding	Enables bonding mode in CPE.
Step 5	exit Example: router(config-controller)# exit	Exits the controller mode.

Configuring a Single-Wire Pair on Line 0

Perform the following tasks to configure single-wire pair on line 0:

SUMMARY STEPS

1. **configure terminal**
2. **controller VDSL *slot***
3. **line-mode single-wire line *line-number***
4. **exit**

DETAILED STEPS

	Command or Action	Purpose
Step 1	configure terminal Example: router#configure terminal	Enters global configuration mode when using the console port.
Step 2	controller VDSL slot Example: router(config)# controller vdsl 0	Enters controller configuration mode.
Step 3	line-mode single-wire line line-number Example: router(config-controller)# line-mode single-wire line 0	Enables 8a through 17a profile and ADSL on line 0 in single-wire (nonbonding) mode.
Step 4	exit Example: router(config-controller)# exit	Exits controller configuration mode.

Configuring a Single-Wire Pair on Line 1

Perform the following tasks to configure single-wire pair on line 1.

SUMMARY STEPS

1. **configure terminal**
2. **controller VDSL slot**
3. **line-mode single-wire line line-number** [profile 30a]
4. **exit**

DETAILED STEPS

	Command or Action	Purpose
Step 1	configure terminal Example: router#configure terminal	Enters global configuration mode when using the console port.

	Command or Action	Purpose
Step 2	controller <i>VDSL slot</i> Example: router(config)# controller vdsl 0	Enters controller configuration mode.
Step 3	line-mode single-wire line <i>line-number</i> [profile 30a] Example: router(config-controller)# line-mode single-wire line 1 profile 30a	Enables profile 8a through 30a profile on line 1 in single-wire (non-bonding) mode. If profile 30a is not specified, profiles 8a to 17a are enabled on that line.
Step 4	exit Example: router(config-controller)# exit	Exits the controller mode.

Configuration Examples

The following example shows how to enable bonding in auto mode:

```
router# configure terminal
router(config)# controller vdsl 0
router(config)# operating mode auto
router(config-controller)# line-mode bonding
router(config-controller)# exit
```

The following example shows how to enable VDSL2 bonding:

```
router# configure terminal
router(config)# controller vdsl 0
router(config)# operating mode vdsl2
router(config-controller)# line-mode bonding
router(config-controller)# exit
```

The following example shows how to remove bonding:

```
router# configure terminal
router(config)# controller vdsl 0
router(config)# no operating mode
router(config-controller)# no line-mode bonding
router(config-controller)# exit
```

The following example shows how to enable profile 8a through 17a on line 0:

```
router# configure terminal
router(config)# controller vdsl 0
router(config-controller)# line-mode single-wire line 0
router(config-controller)# exit
```

The following example shows how to enable profile 30a on line 1:

```
router# configure terminal
router(config)# controller vdsl 0
router(config-controller)# line-mode single-wire line 1 profile 30a
router(config-controller)# exit
```

The following example shows how to remove profile 30a from line 1:

```
router# configure terminal
router(config)# controller vdsl 0
```

```
router(config-controller)# no line-mode single-wire line 1
router(config-controller)# exit
```



Configuring Cisco IOx

Cisco IOx is an end-to-end application enablement platform that provides application hosting capabilities for different application types in a consistent and uniform manner across various Cisco network platforms. The IOx platform allows you to manage the whole life cycle of applications including development, distribution, deployment, hosting, monitoring, and management. This chapter explains how to configure Cisco IOx on Cisco 819 and 800M series routers.

This chapter contains the following sections:

- [Configuring Cisco IOx, page 393](#)
- [Configuration Examples, page 395](#)
- [Developer Mode with Ethernet, page 395](#)
- [Cellular IP Address Type, page 398](#)
- [Accessing the Web Interface of Local Manager, page 400](#)
- [Configuring NTP Server, page 401](#)
- [Configuring IOS NAT for Applications Installed using BRIDGE and NAT Networking Modes, page 401](#)
- [Configuring Guest Serial, page 402](#)
- [Upgrading Cisco IOx, page 403](#)
- [Troubleshooting, page 403](#)

Configuring Cisco IOx

Before you deploy applications on your device, you have to configure IOx. On Cisco 800 series routers, IOS image runs on Core 1 and IOx runs on Core 2. Configuring IOx involves enabling IOx framework on Core 2 of your device.



Note

The prerequisite for configuring IOx on a device is that you should have an IOS image that supports IOx. The IOS image should be 15.5(1)T or later.

Perform the following tasks to configure IOx:

-
- Step 1** Enter the configure terminal command at the privileged EXEC prompt to enter global configuration mode:
- ```
Router# configure terminal
Enter configuration commands, one per line. End with CNTL/Z.
Router(config)#
```
- Step 2** Enter the **interface** command. Specify the interface type, along with the slot number/port number to identify the interface to configure. The interface that you configure here is a physical interface like Gigabit Ethernet. You are configuring this interface for outside connectivity of Core 1 and Core 2.
- ```
Router(config)#interface GigabitEthernet0
Router(config-if)#
```
- Step 3** Assign an **ip address** and **subnet mask** to the interface. Enter **no shutdown** to enable the interface. Enter **ip nat outside** to specify that the interface is connected to the outside network. Enter **Exit** to exit the interface mode.
- ```
Router(config-if)#ip address 172.x.x.x 255.255.255.0
Router(config-if)#no shutdown
Router(config-if)#ip nat outside
Router(config-if)#no shutdown
Router(config-if)#exit
```
- Step 4** Enter the **ip route** command to establish static routes between the interfaces. Enter the **ip default-gateway** command to specify the default gateway.
- ```
Router(config)#ip route 0.0.0.0 0.0.0.0 172.x.x.x
Router(config)#ip default-gateway 172.x.x.x
```
- Step 5** Enter **interface** command to specify the internal interface that helps the router's Core 1 and Core 2 to communicate. The interface name should be **ethernet1** for Cisco 819 Series Routers, and **ethernet0/1** for Cisco 800 M Series Routers. You should not use any other name for this interface. Assign an ip address and subnet mask to this interface. Enter **ip nat inside** to specify that the interface is connected to the inside network (the network subject to NAT translation). Enter **Exit** to exit the interface mode.
- ```
Router(config)#interface ethernet1
Router(config-if)#ip address 192.168.3.1 255.255.255.0
Router(config-if)#ip nat inside
Router(config-if)#no shutdown
Router(config-if)#exit
```
- Step 6** Enter **iox** command to enter the iox configuration mode.
- ```
Router(config)#iox
Router(config-iox)#
```
- Step 7** Configure the **ip address** of the **host** and **default gateway**. The IP address of the default gateway and the IP address of **ethenet1** you configured above should be the same. Enter **Exit** to exit the IOx mode.
- ```
Router(config-iox)host ip address 192.168.3.2 255.255.255.0
Router(config-iox)host ip default-gateway 192.168.3.1
Router(config-iox)exit
```
- Step 8** Next you have to configure the NAT rules for application traffic. Enter the **ip nat inside source list overload** command. This command enables the router to use one global address for many local addresses. When overloading is configured, the TCP or UDP port number of each inside host distinguishes between the multiple conversations using the same local IP address. Packets with source addresses that pass the access list are dynamically translated using global addresses from



the named pool. Enter **ip access-list standard** command to specify the standard IP access list. Enter **permit** command to permit the packets from the named pool.

```
Router(config)#ip nat inside source list NAT_ACL interface GigabitEthernet0 overload
Router(config)#ip access-list standard NAT_ACL
Router(config-std-nacl)#permit 192.168.0.0 0.0.1.255
Router(config-std-nacl)#exit
```

**Step 9**

Finally, specify the PAT entry to direct the browser traffic via IOS to second Core web server using 8443 port.

```
Router(config)#ip nat inside source static tcp 192.168.3.2 8443 interface gigabitEthernet0 8443
```

## Configuration Examples

The following example shows three different use cases:

- Router at the edge of the network (Developer Mode with Ethernet)
- Router in the middle of the network (Stationary with Ethernet)
- Router in the middle of the network (Mobile with Cellular)

## Developer Mode with Ethernet

In this scenario:

- The router is not used for actual routing. It is at the edge of the network.
- This mode suits the users who just need the application to have access to the external network.
- The application sits behind a NAT. So, a DHCP pool assigning a local IP address is configured on IOS.

Perform the following tasks to configure IOx:

**Step 1**

Enter the **configure terminal** command at the privileged EXEC prompt to enter global configuration mode:

```
Router# configure terminal
Enter configuration commands, one per line. End with CNTL/Z.
Router(config)#
```

**Step 2**

First, configure the **VirtualPortGroup** interface which talks to the application. Enter **interface** command to specify the virtual interface of the single IOx application running on the second Core. This interface routes the application traffic. The interface name should be **virtualportgroup0**. You should not use any other name for this interface. Assign an **ip address** and **subnet mask** to the virtual interface. Enter **ip nat inside** command to specify that the interface is connected to the inside network (the network subject to NAT translation).

```
Router(config)#interface VirtualPortGroup0
Router(config-if)#ip address 192.168.1.1 255.255.255.0
Router(config-if)#ip nat inside
Router(config-if)#no shutdown
Router(config-if)#exit
```

**Step 3** Configure a DHCP network pool on IOS from which application acquires an IP address via DHCP. Specify the addresses which you do not want to assign.

```
Router(config)#ip dhcp excluded-address 192.168.1.0 192.168.1.5
```

**Step 4** Configure the DHCP pool for the network (in this case 192.168.1.0/24).

```
Router(config)#ip dhcp pool iox-apps
Router(dhcp-config)#network 192.168.1.0 255.255.255.0
Router(dhcp-config)#default-router 192.168.1.1
Router(dhcp-config)#domain-name sample.com
Router(dhcp-config)#dns-server 171.70.168.183
Router(dhcp-config)#option 42 ip 171.68.38.65 172.x.x.x
Router(dhcp-config)#exit
```

The **option 42** command sends the NTP server details to the application. The IP address 171.68.38.65 is the IP address of the public NTP server, and 172.x.x.x is the IP address of the GE0 interface.

**Step 5** Finally, set up the local NTP server for backup using the `ntp master` command.

```
Router(config)#ntp master
Router(config)#exit
```

An application uses the time-server to synchronize its date and time. An NTP server can be local or public to the router. When the server is local to the router, you have to configure your router first. The command is **ntp master**. You can use **clock read-calendar** command in EXEC mode to sync your router's clock to the hardware clock, if not already.

## Stationary with Ethernet

In this scenario:

- The router is used for actual routing. It is at the middle of the network.
- This mode suits users who need the application to have access to and is accessible from the external network.
- The application does not sit behind a NAT.
- The VirtualPortGroup borrows the external interface IP address. Now it can be reached from outside the router.
- The application acquires its interface IP addresses from an external DHCP server by relaying the DHCP request through the VirtualPortGroup. It will also acquire an external IP address.

Perform the following tasks to configure IOx:

## DETAILED STEPS

|               | Command or Action                                                                                                                                                                                             | Purpose                                                                                                                                                                                                                              |
|---------------|---------------------------------------------------------------------------------------------------------------------------------------------------------------------------------------------------------------|--------------------------------------------------------------------------------------------------------------------------------------------------------------------------------------------------------------------------------------|
| <b>Step 1</b> | Enter the <b>configure terminal</b> command at the privileged EXEC prompt to enter global configuration mode:                                                                                                 | Router# configure terminal<br>Enter configuration commands, one per line. End with CNTL/Z.<br>Router(config)#                                                                                                                        |
| <b>Step 2</b> | Configure the VirtualPortGroup interface which talks to the application. In this scenario, since the DHCP server is external, all you need to do is configure the VirtualPortGroup with an IP helper address. | Router(config)#interface VirtualPortGroup0<br>Router(config-if)#ip unnumbered GigabitEthernet0<br>Router(config-if)#ip helper-address 1.100.30.114<br>Router(config-if)#no shutdown<br>Router(config-if)#exit<br>Router(config)#exit |

## Mobile with Cellular

In this scenario:

- Router is mobile with cellular connectivity (the only WAN link).
- VirtualPortGroup and Application are behind NAT, overloading cellular interface IP address.
- Application obtains the IP address from internal DHCP.
- Application management model depends on the type of IP address subscribed from cellular service provider being public or private.

In this mode:

- You configure cellular interface instead of GigabitEthernet interface as the WAN link.
- You modify references to cellular interface (instead of GigabitEthernet) for default route, NAT address overload, and PAT.
- You assign VirtualPortGroup its own IP address.
- You configure local DHCP pool for application.

Perform the following tasks to configure IOx:

## DETAILED STEPS

|               | Command or Action                                                                                 | Purpose                                                                                                                                                                                                                                                                                                                                                                                                                                                                                                                                            |
|---------------|---------------------------------------------------------------------------------------------------|----------------------------------------------------------------------------------------------------------------------------------------------------------------------------------------------------------------------------------------------------------------------------------------------------------------------------------------------------------------------------------------------------------------------------------------------------------------------------------------------------------------------------------------------------|
| <b>Step 1</b> | Define the Cellular modem AT command when dialer is initiated.                                    | <pre>Router#config terminal Router(config)#chat-script lte "" "AT!CALL1" TIMEOUT 20 "OK"</pre>                                                                                                                                                                                                                                                                                                                                                                                                                                                     |
| <b>Step 2</b> | Configure the Cellular Controller.                                                                | <pre>Router(config)#controller cellular 0 Router(config-controller)#lte gps mode standalone Router(config-controller)#lte gps nmea ip Router(config-controller)#lte modem link-recovery rssi onset-threshold -110 Router(config-controller)#lte modem link-recovery monitor-timer 20 Router(config-controller)#lte modem link-recovery wait-timer 10 Router(config-controller)#lte modem link-recovery debounce-count 5</pre>                                                                                                                      |
| <b>Step 3</b> | Configure the Cellular Interface.                                                                 | <pre>Router(config-controller)#interface cellular 0 Router(config-if)#ip address negotiated Router(config-if)#ip nat outside Router(config-if)#ip virtual-reassembly in Router(config-if)#encapsulation slip Router(config-if)#load-interval 30 Router(config-if)#dialer in-band Router(config-if)#dialer idle-timeout 0 Router(config-if)#dialer string lte Router(config-if)#dialer-group 1 Router(config-if)#no peer default ip address Router(config-if)#async mode interactive Router(config-if)#routing dynamic Router(config-if)#exit</pre> |
| <b>Step 4</b> | Create a dialer list for DDR about traffic of interest.                                           | <pre>Router(config)#dialer-list 1 protocol ip permit</pre>                                                                                                                                                                                                                                                                                                                                                                                                                                                                                         |
| <b>Step 5</b> | Finally, specify the line configuration (use line 3 always) and define default modem chat script. | <pre>Router(config)#line 3 Router(config-line)#script dialer lte Router(config-line)#modem inout</pre>                                                                                                                                                                                                                                                                                                                                                                                                                                             |

## Cellular IP Address Type

When users subscribe to cellular service, by default, the service provider assigns a private IP address. However, there is a way to choose a public address. Even though similar IOS configurations work in both the cases, below table explains the major differences between these two, and its impacts on your IOx application.

**Table 39: Cellular IP Address Type**

|  | Public IP Address | Private IP Address |
|--|-------------------|--------------------|
|  |                   |                    |

|                              |                                                                                    |                                                                                                                                                                                                           |
|------------------------------|------------------------------------------------------------------------------------|-----------------------------------------------------------------------------------------------------------------------------------------------------------------------------------------------------------|
| <p>Routing</p>               | <p>Routable in Internet space.</p>                                                 | <p>Being private to provider's domain, the address need to be translated to a public one before it is routable in Internet space.</p>                                                                     |
| <p>Availability and cost</p> | <p>Check with your local providers for availability and any additional charge.</p> | <p>Common provision offered by most providers.</p>                                                                                                                                                        |
| <p>Static vs Dynamic</p>     | <p>Static.</p>                                                                     | <p>Usually dynamic. This implies that the address will most likely change each time router re-attaches to the cellular network (for instance, after the router reloads or cellular interface resets).</p> |

|                            |                                   |                                                                                                                                                                                                                                              |
|----------------------------|-----------------------------------|----------------------------------------------------------------------------------------------------------------------------------------------------------------------------------------------------------------------------------------------|
| IOx Application Management | Same as Stationary Ethernet mode. | Since router is behind provider's NAT, user will not be able to access router's web server port. Therefore, applications can only be managed locally via router's console port or LAN switch ports with IOS <del>virtual service</del> CLIs. |
|----------------------------|-----------------------------------|----------------------------------------------------------------------------------------------------------------------------------------------------------------------------------------------------------------------------------------------|

## Accessing the Web Interface of Local Manager

After you configure IOx on your router, you can access the web interface to manage the IOx applications. The IP address of the Gigabit Ethernet interface of the router is used to generate the web URL. For example, if the IP address of the GE interface is 172.x.x.x, then the web URL of the Local Manager is https://172.x.x.x:8443.

Log in to the Local Manager using your Username and Password. The User name and the Password is authenticated against the Username and Password used for router login. You should have **privilege 15** to access the Web interface. The following example shows how to enable **privilege 15** on your router:

```
username username privilege 15 password 0 password
```

Log in to Local Manager to add devices (819 and 800M).

## Configuring NTP Server

You configure the NTP server so that all the IOx components (Routers, Applications, Fog director, etc) are synched with the same NTP server. This ensures that the IOS and IOx are using the same date and time. Use the following configurations:

```
ntp update-calendar
ntp server 10.64.58.50
```

## Configuring IOS NAT for Applications Installed using BRIDGE and NAT Networking Modes

If you have installed an App using BRIDGE or NAT networking mode, you have to configure the corresponding NAT configurations on the IOS side.

The App acquires the IP address from the DHCP server configured on the IOS.

### BRIDGE MODE:

- Choose bridge mode during an App installation (in Local Manager or Fog Director).
- Use device details page of FD or LM to:
  - Know the IP address assigned to the App.
  - TCP and UDP ports asked by the App.
  - Internal and external port numbers corresponding to ports asked by the App.

The following example shows the App in Bridge Mode:

- PaaS App requests for ports TCP:9000 and UDP:12000 in its package.yaml.
- 192.168.1.46 is the IP assigned to this App from the DHCP server configured on IOS.
- Both the internal and external port numbers will be same.

You have to perform the following NAT configurations on the IOS side for the traffic coming to the App:

```
ip nat inside source static tcp 192.168.1.46 9000 interface gabitEthernet0 9000
ip nat inside source static udp 192.168.1.46 12000 interface gigabitEthernet0 12000
```

The sensor needs to send TCP / UDP traffic to the following IP:

```
TCP port : <Router_Wan_IP>:9000
UDP port: <Router_Wan_IP>:12000
```

This will be translated into:

```
TCP port : 192.168.1.46:9000
UDP port : 192.168.1.46:12000
```

### NAT MODE:

You have to perform the following configurations if an App is installed in NAT mode:

- Choose NAT mode during an App installation in FD or LM.
- IOx provides an IP address from the DHCP server within the IOx.
- CAF provides DHCP IP address in the range of 192.168.223.x .
- CAF gives internal and external ports corresponding to ports asked by the App.
- Use Device details page of FD or LM to:
  - To know the IP address assigned to the App.
  - TCP and UDP ports asked by the App.
  - Internal and external port numbers corresponding to ports asked by App.
  - The external and internal port numbers will differ.

In NAT mode, you have to configure the NAT rules against the IOx svcbr\_0 IP address which is assigned when the IOx/GOS come up initially (192.168.1.6).

```
TCP : < Router_Wan_ip >: 40000
UDP: < Router_Wan_ip >: 42000
```

This will be translated into:

```
192.168.1.6:40000
192.168.1.6:42000
```

And then it is translated into the following App IP:

```
192.223.1.10:9000
192.223.1.10:12000
```

Perform the following NAT configuration on IOS side:

```
ip nat inside source static tcp 192.168.1.6 40000 interface gabitEthernet0 40000
ip nat inside source static udp 192.168.1.6 42000 interface gabitEthernet0 42000
```

## Configuring Guest Serial

This feature allows the installed IOx applications to access the router's serial interface. This configuration is optional because not all applications need this configuration.

The following example shows how to connect the serial port s0 of a Cisco 819 router to guest:

```
interface serial0
physical-layer async
vrf forwarding internal-score-vrf
no ip address
encapsulation raw-tcp
end
line 7
raw-socket tcp client 192.168.3.2 32000
```

In the **raw-socket tcp client** command, 192.168.3.2 is the IP address for host Linux, and 32000 is the serial TCP port.

On a Cisco 800M series routers, the interface name should be either **serial0/0/0** or **serial0/1/0** depending on the module slot.



The following example shows how to configure a module installed on slot 0 of a Cisco 800M series router:

```
interface Serial0/0/0
physical-layer async
no ip address
encapsulation raw-tcp
!
line 3
raw-socket tcp client 192.168.3.2 32000
```

The following example shows how to configure a module installed on slot 1 of Cisco 800M series router:

```
interface Serial0/1/0
physical-layer async
no ip address
encapsulation raw-tcp
end
line 19
raw-socket tcp client 192.168.3.2 32001
```



**Note**

The Async line associated with serial interface **s0** on Cisco 819 is 7. The Async lines associated with serial interface **s0/0/0** and **s0/1/0** on Cisco 800M routers are 3 and 19 respectively.

An Async line is set to 9600 baud, no parity, and 1 stop bits by default. All TTY terminal settings need to be configured under the Async line in IOS. The following example shows how to change the baud rate to 115Kbps:

```
line 7
raw-socket tcp client 192.168.3.2 32000
stopbits 1
speed 115200
```

```
819-42#show line 7
 Tty Typ Tx/Rx A Modem Roty AccO AccI Uses Noise Overruns Int
 7 TTY 115200/115200- - - - - 0 0 0/0 Se0
```

Line 7, Location: "", Type: ""

## Upgrading Cisco IOx

You can upgrade IOx separately without changing the IOS. The following example shows how to upgrade IOx:

```
Router#configure terminal
Router#iox
 host ip address 192.168.3.2 255.255.255.0
 host ip default-gateway 192.168.3.1
 host boot flash:p1021_c800.xxxxx.bin <<<<<<<<<< new image for IOx
Router#write
Router#reload
```

## Troubleshooting

This section explains how to troubleshoot IOS and IOx.

### Debugging IOS

Use the following commands to debug IOS:

**Table 40: IOS Debug Commands**

| Command | Description | Examples |
|---------|-------------|----------|
|---------|-------------|----------|

|                                       |                                    |                                                                                                                                                                                                                                                                                                                                                                                                                                                                                                                                                                                                                                                                                                                                                                                                                                          |
|---------------------------------------|------------------------------------|------------------------------------------------------------------------------------------------------------------------------------------------------------------------------------------------------------------------------------------------------------------------------------------------------------------------------------------------------------------------------------------------------------------------------------------------------------------------------------------------------------------------------------------------------------------------------------------------------------------------------------------------------------------------------------------------------------------------------------------------------------------------------------------------------------------------------------------|
| <b>debug iox config level error</b>   | Debugs IOx configuration errors.   | <pre>Router#debug iox config level error *Oct 7 08:30:27.951 PDT: if_c800_iox_infra_cli_handler.c :: debug_iox_configuration_command_handler() : 242 - Changed configuration debug level to 3 iox_819_2# iox_819_2# iox_819_2#conf t Enter configuration commands, one per line. End with CNTL/Z. iox_819_2(config)#iox iox_819_2(config-iox)#host ip add 192.168.100.2 255.255.255.0 iox_819_2(config-iox)# *Oct 7 08:30:44.043 PDT: if_c800_iox_trans_mgr.c :: iox_create_transaction() : 50 - Created transaction: tid=14, pid=155 *Oct 7 08:30:44.043 PDT: if_c800_iox_cli_handler.c :: cfg_iox_host_ip_address_cmd_handler () : 387 - host ip address entered address: 192.168.100.2 mask: 255.255.255.0 *Oct 7 08:30:44.043 PDT: if_c800_iox_cli_handler.c :: iox_validate_host_ip_address() : 309 - All checks passed .....</pre> |
| <b>debug iox config level debug</b>   | Debugs IOx configuration.          | <pre>Router#debug iox config level debug iox_819_2#conf t Enter configuration commands, one per line. End with CNTL/Z. iox_819_2(config)#iox iox_819_2(config-iox)#host ip default-gateway 192.168.100.1 % configuration failure: host ip default-gateway iox_819_2(config-iox)# *Oct 7 08:35:10.231 PDT: SCORE_ERR: score_ipc_send_msg_socket 394 Send failed, socket down *Oct 7 08:35:10.231 PDT: if_c800_iox_cli_handler.c :: cfg_iox_host_default_gateway_cmd_handler() : 645 - Sending host ip message unsuccessful</pre>                                                                                                                                                                                                                                                                                                          |
| <b>debug iox config level warning</b> | Debugs IOx configuration warnings. |                                                                                                                                                                                                                                                                                                                                                                                                                                                                                                                                                                                                                                                                                                                                                                                                                                          |

|                                                |                                                                                                                                                                                                                                                                                 |                                                                                                                                                                                                                                                                                                                                                                                                                                                                                                                                                                                                                                                                                                                                                                                                                                                                                                                                                                                                                                                                                     |
|------------------------------------------------|---------------------------------------------------------------------------------------------------------------------------------------------------------------------------------------------------------------------------------------------------------------------------------|-------------------------------------------------------------------------------------------------------------------------------------------------------------------------------------------------------------------------------------------------------------------------------------------------------------------------------------------------------------------------------------------------------------------------------------------------------------------------------------------------------------------------------------------------------------------------------------------------------------------------------------------------------------------------------------------------------------------------------------------------------------------------------------------------------------------------------------------------------------------------------------------------------------------------------------------------------------------------------------------------------------------------------------------------------------------------------------|
|                                                |                                                                                                                                                                                                                                                                                 | <pre>Router#debug iox config level warning iox_819_2#conf t Enter configuration commands, one per line. End with CNTL/Z. iox_819_2(config)#iox iox_819_2(config-iox)#host ip default-gateway 192.168.100.1 % configuration failure: host ip default-gateway iox_819_2(config-iox)# *Oct 7 08:37:06.067 PDT: SCORE_ERR: score_ipc_send_msg_socket 394 Send failed, socket down *Oct 7 08:37:06.067 PDT: if_c800_iox_cli_handler.c :: cfg_iox_host_default_gateway_cmd_ha ndler() : 645 - Sending host ip message unsuccessful</pre>                                                                                                                                                                                                                                                                                                                                                                                                                                                                                                                                                  |
| <p><b>debug iox host-agent level error</b></p> | <p>Use this command if you face any IOx configuration issue from the IOS side. This allows you to monitor messaging between IOS and IOX framework. Note that this is for debugging IOS config/messaging and does not alter the debugging levels of IOx platform in general.</p> | <pre>Router#debug iox host-agent level error Oct 23 22:37:40.598: if_c800_iox_trans_mgr.c :: iox_create_transaction() : 50 - Created transaction: tid=2, pid=103 *Oct 23 22:37:40.598: if_c800_iox_infra_cli_handler.c :: set_debug_level() : 151 - *****[IOS-DUMP]***** **** *Oct 23 22:37:40.598: if_c800_iox_infra_cli_handler.c :: set_debug_level() : 151 - 00 0F 00 06 00 00 00 02 07 01 00 08 01 03 *Oct 23 22:37:40.598: if_c800_iox_infra_cli_handler.c :: set_debug_level() : 151 - ***** **** *Oct 23 22:37:40.598: if_c800_iox_ipc_utils.c :: iox_msg_send() : 137 - Pid: 103 Sending iox message to Score *Oct 23 22:37:40.598: if_c800_iox_cli_handler.c :: iox_cli_wait_for_response() : 207 - CLI is waiting for response - pid: 103 *Oct 23 22:37:40.810: if_c800_iox_ipc_main.c :: iox_rcv_msg_from_ioxhad() : 35 - *****[IOS-DUMP]***** **** *Oct 23 22:37:40.810: if_c800_iox_ipc_main.c :: iox_rcv_msg_from_ioxhad() : 35 - 00 10 00 03 00 00 00 02 00 01 00 *Oct 23 22:37:40.810: if_c800_iox_ipc_main.c :: iox_rcv_msg_from_ioxhad() : 35 - ***** ****</pre> |
| <p><b>debug iox host-agent level debug</b></p> | <p>Debugs IOx host agent.</p>                                                                                                                                                                                                                                                   |                                                                                                                                                                                                                                                                                                                                                                                                                                                                                                                                                                                                                                                                                                                                                                                                                                                                                                                                                                                                                                                                                     |

|                                           |                                                |                                                                                                                                                                                                                                                                                                                                                                                                                                                                                                                                                                                                                                                                                             |
|-------------------------------------------|------------------------------------------------|---------------------------------------------------------------------------------------------------------------------------------------------------------------------------------------------------------------------------------------------------------------------------------------------------------------------------------------------------------------------------------------------------------------------------------------------------------------------------------------------------------------------------------------------------------------------------------------------------------------------------------------------------------------------------------------------|
|                                           |                                                | <pre>Router#debug iox host-agent level debug *Oct 7 08:43:04.727 PDT: if_c800_iox_infra_cli_handler.c :: set_debug_level() : 151 - *****[IOS-DUMP]***** ***** *Oct 7 08:43:04.727 PDT: if_c800_iox_infra_cli_handler.c :: set_debug_level() : 151 - 00 0F 00 06 00 00 00 14 07 01 00 08 01 03 *Oct 7 08:43:04.727 PDT: if_c800_iox_infra_cli_handler.c :: set_debug_level() : 151 - ***** *****</pre>                                                                                                                                                                                                                                                                                       |
| <b>debug iox host-agent level warning</b> | Debugs IOx host agent warnings.                | <pre>Router#debug iox host-agent level warning</pre>                                                                                                                                                                                                                                                                                                                                                                                                                                                                                                                                                                                                                                        |
| <b>reset iox</b>                          | Resets the IOx framework.                      | <pre>Router#reset iox *Oct 23 22:41:05.406: if_c800_iox_trans_mgr.c :: iox_create_transaction() : 50 - Created transaction: tid=4, pid=103 *Oct 23 22:41:05.406: if_c800_iox_infra_cli_handler.c :: exec_iox_infra_command_handler() : 298 - *****[IOS-DUMP]***** ***** *Oct 23 22:41:05.406: if_c800_iox_infra_cli_handler.c :: exec_iox_infra_command_handler() : 298 - 00 11 00 03 00 00 00 04 07 01 01 *Oct 23 22:41:05.406: if_c800_iox_infra_cli_handler.c :: exec_iox_infra_command_handler() : 298 - ***** ***** *Oct 23 22:41:05.406: if_c800_iox_ipc_utils.c :: iox_msg_send() : 137 - Pid: 103 Sending iox message to Score % Couldn't process IOx Infrastructure response</pre> |
| <b>show raw-socket tcp sessions</b>       | Displays the status of the raw socket session. | <pre>Router#show raw-socket tcp sessions ----- ----- TCP Sessions ----- ----- interface tty socket mode local_ip_addr local_port dest_ip_addr dest_port up_time idle time/timeout vrf_name Se0 7 0 client 10.10.10.1 34383 10.10.10.2 32000 00:00:10 00:00:10 /5 min internal-score-vrf</pre>                                                                                                                                                                                                                                                                                                                                                                                               |
| <b>show raw-socket tcp statistic</b>      | Displays the statistics of the raw sockets.    |                                                                                                                                                                                                                                                                                                                                                                                                                                                                                                                                                                                                                                                                                             |

|                                           |                                                   |                                                                                                                                                                                                                                                                                                                                                                                                                  |
|-------------------------------------------|---------------------------------------------------|------------------------------------------------------------------------------------------------------------------------------------------------------------------------------------------------------------------------------------------------------------------------------------------------------------------------------------------------------------------------------------------------------------------|
|                                           |                                                   | <pre> Router# show raw-socket tcp statistic ----- ----- Network-Serial Statistics ----- ----- Interface tty sessions network_in_bytes network_out_bytes network_to_tty_frames tty_to_network_frames vrf_name Se0 7 I 6 6 1 1 internal-score-vrf ----- CEF Connections Statistics ----- tty_id network_in_frames network_in_bytes network_out_frames network_out_bytes 0 0 0 0 0 0 0 0 0 0                 </pre> |
| <p><b>show virtual-service detail</b></p> | <p>Displays application specific information.</p> |                                                                                                                                                                                                                                                                                                                                                                                                                  |

|                                            |                                                 |                                                                                                                                                                                                                                                                                                                                                                                                                                                                                                                                                                                                                                                                                                                                                                                                                                            |
|--------------------------------------------|-------------------------------------------------|--------------------------------------------------------------------------------------------------------------------------------------------------------------------------------------------------------------------------------------------------------------------------------------------------------------------------------------------------------------------------------------------------------------------------------------------------------------------------------------------------------------------------------------------------------------------------------------------------------------------------------------------------------------------------------------------------------------------------------------------------------------------------------------------------------------------------------------------|
|                                            |                                                 | <pre> Router# show virtual-service detail name APP Virtual service APP detail State : Activated Package information Name : APP Path : flash:/iox/tmp/APP.ova Application Name : KVM1 Application Installed version : 2.0 Description : KVM1 Linux Test Distro Signing Key type : Unsigned Method : SHA-1 Licensing Name : kvml_license Version : 3.3 Activated profile name: Resource reservation Disk : 16 MB Memory : 256 MB CPU : 55% system CPU VCPUs : 1 (sockets:1 cores:1 threads:1) Attached devices Type Name Alias ----- NIC dp_1_0 net1 Serial/shell serial0 Disk shared_moun Network interfaces MAC address Attached to interface ----- 52:54:11:11:00:FE VirtualPortGroup0 Resource admission (without profile) : passed Disk space : 16MB Memory : 256MB CPU : 55% system CPU VCPUs : 1 (sockets:1 cores:1 threads:1) </pre> |
| <b>show<br/>virtual-service<br/>global</b> | Displays virtual service<br>global information. |                                                                                                                                                                                                                                                                                                                                                                                                                                                                                                                                                                                                                                                                                                                                                                                                                                            |

|                                                     |                                                                                    |                                                                                                                                                                                                                                                                                                                                                                                                                                                                                                                                                                                      |
|-----------------------------------------------------|------------------------------------------------------------------------------------|--------------------------------------------------------------------------------------------------------------------------------------------------------------------------------------------------------------------------------------------------------------------------------------------------------------------------------------------------------------------------------------------------------------------------------------------------------------------------------------------------------------------------------------------------------------------------------------|
|                                                     |                                                                                    | <pre>Router# show virtual-service global Virtual Service Global State and Virtualization Limits: Infrastructure version : 1.7 Total virtual service installed : 1 Total virtual service activated : 1 Maximum VCPUs per virtual service : 1 Machine types supported : KVM Machine types disabled : LXC Resource virtualization limits: Name Quota Committed Available ----- ----- system CPU (%) 80 55 25 memory (MB) 256 256 0 flash (MB) 1024 11 625</pre>                                                                                                                         |
| <b>show virtual-service list</b>                    | Lists the applications.                                                            | <pre>Router# show virtual-service list Virtual Service List: Name Status Package Name ----- ----- APP Activated APP.ova</pre>                                                                                                                                                                                                                                                                                                                                                                                                                                                        |
| <b>show virtual-service profile</b>                 | Displays information about the appliance profile.                                  | <pre>Router# show virtual-service profile</pre>                                                                                                                                                                                                                                                                                                                                                                                                                                                                                                                                      |
| <b>show virtual-service utilization</b>             | Displays information about the utilization of appliances.                          | <pre>Router# show virtual-service utilization name APP Virtual-Service Utilization: CPU Utilization: Requested Application Utilization: 55 % Actual Application Utilization: 1 % (30 second average) CPU State: R : Running Memory Utilization: Memory Allocation: 262144 Kb Memory Used: 262144 Kb Network Utilization: Name: dp_1_0, Alias: net1 RX Packets: 16 TX Packets: 24 RX Bytes: 2416 TX Bytes: 6624 RX Errors: 0 TX Errors: 0 Storage Utilization: Name: shared_mount, Alias: Capacity(1K blocks): 16384 Used(1K blocks): 20 Available(1K blocks): 16364 Usage: 1 %</pre> |
| <b>virtual-service connect name appname console</b> | Connects to the console of the VM environment that the IOx application is running. | <pre>Router# virtual-service connect name sensorbot console</pre>                                                                                                                                                                                                                                                                                                                                                                                                                                                                                                                    |

### Enabling Log Settings of CAF

You can use the CAF log settings to debug the App life cycle issues. By default, the log settings are set to INFO. Use Fog Director or Local Manager to set the CAF settings to debug.

### Application Specific Debugging

An Administrator of IOx can access the App console using Local Manager. To access the App console, log onto Local Manager, go to **Apps > Manage > App-info** and type the following SSH command:

```
ssh -p {SSH_PORT} -i net_bridge.pem appconsole@10.78.106.163
```

Replace *SSH\_PORT* with the port number that the Admin has configured on the IOS NAT rule. For instance, if 192.168.1.6 is the IP address assigned to the GOS, and NAT rule is configured on IOS to allow SSH through 2222, the final App console access command will be:

```
ssh -p 2222 -i net_bridge.pem appconsole@10.78.106.163
```

### Commonly Faced Issues

**Issue:** A device added to Fog Director is not showing up. The Last Heard column in Fog Director shows 'connection timed out or no route to host'.

**Solution:** This issue happens because the router's WAN IP is not reachable from Fog Director. Correct the reachability issue and make sure that all the necessary configurations are done properly.

**Issue:** WAN IP of the router is reachable but Fog Director does not show the device.

**Solution:** To troubleshoot this issue, do the following:

- Check whether the necessary NAT rule is enabled for port 8443. The following example shows the NAT rule:

```
ip nat inside source list NAT_ACL interface gigabitEthernet0 overload
ip nat inside source static tcp 192.168.1.6 8443 interface gigabitEthernet0 8443
```

- Check whether the GIG5 interface is up.
- Check whether the GOS/IOx is up and running and it has acquired an IP address from the DHCP server.
- Check whether the NAT translation has happened for 8443 from WAN ip to the GOS SVCbr\_0 IP address:

```
829-163#show ip nat translations
Pro Inside global Inside local Outside local Outside global
tcp 10.78.106.163:2222 192.168.1.6:22 --- ---
tcp 10.78.106.163:8443 192.168.1.6:8443 10.232.26.200:57639 10.232.26.200:57639
```

### Serial Data Traffic Issues

Use the following commands to troubleshoot the serial data traffic issues:

**Table 41: Debug Commands for Serial Data Traffic Issues**

| Command | Description | Examples |
|---------|-------------|----------|
|         |             |          |



|                                                                                     |                                                                                                                                                                                                                                                    |                                                                                                                                                                                                                                                                                                                                                                                                                                                                                                                                                                                                                                                                                                                                                                                                                                                                                                                                                                                                                                                                 |
|-------------------------------------------------------------------------------------|----------------------------------------------------------------------------------------------------------------------------------------------------------------------------------------------------------------------------------------------------|-----------------------------------------------------------------------------------------------------------------------------------------------------------------------------------------------------------------------------------------------------------------------------------------------------------------------------------------------------------------------------------------------------------------------------------------------------------------------------------------------------------------------------------------------------------------------------------------------------------------------------------------------------------------------------------------------------------------------------------------------------------------------------------------------------------------------------------------------------------------------------------------------------------------------------------------------------------------------------------------------------------------------------------------------------------------|
| <p><b>show interface serial</b></p>                                                 | <p>Displays the serial interface configuration and statistics.</p>                                                                                                                                                                                 | <pre>Router# show interface serial erial0 is up, line protocol is up Hardware is Serial in async mode MTU 1500 bytes, BW 9 Kbit/sec, DLY 100000 usec, reliability 255/255, txload 1/255, rxload 1/255 Encapsulation RAW-TCP, loopback not set Keepalive not set DTR is pulsed for 5 seconds on reset Last input never, output never, output hang never Last clearing of "show interface" counters 5d21h Input queue: 0/75/0/0 (size/max/drops/flushes); Total output drops: 0 Queueing strategy: fifo Output queue: 0/10 (size/max) 30 second input rate 0 bits/sec, 0 packets/sec 30 second output rate 0 bits/sec, 0 packets/sec 391 packets input, 3247 bytes, 0 no buffer Received 0 broadcasts (0 IP multicasts) 0 runts, 0 giants, 0 throttles 1 input errors, 0 CRC, 1 frame, 0 overrun, 0 ignored, 0 abort 395 packets output, 3160 bytes, 0 underruns 0 output errors, 0 collisions, 0 interface resets 0 unknown protocol drops 0 output buffer failures, 0 output buffers swapped out 0 carrier transitions DCD=up DSR=up DTR=up RTS=up CTS=up</pre> |
| <p><b>debug raw-socket tcp packet</b><br/><b>debug raw-socket driver packet</b></p> | <p>Monitors the serial data flow between IOS and host Linux.</p> <p><b>Note</b> This will dump the entire packet contents on the console. You might want to turn off logging console to prevent the debug messages from flooding your console.</p> |                                                                                                                                                                                                                                                                                                                                                                                                                                                                                                                                                                                                                                                                                                                                                                                                                                                                                                                                                                                                                                                                 |

```
Router# debug raw-socket tcp packet
*Oct 23 18:52:25.912: [From
Network]<-- received 8 bytes on
socket 0 from 192.168.3.2 port
32000
*Oct 23 18:52:25.912:
010300000002C40B
*Oct 23 18:52:25.912: [To
Serial]<-- sending 8 bytes from
socket 0 to interface 7
*Oct 23 18:52:25.912:
rawsocket_async_output[tty 7]:
Received 8 byte from socket...
*Oct 23 18:52:25.912: [Socket -->
Async] 01 03 00 00 00 02 C4 0B
*Oct 23 18:52:25.948: [Async -->
Socket] tty(7) Received 9 byte from
serial...
*Oct 23 18:52:25.948: [Async -->
Socket] 01 03 04 89 2F 80 4F C1 92
*Oct 23 18:52:25.948: [From
Serial]--> received 9 bytes from
interface 7 tty 7
*Oct 23 18:52:25.948:
010304892F804FC192
*Oct 23 18:52:25.948: [To
Network]--> dispatched 9 bytes on
socket 0 to ip 192.168.3.2 port
32000
```

Check whether the serial devices are connected and the serial port on your devices share the same baud rate.



## CHAPTER 20

# Deployment Scenarios

---

This chapter describes and shows some typical deployment scenarios for the Cisco 860, Cisco 880, and Cisco 890 series Integrated Services Routers (ISRs):

- [About the Deployment Scenarios](#), page 413
- [Enterprise Small Branch](#), page 414
- [Internet Service and IPsec VPN with 3G](#), page 415
- [SMB Applications](#), page 416
- [Enterprise Wireless Deployments with LWAPP](#), page 417
- [Enterprise Small Branch Office Deployment](#), page 418

## About the Deployment Scenarios

Major features of the Cisco ISRs include:

- 3G wireless data connectivity backup (some Cisco 880 series ISRs)
- Voice capabilities (some Cisco 880 series ISRs)
- Embedded wireless device (optional)
- Power over Ethernet (all Cisco 880 series ISRs)

### 3G Wireless Backup

Some Cisco 880 series ISRs have 3G wireless data backup capability. See [Configuring Backup Data Lines and Remote Management](#) for details.

### Voice

Some Cisco 880 series ISRs contain voice capabilities. Refer to the Cisco IOS Voice Configuration Library for details.

### Embedded Wireless Device

- Cisco 860 series, Cisco 880 series, and Cisco 890 ISRs have an optional wireless device that runs its own version of the Cisco IOS software.
  - Cisco 890 Series ISRs with embedded access points are eligible to upgrade from autonomous software to Cisco Unified software, if the router is running the IP Base feature set and Cisco IOS 12.4(22)YB software.
  - Cisco 880 Series ISRs with embedded access points are eligible to upgrade from autonomous software to Cisco Unified software, if the router is running the advipservices feature set and Cisco IOS 12.4(20)T software.
  - Cisco 860 Series ISRs with embedded access points are not eligible to upgrade from autonomous software to Cisco Unified software.

**Note**

---

To use the embedded access point in a Cisco Unified Architecture, the Cisco Wireless LAN Configuration (WLC) must be running version 5.1 or later.

---

See [Configuring Wireless Devices](#) for upgrade information.

### Power Over Ethernet

All Cisco 880 Series ISRs contain PoE capabilities. See [Cisco 860 Series, Cisco 880 Series, and Cisco 890 Series Integrated Services Routers Hardware Installation Guide](#) for details.

## Enterprise Small Branch

The figure below shows an Enterprise Small Branch deployment that uses the following technologies and features:

- Group Encrypted Transport VPN (GETVPN) for highly scalable secure branch connectivity
- Cisco IOS firewall (FW) policies that secure the front line of network connectivity and provide network and application layer protection to the enterprise network
- Voice and multicast applications

- Quality of service (QoS) prioritizes critical applications and ensures timely delivery of latency-sensitive and mission-critical applications

**Figure 20: Enterprise Small Branch**

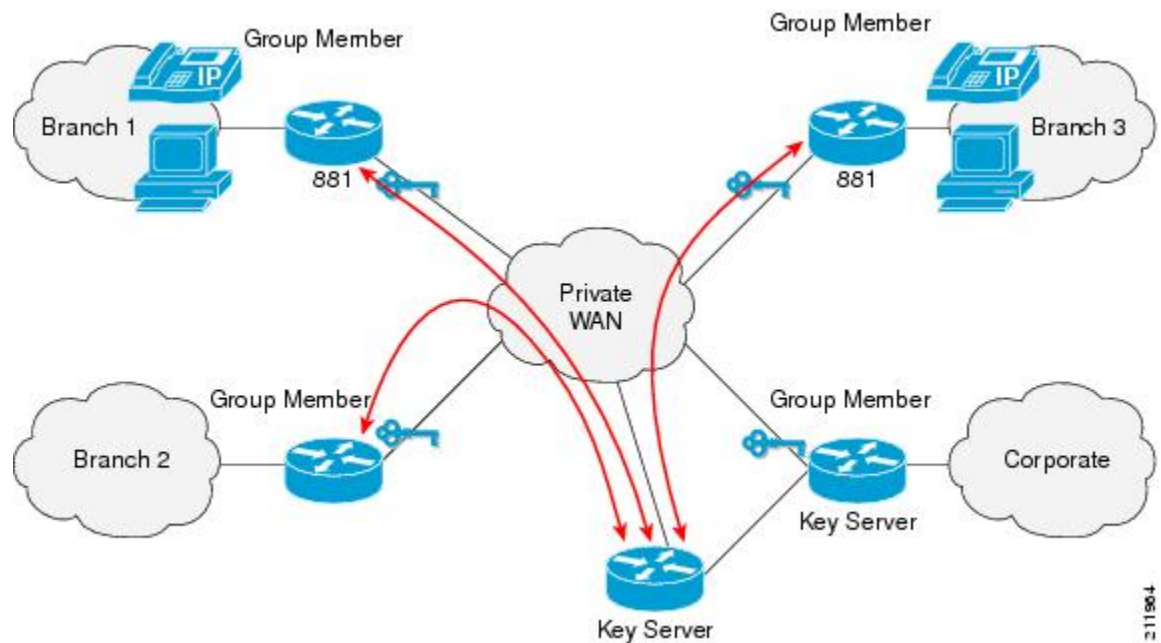

## Internet Service and IPSec VPN with 3G

The figure below shows a remote office deployment that uses 3G wireless technology for both backup and primary applications to communicate to their enterprise data center. Besides providing direct Internet access employing Network Address Translation (NAT), Cisco 880 series ISRs can provide tunneled Virtual Private

Network (VPN) service using IP Security and Generic Routing Encapsulation (IPSec+GRE) for secure and private communication over the public Internet.

**Figure 21: Internet Service and IPSec VPN with 3G**

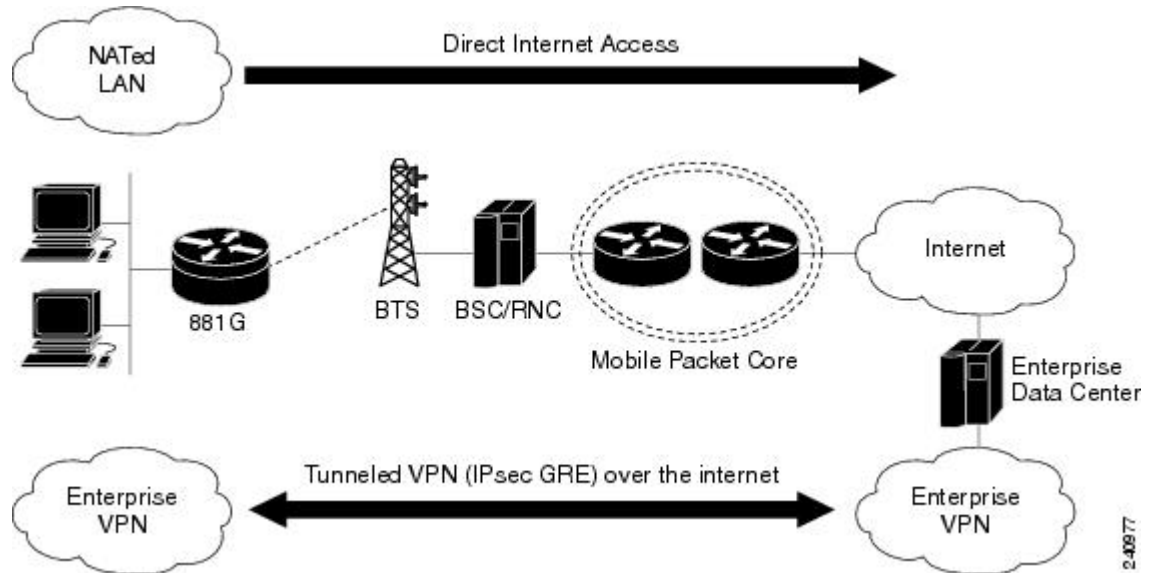

## SMB Applications

The figure below shows a small-to medium-size business deployment (SMB) that uses the following technologies and features at each branch office:

- Easy VPN with Virtual Tunnel Interface (VTI) to simplify secure VPN for remote offices and teleworkers.
- Deep packet inspection firewall for security. Firewalls provide the first level of access checking. They work with other security technologies, including intrusion prevention, encryption, and endpoint security, to provide a well-rounded defense-in-depth enterprise security system.
- Inline Intrusion Prevention Systems (IPS) protection provides additional security, and is a core facet of the Cisco Self-Defending Network. Cisco IOS IPS helps enable the network to defend itself with the intelligence to accurately classify, identify, and stop or block malicious or damaging traffic in real time.
- QoS provides timely delivery of latency-sensitive and mission-critical applications.
- ISDN connectivity backup provides network redundancy in the event that the primary service provider link fails.

- Support for existing analog voice and fax capabilities.

**Figure 22: Small-to Medium-Size Business**

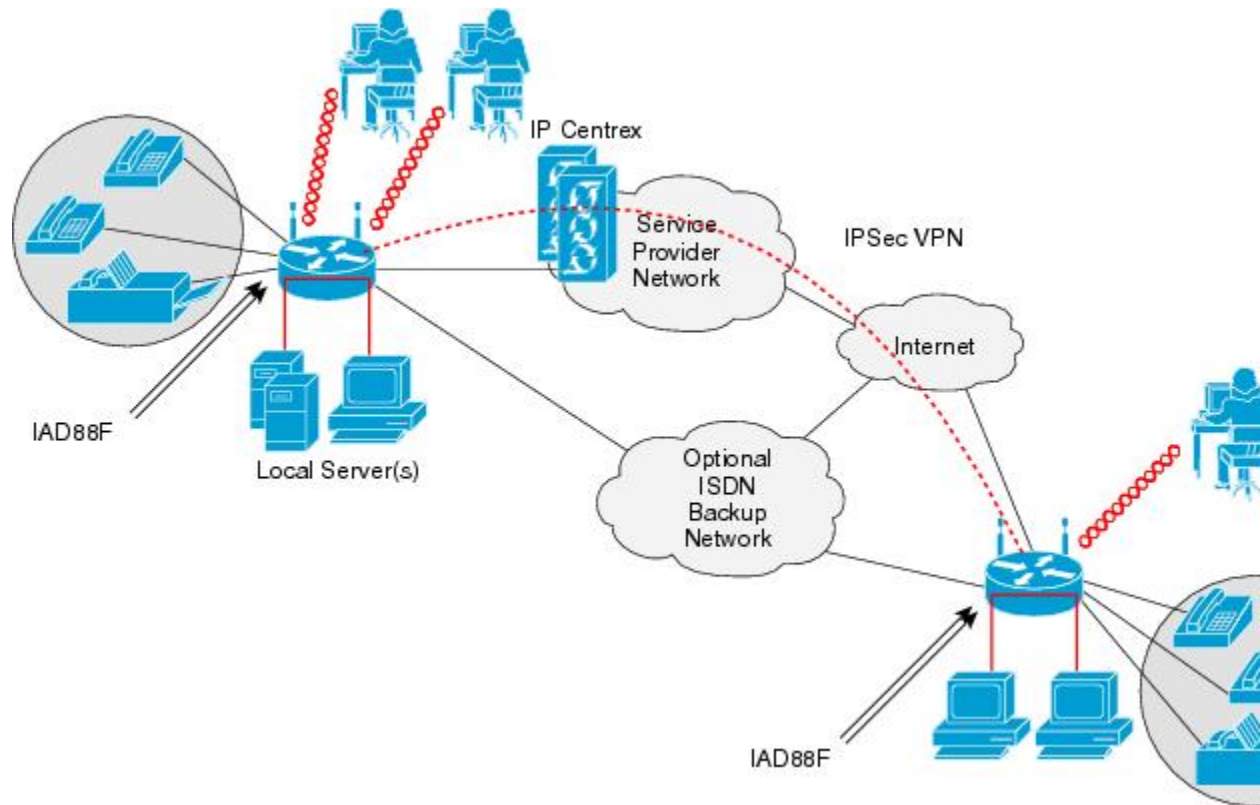

## Enterprise Wireless Deployments with LWAPP

The figure below shows an Enterprise wireless LAN deployment using Lightweight Access Point Protocol (LWAPP) and the following technologies and features:

- Broadband Internet access and VPN connection to a central site.
- Hybrid Remote Edge Access Point (H-REAP) provides wireless LAN services to remote and branch offices without using a wireless LAN controller at each location. With HREAP, organizations can bridge traffic locally, tunnel traffic over the WAN, or tunnel traffic over LWAPP on a per Service Set Identifier (SSID).
- Dynamic RF management with Cisco Wireless Control System (WCS).

- Ability to mix and match embedded access points with external access points.

Figure 23: Wireless LAN with LWAPP

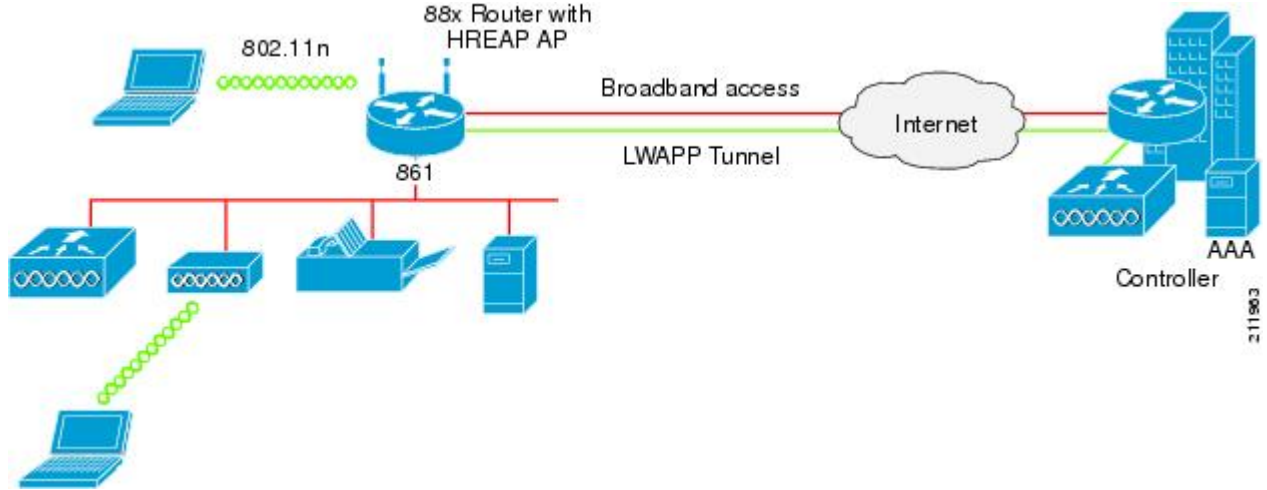

## Enterprise Small Branch Office Deployment

The figure below shows a small branch office or teleworker deployment that uses a gigabit Ethernet fiber connection through the SFP port.

Figure 24: Enterprise Small Branch office Deployment

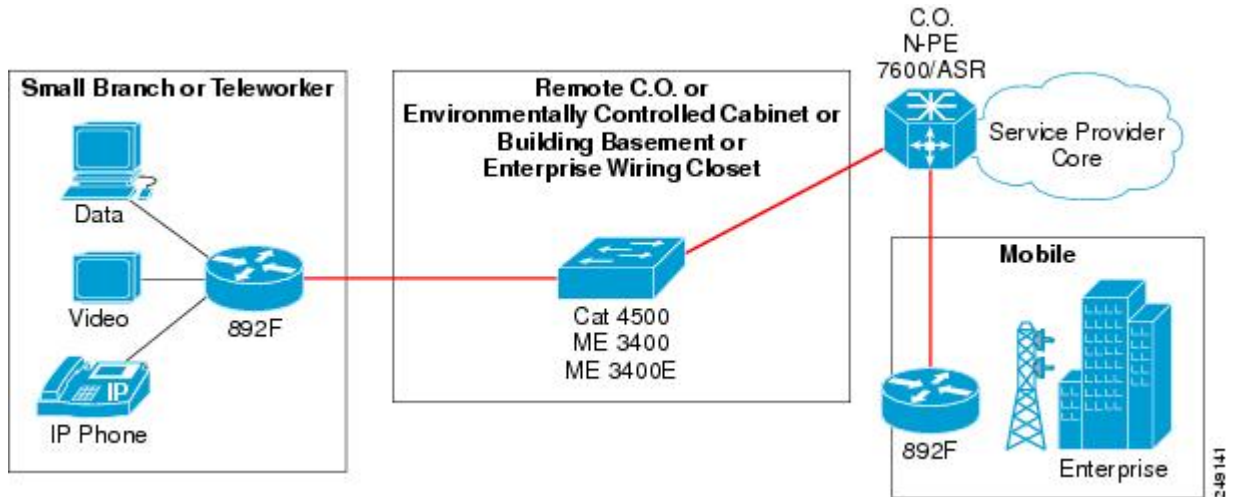





# Troubleshooting Cisco 800 Series Routers

---

Use the information in this chapter to help isolate problems you might encounter or to rule out the router as the source of a problem.

- [Getting Started, page 419](#)
- [Before Contacting Cisco or Your Reseller, page 419](#)
- [ADSL Troubleshooting, page 420](#)
- [SHDSL Troubleshooting, page 420](#)
- [VDSL2 Troubleshooting, page 420](#)
- [show interfaces Troubleshooting Command, page 421](#)
- [ATM Troubleshooting Commands, page 423](#)
- [Software Upgrade Methods, page 428](#)
- [Recovering a Lost Password, page 428](#)
- [Cisco Configuration Professional Express, page 433](#)

## Getting Started

Before troubleshooting a software problem, you must connect a terminal or PC to the router by using the light-blue console port. With a connected terminal or PC, you can view status messages from the router and enter commands to troubleshoot a problem.

You can also remotely access the interface (Ethernet, ADSL, or telephone) by using Telnet. The Telnet option assumes that the interface is up and running.

## Before Contacting Cisco or Your Reseller

If you cannot locate the source of a problem, contact your local reseller for advice. Before you call, you should have the following information ready:

- Chassis type and serial number

- Maintenance agreement or warranty information
- Type of software and version number
- Date you received the hardware
- Brief description of the problem
- Brief description of the steps you have taken to isolate the problem

## ADSL Troubleshooting

If you experience trouble with the ADSL connection, verify the following:

- The ADSL line is connected and is using pins 3 and 4. For more information on the ADSL connection, see the hardware guide for your router.
- The ADSL CD LED is on. If it is not on, the router may not be connected to the DSL access multiplexer (DSLAM). For more information on the ADSL LEDs, see the hardware installation guide specific for your router.
- The correct Asynchronous Transfer Mode (ATM) virtual path identifier/virtual circuit identifier (VPI/VCI) is being used.
- The DSLAM supports discrete multi-tone (DMT) Issue 2.
- The ADSL cable that you connect to the Cisco router must be 10BASE-T Category 5, unshielded twisted-pair (UTP) cable. Using regular telephone cable can introduce line errors.

## SHDSL Troubleshooting

Symmetrical high-data-rate digital subscriber line (SHDSL) is available on the Cisco 888 routers. If you experience trouble with the SHDSL connection, verify the following:

- The SHDSL line is connected and using pins 3 and 4. For more information on the G.SHDSL connection, see the hardware guide for your router.
- The G.SHDSL LED is on. If it is not on, the router may not be connected to the DSL access multiplexer (DSLAM). For more information on the G.SHDSL LED, see the hardware installation guide specific for your router.
- The correct asynchronous transfer mode (ATM) virtual path identifier/virtual circuit identifier (VPI/VCI) is being used.
- The DSLAM supports the G.SHDSL signaling protocol.

Use the **show controllers dsl 0** command in EXEC mode to view an SHDSL configuration.

## VDSL2 Troubleshooting

Very-high-data-rate digital subscriber line 2 (VDSL2) is available on the Cisco 887 routers. If you experience trouble with the VDSL2 connection, verify the following:

- The VDSL2 line is connected and using pins 3 and 4. For more information on the VDSL2 connection, see the hardware guide for your router.
- The VDSL2 LED CD light is on. If it is not on, the router may not be connected to the DSL access multiplexer (DSLAM). For more information on the VDSL2 LED, see the hardware installation guide specific for your router.
- The DSLAM supports the VDSL2 signaling protocol.

Use the **show controllers vdsl 0** command in EXEC mode to view a VDSL2 configuration. The debug vdsl 0 daemon state command can be used to enable the debug messages that print the state transition of VDSL2 training.

If there is trouble with the VDSL firmware file, you can reload or upgrade it without upgrading your Cisco IOS image. Use the command:

**controller vdsl 0 firmware flash:***<firmware file name>*

to load the firmware file into the VDSL modem chipset. Then enter shutdown/no shutdown commands on the controller vdsl 0 interface. After this, the new firmware will be downloaded and the VDSL2 line starts training up.



**Note**

Cisco 860VAE series ISRs require that the router be reloaded (IOS reload) before the new VDSL firmware will be loaded.

If the command is not present or the named firmware file is corrupt or not available, the default firmware file *flash:vdsl.bin* is checked to be present and not corrupt. The firmware in this file is then downloaded to the modem chipset.



**Note**

Cisco 860VAE series ISRs will state the reason of failure during bootstrap if the new VDSL firmware fails to load after IOS reload.

## show interfaces Troubleshooting Command

Use the **show interfaces** command to display the status of all physical ports (Ethernet, Fast Ethernet, and ATM) and logical interfaces on the router. [Table 42: show interfaces Command Output Description](#), on page 422 describes messages in the command output.

The following example shows how to view the status of Ethernet or Fast Ethernet Interfaces:

```
Router# show interfaces ethernet 0 **similar output for show interfaces fastethernet 0
command **
Ethernet0 is up, line protocol is up
Hardware is PQUICC Ethernet, address is 0000.0c13.a4db
(bia0010.9181.1281)
Internet address is 170.1.4.101/24
MTU 1500 bytes, BW 10000 Kbit, DLY 1000 usec,
 reliability 255/255., txload 1/255, rxload 1/255
 Encapsulation ARPA, loopback not set
 Keepalive set (10 sec)
```

The following example shows how to view the status of ATM Interfaces:

```
Router# show interfaces atm 0
ATM0 is up, line protocol is up
```

```

Hardware is PQUICC SAR (with Alcatel ADSL Module)
Internet address is 14.0.0.16/8
MTU 1500 bytes, sub MTU 1500, BW 640 Kbit, DLY 80 usec,
 reliability 40/255, txload 1/255, rxload 1/255
Encapsulation ATM, loopback not set
Keepalive not supported
Encapsulation(s):AAL5, PVC mode
10 maximum active VCs, 1 current VCCs
VC idle disconnect time:300 seconds
Last input 01:16:31, output 01:16:31, output hang never
Last clearing of "show interface" counters never
Input queue:0/75/0 (size/max/drops); Total output drops:0
Queueing strategy:Per VC Queueing
5 minute input rate 0 bits/sec, 0 packets/sec
5 minute output rate 0 bits/sec, 0 packets/sec
 512 packets input, 59780 bytes, 0 no buffer
 Received 0 broadcasts, 0 runts, 0 giants, 0 throttles
 0 input errors, 1024 CRC, 0 frame, 0 overrun, 0 ignored, 0 abort
 426 packets output, 46282 bytes, 0 underruns
 0 output errors, 0 collisions, 2 interface resets
 0 output buffer failures, 0 output buffers swapped out

```

The following example shows how to view the status of Dialer Interfaces:

```

Router# show interfaces dialer 1
Dialer 1 is up, line protocol is up
Hardware is Dialer interface
Internet address is 1.1.1.1/24
MTU 1500 bytes, BW 100000 Kbit, DLY 100000 usec, reliability
 255/255. txload 1/255, rxload 1/255
Encapsulation PPP, loopback not set
Keepalive set (10 sec)
DTR is pulsed for 5 seconds on reset
LCP Closed

```

The table below describes possible command output for the **show interfaces** command.

**Table 42: show interfaces Command Output Description**

| Output                                                  | Cause                                                                                                                                                                                                                                                                                                            |
|---------------------------------------------------------|------------------------------------------------------------------------------------------------------------------------------------------------------------------------------------------------------------------------------------------------------------------------------------------------------------------|
| For ATM Interfaces                                      |                                                                                                                                                                                                                                                                                                                  |
| ATM 0 is up, line protocol is up                        | The ATM line is up and operating correctly.                                                                                                                                                                                                                                                                      |
| ATM 0 is down, line protocol is down                    | <ul style="list-style-type: none"> <li>• The ATM interface has been disabled with the shutdown command.</li> </ul> or <ul style="list-style-type: none"> <li>• The ATM line is down, possibly because the ADSL cable is disconnected or because the wrong type of cable is connected to the ATM port.</li> </ul> |
| ATM 0.n is up, line protocol is up                      | The specified ATM subinterface is up and operating correctly.                                                                                                                                                                                                                                                    |
| ATM 0.n is administratively down, line protocol is down | The specified ATM subinterface has been disabled with the shutdown command.                                                                                                                                                                                                                                      |

| Output                                                                   | Cause                                                                                                                                                                                                                                                                                                                                                                                                                                             |
|--------------------------------------------------------------------------|---------------------------------------------------------------------------------------------------------------------------------------------------------------------------------------------------------------------------------------------------------------------------------------------------------------------------------------------------------------------------------------------------------------------------------------------------|
| ATM 0.n is down, line protocol is down                                   | The specified ATM subinterface is down, possibly because the ATM line has been disconnected (by the service provider).                                                                                                                                                                                                                                                                                                                            |
| For Ethernet/Fast Ethernet Interfaces                                    |                                                                                                                                                                                                                                                                                                                                                                                                                                                   |
| Ethernet/Fast Ethernet n is up, line protocol is up                      | The specified Ethernet/Fast Ethernet interface is connected to the network and operating correctly.                                                                                                                                                                                                                                                                                                                                               |
| Ethernet/Fast Ethernet n is up, line protocol is down                    | The specified Ethernet/Fast Ethernet interface has been correctly configured and enabled, but the Ethernet cable might be disconnected from the LAN.                                                                                                                                                                                                                                                                                              |
| Ethernet/Fast Ethernet n is administratively down, line protocol is down | The specified Ethernet/Fast Ethernet interface has been disabled with the <b>shutdown</b> command, and the interface is disconnected.                                                                                                                                                                                                                                                                                                             |
| For Dialer Interfaces                                                    |                                                                                                                                                                                                                                                                                                                                                                                                                                                   |
| Dialer n is up, line protocol is up                                      | The specified dialer interface is up and operating correctly.                                                                                                                                                                                                                                                                                                                                                                                     |
| Dialer n is down, line protocol is down                                  | <ul style="list-style-type: none"> <li>• This is a standard message and may not indicate anything is actually wrong with the configuration.</li> </ul> <p>or</p> <ul style="list-style-type: none"> <li>• If you are having problems with the specified dialer interface, this can mean it is not operating, possibly because the interface has been brought down with the <b>shutdown</b> command, or the ADSL cable is disconnected.</li> </ul> |

## ATM Troubleshooting Commands

Use the following commands to troubleshoot your ATM interface:

### ping atm interface Command

Use the **ping atm interface** command to determine whether a particular PVC is in use. The PVC does not need to be configured on the router to use this command. The below example shows the use of this command to determine whether PVC 8/35 is in use.

The following example shows how to determine if a PVC is in use:

```
Router# ping atm interface atm 0 8 35 seg-loopback
```

```
Type escape sequence to abort.
Sending 5, 53-byte segment OAM echoes, timeout is 2 seconds:
!!!!
Success rate is 100 percent (5/5), round-trip min/avg/max = 148/148/148 ms
```

This command sends five OAM F5 loopback packets to the DSLAM (segment OAM packets). If the PVC is configured at the DSLAM, the ping is successful.

To test whether the PVC is being used at the aggregator, enter the following command:

```
Router# ping atm interface atm 0 8 35 end-loopback
```

```
Type escape sequence to abort.
Sending 5, 53-byte end-to-end OAM echoes, timeout is 2 seconds:
!!!!
Success rate is 100 percent (5/5), round-trip min/avg/max = 400/401/404 ms
```

This command sends end-to-end OAM F5 packets, which are echoed back by the aggregator.

## show atm interface Command

To display ATM-specific information about an ATM interface, use the **show atm interface atm 0** command from privileged EXEC mode.

The following example shows how to view information about an ATM interface:

```
Router# show atm interface atm 0
Interface ATM0:
AAL enabled: AAL5 , Maximum VCs:11, Current VCCs:0
Maximum Transmit Channels:0
Max. Datagram Size:1528
PLIM Type:INVALID - 640Kbps, Framing is INVALID,
DS3 lbc:short, TX clocking:LINE
0 input, 0 output, 0 IN fast, 0 OUT fast
Avail bw = 640
Config. is ACTIVE
```

The table below describes some of the fields shown in the command output.

**Table 43: show atm interface Command Output Description**

| Field                     | Description                                                                          |
|---------------------------|--------------------------------------------------------------------------------------|
| ATM interface             | Interface number. Always 0 for the Cisco 860 and Cisco 880 series access routers.    |
| AAL enabled               | Type of AAL enabled. The Cisco 860 and Cisco 880 series access routers support AAL5. |
| Maximum VCs               | Maximum number of virtual connections this interface supports.                       |
| Current VCCs              | Number of active virtual channel connections (VCCs).                                 |
| Maximum Transmit Channels | Maximum number of transmit channels.                                                 |

| Field             | Description                                                 |
|-------------------|-------------------------------------------------------------|
| Max Datagram Size | Configured maximum number of bytes in the largest datagram. |
| PLIM Type         | Physical layer interface module (PLIM) type.                |

## debug atm Commands

Use the **debug** commands to troubleshoot configuration problems that you might be having on your network. The **debug** commands provide extensive, informative displays to help you interpret any possible problems.

### Guidelines for Using Debug Commands

Read the following guidelines before using debug commands to ensure appropriate results.

- All debug commands are entered in privileged EXEC mode.
- To view debugging messages on a console, enter the **logging console debug** command.
- Most **debug** commands take no arguments.
- To disable debugging, enter the **undebug all** command.
- To use **debug** commands during a Telnet session on your router, enter the **terminal monitor** command.



**Caution**

Debugging is assigned a high priority in your router CPU process, and it can render your router unusable. For this reason, use **debug** commands only to troubleshoot specific problems. The best time to use debug commands is during periods of low network traffic so that other activity on the network is not adversely affected.

You can find additional information and documentation about the **debug** commands in the [Cisco IOS Debug Command Reference](#).

### debug atm errors Command

Use the **debug atm errors** command to display ATM errors. The **no** form of this command disables debugging output.

The following example shows how to view the ATM errors:

```
Router# debug atm errors
ATM errors debugging is on
Router#
01:32:02:ATM(ATM0.2):VC(3) Bad SAP received 4500
01:32:04:ATM(ATM0.2):VC(3) Bad SAP received 4500
01:32:06:ATM(ATM0.2):VC(3) Bad SAP received 4500
01:32:08:ATM(ATM0.2):VC(3) Bad SAP received 4500
01:32:10:ATM(ATM0.2):VC(3) Bad SAP received 4500
```

## debug atm events Command

Use the **debug atm events** command to display events that occur on the ATM interface processor and to diagnose problems in an ATM network. This command provides an overall picture of the stability of the network. The **no** form of this command disables debugging output.

If the interface is successfully communicating with the Digital Subscriber Line Access Multiplexer (DSLAM) at the telephone company, the modem state is 0x10. If the interface is not communicating with the DSLAM, the modem state is 0x8. Note that the modem state does not transition to 0x10.

The following example shows how to view the ATM interface processor events-success:

```
Router# debug atm events
Router#
00:02:57: DSL: Send ADSL_OPEN command.
00:02:57: DSL: Using subfunction 0xA
00:02:57: DSL: Using subfunction 0xA
00:02:57: DSL: Sent command 0x5
00:02:57: DSL: Received response: 0x26
00:02:57: DSL: Unexpected response 0x26
00:02:57: DSL: Send ADSL_OPEN command.
00:02:57: DSL: Using subfunction 0xA
00:02:57: DSL: Using subfunction 0xA
00:02:57: DSL: Sent command 0x5
00:03:00: DSL: 1: Modem state = 0x8
00:03:02: DSL: 2: Modem state = 0x10
00:03:05: DSL: 3: Modem state = 0x10
00:03:07: DSL: 4: Modem state = 0x10
00:03:09: DSL: Received response: 0x24
00:03:09: DSL: Showtime!
00:03:09: DSL: Sent command 0x11
00:03:09: DSL: Received response: 0x61
00:03:09: DSL: Read firmware revision 0x1A04
00:03:09: DSL: Sent command 0x31
00:03:09: DSL: Received response: 0x12
00:03:09: DSL: operation mode 0x0001
00:03:09: DSL: SM: [DMTDSL_DO_OPEN -> DMTDSL_SHOWTIME]
```

The following example shows how to view the ATM interface processor events—failure:

```
Router# debug atm events
Router#
00:02:57: DSL: Send ADSL_OPEN command.
00:02:57: DSL: Using subfunction 0xA
00:02:57: DSL: Using subfunction 0xA
00:02:57: DSL: Sent command 0x5
00:02:57: DSL: Received response: 0x26
00:02:57: DSL: Unexpected response 0x26
00:02:57: DSL: Send ADSL_OPEN command.
00:02:57: DSL: Using subfunction 0xA
00:02:57: DSL: Using subfunction 0xA
00:02:57: DSL: Sent command 0x5
00:03:00: DSL: 1: Modem state = 0x8
00:03:00: DSL: 1: Modem state = 0x8
00:03:00: DSL: 1: Modem state = 0x8
00:03:00: DSL: 1: Modem state = 0x8
00:03:00: DSL: 1: Modem state = 0x8
00:03:00: DSL: 1: Modem state = 0x8
```

## debug atm packet Command

Use the **debug atm packet** command to display all process-level ATM packets for both outbound and inbound packets. The output reports information online when a packet is received or a transmission is attempted. The **no** form of this command disables debugging output.





**Caution**

Because the **debug atm packet** command generates a significant amount of output for every packet processed, use it only when network traffic is low, so that other system activities are not adversely affected.

The command syntax is:

**debug atm packet** [**interface atm number** [**vcd vcd-number** ]][**vc vpi/vci number**]]

**no debug atm packet** [**interface atm number** [**vcd vcd-number** ]][**vc vpi/vci number**]]

where the keywords are defined as follows:

**interface atm number** (Optional) ATM interface or subinterface number.

**vcd vcd-number** (Optional) Number of the virtual circuit designator (VCD).

**vc vpi/vci number** VPI/VCI value of the ATM PVC.

The below example shows sample output for the **debug atm packet** command.

```
Router# debug atm packet
Router#
01:23:48:ATM0 (O) :
VCD:0x1 VPI:0x1 VCI:0x64 DM:0x0 SAP:AAAA CTL:03 OUI:000000 TYPE:0800 Length:0x70
01:23:48:4500 0064 0008 0000 FF01 9F80 0E00 0010 0E00 0001 0800 A103 0AF3 17F7 0000
01:23:48:0000 004C BA10 ABCD ABCD ABCD ABCD ABCD ABCD ABCD ABCD ABCD ABCD ABCD ABCD
01:23:48:ABCD ABCD ABCD ABCD ABCD ABCD ABCD ABCD ABCD ABCD ABCD ABCD ABCD ABCD ABCD
01:23:48:ABCD ABCD ABCD ABCD ABCD
01:23:48:
01:23:48:ATM0 (I) :
VCD:0x1 VPI:0x1 VCI:0x64 Type:0x0 SAP:AAAA CTL:03 OUI:000000 TYPE:0800 Length:0x70
01:23:48:4500 0064 0008 0000 FE01 A080 0E00 0001 0E00 0010 0000 A903 0AF3 17F7 0000
01:23:48:0000 004C BA10 ABCD ABCD ABCD ABCD ABCD ABCD ABCD ABCD ABCD ABCD ABCD ABCD
01:23:48:ABCD ABCD ABCD ABCD ABCD ABCD ABCD ABCD ABCD ABCD ABCD ABCD ABCD ABCD ABCD
01:23:48:ABCD ABCD ABCD ABCD ABCD
01:23:48:
```

The table below describes some of the fields shown in the **debug atm packet** command output.

**Table 44: debug atm packet Command Output Description**

| Field            | Description                                                                |
|------------------|----------------------------------------------------------------------------|
| ATM0             | Interface that is generating the packet.                                   |
| (O)              | Output packet. (I) would mean receive packet.                              |
| VCD: 0xn         | Virtual circuit associated with this packet, where <i>n</i> is some value. |
| VPI: 0xn         | Virtual path identifier for this packet, where <i>n</i> is some value.     |
| DM: 0xn          | Descriptor mode bits, where <i>n</i> is some value.                        |
| Length: <i>n</i> | Total length of the packet (in bytes) including the ATM headers.           |

## Software Upgrade Methods

Several methods are available for upgrading software on the Cisco 860 and Cisco 880 series Integrated Services Routers, including:

- Copy the new software image to flash memory over the LAN or WAN while the existing Cisco IOS software image is operating.
- Copy the new software image to flash memory over the LAN while the boot image (ROM monitor) is operating.
- Copy the new software image over the console port while in ROM monitor mode.
- From ROM monitor mode, boot the router from a software image that is loaded on a TFTP server. To use this method, the TFTP server must be on the same LAN as the router.

## Recovering a Lost Password

To recover a lost enable or lost enable-secret password:

- 1 [Change the Configuration Register, on page 428](#)
- 2 [Reset the Router, on page 429](#)
- 3 [Reset the Password and Save Your Changes, on page 431](#) (for lost enable secret passwords only)
- 4 [Reset the Configuration Register Value, on page 432](#)



### Note

Recovering a lost password is only possible when you are connected to the router through the console port. These procedures cannot be performed through a Telnet session.



### Tip

See the “Hot Tips” section on Cisco.com for additional information on replacing enable secret passwords.

## Change the Configuration Register

To change a configuration register, follow these steps:

### SUMMARY STEPS

1. Connect an ASCII terminal or a PC running a terminal emulation program to the CONSOLE port on the router.
2. Configure the terminal to operate at 9600 baud, 8 data bits, no parity, and 1 stop bit.
3. At the privileged EXEC prompt (*router\_name #*), enter the **show version** command to display the existing configuration register value (shown in bold at the bottom of this output example):
4. Record the setting of the configuration register.
5. To enable the break setting (indicated by the value of bit 8 in the configuration register), enter the **config-register 0x01** command from privileged EXEC mode.

## DETAILED STEPS

- Step 1** Connect an ASCII terminal or a PC running a terminal emulation program to the CONSOLE port on the Fthe router.
- Step 2** Configure the terminal to operate at 9600 baud, 8 data bits, no parity, and 1 stop bit.
- Step 3** At the privileged EXEC prompt (*router\_name #*), enter the **show version** command to display the existing configuration register value (shown in bold at the bottom of this output example):

### Example:

```
Router# show version
Cisco IOS Software, C880 Software (C880-ADVENTERPRISEK9-M), Version 12.3(nightly
.PCBU_WIRELESS041110) NIGHTLY BUILD, synced to haw_t_pil_pcbu HAW_T_PI1_PCBU_200
40924
Copyright (c) 1986-2004 by Cisco Systems, Inc.
Compiled Thu 11-Nov-04 03:37 by jsomebody
ROM: System Bootstrap, Version 1.0.0.6(20030916:100755) [jsomebody],
 DEVELOPMENT SOFTWARE
Router uptime is 2467 minutes
System returned to ROM by power-on
System image file is "flash:c880-adventerprisek9-mz.pcbu_wireless.041110"
This product contains cryptographic features and is subject to United
States and local country laws governing import, export, transfer and
use. Delivery of Cisco cryptographic products does not imply
use. Delivery of Cisco cryptographic products does not imply
Importers, exporters, distributors and users are responsible for
compliance with U.S. and local country laws. By using this product you
agree to comply with applicable laws and regulations. If you are unable
to comply with U.S. and local laws, return this product immediately.
A summary of U.S. laws governing Cisco cryptographic products may be found at:
http://www.cisco.com/wwl/export/crypto/tool/stqrg.html
If you require further assistance please contact us by sending email to
export@cisco.com.
Cisco 877 (MPC8272) processor (revision 0x00) with 59392K/6144K bytes of memory.
Processor board ID
MPC8272 CPU Rev: Part Number 0xC, Mask Number 0x10
4 FastEthernet interfaces
1 ATM interface
1 802.11 Radio
128K bytes of non-volatile configuration memory.
20480K bytes of processor board System flash (Intel Strataflash)
Configuration register is 0x2102
```

- Step 4** Record the setting of the configuration register.
- Step 5** To enable the break setting (indicated by the value of bit 8 in the configuration register), enter the **config-register 0x01** command from privileged EXEC mode.
- Break enabled—Bit 8 is set to 0.
  - Break disabled (default setting)—Bit 8 is set to 1.

## Reset the Router

To reset the router, follow these steps:

## SUMMARY STEPS

1. If break is enabled, go to [Step 2, on page 430](#). If break is disabled, turn the router off (O), wait 5 seconds, and turn it on (I) again. Within 60 seconds, press the **Break** key. The terminal displays the ROM monitor prompt. Go to [Step 3, on page 430](#).
2. Press break. The terminal displays the following prompt:
3. Enter **confreg 0x142** to reset the configuration register:
4. Initialize the router by entering the **reset** command:
5. Enter **no** in response to the prompts until the following message is displayed:
6. Press **Return**. The following prompt appears:
7. Enter the enable command to enter enable mode. Configuration changes can be made only in enable mode:
8. Enter the **show startup-config** command to display an enable password in the configuration file:

## DETAILED STEPS

**Step 1** If break is enabled, go to [Step 2, on page 430](#). If break is disabled, turn the router off (O), wait 5 seconds, and turn it on (I) again. Within 60 seconds, press the **Break** key. The terminal displays the ROM monitor prompt. Go to [Step 3, on page 430](#).

**Note** Some terminal keyboards have a key labeled *Break*. If your keyboard does not have a Break key, see the documentation that came with the terminal for instructions on how to send a break.

**Step 2** Press break. The terminal displays the following prompt:

**Example:**

```
rommon 2>
```

**Step 3** Enter **confreg 0x142** to reset the configuration register:

**Example:**

```
rommon 2> confreg 0x142
```

**Step 4** Initialize the router by entering the **reset** command:

**Example:**

```
rommon 2> reset
```

The router cycles its power, and the configuration register is set to 0x142. The router uses the boot ROM system image, indicated by the system configuration dialog:

**Example:**

```
--- System Configuration Dialog ---
```

**Step 5** Enter **no** in response to the prompts until the following message is displayed:

**Example:**

```
Press RETURN to get started!
```

**Step 6** Press **Return**. The following prompt appears:

**Example:**

```
Router>
```

**Step 7** Enter the **enable** command to enter enable mode. Configuration changes can be made only in enable mode:

**Example:**

```
Router> enable
```

The prompt changes to the privileged EXEC prompt:

**Example:**

```
Router#
```

**Step 8** Enter the **show startup-config** command to display an enable password in the configuration file:

**Example:**

```
Router# show startup-config
```

---

**What to Do Next**

If you are recovering an enable password, do not perform the steps in the following [Reset the Password and Save Your Changes, on page 431](#) section. Instead, complete the password recovery process by performing the steps in the [Reset the Configuration Register Value, on page 432](#) section.

If you are recovering an enable secret password, it is not displayed in the **show startup-config** command output. Complete the password recovery process by performing the steps in the following [Reset the Password and Save Your Changes, on page 431](#) section.

## Reset the Password and Save Your Changes

To reset your password and save the changes, follow these steps:

**SUMMARY STEPS**

1. Enter the **configure terminal** command to enter global configuration mode:
2. Enter the **enable secret** command to reset the enable secret password in the router:
3. Enter **exit** to exit global configuration mode:
4. Save your configuration changes:

**DETAILED STEPS**

---

**Step 1** Enter the **configure terminal** command to enter global configuration mode:

**Example:**

```
Router# configure terminal
```

**Step 2** Enter the **enable secret** command to reset the enable secret password in the router:

**Example:**

```
Router (config)# enable secret
password
```

**Step 3** Enter **exit** to exit global configuration mode:

**Example:**

```
Router (config)# exit
```

**Step 4** Save your configuration changes:

**Example:**

```
Router# copy running-config startup-config
```

---

## Reset the Configuration Register Value

To reset the configuration register value after you have recovered or reconfigured a password, follow these steps:

### SUMMARY STEPS

1. Enter the **configure terminal** command to enter global configuration mode:
2. Enter the **configure register** command and the original configuration register value that you recorded.
3. Enter **exit** to exit configuration mode:
4. Reboot the router, and enter the recovered password.

### DETAILED STEPS

---

**Step 1** Enter the **configure terminal** command to enter global configuration mode:

**Example:**

```
Router# configure terminal
```

**Step 2** Enter the **configure register** command and the original configuration register value that you recorded.

**Example:**

```
Router(config)# config-reg
value
```

**Step 3** Enter **exit** to exit configuration mode:

**Example:**

```
Router(config)# exit
```

**Note** To return to the configuration being used before you recovered the lost enable password, do not save the configuration changes before rebooting the router.

**Step 4** Reboot the router, and enter the recovered password.

---

## Cisco Configuration Professional Express

After you connect the cables and power up the router, we recommend that you use the Cisco CP Express web-based application to configure the initial router settings.

For instructions on how to use Cisco CP Express to configure the router see the [Cisco CP Express User's Guide](#).







## APPENDIX A

# Cisco IOS Software Basic Skills

Understanding how to use Cisco IOS software can save you time when you are configuring your router. If you are already familiar with Cisco IOS software, go to one of the following chapters:

- [Basic Router Configuration](#)
- [Deployment Scenarios](#)

This appendix contains the following sections which provide basic information:

- [Configuring the Router from a PC, page 435](#)
- [Understanding Command Modes, page 436](#)
- [Getting Help, page 438](#)
- [Enable Secret Passwords and Enable Passwords, page 439](#)
- [Entering Global Configuration Mode, page 440](#)
- [Using Commands, page 440](#)
- [Saving Configuration Changes, page 442](#)
- [Summary, page 442](#)

## Configuring the Router from a PC

You can configure your router from a PC that is connected through the console port by using *terminal emulation* software. The PC uses this software to send commands to your router. The table below lists some common types of terminal emulation software that you can use, depending on the operating system that you are running.

**Table 45: Types of Terminal Emulation Software**

| PC Operating System                                          | Terminal Emulation Software                              |
|--------------------------------------------------------------|----------------------------------------------------------|
| Windows 95, Windows 98, Windows 2000, Windows NT, Windows XP | HyperTerm (included with Windows software), ProComm Plus |
| Windows 3.1                                                  | Terminal (included with Windows software)                |

| PC Operating System | Terminal Emulation Software |
|---------------------|-----------------------------|
| Macintosh           | ProComm, VersaTerm          |

You can use the terminal emulation software to change settings for the router that is connected to the PC. Configure the software to the following standard VT-100 emulation settings so that your PC can communicate with your router:

- 9600 baud
- 8 data bits
- No parity
- 1 stop bit
- No flow control

These settings should match the default settings of your router. To change the router baud, data bits, parity, or stop bits settings, you must reconfigure parameters in the ROM monitor. For more information, see [ROM Monitor](#). To change the router flow control setting, use the **flowcontrol** command in global configuration mode.

For information on how to enter global configuration mode so that you can configure your router, see the [Entering Global Configuration Mode](#), on page 440 section later in this chapter.

## Understanding Command Modes

This section describes the Cisco IOS command mode structure. Each command mode supports specific Cisco IOS commands. For example, you can use the **interface type number** command only from global configuration mode.

The following Cisco IOS command modes are hierarchical. When you begin a router session, you are in user EXEC mode.

- User EXEC
- Privileged EXEC
- Global configuration

The table below lists the command modes that are used in this guide, describes how to access each mode, shows the prompt for each mode, and explains how to exit to a mode or enter another mode. Because each mode configures different router elements, you might need to enter and exit modes frequently. You can see a list of available commands for a particular mode by entering a question mark (?) at the prompt. For a description of each command, including syntax, see the Cisco IOS Release 12.3 documentation set.

Table 46: Command Modes Summary

| Mode                 | Access Method                                                 | Prompt           | Mode Exit and Entrance                                                                                                                                                                                                                          | About This Mode                                                                                                                                                                                                                                                                                                                                                                                             |
|----------------------|---------------------------------------------------------------|------------------|-------------------------------------------------------------------------------------------------------------------------------------------------------------------------------------------------------------------------------------------------|-------------------------------------------------------------------------------------------------------------------------------------------------------------------------------------------------------------------------------------------------------------------------------------------------------------------------------------------------------------------------------------------------------------|
| User EXEC            | Begin a session with your router.                             | Router>          | To exit a router session, enter the <b>logout</b> command.                                                                                                                                                                                      | Use this mode to: <ul style="list-style-type: none"> <li>• Change terminal settings.</li> <li>• Perform basic tests.</li> <li>• Display system information.</li> </ul>                                                                                                                                                                                                                                      |
| Privileged EXEC      | Enter the <b>enable</b> command from user EXEC mode.          | Router#          | <ul style="list-style-type: none"> <li>• To exit to user EXEC mode, enter the <b>disable</b> command.</li> <li>• To enter global configuration mode, enter the <b>configure</b> command.</li> </ul>                                             | <p>Use this mode to:</p> <ul style="list-style-type: none"> <li>• Configure your router operating parameters.</li> <li>• Perform the verification steps shown in this guide.</li> </ul> <p>To prevent unauthorized changes to your router configuration, protect access to this mode by using a password as described in the <a href="#">Enable Secret Passwords and Enable Passwords</a>, on page 439.</p> |
| Global configuration | Enter the <b>configure</b> command from privileged EXEC mode. | Router (config)# | <ul style="list-style-type: none"> <li>• To exit to privileged EXEC mode, enter the <b>exit</b> or <b>end</b> command, or press <b>Ctrl-Z</b>.</li> <li>• To enter interface configuration mode, enter the <b>interface</b> command.</li> </ul> | <p>Use this mode to configure parameters that apply to your router globally.</p> <p>From this mode you can access the following modes:</p> <ul style="list-style-type: none"> <li>• Interface configuration</li> <li>• Router configuration</li> <li>• Line configuration</li> </ul>                                                                                                                        |

| Mode                    | Access Method                                                                                                                                   | Prompt                   | Mode Exit and Entrance                                                                                                                                                                                                                                                                                                                  | About This Mode                                                                                       |
|-------------------------|-------------------------------------------------------------------------------------------------------------------------------------------------|--------------------------|-----------------------------------------------------------------------------------------------------------------------------------------------------------------------------------------------------------------------------------------------------------------------------------------------------------------------------------------|-------------------------------------------------------------------------------------------------------|
| Interface configuration | Enter the <b>interface</b> command (with a specific interface, such as <b>interface atm 0</b> ) from global configuration mode.                 | Router (config-if)#      | <ul style="list-style-type: none"> <li>To exit to global configuration mode, enter the <b>exit</b> command.</li> <li>To exit to privileged EXEC mode, enter the <b>end</b> command, or press <b>Ctrl-Z</b>.</li> <li>To enter subinterface configuration mode, specify a subinterface by using the <b>interface</b> command.</li> </ul> | Use this mode to configure parameters for the router Ethernet and serial interfaces or subinterfaces. |
| Router configuration    | Enter one of the <b>router</b> commands followed by the appropriate keyword—for example <b>router rip</b> —from global configuration mode.      | Router (config- router)# | <ul style="list-style-type: none"> <li>To exit to global configuration mode, enter the <b>exit</b> command.</li> <li>To exit to privileged EXEC mode, enter the <b>end</b> command, or press <b>Ctrl-Z</b>.</li> </ul>                                                                                                                  | Use this mode to configure an IP routing protocol.                                                    |
| Line configuration      | Enter the <b>line</b> command with the desired line number and optional line type, for example, <b>line 0</b> , from global configuration mode. | Router (config- line)#   | <ul style="list-style-type: none"> <li>To exit to global configuration mode, enter the <b>exit</b> command.</li> <li>To exit to privileged EXEC mode, enter the <b>end</b> command, or press <b>Ctrl-Z</b>.</li> </ul>                                                                                                                  | Use this mode to configure parameters for the terminal line.                                          |

## Getting Help

You can use the question mark (?) and arrow keys to help you enter commands.

For a list of available commands for a particular command mode, enter a question mark:

```
Router> ?
access-enable Create a temporary access-list entry
access-profile Apply user-profile to interface
clear Reset functions
.
.
.
```

To complete a command, enter a few known characters followed by a question mark (with no space):

```
Router> sh?
* s=show set show slip systat
```

For a list of command variables, enter the command followed by a space and a question mark:

```
Router> show ?
.
.
.
clock Display the system clock
dialer Dialer parameters and statistics
exception exception information
.
.
.
```

To redisplay a command that you previously entered, press the **Up Arrow** key. You can continue to press the **Up Arrow** key for more commands.

## Enable Secret Passwords and Enable Passwords

By default, the router ships without password protection. Because many privileged EXEC commands are used to set operating parameters, you should password-protect these commands to prevent unauthorized use.

You can use two commands to do this:

- **enable secret** *password*—A very secure, encrypted password.
- **enable** *password*—A less secure, unencrypted local password.

Both the **enable** and **enable secret** passwords control access to various privilege levels (0 to 15). The **enable** password is intended for local use and is thus unencrypted. The **enable secret** password is intended for network use; that is, in environments where the password crosses the network or is stored on a TFTP server. You must enter an **enable secret** or **enable** password with a privilege level of 1 to gain access to privileged EXEC mode commands.

For maximum security, the passwords should be different. If you enter the same password for both during the setup process, your router accepts the passwords, but warns you that they should be different.

An **enable secret** password can contain from 1 to 25 uppercase and lowercase alphanumeric characters. An **enable** password can contain any number of uppercase and lowercase alphanumeric characters. In both cases, a number cannot be the first character. Spaces are also valid password characters; for example, *two words* is a valid password. Leading spaces are ignored; trailing spaces are recognized.

# Entering Global Configuration Mode

To make any configuration changes to your router, you must be in global configuration mode. This section describes how to enter global configuration mode while using a terminal or PC that is connected to your router console port.

To enter global configuration mode, follow these steps:

## SUMMARY STEPS

1. After your router boots up, enter the **enable** or **enable secret** command:
2. If you have configured your router with an enable password, enter it when you are prompted.
3. Enter the **configure terminal** command to enter global configuration mode:

## DETAILED STEPS

---

**Step 1** After your router boots up, enter the **enable** or **enable secret** command:

**Example:**

```
Router> enable
```

**Step 2** If you have configured your router with an enable password, enter it when you are prompted. The enable password does not appear on the screen when you enter it. This example shows how to enter privileged EXEC mode:

**Example:**

```
Password: enable_password
Router#
```

Privileged EXEC mode is indicated by the pound sign (#) in the prompt. You can now make changes to your router configuration.

**Step 3** Enter the **configure terminal** command to enter global configuration mode:

**Example:**

```
Router# configure terminal
Router(config)#
```

You can now make changes to your router configuration.

---

# Using Commands

This section provides some tips about entering Cisco IOS commands at the command-line interface (CLI).

## Abbreviating Commands

You only have to enter enough characters for the router to recognize the command as unique. This example shows how to enter the **show version** command:

```
Router # sh v
```

## Undoing Commands

If you want to disable a feature or undo a command that you entered, you can enter the keyword **no** before most commands; for example, **no ip routing**.

## Command-Line Error Messages

The table below lists some error messages that you might encounter while using the CLI to configure your router.

**Table 47: Common CLI Error Messages**

| Error Message                              | Meaning                                                                              | How to Get Help                                                                                                                                                                               |
|--------------------------------------------|--------------------------------------------------------------------------------------|-----------------------------------------------------------------------------------------------------------------------------------------------------------------------------------------------|
| % Ambiguous command:<br>"show con"         | You did not enter enough characters for your router to recognize the command.        | Reenter the command, followed by a question mark (?) with no space between the command and the question mark.<br><br>The possible keywords that you can enter with the command are displayed. |
| % Incomplete command.                      | You did not enter all the keywords or values required by this command.               | Reenter the command, followed by a question mark (?) with no space between the command and the question mark.<br><br>The possible keywords that you can enter with the command are displayed. |
| % Invalid input detected at<br>'^' marker. | You entered the command incorrectly. The error occurred where the caret (^) appears. | Enter a question mark (?) to display all the commands that are available in this particular command mode.                                                                                     |

# Saving Configuration Changes

You must enter the **copy running-config startup-config** command to save your configuration changes to NVRAM so that they are not lost if there is a system reload or power outage. This example shows how to use this command to save your changes:

```
Router# copy running-config startup-config
Destination filename [startup-config]?
Press Return to accept the default destination filename startup-config , or enter your desired destination filename and press Return.
```

It might take a minute or two to save the configuration to NVRAM. After the configuration has been saved, the following message appears:

```
Building configuration...
Router#
```

## Summary

Now that you have reviewed some Cisco IOS software basics, you can begin to configure your router. Remember:

- You can use the question mark (?) and arrow keys to help you enter commands.
- Each command mode restricts you to a set of commands. If you are having difficulty entering a command, check the prompt, and then enter the question mark (?) for a list of available commands. You might be in the wrong command mode or using the wrong syntax.
- To disable a feature, enter the keyword **no** before the command; for example, **no ip routing**.
- Save your configuration changes to NVRAM so that they are not lost if there is a system reload or power outage.

### Where to Go Next:

To configure your router, go to [Basic Router Configuration](#) and [Deployment Scenarios](#)





## Concepts

---

This appendix contains conceptual information that may be useful to Internet service providers or network administrators when they configure Cisco routers.

- [ADSL, page 443](#)
- [SHDSL, page 444](#)
- [Network Protocols, page 444](#)
- [Routing Protocol Options, page 444](#)
- [PPP Authentication Protocols, page 445](#)
- [TACACS+, page 447](#)
- [Network Address Translation, page 447](#)
- [Easy IP \(Phase 1\), page 447](#)
- [Easy IP \(Phase 2\), page 448](#)
- [Network Interfaces, page 448](#)
- [Dial Backup, page 450](#)
- [QoS, page 450](#)
- [Access Lists, page 452](#)

## ADSL

ADSL is a technology that allows both data and voice to be transmitted over the same line. It is a packet-based network technology that allows high-speed transmission over twisted-pair copper wire on the local loop (“last mile”) between a network service provider (NSP) central office and the customer site, or on local loops created within either a building or a campus.

The benefit of ADSL over a serial or dialup line is that it is always on and always connected, increasing bandwidth and lowering the costs compared with a dialup or leased line. ADSL technology is asymmetric in that it allows more bandwidth from an NSP central office to the customer site than from the customer site to the central office. This asymmetry, combined with always-on access (which eliminates call setup), makes ADSL ideal for Internet and intranet surfing, video on demand, and remote LAN access.

## SHDSL

SHDSL is a technology based on the G.SHDSL (G.991.2) standard that allows both data and voice to be transmitted over the same line. SHDSL is a packet-based network technology that allows high-speed transmission over twisted-pair copper wire between a network service provider (NSP) central office and a customer site, or on local loops created within either a building or a campus.

G.SHDSL devices can extend the reach from central offices and remote terminals to approximately 26,000 feet (7925 m), at symmetrical data rates from 72 kbps up to 2.3 Mbps. In addition, it is repeatable at lower speeds, which means there is virtually no limit to its reach.

SHDSL technology is symmetric in that it allows equal bandwidth between an NSP central office and a customer site. This symmetry, combined with always-on access (which eliminates call setup), makes SHDSL ideal for LAN access.

## Network Protocols

Network protocols enable the network to pass data from its source to a specific destination over LAN or WAN links. Routing address tables are included in the network protocols to provide the best path for moving the data through the network.

## IP

The best-known Transmission Control Protocol/Internet Protocol (TCP/IP) at the internetwork layer is IP, which provides the basic packet delivery service for all TCP/IP networks. In addition to the physical node addresses, the IP protocol implements a system of logical host addresses called IP addresses. The IP addresses are used by the internetwork and higher layers to identify devices and to perform internetwork routing. The Address Resolution Protocol (ARP) enables IP to identify the physical address that matches a given IP address.

IP is used by all protocols in the layers above and below it to deliver data, which means that all TCP/IP data flows through IP when it is sent and received regardless of its final destination.

IP is a connectionless protocol, which means that IP does not exchange control information (called a handshake) to establish an end-to-end connection before transmitting data. In contrast, a connection-oriented protocol exchanges control information with the remote computer to verify that it is ready to receive data before sending it. When the handshaking is successful, the computers have established a connection. IP relies on protocols in other layers to establish the connection if connection-oriented services are required.

Internet Packet Exchange (IPX) exchanges routing information using Routing Information Protocol (RIP), a dynamic distance-vector routing protocol. RIP is described in more detail in the following sections.

## Routing Protocol Options

Routing protocols include the following:

- Routing Information Protocol (RIP)
- Enhanced Interior Gateway Routing Protocol (Enhanced IGRP)

The table below shows the difference between RIP and Enhanced IGRP.

**Table 48: RIP and Enhanced IGRP Comparison**

| Protocol      | Ideal Topology                                                           | Metric                                                                                                                                                                     | Routing Updates                                                                                                  |
|---------------|--------------------------------------------------------------------------|----------------------------------------------------------------------------------------------------------------------------------------------------------------------------|------------------------------------------------------------------------------------------------------------------|
| RIP           | Suited for topologies with 15 or fewer hops.                             | Hop count. Maximum hop count is 15. Best route is one with lowest hop count.                                                                                               | By default, every 30 seconds. You can reconfigure this value and also use triggered extensions to RIP.           |
| Enhanced IGRP | Suited for large topologies with 16 or more hops to reach a destination. | Distance information. Based on a successor, which is a neighboring router that has a least-cost path to a destination that is guaranteed to not be part of a routing loop. | Hello packets sent every 5 seconds, as well as incremental updates sent when the state of a destination changes. |

## RIP

RIP is an associated protocol for IP, and is widely used for routing protocol traffic over the Internet. RIP is a distance-vector routing protocol, which means that it uses distance (hop count) as its metric for route selection. *Hop count* is the number of routers that a packet must traverse to reach its destination. For example, if a particular route has a hop count of 2, then a packet must traverse two routers to reach its destination.

By default, RIP routing updates are broadcast every 30 seconds. You can reconfigure the interval at which the routing updates are broadcast. You can also configure triggered extensions to RIP so that routing updates are sent only when the routing database is updated. For more information on triggered extensions to RIP, see the Cisco IOS Release 12.3 documentation set.

## Enhanced IGRP

Enhanced IGRP is an advanced Cisco-proprietary distance-vector and link-state routing protocol, which means it uses a metric more sophisticated than distance (hop count) for route selection. Enhanced IGRP uses a metric based on a successor, which is a neighboring router that has a least-cost path to a destination that is guaranteed not to be part of a routing loop. If a successor for a particular destination does not exist but neighbors advertise the destination, the router must recompute a route.

Each router that is running Enhanced IGRP sends hello packets every 5 seconds to inform neighboring routers that it is functioning. If a particular router does not send a hello packet within a prescribed period, Enhanced IGRP assumes that the state of a destination has changed and sends an incremental update.

Because Enhanced IGRP supports IP, you can use one routing protocol for multiprotocol network environments, minimizing the size of the routing tables and the amount of routing information.

## PPP Authentication Protocols

The Point-to-Point Protocol (PPP) encapsulates network-layer protocol information over point-to-point links.

PPP originated as an encapsulation protocol for transporting IP traffic over point-to-point links. PPP also established a standard for the assignment and management of IP addresses, asynchronous (start/stop) and bit-oriented synchronous encapsulation, network protocol multiplexing, link configuration, link quality testing, error detection, and option negotiation for such capabilities as network-layer address negotiation and data-compression negotiation. PPP supports these functions by providing an extensible Link Control Protocol (LCP) and a family of Network Control Protocols (NCPs) to negotiate optional configuration parameters and facilities.

The current implementation of PPP supports two security authentication protocols to authenticate a PPP session:

- Password Authentication Protocol (PAP)
- Challenge Handshake Authentication Protocol (CHAP)

PPP with PAP or CHAP authentication is often used to inform the central site which remote routers are connected to it.

## PAP

PAP uses a two-way handshake to verify the passwords between routers. To understand how PAP works, imagine a network topology in which a remote office Cisco router is connected to a corporate office Cisco router. After the PPP link is established, the remote office router repeatedly sends a configured username and password until the corporate office router accepts the authentication.

PAP has the following characteristics:

- The password portion of the authentication is sent across the link in clear text (not scrambled or encrypted).
- PAP provides no protection from playback or repeated trial-and-error attacks.
- The remote office router controls the frequency and timing of the authentication attempts.

## CHAP

CHAP uses a three-way handshake to verify passwords. To understand how CHAP works, imagine a network topology in which a remote office Cisco router is connected to a corporate office Cisco router.

After the PPP link is established, the corporate office router sends a challenge message to the remote office router. The remote office router responds with a variable value. The corporate office router checks the response against its own calculation of the value. If the values match, the corporate office router accepts the authentication. The authentication process can be repeated anytime after the link is established.

CHAP has the following characteristics:

- The authentication process uses a variable challenge value rather than a password.
- CHAP protects against playback attack through the use of the variable challenge value, which is unique and unpredictable. Repeated challenges limit the time of exposure to any single attack.
- The corporate office router controls the frequency and timing of the authentication attempts.

**Note**

---

We recommend using CHAP because it is the more secure of the two protocols.

---

## TACACS+

Cisco 860 and Cisco 880 series routers support the Terminal Access Controller Access Control System Plus (TACACS+) protocol through Telnet. TACACS+ is a Cisco-proprietary authentication protocol that provides remote access authentication and related network security services, such as event logging. User passwords are administered in a central database rather than in individual routers. TACACS+ also provides support for separate modular authentication, authorization, and accounting (AAA) facilities that are configured at individual routers.

## Network Address Translation

Network Address Translation (NAT) provides a mechanism for a privately addressed network to access registered networks, such as the Internet, without requiring a registered subnet address. This mechanism eliminates the need for host renumbering and allows the same IP address range to be used in multiple intranets.

NAT is configured on the router at the border of an *inside network* (a network that uses nonregistered IP addresses) and an *outside network* (a network that uses a globally unique IP address; in this case, the Internet). NAT translates the inside local addresses (the nonregistered IP addresses assigned to hosts on the inside network) into globally unique IP addresses before sending packets to the outside network.

With NAT, the inside network continues to use its existing private or obsolete addresses. These addresses are converted into legal addresses before packets are forwarded onto the outside network. The translation function is compatible with standard routing; the feature is required only on the router connecting the inside network to the outside domain.

Translations can be static or dynamic. A static address translation establishes a one-to-one mapping between the inside network and the outside domain. Dynamic address translations are defined by describing the local addresses to be translated and the pool of addresses from which to allocate outside addresses. Allocation occurs in numeric order, and multiple pools of contiguous address blocks can be defined.

NAT eliminates the need to readdress all hosts that require external access, saving time and money. It also conserves addresses through application port-level multiplexing. With NAT, internal hosts can share a single registered IP address for all external communications. In this type of configuration, relatively few external addresses are required to support many internal hosts, thus conserving IP addresses.

Because the addressing scheme on the inside network may conflict with registered addresses already assigned within the Internet, NAT can support a separate address pool for overlapping networks and translate as appropriate.

## Easy IP (Phase 1)

The Easy IP (Phase 1) feature combines Network Address Translation (NAT) and PPP/Internet Protocol Control Protocol (IPCP). This feature enables a Cisco router to automatically negotiate its own registered WAN interface IP address from a central server and to enable all remote hosts to access the Internet using this single registered IP address. Because Easy IP (Phase 1) uses existing port-level multiplexed NAT functionality within Cisco IOS software, IP addresses on the remote LAN are invisible to the Internet.

The Easy IP (Phase 1) feature combines NAT and PPP/IPCP. With NAT, the router translates the nonregistered IP addresses used by the LAN devices into the globally unique IP address used by the dialer interface. The ability of multiple LAN devices to use the same globally unique IP address is known as overloading. NAT is configured on the router at the border of an inside network (a network that uses nonregistered IP addresses) and an outside network (a network that uses a globally unique IP address; in this case, the Internet).

With PPP/IPCP, Cisco routers automatically negotiate a globally unique (registered) IP address for the dialer interface from the ISP router.

## Easy IP (Phase 2)

The Easy IP (Phase 2) feature combines Dynamic Host Configuration Protocol (DHCP) server and relay. DHCP is a client-server protocol that enables devices on an IP network (the DHCP clients) to request configuration information from a DHCP server. DHCP allocates network addresses from a central pool on an as-needed basis. DHCP is useful for assigning IP addresses to hosts that are temporarily connected to the network or for sharing a limited pool of IP addresses among a group of hosts that do not need permanent IP addresses.

DHCP frees you from having to assign an IP address to each client manually.

DHCP configures the router to forward User Datagram Protocol (UDP) broadcasts, including IP address requests, from DHCP clients. DHCP allows for increased automation and fewer network administration problems by:

- Eliminating the need for the manual configuration of individual computers, printers, and shared file systems
- Preventing the simultaneous use of the same IP address by two clients
- Allowing configuration from a central site

## Network Interfaces

This section describes the network interface protocols that Cisco 860 and Cisco 880 series routers support. The following network interface protocols are supported:

- Ethernet
- ATM for DSL

## Ethernet

Ethernet is a baseband LAN protocol that transports data and voice packets to the WAN interface using carrier sense multiple access collision detect (CSMA/CD). The term is now often used to refer to all CSMA/CD LANs. Ethernet was designed to serve in networks with sporadic, occasionally heavy traffic requirements. The IEEE 802.3 specification was developed in 1980, based on the original Ethernet technology.

Under the Ethernet CSMA/CD media-access process, any host on a CSMA/CD LAN can access the network at any time. Before sending data, CSMA/CD hosts listen for traffic on the network. A host wanting to send data waits until it detects no traffic before it transmits. Ethernet allows any host on the network to transmit whenever the network is quiet. A collision occurs when two hosts listen for traffic, hear none, and then transmit

simultaneously. In this situation, both transmissions are damaged, and the hosts must retransmit at some later time. Algorithms determine when the colliding hosts should retransmit.

## ATM for DSL

Asynchronous Transfer Mode (ATM) is a high-speed multiplexing and switching protocol that supports multiple traffic types, including voice, data, video, and imaging.

ATM is composed of fixed-length cells that switch and multiplex all information for the network. An ATM connection is simply used to transfer bits of information to a destination router or host. The ATM network is considered a LAN with high bandwidth availability. Unlike a LAN, which is connectionless, ATM requires certain features to provide a LAN environment to the users.

Each ATM node must establish a separate connection to every node in the ATM network that it needs to communicate with. All such connections are established through a permanent virtual circuit (PVC).

## PVC

A PVC is a connection between remote hosts and routers. A PVC is established for each ATM end node with which the router communicates. The characteristics of the PVC that are established when it is created are set by the ATM adaptation layer (AAL) and the encapsulation type. An AAL defines the conversion of user information into cells. An AAL segments upper-layer information into cells at the transmitter and reassembles the cells at the receiver.

Cisco routers support the AAL5 format, which provides a streamlined data transport service that functions with less overhead and affords better error detection and correction capabilities than AAL3/4. AAL5 is typically associated with variable bit rate (VBR) traffic and unspecified bit rate (UBR) traffic.

ATM encapsulation is the wrapping of data in a particular protocol header. The type of router that you are connecting to determines the type of ATM PVC encapsulation.

The routers support the following encapsulation types for ATM PVCs:

- LLC/SNAP (RFC 1483)
- VC-MUX (RFC 1483)
- PPP (RFC 2364)

Each PVC is considered a complete and separate link to a destination node. Users can encapsulate data as needed across the connection. The ATM network disregards the contents of the data. The only requirement is that data be sent to the ATM subsystem of the router in a manner that follows the specific AAL format.

## Dialer Interface

A dialer interface assigns PPP features (such as authentication and IP address assignment method) to a PVC. Dialer interfaces are used when configuring PPP over ATM.

Dialer interfaces can be configured independently of any physical interface and applied dynamically as needed.

# Dial Backup

Dial backup provides protection against WAN downtime by allowing a user to configure a backup modem line connection. The following can be used to bring up the dial backup feature in Cisco IOS software:

## Backup Interface

A backup interface is an interface that stays idle until certain circumstances occur, such as WAN downtime, at which point it is activated. The backup interface can be a physical interface such as a Basic Rate Interface (BRI), or an assigned backup dialer interface to be used in a dialer pool. While the primary line is up, the backup interface is placed in standby mode. In standby mode, the backup interface is effectively shut down until it is enabled. Any route associated with the backup interface does not appear in the routing table.

Because the backup interface command is dependent on the router's identifying that an interface is physically down, it is commonly used to back up ISDN BRI connections, asynchronous lines, and leased lines. The interfaces to such connections go down when the primary line fails, and the backup interface quickly identifies such failures.

## Floating Static Routes

Floating static routes are static routes that have an administrative distance greater than the administrative distance of dynamic routes. Administrative distances can be configured on a static route so that the static route is less desirable than a dynamic route. In this manner, the static route is not used when the dynamic route is available. However, if the dynamic route is lost, the static route can take over, and the traffic can be sent through this alternative route. If this alternative route uses a dial-on-demand routing (DDR) interface, then that interface can be used as a backup feature.

## Dialer Watch

Dialer watch is a backup feature that integrates dial backup with routing capabilities. Dialer watch provides reliable connectivity without having to define traffic of interest to trigger outgoing calls at the central router. Hence, dialer watch can be considered regular DDR with no requirement for traffic of interest. By configuring a set of watched routes that define the primary interface, you can monitor and track the status of the primary interface as watched routes are added and deleted.

When a watched route is deleted, dialer watch checks for at least one valid route for any of the IP addresses or networks being watched. If there is no valid route, the primary line is considered down and unusable. If there is a valid route for at least one of the watched IP networks defined and the route is pointing to an interface other than the backup interface configured for dialer watch, the primary link is considered up and dialer watch does not initiate the backup link.

## QoS

QoS refers to the capability of a network to provide better service to selected network traffic over various technologies, including ATM, Ethernet and IEEE 802.1 networks, and IP-routed networks that may use any or all of these underlying technologies. Primary goals of QoS include dedicated bandwidth, controlled jitter



and latency (required by some real-time and interactive traffic), and improved loss characteristics. QoS technologies provide the elemental building blocks for future business applications in campus, WAN, and service provider networks.

QoS must be configured throughout your network, not just on your router running VoIP, to improve voice network performance. Not all QoS techniques are appropriate for all network routers. Edge routers and backbone routers in your network do not necessarily perform the same operations; the QoS tasks they perform might differ as well. To configure your IP network for real-time voice traffic, you need to consider the functions of both edge and backbone routers in your network.

QoS software enables complex networks to control and predictably service a variety of networked applications and traffic types. Almost any network can take advantage of QoS for optimum efficiency, whether it is a small corporate network, an Internet service provider, or an enterprise network.

## IP Precedence

You can partition traffic in up to six classes of service using IP Precedence (two others classes are reserved for internal network use). The queuing technologies throughout the network can then use this signal to expedite handling.

Features such as policy-based routing and committed access rate (CAR) can be used to set precedence based on extended access-list classification. This allows considerable flexibility for precedence assignment, including assignment by application or user, by destination and source subnet, and so on. Typically this functionality is deployed as close to the edge of the network (or administrative domain) as possible, so that each subsequent network element can provide service based on the determined policy.

IP Precedence can also be set in the host or network client with the signaling used optionally. IP Precedence enables service classes to be established using existing network queuing mechanisms (such as class-based weighted fair queueing [CBWFQ]) with no changes to existing applications or complicated network requirements.

## PPP Fragmentation and Interleaving

With multiclass multilink PPP interleaving, large packets can be multilink-encapsulated and fragmented into smaller packets to satisfy the delay requirements of real-time voice traffic; small real-time packets, which are not multilink encapsulated, are transmitted between fragments of the large packets. The interleaving feature also provides a special transmit queue for the smaller, delay-sensitive packets, enabling them to be transmitted earlier than other flows. Interleaving provides the delay bounds for delay-sensitive voice packets on a slow link that is used for other best-effort traffic.

In general, multilink PPP with interleaving is used in conjunction with CBWFQ and RSVP or IP Precedence to ensure voice packet delivery. Use multilink PPP with interleaving and CBWFQ to define how data is managed; use Resource Reservation Protocol (RSVP) or IP Precedence to give priority to voice packets.

## CBWFQ

In general, class-based weighted fair queuing (CBWFQ) is used in conjunction with multilink PPP and interleaving and RSVP or IP Precedence to ensure voice packet delivery. CBWFQ is used with multilink PPP to define how data is managed; RSVP or IP Precedence is used to give priority to voice packets.

There are two levels of queuing; ATM queues and Cisco IOS queues. CBWFQ is applied to Cisco IOS queues. A first-in-first-out (FIFO) Cisco IOS queue is automatically created when a PVC is created. If you use CBWFQ to create classes and attach them to a PVC, a queue is created for each class.

CBWFQ ensures that queues have sufficient bandwidth and that traffic gets predictable service. Low-volume traffic streams are preferred; high-volume traffic streams share the remaining capacity, obtaining equal or proportional bandwidth.

## RSVP

RSVP enables routers to reserve enough bandwidth on an interface to ensure reliability and quality performance. RSVP allows end systems to request a particular QoS from the network. Real-time voice traffic requires network consistency. Without consistent QoS, real-time traffic can experience jitter, insufficient bandwidth, delay variations, or information loss. RSVP works in conjunction with current queuing mechanisms. It is up to the interface queuing mechanism (such as CBWFQ) to implement the reservation.

RSVP works well on PPP, HDLC, and similar serial-line interfaces. It does not work well on multi-access LANs. RSVP can be equated to a dynamic access list for packet flows.

You should configure RSVP to ensure QoS if the following conditions describe your network:

- Small-scale voice network implementation
- Links slower than 2 Mbps
- Links with high utilization
- Need for the best possible voice quality

## Low Latency Queuing

Low latency queuing (LLQ) provides a low-latency strict priority transmit queue for real-time traffic. Strict priority queuing allows delay-sensitive data to be dequeued and sent first (before packets in other queues are dequeued), giving delay-sensitive data preferential treatment over other traffic.

## Access Lists

With basic standard and static extended access lists, you can approximate session filtering by using the established keyword with the permit command. The established keyword filters TCP packets based on whether the ACK or RST bits are set. (Set ACK or RST bits indicate that the packet is not the first in the session and the packet therefore belongs to an established session.) This filter criterion would be part of an access list applied permanently to an interface.



## ROM Monitor

---

The ROM monitor firmware runs when the router is powered up or reset. The firmware helps to initialize the processor hardware and boot the operating system software. You can use the ROM monitor to perform certain configuration tasks, such as recovering a lost password or downloading software over the console port. If there is no Cisco IOS software image loaded on the router, the ROM monitor runs the router.

This appendix contains the following sections:

- [Entering the ROM Monitor, page 453](#)
- [ROM Monitor Commands, page 454](#)
- [ROM Monitor Command Descriptions, page 455](#)
- [Disaster Recovery with TFTP Download, page 456](#)
- [Configuration Register, page 459](#)
- [Console Download, page 460](#)
- [ROM Monitor Debug Commands, page 461](#)
- [Exiting the ROM Monitor, page 463](#)

## Entering the ROM Monitor

To use the ROM monitor, you must be using a terminal or PC that is connected to the router over the console port.

Perform these steps to configure the router to boot up in ROM monitor mode the next time it is rebooted.

### SUMMARY STEPS

1. **enable**
2. **configure terminal**
3. **config-reg 0x0**
4. **exit**
5. **reload**

## DETAILED STEPS

|        | Command or Action         | Purpose                                                                                                                                                                                                                                                                                                                                                                                                                                                                                                      |
|--------|---------------------------|--------------------------------------------------------------------------------------------------------------------------------------------------------------------------------------------------------------------------------------------------------------------------------------------------------------------------------------------------------------------------------------------------------------------------------------------------------------------------------------------------------------|
| Step 1 | <b>enable</b>             | Enters privileged EXEC mode.<br>Enter your password if prompted.                                                                                                                                                                                                                                                                                                                                                                                                                                             |
| Step 2 | <b>configure terminal</b> | Enters global configuration mode.                                                                                                                                                                                                                                                                                                                                                                                                                                                                            |
| Step 3 | <b>config-reg 0x0</b>     | Resets the configuration register.                                                                                                                                                                                                                                                                                                                                                                                                                                                                           |
| Step 4 | <b>exit</b>               | Exits global configuration mode.                                                                                                                                                                                                                                                                                                                                                                                                                                                                             |
| Step 5 | <b>reload</b>             | Reboots the router with the new configuration register value. The router remains in ROM monitor and does not boot the Cisco IOS software.<br><br>As long as the configuration value is 0x0, you must manually boot the operating system from the console. See the <b>boot</b> command in the “ <a href="#">ROM Monitor Command Descriptions, on page 455</a> ” section in this appendix.<br><br>After the router reboots, it is in ROM monitor mode. The number in the prompt increments with each new line. |

## What to Do Next



## Timesaver

Break (system interrupt) is always enabled for 60 seconds after the router reboots, regardless of whether it is set to on or off in the configuration register. During this 60-second window, you can break to the ROM monitor prompt by pressing the Break key.

## ROM Monitor Commands

Enter **?** or **help** at the ROM monitor prompt to display a list of available commands and options, as follows:

```
rommon 1 > ?
alias set and display aliases command
boot boot up an external process
break set/show/clear the breakpoint
confreg configuration register utility
cont continue executing a downloaded image
context display the context of a loaded image
cookie display contents of cookie PROM in hex
copy Copy a file-copy [-b <buffer_size>] <src_file> <dst_file>
delete Delete file(s)-delete <filenames ...>
dir List files in directories-dir <directory>
dis display instruction stream
dnld serial download a program module
format Format a filesystem-format <filesystem>
frame print out a selected stack frame
fsck Check filesystem consistency-fsck <filesystem>
help monitor builtin command help
history monitor command history
meminfo main memory information
```

```

mkdir Create dir(s)-mkdir <dirname...>
more Concatenate (type) file(s)-cat <filenames...>
rename Rename a file-rename <old_name> <new_name>
repeat repeat a monitor command
reset system reset
rmdir Remove a directory
set display the monitor variables
stack produce a stack trace
sync write monitor environment to NVRAM
sysret print out info from last system return
tftpdnld tftp image download
unalias unset an alias
unset unset a monitor variable
xmodem x/ymodem image download

```

## ROM Monitor Commands for 860VAE ISRs

Cisco 866VAE, 867VAE, 866VAE-K9, and 867VAE-K9 ISRs support the following ROM monitor commands. Enter **?** or **help** at the ROM monitor prompt to display a list of available commands and options, as follows:

```

rommon 1 > ?
alias set and display aliases command
boot boot up an external process
confreg configuration register utility
delete Delete file(s)-delete <filenames...>
dev List the device table
dir List files in directories-dir <directory>
format Format a filesystem-format <filesystem>
help monitor builtin command help
history monitor command history
meminfo main memory information
repeat repeat a monitor command
reset system reset
set display the monitor variables
showmon display currently selected ROM monitor
sync write monitor environment to NVRAM
tftpdnld tftp image download
unalias unset an alias
unset unset a monitor variable

```

Commands are case sensitive. You can halt any command by pressing the Break key on a terminal. If you are using a PC, most terminal emulation programs halt a command when you press the Ctrl and the Break keys at the same time. If you are using another type of terminal emulator or terminal emulation software, see the documentation for that product for information on how to send a Break command.

## ROM Monitor Command Descriptions

The table below describes the most commonly used ROM monitor commands.

**Table 49: Commonly Used ROM Monitor Commands**

| Command                 | Description                                               |
|-------------------------|-----------------------------------------------------------|
| <b>help</b> or <b>?</b> | Displays a summary of all available ROM monitor commands. |

| Command                           | Description                                                                                                                                                                                                                                                                                                                                                                                                                                                                                                             |
|-----------------------------------|-------------------------------------------------------------------------------------------------------------------------------------------------------------------------------------------------------------------------------------------------------------------------------------------------------------------------------------------------------------------------------------------------------------------------------------------------------------------------------------------------------------------------|
| -?                                | <p>Displays information about command syntax; for example:</p> <pre>rommon 16 &gt; <b>dis -?</b> usage : dis [addr] [length] The output for this command is slightly different for the <b>xmodem</b> download command:</pre> <pre>rommon 11 &gt; <b>xmodem -?</b> xmodem: illegal option -- ? usage: xmodem [-cyrxu] &lt;destination filename&gt; -c CRC-16 -y ymodem-batch protocol -r copy image to dram for launch -x do not launch on download completion -u upgrade ROMMON, System will reboot after upgrade</pre> |
| <b>reset</b> or <b>i</b>          | Resets and initializes the router, similar to a power up.                                                                                                                                                                                                                                                                                                                                                                                                                                                               |
| <b>dir</b> device:                | <p>Lists the files on the named device; for example, flash memory files:</p> <pre>rommon 4 &gt; dir flash: Directory of flash:/ 2 -rwx 10283208 &lt;date&gt; c880-advsecurityk9-mz 9064448 bytes available (10289152 bytes used)</pre>                                                                                                                                                                                                                                                                                  |
| boot commands                     | For more information about the ROM monitor boot commands, see the <a href="#">Cisco IOS Configuration Fundamentals and Network Management Guide</a> .                                                                                                                                                                                                                                                                                                                                                                   |
| <b>b</b>                          | Boots the first image in flash memory.                                                                                                                                                                                                                                                                                                                                                                                                                                                                                  |
| <b>b flash:</b> <i>[filename]</i> | Attempts to boot the image directly from the first partition of flash memory. If you do not enter a filename, this command will boot this first image in flash memory.                                                                                                                                                                                                                                                                                                                                                  |

## Disaster Recovery with TFTP Download

The standard way to load new software on your router is to use the **copy tftp flash** privileged EXEC command from the Cisco IOS software command-line interface (CLI). However, if the router is unable to boot Cisco IOS software, you can load new software while in ROM monitor mode.

This section describes how to load a Cisco IOS software image from a remote TFTP server to the router flash memory. Use the **tftpdnld** command only for disaster recovery, because it erases all existing data in flash memory before downloading a new software image to the router.

## TFTP Download Command Variables

This section describes the system variables that can be set in ROM monitor mode and that are used during the TFTP download process. There are both required variables and optional variables.

**Note**

The commands described in this section are case sensitive and must be entered exactly as shown.

### Required Variables

These variables must be set with these commands before you use the **tftpdnld** command:

| Variable                                                                  | Command                     |
|---------------------------------------------------------------------------|-----------------------------|
| IP address of the router.                                                 | IP_ADDRESS= ip_address      |
| Subnet mask of the router.                                                | IP_SUBNET_MASK= ip_address  |
| IP address of the default gateway of the router.                          | DEFAULT_GATEWAY= ip_address |
| IP address of the TFTP server from which the software will be downloaded. | TFTP_SERVER= ip_address     |
| Name of the file that will be downloaded to the router.                   | TFTP_FILE= filename         |

### Optional Variables

These variables can be set with these commands before using the **tftpdnld** command:

| Variable                                                                                                                                                                                                                                                                                                                                                                                                                                                                                                                            | Command                      |
|-------------------------------------------------------------------------------------------------------------------------------------------------------------------------------------------------------------------------------------------------------------------------------------------------------------------------------------------------------------------------------------------------------------------------------------------------------------------------------------------------------------------------------------|------------------------------|
| <p>Configures how the router displays file download progress.</p> <p>0—No progress is displayed.</p> <p>1—Exclamation points (!!!) are displayed to indicate file download progress. This is the default setting.</p> <p>2—Detailed progress is displayed during the file download process; for example:</p> <ul style="list-style-type: none"> <li>• Initializing interface.</li> <li>• Interface link state up.</li> <li>• ARPing for 1.4.0.1</li> <li>• ARP reply for 1.4.0.1 received. MAC address 00:00:0c:07:ac:01</li> </ul> | TFTP_VERBOSE= <i>setting</i> |

| Variable                                                                                                                                             | Command                                      |
|------------------------------------------------------------------------------------------------------------------------------------------------------|----------------------------------------------|
| Number of times the router attempts ARP and TFTP download. The default is 7.                                                                         | <b>TFTP_RETRY_COUNT</b> = <i>retry_times</i> |
| Length of time, in seconds, before the download process times out. The default is 2,400 seconds (40 minutes).                                        | <b>TFTP_TIMEOUT</b> = <i>time</i>            |
| Whether or not the router performs a checksum test on the downloaded image:<br><br>1—Checksum test is performed.<br>0—No checksum test is performed. | <b>TFTP_CHECKSUM</b> = <i>setting</i>        |

## Using the TFTP Download Command

To download a file through TFTP perform these steps in ROM monitor mode

### SUMMARY STEPS

1. Use the appropriate commands to enter all the required variables and any optional variables described in preceding sections.
2. Enter the **tftpdnld** command as follows:
3. If you are sure that you want to continue, enter **y** in response to the question in the output:

### DETAILED STEPS

**Step 1** Use the appropriate commands to enter all the required variables and any optional variables described in preceding sections.

**Step 2** Enter the **tftpdnld** command as follows:

**Example:**

```
rommon 1 > tftpdnld -r
```

**Note** The **-r** variable is optional. Entering this variable downloads and boots the new software but does not save the software to flash memory. You can then use the image that is in flash memory the next time you enter the **reload** command.

You will see output similar to the following:

**Example:**

```
IP_ADDRESS: 10.3.6.7
IP_SUBNET_MASK: 255.255.0.0
DEFAULT_GATEWAY: 10.3.0.1
TFTP_SERVER: 192.168.254.254
```



```
TFTP_FILE: c880-advsecurityk9-mz
Do you wish to continue? y/n: [n]:
```

**Step 3** If you are sure that you want to continue, enter **y** in response to the question in the output:

**Example:**

```
Do you wish to continue? y/n: [n]:y
The router begins to download the new file.
```

If you mistakenly entered yes, you can enter **Ctrl-C** or **Break** to stop the transfer before the flash memory is erased.

---

## Configuration Register

The virtual configuration register is in nonvolatile RAM (NVRAM) and has the same functionality as other Cisco routers. You can view or modify the virtual configuration register from either the ROM monitor or the operating system software. Within the ROM monitor, you can change the configuration register by entering the register value in hexadecimal format, or by allowing the ROM monitor to prompt you for the setting of each bit.

## Changing the Configuration Register Manually

To change the virtual configuration register from the ROM monitor manually, enter the **confreg** command followed by the new value of the register in hexadecimal format, as shown in the following example:

```
rommon 1 > confreg 0x2101
You must reset or power cycle for new config to take effect
rommon 2 >
```

The value is always interpreted as hexadecimal. The new virtual configuration register value is written into NVRAM but does not take effect until you reset or reboot the router.

## Changing the Configuration Register Using Prompts

Entering the **confreg** command without an argument displays the contents of the virtual configuration register and a prompt to alter the contents by describing the meaning of each bit.

In either case, the new virtual configuration register value is written into NVRAM but does not take effect until you reset or reboot the router.

The following display shows an example of entering the **confreg** command:

```
rommon 7> confreg

Configuration Summary
enabled are:
console baud: 9600
boot: the ROM Monitor

do you wish to change the configuration? y/n [n]: y
enable "diagnostic mode"? y/n [n]: y
enable "use net in IP bcast address"? y/n [n]:
```

```

enable "load rom after netboot fails"? y/n [n]:
enable "use all zero broadcast"? y/n [n]:
enable "break/abort has effect"? y/n [n]:
enable "ignore system config info"? y/n [n]:
change console baud rate? y/n [n]: y
enter rate: 0 = 9600, 1 = 4800, 2 = 1200, 3 = 2400 [0]: 0
change the boot characteristics? y/n [n]: y
enter to boot:
 0 = ROM Monitor
 1 = the boot helper image
 2-15 = boot system
[0]: 0

Configuration Summary
enabled are:
diagnostic mode
console baud: 9600
boot: the ROM Monitor

do you wish to change the configuration? y/n [n]:

You must reset or power cycle for new config to take effect

```

## Console Download

You can use console download, which is a ROM monitor function, to download either a software image or a configuration file over the router console port. After download, the file is either saved to the mini-flash memory module or to main memory for execution (image files only).

Use console download when you do not have access to a TFTP server.



**Note** If you want to download a software image or a configuration file to the router over the console port, you must use the ROM monitor **dnld** command.



**Note** If you are using a PC to download a Cisco IOS image over the router console port at 115,200 bps, ensure that the PC serial port is using a 16550 universal asynchronous transmitter/receiver (UART). If the PC serial port is not using a 16550 UART, we recommend using a speed of 38,400 bps or less when downloading a Cisco IOS image over the console port.

The following are the syntax and descriptions for the **xmodem** console download command:

**xmodem** [-cyrx] *destination\_file\_name*

**c**

Optional. Performs the download using 16-bit cyclic redundancy check (CRC-16) error checking to validate packets. Default is 8-bit CRC.

|                              |                                                                                                                                                                                                                                                                                                                                                                                                                                                                                |
|------------------------------|--------------------------------------------------------------------------------------------------------------------------------------------------------------------------------------------------------------------------------------------------------------------------------------------------------------------------------------------------------------------------------------------------------------------------------------------------------------------------------|
| <b>y</b>                     | Optional. Sets the router to perform the download using Ymodem protocol. The default is Xmodem protocol. The protocols differ as follows: <ul style="list-style-type: none"> <li>• Xmodem supports a 128-block transfer size. Ymodem supports a 1024-block transfer size.</li> <li>• Ymodem uses CRC-16 error checking to validate each packet. Depending on the device that the software is being downloaded from, this function might not be supported by Xmodem.</li> </ul> |
| <b>r</b>                     | Optional. Image is loaded into DRAM for execution. The default is to load the image into flash memory.                                                                                                                                                                                                                                                                                                                                                                         |
| <b>x</b>                     | Optional. Image is loaded into DRAM without being executed.                                                                                                                                                                                                                                                                                                                                                                                                                    |
| <i>destination_file_name</i> | Name of the system image file or the system configuration file. In order for the router to recognize it, the name of the configuration file must be <i>router_config</i> .                                                                                                                                                                                                                                                                                                     |

Follow these steps to run Xmodem:

**Step 1** Move the image file to the local drive where Xmodem will execute.

**Step 2** Enter the xmodem command.

## Error Reporting

Because the ROM monitor console download uses the console to perform the data transfer, when an error occurs during a data transfer, error messages are only displayed on the console once the data transfer is terminated.

If you have changed the baud rate from the default rate, the error message is followed by a message telling you to restore the terminal to the baud rate specified in the configuration register.

## ROM Monitor Debug Commands

Most ROM monitor debugging commands are functional only when Cisco IOS software has crashed or is halted. If you enter a debugging command and Cisco IOS crash information is not available, you see the following error message:

```
"xxx: kernel context state is invalid, can not proceed."
```

The following are ROM monitor debugging commands:

- **stack** or **k**—Produces a stack trace; for example:

```
rommon 6> stack
Stack trace:
PC = 0x801111b0
Frame 00: FP = 0x80005ea8 PC = 0x801111b0
Frame 01: FP = 0x80005eb4 PC = 0x80113694
Frame 02: FP = 0x80005f74 PC = 0x8010eb44
Frame 03: FP = 0x80005f9c PC = 0x80008118
Frame 04: FP = 0x80005fac PC = 0x80008064
Frame 05: FP = 0x80005fc4 PC = 0xffff03d70
```

- **context**—Displays processor context; for example:

```
rommon 7> context
CPU context of the most recent exception:
PC = 0x801111b0 MSR = 0x00009032 CR = 0x53000035 LR = 0x80113694
CTR = 0x801065e4 XER = 0xa0006d36 DAR = 0xffffffff DSISR = 0xffffffff
DEC = 0xffffffff TBU = 0xffffffff TBL = 0xffffffff IMMR = 0xffffffff
R0 = 0x00000000 R1 = 0x80005ea8 R2 = 0xffffffff R3 = 0x00000000
R4 = 0x8fab0d76 R5 = 0x80657d00 R6 = 0x80570000 R7 = 0x80570000
R8 = 0x00000000 R9 = 0x80570000 R10 = 0x0000954c R11 = 0x00000000
R12 = 0x00000080 R13 = 0xffffffff R14 = 0xffffffff R15 = 0xffffffff
R16 = 0xffffffff R17 = 0xffffffff R18 = 0xffffffff R19 = 0xffffffff
R20 = 0xffffffff R21 = 0xffffffff R22 = 0xffffffff R23 = 0xffffffff
R24 = 0xffffffff R25 = 0xffffffff R26 = 0xffffffff R27 = 0xffffffff
R28 = 0xffffffff R29 = 0xffffffff R30 = 0xffffffff R31 = 0xffffffff
```

- **frame**—Displays an individual stack frame.
- **sysret**—Displays return information from the last booted system image. This information includes the reason for terminating the image, a stack dump of up to eight frames, and, if an exception is involved, the address where the exception occurred; for example:

```
rommon 8> sysret
System Return Info:
count: 19, reason: user break
pc:0x801111b0, error address: 0x801111b0
Stack Trace:
FP: 0x80005ea8, PC: 0x801111b0
FP: 0x80005eb4, PC: 0x80113694
FP: 0x80005f74, PC: 0x8010eb44
FP: 0x80005f9c, PC: 0x80008118
FP: 0x80005fac, PC: 0x80008064
FP: 0x80005fc4, PC: 0xffff03d70
FP: 0x80005ffc, PC: 0x00000000
FP: 0x00000000, PC: 0x00000000
```

- **meminfo**—Displays size in bytes, starting address, available range of main memory, the starting point and size of packet memory, and size of NVRAM; for example:

```
rommon 9> meminfo
Main memory size: 40 MB.
Available main memory starts at 0x10000, size 40896KB
IO (packet) memory size: 5 percent of main memory.
NVRAM size: 32KB
```

## Exiting the ROM Monitor

You must set the configuration register to a value from 0x2 to 0xF for the router to boot a Cisco IOS image from flash memory upon startup or reloading.

The following example shows how to reset the configuration register and cause the router to boot a Cisco IOS image stored in flash memory:

```
rommon 1 > confreg 0x2101
```

You must reset or power cycle for new config to take effect:

```
rommon 2 > boot
```

The router will boot the Cisco IOS image in flash memory. The configuration register will change to 0x2101 the next time the router is reset or power cycled.





## INDEX

802.11d [233](#)  
802.11g [245](#)  
802.1H [238](#)  
819 and IOx [393](#), [395](#)  
    800M and IOx [393](#), [395](#)

### A

ADSL [19](#), [350](#)  
    configuring [350](#)  
    ordering [19](#)  
Aironet extensions [230](#)  
antenna [235](#)  
    selection [235](#)  
antenna command [235](#)  
ARP [331](#)  
    caching [331](#)  
ATM [349](#)  
    interface, configuring for PPPoA [349](#)  
authentication [302](#), [308](#)  
    RADIUS [302](#)  
        login [302](#)  
    TACACS+ [308](#)  
        login [308](#)  
authorization [306](#), [309](#)  
    with RADIUS [306](#)  
    with TACACS+ [309](#)

### B

backoff [245](#)  
bandwidth [231](#)  
banners [319](#), [320](#)  
    configuring [319](#), [320](#)  
        login [320](#)  
        message-of-the-day login [319](#)  
    when displayed [319](#)  
beacon dtim-period command [241](#)  
beacon period command [241](#)

binary synchronous communications [185](#)  
    Seebisync [185](#)  
bisync (binary synchronous communications), primary and secondary roles [185](#)  
blocking communication between clients [239](#)  
bridge-group command [239](#)

### C

carrier busy test [245](#)  
CHAP [181](#)  
    ppp [181](#)  
Cisco 2500 series routers, low-speed serial interfaces [191](#)  
Cisco 2520 to Cisco 2523 routers [197](#)  
    synchronous or asynchronous, setting [197](#)  
client ARP caching [331](#)  
client communication, blocking [239](#)  
client power level, limiting [230](#)  
clocks [188](#)  
    internal, enabling [188](#)  
    signal, inverting [188](#)  
commands [202](#), [220](#), [225](#), [229](#), [230](#), [233](#), [235](#), [237](#), [238](#), [239](#), [240](#), [241](#), [242](#), [243](#), [244](#), [245](#), [299](#), [316](#), [351](#)  
    antenna [235](#)  
    beacon dtim-period [241](#)  
    beacon period [241](#)  
    bridge-group [239](#)  
    dot11 extension aironet [237](#)  
    dot11 interface-number carrier busy [245](#)  
    fragment-threshold [244](#)  
    interface dot11radio [202](#), [220](#)  
    ip domain-name [316](#)  
    packet retries [243](#)  
    payload-encapsulation [238](#)  
    power client [230](#)  
    power local [229](#)  
    rts retries [242](#)  
    rts threshold [242](#)  
    setting privilege levels [299](#)  
    show dsl interface atm [351](#)  
    slot-time-short [245](#)

- commands (*continued*)
    - speed 225
    - switchport protected 240
    - world-mode 233
  - commands station role 222
  - compression 186
    - HDLC 186
  - configuration examples 53, 75, 77, 78, 342, 355, 366
    - DHCP server 366
    - dynamic routes 77
    - EIGRP 53, 78
    - PPPoA with NAT 355
    - PPPoE with NAT 342
    - static route 75
  - configuration prerequisites 19
  - configuring 22, 23, 72, 73, 74, 75, 77, 79, 110, 227, 334, 335, 337, 352, 363
    - DHCP server 363
    - dialer interface 337
    - dynamic routes 75, 77
    - EIGRP, IP 77, 79
    - Fast Ethernet LAN interfaces 72
    - Fast Ethernet WAN interface 23
    - global parameters 22
    - IP EIGRP 77, 79
    - loopback interface 72, 73
    - NATNAT 352
      - configuring with PPPoA 352
    - PPPoE with NAT 334, 335
    - RIP 75
    - static routes 74, 110
    - VLANs 363
    - WAN interface 23
  - connections, secure remote 330
  - corporate network, connecting to 19
  - crypto software image 330
- ## D
- Data Beacon Rate 241
  - data rate setting 224
  - data retries 243
  - default configuration 302, 307, 316
    - DNS 316
    - RADIUS 302
    - TACACS+ 307
  - default configuration, viewing 17, 70
  - delivery traffic indication message (DTIM) 241
  - DHCP 364
    - configuring DHCP server 364
    - IP address assignment 364
  - DHCP server 327, 363, 366
    - configuration example 366
  - DHCP server (*continued*)
    - configuring access point as 327
    - configuring router as 363
    - verify configuration 366
  - dialer interface 337, 347
    - configuring 337, 347
  - diversity 235
  - DNS 316
    - default configuration 316
    - displaying the configuration 316
    - overview 316
    - setting up 316
  - Domain Name System 316
    - See DNS 316
  - domain names 316
    - DNS 316
  - dot11 extension aironet command 237
  - dot11 interface-number carrier busy command 245
  - DSL signaling protocol 350
  - DTIM 241
  - DTR (data terminal ready) 189
    - signal pulsingMCI interface card 189
    - pulsing DTR signal onserial interfaces 189
      - DTR signal pulsing 189
  - duplex, Ethernet port 321
  - dynamic routes 75, 77
    - configuration example 77
    - configuring 75, 77
- ## E
- EIGRP 53, 78
    - configuration example 53, 78
  - enable secret password 296
  - encapsulation method 238
  - encapsulations 185
    - ATM-DXI 185
    - synchronous serialencapsulations 185
      - HDLCHDLC 185
        - encapsulation, default for serial interfaces 185
  - encrypted software image 330
  - encryption for passwords 296
  - Ethernet speed and duplex settings 321
- ## F
- fallback role 221
  - Fast Ethernet LAN interfaces, configuring 72
  - Fast Ethernet WAN interface, configuring 23, 336
  - fragment-threshold command 244
  - fragmentation threshold 244



Frame Relay **183**  
 serial interfaces **183**

## G

G.SHDSL **19**  
 ordering **19**  
 gain **235**  
 global parameters, setting up **22**

## H

half-duplex DCE state machine **193**  
 constant carrier mode **193**  
 controlled-carrier mode **193**  
 receive (figure) **193**  
 transmit (figure) **193**  
 half-duplex DTE state machine **192**  
 receive (figure) **192**  
 transmit **192**  
 transmit (figure) **192**  
 half-duplex timer command **196**  
 half-duplex timer cts-delay command **193**  
 half-duplex timer cts-drop-timeout command **192**  
 half-duplex timer dcd-drop-delay command **193**  
 half-duplex timer dcd-txstart-delay command **193**  
 half-duplex timer rts-drop-delay command **192**  
 half-duplex timer rts-timeout command **192**  
 half-duplex timer transmit-delay command **192, 193**  
 half-duplex timers, tuning **196**  
 HDLC (High Level Data Link Control) **186**  
 compression **186**

## I

inter-client communication, blocking **239**  
 interface dot11radio command **202, 220**  
 interface port labels (table) **15**  
 interfaces **185, 191, 192, 193, 195, 196, 197, 198**  
 configuration (examples) **198**  
 low-speed serial **191, 192, 193, 195, 196, 197**  
 async commands supported **197**  
 configuring **191**  
 constant-carrier mode **195**  
 half-duplex DCE state machine **193**  
 half-duplex DTE state machine **192**  
 sync commands supported **197**  
 synchronous or asynchronous, setting **196**  
 synchronous serial **185**  
 internal clock, enabling **188**

IOx **393, 395**  
 Configuring IOx on 819 and 800M **393, 395**  
 ip domain-name command **316**  
 IP routing, setting up **19**

## K

key features **202**

## L

LAN with DHCP and VLANs, configuring **363, 368**  
 LCP (Link Control Protocol) **181**  
 limiting client power level **230**  
 line coding, NRZI **187**  
 Local Management Interface (LMI) **184**  
 login authentication **302, 308**  
 with RADIUS **302**  
 with TACACS+ **308**  
 login banners **319**  
 loopback interface, configuring **72, 73**

## M

maximum data retries **243**  
 Maximum RTS Retries **242**  
 MCS rates **227, 229**  
 media-type half-duplex command **185**  
 message-of-the-day (MOTD) **319**  
 messages **319**  
 to users through banners **319**  
 mode (role) **222**  
 mode button **293, 294**  
 disabling **293**  
 enabling **294**  
 Multiprotocol Label Switching control processor (MPLSCP) **181**

## N

NAT **334, 339, 342, 355**  
 configuration example **342, 355**  
 configuring with PPPoE **334, 339**  
 Network Control Protocols (NCPs) **181**  
 NRZI (nonreturn to zero inverted) **187**  
 encoding **187**

**P**

- packet retries command [243](#)
- packet size (fragment) [244](#)
- parameters, setting up global [22](#)
- passwords [294, 295, 296, 298](#)
  - encrypting [296](#)
  - overview [294](#)
  - setting [295, 296, 298](#)
    - enable [295](#)
    - enable secret [296](#)
    - with usernames [298](#)
- payload-encapsulation command [238](#)
- point-to-multipoint bridging [332](#)
  - multiple VLAN and rate limiting
    - rate limiting [332](#)
    - configuring for non-root bridge
      - multiple VLAN [332](#)
      - configuring for non-root bridge [332](#)
- port labels for interfaces [15](#)
- ports, protected [240](#)
- power client command [230](#)
- power level [230](#)
  - on client devices [230](#)
- power local command [229](#)
- power-save client device [241](#)
- PPP [181](#)
  - MS-CHAP [181](#)
    - ppp [181](#)
  - PAP [181](#)
    - authentication [181](#)
    - serial interface [181](#)
- ppp authentication command [181](#)
- PPPoA, configuration example [355](#)
- PPPoE [334, 342, 343](#)
  - configuration example [342](#)
  - configuring [334](#)
  - verifying your configuration [343](#)
- prerequisites, for configuration [19](#)
- preventing unauthorized access [294](#)
- privilege levels [295, 299, 301](#)
  - logging into [301](#)
  - overview [295, 299](#)
  - setting a command with [299](#)
- protected ports [240](#)
- Public Secure Packet Forwarding (PSPF) [239](#)
- pulse-time command [189](#)

**R**

- radio [220, 231, 234, 245](#)
  - activity [245](#)
  - congestion [231](#)
  - interface [220](#)
  - preamble [234](#)

- RADIUS [302, 303, 306, 307](#)
  - configuring [302, 306](#)
    - authentication [302](#)
    - authorization [306](#)
  - default configuration [302](#)
  - defining AAA server groups [303](#)
  - displaying the configuration [307](#)
  - limiting the services to the user [306](#)
- Remote Authentication Dial-In User Service [301](#)
  - See RADIUS [301](#)
- request to send (RTS) [242](#)
- restricting access [294, 295, 301, 307](#)
  - overview [294](#)
  - passwords and privilege levels [295](#)
  - RADIUS [301](#)
  - TACACS+ [307](#)
- RFC [238](#)
  - 1042 [238](#)
- RIP [75](#)
  - configuring [75](#)
- roaming [202](#)
- role (mode) [222](#)
- role in radio network [221](#)
- rts retries command [242](#)
- RTS threshold [242](#)
- rts threshold command [242](#)

**S**

- sample configuration [229](#)
- sdhc cts-delay command [196](#)
  - See half-duplex timer command [196](#)
- sdhc rts-timeout command [196](#)
  - See half-duplex timer command [196](#)
- secure remote connections [330](#)
- Secure Shell [330](#)
  - See SSH [330](#)
- serial interface [181, 183](#)
  - link state [181, 183](#)
  - PPP encapsulation [181](#)
- serial interfaces [185, 189, 191](#)
  - configuring [185](#)
  - low-speed [191](#)
  - synchronous [185](#)
    - encapsulation [185](#)
    - supporting cards [185](#)
    - transmit delay
      - transmit delay, serial interface [189](#)
- serial line, encapsulation [185](#)
- serial, low-speed [192](#)
  - DTE, transmit [192](#)
- short slot time [245](#)
- show controllers command [192](#)

show dsl interface atm command [351](#)  
 show process cpu command [186](#)  
 signals, pulsing DTR [189](#)  
 Simple Network Time Protocol [312](#)  
     See SNTP [312](#)  
 slot-time-short command [245](#)  
 SNTP [312](#)  
     overview [312](#)  
 software compression [186](#)  
     HDLC [186](#)  
     LAPB [186](#)  
     PPP [186](#)  
 speed command [225](#)  
 SSH [330](#)  
     configuring [330](#)  
     crypto software image [330](#)  
     described [330](#)  
     displaying settings [330](#)  
 Stacker compressor [186](#)  
 static routes [74, 75, 110](#)  
     configuration [74](#)  
     configuration example [75](#)  
     configuring [74, 110](#)  
 station role command [222](#)  
 switchport protected command [240](#)  
 synchronous serial interface [185](#)  
     encapsulation methods [185](#)  
     overview [185](#)  
 system clock [313](#)  
     configuring [313](#)  
         manually [313](#)  
     displaying the time and date [313](#)  
 system name [315, 316](#)  
     manual configuration [316](#)  
     See also DNS [system name [315](#)  
         zzz] [315](#)  
 system prompt [315](#)  
     default setting [315](#)

## T

TACACS+ [307, 308, 309, 310](#)  
     configuring [308, 309](#)  
         authorization [309](#)  
         login authentication [308](#)

TACACS+ (*continued*)  
     default configuration [307](#)  
     displaying the configuration [310](#)  
     limiting the services to the user [309](#)  
 TCP/IP-oriented configuration [364](#)  
 Terminal Access Controller Access Control System Plus [307](#)  
     See TACACS+ [307](#)  
 time [312](#)  
     See SNTP and system clock [312](#)  
 transmit clock, inverting [188](#)  
 transmitter-delay command [189](#)

## U

unauthorized access [294](#)  
 universal workgroup bridge [221](#)  
 username-based authentication [298](#)

## V

verify [343, 366, 368](#)  
     DHCP server configuration [366](#)  
     PPPoE with NAT configuration [343](#)  
     VLAN configuration [368](#)  
 viewing default configuration [17, 70](#)  
 virtual private dialup network group number, configuring [335](#)  
 VLANs [363, 368](#)  
     configuring [363](#)  
     verify configuration [368](#)  
 VPDN group number, configuring [335](#)

## W

WAN interface, configuring [23, 336](#)  
 Wi-Fi Protected Access (WPA) [213](#)  
 workgroup bridge [222](#)  
     maximum number of clients allowed [222](#)  
 world mode [233](#)  
 world mode roamingworld mode [233](#)  
     always on setting [233](#)  
 world-mode command [233](#)

