

Instructions for use

Infinity Acute Care System



WARNING
To properly use this medical device,
read and comply with these
instructions for use.

Evita Infinity V500
Ventilation unit
SW 2.n

Typographical conventions

- 1 Consecutive numbers indicate steps of action, with the numbering restarting with "1" for each new sequence of actions.
- Bullet points indicate individual actions or different options for action.
 - Dashes indicate the listing of data, options, or objects.
- (A) Letters in parentheses refer to elements in the related illustration.
- A** Letters in illustrations denote elements referred to in the text.

Any text shown on the screen and any labeling on the device are printed in bold and italics, for example, ***PEEP***, ***Air*** or ***Alarms***.

The "greater than" symbol > indicates the navigation path in a dialog window, for example, ***System setup > Ventilation > Modes***. In this example, ***System setup*** represents the dialog window title, ***Ventilation*** represents a horizontally aligned tab, and ***Modes*** a vertically aligned tab.

Trademarks

Trademark	Trademark owner
AutoFlow [®]	Dräger
Infinity [®]	
QuickSet [®]	
ATC [®]	
SmartCare [®]	
Acute Care System [™]	
Medical Cockpit [™]	
DrägerService [®]	
MEDIBUS [™]	

Screen images

Schematic renderings of screen images are used, which may differ in appearance or in configuration from the actual screen images.

Product name used

In these instructions for use, the designation Evita V500 is used for Evita Infinity V500.

Use of terms

Dräger uses the term "Accessory" not only for accessories in the sense of IEC 60601-1, but also for consumable parts, removable parts, and attached parts.

Trademark	Trademark owner
MEDIBUS.X [®]	Dräger
Sekusept [®]	Ecolab
Actichlor [®]	
Oxycide [®]	Ecolab USA
Klorsept [®]	Medentech
BruTab 6S [®]	Bruhin
Descogen [®]	Antiseptica
Dispatch [®]	Clorox
Dismozon [®]	BODE Chemie

Trademark	Trademark owner
Virkon®	DuPont
Perform®	Schülke & Mayr
Mikrozid®	
Buraton®	
acryl-des®	
BIPAP ¹⁾	

1) Licensed trademark

Safety information definitions

WARNING

A WARNING statement provides important information about a potentially hazardous situation which, if not avoided, could result in death or serious injury.

CAUTION

A CAUTION statement provides important information about a potentially hazardous situation which, if not avoided, may result in minor or moderate injury to the user or patient or in damage to the medical device or other property.

NOTE

A NOTE provides additional information intended to avoid inconvenience during operation.

Definition of the target groups

For this medical device users, service personnel, and experts are defined as target groups.

These target groups have been instructed in the use of the medical device and have the necessary knowledge to use, install, reprocess, maintain or repair the medical device.

Dräger emphasizes that the medical device must be used, installed, reprocessed, maintained or repaired exclusively by defined target groups.

Users

Users are persons who may use the medical device in accordance with its intended use.

Service personnel

Service personnel are persons who are responsible for the maintenance of the medical device towards the operating organization.

Service personnel are persons who may install, reprocess, or maintain the medical device.

Experts

Experts are persons who may carry out repair or complex maintenance work on the medical device.

Abbreviations and symbols

For explanations refer to sections "Abbreviations" and "Symbols" in chapter "System overview".

Contents

Typographical conventions	2	Checking readiness for operation	74
Trademarks	2	Selecting the Tube or NIV application mode	83
Safety information definitions	3	Transfer of ventilation settings	84
Definition of the target groups	4	Selecting the therapy type	85
Abbreviations and symbols	4	Starting the therapy	86
		Displaying the status of accessories	87
For your safety and that of your patients	7		
General safety information	8	Operation	89
Product-specific safety information	12	Setting ventilation	91
		NIV – Non-invasive ventilation	99
Application	17	Displaying curves and measured values	102
Intended use	18	Help	106
Indications for use and contraindications	18	Maneuvers	107
Environment of use	18	Medication nebulization	111
		Measurement maneuver Low Flow PV	
System overview	19	Loop	119
Infinity Acute Care System – Workstation		Diagnostics – measurement maneuver	123
Critical Care	20	GS500 gas supply unit	126
Evita V500 ventilation unit	21	O ₂ therapy	127
Trolley 2-90 cm	23	Standby mode	130
GS500 gas supply unit	24	Ending operation	132
Range of functions	25	Storing Evita V500	133
Abbreviations	27	Mains power supply / DC power supply	134
Symbols	33	Intrahospital patient transport	137
		Alarms	139
Operating concept	37	Overview	140
Operating concept for Infinity C500	38	Display of alarms	140
Operating concept for Evita V500	38	Displaying information on alarms	142
		Alarm history	143
Assembly and preparation	43	Setting alarm limits	144
Safety information for assembly and		Setting the volume of the alarm tone	146
preparation	44	Suppressing the alarm tone	147
Preparing the trolley	44	Position of the user to the alarm system	147
Preparing the Medical Cockpit	48	Failure of the acoustic alarm	148
Preparing the ventilation unit	53		
Intrahospital transport	66	Trends and data	149
		Overview	150
Getting started	67	Displaying trends	150
Safety information on getting started	68	Displaying data	154
Switching on Evita V500 and Infinity C500	68	Displaying the logbook	155
Selecting a patient	69	Data export	156
Selecting the breathing circuit and the			
breathing gas humidifier	72		

Monitoring	157	Technical data	277
Information on monitoring	158	Ambient conditions	278
Flow monitoring	159	Set values	279
O ₂ monitoring	164	Performance characteristics	283
CO ₂ monitoring	165	Displayed measured values	286
Configuration	173	Displayed calculated values	291
Information on configuration	174	Monitoring	292
Configuring the screen display	174	Operating data	296
Configuring alarm settings	183	Device ports	301
Configuring ventilation settings	186	Automatic alarm limits	302
Importing and exporting configurations	195	Essential performance characteristics	305
Installing applications	197	Connections to IT networks	306
System status	198	Open-source software	307
System settings	200	Principles of operation	309
Service dialog	203	Description of the ventilation modes	310
Alarm – Cause – Remedy	205	Additional settings for ventilation	332
Reprocessing	243	Special functions	345
Disassembly	244	Description of the therapy types	353
Information on reprocessing	248	Automatic leakage compensation	354
Classifications for reprocessing	250	Flow reduction Anti Air Shower	355
Reprocessing list	251	Measurements	356
Reprocessing procedure	253	Battery concept	359
After reprocessing	259	Pneumatic functional description	363
Maintenance	263	Main menu bar structure	366
Overview	264	Factory-set screen views	371
Inspection	265	List of references	372
Preventive maintenance	266	Index	375
Repair	266	Password for Evita V500 SW 2.n	381
Replacing the ambient air filter	267	Information on the password	381
Replacing the diaphragm of the expiratory valve	267		
Replacing the expiratory valve	268		
Preventive maintenance on the GS500 gas supply unit	268		
Battery maintenance	270		
Disposal	273		
Safety information on disposal	274		
Disposal of packaging material	274		
Disposal of batteries	275		
Disposal of flow sensor and neonatal flow sensor	275		
Disposal of medical devices	275		

For your safety and that of your patients

General safety information	8
Strictly follow these instructions for use	8
Maintenance	8
Safety checks	8
Accessories	8
Not for use in areas of explosion hazard	9
Safe connection to other electrical equipment.	9
Connected devices	9
Device combinations	9
Connection to IT network	10
Patient safety	10
Patient monitoring	10
Information on electromagnetic compatibility . .	11
Disposable articles	11
Sterile accessories	11
Installing accessories	11
Storing the instructions for use	11
Training	12
Product-specific safety information	12
Monitoring ventilation	14
Back-up ventilation with an independent manual ventilation device	14
Handling Infinity ID components	15

General safety information

The following WARNING and CAUTION statements apply to general operation of the medical device.

WARNING and CAUTION statements specific to subsystems or particular features of the medical device appear in the respective sections of these instructions for use or in the instructions for use of another product being used with this device.

Strictly follow these instructions for use

WARNING

Any use of the medical device requires full understanding and strict observation of all sections of these instructions for use. The medical device must only be used for the purpose specified under "Intended use" on page 18 and in conjunction with appropriate patient monitoring (see page 10). Strictly observe all WARNING and CAUTION statements throughout these instructions for use and all statements on medical device labels. Failure to observe these safety information statements constitutes a use of the medical device that is inconsistent with its intended use.

Maintenance

WARNING

The medical device must be inspected and serviced regularly by service personnel. Repairs or complex maintenance work carried out on the medical device must be performed by experts.

Dräger recommends that a service contract is obtained with DrägerService and that all repairs are performed by DrägerService. Dräger recommends that only genuine Dräger parts are used for maintenance.

If the above are not complied with, the correct functioning of the medical device may be compromised.

Observe chapter "Maintenance".

Safety checks

The medical device must be subject to regular safety checks. See chapter "Maintenance".

Accessories

WARNING

Only the accessories indicated on the list of accessories 9039085 (2nd edition or later) have been tested and approved for use with the medical device.

Therefore, it is strongly recommended that only these accessories are used in conjunction with the medical device.

Otherwise, the correct functioning of the medical device may be compromised.

Not for use in areas of explosion hazard

WARNING

This medical device is neither approved nor certified for use in areas where combustible or explosive gas mixtures are likely to occur.

Safe connection to other electrical equipment

WARNING

Risk of patient injury

Electrical connections to equipment not listed in these instructions for use or these assembly instructions must only be made when approved by each respective manufacturer.

Connected devices

WARNING

Risk of electric shock and of device malfunction

Any connected devices or device combinations not complying with the requirements mentioned in these instructions for use may compromise the correct functioning of the medical device. Before operating the medical device, strictly comply with the instructions for use of all connected devices or device combinations.

Device combinations

This device can be operated in combination with other Dräger devices or with devices from other manufacturers. Observe the accompanying documents of the individual devices.

If a device combination is not approved by Dräger, the safety and the functional state of the individual devices may be compromised. The operating organization must ensure that the device combination complies with the applicable editions of the relevant standards for medical devices.

Device combinations approved by Dräger meet the requirements of the following standards:

- IEC_60601-1, 3rd_edition (general requirements for safety, device combinations, software-controlled functions)
- IEC_60601-1-2 (electromagnetic compatibility)
- IEC_60601-1-8 (alarm systems)

Or:

- IEC_60601-1, 2nd_edition (general requirements for safety)
- IEC_60601-1-1 (device combinations)
- IEC_60601-1-2 (electromagnetic compatibility)
- IEC_60601-1-4 (software-controlled functions)
- IEC_60601-1-8 (alarm systems)

Connection to IT network

The connection of the medical device to a network or later changes in the network can result in previously unidentified risks for patients, users and third parties. These risks must be identified and controlled before putting the medical device into operation.

Relevant changes to the network include:

- Configuration changes
- Adding or removing additional equipment
- Update or upgrade of connected devices

Risks

Overloading of the medical device as a result of very high network traffic (e.g., due to "denial of service" attacks) could lead to deactivation of the interfaces. The service functionality would not then be available until the medical device has been restarted. In rare cases, a warm boot may take place and may occur repeatedly.

Patient safety

The design of the medical device, the accompanying documentation, and the labeling on the medical device are based on the assumption that the purchase and the use of the medical device are restricted to persons familiar with the most important inherent characteristics of the medical device. Instructions and WARNING and CAUTION statements are therefore largely limited to the specifics of the Dräger medical device. These instructions for use do not contain references to various hazards which are obvious to users or references to the consequences of medical device misuse, or to potentially adverse effects in patients with different underlying diseases. Medical device modification or misuse can be dangerous.

CAUTION

Risk of patient injury

Do not make therapeutic decisions based solely on individual measured values and monitoring parameters.

Patient monitoring

The user of the medical device is responsible for choosing suitable monitoring that provides appropriate information about medical device performance and the patient's condition.

Patient safety may be achieved by a wide variety of means ranging from electronic surveillance of medical device performance and patient condition to simple, direct observation of clinical signs.

The responsibility for selecting the best level of patient monitoring lies solely with the user of the medical device.

Information on electromagnetic compatibility

General information on electromagnetic compatibility (EMC) according to international EMC standard IEC 60601-1-2:

Electromedical devices are subject to special precautionary measures concerning electromagnetic compatibility (EMC) and must be installed and put into operation in accordance with the EMC information provided in the separate instructions for use "Workstation Critical Care and Workstation Neonatal Care".

Portable and mobile RF communications equipment can affect medical electrical equipment.

WARNING

Do not connect connectors with an ESD warning symbol and do not touch the pins of such connectors without implementing ESD protective measures. Such protective measures may include antistatic clothing and shoes, touching a ground stud before and during connection of the pins, or using electrically insulating and antistatic gloves. All relevant personnel must be instructed in these ESD protective measures.

WARNING

Do not use portable and mobile HF communications equipment, e.g., mobile phones, in the vicinity of the medical device. Maintain separation distances; see EMC information in the separate instructions for use, "Workstation Critical Care and Workstation Neonatal Care".

Disposable articles

WARNING

Risk of patient injury as a result of failure of the accessories

Disposable articles were developed, tested and manufactured for single use only. Reuse, reprocessing or sterilization can lead to a failure of the accessories and cause injuries to the patient.

Do not reuse, reprocess, or sterilize disposable articles.

Sterile accessories

CAUTION

Do not use sterile-packaged accessories if the packaging has been opened, is damaged, or if there are other signs of non-sterility.

Installing accessories

CAUTION

Install accessories to the basic device in accordance with the instructions for use of the basic device. Make sure that there is a safe connection to the basic device system.

Strictly observe instructions for use and assembly instructions.

Storing the instructions for use

CAUTION

The instructions for use must be kept in an accessible location for users.

Training

Training for users is available from the Dräger organization responsible, see www.draeger.com.

Product-specific safety information

WARNING

This medical device is intended to be used only by trained users.

WARNING

Risk of fire

The flow sensor can ignite medications or other substances based on highly flammable substances.

- Do not nebulize medications or other substances that are easily flammable or spray them into the device.
- Do not use substances containing alcohol.
- Do not allow flammable or explosive substances to enter the breathing system or the breathing circuit.

WARNING

Risk of fire

Do not use the medical device in conjunction with flammable gases or flammable solutions that can mix with air, oxygen or nitrous oxide, or other sources of ignition since the medical device could ignite. Do not allow the medical device to come into contact with sources of ignition.

WARNING

Do not use the medical device during magnetic resonance imaging (MRI, NMR, NMI)! This may impair correct functioning of the medical device and endanger the patient.

WARNING

Do not use the medical device in hyperbaric chambers! This may impair correct functioning of the medical device and endanger the patient.

WARNING

Correct functioning of the medical device may be impaired by operation of high-frequency electrosurgery units, defibrillators or short-wave therapy equipment and endanger the patient.

WARNING

Risk of malfunction

Unauthorized modifications to the medical device lead to malfunctions.

This medical device must not be modified unless authorized by the manufacturer.

WARNING

Risk of electric shock

Live components are located under the cover. Do not open the housing of the medical device.

WARNING

Risk of fire

Do not use the medical device in oxygen-enriched rooms since the medical device could ignite.

Medical device malfunctions can increase the O₂ concentration in the ambient air. The medical device is only suitable for use in rooms with sufficient ventilation.

WARNING

Do not obstruct the gas inlet for the safety valve. Otherwise, spontaneous breathing via the emergency breathing valve is not possible in the event of a device failure.

WARNING

With neonates, the administration of increased O₂ concentrations can lead to retinopathy of prematurity.

Use additional monitoring, e.g., external SpO₂.

WARNING

Risk of fire

The use of unapproved O₂ pressure reducers can lead to excess pressure which can cause a fire.

When supplying the ventilator with oxygen from a compressed gas cylinder, only use pressure reducers compliant with ISO 10524. Slowly open the pressure reducer manually. Do not use tools.

WARNING

Risk of unnoticed change in inspiratory O₂ concentration

If an additional flow is delivered by an external flow source, the actual O₂ concentration delivered may deviate from the displayed values.

Use additional monitoring, e.g., external SpO₂ monitoring, if necessary.

WARNING

Risk of patient injury

If leakages are present, e.g., with non-invasive ventilation, the actual tidal volume may deviate from the measured values for V_Te and V_Ti.

Activate leakage compensation and monitor the measured value for V_T. Minimize or remedy all leakages.

WARNING

Risk of failure of flow measurement

Deposits that were not removed during reprocessing can damage the measuring wires in the flow sensor or cause a fire.

- Before inserting the flow sensor check for visible damage, soiling, and particles. Repeat this check regularly.
- Replace flow sensors when damaged, soiled, or not particlefree.

CAUTION

Keep away from sources of heat such as direct sunlight, heat radiators or spotlights! Otherwise the medical device may become too hot.

CAUTION

Do not obstruct or close off the vents on the medical device. Air must be able to enter freely. Otherwise the medical device may become too hot. An alarm is triggered if the medical device overheats during operation.

CAUTION

Positive-pressure ventilation can lead to negative effects, such as barotrauma or strain on the circulatory system.

CAUTION

Risk of patient injury

An additional flow delivered by an external flow source can affect the measured values for airway pressure and flow.

CAUTION

Risk of malfunction

The touch screen has a sensitive surface. Damage to the surface may cause the touch-sensitive controls not to work properly.

Do not operate the screen with sharp objects.

Monitoring ventilation

The following parameters are monitored by the built-in monitoring facilities of Evita V500:

- Airway pressure
- Expiratory minute volume
- Inspiratory tidal volume
- Respiratory rate
- Apnea alarm time
- Inspiratory O₂ concentration
- End-expiratory CO₂ concentration

Changes in these parameters may be caused by:

- Acute changes in the patient's condition
- Incorrect settings and faulty handling
- Device malfunctions
- Failure of power and gas supplies

If a fault occurs in this equipment, separate measuring instruments must be used.

During O₂ therapy, the monitoring functions of the medical device are restricted. See chapter "O₂ therapy" on page 127.

Back-up ventilation with an independent manual ventilation device

WARNING

If a fault is detected in the medical device, its life-support functions may no longer be assured. Ventilation of the patient using an independent ventilation device must be started without delay, if necessary with PEEP and/or an increased inspiratory O₂ concentration (e.g., with a manual resuscitator).

Handling Infinity ID components

Through ownership or purchase of this medical device equipped with RFID technology, you have only acquired the right to use the medical device and RFID technology in conjunction with products approved by Dräger and in strict compliance with these instructions for use. No intellectual property rights or any rights to the use of the medical device or RFID technology are hereby granted, either explicitly or implicitly, which are contrary to the above-mentioned conditions.

WARNING

Risk of patient injury

Although Evita V500 does not exceed the applicable limiting values for electromagnetic fields, radiation can interfere with the functioning of pacemakers. Wearers of pacemakers must keep a distance of at least 25 cm (10 in) between the pacemaker and Evita V500.

Emission of high-frequency energy

This medical device is equipped with an RFID (Radio Frequency Identification) system to enable wireless communication with Infinity ID accessories. Any changes or modifications to the RFID system may only be carried out by experts. Otherwise this may compromise patient safety.

This medical device has been designed and manufactured to comply with emission limit values for high-frequency energy. These limiting values are incorporated in international safety standards such as IEC 60601-1-2 (EN 60601-1-2) which have been defined by regulation authorities, such as the Federal Communications Commission (FCC Rules), Industry Canada (Radio Standards Specifications) and the European Telecommunications Standards Institute (ETSI standards).

The RFID system of this medical device complies with Part 15 of the FCC regulations, and its operation is subject to the following conditions:

- 1 This medical device does not cause any dangerous interference.
- 2 The medical device is not liable to damage caused by the reception of interference, including interference causing undesired operating conditions.

Dräger hereby declares that the RFID system in the ventilation unit is in compliance with the basic requirements and the other pertinent regulations of Directive 1999/5/EC.

This page has been left blank intentionally.

Application

Intended use 18

Indications for use and contraindications . . 18

Environment of use 18

Intended use

The Evita V500 ventilation unit of the Infinity Acute Care System is intended for the ventilation of adults, pediatric patients and neonates. Evita V500 provides mandatory ventilation modes and ventilation modes for

supporting spontaneous breathing and also airway monitoring. The Evita V500 ventilation unit is used with Dräger Infinity C Series Medical Cockpits. The Evita V500 ventilation unit is intended for use in different medical care areas.

Indications for use and contraindications

Indications

The Evita V500 ventilation unit is used in combination with Dräger Infinity C Series Medical Cockpits. Evita V500 is used for treating patients who require temporary or longer term respiratory support for different medical reasons.

It is the responsibility of the user to select the appropriate respiratory mode for the underlying disease of the patient. For all ventilator settings, the user needs to consider the respiratory status and the general state of health of the patient in order to optimally adapt the ventilation settings to the patient's condition. Any changes to the patient's state need to be monitored continuously.

Contraindications

There are no additional contraindications apart from the contraindications contained in chapter "For your safety and that of your patients".

Environment of use

Evita V500 is intended for stationary use in hospitals and medical rooms or for patient transportation within the hospital.

Do not use the device in the following environments:

- In hyperbaric chambers
- For magnetic resonance imaging (MRI, NMR, NMI)
- In conjunction with flammable gases or flammable solutions that can mix with air, oxygen or nitrous oxide
- In areas of explosion hazard
- In areas with combustible or explosive substances

- In rooms without sufficient ventilation

Do not operate the device with helium or helium mixtures.

System overview

Infinity Acute Care System – Workstation	
Critical Care	20
How to use the Workstation Critical Care.	20
Evita V500 ventilation unit	21
Front panel	21
Back panel	22
Left side view	22
Right side view	23
Trolley 2-90 cm	23
GS500 gas supply unit	24
Back panel	24
Range of functions	25
Ventilation functions of Evita V500	25
Monitoring	26
Power supply	26
Gas supply	26
Data transfer	26
Medication nebulizer	26
Attaching accessories	26
Abbreviations	27
Symbols	33

Infinity Acute Care System – Workstation Critical Care

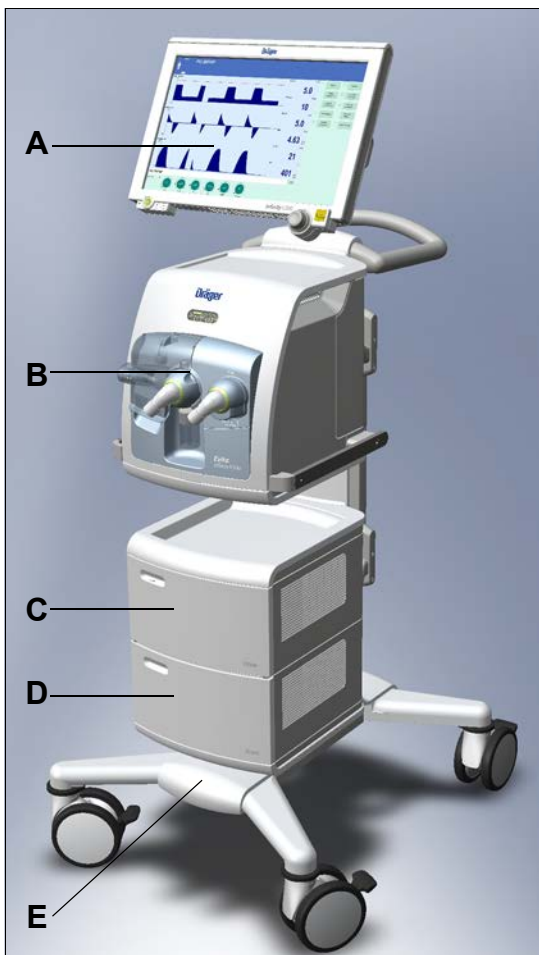

How to use the Workstation Critical Care

The Workstation Critical Care can consist of the following units:

- Infinity C500 (Medical Cockpit)
- Evita V500 (ventilation unit)
- Trolley 2-90 cm (trolley)
- GS500 (gas supply unit)
- PS500 (power supply unit)
- Transport Supply Unit (transport supply unit)

Before using the Workstation Critical Care, carefully read the following instructions for use:

- Instructions for use for "Workstation Critical Care and Workstation Neonatal Care"
- Instructions for use for "Infinity Medical Cockpits"
- Instructions for use for "Evita Infinity V500"
- Instructions for use for "Transport Supply Unit"

The Workstation Critical Care may include additional accessories, see separate list of accessories.

A Infinity C500 – Control and display unit (Medical Cockpit). Strictly follow the instructions for use for "Infinity Medical Cockpits".

B Evita V500 – Ventilation unit

C GS500 – Gas supply unit

D PS500 – Power supply unit

E Trolley 2-90 cm – Trolley

Evita V500 ventilation unit

Front panel

Front view, flap closed

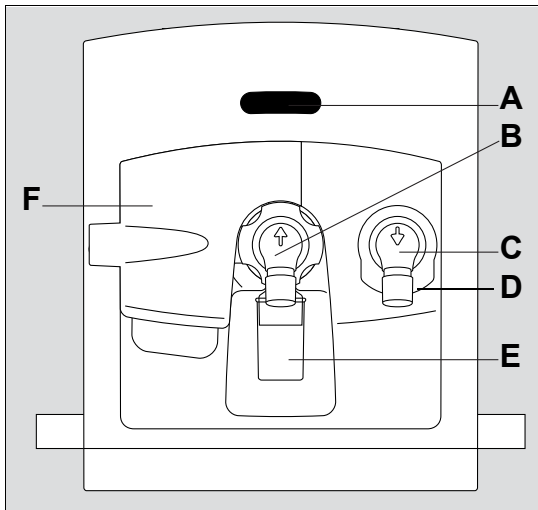

- A** Operation display of ventilation
During ventilation, the inspiratory and expiratory phases are indicated by a bar display. The measured values for minute volume *MVe* and the inspiratory O₂ concentration *FiO₂* are also displayed.
- B** Infinity ID expiratory valve with expiratory port
In the **Neo.** patient category: Infinity ID neonatal expiratory valve with expiratory port **Exp.** (GAS RETURN)
- C** Inspiratory unit (safety valve with inspiratory port) **Insp.** (GAS OUTPUT)
- D** Gas inlet for the **Emergency air intake** safety valve, non-tapered connection, do not obstruct (EMERGENCY AIR INTAKE)
- E** Water trap
- F** Flap

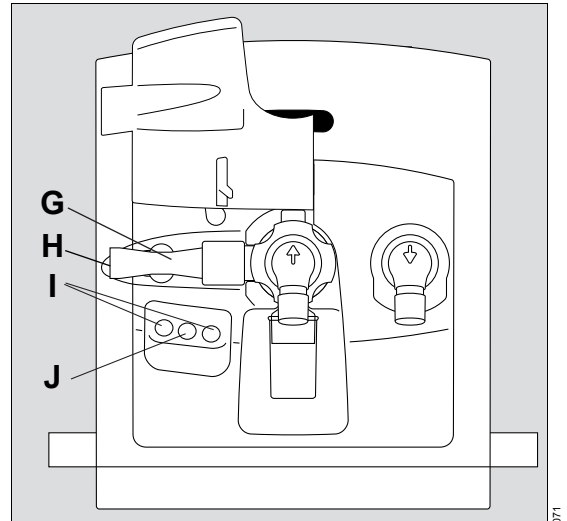

Front view, flap folded upwards

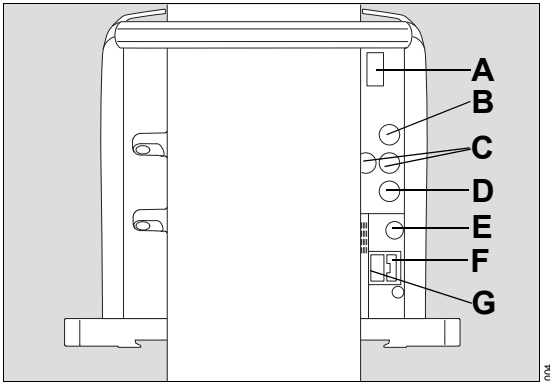

- G** Infinity ID flow sensor
In the **Neo.** patient category: Muffler
- H** Gas outlet **Exhaust**, non-tapered connection (EXHAUST – NOT FOR SPIROMETER)
- I** Connections for future extensions
- J** Nebulizer port (nebulizer gas outlet for pneumatic medication nebulizer)

Back panel



- A** Fuse for the batteries
- B** Connection for the neonatal flow sensor **V5** 
- C** Connections for future extensions **V6, V8**
- D** Connection for CO₂ sensor **V7** 
- E** Potential equalization pin
- F** Fuse for mains power supply **F1, F2**
- G** Connection for mains power supply

Left side view

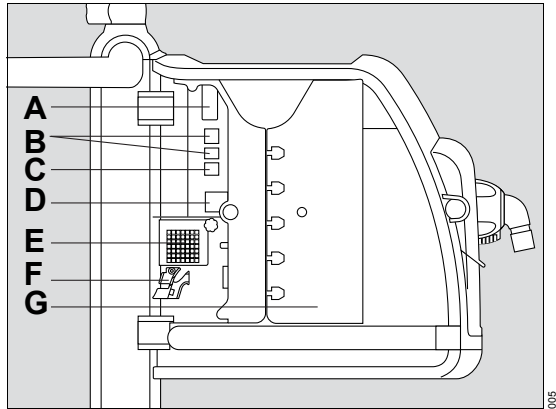

- A** Connection for system cable to Infinity C500 **V1**
- B** Connections for future extensions **V2, V3**
- C** Connection for nurse call **V4**
- D** Toggle switch 
- E** Ambient air filter with cover
- F** Strain relief for cable
- G** Left device flap

Right side view

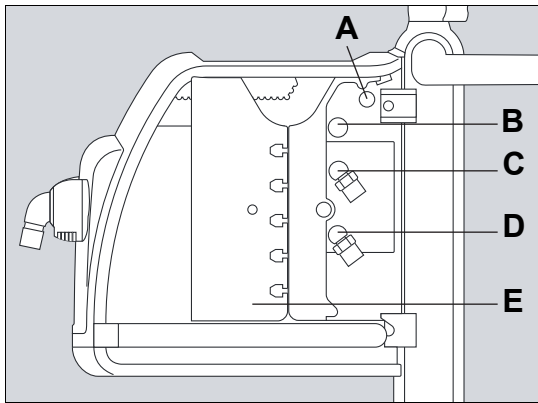

- A** Connection for data cable to the GS500 gas supply unit **V9**
- B** Connection for gas connection to the GS500 gas supply unit
- C** Connection for Air compressed gas hose **Air** (FRESH GAS)
- D** Connection for O₂ compressed gas hose **O₂** (FRESH GAS)
- E** Right device flap

Trolley 2-90 cm

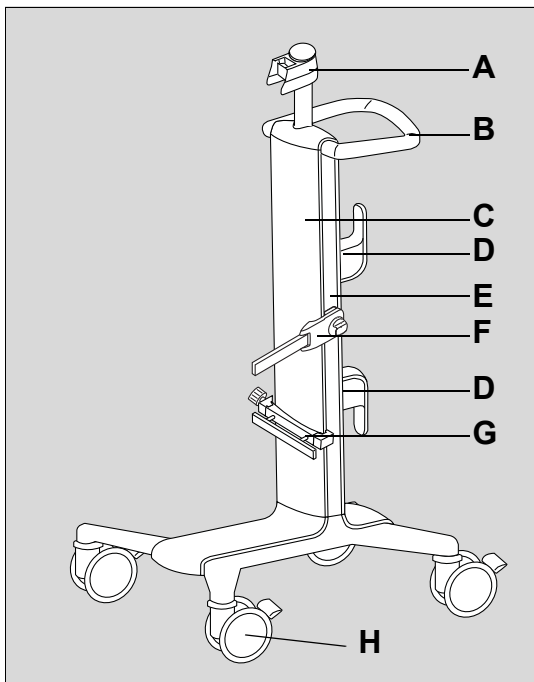

- A** Mount for Infinity C500
- B** Handle
- C** Trolley column
- D** Hose hooks
- E** Alignment aid
- F** Humidifier holder, can be swiveled
- G** Universal holder with standard rail
- H** Double castors with locking brake, set of 4

GS500 gas supply unit

Back panel

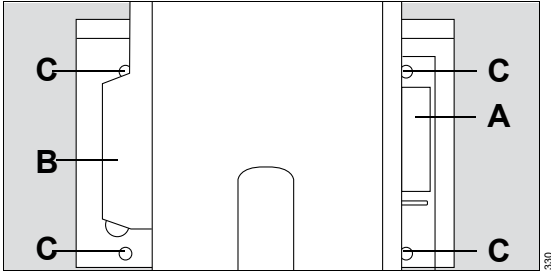

A Rating plate

B Gas connection

C Screws (to hold the side panels in place)

Range of functions

The functions described correspond to the overall functionality of Evita V500. Some functions are only optional and may not be included in the individual device configuration. Optional functions are shown in the separate list of accessories.

Ventilation functions of Evita V500

Ventilation modes:

- Volume-controlled ventilation:
 - VC-SIMV
 - VC-AC
 - VC-CMV
 - VC-MMV
- Pressure-controlled ventilation:
 - PC-SIMV
 - PC-BIPAP
 - PC-AC
 - PC-CMV
 - PC-APRV
 - PC-PSV
- Support of spontaneous breathing:
 - SPN-CPAP/PS
 - SPN-CPAP/VS
 - SPN-PPS

Additional settings for ventilation:

- Apnea Ventilation
- Flow trigger
- Inspiratory termination
- Sigh
- AutoFlow
- Volume Guarantee
- ATC
- AutoRelease
- Variable PS
- SmartCare/PS

Special functions:

- Maneuvers:
 - Manual inspiration/hold
 - Exp. hold
 - Suction maneuver
 - Manual disconnection
- Medication nebulization
- Measurement maneuver Low Flow PV Loop
- Diagnostics – measurement maneuver
 - Intrinsic PEEP measurement
 - Occlusion pressure measurement
 - NIF measurement

Therapy types:

- Invasive ventilation (Tube)
- O₂ Therapy
- Non-invasive ventilation (NIV)

Additional information

For a detailed description of the ventilation modes and the additional settings see page 310. Abbreviations see page 27.

Monitoring

Patient monitoring is supported by the following alarm limit settings:

- Maximum airway pressure P_{aw}
- Expiratory minute volume MVE
- Inspiratory tidal volume VT_i or VT
- Apnea alarm time $Tapn$
- Spontaneous respiratory rate RR_{spon}
- End-expiratory CO_2 concentration $etCO_2$

The inspiratory O_2 concentration is monitored by automatically set limits.

Evita V500 offers the following displays:

- Curves
- Graphic trends
- Numeric trends
- Loops
- Alarm history
- Logbook
- Numeric parameters
- Preconfigured lists for measured values and set values
- Customized lists for measured values and set values
- Smart Pulmonary View

During non-invasive ventilation and O_2 therapy, certain monitoring functions are switched off or can be switched off.

Power supply

Evita V500 is designed for connection to the hospital's mains power supply of 100 to 240 V at 50/60 Hz.

If mains power fails, operation is maintained either via the internal battery of Evita V500 or via the PS500 power supply unit.

Gas supply

Evita V500 features country-specific connections for the gas supply with oxygen and medical compressed air.

The Workstation Critical Care may also be equipped with the GS500 external gas supply unit. GS500 supplies Evita V500 with compressed air.

Data transfer

A variety of interfaces can be used for transferring data:

- USB port for data export and configuration exchange using a USB storage medium
- USB port for installation of optional applications via a SIM card reader and a SIM card
- RS232 port on Infinity C500 for data transfer using the MEDIBUS or MEDIBUS.X protocol

Medication nebulizer

For medication nebulization a pneumatic medication nebulizer can be connected.



Attaching accessories

Accessories can be attached to the following holders:

- Universal holder with standard rail (G93140)
- Humidifier holder, can be swiveled (G93111)
- Humidifier holder for the lateral standard rail (8416325)

Observe the permitted maximum distance to the trolley and the permitted maximum load, see "Maximum loads of holders" on page 46.

Abbreviations

Abbreviation	Explanation	Abbreviation	Explanation
% leak	Leakage in percent	C20/Cdyn	Index of the last 20 % of compliance in relation to the dynamic total compliance
%MV _{spn}	Spontaneous breathing portion of minute volume in percent	C20/Cstat	Index of the last 20 % of compliance in relation to the total compliance determined with the Low-Flow maneuver
%PEF	Percentage of the peak expiratory flow	C _{dyn}	Dynamic compliance
%PIF	Percentage of the peak inspiratory flow	cmH ₂ O	Unit of measurement for pressure 1 cmH ₂ O = approx. 1 mbar
Adult	Adult patient category	CO ₂ slope	Increase of measured CO ₂ value in phase III of the capnogram
Ah	Ampere hours (output specification for batteries)	Compens.	Degree of tube compensation
Air	Connection for Air compressed gas hose (FRESH GAS)	COPD	Chronic Obstructive Pulmonary Disease
ALARM RESET	Acknowledging an alarm message that is no longer active ("Reset")	Cstat	Static compliance
Apnea Vent.	Apnea ventilation	Cycles sigh	Number of cycles during a sigh phase (set value)
APRV	Airway Pressure Release Ventilation	DHCP	Dynamic Host Configuration Protocol
ATC	Automatic Tube Compensation, compensation of the tube resistance	Δ _{int} PEEP	Additional intermittent PEEP for sigh (set value)
Audio paused	Suppress acoustic alarm for 2 minutes: – Infinity C500 (MK31500) with the  key – Infinity C500 (MS18746) with the  key	ΔP _{supp}	Pressure support relative (above PEEP) (set value)
AutoFlow	Special function for automatic optimization of inspiratory flow	E	Elastance
BF	Insulation class Body Floating	EIP	End Inspiratory Pressure
BTPS	Body Temperature Pressure Saturated, measured values based on the condition of the patient's lungs, body temperature 37 °C (98.6 °F), water vapor-saturated gas, ambient pressure and mean airway pressure	EMC	Electromagnetic compatibility
C	Compliance	Emergency air intake	Safety air inlet, inspiratory relief valve (EMERGENCY AIR INTAKE)
		ESD	Electrostatic Discharge
		ET	Endotracheal tube
		etCO ₂	End-expiratory CO ₂ concentration
		ETSI	European Telecommunications Standards Institute

Abbreviation	Explanation	Abbreviation	Explanation
Exhaust	Gas outlet (EXHAUST – NOT FOR SPIROMETER)	Insp. term.	Termination criterion in % from the peak inspiratory flow
Exp.	Label on the device, Expiratory port (GAS RETURN)	Interval sigh	Time between two sigh phases (set value)
Exp.	Expiration	IP21	Degree of protection against ingress of liquids and particles
Exp. term.	Termination criterion in % from the peak expiratory flow	LAN	Local Area Network
FCC	Federal Communications Commission, regulatory authority for communications devices in the U.S.	LIP	Lower Inflection Point
FiO ₂	Inspiratory O ₂ concentration (set value)	mbar	Millibar, unit of measurement for pressure 1 mbar = approx. 1 cmH ₂ O
Flow	Flow (set value)	MEDIBUS	Dräger communications protocol for medical devices
Flow Assist	Flow support in SPN-PPS (set value)	MEDIBUS.X	Dräger communications protocol for medical devices with a data definition which is standardized across all devices
Flow max	Maximum inspiratory flow during NIV (Neo . patient category)	mmHg	Unit of measurement for end-expiratory CO ₂ concentration
Flow trigger	Trigger threshold, sensitivity (set value)	More...	Show more alarms
FRC	Functional Residual Capacity	MRI	Magnetic resonance imaging
GS500	Gas supply unit	MV	Minute volume, leakage-corrected
HME	Heat Moisture Exchanger	MV delay	Duration of alarm suppression for MV high and MV low
hPa	Hectopascal, unit of measurement for pressure 1 hPa = 1 mbar = approx. 1 cmH ₂ O	MV high	Upper alarm limit for minute volume
I:E	Ratio of inspiratory time to expiratory time (set value)	MV low	Lower alarm limit for minute volume
I:Espon	I:E during spontaneous breathing	MVapn	Minute volume during apnea ventilation
IEC/CEI	Alarm tone in accordance with IEC 60601-1-8	MVe	Expiratory minute volume, overall, not leakage-corrected
incl. PEEP	Externally applied PEEP, is contained in the intrinsic PEEP	MVemand	Mandatory expiratory minute volume
Insp.	Label on the device, Inspiratory port (GAS OUTPUT)	MVespon	Spontaneous expiratory minute volume
Insp.	Inspiration	MVi	Inspiratory minute volume, overall, not leakage-corrected
Insp. flow	Inspiratory flow	MVleak	Leakage minute volume

































Abbreviation	Explanation	Abbreviation	Explanation
Neo.	Neonates patient category	PC-PSV	Pressure Control-Pressure Support Ventilation, spontaneous breathing at continuous positive pressure level with pressure support and back-up respiratory rate
NIF	Negative Inspiratory Force, maximum inspiratory effort	PC-SIMV	Pressure Control-Synchronized Intermittent Mandatory Ventilation, intermittent, triggered, pressure-controlled ventilation
NiMH	Nickel-metal hydride (battery technology)	Ped. pat.	Pediatric patient category
NIV	Non-Invasive Ventilation	PEEP	Positive end-expiratory pressure
NMI	Nuclear magnetic imaging	PEEPi	Intrinsic PEEP
NMR	Nuclear magnetic resonance	Phigh	Upper pressure level in APRV (set value)
NO	Nitric oxide	Pinsp	Inspiratory pressure (set value)
NTPD	Normal Temperature Pressure Dry, 20 °C (68 °F), 1013 hPa, dry	PIP	Peak Inspiratory Pressure
O ₂	Connection for O ₂ compressed gas hose (FRESH GAS)	Plimit	Pressure limitation during Low-Flow maneuver (set value)
O ₂ suction	Suction maneuver	Plow	Lower pressure level in APRV (set value)
P0.1	100 ms occlusion pressure	PmanInsp	Pressure of the breath for manual inspiration during NIV (Neo. patient category, SPN-CPAP ventilation mode)
Palv	Alveolar pressure	Pmax	Maximum allowed airway pressure (set value)
Paw	Airway pressure	Pmax/Paw high autose	Linking the maximum airway pressure to the alarm limit Paw high
Paw high	Upper alarm limit for airway pressure	PMC	Point of Maximum Curvature
PC-AC	Pressure Control-Assist Control, assisted-controlled, pressure-controlled ventilation with back-up respiratory rate	Pmean	Mean airway pressure
PC-APRV	Pressure Control-Airway Pressure Release Ventilation, spontaneous breathing under continuous positive airway pressure with brief pressure releases	Pmin	Minimum airway pressure
PC-BIPAP	Pressure Control-Biphasic Positive Airway Pressure, spontaneous breathing under continuous positive airway pressure with 2 different pressure levels	Pplat	Airway pressure on the plateau
PC-CMV	Pressure Control-Continuous Mandatory Ventilation, continuous pressure-controlled ventilation	Press. var.	Variation of pressure support with Variable PS (set value)
		PS	Pressure Support
		PS500	Power supply unit



































Abbreviation	Explanation	Abbreviation	Explanation
Pstart	Initial pressure during Low-Flow maneuver (set value)	SPN-CPAP/PS	Spontaneous-Continuous Positive Airway Pressure/Pressure Support, spontaneous breathing with continuous positive pressure level with or without pressure support
Psupp	Pressure support absolute	SPN-CPAP/VS	Spontaneous-Continuous Positive Airway Pressure/Volume Support, spontaneous breathing with continuous positive pressure level with or without volume support
Ptrach	Pressure in the trachea	SPN-PPS	Spontaneous-Proportional Pressure Support, spontaneous breathing with flow-proportional and volume-proportional pressure support
R	Total resistance	SpO ₂	Partial O ₂ saturation
r ²	Correlation coefficient for the calculation method "Least Mean Square" for R, C and TC	STPD	Standard Temperature Pressure Dry, 0 °C (32 °F), 1013 hPa, dry
REF	Material and revision number of the medical device	Tapn	Apnea alarm time (set value)
RF	Radio Frequency	TC	Time constant tau
RFID	Radio Frequency Identification	TCe	Time constant calculated from VTe and the peak expiratory flow
Rpat	Patient resistance, patient airway resistance	Tdisconnect	Time for disconnection alarm (set value)
RR	Respiratory rate (set value)	Te	Expiratory time (set value)
RR high	Upper alarm limit for respiratory rate	Te RC	Expiratory time based on the resistance and compliance measurements
RRapn	Respiratory rate of apnea ventilation (set value)	TGI	Tracheal Gas Insufflation, tracheal gas insufflation
RRmand	Mandatory portion of respiratory rate	Thigh	Time of upper pressure level in APRV (set value)
RRspon	Spontaneous breathing portion of respiratory rate	Ti	Inspiratory time (set value)
RRtrig	Portion of mandatory triggered breaths	Ti RC	Inspiratory time based on the resistance and compliance measurements
RSB	Rapid Shallow Breathing, quotient of spontaneous respiratory rate and tidal volume	Timax	Maximum inspiratory time for flow during pressure or volume support (set value)
SIM	Subscriber Identity Module, participant identification		
Slope	Pressure rise time (set value)		
Smart Pulmonary View	Graphic display of lung characteristics (Lung display)		
SN	Device serial number		
SPN-CPAP	Spontaneous-Continuous Positive Airway Pressure, spontaneous breathing with continuous positive pressure level		

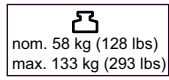

Abbreviation	Explanation	Abbreviation	Explanation
Tispon	Inspiratory time during spontaneous breathing	VC-SIMV	Volume Control-Synchronized Intermittent Mandatory Ventilation, intermittent, triggered, volume-controlled ventilation
Tisupp	Inspiratory time during pressure support	Vds	Serial dead space, serial dead space volume up to the CO ₂ cuvette
Tlow	Time of lower pressure level in APRV	Vds/VTe	Ratio of dead space volume to expiratory tidal volume
Tlow max	Maximum expiratory time during APRV (set value)	VG	Volume Guarantee, Volume Guarantee
TmanInsp	Duration of the breath for manual inspiration during NIV (patient category Neo. , ventilation mode SPN-CPAP)	Vlimit	Volume limitation during Low-Flow maneuver (set value)
Tmax	Calculated maximum time for Low-Flow maneuver	Vol. Assist	Volume support in SPN-PPS (set value)
Tplat	Time of inspiratory plateau	VRLA	Valve-regulated lead-acid (battery technology)
Trach.	Tracheostomy tube	VS	Volume Support
Tube Ø	Inner diameter of tube (set value)	VT	Tidal volume, leakage-corrected
TVS	Transfer of Ventilator Settings	VT high	Upper alarm limit for the inspiratory tidal volume
UIP	Upper Inflection Point	VT low	Lower alarm limit for the inspiratory tidal volume
UMDNS	Universal Medical Device Nomenclature System, nomenclature for medical devices	VTapn	Tidal volume of apnea ventilation (set value)
UN	Rated voltage	VT _{CO₂}	Amount of CO ₂ expired per breath
USB	Universal Serial Bus, serial bus system	VTe	Expiratory tidal volume, not leakage-corrected
Variable PS	Variable pressure support in SPN-CPAP/PS	VTemand	Expiratory tidal volume during a mandatory breath
VC-AC	Volume Control-Assist Control, assisted-controlled, volume-controlled ventilation with fixed inspiratory flow and backup respiratory rate	VTespon	Expiratory tidal volume during a spontaneous breath
VC-CMV	Volume Control-Continuous Mandatory Ventilation, continuous volume-controlled ventilation	VTi	Inspiratory tidal volume, not leakage-corrected
VC-MMV	Volume Control-Mandatory Minute Volume Ventilation, volume-controlled ventilation to ensure minimum minute ventilation	VTimand	Inspiratory tidal volume during a mandatory breath
V'CO ₂	Amount of CO ₂ expired per minute	VTispon	Inspiratory tidal volume during a spontaneous breath

Abbreviation	Explanation
VTmand	Tidal volume during a mandatory breath
Vtrap	Volume trapped in the lungs by intrinsic PEEP, and not exhaled during subsequent expiration
VTspon	Tidal volume during a spontaneous breath

Symbols

Symbol	Explanation	Symbol	Explanation
	Acoustic alarm suppressed for 2 minutes		Lower alarm limit
	Group Views, screen displays		Upper alarm limit
	Group Trends/Data, information on the course of ventilation		Setting or access locked
	Group Special maneuvers		Setting or access unlocked
	Group Alarms		Expiratory valve unlocked
	Group Therapy, ventilation parameter settings	← Exhaust	Gas outlet (EXHAUST – NOT FOR SPIROMETER)
	Group configuration, system settings, and settings for sensors		Adult patient category (Adult)
	Group Start/Standby		Pediatric patient category (Ped. pat.)
	Switch system on or off (with the key on Infinity C500)		Neonates patient category (Neo.)
	Alarm limit off	↑	Display additional information or open Help
	Configure trends	↓	Hide additional information or close Help
	Save screen display	↑↑	Scroll back in tables or lists
	Medication nebulizer	↑↓	Scroll forward in tables or lists
	Charge state of batteries 90 to 100 %	→	Scroll forward in Help
	Charge state of batteries 60 to <90 %	←	Scroll backward in Help
	Charge state of batteries 40 to <60 %		Close dialog window
	Charge state of batteries 20 to <40 %		Active test in the device check
	Charge state of batteries <20 %		Spontaneous breathing activity by the patient
	Batteries defective or no information available on their charge state		NIV, non-invasive ventilation
			Suppress acoustic alarm for 2 minutes (key on Infinity C500 MS18746)

Symbol	Explanation	Symbol	Explanation
	Suppress acoustic alarm for 2 minutes (key on Infinity C500 MK31500)		Device ready for switch-on (only the following symbol is used in the instructions for use: )
	Mains power supply (AC voltage)		Device switched off (only the following symbol is used in the instructions for use: )
	GS500: Mains power supply (AC voltage, if separate mains plug is available)		Labeling for FCC approval
	Power supply from batteries		Labeling in accordance with Directive 93/42/EEC concerning medical products
	Caution: Observe important safety information and precautions in the instructions for use.		Labeling in accordance with Directive 1999/5/EC on radio equipment and telecommunications terminal equipment
	Observe the instructions for use		Serial interface (on Infinity C500)
	Connection for equipotential bonding		LAN port (on Infinity C500)
	Protective earth		USB port (on Infinity C500)
	Application part type BF		DVI port (on Infinity C500)
	Nurse call		Attention!
	Marking point on the trolley – do not lean, press, push or pull against the trolley above the marking points		Warning! Strictly follow instructions for use.
	ESD warning symbol		Label regarding intrahospital transport
	ESD warning symbol		Nominal weight and maximum weight (for information, see chapter "Technical data")
	Information on disposal		Temperature limitation during storage
	Manufacturer		Ambient pressure
 20XX	Date of manufacture		Relative humidity
	Connection for the neonatal flow sensor		
			
			

Symbol	Explanation
	Use by
	Keep dry

This page has been left blank intentionally.

Operating concept

Operating concept for Infinity C500	38
Operating concept for Evita V500	38
Main screen	38
Main menu bar	39
Dialog windows.	40
Therapy bar	40
Therapy control.	40
Setting ventilation parameters	41
Exceeding the set limit of a ventilation parameter	41
Direct setting of ventilation parameters (QuickSet).	41
Linked setting of ventilation parameters.	42

Operating concept for Infinity C500

Infinity C500 is the central operating and display unit. The general operating concept is described in the instructions for use for "Infinity Medical Cockpits".

Operating concept for Evita V500

The following operating concept only contains the specific information and operating steps for Evita V500.

This chapter describes:

- Main screen
- Main menu bar
- Dialogs windows
- Therapy line
- Therapy controls
- Setting ventilation parameters
- Exceeding the set limit of a ventilation parameter
- Direct setting of ventilation parameters (QuickSet)
- Linked setting of ventilation parameters

Main screen

The main screen displays the most important ventilation information at a glance.

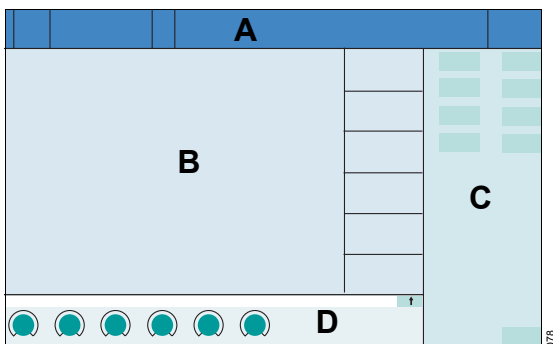

A Header bar with the following fields:

- Patient category, see page 70
- System data, e.g., state of charge of the batteries, see page 135
- Therapy status: Therapy type (ventilation or O₂ Therapy), ventilation mode and additional settings
- Alarms, messages and instructions for the user, see page 140
- Alarm status

B Monitoring area with curves, loops, trends and measured values, see page 102. The display can be configured, see page 176.

C Main menu bar with buttons for opening dialog windows and activating functions, see page 39.

D Therapy bar with the therapy controls for the ventilation parameters of the active ventilation mode, see page 40.

The main screen can be configured for direct access as a **Main screen** button in the main menu bar. See "Assigning functions to additional buttons" on page 179.

Main menu bar

The main menu bar contains fixed assigned and configurable buttons. The buttons are assigned to various groups. Touching a button opens the corresponding dialog window or activates the corresponding function.

Fixed assigned buttons

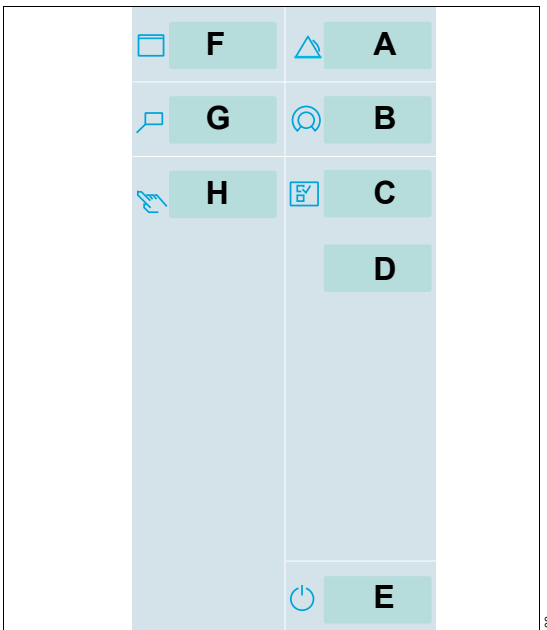

- A Alarms...** for setting the alarm limits and displaying the alarm logbook and listing all active alarms, see page 140.
- B Ventilation settings...** for setting the ventilation mode and the ventilation parameters, see page 91.
- C Sensors/ Parameters...** for calibrating the sensors and for activating or deactivating monitoring, see page 157.
- D System setup...** for configuring the device functions, see page 173.
- E Start/ Standby...** for selecting standby mode or starting therapy, see page 130.

- F Views...** for switching to other configured monitoring area views, see page 102.
- G Trends/Data...** for displaying all the measured and set values, logbook, trends and for exporting data, see page 149.
- H Special maneuvers...** for selecting additional functions, e.g., suction maneuver, see page 108, or medication nebulization, see page 111.

Configurable buttons

Additional buttons for directly accessing functions or dialogs can be configured. These buttons are spatially assigned to the corresponding group. See "Assigning functions to additional buttons" on page 179.

Dialog windows

Dialog windows consist of one or several pages which are displayed by touching the corresponding horizontal or vertical tab. Dialog windows contain elements for operating the device and informing the user on current settings. Dialog windows can be opened by touching a button in the main menu bar.

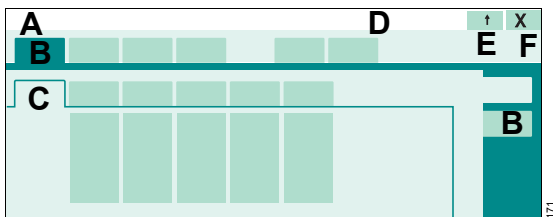

- A Dialog window title
- B Tab to open a page
- C Opened page of the dialog window
- D Message field for dialog-specific information and instructions
- E Button for accessing additional information and the **Help** function (if available)
- F Button for closing the dialog window

Therapy bar

The therapy bar on the main screen contains the therapy controls for the active ventilation mode.

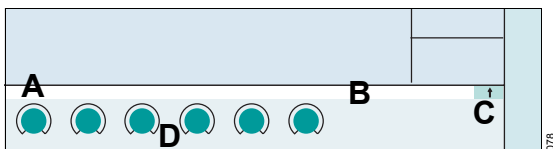

- A Name of active ventilation mode
- B Message field for specific messages on the active ventilation mode
- C Button for opening the dialog window for the ventilation settings of the active ventilation mode
- D Therapy controls

Therapy control

The therapy controls (A) are used to set the ventilation parameters.

Therapy controls are contained in the therapy bar of the active ventilation mode and in the dialog window for the ventilation settings.

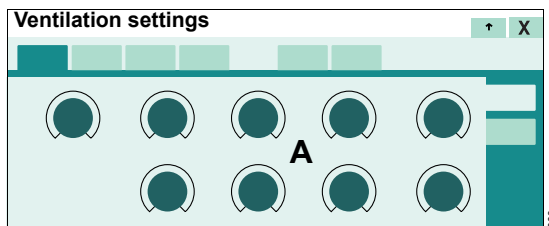

Start-up settings

Arrows ► beside the scales on the therapy controls indicate the start-up values valid when Evita V500 is switched on. These start-up values can be adjusted specifically as required by the hospital. See "Configuring start-up settings for the ventilation parameters" on page 189.

Locking mechanism

The therapy controls in the therapy bar can be locked against the ventilation parameters being changed by accident. See "Locking therapy controls in the therapy bar" on page 182.

Setting ventilation parameters

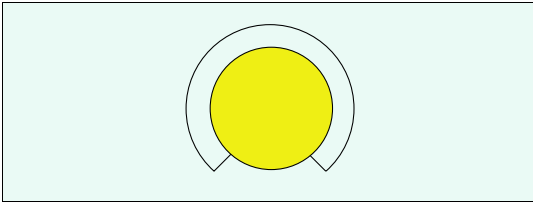

- 1 Touch the therapy control. The color turns yellow. The unit of the parameter to be adjusted is displayed in parentheses.
- 2 Turn the rotary knob to set the value.
- 3 Press the rotary knob to confirm the value. The color of the therapy control turns dark green.

The following chapters of the instructions for use provide a simplified explanation of these steps:
"Use the rotary knob to set and confirm the value."

Exceeding the set limit of a ventilation parameter

When a set limit of a parameter has been reached, Evita V500 displays a message.

- Press the rotary knob to exceed the set limit.

The set limit can be exceeded.

If the maximum set limit for a parameter has been reached, e.g., when it is dependent on other parameters, it is not possible to exceed the set limit.

- Press the rotary knob. Evita V500 adopts the maximum possible set value.

Direct setting of ventilation parameters (QuickSet)

When a ventilation parameter is set directly, the changes to a setting become immediately effective for the patient. The user can immediately see the effect the changed setting has on the patient. The finally chosen setting does not have to be confirmed again.

Ventilation parameters can be set directly in all ventilation modes and can be carried out in the dialog window for the ventilation settings. Direct settings are only possible in the therapy bar when the therapy controls are not locked.

O₂ and Flow cannot be set directly.

Setting ventilation parameters directly

- 1 Touch the corresponding therapy control.
- 2 Press the rotary knob and hold for approximately 3 seconds.

The therapy control changes to dark green with a yellow edge. The direct setting function is now active.

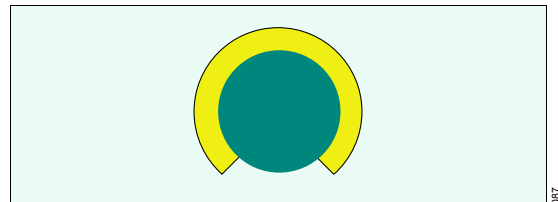

- 3 Press and hold the rotary knob and turn to set the value.

The set value is immediately effective.

Exceeding the set limit of a parameter with direct setting

When a set limit of a parameter has been reached, Evita V500 displays a message.

- 4 Release rotary knob for a short moment.
- 5 Press the rotary knob again and turn it.

The set limit can be exceeded.

Linked setting of ventilation parameters

The linked setting is possible for **PEEP/Pinsp** and for **RR/Ti**.

Linking **PEEP Pinsp**

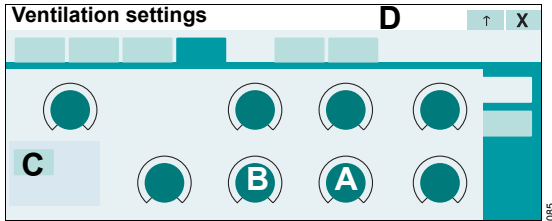

- 1 Touch the therapy control **PEEP** (A) or **Pinsp** (B); the color turns to yellow.

The **Link** button (C) is displayed.

- 2 Touch the **Link** button (C).

The therapy control of the other linked parameter to be linked (**Pinsp** or **PEEP**) turns yellow.

- 3 Turn the rotary knob to set the value for **PEEP** and **Pinsp**. The other value is also automatically changed so that the difference in pressure remains constant.

- 4 Press the rotary knob to confirm the value.

Both therapy controls turn dark green.

Linking **RR Ti**

Setting **RR** and **Ti** is effected analogously to the linked setting of **PEEP** and **Pinsp**. The I:E ratio remains constant. If the respiratory rate is increased, the inspiratory time is reduced. If the inspiratory time is increased, the respiratory rate is reduced.

Additional information

If a condition is reached in which a parameter cannot be changed anymore when setting linked parameters, Evita V500 displays a corresponding message in the message field (D).

Assembly and preparation

Safety information for assembly and preparation	44
Preparing the trolley	44
Safety information on the trolley	44
Connecting the universal holder with standard rail to the trolley	45
Connecting the humidifier holder to the trolley	45
Securing accessories to the standard rail	46
Securing the compressed gas cylinders to the trolley	46
Preparing the Medical Cockpit	48
Positioning Infinity C500	48
Positioning Infinity C500	48
Connecting the system cable	49
Using the MEDIBUS or the MEDIBUS.X protocol	51
LAN and USB interfaces of Infinity C500	52
Preparing the ventilation unit	53
Preparing the expiratory valve	53
Fitting the flow sensor	54
Safety information for the use of HMEs, bacterial filters, and breathing circuits	56
Preparing the breathing gas humidifier	57
Connecting the breathing circuit	58
Installing a neonatal flow sensor	59
Replacing the neonatal flow sensor insert	60
Installing a CO ₂ cuvette and CO ₂ sensor	61
Connecting the mains power supply to Evita V500	62
Connecting the mains power supply to the GS500 gas supply unit	63
Power supply from batteries	63
Failure of the power supply	63
Potential equalization	63
Connecting the gas supply	64
Connecting the nurse call	65
Closing the flaps at the side of the device	66
Intrahospital transport	66

Safety information for assembly and preparation

WARNING

Before each use, reprocess the device and all accessories in accordance with the instructions for use, see "Reprocessing list" on page 251. Observe the hospital hygiene regulations!

WARNING

Securely mount Evita V500. Check for secure fit. Danger of damage to device or personal injury!

WARNING

Risk of tipping over

Do not tilt the device by more than 5°.

WARNING

Do not place any containers with liquid on or above the device! Penetrating liquid may cause malfunction of or damage to the device, which may endanger the patient.

WARNING

Failure to observe the permitted maximum load and weight distribution may result in the device toppling over. Danger of damage to device or personal injury! Observe the permitted maximum load and weight distribution, see "Maximum load" on page 299.

CAUTION

When parking the device, lock all the double castors of the trolley and check that the brakes are working properly.

Preparing the trolley

Safety information on the trolley

WARNING

Do not use the trolley in the event of visible damage, e.g., damaged double castors! Contact DrägerService.

WARNING

Do not lean, press, push or pull against the trolley above the marking points on the trolley. The trolley could topple over.

CAUTION

Connect all devices securely to the trolley. Check for secure fit. Danger of damage to device or personal injury!

Connecting the universal holder with standard rail to the trolley

Attach the universal holder with standard rail to the front of the trolley.

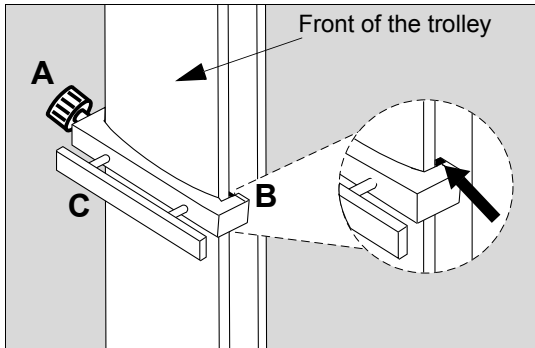

- 1 Unscrew the adjusting screw (A) completely.
- 2 Attach the right-hand side of the universal holder to the right-hand side of the rail (B). Make sure that the catch of the universal holder is completely behind the alignment aid.
- 3 Align the universal holder (C) horizontally and press the left-hand side of the universal holder onto the left-hand side of the column.
- 4 Tighten the adjusting screw (A). Make sure that the catch of the universal holder is completely behind the alignment aid.
- 5 Check that the universal holder is fixed securely.

Adjusting the height of the universal holder

- 1 Unscrew the adjusting screw (A).
- 2 Adjust the height of the universal holder (C).
- 3 Align the universal holder horizontally.
- 4 Retighten the adjusting screw (A).

Connecting the humidifier holder to the trolley

The humidifier holder is attached to the front of the trolley. The humidifier holder can be fastened on the left or right-hand side of the trolley column. The attachment of the humidifier holder on the right-hand side is shown.

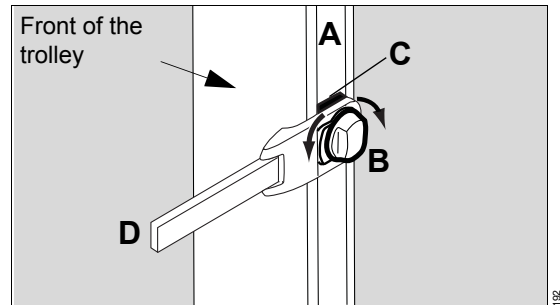

- 1 Hold the humidifier holder at the desired height on the guide (A) of the trolley column.
- 2 Turn the clamping screw (B) to the left until the base (C) fits into the guide of the trolley column.
- 3 Turn the clamping screw (B) to the right until the humidifier holder is secured firmly in the guide.
- 4 Move the standard rail (D) to the desired position.

Securing accessories to the standard rail

Maximum loads of holders

The following information applies to the holders:

Holder	Position of the holder	Maximum load	Possible accessories	Maximum distance to the lateral standard rail
Universal holder with standard rail (G93140)	On the front of the trolley	10 kg (22 lb)	Breathing gas humidifier, medication nebulizer	–
Humidifier holder, can be swiveled (G93111)	On the side of the trolley	5 kg (11 lb)	Breathing gas humidifier	–
Humidifier holder for the lateral standard rail (8416325)	On the lateral standard rails of the ventilation unit ¹⁾	5 kg ²⁾ (11 lb)	Breathing gas humidifier	10 cm (3.9 in)
IACS hinged arm (MP00690)	On the lateral standard rails of the ventilation unit ¹⁾	1 kg (2.2 lb)	Breathing hoses	100 cm (39.4 in)

- 1) Maximum load on the lateral standard rails of the ventilation unit: 5 kg (11 lb) on each lateral standard rail
- 2) If a hinged arm is attached to the lateral standard rails of the ventilation unit in addition to the humidifier holder (8416325), the maximum load of 5 kg (11 lb) per side rail must be observed. The humidifier holder can then only support 4 kg (8.8 lb).

Securing the compressed gas cylinders to the trolley

Only available with the cylinder holder option

WARNING

Securely attach the compressed gas cylinders to the trolley, using both hook-and-loop straps. Otherwise there is a risk of the trolley toppling over. Danger of damage to device or personal injury!

WARNING

Have the height of the upper holder adjusted to the respective compressed gas cylinders by service personnel. The height must be adjusted so that the top half of the compressed gas cylinders are secured by the hook-and-loop strap. Otherwise there is a risk of the trolley toppling over. Danger of damage to device or personal injury!

WARNING

The length of the hook-and-loop straps must match the diameter of the compressed gas cylinders to ensure that the hook-and-loop straps can hold the cylinders securely. If necessary have an appropriate hook-and-loop strap fitted by service personnel. This is essential to ensure that the compressed gas cylinders are properly secured.

Compressed gas cylinders with the following dimensions can be secured:

- Diameter: 80 to 176 mm (3.15 to 6.93 in)
 Length: 420 to 760 mm (16.54 to 29.92 in)

WARNING

Not every combination of compressed gas cylinder diameter and length can be secured. When used in combination with a pressure reducer, the compressed gas cylinder must not come into contact with the console of the trolley. The maximum diameter is 176 mm (6.93 in) when the base of the compressed gas cylinder is resting completely on the base plate of the lower holder or is semi-spherical in shape.

- 1 Place the cylinders into the mountings on the trolley.
- 2 Secure each cylinder with 2 hook-and-loop strap (A).
- 3 Secure the compressed gas hoses by hanging them over the hose hooks (B).

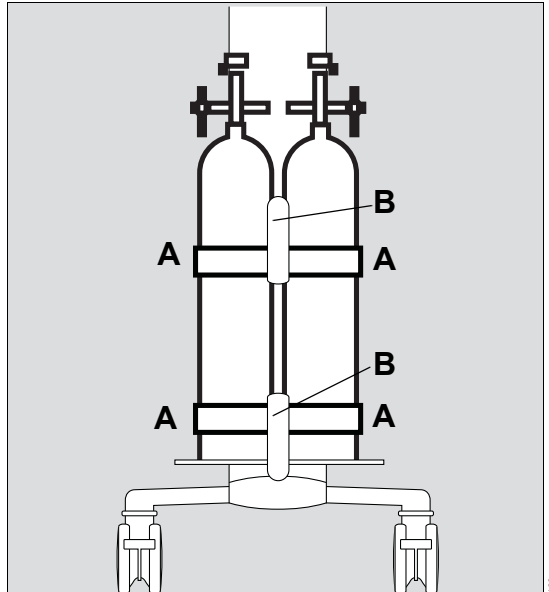

WARNING

Position the compressed gas cylinders fitted with pressure reducers in such a way to prevent the pressure reducers from being damaged during transport. The lower part of the trolley is designed to protect against collisions. Take particular care when the compressed gas cylinders being used extend beyond this collision protection.

Preparing the Medical Cockpit

Positioning Infinity C500

Infinity C500 is suitable for positioning on the trolley or on a standard rail.

Positioning Infinity C500 on the trolley

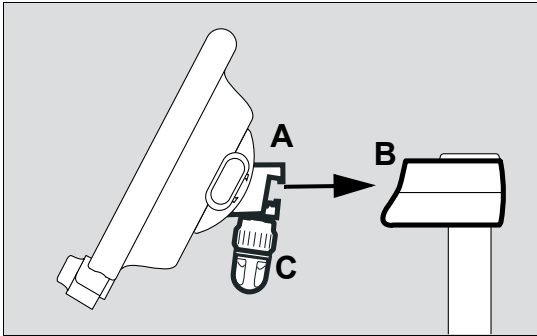

- 1 Hook the Infinity C500 holder (A) into the mounting (B) on the trolley.
- 2 Tighten the locking screw (C).
- 3 Make sure that Infinity C500 is securely attached to the trolley.

Positioning Infinity C500 on a standard rail

If Infinity C500 is connected to the trolley:

- 1 Unscrew the locking screw (C).
- 2 Lift Infinity C500 out of the mounting (B) on the trolley.
- 3 Hook Infinity C500 into the standard rail.
- 4 Tighten the locking screw.
- 5 Make sure that Infinity C500 is securely attached to the standard rail.

Positioning Infinity C500

Tilting the position of Infinity C500

Infinity C500 can be tilted down and up.

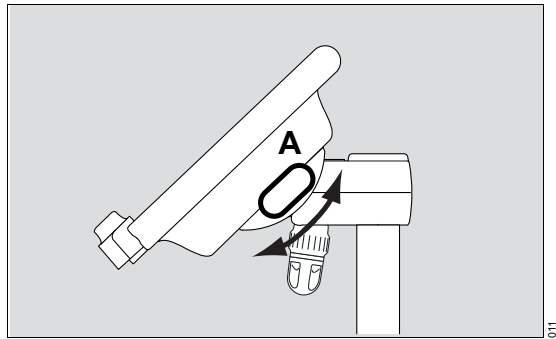

- 1 Press and hold the tilt release button (A).
- 2 At the same time, tilt Infinity C500 to the desired working position.
- 3 Release the button and make sure that it engages securely.

Turning Infinity C500

Infinity C500 can be turned by a maximum of 180° counterclockwise or 90° clockwise.

- Turn to the desired working position.

Connecting the system cable

The system cable is connected to Infinity C500 and to Evita V500. The system cable is fixed in a clamp.

Connecting the system cable to Infinity C500

On Infinity C500 (MS18746):

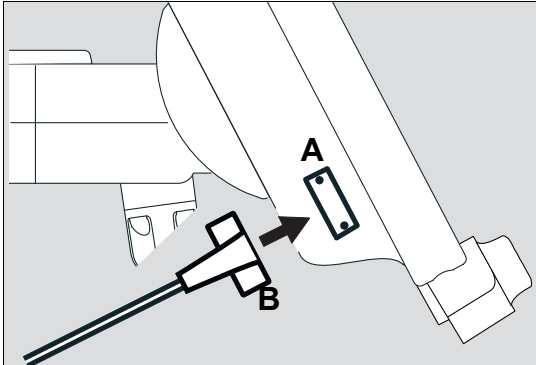

On Infinity C500 (MK31500):

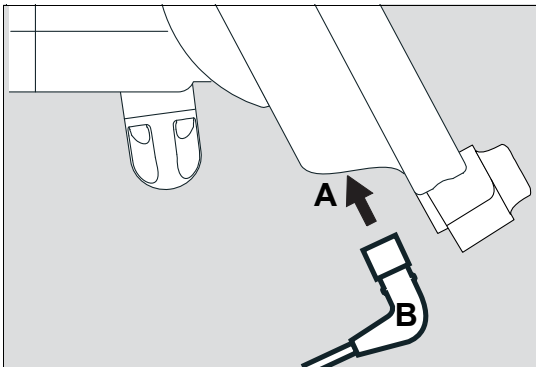

- 1 Unscrew the cover from the socket (A).
- 2 Insert the system cable connector (B) into the socket (A). Ensure that the connector is inserted with the correct orientation.
- 3 Screw the cover back on.

Connecting the system cable to Evita V500

- 1 Open the flap on the left-hand side of Evita V500.
- 2 Run the system cable between Evita V500 and the handle.

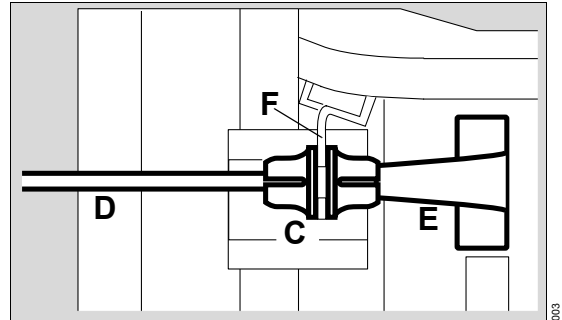

- 3 Clip the protective sleeve (C) immediately after the connector (E) onto the system cable (D). Align the protective sleeve so that the slots of the protective sleeve are facing downwards and upwards.
- 4 Insert the system cable connector (E) into the socket until the connector audibly clicks into place.
- 5 Insert the protective sleeve (C) into the protective plate (F) at the same time.
- 6 Turn the protective sleeve (C) by approximately 90° until it clicks into place. The cable is secured.
- 7 Close the left-hand flap.

Disconnecting the system cable from Evita V500

- 1 Push the locking mechanism on the connector (E) backwards and pull out the connector.
- 2 Turn the protective sleeve (C) by approximately 90° and withdraw it from the protective plate (F).

Fixing the system cable in the clamp (G)

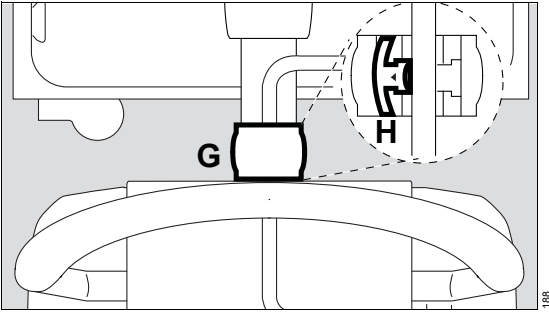

- 1 Open the clamp cover (H).
- 2 Place the system cable into the clamp. Keep the cable length short between the clamp and Evita V500.
- 3 Close the clamp cover (H) and engage. Ensure that the cover engages securely.

Removing the system cable from the clamp

- 1 Open the clamp cover.
- 2 Remove the cable from the clamp.
- 3 Close the clamp cover and engage.

Using the MEDIBUS or the MEDIBUS.X protocol

WARNING

Risk of patient injury

All data transferred via the MEDIBUS interface are for information only and must not be used as the sole basis for diagnostic or therapeutic decisions. The MEDIBUS interface is not intended for use with a distributed alarm system conforming to IEC 60601-1-8:2012.

MEDIBUS and MEDIBUS.X are software protocols for transferring data between Evita V500 and an external medical or non-medical device (e.g., patient monitors or computers for data management systems).

Additional information

For MEDIBUS:

"MEDIBUS for V and VN ventilators" (9039527)

"Dräger RS 232 MEDIBUS, Protocol Definition" (9028258)

For MEDIBUS.X:

"MEDIBUS.X, Rules and Standards for Implementation" (9052607)

"MEDIBUS.X, Profile Definition for Data Communication V1.n" (9052608)

Connecting an external device for using MEDIBUS or MEDIBUS.X

On Infinity C500 (MS18746):

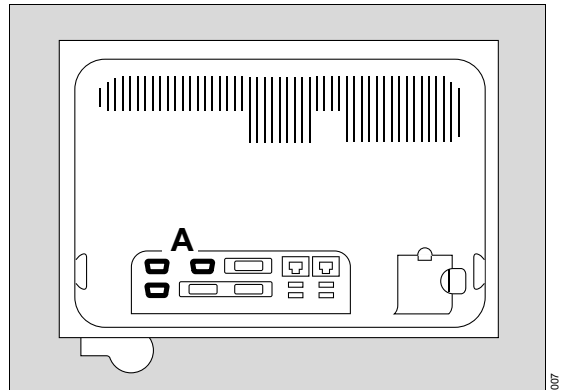

On Infinity C500 (MK31500):

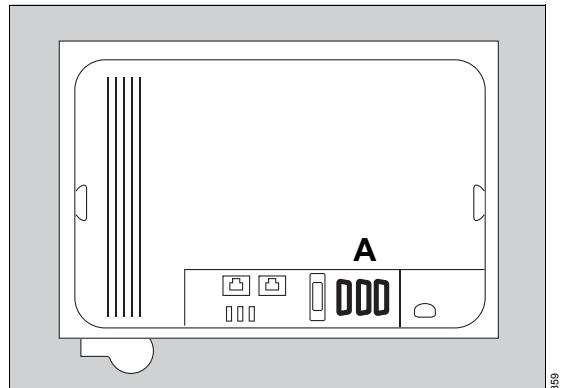

- Connect an external device to the COM 1, COM 2 or COM 3 interface  (A) of Infinity C500. Use MEDIBUS cable 8416326.

Configuring the interface

A description is given in chapter "Configuring interfaces" on page 201.

LAN and USB interfaces of Infinity C500

On Infinity C500 (MS18746):

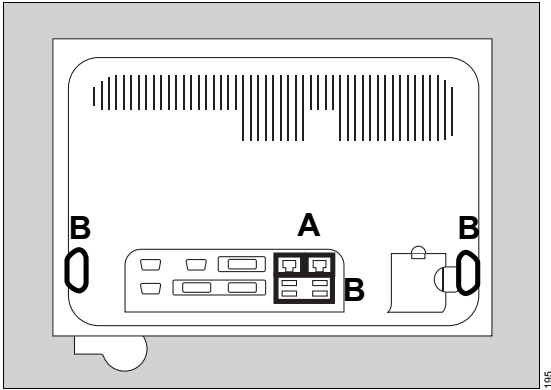

On Infinity C500 (MK31500):

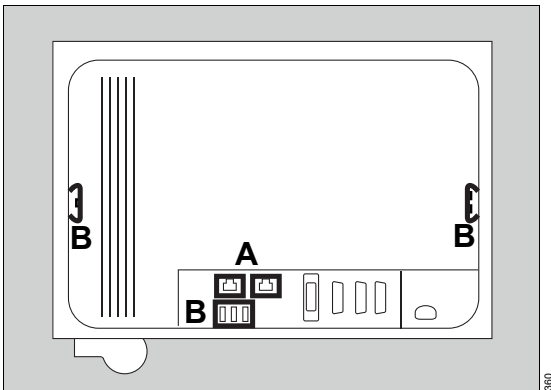

Use of LAN interfaces (A) of Infinity C500 is permitted exclusively for service purposes.

Only connect the following to the USB port (B):

- USB storage medium
- USB SIM card reader
- Aerogen nebulizer

WARNING

Risk of voltage surges and device malfunction

Do not connect a device that has its own power supply to the USB port, e.g., a printer or external hard drive.

WARNING

Do not simultaneously touch the connectors of the interfaces and the patient. Risk of electric shock.

Preparing the ventilation unit

Preparing the expiratory valve

The expiratory valve must be selected in accordance with the patient category:

Adult	Infinity ID expiratory valve
Ped. pat.	Infinity ID expiratory valve or Infinity ID neonatal expiratory valve
Neo.	Infinity ID neonatal expiratory valve

WARNING

Only use properly reprocessed expiratory valves which have been sufficiently dried. Otherwise the proper functioning of the device may be impaired and the patient endangered.

The expiratory valve is mounted and then inserted into the ventilation unit.

Fitting the Infinity ID expiratory valve

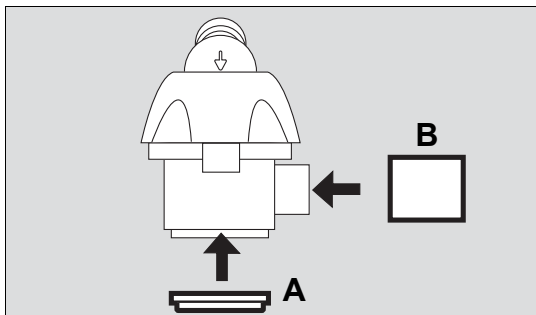

- 1 Fit the diaphragm (A) onto the edge of the expiratory valve housing. Make sure that the diaphragm is fitted properly.
- 2 If the flow sensor sleeve (B) has been removed, fit the flow sensor sleeve.

Fitting the Infinity ID neonatal expiratory valve

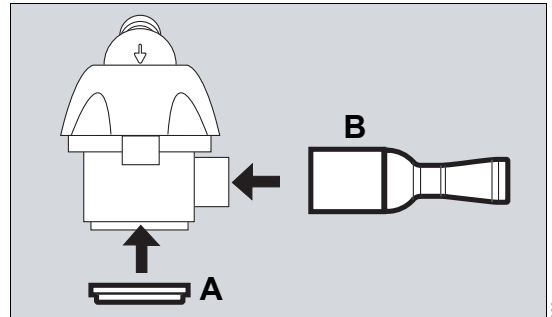

- 1 Fit the diaphragm (A) onto the edge of the expiratory valve housing. Make sure that the diaphragm is fitted properly.
- 2 If the muffler (B) has been removed, fit the muffler.

Only the Infinity ID expiratory valve is described in the following sections. However, the Infinity ID neonatal expiratory valve is prepared using the same method.

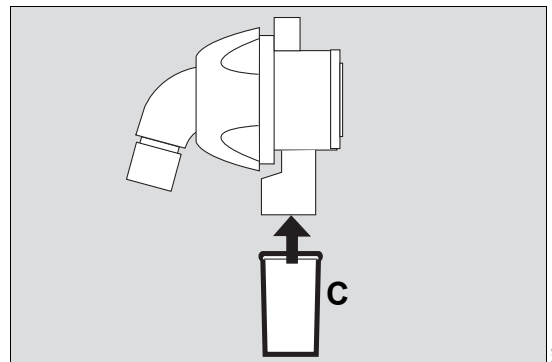

- 3 Fit the water trap container (C).

Opening the flap

Open the flap (D) before inserting the expiratory valve.

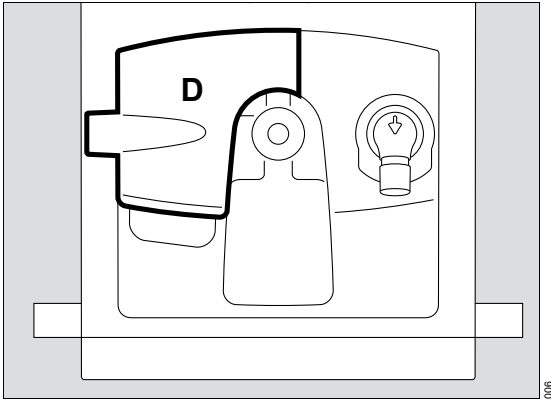

- Open the flap (D) by lifting the lower edge upwards.

Inserting the expiratory valve into the ventilation unit

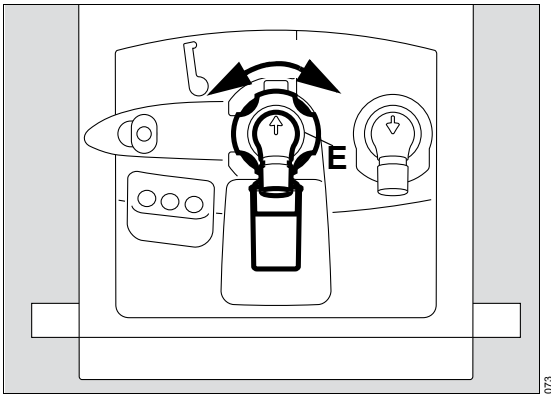

- 1 Turn the locking ring (E) as far as possible to the left.
- 2 Push the expiratory valve into the fitting.
- 3 Turn the locking ring (E) as far as it will go to the right until it clicks audibly into place.
- 4 Check that it is properly secured by gently pulling on the expiratory valve.

Fitting the flow sensor

WARNING

Risk of fire

Residual vapors of easily flammable disinfectants (e.g., alcohols) and deposits that were not removed during reprocessing can ignite when the flow sensor is in use.

- Ensure particle-free cleaning and disinfection.
- After disinfection, allow the flow sensor to air for at least 30 minutes.
- Before inserting the flow sensor check for visible damage and soiling, such as residual mucus, medication aerosols, and particles.
- Replace flow sensors when damaged, soiled, or not particlefree.

The flow sensor must be selected in accordance with the patient category:

Adult	Infinity ID flow sensor
Ped. pat.	Infinity ID flow sensor or neonatal flow sensor
Neo.	Neonatal flow sensor

When using a neonatal flow sensor, see "Installing a neonatal flow sensor" on page 59.

Fitting the Infinity ID flow sensor

Prerequisite: The flap is opened.

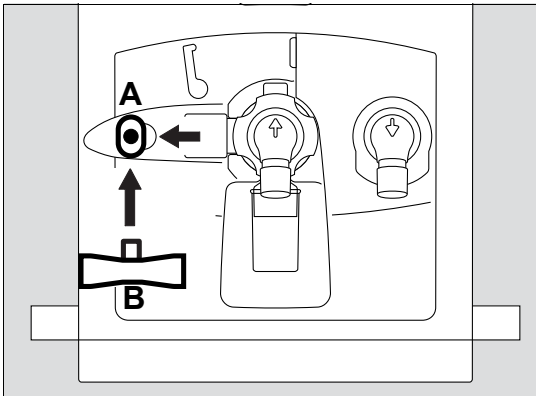

- 1 Push the socket (A) all the way to the left.
- 2 Insert the flow sensor (B) with the plug facing towards the device, into the socket and push it fully into the socket.

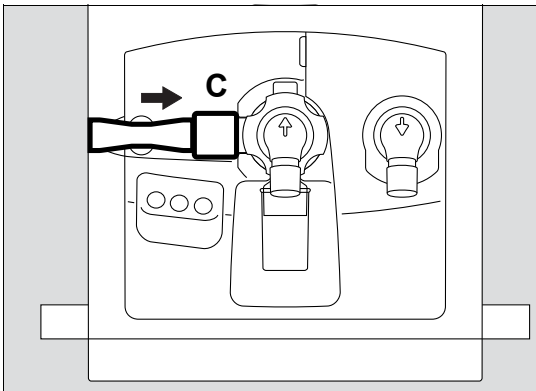

- 3 Push the flow sensor to the right up to the stop in the flow sensor sleeve (C) of the Infinity ID expiratory valve.

Closing the flap

If the Infinity ID expiratory valve and the Infinity ID flow sensor or the Infinity ID neonatal expiratory valve and the muffler are fitted, tilt the flap (D) downwards.

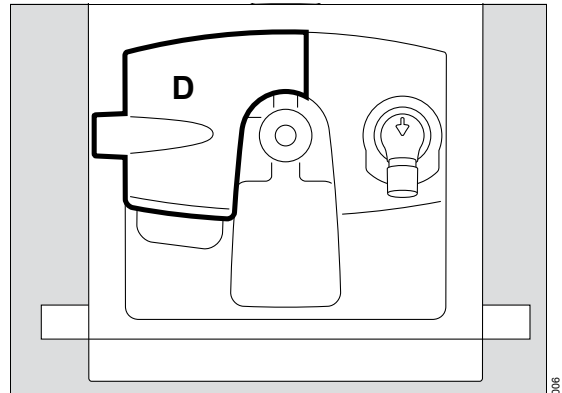

Leave the flap closed during ventilation.

Safety information for the use of HMEs, bacterial filters, and breathing circuits

WARNING

Increased resistance

Medication nebulization and active humidification may increase the resistance of additional components.

Check the breathing circuit regularly for signs of increased resistance and replace additional components if necessary.

CAUTION

Additional components in the breathing circuit such as bacterial filters, HME or CO₂ cuvettes may increase the dead space, compressible volume, and resistance.

Particular care and monitoring are required when using additional components.

Before checking the breathing circuit (see chapter "Getting started"), attach all necessary additional components up to the patient connector.

Additional components in the breathing circuit can increase the inspiratory and expiratory breathing resistance and exceed standard requirements. Examples: Inspiratory and expiratory bacterial filters, HMEs, coaxial hoses.

Evita V500 is designed to minimize the patient's work of breathing. Operation does therefore not require inspiratory or expiratory bacterial filters. The use of bacterial filters or HMEs requires particular care and monitoring by the user. Especially during medication nebulization and humidification, the resistance of the expiratory bacterial filter may increase gradually.

A higher breathing resistance leads to a greater work of breathing and trigger effort. Under unfavorable conditions, this can lead to an intrinsic PEEP, which can be recognized by the fact that the expiratory flow does not return to "baseline" at the end of expiration. If the PEEP is unacceptably high, this is indicated by an alarm. For additional information, see "Automatic alarm limits" on page 302.

The breathing resistance in the patient connector cannot be monitored directly by Evita V500. For this reason:

- Before starting ventilation, determine in standby mode inspiratory and expiratory breathing resistance in the breathing circuit by means of the breathing circuit check.
- Check the condition of the patient and the device's measured values for volume and resistance more frequently.
- Observe the instructions for use for the HMEs, bacterial filters and breathing circuits in use.

Information on breathing circuits with variable compliance

Some breathing circuits feature a position-dependent compliance. This results in an increased variability of hose compliance. Breathing circuits of this type can increase the inaccuracy of volume measurement under certain circumstances.

WARNING

When using breathing circuits with variable compliance, volume-controlled ventilation is restricted. After changing the hose length, immediately perform a check of the breathing circuit to ensure that the hose compliance values are correct.

Evita V500 detects the changed ventilation situation and generates the low-priority **Volume measurement inaccurate** alarm message. In these cases, switch to pressure-controlled ventilation and use independent volume monitoring. Correct entry of the breathing circuit being used prevents Evita V500 from generating an alarm in the case of non-variable breathing circuits.

Preparing the breathing gas humidifier

- Prepare the Fisher & Paykel MR850 breathing gas humidifier in accordance with the corresponding instructions for use.

CAUTION

Do not use an HME together with a breathing gas humidifier! This can lead to an increased breathing resistance.

Attaching the Fisher & Paykel MR 850 breathing gas humidifier

The breathing gas humidifier can be connected in the following ways:

- on the standard rail of the universal holder
- on the humidifier holder of the trolley
- on the humidifier holder for the lateral standard rail

Connecting the breathing gas humidifier on the universal holder with standard rail

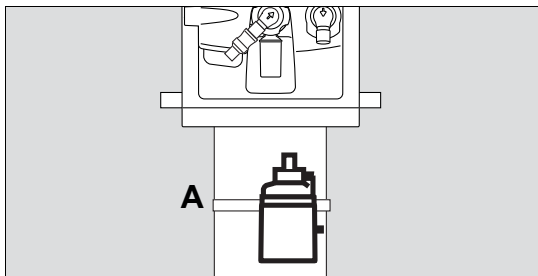

- Clamp the breathing gas humidifier to the standard rail (A) under the ventilation unit and screw firmly into place.

Connecting the breathing gas humidifier to the humidifier holder of the trolley

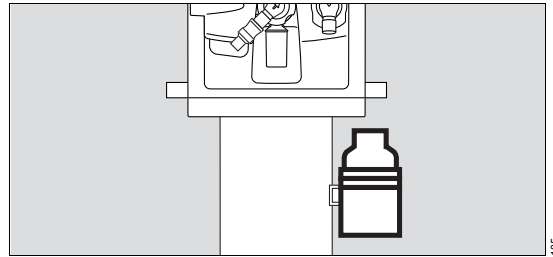

- Connect the breathing gas humidifier to the humidifier holder of the trolley.
- Tilt the breathing gas humidifier into the correct position.

Attaching the breathing gas humidifier to the humidifier holder for the lateral standard rail

If a compressor is used on the trolley, use the humidifier holder for the lateral standard rail. The holder can be connected to the left-hand or right-hand side of device.

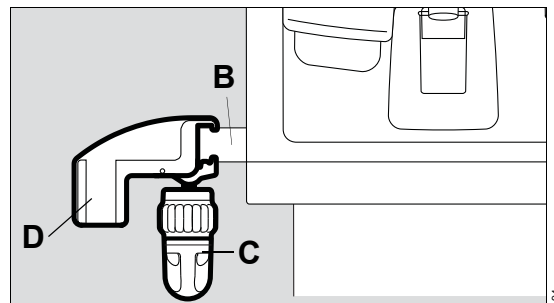

- 1 Hook the holder on the lateral standard rail (B) of Evita V500. Position the holder on the standard rail so that the flap at the side of the unit can still be opened.
- 2 Turn the clamping screw (C) until the holder is fixed securely on the rail.
- 3 Attach the breathing gas humidifier to the mount (D).

Additional information

For the order numbers of the holder for the breathing gas humidifier, see the list of accessories.

Connecting the breathing circuit

WARNING

Do not use antistatic or conductive breathing hoses. The use of these materials increases the risk of electric shock to the patient and of fire in an oxygen-enriched environment.

CAUTION

The sterile packaging of disposable articles must only be opened immediately before use. Otherwise there is a risk of infection.

- 1 Hang the hinged arm (A) on the lateral standard rail of Evita V500 and tighten the screws. Depending on the desired position of the device in relation to the bed, the hinged arm can be fitted to either side of Evita V500.

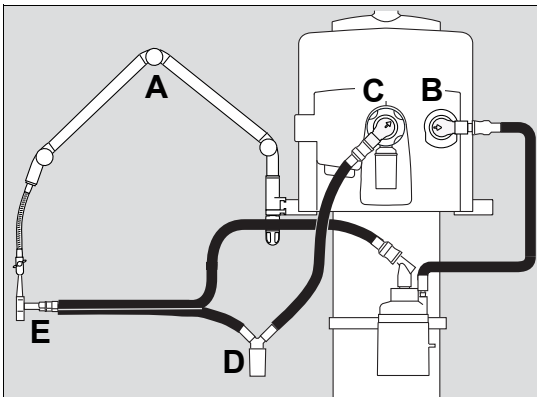

- 2 Connect breathing hoses to the inspiratory port (B) and to the expiratory port (C).

When using breathing hoses for ventilating neonatal patients, the inspiratory hose is pushed into the inspiratory port (B). The expiratory hose is pushed onto the expiratory port (C).

CAUTION

Do not reverse the connections for inspiration (B) and expiration (C). Humidification is ineffective if the connections are reversed.

- 3 Turn the inspiratory port and expiratory port in the direction of hoses.

A water trap is required for the Fisher & Paykel MR850 breathing gas humidifier depending on the breathing circuit used.

- 4 If a water trap is required, install the water trap (D) in a vertical position.
- 5 Connect the Y-piece (E) to the breathing hoses.
- 6 Insert the Y-piece or the breathing hoses in the opening of the hinged arm.

Using the Infinity ID breathing circuit

Evita V500 recognizes the use of an Infinity ID breathing circuit. The message **Infinity ID breathing circuit detected.** is displayed in the header bar.

The following Infinity ID functions are supported:

- Detection of reversed hoses
- Detection of non-compliance with the settings for the breathing circuit, patient category or humidification type
- Automatic configuration of breathing circuit and humidifier
- Transfer of ventilation settings

Automatic configuration of breathing circuits and humidifiers, and transfer of ventilation settings are only supported in standby mode.

- Fit the Infinity ID breathing hoses in standby mode.

If accessories without RFID functionality are combined with Infinity ID accessories, Infinity ID functions may be restricted or unavailable.

Setting the breathing circuit

Evita V500 supports the user in selecting the breathing circuit on the page **Start/Standby > Br. circuit/ Humidifier**.

- Set the breathing circuit according to the patient category.

Whenever the breathing hoses or the breathing gas humidifier have been changed

- Check the breathing circuit, see "Performing the breathing circuit check" on page 78.

Additional information

Transfer of ventilation settings, see page 84.

For the order numbers of the breathing circuits and the hinged arm, see the list of accessories.

Installing a neonatal flow sensor

WARNING

Risk of fire

Residual vapors of easily flammable disinfectants (e.g., alcohols) and deposits that were not removed during reprocessing can ignite when the flow sensor is in use.

- Ensure particle-free cleaning and disinfection.
- After disinfection, allow the flow sensor to air for at least 30 minutes.
- Before inserting the flow sensor check for visible damage and soiling, such as residual mucus, medication aerosols, and particles.
- Replace flow sensors when damaged, soiled, or not particlefree.

A neonatal flow sensor must be used for the **Neo.** patient category.

A neonatal flow sensor or the Infinity ID flow sensor can be used for the **Ped. pat.** patient category.

The following neonatal flow sensors are available:

- Neonatal flow sensor ISO 15 (8411130)
- Neonatal flow sensor Y-piece (8410185)

If a neonatal flow sensor and HME are used in the patient categories **Neo.** or **Ped. pat.**, the HME must be installed between the neonatal flow sensor and the patient connector.

Installing a neonatal flow sensor ISO 15 (8411130)

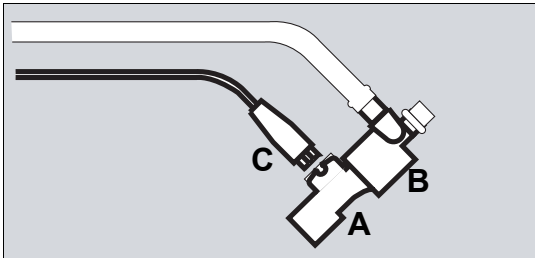

- 1 Insert the neonatal flow sensor (A) into the patient connector of the Y-piece (B).
- 2 Connect plug (C) of the flow sensor cable to the flow sensor.

Installing a neonatal flow sensor Y-piece (8410185)

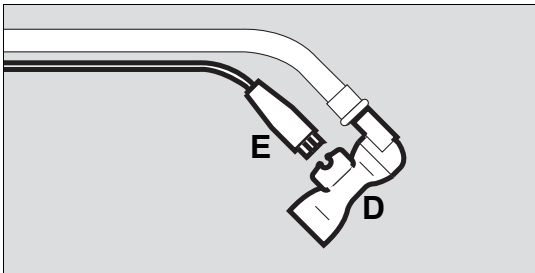

- 1 Connect Y-piece with integrated neonatal flow sensor (D) to the breathing hoses.
- 2 Connect plug (E) of the flow sensor cable to the flow sensor.

Further procedure for both neonatal flow sensors

- 3 Position patient connector of the Y-piece to point approx. 45° downwards to prevent condensation from forming on the neonatal flow sensor.
- 4 Run the cables along the breathing hoses to the device.

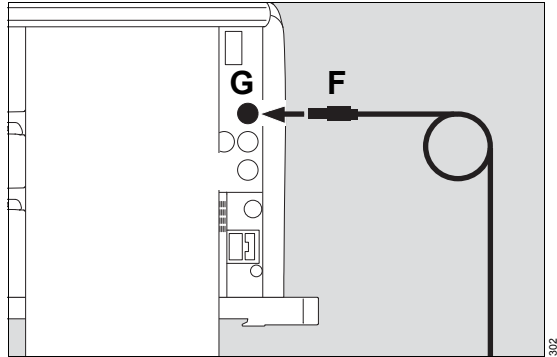

- 5 Insert the connector (F) of the flow sensor cable into the socket (G) at the rear of Evita V500.

Additional information

For the order numbers of the neonatal flow sensor, see the list of accessories.

Replacing the neonatal flow sensor insert

If Evita V500 displays the alarm message **Neonatal flow sensor?**, then the insert of the neonatal flow sensor must be replaced.

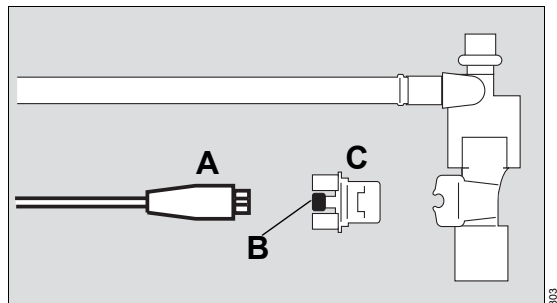

- 1 Disconnect plug (A) of the flow sensor cable from the neonatal flow sensor.
- 2 Gently press the knobs (B) on both sides while pulling the insert (C) out of the flow sensor housing.
- 3 Push in new insert (C) until it engages.

- 4 Connect plug (A) of the flow sensor cable to the neonatal flow sensor.
- 5 Calibrate the neonatal flow sensor, see page 159.

Additional information

"Information on checking the CO₂ sensor" on page 166.

For the order numbers of the accessories for the "CO₂ monitoring" application, see the list of accessories.

Installing a CO₂ cuvette and CO₂ sensor

Do not carry out CO₂ measurements on premature infants because the CO₂ cuvette significantly increases the dead space.

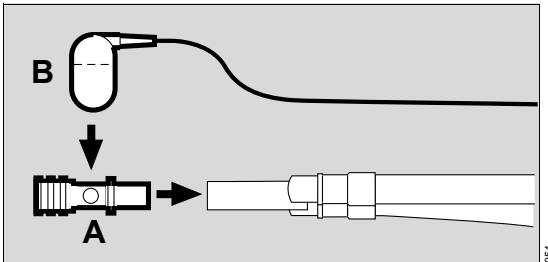

- 1 Insert the cuvette (A) into the patient connector of the Y-piece. The cuvette windows are facing to the side.
- 2 Fit the CO₂ sensor (B) on the cuvette. The cable is facing towards the device.

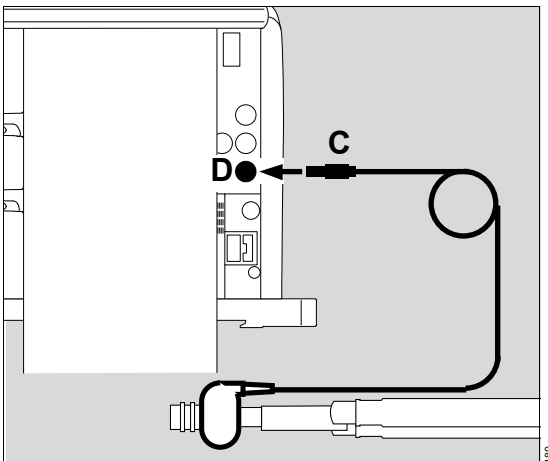

- 3 Insert the connector (C) of the CO₂ sensor into the socket (D) at the rear of Evita V500.
- 4 Select the cuvette type, see page 165.

Connecting the mains power supply to Evita V500

WARNING

Risk of electric shock and of device failure

If the device is connected to a power socket with incorrect mains voltage or without a protective ground, the user can be injured and the device damaged.

Only connect the power cable to power sockets with a protective ground and the correct mains voltage. Observe the technical data.

NOTE

The mains power socket in use must be freely accessible during operation.

The mains voltage must conform to the voltage range specified on the rating plate (100 V to 240 V, 50/60 Hz).

- 1 Plug the appliance socket (A) onto the appliance connector (B).

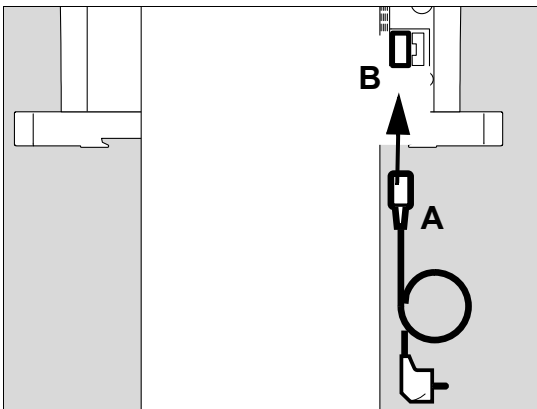

- 2 Position the power cable (C) in the clamp (D). Fit the clamp into the housing (E). Tighten the screw (F) (stress relief).

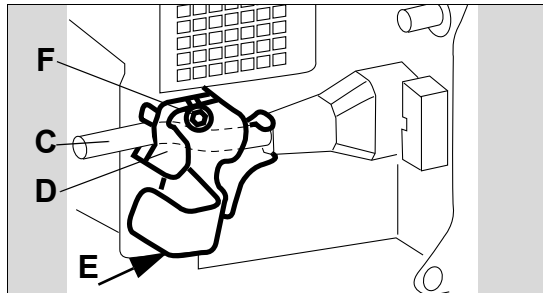

- Insert the mains plug into the mains power socket.

The LED  on Infinity C500 lights up green.



Checking the toggle switch on Evita V500

CAUTION

Do not press the toggle switch during ventilation.

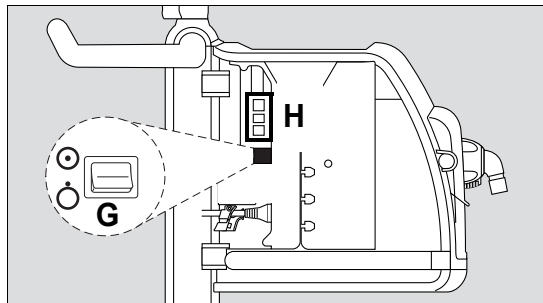
Prerequisite: The flap on the left-hand side of the device is opened.



- Check whether the toggle switch (G) is set to  (on).
- If the toggle switch is set to  (off), set it to  (on).

WARNING

Do not simultaneously touch the connectors of the interfaces (H) and the patient. Risk of electric shock.

Connecting the mains power supply to the GS500 gas supply unit

If Evita V500 is not equipped with the PS500 power supply unit, and the GS500 gas supply unit features a separate mains plug:

- Plug the mains plug of the gas supply unit into the mains socket.

The \sim LED on GS500 lights up green.

Power supply from batteries

Charge the batteries completely before initial use.

If the mains power fails, operation is maintained either via the internal battery of Evita V500 or via the PS500 power supply unit.

Additional information

For additional information, see "Mains power supply / DC power supply" on page 134.

Failure of the power supply

If the mains power fails, operation is maintained via batteries.

If the mains power fails and the batteries are discharged, Evita V500 issues a power failure alarm.

The following data are retained even in the event of a power supply failure:

- Set values for ventilation
- Alarm limits
- Set values for monitoring

When the power supply is restored, the device starts automatically with the previous values.

Potential equalization

Differences in electrical potential between devices can be reduced by potential equalization. Potential equalization does not replace the protective ground connection. During operation, the potential equalization connections must be readily accessible and must be removable without tools.

Connecting the potential equalization cable

- 1 Plug one end of the potential equalization cable fully on to the potential equalization pin on Evita V500.
- 2 Connect the other end of the potential equalization cable to the hospital potential equalization socket.

Connecting the gas supply

WARNING

Do not bring any oxygen supply components into contact with oil and grease. Danger of explosion through spontaneous ignition!

WARNING

Only use compressed gases approved for medical use. The compressed gases must be free of dust and oil particles and dry. Otherwise the proper functioning of the device cannot be ensured.

Central gas supply

Prerequisite: The flap on the right-hand side of the device is opened.

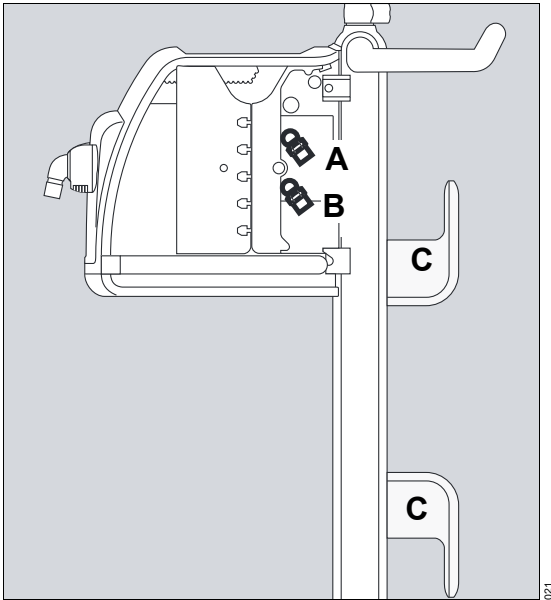

- 1 Screw the Air compressed gas hose to the **Air** (A) connection and the O₂ compressed gas hose to the **O₂** connection (B) of Evita V500.
- 2 Plug the probes into the wall terminal units of the central gas supply system.

- 3 Position the compressed gas hoses over the hose hooks (C).

The gas delivered through compressed gas hoses is used as fresh gas (FRESH GAS).

Additional information

For the order numbers of the compressed gas hoses, see the list of accessories.

Gas supply from cylinders

If the central gas supply system fails or is not available, the gas can be supplied from cylinders.

Additional information

Air supply from a gas supply unit (GS500), see "GS500 gas supply unit" on page 126.

Connecting the nurse call

The nurse call is used for transmitting high-priority alarm messages (warning) to a central hospital alarm system.

Safety information for using the nurse call

WARNING

Risk of patient injury

All data transferred via the nurse call are for information only and must not be used as the sole basis for diagnostic or therapeutic decisions. The nurse call is not intended for use with a distributed alarm system conforming to IEC 60601-1-8:2012.

CAUTION

A fault in any of the components in the link between the nurse call and the central hospital alarm system (e.g., in the unit's electronics for nurse call, in the unit's power supply or in the alarm generator of the central hospital alarm system) can result in failure of the nurse call.

CAUTION

Connection of a nurse call does not relieve staff of their duty to check the monitoring on the device screen at regular intervals. Screen displays must be checked regularly.

CAUTION

All alarms on Evita V500 must be checked regularly even when the nurse call is connected. Do not use nurse call as the sole source of alarm information!

Connecting the nurse call to the central hospital alarm system

- The nurse call cable must be connected to the lead to the central hospital alarm system by service personnel.

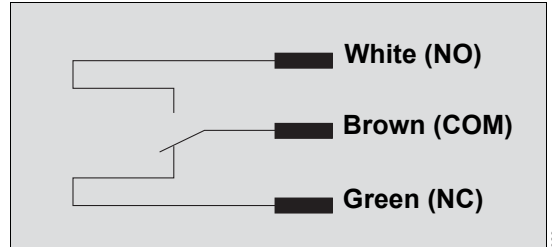

As soon as Evita V500 signals an alarm, the connection between the white cable and the brown cable (NO and COM) is closed and the nurse call is activated.

Connecting the nurse call to the ventilation unit

Prerequisite: The flap on the left-hand side of the device is opened.

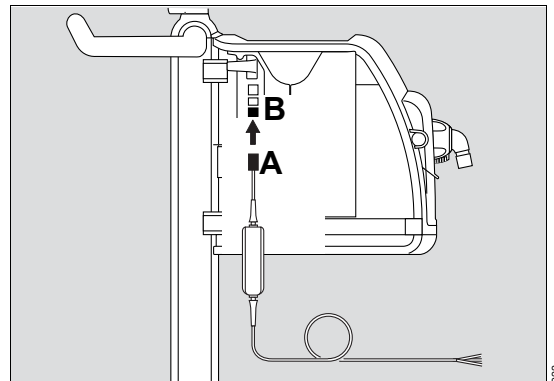

- 1 Plug the nurse call connector (A) into the socket (B) until it engages audibly.

NOTE

The connector must engage audibly into the socket to ensure all alarm messages are transmitted properly.

- 2 Check the correct operation of connected nurse call system.

Information on the nurse call

High-priority alarm messages (warning) are transmitted to a central hospital alarm system. Medium-priority (caution) and low-priority (note) alarm messages are not transmitted.

The nurse call is also activated when the internal acoustic alarm generator in the device is defective.

If, in the event of an alarm, the  key (**Audio paused**) is pressed, the acoustic alarm on the device and the nurse call are suppressed for 2 minutes.

Additional information

For the order number of the nurse call cable, see the list of accessories.

Closing the flaps at the side of the device

- Close the lateral flaps of the device after preparation.

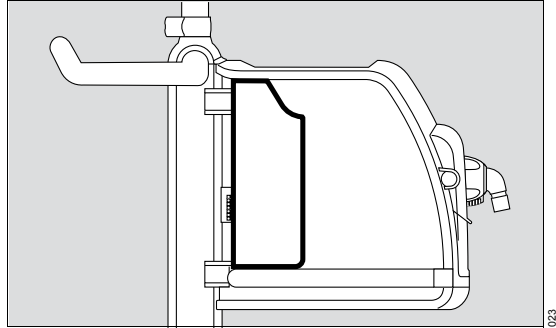

CAUTION

Keep both lateral flaps on the device closed during operation to prevent accidental actuation of the toggle switch or connections becoming loose.

Intrahospital transport

Transport refers to any movement of the medical device without the patient that does not serve to position the medical device.

Increasing the tipping stability

- Swivel the control and display unit (Medical Cockpit) until it is centrally aligned with the ventilation unit.
- Set the hinged arms to minimum extension.
- Drain the water container of the breathing gas humidifier.
- Secure the breathing gas humidifier to the trolley, not to the lateral standard rails of the ventilation unit.
- Do not attach any additional parts to the lateral standard rails of the ventilation unit.

- If fitted, slide the bed coupling into its retracted position.
- Grasp the trolley handle firmly and push the device in longitudinal direction.

The safety information regarding intrahospital patient transport also applies, see chapter "Intrahospital patient transport" on page 137.

Getting started

Safety information on getting started	68
Switching on Evita V500 and Infinity C500	68
Selecting a patient	69
Using the settings of the previous patient.	69
Admitting a new patient	69
Selecting the breathing circuit and the breathing gas humidifier	72
Checking readiness for operation	74
Safety information on the system check.	74
Starting the system check.	74
Performing the device check	75
Performing the breathing circuit check	78
Displaying the results of the breathing circuit check	81
Checking the switch-over to battery operation.	82
Checking the alarm signaling	82
Checking alarm limits	82
Test of the acoustic alarm system	82
Selecting the Tube or NIV application mode	83
Setting parameters for the tube	83
Transfer of ventilation settings	84
Selecting the therapy type	85
Starting the therapy	86
Displaying the status of accessories	87

Safety information on getting started

WARNING



Ventilation does not take place in standby mode! The device must only be set to standby mode when no patient is connected to the device. The patient may otherwise be jeopardized.

CAUTION

Condensation may form when the device is moved from a cold storage location to a warm environment. Do not switch on the device as otherwise its proper functioning may be adversely affected. Wait until the condensation has dried.

Switching on Evita V500 and Infinity C500

Prerequisites:

- Evita V500, Infinity C500, PS500 and GS500 are reprocessed and assembled ready for operation.
- The mains power supply and the gas supply are connected.
- The Evita V500 toggle switch is set to  (on).
- Press the  key (A) on Infinity C500.

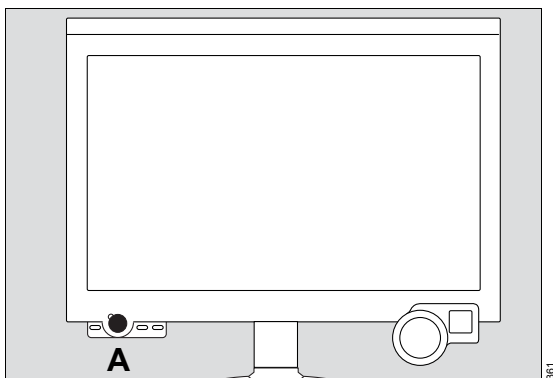

The system is started. The **Start** dialog is displayed.

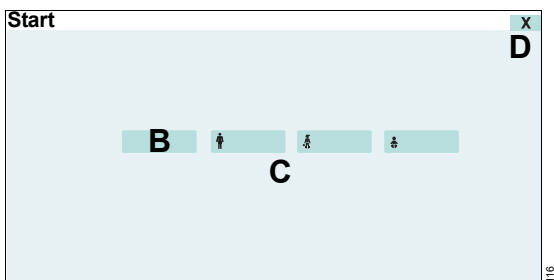

Evita V500 provides you with two options:

- Use settings of previous patient (B)
- Admit new patient (C)

If the **Start** dialog is closed using the **X** button (D), Evita V500 adopts the settings of the previous patient.

If a data loss occurs, the previous settings cannot be recovered. The **Current patient** button (B) is not displayed.

Selecting a patient

Using the settings of the previous patient

Prerequisite: The **Start** dialog is opened.

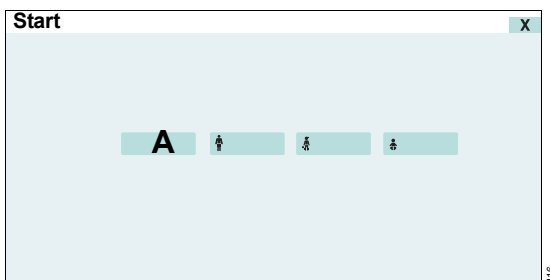

- Touch the **Current patient** button (A).

The last used patient-related settings including the alarm limits, application mode and device status are restored. O₂ monitoring and flow monitoring are switched on, see "Information on monitoring" on page 158.

The **Start/Standby** page (B) is displayed. Evita V500 is in standby mode.

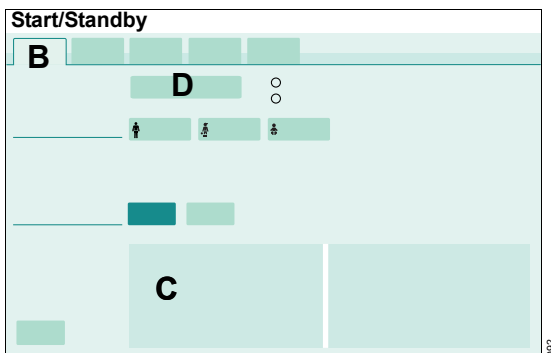

Evita V500 displays the ventilation parameter start-up settings (C). The **Start ventilation** button (D) can be used to start the therapy. When the therapy is started, the settings become effective.

Admitting a new patient

For a new patient, Evita V500 determines the ventilation parameters' start-up settings based on the patient category (factory setting) or the body weight. The factory settings for the settings dependent on patient category and weight can be changed in the **System setup** dialog window.

The patient category or the body weight can only be changed when a new patient is admitted. In the **Adult** and **Ped. pat.** patient categories, the body height is entered and from that the ideal body weight is determined. In the **Neo.** patient category, the body weight is entered directly. The weight-dependent setting for a new patient is only possible after selecting **Weight** in the **System setup** dialog window.

The alarm limit start-up settings are recalculated according to the customized system configuration.

When a new patient is admitted, the settings and trend data of the previous patient are deleted.

Prerequisite: The **Start** dialog is opened.

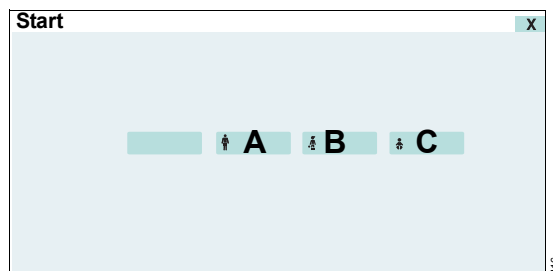

- 1 Touch the following button for a new patient:
 - **New Adult** (A) for new adult patients
 - **New Ped. pat.** (B) for new pediatric patients
 - **New Neo.** (C) for new neonatal patients



The respective button turns yellow.

- 2 Confirm with the rotary knob.

The **Start/Standby** page is displayed. Evita V500 is in standby mode.

Ventilation parameter start-up settings by patient category

The **Start/Standby** page (D) contains the buttons for the patient category:

-  **New Adult** (E)
-  **New Ped. pat.** (F)
-  **New Neo.** (G)

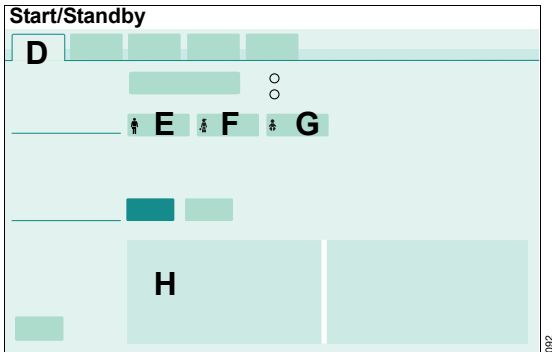

- 1 Touch the button for the desired patient category (E), (F) or (G).
- 2 Confirm with the rotary knob.

The ventilation parameters displayed in the lower part of the page (H) are the start-up settings for the selected patient category.

Determining the start-up settings can take up to 5 seconds. No entries can be made during this time.

Ventilation parameter start-up settings by body height/body weight

Prerequisite: In the **System setup** dialog window, the **Weight** function was configured and a new patient was admitted.

In the **Adult** and **Ped. pat.** patient categories, the **Start/Standby** page (D) contains the button for body height (I) and the field for the ideal body weight (J).

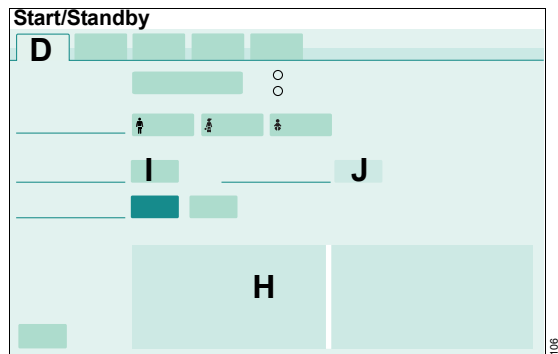

- 1 Touch the button for the body height (I).
- 2 Set the body height by turning the rotary knob and push to confirm.

Evita V500 determines the start-up values for **VT**, **RR**, **Slope** and **Flow trigger** based on the ideal body weight calculated from the body height. The values for **VT** and **RR** are displayed in the lower part of the page (H). The other ventilation parameters displayed in the lower part of the page are start-up settings for the selected patient category.

In the **Neo**. patient category, the patient's body weight is set directly. The **Start/Standby** page (D) contains the button for this start-up body weight (K).

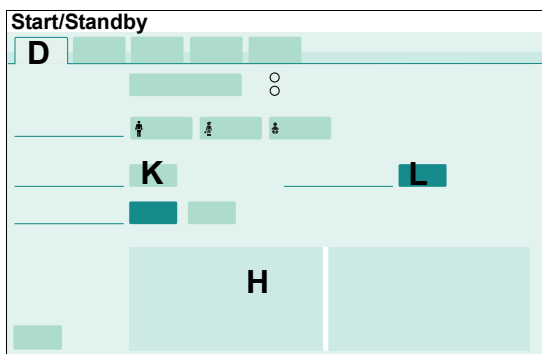

- 1 Touch the button for the start-up body weight (K).
- 2 Using the rotary knob, set the start-up body weight and confirm the value.

The button for the current body weight (L) is displayed. After the patient has been admitted, the current body weight corresponds to the start-up body weight.

Evita V500 determines the start-up values for **VT**, **RR**, **Slope** and **Flow trigger** based on the start-up body weight. The values for **VT** and **RR** are displayed in the lower part of the page (H). The other ventilation parameters displayed in the lower part of the page are start-up settings for the selected patient category.

Determining the start-up settings can take up to 5 seconds. No entries can be made during this time.

Setting the body weight during ventilation

As a result of setting the ideal body weight in the **Adult** and **Ped. pat.** patient categories or the current body weight in the **Neo**. patient category, measurements are displayed relative to the body weight, e.g., **VT/kg BW**.

Setting the body weight is only possible on the **Start/Standby** page during ventilation.

In the **Adult** and **Ped. pat.** patient categories:

- 1 Touch the button for the ideal body weight.
- 2 Using the rotary knob, set the ideal body weight and confirm the value.

In the **Neo**. patient category:

- 1 Touch the button for the current body weight.
- 2 Using the rotary knob, set the current body weight and confirm the value.

Whenever the patient category has been changed

Check the breathing circuit, see chapter "Performing the breathing circuit check" on page 78.

Additional information

The configuration for the ventilation parameter start-up values by body height/body weight or by patient category is entered on the **System setup > Ventilation > Start settings** page. See chapter "Configuring start-up settings for the ventilation parameters" on page 189.

For information on configuring customized alarm limits, see chapter "Setting start-up values for alarm limits" on page 183.

For information on starting the therapy, see chapter "Starting the therapy" on page 86.

Selecting the breathing circuit and the breathing gas humidifier

The breathing circuit and the breathing gas humidifier can only be selected in standby mode.

- 1 Touch the **Start/ Standby...** button in the main menu bar.
- 2 Touch the **Br. circuit/ Humidifier** tab (A).

The page for selecting the breathing circuit and the breathing gas humidifier is displayed.

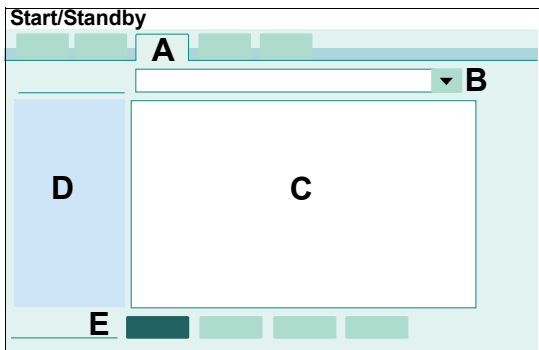

Selecting the breathing circuit from the selection list

- 3 Touch the ▼ button (B).
- 4 Select the breathing circuit used from the selection list.
- 5 Confirm with the rotary knob.

To help with the selection, the selected breathing circuit is displayed as a detailed representation (C) and also described as text (D).

Evita V500 automatically selects the appropriate humidification type based on the breathing circuit (E) selected. Some breathing circuits provide the selection of **HME/Filter** and **None**.

If the breathing circuit used is not included in the selection list

- 1 Touch the ▼ button (B).
- 2 Select **Other** from the selection list.
- 3 Confirm with the rotary knob.
- 4 Select the humidification type (E):
 - **Active humid., exp. unheated**
 - **Active humid., exp. heated**
 - **HME/Filter**
 - **None**

Touch the corresponding button.

Using the user-defined breathing circuit

Prerequisite: The **User-defined hose settings** function is enabled, see page 187.

- 1 Touch the ▼ button (B).
- 2 Select **User-defined breathing circuit** from the selection list.
- 3 Confirm with the rotary knob.
- 4 Select the humidification type (E).
- 5 Perform the breathing circuit check, see page 78.
- 6 Save the measured values for hose compliance and hose resistance, see page 81.

Infinity ID breathing circuits

When using Infinity ID breathing circuits, the connected hose type as well as the corresponding humidification type are set automatically.

If the message ***Infinity ID breathing circuit detected.*** is not displayed when an Infinity ID breathing circuit is connected, then use a different Infinity ID breathing circuit. If the message is still not displayed, replace the Infinity ID expiratory valve (for the **Neo.** patient category: Infinity ID neonatal expiratory valve) or the inspiratory valve.

Whenever the breathing circuit or the breathing gas humidifier have been changed

- Check the breathing circuit, see "Performing the breathing circuit check" on page 78.

Checking readiness for operation

The system check consists of the following elements:

- Device check
- Breathing circuit check
- Battery check

The battery check must be performed during initial commissioning of the device. For further information on the battery check, see page 266 and page 270.

Safety information on the system check

WARNING

Before using on the patient

- **Perform the device check. If a malfunction is detected, do not operate the device! Patient hazard!**
- **Perform the breathing circuit check to ensure the pressure measurement accuracy. Otherwise the airway pressure may deviate from the set values.**

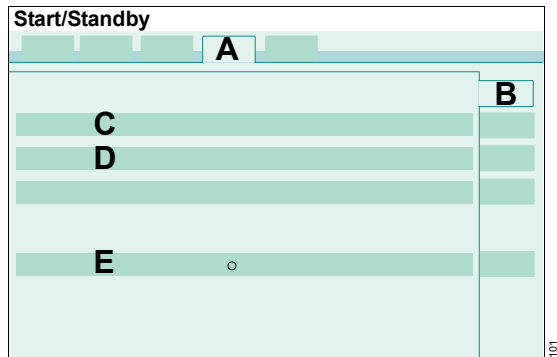

Evita V500 displays the following on the **Overview** page (B):

- Last device check with date, time, and result (C)
- Last breathing circuit check with date, time, and the amount of leakage determined (D)
- Battery check, result of the last battery check, and date for the next battery check (E)

Starting the system check

The system check is only possible in standby mode.

- 1 Touch the **Start/ Standby...** button in the main menu bar.
- 2 Touch the **System check** tab (A).

Performing the device check

The device check is only possible in standby mode.

Keeping the test lung ready

- Adult test lung (MP02400) for the adult breathing circuit
- Pediatric test lung (8409742) for the pediatric and neonatal breathing circuit

The test lung must only be inserted into the patient connector of the Y-piece after instruction by Evita V500.

Starting the device check

Prerequisites: The medication nebulizer is not connected. The **System check** page (A) is opened.

- 1 Touch the **Device check** tab (B).

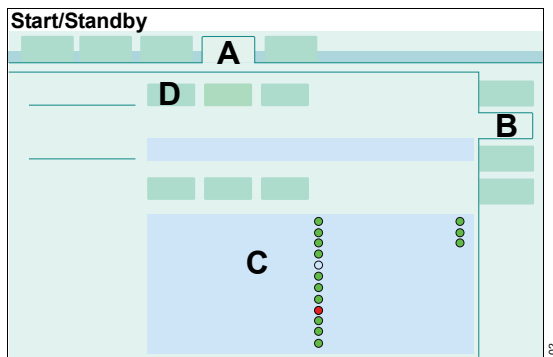

Evita V500 displays the individual test steps in a list (C). The size of the list depends on the available applications.

- 2 Touch the **Start** button (D).
- 3 Confirm with the rotary knob.

Test steps in the device check

In the device check the following test steps are performed:

- Auxiliary acoustical alarm (Check of the auxiliary alarm / power failure alarm)
There is no need for the user to test other parts of the alarm system, as they are tested in the self-test.
- Breathing circuit connection (visual inspection of breathing circuit)
- Inspect humidifier (visual inspection of breathing gas humidifier)
- Calibration of expiratory flow sensor
- CO₂ sensor: Zero calibration
- Neonatal flow sensor: Calibration
- Neonatal flow sensor: Measurement
- Test lung connection
- Gas supply sensors: Calibration
- O₂ supply
- Air supply
- Gas supply unit (if the gas supply unit function is activated)
- Pressure sensor calibration valve
- Expiratory valve (expiratory valve check)
- Safety valve (safety function check)
- O₂ sensor: Calibration
- Nebulizer (medication nebulizer control check)

Device check procedure

Evita V500 guides the user in the form of a question/answer dialog through the respective test step. The instruction field (E) displays the questions or instructions how to carry out the test steps.

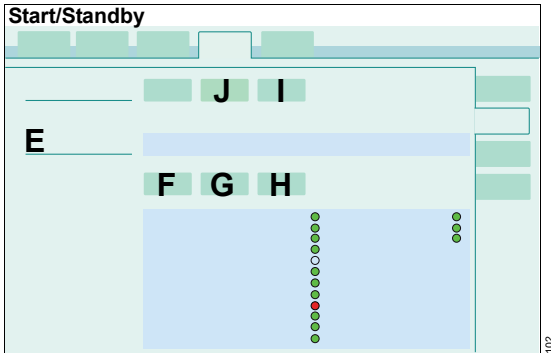

The questions must be answered by touching the **Yes** (F) or **No** (G) buttons.

The **Next test** button (H) can be used to skip the test steps.

A test step is also skipped if the necessary prerequisites have not been met.

The test steps in the device check are displayed with the following symbols:

Rotating symbol ☹	Active test step
Green dot	Correct result
Red dot	Incorrect result
Colorless dot	Test step not performed

Repeating test steps in the device check

- 1 Touch the **Repeat** button (I).
- 2 Confirm with the rotary knob.

All test steps that have not yet been performed or that were unsuccessful are repeated.

Aborting the device check

- 1 Touch the **Cancel** button (J).
- 2 Confirm with the rotary knob.

The device check is also aborted when the **Device check** page is exited. The device check can be continued when the **Device check** page is recalled.

- 1 Touch the **Repeat** button (I).
- 2 Confirm with the rotary knob.

Test results

The test results obtained from the device check and the calibration and zero-checking values of the sensors remain stored until the next calibration, even if the device is switched off.

Incorrect test steps and remedies

Errors in the following safety-relevant test steps generate the medium-priority alarm message

Device check failed:



- Pressure sensor calibration valve
- Expiratory valve
- Safety valve

The alarm cannot be acknowledged. Do not start ventilation!

Errors in non-safety-relevant test steps or test steps that are not performed on account of a prerequisite generate the low-priority alarm message **Device check incomplete**.

The alarm causes and their remedies are displayed on the **Current alarms** page.

The following table shows the remedies for eliminating the errors during the device check:

Test step	Remedy
Auxiliary acoustical alarm	Contact DrägerService.
CO ₂ sensor: Zero calibration	Check whether the CO ₂ sensor is connected. Wait for the CO ₂ sensor to complete its three-minute warm-up phase. Check whether the CO ₂ sensor or the cuvette is soiled.
Neonatal flow sensor: Calibration	Clean the flow sensor. Seal the flow sensor during calibration. Check whether the flow sensor cable is connected.
Gas supply unit	Check whether the gas connection to the device is kinked. Check whether the data cable is connected. If GS500 is running continuously, shut down and switch off Evita V500 (toggle switch to ).
Gas supply sensors: Calibration	Check whether the compressed gas hoses are connected. Shut down Evita V500 and switch it off (toggle switch to ).
O ₂ supply	Check whether the O ₂ compressed gas hose is connected.
Air supply	Check whether the Air compressed gas hose is connected.
Pressure sensor calibration valve	Connect the test lung. Check the breathing circuit for leaks. Check whether the compressed gas hoses are connected. Check whether the expiratory valve is properly engaged.
Expiratory valve	Check whether the water trap is connected. Check whether the expiratory valve is properly engaged. Check whether the flow sensor is correctly inserted (only for Adult and Ped. pat. patient categories).
Safety valve	Connect the test lung. Check the breathing circuit for leaks. Check whether the compressed gas hoses are connected. Check whether the expiratory valve is properly engaged.
O ₂ sensor: Calibration	Check whether the compressed gas hoses are connected.
Nebulizer	Prerequisite: The medication nebulizer is not connected. Check whether the compressed gas hoses are connected.

- Eliminate the causes of the error and repeat the test step.
- If the test step still fails, contact DrägerService.

Calibrating the gas supply sensors

The calibration of the gas supply sensors takes approximately 2 minutes. This test step must be performed every 3 months. If it is not necessary to perform a test step, it can be skipped by pressing **No**. The test step is still displayed as "successfully completed" (green dot).

If the test step is skipped with **Next test**, the test step is displayed as "not performed" (colorless dot).

If a complete calibration is necessary after 3 months and the test step is skipped with **Next test**, the test step is displayed as "failed" (red dot).

Calibrating the O₂ sensor

The O₂ sensor is calibrated during each device check. Regular calibration of the O₂ sensor ensures the specified accuracy.

If the test step is skipped with **Next test** and the O₂ sensor is not calibrated for 3 months, the accuracy of the O₂ sensor will be reduced. In the parameter field for FiO₂, a question mark will be displayed next to the measurement. After calibration during the device check the sensor will work again with full accuracy. The measured value is displayed in the parameter field.

If the test step is skipped with **Next test**, the test step is displayed as "not performed" (colorless dot).

If Evita V500 requires the O₂ sensor to be calibrated and the test step is still skipped with **Next test**, the test step is displayed as failed (red dot).

CAUTION

If the quality of the oxygen from the central gas supply system is inadequate, calibrate the O₂ sensor with an appropriate calibration gas (100 % O₂). Otherwise this may result in an incorrect calibration.

After the device check

The user is requested in field (E) to perform the check of the breathing circuit.

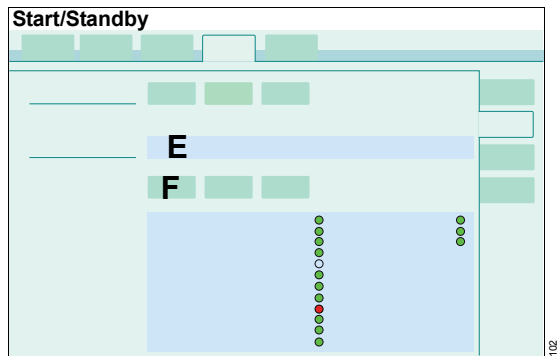

- Confirm with **Yes** (F).

The page for the breathing circuit check is opened.

Performing the breathing circuit check

The check is only possible in standby mode.

The breathing circuit check must be performed after:

- Device check
- Changing the breathing circuit
- Changing the breathing gas humidifier
- Changing the patient category

Test steps during the breathing circuit check

The following test steps are performed:

- Leakage of the breathing circuit
- Compliance of the breathing circuit
- Insp. Resistance
- Exp. Resistance

An additional leakage test is required if a coaxial breathing circuit is used, see "Testing a coaxial breathing circuit" on page 80.

Starting the breathing circuit check

Prerequisite: The **System check** page (A) is opened.

- 1 Touch the **Breathing circ. check** tab (B).

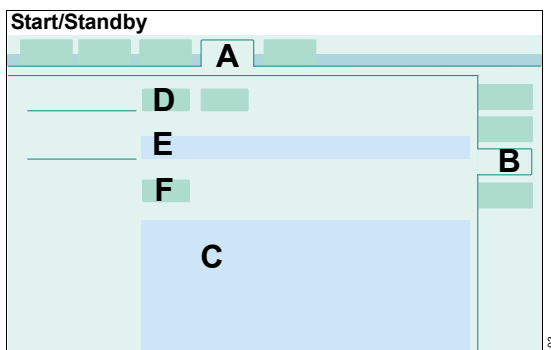

The values of the last test are displayed (C). If a valid measurement has not yet taken place, the standard values are displayed.

- 2 Touch the **Start** button (D).
- 3 Confirm with the rotary knob.
- 4 When requested by Evita V500 in the instruction field (E): Seal the patient connection port, e.g., with a sterile glove. Confirm with **OK** (F).
- 5 When requested, open the patient connection port. Confirm with **OK** (F).

The current leakage flow is displayed continuously throughout the test. A leakage flow of up to 300 mL/min at a pressure of 60 mbar (60 cmH₂O) is acceptable.

After the leakage test, Evita V500 determines the compliance and the inspiratory and expiratory resistance of the breathing circuit. Based on the calculated compliance of the breathing circuit, Evita V500 automatically corrects the volume-controlled breaths as well as the measured flow monitoring values.

When changing the breathing circuit and type of humidifier, Evita V500 automatically resets the values for hose compliance and hose resistance to default values.

When using Infinity ID breathing circuits, the default values of the breathing circuit detected are used. The leakage measurement becomes invalid.

When the patient category is changed, the breathing circuit that was last used in this category is selected and the corresponding values for hose compliance and hose resistance are used.

The leakage measurement becomes invalid when a new patient is admitted to the same patient category. The values for hose resistance and hose compliance are retained.

It is recommended to perform the breathing circuit check before commencing patient ventilation with a newly started device.

Canceling the breathing circuit check

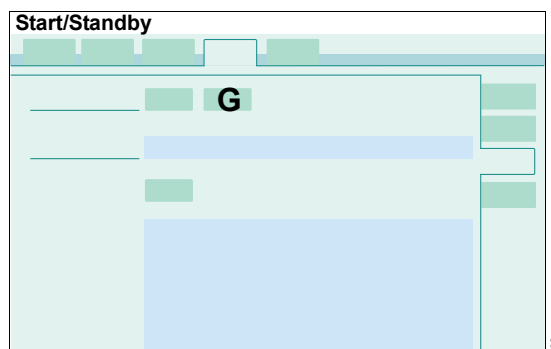

- 1 Touch the **Cancel** button (G).
- 2 Confirm with the rotary knob.

The leakage measurement becomes invalid. The values for hose resistance and hose compliance are reset to the default values.

Repeating the breathing circuit check

If the breathing circuit is changed after the breathing circuit check, the humidification type or the patient category is changed, the breathing circuit check will have to be repeated.

The breathing circuit check is also necessary when using Infinity ID breathing circuits.

Testing a coaxial breathing circuit

This test is only required for coaxial breathing circuits. The test measures the leakage of the inner hose.

Connect the coaxial breathing circuit:

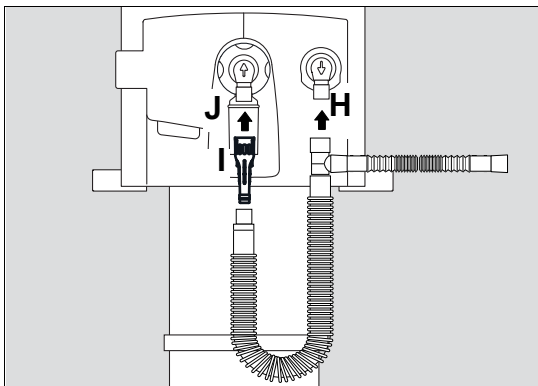

- 1 Fit the inspiratory connector of the coaxial breathing circuit to the inspiratory port (H).
- 2 Insert the coaxial test adapter (I) into the patient connector of the coaxial breathing circuit.
- 3 Fit the patient connector of the breathing hose, together with the coaxial test adapter, to the expiratory port (J).

Perform the test:

Prerequisite: The **System check > Breathing circ. check** page is opened.

- 4 Start the breathing circuit check, see page 79.

The leakage test of the inner hose will be performed.

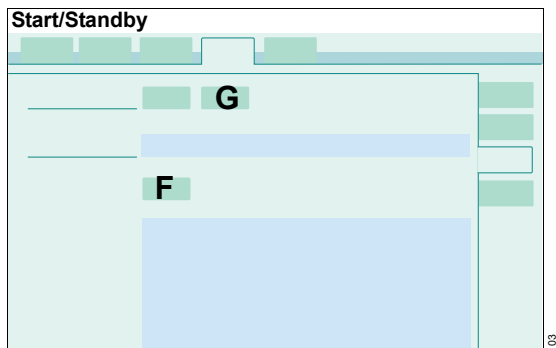

- 5 If the displayed leakage value is permanently below 120 mL/min, the **OK** button (F) turns light green. Then touch the **Cancel** button (G). The check of the coaxial breathing circuit is completed. Continue with step 6.

If the displayed leakage value is unstable or is permanently above 120 mL/min, touch the **Cancel** button (G). Remove the coaxial breathing circuit from the device and dispose of it. If required, perform a new test with a new coaxial breathing circuit.

After the test:

- 6 Remove the patient connector of the breathing hose, together with the coaxial test adapter, from the expiratory port.
- 7 Remove the coaxial test adapter from the patient connector of the coaxial breathing circuit and dispose of it.
- 8 Fit the expiratory connector of the coaxial breathing circuit to the expiratory port (J).
- 9 Perform the breathing circuit check, see "Starting the breathing circuit check" on page 79.

User-defined breathing circuit

Prerequisite: The user-defined breathing circuit has been selected, see "Using the user-defined breathing circuit" on page 72.

The values for hose resistance and hose compliance can be saved and are then available when that breathing circuit is selected again.

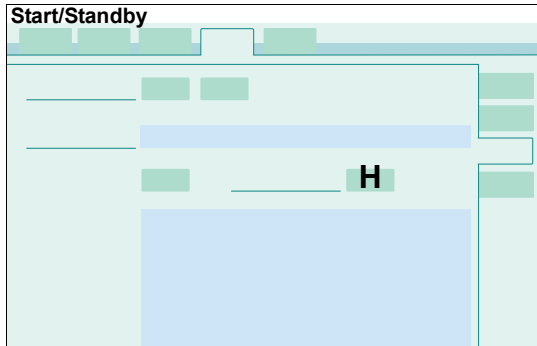

- Touch the **Save** button (H).

Displaying the results of the breathing circuit check

Prerequisite: The **System check** page (A) is opened.

- Touch the **Check results** tab (I).

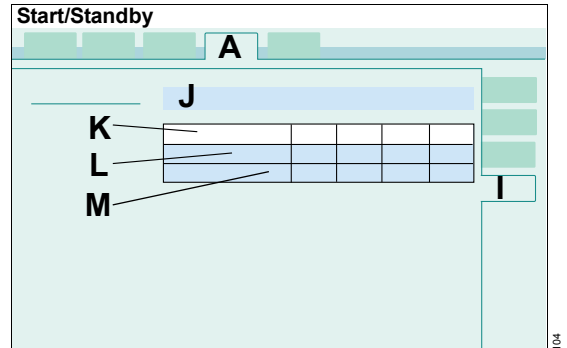

The detailed results of the check are displayed:

- Compliance [mL/mbar] (J)
- Flow [L/min] (K)
- Inspiratory resistance [mbar/L/s] (L)
- Expiratory resistance [mbar/L/s] (M)

Display of the results of the system check on the Start/Standby page

After the system check, the results are displayed on the **Start/Standby > Start/ Standby** page.

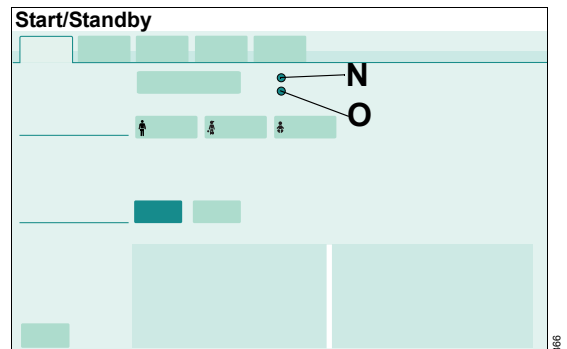

- Result of device check (N)
- Result of breathing circuit check (O)

Checking the switch-over to battery operation

- 1 Unplug the power plug.

If there is a PS500 power supply unit present, the device switches over to the PS500 without interruption. If there is no PS500 present or the PS500 is discharged, the device switches over to the internal battery without interruption. The **Battery activated** alarm is displayed.

- 2 Plug the power plug back in.

The device switches back to mains operation. The **Battery activated** alarm message goes out.

Checking the alarm signaling

When the system check has been successfully completed, the device is ready for operation. The alarm signaling can be checked additionally.

The description of alarm signaling can be found in chapter "Alarms." Additional information on alarm criteria can be found in chapter "Alarm – Cause – Remedy."

High-priority alarm message

- 1 Start ventilation.
- 2 After 2 minutes set the upper alarm limit for **MVe** to a value below the measured value of **MVe**.

The **MV high** alarm is triggered.

Medium-priority alarm message

- 1 Start ventilation.
- 2 Set the upper alarm limit for **VT** to a value below the measured value of **VT**.

The **VT high** alarm is triggered.

Low-priority alarm message

- 1 Start ventilation.
- 2 In the **Special maneuvers > Maneuvers** dialog window, touch and hold the **Man. insp./hold** button until the **Inspiratory hold interrupted** alarm is triggered.

Checking alarm limits

The alarm limits for a settable alarm can be checked by setting the alarm limits appropriately. When the alarm limit is exceeded, the corresponding alarm is triggered.

Additional information on setting alarm limits can be found in chapter ""Setting alarm limits" on page 144."

Test of the acoustic alarm system

The acoustic alarm system need not be tested by the user. The device tests the functions of the acoustic alarm system automatically during the device check.

Selecting the Tube or NIV application mode

Evita V500 can switch between non-invasive ventilation and tube ventilation.

The application mode can only be selected in standby mode.

- 1 Touch the **Start/ Standby...** button in the main menu bar.
- 2 Touch the **Tube/NIV** tab (A).

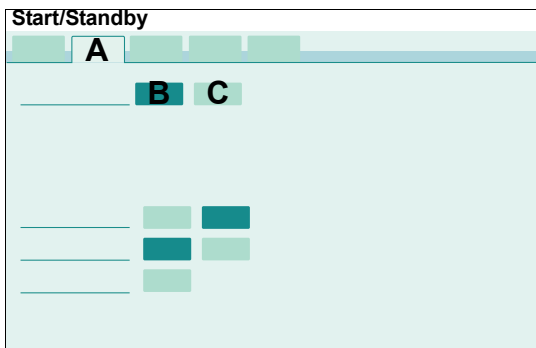

- 3 Touch the **Tube** (B) or **NIV** (C) button.
- 4 Confirm with the rotary knob.

Observe the information on changing the application mode!

CAUTION

Application mode **NIV** must not be activated with intubated patients.

WARNING

Alarm limits and ventilation settings must be checked or set again in order to ensure complete monitoring of ventilation after changing from NIV application mode to Tube application mode.

Additional information

For information on using the **NIV** application mode for non-invasive ventilation, see "NIV – Non-invasive ventilation" on page 99.

Setting parameters for the tube

The inner diameter of the tube and the tube type can be entered for the following functions:

- Display of **P_{trach}**, independent of ATC,
- Measurement of patient resistance **R_{pat}** and the **C₂₀/C_{dyn}** index

If the inner diameter of the tube and the tube type are entered, the measured value **R_{pat}** corresponds with the patient resistance. **R_{pat}** and **C₂₀/C_{dyn}** are only displayed correctly if the inner diameter of the tube and the tube type are entered correctly. The measured value **R** always corresponds with the total resistance.

Prerequisite: The **Tube/NIV** page (A) is opened. The **Tube** application mode has been selected.

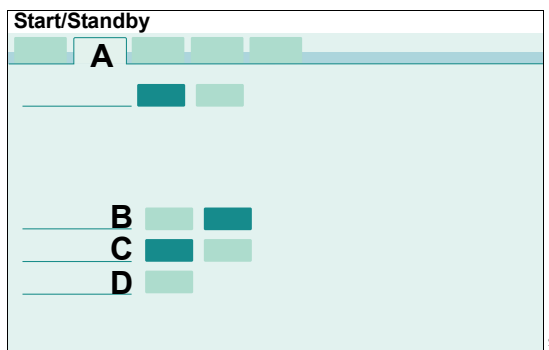

Activating or deactivating the calculation of tracheal pressure

- 1 Touch the appropriate button (B).
- 2 Confirm with the rotary knob.

If ATC is switched off, the calculation of tracheal pressure is always deactivated when a new patient is admitted.

Selecting the tube type

The tube type can only be selected in the **Adult** and **Ped. pat.** patient categories.

- 1 Touch the appropriate button (C).
- 2 Confirm with the rotary knob.

Entering the inner diameter of the tube

- 1 Touch the (D) button.
- 2 Set the value by turning the rotary knob and push to confirm.

Transfer of ventilation settings

Infinity ID breathing circuits can store the patient's ventilation settings (TVS). When the Infinity ID breathing circuit with the stored ventilation settings is connected to Evita V500, Evita V500 displays those ventilation settings.

Transferring ventilation settings to Evita V500

Prerequisites:

- Evita V500 is in standby mode.
- Import of the ventilation settings is activated, see "Configuring the import of ventilation settings" on page 187.
- The Infinity ID breathing circuit has been used on a device which supports TVS. The same system time must be set on both devices (transmitting device and receiving device). Observe instructions for use of device.
- The ventilation settings stored to the Infinity ID breathing circuit are no older than 120 minutes.

- 1 Touch the **Start/ Standby...** button in the main menu bar.

The **Start/Standby** page (A) is displayed.

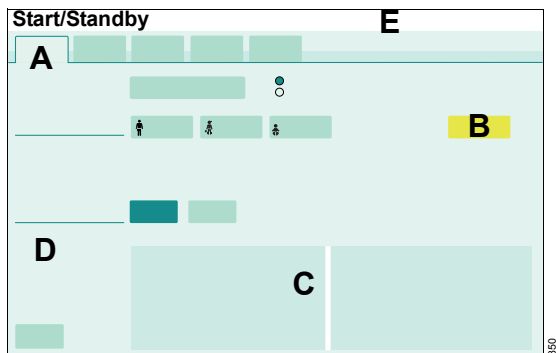

- 2 Connect the Infinity ID breathing hoses.

Evita V500 displays the button (B) with the detected Infinity ID breathing circuit:

-  **TVS Adult**
-  **TVS Ped**
-  **TVS Neo**

The stored ventilation settings (C) and the device (D) which has transferred the ventilation settings to the Infinity ID breathing circuit are displayed in the lower part of the page. Information is displayed in the message field (E).

WARNING

If incorrect ventilation settings are transferred by the Infinity ID breathing circuit, the patient may be endangered.

All the transferred ventilation settings must be checked by the user and adapted to the current patient situation before confirmation.

- 3 Check the ventilation settings and confirm them with the rotary knob.
- 4 Start the therapy, see page 86.

Transferring ventilation settings to Infinity ID breathing circuit

During therapy, all the ventilation parameters and alarm limits are transferred to the connected Infinity ID breathing circuit on a regular basis. If the last update took place more than 120 minutes ago, the stored ventilation settings become invalid. If this Infinity ID breathing circuit is then connected to a device supporting TVS, no ventilation settings are displayed.

Selecting the therapy type

Evita V500 can choose between therapy types **Ventilation** and **O₂ Therapy**.

The therapy type can only be changed in standby mode.

- 1 Touch the **Start/ Standby...** button in the main menu bar.

The **Start/Standby** page (A) is displayed.

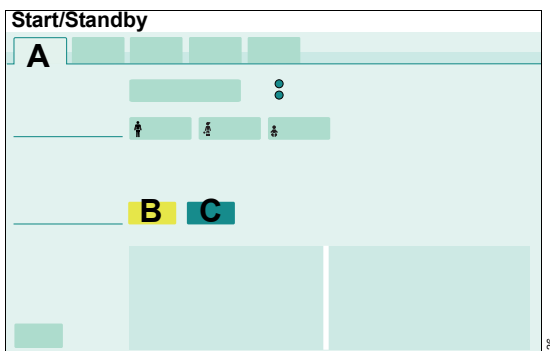

- 2 Touch the **Ventilation** (B) or the **O₂ Therapy** (C) button.
- 3 Confirm with the rotary knob.

Additional information

"O₂ therapy" on page 127.

"Setting ventilation" on page 91.

Starting the therapy

Before using on the patient

- Carry out a system check to ensure that Evita V500 is operating correctly, see page 74.
- Check the therapy settings: Set the alarm limits, see page 144. Set the ventilation modes and ventilation parameters, see "Setting ventilation" on page 91.

Starting ventilation or O₂ therapy

- 1 Touch the **Start/ Standby...** button in the main menu bar.

The **Start/Standby** page (A) is displayed.

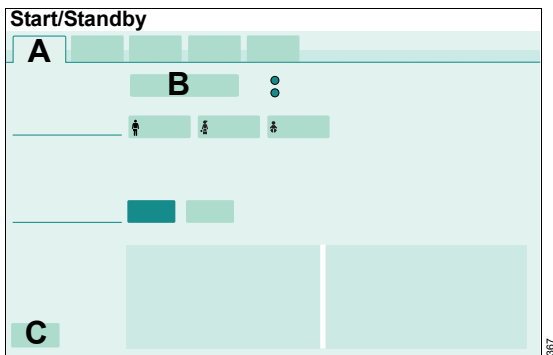

- 2 Touch the **Start ventilation** button (B) and confirm with the rotary knob.

Evita V500 starts the therapy with the set ventilation parameters. The main page for ventilation or O₂ therapy is displayed.

Additional information

The page for the ventilation settings can be opened with the **Ventilation settings...** button (C).

Displaying the status of accessories

- 1 Touch the **Start/ Standby...** button in the main menu bar.
- 2 Touch the **Accessory status** tab (A).

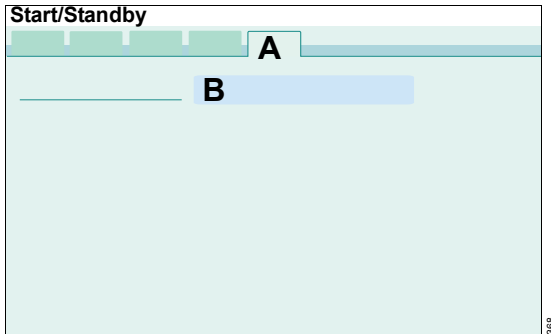

In field (B) Evita V500 displays the time until it is recommended to exchange the accessories.

Sterilization of the expiratory valve or inspiratory valve may gradually impair the operation of RFID transmission. This may mean that Infinity ID breathing circuit functions may not work or may no longer work reliably. The status of the Infinity ID accessories is not displayed.

Additional information

The time for the exchange interval can be configured on the **System setup > System status > Exchange intervals** page. See "Configuring exchange intervals" on page 198.

This page has been left blank intentionally.

Operation

Setting ventilation	91	Required steps after medication nebulization	117
Overview	91	Fitting the Aeroneb nebulizer	118
Opening the Ventilation settings dialog window	91	Measurement maneuver Low Flow PV Loop	119
Selecting ventilation modes	91	Measurement principle	119
Setting ventilation parameters	92	Opening the measurement maneuver	119
General settings for ventilation	93	Performing measurement	120
Additional settings for ventilation	96	Limiting the measurement maneuver	120
NIV – Non-invasive ventilation	99	Aborting measurement	121
Overview	99	Evaluating measurement	121
Safety information when using NIV	99	History	122
Selecting the NIV application mode	99	Diagnostics – measurement maneuver	123
Starting NIV ventilation	100	Overview	123
Setting ventilation parameters for NIV	100	Occlusion pressure – P0.1	123
Monitoring during NIV	101	Intrinsic PEEP – PEEPi	124
Displaying curves and measured values	102	Negative Inspiratory Force – NIF	125
Overview	102	GS500 gas supply unit	126
Changing the screen view	102	Installing the bacterial filter	126
Changing the display of monitoring fields	102	Using the gas supply unit	126
Evaluating loops	104	O2 therapy	127
Freezing waveforms	104	Safety information for O2 therapy	127
Smart Pulmonary View	105	Preparing O2 therapy	127
Help	106	Switching on O2 therapy	128
Maneuvers	107	Setting FiO2 and flow for O2 therapy	128
Overview	107	Switching off O2 therapy	129
Manual inspiration – Manual inspiration/hold	107	Standby mode	130
Expiratory hold	108	Activating standby mode	130
Oxygen enrichment for suction maneuver	108	Continuing the therapy	131
Manual disconnection	110	Ending operation	132
Medication nebulization	111	Disconnecting the device from the mains voltage	133
Safety information on medication nebulization	111	Storing Evita V500	133
Preparing the pneumatic medication nebulizer	113		
Installing the medication nebulizer into the breathing circuit	113		
Switching on medication nebulization	115		
Aborting medication nebulization	117		

Mains power supply / DC power supply	134
Components and terms	134
Use of power supplies	134
Battery operation	135
Charging batteries	135
Care and maintenance of the batteries	136
Intrahospital patient transport	137

Setting ventilation

Overview

This chapter describes how to set ventilation modes and general settings as well as additional settings for ventilation parameters.

For a detailed description of the ventilation modes and ventilation parameters, see chapters "Description of the ventilation modes" on page 310 and "Additional settings for ventilation" on page 332.

Opening the *Ventilation settings* dialog window

The *Ventilation settings* dialog window can be opened as follows:

- Touch the ***Ventilation settings...*** button (A) in the main menu bar.
- Touch the ↑ button (B) in the therapy bar.
- Touch the displayed ventilation mode (C) in the header bar.

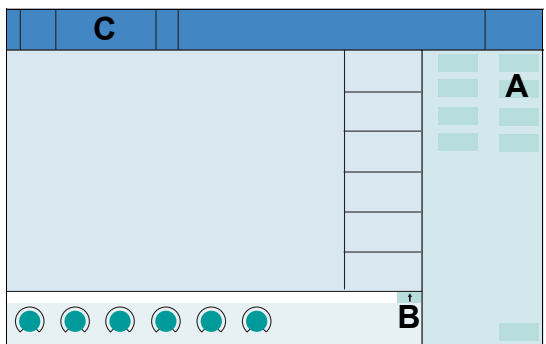

Evita V500 opens the *Ventilation settings* dialog window.

The page for the active ventilation mode (D) with the ***General settings*** tab (F) is displayed by default. The corresponding therapy controls (E) are displayed.

The tab for ***Additional settings*** (G) can be used to supplement the active ventilation mode with additional settings.

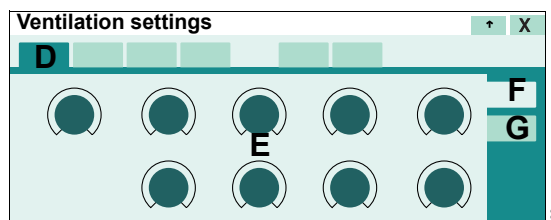

Selecting ventilation modes

Prerequisite: The ***General settings*** page (A) is opened.

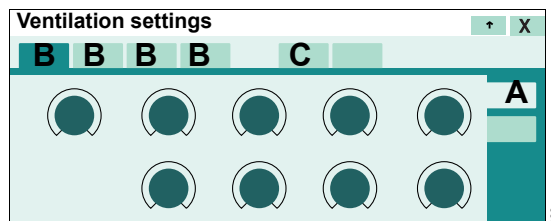

The *Ventilation settings* dialog window contains 5 tabs for selecting the ventilation modes. 4 tabs (B) have ventilation modes permanently assigned to them. The fifth tab (C) can be used to select another ventilation mode, which can be selected from the available ventilation modes.

The following 4 ventilation modes are preset at the factory:

- VC-AC
- PC-BIPAP
- VC-SIMV
- SPN-CPAP/PS

For information on changing the assignment of ventilation modes, see "Configuring start-up settings for the ventilation modes" on page 188.

Selecting an additional ventilation mode in the dialog window

- 1 Touch the **Other modes** tab (D).

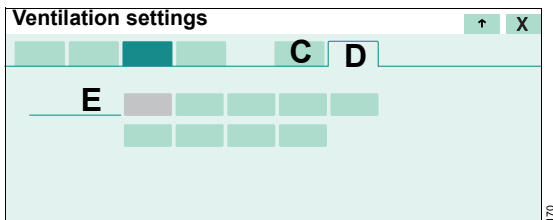

All the available ventilation modes (E) are displayed.

- 2 Touch the button for the corresponding ventilation mode. The color of the tab (D) turns yellow.
- 3 Confirm with the rotary knob.

The additional ventilation mode is displayed in the fifth tab (C). The ventilation mode is active.

Changing the ventilation mode

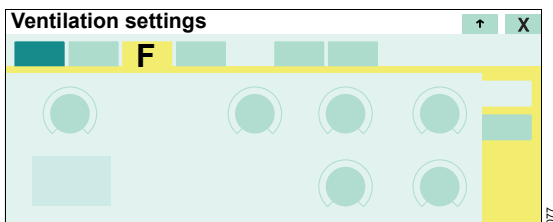

- 1 Touch the corresponding tab, e.g., (F). The color of the tab turns yellow.
- 2 Preset the ventilation parameters if necessary.

- 3 Confirm with the rotary knob. The color of the tab turns dark green.

The ventilation mode is active. The settings are applied to the patient.

Setting ventilation parameters

Prerequisite: The **General settings** page (A) is opened.

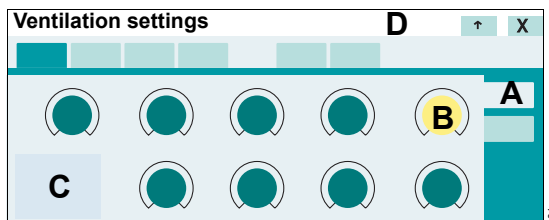

- 1 Touch the corresponding therapy control, e.g., (B).
- 2 Set the value by turning the rotary knob and push to confirm.

The additional ventilation parameters derived from the ventilation parameter are calculated by Evita V500 and displayed in the setting assistance field (C).

Information is displayed in the message field (D), e.g., when the setting limit of a parameter has been reached.

Setting ventilation parameters in the therapy bar

The ventilation parameters of the active ventilation mode can also be set with the therapy controls in the therapy bar (E).

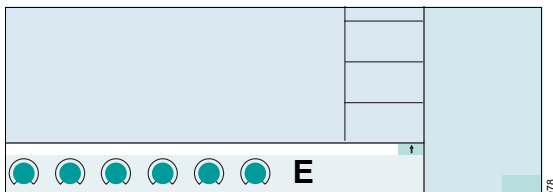

Additional information

"Exceeding the set limit of a ventilation parameter" on page 41.

"Direct setting of ventilation parameters (QuickSet)" on page 41.

"Linked setting of ventilation parameters" on page 42.

General settings for ventilation

The general settings for the ventilation parameters are listed in the following tables:

- Volume-controlled ventilation modes (only in the **Adult** and **Ped. pat.** patient categories)
- Pressure-controlled ventilation modes
- Spontaneous breathing support

WARNING

Do not suction during volume-controlled ventilation. Flow delivery is limited in this form of ventilation. As a result, negative pressures are possible. Patient hazard!

WARNING

In the Neo. patient category, always use the neonatal flow sensor for ventilation in the Tube application mode. Otherwise, measurement accuracy will be impaired. Patient hazard!

CAUTION

In volume-controlled ventilation modes for pediatric patients with relatively low compliance, deviations in VT and MV are possible. In such cases, change to pressure-controlled ventilation.

WARNING

If flow measurement is deactivated for SPN-CPAP, use a separate monitoring device.

CAUTION

Only remove the water trap of the expiratory valve briefly during ventilation. Otherwise, ventilation will be impaired.

Volume-controlled ventilation modes

Ventilation parameters	Ventilation mode			
	VC-SIMV	VC-CMV	VC-AC	VC-MMV
FiO ₂	X	X	X	X
VT	X	X	X	X
Ti	X	X	X	X
RR	X	X	X	X
Slope	X	X ¹⁾	X ¹⁾	X
Pmax	X ²⁾	X ²⁾	X ²⁾	X ²⁾
Flow	X ³⁾	X ³⁾	X ³⁾	X ³⁾
PEEP	X	X	X	X
ΔPsupp	X			X

- 1) if **AutoFlow** is switched on
- 2) if **Pmax/Paw high auto** is activated
- 3) if **AutoFlow** is switched off

Pressure-controlled ventilation modes

Ventilation parameters	Ventilation mode					
	PC-SIMV	PC-BIPAP	PC-AC	PC-CMV	PC-APRV	PC-PSV
FiO ₂	X	X	X	X	X	X
VT	X ¹⁾		X ¹⁾	X ¹⁾		X ¹⁾
Ti	X	X	X	X		
RR	X	X	X	X		X
Slope	X	X	X	X	X	X
Pmax	X ²⁾	X ²⁾	X ²⁾	X ²⁾	X ²⁾	X ²⁾
Pinsp	X	X	X	X		X
PEEP	X	X	X	X		X
ΔPsupp	X	X				
Timax						X ³⁾
Thigh					X	
Tlow					X ⁴⁾	
Phigh					X	
Plow					X	
Tlow max					X ⁵⁾	
Exp. term.					X ⁵⁾	

- 1) if **VG** is switched on
- 2) if **Pmax/Paw high auto** is activated and **ATC** or **Apnea Ventilation** or **VG** is switched on
- 3) in the **Neo** patient category in the **Tube** application mode, or in the **Adult** and **Ped. pat.** patient categories in the application mode **NIV**
- 4) if **AutoRelease** is switched off
- 5) if **AutoRelease** is switched on

Spontaneous breathing support

Ventilation parameters	Ventilation mode			
	SPN-CPAP/PS	SPN-CPAP/VS	SPN-CPAP ¹⁾	SPN-PPS
FiO ₂	X	X	X	X
VT		X		
T _{imax}	X ²⁾	X ²⁾		X ²⁾
Slope	X	X	X	
P _{max}	X ³⁾	X ³⁾		X ³⁾
PEEP	X	X	X	X
ΔP _{supp}	X			
Vol. Assist				X
Flow Assist				X
T _{manInsp}			X	
P _{manInsp}			X	

- 1) only available in the **Neo.** patient category in the **NIV** application mode
- 2) in the **NIV** application mode or in the **Neo.** patient category
- 3) if **P_{max}/P_{aw} high auto** is activated

Additional settings for ventilation

Overview of possible supplementary settings

The ventilation modes can be combined with additional settings to optimize ventilation. The table shows the possible additional settings for the respective ventilation mode.

Ventilation mode	Additional settings								
	Apnea Ventilation	Trigger	Insp. term.	Sigh	AutoFlow	ATC	Volume Guarantee	Auto Release	Variable PS
VC-SIMV	X	X	X	X	X	X			
VC-CMV				X	X	X			
VC-AC		X		X	X	X			
VC-MMV		X	X	X	X	X			
PC-SIMV	X	X	X	X		X	X		
PC-BIPAP	X	X	X	X		X			
PC-AC		X		X		X	X		
PC-CMV				X		X	X		
PC-APRV	X					X		X	
PC-PSV		X	X	X		X	X		
SPN-CPAP/PS	X	X	X			X			X
SPN-CPAP/VS	X	X	X			X			
SPN-PPS	X	X	X			X			

Setting the supplementary settings

Prerequisite: The page with the active ventilation mode is open.

- 1 Touch the **Additional settings** tab (A).

The additional settings of the active ventilation mode are displayed.

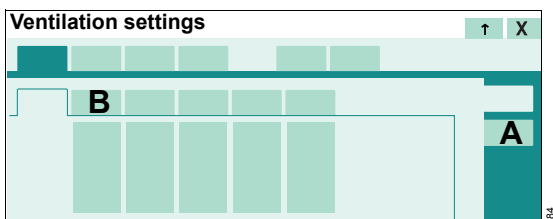

- 2 Touch the tab of the respective additional setting (B).

The page for setting the corresponding parameters is opened.

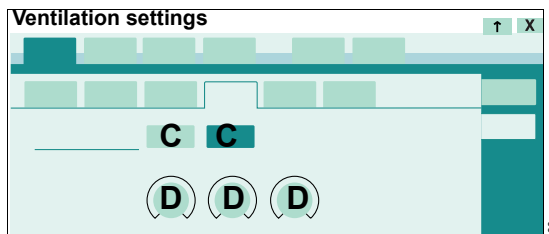

- 3 Use the buttons (C) to activate or deactivate the additional setting.

- 4 Touch the corresponding therapy control (D).
- 5 Set the value by turning the rotary knob and push to confirm.

The **Trigger** and **Apnea Ventilation** additional settings can be configured as buttons in the main menu bar to enable direct access. See "Assigning functions to additional buttons" on page 179.

Ventilation parameters for the additional settings

CAUTION

High trigger sensitivity may lead to auto-triggering of the ventilator.

Additional settings	Ventilation parameters	Dependencies, information
Apnea Ventilation	On/Off	
	VTapn	
	RRapn	
	Pmax	If Pmax/Paw high autaset is configured
	PEEP	In PC-APRV
	Flow trigger	In PC-APRV
	Slope	In SPN-PPS
		For configuration of the Automatic return from Apnea Ventilation function, see "Configuring general settings" on page 194. For a description, see "Automatic return from apnea ventilation" on page 334.
Trigger/ Termin.	Flow trigger	
	Insp. term.	
		Can be configured on the System setup > Ventilation > Start settings > General settings page
Sigh	On/Off	
	Δ intPEEP	
	Interval sigh	
	Cycles sigh	
AutoFlow	On/Off	
	Slope	If not adjustable on the General settings Pmax page
	Pmax	If Pmax/Paw high autaset is configured

Additional settings	Ventilation parameters	Dependencies, information
ATC	On/Off	See chapter "Configuration" on page 173.
	Tube type (ET/Trach.)	The tube type cannot be selected in the Neo. patient category.
	Tube Ø	Inner diameter of the tube
	Compens.	Degree of compensation: Compens. = 100 % – airway pressure regulation to trachea level
	Pmax	If Pmax/Paw high autose t is configured
Volume Guarantee	On/Off	See chapter "Configuration" on page 173.
	VT	
	Pmax	If Pmax/Paw high autose t is configured
	Pinsp	If VG is switched off
AutoRelease	On/Off	
	Exp. term.	
	Tlow	If AutoRelease is switched off
	Tlow max	If AutoRelease is switched on
Variable PS	Press. var.	
	Psupp	
	Pmax	If Pmax/Paw high autose t is configured
		Only in the Adult and Ped. pat. patient categories

Additional information

For a detailed description of the additional settings, see chapter "Additional settings for ventilation" on page 332.

NIV – Non-invasive ventilation

Overview

Evita V500 can be used for the ventilation of intubated patients (application mode **Tube**) and for non-invasive ventilation (application mode **NIV**).

This chapter describes the use of non-invasive ventilation in the **NIV** application mode.

In the **Adult** and **Ped. pat.** patient categories, all the ventilation modes may be selected in the **NIV** application mode. In the **Neo.** patient category, only the **SPN-CPAP** and **PC-CMV** ventilation modes may be selected.

Safety information when using NIV

WARNING

Avoid high airway pressures. Danger of aspiration!

WARNING

Alarm limits and ventilation settings must be checked or set again in order to ensure complete monitoring of ventilation after changing from **NIV** application mode to **Tube** application mode.

CAUTION

Application mode **NIV** must not be activated with intubated patients!

CAUTION

Use of masks increases the dead space. Observe the mask manufacturer's instructions!

NOTE

Use suitable masks. Otherwise excessive leakages may occur.

Automatic tube compensation (ATC) which is activated in **Tube** application mode is ineffective in **NIV** application mode.

Selecting the **NIV** application mode

The application mode can only be selected in standby mode.

- 1 Touch the **Start/ Standby...** button in the main menu bar.

Evita V500 opens the **Start/Standby** dialog window. The **Start/Standby** page appears by default.

- 2 Touch the **Standby** button and confirm with the rotary knob.

Evita V500 is in standby mode.

- 3 Touch the **Tube/NIV** tab (A).

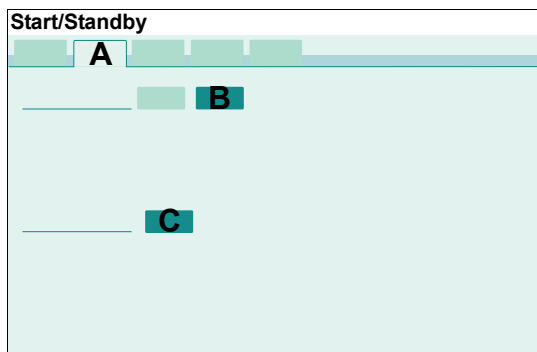

- 4 Touch the **NIV** button (B) and confirm with the rotary knob.

Evita V500 is in the **NIV** application mode. Evita V500 displays the symbol  in the header bar.

In the **Neo.** patient category, flow monitoring is deactivated.

Limiting the inspiratory flow in the Neo. patient category

In the **Neo.** patient category the inspiratory flow can be limited with the **Flow max** setting. The base flow and the nebulizer flow (if active) are not affected by this setting. If the **NIV** application mode is selected, the setting is reset to the maximum value.

To limit the maximum flow:

- Touch the **Flow max** button (C). Set the value by turning the rotary knob and push to confirm.

Starting NIV ventilation

Prerequisite: The **Start/Standby** dialog window is opened.

- 1 Touch the **Start/Standby** tab (A).

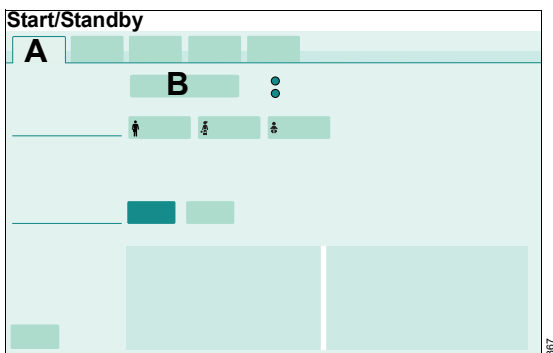

- 2 Touch the **Start ventilation** button (B) and confirm with the rotary knob.

Evita V500 starts the therapy with the set ventilation parameters. The main screen for ventilation is displayed.

Setting ventilation parameters for NIV

- Set the ventilation parameters as described under "Setting ventilation parameters" on page 92.

Therapy control **Timax**

The therapy control **Timax** (A) limits the maximum duration of supported breaths (Pressure Support, Volume Support, PPS) because the inspiratory termination criterion may be ineffective with very high leakages.

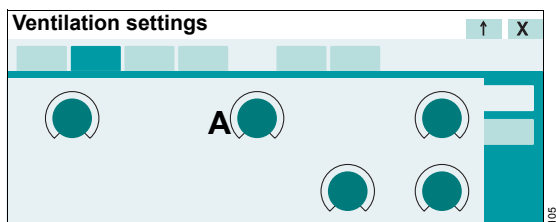

- Set the value for **Timax** by turning the rotary knob and push to confirm.

Therapy controls **TmanInsp** and **PmanInsp**

Prerequisite: The **Neo.** patient category and the **SPN-CPAP** ventilation mode are set.

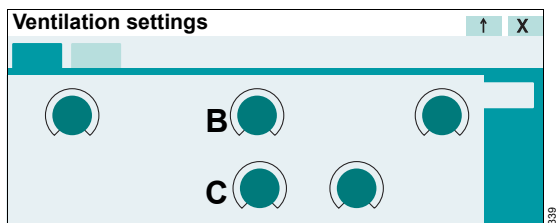

During manual inspiration, the duration of the mandatory breath is determined by the **TmanInsp** therapy control (B).

During manual inspiration, the pressure of the mandatory breath is determined by the **PmanInsp** therapy control (C).

- Set and confirm the relevant values using the rotary knob.

Monitoring during NIV

The following settings are necessary in order to avoid false alarms and ensure monitoring:

- Adjust both alarm limits for MVe in line with the current value.
- Use additional monitoring, e.g., external SpO₂, if necessary.

The following alarm limits may be deactivated in order to avoid artefacts:

- **MV low**
- **VT high**
- **VT low**
- **Tapn**

WARNING

Alarm limits may only be deactivated if the safety of the patient is not jeopardized by the absence of an alarm!

A message is displayed in the header bar if an alarm limit has been deactivated.

A delay time **Tdisconnect** between 0 and 60 seconds can be set for the lower alarm limit for the airway pressure.

Additional information

"Setting alarm limits" on page 144.

Displaying curves and measured values

Overview



This chapter describes how curves and measured values are displayed on the main screen as well as how to change the screen views during operation.

Changing the screen view

Evita V500 displays a preconfigured view on the main screen.

6 hospital-defined views can be created in the **System setup** dialog window.

1 Touch the **Views...** button in the main menu bar.

Evita V500 opens the **Views** dialog. The symbols next to the buttons indicate whether the relevant view is locked  or can be changed .

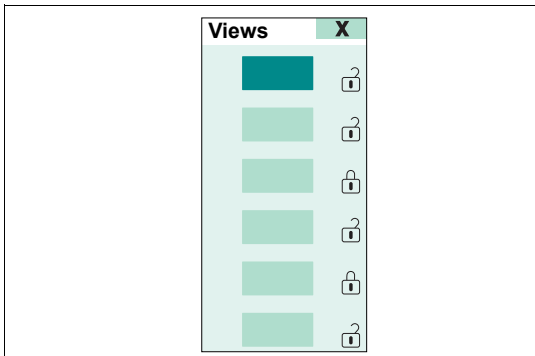

2 Touch the button for the corresponding view.

The screen displays the selected view.

Closing the Views dialog

- Touch the **X** button.

Changing the display of monitoring fields

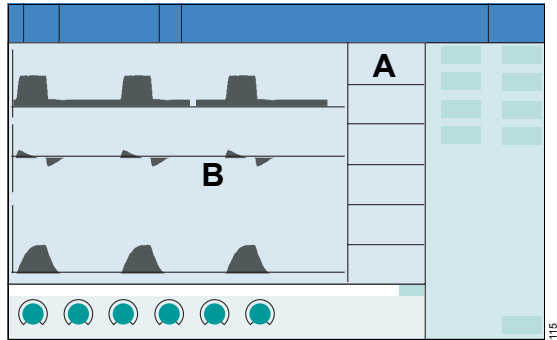

The parameters can be displayed in parameter fields (A) and in the curve field (B).

The fields can be standard or double in size. The information that can be displayed depends on the size of the fields:

Parameter fields

Standard size	Single parameter
	Two parameters
	Short trend for measured values
	Short trend for set values
Double size	Single parameter
	Parameter group
	Loop
	Short trend for measured values
	Short trend for set values

Curve fields

Standard size	Single curve
	Trend for measured values
	Trend for set values
	Tabular trend
	Multi-trend
	Alarm history
	Recruitment trends
Double size	Single curve
	Single loop
	Double loops
	Trend for measured values
	Trend for set values
	Tabular trend
	Multi-trend
	Alarm history
	Lung display (Smart Pulmonary View)
	Recruitment trends

Selecting the display of parameter fields

- 1 Touch the parameter field.

The selected parameter field is highlighted. Evita V500 opens the dialog for the contents of the parameter field.

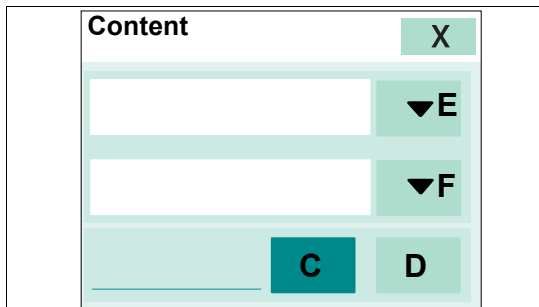

Selecting the field size

- 2 Touch the **1x** button (C) for standard size or **2x** (D) for double size.

Selecting the display format

- 3 Touch the (E) button.

The selection list for the display of parameters is displayed according to the selected size of the parameter field.

- 4 Select the display format and confirm with the rotary knob.

Selecting the parameter

- 5 Touch the (F) button.

The selection list for the displayable parameters is displayed.

- 6 Select the parameter and confirm it with the rotary knob.

Closing the dialog

- 7 Touch the **X** button. The dialog is closed.

Selecting the display of curve fields

- 1 Touch the curve field.

The selected curve field is highlighted. Evita V500 opens the dialog for the contents of the curve field.

- 2 Proceed as described under "Selecting the display of parameter fields".

Additional information

"Configuring the screen view" on page 176.
 "Factory-set screen views" on page 371.

Evaluating loops

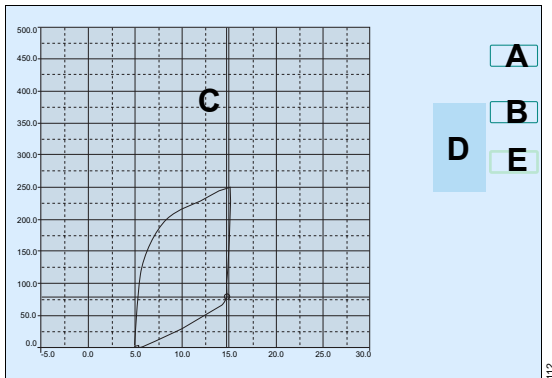

Displaying a reference loop

- Touch the **Ref.** button (A).

A loop is recorded and displayed as a reference loop.

The date and the time of the loop appear beside the button (A). The reference loop is drawn in black. The reference loop remains displayed until the **Ref.** button (A) is touched again.

Recording the current loop in order to freeze, display and save it afterwards

- Touch the **Capture loop** button (B).

The current loop is frozen. The loops are drawn in blue. After "freezing", a cursor (C) is displayed which can be moved with the rotary knob. The respective values are displayed (D).

Recording up to 10 loops of mandatory or spontaneous breaths

- 1 Touch the **Draw** button (E).
- 2 Set how many loops should be recorded with the rotary knob and push to confirm.

The set number is displayed in the button.

Additional information

A grid only appears if loops are displayed in the complete curve field.

Freezing waveforms

The **Freeze waveforms** function can be configured as a button in the main menu bar to enable direct access. See "Assigning functions to additional buttons" on page 179.

- Touch the **Freeze waveforms** button in the main menu bar.

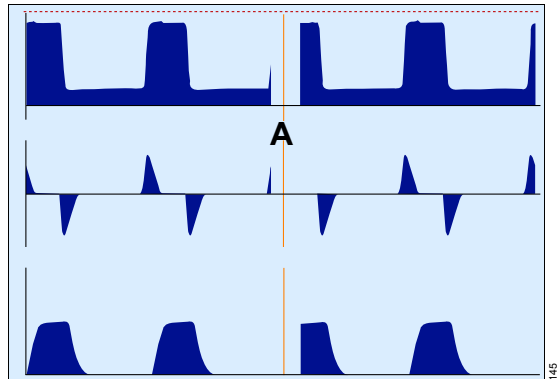

The current curves are immediately frozen. The cursor (A) displays the time of "freezing" and the value at the cursor position.

To display a measured value at a certain moment in time:

- Position the cursor on the time with the rotary knob.

The measured value or the measured value pair are displayed above the curve.

To cancel the **Freeze waveforms** function:

- Touch the **Freeze waveforms** button in the main menu bar again.

Smart Pulmonary View

Smart Pulmonary View is a graphic display of the compliance and resistance as well as of the spontaneous and mandatory minute volume.

A double-size curve field must be configured in order to display Smart Pulmonary View. See "Configuring the screen view" on page 176.

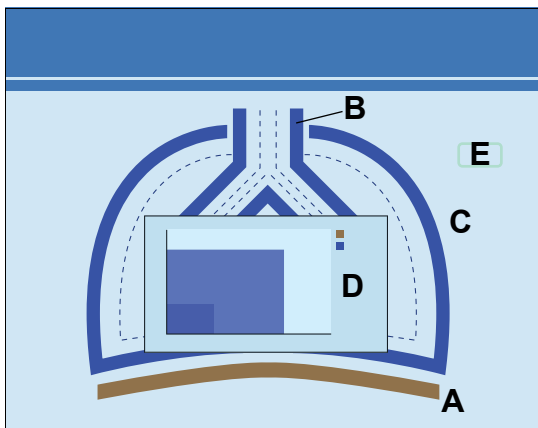

- A** The movement of the diaphragm indicates synchronized mandatory breaths, supported (triggered) breaths, or spontaneous breaths.
- B** The blue line around the trachea indicates the resistance **Rpat**. The higher the resistance, the thicker the line. The value is also displayed.
- C** The blue line around the lungs indicates the compliance **Cdyn**. The higher the compliance, the thinner the line. The value is also displayed.
- D** Diagram displaying the relationship between spontaneous breathing and mandatory ventilation. The following parameters are displayed in different colors:
 - **VTspon** and **RRspon**
 - **VTmand** and **RRmand**

Smart Pulmonary View must be calibrated for each new patient. If the measured values for **Rpat** and **Cdyn** are outside the current display range, a red line appears and calibration is required. Evita V500 displays the following information:

Touch "Take reference".

Calibrating Smart Pulmonary View:

- Touch the **Take reference** button (E).

The display range is adapted to the current measured values. The measured values from the last calibration are displayed as a broken line.

Additional information

For a detailed description, see "Smart Pulmonary View" on page 352.

Help

WARNING

Risk of operating error

The **Help** function is not a substitute for the instructions for use. The instructions for use must be observed to ensure safe operation.

The **Help** function can be configured as a button in the main menu bar to enable direct access. See "Assigning functions to additional buttons" on page 179.

Opening Help

- Touch the **Help...** button in the main menu bar.

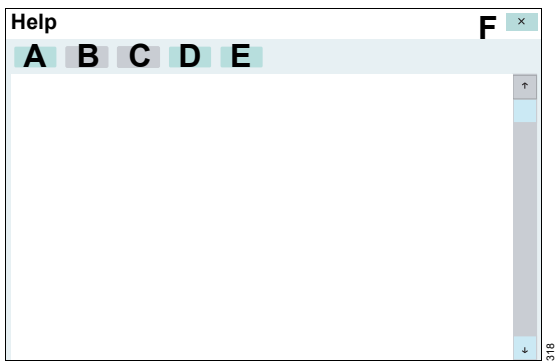

The following buttons are available in the **Help** dialog window:

- **Home** (A) to open the start page
- ← (B) to scroll back
- → (C) to scroll forward
- **Content** (D) to open the table of contents
- **Index** (E) to open the index

- Touch the appropriate button.

Closing Help

- Touch the (F) button.

Opening Help in the dialog window

The Help function can also be opened in the following dialog windows:

- **Ventilation settings**
- **Special maneuvers > Nebulization**
- **Special maneuvers > Maneuvers**

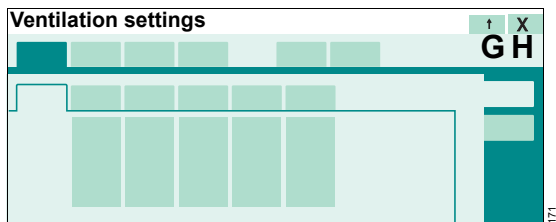

- Touch the ↑ button (G) in the dialog window.

The appropriate section of the Help is displayed.

Closing Help

- Touch the ↓ (G) or the (H) button in the dialog window.

Maneuvers

Overview

Evita V500 permits the following measurement maneuvers on the **Special maneuvers > Maneuvers** page:

- Manual inspiration – Manual inspiration/hold
- Expiratory hold
- Oxygen enrichment for suction maneuver
- Manual disconnection

Manual inspiration – Manual inspiration/hold

The **Manual inspiration/hold** maneuver can be activated in all ventilation modes and offers the following options:

- Between two mandatory breaths, a breath can be manually started and held. The pattern of the manually started breath corresponds to the ventilation pattern of the currently active automatic ventilation mode.
- Regardless of the start time, a mandatory breath can be prolonged.

- 1 Touch the **Special maneuvers...** button in the main menu bar.

Evita V500 opens the **Special maneuvers** dialog window.

- 2 Touch the **Maneuvers** tab (A) if the page is not already preset.

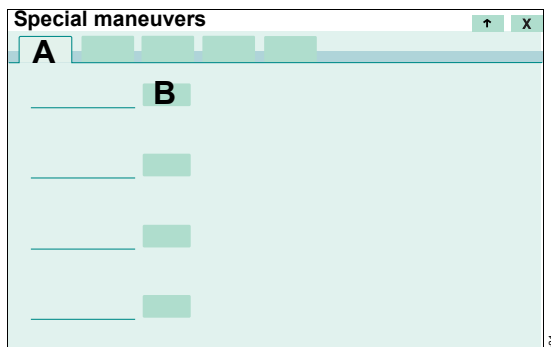

Triggering manual inspiration

- Briefly touch the **Man. insp./hold** button (B).

Manually extending inspiration

- Touch and **hold** the **Man. insp./hold** button (B) for the desired inspiratory time.

Evita V500 triggers an extended breath or extends an already triggered mandatory breath.

Evita V500 automatically ends inspiration:

- After a maximum of 40 seconds in the **Adult** and **Ped. pat.** patient categories
- After a maximum of 5 seconds in the **Neo.** patient category

WARNING

The Manual inspiration/hold maneuver must not be used during endotracheal suction. Otherwise negative pressure may jeopardize the patient.

Additional information

The **Manual inspiration/hold** maneuver can be configured as a **Man. insp./hold** button in the main menu bar to enable direct access. See "Assigning functions to additional buttons" on page 179.

Expiratory hold

Expiratory hold can be activated in all ventilation modes. The maneuver is required for determining the measured NIF factor for weaning. This maneuver is not available in the **Neo.** patient category.

- 1 Touch the **Special maneuvers...** button in the main menu bar.

Evita V500 opens the **Special maneuvers** dialog window.

- 2 Touch the **Maneuvers** tab (A) if the page is not already preset.

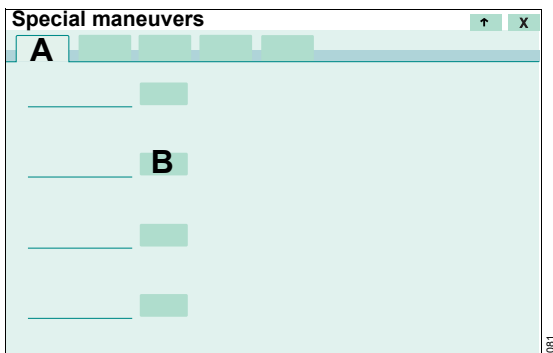

- 3 Touch and **hold** the **Exp. hold** button (B) for the desired expiratory time. Expiration is ended by Evita V500 after a maximum of 45 seconds in the **Adult** patient category and 30 seconds in the **Ped. pat.** patient category.

WARNING

Expiratory hold must not be used during endotracheal suction. Otherwise negative pressure may jeopardize the patient.

Additional information

Displaying NIF, see "Negative Inspiratory Force – NIF" on page 125.

For a detailed description, see "Negative Inspiratory Force – NIF" on page 350.

The **Exp. hold** maneuver can be configured as a button in the main menu bar to enable direct access. See "Assigning functions to additional buttons" on page 179.

Oxygen enrichment for suction maneuver

Overview

To avoid hypoxia during endotracheal suction, Evita V500 offers a function for oxygen enrichment.

For the **Adult** patient category, the O₂ concentration is increased to 100 Vol%. For the **Ped. pat.** and **Neo.** patient categories, the O₂ concentration is increased to the current inspiratory O₂ concentration, multiplied by a factor. The factor can be configured, see page 194.

After oxygen enrichment is started, Evita V500 ventilates the patient with an increased O₂ concentration for an initial oxygen enrichment phase of 180 seconds max. During this time, Evita V500 waits for a disconnection.

When the device is disconnected for suction, Evita V500 interrupts ventilation. During the suction phase, the acoustic alarms are suppressed so that the suction maneuver is not disturbed.

After suction and automatically recognized reconnection, Evita V500 delivers an increased O₂ concentration for the final oxygen enrichment phase of 120 seconds.

During suction and for 120 seconds afterwards, the lower alarm limit for the minute volume is switched off.

Initial and final oxygen enrichment are only possible with a fully functioning flow sensor and if flow monitoring is switched on!

WARNING

Select an appropriate suction catheter for suction. Otherwise this may result in a too high negative pressure.

WARNING

Do not suction during volume-controlled ventilation. Flow delivery is limited with this form of ventilation and therefore a high negative pressure may occur.

WARNING

Risk of patient injury during suction in a closed breathing circuit

Using closed suction systems produces negative pressure in the patient's airways. This leads to impaired ventilation and therefore to impaired gas exchange.

Observe patient condition.

Before suction

- 1 Touch the **Special maneuvers...** button in the main menu bar.

Evita V500 opens the **Special maneuvers** dialog window.

- 2 Touch the **Maneuvers** tab (A) if the page is not already preset.

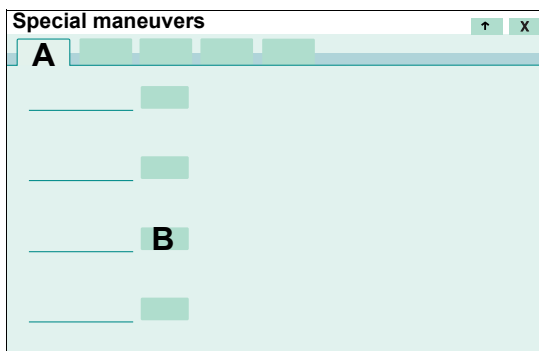

- 3 Touch the **O₂ suction** button (B) and confirm with the rotary knob.

The oxygen enrichment program is started.

Evita V500 ventilates in the set ventilation mode with an increased O₂ concentration:

Patient category : 100 Vol% O₂
Adult

Patient categories : 1 to 2 times the current
Ped. pat. and **Neo.** FiO₂ concentration

If PEEP is not set to more than 4 mbar (4 cmH₂O), a PEEP of 4 mbar (4 cmH₂O) will be applied automatically. This PEEP allows Evita V500 to detect disconnection. The other ventilation parameters remain unaffected.

Screen display:



The field (C) in the header bar continuously displays the initial oxygen enrichment phase with the remaining time in seconds.

Initial oxygen enrichment lasts for a maximum of 180 seconds. During this time Evita V500 waits for a disconnection for suction. Evita V500 terminates the oxygen enrichment if there is no disconnection after the 180 seconds have elapsed.

After disconnection for suction, Evita V500 delivers a minimal flow for the duration of disconnection in order to detect automatically the end of the disconnection phase. 120 seconds are available for suctioning. In the header bar, the disconnection phase with the remaining time available for suction is displayed continuously in seconds (C).

Automatic termination of oxygen enrichment

If there is no reconnection when the time available (120 seconds) has elapsed, the oxygen enrichment is terminated. All alarms are immediately active again. Evita V500 continues to ventilate immediately in the set ventilation mode.

After reconnection

After reconnection, Evita V500 continues ventilating in the set ventilation mode, except that for 120 seconds an increased O₂ concentration will continue to be delivered for final oxygen enrichment.

In the header bar, the remaining time available for the final oxygen enrichment phase is displayed continuously in seconds.

Terminating oxygen enrichment prematurely

- Touch the **O₂ suction** button again and confirm with the rotary knob.

Additional information

The suction maneuver can be configured as a **O₂ suction** button in the main menu bar to enable direct access. See "Assigning functions to additional buttons" on page 179.

Manual disconnection

When the **Manual disconnection** maneuver is activated, Evita V500 reduces flow delivery. The patient can be disconnected within the next 10 seconds. When the patient is reconnected, Evita V500 resumes ventilation in the set ventilation mode.

- 1 Touch the **Special maneuvers...** button in the main menu bar.

Evita V500 opens the **Special maneuvers** dialog window.

- 2 Touch the **Maneuvers** tab (A) if the page is not already preset.

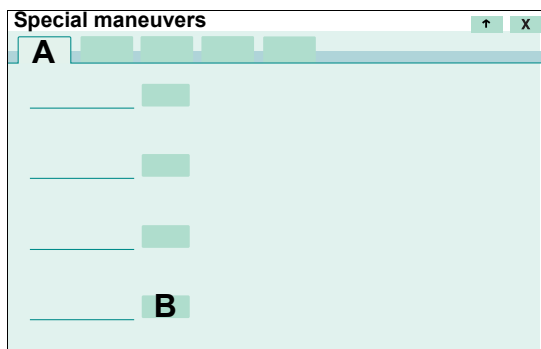

Activating manual disconnection

- Touch the **Manual discon.** button (B) and confirm with the rotary knob.

Additional information

The **Manual disconnection** maneuver can be configured as a **Manual discon.** button in the main menu bar to enable direct access. See "Assigning functions to additional buttons" on page 179.

Medication nebulization

Safety information on medication nebulization

WARNING

Risk of fire

The flow sensor can ignite medications or other substances based on highly flammable substances.

- Do not nebulize medications or other substances that are easily flammable or spray them into the device.
- Do not use substances containing alcohol.
- Do not allow flammable or explosive substances to enter the breathing system or the breathing circuit.

CAUTION

During medication nebulization, do not use a heat and moisture exchanger (HME) at the Y-piece. The medication will not be appropriately administered to the patient.

CAUTION

Do not place a bacterial filter on the nebulizer outlet during nebulization! Bacterial filters may increase the flow resistance and impair ventilation.

CAUTION

Remove the medication nebulizer after use. Accidental medication nebulization may impair ventilation.

CAUTION

Surplus nebulized medication can affect the ambient air.

CAUTION

If no pneumatic medication nebulizer is connected, switch off the nebulization function. Otherwise, Evita V500 will deliver a tidal volume that is too low.

CAUTION

Ventilation impaired

If unapproved pneumatic medication nebulizers are used, the tidal volume and O₂ concentration actually delivered may deviate from the displayed values.

Only use the medication nebulizers listed in the current list of accessories.

CAUTION

Ventilation impaired

Aerosols may impair the functional integrity of the expiratory valve.

When using medication nebulization, shorten the reprocessing cycles for the expiratory valve.

Failure of the Air supply

If the Air supply fails during medication nebulization, the medication nebulizer will continue to operate with 100 Vol% O₂. In this case, deviations in the inspiratory O₂ concentration are possible.

Air supply from the GS500 gas supply unit

If Evita V500 is supplied with Air from the GS500 gas supply unit and O₂ is supplied from the central gas supply system, the medication nebulizer operates with O₂ only.

The measured value **F_{IO2}** indicates the O₂ concentration of the gas supplied at the inspiratory port and not the O₂ concentration reaching the patient. For deviations, see page 346.

Using a pneumatic medication nebulizer in the **Adult patient category**

Medication nebulization may be used in all ventilation modes.

Evita V500 applies the medication aerosol in synchronization with the inspiratory flow phase and maintains a constant minute volume.

If Evita V500 is supplied with Air and O₂ from the central gas supply system, the medication nebulizer is operated with mixed gas at the set O₂ concentration. Small deviations in the inspiratory O₂ concentration of up to ± 4 Vol% are possible. To avoid greater deviations, Evita V500 automatically switches off medication nebulization at inspiratory flows below 14 L/min.

Using a pneumatic medication nebulizer in the **Ped. pat. patient category (with Infinity ID flow sensor)**

Medication nebulization is possible in the pressure-controlled ventilation modes. In volume-controlled ventilation modes, nebulization is only possible while using the AutoFlow ventilation mode extension.

The medication nebulizer nebulizes continuously. The aerosol generated during expiration does not reach the lungs, however.

If Evita V500 is supplied with Air and O₂ from the central gas supply system, the medication nebulizer is operated with mixed gas at the set O₂ concentration. Small deviations in the inspiratory O₂ concentration of up to ± 4 Vol% are possible. For respiratory rates above 12/min, refer to the graph on page 345.

CAUTION

For respiratory rates of less than 12/min, major deviations in O₂ concentration may occur in extreme cases. Such deviations cannot be detected by the device's internal monitoring of O₂ concentration.

For this reason, do not use the medication nebulizer at respiratory rates of less than 12/min!

CAUTION

The inspiratory tidal volume displayed may be considerably higher or lower than the actual inspiratory tidal volume applied to the patient on account of tolerances in the nebulizer flow. Pressure-controlled ventilation is therefore recommended during nebulization.

Compare the current measured values for minute and tidal volumes with the measured values before nebulization.

If the VT and MV values differ significantly, the ventilation pressure can be used for assessment of the ventilation.

VT and MV values can be assessed by comparing the difference between PEEP and plateau pressure before and during nebulization.

In order to avoid false alarms and ensure monitoring:

- Adjust both alarm limits for MVE in line with the current value.
- Use additional monitoring, e.g., external SpO₂, if necessary.

Using a pneumatic medication nebulizer in the **Neo. and Ped. pat. patient categories (with neonatal flow sensor)**

Medication nebulization is possible in the pressure-controlled ventilation modes. In the **Ped. pat.** patient category, medication nebulization is also possible in volume-controlled ventilation modes in conjunction with AutoFlow.

The medication nebulizer nebulizes continuously. The aerosol generated during expiration does not reach the lungs, however.

If Evita V500 is supplied with Air and O₂ from the central gas supply system, the medication nebulizer is operated with mixed gas at the set O₂ concentration. Small deviations in the inspiratory O₂ concentration of up to ± 4 Vol% are possible. For respiratory rates above 12/min, refer to the graph on page 345.

In order to avoid false alarms and ensure monitoring:

- Use additional monitoring, e.g., external SpO₂, if necessary.

Preparing the pneumatic medication nebulizer

Only use pneumatic medication nebulizer 8412935 (with white body core). If other pneumatic medication nebulizers are used, there may be major deviations in tidal volume and inspiratory O₂ concentration!

CAUTION

If medication nebulization is performed using an incorrect medication chamber, there is a danger of considerable deviations in the tidal and minute volumes.

- Prepare the medication nebulizer in accordance with the corresponding instructions for use.

Installing the medication nebulizer into the breathing circuit

For use in the *Adult* patient category

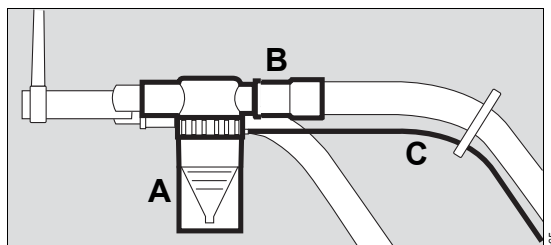

- 1 Connect the medication nebulizer (A) to the inspiratory side of the Y-piece.
- 2 Connect the inspiratory hose (B) to the medication nebulizer.
- 3 Place the medication nebulizer in the vertical position.
- 4 Using clamps, run the nebulizer hose (C) back to Evita V500 along the inspiratory hose.

For use in the *Ped. pat.* and *Neo.* patient categories

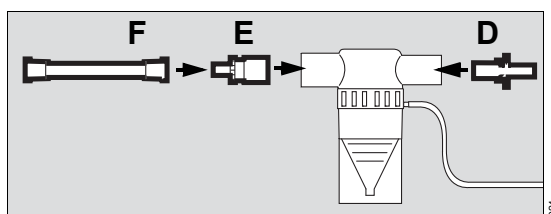

- 1 Insert the catheter connector (D) in the inlet port of the medication nebulizer.
- 2 Insert the adapter (E) in the outlet port of the medication nebulizer.
- 3 Fit the corrugated hose (F), length 0.13 m (5.1 in) to the adapter (E).

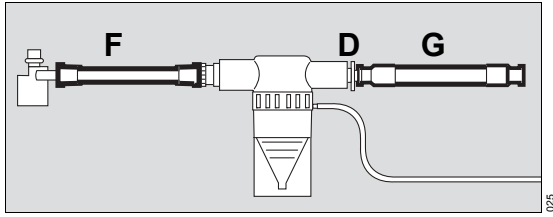

- 4 Remove the corrugated hose of the breathing circuit (G) from the inspiratory port of the Y-piece and connect it to the catheter connector (D).
- 5 Connect the free end of the corrugated hose (F) to the inspiratory port of the Y-piece.

Additional information

The catheter connector (D) and adapter (E) can be ordered under order number 8411031, see the list of accessories.

When using on the incubator

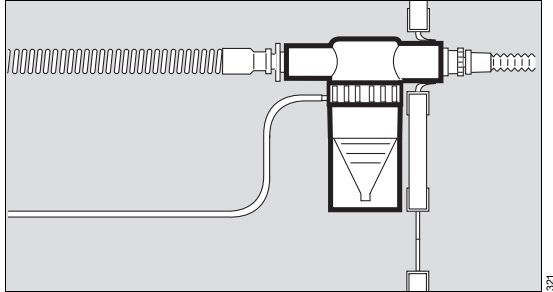

- Push the inlet port or the outlet port of the medication nebulizer into the upper hose guide of the incubator.

When using without incubator

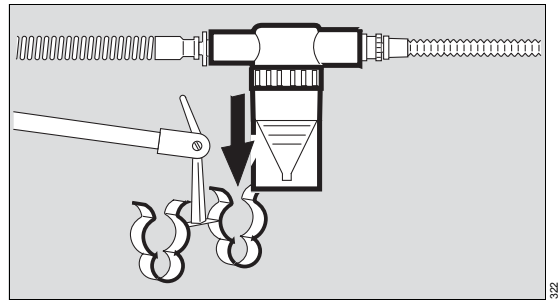

- 1 Press the inlet port or the outlet port of the medication nebulizer into one side of the clip and the expiratory hose into the other.
- 2 Place the medication nebulizer in the vertical position.

Connecting the nebulizer hose

WARNING
 The nebulizer port (H) must be used for nebulization only! Otherwise the proper functioning of the device may be disrupted and the patient endangered.

- Connect the nebulizer hose (I) to the nebulizer port (H).

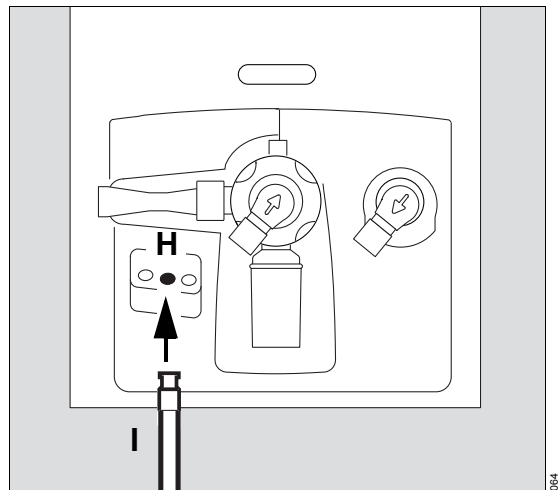

- Fill the medication nebulizer in accordance with the corresponding instructions for use.

CAUTION

Check the correct functioning of the medication nebulizer. Check whether aerosol is generated. A medication nebulizer fault is not detected by Evita V500.

Switching on medication nebulization

- 1 Touch the **Special maneuvers...** button in the main menu bar.
- 2 Touch the **Nebulization** tab (A).

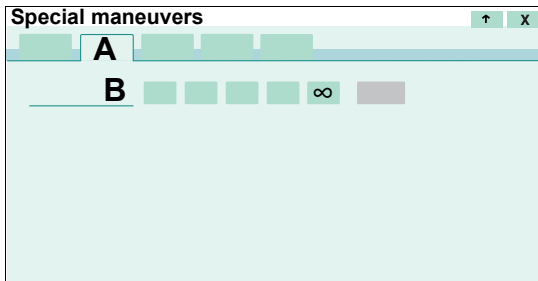

- 3 Touch the button for the desired nebulization time (B).

Nebulization can be set to 5, 10, 15, or 30 minutes or to continuous nebulization.

In the **Adult** and **Ped. pat.** patient categories (with Infinity ID flow sensor), the nebulization starts. See "During medication nebulization" on page 116.

Additional operating steps are necessary when using the neonatal flow sensor.

Deactivating flow monitoring with neonatal flow sensor

When the neonatal flow sensor is used, Evita V500 requests the user in the instruction field (C) to switch off flow monitoring.

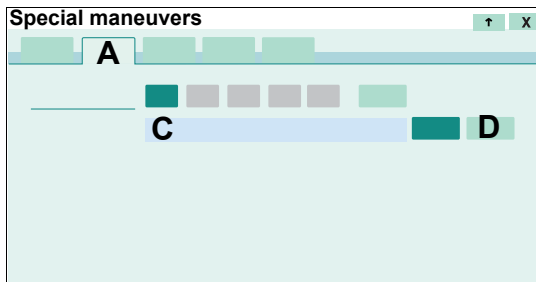

- Touch the **Off** button (D) and confirm with the rotary knob.

Removing the neonatal flow sensor from the breathing circuit

In the instruction field (E) Evita V500 requests the user to remove the neonatal flow sensor from the breathing circuit.

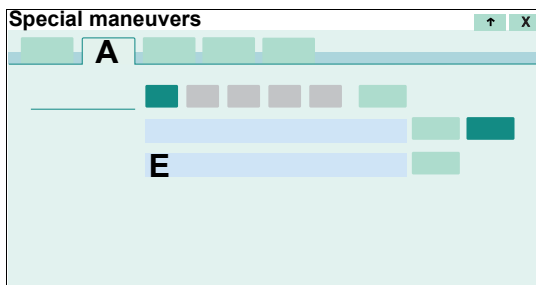
**WARNING****Risk of fire**

The measuring wires of the neonatal flow sensor are very hot and may ignite deposits of medication aerosols during nebulization.

- Before medication nebulization, remove the complete ISO 15 neonatal flow sensor, or remove the sensor insert from the neonatal flow sensor Y-piece and insert a sealing plug.
- Use additional monitoring since otherwise the minute volume is not monitored and apnea monitoring is limited.

When using the neonatal flow sensor Y-piece (8410185):

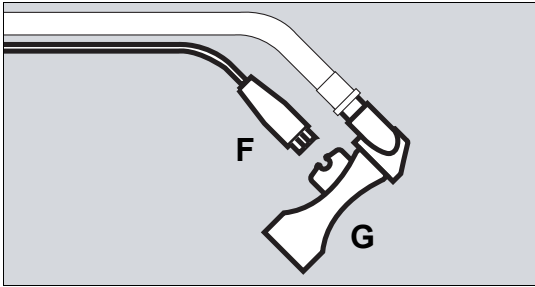

- 1 Disconnect plug (F) of the flow sensor cable from the neonatal flow sensor (G).

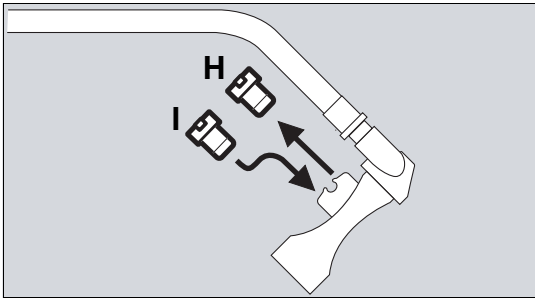

- 2 Remove the insert (H).
- 3 Insert the sealing plug (I) (8411024). The sealing plug is a component of the medication nebulizer.

When using the neonatal flow sensor ISO 15 (8411130):

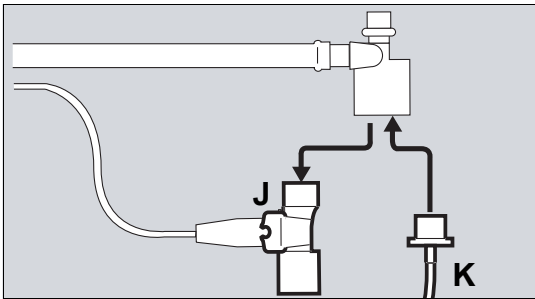

- 1 Remove the flow sensor (J) from the tube and the Y-piece.
- 2 Connect the tube (K) to the Y-piece.

- Replace or clean the neonatal flow sensor if there is visible soiling. See "Dismantling the neonatal flow sensor" on page 246.

After removing the neonatal flow sensor

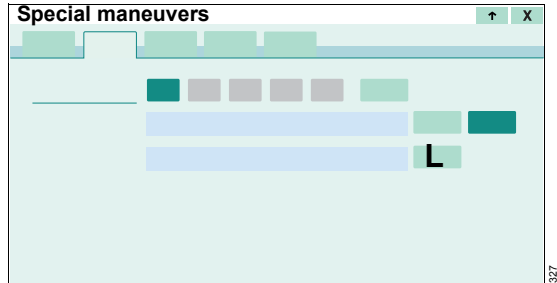

- Touch the **Done** button (L).

During medication nebulization

Evita V500 starts nebulization. The  symbol and the remaining nebulization time is displayed in the screen header bar.

Evita V500 automatically switches off the medication nebulizer after the set nebulization time has elapsed.

A message indicating that nebulization has been ended appears in the screen header bar.

Additional information

In the **Ped. pat.** patient category (with neonatal flow sensor), further medication nebulization begins when the nebulization time is entered, if flow monitoring with neonatal flow sensor has already been switched off.

In the **Neo.** patient category, removal of the neonatal flow sensor must be confirmed again.

During continuous medication nebulization

The **Continuous nebulization in progress.** message is displayed in the screen header bar.

Medication nebulization is interrupted every 30 minutes and the flow sensor is calibrated. After the flow sensor has been calibrated, medication nebulization is continued.

When continuous medication nebulization is used in the patient category **Neo.** or **Ped. pat.** and the neonatal flow sensor has therefore been removed, medication nebulization is not interrupted.

If the parameter field for continuous nebulization **Cont. neb.** has been configured for display, the duration of medication nebulization is displayed.

Aborting medication nebulization

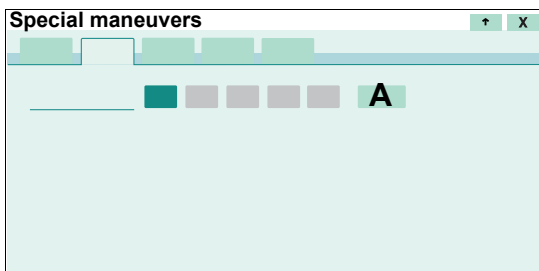

- Touch the **Cancel** button (A).

Required steps after medication nebulization

After medication nebulization in the **Adult** patient category, the Infinity ID flow sensor is automatically cleaned by heating and calibrated.

- 1 Remove any residual medication. Observe the instructions for use of the medication nebulizer.
- 2 If a bacterial filter is used to protect the expiratory valve, exchange or remove the bacterial filter.

When using the neonatal flow sensor, the following steps are also required:

- 3 Reconnect the neonatal flow sensor.

When using the neonatal flow sensor Y-piece (8410185):

- Remove the sealing plug and push the insert back in.
- Reconnect plug of the flow sensor cable.

When using the neonatal flow sensor ISO 15 (8411130):

- Re-insert the neonatal flow sensor in the Y-piece.

- 4 Activate flow monitoring with neonatal flow sensor, see page 163.
- 5 Calibrate the neonatal flow sensor, see page 159.

Additional information

The **Nebulization** maneuver can be configured as a **Nebulization** button in the main menu bar to enable direct access. See "Assigning functions to additional buttons" on page 179.

Nebulization may lead to increased deposits. Consequently, it may be necessary to change the following components more often:

- Flow sensor
- Expiratory valve

Fitting the Aeroneb nebulizer

- Observe the instructions for use of the Aeroneb nebulizer.
- Observe the "Safety information for the use of HMEs, bacterial filters, and breathing circuits" on page 56.
- Observe the "Safety information on medication nebulization" on page 111.
- Do not switch on the **Nebulization** maneuver on Evita V500 as the Aeroneb nebulizer does not require a nebulizer flow from Evita V500.

Before nebulization with Aeroneb

When using the neonatal flow sensor, the following steps are also required:

- 1 Deactivate flow monitoring with neonatal flow sensor, see page 162.
- 2 Remove the neonatal flow sensor from the breathing circuit, see page 115.

WARNING

Risk of fire

The measuring wires of the neonatal flow sensor are very hot and may ignite deposits of medication aerosols during nebulization.

- Before medication nebulization, remove the complete ISO 15 neonatal flow sensor, or remove the sensor insert from the neonatal flow sensor Y-piece and insert a sealing plug.
- Use additional monitoring since otherwise the minute volume is not monitored and apnea monitoring is limited.

After nebulization with Aeroneb

- 1 If a bacterial filter is used to protect the expiratory valve, exchange or remove the bacterial filter.
- 2 Calibrate the Infinity ID flow sensor, see page 161. Aerosols distort the flow measurement!

When using the neonatal flow sensor, the following steps are also required:

- 3 Reconnect the neonatal flow sensor.

When using the neonatal flow sensor Y-piece (8410185):

- Remove the sealing plug and push the insert back in.
- Reconnect plug of the flow sensor cable.

When using the neonatal flow sensor ISO 15 (8411130):

- Re-insert the neonatal flow sensor in the Y-piece.
- 4 Activate flow monitoring with neonatal flow sensor, see page 163.
 - 5 Calibrate the neonatal flow sensor, see page 159.

Additional information

- For the order number of the Aeroneb nebulizer, see the list of accessories.

Measurement maneuver Low Flow PV Loop

This chapter describes how to use the Low Flow PV Loop measurement maneuver. This measurement maneuver is not available in the **Neo**. patient category.

Measurement principle

Evita V500 determines the Low Flow PV Loop during an extended inspiration or an inspiration and expiration with a constant and low flow.

The measurement maneuver can only be performed in the **Adult** and **Ped. pat.** patient categories.

The measurement maneuver must only be carried out on patients without spontaneous breathing.

Additional information

For a detailed description, see "Low Flow PV Loop" on page 346.

Opening the measurement maneuver

- 1 Touch the **Special maneuvers...** button in the main menu bar.
- 2 Touch the **Low Flow PV Loop** tab (A) if the page is not already preset.

The **Info** page (B) is displayed.

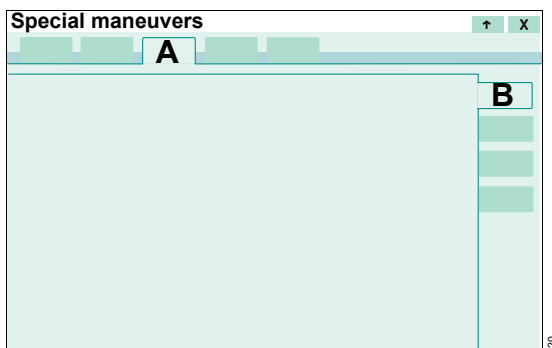

CAUTION

Observe the following information on performing the measurement:

- The application of a Low Flow PV Loop maneuver could decrease the systemic circulatory pressure of the patient and could cause e.g. a pneumothorax. Carefully assess the condition of the patient before adjusting the settings.
- The pressure and applied volumes must be adapted to the patient.
- The patient must be hemodynamically stable. Closely monitor the arterial blood pressure during the procedure. The sudden release of high airway pressure may overstrain the heart and impair cardiac function.
- The calculated maximum duration of the procedure must be adapted to the patient.
- These measurements are only valid if the patient is not breathing spontaneously.
- Minimize leakages before performing the procedure.
- This maneuver cannot be started within 60 seconds after previous Low Flow PV Loop maneuver, nebulization or suctioning.
- The running measurement is not interrupted by opening a different screen page.

Performing measurement

Prerequisite: The **Low Flow PV Loop** page is opened.

- 1 Touch the **Procedure** tab (A).

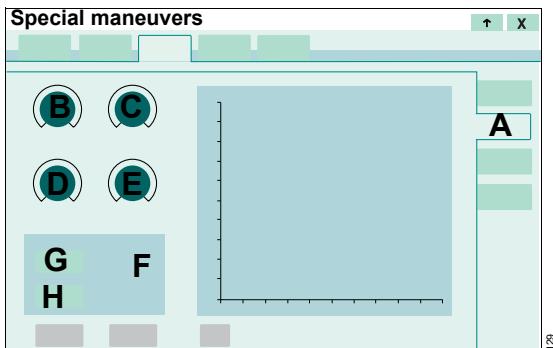

- 2 Touch the relevant therapy control for **Pstart** (B), **Plimit** (C), **Low Flow** (D), **Vlimit** (E).

- 3 Set the values by turning the rotary knob and push to confirm.

Pstart can be set between 0 and PEEP.

Plimit and **Vlimit** are limited by the alarm limit.

- Adjust the alarm limits if necessary, see page 144.

The calculated maximum duration of the measurement maneuver **Tmax** (F) is displayed.

Prerequisites for recording

The following prerequisites must be met for recording:

- Valid flow, pressure, and leakage values
- Precise flow values
- Flow monitoring with Infinity ID flow sensor activated
- Mandatory expiratory time < 30 seconds
- RR $\geq 2/\text{min}$
- If Apnea Ventilation is switched on, the function must not be active.
- Tube therapy type set
- Sensor calibration not active
- Ventilation mode with mandatory breaths

- The maneuver cannot be started until 60 seconds after a preceding Low Flow PV Loop maneuver, medication nebulization or suction.

Recording inspiration and expiration

- 1 Touch the **Start insp. + exp.** button (G).
- 2 Confirm with the rotary knob.

Recording inspiration

- 1 Touch the **Start insp. only** button (H).
- 2 Confirm with the rotary knob.

Limiting the measurement maneuver

Prerequisite: Measurement active

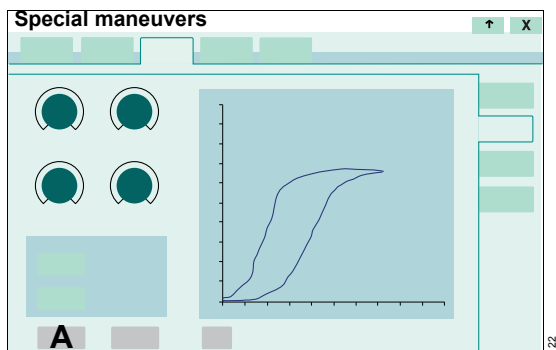

During inspiratory and expiratory measurement

- Touch the **Stop insp.** button (A).

Evita V500 ends inspiration. Expiration occurs at the set flow.

During the inspiratory measurement

- Touch the **Stop insp.** button (A).

Evita V500 ends inspiration. Expiration occurs with an adjustable pressure decrease. This value can be configured on the **System setup > Ventilation > Procedure** page.

Aborting measurement

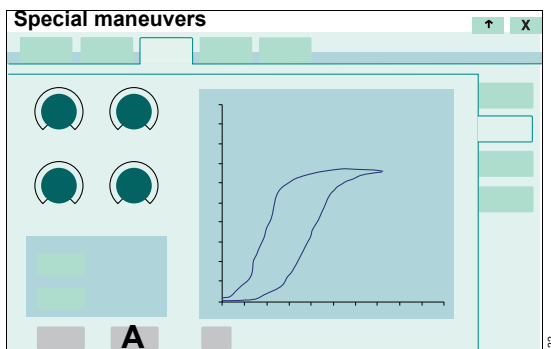

- 1 Touch the **Cancel** button (A).
- 2 Confirm with the rotary knob.

Evita V500 ends the measurement, the pressure falls immediately to the set PEEP.

Exiting the running measurement page

The running measurement is not interrupted by opening a different screen page.

Returning to the measurement dialog

- Touch the **Special maneuvers...** button in the main menu bar.

During a running measurement, the **Procedure** page, where the buttons to end the measurement maneuver are located, is opened.

Performing new measurement

A new measurement can only be performed after 60 seconds.

During this time, the **Start insp. + exp.** and **Start insp. only** buttons are grayed out and cannot be activated.

Evaluating measurement

Prerequisite: Measurement has been performed.

- 1 Touch the **Analysis** tab (A).

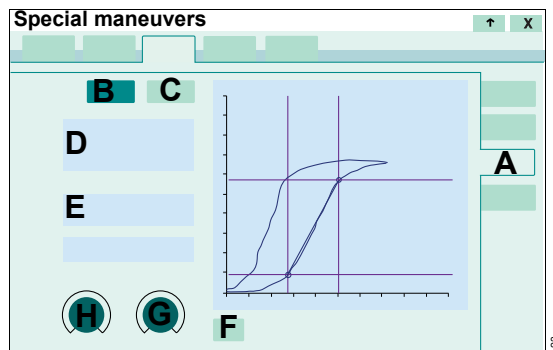

Measuring a loop

- 2 Touch the **Cursor 1** (B) or **Cursor 2** (C) button.

Cursors are represented by a cross-hair cursor. There is a circle at their intersection. When the loop has an S-like shape, the cursors are positioned on characteristic points of the loop (UIP or PMC). Otherwise, the cursors are positioned at the left or right edge of the graph.

- 3 Position the selected cursor on an identified point with the rotary knob.

The corresponding measured values for Paw and VTi are displayed (D).

The static compliance between 2 values is calculated and displayed.

The **Cstat** value displayed in the field (D) is the static compliance over the complete breath. The **Cstat (Paw)** value displayed in the field (E) is the static compliance between the set cursor positions.

The measured values are compliance and leakage compensated.

Displaying reference loops

The current loop can be compared with the measured values from previous maneuvers. The device stores the results of up to 10 maneuvers. Under the loops the ventilation mode applied at the start of the maneuver is displayed with the settings for PEEP and P_{insp} or VT. Reference loops cannot be measured with the cursor.

- Touch the **Retr. Ref.** button (F) repeatedly until the required reference loop is displayed.

Optimizing settings

Depending on the set ventilation mode, the **PEEP** or **P_{low}** (H) and **P_{insp}** or **P_{high}** or **VT** (G) therapy controls are displayed and can be adjusted on the opened **Analysis** page.

- Touch the therapy control, set the value and confirm.

During setting, a corresponding line appears in the PV-Loop in order to facilitate optimization of the settings.

Additional information

For a detailed description of the identification of characteristic points, see "Low Flow PV Loop" on page 346.

History

Evita V500 can save up to 10 PV loops with characteristic points in the **History**. Reference loops cannot be displayed.

Recalling and measuring a PV-Loop

Prerequisite: The **Low Flow PV Loop** page is opened.

- 1 Touch the **History** tab (A).

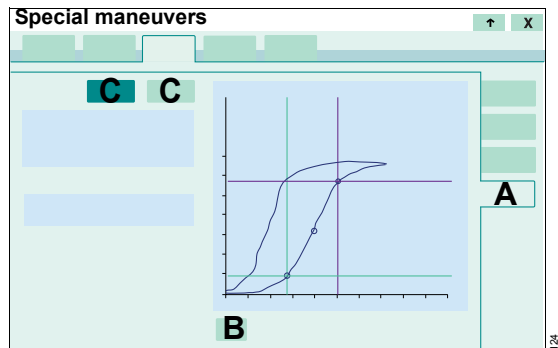

- 2 Touch the **Retr. Ref.** button (B) until the desired PV-Loop is displayed.

If characteristic points were identified, these points are displayed.

- 3 Measure a curve with a cursor (C).

Under the loops the ventilation mode applied at the start of the maneuver is displayed with the settings for PEEP and P_{insp} or VT.

Additional information

The **Low Flow PV Loop** maneuver can be configured as a **Low Flow PV Loop** button in the main menu bar to enable direct access. See "Assigning functions to additional buttons" on page 179.

Diagnostics – measurement maneuver

Overview

Evita V500 permits the following measurement maneuvers on the **Diagnostics** screen:

- Occlusion pressure – P0.1
- Intrinsic PEEP – PEEPi
- Negative Inspiratory Force – NIF

The measurement maneuvers are not available in the **Neo** patient category.

For a detailed description of the measurement maneuvers, see chapter "Diagnostics – measurement maneuver" on page 348.

Additional information

The **Diagnostics** page can be configured for direct access into the main menu bar as the **Diagnostics** button. The individual diagnostic functions can be configured for direct access as **P0.1**, **PEEPi** and **NIF** buttons in the main menu bar. See "Assigning functions to additional buttons" on page 179.

Occlusion pressure – P0.1

General

The occlusion pressure P0.1 characterizes the negative pressure during a short occlusion (0.1 seconds) at the start of spontaneous inspiration.

This measurement maneuver can be used in all ventilation modes at regular intervals in order to check the respiratory drive of a spontaneously breathing patient or to assess the amount of spontaneous breathing during controlled ventilation.

Starting the measurement maneuver

- 1 Touch the **Special maneuvers...** button in the main menu bar.
- 2 Touch the **Diagnostics** tab (A).
- 3 Touch the **P0.1** tab (B) if the page is not already preset.

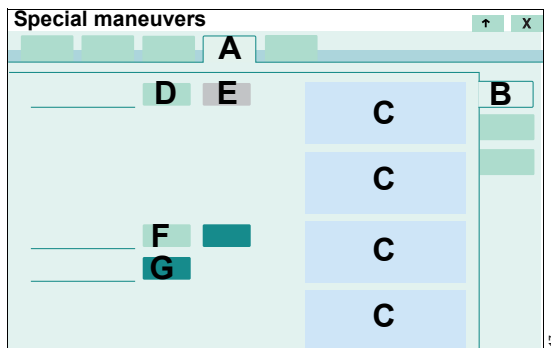

Evita V500 displays the P0.1 values of the 4 previous measurements (C).

Performing a measurement manually

- 1 Touch the **Start** button (D).
- 2 Confirm with the rotary knob.

Evita V500 starts the P0.1 measurement with the next spontaneous inspiration.

Cancel measurement

- Touch the **Cancel** button (E).

Using automatic P0.1 measurement

- 1 Touch the **On** button (F).
- 2 Set the time interval. Touch the button for the time interval (G). Set the value by turning the rotary knob and push to confirm.

The remaining time until the next measurement is displayed.

To observe the therapy success, record the measured value P0.1 as a trend.

Intrinsic PEEP – PEEPi

General

Intrinsic PEEP is the actual end-expiratory pressure inside the lungs.

This special procedure can be performed in all ventilation modes. Breathing activity by the patient during this maneuver can distort the measured values.

Starting the measurement maneuver

- 1 Touch the **Special maneuvers...** button in the main menu bar.
- 2 Touch the **Diagnostics** tab (A).
- 3 Touch the **PEEPi** tab (B).

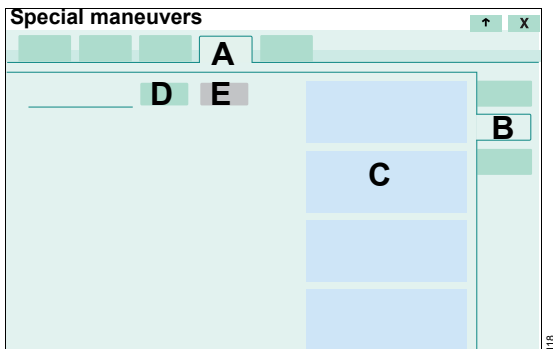

Evita V500 displays the following values for the 4 previous measurements (C):

- **PEEPi** (intrinsic PEEP)
 - **incl. PEEP** (intrinsic PEEP taking the set PEEP into account)
 - **Vtrap**
 - Date and time of the measurement
- 4 Touch the **Start** button (D) and confirm with the rotary knob.

Evita V500 starts the PEEPi measurement.

The measurement can be aborted with **Cancel** (E).

Negative Inspiratory Force – NIF

General

The Negative Inspiratory Force Index (NIF) measures a patient's maximum inspiratory effort after exhaling. The breathing circuit is closed during measurement of the NIF. The NIF value is also known as the Maximum Inspiratory Pressure (MIP). As a result of the inspiratory effort during manual expiration, the patient generates a negative pressure in relation to PEEP. Evita V500 determines the NIF value during manual expiration.

Starting the measurement maneuver

- 1 Touch the **Special maneuvers...** button in the main menu bar.
- 2 Touch the **Diagnostics** tab (A).
- 3 Touch the **NIF** tab (B).

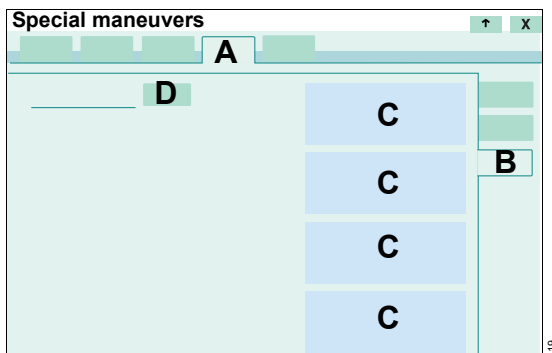

Evita V500 displays the NIF values of the last measurements, including the time and date (C).

- 4 Touch and **hold** the **Exp. hold** button (D) for the desired expiratory time. Expiration is ended by Evita V500 after a maximum of 45 seconds in the **Adult** patient category and 30 seconds in the **Ped. pat.** patient category.

GS500 gas supply unit

In order to ensure a continuous Air supply, Evita V500 can be equipped with the GS500 gas supply unit. If Evita V500 is connected to the central gas supply system, GS500 ensures the supply of Air to the device in the case of failure of the central gas supply system and during intrahospital patient transport.

Installing the bacterial filter

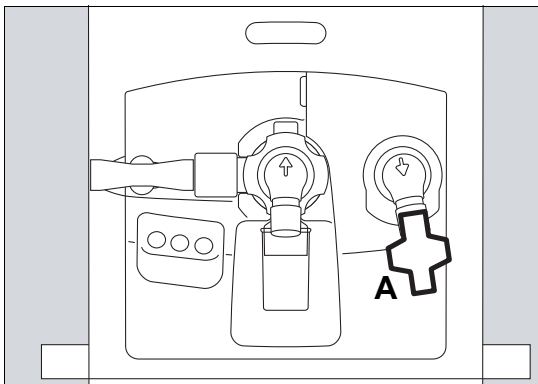

- Fit the bacterial filter (A) onto the inspiratory port.

Using the gas supply unit

Prerequisite: Functionality of the gas supply unit is activated, see "Configuring supply units" on page 203.

If Evita V500 is not connected to the central gas supply system, GS500 starts the supply of Air automatically.

In the event of failure of the central Air supply, or if the probe of the Air compressed gas hose becomes detached from the wall terminal unit of the central gas supply system, Evita V500 displays an alarm message. The gas supply unit starts the supply of Air using GS500 after 4 seconds at the latest.

Switching on the gas supply unit for intrahospital patient transport

- 1 Touch the **Special maneuvers...** button in the main menu bar.
- 2 Touch the **Transport** tab (A).
- 3 Touch the **On** button (B).

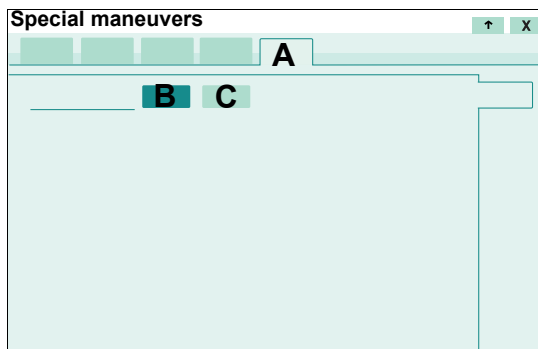

- 4 Pull out the probe of the Air compressed gas hose from the wall terminal unit of the central gas supply system.
- If the probe of the Air compressed gas hose has not been pulled out within 5 minutes of the gas supply unit being switched on, Evita V500 switches off the gas supply unit.
- 5 Pull the probe of the O₂ compressed gas hose out from the wall terminal unit of the central gas supply system and provide a replacement O₂ supply if necessary.

Switching off the gas supply unit

- Touch the **Off** button (C).

Additional information

- Deactivating functionality of the gas supply unit, see "Configuring supply units" on page 203.

O₂ therapy

Safety information for O₂ therapy

During O₂ therapy, only the O₂ concentration and the inspiratory pressure are monitored.

CAUTION

Only use oxygen masks for the O₂ therapy. Do not use masks for non-invasive ventilation (NIV). Use of unsuitable masks may jeopardize the patient.

CAUTION

Internal monitoring is deactivated. Airway pressure and ventilation parameters, e.g., flow, minute volume or apnea are not monitored. Use external SpO₂ monitoring for patients who are dependent on an increased defined O₂ concentration. Otherwise a worsening of the patient's condition cannot be detected.

NOTE

If the pressure needed for the set flow exceeds 30 mbar (30 cmH₂O), the device issues an alarm and the safety valve is opened. The cause may be a kinked breathing hose or a blocked mask or nasal cannula.

Observe the specified flows and sizes of the particular accessories.

Preparing O₂ therapy

Attaching breathing hoses

WARNING

Do not use antistatic or conductive breathing hoses. The use of these materials increases the risk of electric shock to the patient and of fire in an oxygen-enriched environment.

Preparing a system with a Fisher & Paykel MR 850 breathing gas humidifier

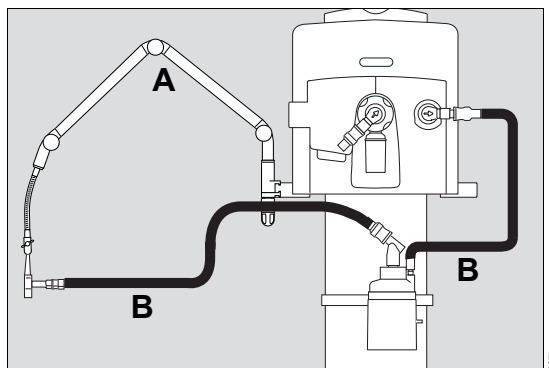

- 1 Hang the hinged arm (A) on the rail and tighten the screws. Depending on the desired position of the device in relation to the bed, the hinged arm can be fitted to either side of the device.
- 2 Fit the breathing hoses (B) for inspiration. The expiratory ports on the device and on the Y-piece remain open!
- 3 Switch on Evita V500. See page 68.
- 4 Switch Evita V500 to standby. See page 130.
- 5 Activate O₂ monitoring. See page 164.

The alarm limits for VT, MVe, RR, Paw, Tapn are not active. The alarm limits for O₂ monitoring are automatically set by the device.

Switching on O₂ therapy

O₂ therapy can only be switched on in standby mode.

- 1 Touch the **Start/ Standby...** button in the main menu bar.

Evita V500 opens the **Start/Standby** dialog window. The **Start/Standby** page (A) is displayed by default.

- 2 Touch the **Standby** button (B) and confirm with the rotary knob.

Evita V500 is in standby mode.

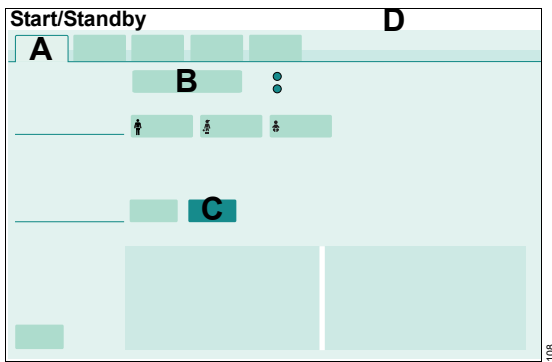

- 3 Touch the **O₂ Therapy** button (C).

The message field (D) displays the information to use specific masks for O₂ therapy.

- 4 Connect the mask for the O₂ therapy.
- 5 Touch the **Start ventilation** button (B) and confirm with the rotary knob.

O₂ therapy is switched on. Evita V500 displays the main screen with the therapy bar (E) for O₂ therapy. The message **O₂ Therapy** is displayed in the header bar (F).

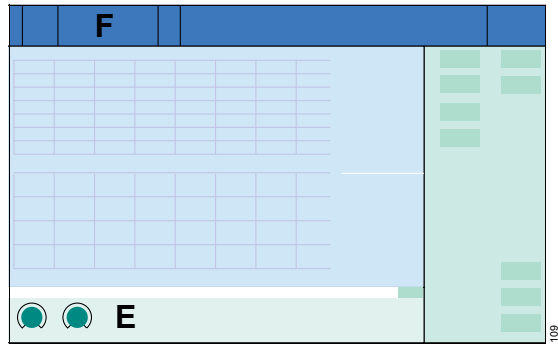

During O₂ therapy, the screen display on the main screen cannot be customized.

Setting FiO₂ and flow for O₂ therapy

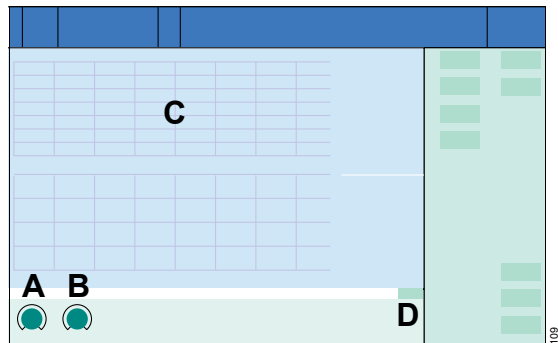

- 1 Touch the corresponding therapy control in the therapy bar:
 - **FiO₂** (A)
 - **Flow** (B)
- 2 Set the value by turning the rotary knob and push to confirm.

The FiO₂ concentration is represented graphically (C).

Setting O₂ and flow in the dialog window

The O₂ and flow can also be set in the **Ventilation settings** dialog window.

- Touch the **Ventilation settings...** button.

Or

- Touch the ↑ button (D).

Switching off O₂ therapy

- 1 Touch the **Start/ Standby...** button.

Evita V500 opens the **Start/Standby** dialog window. The **Start/Standby** page is displayed by default.

- 2 Touch the **Standby** button and confirm with the rotary knob.

Evita V500 is in standby mode. O₂ therapy is switched off. The therapy type can be switched to ventilation.

Standby mode

Switch to standby mode for the following actions:

- Keep Evita V500 ready for operation while the patient is absent
- Change the therapy type between ventilation and O₂ therapy
- Change the patient category
- Change the application mode
- Perform the device and breathing circuit check
- Query the status of accessories
- Switch off Evita V500

- 3 Touch the **ALARM RESET** button in the header bar and confirm with the rotary knob.

Evita V500 is in standby mode. **Standby** is displayed in the screen header bar.

WARNING

Ventilation does not take place in standby mode! The device must only be set to standby mode when no patient is connected to the device. The patient may otherwise be jeopardized.

Activating standby mode

- 1 Touch the **Start/ Standby...** button in the main menu bar.

Evita V500 opens the **Start/Standby** dialog window. The **Start/Standby** page (A) is displayed by default.

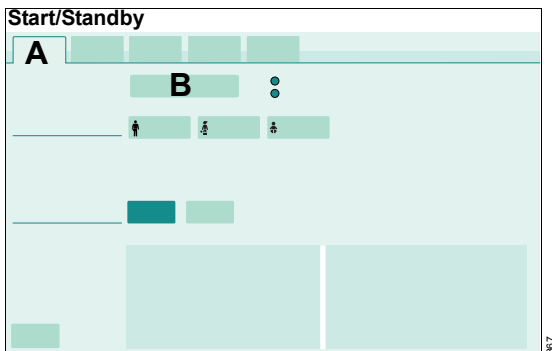

- 2 Touch the **Standby** button (B) and confirm with the rotary knob.

The message **Standby mode activated** is displayed in the header bar.

Continuing the therapy

- 1 Check the ventilation settings (A) of the current patient.

Change the ventilation settings if necessary. Touch the **Ventilation settings** button (B). Evita V500 opens the corresponding page.

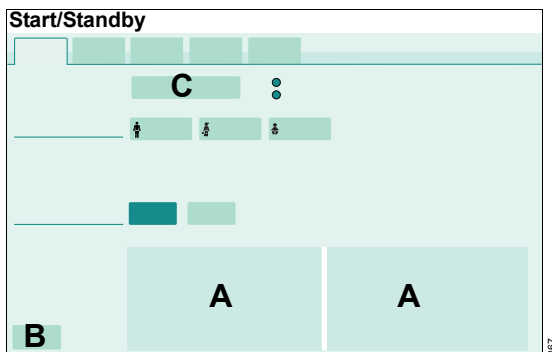

- 2 Touch the **Start ventilation** button (C) and confirm with the rotary knob.

The main screen is displayed; Evita V500 continues ventilating.

Additional information

If the patient category or the body weight is changed, Evita V500 determines new start-up values for ventilation. See "Admitting a new patient" on page 69.

For information on changing ventilation settings, see "Setting ventilation" on page 91.

Ending operation

- 1 Switch Evita V500 to standby mode: Touch the **Start/ Standby...** button in the main menu bar. Touch the **Standby** button and confirm with the rotary knob.

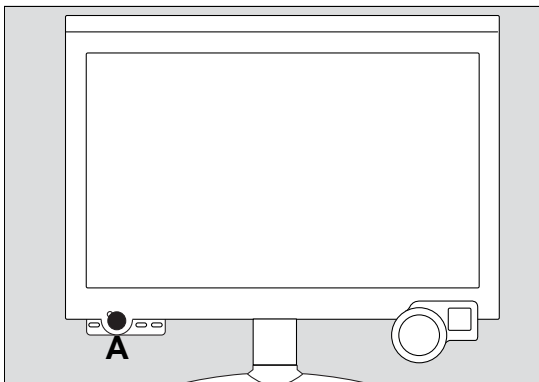

- 2 Press the  key (A) on Infinity C500.

Evita V500 opens the **Shut down device** dialog.

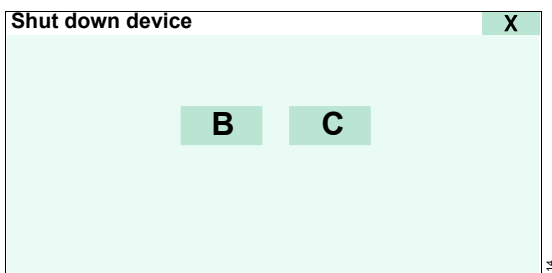

- 3 Touch the **OK** button (B) and confirm with the rotary knob.

Evita V500 ends operation.

To return to standby mode:

- Touch the **Cancel** button (C).

When Evita V500 is not in standby mode and the  button (A) is pressed, the **Start/Standby** page is opened.

As soon as the screen is completely dark

- Disconnect the mains plug from the mains power socket.
- Pull the probe of the Air compressed gas hose and the probe of the O₂ compressed gas hose out from the wall terminal units of the central gas supply system.

CAUTION



Disconnect the compressed gas hoses from the central gas supply system. Otherwise minute internal leaks could contaminate the central gas supply system through the reverse flow of supply gases.

If Evita V500 cannot be switched off on account of a device malfunction

- 1 Open the device flap on the left side of Evita V500.
- 2 Set the toggle switch to  (off).

Once the toggle switch has been pressed and the mains plug is disconnected, Evita V500 cannot be switched on.

Placing back into operation

- 1 Insert the mains plug into the mains power socket.
- 2 Open the device flap on the left side of Evita V500.
- 3 Set the toggle switch to  (on).
- 4 Switch on Evita V500: Press the  key on Infinity C500.

Disconnecting the device from the mains voltage

In the event of device malfunctions or other hazards, the device must be completely disconnected from the mains voltage.

When the toggle switch is at  (off), only parts of the device are disconnected from the mains voltage. The batteries continue to be charged. To completely disconnect the device from the mains voltage, unplug the mains plug.

Storing Evita V500

Switch Evita V500 to energy-saving mode if storing for longer periods.

- 1 End operation. See "Ending operation" on page 132.
- 2 Set the toggle switch on the left side of Evita V500 to  (off) immediately after switching off the device.
- 3 Disconnect the mains plug from the mains power socket.

Mains power supply / DC power supply

Components and terms

Mains power supply

The device is supplied with mains power via the power cable. Information on voltage ranges and mains power characteristic values can be found in chapter Technical Data, Operating data.

Internal Battery

The internal battery is supplied with the device.

PS500 power supply unit

In addition to the internal battery, the device can optionally be equipped with the PS500 power supply unit.

Use of power supplies

The device is supplied with electric power from the following sources in the order stated:

- Mains power
- Batteries in the PS500 (if present)
- Internal battery

The switch-over between these sources takes place without interruption to operation according to the following rules:

- If the mains voltage is sufficient, the power is supplied from the mains.
- If the mains voltage is not sufficient or during a battery check, the power is supplied from the batteries.

Display of power supplies

The power supply is displayed on the Infinity C500 operating and display unit.

On Infinity C500 (MS18746):

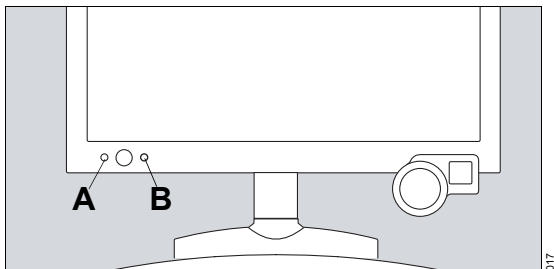

On Infinity C500 (MK31500):

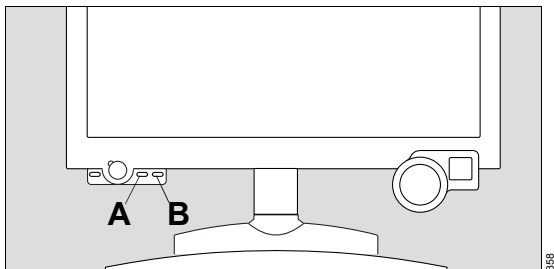

A LED  for mains power:

- Lights green when mains power is applied and the toggle switch is in the  position.
- If the LED does not light up, the device is disconnected from the mains power.

B LED  for the internal battery:

- Lights green when the battery charge is greater than approx. 90 %.
- Lights yellow when the battery charge is between 10 % and 90 % approx.
- Does not light if the internal battery is faulty, discharged or device is switched off with the toggle switch (energy-saving mode).

NOTE

The LED  indicates only the battery charge of the internal battery, even when the PS500 is present.

Battery operation

Alarm messages during battery operation

Switch-over to the batteries is indicated with the alarm message **Battery activated**. The alarm priority can be configured, see "Setting the priority of the battery alarms" on page 185.

Alarm messages are displayed according to the battery charge remaining in order to warn against the complete discharge of the batteries. Alarm messages, see chapter "Alarm – Cause – Remedy."

- Reestablish the mains power supply immediately to avoid interruption of the ventilation functions.

When battery supply is no longer needed, recharge the batteries, see chapter "Charging batteries".

Operating time during battery operation

The operating time depends on the following battery factors:

- Age
- Utilization (frequency, duration, and power consumption)
- Battery charge
- Ambient temperature

For operating times when batteries are fully charged and new, and ventilation is typical, see chapters "Battery ageing" on page 359 and "Batteries" on page 296.

Observe the maintenance intervals.

Charging batteries



The batteries are charged when the device is supplied with mains voltage. The  symbol (A) is displayed in the screen header bar.







- The batteries are charged in the following order:
- Internal battery
 - Batteries in the PS500 (if present)

Charging times

For information on the charging times, see page 297.

Battery charge indication on the screen

The battery charge is indicated by the symbol (B) in the header bar on the screen. The battery charge indication applies to both charging and discharging. When the batteries are being charged, the last segment in the battery symbol flashes white.

Symbol	Battery charge
	90 to 100 %
	60 to <90 %
	40 to <60 %
	20 to <40 %
	<20 %, flashes light and dark red in 1-second pulses
	Batteries faulty or no information available on the battery charge

The battery charge indication applies to both charging and discharging.

The battery charge indication always shows the total battery charge that is available. If there is a PS500 present, the battery charge available from the internal battery and the PS500 will be displayed.

A flashing  symbol (C) indicates the following:

- The battery check is running.
- The interval for the battery check has expired.
- The last battery check failed.
- Battery replacement is recommended.

Parameter field **Battery**

In addition to the battery charge indication, the **Battery** parameter field can be configured.

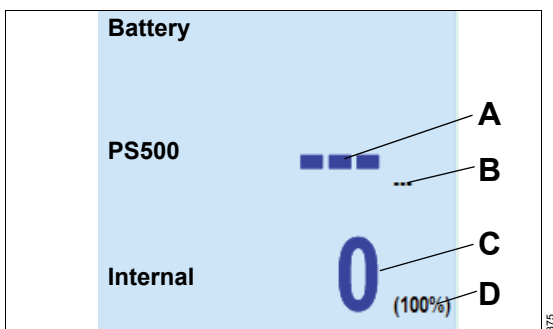

The **Battery** parameter field contains the following information:

- **PS500** (if present)
 - Operating time in minutes (value corresponds to the operating time when the battery is used at the present power consumption) (A)
 - Battery charge in percent (B)
- **Internal** (internal battery)
 - Operating time in minutes (value corresponds to the operating time when the battery is used at the present power consumption) (C)
 - Battery charge in percent (D)

NOTE

Ageing and use of the batteries can result in a shorter operating time compared with new batteries.

Depending on the battery used, the battery charge is indicated to the nearest 5 or 10 minutes.

It is always the minimum calculated operating time that is displayed.

Care and maintenance of the batteries

Take note of the following to limit premature ageing of the battery:

- Operate the device under the stated ambient conditions
- Avoid storing the device with discharged or partially discharged batteries
- Connect the device to the mains power supply after battery operation
- Avoid shocks and vibrations
- Perform the recommended battery checks

Intrahospital patient transport

WARNING

Do not tilt the device by more than 10°. Failure to observe this may result in the device toppling over. Danger of damage to device or personal injury!

WARNING

The device must not be placed on the bed while transferring a patient within the hospital. The device could topple over or fall down. Danger of damage to device or personal injury!

WARNING

Do not lean, press, push or pull against the trolley above the marking points on the trolley. The trolley could topple over.

WARNING

Do not move trolley faster than at a walking pace. There is an increased danger of the trolley toppling over at thresholds, uneven surfaces and ramps. Reduce the speed of transport further. Danger of damage to equipment!

WARNING

Two people are always required to move the device. Otherwise there is an increased risk of the device toppling over.

WARNING

Make sure to securely hold onto the handle of the trolley whenever moving or positioning the device. Otherwise there is an increased risk of the device toppling over.

WARNING

Risk of patient injury due to discharged batteries
Only start transporting patients if the batteries are sufficiently charged.

When transporting a patient within the hospital, the user must ensure that the patient is monitored at all times.

When transporting the patient within the hospital, grasp the trolley handle firmly and push the device in longitudinal direction.

Using Evita V500 with a safety bar

CAUTION

During intrahospital patient transport, Evita V500 must be used with a safety bar (A) in order to prevent accidental disconnection of the breathing hoses or damage to the inspiratory port and the expiratory port.

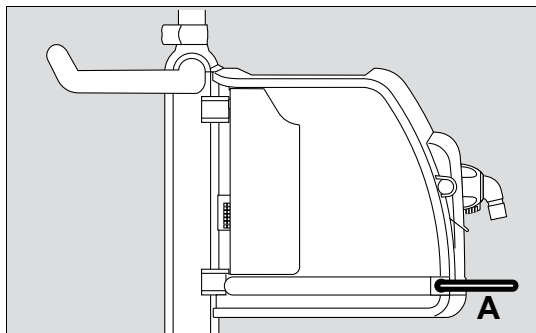

Increasing the toppling stability during intrahospital patient transport

To ensure that the equipment cannot topple over, the accessories must be moved to the most advantageous position:

- 1 Hinged arm set to minimum deflection.
- 2 Hoses and cables hooked as close as possible to the trolley.
- 3 Humidifier secured to the trolley, not to the lateral rails of Evita V500.

Additional information

Air supply from the GS500 gas supply unit, see "GS500 gas supply unit" on page 126.

Power supply, see "Mains power supply / DC power supply" on page 134.

For the order number of the safety bar, see the list of accessories.

Alarms

Overview	140
Display of alarms	140
Alarm priorities	141
Optical alarm signals	141
Acoustic alarm signals	141
Displaying information on alarms	142
Displaying current alarms	142
Displaying the cause and remedy for an alarm	142
Acknowledging an alarm message that is no longer active	142
Acknowledging all alarm messages that are no longer active	142
Alarm history	143
Setting alarm limits	144
How to set an alarm limit	144
Deactivating alarm limits	144
Response to power failure	145
Display of alarm limits in the parameter field ..	145
Setting the volume of the alarm tone	146
Suppressing the alarm tone	147
Position of the user to the alarm system . . .	147
Failure of the acoustic alarm	148

Overview

Alarms are issued acoustically and visually. The alarm tone can be suppressed for 2 minutes.

The **Alarms** dialog window provides the following functions for selection:

- Setting alarm limits
- Displaying current alarms
- Alarm history
- Alarm settings

Display of alarms

In the event of an alarm, the system displays the relevant alarm message in the alarm message field (A). If the parameter field (B) is configured to display an individual parameter, the parameter field (B) of the parameter triggering the alarm flashes. The alarm bar (D) flashes in the color of the corresponding alarm priority.

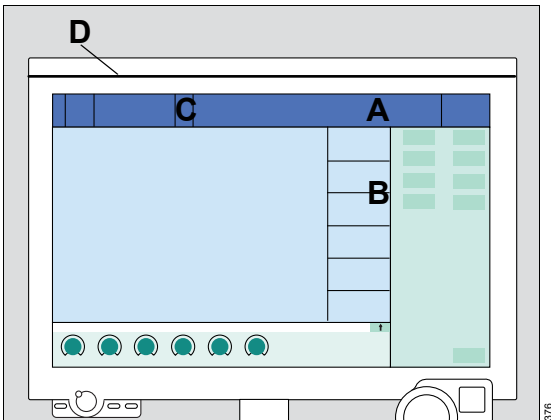

If the alarm message field (A) contains more alarms than can be displayed, the **More...** button (C) appears in the header bar. Touching this button opens the page containing all the active alarms.

Alarm priorities

A certain priority, indicating the urgency, is assigned to each alarm.

The following table shows the differences between the alarm priorities with respect to identification and the action required.

Alarm priority	Identification		Action required
High	Red	!!!	Immediate action is necessary in order to avert an acute danger
Medium	Yellow	!!	Prompt action is necessary in order to avert a danger
Low	Turquoise	!	Attention is necessary, but a delayed response is sufficient

Optical alarm signals

The following optical alarm signals are displayed in the event of an alarm.

	Alarm priority		
	High	Medium	Low
Alarm message field	Alarm message on a red background	Alarm message on a yellow background	Alarm message on a turquoise background
Parameter field	Flashes red	Flashes yellow	–
Alarm bar	Flashes red	Flashes yellow	–

If several alarms occur at the same time, the two most urgent alarms are displayed first.

High-priority alarm messages that are no longer active are displayed in the background color of the alarm message field.

In the tables for **Current alarms** and **Alarm history** the priority of the alarm messages is also indicated by exclamation marks.

Acoustic alarm signals

Evita V500 generates different alarm tone sequences to indicate alarms acoustically. The alarm tone sequences can be configured, see "Selecting alarm tone sequences" on page 185.

Displaying information on alarms

Displaying current alarms

To display the current alarms, proceed as follows:

- 1 Touch the alarm message in the header bar.
- Or
- 1 Touch the **Alarms...** button in the main menu bar.
- 2 Touch the **Current alarms** tab (A).

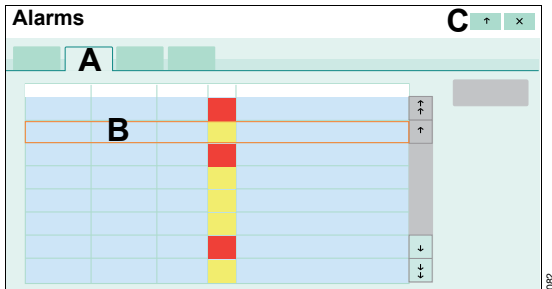

All the current alarm messages are displayed chronologically with the corresponding duration, priority and alarm message text in the list (B).

Displaying the cause and remedy for an alarm

- 1 Touch the alarm message or select it in the list (B) with the rotary knob.
- 2 Touch the (C) button.

This displays the cause and remedy for the alarm message selected.

- 3 Eliminate the fault.

Additional information

For a list of causes and remedies, see chapter "Alarm – Cause – Remedy" on page 205.

Acknowledging an alarm message that is no longer active

After the fault has been eliminated, the alarm tone is silenced. Medium- and low-priority alarm messages expire automatically. High-priority alarm messages continue to be displayed for information after the cause of the alarm has been eliminated and need to be acknowledged.



- 1 Touch the **ALARM RESET** button (A) in the header bar.
- 2 Confirm with the rotary knob.

Acknowledging all alarm messages that are no longer active

Prerequisite: The **Current alarms** page (A) is opened.

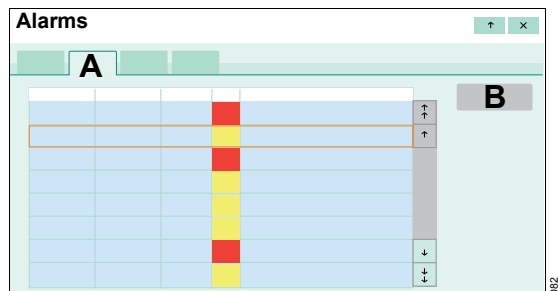

- 1 Touch the **Reset all** button (B).
- 2 Confirm with the rotary knob.

The acknowledgeable messages are deleted in the header bar and in the list containing the current alarms. However, Evita V500 records all alarm messages in the alarm history.

Alarm history

The alarm history records all alarm messages in chronological order.

The entries in the alarm history are also retained after the device has been switched off and on again or following a power supply failure.

The alarm history is part of the logbook. The length of the alarm history depends on the number of logbook entries.

When the logbook reaches its maximum size, the oldest entry in the logbook is deleted as each new entry is logged.

Switching the device off and on are not recorded in the logbook.

- 1 Touch the **Alarms...** button in the main menu bar.
- 2 Touch the **Alarm history** tab (A).

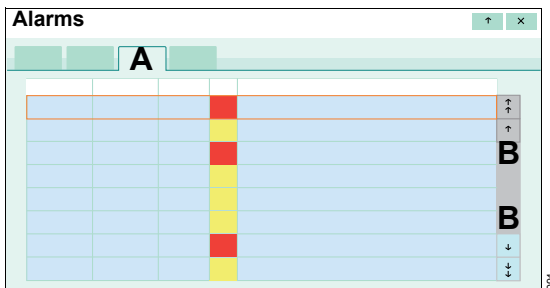

- 3 Use the buttons (B) to scroll in the alarm history.

Setting alarm limits

- Touch the **Alarms...** button in the main menu bar.

The **Limits** page (A) appears by default.

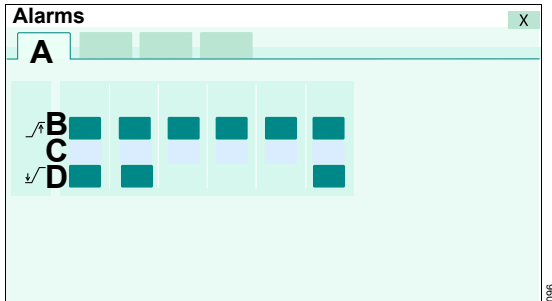

The alarm limit settings and the current measured value are displayed.

- (B) : Upper alarm limit
- (C) Current value : Current measured value
- (D) : Lower alarm limit

How to set an alarm limit

Prerequisite: The **Limits** page (A) is opened.

- 1 Touch the corresponding button for the alarm limit.
- 2 Set the value by turning the rotary knob and push to confirm.

WARNING

The alarm limits must be set to meet the needs of the therapy required by the current patient. The patient may otherwise be jeopardized. Setting extreme alarm limits can render the alarm system useless.

Additional information

The start-up values for the alarm limits can be configured specifically as required by the hospital concerned, see page 183.

The alarm limits are displayed depending on the ventilation parameter in the parameter field.

Deactivating alarm limits

WARNING

Alarms must only be deactivated if the safety of the patient is not jeopardized by the absence of an alarm!

The following alarm limits can be deactivated:

Patient category	Invasive ventilation	Non-invasive ventilation
Adult	RR high	MV low
	VT high	RR high
	VT low	Tapn
	–	VT high
	–	VT low
Ped. pat.	RR high	MV low
	VT high	RR high
	VT low	Tapn
	–	VT high
	–	VT low
Neo.	MV low	–
	RR high	RR high
	Tapn	Tapn
	VT high	–
	VT low	–

How to deactivate an alarm limit

- 1 Touch the corresponding button for the alarm limit.
- 2 Continue turning the rotary knob until **Off** is displayed instead of the value.
- 3 Confirm with the rotary knob.

The alarm limit is deactivated. Evita V500 displays the  symbol in the header bar and the deactivated alarm limit. The header bar can display up to 5 deactivated alarm limits.

Response to power failure

Alarm limits are also retained in the event of a power failure, e.g., caused by a defective internal battery.

Display of alarm limits in the parameter field

If the alarm limits are assigned to a ventilation parameter, the alarm limits are displayed in the parameter fields for single parameters (standard and double size).

The following assignments have been defined:

Alarm limits	Measured values
MV high, MV low	MVe
VT high, VT low	VT, VTi
Paw high	PIP
RR high	RR

Setting the volume of the alarm tone

WARNING

Unnoticed alarms in loud environments

Alarm situations are not recognized.

Set the volume of the alarm tone so that alarms can be heard.

- 1 Touch the **Alarms...** button in the main menu bar.
- 2 Touch the **Settings** tab (A).

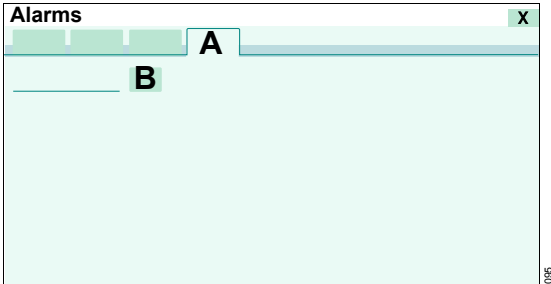

- 3 Touch the (B) button.
- 4 Set the volume of the alarm tone by turning the rotary knob and push to confirm.

During the automatic switch-over between day and night modes, the alarm tone volume setting is overwritten by the volumes defined for these times. An automatic increase in volume can be activated. See "Setting the alarm tone" on page 185.

The lower value for the volume of the alarm tone is limited by the configured minimum volume of the alarm tone. The minimum volume can be configured on the **System setup > Alarms > Alarm vol./tone** page, see "Setting the alarm tone" on page 185.

Additional information

The **Settings** page can be configured for direct access into the main menu bar as the **Alarm volume** button. See "Assigning functions to additional buttons" on page 179.

Suppressing the alarm tone

The alarm tone can be suppressed for a maximum of 2 minutes.

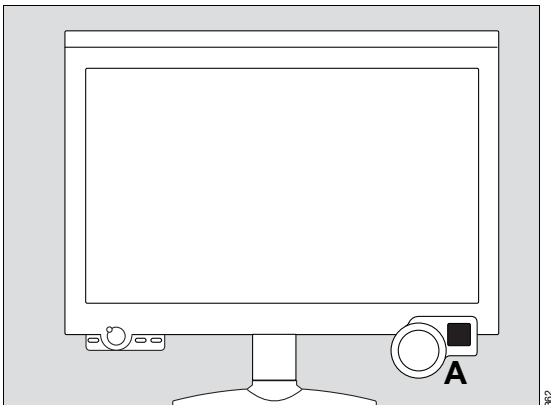

- Press the  (Audio paused) key (A).

This suppresses the acoustic alarm for 2 minutes.

Evita V500 displays the  symbol in the header bar and the remaining time for the suppressed alarm tone.

If an alarm with a higher priority appears during this time, the alarm tone sounds once.

If the fault triggering the alarm is not eliminated after 2 minutes, the alarm tone sounds again.

Reactivate the alarm tone before the suppression time has elapsed:

- Press the  (Audio paused) key (A) again.

Position of the user to the alarm system

The optical alarm signals are designed as follows:

- At a distance of 4 m (157 in) it is possible to recognize which device is generating an alarm.
- At a distance of 1 m (39 in) the alarm message can be read clearly.

The alarm volume can be set so that the acoustic alarm signals can be heard in the vicinity of the device, see "Setting the alarm tone" on page 185.

Failure of the acoustic alarm

If the loudspeaker for acoustic alarm signaling (main alarm) fails on account of a defect, an intermittent tone will be generated by the loudspeaker for the auxiliary alarm.

This intermittent tone is also used for the power failure alarm.

Additional information on the power failure alarm

See "Failure of the power supply" on page 63.

Trends and data

Overview	150
Displaying trends	150
Graphic trends	150
Apnea trend, apnea ventilation trend	152
Tabular trend	153
Displaying data	154
Displaying hospital-specific data	154
Displaying all measured values	154
Displaying set values	154
Displaying the logbook	155
Data export	156

Overview

Evita V500 saves measured value and trend data. Trends are displayed in the form of a graphic or a table. The following can be displayed: current measured values, settings and hospital-specific combinations of measured and set values. The logbook can save up to a maximum of 5000 entries. Data can be exported with a USB storage medium.

The **Trends/Data** dialog window provides the following functions for selection:

- Display trends
- Display data
- Logbook
- Data export

Displaying trends

Trends are displayed as a graphic or a table. Trends are recorded for up to 7 days.

In graphic trends, measured values are displayed in blue and set values in green. In the apnea trend, the number of the apneic events that occurred per minute is represented as a histogram.

In tabular trends, measured values are displayed in blue lettering and set values in green lettering.

Displaying an additional graphic trend

Prerequisite: The **Trends** page (A) is opened.

- Touch the **Graphics 2** tab (C).

Each page contains 2 graphic trend displays (D).

Graphic trends

- 1 Touch the **Trends/Data...** button in the main menu bar.

Evita V500 opens the **Trends** page (A) with the **Graphics 1** page (B).

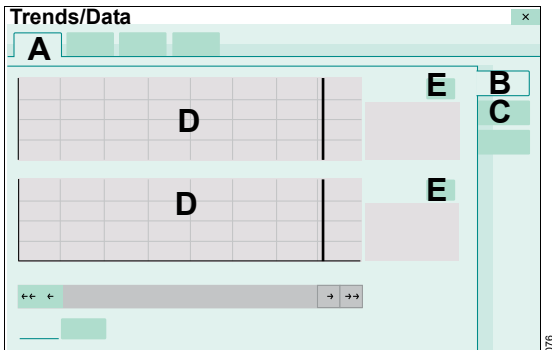

Selecting parameters for the graphic trend display

Prerequisite: The **Graphics 1** or **Graphics 2** page is open.

1 Touch the  button (E).

The **Setup** dialog is displayed with the buttons for **Meas.** (F) and **Settings** (G).

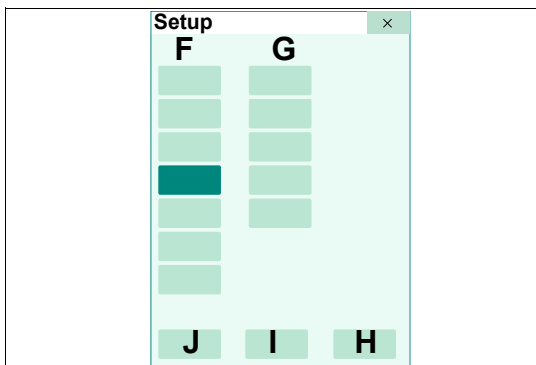

The measurements (F) are divided into the following parameter types:

- Pressures
- Minute vol.
- Volume/Flow
- Gases
- Timing/Cycl.
- Others
- Events

The settings (G) are divided into the following parameter types:

- Pressures
- Volume/Flow
- Gases
- Timing/Cycl.
- Others

2 Touch the appropriate button for measurements or settings.

Another dialog containing all the parameters of the selected parameter type is displayed.

3 Touch the desired parameter.

4 Confirm with the **OK** button (H).

The dialog for the group selected is closed.

A maximum of 3 parameters can be selected for each graphic trend display. If 3 parameters are already selected, one parameter must be deselected before selecting a new parameter.

5 Confirm the parameter selection with the **OK** button (H).

The selected parameters are displayed in the trend display. The **Setup** dialog is closed.

The selection can be aborted with **Cancel** (I). The previous selection is displayed in the graphic trend.

Clear (J) can be used to delete all parameter selections made.

Deselecting a parameter in the trend display

Touch the parameter to be deselected in the parameter type dialog. The button turns pale green.

Selecting a time interval for the graphic trend display

Prerequisite: The **Graphics 1** or **Graphics 2** page is open.

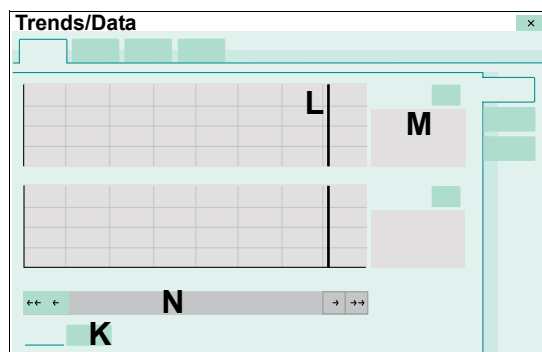

1 Touch the button for the time interval (K).

2 Select the time interval from the selection list (2, 4, 8, 12 hours; 1 day, 7 days).

Displaying the value of a parameter at a certain moment in time

- Position the cursor (L) on the time by turning the rotary knob or touching the time.

The parameter value and the marked time are displayed (M).

The marked time in the trend display also corresponds with the marked row of this time in the logbook.

Changing the displayed time period

- Touch the buttons in the scrollbar (N) or turn the rotary knob.

Apnea trend, apnea ventilation trend

In the apnea trend, the number of the apneic events that occurred per minute is represented as a histogram. The number per minute is represented as a bar height. If an apnea lasts longer than one minute, the apnea is only counted once in the period of occurrence.

In the apnea ventilation trend, the system displays whether or not apnea ventilation is activated.

Prerequisite: The **Graphics 1** or **Graphics 2** page is open.

- 1 Touch the  button.
- 2 In the **Setup** dialog window under **Meas.**, touch the **Events** parameter type.
- 3 Select the **Apnea** or **Apnea Vent.** event.

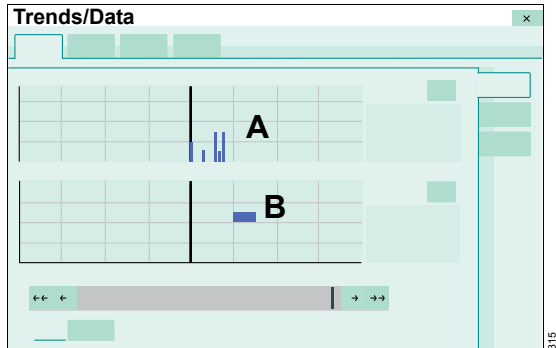

- A Apnea trend
- B Apnea ventilation trend

Additional information

The apnea trend is only recorded when apnea ventilation is switched off.

The duration of an apnea is displayed only in the alarm history.

Tabular trend

Evita V500 displays the trends of all parameters in a table. The parameters that are first displayed correspond with the parameters configured specifically for the hospital. These are followed by all measured values, and then all set values.

- 1 Touch the **Trends/Data...** button in the main menu bar.
- 2 Touch the **Table** tab (A).

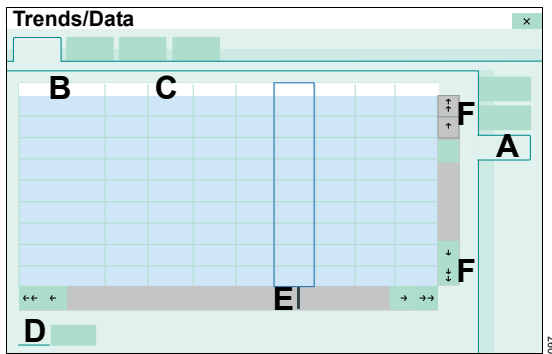

The trend values for the parameters (B) with the units are displayed in 7 to 8 time columns (C). Use the buttons (F) to scroll in the trend table.

Selecting a time interval for the tabular trend display

- 1 Touch the button for the time interval (D).
- 2 Select the time interval from the selection list (5, 10, 30 minutes; 1, 2, 6, 12 hours; 1 day).

The tabular trends are available for the following times according to the selected time interval:

Time interval	Availability
5, 10, 30 minutes	1 day
1 hour	2 days
2, 6, 12 hours, 1 day	7 days

Displaying the value of a parameter at a certain moment in time

- Position the cursor (E) on the time by turning the rotary knob or touching the time.

Additional information

"Configuring the display of hospital-specific measured values and settings" on page 178.

The **Table** page can be configured for direct access into the main menu bar as the **Trends table** button. See "Assigning functions to additional buttons" on page 179.

Displaying data

The following data can be displayed:

- Hospital-specific data
- Measured values 1
- Measured values 2
- Set values

Measured values are displayed on a blue background and set values on a green background.

Displaying hospital-specific data

- 1 Touch the **Trends/Data...** button in the main menu bar.
- 2 Touch the **Values** tab (A).

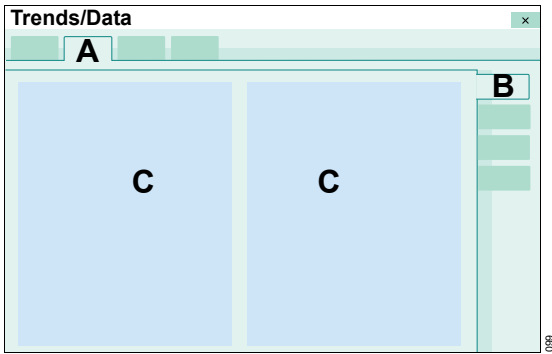

Evita V500 opens the page containing the current, hospital-specific measured and set values (B).

Evita V500 displays the hospital-specific measured and set values (C) selected in the system setup.

Additional information

"Configuring the display of hospital-specific measured values and settings" on page 178.

Displaying all measured values

Prerequisite: The **Values** page (A) is opened.

- Touch the **Values 1** (B) or **Values 2** (C) tab.

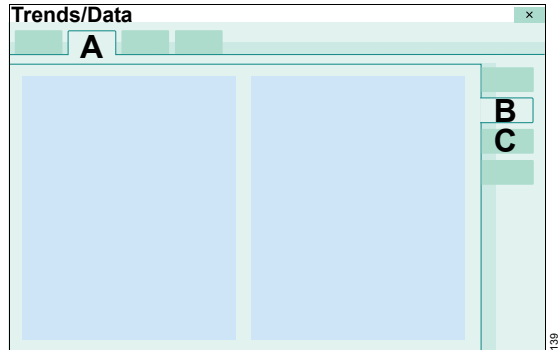

Displaying set values

Prerequisite: The **Values** page (A) is opened.

- Touch the **Settings** tab (B).

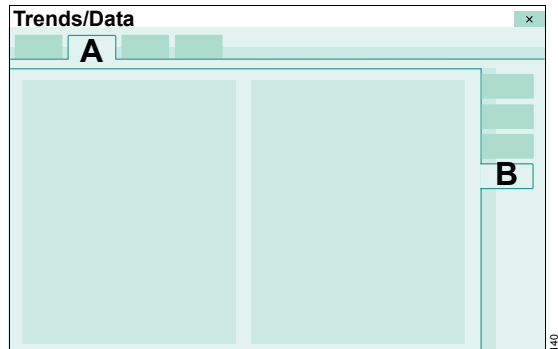

Additional information

The **Values** page can be configured for direct access into the main menu bar as the **Values** button. See "Assigning functions to additional buttons" on page 179.

Displaying the logbook

The logbook records changes, events and alarms in chronological order. A maximum of 5000 logbook entries is possible. Events include, for example, use of the medication nebulizer or flow calibration. For alarms only the occurrence of the alarm condition is recorded, not its termination.

The entries in the logbook are also retained after the device has been switched off and on again or following a power supply failure.

- 1 Touch the **Trends/Data...** button in the main menu bar.
- 2 Touch the **Logbook** tab (A).

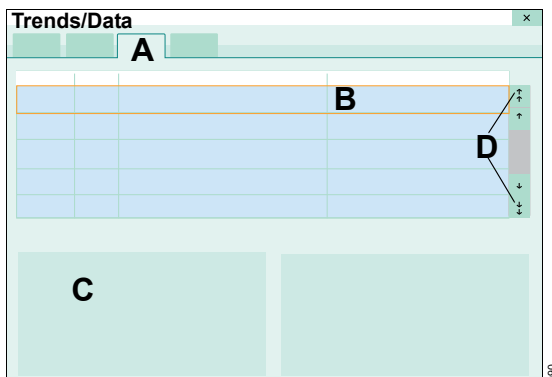

Evita V500 opens the logbook. The cursor (B) marks a row in the logbook. The marked row corresponds with the cursor position in the trend display.

For the marked row Evita V500 displays all the set values of the ventilation mode effective at this time in the field (C).

Displaying the setting parameters at another moment in time

- Select the row by turning the rotary knob or touching the row.

With the button (D) the cursor will be moved backwards or forwards by at least 24 hours.

Additional information

The **Logbook** page can be configured for direct access into the main menu bar as the **Logbook** button. See "Assigning functions to additional buttons" on page 179.

Data export

The data export takes place via a USB storage medium. A maximum of 5000 logbook entries from the last 7 days can be exported.

- 1 Insert the USB storage medium into a USB port on Infinity C500.
- 2 Touch the **Trends/Data...** button in the main menu bar.
- 3 Touch the **Export data** tab (A).

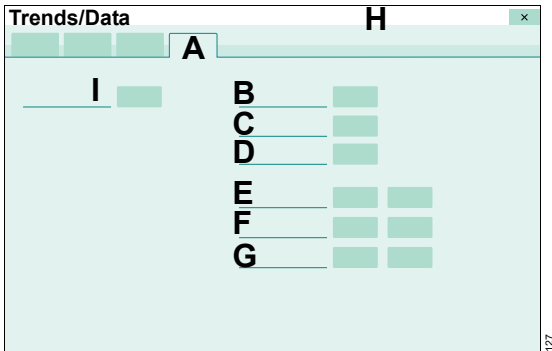

The following data can be exported:

- Current settings and measured values (B)
- Results obtained from the device check (C)
- Results obtained from the breathing circuit check (D)
- Logbook 1 day or 7 days (E)
- Alarm history 1 day or 7 days (F)
- Trends 1 day or 7 days (G)

- 4 Touch the appropriate button for the export of the related data.
- 5 For the export of all the data, touch the **All data** button (I).

The data is exported to the USB storage medium. After the successful completion of the data export, Evita V500 displays a message in the message field (H).

After the data export

- Remove the USB storage medium from the USB port after waiting at least 2 seconds.

If data export was not successful

If data export fails owing to the USB storage medium being full, the buttons are deactivated.

- Remove the USB storage medium from the USB port and use a different USB storage medium.

Additional information

The buttons are deactivated when a USB storage medium is not connected.

The exported files can only be viewed with a Unicode-enabled editor and a Unicode font.

An import into word processors or spreadsheets is possible.

Monitoring

Information on monitoring	158
Possible displays for measured values	158
Information on the sensors used	158
Flow monitoring	159
Information on flow monitoring	159
Calibrating the neonatal flow sensor	159
Calibrating the Infinity ID flow sensor	161
Deactivating or activating flow monitoring	162
O₂ monitoring	164
Calibrating the O ₂ sensor	164
Deactivating or activating O ₂ monitoring	164
CO₂ monitoring	165
Information on CO ₂ monitoring	165
Selecting cuvette type	165
Information on checking the CO ₂ sensor	166
Information on the alarm messages issued during CO ₂ monitoring	166
Checking the CO ₂ zero indication	167
Performing a CO ₂ zero calibration	167
Checking the calibration of the CO ₂ sensor with a test filter	168
Checking the calibration of the CO ₂ sensor with test gas	169
Performing the calibration of the CO ₂ sensor	170
Deactivating or activating CO ₂ monitoring	171

Information on monitoring

Monitoring is activated at the factory. Each monitoring function can be deactivated separately.

O₂ monitoring and flow monitoring are switched on after the device is switched on. In the **Ped. pat.** patient category, the flow monitoring is switched on according to the flow sensor and expiratory valve used. The unused flow monitoring is switched off.

Possible displays for measured values

Instead of a measured value, the following displays are possible in the parameter fields or tables:

Display	Cause
Off	Monitoring deactivated by user
ERR	Sensor error
CAL	Calibration active, no measured value display possible
Measured value?	Reduced sensor accuracy
No measured value	Prerequisites for measurement or calculation currently not met
+++	Measured value above specified measurement range
---	Measured value below specified measurement range

Display of etCO₂ measurements

The measured value for etCO₂ can be displayed in Vol%, kPa or mmHg. The display is configurable, see "Configuring units" on page 201.

Information on the sensors used

Evita V500 uses the following sensors for measurement and monitoring purposes:

- Neonatal flow sensor in the **Neo.** and **Ped. pat.** patient categories
- Infinity ID flow sensor in the **Adult** and **Ped. pat.** patient categories
- O₂ sensor
- Pressure sensor
- CO₂ sensor

CAUTION

Regular calibration is essential to ensure that the sensors deliver reliable and accurate results. Otherwise the proper functioning of the device may be impaired.

Automatic calibration of the pressure sensors takes place immediately and an hour after the device has been switched on, afterwards every 12 hours.

For calibrating or checking the other sensors, see:

- "Calibrating the neonatal flow sensor" on page 159
- "Calibrating the Infinity ID flow sensor" on page 161
- "Calibrating the O₂ sensor" on page 164
- "Information on checking the CO₂ sensor" on page 166

The calibration or zero-checking values of the sensors that were last determined remain stored until the next calibration or zero check, even if the device is switched off.

Flow monitoring

Information on flow monitoring

The following flow sensors are used for flow monitoring in accordance with the patient category:

Adult	Infinity ID flow sensor
Ped. pat.	Infinity ID flow sensor or neonatal flow sensor
Neo.	Neonatal flow sensor

The measured values for **MVe** and **VTe** are not leakage-corrected and are therefore lower than the actual minute and tidal volumes applied to the patient if a leakage occurs. When leakage compensation is activated, the measured volume and flow values as well as the curves for flow and volume are displayed with leakage correction.

Evita V500 compensates leakages up to 100 % of the set tidal volume **VT**. Pressure-controlled ventilation is recommended in the case of larger leakages.

In order to avoid false alarms and assure proper monitoring, the following settings are required:

- Adjust both alarm limits for MVe in line with the current value.
- Use additional monitoring, e.g., external SpO₂, if necessary.

Flow monitoring with neonatal flow sensor in the Neo. patient category

CAUTION

Risk of patient injury

Use additional external monitoring during ventilation with very low tidal volumes.

Flow monitoring in the Ped. pat. patient category

If the neonatal flow sensor is present and intact in the **Ped. pat.** patient category, flow monitoring is performed via that sensor.

If the neonatal flow sensor is faulty or if flow monitoring with the neonatal flow sensor is deactivated, flow monitoring is performed using the Infinity ID flow sensor present in Evita V500. Volume-controlled ventilation continues to be possible.

CAUTION

Do not use neonatal flow sensors for bigger pediatric patients with serious infections and severe coughing. Coughed-up secretions can cause corrosion in the neonatal flow sensor. Use the Infinity ID flow sensor present in Evita V500 for flow monitoring.

Calibrating the neonatal flow sensor

Calibration of the neonatal flow sensor corresponds to a zero calibration.

Manual calibration of the neonatal flow sensor is necessary:

- During the device check and before use
- At least once a day
- After replacing the neonatal flow sensor
- After medication nebulization

Recalibration is not necessary if the neonatal flow sensor has been unplugged only briefly.

Before each manual calibration, whether started from the device check or from the

Sensors/Parameters dialog window, Evita V500 automatically cleans the neonatal flow sensor by heating.

WARNING

Risk of fire

Residual vapors of easily flammable disinfectants (e.g., alcohols) and deposits that were not removed during reprocessing can ignite when the flow sensor is in use.

- Ensure particle-free cleaning and disinfection.
- After disinfection, allow the flow sensor to air for at least 30 minutes.
- Before inserting the flow sensor check for visible damage and soiling, such as residual mucus, medication aerosols, and particles.
- Replace flow sensors when damaged, soiled, or not particlefree.

Removing the neonatal flow sensor

- 4 Remove the tube connector.

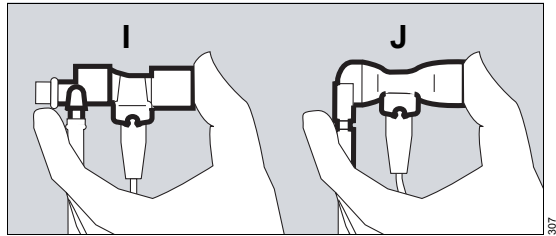

- 5 Put on a sterile glove.
- 6 Seal the neonatal flow sensor ISO 15 (I) or neonatal flow sensor Y-piece (J).

This ensures that the requirement for calibration (flow = 0) is met.

Starting calibration of the neonatal flow sensor

- 1 Touch the **Sensors/Parameters...** button in the main menu bar.

Evita V500 opens the **Sensors/Parameters** dialog window. The **Neonatal flow sensor** page (A) is displayed by default.

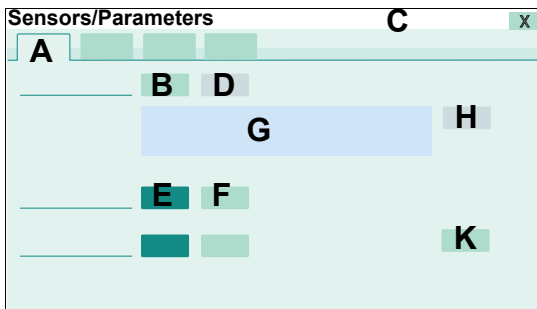

Select the sensor type being used:

- 2 Touch the **Y flow sensor** (E) or **ISO-15 flow sensor** (F) button.
- 3 Touch the **Start** button (B).

The instruction field (G) displays the instructions for performing calibration. Button (H) is preselected.

Performing calibration

- 7 Press the rotary knob.

Evita V500 calibrates the neonatal flow sensor.

Evita V500 displays calibration information in the message field (C).

At the completion of calibration, the **Start** button (B) turns pale green.

Canceling calibration of the neonatal flow sensor

- Touch the **Cancel** button (D).

After calibration of the neonatal flow sensor

- 8 Connect the tube connector.

Setting the flow trigger

- Touch the **Trigger** button (K).

Evita V500 opens the page for setting the flow trigger. For additional information, see "Additional settings for ventilation" on page 96.

Additional information

The **Neonatal flow sensor** page can be configured for direct access into the main menu bar as the **Neonatal flow sensor** button. See "Assigning functions to additional buttons" on page 179.

Calibrating the Infinity ID flow sensor

Calibration of the Infinity ID flow sensor in the device corresponds to a zero calibration.

Calibration of the Infinity ID flow sensor takes place automatically:

- At the start of ventilation
- Every hour during ventilation or if deviations are detected
- After flow sensor replacement
- After medication nebulization

Manual calibration of the Infinity ID flow sensor is necessary:

- During the device check

Before each manual calibration, whether started from the device check or from the **Sensors/Parameters** dialog window, Evita V500 cleans the Infinity ID flow sensor automatically by heating. This heating is performed 30 minutes after switching on the device at the earliest, or 30 minutes after replacement of the Infinity ID flow sensor at the earliest. Following medication nebulization, the device automatically cleans the Infinity ID flow sensor by heating and performs calibration.

WARNING

Risk of fire

Residual vapors of easily flammable disinfectants (e.g., alcohols) and deposits that were not removed during reprocessing can ignite when the flow sensor is in use.

- Ensure particle-free cleaning and disinfection.
- After disinfection, allow the flow sensor to air for at least 30 minutes.
- Before inserting the flow sensor check for visible damage and soiling, such as residual mucus, medication aerosols, and particles.
- Replace flow sensors when damaged, soiled, or not particlefree.

Starting calibration of the Infinity ID flow sensor

- 1 Touch the **Sensors/Parameters...** button in the main menu bar.

Evita V500 opens the **Sensors/Parameters** dialog window.

- 2 Touch the **Flow sensor** tab (A).

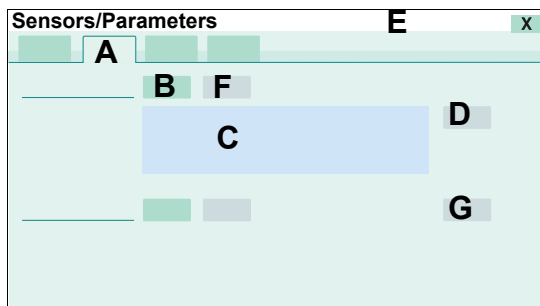

- 3 Touch the **Start** button (B).
- 4 The device displays information about the calibration in the notification field (C). Button (D) is preselected. Confirm with the rotary knob.

Evita V500 uses the next inspiratory phase for calibration of the Infinity ID flow sensor. Short inspiratory times are extended to approximately 1 second.

Evita V500 displays calibration information in the message field (E).

At the completion of calibration, the **Start** button (B) turns pale green.

Canceling calibration of the Infinity ID flow sensor

- Touch the **Cancel** button (F).

Setting the flow trigger

- Touch the **Trigger** button (G).

Evita V500 opens the page for setting the flow trigger. For additional information, see "Additional settings for ventilation" on page 96.

Additional information

The **Flow sensor** page can be configured for direct access into the main menu bar as the **Flow sensor** button. See "Assigning functions to additional buttons" on page 179.

The Infinity ID flow sensor can be reused as long as automatic calibration is possible.

Deactivating or activating flow monitoring

The ventilation functions and ventilation monitoring are limited when flow monitoring is deactivated.

Flow monitoring with the Infinity ID flow sensor cannot be fully substituted by external monitoring. Set the minute volume alarm limits of the substitute monitoring accordingly.

WARNING

If flow and volume monitoring is deactivated, ensure that appropriate substitute monitoring is available immediately. The patient may otherwise be jeopardized.

WARNING

No apnea monitoring takes place when flow monitoring is deactivated. Use an independent apnea monitoring.

WARNING

If flow monitoring with the Infinity ID flow sensor is not available, disconnection cannot be reliably detected.

CAUTION

Neither volume-controlled nor patient-triggered ventilation is possible when flow monitoring with the Infinity ID flow sensor is deactivated.

Patient-triggered ventilation is not possible when flow monitoring with the neonatal flow sensor is deactivated.

Flow monitoring can be deactivated, e.g.:

- If medication nebulization is being performed
- To permit ventilation in the event of major tube leakage
- If the flow sensor has failed but cannot be replaced immediately.
A defective or disconnected flow sensor can lead to deviations in the minute and tidal volumes or to auto-triggering.

In the **Neo.** patient category, Evita V500 deactivates flow monitoring when changing to the **NIV** application mode.

Deactivating flow monitoring with neonatal flow sensor

- 1 Touch the **Sensors/Parameters...** button in the main menu bar.
- 2 Touch the **Neonatal flow sensor** tab (A).

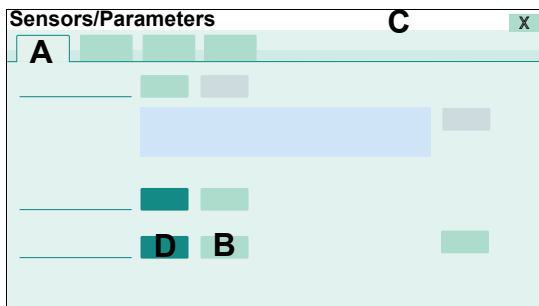

- 3 Touch the **Off** button (B) and confirm with the rotary knob.

Evita V500 displays the following information in the message field (C): **External monitoring must be used!**

Flow monitoring with the neonatal flow sensor is deactivated. Evita V500 displays the symbol  **Flow** in the header bar. The measured values are no longer displayed. The alarm function is deactivated.

In the **Ped. pat.** patient category, flow monitoring is only deactivated if no Infinity ID flow sensor is present in Evita V500 or if flow monitoring with this flow sensor is deactivated.

Activating flow monitoring with neonatal flow sensor

Reactivate flow monitoring after exchanging the neonatal flow sensor or as soon as possible.

Prerequisite: The **Neonatal flow sensor** page (A) is opened.

- Touch the **On** button (D) and confirm with the rotary knob.

Flow monitoring is activated.

Deactivating flow monitoring with the Infinity ID flow sensor

- 1 Touch the **Sensors/Parameters...** button in the main menu bar.
- 2 Touch the **Flow sensor** tab (E).

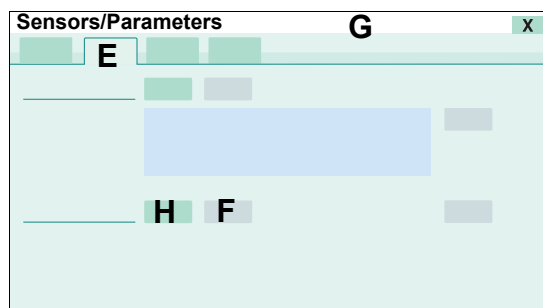

- 3 Touch the **Off** button (F) and confirm with the rotary knob.

Evita V500 displays the following information in the message field (G): **External monitoring must be used!**

Flow monitoring is deactivated. Evita V500 displays the symbol  **Flow** in the header bar. The measured values are no longer displayed. The alarm function is deactivated.

Activating flow monitoring with the Infinity ID flow sensor

Reactivate flow monitoring after replacing the Infinity ID flow sensor or as soon as possible.

Prerequisite: The **Flow sensor** page (E) is opened.

- Touch the **On** button (H) and confirm with the rotary knob.

Flow monitoring is activated.

O₂ monitoring

Calibrating the O₂ sensor

The O₂ sensor is calibrated during the device check. Regular calibration during the device check ensures the specified accuracy. If the O₂ sensor is not calibrated for 3 months, the accuracy of the O₂ sensor will be reduced. The parameter field for the O₂ concentration displays a question mark in addition to the measured value.

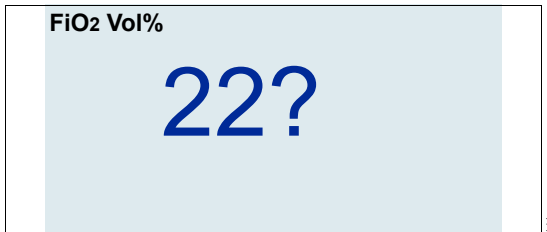

After calibration during the device check the sensor will work again with full accuracy.

CAUTION

If the quality of the oxygen from the central gas supply system is inadequate, calibrate the O₂ sensor with calibration gas (100 % O₂). Otherwise this may result in an incorrect calibration.

Additional information

"Performing the device check" on page 75.

The **O₂ sensor** page can be configured for direct access into the main menu bar as the **O₂ sensor** button. See "Assigning functions to additional buttons" on page 179.

The O₂ sensor is deactivated in standby mode. When the therapy is started, the O₂ concentration is not displayed until after about 5 seconds.

Deactivating or activating O₂ monitoring

WARNING

If O₂ monitoring is deactivated, ensure that appropriate substitute monitoring is available immediately. The patient may otherwise be jeopardized.

O₂ monitoring can be replaced by appropriate substitute monitoring. Set the O₂ alarm limits for the substitute monitoring according to the set value for FiO₂:

FiO₂ <60 Vol% → O₂ ±4 Vol%

FiO₂ ≥60 Vol% → O₂ ±6 Vol%

Deactivating O₂ monitoring

- 1 Touch the **Sensors/Parameters...** button in the main menu bar.
- 2 Touch the **O₂ sensor** tab (A).

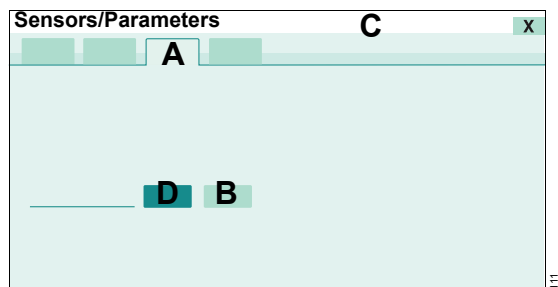

- 3 Touch the **Off** button (B) and confirm with the rotary knob.

Evita V500 displays the following information in the message field (C): **External monitoring must be used!**

O₂ monitoring is deactivated. Evita V500 displays the symbol  **FiO₂** in the header bar. The measured values are no longer displayed. The corresponding alarm function is deactivated.

Activating O₂ monitoring

Reactivate O₂ monitoring as soon as possible.

Prerequisite: The **O₂ sensor** page (A) is opened.

- Touch the **On** button (D) and confirm with the rotary knob.

O₂ monitoring is activated.

CO₂ monitoring

Information on CO₂ monitoring

The **CO₂ sensor** page can be configured for direct access into the main menu bar as the **CO₂ sensor** button. See "Assigning functions to additional buttons" on page 179.

Selecting cuvette type

The following cuvettes can be used:

- Reusable cuvettes
- Disposable cuvettes

The cuvette type used must be selected on the **Zero calib. on/off** page.

CAUTION

The cuvette windows of the reusable cuvette have different optical properties to the cuvette windows of the disposable cuvette.

The cuvette type used must therefore be selected correctly on the **Zero calib. on/off** page.

Otherwise the zero point will be shifted by up to 8 mmHg CO₂.

- 1 Touch the **Sensors/Parameters...** button in the main menu bar.
- 2 Touch the **CO₂ sensor** tab (A).

The **Zero calib. on/off** page (B) appears by default.

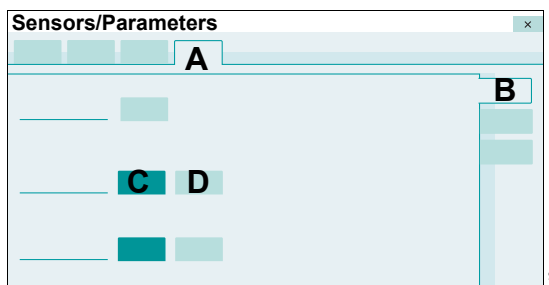

- 3 Touch the **Reusable** (C) or the **Disposable** (D) button.

If the selected cuvette does not correspond to the cuvette used, the alarm message **Check CO₂ cuvette** is displayed.

Information on checking the CO₂ sensor

The CO₂ sensor is factory-calibrated and can be used on any Evita V500.

Information on checking the zero indication and zero calibration

When checking the zero indication or performing zero calibration, the CO₂ concentration in the cuvette or in the cuvette slot of the sensor must not be higher than the background concentration in rooms of approximately 0.4 mmHg or 0.05 Vol%. For this reason, do not breathe on or into the cuvettes or into the cuvette slot.

The following checks are required for the CO₂ sensor:

Check	When required?
Check CO ₂ zero indication in ambient air	Required before measurement and when changing the CO ₂ sensor to another ventilation unit.
Perform a CO ₂ zero calibration	If the CO ₂ zero indication in ambient air is not between 0 and 1 mmHg (or 0 and 0.1 Vol%, or 0 and 0.1 kPa).
Check calibration of the CO ₂ sensor with a test filter	Required in intervals of one month.
Check calibration of the CO ₂ sensor with test gas	When the test values are not adhered to during the calibration check with test filter.
Perform calibration of the CO ₂ sensor	When the test values are not adhered to during the calibration check with test gas.

Zero calibration in ambient air, calibration check with test filter or test gas and calibration of the CO₂ sensor can be performed during ventilation.

Information on the alarm messages issued during CO₂ monitoring

This information refers to the alarm messages which are generated due to a soiled cuvette or sensor.

Alarm message Clean CO₂ cuvette

If the **Clean CO₂ cuvette** message is displayed, the following panes may be soiled:

- Cuvette (disposable or reusable cuvette)
- CO₂ sensor

- 1 Clean the cuvette or use another cuvette.
 - When using reusable cuvettes, insert a clean reusable cuvette.
 - When using disposable cuvettes, insert a new disposable cuvette.

- 2 Clean the CO₂ sensor.

Alarm message CO₂ zero calibration?

If the **CO₂ zero calibration?** message is displayed or if incorrect measured values are suspected, e.g., etCO₂ values too low or inspiratory values too high, then proceed as follows:

- 1 Check whether the cuvette windows are soiled.
- 2 Clean the soiled windows. Or, if a reusable cuvette was used previously, use a clean reusable cuvette. If a disposable cuvette was used previously, use a new disposable cuvette.

If the cuvette windows are extremely soiled, e.g., from deposits due to medication nebulization, this may result in a zero shift. The CO₂ measured values may be incorrect even before insufficient measuring light causes the **Clean CO₂ cuvette** message to appear.

If the **CO₂ zero calibration?** message does not disappear or if the measured CO₂ values remain suspect, a zero calibration must be performed.

Checking the CO₂ zero indication

The check of the CO₂ zero indication in ambient air is performed with a clean CO₂ sensor that is placed on the cuvette used for measurement.

Prerequisite: Evita V500 is switched on and at least the three-minute warm-up phase for the CO₂ sensor has elapsed. After 3 minutes, the measured CO₂ values will be inside the specified tolerance range.

- 1 Fit the CO₂ sensor on the cuvette.
- 2 Select the cuvette type, see page 165.
- 3 To display CO₂ measured values as a curve, see "Changing the display of monitoring fields" on page 102.
- 4 Remove the CO₂ sensor with the cuvette from the breathing circuit and hold it in ambient air. Do not breathe on or into the cuvette.

Instead of the cuvette from the breathing circuit, another clean cuvette of the selected type (disposable or reusable) can be used.

- 5 Observe the measured CO₂ value. If 0 to 1 mmHg (or 0 to 0.1 Vol% or 0 to 0.1 kPa) is not displayed in the ambient air, perform a zero calibration.

Performing a CO₂ zero calibration

Zero calibration is performed in ambient air and with a clean CO₂ sensor which is removed from the cuvette.

Prerequisite: Evita V500 is switched on and at least the three-minute warm-up phase for the CO₂ sensor has elapsed. After 3 minutes, the measured CO₂ values will be inside the specified tolerance range.

Starting zero calibration

- 1 Touch the **Sensors/Parameters...** button in the main menu bar.
- 2 Touch the **CO₂ sensor** tab (A).

The **Zero calib. on/off** page (B) appears by default.

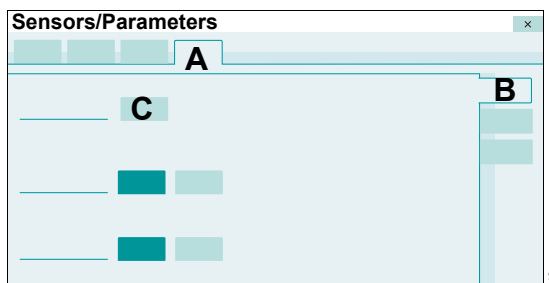

- 3 Touch the **Start** button (C).

When requested by Evita V500:

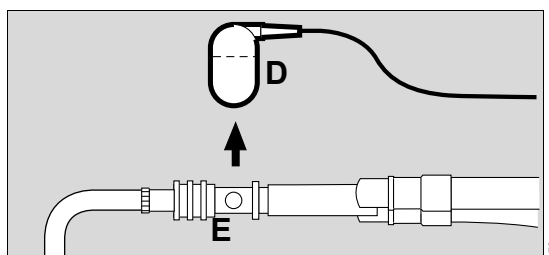

- 4 Remove the CO₂ sensor (D) from the cuvette (E).
- 5 Confirm with the rotary knob.

Evita V500 performs the zero calibration and displays the message **Calibration in progress..**

If zero calibration was successful

After approximately 5 seconds, Evita V500 reports **Zero calibration successful..**

- Fit the CO₂ sensor (D) back on the cuvette (E).

If zero calibration was not successful

Evita V500 reports **Zero calibration failed..**

- Repeat zero calibration.

If zero calibration is still impossible

- 1 Check whether the sensor is soiled and clean it if necessary. If the sensor is faulty, replace it.
- 2 Repeat zero calibration.

- 2 Remove the sensor from the cuvette and connect it to the test filter (E) on the sensor cable.

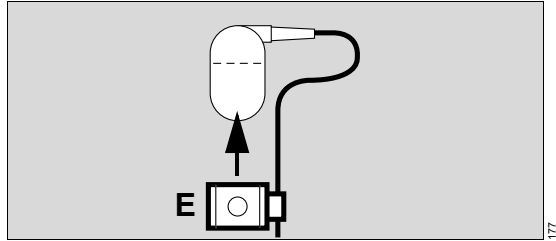

- 3 Touch the **Filter check** button (C) and confirm with the rotary knob.

Evita V500 starts the check and displays the progress and result of the check in the message field (D).

Checking the calibration of the CO₂ sensor with a test filter

Perform the calibration check of the CO₂ sensor with a test filter at intervals of one month.

Before the check

Prerequisite: Evita V500 is switched on and at least the three-minute warm-up phase for the CO₂ sensor has elapsed.

- Perform CO₂ zero calibration in ambient air.

Starting the calibration check of the CO₂ sensor with a test filter

Prerequisite: The **CO₂ sensor** page (A) is opened.

- 1 Touch the **Check sensor** tab (B).

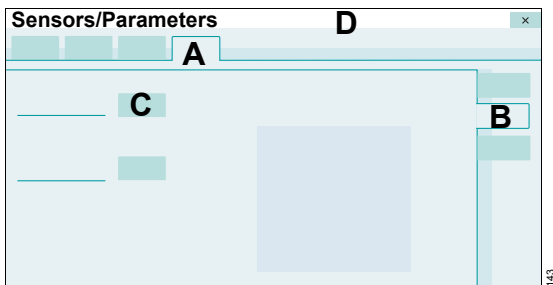

If the check was successful

Evita V500 displays the message **Filter check successful..** The test value is within the permissible tolerance.

- Fit the CO₂ sensor back on the cuvette.

If the check was not successful

Evita V500 displays the message **Filter check failed..** The test value is outside the permissible tolerance.

- Check the CO₂ calibration with test gas.

Checking the calibration of the CO₂ sensor with test gas

Perform the check when the test values are not within the permitted tolerance during the calibration check of the CO₂ sensor with test filter.

CAUTION

For the check and calibration only use a test gas which consists of CO₂ and N₂! Otherwise display deviations of ± 0.5 Vol% CO₂ may occur.

Before the check

Prerequisite: Evita V500 is switched on and at least the three-minute warm-up phase for the CO₂ sensor has elapsed.

- Perform CO₂ zero calibration in ambient air.

Connecting the test gas supply

The test gas must consist only of CO₂ and N₂!

- 1 Use the reusable cuvette from the calibration set!

At the start of the check with test gas, Evita V500 automatically sets the cuvette type to **Reusable**.

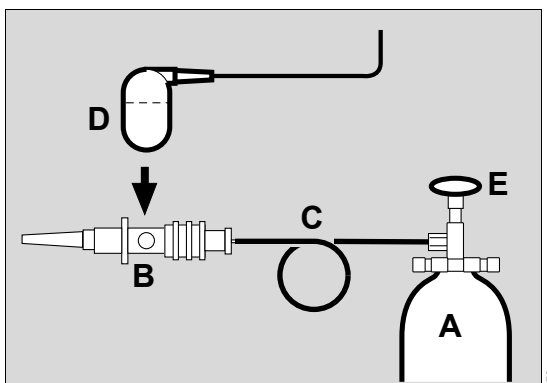

- 2 Connect the test gas cylinder (A) and the cuvette (B) of the calibration set to the hose (C).
- 3 Fit the CO₂ sensor (D) on the cuvette (B) from the calibration set.

- 4 Read the CO₂ concentration of the test gas from the test gas cylinder (A).
- 5 Open the test gas cylinder (E) and set the test gas flow to 0.1 L/min.

Starting the calibration check of the CO₂ sensor with test gas

Prerequisite: The **CO₂ sensor** page (F) is opened.

- 1 Touch the **Check sensor** tab (G).

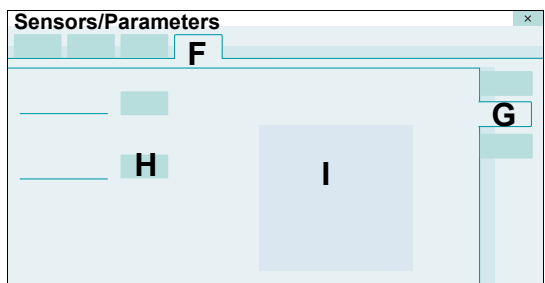

- 2 Touch the **Gas check** button (H).

Evita V500 displays the measured CO₂ concentration (I).

About 1 minute after the test gas flow has been set, the measured CO₂ value must match the CO₂ content of the test gas read from the test gas cylinder with a tolerance of ± 0.2 Vol%.

Evita V500 terminates the check with test gas approx. 1 minute after the start.

- 3 Close the test gas cylinder again.

If the test value is outside the permitted tolerance, the CO₂ sensor must be recalibrated with test gas.

After the calibration check of the CO₂ sensor with test gas

The cuvette type is automatically reset to the previously set cuvette type.

- Fit the CO₂ sensor back on the cuvette in the breathing circuit.

Performing the calibration of the CO₂ sensor

The CO₂ sensor must be calibrated if the test values are not within the permitted tolerance during the calibration check with test gas.

CAUTION

For the check and calibration only use a test gas which consists of CO₂ and N₂! Otherwise display deviations of ±0.5 Vol% CO₂ may occur.

Before calibration

Prerequisite: Evita V500 is switched on and at least the three-minute warm-up phase for the CO₂ sensor has elapsed.

- Perform CO₂ zero calibration in ambient air.

Connecting the test gas supply

The test gas must consist only of CO₂ and N₂!

- 1 Use the reusable cuvette from the calibration set!

At the start of calibration, Evita V500 automatically sets the cuvette type to **Reusable**.

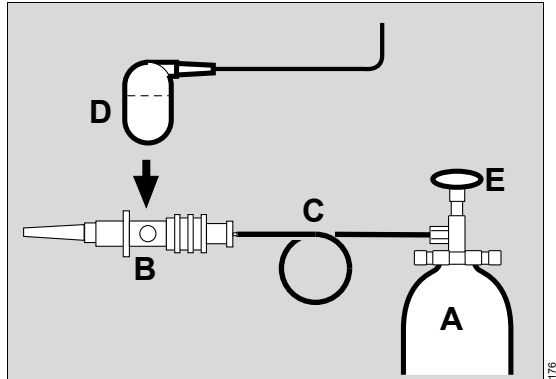

- 2 Connect the test gas cylinder (A) and the cuvette (B) of the calibration set to the hose (C).
- 3 Fit the CO₂ sensor (D) on the cuvette (B) from the calibration set.
- 4 Read the CO₂ concentration of the test gas from the test gas cylinder (A).
- 5 Open the test gas cylinder (E) and set the test gas flow to 0.1 L/min.

Starting calibration of the CO₂ sensor with test gas

Prerequisite: The **CO₂ sensor** page (F) is opened.

- 1 Touch the **Calibration** tab (G).

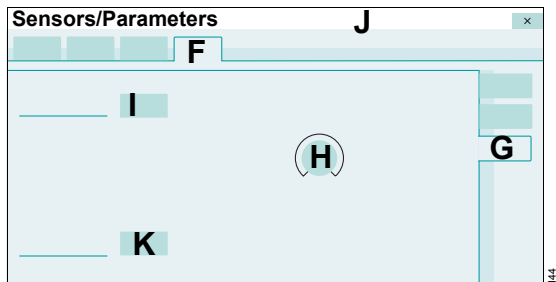

- 2 Touch the **CO₂ sensor** therapy control (H). Enter the value for the CO₂ concentration in the test gas with the rotary knob and confirm.
- 3 About 1 minute after setting the test gas flow, touch the **Start** button (I) and confirm with the rotary knob.

Evita V500 starts the calibration of the CO₂ sensor and displays the progress and result of the calibration in the message field (J).

- 4 Close the test gas cylinder again.

If calibration was successful

Evita V500 displays the message **CO₂ sensor calib. with test gas successful.**

The cuvette type is automatically reset to the previously set cuvette type.

- Fit the CO₂ sensor back on the cuvette in the breathing circuit.

If calibration was not successful

Evita V500 displays the message **Calibration of CO₂ sensor with test gas failed.**

If calibration failed, the following causes are possible:

Cause	Remedy
The CO ₂ concentration entered does not match the value on the test gas cylinder.	Check the CO ₂ concentration entered and repeat calibration of the CO ₂ sensor.
The test gas cylinder is empty.	Use a new test gas cylinder and repeat calibration of the CO ₂ sensor.
The CO ₂ sensor is soiled.	Clean the CO ₂ sensor and repeat calibration of the CO ₂ sensor.
The CO ₂ sensor is faulty.	Replace the CO ₂ sensor and check the CO ₂ zero indication.

Resetting the calibration of the CO₂ sensor

If problems occurred during calibration, the sensor can be reset to the delivery default values.

Prerequisite: The **Calibration** page is opened.

- 1 Touch the **Reset calibration** button (K) and confirm with the rotary knob.

After approximately 5 seconds, the factory-set calibration value is effective again and must be checked with the test filter.

- 2 Check the calibration of the CO₂ sensor with test filter, see page 168.

Deactivating or activating CO₂ monitoring

Deactivate CO₂ monitoring when a defective CO₂ sensor cannot immediately be exchanged or the CO₂ measured values are currently not needed.

Deactivating CO₂ monitoring

- 1 Touch the **Sensors/Parameters...** button in the main menu bar.
- 2 Touch the **CO₂ sensor** tab (A).
- 3 Touch the **Zero calib. on/off** tab (B) if the page is not already preset.

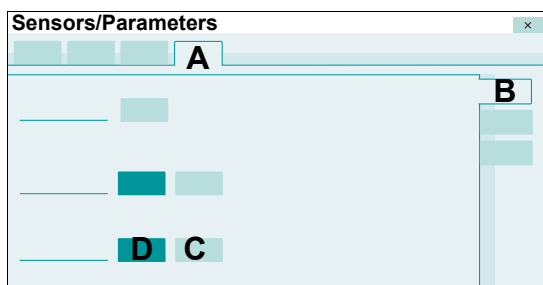

- 4 Touch the **Off** button (C) and confirm with the rotary knob.

CO₂ monitoring is deactivated. Evita V500 displays **Off** in the CO₂ parameter field. The measured values are no longer displayed. The alarm function is deactivated.

Activating CO₂ monitoring

Prerequisite: The **Zero calib. on/off** page (B) is opened.

- Touch the **On** button (D) and confirm with the rotary knob.

CO₂ monitoring is activated.

Configuration

Information on configuration	174
Configuring the screen display	174
Adjusting illumination and brightness	175
Configuring the screen view	176
Configuring the display of hospital-specific measured values and settings	178
Assigning functions to additional buttons	179
Selecting parameters for the graphic trend display	180
Locking therapy controls in the therapy bar	182
Configuring alarm settings	183
Setting start-up values for alarm limits	183
Setting the alarm tone	185
Configuring ventilation settings	186
Configuring start-up settings for the patient category	187
Configuring start-up settings for the ventilation modes	188
Configuring start-up settings for the ventilation parameters	189
Configuring general settings	194
Setting a maneuver	194
Importing and exporting configurations	195
Installing applications	197
System status	198
Displaying general status information	198
Configuring exchange intervals	198
System settings	200
Selecting country-specific settings	200
Configuring units	201
Configuring interfaces	201
Configuring supply units	203
Service dialog	203

Information on configuration

The **System setup** dialog window provides the user with the following configuration options:

- Screen layout
- Alarms
- Ventilation
- Config. exchange (Importing and exporting configurations)
- Applications
- System status
- Exchange intervals
- System

To prevent unauthorized adjustments, the following pages are password-protected:

- Screen layout > Views
- Alarms
- Ventilation
- Config. exchange
- Applications
- Exchange intervals

The password only needs to be entered once as long as the **System setup** dialog window remains open.

For additional information on the password, see page 381.

Configuring the screen display

The following settings can be configured on the **System setup > Screen layout** page:

- General settings (General settings)
- Views
- Customized data (Customized data)
- Config. buttons (Configurable buttons)
- Trends graphic 1
- Trends graphic 2
- Therapy bar

The customized settings for Trends graphic 1 and Trends graphic 2 become effective with the admission of a new patient. The other customized screen display settings are immediately effective.

- Touch the **System setup...** button.

Evita V500 opens the **System setup** dialog window. The **Screen layout** page is displayed by default.

Adjusting illumination and brightness

Prerequisite: The **Screen layout** page (A) is opened.

- 1 Touch the **General settings** tab (B).

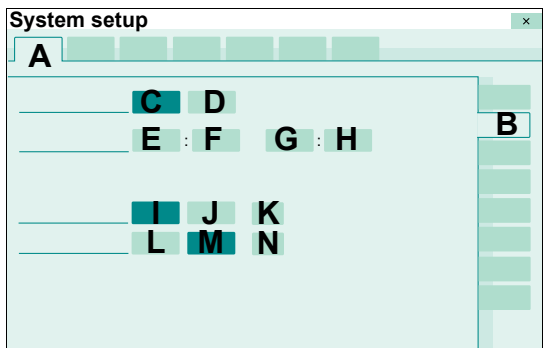

Automatic changeover of day and night mode

If the automatic changeover of day and night mode is switched on, the system will automatically change over the following settings:

- Illumination of the screen
- Volume of the alarm tone
- Automatic increase of the alarm tone volume

- Touch the **On** (C) or **Off** (D) button.

Selecting the time period for screen illumination at night

The illumination of the screen is reduced with a dark background color for the time period entered.

Hours (E) : minutes (F) to hours (G) : minutes (H).

- 1 Touch the appropriate button.
- 2 Set the time by turning the rotary knob and push to confirm.

If the automatic changeover for the illumination of the screen is switched on, the system will change over at the times entered.

The **Day/Night** button in the main menu bar can be configured to enable direct access to the reduced screen illumination mode that uses a dark background color, see page 179.

Adjusting screen brightness

The screen brightness can be adjusted automatically or manually.

Activating automatic brightness adjustment:

- Touch the **Automatic** button (I).

Adjusting brightness manually:

- 1 Touch the **Manual** button (J).
- 2 Touch the (K) button.
- 3 Set the value by turning the rotary knob and push to confirm.

Adjusting automatic screen dimming

Automatic dimming of the screen can be set for standby mode and battery operation.

- 1 Touch the **On** button (L).
- 2 Touch the (N) button.
- 3 Set the value by turning the rotary knob and push to confirm.

Switching off automatic screen dimming:

- Touch the **Off** button (M).

Configuring the screen view

Prerequisite: The **Screen layout** page (A) is opened.

- 1 Touch the **Views** tab (B).
- 2 Enter password and confirm with **Enter**.

The **Views** page is displayed.

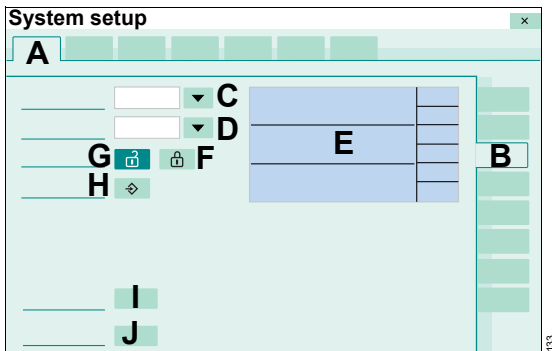

Selecting the view

- 3 Touch the ▼ button (C).

Evita V500 opens the selection list for the views. 6 views can be configured (**View 1 to View 6**).

- 4 Select the respective view by turning the rotary knob and push to confirm.

Selecting the format template

The format templates can only be selected if the selected view is not locked. The button (G) is dark green.

- 5 Touch the ▼ button (D).

Evita V500 opens the selection list containing the existing format templates.

- 6 Select the desired template by turning the rotary knob and push to confirm.

The selected format template is displayed (E).

Adjusting the selected view

- 7 Touch a field in the view (E).

The dialog for the field contents is displayed.

- 8 Select the parameter, display format and display size for curves and parameter fields. See "Changing the display of monitoring fields" on page 102.

Locking the view against overwriting

- Touch the  button (F).

The selected view is locked and cannot be changed. The display of the monitoring fields cannot be changed on the main page.

Deactivating the lock

- Touch the  button (G).

Saving the view

- 1 Touch the  button (H).
- 2 Confirm with the rotary knob.

The current view for the selected view (**View 1 to View 6**) is saved.

Reset current view

Each view can be reset individually, either to factory or saved settings. The view must not be locked.

Loading factory settings

- 1 Touch the **Dräger default** button (I).
- 2 Confirm with the rotary knob.

For information on the factory settings for the views, see chapter "Factory-set screen views" on page 371.

Loading saved settings

- 1 Touch the **Load** button (J).
- 2 Confirm with the rotary knob.

Overview of format templates

The following format templates are available for selection:

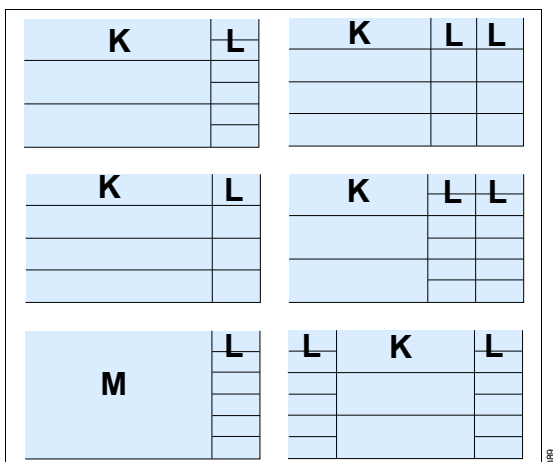

The (K), (L) and (M) fields can be configured with customized settings. All fields can also be configured without contents. The following settings are possible:

K		L		M
Field size 1x	Field size 2x	Field size 1x	Field size 2x	
Waveform	Waveform	Single parameter	Single parameter	Single parameter
Trends (meas.)	Loop	Double parameter	Parameter groups	Double parameter
Trends (settings)	Double loop	Trends (meas.)	Loop	Parameter groups
Trends table	Trends (meas.)	Trends (settings)	Trends (meas.)	Waveform
Multi Trend	Trends (settings)		Trends (settings)	Loop
Recruitment trends	Trends table			Double loop
Alarm history	Multi Trend			Trends (meas.)
	Recruitment trends			Trends (settings)
	Alarm history			Trends table
	Lung display (Smart Pulmonary View)			Multi Trend
				Recruitment trends
				Alarm history
				Lung display (Smart Pulmonary View)

Configuring the display of hospital-specific measured values and settings

A maximum of 20 measured and set values can be grouped together. The hospital-specific measured and set values are displayed on the **Trends/Data > Values > Customized data** page.

Prerequisite: The **Screen layout** page (A) is opened.

- 1 Touch the **Customized data** tab (B).

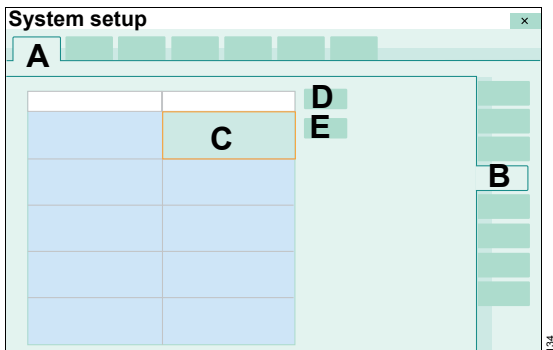

Additional information

Measured values are displayed in the list with a blue background color and set values with a green background color.

Selecting a row in the list

- Turn the rotary knob until the desired row is marked in column 1 or 2 (C) or touch the row.

Configuring the display of hospital-specific measured values

Prerequisite: The desired row is marked.

- 1 Touch the **Values** button (D).
- 2 Select the parameter from the selection list with the rotary knob and push to confirm.

Configuring the display of hospital-specific set values

Prerequisite: The desired row is marked.

- 1 Touch the **Settings** button (E).
- 2 Select the parameter from the selection list with the rotary knob and push to confirm.

Assigning functions to additional buttons

Additional buttons can be assigned in the main menu bar to enable direct access to a function or to directly open a page. The buttons are spatially assigned to the corresponding group.

Prerequisite: The **Screen layout** page (A) is opened.

- 1 Touch the **Config. buttons** tab (B).

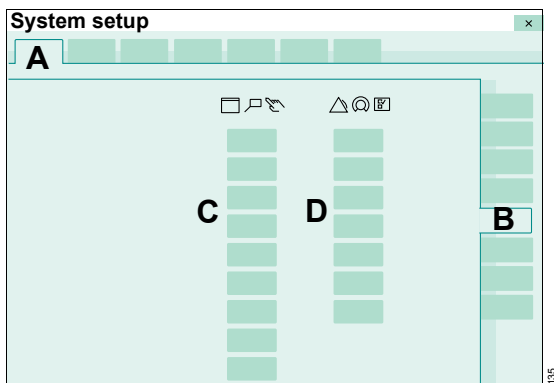

In the first column (C), the buttons can be selected for the left column of the main menu bar. In the second column (D), the buttons can be selected for the right column of the main menu bar.

- 2 Touch the button.
- 3 Select the desired button from the selection list with the rotary knob and push to confirm.

Evita V500 displays the selected button in the main menu bar.

Additional information

For information on the display of additional buttons and their location in the main menu bar, see "Main menu bar structure" on page 366.

Selecting parameters for the graphic trend display

The graphic trend display for the **Trends/Data > Trends > Graphics 1** and **Graphics 2** pages can be configured. The settings become effective with the admission of a new patient.

Prerequisite: The **Screen layout** page (A) is opened.

- 1 Touch the **Trends graphic 1** (B) or **Trends graphic 2** (C) tab.

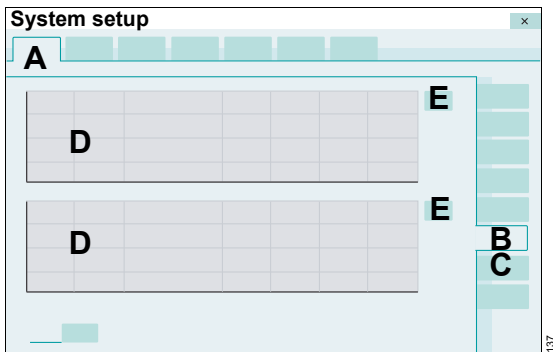

Each page contains 2 graphic trend displays (D). A maximum of 3 parameters can be configured for each trend display.

Configuring the trend display

- 1 Touch the  button (E).

Evita V500 opens the **Setup** dialog with the buttons for **Meas.** (F) and **Settings** (G).

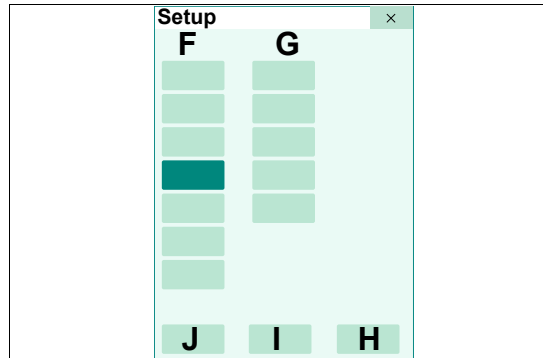

The measured values (F) are divided into the following parameter types:

- Pressures
- Minute vol.
- Volume/Flow
- Gases
- Timing/Cycl.
- Others
- Events

The settings (G) are divided into the following parameter types:

- Pressures
- Volume/Flow
- Gases
- Timing/Cycl.
- Others

- 2 Touch the appropriate button for measured values or set values.

Evita V500 opens another dialog containing all the parameters of the selected parameter type (example **Volume/Flow**).

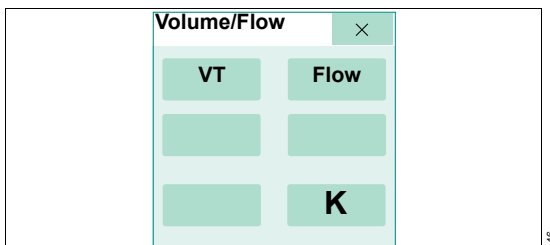

- 3 Touch the parameter. The button turns dark green.
- 4 Confirm with the **OK** button (K).

The dialog for the parameter type is closed.

A maximum of 3 parameters can be selected for each graphic trend display.

- 5 Select further parameters according to step 2 to 4.
- 6 Confirm the selected measured values and set values with the **OK** button (H).

The selected parameters are displayed in the trend display. The **Setup** dialog is closed.

The selection can be aborted with **Cancel** (I). The previous selection is displayed in the graphic trend.

Clear (J) can be used to delete all parameter selections made.

Deselecting a parameter in the trend display

- Touch the parameter to be deselected in the parameter type dialog. The button turns pale green.

Selecting a time interval

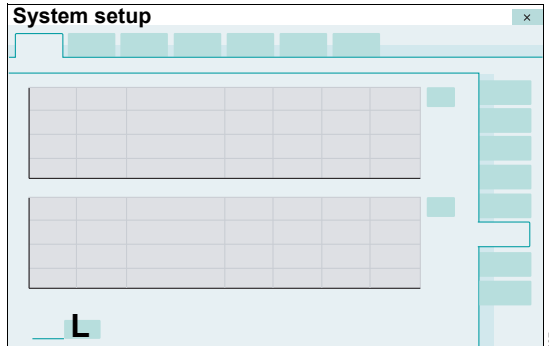

- Touch the (L) button. Select the time interval from the selection list: 2, 4, 8, 12 hours, 1 day, 7 days.

Locking therapy controls in the therapy bar

The therapy controls in the therapy bar can be locked to prevent accidental changes from being made to the ventilation parameters.

Prerequisite: The **Screen layout** page (A) is opened.

- 1 Touch the **Therapy bar** (B) tab.

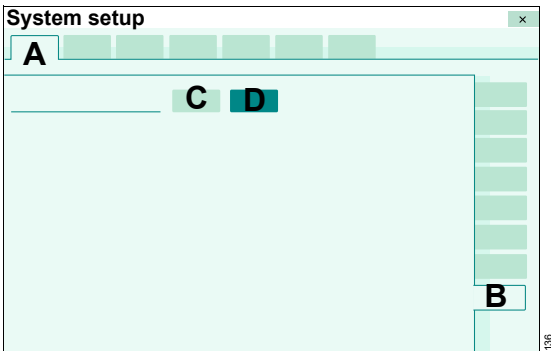

- 2 Touch the **On** button (C).

The therapy controls in the therapy bar are locked. The ventilation parameters can only be changed in the **Ventilation settings** dialog window.

Canceling the lock

- On the **Therapy bar** page, touch the **Off** button (D).

Configuring alarm settings

The customized settings for the start-up values of the alarm limits become effective with the admission of a new patient. The customized alarm tone settings are effective immediately depending on the time of day. The selection of the alarm tone sequence is effective immediately.

- 1 Touch the **System setup...** button in the main menu bar.
- 2 Touch the **Alarms** tab.
- 3 Enter password and confirm with **Enter**.

Evita V500 displays the following configurable alarm settings in the overview:

- Start-up values for alarm limits
- Alarm volume and alarm tone

Setting start-up values for alarm limits

CAUTION



If several devices of the same type are used on a ward, the alarm defaults must be configured identically on all devices. The patient may otherwise be jeopardized.

Prerequisite: The **Alarms** page (A) is opened.

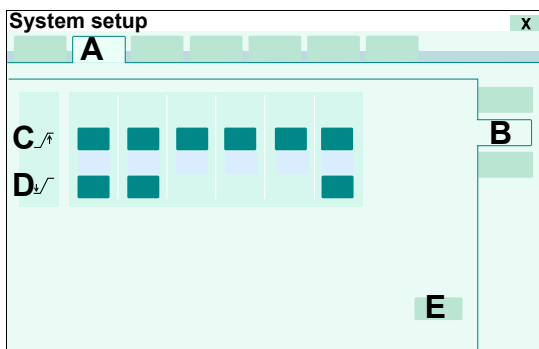
- 1 Touch the **Preset limits** tab (B).



Evita V500 displays the start-up values used for the alarm limits.

- (C)  upper alarm limit
- (D)  lower alarm limit

- 2 Touch the relevant button for the alarm limit.
- 3 Set the value by turning the rotary knob and push to confirm.

Selecting the factory settings

- Touch the **Dräger default** button (E) and confirm with the rotary knob.

The **Dräger default** button also resets other start-up settings on the **Ventilation** page and the **Alarms** page to the factory settings.

Table of alarm limits

The following table lists the alarm limits with the setting range and the factory-set start-up values (Dräger default).

Parameter	Setting range	Factory-set start-up value (Dräger default)
↗ MVe	1 to 100 %	(VT x RR) +50 %
↘ MVe	Off, 1 to 100 %	(VT x RR) –20 %
↗ MV delay	0 to 30 seconds	0 seconds
↘ MV delay	0 to 30 seconds	0 seconds
↗ VT	1 to 100 %, Off	VT +99 %
↘ VT	Off, 1 to 100 %	VT –50 %
↗ Paw	7 to 105 mbar (7 to 105 cmH ₂ O)	30 mbar (30 cmH ₂ O)
↗ RR	1 to 100 %, Off	RR +20 %
↗ Tapn	5 to 60 seconds	15 seconds
↗ etCO ₂	0.1 to 13.1 Vol%	8.0 Vol%
	1 to 98 mmHg	60 mmHg
	0.1 to 13.3 kPa	–
↘ etCO ₂	0 to 13.0 Vol%	4.0 Vol%
	0 to 97 mmHg	30 mmHg
	0 to 13.2 kPa	–

Additional information

The alarm limits for the minute volume are set as a percentage of the start-up value (VT x RR). To configure VT and RR, see "Configuring start-up settings for the ventilation parameters" on page 189.

For an overview of the device's internal alarm limits, see chapter "Automatic alarm limits" on page 302.

Setting the alarm tone

WARNING

Unnoticed alarms in loud environments

Alarm situations are not recognized.

Set the volume of the alarm tone so that alarms can be heard.

Prerequisite: The **Alarms** page (A) is opened.

- 1 Touch the **Alarm vol./tone** tab (B).

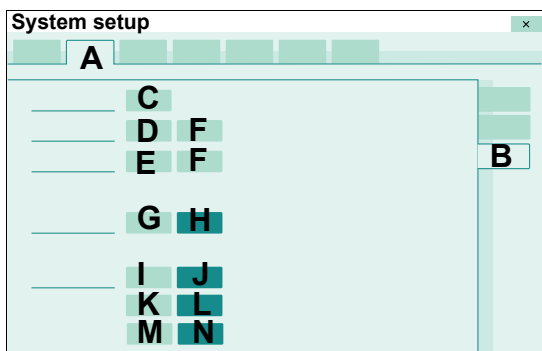

Setting the minimum alarm volume

Configuring the minimum alarm volume sets the lower limit of the factory setting for the volume of the alarm tone (10 to 100 %). This allows the setting range to be adjusted to the acoustical situation at operation site.

- 2 Touch the (C) button.
- 3 Set the value for the minimum volume by turning the rotary knob and push to confirm.

Setting the volume for day or night

- 4 For the day setting, touch the button (D).
- 5 Set the value for the sound level by day by turning the rotary knob and push to confirm.
- 6 For the night setting, touch the button (E).
- 7 Set the value for the sound level by night by turning the rotary knob and push to confirm.

Activating the automatic sound level increase

The **Auto increase** function can be set separately for day and night.

- Touch the appropriate **Auto increase** button (F).

Selecting alarm tone sequences

Evita V500 offers the following alarm tone sequences:

- (G) **IEC/CEI** as per IEC 60601-1-8
- (H) **Dräger ventilation** usual alarm tone sequences of Dräger ventilators

- Touch the appropriate button.

Setting the priority of the battery alarms

The device offers the following priorities for battery alarms:

- (I) **IEC/CEI** Priority of the battery alarm in accordance with IEC 60601-2-12, ISO 80601-2-12
- (J) **Dräger ventilation** Priority of the battery alarm according to Dräger

The **Battery activated** alarm message indicating the changeover to battery operation can be configured as a high- or medium-priority alarm when **Dräger ventilation** is selected.

- Touch the **Medium** (K) or **High** (L) button and confirm.

Depending on the setting (*IEC/CEI* or *Dräger ventilation*), alarm messages have the following priority:

Alarm message	Priority <i>IEC/CEI</i>	Priority <i>Dräger ventilation</i>
<i>Battery activated</i>	Low-priority alarm message	High-priority or medium-priority alarm message
<i>Battery low</i>	Medium-priority alarm message	High-priority alarm message
<i>Battery discharged</i>	High-priority alarm message	High-priority alarm message

Configuring the confirmation prompt

The display of messages and alarms requesting confirmation of ventilation settings can be switched on (M) or off (N).

- Touch the appropriate button and confirm.

Configuring ventilation settings

The following ventilation configurations are possible:

- Configuration of patient category for start-up
- Configuration of main ventilation modes
- Configuration of start-up ventilation settings
- Configuration of general settings for ventilation
- Configuration of settings for maneuvers

The customized ventilation settings become effective with the admission of a new patient.

- 1 Touch the ***System setup...*** button in the main menu bar.
- 2 Touch the ***Ventilation*** tab.
- 3 Enter password and confirm with ***Enter***.

Configuring start-up settings for the patient category

Prerequisite: The **Ventilation** page (A) is opened.

- 1 Touch the **Patient category** tab (B).

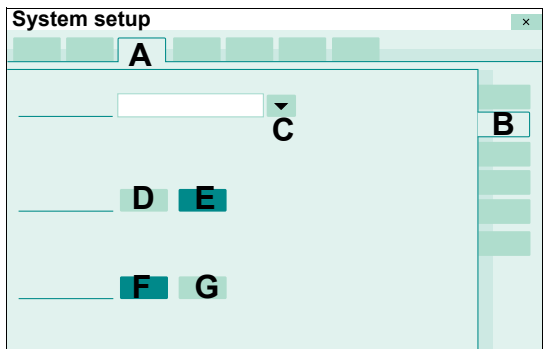

- 2 Touch the ▼ button (C).

Evita V500 opens the selection list. The following patient categories are available for selection:

- **Adults only**
- **Pediatric patients only**
- **Adults, pediatric patients**
- **Adults, ped. patients, neonates**
- **Pediatric patients, neonates**
- **Neonates only**

- 3 Select the patient category with the rotary knob and push to confirm.

Evita V500 displays the buttons for the selected patient category on the **Start** and **Start/Standby** pages.

Configuring a user-defined breathing circuit

When the **User-defined hose settings** function is activated, a user-defined breathing circuit can be selected on the **Start/ Standby... > Br. circuit/ Humidifier** page.

Activating a user-defined breathing circuit:

- Touch the **On** button (D).

Deactivating a user-defined breathing circuit:

- Touch the **Off** button (E).

Additional information

Using the user-defined breathing circuit, see page 72.

Configuring the import of ventilation settings

When import of ventilation settings is activated, the ventilation settings stored on the Infinity ID breathing circuit are transferred to Evita V500.

Activating import of ventilation settings:

- Touch the **On** button (F).

Deactivating import of ventilation settings:

- Touch the **Off** button (G).

Additional information

Transfer of ventilation settings, see page 84.

Configuring start-up settings for the ventilation modes

CAUTION

If the ventilation start-up values are configured differently to the Dräger standard values, this configuration must be identical for all Evita V500 devices belonging to a ward. The patient may otherwise be jeopardized.

The button with the active ventilation mode is highlighted in gray and cannot be changed. The button assignment can only be changed when another ventilation mode is activated in the **Ventilation settings** dialog window.

Depending on configuration, the number of displayed ventilation modes can vary between 1 and 4.

Prerequisite: The **Ventilation** page (A) is opened.

1 Touch the **Modes** tab (B).

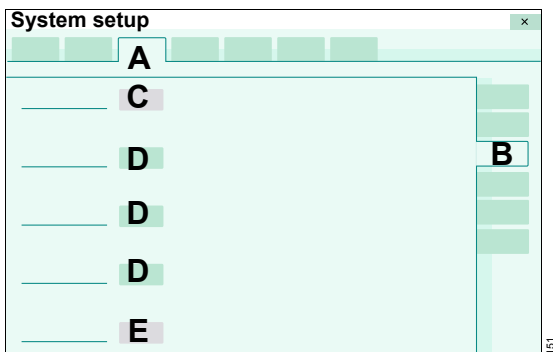

Evita V500 displays the start mode (C) and 3 ventilation modes (D). These ventilation modes are displayed in the **Ventilation settings** dialog window after Evita V500 has been started.

The ventilation mode (E) configured under **Other modes** is displayed as an additional mode for information purposes and can be changed in the **Ventilation settings** dialog window.

2 Touch the appropriate button.

Evita V500 opens the ventilation mode selection list.

3 Select the mode with the rotary knob and push to confirm.

If --- is configured for a ventilation mode, the corresponding page is not available in the **Ventilation settings** dialog window.

The same ventilation mode cannot be configured on 2 buttons.

Configuring start-up settings for the ventilation parameters

Prerequisite: The **Ventilation** page (A) is opened.

- 1 Touch the **Start settings** tab (B).

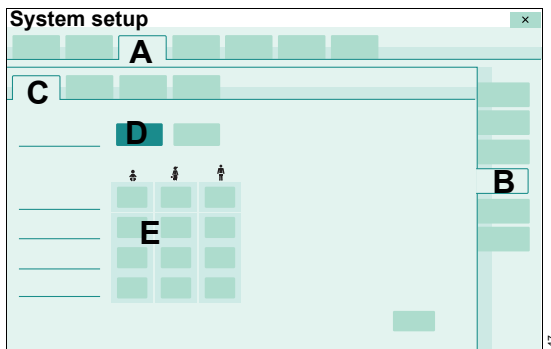

Evita V500 displays the following pages for the ventilation start-up settings:

- VT, RR, Trigger
- Pressures, O₂, I:E
- Other settings
- ATC

The **VT, RR, Trigger** page (C) appears by default.

Setting start-up values for VT, RR, Slope, and Flow trigger

Depending on the patient category or the patient's weight, these start-up values can be set:

- VT
- RR
- Slope
- Flow trigger

Setting start-up values depending on the patient category

- 1 If not yet preset, touch the **Patient** button (D) and confirm with the rotary knob.

Evita V500 displays the start-up values for the different patient categories (E).

- 2 Touch the appropriate button (E).
- 3 Set the value by turning the rotary knob and push to confirm.

After the start of ventilation, Evita V500 begins ventilation with the start-up values, dependent on the patient category set on the **Start/Standby** page.

Setting start-up values depending on the body height/weight

Prerequisite: The **VT, RR, Trigger** page (C) is opened.

- 1 Touch the **Weight** button (F) and confirm with the rotary knob.

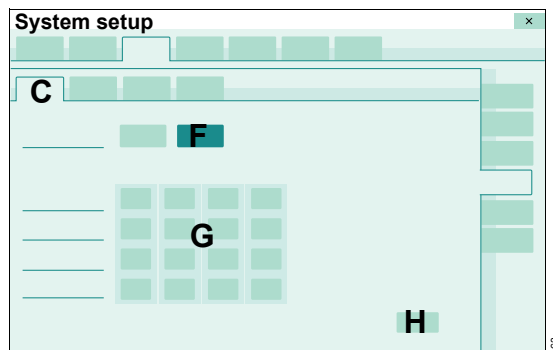

Evita V500 displays the start-up values for the different body weights (G).

- 2 Touch the appropriate button (G).
- 3 Set the value by turning the rotary knob and push to confirm.

After the start of ventilation, Evita V500 begins ventilation with the start-up values, depending on the body height set on the **Start/Standby** page and the ideal body weight derived from that, or with the set start-up body weight in the **Neo** patient category.

Selecting the factory settings

- Touch the **Dräger default** button (H) and confirm with the rotary knob.

The **Dräger default** button also resets other start-up settings on the **Ventilation** page and the **Alarms** page to the factory settings.

Tables for start-up values

The following tables show the factory-set start-up values (Dräger default) for **VT**, **RR**, **Slope** and **Flow trigger**.

The following table applies to the selection of start-up values depending on the patient category:

Patient category	Factory-set start-up value			
	VT (mL)	RR (1/min)	Slope (s)	Flow trigger (L/min)
Neo.	5.0	60	0.1	0.3
Ped. pat.	50	29	0.2	1.0
Adult	500	12	0.2	2.0

The following table applies to the selection of start-up values depending on the body weight according to the Radford nomogram:

Weight (kg)	Factory-set start-up value			
	VT (mL)	RR (1/min)	Slope (s)	Flow trigger (L/min)
0.5	3.0	100	0.05	0.2
5	36	32	0.2	1.0
15	110	26	0.2	1.0
75	520	12	0.2	2.0

Setting start-up values for pressures, FiO₂ and I:E

Prerequisite: The **Start settings** page (A) is opened.

- 1 Touch the **Pressures, O₂, I:E** tab (B).

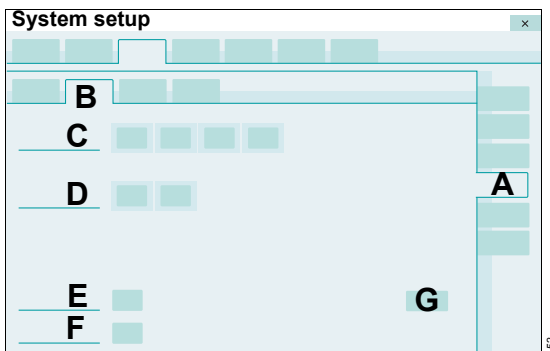

- 2 Touch the corresponding button for the parameters:
 - **Pressures** (C)
 - **APRV pressures** (D)
 - **FiO₂** (E)
 - **I:E** (F)
- 3 Set the value by turning the rotary knob and push to confirm.

Selecting the factory settings

- Touch the **Dräger default** button (G) and confirm with the rotary knob.

The **Dräger default** button also sets other start-up settings on the **Ventilation** page and the **Alarms** page to the factory settings.

Parameter	Factory-set start-up value (<i>Dräger default</i>)
PEEP	5 mbar (5 cmH ₂ O)
ΔP _{supp}	0 mbar (0 cmH ₂ O)
P _{insp}	15 mbar (15 cmH ₂ O)
P _{max}	40 mbar (40 cmH ₂ O)
P _{low}	5 mbar (5 cmH ₂ O)
P _{high}	15 mbar (15 cmH ₂ O)
FiO ₂	21 Vol%
I:E	1:2

Defining the start-up setting of the additional settings

Prerequisite: The **Start settings** page (A) is opened.

1 Touch the **Other settings** tab (B).

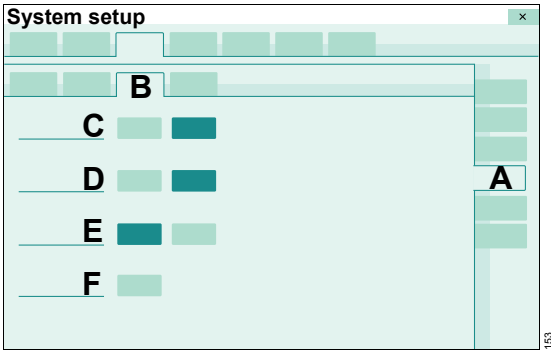

The following settings can be switched on or off:

- **Volume Guarantee** (C)
- **AutoFlow** (D)
- **Apnea Ventilation** (E)

2 Touch the **On** or **Off** button.

3 Confirm with the rotary knob.

A start-up value can be set for the expiratory termination criterion **Exp. term.** (F):

4 Touch the (F) button.

5 Set the value by turning the rotary knob and push to confirm.

If the **Dräger default** button is touched on another page, e.g., the **Ventilation > Start settings** page or the **Alarms** page, the settings are also set to the factory settings.

Defining start-up settings for tube compensation

Prerequisite: The **Start settings** page (A) is opened.

- 1 Touch the **ATC** tab (B).

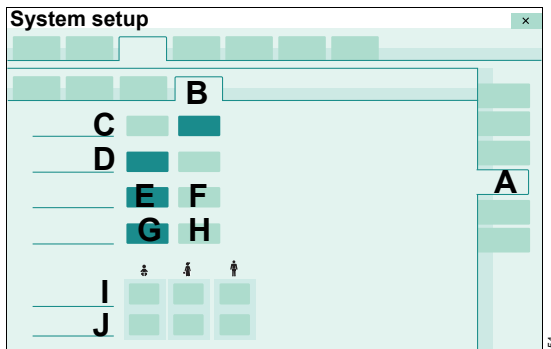

The following settings can be switched on or off:

- **Tube comp. (ATC)** (C)
- **Expiratory compensation** (D)

- 2 Touch the **On** or **Off** button and confirm with the rotary knob.

Inspiratory compensation can be selected for spontaneous and mandatory or only spontaneous breaths:

- **Spon + mand** (E)
- **Only spon** (F)

- 3 Touch the appropriate button and confirm with the rotary knob.

Selecting the tube type:

- 4 Touch the **ET** (G) or **Trach.** (H) button and confirm.

Enter the tube diameter (I) according to the selected tube type:

- **ET**: 2 to 12 mm
- **Trach.**: 2.5 to 12 mm

In the **Neo.** patient category, only the **ET** tube type (G) is available.

The setting range for the tube diameter is selectable in accordance with the patient category:

- Patient category Adult: 5 to 12 mm
- Patient category Ped. pat.: 2 to 8 mm
- Patient category Neo.: 2 to 5 mm

- 5 Touch the relevant button for the patient category.

- 6 Set the value for the tube diameter by turning the rotary knob and push to confirm.

Enter degree of compensation (J) for the respective patient category: 0 to 100 %

- 7 Touch the relevant button for the patient category.

- 8 Set the value for the degree of compensation by turning the rotary knob and push to confirm.

Evita V500 starts with the start-up settings selected for the ventilation parameters.

The customized settings for inspiratory and expiratory compensation are immediately effective when **ATC** is set.

When touching the **Dräger default** button, the settings for inspiratory and expiratory compensation are also set to the factory settings.

Configuring general settings

Prerequisite: The **Ventilation** page (A) is opened.

- 1 Touch the **General settings** tab (B).

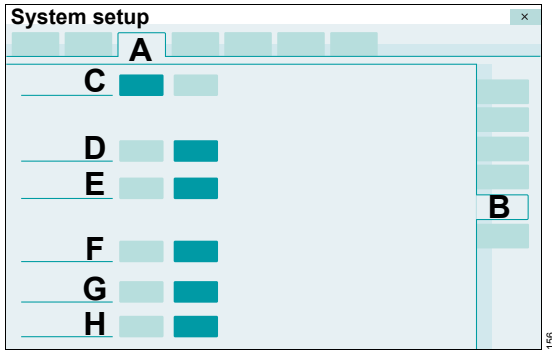

The following settings can be switched on or off:

- **Leakage Compensation** (C)
- **Automatic return from Apnea Ventilation** (D)
- **Apnea Ventilation alarm** (E)
- **Pmax/Paw high autose** (F)
- **Inspiratory termination** (G)
- **Anti Air Shower** (H)

- 2 Touch the **On** or **Off** button as appropriate and confirm with the rotary knob.

Evita V500 starts with the selected settings.

For further information on the **Anti Air Shower** function, see page 355.

Setting a maneuver

Prerequisite: The **Ventilation** page (A) is opened.

- 1 Touch the **Maneuver** tab (B).

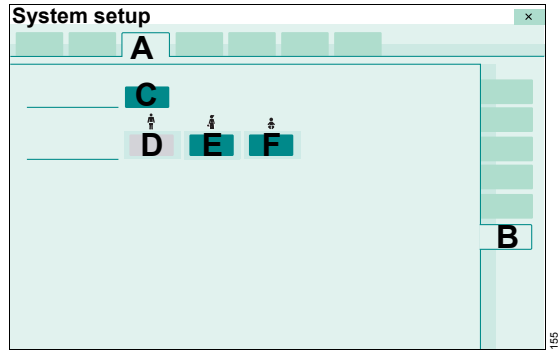

Setting the pressure drop for limitation of an only inspiratory **Low Flow PV Loop** maneuver

- 2 Touch the (C) button.
- 3 Set the value for the pressure drop by turning the rotary knob and push to confirm.

Setting the FiO₂ concentration for the suction maneuver

For the **Adult** patient category, the start-up value for FiO₂ (D) is set to 100 Vol% and cannot be changed.

Ped. pat. and **Neo.** patient categories:

For the suction maneuver, FiO₂ is set based on the current FiO₂ concentration using a factor between 1.0 and 2.0.

- 4 Touch button (E) or (F).
- 5 Set the factor by turning the rotary knob and push to confirm.

Evita V500 starts with the selected start-up settings.

Importing and exporting configurations

Evita V500 can export the device configuration on a USB storage medium. The configuration saved on the USB storage medium can be imported to other Evita V500 devices.

The following settings from the system configuration are exported and imported:

Screen layout	General settings		
	Views ¹⁾		
	Customized data		
	Config. buttons		
	Trends graphic 1		
	Trends graphic 2		
	Therapy bar		
Alarms	Preset limits		
	Alarm vol./tone		
Ventilation	Patient category		
	Modes		
	Start settings	VT, RR, Trigger	
		Pressures, O ₂ , I:E	
		Other settings	
		ATC	
	General settings		
Maneuver			
System status	Exchange intervals		
System	Country		
	Units		
	Interface	LAN	
		COM	
External display			

- 1) Views are only exported if the view configured was first saved on the **Screen layout** page. When a configuration is imported, all the current views are overwritten, including the locked views.

Preparing the configuration exchange

- Insert the USB storage medium into a USB port on Infinity C500.
- 1 Touch the **System setup...** button in the main menu bar.
 - 2 Touch the **Config. exchange** tab (A).

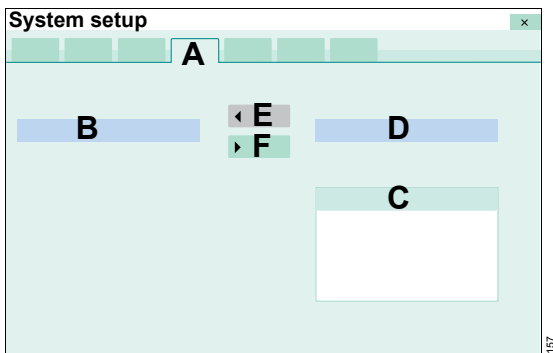

- B** Configuration on the device with the date of export
- C** Existing configurations on the USB storage medium
- D** Selected configuration on the USB storage medium with the date of export

Importing a configuration from a USB storage medium to the device

A configuration can only be imported in standby mode.

- 1 Switch Evita V500 to standby mode.
- 2 Select a configuration from the USB storage medium (C).
- 3 Touch the ◀ **Import** button (E).
- 4 Confirm with the rotary knob.

If there is no valid configuration saved on the USB storage medium, the system issues a message.

After the import, Evita V500 is switched off automatically.

- 5 Switch Evita V500 on again.

Evita V500 reports the completion of the configuration with a low-priority alarm.

- 6 Check the settings of the imported configuration.

Exporting a configuration from the device to a USB storage medium

- 1 Touch the ▶ **Export** button (F).
- 2 Confirm with the rotary knob.

If the USB storage medium already contains a configuration, a message appears stating that this configuration will be overwritten.

No export is possible onto the USB storage medium if it is full. The ▶ **Export** button (F) is grayed out and cannot be activated.

Installing applications

Evita V500 can be supplemented with additional Dräger applications. The applications are installed with a SIM card.

- 1 Insert the SIM card into the USB SIM card reader.
- 2 Insert the USB SIM card reader into a USB port on Infinity C500.
- 3 Touch the **System setup...** button in the main menu bar.
- 4 Touch the **Applications** tab (A).
- 5 Enter password and confirm with **Enter**.

Additional information

The **Applications** page can be configured as a button in the main menu bar for direct access. See "Assigning functions to additional buttons" on page 179.

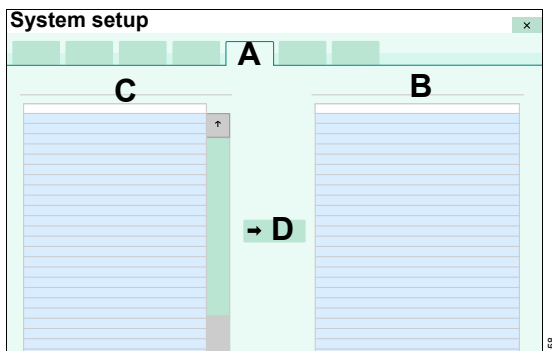

Evita V500 displays the already installed applications (B) and the applications available on the SIM card (C).

Installing applications

- 1 Touch the **Install** button (D).
- 2 Select the application from the (C) list with the rotary knob and push to confirm.
- 3 Install the next application (repeat steps 1 to 3).
- 4 After all applications are installed, restart Evita V500.

The installed applications are displayed in the (B) list.

System status

The **System status** page contains the following information:

- General status information on maintenance and operating hours
- Exchange intervals

Displaying general status information

- 1 Touch the **System setup...** button in the main menu bar.
- 2 Touch the **System status** tab (A).
- 3 Enter password and confirm with **Enter**.
- 4 Touch the **General status** tab (B).

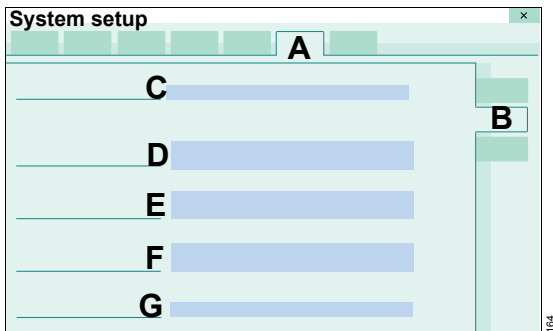

The following information is displayed:

- Next service due (C)
- Cockpit (D)
 - Operating hours: Standby
 - Operating hours: Running
- Ventilation unit (E)
 - Operating hours: Standby
 - Operating hours: Running
 - Internal battery installation date
- Gas supply unit (GS500) (F)
 - Operating hours: Blower
 - Installation date
- Power supply unit (PS500) (G), if present
 - Installation date of the batteries in the PS500

Configuring exchange intervals

The user can configure how much of the period of use elapses before Evita V500 displays a message indicating that the next exchange of an accessory is due. This depends on the device type and software version.

The exchange interval must be defined in accordance with the applicable hygiene guidelines or in accordance with the specifications of the corresponding accessory's instructions for use.

WARNING

Risk of inappropriate operating life

Exchange monitoring only considers the actual period of use and not the current status of the Infinity ID accessory and therefore does not release the user from the responsibility of periodically checking the accessory.

The exchange interval set for exchange monitoring does not guarantee that the accessory will last until the exchange interval has expired.

Opening the exchange interval page

- 1 Touch the **System setup...** button in the main menu bar.
- 2 Touch the **System status** tab (A).
- 3 Enter password and confirm with **Enter**.
- 4 Touch the **Exchange intervals** tab (B).

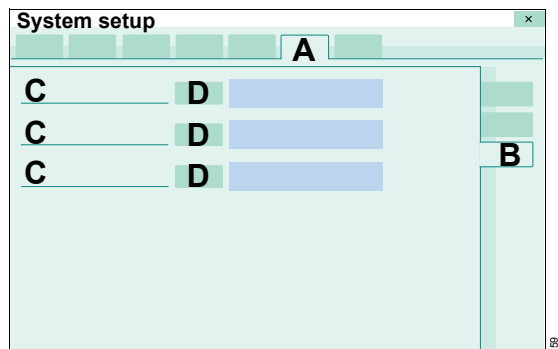

The exchange interval and the period of use already elapsed for the relevant accessory (C) are displayed.

Setting the exchange intervals

- 5 Touch the appropriate button (D).
- 6 Set the value by turning the rotary knob and push to confirm.

The settings are effective immediately.

No display of exchange intervals

- Touch the appropriate button (D). Set **Off** by turning the rotary knob and push to confirm.

Additional information

Evita V500 displays the remaining period of use for the accessories on the **Start/Standby > Accessory status** page.

Sterilization of the expiratory valve or inspiratory valve may gradually impair the operation of RFID transmission. This may mean that Infinity ID breathing circuit functions may not work or may no longer work reliably. The period of use for the Infinity ID accessories is displayed with ---.

System settings

The following system settings can be configured:

- Country
- Units
- Interface (interfaces)
- Supply units (supply units)
- Service

The customized settings are immediately effective.

1 Touch the **System setup...** button.

2 Touch the **System** tab.

Evita V500 displays the following configurable settings in an overview:

- Language, date and time
- Units for measured values and settings
- Network and serial interfaces
- GS500
- Service information

Selecting country-specific settings

Prerequisite: The **System** page (A) is opened.

1 Touch the **Country** tab (B).

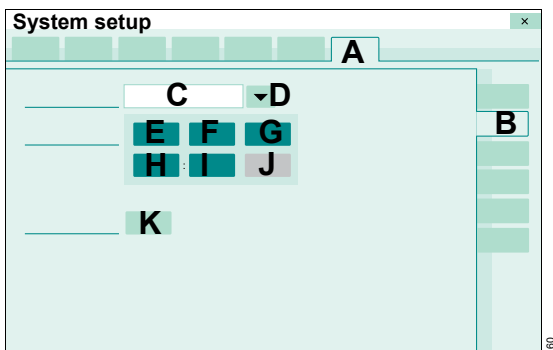

Selecting the screen text language

Evita V500 is factory set to the customer's own language. The current language is displayed in the field (C).

Selecting a different language:

2 Touch the ▼ button (D).

Evita V500 opens the selection list containing the available languages.

3 Select the language with the rotary knob and push to confirm.

Setting the date and time

Evita V500 does not change over automatically between daylight saving time and standard time. The user must change the time manually. Otherwise the times will be incorrect on the screen and for saved values and actions (e.g., in the logbook).

Changing the system time changes the time displayed in trends, logbook, alarm history, maneuver measured values and reference loops. The data saved up to the change is displayed with the system time up till then.

1 Touch the appropriate button:

- Day (E)
- Month (F)
- Year (G)
- Hours (H)
- Minutes (I)

The order of the buttons (E) and (F) varies depending on language.

2 Set the value by turning the rotary knob and push to confirm.

3 After completing all the settings for the date and time, touch the **Apply** button (J).

Entering the height above sea level

The ambient pressure is considered in the calculation of measured values. The ambient pressure sensor is checked for plausibility using the entered height above sea level. Incorrect entries can mean that the ambient pressure sensor is recognized as incorrect.

- 1 Touch the (K) button.
- 2 Set the height by turning the rotary knob and push to confirm.

Configuring units

Prerequisite: The **System** page (A) is opened.

- 1 Touch the **Units** tab (B).

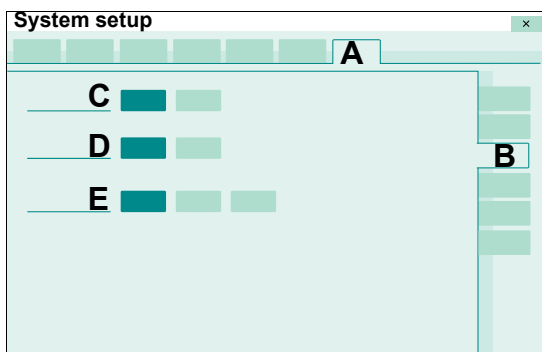

The units for the following parameters can be selected.

- **Airway pressure** (C) in *mbar* or *cmH₂O*
 - **Height** (D) in *m*, *cm* or *feet, inch*
 - **CO₂** (E) in *Vol%* or *mmHg* or *kPa*.
- The units selected for the CO₂ measured value are adopted for selection of the alarm limit.

- 2 Touch the relevant button for the unit.

Configuring interfaces

The communication settings can be configured to enable connection to a network and data exchange with other devices.

LAN

Use of LAN ports is exclusively permitted for service purposes. Parameters must be set for connection to a network.

Prerequisite: The **System** page (A) is opened.

- 1 Touch the **Interface** tab (B).

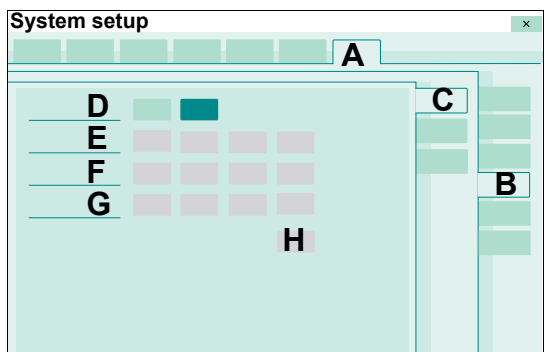

The **LAN** page (C) appears by default. The settings are displayed. **DHCP** (D) must be deactivated in order to change the settings.

To deactivate **DHCP** (D):

- 1 Touch the **Off** button.
- 2 Touch the relevant button for the network parameters:
 - **IP address** (E)
 - **Subnet mask** (F)
 - **Gateway** (G)
- 3 Enter the login details using the rotary knob and confirm.
- 4 Touch the **Apply** button (H).

To activate **DHCP** (D):

- 5 Touch the **On** button.

Serial interfaces

The serial interfaces (COM 1, COM 2 and COM 3) are used for data exchange with MEDIBUS-capable display devices, e.g., patient monitor or patient data management system.

Prerequisite: The **System** page (A) is opened.

- 1 Touch the **Interface** tab (B).
- 2 Touch the **COM** tab (C).

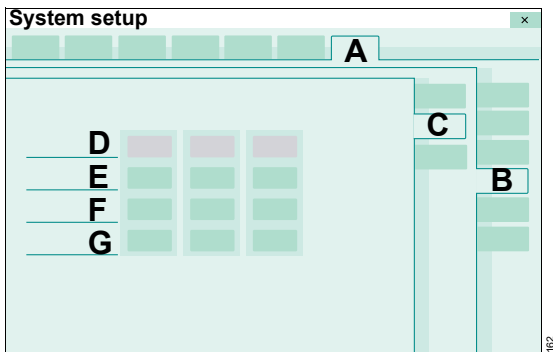

The settings for **COM 1**, **COM 2**, and **COM 3** are displayed. **MEDIBUS** or **MEDIBUS.X** can be selected for the **Protocol** parameter.

- 3 Touch the relevant button for the interface parameters:
 - **Protocol** (D)
 - **Baud rate** (E)
 - **Parity** (F)
 - **Stop bit** (G)
- 4 Select the setting with the rotary knob and push to confirm.

External screen

If a second screen is connected to Infinity C500, the user has to define whether the screen is analog or digital.

Prerequisite: The **System** page (A) is opened.

- 1 Touch the **Interface** tab (B).
- 2 Touch the **External display** tab (C).

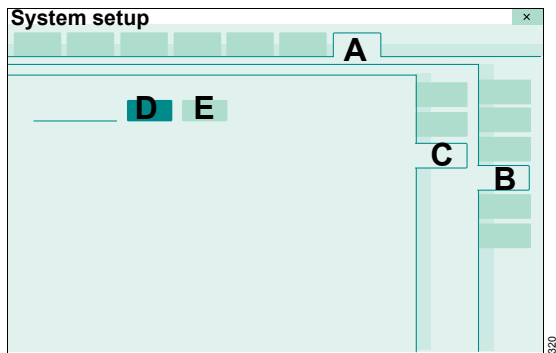

- 3 Touch the **Digital** (D) or **Analog** (E) button.

Additional information

The serial interface connectors are located on the rear of Infinity C500.

Configuring supply units

Functionality of the GS500 gas supply unit

The functionality of the gas supply unit can be deactivated if Evita V500 is equipped with a gas supply unit that is currently not supposed to be used.

Prerequisite: The **System** page (A) is opened.

- Touch the **Supply units** tab (B).

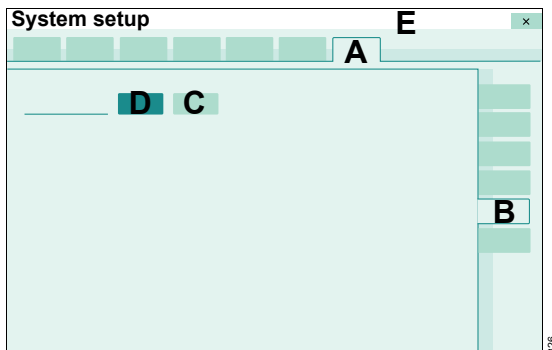

- Touch the **Off** button (C).

The gas supply unit is no longer available. In the device check, the system does not display the test step **Gas supply unit**.

Activating the functionality of the gas supply unit:

- 1 Touch the **On** button (D).

Evita V500 displays in the message field (E) that the device check has to be carried out.

- 2 Perform device check.

Additional information

For information on using the gas supply unit, see "GS500 gas supply unit" on page 126

Service dialog

The service dialog is password-protected and reserved for DrägerService or experts.

For further information on Remote Service, see chapter "Remote Service" on page 265.

This page has been left blank intentionally.

Alarm – Cause – Remedy

The alarm messages are displayed in the message field of the header bar in hierarchical order. See "Display of alarms" on page 140.

In order to classify the alarms within an alarm category, internal priority numbers are given after the exclamation marks in the table below. The most critical alarm is awarded the number 255. The priority of the alarm decreases the lower the number is.

In the following table, the alarm messages are listed in alphabetical order. If an alarm occurs, the table helps to identify causes and remedies. The different causes and remedies should be worked through in the order listed until the alarm has been resolved.

The acknowledgeable alarm messages can be found in the chapter "Alarm – Cause – Remedy". For alarm messages that can be acknowledged the "Remedy" column in the table contains the information that the alarm message can be acknowledged by pressing the **ALARM RESET** button and confirming with the rotary knob.

The following alarm messages that can be acknowledged are not listed:

- ***Suction maneuver overused?***
- ***PEEP high (!!)***
- ***Flow sensor? Ventilation impaired***
- ***Low Flow PV Loop maneuver overused?***

Alarm priority	Alarm	Cause	Remedy	
!	060	Accessory ID detection failed	<p>Accessory ID detection malfunction.</p> <p>Ventilation can be started without ID functions.</p> <p>Call DrägerService.</p>	
!	100	Air supply low, GS500 active	<p>Air supply insufficient to deliver the required flow and pressure.</p> <p>Air is supplied by the gas supply unit GS500.</p> <p>Air supply is not required when FiO₂ = 100 Vol%.</p>	<p>Check connection to Air supply.</p> <p>Make sure supply pressure is greater than 3 bar (43.5 psi).</p> <p>Consider readjusting ventilation settings.</p> <p>Remove connection to Air supply if alarm condition persists (to avoid reverse flow into the Air supply).</p>
			<p>Central Air supply insufficient.</p> <p>Gas delivery system is supplied with Air delivered by GS500.</p>	<p>Check connection to central air supply and to gas supply unit GS500.</p> <p>Make sure that the supply pressure is greater than 3 bar (43.5 psi).</p> <p>Adjust ventilation settings, if necessary.</p>
!!!	190	Airway obstructed?	<p>The ventilation unit applies only a very small volume with each mechanical breath. The tube or mask could be blocked.</p>	<p>Check patient condition.</p> <p>Check tube or mask.</p>
			<p>Patient breathes against the mechanical breaths during pressure-controlled ventilation.</p>	<p>Check patient condition.</p> <p>Check ventilation settings.</p>
!!!	205	Airway pressure high	<p>Breathing hose kinked.</p>	<p>Check breathing circuit.</p> <p>Check tube or mask.</p>
			<p>The upper alarm limit for the airway pressure has been exceeded. The patient is breathing against the ventilation unit or coughing.</p>	<p>Check patient condition.</p> <p>Check ventilation settings.</p>
			<p></p>	<p>Adjust alarm limit if necessary.</p>

Alarm priority	Alarm	Cause	Remedy
!!! 200	Airway pressure low	Leakage or disconnection.	Check breathing circuit for tight connections.
			Check whether the expiratory valve is properly engaged.
			Make sure that the tube or mask is connected correctly.
!!! 140	Airway pressure negative	Airway pressure has fallen below –10 mbar (–10 cmH ₂ O).	Disconnect tube for suctioning.
			Check patient condition.
		The breathing hose is connected to the expiratory valve during O ₂ therapy.	Check ventilation settings. Connect breathing hose to the inspiratory valve.
! 200	Alarm limit not confirmed	One or more alarm limits have been changed but not confirmed.	If necessary, change these alarm limits and confirm the change with the rotary knob.
! 120	Alarm system failure	Failure of primary alarm speaker. In case of an alarm situation, the auxiliary acoustical alarm will sound.	To continue ventilation with this device, continuously monitor the device functions. Call DrägerService.
!! 100	Ambient pressure sensor?	Altitude setting deviates too much from measured ambient pressure.	Check altitude setting and adjust if necessary. If the setting has been adjusted, the device check must be repeated.
		Ambient pressure sensor failure.	Accuracy of measured values depending on the atmospheric pressure could be impaired (e.g., MV, O ₂ concentration). Call DrägerService.

Alarm priority	Alarm	Cause	Remedy	
!!!	181	Apnea	The patient has stopped breathing.	Check patient condition. Apply controlled ventilation if necessary.
			Obstruction.	Check patient condition. Check breathing circuit. Check tube or mask.
			Flow sensor is not calibrated or faulty.	Calibrate flow sensor and replace it if necessary.
!!	230	Apnea Ventilation	Due to detected apnea, the ventilation unit has automatically switched to Apnea Ventilation.	Check patient condition. Check tube or mask. Check ventilation settings and patient condition. Return to the original ventilation mode by touching the "Apn. Vent. reset" button and confirm with rotary knob.
!	020	Application already installed	Application is already installed.	Acknowledge message by touching "ALARM RESET" button and confirm with rotary knob.
!	020	Application transfer failed	Invalid application.	Acknowledge message by touching "ALARM RESET" button and confirm with rotary knob. Call DrägerService.
			Application installation failed.	Acknowledge message by touching "ALARM RESET" button and confirm with rotary knob. Call DrägerService.

Alarm priority	Alarm	Cause	Remedy
!!	050 "Audio paused" key used too often	The "Audio paused" key is either faulty or was pressed more than 80 times per hour.	The function of the "Audio paused" key is not available while the defect exists. If the defect cannot be remedied, call DrägerService.
!!	050 "Audio paused" overused or stuck	The "Audio paused" button is either stuck or faulty or was pressed for more than 6 seconds.	Ventilation functions are not affected. Do not press the "Audio paused" button longer than 6 seconds. If the error persists, call DrägerService.
!!	120 Auxiliary acoustical alarm failure	Failure of auxiliary alarm speaker. In case of mains failure and discharged battery, there is no power failure alarm. In case of faulty primary alarm speaker, there is no acoustical alarm at all.	To continue ventilation with this device, continuously monitor the device functions. Downgrade alarm priority by touching "ALARM RESET" button and confirm with rotary knob. Call DrägerService.
!!!	160 Battery activated	The ventilation unit is powered by the battery as there is no mains power supply.	Connect device to the mains power supply.
!!	200 Battery activated	The ventilation unit is powered by the battery as there is no mains power supply.	Connect device to the mains power supply.
!	201 Battery activated	The ventilation unit is powered by the battery as there is no mains power supply.	Connect device to the mains power supply.

Alarm priority	Alarm	Cause	Remedy
! 127	Battery charging deferred	Battery charging is deferred to prevent battery overheating. The device can be used normally.	Battery charging continues automatically and is indicated by a flashing segment in the battery symbol.
! 100	Battery check in progress	The battery check has been started.	Wait until the battery check is completed. In the event of mains power supply failure, battery operation is limited.
! 100	Battery check recommended	The interval for the battery check has been exceeded.	Perform the battery check.
!!! 254	Battery discharged	The remaining calculated operating time of the battery is less than 5 minutes.	Connect device immediately to the mains power supply.
!! 120	Battery failure	Battery operation is not available in the event of mains power supply failure.	To continue ventilation with this device, continuously monitor the device functions. Call DrägerService.
!!! 250	Battery low	The remaining calculated operating time of the battery is less than 10 minutes.	Connect device to the mains power supply.
!! 251	Battery low	The remaining calculated operating time of the battery is less than 10 minutes.	Connect device to the mains power supply.
!! 105	Breath. circ. does not fit to patient category	Connected breathing circuit does not fit to selected patient category.	Use suitable breathing circuit or select correct patient category.
!! 100	Breathing circuit does not match config.	Breathing circuit has been exchanged. The new breathing circuit does not match the one that was used before.	Check breathing circuit. Acknowledge message by pressing "ALARM RESET" and confirm.

Alarm priority	Alarm	Cause	Remedy
!	060 Breathing circuit ID invalid	Accessory ID detection failed. No automatic adjustment of breathing circuit properties.	Replace ID Breathing Circuit or perform breathing circuit check. Acknowledge message by touching "ALARM RESET" button and confirm with rotary knob.
		Accessory ID detection failed. Breathing circuit exchange interval cannot be monitored.	Replace Infinity ID Breathing Circuit or acknowledge message by touching "ALARM RESET" button and confirm with rotary knob.
!!	205 Breathing hose kinked	The pressure at the inspiratory port is greater than 30 mbar (30 cmH ₂ O), e.g., due to a kinked or blocked hose, or a blocked mask.	Check breathing circuit. Check mask.
!!	105 Breathing hoses interchanged	Inspiratory and expiratory limbs of the breathing circuit are connected reversely to the ventilation unit.	Connect inspiratory and expiratory limbs of the breathing circuit correctly.
!	100 Calibration of expiratory flow sensor failed	Calibration of expiratory flow sensor failed.	Calibrate flow sensor and replace it if necessary.
!!!	240 Calibration of gas delivery system required	Technical malfunction detected during operation. Calibration of gas delivery system failed. Recalibration necessary. Ventilation not possible.	Disconnect patient from the device and continue ventilation without delay using another independent ventilator. Perform device check.

Alarm priority	Alarm	Cause	Remedy
!	012 Calibration of gas delivery system required	<p>Technical malfunction detected in standby mode.</p> <p>Calibration of gas delivery system failed.</p> <p>Recalibration necessary.</p>	<p>Perform device check.</p> <p>Do not start with ventilation before device check is performed: Ventilation will not be possible.</p>
		<p>Technical malfunction detected in standby mode.</p> <p>Calibration of gas delivery system is due.</p> <p>Accuracy of gas delivery system could be impaired.</p> <p>Recalibration necessary.</p>	<p>Perform device check.</p>
		<p>Technical malfunction detected in standby mode.</p> <p>Calibration of gas delivery system failed.</p>	<p>Perform device check.</p> <p>Do not start with ventilation before device check is performed: Ventilation will not be possible.</p> <p>If alarm cannot be resolved by performing device check, call DrägerService.</p>

Alarm priority	Alarm	Cause	Remedy
!!! 228	Calibration of neo. flow sensor required	Calibration data is corrupted.	<p>Patient category "Neonates":</p> <p>Calibrate neonatal flow sensor.</p> <p>If calibration was not successful, deactivate neonatal flow monitoring and use external flow monitoring.</p> <p>Call DrägerService.</p> <hr/> <p>Patient category "Pediatric patients":</p> <p>Calibrate neonatal flow sensor.</p> <p>If calibration was not successful, deactivate integrated neonatal flow monitoring.</p> <p>Continue ventilation with expiratory flow sensor.</p> <p>Call DrägerService.</p>
!! 115	Calibration of neo. flow sensor required	After switching on the ventilation unit, the neonatal flow sensor needs to be calibrated.	Calibrate neonatal flow sensor.
!!! 228	Calibration of neonatal flow sensor failed	Calibration of neonatal flow sensor failed.	<p>Calibrate neonatal flow sensor.</p> <p>Seal neonatal flow sensor properly during calibration.</p> <hr/> <p>Neonatal flow sensor malfunction.</p> <p>Replace neonatal flow sensor or sensor insert and calibrate the new sensor.</p>

Alarm priority	Alarm	Cause	Remedy
!! 115	Calibration of neonatal flow sensor failed	Calibration of neonatal flow sensor failed.	Calibrate neonatal flow sensor. Seal neonatal flow sensor properly during calibration.
		Neonatal flow sensor malfunction.	Replace neonatal flow sensor or sensor insert and calibrate the new sensor.
!! 100	Check CO2 cuvette	The selected type of CO2 cuvette is not correct.	Select the correct type of CO2 cuvette.
		CO2 cuvette or sensor soiled.	Clean the CO2 cuvette or sensor.
		CO2 sensor drift.	Perform zero calibration.
		Inspiratory CO2 concentration high.	Check ventilation settings. Check patient condition.
!! 140	Check settings	Loss of stored data was detected.	Check all settings and adjust if necessary. Acknowledge message by touching "ALARM RESET" button and confirm with rotary knob.
!! 252	Check ventilation settings	Due to data loss, the device uses previous settings.	Check all therapy settings and adjust them if necessary. Acknowledge message by touching "ALARM RESET" button and confirm with rotary knob.

Alarm priority	Alarm	Cause	Remedy	
!!	252	Check ventilation settings	While adjusting ventilation settings or alarm limits, a power interruption occurred.	The device may apply default settings. Check ventilation settings and alarm limits. Acknowledge message by touching "ALARM RESET" button and confirm with rotary knob.
			Data loss.	The device may apply default settings. Check ventilation settings and alarm limits. Acknowledge message by touching "ALARM RESET" button and confirm with rotary knob.
!!!	144	Clean CO ₂ cuvette	Cuvette or sensor window is soiled, e.g. with deposits due to nebulization.	Use clean cuvette and/or clean CO ₂ sensor.
!!!	145	CO ₂ measurement failed	CO ₂ sensor faulty.	Replace faulty CO ₂ sensor.
			CO ₂ measurement incorrect.	Use external CO ₂ monitoring and deactivate integrated CO ₂ monitoring. Call DrägerService.
!!!	146	CO ₂ sensor?	Plug of CO ₂ sensor was removed during operation.	Reinsert plug.
			CO ₂ sensor not positioned on cuvette.	Place CO ₂ sensor on cuvette.
			CO ₂ sensor faulty.	Replace faulty CO ₂ sensor.
!!!	142	CO ₂ zero calibration?	Zero point of the CO ₂ sensor is outside of the tolerance range.	Perform zero calibration.
			Cuvette or sensor window is soiled, e.g. with deposits due to nebulization.	Use clean cuvette and/or clean CO ₂ sensor.

Alarm priority	Alarm	Cause	Remedy
! 100	Cockpit restarted	Internal communication error caused restart of the cockpit.	Check all therapy settings and adjust them if necessary. Acknowledge message by touching "ALARM RESET" button and confirm with rotary knob.
! 100	Continuous nebulization activated	Continuous nebulization was activated by the user.	To end continuous nebulization, press the "Cancel" button if required.
!!! 252	Data loss	Loss of stored data was detected.	To continue ventilation with this device, continuously monitor the device functions. Downgrade alarm priority by touching "ALARM RESET" button and confirm with rotary knob. Call DrägerService.
!! 252	Data loss	Loss of stored data was detected.	To continue ventilation with this device, continuously monitor the device functions. Downgrade alarm priority by touching "ALARM RESET" button and confirm with rotary knob. Call DrägerService.
!! 240	Device check failed	A safety-related failure was detected during device check.	Do not use this device for ventilation therapy. Call DrägerService. Check assembly and position of expiratory valve. Replace expiratory valve if required. Do not use this device for ventilation therapy unless the device check was repeated successfully.

Alarm priority	Alarm	Cause	Remedy
!	100 Device check incomplete	Device check not completely performed or partially unsuccessful.	Perform device check. Acknowledge message by touching "ALARM RESET" button and confirm with rotary knob.
!!!	253 Device failure	A system failure was detected.	Disconnect patient from the device and continue ventilation without delay using another independent ventilator. Call DrägerService.
!!!	253 Device failure	Due to missing measurements, ventilation is not possible anymore.	Immediately disconnect the patient from the device and continue ventilation without delay using another independent ventilator. Call DrägerService.
!!!	253 Device failure (1)	Internal safety system failure.	Disconnect patient from the device and continue ventilation without delay using another independent ventilator. Call DrägerService.
!!!	253 Device failure (10)	A failure was detected by the safety software system.	Disconnect patient from the device and continue ventilation without delay using another independent ventilator. Call DrägerService.

Alarm priority	Alarm	Cause	Remedy
!!! 253	Device failure (11)	A failure was detected during the start-up phase.	Disconnect patient from the device and continue ventilation without delay using another independent ventilator. Call DrägerService.
!!! 253	Device failure (12)	A system failure was detected.	Disconnect patient from the device and continue ventilation without delay using another independent ventilator. Call DrägerService.
!! 090	Device failure (13)	The broken wire detection for the flow sensor is faulty.	Ventilation functions are not affected. Call DrägerService.
!!! 253	Device failure (2)	Internal safety system failure.	Do not use this device for ventilation therapy. Call DrägerService.
!!! 253	Device failure (3)	Internal communication failure.	Disconnect patient from the device and continue ventilation without delay using another independent ventilator. Call DrägerService.
!!! 253	Device failure (4)	Defective system data storage media detected.	Disconnect patient from the device and continue ventilation without delay using another independent ventilator. Switch off the device. Call DrägerService.

Alarm priority	Alarm	Cause	Remedy
!!!	253 Device failure (5)	Gas delivery system faulty.	Disconnect patient from the device and continue ventilation without delay using another independent ventilator. Call DrägerService.
!!!	253 Device failure (6)	Gas delivery system faulty.	Disconnect patient from the device and continue ventilation without delay using another independent ventilator. Call DrägerService.
!!!	253 Device failure (7)	Gas delivery system faulty.	Disconnect patient from the device and continue ventilation without delay using another independent ventilator. Call DrägerService.
!!!	253 Device failure (8)	Test alarm which should only be triggered during maintenance.	Disconnect patient from the device and continue ventilation without delay using another independent ventilator. Call DrägerService.
!!	100 Device failure (9)	No mass storage device found.	Acknowledge message by touching "ALARM RESET" button and confirm with rotary knob. Call DrägerService.

Alarm priority	Alarm	Cause	Remedy
!!! 200	Device temperature high	The internal device temperature is too high.	<p>Disconnect patient from the device and continue ventilation without delay using another independent ventilator.</p> <p>Switch off the device.</p> <p>Call DrägerService.</p>
!! 141	Device temperature measurement failed	<p>Failure of the internal breathing-gas temperature measurement.</p> <p>In case of a too high breathing-gas temperature, there is no alarm.</p>	<p>To continue ventilation with this device, use external breathing gas temperature monitoring.</p> <p>Call DrägerService.</p>
		<p>Failure of the internal temperature measurement.</p> <p>No alarm in case of a too high device temperature.</p>	<p>To continue ventilation with this device, continuously monitor the device functions.</p> <p>Call DrägerService.</p>
!!! 200	Disconnection?	Leakage or disconnection.	Check breathing circuit for tight connections.
			Check whether the expiratory valve is properly engaged.
			Make sure that the tube or mask is connected correctly.
!!! 138	etCO ₂ high	Upper alarm limit for end-expiratory CO ₂ concentration has been exceeded.	<p>Check patient condition.</p> <p>Check ventilation settings.</p> <p>Adjust alarm limit if necessary.</p> <p>Perform CO₂ zero calibration if necessary.</p> <p>Check whether the cuvette windows are soiled.</p>

Alarm priority	Alarm	Cause	Remedy
!!!	138 etCO ₂ low	Lower alarm limit for end-expiratory CO ₂ concentration has been exceeded.	Check patient condition. Check ventilation settings. Adjust alarm limit if necessary. Perform CO ₂ zero calibration if necessary. Check whether the cuvette windows are soiled.
!!!	227 Expiratory flow measurement failed	Water in flow sensor.	Dry flow sensor.
		Flow sensor is not calibrated or faulty.	Calibrate flow sensor and replace it if necessary.
		Flow measurement malfunction.	Ventilation functions are affected. To continue ventilation with this device, use external flow monitoring and deactivate integrated flow monitoring. Call DrägerService.
!	150 Expiratory hold interrupted	The "Exp. hold" button was pressed too long.	Release "Exp. hold" button.
!!!	220 Expiratory valve faulty	Expiratory valve is not properly connected to the socket.	Insert expiratory valve correctly.
		Expiratory valve faulty.	Replace expiratory valve.
		Flow sensor is not calibrated or faulty.	Calibrate flow sensor and replace it if necessary.
!!!	105 Expiratory valve incompatible	Incompatible expiratory valve connected to the socket.	Replace expiratory valve.

Alarm priority	Alarm	Cause	Remedy
!!	100	Expiratory valve incompatible	Incompatible expiratory valve connected to the socket. Replace expiratory valve.
!!!	130	FiO ₂ high	O ₂ sensor is not calibrated. Calibrate O ₂ sensor.
			Mixer function faulty. Call DrägerService.
!!!	130	FiO ₂ low	O ₂ sensor is not calibrated. Calibrate O ₂ sensor.
			Mixer function faulty. Call DrägerService.
!!	100	Flow measurement inaccurate	Flow sensor is not calibrated or faulty. Calibrate flow sensor and replace it if necessary.
			Water in flow sensor. Drain water trap of breathing circuit. Dry flow sensor.
			Flow measurement is not reliable. Expiratory minute volume exceeds minute volume delivered by the ventilation unit. To continue ventilation with this device, use external flow monitoring and deactivate integrated flow monitoring. This could impair the quality of ventilation. Call DrägerService.
!!!	228	Flow sensor? Ventilation impaired	Flow sensor is not correctly inserted in rubber lip of expiratory valve. Insert flow sensor correctly.
!!	140	Flow sensor? Ventilation impaired	Activate flow monitoring.
			Change to a ventilation mode that does not require a flow sensor.
			Calibrate flow sensor and replace it if necessary.

Alarm priority	Alarm	Cause	Remedy
!!! 110	GS500 communication failure	Communication to gas supply unit GS500 lost.	<p>Check communication connection to gas supply unit GS500.</p> <p>Acknowledge message by pressing "ALARM RESET" and confirm.</p> <p>Call DrägerService.</p>
! 110	GS500 communication failure	Communication to gas supply unit GS500 lost.	<p>Check communication connection to gas supply unit GS500.</p> <p>Acknowledge message by pressing "ALARM RESET" and confirm.</p> <p>Call DrägerService.</p>
!!! 100	GS500 failure	<p>Air supply insufficient to deliver required flow and pressure.</p> <p>Gas delivery system supplied with O₂ only.</p> <p>Ventilation continues with O₂ only.</p>	<p>Check connection to gas supply unit GS500.</p> <p>If this condition persists, call DrägerService.</p>
!!! 110	GS500 internal failure	Gas supply unit GS500 has reported a failure.	<p>Shut down ventilation unit. Switch toggle switch to "Off" to disconnect ventilation unit from power supply. Switch toggle switch to "On" and restart ventilation unit.</p> <p>If this condition persists, call DrägerService.</p>

Alarm priority	Alarm	Cause	Remedy
!! 110	GS500 internal failure	Gas supply unit GS500 has reported a failure.	Shut down ventilation unit. Switch toggle switch to "Off" to disconnect ventilation unit from power supply. Switch toggle switch to "On" and restart ventilation unit. If this condition persists, call DrägerService.
!!! 110	GS500 temperature too high	Gas supply unit GS500 temperature is too high.	Shut down ventilation unit. Switch toggle switch to "Off". Call DrägerService.
! 060	ID expiratory heated filter failure	Accessory ID detection failed. Exchange interval of the expiratory heated filter cannot be monitored.	Replace ID expiratory heated filter or acknowledge message by touching "ALARM RESET" key and confirm with rotary knob.
! 060	ID tag of expiratory valve faulty	Accessory ID detection failed. Expiratory valve exchange interval cannot be monitored.	Replace Infinity ID Expiratory Valve or acknowledge message by touching "ALARM RESET" button and confirm with rotary knob.
!! 030	ID tag of flow sensor faulty	Accessory ID detection failed. Flow sensor exchange interval cannot be monitored.	Replace Infinity ID Flow Sensor or acknowledge message by touching "ALARM RESET" button and confirm with rotary knob.

Alarm priority	Alarm	Cause	Remedy
!	020 Import failed, check settings	Configuration import failed.	Check all settings and adjust if necessary. Acknowledge message by touching "ALARM RESET" button and confirm with rotary knob.
!	020 Import successful, check settings	Configuration import was successful.	Check all settings and adjust if necessary. Acknowledge message by touching "ALARM RESET" button and confirm with rotary knob.
!	001 Incompatible flow sensor detected	An incompatible flow sensor is connected to the ventilation unit. Ventilation and monitoring could be impaired.	Replace incompatible flow sensor with an Infinity ID Flow Sensor.
!	150 Inspiratory hold interrupted	The "Man. insp./hold" button was pressed too long.	Release "Man. insp./hold" button.
!!	210 Internal battery activated	The batteries of PS500 are depleted. Power supply is provided by the internal battery.	Connect device to the mains power supply.
!!	120 Internal power supply failure	Technical failure detected.	To continue ventilation with this device, continuously monitor the device functions. Call DrägerService.
!	140 Leakage	Only monitored for intubated patients! The measured relative leakage exceeds 55 %.	Check for leakages in breathing circuit. Make sure that the tube is connected correctly.

Alarm priority	Alarm	Cause	Remedy
!! 040	Low Flow PV Loop maneuver failed	Internal error during Low Flow PV Loop maneuver.	Do not perform Low Flow PV Loop maneuver until the device was checked. Call DrägerService.
! 140	Low Flow PV Loop maneuver overused?	Low Flow PV Loop maneuver has been performed more than 5 times within an hour.	Perform Low Flow PV Loop maneuver less frequently.
! 008	MEDIBUS communication failed	MEDIBUS communication failure.	Ventilation functions are not affected. Check MEDIBUS connection. Check MEDIBUS settings.
!!! 160	MV high	The minute volume exceeds the upper alarm limit.	Check patient condition.
			Check ventilation settings.
			Adjust alarm limit if necessary.
		Water in flow sensor.	Drain water trap of breathing circuit. Dry flow sensor.
		Flow sensor is not calibrated or faulty.	Calibrate flow sensor and replace it if necessary.

Alarm priority	Alarm	Cause	Remedy	
!!!	160	MV low	The minute volume has fallen below the lower alarm limit.	Check patient condition.
				Check ventilation settings.
				Adjust alarm limit if necessary.
			Obstruction.	Check patient condition.
				Check breathing circuit.
				Check tube or mask.
			Flow sensor is not calibrated or faulty.	Calibrate flow sensor and replace it if necessary.
			Leakage or disconnection.	Check breathing circuit for tight connections.
				Check whether the expiratory valve is properly engaged.
				Make sure that the tube or mask is connected correctly.
	Device failure.	Disconnect patient from the device and continue ventilation without delay using another independent ventilator.		
		Call DrägerService.		

Alarm priority	Alarm	Cause	Remedy
!!	110	Nebulization canceled	<p>Check connections to Air and O₂ supply.</p> <p>Make sure supply pressures are greater than 3 bar (43.5 psi).</p> <p>Acknowledge message by touching "ALARM RESET" button and confirm with rotary knob.</p>
		Inspiratory flow insufficient for nebulization.	<p>Increase inspiratory flow to more than 9 L/min for neonates and pediatric patients or 16 L/min for adults.</p> <p>Acknowledge message by touching "ALARM RESET" button and confirm with rotary knob.</p>
		Air supply insufficient to deliver required flow and pressure for nebulization.	<p>Check connection to Air supply.</p> <p>Make sure supply pressure is greater than 3 bar (43.5 psi).</p> <p>Acknowledge message by touching "ALARM RESET" button and confirm with rotary knob.</p>
		O ₂ supply insufficient to deliver required flow and pressure for nebulization.	<p>Check connection to O₂ supply.</p> <p>Make sure supply pressure is greater than 3 bar (43.5 psi).</p> <p>Acknowledge message by touching "ALARM RESET" button and confirm with rotary knob.</p>

Alarm priority	Alarm	Cause	Remedy
		<p>Internal supply pressures too high.</p> <p>Air and O₂ supply inappropriate to deliver required flow and pressure for nebulization.</p> <p>Nebulization canceled.</p>	<p>Acknowledge message by touching "ALARM RESET" button and confirm with rotary knob.</p> <p>Call DrägerService.</p>
		<p>Neonatal flow monitoring active.</p> <p>Nebulization is only possible if neonatal flow monitoring is deactivated and neonatal flow sensor is removed from breathing circuit.</p>	<p>Deactivate neonatal flow monitoring and remove neonatal flow sensor.</p> <p>Acknowledge message by touching "ALARM RESET" button and confirm with rotary knob.</p>
		<p>Expiratory flow monitoring failed.</p> <p>Nebulization is only possible if expiratory flow monitoring is activated.</p>	<p>Check expiratory flow sensor and check whether expiratory flow monitoring is activated.</p> <p>Acknowledge message by touching "ALARM RESET" button and confirm with rotary knob.</p>
		<p>Incompatible ventilation mode.</p> <p>Nebulization is only possible in volume-controlled ventilation modes with AutoFlow or in pressure-controlled ventilation modes.</p>	<p>Select an appropriate ventilation mode.</p> <p>Acknowledge message by touching "ALARM RESET" button and confirm with rotary knob.</p>
		<p>Incompatible ventilation mode.</p> <p>Nebulization is only possible in pressure-controlled ventilation modes without Volume Guarantee.</p>	<p>Select an appropriate ventilation mode.</p> <p>Acknowledge message by touching "ALARM RESET" button and confirm with rotary knob.</p>
!	100 Nebulization finished	Nebulization finished or canceled.	Acknowledge message by touching "ALARM RESET" button and confirm with rotary knob.

Alarm priority	Alarm	Cause	Remedy
! 100	Nebulization finished	Nebulization finished or canceled.	Install neonatal flow sensor. Switch on neonatal flow monitoring. Acknowledge message by pressing "ALARM RESET" and confirm.
!! 100	Nebulizer uses Air only	O ₂ supply insufficient to deliver required flow and pressure for nebulization. Nebulizer is supplied with Air only. Increased deviation from the set FiO ₂ .	Check connection to O ₂ supply. Make sure supply pressure is greater than 3 bar (43.5 psi). Downgrade alarm priority by touching "ALARM RESET" button and confirm with rotary knob.
!! 100	Nebulizer uses O ₂ only	Air supply insufficient to deliver required flow and pressure for nebulization. Nebulizer is supplied with O ₂ only. Increased deviation from the set FiO ₂ .	Check connection to Air supply. Make sure supply pressure is greater than 3 bar (43.5 psi). Downgrade alarm priority by touching "ALARM RESET" button and confirm with rotary knob.

Alarm priority	Alarm	Cause	Remedy
!!! 228	Neonatal flow measurement failed	Neonatal flow measurement malfunction.	<p>In case of modes with tidal volume or trigger setting: Check ventilation settings. Change ventilation mode if required.</p> <p>Use external flow monitoring and deactivate the integrated flow monitoring. Call DrägerService.</p> <hr/> <p>In case of modes without tidal volume or trigger setting: Ventilation functions are not affected. To continue ventilation with this device, use external flow monitoring and deactivate the integrated neonatal flow monitoring. Call DrägerService.</p> <hr/> <p>Patient category "Pediatric patient": Deactivate integrated neonatal flow monitoring and use expiratory flow monitoring. Call DrägerService.</p>
!! 115	Neonatal flow measurement failed	Neonatal flow measurement malfunction.	<p>Ventilation continues with expiratory flow sensor. Deactivate integrated neonatal flow monitoring. Call DrägerService.</p>

Alarm priority	Alarm	Cause	Remedy
!!!	228 Neonatal flow sensor failure	Neonatal flow sensor cable faulty.	Replace neonatal flow sensor cable.
		Neonatal flow sensor faulty.	Replace neonatal flow sensor or sensor insert and calibrate the new sensor.
		Neonatal flow measurement malfunction.	In case of modes with tidal volume or trigger setting: Check ventilation settings. Change ventilation mode if required. Use external flow monitoring and deactivate the integrated flow monitoring. Call DrägerService. In case of modes without tidal volume or trigger setting: Ventilation functions are not affected. To continue ventilation with this device, use external flow monitoring and deactivate the integrated neonatal flow monitoring. Call DrägerService.
!!	115 Neonatal flow sensor failure	Neonatal flow sensor cable faulty.	Replace neonatal flow sensor cable.
		Neonatal flow sensor faulty.	Replace neonatal flow sensor or sensor insert and calibrate the new sensor.
		Neonatal flow measurement malfunction.	Ventilation continues with expiratory flow sensor. Deactivate integrated neonatal flow monitoring. Call DrägerService.

Alarm priority	Alarm	Cause	Remedy
!	100 Neonatal flow sensor replaced?	Reconnection of the neonatal flow sensor detected.	Confirm message if calibrated neonatal flow sensor is still used. Otherwise calibrate neonatal flow sensor.
		Neonatal flow monitoring was temporarily deactivated.	Confirm message if calibrated neonatal flow sensor is still used. Otherwise calibrate neonatal flow sensor.
!!	115 Neonatal flow sensor soiled	Water or secretion in the neonatal flow sensor.	Replace neonatal flow sensor or sensor insert and calibrate the new sensor.
!!!	229 Neonatal flow sensor?	Neonatal flow sensor is not connected.	Check connections of the neonatal flow sensor and cable.
		Neonatal flow sensor malfunction.	Replace neonatal flow sensor or sensor insert and calibrate the new sensor.
!!!	140 Neonatal flow sensor?	Neonatal flow sensor not installed in the breathing circuit.	Check whether the neonatal flow sensor is fitted correctly.
			Replace neonatal flow sensor if necessary.

Alarm priority	Alarm	Cause	Remedy
!! 119	Neonatal flow sensor?	Neonatal flow sensor is not connected.	Check connections of the neonatal flow sensor and cable.
		Neonatal flow sensor malfunction.	Replace neonatal flow sensor or sensor insert and calibrate the new sensor.
! 140	Neonatal flow sensor?	Neonatal flow sensor not installed in the breathing circuit.	Check whether the neonatal flow sensor is fitted correctly.
			Replace neonatal flow sensor if necessary.
!!! 250	No Air supply	<p>Air supply insufficient to deliver required flow and pressure.</p> <p>Gas delivery system supplied with O₂ only.</p> <p>Ventilation continues with O₂ only.</p>	<p>Check connection to Air supply.</p> <p>Make sure supply pressure is greater than 3 bar (43.5 psi).</p> <p>Consider readjusting ventilation settings.</p> <p>Remove connection to Air supply if alarm condition persists (to avoid reverse flow into the Air supply).</p>
! 100	No Air supply	<p>Air supply insufficient.</p> <p>If FiO₂ = 100 Vol%, Air supply is not required.</p>	<p>Check connection to Air supply.</p> <p>Make sure supply pressure is greater than 3 bar (43.5 psi).</p> <p>Consider readjusting ventilation settings.</p> <p>Remove connection to Air supply if alarm condition persists (to avoid reverse flow into the Air supply).</p>

Alarm priority	Alarm	Cause	Remedy
!!! 250	No O ₂ supply	O ₂ supply insufficient to deliver required flow and pressure. Gas delivery system supplied with Air only. Ventilation continues with Air only.	Check connection to O ₂ supply. Make sure supply pressure is greater than 3 bar (43.5 psi). Consider readjusting ventilation settings. Remove connection to O ₂ supply if alarm condition persists (to avoid reverse flow into the O ₂ supply).
! 100	No O ₂ supply	O ₂ supply insufficient. If FiO ₂ = 21 Vol%, O ₂ supply is not required.	Check connection to O ₂ supply. Make sure supply pressure is greater than 3 bar (43.5 psi). Consider readjusting ventilation settings. Remove connection to O ₂ supply if alarm condition persists (to avoid reverse flow into the O ₂ supply).
!! 119	Nurse call failure	Technical failure detected.	To continue ventilation with this device, continuously monitor the device functions. Call DrägerService.
!! 110	O ₂ and Air supply pressures differ too much	The difference between O ₂ supply pressure and Air supply pressure can lead to an incorrect O ₂ concentration during nebulization.	Check connections to Air and O ₂ supply. Make sure supply pressures are greater than 3 bar (43.5 psi). Acknowledge message by touching "ALARM RESET" button and confirm with rotary knob.

Alarm priority	Alarm	Cause	Remedy
!!!	132	O ₂ measurement failed	<p>O₂ measurement failed.</p> <p>To calibrate the O₂ sensor, perform the device check.</p> <p>Ventilation can be continued also if the alarm does not disappear. Use external O₂ monitoring and deactivate the integrated O₂ monitoring.</p> <p>Call DrägerService.</p>
!!	040	Oxygenation maneuver failed	<p>Internal error during oxygenation maneuver.</p> <p>Do not perform suction maneuver until the device was checked.</p> <p>Call DrägerService.</p>
!!!	140	PEEP high	<p>Expiratory valve or breathing circuit obstructed.</p> <p>Check breathing circuit and expiratory valve.</p> <p>Check for condensate.</p>
			<p>Expiratory resistance increased.</p> <p>Check viral/bacterial filter. Replace it if necessary.</p>
			<p>Device failure.</p> <p>Disconnect patient from the device and continue ventilation without delay using another independent ventilator.</p> <p>Call DrägerService.</p>
!!	140	PEEP high	<p>Expiratory valve or breathing circuit obstructed.</p> <p>Check breathing circuit and expiratory valve.</p> <p>Check for condensate.</p>
			<p>Expiratory resistance increased.</p> <p>Check viral/bacterial filter. Replace it if necessary.</p>
			<p>Device failure.</p> <p>Disconnect patient from the device and continue ventilation without delay using another independent ventilator.</p> <p>Call DrägerService.</p>

Alarm priority	Alarm	Cause	Remedy
!!!	140 PEEP low	Measured PEEP is 5 mbar (5 cmH ₂ O) less than set PEEP.	Check breathing circuit for tight connections.
			Check whether the expiratory valve is properly engaged.
			Make sure that the tube or mask is connected correctly.
!!	210 Perform device and breathing circuit check	Device check and breathing circuit check must be performed before operation.	Perform device check. Acknowledge message by touching "ALARM RESET" button and confirm with rotary knob.
!!!	140 Plow high	Expiratory valve or breathing circuit obstructed.	Check breathing circuit and expiratory valve.
			Check for condensate.
		Expiratory resistance increased.	Check viral/bacterial filter. Replace it if necessary.
		Device failure.	Disconnect patient from the device and continue ventilation without delay using another independent ventilator. Call DrägerService.
		Not monitored if AutoRelease is enabled. Not monitored if Tlow is set to less than 1 second.	To enable monitoring switch off AutoRelease or increase Tlow to >1 second.
!!!	140 Plow low	Measured Plow is 5 mbar (5 cmH ₂ O) less than set Plow.	Check breathing circuit for tight connections.
			Check whether the expiratory valve is properly engaged.
			Make sure that the tube or mask is connected correctly.

Alarm priority	Alarm	Cause	Remedy
!	140 Pressure limited	The pressure of a breath is limited by the set "Paw high" limit or Pmax.	Check patient condition.
			Check ventilation settings.
			Adjust "Paw high" alarm limit or Pmax.
!	140 Pressure limited! VT not reached	The pressure of a breath is limited by the set "Paw high" limit or Pmax. The set volume could not be delivered.	Check patient condition.
			Check ventilation settings.
			Adjust "Paw high" alarm limit or Pmax.
!!!	238 Pressure measurement failed	Pressure measurement malfunction.	<p>Disconnect patient from the device and continue ventilation without delay using another independent ventilator.</p> <p>Call DrägerService.</p>
!!	140 Pressure measurement impaired	Pressure measurement malfunction.	<p>Accuracy of measured values based on pressure could be impaired.</p> <p>To continue ventilation with this device, continuously monitor the device functions.</p> <p>Call DrägerService.</p>
!!	100 Pressure measurement inaccurate	Fluid in expiratory valve.	Replace expiratory valve. Clean and dry used one.
		Breathing circuit check has not been performed.	Perform or repeat breathing circuit check.
		The inspiratory or expiratory hose is obstructed.	Check breathing circuit.
		Pressure measurement failure.	<p>Disconnect patient from the device and continue ventilation without delay using another independent ventilator.</p> <p>Call DrägerService.</p>

Alarm priority	Alarm	Cause	Remedy
!! 140	Pressure sensor? Ventilation impaired	Ventilation patterns for which a pressure sensor is necessary cannot be performed. The ventilation unit applies back-up ventilation.	To continue ventilation with this device, use external pressure monitoring. Call DrägerService.
! 100	Product test: Not for clinical use	License for product test is installed.	Call DrägerService.
!!! 150	Respiratory rate high	The patient is breathing at a high respiratory rate.	Check patient condition. Check ventilation settings or spontaneous respiratory rate. Adjust alarm limit if necessary.
		The set respiratory rate exceeds upper alarm limit.	Adjust the respiratory rate or the upper alarm limit for the respiratory rate.
		Auto triggering caused by water in the breathing circuit.	Drain water trap of breathing circuit. Dry flow sensor. Check breathing circuit.
! 100	Restart of ventilation unit delayed	Technical failure detected. Last restart was delayed.	Downgrade alarm priority by touching "ALARM RESET" button and confirm with rotary knob. To continue ventilation with this device, continuously monitor the device functions. Call DrägerService.
!! 050	Rotary knob stuck or pressed too long	The rotary knob is either faulty or was pressed for more than 20 seconds without turning.	If you are still pressing the rotary knob, release it. Otherwise press and turn rotary knob repeatedly. If alarm condition persists, settings cannot be adjusted anymore. Disconnect patient from the device and continue ventilation without delay using another independent ventilator. Call DrägerService.

Alarm priority	Alarm	Cause	Remedy
!! 050	Rotary knob used too often	The rotary knob is either faulty or was pressed more than 5 times per second.	<p>Press and turn rotary knob repeatedly.</p> <p>If alarm condition persists, settings cannot be adjusted anymore.</p> <p>Disconnect patient from the device and continue ventilation without delay using another independent ventilator.</p> <p>Call DrägerService.</p>
! 100	Service date approaching	Service date is almost reached.	<p>Acknowledge message by touching "ALARM RESET" button and confirm with rotary knob.</p> <p>Call DrägerService.</p>
! 100	Service date reached	Service is due.	<p>Acknowledge message by touching "ALARM RESET" button and confirm with rotary knob.</p> <p>Call DrägerService.</p>
! 200	Setting not confirmed	One or more settings have been changed but not confirmed.	If necessary, change these settings and confirm the change with the rotary knob.
!!! 255	Standby mode activated	Device has been switched to standby mode.	Acknowledge standby mode by touching "ALARM RESET" button and confirm with rotary knob.
!! 040	Suction maneuver failed	Internal error during suction maneuver.	<p>Do not perform suction maneuver until the device was checked.</p> <p>Call DrägerService.</p>
! 140	Suction maneuver overused?	The suction maneuver has been performed more than 5 times within an hour.	Perform suction maneuver less frequently.

Alarm priority	Alarm	Cause	Remedy	
!	001	TVS import not possible	TVS data is inconsistent.	Adjust the patient settings manually.
			TVS data is too old.	Check the system time.
!	200	Ventilation mode not confirmed	The ventilation mode has been changed but not confirmed.	If necessary, change the ventilation mode and confirm the change with the rotary knob.
!!	255	Ventilation unit restarted	Internal communication error caused restart of the ventilation unit.	Check all therapy settings and adjust them if necessary. Acknowledge message by touching "ALARM RESET" button and confirm with rotary knob.
!!	166	VT high	The upper alarm limit of the applied inspiratory tidal volume has been exceeded during three consecutive breaths.	Check patient condition.
				Check ventilation settings.
				Adjust alarm limit if necessary.
			Leakage or disconnection.	Check breathing circuit for tight connections.
			Check whether the expiratory valve is properly engaged.	
Make sure that the tube or mask is connected correctly.				
!!	166	VT high (minimum pressure)	Patient breathes spontaneously more volume than set.	Check patient condition.
				Check ventilation settings.
			Due to leakage or increased compliance, the tidal volume delivered with minimum airway pressure is higher than set.	Check patient condition.
				Check ventilation settings.
Check for leakages in breathing circuit.				

Alarm priority	Alarm	Cause	Remedy
!!	166 VT low	The lower alarm limit of the applied inspiratory tidal volume has been exceeded during five (adult and pediatric patients) or eight (neonatal patients) consecutive breaths.	<p>Check patient condition.</p> <p>Check ventilation settings.</p> <p>Adjust alarm limit if necessary.</p>
!	140 VT not reached	Set volume could not be delivered in volume-controlled ventilation.	<p>Check patient condition.</p> <p>Check ventilation settings.</p>
!	140 VT not reached, leakage	Set volume cannot be reached. Flow delivery terminated.	<p>Check for leakages in breathing circuit.</p> <p>Make sure that the tube or mask is connected correctly.</p>
!	140 VT not reached, Pmax active	Pressure limit Pmax is active.	<p>Check patient condition.</p> <p>Check ventilation settings.</p> <p>If pressure limited ventilation is acceptable, acknowledge message by touching "ALARM RESET" button and confirm with rotary knob.</p>
!	100 Wrong or invalid applications found	Wrong or defective application card.	Call DrägerService.

Reprocessing

Disassembly	244
Observe before disassembly	244
Disconnecting the breathing circuit	244
Removing the Infinity ID flow sensor	244
Dismantling the expiratory valve	245
Dismantling the CO ₂ sensor	245
Dismantling the neonatal flow sensor	246
Dismantling the inspiratory unit	246
Dismantling the pneumatic medication nebulizer	247
Dismantling other accessories.	247
Information on reprocessing	248
Safety information	248
Classifications for reprocessing	250
Classification of medical devices	250
Classification of device-specific components	250
Reprocessing list	251
Reprocessing procedure	253
Validated reprocessing procedures	253
Disinfectants	254
Surface disinfection with cleaning	255
Manual cleaning followed by disinfection by immersion	255
Machine cleaning with thermal disinfection	256
Steam sterilization	256
Special reprocessing measures.	257
After reprocessing	259
Assembling the components	259
Preparations before reuse	261

Disassembly

Observe before disassembly

- 1 Switch off the device and all devices connected to it.
- 2 Disconnect the mains plugs.
- 3 Drain the water traps and the breathing hoses.
- 4 Drain the water reservoir of the breathing gas humidifier.

Disconnecting the breathing circuit

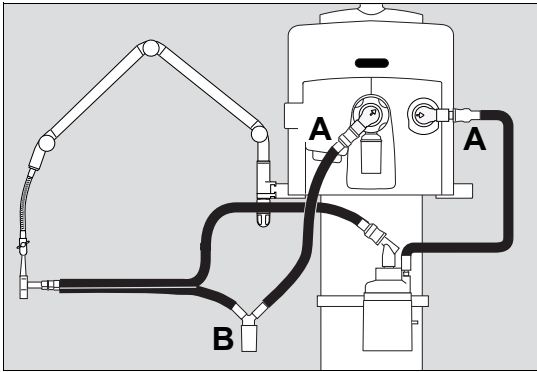

- 1 Pull the breathing hoses from the inspiratory port and the expiratory port (A).
- 2 If fitted: Remove the water trap (B) from the breathing hose.
- 3 Remove the water trap container from the water trap. Empty the water trap container.

Removing the Infinity ID flow sensor

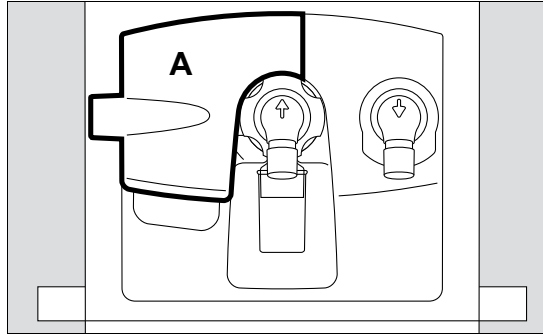

- 1 Open the flap (A) by lifting the lower edge upwards.

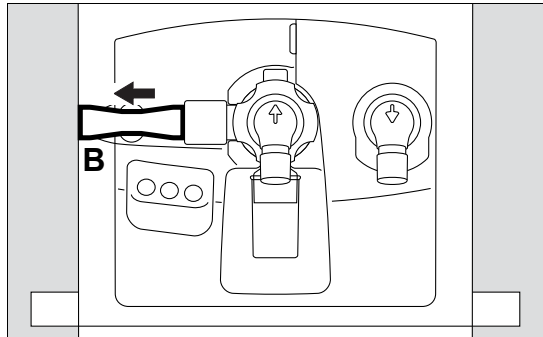

- 2 Push the flow sensor (B) as far as it will go to the left.

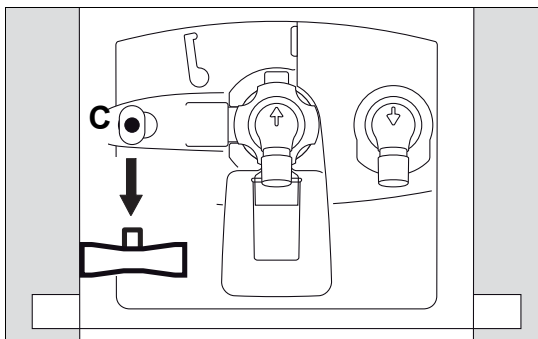

- 3 Remove the flow sensor from the socket (C).

Dismantling the expiratory valve

Only the Infinity ID expiratory valve is described in the following sections. The Infinity ID neonatal expiratory valve is dismantled in the same manner.

Removing the expiratory valve

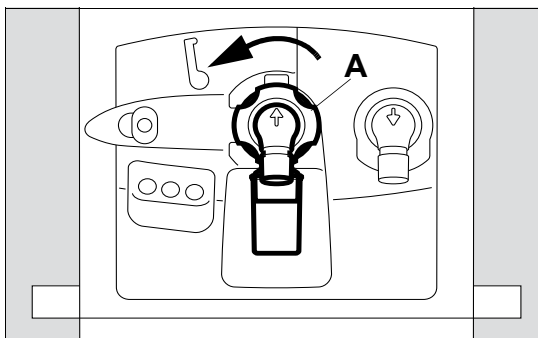

- 1 Turn the locking ring (A) as far as possible to the left.
- 2 Remove the expiratory valve from the fitting.

Dismantling the expiratory valve

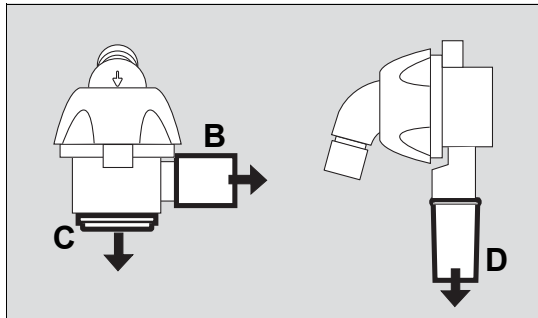

- 1 Pull the flow sensor sleeve (B) off the Infinity ID expiratory valve or pull the muffler (B) from the Infinity ID neonatal expiratory valve.
- 2 Remove the diaphragm (C). Do not dismantle the diaphragm any further.
- 3 Remove the water trap container (D). Empty the water trap container.

Dismantling the CO2 sensor

- 1 Remove the CO2 sensor plug from the socket.

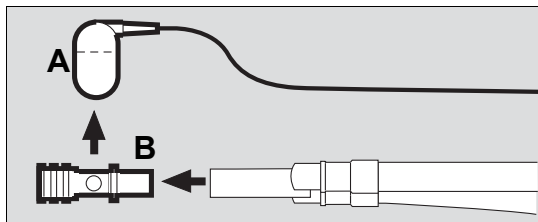

- 2 Remove the CO2 sensor (A) from the cuvette.
- 3 Remove the cuvette (B) from the patient connector of the Y-piece.

Dismantling the neonatal flow sensor

- Disconnect the sensor plug on the rear of the device.

Dismantling the neonatal flow sensor ISO 15 (8411130)

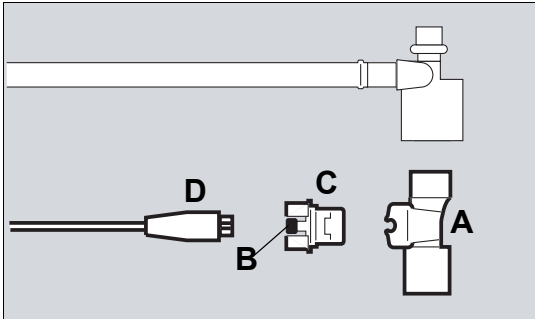

- 1 Remove the flow sensor housing (A) from the Y-piece.
- 2 Disconnect plug (D) of the flow sensor cable from the neonatal flow sensor.
- 3 Gently press the knobs (B) on both sides while pulling the insert (C) out of the flow sensor housing.

Dismantling the neonatal flow sensor Y-piece (8410185)

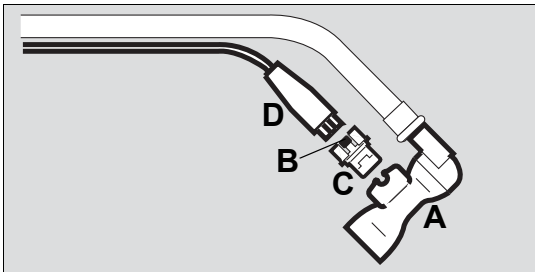

- 1 Pull the Y-piece (A) out of the breathing hoses.
- 2 Disconnect plug (D) of the flow sensor cable from the neonatal flow sensor.
- 3 Gently press the knobs (B) on both sides while pulling the insert (C) out of the Y-piece.

Dismantling the inspiratory unit

When the inspiratory unit must be reprocessed:

The inspiratory unit must only be reprocessed when patient gas has passed through the safety valve. In the case of spontaneously breathing patients, this can occur in the following situations:

- Excess pressure in the system caused by a kink in the expiratory hose
- Failure of both supply gases
- Complete failure of the power supply (failure of mains power supply and discharged or faulty batteries)

Removing the inspiratory unit

The inspiratory unit must only be removed when the device is switched off.

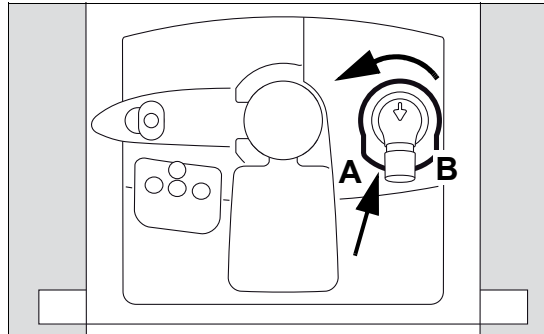

- 1 Press and hold the locking lever (A) on the underside of the inspiratory unit.
- 2 Simultaneously turn the inspiratory unit (B) approx. 20° counterclockwise.
- 3 Remove the inspiratory unit from the fitting.

Dismantling the inspiratory unit

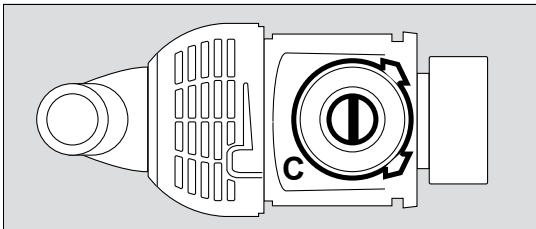

- 1 Remove the diaphragm with adapter (C) from the fitting of the inspiratory unit.
- 2 Do not dismantle the inspiratory unit any further.

Dismantling the pneumatic medication nebulizer

After use in the patient category *Adult*

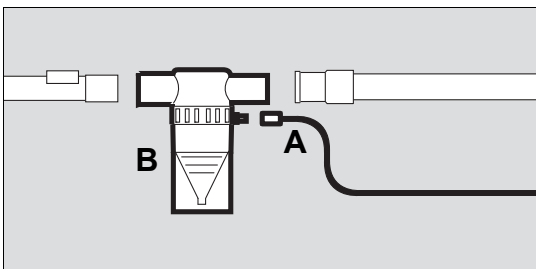

- 1 Remove the nebulizer hose (A) from the medication nebulizer (B) and from the nebulizer port on the device.
- 2 Remove the medication nebulizer (B) from the breathing circuit.
- 3 Dismantle the medication nebulizer in accordance with the corresponding instructions for use.

After use in the patient categories *Ped. pat.* and *Neo.*

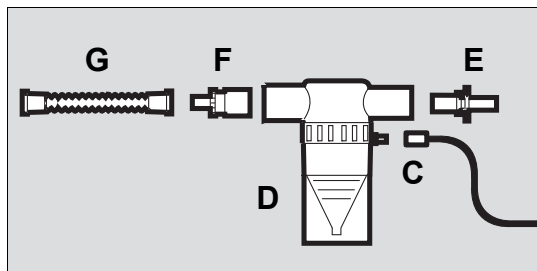

- 1 Remove the nebulizer hose (C) from the medication nebulizer (D) and from the nebulizer port on the device.
- 2 Remove the medication nebulizer (D) from the breathing circuit.
- 3 Pull the catheter connector (E) out of the inlet port.
- 4 Pull the adapter (F) out of the outlet port.
- 5 Remove the corrugated hose (G) from the adapter (F).
- 6 Dismantle the medication nebulizer in accordance with the corresponding instructions for use.

Dismantling other accessories

- Dismantle the breathing gas humidifier, the Aeroneb nebulizer and the bacterial filter in accordance with the corresponding instructions for use.

Information on reprocessing

Instructions for reprocessing are based on internationally accepted guidelines, e.g., standard ISO 17664.

The components through which contaminated breathing gas passes during normal operation and in the event of a fault must be reprocessed. In normal operation breathing gas passes through the expiratory valve or the expiratory valve with ejector and muffler and other accessories in the expiratory path. In the event of a fault, the inspiratory unit and other accessories in the inspiratory path can become contaminated.

Safety information

WARNING

Risk due to inappropriately reprocessed products

Reusable products must be reprocessed, otherwise there is an increased risk of infection.

- Observe the hygiene regulations and reprocessing regulations of the healthcare facility.
- Observe national hygiene regulations and reprocessing regulations.
- Use validated procedures for reprocessing.
- Reprocess reusable products after every use.
- Observe the manufacturer's instructions for cleaning agents, disinfectants, and reprocessing devices.

CAUTION

Risk due to faulty products

Signs of wear, e.g., cracks, deformation, discoloration, or peeling, may occur with reprocessed products.

Check the products for signs of wear and replace them if necessary.

CAUTION

For infectious patients, all parts that come into contact with breathing gas also have to be sterilized after disinfection and cleaning.

CAUTION

Health hazard

Do not sterilize parts in ethylene oxide. Ethylene oxide may diffuse into the parts.

Safety information on disposable articles

WARNING

Risk of patient injury as a result of failure of the accessories

Disposable articles were developed, tested and manufactured for single use only. Reuse, reprocessing or sterilization can lead to a failure of the accessories and cause injuries to the patient.

Do not reuse, reprocess, or sterilize disposable articles.

Safety information on flow sensors**WARNING****Risk of fire**

Residual vapors of easily flammable disinfectants (e.g., alcohols) and deposits that were not removed during reprocessing can ignite when the flow sensor is in use.

- **Ensure particle-free cleaning and disinfection.**
- **After disinfection, allow the flow sensor to air for at least 30 minutes.**
- **Before inserting the flow sensor check for visible damage and soiling, such as residual mucus, medication aerosols, and particles.**
- **Replace flow sensors when damaged, soiled, or not particlefree.**

Safety information on the neonatal flow sensor**CAUTION****Risk of failure of flow measurement**

Improper reprocessing and soiling, such as deposits or particles, can damage the flow sensor:

- No machine cleaning or disinfection of the sensor insert
- No plasma sterilization or radiation sterilization
- No compressed air
- No water jets, compressed air, brushes or the like when cleaning the sensor insert
- No ultrasonic bath
- Clean and disinfect the flow sensor in accordance with the corresponding instructions for use.
- For disinfecting the flow sensor use only clean disinfectant solutions.

Safety information on the Infinity ID flow sensor**CAUTION****Risk of failure of flow measurement**

Improper reprocessing and soiling, such as deposits or particles, may damage the flow sensor:

- No machine cleaning or disinfection
- No plasma sterilization or radiation sterilization
- No water jets, compressed air, brushes or the like
- No ultrasonic bath
- No hot steam sterilization
- Clean and disinfect the flow sensor in accordance with the corresponding instructions for use.
- For disinfecting the flow sensor use only clean disinfectant solutions.

NOTE

- Do not use brushes for reprocessing the sensor insert and do not use a syringe on the sensor insert.
- For reprocessing the housing use lint-free brushes only.

Classifications for reprocessing

Classification of medical devices

Medical devices and their components are classified according to the way they are used and the resulting risk.

Classification	Explanation
Non-critical	Components that come only into contact with skin that is intact
Semi-critical (A, B)	Components that carry breathing gas or come into contact with mucous membranes or pathologically altered skin
Critical (A, B, C)	Components that penetrate skin or mucous membranes or come into contact with blood

Classification of device-specific components

Observe the instructions for use for the components.

The following classification is a recommendation from Dräger.

Non-critical

- Evita V500 ventilation unit
- Medical Cockpit display unit
- GS500 gas supply unit
- PS500 power supply unit
- Trolley with accessory mounts
- System cable
- Compressed gas hoses
- CO₂ sensor
- Connection cable for the neonatal flow sensor
- Data link cable

Semi-critical A

- Reusable cuvette for the CO₂ sensor
- Infinity ID flow sensor
- Neonatal flow sensor Y-piece or ISO 15, including individual parts

Semi-critical B

- Infinity ID expiratory valve, including individual parts
- Infinity ID neonatal expiratory valve, including individual parts
- Inspiratory unit, including individual parts

Reprocessing list

Components	Surface disinfection with cleaning	Manual cleaning followed by disinfection by immersion	Machine cleaning with thermal disinfection	Steam sterilization	Special reprocessing measures
Evita V500 ventilation unit	Yes	No	No	No	No
Medical Cockpit display unit	Yes	No	No	No	Do not spray cleaning agent and disinfectant directly on the touch screen.
GS500 gas supply unit	Yes	No	No	No	No
PS500 power supply unit	Yes	No	No	No	No
Trolley with accessory mounts	Yes	No	No	No	No
System cable	Yes	No	No	No	No
Compressed gas hoses	Yes	No	No	No	No
CO ₂ sensor	Yes	No	No	No	Avoid residues on the test filter.
Connection cable for the neonatal flow sensor	Yes	No	No	No	No
Data link cable	Yes	No	No	No	No
Reusable cuvette for the CO ₂ sensor	No	Possible	Yes	Yes	Wipe off any contamination, particularly inside and outside the windows, using a soft disposable tissue and cotton swabs, under running water if necessary. Only cleaning agent, and no rinse aid, must be used for automatic cleaning of the cuvette. Otherwise, there is a risk of cracks developing.

Components	Surface disinfection with cleaning	Manual cleaning followed by disinfection by immersion	Machine cleaning with thermal disinfection	Steam sterilization	Special reprocessing measures
Infinity ID flow sensor	No	Yes	No	No	See "Infinity ID flow sensor" on page 257.
Neonatal flow sensor Y-piece or ISO 15	No	Yes	No	No	See "Neonatal flow sensors" on page 258.
Infinity ID expiratory valve	No	Possible	Yes	Yes ¹⁾	No
Infinity ID neonatal expiratory valve	No	Possible	Yes	Yes ¹⁾	See "Infinity ID neonatal expiratory valve" on page 257.
Inspiratory unit	No	Possible	Yes	Yes ¹⁾	Only reprocess the inspiratory unit if breathing gas has passed through the safety valve.

1) For further information on sterilizing, see page 256.

Reprocessing procedure

Validated reprocessing procedures

At the time of product-specific validation, the following reprocessing procedures showed good material compatibility and effectiveness:

Procedure	Agent	Manufacturer	Concentration	Contact time	Temperature
Surface disinfection with cleaning	Buraton 10F	Schülke & Mayr	1 %	30 min	–
	neoform Med AF ¹⁾	Dr. Weigert	According to manufacturer's data	According to manufacturer's data	–
	Dismozon pur ²⁾	Bode Chemie	1.5 %	15 min	–
Manual cleaning	Neodisher LM2	Dr. Weigert	3 %	30 min	–
	Sekusept Pulver Classic ³⁾	Ecolab	4 %	15 min	–
Disinfection by immersion ⁴⁾	Sekusept Pulver Classic ⁵⁾	Ecolab	4 %	15 min	–
	Korsolex Extra	Bode Chemie	3 %	15 min 30 min ⁶⁾	–
Machine cleaning	Neodisher Mediclean Neodisher MediClean Forte ⁷⁾	Dr. Weigert	According to manufacturer's data	–	–
Machine disinfection (thermal)	–	–	–	10 min	93 °C (199.4 °F)
Steam sterilization	–	–	–	5 min	134 °C (273.2 °F)

1) For Dräger Infinity MCable – CO₂ mainstream sensor

2) For Medical Cockpit

3) For Infinity ID neonatal expiratory valve, neonatal flow sensor, Infinity ID flow sensor

4) Not for CO₂ sensor

5) For neonatal flow sensor

6) For neonatal flow sensor, Infinity ID flow sensor

7) For reusable cuvette for the CO₂ sensor

The effectiveness of the listed reprocessing procedures has been validated by independent laboratories that certified to the standard ISO 17025.

Disinfectants

Use disinfectants that are nationally approved and are suitable for the particular reprocessing procedure.

The manufacturers of the surface disinfectants have verified at least the following spectra of activity:

- Bactericidal
- Yeastcidal
- Virucidal or virucidal against enveloped viruses

Surface disinfectants

At the time of the test, the surface disinfectants listed in the following table showed good material compatibility. They can be used in addition to the surface disinfectants listed in the section "Validated reprocessing procedures".

Observe the specifications of the surface disinfectant manufacturers.

Other surface disinfectants are used at one's own risk.

Class of active ingredient	Surface disinfectant	Manufacturer
Chlorine-releasing agents	Actichlor plus	Ecolab
	BruTab 6S	Brulin
	Clorox Professional Disinfecting Bleach Cleaner	Clorox
	Dispatch Hospital Cleaner Disinfectant Towels with Bleach	
	Klorsept 17	Medentech
Oxygen-releasing agents	Descogen Liquid	Antiseptica
	Descogen Liquid r.f.u.	
	Dismozon plus	Bode Chemie
	Dismozon pur	
	Oxycide	Ecolab USA
	Perform	Schülke & Mayr
	Virkon	DuPont
Quaternary ammonium compounds	Mikrozid sensitive liquid ¹⁾	Schülke & Mayr
	Mikrozid sensitive wipes ¹⁾	
	Mikrozid alcohol free liquid ¹⁾	
	Mikrozid alcohol free wipes ¹⁾	
	acryl-des ¹⁾	
Aldehydes	Buraton 10 F	Schülke & Mayr

1) Virucidal against enveloped viruses

Dräger states that oxygen-releasing agents and chlorine-releasing agents may cause color change in some materials. Color change does not indicate that the product is not functioning correctly.

Surface disinfection with cleaning

WARNING

Risk due to penetrating liquid

Penetrating liquid may cause the following:

- Damage to the device
- Electric shock
- Device malfunctions

Ensure that no liquid penetrates the device.

- 1 Remove soiling immediately. Use a cloth dampened with disinfectant to remove soiling.
- 2 Perform surface disinfection.
- 3 After the product has been exposed to the disinfectant for the specified contact time, remove residual disinfectant.
- 4 Wipe with a cloth dampened with water (preferably drinking-water quality). Allow the product to dry.
- 5 Check the product for visible soiling. Repeat steps 1 to 5 if necessary.
- 6 Check the product for visible damage and replace if necessary.

Manual cleaning followed by disinfection by immersion

Manual cleaning

The cleaning agent that is used must have a pH of between 9 and 12.

- 1 Wash off superficial soiling under running water.
- 2 Prepare the cleaning solution in accordance with the manufacturer's instructions.
- 3 Swirl the product backwards and forwards several times in the solution. Make sure that the solution reaches all surfaces and interior spaces.
- 4 Rinse the product under running water until residual cleaning agent is no longer discernible.
- 5 Check the product for visible soiling. Repeat steps 1 to 5 if necessary.
- 6 Check the product for visible damage and replace if necessary.

Disinfection by immersion

- 1 Prepare the disinfectant solution in accordance with the manufacturer's instructions.
- 2 Swirl the product backwards and forwards several times in the solution. Make sure that the solution reaches all surfaces and interior spaces.
- 3 After the contact time has elapsed, rinse the product under running water until residual disinfectant is no longer discernible.
- 4 Check the product for visible damage and replace if necessary.
- 5 Thoroughly shake out residual water. Allow the product to dry completely.

Machine cleaning with thermal disinfection

Use a washer-disinfector that meets the requirements of the standard ISO 15883. Dräger recommends the use of a cart for anesthesia accessories and ventilation accessories.

- 1 Securely position the product in the basket.
Ensure the following:
 - All surfaces and interior spaces can be flushed completely.
 - The water can drain off freely.
- 2 Use a suitable cleaning agent.
- 3 Select a suitable cycle.
- 4 Use demineralized water for the final rinsing.
- 5 After the cycle has ended, check the product for visible soiling. If necessary, repeat the cycle or perform manual cleaning and disinfection by immersion.
- 6 Check the product for visible damage and replace if necessary.
- 7 Allow the product to dry completely.

Steam sterilization

Use a steam sterilizer that meets the requirements of the standard ISO 17665. Dräger recommends steam sterilization with fractionated vacuum.

Prerequisite: The product has been cleaned and disinfected.

- 1 Sterilize the product.
- 2 Check the product for visible damage and replace if necessary.

Additional information

Sterilization of the expiratory valve or inspiratory valve may gradually impair the operation of RFID transmission. This may mean that Infinity ID breathing circuit functions may not work or may no longer work reliably. If the message ***Infinity ID breathing circuit detected.*** is not displayed when an Infinity ID breathing circuit is connected, then use a different Infinity ID breathing circuit. If the message is still not displayed, replace the expiratory valve or inspiratory valve.

Special reprocessing measures

Infinity ID flow sensor

Manual cleaning followed by disinfection by immersion must be carried out for complete reprocessing of the flow sensor.

Manual cleaning:

The cleaning agent that is used must have a pH of between 9 and 12.

- 1 Prepare the cleaning agent in accordance with the manufacturer's data in a container with a cover.
- 2 Place the flow sensor in the solution, ensuring there are no bubbles. Swirl the flow sensor vigorously at least 3 times at the beginning and end of the contact time. Make sure that the solution reaches all surfaces and interior spaces.
- 3 Rinse the flow sensor in the water bath (preferably drinking-water quality) until cleaning agent residues are no longer discernible.

Disinfection by immersion:

- 1 Prepare the disinfectant solution in accordance with the manufacturer's instructions.
- 2 Swirl the flow sensor backwards and forwards several times in the solution. Make sure that the solution reaches all surfaces and interior spaces.
- 3 Rinse the flow sensor in the water bath (preferably drinking-water quality) until disinfectant residues are no longer discernible.
- 4 Check the flow sensor for visible soiling and for damage to the measuring wires and their pegs.
- 5 Thoroughly shake out residual water. Allow the flow sensor to dry completely.

Sterilization:

CAUTION

Risk of patient injury due to failure of the flow measurement.

Sterilization can damage the flow sensor. Do not sterilize the flow sensor.

Infinity ID neonatal expiratory valve

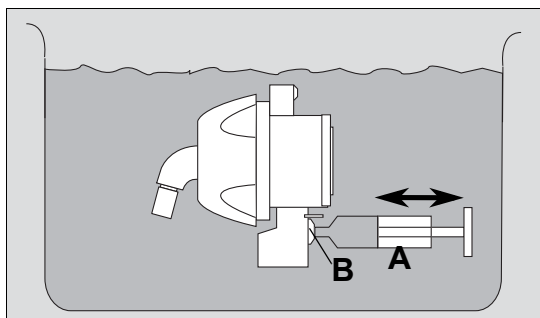

Carry out manual cleaning:

- 1 Immerse the neonatal expiratory valve in the solution and agitate it slightly so that the air can escape.
- 2 Before the contact time begins and after it has elapsed, fit a syringe (A) containing 20 mL of solution to the ejector channel (B). Inject and extract the solution several times with the syringe.

Perform manual disinfection in the same manner.

Neonatal flow sensors

Manual cleaning followed by disinfection by immersion must be carried out for complete reprocessing of the flow sensor.

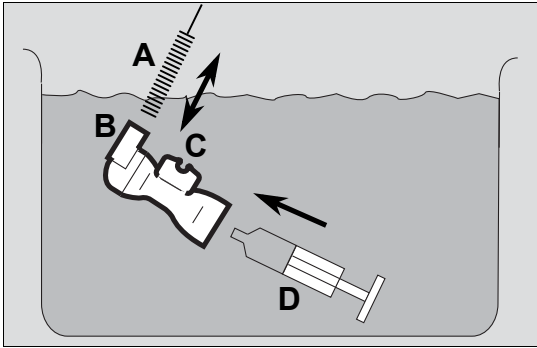

NOTE

- Do not use brushes for reprocessing the sensor insert and do not use a syringe on the sensor insert.
- For reprocessing the housing use lint-free brushes only.

Manual cleaning:

The cleaning agent that is used must have a pH of between 9 and 12.

- 1 Prepare the cleaning agent in accordance with the manufacturer's data in a container with a cover.
- 2 Place the housing and sensor insert in the solution, ensuring there are no bubbles. Swirl the parts back and forth for approx. 1 minute at the beginning and end of the contact time. Make sure that the solution reaches all surfaces and interior spaces.
- 3 At the beginning and end of the contact time, spray through each opening in the housing 3 times using a 20 mL syringe (D).

- Clean the housing and the Y-piece (B) with a lint-free brush (A). Insert and remove it vertically ten times in each of the two connection openings of the Y-piece (B) and then, at an angle, insert and remove it ten times in both corners of the opening for the sensor insert (C).

- 4 Rinse the housing and sensor inset in a water bath (at least drinking-water quality) until cleaning agent residues are no longer discernible.

Disinfection by immersion:

- 1 Prepare the disinfectant solution in accordance with the manufacturer's data in a container with a cover.

- 2 Place the housing and sensor insert in the solution, ensuring there are no bubbles. Swirl the parts back and forth for approx. 1 minute at the beginning and end of the contact time. Make sure that the solution reaches all surfaces and interior spaces.

- 3 At the beginning and end of the contact time, spray through each opening in the housing 3 times using a 20 mL syringe (D).

- Clean the housing and the Y-piece (B) with a lint-free brush (A): Insert and remove it vertically ten times in each of the two connection openings of the Y-piece (B) and then, at an angle, insert and remove it ten times in both corners of the opening for the sensor insert (C).

- 4 Rinse the housing and sensor inset in a water bath (at least drinking-water quality) until disinfectant residues are no longer discernible.

- 5 Check parts for visible soiling or damage. Check the sensor insert for damage to the measuring wires and their pegs.

- 6 Thoroughly shake out residual water. Allow the parts to dry completely.

Machine cleaning with thermal disinfection:

CAUTION

Only carry out machine cleaning and disinfection on the housing.

Sterilization:

Only sterilize the flow sensor when it is assembled.

CAUTION

Risk of patient injury due to failure of the flow measurement.

Improper sterilization may damage the flow sensor. Only use the specified sterilization procedures.

After reprocessing

Assembling the components

Assembling expiratory valve

- 1 Make sure all parts of the expiratory valve are completely dry, otherwise this may impair proper functioning.

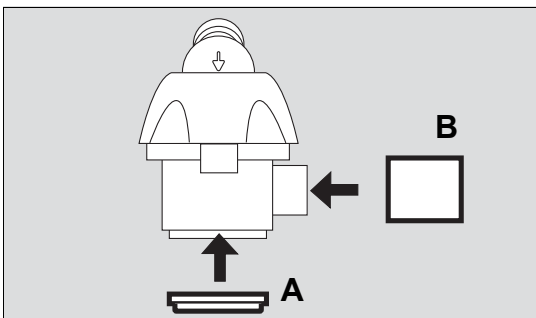

- 2 Fit the flow sensor sleeve (B) on the Infinity ID expiratory valve or fit the muffler (B) on the Infinity ID neonatal expiratory valve.
- 3 Fit the diaphragm (A) onto the edge of the expiratory valve housing.

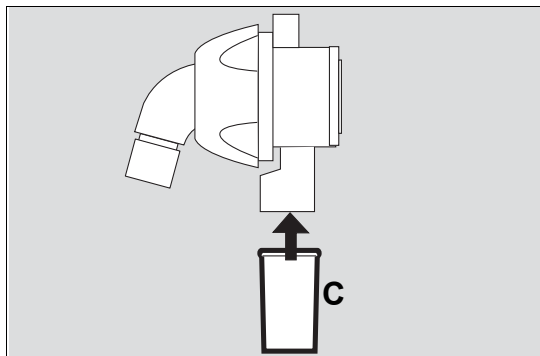

- 4 Fit the water trap container (C).

Inserting the expiratory valve into Evita V500

Only the Infinity ID expiratory valve is described in the following section. The neonatal expiratory valve is inserted in the same way.

Prerequisite: The flap on the front is pivoted upwards.

- 1 Turn the locking ring (D) as far as possible to the left.
- 2 Push the expiratory valve into the fitting.

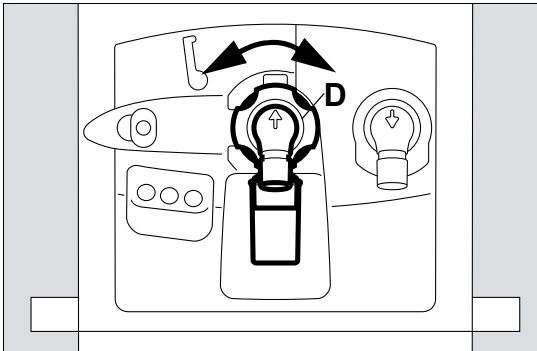

- 3 Turn the locking ring (D) as far as it will go to the right until it clicks audibly into place.
- 4 Check that it is properly secured by gently pulling on the expiratory valve.
- 5 Close the flap.

Further information on the expiratory valve:

The expiratory valve can be reused as long as the test point in the device check is passed. Exchange the expiratory valve if signs of wear become visible, such as cracks in the plastic parts, deformation and hardening of the rubber parts. Discolorations of the metal insert do not impair its function.

Assembling the inspiratory unit

- 1 Make sure the inspiratory unit and diaphragm are completely dry, otherwise this may impair proper functioning.

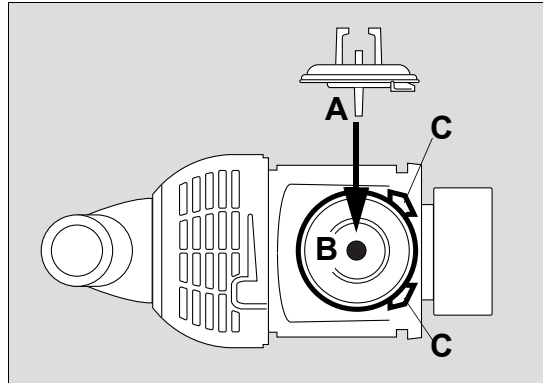

- 2 Insert the adapter (A) of the diaphragm into the opening of the fitting (B). The adapter must be able to slightly move up and down in the opening.
- 3 Position the diaphragm in such a way that it is in the recesses (C) of the fitting.

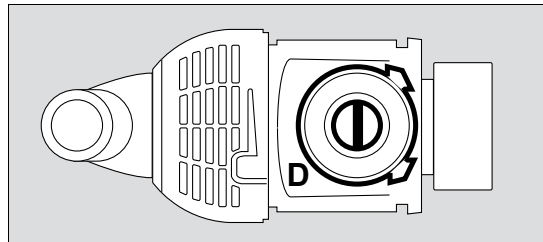

- 4 Fit the diaphragm onto the edge of the fitting (D).

Inserting the inspiratory unit into Evita V500

- 1 Insert the inspiratory unit (E) into the recesses of the fitting and push as far as it will go into the fitting.

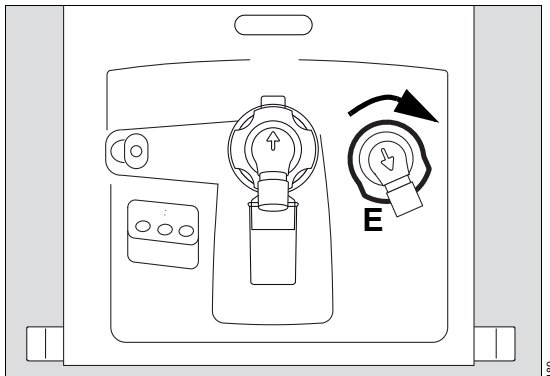

- 2 Turn the inspiratory unit in clockwise direction until the lock clicks into place.
- 3 Check whether the inspiratory unit is properly engaged.

Assembling accessories

Assemble the medication nebulizer and breathing gas humidifier in accordance with the corresponding instructions for use.

- Fit the medication nebulizer into the breathing circuit, see page 113.
- Prepare the breathing gas humidifier, see page 57.

Preparations before reuse

- 1 Assemble and prepare the device so that it is ready for use, see chapter "Assembly and preparation".
- 2 Check the operational readiness, see chapter "Getting started".

This page has been left blank intentionally.

Maintenance

Overview	264
Definition of maintenance concepts	264
Inspection	265
Safety checks	265
Remote Service	265
Preventive maintenance	266
Repair	266
Replacing the ambient air filter	267
Replacing the diaphragm of the expiratory valve	267
Replacing the expiratory valve	268
Preventive maintenance on the GS500 gas supply unit	268
Replacing the breathing gas filter in the blower unit	268
Replacing the filter mat	269
Battery maintenance	270
Information on battery maintenance	270
Battery check	270
Battery check page	272

Overview

This chapter describes all maintenance steps necessary to maintain the proper functioning of the device. These measures must be performed by the personnel responsible.

Only perform maintenance work when no patient is connected to the device.

CAUTION

Disinfect and clean device or device parts before any maintenance measures and also before returning the medical device for repair.

WARNING

Risk of electric shock

Current-carrying components are located under the cover. Do not remove the cover. Maintenance work must be performed by service personnel or by experts. Dräger recommends DrägerService to perform these tasks.

Definition of maintenance concepts

Concept	Definition
Maintenance	Appropriate measures intended to retain the specified condition of a medical device
Inspection	Measures intended to determine and assess the actual state of a medical device
Preventive maintenance	Repeated indicated measures intended to retain the specified condition of a medical device
Repair	Measures intended to restore the functional condition of a medical device after the failure of a device function

Inspection

Inspections must be carried out regularly according to the following specifications and in the specified intervals.

Checks	Interval	Personnel responsible
Inspection and safety checks ¹⁾	Every 12 months	Service personnel

1) Designation applies to the Federal Republic of Germany; corresponds to the "Recurring safety inspection" in the Republic of Austria

Safety checks

The safety checks are no substitute for the preventive maintenance measures (including preventive replacement of wear parts) indicated by the manufacturer.

CAUTION

Perform safety checks at the indicated intervals. Otherwise, the correct functioning of the medical device can be impaired.

- 1 Check accompanying documents:
 - Instructions for use are available.
- 2 Perform a functional test of the following features:
 - Perform a device check and a breathing circuit check according to the instructions for use.
 - Perform a functional test of the airway pressure measurement.
 - Perform a functional test of the flow measurement.
 - Perform a functional test of the batteries (Evita V500 or PS500).
- 3 Verify that the device combination is in good condition:
 - Labels complete and legible.
 - No visible damage.
 - Fuses which are accessible from the outside are in compliance with the specified values.
- 4 Check that the equipment of the medical device is complete according to the instructions for use.
- 5 Check the electrical safety according to IEC 62353.
- 6 Check safety features:
 - Correct functioning of the emergency expiratory valve: Pressure rise 1.9 to 4.4 mbar (1.9 to 4.4 cmH₂O) at a flow of 4.5 to 5.5 L/min.
 - Correct functioning of the non-return valve in the expiratory valve.
 - Correct functioning of the emergency breathing valve: Maximum pressure drop of 4 mbar (4 cmH₂O) at a suction flow of 60 to 65 L/min.
 - Correct functioning of the alarm generator
 - Correct functioning of the non-return valves in the gas inlet for O₂ and Air

Remote Service

From software release SW 2.20, Evita V500 supports the following Remote Service functionalities:

- Help Ticket
- Remote Device Check

Contact the responsible DrägerService representative for further information on the Remote Service function.

Preventive maintenance

WARNING

Risk due to defective components

Device failure is possible due to wear or material fatigue of the components. To maintain the function of all components, this device must be inspected and serviced at the intervals specified by the manufacturer.

Maintenance intervals

Component	Interval	Measure	Personnel responsible
Ambient air filter	Every 4 weeks	Cleaning, replace if necessary, see page 267	User
	Every 12 months	Replace, see page 267	User
Diaphragm of the expiratory valve	Every 12 months	Replace, see page 267	User
Expiratory valve	Every 2 years	Replace, see page 268	User
GS500: Breathing gas filter in the blower unit	Every 12 months	Replace, see page 268	Service personnel
GS500: Filter mat	Every 12 months	Replace, see page 268	Service personnel
Batteries	Every 3 months	Check capacity, see page 270	Service personnel
		Replace if necessary	Experts
	Every 2 years	Replace	Experts
Air filter (in the Air gas inlet)	Every 2 years	Replace	Experts
O ₂ filter (in the O ₂ gas inlet)	Every 6 years	Replace	Experts

Repair

Dräger recommends that all repairs are carried out by DrägerService and that only original Dräger parts are used.

Replacing the ambient air filter

CAUTION

Replace the ambient air filter at regular intervals. Otherwise operation of the device may be impaired.

Visually inspect the ambient air filter for contamination after 4 weeks; clean or replace if necessary. Replace after 12 months at the latest.

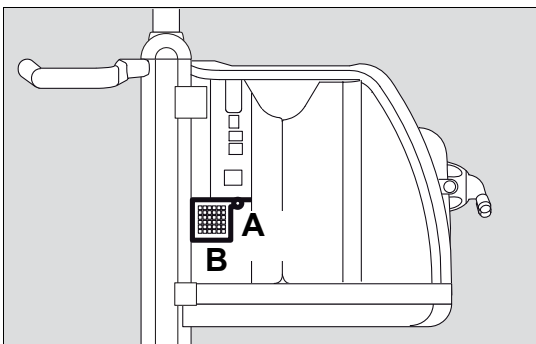

- 1 Unscrew the screw (A) on the cover of the ambient air filter.
- 2 Open the cover (B).
- 3 Remove the filter from the mount.
- 4 Fit a new filter or clean the old filter in warm soapy water and dry thoroughly.
- 5 Insert the filter into the mount without creasing.
- 6 Close the cover (B) and retighten the screw (A).
- 7 Dispose of used filter with domestic waste.

Replacing the diaphragm of the expiratory valve

Prerequisite: The expiratory valve has been removed, see "Removing the expiratory valve" on page 245.

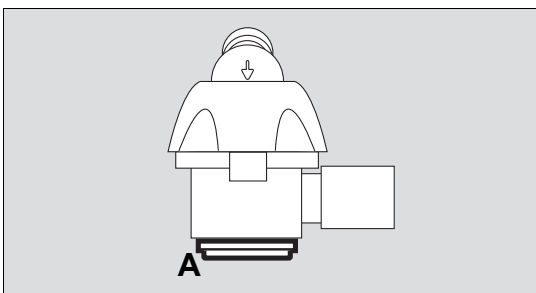

- 1 Remove the diaphragm (A).
- 2 Fit the new diaphragm onto the edge of the expiratory valve housing. Make sure that the diaphragm is fitted properly.
- 3 Dispose of used diaphragm with domestic waste.
- 4 Fit the expiratory valve, see "Inserting the expiratory valve into the ventilation unit" on page 54.

Replacing the expiratory valve

- 1 Remove the expiratory valve, see page 245.
Dispose of the expiratory valve in accordance with local waste disposal regulations.
- 2 Fit the expiratory valve, see page 259.
- 3 Insert the expiratory valve into the ventilation unit, see page 260.

Preventive maintenance on the GS500 gas supply unit

Replacing the breathing gas filter in the blower unit

The breathing gas filter is located behind the left-hand side panel of the GS500 gas supply unit.

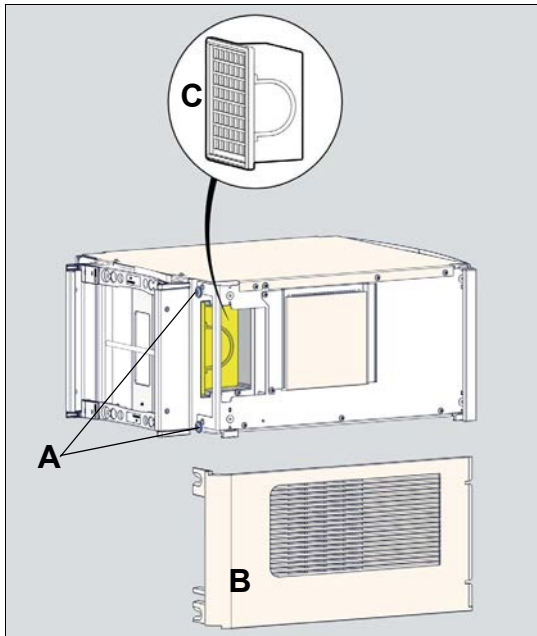

- 1 Loosen the screws on the rear of the device sufficiently for the side panel to be removed. Remove the side panel. Ensure that the filter mat attached to the side section is not loosened.
- 2 Take hold of the breathing gas filter by the handle and withdraw it from the GS500 gas supply unit. Dispose of the used breathing gas filter in accordance with local waste disposal regulations.
- 3 Fit the new breathing gas filter. Insert it into the GS500 gas supply unit until it reaches the end stop.
- 4 Fit the side panel and tighten the screws.

Replacing the filter mat

The filter mat is fastened to the inside of the left-hand side panel of the GS500 gas supply unit.

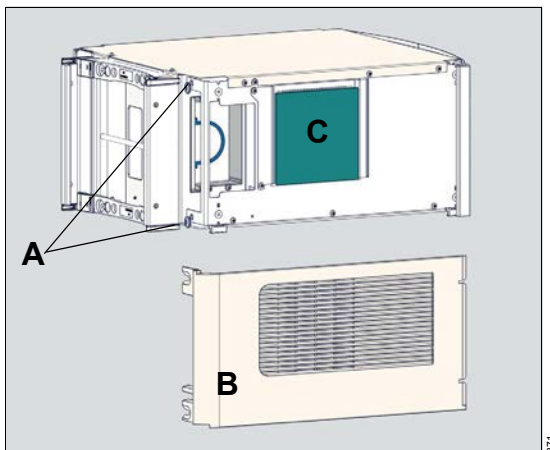

- 1 Loosen the screws on the rear of the device sufficiently for the side panel to be removed. Remove the side panel.
- 2 Remove the filter mat and dispose of it in accordance with local waste disposal regulations.
- 3 Fit the new filter mat with its side to the boundary. Carefully press the filter mat on to the pointed retaining elements. Check that the filter mat is secured.
- 4 Fit the side panel and tighten the screws.

Battery maintenance

Information on battery maintenance

The following actions are required to achieve the maximum life span of the batteries:

- Always fully charge the batteries.
- Connect the device to the mains power supply at the latest after 5 days to charge the batteries. Observe the required charging time.

If recharging is not possible after 5 days at the latest, do the following:

- Set the toggle switch to the  position and then disconnect the power plug.

The device is then in the energy-saving mode and the discharge is reduced to the self-discharge of the batteries. Check that the capacity of the batteries is sufficient before use on a patient. The batteries may be exhausted or faulty as a result of excessively long storage.

Batteries are wear parts. The replacement intervals depend on the utilization. Observe the test intervals.

Storage at an increased ambient temperature reduces the life span of the batteries. The storage duration must not be exceeded. See "Ambient conditions" on page 278.

The capacity of the batteries used must be checked regularly.

The batteries must have sufficient capacity. Replace the batteries if necessary.

Battery check

A battery check is required at regular intervals to determine the current state of the batteries. The battery check determines the approximate operating time.

The battery check consists of a charge-discharge cycle. After the batteries have been fully charged, the device is operated in test mode with power supply from the batteries. The determined operating time is the approximate operating time to be expected in the next period of battery operation with typical ventilation without GS500.

Dräger recommends the following test intervals:

Internal battery (NiMH)	Every 3 months
PS500 power supply unit (VRLA)	Every 3 months

Prerequisites for the battery check

- The device is connected to the central gas supply.
- The device is connected to the mains power supply.
- The device is prepared and ready for use.
- The test lung is connected.
- A ventilation pattern is set, e.g.:
 - PC-AC
 - $FI_{O_2} = 21\%$
 - $RR = 12/\text{min}$
 - $P_{\text{insp}} = 20 \text{ mbar}$ (or hPa or cmH₂O)
 - $PEEP = 5 \text{ mbar}$ (or hPa or cmH₂O)

The following table shows the typical operating time to be expected as a function of the ageing of a new battery.

If the batteries do not correspond to the approximate operating time listed, replacement of the batteries is recommended.

Age of the battery	Operating time of the internal battery (NiMH) with a full charge	Operating time of PS500 (VRLA) with a full charge
3 months	29 min	225 min
6 months	28 min	210 min
9 months	27 min	195 min
12 months	26 min	180 min
15 months	25 min	165 min
18 months	24 min	150 min
21 months	23 min	135 min
24 months	22 min	120 min

NOTE

The operating time may be reduced due to the utilization of the battery. The data are approximate values and cannot be regarded as guaranteed for every battery.

NOTE

Replace the batteries if the operating time falls below the minimum value (see chapter "Battery ageing" on page 359) or after 24 months.

Battery check page

Prerequisite: The **Start/Standby > System check** (A) dialog window is opened.

1 Touch the **Battery check** tab (B).

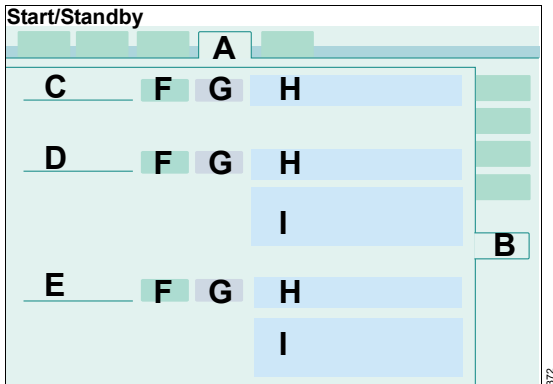

The **Battery check** page contains the following:

- Battery check complete (C)
- Battery check PS500 (D)
- Battery check internal battery (E)

Information displayed in the (I) field for each battery:

- Date of the last battery check
- Determined operating time (value determined in the battery check during typical ventilation without GS500). See chapter "Battery check" on page 270.
- Next battery check due in xx days
- Battery replacement in xx months
- Current operating time
This value is indicated to the nearest 5 or 10 minutes depending on the battery used and based on the present power consumption of the device.

Starting the battery check

The battery check can only be started if the device is connected to the mains power supply.

- Touch the **Start** button (F) and confirm. The appropriate battery check will be started. The result of the battery check is displayed after completion.

The duration of the battery check is decremented in hours and displayed in field (H).

If a battery check fails, the device will cancel the check. The canceled check is shown as a colorless dot.

Canceling the battery check

- Touch the **Cancel** button (G) and confirm. The appropriate battery check will be canceled. The canceled check is shown as a colorless dot.

Disposal

- Safety information on disposal 274**
- Disposal of packaging material 274**
- Disposal of batteries 275**
- Disposal of flow sensor and neonatal
flow sensor 275**
- Disposal of medical devices 275**

Safety information on disposal

CAUTION

The device and its components must be disinfected and cleaned before disposal!

For countries subject to EU Directive 2002/96/EC

This device is subject to EU Directive 2002/96/EC (WEEE).

In order to comply with its registration according to this directive, this device may not be disposed of at municipal collection points for waste electrical equipment. Dräger has authorized a company to collect and dispose of this device. To initiate collection or for further information, visit Dräger on the Internet at www.draeger.com. Use the Search function with the keyword "WEEE" to find the relevant information. If access to the Dräger website is not possible, contact the local Dräger organization.

Disposal of packaging material

Dispose of the packaging material of the device and the accessories listed in the list of accessories in accordance with the applicable laws and regulations.

Disposal of batteries

The medical device contains batteries with toxic substances.

In the Federal Republic of Germany: The user is obliged by the ordinance on the return and disposal of used batteries to return batteries which contain toxic substances either to the manufacturer/sales outlet or to a collection center operated by public

waste disposal corporations. The battery installed in the device must therefore be removed by experts before the device can be disposed of.

Observe the applicable laws and regulations for battery disposal.

Disposal of flow sensor and neonatal flow sensor

The flow sensor must be disposed of as infectious waste. Low-emission combustion at over 800 °C (1472 °F).

Disposal of medical devices

At the end of its service life:

- Consult the relevant waste disposal company for appropriate disposal.
- Observe the applicable laws and regulations.

This page has been left blank intentionally.

Technical data

Ambient conditions	278
Set values	279
Performance characteristics	283
Displayed measured values	286
Displayed calculated values	291
Monitoring	292
Operating data	296
Device ports	301
Automatic alarm limits	302
Essential performance characteristics	305
Connections to IT networks	306
Information on connecting to the network.	306
Open-source software	307

Ambient conditions

During operation

Temperature	10 to 40 °C (50 to 104 °F)
Pressure range	700 to 1060 hPa
Altitude	up to 3000 m (9842 ft)
Relative humidity	10 to 90 %, non-condensing

During storage and transportation

Pressure range	500 to 1060 hPa
Relative humidity	5 to 95 %, non-condensing
Temperature	

The technical specifications of the battery manufacturer regarding storage duration refer to a relative humidity of 45 to 85 %. Storage outside this range is possible. In this case, perform a battery test before using the device. Charging every 6 months at the latest is recommended. Several charge and discharge cycles may be required as a battery test in order to completely reactivate the electrochemical composition after long term storage.

Device without PS500 batteries for charging subsequent to storage

For storage up to 6 months	-20 to <45 °C (-4 to <113 °F)
For storage up to 1 month	-20 to <55 °C (-4 to <131 °F)
For storage up to 1 week	-20 to 60 °C (-4 to 140 °F)

Device with PS500 batteries for charging subsequent to storage

For storage up to 6 months	-15 to 25 °C (5 to 77 °F)
For storage up to 3 months	-15 to 40 °C (5 to 104 °F)

Depending on the accessories used, more stringent ambient conditions can apply. Observe corresponding instructions for use.

Set values

The desired parameters can be set without loss of accuracy using the therapy controls. The controlled parameters – pressure, Flow, volume, and O₂ concentration – can only be applied with the accuracy of the associated measured values.

The accuracies indicated apply only under the following conditions:

- The device is ready for operation, see chapter "Getting started".
- Any accessories being used are approved for the device, see the list of accessories.
- The type of humidification is selected correctly in the **Start/Standby > Br. circuit/ Humidifier** dialog window.

The tolerances do not include the measurement uncertainty of external test equipment. This information is available on request.

Respiratory rate	RR
Adults	0.5 to 98/min
Pediatric patients	0.5 to 150/min
Neonates	0.5 to 150/min
Inspiratory time	Ti
Adults	0.11 to 10 s
Pediatric patients	0.1 to 10 s
Neonates	0.1 to 10 s
Maximum inspiratory time for flow cycled breaths	Timax
Adults	0.1 to 4 s
Pediatric patients	0.1 to 4 s
Neonates	0.1 to 1.5 s
Tidal volume	VT
Adults	100 to 3000 mL
Pediatric patients	20 to 300 mL
Neonates	2 to 100 mL
Tidal volume for pressure support	VT
Adults	100 to 3000 mL
Pediatric patients	20 to 300 mL
Neonates	2 to 100 mL
Activation state of Apnea Ventilation	On, off

Set values (cont.)

Status of the function Automatic return from Apnea Ventilation	On, off
Tidal volume during Apnea Ventilation	VTapn
Adults	100 to 3000 mL
Pediatric patients	20 to 300 mL
Neonates	2 to 100 mL
Respiratory rate during Apnea Ventilation	RRapn
Adults	2 to 80/min
Pediatric patients	2 to 150/min
Neonates	2 to 150/min
Inspiratory flow	Flow
Adults	2 to 120 L/min
Pediatric patients	2 to 30 L/min
Maximum inspiratory flow in NIV mode for neonates Flow max	0 to 30 L/min
Inspiratory pressure Pinsp	1 to 95 mbar (or hPa or cmH ₂ O)
Inspiratory pressure limit Pmax	2 to 100 mbar (or hPa or cmH ₂ O)
O ₂ concentration FiO₂	21 to 100 Vol%
T0...90	Test conditions in accordance with ISO 80601-2-12:2011, Sec. 201.12.1.104
Time until the adjusted O ₂ value reaches the patient connection	taking account of the airway-conducting accessories with the greatest internal volume; with flow monitoring switched on
Adults	<36 s, for a VT of 500 mL <50 s, for a VT of 150 mL
Pediatric patients	For a VT of 150 mL: <25 s, with Neo flow monitoring <45 s, with expiratory flow monitoring; For VT of 30 mL: <35 s, with Neo flow monitoring <65 s, with expiratory flow monitoring
Neonates	<18 s
Positive end-expiratory pressure PEEP	0 to 50 mbar (or hPa or cmH ₂ O)
Trigger sensitivity Flow trigger	0.2 to 15 L/min
Pressure support Psupp	0 to 95 mbar (or hPa or cmH ₂ O)

Set values (cont.)

Rise time for pressure support	Slope
Adults	0 to 2 s
Pediatric patients	0 to 2 s
Neonates	0 to 1.5 s
Termination criterion (peak inspiratory flow)	5 to 70 %PIF
Insp. term.	
Airway Pressure Release Ventilation	APRV
Inspiratory time T_{high}	0.1 to 30 s
Expiratory time T_{low}	0.05 to 30 s
Maximum time of low pressure level in APRV/PEF T_{low max}	0.05 to 30 s
Inspiratory pressure P_{high}	1 to 95 mbar (or hPa or cmH ₂ O)
Expiratory pressure P_{low}	0 to 50 mbar (or hPa or cmH ₂ O)
Termination criterion (peak expiratory flow)	1 to 80 %PEF
Exp. term.	
Automatic Tube Compensation	ATC
Inner diameter of the tube	Tube Ø
Endotracheal tube	ET
Adults	5 to 12 mm (0.2 to 0.47 in)
Pediatric patients	2 to 8 mm (0.08 to 0.31 in)
Neonates	2 to 5 mm (0.08 to 0.2 in)
Tracheostomy tube	Trach.
Adults	5 to 12 mm (0.2 to 0.47 in)
Pediatric patients	2.5 to 8 mm (0.1 to 0.31 in)
Degree of tube compensation Compens.	0 to 100 %
Status of ATC during mandatory inspiration	On/Off
Inspiratory compensation	
Status of ATC during the expiratory phase	On/Off
Expiratory compensation	

Set values (cont.)

Proportional Pressure Support	PPS
Flow Assist Flow Assist	
Adults	0 to 30 mbar/L/s (or hPa/L/s or cmH ₂ O/L/s)
Pediatric patients	0 to 100 mbar/L/s (or hPa/L/s or cmH ₂ O/L/s)
Neonates	0 to 300 mbar/L/s (or hPa/L/s or cmH ₂ O/L/s)
Volume Assist Vol. Assist	
Adults	0 to 100 mbar/L (or hPa/L or cmH ₂ O/L)
corresponds to compliance compensation	10000 to 10 mL/mbar (or mL/hPa or mL/cmH ₂ O)
Pediatric patients	0 to 1000 mbar/L (or hPa/L or cmH ₂ O/L)
corresponds to compliance compensation	10000 to 1 mL/mbar (or mL/hPa or mL/cmH ₂ O)
Neonates	0 to 4000 mbar/L (or hPa/L or cmH ₂ O/L)
corresponds to compliance compensation	1000 to 0.3 mL/mbar (or mL/hPa or mL/cmH ₂ O)
O ₂ Therapy	
Continuous Flow Flow (BTPS)	2 to 50 L/min
O ₂ concentration FiO₂	21 to 100 Vol%
Variable PS	
Status	On/Off
Pressure variability	0 to 100 %
Leakage compensation	On/Off
	On: full compensation active
	Off: only trigger compensation active
Maneuver settings	
Initial pressure during Low-Flow PV loop maneuver Pstart	0 to 50 mbar (or hPa or cmH ₂ O)
Pressure limitation during Low-Flow PV loop maneuver Plimit	1 to 80 mbar (or hPa or cmH ₂ O)
Volume limitation during Low-Flow PV loop maneuver	Vlimit
Adults	100 to 3000 mL
Pediatric patients	20 to 300 mL
Neonates	2 to 100 mL
Flow during Low-Flow PV loop maneuver	Low Flow
Adults	2 to 15 L/min
Pediatric patients	2 to 10 L/min

Set values (cont.)

Pressure drop during Low-Flow PV loop maneuver if "inspiration only" has been selected	1 to 6 mbar/s (or hPa/s or cmH ₂ O/s)
Sigh pressure Δ <i>intPEEP</i>	0 to 20 mbar (or hPa or cmH ₂ O)
Time interval between sighs <i>Interval sigh</i>	20 s to 180 min
Number of cycles for a sigh <i>Cycles sigh</i>	1 to 20 exhalations
Oxygen enrichment for suction maneuver	
Factor for neonates	1 to 2
Factor for pediatric patients	1 to 2

Performance characteristics

Control principle	time-cycled, volume-constant, pressure-controlled
Intermittent PEEP duration	1 to 20 expiratory cycles
Medication nebulization	For 5, 10, 15, 30 minutes, continuously (∞)
Endotracheal suction	
Disconnection detection	automatic
Reconnection detection	automatic
Initial oxygen enrichment	max. 3 minutes
Active suction phase	max. 2 minutes
Final oxygen enrichment	max. 2 minutes
Supply system for spontaneous breathing and P _{supp}	adaptive CPAP system with high initial flow
Inspiratory flow (BTPS)	max 180 L/min
Base flow, neonates	6 L/min
Base flow, neonates, with active pneumatic nebulization	9 L/min
Base flow, pediatric patients	3 L/min
Base flow, pediatric patients, with active pneumatic nebulization	9 L/min
Base flow, adults	2 L/min

In a combination of proximal flow sensor with filters, HME, Ergostar and CO₂ cuvette, the airway resistance of the system can be more than 6 mbar (or hPa or cmH₂O) if there is a failure of the device and a Flow of 15 L/min.

Performance characteristics (cont.)

Inspiratory resistance on device failure

Adults, maximum value	<6 mbar at 30 L/min <6 hPa at 30 L/min <6 cmH ₂ O at 30 L/min
Pediatric patients, maximum value	<6 mbar at 15 L/min <6 hPa at 15 L/min <6 cmH ₂ O at 15 L/min
Neonates, maximum value	<1.5 mbar at 2.5 L/min <1.5 hPa at 2.5 L/min <1.5 cmH ₂ O at 2.5 L/min

Expiratory resistance on device failure

Adults, maximum value	<5.5 mbar at 30 L/min <5.5 hPa at 30 L/min <5.5 cmH ₂ O at 30 L/min
Pediatric patients, maximum value	<6.0 mbar at 15 L/min <6.0 hPa at 15 L/min <6.0 cmH ₂ O at 15 L/min
Neonates, maximum value	<1.0 mbar at 2.5 L/min <1.0 hPa at 2.5 L/min <1.0 cmH ₂ O at 2.5 L/min

Accuracy of measured values

Depending on the patient category, the accuracies indicated for the measured values apply to the following performance characteristics of the breathing circuit.

Breathing circuit for adults including additional components

Compliance	≤3.0 mL/mbar (or mL/hPa or mL/cmH ₂ O)
Inspiratory resistance	<6 mbar at 30 L/min <6 hPa at 30 L/min <6 cmH ₂ O at 30 L/min
Expiratory resistance	<6 mbar at 30 L/min <6 hPa at 30 L/min <6 cmH ₂ O at 30 L/min

Performance characteristics (cont.)

Breathing circuit for pediatric patients including additional components	
Compliance	≤3.0 mL/mbar (or mL/hPa or mL/cmH ₂ O)
Inspiratory resistance	<6 mbar at 15 L/min <6 hPa at 15 L/min <6 cmH ₂ O at 15 L/min
Expiratory resistance	<6 mbar at 15 L/min <6 hPa at 15 L/min <6 cmH ₂ O at 15 L/min
Breathing circuit for neonates including additional components	
Compliance	≤1.5 mL/mbar (or mL/hPa or mL/cmH ₂ O)
Inspiratory resistance	<1.5 mbar at 2.5 L/min <1.5 hPa at 2.5 L/min <1.5 cmH ₂ O at 2.5 L/min
Expiratory resistance	<1.0 mbar at 2.5 L/min <1.0 hPa at 2.5 L/min <1.0 cmH ₂ O at 2.5 L/min
Compliance of device incl. breathing circuit	
Adults, maximum value	<3.0 mL/mbar <3.0 mL/hPa <3.0 mL/cmH ₂ O
Neonates, maximum value	<1.3 mL/mbar <1.3 mL/hPa <1.3 mL/cmH ₂ O
Additional functions	
Safety valve	Opens if medical compressed air supply fails (supply gas flow is not sufficient to provide the inspiratory flow required), enables spontaneous breathing with ambient air.

Displayed measured values

Accuracy does only apply for the measurement range specified.

Airway pressure measurement

Plateau pressure	<i>Pplat</i>
Positive end-expiratory pressure	<i>PEEP</i>
Peak Inspiratory Pressure	<i>PIP</i>
Mean airway pressure	<i>Pmean</i>
Minimum airway pressure	<i>Pmin</i>
Lower pressure level in APRV	<i>Plow</i>
End-inspiratory pressure for mandatory breaths	<i>EIP</i>
Upper pressure level in APRV	<i>Phigh</i>
Intrinsic PEEP (determined via PEEPi maneuver)	<i>PEEPi</i>
Range	within the setting range of 0 to a maximum of 95 mbar (or hPa or cmH ₂ O) (within the maximum sensor measuring range of –60 to 120 mbar (or hPa or cmH ₂ O))
Accuracy	In phases without flow: ±6 % of measured value or ±0.5 mbar (or hPa or cmH ₂ O), whichever is greater otherwise: ±2 mbar (or hPa or cmH ₂ O)
T0...90 (for Pmean)	33 s for intubated adults, 20 s for adults with NIV, 20 s for pediatric patients, 10 s for neonates

O₂ measurement (inspiratory side)

Inspiratory O ₂ concentration (in dry air)	<i>FiO₂</i>
Range	18 to 100 Vol%
Accuracy	±3 Vol% at 20 °C (68 °F)
Drift of measurement accuracy	0.2 Vol% in 6 hours (corresponding to ISO 21647, ISO 80601-2-55).
The measured values of the O ₂ measurement are barometrically pressure compensated.	
Rise time T0...90	500 ms
Warm-up time	max. 3 minutes, typ. 1 minute

Displayed measured values (cont.)

Flow measurement (expiratory)

Minute volume measurement

Expiratory minute volume	MVe
Inspiratory minute volume	MVi
Mandatory expiratory minute volume	MVemand
Spontaneous expiratory minute volume	MVespon
Minute volume, leakage-compensated	MV
Range	0 to 99 L/min BTPS
Accuracy	±10 % of the measured value, if the measured expiratory tidal volume is greater than 100 mL, under calibration conditions (1013 mbar (1013 cmH ₂ O), dry gas, 20 °C (68 °F)), 5 % CO ₂ , with the flow sensor flap closed and no leakage

T0...90

Adults	33 s
Pediatric patients	33 s

Tidal volume measurement

Tidal volume

Inspiratory tidal volume (not leakage-compensated) of mandatory breaths	VTimand
Expiratory tidal volume (not leakage-compensated) of mandatory breaths	VTemand
Inspiratory tidal volume (not leakage-compensated) of spontaneous breaths	VTispon
Range	0 to 5500 mL, BTPS
Accuracy	±10 % of the measured value or ±10 mL, whichever is greater, under calibration conditions (1013 mbar (1013 cmH ₂ O), dry gas, 20 °C (68 °F)), 5 % CO ₂ , with the flow sensor flap closed and no leakage

Displayed measured values (cont.)

Volume trapped in the lungs (determined by the PEEPi maneuver)	Vtrap
Range	0 to 1500 mL, BTPS
Accuracy	±12 % of the measured value or ±12 mL, whichever is greater, under calibration conditions (1013 mbar (1013 cmH ₂ O), dry gas, 20 °C (68 °F)), 5 % CO ₂ , with the flow sensor flap closed and no leakage
Flow measurement (proximal)	
Minute volume measurement	
Expiratory minute volume	MVe
Inspiratory minute volume	MVi
Mandatory expiratory minute volume	MVemand
Spontaneous expiratory minute volume	MVespon
Minute volume, leakage-compensated	MV
Range	0 to 30 L/min BTPS
Accuracy	Measured with neonatal flow sensor: ±10 % of measured value or ±0.6 mL * (RR + 2), whichever is greater under calibration conditions during device check (at 1013 mbar (1013 cmH ₂ O), gas with 50 % rel. humidity, 23 °C (73.4 °F)), no leakage and using a Dräger Y-piece
T0...90	
Pediatric patients	33 s
Neonates	20 s
Tidal volume measurement	
Tidal volume	VT
Inspiratory tidal volume (not leakage-compensated) of mandatory breaths	VTimand
Expiratory tidal volume (not leakage-compensated) of mandatory breaths	VTemand
Inspiratory tidal volume (not leakage-compensated) of spontaneous breaths	VTispon

Displayed measured values (cont.)

Volume trapped in the lungs (determined by the PEEPi maneuver)	Vtrap
Range	0 to 1000 mL, BTPS
Accuracy	Measured with neonatal flow sensor: ±10 % of measured value or ±0.6 mL, whichever is greater, under calibration conditions during device check (at 1013 mbar (1013 cmH ₂ O), gas with 50 % rel. humidity, 23 °C (73.4 °F)), no leakage and using a Dräger Y-piece
Respiratory rate measurement	
Respiratory rate	RR
Mandatory respiratory rate	RRmand
Portion of mandatory triggered breaths	RRtrig
Spontaneous respiratory rate	RRspon
Range	0 to 300/min
Accuracy	±1/min for respiratory rates ≥2/min and ±2/min for respiratory rates <2/min
T0...90	33 s
Effective inspiratory time during spontaneous breathing Tispon	0 to 20 s
Effective expiratory time, only if additional AutoRelease setting is active Tlow	0 to 20 s
Inspiratory time to expiratory time ratio for mandatory ventilation I:E	1:300 to 600:1
Inspiratory time to expiratory time ratio for spontaneous breathing I:Espon	1:300 to 600:1
CO ₂ measurement in mainstream	
End-expiratory CO ₂ concentration	etCO₂
Range	0 to 100 mmHg or 0 to 13.2 Vol% (at 1013 mbar (1013 cmH ₂ O)) or 0 to 13.3 kPa
Accuracy	±2.0 mmHg in the range 0 to 40 mmHg, ±5 % of the measured value in the range 41 to 100 mmHg ±0.27 kPa in the range 0 to 5.33 kPa, ±5 % of the measured value in the range 5.34 to 13.3 kPa ±0.26 in the range 0 to 5.26 Vol%, ±5 % of the measured value in the range 5.27 to 13.2 Vol%

Displayed measured values (cont.)

Measurement conditions	Respiratory rate (adults): 6 to 40/min Respiratory rate (pediatric patients): 40 to 100/min Inspiratory time: >250 ms Expiratory time: >250 ms
Drift of measurement accuracy	<0.03 Vol% (at 5.00 Vol%) for 6 h
The measured values of the CO ₂ measurement are barometrically pressure compensated.	
T10...90	<35 ms
Total response time	<200 ms
Warm-up time, typical	<3 min (at 23 °C)
CO ₂ production	V'CO₂
Range	0 to 999 mL/min, STPD
Accuracy	±12 %
T10...90	33 s
Serial dead space	V_{ds}
Range	0 to 999 mL, BTPS
Accuracy	±15 % of the measured value or ±10 mL, whichever is greater, under calibration conditions (1013 mbar (1013 cmH ₂ O), dry gas, 20 °C (68 °F)), 5 % CO ₂ , with the flow sensor flap closed and no leakage
Exhaled CO ₂ per breath	VTCO₂
Range	0 to 550 mL BTPS
Accuracy	±12 %
With reference to the displayed measured values, the following dead space volumes must be taken into account	
CO ₂ cuvette, adults (6870279, MP01062)	4.3 mL
CO ₂ cuvette, pediatric patients (6870280, MP01063)	1.9 mL
Neonatal flow sensor ISO 15 (8411130)	0.9 mL
Neonatal flow sensor Y-piece (8410185)	1.7 mL

Displayed calculated values

Dynamic compliance	C_{dyn}
Range	0 to 650 mL/mbar (mL/cmH ₂ O)
Resistance	R
Range	0 to 1000 mbar/(L/s) (or hPa/(L/s) or cmH ₂ O/(L/s))
Patient resistance	R_{pat}
Range	0 to 1000 mbar/(L/s) (or hPa/(L/s) or cmH ₂ O/(L/s))
Leakage minute volume	MV_{leak}
Range	0 to 99 L/min BTPS
T0...90	33 s for intubated adults, 20 s for adults with NIV, 20 s for pediatric patients, 10 s for neonates
Leakage in % % leak	0 to 100 %
Spontaneous breathing portion of minute volume in percent %MV_{spon}	0 to 100 %
Rapid Shallow Breathing	RSB
Range	
Adults	0 to 9999 (/min/L)
Pediatric patients	0 to 9999 (/min/L)
Neonates	0 to 300 (/min/mL)
For accuracy, see measurement of VT and RR	
Negative Inspiratory Force	NIF
Range	-80 to 0 mbar (or hPa or cmH ₂ O)
Accuracy	±6 % of measured value or ±0.5 mbar (or hPa or cmH ₂ O), whichever is greater
Occlusion pressure P0.1	0 to -25 mbar (or hPa or cmH ₂ O)
Elastance E	0 to 9999 mbar/L (or hPa/L or cmH ₂ O/L)
Static compliance (determined by Low Flow PV loop maneuver) C_{stat}	0 to 500 mL/mbar (or mL/hPa or mL/cmH ₂ O)
Ratio of the compliance of the last 20 % of ΔP (P_{insp} – PEEP) during inspiration to the total compliance C₂₀/C_{dyn}	0 to 5
Ratio of compliance of the last 20 % of ΔP (P_{insp} – PEEP) during inspiration to the total compliance (determined by Low Flow PV loop maneuver) C₂₀/C_{stat}	0 to 5

Displayed calculated values (cont.)

Tidal volume per kg of body weight	0 to 100 mL/kg
Time constant of expiration <i>T_{Ce}</i>	0 to 20 s
Dead space ventilation	<i>V_{ds}/V_{Te}</i>
Range	0 to 100 %
<i>CO₂ slope</i>	
Range	0 to 9.99 Vol%/L or 0 to 9.99 kPa/L or 0 to 74.9 mmHg/L
Curve displays	
Airway pressure P _{aw} (t)	–30 to 100 mbar (or hPa or cmH ₂ O)
Flow (t)	–180 to 180 L/min
Volume V (t)	2 to 3000 mL
CO ₂ (t)	0 to 100 mmHg or 0 to 13.2 Vol% (at 1013 mbar (1013 cmH ₂ O)) or 0 to 13.3 kPa

Monitoring

Alarm sound pressure level L_(A) at operator's position:
 Operator's position: at front of device at a distance of 1 m (39 in) and a height of 1.5 m (59 in).
 Free field measurement in accordance with ISO 3744 and IEC 60601-1-8:2003

Alarm tone sequence ***IEC/CEI***

Range for high-priority alarms	from about 52 dB(A) to 70 dB(A)
Range for medium-priority alarms	from about 49 dB(A) to 67 dB(A)
Range for low-priority alarms	from about 46 dB(A) to 65 dB(A)
Incrementation	adjustable in 9 increments

Alarm tone sequence ***Dräger ventilation***

Range for high-priority alarms	from about 55 dB(A) to 73 dB(A)
Range for medium-priority alarms	from about 51 dB(A) to 70 dB(A)
Range for low-priority alarms	from about 47 dB(A) to 65 dB(A)
Incrementation	adjustable in 9 increments

Alarm sound pressure level for power failure alarm and auxiliary alarm	from about 70 dB(A) to 75 dB(A)
--	---------------------------------

Monitoring (cont.)

Sound pressure level LPA of alarm signals measured in accordance with IEC 60601-1-8 and A1:2012:

Alarm tone sequence IEC/CEI	
Range for high-priority alarms according to volume setting	Approx. 55 dB(A) to 72 dB(A)
Range for medium-priority alarms according to volume setting	Approx. 52 dB(A) to 69 dB(A)
Range for low-priority alarms according to volume setting	Approx. 49 dB(A) to 67 dB(A)
Incrementation	adjustable in 9 increments
Alarm tone sequence Dräger ventilation	
Range for high-priority alarms according to volume setting	Approx. 55 dB(A) to 72 dB(A)
Range for medium-priority alarms according to volume setting	Approx. 53 dB(A) to 70 dB(A)
Range for low-priority alarms according to volume setting	Approx. 45 dB(A) to 62 dB(A)
Incrementation	adjustable in 9 increments
Range for power supply failure alarm and auxiliary alarm	Approx. 70 dB(A) to 75 dB(A)
Delay time to sounding of auxiliary alarm if main alarm has failed	max. 18 s
Expiratory minute volume	MVe
Upper alarm limit alarm	if the upper alarm limit has been exceeded
Setting range in invasive ventilation	0.03 to 41 L/min
Setting range in non-invasive ventilation	0.03 to 60 L/min
Alarm suppression	during and 2 minutes after the Low Flow PV loop maneuver
Alarm delay	MV delay.
Adults	0 to 30 s
Pediatric patients	0 to 20 s
Neonates	0 to 15 s

Monitoring (cont.)

Lower alarm limit alarm	if the value has fallen below the lower alarm limit
Setting range	0.02 to 40 L/min, Off (with NIV or neonates)
Alarm suppression	2 minutes after leaving standby during and 2 minutes after suction maneuver 2 minutes after switching on flow monitoring during and 2 minutes after the Low Flow PV loop maneuver
Alarm delay	MV delay
Adults	0 to 30 s
Pediatric patients	0 to 20 s
Neonates	0 to 15 s
Airway pressure	Paw
Upper alarm limit alarm	if the upper alarm limit has been exceeded
Setting range	7 to 105 mbar (or hPa or cmH ₂ O)
Maximum airway pressure	120 mbar (or hPa or cmH ₂ O)
Inspiratory O ₂ concentration	FiO₂
Upper alarm limit alarm	after 30 seconds at the latest, if the upper alarm limit has been continuously exceeded
Lower alarm limit alarm	after 30 seconds at the latest, if the lower alarm limit has been continuously undershot
Setting range	both alarm limits are automatically assigned to the set value: under 60 Vol% with ± 4 Vol%, from 60 Vol% with ± 6 Vol% (lower alarm limit 18 Vol% at 21 Vol%)
End-expiratory CO ₂ concentration	etCO₂
Upper alarm limit alarm	if the upper alarm limit has been exceeded
Setting range	1 to 98 mmHg (or 0.1 to 13.1 Vol% or 0.1 to 13.3 kPa)
Lower alarm limit alarm	if the value has fallen below the lower alarm limit
Setting range	0 to 97 mmHg (or 0 to 13.0 Vol% or 0 to 13.2 kPa)
Respiratory rate	RR
Upper alarm limit alarm	if the respiratory rate (mandatory and spontaneous breaths) has been exceeded
Setting range	5 to 200/min, Off

Monitoring (cont.)

Volume monitoring	VT
Upper alarm limit alarm	if the tidal volume administered exceeds the upper alarm limit, the inspiration will be aborted and the expiration valve opened
Setting range	
Adults	110 to 3100 mL, Off
Pediatric patients	21 to 3100 mL, Off
Neonates	3 to 3100 mL, Off
Alarm suppression	during the first three consecutive breaths where the applied inspiratory tidal volume exceeds the upper alarm limit
Alarm suppression	during suction, except for the final oxygen enrichment
Lower alarm limit alarm	if the set tidal volume has not been supplied
Setting range	1 to 2900 mL, Off
Alarm suppression	
Adults	during the first five consecutive breaths where the applied inspiratory tidal volume has fallen below the lower alarm limit
Pediatric patients	during the first five consecutive breaths where the applied inspiratory tidal volume has fallen below the lower alarm limit
Neonates	during the first eight consecutive breaths where the applied inspiratory tidal volume has fallen below the lower alarm limit
Apnea alarm time	Tapn
Alarm	if no breathing activity is detected
Setting range	5 to 60 seconds, Off
Disconnect alarm delay time	Tdisconnect
Setting range	0 to 60 seconds

Operating data

Protection class

Ventilation unit Evita V500 Medical Cockpit Infinity C500 Gas supply unit GS500 Power supply unit PS500	Class I
CO ₂ sensor (sensor connected)	Type BF
Proximal flow sensor (sensor connected)	Type BF
Degree of protection against ingress of liquids and particles	IP21 Protection against particles with a diameter of more than 12.5 mm (0.47 in) Protection against vertically dripping water

Mains power supply

Mains power connection	100 V to 240 V 50/60 Hz
Current consumption	
at 230 V	Max. 1.4 A
at 100 V	Max. 3.0 A
Inrush current	Approx. 8 to 24 A peak Approx. 6 to 17 A quasi RMS
Power consumption	
maximum	300 W
during ventilation, without charging the battery	Approx. 100 W ventilation unit with Medical Cockpit Approx. 180 W with GS500
Device fuses	
Range 100 V to 240 V	F6.3H 250V IEC 60127-2/V (2 pcs.) Ventilation unit

Batteries

The operating time applies when the batteries are fully charged and new and ventilation is typical.

Low temperatures may reduce the operating time.

The charging time applies to new and completely discharged batteries when ventilation is typical and GS500 is not used.

The actual charging time depends on the battery charge.

If GS500 is operating or the ambient temperature is high, the battery charging process may be restricted or interrupted.

Operating data (cont.)

Typical ventilation

Ventilation mode	PC-AC
FiO ₂	21 Vol%
PEEP	5 mbar (or hPa or cmH ₂ O)
Pinsp	20 mbar (or hPa or cmH ₂ O)
RR	12/min
Measured MV	6 L/min
Ambient temperature	22 °C (71.6 °F)

Internal battery of ventilation unit (without PS500)

Type	NiMH battery, sealed
Fuse	F15A 80V UL248
Capacity	2.5 Ah
Voltage	24 V
Current	0 to 15 A
Operating time if mains power supply is not available	
without GS500	30 minutes
with GS500	15 minutes
Charging	
Charging time (to charge battery fully)	<4 hours (<2 hours for 80 % charge)

Batteries of power supply unit PS500

Type	VRLA batteries
Fuse	triple F15A 80V UL248
Capacity	24 Ah
Voltage	24 V
Current	0 to 15 A
Operating time if mains power supply is not available	
without GS500	240 minutes
with GS500	120 minutes
Charging	
Charging time (to charge battery fully)	<24 hours (<20 hours for 80 % charge)

Operating data (cont.)

Gas supply

O₂ operating pressure 2.7 to 6.0 bar (or 270 to 600 kPa or 39 to 87 psi)

O₂ peak input flow 130 L/min (at 2.8 bar inlet pressure)
180 L/min (at 4.0 bar inlet pressure)

O₂ connection depending on configuration: DIN, NIST, DISS, Air Liquide

Air operating pressure 2.7 to 6.0 bar (or 270 to 600 kPa or 39 to 87 psi)

Air peak input flow 130 L/min (at 2.8 bar inlet pressure)
180 L/min (at 4.0 bar inlet pressure)

Air connection depending on configuration: DIN, NIST, DISS, Air Liquide

Dew point at least 5 Kelvin or 5 °C or 9 °F below ambient temperature

Oil concentration <0.1 mg/m³

Particle size Dust-free air (filtered with pore size <1 µm)

Gas consumption

Consumption for ventilation Depends on ventilation settings

Consumption for pneumatic medication nebulizer Compressed air or O₂, max. 2.1 bar (or 210 kPa or 30.5 psi), max. 11 L/min

Automatic gas switch-over if one gas fails, the device switches to the other gas

Noise emission in accordance with ISO 80601-2-12:2011 under consideration of ISO 4871:2009 and ISO 3744:2010

A-class mean surface sound pressure level (L_{pA}) with a radius of 2 m (79 in) Approx. 33.0 dB
Approx. 43.5 dB with GS500

Uncertainty (k) 3.5 dB

A-class surface sound pressure level (LWA) Approx. 46.0 dB
Approx. 57.5 dB with GS500

Uncertainty (k) 3.5 dB

Dimensions (W x H x D)

Evita V500 with lateral standard rail (without Infinity C500) 361 mm x 320 mm x 410 mm
(14.3 in x 12.6 in x 16.1 in)

Evita V500 and Infinity C500 on the trolley, carrier frame without bar 577 mm x 1420 mm x 687 mm
(22.7 in x 55.9 in x 27.1 in)

Evita V500 and Infinity C500 on the trolley, carrier frame with bar 577 mm x 1420 mm x 700 mm
(22.7 in x 55.9 in x 27.6 in)

Operating data (cont.)

Weight

Ventilation unit	Approx. 17 kg (37.5 lb)
Medical Cockpit with holder	Approx. 8 kg (17.6 lb)
Trolley	Approx. 33 kg (72.8 lb)
Evita V500 and Infinity C500	Approx. 25 kg (55.1 lb)
Evita V500 and Infinity C500 on trolley	Approx. 59 kg (130 lb)
PS500	Approx. 27 kg (59.5 lb)
GS500	Approx. 10.5 kg (23 lb)
Nominal weight (weight of ventilation unit and Medical Cockpit on trolley)	58 kg (128 lb)
Maximum weight (permitted maximum total weight)	133 kg (293 lb)

Maximum load

Trolley	100 kg (220.5 lb)
Universal holder with standard rail (G93140)	10 kg (22 lb)
Humidifier holder (8416325)	5 kg (11 lb)
Humidifier holder (G93111)	5 kg (11 lb)

If a hinged arm is attached to the lateral standard rails of the ventilation unit in addition to the humidifier holder (8416325), the maximum load of 5 kg (11 lb) per lateral rail must be observed. The humidifier holder can then only support 4 kg (8.8 lb).

Electromagnetic compatibility EMC	tested in accordance with IEC 60601-1-2
Classification according to EC Directive 93/42/EEC, Annex IX	II b
UMDNS code Universal Medical Device Nomenclature System – Nomenclature for medical devices	17-429

Operating data (cont.)

Materials used

Breathing hose (reusable)	Silicone rubber (milky, transparent)
Water trap (reusable)	Polysulphone (gray, transparent)
Y-piece (reusable)	Polysulphone (yellow, transparent)
Expiratory valve (reusable; housing, closure, nozzle)	Polyamide
Inspiratory unit (reusable; housing, nozzle)	Polyamide
Diaphragm	Silicone rubber and nickel (whitish and gray)
Reusable CO ₂ cuvette	Polysulphone with sapphire windows (yellow, transparent: adult cuvette; gray violet, transparent: pediatric cuvette)
Disposable CO ₂ cuvette	Styrene-butadiene copolymer SBC (white, transparent: adult cuvette; blue, transparent: pediatric cuvette)
CO ₂ sensor	Polysulphone (white)
CO ₂ sensor cable	Polyurethane (gray)

For Nurse call

Connection	via cable 8417370 only
Potential-free DC contact	
Input voltage	24 V DC max.
Input current	1 A DC max.
Switching capacity	15 W max.
Contact pin assignment, see chapter "Assembly and preparation", "Connecting the nurse call"	

Device ports

Outputs

V1	System cable
V2, V3	not used
V4	Nurse call
V5	Neonatal flow sensor
V6	not used
V7	CO ₂ sensor
V8	not used
V9	GS500

MEDIBUS or MEDIBUS.X protocol

Baud rate	1200, 2400, 4800, 9600, 19200, 38400 baud (19200 and 38400 baud are required for transmitting high-speed data, e.g., for the flow waveform)
Data bits	8
Parity	even, odd, no
Stop bits	1 or 2
Pin assignment of COM1, COM2 and COM3	
Pin 1	DCD
Pin 2	RXD
Pin 3	TXD
Pin 4	DTR
Pin 5	GND
Pin 6	DSR
Pin 7, 8	RTS/CTS
Pin 9	RI
Housing	SHLD

Galvanic isolation

V1	The port is not electrically isolated from the device electronics.
V2, V3	not used
V4	The port is not electrically isolated from the device electronics.
V5	The port is electrically isolated from the device electronics (Type BF). The test voltage for electrical isolation is 1500 V.
V6	not used

Device ports (cont.)

V7	The port is not electrically isolated from the device electronics.
V8	not used
V9	The port is electrically isolated from the device electronics. The test voltage for electrical isolation is 500 V.

Automatic alarm limits

The following tables describe the alarm limits which cannot be set by the user.

Pressure monitoring

Alarm message	Description/Detection
<i>Airway pressure high</i>	The airway pressure is monitored to detect whether the upper alarm limit is exceeded. If the alarm limit indicating a too high airway pressure is linked to ventilation therapy controls, this limit is set 5 mbar (5 cmH ₂ O) above the highest pressure which is regularly applied during ventilation according to the user settings. This connection is switched off at the factory.
<i>Breathing hose kinked</i> (O ₂ Therapy)	An excessive pressure during an O ₂ therapy is monitored. The alarm limit is set at 30 mbar (30 cmH ₂ O).
<i>Airway pressure negative</i>	Situations in which the pressure becomes negative are monitored. The alarm limit is set at -10 mbar (-10 cmH ₂ O).
<i>PEEP high/Plow high</i> (!!!)	The alarm limit is 8 mbar (8 cmH ₂ O) above the set PEEP or Plow level. The alarm triggers a pressure release to ambient pressure. The alarm is not triggered below 11 mbar (11 cmH ₂ O). An alarm is triggered if this condition applies for 2 breaths or after a maximum of 15 seconds. To avoid false alarms, it is not monitored whether the lower pressure level has been reached if in APRV and if Tlow is smaller 1 s or AutoRelease is activated.
<i>PEEP high/Plow high</i> (!!)	The alarm limit is 4 mbar (4 cmH ₂ O) above the set PEEP. An alarm is triggered if this condition applies for 2 breaths or after a maximum of 15 seconds.

Alarm message	Description/Detection
PEEP low/Plow low	A too low PEEP or Plow value during ventilation is monitored. The alarm limit depends on the set value of the PEEP or Plow level. The alarm limit is 5 mbar (5 cmH ₂ O) below the set value. An alarm is triggered if this condition applies for 10 breaths.
Pressure limited (ATC/PPS)	The upper pressure limit is monitored to detect whether it is reached when using ATC or PPS. If the Paw high alarm limit is adjustable, the alarm limit is derived from this value and lies in the range Paw high –5 mbar (–5 cmH ₂ O) to Paw high –1 mbar (–1 cmH ₂ O), depending on how close the Paw high value comes to the currently applied ventilation. If the Paw high alarm limit is linked (Pmax/Paw high autose t), the pressure limit corresponds to the value of the Pmax therapy control.
Airway pressure low	An insufficient airway pressure is monitored by checking whether the integral of undercutting the measured pressure values of the lower pressure level exceeds 22.5 mbar x s (22.5 cmH ₂ O x s).

Volume monitoring

The expiratory minute volume **MVe** is monitored within the set alarm limits.

The inspiratory tidal volume **VTi** or, when leakage compensation is switched on, the leakage-compensated tidal volume **VT** is monitored within the set alarm limits.

Because the device ensures the minimum inspiratory tidal volume when volume-controlled ventilation modes or pressure-controlled ventilation modes with Volume Guarantee are selected, it is not possible to set the lower alarm limit for **VTi** or **VT** manually.

Alarm message	Description/Detection
VT not reached, leakage VT not reached VT not reached, Pmax active	Volume-controlled breaths are monitored to detect whether the set volume is reached. The alarm limit is set at 90 % of the set value for VT.
Pressure limited	During ventilation with AutoFlow or Volume Guarantee, breaths are monitored to detect whether the volume to be applied is reached if the applied ventilation pressure cannot automatically be increased any further. The alarm limit is set at the set value for the volume.

Monitoring of the breathing circuit and the patient connection

Alarm message	Description/Detection
Disconnection?	<p>Disconnection is monitored by checking that the mandatory breaths reach a minimum pressure level. The alarm limit is derived from the set points for ventilation.</p> <p>During pressure-controlled ventilation, the alarm is triggered when the airway pressure is lower than the lower pressure level plus 50 % of the pressure difference between the upper and lower pressure levels.</p> <p>During pressure-supported ventilation, the alarm is triggered when the airway pressure is lower than the lower pressure level plus 30 % of the pressure difference between the upper and lower pressure levels.</p> <p>During ventilation with AutoFlow, Volume Guarantee and volume support, the limit is 50 % of the pressure difference between the upper pressure level and the lower pressure level currently calculated by Evita V500.</p> <p>During volume-controlled ventilation, the pressure level is 5 mbar (5 cmH₂O) above PEEP.</p> <p>All pressure criteria become ineffective if a sufficient expiration has been detected.</p> <p>In the event of an excessive inspiratory flow at the current airway pressure, a disconnection due to excessive inspiratory volume is detected. This volume depends on the patient category:</p> <ul style="list-style-type: none"> – 4.5 L in the patient category Adult – 1.5 L in the patient category Ped. pat. – 0.5 L in the patient category Neo.
Leakage	<p>Leakages are monitored in the Adult and Ped. pat. patient categories. The alarm limit is set at 55 % of relative Leakage. Leakages during NIV are not monitored.</p>
Airway obstructed?	<p>Obstructions in the breathing circuit are monitored by observing the Flow delivered to the patient during a defined period.</p>

FiO₂ monitoring

Alarm message	Description/Detection
FiO₂ high	<p>An excessive O₂ concentration of the applied gas is monitored.</p> <p>The alarm limit is 4 Vol% above the set value if this is less than or equal to 60 Vol%.</p> <p>The alarm limit is 6 Vol% above the set value if this is greater than 60 Vol%.</p>
FiO₂ low	<p>An insufficient O₂ concentration of the applied gas is monitored.</p> <p>For an FiO₂ concentration of 21 Vol% the alarm limit is 18 Vol%.</p> <p>The alarm limit is 4 Vol% below the set value if this is greater than 21 Vol% and less than or equal to 60 Vol%.</p> <p>The alarm limit is 6 Vol% below the set value if this is greater than 60 Vol%.</p>

CO₂ monitoring

Alarm message	Description/Detection
CO₂ sensor?	<p>The correct functioning of the CO₂ sensor is monitored. An alarm is immediately generated in the event of a technical defect or if a sensor is not connected.</p> <p>An alarm is generated after 60 s if the sensor is removed from the cuvette or the sensor does not detect any breathing activity.</p>

Essential performance characteristics

The essential performance consists in a controlled and monitored patient ventilation with user-defined settings for the monitoring functions

- minimum and maximum tidal volume,
- maximum airway pressure,
- minimum and maximum O₂ concentration in the breathing gas,

or, if a set limit is exceeded, an appropriate alarm.

Additionally, the integrated monitoring alarms in the following situations:

- Failure of the external power supply
- Battery discharge
- Failure of the gas supply

Connections to IT networks

In an IT network, data can be exchanged by means of wired or wireless technologies. An IT network can be any data interface (e.g., RS232, LAN, USB, printer interface) that is described in standards and conventions.

During operation, this device can exchange information with other devices by means of IT networks and supports the following functions:

- Display of waveforms and parameter data
- Signaling of alarms
- Transfer of device settings and patient data
- Service mode, access to logbooks

Connecting this device to a network that incorporates other devices or making subsequent changes to that network can lead to new risks for patients, users, and third parties. Before the device is connected to the network or the network is changed, these risks must be identified, analyzed, and evaluated, and appropriate measures taken.

Examples of subsequent changes to the network:

- Changing the network configuration
- Removing devices from the network
- Adding new devices to the network
- Performing upgrades or updates on devices that are connected to the network

Information on connecting to the network

Prerequisites

This device must only be connected to the network by service personnel. The IT representative of the hospital must be consulted in advance.

The following documents must be observed:

- Accompanying documents of this device
- Description of the network interface
- Description of the network-based alarm systems

Dräger recommends complying with IEC 80001-1 (risk management for IT networks with medical devices).

Serial interfaces

The following interfaces are supported:

- RS232 interfaces conforming to EIA RS232 (CCITT V.24/V.28) for the following applications:
 - MEDIBUS, MEDIBUS.X
 - Connection to medical devices from other manufacturers

Consequences of using an unsuitable network

If the network does not meet the requirements, dangerous situations can result. The following situations can occur with this device:

- Due to an insecure decentralized alarm system:
 - Alarms or data are transmitted at the wrong time.
 - Alarms are not transmitted.
- During an interruption of the network connection:
 - Suppressed alarms or alarm tones are not reactivated, but remain suppressed.
 - Alarms are not transmitted.
- Without firewall and antivirus software:
 - Data are not protected.
 - Device settings are changed.
 - The device generates false alarms or no alarms.

- Data are sent incomplete, sent to the wrong device, or not sent at all.
- Patient data are intercepted, falsified, or damaged.
- Data have incorrect time stamps.

Requirements for the electrical characteristics of connected devices and networks

The analog and digital ports are only appropriate for connecting devices or networks that have a nominal voltage on the network side of max. 24 V DC and meet the requirements of one of the following standards:

- IEC 60950-1: Ungrounded SELV circuits
- IEC 60601-1 (as of 2nd edition): Touchable secondary circuits

Open-source software

Dräger devices that use software may use open-source software, depending on their setup. Open-source software may be subject to different terms of license. Additional information regarding the open-source software used in this device is available at the following web page:

www.draeger.com/opensource

This page has been left blank intentionally.

Principles of operation

Description of the ventilation modes	310	Measurements	356
VC-CMV	310	Flow/volume measurement	356
VC-SIMV	312	Measurement principles	357
VC-AC	314	Airway pressure measurement	358
VC-MMV	316	Battery concept	359
PC-CMV	318	General information	359
PC-BIPAP	319	Display of battery charge	359
PC-SIMV	321	Battery ageing	359
PC-AC	323	Alarm behavior in battery operation	361
PC-PSV	324	Pneumatic functional description	363
PC-APRV	326	Main menu bar structure	366
SPN-CPAP/PS	327	Factory-set screen views	371
SPN-CPAP/VS	328	List of references	372
SPN-CPAP	329		
SPN-PPS	330		
Additional settings for ventilation	332		
Apnea Ventilation	332		
Flow trigger	335		
Inspiratory termination	336		
Sigh	337		
AutoFlow/Volume Guarantee	338		
ATC	340		
AutoRelease	343		
Variable PS	344		
Special functions	345		
Medication nebulization	345		
Low Flow PV Loop	346		
Diagnostics – measurement maneuver	348		
C20/C	351		
Smart Pulmonary View	352		
Description of the therapy types	353		
O ₂ therapy	353		
NIV – Non-invasive ventilation	353		
Automatic leakage compensation	354		
Flow reduction Anti Air Shower	355		

Description of the ventilation modes

VC-CMV

Volume Control-Continuous Mandatory Ventilation

Continuous volume-controlled ventilation with fixed inspiratory flow

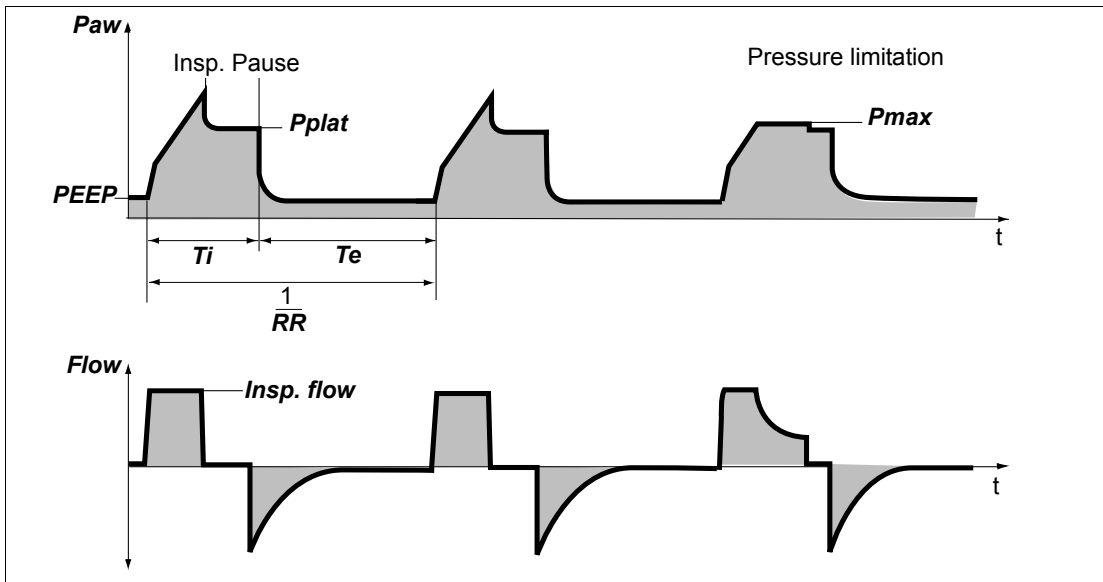

Volume-controlled ventilation

The tidal volume of the mandatory breaths is determined by the volume **VT**. The duration of the mandatory breaths is determined by **Ti**. The pressure rise is determined by the inspiratory flow **Insp. flow**. If the inspiratory flow is so high that the set tidal volume is reached before inspiratory time **Ti** has fully elapsed, an inspiratory pause occurs. If leakage compensation is activated, Evita V500 increases the inspiratory flow in order to apply the set volume despite leakages.

The mandatory breaths are time-cycled and are not triggered by the patient. The number of mandatory breaths is determined by the respiratory rate **RR**.

In the **Neo**. patient category, this mode is only available with AutoFlow activated.

In the **Neo**. patient category, **VC-CMV** is not selectable with non-invasive ventilation.

Pressure limitation

The therapy control ***Pmax*** is activated when the user links the alarm limit ***Paw high*** to the therapy control ***Pmax***. Evita V500 can avoid the pressure peak with the pressure limitation ***Pmax***, complying with the set tidal volume ***VT***.

The tidal volume ***VT*** remains constant provided the plateau pressure ***Pplat*** is present. Evita V500 limits the pressure by reducing the inspiratory flow when the set ***Pmax*** value is reached.

If the tidal volume ***VT*** can no longer be applied with the selected pressure ***Pmax***, e.g., due to reduced compliance, the low-priority alarm ***VT not reached, Pmax active*** is generated.

VC-SIMV

Volume Control-Synchronized Intermittent Mandatory Ventilation

Intermittent, triggered, volume-controlled ventilation with a fixed inspiratory flow, allowing spontaneous breathing during the expiratory phase.

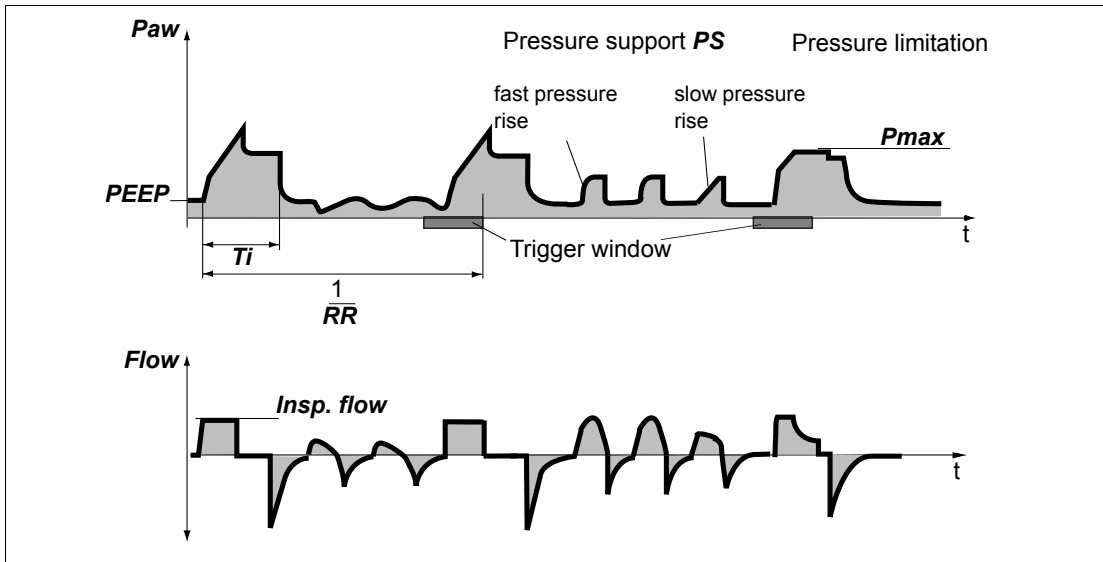

Volume-controlled ventilation

The tidal volume of the mandatory breaths is determined by the volume **VT**. The duration of the mandatory breaths is determined by **Ti**. The pressure rise is determined by the inspiratory flow **Insp. flow**. If the inspiratory flow is so high that the set tidal volume is reached before inspiratory time **Ti** has fully elapsed, an inspiratory pause occurs. If leakage compensation is activated, Evita V500 increases the inspiratory flow in order to apply the set volume despite leakages.

In the **Neo.** patient category, this mode is only available with AutoFlow activated.

In the **Neo.** patient category, **VC-SIMV** is not selectable with non-invasive ventilation.

Synchronization

The mandatory breaths can be triggered by the patient's inspiratory effort from the PEEP level.

A mandatory breath can only be triggered within a "trigger window" by the flow trigger in synchrony with the patient's spontaneous inspiratory effort. This prevents the mandatory breath being applied during expiration.

The trigger window is 5 seconds in the **Adult** patient category and 1.5 seconds in the **Ped. pat.** and **Neo.** patient categories.

For expiratory times shorter than 5 seconds in the **Adult** patient category or 1.5 seconds in the **Ped. pat.** and **Neo.** patient category, the trigger window covers the entire expiratory time minus a refractory period for the previous expiration.

Synchronization of mandatory breaths reduces the expiratory time. Evita V500 extends the subsequent expiratory time or spontaneous breathing time by the missing time. This prevents an increase of the mandatory respiratory rate.

The number of mandatory breaths is determined by the respiratory rate **RR**.

If the patient breathes in at the beginning of the trigger window and has already inspired a significant volume, Evita V500 takes this volume into account. During the subsequent mandatory breath, the ventilation unit reduces the inspiratory flow phase and extends the inspiratory pause.

Pressure support

During spontaneous breathing from the PEEP level, the patient can be supported with **PS**. Every inspiratory effort of the patient that meets the trigger criteria triggers a pressure-supported breath. By setting the trigger level, the patient's inspiratory efforts are synchronized. The time, number, and duration of pressure-supported breaths is determined by the patient's spontaneous breathing.

As in all pressure-controlled ventilation modes, the tidal volume supplied depends on the difference in pressure "P_{supp} – PEEP", the lung mechanics (resistance and compliance) and the patient's respiratory drive. The pressure rise from the lower pressure level **PEEP** to the upper pressure level **P_{supp}** is determined by the **Slope** setting.

The pressure support is terminated as soon as the inspiratory flow falls below a certain proportion of the maximum inspiratory flow.

The proportion of the maximum inspiratory flow can be adjusted using the **Insp. term.** setting. If the **Insp. term.** setting is not configured, this proportion is 25 % in the **Adult** patient category and 15 % in the **Ped. pat.** and **Neo.** patient categories.

The pressure support is also terminated as soon as the duration of the support has reached the maximum inspiratory time. For intubated patients, the maximum inspiratory time is limited to 4 seconds in the **Adult** patient category and to 1.5 seconds in the **Ped. pat.** and **Neo.** patient category. In non-invasive ventilation, the maximum inspiratory time is limited to 130 % of **Ti** (maximum 4 seconds) in the **Adult** patient category and to 130 % of **Ti** (maximum 1.5 seconds) in the **Ped. pat.** patient category.

Pressure limitation

The therapy control **Pmax** is activated when the user links the alarm limit **Paw high** to the therapy control **Pmax**. Evita V500 can avoid the pressure peak with the pressure limitation **Pmax**, complying with the set tidal volume **VT**.

The tidal volume **VT** remains constant provided the plateau pressure **Pplat** is present. Evita V500 limits the pressure by reducing the inspiratory flow when the set **Pmax** value is reached.

If the tidal volume **VT** can no longer be applied with the selected pressure **Pmax**, e.g., due to reduced compliance, the low-priority alarm **VT not reached, Pmax active** is generated.

VC-AC

Volume Control-Assist Control

Assisted-controlled, volume-controlled ventilation with fixed inspiratory flow and backup respiratory rate

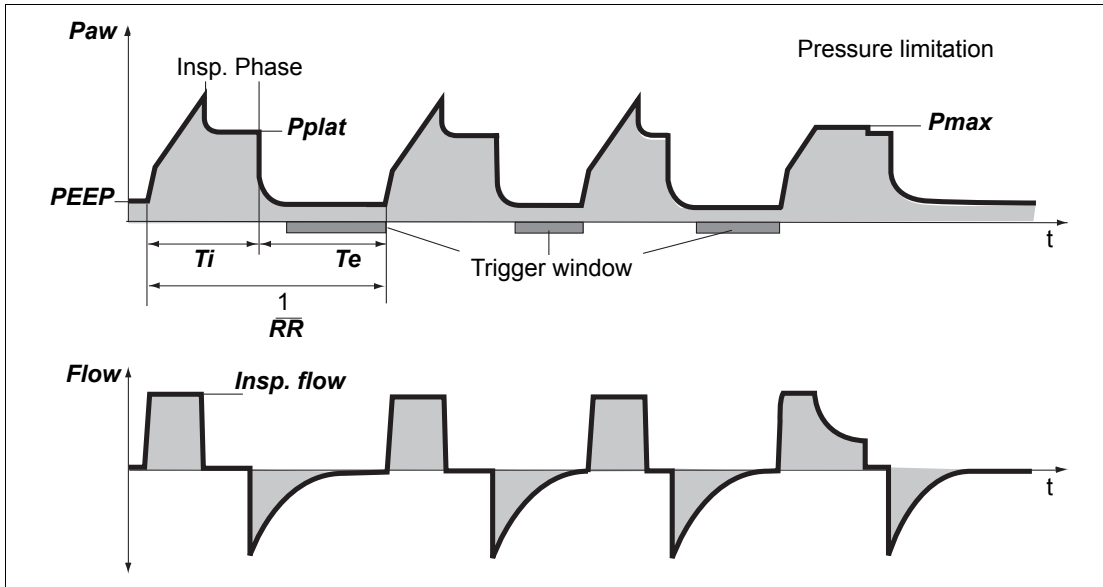

Volume-controlled ventilation

The tidal volume of the mandatory breaths is determined by the volume **VT**. The duration of the mandatory breaths is determined by **Ti**. The pressure rise is determined by the inspiratory flow **Insp. flow**. If the inspiratory flow is so high that the set tidal volume is reached before inspiratory time **Ti** has fully elapsed, an inspiratory pause occurs. If leakage compensation is activated, Evita V500 increases the inspiratory flow in order to apply the set volume despite leakages.

In the **Neo**. patient category, this mode is only available with AutoFlow activated.

In the **Neo**. patient category, **VC-AC** is not selectable with non-invasive ventilation.

Assisted-controlled ventilation

Every inspiratory effort of the patient from the PEEP level triggers a synchronized mandatory breath. Thus, the time and number of mandatory breaths are determined by the patient. The trigger window covers the expiratory time minus a refractory period for the previous expiration. The expiratory time is determined by the respiratory rate **RR** and the inspiratory time **Ti**. A non-synchronized mandatory breath is triggered at the latest at the end of the expiratory time (back-up respiratory rate). The minimum number of mandatory breaths is determined by the respiratory rate **RR**.

Pressure limitation

The therapy control ***Pmax*** is activated when the user links the alarm limit ***Paw high*** to the therapy control ***Pmax***. Evita V500 can avoid the pressure peak with the pressure limitation ***Pmax***, complying with the set tidal volume ***VT***.

The tidal volume ***VT*** remains constant provided the plateau pressure ***Pplat*** is present. Evita V500 limits the pressure by reducing the inspiratory flow when the set ***Pmax*** value is reached.

If the tidal volume ***VT*** can no longer be applied with the selected pressure ***Pmax***, e.g., due to reduced compliance, the low-priority alarm ***VT not reached, Pmax active*** is generated.

VC-MMV

Volume Control-Mandatory Minute Volume Ventilation

Volume-controlled ventilation to ensure mandatory minute ventilation

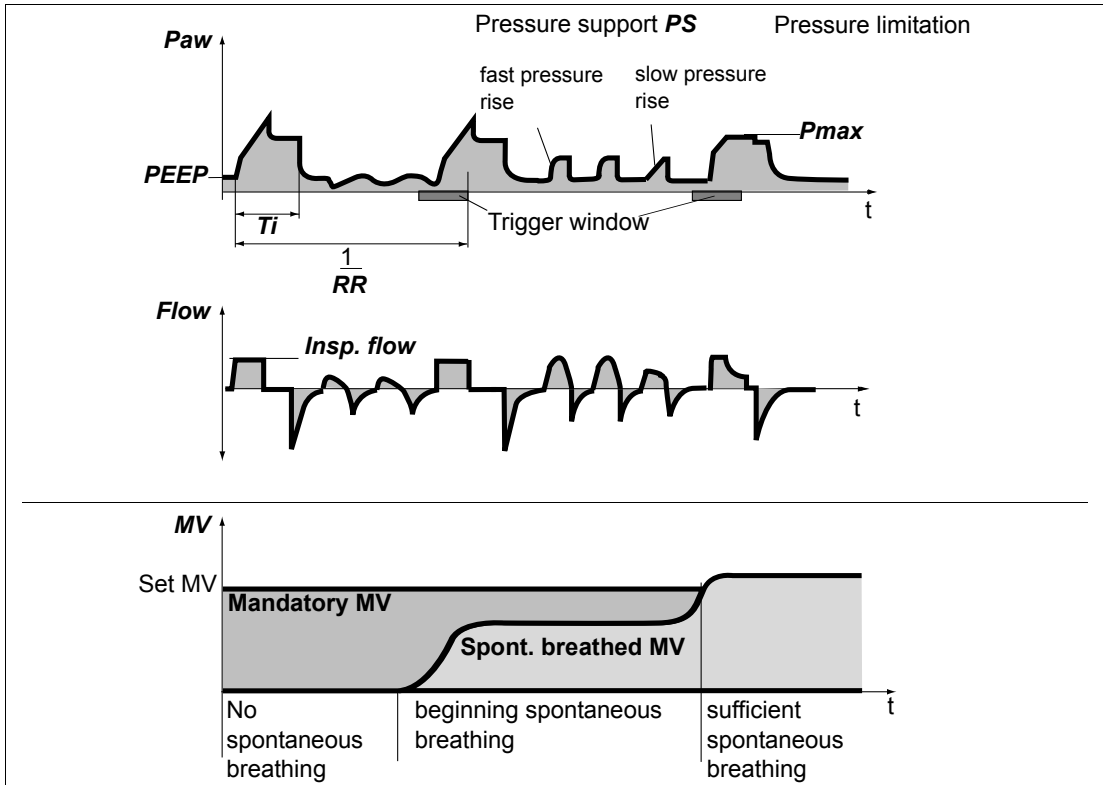

208

Volume-controlled ventilation

The tidal volume of the mandatory breaths is determined by the volume **VT**. The duration of the mandatory breaths is determined by **Ti**. The pressure rise is determined by the inspiratory flow **Insp. flow**. If the inspiratory flow is so high that the set tidal volume is reached before inspiratory time **Ti** has fully elapsed, an inspiratory pause occurs.

If leakage compensation is activated, Evita V500 increases the inspiratory flow in order to apply the set volume despite leakages.

In the **Neo.** patient category, this mode is only available with AutoFlow activated.

In the **Neo.** patient category, **VC-MMV** is not selectable with non-invasive ventilation.

MMV works similar to SIMV, however, the mandatory breaths are only provided if spontaneous breathing is not sufficient and below the prescribed minimum ventilation. Should spontaneous breathing increase, fewer mandatory breaths will be provided. The minimum ventilation is determined by the setting of the tidal volume **VT** and the respiratory rate **RR**.

The maximum number of mandatory breaths is determined by the respiratory rate **RR**. However, this number is only provided when insufficient spontaneous breathing is present.

Pressure support

During spontaneous breathing from the PEEP level, the patient can be supported with **PS**. Every inspiratory effort of the patient that meets the trigger criteria triggers a pressure-supported breath. By setting the trigger level, the patient's inspiratory efforts are synchronized. The time, number, and duration of pressure-supported breaths is determined by the patient's spontaneous breathing.

As in all pressure-controlled ventilation modes, the tidal volume supplied depends on the difference in pressure "P_{supp} – PEEP", the lung mechanics (resistance and compliance) and the patient's respiratory drive. The pressure rise from the lower pressure level **PEEP** to the upper pressure level **P_{supp}** is determined by the **Slope** setting.

The pressure support is terminated as soon as the inspiratory flow falls below a certain proportion of the maximum inspiratory flow.

The proportion of the maximum inspiratory flow can be adjusted using the **Insp. term.** setting. If the **Insp. term.** setting is not configured, this proportion is 25 % in the **Adult** patient category and 15 % in the **Ped. pat.** and **Neo.** patient categories.

The pressure support is also terminated as soon as the duration of the support has reached the maximum inspiratory time. For intubated patients, the maximum inspiratory time is limited to 4 seconds in the **Adult** patient category and to 1.5 seconds in the **Ped. pat.** and **Neo.** patient category. In non-invasive ventilation, the maximum inspiratory time is limited to 130 % of **Ti** (maximum

4 seconds) in the **Adult** patient category and to 130 % of **Ti** (maximum 1.5 seconds) in the **Ped. pat.** patient category.

Pressure limitation

The therapy control **Pmax** is activated when the user links the alarm limit **Paw high** to the therapy control **Pmax**. Evita V500 can avoid the pressure peak with the pressure limitation **Pmax**, complying with the set tidal volume **VT**.

The tidal volume **VT** remains constant provided the plateau pressure **Pplat** is present. Evita V500 limits the pressure by reducing the inspiratory flow when the set **Pmax** value is reached.

If the tidal volume **VT** can no longer be applied with the selected pressure **Pmax**, e.g., due to reduced compliance, the low-priority alarm **VT not reached, Pmax active** is generated.

PC-CMV

Pressure Control-Continuous Mandatory Ventilation

Continuous pressure-controlled ventilation allowing spontaneous breathing (open system) during the entire respiratory cycle

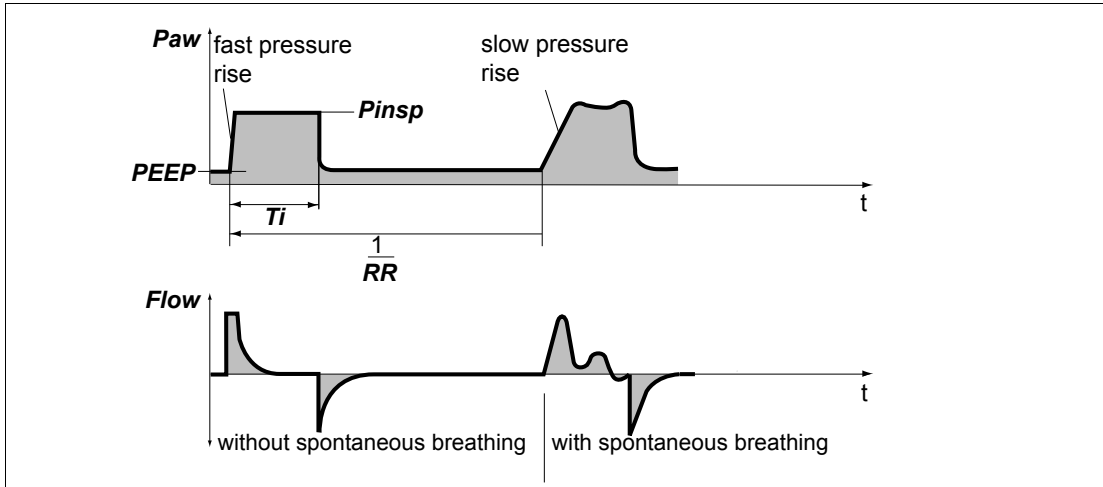

Pressure-controlled ventilation

The upper pressure level is determined by P_{insp} . The duration of the mandatory breaths is determined by T_i . As in all pressure-controlled ventilation modes, the tidal volume supplied depends on the difference in pressure " $P_{insp} - PEEP$ ", the lung mechanics (resistance and compliance) and the patient's respiratory drive. The pressure rise from the lower pressure level $PEEP$ to the upper pressure level P_{insp} is determined by the **Slope** setting.

The mandatory breaths are time-cycled and are not triggered by the patient. The number of mandatory breaths is determined by the respiratory rate RR .

PC-BIPAP

Pressure Control-Biphasic Positive Airway Pressure

Intermittent, synchronized, pressure-controlled ventilation allowing spontaneous breathing (open system) during the entire respiratory cycle and expiratory synchronization

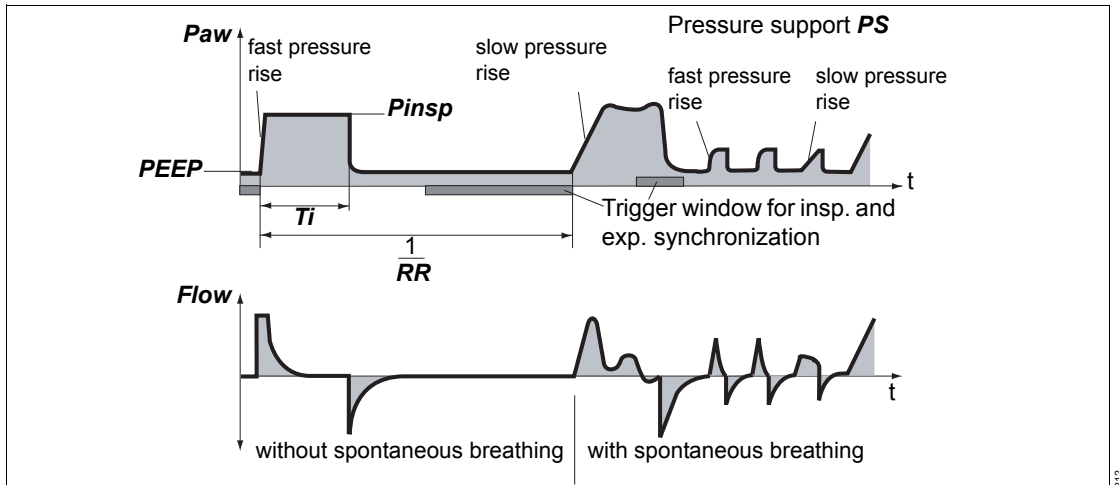

Pressure-controlled ventilation

The upper pressure level is determined by P_{insp} . The duration of the mandatory breaths is determined by T_i . As in all pressure-controlled ventilation modes, the tidal volume supplied depends on the difference in pressure " $P_{insp} - PEEP$ ", the lung mechanics (resistance and compliance) and the patient's respiratory drive. The pressure rise from the lower pressure level $PEEP$ to the upper pressure level P_{insp} is determined by the **Slope** setting.

The change-over from the inspiratory to the expiratory pressure level is synchronized with the patient's spontaneous breathing. Synchronization of the mandatory breath reduces the duration of the mandatory breath. Evita V500 extends the subsequent breath by the missing time. This prevents an increase in respiratory rate.

In the **Neo.** patient category, this mode is not available with non-invasive ventilation.

Synchronization

The mandatory breaths can be triggered by the patient's inspiratory effort on PEEP level.

A mandatory breath can only be triggered within a "trigger window" by the flow trigger in synchrony with the patient's spontaneous inspiratory effort. This prevents the mandatory breath being applied during expiration.

The trigger window is 5 seconds in the **Adult** patient category and 1.5 seconds in the **Ped. pat.** and **Neo.** patient categories.

For expiratory times shorter than 5 seconds in the **Adult** patient category or 1.5 seconds in the **Ped. pat.** and **Neo.** patient category, the trigger window covers the entire expiratory time minus a refractory period for the previous expiration.

Synchronization of mandatory breaths reduces the expiratory time. Evita V500 extends the subsequent expiratory time or spontaneous breathing time by the missing time. This prevents an increase of the mandatory respiratory rate.

The number of mandatory breaths is determined by the respiratory rate **RR**.

Pressure support

During spontaneous breathing from the PEEP level, the patient can be supported with **PS**. Every inspiratory effort of the patient that meets the trigger criteria triggers a pressure-supported breath. By setting the trigger level, the patient's inspiratory efforts are synchronized. The time, number, and duration of pressure-supported breaths is determined by the patient's spontaneous breathing.

As in all pressure-controlled ventilation modes, the tidal volume supplied depends on the difference in pressure "P_{supp} – PEEP", the lung mechanics (resistance and compliance) and the patient's respiratory drive. The pressure rise from the lower pressure level **PEEP** to the upper pressure level **P_{supp}** is determined by the **Slope** setting.

The pressure support is terminated as soon as the inspiratory flow falls below a certain proportion of the maximum inspiratory flow.

The proportion of the maximum inspiratory flow can be adjusted using the **Insp. term.** setting. If the **Insp. term.** setting is not configured, this proportion is 25 % in the **Adult** patient category and 15 % in the **Ped. pat.** and **Neo.** patient categories.

The pressure support is also terminated as soon as the duration of the support has reached the maximum inspiratory time. For intubated patients, the maximum inspiratory time is limited to 4 seconds in the **Adult** patient category and to 1.5 seconds in the **Ped. pat.** and **Neo.** patient category. In non-invasive ventilation, the maximum

inspiratory time is limited to 130 % of **Ti** (maximum 4 seconds) in the **Adult** patient category and to 130 % of **Ti** (maximum 1.5 seconds) in the **Ped. pat.** patient category.

PC-SIMV

Pressure Control-Synchronized Intermittent Mandatory Ventilation

Intermittent, triggered, pressure-controlled ventilation allowing spontaneous breathing (open system) during the entire respiratory cycle

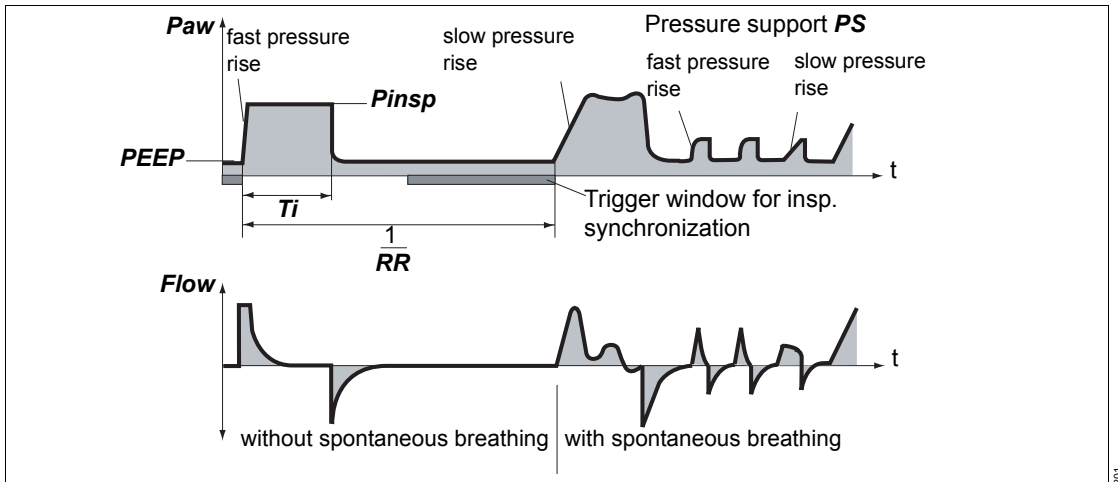

Pressure-controlled ventilation

The upper pressure level is determined by P_{insp} . The duration of the mandatory breaths is determined by T_i . As in all pressure-controlled ventilation modes, the tidal volume supplied depends on the difference in pressure " $P_{insp} - PEEP$ ", the lung mechanics (resistance and compliance) and the patient's respiratory drive. The pressure rise from the lower pressure level $PEEP$ to the upper pressure level P_{insp} is determined by the **Slope** setting.

In the **Neo.** patient category, this mode is not available with non-invasive ventilation.

Synchronization

The mandatory breaths can be triggered by the patient's inspiratory effort from the PEEP level.

By setting the trigger level, the mandatory breaths can be synchronized with the patient's inspiratory efforts.

A mandatory breath can only be triggered within a "trigger window" by the flow trigger in synchrony with the patient's spontaneous inspiratory effort. This prevents the mandatory breath being applied during expiration.

The trigger window is 5 seconds in the **Adult** patient category and 1.5 seconds in the **Ped. pat.** and **Neo.** patient categories. For expiratory times shorter than 5 seconds in the **Adult** patient category or 1.5 seconds in the **Ped. pat.** and **Neo.** patient category, the trigger window covers the entire expiratory time minus a refractory period for the previous expiration.

Synchronization of mandatory breaths reduces the expiratory time. Evita V500 extends the subsequent expiratory time or spontaneous breathing time by the missing time. This prevents an increase of the mandatory respiratory rate.

The number of mandatory breaths is determined by the respiratory rate **RR**.

Pressure support

During spontaneous breathing from the PEEP level, the patient can be supported with **PS**. Every inspiratory effort of the patient that meets the trigger criteria triggers a pressure-supported breath. By setting the trigger level, the patient's inspiratory efforts are synchronized. The time, number, and duration of pressure-supported breaths is determined by the patient's spontaneous breathing.

As in all pressure-controlled ventilation modes, the tidal volume supplied depends on the difference in pressure "P_{supp} – PEEP", the lung mechanics (resistance and compliance) and the patient's respiratory drive. The pressure rise from the lower pressure level **PEEP** to the upper pressure level **P_{supp}** is determined by the **Slope** setting.

The pressure support is terminated as soon as the inspiratory flow falls below a certain proportion of the maximum inspiratory flow.

The proportion of the maximum inspiratory flow can be adjusted using the **Insp. term.** setting. If the **Insp. term.** setting is not configured, this proportion is 25 % in the **Adult** patient category and 15 % in the **Ped. pat.** and **Neo.** patient categories.

The pressure support is also terminated as soon as the duration of the support has reached the maximum inspiratory time. For intubated patients, the maximum inspiratory time is limited to 4 seconds in the **Adult** patient category and to 1.5 seconds in the **Ped. pat.** and **Neo.** patient category.

In non-invasive ventilation, the maximum inspiratory time is limited to 130 % of **Ti** (maximum 4 seconds) in the **Adult** patient category and to 130 % of **Ti** (maximum 1.5 seconds) in the **Ped. pat.** patient category.

PC-AC

Pressure Control-Assist Control

Assist-controlled, pressure-controlled ventilation allowing spontaneous breathing during the entire respiratory cycle and backup respiratory rate

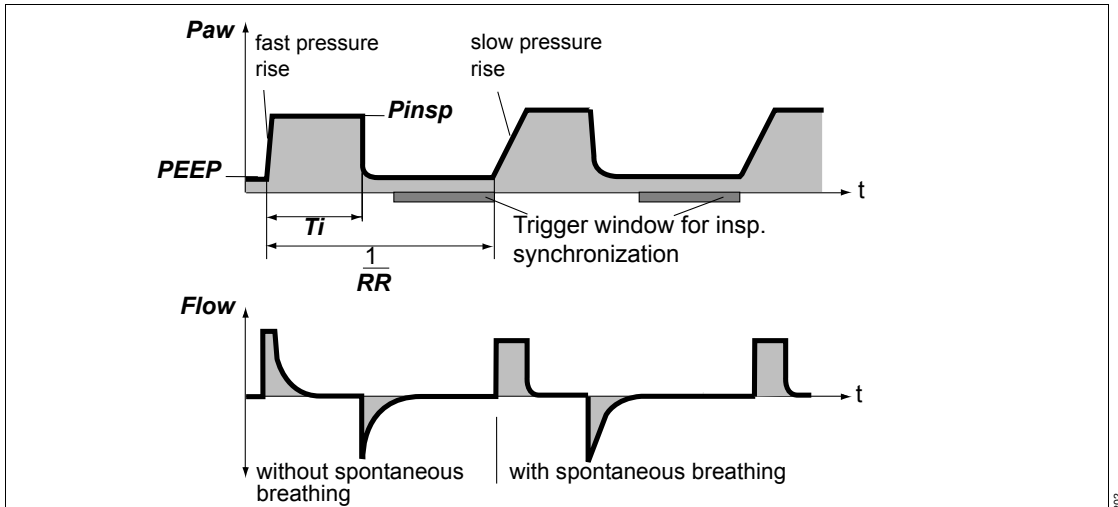

Pressure-controlled ventilation

The upper pressure level is determined by ***P_{insp}***. The duration of the mandatory breaths is determined by ***T_i***. As in all pressure-controlled ventilation modes, the tidal volume supplied depends on the difference in pressure "***P_{insp}*** – ***PEEP***", the lung mechanics (resistance and compliance) and the patient's respiratory drive. The pressure rise from the lower pressure level ***PEEP*** to the upper pressure level ***P_{insp}*** is determined by the ***Slope*** setting.

In the **Neo** patient category, this mode is not available with non-invasive ventilation.

Assisted-controlled ventilation

Every inspiratory effort of the patient from the **PEEP** level triggers a synchronized mandatory breath. Thus, the time and number of mandatory breaths are determined by the patient.

The trigger window covers the expiratory time minus a refractory period for the previous expiration. The expiratory time is determined by the respiratory rate ***RR*** and the inspiratory time ***T_i***. A non-synchronized mandatory breath is triggered at the latest at the end of the expiratory time (back-up respiratory rate).

The minimum number of mandatory breaths is determined by the respiratory rate ***RR***.

PC-PSV

Pressure Control-Pressure Support Ventilation

Pressure-controlled ventilation with guaranteed minimum respiratory rate (backup respiratory rate)

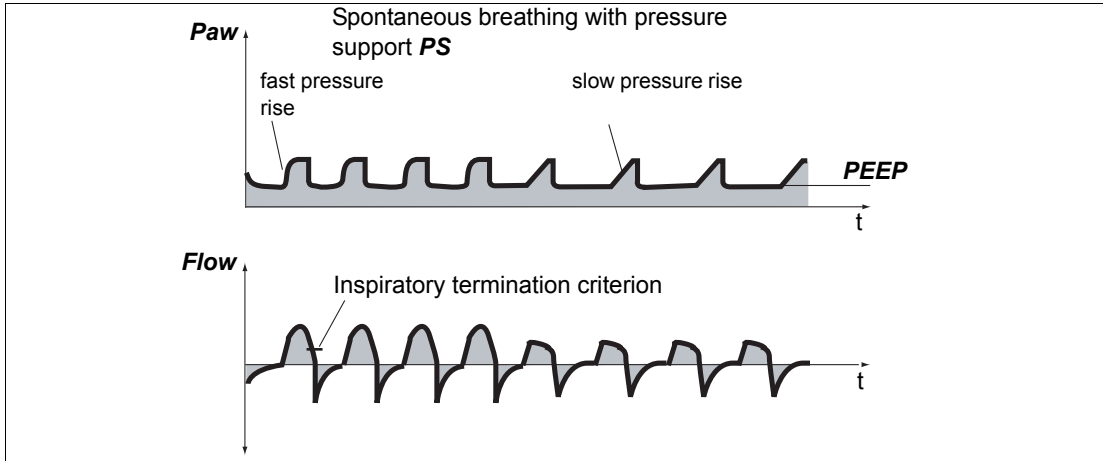

310

Pressure support

During spontaneous breathing from the PEEP level, the patient can be supported with **PS**. The level of pressure support is determined by **P_{insp}**. Every inspiratory effort of the patient that meets the trigger criteria triggers a pressure-supported breath. By setting the trigger level, the patient's inspiratory efforts are synchronized. The time, number, and duration of pressure-supported breaths is determined by the patient's spontaneous breathing. If the patient's respiratory rate is less than the set back-up respiratory rate **RR** or there is no spontaneous breathing present, the device administers pressure-supported breaths with the respiratory rate **RR**.

As in all pressure-controlled ventilation modes, the tidal volume supplied depends on the difference in pressure "**P_{insp}** – PEEP", the lung mechanics (resistance and compliance) and the patient's respiratory drive. The pressure rise from the lower pressure level PEEP to the upper pressure level **P_{insp}** is determined by the **Slope** setting.

The pressure support is terminated as soon as the inspiratory flow falls below a certain proportion of the maximum inspiratory flow.

The proportion of the maximum inspiratory flow can be adjusted using the **Insp. term.** setting. If the **Insp. term.** setting is not configured, this proportion is 25 % in the **Adult** patient category and 15 % in the **Ped. pat.** and **Neo.** patient categories.

The pressure support is also terminated as soon as the duration of the support has reached the maximum inspiratory time.

For intubated patients, the maximum inspiratory time is limited to 4 seconds in the **Adult** patient category and to 1.5 seconds in the **Ped. pat.** patient category. For the **Neo.** patient category, the maximum inspiratory time can be set with **Timax** to a maximum of 1.5 seconds.

In non-invasive ventilation, the maximum duration of a breath for the **Adult** and **Ped. pat.** patient categories can be set with **Timax**. In the **Neo.** patient category, this mode is not available with non-invasive ventilation.

PC-APRV

Pressure Control-Airway Pressure Release Ventilation

Spontaneous breathing under continuous positive airway pressure with brief pressure releases

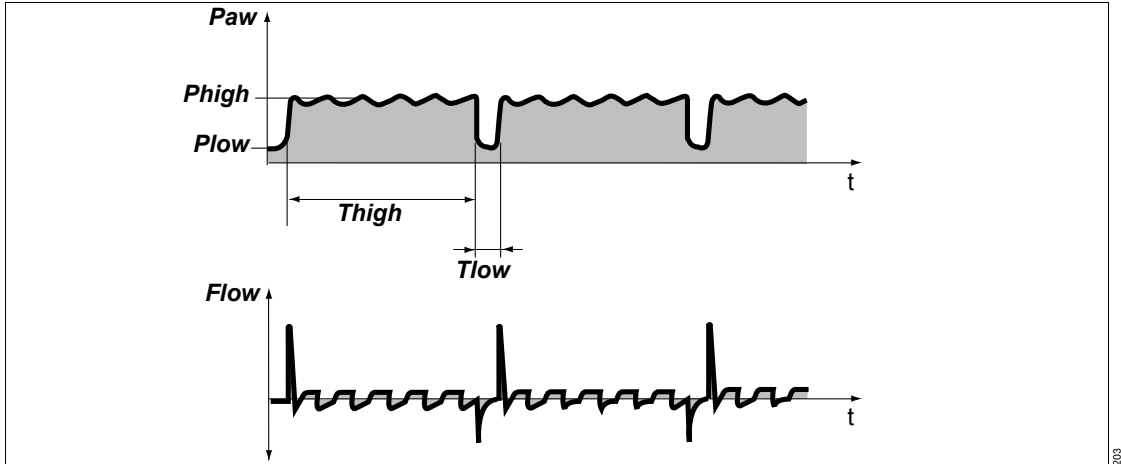

The patient breathes spontaneously at a high pressure level **Phigh** for an adjustable length of time **Thigh**. For very short expiratory times **Tlow**, Evita V500 switches to a low pressure level **Plow**. The normal lung areas are emptied, but the "slow" lung areas only change volume to a lesser extent*.

The number of pressure releases is determined by the **Thigh** and **Tlow** settings. The releases are time-cycled and are not triggered by the patient. The duration is determined by **Tlow**. The tidal volume exchanged during the release phases depends on the difference in pressure **Phigh** – **Plow**, the lung mechanics (resistance and compliance) and the length of pressure release **Tlow**. The steepness of the pressure rise from the lower pressure level **Plow** to the upper pressure level **Phigh** is determined by the **Slope** setting.

During the activation of **AutoRelease**, the duration of pressure releases is determined by the expiratory flow trace. The **Exp. term.** setting

determines the percentage by which the expiratory flow must fall short of in relation to the peak flow for the ventilation to return to the high pressure level.

When **AutoRelease** is switched on, the change-over from the upper pressure level **Phigh** to the lower pressure level **Plow** is synchronized with the patient's spontaneous breathing.

Synchronization of the mandatory breath reduces the time on the upper pressure level. Evita V500 prolongs the subsequent ventilation time on the upper pressure level by the missing time. This prevents an increase in respiratory rate.

In the **Neo.** patient category, this mode is not available with non-invasive ventilation.

* References [1], [2], [3], [4], see page 372.

SPN-CPAP/PS

Spontaneous-Continuous Positive Airway Pressure/Pressure Support

Spontaneous breathing with continuous positive pressure level with or without pressure support

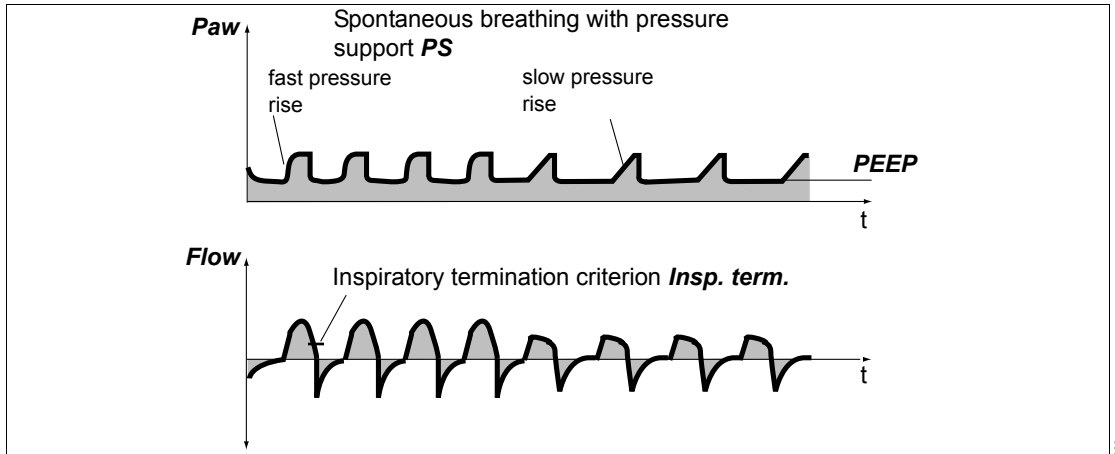

When the pressure support is not switched on, the patient's spontaneous breathing is merely supported by an increased **PEEP**.

During spontaneous breathing from the PEEP level, the patient can be supported with **PS**. Every inspiratory effort of the patient that meets the trigger criteria triggers a pressure-supported breath. The time, number, and duration of pressure-supported breaths is determined by the patient's spontaneous breathing.

As in all pressure-controlled ventilation modes, the tidal volume supplied depends on the difference in pressure " $P_{\text{supp}} - \text{PEEP}$ ", the lung mechanics (resistance and compliance) and the patient's respiratory drive. The pressure rise from the lower pressure level **PEEP** to the upper pressure level **Psupp** is determined by the **Slope** setting.

The pressure support is terminated as soon as the inspiratory flow falls below a certain proportion of the maximum inspiratory flow.

The proportion of the maximum inspiratory flow can be adjusted using the **Insp. term.** setting. If the **Insp. term.** setting is not configured, this proportion is 25 % in the **Adult** patient category and 15 % in the **Ped. pat.** and **Neo.** patient categories.

The pressure support is also terminated as soon as the duration of the support has reached the maximum inspiratory time. For intubated patients, the maximum inspiratory time is limited to 4 seconds in the **Adult** patient category and to 1.5 seconds in the **Ped. pat.** patient category. For the **Neo.** patient category, the maximum inspiratory time can be set with **Timax** to a maximum of 1.5 seconds. In non-invasive ventilation, the maximum duration of support can be set with **Timax**.

In the **Neo.** patient category, this mode is not available with non-invasive ventilation.

SPN-CPAP/VS

Spontaneous-Continuous Positive Airway Pressure/Volume Support

Spontaneous breathing with continuous positive pressure level with or without volume support

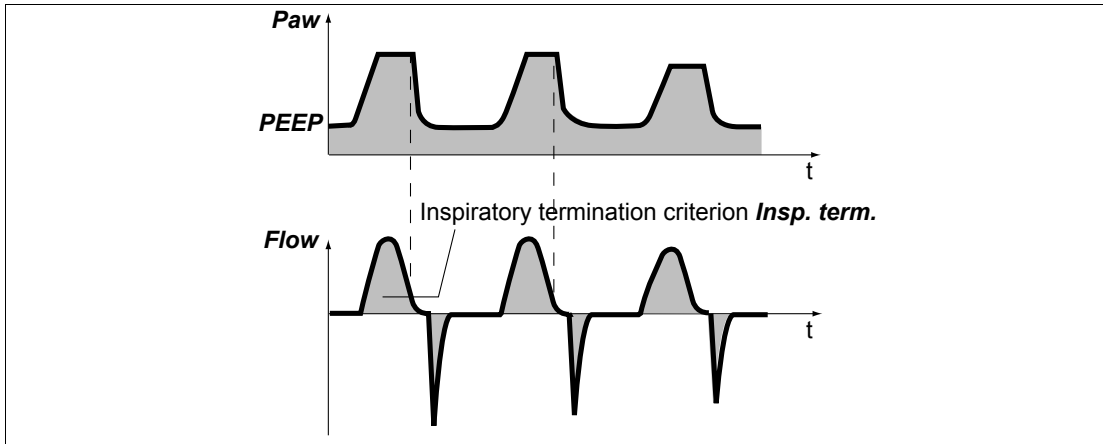

For volume support **VS**, every inspiratory effort by the patient on the PEEP level that meets the trigger criteria triggers a volume-supported breath. By setting the trigger level, the patient's inspiratory efforts are synchronized. The time, number and duration of volume-supported breaths is determined by the patient's spontaneous breathing. The pressure rise is determined by the **Slope** setting.

The volume support is terminated as soon as the inspiratory flow falls below a certain proportion of the maximum inspiratory flow. The proportion of the maximum inspiratory flow can be adjusted using the **Insp. term.** setting. If the **Insp. term.** setting is not configured, this proportion is 25 % in the **Adult** patient category and 15 % in the **Ped. pat.** and **Neo.** patient categories.

The volume support is also terminated as soon as the duration of the support has reached the maximum inspiratory time.

For intubated patients, the maximum inspiratory time is limited to 4 seconds in the **Adult** patient category and to 1.5 seconds in the **Ped. pat.** patient category. For the **Neo.** patient category, the

maximum inspiratory time can be set with **Timax** to a maximum of 1.5 seconds. In non-invasive ventilation, the maximum duration of support for the **Adult** and **Ped. pat.** patient categories can be set with **Timax**.

In the **Neo.** patient category, this mode is not available with non-invasive ventilation.

The set tidal volume of the supported breaths is reached through the automatically controlled pressure level of the volume support. With volume support, the support pressure is automatically adjusted to changes in lung conditions (resistance and compliance) and to the spontaneous breathing demand of the patient.

If Paw high is linked to the Pmax therapy control, set the maximum pressure that can be applied with the Pmax setting!

If ***Paw high*** is not linked to the ***Pmax*** therapy control, always set the ***Paw high*** alarm limit so that Evita V500 generates an alarm in the event of an increase in airway pressure due to reduced compliance. The maximum pressure that can be applied is limited to 5 mbar (5 cmH₂O) below the upper alarm limit.

SPN-CPAP

Spontaneous-Continuous Positive Airway Pressure

Spontaneous breathing with continuous positive pressure level in the application mode ***NIV***

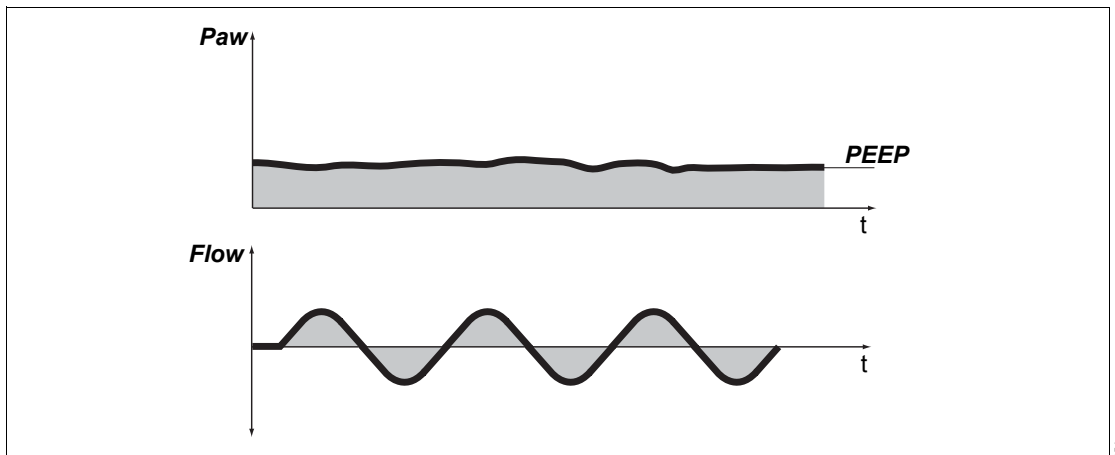

The ***SPN-CPAP*** ventilation mode is only available with non-invasive ventilation in the ***Neo***. patient category.

The patient's spontaneous breathing is supported with an increased PEEP.

For the ***Manual inspiration/hold*** maneuver, the pressure of the breath is set with the ***PmanInsp*** therapy control and the duration of the breath is set with the ***TmanInsp*** therapy control.

SPN-PPS

Spontaneous-Proportional Pressure Support

Spontaneous breathing with flow- and volume-proportional pressure support

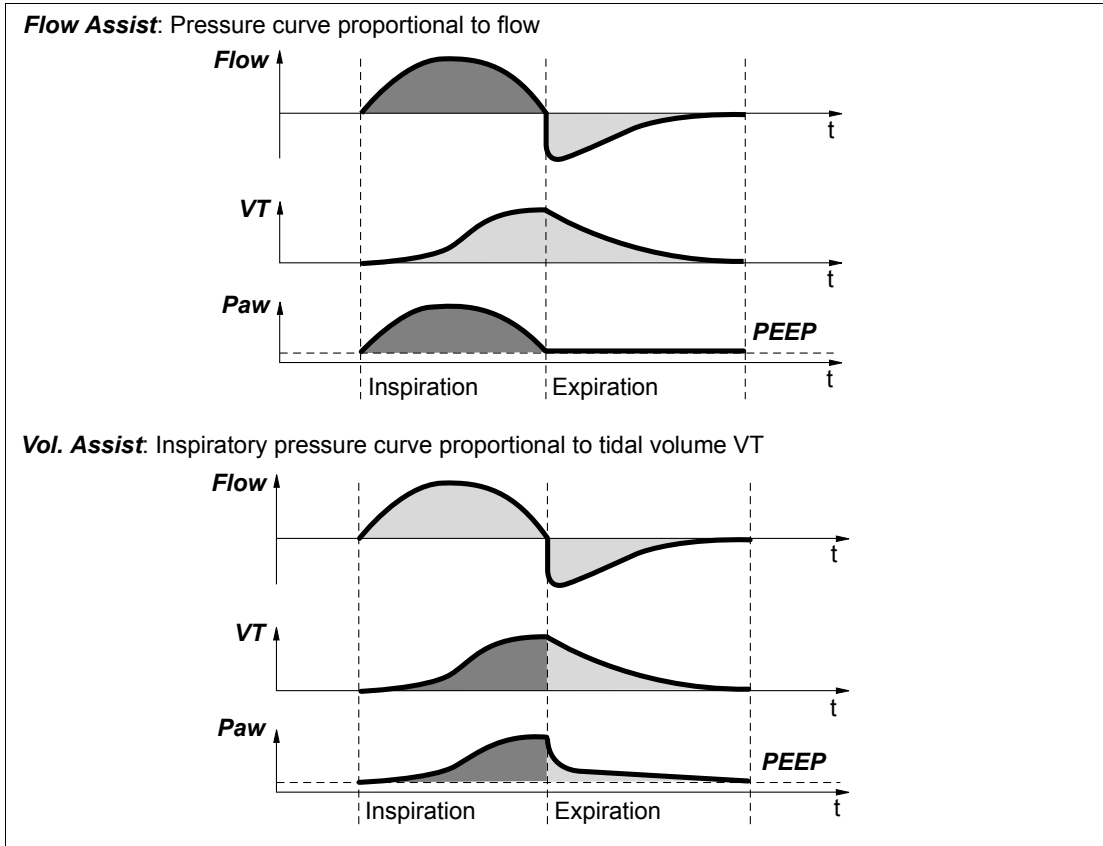

In ventilation mode SPN-PPS, Evita V500 supports the patient's spontaneous breathing in proportion to the inspiratory effort. If the patient breathes strongly, Evita V500 supports this effort with high pressure support. If the patient has shallow breathing, Evita V500 reacts with low pressure support. Mechanical support is omitted altogether if there is no spontaneous breathing. Monitoring of apnea and minute volume must therefore be set appropriately.

The degree of support in PPS mode can be set separately according to the resistive and elastic components. Using the resistive proportion **Flow Assist**, the user defines how much of the resistive work of breathing is taken over by Evita V500. Using the elastic proportion **Vol. Assist**, the user defines how much of the elastic work of breathing is taken over by Evita V500. This support is only effective during inspiration.

The pressure support is terminated as soon as the inspiratory flow falls below a certain proportion of the maximum inspiratory flow. The proportion of the maximum inspiratory flow can be adjusted using the **Insp. term.** setting.

If the **Insp. term.** setting is not configured, this proportion is 25 % in the **Adult** patient category and 15 % in the **Ped. pat.** and **Neo.** patient categories.

The pressure support is also terminated as soon as the duration of the support has reached the maximum inspiratory time. For intubated patients, the maximum inspiratory time is limited to 4 seconds in the **Adult** patient category and to 1.5 seconds in the **Ped. pat.** patient category. For the **Neo.** patient category, the maximum inspiratory time can be set with **Timax** to a maximum of 1.5 seconds. In non-invasive ventilation, the maximum duration of support for the **Adult** and **Ped. pat.** patient categories can be set with **Timax**.

In the **Neo.** patient category, this mode is not available with non-invasive ventilation.

If Paw high is linked to the Pmax therapy control, set the maximum pressure that can be applied with the Pmax setting!

If Paw high is not linked to the Pmax therapy control, always set the Paw high alarm limit so that Evita V500 generates an alarm in the event of an increase in airway pressure due to reduced compliance. The maximum pressure that can be applied is limited to 5 mbar (5 cmH₂O) below the upper alarm limit.

Always set the alarm limit VT high in order to generate an alarm in the event of an increase in airway pressure and tidal volume resulting from excessive support.

Additional settings for ventilation

Apnea Ventilation

Apnea ventilation in the *Adult and Ped. pat.* patient categories

For switching over automatically to volume-controlled mandatory ventilation in case of apnea.

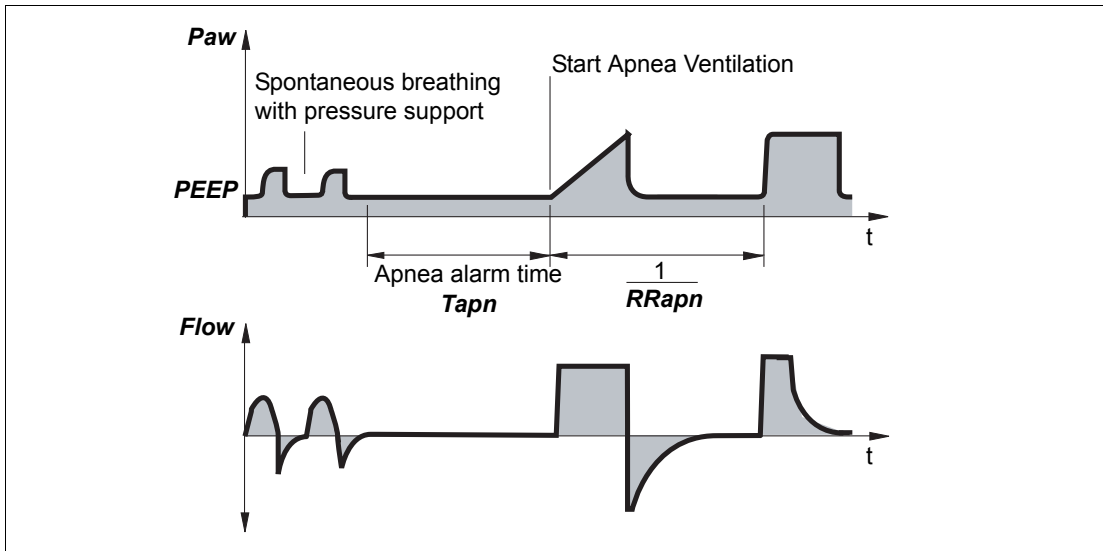

222

If the patient is ventilated using a volume-controlled mode without AutoFlow, apnea ventilation is also volume-controlled without AutoFlow. In all other cases, apnea ventilation is volume-controlled with AutoFlow.

For Evita V500 to be able to detect an apnea, flow measurement must function and the flow monitoring must be activated.

Evita V500 detects an apnea when no expiratory flow is measured or insufficient inspiratory gas is delivered during the set apnea alarm time T_{Apn} . If apnea ventilation is activated, the device starts volume-controlled ventilation with the ventilation parameters RR_{Apn} and VT_{Apn} .

The inspiratory time for apnea ventilation is determined from the set apnea respiratory rate RR_{Apn} and a fixed I:E ratio of 1:2.

The patient can breathe spontaneously and the mandatory breaths are synchronized with the patient's spontaneous breathing. The apnea ventilation respiratory rate RR_{Apn} remains constant. Evita V500 provides synchronized intermittent mandatory ventilation.

Apnea ventilation is terminated by touching the **Apn. Vent. reset** button. Evita V500 continues ventilating in the previously set ventilation mode. Changing the ventilation mode or the additional settings, e.g., **PS**, also terminates apnea ventilation.

If an apnea situation generating an alarm occurs again during apnea ventilation, this indicates that the apnea ventilation respiratory rate **RRapn** has been set too low in relation to apnea alarm time **Tapn**.

Apnea ventilation in the Neo. patient category

For switching over automatically to volume-guaranteed mandatory ventilation in case of apnea.

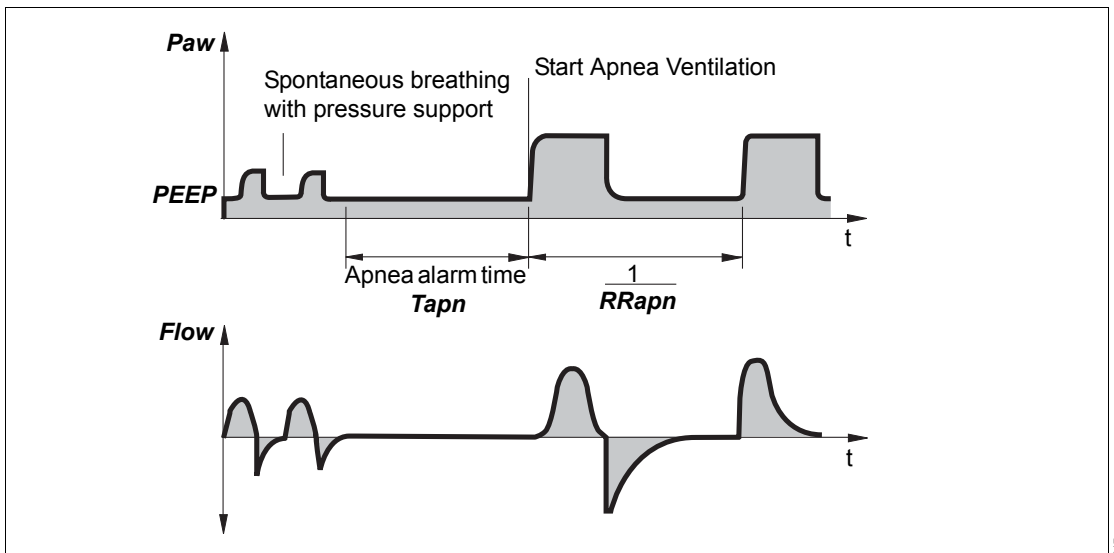

For Evita V500 to be able to detect an apnea, flow measurement with the neonatal flow sensor must function and flow monitoring with the neonatal flow sensor must be activated.

Evita V500 detects an apnea when no expiratory flow is measured or insufficient inspiratory gas is delivered during the set apnea alarm time **Tapn**. If apnea ventilation is activated, the device starts volume-guaranteed ventilation with the ventilation parameters **RRapn** and **VTapn**. The inspiratory time for apnea ventilation is determined from the set apnea respiratory rate **RRapn** and a fixed I:E ratio of 1:2.

The patient can breathe spontaneously and the mandatory breaths are synchronized with the patient's spontaneous breathing. The apnea

ventilation respiratory rate **RRapn** remains constant. Evita V500 provides synchronized intermittent mandatory ventilation.

Apnea ventilation is terminated by touching the **Apn. Vent. reset** button. Evita V500 continues ventilating in the previously set ventilation mode. Changing the ventilation mode or the additional settings, e.g., **PS**, also terminates apnea ventilation.

If an apnea situation generating an alarm occurs again during apnea ventilation, this indicates that the apnea ventilation respiratory rate **RRapn** has been set too low in relation to apnea alarm time **Tapn**.

Automatic return from apnea ventilation

If the **Automatic return from Apnea Ventilation** function is configured, then the device automatically switches to the previous ventilation mode when sufficient spontaneous breathing is resumed. The following conditions must be met:

- Apnea ventilation must have been active for at least 2 minutes.
- The alarm message **MV low** is not active.
- One of the following conditions must additionally be met:
 - The ratio of MVespon to MVe is greater than 25 % and the ratio of MVleak to MVe is less than 40 %.
 - Or
 - 80 % of the mandatory breaths are triggered spontaneously.

If apnea reoccurs within 3 minutes following automatic termination of apnea ventilation in the **Adult** and **Ped. pat.** patient categories, the **Automatic return from Apnea Ventilation** function is disabled until apnea ventilation is terminated manually or another ventilation mode is selected.

For configuration of the **Automatic return from Apnea Ventilation** function, see "Configuring general settings" on page 194.

Flow trigger

The flow trigger is used to synchronize mandatory breaths with spontaneous breathing. The flow trigger is also used to trigger breaths with SPN-CPAP/PS and SPN-CPAP/VS.

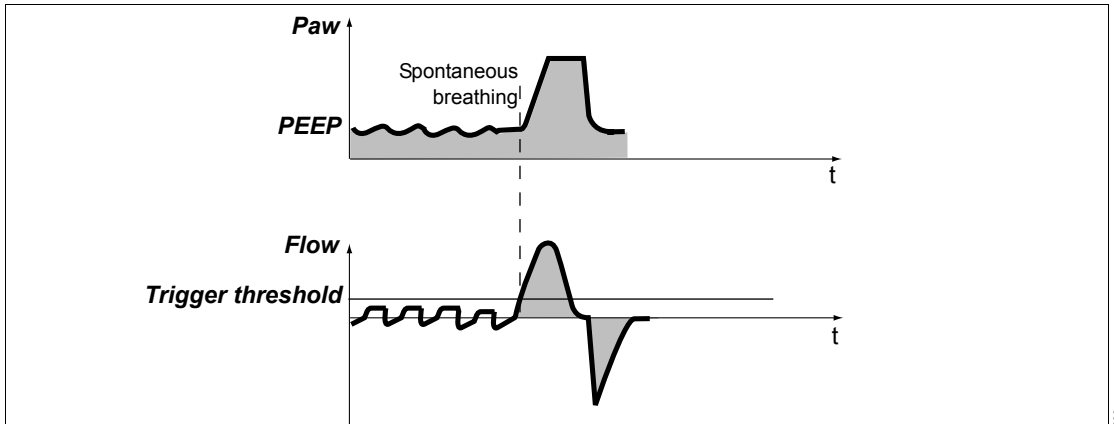

With the **Flow trigger** threshold, the mandatory breaths are synchronized with the inspiratory efforts. The start setting of the flow trigger can be configured on the page **System setup > Ventilation > Start settings > VT, RR, Trigger**.

Spontaneous breathing activity by the patient is indicated on the screen by the brief appearance of the  symbol.

In order to prevent a possible error when measuring the respiratory rate, e.g., caused by cardiogenic oscillations, only those spontaneous breaths are counted which meet the adjustable trigger criterion.

Inspiratory termination

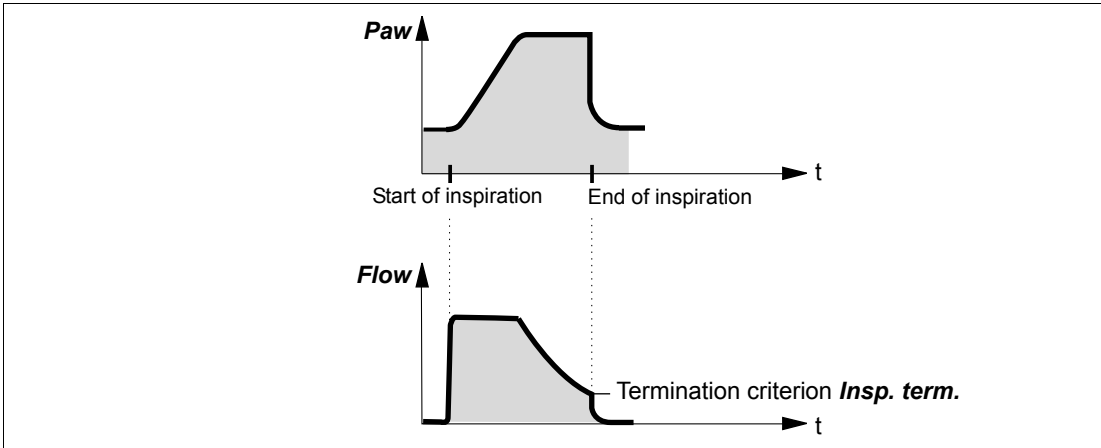

228

For spontaneous breaths supported with **PS**, **VS** and **PPS**, the length of inspiration is determined by the inspiratory termination criterion. Inspiratory termination specifies at which percentage of the peak inspiratory flow **Insp. term.** expiration is to start.

The standard setting is 25 % in the **Adult** patient category and 15 % in the **Ped. pat.** and **Neo.** patient categories.

The termination criterion can be configured on the page **System setup > Ventilation > Start settings > Other settings**.

When configured, the inspiratory termination can be set with the **Insp. term.** therapy control in order to achieve better adaptation to the patient's lung properties and breathing pattern.

Sigh

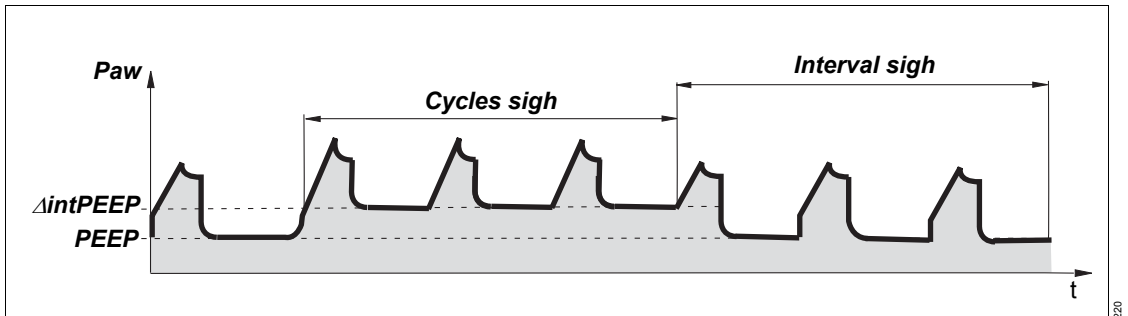

Atelectasis can be prevented by activating the sigh function and setting the sigh in the form of an intermittent PEEP. The purpose of expiratory sigh is to open collapsed areas of the lungs or to keep open "more dependent" areas of the lungs.

The sigh function can be activated in all ventilation modes with mandatory breaths, except for PC-APRV. When the sigh function is activated, the end-expiratory pressure PEEP increases by the set value of the intermittent PEEP.

The time between the two sigh phases can be set with the therapy control **Interval sigh**.

The therapy control **Cycles sigh** controls how many respiratory cycles are covered by the sigh phase. The average airway pressure is higher, and a longer filling time is normally available.

In pressure-controlled ventilation, the inspiratory pressures **P_{insp}**, **P_{supp}** increase by the amount **ΔintPEEP**.

AutoFlow/Volume Guarantee

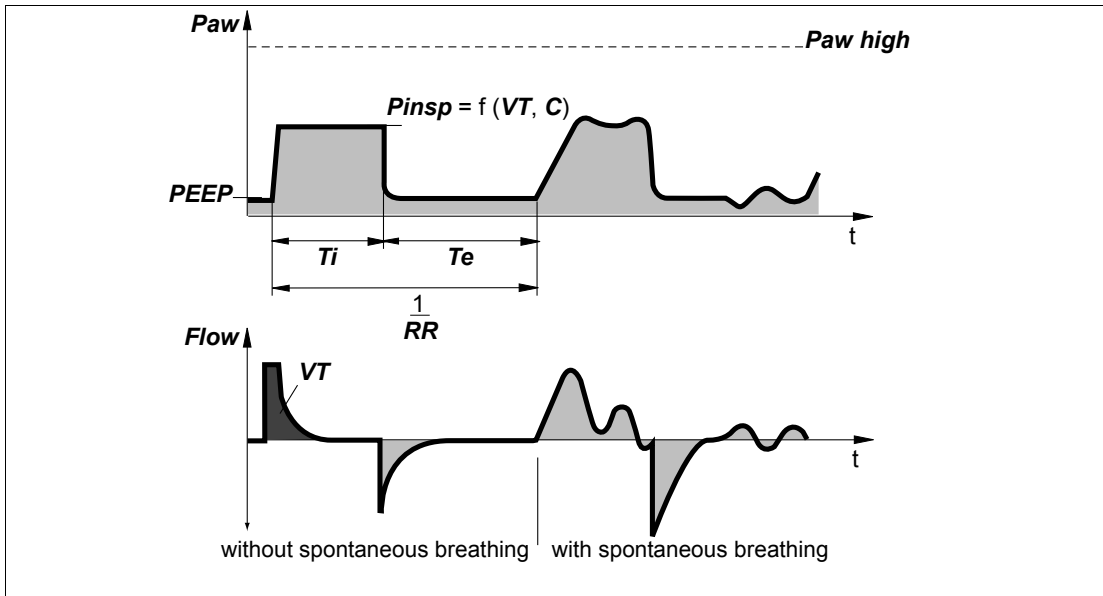

225

Evita V500 provides ventilation with AutoFlow/Volume Guarantee with a decreasing flow in order to avoid pressure peaks. Evita V500 determines the pressure required for the set tidal volume, with consideration of the lung conditions (compliance, resistance) and the patient's spontaneous breathing demand.

When the patient breathes in, Evita V500 delivers an additional inspiratory flow limited by the alarm limit **VT high**. The patient can also breathe out during the inspiratory plateau phase. The alarm limit for **VT high** must be set with care to prevent, for example, overinflation of the lungs following rapid changes in compliance.

The inspiratory pressure is limited by the alarm limit **Paw high**. The maximum applied pressure is limited to 5 mbar (5 cmH₂O) below the upper pressure limit **Paw high**. Always set this alarm limit in order to generate an alarm in the event of an increase in airway pressure due to reduced compliance.

If the **Paw high** alarm limit is linked to the **Pmax** therapy control, the user can adjust the maximum value for the airway pressure. Since the value set for **Pmax** may be reached in this case with **AutoFlow/Volume Guarantee**, the current condition of the patient must always be taken into consideration when setting the value, in order to exclude the possibility of causing harm if the airway pressure is too high.

The minimum inspiratory pressure for mandatory non-triggered breaths is 3 mbar (3 cmH₂O) above PEEP; for triggered mandatory and spontaneous breaths it is 0.1 mbar (0.1 cmH₂O) above PEEP.

Typically, the selected inspiratory time **Ti** is much longer than the lung filling time. The inspiratory pressure **P_{insp}** corresponds to the minimum value calculated from the tidal volume **VT** and compliance **C** of the lungs. The inspiratory flow is automatically controlled so that there is no pressure peaks caused by the resistances of the tube and the airways. With AutoFlow/Volume Guarantee, changes in inspiratory flow occur in steps of max. 3 mbar (3 cmH₂O) from breath to breath.

If the tidal volume **VT** is reached (inspiratory flow = 0) before the inspiratory time **Ti** has fully elapsed, the control system for the inspiratory and expiratory valves ensures that the patient can breathe in and out during the remaining inspiratory time, even during the constant pressure plateau **Pplat**. If the patient breathes in or out during mandatory inspiration, the inspiratory pressure does not fluctuate during that breath. Only the inspiratory and expiratory flow are adapted to the patient's demand. The applied tidal volume **VT** may deviate from the set tidal volume **VT** in individual breaths. However, as an average over time, a constant tidal volume **VT** is supplied.

Exceeding the tidal volume **VT** can be limited by the alarm limit **VT high**. If the set alarm limit is exceeded once, Evita V500 generates a low priority alarm message (!). If it is exceeded three times in succession, Evita V500 generates a medium priority alarm message (!!). Tidal volume is actively limited to the value of the alarm limit **VT high** by switching to PEEP level.

Regardless of the alarm limit **VT high** setting, Evita V500 ends an AutoFlow/Volume Guarantee breath when the supplied inspiratory volume (minus the volume supplied for breathing circuit compliance compensation) exceeds the set volume by 100 %. This may occur in the event of a major leakage. In this case, Evita V500 generates the low priority alarm message **VT not reached, leakage**.

Set the alarm limits **MV high** and **MV low** appropriately in order to avoid excessive or insufficient flow following rapid changes in compliance. When using AutoFlow/Volume Guarantee, activate flow monitoring!

A set inspiratory time **Ti** shorter than the lung filling time can be recognized from the flow curve. The flow at the end of the inspiratory time has not dropped to zero. In this case, it must be decided whether the current condition of the patient permits prolongation of the inspiratory time **Ti** in order to reduce peak pressure even further. This effect can also be caused during ventilation, e.g., due to a build-up of secretion. In this situation, the pressure is limited by Evita V500 as described. If the set tidal

volume **VT** can no longer be fully applied as a result, the low-priority alarm message **Pressure limited** is generated.

The pressure rise from the PEEP level to the inspiratory level can be even more closely adapted to the needs of the patient by adjusting the pressure rise time **Slope**.

If the AutoFlow/Volume Guarantee function in the **Ped. pat.** and **Neo.** categories is switched on and a manual inspiration (**Man. insp./hold**) is triggered, a breath is applied to the maximum pressure **Pmax**.

Start-up procedure with AutoFlow/Volume Guarantee

When AutoFlow/Volume Guarantee is switched on, Evita V500 applies the set tidal volume **VT** by means of a volume-controlled breath with minimum inspiratory flow and subsequent inspiratory pause. The plateau pressure calculated for this breath serves as the startup value for inspiratory pressure under AutoFlow/Volume Guarantee. If an appropriate pressure cannot be calculated for this breath or the volume cannot be applied, Evita V500 applies a pressure-controlled breath with an inspiratory pressure of 5 mbar (5 cmH₂O) above the set PEEP. Evita V500 measures the applied volume in this case and calculates an initial target pressure for the set volume. The next mandatory breath is applied with an inspiratory pressure that corresponds to 75 % of this target pressure. Evita V500 measures the applied volume again and calculates a new target pressure for the set volume. The next mandatory breath is applied with this target pressure. As described above, the following mandatory breaths are changed in the inspiratory pressure so that the set volume is reached on average.

ATC

Automatic Tube Compensation

Compensation of the tube resistance

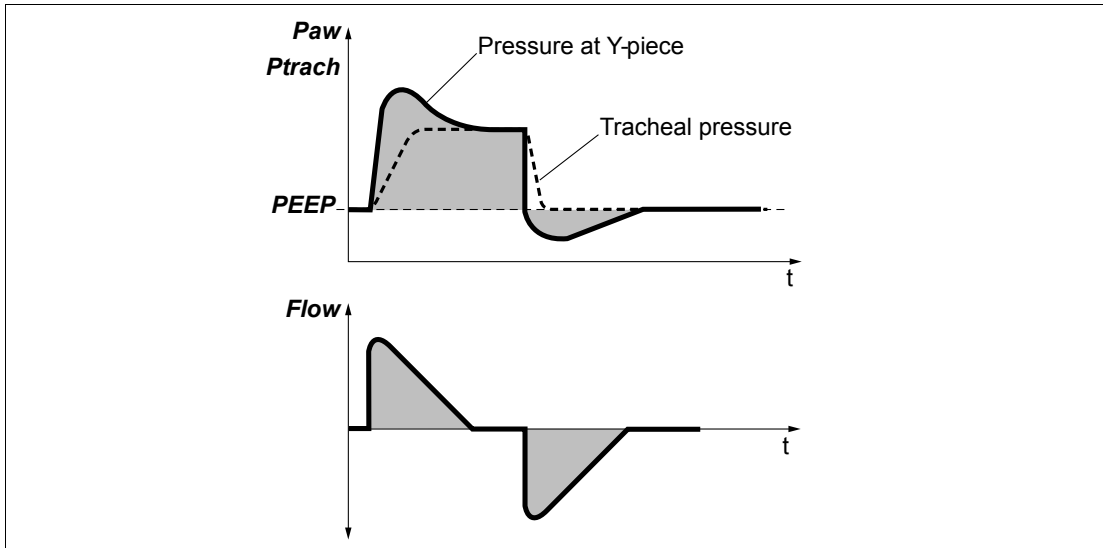

226

ATC regulates the airway pressure to the tracheal level. This function calculates and displays the tracheal pressure on the basis of a mathematical tube model, the set tube type and the inner diameter of the tube.

When tube compensation is activated, Evita V500 displays the calculated tracheal pressure in the pressure curve together with the pressure at the Y-piece as a line. Activated tube compensation is indicated by **ATC** and the tube diameter in the page header bar.

When selecting loops, tracheal pressure can also be selected as a parameter. Tracheal pressure can also be displayed when tube compensation is deactivated if the calculation of the tracheal pressure was activated on the page **Start/Standby > Tube/NIV** and the tube type and diameter were entered. Evita V500 uses this value for calculating leakage and determining the lung mechanics, but not for tube compensation. The selected degree of compensation is not considered when displaying tracheal pressure or when determining leakage and lung mechanics.

Calculating tracheal pressure

Evita V500 calculates tracheal pressure on the basis of a square function of tube resistance and patient flow.

$$P_{\text{Trachea}} = P_{\text{aw}} - K_{\text{Tube}} \times \text{Flow} \times |\text{Flow}|$$

P_{Trachea} : Pressure in the trachea

P_{aw} : Pressure at the Y-piece of the breathing circuit

K_{Tube} : Tube coefficient (see page 342)

Flow: Patient flow

Inspiration: Flow >0

Expiration: Flow <0

The selected tube type and the inner diameter of the tube must correspond with the real tube for correct calculation and display of the tracheal pressure. This is required for correct tube compensation.

When tube compensation is activated, the ventilation pressure in the breathing circuit is increased during inspiration or decreased during expiration. The airway pressure is adjusted to the tracheal level if 100 % compensation of the tube resistance has been selected.

Expiratory tube compensation can be deactivated.

In volume-controlled ventilation modes with a constant inspiratory flow (VC-CMV, VC-SIMV, VC-MMV, VC-AC) tube compensation is only active during the expiration and spontaneous breathing phases.

For the mandatory portion of the breath, the inspiratory tube compensation can be deactivated.

When tube compensation is activated, Evita V500 controls the ventilation pressure so that the resistive work of breathing on the tube is compensated in accordance with the selected degree of compensation.

Depending on the direction of the patient flow, the airway pressure is increased during inspiration or decreased during expiration.

The airway pressure can be reduced to a minimum of 0 mbar (0 cmH₂O).

The maximum value for the airway pressure can be set using the **Pmax** therapy control. If **Pmax** is not linked to the alarm limit **Paw high**, the maximum pressure is limited to 5 mbar (5 cmH₂O) below the alarm limit **Paw high**. The pressure limitation message is displayed when the maximum permitted values are reached.

If the value selected for **Paw high** or **Pmax** is too low, it may impair the effectiveness of tube compensation. If the value selected for **Paw high** or **Pmax** is too high, it may result in unwanted high airway pressures.

When setting **Pmax**, be aware that this value may actually be reached in contrast to the value for **Paw high**.

Calculating the support

The level of support ΔP_{aw} applied during ATC is calculated on the basis of a square law function of tube resistance and patient flow.

$\Delta P_{aw} = \text{Comp.} \times K_{\text{Tube}} \times \text{Flow} \times |\text{Flow}|$

Comp.: Degree of compensation 0 to 100 %

K_{Tube} : Tube coefficient (see page 342)

Flow: Patient flow

Tube coefficient

The tube coefficient K_{Tube} is largely determined on the basis of the results obtained by Guttman et al*.

The tube coefficient K_{Tube} for the full-length tube is always taken as the basis. The effect of the shortened length is negligible.

The values for the tube coefficients are shown in the following tables.

* Literature reference [5], see page 372

Table for endotracheal tube:

Inner diameter of the tube (mm)	Tube coefficient K_{Tube} (mbar/L ² /s ²)
2.00	1834.00
2.50	600.00
3.00	340.00
3.50	170.00
4.00	100.00
4.50	50.00
5.00	30.96
5.50	23.70
6.00	17.21
6.50	13.05
7.00	10.56
7.50	8.41
8.00	6.57
8.50	5.17
9.00	4.29
9.50	3.80
10.00	3.50
10.50	3.00
11.00	2.50
11.50	2.00
12.00	1.50

Table for tracheostomy tube:

Inner diameter of the tube (mm)	Tube coefficient K_{Tube} (mbar/L ² /s ²)
2.50	600.00
3.00	340.00
3.50	170.00
4.00	100.00
4.50	50.00
5.00	30.96
5.50	15.40
6.00	10.00
6.50	7.90
7.00	6.38
7.50	5.20
8.00	4.50
8.50	3.70
9.00	2.95
9.50	2.65
10.00	2.50
10.50	2.05
11.00	1.65
11.50	1.35
12.00	1.10

AutoRelease

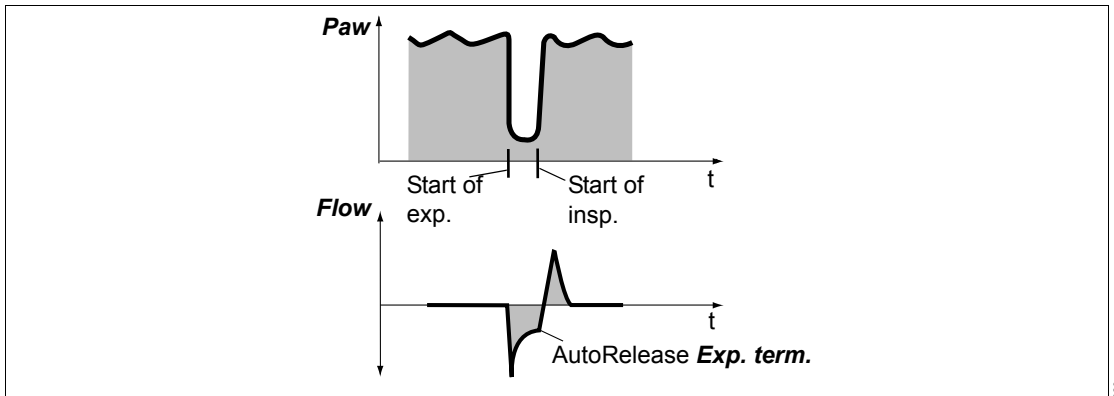

In ventilation mode PC-APRV, the duration of pressure release is determined from the expiratory flow curve when **AutoRelease** is activated. The **Exp. term.** setting specifies when the ventilation returns to the pressure level **P_{high}** dependent on the decline in percent of the peak expiratory flow. The therapy control **T_{low max}** limits the maximum duration of pressure release.

When **AutoRelease** is switched on, the change-over from the upper pressure level **P_{high}** to the lower pressure level **P_{low}** is synchronized with the patient's spontaneous breathing.

Synchronization of the mandatory breath reduces the effective time of the upper pressure level. Evita V500 prolongs the subsequent ventilation time on the upper pressure level by the missing time. This prevents an increase of the respiratory rate resulting from the settings.

Variable PS

Random variation of pressure support in the SPN-CPAP/PS ventilation mode.

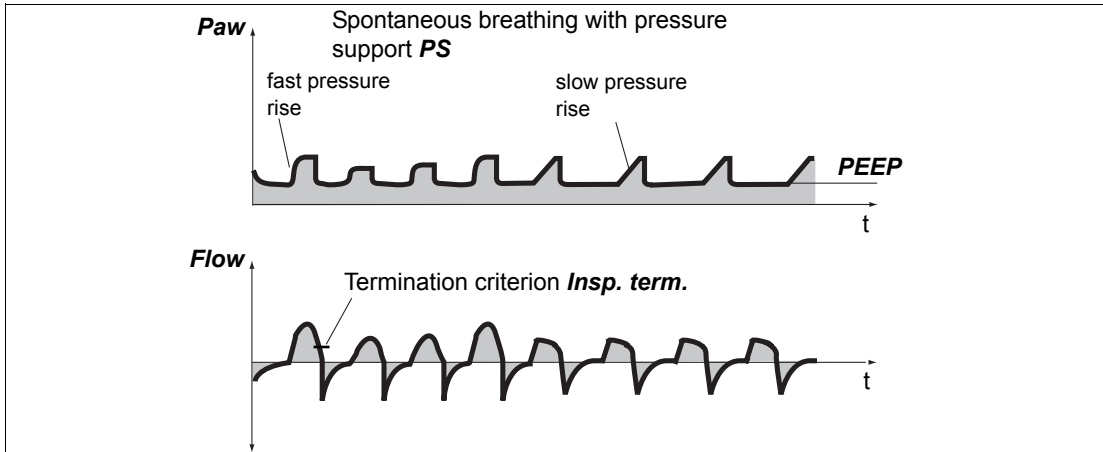

324

Pressure controlled ventilation is frequently used when weaning the patient from ventilation. Various additional device functions can be combined with the SPN-CPAP/PS ventilation mode. The same applies to **Variable PS**. The basic principle of pressure supported spontaneous breathing is fully retained and is not modified.

When **Variable PS** is activated, the individual breaths are applied at differing pressure support levels. The extent of the **Press. var.** variation can be modified at any time. Setting is performed as a percentage of the set pressure support. The **Press. var.** variation can be modified in a range from 0 to 100 %. Different ventilation pressures and tidal volumes occur as a result of the variation in pressure support. These ventilation pressures and tidal volumes are independent of the patient's inspiratory effort. The variation of the support pressure is performed based on the fixed mean support pressure **P_{supp}**. The maximum support pressure achievable through the variation is limited by the maximum airway pressure setting **P_{max}**. The lower limit for the variation is specified by the set CPAP level.

Limitation of the variation in pressure support **P_{supp}** through the maximum airway pressure **P_{max}** should basically be regarded as a restriction

of variability. This means that the set variability may not be fully exploited. Limitation via **P_{max}** also limits the variability of the pressure support **P_{supp}** downwards.

Independently of patient's inspiratory effort, the variation of pressure support through **Variable PS** can lead to a greater variability of the tidal volume **VT** than is the case with conventional pressure supported ventilation. Moreover, **Variable PS** can result in improved oxygenation and a redistribution of the pulmonary blood flow.*

Through the variability of pressure support **P_{supp}**, the inspiratory tidal volume **VT_i** or **VT** and the expiratory tidal volume **VT_e** also vary. The corresponding measured values are displayed as mean values.

Variable PS can be combined with **ATC** and **Apnea Ventilation**.

* Literature reference [33], see page 372

Special functions

Medication nebulization

Insp. O₂ concentration during medication nebulization

Use only medication nebulizer 8412935 (white central section core). If other medication nebulizers are used, considerable deviations may occur in the tidal volume and the inspiratory O₂ concentration!

To minimize the deviation from the set O₂ concentration, Evita V500 uses a gas mixture to drive the medication nebulizer. The gas mixture is generated by switching over between compressed air and O₂ in short time intervals.

In the **Adult** patient category, Evita V500 synchronizes application of the medication aerosol with the inspiratory flow phase and maintains a

constant minute volume. The medication nebulizer is supplied with compressed air, O₂ or a mixture of compressed air and O₂ by Evita V500, depending on the set O₂ concentration.

In the **Ped. pat.** and **Neo.** patient categories, the medication nebulizer nebulizes continuously. The aerosol generated during expiration does not reach the lungs, however. The medication nebulizer is supplied with compressed air, O₂ or a mixture of compressed air and O₂ by Evita V500, depending on the set O₂ concentration.

The graph shows the possible deviations in the applied O₂ concentration as a function of the set FiO₂ concentration with a minimal inspiratory flow (14 L/min) in the **Adult** patient category and at respiratory rates above 12/min in the **Ped. pat.** and **Neo.** patient categories.

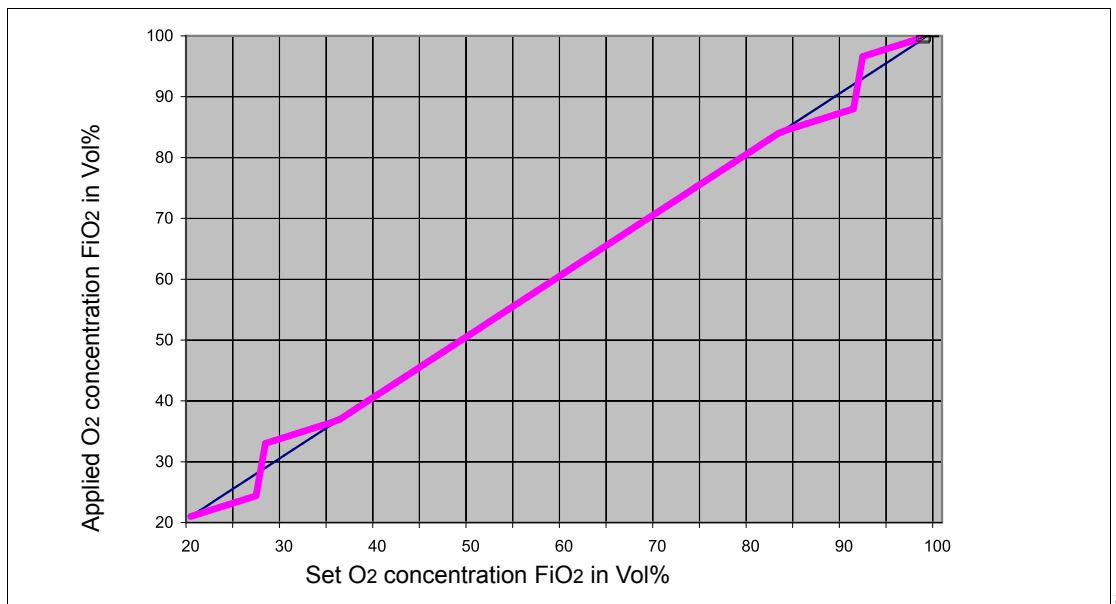

Air supply from the GS500 gas supply unit

If Evita V500 is supplied with Air from the GS500 gas supply unit and O₂ is supplied from the central gas supply system, the medication nebulizer operates with O₂ only. The measured value **FI_{O2}** indicates the O₂ concentration of the gas supplied at the inspiratory port and not the O₂ concentration administered to the patient. Depending on the patient category, the following systematic deviations are possible:

Adult	up to +32 Vol%
Ped. pat.	up to +40 Vol%
Neo.	up to +40 Vol%

Low Flow PV Loop

The **Low Flow PV Loop** measuring procedure records a static pressure-volume curve, which can be used to assess the mechanical properties of the lungs.

By slowly filling the lungs with a small, constant flow, only the elasticity properties are determined in the PV-Loop. This almost static process shows a good correlation with the static Super-Syringe or Occlusion Method [6, 7, 8]*, as long as the flow is small [9 to 13]*.

There are various approaches for optimizing ventilation settings based on measurements of the lung mechanics. All approaches aim at avoiding a recurrent collapsing and re-opening of alveoli and a possible overinflation of the lungs. It is recommended to set the **PEEP** on the basis of the lower inflection point (LIP) and to limit the tidal volume **VT** or plateau pressure **Pplat** on the basis of the upper inflection point (UIP) [14 to 17]*. Other research recommends taking into account the expiratory limb of the PV-Loop when determining the positive end-expiratory pressure (PEEP) required to maintain an alveolar recruitment. Characteristic points on the expiratory limb are described in this context as the point of maximum curvature (PMC) [6, 9, 11, 14, 18 to 24]*.

Evita V500 calculates the static compliance **Cstat** based on the volume applied for inspiration during the maneuver and the generated pressure difference.

The alveolar pressure is calculated from the airway pressure using the following formula:

$$Palv = Paw - Rk1 \times Flow - Rk2 \times |Flow| \times Flow$$

Rk1 and Rk2 are coefficients which have been calculated during dynamic calculation of patient resistance R.

Evita V500 calculates the overinflation index **C20/Cstat**. C20 is the compliance that results when only the upper 20 % of the applied pressure range is taken into account. **C20/Cstat** under 0.8 may indicate overinflation of the lungs [25]*.

The recorded data is analyzed using the method according to Harris RS, Hess DR, Venegas JG [26]*. Upon successful calculation, three characteristic points are marked in the loop:

- the lower inflection point on the inspiratory section of the loop
- the upper inflection point on the inspiratory section of the loop
- the upper inflection point on the expiratory section of the loop or point of maximum curvature on the expiratory section of the loop

To evaluate the results of the maneuver, two cursors can be moved over the PV-Loop. The values for pressure and volume marked by the cursor are displayed. The static compliance between 2 values is calculated and displayed. If characteristic points are identified on the loop, the two cursors are initially positioned on these points so that the corresponding values can be read off.

The last ten loops can be stored in the display for reference, but cannot be measured. On the **Special maneuvers > Low Flow PV Loop > History** page, the last ten loops, including the inflection points where applicable, are stored and can be measured with the cursor.

* List of references, see page 372

Optimization of the settings **PEEP** and **VT** or **Pinsp** can be performed directly on the **Special maneuvers > Low Flow PV Loop > Analysis** page. A horizontal or vertical line indicates the position on the PV loop during setting.

Performing a Low Flow maneuver can involve risks for the patient such as decreasing the patient's systemic circulatory pressure or causing a pneumothorax. The condition of the patient must therefore be taken into account when making the settings.

The applied pressures and volumes must be suitable for the patient. Potentially high intrathoracic pressures can be applied over a relatively long period while performing the maneuver. The patient must therefore be considered to be hemodynamically stable before starting the maneuver. The vital signs must be closely monitored and documented during the entire measurement. A significantly higher venous return caused by an abrupt relieving of the intrathoracic pressure can overstrain the heart under certain conditions. This is why the maneuver is usually terminated with an adjustable pressure decrease, even after only an inspiratory application.

The maneuver is similar to an apnea with a single slow breath. An acceptable maneuver duration should also be estimated for the patient. To avoid lengthy periods with a reduced gas exchange, the maneuver can only be restarted after 60 seconds following nebulization, suction or a previous Low Flow PV Loop.

Spontaneous breathing or leaks during the maneuver distort the measured values and should be ruled out before the application.

Depending on the duration of the maneuver and the metabolic rate of the patient, the expiratory limb of a PV Loop, in particular, can be easily influenced by the O₂ consumption, which is not offset by a corresponding CO₂ production*.

* Literature references [27, 28], see page 372

Diagnostics – measurement maneuver

Occlusion pressure – P0.1

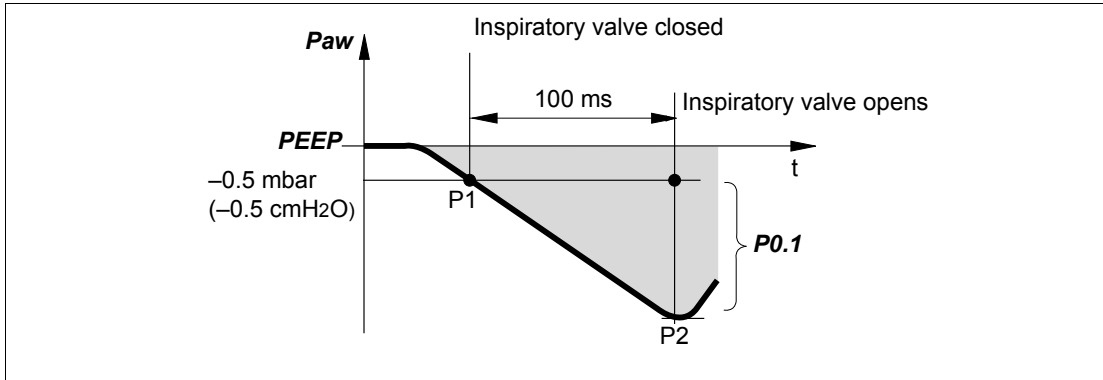

227

Respiratory drive can be measured at the start of inspiration by measuring the mouth pressure during a short term occlusion. Within the first 100 ms, the pressure is not influenced by physiological reactions that would try to compensate for the occlusion (e.g., reflexive interruption of breathing or increased respiratory drive). In principle, this pressure is also independent of the muscle strength of the diaphragm. Therefore, the negative mouth pressure $P0.1$ after 0.1 seconds is a direct measure of neuromuscular respiratory drive*.

Evita V500 displays the value for the measured pressure difference without a negative sign. For patients with healthy lungs and regular breathing, $P0.1$ will be about 3 to 4 mbar (3 to 4 cmH_2O). A high $P0.1$ value signifies a high respiratory drive, which can only be maintained for a limited period of time. $P0.1$ values above 6 mbar (6 cmH_2O), e.g., for a COPD patient, indicate impending exhaustion (RMF – respiratory muscle fatigue).

Evita V500 keeps the inspiratory valve closed after one expiration and measures the airway pressure produced by the patient's inspiratory effort during 100 ms. The 100 ms time interval starts when a negative pressure of -0.5 mbar ($-0.5 \text{ cmH}_2\text{O}$) below $PEEP/CPAP$ is measured during the inspiratory effort. The second pressure value is determined after 100 ms. Simultaneously, the inspiratory valve is opened. The patient can breathe normally again. The occlusion pressure $P0.1$ is the difference between the pressure values " $P2 - P1$ ".

* Literature reference [29], [30], see page 372

Intrinsic PEEP – $PEEP_i$

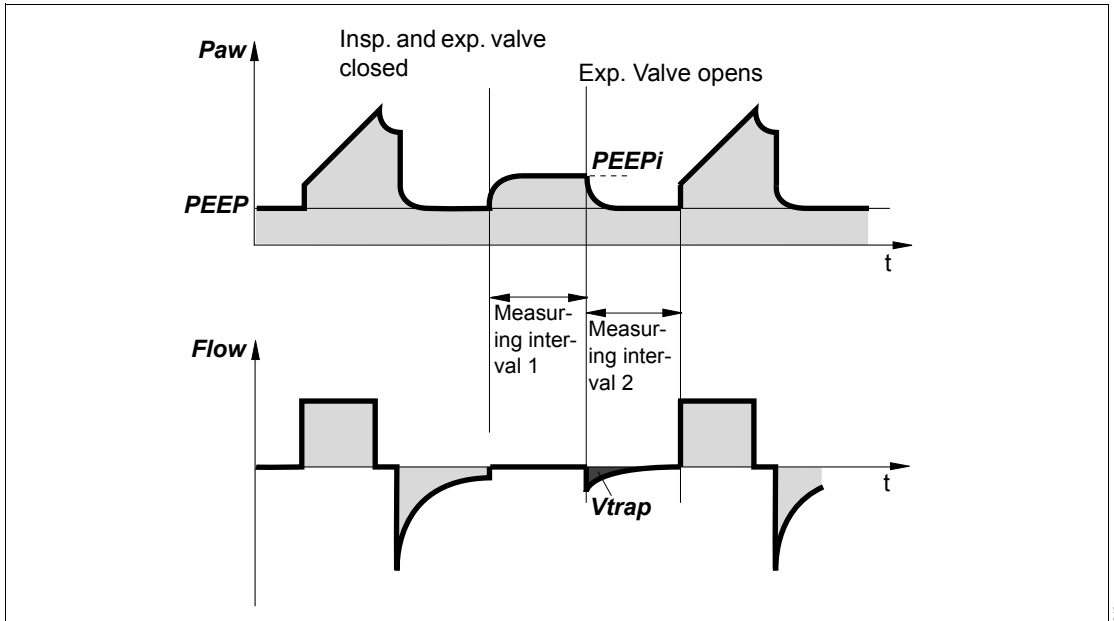

Intrinsic PEEP is the actual end-expiratory pressure inside the lungs. Owing to dynamic influences of the lung mechanics (resistance, compliance, closing volume) and the ventilation setting parameters, the Intrinsic PEEP may deviate from the PEEP in the upper airways.

This measurement maneuver also measures the “trapped” volume V_{trap} in the lungs, which does not participate in gas exchange.

The Intrinsic PEEP is measured in two phases. Evita V500 keeps the inspiratory and expiratory valves closed during measuring interval 1. This ensures that it is impossible for inspiratory gas to flow into the breathing circuit or for gas to escape from it. During this closed phase, pressure is equalized between the lungs and the circuit system. Evita V500 measures the pressure over time.

Measuring interval 1 is terminated:

- when no pressure changes are detected any longer, but at the earliest after 0.5 seconds,
- at the latest after 3 seconds in the **Adult** patient category and after 1.5 seconds in the **Ped. pat.** patient category

The start value corresponds to PEEP and the value at the end of the closed phase is the Intrinsic PEEP. At the end of measuring interval 1, Evita V500 opens the expiratory valve and measures the expiratory flow generated by Intrinsic PEEP during measuring interval 2. During this period, lung pressure is allowed to decrease to PEEP level.

Measuring interval 2 is terminated:

- when the expiratory flow has returned to 0, but after 0.5 seconds at the earliest,
- at the latest after 7 seconds in the **Adult** patient category and after 3.5 seconds in the **Ped. pat.** patient category

The integrated flow corresponds to the air volume trapped in the lungs V_{trap} by Intrinsic PEEP.

Measuring times of the measuring interval 1 for Intrinsic PEEP:

- Patient category **Adult** max. 3 seconds
- Patient category **Ped. pat.:** max. 1.5 seconds

Measuring times of the measuring interval 2 for Vtrap:

- Patient category **Adult** max. 7 seconds
- Patient category **Ped. pat.:** max. 3.5 seconds

Negative Inspiratory Force – NIF

The Negative Inspiratory Force Index (NIF)* measures a patient's maximum inspiratory effort after exhaling. The breathing circuit is closed during measurement of NIF. The NIF value is also known as the Maximum Inspiratory Pressure (MIP). As a result of the inspiratory effort during manually extended expiration, the patient generates a negative pressure in relation to PEEP. The probability that the patient can be weaned successfully increases with the magnitude of this negative pressure. Patients reaching a NIF value of less than –30 mbar (–30 cmH₂O) can in all probability be weaned successfully. Weaning of patients with a NIF value not below –20 mbar (–20 cmH₂O) will most likely prove unsuccessful.

Evita V500 determines the NIF value during manually extended expiration. The breathing circuit closes following an expiration by the patient while the **Exp. hold** button remains pressed. Evita V500 then measures the maximum inspiratory effort made by the patient. The NIF value is measured as a pressure relative to PEEP. The measuring procedure is ended when the **Exp. hold** button is released or after a maximum of 15 seconds. Evita V500 displays the last measured NIF value and the time when the measurement was made.

Influence of spontaneous breathing on resistance and compliance values

Spontaneous breathing influences the compliance **C_{dyn}** and resistance **R** values as follows:

- Trigger activity
The trigger activity is filtered out of the calculation and has virtually no influence on **C_{dyn}** and **R**.

- Patient breathing synchronously with the ventilator
 - **C_{dyn}** becomes incorrectly high
 - **R** becomes incorrectly low

Changes in the values indicate to what extent the patient is able to perform work of breathing and determine ventilation.

The trend display provides information on progress.

- Patient breathing synchronously against the ventilator
 - **C_{dyn}** becomes incorrectly low
 - **R** becomes incorrectly high
- Purely spontaneous breathing
In the case of purely spontaneous breathing, no information on **C_{dyn}** and **R** is available.

* Literature reference [31], [32], see page 372

C20/C

The C20/C index is a calculation of the compliance of the last 20 % (C20) of a breath in relation to the compliance (C) of the entire breath.

During a breath, Evita V500 determines continuously the pressure applied and the resulting tidal volume. The compliance of the last 20 % of a breath determined in this manner is set in proportion to the total compliance.

From the ratio determined, the following information can be derived:

- C20/C < 1: A decrease of compliance at the end of the breath was detected. The lungs may be overinflated.
- C20/C > 1: An increase of compliance at the end of the breath was detected. Tidal recruitment may be occurring.
- C20/C = 1: No change in compliance at the end of a breath could be detected. The lungs may not be overinflated, or tidal recruitment may not be occurring.

The calculation of C20/C takes into account the effect of the resistance of the endotracheal tube used or the tracheostomy tube used. For this, the tube diameter is required. The correct tube diameter entry of the tube used determines the quality of the C20/C index calculated.

The C20/C index is always displayed as long as a correction delivers plausible results with regard to the resistance. If, for instance, a smaller tube diameter was entered than that of the tube actually used, a correction to the measured values may deliver an implausible result. In this case, no C20/C index is displayed. The parameter field remains empty.

Smart Pulmonary View

Graphic display of lung characteristics

Smart Pulmonary View is a graphic display of lung flexibility (compliance) and resistance of the airways (resistance).

The representation corresponds to the displayed measured values of the respective patient.

The display range of compliance is 0 to 400 mL/mbar (400 mL/cmH₂O).

The display range of resistance is 0 to 300 mbar/L/s (300 cmH₂O/L/s).

To detect an improvement or deterioration of the patient's condition with regard to compliance and resistance, it is possible to adapt the representation to the current values of the patient. One measuring range starts at 0 and goes to double the value of the current compliance; the other measuring range starts at 0 and goes to double the value of the current resistance. After the adaptation, the measuring values determined are displayed as reference values with the time and date. In the graph, the current values (calibration values) are displayed as an orange broken line. The scales for compliance and resistance are adapted.

The compliance and resistance measured respectively are displayed by thin or thick lines accordingly.

The point when the maximum value that is based on the last calibration is reached is represented with a red line as a boundary. This indicates that the measured values determined can no longer be represented graphically. The measured values are outside the display range. Evita V500 displays a request for a new calibration.

The diaphragm is displayed schematically underneath the representation of the lungs. The movement of the diaphragm indicates synchronized mandatory breaths, supported (triggered) breaths, or spontaneous breaths.

The ratio between spontaneous breathing and mandatory ventilation is displayed in a diagram:

- **RR_{spon}** and **VT_{spon}** represent the spontaneous minute volume as an area
- **RR_{mand}** and **VT_{mand}** represent the mandatory minute volume as an area

The display is a qualitative representation of the respective minute volume.

From this, the following information can be derived:

- The ratio between the spontaneous and mandatory minute volumes
- The quality and pattern of the spontaneous breathing, e.g., Rapid Shallow Breathing

Smart Pulmonary View is a qualitative representation of the ventilation situation. Local pathophysiological peculiarities, such as atelectasis or airway obstructions of the lungs, cannot be displayed.

Furthermore, individual patient situations cannot be displayed, such as the condition after a pneumectomy or a diaphragmatic hernia.

Description of the therapy types

O₂ therapy

O₂ therapy can be used for patients with independent breathing. The continuous flow is applied via an oxygen mask, a hood, or nasal cannula. The O₂ concentration and the flow can be set.

In the **Neo** patient category, only the SPN-CPAP or PC-CMV ventilation modes may be selected. When using prongs or a mask, the neonatal flow sensor must be removed from the breathing circuit. Evita V500 switches off flow monitoring with the neonatal flow sensor.

NIV – Non-invasive ventilation

Non-invasive ventilation by mask for patients with spontaneous breathing

Leakages are greater with non-invasive ventilation than with invasive ventilation. Evita V500 takes into account the leakages in the **NIV** application mode accordingly. The inspiratory trigger and the termination criterion are automatically adapted to the measured leakage. This prevents auto-triggering due to a flow trigger which has been set too low and extended inspirations as well as insufficient inspiration due to a termination criterion which has been set too high.

The inspiratory tidal volume is typically far higher than the patient's tidal volume. The expiratory tidal volume is slightly lower than the patient's tidal volume. The measured values for tidal volume are leakage-corrected and indicate the patient's actual tidal volume. In the ventilation modes with AutoFlow and Volume Guarantee, the corrected measured values are set when leakage compensation is selected. During volume-controlled ventilation, the inspiratory volume escaping through the leak is additionally supplied.

The **VT low**, **VT high**, **MV low** and **Tapn** alarm limits can be deactivated in the **NIV** application mode. The **Tdisconnect** setting can be used to delay the **Airway pressure low** alarm.

Automatic leakage compensation

Mode of operation

Evita V500 determines the difference between the delivered inspiratory flow and the measured expiratory flow. This difference provides a measure of the amount of leakage and is displayed by Evita V500 as the leakage minute volume **MVleak** and relatively as **% leak** (MVleak to MVi).

The calculation of leakage compensation takes into account the airway pressures. A higher percentage of volume is lost on the inspiratory side than on the expiratory side because the pressure during inspiration is higher. The displayed leakage minute volume **MVleak** is based on the mean pressure **Pmean**. The leakage minute volume **MVleak** also takes the inspiratory leakages into account. Due to technical tolerances, a small leakage minute volume may be displayed even in the case of a leak-free breathing circuit. If there is a rapid change in the leakage, e.g., due to the leak being opened or closed suddenly, Evita V500 needs a few breaths to identify the new leakage value. Evita V500 prevents any potentially dangerous rises in pressure which might occur as a result of this.

During volume-controlled ventilation, without AutoFlow, Evita V500 supplies additional volume in order to compensate the leakage. Unlimited volume compensation is, however, inappropriate. Evita V500 compensates for volume losses of up to 100 % of the set tidal volume **VT**.

Volume and flow values are displayed leakage-compensated with the exception of the expiratory minute volume measured and all measured values which are explicitly marked as inspiratory or expiratory, such as **VTi** and **VTe**.

The inspiratory flow trigger threshold and the inspiratory termination criterion are applied to the leakage-compensated flow, with both settings being continuously optimized with regards to the leakage.

Example of leakage compensation during volume-controlled ventilation

The mode of operation is illustrated using a simplified example with the following values:

- Set tidal volume $VT = 500$ mL
- 10 % tube leak

Mode of operation without leakage compensation: Evita V500 delivers 500 mL. This is displayed as the inspiratory tidal volume **VTi**. 50 mL escape as leakage during inspiration. 450 mL reach the lungs. 450 mL are expired, of which 45 mL again escape as leakage. 405 mL are measured on the expiratory side and indicated as **VTe**.

As a result, an inspiratory minute volume of 5.0 L/min will be delivered at a respiratory rate of 10/min and an expiratory minute volume of 4.05 L/min will be measured. The lungs are ventilated with a minute volume of 4.5 L/min. Without leakage compensation, the **VT** therapy control determines the volume supplied by Evita V500.

Mode of operation with leakage compensation: With automatic leakage compensation, Evita V500 delivers 550 mL on the basis of the measured leakage minute volume instead of a tidal volume of 500 mL. 500 mL enter the lungs and the inspiratory tidal volume is 500 mL. This value is displayed as the inspiratory tidal volume **VT**.

The volume measured on the expiratory side is displayed without compensation, even when leakage compensation is activated, and is therefore 450 mL. The minute volume measured on the expiratory side is 4.5 L/min and is also displayed uncompensated. Otherwise, expiratory leakage compensation might block a low minute volume alarm. Evita V500 is intended to always generate an alarm in the event of an excessively low minute volume.

With leakage compensation, the **VT** therapy control determines the volume to be delivered to the patient.

Example of leakage compensation with AutoFlow or Volume Guarantee

The mode of operation is illustrated using a simplified example with the following values:

- Set tidal volume VT = 500 mL
- 10 % leakage

Mode of operation without leakage compensation: Evita V500 selects the inspiratory pressure so that VT_i = 500 mL is delivered during inspiration. The patient only receives 450 mL.

Mode of operation with leakage compensation: Evita V500 selects the inspiratory pressure so that the leakage-corrected VT delivered to the patient is 500 mL. The inspiratory tidal volume is correspondingly higher.

Example of leakage compensation with flow trigger or inspiratory termination criterion

The mode of operation is illustrated using a simplified example with the following values:

- Flow trigger setting 2 L/min
- Leakage increases from 0 % to 20 %

Mode of operation without leakage compensation: If the leakage flow is above the flow trigger threshold, the user must increase the flow trigger threshold in order to avoid auto-triggering. If the leakage is reduced, the user must increase the sensitivity of the flow trigger again. The same applies to the inspiratory termination criterion in specific ventilation modes.

Mode of operation with leakage compensation: Evita V500 determines the leakage flow. The leakage flow is subtracted from the total flow in order to determine the patient flow. Only this flow is used for the flow trigger or the inspiratory termination criterion. After a few breaths Evita V500 "learns" the leakage and avoids auto-triggering. If the leakage is closed, the sensitivity of the flow trigger is automatically increased again. The same applies to the inspiratory termination criterion (if configured) for breaths with pressure support or volume support.

Flow reduction Anti Air Shower

When the **Anti Air Shower** function is activated and a disconnection is detected during ventilation, the flow is reduced until reconnection is detected. Simultaneously, the **Disconnection?** alarm is displayed. With non-invasive ventilation, the time before the alarm is triggered can be delayed with **Tdisconnect**. The minute ventilation can be reduced due to the already reduced flow.

To configure the **Anti Air Shower** function, see "Configuring general settings" on page 194.

Measurements

Flow/volume measurement

Independent of whether ventilation is pressure or volume-controlled, positive pressures are generated both in the breathing circuit as well as in the patient's lungs. The volume delivered by the ventilator is distributed to both the patient lungs and the breathing circuit used between patient and ventilator. This distribution occurs according to the ratio of lung compliance versus breathing circuit compliance.

Resulting expiratory deviations for the measured value of flow and the calculated values of minute ventilation and tidal volume are minimal during ventilation in the **Adult** patient category. This is due to the relatively large lung compliance compared to the considerably smaller compliance of the breathing hoses. Significant differences are possible during ventilation in the **Ped. pat.** and **Neo.** patient categories. As only the volume actually entering and leaving the lungs is relevant for the efficiency of ventilation, Evita V500 always compensates for the effect of breathing circuit compliance on ventilation.

Compensating for the effect of breathing circuit compliance

During the breathing circuit check before the start of ventilation, Evita V500 determines the compliance of the breathing hoses. It then compensates for the effect of this compliance on flow and volume measurement during ventilation.

Depending on the airway pressure, Evita V500 increases ventilatory volume to the same amount that remains in the breathing hoses. Evita V500 compensates hose-dependent volume losses up to a compliance of 4 mL/mbar in the **Adult** patient category and 3 mL/mbar in the **Ped. pat.** and **Neo.** patient categories.

In addition to the influence of breathing circuit compliance, flow/volume measurement is affected by:

- the ambient conditions temperature and pressure
- the composition of the gas
- leakages in the breathing circuit

Evita V500 takes these effects into account and corrects the set and measured values accordingly.

Adaptation to ambient conditions

The volume of a gas depends on the ambient conditions with regard to temperature, pressure, and humidity. In lung physiology, reference is made to the conditions inside the lungs for the values of minute volume and tidal volume: 37 °C (99 °F) body temperature, pressure inside the lungs, 100 % relative humidity.

Measured values for flow and volume under these conditions are characterized as BTPS. Medical gases from cylinders or from a central supply are dry (approximately 0 % relative humidity) and are delivered from the ventilator at 20 °C (68 °F) and 1013 mbar (1013 cmH₂O). Measured values for flow and volume under these conditions are characterized as NTPD.

The difference between values measured as NTPD and BTPS is approximately 12 % at a pressure of 1013 mbar (1013 cmH₂O).

Example: 250 mL tidal volume NTPD become 282 mL BTPS when warmed to 37 °C (99 °F) and humidified to 100 % relative humidity.

Evita V500 controls tidal volume in such a way that the set tidal volume value is applied under BTPS conditions in the lungs.

Measurement principles

Measurement principle of the flow measurement

The measurement principle used for flow measurement is based on hot-wire anemometry. Hot-wire anemometry is a thermal measurement procedure in which the measuring wires of the flow sensor are kept at a constant excess temperature. The higher the flow, the more current is required to maintain a constant excess temperature. The flow rate is calculated based on the magnitude of the heating current.

To ensure correct function, check for visible damage, soiling, and particles before inserting the flow sensor. Repeat this check regularly. Replace flow sensors when damaged, soiled, or not particlefree. If the measurement wires of the flow sensor glow continuously during operation, this is an indication of contamination. Immediately reprocess or replace the flow sensor.

Flow measurement with expiratory flow sensor

Expiratory flow is measured with a hot wire anemometer. The flow passes through the sensor, cooling the hot wire in the process. The amount of energy required to maintain the hot wire at a temperature of 130 °C (360 °F) is a measure of the flow.

Flow measurement with neonatal flow sensor

The flow is measured with a hot wire anemometer between the Y-piece and the tube. The flow direction is detected by the use of two hot wires, one of which is shielded on one side.

The amount of energy required to maintain the wire at a temperature of 400 °C (752 °F) is used as a measure of the flow passing through the sensor, cooling the hot wire in the process.

The lowest flow at which detection functions reliably is 0.2 L/min. Lower flow values are therefore suppressed and displayed as zero.

Two different sensor types are available:

- Y-sensor, integrated in the Y-piece
- ISO sensor to insert between Y-piece and tube connector

Both sensor types use the same sensor insert. Despite this, the sensor properties are not identical. The sensor type is set in the **Sensors/Parameters > Neonatal flow sensor** dialog window in order to adapt the measurement for this type of sensor optimally.

O₂ measurement

A heating and a temperature sensor are positioned in a homogeneous magnetic field which is periodically activated and deactivated. The thermal conductivity of O₂ changes due to the magnetic field. The change in thermal conductivity is a measure of the O₂ concentration.

CO₂ measurement

CO₂ is measured via a mainstream system based on absorption measurement.

A light source generates a spectrum. Two light detectors record the characteristic absorption spectrum and supply electrical signals that change with the CO₂ concentration.

These signals are then evaluated and displayed. Heating the CO₂ sensor probe prevents condensation.

Airway pressure measurement

Evita V500 measures the airway pressure indirectly by means of two internal pressure sensors. The sensors are installed in the inspiratory and expiratory lines, thereby eliminating the need for an external pressure measuring line between the Y-piece and the device. As long as one side is without flow, the measured value of the flowless pressure sensor corresponds to the airway pressure at the Y-piece.

In the **Neo**. patient category, there is a constant base flow during ventilation. However, due to this constant base flow, the zero-flow condition is never attained either on the inspiratory or expiratory side. The pressure measured by the inspiratory pressure sensor varies with the variations in airway pressure but is increased by the pressure drop in the inspiratory line of the breathing circuit. The pressure measured by the expiratory pressure sensor is reduced by the pressure drop in the expiratory line of the breathing circuit. These pressure differences are caused by the flow resistance of the breathing circuit.

During expiration, the value measured at the inspiratory pressure sensor (**P_{insp}**) is reduced by the pressure drop caused by the base flow (Flow_{bf}) in the inspiratory line of the breathing circuit (R_{insp}):

$$P_{aw} = P_{insp} - R_{insp} \times \text{Flow}_{bf}$$

P_{aw}: Airway pressure at Y-piece

P_{insp}: Airway pressure at the inspiratory pressure sensor

R_{insp}: Flow resistance of the inspiratory breathing hose

Flow_{bf}: Base flow

During inspiration, the value measured by the expiratory pressure sensor (P_{exp}) is raised relative to the airway pressure by the amount of the pressure drop caused by the flow (normally Flow_{out} ≤ Flow_{bf}) through the expiratory line of the breathing circuit (R_{exp}):

$$P_{aw} = P_{exp} + R_{exp} \times \text{Flow}_{out}$$

P_{aw}: Airway pressure at Y-piece

P_{exp}: Airway pressure in expiratory breathing hose

R_{exp}: Flow resistance of the expiratory breathing hose

Flow_{out}: Flow through the expiratory valve during inspiration

The hose resistances are determined by Evita V500 during the breathing circuit check.

Battery concept

General information

At the time of manufacture and delivery, batteries have a typical capacity which is in accordance with the information specified in the battery manufacturer's data sheet. The electrochemical composition of the battery is the determining factor for its total capacity. The operating time of the batteries derived from these specifications can be found in the "Technical Data" chapter.

NOTE







The capacity of batteries changes with increasing age and utilization.

All the following information and specifications refer to perfectly functioning batteries. If batteries are defective or faulty, the functional integrity, e.g., battery charge indication or alarms, may be impaired. See chapter "Battery check" on page 270.

Display of battery charge

The battery charge indication shows the available battery charge determined by the electrochemical processes. When the batteries are, e.g., fully charged, this state is indicated by a corresponding symbol.

Symbol Battery charge

	90 to 100 %
	60 to <90 %
	40 to <60 %
	20 to <40 %
	<20 %, flashes light and dark red in 1-second pulses.
	Batteries defective or no information available on the battery charge.

The battery charge indication is a relative indication which is based on the electrochemical properties of the battery. The battery charge indication is evaluated on the basis of a battery model.

The use of a model-based indication is a state-of-the-art technique which finds application in many fields, e.g., computers, mobile phones, etc.

The model-based indication of battery charge takes account of the following information, among other things:

- Type of battery (e.g., NiMH or VRLA)
- Maximum capacity on delivery (e.g., 12 Ah)
- Age of the battery (e.g., new or 2 years)
- Capacity spent (irreversibly lost) over the utilization time (e.g., 1000 Ah)
- Present power requirement of the device (power consumption, e.g., 2.5 A)
- Discharge mode
- Charging mode

If the power consumption changes, e.g., due to switching to Standby, operation of a GS500, or adjustment of the screen brightness, the remaining available operating time of the device also changes. The battery charge indication is updated to take account of the present power requirement (power consumption).

In accordance with the specification, the battery charge indication is only displayed and updated after the device has been completely started up. This procedure may take a few minutes.

Battery ageing

The electrochemical composition of a battery alters as a result of ageing and utilization. Consequently every battery loses a proportion of its maximum capacity in comparison with its new condition. This loss of capacity is typically irreversible.

As a result of ageing and utilization of the battery, there is a change in the actual maximum operating time which is displayed by the percentage values in

the battery charge indication. The percentage value refers to the currently available operating time of batteries which were fully charged before use.

New batteries

The following data for minimum operating time apply to new and fully charged batteries. The  symbol for a fully charged battery is displayed. See also the "Display of battery charge" chapter and the "Technical Data" chapter. Owing to production fluctuations during the manufacture of batteries, the operating time can be considerably longer.

Battery used (Battery type)	Minimum operating time without operation of a GS500	Minimum operating time with operation of a GS500
Internal battery	30 min	15 min
PS500	240 min	120 min

Aged batteries, e.g., 2 years old

The following data for minimum operating time apply, e.g., to 2-year old and fully charged batteries. The data are approximate values and cannot be regarded as guaranteed for every battery. The  symbol for a fully charged battery is displayed. See also the "Display of battery charge" chapter and the "Technical Data" chapter.

Battery used (Battery type)	Minimum operating time without operation of a GS500	Minimum operating time with operation of a GS500
Internal battery	22 min	11 min
PS500	120 min	60 min

NOTE

A reduction in the capacity of batteries due to ageing and utilization is normal. As a greatly simplified approximation, an average linear reduction in capacity can be assumed. The current individual capacity of a battery depends on the following factors, among others:

- Age
- Utilization (frequency, duration, and power consumption)
- Battery charge
- Ambient temperature

Spent batteries

NOTE

When the internal battery and the batteries in the PS500 show less than the following residual operating times, they are considered to be spent.

Battery used (Battery type)	Spent with remaining residual operating time without operation of a GS500
Internal battery	<22 min
PS500	<120 min

Alarm behavior in battery operation

The switch-over of the device to battery operation is indicated by the **Battery activated** alarm (see chapter "Alarm – Cause – Remedy"). The alarm can be acknowledged by the user. Consequently the **Battery activated** alarm will no longer be displayed until the mains power supply is re-established.

When the device is equipped with a PS500 power supply unit, in battery operation the PS500 is discharged first. If the mains power supply has not

been re-established, the device switches over to the internal battery after the operating time of the PS500 has elapsed. The switch-over is indicated by the **Internal battery activated** alarm.

At the end of the operating time of the internal battery, the device generates the **Battery low** alarm. The **Battery discharged** alarm follows after that.

These alarms appear at the time specified by the model-based calculation for the particular battery.

Schematic representation of the sequence of alarms

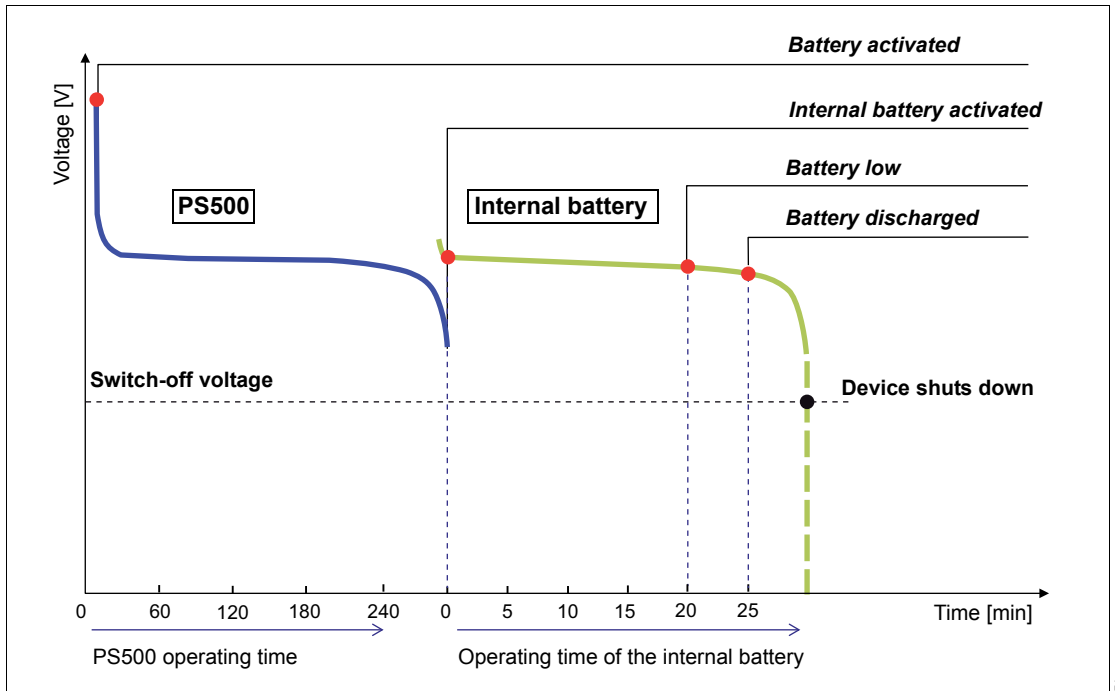

The schematic representation of the sequence of alarms with respect to battery utilization is shown in an example with a PS500 but without the use of a GS500. The representation corresponds to the operating time of new and fully charged batteries.

When the voltage drop of the internal battery reaches an operationally critical value, a shut-down of the device due to an inadequate supply is immediately imminent. In this case the power supply failure alarm sounds.

NOTE

If the device displays the **Battery low** alarm message or the **Battery discharged** alarm message, connect the device to the mains power supply.

NOTE

When the remaining calculated operating time is less than 10 minutes, the model-based **Battery low** alarm appears. When the remaining calculated operating time is less than 5 minutes, the model-based **Battery discharged** alarm appears.

NOTE

The operating time remaining after the corresponding alarms can be considerably longer than the specified minimum operating time.

NOTE

When the device is fitted with the GS500 gas supply unit, the device calculates the time for the **Battery discharged** alarm allowing for the power consumption of a GS500, regardless of whether the GS500 is activated or not.

Pneumatic functional description

Pneumatic circuit diagram of Evita V500

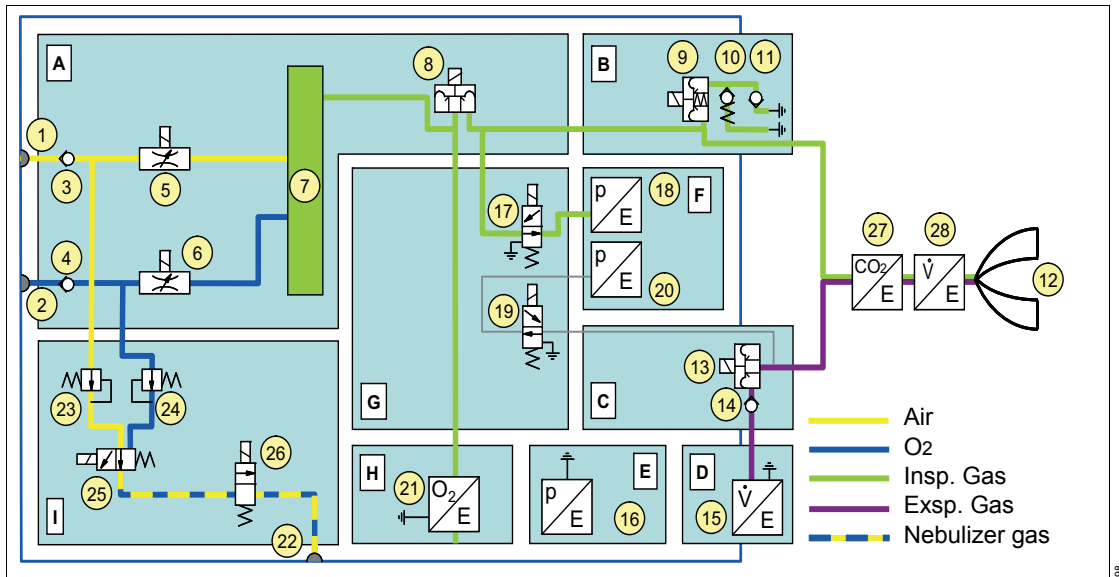

- | | |
|---------------------------------------|---|
| 1 Air gas inlet | 16 Barometric pressure sensor |
| 2 O ₂ gas inlet | 17 Calibration valve for inspiratory pressure sensor |
| 3 Air non-return valve | 18 Inspiratory pressure sensor |
| 4 O ₂ non-return valve | 19 Calibration valve for expiratory pressure sensor |
| 5 Air metering valve | 20 Expiratory pressure sensor |
| 6 O ₂ metering valve | 21 O ₂ sensor |
| 7 Tank | 22 Nebulizer outlet |
| 8 Mixed gas metering valve | 23 Air pressure regulator |
| 9 Safety valve | 24 O ₂ pressure regulator |
| 10 Emergency expiratory valve | 25 Nebulizer mixer valve |
| 11 Emergency breathing valve | 26 Nebulizer changeover valve |
| 12 Patient's lungs | 27 CO ₂ sensor |
| 13 Expiratory valve | 28 Neonatal flow sensor (depending on the patient category) |
| 14 Non-return valve | |
| 15 Expiratory Infinity ID flow sensor | |

- A Gas mixture and gas metering assembly
- B Inspiratory unit assembly
- C Expiratory unit assembly
- D Expiratory Infinity ID flow sensor
- E Barometric pressure sensor
- F Pressure measurement assembly
- G Calibration assembly
- H O₂ sensor
- I Medication nebulization assembly

Description of the pneumatic mode of operation

Evita V500 consists of 9 pneumatic assemblies.

The **gas mixture and dosage** assembly (A) delivers the time-variable flow of a gas mixture with adjustable proportions of O₂ and air. Gas from the (central) gas supply system enters the device via the gas inlet connections for O₂ and air (1, 2). Two non-return valves (3, 4) prevent one gas from returning to the supply line of the other gas. The mixing of the gases takes place in the tank (7) and is controlled via two control valves (5, 6). The supplied inspiratory flow is controlled via a third control valve (8).

The **inspiratory unit** assembly (B) consists of the safety valve (9) and two non-return valves (10, 11). In normal operation, the safety valve is closed so that the inspiratory flow is supplied to the patient (12) from the gas mixture and gas metering assembly. During other operating states, e.g., when Evita V500 is in standby, the safety valve is open and enables spontaneous inspiration through the emergency breathing valve (11). The emergency expiratory valve (10) provides a second channel for expiration when the expiratory valve (13) is blocked.

The **expiratory valve** assembly (C) consists of the expiratory valve (13) and a non-return valve (14).

The expiratory valve is a proportional valve and is used to adjust the pressure in the breathing system. In conjunction with the spring-loaded valve of the emergency air outlet (10), the non-return

valve (14) prevents pendulum breathing during spontaneous breathing. The expiratory **Infinity ID flow sensor** (D, 15) measures the expiratory flow in accordance with the hot-wire anemometry measurement principle. Therefore the measured flow is a mass flow (NTPD).

The inspiratory unit, expiratory unit, and expiratory Infinity ID flow sensor assemblies can be detached from Evita V500 for cleaning purposes.

The mass flow to volume flow conversion (BTPS) requires knowledge of the ambient pressure. The ambient pressure is measured with the **barometric pressure sensor** (E, 16).

The pressure in the breathing system is measured with two independent pressure sensors (18, 20) that form the **pressure measurement** assembly (F). The pressure sensors are regularly zero calibrated. For this, the pressure sensors are connected to ambient pressure via the two calibration valves (17, 19). The calibration valves form the **calibration** assembly (G).

The **O₂ sensor** (H, 21) measures the inspiratory O₂ concentration based on a sidestream measurement principle. For calibration by the user during the device check, the O₂ sensor can be flushed with pure O₂ from the tank (7).

A pneumatic medication nebulizer can be connected to the nebulizer gas outlet (22) for medication nebulization. Evita V500 provides an intermittent gas flow consisting of O₂ and air to drive the medication nebulizer. This ensures that the deviation of the set O₂ concentration remains within the specified limits. For this, the gas from the two gas inlet connections (1, 2) is throttled by the pressure regulators (23, 24). The intermittent gas delivery is done by nebulizer mixer valve (25). The nebulizer changeover valve (26) closes the nebulizer gas outlet when the nebulizer function is not switched on.

The nebulizer mixer valve, the nebulizer changeover valve, and the two pressure regulators form the **medication nebulization** assembly (I).

The CO₂ concentration of the breathing gas can be measured using the CO₂ sensor (27). CO₂ is measured according to an optical measurement principle in the mainstream.



An active breathing gas humidifier and a pneumatic medication nebulizer can also be installed. Additional information can be found in the chapters "Assembly and preparation" and "Operation".

Main menu bar structure

The following table lists the buttons of the main menu bar with the resulting dialog windows of the same name and the tabs. Touching a tab opens the corresponding page. The dark gray buttons are always contained in the main menu bar. The white

buttons are freely configurable and are assigned to the respective group. The freely configurable buttons open the corresponding page in the dialog window or activate a function.

Group symbol	Button in main menu bar	Horizontal tab	Vertical tab	Additional tabs
△	Alarms...	Limits		
		Current alarms		
		Alarm history		
		Settings		
	Alarm volume			
⊙	Ventilation settings...	Modes 1, 2, 3, 4		
			General settings	
			Additional settings	
				Overview
				Apnea Ventilation
				Trigger/ Termin.
				Sigh
				AutoFlow/ Volume Guarantee
				ATC
				Auto Release
				Variable PS
		Mode 5		
			General settings	
			Additional settings	
			Overview	
			Apnea Ventilation	
			Trigger/ Termin.	
			Sigh	
			AutoFlow/ Volume Guarantee	
			ATC	
			Auto Release	
			Variable PS	
	Other modes			<i>continued next page</i>

Group symbol	Button in main menu bar	Horizontal tab	Vertical tab	Additional tabs
	Trigger			
	Apnea Ventilation			
	Views...			
	Day/Night			
	Freeze waveforms			
	Export screenshot			
	Main screen			
	Trends/Data...	Trends		
			Graphics 1	
			Graphics 2	
			Table	
		Values		
			Customized data	
			Values 1	
			Values 2	
			Settings	
		Logbook		
		Export data		
	Trends table			
	Values			
	Logbook			
	Customized data			
	Special maneuvers...	Maneuvers		
		Nebulization		
		Low Flow PV Loop		
			Info	
			Procedure	
			Analysis	
			History	
		Diagnostics		
			P0.1	
			PEEPi	
			NIF	
	Nebulization			
	Low Flow PV Loop			
	Diagnostics			
	O2 suction			
	Man. insp./hold			
				<i>continued next page</i>

Group symbol	Button in main menu bar	Horizontal tab	Vertical tab	Additional tabs
	P0.1			
	PEEPi			
	NIF			
	Exp. hold			
	Manual disconnection			
EV	Sensors/ Parameters...	Neonatal flow sensor		
		Flow		
		O2 sensor		
		CO2 sensor		
			Zero calib. on/off	
			Check sensor	
			Calibration	
	Neonatal flow sensor			
	Flow sensor			
	O2 sensor			
	CO2 sensor			
	System setup...	Screen layout		
			Overview	
			General settings	
			Views	
			Customized data	
		Config. buttons		
		Trends graphic 1		
		Trends graphic 2		
		Therapy bar		
	Alarms			
		Overview		
		Preset limits		
		Alarm vol./tone		
	Ventilation			
		Overview		
		Patient category		
		Modes		
		Start settings		
			<i>continued next page</i>	

Group symbol	Button in main menu bar	Horizontal tab	Vertical tab	Additional tabs
				VT, RR, Trigger
				Pressures, O ₂ , I:E
				Other settings
				ATC
			General settings	
			Maneuver	
		Config. exchange		
		Applications		
		System status		
			Overview	
			General status	
			Exchange intervals	
		System		
			Overview	
			Country	
			Units	
			Interface	
				LAN
				COM
				External display
			Supply units	
			Service	
				System Information
				Operating Data
				Options
				Service Call
	Applications			
	Help...			
				<i>continued next page</i>

Group symbol	Button in main menu bar	Horizontal tab	Vertical tab	Additional tabs
	Start/ Standby...			
		Start/Standby		
		Tube/NIV		
		Br. circuit/ Humidifier		
		System check		
			Overview	
			Device check	
			Breathing circ. check	
			Check results	
			Battery check	
		Accessory status		

Factory-set screen views

View 1		View 2	
Waveform Paw	FiO2	Short trend PIP	Waveform Paw
	Pmean		
Waveform Flow	PEEP	Short trend MVespon	Waveform Flow
	MVe		
Waveform Volume	RR	Short trend RRspon	Waveform Volume
	VT		
View 3		View 4	
Loop Pressure Volume	Cdyn	Waveform Paw	FiO2
	C20/Cdyn		% leak
	R	Waveform Flow	PEEP
	TC		MVe MVespon
	% leak	Waveform Volume	RR RRspon VTspon
View 5		View 6	
Waveform Paw	FiO2	Waveform Paw	FiO2
	Pplat PEEP		Pmean
Waveform Flow	VTmand VTspon	Waveform Flow	Tlow
	RR RRspon		MVe MVespon
Waveform Volume	MVe MVespon	Waveform Volume	RR RRspon VTspon
	R Cdyn		

List of references

- [1] Meyer, J.: Neue Beatmungsformen. *Anästhesiol. Intensivmed. Notfallmed. Schmerzther.* 26 (1991): 337-342
- [2] Vincent, J.-L.: *Yearbook of Intensive Care and Emergency Medicine.* Springer-Verlag, 1993
- [3] Stock, M. C., Downs, J. B., Frolicher, D.: Airway Pressure Release Ventilation. *Critical Care Medicine* 15 (1987): 462-466
- [4] Räsänen, J., Cane, R. D., Downs, J. B., et al.: Airway Pressure Release Ventilation During Acute Lung Injury: A Prospective Multicenter Trial. *Critical Care Medicine* 19 (1991): 1234-1241
- [5] Guttman, W., Eberhard, L., Fabry, B., et al.: Continuous Calculation of Tracheal Pressure in Tracheally Intubated Patients. *Anesthesiology* 79 (1993): 503-513
- [6] Mehta, S., Stewart, T. E., MacDonald, R., et al.: Temporal Change, Reproducibility, and Interobserver Variability in Pressure-Volume Curves in Adults with Acute Lung Injury and Acute Respiratory Distress Syndrome. *Critical Care Medicine* 31 (2003): 2118-2125
- [7] Servillo, G., De Robertis, E., Maggiore, S., et al.: The Upper Inflection Point of the Pressure-Volume Curve. Influence of Methodology and of Different Modes of Ventilation. *Intensive Care Medicine* 28 (2002): 842-849
- [8] Servillo, G., Svantesson, C., Beydon, L., et al.: Pressure-Volume Curves in Acute Respiratory Failure: Automated Low Flow Inflation Versus Occlusion. *Am J Respir Crit Care Med* 155 (1997): 1629-1636
- [9] Gama, A. M., Meyer, E. C., Gaudêncio, A. M., et al.: Different Low Constant Flows Can Equally Determine the Lower Inflection Point in Acute Respiratory Distress Syndrome Patients. *Artif Organs.* 25 (2001): 882-889
- [10] Blanc, Q., Sab, J. M., Philit, F., et al.: Inspiratory Pressure-Volume Curves Obtained Using Automated Low Constant Flow Inflation and Automated Occlusion Methods in ARDS Patients with a New Device. *Intensive Care Medicine* 28 (2002): 990-994
- [11] Albaiceta, G. M., Piacentini, E., Villagra, A., et al.: Application of Continuous Positive Airway Pressure to Trace Static Pressure-Volume Curves of the Respiratory System. *Critical Care Medicine* 31 (2003): 2514-2519
- [12] Bensenor, F. E., Vieira, J. E., Auler, J. O. Jr.: Guidelines for Inspiratory Flow Setting When Measuring the Pressure-Volume Relationship. *Anesth Analg.* 97 (2003): 145-150
- [13] Rouby, J.-J., Vieira, S.: Pressure/Volume Curves and Lung Computed Tomography in Acute Respiratory Distress Syndrome. *European Respiratory Journal* 22 (2003), no. Supplement 42: 27-36
- [14] Takeuchi, M., Goddon, S., Dolhnikoff, M., et al.: Set Positive End-expiratory Pressure During Protective Ventilation Affects Lung Injury. *Anesthesiology* 97 (2002): 682-692
- [15] Matamis, D., Lemaire, F., Harf, A., et al.: Total Respiratory Pressure-Volume Curves in the Adult Respiratory Distress Syndrome. *Chest.* 86 (1984): 58-66
- [16] Suter, P. M., Fairley, B., Isenberg, M. D.: Optimum End-expiratory Airway Pressure in Patients with Acute Pulmonary Failure. *N Engl J Med* 292 (1975): 284-289

- [17] Amato, M. B., Barbas, C. S., Medeiros, D. M., et al.: Beneficial Effects of the "Open Lung Approach" with Low Distending Pressures in Acute Respiratory Distress Syndrome. A Prospective Randomized Study on Mechanical Ventilation. *Am J Respir Crit Care Med* 152 (1995): 1835-1846
- [18] Arnold, J. H.: To Recruit or not Derecruit: that Is the Question. *Critical Care Medicine* 30 (2002): 1925-1927
- [19] Harris, R. S., Hess, D. R., Venegas, J. G.: An Objective Analysis of the Pressure-Volume Curve in the Acute Respiratory Distress Syndrome. *Am J Respir Crit Care Med* 161 (2000): 432-439
- [20] Hickling, K. G.: The Pressure-Volume Curve is Greatly Modified by Recruitment. A Mathematical Model of ARDS Lungs. *Am J Respir Crit Care Med* 158 (1998): 194-202
- [21] Kallet, R. H.: Pressure-Volume Curves in the Management of Acute Respiratory Distress Syndrome. *Respir Care Clin N Am* 9 (2003): 321-341
- [22] Pelosi, P., Gattinoni, L.: Respiratory Mechanics in ARDS: a Siren for Physicians? *Intensive Care Medicine* 26 (2000): 653-656
- [23] Rimensberger, P. C., Cox, P. N., Frndova, H., et al.: The Open Lung During Small Tidal Volume Ventilation: Concepts of Recruitment and "Optimal" Positive End-expiratory Pressure. *Critical Care Medicine* 27 (1999): 1946-1952
- [24] Rimensberger, P. C., Pristine, G., Mullen, B. M., et al.: Lung Recruitment During Small Tidal Volume Ventilation Allows Minimal Positive End-expiratory Pressure without Augmenting Lung Injury. *Critical Care Medicine* 27 (1999): 1940-1945
- [25] Fisher, J. B., Mammel, M. C., Coleman, J. M., et al.: Identifying Lung Overdistention During Mechanical Ventilation by Using Volume-Pressure Loops. *Pediatr Pulmonol* 5 (1988): 10-14
- [26] Harris, R. S., Hess, D. R., Venegas, J. G.: An Objective Analysis of the Pressure-Volume Curve in the Acute Respiratory Distress Syndrome. *Am J Respir Crit Care Med* 161 (2000): 432-439
- [27] Dall'ava-Santucci, J., Armaganidis, A., Brunet, F., et al.: Causes of Error of Respiratory Pressure-Volume Curves in Paralyzed Subjects. *J Appl Physiol* 64 (1988): 42-49
- [28] Gattinoni, L., Mascheroni, D., Basilico, E., et al.: Volume/Pressure Curve of Total Respiratory System in Paralyzed Patients: Artefacts and Correction Factors. *Intensive Care Medicine* 13 (1987): 19-25
- [29] Sassoan, C. S., Te, T. T., Mahutte, C. K., et al.: Airway Occlusion Pressure. An Important Indicator for Successful Weaning in Patients with Chronic Obstructive Pulmonary Disease. *Am Rev Respir Dis* 135 (1987): 107-113
- [30] Kuhlen, R., Hausmann, S., Pappert, D., et al.: A New Method for P0.1 Measurement Using Standard Respiratory Equipment. *Intensive Care Medicine* 21 (1995): 554-560
- [31] Jubran, A.: Advances in Respiratory Monitoring During Mechanical Ventilation. *Chest* 116 (1999): 1416-1425
- [32] Tobin, M. J., Charles, G. A.: Discontinuation of Mechanical Ventilation. In: Tobin, M. J.: *Principles and Practice of Mechanical Ventilation*. 1177-1206. McGraw-Hill, 1994.
- [33] Gama de Abreu, M., Spieth, P. M., Pelosi, P., et al.: Noisy Pressure Support Ventilation: A Pilot Study on a New Assisted Ventilation Mode in Experimental Lung Injury. *Critical Care Medicine* 36 (2008): 818-827

This page has been left blank intentionally.

Index

A	
Abbreviations	27
Accessories	8
Attaching	26
Accessories, displaying the status of	87
Acoustic alarm, failure	148
Additional buttons	179
Additional settings for ventilation	96
Description	332
Start-up settings	192
Ventilation parameters	97
Aeroneb nebulizer	118
Alarm history	143
Alarm limits	
Automatic setting	302
Configuring start-up values	183
Deactivating	144
In event of power failure	145
Setting	144
Table	184
Alarm priorities	141
Alarm tone	
Setting the volume	146
Suppressing	147
Alarm-Cause-Remedy	205
Alarms	
Acknowledging	142
Current alarms	142
Displaying causes and remedies	142
Ambient air filter, replacing	267
Anti Air Shower	
Description	355
Switch on or off	194
Apnea ventilation	
Auto. Return, switching on or off	194
Description	332
Switch alarm on or off	194
Switch on or off	192
Application mode	
NIV	99
Selecting	83
Tube	83
Assembly	259
ATC	
Description	340
Switch on or off	193
Audio paused	27
AutoFlow	
Description	338
Switch on or off	192
Automatic alarm limits	302
Automatic leakage compensation	354
AutoRelease, description	343
B	
Back panel	22
Bacterial filter	56
Battery	
Disposal	275
Internal	134
Battery charging	135
Battery check	272
Battery concept	359
Battery maintenance	270
Battery operation	135
Before reuse	261
Body height/body weight	70
Breathing circuit	
Check	78
Connecting	58
Disconnecting	244
Safety information	56
Selecting	72
Setting	59
User-defined	72
Breathing gas humidifier	
Attaching	57
Selecting	72
Brightness, adjusting	175
BTPS	356
C	
C20/C, description	351
Calibrating the O ₂ sensor	164
Checking readiness for operation	74
CO ₂ monitoring	165
Deactivating or activating	171
CO ₂ sensor	
Check calibration with test filter	168
Check calibration with test gas	169
Installing	61
Performing calibration	170
CO ₂ zero calibration	167

CO ₂ zero indication	167	F	
Coaxial breathing circuit	80	Factory settings	190
Compressed gas cylinders	46	Fisher & Paykel MR 850	57
Configuration	173	Flow / volume measurement	356
Configuring alarm settings	183	Flow monitoring	159
Configuring units	201	Deactivating or activating	162
Connecting the nurse call	65	Flow reduction	355
Connection with other electrical equipment	9	Flow sensor	
Contraindications	18	Disposal	275
Country-specific settings	200	Fitting	54
Curve fields, selecting the display	103	Flow sensor (Infinity ID)	
Curves and measured values, displaying	102	Calibrating	161
Cuvette type, selecting	165	Fitting	55
		Flow trigger, description	335
D		Format templates	176
Data export	156	Freezing waveforms	104
Data transfer	26	Front panel	21
Date and time	200	Fuse	22
DC power supply	134		
Definitions	3	G	
Description	309	Gas supply	26
Device check	75	Central gas supply	64
Diagnostics	123	Connecting	64
Dialogs windows	40	From cylinders	64
Disassembly	244	Gas supply unit GS500	126
Disinfection	243	Connecting the mains power supply	63
Display data	154	General settings for ventilation	93
Displaying data		Getting started	67
All measurements	154	Safety information	68
Hospital-specific data	154	Graphic trends	150
Set values	154	GS500 gas supply unit	
Disposable cuvettes	165	Functionality	203
Disposal	273		
Disposal of the device	275	H	
		Header bar	38
E		Height above sea level	201
Electrical supply		Help	106
Failure	63	HME	56
Internal battery	63	Hospital-specific measured values	178
Mains power supply	62	Humidifier holder	45
Environment of use	18		
Exchange intervals	198	I	
Expiratory compensation, switching on or off	193	Illumination adjusting	175
Expiratory hold	108	Import/export of configurations	195
Expiratory valve		Indications	18
Dismantling	245	Infinity Acute Care System, system overview	20
Inserting	54, 260		
Preparing	53		
Replace diaphragm	267		
External screen	202		

Infinity C500	
Positioning	48
Preparing	48
Infinity ID breathing circuit	58, 73
Infinity ID components	15
Inspection	8
Inspiratory hold	107
Inspiratory termination	
Description	336
Switch on or off	194
Inspiratory termination criterion	336
Installing a CO ₂ cuvette	61
Installing applications	197
Intended use	18
Interfaces, configuring	201
Intrahospital patient transport	137
Intrinsic PEEP	
Applying	124
Description	349
L	
LAN	201
Lateral flaps on the device	66
Leakage compensation	
Description	354
Switch on or off	194
List of references	372
Logbook, displaying	155
Loops	
Evaluating	104
Reference loop	104
Low Flow PV Loop	
Description	346
Performing	119
M	
Main menu bar	39
Structure	366
Main screen	38
Mains power supply	134
Maintenance	263
Maneuvers	107
Manual disconnection	110
Manual inspiration	107
Manual ventilation device	14
Measurement maneuver, description	348
Measurement principles	357
MEDIBUS	51
Medication nebulization	
Applying	111
Description	345
Switching on	115
Medication nebulizer	26
Dismantling	247
Installing	113
Preparing	113
Monitoring	26, 157
Monitoring fields, changing display	102
Monitoring functions	26
N	
Negative Inspiratory Force	
Description	350
Measurement	125
Neonatal flow sensor	
Calibrating	159
Dismantling	246
Disposal	275
Installing	59
Replacing insert	60
New patient	69
Non-invasive ventilation	
Applying	99
Description	353
NTPD	356
O	
O ₂ monitoring	164
Deactivating or activating	164
O ₂ therapy	127
Description	353
Setting O ₂ and flow	128
Switching off	129
Switching on	128
Observe the instructions for use	8
Occlusion pressure P0.1	123
Description	348
Operating concept	38
Operation	89
Operation display of ventilation	21
Oxygen enrichment for suction maneuver	108
P	
Parameter fields, selecting the display	103
Password	174, 381
Patient category	70
Patient monitoring	10, 14
Patient safety	10

Patient transport	137	System overview	
Pmax/Paw high AutoSet		GS500	24
Switch on or off	194	Infinity Acute Care System	20
Pneumatic functional description	363	Trolley	23
Pneumatic medication nebulizer	112	System settings	200
Power failure alarm	63	System status	198
Power on	68	T	
Power supply	26	Tabular trend	153
Power supply unit PS500	134	Technical data	277
Preparing the ventilation unit	53	Test lung	75
Pressure-controlled ventilation modes	94	Therapy controls	40
Previous patient	69	Therapy controls, locking	182
R		Therapy line	40
Range of functions	25	Therapy type, selecting	85
Repair	8	Therapy, starting	86
Reprocessing	243	Toggle switch	62
Reprocessing list	251	Trademarks	2
Reusable cuvettes	165	Trends	
S		Configuring display	180
Safety checks	8	Displaying	150
Safety information		Trolley, preparation	44
General	8	U	
Product-specific	12	Units of measurement, configuring	201
Screen display, configuring	174	Universal holder with standard rail	45
Screen text language	200	USB storage medium	196
Screen view		V	
Changing	102	Variable PS, description	344
Selecting a patient	69	Ventilation functions	25
Sensors	158	Ventilation modes	
Service	8	Description	310
Service dialog	203	Selecting	91
Setting ventilation	91	Ventilation parameters	
Sigh, description	337	Exceeding set limit	41
Smart Pulmonary View	105	Linked setting	42
Description	352	Setting	41, 92
Spontaneous breathing support	95	Setting directly	41
Screen view		Ventilation settings	
Configuring	176	Configuring import	187
Standby	130	Transferring	84
Start-up settings	187, 188, 192	Ventilation settings, configuring	186
Suction	109	Volume guarantee	
Supply units, configuring	203	Description	338
Surface disinfectant	254	Switch on or off	192
Symbols	33	Volume-controlled ventilation modes	94
System cable			
Connecting	49		
Disconnecting	49		
Fixing	50		
System check	74		

This page has been left blank intentionally.

Password for Evita V500 SW 2.n

Cut out from the Evita V500 instructions for use SW 2.n

To prevent unauthorized adjustments, the following pages are password-protected:

- **System setup > Screen layout > Views**
- **System setup > Alarms**
- **System setup > Ventilation**
- **System setup > Applications**
- **System setup > Exchange intervals**

4572

Information on the password

To prevent unauthorized adjustments, the following pages in the dialog window **System setup** are password-protected:

- **Screen layout > Views**
- **Alarms**
- **Ventilation**
- **Applications**
- **Exchange intervals**

The password appears on this page of the instructions for use. Cut out the area with the password and keep in a place which is safe from access by unauthorized persons.

If the area with the password has been removed, ask the person responsible for your device about making adjustments to the pages specified.

This page has been left blank intentionally.

This page has been left blank intentionally.

These Instructions for use only apply to
Evita Infinity V500 SW 2.n

with the Serial No.:

Without a Serial No. filled in by Dräger, these
Instructions for use are provided for general
information only and do not apply to a specific
medical device or unit.

These Instructions for use are provided for
customer information only and will only be
updated or exchanged upon customer request.



Directive 93/42/EWG
concerning medical devices



Labeling in accordance with Directive 1999/5/EC
on radio equipment
and telecommunications terminal equipment

 **Manufacturer**



Drägerwerk AG & Co. KGaA

Moislinger Allee 53 – 55
D-23542 Lübeck
Germany



+49 451 8 82-0

FAX

+49 451 8 82-20 80



<http://www.draeger.com>

9052161 – GA 6500.311 en

© Drägerwerk AG & Co. KGaA

Edition: 9 – 2016-04

(Edition: 1 – 2009-06)

Dräger reserves the right to make modifications
to the device without prior notice.

