

SeeSnake[®] DVD *Pak 2*



⚠ WARNING!

Read this Operator's Manual carefully before using this tool. Failure to understand and follow the contents of this manual may result in electrical shock, fire and/or serious personal injury.

SeeSnake[®] DVD *Pak 2*

Record product serial number below as it appears on the nameplate.

Serial No.

--	--

Table of Contents

Recording Form for Machine Serial Number	1
Safety Symbols	3
General Safety Rules	
Work Area Safety	3
Electrical Safety	3
Personal Safety	3
Equipment Use and Care.....	3
Battery Use and Care.....	4
Service.....	4
Specific Safety Information	
DVDPak2 Safety	4
Description, Specifications, and Standard Equipment	
Description	5
Specifications.....	5
Standard Equipment	6
DVDPak2 Components	6
Keypad and Icon Legends	6
Pre-Operation Inspection	7
Work Area and Equipment Set Up	
DVDPak2 Placement.....	8
Connecting the DVDPak2	8
Powering the DVDPak2.....	9
Operating Instructions	
Starting Up the DVDPak2.....	10
Turning ON the Monitor and the DVDR	10
Turning OFF the Monitor and the DVDR	10
DVDPak2 Settings.....	11
Recording an Inspection	12
Play Back Recorded Video.....	12
Locating the Camera Using the Sonde	13
Cleaning Instructions	13
Accessories	14
Transport and Storage	14
Service and Repair	14
Disposal	14
Battery Disposal	14
DVDPak2 Troubleshooting	15
Lifetime Warranty	Back Cover

RIDGID reserves the right to change the specifications of the hardware, software, or both as described in this manual without notice. Visit www.SeeSnake.com for current updates and supplemental information pertaining to this product. Due to product development, the photos and other presentations specified in this manual may differ from the actual product.

Other trademarks or registered trademarks mentioned in this manual are the property of their respective owners.

Safety Symbols

In this operator's manual and on the product, safety symbols and signal words are used to communicate important safety information. This section is provided to improve understanding of these signal words and symbols.



This is the safety alert symbol. It is used to alert you to potential personal injury hazards. Obey all safety messages that follow this symbol to avoid possible injury or death.

DANGER

DANGER indicates a hazardous situation which, if not avoided, will result in death or serious injury.

WARNING

WARNING indicates a hazardous situation which, if not avoided, could result in death or serious injury.

CAUTION

CAUTION indicates a hazardous situation which, if not avoided, could result in minor or moderate injury.

NOTICE

NOTICE indicates information that relates to the protection of property.



This symbol means read the operator's manual carefully before using the equipment. The operator's manual contains important information on the safe and proper operation of the equipment.



This symbol means always wear safety glasses with side shields or goggles when handling or using this equipment to reduce the risk of eye injury.



This symbol indicates the risk of electrical shock.

General Safety Rules

WARNING

Read all safety warnings and instructions. Failure to follow the warnings and instructions may result in electric shock, fire, and/or serious injury.

SAVE THESE INSTRUCTIONS!

Work Area Safety

- Keep your work area clean and well lit. Cluttered or dark areas invite accidents.
- Do not operate equipment in explosive atmospheres, such as in the presence of flammable liquids, gases, or dust. Equipment can create sparks which may ignite the dust or fumes.
- Keep children and bystanders away while operating equipment. Distractions can cause you to lose control.

Electrical Safety

- Avoid body contact with earthed or grounded surfaces such as pipes, radiators, ranges, and refrigerators. There is an increased risk of electrical shock if your body is earthed or grounded.
- Do not expose equipment to rain or wet conditions. Water entering equipment will increase the risk of electrical shock.
- Do not abuse the cord. Never use the cord for carrying, pulling, or unplugging the power tool. Keep cord away from heat, oil, sharp edges, and moving parts. Damaged or entangled cords increase the risk of electric shock.

- If operating equipment in a damp location is unavoidable, use a ground fault circuit interrupter (GFCI) protected supply. Use of a GFCI reduces the risk of electric shock.
- Keep all electrical connections dry and off the ground. Do not touch equipment or plugs with wet hands to reduce the risk of electrical shock.

Personal Safety

- Stay alert, watch what you are doing, and use common sense when operating equipment. Do not use equipment while you are tired or under the influence of drugs, alcohol, or medication. A moment of inattention while operating equipment may result in serious personal injury.
- Use personal protective equipment. Always wear eye protection. The appropriate use of protective equipment such as a dust mask, non-skid safety shoes, a hard hat, and hearing protection will reduce personal injuries.
- Do not overreach. Keep proper footing and balance at all times. This enables better control of the equipment in unexpected situations.
- Dress properly. Do not wear loose clothing or jewelry. Keep your hair, clothing, and gloves away from moving parts. Loose clothes, jewelry, and long hair can be caught in moving parts.

Equipment Use and Care

- Do not force equipment. Use the correct equipment for your application. The correct equipment will do the job better and safer at the rate for which it is designed.

- **Do not use equipment if the power switch does not turn it ON and OFF.** Any equipment that cannot be controlled with the power switch is dangerous and must be repaired.
- **Disconnect the plug from the power source and/or the battery pack from the equipment before making adjustments, changing accessories, or storing.** Preventive safety measures reduce the risk of injury.
- **Store idle equipment out of the reach of children and do not allow persons unfamiliar with the equipment or these instructions to operate the equipment.** Equipment can be dangerous in the hands of untrained users.
- **Maintain equipment.** Check for misalignment or binding of moving parts, missing parts, breakage of parts, and any other condition that may affect the equipment's operation. If damaged, have the equipment repaired before use. Many accidents are caused by poorly maintained equipment.
- **Use the equipment and accessories in accordance with these instructions; taking into account the working conditions and the work to be performed.** Use of the equipment for operations different from those intended could result in a hazardous situation.
- **Use only accessories that are recommended by the manufacturer for your equipment.** Accessories that may be suitable for one piece of equipment may become hazardous when used with other equipment.
- **Keep handles dry, clean, and free from oil and grease.** This allows for better control of the equipment.

Battery Use and Care

⚠ WARNING

Read the battery charger manual before using the charger or batteries. Failure to read, understand and follow the contents of the charger manual may result in extensive property damage, severe personal injury, or death.

- **Recharge only with the charger specified by the manufacturer.** A charger suitable for one type of battery pack may create a risk of fire when used with another battery pack.
- **Use equipment only with specifically designated battery packs.** Use of any other battery packs may create a risk of injury and fire.
- **Do not probe battery with conductive objects.** Shorting of battery terminals may cause sparks, burns, or electrical shock. When the battery pack is not in use, keep it away from other metal objects, like paper clips, coins, keys, nails, screws or other small metal objects that can make a connection from one

terminal to another. Shorting the battery terminals together may cause burns or a fire.

- **Under abusive conditions, liquid may eject from battery; avoid contact.** If contact occurs, flush with water. If liquid contacts eyes, seek medical help. Liquid ejected from the battery may cause irritation or burns.
- **Use and store batteries and chargers in dry, appropriate temperature areas.** Extreme temperatures and moisture can damage batteries and result in leakage, electrical shock, fire or burns. See charger manual for more information.
- **Do not cover charger while in use.** Proper ventilation is required for correct operation. Covering charger in use could result in fire.
- **Properly dispose of batteries.** Exposure to high temperatures can cause the batteries to explode; do not dispose of in a fire. Some countries have regulations concerning battery disposal. Follow all applicable regulations.

Service

Ensure a qualified repair person services your equipment using only identical replacement parts to maintain the safety of the tool. Remove the batteries and refer servicing to qualified service personnel under any of the following conditions:

- If liquid has been spilled or objects have fallen into the product.
- If the product does not operate normally when following the operating instructions.
- If the product has been dropped or damaged.
- When the product exhibits a distinct change in performance.

Specific Safety Information

⚠ WARNING

This section contains important safety information that is specific to the DVDPak2. Read these precautions carefully before using the DVDPak2 to reduce the risk of electrical shock, fire, or other serious personal injury.

SAVE ALL WARNINGS AND INSTRUCTIONS FOR FUTURE REFERENCE!

Keep this manual with the equipment for use by the operator.

DVDPak2 Safety

- **An improperly grounded electrical outlet can cause electrical shock and/or severely damage equipment.** Always check work area for a properly grounded electrical outlet. Presence of a three-prong or GFCI outlet does not ensure that the outlet is

properly grounded. If in doubt, have the outlet inspected by a licensed electrician.

- **Do not operate this equipment if operator or DVDPak2 is standing in water.** Operating the DVDPak2 while in water increases the risk of electrical shock.
- **Do not use where a danger of high voltage contact is present.** The equipment is not designed to provide high voltage protection and isolation.
- **Read and understand this operator's manual, the reel operator's manual, the instructions for any other equipment in use and all warnings before operating the DVDPak2.** Failure to follow all instructions and warnings may result in property damage and/or serious personal injury.
- **Always use appropriate personal protective equipment when handling and using equipment in drains.** Drains may contain chemicals, bacteria, and other substances that may be toxic, infectious, cause burns or other issues. Appropriate personal protective equipment always includes safety glasses and may include drain cleaning gloves or mitts, latex or rubber gloves, face shields, goggles, protective clothing, respirators, and steel toed footwear.
- **If using drain cleaning equipment at the same time as drain inspection equipment, only wear RIDGID drain cleaning gloves.** Never grasp the rotating drain cleaning cable with anything else, including other gloves or a rag which can become wrapped around the cable and cause hand injuries. Only wear latex or rubber gloves under RIDGID drain cleaner gloves. Do not use damaged drain cleaning gloves.
- **Practice good hygiene.** Use hot, soapy water to wash hands and other body parts exposed to drain contents after handling or using drain inspection equipment. To prevent contamination from toxic or infectious material, do not eat or smoke while operating or handling drain inspection equipment.

The warnings, cautions, and instructions discussed in this operator's manual cannot cover all possible conditions and situations that may occur. It must be understood by the operator that common sense and caution are factors which cannot be built into this product, but must be supplied by the operator.

The EC Declaration of Conformity (890-011-320.10) will accompany this manual as a separate booklet when required.

If you have any questions concerning this RIDGID product:

- Contact your local RIDGID distributor.

- Visit www.RIDGID.com or www.RIDGID.eu to find your local RIDGID contact point.
- Contact RIDGID Technical Services Department at rtctechservices@emerson.com, or in the U.S. and Canada call 800-519-3456.

Description, Specifications, and Standard Equipment

Description

The DVDPak2 is a robust, lightweight, weather-resistant camera monitor, control, and recording unit for use with a SeeSnake Pipe Inspection System. Combined with the Sony VRD-MC6 Digital Video Disc Recorder (DVDR), the DVDPak2 can be used to monitor, record, and store video in a convenient DVD format.

The DVDPak2 can easily connect with a SeeSnake Reel and camera to monitor and record the view from the camera. The 5.7 in [144.5 mm] LCD monitor on the DVDPak2 can be used to view the inspection independent of the DVDR.

Specifications

Table 1 SeeSnake DVDPak2 Specifications	
Weight without battery	8.0 lb [3.63 kg]
Closed dimensions:	
Length	15.9 in [403.8 mm]
Width	9.1 in [231.4 mm]
Height	5.5 in [144.8 mm]
LCD monitor:	
Resolution	320 × 240 pixels
Monitor size	5.7 in [144.5 mm]
Contrast ratio	350:1
Brightness	500 Cd/m ²
Power source	100 — 240 VAC/50 — 60Hz, 1.5 A or 18 V Li-Ion Battery
Power rating	15 — 19 VDC, 40 W
Battery type	One 18 V Li-Ion
Operating environment:	
Temperature (DVDR)	5°F to 95°F [-15°C to 35°C]
Temperature (Monitor)	-4°F to 158°F [-20°C to 70°C]
Humidity	5% RH to 95% RH
Altitude	13,120 ft [4,000 m]

Standard Equipment

- DVDPak2 with Sony VRD-MC6 DVDR
- Operator's Manual
- Operator's DVD
- 100 – 240 VAC to 15 VDC power converter and supply
- RCA Cable
- Sony VRD-MC6 DVDR Operator's Manual

DVDPak2 Components



Figure 1 – DVDPak2 Components

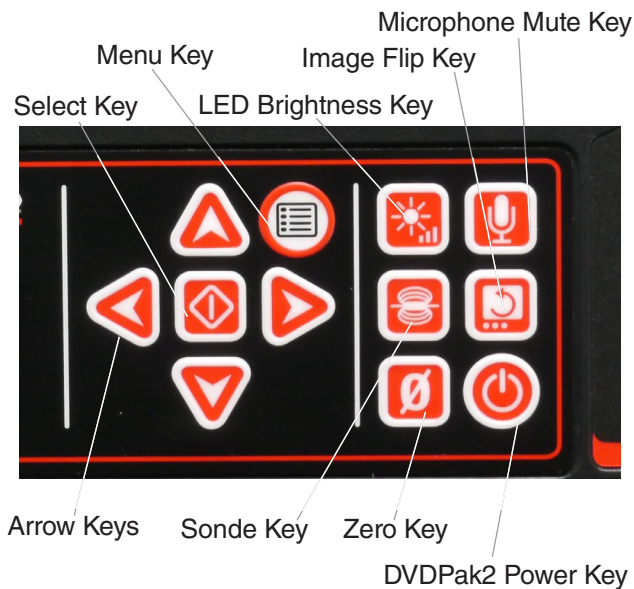

Figure 2 – DVDPak2 Keypad











Figure 3 – DVDR Button Controls





Keypad and Icon Legends

Table 2 DVDR Button Controls		
Icon	Name	Function
	Return Button	Brings up the DVDR Menu
	Power Button	Turns the DVDPak2 ON and OFF and controls the screen power.
	Record Button	Starts and pauses DVDR recording
	Arrow Buttons	Highlights menu selections
	Enter Button	Chooses a highlighted menu option
	Stop Button	Stops recording or playback
	Eject Button	Opens the disc tray

**Table 3
DVDPak2 Keys**

Icon	Name	Function
	Power Key	Powers the DVDPak2 monitor ON and OFF. Does not control the DVDR power.
	Select Key	Used to select menu items.
	Arrow Keys	Used to navigate menus and screens.
	Menu Key	Brings up monitor display options
	LED Brightness Key	Controls the LEDs in the camera. Press to step up or down through various brightness levels or press once and then use the arrow keys to step through the brightness levels.
	Sonde Key	Toggles the Sonde ON or OFF.
	Zero Key	Press the Zero Key once to reset a temporary relative zero point for intermediate measurement. Relative zero will appear in parenthesis. Press the Zero Key a second time to stop relative zero and return to your actual count. Or press and hold the Zero Key to do a hard reset.
	Microphone Mute Key	Toggles the microphone ON or OFF. When ON, the LED on the Microphone Mute Key will be gold.
	Image Flip Key	Vertically flips the image on the monitor, but does not affect the image as recorded by the DVDR.

**Table 4
DVDPak2 Screen Icons**

Icon	Name	Function
	Battery Level	Indicates the charge state of the battery
	Microphone Off	Indicates that the microphone has been muted
	Sonde	Indicates that the Sonde has been turned ON
	Brightness Control	Appears during the adjustment of the monitor brightness

Pre-Operation Inspection

⚠ WARNING



Before each use, inspect your DVDPak2 and correct any problems to reduce the risk of serious injury from electrical shock or other causes and prevent machine damage.

1. Confirm that the power is OFF, that any external power and cords are disconnected, and that the battery is removed. Inspect the cords, cables, and connectors for damage or modification.
2. Clean any dirt, oil, or other contamination from the DVDPak2 to aid in inspection and to prevent the unit from slipping from your grip during transport or use.
3. Inspect the DVDPak2 for any broken, worn, missing, misaligned or binding parts, or any other condition which might prevent safe, normal operation.
4. Inspect any other equipment being used per its instructions to make sure it is in good, usable condition.
5. If any problems are found, do not use the unit until the problems are corrected.

Work Area and Equipment Set Up

⚠ WARNING



Set up the DVDPak2 and work area in accordance with these procedures to reduce the risk of injury from electrical shock, fire, and other causes and to prevent damage to the DVDPak2.

1. Check work area for the following:
 - Adequate lighting.
 - Flammable liquids, vapors, or dust that may ignite. If present, do not work in area until sources have been identified and corrected. The DVDPak2 is not explosion proof. Electrical connections can cause sparks.
 - Clear, level, stable dry place for operator. Do not use the machine while standing in water.
 - If using external power, clear path to the electrical

outlet that does not contain any potential sources of damage for the power cord.

2. Inspect the work and determine the correct RIDGID equipment for the task. Using incorrect equipment for an application can cause injury or equipment damage. For a complete list of RIDGID inspection equipment, consult the Ridge Tool Catalog at www.ridgid.com or www.ridgid.eu.
3. Ensure the equipment has been inspected as specified by the operator's manual.
4. Evaluate the work area and erect barriers as necessary to keep bystanders away. Bystanders can distract the operator during use. If working near traffic, erect cones or other barriers to alert drivers.
5. Remove fixtures such as the water closet or sink to allow access as required.

DVDPak2 Placement

Open the monitor and the sunshade on the DVDPak2. Place the DVDPak2 in an area and in a position that allows easy access and viewing while manipulating the camera and push cable during an inspection. To reduce the risk of electrical shock, ensure the location is dry and that the DVDPak2 and other equipment will not become wet during use. The DVDPak2 is not waterproof and exposure to wet conditions can cause electrical shock or equipment damage.

Place the camera and reel as instructed in its operator's manual. Ensure the DVDPak2 and the cable reel are stable.

Connecting the DVDPak2

SeeSnake System Cable

Plug the SeeSnake System Cable into the matching connector on the back of the DVDPak2. To join the connectors, align the guide pin to the guide socket, push the connector straight in and tighten the outer locking sleeve. The guide ridge on the top of the cable connector will point up when the plug is correctly aligned (See Figure 4).



Figure 4 – Connecting the SeeSnake System Cable to the DVDPak2

Table 5 DVDPak2 Connections	
Icon	Name
	SeeSnake System Connector
	Video In Port
	A/V Out Port
	Transmitter Clip-on Terminal
	DVDPak2 Power Port
	DVDR-only Power Port

External Monitor Options

To use the DVDPak2 with an external SeeSnake monitor, use the included RCA cable to connect the external monitor to the Video Input Port on the back of the DVDPak2 (See Item 1, Figure 5).



Figure 5 – DVDPak2 Connections

The A/V out port will pass live video and audio to another DVDR or monitor. If connected to a monitor with speakers, prevent potential feedback interference by muting the microphone.

The A/V out port does not transmit recorded video or audio output from the DVDR.

Powering the DVDPak2

The DVDPak2 can be powered with a RIDGID 18 V Li-Ion battery or by using the included AC/DC power converter. To reduce the risk of electrical shock, use battery power whenever possible. The power converter is not rated for outdoor use. If using the power converter, only use the DVDPak2 indoors.

Battery Power

The DVDPak2 can be powered with a RIDGID 18 V Li-Ion battery. Rated at 2.2 Ah, a fully charged battery should power the DVDPak2 from 2.5 hours to 3 hours with normal usage. Actual battery operation time will vary with battery rating and use.

With dry hands, slide a fully charged RIDGID 18 V Li-Ion battery onto the battery dock located on the back of the DVDPak2.



Figure 6 – Battery Installed

Ensure the battery locks onto the dock. See the *Battery Charger Operator's Manual* for more information on charging the battery.

When the DVDPak2 is ON and when the battery is in the battery dock, the battery LEDs (See Item 1, Figure 7) located underneath the hinge of the DVDPak2 monitor will reflect the state of the battery as shown in Table 6.

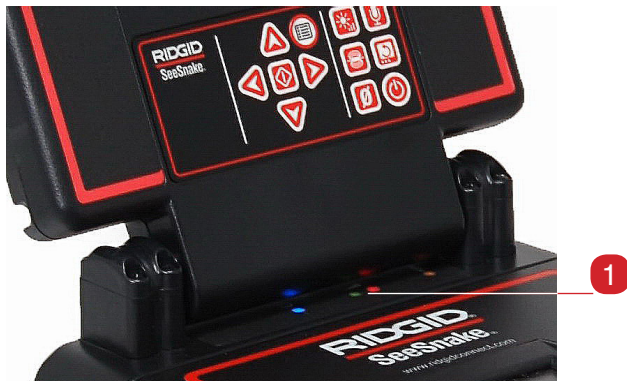



Figure 7 – Battery Status LEDs

Table 6
DVDPak2 Battery Status

Battery Status	External Power Not Connected	External Power Connected
Full	Solid green	Green blinking
Medium	Solid green and red	Green and red blinking
Low	Solid red, 4 beeps	Red blinking
Dead	Solid red for 5 seconds, 5 second beep and shutdown	—

Outlet Power

Power the DVDPak2 with the included AC/DC power supply in accordance with the following:

1. Plug the power cord into the power supply.
2. Plug the power supply into the 40 W jack  located in the back of the DVDPak2.
3. Plug the power cord into a standard outlet.

If using an extension cord no longer than 25 ft [7.6 m], use a gauge of at least 18 AWG. If using an extension cord longer than 25 ft [7.6 m], use a gauge of at least 16 AWG.

NOTE: To reduce the risk of electrical shock, only use the external power supply indoors and always use dry hands to connect the power supply.

Operating Instructions

⚠ WARNING



Always wear eye protection to protect your eyes against dirt and other foreign objects.

When inspecting drains that might contain hazardous chemicals or bacteria, wear appropriate protective equipment, such as latex gloves, goggles, face shields, and respirators to prevent burns and infections.

Do not operate this equipment if operator or machine is standing in water. Operating machine while in water increases the risk of electrical shock. Rubber soled, non-slip shoes can help prevent slipping and electric shock, especially on wet surfaces.

Follow operating instructions to reduce the risk of injury from electrical shock and other causes.

Starting Up the DVDPak2

Before starting up the DVDPak2 perform the following functions:



1. Check that the unit is properly set up.
2. Connect the DVDPak2 to a SeeSnake camera or use the provided RCA cable to connect the DVDPak2 to an external SeeSnake monitor.
3. Place the SeeSnake camera head into the guide hoop of the SeeSnake Reel.
4. Turn ON the DVDPak2 by pressing the Power Button .
5. If a DVD is already in the disc tray, the DVDPak2 will perform a disc check. If a DVD is not already in the DVDPak2, lift the front cover over the disc tray and press the Eject Button  to open the tray. Insert a blank DVDR or DVDRW disc into the tray and manually push the disc tray closed (See Figure 8).
6. Close the front cover to protect against dust and moisture.
7. If an unformatted disc has been inserted into the DVDPak2, format the disc by pressing the Return Button  when prompted. The DVDPak2 will not record to an unformatted disc.



Figure 8 – Disc Tray

When a formatted disc is inserted into the DVDPak2, the view from the camera should appear on both the DVDR screen and on the monitor of the DVDPak2 (See Figure 9). If the camera view does not appear, change the video display settings as specified on page 11.

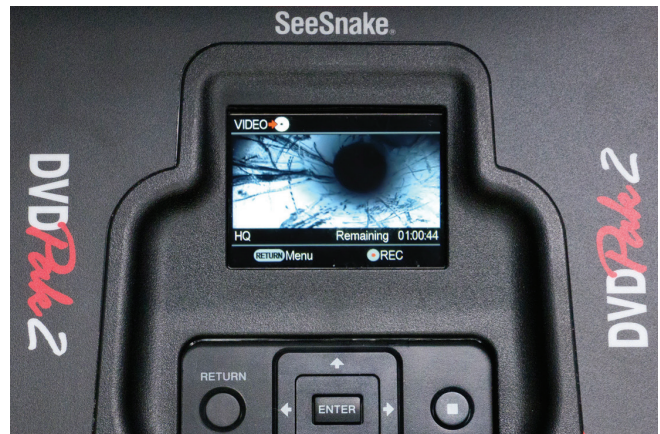





Figure 9 – Camera Image on DVDR screen

Turning ON the Monitor and the DVDR

Press the Power Button  to turn on the DVDR and the DVDPak2 monitor.

To turn on the DVDPak2 monitor independently of the DVDR, press the Power Key . Using the DVDPak2 monitor independently of the DVDR will conserve battery power since the DVDR will not be ON.

Turning OFF the Monitor and the DVDR







When ON simultaneously, press the Power Button  to turn OFF both the monitor and the DVDR.

If using the monitor independently of the DVDR, press the Power Key on the keypad  to turn OFF the monitor.

DVDPak2 Settings









Video Display Settings



If the camera view does not display on the DVDPak2 monitor, perform the following functions to correct the video display source:

1. Press the Return Button  to access the Main Menu of the DVDR. Note that depending on the current menu location, the Return Button  may require multiple pushes to allow access to the Main Menu of the DVDR.
2. Use the Up and Down Arrow Buttons  to highlight "Video  DVD" and press the Enter Button .
3. Use the Up and Down Arrow Buttons  to highlight "Video In" and press the Enter Button .

Auto Chapter Setting



If the Auto Chapter setting is OFF, the DVDR will start a new chapter each time the recording is paused. To turn the Auto Chapter setting OFF, perform the following functions:







1. Press the Return Button  to access the Main Menu of the DVDR. Note that depending on the current menu location, the Return Button  may require multiple pushes to allow access to the Main Menu of the DVDR.
2. Use the Up and Down Arrow Buttons  to highlight "Setup" and press the Enter Button .
3. Use the Up and Down Arrow Buttons  to highlight "Auto Chapter" and press the Enter Button .
4. Use the Up and Down Arrow Buttons  to highlight "OFF" and press the Enter Button .

Alternatively, Auto Chapter can be set to start a new chapter after every 5 minutes, 10 minutes, or 15 minutes of recording. Use the Up and Down Arrow Buttons  to highlight a time interval within the Auto Chapter Menu and press the Enter Button .

NTSC/PAL Video Setting

The DVDPak2 supports both NTSC and PAL video settings. The DVDPak2 will not record if the video setting conflicts with the disc format. Change the video setting by performing the following functions:





1. Press the Return Button  to access the Main Menu of the DVDR. Note that depending on the current menu location, the Return Button  may require multiple pushes to allow access to the Main Menu of the DVDR.

2. Use the Up and Down Arrow Buttons  to highlight "Setup" and press the Enter Button .
3. Use the Up and Down Arrow Buttons  to highlight "Color System" and press the Enter Button .
4. Use the Up and Down Arrow Buttons  to highlight either PAL or NTSC and press the Enter Button .

Units Setting





If connected to a SeeSnake Reel that contains the CountPlus cable-measurement system, the DVDPak2 will display the distance in either meters or feet. If set to "Auto" the DVDPak2 will automatically display the cable-measurement in meters if PAL is set and in feet if NTSC is set.

To change the cable-measurement units, perform the following functions:



1. Press the Menu Key .
2. Use the Down Arrow Key  to highlight "Unit" and press the Select Key  to toggle between feet, meters, and auto.
3. Press the Menu Key  to close the menu.

Color, Contrast, and Brightness Settings

To adjust the color, contrast, or brightness settings as viewed by the camera on the DVDPak2, perform the following functions:

1. Press the Menu Key  on the DVDPak2 Keypad.
2. Use the Up and Down Arrow Keys  to scroll down and highlight "Color," "Contrast," or "Brightness" and use the Left and Right Arrow Keys  to make adjustments. A status bar will appear on the screen to visually represent the color adjustments.
3. Press the Menu Key  to close the menu

Camera LEDs Brightness Setting

To change the brightness of the LEDs on the camera head, push the Brightness Key  and use the Left and Right Arrow Keys  to adjust the brightness. Press the Menu Key  to close the menu.

Alternatively, push the Brightness Key  multiple times to first increase and then decrease the brightness of the LEDs on the camera head.

Zero-point Setting

If using a SeeSnake Reel equipped with the CountPlus cable-measurement counter, the cable-measurement will appear on the monitor of the DVDPak2. To set an interim zero-point while using the CountPlus, press the









Zero Key . The DVDPak2 will display the distance from an interim zero-point in brackets. Press the Zero Key  for local zero and press the Zero Key  again to return to global count. Press and hold the Zero Key  to do a hard reset.

Image Rotation

During inspections, the camera may rotate in the line. To rotate the camera view as seen on the DVDPak2 monitor, press the Image Flip Key  to vertically rotate the image. While the image will rotate on the DVDPak2 monitor, the DVDPak2 will record the image as originally displayed.





Microphone Mute

The DVDPak2 has a microphone located on the bottom left of the screen, as indicated by the Microphone Icon . The DVDPak2 turns ON the microphone by default. To turn OFF the microphone, press the Microphone Mute Key . When the microphone is OFF, the Microphone Mute Icon  will appear on the screen. When the microphone is ON, the Microphone Mute LED located underneath the hinge of the DVDPak2 will be lit.

Recording an Inspection

NOTICE Moving the DVDPak2 during recording may physically damage the disc and may prevent the DVD from playing. If the DVDPak2 unexpectedly loses power, unsaved chapters will be lost.









To record an inspection on the DVDPak2, perform the following functions:

1. Insert a DVDR or DVDRW disc into the DVDPak2.
2. Press the Record Button  on the DVDR. The screen on the DVDR will show, "Recording" and the elapsed time. During recording, the Record Button  will also be outlined in red.
3. Press the Record Button  to pause and resume the recording.
4. Press the Stop Button  to stop the recording. After pressing the Stop Button  and after a brief pause, the amount of recording time remaining on the current disc will be shown on the DVDR screen.

Finalizing a Disc

To allow the disc to play back in a DVD player, the disc needs to be finalized. Unless a rewriteable disc, such as a DVDRW has been used, a disc can no longer be recorded to after finalization.

To finalize a disc, perform the following functions:

1. Press the Return Button  to return to the Main Menu. Note that depending on the current menu location, the Return Button  may require multiple pushes to allow access to the Main Menu of the DVDR.
2. Use the Down Arrow Button  to highlight "Setup" and press the Enter Button .
3. From the Setup Menu use the Down Arrow Button  to highlight "Finalize Disc" and press the Enter Button .
4. When prompted, use the Up Arrow Button  to highlight "Yes" and to confirm the finalization of the Disc (See Figure 10). To cancel the finalization, press the Enter Button  to return to the Setup Menu.

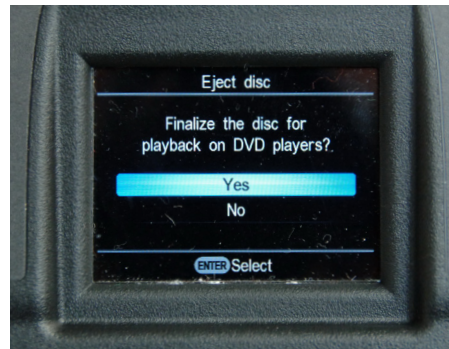







Figure 10 – Finalizing the Disc

Play Back Recorded Video

To play back recorded chapters on the DVDPak2, perform the following functions:

1. Press the Return Button  to return to the main menu. Note that the Return Button  may require multiple pushes to allow access to the Main Menu of the DVDR.
2. Use the Down Arrow Button  to highlight "DVD Preview" and press the Enter Button .
3. If the disc has not been finalized, the last recorded video will appear and play back on the DVDR screen.
4. If the disc has been finalized, a series of thumbnails, each representing existing chapters recorded on the disc will be displayed on the screen. Highlight a thumbnail and press the Enter Button  to begin play back.

Note that audio will not be played during play back, but will be heard when the disc is played on a DVD player.

To return to recording mode, perform the following functions:

1. Press the Return Button ● to return to the Main Menu. Note that depending on the current menu location, the Return Button ● may require multiple pushes to allow access to the Main Menu of the DVDR.
2. Use the Up Arrow Button ↑ to highlight “Video → DVD” and press the Enter Button □.
3. Use the Down Arrow Button ↓ to select “Video In” and press the Enter Button □.

Locating the Camera Using the Sonde

Many SeeSnake pipe inspection systems have a built-in Sonde which transmits a locatable 512 Hz signal. When the Sonde is turned ON, a locator such as the RIDGID SR-20, SR-60, Scout™ or NaviTrack® II set to 512 Hz will be able to detect it, allowing you to detect the camera's location underground.

Press the Sonde Key  on the DVDPak2 to turn the Sonde ON and OFF.

To locate the camera using the Sonde, run the SeeSnake push cable from 5 ft to 10 ft [1.5 m to 3 m] into the pipe and use the locator to find the Sonde's position. If desired, extend the SeeSnake push cable from 5 ft to 10 ft [1.5 m to 3 m] further down-pipe and locate the Sonde again starting from the previous located position. To locate the Sonde, turn the locator ON and set it to Sonde mode. Scan in the direction of the Sonde's probable location until the locator detects the Sonde.

Once you have detected the Sonde, use the locator indications to zero in on its location precisely. For detailed instructions on Sonde locating, consult the Operator's Manual for the locator model you are using.

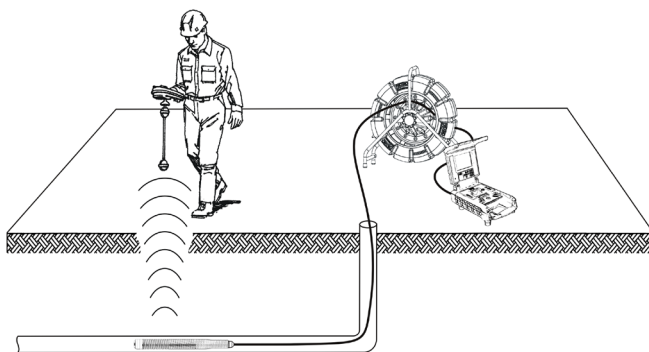

Figure 11 – Locating the Sonde

Set the line transmitter and the locator to the same frequency and use the locator to trace the line (See Figure 11). The camera's built-in Sonde may be on

at the same time and, if equipped with SimulTrace™ dual-frequency capability, you can use the locator to follow the push cable to the camera's location and then detect the Sonde in the camera as you approach it above ground.

Line Tracing the SeeSnake Push Cable

The DVDPak2 also enables you to trace the line of the push cable underground, using a standard RIDGID locator, such as the NaviTrack® II, the Scout™, the SR-20, or the SR-60. To line-trace the push cable, connect a line transmitter with one connector well-grounded to the grounding stake and the other connector clipped to the Transmitter Clip-on Terminal.

Set the line transmitter and the locator to the same frequency and use the locator to trace the line. The camera's built-in Sonde may be on at the same time and, if equipped with SimulTrace™ dual-frequency capability, you can use the locator to follow the push cable to the camera's location and then detect the Sonde in the camera as you approach it above ground.

If using a line transmitter that is not equipped with the SimulTrace™ feature, use a line transmitter and a locator to line-trace the SeeSnake push cable. When the signal fades, switch the locator to Sonde mode at the frequency of the in-line Sonde, usually 512 Hz. Pick the signal up from where the line-trace frequency started to weaken and zero in on the in-line Sonde. Because locating frequencies from transmitters can distort the image on the monitor, turn the Sonde and the line transmitters OFF during the inspection of line interior and only turn ON the Sonde and line transmitter when ready to locate.

Cleaning Instructions

⚠ WARNING

Disconnect all cords and cables and remove batteries prior to cleaning the DVDPak2 to reduce the risk of electrical shock.

Do not use liquid or abrasive cleaners on the DVDPak2. Clean the DVDPak2 with a damp cloth. Only use cleaners approved for use on LCD screens to clean the screen on the DVDPak2. Do not allow any liquid to enter the DVDPak2.

Accessories

⚠ WARNING

The following RIDGID products have been designed to function with the DVDPak2. Other accessories suitable for use with other tools may become hazardous when used with the DVDPak2. To reduce the risk of serious injury, only use accessories specifically designed and recommended for use with the DVDPak2.

Table 7 SeeSnake DVDPak2 Accessories	
Catalog # US	Description
32743	18 V Li-Ion rechargeable battery
32068	Battery charger
32648	Dual battery kit with charger
32708	Single battery kit with charger
Various	RIDGID SeekTech or NaviTrack Locator
Various	RIDGID SeekTech or NaviTrack Transmitters
Various	CountPlus Cable Counter cable-measurement system, normally built in to SeeSnake Pipe Inspection Systems

Transport and Storage

Keep the DVDPak2 indoors or well-covered in wet weather to reduce the risk of electrical shock. Store the DVDPak2 in a locked area, out of the reach of children and people unfamiliar with its operation. The DVDPak2 could cause serious injury in the hands of untrained users. Do not expose to heavy shocks or impacts during transport.

Remove batteries before shipping and before storing for extended periods.

Store the DVDPak2 in temperatures from 5°F to 95°F [-15°C to 35°C]. Store the unit away from heat sources such as radiators, heat registers, stoves, and other products (including amplifiers) that produce heat.

Service and Repair

⚠ WARNING

Improper service or repair can make the DVDPak2 unsafe to operate.

Service and repair of the DVDPak2 must be performed by a RIDGID Independent Authorized Service Center.

For information on your nearest RIDGID Independent Service Center or any service or repair questions:

- Contact your local RIDGID distributor.
- Visit www.RIDGID.com or www.RIDGID.eu to find your local Ridge Tool contact point.
- Contact Ridge Tool Technical Service Department at rttechservices@emerson.com or, in the U.S. and Canada, call 800-519-3456.

Disposal

Parts of the unit contain valuable materials that can be recycled. There are companies that specialize in recycling that may be found locally. Dispose of the components in compliance with all applicable regulations. Contact your local waste management authority for more information.



For EC countries: Do not dispose of electrical equipment with household waste!

According to the European Guideline 2002/96/EC for Waste Electrical and Electronic Equipment and its implementation into national legislation, electrical equipment that is no longer usable must be collected separately and disposed of in an environmentally-correct manner.

Battery Disposal



The RBRC™ (Rechargeable Battery Recycling Corporation) Seal on the battery packs signifies that RIDGID has already paid the cost of recycling the Li-Ion battery packs.

RBRC™, RIDGID®, and other battery suppliers have developed programs in the U.S. and Canada to collect and recycle rechargeable batteries. Normal and rechargeable batteries contain materials that should not be directly disposed of in nature and contain valuable materials that can be recycled. Help to protect the environment and conserve natural resources by returning your used batteries to your local retailer or an authorized RIDGID service center for recycling. Your local recycling center can also provide you with additional drop-off locations.

RBRC™ is a registered trademark of the Rechargeable Battery Recycling Corporation.

For EC countries: Defective or used battery packs/batteries must be recycled according to the guideline 2006/66/EC.

Table 8
DVDPak2 Troubleshooting

Problem	Probable Fault Location	Solution
Camera image not seen	No power to SeeSnake Reel	Check power is correctly plugged in
		Check the switch on the DVDPak2
	Connections faulty	Check orientation, seating, and pin condition in the SeeSnake connection.
	Video display set to wrong source	Set the video source as described in the Video Display Set Up section
	Batteries low	Recharge batteries or connect the DVDPak2 to an external power supply.
Flashing battery warning	Batteries low	Recharge batteries or connect the DVDPak2 to an external power supply.

Ridge Tool Company

400 Clark Street
Elyria, Ohio 44035-6001
U.S.A.

www.RIDGID.com
1-800-474-3443



Ridge Tool Europe

Research Park Haasrode
3001 Leuven
Belgium

www.RIDGID.eu
+ 32 (0)16 380 280

What is covered

RIDGID® tools are warranted to be free of defects in workmanship and material.

How long coverage lasts

This warranty lasts for the lifetime of the RIDGID® tool. Warranty coverage ends when the product becomes unusable for reasons other than defects in workmanship or material.

How you can get service

To obtain the benefit of this warranty, deliver via prepaid transportation the complete product to RIDGE TOOL COMPANY, Elyria, Ohio, or any authorized RIDGID® INDEPENDENT SERVICE CENTER. Pipe wrenches and other hand tools should be returned to the place of purchase.

What we will do to correct problems

Warranted products will be repaired or replaced, at RIDGE TOOL'S option, and returned at no charge; or, if after three attempts to repair or replace during the warranty period the product is still defective, you can elect to receive a full refund of your purchase price.

What is not covered

Failures due to misuse, abuse or normal wear and tear are not covered by this warranty. RIDGE TOOL shall not be responsible for any incidental or consequential damages.

How local law relates to the warranty

Some states do not allow the exclusion or limitation of incidental or consequential damages, so the above limitation or exclusion may not apply to you. This warranty gives you specific rights, and you may also have other rights, which vary, from state to state, province to province, or country to country.

No other express warranty applies

This FULL LIFETIME WARRANTY is the sole and exclusive warranty for RIDGID® products. No employee, agent, dealer, or other person is authorized to alter this warranty or make any other warranty on behalf of the RIDGE TOOL COMPANY.

**We
Build
Reputations™**

RIDGID®

EMERSON
Commercial & Residential Solutions

RIDGID reserves the right to change the specifications of the hardware, software, or both as described in this manual without notice. Visit www.ridgid.com for current updates and supplemental information pertaining to this product. Due to product development, the photos and other presentations specified in this manual may differ from the actual product.

Other trademarks or registered trademarks mentioned in this manual are the property of their respective owners.