



HelixNet[®]

Digital Partyline User Guide



PN: 399G159 Rev: A 24 November 2015

Document Reference

Clear-Com HelixNet Partyline User Guide

Part Number: 399G159 Revision: A

Legal Disclaimers

Copyright © 2015 HME Clear-Com Ltd.

All rights reserved.

Clear-Com, the Clear-Com logo, Clear-Com Concert and HelixNet are registered trademarks of HM Electronics, Inc.

The software described in this document is furnished under a license agreement and may be used only in accordance with the terms of the agreement.

The product described in this document is distributed under licenses restricting its use, copying, distribution, and decompilation/reverse engineering. No part of this document may be reproduced in any form by any means without prior written authorization of Clear-Com, an HME Company.

This product is covered by U.S. Patent Nos. 8,311,085 and 8,553,865 and by European Patent No. 2 176 987 B1.

Clear-Com Offices are located in California, USA; Cambridge, UK; Montreal, Canada; and Beijing, China. Specific addresses and contact information can be found on Clear-Com's corporate website:

www.clearcom.com

Clear-Com Contacts

Americas and Asia-Pacific Headquarters

California, United States

Tel: +1.510.337.6600

Email: CustomerServicesUS@clearcom.com

Europe, Middle East, and Africa Headquarters

Cambridge, United Kingdom

Tel: +44 1223 815000

Email: SalesSupportEMEA@clearcom.com

China Office

Beijing Representative Office

Beijing, P.R.China

Tel: +8610 65811360 / 65815577

Contents

Contents 3

- 1 Introduction 8**
 - 1.1 Important Safety instructions 8
 - 1.2 Methods of connection: system overview 10
 - 1.3 Further information..... 14

- 2 Panels and Interfaces 15**
 - 2.1 Main Station/Remote Station: Front panel 15
 - 2.2 HMS-4X Main Station: rear panel 22
 - 2.3 Remote Station rear panel 28
 - 2.4 Speaker Station 31
 - 2.5 HBP-2X Beltpack 39

- 3 Installing HelixNet Partyline 44**
 - 3.1 Planning your HelixNet Partyline installation 45
 - 3.2 Installing the Main Station/Remote Station..... 50
 - 3.3 Installing the Speaker Station 51
 - 3.4 Installing the HBP-2X Beltpacks..... 54
 - 3.5 HelixNet infrastructure 54
 - 3.6 Converting analogue partylines to HelixNet 56

- 4 IP Network Structure 57**
 - 4.1 Network connections..... 57
 - 4.2 Multiple Groups in the same IP Network..... 58
 - 4.3 Link Local Environments 58

- 5 Configuring and managing the Main Station from device menus 61**
 - 5.1 Using the Menus..... 61
 - 5.2 Configuring the Audio settings..... 63
 - 5.3 Selecting Station Settings..... 69
 - 5.4 Configuring the channel settings..... 74



5.5	Configuring the Control I/O.....	76
5.6	Configuring Module Settings.....	78
5.7	Administration	88
5.8	Diagnostics.....	91
5.9	Setting up a key Expansion Group	93
6	Configuring and managing the Remote Station from device menus	97
6.1	Configuring the audio settings.....	97
6.2	Selecting Station Settings.....	101
6.3	Configuring the channel settings.....	101
6.4	Configuring the Control I/O.....	103
6.5	Connecting the Remote Station to a Main Station using LAN	104
6.6	Administration	105
6.7	Diagnostics.....	107
6.8	Setting up a key Expansion Group	108
7	Using the Main Station/Remote Station	109
7.1	Using the gooseneck mic, loudspeaker and headset.....	109
7.2	Entering and exiting Menu mode.....	111
7.3	A HelixNet Link-Group Overview	112
7.4	Device configuration in the CCM	113
7.5	Linking Main Stations in the CCM	114
7.6	Using the channel keysets	116
7.7	Using the All Talk key.....	117
7.8	Using the SA [<i>Stage Announce</i>] key	117
7.9	Using the RMK [<i>Remote Mic Kill</i>] key	118
7.10	Line 1 and 2 LEDs.....	119
7.11	Line and LAN LEDs.....	120
8	Configuring and managing the Speaker Station from device menus	121
8.1	Using the Menus.....	121
8.2	Configuring the Audio settings.....	122
8.3	Station Settings	122

8.4	Connecting the Speaker Station to a Main Station	123
8.5	Module Settings	123
8.6	Administration	123
8.7	Diagnostics.....	124
9	Using the Speaker Station	125
9.1	Using the gooseneck mic, loudspeaker and headset.....	125
9.2	Entering and exiting Menu mode.....	127
9.3	Using the channel keysets	127
9.4	Line and LAN LEDs.....	128
10	Configuring and managing the HBP-2X Beltpack from device menus	129
10.1	Using the Menus.....	129
10.2	Configuring the Role settings.....	130
10.3	Configuring the Audio settings.....	130
10.4	Audio settings for the microphone.....	132
10.5	Configuring the Beltpack Settings	132
10.6	Configuring the Display Settings	134
10.7	Administration	136
10.8	Diagnostics.....	137
11	Using the HBP-2X Beltpack.....	138
11.1	Using the beltpack keysets.....	138
11.2	Entering and exiting Menu mode.....	139
11.3	Adjusting the Program Feed volume level.....	139
12	Roles	140
12.1	Roles overview	140
12.2	Example Roles set up	141
12.3	Device default Roles	145
12.4	To select a Role for a device.....	145
12.5	Creating and editing Roles in the CCM	145
13	Core Configuration Manager (CCM)	149
13.1	Access the CCM.....	150

13.2	Minimum requirements for the CCM	150
13.3	Overview page	151
13.4	Home page	152
13.5	General Page	153
13.6	Save/Restore System Settings	154
13.7	Linking page	155
13.8	Roles Page	156
13.9	Assignments page	158
14	Using the CCM to configure Roles	162
14.1	Editing Main Station roles	162
14.2	General Purpose Input (GPI) and General Purpose Output (GPO) triggers.	167
14.3	Editing Remote Station roles	171
14.4	Editing Speaker Station roles	172
14.5	Editing the Beltpack roles	173
14.6	Disable menu access on any device from the CCM	176
14.7	Configure a stacked key on a beltpack using the CCM	176
14.8	Call a beltpack using the USB flasher feature	177
15	Linking in the Core Configuration Manager (CCM)	179
15.1	A HelixNet Link-Group Overview	179
15.2	Device configuration in the CCM	180
15.3	Linking Main Stations in the CCM	181
16	Linking Main Stations (cabling and linking from device menus)	184
16.1	Linking scenarios	184
17	Linking Remote Stations and Speaker Stations.....	188
17.1	Linking scenarios	189
17.2	Networking Specifications	194
18	Connecting to Other Intercom Systems	195
18.1	Connecting HelixNet Partyline to Encore®	195
18.2	Connecting HelixNet Partyline to RTS (Telex) two-wire systems ..	198

18.3	Connecting HelixNet Partyline to Tempest®	201
18.4	Connecting HelixNet Partyline to CellCom® / FreeSpeak®	207
18.5	Connecting HelixNet Partyline to the DX210	212
18.6	Connecting HelixNet Partyline to Eclipse®	217
18.7	Connecting HelixNet Partyline to two-way radio systems	223
19	Specifications	230
19.1	Main Station (HMS-4X).....	230
19.2	Two-wire module (HLI-2W2)	236
19.3	Four-wire module (HLI-4W2).....	237
19.4	Remote Station (HRM-4X).....	237
19.5	Speaker Station (HKB-4X)	243
19.6	Beltpack (HBP-2X)	246
20	Glossary	248
21	Menu maps	251
22	Menu trees	274
23	Cabling reference	279
23.1	Interoperability	279
23.2	Cable capacitance versus distance	280
23.3	Cable connections.....	284
24	Troubleshooting	289
25	Compliance	292

1 Introduction

This guide is intended to help you install, configure, and use the **HelixNet Partyline™** system.

HelixNet Partyline is a digital intercom system, featuring the award-winning I.V. Core Technology from Clear-Com®. The system is designed to be as simple to use and configure as a two-wire intercom / analog Partyline system, while exploiting the flexibility and network management capabilities of a matrix system.

To expedite integration with your existing intercom infrastructure, HelixNet Partyline also features:

- Highly configurable Control I/O and Module settings.
- Intuitive and easy to use online Core Configuration Manager to configure and control HelixNet units.
- Flexible cabling options (microphone cable, CAT5).
Note: Cabling for a HelixNet system should always be screened.
- Optional 2-Wire and 4-Wire interface modules.
- Optional Main Station linking (LAN or Fiber or combination).
- Expansion option to enable talk and listen on more than four channels.
- Beltpacks and wall/desktop Remote Stations that connect to a system that contains a Main Station.

1.1 Important Safety instructions

HelixNet digital partyline uses cable infrastructure to transport audio and data over a range of frequencies. The maximum frequency used for transmission is approximately 25MHz. Depending on the amount of audio and data transmitted, HelixNet digital partyline can work with as much as 90dB signal attenuation. However, the receivers are very sensitive and are susceptible to crosstalk between cables.

Therefore it is important to maintain cable shield integrity through all connectors, splitter boxes and patch panels.

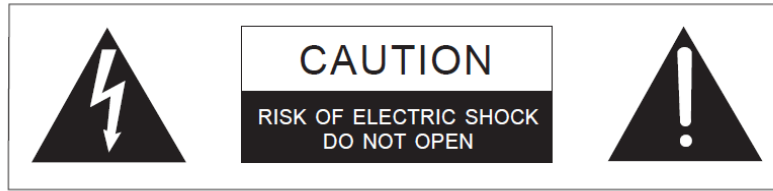
- Read these instructions.
- Keep these instructions.
- Heed all warnings.
- Follow all instructions.
- Do **not** use this apparatus near water.
- Clean only with dry cloth.

- Do **not** block any ventilation openings. Install in accordance with the manufacturer's instructions.
- Do **not** install near any heat sources such as radiators, heat registers, stoves, or other apparatus (including amplifiers) that produce heat.
- Do **not** defeat the safety purpose of the polarized or grounding-type plug. A polarized plug has two blades and a third grounding prong. The wide blade or the third prong is provided for your safety. If the provided plug does not fit into your outlet, consult an electrician for replacement of the obsolete outlet.
- Protect the power cord from being walked on or pinched particularly at plugs, convenience receptacles, and the point where they exit from the apparatus.
- Only use attachments/accessories specified by the manufacturer.
- Use only with the cart, stand, tripod, bracket, or table specified by the manufacturer, or sold with the apparatus. When a cart is used, use caution when moving the cart/apparatus combination to avoid injury from tip-over.
- Unplug this apparatus during lightning storms or when unused for long periods of time.
- Refer all servicing to qualified service personnel. Servicing is required when the apparatus has been damaged in any way, such as power-cord supply or plug is damaged, liquid has been spilled or objects have fallen into the apparatus, the apparatus has been exposed to rain or moisture, does not operate normally, or has been dropped.

Warning: To reduce the risk of fire or electric shock, do not expose this product to rain or moisture.

1.1.1 **Safety symbols**

Familiarize yourself with the safety symbols in **Figure 1: Safety symbols**. These symbols are displayed on the apparatus and warn you of the potential danger of electric shock if the system is used improperly.



This symbol alerts you to the presence of uninsulated dangerous voltage within the product's enclosure that might be of sufficient magnitude to constitute a risk of electric shock. Do not open the product's case.



This symbol informs you that important operating and maintenance instructions are included in the literature accompanying this product.

Figure 1-1: Safety symbols

Note: Important. For compliance notices, see 20 Compliance.

1.2 Methods of connection: system overview

HelixNet devices can be connected in several different ways. A combination of these methods can be used.

1.2.1 Connecting by cable (powerline).

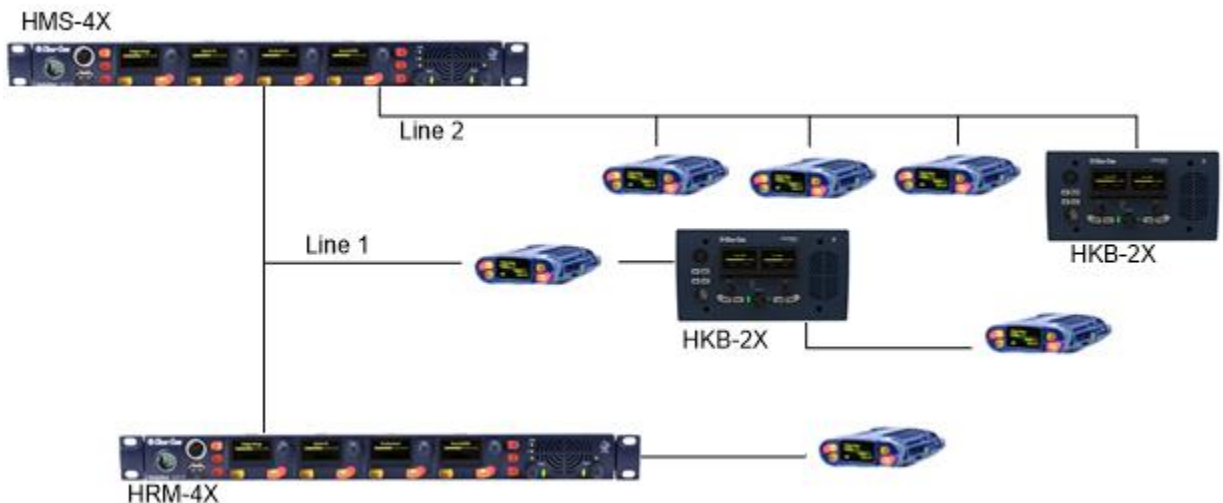


Figure 1-2 Connecting devices by cable

In this scenario devices are connected by cable in either a daisy chain or home run fashion. Power and data are passed down this connection in what is known as a powerline.

See 17 Linking Remote Stations and Speaker Stations for detail on different types of device layout (topologies).

Up to 20 beltacks can be connected to one Main Station, and Remote and Speaker Stations can be included in the powerline.

However, including Remote and Speaker Stations in the powerline will affect the amount of devices that can be connected, as Main and Remote Stations draw more power than beltacks.

You can find the URL to a powerline/distance calculator at the beginning of Chapter 3. Installing HelixNet Partyline.

1.2.2 Pairing by LAN

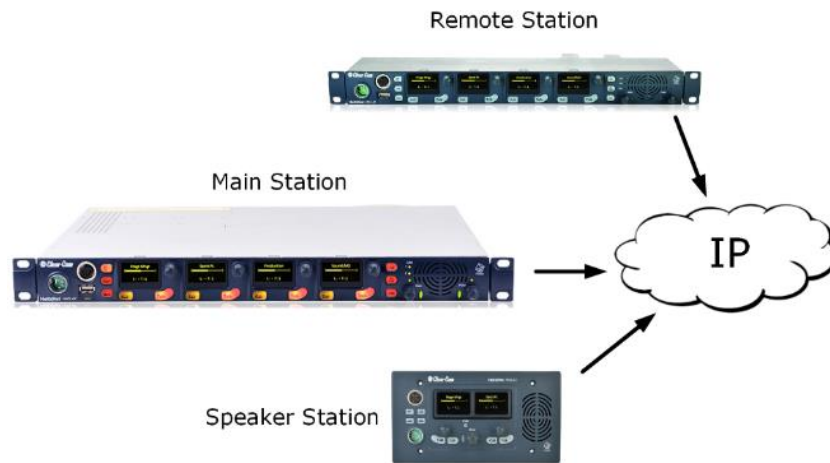


Figure 1-3 Pairing by LAN (or Fiber)

When pairing by LAN, devices are connected to the same network by Ethernet cable (RJ45) and then paired from the device menus.

See 17.1.2 Ethernet point-to-point link for more detail.

Note: Pairing by LAN offers better latency than connecting with cable.

1.2.3 Connecting more than one Main Station (Linking)

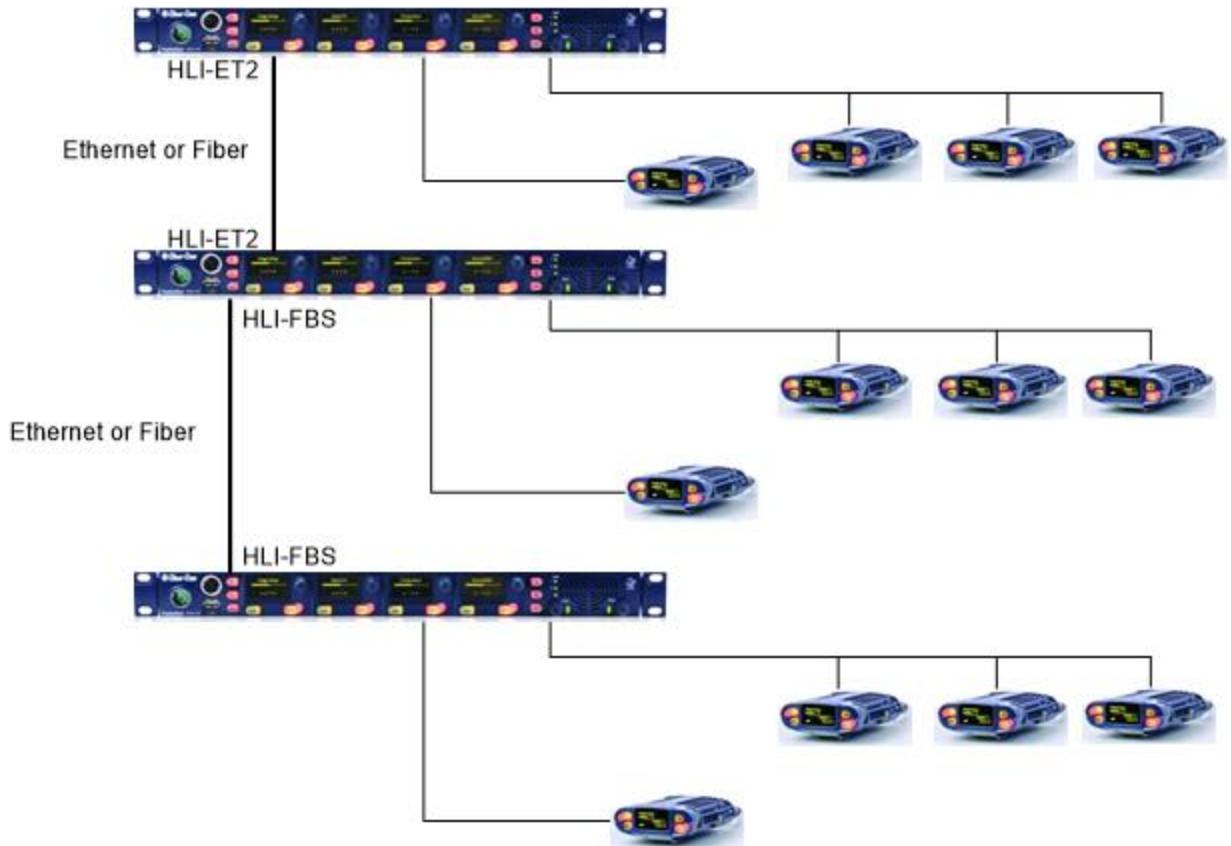


Figure 1-4 Linking Main Stations by Ethernet

Up to three Main Stations can be linked. In earlier versions of HelixNet (2.0 and below) linking Main Stations was a way of expanding the Channel capacity of your system (4 Channels on each Main Station). In HelixNet 3.0 this is no longer necessary as each Main Station already has 12 Channels, with the option of licensing another 12 (24 Channels in total). A system, regardless of the number of linked HMS units, will have 12 channels by default with the potential of increasing that number to 24 with the purchase of a license for each HMS within the Link-Group.

Linking Main Stations in HelixNet 3.0 has the following benefits:

- More beltpack connections (20 per Main Station)
- System distribution as far as your LAN allows.
- The ability to configure all devices from an Internet browser using the CCM (Core Configuration Manager).

Once connected, Main stations in a Link-Group can be configured from any unit

Browser pointed at the host unit



The host unit is able to configure any other unit in the group (by proxy)

Click on any unit to access configuration and control options

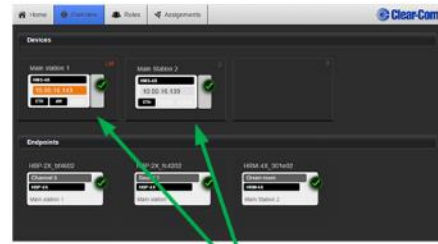


Figure 1-5 Linking Main Stations in the Core Configuration Manager (CCM)

Main Stations can be linked using different methods:

- By Ethernet and RJ-45 cable in your LAN. See 16 Linking Main Stations (cabling and linking from device menus).
- By IP address/hostname using the CCM. See 15 Linking in the Core Configuration Manager (CCM)

1.2.4 Key Expansion Groups (Main Stations and Remote Stations)



HRM/HMS Expanding over IP:

- All devices in the Expansion Group use the headset/microphone/loudspeaker of a "Host" HRM or HMS
- Some menus disappear from the "Expanded" HRM/HMS devices (e.g. microphone, headset, display settings).

Figure 1-6 Key Expansion Group

Devices can be set up as a key Expansion Group to allow convenient control of audio from one device, and to increase the "key" capacity so that a user can view and control more than 4 keys (up to 24 with 5 expansion panels).

See 5.9 Setting up a key Expansion Group for detail.

1.3 Further information

For the latest information about **HelixNet Partyline**, including software updates, see:

<http://www.clearcom.com/product/helixnet>.

For information about **Clear-Com accessories**, including headsets and gooseneck microphones, see <http://www.clearcom.com/product/accessories>.

For **legal** and **contact** information, see Page 2 of this guide.

2 Panels and Interfaces

2.1 Main Station/Remote Station: Front panel

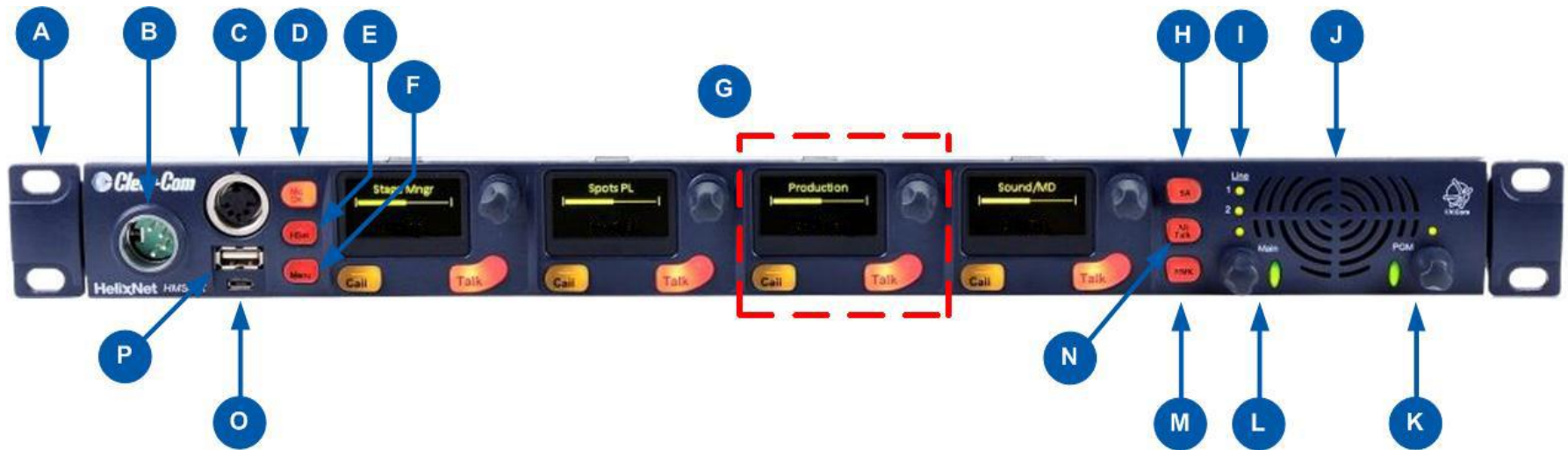


Figure 2-1: Main Station/Remote Station: Front panel

Key to Main Station/Remote Station: Front panel											
Feature	Description										
A	Ear for rack mounting Main Station/Remote Station.										
B	<p>Headset socket (4-pin XLR-M)</p> <table border="1"> <thead> <tr> <th>Pin</th> <th>Function</th> </tr> </thead> <tbody> <tr> <td>1</td> <td>Mic ground</td> </tr> <tr> <td>2</td> <td>Mic +</td> </tr> <tr> <td>3</td> <td>Earphone ground</td> </tr> <tr> <td>4</td> <td>Earphone</td> </tr> </tbody> </table> <p>Table 2-1: Headset socket pin out</p>	Pin	Function	1	Mic ground	2	Mic +	3	Earphone ground	4	Earphone
Pin	Function										
1	Mic ground										
2	Mic +										
3	Earphone ground										
4	Earphone										
C	Gooseneck microphone socket (3-pin female Tuchel connector)										
D	Mic control [MIC ON]. Press to activate mic audio.										
E	Headset key [HSET]. Press to activate the headset mic. When the headset is connected, the gooseneck microphone is disconnected. Audio output to the loudspeaker is diverted to the headphones.										
F	Menu. Press to display the Main Station menus in the display screens [G]. Use the rotary control for each display screen to scroll and select menu items. See <i>2.1.1 Main Station/Remote channel keyset</i> .										
G	Channel keyset. There is a keyset (set of controls) addressable to any of the available channels. See <i>2.1.1 Main Station/Remote channel keyset</i> .										
H	<p>Stage Announce [SA]. Press to talk to connected Public Address (PA) / Stage Announce (SA) system (see <i>2.2 HMS-4X Main Station: rear panel</i>).</p> <p>SA mutes any active Talk key on any of the 4 keysets, and transmits audio from either headset or gooseneck microphone to the SA Output port on the rear of the unit. If the SA is assigned to a Channel, then any talker within the channel has their audio routed to the associated SA Port.</p> <p>When the SA is pressed, Mic select [MIC ON] is also lit bright red, indicating that mic audio is active. See <i>7.8 Using the SA [Stage Announce] key</i>.</p>										

Key to Main Station/Remote Station: Front panel													
Feature	Description												
I	<p>Master Station LEDs for lines 1 and 2 (digital partylines). The LEDs indicate the status of the intercom circuit powering. When an LED is lit:</p> <ul style="list-style-type: none"> • Green, the line is functioning. • Amber, the line is busy. • Red, there is an error or fault on the line. <p>Remote Station LEDs for line status and LAN status. The LEDs indicate the status of the intercom circuit powering. When an LED is lit: Green, the line is functioning. Amber, the line is busy. Red, there is an error or fault on the line.</p> <p>If there is a fault on a powerline output, the Line STATUS indicator will turn off and the red FAULT indicator will flash. Possible causes of a fault include overvoltage, overcurrent, short circuit to ground or severe brown-outs.</p>												
J	<p>Loudspeaker. When a headset is connected [B] and selected [E], loudspeaker output is diverted to the headphones.</p>												
K	<p>Program feed audio level rotary control [Program].</p> <ul style="list-style-type: none"> • To increase the volume of the program feed to the loudspeaker / headphones, turn clockwise (up to 360°). • To decrease the volume, turn anticlockwise (up to 360°). As you increase or decrease the volume, the level control LEDs pass through a range of indicator colors: <table border="1"> <thead> <tr> <th>LED color</th> <th>Volume level</th> </tr> </thead> <tbody> <tr> <td>Green</td> <td>Low</td> </tr> <tr> <td>Amber / Green</td> <td>Low / Medium</td> </tr> <tr> <td>Amber</td> <td>Medium</td> </tr> <tr> <td>Red / Amber</td> <td>Medium / High</td> </tr> <tr> <td>Red</td> <td>High</td> </tr> </tbody> </table> <p style="text-align: center;">Table 2-2 : Volume Indicator colors</p>	LED color	Volume level	Green	Low	Amber / Green	Low / Medium	Amber	Medium	Red / Amber	Medium / High	Red	High
LED color	Volume level												
Green	Low												
Amber / Green	Low / Medium												
Amber	Medium												
Red / Amber	Medium / High												
Red	High												
L	<p>Loudspeaker / Headphone audio level rotary control [Main]. To increase the volume to the loudspeaker / headphones, turn clockwise (up to 360°). To decrease the volume, turn anticlockwise (up to 360°). Push to mute or unmute. As you increase or decrease the volume, the level control LEDs pass through a range of indicator colors. For more information, see Table 2-2 : Volume Indicator colors</p>												

Key to Main Station/Remote Station: Front panel	
Feature	Description
M	<p>Main Station: Remote Mic Kill [RMK]. Press to:</p> <ul style="list-style-type: none"> Unlatch all latched talk keys for either all displayed Channels or all Channels within the system (configurable within the Role) <p>Remote Station: Option [OPT] – Can be configured as an RMK button (see section 7.9 Using the RMK [Remote Mic Kill] key).</p>
N	All Talk. Press to talk to all channels (intercom devices and systems) connected to the Main Station.
O	<p>USB 2.0 (Micro-AB) connector. For software upgrades (see 5.7.2 Updating the software and 5.7.6 Saving and restoring the software settings).</p> <p>Note: This connector is not present on the Remote Station.</p>
P	<p>USB 2.0 (Standard-A) connector. For software upgrades (see 5.7.2 Updating the software and 5.7.6 Saving and restoring the software settings).</p>

Table 2-3 Key to Main Station/Remote Station front panel diagram

Note: The Main Station/Remote Station does not have a power switch, button or key. The system powers up when you connect the power supply. Power up time depends on the amount of equipment connected.

2.1.1.1 Main Station/Remote channel keyset and display













Figure 2-2: Main Station/Remote Station (Front panel): Keyset

Key to Main Station/Remote Station front panel: Channel keyset	
Feature	Description
A	<p>Display screen.</p> <p>There are multiple screensaver options. If the Rotary controls are touched, this screen also displays the sound level on the Channel (controlled by the rotary) and the system information icons. For an explanation of system information icons see Table 2-5 Main Station/Remote Station display icons and indicators.</p> <p>In Menu mode, the display screens display the four levels of menu. The menu hierarchy proceeds left to right:</p> <ul style="list-style-type: none"> • The top level menu is presented in the first screen (furthest left on the front panel). • The lowest level menu is presented in the fourth screen (furthest right on the front panel). <p>If the display is in Menu mode, the display screen times out of Menu mode and displays the channel label if no key is pressed for 20 seconds.</p> <p><i>For more information about Menu mode, see 5.1 Using the Menus.</i></p>
B	<p>Rotary control. Turn to increase or decrease the listen volume level for the channel, or to scroll menu items when in menu mode. To select menu items, press the control.</p>
C	<p>Talk key. Press to talk on the channel and to all nodes (intercom devices and systems) listening into the channel.</p>
D	<p>Call key. Press to send a call signal to all nodes (intercom devices and systems) listening into the channel.</p>

Table 2-4: Key to Main Station/Remote Station front panel: Key Set

Note: If the Main Station/Remote Station remains inactive for 10 minutes, the display screens enter screensaver mode (see **5.3.9 Setting the screensaver**).

Main Station/Remote Station display icons and indicators		
Name	Icon	Description
Channel label		A descriptive name for the channel. The maximum length is 10 characters.
Channel listen volume level		The volume of the channel audio.
Link with another HMS		Appears on the Main Station when linking is enabled.
Not linked		Appears on the Main Station when a connection to another Main Station is lost.
Paired		Appears on the Remote Station and Speaker Station when it is connected properly over LAN.
Not paired		Flashes on the Remote Station and Speaker Station when the connection is not configured properly.
Signal strength		Appears on the Remote Station, Speaker Station and beltpack. One to five bars indicate the strength of the signal from the Main Station.
Locked	Locked	Appears on the beltpack when you try to access the menu while the menu has been locked at the Main Station.
Mute		Appears on the Main Station, Remote Station and Speaker Station when the rotary control for any channel on the Main/Remote Station is pressed.
Opto (GPI)		Appears on the Main Station and Remote Station close to the Call or Talk button if it is associated with an Opto.
Relay (GPO)		Appears on the Main Station and Remote Station close to the Call or Talk button if it is associated with a Relay.
Program	PGM	Appears on the Main Station, Remote Station, Speaker Station and beltpack when a program input is assigned to a channel.
IFB	IFB	Appears on the Main Station, Remote Station, Speaker Station and beltpack when a program input is assigned to a channel and IFB is enabled.
2W/4W	2W/4W	Appears on the Main Station, Remote Station and Speaker Station when a 2W/4W input is assigned



Main Station/Remote Station display icons and indicators		
Name	Icon	Description
		to a channel.
Limiters	LIM	Appears on the Main Station, Remote Station, Speaker Station and beltpack when the headset limiter is enabled.
Expansion		Appears on the Main Station and Remote Station when the device is part of an Expansion Group.
Warning		Appears on the Main Station, Remote Station, Speaker Station and beltpack when something is wrong. Warning messages can be accessed in the Diagnostic menu.

Table 2-5 Main Station/Remote Station display icons and indicators

2.2 HMS-4X Main Station: rear panel

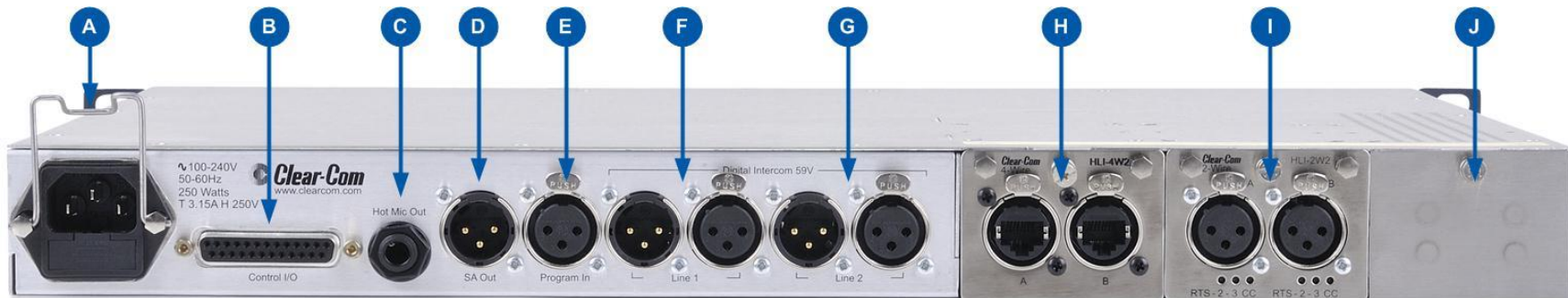


Figure 2-3: HMS-4X Main Station: rear panel (including optional modules HLI-2W2 and HLI-4W2)

Key to Main Station: rear panel																																																									
Feature	Description																																																								
A	Power supply with metal cable clip. The power supply operates at 100 - 240 VAC / 50-60Hz / 250 watts / T 3.15A H 250 V.																																																								
B	<p>Control I/O (25 way female D-type). Use to connect up to 4 relay control outputs and 4 optically isolated control inputs (see 5.5 <i>Configuring the Control I/O</i>).</p> <table border="1" style="margin-left: auto; margin-right: auto;"> <thead> <tr> <th>Pin</th> <th>Function</th> <th>Pin</th> <th>Function</th> </tr> </thead> <tbody> <tr> <td>Pin 1</td> <td>Relay 1 NC</td> <td>Pin 14</td> <td>Relay1 Pole</td> </tr> <tr> <td>Pin 2</td> <td>Relay 1-NO</td> <td>Pin 15</td> <td>Relay 2 NC</td> </tr> <tr> <td>Pin 3</td> <td>Relay2-Pole</td> <td>Pin 16</td> <td>Relay 2-NO</td> </tr> <tr> <td>Pin 4</td> <td>Relay 3 NC</td> <td>Pin 17</td> <td>Relay3 Pole</td> </tr> <tr> <td>Pin 5</td> <td>Relay 3-NO</td> <td>Pin 18</td> <td>Relay 4 NC</td> </tr> <tr> <td>Pin 6</td> <td>Relay4-Pole</td> <td>Pin 19</td> <td>Relay 4-NO</td> </tr> <tr> <td>Pin 7</td> <td></td> <td>Pin 20</td> <td>+5V</td> </tr> <tr> <td>Pin 8</td> <td>GND</td> <td>Pin 21</td> <td>+5V</td> </tr> <tr> <td>Pin 9</td> <td>GND</td> <td>Pin 22</td> <td>Opto 1-</td> </tr> <tr> <td>Pin 10</td> <td>Opto 1+</td> <td>Pin 23</td> <td>Opto 2-</td> </tr> <tr> <td>Pin 11</td> <td>Opto 2+</td> <td>Pin 24</td> <td>Opto 3-</td> </tr> <tr> <td>Pin 12</td> <td>Opto 3+</td> <td>Pin 25</td> <td>Opto 4-</td> </tr> <tr> <td>Pin 13</td> <td>Opto 4+</td> <td></td> <td></td> </tr> </tbody> </table> <p style="text-align: center;">Table 2-6: Control I/O pin out</p>	Pin	Function	Pin	Function	Pin 1	Relay 1 NC	Pin 14	Relay1 Pole	Pin 2	Relay 1-NO	Pin 15	Relay 2 NC	Pin 3	Relay2-Pole	Pin 16	Relay 2-NO	Pin 4	Relay 3 NC	Pin 17	Relay3 Pole	Pin 5	Relay 3-NO	Pin 18	Relay 4 NC	Pin 6	Relay4-Pole	Pin 19	Relay 4-NO	Pin 7		Pin 20	+5V	Pin 8	GND	Pin 21	+5V	Pin 9	GND	Pin 22	Opto 1-	Pin 10	Opto 1+	Pin 23	Opto 2-	Pin 11	Opto 2+	Pin 24	Opto 3-	Pin 12	Opto 3+	Pin 25	Opto 4-	Pin 13	Opto 4+		
Pin	Function	Pin	Function																																																						
Pin 1	Relay 1 NC	Pin 14	Relay1 Pole																																																						
Pin 2	Relay 1-NO	Pin 15	Relay 2 NC																																																						
Pin 3	Relay2-Pole	Pin 16	Relay 2-NO																																																						
Pin 4	Relay 3 NC	Pin 17	Relay3 Pole																																																						
Pin 5	Relay 3-NO	Pin 18	Relay 4 NC																																																						
Pin 6	Relay4-Pole	Pin 19	Relay 4-NO																																																						
Pin 7		Pin 20	+5V																																																						
Pin 8	GND	Pin 21	+5V																																																						
Pin 9	GND	Pin 22	Opto 1-																																																						
Pin 10	Opto 1+	Pin 23	Opto 2-																																																						
Pin 11	Opto 2+	Pin 24	Opto 3-																																																						
Pin 12	Opto 3+	Pin 25	Opto 4-																																																						
Pin 13	Opto 4+																																																								
C	<p>Hot Mic output. This connection is a 1/4-in (0.64 cm) phone jack. It provides an output signal from the selected headset or panel microphone. The Hot Mic output is always live. Audio from the mic is routed through the Hot Mic output even if the mic is inactive (off).</p> <table border="1" style="margin-left: auto; margin-right: auto;"> <thead> <tr> <th>Pin</th> <th>Function</th> </tr> </thead> <tbody> <tr> <td>Tip</td> <td>Mic</td> </tr> <tr> <td>Ring</td> <td>IFB mute signal</td> </tr> <tr> <td>Sleeve</td> <td>Ground</td> </tr> </tbody> </table> <p style="text-align: center;">Table 2-7: Hot Mic pin out</p>	Pin	Function	Tip	Mic	Ring	IFB mute signal	Sleeve	Ground																																																
Pin	Function																																																								
Tip	Mic																																																								
Ring	IFB mute signal																																																								
Sleeve	Ground																																																								

<p>D</p>	<p>SA [Stage Announce] line out (3-pin male XLR).</p> <table border="1" data-bbox="576 247 1356 436"> <thead> <tr> <th>Pin</th> <th>Function</th> </tr> </thead> <tbody> <tr> <td>Pin 1</td> <td>Ground</td> </tr> <tr> <td>Pin 2</td> <td>Positive</td> </tr> <tr> <td>Pin 3</td> <td>Negative</td> </tr> </tbody> </table> <p style="text-align: center;">Table 2-8: SA pin out</p>	Pin	Function	Pin 1	Ground	Pin 2	Positive	Pin 3	Negative
Pin	Function								
Pin 1	Ground								
Pin 2	Positive								
Pin 3	Negative								
<p>E</p>	<p>Program Input (3-pin female XLR).</p> <table border="1" data-bbox="576 588 1356 777"> <thead> <tr> <th>Pin</th> <th>Function</th> </tr> </thead> <tbody> <tr> <td>Pin 1</td> <td>Ground</td> </tr> <tr> <td>Pin 2</td> <td>Positive</td> </tr> <tr> <td>Pin 3</td> <td>Negative</td> </tr> </tbody> </table> <p style="text-align: center;">Table 2-9: Program input pin out</p>	Pin	Function	Pin 1	Ground	Pin 2	Positive	Pin 3	Negative
Pin	Function								
Pin 1	Ground								
Pin 2	Positive								
Pin 3	Negative								
<p>F</p>	<p>Line 1 (digital partyline). (3-pin male and female XLR connectors).</p> <table border="1" data-bbox="576 930 1356 1119"> <thead> <tr> <th>Pin</th> <th>Function</th> </tr> </thead> <tbody> <tr> <td>Pin 1</td> <td>Ground</td> </tr> <tr> <td>Pin 2</td> <td>+30V DC and Audio</td> </tr> <tr> <td>Pin 3</td> <td>-30V DC and Audio</td> </tr> </tbody> </table> <p style="text-align: center;">Table 2-10: Line 1 pin out</p>	Pin	Function	Pin 1	Ground	Pin 2	+30V DC and Audio	Pin 3	-30V DC and Audio
Pin	Function								
Pin 1	Ground								
Pin 2	+30V DC and Audio								
Pin 3	-30V DC and Audio								
<p>G</p>	<p>Line 2 (digital partyline). (3-pin male and female XLR connectors).</p> <table border="1" data-bbox="576 1270 1356 1459"> <thead> <tr> <th>Pin</th> <th>Function</th> </tr> </thead> <tbody> <tr> <td>Pin 1</td> <td>Ground</td> </tr> <tr> <td>Pin 2</td> <td>+30V DC and Audio</td> </tr> <tr> <td>Pin 3</td> <td>-30V DC and Audio</td> </tr> </tbody> </table> <p style="text-align: center;">Table 2-11: Line 2 pin out</p>	Pin	Function	Pin 1	Ground	Pin 2	+30V DC and Audio	Pin 3	-30V DC and Audio
Pin	Function								
Pin 1	Ground								
Pin 2	+30V DC and Audio								
Pin 3	-30V DC and Audio								
<p>H</p> <p>I</p> <p>J</p>	<p>Slots for optional interface modules. For more information, see HMS-4X Main Station rear panel: Interface modules.</p>								

Table 2-12: Key to HMS-4X Main Station rear panel diagram


Warning: Only connect power supply to earthed supply sockets. Ensure that the power supply is routed to avoid sharp bends, hot surfaces, pinches and abrasion. For more safety guidance, see the Safety Instructions at the front of this guide.




Note: The HMS-4X Main Station does not have a power switch, button or key. The system powers up when you connect the power supply.

2.2.1 HMS-4X Main Station rear panel: Interface modules

Up to three Interface modules (of the same or different types) can be fitted to the extension bay of the Main Station. When looking at the rear of the Main Station, expansion slot 1 is the left-hand slot, expansion slot 2 is the middle slot, and expansion slot 3 is the right-hand slot.

Warning: The interface modules are NOT hot pluggable. Ensure that the Main Station is powered down before inserting or removing modules.

Interface module	Description								
<p>Two-wire interface module (HLI-2W2)</p> 	<p>This is a two channel device that enables interoperability with, CellCom® / FreeSpeak®, and HME DX210 systems, as well as both Clear-Com and RTS analog partyline systems.</p> <p>Note: This module requires a powered analog partyline. The module provides two analog partyline connectors (3 pin female XLR connectors) with the following pin out:</p> <table border="1" data-bbox="618 1031 1398 1255"> <thead> <tr> <th>Pin</th> <th>Function</th> </tr> </thead> <tbody> <tr> <td>1</td> <td>Ground</td> </tr> <tr> <td>2</td> <td>Power [Option for RTS mode: power and audio]</td> </tr> <tr> <td>3</td> <td>Audio</td> </tr> </tbody> </table> <p>Table 2-13: two-wire Interface Module pin out</p> <p>Use HelixNet Main Station menus to set the module for either RTS or Clear-Com systems. If RTS mode is selected, you can set either:</p> <ul style="list-style-type: none"> • Pin 2 for power to mixed audio channel (1 – 24) • Pin 3 for power to mixed audio channel (1 – 24) • Select either pin and assign required channel to it. 	Pin	Function	1	Ground	2	Power [Option for RTS mode: power and audio]	3	Audio
Pin	Function								
1	Ground								
2	Power [Option for RTS mode: power and audio]								
3	Audio								

Interface module	Description																											
<p data-bbox="284 218 565 289">Four-wire interface module (HLI-4W2)</p> 	<p data-bbox="613 218 1482 499">This is a two channel device that enables interoperability with the Eclipse® digital matrix system and other four-wire audio sources such as telephone hybrids, AB-120/-100, PA (Public Address) / SA (Stage Announce) systems. The module also enables HelixNet-to-HelixNet connections using four-wire audio ports. Two four-wire connectors (EtherCON type RJ45 socket) are provided with the following pin out:</p> <table border="1" data-bbox="618 506 1398 926"> <thead> <tr> <th>Pin</th> <th>Function</th> </tr> </thead> <tbody> <tr> <td>1</td> <td>RS-422 data TX+</td> </tr> <tr> <td>2</td> <td>RS-422 data TX-</td> </tr> <tr> <td>3</td> <td>Audio send +</td> </tr> <tr> <td>4</td> <td>Audio receive +</td> </tr> <tr> <td>5</td> <td>Audio receive -</td> </tr> <tr> <td>6</td> <td>Audio send -</td> </tr> <tr> <td>7</td> <td>RS-422 data RX+</td> </tr> <tr> <td>8</td> <td>RS-422 data RX-</td> </tr> </tbody> </table> <p data-bbox="695 947 1398 978" style="text-align: center;">Table 2-14: four-wire interface module pin out</p>	Pin	Function	1	RS-422 data TX+	2	RS-422 data TX-	3	Audio send +	4	Audio receive +	5	Audio receive -	6	Audio send -	7	RS-422 data RX+	8	RS-422 data RX-									
Pin	Function																											
1	RS-422 data TX+																											
2	RS-422 data TX-																											
3	Audio send +																											
4	Audio receive +																											
5	Audio receive -																											
6	Audio send -																											
7	RS-422 data RX+																											
8	RS-422 data RX-																											
<p data-bbox="284 999 553 1071">Ethernet interface module (HLI-ET2)</p> 	<p data-bbox="613 999 1482 1108">Enables linking of Main Stations, and connection of Remote Stations and Speaker Stations via LAN. Contains Two 10/100 Mbps RJ45 EtherCON ports.</p> <table border="1" data-bbox="618 1115 1474 1535"> <thead> <tr> <th>Pin</th> <th>Name</th> <th>Function</th> </tr> </thead> <tbody> <tr> <td>1</td> <td>TX+</td> <td>Transmit Data+</td> </tr> <tr> <td>2</td> <td>TX-</td> <td>Transmit Data-</td> </tr> <tr> <td>3</td> <td>RX+</td> <td>Receive Data+</td> </tr> <tr> <td>4</td> <td>n/c</td> <td>Not connected</td> </tr> <tr> <td>5</td> <td>n/c</td> <td>Not connected</td> </tr> <tr> <td>6</td> <td>RX-</td> <td>Receive Data-</td> </tr> <tr> <td>7</td> <td>n/c</td> <td>Not connected</td> </tr> <tr> <td>8</td> <td>n/c</td> <td>Not connected</td> </tr> </tbody> </table> <p data-bbox="699 1556 1393 1587" style="text-align: center;">Table 2-15: Ethernet interface module pin out</p> <div data-bbox="634 1608 727 1686" style="display: inline-block; vertical-align: middle;">  </div> <p data-bbox="764 1608 1433 1818" style="margin-left: 20px;">Warning: Both ports are configured to bridge traffic from one port to the other in order to work in a daisy-chained configuration. Spanning Tree Protocol is not enabled on these ports, therefore do not connect them both to the same network.</p>	Pin	Name	Function	1	TX+	Transmit Data+	2	TX-	Transmit Data-	3	RX+	Receive Data+	4	n/c	Not connected	5	n/c	Not connected	6	RX-	Receive Data-	7	n/c	Not connected	8	n/c	Not connected
Pin	Name	Function																										
1	TX+	Transmit Data+																										
2	TX-	Transmit Data-																										
3	RX+	Receive Data+																										
4	n/c	Not connected																										
5	n/c	Not connected																										
6	RX-	Receive Data-																										
7	n/c	Not connected																										
8	n/c	Not connected																										


Interface module	Description
<p data-bbox="284 220 552 283">Fiber interface module (HLI-FBS)</p> 	<p data-bbox="617 220 1453 325">Enables linking of Main Stations. Contains two SFP cage slots. The module is supplied with one transceiver fitted. Any 100BASE-X SFP can be connected.</p> <div data-bbox="641 378 722 451"> </div> <p data-bbox="771 378 1437 588">Warning: Both ports are configured to bridge traffic from one port to the other in order to work in a daisy-chained configuration. Spanning Tree Protocol is not enabled on these ports, therefore do not connect them both to the same network.</p>

Table 2-16: HMS-4X Main Station rear panel: Interface Modules

2.3 Remote Station rear panel

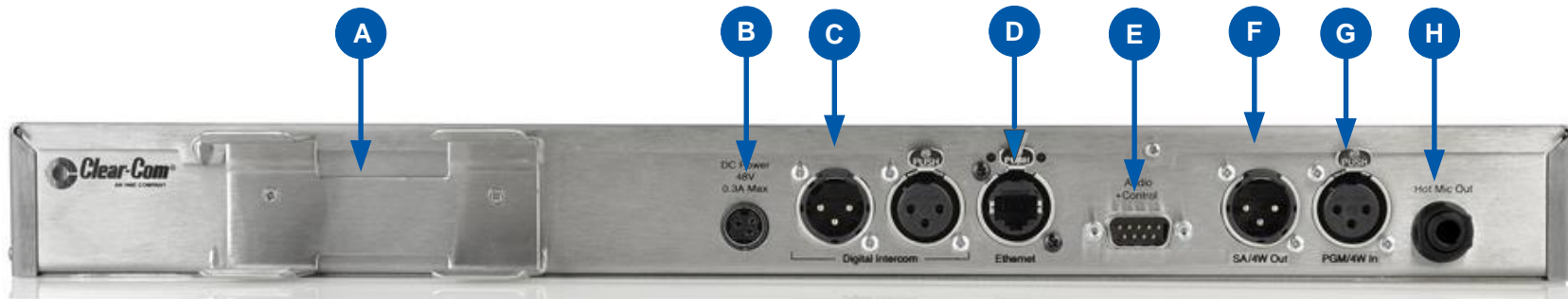


Figure 2-4 HRM-4X Remote Station rear panel

Key to Remote Station: rear panel																					
Feature	Description																				
A	PSU holder for a separate external AC-DC power supply. The external PSU provides the 48V required and at its input takes 100-240V, 50-60Hz.																				
B	Power supply. The power input connector is a low voltage DC connection. It is 48VDC at a max power of 12.95W.																				
C	<p>Line 1 (digital partyline). (3-pin male and female XLR connectors).</p> <table border="1"> <thead> <tr> <th>Pin</th> <th>Function</th> </tr> </thead> <tbody> <tr> <td>Pin 1</td> <td>Ground</td> </tr> <tr> <td>Pin 2</td> <td>+30V DC and Audio</td> </tr> <tr> <td>Pin 3</td> <td>-30V DC and Audio</td> </tr> </tbody> </table> <p style="text-align: center;">Table 2-17: Line 1 pin out</p>	Pin	Function	Pin 1	Ground	Pin 2	+30V DC and Audio	Pin 3	-30V DC and Audio												
Pin	Function																				
Pin 1	Ground																				
Pin 2	+30V DC and Audio																				
Pin 3	-30V DC and Audio																				
D	Power Over Ethernet (RJ45 connector)																				
E	<p>Control input/output (DB9 connector)</p> <table border="1"> <thead> <tr> <th>Pin</th> <th>Function</th> </tr> </thead> <tbody> <tr> <td>Pin 1</td> <td>Audio out +</td> </tr> <tr> <td>Pin 2</td> <td>Audio in +</td> </tr> <tr> <td>Pin 3</td> <td>GND</td> </tr> <tr> <td>Pin 4</td> <td>Relay NC</td> </tr> <tr> <td>Pin 5</td> <td>Relay NO</td> </tr> <tr> <td>Pin 6</td> <td>Audio out -</td> </tr> <tr> <td>Pin 7</td> <td>Audio in -</td> </tr> <tr> <td>Pin 8</td> <td>Opto</td> </tr> <tr> <td>Pin 9</td> <td>Relay pole</td> </tr> </tbody> </table> <p style="text-align: center;">Table 2-18 Control input/output pinout</p> <p>The audio connections in this connector are wired directly to the SA and program connectors. Only one or the other can be used at one time.</p>	Pin	Function	Pin 1	Audio out +	Pin 2	Audio in +	Pin 3	GND	Pin 4	Relay NC	Pin 5	Relay NO	Pin 6	Audio out -	Pin 7	Audio in -	Pin 8	Opto	Pin 9	Relay pole
Pin	Function																				
Pin 1	Audio out +																				
Pin 2	Audio in +																				
Pin 3	GND																				
Pin 4	Relay NC																				
Pin 5	Relay NO																				
Pin 6	Audio out -																				
Pin 7	Audio in -																				
Pin 8	Opto																				
Pin 9	Relay pole																				
F	<p>SA [Stage Announce] line out (3-pin female XLR).</p> <table border="1"> <thead> <tr> <th>Pin</th> <th>Function</th> </tr> </thead> <tbody> <tr> <td>Pin 1</td> <td>Ground</td> </tr> <tr> <td>Pin 2</td> <td>Positive</td> </tr> </tbody> </table>	Pin	Function	Pin 1	Ground	Pin 2	Positive														
Pin	Function																				
Pin 1	Ground																				
Pin 2	Positive																				

Key to Remote Station: rear panel									
Feature	Description								
	<table border="1"> <tr> <td>Pin 3</td> <td>Negative</td> </tr> </table> <p style="text-align: center;">Table 2-19 SA pinout</p>	Pin 3	Negative						
Pin 3	Negative								
G	<p>Program Input (3-pin m XLR).</p> <table border="1"> <thead> <tr> <th>Pin</th> <th>Function</th> </tr> </thead> <tbody> <tr> <td>Pin 1</td> <td>Ground</td> </tr> <tr> <td>Pin 2</td> <td>Positive</td> </tr> <tr> <td>Pin 3</td> <td>Negative</td> </tr> </tbody> </table> <p style="text-align: center;">Table 2-20 Program input pinout</p>	Pin	Function	Pin 1	Ground	Pin 2	Positive	Pin 3	Negative
Pin	Function								
Pin 1	Ground								
Pin 2	Positive								
Pin 3	Negative								
H	<p>Hot Mic output. This connection is a 1/4-in (0.64 cm) phone jack. It provides an output signal from the selected headset or panel microphone. The Hot Mic output is always live. Audio from the mic is routed through the Hot Mic output even if the mic is inactive (off).</p> <table border="1"> <thead> <tr> <th>Pin</th> <th>Function</th> </tr> </thead> <tbody> <tr> <td>Tip</td> <td>Mic</td> </tr> <tr> <td>Ring</td> <td>IFB mute signal</td> </tr> <tr> <td>Sleeve</td> <td>Ground</td> </tr> </tbody> </table> <p style="text-align: center;">Table 2-21: Hot Mic pin out</p>	Pin	Function	Tip	Mic	Ring	IFB mute signal	Sleeve	Ground
Pin	Function								
Tip	Mic								
Ring	IFB mute signal								
Sleeve	Ground								

Table 2-22: Key to Remote Station rear panel diagram

2.4 Speaker Station



Figure 2-5 Speaker Station front panel

Key to Speaker Station front panel											
Feature	Description										
A	<p>Tilt adjustable display screen. The following default information is displayed:</p> <ul style="list-style-type: none"> • The channel label. • The channel listen (volume) level. <p>For a full description of the display screen information, see Table 2-5 Main Station/Remote Station display icons and indicators.</p> <p>In Menu mode, the display screens display the four levels of menu. The menu hierarchy proceeds left to right:</p> <ul style="list-style-type: none"> • The top level menu is presented in the first screen (furthest left on the front panel). • The lowest level menu is presented in the fourth screen (furthest right on the front panel). <p>If the display is in Menu mode, the display screen times out of Menu mode and displays the channel label if no key is pressed for 20 seconds.</p> <p><i>For more information about Menu mode, see 5.1 Using the Menus.</i></p>										
B	<p>Rotary control. Turn to increase or decrease the listen volume level for the channel, or to scroll menu items when in menu mode. To select menu items, push the control.</p>										
C	<p>Talk key. Press to talk on the channel and to all nodes (intercom devices and systems) listening into the channel.</p>										
D	<p>Loudspeaker / Headphone audio level rotary control [Main]. To increase the volume to the loudspeaker / headphones, turn clockwise (up to 360°). To decrease the volume, turn counter clockwise (up to 360°). As you increase or decrease the volume, the level control LEDs pass through a range of indicator colors. For more information, see Table 2-2 : Volume Indicator colors</p>										
E	<p>Program feed audio level rotary control [PGM]. To increase the volume of the program feed to the loudspeaker / headphones, turn clockwise (up to 360°). To decrease the volume, turn counter clockwise (up to 360°).</p>										
F	<p>Call key. Press to send a call signal to all Keysets assigned to the same Channel. There are two Call keys on the beltpack, one for each of the displayed channels.</p>										
G	<p>Headset socket (4-pin XLR-M)</p> <table border="1" style="margin-left: auto; margin-right: auto;"> <thead> <tr> <th>Pin</th> <th>Function</th> </tr> </thead> <tbody> <tr> <td>1</td> <td>Mic ground</td> </tr> <tr> <td>2</td> <td>Mic positive</td> </tr> <tr> <td>3</td> <td>Earphone ground</td> </tr> <tr> <td>4</td> <td>Earphone positive</td> </tr> </tbody> </table> <p style="text-align: center;">Table 2-23 : Headset socket pin out</p>	Pin	Function	1	Mic ground	2	Mic positive	3	Earphone ground	4	Earphone positive
Pin	Function										
1	Mic ground										
2	Mic positive										
3	Earphone ground										
4	Earphone positive										

Key to Speaker Station front panel	
Feature	Description
H	Headset/microphone key set. There is a keyset (set of controls) to control the headset/microphone inputs and menu options. See Figure 2-6 Speaker Station keyset.
I	Gooseneck microphone connector (3-pin female Tuchel connector)

Table 2-24 Key to Speaker Station front panel

2.4.1 Speaker Station front panel function buttons



Figure 2-6 Speaker Station keyset

Key to Speaker Station front panel function buttons	
Feature	Description
A	Mic control [MIC ON]. Press to activate mic audio.
B	Shift key. Press to display two alternative channels on the Speaker Station displays.
C	Menu. Press to display the Speaker Station menus in the display screens. Use the rotary control for each display screen to scroll and


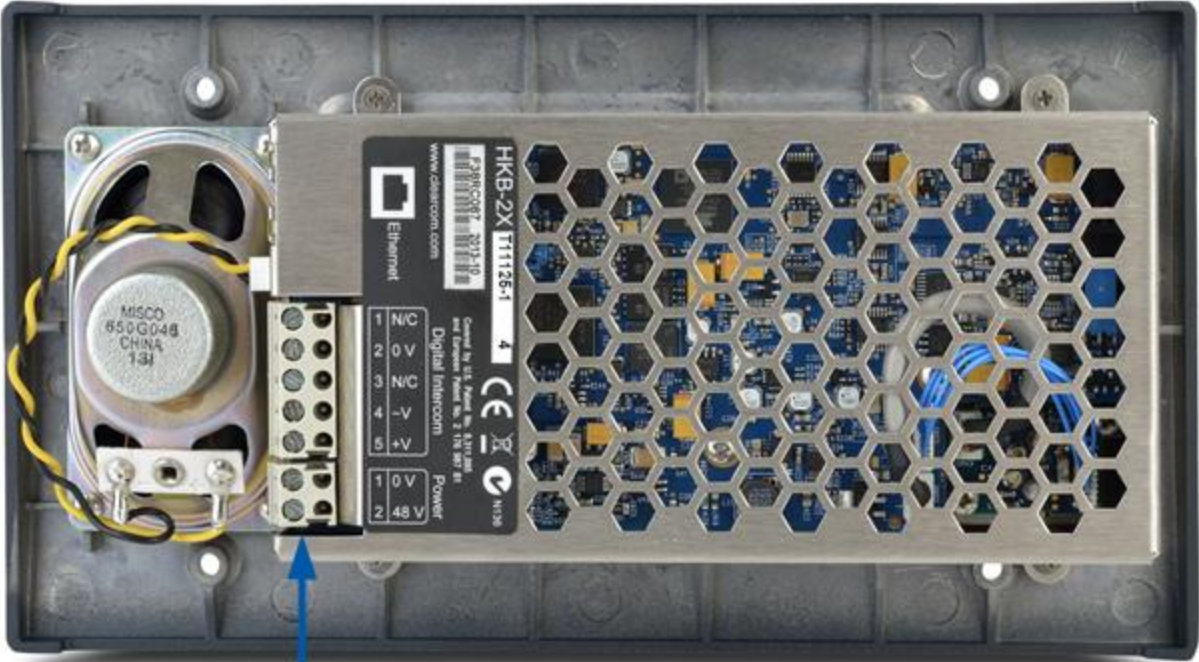
Key to Speaker Station front panel function buttons	
Feature	Description
	select menu items.
	Headset key [HSET]. Press to activate the headset mic. When the headset is connected, the gooseneck microphone is disconnected. Audio output to the loudspeaker is diverted to the headphones.

Table 2-25 Key to Speaker Station front panel keyset

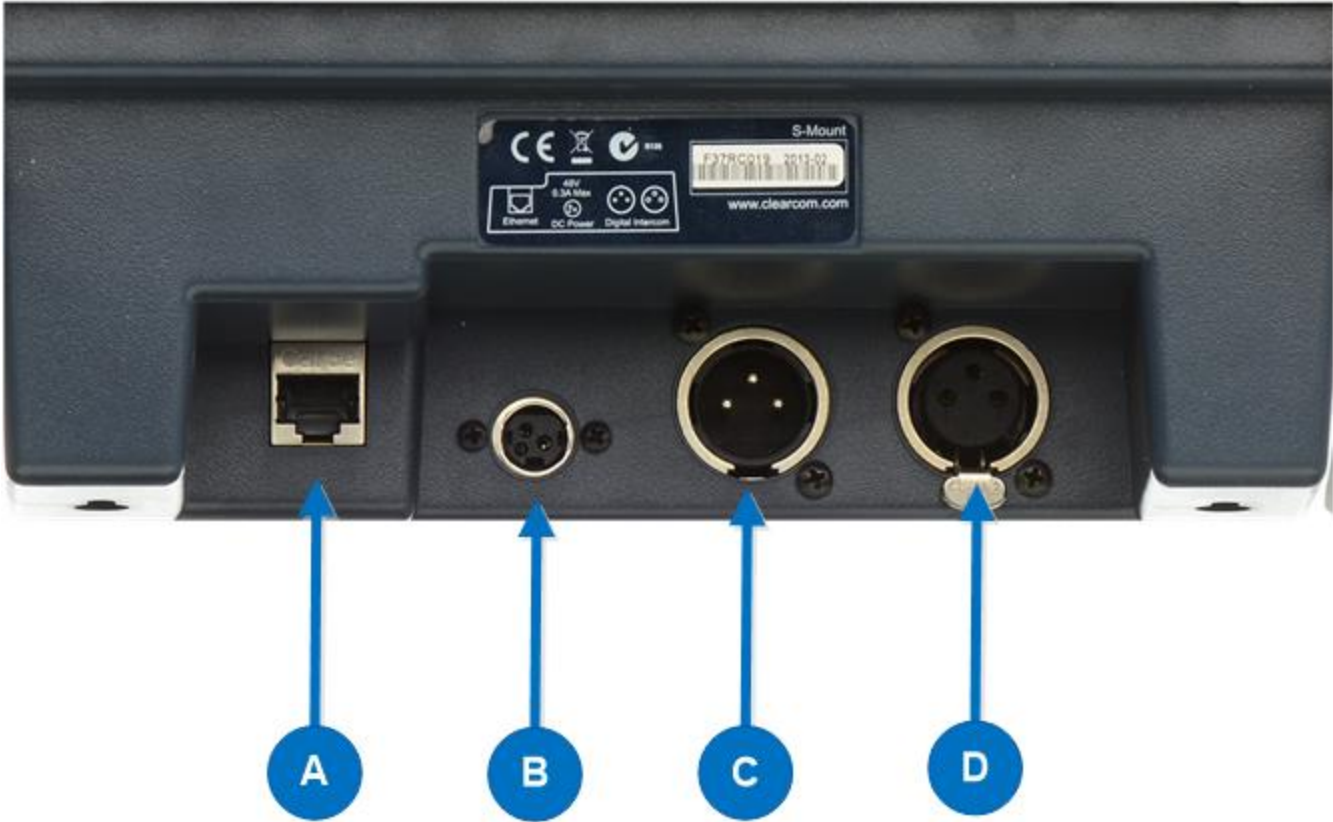
2.4.2 Speaker Station rear panel



Digital intercom screw terminals

Speaker Station rear connectors	
Digital Intercom	
1	Not connected
2	Ground
3	Not connected
4	-30V DC and audio
5	+30V DC and audio
Power	
1	Ground
2	48V DC

2.4.3 S-Mount rear panel



Key to S-Mount rear panel keyset									
Feature	Description								
A	Ethernet/Power over Ethernet connection (RJ45)								
B	Power connection.								
C	<p>Line 1 Digital Party Line. (3-pin male XLR connector).</p> <table border="1"> <thead> <tr> <th>Pin</th> <th>Function</th> </tr> </thead> <tbody> <tr> <td>Pin 1</td> <td>Ground</td> </tr> <tr> <td>Pin 2</td> <td>+30V DC and Audio</td> </tr> <tr> <td>Pin 3</td> <td>-30V DC and Audio</td> </tr> </tbody> </table> <p style="text-align: center;">Table 2-26 Line 1 pinout</p>	Pin	Function	Pin 1	Ground	Pin 2	+30V DC and Audio	Pin 3	-30V DC and Audio
Pin	Function								
Pin 1	Ground								
Pin 2	+30V DC and Audio								
Pin 3	-30V DC and Audio								
D	<p>Line 2 Digital Party Line. (3-pin female XLR connector).</p> <table border="1"> <thead> <tr> <th>Pin</th> <th>Function</th> </tr> </thead> <tbody> <tr> <td>Pin 1</td> <td>Ground</td> </tr> <tr> <td>Pin 2</td> <td>+30V DC and Audio</td> </tr> <tr> <td>Pin 3</td> <td>-30V DC and Audio</td> </tr> </tbody> </table> <p style="text-align: center;">Table 2-27 Line 1 pinout</p>	Pin	Function	Pin 1	Ground	Pin 2	+30V DC and Audio	Pin 3	-30V DC and Audio
Pin	Function								
Pin 1	Ground								
Pin 2	+30V DC and Audio								
Pin 3	-30V DC and Audio								

Table 2-28 Key to S-Mount rear panel

2.5 HBP-2X Beltpack

2.5.1 HBP-2X user controls (front and side view)



Figure 2-7: HBP-2X beltpack (front and side view)

Note: The beltpack has two Keysets, each containing one Call button (E) and one Talk button (F).

Key to HBP-2X user controls (front and side view)	
Feature	Description
A	Menu key. Press firmly to enter Menu mode (see also D E). To exit Menu mode, press the Menu key again. The display screen times out of Menu mode and displays the channel label(s) if no key is pressed for 20 seconds.
B	USB 2.0 (Micro-AB) connector. For software upgrades.
C	Casing. Metal casing for robust use. For information about the beltclip, beltloops, and feet, see 2.5.3 <i>HBP-2X beltclip, beltloops and feet (base view)</i> .
Keypad	
D	Rotary control. Turn to increase and decrease the listen volume level for the channel. In Menu mode, you can turn either of the side-mounted rotary controls to scroll menu items. To select (enter) items, press the right-hand Call key (see E).
E	Call key. Press to send a call signal to all Keypads assigned to the same Channel. There are two Call keys on the beltpack, one for each of the supported channels. In Menu mode, press the right-hand Call key to select (enter) menu items (see also A D). Use the left-hand Call key to go back one menu level.
F	Talk key. Press to talk to all nodes (intercom devices and systems) listening into the channel. There are two Talk keys on the beltpack, one for each of the supported channels.
G	Display screen. When the beltpack is not in Menu mode, the labels and volume level for each of the two channels supported by the beltpack are displayed on screen. For a full description of the display screen information, see Table 2-5 Main Station/Remote Station display icons and indicators .
	Note: The beltpack has two Keypads, each containing one Call button (E) and one Talk button (F).

Table 2-29: Key to HBP-2X Beltpack (front and side view)

2.5.2 HBP-2X connectors and controls (rear view)



Figure 2-8: HBP-2X connectors and controls (rear view)

Key to HBP-2X Beltpack (Rear view)									
Feature	Description								
A	<p>Line (Digital Partyline) (3-pin female XLR connector).</p> <table border="1"> <thead> <tr> <th>Pin</th> <th>Function</th> </tr> </thead> <tbody> <tr> <td>1</td> <td>Ground</td> </tr> <tr> <td>2</td> <td>+30V DC and Audio</td> </tr> <tr> <td>3</td> <td>-30V DC and Audio</td> </tr> </tbody> </table> <p>Table 2-30: Line (female) pin out</p>	Pin	Function	1	Ground	2	+30V DC and Audio	3	-30V DC and Audio
Pin	Function								
1	Ground								
2	+30V DC and Audio								
3	-30V DC and Audio								
B	<p>Line (Digital Partyline) (3-pin male XLR connector). Pass-through for daisy chain connection (see <i>Figure 3-2: Example system topologies (layouts)</i>).</p> <table border="1"> <thead> <tr> <th>Pin</th> <th>Function</th> </tr> </thead> <tbody> <tr> <td>1</td> <td>Ground</td> </tr> <tr> <td>2</td> <td>+30V DC and Audio</td> </tr> <tr> <td>3</td> <td>-30V DC and Audio</td> </tr> </tbody> </table> <p>Table 2-31: Line (male) pin out</p>	Pin	Function	1	Ground	2	+30V DC and Audio	3	-30V DC and Audio
Pin	Function								
1	Ground								
2	+30V DC and Audio								
3	-30V DC and Audio								

Key to HBP-2X Beltpack (Rear view)																							
Feature	Description																						
C	Program feed (volume) control wheel. Turn to increase or decrease the overall listen volume level of the program feed. To assign programs to a channel, see 5.4.2 Assigning the Program Listen to a channel and 14.1.5 Editing the Program Input																						
D	<p>2.5 mm TRS headset input.</p> <table border="1" style="margin-left: auto; margin-right: auto;"> <thead> <tr> <th></th> <th>Function</th> </tr> </thead> <tbody> <tr> <td>Tip</td> <td>Audio +</td> </tr> <tr> <td>Ring</td> <td>Audio -</td> </tr> <tr> <td>Sleeve</td> <td>Ground</td> </tr> </tbody> </table>		Function	Tip	Audio +	Ring	Audio -	Sleeve	Ground														
	Function																						
Tip	Audio +																						
Ring	Audio -																						
Sleeve	Ground																						
E	<p>Headset connector (4-pin male or 5-pin female XLR connector).</p> <table border="1" style="margin-left: auto; margin-right: auto;"> <thead> <tr> <th>Pin</th> <th>Function</th> </tr> </thead> <tbody> <tr> <td>1</td> <td>Mic ground</td> </tr> <tr> <td>2</td> <td>Mic positive</td> </tr> <tr> <td>3</td> <td>Earphone ground</td> </tr> <tr> <td>4</td> <td>Earphone positive</td> </tr> </tbody> </table> <p style="text-align: center;">Table 2-32: 4-pin headset socket pin out</p> <table border="1" style="margin-left: auto; margin-right: auto;"> <thead> <tr> <th>Pin</th> <th>Function</th> </tr> </thead> <tbody> <tr> <td>1</td> <td>Mic ground</td> </tr> <tr> <td>2</td> <td>Mic positive</td> </tr> <tr> <td>3</td> <td>Earphone ground</td> </tr> <tr> <td>4</td> <td>Earphone right</td> </tr> <tr> <td>5</td> <td>Earphone left</td> </tr> </tbody> </table> <p style="text-align: center;">Table 2-33: 5-pin headset socket pin out</p>	Pin	Function	1	Mic ground	2	Mic positive	3	Earphone ground	4	Earphone positive	Pin	Function	1	Mic ground	2	Mic positive	3	Earphone ground	4	Earphone right	5	Earphone left
Pin	Function																						
1	Mic ground																						
2	Mic positive																						
3	Earphone ground																						
4	Earphone positive																						
Pin	Function																						
1	Mic ground																						
2	Mic positive																						
3	Earphone ground																						
4	Earphone right																						
5	Earphone left																						

Table 2-34: Key to HBP-2X Beltpack connectors and controls (base view)

2.5.3 HBP-2X beltclip, beltloops and feet (base view)



Figure 2-9: HBP-2X Beltpack: base view

Key to HBP-2X Beltpack (Base view)	
Feature	Description
A	Beltclip. The beltclip is secured to the unit with three screws, and may be removed, according to your requirements.
B	Feet (positions only). The beltpack can also be placed on a level surface (once the beltclip has been removed). To give the beltpack more grip on the surface, attach the four rubber feet supplied with the beltpack.
C	Beltloops (one either side). Use to thread through a belt or strap for securing the beltpack to a belt or a fixed position.

Table 2-35: Key to HBP-2X Beltclip, beltloops and feet (base view)

3 ***Installing HelixNet Partyline***

This chapter describes how to install your HelixNet Partyline system. It also provides basic guidance on planning your installation.

For related information, see **23 Cabling reference** and the Powerline cable distance calculator at:

<http://www.clearcom.com/userfiles/file/Software/HelixNetCablingCalculator/index.html#/>

Tip: For guidance on connecting HelixNet Partyline to other systems, using the optional interface modules, see **18 Connecting to Other Intercom Systems**.



*Do **not** plug any non-approved equipment into HelixNet Partyline. HelixNet Partyline operates at different voltage levels than analog two-wire partyline systems. Do **not** plug any analog two-wire partyline equipment into the HelixNet partyline ports, as this may cause damage.*

*For more safety instructions, see **1.1 Important Safety instructions**.*

3.1 Planning your HelixNet Partyline installation

3.1.1 Comparing digital with analog cabling

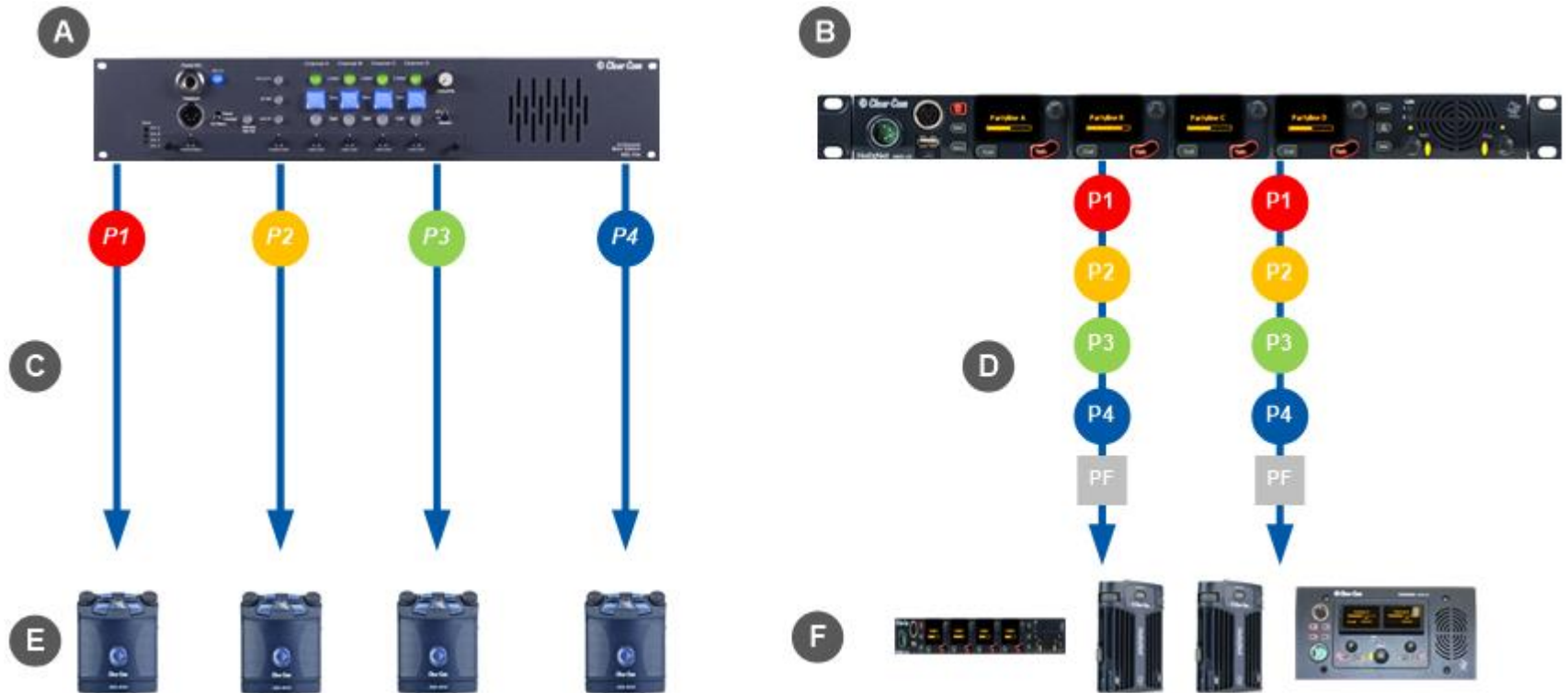


Figure 3-1: Analog and digital cabling comparison

Note: The program is always a participant within a Channel and cannot exist outside of a Channel.

Key to analog and digital cabling comparison diagram	
Feature	Description
A	Example 4-channel analog Main Station (MS-704 shown).
B	HMS-4X Main Station (digital Main Station).
P1 P2 P3 P4 PF	Partyline channel 1 Partyline channel 2 Partyline channel 3 Partyline channel 4 Program Feed Note: The program is always a participant within a Channel and cannot exist outside of a Channel.
C	In a traditional analog partyline system, one cable is dedicated to each partyline channel. This can make it more difficult to build redundancy or spare capacity into the installation (owing to the number of connectors / cables dedicated to the delivery of channels).
D	In the HelixNet system, one cable can carry multiple channels. Because one cable can carry all channels, the second connector for each line can either be used for redundancy (flybacks) or for future extensions / changes to the cabling topology (layout).
E	Example analog partyline devices including RS-701 beltpacks. Analog beltpacks must be re-cabled to use alternative channels, requiring the physical re-location of cabling for new configurations. To aid switching, Clear-Com sells additional switching equipment (the SB-704 and RCS-2700 devices). The RS-702 (6-pin XLR) beltpack requires the YC-36 splitter / combiner to combine 2 channels into a 6-pin configuration, and multi-conductor cables. The RS-703 (3-pin XLR) beltpack requires a TWC-701 device to combine 2 Clear-Com channels in a single twisted pair.
F	Example analog partyline devices including HBP-2X Beltpacks. Digital beltpacks can support any two of the partyline channels (plus Program Feed), wherever they are physically located on the system. New configurations of beltpacks and channels can be deployed without the physical relocation of assets.

Table 3-1: Key to analog and digital cabling comparison diagram

Note: The capabilities of different cable types may impact how far away beltacks can be placed from the Main Station, and the topologies you use. For more information about cabling, see **23 Cabling reference**.

3.1.2 Topologies

HelixNet Partyline can be deployed using a wide range of topologies, both complex and straightforward. The following table describes three standard types of topology:

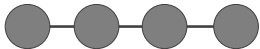
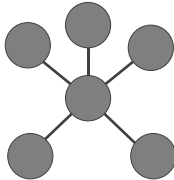
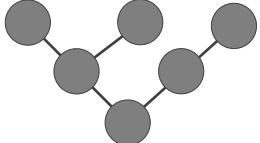
Topology	Description
<p>Daisy-chain</p> 	<p>In a daisy-chain topology, the Main Station is connected to the first unit. The units are then connected in a series, using the pass-through connector on the back / rear of the device to pass on the connection. No termination is required.</p> <p>Daisy-chains can be either linear or loop back to the Main Station to form a ring for redundancy.</p>
<p>Star</p> 	<p>In a star topology, the Main Station is connected to a passive (Y) splitter such as an XLR Bulkhead or Mult-box. The units are then connected to the splitter point-to-point.</p>
<p>Tree</p> 	<p>A tree topology is a more complex version of the star topology, using serially connected passive (Y) splitters. The units are connected to each splitter point-to-point (forming a branch of the tree).</p>

Table 3-2: Topology types

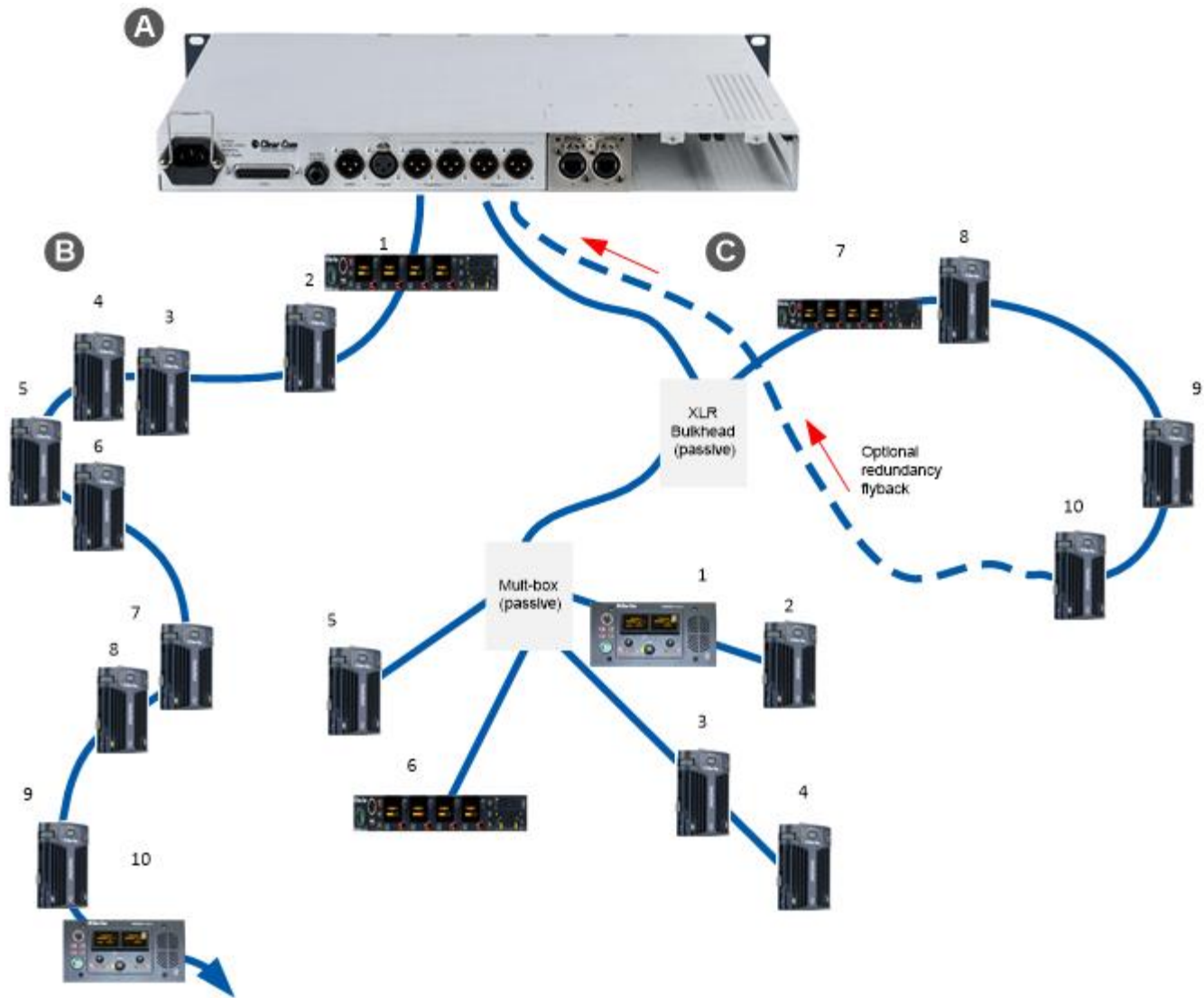


Figure 3-2: Example system topologies (layouts)

Key to example system topologies (layouts) diagram	
Feature	Description
A	<p>HMS-4X Main Station (digital Main Station) (rear panel). There are two lines (digital partylines) on the Main Station, each of which can support up to 10 digital HBP-2X beltpacks. There are two connectors (3-pin XLR, male and female) for each line.</p>
B	<p>Daisy chained HBP-2X Beltpacks. To create a 'daisy chain' of connected beltpacks: Connect the first beltpack to the Main Station, using either of the 3-pin XLR connectors (female or male) on the base of the beltpack. Pass on the connection to the second beltpack, using the remaining connector as the pass through. Repeat for all beltpacks (up to 10) in the chain. No cable termination is required. You can locally power an HRM or HKB within a daisy chain. This prevents the normal draw off the powerline by the locally powered device.</p>
C	<p>The second layout uses an XLR Bulkhead and a Mult-box (passive (Y) splitters) to combine: A daisy chain (with optional redundancy flyback). Point-to-point connected beltpacks (using the Mult-box). The complexity and variety of layouts does not restrict physical access to channels. Because HelixNet Partyline is a digital system, the HelixNet Stations can access any of the available channels (plus a Program Feed), however they are connected to the Main Station (see <i>Figure 3-1: Analog and digital cabling comparison</i>).</p>

Table 3-3: Key to example topologies (layouts)

3.2 Installing the Main Station/Remote Station

The Main Station/Remote Station is a **19" 1RU-height** device that you can install to either:

- A standard 19" rack.
- A shelf, cabinet or other flat surface.

3.2.1 Main Station power up

There is no power switch, button or key on the Main Station. To power up the unit:

- 1) Connect the power cord to the power supply connector on the Main Station.

Note: The Main Station has a cable retaining clip to secure the power cord. The retaining clip is detached for shipping and must be refitted.

Note: For the location of the power supply connector, see **A** in **Table 2-12: Key to HMS-4X Main Station rear panel diagram** and **Table 2-22: Key to Remote Station rear panel diagram**.

- 2) Connect the power cord to the power source. The unit requires an input voltage between 100 - 240 VAC / 50-60Hz/ 250 watts / T 3.15A H 250 V.



Only connect power supply to earthed supply sockets. Ensure that the power supply is routed to avoid sharp bends, hot surfaces, pinches and abrasion.

*For safety guidance, see the **Safety Instructions** at the front of this guide.*

3.2.2 Remote Station power up

The Remote Station is powered by an external power source. This can be:

- An external power supply (supplied)
- Power over Ethernet (PoE)

Note: To use PoE, you must connect a third-party PoE switch between the Remote Station and the Main Station.

- From the Main Station digital power line

3.3 Installing the Speaker Station

The Speaker Station can be installed either:

- Mounted in an S-Mount bracket for desktop use
- Mounted in an S-Mount bracket for installation on a wall
- Mounted inside a NEMA standard 4-gang wall box.

Note: The S-Mount bracket is an optional item ordered separately.

3.3.1 Speaker Station in an S-Mount bracket



Figure 3-3 Speaker Station in S-Mount bracket

You can adjust the S-Mount bracket by pressing one of the release buttons on either side of the bracket. You can adjust the bracket in 10-degree steps from 80 degrees to horizontal. Indicators are present beside the release buttons that show the adjustment steps.

To install the Speaker Station:

- 1) Connect a powerline XLR-3 port on the Speaker Station to a powerline XLR-3 port on a Main Station.

Or

Connect an Ethernet port on the Speaker Station to an Ethernet port on an HMS-4X HLI-ET2 option module.

- 2) Connect a headset or microphone to the Speaker Station.
- 3) Connect power supply to the DC power port on the Speaker Station. (Not necessary if using Powerline or PoE.)

3.3.2 **Speaker Station in an S-Mount bracket wall installation**

When the Speaker Station is fully closed, you can mount it on a wall using the rear keyholes:

- 1) Space the wall screws to match the distance between the rear keyholes. See Figure 3-4.
- 2) If necessary, remove the Speaker Station from the S-Mount bracket.
- 3) Hang the S-Mount bracket on the wall screws.
- 4) Tighten the wall screws.
- 5) Install the Speaker Station.



Figure 3-4 S-Mount bracket with keyholes

3.3.3 **Speaker Station mounted inside a NEMA standard 4-gang wall box**

To connect the Speaker Station:

- 1) Connect the Digital Intercom screw terminals on the Speaker Station to a powerline XLR-3 port on an HMS-4X.

Or

Connect the Ethernet port on the Speaker Station to either the IP network in which the HMS resides or directly to one of the Ethernet ports on the HMS.

- 2) Connect a headset or microphone to the Speaker Station.
- 3) If required, remove the connector from the optional power supply and connect the power supply to the Power screw terminals on the Speaker Station.

3.4 Installing the HBP-2X Beltpacks

The HBP-2X Beltpack is a device that you can:

- Wear at your belt using the beltclip.
- Install to a shelf or other flat surface.
- Attach to a pole or other fixed upright position.

For more information, see **2.5.3 HBP-2X beltclip, beltloops and feet (base view)**

3.4.1 Power up

The HBP-2X Beltpack is powered from the standard mic cable that connects the device with the HMS-4X Main Station (see below).

3.4.2 Connecting the HBP-2X Beltpack to the Main Station

To connect the HBP-2X Beltpack to the Main Station:

- 1) There are two powerline connections on the Main Station which can each support up to 10 digital HBP-2X beltpacks. There are two connectors (3-pin XLR, male and female) for each line.

Connect the cable to the selected connector on the Main Station.

Note: For the location of Lines 1 and 2 (the powerlines) on the Main Station, see **F** **G** in **Figure 2-3: HMS-4X Main Station: rear panel**

- 2) Connect the cable to the beltpack, using one of the two 3-pin XLR connectors (male and female) on the base / rear of the beltpack.

For example topologies, see **3.1.2 Topologies**.

3.5 HelixNet infrastructure

This section contains guidelines for using HelixNet infrastructure components including cables, connectors, splitter boxes and patch panels. HelixNet digital partyline uses cable infrastructure to transport audio and data over a range of frequencies. The maximum frequency used for transmission is approximately 25MHz. Depending on the amount of audio and data transmitted, HelixNet digital partyline can work with as much as 90dB signal attenuation. However, the receivers are very sensitive and are susceptible to crosstalk between cables.

Therefore it is important to maintain cable shield integrity through all connectors, splitter boxes and patch panels.

The symptoms of crosstalk are:

- Main Station front panel LINE LED indicator turns amber or red
- Beltpacks, Remote Stations and Speaker Stations take longer than usual to boot and connect.
- Beltpack, Remote Station and Speaker Station front panel signal strength indicators show lower than usual signal strength (zero or one bar).
- Main Station diagnostics screen (Diagnostics->Powerlines) indicates collisions or errors on the line.

3.5.1 Cables and connectors

Clear-Com recommends the following shielded cables:

Microphone cables

Belden 9207 and 9463F with the two main conductors connected to XLR pin 2 and 3 and the drain wire to pin 1.

Cat cables

Belden 1351A or 1533P with the following connections at the XLR connector:

Cat5/5e/6	XLR
White/Orange	1
Orange	1
White/Green	3
Blue	2
White/Blue	3
Green	2
White/Brown	3
Brown	2
Shield/Drain	1

It is important to connect the cable shield or drain wire to the XLR pin 1 to maintain the shield integrity throughout the cable and connector.

Note: The total amount of cable deployed for a digital intercom line contributes to the total capacitance of the line, even though some cables might not have a Beltpack connected at the other end. The more capacitance there is, the more attenuation there will be. Clear-Com recommends that you use the minimum amount of cable. For example, daisy-chain or split a cable at the far end, close to the Beltpacks, rather than make two homeruns to a central patch panel.

3.5.2 Patch panels

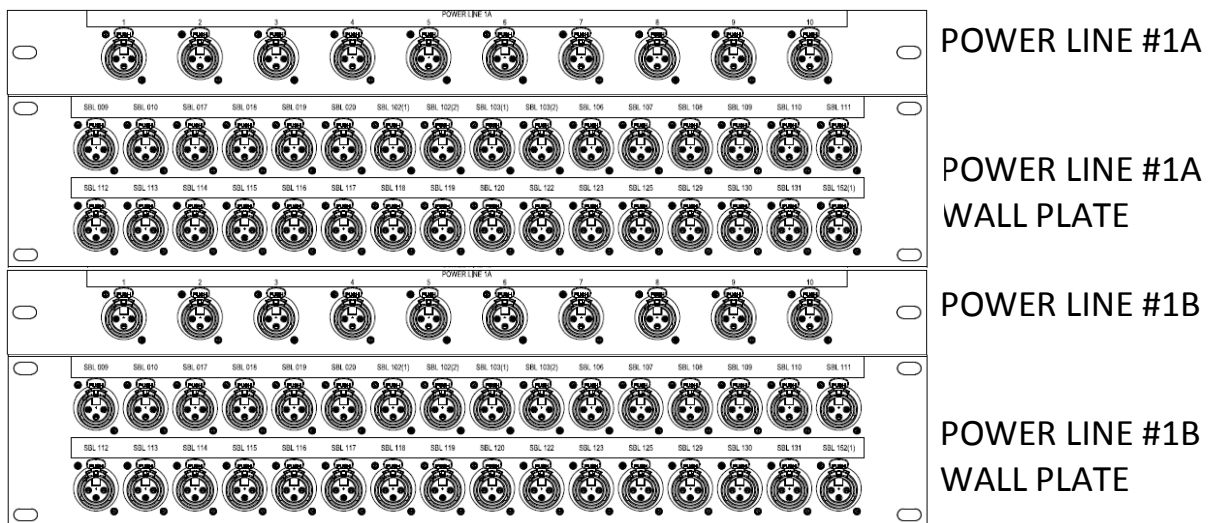
Clear-Com recommends XLR patch panels. These should be made of 3 pin XLR feed-through adapters (for example, Neutrik NA3MDF) that maintain shield

integrity from the back to the front. These adapters also enable easier rewiring of the back or the front of the panel.

3.5.3 Splitter boxes

Ensure that you split the digital intercom lines within a shielded enclosure. For example, a 1RU shielded chassis, such as Middle Atlantic CH1, and daisy-chained XLR connectors (for example, Neutrik NC3MD or NC3FD).

To prevent crosstalk between lines, ensure that each shielded splitter box contains only one digital intercom line. If you have to split more than one digital intercom line, use multiple shielded enclosures.



For more information on cabling see **23.3 Cable connections**

3.6 Converting analogue partylines to HelixNet

Many partyline installations use daisy-chained power terminal blocks to passively split analog partylines. This way of splitting works relatively well for one HelixNet Main Station. But because the cable shielding through those blocks is not maintained, it makes the communication much more sensitive to interference.

Also, crosstalk occurs if two or more Main Stations use terminal blocks that are close to each other.

To maintain shield integrity, Clear-Com recommends that you:

- Place existing terminal blocks in shielded and grounded enclosures

Or

- Replace the terminal blocks with shielded and grounded XLR splitter boxes and XLR patch panels.

4 IP Network Structure

4.1 Network connections

Connecting in an existing IP network requires planning with your IT department in order to plan the IP addressing scheme. By default HelixNet Main Station uses automatic IP addressing (DHCP) enabled. In order for that to work properly in an existing IP network there must be a DHCP server handing out IP addresses. If no DHCP server is found, a Main Station will revert to an unused link-local address in the 169.254.0.0/16 block. (See 4.3 Link Local Environments for more information).

Through the Networking menu on the devices, you can disable DHCP and set static IP addresses.

Note: For HelixNet 3.0 and above, it is not necessary to be on the same Subnet, the devices will link across your LAN.

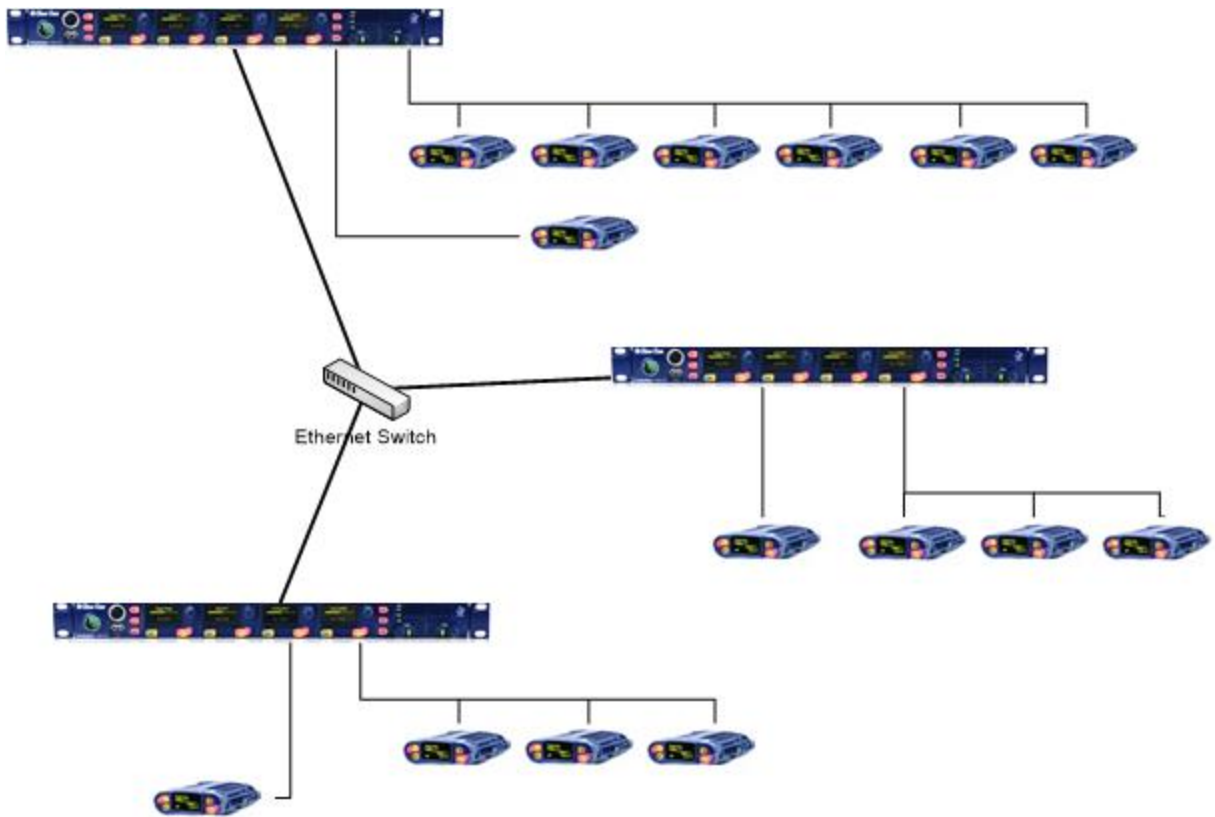


Figure 4-1: Network connections

4.2 Multiple Groups in the same IP Network

Multiple groups in the same network can be achieved by having multiple Link-Masters. Each Link-Master will head a group of Main Stations and will not interfere with other groups.

Networking Specifications

Specification	Value
Latency on Powerline	40-80ms (Depends on cable type and length, and how many devices are connected. The greater the number of devices, the greater the latency.)
Latency over IP Network	30ms + Network Latency (Main Station to Main Station)
Bandwidth used	300 kbps per active Talker, for a maximum of 1 talker per device in the system Each Beltpack and Speaker Station counts as 1 device Each Main Station and Remote Station counts as 2 devices
IP version	IPv4

Table 4-1 Networking specifications

4.3 Link Local Environments

4.3.1 What is link-local?

A link-local address is an IP address within the local segment of any network. Routers do not pass information to these as link-local addresses are not guaranteed to be unique beyond a single network segment. When first connected to a network, your HelixNet device will attempt to get an IP address via Dynamic Host Configuration Protocol (DHCP). If no DHCP server is available the unit will automatically enter link-local IP mode. A link-local IP address will take the form: 169.254.xxx.xxx.

4.3.2 Working with a device in link-local mode

Devices will revert to link-local mode if they are configured to DHCP and fail to find a DHCP address on the network or device they are attempting to connect to. Any DHCP enabled device connected directly to a device in link-local using a standard Ethernet cable will enter link-local mode automatically.

Note: The units will operate in link-local, but for optimum performance it is recommended that they are used with either static or DHCP network settings. In link-local, the address will change each time the device reboots resulting in potential loss of connection to endpoints

The easiest way to take a HelixNet device out of link-local mode is to allocate a new IP address to the unit from the device front menus. Please ensure with your network administrator that there will be no IP clashes with this address.

4.3.3 Change the IP address of a HelixNet device from the device front menu screens

To change a unit's IP address, you must first disable DHCP. Press the **Menu** button on front of device to enter **Menu mode**.

1) To enable or disable DHCP:

a) In **Menu mode**, select **Networking**.

Note: The Networking menu only appears if an Ethernet or Fiber interface module is detected.

b) From the second menu, select **Preferences**.

c) From the third menu, select **DHCP**.

d) From the fourth display screen, select one of the following:

- Disabled
- Enabled (default)

2) To edit the IP address:

a) In **Menu mode**, select **Networking**.

Note: The Networking menu only appears if an Ethernet or Fiber interface module is detected.

b) From the second menu, select **Preferences**.

c) From the third menu, select **IP Address**.

d) From the fourth display screen, edit the IPv4 address.

Note: The HelixNet system uses a 10.0.0.x IP address range internally between the Main Station and the Beltpacks, and therefore will not allow setting the external IP address to anything in that range.

Note: If you change the IP address (either manually or through DHCP), the link between stations will be broken and you have to reboot the Main Station to link again. The following message will appear as a banner (inverted text) at the bottom across the four displays on the Main Station

IP address | changed, | reboot | to link

If that message appears, pressing the Menu key will bring you directly to: **Administration->Reset->Reboot->Reboot Now**

4.3.4 **Accessing the Core configuration Manager (CCM) of a HelixNet unit in link-local mode**

As an alternative to configuring your device from the front menu screens you can use the browser based CCM.

To access the CCM of a HelixNet unit in link-local, you must connect to it from a computer that is also in link-local mode.

A computer can be put into link-local mode by ensuring it is in DHCP mode and connecting it to the unit that is in link-local with a standard Ethernet cable. The computer will look for a dynamically generated IP address (DHCP), and when it does not find one will enter link-local mode automatically.

Once the computer is connected to the HelixNet device and in link-local mode, you can connect to your unit by opening a browser window on the computer and inputting the unit's IP address (from the front panel display) into the address field. This takes you to the Core Configuration Manager where you can configure the device as usual. See 13 Core Configuration Manager (CCM) for more detail.

Note: The units will operate in link-local, but for optimum performance it is recommended that they are used with either static or DHCP network settings.

5 **Configuring and managing the Main Station from device menus**

This chapter describes how to configure the settings and manage the Main Station using **Menu mode**. It also shows you how to monitor and diagnose performance issues, using the **Diagnostics** menus.

Tip: For a quick reference to the Main Station menus, see **21 Menu maps**.

5.1 **Using the Menus**

To place the Main Station in **Menu mode**, press the **Menu key** to the left of the first display screen.

In Menu mode, the display screens display the four levels of menu. The menu hierarchy proceeds left to right:

- The **top level** menu is presented in the first screen.
- The **lowest level** menu is presented in the fourth screen (furthest right on the front panel).

Note: If Menu mode is **locked**, you must unlock the menus from CCM before you can enter the menu. See **section 6**.

5.1.1 **Configuring settings**

To configure settings:

- 1) For each menu, turn the **rotary control** clockwise to scroll down the menu items. Turn counter clockwise to scroll up the menu items.

Off-screen menu items are indicated by arrows at the top and/or bottom of the screen.

Selected menu items (which create your path through the four menus) are highlighted in solid yellow.

The fourth menu displays the settings that relate to your previous menu choices (system features or functionality).

The **current setting** is indicated by a dotted box around the menu item

- 2) When you have selected a setting by rotating the right hand rotary control, press that **rotary control** to enable the setting on the Main Station.

5.1.2 **Exiting Menu mode**

To exit menu mode press the menu key.

Note: If no key is pressed for 20 seconds, the menu will time out and display screens will revert to their normal mode of operation.

5.2 Configuring the Audio settings

5.2.1 Audio settings for the headset

To configure the audio settings for the headset:

- 1) In **Menu mode**, select **Audio Settings** and then **Headset**.
- 2) To adjust the level of sidetone on the headset:
 - a) In the third menu, select **Sidetone Gain**.
 - b) In the fourth menu, select one of the following:
 - 0dB
 - - 6dB
 - - 12dB (default)
 - - 18dB
 - c) To enable (confirm) the selected setting, press the **rotary control**.
- 3) To limit the audio level delivered to the headphones (or to disable headphone limiting):
 - a) In the third menu, select **Headphone Limit**.
 - b) In the fourth menu, select one of the following:
 - Off
 - +6dB
 - 0dB (default)
 - - 6dB
 - c) To confirm the selected setting, press the **rotary control**.

Note: When Headphone Limit is set to anything but Off, a LIM indication will be shown on the leftmost display.
- 4) To set the **Headphone Gain**:
 - a) In the third menu, select **Headphone Gain**.
 - b) In the fourth menu, select one of the following:
 - 0dB (default)
 - +3dB
 - +6dB
 - +9dB
 - +12dB

- c) To confirm the selected setting, press the **rotary control**.
- 5) To set (or disable) sidetone tracking on the headset:
 - a) In the third menu, select **Sidetone Control**.
 - b) In the fourth menu, select one of the following:
 - **Tracking** - The sidetone volume will follow (track) the Main volume level.
 - **Non-Tracking** - The sidetone volume is set to maximum.
 - **Disabled** - Sidetone is disabled.

Note: The default is **Tracking**.

- c) To confirm the selected setting, press the **rotary control**.
- 6) To select the type of microphone on the headset:
 - a) In the third menu, select **HS Mic Type**.

Note: **HS** = Headset.

- b) In the fourth menu, select either of the following types of microphone:
 - Electret (-15dB)
 - Dynamic (0dB) (default)
 - Dynamic (-10dB)
- c) To confirm the selected setting, press the **rotary control**.

5.2.2 Audio settings for the microphone

To configure the audio settings for the microphone:

- 1) In Menu mode, select **Audio Settings** and then **Microphone**.
- 2) To select the Headroom:
 - a) From the third menu, select **Headroom**.
 - b) From the fourth menu, select one of the following:
 - Normal (default)
 - High - Reduces the analog input gain and increases the digital gain accordingly. That reduces digital clipping at the A/D converter but increases the noise floor. This setting is intended for use in environments with very high background noise.

- 3) To enable or disable the Contour Filter:
 - a) From the third menu, select **Contour Filter**
 - b) From the fourth menu, select one of the following:
 - **Enabled** - The Contour filter is a Clear-Com algorithm enhancing speech intelligibility, especially when whispering or talking at a low volume.
 - **Disabled**

Note: The default is **Enabled**.

5.2.3 Audio setting for the Program Input

To configure the label (name) for the Program Input (Program Feed) gain:

- 1) In **Menu mode**, select **Audio Settings** and then **Program Input**.
- 2) From the third menu, select **Label**.
- 3) From the fourth menu, select the existing label by scrolling to it and pushing the rotary controller. Edit the label by rotating the controller to scroll through letters and digits and pushing to select a letter/digit.
- 4) When you have done, scroll to **Save** and push the rotary controller. To exit without saving changes, go back to the third screen.

To configure the audio setting for the Program Input (Program Feed) gain:

- 5) In **Menu mode**, select **Audio Settings** and then **Program Input**.
- 6) From the third menu, select **Gain**.
- 7) From the fourth menu, select one of the following:
 - + 12dB
 - + 6dB
 - 0dB (default)
 - - 6dB
 - - 12dB
- 8) To confirm the selected setting, press the **rotary control**.

9) The GPO trigger activates a relay when receiving a call or activating a talk on a partyline channel. You can enable or disable the GPO trigger. To configure the audio setting for the GPO trigger:

1) In **Menu mode**, select **Audio Settings** and then **Program Input**.

2) From the third menu, select **GPO Trigger**.

3) From the fourth menu, select one of the following:

- Enabled (default)
- Disabled

4) To confirm the selected setting, press the **rotary control**.

Note: You can also configure the GPO trigger using **Menu Mode > Modules Settings**.

To select the VOX:

1) From the third menu, select **VOX**.

a) From the fourth menu, select one of the following:

- Enabled
- Disabled (default)

2) To confirm the selected setting, press the **rotary control**.

To select the VOX Off Delay:

1) From the third menu, select **VOX Off Delay**.

2) From the fourth menus, select one of the following:

- .5 sec (default)
- 1 sec
- 2 sec
- 3 sec
- 4 sec

3) To confirm the selected setting, press the **rotary control**.

5.2.4 **Audio settings for Program IFB [*Interruptible Foldback*]**

IFB allows you to temporarily interrupt the continuous program listen (program feed) and speak to the channels connected to the program listen. This applies to a Channel to which the Program Input is assigned. If any participant within the

channel talks, the program is dimmed. See also **5.4.2 Assigning the Program Listen to a channel.**

To configure the audio settings for Program IFB [*Interruptible Foldback*]:

- 1) In **Menu mode**, select **Audio Settings** and then **Program IFB**.
- 2) From the third menu, select **IFB Dim Level**.
Note: The IFB Dim Level determines the amount that the volume level of the Program Level is reduced by when it is interrupted by the IFB.
- 3) From the fourth menu (fourth display screen), select one of the following:
 - IFB Disabled (default)
 - - 6dB
 - -12dB
 - -18dB
 - -24dB
 - Full Cut
- 4) To confirm the selected setting, press the **rotary control**.

5.2.5 **Audio settings for the SA [*Stage Announce*] Output**

To configure the audio settings for the SA [*Stage Announce*] Output:

- 1) In **Menu mode**, select **Audio Settings** and then **SA Output**.
- 2) From the third menu, select **Gain**.
- 3) From the fourth menu, select one of the following:
 - + 12dB
 - + 6dB
 - 0dB (default)
 - - 6dB
 - - 12dB
- 4) To confirm the selected setting, press the **rotary control**.

5.2.6 **Audio settings for the Hot Mic Output**

To configure the audio settings for the Hot Mic Output:

- 1) In **Menu mode**, select **Audio Settings** and then **Hot Mic Output**.
- 2) From the third menu, select **Gain**.
- 3) From the fourth menu, select one of the following:
 - + 12dB
 - + 6dB
 - 0dB (default)
 - - 6dB
 - -12dB
- 4) To confirm the selected setting, press the **rotary control**.

5.2.7 **Audio settings for the Front Panel**

To configure the audio settings for the Front Panel:

- 1) In **Menu mode**, select **Audio Settings** and then **Front Panel**.
- 2) From the third menu, select **Loudspeaker Dim**.
- 3) From the fourth menu, select one of the following:
 - 0 dB
 - -3 dB
 - -6 dB (default)
 - -12 dB
 - -24 dB
- 4) To confirm the selected setting, press the **rotary control**.

5.3 Selecting Station Settings

5.3.1 Setting Preferences

To set the **Preferences**:

- 1) In **Menu mode**, select **Station Settings** and then **Preferences**. You will see **Roles** in the third menu.
- 2) From the fourth menu, select the required Role. Select **local config** if you do not wish to use a role.
- 3) To confirm the selected setting, press the **rotary control**.

5.3.2 Setting Keypad Assignments

To set the **Keypad Assignments**:

- 1) In Menu mode, select Station Settings and then **Keypad Assign**.
- 2) From the third menu, select required **Keypad** (1 – 4).
- 3) From the fourth menu, select a Channel (1 – 24) to assign to the Keypad.
- 4) Repeat this procedure for the remaining Keypads.
- 5) To confirm the selected setting, press the **rotary control**.

5.3.3 Setting key latching

To enable or disable front panel keys for latching:

- 1) In **Menu mode**, select **Station Settings** and then **Keypads**.
- 2) From the third menu, select either:

Key(s)	Description
Talk #1	Talk keys for the four available channels.
Talk #2	
Talk #3	
Talk #4	
SA Out key	Key used to talk to a connected public address or Stage Announce (SA) system.

Table 5-1: Setting key latching

Note: The All Talk and **RMK (Remote Mic Kill)** key are also displayed in the list. Those keys **cannot** be latched. To find out how to configure the RMK and All Talk keys, see **5.3.5 Setting the All Talk key**.

Note: **The All Talk** key allows you to talk to all Channels at once with the push of a button. Select **All Channels** to talk to all 12 (or 24 according to license) Channels on your system. Select **Visible Channels** to talk to the Channels visible on your four device Keypad screens.

- 3) In **menu** mode select **Station Settings** and then **Keysets**.
- 4) From the third menu, select **All Talk**.
- 5) From the fourth menu, select **All Channels** or **Visible Channels**.
- 6) To confirm the selected setting, press the **rotary control**.

5.3.4 Setting the RMK (Remote Mic Kill) key.

Tip: For a quick reference to the location of keys on the front panel, see **2.1 Main Station/Remote Station: Front panel**.

- 1) In **menu** mode select **Station Settings** and then **Keysets**.
- 2) From the third menu, select **RMK**.
- 3) From the fourth menu, select **either** of the following:
 - All Channels
 - Visible Channels
 - Disabled
- 4) To confirm the selected setting, press the **rotary control**.

Note: Select **All Channels** to close the microphone on all 12 (or 24 according to license) Channels on your system. Select **Visible Channels** to close the microphone to the Channels visible on your four device Keypad screens.

5.3.5 Setting the All Talk key

The **All Talk** key allows you to talk to all Channels at once with the push of a button. Select **All Channels** to talk to all 12 (or 24 according to license) Channels

on your system. Select **Visible Channels** to talk to the Channels visible on your four device Keypad screens.

- 1) In **menu** mode select **Station Settings** and then **Keypads**.
- 2) From the third menu, select **All Talk**.
- 3) From the fourth menu, select **All Channels** or **Visible Channels**.
- 4) To confirm the selected setting, press the **rotary control**.

5.3.6 **Setting the RMK (Remote Mic Kill) key**

The RMK (Remote Mic Kill) key is used to:

- Deselect any latched keypad Talk routes.
- Turn off any latched Talk on connected analog partyline equipment.

To enable or disable the RMK (Remote Mic Kill) key:

- 1) In **Menu mode**, select **Station Settings** and then **Keypads**.
- 2) From the third menu, select **RMK**.
Note: *Talk Latch* and the *SA Output Key* are also listed in this menu. See **5.3 Selecting Station Settings**.
- 3) From the fourth menu, select **either** of the following:
 - All Channels (12 or 24 according to license)
 - Visible Channels (default)
 - Disabled
- 4) To confirm the selected setting, press the **rotary control**.

5.3.7 **Setting display screen brightness**

By default, the display screens are set for **medium** brightness. To set the brightness of the display screens:

- 1) In **Menu mode**, select **Station Settings** and then **Display**.
- 2) From the third menu, select **OLED Brightness**.

- 3) From the fourth menu, select one of the following brightness settings:
 - High
 - Medium (default)
 - Low
- 4) To confirm the selected setting, press the **rotary control**.

5.3.8 Setting key brightness

By default, the front panel keys are set to **High / Low**. To set the brightness of all front panel keys:

- 1) In **Menu mode**, select **Station Settings** and then **Display**.
- 2) From the third menu, select **Key Brightness**.
- 3) From the fourth menu, select one of the following brightness settings:

Key(s)	Description
High / Low	The default setting. Keys are lit bright when active and lit dim when inactive.
High / Off	Keys are lit bright when active and are unlit when inactive.
Low / Off	Keys are lit dim when active and are unlit when inactive.
Off / Off	Keys are unlit, whether or not they are active or inactive.

Table 5-2: Setting key brightness

- 4) To confirm the selected setting, press the **rotary control**.

5.3.9 Setting the screensaver

The screensaver features the channel label and is enabled by default. The display screens enter screensaver mode when the Main Station has been inactive for 10 minutes.

Tip: To exit screensaver mode, press any key on the front panel.

To enable or disable the screensaver:

- 1) In **Menu mode**, select **Station Settings** and then **Display**.
- 2) From the third menu, select **Screensaver**.

- 3) From the fourth menu, select either:
 - **Channel Name** (default)
 - **Hostname**
 - **Role Name**
 - **Blank**
 - **Disabled**
- 4) To confirm the selected setting, press the **rotary control**.

5.4 Configuring the channel settings

5.4.1 Editing the channel label

The maximum length for a channel label is **12 characters**.. To edit the channel label:

Note: Channel labels will be dictated by the Link Master when Main Stations are linked.

- 1) In **Menu mode**, select **Channels** and then the name of the channel you want to edit.
- 2) From the third menu, select **Label**.
- 3) Select **Clear** and press the rotary control to clear the channel label.
- 4) In the fourth menu, the following prompt is displayed above the channel label:

[Press to edit]

Press the **rotary control**.

- 5) The first letter of the channel label is shown as selected. The following prompt is displayed above the channel label:

[Scroll / Press to Select]

Scroll to the character you want to edit by turning the **rotary control**. To begin editing, press the **rotary control**.

- 6) The character you have selected for editing is shown in a box with a dotted border.

To display alternative characters in the box, turn the rotary control. The range of available characters comprises the following:

Characters	Description / range
Numbers (numeric)	0 to 9
Letters	Capital letters = A to Z Small letters = a to z
Symbols	# & * () - _ = + / ! @ : Note: You can also select a space.

Table 5-3: Channel label characters

To select a character, press the **rotary control**.

- 7) When you have selected a replacement character, scroll to the next character you want to edit. When you have finished editing the channel label, scroll to **Save** (displayed beneath the channel label).

To save the channel label, press the **rotary control**.

5.4.2 Assigning the Program Listen to a channel

To assign (or unassign) the Program Listen (Program Feed) to a channel:

- 1) In **Menu mode**, select **Channels** and then the name of the channel.
- 2) From the third menu, select **Program Listen**.
- 3) From the fourth menu, select either **None**, or choose from the list of available programs.

Note: The default is **None**.

- 4) To confirm the selected setting, press the **rotary control**.

Tip: When you assign the Program Listen to a channel, **PGM** is displayed on the display screen (under the listen level bar, to the left) for that channel.

5.4.3 Assigning a GPO relay to a channel

You can assign a relay that is triggered on receiving a call or detecting a talk on a partyline channel. To assign (or unassign) a relay:

- 1) In **Menu mode**, select **Channels** and then the name of the channel.
- 2) From the third menu, select **GPO on Talk** or **GPO on Call**.
- 3) From the fourth menu, select either **None**, or choose from the list of available relays.

Note: The default is **None**.

- 4) To confirm the selected setting, press the **rotary control**.

5.5 Configuring the Control I/O

The Control I/O connector (25 way female D-type) on the rear panel allows you to connect up to 4 relay outputs or 4 opto inputs and control them through the Main Station keysets:

I/O type	Description
Opto inputs	Opto inputs enable you to connect a foot switch or other control device and use it to trigger Call or Talk functions.
Relay outputs	Relay outputs enable you to use Call or Talk keys to trigger any external device that accepts a standard contact closure (such as a theater curtain or an On Air light, or the beltpack USB flasher).

Table 5-4: Opto inputs and Relay outputs

5.5.1 Configuring Opto inputs

To configure the Control I/O for Opto inputs:

- 1) In **Menu mode**, select **Control I/O**.
- 2) From the second menu, select **Inputs**.
- 3) From the third menu, select one of the following:
 - Opto 1
 - Opto 2
 - Opto 3
 - Opto 4
- 4) From the fourth menu (fourth display screen), select one of the following:
 - None
 - Call Key 1
 - Talk Key 1
 - Call Key 2
 - Talk Key 2
 - Call Key 3
 - Talk Key 3
 - Call Key 4
 - Talk Key 4

- 5) To confirm the selected setting, press the **rotary control**.

5.5.2 Configuring Relay outputs

To configure the Control I/O for Relay outputs:

- 1) In **Menu mode**, select **Control I/O**.
- 2) From the second menu, select **Outputs**.
- 3) From the third menu, select one of the four available Relay outputs:
 - Relay 1
 - Relay 2
 - Relay 3
 - Relay 4
- 4) From the fourth menu, select one of the following:
 - None (default)
 - Call Key 1
 - Talk Key 1
 - Call Key 2
 - Talk Key 2
 - Call Key 3
 - Talk Key 3
 - Call Key 4
 - Talk Key 4
 - SA Key

Note: The number of the key relates to the keyset to which it belongs (for example, Call Key 1 is the Call key for the first keyset / display screen).

- 5) To confirm the selected setting, press the **rotary control**.

5.6 Configuring Module Settings

Up to three optional interface modules can be fitted to the expansion bay of the HMS-4X Main Station.

Warning: The interface modules are not hot pluggable. Ensure that the Main Station is powered down before inserting or removing modules.

The **Menu mode > Module Settings** are used to set up the interface modules.

Tip: For more detailed information about interface modules, including pin out information, see: **2.2.1 HMS-4X Main Station rear panel: Interface modules.**

5.6.1 Configuring a Four-wire interface module

The following procedure shows you how to configure the Module Settings for a **Four-wire interface module**.

To configure the Module Settings for a four-wire interface module:

- 1) In **Menu mode**, select **Module Settings**.
- 2) From the second menu, select one of the two available ports on the two-wire interface module:

Slot 2/Port A 4W

Slot 2/Port B 4W

Note: In this example, the four-wire module has been fitted to slot 2 in the expansion bay. The expansion bay contains three slots.

4W = four-wire.

- 3) To associate one of the four available channels with the selected port, or to disable channels associations:
 - a) From the third menu, select **Channel Assign**.
 - b) From the fourth menu, select one of the following:
 - Disabled (default)
 - Channel 1.
 - Channel 2.
 - Channel 3.
 - Channel 4.
 - ...
 - c) To confirm the selected setting, press the **rotary control**.

- 4) The Program Output allows a program feed associated with the channel assigned to the four wire port to either be delivered to that 4 wire port alongside the other channel audio or not. To set the Program Output:
 - a) From the third menu, select **Program Output**.
 - b) From the fourth menu, select one of the following:
 - Unmute
 - Mute (default)
- 5) To confirm the selected setting, press the **rotary control**.
- 6) To set the input level for the four-wire port:
 - a) From the third menu (third display screen), select **Input Gain**.
 - b) From the fourth menu (fourth display screen), select one of the following:
 - +12dB
 - + 6dB.
 - 0dB (default)
 - -6dB.
 - -12dB
 - c) To confirm the selected setting, press the **rotary control**.
- 7) To set the output level for the four-wire port:
 - a) From the third menu, select **Output Gain**.
 - b) From the fourth menu, select one of the following:
 - +12dB
 - + 6dB.
 - 0dB (default)
 - -6dB.
 - -12dB
- 8) To confirm the selected setting, press the **rotary control**.
- 9) To set the **GPO** trigger for the **Program Output**:
 - a) From the third menu, select **GPO**.
 - b) From the fourth menu, select one of the following:
 - Enabled
 - Disabled

- 10) If you are setting up a continuous audio (program) feed using the four-wire interface module, then you may want to enable the **VOX functionality**. To help reduce redundant noise, the VOX functionality automatically deactivates and activates the continuous audio feed, at an automatically determined volume threshold.

Note: If you assign a program and a four-wire interface to the same channel, VOX is automatically enabled.

To enable or disable VOX:

- a) From the third menu, select **VOX**.
 - b) From the fourth menu, select one of the following:
 - Enabled.
 - Disabled (default)
 - c) To confirm the selected setting, press the **rotary control**.
- 11) The **VOX Delay OFF** setting determines the length of time to wait before deactivating the incoming audio. To set the VOX Delay OFF setting:
 - a) From the third menu, select **VOX Delay OFF**.
 - b) From the fourth menu, select one of the following:
 - .5 sec (default)
 - 1 sec
 - 2 sec
 - 3 sec
 - 4 sec
 - c) To confirm the selected setting, press the **rotary control**.

5.6.2 Configuring a Two-wire interface module

The following procedure shows you how to configure the Module Settings for a **Two-wire interface module**.

Note: The Two-wire interface module must receive power from the partyline.

To configure the Module Settings for a Two-wire interface module:

- 1) In **Menu mode**, select **Module Settings**.

- 2) From the second menu, select one of the two available ports on the two-wire interface module:

Slot 1/Port A 2W

Slot 1/Port B 2W

Note: In this example, the two-wire module has been fitted to slot 1 in the expansion bay. The expansion bay contains three slots.

2W = Two-wire.

- a) To associate one of the four available channels (or to disable channels associations) with the selected port:
From the third menu (third display screen), select **Channel Assign**.
 - b) From the fourth menu, select one of the following:
 - Disabled (default)
 - Channel 1
 - Channel 2
 - Channel 3
 - Channel 4
 - ...
 - c) To confirm the selected setting, press the **rotary control**.
- 3) The Program Output allows a program feed associated with the channel assigned to the four wire port to either be delivered to that 4 wire port alongside the other channel audio or not. To set the Program Output:
 - a) From the third menu, select **Program Output**.
 - b) From the fourth menu, select one of the following:
 - Unmute (default)
 - Mute
 - 4) To confirm the selected setting, press the **rotary control**.
 - 5) **Auto-nulling** helps to reduce echo while talking on a two-wire audio system. To start Auto-nulling on the selected port:
 - a) From the third menu, select **Auto-Nulling**.
 - b) From the fourth menu, select **Start**.
- Note:** Auto-nulling is only applicable to two-wire audio. **All** Talk routes/keys must be **disabled** before Auto-nulling can commence. If an echo persists, ensure all Talk routes are disabled and re-null the system.

- 6) The Two-wire interface module is set for Clear-Com systems by default. However, you can also set the two-wire ports for use with RTS analog partyline systems. If you are connecting to an **RTS** system, you also have a choice of two different pinouts:

RTS pinout option	Description
RTS Audio Pin 2	Pin 2 is used for both power and audio.
RTS Audio Pin 3	Pin 3 is used for audio (Pin 2 is used for power only).

Table 5-5: Configuring Module Settings: RTS pinout options

Note: For detailed pinout information, see **2.2.1 HMS-4X Main Station rear panel: Interface modules.**

To configure the port for either Clear-Com or RTS systems:

- a) From the third menu, select **Mode**.
 - b) From the fourth menu, select one of the following:
 - Clear-Com
 - RTS Audio Pin 2
 - RTS Audio Pin 3
 - c) To confirm the selected setting, press the **rotary control**.
- 7) To set the **Input Gain**:
- From the third menu, select **Input Gain**.
- From the fourth menu, select one of the following:
- +3 dB
 - +2 dB
 - +1 dB
 - 0 dB (default)
 - -1 dB
 - -2 dB
 - -3 dB

- 8) To set the **Output Gain**:
- a) From the third menu, select **Output Gain**.
 - b) From the fourth menu, select one of the following:
 - +3 dB
 - +2 dB
 - +1 dB
 - 0 dB (default)
 - -1 dB
 - -2 dB
 - -3 dB
- 9) To set the **GPO** trigger for the **Program Output**:
- c) From the third menu, select **GPO**.
 - d) From the fourth menu, select one of the following:
 - Enabled
 - Disabled
- 10) Enabling **RMK [Remote Mic Kill] Input** allows an external source such as the main (base) station of the connected two-wire system to send an RMK signal to the analog beltacks attached to the HelixNet Main Station.
- Note:** If this is enabled and the analog party line system is powered down, it will be interpreted by the HelixNet Main Station as an RMK input and all talk routes will be switched off.

To enable RMK Input:

- a) From the third menu (third display screen), select **RMK Input**.
 - b) From the fourth menu (fourth display screen), select one of the following:
 - Enabled
 - Disabled (default)
 - c) To confirm the selected setting, press the **rotary control**.
- 11) Enabling **RMK [Remote Mic Kill] Output** allows you to send an RMK signal from the HelixNet Main Station to the connected analog beltacks.

To enable RMK Output:

- a) From the third menu, select **RMK Output**.
- b) From the fourth menu, select one of the following:
 - Enabled

- Disabled (default)

To confirm the selected setting, press the **rotary control**.

- 12) If you are setting up a continuous audio (program) feed using the two-wire interface module, then you may want to enable the **VOX functionality**. To help reduce redundant noise, the VOX functionality automatically deactivates and activates the continuous audio feed, at an automatically determined volume threshold.

Note: If you assign a program and a two-wire interface to the same channel, VOX is automatically enabled.

To enable or disable VOX:

- a) From the third menu, select **VOX**.
 - b) From the fourth menu, select one of the following:
 - Enabled
 - Disabled (default)
 - c) To confirm the selected setting, press the **rotary control**.
- 13) The **VOX Delay OFF** setting determines the length of time to wait before deactivating the incoming audio. To set the VOX Delay OFF setting:
 - a) From the third menu, select **VOX Delay OFF**.
 - b) From the fourth menu, select one of the following:
 - .5 sec (default)
 - 1 sec
 - 2 sec
 - 3 sec
 - 4 sec
 - c) To confirm the selected setting, press the **rotary control**.

5.6.3 Configuring an Ethernet or Fiber interface module

The following procedure shows you how to configure the Module Settings for an **Ethernet interface module**.

To configure the Module Settings for an Ethernet interface module:

- 1) To view status information about Main Stations:
 - a) In **Menu mode**, select **Networking**.

Note: The Networking menu only appears if at least one Ethernet or Fiber interface module is detected.

- b) From the second menu, select **Stations**. A list of station IDs is given for each Main Station in the network. Each station ID in the list is preceded by the letter M- for the Link-Master station itself and S- for all Link-Member (S stands for Slave).
 - c) From the third menu select the required station ID.
 - d) From the fourth menu you can view the following:
 - **Status** – Enabled or Disabled
 - **IP** – The IP address.
- 2) To edit or change the **Hostname** for your device:
- a) In **Menu mode**, select **Networking**.
 - b) From the second menu, select **Preferences**
 - c) From the third menu, select **Hostname**
 - d) From the fourth menu, select the name by pushing and turning the **Rotary controller**.
 - e) Edit the name by turning the controller to select a letter or number and pushing to select it. Then turn to scroll through letters. Push to commit.
 - f) When you have done, scroll to **SAVE** and push to commit.
- 3) To enable or disable DHCP:
- g) In **Menu mode**, select **Networking**.
- Note:** The Networking menu only appears if an Ethernet or Fiber interface module is detected.
- h) From the second menu, select **Preferences**.
 - i) From the third menu, select **DHCP**.
 - j) From the fourth display screen, select one of the following:
 - Disabled
 - Enabled (default)
- 4) To edit the IP address:
- k) In **Menu mode**, select **Networking**.
- Note:** The Networking menu only appears if an Ethernet or Fiber interface module is detected.
- l) From the second menu, select **Preferences**.
 - m) From the third menu, select **IP Address**.

n) From the fourth display screen, edit the IPv4 address.

Note: You can only edit the IPv4 address if DHCP is disabled.

Note: The HelixNet system uses a 10.0.0.x IP address range internally between the Main Station and the Beltpacks, and therefore will not allow setting the external IP address to anything in that range.

Note: If you change the IP address (either manually or through DHCP), the link between stations will be broken and you have to reboot the Main Station to link again. The following message will appear as a banner (inverted text) at the bottom across the four displays on the Main Station

IP address | changed, | reboot | to link

If that message appears, pressing the Menu key will bring you directly to: **Administration->Reset->Reboot->Reboot Now**

5) To edit the Gateway:

a) In **Menu mode**, select **Networking**.

Note: The Networking menu only appears if an Ethernet or Fiber interface module is detected.

b) From the second menu, select **Preferences**.

c) From the third menu, select **Gateway**.

d) From the fourth display screen, edit the gateway.

Note: You can only edit the gateway if DHCP is disabled.

6) To edit the Subnet Mask:

a) In **Menu mode**, select **Networking**.

Note: The Networking menu only appears if an Ethernet or Fiber interface module is detected.

b) From the second menu, select **Preferences**.

c) From the third menu, select **Subnet Mask**.

d) From the fourth display screen, edit the Subnet Mask.

Note: You can only edit the Subnet Mask if DHCP is disabled.

7) To enable or disable **linking**:

a) In **Menu mode**, select **Networking**.

Note: The Networking menu only appears if an Ethernet or Fiber interface module is detected.

b) From the second menu, select **Linking**.

c) From the third menu, select **Link Mode**.

- d) From the fourth display screen, select one of the following:
 - Disabled (default)
 - Master
 - Member
- e) If Member is selected, the menu asks you to pick a Link-Master to connect to in the Networking>Link To Master menu. It can be done by picking from a hostname list or by entering an IP address.

8) To enable a key **Expansion Group**:

When you connect HelixNet Main and Remote Stations in a key Expansion Group relationship, you enable control of keysets on up to three stations from one host device. This makes controlling larger systems much more convenient. In order to set up an Expansion Group, the devices must be on the same IP network, and able to see each other.

First, decide which device to designate as Host.

- a) In **Menu mode**, select **Networking**.

Note: The Networking menu only appears if an Ethernet or Fiber interface module is detected.

- b) From the second menu, select **Expansion Mode**.
- c) From the third menu, select **Host**.
- d) From the fourth menu select **Enabled**. A stacking icon will flash on the menu screen to indicate that the device is open for pairing.
- e) From the device you wish to connect as an **Expanded panel**, in **Menu Mode**, select **Networking**.
- f) From the second menu, select **Expansion Mode**.
- g) From the third menu, select **Expand to Host**.
- h) From the fourth menu, select the Host device, which should be visible by name.
- i) This connects the devices in a key Expansion relationship.

When an Expansion Group is successfully established, a steady stacking icon will appear in the menu screens of the devices.

5.6.4 Viewing the Module Settings: Version information

The software (firmware) for the ports on the interface module must match that on the HelixNet Main Station itself.

Note: Ethernet and fiber option modules do not contain software.

To check the software version for the Main Station and each port on the interface module:

- 1) In Menu mode, select **Administration > Software > Current**.
- 2) In the fourth menu, use the **rotary control** to scroll the displayed software versions.
- 3) The software versions for each port are listed under **Snx**, where **n** indicates the slot number, and **x** indicates port A or port B.

The software versions for the two processors in the Main Station (Main Station and IV-Router) are listed under MS and IVR respectively.

5.7 Administration

In **Menu mode > Administration**, you can:

- View the current versions of the software for the system.
- Update the software (firmware).
- Lock or unlock the menus on HBP-2X beltacks, Remote Stations and Speaker Stations connected to the Main Station.
- Reset the Main Station to the default settings.
- Manually reboot the Main Station.
- Save and Restore the settings.

5.7.1 Viewing the current versions of the software

To view the current versions of the software on the Main Station, see 4.6.4 Viewing the Module Settings: Version information.

5.7.2 Updating the software

Any HBP-2X beltacks, Remote Stations and Speaker Stations that are connected to the Main Station are automatically updated. The units remain non-functional for approximately 5 minutes while they are updated.

To update the software:

- 1) After downloading the software update, copy the update to a USB memory stick.
- 2) Insert the memory stick into the USB 2.0 (A) connector. See **Table 2-3 Key to Main Station/Remote Station front panel** diagram.
- 3) In **Menu mode**, select **Administration** and then **Software**.

- 4) From the third menu, select **Update**.
- 5) The fourth menu displays the new software version information on the USB memory stick. To start updating the Main Station with the new software, press the rotary control.

The process of updating the software takes several minutes. Please wait while all connected devices are updated. The following system messages are displayed during the process:

```
Loading image
Erasing flash
Writing to flash
Verifying flash
Successful
```

Note: Do not remove the USB memory stick from the Main Station until the software update is completed, including the update to any connected devices.



*Do **not** turn off the power to the Main Station during the software (firmware) update. Turning off the power can damage the device.*

Note: The Main Station resets **automatically**. You are **not** required to restart the Main Station. To check that the software upgrade was performed successfully, see **5.7.1 Viewing the current versions of the software**.

5.7.3 To upgrade the License on your HelixNet Main Station

The Main Station arrives with a license for 12 Channels. In order to upgrade to 24 Channels you need to obtain a License code from your Clear-Com dealer. Your dealer will need the system id of your device, available from the front menu screens.

- 1) In **Menu mode**, select **Administration** and then **License**.
- 2) From the third menu, select **Current**.
- 3) In the fourth menu, the top item is the system ID. Give this to your dealer to obtain a license to upgrade.
- 4) When you have the license code, input it into this screen. The Rotary controller can be used to scroll to the input code section, and then used to enter the code. Push to select a digit or letter. Scroll to the required letter. Push to commit information.

5.7.4 **Resetting the Main Station to default (factory mode) settings.**

To reset the Main Station to its default (factory mode) settings:

- 1) In **Menu mode**, select **Administration** and then **Reset**.
- 2) The third menu displays a selected menu item: **Reset to Default**.
- 3) In the fourth menu, select between:
 - Reset HMS
 - Reset Devices
 - Reset All

The beltpacks will receive updated (default) role information. All other local beltpack settings will **not** be reset if the Main Station is reset to default settings.

Resetting a Main Station to factory settings will erase any Role configurations you have made. Please save Role configurations before doing this.

5.7.5 **Manually rebooting the Main Station**

To manually reboot the Main Station:

- 1) In **Menu mode**, select **Administration** and then **Reset**.
- 2) The third menu select **Reboot**.
- 3) In the fourth menu, select **Reboot Now**.

When the **rotary control** is pressed, the display changes to **Rebooting ...** for 2 seconds, and then the Main Station reboots.

5.7.6 **Saving and restoring the software settings.**

To save or restore the software settings:

- 1) Insert a memory stick into the USB 2.0 (A) connector. See **Table 2-3 Key to Main Station/Remote Station front panel** diagram.
- 2) In **Menu mode**, select **Administration** and then **Settings**.
- 3) To save, in the third menu, select **Save**. Once you select **Save** you should not remove the USB stick right away. Depending on the USB stick it might take up to 5 seconds to complete.
 - a) In the fourth menu, select **Local**.

- 4) To restore all HMS settings, including Networking, Linking and Expansion settings, in the third menu, select **Restore Local**.
 - a) In the fourth menu, select a file from USB.
- 5) To restore all Roles and Channel names only, in the third menu, select **Restore System**.
 - b) In the fourth menu, select a file from USB.

5.8 Diagnostics

The **Diagnostics** menus help you to monitor the performance of the Main Station and diagnose possible system issues.

If the warning icon shows up in the Main display, warning message will show up here in the Diagnostics menu.

5.8.1 Viewing hardware information

To view information about the hardware (PCBs) on the Main Station:

- 1) In **Menu mode**, select **Diagnostics** and then **Hardware**.
- 2) From the third menu, select one of the following:
 - Main PCB
 - Slot 1 PCB
 - Slot 2 PCB
 - Slot 3 PCB

Note: **Slot 1**, **Slot 2** and **Slot 3** refer to the interface module slots in the Main Station extension bay. When looking at the rear of the module, **slot 1** is the left-hand slot, **slot 2** is the middle slot, and **slot 3** is the right-hand slot.

The fourth menu displays the **Part number**, **Revision** and **Serial numbers** for the PCB. The format is similar to the following:

```
Part xxxxxxx  
Revision: x  
Serial: x
```

Where **x** is a numerical value.

5.8.2 Viewing temperature information

To view the temperature of the Main Station:

- 1) In **Menu mode**, select **Diagnostics** and then **Hardware**.

- 2) From the third menu, select one of the following temperature sensors:
 - Sensor 1
 - Sensor 2
 - Sensor 3

The fourth menu displays the temperature, for example:

+30°C

Environmental note:

The recommended operating temperature range for the HelixNet HMS-4X Main Station is **0 to +40°C**. The storage temperature range for the Main Station is **-30 to +70°C**.

For more environmental information, see **3 Installing HelixNet Partyline**.

5.8.3 Viewing powerline information and status

There are two digital partylines (**Line 1** and **Line 2**) on the HMS-4X Main Station. Line 1 and Line 2 are also referred to as **powerlines**.

Each line can support up to 10 HBP-2X beltpacks, Remote Stations or Speaker Stations.

Note: See also **F**, **G** and **I** in **Table 2-3 Key to Main Station/Remote Station front panel** diagram.

To view line information and status:

- 1) In **Menu mode**, select **Diagnostics** and then **Powerlines**.
- 2) From the third menu, select one of the following:
 - Powerline 1 (refers to Line 1)
 - Powerline 2 (refers to Line 2)
- 3) The fourth menu displays the status and other measures / information for the powerline. The status of the powerline is either **Ok** [operating normally], **Busy** or **Error**.

For more details of the information displayed, see **21 Menu maps**.

Note: Powerline status is also indicated by the powerline LEDs on the front panel.

Green LED = **OK**

Amber LED = **Busy**

Red LED = **Error**

For more information about powerline diagnostics, see **24 Troubleshooting**.

5.8.4 Viewing keysets information

To view information about the keysets:

- 1) In **Menu mode**, select **Diagnostics** and then **Keysets**.
- 2) From the third menu (third display screen), select a keyset from 1 to 4.
- 3) The fourth menu (fourth display screen) displays the following status information:
 - **Name** – The channel name
 - **Talkers** – The number of talkers on the partyline
 - **Main Stations** – The number of Main Stations listening
 - **Beltpacks** – The number of beltpacks listening on the partyline
 - **Remote** – The number of Remote Stations listening
 - **Speaker** – The number of Speaker Stations listening.
 - **2-Wire** – The number of 2-wire ports listening
 - **4-Wire** – The number of 4-wire ports listening

5.9 Setting up a key Expansion Group

HelixNet 3.0 units can be Expanded and stacked in order to allow for visual monitoring and easy control of multiple channels. Up to three devices (HMS-4X, HRM-4X) can be stacked in an Expansion Group, allowing for convenient observation and control of up to 12 Keysets. This gets rid of the need for multiple key presses and microphones. When using this type of connectivity, the Expanded panels act as slaves to the Host panel.



HRM/HMS Expanding over IP:

- All devices in the Expansion Group use the headset/microphone/loudspeaker of a "Host" HRM or HMS
- Some menus disappear from the "Expanded" HRM/HMS devices (e.g. microphone, headset, display settings).

Figure 5-1 A key Expansion Group

To set up an Expansion Group, once the devices have been connected to the same LAN by Ethernet cable, you will need to identify a Host device. This is done from the front panel menu of the device under **Station Settings**. Then designate the panel(s) to be stacked as Expansion Panel(s).

Once this set up is established, you will be able to control all Channels from the Host panel.

- Volume and buttons are synched.
- Unused buttons on Expanded panel are disabled: **HSet, Mic On, SA, All Talk, OPT, Main, PGM.**

Restrictions:

- Devices can only connect as an Expansion Group over LAN, not when connected over digital partyline.
- HMS-4X or HRM-4X can act as Host Panel.
- HMS-4X can only act as a key Expansion Panel to another HMS-4X.
- HRM-4X can act as a Key Panel to an HMS-4X and an HRM-4X.
- If an HRM-4X is already Paired to an HMS-4X it will only see Host Panels that are part of the same group.
- If an HRM-4X is not Paired yet to an HMS-4X it will see all Host Panels in the subnet and will automatically Pair at the same time a Host Panel is selected.
- An Expansion Group must be set up from the device menus, and cannot be set up from the CCM.

5.9.1 To set up a key Expansion Group (example set-up)

Designate the expansion Host unit:

- 1) On the device, press the **MENU** button to enter menu mode.
Note: For each menu, turn the **rotary control** clockwise to scroll down the menu items. Turn counter clockwise to scroll up the menu items.

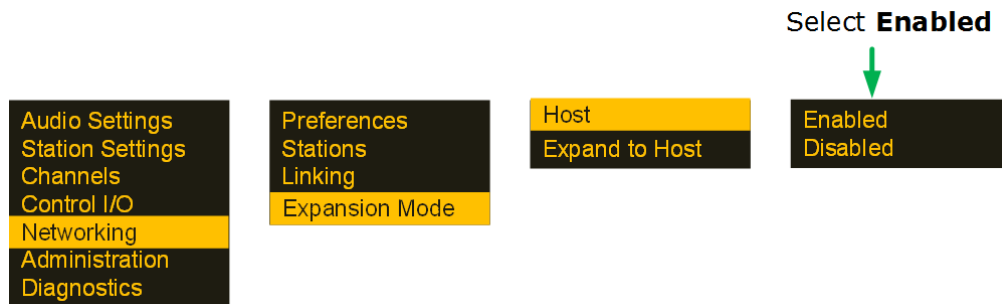
Off-screen menu items are indicated by arrows at the top and/or bottom of the screen.

Selected menu items (which create your path through the four menus) are highlighted in solid yellow.

The **current setting** is indicated by a dotted box around the menu item

When you have selected a setting by rotating the right hand rotary control, press that **rotary control** to enable the setting on the Main Station.

- 2) Navigate to **Menu > Networking > Expansion Mode**. Select **Host**.
- 3) From the 4th screen on the device select **Enabled**. The device will then be open for expansion.



Enable expansion on Host device

Note: On both Host and Expansion panels a “stacking” icon will flash until connection is established.



Designate the Expansion panel and link it to the host:

- 4) From the front panel menus of the panel you wish to expand from the host, navigate to **Menu > Networking > Expansion Mode > Host**

- 5) Select the required host panel using the rotary controllers, which, providing the devices are on the same network, will be visible in the 4th screen.
- 6) The stacking icon will flash in the screen until connection is established. Once the connection is established, the icon will show solid.



Select Host from Expansion Panel

6 **Configuring and managing the Remote Station from device menus**

This chapter describes how to configure the settings and manage the Remote Station using **Menu mode**. It also shows you how to monitor and diagnose performance issues, using the **Diagnostics** menu.

Tip: For a quick reference to the Remote Station menus, see **21 Menu maps**.

For general information about using the menus and configuring settings, see **5.1 Using the Menus**.

Note: Some of the configuration information for the Remote Station is the same as for the Main Station. In these case, you are referred to the relevant sections of chapter 5.

Note: If Menu mode is **locked**, you must unlock the menus from CCM before you can enter the menu. See **section 6**.

6.1 **Configuring the audio settings**

6.1.1 **Audio settings for the headset**

To configure the audio settings for the headset, see **5.2.1 Audio settings for the headset**.

Note: This does not apply to the Remote Station in expansion mode.

6.1.2 **Audio settings for the microphone**

To configure the audio settings for the microphone, see **5.2.2 Audio settings for the microphone**.

Note: This does not apply to the Remote Station in expansion panel mode.

6.1.3 **Settings for program/audio in**

To configure the audio settings for the program/audio in:

- 1) In **Menu mode**, select **Audio Settings** and then **PGM/Audio In**.
- 2) To edit the label for this input:
 - a) From the third menu, select **Label**.
 - b) From the fourth menu, select the existing label by scrolling to it and pushing the rotary controller. Edit the label by rotating the controller to scroll through letters and digits and pushing to select a letter/digit.

- c) When you have done, scroll to **Save** and push the rotary controller. To exit without saving changes, go back to the third screen.
- 3) To select the gain:
- d) From the third menu, select **Gain**.
- e) From the fourth menu, select one of the following:
- + 12dB
 - + 6dB
 - 0dB (default)
 - - 6dB
 - - 12dB
- f) To confirm the selected setting, press the **rotary control**.
- 4) To select the IFB dim level:
- a) From the third menu, select **IFB Dim Level**.
- Note:** The IFB Dim Level determines the volume level the Program Level is reduced to when it is interrupted by the IFB.
- b) From the fourth menu, select one of the following:
- IFB Disabled (default)
 - - 6dB
 - -12dB
 - -18dB
 - -24dB
 - Full Cut
- c) To confirm the selected setting, press the **rotary control**.
- 5) The GPO trigger activates a relay when receiving a call or activating a talk on a partyline channel. You can enable or disable the GPO trigger.
- a) In Menu mode, select Audio Settings and then Program Input.
- b) From the third menu, select **GPO Trigger**.
- c) From the fourth menu, select one of the following:
- Enabled (default)
 - Disabled
- d) To confirm the selected setting, press the **rotary control**.
- Note:** You can also configure the GPO trigger using **Menu Mode > Modules Settings**.

- 6) To select the VOX:
 - e) From the third menu, select **VOX**.
 - f) From the fourth menu, select one of the following:
 - Enabled
 - Disabled (default)
 - g) To confirm the selected setting, press the **rotary control**.

- 7) To select the VOX Off Delay:
 - a) From the third menu, select **VOX Off Delay**.
 - b) From the fourth menus, select one of the following:
 - .5 sec (default)
 - 1 sec
 - 2 sec
 - 3 sec
 - 4 sec
 - c) To confirm the selected setting, press the **rotary control**.

6.1.4 **Audio settings for the SA (Stage Announce) output**

To configure the settings for the SA output:

- 1) In **Menu mode**, select **Audio Settings** and then **SA/Audio out**.

- 2) To select the mode:
 - a) From the third menu, select **Mode**.
 - b) From the fourth menu, select one of the following:
 - Channel Assigned (default)
 - SA
 - c) To confirm the selected setting, press the **rotary control**.

- 3) To select the gain:
 - a) From the third menu, select **Gain**.
 - b) From the fourth menu, select one of the following:
 - +12dB
 - +6dB
 - 0dB (default)
 - -6dB

- -12dB
 - c) To confirm the selected setting, press the **rotary control**.
- 4) The Program Output setting enables the program to be delivered to this output if it is assigned to a channel that also has a program feed assigned. To select the program output:
- a) From the third menu, select **Program Output**.
 - b) From the fourth menu, select one of the following:
 - Unmute (default)
 - Mute
 - [SA Mode]
 - c) To confirm the selected setting, press the **rotary control**.
- 5) To associate one of the four available channels (or to disable channels associations) with the selected port:
- a) From the third menu, select **Channel Assign**.
 - b) From the fourth menu, select one of the following:
 - Disabled (default)
 - Channel 1
 - Channel 2
 - Channel 3
 - Channel 4
 - ...
 - c) To confirm the selected setting, press the **rotary control**.

6.1.5 **Audio settings for Hot Mic Output**

To configure the audio settings for the Hot Mic Output, see **5.2.6 Audio settings for the Hot Mic Output**.

Note: This does not apply to the Remote Station in expansion mode.

6.1.6 **Audio settings for the Front Panel**

To configure the audio settings for the Front Panel, see **5.2.7 Audio settings for the Front Panel**.

Note: This does not apply to the Remote Station in expansion panel mode.

6.2 Selecting Station Settings

6.2.1 Setting Preferences

To set the **Preferences**:

- 1) In **Menu mode**, select **Station Settings** and then **Preferences**.
- 2) You will see **Roles** in the third screen.
- 3) From the fourth screen, select the required Role. Select **Local config** if you do not wish to use a Role.

6.2.2 Setting Keypad Assignments

To configure the Keypad Assignments settings, see **5.3.2 Setting Keypad Assignments**.

6.2.3 Setting key latching

To configure the key latching settings, see **5.3.3 Setting key latching**.

6.2.4 Settings the RMK (Remote Mic Kill) key

To configure the RMK settings, see **5.3.6 Setting the RMK (Remote Mic Kill) key**

Note: This does not apply to the Remote Station in expansion panel mode.

6.2.5 Setting display screen brightness

To configure the display screen brightness, see **5.3.7 Setting display screen brightness**

6.2.6 Setting key brightness

To configure the key brightness settings, see **5.3.8 Setting key brightness**.

6.2.7 Setting the screensaver

To configure the screensaver settings, see **5.3.9 Setting the screensaver**.

6.3 Configuring the channel settings

6.3.1 Editing the channel label

To edit the channel label, see **5.4.1 Editing the channel label**.

6.3.2 **Assigning the Program Listen to a channel**

To assign the program listen to a channel, see **5.4.2 Assigning the Program Listen to a channel**.

6.3.3 **Assigning a GPO relay to a channel**

You can assign a relay that is triggered on receiving a call or detecting a talk on a partyline channel. See **5.4.3 Assigning a GPO relay to a channel**.

6.4 Configuring the Control I/O

The Control I/O connector on the rear panel allows you to connect one relay output or one opto input and control them through the Remote Station keysets:

I/O type	Description
Opto inputs	Opto inputs enable you to connect a foot switch or other control device and use it to trigger Call or Talk functions.
Relay outputs	Relay outputs enable you to use Call or Talk keys to trigger any external device that accepts a standard contact closure (such as a theater curtain or an On Air light).

Table 6-1: Opto inputs and Relay outputs

6.4.1 Configuring Opto inputs

To configure the Control I/O for the Opto input:

- 1) In **Menu mode**, select **Control I/O**.
- 2) From the second menu, select **Inputs**.
- 3) From the third menu, select **Opto 1**
- 4) From the fourth menu, select one of the following:
 - None (default)
 - Call Key 1
 - Talk Key 1
 - Call Key 2
 - Talk Key 2
 - Call Key 3
 - Talk Key 3
 - Call Key 4
 - Talk Key 4

Note: The number of the key relates to the keyset to which it belongs (for example, Call Key 1 is the Call key for the first keyset / display screen).

- 5) To confirm the selected setting, press the **rotary control**.

6.4.2 Configuring the Relay output

To configure the Control I/O for the Relay output:

- 1) In **Menu mode**, select **Control I/O**.
- 2) From the second menu, select **Outputs**.
- 3) From the third menu, select **Relay 1**
- 4) From the fourth menu, select one of the following:
 - None (default)
 - Call Key 1
 - Talk Key 1
 - Call Key 2
 - Talk Key 2
 - Call Key 3
 - Talk Key 3
 - Call Key 4
 - Talk Key 4
 - SA Key

Note: The number of the key relates to the keyset to which it belongs (for example, Call Key 1 is the Call key for the first keyset / display screen).

- 5) To confirm the selected setting, press the **rotary control**.

6.5 Connecting the Remote Station to a Main Station using LAN

To connect the Remote Station to a Main Station:

- 1) Ensure that the Remote Station is physically connected to the Main Station.
- 2) In **Menu mode**, select **Networking**, and then **Pair to Station**.
- 3) From the third menu, select the **Station ID** to connect to.

To set the preferences:

- 1) In **Menu mode**, select **Networking**, and then **Preferences**.

From the third menu, select **DHCP**.

- a) Select one of the following:
 - Enabled (default)
 - Disabled
- 2) From the third menu, select **IP Address**, and enter the correct IP address.
- 3) From the third menu, select **Gateway**, and enter the correct gateway address.
- 4) From the third menu, select **Subnet Mask**, and enter the correct subnet mask

6.6 Administration

In **Menu mode > Administration**, you can:

- View the current versions of the software for the system.
- Update the software (firmware).
- Reset the Remote Station to the default (factory mode) settings.
- Manually reboot the Remote Station.
- Save and Restore the software settings.

6.6.1 Viewing the current versions of the software

To view the current versions of the software on the Remote Station:

- 1) In **Menu mode**, select **Administration** and then **Software**.
- 2) From the third menu, select **Current**.
- 3) In the fourth menu, use the **rotary control** to scroll the displayed software versions. The software versions for the HelixNet system and Remote Station are shown.

6.6.2 Updating the software

Software can be updated from a Main Station or locally in the USB connector on the front of a Remote Station. Updating from the Main Station is recommended when possible.

To update the software:

- 1) After downloading the software update, copy the update to a USB memory stick.

- 2) Insert the memory stick into the USB connector.
- 3) In **Menu mode**, select **Administration** and then **Software**.
- 4) From the third menu, select **Update**.
- 5) The fourth menu displays the new software version information on the USB memory stick. To start updating the Main Station with the new software, press the rotary control.

The process of updating the software takes several minutes. The following system messages are displayed during the process:

```
Loading image
Erasing flash
Writing to flash
Verifying flash
Successful
```



*Do **not** turn off the power to the Remote Station during the software (firmware) update. Turning off the power can damage the device.*

Note: Do not remove the USB memory stick from the Main Station or Remote Station until the software update is completed.

Note: The Remote Station resets **automatically**. You are **not** required to restart the Remote Station. To check that the software upgrade was performed successfully, see **6.6.1 Viewing the current versions of the software**.

6.6.3 **Resetting the Remote Station to default settings.**

To reset the Remote Station to its default (factory mode) settings:

- 1) In **Menu mode**, select **Administration** and then **Reset**.
- 2) The third menu displays a selected menu item: **Reset to Default**.
- 3) In the fourth menu, select **Reset Now**.

6.6.4 **Manually rebooting the Remote Station**

To manually reboot the Remote Station:

- 1) In **Menu mode**, select **Administration** and then **Reset**.
- 2) The third menu select **Reboot**.

- 3) In the fourth menu, select **Reboot Now**.

When the **rotary control** is pressed, the display changes to **Rebooting ...** for 2 seconds, and then the Remote Station reboots.

6.6.5 Saving and restoring the software settings.

To save or restore the software settings:

- 1) In **Menu mode**, select **Administration** and then **Settings**.
- 2) To save, in the third menu, select **Save**. Once you select **Save** you should not remove the USB stick right away. Depending on the USB stick it might take up to 5 seconds to complete.
 - a) In the fourth menu, select either saving to a USB stick or saving locally.
- 3) To restore, in the third menu, select **Restore**.
 - a) In the fourth menu, select either restoring from a USB stick or restoring from a list of files.

6.7 Diagnostics

The **Diagnostics** menus help you to monitor the performance of the Remote Station and diagnose possible system issues.

6.7.1 Viewing powerline information and status

To view line information and status:

- 1) In **Menu mode**, select **Diagnostics** and then **Powerlines**.
- 2) From the third menu, select Powerline 1.
- 3) The fourth menu displays the status and other measures / information for the powerline. The status of the powerline is either **Ok** [operating normally], **Busy** or **Error**.

For more details of the information displayed, see **21 Menu maps**.

Note: Powerline status is also indicated by the powerline LEDs on the front panel.

Green LED = **Ok**

Amber LED = **Busy**

Red LED = **Error**

For more information about powerline diagnostics, see **24 Troubleshooting**.

6.7.2 Viewing network information

To view network status information:

- 1) In **Menu mode**, select **Diagnostics** and then **Network**.
- 2) To view status information about the powerline:
 - a) From the third menu, select **Powerline**.
 - b) On the fourth menu, the IP address is given.
- 3) To view status information about the Ethernet:
 - a) From the third menu, select **Ethernet**.
 - b) On the fourth menu, the IP address is given.

6.7.3 Viewing keyset information

To view information about the keysets:

- 1) In **Menu mode**, select **Diagnostics** and then **Keysets**.
- 2) From the third menu, select a keyset from 1 to 4.
- 3) The fourth menu displays the following status information:
 - **Name** – The channel name
 - **Talkers** – The number of talkers on the partyline
 - **Main Stations** – The number of Main Stations listening
 - **Beltpacks** – The number of beltpacks listening on the partyline
 - **Remote** – The number of Remote Stations listening
 - **Speaker** – The number of Speaker Stations listening.
 - **2-Wire** – The number of 2-wire ports listening
 - **4-Wire** – The number of 4-wire ports listening

6.8 Setting up a key Expansion Group

See 5.9 Setting up a key Expansion Group

7 Using the Main Station/Remote Station

This chapter describes how to use the Main Station/Remote Station, after your HelixNet Partyline system has been installed and configured.

For more information about integrating and using HelixNet Partyline with your existing intercom infrastructure, see **3 Installing HelixNet Partyline**.

Tip: For a quick reference to the functionality of the HMS-4X Main Station, the optional interface modules and the HBP-2X Beltpack, see **2 Panels and Interfaces**.

7.1 Using the gooseneck mic, loudspeaker and headset

To use a **gooseneck mic** to talk to connected intercom users, devices (including HBP-2X beltpacks) and systems:

- 1) Connect the gooseneck mic, using the gooseneck mic connector (3-pin female Tüchel connector) on the left of the front panel.

Note: For the location of the gooseneck mic connector, see  in **Table 2-3 Key to Main Station/Remote Station front panel** diagram.

- 2) To talk to other intercom users and devices:
 - a) Press the appropriate **Talk key**

When the mic (gooseneck or headset) is live, the **Mic On key** is activated automatically.

- b) Speak into the mic.

Use the front panel **loudspeaker** to listen to connected intercom users, devices and the Program Feed.

To adjust the volume level:

- 3) Adjust the volume of all incoming audio by turning the loudspeaker rotary control [**Main**], located to the left of the loudspeaker.

Adjust the volume of the Program Feed in **relation to** the overall volume level by turning the auxiliary loudspeaker rotary control [**Prog**], located to the right of the loudspeaker. The **Prog** volume control is subordinate to the **Main** volume control.

To increase the volume level, turn the **rotary control(s)** clockwise. To decrease the volume level, turn the **rotary control(s)** counter-clockwise.

Note: When you connect a headset, incoming audio is routed to the headset instead of the loudspeaker.

As you increase or decrease the volume, the level control LEDs pass through a range of indicator colors:

LED color	Volume level
Green	Low
Amber / Green	Low / Medium
Amber	Medium
Red / Amber	Medium / High
Red	High

Table 7-1: Loudspeaker volume indicator colors

To use a **headset** to talk and listen to connected intercom users, devices and systems:

- 1) Connect the headset, using the headset connector (4-pin XLR-M) on the far left of the front panel.

The **Headset key** is automatically activated. Incoming audio is routed to the headset instead of the loudspeaker.

Note: For the location of the headset connector and the headset key, see **B E** in **Table 2-3 Key to Main Station/Remote Station front panel** diagram.

To configure audio settings for the headset, see **5.2.1 Audio settings for the headset**.

- 2) To talk to other intercom users and devices:
 - a) Press the appropriate **Talk key**.

When the microphone (gooseneck or headset) is live, the **Mic On key** is activated automatically.

- b) Speak into the microphone.

- 3) To adjust the volume level of incoming audio to the headset:
 - a) Adjust the volume of all incoming audio by turning the loudspeaker rotary control **[Main]**. The control is located to the left of the loudspeaker.
 - b) Adjust the volume of the Program Feed in **relation to** the overall volume level by turning the auxiliary loudspeaker rotary control **[Prog]**. The control is located to the right of the loudspeaker.

The **Prog** volume control is subordinate to the **Main** volume control.

7.1.1 Switching between the headset mic and the gooseneck mic

When both a Headset microphone and a gooseneck microphone are connected, press the **Headset key** to activate the headset mic.

Press the **Headset key** again to switch to the gooseneck mic (and deactivate the headset mic).

Tip: *To find out more about Clear-Com accessories, including headsets and gooseneck microphones, see <http://www.clearcom.com/product/accessories>.*

7.2 Entering and exiting Menu mode

Use **Menu mode** to:

- Configure the settings for the Main Station, including channel and audio settings.
- Administrate the system, monitor system performance and diagnose system issues.
- Perform software updates.

In **Menu mode**, the display screens display the four levels of menu. The menu hierarchy proceeds left to right:

- The **top level** menu is presented in the first screen (furthest left on the front panel).
- The **lowest level** menu is presented in the fourth screen (furthest right on the front panel).

To place the Main Station in **Menu mode**, press the **Menu key** to the left of the first (left) display screen. To exit Menu mode, do either of the following:

- Press the **Menu key** again.
- Wait until Menu mode times out. If you fail to press any key on the front panel for 20 seconds, the display screens revert to showing the standard channel information, see **Table 2-5 Main Station/Remote Station display icons and indicators**.

Tip: For more detailed information about using the Main Station menus, see **15 Linking in the Core Configuration Manager (CCM)**.

Main Stations can be linked from the CCM. Each Main Station has 12 Channels with the option of licensing 12 more (24 in total). When linking Main Stations, Channels with the same number are merged together into one Channel. Linking Main Stations will also have the effect of increasing your I/O and device module options (more beltpacks and a larger area covered).

Note: Linked Main Stations should have the same amount of licensed channels. If you link a 24 Channel device to a 12 Channel device the system will default to 12 Channels only. To buy a license for more Channels see 5.8.1 License.

Main Stations can still be linked from the device menus. See 12 Linking Main Stations.

7.3 A HelixNet Link-Group Overview

- A HelixNet Link-Group can contain up to three Main Stations. More is possible but not advised.
- A Link-Group must have one device designated as Link-Master.
- The Link-Group performs a “best effort” approach to creating a mesh network between all the devices within the group.

A Mesh Network

Once joined to the Link-Group, all devices attempt to connect to all other devices within the group.

- Configuration and control of any device is possible through any other unit in the group
- Configuration information is both distributed and persisted within every node of the group
- Significantly reduces loss of service

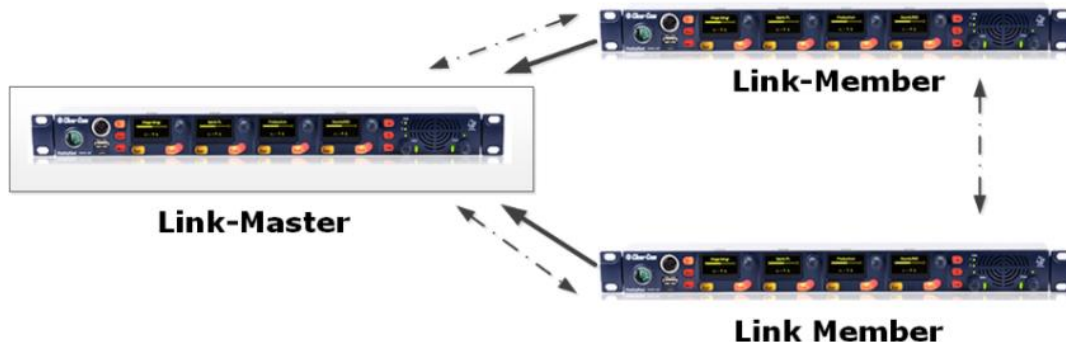


Figure 7-1 A Link-Group

7.3.1 The Link-Master

The Link-Master designation serves three main purposes:

- 1) It facilitates Link-Group membership.
- 2) It is the owner of configured Role information, meaning that Roles will only persist (be maintained consistently) if the Link-Master is operational.

- 3) It is responsible for the synchronization and distribution of both configuration (Roles) and device availability status throughout the Link-Group.

Note: Clear-Com recommends that the IP address of the Link-Master is allocated statically. When allocated by DHCP, the IP address can change. If this happens the Link-Members will no longer be able to reach the Link-Master device, and Role information may not be persisted.

Note: Any device can be set to Link-Master or Link-Member. The default setting for HelixNet linking mode is **Linking Disabled**. This setting stops the device from broadcasting its name to the network (via its mDNS index).

Note: Linked Main Stations need 2 – 5 Mbps of bandwidth.

7.3.2 The Link-Members

HelixNet devices that are not identified as master will have the designation of Link-Member. Joining a device to a Link-Group requires that device to be set to Link-Member which will prompt the user to enter the IP address of the Link-Master.

7.4 Device configuration in the CCM

Note: Any IP connectivity requires an Ethernet or Fiber module fitted to the Main Station.

Once the units have joined a Link-Group, the devices can be configured either directly or by proxy. The host device is the unit which a browser is currently directed to.

The **Home** button will always take you to the host device's configuration page.

- Proxy configuration can be accomplished by clicking on any device within the **Overview** page.

Once connected, Main stations in a Link-Group can be configured from any unit

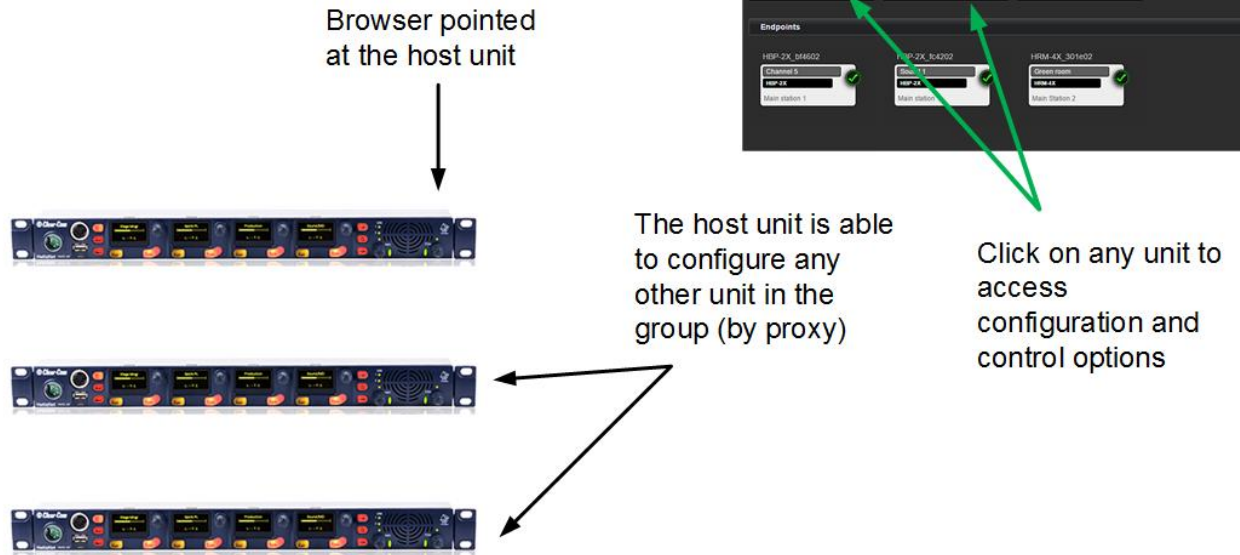


Figure 7-2 Host device concept

Note: The host device will always have an orange highlight in the CCM.

7.5 Linking Main Stations in the CCM

Main Stations to be linked in the CCM must first be connected by cable as described in Chapter 3. Installation and Chapter 12, Linking Main Stations.

In order to create a Link-Group in the CCM, you must designate one unit as Link-Master. The other units are designated Link-Member and are joined to the Master via the Master's IP address. This is achieved in the **Linking** page of each unit.

- 1) From a browser, access the CCM of HelixNet Main Station #1 by typing its IP address into the URL field.

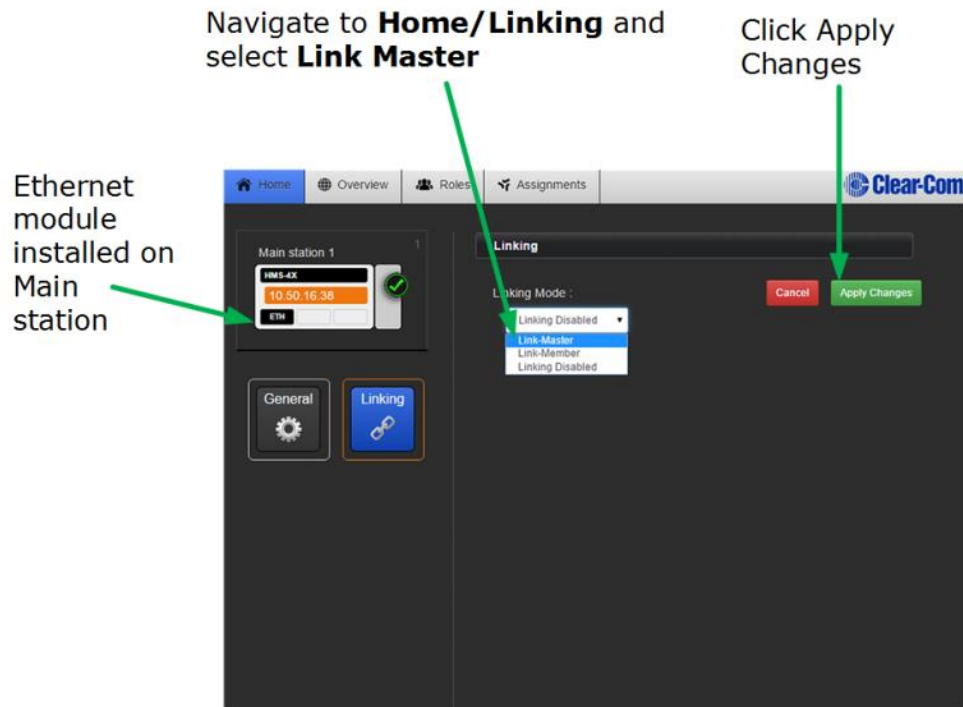
Default login and password for the CCM: **admin, admin.**

Note: The unit's IP address can be found in the device's display screens: **Menu > Networking > Preferences > IP address.**

Note: The Link-Master IP must be statically allocated to prevent loss of service.

- 2) Navigate to **Home > Linking** in the CCM. From the drop-down box select **Link-Master** and click **Apply Changes**. This designates this unit as Link-Master.

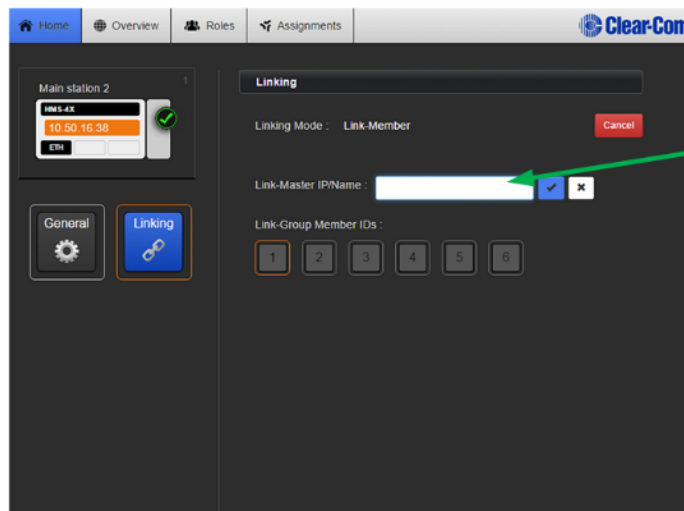
Note: The default linking mode is: **Linking Disabled**.



- 3) From a new browser window, access the CCM of device #2 by typing the unit's IP address into the URL field.

You will have to enter the password and login for the device (Default, **admin, admin**)

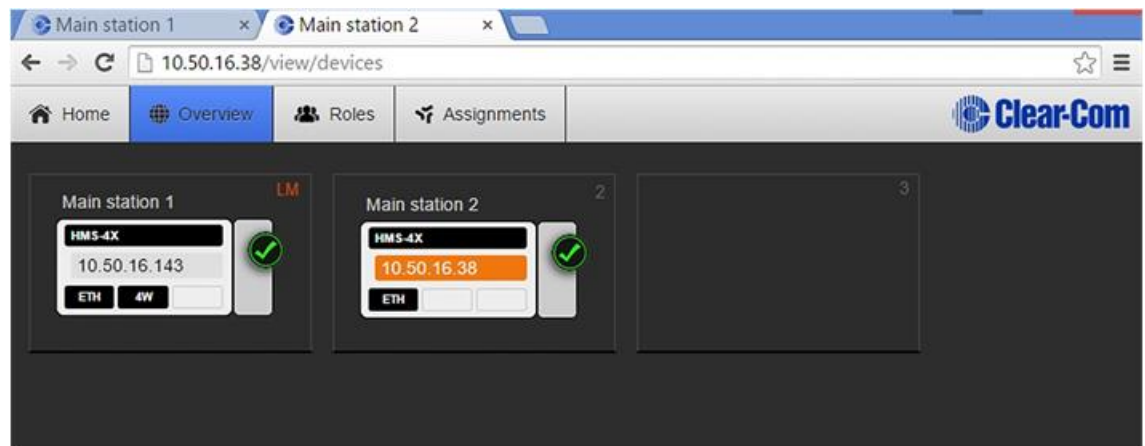
- 4) Navigate to **Home > Linking** and select Link-Member from the drop down box.
- 5) You will be prompted for the IP address of the Link-Master. Within the Master IP address field, enter the IP address of device #1. Click on blue check mark or <ENTER> key to submit.



Input Link Master IP or name

Either accept the default **Link Group Member ID** (orange highlight) or select a new one by clicking on it. Click **Apply Changes**. This links this device to the Link Master.

- 6) Navigate to the **Overview** page (top navigation bar). Both HelixNet devices should be displayed on this page.



- 7) Repeat steps 3) to 6) for a third device if required.

Tip: Configuring and managing the Main Station.

7.6 Using the channel keysets

A keyset (set of controls) is located next to each of the four display screens. In operating mode, each keyset is dedicated to the control of one of the four supported intercom channels. For details of the standard on screen information for each channel, see **Table 2-5 Main Station/Remote Station display icons and indicators**.

Note: To change (edit) the channel label (name), see **5.4.1 Editing the channel label**.

The display screens enter screensaver mode (if enabled) if the Main Station remains inactive for 10 minutes. Press any key to leave screensaver mode.

To send a **call signal** to all the connected devices on that channel, press the **Call key**.

To **talk** to all the devices on that channel:

- 1) Press the **Talk key**. When the gooseneck or headset mic is live, the **Mic On key** is activated automatically.
- 2) Speak into the headset or gooseneck mic (see also **7.1 Using the gooseneck mic, loudspeaker and headset**).

To **adjust the volume** of incoming audio, turn the **rotary control**. Turn the rotary control clockwise to increase the volume, and counter-clockwise to decrease volume. The current volume level is shown on screen.

To **mute** incoming audio, press the **rotary control**. The display screen displays the muted volume bar.

To **unmute** incoming audio (restoring the audio to its previous volume level), press the **rotary control** again.

Note: In **Menu mode**, the **rotary control** for each channel keyset is used to scroll and select menu items. For more information, see **5.1 Using the Menus**.

7.7 Using the All Talk key

To talk to all connected intercom users, devices and systems, **excluding** the SA (*Stage Announce*) facility:

- 1) Press the **All Talk key** to the right of the fourth (last) display screen. **Talk keys** for all channels are activated automatically. When the mic (gooseneck or headset) is live, the **Mic On key** is also activated automatically.
- 2) Speak into the headset or gooseneck mic (see also **7.1 Using the gooseneck mic, loudspeaker and headset**).

Note: **All Channels** will enable you to talk to 12 (or 24, according to license) Channels. **Visible Channels** will enable you to talk to the four Channels visible in the menu screens of your device.

7.8 Using the SA [Stage Announce] key

Use the **SA [Stage Announce] key** to speak to an attached SA or Public Address system (sometimes simply a loudspeaker within the studio, theater or event area). To make a studio / public announcement:

- 1) Press the **SA key** to the right of the fourth (last) display screen.
When the mic (gooseneck or headset) is live, the **Mic On key** is also activated automatically.
- 2) Speak into the headset or gooseneck mic (see also **7.1 Using the gooseneck mic, loudspeaker and headset**).

7.9 Using the RMK [*Remote Mic Kill*] key

Note: The RMK key is only present on the HelixNet Main Station. The Remote Station has instead an OPT key which is non-functional.

Use the RMK [*Remote Mic Kill*] key to:

- Send a message to all connected HelixNet Partyline devices to deselect any latched (active) **Talk keys**.
- Turn off any latched **Talk keys** on connected analog partyline beltpacks and stations.

Note: **All Channels** will turn off Talk keys on 12 (or 24 according to license) Channels. **Visible Channels** will turn off Talk keys on the four Channels you can see on the front of the device.

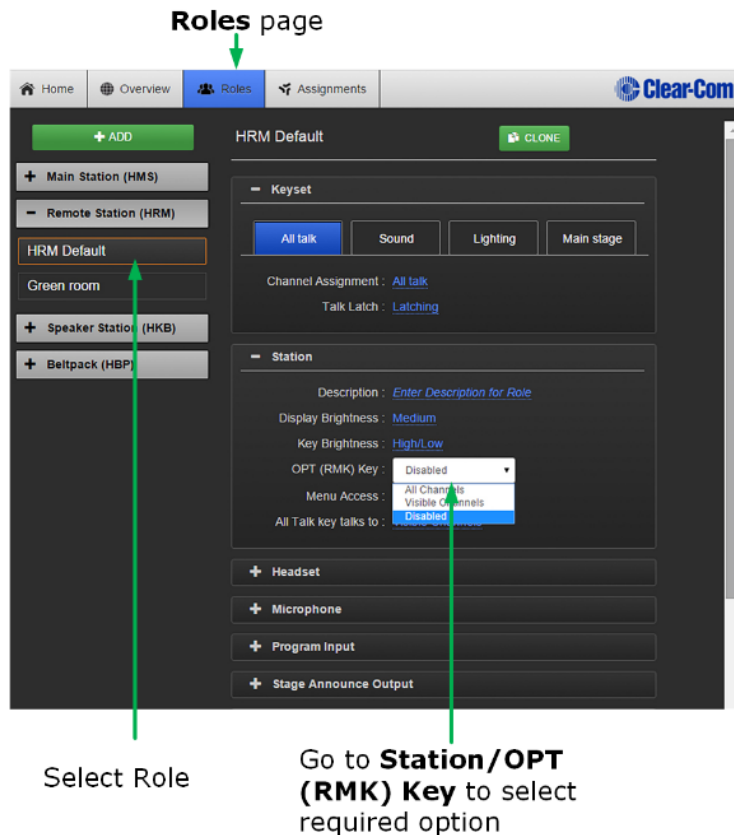
Note: The OPT key can be used in HelixNet 3.0 and above. The Remote Station must have a Role selected to use this function. To enable the key, navigate to the **Roles** page in the CCM, the browser-based configuration tool served by your device.

To enable the OPT (RMK) key on a Remote Station:

- 1) Input the IP address of your device into the URL field on a browser. The IP address is found in the 4th screen on the front of your device: **MENU > Networking > Preferences > IP address.**

Default Username and Password for the CCM: **admin, admin.**

- 2) This takes you to the **Overview** page in the Core Configuration Manager (CCM). Navigate to **Roles > Remote Station > Role > Station > OPT (RMK) Key** in the CCM and select the option by clicking on it.



- 3) Select required option: **All Channels** to activate RMK on 12 or 24 Channels, **Visible Channels** to activate RMK on the Channels visible on your device only, or **Disabled** (default setting).

Enabling this option in the CCM takes effect immediately on your system, provided the Role is selected on your device. For more information on Roles see 12 Roles.

7.10 Line 1 and 2 LEDs

Note: This section only applies to the HelixNet Main Station.

The HBP-2X beltpacks, Remote Stations and Speaker Stations are connected by one of the two lines to the Main Station.

The color of the **Line 1 and Line 2 LEDs** to the left of the front panel loudspeaker indicate the service status of each powerline:

- **Green** LED = **Ok**.
- **Amber** LED = **Busy**.
- **Red** LED = **Error**.

For more information:

- About the service status of Lines 1 and 2, see **5.8.3 Viewing powerline information and status**.
- About monitoring system performance and diagnosing system issues on the Main Station, see **5.8 Diagnostics**.

7.11 Line and LAN LEDs

Note: This section only applies to the HelixNet Remote Station and Speaker Station.

The Remote Station has a line LED that indicates the status of a powerline connection to the Main Station. The LAN LED indicates the status of the Ethernet connection, if present.

The color of the **Line and LAN LEDs** to the left of the front panel loudspeaker indicate the service status of each powerline:

- **Green** LED = **Ok**.
- **Amber** LED = **Busy**.
- **Red** LED = **Error**.

8 **Configuring and managing the Speaker Station from device menus**

This chapter describes how to configure the settings and manage the Speaker Station using **Menu mode**. It also shows you how to monitor and diagnose performance issues, using the **Diagnostics** menus.

Tip: For a quick reference to the Speaker Station menus, see **21 Menu maps**.

For general information about using the menus and configuring settings, see **5.1 Using the Menus**.

There is a next and a back activated by pressing the rotary encoders (right one for next, left one for back). There are two levels of the menu, one on the left screen and one on the right. Next and back shifts the menu by one level down or up.

8.1 **Using the Menus**

To place the Speaker Station in **Menu mode**, press the **Menu key**. The Speaker Station menus appear in the display screens.

Note: The **Speaker Station** menu comes up in the **Roles** menu by default.

Note: If Menu mode is **locked**, you must unlock the menus from CCM before you can enter the menu. See **section 6**.

8.1.1 **Configuring settings**

To configure settings:

- 1) For each menu, turn the **rotary control** to scroll the menu items. Turn the rotary control:
 - Counter-clockwise to scroll up the menu items.
 - Clockwise to scroll down the menu items.

To return to the previous level of menu, press the **left-hand rotary key**.

To go to the next level of menu, press the **right-hand rotary key**.

Selected menu items are highlighted in solid yellow.

- 2) When you have selected a setting, press the **right-hand rotary key** to enable the setting on the Speaker Station.

8.1.2 **Exiting Menu mode**

To exit **Menu mode** do either of the following:

- Press the **Menu** key.

- Wait until Menu mode times out. If you fail to press any key on the Speaker Station for 20 seconds, the display screen reverts to showing the standard channel information.

8.2 Configuring the Audio settings

8.2.1 Audio settings for the headset

To configure the audio settings for the headset, see **5.2.1 Audio settings for the headset**.

8.2.2 Audio settings for the microphone

To configure the audio settings for the microphone, see **5.2.2 Audio settings for the microphone**.

8.2.3 Audio settings for the Front Panel

To configure the audio settings for the front panel, see **5.2.7 Audio settings for the Front Panel**.

8.3 Station Settings

8.3.1 Setting Keypad Assignments

To configure the Keypad Assignments settings, see **5.3.2 Setting Keypad Assignments**.

8.3.2 Setting key latching

To configure key latching, see **5.3.3 Setting key latching**.

You can also configure key latching so that the Talk keys automatically unlatch whenever the Shift key is pressed. To do so:

- 1) In Menu mode, select **Station Settings** and then **Keypads**.
- 2) From the third menu, select **Unlatch on Shift**.
- 3) From the fourth menu select:
 - Enabled (default)
 - Disabled

8.3.3 Setting display screen brightness

To configure display screen brightness, see **5.3.7 Setting display screen brightness**.

8.3.4 **Setting key brightness**

To configure key brightness, see **5.3.8 Setting key brightness**.

8.3.5 **Setting the screensaver**

To configure the screensaver, see **5.3.9 Setting the screensaver**.

8.4 **Connecting the Speaker Station to a Main Station**

To connect the Speaker Station to a Main Station, see **6.5 Connecting the Remote Station to a Main Station using** .

8.5 **Module Settings**

See **5.6 Configuring Module Settings**

8.6 **Administration**

8.6.1 **Viewing the current versions of the software**

To view the current version of the software, see **6.6.1 Viewing the current versions of the software**.

8.6.2 **Updating the software**

To update the software, see **6.6.2 Updating the software**.

Note: You can only update the Speaker Station software from the Main Station.

8.6.3 **Resetting the Speaker Station to default (factory mode) settings.**

To reset the Speaker Station to its default (factory mode) settings see:

- 1) In **Menu mode**, select **Administration** and then **Reset**.
- 2) The third menu displays a selected menu item: **Reset to Default**.
- 3) In the fourth menu, select **Reset Now**.

8.6.4 **Manually rebooting the Speaker Station**

To manually reboot the Speaker Station:

- 1) In **Menu mode**, select **Administration** and then **Reset**.
- 2) The third menu select **Reboot**.

3) In the fourth menu, select **Reboot Now**.

When the **rotary control** is pressed, the display changes to **Rebooting ...** for 2 seconds, and then the Speaker Station reboots.

8.7 Diagnostics

8.7.1 Viewing powerline information and status

To view powerline information and status, see **6.7.1 Viewing powerline information and status**.

8.7.2 Viewing network information

To view network information, see **6.7.2 Viewing network information**.

8.7.3 Viewing keysets information

To view key sets information, see **6.7.3 Viewing keyset information**.

9 Using the Speaker Station

This chapter describes how to use the Speaker Station, after your HelixNet Partyline system has been installed and configured.

For more information about integrating and using HelixNet Partyline with your existing intercom infrastructure, see **3 Installing HelixNet Partyline**.

9.1 Using the gooseneck mic, loudspeaker and headset

To use a **gooseneck mic** to talk to connected intercom users, devices (including HBP-2X belt packs) and systems:

- 1) Connect the gooseneck mic, using the gooseneck mic connector (3-pin female Tichel connector) on the left of the front panel.

Note: For the location of the gooseneck mic connector, see **Table 2-24 Key to Speaker Station front panel**

- 2) To talk to other intercom users and devices:
 - a) Press the **Talk key**.

When the mic (gooseneck or headset) is live, the **Mic** key is activated automatically.

- b) Speak into the microphone.

Use the front panel **loudspeaker** to listen to connected intercom users, devices and the Program Feed.

To adjust the volume level:

- 3) Adjust the volume of all incoming audio by turning the loudspeaker rotary control **[Main]**, located in the center of the panel.

To increase the volume level, turn the **rotary control(s)** clockwise. To decrease the volume level, turn the **rotary control(s)** counter-clockwise.

Note: When you connect a headset, incoming audio is routed to the headset instead of the loudspeaker.

As you increase or decrease the volume, the level control LED passes through a range of indicator colors:

LED color	Volume level
Green	Low
Amber / Green	Low / Medium
Amber	Medium
Red / Amber	Medium / High
Red	High

Table 9-1: Loudspeaker volume indicator colors

To use a **headset** to talk and listen to connected intercom users, devices and systems:

- 4) Connect the headset, using the headset connector (4-pin XLR-M) on the far left of the front panel.

The **Headset key** is automatically activated. Incoming audio is routed to the headset instead of the loudspeaker.

Note: For the location of the headset connector and the headset key, see **Table 2-24 Key to Speaker Station front panel** Table 2-3 Key to Main Station/Remote Station front panel diagram.

To configure audio settings for the headset, see **8.2.1 Audio settings for the headset**

- 5) To talk to other intercom users and devices:
 - a) Press the appropriate **Talk key**.

When the microphone (gooseneck or headset) is live, the **Mic key** is activated automatically.

- b) Speak into the microphone.

- 6) To adjust the volume level of incoming audio to the headset:
 - a) Adjust the volume of all incoming audio by turning the loudspeaker rotary control **[Main]**. The control is located to the left of the loudspeaker.
 - b) Adjust the volume of the Program Feed using the **PGM** rotary control.

9.1.1 Switching between the headset mic and the gooseneck mic

When both a Headset microphone and a gooseneck microphone are connected, press the **Headset key** to activate the headset microphone, and press the **Mic** key to activate the microphone.

Tip: To find out more about Clear-Com accessories, including headsets and gooseneck microphones, see <http://www.clearcom.com/product/accessories>.

9.2 Entering and exiting Menu mode

Use **Menu mode** to:

- Configure the settings for the Speaker Station, including channel and audio settings.
- Administrate the system, monitor system performance and diagnose system issues.

In **Menu mode**, the display screens display the four levels of menu. The menu hierarchy proceeds left to right:

- The **top level** menu is presented in the first screen (left on the front panel).
- The **second level** menu is presented in the second screen (right on the front panel).

To place the Speaker Station in **Menu mode**, press the **Menu key** to the left of the first (left) display screen. To exit Menu mode, do either of the following:

- Press the **Menu key** again.
- Wait until Menu mode times out. If you fail to press any key on the front panel for 20 seconds, the display screens revert to showing the standard channel information:
 - Channel label (name).
 - Listen (volume) level.

Tip: For more detailed information about using the Main Station menus, see **5 Configuring and managing the Main Station from device menus**.

This chapter describes how to use the Main Station/Remote Station, after your HelixNet Partyline system has been installed and configured.

For more information about integrating and using HelixNet Partyline with your existing intercom infrastructure, see **3 Installing HelixNet Partyline**.

Tip: For a quick reference to the functionality of the HMS-4X Main Station, the optional interface modules and the HBP-2X Beltpack, see **2 Panels and Interfaces**.

9.3 Using the channel keysets

A keyset (set of controls) is located next to each of the four display screens. In operating mode, each keyset is dedicated to the control of one of the four supported intercom channels. For details of the standard on screen information for each channel, see **Table 2-5 Main Station/Remote Station display icons and indicators**.

Note: To change (edit) the channel label (name), see **3.4.1 Editing the channel label**.

The display screens enters screensaver mode (if enabled) if the Main Station remains inactive for 10 minutes. Press any key to leave screensaver mode.

To send a **call signal** to all the connected devices on that channel, press the **Call key**.

To **talk** to the all the devices on that channel:

- 1) Press the **Talk key**. When the gooseneck or headset mic is live, the **Mic On key** is activated automatically.
- 2) Speak into the headset or gooseneck mic (see also **5.1 Using the gooseneck mic, loudspeaker and headset**).

To **adjust the volume** of incoming audio, turn the **rotary control**. Turn the rotary control clockwise to increase the volume, and counter-clockwise to decrease volume. The current volume level is shown on screen.

To **mute** incoming audio, press the **rotary control**. The display screen displays the muted volume bar.

To **unmute** incoming audio (restoring the audio to its previous volume level), press the **rotary control** again.

Note: In **Menu mode**, the **rotary control** for each channel keyset is used to scroll and select menu items. For more information, see **3.1 Using the Menus**.

9.4 Line and LAN LEDs

The Speaker Station has a line LED that indicates the status of a powerline connection to the Main Station. The LAN LED indicates the status of the Ethernet connection, if present.

The color of the **Line and LAN LEDs** to the left of the front panel loudspeaker indicate the service status of each powerline:

- **Green** LED = **Ok**.
- **Amber** LED = **Busy**.
- **Red** LED = **Error**.

10 **Configuring and managing the HBP-2X Beltpack from device menus**

This chapter describes how to configure the settings and manage the HBP-2X Beltpack using **Menu mode**. It also shows you how to monitor and diagnose performance issues, using the **Diagnostics** menus.

Tip: For a quick reference to the Main Station menus, see **21 Menu maps**.

10.1 **Using the Menus**

To place the beltpack in **Menu mode**, press the **Menu key** on the top of the beltpack.

Note: The **Beltpack** menu shows the **Roles** menu by default.

Note: If Menu mode is **locked** on the beltpack, you must unlock the menus from CCM before you can enter the menu. See **section 6**.

To enter the menu mode from the Roles screen, press the left hand Call button.

10.1.1 **Configuring settings**

To configure settings:

- 1) For each menu, turn either of the side-mounted **rotary controls** to scroll the menu items. Turn the rotary control:
 - Counter-clockwise to scroll up the menu items.
 - Clockwise to scroll down the menu items.

Off-screen menu items are indicated with arrows at the top and / or bottom of the display screen.

Back (with an arrow pointing **left**) indicates a previous level of menu.

To return to the previous level of menu, press the **left-hand Call key**.

An arrow pointing **right** indicates another level of menu under that menu item.

To go to the next level of menu, press the **right-hand Call key**.

Selected menu items are highlighted in solid yellow.

- 2) The final level of menu (the second or third display screen) displays the settings that relate to your previous menu choices (system features or functionality).

The **current setting** is indicated by a dotted box around the menu item

When you have selected a setting, press the **right-hand Call key** to enable the setting on the Main Station.

10.1.2 Exiting Menu mode

To exit **Menu mode** on the beltpack, do either of the following:

- Press the Menu key.
- Wait until Menu mode times out. If you fail to press any key on the beltpack for 20 seconds, the display screen reverts to showing the standard channel information.

10.2 Configuring the Role settings

To configure the Role settings for the headset

- 1) In **Menu mode** press the left-hand Call Key and then select **Roles**.
- 2) Select the required Role.
- 3) To confirm the selected setting, press the **right-hand Call key**.
- 4) The beltpack applies the setting and reverts to the standard display screen.

10.2.1 Viewing Hostname

The hostname (the unique name given to any device on a network) of your beltpack can be seen in the Roles section of the menu.

To view the hostname for your beltpack:

- 1) In **Menu mode** press the left-hand Call Key and then select **Roles**.
- 2) The device's hostname can be seen at the top of the list of available Roles.

Note: You cannot change the hostname from this screen. The hostname for beltpacks must be change from the web based Core configuration Manager (the CCM). From the **Overview** page of the CCM, click on any device image to access configuration details for that device's hostname.

10.3 Configuring the Audio settings

To configure the audio settings for the headset:

- 1) In **Menu mode** press the left-hand Call Key and then select **Audio Settings**.
- 2) To adjust sidetone gain on the headset:

- a) Select Sidetone Gain.
- b) Select one of the following:
 - 0dB
 - - 6dB
 - -12dB (default)
 - -18dB

c) To confirm the selected setting, press the **right-hand Call key**.

Go back to the previous menu level by pressing the **left-hand Call key**.

- 3) To limit the maximum audio level that can be delivered to the headphones:

- a) Select Headphone Limit.
- b) Select one of the following:
 - Off
 - +6dB
 - 0dB (default)
 - - 6dB

c) To confirm the selected setting, press the **right-hand Call key**.

Note: When Headphone Limit is set to anything except **Off**, a LIM indication will show up at the top right of the display

Go back to the previous menu level by pressing the **left-hand Call key**.

- 4) Sidetone tracking means that the sidetone level varies according to the main volume level. To set (or disable) sidetone tracking on the headset:
 - a) Select Sidetone Control.
 - b) Select one of the following:
 - Tracking (default)
 - Non-Tracking
 - Disabled

c) To confirm the selected setting, press the **right-hand Call key**.

Go back to the previous menu level by pressing the **left-hand Call key**.

- 5) To set the type of mic on the headset:
 - a) Select **HS Mic Type**.
 - b) Select either of the following types of mic.
 - Electret (-15 dB)
 - Dynamic (0 dB) (default)
 - Dynamic (-10 dB)

Note: In electret mode, phantom power is provided for an electret mic. In dynamic mode, no phantom power is provided. Mic input levels are also adjusted between the different modes to suit the different mic types.

 - c) To confirm the selected setting, press the **right-hand Call key**.

10.4 Audio settings for the microphone

To configure the audio settings for the microphone:

- 1) In Menu mode, select **Audio Settings** and then **Microphone**.
- 2) To select the Headroom:
 - a) From the third menu, select **Headroom**.
 - b) From the fourth menu, select one of the following:
 - Normal (default)
 - High
- 3) To enable or disable the Contour Filter:
 - a) From the third menu, select **Contour Filter**
 - b) From the fourth menu, select one of the following:
 - Enabled (default)
 - Disabled

10.5 Configuring the Beltpack Settings

In **Menu mode > Beltpack Settings**, you can:

- Assign channels to the left and right beltpack keysets (set of controls).
- Enable (or disable) **Talk key** latching.
- Enable (or disable) beltpack vibration when a call signal is received.
- Enable (or disable) the USB flasher mode for the beltpack.

Tip: For a quick reference to the keysets on the HBP-2X Beltpack, see **2.5.1 HBP-2X user controls (front and side view)**.

10.5.1 Assigning channels

You can assign any two available channels to the beltpack (including the same channel to both keysets).

To assign a channel:

- 1) In Beltpack Settings select Left Channel or Right Channel.
- 2) Select one of the available channels (or none):
- 3) To confirm the selected setting, press the **right-hand Call key**.

10.5.2 Setting Talk key latching

To enable (or disable) **Talk key** latching:

- 1) In Beltpack Settings select Right Talk Latch or Left Talk Latch
- 2) Select one of the following:
 - Latching (default)
 - Non-Latching
 - Disabled

Note: The setting applies to both channels on the beltpack.

- 3) To confirm the selected setting, press the **right-hand Call key**.

10.5.3 Setting USB Flasher mode

To enable (or disable) **USB Flasher** mode

- 1) In Beltpack Settings select either Left Keypad or Right Keypad
- 2) Select USB Flasher
- 3) Select one of the following:
 - Disabled (default)
 - Blinking
 - Solid
- 4) To confirm the selected setting, press the **right-hand Call key**.

10.5.4 Setting the beltpack to vibrate when called

To enable (or disable) vibration when a **Call signal** is received:

- 1) In Beltpack Settings select Vibrate on Call.
- 2) Select one of the following:
 - On
 - Off (default)
- 3) To confirm the selected setting, press the **right-hand Call key**.

10.6 Configuring the Display Settings

In **Menu mode > Display Settings**, you can:

- Set the brightness of the display screen.
- Set the brightness of the **Talk** and **Call** keys.
- Enable (or disable) the screensaver.
- Rotate the display.

10.6.1 Setting display screen brightness

By default, the display screen is set to **medium** brightness. To set the brightness of the display screen:

- 1) In **Menu mode**, press the left-hand Call Key and then select **Display Settings**.
- 2) Select OLED Brightness.
- 3) Select one of the following:
 - High
 - Medium (default)
 - Low
- 4) To confirm the selected setting, press the **right-hand Call key**.

10.6.2 Setting the brightness of the Talk and Call keys

By default, the **Talk** and **Call keys** are lit when **active (on)** and dim when **inactive (off) (High / Low)**.

To set the brightness of the Talk and Call keys:

- 1) In **Menu mode**, press the left-hand Call Key and then select **Display Settings**.
- 2) Select Key Brightness.
- 3) Select one of the following brightness settings:

Key(s)	Description
High / Low (default)	Keys are brightly lit when active (on) and dim when inactive (off).
High / Off	Keys are lit when active (on) and are unlit when inactive (off).
Low / Off	Keys are lit dim when active (on) and are unlit when inactive (off).
Off / Off	Keys are unlit, whether or not they are active (on) or inactive (off).

Table 10-1: Setting the brightness of the Talk, Call and Menu keys

- 4) To confirm the selected setting, press the **right-hand Call key**.

10.6.3 Set Rotate Display

You can set the backpack display to rotate according to its physical position.

- 1) In **Menu mode**, press the left-hand Call Key and then select **Display Settings**.
- 2) Select **Rotate Display**.
- 3) Select one of the following:
 - Enabled
 - Disabled (default)

10.6.4 Setting the screensaver

The screensaver is displayed on screen after 10 minutes of inactivity on the backpack. To enable (or disable) the screensaver:

- 1) In **Menu mode**, press the left-hand Call Key and then select **Display Settings**.
- 2) Select **Screensaver**.
- 3) Select one of the following:
 - Channel Name (default)

- Hostname
- Role Name
- Blank
- Disabled

4) To confirm the selected setting, press the **right-hand Call key**.

10.7 Administration

In **Menu mode > Administration**, you can:

- View the IP address for the network.
- View the current version of the software on the beltpack.
- Reset the beltpack to default (factory mode) settings.

*The beltpacks receive updated (default) channel label information. Other local beltpack settings will **not** be reset if the Main Station is reset to default settings.*

10.7.1 Viewing the IP address

To view the IP address for the network:

- 1) In **Menu mode**, press the left-hand Call Key and then select **Administration**.
- 2) Select **Network**.
- 3) The IP address for the network is displayed. The IP address appears similar to the following example:

10.0.0.1

To view the current version of the software on the beltpack:

- 1) In **Menu mode**, press the left-hand Call Key and then select **Administration**.
- 2) Select Software Version.
- 3) The current version of the software is displayed. The software version information will appear similar to the following example:

np1-**x.x.xx.xxxx**, uboot

Where **x** is a numerical value.

10.7.2 Resetting the beltpack to default (factory mode) settings

To reset the beltpack to default (factory mode) settings:

- 1) In **Menu mode**, press the left-hand Call Key and then select **Administration**.
- 2) Select Reset to Default.
- 3) **Reset Now** is displayed (shown as selected). To reset the beltpack, press the **right-hand Call key**.

10.8 Diagnostics

The **Diagnostics** menus help you to monitor the performance of the beltpack and diagnose possible system issues.

10.8.1 Viewing information about the hardware (main PCB) on the beltpack

To view information about the **Part**, **Revision** and **Serial number** of the main PCB on the beltpack:

- 1) In **Menu mode**, press the left-hand Call Key and then select **Diagnostics**.
- 2) Select Hardware > Main PCB.

The **Part**, **Revision** and **Serial number** for the PCB are displayed. The format is similar to the following:

```
Part xxxxxxx  
Revision: x  
Serial: x
```

Where **x** is a numerical value.

10.8.2 Viewing powerline information and status

To view powerline information and status:

- 1) In **Menu mode**, press the left-hand Call Key and then select **Diagnostics**.
- 2) Select **Powerline**.

The status and other powerline information are displayed. For more information, see **21 Menu maps**.

11 Using the HBP-2X Beltpack

This chapter describes how to use the **HBP-2X Beltpack**, after your HelixNet Partyline system has been installed and configured.

For more information about integrating and using HelixNet Partyline with your existing intercom infrastructure, see **18 Connecting to Other Intercom Systems**.

Tip: For a quick reference to the functionality of the HBP-2X Beltpack, the HMS-4X Main Station, and the optional interface modules, see **2 Panels and Interfaces**.

11.1 Using the beltpack keysets

The HBP-2X Beltpack supports two Partyline channels, with a separate keyset (set of controls) dedicated to the control of each channel:

- The **left-hand keyset** controls the first (top) channel displayed on screen.
- The **right-hand keyset** controls the second (bottom) channel displayed on screen.

For details of the standard on screen information for each channel, see **Table 2-5 Main Station/Remote Station display icons and indicators**.

Note: For more information about:

- Using the beltpack in Menu mode, see **10 Configuring and managing the HBP-2X Beltpack**.
- Changing (editing) the channel label (name), see **5.4.1 Editing the channel label**.

The display screens enters screensaver mode (if enabled) if the beltpack remains inactive for a period of time. Press any key to exit screensaver mode.

To send a **call signal** to all the connected devices (beltpacks and Main Station) on that channel, press the **Call key**.

To **talk** to all the devices connected to the channel:

- 1) Connect a headset, using the 4-pin XLR-M connector on the base / rear of the beltpack.

Note: For the location of the headset connector and the headset key, see **E** in **Table 2-34: Key to HBP-2X Beltpack connectors and controls (base view)**.

- 2) Press the **Talk key**.
- 3) Speak into the headset mic.

To adjust the volume of incoming audio for a channel, turn the appropriate side-mounted **rotary control**.

Turn the rotary control clockwise to increase the volume, and counter-clockwise to decrease volume. The current volume level for the channel is shown on screen.

11.2 Entering and exiting Menu mode

Use **Menu mode** to:

- Configure the settings for the Main Station, including channel and audio settings.
- Monitor beltpack performance and diagnose issues.

To enter Menu mode, press the **Menu key**. To exit Menu mode, press the Menu key again.

For more information about using Menu mode on the beltpack, see **10 Configuring and managing the HBP-2X Beltpack**.

11.3 Adjusting the Program Feed volume level.

To adjust the listen level (volume) of the **Program Feed** to the beltpack, turn the rear / base rotary control.

Turn upwards to increase the listen level (volume), and downwards to decrease the listen level (volume).

While the listen level is adjusted, the listen level for the Program Feed replaces the standard channel information on screen.

The Main Station is used to assign the **Program Feed** to channels. For more information, see

5.4.2 Assigning the Program Listen to a channel.

12 Roles

12.1 Roles overview

A Role is a pre-set configuration that includes Channel assignment, audio settings, IFBs, relays etc. Each HelixNet device has a default Role that can be used as it is or modified to fit requirements. Each Role can be given a name (a label) that corresponds to a common user workflow, such as producer, director, A1, etc.

When adding new Roles, you will modify an existing template, using either the default Role for that device, or another Role that you have already made. Default Roles can be modified but not deleted or loaded to devices, you will always work with a copy. Default Roles can be returned to factory settings if required.

To use Roles you must have HelixNet 3.0 or above installed on your Main Stations.

Roles are created and edited in the Core Configuration Manager (CCM) and are a feature of HelixNet 3.0 and above. Once created in the **Roles** page, a Role will be available for selection from any device which is connected to your HelixNet system. Roles can be configured for:

- Main Stations
- Remote Stations
- Speaker Stations
- Beltpacks.

Roles can be created, cloned, edited and deleted in the Roles page.

Each device has a set of configuration options relevant to that unit. Configurable details include keysets, audio settings, program feeds and relays.

Note: A Role can be selected by many devices.

Roles can be created in the CCM at any time, but to use the Roles, devices must be connected to your system (for more information, see 16 Linking Main Stations and 17 Linking Remote Stations and Speaker Stations).

To create and use Roles

- 1) Open the CCM by typing the Main Station's IP into the URL field of a browser (Default username and password: admin, admin).
- 2) Go to the **Roles** page in the CCM by clicking on the Roles button in the top navigation bar.
- 3) Add or clone a Role or Roles.
- 4) Configure Role parameters (you can use editable default settings).

- 5) Select a Role from the device panel menus and load that Role to the device.

Once a role has been selected on a device, this role will persist over power cycles until a new role is selected or the device is returned to factory settings.

Each device has the ability to operate a configuration local to that device (local config), or a selected role that can be pre-configured in the CCM.

If a Role is edited in the device menus rather than the CCM, these changes will be reflected in the CCM. The latest configuration change, whether this is made in the CCM or from the device will dominate, neither interface has precedence.

Roles contain	Roles do NOT contain
Audio settings	Network settings (IP address, DHCP etc.)
Keypad Assignment	Pairing information (HKB and HRM over IP)
Station settings	Linking information (Link Master/Link Member)
2W/4W module assignment	Expansion information (Host/Expanded panel)
Program feed assignment	
GPIO configuration	

12.2 Example Roles set up

The following tables give an example of how roles could be set up in a working scenario.

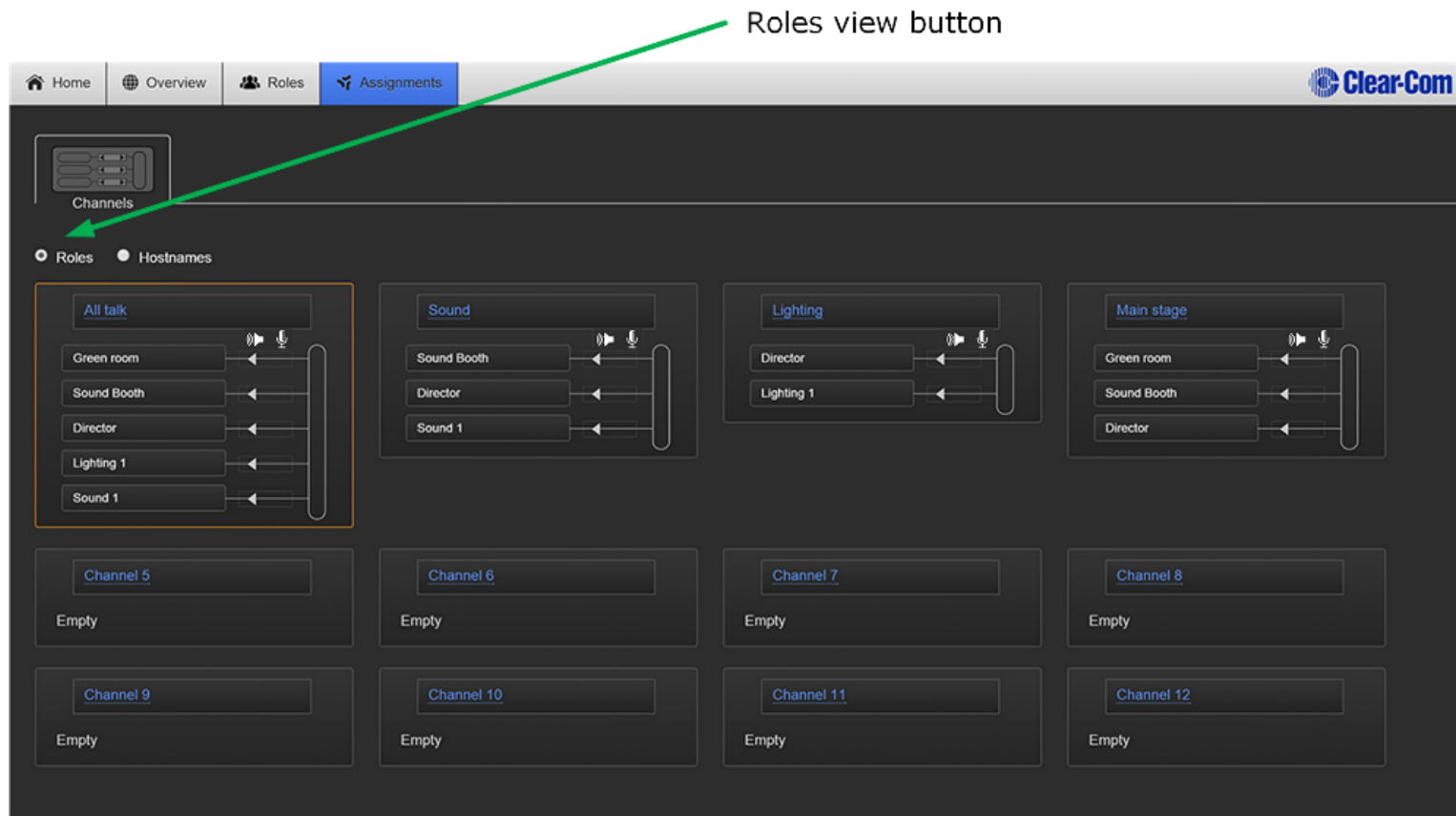
Device type	Device hostname	Roles available for selection	Role selected by device
Main Station	main_station_1	Local config	Director 1
		Director 1	
		Director 2	
		Sound booth	
	main_station_2	Local config	Sound booth
		Director 1	
		Director 2	

		Sound booth	
--	--	-------------	--

Device type	Device hostname	Roles available for selection	Role selected by device
Remote Station	remote_station_1	Local config	Green room
		Green room	

Device type	Device hostname	Roles available for selection	Role selected by device
Speaker Station	speaker_station_1	Local config	Local config
		None configured	

Device type	Device hostname	Roles available for selection	Role selected by device
Belt pack	HBP-2X xxxxxxxxxx	Local config	Lighting 1
		Lighting 1	
		Lighting 2	
		Sound 1	
		Sound 2	
	HBP-2X xxxxxxxxxx	Local config	Sound 1
		Lighting 1	
		Lighting 2	
		Sound 1	
		Sound 2	



Live Roles are visible in the **Assignments** page

Figure 12-1 Example of Roles use in the Assignments page of the CCM

Note: A Role can be selected by many devices.

For more detail on setting up Roles see **14 Using the CCM to configure Role.**

Note: Program input feeds are an exception in this screen, they will always be associated with a device rather than a Role.

12.3 Device default Roles

Each device type has a default configuration which can be edited and/or cloned, but not deleted. When creating new Roles you will always use an existing Role as a template. The default Role is editable, so you can create Roles based on a default Role edited to reflect your system requirements.

If you edit the default Role of any device, this configuration will persist until the device is returned to factory settings in the **General > Maintenance** page of the CCM.

12.4 To select a Role for a device

Select a role for a device from the display panels on that device. Go to **Menu > Station Settings > Preferences > Roles** to select a role.

- 1) On the device, press the **MENU** button to enter menu mode.
- 2) For each menu, turn the **rotary control** clockwise to scroll down the menu items. Turn counter clockwise to scroll up the menu items.

Off-screen menu items are indicated by arrows at the top and/or bottom of the screen.

Selected menu items (which create your path through the four menus) are highlighted in solid yellow.

The **current setting** is indicated by a dotted box around the menu item

- 3) When you have selected a setting by rotating the right hand rotary control, press that **rotary control** to enable the setting on the Main Station.

Belpacks will display a Role selection screen when first powered up. Simply select the required Role.

For more information, see **5.1 Using the Menus**.

12.5 Creating and editing Roles in the CCM

- Use the **ADD** button to create a new role with a new label based on a default template. This is the easiest way to create roles quickly with different labels, for example Camera, Sound, Production and so on.
- Use the **CLONE** button to copy an existing Role. This is the easiest way to create copies of Roles with the same label (appended by one), for example Camera!, Camera2, Camera3 and so on.

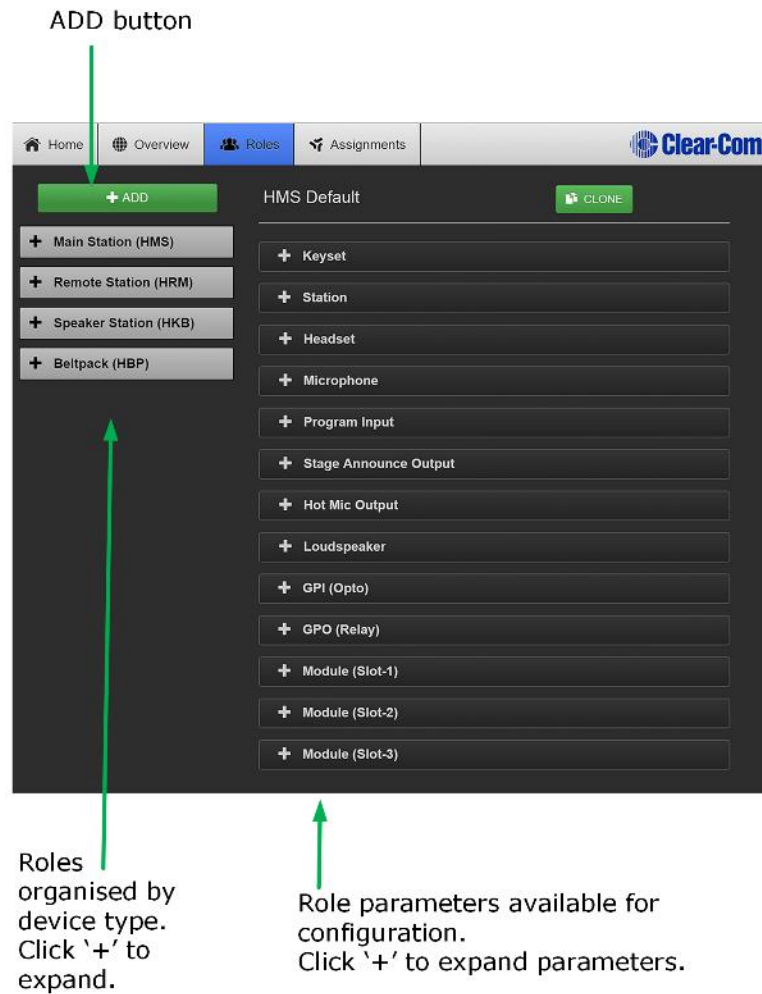


Figure 12-2 The Roles page in the CCM

- 1) Navigate to the **Roles** page in the CCM. When creating Roles you will always use an existing Role as a template.
- 2) Click **ADD**.
An overlay screen will appear on the page.
- 3) From the left of the screen, select the HelixNet device type you require. Give the device a name in the **Label** field. Select a template Role from the drop-down box.

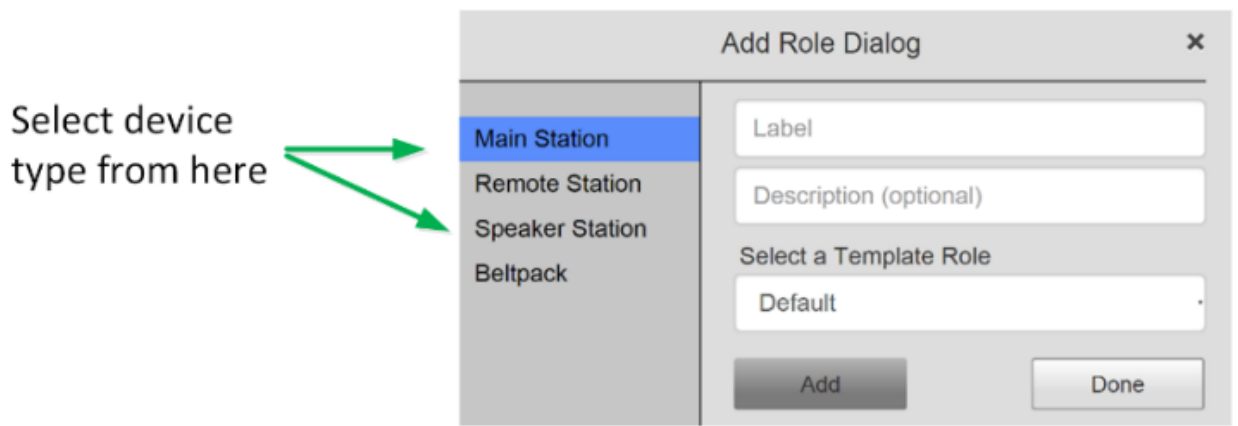


Figure 8-2 Add Role Dialog

4) Click **Add**. This creates a new role which you will see on the left side of the page under device type.

5) When you have finished creating new roles, click **Done**.

Once a Role has been created or cloned it can be edited. To edit a Role, click on it on the left side of the page so it has an orange highlight. Then access configuration parameters on the center right of the page.

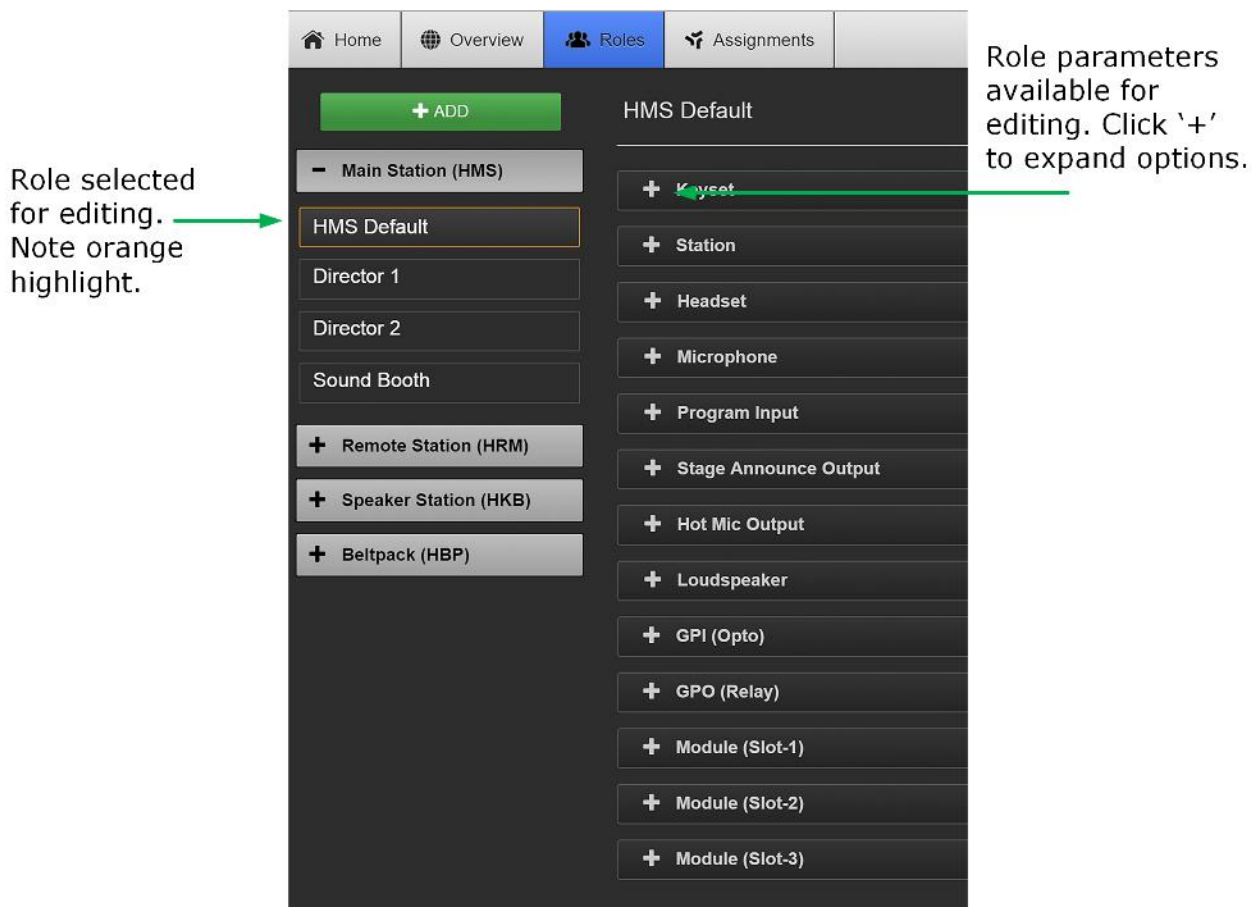


Figure 12-3 Edit Roles

Roles can be deleted in this page.

Note: You cannot delete the default Role

13 Core Configuration Manager (CCM)

From the browser based Core Configuration Manager (CCM) create and edit Roles and monitor working system for a Link Group. Click on any device to configure it.

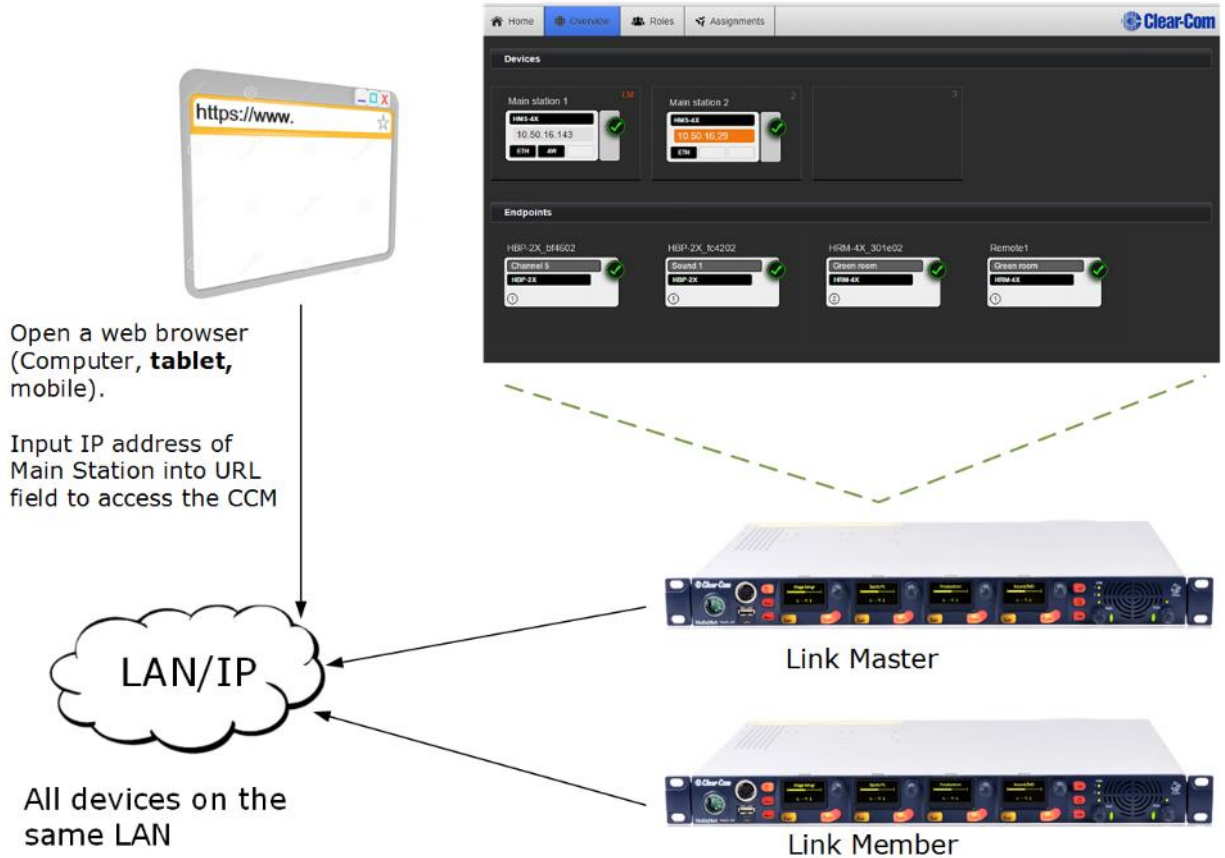


Figure 13-1 CCM overview

You can configure and control HelixNet units from the web-based Core Configuration Manager. This includes:

- Linking Main Stations
- Configuring of audio and signalization routing throughout the HelixNet Link-Group:
 - Creating configuration Roles for HelixNet devices (Main Stations, Remote Stations, Speaker Stations and beltpacks)
 - Assigning Roles to devices
 - Saving and changing configuration Roles for devices

- System monitoring and control. The CCM provides a real-time visual representation of your working intercom system on the Assignments page.
- Access to device control menus can be restricted from the CCM.
- Upgrading units.

Note: You can also configure and control HelixNet units using the front panel menu interfaces on each unit. See:

- **5 Configuring and managing the Main Station from device menus**
- **6 Configuring and managing the Remote Station from device menus**
- **8 Configuring and managing the Speaker Station from device menus**
- **10 Configuring and managing the HBP-2X Beltpack from device menus**

Note: Some functionality (for example, Roles) is only available from the CCM.

13.1 Access the CCM

To access the Core Configuration Manager, enter the IP address of the HelixNet Main Station, as displayed on the front panel, into the URL field of your browser. If the unit is reachable over your network, this will take you to the **Overview** page of the CCM that is served by the unit.

Note: Default username and password for the CCM: **admin, admin**.

13.2 Minimum requirements for the CCM

The CCM is supported on the latest versions of all major web browsers including Google Chrome, Safari, Firefox, Internet Explorer.

Note: Any IP connectivity in HelixNet requires an Ethernet module in the Main Station.

13.3 Overview page

All devices connected to your system appear in this screen

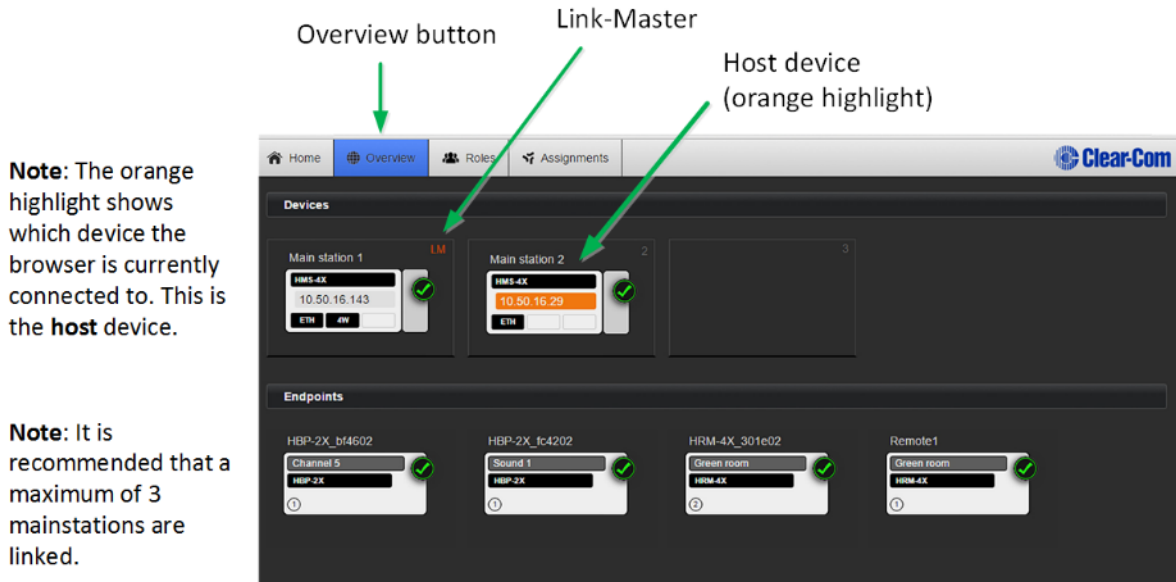


Figure 13-2 Overview page

Note: There is a navigation bar at the top of the page: **Home, Overview, Roles, Assignments.**

As HelixNet Main Stations are added to the group, they appear in this screen. To access the configuration and control options for any one of the units in the group, click on the device within the **Overview** page. Linked units can be configured either from the host device, or by proxy from this screen.

In this page, Devices, in the upper part of the screen represent the linked Main Stations. Endpoints, in the lower part of the screen are the devices which are paired or powerlined to the Main Stations. In this screen, clicking on a Main Station image will offer comprehensive configuration options. Clicking on an Endpoint allows you to change its name or Role and to reboot or reset to default. There is also a troubleshooting option. Click on device images to explore configuration options available for different devices on this page.

Note: The **Home** button takes you to the **General** page of the Main Station your browser is connected to (the host device) which has an orange highlight.

Main Station device image shows:
Hostname
Model
IP address (orange highlight if this is the device your browser is pointing to, the host device)
Modules installed on Main Station

Endpoint device image shows:
Hostname
Selected Role
Model
Main Station the device is connected to.

13.4 Home page

From the Home page of a Main Station, you can access general functions relating to the device your browser is pointing to (the host device) and also link devices.

There are two buttons in the left margin, below the device image; **General**, and **Linking**. Click on a button to access a configuration page.

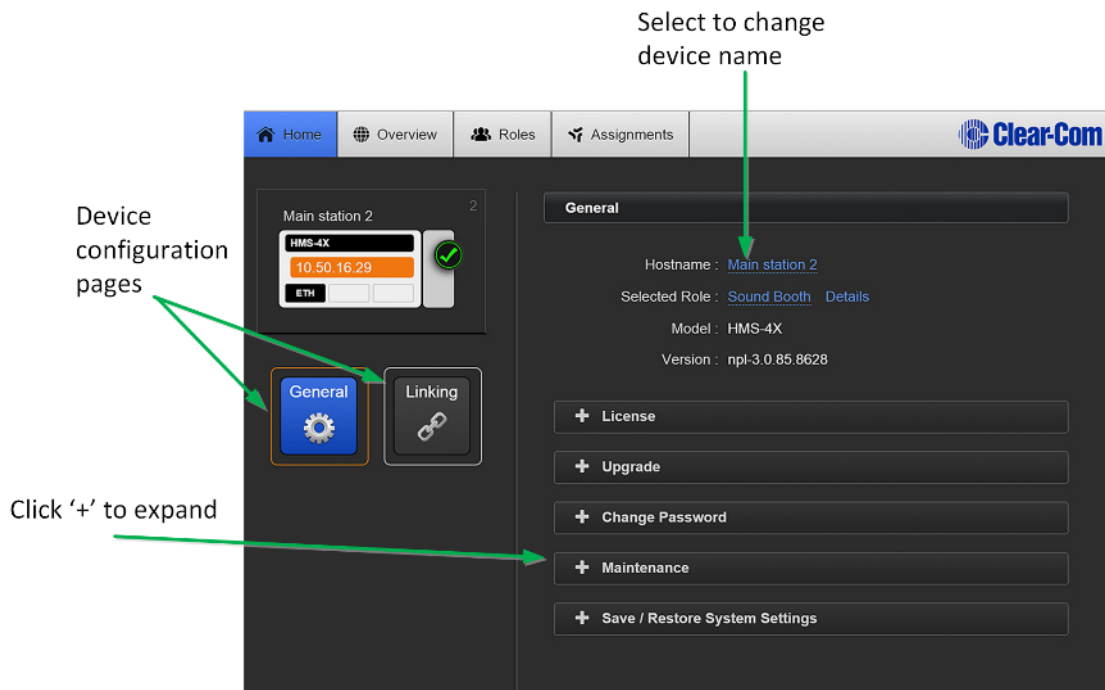


Figure 13-3 Home page

13.4.1 Changing a device hostname from the Home page

To change a device name, click on the existing name and enter a new one. Either press the <ENTER> key or click the blue check mark to apply changes.

When using hostnames, it is advisable to follow the usual conventions for giving labels to devices used in electronic communication. For instance; do not use

spaces, do not rely on case sensitivity, and make the name meaningful in a way appropriate to the context. This field can be up to 14 characters.

13.5 General Page

13.5.1 License

Your HelixNet Main Station arrives with a license for 12 Channels. To increase capacity to 24 Channels, please contact your Clear-Com dealer. You will need to provide your system ID, listed in this section of the CCM. When you receive a license code from them, input it here to increase available Channels. Each linked device must be licensed from the home page of the host device, units cannot be licensed by proxy.

In a Link Group, each device must be licensed. If one unit has only 12 Channels and the rest have 24, the whole group will use only 12 Channels by default.

The device system ID can also be found in the device menus screens (**Administration/License/Current**).

13.5.2 Upgrade (firmware)

In order to upgrade your device, you will need to import the upgrade file provided by Clear-Com. You will do this on this page. A linked HelixNet Main Station must be upgraded from the host device (the device that the browser is currently addressing). The units cannot be upgraded by proxy.

Note: When upgrading your Main Station, any units connected to it (Remote Stations, Speaker Stations and beltacks) will also be upgraded. Please make sure you wait until total upgrade is complete. Only the Computer to HelixNet Main Station transfer is shown in this screen. Please check progress of additional devices on the device menu screens.

Note: All devices in a Link-Group MUST be running the same version of the software.

- 1) Navigate to **Home > General** in the CCM.
- 2) Expand the **Upgrade** option (click on '+').
- 3) Click **Select File** and navigate to the upgrade file (.gz extension). Select the upgrade file to upload it.
- 4) When the upgrade file is loaded, **Upgrade** will light up. When this happens, click on it to upgrade. When the upgrade is finished, the unit will reboot by itself.

13.5.3 Change password

Change the password to the Core Configuration Manager local to that device.

13.5.4 Maintenance

Reset the unit to factory settings, or reboot the system.

Note: In this context, **Reset to Default** will erase all Role and Channel information. Channels will return to Channel 'n' where 'n' is 1 to 24. Roles will revert to factory default settings.

To reset Hostname, network, linking, pairing and expansion settings use the device front panel menus. See 5.7.4 Resetting the Main Station to default (factory mode) settings.

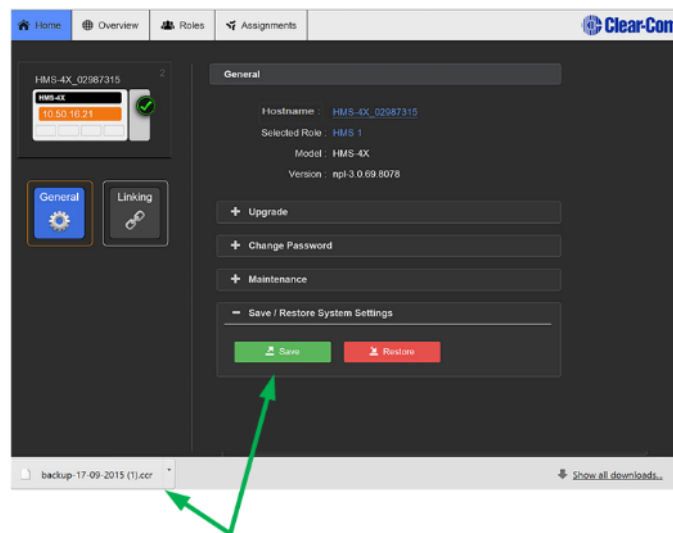
Note: If the device is a Link-Master it will also erase the Roles of any linked devices.

Please be sure to save any Role configurations you wish to keep before using Reset to Default.

Support Info provides a 'snapshot' of the device's operational information for troubleshooting purposes. A file containing **Support Info** can be sent to Clear-Com engineers or help desk to aid diagnosis of problems.

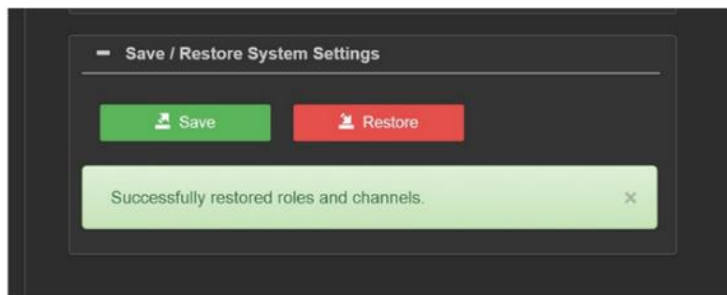
13.6 Save/Restore System Settings

This is where you will save the roles and channels configured on your system to an external storage device. Clicking the green **Save** button will cause a backup file to be saved to the download directory. From there it can be renamed and saved as required.



Clicking on the green **Save** button will cause a backup file of your configured roles to be saved to your download directory.

When restoring configured roles and channels from an external file, clicking on the red **Restore** button will allow you to navigate to the location of the saved file. The file has a .cca extension. Select the file to restore it. If the restore is successful you will see a 'successfully restored' message.



Note: Save System Settings in this context will save Role information but not network, pairing, expansion or linking information.

13.7 Linking page

This is where the linking mode of the HelixNet Main Station is set to either Link-Master or, if connecting to a Link-Group, Link-Member. When linking a Link-Member to a Link-Master you will provide the device with the Link-Master IP or Hostname in this page. If you wish to re-configure a Link-Group, you will change the link status of the device in this page, which will have the effect of removing it from the group.

Note: A device's Hostname is available in the General page of the CCM.

Select Link status here

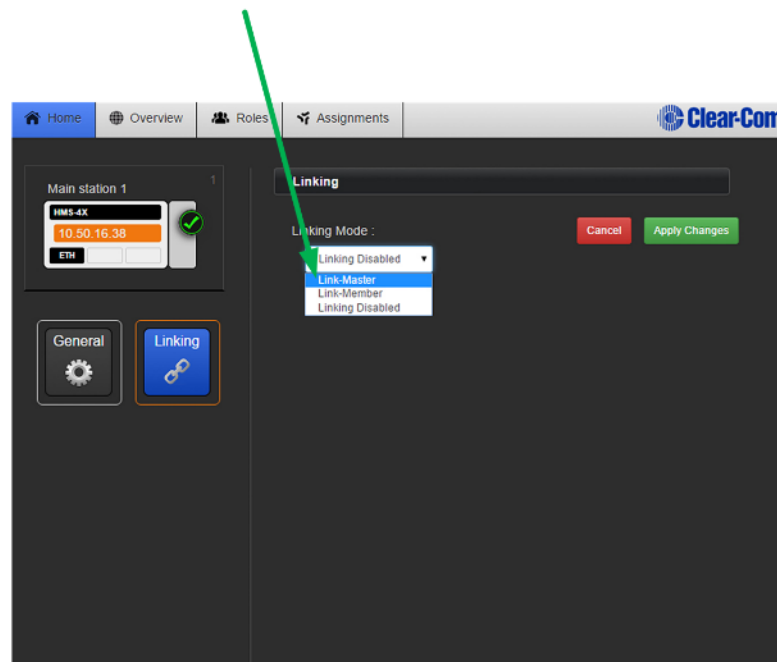


Figure 13-4 Linking page in the CCM

For more information about Linking see **15 Linking in the Core Configuration Manager (CCM)**.

13.8 Roles Page

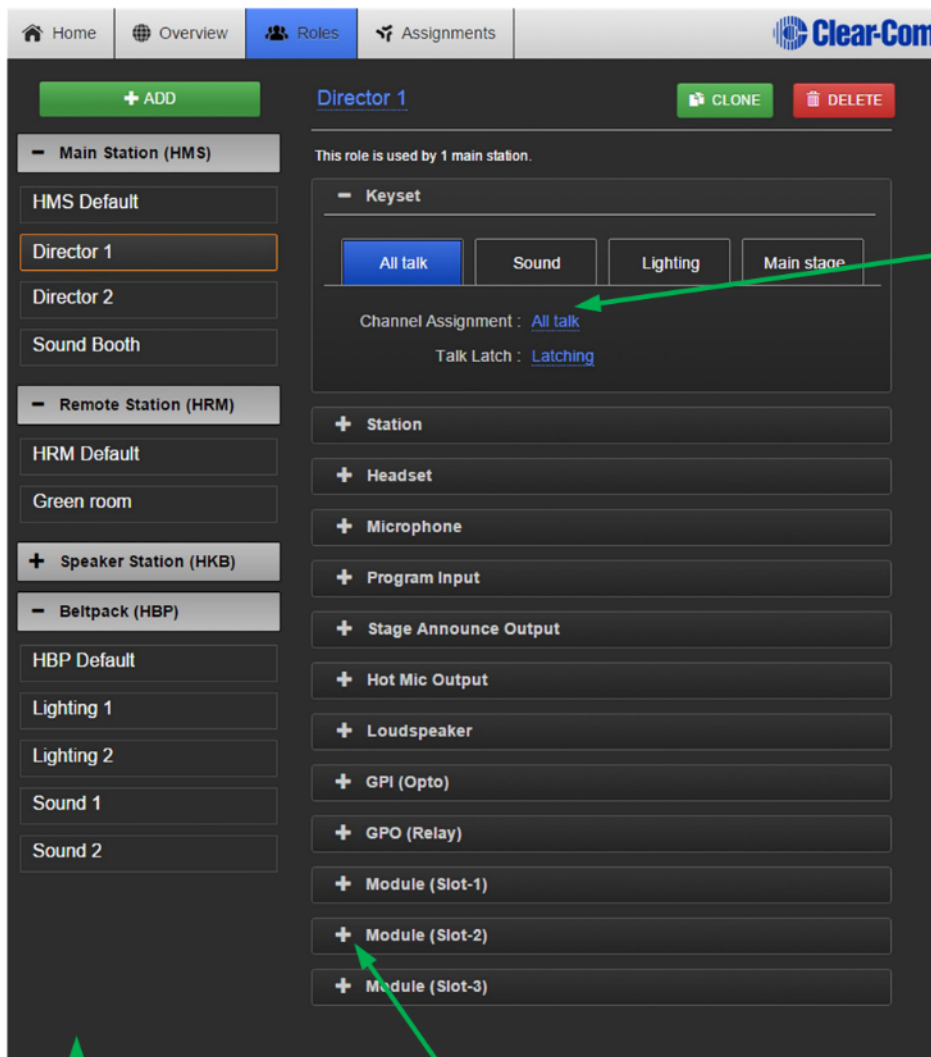
To access the **Roles** page, select **Roles** from the top navigation bar. On this page you will create, delete, clone and edit Roles.

Roles available for editing, cloning and configuration are in the left margin of the page. Role parameters available for configuration are on the right of the page.

To create a Role , click the device type you require on the left hand side of the page (Main Station, Remote Station, Speaker Station or Beltpack), choose a template (in the first instance this will be the Default role for that device) and click 'ADD'.

To edit a Role click on the required Role in the left of the page. When it is selected for editing, it will have an orange highlight.

Note: Changes made to Roles here are live.



Click Channel Assignment to assign audio to Channel

Roles available for editing.

Note: Orange highlight on selected Role

Selected Role parameters available for configuration.

Click '+' to expand a section.

Figure 13-5 The Roles page with example Roles

For more detail about Roles see Chapter 12 Roles.

13.8.1 Audio Assignment

In HelixNet 3.0, audio assignment is achieved in the **Roles** page. You will assign audio to a Channel on a **Keyset**. For a description of a Keyset (available on the front panel of all devices) see **2.1.1 Main Station/Remote channel keyset and display**. A Main Station, a Remote Station and a Speaker Station have 4 Keysets

on each device. Beltpacks have two Keysets on each device (beltpacks can also have many Channels stacked on one key).

13.9 Assignments page

The Assignments page has two main functions in HelixNet 3.0. From this page in the CCM you can:

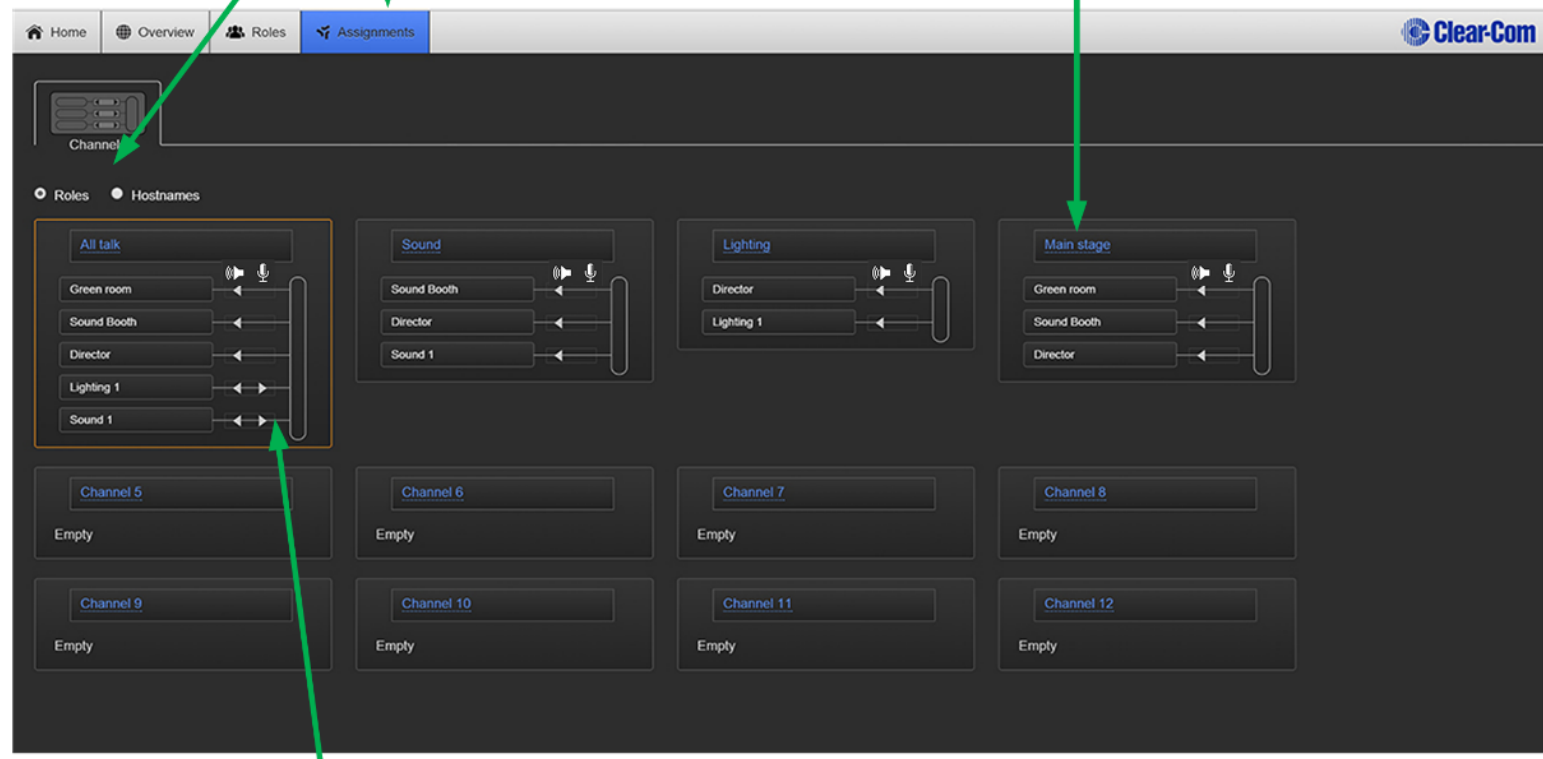
- Change Channel names
- See a real-time, visual representation of devices and Roles in use. Any changes to the configuration are reflected immediately in this page and the working system.

This page toggles between **Hostname** view and **Roles** view.

Select **Roles** view or **Hostname** view

Click **Assignments** button to see page

Click to change Channel name



Arrows indicate direction of input into Channel

Assignments page showing example **Roles** active in the system.

Figure 13-6 Assignments Page

13.9.1 Hostname view

A Hostname is the name given to a physical device in the system, and is the label used for network communication. Main Station Hostnames can be changed in the Home page of the CCM. See 13.4.1 Changing a device hostname from the Home page. Other device Hostnames (Endpoints) can be changed from the **Overview** page. Click on any device image to select it.

Program inputs, 2W ports, 4W ports and HRM-4X Audio Output are displayed with a default label that can be changed from the **Roles** Page.

13.9.2 Roles view

Roles view indicates the configuration details of Roles selected on devices. Roles view changes as different configurations are selected and loaded. Program inputs, 2W ports, 4W ports and HRM-4X Audio Output are displayed with a default label that can be changed from the Roles Page.

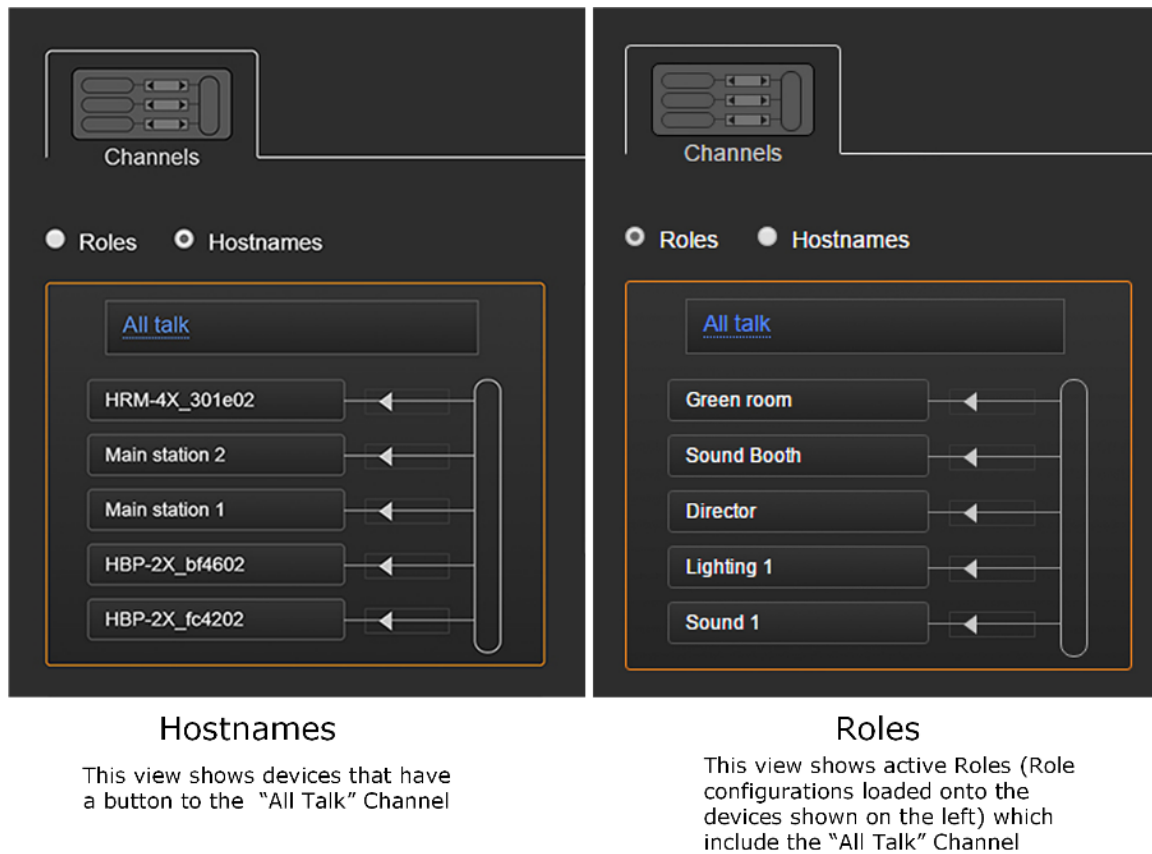
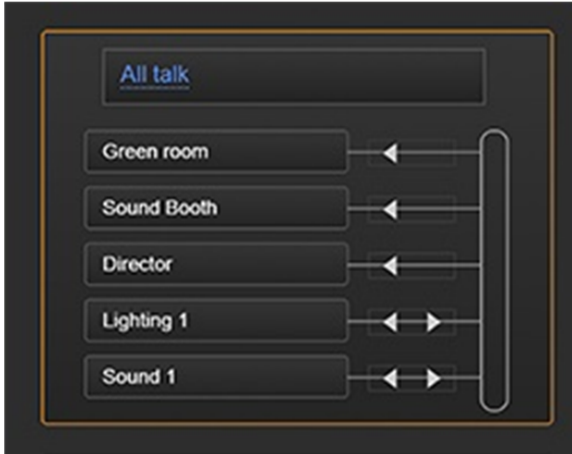


Figure 13-7 Hostnames and Roles view

13.9.3 Channels

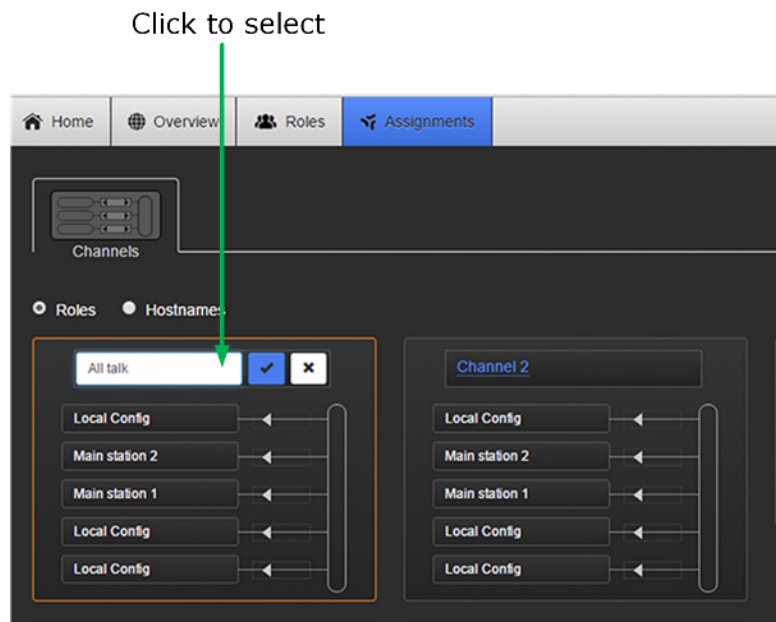
Any audio routed through the HelixNet system is contained within a Channel. Channels operate as virtual partylines; audio sources assigned to a Channel will be able to talk and listen to all other sources assigned to the same Channel.



- Devices with a key to the Channel labeled "All Talk" can communicate with each other.
- 2-wire and 4-wire ports can be mixed in one Channel.
- No limit to the number of devices with a key to a Channel. Multiple audio sources will not affect audio quality or latency.

13.9.4 To rename a channel

- 1) In the **Assignments** page, click on the blue Channel name to select it



- 2) Enter the new name.
- 3) Click the blue check mark or <Enter> to submit change.

14 Using the CCM to configure Roles

14.1 Editing Main Station roles

You can edit any Main Station Role including default Roles in the CCM.

14.1.1 Editing the Keypad

Each device has four Keypads, one for each channel. The Keypad is used to control the Channel. You can configure:

- Which Channel is assigned to the Keypad
 - If the Talk key on the Keypad is latching or non-latching
- 1) From the drop-down list of Roles, select the Role you wish to edit.
 - 2) Select **Keypad**.

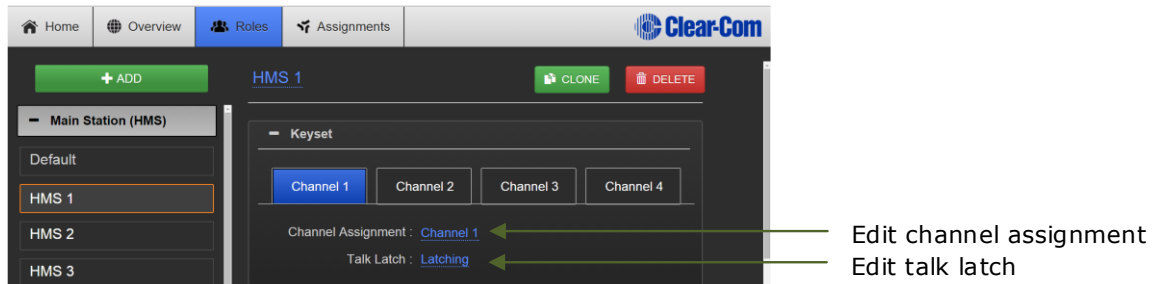


Figure 14-1 Editing keysets

- 3) Select the key you wish to edit (Channel 1, 2, 3, or 4).
- 4) To assign a different Channel to the key, click **Channel Assignment**.

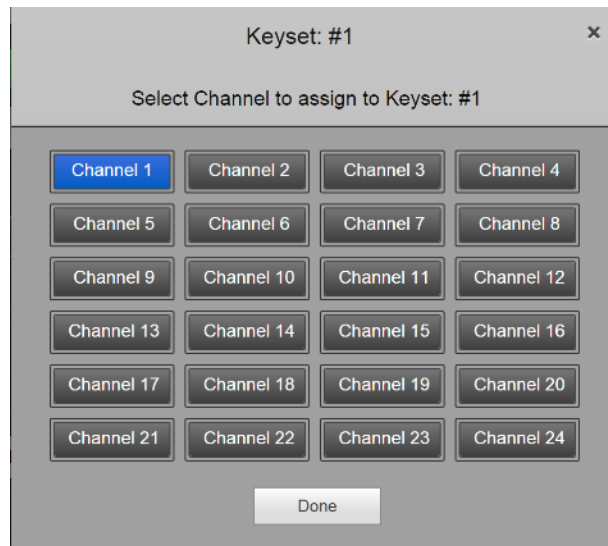


Figure 14-2

- 5) Select the channel you require, and then click **Done**.
- 6) To configure Talk key operation, click **Talk Key**, and select **Latching** (default), **Non-Latching** or **Disabled**.
- 7) Repeat the above steps for each Keyset.

14.1.2 Editing the Station

- 1) From the top left of the **Roles** screen, select **Main Station (HMS)**.
- 2) From the drop-down list of roles, select the role you wish to edit.
- 3) Select **Station**.

You can configure the following:

Setting	Options
Description	Enter station description
Display Brightness	Low Medium (default) High

Setting	Options
Key Brightness	High/Low. The default setting. Keys are lit bright when active and lit dim when inactive. High/Off. Keys are lit bright when active and are unlit when inactive. Low/Off. Keys are lit dim when active and are unlit when inactive. Off/Off. Keys are unlit, whether or not they are active or inactive.
Screensaver	Channel Name (default) Hostname Role Name Blank Disabled
RMK Key (Remote Microphone Kill)	Visible Channels(default)/All Channels/Disabled "Visible Channels" will select Channels visible on device Keysets. "All Channels" will select all Channels available on the device; 12 or 24.
Menu Access	Enabled (default) Disabled
All Talk key talks to	Visible Channels(default)/All Channels "Visible Channels" will talk to Channels visible on device Keysets. "All Channels" will talk to all Channels available on the device (12 or 24 depending on your license).

- 4) For each setting, select the option you require.

14.1.3 Editing the Headset

- 1) From the top left of the **Roles** screen, select **Main Station (HMS)**.
- 2) From the drop-down list of roles, select the role you wish to edit.
- 3) Select **Headset**.

You can configure the following:

Setting	Options
Sidetone Gain	Adjust slider control from -18dB to 0dB (Default -12dB)
Headphone Gain	0db (default) to 12dB

Setting	Options
Headphone Limit	Off (default) +6dB 0dB -6dB
Sidetone Control	Tracking (default) Non-Tracking Disabled
HS Mic Type	Electret(-15dB) Dynamic (0dB) (default) Dynamic (-10dB)

- 4) For each setting, select the option you require.

14.1.4 Editing the Microphone

- 1) From the top left of the **Roles** screen, select **Main Station (HMS)**.
- 2) From the drop-down list of roles, select the role you wish to edit.
- 3) Select **Microphone**.

You can configure the following:

Setting	Options
Headroom	Normal (default) High
Contour Filter	Enabled (default) Disabled

- 4) For each setting, select the option you require.

14.1.5 Editing the Program Input

- 1) From the top left of the **Roles** screen, select **Main Station (HMS)**.
- 2) From the drop-down list of roles, select the role you wish to edit.
- 3) Select **Program Input**.

You can configure the following:

Setting	Options
Label	Use to give the program input a meaningful name

Setting	Options
Gain	Adjust slider control from -12dB to 12dB (Default 0dB)
VOX	Disabled (Default)/Enabled
VOX Off Delay	0.5s (Default) – 4 s
IFB Dim Level	IFB Disabled -6 dB -12 dB -18 dB -24 dB Full Cut
Channel Assignment	Select a channel from the list of channels.
GPO trigger	Enabled (Default)/Disabled

4) For each setting, select the option you require.

Note: When assigning a program input to a Channel in the CCM, the system assumes that program input is associated with a device. This will be reflected in the **Assignments** page in the CCM, where a program input is assigned to a Channel, the device hostname rather and the Role name will be visible in **Roles** view.

Note: When controlling an IFB dim level on a Program Input you must edit the Role for the device the Program Input comes in on. For instance, if the Program Input is attached to the Main Station, you will edit the Role for that Main Station and this will control the dim level on Remotes, Speaker Stations and beltpacks connected to the Main Station.

14.1.6 Editing the Stage Announce Output

- 1) From the top left of the **Roles** screen, select **Main Station (HMS)**.
- 2) From the drop-down list of roles, select the role you wish to edit.
- 3) Select **Stage Announce Output**.

You can configure the following:

Setting	Options
Label	Give the output port a meaningful name
Gain	Adjust slider control from -12dB to 12dB (Default 0dB)
SA Button	Latching/Non-Latching (default)

4) For each setting, select the option you require.

14.1.7 Editing the Hot Mic Output

- 1) From the top left of the **Roles** screen, select **Main Station (HMS)**.
- 2) From the drop-down list of roles, select the role you wish to edit.
- 3) Select **Hot Mic Output**.

You can configure the following:

Setting	Options
Gain	Adjust slider control from -12dB to 12dB (Default 0dB)

- 4) For each setting, select the option you require.

14.1.8 Editing the Loudspeaker

- 1) From the top left of the **Roles** screen, select **Main Station (HMS)**.
- 2) From the drop-down list of roles, select the role you wish to edit.
- 3) Select **Loudspeaker**.

You can configure the following:

Setting	Options
Dim	0 dB (default) -3 dB -6 dB -12 dB -24 dB

- 4) For each setting, select the option you require.

14.2 General Purpose Input (GPI) and General Purpose Output (GPO) triggers.

The GPIs and GPOs can be used to link the system to an external appliance.

The **GPI (Opto)** enables a Talk or Call button press on any one of the 4 keysets local to the selected device to be triggered by an external appliance (such as a foot pedal).

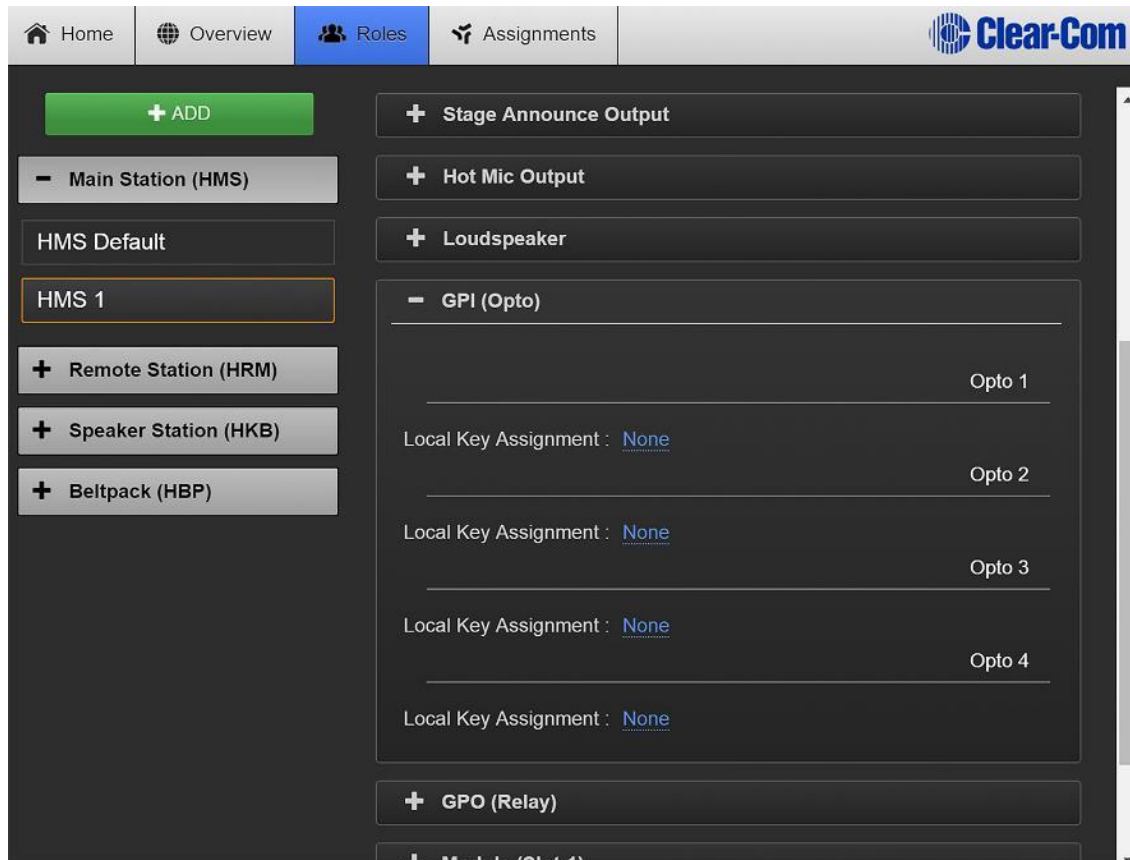
The **GPO (Relay)**, sends a signal to an external appliance (such as a light switch) that is triggered from the 4 local keysets or (in contrast to the GPO) a signal that is not local to the selected device. A GPO can be triggered by:

- Talk or Call button press

- A call signal
- Detection of audio of any kind on a channel (VOX).

Editing the GPI (Opto)

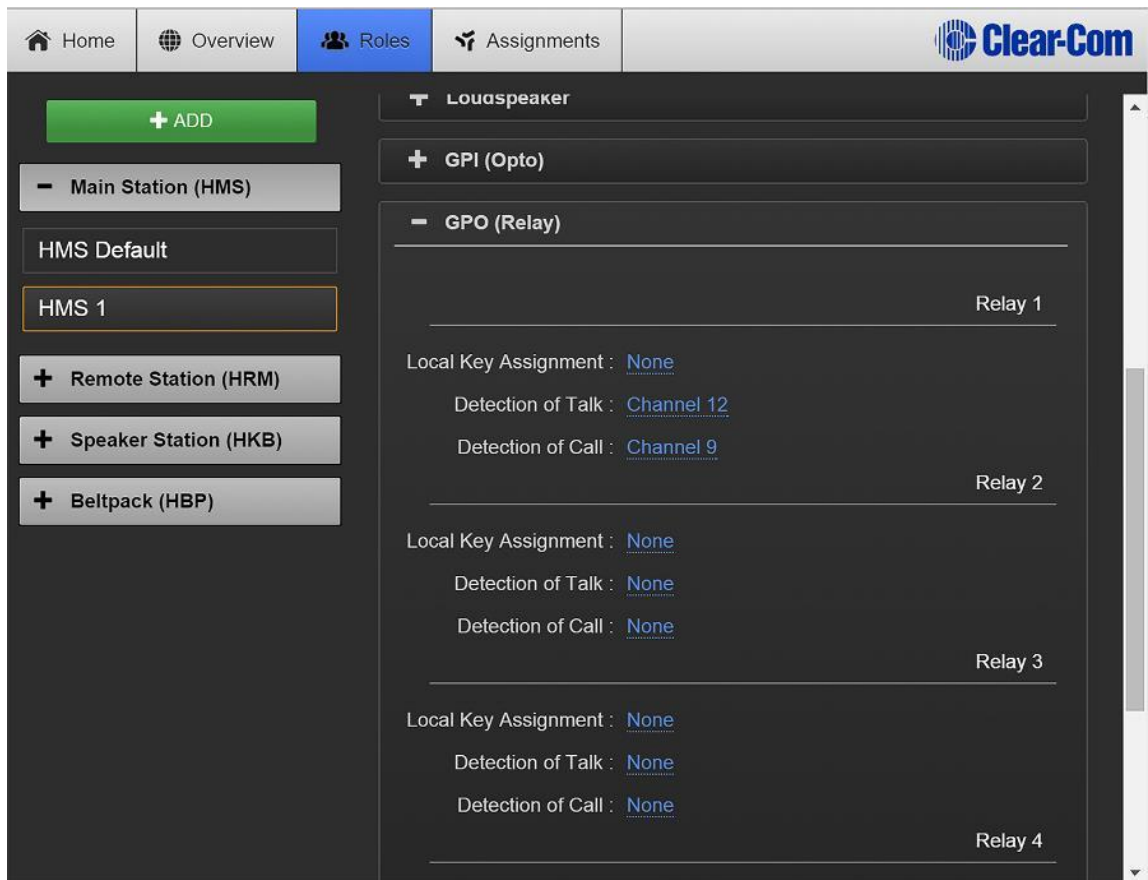
- 1) From the top left of the **Roles** screen, select **Main Station (HMS)**.
- 2) From the drop-down list of roles, select the role you wish to edit.
- 3) Select **GPI (Opto)**.



- 4) For each GPI select the local keyset (1 – 4) and you wish to activate (Talk or Call).

Editing the GPO

- 1) From the top left of the **Roles** screen, select **Main Station (HMS)**.
- 2) From the drop-down list of roles, select the role you wish to edit.
- 3) Select **GPO (Relay)**.



4) For each GPO, select the signal(s) that you wish to trigger the external appliance, **Local Key Assignment**, **Detection of Talk** from any device and/or **Detection of Call** from any device.

5) Select the Channel you require then click **Done**.

14.2.1 Editing Module slots 1 – 3

Module slots 1 – 3 in the CCM correspond to the modules installed on the back of your Main Station. If module configuration in the CCM does not match what is on the device, a warning message will be given in the CCM.

For each module, chose between 3 types:

- None/Ethernet/Fiber
- 2-wire
- 4-wire

None/Ethernet/Fiber

There are no configuration options associated with this module type.

2-wire

For each XLR port (A & B) configure the following to connect 2 audio channels to analogue partylines:

Setting	Options
Label	Use to give the port a meaningful name
Channel Assignment	Choose one from total Channels (12 or 24 depending on license)
Program Output	Mute (default) Unmute
Mode	Clear-Com (default) RTS 2-pin RTS 3-pin
Input Gain	-3 dB – 3 dB (default = 0)
Output Gain	-3 dB – 3 dB (default = 0)
RMK Input	Enabled (default) Disabled
RMK Output	Enabled (default) Disabled
VOX	Enabled (default) Disabled
VOX Off Delay	0.5 s (default) – 4.0 s
GPO Trigger	Enabled (default) Disabled

4-wire

For each RJ45 port (A & B) configure the following to connect two Channels to an Eclipse MVX card:

Setting	Options
Label	Use to give the port a meaningful name
Channel Assignment	Choose one from total Channels (12 or 24 depending on license)
Program Output	Mute (default) Unmute
Input Gain	-3 dB – 3 dB (default = 0)
Output Gain	-3 dB – 3 dB (default = 0)

VOX	Enabled (default) Disabled
VOX Off Delay	0.5 s (default) – 4.0 s
GPO Trigger	Enabled (default) Disabled

14.3 Editing Remote Station roles

Editing the Keypad

See 14.1.1 Editing the Keypad.

14.3.1 Editing the Station

- 1) From the drop-down list of roles, select the role you wish to edit.
- 2) Select **Station**.

You can configure the following:

Setting	Options
Description	Enter station description
Display Brightness	Low Medium (default) High
Key Brightness	High/Low. The default setting. Keys are lit bright when active and lit dim when inactive. High/Off. Keys are lit bright when active and are unlit when inactive. Low/Off. Keys are lit dim when active and are unlit when inactive. Off/Off. Keys are unlit, whether or not they are active or inactive.
Screensaver	Channel Name (default) Hostname Role Name Blank Disabled
OPT (RMK) Key	Disabled (Default)/All Channels/Visible Channels. This option allows you to enable RMK on remote stations. See 7.9 Using the RMK [<i>Remote Mic Kill</i>] key

Setting	Options
Menu Access	Enabled (default) Disabled
All Talk key talks to:	Visible Channels (Default)/All Channels

3) For each setting, select the option you require.

Note: Each device has the capacity for either 12 or 24 Channels (depending on license). These will all be enabled if you choose 'All Channels'. "Visible Channels" enables only those Channels selected and visible on device Keysets.

Editing the Headset

See 14.1.3 Editing the Headset.

Editing the Microphone

See 14.1.4 Editing the Microphone.

Editing the Program Input

See 14.1.5 Editing the Program Input

Editing the Stage Announce Output

See 14.1.6 Editing the Stage Announce Output

Editing the Hot Mic Output

See 14.1.7 Editing the Hot Mic Output.

Editing the Loudspeaker

See 14.1.8 Editing the Loudspeaker.

Editing the GPI (Opto)

14.2 General Purpose Input (GPI) and General Purpose Output (GPO) triggers.

14.4 Editing Speaker Station roles

Editing the Keypad

See 14.1.1 Editing the Keypad

14.4.1 Editing the Station

1) From the drop-down list of roles, select the role you wish to edit.

2) Select **Station**.

You can configure the following:

Setting	Options
Description	Enter station description
Display Brightness	Low Medium (default) High
Key Brightness	High/Low. The default setting. Keys are lit bright when active and lit dim when inactive. High/Off. Keys are lit bright when active and are unlit when inactive. Low/Off. Keys are lit dim when active and are unlit when inactive. Off/Off. Keys are unlit, whether or not they are active or inactive.
Screensaver	Channel Name (default) Hostname Role Name Blank Disabled
Menu Access	Enabled (default) Disabled
Unlatch on Shift	Enabled (default) Disabled

3) For each setting, select the option you require.

Editing the Headset

See 14.1.3 Editing the Headset.

Editing the Microphone

See 14.1.4 Editing the Microphone

Editing the Loudspeaker

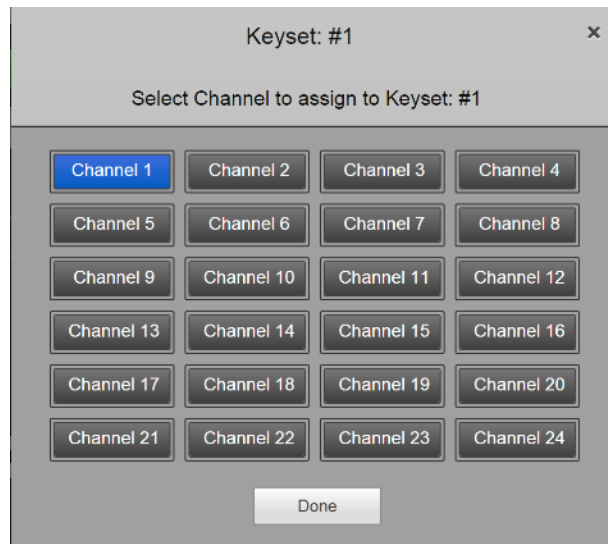
See 14.1.8 Editing the Loudspeaker.

14.5 Editing the Beltpack roles

14.5.1 Editing the Keypad

Each Beltpack has two keysets, one for each selected channel. The keypad is used to control the channel. You can configure:

- Whether the talk keys are stacked
 - Which channel is assigned to the keyset
 - If the Talk key on the keyset is latching or non-latching
- 1) From the top left of the **Roles** screen, select **Beltpack (HBP)**.
 - 2) From the drop-down list of roles, select the role you wish to edit.
 - 3) Select **Keyset**.
 - 4) Select the key you wish to edit.
 - 5) To set a key as stacked, select the **Stacked Key** checkbox. For detail on setting stacked keys see 14.7 Configure a stacked key on a beltpack using the CCM.
 - 6) To assign a different channel to the key, click **Channel Assignment**.



- 7) Select the channel you require, and then click **Done**.
- 8) To configure Talk key operation, click **Talk Key**, and select **Latching** (default), **Non-Latching** or **Disabled**.
- 9) Repeat the above steps for each keyset.
- 10) Set **USB Flasher Mode** (default **Disabled**). For more detail on USB flasher functionality see 14.8 Call a beltpack using the USB flasher feature.

14.5.2 Editing the General Settings

- 1) From the drop-down list of roles, select the role you wish to edit.
- 2) Select **Station**.

You can configure the following:

Setting	Options
Description	Enter station description
Display Brightness	Low Medium (default) High
Key Brightness	High/Low. The default setting. Keys are lit bright when active and lit dim when inactive. High/Off. Keys are lit bright when active and are unlit when inactive. Low/Off. Keys are lit dim when active and are unlit when inactive. Off/Off. Keys are unlit, whether or not they are active or inactive.
Vibrate on Call	Enabled Disabled (default)
Rotate Display	Enabled Disabled (default)
Screensaver	Channel Name (default) Hostname Role Name Blank Disabled
Menu Access	Enabled (default) Disabled

- 3) For each setting, select the option you require.

Editing the Headset

See 14.1.3 Editing the Headset.

Editing the Microphone

See 14.1.4 Editing the Microphone

14.6 Disable menu access on any device from the CCM

You can disable menu access to any device, from a Main Station to a beltpack, in the **Roles** page.

- 1) Navigate to **Roles > Device > Role > Station > Menu Access**
- 2) Select required access mode. <Enter> to select option.

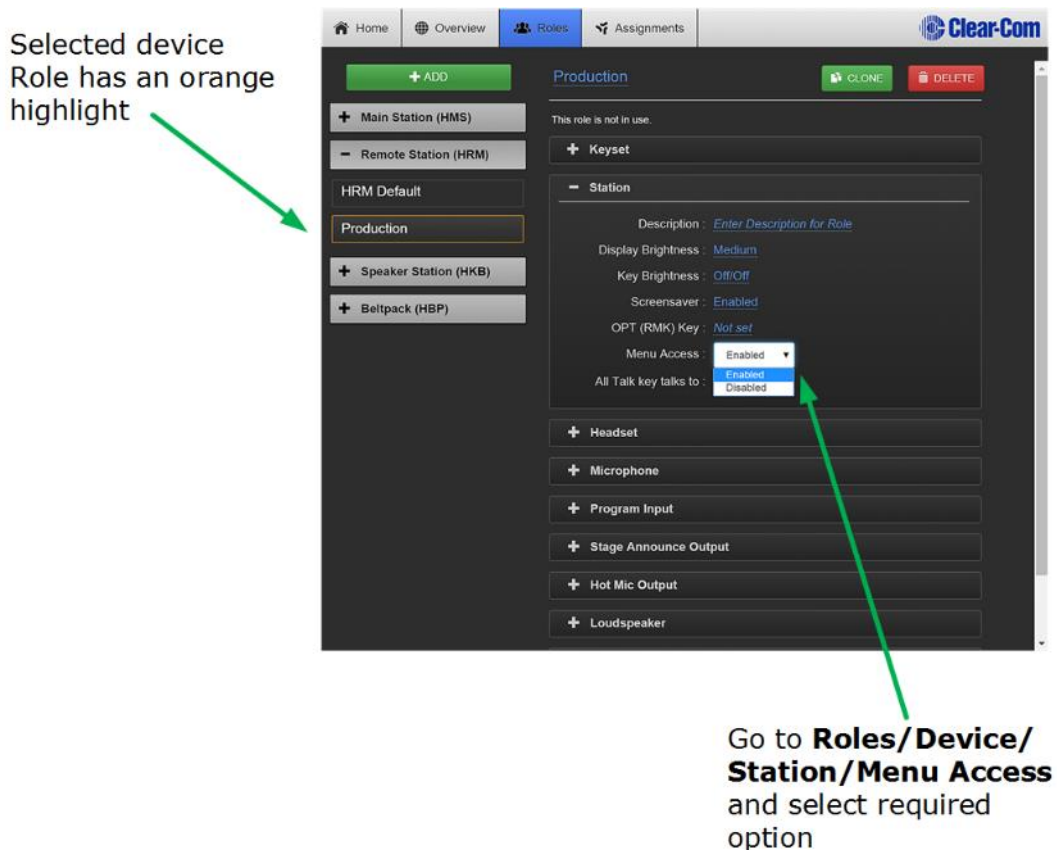


Figure 14-3 Enable/disable menu access

14.7 Configure a stacked key on a beltpack using the CCM

You can configure stacked keys on a beltpack, putting two or more Channels on the same key. This enables the beltpack user to talk and listen to two groups simultaneously. Pressing the Talk or Call button on the beltpack will initiate a talk or call to all the Channels on the stacked key. If a Channel user activates a call to the beltpack, the Call label will flash and vibrate is enabled.

Beltpack stacked keys can only be configured through the Core Configuration Manager (CCM).

To configure a stacked key on a beltpack:

- 1) Navigate to **Roles > Beltpack (HBP) > Role > Keysets** and select the Channel tab you wish to stack a key on.
- 2) Click the **Stacked Key** checkbox. This automatically unassigns any Channels already on this Keyset.
- 3) Click **Channel Assignment**
- 4) Select all the Channels you wish to assign to the Keyset. Click **Done**. The Channels will be stacked on the Keyset.
- 5) Set the **Talk Key** as required.

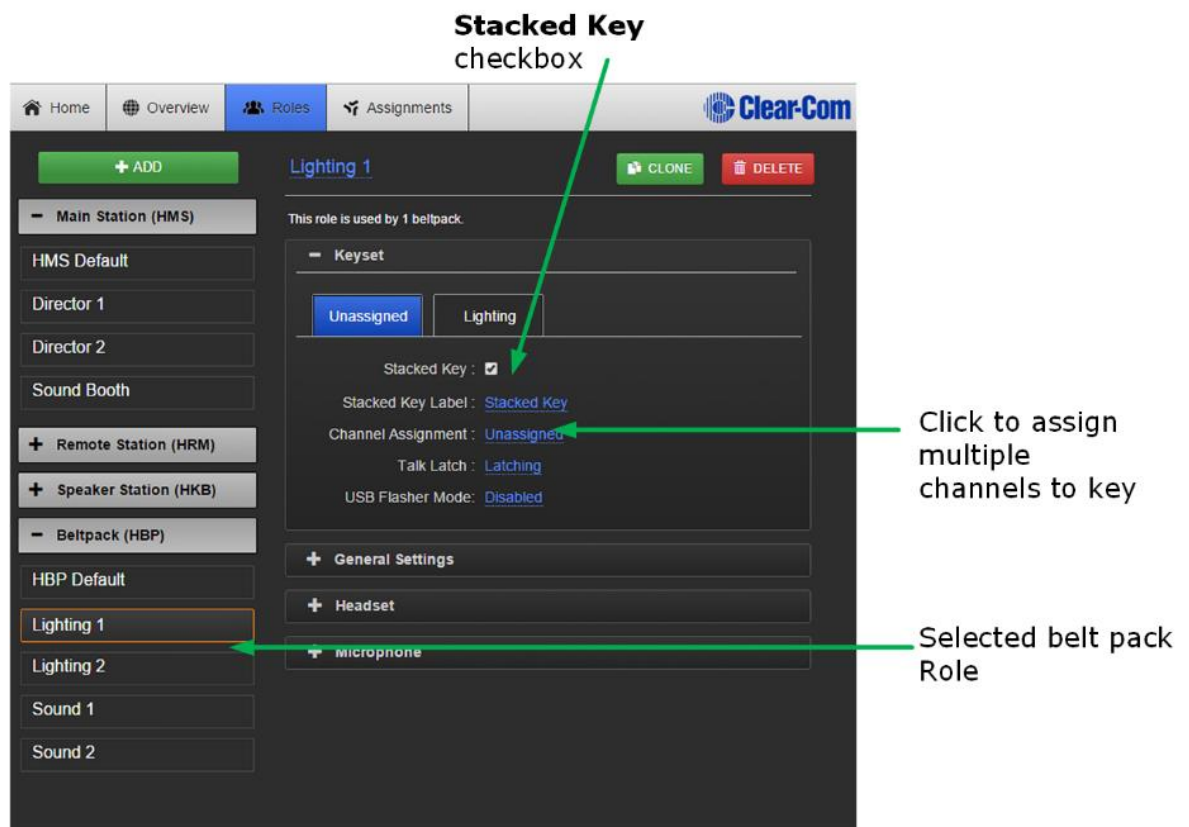


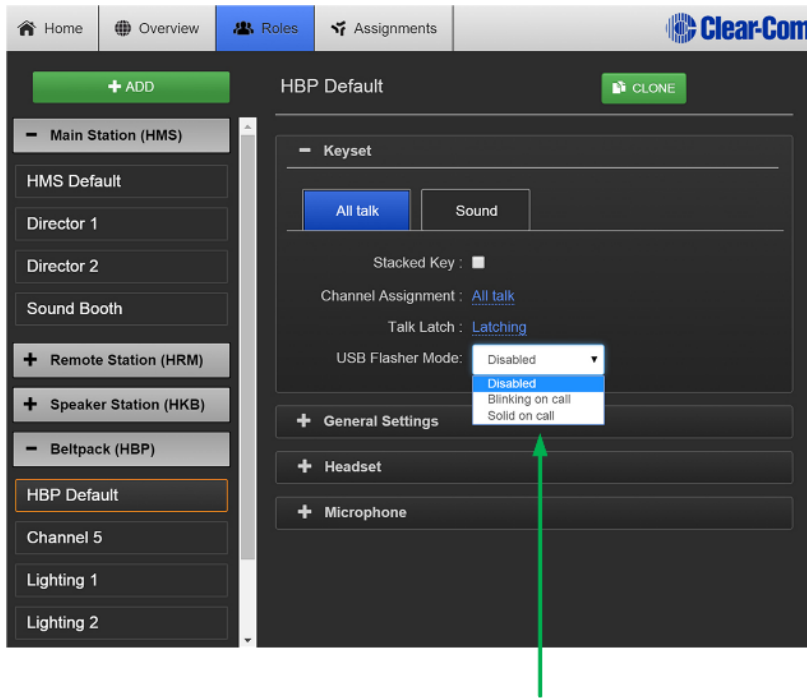
Figure 14-4 Configure a stacked key

14.8 Call a beltpack using the USB flasher feature

To use this feature you will need a USB-powered light and a micro-to-type A USB adapter.

- 1) Set the USB flasher functionality in the beltpack Role.

2) Call the beltpack and see the light flashing.



USB flasher mode setting

Figure 14-5 Set USB flasher on beltpack

15 Linking in the Core Configuration Manager (CCM)

Main Stations can be linked from the CCM. Each Main Station has 12 Channels with the option of licensing 12 more (24 in total). When linking Main Stations, Channels with the same number are merged together into one Channel. Linking Main Stations will also have the effect of increasing your I/O and device module options (more beltacks and a larger area covered).

Note: Linked Main Stations should have the same amount of licensed channels. If you link a 24 Channel device to a 12 Channel device the system will default to 12 Channels only. To buy a license for more Channels see 13.5.1 License.

Main Stations can still be linked from the device menus. See 16 Linking Main Stations.

15.1 A HelixNet Link-Group Overview

- A HelixNet Link-Group can contain up to three Main Stations. More is possible but not advised.
- A Link-Group must have one device designated as Link-Master.
- The Link-Group performs a “best effort” approach to creating a mesh network between all the devices within the group.

A Mesh Network

Once joined to the Link-Group, all devices attempt to connect to all other devices within the group.

- Configuration and control of any device is possible through any other unit in the group
- Configuration information is both distributed and persisted within every node of the group
- Significantly reduces loss of service

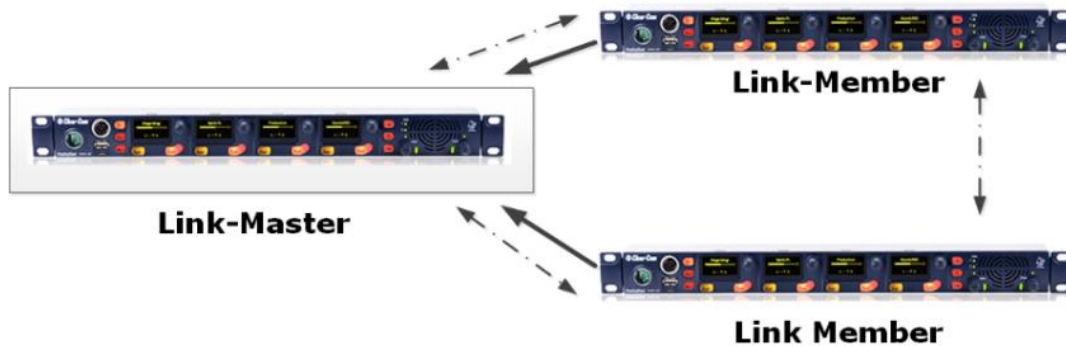


Figure 15-1 A Link-Group

15.1.1 The Link-Master

The Link-Master designation serves three main purposes:

- 1) It facilitates Link-Group membership.
- 2) It is the owner of configured Role information, meaning that Roles will only persist (be maintained consistently) if the Link-Master is operational.
- 3) It is responsible for the synchronization and distribution of both configuration (Roles) and device availability status throughout the Link-Group.

Note: Clear-Com recommends that the IP address of the Link-Master is allocated statically. When allocated by DHCP, the IP address can change. If this happens the Link-Members will no longer be able to reach the Link-Master device, and Role information may not be persisted.

Note: Any device can be set to Link-Master or Link-Member. The default setting for HelixNet linking mode is **Linking Disabled**. This setting stops the device from broadcasting its name to the network (via its mDNS index).

Note: Linked Main Stations need 2 – 5 Mbps of bandwidth.

15.1.2 The Link-Members

HelixNet devices that are not identified as master will have the designation of Link-Member. Joining a device to a Link-Group requires that device to be set to Link-Member which will prompt the user to enter the IP address of the Link-Master.

15.2 Device configuration in the CCM

Note: Any IP connectivity requires an Ethernet or Fiber module fitted to the Main Station.

Once the units have joined a Link-Group, the devices can be configured either directly or by proxy. The host device is the unit which a browser is currently directed to.

The **Home** button will always take you to the host device's configuration page.

- Proxy configuration can be accomplished by clicking on any device within the **Overview** page.

Once connected, Main stations in a Link-Group can be configured from any unit

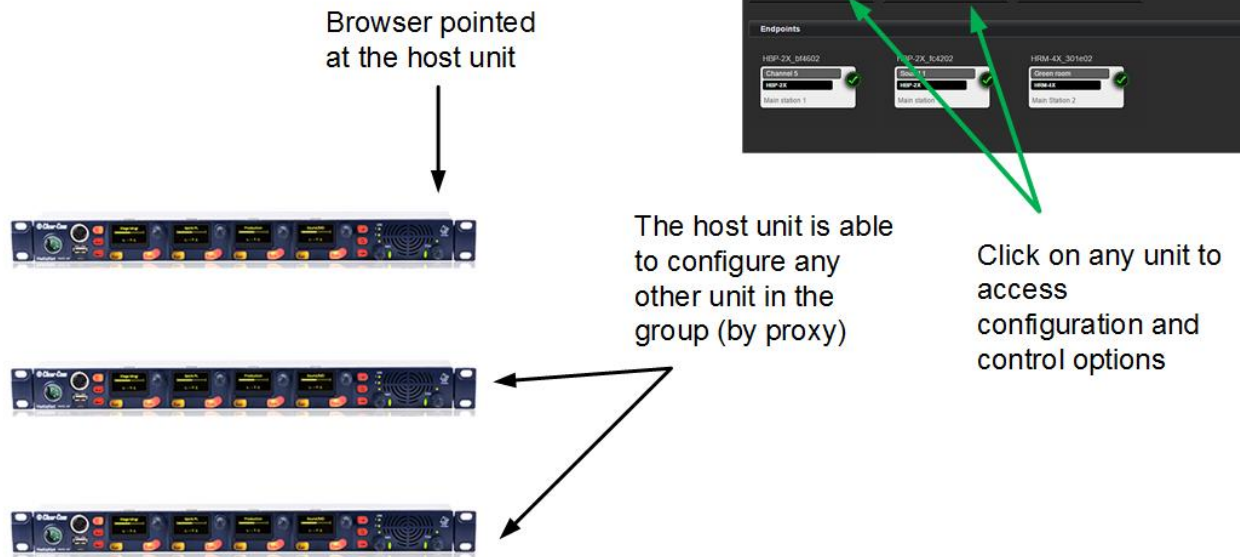


Figure 15-2 Host device concept

Note: The host device will always have an orange highlight in the CCM.

15.3 Linking Main Stations in the CCM

Main Stations to be linked in the CCM should first be connected by LAN to the same network and able to see each other.

In order to create a Link-Group in the CCM, you must designate one unit as Link-Master. The other units are designated Link-Member and are joined to the Master via the Master's IP address. This is achieved in the **Linking** page of each unit.

- 1) From a browser, access the CCM of HelixNet Main Station #1 by typing its IP address into the URL field.

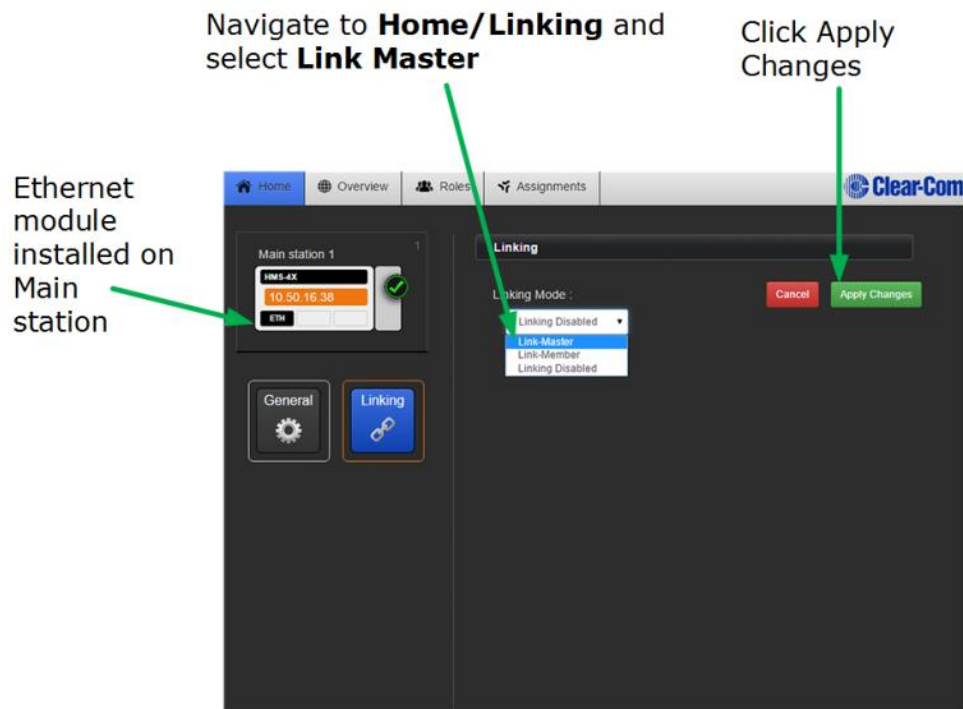
Default login and password for the CCM: **admin, admin.**

Note: The unit's IP address can be found in the device's display screens: **Menu > Networking > Preferences > IP address.**

Note: The Link-Master IP must be statically allocated to prevent loss of service.

- 2) Navigate to **Home > Linking** in the CCM. From the drop-down box select **Link-Master** and click **Apply Changes**. This designates this unit as Link-Master.

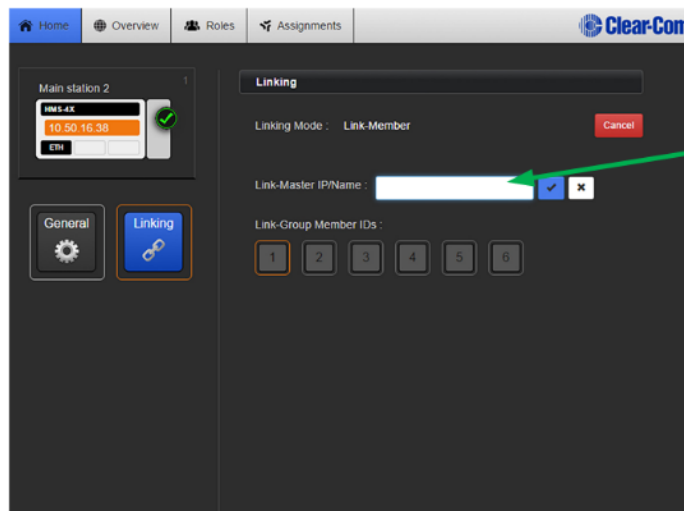
Note: The default linking mode is: **Linking Disabled**. When a device has been designated either Link Master or Link Member it will be looking for a pairing and a link icon will flash in the device screens. **Linking Disabled** prevents this.



- 3) From a new browser window, access the CCM of device #2 by typing the unit's IP address into the URL field.

You will have to enter the password and login for the device (Default, **admin, admin**)

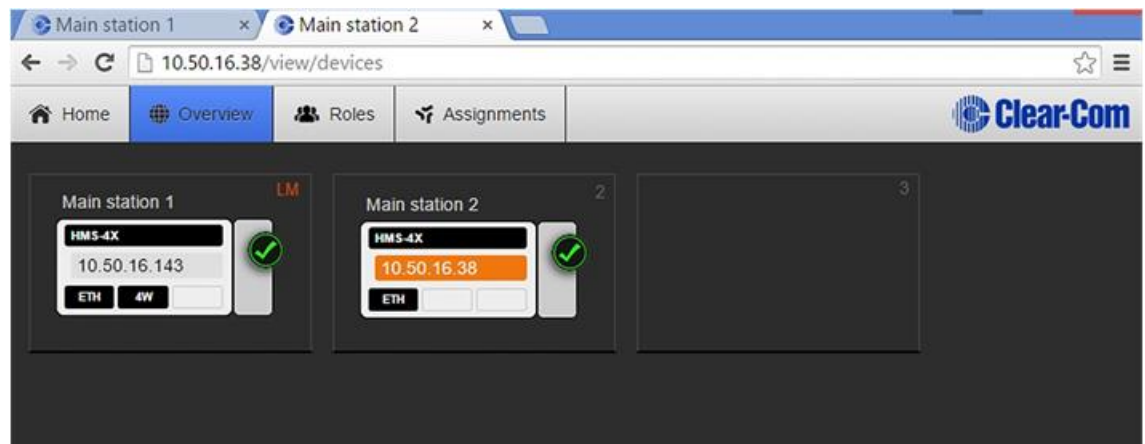
- 4) Navigate to **Home > Linking** and select Link-Member from the drop down box.
- 5) You will be prompted for the IP address (or hostname) of the Link-Master. Within the Master IP address field, enter the IP address of device #1. Click on blue check mark or <ENTER> key to submit.



Input Link Master IP or name

Either accept the default **Link Group Member ID** (orange highlight) or select a new one by clicking on it. Click **Apply Changes**. This links this device to the Link Master.

- 6) Navigate to the **Overview** page (top navigation bar). Both HelixNet devices are now displayed on this page.



- 7) Repeat steps 3) to 6) for a third device if required.

16 Linking Main Stations (cabling and linking from device menus)

This chapter describes how to link Main Stations using the device menus rather than the Core Configuration Manager. You can connect Main Stations directly using Ethernet or Fiber, or connect them over a LAN via Ethernet.

Main Station linking is achieved using interface modules fitted to the extension bay of the Main Station. There are two modules:

- Ethernet interface module (HLI-ET2). This module provides an Ethernet connection between Main Stations.
- Fiber interface module (HLI-FBS). This module provides a Fiber connection between Main Stations.

Each Main Station has 12 channels, and can connect up to 20 beltpacks.

Note: If you change the network topology between any two stations, you must reboot the stations.



Warning: Both ports are configured to bridge traffic from one port to the other in order to work in daisy-chain. Spanning Tree Protocol is not enabled on those ports, therefore do not connect them both to the same network.

16.1 Linking scenarios

Main Stations are connected together using CAT, CAT5e or CAT6 shielded cable. They can also be connected using fiber. There are various topologies that you can create. Some of these are illustrated below.

16.1.1 Linking two Main Stations over LAN

- 1) Insert an HLI-ET2 Ethernet interface module in each station. Use any of the three slots available.

Note: Ensure that the Main Station is powered down before inserting modules.

- 2) Connect a regular Ethernet cable (for example, CAT5, CAT5e, CAT6, CAT6e) from one HLI-ET2 port on one station to one HLI-ET2 port on the other station.
- 3) Power up both stations. Verify that the green LED on each HLI-ET2 port is flashing.

- 4) On one HMS go to **Networking->Linking->Link Mode** menu and select **Master**.
- 5) On the other HMS go to **Networking->Linking->Link Mode** and select **Member**. Then in **Networking->Link to Master** select the Master HMS you identified in the previous step..

Note: In HelixNet 3.0 each Main Station has 12 Channels. Linking 3.0 Main Stations will have the effect of giving you more I/O and module options.

Note: You should see a Link icon  on the Main Station display.

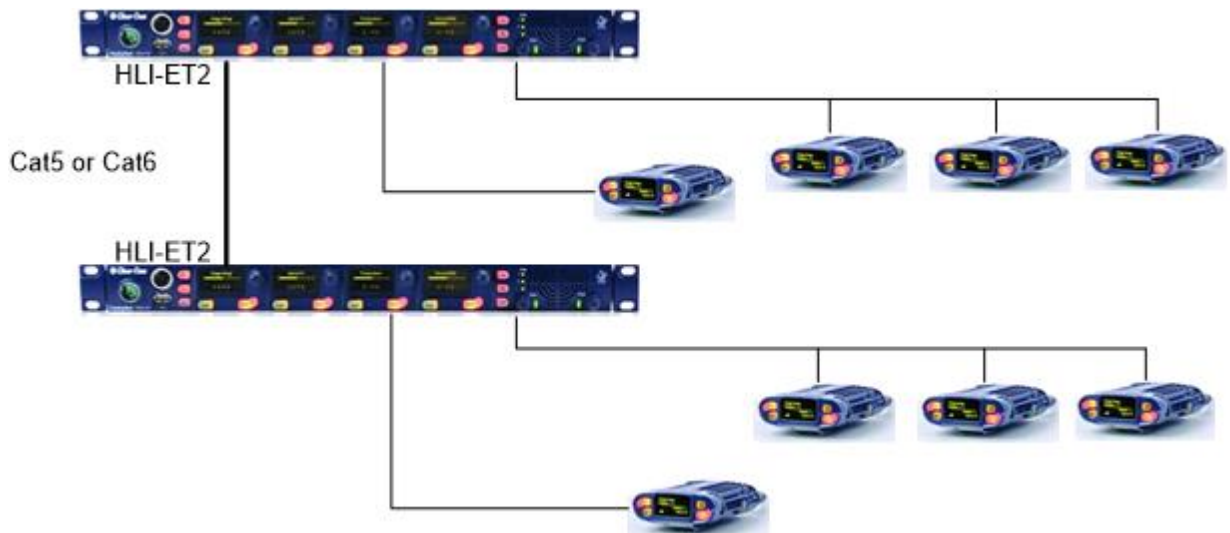


Figure 16-1: Linking two stations over LAN

16.1.2 Linking two Main Stations with Fiber

- 1) Insert an HLI-FBS Fiber interface module in each station. Use any of the three slots available.
Note: Ensure that the Main Station is powered down before inserting modules.
- 2) Ensure that an SFP Transceiver is connected into one HLI-FBS module port on each station.
- 3) Connect Two Fibers from one HLI-FBS port on one station to one HLI-FBS port on the other station. If using Single connector fiber, make sure that Tx on one goes to Rx on the other.
- 4) Power up both stations. Verify that the green LED on each HLI- FBS port is flashing.
- 5) On one HMS go to **Networking->Linking->Link Mode** menu and select **Master**.

- 6) On the other HMS go to **Networking->Linking->Link Mode** and select **Member**. Then in **Networking->Link to Master** select the Master HMS you identified in the previous step.

Note: You should see a Link icon  on the Main Station display.

Note: In HelixNet 3.0 each Main Station has 12 Channels. Linking Main Stations in 3.0 will have the effect of giving you more I/O and module options.

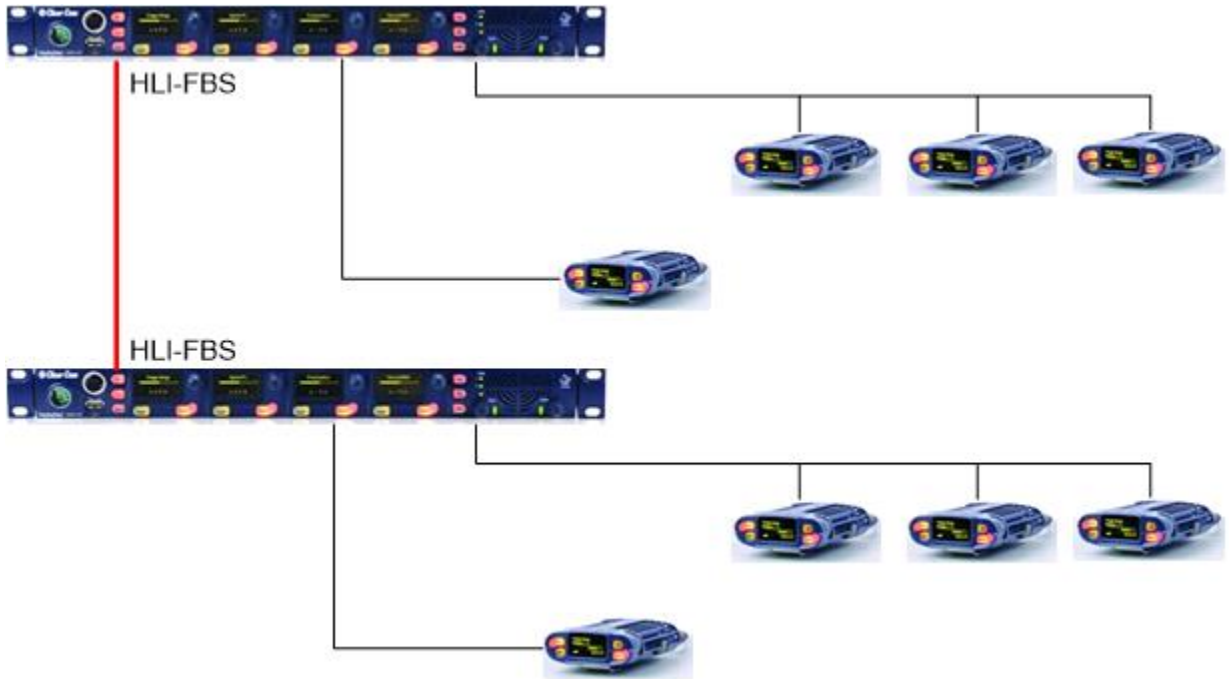


Figure 16-2: Linking two stations with Fiber

16.1.3 Linking three Main Stations in a daisy chain

You can daisy chain stations following all the instructions of the previous sections using the second port on one of the HLI-ET2 or HLI-FBS module to connect to a third station. Then enable linking on the third station. The advantage of daisy chain is that it does not require any additional equipment for interconnection. The disadvantage is that if you disconnect or power down a station in the middle it will break the chain and prevent audio from passing between the units either side of the break.

You can also mix Ethernet and Fiber in the chain using an additional slot in a station in the middle of the chain.

Alternatively, you can save a slot by using an HLI-FBS module in the middle station, populating one port with a fiber SFP transceiver and one port with a 10/100Base-T electrical SFP transceiver.

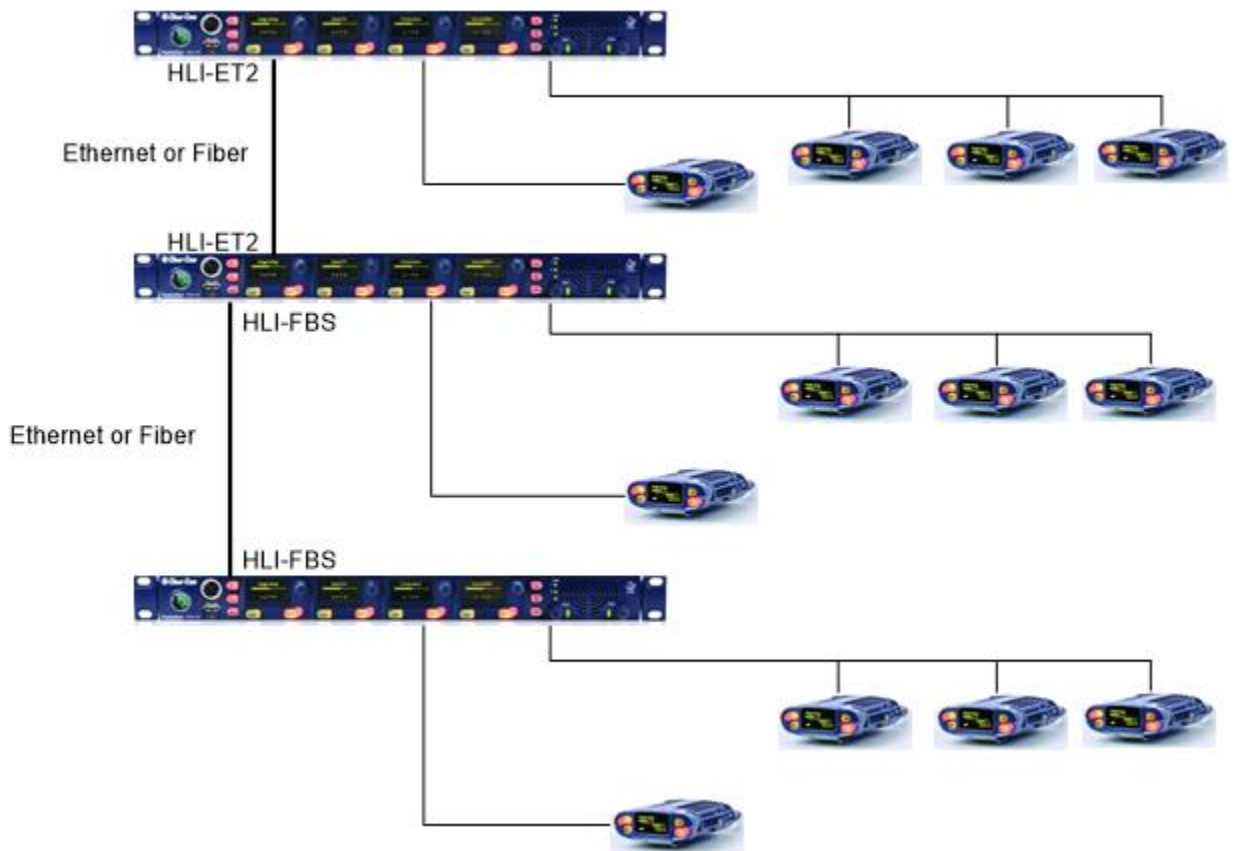


Figure 16-3: Linking three Main Stations in a daisy chain

16.1.4 Resource Sharing between Linked Stations

When Channels are linked, Channels of the same number (1 – 24) will merge their audio together. This means that any audio available on separate Main Stations will be heard in the Channel of the same number on a linked Main Station.

If linked Main Stations do not have the same number of licensed Channels (12 or 24), all devices will default to 12 Channels.

17 Linking Remote Stations and Speaker Stations

This chapter describes how to link Remote and Speaker Stations to Main Stations. You can connect Remote and Speaker Stations on one of the Digital Intercom Lines, point-to-point to a Main Station Ethernet interface module (HLI-ET2) or over an IP network.

Linking to a Main Station over an IP network requires an Ethernet interface module fitted to the extension bay of the Main Station (HLI-ET2).

Note: If the IP address on a Remote Station or Speaker Station changes, you must either reboot the Remote Station or disable and then re-enable the DHCP on the Remote Station.



Warning: Digital intercom lines and the Ethernet connections are mutually exclusive on Remote and Speaker Stations. If both are connected it will be detected as a fault, communication over both ports will stop and both status LEDs will blink RED. This requires a reboot of the station using **Administration > Reset > Reboot**



Warning: When changing the connection from digital intercom line to Ethernet or vice-versa, you must disconnect one cable and then wait until the unit has detected a loss of connection before connecting the other cable. Otherwise, they will briefly be detected as both connected.



Warning: When changing the power connections to a Remote Station, a network storm error message may appear. If so, disconnect the power cable, and reboot the Remote Station.

17.1 Linking scenarios

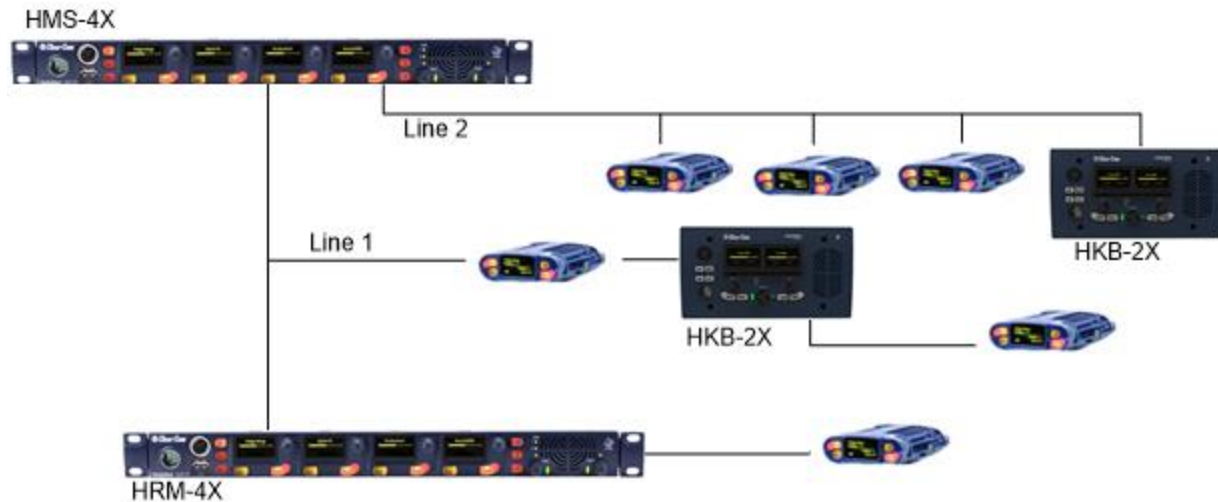
There are various topologies that you can create. Some of these are illustrated below.

17.1.1 Digital Partyline Intercom

Remote and Speaker Stations have Digital Intercom 3-pin XLR connectors (female and male) and can connect to Main Stations along with Beltpacks.

Note: A Remote or a Speaker Station draws current equivalent to three Beltpacks when the loudspeaker is in use. If the Remote or Speaker Station is locally powered using a power supply, it does not draw current from the digital intercom line.

- 1) Connect an XLR cable from a Main Station to the Remote or Speaker Station.
- 2) Power up the Main Station and verify that the Line 1 and Line 2 status LED are green on Main Station.
- 3) On a Remote Station you can verify that the Line status LED is steady green.



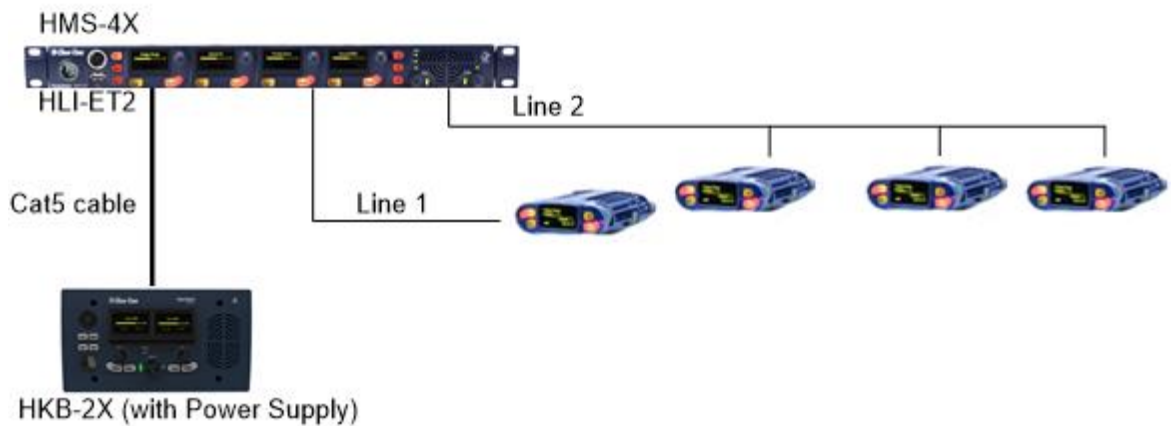
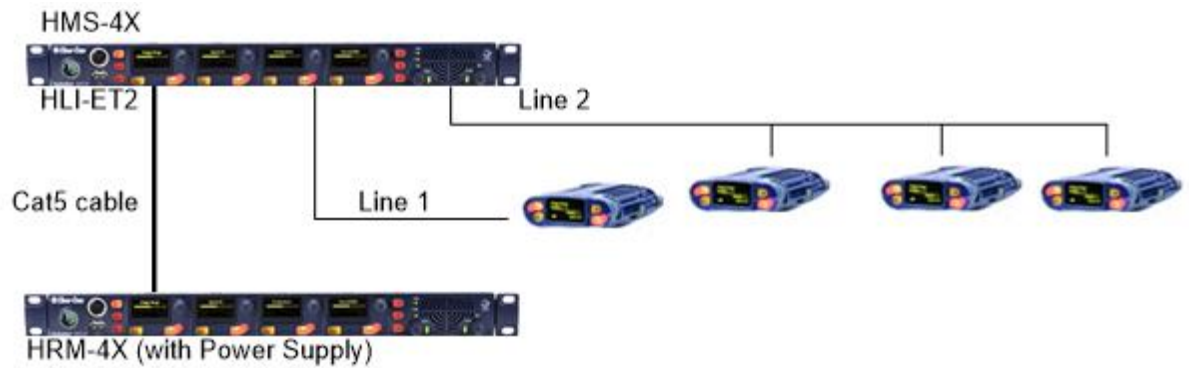
17.1.2 Ethernet point-to-point link

Remote and Speaker Stations have RJ45 Ethernet connectors and can connect to Main Stations over Ethernet.

- 1) Insert an HLI-ET2 Ethernet interface module in the Main Station. Use any of the three slots available.

Note: Ensure that the Main Station is powered down before inserting modules.

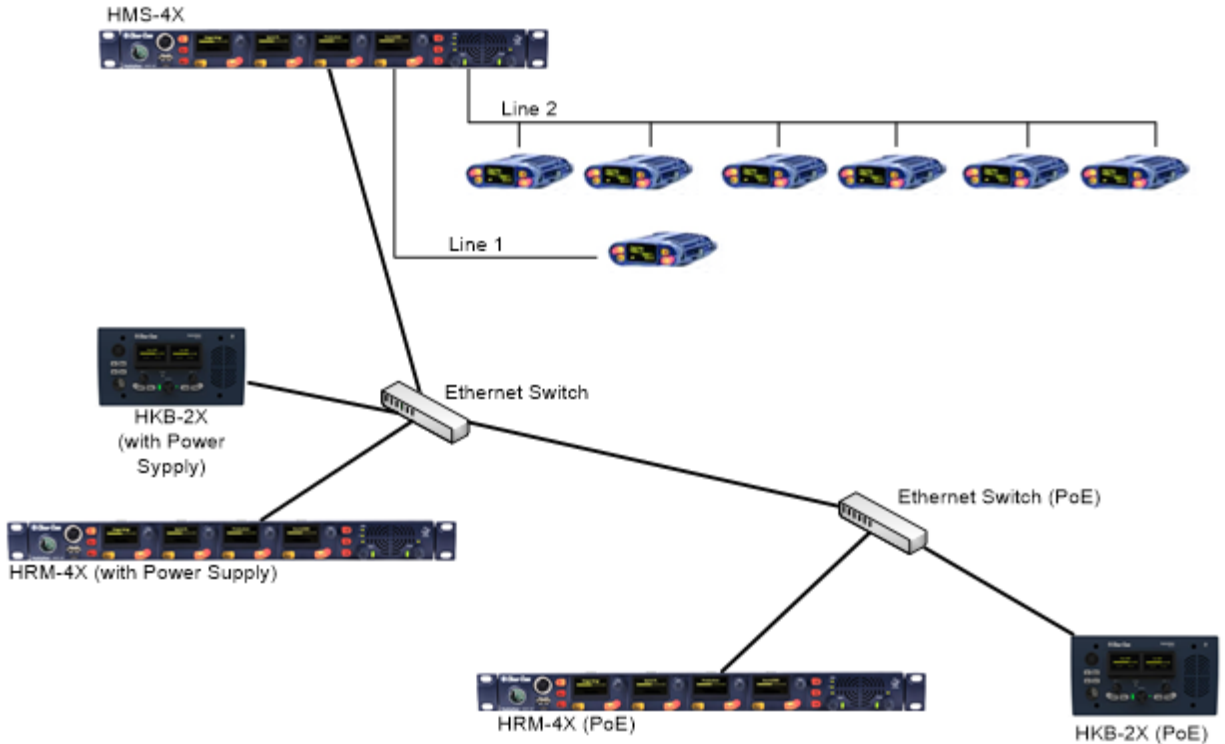
- 2) Connect a regular Ethernet cable (for example, CAT5, CAT5e, CAT6, CAT6e) from one HLI-ET2 port on one station to the Remote or Speaker Station.
- 3) Connect an external AC/DC power adapter to the Remote or Speaker Station
- 4) Power up both Stations. Verify that the green LEDs on the HLI-ET2 port and on the Remote or Speaker Station are on.
- 5) Go to **Networking->Pair to Station->By Name** on the Remote or Speaker Station. You should see one entry indicating that the Remote or Speaker Station has properly detected the Main Station. Select this entry.
- 6) Go to **Station Settings->Keyset Assign** and assign channels to any keyset.



17.1.3 Local IP Network

- 1) Insert an HLI-ET2 Ethernet interface module into the Main Station. Use any of the three slots available.
Note: Ensure that the Main Station is powered down before inserting modules.
- 2) Connect a regular Ethernet cable (for example, CAT5, CAT5e, CAT6, CAT6e) from one HLI-ET2 port to an Ethernet Switch and connect Remote or Speaker Stations to Ethernet Switch as well.
- 3) Connect an external AC/DC power adapter to the Remote or Speaker Station or connect them on a Power over Ethernet (PoE) port on the Ethernet Switch.
- 4) Power up all Stations. Verify that the green LED on the HLI-ET2 port and on the Remote or Speaker Station is on.

- 5) Go to **Networking->Link to Station->By Name** on each Remote and Speaker Station. You should see one entry indicating that the Remote or Speaker Station has properly detected the Main Station. Select this entry.
- 6) Go to **Station Settings->Keyset Assign** and assign channels to any keyset.

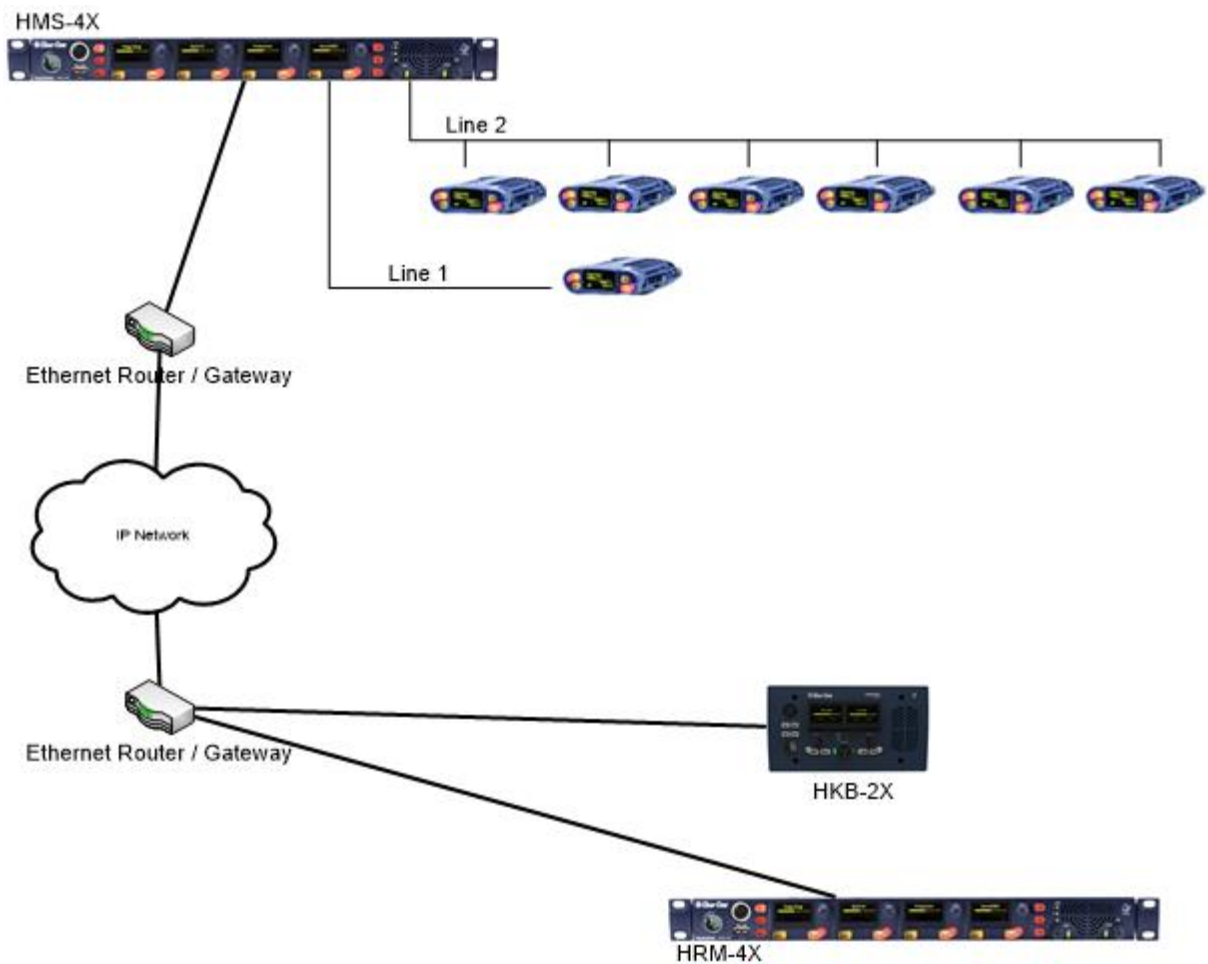


17.1.4 Remote IP Network

Remote and Speaker Stations can connect to a Main Station that is not within the same network Broadcast Domain.

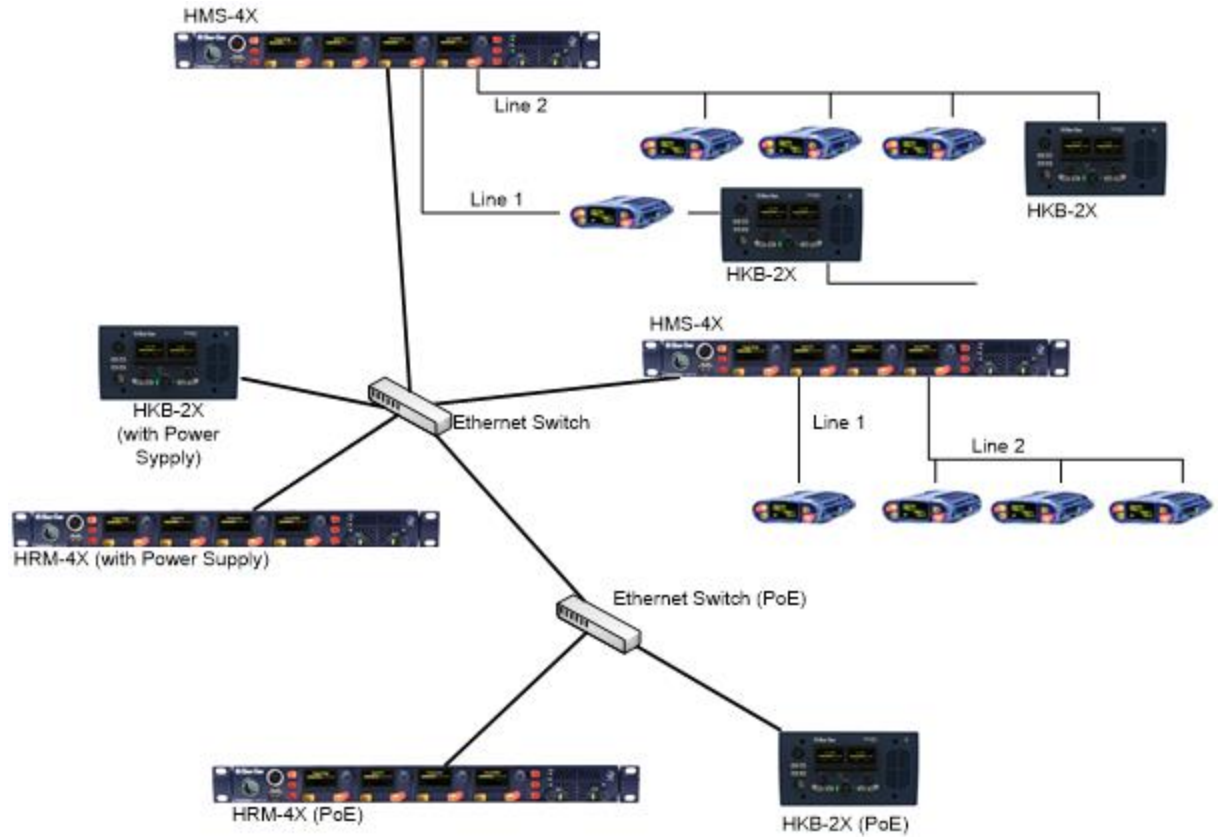
- 1) Insert an HLI-ET2 Ethernet interface module in the Main Station. Use any of the three slots available.
Note: Ensure that the Main Station is powered down before inserting modules.
- 2) Connect a regular Ethernet cable (for example, CAT5, CAT5e, CAT6, CAT6e) from one HLI-ET2 port to a Router/Gateway. Make sure you know the Gateway IP address for that first subnet.
- 3) Connect Remote or Speaker Stations to a Router/Gateway. Make sure you know the Gateway IP address for that second subnet.

- 4) Connect an external AC/DC power adapter to the Remote or Speaker Station or connect them on a Power over Ethernet (PoE) port on the Ethernet Switch.
- 5) Power up all Stations. Verify that the green LED on the HLI-ET2 port and on the Remote or Speaker Station is on.
- 6) On the Main Station, go to **Networking->Preferences->IP Address** and note the IP address of the Main Station. Make sure that **Networking->Preferences->Gateway** and **Networking->Preferences->Netmask** match that of your subnet.
- 7) On each Remote and Speaker Station make sure that all **Networking->Preferences** match that of your subnet.
- 8) On each Remote and Speaker Station go to **Networking->Link to Station->By Address** and enter the IP address of the Main Station.
- 9) Go to **Station Settings->Keyset Assign** and assign channels to any keyset.



17.1.5 Mixed Linking

Here is one example of how all the previous linking could be mixed with Main Station Linking.



17.2 Networking Specifications

Specification	Value
Latency on Powerline	40-80ms (depends on the distance and the number of Devices (HBP, HRM, HKB) on the line. More distance or more Devices means more latency)
Latency over IP Network	30ms + Network Latency
Bandwidth used	HRM-4X: 600 kbps to the Main Station, 2.5 Mbps from the Main Station. HKB-2X: 300 kbps to the Main Station, 1.5 Mbps from the Main Station.
IPv4	UDP Port 6001 (Digital Intercom) TCP Port 6001 (Digital Intercom) UDP Port 5353 (mDNS)

18 Connecting to Other Intercom Systems

This chapter provides basic guidance on connecting your HelixNet Partyline system to a range of other intercom systems, including:

- Two-wire cabled partyline systems (RTS and Clear-Com Encore®).
- Two-wire / four-wire wireless systems (Tempest, CellCom® / FreeSpeak®, and the DX210).
- Digital matrix systems (Eclipse® MVX four-wire).
- Two way radio systems.

The HMX-4X Main Station is connected to these systems using the optional Two-wire and Four-wire interface modules.

18.1 Connecting HelixNet Partyline to Encore®

18.1.1 About Encore

Encore is the plug-and-play analog two-wire partyline system from Clear-Com.

Clear-Com Encore is widely used in theaters, schools, local broadcast stations, churches and other small to mid-size live productions.

Two and four channel versions of the Encore Main Stations and Remote Stations are available.

Tip: For more information about Encore, see your **Encore documentation** or visit the **Analog Partyline Intercom** pages on the Clear-Com website:
<http://www.clearcom.com/product/partyline>.

18.1.2 Quick reference: Connecting to Encore

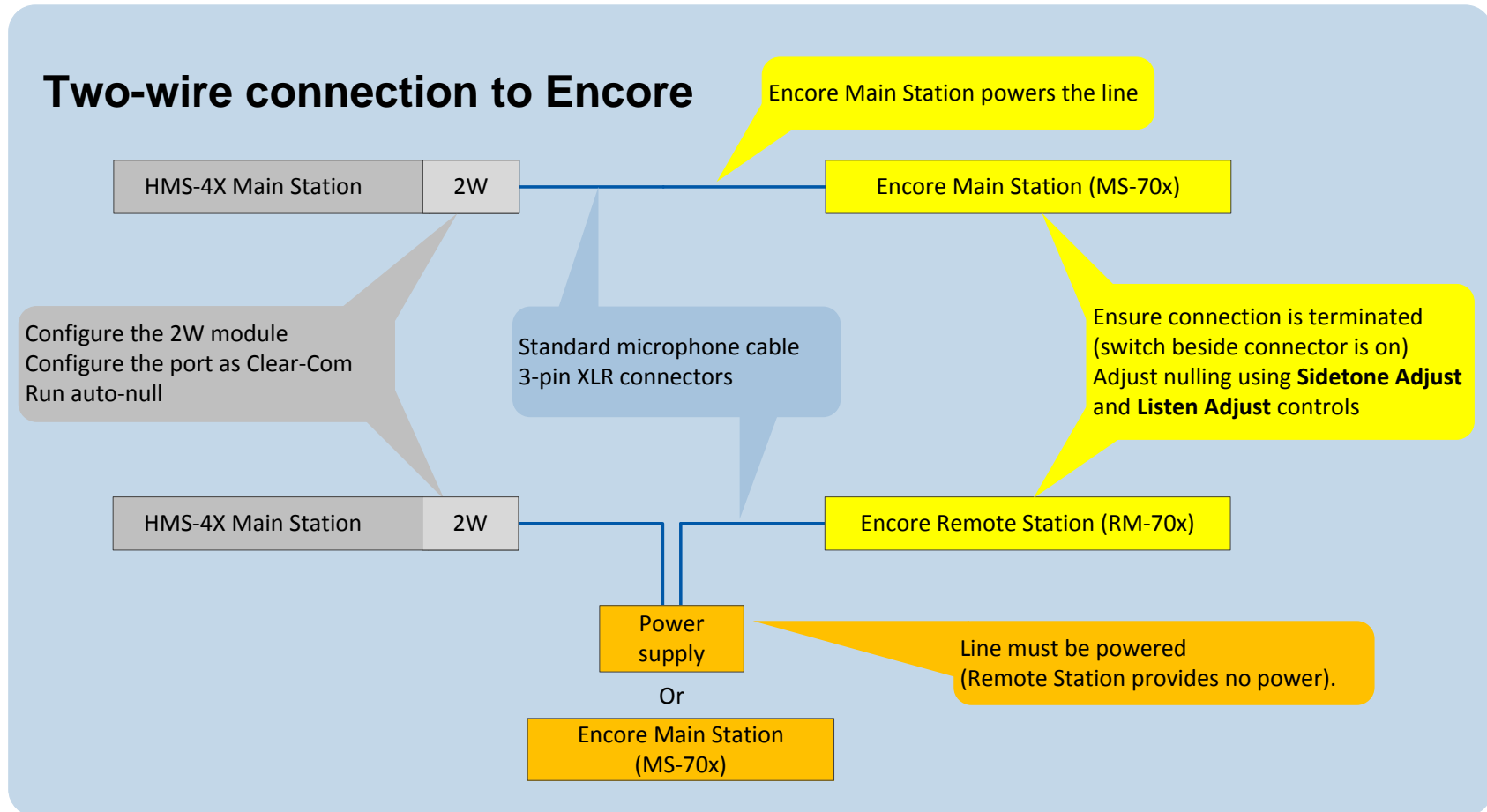


Figure 18-1: Two-wire connection to Encore

18.1.3 Connecting to an Encore Main Station

Note: The following procedure assumes that a two-wire interface module has been fitted to the HMS-4X Main Station. For more information about interface modules, see **2.2.1 HMS-4X Main Station rear panel: Interface modules**.

Note: A HelixNet system with HLI-2W2 must be able to receive power from an analog partyline.

To connect your HelixNet Partyline system to an Encore Main Station (for example, the four channel **MS-704**):

- 1) On the HMS-4X Main Station, configure the **Module Settings** for the two-wire interface module (**Menu mode > Module Settings**). For the full procedure, see **5.6.2 Configuring a Two-wire interface module**.

Note: Check that the two-wire module is configured for **Clear-Com systems** (the default) and run the **Auto-null**. Auto-nulling helps to reduce echo while talking on a two-wire audio system. You must run auto-null every time you change the cabling.

- 2) Physically connect the HMS-4X Main Station to the Encore Main Station, using the 3-pin XLR connectors:
 - On the HMS-4X Main Station two-wire interface module.
 - On the back panel (rear) of the Encore Main Station.

There are four channels (A, B, C and D), comprising two 3-pin XLR connectors, on the MS-704.

Connect to the selected channel using standard microphone cabling.

Note: The Two-wire module will not function without an attached power supply on the analog side of the interface.

Ensure that the connection is terminated (using the termination switch beside the connectors). The default position for the switch is **on**.

- 3) On the Encore (MS-704) Main Station, adjust nulling for the selected channel (either channel A, B, C or D on the MS-704). Nulling helps to reduce echo while talking on a two-wire audio system.

Tip: The amount of null that is required changes when you add or remove devices, or alter the length of the cabling. For optimum performance, Clear-Com recommends that you adjust the nulling every time you make a change to the system configuration.

Note: Ensure that **all** Talk keys/routes are disabled before auto-nulling commences.

To adjust nulling on a channel on the Encore Main Station (MS-704):

- a) Turn the screwdriver-adjustable **Sidetone Adjust** control (just below the headset connector) to the appropriate level.

- b) Turn the screwdriver-adjustable **Listen level** control (the null control, located just below the channel **Talk** button and **Call** LED) for the channel to the appropriate level.

Tip: If the headset microphone is being used, hum or gently scratch the mic for a continuous signal source to null on. If a good null is not attainable, switch the **Long / Short DIP switch** for the channel to its opposite setting. Use the setting that produces the best audio quality.

To optimize audio quality, you may also want to adjust the **Audio Settings** on the HMS-4X Main Station. For more information, see **5.2 Configuring the Audio settings**.

18.1.4 **Connecting to Encore Remote Stations**

Connecting to an Encore Remote Station (for example, the RM-704) is similar to connecting to an Encore Main Station (see **18.1.2 Quick reference: Connecting to Encore**).

You will require a **separate power supply**, for example, the PS-702 (two channel) or PS-704 (four channel) power supply, to power the Remote Station which is unpowered and any connected wired beltpacks.

18.2 Connecting HelixNet Partyline to RTS (Telex) two-wire systems

18.2.1 **About RTS two-wire systems**

HelixNet Partyline is also designed for interoperability with RTS (Telex) TW (two-wire) analog partyline systems from Telex.

RTS two-wire systems include fully programmable intercom (main) stations, remote Speaker Stations, two-wire beltpacks, and two-wire power supplies.

18.2.2 Quick reference: Two-wire connection to RTS 2W system

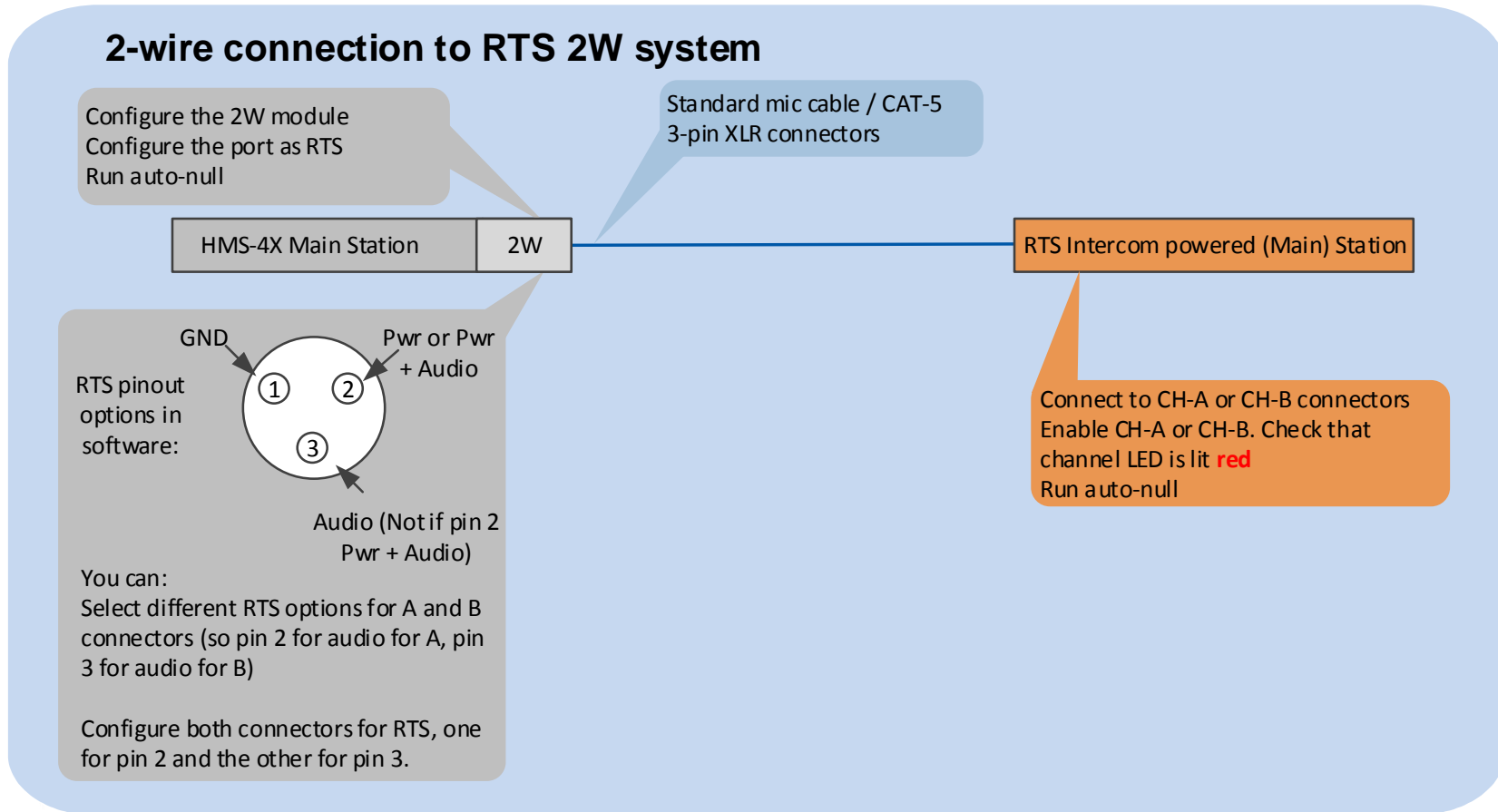


Figure 18-2: Two-wire connection to RTS 2W system

18.2.3 Connecting to an RTS (Telex) intercom station

To connect your HelixNet Partyline system to an RTS intercom station (in this case, the 2 channel MCE325 user station):

- 1) On the HMS-4X Main Station, configure the **Module Settings** for the two-wire interface module.

For the full procedure, see **5.6.2 Configuring a Two-wire interface module**.

Ensure that you:

- **Configure port(s) for RTS systems.** You can select from two different pinouts when connecting to an RTS two-wire system:

RTS pinout option	Description
RTS Audio Pin 2	Pin 2 is used for both power and audio.
RTS Audio Pin 3	Pin 3 is used for audio (Pin 2 is used for power only).

Table 18-1: Configuring Module Settings: RTS pinout options

- **Run auto-null.** Auto-nulling helps to reduce echo while talking on a two-wire audio system. You must run auto-null every time you change the cabling.
- 2) Physically connect the HMS-4X Main Station to the RTS intercom station (MCE325). The two channels of RTS TW intercom must be split prior to connection with either of the Two-wire module ports. RTS Audio Pin 2 carries the power that is required for the Two-wire module.

Powering the connection:

You must power the connection between the systems using either a dedicated power supply or an RTS power supply.

Tip: For more information about the PK-7 or PS-70x power supply devices from Clear-Com, see <http://www.clearcom.com/product/partyline/power-supplies>

Connecting to the MCE325 device:

There are three 3-pin XLR connectors on the rear panel of the MCE325 device. In two-wire mode:

- The left and right-hand connectors are used for intercom channels 1 and 2 input/ output.
- The center connector is used for channels 3 and 4 input / output.

- Connect to the selected channel using standard microphone cabling.

Note: The MCE325 is designed for use with intercom lines with a 200-ohm line terminating impedance. A 200 ohm termination plug is connected to the center 3-pin XLR connector to prevent channels 3 and 4 from oscillating when the MCE325 is in two-channel mode.

- 3) On the RTS device (in this case, the MCE325), adjust the nulling (if necessary) on the channel to which the HMS-4X Main Station is connected.

Nulling helps to reduce echo while talking on a two-wire audio system. A **sidetone nulling trimmer** (control) is provided for each of the four channels on the device.

To adjust a sidetone nulling trimmer:

- a) Turn the speaker switch on (even if an external speaker is not connected). This turns off the internal sidetone trimmer, which controls the sidetone level in headsets.
- b) Turn on the microphone. Activate the relevant **Talk** button and speak into the microphone.
- c) To minimize echo, adjust the **sidetone nulling trimmer** (located under the **CH1** and **CH2** rotary controls).

Note: The default setting for each trimmer is for maximum nulling of the microphone signal when a 200-ohm resistance terminates the channel. However, you may have to adjust the nulling according to the system configuration.

18.3 Connecting HelixNet Partyline to Tempest®

18.3.1 About Tempest

Tempest is a digital wireless intercom system, comprising a base station (Main Station) and belt stations (beltpacks). There are two-wire and four-wire versions of Tempest available. The system operates in either:

- The 2.4GHz ISM band (Tempest 2400 models).
- The 900 MHz ISM band (Tempest 900 models).

Tip: For more information about Tempest, see your Tempest documentation or visit the wireless intercom pages on the Clear-Com website: <http://www.clearcom.com/product/wireless>.

18.3.2 Quick reference: Two-wire connection to Tempest

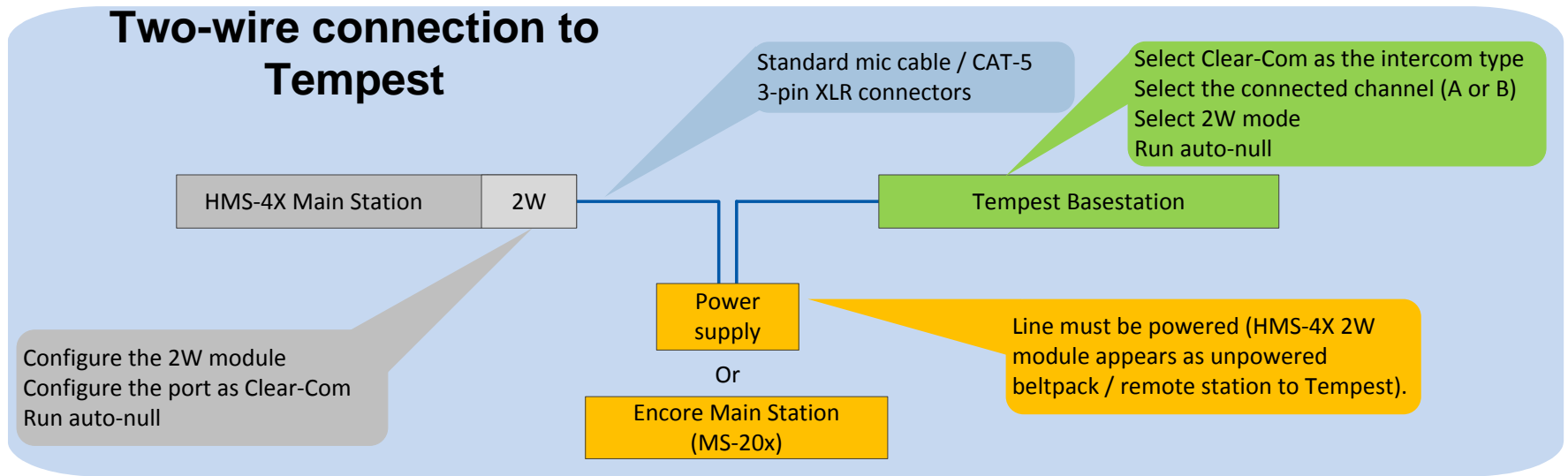


Figure 18-3: Two-wire connection to Tempest

18.3.3 Two-wire connection to Tempest

To connect your HelixNet Partyline system to Tempest, using a two-wire connection:

- 1) On the HMS-4X Main Station, configure the **Module Settings** for the two-wire interface module.

For the full procedure, see **5.6.2 Configuring a Two-wire interface module**.

Note: Check that the Two-wire module is configured for **Clear-Com systems** (the default) and run **Auto-null**. Auto-nulling helps to reduce echo while talking on a two-wire audio system. You must run auto-null every time you change the cabling.

- 2) On the Tempest base station:
 - a) Select **Clear-Com** as the intercom type, using the slide switch on the front panel.
 - b) Configure an intercom channel for two-wire connection:
 - i. Select the intercom channel (A or B), using the **CHAN** selection button on the front panel.
 - ii. Select two-wire connection for the intercom channel, using the **two-wire / four-wire** selection button on the front panel.
 - c) Enable **Auto-null**, using the Tempest menu screens. Enable **Manual Null** to remove any residual echo, where desired.

For more detailed information about setting up a two-wire connection on the Tempest base station, see your **Tempest reference manual**.



Always set the intercom type before you connect a two-wire intercom system to the Tempest Base station.

Never change the setting while the systems are connected. Changing the setting while the systems are connected can damage the Tempest Base station and / or the other system (in this case, HelixNet Partyline).

- 3) Physically connect the HelixNet Partyline and Tempest systems.

Powering the connection:

Tempest has a Master Mode setting that supplies power to the two-wire connection. In this case, no external power supply is required. Otherwise, you must power the connection between the systems using either a

dedicated power supply (such as the PK-7, PS-702, or PS-704), or a powered Encore Main Station (such as the MS-702 or MS-704).

Tip: For more information about the PK-7 or PS-70x power supply devices from Clear-Com, see <http://www.clearcom.com/product/partyline/power-supplies>

Connecting to Tempest:

You can use standard microphone cable or CAT5 cable types to connect the HMS-4X Main Station to the Tempest Base station. 3-pin XLR connectors are located:

- On the HMS-4X Main Station two-wire interface module.
- On the back panel (rear) of the Tempest Base station.

Tip: Tempest provides two-wire input/output gain adjustments, and can be utilized to either balance the gains between HelixNet and Tempest or connect two-wire system interfaces through a Tempest base station.

- 4) Adjust the **In / Out** volume level controls on the Tempest Base station. The **In / Out** volume levels have the following ranges:

Volume level	Range
In	-18dB to +4dB
Out	-18dB to +4dB

Table 18-2: Tempest Base station In / Out volume levels

For more information, see your *Tempest reference manual*.

Tip: To optimize audio quality, you may also want to adjust the **Audio Settings** on the HMS-4X Main Station. For more information, see **5.2 Configuring the Audio settings**.

18.3.4 Quick reference: Four-wire connection to Tempest

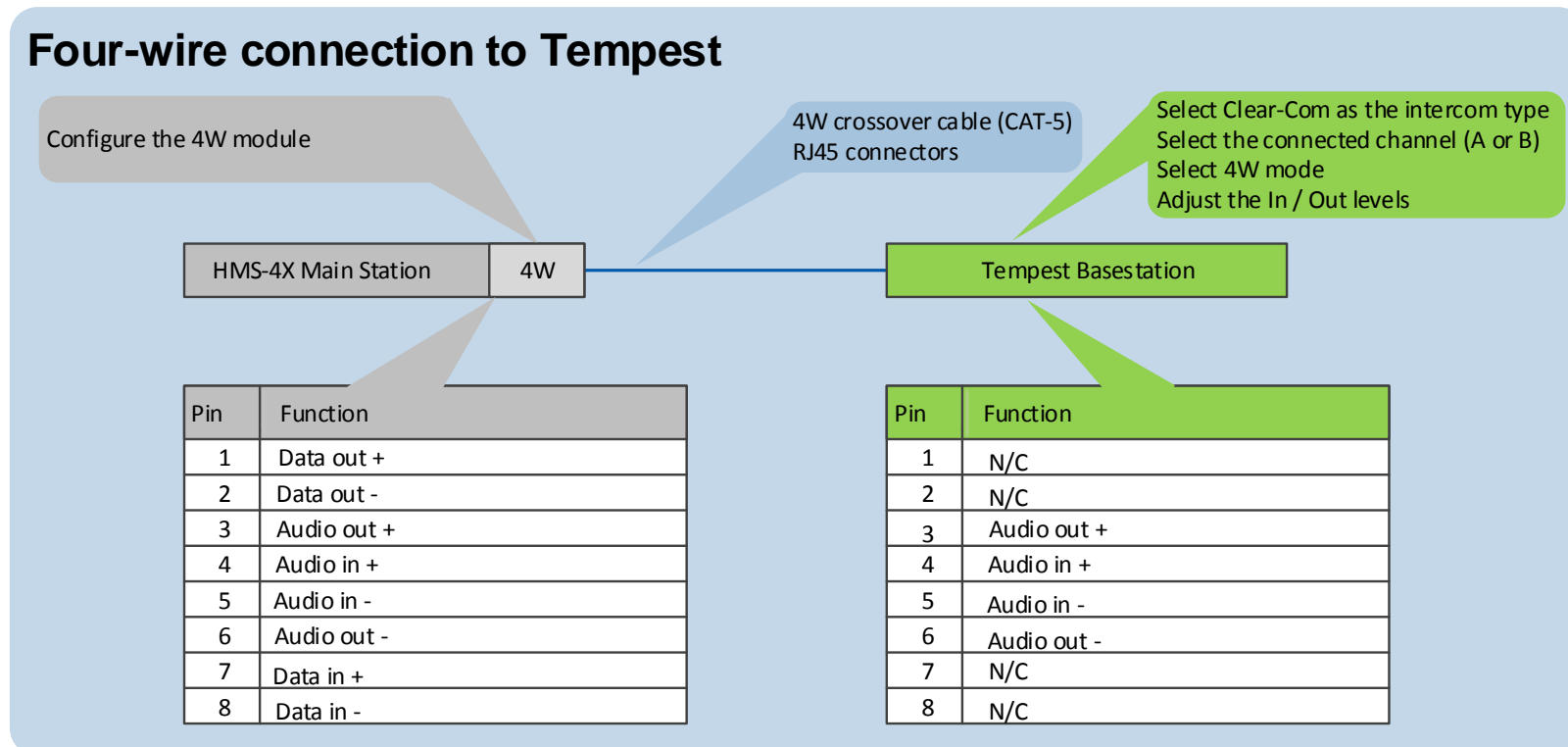


Figure 18-4: Four-wire connection to Tempest

18.3.5 Four-wire connection with Tempest

To connect your HelixNet Partyline system with Tempest, using a four-wire connection:

- 1) On the HMS-4X Main Station, configure the **Module Settings** for the Four-wire interface module, see **5.6.1 Configuring a Four-wire interface module**.
- 2) On the Tempest Base station, configure an intercom channel for four-wire connection:
 - a) Select the intercom channel (**A** or **B**), using the **CHAN** selection button on the front panel.
 - b) Select four-wire connection for the intercom channel, using the **two-wire / four-wire** selection button on the front panel.
- 3) Connect the HMS-4X Main Station and the Tempest Base station, using four-wire crossover CAT5 cabling.

Note: For pinout information for the two systems, see the **quick reference diagram** in **18.3.4. Quick reference: Four-wire connection to Tempest**.

RJ45 connectors are located:

- On the HMS-4X Main Station four-wire interface module.
 - On the back panel (rear) of the Tempest Base station (the top RJ45 connector is for **intercom channel A** and the bottom RJ45 connector for **intercom channel B**).
- 4) Adjust the **In / Out** levels controls on the Tempest Base station, where necessary.

For more information, see your **Tempest reference manual**.

Tip: To optimize audio quality, you may also want to adjust the **Audio Settings** on the HMS-4X Main Station. For more information, see **5.2 Configuring the Audio settings**.

18.4 Connecting HelixNet Partyline to CellCom® / FreeSpeak®

18.4.1 About CellCom / FreeSpeak

CellCom / FreeSpeak is a wireless intercom system from Clear-Com, operating within the license-free 1.92-1.93GHz frequency band. The system is branded as CellCom in North America and as FreeSpeak in the rest of the world.

CellCom /FreeSpeak combines DECT and wireless auto-roaming technologies to allow users to move freely without losing communication connection. Active Antennas enable a beltpack-to-base station distance range of up to 3200ft (1000m).

You can connect up to 20 full-duplex wireless beltpacks (which operate as fully programmable mobile panels) to one CellCom / FreeSpeak base station (Main Station).

Note: CellCom / FreeSpeak can also operate as an integrated solution, with up to 35 beltpacks connected to a Clear-Com digital Matrix frame.

Tip: For more information about CellCom / FreeSpeak, see your CellCom / FreeSpeak documentation or visit the wireless intercom pages on the Clear-Com website: <http://www.clearcom.com/product/wireless>.

18.4.2 Quick reference: Two-wire connection to CellCom / FreeSpeak

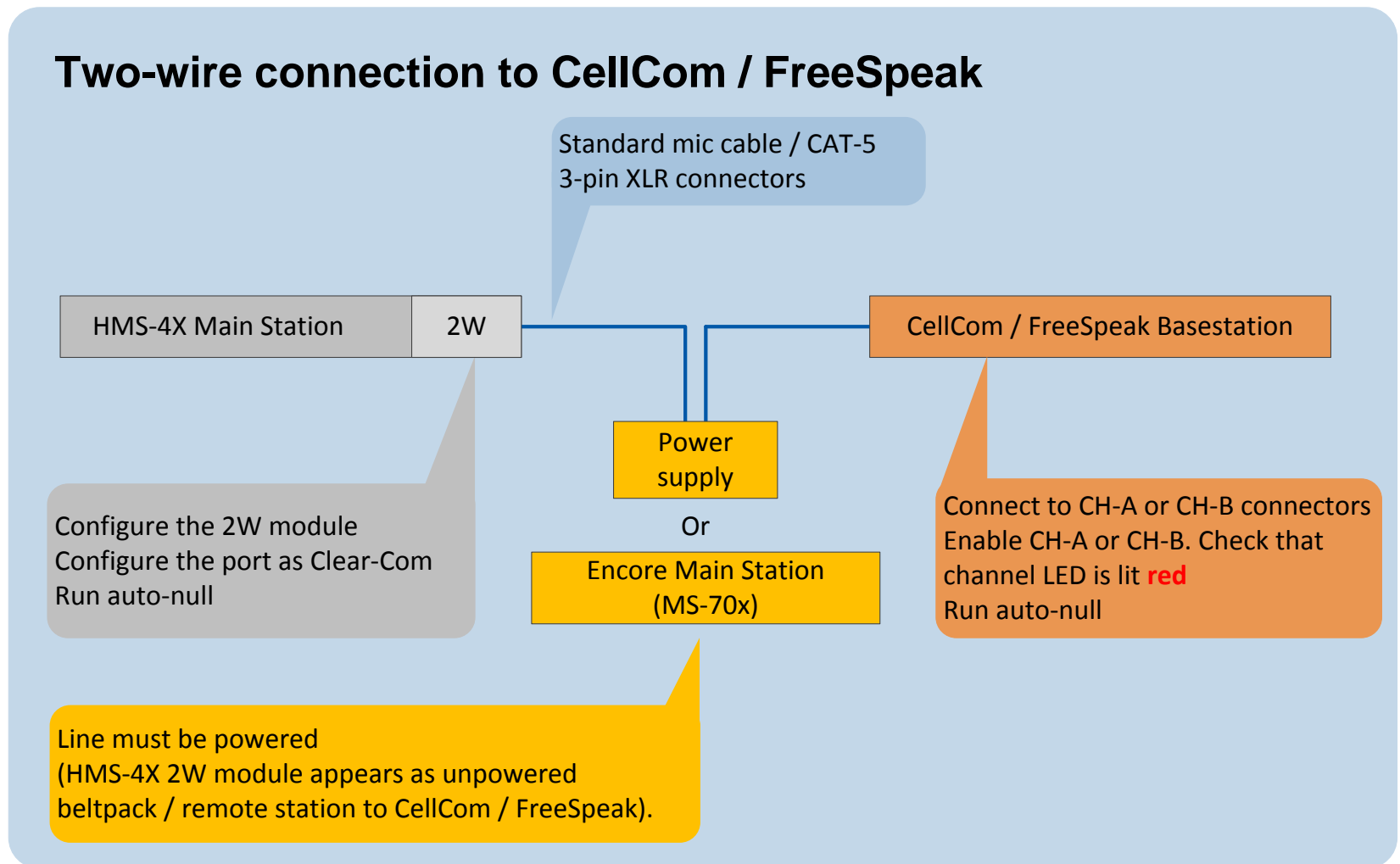


Figure 18-5: Two-wire connection to CellCom / FreeSpeak

18.4.3 Two-wire connection to CellCom / FreeSpeak

To connect your HelixNet Partyline system to a CellCom / FreeSpeak base station (Main Station), using a two-wire connection:

- 1) On the HMS-4X Main Station, configure the **Module Settings** for the two-wire interface module. See **5.6.2 Configuring a Two-wire interface module**.

Note: Check that the two-wire module is configured for **Clear-Com systems** (the default) and enable **Auto-nulling**. Auto-nulling helps to reduce echo while talking on a two-wire audio system.

- 2) There are two partyline channels on the CellCom / FreeSpeak base station (**CH-A** and **CH-B**). Before connecting the HMS-4X Main Station to the base station, ensure that the partyline LED on the front panel for the selected channel is **off**.

Off indicates that the partyline connection is currently disabled from the base station.

Note: If the channel is currently enabled, the partyline LED is lit **red**.

- 3) Physically connect the HMS-4X Main Station to one of the two partyline channels on the CellCom / FreeSpeak base station (Main Station).

Powering the connection:

You must power the connection between the systems using either a dedicated power supply (such as the PK-7, PS-702, or PS-704), or a powered Encore Main Station (such as the MS-702 or MS-704).

Tip: For more information about the PK-7 or PS-70x power supply devices from Clear-Com, see <http://www.clearcom.com/product/partyline/power-supplies>

Connecting the systems:

Use standard microphone cable to connect the two systems. There are 3-pin XLR connectors:

- On the HMS-4X Main Station two-wire interface module.
- On the back panel of the CellCom / FreeSpeak Base station. Two 3-pin XLR connectors, one male, one female, are provided for each of the two partyline channels (**CH-A** and **CH-B**).

- 4) On the CellCom / FreeSpeak base station, press **Enable** on the front panel (located directly beneath the LED for the connected channel (**CH-A** or **CH-B**)). The LED for the channel is lit **red**.

The base station automatically detects and configures the appropriate power and termination settings when the channel is enabled. The base

station also remembers that the channel is enabled the next time the base station is powered up.

- 5) On the CellCom / FreeSpeak base station, press **Enable** again and **hold**. The base station activates auto-nulling on the connected channel. Auto-nulling helps to reduce echo while talking on a two-wire audio system.

18.4.4 Quick reference: Four-wire connection to CellCom / FreeSpeak

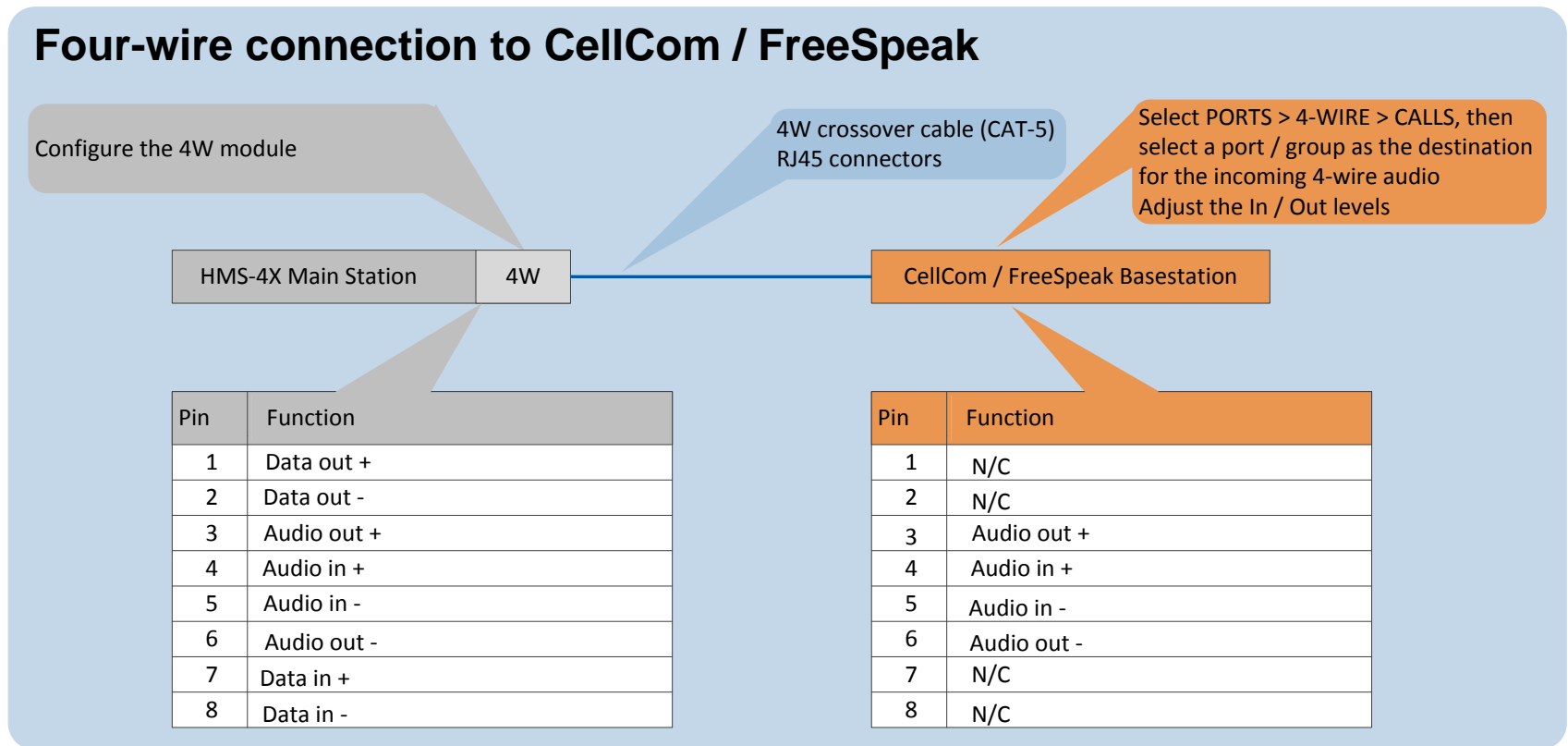


Figure 18-6: Four-wire connection to CellCom / FreeSpeak

18.4.5 Four-wire connection to CellCom / FreeSpeak

To connect your HelixNet Partyline system with a CellCom / FreeSpeak base station (Main Station), using a four-wire connection:

- 1) On the HMS-4X Main Station, configure the **Module Settings** for the four-wire interface module. For the procedure, see **5.6.1 Configuring a Four-wire interface module**.
- 2) Connect the HMS-4X Main Station and the CellCom / FreeSpeak base station, using four-wire crossover CAT5 cabling.

Note: For pinout information for the two systems, see the **quick reference diagram** in **18.4.4 Quick reference: Four-wire connection to CellCom / FreeSpeak**.

RJ-45 connectors are located:

- On the HMS-4X Main Station four-wire interface module.
 - On the back panel (rear) of the CellCom / FreeSpeak base station. There are four RJ45 connectors for four-wire connections on the base station.
- 3) Adjust the **In / Out** volume levels, using the CellCom / FreeSpeak front panel display. For more information, see your **CellCom / FreeSpeak documentation**.

Tip: To optimize audio quality, you may also want to adjust the **Audio Settings** on the HMS-4X Main Station. For more information, see **5.2 Configuring the Audio settings**.

18.5 Connecting HelixNet Partyline to the DX210

18.5.1 About the DX210

The Clear-Com HME DX210 is a 2 channel wireless intercom system. The base station (Main Station) supports up to 15 beltpacks or all-in-one headsets (headsets operating as beltpacks).

The DX210 supports Clear-Com and RTS cabled two-wire intercom systems, and also has four-wire and auxiliary audio connections.

The DX210 operates in the license-free 2.4GHz band, and has provisions for spectrum-friendly co-existence with other devices in the same band.

Tip: For more information about the DX210, see your DX210 documentation or visit the wireless intercom pages on the Clear-Com website:
<http://www.clearcom.com/product/wireless>.

18.5.2 Quick reference: Two-wire connection to DX210

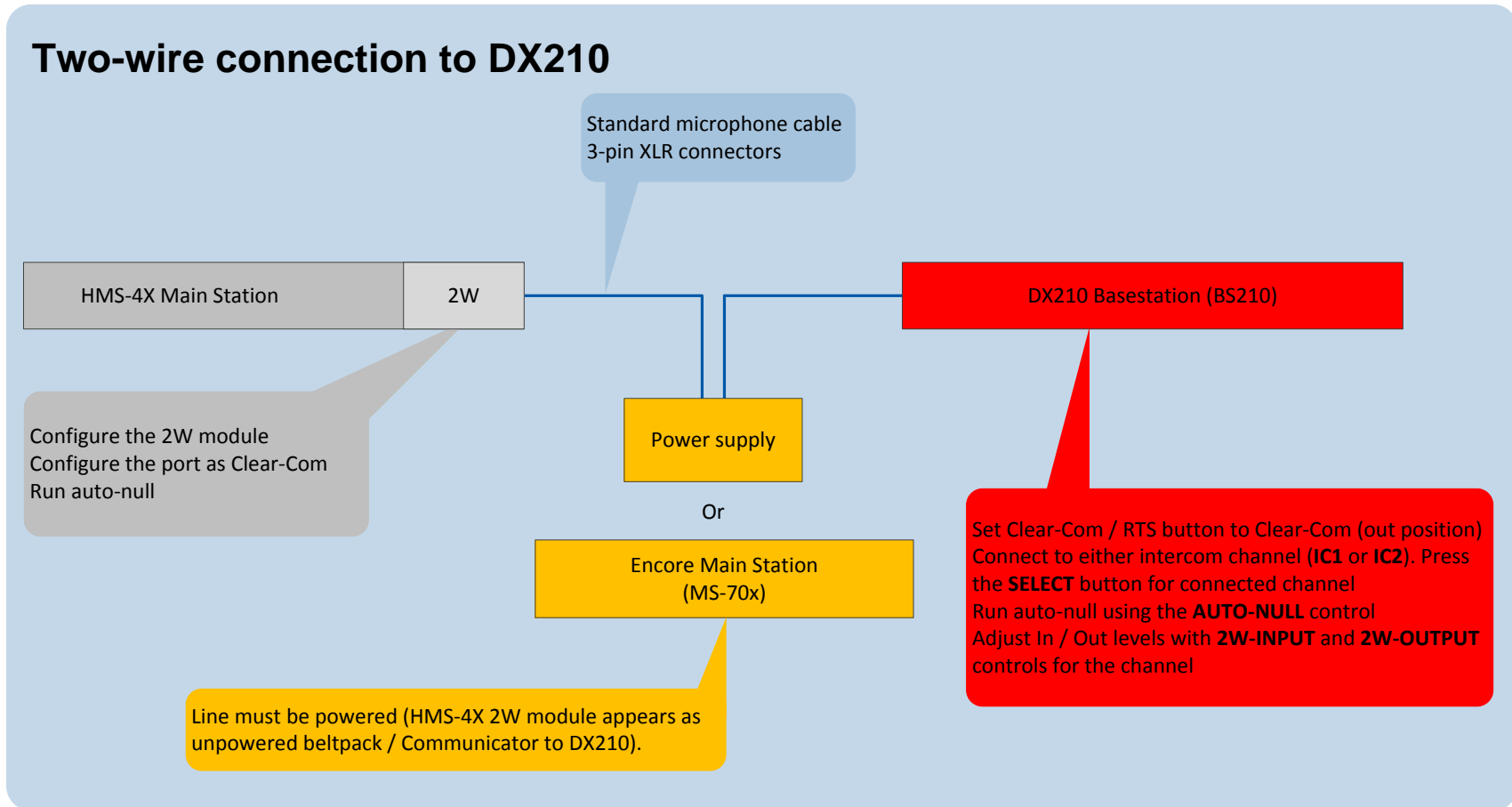


Figure 18-7: two-wire connection to DX210

18.5.3 Two-wire connection to the DX210

To connect your HelixNet Party-line system to the DX210 base station (Main Station), using a two-wire connection:

- 1) On the HMS-4X Main Station, configure the **Module Settings** for the Two-wire interface module. For the procedure, see **5.6.2 Configuring a Two-wire interface module**.

Note: Check that the two-wire module is configured for **Clear-Com systems** (the default) and run **Auto-null**. Auto-nulling helps to reduce echo while talking on a two-wire audio system. You must run auto-null every time you change the cabling.

- 2) On the rear panel of the DX210 base station, ensure that the **Clear-Com / RTS** button is set to **Clear-Com** mode (the **out position**).
- 3) Physically connect the HMS-4X Main Station to one of the two intercom channels on the DX210 base station (Main Station).

Powering the connection:

You must power the connection between the systems using either a dedicated power supply (such as the PK-7, PS-702, or PS-704), or a powered Encore Main Station (such as the MS-702 or MS-704).

Tip: For more information about the dedicated power supply devices (PK-7 or PS-70x devices) from Clear-Com, see <http://www.clearcom.com/product/partyline/power-supplies>

Connecting the systems:

Use standard microphone cable to connect the two systems. 3-pin XLR connectors are located:

- On the HMS-4X Main Station two-wire interface module.
- On the back panel (rear) of the DX210 base station.

Two 3-pin XLR connectors (one male, one female) are provided for each of the two intercom channels (**IC1** and **IC2**) on the base station.

- 4) On the front panel of the DX210 base station, press the **SELECT** button for the connected intercom channel (either **IC1** or **IC2**).

The **2-W** (two-wire) LED next to the **SELECT** button is lit **green**.

Note: If power is **not** detected at the connector, the **2-W** LED is lit **red**. No audio can be transmitted between the systems. When the HMS-4X Main Station is powered, power is supplied to the connection and the **2-W** LED is lit **green**.

- 5) Apply auto-nulling to the connected channel (either IC1 or IC2) on the DX210 base station. Auto-nulling helps to reduce echo while talking on a two-wire audio system. To apply auto-nulling:
 - a) Insert a pen or similar pointed object into the **AUTO-NULL** hole on the front panel.
 - b) Press and hold **AUTO-NULL** for 2 seconds.

Note: Before applying auto-nulling, ensure that there are no open microphones on the wired intercom. If users are wearing headsets, you must notify them of the audio-sweep that precedes the application of auto-nulling.

- 6) Adjust the two-wire intercom receive and send levels (in / out levels), using the **2-W INPUT** and **2-W OUTPUT** controls for the connected channel (**IC1** or **IC2**) on the DX210 base station front panel. For more information, see your **DX210 documentation**.

Tip: To optimize audio quality, you may also want to adjust the **Audio Settings** on the HMS-4X Main Station. For more information, see **5.2 Configuring the Audio settings**.

18.5.4 Quick reference: Four-wire connection to DX210

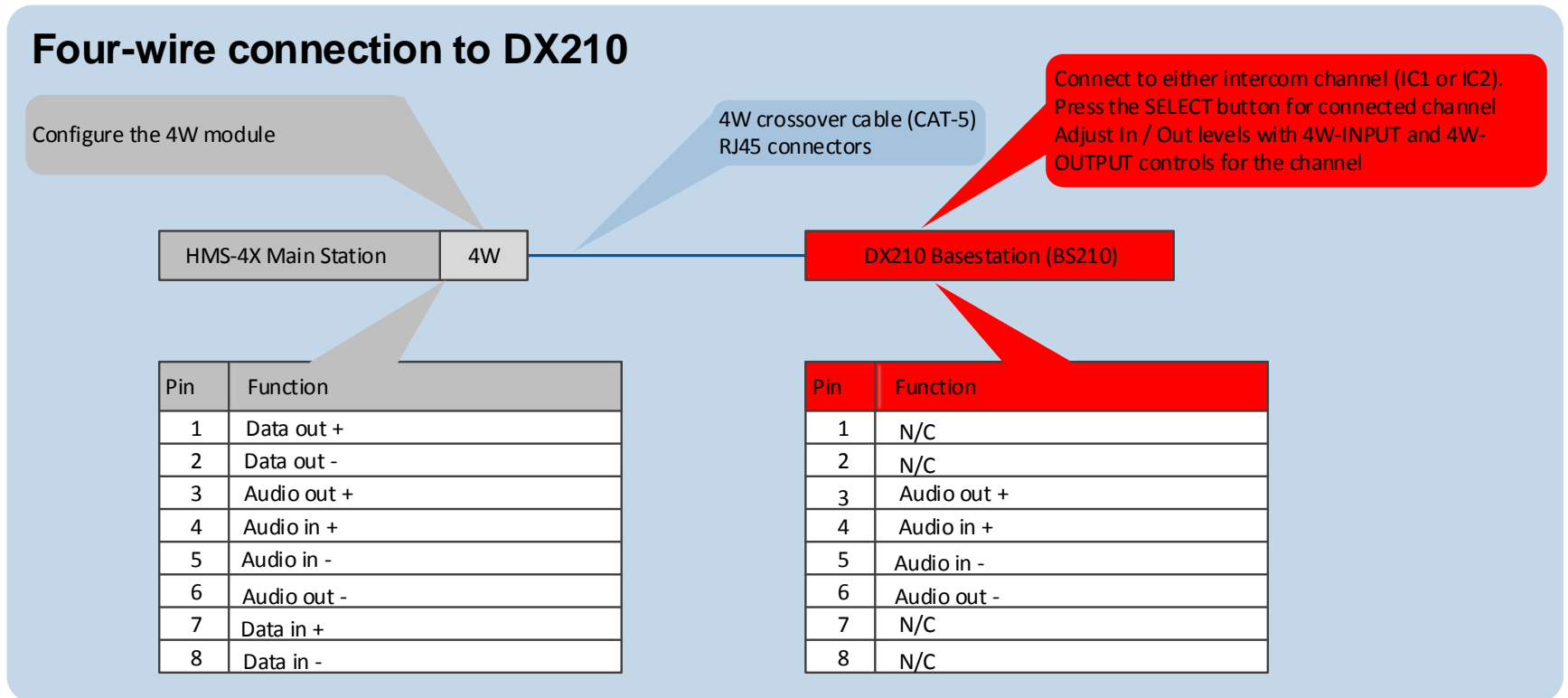


Figure 18-8: Four-wire connection to DX210

18.5.5 Four-wire connection to the DX210

To connect your HelixNet Partyline system with a DX210 base station (BS210), using a four-wire connection:

- 1) On the HMS-4X Main Station, configure the **Module Settings** for the Four-wire interface module. See **5.6.1 Configuring a Four-wire interface module**.
- 2) Connect the HMS-4X Main Station and the DX210 base station (BS210), using four-wire crossover CAT5 cabling.

Note: For pinout information for the two systems, see the **quick reference diagram** in **18.5.4 Quick reference: Four-wire connection to DX210**.

RJ45 connectors are located:

- On the HMS-4X Main Station Four-wire interface module.
- On the back panel (rear) of the DX210 base station (BS210).

There is an RJ45 (four-wire) connector for each of the intercom channels on the DX210 base station (**IC1** and **IC2**). Connect the systems with a four-wire crossover CAT5 cable.

- 3) Adjust the **In / Out** volume levels, using the CellCom / FreeSpeak front panel display. For more information, see your **CellCom / FreeSpeak documentation**.

Tip: To optimize audio quality, you may also want to adjust the **Audio Settings** on the HMS-4X Main Station. For more information, see **5.2 Configuring the Audio settings**

18.6 Connecting HelixNet Partyline to Eclipse®

18.6.1 About Eclipse

Eclipse is the digital matrix system from Clear-Com. A wide choice of system frames, system cards and modules enables the unification of multiple intercom systems (digital, analog, wired and wireless) in a single intercoms infrastructure.

Eclipse is configured, managed and maintained using the intuitive Eclipse Configuration Software (EHX). The Production Maestro® software provides a centralized routing tool, to assist with four-wire configurations. Logic Maestro is a graphical programming tool for ECS, simplifying the design and programming of complex logical functions.

The following procedures reference the following Eclipse devices:

- **The Eclipse or Eclipse-HX system frame.** For example, the Eclipse Median is a 6RU frame that houses 2 CPU and 7 matrix slots with 8 built-in interface module slots.
- **The CCI-22 interface module.** The CCI-22 is the two-wire party-line interface (Clear-Com and / or RTS) to Eclipse. ECS views a direct, four-wire HelixNet Party-line connection with the system frame as a 'virtual' CCI-22 connection.

Tip: For more information about Eclipse, see your Eclipse / EHX documentation or visit the digital matrix pages on the Clear-Com website:
<http://www.clearcom.com/product/digital-matrix>.

18.6.2 Quick reference: Two-wire connection to Eclipse

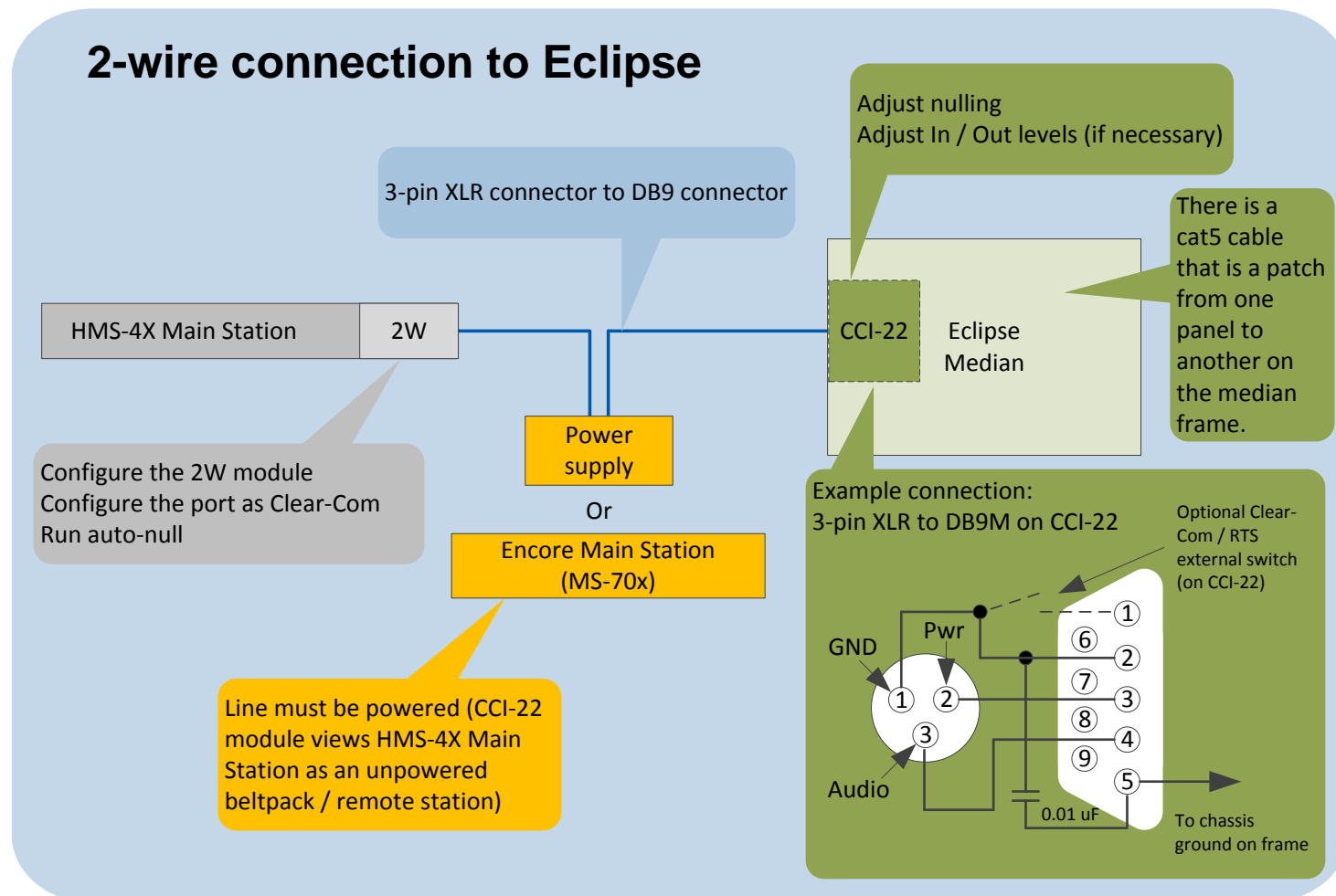


Figure 18-9: Two-wire connection to an Eclipse Matrix

18.6.3 Two-wire connection to an Eclipse or Eclipse-HX system frame

To connect your HelixNet Partyline system to an Eclipse or Eclipse-HX System, using a two-wire connection:

- 1) On the HMS-4X Main Station, configure the **Module Settings** for the Two-wire interface module. For the procedure, see **5.6.2 Configuring a Two-wire interface module**.

Note: Check that the two-wire module is configured for **Clear-Com systems** (the default) and run **Auto-null**. Auto-nulling helps to reduce echo while talking on a two-wire audio system. You must run auto-null every time you change the cabling.

- 2) Physically connect the HMS-4X Main Station to the CCI-22 dual-channel party-line interface module.

The CCI-22 may be fitted:

- Directly to an Eclipse or Eclipse-HX System.
- An interface frame (such as the IMF-3 or IMF-102), connected to the Eclipse matrix.

Tip: For more information about installing and using the CCI-22, see the CCI-22 Manual, or go to: <http://www.clearcom.com/product/digital-matrix/interface-modules/cci-22>

Powering the connection:

You must power the connection between the HMS-4X Main Station and the CCI-22 using either a dedicated power supply (such as the PK-7, PS-702, or PS-704), or a powered Encore Main Station (such as the MS-702 or MS-704).

Tip: For more information about the PK-7 or PS-70x power supply devices from Clear-Com, see <http://www.clearcom.com/product/partyline/power-supplies>

Connecting the systems:

There are two parallel DB-9M Interface I/O connectors on the CCI-22. The two-wire module on the HMS-4X Main Station features two 3-pin XLR connectors. For more information about wiring the connection, see:

- 18.6.2 Quick reference: Two-wire connection to Eclipse.
- The CCI-22 Manual.

- 3) Apply nulling to the connected channel on the CCI-22. To null the channel:
 - a) Insert the accessory earphone into the front-panel **Test** jack. A test tone, for all frequencies, is produced every 0.5s.

- b) While listening to the test tone, adjust the **R** (Resistance) control until the tone is at a minimum.
- c) Repeat Step b. for the **L** (Inductance) and **C** (Capacitance) controls. These controls compensate for each component of the line's impedance, providing the best possible null.

Because the **R**, **L** and **C** controls interact, you may have to adjust these controls several times to minimize the test tone / achieve a deep null.

Note: The null circuit on the CCI-22 is effective on line lengths between 0 - 4000 feet (1200m) with impedances in the range of 120 to 350 ohms. Nulling can reduce local audio in the received signal by < 30 dB over the 200 Hz - 8 kHz frequency range.

Tip: For more information on the CCI-22 nulling circuit, see the **CCI-22 Manual**.

- 4) If necessary, adjust the **In / Out** level controls on the CCI-22 (**Send** and **Recv**, located on the front panel next to the **R**, **L** and **C** nulling controls).

Note: The **Send** level control affects the level of the audio signals from the

Eclipse Matrix to the external party-line, and the **Recv** control affects the level of the audio from the party-line into the matrix. The Send and Receive controls have a range of ± 13 dB.

Tip: For more information about managing the HelixNet to Eclipse connection in EHX, see your EHX documentation (including **Help**).

18.6.4 Quick reference: Four-wire connection to Eclipse

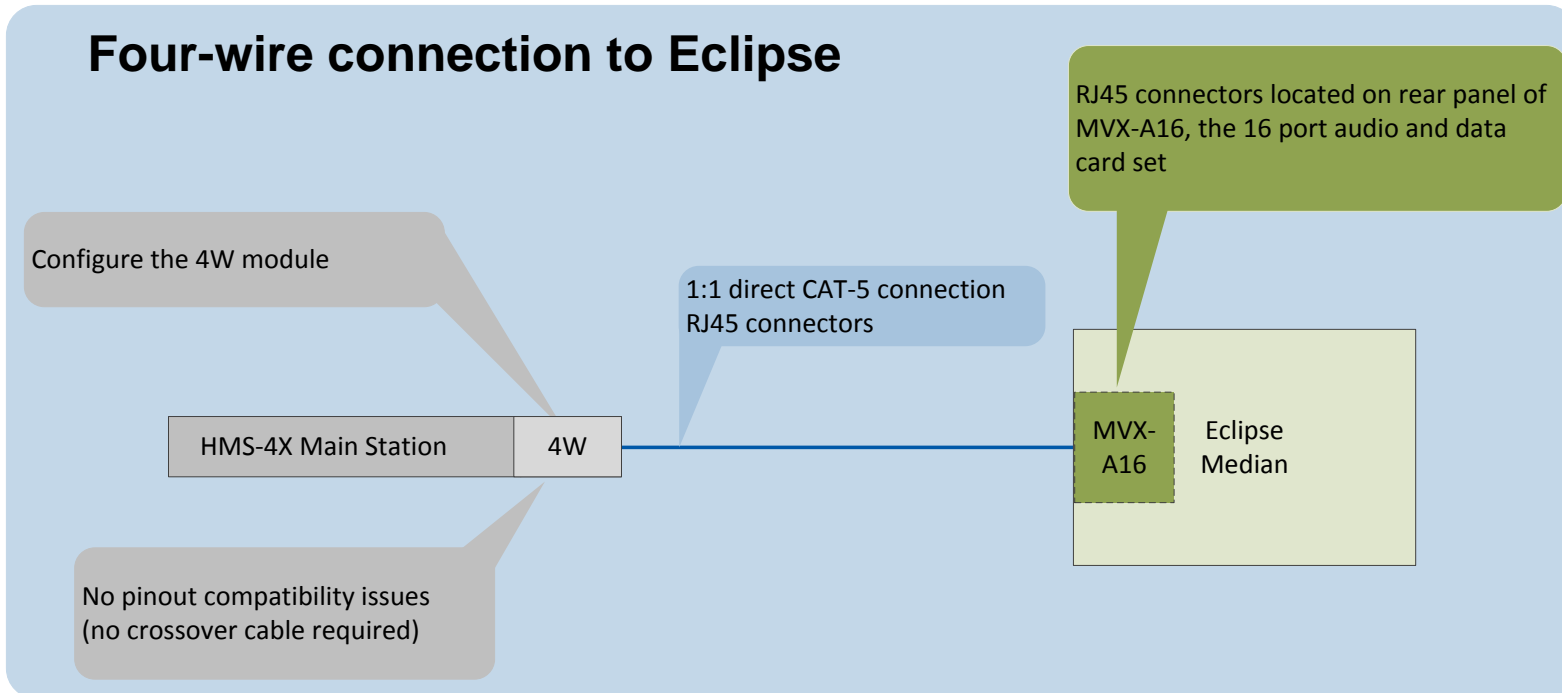


Figure 18-10: Four-wire connection to Eclipse Matrix

18.6.5 Four-wire connection to Eclipse

To connect your HelixNet Partyline system to an Eclipse or Eclipse-HX System, using a four-wire connection:

- 1) On the HMS-4X Main Station, configure the **Module Settings** for the four-wire interface module. For the procedure, see **5.6.1 Configuring a Four-wire interface module**.
- 2) Connect the HMS-4X Main Station directly to the MVX-A16 card (the 16 port audio and data card set) with **standard** CAT5 cable.

Note: For pinout information for the two systems, see the **quick reference diagram** in **18.6.4 Quick reference: Four-wire connection to Eclipse**.

RJ45 connectors are located:

- On the HMS-4X Main Station four-wire interface module.
- On the rear panel of the MVX-A16 card.

Tip: To optimize audio quality, you may want to adjust the **Audio Settings** on the HMS-4X Main Station. For more information, see **5.2 Configuring the Audio settings**

Tip: For more information about managing the HelixNet to Eclipse connection in EHX, see your EHX documentation (including EHX Help).

18.7 Connecting HelixNet Partyline to two-way radio systems

Two-way radio systems (also known as walkie-talkies) are widely used for wireless communication where quick deployment is a required.

HelixNet can interface to a two-way radio system audio along with transmit key control.

The following examples show how you can setup HelixNet to activate a relay on a Main Station or a Remote Station every time someone activates a Talk key on the selected Partyline Channel.

Note: HelixNet provides and expects 4W audio at line level (0dBu).

18.7.1 Quick Reference: four-wire and control connection to radio system

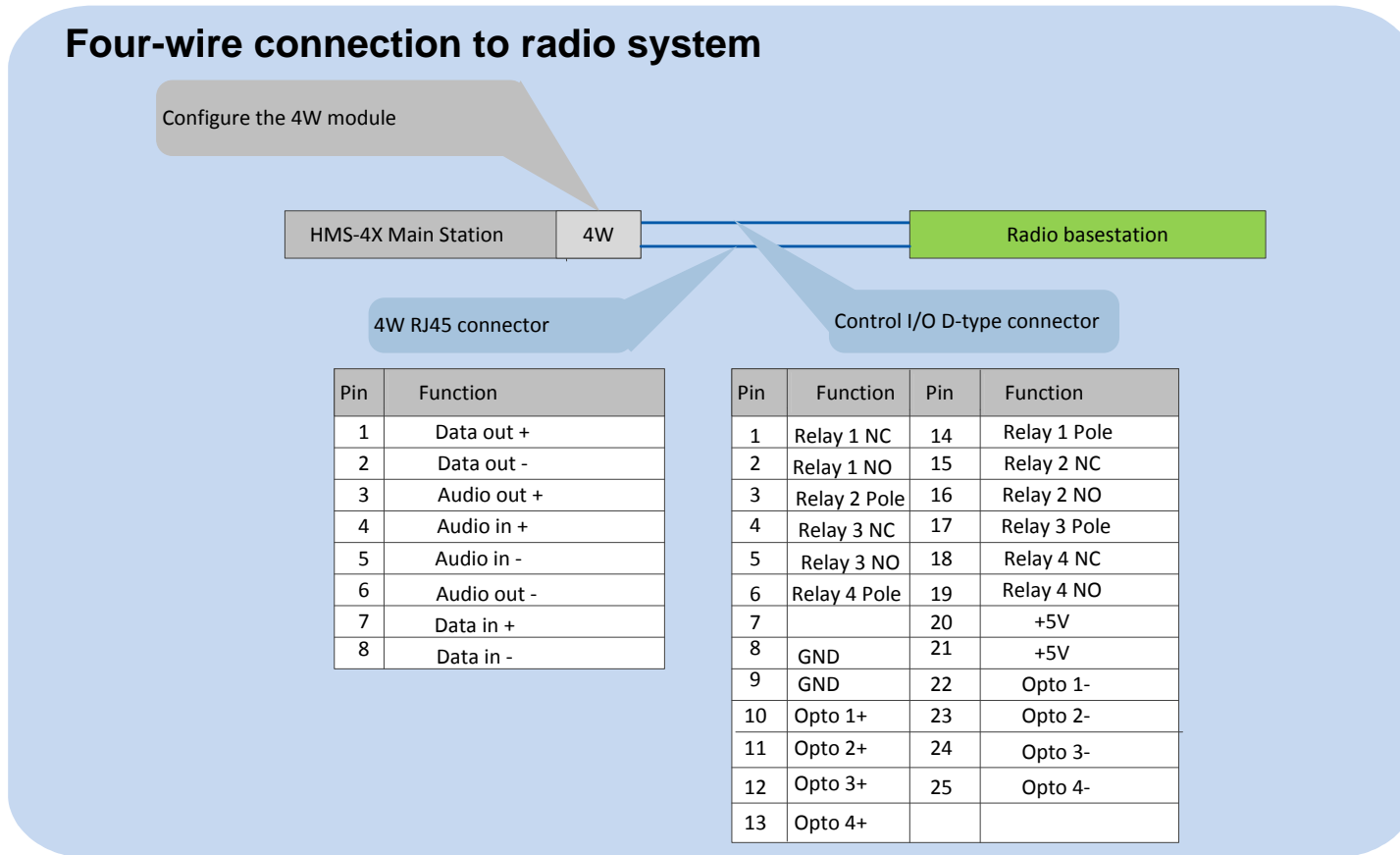


Figure 18-11 Four-wire and control connection to radio system

18.7.2 Four-wire and control connection to radio system

To connect the HelixNet Partyline to a radio system using four-wire:

- 1) In the **Modules Settings** menu, select **Slot n/Port A/B 4W > Channel Assign > Channel #** to assign the 4W port to a **Channel**, for example Channel A.
- 2) In the **Modules Settings** menu, select **Slot n/Port A/B 4W > GPO Trigger > Disable** to set **GPO Trigger** to **Disable** for that 4W port.
- 3) In the **Channels** menu, select **Channel # > GPO on Talk > Relay #** to select a Relay.
- 4) Connect the 4W audio and the configured Relay to the radio base station.

18.7.3 Quick reference: two-wire and control connection to radio system

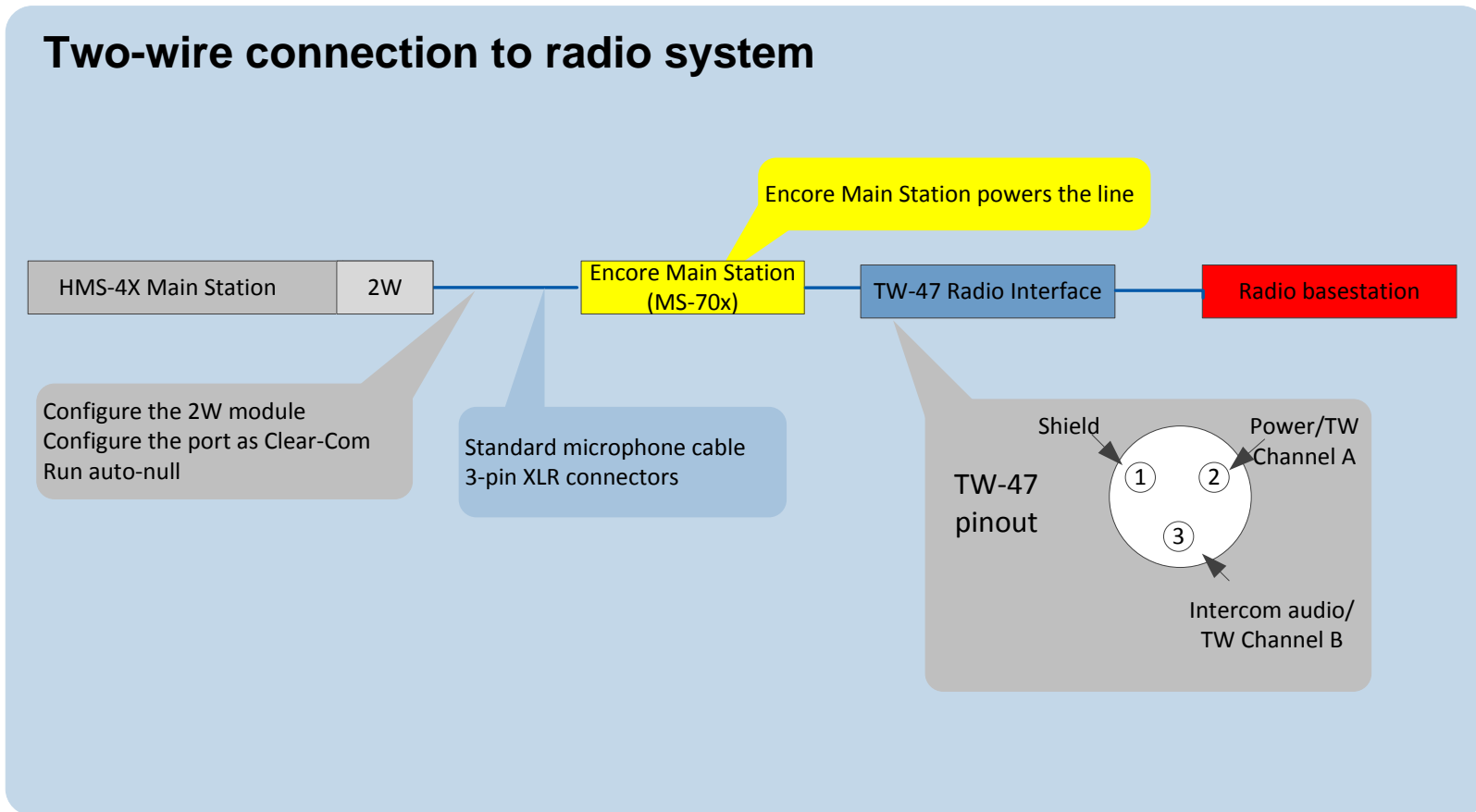


Figure 18-12 Two-wire and control connection to radio system

18.7.4 Two-wire and control connection to radio system

The two-wire connection uses a TW-47 radio interface. Because this has no power supply, you must use an Encore Main Station to supply power. You can also use an alternative source of power, such as a PK-7, PS-702 or PS-704.

The diagram in Figure 18-12 shows a system using an Encore Main Station.

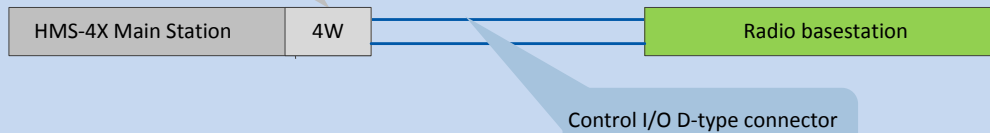
To connect the HelixNet Partyline to a radio system using two-wire:

- 1) Connect the HelixNet Partyline to the Encore Main Station. For details, see **18.1 Connecting HelixNet Partyline to Encore®**.
- 2) In the **Modules Settings** menu, select **Slot n/Port A/B 2W > Channel Assign > Channel #** to assign the 2W port to a **Channel**, for example Channel A.
- 3) Connect the Encore Main Station to the TW-47 radio interface.
- 4) Connect the TW-47 radio interface to the radio base station.

18.7.5 Quick reference: Main Station connection to radio system

Four-wire connection to radio system

Configure the 4W module



Pin	Function	Pin	Function
1	Relay 1 NC	14	Relay 1 Pole
2	Relay 1 NO	15	Relay 2 NC
3	Relay 2 Pole	16	Relay 2 NO
4	Relay 3 NC	17	Relay 3 Pole
5	Relay 3 NO	18	Relay 4 NC
6	Relay 4 Pole	19	Relay 4 NO
7		20	+5V
8	GND	21	+5V
9	GND	22	Opto 1-
10	Opto 1+	23	Opto 2-
11	Opto 2+	24	Opto 3-
12	Opto 3+	25	Opto 4-
13	Opto 4+		

Figure 18-13 Main Station connection to radio system

To connect the HelixNet Main Station to a radio system using four-wire:

- 1) In the **Audio Settings** menu, select **PGM/Audio In > GPO Trigger > Disable**.
- 2) In the **Audio Settings** menu, select **SA/Audio Out Mode > Channel Assign**.
- 3) Assign the SA/Audio Out to a Channel.
- 4) In the **Channel** configuration select the Remote Station Program under the Program Listen menu.
- 5) In the **Channels** menu, select **Channel # > GPO on Talk > Relay 1**.
- 6) Connect the audio and the Relay to the radio base station.

19 Specifications

19.1 Main Station (HMS-4X)

19.1.1 Connectors

Specification	Description / value
Intercom Powerline Outputs	Four 3-pin XLR. Two male and two female.
Headset	4-pin XLR-M
USB	USB Type A and Micro-AB
Program	3-pin XLR-F
SA (Stage Announce)	3-pin XLR-M
Hot Mic / IFB Interface	1/4 in. (0.64 cm) phone jack
GPIO	25 way D-type female

Table 19-1: Main Station: Connectors

19.1.2 Microphone pre-amplifier

Specification	Description / value
Headset Mic impedance:	200Ω (Dynamic)
Headset Mic Voltage	1.7V (Electret selectable)
Limiter	+23dB
The following specified for a route to 4-wire output @ 0dBu out	
Mic gain	60dB (dynamic) 45dB (electret)
Frequency response	300Hz – 10kHz ± -3dB (contoured for intelligibility)
Distortion	<0.2% THD @ 1kHz
Noise-	<-55dBu dynamic, <-65dBu electret

Table 19-2: Main Station: Microphone pre-amplifier

19.1.3 Headphone amplifier

Specification	Description / value
Load impedance	32Ω
Output level	+12dBu before clipping
Sidetone	-12dB (selectable)
The following specified for a route from a 4-wire input @ 0dBu in	
Max gain	0dB
Frequency response	40Hz - 10kHz ± 3dB
Distortion	<0.1% THD @ 1kHz
Noise	<-65dBu
Headphone limiter	0dBu (selectable)

Table 19-3: Main Station: Headphone amplifier

19.1.4 Loudspeaker amplifier

Specification	Description / value
Load impedance	8Ω
Output level	+18dBu before clipping
Max gain	18dB
The following specified for a route from a 4-wire input @ 0dBu in	
Frequency response	200Hz - 10kHz ± 3dB
Distortion	<1% THD @ 1 kHz
Noise	<-50dBu

Table 19-4: Main Station: Loudspeaker amplifier

19.1.5 Program line input and Four-wire option module inputs

Specification	Description / value
Maximum level before clipping	18dBu
Nominal input level	0dBu (selectable)
Input impedance	$\geq 10\text{K}\Omega$
The following specified for a route to 4-wire output @ 0dBu out	
Frequency response	20Hz - 10kHz \pm 3dB
Distortion	<0.2% THD @ 1kHz
Noise	<-65dBu

Table 19-5: Main Station: Program line input and four-wire option module inputs

19.1.6 Four-wire module outputs

Specification	Description / value
Maximum level before clipping	18dBu
Nominal input level	0dBu (selectable)
Input impedance	$\leq 100\Omega$

Table 19-6: Main Station: Four-wire module outputs

19.1.7 Stage Announce outputs

Specification	Description / value
Maximum level before clipping	18dBu
Nominal output level	0dBu (selectable)
Output impedance	$\leq 100\Omega$
The following specified for a route from a dynamic headset	
Frequency response	300Hz - 12kHz \pm 3dB
Distortion	<0.1% THD @ 1kHz
Noise	<-55dBu

Table 19-7: Main Station: Stage Announce outputs

19.1.8 Hot Mic output

Specification	Description / value
Maximum level before clipping	12dBu
Nominal output level	0dBu (selectable)
Output impedance	$\leq 100\Omega$
The following specified for a route from a dynamic headset	
Frequency response	300Hz - 12kHz \pm 2dB
Distortion	<0.2% THD @ 1kHz
Noise	<-55dBu

Table 19-8: Main Station: Hot Mic output

19.1.9 Helix Digital Partyline

Specification	Description / value
Maximum level before clipping	6dBu
Nominal input level	-18dBu (C-C) -12dBu (RTS)
Input impedance	>= 10K Ω bridging
The following specified for a circuit to a 4-wire output @0dBu in:	
Frequency response	100Hz - 10 kHz \pm 3dB
Distortion	<0.2% THD @ 1kHz
Noise	<-55dBu
The following specified for a circuit from a 2-wire input @0dBu out:	
Frequency response	40Hz - 10kHz \pm 3dB
Distortion	<0.2% THD @ 1kHz
Noise	<-55dBu
Auto-nulling and echo cancellation	Yes
RTS / Clear-Com selectable	Yes
Termination	External
Power	30V external

Table 19-9: Main Station: Partyline

19.1.10 Ethernet

Specification	Description / value
Fast Ethernet standard	100BaseT only, Auto MDIX

Table 19-10: Main Station: Ethernet

19.1.11 Mains power

Specification	Description / value
Input Voltage range	100 – 240VAC
Input frequency range	50 – 60Hz
Input power	<=250W
Powerline Intercom Output Voltage	59VDC ± 1V
Output current per channel	1.5A (continuous)

Table 19-11: Main Station: Mains power

19.1.12 Environmental

Specification	Description / value
Temperature	0°C - 40°C (32°F - 104°F)
Humidity	0 - 90% relative humidity

Table 19-12: Main Station: Environmental

19.1.13 Dimensions and weight

Specification	Description / value
Dimensions	19in.W x 1.75in.H x ? in. D (483 mm x 44 mm x ? mm)
Weight	5.83lbs. (2.65kg)

Table 19-13: Main Station: Dimensions and weight

19.1.14 Networking Specifications for Linked Main Stations

Specification	Value
Latency on Powerline	40-80ms (Depends on cable type and length, and how many devices are connected. The greater the number of devices, the greater the latency.)
Latency over IP Network	30ms + Network Latency (Main Station to Main Station)

Bandwidth used	300 kbps per active Talker, for a maximum of 1 talker per device in the system Each Beltpack and Speaker Station counts as 1 device Each Main Station and Remote Station counts as 2 devices
IP version	IPv4

Table 19-14 Networking specifications

19.2 Two-wire module (HLI-2W2)

19.2.1 Connectors

Specification	Description / value
Intercom line	(2) 3-Pin XLR-F

Table 19-15: two-wire module: Connectors

19.2.2 Dimensions and weight

Specification	Description / value
Dimensions	7.05 in. H x 2.24 in. W x 1.54 in. D (179 x 57 x 39 mm)
Weight	13 oz. (0.35 kg)

Table 19-16: Two-wire module: Dimensions and weight

19.2.3 Power requirements (external)

Specification	Description / value
Per channel	0.025mA/channel
DC Voltage range	20 – 30 Volts

Table 19-17: Two-wire module: Power requirements

19.2.4 Environmental

Specification	Description / value
Temperature	0°C - 40°C (32°F - 104°F)

Humidity	0 - 90% relative humidity
-----------------	---------------------------

Table 19-18: Two-wire module: Environmental

19.3 Four-wire module (HLI-4W2)

19.3.1 Connectors

Specification	Description / value
Intercom line	(2) RJ-45 (Ethercon)

Table 19-19: Four-wire module: Connectors

19.3.2 Dimensions and weight

Specification	Description / value
Dimensions	7.05 in. H x 2.24 in. W x 1.54 in. D (179 x 57 x 39 mm)
Weight	13 oz. (0.35 kg)

Table 19-20: four-wire module: Dimensions and weight

19.3.3 Environmental

Specification	Description / value
Temperature	0°C - 40°C (32°F - 104°F)
Humidity	0 - 90% relative humidity

Table 19-21: four-wire module: Environmental

19.4 Remote Station (HRM-4X)

19.4.1 Connectors

Specification	Description / value
Intercom Powerline Outputs	Four 3-pin XLR. Two male and two female.
Headset	4-pin XLR-M
USB	USB Type A

Specification	Description / value
Program	3-pin XLR-F
SA (Stage Announce)	3-pin XLR-M
Hot Mic / IFB Interface	1/4 in. (0.64 cm) phone jack
Control input/output	9-pin D-type

Table 19-22: Remote Station: Connectors

19.4.2 Microphone pre-amplifier

Specification	Description / value
Headset Mic impedance:	200 Ω (Dynamic)
Headset Mic Voltage	1.7V (Electret selectable)
Limiter	+23 dB
The following specified for a route to 4-wire output @ 0dBu out	
Mic gain	60dB (dynamic) 45dB (electret)
Frequency response	300 Hz – 10 kHz + / -3dB (contoured for intelligibility)
Distortion	<0.2% THD @ 1 kHz
Noise-	<-55dBu dynamic, <-65dBu electret

Table 19-23: Remote Station: Microphone pre-amplifier

19.4.3 Headphone amplifier

Specification	Description / value
Load impedance	32 Ω
Output level	+12dBu before clipping
Sidetone	-12dB (selectable)
The following specified for a route from a 4-wire input @ 0dBu in	
Max gain	0dB

Specification	Description / value
Frequency response	40 Hz - 10 kHz \pm 3dB
Distortion	<0.1% THD @ 1 kHz
Noise	<-65dBu
Headphone limiter	0dBu (selectable)

Table 19-24: Remote Station: Headphone amplifier

19.4.4 Loudspeaker amplifier

Specification	Description / value
Load impedance	8 Ω
Output level	+18dBu before clipping
Max gain	18dB
The following specified for a route from a 4-wire input @ 0dBu in	
Frequency response	200 Hz - 10 kHz \pm 3dB
Distortion	<1% THD @ 1 kHz
Noise	<-50dBu

Table 19-25: Remote Station: Loudspeaker amplifier

19.4.5 Program line input and four-wire option module inputs

Specification	Description / value
Maximum level before clipping	18 dBu
Nominal input level	0dBu(selectable)
Input impedance	$\geq 10 \text{ K}\Omega$
The following specified for a route to 4-wire output @ 0dBu out	
Frequency response	20 Hz - 10 kHz $\pm 3\text{dB}$
Distortion	$< 0.2\%$ THD @ 1 kHz
Noise	$< -65\text{dBu}$

Table 19-26: Remote Station: Program line input and four-wire option module inputs

19.4.6 Four-wire module outputs

Specification	Description / value
Maximum level before clipping	18 dBu
Nominal input level	0 dBu(selectable)
Input impedance	$\leq 100\Omega$

Table 19-27: Remote Station: Four-wire module outputs

19.4.7 Stage Announce outputs

Specification	Description / value
Maximum level before clipping	18 dBu
Nominal output level	0dBu(selectable)
Output impedance	<= 100Ω
The following specified for a route from a dynamic headset	
Frequency response	300Hz - 12kHz ±3dB
Distortion	<0.1% THD @ 1kHz
Noise	<-55dBu

Table 19-28: Remote Station: Stage Announce outputs

19.4.8 Hot Mic output

Specification	Description / value
Maximum level before clipping	12 dBu
Nominal output level	0dBu(selectable)
Output impedance	<= 100Ω
The following specified for a route from a dynamic headset	
Frequency response	300 Hz - 12 kHz ±2dB
Distortion	<0.2% THD @ 1 kHz
Noise	<-55dBu

Table 19-29: Remote Station: Hot Mic output

19.4.9 Helix Digital Partyline

Specification	Description / value
Maximum level before clipping	6 dBu
Nominal input level	-18dBu (C-C) -12dBu (RTS)
Input impedance	>= 10K Ω bridging
The following specified for a circuit to a 4-wire output @0dBu in:	
Frequency response	100Hz - 10 kHz \pm 3dB
Distortion	<0.2% THD @ 1 kHz
Noise	<-55dBu
The following specified for a circuit from a 2-wire input @0dBu out:	
Frequency response	40 Hz - 10 kHz \pm 3dB
Distortion	<0.2% THD @ 1 kHz
Noise	<-55dBu
Auto-nulling and echo cancellation	Yes
RTS / Clear-Com selectable	Yes
Termination	External
Power	30V external

Table 19-30: Remote Station: Partyline

19.4.10 Ethernet

Specification	Description / value
Fast Ethernet standard	100BaseT only, Auto MDIX

Table 19-31: Remote Station: Ethernet

19.4.11 Mains power

Specification	Description / value
Input Voltage range	100 – 240 VAC
Input frequency range	50 – 60 Hz
Input power	<=250W
Powerline Intercom Output Voltage	59VDC ± 1V
Output current per channel	1.5A (continuous)

Table 19-32: Remote Station: Mains power

19.4.12 Environmental

Specification	Description / value
Temperature	0°C - 40°C (32°F - 104°F)
Humidity	0 - 90% relative humidity

Table 19-33: Remote Station: Environmental

19.4.13 Dimensions and weight

Specification	Description / value
Dimensions	19 in. W x 1.75 in. H x ? in. D (483 mm x 44 mm x ? mm)
Weight	5.83 lbs. (2.65 kg)

Table 19-34: Remote Station: Dimensions and weight

19.5 Speaker Station (HKB-4X)

19.5.1 Connectors

Specification	Description / value
Intercom line	Two 3-pin XLR. One male and one female.

Specification	Description / value
Headset	4-pin XLR-M

Table 19-35: Speaker Station: Connectors

19.5.2 Microphone pre-amplifier

Specification	Description / value
Headset Mic impedance:	200 Ω (Dynamic)
Headset Mic Voltage	1.7V (Electret selectable)
Limiter	+23 dB
The following specified for a route to 4-wire output @ 0dBu out:	
Mic gain	60dB (dynamic) 45dB (electret)
Frequency response	300 Hz – 10 kHz + / -3dB (contoured for intelligibility)
Distortion	<0.2% THD @ 1 kHz
Noise-	<-55dBu dynamic, <-65dBu electret

Table 19-36: Speaker Station: Microphone pre-amplifier

19.5.3 Headphone amplifier

Specification	Description / value
Load impedance	>32 Ω
Output level	+12dBu before clipping
Sidetone	-12dB (selectable)
The following specified for a route from a 4-wire input @0dBu in:	
Max gain	0dB
Frequency response	40 Hz - 10 kHz \pm 3dB
Distortion	<0.1% THD @ 1 kHz
Noise	<-65dBu (@ max gain)
Headphone limiter	-0dBu (selectable)

Table 19-37: Speaker Station: Headphone amplifier

19.5.4 Ethernet

Specification	Description / value
Fast Ethernet standard	100BaseT only, Auto MDIX

Table 19-38: Speaker Station: Ethernet

19.5.5 Power requirements

Specification	Description / value
Power requirements	4W
DC Voltage range	30 – 60 Volts

Table 19-39: Speaker Station: Power requirements

19.5.6 Environmental

Specification	Description / value
Temperature	0°C - 40°C (32°F - 104°F)
Humidity	0 - 90% relative humidity

Table 19-40: Speaker Station: Environmental

19.6 Beltpack (HBP-2X)

19.6.1 Connectors

Specification	Description / value
Intercom line	Two 3-pin XLR. One male and one female.
Headset	4-pin XLR-M and 2.5mm TRS jack
USB	Micro-AB
TRS Headset	3.5mm mini jack

Table 19-41: Beltpack: Connectors

19.6.2 Microphone pre-amplifier

Specification	Description / value
Headset Mic impedance:	200 Ω (Dynamic)
Headset Mic Voltage	1.7V (Electret selectable)
Limiter	+23 dB
The following specified for a route to 4-wire output @ 0dBu out:	
Mic gain	60dB (dynamic) 45dB (electret)
Frequency response	300 Hz – 10 kHz + / -3dB (contoured for intelligibility)
Distortion	<0.2% THD @ 1 kHz
Noise-	<-55dBu dynamic, <-65dBu electret

Table 19-42: Beltpack: Microphone pre-amplifier

19.6.3 Headphone amplifier

Specification	Description / value
Load impedance	>32 Ω
Output level	+12dBu before clipping
Sidetone	-12dB (selectable)
The following specified for a route from a 4-wire input @0dBu in:	
Max gain	0dB
Frequency response	40 Hz - 10 kHz \pm 3dB
Distortion	<0.1% THD @ 1 kHz
Noise	<-65dBu (@ max gain)
Headphone limiter	-0dBu (selectable)

Table 19-43: Beltpack: Headphone amplifier

19.6.4 Power requirements

Specification	Description / value
Power requirements	4W
DC Voltage range	30 – 60 Volts

Table 19-44: Beltpack: Power requirements

19.6.5 Environmental

Specification	Description / value
Temperature	0°C - 40°C (32°F - 104°F)
Humidity	0 - 90% relative humidity

Table 19-45: Beltpack: Environmental

20 Glossary

Channel	<p>Any audio routed through the HelixNet system must be configured into a Channel. Channels operate as virtual partylines, which means that audio sources assigned to a Channel will be able to talk and listen to all other sources assigned to that Channel. In order for an audio source on one device to talk to an audio source on another device, the two Keysets must be brought together into one Channel.</p> <p>Many audio sources in one Channel will not have a negative effect on audio quality or latency.</p>
Daisy-chaining	<p>Devices are daisy-chained when they are linked together by cable in a line, as in a daisy chain. Other linking topologies are available, such as a star or tree. In HelixNet, it is possible to daisy chain Remote Stations, Speaker Stations and beltpacks to the Main Station using a powerline that transmits both data and power. However, the number and type of devices linked will have an effect on the powerline. 10 beltpacks can be linked (powerlined), but if a Remote Station is added into the line, the total number of devices possible in the chain will go down due to the higher power requirement of the Remote station. See 17 Linking Remote Stations and Speaker Stations</p> <p>You can find the URL to a powerline/distance calculator at the beginning of Chapter 3. Installing HelixNet Partyline</p>
Expansion Group	<p>In an Expansion Group, Main Stations and Remote Stations (up to 3) are linked over IP in a host/slave relationship. This means that the audio on all of the stations is controlled from the host station, using one headset and speaker, creating a convenient and easy to use set-up.</p> <p>Expansion Groups must be established from the front panel menus on the device(s).</p> <p>See 5.9 Setting up a key Expansion Group</p>

<p>KeySet</p>	<p>A Keyset is a HelixNet unit that consists of an audio source or Channel and a set of controls associated with that Channel. The associated controls are: a menu screen, a rotary control, a Talk button and a Call button. Main Stations and Remote Stations have 4 Keysets, which can be seen on the front panel of the device. Speaker Stations also have 4 Keysets, though only 2 are visible on the device, the 4 Keysets operate in a split screen. Beltpacks have 2 Keysets.</p> <p>See 2.1.1 Main Station/Remote channel keyset and display</p>
<p>Linking/ Link Group</p>	<p>Only Main Stations can be linked.</p> <p>Linking Main Stations in HelixNet allows more beltpacks to be used and increases intercom range as far as your LAN will allow. The linked Main Stations create a mesh connectivity, which ensures robust audio transmission.</p> <p>When Linking Main Stations in HelixNet 3.0 and above, Channels with the same number (1 – 24) are merged.</p> <p>Devices can be linked either from the unit front menus or from the browser based Core Configuration Manager (CCM). When linked in the CCM, devices and Roles can be configured by proxy from any Main Station in the Link Group.</p> <p>See 15 Linking in the Core Configuration Manager (CCM) and 16 Linking Main Stations (cabling and linking from device menus) for more information.</p>
<p>Pairing</p>	<p>Remote or Speaker Stations are connected to the Main Station over LAN/IP. This allows Main Station Channels to be available to a remote connection, either an HRM (Remote Station) or an HKB (Speaker Station). Pairing over IP will provide better latency than connecting with a powerline.</p> <p>See 17.1.2 Ethernet point-to-point link</p>

<p>Role</p>	<p>A Role is a pre-set configuration that includes Channel assignment, audio settings, IFBs, relays etc. Each HelixNet device has a default Role that can be used as it is or modified to fit requirements. Each Role can be given a name (a label) that corresponds to a common user workflow, such as producer, director, A1, etc.</p> <p>When adding new Roles, you will modify an existing template, using either the default Role for that device, or another Role that you have already made. Default Roles can be modified but not deleted or loaded to devices, you will always work with a copy. Default Roles can be returned to factory settings if required.</p> <p>To use Roles you must have HelixNet 3.0 or above installed on your Main Stations.</p> <p>See 12 Roles for more information.</p>
-------------	---

21 Menu maps

HMS-4X Main Station menu map

Menu 1 (First) >	Menu 2 >	Menu 3 >	Menu 4 (Last)
Audio Settings	Headset	Sidetone Gain	Range: 0dB to -18dB Default: -12db
		Headphone Limit	Range: +6dB to -6dB Default: 0db
		Sidetone Control	Tracking Non-Tracking Disabled Default: Tracking
		HS Mic Type	Electret Dynamic (0 dB) Dynamic (-10 dB) Default: Dynamic (0 dB)
	Microphone	Headroom	Normal High Default: Normal
		Contour Filter	Enabled Disabled Default: Enabled
	Program Input	Label	12 characters
		Gain	Range: +12dB to -12dB Default: 0db

Menu 1 (First) >	Menu 2 >	Menu 3>	Menu 4 (Last)
		GPO Trigger	Enabled Disabled Default: Enabled
		VOX	Enabled Disabled Default: Disabled
		VOX Off Delay	Range: 0.5 – 4 sec Default: 0.5 sec
	Program IFB	IFB Dim Level	IFB Disabled + Range: -6dB - -24dB + Full Cut
	SA Output	Gain	Range: +12dB to -12dB Default: 0db
	Hot Mic Output		
	Front Panel	Loudspeaker Dim	Range: 0dB to -24dB Default: -6dB
Station Settings	Preferences	Roles	Select Role or Local Config
			Station ID Alphanumeric entry
	Keypset Assign	Keypset 1 – 4	None Channel 1 – 12 (or 24)
	Keypsets	Talk #1 Latch	Latching Non-Latching Default: Latching
		Talk #2 Latch	
		Talk #3 Latch	

Menu 1 (First) >	Menu 2 >	Menu 3>	Menu 4 (Last)
		Talk #4 Latch	
		SA Output Key	Latching Non-Latching Default: Non-latching
		All Talk	Toggle All Channels/Visible Channels Default All Channels
		RMK	Disabled All Channels Visible Channels Default: Enabled All Channels
	Display	OLED Brightness	High Medium Low Default: Medium
		Key Brightness	High / Low High / Off Low / Off Off / Off Default: High / Low
		Screensaver	Enabled Disabled Default: Enabled
Channels	Channel 1 Channel 2 Channel 3 Channel 4 [...]	Label	Press to Edit Max. length for labels = 10 characters
		Program Listen	None List of programs Default: None
		GPO on Talk	Default: None Relay 1 - 4
		GPO on Call	Default: None

Menu 1 (First) >	Menu 2 >	Menu 3>	Menu 4 (Last)
			Relay 1 - 4
Control I/O	Inputs	Opto 1	None
		Opto 2	Call Key 1
		Opto 3	Talk Key 1
		Opto 4	Call Key 2
	Outputs	Relay 1	Talk Key 2
		Relay 2	Call Key 3
		Relay 3	Talk Key 3
		Relay 4	Call Key 4
			Talk Key 4
			Default: None

Menu 1 (First) >	Menu 2 >	Menu 3>	Menu 4 (Last)
Module Settings	Slot <i>n</i> /Port A/B 4W	Channel Assign	Disabled Channel A Channel B Channel C Channel D Default: Disabled
		Program Output	Unmute Mute Default: Mute
		GPO Trigger	Enabled Disabled Default: Enabled
		Input Gain	Range: +12dB to -12dB Default: 0db
		Output Gain	
		VOX	Enabled Disabled Default: Disabled
		VOX Off Delay	Range: [0].5 – 4 secs Default: [0].5 secs
	Slot <i>n</i> /Port A/B 2W	Channel Assign	Disabled Channel A Channel B Channel C Channel D Default: Disabled
		Program Output	Unmute Mute Default: Unmute

Menu 1 (First) >	Menu 2 >	Menu 3>	Menu 4 (Last)
		Auto-Nulling	Start
		Mode	Clear-Com RTS Audio Pin 2 RTS Audio Pin 3 Default: Clear-Com
		GPO Trigger	Enabled Disabled Default: Enabled
		Input Gain	Range: -3dB to +3dB Default: 0db
		Output Gain	
		RMK Input	Enabled Disabled Default: Enabled
		RMK Output	
		VOX	Enabled Disabled Default: Disabled
		VOX Off Delay	Range: [0].5 – 4 secs Default: [0].5 secs
Network	Stations	Preferences	Hostname (12 chars) DHCP enabled/disabled IP address (enter IP address) Subnet mask Gateway
		[Station IDs}	(info only) Hostname Linked status IP address
	Linking	Link mode	Disabled Link Master Link Member

Menu 1 (First) >	Menu 2 >	Menu 3 >	Menu 4 (Last)
	Link to Master	By name By IP address	
	Expansion Mode	Host Expand to host	Enabled Disabled (default)
Administration	Software	Current	MS Version IVR Version Snx Version where n is slot number and x is the port
		Update	None or version list
	Beltpacks	Menu Lock	Unlock All Lock All
	Reset	Reset to Default	Reset HMS Reset Devices Reset All
		Reboot	Reboot Now
	Settings	Save	USB drive or file list
		Restore local	USB drive or file list
			Restore system
Diagnostics	Hardware	Main PCB	Part: [Part_Number] Revision: [Revision] Serial number: [Serial number]
		Slot 1 PCB	
		Slot 2 PCB	
		Slot 3 PCB	
	Temperature	Sensor 1	Temperature in °C.
		Sensor 2	Note: Single fan on if any sensor > 60°C.
		Sensor 3	

Menu 1 (First) >	Menu 2 >	Menu 3>	Menu 4 (Last)
			<i>Double fan on if any sensor > 65°C. Double fan off if < 55°C / single fan off if < 50°C.</i>
	Powerlines	Powerline 1 Powerline 2	Status: [OK or BUSY (according to responses to MME requests)]. DMC:[MAC of powerline modem] HMC: [MAC of local blackfin processor] Beltpacks: [# of beltpacks detected by powerline modem] Collision rate: [Percentage (0% when operating normally)] Error rate: [Percentage (0% when operating normally)] Volts: [Voltage]
	Keysets	Keyset 1 Keyset 2 Keyset 3 Keyset 4	Name: Channel name Talkers: Number of talkers on party line Devices: Number of beltpacks listening on party line Main Stations: Number of Main Stations listening 2-Wire: Number of 2-Wire ports listening 4-Wire: Number of 4-Wire ports listening

HRS-4X Remote Station menu map

Menu 1 (First) >	Menu 2 >	Menu 3>	Menu 4 (Last)
Audio Settings	Headset	Sidetone Gain	Range: 0dB to -18dB Default: -12db
		Headphone Limit	Off + Range: +6dB to -6dB Default: 0db
		Sidetone Control	Tracking Non-Tracking Disabled Default: Tracking
		HS Mic Type	Electret Dynamic (0 dB) Dynamic (-10 dB) Default: Dynamic (0 dB)
	Microphone	Headroom	Normal High Default: Normal
		Contour Filter	Enabled Disabled Default: Enabled
	Program Input	Gain	Range: +12dB to -12dB Default: 0db
		IFB Dim Level	Range: --6dB to -24dB Default: Off
		GPO Trigger	Enabled Disabled Default: Enabled
		VOX	Enabled Disabled

Menu 1 (First) >	Menu 2 >	Menu 3>	Menu 4 (Last)
			Default: Disabled
		VOX Off Delay	Range: 0.5 - 4sec Default: 0.5sec
	SA Output	Mode	Channel Assigned SA Default: Channel Assigned
		Gain	Range: +12 to -12dB Default: 0dB
		Program Output	Unmute Mute Default: Mute
		Channel Assign	Disabled Channel A Channel B Channel C Channel D Default: Disabled
	Hot Mic Output	Gain	Range: +12 to -12dB Default: 0dB
	Front Panel	Loudspeaker Dim	Range: 0dB to -24dB Default: -6dB

Menu 1 (First) >	Menu 2 >	Menu 3>	Menu 4 (Last)
Station Settings	Preferences	Roles	Default: HRM – [unique ID Select Role or Local Config]
	Keypad Assign	Keypad 1 – 4	Channel 1 – 12 (or 24)
	Keysets	Talk 1 - 4	Latching Non-Latching Default: Latching
		All Talk	All Channels Visible Channels
		SA Output Key	Latching Non-Latching Default: Non-latching
		RMK	Enabled Disabled Default: Enabled
	Display	OLED Brightness	High Medium Low Default: Medium
		Key Brightness	High / Low High / Off Low / Off Off / Off Default: High / Low
		Screensaver	Enabled Disabled Default: Enabled
	Channels	Channel 1 Channel 2 Channel 3	Label
Program Listen			None List of programs

Menu 1 (First) >	Menu 2 >	Menu 3>	Menu 4 (Last)
	Channel 4 [...]		Default: None
		GPO on Talk	Default: None Relay 1 - 4
		GPO on Call	Default: None Relay 1 - 4

Menu 1 (First) >	Menu 2 >	Menu 3>	Menu 4 (Last)
Control I/O	Inputs	Opto 1	None Call Key 1 Talk Key 1 Call Key 2 Talk Key 2 Call Key 3 Talk Key 3 Call Key 4 Talk Key 4 Default: None
	Outputs	Relay 1	
Network	Preferences	Hostname (12 char) DHCP enabled/disabled IP address (enter if required) Subnet mask Gateway	
	Pair to Station	By Name By Address	Enabled Disabled Default: Enabled
	Expansion mode	Host (enabled/disabled) Expand to host (none/hostname)	
Administration	Software	Current	HelixNet System Version Remote Station Version
		Update	None or version list
	Reset	Reset to Default	Reset Now
		Reboot	Reboot Now
	Settings	Save	USB drive or local
Restore local		USB drive or file list	
Diagnostics	Main PCB		

Menu 1 (First) >	Menu 2 >	Menu 3 >	Menu 4 (Last)
	Powerlines	Powerline 1	Status: [status] DMC: {MAC} HMC: [MAC] MMC: [MAC] Rx rate: [Mbps] Tx rate: [Mbps]
	Network	Status	IP Address
		IP Address	
		IP Mask	
		Mac	
Keysets	Keyset 1 Keyset 2 Keyset 3 Keyset 4	Name: Channel name Talkers: Number of talkers on party line Devices: Number of beltpacks listening on party line Main Stations: Number of Main Stations listening 2-Wire: Number of 2-Wire ports listening 4-Wire: Number of 4-Wire ports listening	

HKB-4X Speaker Station menu map

Menu 1 (First) >	Menu 2 >	Menu 3 >	Menu 4 (Last)
Roles	Select Role or Local Config.		
Audio Settings	Headset	Sidetone Gain	Range: 0dB to -18dB Default: -12db
		Headphone Limit	Off + Range: +6dB to -6dB Default: 0db
		Sidetone Control	Tracking Non-Tracking Disabled Default: Tracking
		HS Mic Type	Electret (-15dB) Dynamic (0 dB) Dynamic (-10 dB) Default: Dynamic (0 dB)
	Microphone	Headroom	Normal High Default: Normal
		Contour Filter	Enabled Disabled Default: Enabled
	PGM/audio in	Label (12 char) Gain IFB dim level	

Menu 1 (First) >	Menu 2 >	Menu 3>	Menu 4 (Last)
		GPO trigger Vox Vox off delay	
	SA/audio out	Mode (toggle Channel assign/SA) Gain Program Output (mute/unmute) Channel assign (1 - 24)	
	Hot mic output	Gain	
	Front Panel	Loudspeaker Dim	Range: 0dB to --24dB Default: -6db
Station Settings	Keyset Assign	Keyset 1 - 4	Channel 1 - 12 (or 24 depending on license)
	Keysets	Talk 1 - 4	Latching Non-Latching Default: Latching
		SA out key (latch/non latch)	
		All Talk (All Channels (up to 24)/Visible Channels (4))	

Menu 1 (First) >	Menu 2 >	Menu 3>	Menu 4 (Last)
		RMK (All Channels (up to 24)/Visible Channels (4))	
	Display	OLED Brightness	High Medium Low Default: Medium
		Key Brightness	High / Low High / Off Low / Off Off / Off Default: High / Low
		Screensaver	Enabled Disabled Default: Enabled
Network	Pair to Station	By Name	Separate IP address: xx.xx.xx.xx where x is a numeric value
		By Address	
	Preferences	DHCP	Enabled Disabled Default: Enabled
		IP Address	IP address: xx.xx.xx.xx where x is a numeric value
	Gateway	IP address: xx.xx.xx.xx where x is a numeric value	

Menu 1 (First) >	Menu 2 >	Menu 3>	Menu 4 (Last)
		Subnet Mask	IP address: xx.xx.xx.xx where x is a numeric value
Administration	Software	Current	HelixNet Speaker Station
	License	Current/Enter code	
	Reset	Reset to Default	Reset Now
		Reboot	Reboot Now
Setting	Save/restore		
Diagnostics	Powerlines	Powerline 1	Status: [OK or BUSY (according to responses to MME requests)]. DMC:[MAC of powerline modem] HMC: [MAC of local blackfin processor] Rx rate:[Mbps] Tx rate:[Mbps] Status:[status] IP Addr [IP Address] IP Mask [Subnet Mask] MAC:[MAC Address]
	Networking	Ethernet	
	Keysets	Keyset 1 Keyset 2 Keyset 3 Keyset 4	Name: Channel name Talkers: Number of talkers on party line Devices: Number of beltpacks listening on party line Main Stations: Number of Main Stations listening 2-Wire: Number of 2-Wire ports listening 4-Wire: Number of 4-Wire ports listening

Menu 1 (First) >	Menu 2 >	Menu 3 >	Menu 4 (Last)
	Hardware		
	Voice clients		

HBP-2X Beltpack menu map

Menu 1 (First) >	Menu 2 >	Menu 3 (Last)
Roles	Select Role or Local Config	
Audio Settings	Sidetone Gain	Range: 0dB to -18dB Default: -12dB
	Headphone Limit	Off + Range: +6 to -12dB Default: 0dB
	Sidetone Control	Tracking Non-tracking Disabled Default: Tracking
	HS Mic Type	Electret (-15dB) Dynamic (0dB) Dynamic (-10dB) Default: Dynamic (0dB) Note: <i>Electret = 35dB fixed gain, non-user adjustable.</i> <i>Dynamic = 50dB fixed gain, non-user adjustable.</i>
	Headroom	Normal High Default: Normal
	Contour Filter	Enabled Disabled

Menu 1 (First) >	Menu 2>	Menu 3 (Last)
		Default: Enabled
Beltpack Settings	Left Channel	None
	Right Channel	Channel assign (1 – 24) Talk (latch/non latch) Default: Latch USB flasher (disabled/blinking/solid) Default: disabled
	Vibrate On Call	On Off Default: Off
Display Settings	OLED Brightness	High Medium Low Default: Medium
	Key Brightness	High / Low High / Off Low / Off Off / Off Default: High / Low
	Rotate Display	Enabled Disabled Default: Disabled

Menu 1 (First) >	Menu 2>	Menu 3 (Last)	
	Screensaver	Channel Hostname Role (default) Blank Disabled	
Network	IP Address	IP address: xx.xx.xx.xx where x is a numeric value	
Administration	Software Version	npl-1.0.x, uboot	
	Software Update	npl-1.0.x	
	Reset to Default	Reset Now	
	Hardware Important Note: There are 4 levels of Menu for Hardware	Main PCB	
Diagnostics	Powerline Note: <i>Line (partyline) that connects beltpack to the network (and which also powers the beltpack).</i>	Status: [OK or BUSY (according to responses to MME requests)]. DMC:[MAC of powerline modem] HMC: [MAC of local blackfin processor] MMC: [MAC of the Main Station	Part: [Part_Number] Revision: [Revision] Serial number: [Serial number]

Menu 1 (First) >	Menu 2>	Menu 3 (Last)	
		powerline modem, to which the beltpack is connected] Rx rate: Range: 140 – 150 Mbps Tx rate: Range: 140 – 150 Mbps	
	Keysets 1 to 4	Name: Channel name Talkers: Number of talkers on party line Beltpacks: Number of beltpacks listening on party line Main Stations: Number of Main Stations listening 2-Wire: Number of 2-Wire ports listening 4-Wire: Number of 4-Wire ports listening	

Table 21-1: HBP-2X Beltpack

22 *Menu trees*

This chapter provides tree diagrams of the menu structure of all the HelixNet devices. Use these diagrams to gain a quick overview of what menu options are available, and where to find them.

Note: Items marked with an asterisk (*) are not present in expansion mode.

Table 22-1 Main Station menu tree

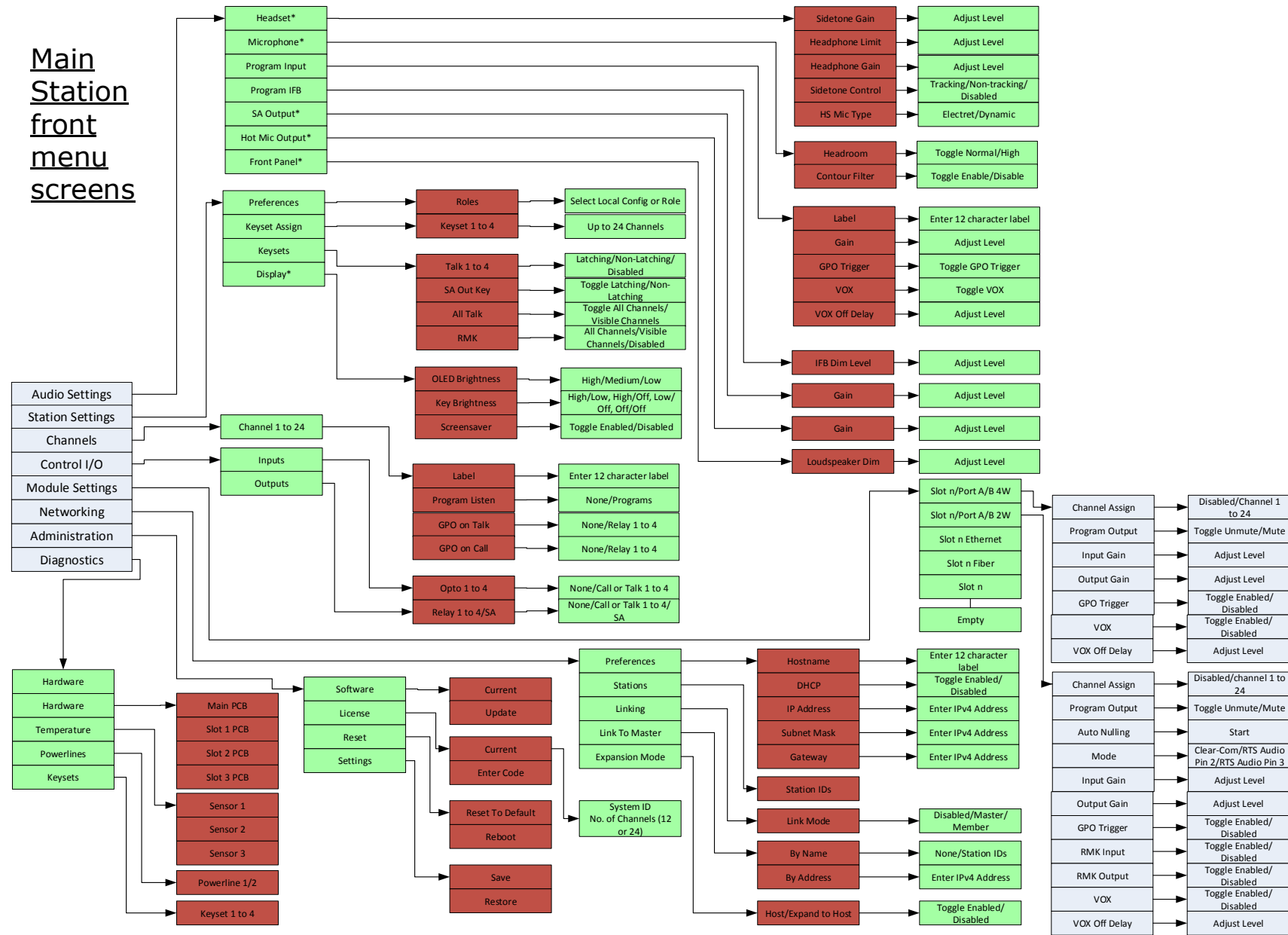


Table 22-2 Remote Station menu tree

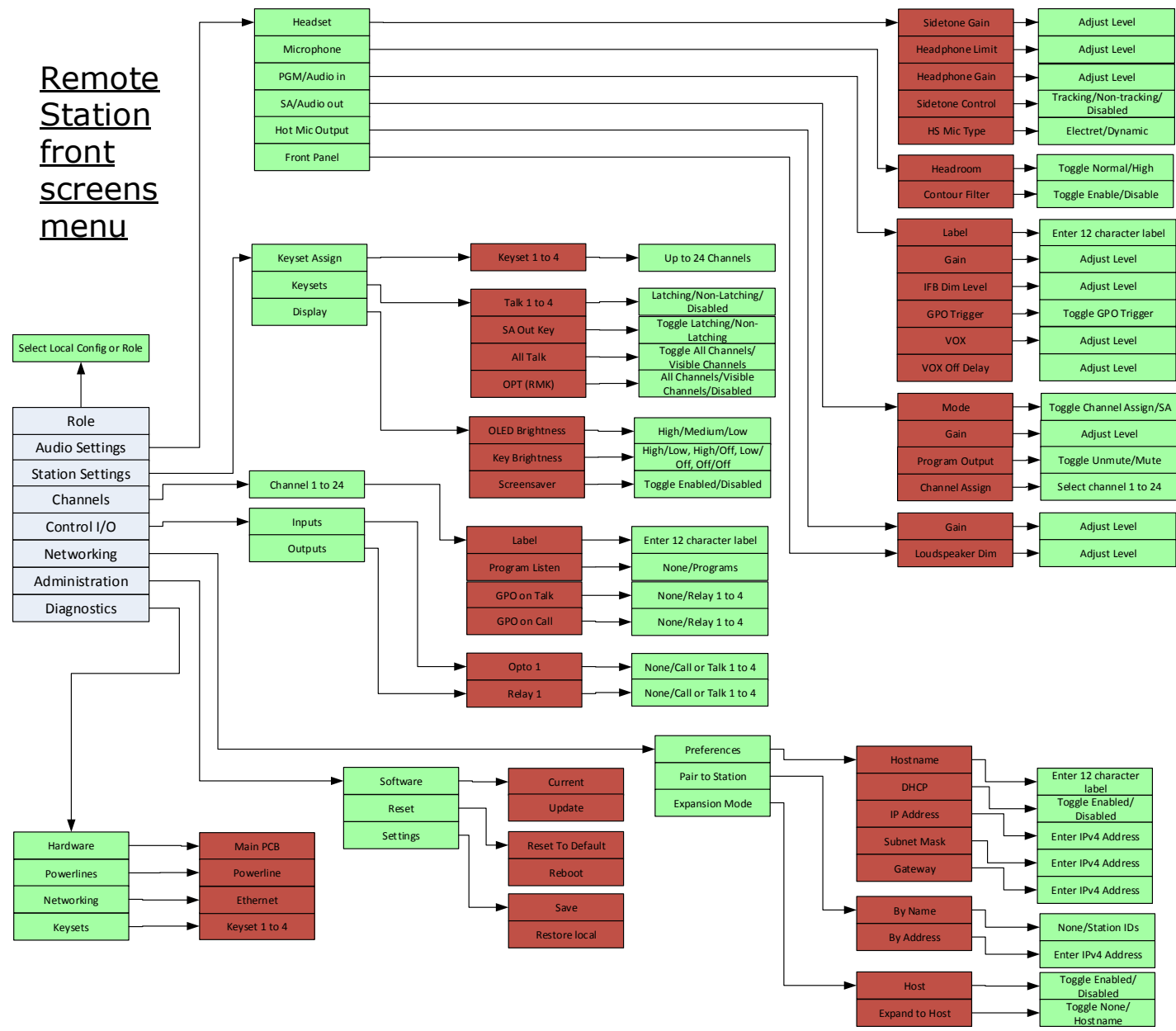
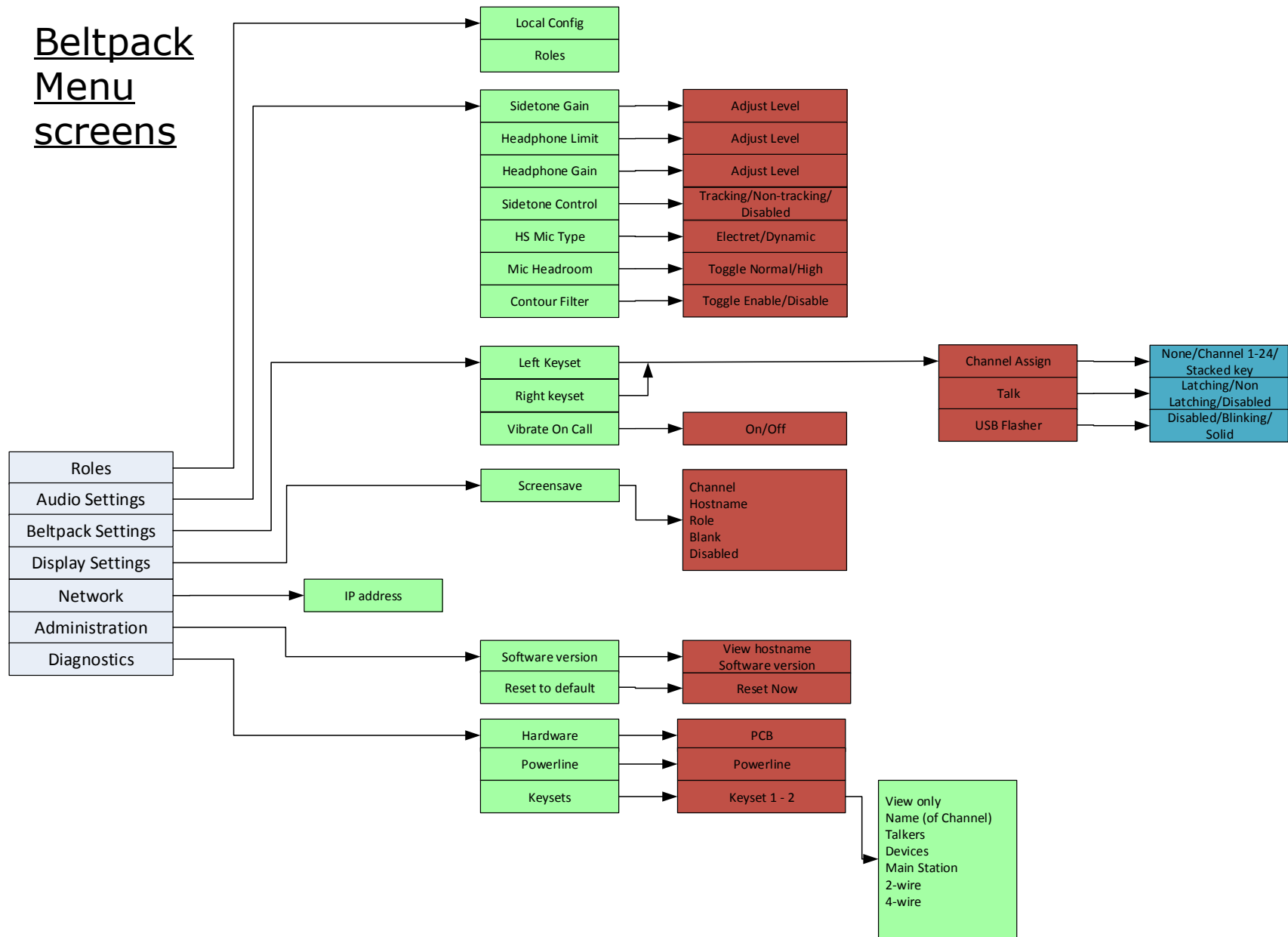


Table 22-4 Beltpack menu tree

Beltpack Menu screens



23 Cabling reference

You can connect HBP-2X Beltpacks using:

- A wide range of standard microphone (intercom) cable types (16 AWG – 26 AWG).
- CAT5, CAT5e and CAT6 cable types.

XLR cable	CAT5/6 cable
Pin 1	Pin 1 and Pin 2 and shield/drain wire
Pin 2	Pin 3, Pin 5 and Pin 7
Pin 3	Pin 4, Pin 6 and Pin 8

Table 23-1 Recommended cabling scheme

Clear-Com recommends the following cable types:

- Belden 9207 for fixed installation
- Belden 9463F for portable installations

Note: Cat 5 screen should be connected to chassis at one end of cable only.

Note: Clear-Com recommends the use of shielded twisted pair cabling.

You can also mix CAT cables and microphone cables when connecting to the HMS-4X Main Station. For example, you might use CAT cables to trunk long distances, and flexible microphone cables to connect HBP-2X Beltpacks to bulkheads.

Note: The cabling information provided in this guide is for guidance only. For in-depth, tailored advice on cabling, Clear-Com recommends that you contact your Clear-Com representative.

23.1 Interoperability

The optional interface modules (two-wire, four-wire, 10/100BaseT Ethernet and Fiber Channel) for the HMS-4X Main Station enable interoperability with your existing communications infrastructure.

You can connect the HMS-4X Main Station to:

- Two-wire intercom systems and devices (including Encore and RTS) using standard microphone cable (16 AWG – 26 AWG).
- Four-wire intercom systems and devices (including Eclipse) using Ethernet (CAT) cable.

Tip: For more information about integrating HelixNet Partyline into your existing communications infrastructure, see **18 Connecting to Other Intercom Systems**.

23.2 Cable capacitance versus distance

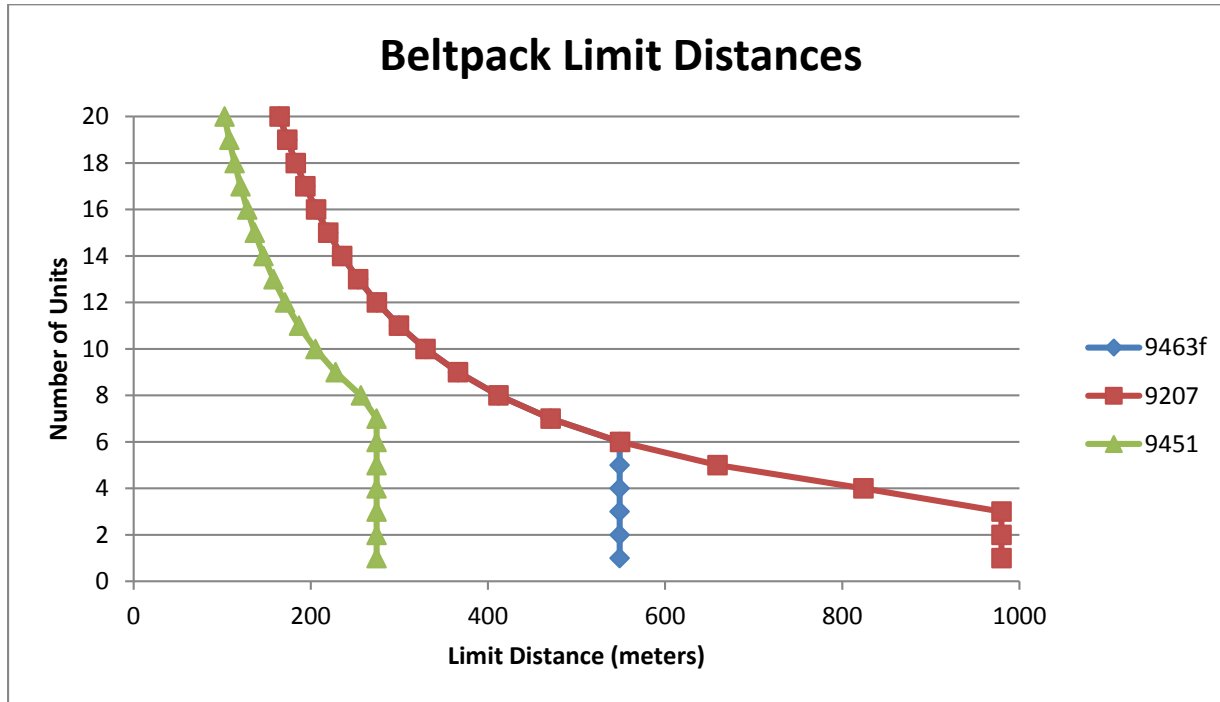
Standard microphone cables impose distance limitations at their upper limits due to cable capacitance.

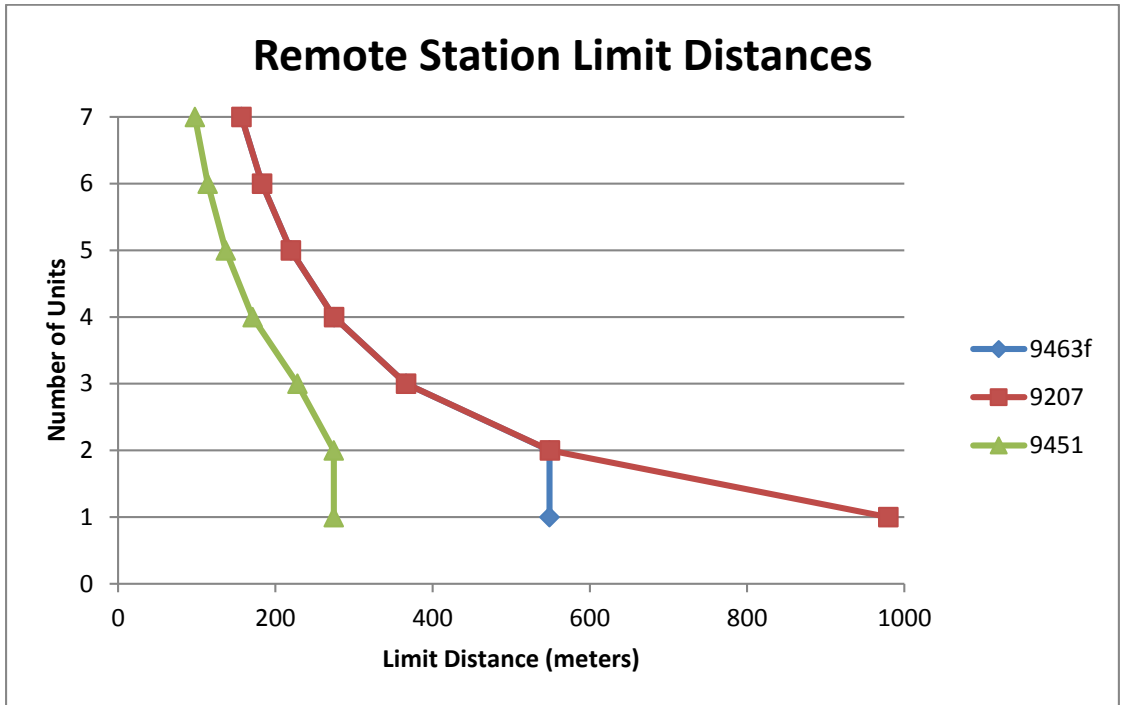
If your priority is audio quality, experiment with attaching one or two fewer devices to each line. Your choice of topology (daisy chain, star or tree) may also impact audio quality over distance.

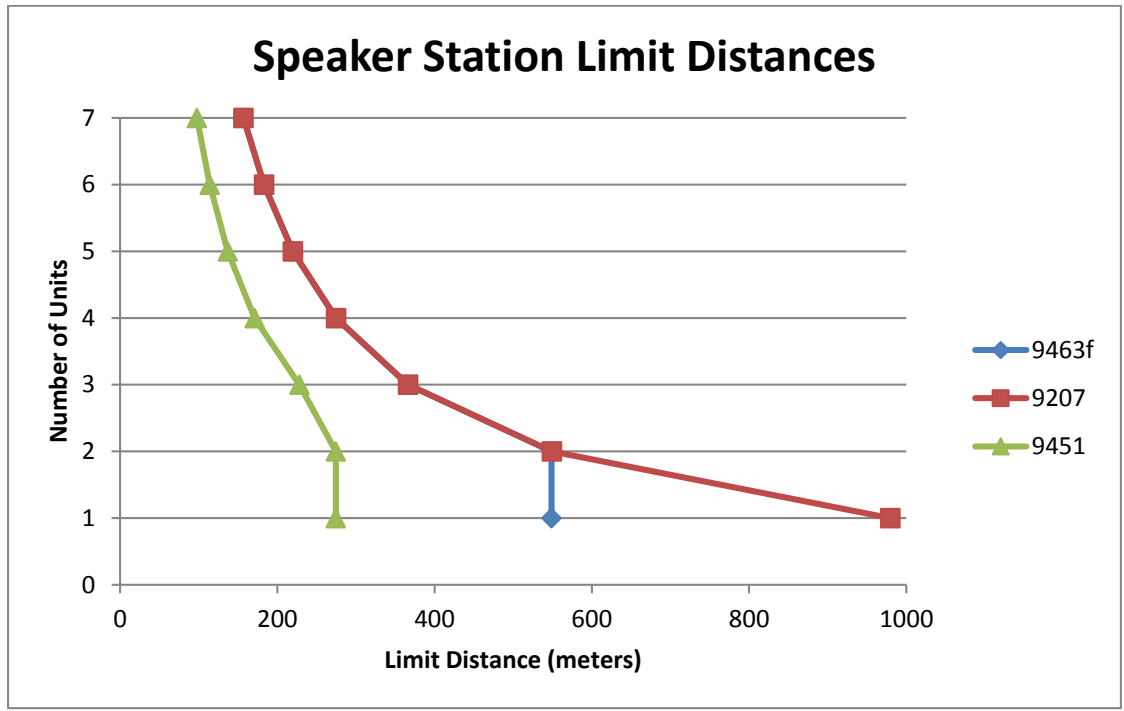
Manufacturer	Cable type	Gauge (AWG)	Style	Attenuation / 100m
Belden	9463f	20	Std	16 dB
Belden	9207	20	Std	9 dB
Belden	1533P	24	Cat5e	11 dB

Table 23-2: Cable capacitance

Quick reference: Cable capacity versus distance







Note: The above graphs are intended as a general guide only. Actual cable performance may vary, depending on the conditions and complexity of the installation.

23.3 Cable connections

The diagrams on the following pages reference the following labels and notes.

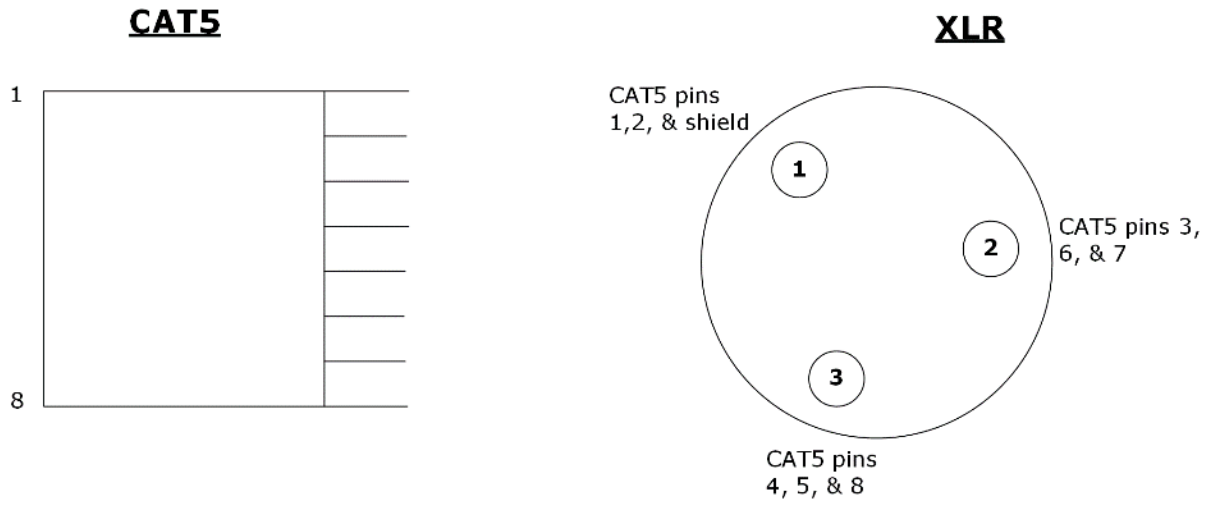
Label	Manufacturer	Part Number	Description
1	Clear-Com	HMS-4X	HelixNet Main Station
2	Belden	8760,9207 Or 9463F	18 or 20 AWG twisted pair cable terminated with 3-pin XLR
3	Middle Atlantic (or equivalent)	CH-1	1 RU shielded chassis
4	Neutrik (or equivalent)	NC3FD-L-B-1	3 pole female chassis mount
5	Neutrik (or equivalent)	NC3MD-L-B-1	3 pole male chassis mount
6	Neutrik (or equivalent)	NA3MDF	3 PIN XLR M-F FEED THRU ADAPTER
7	Belden (or existing cabling)	1351A or 1533P	24 AWG, shielded cat 6 cabling
8	Belden	8760,9207 or 9463F	XLR3 M-F patch cord
9	Belden	8760,9207 or 9463F	18 or 20 AWG twisted pair cable

Table 23-3 Label descriptions

Label	Note
1	Wire in accordance with Table 23-5
2	Equipment rack, breakout box chassis and patch panel must be connected to safety earth
3	Connect up to 32 wall plate locations to patch panel with individual CAT 5 cables
4	If multiple wall plates are co-located at a remote location, daisy chain their wiring at the remote location and connect a single CAT 5 cable from the remote location back to the patch panel
5	Use short length, high quality XLR patch cords with shielded connectors
6	Do not patch between separate power lines
7	Assemble item 6 to panel with male connectors to front



Table 23-4 Notes



CAT5	XLR
1	1
2	1
3	2
4	3
5	3
6	2
7	2
8	3
Shield	1

Table 23-5 Wiring diagram



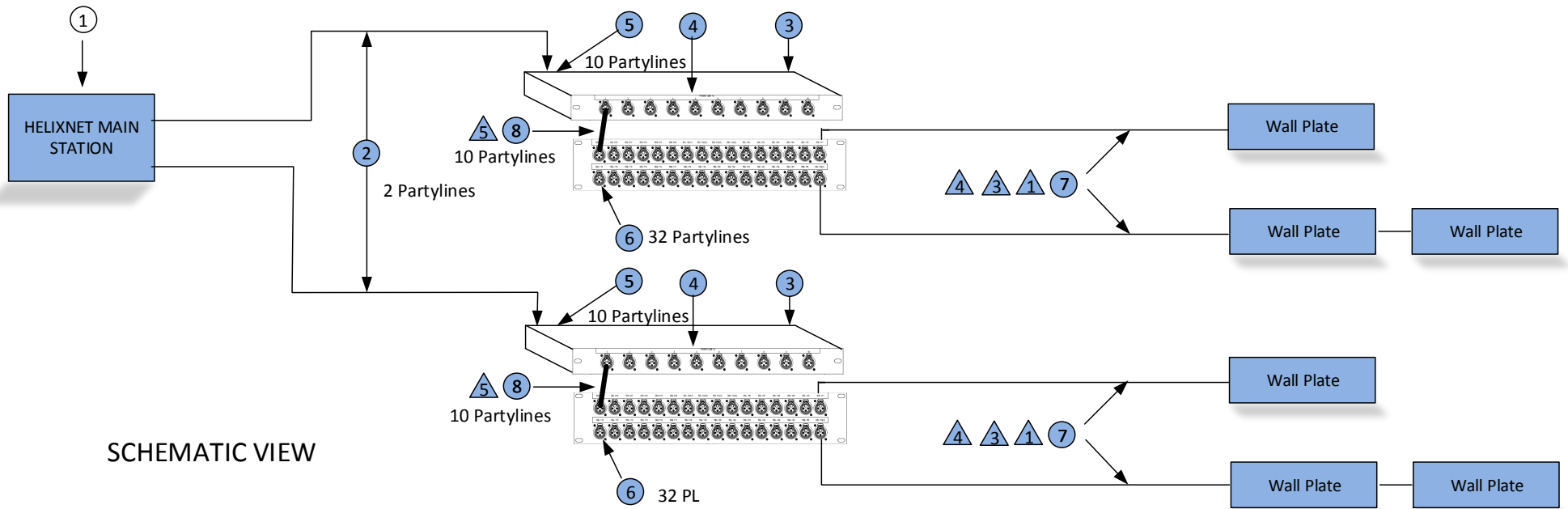


Figure 23-1 Cabling schematic

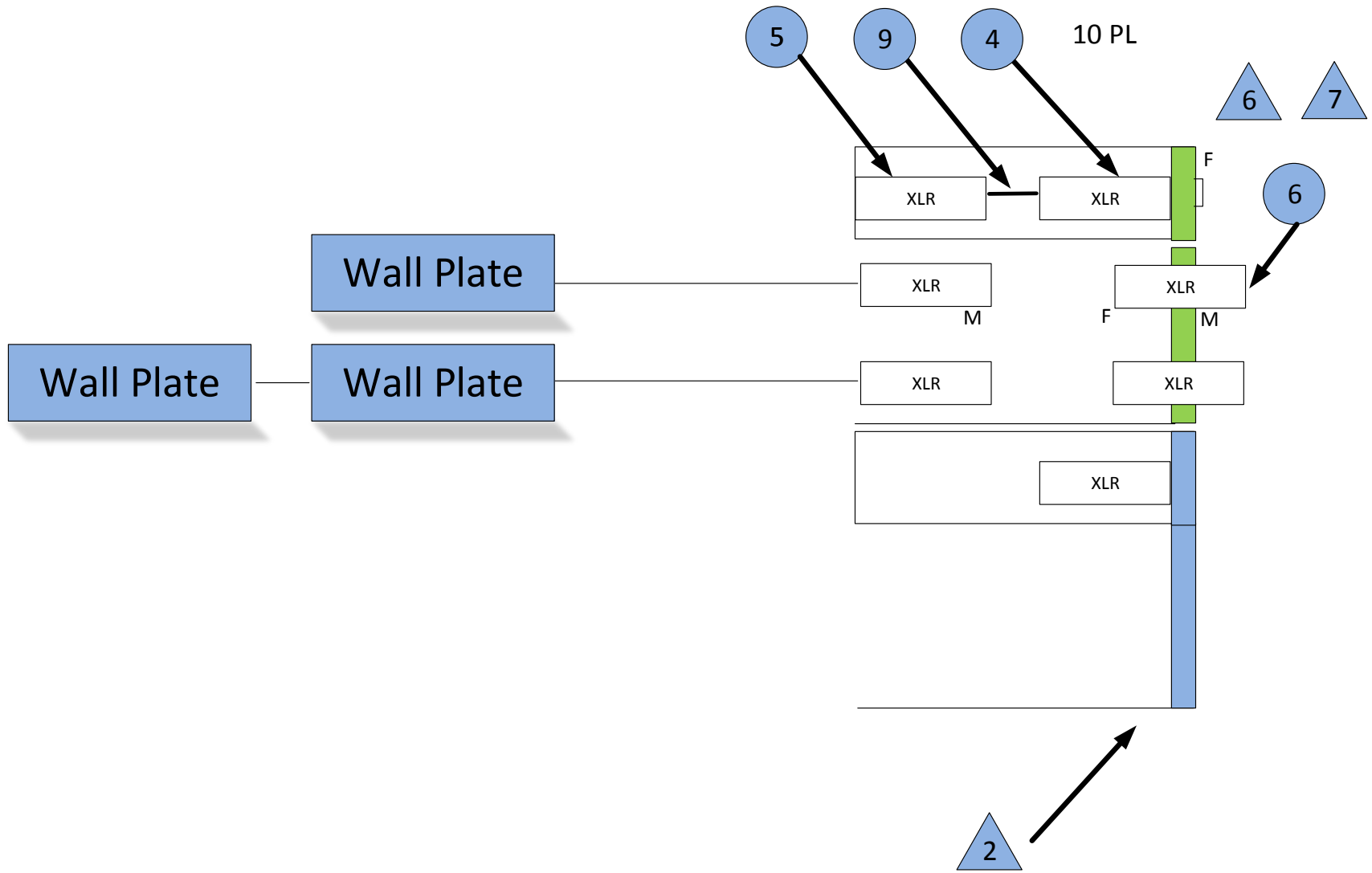
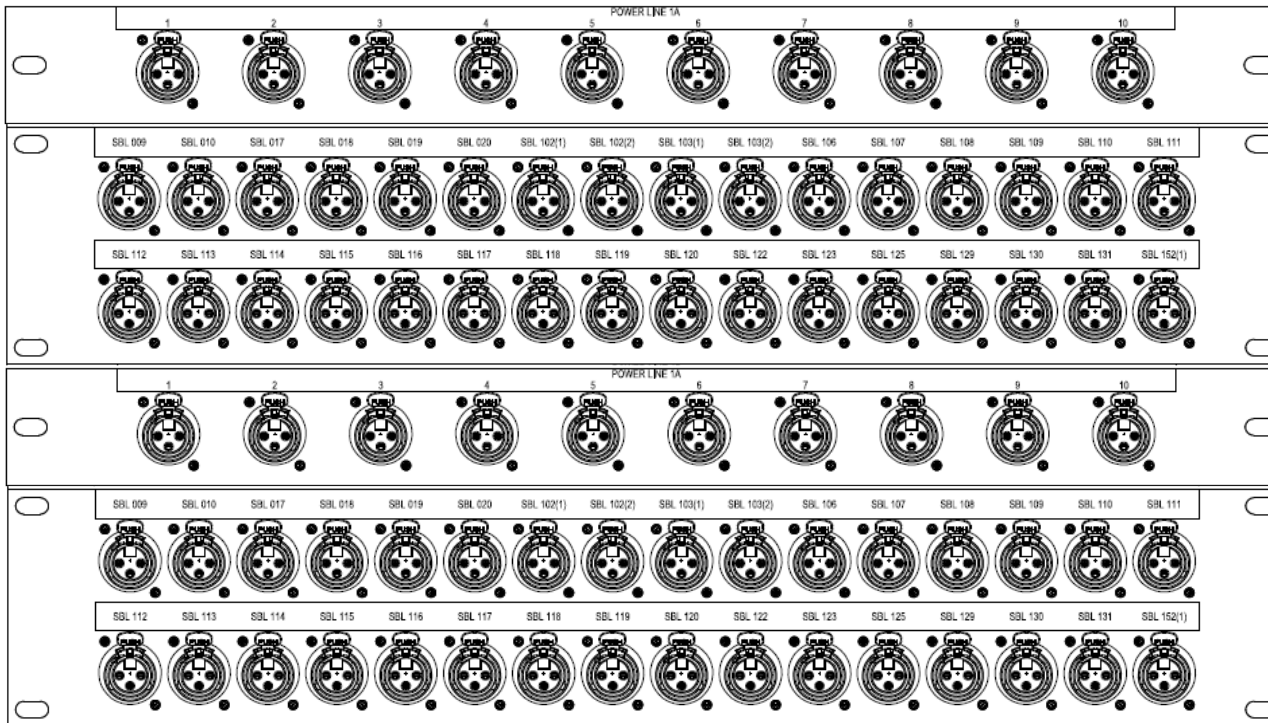


Figure 23-2 Cabling side view



POWER LINE #1A

POWER LINE #1A
WALL PLATE

POWER LINE #1B

POWER LINE #1B
WALL PLATE

Figure 23-3 Front view

24 Troubleshooting

Issue	Solution
<p>Why are the Talk keys flashing periodically?</p>	<p>Flashing Talk keys may indicate a fault in the cable.</p> <p>Check the cable for short-circuit conditions and replace if necessary.</p>
<p>The Call functionality on my analog beltpack is no longer working.</p>	<p>HelixNet Partyline operates at different voltage levels than analog two-wire partyline systems.</p> <p>The analog beltpack may have been damaged if it was connected to a HelixNet Main Station partyline port.</p> <p>Contact Clear-Com for repair options.</p>
<p>I cannot pass audio to wired / wireless intercom equipment over the Two-wire module.</p>	<p>Two-wire option modules require an external power supply. See 18 Connecting to Other Intercom Systems.</p>
<p>Why do I hear an echo when interfacing via a two-wire audio port?</p>	<p>Run auto-nulling.</p> <p>Ensure that all unused Talk keys in the system are unlatched.</p>
<p>Echo occurs even after Two wire module has been auto-nulled.</p>	<p>Check to ensure all open Talk keys are not latched and re-null.</p>
<p>There is no audio or only partial audio (send or receive, but not both) between other audio systems / sources connected over four-wire.</p>	<p>Check the cable used to connect the equipment.</p> <p>HelixNet to Eclipse four-wire connections only require a standard CAT cable, whereas other four-wire connections (to Tempest™, CellCom / FreeSpeak, and other systems) require an audio crossover cable. See:</p> <ul style="list-style-type: none"> • 2.2.1 HMS-4X Main Station rear panel: Interface modules • 18 Connecting to Other Intercom Systems

<p>Line 1 (or Line 2) LED is blinking red.</p>	<p>There is a short-circuit somewhere on that Powerline. Unplug everything from that Powerline and add cables and Beltpacks one at a time until you find the short-circuit.</p>
<p>Line 1 (or Line 2) LED is steady red and one or more Beltpack has no bars showing up for signal strength.</p>	<p>There are digital errors or there is cross-talk on that Powerline. Look at the Diagnostics->Powerlines->Powerline 1(or 2) page.</p> <p>If the number of Beltpacks showing there is greater than what you physically connected to that Powerline, cross-talk is happening between the Powerlines. Make sure you are using properly shielded Mic cables or Cat cables.</p> <p>If the number of Beltpacks showing there does match what you physically connected to that Powerline and errors or high collision rate is displayed, verify that you don't exceed the number of Beltpacks per Powerline or distance as per the Cable capacity versus distance table.</p> <p>High collision rate means communication issues on the powerline. Possible causes are:</p> <ul style="list-style-type: none"> • Unshielded or bad cables • Powerline 1 looped back into Powerline 2 (or from one HMS to another) • Cables too long • Too many cables in the infrastructure (even unconnected strand count) • Too many devices on the Powerline • Faulty device
<p>I inserted my USB drive with a ccb file on it and the Administration->Software->Update menu shows "None".</p>	<p>Make sure that your USB drive is formatted with at least one partition. Make sure your .ccb file is in the root directory of the first partition on your USB drive. If not you can run diskpart on Windows Vista and later versions of Windows to create a partition.</p>
<p>I upgraded to 1.1 but I cannot see the Networking menu.</p>	<p>Make sure you properly inserted an Ethernet or Fiber module in one of the option module slots. You can verify that they are detected by looking at the Modules Settings menu.</p>
<p>I powered up two Main Stations and they are not showing up in the</p>	<p>Make sure your Ethernet or Fiber cable is properly connected to a router, a switch or another Main Station. There is a green LED</p>

<p>Networking > Stations list.</p>	<p>beside each Ethernet and Fiber port to indicate that the connection is fine. Look at each station IP address and Subnet Mask under Networking > Preferences and make sure that they are part of the same subnet. Also make sure that their IP address is different from any other device on your IP network.</p>
<p>My connection to the CCM is intermittent.</p>	<p>This is generally caused by more than one device using the same IP address. Check with your network administrator that there is no IP clash.</p>
<p>My device has gone into link-local mode. (IP address = 169.254.XX.XX)</p>	<p>If your device is set to Dynamic Host Configuration Protocol (DHCP) and there is no DHCP available on the network it is connected to it will revert to link-local automatically. You need to allocate a static IP address to this device. See Chapter 4 for more information.</p>

Table 24-1: Troubleshooting

25 Compliance

FCC notice

This device complies with Part 15 of the FCC rules. Operation is subject to the following two conditions: (1) This device may not cause harmful interference, and (2) This device must accept any interference received, including interference that may cause undesired operation.

NOTE: This equipment has been tested and found to comply with the limits for a Class A digital device, pursuant to Part 15 of the FCC rules. These limits are designed to provide reasonable protection against harmful interference when the equipment is operated in a commercial environment. This equipment generates, uses and can radiate radio frequency energy and, if not installed and used in accordance with the instruction manual, may cause harmful interference to radio communication. Operation of this equipment in a residential area is likely to cause harmful interference, in which case the user will be required to correct the interference at his own expense.

Changes or modifications not expressly approved by Clear-Com, LLC, an HM Electronics, Inc. company could void the user's authority to operate this equipment.

Industry Canada Compliance Statement

This Class[A] digital device complies with Canadian ICES-003.

Avis de conformité à la réglementation d'Industrie Canada

Cet appareil numérique de la class[*] est conforme à la norme NMB-003 du Canada.

Korean notice

A급 기기 (업무용 방송통신기자재)

이 기기는 업무용(A급)으로 전자파적합기기로서 판매자 또는 사용자는 이 점을 주의하시기

바라며, 가정외의 지역에서 사용하는 것을 목

적으로 합니다.

The HMS-4X, HRM-4X, HBP-2X, HBP-2XS, HLI-2W2 and HLI-4W2 products comply with the following specifications:

EN55022 Emissions

EN55024 Immunity

Electromagnetic Compatibility Directive 2004/108/EC

Low Voltage Directive 2006/95/EC

Warning:

This is a Class A product. In a domestic environment this product may cause radio interference in which case the user may be required to take adequate measures.

The HMS-4X, HLI-2W2 and HLI-4W2 products comply with the following specifications:

UL 60065-7

CAN/CSA-C22.2 No.60065-3

IEC 60065-7

Waste Electrical And Electronic Equipment (WEEE)

The European Union (EU) WEEE Directive (2002/96/EC) places an obligation on producers (manufacturers, distributors and/or retailers) to take-back electronic products at the end of their useful life. The WEEE Directive covers most Clear-Com products being sold into the EU as of August 13, 2005. Manufacturers, distributors and retailers are obliged to finance the costs of recovery from municipal collection points, reuse, and recycling of specified percentages per the WEEE requirements.

Instructions for Disposal of WEEE by Users in the European Union

The symbol shown below is on the product or on its packaging which indicates that this product was put on the market after August 13, 2005 and must not be disposed of with other waste. Instead, it is the user's responsibility to dispose of the user's waste equipment by handing it over to a designated collection point for the recycling of WEEE. The separate collection and recycling of waste equipment at the time of disposal will help to conserve natural resources and ensure that it is recycled in a manner that protects human health and the environment. For more information about where you can drop off your waste equipment for recycling, please contact your local authority, your household waste disposal service or the seller from whom you purchased the product.



Figure 25-1: WEEE Symbol