

Uninterruptible Power Supply (UPS)

Control Unit **S8BA-24D24D□□□SBF**

Battery Unit **S8BA-S□□□L**

User's Manual

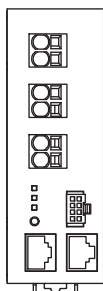
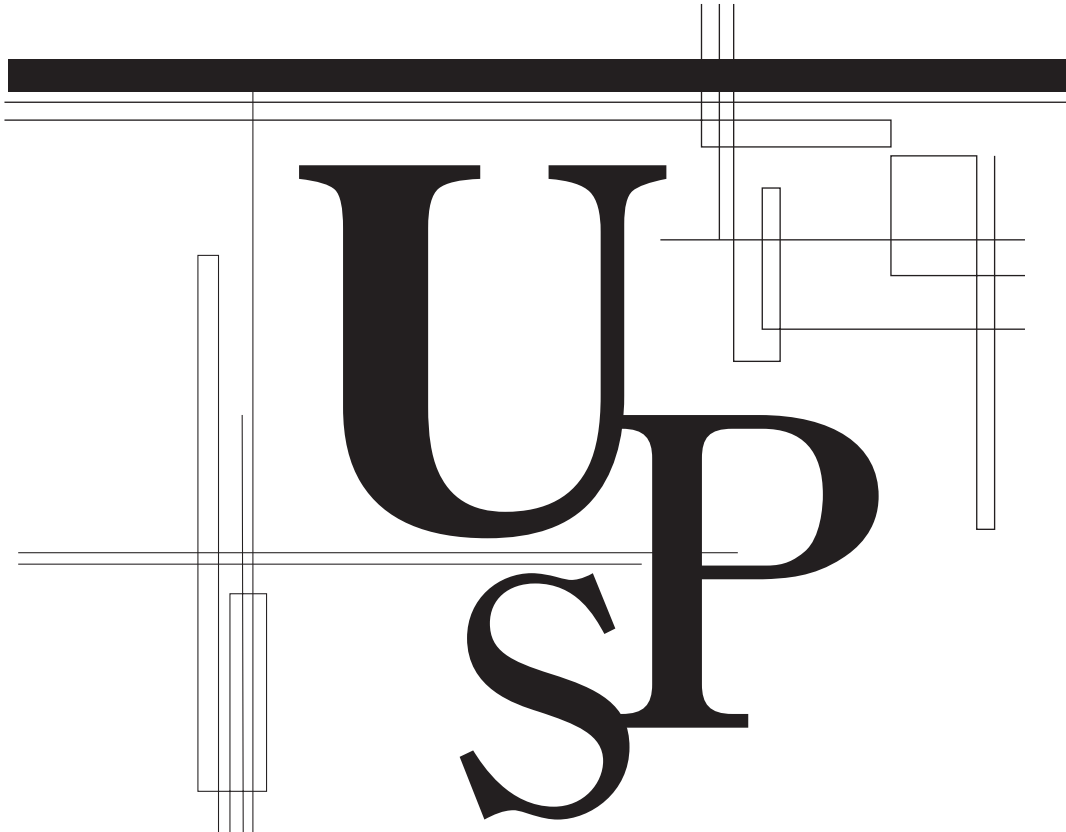

S8BA-24D24D480SBF

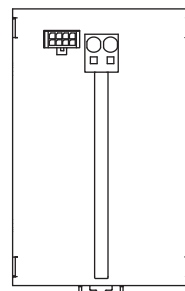

S8BA-S480L

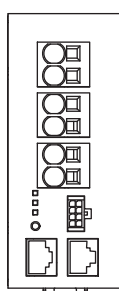

S8BA-24D24D960SBF

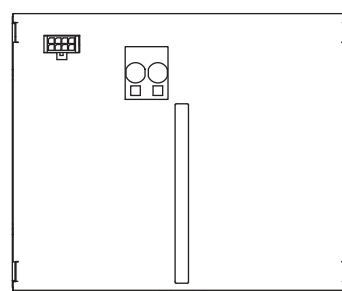

S8BA-S960L

Introduction

Thank you for purchasing OMRON's Uninterruptible Power Supply (UPS).

This manual contains information that is necessary to use the "Uninterruptible Power Supply (UPS)". Read this manual carefully and make sure that you understand the functionality and performance of the product before using it in your system.

Keep this manual in a safe place where it will be available for reference during operation.

Intended audience

This manual is intended for:

Personnel with knowledge of electric systems (the level of knowledge an electrical engineer has or its equivalent) and at the same time

- Personnel in charge of introducing FA systems
- Personnel in charge of designing FA systems
- Personnel in charge of installing and connecting FA systems
- Personnel in charge of managing FA systems and facilities

Applicable products

This manual covers the following products:

- Uninterruptible Power Supply (UPS) S8BA Series
 - S8BA-24D24D480SBF
 - S8BA-24D24D960SBF
 - S8BA-S480L
 - S8BA-S960L

Important notice

- No part of this manual may be copied, reproduced, or used in any form without our permission.
- Please be informed that the specifications may be changed without prior notice for the purpose of improving the contents of this manual.
- We have checked the content of this manual and believe it to be accurate. However, if you find any errors or have any questions, contact our sales personnel.

At that time, give the Man. No. (manual number) in the back of your manual.

Trademarks

- System names and product names indicated in this manual are registered trademarks or trademarks of their respective owners.

Manual Structure

Page Structure and Icons

The following page structure and icons are used in this manual.

The diagram illustrates the structure of a manual page. On the left, annotations identify various elements:

- Level 1 heading:** Points to the page number '4' in the top right corner.
- Level 2 heading:** Points to the section title '4-3 Mounting Units'.
- Level 3 heading:** Points to the sub-section title '4-3-1 Connecting Controller Components'.
- A step in a procedure:** Points to the numbered step '1'.
- Special information:** Points to a warning icon and the 'Precautions for Correct Use' section.
- Manual name:** Points to the footer text 'NJ-series CPU Unit Hardware User's Manual (W500)'.

 On the right, additional annotations describe the page's layout:

- Page tab:** Points to the page number '4' in the right margin.
- Page tab:** Points to the page number '4' in the bottom right corner.

 The page content includes:

- Section 4: Installation and Wiring
- Section 4-3: Mounting Units
- Section 4-3-1: Connecting Controller Components
- Text: The Units that make up an NJ-series Controller can be connected simply by pressing the Units together and locking the sliders by moving them toward the back of the Units. The End Cover is connected in the same way to the Unit on the far right side of the Controller.
- Step 1: Join the Units so that the connectors fit exactly. Includes a diagram showing 'Hook', 'Connector', and 'Hook holes'.
- Step 2: The yellow sliders at the top and bottom of each Unit lock the Units together. Move the sliders toward the back of the Units as shown below until they click into place. Includes a diagram showing 'Release' and 'Lock' positions for a 'Slider'.
- Precautions for Correct Use: The sliders on the tops and bottoms of the Power Supply Unit, CPU Unit, I/O Units, Special I/O Units, and CPU Bus Units must be completely locked (until they click into place) after connecting the adjacent Unit connectors.
- Footer: NJ-series CPU Unit Hardware User's Manual (W500) and page number 4-9.

Note This illustration is provided only as a sample. It may not literally appear in this manual.

Special Information

Special information in this manual is classified as follows:



Precautions for Safe Use

Precautions on what to do and what not to do to ensure safe usage of the product.



Precautions for Correct Use

Indicates the items to be implemented or avoided when the product is not operating, or to prevent a negative impact on the performance and functions.



Additional Information

Additional information to read as required.

This information is provided to increase understanding or make operation easier.



References are provided to more detailed or related information.

Points to be Considered Regarding Notations

In this manual, the control unit and battery unit are collectively specified as the "UPS".

The same holds true when "the unit" or "this product" is specified.

Moreover, if the control unit and battery unit are to be indicated individually, they are respectively specified as the "control unit" and "battery unit".

Table of Contents

1	Overview of the product	A	Appendix	1	A
2	Preparation			2	
3	Installation and connection			3	
4	Operations			4	
5	Maintenance and inspection			5	
6	To perform shutdown processing of the devices when a power failure occurs			6	
7	Using the I/O signal functions			7	
8	Troubleshooting			8	

CONTENTS

Introduction.....	1
Manual Structure.....	2
Table of Contents.....	5
Terms and Conditions Agreement	8
Safety precautions.....	10
Regulations and standards.....	17
Revision History.....	19

Section 1 Overview of the product

1-1 Features of this product	1-2
1-2 Specifications	1-3
1-3 Procedure from installation to operation	1-5

Section 2 Preparation

2-1 Unpacking the product	2-2
2-2 Checking the contents	2-3
2-3 Name of each part	2-4
2-4 Diagram of the Input/output circuit block	2-6

Section 3 Installation and connection

3-1 Installation.....	3-2
3-1-1 DIN rail installation.....	3-4
3-2 Connection.....	3-5
3-2-1 UPS connection order.....	3-5
3-2-2 Connecting the UPS control unit and battery unit with a battery connection cable	3-6
3-2-3 Connecting a device to the output terminal block.....	3-8
3-2-4 Connecting the input power supply to the input terminal block.....	3-8
3-2-5 Connecting a cable to the battery terminal block, input terminal block and output terminal block....	3-9

Section 4 Operations

4-1 Checking the operation.....	4-2
4-1-1 LED display.....	4-2
4-1-2 Backup operation time setting / Battery replacement mode selection switch	4-5
4-2 Start and stop procedures and basic operation	4-6
4-2-1 Start and stop procedures.....	4-6

Section 5 Maintenance and inspection

5-1	Inspecting the battery	5-2
5-1-1	Expectancy of the battery	5-2
5-1-2	Estimated backup time	5-2
5-2	Replacing the battery unit	5-4
5-2-1	Notification that the battery unit needs to be replaced.....	5-4
5-2-2	Procedure for replacing the battery unit.....	5-6
5-3	Cleaning the Unit	5-9

Section 6 To perform shutdown processing of the devices when a power failure occurs

6-1	The outline on the UPS monitoring software	6-2
6-1-1	UPS monitoring software	6-2
6-1-2	How to connect.....	6-2

Section 7 Using the I/O signal functions

7-1	I/O signal functions	7-2
7-1-1	Type of output signals.....	7-2
7-1-2	Type of input signals.....	7-2
7-1-3	CONTACT port (RJ45 connector).....	7-3
7-1-4	Contact signal ratings	7-3
7-1-5	Contact signal circuit.....	7-3
7-1-6	Precautions and notes for the use of the I/O signal functions	7-4
7-1-7	Example of the use of the Contact Signal circuit	7-4

Section 8 Troubleshooting

8-1	Troubleshooting	8-2
------------	------------------------------	------------

Appendix

A-1	Dimensions	A-2
A-2	Characteristic data	A-5
A-2-1	Derating curve	A-5
A-2-2	Overcurrent protection curve	A-6

Terms and Conditions Agreement

Warranty, Limitations of Liability

Warranties

● Exclusive Warranty

Omron's exclusive warranty is that the Products will be free from defects in materials and workmanship for a period of twelve months from the date of sale by Omron (or such other period expressed in writing by Omron). Omron disclaims all other warranties, express or implied.

● Limitations

OMRON MAKES NO WARRANTY OR REPRESENTATION, EXPRESS OR IMPLIED, ABOUT NON-INFRINGEMENT, MERCHANTABILITY OR FITNESS FOR A PARTICULAR PURPOSE OF THE PRODUCTS. BUYER ACKNOWLEDGES THAT IT ALONE HAS DETERMINED THAT THE PRODUCTS WILL SUITABLY MEET THE REQUIREMENTS OF THEIR INTENDED USE.

Omron further disclaims all warranties and responsibility of any type for claims or expenses based on infringement by the Products or otherwise of any intellectual property right.

● Buyer Remedy

Omron's sole obligation hereunder shall be, at Omron's election, to (i) replace (in the form originally shipped with Buyer responsible for labor charges for removal or replacement thereof) the non-complying Product, (ii) repair the non-complying Product, or (iii) repay or credit Buyer an amount equal to the purchase price of the non-complying Product; provided that in no event shall Omron be responsible for warranty, repair, indemnity or any other claims or expenses regarding the Products unless Omron's analysis confirms that the Products were properly handled, stored, installed and maintained and not subject to contamination, abuse, misuse or inappropriate modification. Return of any Products by Buyer must be approved in writing by Omron before shipment. Omron Companies shall not be liable for the suitability or unsuitability or the results from the use of Products in combination with any electrical or electronic components, circuits, system assemblies or any other materials or substances or environments. Any advice, recommendations or information given orally or in writing, are not to be construed as an amendment or addition to the above warranty.

See <http://www.omron.com/global/> or contact your Omron representative for published information.

Limitation on Liability; Etc

OMRON COMPANIES SHALL NOT BE LIABLE FOR SPECIAL, INDIRECT, INCIDENTAL, OR CONSEQUENTIAL DAMAGES, LOSS OF PROFITS OR PRODUCTION OR COMMERCIAL LOSS IN ANY WAY CONNECTED WITH THE PRODUCTS, WHETHER SUCH CLAIM IS BASED IN CONTRACT, WARRANTY, NEGLIGENCE OR STRICT LIABILITY.

Further, in no event shall liability of Omron Companies exceed the individual price of the Product on which liability is asserted.

Application Considerations

Suitability of Use

Omron Companies shall not be responsible for conformity with any standards, codes or regulations which apply to the combination of the Product in the Buyer's application or use of the Product. At Buyer's request, Omron will provide applicable third party certification documents identifying ratings and limitations of use which apply to the Product. This information by itself is not sufficient for a complete determination of the suitability of the Product in combination with the end product, machine, system, or other application or use. Buyer shall be solely responsible for determining appropriateness of the particular Product with respect to Buyer's application, product or system. Buyer shall take application responsibility in all cases.

NEVER USE THE PRODUCT FOR AN APPLICATION INVOLVING SERIOUS RISK TO LIFE OR PROPERTY OR IN LARGE QUANTITIES WITHOUT ENSURING THAT THE SYSTEM AS A WHOLE HAS BEEN DESIGNED TO ADDRESS THE RISKS, AND THAT THE OMRON PRODUCT(S) IS PROPERLY RATED AND INSTALLED FOR THE INTENDED USE WITHIN THE OVERALL EQUIPMENT OR SYSTEM.

Programmable Products

Omron Companies shall not be responsible for the user's programming of a programmable Product, or any consequence thereof.

Disclaimers

Performance Data

Data presented in Omron Company websites, catalogs and other materials is provided as a guide for the user in determining suitability and does not constitute a warranty. It may represent the result of Omron's test conditions, and the user must correlate it to actual application requirements. Actual performance is subject to the Omron's Warranty and Limitations of Liability.

Change in Specifications

Product specifications and accessories may be changed at any time based on improvements and other reasons. It is our practice to change part numbers when published ratings or features are changed, or when significant construction changes are made. However, some specifications of the Product may be changed without any notice. When in doubt, special part numbers may be assigned to fix or establish key specifications for your application. Please consult with your Omron's representative at any time to confirm actual specifications of purchased Product.

Errors and Omissions



Information presented by Omron Companies has been checked and is believed to be accurate; however, no responsibility is assumed for clerical, typographical or proofreading errors or omissions.

Safety precautions

Important information for safe operation is described.







Be sure to read it before installation and start of use.

The safety symbols and their meaning used in this manual are as follows:

 WARNING	If you fail to use the product properly, it may result in injuries, mild or moderate, and may lead to death. Additionally, there may be severe property damage.
 Caution	If you fail to use the product properly, it may result in injuries, mild or moderate, or damage on property.

*Property damage means damage to houses/household effects, livestock, and pets.

•Meaning of graphical symbols

	<ul style="list-style-type: none"> •General inhibition Notice prohibiting an unspecified general action.
	<ul style="list-style-type: none"> •General instruction Notice instructing an unspecified general action.
	<ul style="list-style-type: none"> •Do-not-disassemble prohibition Notice prohibiting disassembly. Disassembling the unit may lead to electric shock or other accidents.
	<ul style="list-style-type: none"> •Prohibition of use in locations subject to water such as a bathroom and shower room. Notice prohibiting exposure to water. Using a unit without waterproofing in locations subject to water may result in accidents due to electric shock.
	<ul style="list-style-type: none"> •Do-not-touch prohibition Notice prohibiting touching. Under specific conditions, touching the unit at specific locations could result in accidents.
	<ul style="list-style-type: none"> •Explosion alert Notice alerting the user to the possibility of explosion under certain conditions.

Note that events categorized as a caution required matter also may cause more serious results under certain conditions.

The information described here is very important and must be strictly observed.

Warning

WARNING

For use of this product

- Provide safety measures outside the UPS to ensure safety in the entire system even if the UPS is damaged or an abnormality occurs due to an external factor. Not doing so may result in serious accidents due to incorrect operation.



Wiring

Do not short between the connector terminals.

- Doing so may result in electric shock.
- The battery unit's protection board may be damaged due to a short-circuit.
- Connect each connection cable to the correct connected device.
- Connect the terminal of each connection cable to the connector port with correct polarity.
- Be sure to follow the connection procedure described in *3-2-2 Connecting the UPS control unit and battery unit with a battery connection cable* on page 3-6.



When the Battery Unit is Replaced

Dispose of or collect (recycle) the battery unit according to your own rules set for that purpose or as instructed by laws and regulations.

- Do not dispose of it in fire. Otherwise, it could explode.



Caution

Caution

For installation and connection

Pay attention to the weight and balance when carrying the unit, and install it in a solid and stable location.













- Do not drop the battery unit and do not expose it to strong impact. Dropping the unit may result in injury or fire.
- If you drop the unit, have it inspected and repaired. For repairs, contact our sales personnel.









Keep plastic package bags out of reach of children.



- Children may suffocate if they place their heads into plastic bags.



<p>Be sure to connect the input power supply of the unit to a DC power supply device having a rated voltage (24 VDC), or a battery power feed system.</p>	
<ul style="list-style-type: none"> The input voltage ranges for the UPS are as shown below. Check that the output voltage of the DC power supply device connected to the input terminal of the UPS is within any of the voltage ranges below. Voltage range: 23 to 28 V DC 	
<ul style="list-style-type: none"> Connecting to a DC or AC power supply device with a different voltage may result in malfunction in or damage to the UPS, or cause a fire. 	
<p>When an abnormality (unusual sound or smell) occurs, turn OFF the unit's "Power" switch to stop the output, and stop the supply of commercial power.</p>	
<p>To make an emergency stop, turn the rotary switch to "BATT REP" and turn off the input power after the LED changes from fast blinking to slow blinking.</p>	
<ul style="list-style-type: none"> When performing maintenance on the connected devices, follow the above instructions to ensure safety. 	
<p>When installing the input cable, make sure to perform the connection as specified.</p>	
<p>Make sure to stop the primary power supply before connecting the unit to the input power supply terminal.</p>	
<ul style="list-style-type: none"> When connecting a cable to the terminal block, use a cable that complies with the input current specification of the UPS. Failure to do so may result in electric shock or ground fault. 	
<p>Do not disassemble, repair, or modify the unit.</p>	
<ul style="list-style-type: none"> Doing so may cause an electric shock or a fire. 	
<p>Do not install the unit in other than specified orientations.</p>	
<ul style="list-style-type: none"> Dropping or toppling the unit may cause injury. If you install the unit in an orientation other than specified, the internal temperature may rise, eventually damaging the UPS or deteriorating the battery. 	
<p>Do not use the unit at a location where the operating environment temperature is more than 55°C.</p>	
<ul style="list-style-type: none"> The battery deteriorates rapidly. It may result in fire. If the battery's resin separator is damaged, the battery may be short-circuited inside, and may cause an abnormal heating, smoke, rupture or fire. 	
<ul style="list-style-type: none"> Doing so may cause a failure or malfunction of the unit. 	
<p>Do not exceed the ranges specified for environmental conditions during use/storage.</p>	
<p>Do not install or store the unit in the places listed below.</p>	
<ul style="list-style-type: none"> Do not store in places where the humidity is lower than 10% or higher than 90%. Do not use the unit in places where the ambient temperature is lower than 0°C or higher than 55°C. (With no condensation) 	
<ul style="list-style-type: none"> Do not use in places where the humidity is lower than 10% or higher than 90%. Do not install/store the unit in closed places such as cabinets with no clearance, places where there is flammable or corrosive gas, places with large amounts of dust, places exposed to direct sunlight, places exposed to shock or vibration, salty or wet places, or outdoors. 	
<ul style="list-style-type: none"> Installation or storing the unit in such a place may cause a fire. 	
<p>When you use plug strip and other plugs to connect additional devices, do not connect devices that exceed the current capacity of the available plugs.</p>	
<ul style="list-style-type: none"> The current protection of the unit may operate, which may stop the output. The cable heats up, which may cause a fire. 	
<p></p>	

<p>Do not use a cable with damaged insulation.</p> <p>Do not pinch or sharply bend the cable.</p> <p>Do not fold or knot the cable.</p> <ul style="list-style-type: none"> • Doing so may cause the cable to be damaged or heated, which may cause an electric shock or a fire. • If the cable is damaged, stop using the unit and have the cable repaired. • For repair, contact our sales personnel. 	
<p>Do not connect any devices other than rated voltage is 24 VDC.</p> <ul style="list-style-type: none"> • The rated output voltage of this unit is 24 VDC. • Overvoltage or overcurrent may damage the connected devices. • The output voltage range is 22 to 30 VDC. 	
<p>All of the included accessories are designed to be used with the unit. Do not use the accessories with other devices.</p> <ul style="list-style-type: none"> • Doing so may compromise the safety of devices. 	
<p>When this product is used in compliance with CE marking, please use under 2 m communication cable.</p>	
<p>Do not block the air vents (upper and lower).</p> <ul style="list-style-type: none"> • Doing so will cause the internal temperature to rise, which may cause the unit to fail and the battery to deteriorate. • During installation, leave a space of 50 mm or more above the top and below the bottom. 	
<p>Do not connect the RS232C/USB port or the CONTACT port to a LAN device using a LAN cable.</p> <ul style="list-style-type: none"> • Connection to a LAN device may result in malfunction in or damage to the UPS or the LAN device. 	
<p>Do not run this unit in parallel.</p> <ul style="list-style-type: none"> • Operating this unit in parallel may cause a failure or malfunction. 	

For use

<p>Do not allow the unit to come in contact with water.</p> <ul style="list-style-type: none"> • Doing so may cause an electric shock or a fire. • Doing so may cause an abnormal heating, smoke, rupture, or fire on the battery. • If the unit comes in contact with water, immediately stop using it and have it inspected and repaired. To make an emergency stop, turn the rotary switch to "BATT REP" and turn off the input power after the LED changes from fast blinking to slow blinking. • For repair, contact our sales personnel. 											
<p>When the battery unit is dead, replace it immediately or stop using the unit.</p> <ul style="list-style-type: none"> • Continuing the use of it may cause fire or electric shock due to liquid leaks. 											
<table border="1" style="display: inline-table; vertical-align: top;"> <thead> <tr> <th>Ambient temperature</th> <th>Expected life</th> </tr> </thead> <tbody> <tr> <td>25°C</td> <td>10 years</td> </tr> <tr> <td>35°C</td> <td>6.7 years</td> </tr> <tr> <td>45°C</td> <td>3.7 years</td> </tr> <tr> <td>55°C</td> <td>1.9 years</td> </tr> </tbody> </table> <p>*The values in the table are the expected life under standard use conditions and are not guaranteed.</p>	Ambient temperature	Expected life	25°C	10 years	35°C	6.7 years	45°C	3.7 years	55°C	1.9 years	
Ambient temperature	Expected life										
25°C	10 years										
35°C	6.7 years										
45°C	3.7 years										
55°C	1.9 years										

Occasionally, wipe off dust on the input terminal block and the output terminal block with a dry cloth.

- Accumulated dust may cause a fire.

Before wiping off dust, stop all connected devices and the unit, and stop the supply of commercial power.

The unit will stop after 30 seconds of setting the mode selection/backup operation time selection switch to "0.5".



Do not use the unit in a closed place and do not cover the unit.

- Doing so may cause abnormal heating or a fire.



If you notice something unusual such as abnormal sound or smell, discoloration, deformation, and heating, turn OFF the unit's power and stop the supply from the input power supply.

To make an emergency stop, turn the rotary switch to "BATT REP" and turn off the input power after the LED changes from fast blinking to slow blinking.

- Using the unit under such conditions may cause an abnormal heating, rupture or fire.
- If you notice such a condition, stop using the unit and contact our sales personnel for inspection and repairs.



If fluid leaks from the interior, do not touch the fluid.

- Doing so may cause blindness or burns.
- If the fluid contacts your eyes or skin, wash it out with lots of clean water and consult your doctor. The fluid may damage your eye if your eye is left untreated.



Do not place any objects on the unit, and do not drop heavy objects onto the unit.

- Doing so may cause distortion/damage to the case or a failure of the internal circuit, which may cause a fire.



The unit is equipped with an output circuit that can supply power to the connected devices even if the unit stops due to a failure or mis-operation of the internal circuit function.

If you want to stop the output, stop the source of the "input power supply".

- Output is continuing even when all indicators of the front panel are off.



When charging the battery, if the battery cannot be charged completely even after the pre-determined charging time, turn OFF the "Power" switch of the unit to stop charging the battery.

The unit will stop after 30 seconds of setting the mode selection/backup operation time selection switch to "0.5".

- Otherwise, it may cause an abnormal heating, smoke, rupture or fire on the battery.



For maintenance

When performing maintenance of the connected equipment, turn OFF the unit's power and stop the supply from the input power supply.

The unit will stop after 30 seconds of setting the mode selection/backup operation time selection switch to "0.5".

- Even if the input power supply is stopped in the operating state, the power supply output of the unit will not stop, and power will be supplied from the battery.



Do not disassemble, repair, or modify the unit.



- Doing so may cause an electric shock or a fire.









If fluid leaks from the interior, do not touch the fluid.

- Doing so may cause blindness or burns.
- If the fluid contacts your eyes or skin, wash it out with lots of clean water and consult your doctor.



Do not throw the unit into fire.	<ul style="list-style-type: none"> • Since the battery is incorporated in the unit, the insulator may melt, the gas exhaust valve or protection mechanism may be damaged, or the electrolyte may catch fire, and it may result eventually in an abnormal heating, smoke, rupture or fire. 	
Do not insert metal objects into the input terminal block and the output terminal block of the UPS.		
<ul style="list-style-type: none"> • Doing so may result in electric shock. 		
Do not insert metal objects into the battery connectors. Do not short between the connector terminals.	<ul style="list-style-type: none"> • Doing so may result in electric shock. • The battery unit's protection board may be damaged due to a short-circuit. 	

When the Battery Unit is Replaced

Do not use other than the designated battery unit.	<ul style="list-style-type: none"> • Not doing so may cause a fire. • Product model: S8BA-S480L, S8BA-S960L 	
Do not replace the battery unit in a place where there is flammable gas.		
<ul style="list-style-type: none"> • Spark may occur when connecting the battery unit, which may cause an explosion or fire. 		
If fluid leaks from the battery unit, do not touch the fluid.	<ul style="list-style-type: none"> • Doing so may cause blindness or burns. • If the fluid contacts your eyes or skin, wash it out with lots of clean water and consult your doctor. 	
Do not disassemble or modify the battery unit.		
<ul style="list-style-type: none"> • A safety mechanism and protection mechanism to prevent danger are embedded into the battery unit. If these are damaged, it may cause the battery to emit heat, smoke, explode, or catch fire. 		
Do not drop the battery unit and do not expose it to strong impact.	<ul style="list-style-type: none"> • Dropping the unit may result in injury or fire. • Doing so may cause a leakage, abnormal heating, smoke, rupture or fire on the battery unit. And, if the battery unit's protection mechanism is broken, the battery may be charged at an abnormal current or voltage, an abnormal chemical reaction may occur inside the battery, and it may result eventually in an abnormal heating, smoke, rupture or fire. 	
Do not short the battery unit with metal objects.	<ul style="list-style-type: none"> • Doing so could cause an electric shock, fire or burn. • Some electrical energy still remains inside the spent battery unit. 	
Do not dispose of battery units in a fire.		
<ul style="list-style-type: none"> • The insulator inside the battery unit may melt, the gas exhaust valve or protection mechanism may be damaged, or the electrolyte may catch fire, and it may result eventually in abnormal heating, smoke, rupture or fire. 		

Important Safety Points

■ Before using

- The battery has not been charged at the time of purchase. Be sure to charge it before use.
- Connect this unit to the input power supply to charge the battery unit.

When moving the unit from a cold place to a warm place, leave it for several hours before using it.

- If the unit is promptly turned ON after being moved to a warmer place, condensation may form inside the unit and cause it to fail.

Take measures for handling unforeseen accidents, such as data backup and system redundancy.

- The output may stop when there is failure in this unit.

■ Connecting

Do not short the unit output lines together, and do not short the battery connection cable (to ground).

- The unit may fail.

In the event you transfer or sell this unit to a third party, please include all of the documentation that came with the unit. This is to ensure that the unit is used in line with the conditions described in the included documentation.

- This manual contains important safety-related information. Please read and understand the contents of the manual before beginning operation. If this manual is misplaced, download the manual from our website.

■ Using

Before stopping the commercial power to the unit, turn OFF the "Power" switch of the unit.

The unit will stop after 30 seconds of setting the mode selection/backup operation time selection switch to "0.5".

- The unit enters Battery Mode when input power supply is stopped.
- If the frequency of backup operation becomes high, the battery life may be significantly reduced.

Do not use for an application that frequently requires Battery Mode.

- The battery unit will deteriorate and fail to maintain the specified backup time.

If you want the UPS to stand by in a UPS startup state, set 3 months or less for the input power supply stop period.

- The UPS startup state means the state of waiting for startup triggered by a remote ON/OFF or BS signal.
- If the UPS is left unused in the above state for 3 months or longer, the battery goes into overdischarge state, and the backup time may become shorter or the battery may become unusable.

■ Storing

Storing the battery in UPS for a long term, store at an environment less than 25°C and recharge 15 to 30 minutes the battery within 1 year.

- The battery self-discharges even when it not being used, and it goes into overdischarge state if it is left for a long period of time. The backup time may become shorter or the battery may become unusable.
- We recommend keeping the temperature 25°C or less when storing the unit for long periods of time.
- Turn OFF the unit's power when storing it.

Do not install or store the unit in a place exposed to direct sunlight.

- The rise of temperature may cause the battery unit to deteriorate rapidly and become unusable.
-

Regulations and standards

Use overseas

To export (or provide to non-residents of Japan) a model of this product that is categorized as a merchandise (or technology) requiring the export permission and approval stipulated by the Foreign Exchange and Foreign Trade Law, the export permission and approval (or service transaction permission) in accordance with the said law are required.

Conformance to each Directive

● Applicable directives

- EMC Directives

● Principles regarding conformance

OMRON electronic devices that comply with EC Directives also conform to the related EMC standards so that they can be more easily built into other devices or the overall machine. The actual products have been checked for conformity to EMC standards*.

Whether the products conform to the standards in the system used by the customer, however, must be checked by the customer. EMC-related performance of the OMRON devices that comply with EC Directives will vary depending on the configuration, wiring, and other conditions of the equipment or control panel on which the OMRON devices are installed. The customer must, therefore, perform the final check to confirm that devices and the overall machine conform to EMC standards.

- *1. Applicable EMC (Electromagnetic Compatibility) standards are as follows: EMS (Electromagnetic Susceptibility): EN 61000-6-2, EMI (Electromagnetic Interference): EN 61000-6-4, and EN 61000-6-4 Radiated emission: 10-m regulations

● Conformance to EC Directives

This product complies with EC Directives. To ensure that the machine or device in which this product is used complies with EC Directives, the product must be installed as follows:

- This product must be installed within a control panel.
- You must use reinforced insulation or double insulation for the direct power supply equipment connected to this product.
- Models of this product that comply with EC Directives also conform to the Common Emission Standard. Radiated emission characteristics (10-m regulations), in particular, may vary depending on the configuration of the control panel used, other devices connected to the control panel, wiring, and other conditions. Therefore, even when using a model of this product that complies with EC Directives, you must confirm and ensure the compliance to EC Directives of the entire machine or equipment.
- This is a Class A product (for industrial environments). In a residential environment, it may cause radio interference. If radio interference occurs, the user may be required to take appropriate measures.

● Conformance to UL

- This product must be installed within a control panel with an internal heater or other unit to protect against the formation of condensation (Standard mounting only).
- Gaps in the door to the control panel must be completely filled or covered with gaskets or other material.
- For use in Pollution Degree 2 Environment.

- Surrounding Air Temperature, 55°C.
- Make sure to connect the device with Class 2 output to the USB port.

● **Conformance to FCC**

- FCC CAUTION

Changes or modifications not expressly approved by the party responsible for compliance could void the user's authority to operate the equipment.



Precautions for Safe Use

This equipment has been tested and found to comply with the limits for a Class A digital device, pursuant to part 15 of the FCC Rules. These limits are designed to provide reasonable protection against harmful interference when the equipment is operated in a commercial environment. This equipment generates, uses, and can radiate radio frequency energy and, if not installed and used in accordance with the instruction manual, may cause harmful interference to radio communications. Operation of this equipment in a residential area is likely to cause harmful interference in which case the user will be required to correct the interference at his own expense.

Revision History

A manual revision code appears as a suffix to the catalog number on the front and back covers of the manual.

Man.No.	U726-E1-01
----------------	-------------------

↑ Revision code

Revision code	Date	Revised content
01	March 2018	Original production



1

Overview of the product

This section describes the characteristics and specifications of the product.

1-1	Features of this product	1-2
1-2	Specifications	1-3
1-3	Procedure from installation to operation	1-5

1-1 Features of this product

- The Uninterruptible Power Supply (UPS) protects such devices as PLC and IPC* from power failures, voltage variations, and instantaneous voltage drops.
- Under normal conditions, the UPS outputs 24 VDC of electrical power from the DC power supply as-is. When an abnormality is detected in the 24 VDC power supply such as a power failure and voltage variation, the UPS switches to battery supply to continue to provide 24 VDC of electrical power.
- For the specifications of PLC and IPC for power supply input and operation in the event of momentary power interruptions, check the respective manuals.

*IPC: Industrial PC (Industrial use computer)

List of models

The product has the following models:

Unit model	Specifications
S8BA-24D24D480SBF	Control unit (480 W)
S8BA-24D24D960SBF	Control unit (960 W)
S8BA-S480L	Battery unit (for 480 W)
S8BA-S960L	Battery unit (for 480 W / 960 W)

Note The control unit (960 W) and battery unit (480 W) cannot be connected.

1-2 Specifications

Description		Capacity	480 W	960 W	
DC input	Rated input voltage		24 VDC		
	Input voltage range		23 to 28 VDC		
	Input maximum current	for rated input voltage for rated loads connected	21.5 A	43.5 A	
	Input terminal		Push-in terminal block		
	Input protection		Fuse (cannot be replaced by the customer)		
	Input protection capacity		30 A	60 A	
DC output	Rated current	for rated output voltage	20 A	40 A	
	Switching time		Uninterrupted		
	Output voltage	Normal operation	Input voltage through output 22 to 30 VDC		
		Backup operation	21 to 28 V (the voltage cannot be adjusted)		
	Output terminal		Push-in positive terminal block		
	Overload protection	Warning display • UPS output will continue through bypass [during normal operation] • UPS output will continue through battery [during backup operation]		101% or more	
		Output stopped by overload protection • Stop output [during normal operation] • The internal power supply to the UPS will stop after 10 sec. [during backup operation]		111% or more	
		Warning display cancellation (During normal operation, during backup operation)		93% or more	
	Battery unit	Type		Lithium-ion battery	
		Rated voltage		25.2 VDC	
Rated capacity		3900 mAh	7800 mAh		
Battery life expectancy		10 years (25°C), 6.7 years (35°C), 3.7 years (45°C), 1.9 years (55°C)			
Replacement by user		Yes (Hot swapping)			
Battery Life Counter Function		Yes			
Charging time		8 hours (90%)* ¹			
Backup time (25°C, initial characteristics)		6 min. (constant power rated load) The backup time can be set from the mode selection / backup operation time selection switch, or the shutdown software.			

1 Overview of the product

Description		Capacity	480 W	960 W
Structure	Dimensions (W×H×D mm)		44 × 124 × 111.4 (UPS control unit 20 A) 80 × 124 × 111.4 (battery unit 20 A)	52 × 124 × 111.4 (UPS control unit 40 A) 150 × 124 × 111.4 (battery unit 40 A)
	Weight	Weight of control unit	Approx. 0.6 kg	Approx. 0.7 kg
		Weight of battery unit	Approx. 1.5 kg	Approx. 2.5 kg
	Cooling method		Natural cooling	
Environment	Operating environment temperature / humidity		0°C to 55°C / 10% to 90%RH with no condensation	
	Storage environment temperature / humidity		-20°C to 55°C / 10% to 90%RH with no condensation	
	Vibration resistance		JIS C 60068-2-6 compliant 5 to 8.4Hz amplitude: 3.5mm, 8.4 to 150Hz acceleration rate: 9.8m/s ² X, Y, and Z directions: 100min. (Sweep time: 10min.×Sweep count 10 times=Total: 100min.)	
	Shock resistance		JIS C 60068-2-27 compliant: 147m/s ² X, Y, and Z directions three times	
Dielectric breakdown voltage	Withstand voltage		DC external terminals to casing: 510 V AC, 1 minute, leakage current 5 mA max.	
	Insulation resistance		DC external terminals to casing: 20 MΩ or more. (500 V DC)	
Standard compliance	Safety standard		UL508 / CE / C22.2 No.107.1-01	
	EMI	Radiation disturbance field strength	EN61000-6-4 / FCC / ICES / RCM	
Internal power consumption (normal ^{*2} / maximum)			7 W / 29 W	15 W / 58 W
Serial communication	RS232C (Interface terminal)		Yes (RJ45)	
	USB (Interface terminal)			
I/O signal (Interface terminal)			Yes (RJ45)	

*1. When using in an environment at a high temperature, charging may be paused by charging temperature protection, then the charging time will be longer than specified time.

*2. Conditions: With rated loads connected, at a rated input voltage, and at a full battery charge.

1-3 Procedure from installation to operation

The procedure from installation to operation is shown below.

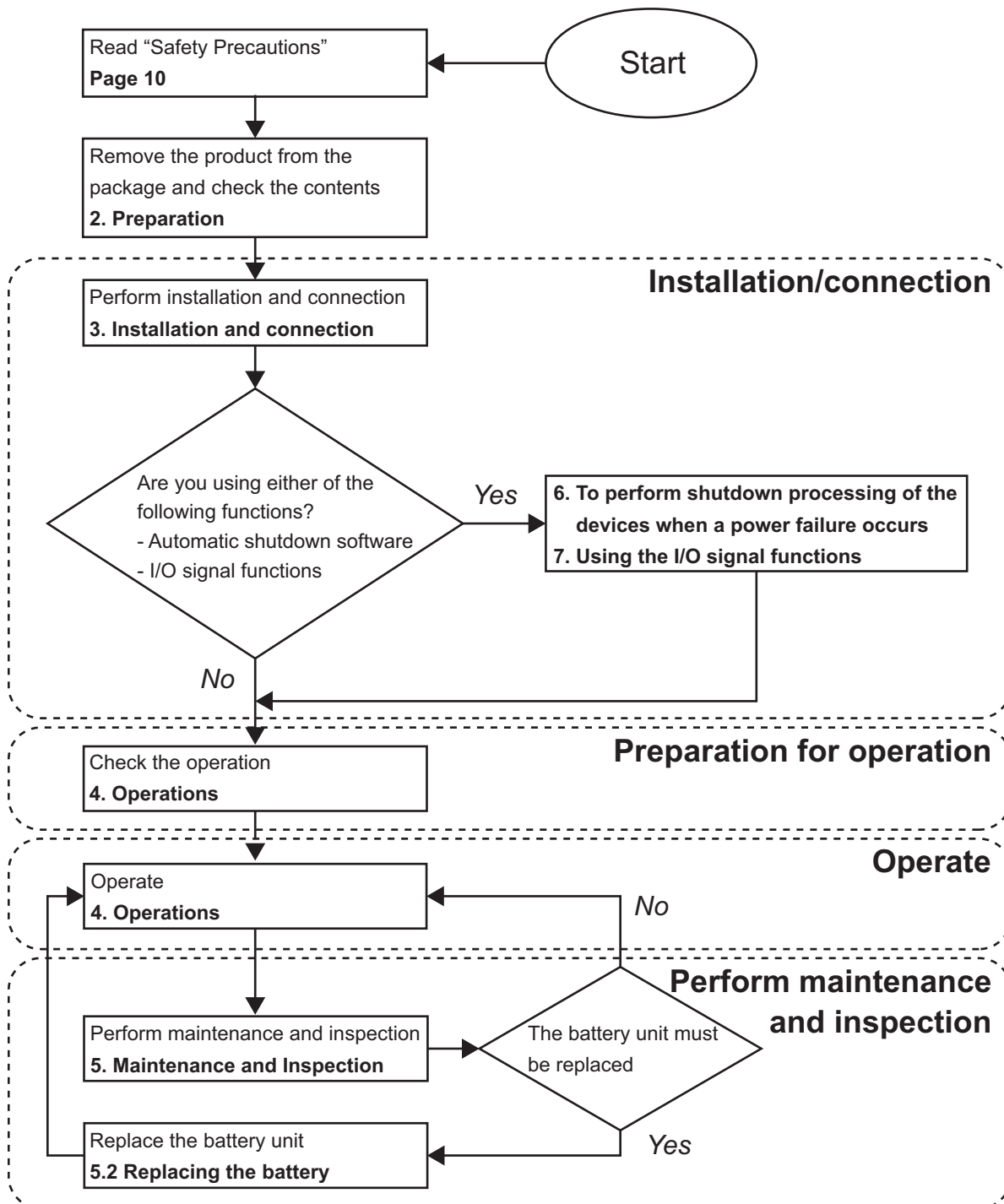

2

Preparation

This section describes the preparations for using the product.

2-1	Unpacking the product	2-2
2-2	Checking the contents	2-3
2-3	Name of each part	2-4
2-4	Diagram of the Input/output circuit block	2-6

2-1 Unpacking the product

Open the package box and take out the control unit, battery unit, and accessories.



Caution

Carry the unit considering its weight and balance, and place it on a stable and robust base.

- If you drop the unit, the protection mechanism inside the battery unit may be broken, and it may result eventually in a fluid leak, abnormal heating, smoke, rupture, or fire.
 - If you drop the unit, have it inspected and repaired.
 - For repair, contact our sales personnel.
-



2-2 Checking the contents

Check whether all the package contents are included and there is no damage found on their appearance.

If you should notice defects or anything wrong, contact our sales personnel.

2

Accessories related to the control unit

Description	Quantity
Instruction manual	1
Compliance information sheet	1
USB cable (2.2 m)	1



Instruction manual
Compliance information sheet

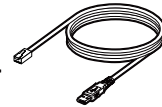

USB cable (2.2 m)

Accessories related to the battery unit

Description	Quantity
Instruction manual	1
Compliance information sheet	1
Battery communication cable	1



Instruction manual

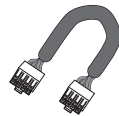

Battery communication cable

Related products

Description	Model	Length
Communication cable (male for RS232C port)	S8BW-C01	2 m
Communication cable (for CONTACT port)	S8BW-C02	2 m

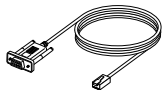

Connection cable
(RS232C)



Connection cable
(CONTACT)

2-3 Name of each part

This section describes the name of each part of the UPS.

For information on the function of each part, refer to *Section 3 Installation and connection* and *Section 4 Operations* that provide the details.

Front view

● S8BA-24D24D480SBF

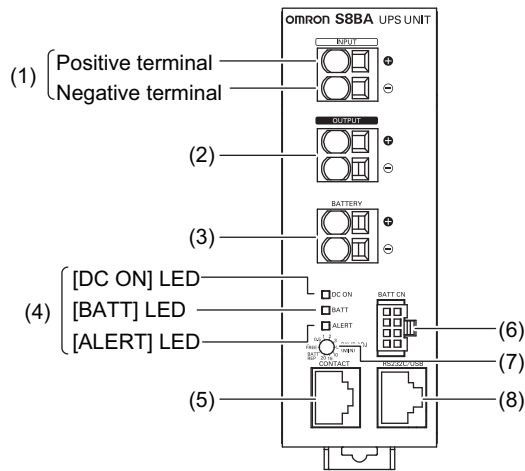

- (1) DC input terminal block
- (2) DC output terminal block
- (3) Battery connection terminal block
- (4) LED indicators

● S8BA-S480L

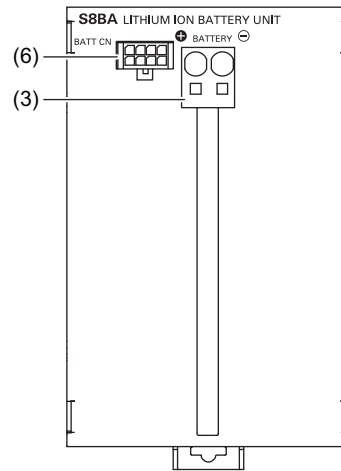

- (5) CONTACT port
- (6) Battery communication port
- (7) Mode selection / Backup time setting switch
- (8) RS232C/USB port

● S8BA-24D24D960SBF

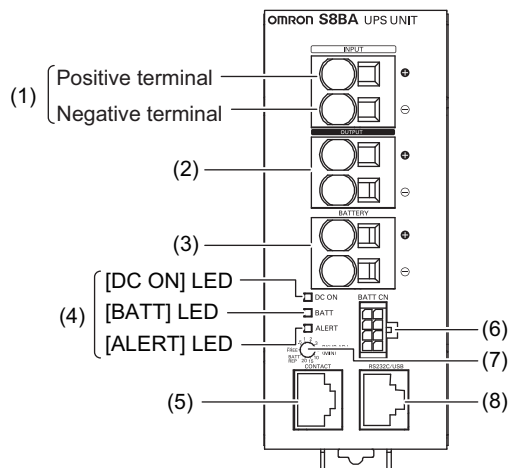

- (1) DC input terminal block
- (2) DC output terminal block
- (3) Battery connection terminal block
- (4) LED indicators

● S8BA-S960L

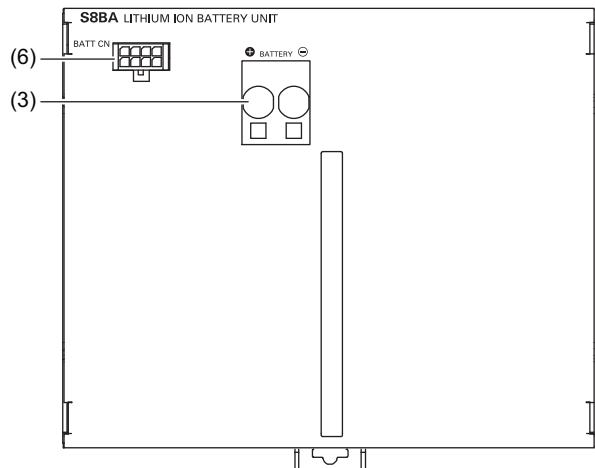

- (5) CONTACT port
- (6) Battery communication port
- (7) Mode selection / Backup time setting switch
- (8) RS232C/USB port

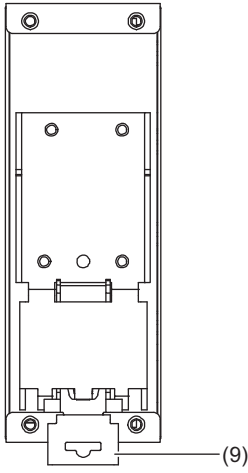
Rear view● **S8BA-24D24D480SBF**

(9) DIN rail stopper

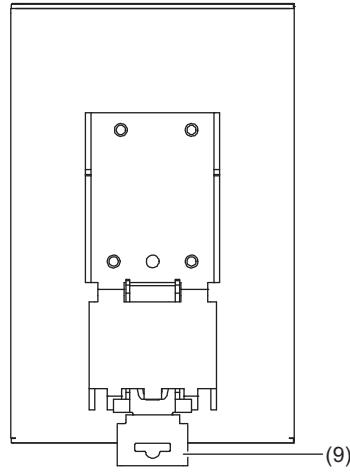
● **S8BA-S480L**

(9)

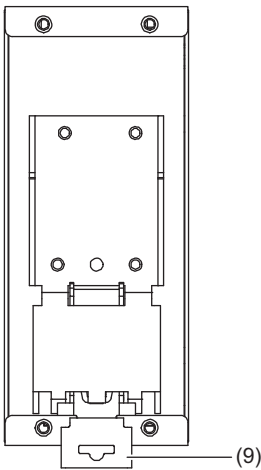
● **S8BA-24D24D960SBF**

(9) DIN rail stopper

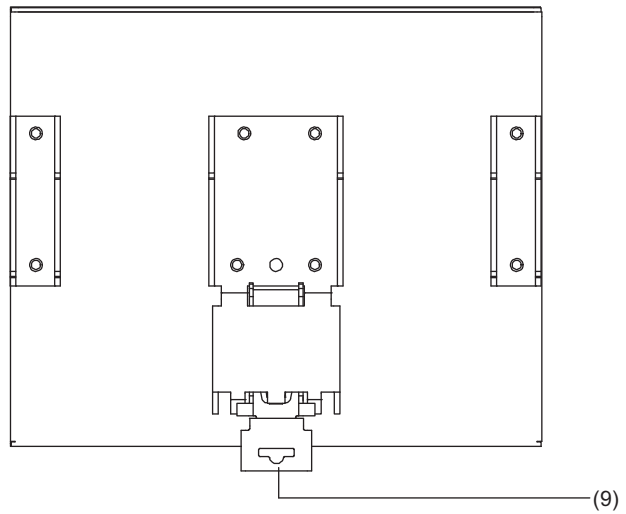
● **S8BA-S960L**

(9)

2-4 Diagram of the Input/output circuit block

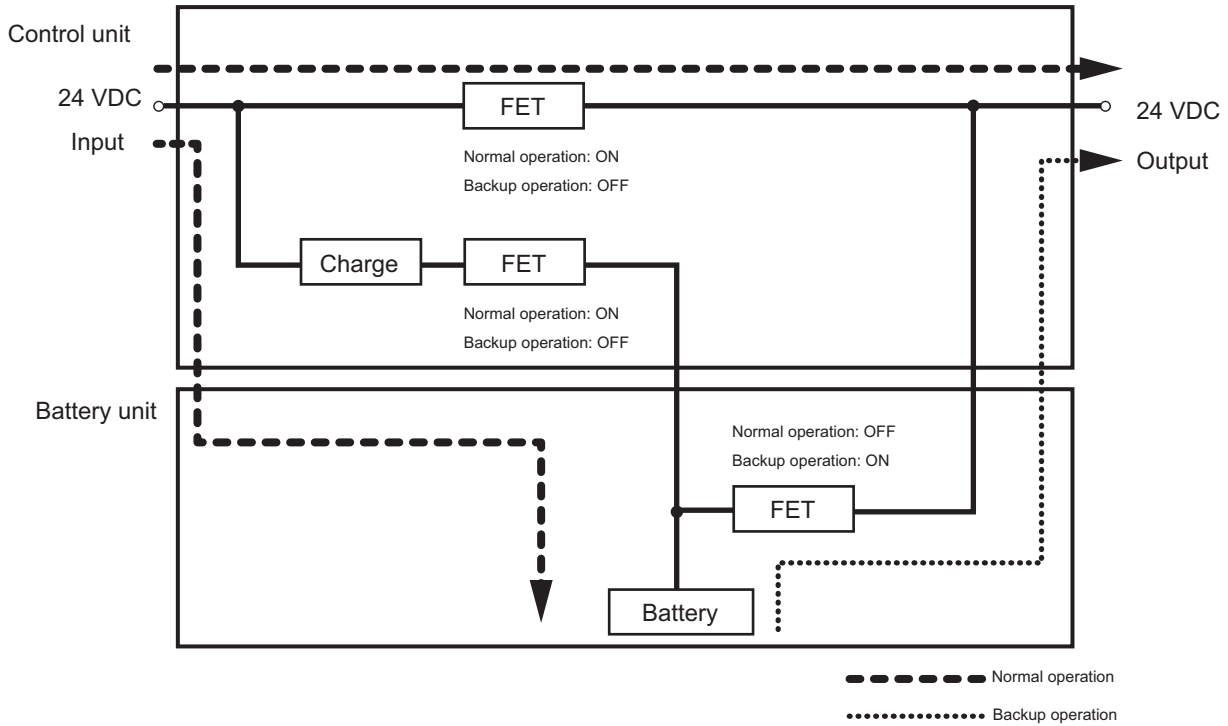

Note 1. In normal operation, 24 VDC is output as-is for charging the battery and from the input power supply. If the 24 VDC from the input power supply becomes lower, the operation automatically switches to backup operation, and 24 VDC is output from the battery.

3

Installation and connection

This section describes how to install and connect the product.

3-1 Installation	3-2
3-1-1 DIN rail installation	3-4
3-2 Connection	3-5
3-2-1 UPS connection order	3-5
3-2-2 Connecting the UPS control unit and battery unit with a battery connection cable .	3-6
3-2-3 Connecting a device to the output terminal block	3-8
3-2-4 Connecting the input power supply to the input terminal block	3-8
3-2-5 Connecting a cable to the battery terminal block, input terminal block and output terminal block	3-9

3-1 Installation

This section describes how to install the UPS.

For details on the precautions during installation, refer to *For installation and connection* on page 11.

The UPS permits the following installing methods. Choose the one best suited for the environment.



Precautions for Safe Use

Before installing this device, make a record of the serial number of this device.

The product serial number is required when contacting us about the device.

The product serial number is written on the sticker attached to the side of the UPS.

Correct positions

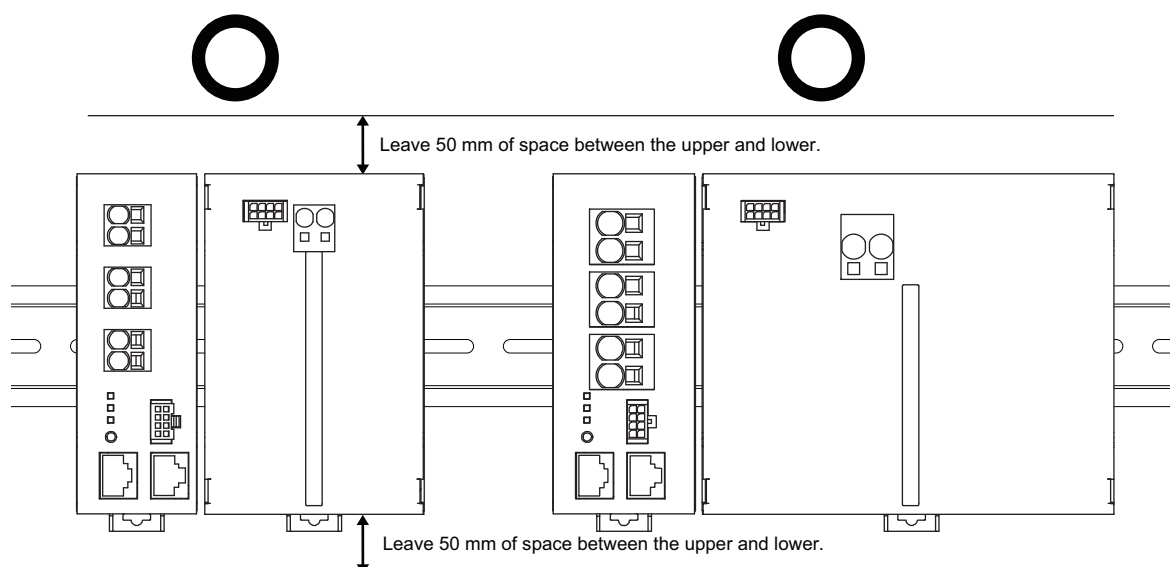

- Note 1. This UPS can be mounted with the sides in close contact.
Up to 3 units can be mounted in close contact.
Follow the derating curve during mounting with the sides in close contact. For details, refer to *A-2 Characteristic data* on page A-5.
2. When you install devices other than the UPS on the left or the right of the UPS, leave a space of at least 15 mm.

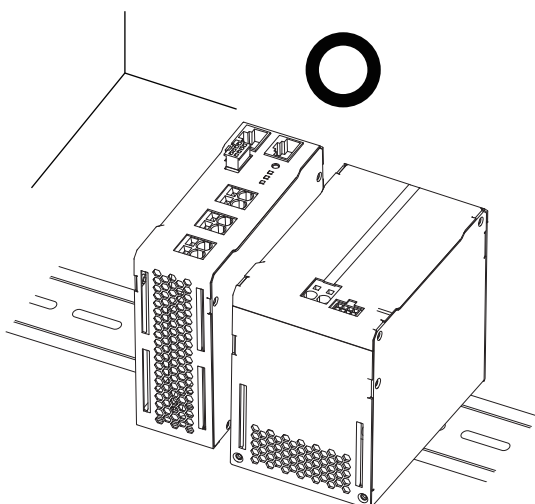

Incorrect positions

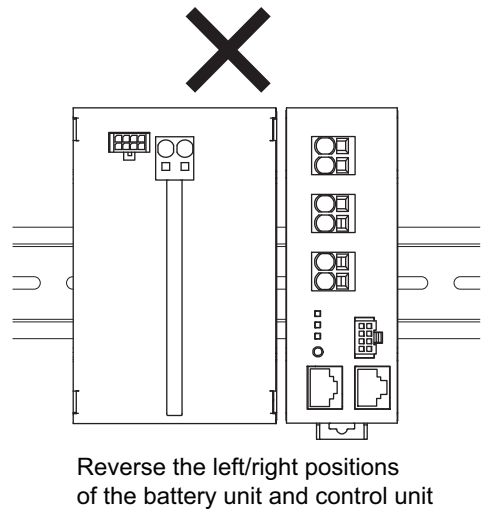
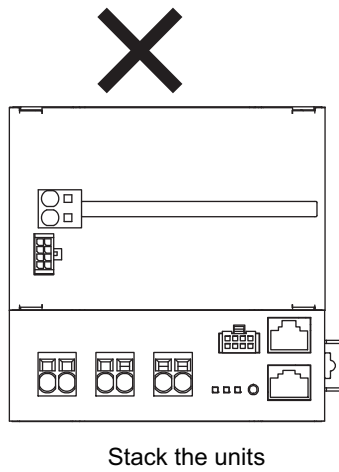
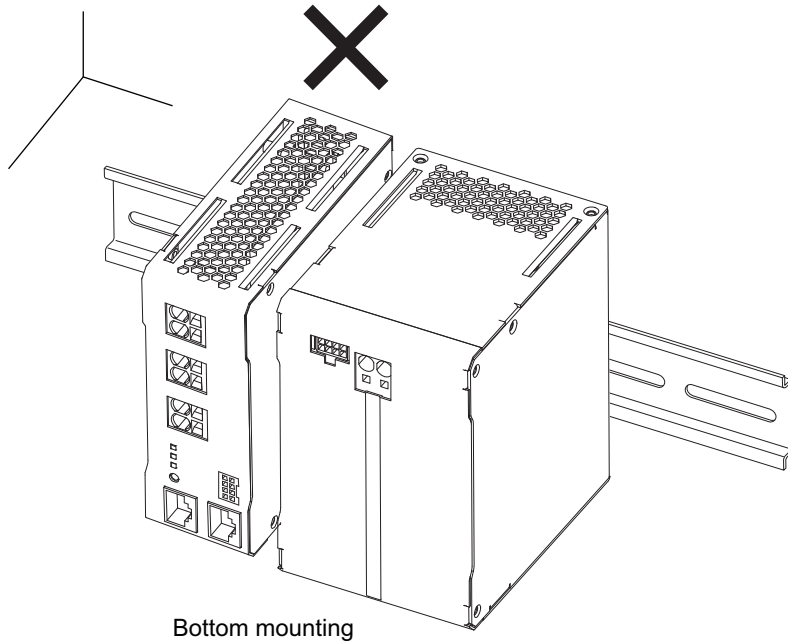
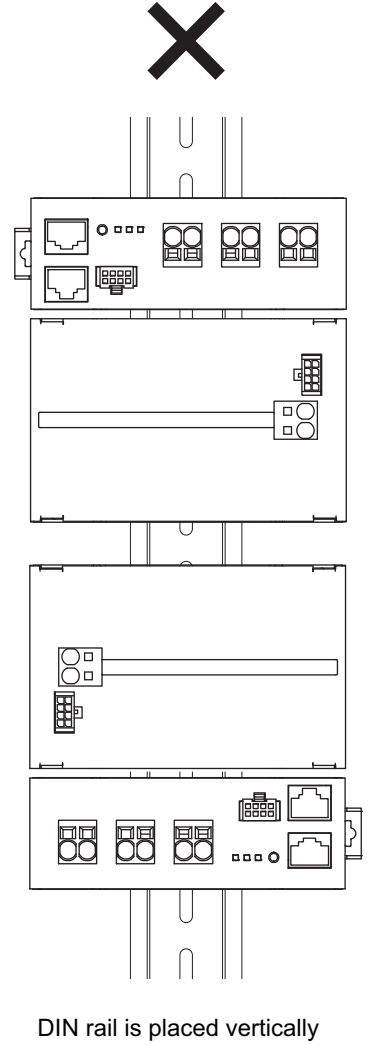
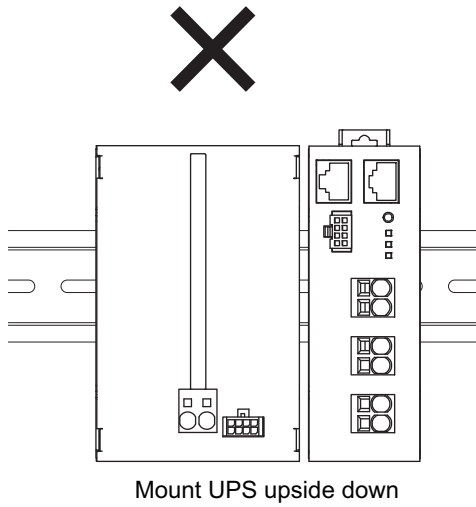

3-1-1 DIN rail installation

- 1 Lower the rail stopper until you hear a click, and hook part A on one end of the rail.

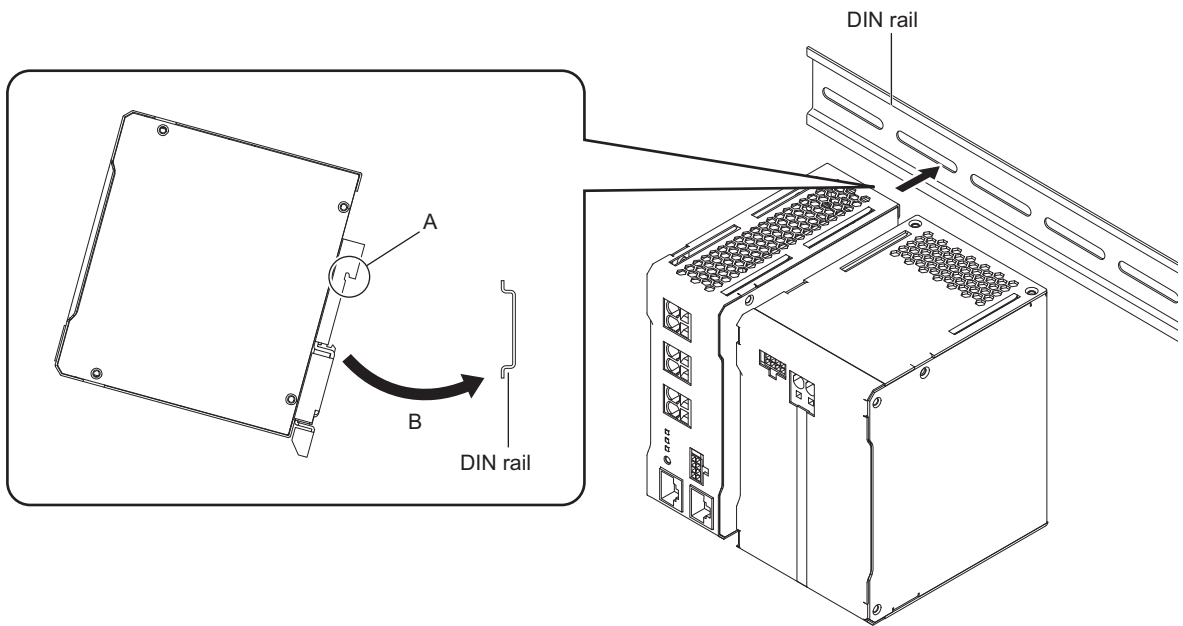

- 2 Push the rail stopper in the B direction, and then raise and lock it.



Additional Information

When removing, insert the flat blade screwdriver in the C part and pull it out.

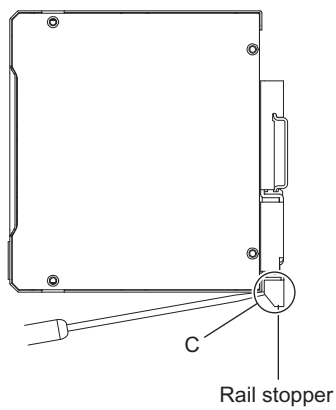

3-2 Connection

This section describes how to connect the UPS.

For details on the precautions during connection, refer to *For installation and connection* on page 11.

3-2-1 UPS connection order

Connections to the UPS must be made in the following order:

- 1** Connect the control unit and the battery unit with a battery connection cable.
Connecting the UPS control unit and battery unit with a battery connection cable on page 6
- 2** Connect the cables to be connected to the input terminal block and output terminal block at the control unit side.
Connecting a cable to the battery terminal block, input terminal block and output terminal block on page 9
- 3** Connect the UPS to the devices on the output terminal block.
Connecting a device to the output terminal block on page 8
- 4** Connect the UPS to the input power supply on the input terminal block.
Connecting the input power supply to the input terminal block on page 8

Note Sparks or noise may occur when connecting the UPS. This is not abnormal.

3-2-2 Connecting the UPS control unit and battery unit with a battery connection cable

1 Install the UPS control unit and battery unit on a DIN rail.
For details, refer to *3-1-1 DIN rail installation* on page 3-4.

2 Insert the cables in the UPS control unit and battery unit in the following order:
For details about connecting the cables to the terminal block, refer to *3-2-5 Connecting a cable to the battery terminal block, input terminal block and output terminal block* on page 3-9.

(1) Battery connection cable UPS control unit Positive side

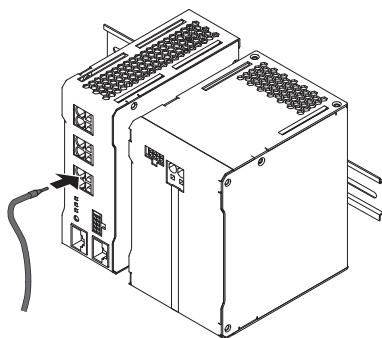

(2) Battery connection cable Battery unit side Positive side

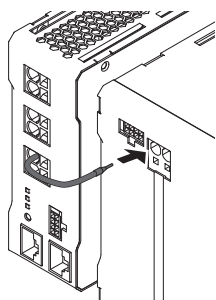

(3) Battery connection cable UPS control unit Negative side

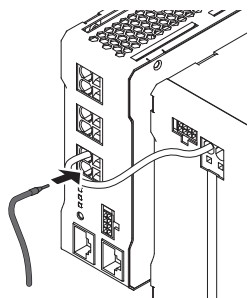

(4) Battery connection cable Battery unit side Negative side

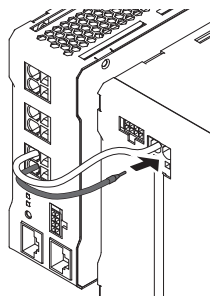

- (5) Battery communication cable UPS control unit side

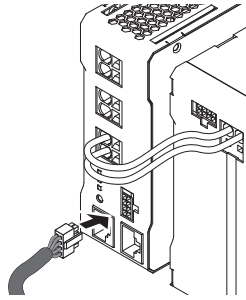

- (6) Battery communication cable Battery unit side

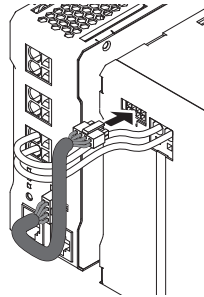

- 3** Connect devices you want to back up to the output terminal block of the control unit.
- 4** Connect the DC power supply device to the input terminal block of the control unit.

3-2-3 Connecting a device to the output terminal block

- 1** Connect devices you want to back up to output terminals of this unit.
For details about connecting the cables to the terminal block, refer to *3-2-5 Connecting a cable to the battery terminal block, input terminal block and output terminal block* on page 3-9.

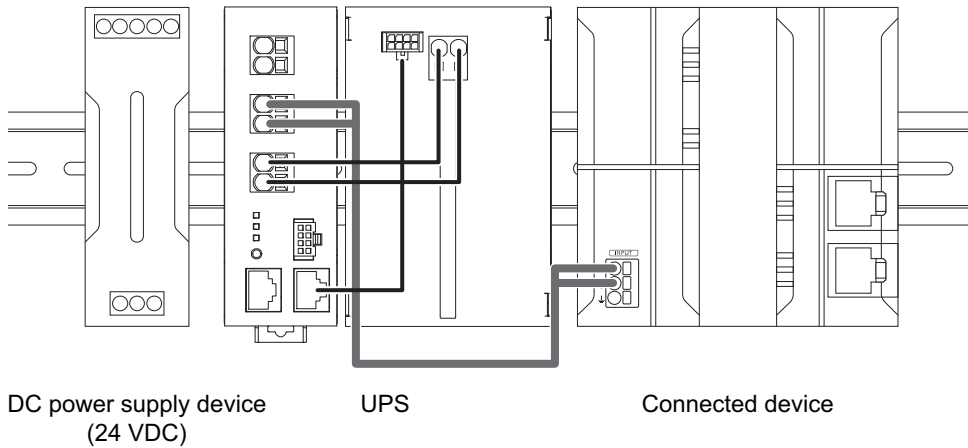

- 2** When using the UPS monitoring software or the I/O signal, connect the unit to the target device with a connection cable.
For details on the connection method, refer to *Section 6 To perform shutdown processing of the devices when a power failure occurs* and *Section 7 Using the I/O signal functions*.

3-2-4 Connecting the input power supply to the input terminal block

- 1** Connect an input cable to the input terminal block of the unit.
For details about connecting the cables to the terminal block, refer to *3-2-5 Connecting a cable to the battery terminal block, input terminal block and output terminal block* on page 3-9.
- 2** Connect the input cable to the DC power supply device.
When you turn ON the input power supply, the power output operation starts, and at the same time, battery charging operations starts, and the battery will be completely charged in about 8 hours.

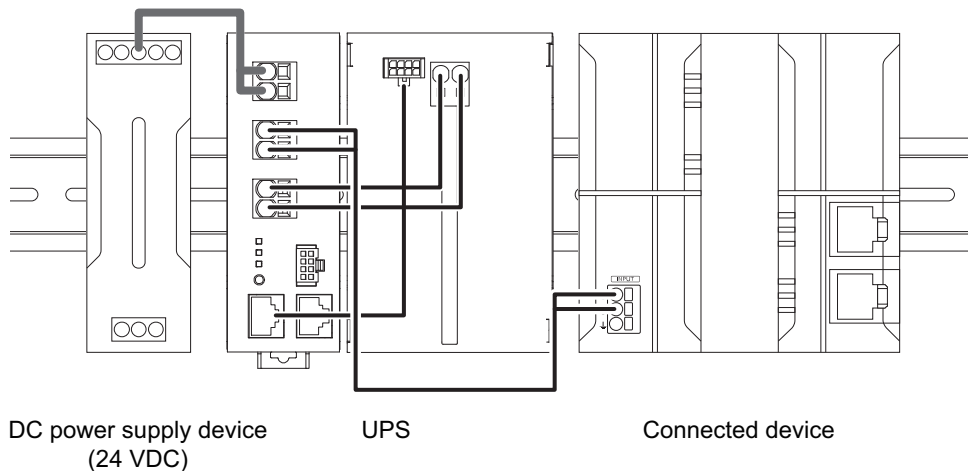

**Precautions for Safe Use**

Note that the battery has not been charged. Charge the battery when you use the UPS for the first time.

3-2-5 Connecting a cable to the battery terminal block, input terminal block and output terminal block

For details about the connectable sizes and recommended cable sizes, see the following table.

			20 A	40 A
Connectable sizes	Cable	Solid wire	0.2 to 10 mm ²	0.75 to 16.0 mm ²
		Stranded wire	0.2 to 6 mm ²	
		AWG	AWG 8 to 24	AWG 6 to 18
Stripped cable length			8 to 10 mm	18 mm
Recommended sizes		Solid wire / Stranded wire	2.0 mm ²	8.0 to 14.0 mm ²
		AWG	AWG 12	AWG 6 to 8
Temperature rating for recommended cable			90°C	

**WARNING**

Do not short between the connector terminals.

- Doing so may result in electric shock.
- The protection board inside the battery unit may be damaged due to a short-circuit.
- Connect each connection cable to the correct connected device.
- Connect the terminal of each connection cable to the connector port with correct polarity.
- Be sure to follow the above connection procedure.



● Recommended ferrule terminals and tools

- Recommended ferrule terminals

Applicable wire		Ferrule conductor length (mm)	Insulation stripping margin [mm] (when using ferrule terminals)	Recommended ferrule terminals		
(mm ²)	(AWG)			Manufactured by Phoenix Contact	Manufactured by Widemüller	Manufactured by WAGO
0.25	24	8	10	AI 0,25-8	H0.25/12	FE-0.25-8N-YE
		10	12	AI 0,25-10	-	-
0.34	22	8	10	AI 0,34-8	H0.34/12	FE-0.34-8N-TQ
		10	12	AI 0,34-10	-	-
0.50	2 to 0	8	10	AI 0,5-8	H0.5/14	FE-0.5-8N-WH
		10	12	AI 0,5-10	H0.5/16	FE-0.5-10N-WH
0.75	18	8	10	AI 0,75-8	H0.75/14	FE-0.75-8N-GY
		10	12	AI 0,75-10	H0.75/16	E-0.75-10N-GY
1/1.25	18/17	8	10	AI 1-8	H1.0/14	FE-1.0-8N-RD
		10	12	AI 1-10	H1.0/16	FE-1.0-10N-RD
1.25/1.5	17/16	8	10	AI 1,5-8	H1.5/14	FE-1.5-8N-BK
		10	12	AI 1,5-10	H1.5/16	FE-1.5-10N-BK
2.5	14	10	12	AI 2,5-10	H2.5/16DS	FE-2.5-10N-BU

Applicable wire		Ferrule conductor length (mm)	Insulation stripping margin [mm] (when using ferrule terminals)	Recommended ferrule terminals		
(mm ²)	(AWG)			Manufactured by Phoenix Contact	Manufactured by Widemüller	Manufactured by WAGO
4	12	12	14	AI4.0-12 GY	H4.0/20D	FE-4.0-12N-GY
6	10	12	14	AI6.0-12 YE	H6.0/20	FE-6.0-12N-YE
10	8	12	14	AI10-12 RD	H10.0/22EB	FE-10-12N-RD
		18	20	AI10-18 RD	H10.0/28	FE-10-18N-RD
16	6	18	20	AI16-18 BU	H16.0/28	FE-16-18N-BU

- Crimping tool

Specialist crimping tool	Compression range (mm)	Model	Manufacturer
	0.25 to 6mm	CRIMPFOX6	Manufactured by Phoenix Contact
	0.5 to 6mm	CRIMPFOX6T-F	
	0.4 to 10mm	CRIMPFOX10S	
	10 to 25mm	CRIMPFOX 25R	
	0.14 to 6mm	PZ6 Roto L	Manufactured by Widemüller
	6 to 16mm	PZ16	Manufactured by WAGO
	0.24 to 5mm	variocrimp 4	
6 to 16mm	variocrimp 16		

Note Make sure that the wire insulation outer diameter is less than the inner diameter of the insulated sleeve of the recommended ferrule terminal.

Connecting a cable to the terminal block

- 1 Insert the tip of a flat blade screwdriver with a thin blade into the square hole at the right of the terminal block.

Use a flat blade screwdriver of the following size.

20A: 2.5mm or less

40A: 3 mm or less

Then, the cable lock is released.

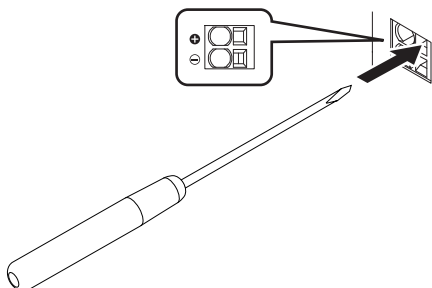

- 2** With the tip of the flat blade screwdriver in the hole, insert a cable into a round hole at the left of the terminal block.

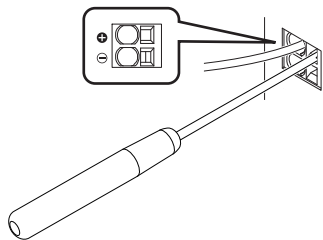

- 3** Pull out the flat blade screwdriver. Then, the cable is locked.

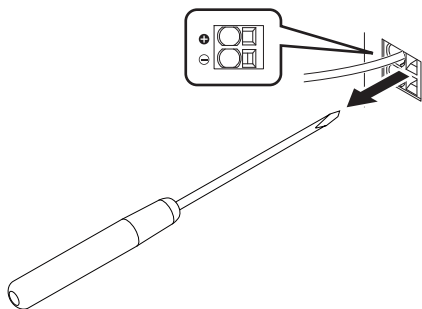

Removing a connected cable from the terminal block

- 1** Insert the tip of a flat blade screwdriver with a 3 mm or less thin blade into a square hole at the right of the terminal block and pull out the cable.

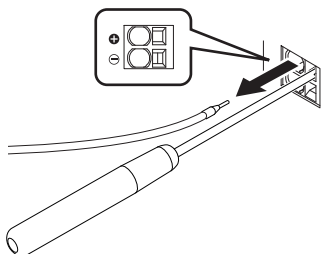

- 2** Pull out the flat blade screwdriver.

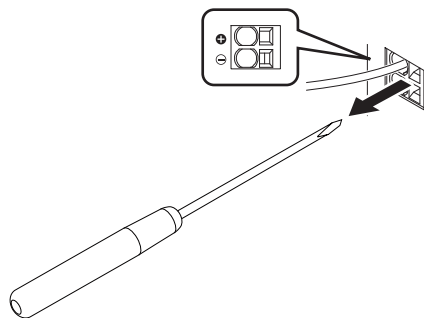

4

Operations

This section describes the operations of the product.

4-1	Checking the operation	4-2
4-1-1	LED display	4-2
4-1-2	Backup operation time setting / Battery replacement mode selection switch ..	4-5
4-2	Start and stop procedures and basic operation	4-6
4-2-1	Start and stop procedures	4-6

4-1 Checking the operation

4-1-1 LED display

Types of LEDs

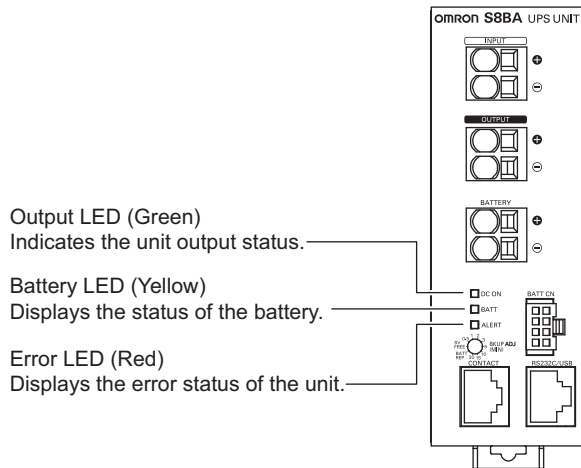

Operation of the LED

- **Blinking ()**

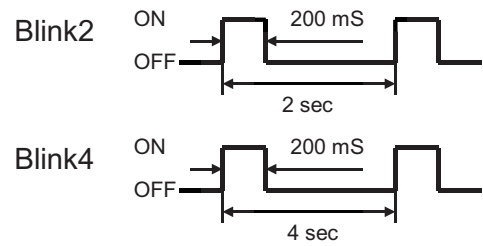
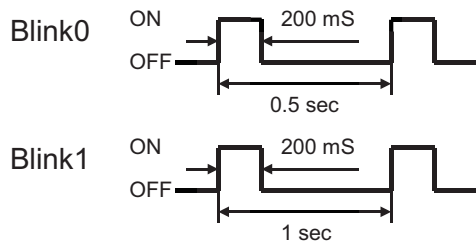

- **Steadily ON ()**

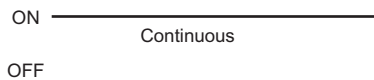











For details, refer to *Concept of LED display* on page 4-3.

Concept of LED display

■ : Steadily ON ▣ : Blink □ : OFF

No.	LED display			UPS output	Charge /Dis-charge	Input power supply	Description	Procedures
	[DC ON] LED (Green)	[BATT] LED (Yellow)	[ALERT] LED (Red)					
1	□	□	□	OFF	---	OFF	No DC input. Operation paused.	---
2	■	▣ Blink 4	□	ON	Charge	ON	DC input. Operating normally. Charging.	---
3	■	□	□	ON	---	ON	DC input. Operating normally.	---
4	■	■	□	ON	Dis-charge	OFF	Backup operation due to power failure or DC input error. Output will stop if backup operation is continued.	Process the termination of the connected devices you are using, and then stop the devices.
5	■	▣ Blink 1	□	ON	Dis-charge	OFF	(Same as above) Battery level is low, so output will stop soon.	
6	■	(*1) (*2) (*3)	▣ Blink 0	ON	Charge/ Dis-charge	ON/ OFF	Overpower detected (101% or above) because connections exceeded capacity limit (output continues).	Reduce connected devices until the display condition becomes as shown in No.3.
7	□	(*1) (*2) (*3)	▣ Blink 0	OFF	Charge/ Dis-charge	ON/ OFF	Output stopped due to the detection of a short-circuit on connected device side or due to connections significantly exceeding capacity limit.	Check that the DC input of connected devices is not short-circuited, or that the connection capacity does not exceed the rated capacity.
8	▣ Blink 4	(*1) (*2)	□	OFF	---	ON	Output cannot be started because the DC input voltage is outside the specified range. Note: If this display occurs when the unit has been stopped by input of the backup stop signal (BS) (Page 7-2) or by using the UPS monitoring software (Page 6-2), the remedy to the right is not required because the input voltage is within the specification range.	Use in the DC input voltage range described in the specification.
9	▣ Blink 4	▣ Blink 2	□	OFF	Charge	ON	Waiting to start up due to low battery.	Continue charging the battery. When the set battery level is reached, the UPS automatically restarts.
10	■	▣ Blink 0	▣ Blink 0	ON	---	ON	Charging was stopped because the ambient temperature was detected as 55°C or above or 0°C or below. (Displayed only during normal operation.)	Ensure that the ambient temperature is between 0°C and 55°C.

No.	LED display			UPS output	Charge /Dis-charge	Input power supply	Description	Procedures
	[DC ON] LED (Green)	[BATT] LED (Yellow)	[ALERT] LED (Red)					
11		 Blink 2	 Blink 2	ON	Charge	ON	Battery not connected or incorrectly connected, or battery life counter counted up to limit. (Displayed during normal operation only.)	Replace the battery unit. By purchasing a new battery unit, you (the customer) can replace the battery yourself (refer to 5-2 Replacing the battery unit on page 5-4).
12		 Blink 2		ON	---	ON	A battery abnormality was detected.	
13		(*1) (*2)	 Blink 2	ON	---	ON	UPS life counter counted up to limit. (Displayed during normal operation only.)	Replace the UPS.
14		(*1) (*2)		---	---	---	An UPS abnormality was detected.	Stop the unit, discontinue the input power supply, and then connect the unit to the input power supply again. If there is no change in the display contents, the unit has an error. Replace the control unit.

Note 1. The LED display becomes  (OFF) when the unit charging operation is stopped.

2. The LED display becomes  (Blink 4) during unit charging operation.

3. The LED display becomes  (Steadily ON) during unit backup operation.

4-1-2 Backup operation time setting / Battery replacement mode selection switch

Switching to the backup operation time setting / Battery replacement mode

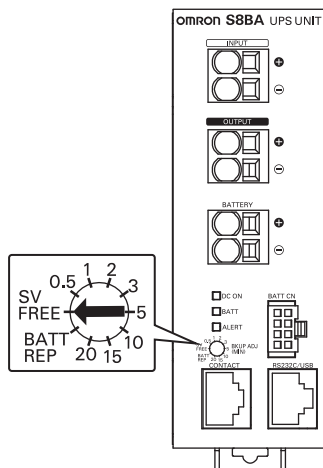

Sets the backup operation time.

For the setting, use a 2.5 mm or less flat-head screwdriver.

Set value	Description
SV FREE	Maximum (back up until battery runs out)
0.5	30 seconds
1	1 min.
2	2 min.
3	3 min.
5	5 min.
10	10 min.
15	15 min.
20	20 min.
BATT REP	Switches to the battery replacement mode. Set at the time of replacing the battery unit.

4-2 Start and stop procedures and basic operation

4-2-1 Start and stop procedures

For details on the precautions for use, including start and stop of the product, refer to *For use* on page 13.

Start procedure

Connect the unit to the input power supply.

- Output starts directly through the input power supply (The LED indicators are as shown on the right side).
- When the input power is ON, the battery is charged automatically.

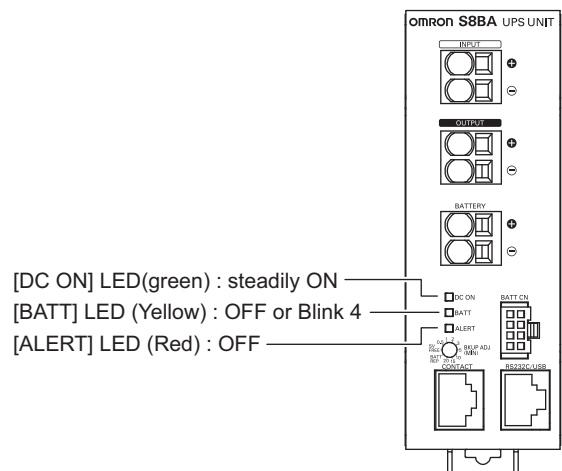

Startup sequence

This section describes the startup sequence.

The unit starts as soon as it is connected to the input power supply.

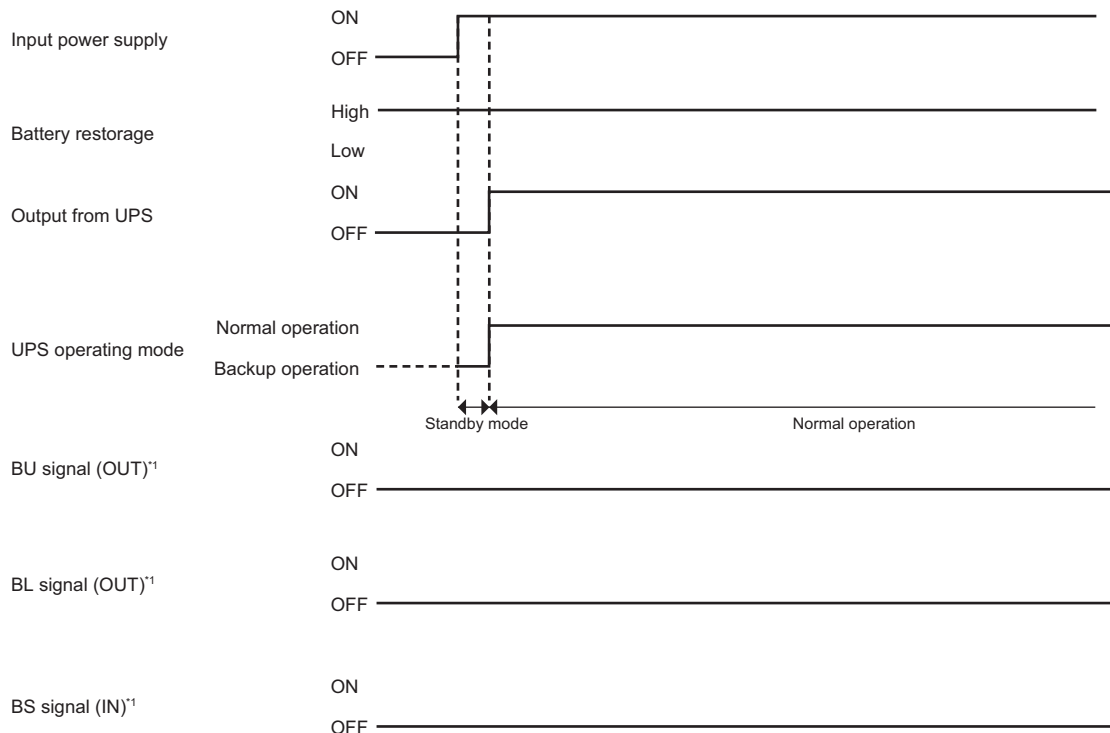

*1. For details, refer to 7-1 I/O signal functions on page 7-2.

The backup sequence when power failure/voltage drop (instantaneous voltage drop) occurs

Explains the backup sequence when a power failure occurs.

● When the input power supply recovers while the battery level is sufficiently high

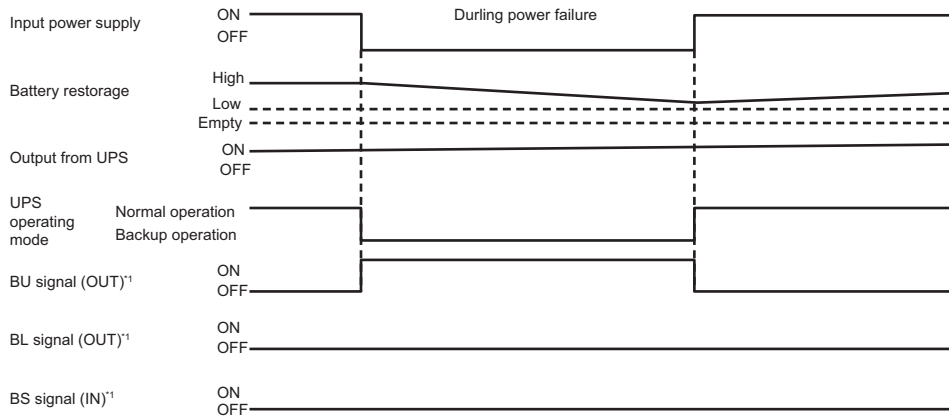

*1. For details, refer to 7-1 I/O signal functions on page 7-2.

● When the input power supply recovers while the battery level is low

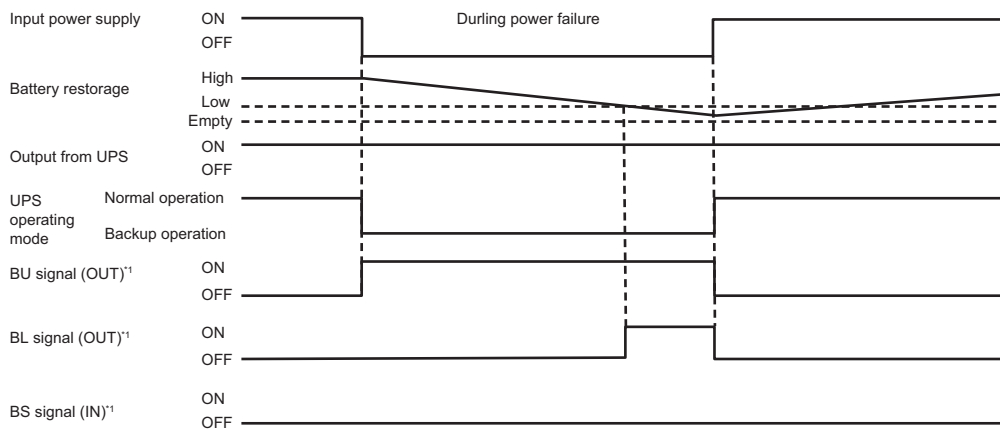

*1. For details, refer to 7-1 I/O signal functions on page 7-2.

● When the input power supply does not recover until the battery becomes empty

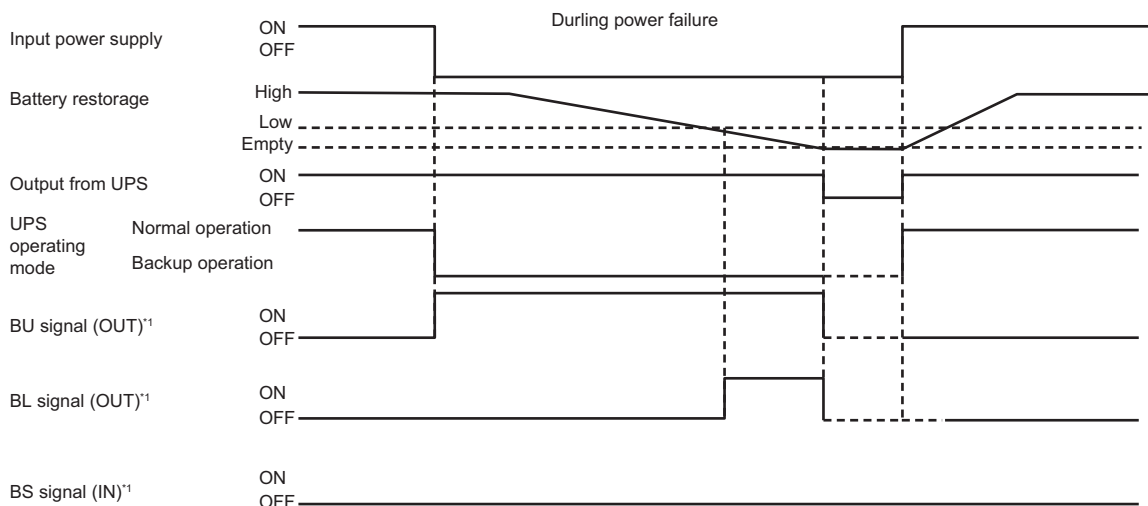

*1. For details, refer to 7-1 I/O signal functions on page 7-2.

● For shutdown by a BS signal

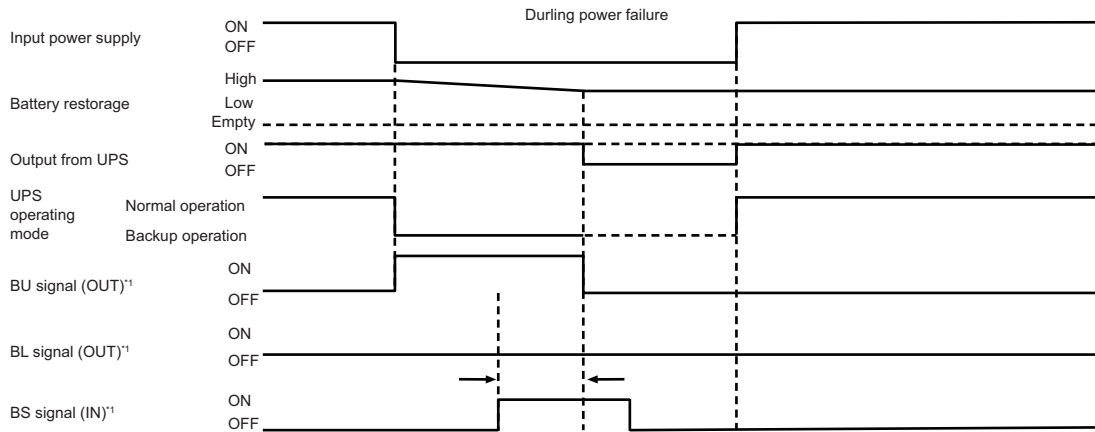

*1. For details, refer to 7-1 I/O signal functions on page 7-2.

Input and output voltage time chart when shifting to backup operation

Explains the operation when shifting to backup operation due to power failure or input voltage drop.

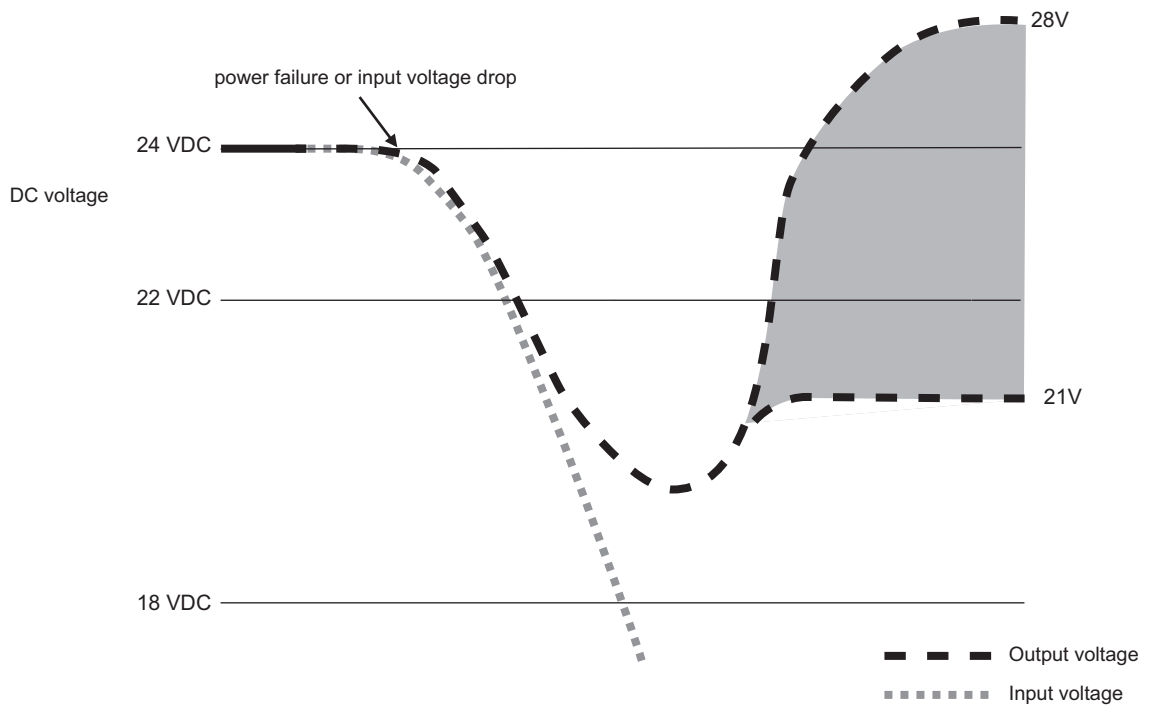

Operation after a power failure

If a power failure or input power supply error occurs, the operation automatically switches to backup operation to continue the power output by using electrical power from the battery.

■ : Steadily ON ▣ : Blink □ : OFF

LED display			Output	Description
[DC ON] LED (Green)	[BATT] LED (Yellow)	[ALERT] LED (Red)		
■	■	□	ON	Backup operation is in progress in the battery due to power failure or input power supply error.
■	▣ Blink 1	□	ON	Backup is operating due to power failure or AC input error. Battery level is low, so output will stop soon.
□	□	□	OFF	Battery is dead, so output stopped.

Operation when power is restored

● When power is restored during backup operation

When power is restored during backup operation, the output from input power supply automatically starts again and the output operation continues. In addition, the battery charging operation starts.

● When power is restored after the power supply output stops

If the power supply output stops due to empty battery unit, the unit automatically restarts and resumes the power supply output when power is restored. And the battery charging operation starts.

Operation when stopping

Set the unit's mode selection / backup operation time selection switch to "0.5" (Backup operation time setting: 30 sec.), and stop the input power supply.

After 30 sec. have elapsed, the unit turns OFF and the output stops.

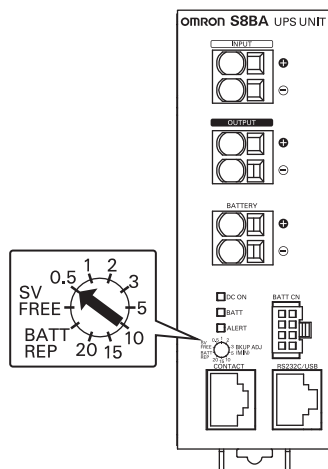

Additional Information

If you stop the unit, the battery charging stops.

5

Maintenance and inspection

This section describes how to perform maintenance of this product and also how to replace the battery unit.

5-1	Inspecting the battery	5-2
5-1-1	Expectancy of the battery	5-2
5-1-2	Estimated backup time	5-2
5-2	Replacing the battery unit	5-4
5-2-1	Notification that the battery unit needs to be replaced	5-4
5-2-2	Procedure for replacing the battery unit	5-6
5-3	Cleaning the Unit	5-9

5-1 Inspecting the battery

The battery has a limited lifespan.

(The life varies depending on your storage/use environment and backup frequency.)

The nearer the end of the life is, the more rapidly deterioration proceeds.



Caution

For details on the precautions when performing maintenance, refer to For maintenance on page 10. For maintenance on page 14



5-1-1 Expectancy of the battery

Operating environment temperature	Battery life expectancy
25°C	10 years
35°C	6.7 years
45°C	3.7 years
55°C	1.9 years

Note Not a guaranteed performance.

5-1-2 Estimated backup time

The backup time varies depending on the capacity of connected devices.

After calculating the total capacity of connected devices, refer to the graph of the backup time to obtain an estimation of the initial value of the backup time. (This is also applied to checking the battery.)

1 Convert the total capacity (power consumption) of the connected devices to watts (W).

The indicator can show values in two different ways: amperes (A), and watts (W).

Example 1: 24 VDC, 145 W

Example 2: 24 VDC, 1.8 A

For devices that use the A indication, convert the capacity into W.

Average ambient temperature	Value
A	$W = A \times 24$

Example : $1.8 (A) = 1.8 \times 24 (W) = 43.2 (W)$

2 Add the values converted into W to obtain the total capacity of the connected devices.

3 Calculate the initial value of the backup time for the total capacity of the connected devices from the graph below.

- Graph of backup time (graph of initial values for products that have not been used at 25°C).

The backup time becomes shorter than the graph (table) below when temperature is lower.

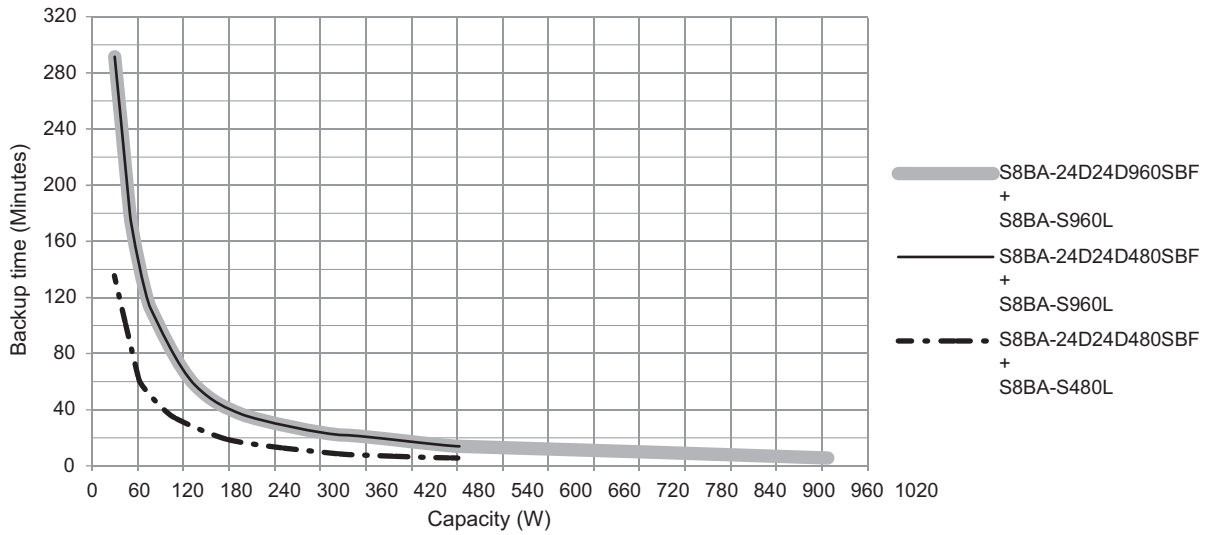

Backup time table (Time unit: minutes)

Model	Capacity (Watt)																	
	30	60	90	120	180	240	300	360	420	480	540	600	660	720	780	840	900	960
S8BA-24D24D960SBF + S8BA-S960L	290	138	94	66	43	30	24	20	16	14	13	12	11	10	9	8	7	6
S8BA-24D24D480SBF + S8BA-S960L	290	138	94	66	43	30	24	20	16	14	---	---	---	---	---	---	---	---
S8BA-24D24D480SBF + S8BA-S480L	134	63	41	29	19	15	11	9	8	6	---	---	---	---	---	---	---	---

Note These backup times are for reference only. Times may vary according to the lifespan of the battery and the external environment (temperature, etc).

5-2 Replacing the battery unit

This UPS supports hot swapping. The battery unit can be replaced both when the power is turned OFF (while the power output is OFF) and when the power is turned ON (while the power output is ON).

Caution

For details on the precautions for maintenance, refer to *For maintenance* on page 14 and *When the Battery Unit is Replaced* on page 15



Precautions for Correct Use

- When replacing the battery unit, set the unit to "BATT REP" (Battery replacement mode) using the mode selection / backup operation time selection switch.
Perform a reset with the "input power supply" ON.
- The battery life counter is automatically reset when the battery unit is replaced.
If you replace the battery unit without activating the battery replacement mode, the battery life may not be detected accurately because the battery life counter is not reset.
- Do not replace the battery unit while the UPS is operating in backup mode. Output will stop.



Precautions for Correct Use

- If an input power supply error such as a power failure occurs when replacing the battery unit while in operation, backup cannot be performed and output stops.

5-2-1 Notification that the battery unit needs to be replaced

When the battery unit replacement period is reached, the LED indicators show "[DC ON] LED: Green (Steadily on) / [BATT] LED: Yellow (Blink 2) / [ALERT] LED: Red (Blink 2)".

The battery life is determined by the counter function. The battery life counter operates while input power is supplied after shipment. (When the operating environment temperature of the battery unit is higher than 25°C, the value of the counter will be incremented at a faster pace.)

Caution

- The battery unit used in the unit has a limited lifespan. The life varies depending on your use environment and backup frequency.
- The nearer the end of the life is, the more rapidly deterioration proceeds.
- The battery unit deteriorates even if it is stored. The higher the temperature is, the shorter the life becomes.



Battery Life Counter Function

The function that counts the battery unit energization time and notifies the user when it is time to replace the battery unit is called the battery life counter function.

The UPS measures the ambient temperature at every 8 hours and adds the counter value according to the measured temperature. Here, the initial value of the lifespan counter before adding the counter value, which is measured at every 8 hours, is set to 0.

The lifespan of the lithium battery tends to be affected by the charging time and the ambient temperature; thus the temperature coefficient is set to "1.0" for 25 degrees Celsius or lower, while it is set to higher as the temperature rises above 25 degrees Celsius.

When the counter value reaches the specified value (equivalent to 50% of the battery capacity initial value), notification is performed by the LED.

Calculation formula: $t = 109,575 / 10\alpha * 8$

t: Battery life (hour)

109,575: Counter value showing the battery deterioration (equivalent to 50% of the battery capacity of the initial value)

α : Temperature coefficient

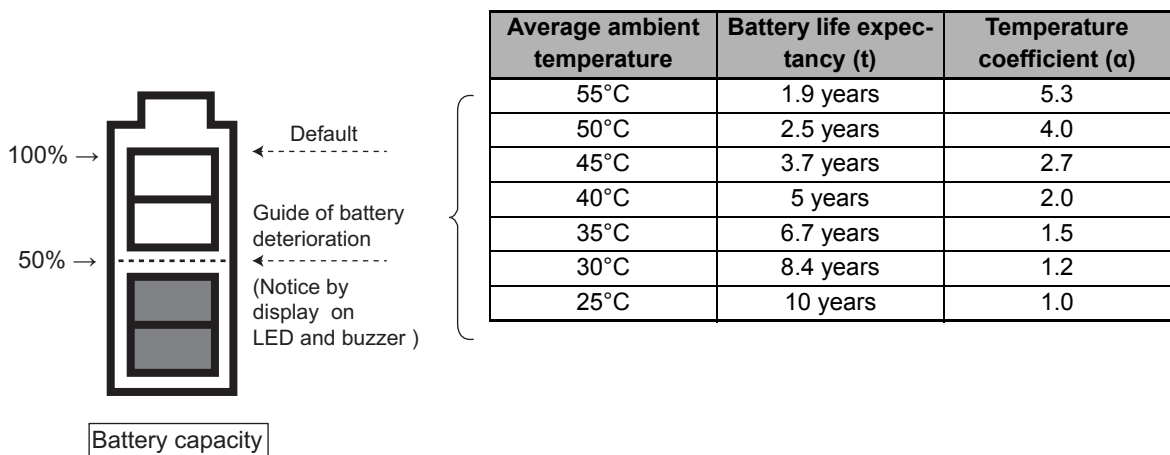

Guidelines for how often to check the battery unit

Average ambient temperature	6-month check	3-month check
55°C	For the first 1 years after starting use	When 1 years or more have passed after starting use
50°C	For the first 1.5 years after starting use	When 1.5 years or more have passed after starting use
45°C	For the first 3 years after starting use	When 3 years or more have passed after starting use
25°C	For the first 6 years after starting use	When 6 years or more have passed after starting use

5-2-2 Procedure for replacing the battery unit

For details on the precautions to be taken when replacing the battery unit, refer to *When the Battery Unit is Replaced* on page 15 in the "Safety precautions" at the beginning of this manual.



Precautions for Safe Use

Be sure to activate the battery replacement mode before replacing the battery unit.

- When replacing the battery unit, set the unit to "BATT REP" (Battery unit replacement mode) using the mode selection / backup operation time selection switch.
- The battery life counter is automatically reset when the battery unit is replaced.
If the battery unit is replaced without setting the battery replacement mode, the battery life may not be detected accurately because the battery life counter is not reset.



Additional Information

Buy a new battery unit for replacement.

- 1 Set the unit's mode selection / backup operation time selection switch to the battery replacement mode.

The setting is complete when the LED indicators show "[DC ON] LED: Green (Blink 0) / [BATT] LED: Yellow (Blink 0) / [ALERT] LED: Red (Blink 0)" for a few seconds before showing "[DC ON] LED: Green (Blink 4) / [BATT] LED: Yellow (Blink 4) / [ALERT] LED: Red (Blink 4)".

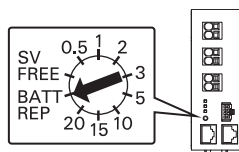

Set to "BATT REP".

2 Pull out the cables from the old battery unit in the following order:

For details about the method of connecting cables to the terminal block, refer to 3-2-5 *Connecting a cable to the battery terminal block, input terminal block and output terminal block* on page 3-9"

- (1) Battery communication cable

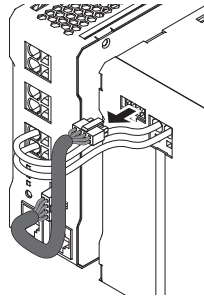

- (2) BATT connection cable Negative side

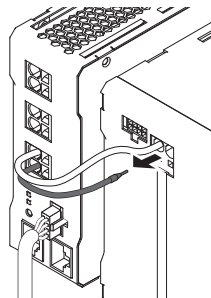

- (3) BATT connection cable Positive side

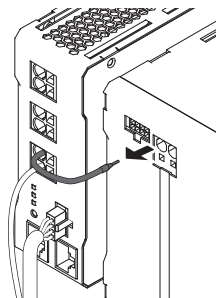

3 Remove the old battery unit.

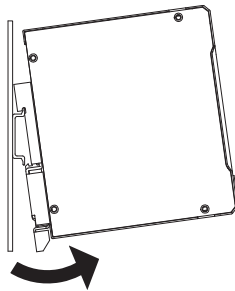

4 Install the new battery unit.

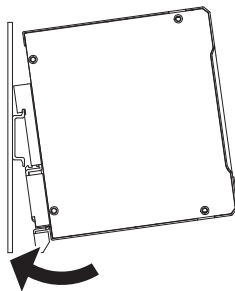

5 Insert the cables in the new battery unit in the following order:

For details about the method of connecting cables to the terminal block, refer to 3-2-5 *Connecting a cable to the battery terminal block, input terminal block and output terminal block* on page 3-9"

- (1) BATT connection cable Positive side

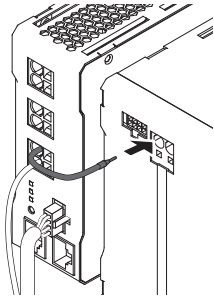

- (2) BATT connection cable Negative side

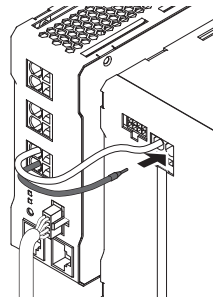

- (3) Battery communication cable

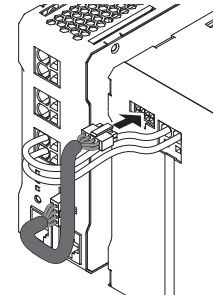

Few seconds after connecting the battery communication cable, the LED indicators show "[DC ON] LED: Green (Blink 0) / [BATT] LED: Yellow (Blink 0) / [ALERT] LED: Red (Blink 0)".

6 Finally, set the unit's mode selection / backup operation time selection switch to the Backup Time Setting mode.

The setting is complete when the LED indicators show "[DC ON] LED: Green (Steadily on) / [BATT] LED: Yellow (Off) / [ALERT] LED: Red (Off)".

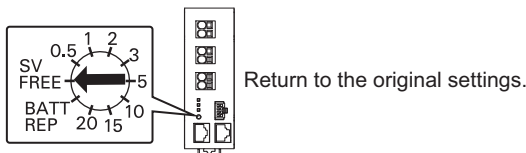

Precautions for Correct Use

Do not short between the terminals of the battery communication cable.

- Doing so may result in electric shock.
- The protection board inside the battery unit may be damaged due to a short-circuit.
- Connect each connection cable to the correct connected device.
- Connect the terminal of each connection cable to the connector port with correct polarity.
- Be sure to follow the above connection procedure.

Battery unit replacement is now complete.

5-3 Cleaning the Unit



Caution

For details on the precautions when performing maintenance, refer to For maintenance on page 10. *For maintenance* on page 14



- 1** Cleaning the UPS
Moisten a soft cloth with water or detergent, squeeze it tightly, and wipe the product lightly.
Do not use chemicals such as thinner and benzene. (They cause deformation or discoloration.)
- 2** Removing dust from the input terminal block and the output terminal block terminal blocks of the UPS
Stop all the connected devices and the UPS and turn the “input power supply” OFF.
Then, remove dust with a dry cloth and turn the “input power supply” ON again.
Note For information on the connection procedure, refer to 3-2 *Connection* on page 3-5.



To perform shutdown processing of the devices when a power failure occurs

This section describes how to use the UPS monitoring software.

6-1-1UPS monitoring software	6-2
6-1-1 UPS monitoring software	6-2
6-1-2 How to connect	6-2
6-1-2How to connect	6-2

6-1 The outline on the UPS monitoring software

6-1-1 UPS monitoring software

"Simple Shutdown Software" or "PowerAttendant Lite" allows you to automatically shut down the PC when a power failure occurs.

For more information, refer to the manual of this software.

Install either "Simple Shutdown Software" or "PowerAttendant Lite". These two cannot be used at the same time.

6-1-2 How to connect

- 1 Connect the UPS to a computer.
 - USB connection: The USB cable that comes with the product can be used.
 - RS232C connection: An optional connection cable (S8BW-C01) is required.

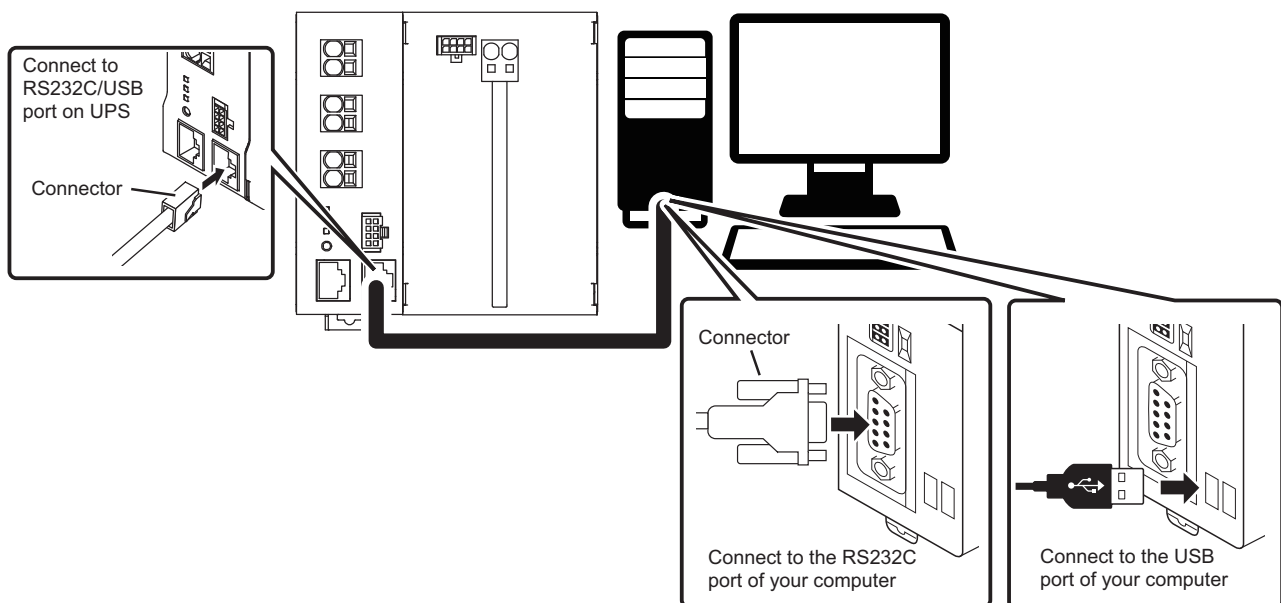

- 2 Install "Simple Shutdown Software" in your computer.
For details, see the manual for the above software.

- Cable pin configuration
- Using an RS-232C cable

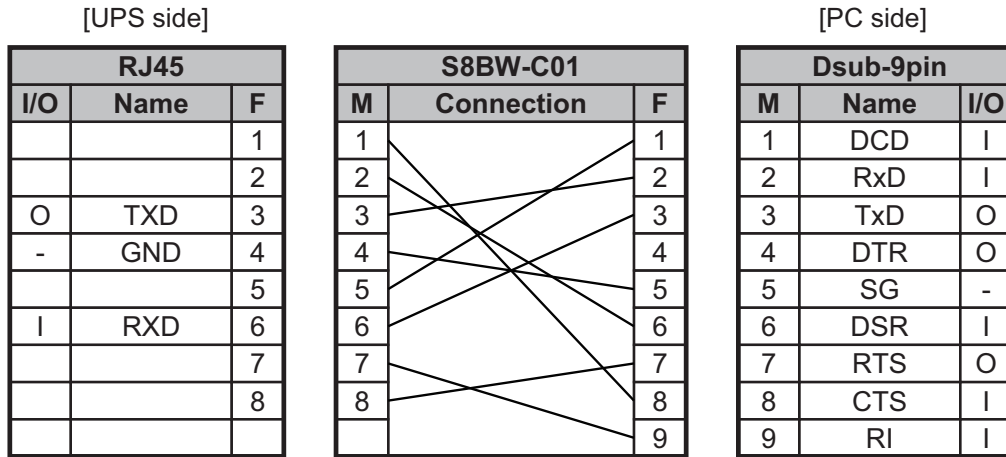

- Using a USB cable

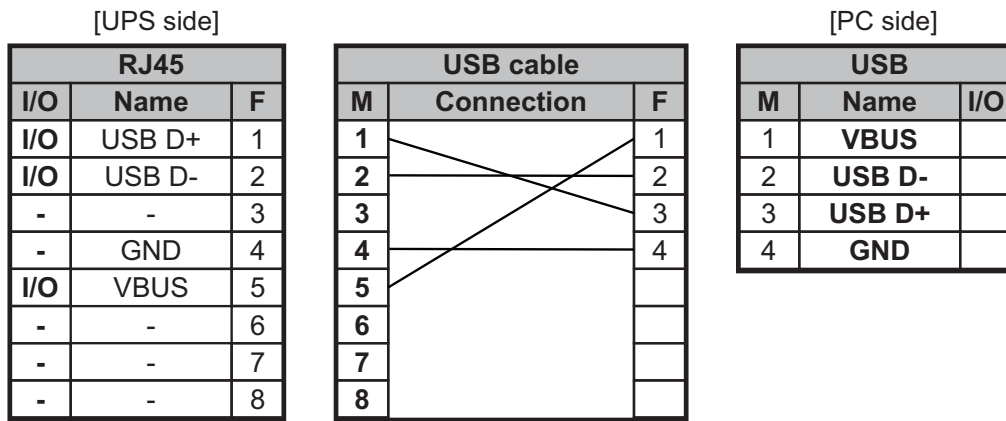

Precautions for Safe Use

When the power is restored while auto shutdown processing is being performed after the "Settings for automatically stopping the UPS after OS shutdown" have been made.

- If a power failure occurs and then the power is restored while auto shutdown is still in progress, UPS output will stop temporarily after the set time elapses.
Therefore, after shutdown is finished, do not turn on the computer until the UPS has finished restarting.



Using the I/O signal functions

This section describes the I/O signals of the product.

7-1 I/O signal functions	7-2
7-1-1 Type of output signals	7-2
7-1-2 Type of input signals	7-2
7-1-3 CONTACT port (RJ45 connector)	7-3
7-1-4 Contact signal ratings	7-3
7-1-5 Contact signal circuit	7-3
7-1-6 Precautions and notes for the use of the I/O signal functions	7-4
7-1-7 Example of the use of the Contact Signal circuit	7-4

7-1 I/O signal functions

● About contact signal

You can develop your unique system based on the following specifications to automate the process at a power failure. You can perform power-failure processing by allowing the system to detect the backup signal (BU) and also perform system shutdown processing by allowing the system to detect the low battery level signal (BL). Also, by inputting the backup stop signal (BS) from the system, you can stop the UPS with a sufficient battery level to prepare for the next occurrence of a power failure.

7-1-1 Type of output signals

The UPS has 4 kinds of output signals.

The output circuit consists of an open collector circuit using a photo coupler.

Signal	Description
Backup signal output (BU)	Stays ON during backup operation at a power failure.
Low battery level signal output (BL)	Goes ON when the battery becomes weak during backup operation at a power failure.
Trouble signal output (TR)	Goes ON when an internal failure of the UPS occurs or when the battery life counter expires.
Battery replacement signal output (WB)	Goes ON when it is detected that the battery lifespan has expired or the battery has deteriorated. (The battery life counter goes on counting till the time the input power is being supplied.)

7-1-2 Type of input signals

The UPS has 2 kinds of input signals.

Signal	Description
UPS Stop Signal input (BS)	When the BS signal is ON (High), the output of the UPS is stopped after the time period specified in advance has elapsed*1.
Remote ON/OFF signal	Remote ON/OFF signals can be used to start and stop the UPS, by using either an externally connected contact or the ON/OFF status of the open collector circuit. When signal is OFF, the UPS will be turned on. When signal is ON, the UPS will be turned off. In the factory settings, the UPS stops operation when this is short-circuited. You must connect the unit to the input power supply to be able to use this function.

*1. BS signal delay time

It is possible to set the period of time from when a BS signal is received until the output of the UPS is stopped. The output of the UPS can be stopped by inputting the voltage signal (High).

7-1-3 CONTACT port (RJ45 connector)

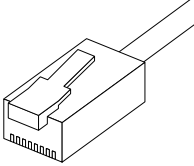
Outlook of the connector	Pin number	Cable color	Description
	1	White/orange	Backup signal output (BU)
	2	Orange	Remote ON/OFF input (-)
	3	White/green	Trouble signal output (TR)
	4	Blue	COMMON (COM)
	5	White/blue	Battery LOW signal output (BL)
	6	Green	Backup stop signal input (BS)
	7	White/brown	Battery replacement signal output (WB)
	8	Brown	Remote ON/OFF input (+)

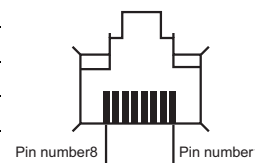

7-1-4 Contact signal ratings

Signal	Description
Signal output (BL, TR, BU, WB)	<ul style="list-style-type: none"> Applicable voltage: 50 VDC or less Maximum current: 500 mA BU signal minimum response time: 5ms
Remote ON/OFF input	<ul style="list-style-type: none"> Voltage between terminals: DC3.3V Current when closed: 10 mA max. Maximum signal response time At stop: 100 ms At start: 300 ms
UPS Stop Signal input (BS)	<ul style="list-style-type: none"> Input voltage: <ul style="list-style-type: none"> HIGH(ON) 8 to 24 VDC LOW(OFF) 0.5 VDC or less Input current: 250 mA Maximum signal response time At stop: 100 ms At start: 300 ms

7-1-5 Contact signal circuit

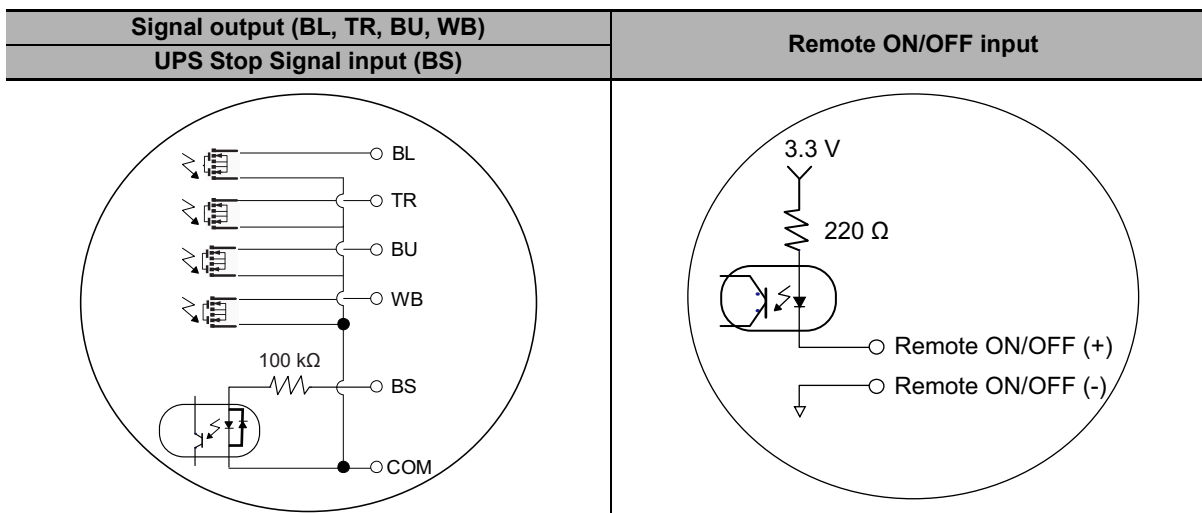

7-1-6 Precautions and notes for the use of the I/O signal functions



Precautions for Safe Use

When connecting a device such as a relay that generates counter electromotive force to the signal output circuit, connect diodes that prevent counter electromotive force to both ends of the relay.

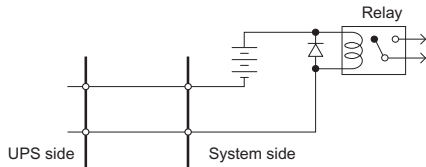

Connection cable
(Twisted or shielded)

7-1-7 Example of the use of the Contact Signal circuit

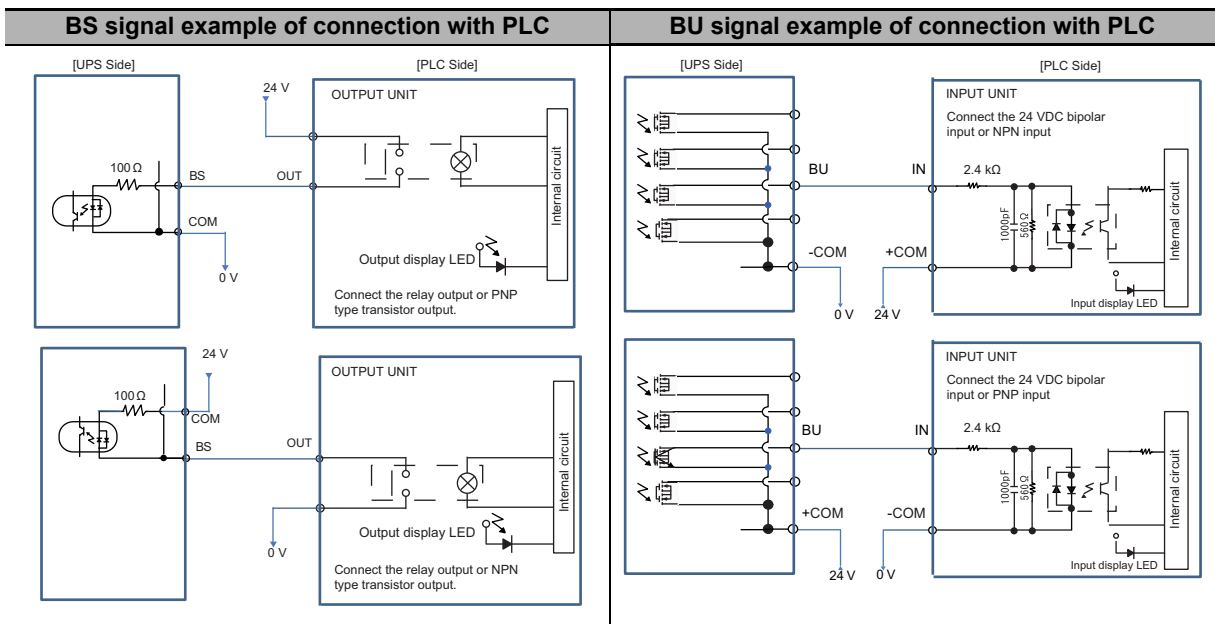



8

Troubleshooting

This section describes how to check and handle errors that occur at the time of using the product.

8-1	Troubleshooting	8-2
------------	------------------------------	------------

8-1 Troubleshooting

Perform the checks shown below if the unit is operating abnormally.

Problem	Check and remedy
<p>The unit does not start operation.</p> <p>There is no LED display even when the unit is connected to the input power supply.</p>	<p>Make sure the AC input is securely connected to commercial power.</p> <p>If the status indicator does not display properly after you perform the above operation, there is a problem with the unit.</p> <p>Refer to <i>Concept of LED display</i> on page 4-3.</p>
<p>Backup is not possible.</p> <p>The computer stops when a power failure occurs.</p>	<p>The battery may not be fully charged.</p> <p>Perform the test after charging the battery for at least 8 hours.</p> <p>The battery charging operation starts when the battery is connected to the input power supply. The battery is not charged when it is not connected to the input power supply.</p>
<p>Backup is performed too frequently.</p> <p>Frequent switching is performed although a power failure does not occur.</p> <p>You hear the sound of switching.</p>	<p>Variations (decrease) in the input power occur frequently. Or, noise may be included that significantly distorts the voltage waveform of the input power.</p> <ul style="list-style-type: none"> • Make sure the voltage of the input power supply to which the unit is connected is normal. • The voltage may also drop when the cable used to connect the unit is long or too thin.
<p>The power is not turned ON even when the unit is connected to the input power supply.</p>	<p>Check the voltage value of the input power supply when the LED display is "[DC ON] LED: Green (Blink 4) / [BATT] LED: Yellow (Off) / [ALERT] LED: Red (Off)".</p>
<p>The battery unit replacement display "[DC ON] LED: Green (Steadily on) / [BATT] LED: Yellow (Blink 2) / [ALERT] LED: Red (Blink 2)" appears.</p>	<p>Battery life counter counted up to limit. The battery unit has been used up to its end-of-life. Replace the battery unit.</p> <p>Refer to "5-2-1 Notification that the battery needs to be replaced".</p>
<p>The LED indicators show "[DC ON] LED: Green (Steadily on) / [BATT] LED: Yellow (Off, Steadily on, or Blink 4) / [ALERT] LED: Red (Blink 0)".</p>	<p>There are too many connected devices. Reduce the number of connected devices until the LED display becomes "[DC ON] LED: Green (Steadily on) / [BATT] LED: Yellow (Off or Blink 4) / [ALERT] LED: Red (Off)".</p>
<p>The LED indicators show "[DC ON] LED: Green (Off) / [BATT] LED: Yellow (Off, Steadily on, or Blink 4) / [ALERT] LED: Red (Blink 0)".</p>	<p>Output stopped due to connections exceeding capacity limit. Turn OFF all power to the unit and connected devices, and reduce the number of connected devices. Then, turn the power to the unit and connected devices back ON and check whether the LED display becomes "[DC ON] LED: Green (Steadily on) / [BATT] LED: Yellow (Off or Blink 4) / [ALERT] LED: Red (Off)".</p>

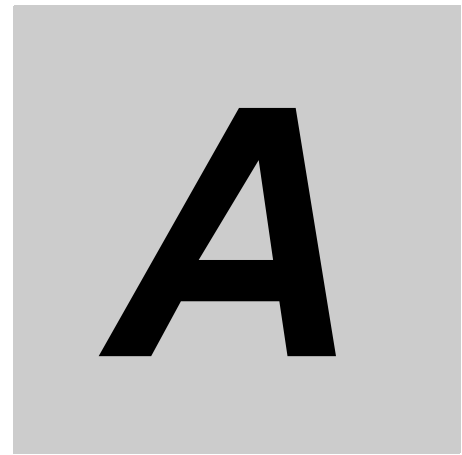

Appendix



This section describes the dimensions and characteristic data of the product.

A-1	Dimensions	A-2
A-2	Characteristic data	A-5
A-2-1	Derating curve	A-5
A-2-2	Overcurrent protection curve	A-6

A-1 Dimensions

S8BA-24D24D480SBF

Note Unit: mm / Tolerance:±1mm

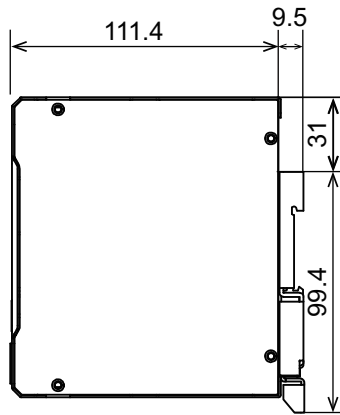
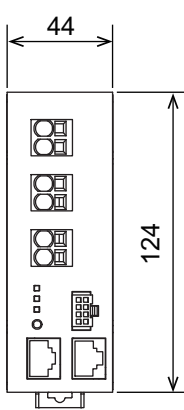
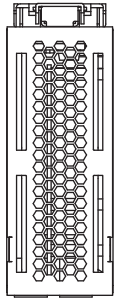

S8BA-S480L

Note Unit: mm / Tolerance:±1mm

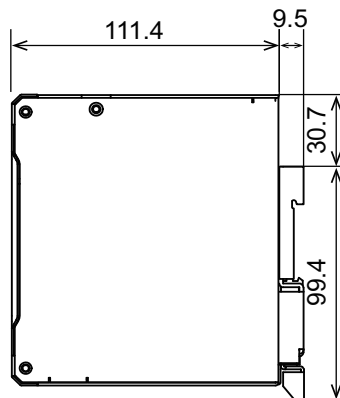
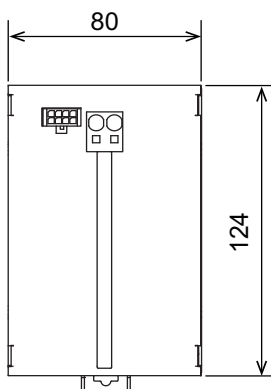
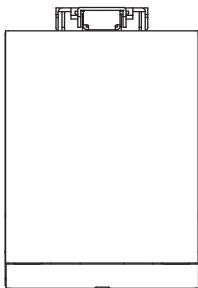

S8BA-24D24D960SBF

Note Unit: mm / Tolerance:±1mm

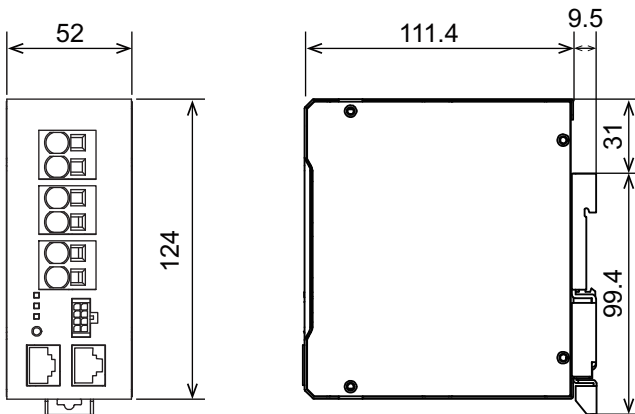
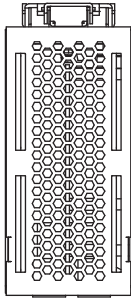

S8BA-S960L

Note Unit: mm / Tolerance:±1mm

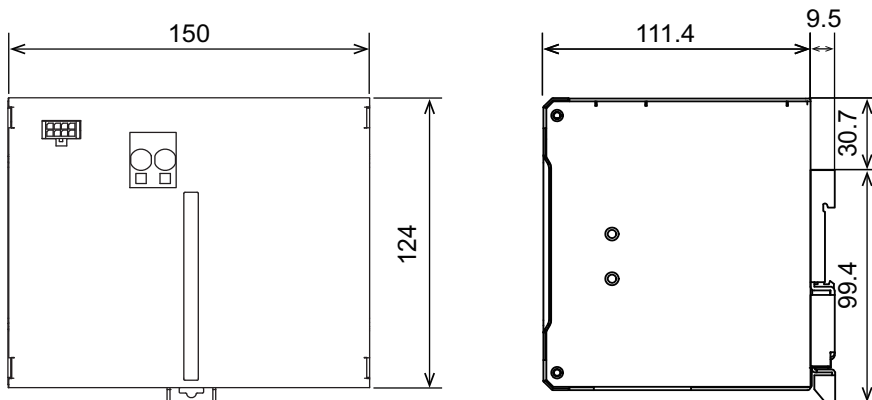
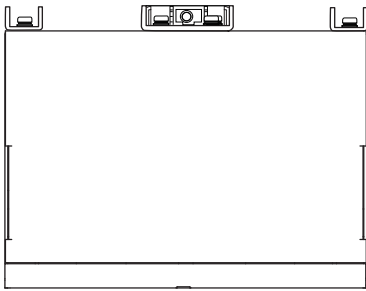

A

Optional items for rail mounting

● Support rail (Aluminum)

PFP-100N

PFP-50N

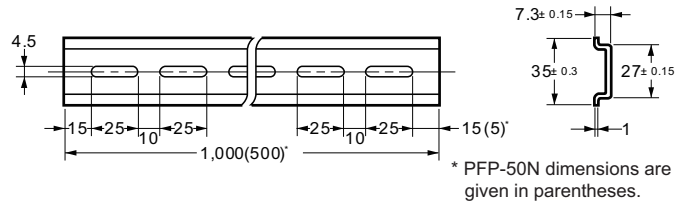
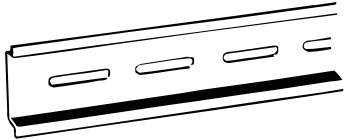

● Support rail (Aluminum)

PFP-100N2

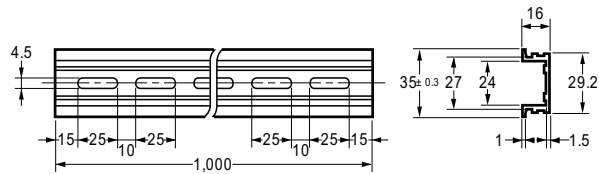
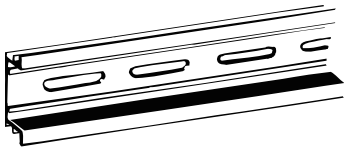

● Fastening plate (End plate)

PFP-M

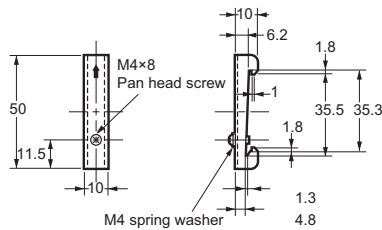

Note 1. If the DIN rail is subjected to vibration or shocks, scrap metal can be produced because of aluminum abrasion. In such a case, use a steel DIN rail instead.

2. If the product slides sideways, attach an end plate (PFP-M) on both sides of the main body.

A-2 Characteristic data

A-2-1 Derating curve

- Standard mounting (15 mm or more space between the left and right)

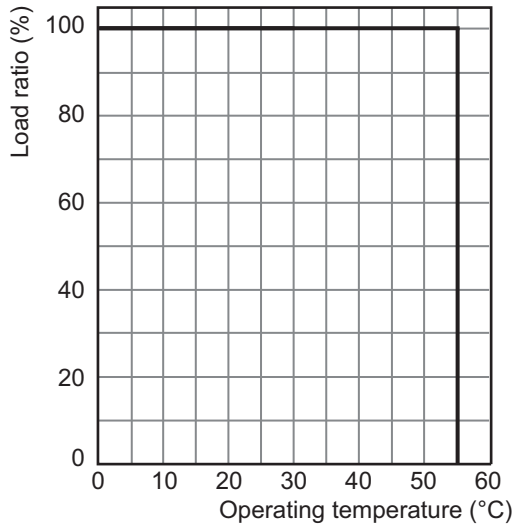

- Contact mounting (less than 15 mm space at the left and right)

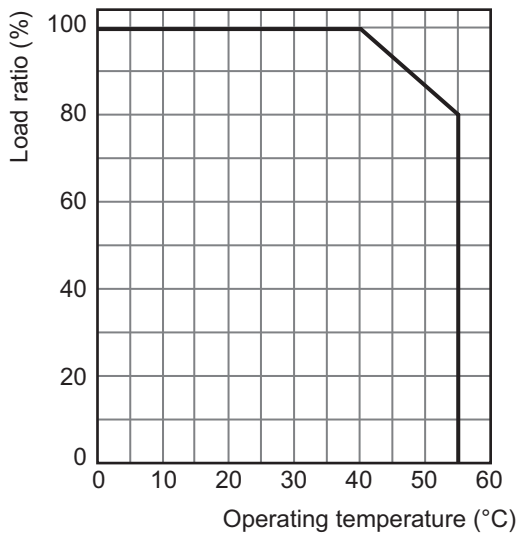

A-2-2 Overcurrent protection curve

● 480W/960W

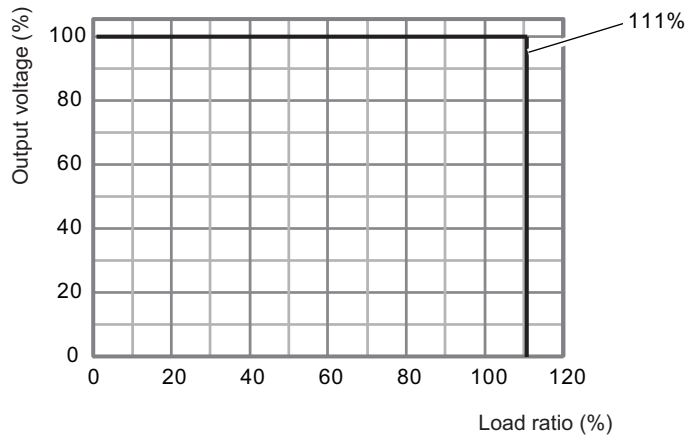

OMRON Corporation Industrial Automation Company
Kyoto, JAPAN

Contact: www.ia.omron.com

Regional Headquarters

OMRON EUROPE B.V.

Wegalaan 67-69, 2132 JD Hoofddorp
The Netherlands
Tel: (31)2356-81-300/Fax: (31)2356-81-388

OMRON ELECTRONICS LLC

2895 Greenspoint Parkway, Suite 200
Hoffman Estates, IL 60169 U.S.A.
Tel: (1) 847-843-7900/Fax: (1) 847-843-7787

OMRON ASIA PACIFIC PTE. LTD.

No. 438A Alexandra Road # 05-05/08 (Lobby 2),
Alexandra Technopark,
Singapore 119967
Tel: (65) 6835-3011/Fax: (65) 6835-2711

OMRON (CHINA) CO., LTD.

Room 2211, Bank of China Tower,
200 Yin Cheng Zhong Road,
PuDong New Area, Shanghai, 200120, China
Tel: (86) 21-5037-2222/Fax: (86) 21-5037-2200

Authorized Distributor:

© OMRON Corporation 2015-2018 All Rights Reserved.
In the interest of product improvement,
specifications are subject to change without notice.

Cat. No. U726-E1-01

0418