

Doc 9643
AN/941



Manual on Simultaneous Operations on Parallel or Near-Parallel Instrument Runways (SOIR)

Approved by the Secretary General
and published under his authority

First Edition — 2004

International Civil Aviation Organization

Published in separate English, Arabic, Chinese, French, Russian and Spanish editions by the International Civil Aviation Organization. All correspondence, except orders and subscriptions, should be addressed to the Secretary General.

Orders should be sent to one of the following addresses, together with the appropriate remittance in U.S. dollars or in the currency of the country in which the order is placed. Customers are encouraged to use credit cards (MasterCard, Visa or American Express) to avoid delivery delays. Information on payment by credit card and by other methods is available in the Ordering Information Section of the *Catalogue of ICAO Publications*.

International Civil Aviation Organization. Attention: Customer Services Unit, 999 University Street, Montréal, Quebec, Canada H3C 5H7
Telephone: +1 514-954-8022; Facsimile: +1 514-954-6769; Sitatex: YULCAYA; E-mail: sales@icao.int;
World Wide Web: <http://www.icao.int>

Botswana. Kags and Tsar Investments (PTY) Ltd., Private Bag 254/525, Gaborone
Telephone: +267 390 4384/8; Facsimile: +267 395 0004; E-mail: ops@kagsandtsar.co.bw

Cameroon. KnowHow, 1, Rue de la Chambre de Commerce-Bonanjou, B.P. 4676, Douala / Telephone: +237 343 98 42; Facsimile: +237 343 89 25;
E-mail: knowhow_doc@yahoo.fr

China. Glory Master International Limited, Room 434B, Hongshen Trade Centre, 428 Dong Fang Road, Pudong, Shanghai 200120
Telephone: +86 137 0177 4638; Facsimile: +86 21 5888 1629; E-mail: glorymaster@online.sh.cn

Egypt. ICAO Regional Director, Middle East Office, Egyptian Civil Aviation Complex, Cairo Airport Road, Heliopolis, Cairo 11776
Telephone: +20 2 267 4840; Facsimile: +20 2 267 4843; Sitatex: CAICAYA; E-mail: icaomid@cairo.icao.int

Germany. UNO-Verlag GmbH, August-Bebel-Allee 6, 53175 Bonn / Telephone: +49 0 228-94 90 2-0; Facsimile: +49 0 228-94 90 2-22;
E-mail: info@uno-verlag.de; World Wide Web: <http://www.uno-verlag.de>

India. Oxford Book and Stationery Co., 57, Medha Apartments, Mayur Vihar, Phase-1, New Delhi – 110 091
Telephone: +91 11 65659897; Facsimile: +91 11 22743532

India. Sterling Book House – SBH, 181, Dr. D. N. Road, Fort, Mumbai 400 001
Telephone: +91 22 2261 2521, 2265 9599; Facsimile: +91 22 2262 3551; E-mail: sbh@vsnl.com

India. The English Book Store, 17-L Connaught Circus, New Delhi 110001
Telephone: +91 11 2341-7936, 2341-7126; Facsimile: +91 11 2341-7731; E-mail: ebs@vsnl.com

Japan. Japan Civil Aviation Promotion Foundation, 15-12, 1-chome, Toranomom, Minato-Ku, Tokyo
Telephone: +81 3 3503-2686; Facsimile: +81 3 3503-2689

Kenya. ICAO Regional Director, Eastern and Southern African Office, United Nations Accommodation, P.O. Box 46294, Nairobi
Telephone: +254 20 7622 395; Facsimile: +254 20 7623 028; Sitatex: NBOCAYA; E-mail: icao@icao.unon.org

Mexico. Director Regional de la OACI, Oficina Norteamérica, Centroamérica y Caribe, Av. Presidente Masaryk No. 29, 3^{er} Piso, Col. Chapultepec Morales, C.P. 11570, México D.F. / Teléfono: +52 55 52 50 32 11; Facsimile: +52 55 52 03 27 57;
Correo-e: icao_nacc@mexico.icao.int

Nigeria. Landover Company, P.O. Box 3165, Ikeja, Lagos
Telephone: +234 1 4979780; Facsimile: +234 1 4979788; Sitatex: LOSLORK; E-mail: aviation@landovercompany.com

Peru. Director Regional de la OACI, Oficina Sudamérica, Av. Víctor Andrés Belaúnde No. 147, San Isidro, Lima (Centro Empresarial Real, Vía Principal No. 102, Edificio Real 4, Floor 4)
Teléfono: +51 1 611 8686; Facsimile: +51 1 611 8689; Correo-e: mail@lima.icao.int

Russian Federation. Aviaizdat, 48, Ivan Franko Street, Moscow 121351 / Telephone: +7 095 417-0405; Facsimile: +7 095 417-0254

Senegal. Directeur régional de l'OACI, Bureau Afrique occidentale et centrale, Boîte postale 2356, Dakar
Téléphone: +221 839 9393; Fax: +221 823 6926; Sitatex: DKRCAYA; Courriel: icaodkr@icao.sn

Slovakia. Letové prevádzkové služby Slovenskej Republiky, Štátny podnik, 823 07 Bratislava 21
Telephone: +421 2 4857 1111; Facsimile: +421 2 4857 2105; E-mail: sa.icao@Ips.sk

South Africa. Avex Air Training (Pty) Ltd., Private Bag X102, Halfway House, 1685, Johannesburg
Telephone: +27 11 315-0003/4; Facsimile: +27 11 805-3649; E-mail: avex@iafrica.com

Spain. A.E.N.A. — Aeropuertos Españoles y Navegación Aérea, Calle Juan Ignacio Luca de Tena, 14, Planta Tercera, Despacho 3. 11, 28027 Madrid / Teléfono: +34 91 321-3148; Facsimile: +34 91 321-3157; Correo-e: ssc.ventasoci@aena.es

Switzerland. Adeco-Editions van Diermen, Attn: Mr. Martin Richard Van Diermen, Chemin du Lacuez 41, CH-1807 Blonay
Telephone: +41 021 943 2673; Facsimile: +41 021 943 3605; E-mail: mvandiermen@adeco.org

Thailand. ICAO Regional Director, Asia and Pacific Office, P.O. Box 11, Samyae Ladprao, Bangkok 10901
Telephone: +66 2 537 8189; Facsimile: +66 2 537 8199; Sitatex: BKKCAYA; E-mail: icao_apac@bangkok.icao.int

United Kingdom. Airplan Flight Equipment Ltd. (AFE), 1a Ringway Trading Estate, Shadowmoss Road, Manchester M22 5LH
Telephone: +44 161 499 0023; Facsimile: +44 161 499 0298; E-mail: enquiries@afeonline.com; World Wide Web: <http://www.afeonline.com>

Catalogue of ICAO Publications

Issued annually, the Catalogue lists all publications currently available. Supplements to the Catalogue announce new publications, amendments, supplements, etc. The Catalogue is accessible on the ICAO website at www.icao.int.

**Doc 9643
AN/941**



Manual on Simultaneous Operations on Parallel or Near-Parallel Instrument Runways (SOIR)

**Approved by the Secretary General
and published under his authority**

First Edition — 2004

International Civil Aviation Organization

AMENDMENTS

The issue of amendments is announced regularly in the *ICAO Journal* and in the monthly *Supplement to the Catalogue of ICAO Publications and Audio-visual Training Aids*, which holders of this publication should consult. The space below is provided to keep a record of such amendments.

RECORD OF AMENDMENTS AND CORRIGENDA

AMENDMENTS			
No.	Date applicable	Date entered	Entered by

CORRIGENDA			
No.	Date of issue	Date entered	Entered by

FOREWORD

At the request of the Air Navigation Commission (ANC), the ICAO Secretariat prepared a report on simultaneous operations on parallel or near-parallel instrument runways, which included proposals regarding minimum distances between instrument runways. In 1980, the ANC reviewed the report, recognizing the difficulty in determining acceptable distances between parallel instrument runways and agreeing on the need for ICAO to study the matter further. States and selected international organizations were invited to provide information on current practices and related questions with respect to minimum distances between parallel runways for simultaneous use under instrument flight rules (IFR).

Four States indicated that they had operational experience with simultaneous operations on parallel instrument runways and had conducted studies on the subject. The requirements for the simultaneous use of such runways were considerable, and there was support for ICAO to develop specifications and undertake work on this subject.

The Commission, in light of the views expressed by selected States and international organizations on minimum distances between instrument runways used for simultaneous operations, noted the complex nature of the subject and the fact that it covered many disciplines in the air navigation field. It also agreed that guidance material was needed in view of the complexity of the subject. In January 1981, the Commission decided to proceed with the study and authorized the establishment of an air navigation study group, designated the Simultaneous Operations on Parallel or Near-Parallel Instrument Runways (SOIR) Study Group, to assist the Secretariat in its work.

Subsequently, at the request of the ANC, this manual on simultaneous operations on parallel or near-parallel

instrument runways was prepared by the ICAO Secretariat, with the assistance of the study group.

The information contained in this manual reflects the experience accumulated by several States and is intended to facilitate implementation of related provisions in Annex 14 — *Aerodromes*, Volume I — *Aerodrome Design and Operations*, Chapters 1 and 3; the *Procedures for Air Navigation Services — Air Traffic Management* (PANS-ATM, Doc 4444), Chapter 6; and the *Procedures for Air Navigation Services — Aircraft Operations* (PANS-OPS, Doc 8168), Volume I, Part I, Chapter 1, and Volume II, Part II, Chapter 6.

Following the updating of the ICAO provisions related to SOIR, applicable on 9 November 1995, the SOIR Study Group continued to assist in evaluating the use of new technologies, such as the global navigation satellite system (GNSS), for the purpose of supporting simultaneous IFR operations on closely spaced parallel runways, with a view to updating the relevant provisions and guidance material as necessary.

This manual is intended to be a living document. Periodic amendments or new editions will be published on the basis of experience gained and of comments and suggestions received from users of this manual. Readers are therefore invited to address their comments, views and suggestions to:

The Secretary General
999 University Street
Montréal, Quebec H3C 5H7
Canada

TABLE OF CONTENTS

	<i>Page</i>		<i>Page</i>
Glossary of terms and abbreviations/acronyms	(vii)	Chapter 3. Independent instrument departures from parallel runways (Mode 3)	3-1
Chapter 1. Operational concepts and considerations	1-1	3.1 General	3-1
1.1 General	1-1	3.2 Requirements and procedures	3-1
1.2 Modes of operation	1-1	3.3 Runway spacings	3-1
1.3 Factors affecting simultaneous operations on parallel instrument runways	1-2	Chapter 4. Segregated operations on parallel runways (Mode 4)	4-1
Chapter 2. Simultaneous approaches to parallel runways (Modes 1 and 2)	2-1	4.1 General	4-1
2.1 General	2-1	4.2 Requirements and procedures	4-1
2.2 Independent parallel instrument approaches (Mode 1)	2-1	4.3 Runway spacings	4-1
2.2.1 Requirements and procedures	2-1	Chapter 5. Near-parallel runways	5-1
2.2.2 No transgression zone (NTZ)	2-3	5.1 General	5-1
2.2.3 Normal operating zone (NOZ)	2-4	5.2 Ground equipment	5-1
2.2.4 Combination of normal operating zones and no transgression zones	2-4	Chapter 6. Training of ATS personnel	6-1
2.2.5 Spacing requirements of independent parallel instrument approaches	2-4	6.1 General	6-1
2.2.6 Safety-related issues affecting independent approaches to closely spaced parallel instrument runways	2-6	6.2 Training for approach controllers	6-1
2.3 Dependent parallel instrument approaches (Mode 2)	2-8	6.3 Training for aerodrome controllers	6-1
2.3.1 General	2-8	Chapter 7. Implementation	7-1
2.3.2 Requirements and procedures	2-8	7.1 Trials	7-1
2.3.3 Safety-related issues affecting dependent approaches to closely spaced parallel instrument runways	2-9	7.2 Implementation	7-1
2.4 Differences between independent and dependent parallel approaches	2-10	Appendix A — Precision runway monitors and safety issues relating to independent parallel approaches to closely spaced parallel instrument runways	APP A-1
		Appendix B — Example of runway spacings and ATC procedures used in France	APP B-1

GLOSSARY OF TERMS AND ABBREVIATIONS/ACRONYMS

Terms that are defined in Standards and Recommended Practices (SARPs) and Procedures for Air Navigation Services (PANS) are used in accordance with the meanings and usages given therein. In this manual, however, there are a number of other terms describing facilities, services, procedures, etc., related to aerodrome operations and air traffic services that are not yet included in Annexes or PANS documents. These terms and abbreviations, including definitions contained in Annex 14, the PANS-ATM, and the PANS-OPS, are given below.

TERMS

Airborne collision avoidance system (ACAS). An aircraft system based on secondary surveillance radar (SSR) transponder signals which operates independently of ground-based equipment to provide advice to the pilot on potential conflicting aircraft that are equipped with SSR transponders.

Correction zone. Additional airspace provided for the purpose of resolving conflicts.

Delay time. The time allowed for an air traffic controller to react, coordinate and communicate the appropriate command to the pilot, for the pilot to understand and react, and for the aircraft to respond.

Dependent parallel approaches. Simultaneous approaches to parallel or near-parallel instrument runways where radar separation minima between aircraft on adjacent extended runway centre lines are prescribed.

Deviation alert. An aural and visual alarm indicating situations where an aircraft deviates into the no transgression zone (NTZ) established between parallel runway approaches.

Independent parallel approaches. Simultaneous approaches to parallel or near-parallel instrument runways where radar separation minima between aircraft on adjacent extended runway centre lines are not prescribed.

Independent parallel departures. Simultaneous departures from parallel or near-parallel instrument runways.

Miss distance. The minimum lateral spacing achieved when the tracks of both aircraft are parallel after the threatened aircraft has executed the evading manoeuvre in the deviation analysis.

Mixed parallel operations. Simultaneous approaches and departures on parallel or near-parallel instrument runways.

Near-parallel runways. Non-intersecting runways whose extended centre lines have an angle of convergence/divergence of 15 degrees or less.

Normal operating zone (NOZ). Airspace of defined dimensions extending to either side of an ILS localizer course and/or MLS final approach track. Only the inner half of the normal operating zone is taken into account in independent parallel approaches.

No transgression zone (NTZ). In the context of independent parallel approaches, a corridor of airspace of defined dimensions located centrally between the two extended runway centre lines, where a penetration by an aircraft requires a controller intervention to manoeuvre any threatened aircraft on the adjacent approach.

Precision runway monitor (PRM). A specialized secondary surveillance radar system for monitoring of aircraft conducting simultaneous independent instrument approaches to parallel runways spaced less than 1 525 m (5 000 ft) but not less than 1 035 m (3 400 ft) apart. The equipment should have a minimum azimuth accuracy of 0.06 degrees (one sigma), an update period of 2.5 seconds or less, and a high resolution display providing position prediction and deviation alert.

Segregated parallel operations. Simultaneous operations on parallel or near-parallel instrument runways in which one runway is used exclusively for approaches and the other runway is used exclusively for departures.

Semi-mixed parallel operations. Simultaneous operations on parallel or near-parallel instrument runways in which one runway is used exclusively for departures while the other runway is used for a mixture of approaches and departures, or one runway is used exclusively for approaches while the other runway is used for a mixture of approaches and departures.

ABBREVIATIONS/ACRONYMS

ATC air traffic control
ATIS automatic terminal information service
ATS air traffic service

GNSS global navigation satellite system
IFR instrument flight rules
ILS instrument landing system
MLS microwave landing system
mrad milliradian(s)
NOZ normal operating zone
NTZ no transgression zone
PGDP probability-of-good-data point
PRM precision runway monitor
s second(s)
SOIR simultaneous operations on parallel or
near-parallel instrument runways
SSR secondary surveillance radar
VMC visual meteorological conditions

Chapter 1

OPERATIONAL CONCEPTS AND CONSIDERATIONS

1.1 GENERAL

1.1.1 The use of parallel or near-parallel runways to maximize aerodrome capacity is an old concept. In Annex 14, Volume I, Chapter 3, 3.1.10, it is recommended that where parallel runways are provided for simultaneous use under visual meteorological conditions (VMC) only, the minimum distance between their centre lines should be 210 m (690 ft) when the runways are intended for use by medium or heavy aeroplanes. Under instrument flight rules (IFR), however, the safety of parallel runway operations is affected by several factors such as the accuracy of the surveillance radar monitoring system, the ability of controllers to intervene when an aircraft deviates from the instrument landing system (ILS) localizer course or the microwave landing system (MLS) final approach track, the precision with which aircraft can navigate to the runway, and the controller, pilot and aircraft reaction times.

1.1.2 The impetus for considering simultaneous operations on parallel or near-parallel instrument runways under IFR is provided by the need to increase capacity at busy aerodromes. This increase in capacity can be accomplished either by using existing parallel runways more efficiently or by building additional runways. The cost of the latter can be very high; on the other hand, an aerodrome already having parallel runways, each equipped with ILS and/or MLS, could increase its capacity if these runways could be safely operated simultaneously and independently under IFR. However, other factors, such as surface movement guidance and control, environmental considerations, and landside/airside infrastructure, may negate the advantages to be gained from simultaneous operations.

1.2 MODES OF OPERATION

1.2.1 *Simultaneous parallel approaches*

Two basic modes of operation are possible:

- Mode 1, *independent parallel approaches*: simultaneous approaches to parallel or near-parallel instrument runways where radar separation minima between aircraft on adjacent extended runway centre lines **are not** prescribed; and
- Mode 2, *dependent parallel approaches*: simultaneous approaches to parallel or near-parallel instrument runways where radar separation minima between aircraft on adjacent extended runway centre lines **are** prescribed.

1.2.2 *Simultaneous parallel departures*

- Mode 3, *independent parallel departures*: simultaneous departures from parallel or near-parallel instrument runways.

Note.— When the spacing between two parallel runways is less than the specified value dictated by wake turbulence considerations, the runways are considered as a single runway with regard to separation between departing aircraft.

1.2.3 *Segregated parallel approaches/departures*

- Mode 4, *segregated parallel operations*: simultaneous operations on parallel or near-parallel instrument runways in which one runway is used exclusively for approaches and the other runway is used exclusively for departures.

1.2.3.1 In the case of segregated parallel approaches and departures (Mode 4), there may be semi-mixed operations, i.e. one runway is used exclusively for departures, while the other runway is used for a mixture of approaches and departures; or, one runway is used exclusively for approaches while the other is used for a mixture of approaches and departures. There may also be mixed operations, i.e. simultaneous parallel approaches with

departures interspersed on both runways. In all cases, however, semi-mixed or mixed operations may be related to the four basic modes listed in 1.2.1, 1.2.2 and 1.2.3 as follows:

	<i>Mode</i>
a) <i>Semi-mixed parallel operations</i>	
1) One runway is used exclusively for approaches while:	
— approaches are being made to the other runway, or	1 or 2
— departures are in progress on the other runway.	4
2) One runway is used exclusively for departures while:	
— approaches are being made to the other runway, or	4
— departures are in progress on the other runway.	3
b) <i>Mixed parallel operations</i>	
All modes of operation are possible.	1, 2, 3, 4

1.3 FACTORS AFFECTING SIMULTANEOUS OPERATIONS ON PARALLEL INSTRUMENT RUNWAYS

1.3.1 In the case of simultaneous parallel approaches to two parallel or near-parallel instrument runways, each with an associated instrument approach procedure, the approach minima of each runway are not affected. The operating minima used are identical to those applied for single runway operations.

1.3.2 There are some special procedures that have been promulgated in States using independent parallel approaches. To make flight crews aware of the importance of executing precise manoeuvres to intercept and follow closely the ILS localizer course or MLS final approach track, flight crews are notified prior to commencing approach that simultaneous parallel instrument approaches are in progress. This procedure also alerts flight crews to

the possibility of an immediate evasive manoeuvre (break-out) in case of a deviation by an aircraft on the adjacent extended centre line.

1.3.3 Theoretical studies indicate that the maximum arrival capacity may be achieved by operating independent parallel approaches, followed by dependent parallel approaches. These theoretical gains can, however, often be significantly lower in practice due to practical difficulties associated with implementation.

1.3.4 Further reductions in the theoretical capacity may arise through a lack of pilot familiarity with the procedures at aerodromes where there is a high proportion of unscheduled flights. Lack of familiarity can also result in the selection of incorrect ILS or MLS frequencies, while language difficulties, in particular lack of proficiency in the English language, may present communication problems between controllers and pilots.

1.3.5 When there are aircraft departing during mixed or semi-mixed operations, gaps have to be created in the landing stream. The effect of this is a reduction in the arrival capacity in order to accommodate departures; hence, it is a critical factor in determining the maximum runway capacity. Also, when operating departures on the landing runway, the probability of missed approaches increases with a corresponding reduction in capacity.

1.3.6 Factors that can affect the maximum capacity or the desirability of operating parallel runways simultaneously are not limited to runway considerations. Taxiway layout and the position of passenger terminals relative to the runways can make it necessary for traffic to cross active runways, a situation which may lead not only to delays but also to a reduction in the level of safety due to the possibility of runway incursions. The total surface movement environment must be carefully assessed when determining how particular parallel runways are to be used.

1.3.7 The decision to implement simultaneous operations at a particular location must take into consideration all of the foregoing factors, as well as any other constraints such as environmental considerations.

Chapter 2

SIMULTANEOUS APPROACHES TO PARALLEL RUNWAYS (MODES 1 AND 2)

2.1 GENERAL

2.1.1 Procedures exist for independent and dependent approaches to parallel runways under IFR. An extension of these procedures to reduced runway spacings can permit a broader application. This chapter presents the requirements for such reductions in spacing for parallel runway ILS and/or MLS approaches.

2.1.2 The concepts, procedures and dimensions applicable to independent and dependent parallel approaches are based on, and apply to, autopilot or hand-flown ILS or MLS procedures. The use of other precision approach aids technology not covered in this manual may necessitate changes to the separation and spacing requirements of parallel runway operations.

2.1.3 The primary purpose for permitting simultaneous operations on parallel or near-parallel instrument runways is to increase runway capacity. The largest increase in arrival capacity is achieved through the use of independent approaches (Mode 1) to parallel or near-parallel instrument runways.

2.1.4 A potential problem associated with closer runway spacings is the possibility that an aircraft will make the approach to the wrong runway. There are at least two ways this situation might occur:

- a) The pilot may misinterpret the approach clearance or use the incorrect approach chart and line up on the wrong ILS localizer or MLS final approach track. This situation could be avoided if procedures are instituted which require confirmation of the runway assignment, i.e. verbal verification of the ILS localizer or MLS frequency. Such procedures would reduce, but not eliminate, the risk of an aircraft approaching the wrong runway.
- b) The pilot on an instrument approach may, after reaching visual conditions, visually acquire and line

up for the wrong runway. This situation involves a correct approach but visual acquisition of the wrong runway. Such an event might occur too quickly and too close to the threshold to be reliably detected or resolved by the controller. If this situation is determined to be a problem, some means of improving visual runway identification may be required.

2.1.5 As the spacing between parallel runways decreases, it becomes more difficult for the approach controller to determine from a conventional radar display whether an aircraft is correctly aligned. Errors in both surveillance and navigation contribute to the uncertainty regarding an aircraft's intentions. Improvements in both surveillance and navigation performance may therefore be required to ensure that the number of false alarms is kept low.

2.1.6 In addition to helping with the runway misidentification problem, an improved surveillance system may have an effect on the resulting miss distance in the event of a deviation. Any violation of the required separation would be detected sooner, allowing more time for the controller to act.

2.2 INDEPENDENT PARALLEL INSTRUMENT APPROACHES (MODE 1)

2.2.1 Requirements and procedures

Note.— See the Procedures for Air Navigation Services — Air Traffic Management (PANS-ATM, Doc 4444), Chapter 6, 6.7.3.2.

2.2.1.1 Independent parallel approaches may be conducted to parallel runways provided:

- a) the runway centre lines are spaced by the distance specified in Annex 14, Volume I, and:

- 1) where runway centre lines are spaced by less than 1 310 m (4 300 ft) but not less than 1 035 m (3 400 ft), suitable SSR equipment, with a minimum azimuth accuracy of 0.06 degrees (one sigma), an update period of 2.5 seconds or less and a high resolution display providing position prediction and deviation alert is available; or
 - 2) where runway centre lines are spaced by less than 1 525 m (5 000 ft) but not less than 1 310 m (4 300 ft), SSR equipment with performance specifications other than the foregoing may be applied, provided they are equal to or better than those stated under 3) below, and when it is determined that the safety of aircraft operation would not be adversely affected; or
 - 3) where runway centre lines are spaced by 1 525 m (5 000 ft) or more, suitable surveillance radar with a minimum azimuth accuracy of 0.3 degrees (one sigma) or better and an update period of 5 seconds or less is available;
- Note.—Background information related to safety issues and precision runway monitoring (PRM) systems necessary for the implementation of independent approaches to closely spaced parallel instrument runways can be found in Appendix A.*
- b) ILS and/or MLS approaches are being conducted on both runways;

Note.— It is preferred that an ILS and/or MLS serving a runway used for simultaneous parallel approaches has co-located precision distance measuring equipment (DME).

 - c) the missed approach track for one approach diverges by at least 30 degrees from the missed approach track of the adjacent approach;
 - d) an obstacle survey and evaluation is completed, as appropriate, for the areas adjacent to the final approach segments;
 - e) aircraft are advised of the runway identification and ILS localizer or MLS frequency as early as possible;
 - f) radar vectoring is used to intercept the ILS localizer course or the MLS final approach track;
 - g) a no transgression zone (NTZ) at least 610 m (2 000 ft) wide is established equidistant between extended runway centre lines and is depicted on the radar display;
 - h) separate radar controllers monitor the approaches to each runway and ensure that when the 300 m (1 000 ft) vertical separation is reduced:
 - 1) aircraft do not penetrate the depicted NTZ; and
 - 2) the applicable minimum longitudinal separation between aircraft on the same ILS localizer course or MLS final approach track is maintained; and
 - i) if no dedicated radio channels are available for the radar controllers to control the aircraft until landing:
 - 1) transfer of communication of aircraft to the respective aerodrome controller's frequency is effected before the higher of two aircraft on adjacent final approach tracks intercepts the ILS glide path or the specified MLS elevation angle; and
 - 2) the radar controllers monitoring the approaches to each runway are provided with the capability to override transmissions of aerodrome control on the respective radio channels for each arrival flow.
- 2.2.1.2 As early as practicable after an aircraft has established communication with approach control, the aircraft shall be advised that independent parallel approaches are in force. This information may be provided through the automatic terminal information service (ATIS) broadcasts.
- 2.2.1.3 Whenever parallel approaches are carried out, separate radar controllers should be responsible for the sequencing and spacing of arriving aircraft to each runway.
- 2.2.1.4 When an aircraft is being vectored to intercept the ILS localizer course or MLS final approach track, the final vector shall enable the aircraft to intercept the ILS localizer course or MLS final approach track at an angle not greater than 30 degrees and to provide at least 2 km (1.0 NM) straight and level flight prior to ILS localizer course or MLS final approach track intercept. The vectors shall also enable the aircraft to be established on the ILS localizer course or MLS final approach track in level flight for at least 3.7 km (2.0 NM) prior to intercepting the ILS glide path or specified MLS elevation angle.

2.2.1.5 A minimum of 300 m (1 000 ft) vertical separation or, subject to radar system and radar display capabilities, a minimum of 5.6 km (3.0 NM) radar separation shall be provided at least until 19 km (10 NM) from the threshold and until aircraft are established:

- a) inbound on the ILS localizer course and/or MLS final approach track; and
- b) within the normal operating zone (NOZ).

2.2.1.6 Subject to radar system and radar display capabilities, a minimum of 5.6 km (3.0 NM) radar separation shall be provided between aircraft on the same ILS localizer course or MLS final approach track unless increased longitudinal separation is required due to wake turbulence or for other reasons.

2.2.1.7 Each pair of parallel approaches has a “high side” and a “low side” for vectoring to provide vertical separation until aircraft are established inbound on their respective parallel ILS localizer course and/or MLS final approach track. The low-side altitude should be such that the aircraft will be established on the ILS localizer course or MLS final approach track well before ILS glide path or specified MLS elevation angle interception. The high-side altitude should be 300 m (1 000 ft) above the low side at least until 19 km (10 NM) from the threshold.

2.2.1.8 If an aircraft is observed to deviate from its course towards the NTZ boundary, the appropriate monitoring controller will instruct the aircraft to return to the correct ILS localizer course/MLS final approach track immediately. In the event an aircraft is observed to penetrate the NTZ, the appropriate monitoring controller will instruct the aircraft on the adjacent localizer course or MLS final approach track to immediately climb and turn to an assigned altitude and heading in order to avoid the deviating aircraft. Any heading instruction shall not exceed 45 degrees track difference with the ILS localizer course or MLS final approach track. Where parallel approach obstacle assessment surfaces (PAOAS) criteria are applied to the obstacle assessment, the air traffic controller shall not issue the heading instruction to aircraft below 120 m (400 ft) above the threshold elevation.

2.2.1.9 Radar monitoring shall not be terminated until:

- a) visual separation is applied, provided procedures ensure that both radar controllers are advised whenever visual separation is applied; or

- b) the aircraft has landed or, in case of a missed approach, is at least 2 km (1.0 NM) beyond the departure end of the runway, and adequate separation with any other traffic is established.

Note.— There is no requirement to advise the aircraft that radar monitoring has been terminated.

2.2.2 No transgression zone (NTZ)

2.2.2.1 Since radar separation is not provided between traffic on adjacent extended runway centre lines in Mode 1 approaches, there must be an established means of determining when an aircraft deviates too far from the ILS localizer course or the MLS final approach track. This is achieved through the concept of the NTZ (see Figure 2-1).

2.2.2.2 The NTZ is a corridor of airspace established equidistant between two extended runway centre lines. The NTZ has a minimum width of 610 m (2 000 ft) and extends from the nearest threshold out to the point where the 300 m (1 000 ft) vertical separation is reduced between aircraft on the adjacent extended runway centre lines. The significance of the NTZ is that the monitoring radar controllers must intervene to establish separation between aircraft if any aircraft is observed to penetrate the NTZ. The width of the NTZ depends on the following four factors:

- a) *Detection zone.* Some airspace allowance must be made for limitations of the surveillance system and for controller observation/reaction time in the detection of a deviating aircraft. The allowance is dependent on the update rate and accuracy of the radar system, and the resolution of the radar display used.
- b) *Delay time/reaction time.* Some airspace allowance must be made:
 - 1) for the time during which the controllers react, determine the appropriate resolution manoeuvre, and communicate the appropriate instructions to achieve separation;
 - 2) for the time it takes the pilot to understand the instructions and react; and
 - 3) for the aircraft to respond to the control inputs.
- c) *Correction zone.* An additional airspace allowance must be made for the completion of the resolution manoeuvre by the threatened aircraft.

- d) *Miss distance.* In the deviation analysis, allowance must be made for adequate track spacing. It must include lateral spacing and an allowance for the fact that the threatened aircraft may not be exactly on the extended runway centre line of the adjacent runway.

2.2.2.3 The determination of airspace allowances for the detection zone, delay time/reaction time, correction zone and miss distance is based on several assumptions. One of the most complicated and important tasks of the monitoring radar controller is the determination of the appropriate manoeuvre for the threatened aircraft following a failure of the deviating aircraft to return to its appropriate ILS localizer course or MLS final approach track. Turning away from the threat may not always provide the optimum separation. The amount of time allocated to the controller for determining the proper resolution manoeuvre must therefore be generous.

2.2.3 Normal operating zone (NOZ)

2.2.3.1 The NOZ is the airspace in which aircraft are expected to operate while manoeuvring to pick up and fly the ILS localizer course or the MLS final approach track (see Figure 2-1).

2.2.3.2 There is one NOZ associated with each extended runway centre line. The NOZ is centred on the extended runway centre line, and its total width is twice the distance from the extended runway centre line to the nearest edge of the NTZ. Thus, the airspace between two extended runway centre lines consists of the NTZ and the two inner halves of the NOZs associated with each extended runway centre line. Once established on the ILS localizer course/MLS final approach track, aircraft are expected to remain within the NOZ without radar controller interventions.

2.2.3.3 The NOZ extends from the threshold out to the point where the aircraft joins the extended runway centre line. The width of the NOZ is determined by taking into account the guidance systems involved and the track-keeping accuracy of the aircraft; the more precise the navigation aids and track-keeping, the narrower the NOZ.

2.2.3.4 The width of the NOZ is such that the likelihood of any normally operating aircraft straying outside of the NOZ is very small. This assists in keeping the controller workload low and gives pilots confidence that all action taken by the monitoring controller is

absolutely necessary and not the result of a nuisance alarm. The remainder of the spacing between the approach tracks, i.e. the NTZ, must then provide for the safe resolution of potential conflicts.

2.2.4 Combination of normal operating zones and no transgression zones

The size of NOZs and the NTZ is determined according to the runway situation. In the case of existing parallel runways, the width of the NTZ is first determined based on the safety considerations described earlier. The remaining airspace can then be allocated to the two inner halves of the NOZs associated with each extended runway centre line. The results then dictate the required level of precision of the approach guidance system that is necessary. When there is only one runway and the question is how close to it a parallel runway can be built, the answer is derived in a similar fashion: first, the desired width of the NTZ is determined based on safety considerations; then, the desired widths of the inner halves of the two NOZs are determined. The lateral spacing for the new runway would thus be the sum of the NTZ width and the width of the two inner halves of the NOZs. Figure 2-2 shows one example using runway spacing of 1 310 m (4 300 ft).

2.2.5 Spacing requirements of independent parallel instrument approaches

2.2.5.1 The NTZ must provide for the safe resolution of potential conflicts. In the deviation scenario, it is assumed that the deviating aircraft penetrates the NTZ at a 30-degree angle and proceeds on this track toward the aircraft on the adjacent approach. The threatened aircraft is vectored away to achieve separation, and the deviation analysis ends when the threatened aircraft has achieved a 30-degree track change to parallel the intruder's track. Other initial deviation scenario assumptions include the following:

- a) aircraft speeds of 278 km/h (150 kt);
- b) recovery turn rate of 3 degrees per second;
- c) navigation accuracy of 46 m (150 ft) (one sigma) at 19 km (10 NM); and
- d) the navigation accuracy of the non-deviating aircraft is considered to be contained within the three sigma value of the net position-keeping accuracy.

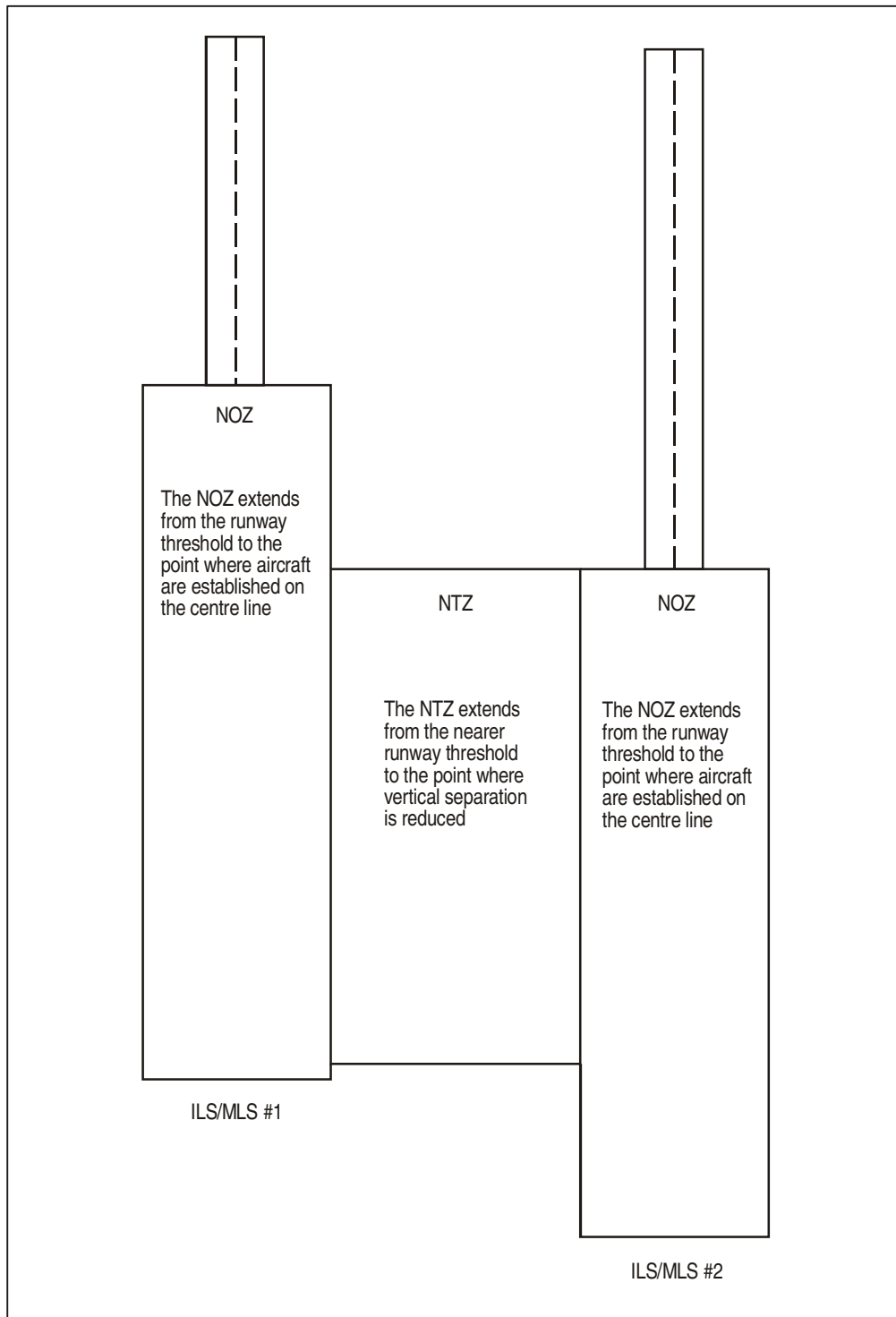

Figure 2-1. Example of normal operating zones (NOZs) and no transgression zone (NTZ)

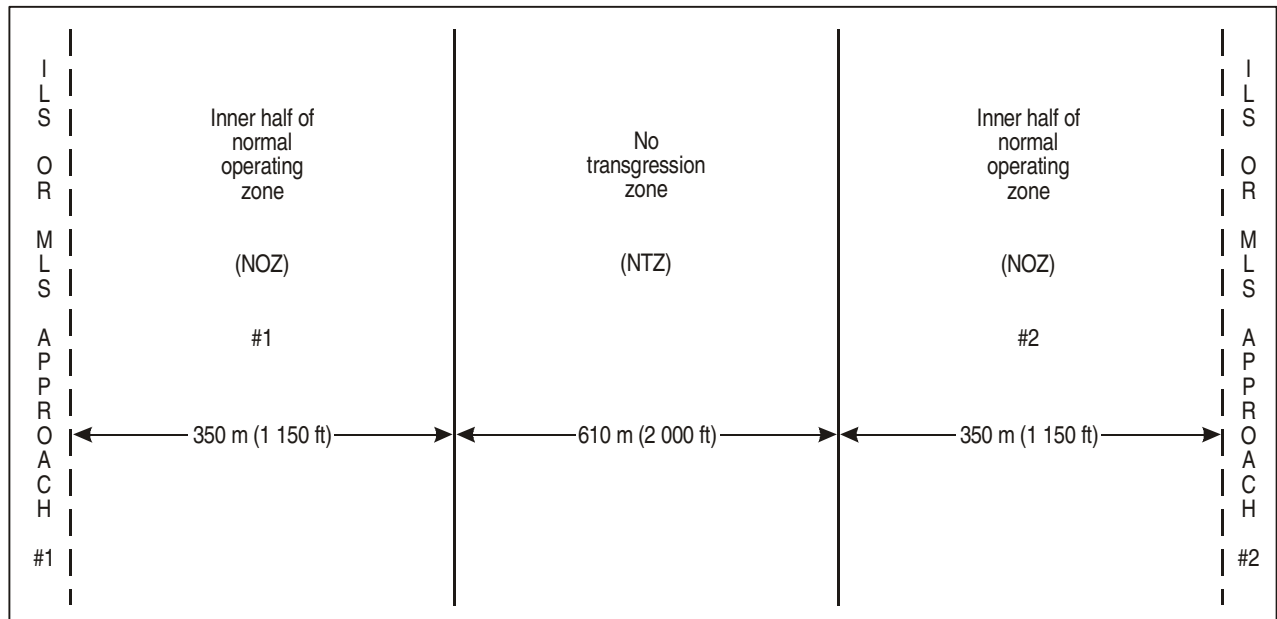

Figure 2-2. Example of spacing of NOZs and NTZ

2.2.5.2 The corresponding values used to ascertain the 1 310 m (4 300 ft) runway spacing are:

- a) *detection zone*: 275 m (900 ft) using surveillance radar with a minimum azimuth accuracy of 0.3 degrees (one sigma) and an update rate of 5 seconds or less;
- b) *delay time*: 8 seconds which corresponds to 300 m (1 000 ft) assuming a dedicated radar monitoring controller with a frequency override broadcast capability;
- c) *correction zone*: 180 m (600 ft) with an assumed 3-degree-per-second correction rate by the threatened aircraft;
- d) *miss distance*: 60 m (200 ft) with a 140 m (450 ft) navigation buffer which means a threatened aircraft is assumed to be not more than 140 m (450 ft) off its centre line at the time of the threat as opposed to being within its own NOZ; and
- e) *inner half of NOZ*: A value of 350 m (1 150 ft) which is the width of the inner half of the NOZ of the deviating aircraft. It is based on the following factors:

- 1) *guidance*: a front-course ILS and/or MLS being flown manually or auto-coupled; and
- 2) *flying precision*: an analysis of an assortment of radar data associated with ILS or MLS approaches.

2.2.6 Safety-related issues affecting independent approaches to closely spaced parallel instrument runways

Note.— Background information related to safety issues and precision runway monitoring (PRM) systems necessary for the implementation of independent approaches to closely spaced parallel instrument runways can be found in Appendix A.

Independent operations on closely spaced parallel runways are extremely safety-critical and should be undertaken only after considerable attention has been devoted to several safety-related issues. In particular, the issues listed below need to be addressed before any implementation.

- a) *Weather limitations*. Independent instrument approaches to parallel runways spaced by less than 1 525 m (5 000 ft) but not less than 1 035 m

- (3 400 ft) between centre lines should, as prescribed by the appropriate air traffic services (ATS) authority, be suspended under certain adverse weather conditions (e.g. windshear, turbulence, downdrafts, crosswind and severe weather such as thunderstorms) which might increase ILS localizer course/MLS final approach track deviations to the extent that safety may be impaired and/or an unacceptable number of deviation alerts would be generated. ATS authorities should establish criteria for the suspension of simultaneous operations on parallel or near-parallel instrument runways under these conditions and should ensure that independent/dependent parallel approaches are only conducted when aircraft are able to adequately follow the ILS localizer course/MLS final approach track. Consideration should be given to the weather characteristics at each individual aerodrome.
- b) *ILS or MLS flight technical error.* Aircraft using the ILS localizer course or MLS final approach track signals are subject to errors from several sources, including the accuracy of the signal, the accuracy of the airborne equipment, and the ability of the pilot or autopilot to follow the navigational guidance (flight technical error (FTE)). Deviations from the ILS localizer course or MLS final approach track may vary with the runway under consideration; it is therefore essential that the FTE be measured at each installation and the procedures adapted to ensure that false deviation alerts are kept to a minimum.
- c) *Communications.* When there is a large deviation from the final approach track, communication between the controllers and pilots involved is critical. For independent parallel approaches, two aerodrome controllers are required, one for each runway, with separate aerodrome control frequencies. The two monitoring radar controllers can transmit on either of these frequencies, automatically overriding transmissions by the aerodrome controllers, or can use dedicated radio channels, if available. It is essential that a check of the override capability at each monitor position be performed prior to the monitoring radar controllers assuming responsibility of the position. ATS authorities should take steps to ensure that, in the event of a deviation, the monitoring radar controller will be able to contact the deviating aircraft and the endangered aircraft immediately. This will involve studying the proportion of time during which communications are blocked.
- d) *Obstacle evaluation.* Since aircraft may need to be turned away from the final approach track at any point during the approach, an obstacle survey and evaluation must be completed for the area opposite the other parallel runway in order to safeguard early turns required to avoid potential intruding aircraft from the adjacent final approach. This check can be made using a set of defined parallel approach obstacle assessment surfaces (PAOAS). Any obstacle that, in the opinion of the appropriate ATS authority, would adversely affect a break-out during independent parallel approaches to closely spaced parallel runways should be depicted on the display to help the monitoring radar controller.
- Note.— An example of a method to assess these obstacles is included in the PANS-OPS, Volume II, Part III. Detailed criteria on the obstacle clearance survey adjacent to the final approach segment are contained in FAA Order 8260.41.*
- e) *Pilot training.* Operators should ensure that flight crews conducting simultaneous independent approaches to parallel runways are adequately trained. Immediate break-out manoeuvres, which are performed on instruction by air traffic control, are different from the missed approach procedures in which pilots are already proficient. The parameters for the manoeuvre, pilot training and periodic proficiency requirements need to be defined by States and operators. Deviations may cause the radar controller to issue instructions to return to the ILS localizer course or MLS final approach track by overriding the aerodrome control frequency. It must be clear to the pilot-in-command that the word “immediately”, when used by the monitoring radar controller, indicates an emergency manoeuvre that must be carried out instantly to maintain spacing from another aircraft.
- f) *Controller training.* Prior to being assigned monitoring duties, air traffic controllers must receive training, including instruction in the specific duties required of a monitoring radar controller.
- g) *Risk analysis.* A risk analysis using available data indicated that the probability of having a miss distance of less than 150 m (500 ft) between aircraft is expected to be less than 1 per 56 000 000 approaches, i.e. 1.8×10^{-8} . This has proved the concept; however, it has not been demonstrated that all such operations anywhere in the world would be

- safe. It is therefore essential that, wherever independent approaches to closely spaced parallel runways are contemplated, a risk analysis be completed for each location to ensure satisfactory levels of safety.
- h) *Airborne collision avoidance system (ACAS)*. During operational evaluations of ACAS II, some unnecessary missed approaches occurred as a result of “nuisance” resolution advisories (RAs). To remedy this situation, a number of modifications were made to the collision avoidance logic. These modifications, however, did not completely eliminate such occurrences. Accordingly, the use of “traffic advisory (TA) only” mode during parallel approach operations should be recommended and indicated on the published approach charts.
- i) *Transponder failure*. SSRs and PRMs are dependent on the aircraft transponder for detection and display of aircraft to the monitoring radar controller. If an aircraft without an operating transponder arrives at an aerodrome, air traffic control (ATC) will create a gap in the arrival flow so that the aircraft will not require monitoring. If an aircraft transponder fails during an instrument approach, the monitoring radar controller will instruct any adjacent aircraft to break out.
- j) *Fast/slow aircraft*. If a fast aircraft deviates towards a slower aircraft on the adjacent approach, the slower aircraft may not be able to escape fast enough to ensure safe spacing. ATC will create a gap in the arrival flow to safeguard the approaches of slower aircraft.
- k) *Approach chart notation*. The charts showing instrument approach procedures to runways used for simultaneous parallel instrument operations should indicate such operations, particularly using the term “closely spaced parallel runways”. The terminology should be reflected in the title of the approach chart including the runway identification.
- l) *Unnecessary break-outs*. An unnecessary break-out is a situation in which the monitoring radar controller initiates a break-out and the deviating aircraft subsequently remains in the NOZ. The number of alerts, both true and false, should be monitored as a method of assessing the performance of the system. It may be necessary to amend the parameters of the alerting mechanism if too many false alerts are experienced.
- m) *Autopilots*. Older autopilots predominantly in use in aging aircraft do not provide significant FTE reduction. Autopilots manufactured today are considerably more advanced and can reduce the FTE if they are used during simultaneous ILS/MLS operations.

2.3 DEPENDENT PARALLEL INSTRUMENT APPROACHES (MODE 2)

2.3.1 General

2.3.1.1 If the spacing between runway centre lines is not adequate for independent parallel approaches, a dependent approach procedure may be used when the runways are spaced by 915 m (3 000 ft) or more. In these situations, controller monitoring requirements are eased and runway spacing is reduced, compared to the requirements for independent parallel approaches.

2.3.1.2 For dependent parallel approaches, the radar separation between aircraft on adjacent approaches gives a measure of protection which is provided by the NOZ and NTZ for independent parallel approaches; consequently, dependent parallel approaches can be conducted at closer runway spacings than independent parallel approaches.

2.3.2 Requirements and procedures

Note.— See the Procedures for Air Navigation Services — Air Traffic Management (PANS-ATM, Doc 4444), Chapter 6, 6.7.3.4.

2.3.2.1 Dependent parallel approaches may be conducted to parallel runways provided:

- a) the runway centre lines are spaced by the distance specified in Annex 14, Volume I;
- b) the aircraft are radar-vectorred to intercept the final approach track by separate radar controllers who are responsible for the sequencing and spacing of arriving aircraft to each runway;
- c) suitable surveillance radar with a minimum azimuth accuracy of 0.3 degrees (one sigma) and an update period of 5 seconds or less is available;
- d) ILS and/or MLS approaches are being conducted on both runways;

Note.— It is preferred that an ILS and/or MLS serving a runway used for simultaneous parallel approaches has co-located precision distance measuring equipment (DME).

- e) aircraft are advised that approaches to both runways are in use (this information may be provided through the ATIS);
- f) the missed approach track for one approach diverges by at least 30 degrees from the missed approach track of the adjacent approach; and
- g) the approach control unit has the capability to override transmissions of the aerodrome control unit.

2.3.2.2 The minimum radar separation to be provided between aircraft established on the ILS localizer course and/or MLS final approach track shall be:

- a) 5.6 km (3.0 NM) between aircraft on the same ILS localizer course or MLS final approach track unless increased longitudinal separation is required due to wake turbulence; and
- b) 3.7 km (2.0 NM) between successive aircraft on adjacent ILS localizer courses or MLS final approach tracks (see Figure 2-3).

2.3.2.3 A minimum of 300 m (1 000 ft) vertical separation or a minimum of 5.6 km (3.0 NM) radar separation shall be provided between aircraft during turn-on to parallel ILS localizer courses and/or MLS final approach tracks.

2.3.2.4 Each pair of parallel approaches has a “high side” and a “low side” for vectoring to provide vertical separation until aircraft are established inbound on their respective parallel ILS localizer course and/or MLS final approach track. The low-side altitude should be such that the aircraft will be established on the ILS localizer course or MLS final approach track well before ILS glide path or specified MLS elevation angle interception. The high-side altitude should be 300 m (1 000 ft) above the low side at least until 19 km (10 NM) from the threshold.

2.3.2.5 No separate monitoring controller is required. Instead, the radar approach controller monitors the approaches to prevent violations of required separation.

2.3.3 Safety-related issues affecting dependent approaches to closely spaced parallel instrument runways

2.3.3.1 The minimum spacing between two aircraft in the event of a deviation is calculated using techniques similar to those used for independent parallel approaches.

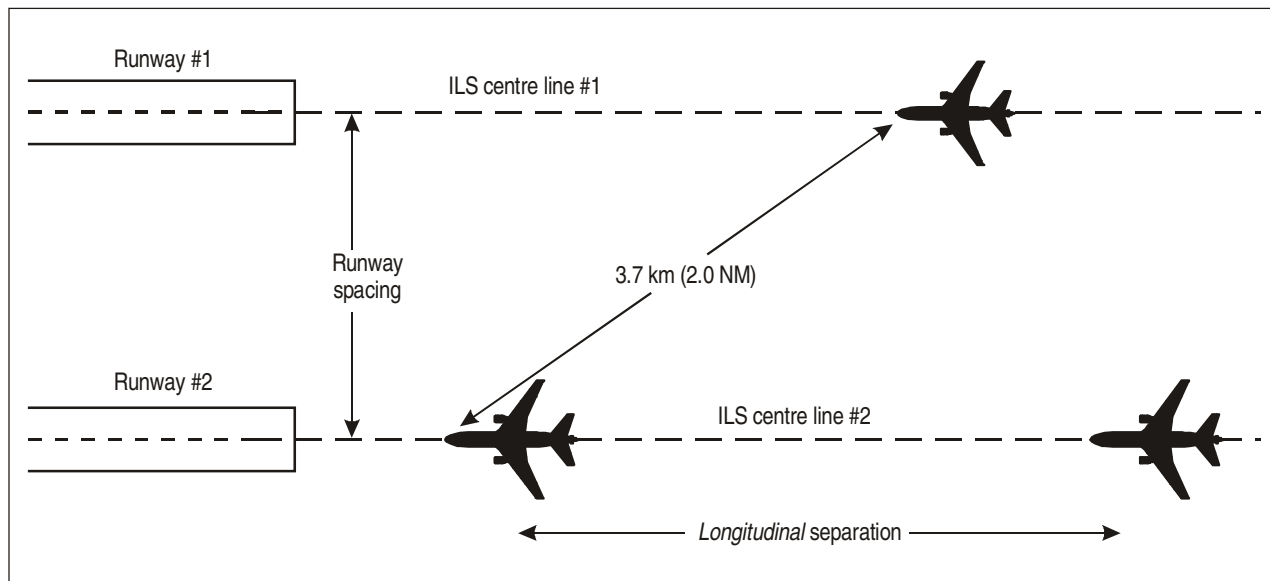

Figure 2-3. Dependent parallel approaches

Current procedures allow dependent parallel approaches to runways as close as 915 m (3 000 ft) apart. The minimum distance between aircraft in the event of a deviation at 915 m (3 000 ft) runway spacing is greater than that for a spacing of 1 310 m (4 300 ft). As the runway spacing decreases, the minimum distance between aircraft increases (see Table 2-1). Two factors apply:

- a) since radar separation is applied diagonally, less distance between runways means a greater in-trail distance between the aircraft; and
- b) less distance between runways also means that the deviating aircraft crosses the adjacent approach track more quickly.

2.3.3.2 Before the required runway spacing for dependent parallel approaches can be reduced, however, other potential problems must be addressed. At present, for wake turbulence reasons, parallel runways spaced less than 760 m (2 500 ft) apart are considered to be a single runway. Alternating arrivals would therefore have to be separated by the single runway separation minima.

Note.— See PANS-ATM, Chapter 8, 8.7.4.4, for wake turbulence radar separation minima.

2.4 DIFFERENCES BETWEEN INDEPENDENT AND DEPENDENT PARALLEL APPROACHES

2.4.1 The differences in the concepts and geometries of independent and dependent parallel approaches have led to differences in the assumptions, and occasionally the methodologies, of the analyses of the two modes of operation. For example, different criteria are used for deciding that a deviation has occurred; for independent parallel approaches, an aircraft entering the NTZ between the two runways constitutes a deviation, while for dependent parallel approaches, a violation of the diagonal separation between aircraft on adjacent approaches constitutes a deviation. The differences are summarized in Table 2-2.

2.4.2 Several of the inputs to the deviation analyses differ between the two cases because of the use of the different triggers. Since the lateral departure from the centre line is the indication of a deviation in the case of independent parallel approaches, the lateral (azimuth) error of the radar and display is an input. For dependent parallel

approaches, the diagonal separation between the aircraft is significant; although there is a lateral component to this separation, it is principally a longitudinal measure. A combination of the radar range error and longitudinal display errors is, therefore, input to the dependent parallel approach analysis.

2.4.3 For independent parallel approaches, the size of the NOZ is determined. The lateral navigation error and the acceptable rate of false alerts (for deviations beyond the inner half of the NOZ) are required for this determination. The dependent parallel approach calculations do not need to consider a lateral NOZ since a longitudinal trigger is used.

2.4.4 Other differences in the inputs reflect the fact that two monitoring radar controllers are required for independent (but not dependent) parallel approaches. It is therefore assumed that any penetration of the NTZ would be detected immediately. For dependent parallel approaches without separate monitoring radar controllers, the radar approach controller's attention would at times be directed elsewhere. For this reason, a value of 0.5 was assigned to the PGDP.

2.4.5 The absence of separate monitoring positions also leads to a difference in the delay times used in the calculations. It is assumed that it will take 8 s for the monitoring controller to react, coordinate with the other monitoring controller and determine the appropriate resolution manoeuvre, and communicate the instructions to achieve separation, and for the pilot and aircraft to respond. For dependent parallel approaches, it is assumed that the controller would wait for the next update to verify that a deviation has actually occurred.

2.4.6 Only the lateral component of the track separation is considered in the case of independent parallel approaches; however, a longitudinal component may exist as well, but it is not relevant to the calculation. The initial longitudinal position of the aircraft is not fixed. Therefore, an expected value of longitudinal separation could be calculated, although it would require data on the probable relative position at the start of the deviation.

2.4.7 The dependent parallel approach analysis is based on the minimum separation between aircraft in the event of a deviation since both the initial lateral and longitudinal positions of the aircraft are known.

**Table 2-1. Minimum distance between aircraft
in the event of a deviation for dependent parallel approaches**

<i>Runway spacing</i>	<i>Minimum distance</i>
1 310 m (4 300 ft)	2 135 m (7 000 ft)
915 m (3 000 ft)	2 300 m (7 550 ft)

Note.— Airspeeds = 278 km/h (150 kt).

**Table 2-2. Summary of differences between independent
and dependent parallel approaches**

<i>Situation</i>	<i>Independent parallel approaches</i>	<i>Dependent parallel approaches</i>
Deviation	Violation of NTZ (lateral boundary)	Violation of separation (mainly longitudinal)
Inputs to analysis	Azimuth error (radar and display) Lateral navigation error False alarm rate PGDP* = 1.0 (implicit) 2 monitoring controllers 8-second control delay	Combined range and azimuth error (mostly display) Lateral navigation error not considered False alarm rate not explicitly considered PGDP* = 0.5 (input) No separate monitoring controllers 12-second control delay
Deviation resolution criteria	Miss distance	Minimum separation between aircraft

* Probability-of-good-data point (PGDP) — The probability that a good radar return will be displayed and recognized by the controllers.

Chapter 3

INDEPENDENT INSTRUMENT DEPARTURES FROM PARALLEL RUNWAYS (MODE 3)

3.1 GENERAL

Parallel runways may be used for independent instrument departures as follows:

- a) both runways are used exclusively for departures (independent departures);
 - b) one runway is used exclusively for departures, while the other runway is used for a mixture of arrivals and departures (semi-mixed operation); and
 - c) both runways are used for mixed arrivals and departures (mixed operation).
- c) suitable surveillance radar capable of identifying the aircraft within 2 km (1.0 NM) from the end of the runway is available; and
 - d) ATS operational procedures ensure that the required track divergence is achieved.

3.3 RUNWAY SPACINGS

3.3.1 There is no requirement, other than satisfactory two-way radiocommunications, for any other specialized form of control or navigation aid facility for the conduct of independent instrument departures when the spacing between parallel runways is 1 525 m (5 000 ft) or more and a course divergence after take-off of 45 degrees or more can be achieved (see Figure 3-1).

3.3.2 Simultaneous take-off of aircraft departing in the same direction from parallel runways is authorized where the runway centre lines are spaced by at least 760 m (2 500 ft), suitable surveillance radar is available, and courses diverge by 15 degrees or more immediately after departure (see Figure 3-2).

3.2 REQUIREMENTS AND PROCEDURES

Independent IFR departures may be conducted from parallel runways provided:

- a) the runway centre lines are spaced by the distance specified in Annex 14, Volume I;
- b) the departure tracks diverge by at least 15 degrees immediately after take-off;

Note.— Procedures for independent instrument departures from parallel runways are contained in the PANS-ATM, Chapter 6, 6.7.

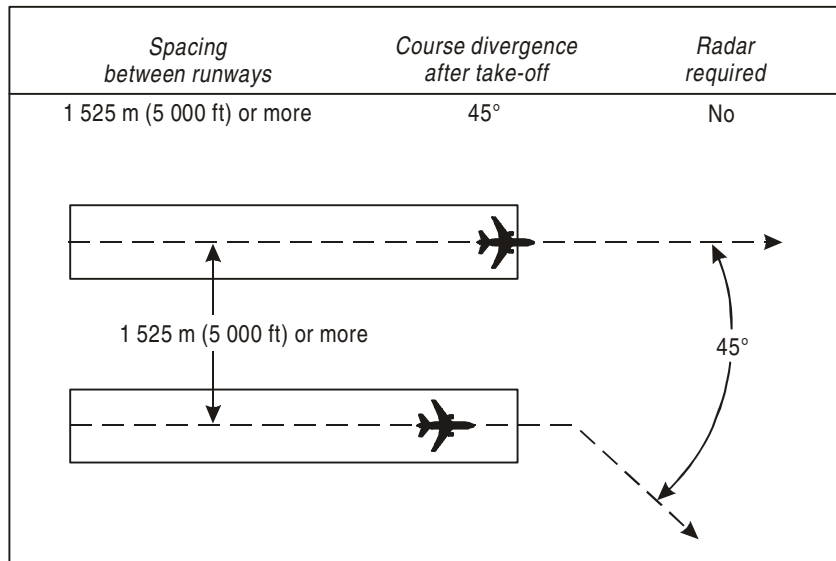

Figure 3-1. Independent instrument departures when parallel runway spacing is 1 525 m (5 000 ft) or more

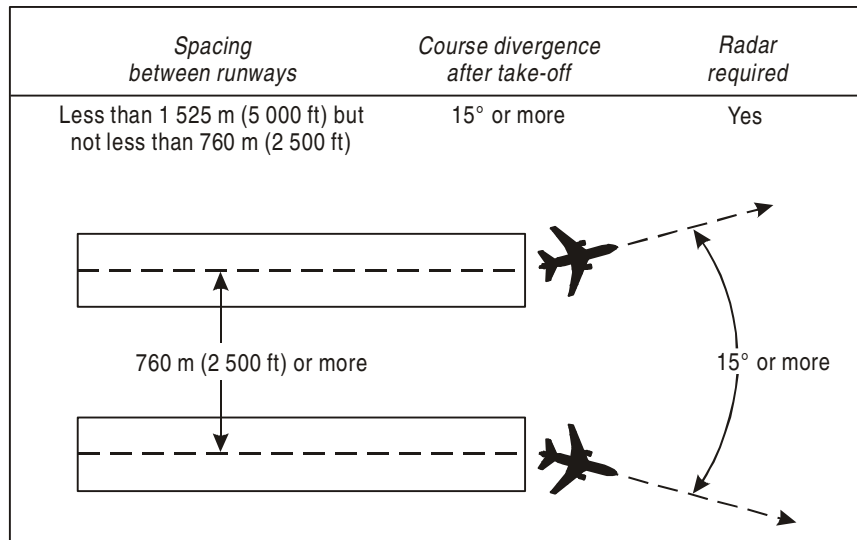

Figure 3-2. Independent instrument departures when parallel runway spacing is less than 1 525 m (5 000 ft) but not less than 760 m (2 500 ft)

Chapter 4

SEGREGATED OPERATIONS ON PARALLEL RUNWAYS (MODE 4)

4.1 GENERAL

4.1.1 Theoretical studies and practical examples indicate that maximum aerodrome capacities can be achieved by using parallel runways in a mixed mode of operation. In many cases, however, other factors (such as the landside/airside infrastructure, the mix of aircraft types, and environmental considerations) result in a lower, achievable capacity.

4.1.2 Other factors (such as non-availability of landing aids on one of the parallel runways or restricted runway lengths) may preclude the conducting of mixed operations at a particular aerodrome.

4.1.3 Because of these constraints, maximum runway capacity may, in some cases, only be achieved by adopting a fully segregated mode of operation, i.e. one runway is used exclusively for landings, while the other is used exclusively for departures.

4.1.4 The advantages to be gained from segregated parallel operations as compared with mixed parallel operations are:

- a) separate monitoring controllers are not required;
- b) no interaction between arriving and departing aircraft on the same runway and consequential reduction in the number of potential missed approaches;
- c) an overall less complex ATC environment for both radar approach controllers and aerodrome controllers; and
- d) a reduced possibility of pilot error due to selection of wrong ILS or MLS frequency.

4.2 REQUIREMENTS AND PROCEDURES

4.2.1 Segregated parallel operations may be conducted on parallel runways provided:

- a) the runway centre lines are spaced by the distance specified in Annex 14, Volume I; and
- b) the nominal departure track diverges immediately after take-off by at least 30 degrees from the missed approach track of the adjacent approach.

4.2.2 The following types of approaches may be conducted in segregated parallel operations provided that suitable surveillance radar and the appropriate ground facilities conform to the standard necessary for the specific type of approach:

- a) ILS and/or MLS approach;
- b) surveillance radar or precision radar approach; and
- c) visual approach.

4.3 RUNWAY SPACINGS

4.3.1 When parallel runway thresholds are even and the runway centre lines are at least 760 m (2 500 ft) apart, simultaneous operations between an aircraft departing on one runway and an aircraft on final approach to another parallel runway may be authorized if the departure course diverges immediately after take-off by at least 30 degrees from the missed approach track of the adjacent approach until other separation is applied (see Figure 4-1).

4.3.2 The minimum distance between parallel runway centre lines for segregated parallel operations may be decreased by 30 m (98 ft) for each 150 m (500 ft) that the arrival runway is staggered toward the arriving aircraft, to

a minimum of 300 m (984 ft) (see Figure 4-2), and should be increased by 30 m (98 ft) for each 150 m (500 ft) that the arrival runway is staggered away from the arriving aircraft (see Figure 4-3).

Note 1.— In the event of a missed approach by a heavy aircraft, wake turbulence separation should be applied or,

alternatively, measures taken to ensure that the heavy aircraft does not overtake an aircraft departing from the adjacent parallel runway.

Note 2.— Procedures for segregated parallel operations are contained in the PANS-ATM, Chapter 6, 6.7.3.5, and the PANS-OPS, Volume I, Part VII, Chapter 1.

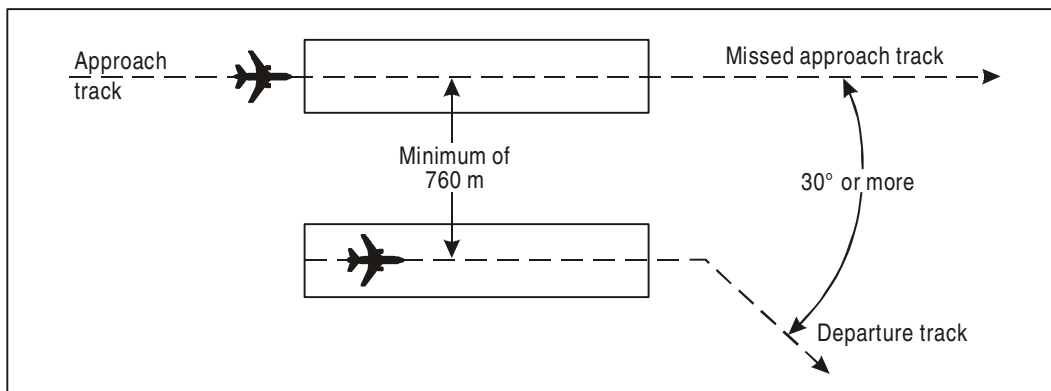

Figure 4-1. Segregated parallel operations where thresholds are even

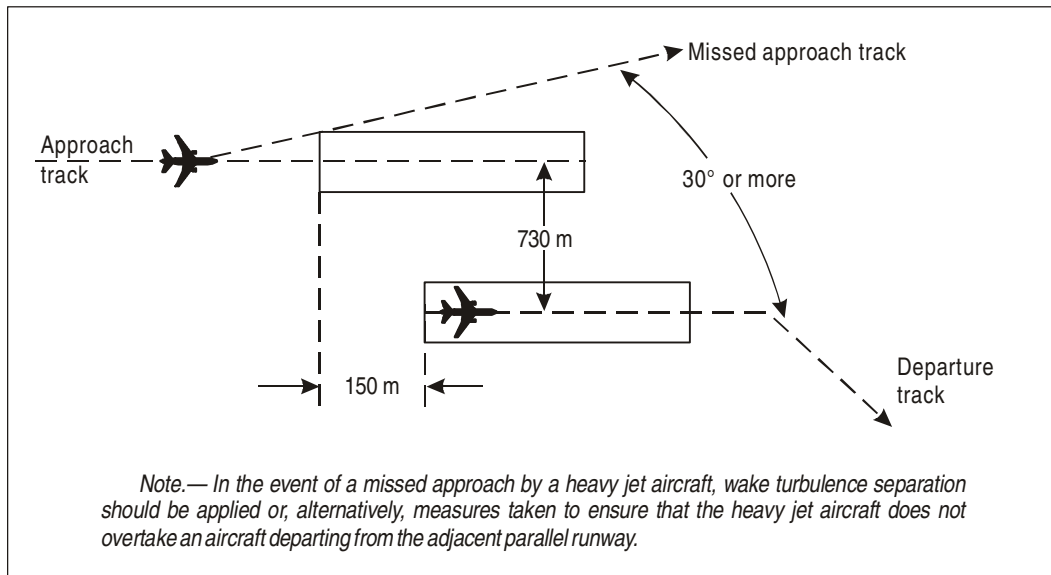

Figure 4-2. Segregated parallel operations where runways are staggered

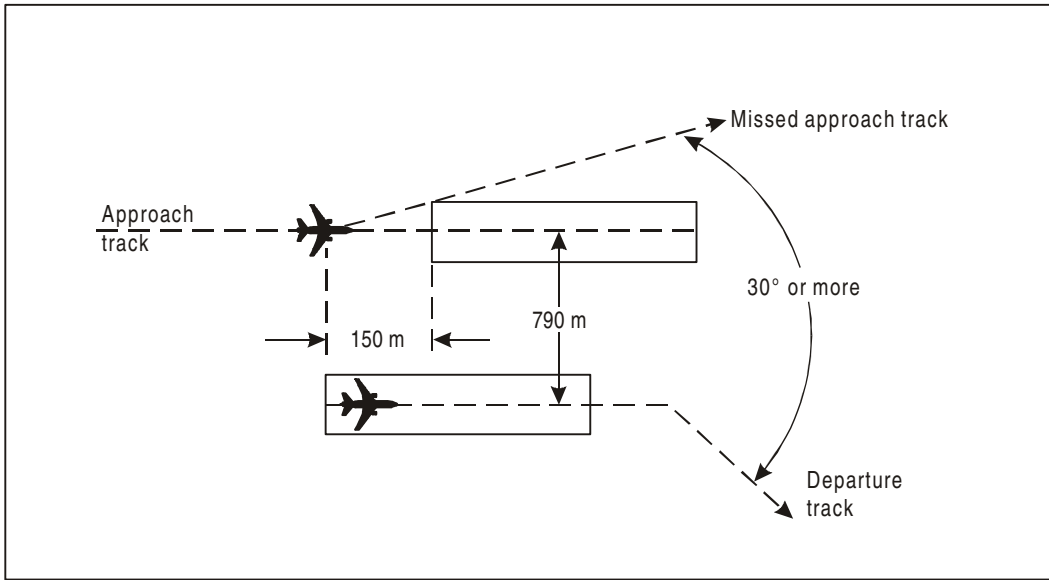

Figure 4-3. Segregated parallel operations where runways are staggered

Chapter 5

NEAR-PARALLEL RUNWAYS

5.1 GENERAL

5.1.1 Near-parallel runways are non-intersecting runways whose extended centre lines have an angle of convergence/divergence of 15 degrees or less.

5.1.2 No special procedures have been developed for simultaneous operations to near-parallel runways. Each situation is considered on a case-by-case basis and is dependent on a number of variable conditions.

5.1.3 The most important factor to be considered in developing procedures for simultaneous operations to near-parallel runways is the point at which the runway centre lines converge. This point depends on the relative position of the two runways (even or staggered) and the angle of convergence.

5.1.4 It is also important to consider whether the two runways are used simultaneously in the converging or diverging direction. In the diverging direction of two

near-parallel runways, independent approaches are not possible where there are intersecting approach paths. On the other hand, for independent departure or segregated operations, the diverging direction leads to a natural lateral separation and is acceptable (see Figure 5-1). An example of converging/diverging runway operations is at Appendix B.

5.1.5 The various modes of operation described in the preceding chapters should also be considered for near-parallel runway operations. A study must be made for each mode of operation for each specific aerodrome before such procedures can be implemented.

5.2 GROUND EQUIPMENT

Ground equipment should conform to the standard necessary for the type of approaches conducted at the aerodrome. Surveillance radar equipment should be required.

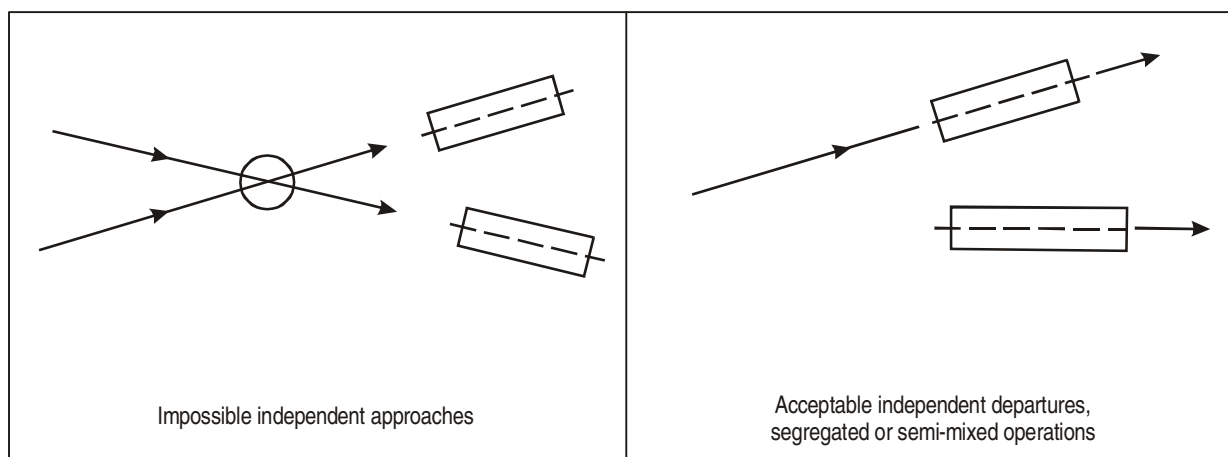

Figure 5-1. Operations on near-parallel runways

Chapter 6

TRAINING OF ATS PERSONNEL

6.1 GENERAL

6.1.1 Training of ATS personnel is a prerequisite for the introduction of operations on parallel instrument runways. This chapter describes only the additional training that should be given to aerodrome controllers at units where they may be assigned a limited responsibility for separation of IFR flights. In the case of approach controllers, only those additional measures which are specific to simultaneous parallel operations are described.

6.1.2 When parallel approaches are contemplated, the training plan should include training in a simulator so that controllers learn to observe, detect and react to deviating aircraft situations.

6.1.3 The training should be incorporated into the unit training plan and the required knowledge and skill levels should be satisfactorily demonstrated to the competent authority.

6.1.4 Training should be divided into two categories: training for approach controllers and training for aerodrome controllers.

6.2 TRAINING FOR APPROACH CONTROLLERS

Since approach controllers are already fully qualified in both radar and non-radar procedures, the only additional training required for them would be:

- a) an explanation of additions and changes to the procedures and agreements between the approach control unit and the aerodrome control tower;
- b) instructions in the application of vertical separation until the aircraft is at least 19 km (10 NM) from the threshold and is within the NOZ established on the ILS localizer course and/or MLS final approach track;

- c) instructions in the monitoring of aircraft on approaches to ensure containment within the NOZ and avoidance of the NTZ;
- d) instructions regarding action to be taken if aircraft stray from the ILS localizer course and/or MLS final approach track; and
- e) instructions in the procedures to follow in the event of a missed approach.

6.3 TRAINING FOR AERODROME CONTROLLERS

Aerodrome controllers at aerodromes where simultaneous parallel approaches/departures are to be used may provide separation, within prescribed limits, between IFR aircraft. It will therefore be necessary to train them in some or all of the following areas:

- a) basic radar theory;
- b) operation, set-up and alignment of radar equipment in use at the unit;
- c) identification of aircraft;
- d) radar separation minima and their application;
- e) provisions regarding terrain clearance;
- f) provision of radar vectors and position information, including:
 - 1) when vectors may or shall be used;
 - 2) methods of vectoring aircraft; and
 - 3) termination of vectoring;
- g) action to be taken in the event of radar or communications failure, including:

- 1) air-ground communication failure procedures;
and
 - 2) procedures for communications failure during
radar vectoring;
 - h) action to be taken and instructions to be issued in
the event of a missed approach; and
 - i) the terms, procedures and agreements (and their
application) between the approach control unit and
the aerodrome control tower. In particular, they
should know the provisions governing the release
of successive IFR departures (where authorized)
and the release of independent parallel departures
with reference to arriving aircraft (including those
carrying out missed approaches).
-

Chapter 7

IMPLEMENTATION

7.1 TRIALS

7.1.1 A decision to implement independent or dependent operations on parallel or near-parallel instrument runways should only be taken after a trial and familiarization period during which it has been satisfactorily proven that all the elements, such as ground equipment, personnel qualifications and ATC procedures, are properly integrated in the overall system.

7.1.2 The trials should be monitored by a group which should include ATS experts, representatives of operators, and aerodrome authorities. The trial period should cover a sufficient number of approaches in various conditions, so that the monitoring group can evaluate the level of risk of inadvertent intrusion of the NTZ by an aircraft and the capability of ATC to react adequately to such a situation. For example, the trial period should include a number of operations in adverse wind conditions in order to assess the ability of the ATC personnel to cope with deviations. The trials should also determine the ability of the ATC personnel to establish and maintain the required radar separation while monitoring the operations in various weather conditions.

7.1.3 It is advisable during the trial period to specify weather conditions allowed in the first stage of the trial so that the “see-and-avoid” principle can be applied by the pilot. These weather conditions should then be cautiously and progressively reduced as the trials progress satisfactorily.

7.2 IMPLEMENTATION

7.2.1 Before implementing operations on parallel instrument runways, it should be ensured that:

- a) the runways concerned are suitably equipped;
- b) the procedures appropriate to such operations have been determined and tested; and

- c) the local ATC units are suitably equipped and personnel are properly trained.

7.2.2 The procedure should be promulgated by the AIRAC system, giving a notice of 56 days, and should contain the following elements:

- a) runways involved, with their respective ILS or MLS characteristics (frequency, identification, category);
- b) a general description of runway usage;
- c) periods of availability;
- d) special status (e.g. on trial, with weather limitations), if any;
- e) description of the NOZ and the NTZ (independent parallel approaches only);
- f) airborne equipment requirements; and
- g) description of the procedures, including radar monitoring, missed approach procedure, and advisory and corrective ATC actions vis-à-vis one or both aircraft when an aircraft is observed leaving the ILS localizer course and/or the MLS final approach track, or approaching the edge of the NOZ, or penetrating the NTZ.

Note.— For independent parallel approaches, particular emphasis is to be placed on the levels of the ILS glide path and/or the MLS elevation angle interception (“high side” and “low side”) and on the requirement to maintain these levels until the aircraft is established on both the ILS localizer/glide path and/or the MLS final approach track/elevation angle.

7.2.3 The appropriate ATS authority should provide information and guidance for pilots relevant to the selected

mode(s) of operation associated with the use of parallel and near-parallel instrument runways. Following the trials, information on the modes of simultaneous operation selected should be included in the Aeronautical Information Publication (AIP).

7.2.4 Instrument approach charts for a runway where simultaneous independent or dependent parallel approaches

are permitted should contain a note indicating clearly the runways involved and whether they are “closely spaced” parallel runways.

7.2.5 ATIS broadcasts should include the fact that independent parallel approaches or independent parallel departures are in progress, specifying the runways involved.

Appendix A

PRECISION RUNWAY MONITORS AND SAFETY ISSUES RELATING TO INDEPENDENT PARALLEL APPROACHES TO CLOSELY SPACED PARALLEL INSTRUMENT RUNWAYS

1. PRECISION RUNWAY MONITOR (PRM)

1.1 Theoretical studies indicated that new radar system and radar display technologies could be successfully applied to simultaneous operations on closely spaced parallel instrument runways. In order to validate the practicability of operational implementation, a programme of demonstrations of new precision runway monitor (PRM) sensors was initiated. New equipment and procedures were demonstrated at two international airports which had parallel runways with 1 035 m (3 400 ft) and 1 065 m (3 500 ft) spacing between the centre lines, respectively. The objective of the demonstrations was to determine the feasibility of, and prerequisites for, implementing independent parallel instrument approaches at airports where the existing parallel runways were not being utilized efficiently under IMC due to their close spacings.

1.2 Three major activities were included in the PRM demonstration programme:

- a) a proof-of-concept activity which involved the development and testing of two engineering prototype PRM systems to establish their technical feasibility;
- b) operational demonstrations to provide opportunities for air traffic controllers, airline industry representatives, and pilots to observe the PRM systems in operation; and
- c) a performance evaluation to measure the effectiveness of the system.

1.3 In order to support a reduced parallel runway spacing, it was concluded that a number of technical

improvements were required, i.e. improved SSR azimuth accuracy, improved SSR update rate, radar displays with higher resolution, and automatic deviation alerts. During the PRM proof-of-concept activity, two candidate SSR systems were installed and tested. An electronically scanned, circular-array radar provided an azimuth accuracy of 0.06 degrees (one sigma) and an update rate of 0.5 seconds or less. A second candidate radar, based on a Mode S ground interrogator, provided the same azimuth accuracy. The existing radar had one SSR antenna and an update period of 4.8 seconds. For the PRM demonstration programme, a second SSR antenna was added to the back of the existing antenna, enabling the aircraft position to be updated every 2.4 seconds.

1.4 A new-technology, high-resolution colour display, which was used as part of the proof-of-concept activity, enabled the monitoring radar controllers to detect deviations from the centre line as small as 30 m (98 ft). In addition, the display system incorporated automatic alerts, designed to focus a controller's attention on a possible deviation before the aircraft entered the NTZ which was 610 m (2 000 ft) wide for a spacing of 1 035 m (3 400 ft) between runway centre lines. Furthermore, the system predicted the position of each aircraft for the next ten seconds. If this prediction indicated that the aircraft would enter the NTZ within ten seconds, a "caution alert" was generated, the radar position symbol of the aircraft was shown in yellow and an audible alert was emitted. If the aircraft entered the NTZ, a second level alert (warning) was generated and the radar position symbol was shown in red. The scale of the axis perpendicular to the runways was enlarged four times compared with the scale of the axis along the approach tracks which made lateral deviations from the centre line more readily apparent to the monitoring radar controller.

1.5 The operational demonstrations used live flight tests and full-motion aircraft simulators flying predefined deviation scenarios to allow controllers, pilots and airline industry representatives to see and experience the PRM system in operation. Radio communications were analysed to provide communications delay data. Pilot and aircraft response times were measured using full-motion flight simulators for aircraft types B 727 and DC 10.

1.6 The system performance evaluation activity used a statistical collision risk model developed during the PRM programme. This model used data collected during the programme and provided estimates of the probability of a miss distance of less than 150 m (500 ft) occurring due to an unresolved deviation. The model simulated a large number (100 000) of “worst case” deviations (30-degree deviations, assuming that in only one per cent of such deviations would the pilot be unable to respond to a controller’s instruction to return to the centre line) and measured the minimum spacing for each. The model indicated that about one “worst case” deviation in 250 would result in a minimum spacing of less than 150 m (500 ft). Combined with a target of one “worst case” deviation per 25 million approaches, one 30-degree deviation in 1 000 or more independent parallel approach pairs could be tolerated.

1.7 The specifications for precision runway monitors are shown in Table A-1.

2. BACKGROUND SAFETY-RELATED ISSUES

2.1 *ILS or MLS flight technical error.* A significant amount of total navigation system error (TNSE) data (i.e. aggregate aircraft deviations from the extended runway centre line) was collected, mainly within 19 km (10 NM) from the runway threshold. It was concluded that, when vertical separation is maintained until at least 19 km (10 NM) from the runway threshold, the number of TNSE is acceptable for independent parallel approaches. A data collection of TNSE was conducted during which IFR flights were tracked as far as 74 km (40 NM) from the runway threshold. It was found that TNSE increases with range and that approach controllers may have to intervene to minimize operational disruptions. The safety and success of independent approaches on closely spaced parallel

runways are critically dependent on the aircraft’s ability to closely follow the ILS localizer course or MLS final approach track. Obviously, major deviations cause a threat to aircraft on adjacent approaches, but minor deviations may also cause an unacceptable number of false alerts and therefore affect the smooth running of the operation. The measurements of deviations from the ILS localizer course/MLS final approach track are critical in the development of operational procedures.

2.2 *Communications.* The monitoring radar controller cannot override a transmission from an aircraft. To take this into account in the collision risk model, aerodrome control communications were recorded at three major airports during instrument meteorological conditions. An analysis indicated that blocked communications situations would occur in only 4 per cent of the “worst case” deviations and would therefore not change the overall risk calculations upon which the operations were based. The likelihood of communications failure due to stuck microphones on both frequencies coincident with a 30-degree deviation was extremely remote. The combination of communication blockages while having a miss distance of less than 150 m (500 ft) between aircraft during operations was expected to be no more than 1 occurrence per 1 400 000 000 simultaneous ILS approaches, i.e. 7×10^{-10} .

2.3 *MLS and new technologies.* The MLS, when used for straight-in approaches, provides for at least the same system accuracy as ILS CAT I. Therefore, the results of the ILS TNSE data assessment are equally applicable to MLS approaches. With regard to new precision approach aids technology, including the global navigation satellite system (GNSS), work is under way to evaluate those systems for the purpose of supporting simultaneous instrument operations to closely spaced parallel runways.

2.4 *Unnecessary break-outs.* An unnecessary break-out is a situation in which the monitoring radar controller initiates a break-out and the deviating aircraft subsequently remains in the normal operating zone. This may occur when an aircraft acts as though it will penetrate the NTZ and generates a PRM alert, but subsequently completes its approach without entering the NTZ. If unnecessary break-outs occur frequently, the system is perceived as generating too many false alerts and the warning may not be believed, causing safety hazards. In addition, unnecessary break-outs decrease the efficiency gains obtained by implementing independent parallel instrument approaches.

Table A-1. Precision runway monitor specifications

Type	Monopulse secondary surveillance radar (MSSR) for civil air traffic control.
Function	Interrogates Mode-A and Mode-C transponders. Receives and processes replies. Measures target range, azimuth angle, and reply amplitude. Displays target information on a high-resolution display.
Frequency	1 030 MHz (transmit), 1 090 MHz (receive)
Operating modes	Mode-A, Mode-C, can be upgraded to Mode-S
Transmitter	Solid-state, 1 100 watts peak, variable
Pulse repetition frequency	450 maximum
Antenna size	Circular 5.2 m (17.1 ft) diameter, 1.6 m (5.1 ft) high
Antenna elements	128 columns, each with 10 dipole radiators
Antenna gain	21 dB \pm 0.3 dB over 360 degrees of horizontal coverage
Antenna beam shape	Sum (Σ) and difference (Δ)
Antenna beamwidth (azimuth) (elevation)	Normal, 3.2 degrees 11 degrees
Coverage (azimuth) (elevation)	360 degrees in 4 096 discrete beam positions Up to 40 degrees
Azimuth accuracy	Within 0.057 degrees (one sigma)
Azimuth resolution	Resolves radar blips with 183 m (600 ft) lateral spacing at 19 km (10 NM).
Range coverage	Greater than 59 km (32 NM), expandable to 370 km (200 NM).
Range accuracy	Better than \pm 18.3 m (60 ft) excluding transponder bias error.
Range resolution	Less than 185 m (0.1 NM).
Monopulse receiver	Digital (12 bit A/D), self-compensating for phase and amplitude errors between the sum and difference channels.
Radar blip tracking	More than 25 radar blips at 1.0-second update rate while searching for new blips.
Displays	High-resolution colour monitors.
Built-in test	Full built-in test initiated at power up. In every second, a minimum of 450 ms is scheduled for built-in testing. A monitor detects failures to the individual antenna column.
Monitoring	Maintenance display and printer available both in the equipment shelter and at the operations site.

Appendix B

EXAMPLE OF RUNWAY SPACINGS AND ATC PROCEDURES USED IN FRANCE

1. RUNWAY CONFIGURATION

Simultaneous operations on near-parallel runways are conducted at Paris/Orly Airport, France. The runways are oriented 07/25 and 08/26 (see Figure B-1).

2. OPERATIONS

2.1 The two runways 07/25 and 08/26 which have a 13-degree angle of convergence are used for segregated independent operations:

- easterly: 07 for landing, 08 for take-off;
- westerly: 26 for landing, 25 for take-off.

2.2 For departures in the easterly direction (07/08), the two runways are treated as independent because the

divergence leads to a natural lateral separation (see Figure B-2).

2.3 In the westerly direction (25/26), there is some dependence because the runways are converging. Appropriate separation has to be maintained between the take-off course on runway 25 and missed approach course on runway 26 (see Figure B-3). When weather conditions are favourable, the two runways are operated as independent runways because in the initial phase of missed approach, visual contact with aircraft taking off on the other runway can be maintained. In weather conditions where visibility is below 2 000 m (6 500 ft) and/or cloud base below 150 m (500 ft), when an aircraft on final approach is 3.7 km (2.0 NM) from the threshold, no take-off clearance is issued until the controller is confident that a missed approach will not take place.

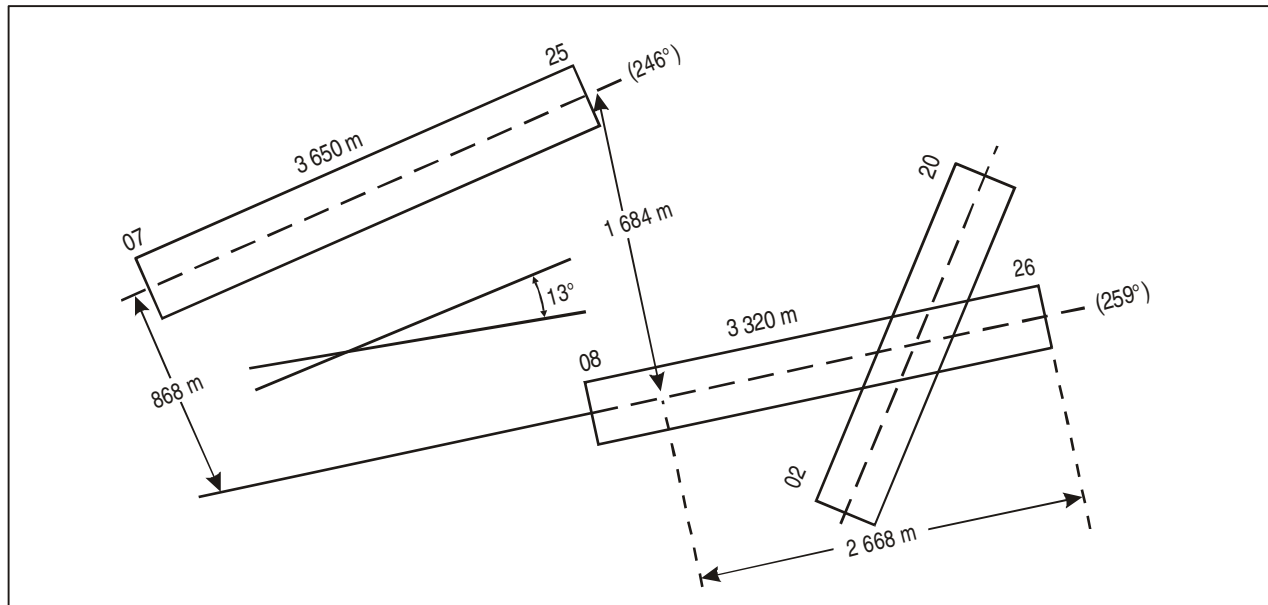

Figure B-1. Simultaneous operations on near-parallel runways

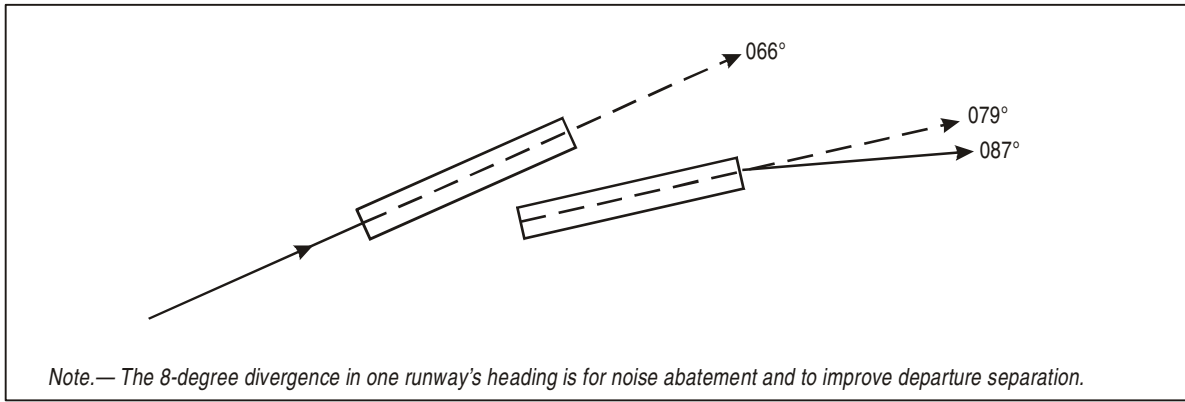

Figure B-2. Departures in easterly direction (independent runways)

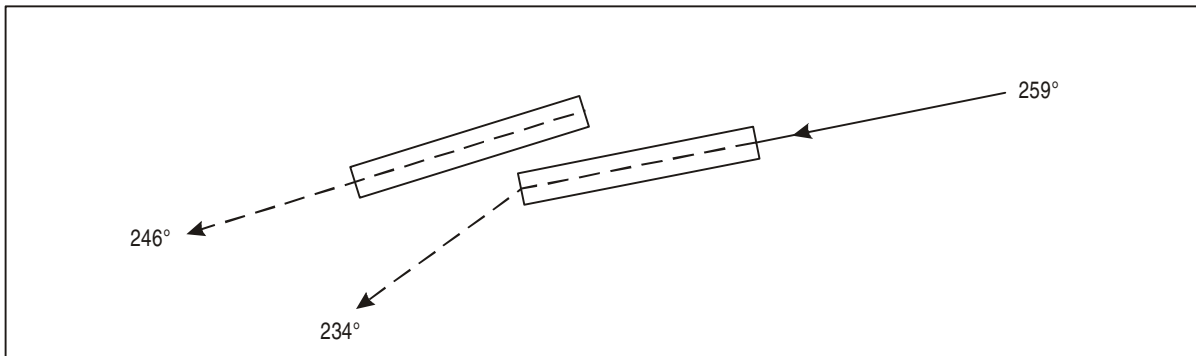

Figure B-3. Departures in westerly direction (converging runways)

— END —

ICAO TECHNICAL PUBLICATIONS

The following summary gives the status, and also describes in general terms the contents, of the various series of technical publications issued by the International Civil Aviation Organization. It does not include specialized publications that do not fall specifically within one of the series, such as the *Aeronautical Chart Catalogue*.

- *International Standards and Recommended Practices (SARPs)* are adopted by the Council in accordance with Articles 54, 37 and 90 of the Convention on International Civil Aviation and are designated, for convenience, as Annexes to the Convention. The uniform application by Contracting States of the specifications contained in the International Standards is recognized as necessary for the safety or regularity of international air navigation while the uniform application of the specifications in the Recommended Practices is regarded as desirable in the interest of safety, regularity or efficiency of international air navigation. Knowledge of any differences between the national regulations or practices of a State and those established by an International Standard is essential to the safety or regularity of international air navigation. In the event of non-compliance with an International Standard, a State has, in fact, an obligation, under Article 38 of the Convention, to notify the Council of any differences. Knowledge of differences from Recommended Practices may also be important for the safety of air navigation and, although the Convention does not impose any obligation with regard thereto, the Council has invited Contracting States to notify such differences in addition to those relating to International Standards.
- *Procedures for Air Navigation Services (PANS)* are approved by the Council for worldwide application. They contain, for the most part, operating procedures regarded as not yet having attained a sufficient degree of maturity for adoption as International Standards and Recommended Practices, as well as material of a more permanent character which is considered too detailed for incorporation in an Annex, or is susceptible to frequent amendment, for which the processes of the Convention would be too cumbersome.
- *Regional Supplementary Procedures (SUPPS)* have a status similar to that of PANS in that they are approved by the Council, but only for application in the respective regions. They are prepared in consolidated form, since certain of the procedures apply to overlapping regions or are common to two or more regions.

The following publications are prepared by authority of the Secretary General in accordance with the principles and policies approved by the Council.

- *Technical Manuals* provide guidance and information in amplification of the International Standards, Recommended Practices and PANS, the implementation of which they are designed to facilitate.
 - *Air Navigation Plans* detail requirements for facilities and services for international air navigation in the respective ICAO Air Navigation Regions. They are prepared on the authority of the Secretary General on the basis of recommendations of regional air navigation meetings and of the Council action thereon. The plans are amended periodically to reflect changes in requirements and in the status of implementation of the recommended facilities and services.
 - *ICAO Circulars* make available specialized information of interest to Contracting States. This includes studies on technical subjects.
-

© ICAO 2004
4/04, E/P1/1500

Order No. 9643
Printed in ICAO

