

# Gold Operator Manual

**Premium Series**



**PRO**  
**MOW**

Reel Mower System

**Call ProMow for ALL Service Needs**  
**Toll Free: 1-877-477-6669**

**PRO**<sup>®</sup>  
**MOW**



Dear Valued Customer....

Let me take this opportunity to congratulate you on your purchase of a ProMow Reel Mower System. You have purchased perhaps the most revolutionary new product since the Weedeater! No other product exists that will allow you to mow your yard in 1/3 of the time and give you professionally manicured results all for a fraction of the cost of any alternative.

When used as directed, your ProMow unit will leave your yard looking healthy and lush. After all, the most qualified greenskeepers in the world use ganged reel mowers to manicure their golf courses to "green carpet" perfection!

I recommend that you spend a few minutes and read the mowing tips and the troubleshooting guide found in the following pages. I believe these tips will make your ProMow experience much more satisfying and give you optimum performance with your new ProMow unit.

Also, please take a minute and complete the warranty page found in your packet. You may also complete the registration of your mower online, just link to our web site: [www.promow.com/register.html](http://www.promow.com/register.html). We will need this information should you ever need warranty service and to notify you of changes, upgrades, or possible recall conditions. This information will not be sold or used by anyone other than ProMow, Inc.

Once again, we appreciate your business and hope you experience all the benefits a ProMow mower can bring to you.

Sincerely,

A handwritten signature in black ink, appearing to read "Douglas J. Short", written over a horizontal line.

Douglas J. Short  
CEO  
ProMow, Inc.

**Gold 7 Pictured**

Front Wing (Long)

Rear Wing (Short)

- Gold 3** - No Wings Used
- Gold 5** - 2 Rear Wings Used
- Gold 7** - 2 Front and 2 Rear Wings Used

Attach wing to frame, tighten bolt secure, snug as possible that allows wing to flex with weight or reel. Oil connection.

Keep wing bolts tight to avoid hole wear and mower tracking true.

(G) Attach to Power Unit.

Tongue top surface should be nearly level when attached to power unit.

(G)

Attach reel to frame as shown (Figure 1) and (Figure 2). Go through top hole of mower and frame tab and pin.

Roller brackets will change height of rear of mower. Use these to level mower. A level mower will cut best.

**Figure 1**

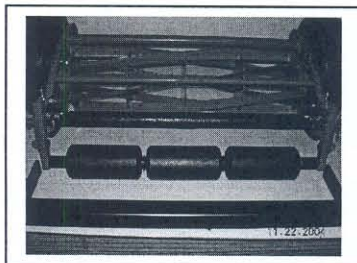

**Figure 2**

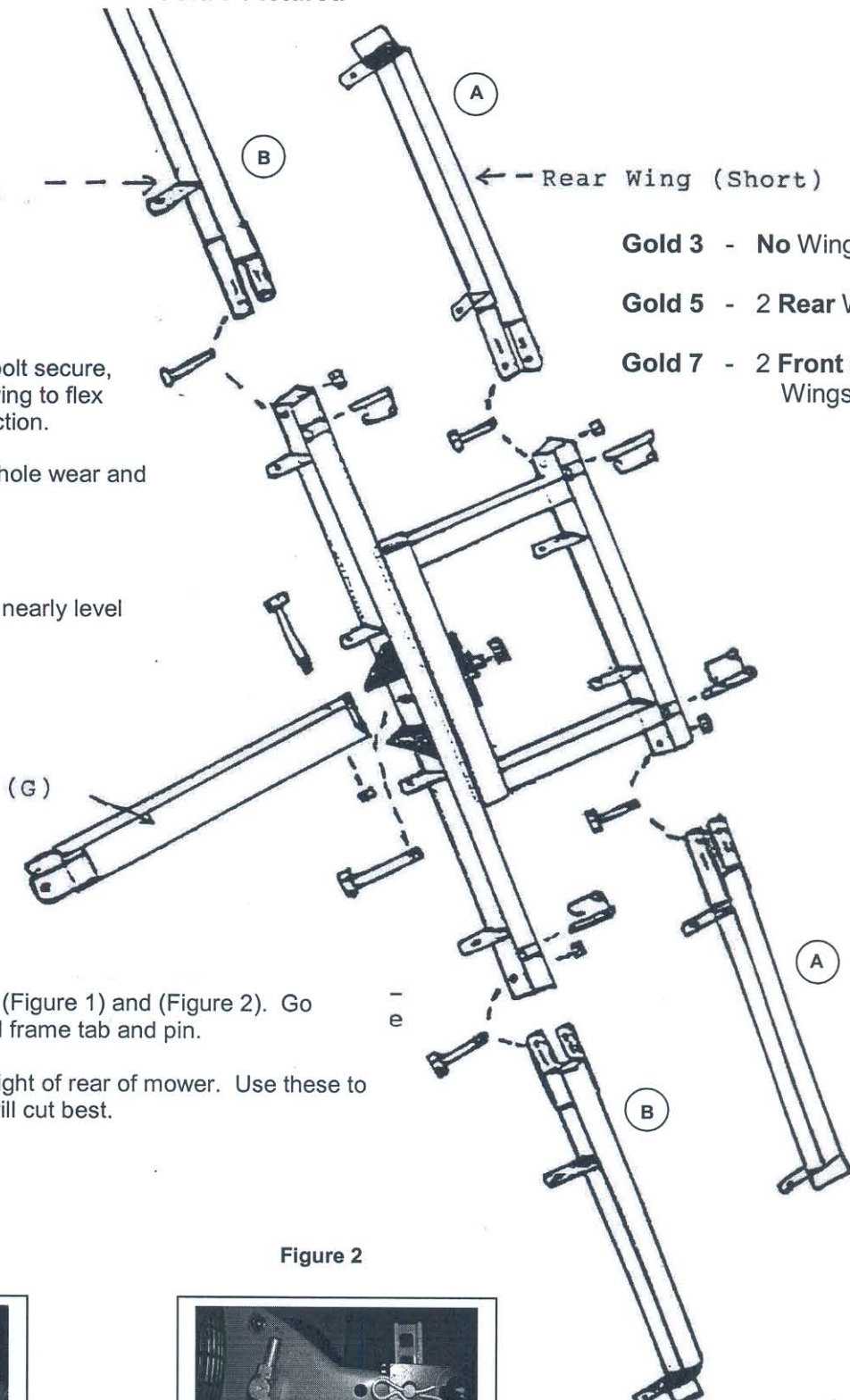
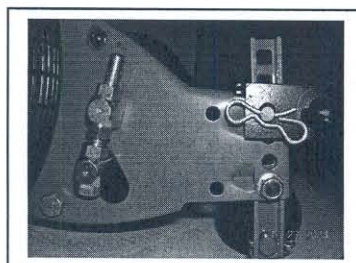



## MAINTENANCE & ADJUSTMENT

### Cutting Height Adjustment

Cutting height is determined by the axle bolt setting as shown in Figure 1. To change height setting, you will need 2 - 9/16" wrench's. Remove the black hub cap on the outer side of the wheel. Use 1 - 9/16" wrench on the axle, the other one on the nut as shown in Figure 1. Loosen the nut until about 1/2 of the threads of the nut are still on the bolt. Next, the washer needs to pop out of the hole to allow the axle bolt to move to the desired setting. Washer needs to fit into the hole and bolt needs to be tightened. Use a wrench on the outer side and on the nut and tighten securely. Do not over tighten as this could damage the axle. For an even cut, all wheel axles need to be at the same setting. **Raising axle lowers** cutting height, **lower axle raises** cutting height. **Always re-check axle bolt nut for tightness after height settings have been changed. Do not operate mower with loose bolts**

**Figure 1**

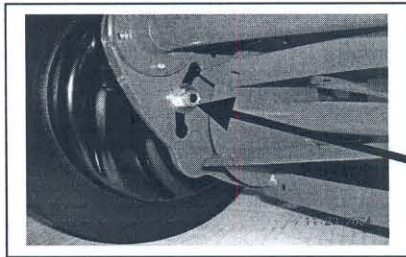

ROLLER BRACKET  
ADJUSTING NUT  
  
AXLE BOLT

**Figure 2**

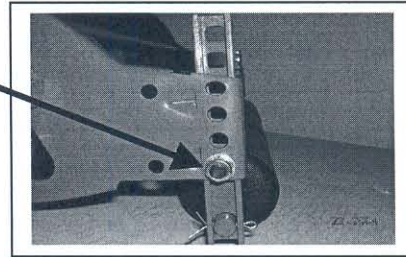

Roller brackets, Figure 2, are intended to level mower. Small height changes can be obtained by moving the bracket up or down. Be sure all mowers are set at the same position to obtain a level cut. For best cutting results use this adjustment to level the cutter bar.

### Height Settings

Bottom Hole	2 3/4"
Middle Hole	1 1/2"
Top Hole	5/8"

All heights measured on flat surface.  
Actual cut may vary from chart.  
For high cut, locate axle bolt in bottom hole.  
Adjust roller bracket, Figure 2 to level cutter bar for the best quality cut.

### Reel Adjustment

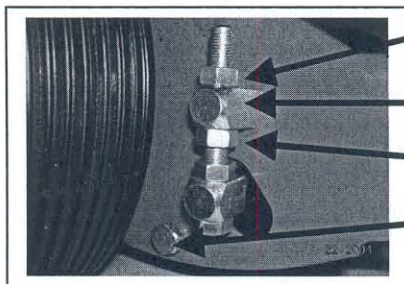

UPPER NUT  
UPPER TRUNNION  
LOWER NUT  
CUTTER BAR NUT

To tighten cutter bar, simply loosen upper nut slightly and tighten lower nut. To loosen cutter bar loosen lower nut slightly and tighten upper nut. Use same procedure on both sides of reel. **DO NOT OVERTIGHTEN – DAMAGE COULD RESULT!**

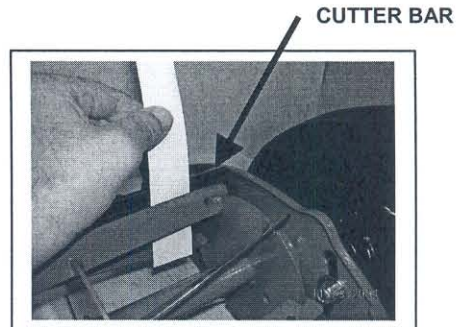

When properly adjusted, you will hear a whispering sound and should cut paper across entire cutter bar.

### SHARPENING YOUR REELS

Sharpening can be done by the owner with a ProMow Sharpening Kit.

**For Technical Service call: 1-877-477-6669**

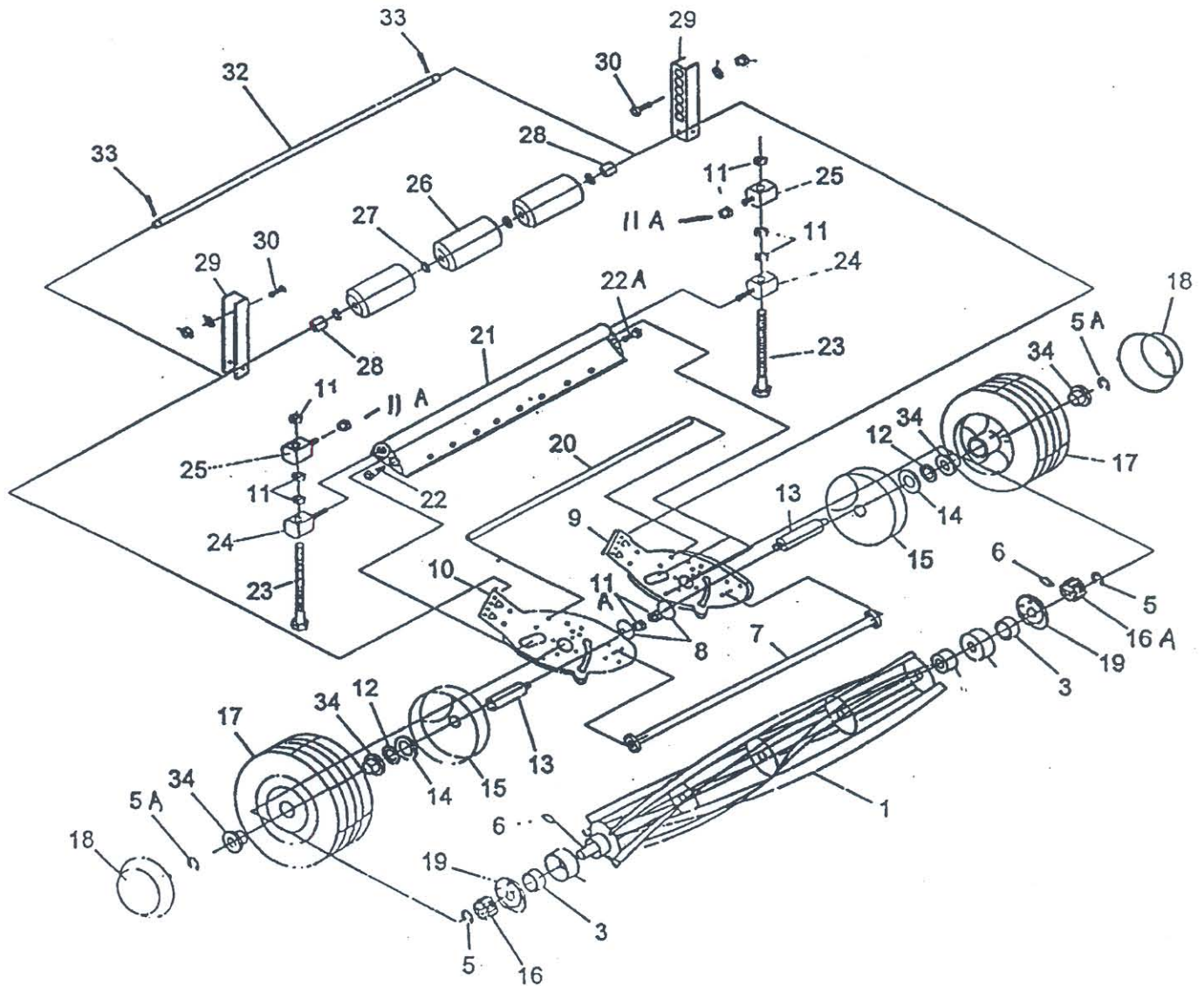

**GOLD A 21" REEL  
PARTS LISTING**

REF NO	PART NO	QTY.	DESCRIPTION	REF NO	PART NO	QTY	DESCRIPTION
1	3135-036	1	21" Reel Assembly	18	2674-032	2	Hub Cap
3	44232	2	Bearing	19	1629-009	2	Bearing Retainer
5	1650-021	2	Retaining Ring	20	6239	1	Rear Spacer
5A	1650-001	2	Retaining Ring	21	3134-024	1	Cutter Bar Assembly
6	0323-000	3	Pawl	22	1509-086	1	Screw Front LH
7	1112-015	1	Spacer Tube	22A	0455-000	1	Screw Front RH
8	1657-19	2	Step Bushing	23	46331	2	Cutter Bar Adj. Bolt
9	63318	1	Side Plate RH	24	46330	2	Trunion Lower
10	63319	1	Side Plate LH	25	46329	2	Trunion Upper
11	0052-00	6	Nut	26	1658-012	3	Roller
11A	44738	4	Lock Nut	27	R19171616	4	Washer
12	44008	2	Washer	28	46679	2	Spacer
13	1631-051	2	Axle	29	2609	2	Roller Bracket
14	1540-118	2	Washer	30	43079	2	Carriage Bolt
15	1118-014	2	Gear Housing	32	1632-084	1	Roller Shaft
16	0428-000	1	Pinion Gear LH	33	1548	2	Cotter Pin
16A	0428-001	1	Pinion Gear RH	34	45088	4	Wheel Bushing
17	1108-095	2	Wheel Assembly 21"				

**OIL REELS AFTER EACH USE TO PREVENT RUST AND TO LUBRICATE CUTTING BLADES. USE LIGHT OIL SUCH AS W-D 40**



# MAINTENANCE AND WARRANTY INFORMATION

- **Maximum** speed in smooth conditions should not exceed a brisk walk or 4 miles per hour. In rough conditions slow down more. Bouncing reels will not give the desired cut.
- Loss of parts due to loose bolts are not covered by warranty.
- Check all bolts for tightness regularly, especially the axle and roller bracket bolts
- Wing bolts need to be kept tight to prevent hole wear. Wings need to be able to flex with the terrain. Oil pivot points of wings.
- Lubricate reels regularly with a light oil such as WD-40 after each use to prevent any rust from forming on cutting surfaces.
- **For problem or questions call ProMow toll-free: 1-877-477-6669.**
- **Refer to owner's manual for more information on warranty and maintenance.**

## PROMOW MOWING TIPS

- **THIS IS A FINISH CUT MOWER ONLY.** IT IS NOT INTENDED TO CUT WEEDS OR VERY TALL GRASS.
- FOR BEST RESULTS WHEN MOWING, DO NOT CUT OFF MORE THAN 1"-2" OF GRASS DURING EACH MOWING.
- IF YOU ALLOW YOUR GRASS TO GROW TO A TALLER LENGTH, MOWING TWICE WILL RESULT IN THE SMOOTHTEST CUT.
- EACH TIME YOU MOW, MOW AT A DIFFERENT ANGLE. CROSS MOWING WILL RESULT IN THE SMOOTHTEST CUT.
- CHECK CUTTER BARS EVERY 2-3 MOWINGS. TO KNOW THE BARS ARE ADJUSTED, REELS WILL JUST TOUCH THE CUTTER BAR MAKING A LIGHT WHISPING NOISE AND SHOULD CUT PAPER ACROSS THE ENTIRE CUTTER BAR. TO ADJUST CUTTER BARS REFER TO "MAINTENANCE AND ADJUSTMENT" PAGE.
- IF YOU NOTICE WHEEL MARKS FROM TRACTOR, YOU ARE WAITING TOO LONG BETWEEN MOWINGS OR YOUR GRASS MAY BE TOO WET.
- TO HELP ON RUST & WEAR, SPRAY W-D 40, OR SIMILAR LUBRICANT ON THE CUTTER BAR AFTER EACH MOWING.
- ALWAYS STORE IN A DRY PLACE.
- AFTER CONSIDERABLE USE YOUR PROMOW UNIT MAY NEED TO BE SHARPENED. THIS CAN BE DONE AT HOME WITH A PROMOW SHARPENING KIT OR THROUGH YOUR LOCAL SHARPENING SHOP.

## CUSTOMER RESPONSIBILITIES

- READ AND FAMILIARIZE YOURSELF WITH ALL INSTRUCTIONS AND USAGE HINTS IN THIS MANUAL.
- INSPECT YOUR MOWING AREA FOR ANY DEBRIS OR OBJECTS THAT COULD CAUSE PROBLEMS AND REMOVE PRIOR TO MOWING.
- MAKE SURE YOUR MOWER IS IN SAFE OPERATING CONDITION. DO NOT ATTEMPT TO OPERATE IF YOU HAVE ANY DAMAGE. REPAIR IT FIRST.
- \*\*TRAVEL AT A SAFE SPEED. EXCESSIVE SPEED IS UNSAFE AND MAY CAUSE DAMAGE TO THE UNIT.
- DO NOT MOW NEAR SMALL CHILDREN OR OTHER PEOPLE.
- PERIODICALLY CHECK YOUR UNIT FOR DAMAGE AND MAKE SURE ALL NUTS AND BOLTS ARE TIGHT.
- ALWAYS EXERCISE CARE WHEN OPERATING YOUR MOWER, AVOID STRIKING OR RUNNING INTO OR OVER SOLID OBJECTS OR DEBRIS.

## CARE

- KEEP YOUR MOWER CLEAN AND REGULARLY LUBRICATE BLADES WITH WD-40 OR SIMILAR LUBRICANT. RECOMMENDED AFTER EACH MOWING.
- CHECK ALL BOLTS AND NUTS TO BE SURE THEY ARE PROPERLY SECURED.
- STORE IN A CLEAN DRY AREA.
- DO NOT TRAVEL WITH THE WINGS IN UPRIGHT POSITION. DAMAGE TO THE FRAME OR MOWER HEADS CAN RESULT.
- IF YOU HAVE ANY QUESTIONS OR PROBLEMS CALL PROMOW TOLL FREE: 1-877-477-6669.

## WARRANTY

SEE "WARRANTY REGISTRATION - NEW EQUIPMENT LIMITED WARRANTY" IN THIS MANUAL. WARRANTY WILL NOT BE EFFECTIVE UNLESS REGISTERED BY COMPLETING FORM AND MAILING TO PROMOW.

**\*\*CAUTION: A brisk walk, about 4 MPH, should be considered top speed. Reduce speed down from 4 MPH on rough terrain. Speeds that exceed 4 MPH on smooth turf will cause premature wearing of the bearings and possible damage to the reel itself.**

### EVIDENCE OF EXCESSIVE SPEED WILL VOID WARRANTY

**Problem or Questions? Call ProMow Toll-Free: 1-877-477-6669**



# WARRANTY REGISTRATION

## NEW EQUIPMENT LIMITED WARRANTY

### LIMITED WARRANTY

ProMow, Inc. product warranties and obligations set forth below are in lieu of any other express warranties or obligations of ProMow, Inc., its distributors, or retailers. The warranties and limitations extend only to the original purchaser or to the person for whom the product was originally purchased for.

For one year from purchase on mower heads and two years on frames (warranty card must be on record to enforce warranty) ProMow, Inc. will replace free of charge to the original buyer, any part(s) found defective in material or workmanship upon examination by our factory or a factory authorized service center. Damage due to misuse, abuse, or modification is excluded...as in normal wear such as tire wear, dulling of blades, lost parts, etc. Parts sent to factory for replacement must be shipped pre-paid by the buyer. **Contact ProMow, Inc. for all warranty claims and adjustments prior to shipping.** ProMow reserves the right to make changes in materials or design of the product at any time without notice. No other warranty of any kind whatsoever, express or implied, is made with respect to this sale; and all implied warranties of merchantability and fitness for a particular purpose which exceed the obligations set forth in this written warranty are hereby disclaimed and excluded from this sale.

Date of Purchase: \_\_\_\_\_

Model: \_\_\_\_\_

Serial No: \_\_\_\_\_

Name: \_\_\_\_\_

Street: \_\_\_\_\_

City: \_\_\_\_\_

State: \_\_\_\_\_ Zip: \_\_\_\_\_

Daytime Phone: \_\_\_\_\_

E-Mail: \_\_\_\_\_

(This data for ProMow Use Only)

Web: [www.promow.com](http://www.promow.com)

### LIMITATION OF REMEDY

During the warranty period, ProMow will at its option either repair or replace defective mower heads or frames. **To obtain repair or replacement, call ProMow, Inc customer service for a return authorization number.** Then attach your name, address, phone number, description of problem and proof of purchase (for example, a sales receipt or cancelled check) to the product. At your expense, ship or deliver the product to ProMow, Inc. located at 8318 Clinton Park Drive, Ft. Wayne, Indiana 46825.

Some states do not allow limitations on how long warranty lasts, and some states do not allow the exclusion of limitations of incidental or consequential damages, so the above limitations or exclusions may not apply to you.

### RELEASE OF LIABILITY

I agree that I will release ProMow, Inc, its distributors and retailers from any and all responsibility or liability for injuries or damages to the user of the ProMow gang-reel mowers I am purchasing, or to any other person. I agree not to make a claim against ProMow, Inc., its distributors or retailers for injuries or damages relating to use of the equipment, other than such claims are allowed by the limited warranty set forth above.

Dealer Name: \_\_\_\_\_

Address: \_\_\_\_\_

City: \_\_\_\_\_

State: \_\_\_\_\_ Zip: \_\_\_\_\_

WARRANTY WILL NOT BE EFFECTIVE UNLESS  
REGISTERED BY COMPLETING THIS FORM AND  
MAILING WITHIN 15 DAYS OF PURCHASE.

MAIL TO: ProMow, Inc. 8318 Clinton Park Drive  
Ft. Wayne, IN 46825 (260) 482-6699