

Invacare® Homecare Beds

5411IVC, 5410IVC, 5311IVC, 5310IVC, 5307IVC,
5411LowIVC, 5410LowIVC

en User Manual



This manual **MUST** be given to the user of the product.
BEFORE using this product, read this manual and save for future reference.



Yes, you can!

©2017 Invacare Corporation

All rights reserved. Reproduction, duplication or modification in whole or in part is prohibited without prior written permission from Invacare. Trademarks are identified by ™ and ®. All trademarks are owned by or licensed to Invacare Corporation or its subsidiaries unless otherwise noted. Making USA Experiences Possible is a registered trademark in the U.S.A.

Contents

1 General	4
1.1 Symbols	4
1.2 Intended Use	4
2 Overview	5
2.1 Label Locations	5
2.2 Technical Specifications	5
2.3 Accessories and Accessory Weight	7
2.4 Operating Conditions	7
3 Safety	8
3.1 General Guidelines	8
3.2 Operating Information	16
3.3 Servicing Double-Insulated Products	17
3.4 Disposal	17
4 Set-up	18
4.1 Receiving	18
4.2 Unpacking	18
4.3 Inspecting	20
4.4 Assembling the Head and Foot Spring Sections	21
4.5 Assembling the Spring Fabric	22
4.6 Adjusting and Reconnecting the Head Section Pulley Tab	22
4.7 Installing the Casters	23
4.8 Assembling the Universal Bed Ends	24
4.9 Installing Low Bed Ends	25
4.9.1 Installing the Casters onto the Low Bed Ends	25
4.10 Assembling/Installing/Removing Drive shaft	26
4.11 Inspecting the Bed	27
4.11.1 Installing/Removing Cable Lock	29
4.11.2 Installing the Manual Crank for Hi/Lo Function	29
4.11.3 Installing/Removing the Pendant	30
4.12 Storing the Bed	30
5 Operation	31
5.1 Bed Operation and Component Overview	31
5.2 Operating Full Electric Bed	32
5.3 Operating the Semi-Electric Bed	34
5.3.1 Using the Emergency Crank	35
5.4 Operating the Manual Bed	36
5.5 Optional Bed Rails	36
6 Maintenance	38
6.1 Service Life	38
6.2 Wear and Tear Items	38
6.3 Cleaning the Bed	39
6.4 Maintenance and Cleaning Checklist	41
7 Troubleshooting	43
7.1 Troubleshooting Mechanical	43
7.2 Troubleshooting Electrical	44
8 Warranty	46
8.1 Limited Warranty	46

1 General

1.1 Symbols

Signal words are used in this manual and apply to hazards or unsafe practices which could result in personal injury or property damage. Refer to the table below for definitions of the signal words.



DANGER!

- Danger indicates an imminently hazardous situation which, if not avoided, will result in death or serious injury.



WARNING!

- Warning indicates a potentially hazardous situation which, if not avoided, could result in death or serious injury.



CAUTION!

- Caution indicates a potentially hazardous situation which, if not avoided, may result in property damage.



- Gives useful tips, recommendations and information for efficient, trouble-free use.

1.2 Intended Use

The bed is intended to be used as a mattress support system. The bed allows for articulation of the head and foot sections to provide different positions for the patient. It is intended to be used in home care and long term care facilities.

2 Overview

2.1 Label Locations

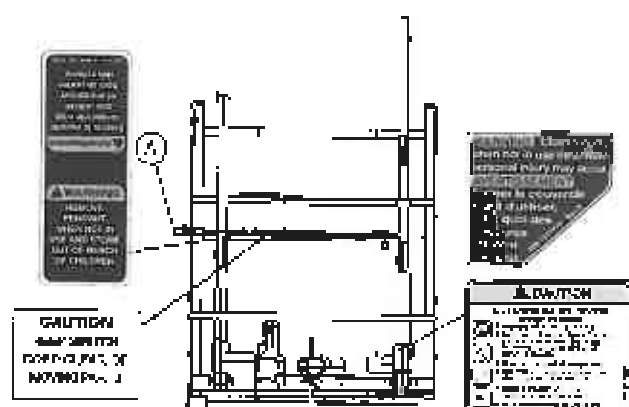

- 1 Underside of bed shown.
- 2 Warning label 1117179 Rev B located on the gearbox (not shown).
- 3 = Pendant cord

2.2 Technical Specifications

Full Electric 5410/VC, 5411/VC

SHIPPING WEIGHT	176.5 lbs (80.1 kg)
WEIGHT CAPACITY	
OCCUPANT	350 lbs (159 kg)
SAFE WORKING LOAD	450 lbs (204 kg)
OVERALL LENGTH	88 in (223.1 cm)
OVERALL WIDTH	36 in (91.4 cm)
SPLIT SPRING TO ENDS	
HEAD	43 in (109.2 cm)
FOOT	15 in (114.3 cm)
ADJUSTMENT RANGE	
DECK	15 in (38 cm) ± 2 in to 23 in (58.3 cm) ± 2 in
BFO END	26 1/4 in (66.7 cm) to 33 1/2 in (85.7 cm)
COMPONENTS	Head Spring, Universal Bed ends, Foot Spring Three Motors

Medare® Homecare Beds

Semi-Electric Single Crank Hi/Lo S310IVC, S311IVC

SHIPPING WEIGHT	172 lbs (78.0 kg)
WEIGHT CAPACITY	
OCCUPANT	350 lbs (159 kg)
SAFE WORKING LOAD	450 lbs (204 kg)
OVERALL LENGTH	88 in (223.4 cm)
OVERALL WIDTH	36 in (91.4 cm)
SPLIT SPRINGS TO ENDS	
HEAD	43 in (109.2 cm)
FOOT	45 in (114.3 cm)
ADJUSTMENT RANGE	
DECK	15 in (38 cm) ± 2 in to 23 in (58.3 cm) ± 2 in
BED END	26 3/4 in (66.7 cm) to 33 3/4 in (85.7 cm)
COMPONENTS	Head Spring, Universal Bed Ends, Foot Spring, Two Motors

Manual Single Crank-Hi/Lo S307IVC

SHIPPING WEIGHT	161.5 lbs (73.3 kg)
WEIGHT CAPACITY	
OCCUPANT	350 lbs (159 kg)
SAFE WORKING LOAD	450 lbs (204 kg)
OVERALL LENGTH	88 in (223.4 cm)
OVERALL WIDTH	36 in (91.4 cm)
SPLIT SPRINGS TO ENDS	
HEAD	43 in (109.2 cm)
FOOT	45 in (114.3 cm)
ADJUSTMENT RANGE	
DECK	15 in (38 cm) ± 2 in to 23 in (58.3 cm) ± 2 in
BED END	26 3/4 in (66.7 cm) to 33 3/4 in (85.7 cm)
COMPONENTS	Head Spring, Universal Bed Ends, Foot Spring, Two Crank

2.3 Accessories and Accessory Weight



WARNING!
Risk of Injury or Damage
 To avoid injury or damage from misuse:
 - DO NOT install the accessories without reading and understanding all of the instructions in the instruction sheet that accompanies them.

Accessories are subject to change. Contact Dealer or Invacare for current list

DESCRIPTION	MODEL NUMBER	WEIGHT
BED RAIL, FULL	6629	28 lbs (12.7 kg)
	6629P	28 lbs (12.7 kg)
BED RAIL, HALF LENGTH	6630US	24 lbs (10.9 kg)
ASSIST RAIL	6632	24 lbs (10.9 kg)
TRAPEZE	7740A	30 lbs (13.6 kg)
	7744P	23 lbs (10.4 kg)
MATTRESS	5160	20 lbs (9.1 kg)
	5184	26 lbs (11.8 kg)
	5185	30 lbs (13.6 kg)
	5185X1	30 lbs (13.6 kg)

Accessories are subject to change. Contact Dealer or Invacare for current list		
DESCRIPTION	MODEL NUMBER	WEIGHT
MATTRESS	Solace Series, Softform Series	23-31 lbs (10.4-14.1 kg) varies depending on model
	microAir Series	17-56 lbs (7-25.4 kg) varies depending on model
BED EXTENDER, CENTER	5143	8 lbs (3.6 kg)
BED EXTENDER, HEAD END	5143A	19 lbs (8.6 kg)

2.4 Operating Conditions

RECOMMENDED STORAGE AND SHIPPING TEMPERATURE	-22°F to 158°F (-30°C to 70°C) up to 93% relative humidity, non condensing
RECOMMENDED OPERATING TEMPERATURE	41°F to 104°F (5°C to 40°C) 15% to 93% relative humidity, non condensing
RECOMMENDED ATMOSPHERIC PRESSURE	700 hpa to 2060 hpa

3 Safety

3.1 General Guidelines



DANGER!

Risk Of Death, Injury, Or Damage

Improper use of this product may cause injury or damage.

- If you are unable to understand the warnings, cautions or instructions, contact a healthcare professional, dealer or technical personnel before attempting to use this equipment.
- Do not use this product or any available optional equipment without first completely reading and understanding these instructions and any additional instructional material such as user manuals, service manuals or instruction sheets supplied with this product or optional equipment.

Continued use of the product with damaged parts could lead to the product malfunctioning, causing injury to the user and/or caregiver.

- Check ALL product components and carton for damage, and test components before use. DO NOT use product if components are damaged or if product is not working properly. Contact a qualified technician or Invacare for repair.



DANGER!

Risk Of Death, Injury, Or Damage

To avoid injury or product damage:

- Set-up and Assembly instructions MUST be performed by qualified technicians only. "Qualified Technician Only" sections are marked accordingly.

- THE INFORMATION CONTAINED IN THIS DOCUMENT IS SUBJECT TO CHANGE WITHOUT NOTICE.



DANGER!

Risk Of Death, Injury, Or Damage

Litged cigarettes can cause a fire or other related hazards resulting in death, injury, or damage.

- Do not smoke while using this product.
- Do not allow others to smoke near this product.



DANGER!

Risk Of Death, Injury, Or Damage

Bed accessories designed by other manufacturers have NOT been tested by Invacare. Use of NON-Invacare bed accessories may result in injury or death.

- Use ONLY Invacare rails, mattresses, bed extenders and other accessories with Invacare bed products.

**DANGER!****Risk of Death, Injury or Damage**

Improper assembly may cause injury or damage. Use of incorrect or improper parts, including replacement (service) parts, may cause injury or damage.

- Replacement parts **MUST** match original Invacare parts.

**DANGER!****Risk of Injury or Death**

To reduce the risk of electrical shock:

- Always unplug the product from the electrical outlet before cleaning.

**DANGER!****Risk Of Death, Injury, Or Damage**

To reduce the risk of shock:

- Unplug from the outlet before servicing.
- Close supervision is necessary when the product is used by, or near children and/or disabled persons.
- Use this product only for its intended use as described in these instructions. **DO NOT** use attachments not recommended by the manufacturer.
- If liquid is spilled in or around the product, unplug before cleaning. Clean up the spill and allow the product or the area around the product to dry thoroughly before using the controls again.

**DANGER!****Risk Of Death, Injury, Or Damage**

To avoid shock, product damage and personal injury:

- **DO NOT** use outdoors.
- Connect this product to a properly grounded outlet only. Refer to Operation.
- **DO NOT** place video equipment such as televisions or computer monitors on product.

Operating Information**DANGER!****Risk Of Death, Injury, Or Damage**

To avoid injury or damage when operating product:

- After any adjustments, repair or service and before use, make sure all attaching hardware is tightened securely.
- Close supervision is necessary when the product is used near children or pets OR when this product is operated by or near people with physical/mental disabilities. Physically challenged individuals who cannot prevent themselves from rolling/climbing out of the product may require alternative safe means of restraint.
- The product is not designed to be used as a patient transport. When transporting a patient, use an approved patient transport. Otherwise, injury or damage may result.



DANGER!

Risk Of Injury Or Damage

To avoid injury or damage when operating/moving bed:

- ALWAYS ensure that the individual utilizing the bed is positioned properly within the confines of the bed. DO NOT let any extremities protrude over the side or between the bed rails when performing these functions.
- Be aware of potential pinch points when operating bed, rails or other accessories.
- Make sure head and foot springs/sections are connected securely to the bed ends before use.
- The bed is equipped with locking casters. Before using the bed, test the wheel locks to ensure casters lock correctly. When transferring into or out of the bed, ALWAYS lock the casters. Even with casters properly locked, some flooring surfaces (such as tile or wood,) will allow the bed to move under some conditions. Using the bed on these types of surfaces MUST be evaluated by the care provider. DO NOT transfer occupant if bed is not stable. Otherwise, injury and/or damage may occur.
- DO NOT move product with locking casters in LOCKED position.



DANGER!

Risk Of Death, Injury, Or Damage

To avoid pinching, crush and collapse hazards from bed deck contact with objects under the bed:

- DO NOT place any objects or let any individual underneath the bed or in between the raised bed frame components at any time.

To avoid risk of death or injury from choking or ingestion of small parts or materials:

- Closely supervise children, pets, or individuals with physical/mental disabilities.



Refer to the **Bed Rail Entrapment Risk Notification Guide** at www.invacare.com for additional safety information.

**DANGER!**

Risk Of Death, Injury, Or Damage
Patient entrapment from the use of bed side rails may cause injury or death. To avoid patient entrapment:

- The Invacare mattress MUST fit firmly against the bed frame AND bed side rails to prevent patient entrapment. Follow the manufacturer's instructions. Monitor patient frequently. Read and understand the User Manual prior to using the Invacare bed and bed rails. User manuals are available at www.invacare.com or your dealer.
- After any adjustments, repair or service and before use, make sure all attaching hardware is tightened securely.

**DANGER!**

Risk Of Death, Injury, Or Damage
Conditions such as restlessness, mental deterioration and dementia or seizure disorders (uncontrolled body movement), sleeping problems, and incontinence can significantly impact a patient's risk of entrapment. Pediatric patients or patients with small body size may also have an increased risk of entrapment.

- Monitor patients with these conditions frequently.
- Place the mattress deck in the flat position when left unattended.

**WARNING!**

Risk Of Injury Or Adverse Health Consequences
Fall hazard exists due to bed height.

- Always leave bed in lowest height when unattended.

Replacement Parts/Accessories**DANGER!**

Risk Of Death, Injury, Or Damage

- To avoid fire hazards and tubing entanglement:
- Use mask or nasal type oxygen administering equipment only in conjunction with the manual/electric bed. The use of any other type of oxygen administering equipment can result in a fire hazard.
 - When using nasal or masked type oxygen administering equipment, the oxygen or air tubing MUST be routed and secured properly to ensure that the tubing does not become entangled and/or severed during normal operation of manual/electric bed.
 - Do not use this bed in Active Treatment "Ether Environments."

**DANGER!**

Risk Of Death, Injury, Or Damage

- To avoid fire hazards, injury or damage:
- DO NOT use product with flammable gases. Explosion may occur.

Invacare® Invecare Bed



WARNING!

Risk Of Injury Or Damage

To avoid injury or damage from misuse or entrapment:

- Read and understand the instructions or label provided with mattress.
- If you do not understand the instructions or if instructions are missing, contact the mattress manufacturer.



DANGER!

Risk of Death or Injury

An increased risk of patient entrapment may occur over time due to mattress compression.

Periodically monitor gaps between the bed, mattress, and/or bed rail. Where gaps occur, patient entrapment is possible and the mattress should be replaced.



DANGER!

Risk Of Death, Injury, Or Damage

To avoid entrapment, product damage, and/or personal injury:

- Invacare recommends that the mattress be centered on the bed frame. Otherwise, individuals may become trapped between the bed rail and the bed frame.
- ALWAYS test to make sure that the side rails are properly and securely in place before using. Otherwise, injury or damage may occur.



DANGER!

Risk Of Injury Or Adverse Health Consequences

Fall hazard exists due to use of Non-Invacare mattresses. Non-Invacare mattresses are potentially incompatible with Invacare beds.

- To avoid injury, ensure that only Invacare mattresses are used with Invacare beds at all times.

**DANGER!****Risk Of Death, Injury, Or Damage**

To avoid entrapment, product damage, and/or personal injury:

- When used with a manual/electric bed, the bed rails DO NOT fall under any weight limitations. Bed rails can be deformed or broken if excessive side pressure is exerted on the bed rails. These bed rails are used for the purpose of preventing an individual from inadvertently rolling out of bed. The bed rails are not intended nor may be used for restraint purposes. If an individual is capable of injuring himself/herself, a physician or a healthcare professional should be consulted for alternative means of safe restraint.
- After raising/lowering the head/foot end of the electric bed, check the distance between the bottom of the bed rail and the mattress. If there is excessive distance between the bottom of the bed rail and the mattress in which individuals may become entangled, adjust the height of the bed rail (if applicable), or provide alternative means of patient protection.
- DO NOT use the side rails as push handles for moving the electric bed.
- Replacement mattresses and bed side rails with dimensions different from the original equipment supplied or specified by the bed frame manufacturer are not interchangeable. Variations in bed side rail design, width and thickness or firmness of the mattress could cause/contribute to entrapment.

1134831-11-05

Safety

**DANGER!****Risk of Death, Injury or Damage**

To avoid injury or damage from misuse or entrapment:

- Proper patient assessment and monitoring, and proper maintenance and use of equipment is required to reduce the risk of entrapment. Variations in bed rail dimensions and mattress thickness, size or density could increase the risk of entrapment. Visit the FDA website at <http://www.fda.gov> to learn about the risks of entrapment. Review "A Guide to Bed Safety", published by the Hospital Bed Safety Workgroup. Use the link located under each bed rail product entry to access this bed safety guide.
- Refer to the user manuals for beds and rails for additional product and safety information.
- Patient entrapment from the use of bed side rails may cause injury or death. The Invacare mattress MUST fit firmly against the bed frame AND bed side rails to prevent patient entrapment. Follow the manufacturer's instructions. Monitor patient frequently. Read and understand the User Manual prior to using this equipment. Invacare manuals are available at www.invacare.com or your dealer.
- An increased risk of patient entrapment may occur over time due to mattress compression. Periodically monitor gaps between the bed, mattress, and/or bed rail. Where gaps occur, patient entrapment is possible and the mattress should be replaced.

17

InVision® Homecare Bed

Electrical



WARNING!

Risk Of Death, Injury, Or Damage

Shock hazards and risk of fire exist due to use of improper extension cord and use of three prong adapters.

- To avoid injury or product damage, when using an extension cord, use only a UL approved three prong extension cord having at least 16 AWG (American Wire Gauge) wire and the same or higher electrical rating as the product being connected.

To reduce the risk of electric shock, this furnishing has a polarized plug (one blade is wider than the other). This plug will fit in a polarized outlet only one way.

- If the plug does not fit fully in the outlet, reverse the plug. If it still does not fit, contact a qualified electrician to install the proper outlet.
- **DO NOT** change the plug in any way.



WARNING!

Risk Of Injury Or Damage

To avoid product damage and persons' injury:

- Disconnect pendant when not in use and store out of reach of children.

Grounding Information



WARNING!

Risk Of Injury Or Damage

To avoid injury or damage from improper grounding or using damaged parts:

- **DO NOT** operate the product if the cord or outlet is damaged.
- **DO NOT** operate the product if any motor has malfunctioned or is damaged in any manner.

Radio Frequency Interference



Use of portable and mobile RF communications equipment can affect medical electrical equipment.



WARNING!

Risk of Product Damage

Electronic equipment may be influenced by Radio Frequency Interference (RFI).

- Caution should be exercised with regard to the use of portable communications equipment in the area around such equipment.
- If RFI causes erratic behavior, unplug the product immediately. Leave unplugged while transmission is in progress.

**WARNING!****Risk Of Product Damage**

The use of accessories, transducers, rods and cables other than those specified by the manufacturer, may result in increased emissions or decreased immunity of this bed.

- This product should not be used adjacent to or stacked with other equipment and that if adjacent or stacked use is necessary, this product should be observed to verify normal operation in the configuration in which it will be used.

Weight Limitations**DANGER!****Risk Of Death, Injury, Or Damage**

To avoid bed collapse and resulting injury or damage:

- The weight limit of the occupant of the bed CANNOT exceed 350 lbs (159 kg). The TOTAL weight limit of the bed (including accessories, mattress, occupant and any other objects positioned on the bed) cannot exceed 450 lbs (204 kg) (Safe Working Load).
- NEVER permit more than one person on the bed at any time.
- Body weight should be evenly distributed over the surface of the bed. DO NOT lay, sit or lean in such a way that your entire body weight is placed only on raised head or foot sections of the bed. This includes when repositioning or transferring IN or out of bed.

3.2 Operating Information



DANGER!

Risk of Death, Injury or Damage

To avoid electrical damage, product damage, shock and/or personal injury:

- DO NOT unplug power cord from junction box.
- When product is not to be used for an extended period, unplug electric bed from the wall outlet.
- Keep all product components and accessories a minimum of 22 inches away from hot or heated surfaces.



DANGER!

Risk Of Death, Injury, Or Damage

To avoid product damage and/or personal injury from fall or entrapment:

- Invacare recommends the use of mattress keepers.



DANGER!

Risk Of Injury Or Adverse Health Consequences

Fall hazard exists due to incorrect installation of bed rails.

- To avoid injury, ensure that the Invacare bed rails are installed correctly and securely attached to the bed while entering or exiting.

Fall hazard exists due to use of Non-Invacare bed rails. Non-Invacare bed rails are potentially incompatible with Invacare beds.

- To avoid injury, ensure that only Invacare bed rails are used with Invacare beds at all times.

Fall hazard exists due to use of Non-Invacare mattresses. Non-Invacare mattresses are potentially incompatible with Invacare beds.

- To avoid injury, ensure that only Invacare mattresses are used with Invacare beds at all times.

**DANGER!****Risk of Death, Injury or Damage**

To avoid serious injury or product damage from tripping, entanglement and/or pinched, or severed cords:

- Ensure all cord(s) are routed and secured properly.
- Keep all moving parts, including the main frame, mattress deck, and all drive shafts, free of obstruction (i.e. blankets/sheets, tubing, wiring, cords, etc.) during operation of the product.
- Do not roll the product over the power or pendant cord.

**WARNING!****Risk of Injury or Damage**

The emergency crank will turn when motor is on and could cause personal injury or damage to the bed.

- ALWAYS remove the emergency crank before performing electronic functions.

**WARNING!****Risk of Injury or Damage**

Due to a power outage or an electronic malfunction, an emergency crank is provided.

- DO NOT use the emergency crank to raise the bed. Personal injury or damage to the crank may occur.

3.3 Servicing Double-Insulated Products

Protection to the user against electrical shock hazard is provided by using double insulated construction. Servicing a double-insulated product requires extreme care and knowledge of the system, and is to be done only by qualified service personnel. Replacement parts for a double-insulated product must be identical to the parts they replace. A double-insulated product is marked with the words "DOUBLE INSULATION" or "DOUBLE INSULATED" or the double insulated symbol.



3.4 Disposal

Follow local governing ordinances and recycling plans regarding disposal of the product or components normally used in operation. The product does not generate waste or residue in operation. Any accessories not part of the product MUST be handled in accordance with the individual product marking for disposal.

This product has been supplied from an environmentally aware manufacturer that complies with the Waste Electrical and Electronic Equipment (WEEE) Directive 2012/19/EC.

This product may contain substances that could be harmful to the environment if disposed of in places (landfills) that are not appropriate according to legislation.

Please be environmentally responsible and recycle this product through your recycling facility at its end of life.

4 Set-up

4.1 Receiving



WARNING!

Risk of Injury or Damage

"Qualified Technician Only" sections are marked accordingly.

- Set-up and Assembly instructions **MUST** be performed by qualified technicians only.

1. Count cartons before signing shipping papers.
2. Designate someone at the facility to receive and inspect all merchandise. Use the master order acknowledgment to check off items as they are received.
3. Compare the number of cartons shipped with the number of cartons actually received and note such on the consignee copy of the freight bill. Make sure to have the truck driver sign the copy acknowledging the count.
4. If shortage occurs, **IMMEDIATELY** contact InvoCare Customer Service department at (800) 333-6900.

4.2 Unpacking



DANGER!

Risk of Injury or Damage

Continued use of the product with damaged parts could lead to the bed malfunctioning, causing injury to the user and/or caregiver.

- Check ALL product components and carton for damage, and test components before use. In case of damage or if the product is not working properly, contact a qualified technician or InvoCare for repair.
- Any modifications to the Healthcare Beds are strictly prohibited.



WARNING!

Risk of Injury or Damage

To avoid damage or personal injury:

- **DO NOT** plug the power cord into a power source until assembly is complete.
- **DO NOT** attempt to operate bed controls prior to completion of assembly.

Unpacking the Bed Ends

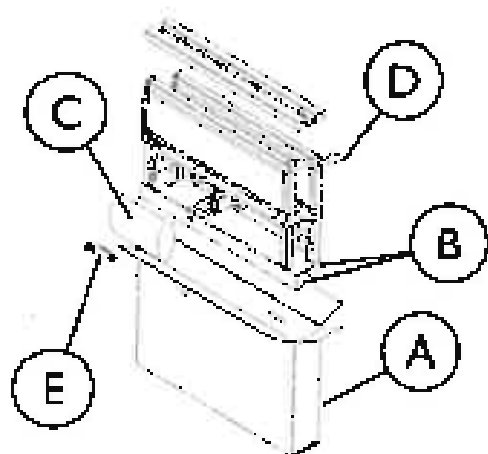

1. Remove any loose packing from the carton (A).
2. Bed End carton (B) includes:
 - Two Universal Bed Ends (C)
 - Four Casters (two locking and two non-locking casters) (E)
 - One Drive Shaft Assembly in two pieces (D)
 - One Hand Crank (B)

Unpacking Foot and Head Spring Sections

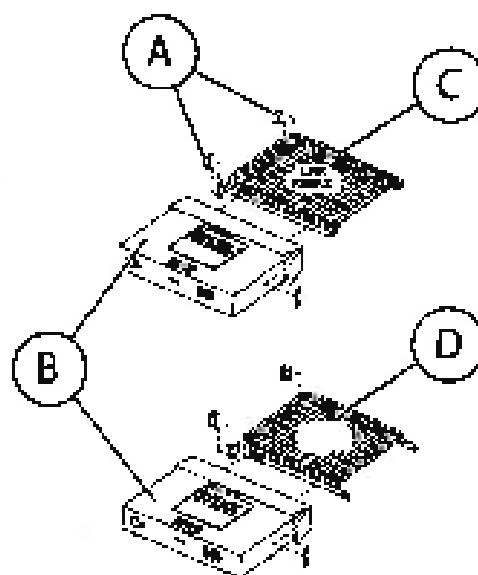

1. Remove any loose packing (A) from the carton (B).
2. Foot Spring Section carton includes:
 - One Foot Spring (C) (electric beds include pendant, junction box with power cord, and head, foot and hi/lo (full electric only) motors with cables)
 - One emergency crank handle (electric beds ONLY).
3. Head Spring Section carton includes:
 - One Head Spring (D).

Invacare® HiVitalCare Bed

Optional Low Bed End Kit

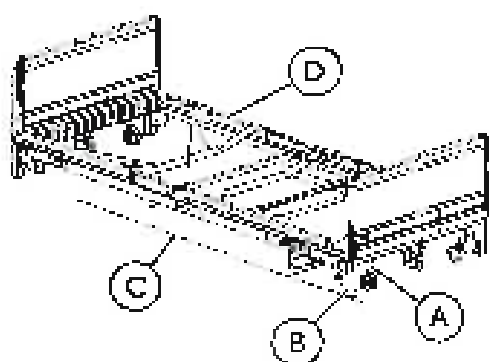

This kit includes the following:

- Two Universal Low Bed Ends.
- Four Casters (two locking and two non-locking casters).
- One Drive Shaft Assembly in two pieces.

Height Range is as follows:

- With casters installed in position (A), the height range is 9 1/2 to 20 inches.
- With casters installed in position (B) (outer bed legs), the height range is 12 to 23 inches.

 Measurements taken from floor (A) to bed deck (B).

4.3 Inspecting



DANGER!

Risk Of Injury Or Damage

To avoid injury or damage, inspect the following and contact a qualified technician or Invacare if any of the following issues are present:

- Pendant covering is cracked or damaged.
- Power cord or plug have cuts or damage.
- Motor cables have cuts or damage.
- Junction box or connectors are damaged.
- Emergency crank is missing or damaged.



DANGER!

Risk Of Injury Or Damage

To avoid injury or damage:

- Ensure that the connectors are plugged into the junction box and lit properly.

4.4 Assembling the Head and Foot Spring Sections

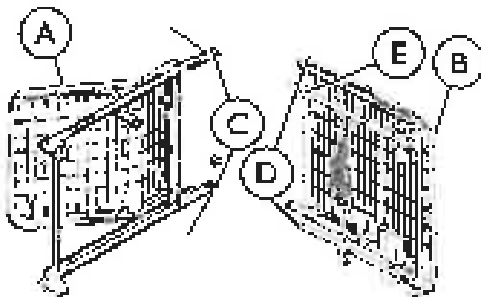

1. Remove the head spring section (5000 IVC) **A** of the bed from the packing carton.
2. Place the head spring section on its side to your left so the center mounting latches **C** are on the right.
3. Open the head spring section to a 45° to 90° angle to support the spring section.
4. Remove the foot spring section **B** of the bed from the packing carton.
5. Place the foot spring section on its side on your right with the head spring pull tube **D** at the top of the assembly. The center mounting rivets **E** should be on the left.

Note For set-up purposes, the motors on the semi-electric (5890IVC and 5891IVC) and full electric (5490IVC and 5491IVC) foot springs as well as the crank handles on the manual foot springs (5770IVC) should be on your right.

5. Place the head and foot springs approximately 50" from each other.

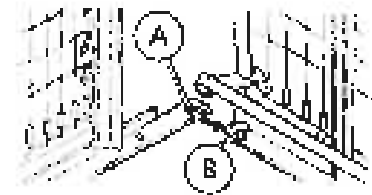



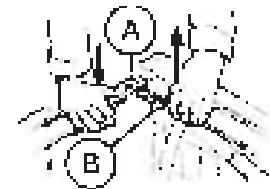

7. Hook the bottom head spring center mounting latch **C** to the bottom foot spring center mounting rivet **E**.

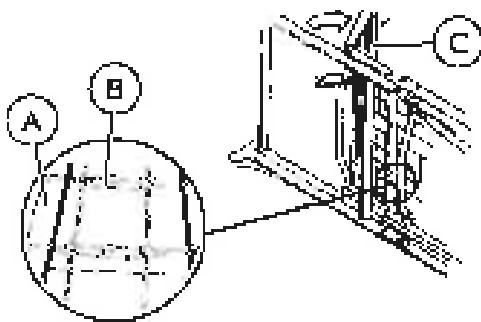

8. Hook the top head spring center mounting latch **C** to the top foot spring center mounting rivet **E**.
 - It may be necessary to lift the head spring or foot spring slightly to secure the mounting latches and rivets.
9. After head and foot springs are connected, push the springs into a horizontal (straight) position while keeping the springs on their sides.









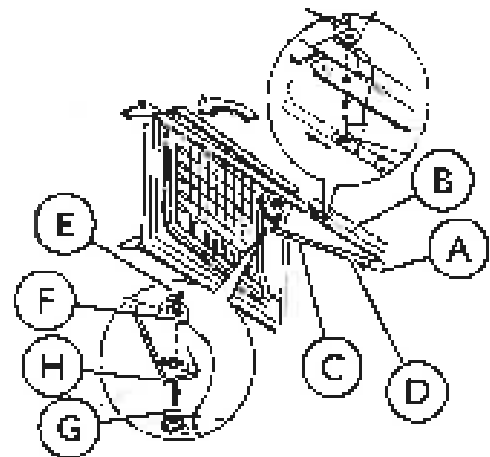

4.5 Assembling the Spring Fabric



1. Lift the head spring  away from the bed frame to give slack to the fabric.
2. Connect the spring fabric  together with the links  provided.

4.6 Adjusting and Reconnecting the Head Section Pull Tube



1. To disconnect the head pull tube assembly  from the side frame of the head spring, remove the hitch pin  and grommet/washer  from the clevis pin .
2. Extend the inner pull tube shaft  manually until the spring button "clicks" into the adjustment hole of the outer pull tube .
3. Connect the pull tube and assembly  to the lift arm of the head spring as follows:
 - a. Insert the clevis pin  into the lift arm slot .
 - b. Replace the grommet/washer .
 - c. Secure with hitch pin .

4.7 Installing the Casters

If low bed ends were ordered, proceed to 4.9 Installing Low Bed Ends, page 25, instead of performing this procedure.



WARNING!

Risk of Injury or Damage

To avoid damage or personal injury from instability:

- Ensure that the locking casters are installed diagonally from each other and are locked.



ALWAYS locate locking casters in the same location on each bed end so that they will always be assembled diagonally opposite each other when inventory is mixed.



If two locking casters are not included with the bed, contact a qualified dealer.

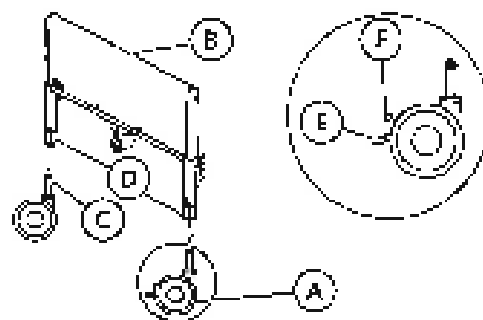
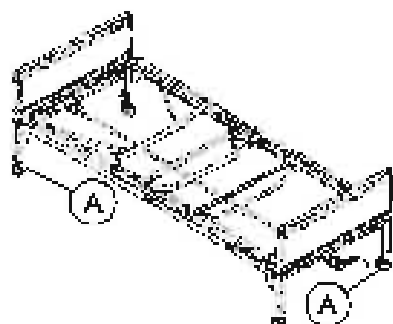

1. To install casters **(C)**, lay the bed ends **(B)** flat on the floor.
2. Insert the shaft of caster assembly **(C)** into the caster socket **(D)**.
3. To prevent excess movement of the bed during assembly, lock each of the two locking casters by pushing down on the caster lock **(E)**.
 - Locking the casters may not prevent the bed from moving on slick or slippery surfaces.
4. To unlock each of the two locking casters, pull up on the caster lock **(E)**.

4.B Assembling the Universal Bed Ends

Invacare recommends that two people perform this procedure.

Before assembling bed, ensure that the locking casters are attached to the universal bed ends diagonally across from each other.

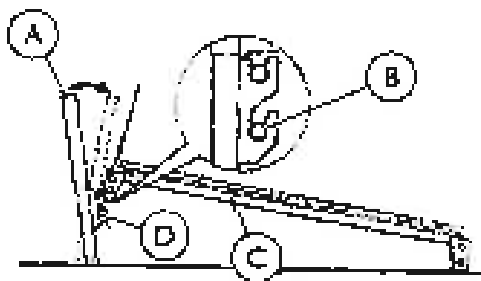

1. Stand one bed end (A) as close to the head spring section (D) as possible.
2. Grasp the head spring section by the side and raise it until the rivets on the corner plates of the spring section are high enough to place into the corner locks (C) on the bed end.



WARNING!

Risk of Injury or Damage

To avoid injury or damage from misuse:
- DO NOT place your hand between the spring section and the bed end.

3. Tilt the bed end toward the head spring section and place the rivets (B) into the corner locks.
4. Return the universal bed end to its full upright position. The head spring rivets will lock into place.
5. Repeat the same procedure for other universal bed end.

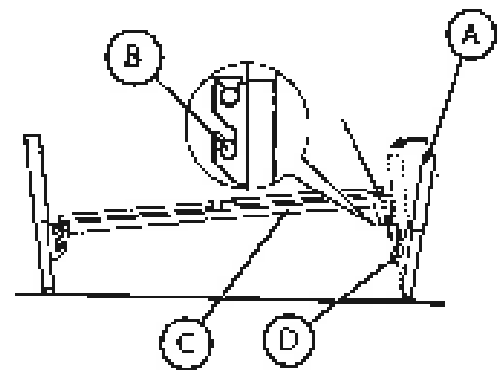

4.9 Installing Low Bed Ends

The low height feature of the Low Bed Ends creates specific use requirements that are different from the Universal Bed Ends.

- ⓘ Prior to using other Invcare accessories, ALWAYS verify proper placement of these products to allow for unobstructed and proper use in accordance with their respective user manuals.

Low bed ends are designed to be used with Invcare full electric foot spring 5480LDW and head spring 5000IVC.



CAUTION!

Risk of Damage

The Low Bed Ends are designed to be used in pairs. If not used as a pair, bed will not sit level and will not work properly possibly resulting in damage to the bed.

- DO NOT combine low bed end with any other bed end.

4.9.1 Installing the Casters onto the Low Bed Ends

- ⓘ On low bed, casters only operate when bed is in lowest position.

Always install locking caster in the same location on each bed and so that they will always be diagonally opposite each other when bed is assembled.

If two (2) locking casters are NOT included with the bed, contact a qualified dealer.

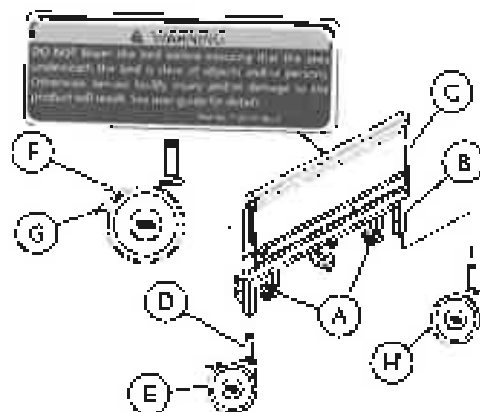

1. Determine desired bed height position. Install casters Ⓜ in either the caster sockets Ⓜ or in the bed legs Ⓜ for increased bed height.
2. Install casters by first laying the bed ends Ⓜ flat on the floor.
3. Insert the shaft Ⓜ of caster assembly into the caster socket.
4. To prevent excess movement of the bed during assembly, lock the two (2) locking casters by pushing DOWN on the caster lock Ⓜ.
 - ⓘ Locking the casters may NOT prevent the bed from moving on slick or slippery surfaces.
5. To unlock the two (2) locking casters Ⓜ, pull UP on the caster lock Ⓜ.
6. Refer to 4.8 Assembling the Universal Bed Ends, page 24 for instructions on how to install Low Bed Ends.

4.10 Assembling/Installing/Removing Drive Shaft

Reverse this procedure to remove the drive shaft.

The drive shaft for Hi/Lo function consists of two sections that are shipped unassembled. The inner drive shaft has a positioning spring button, and the outer drive shaft has multiple holes and a spring-loaded end.

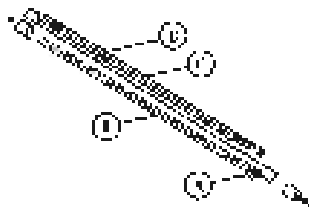

1. Remove the plastic caps from each end of the drive shaft.
2. Press the spring button (A) on the inner drive shaft (C) and insert the inner drive shaft into the outer drive shaft (D).

3. Engage the spring button into the third positioning hole (B).

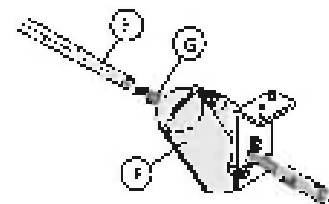

4. Push in on the spring loaded end of the drive shaft (D) and attach to the hi/lo motor (E) output shaft (F).

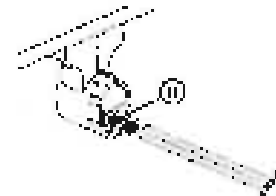

5. Attach the drive shaft to the gear box head end (E) (bottom opening) at the head end of the bed.
6. Ensure the Hi/Lo motor output shaft spring loaded coupler is properly aligned with the foot end gear box.

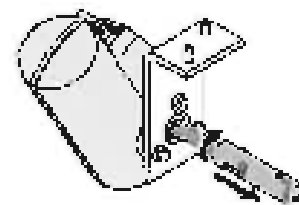

7. Release the Hi/Lo motor output shaft spring-loaded coupler by pushing in against the Hi/Lo motor output shaft spring-loaded coupler and turning clockwise.

 The coupling will release and engage the foot and toe gear box output shaft cross pins.

8. Ensure that all components are securely installed.



WARNING!

Risk Of Damage

To avoid product damage:

- DO NOT open assemblies such as the motors, pendant, junction boxes or gear boxes. No user serviceable parts are inside. Contact dealer or Invisium for repair/replacement.
- Ensure gear box cover and all other assemblies are closed.
- Unplug the power cord from its power source before performing any maintenance on the product. DO NOT unplug the power cord from the junction box. Damage to cord will result.

4.1.1 Inspecting the Bed

Electric Beds



WARNING!



Risk of Injury or Damage

To avoid injury or damage:

- When installing any connectors into the junction box, be sure the cable lock is secure after installation.



The following procedure is for full/semi electric beds only.

All motors, the junction box , connectors  and wiring are located on the foot spring section.

All connectors will arrive plugged into the junction box. If a connector is not plugged into the junction box when received or if a function of the bed is not working use the color coding to check the placement of the connectors. Each connector and junction box slot is color coded.



The color rings on the cables are not visible when the cables are plugged in and the cable lock is attached.

Invacare® Homecare Bed

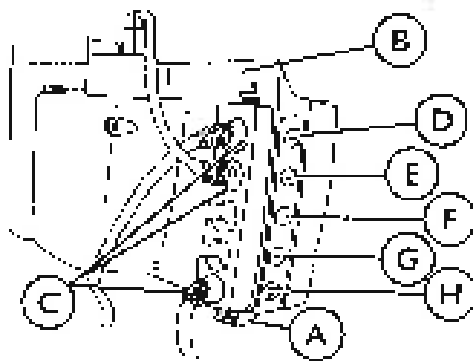

Letter	Color	Cable
B	Yellow	Foot Spring Height Adjustment
E	Blue	Head Spring Height Adjustment
G	Red	Full Electric III/IV Motor
H	White	DO NOT USE
A	Green	Pendant

1. Inspect the power supply cord and motor cables for cuts or damage to the cord and/or plug.
2. Inspect the junction box for any damage to the connectors.
3. Ensure that all cable plugs are connected securely.
4. Make sure all cables are routed through the cable lock slots.
5. Securely attach the cable lock (H). Refer to 4.11.1 Installing/Removing Cable Lock, page 29.
6. If damage is found, contact an Invacare Customer Service Representative to report the damaged items and request appropriate replacement parts or products.



WARNING!

Risk of Injury or Damage

To avoid injury or damage from misuse:

- The removal and installation of cables and the cable lock are to be performed by a qualified technician.

Manual Beds

1. Raise and lower the cranks at the foot of the bed to make sure they work correctly. Refer to 5.4 Operating the Manual Bed, page 36.
2. If no damage is found, set-up the bed for use.
3. If damage is found, contact an Invacare Customer Service Representative to report the damaged items and request appropriate replacement parts or products.

4.11.1 Installing/Removing Cable Lock

The following should be performed by a qualified technician only.

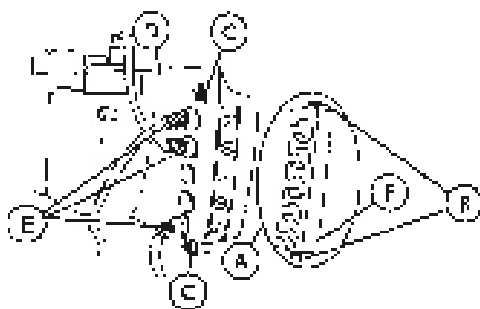

Installing

1. With the cables seated to the proper connector on control box, slide the cables (B) into the appropriate cable lock slots (D).
2. Depress the cable lock clips (C).
3. Push the cable lock clips into the locking slots (D) on the junction box (A), until they click in place.

Removing

1. Compress the cable lock clips (C) firmly.
2. Carefully pull the cable lock (E) away from the junction box (A).
3. Slide the cable lock (E) off of the cables (B).

4.11.2 Installing the Manual Crank for Hi/Lo Function

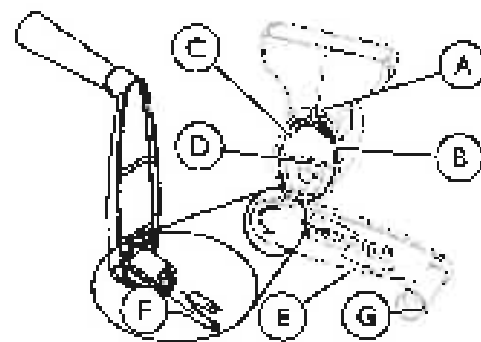

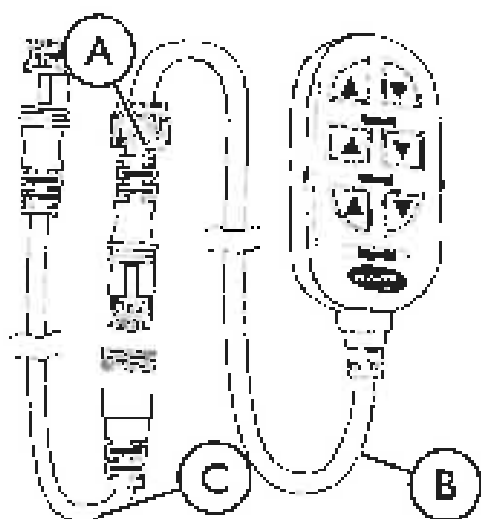

1. Pinch the ears (C) on the input drive shaft cover (B) to open the cover.
2. Flip the input drive shaft cover up and push until it attaches to the gear box (A). The cross pins (D) will now be accessible.
3. Connect the manual crank (E) to the cross pins until the spring (F) engages the cross pins.
4. Unfold the handle (G) on the hand crank.

4.11.3 Installing/Removing the Pendant



For Canadian Customers who need to disable operation of electric beds: These Models have pendants that can be removed and stored in a secure place.

1. To disable operation of the electric bed, unscrew the union nut  on the standard pendant cable  that attaches to the extension cable .
2. Unplug the standard pendant cable from the extension cable.

4.12 Storing the Bed



WARNING!
Risk Of Injury Or Damage
To avoid product damage and personal injury
– DO NOT place other objects on top of the cartons.



WARNING!
Risk Of Injury Or Damage
To avoid product damage and personal injury
– Disconnect pendant when not in use and store out of reach of children.

If bed is not being assembled immediately, retain the cartons and packaging for storage until ready for assembly.

Store the Invacare Homecare bed in a dry area.

5 Operation

5.1 Bed Operation and Component Overview



WARNING!

Risk Of Injury Or Damage

To avoid electrical damage, product damage, shock and/or personal injury:

- DO NOT unplug power cord from junction box.
- When product is not to be used for an extended period, unplug product from the wall outlet.
- Keep all product components and accessories a minimum of 12 inches away from hot or heated surfaces.
- After the product has been assembled and before use, always test to make sure that all sections of the product are properly and securely in place. If any problems arise during the test, recheck all electrical connections and mechanical hook ups and then retest. If the product is not working properly, contact a qualified technician or Invacare for repair.



WARNING!

Risk Of Injury Or Damage

To avoid unintentionally pressing the pendant buttons and causing injury or damage:

- DO NOT place pendant under or between objects.



WARNING!

Risk Of Injury Or Damage

A safety feature of this product includes protection against overheating caused by excessive or extended periods of operation. Depending on the duration, this includes multiple or repeated adjustments or the use of multiple functions at one time.

- To ensure trouble free operation, ALWAYS allow a slight pause between multiple adjustments and avoid pressing more than one function button at a time. If thermal protection activation should occur, the product will not respond to pendant commands. Given this situation, release the pendant button and allow the product to sit for several minutes. This will allow the protection function time to reset and restore product function. Depending on severity of the initial overheating, this could take up to 30 minutes.
- After the thermal protection activation period is complete, the bed may be prone to sudden movement. Use caution when using the product after the protection function time has reset and the pendant function has been restored.

InvoCare® HomeCare Bed

Before placing the bed into use, test the bed by operating it through all phases of operation.

1. If any problems arise during the test, recheck all electrical connections and mechanical hook ups.
2. Full electric beds use a six-function pendant for all bed operations.
3. Semi-electric beds use a four-function pendant for head and foot spring operations and a hand crank for Hi/Lo bed operation.
4. Manual beds use three hand cranks for all bed operations.

- To operate the Electric bed using the six button controller, refer to 5.2 Operating Full Electric Bed, page 33.

To operate the Semi-Electric bed using the four button controller, refer to 5.3 Operating the Semi-Electric Bed, page 34.

To operate the Manual bed using the three hand cranks, refer to 5.4 Operating the Manual Bed, page 36.

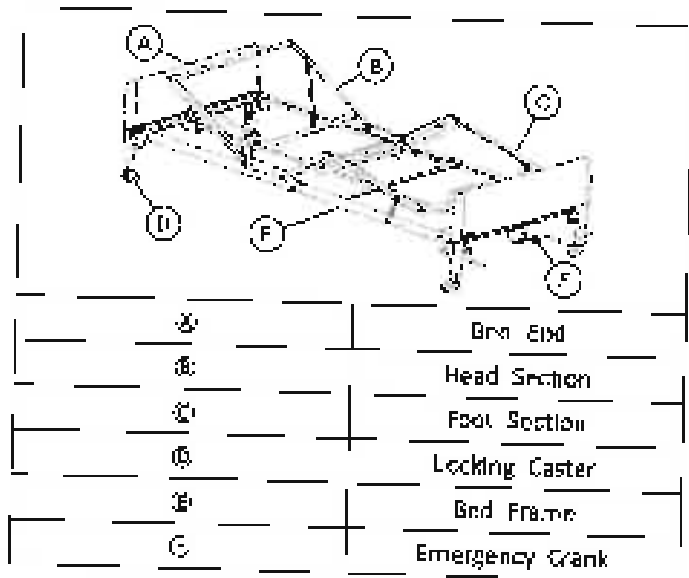

DANGER!

Risk of Death, Injury or Damage

Pendant malfunction may cause injury or damage.
 - Unplug bed from electrical outlet and contact a qualified technician or InvoCare for repair if any malfunction is detected.

5.2 Operating Full Electric Bed

Models 5410IVC and 5411IVC

Before placing the bed into use, test the bed by operating it through all phases of its operation.







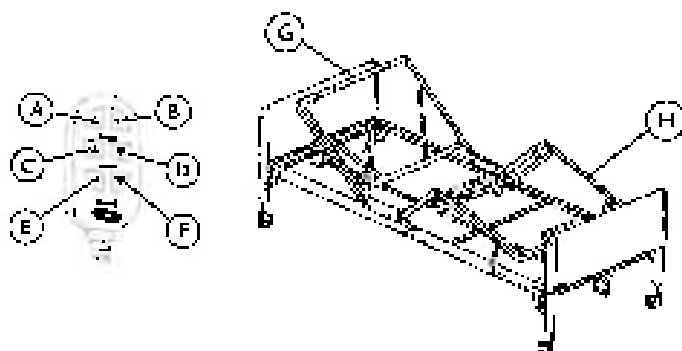

1. Use the six function pendant for all bed operations.
2. If any problems arise during the test, recheck all electrical connections and mechanical hook ups.

 All electric beds come with an emergency crank to allow the bed to be lowered in the event of a power outage.



Raising and Lowering the Head and Foot Sections



 Link Fabric not shown.

1. To raise the head of the bed , press the "Head Up" button .
2. To lower the head of the bed , press the "Head Down" button .
3. To raise the foot of the bed , press the "Foot Up" button .
4. To lower the foot of the bed , press the "Foot Down" button .

Raising and Lowering the Entire Bed

1. To raise the entire bed, press the "Bed Up" button .
2. To lower entire bed, press the "Bed Down" button .

Invacare® Manual Bed

5.3 Operating the Semi-Electric Bed

Models 5310WC and 5311WC

Before placing the bed into use, test the bed by operating it through all phases of its operation.

1. Perform the following:
 - Use the four function pendant for head and foot spring operations.
 - Use the hand crank for Hi/Lo bed operation.
2. If any problems arise during the test, recheck all electrical connections and mechanical hook ups.

 All semi-electric beds come with an emergency crank to allow the bed to be lowered in the event of a power outage.

Raising and Lowering the Head and Foot Sections

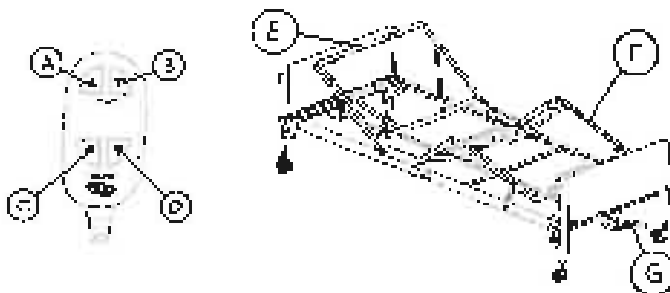

 Lin® Fabric not shown.

1. To raise the head of the bed (D), press the "Head Up" button (A).
2. To lower the head of the bed (E), press the "Head Down" button (B).
3. To raise the foot of the bed (F), press the "Foot Up" button (C).
4. To lower the foot of the bed (G), press the "Foot Down" button (H).

Raising and Lowering the Entire Bed

1. To raise and lower the entire bed, use crank (I).

5.3.1 Using the Emergency Crank



WARNING!

Risk Of Injury Or Damage

Due to a power outage or an electronic malfunction, an emergency crank is provided.

- Do NOT use the emergency crank to raise the bed. Personal injury or damage to the crank may occur.



WARNING!

Risk Of Injury Or Damage

To avoid injury or damage from moving parts:

- Unplug the bed from the wall outlet before using the emergency crank.

Failure to remove the emergency crank may cause damage or personal injury.

- The emergency crank MUST be removed before the bed is used.

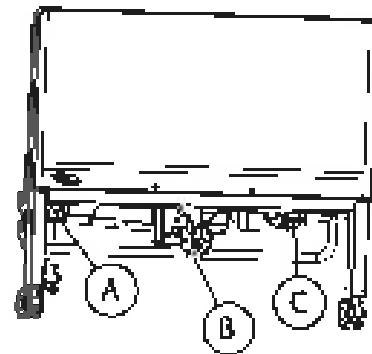

You should find the emergency crank stored in the link fabric of the spring deck. If you do not find the crank, contact your dealer.

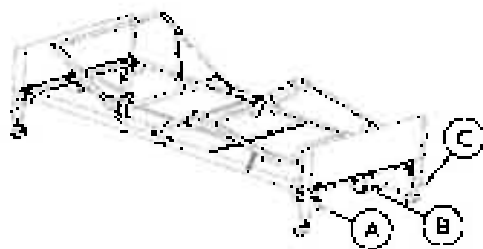

1. Remove the emergency crank from the spring deck of the bed under the mattress.
2. Locate the exposed shaft end according to the function you want to perform.
 - Lower the head section with shaft end (B).
 - Lower the foot section with shaft end (C).
 - Lower the entire bed with shaft end (A).

5.4 Operating the Manual Bed



 Link fabric not shown.

Before placing the bed into use, test the bed by operating it through all phases of its operation.

1. Perform the following:
 - Raise and lower the head section with hand crank .
 - Raise and lower the foot section with hand crank .
 - Raise and lower the entire bed with hand crank .
2. If any problems arise during the test, recheck all mechanical hook ups.

5.5 Optional Bed Rails



WARNING!

Risk Of Injury Or Damage

To avoid injury or damage from misuse:
- DO NOT install the optional bed rails without reading and understanding the **Bed Rail Risk Notification Guide** that accompanies this manual and is included with each bed rail kit. The **Bed Rail Risk Notification Guide** can also be found at www.invacare.com.



DANGER!

Risk Of Death, Injury Or Damage

To avoid entrapment, damage, and/or personal injury:

- These bed rails are intended to prevent an individual from inadvertently rolling out of bed. Do not use for restraint purposes.
- Invacare recommends the use of two sets of half length bed rails: one set at the head end of the bed, and one set at the foot end of the bed where permitted.
- Use **ONLY** Invacare rails with Invacare products.
- **DO NOT** use the bed rails as push handles when moving the bed.



WARNING!

Risk Of Injury Or Damage

To avoid personal injury or damage from misuse:
- Bed rail **IS NOT** an assist rail for getting into or out of bed.

**WARNING!****Risk Of Death, Injury Or Adverse Health Consequences**

Fall hazard exists due to incorrect installation of bed rails.

- To avoid injury, ensure that the Invacare bed rails are installed correctly and securely attached to the bed while entering or exiting.

Fall hazard exists due to use of NON-Invacare bed rails. Non-Invacare bed rails are potentially incompatible with Invacare beds.

- To avoid injury, ensure that only Invacare bed rails are used with Invacare beds at all times.

Fall hazard exists due to use of NON-Invacare mattresses. Non-Invacare mattresses are potentially incompatible with Invacare beds.

- To avoid injury, ensure that only Invacare mattresses are used with Invacare beds at all times.

**WARNING!****Risk Of Death, Injury, Or Damage**

To avoid entrapment, product damage, and/or personal injury:

- When used with a manual/electric bed, the bed rails DO NOT fall under any weight limitations. Bed rails can be deformed or broken if excessive side pressure is exerted on the bed rails. These bed rails are used for the purpose of preventing an individual from inadvertently rolling out of bed. The bed rails are not intended nor may be used for restraint purposes. If an individual is capable of injuring himself/herself, a physician or a healthcare professional should be consulted for alternative means of safe restraint.
- After raising/lowering the head/foot end of the electric bed, check the distance between the bottom of the bed rail and the mattress. If there is excessive distance between the bottom of the bed rail and the mattress in which individuals may become entangled, adjust the height of the bed rail (if applicable), or provide alternative means of patient protection.
- DO NOT use the side rails as push handles for moving the electric bed.
- Replacement mattresses and bed side rails with dimensions different from the original equipment supplied or specified by the bed frame manufacturer are not interchangeable. Variations in bed side rail design, width and thickness or firmness of the mattress could cause/contribute to entrapment.

6 Maintenance

6.1 Service Life



WARNING!

Risk of Injury or Damage

Use of the product beyond this time period may cause product damage and injury.

- This product has an expected lifetime of seven (7) years when used in accordance with safety instructions, maintenance intervals and correct use stated in this manual.
- Perform all maintenance according to the recommended schedule in this manual.

- * The effective bed lifetime can vary according to the frequency and intensity of use.

6.2 Wear and Tear Items

Normal wear and tear items and components include, but are not limited to the items in the table:

Wear and Tear Items
Hand Pendants
Crank Handle
Casters—tread wear, brake levers
Drive Shafts

Invacare reserves the right to ask for any item back that has an alleged defect in workmanship. See the Warranty that shipped with the product for specific warranty information.

6.3 Cleaning the Bed

QUALIFIED TECHNICIAN ONLY

Washing the Bed Ends

 **WARNING!**
Risk of Injury or Damage
 To avoid injury or damage from misuse:

- Read all guidelines, warnings and cautions before performing any repair/maintenance on the bed.
- All repair and maintenance on the bed should be performed by a qualified technician.

 **DANGER!**
Risk of Injury or Death
 To prevent a fall or fire:

- Inspect bed ends for leaking grease.
- Contact service provider if grease or other residue is detected.

 **CAUTION!**
Risk of Damage
 To protect flooring from damage or staining, perform the following:

- Ensure bed ends are completely drained and dry before placing on flooring.

 **DANGER!**
Risk Of Death, Injury, or Damage
 To avoid damage to electric controls:

- If a liquid is spilled in or around the electric bed, unplug the electric bed before cleaning.
- Clean up the spill and allow the electric bed or the area around the electric bed to dry thoroughly before using the electric controls again.

 **WARNING!**
Risk Of Injury Or Damage
 Grease may leak from the gearbox and cause injury or damage from falling or fire:

- Follow the maintenance instructions in this manual.
- Routinely inspect the gearbox for grease leakage.

If the gearbox is leaking grease:

- Stop use immediately.
- Keep the product away from sparks, flame, and open heat sources.
- Contact your dealer or Invacare for repair.

 **WARNING!**
Risk Of Injury Or Damage
 To avoid product damage or injury from malfunction:

- Clean the product according to the instructions.
- The product may be damaged from multiple or excessive cleaning.

Insure® Homecare Beds

1. Stand or prop each bed end in an upright position on its legs.
2. Using a mild soap/detergent and soft bristle brush or sponge, scrub all exterior surfaces.
3. Using a hose and nozzle attachment, rinse bed ends thoroughly with plain cold or warm water.
 - " Do not exceed a water temperature of 110° F.
 - ⌚ Use household tap pressure. DO NOT use pressure washers or steam cleaners. DO NOT use solvents, bleach, alcohol, petroleum products, caustic agents or highly alkaline or acidic agents to clean the bed.
4. Tip bed end from side to side to allow any collected or trapped water to drain.
5. Thoroughly towel dry bed end and all components.
5. Repeat drying process until all components are dry.
 - ⌚ Ensure that the bed end is completely dry before storing.

Cleaning the Head and Foot Sections



WARNING!

Risk of Injury or Damage

The electric motors, control box and pendant are NOT protected against the entrance of dust and liquids.

- DO NOT spray liquids into any electrical components.
- DO NOT wash head or foot section.
- DO NOT allow electrical components to get wet.

2. Unplug the power cord of electric beds before performing maintenance.
2. Wipe down the bed with disinfectant. Allow it to dry completely.

6.4 Maintenance and Cleaning Checklist

Invacare recommends the following maintenance/cleaning procedures be conducted initially, between users, or as needed. This form is provided as a guide to help with documentation.

Cleaning and Disinfecting Bed

- Unplug the power cord of electric beds before performing maintenance.
- Wipe down with disinfectant. Allow to dry completely.

Mechanical Inspection and Maintenance

- Inspect all bed components (i.e. rails, clevis pins, hitch pins, etc.) for damage or excessive wear and replace as necessary.
- Visually examine all welds for cracks.
- Inspect the head and foot spring sections for bending, warping or damage.
- Check drive shaft and drum shaft connections for bending, damage or excessive wear.
- Inspect pull tubes and mounting hardware for bending, damage or excessive wear.
- Inspect all bolts and rivets to ensure that they are securely tightened and functioning properly.
- Check casters to ensure they lock, if applicable, and roll properly.
- Ensure end caps are in place and secure. Replace if missing or damaged.

In addition, dealers should inspect bed ends for proper operation:

1. Adjust bed ends to the lowest position.
2. Remove bed ends from head or foot spring.

1124035 H-03

3. Remove bed end caps and plastic cover.
4. Inspect cables and pulleys for wear.
5. Inspect Acme screws for lubrication. Apply a light lithium based grease if necessary.
6. Reinstall the plastic cover and end caps.

Electrical Inspection and Maintenance

- Inspect all electrical bed components for damage or excessive wear (i.e., cracked or broken housings, or worn components).
- Check pendant, power and motor cords for chafing, cuts or excessive wear.
- Make sure all plugs are fully attached and free of damage.
- Check all functions:
 1. Head raises and lowers properly.
 2. Foot raises and lowers properly.
 3. Bed ends raise and lower properly.

In addition dealers should inspect all electrical bed components:

- Chafing
- Nicks in the insulation
- Missing insulation
- Exposed internal wiring or conductors
- Signs of pinching or crushing
- Broken or deformed connectors

- If these conditions are present, the bed MUST not be used until the damaged component/wiring is replaced. Modification or other forms of repair including electrical or similar tape MUST NEVER be used.

Invokair® Homecare Bed:

PASS/FAIL

- PASS:** Bed and all components have passed all of the preceding inspection criteria, and the bed is ready for placement into a client's home.
- FAIL:** Bed, or any component, has failed any of the preceding inspection criteria. Tag the bed or component with a complete description of the failure(s) and have the bed serviced.

7 Troubleshooting

7.1 Troubleshooting Mechanical

SYMPTOM	PROBABLE CAUSE	SOLUTION
Bed does not stay in place.	Casters unlocked.	Lock Casters.
Bed springs do not move.	Pull tube.	Check pull tube(s) for binding. Call dealer for repairs.
	Manual Beds - crank(s) not working.	Call dealer.
Bed ends move in opposite directions (electrical or manual bed).	Drive Shaft connected to wrong gear box shaft.	Call dealer.
Hi/Lo function does not work.	Crank not properly installed.	Call dealer.
	Drive shaft disconnected.	Call dealer.
Pressing function on pendant results in motion other than that intended.	Motor cable connections to junction box incorrect.	Call dealer.

7.2 Troubleshooting Electrical

SYMPTOM	PROBABLE CAUSE	SOLUTION
Bed spring does not move.	End of stroke reached.	Operate opposite button.
Bed Spring does not stop moving.	Pendant	Check for depressed/stuck buttons. If button is stuck, call dealer for repair.
Bed Hi/La movement does not stop.	Cables.	Check cables, if damaged call dealer.
Bed is producing unusual sounds, burning odors, or movement deviations observed in the controls, motors, or the limits switch functions.	Motors are not functioning properly.	Call dealer.

SYMPTOM	PROBABLE CAUSE	SOLUTION
Full Electric Bed: Hi/Lo function does not work.	Bed not plugged in.	Ensure power cord is plugged into power source.
	Pendant not functioning.	Ensure Pendant is correctly connected to junction box.
	Cables.	Ensure Pendant cable not entangled/pinched.
		Ensure cables are not entangled/pinched.
	Broken cable lock.	Call the dealer for repair/replacement of cables and/or motors.
	Household fuse or breaker blown.	Call dealer to replace cable lock.
	Motors are not functioning.	Check household fuse/breaker box.
Hi/Lo Motor.	Call dealer.	
	Ensure cables are not entangled or pinched.	
Thermal Protection Activated.	Call dealer.	
	Allow bed unit to sit for 30 minutes and retry.	

8 Warranty

8.1 Limited Warranty

PLEASE NOTE: THE WARRANTY BELOW HAS BEEN LIMITED TO COMPLY WITH FEDERAL LAW APPLICABLE TO PRODUCTS MANUFACTURED AFTER JULY 4, 1975.

This warranty is extended only to the original purchaser who purchases this product when new and unused from Inovance or a dealer. This warranty is not extended to any other person or entity and is not transferrable or assignable to any subsequent purchaser or owner. Coverage under this warranty will end upon any such subsequent sale or other transfer of title to any other person.

This warranty gives you specific legal rights and you may also have other legal rights which vary from state to state.

Inovance warrants the mechanical and electrical components of this product when purchased new and unused to be free from defects in materials and workmanship for a period of two years from date of purchase from Inovance or a dealer, with a copy of the seller's invoice required for coverage under this warranty. Inovance warrants all copies of this product when purchased new and unused to be free from defects in materials and workmanship for a period of five years from date of purchase from Inovance or a dealer, with a copy of the seller's invoice required for coverage under this warranty. If within such warranty periods any such product shall be proven to be defective, such product shall be repaired or replaced at Inovance's option. This warranty does not include any labor or shipping charges incurred in replacement part installation or repair of any such product. Inovance's sole obligation and your exclusive remedy under this warranty shall be limited to such repair and/or replacement.

For warranty service, please contact the dealer from whom you purchased your Inovance product. In the event you do not receive satisfactory warranty service, please write directly to Inovance at the address on the Card above, provide dealer's name, address, and the date of purchase, include nature of the defect and, if the product is serializable, include the serial number. Do not return products to our factory without our prior consent.

LIMITATIONS AND EXCLUSIONS: THE FOREGOING WARRANTY SHALL NOT APPLY TO UTILITY EQUIPMENT PRODUCTS IF THE SERIAL NUMBER HAS BEEN REMOVED OR DELETED. PRODUCTS SUBJECTED TO NEGLIGENCE, ABUSE, IMPROPER OPERATION, MAINTENANCE, OR STORAGE. PRODUCTS INCIDENT TO FAULTS INVOLVING EXPRESS WRITTEN CONSENT INSTALLATIONS, BUT NOT LIMITED TO, MODIFICATION THROUGH THE USE OF UNAUTHORIZED PARTS OR ATTACHMENTS; PRODUCTS DAMAGED BY REASON OF REPAIRS MADE TO ANY COMPONENT WITHOUT THE SPECIFIC CONSENT OF INOVANCE, OR TO A PRODUCT DAMAGED BY CIRCUMSTANCES BEYOND INOVANCE'S CONTROL. AND SUCH EVALUATION WILL BE SOLELY DETERMINED BY INOVANCE. THIS WARRANTY SHALL NOT APPLY TO NORMAL WEAR AND TEAR OR FAILURE TO ADHERE TO THE PRODUCT INSTRUCTIONS.

THE FOREGOING EXPRESS WARRANTY IS EXCLUSIVE AND IN LIEU OF ANY OTHER WARRANTY'S IMPLICATIONS, WHETHER EXPRESS OR IMPLIED, INCLUDING THE IMPLIED WARRANTIES OF MERCHANTABILITY AND FITNESS FOR A PARTICULAR PURPOSE, AND THE SOLE REMEDY FOR VIOLATIONS OF ANY WARRANTY WHATSOEVER, SHALL BE LIMITED TO REPAIR OR REPLACEMENT OF THE DEFECTIVE PRODUCT PURSUANT TO THE TERMS CONTAINED HEREIN. THE APPLICATION OF ANY IMPLIED WARRANTY WHATSOEVER SHALL NOT EXTEND BEYOND THE DURATION OF THE EXPRESS WARRANTY PROVIDED HEREIN. INOVANCE SHALL NOT BE LIABLE FOR ANY CONSEQUENTIAL OR INCIDENTAL DAMAGES WHATSOEVER.

Some states do not allow the exclusion or limitation of incidental or consequential damages, or the reduction of how long an implied warranty lasts, so the above exclusion and limitation may not be applicable.

THIS WARRANTY SHALL BE EXTENDED TO COMPLY WITH STATE/PROVINCIAL LAWS AND REQUIREMENTS.

11-11-11

Invacare Corporation
USA

One Invacare Way
Elyria, Ohio USA
44035
(800) 333-6900



1.14296-1-GS 01/02 03



www.invacare.com

Canada

570 Matheson Blvd E Unit 8
Mississauga Ontario
L4Z 4G4 Canada
800-668-5324



Manufacturing Location

2101 E. Lake Mary Blvd
Sanford, Florida USA
32773

Making Life's Experiences Possible[®]



Yes, you can!