

# SW218



User Manual  
Version 1.0

# Table of Contents

---

<b>Get Started</b> .....	05
What's in the box .....	05
<b>Set up SW218</b> .....	06
Compatibility with Mobile .....	06
Download the APP .....	06
Wear SW218 .....	07
Change the wristband.....	09
To remove the wristband .....	09
To attach a wristband .....	10
Charge your watch .....	11
Pair with Phone .....	12
Check connect state .....	13
Disconnect from phone .....	13
Forget device .....	14
How to use .....	14
Change watch faces .....	15
<b>Basics Navigation</b> .....	16
Brightness adjustment .....	16
Vibration adjustment .....	16
Lift Wrist to Wake Up .....	17
Find Device & Phone .....	18

Shake for Photograph .....	19
Sedentary reminder .....	20
Drink Reminding .....	21
Medicine reminder .....	22
<b>Notifications</b> .....	23
Set up notifications .....	23
See incoming notifications .....	24
Phone Remind and Reject phone calls .....	25
<b>Timekeeping</b> .....	26
Set an alarm .....	26
Set a stopwatch .....	27
<b>Activity and Sleep</b> .....	28
Track a daily activity .....	28
Choose a goal .....	28
Track your sleep .....	29
See your heart rate .....	30
Enhanced Heart Rate Measurement .....	31
Blood pressure measure .....	32
Blood Oxygen Measure .....	33

<b>Fitness and Exercise</b> .....	34
Track and analyze exercise with the app .....	34
Track and exercise .....	34
To track an exercise .....	34
Check your workout summary .....	36
<b>Reset</b> .....	37
Reset SW218 .....	37
<b>Troubleshooting</b> .....	38
Heart-rate signal missing .....	38
Other issues .....	39
Return policy and warranty .....	39
<b>Specifications</b> .....	40
<b>Safety Notices</b> .....	41

# Get Started

---

Welcome to SW218, an all-day companion that lasts 5+ days.

## What's in the box

Your SW218 box includes



smart watch



charging cable



Service Card

SW218 has multi-color options.



# Set up SW218

---

## Compatibility with Mobile



IOS 10.0 & above



Android 5.0 & above

NOT SUPPORTED: Windows/Amazon Kidle/Amazon Fire/PC/ Tablet/Ipad/SAMSUNG J1/J2/J3/J5/J7

## Download the APP

Search "JYouPro" App on the App store or Google Play store.  
Or scan the QR code to download:

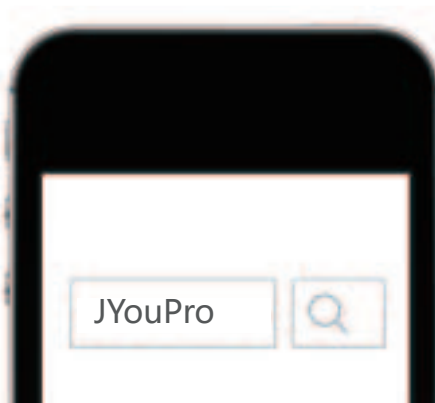

# Wear SW218

Placement for all-day wear vs exercise:

When you're not exercising, wear SW218 a finger's width above your wrist bone.

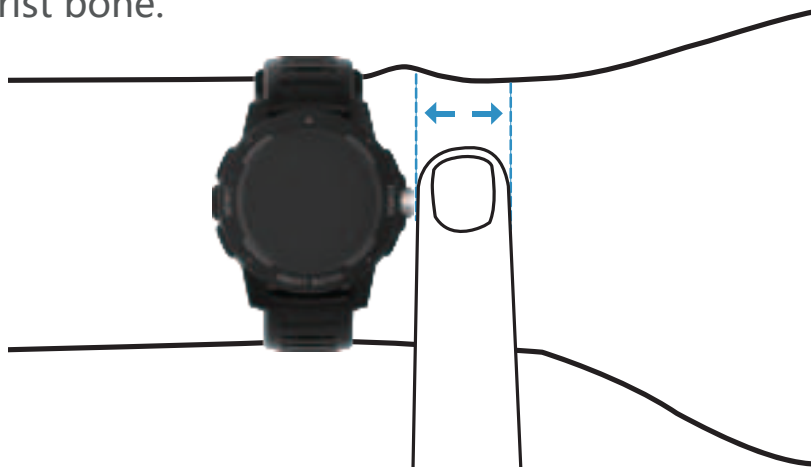

For optimized heart-rate tracking while exercising:

- Try wearing SW218 higher on your wrist during exercise for an improved fit and more accurate heart-rate reading.

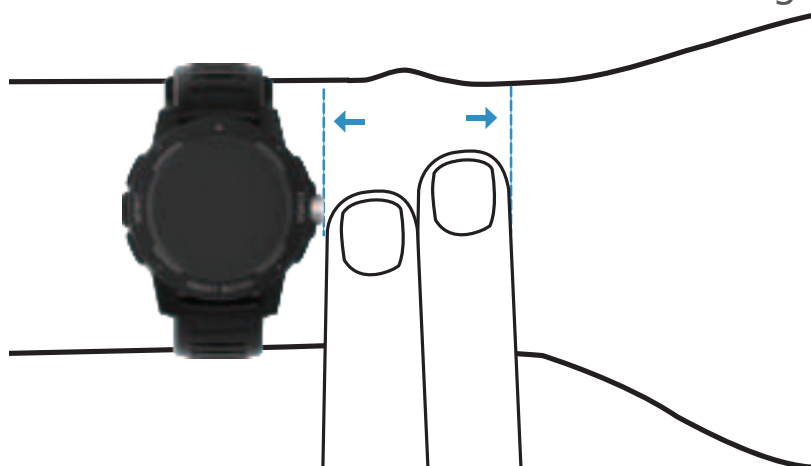

- Make sure the watch is in contact with your skin.
- Don't wear your watch too tight, a tight wristband restricts blood flow, potentially affecting the heart-rate signal. The watch should be slightly tighter (snug but not constricting) during exercise.

With high-intensity interval training or other activities where your wrist is moving vigorously and non-rhythmically, the movement may limit the sensor's ability to provide a heart-rate reading. If your watch doesn't show a heart-rate reading, try relaxing your wrist and staying still briefly.





# Change the wristband

## To remove the wristband:

1. Turn over SW218 and find the quick-release lever.
2. While pressing the quick-release lever inward, gently pull the wristband away from the watch to release it.
3. Repeat on the other side.

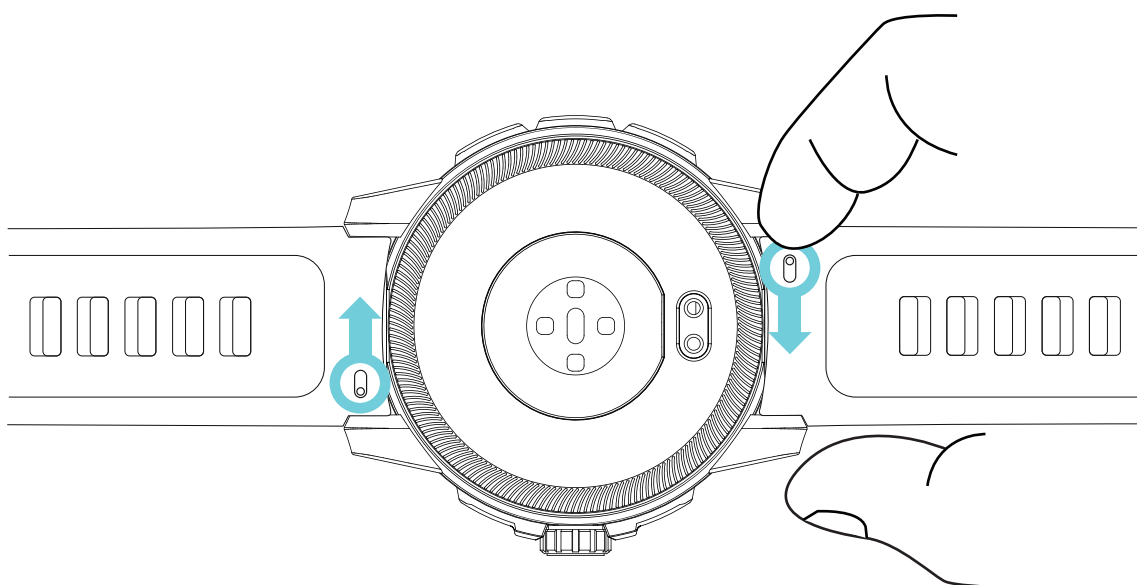

## To attach a wristband:

1. Attach the wristband with the clasp to the top of the watch. Slide the pin (the side opposite the quick-release lever) into the notch on the watch.

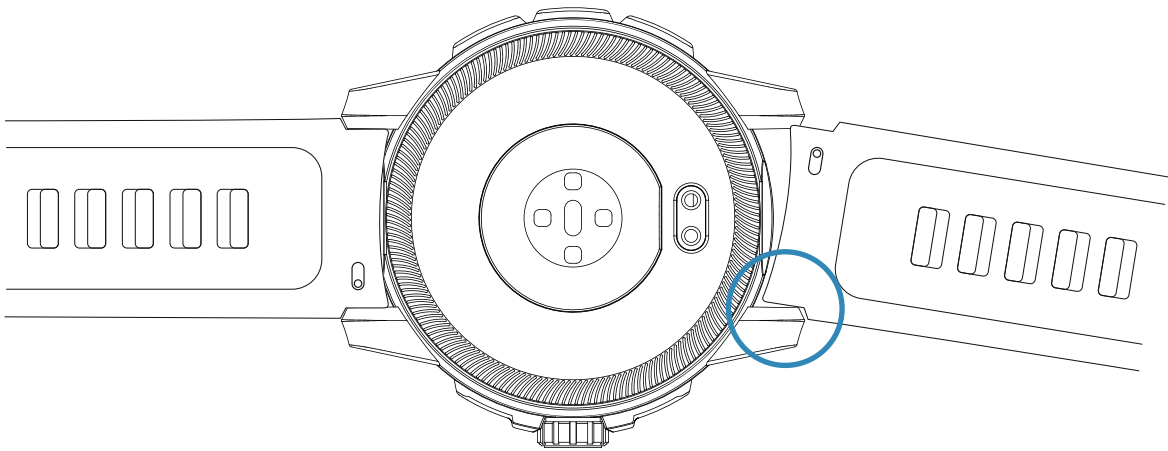

2. While pressing the quick-release lever inward, slide the other end of the wristband into place.

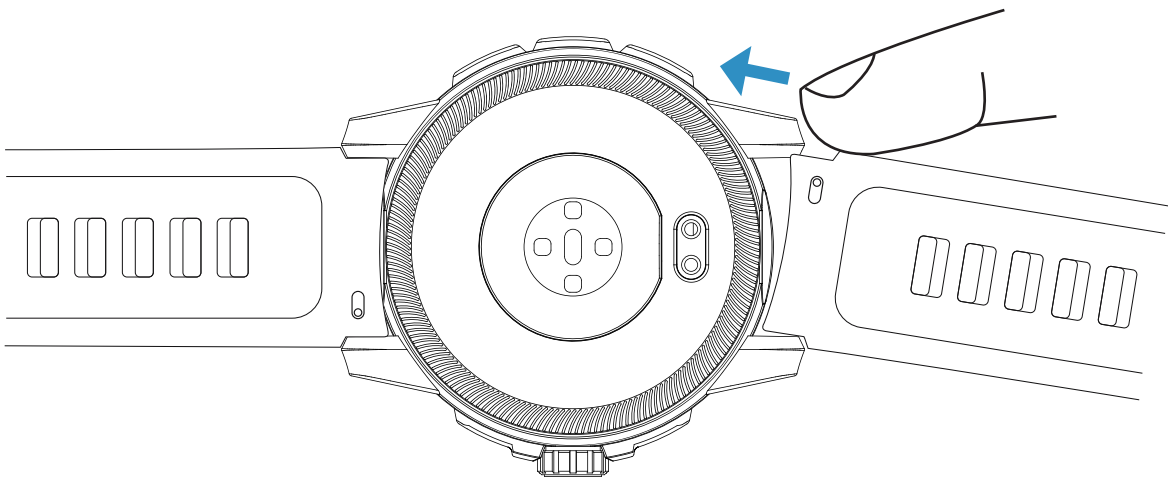

3. When both ends of the pin are inserted, release the quick-release lever.



# Charge your watch

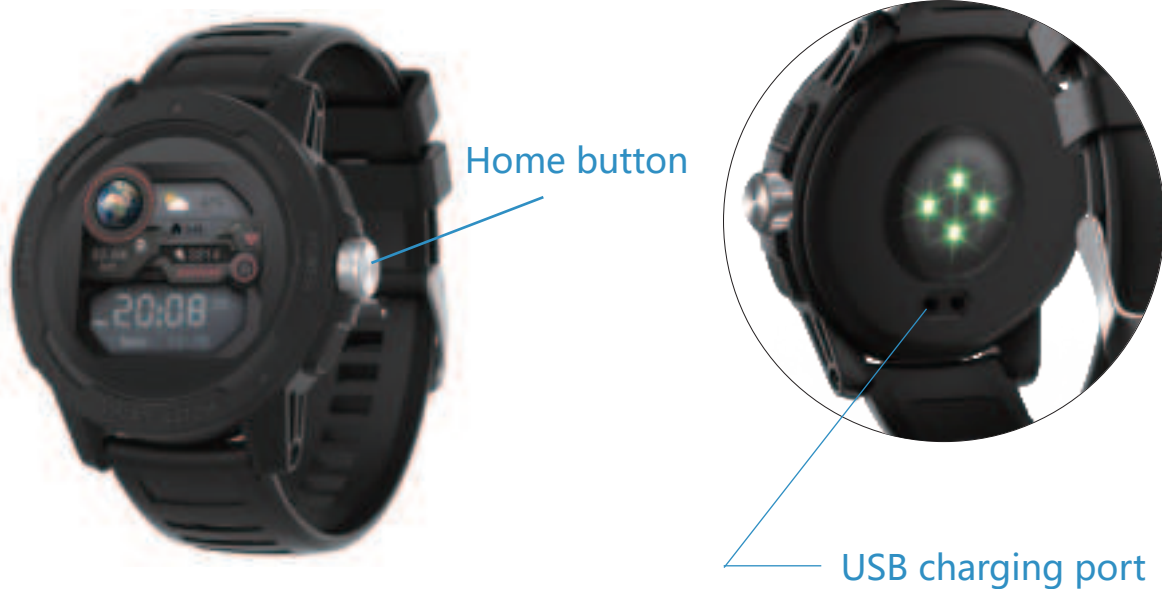

Please full charge your new device 2 hours before initial use.

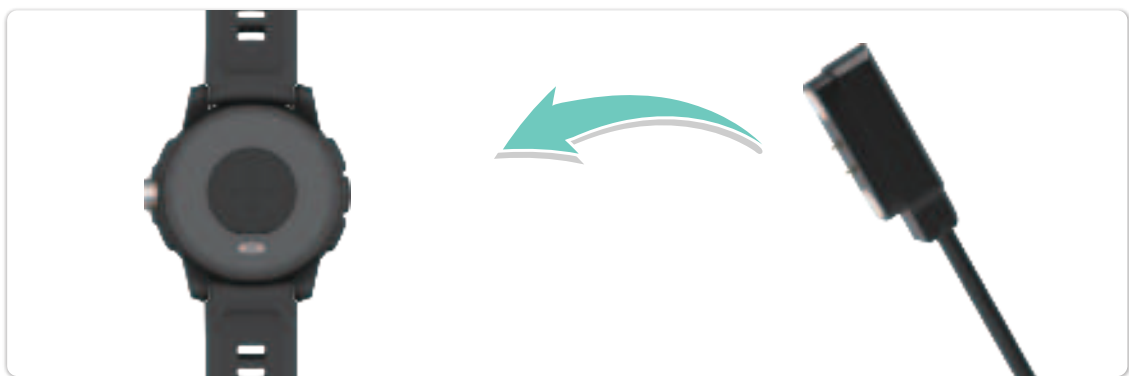

# Pair with phone

Steps:

- 1). Make sure your phone bluetooth is on.
- 2). Open "JYouPro" App, on the bottom toolbar, go to "Device" tab.
- 3). Tap to "+ Add Peripheral Now" to search the device named SW218-XXX to connect. The Watch will synchronize time with your phone after paired.

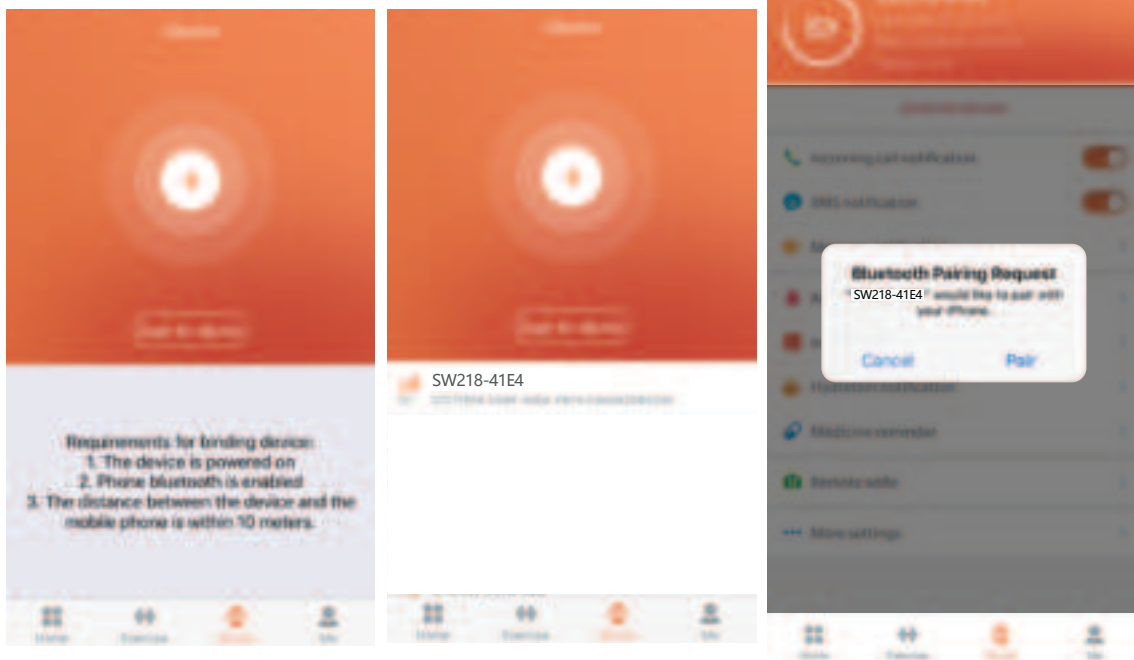

Note: please do not pair the watch from bluetooth list directly.



## Check connect state

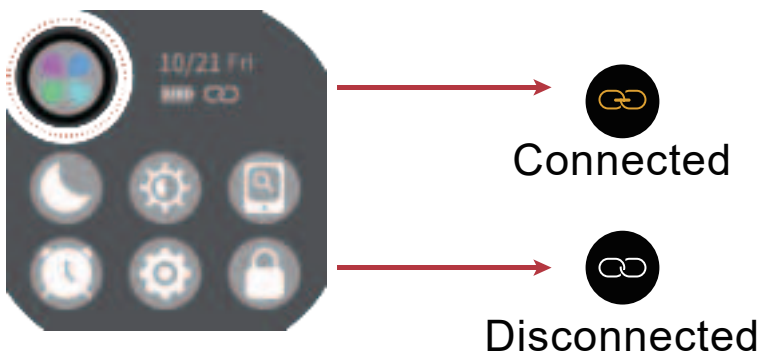

## Disconnect from phone

Steps: Open "JYouPro" App → Device → Unbundling Bracelet

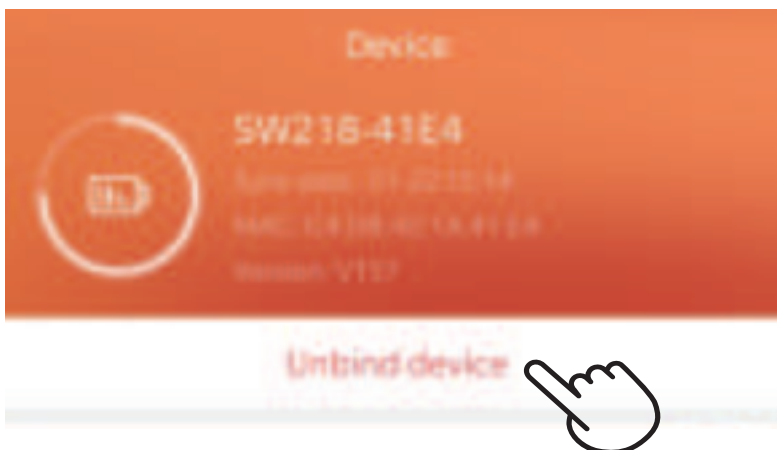

# Forget device

Steps: Go to phone's settings → Bluetooth → Click  → Forget This Device → Forget Device

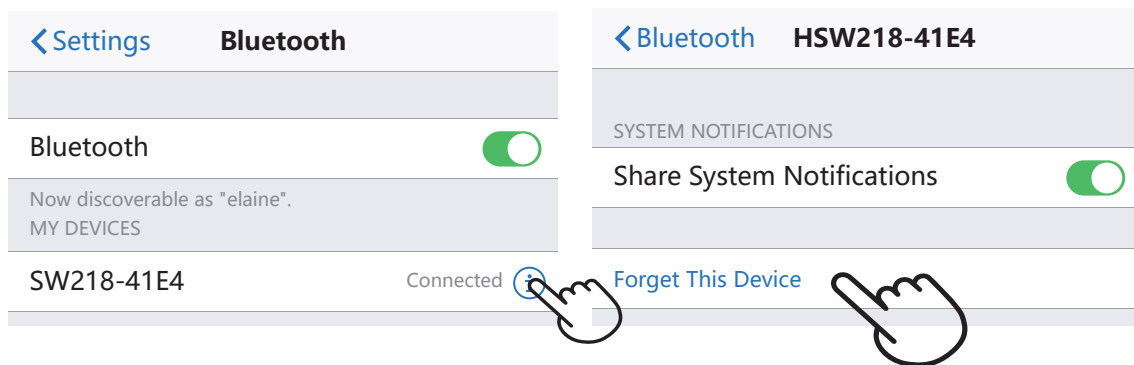

## How to use



Long press the screen 2s, you can choose one dial you like.

Short press button, it show the watch dial.

Long press button 4s, it show shutdown options appear.

## Change watch faces

Change dial steps : In the watch main interface, hold the screen to change the theme interface.



# Basics Navigation

---

## Brightness Level

Brightness Level: swipe up→Setting→Bright screen display→Click “+” or “-” to adjust the brightness



## Do not disturb mode setting

Steps: swipe down→click first icon to turn on/off do not disturb mode.





# Lift Wrist to Wake Up

When the hand is raised, the screen will automatically light up. Open this setting on app. You can set the time of quick look on app.

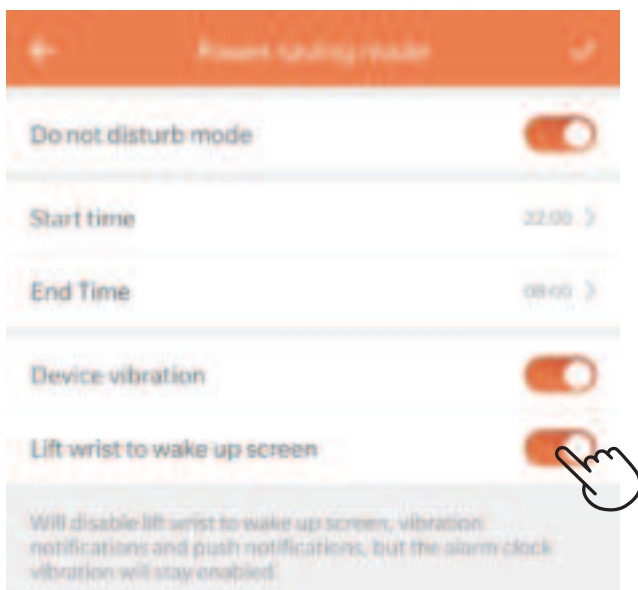

# Find Device & Phone

Find Device: Open JYouPro App → Device → More settings → Device search → the device will vibrate.

Find Phone: Swipe up on the watch face → Find phone → the phone will Ring (make sure your phone is in Unmute state)

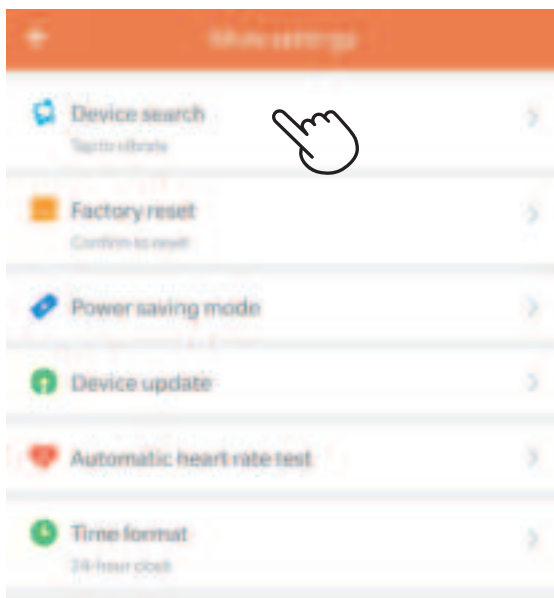

# Shake for Photograph

Please turn on this function in app before taking photos.  
Steps: Open "JYouPro" App → Device → Remote selfie → Shake To Take Picture

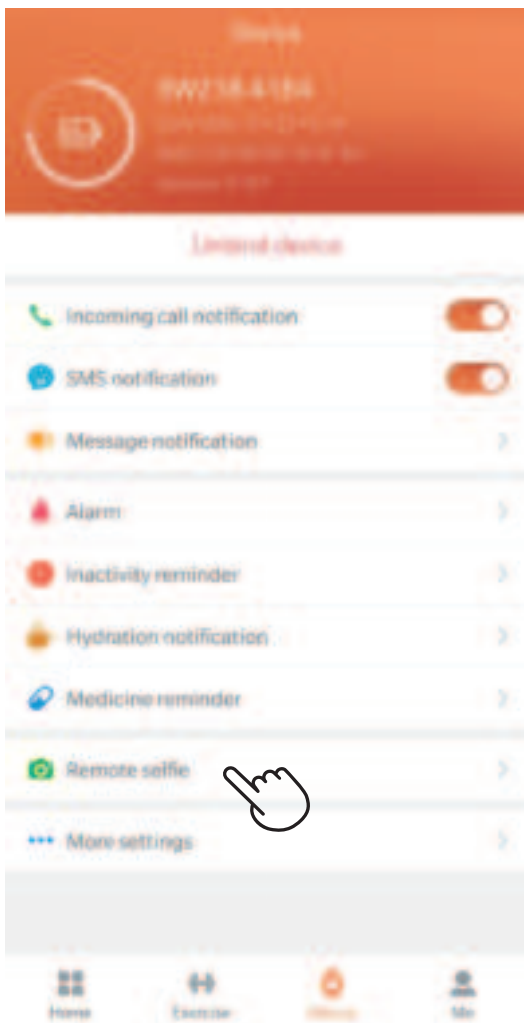

# Sedentary reminder

Please turn on this function in app.

Steps: Open "JYouPro" App → Device → Inactivity  
Reminder → Set start/ end time/Sedentary duration

Please turn on the No Interruptions for Luch Breakfast

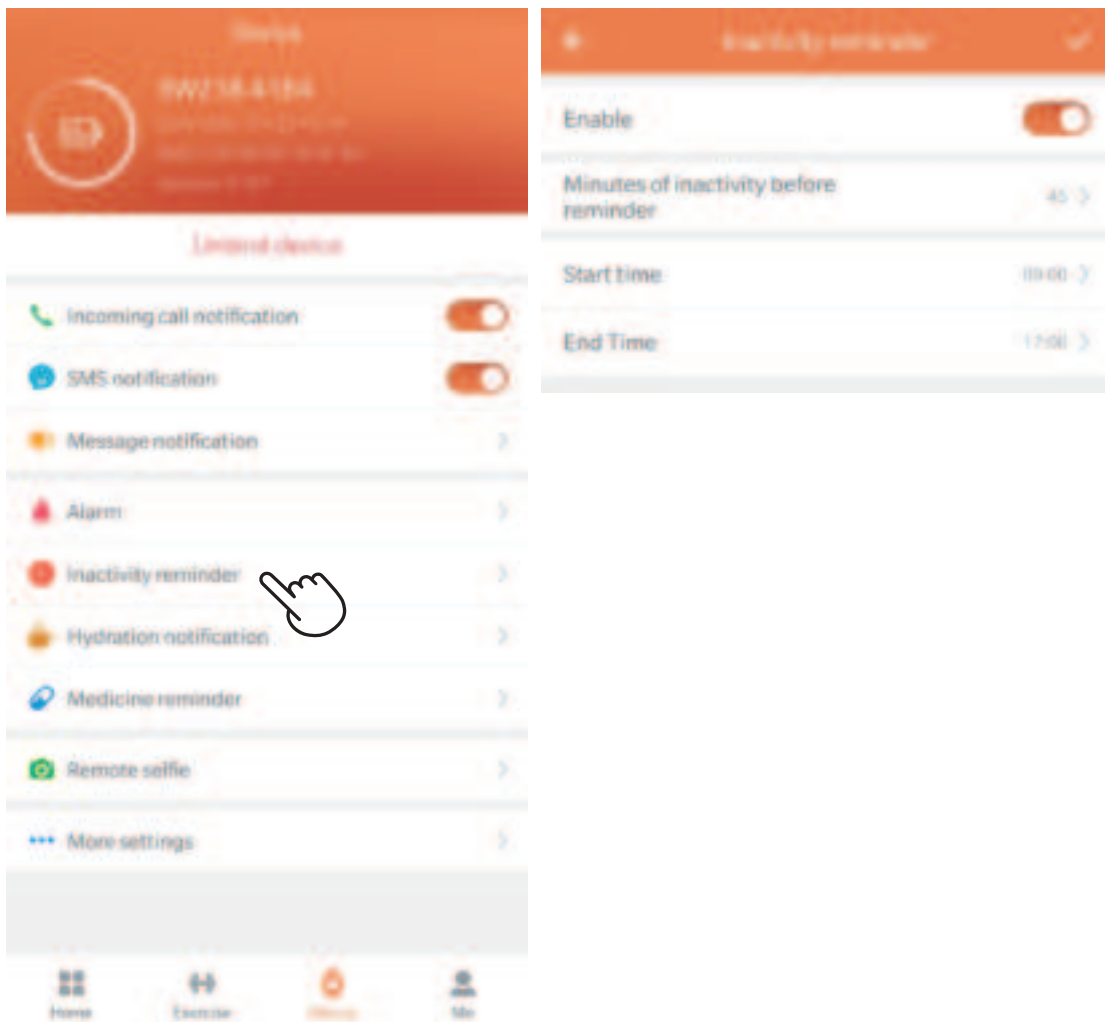

# Drink Reminding

8 cup of water a day, keeps doctor away.

Go to "JYouPro" App→Device→Hydration notification→Turn on  
→Set the time.

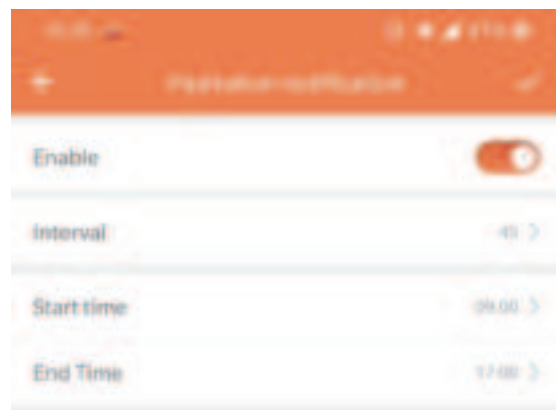
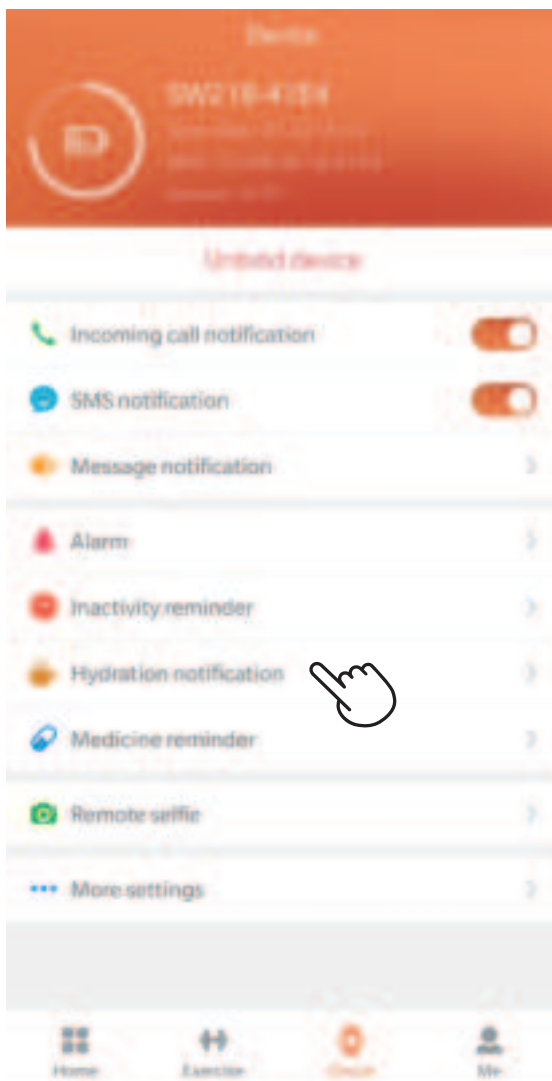

# Medicine reminder

Don't forget to take medicine no matter how busy you are.  
Go to "JYouPro" App→Device→Medicine reminder→Turn on→  
Set the time.

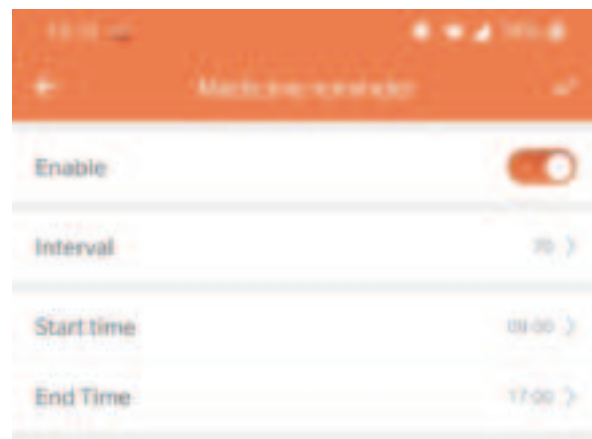
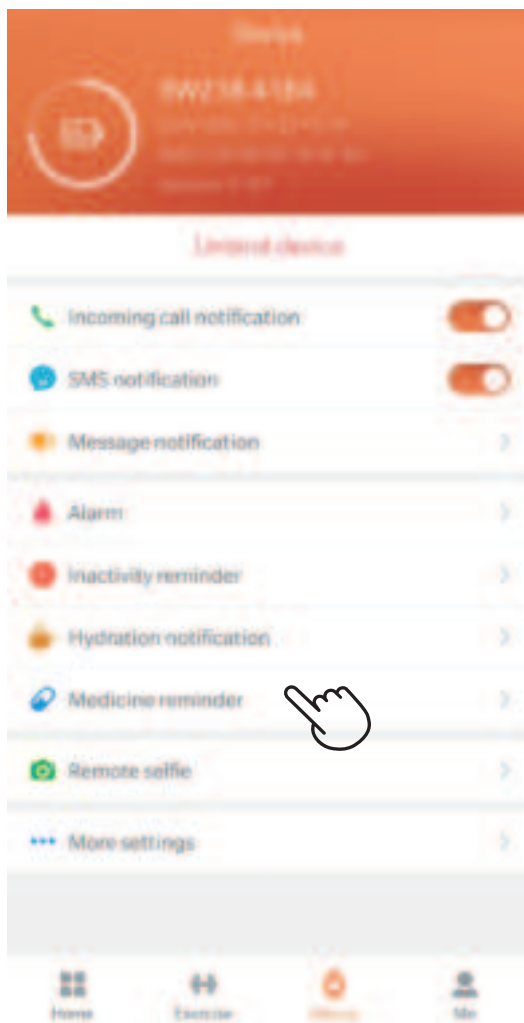

# Notifications

---

SW218 can display call, text and app notifications from your phone to keep you informed. The phone and watch must be connected with each other to receive notifications.

## Set up notifications

Check that bluetooth on your phone is on and that your phone can receive notifications (often under Settings →Notifications).

Then set up notifications:

1. With your watch nearby, from the "JYouPro" app dash board, tap the "Device" icon → Message Reminding →Turn on the app you need to reminding



# See incoming notifications

When your phone and SW218 are within range, a notification causes the watch to vibrate.

In the watch main interface, swipe right to check the history message, you also can long press the message to delete the message on the smart watch.





# Phone remind and reject phone calls

If paired to an iPhone or Android phone, please allow notification request. You can hang up phone calls on the smart watch.

The caller's name appears if that person is in your contacts list; otherwise you see a phone number.



# Daily weather forecast

Weather forecast: swipe up→weather→see the weather of the day→click once on the screen to see the weather forecast for the last 4 days.

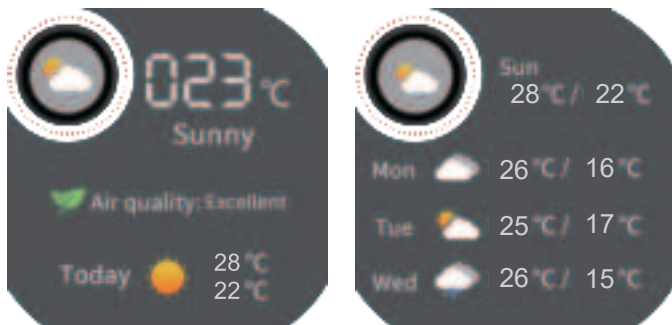

# Bracelet Alarms

Alarms vibrate to awake or alert you at a time you set. Set up to 5 alarms to occur once or on multiple days of the week. You can also time events with the stopwatch or set a countdown timer.

## Set an alarm

Set, manage, and close alarms in the app.

Set alarm steps: Go to "JYouPro" APP → Device → Alarm → Click to choose time.

You can set up to 5 alarms.

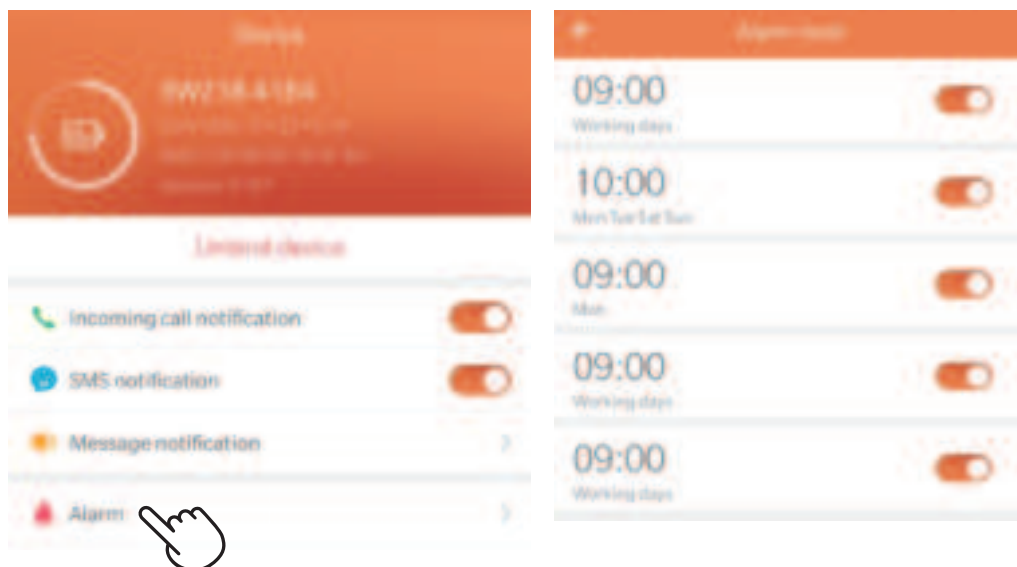

# Set a stopwatch

To use the stopwatch: In the watch main interface → swipe up →  → Stopwatch → Click triangle icon to start or stop → Click the left icon to reset → Swipe right to get out.



# Activity and Sleep

---

## Track a daily activity

SW218 tracks your progress toward a daily activity goal of your choice. When you reach your goal, the watch vibrates and shows a celebration.



## Choose a goal

Set a goal to help you get started on your health and fitness journey. To begin, your goal is 8,000 steps per day, choose to increase or decrease the number of steps.



# Track your sleep

Wear SW218 to bed to automatically track your time asleep and sleep stages (time spent in awake, light sleep, and deep sleep).

To see your sleep status, sync your watch when you wake up and check the app.

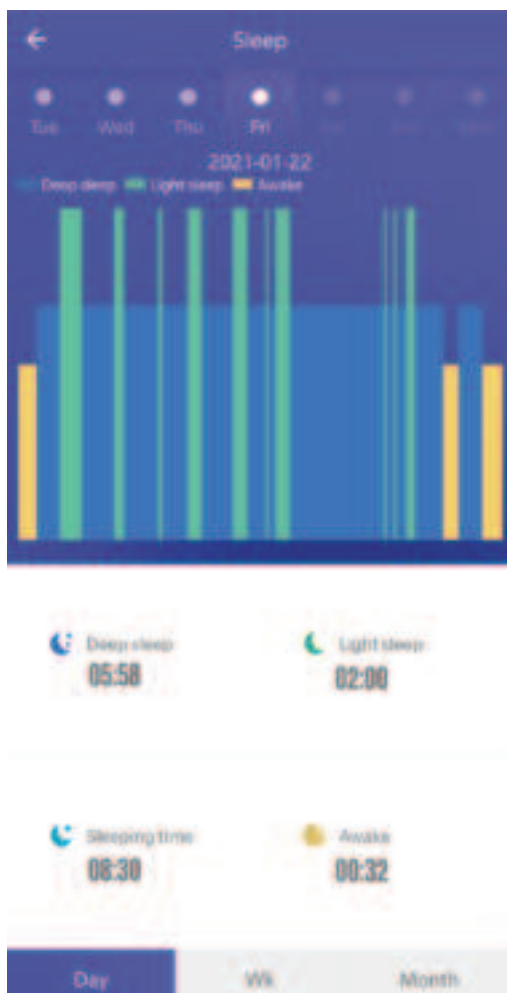

Tips: SW218 only record sleep from 8:00PM - 8:00AM.



# See your heart rate

SW218 will measure the heart rate of the user in the heart rate measurement interface. After measurement, the result will be displayed.

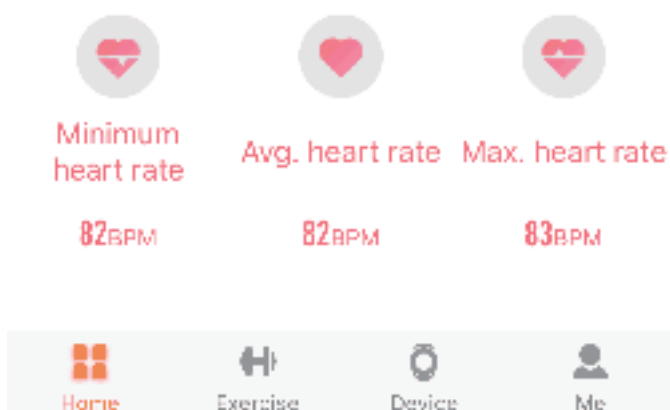
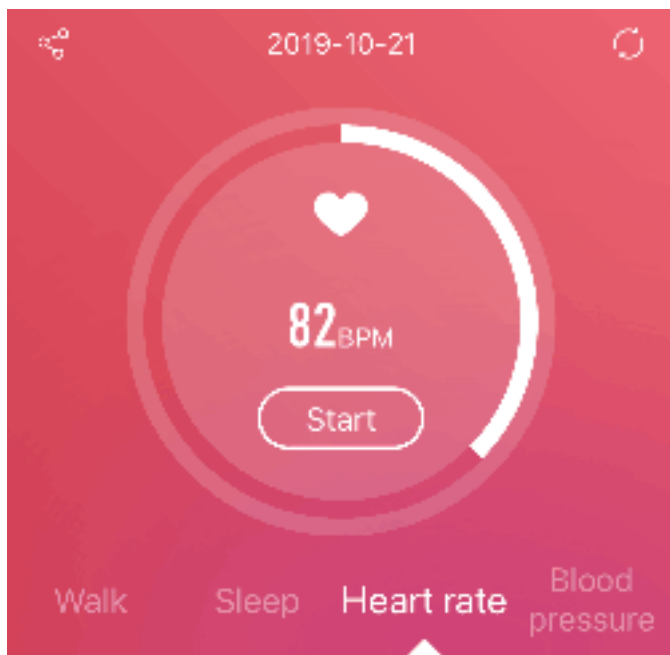

## Enhanced Heart Rate Measurement

To set automatic monitoring of ON/OFF operation procedure:  
Open "JYouPro" App → Turn on Automatic heart rate test  
Set the time of Health Timing Monitor.

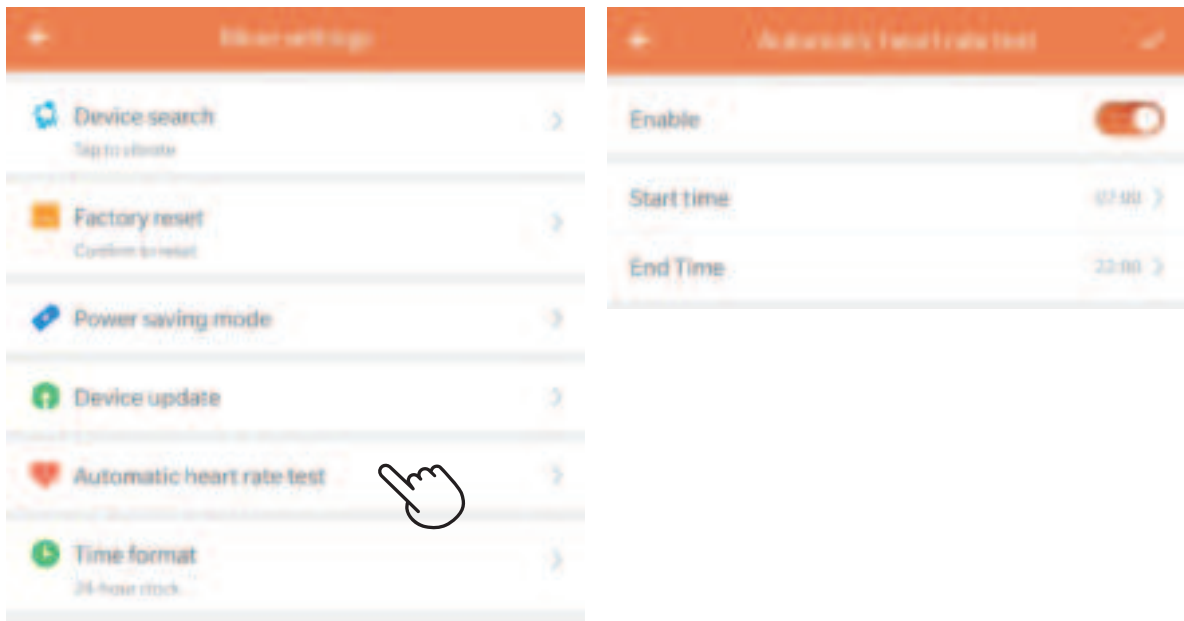

# Blood pressure measure

BP Measuring in smart watch directly

Go to your smart watch → Swipe up → Health → Blood pressure → Wait for one minute.

BP Measuring in "JYouProo" APP

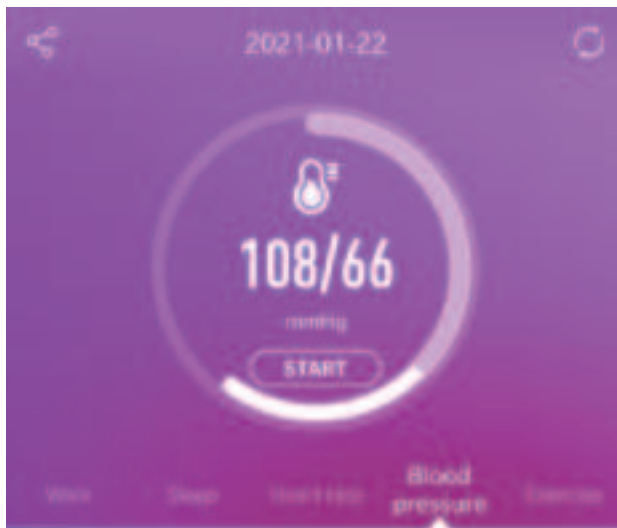



# Blood Oxygen Measure

Blood Oxygen Measuring in smart watch directly

Go to your smart watch → Swipe up → Health → Blood Oxygen → Wait for one minute.

BP Measuring in "JYouPro" APP

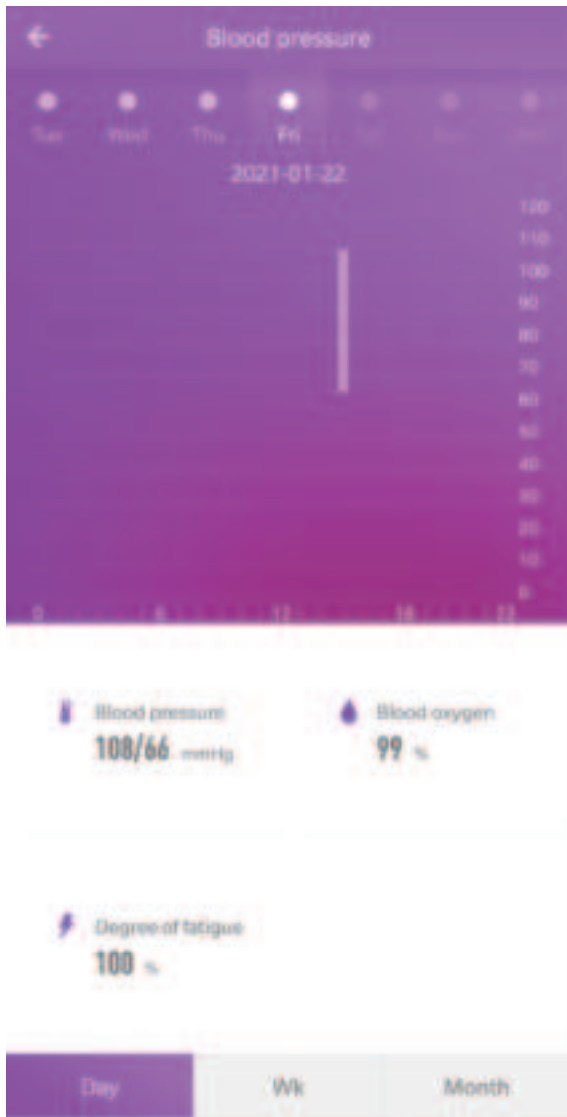

# Fitness and Exercise

---

## Track and analyze exercise with the app

Track specific exercises with the app to see real-time stats, including heart-rate data, calories burned, elapsed time, and a post-workout summary on your wrist. For complete workout stats, and route information if you used GPS, review your exercise history in the FitCouldPro app.

## Track and exercise

### To track an exercise

1. On your watch, swipe up to find "sport", and tap to choose sport mode.

2. When you're done with your workout or want to pause, tap the red button on the screen.

When you want to end exercise, click the square icon to end and touching button to exit.

If you want to restart it, click the red button on the screen to restart.



Note: SW218 shows 3 real-time stats of your choice.



## Check your workout summary

After you complete a workout, SW218 shows a summary of your stats. You can choose sport mode on watch or on the app. When you select the exercise mode on the watch, the watch will display your current exercise data after you finish exercising.

When you select the exercise mode on the APP, after the exercise with your mobile phone is over, the APP will display all your exercise records. If you need GPS to record your exercise route, you could turn on the GPS on the APP.



# Reset

---

Some troubleshooting steps may require you to restart your watch, while erasing it is useful if you want to give SW218 to another person.

## Restart SW218

To restart your watch, on your watch, swipe up→Setting→System→reset

In the off state, hold 3s on button to power on.



# Troubleshooting

---

## Heart-rate signal missing

SW218 continuously tracks your heart rate while you're exercising and throughout the day. If the heart-rate sensor on your watch has difficulty detecting a signal, the green light on the back of the watch will continue to flash.

Next, please make sure you're wearing your watch correctly, either by moving it higher or lower on your wrist or by tightening or loosening the wristband. SW218 should be in contact with your skin.

After holding your arm still and straight for a short time, you should see your heart rate again.



## Other issues

If you experience any of the following issues, restart your device:

1. Won't sync;
2. Won't respond to button press;
3. Won't track steps or other data;

See "Reset SW218" on how to reset your watch.

## Return policy and warranty

To learn more about your smart watch and warranty, visit [amazon.uk@bingo-fit.com](mailto:amazon.uk@bingo-fit.com)

Website:

[www.bingo-fit.com](http://www.bingo-fit.com)



# Specifications

---

System requirements	IOS system 10.0 or above; Android system 5.0 or above; Support bluetooth with 5.0 version
Bluetooth version	BLE 5.0
Screen display	1.4 TFT 240*240
Battery capacity	210mAh
Stand-by time	10 days
Operating days	5-7 days
Motor	Build in, vibrating reminder
Waterproof level	IP68





# Safety Notices

---

1. The wristband that comes with watch is made of flexible, durable elastomer material similar to that used in many sports watches.
2. The buckle and button on watch are made of stainless steel. While all stainless steel contains traces of nickel and can cause an allergic reaction in someone with nickel sensitivity, the amount of nickel in watch meets the European Union's stringent Nickel Directive.
3. Make sure the watch is not worn too tightly. The watch should be worn loosely and can be moved up and down the wrist.
4. Before putting the watch back on your wrist, make sure your skin is dry.
5. This watch is IP68 waterproof. **But we do not recommend you wear it for taking shower with warm or hot water.** Such behavior may reduce its life.

**Note:** Please remove your watch and consult your doctor before re-wearing if you experience redness, swelling, itchiness, or any other irritation or discomfort on your skin around.

