

# FANATEC®

## CSL Pedals Clutch kit



4

**Quick Guide**

EN

4

**Kurzanleitung**

DE

1

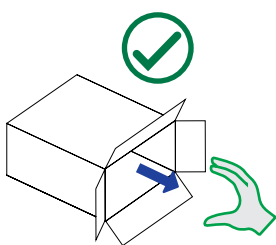
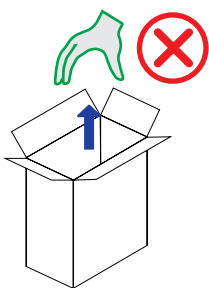
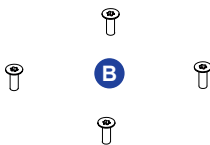
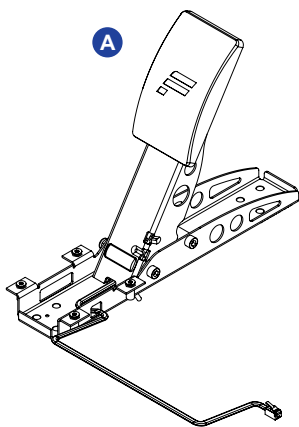

2

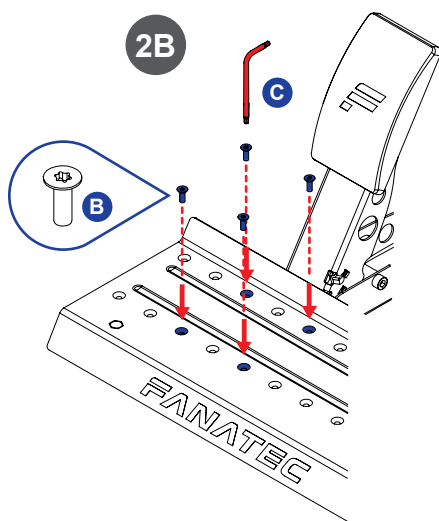
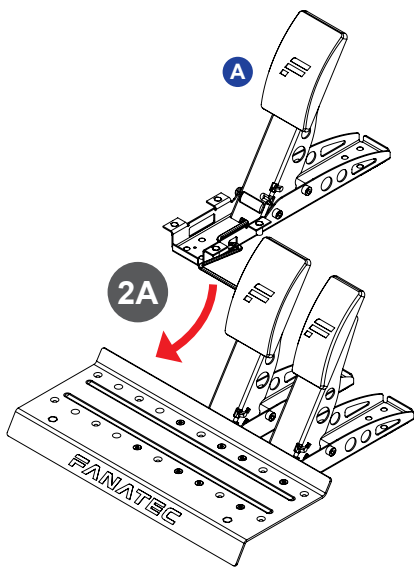

2C

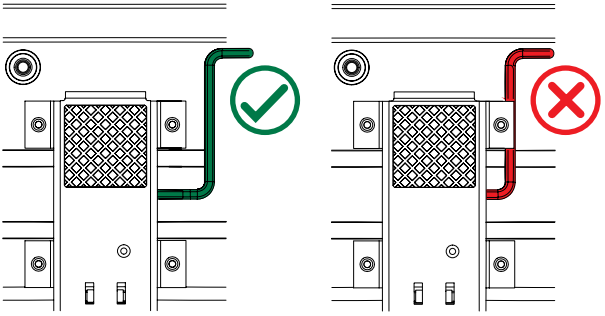

2D

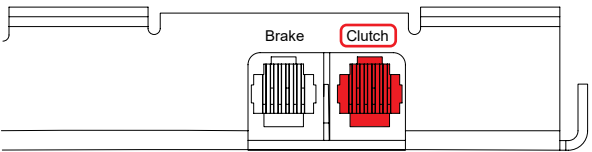

# Quick Guide

## 1 PACKAGE CONTENTS

- A 1x CSL Pedals Clutch Kit
- B 4x M4x12 mm Countersunk Mounting Bolts
- C 1x T20 Torx Key

For compatibility information, visit the product page on [Fanatec.com](https://www.fanatec.com).

## 2 INSTALLATION

**2C** **NOTE:** Clip RJ12 cable into cable buckets under heel rest.

### 3 SUPPORT

Our Support Team is ready to help you! Visit [fanatec.com/support/faq](https://www.fanatec.com/support/faq) for assistance.

Download our app:



[Fanatec.com/app](https://www.fanatec.com/app)

### 4 VIDEO

Watch our **CSL Pedals Clutch Kit** video guide:



[Fanatec.com/QR/CSL-P-CK](https://www.fanatec.com/QR/CSL-P-CK)

This product is under warranty of Endor AG. Refer to the included warranty sheets as well as the terms & conditions of Endor AG on [Fanatec.com](https://www.fanatec.com).

# Kurzanleitung

## 1 PACKUNGSIHALT

- A 1x CSL Pedals Clutch Kit
- B 4x M4x12 mm Senkkopfschrauben
- C 1x T20 Torx-Schlüssel

Informationen zur Kompatibilität finden Sie in der Beschreibung dieses Produkts auf [Fanatec.com](https://www.fanatec.com).

## 2 INSTALLATION

**2C** **HINWEIS:** Stecken Sie das RJ12-Kabel in die Kabelklappen unter der Fersenstütze.

### 3 UNTERSTÜTZUNG

Unser Support-Team hilft Ihnen gerne weiter! Besuchen Sie [fanatec.com/support/faq](https://www.fanatec.com/support/faq) für weitere Unterstützung.

Laden Sie unsere App herunter:



[Fanatec.com/app](https://www.fanatec.com/app)

### 4 VIDEO

Sehen Sie sich unser **CSL Pedals Clutch Kit** - Video Tutorial:



[Fanatec.com/QR/CSL-P-CK](https://www.fanatec.com/QR/CSL-P-CK)

Dieses Produkt unterliegt der Garantie der Endor AG. Beachten Sie die beiliegenden Garantieblätter sowie die Allgemeinen Geschäftsbedingungen der Endor AG auf [Fanatec.com](https://www.fanatec.com).



Contact | Зв'язатися:  
 Endor AG  
 E.ON-Allee 3 - 84036 Landshut - Germany  
 Telephone | Телефон: +49 (871) 9221-122  
 Email | Електронна пошта: [info.webshop@fanatec.com](mailto:info.webshop@fanatec.com)

This product meets the requirements of the Technical Regulations which limit the use of certain hazardous substances in electrical and electronic equipment.

Цей продукт відповідає вимогам RoHS (Директива ЄС 2011/65 / ЄС).

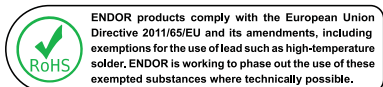

Manufactured and distributed by



Fanatec® is a registered trademark of Endor AG  
 Designed and developed by Endor AG in Germany

E.ON-Allee 3 - 84036 Landshut - Germany  
 Telephone: +49 (871) 9221-122 Fax: +49 (871) 9221-221  
 Email: [info.webshop@fanatec.com](mailto:info.webshop@fanatec.com)  
 Website: [www.fanatec.com](http://www.fanatec.com) - [www.endor.ag](http://www.endor.ag)  
 Made in China

Thank you for choosing

***FANATEC***<sup>®</sup>

