



National Health and Nutrition Examination Survey (NHANES)

Anthropometry Procedures Manual



January 2016

Table of Contents

Chapter		Page
1	Overview of Anthropometry	1-1
	1.1 Background of Anthropometric Measurements.....	1-1
	1.2 Purpose of Anthropometrics	1-2
	1.3 Importance of Anthropometric Data	1-2
	1.4 Overview of NHANES Anthropometry Examination.....	1-4
	1.5 Role of Anthropometric Examiner and Recorder	1-5
	References	1-6
2	EQUIPMENT	2-1
	2.1 Description of the Body Measurement Room in the MEC	2-1
	2.2 Equipment and Supplies	2-1
	2.2.1 Equipment	2-1
	2.2.2 Supplies	2-7
	2.3 Equipment Care and Maintenance	2-10
	2.4 Equipment Malfunctions	2-11
	2.5 Setup Procedures.....	2-12
	2.5.1 Calibration Weights	2-12
	2.5.2 Digital Weight Scale	2-12
	2.5.3 Portable Scale	2-12
	2.5.4 Sitting Box	2-13
	2.5.5 Stadiometer.....	2-13
	2.5.6 Infantometer.....	2-13
	2.5.7 Abdominal Calipers.....	2-14
	2.5.8 Knee Caliper.....	2-14
	2.5.9 Measurement Tapes and Ruler	2-14
	2.5.10 Supplies	2-15
	2.6 Teardown Procedures	2-15
	2.6.1 Calibration Weights	2-15
	2.6.2 Digital Weight Scale	2-15
	2.6.3 Portable Scale	2-16
	2.6.4 Sitting Box	2-16
	2.6.5 Stadiometer.....	2-16
	2.6.6 Infantometer.....	2-16

<u>Chapter</u>		<u>Page</u>
	2.6.7 Abdominal Caliper.....	2-17
	2.6.8 Exam Table.....	2-17
	2.6.9 Knee Caliper.....	2-17
	2.6.10 Measurement Tapes and Ruler.....	2-17
	2.6.11 Supplies.....	2-17
3	Examination Protocol.....	3-1
3.1	Eligibility Criteria.....	3-1
3.2	Pre-examination Procedures.....	3-1
3.3	General Guidelines for Measuring and Recording.....	3-2
3.4	Examination Procedures.....	3-3
3.4.1	Recumbent Length.....	3-3
3.4.2	Head Circumference.....	3-5
3.4.3	Standing Height.....	3-6
3.4.4	Weight.....	3-9
3.4.5	Upper Leg Length.....	3-10
3.4.6	Upper Arm Length.....	3-13
3.4.7	Arm Circumference.....	3-17
3.4.8	Abdominal (Waist) Circumference.....	3-19
3.4.9	Sagittal Abdominal Diameter (SAD) Measurement.....	3-21
3.4.10	Comment Screen.....	3-25
3.4.11	Special Circumstances.....	3-26
3.5	Special Considerations.....	3-26
3.5.1	SPs in Street Clothes.....	3-26
3.5.2	Children.....	3-27
3.5.3	SPs in Wheelchairs.....	3-27
3.5.4	Amputees.....	3-28
3.5.5	Comprehension or Language Difficulties.....	3-28
3.6	Post-examination Procedures.....	3-29

<u>Chapter</u>		<u>Page</u>
4	ISIS Data entry.....	4-1
	4.1 General Screen Information.....	4-1
	4.2 Pregnancy Screen.....	4-3
	4.3 Stature Screen.....	4-4
	4.3.1 Height Correction.....	4-7
	4.3.2 Stature Comments.....	4-8
	4.4 Weight Screen.....	4-10
	4.4.1 Weight Comments.....	4-11
	4.4.2 Tare and Reset.....	4-12
	4.5 Sitting Measures Screen.....	4-13
	4.6 Upper Arm Length Screen.....	4-14
	4.7 Circumference Measures Screen.....	4-15
	4.8 Sagittal Abdominal Diameter (SAD) Measures Screen.....	4-18
	4.9 SP Information Screen.....	4-22
	4.10 Amputations Screen.....	4-23
	4.11 Anthropometry Component Status Screen.....	4-25
5	QUALITY CONTROL.....	5-1
	5.1 Introduction to Quality Control for Anthropometry.....	5-1
	5.2 Equipment Calibrations.....	5-1
	5.2.1 Digital Weight Scale.....	5-4
	5.2.2 Portable Scales.....	5-9
	5.2.3 Stadiometer.....	5-10
	5.2.4 Infantometer.....	5-11
	5.2.5 Abdominal Calipers.....	5-13
	5.2.6 Equipment Swap.....	5-14
	5.3 ISIS Examination Screens.....	5-15
	5.4 Observations, Replication, and Review.....	5-15

<u>Appendix</u>		<u>Page</u>
A	BODY MEASURES RECORDING FORM.....	A-1
B	PROCEDURES FOR CONDUCTING ANTHROPOMETRY GOLD STANDARD REPLICATE EXAMINATIONS.....	B-1

Tables

3-1	Body measurements by age category	3-1
5-1	Anthropometry equipment calibrations	5-2

Exhibits

2-1	Infantometer.....	2-3
2-2	Digital weight scale—uncovered.....	2-4
2-3	Digital scale measurement device.....	2-4
2-4	Portable scale.....	2-4
2-5	Calibration weights	2-4
2-6	Stadiometer headpiece and digital measurement device	2-5
2-7	Stadiometer calibration rod	2-5
2-8	Sitting box.....	2-5
2-9	Knee caliper, tape measures, and ruler	2-5
2-10	Exam Table.....	2-6
2-11	Standard abdominal caliper	2-6
2-12	Custom abdominal caliper.....	2-6
2-13	Step stool	2-7
2-14	Calibration rod	2-7

<u>Exhibits</u>		<u>Page</u>
2-15	Cushion pads.....	2-7
2-16	Anthropometry supplies (1).....	2-9
2-17	Anthropometry supplies (2).....	2-10
3-1	Recumbent length head position.....	3-4
3-2	Recumbent length feet position.....	3-5
3-3	Head circumference tape position	3-6
3-4	Standing height position.....	3-7
3-5	Frankfort horizontal plane	3-9
3-6	Upper leg length measurement position	3-11
3-7	Knee caliper positioned on edges of patella	3-12
3-8	Upper leg length mark	3-13
3-9	Upper leg length tape position.....	3-13
3-10	SP position for upper arm length and midpoint.....	3-14
3-11	Upper arm bony landmarks	3-15
3-12	Marking spine extending from acromion process	3-15
3-13	Marking upper arm length midpoint	3-15
3-14	Infant upper arm length.....	3-16
3-15	CORRECT tape placement for upper arm length	3-16
3-16	INCORRECT tape placement for upper arm length	3-16
3-17	Adult arm circumference.....	3-18
3-18	Infant arm circumference.....	3-18

<u>Exhibits</u>		<u>Page</u>
3-19	Waist circumference mark.....	3-20
3-20	Measuring tape position for waist circumference.....	3-20
3-21	SP positioned at table.....	3-21
3-22	Marking right iliac crest.....	3-22
3-23	Marking the iliac level line.....	3-22
3-24	Align upper arm to iliac level line.....	3-23
3-25	Take measurement.....	3-24
3-26	Reading the caliper.....	3-24
3-27	Acceptable and unacceptable spirit level positions.....	3-25
4-1	Logon SP screen.....	4-1
4-2	ISIS screen characteristics.....	4-2
4-3	Edit Check box.....	4-3
4-4	Pregnancy question.....	4-4
4-5	Stature screen—SPs 0-6 months.....	4-5
4-6	Stature screen—SPs 7-23 months.....	4-5
4-7	Stature screen—SPs 24-47 months.....	4-6
4-8	Stature screen—SPs 4 years and older.....	4-6
4-9	Stature screen—height correction.....	4-7
4-10	Stature screen—recumbent length blank comments.....	4-9
4-11	Stature screen—standing height value comments.....	4-9

<u>Exhibits</u>		<u>Page</u>
4-12	Weight screen.....	4-10
4-13	Weight screen—lb/kg warning message.....	4-11
4-14	Weight screen—comments list.....	4-12
4-15	Weight screen—tare and reset functions	4-13
4-16	Sitting measures screen	4-14
4-17	Upper arm length screen	4-15
4-18	Circumference measures screen—arm circumference (SPs 2–23 months)	4-16
4-19	Circumference measures screen—arm and waist circumference (SPs 24 months to 19 years).....	4-16
4-20	Circumference measures screen—arm circumference (SPs 20 years and older)	4-17
4-21	Circumference measures screen—waist circumference (SPs 20 years and older)	4-17
4-22	First set of SAD measures screen	4-18
4-23	First set of SAD measures—comments for 1st measurement	4-19
4-24	Second set of SAD measures screen.....	4-20
4-25	SAD measures—edit check screen	4-20
4-26	SAD measures—remind screen	4-21
4-27	SAD measures—Comments screen.....	4-21
4-28	SP Information screen	4-22
4-29	Amputations screens	4-24
4-30	Anthropometry component status screen—Complete.....	4-25

<u>Exhibits</u>		<u>Page</u>
4-31	Anthropometry component status screen—Partial.....	4-26
5-1	Body measures quality control check box.....	5-2
5-2	Not all QC Done message box.....	5-3
5-3	Time to do Mid-Stand QC message box.....	5-3
5-4	Digital weight scale full calibration	5-4
5-5	Digital weight scale daily calibration	5-5
5-6	Digital scale measurement device.....	5-6
5-7	Digital weight scale full calibration—scale set to lb	5-7
5-8	Digital weight scale daily calibration—scale set to lb.....	5-7
5-9	Digital weight scale full calibration—lb setting error message	5-8
5-10	Digital weight scale daily calibration—lb setting error message.....	5-8
5-11	Portable scales calibration	5-9
5-12	Stadiometer calibration: In calibration.....	5-10
5-13	Stadiometer calibration: Out of calibration—recalibrated	5-11
5-14	Infantometer calibration: In calibration	5-12
5-15	Infantometer calibration: Out of calibration—recalibrated	5-12
5-16	Abdominal caliper calibration: In calibration	5-13
5-17	Equipment swap screen.....	5-14

Overview of Anthropometry

1

1.1 Background of Anthropometric Measurements

Anthropometry is the study of the measurement of the human body in terms of the dimensions of bone, muscle, and adipose (fat) tissue. The word “anthropometry” is derived from the Greek word “anthropo” meaning “human” and the Greek word “metron” meaning “measure” (Ulajaszek, 1994). The field of anthropometry encompasses a variety of human body measurements. Weight, stature (standing height), recumbent length, skinfold thicknesses, circumferences (head, waist, limb), limb lengths, and breadths (shoulder, wrist) are examples of anthropometric measures.

Several indexes and ratios can be derived from anthropometric measurements. Perhaps the most well-known indicator of body fatness is the body mass index or “BMI.” BMI values are calculated for NHANES participants using measured height and weight values as follows: weight (kilograms)/height squared (meters). BMI criteria are used to screen for weight categories: underweight (BMI values < 18.5); normal or desirable weight (BMI values 18.5-24.9); overweight (BMI values 25.0-29.9); obese—Class I (BMI values 30.0-34.9); obese—Class II (BMI values 35.0-39.9); and extremely obese—Class III (BMI values \geq 40.0) (National Institutes of Health, 1998). The NHANES BMI results are used to track weight trends in the U.S. population. The National Institutes of Health, Centers for Disease Control and Prevention (CDC), and many other research groups have reported on the health risks associated with overweight and obesity using NHANES interview and health examination data.

In addition, sagittal abdominal diameter (SAD) will be measured in the body measures component. SAD, a simple anthropometric index of visceral adiposity, is well correlated with obesity-related metabolic disturbances such as lipid, insulin, C-peptide, glucose, and uric acid levels; blood pressure; lung function; and combined risk scores intended to reflect insulin resistance. SAD is thought to be a better predictor of cardiovascular disease than any other anthropometric measurements including BMI, waist circumference, and waist-hip ratio. However, epidemiological and clinical applications of the SAD measurement are hampered by a lack of reference ranges and cut points to assign risk categories based on a representative U.S. population. Collecting accurate population-based data on SAD measurement will be a key component for improving the assessments of health risks related to weight in the clinical practices and epidemiological studies.

1.2 Purpose of Anthropometrics

The purpose of the NHANES anthropometry component is to collect high-quality body measurement data using standardized examination procedures and calibrated equipment. Accurate data are fundamental to the evaluation of anthropometric trends over time. It is crucial for researchers to know that the differences evident between NHANES surveys reflect true differences in the NHANES body measurement values rather than technologist and protocol variability and/or measurement error. In order to ensure the collection of high-quality data, NHANES staff are trained to follow standardized examination protocols, to calibrate equipment according to a prescribed schedule and method, and to measure and record the survey data with precision. Additionally, retraining sessions, gold standard examinations performed by expert examiners and field observations, are conducted on a regular basis to reinforce the importance of measurement precision and standardized data collection methodology.

1.3 Importance of Anthropometric Data

Anthropometry is a key component of nutrition status assessment in children and adults (Simko and Cowell, 1995). The NHANES anthropometry data have been used to track growth and weight trends in the U.S. population for more than 30 years (Flegal et al., 2010; Hedley, 2004). The anthropometric data for infants and children reflect general health status and dietary adequacy and are used to track trends in growth and development over time. The CDC has used NHANES data to produce national reference standards or “growth charts.” These CDC growth charts are used extensively by pediatricians and researchers in the U.S. and abroad (Kuczmarski, 2002). A description of the history and statistical methodology that was used to develop the latest growth charts can be found at the CDC web site: <http://www.cdc.gov/growthcharts/>. The highly publicized NHANES data trends showing increases in overweight and obesity among U.S. children and adolescents underscore the importance of NHANES to provide continuous health data (Ogden, 2002). Although recent data show that the overall rates of obesity have plateaued or even declined among children 2-5 years of age, obesity remains a major public health problem. It is important to continue to track the prevalence of obesity among U.S. adults and children (Ogden, 2014).

The NHANES anthropometric data are used to evaluate health and dietary status, disease risk, and body composition changes that occur over the adult lifespan. Researchers in diverse health disciplines including cardiovascular health, gerontology, nutrition, and occupational health use anthropometric data to examine health status and health care utilization trends in U.S. adults. Current U.S. demographic trends project significant growth among race/ethnic subgroups and adults 75 years and older. These trends are reflected in the NHANES sample, which includes a large proportion of adults 60 years and older, African Americans, and Hispanics. Racial and ethnic minorities are more likely to be medically underserved compared to non-Hispanic whites in terms of having a regular source of health care, health insurance, and access to preventive health services. Valuable health information on population groups that might not be reflected in other health reporting systems is routinely collected in surveys sponsored by the National Center for Health Statistics (Fryar et al., 2012).

With respect to the “graying” U.S. population, the “baby boomer” generation is approaching retirement age. What will their quality of life be like during their “golden years?” How much health care will older persons need to maintain their health? What types of health conditions will be more prevalent among older Americans? Functional status and general well-being are inevitably linked to weight status. A recent analysis of the NHANES 1999-2002 data using BMI criteria determined that overweight and obese individuals were more likely to report fair or poor health (rather than good or excellent health), activity limitations, and more health provider visits per year compared to normal weight adults (McDowell, 2006).

The NHANES circumference measures assess subcutaneous and visceral fat tissue. Recent reports based on NHANES showed increasing mid-arm circumference measurements in children and adults (Osthega, Dillon, Carroll, et al., 2005; Otshega, Dillon, Prineas, et al. 2006). These data have been used to formulate guidelines for health practitioners regarding the selection of blood pressure cuff sizes for children and adults. In addition, the NHANES waist circumference data are widely used to assess cardiovascular disease risk. Specifically, individuals who have large deposits of abdominal fat tissue are at increased risk for hypertension, adult-onset diabetes mellitus, cardiovascular disease, gallstones, arthritis, and some forms of cancer.

The NHANES caliper-measured supine SAD will provide the first national reference data across various demographic groups. These data will allow researchers to compare SAD with waist circumference in the U.S. adult population and to examine the relationship between SAD, other indicators of obesity, and cardiovascular disease risk.

Although much of the attention in today's popular media is on overweight and obesity, NHANES data can also be used to track trends in **underweight**. Underweight may occur due to a variety of factors, such as poor nutrition and eating habits, substance abuse, chronic illness, medication therapy, surgical procedures, and other health problems.

NHANES is the only study that produces national estimates for the U.S. population—all ages and all sizes. NCHS continues to publish reports based on the NHANES anthropometry data. The most recent national reference data for children and adults based on NHANES 2007-2010 are available through the CDC web site at the following link:

http://www.cdc.gov/nchs/data/series/sr_11/sr11_252.pdf. The NHANES body measures examination data files are also publicly available and may be downloaded from the NHANES web site: <http://www.cdc.gov/nchs/nhanes.htm>. To retrieve information on the NHANES

anthropometry training methodologies and examination protocols, refer to the following link:

http://www.cdc.gov/nchs/nhanes/nhanes_questionnaires.htm. This offers access to the NHANES anthropometric procedures training manuals used for each NHANES, as well as the NHANES III Anthropometric Procedures video.

http://www.cdc.gov/nchs/nhanes/nhanes3/anthropometric_videos.htm. Lastly, hyperlinks for data, questionnaires, and manuals for each NHANES survey are also provided on the NHANES web site.

1.4 Overview of NHANES Anthropometry Examination

The NHANES anthropometry or body measures examination is conducted in trailer 1 of the mobile examination center (MEC). All NHANES participants or sample persons (SPs) are eligible for the anthropometry examination component. Specific measurements are completed dependent on the age of the participant. The complete set of measurements includes weight, height, upper leg and arm lengths, waist and arm circumferences, and sagittal abdominal diameter. The anthropometry examination protocol and procedures are described in Chapter 3, Examination Protocol. A health technologist and recorder work as a team to collect the anthropometry data. Examination results are saved to the study database using the Integrated Survey Information System (ISIS) anthropometry computer application. Funding for the anthropometry examination component is provided solely by NCHS.

1.5 Role of Anthropometric Examiner and Recorder

The anthropometry component is staffed by trained health technologists and recorders. The NHANES health technologists may serve as examiners or recorders for this component. In addition, other MEC staff are trained to record anthropometry examination results. When two health technologists are assigned by the MEC coordinator to the anthropometry room, the technologist assigned as the **examiner** should complete the entire examination.

The examiner will position the participant, take all measurements, and tell the recorder the measurement values to record as described in Chapter 3, Examination Protocol. The recorder will enter the examination results in the ISIS anthropometry component software application. The ISIS module is programmed to present the anthropometry data entry screens in the correct sequence based on the age of the participant. The ISIS interface is also preprogrammed with age- and gender-specific edit ranges for each measurement, based on previous NHANES data. This feature is designed to reduce data entry errors that may result from either incorrect measurement or data entry errors. Chapter 4 describes the quality control features of the ISIS anthropometry application. If a recorded value falls outside the preprogrammed edit range, the ISIS system will alert the recorder that the recorded value is unusual. The recorder should always ask the examiner to verify the measurement value before proceeding to the next measurement. If a measurement or recording error was made, the recorder will enter the correct value; if the original value is correct, the value is retained. Since NHANES includes participants of all shapes, sizes, and body builds, some unusual values are legitimate; however, measurement and recording errors do occasionally occur. Therefore, teamwork between the examiner and recorder is essential in order to measure and record accurate data.

Another important duty of the recorder is to help the examiner position the participants during their examination. In this role the recorder also alerts the examiner if the respondent needs to be repositioned. For example, when the waist circumference is determined, the recorder checks that the tape measure lies parallel to the floor and snug but without compressing the skin. Also, the recorder participates in taking recumbent length measurements on infants and young children. Assistance is needed because several body sites must be aligned to obtain an accurate measurement. Lastly, the recorder marks body sites that are measured by the examiner and hands equipment and supplies to the examiner when needed.

References

- Flegal, K.M., Carroll, M.D., Ogden, C.L., and Curtin, L.R. Prevalence and trends in obesity among U.S. adults, 1999-2008. *JAMA*. 2010;303(3):235-41.
- Fryar, C.D., Gu, Q., Ogden, C.L. Anthropometric reference data for children and adults: United States, 2007–2010. National Center for Health Statistics. *Vital Health Stat 11*. 2012;(252). Available at: http://www.cdc.gov/nchs/data/series/sr_11/sr11_252.pdf (Accessed December 07, 2012).
- Hedley, A.A., Ogden, C.L., Johnson, C.L., Carroll, M.D., Curtin, L.R., and Flegal, K.M. Prevalence of overweight and obesity among U.S. children, adolescents, and adults, 1999-2002. *JAMA*. 2004;291(23):2847-50.
- Kuczumarski, R.J., Ogden, C.L., Guo, S.S., Grummer-Strawn, L.M., Flegal, K.M., Mei, Z., Wei, R., Curtin, L.R., Roche, A.F., and Johnson, C.L. 2000 CDC Growth Charts for the United States: methods and development. *Vital Health Stat 11*. 2002;(246):1-190.
- McDowell, M.A., Hughes, J.P., and Borrud, L.G. Health characteristics of U.S. adults by body mass index category: Results from NHANES 1999-2002. *Public Health Rep*. 2006;121(1):67-73.
- National Institutes of Health. Clinical guidelines on the identification, evaluation, and treatment of overweight and obesity in Adults—The Evidence Report. NIH Publication No. 98-4083. 1998. Available at: http://www.nhlbi.nih.gov/files/docs/guidelines/ob_gdlns.pdf. Accessed October 12, 2015.
- Ogden, C.L., Carroll, M.D., Kit, B.K., and Flegal, K.M. Prevalence of childhood and adult obesity in the United States, 2011-2012. *JAMA*. 2014;311(8):806-14.
- Ogden, C.L., Flegal, K.M., Carroll, M.D., and Johnson, C.L. Prevalence and trends in overweight among U.S. children and adolescents, 1999-2000. *JAMA*. 2002;288(14):1728-32.
- Ostchega, Y., Dillon, C., Carroll, M., Prineas, R.J., and McDowell, M. U.S. demographic trends in mid-arm circumference and recommended blood pressure cuffs: 1988-2002. *J Hum Hypertens*. 2005;19(11):885-91.
- Ostchega, Y., Dillon C., Prineas, R.J., McDowell, M., Carroll, M. Tables for the selection of correct blood pressure cuff size based on self-reported height and weight and estimating equations for mid-arm circumference: Data from the U.S. National Health and Nutrition Examination Survey. *J Hum Hypertens*. 2006;20(1):15-22.
- Simko, M., and Cowell, C. Nutrition Assessment: A Comprehensive Guide for Planning Intervention. Second Edition. Jones and Bartlett. 1995.
- Ulijaszek, S.J. Anthropology: The Individual and the Population. Cambridge University Press. 1994.

2.1 Description of the Body Measurement Room in the MEC

The body measurement room is located in trailer 1 of the MEC. The room is equipped with unique features designed to facilitate accurate and efficient measurement, including wall mirrors to facilitate waist circumference measurements; a custom-built box where survey participants (SPs) can sit for the upper leg length measurement; a flat exam table where SPs can lie down for the sagittal abdominal diameter (SAD) measurement; and a digital scale that is housed in an opening in the floor. Additionally, the digital floor scale, stadiometer, and infantometer are linked electronically to the NHANES Integrated Survey Information System (ISIS) for quick and accurate data entry.

2.2 Equipment and Supplies

A brief description of the anthropometry component equipment and supplies is provided below. In addition, Exhibits 2-1 to 2-15 display photographs of these items for reference. At the beginning and end of each stand, the health technologist will take an inventory of all component-specific equipment and supplies. Any needed items should be noted on the inventory sheet, reported to the chief technologist and MEC manager, and documented in the Unusual Field Occurrence or UFO system (refer to *UFO Utility Manual* for details).

2.2.1 Equipment

- Infantometer: The infantometer is used to measure the recumbent length of SPs from birth through age 47 months. A digital measurement device is connected to the acrylic foot piece and interfaces directly with the ISIS anthropometry application.
- Head circumference tape: Maximal head circumference of SPs from birth through age 6 months is measured using a plastic measuring tape. The measurement end is inserted into a slot at the zero end of the tape.

- **Stadiometer:** The stadiometer is used to measure stature in SPs aged 2 years and older. A digital measurement device is connected to the acrylic headpiece and interfaces directly with the ISIS anthropometry application.
- **Height adjustment ruler:** A 15-centimeter (cm) plastic ruler is used to correct stature measurements when SPs have hair styles that interfere with the stadiometer headpiece placement, or when they are unwilling to remove their shoes. The recorder enters the height correction factor in ISIS, which automatically calculates an adjusted height value.
- **Stadiometer calibration rod:** A 100-cm metal rod is used to calibrate the stadiometer at the beginning of a stand and on a daily basis. When not in use, the rod is stored in the holding grips on the side of the stadiometer.
- **Digital weight scale:** The digital weight scale used to weigh SPs is built into the exam room floor. This high-performance instrument is linked directly to the ISIS anthropometry application. The maximum capacity of the digital weight scale is 600 pounds.
- **Portable scales:** Two portable scales are available in each MEC for use in the event of a malfunction of the digital weight scale, or if an SP's weight exceeds the digital scale capacity. Each scale has a maximum capacity of 440 pounds. Four AA batteries are used to power each scale.
- **Calibration weights:** Each MEC has a set of fifteen 10-kilogram (kg) weights. The weights are used to calibrate the portable scales at the beginning of a stand and to calibrate the digital weight scale daily and at the beginning, middle, and end of a stand. When not in use, the weights are stored on a sliding tray in the exam room cabinet.
- **Sitting box:** A blue rectangular box is used as a seat for the SP during the upper leg length measurement. Also, some children may need to stand on the box while the health technologist takes their body measurements.
- **Knee caliper:** A metal, sliding caliper is used to mark the distal end of the femur in the determination of the upper leg length. When not in use, the caliper is stored in a protective case in the cabinet drawer. Two knee calipers are available in each MEC.

- Steel measuring tape: A retractable steel measuring tape is used to take length and circumference measurements.
- Exam table: An exam table with a weight capacity of 600 pounds for SPs to lie down for the SAD measurements.
- Step stool: A metal step stool will be used to assist SPs in stepping on and off the table.
- Holtain-Kahn calipers: Two sizes of abdominal calipers will be used. The standard size will measure from 4.4 cm to 36.2 cm and the custom size from 3.7 cm to 51 cm. There is a built-in spirit level that ensures a vertical measurement.
- Cushion pads: Several hard foam pads are available in each MEC. The pads could be stacked and placed under the abdominal caliper for severely lordotic participants.
- Caliper calibration rod: A 25-cm metal rod is used to calibrate the abdominal calipers.

Exhibits 2-1 to 2-15 show photos of the anthropometry equipment.

Exhibit 2-1. Infantometer

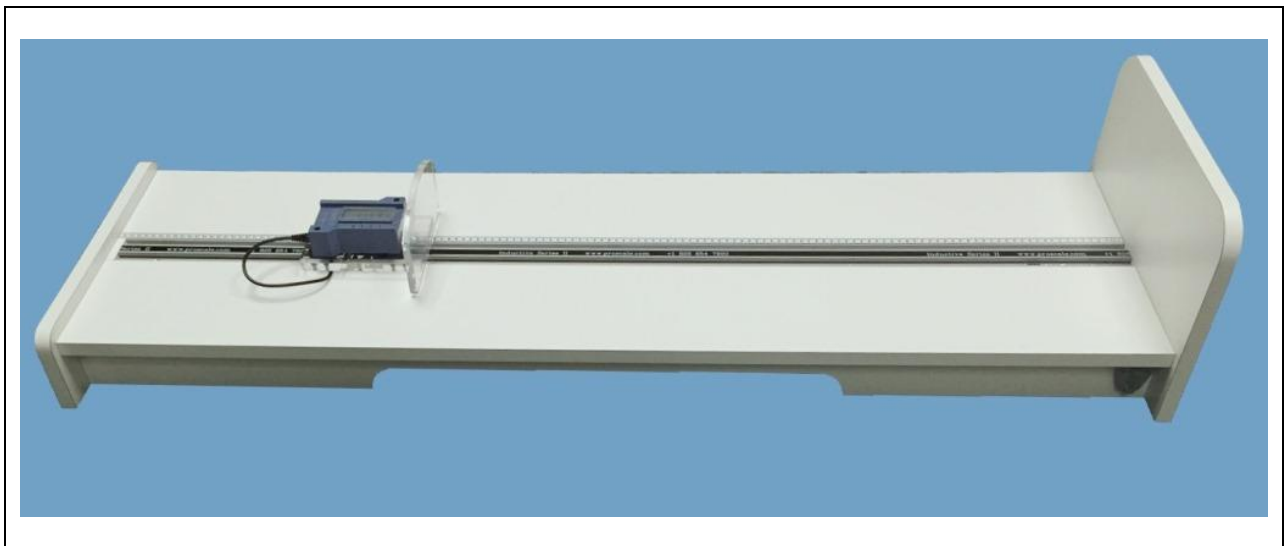

Exhibit 2-2. Digital weight scale —uncovered



Exhibit 2-3. Digital scale measurement device



Exhibit 2-4. Portable scale



Exhibit 2-5. Calibration weights

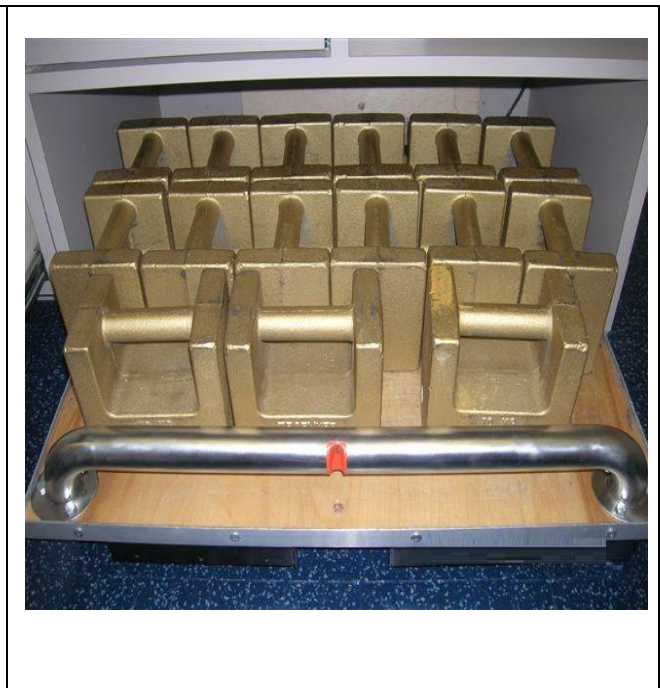

Exhibit 2-6. Stadiometer headpiece and digital measurement device



Exhibit 2-7. Stadiometer calibration rod

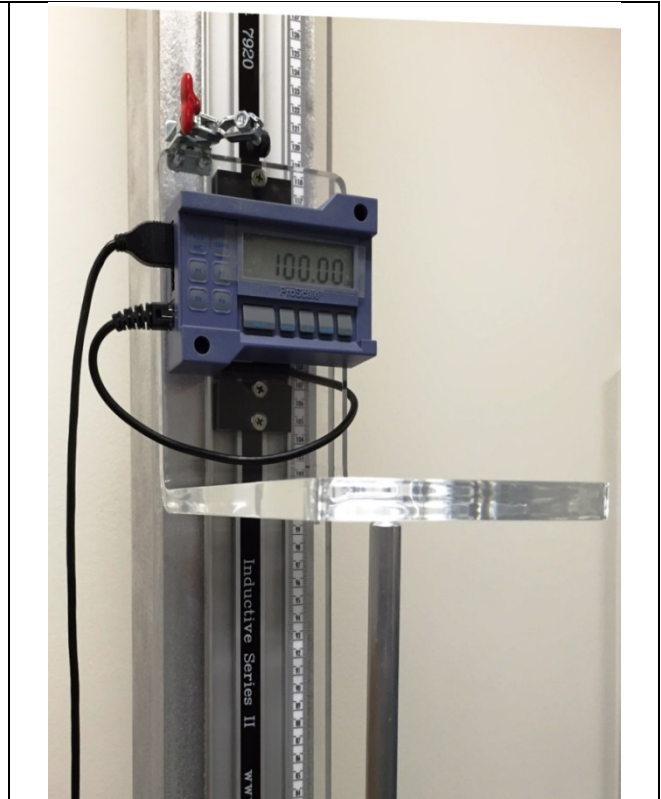

Exhibit 2-8. Sitting box



Exhibit 2-9. Knee caliper, tape measures, and ruler

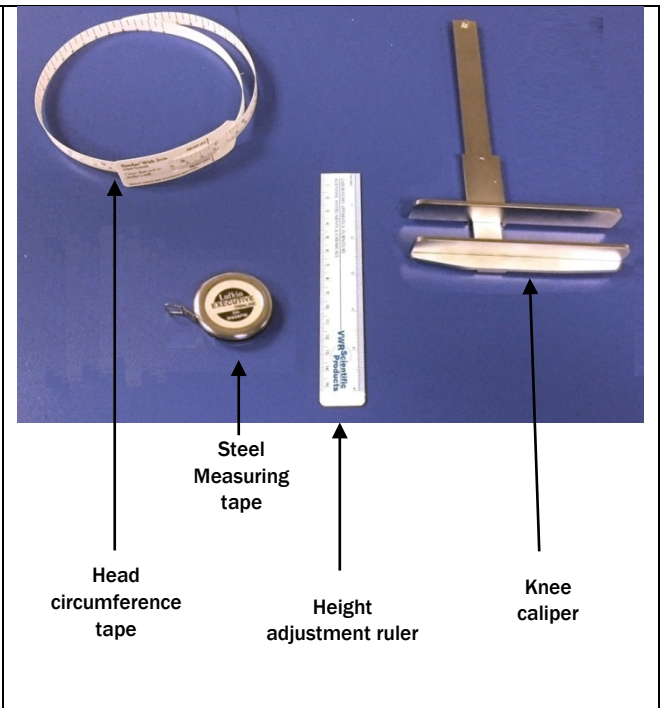

Exhibit 2-10. Exam table



Exhibit 2-11. Standard abdominal caliper



Exhibit 2-12. Custom abdominal caliper



Exhibit 2-13. Step stool

Exhibit 2-14. Calibration rod

Exhibit 2-15. Cushion pads



2.2.2 Supplies

- Black/white cosmetic pencil: The technologist and recorder make all body marks on the SP using a wax-based cosmetic pencil. The health tech will use an appropriate color so that the markings are clearly visible on the SP's skin.
- Drop dispenser: A small dropper bottle is used to dispense baby oil to remove the cosmetic pencil marks.
- Baby oil: Baby oil is supplied on each MEC for removing cosmetic pencil marks from the SP's skin. A small drop dispenser holds the oil for use during exams. Refills are obtained from a larger bottle of baby oil that is stored in the cabinet drawer.
- Absorbent pad (Chux): A clean Chux pad is laid on the infantometer before each use. The pads may also be placed beneath an infant while the guardian removes the child's clothing in preparation for taking measurements.
- Alcohol wipes: Prepackaged alcohol wipes will be used daily by the technologist to clean the surface of equipment such as the knee calipers and tape measures.

- Batteries: Two types of batteries—CR123 and AA. The CR123 batteries are used to power the digital measurement devices for the stadiometer and infantometer. The AA batteries are used to power the portable scales. Both types of batteries are removed at the end of a stand and replaced at the beginning of a stand.
- Disinfectant wipes: A container of disinfectant wipes is provided on each MEC for cleaning the surface area of the infantometer, sitting box, and other areas that require cleaning as needed.
- Blunt-edge scissors: Stainless steel, blunt-edge scissors are used by the technologist to cut the SP gown pants and shirt in preparation for leg and arm measurements.
- Cotton cloth: A cotton cloth is supplied on each MEC for wiping the surface of the aluminum track and digital measurement device of the stadiometer and infantometer.
- Gauze pads: Each MEC has a supply of 2x2 inch gauze pads. The pads are used to wipe off cosmetic pencil marks with baby oil.
- Masking tape: At the end of the anthropometry exam, the technologist tapes the exam gowns to afford privacy to the SP.
- Paper: A white roll of paper will be used to cover the table before SPs lie down.
- Sanitizing wipes: A container of sanitizing wipes is provided for cleaning the surface area of the exam table and the abdominal caliper.
- Screwdrivers: Two screwdrivers—a flat and a Phillips head—are used to open the digital measurement device of the stadiometer and infantometer when changing the batteries. The screwdrivers are also used to adjust screws on the measurement column and digital measurement device of the stadiometer and infantometer. Both screwdrivers are stored in the cabinet drawers.
- Sewing machine oil: A 4-oz bottle of all-purpose, sewing machine oil is supplied in each MEC. The oil is used to lubricate the aluminum track of the stadiometer and infantometer when sliding the head/foot piece becomes difficult.

- Scrub brush: A black hand brush is kept on each MEC for cleaning heavily soiled areas as needed.
- Weight tray bolt: A bolt is used to secure the weight tray in place during travel between stands. During a stand, the bolt is taped to the inside of the exam room cabinet for easy access. The bolts may vary by MEC.

Exhibits 2-16 and 2-17 show photos of the anthropometry supplies.

Exhibit 2-16. Anthropometry supplies (1)

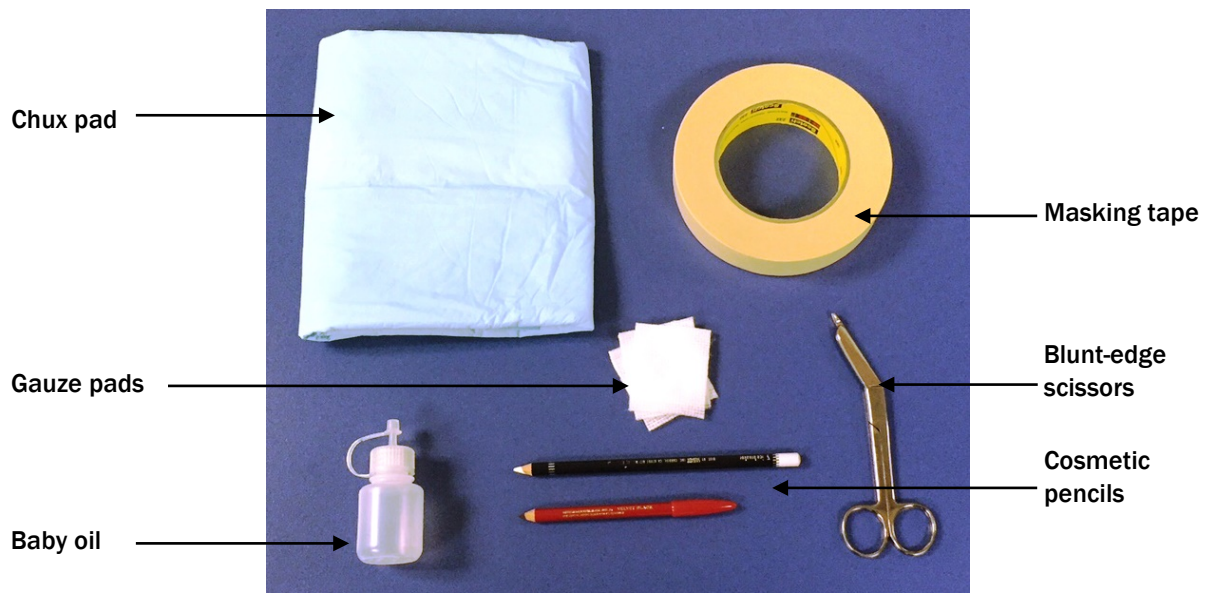

Exhibit 2-17. Anthropometry supplies (2)



2.3 Equipment Care and Maintenance

Follow the procedures below to ensure that the anthropometry equipment functions properly and remains hygienic throughout the stand.

Start of Stand and Daily

- Clean the surface of the knee calipers, abdominal calipers, and tape measures with disinfectant wipes.
- Clean the white area of the infantometer and sitting box with bleach disinfectant wipes. Use paper towels or the scrub brush if necessary.

NOTE: The Formula 409 cleaner that is generally supplied on each MEC can be used to remove dirt, but it is not suitable for use as a **disinfectant**.

- Clean the exam table with sanitizing wipes.
- Clean the **acrylic area of the head/foot piece of the stadiometer and infantometer** with alcohol wipes.

- Clean the **digital measurement device of the stadiometer and infantometer** with a dry cloth or paper towel.

NOTE: Do not allow any fluid to drip into the housing of the digital measurement device.

- Check that the head/foot piece of the stadiometer and infantometer slides smoothly along the measurement column. Clean the **aluminum track** with a damp cloth or paper towel. As needed, lubricate the track with sewing machine oil—place a few drops of the oil along the track and then slide the head/foot piece up and down the column.

2.4 Equipment Malfunctions

All equipment malfunctions or repair needs must be reported promptly to the technologist in charge of body measures, MEC manager, and home office component specialist. If the issue is computer-related and cannot be resolved by the health technologist and/or MEC manager, please contact the home office ISIS support staff.

Equipment issues should be documented in the Unusual Field Occurrence (UFO) system and Equipment Tracking System (ETS) as appropriate (refer to the *UFO Utility Manual* and *ETS User Guide* for details). The component specialist will contact the equipment manufacturer for assistance.

A complete set of backup anthropometry equipment is kept at the home office for training and ISIS testing purposes. Some backup equipment for the anthropometry component is kept in each MEC for use until the malfunctioning equipment can be repaired or replaced. Specifically, two portable scales will serve as substitutes for the digital weight scale; spare abdominal and knee calipers are kept in the cabinet.

The ISIS anthropometry software application can be used in a manual data entry mode. This feature is especially valuable in the event that the stadiometer, infantometer, or digital weight scale fails to transfer data directly to ISIS. If the ISIS system fails to capture one or more data points, the examiner should complete a UFO, including the SP ID, the missing values, and a description of the problem encountered during the exam.

If ISIS is completely unavailable for use during a session, the examiner can still perform the component. The recorder should record all measurements on the Body Measures Recording Form (see Appendix A). Several copies of the form should be kept in the cabinet drawer. MEC staff can

obtain additional copies in the “Blank Forms Directory” on the MEC staff lounge computer or via an email request to the home office component specialist. Recorders should print all hard-copy form data legibly. The Body Measures Recording Form can be faxed or mailed to the home office. The component specialist will then complete a Back-End-Edit-Request (BEER) to add the data to the study database.

2.5 Setup Procedures

The following procedures describe how to set up the anthropometry equipment and supplies at the start of a stand.

2.5.1 Calibration Weights

- Remove the weight tray bolt to allow the tray to slide freely. Tape the bolt to the inside of the cabinet for easy access. Place the unfinished bumper board at the back of the weight tray.
- Use the weights to calibrate the digital weight scale and portable scales (see Chapter 5, Quality Control, Section 5.2, Equipment Calibrations).

2.5.2 Digital Weight Scale

- Remove the cover from the scale.
- Calibrate the scale using the calibration weights (see Chapter 5, Quality Control, Section 5.2, Equipment Calibrations).
- Return the cover to the scale.

2.5.3 Portable Scale

- Remove the wooden stick from the cabinet drawer handles and place it in the anthropometry storage container.
- Remove the two portable scales from the cabinet drawers.
- Reconnect or replace the four AA batteries in each scale.

- Calibrate the portable scales using the calibration weights (see Chapter 5, Quality Control, Section 5.2, Equipment Calibrations).
- Return the portable scales to the cabinet drawers.

2.5.4 Sitting Box

- Remove the bungee cord from around the sitting box and store the strap in the anthropometry storage container.
- Leave the sitting box against the corner wall where the mirrors are located.
- Raise the seat located beside the sitting box.

2.5.5 Stadiometer

- Replace the CR123 battery in the digital measurement device for the stadiometer.
- Calibrate the stadiometer using the 100-cm calibration rod (see Chapter 5, Quality Control, Section 5.2, Equipment Calibrations). When not in use, the rod should be kept in the holding grips on the side of the stadiometer.
- Slide the head piece of the stadiometer to the top of the measurement column.

2.5.6 Infantometer

- Remove the bungee cord from the infantometer and store it in the anthropometry storage container.
- Remove the bar code wand and padding from between the foot piece and the headboard. Store the padding in the cabinet drawers.
- Replace the CR123 battery in the digital measurement device of the infantometer.

- Calibrate the infantometer (see Chapter 5, Quality Control, Section 5.2, Equipment Calibrations).

When calibrated, the result should read 0.0 cm.

- Slide the foot piece of the infantometer to the left end of the measurement column.

2.5.7 Abdominal Calipers

- Check that the metal screw that holds the lower (fixed) arm to the vertical shaft of the calipers is tight; retighten if necessary using the small (“Allen”) hex wrench.
- Check that the lower arm is aligned with the upper arm; adjust if necessary.
- Check the 16 plastic screws on the hub of the upper (sliding) arm; tighten or loosen if necessary to allow the hub to slide smoothly, but not too fast. If the upper arm is not precisely parallel to the lower arm, adjusting these plastic screws can correct the problem.
- Calibrate both abdominal calipers using the caliper calibration rod (see Chapter 5, Quality Control, Section 5.2, Equipment Calibrations).

2.5.8 Knee Caliper

- If not already done, remove the wooden brace from the cabinet drawers and place it in the anthropometry storage container.
- Remove one knee caliper from the cabinet drawers and place it on a wall hook.

2.5.9 Measurement Tapes and Ruler

- If not already done, remove the wooden brace from the cabinet drawers and place it in the anthropometry storage container.
- Remove the insertion tape from the cabinet drawers and place it on a wall hook or in the wall bin beside the computer terminal.
- Remove the steel measuring tape and height adjustment ruler from the cabinet drawers and ensure that they are accessible.

2.5.10 Supplies

- If not already done, remove the wooden brace from the cabinet drawers and place it in the anthropometry storage container.
- Ensure that the following supplies are accessible: cosmetic pencils, drop dispenser filled with baby oil, gauze pads, masking tape, and infant blue Chux.
- Ensure that the following additional supplies are available: alcohol wipes, cotton cloth, disinfectant wipes, scrub brush, sewing machine oil, hex key set, and screwdrivers.
- Remove the bungee cord and designated soft padding from the computer monitor and store this in the anthropometry storage container.
- Ensure that a small trash can is available in the room.

2.6 Teardown Procedures

At the end of the stand, follow the procedures described below to pack up the anthropometry equipment for travel to the next stand. The anthropometry storage container will need to be retrieved from the MEC belly compartment and brought to the exam room.

2.6.1 Calibration Weights

- Use the weights to calibrate the digital weight scale (see Chapter 5, Quality Control, Section 5.2, Equipment Calibrations).
- Place the unfinished bumper board at the front of the weight tray and replace the bolt to secure the weight tray in place for travel.

2.6.2 Digital Weight Scale

- Calibrate the scale using the calibration weights (see Chapter 5, Quality Control, Section 5.2, Equipment Calibrations).
- Place the cover on the scale.

2.6.3 Portable Scale

- Disconnect the batteries in each portable scale.
- Leave the scales in the cabinet drawers.

2.6.4 Sitting Box

- Slide the sitting box against the corner wall where the mirrors are located.

NOTE: The facility and equipment specialist will remove and store the mirror from the exit door wall.

- Remove a bungee cord from the anthropometry storage container and place the strap around two legs of the box. Attach the ends of the strap to the designated wall hooks.
- Lower the folding seat located beside the sitting box.

2.6.5 Stadiometer

- Remove the CR123 battery from the digital measurement device of the stadiometer.
- Check that the screws at the top of the measurement column are secured. If necessary, tighten the screws using the Phillips head screwdriver.
- Loosely bungee cord the stadiometer to the wall hooks with the strap under the acrylic mount. In this way the stadiometer is secure without stressing the mounts.

2.6.6 Infantometer

- Remove a strap and padding from the anthropometry storage container.
- Remove the CR123 battery from the digital measurement device of the infantometer.
- Slide the foot piece to the right end of the measurement column.
- Place a bungee cord around the metal base of the foot piece and attach the ends of the strap to the hooks on the headboard.
- Wrap the bar code wand in the padding and insert this between the foot piece and the headboard.

2.6.7 Abdominal Caliper

- Place the abdominal calipers in their protective case.
- Place a bungee cord around the case and secure it to the bottom shelf of the exam table.

2.6.8 Exam Table

- Cover the table with the protective blanket.

2.6.9 Knee Caliper

- Place the knee caliper in the cabinet drawers.

2.6.10 Measurement Tapes and Ruler

- Place the plastic insertion tape, steel measuring tape, and height adjustment ruler in the cabinet drawers.

2.6.11 Supplies

- Place the following supplies in the cabinet drawers: cosmetic pencils, drop dispenser filled with baby oil, gauze pads, masking tape, infant blue Chux, blunt-edge scissors, and alcohol wipes.
- To avoid spillage during travel, ensure that the large refill bottle of baby oil is upright and in a plastic bag in the cabinet drawer.
- Ensure that the following additional supplies remain stored in the cabinet drawers: cotton cloth, bleach disinfectant wipes, scrub brush, sewing machine oil, hex key set, and screwdrivers.
- Place the computer keyboard and mouse (with cables still attached) in the top drawer of the cabinet.
- Enclose the computer monitor in the designated soft padding and strap a bungee cord loosely around this to hold it in place without stressing the hardware.

- Remove the wooden brace from the anthropometry storage container and insert it in the cabinet drawer handles.
- Discard any trash in the room.

3.1 Eligibility Criteria

All NHANES survey participants (SPs) are eligible for the anthropometry or body measurement component in the mobile examination center (MEC). The anthropometry protocol requires specific measurements depending on the age of the SP. Table 3-1 lists the required measurements by age category.

Table 3-1. Body measurements by age category

Birth+	2 months+	2 years+	8 years+
Recumbent length	Recumbent length	Recumbent length (through 47 months)	
Head circumference	Head circumference (through 6 months)		
Weight	Weight	Standing height Weight	Standing height Weight
	Upper arm length	Upper arm length	Upper leg length Upper arm length
	Arm circumference	Arm circumference	Arm circumference
		Waist circumference	Waist circumference Sagittal abdominal diameter

3.2 Pre-examination Procedures

If possible, prepare the room for the examination before the SP enters the room. The recorder will confirm that all supplies needed for the exam are available and accessible: cosmetic pencil, gauze pads, baby oil, masking tape strips, scissors, steel measuring tape, abdominal calipers, head circumference tape, and absorbent Chux pads.

When the SP enters the room, introduce yourself and the recorder and close the exam room curtain. The examiner or recorder will open the anthropometry component in the Integrated Survey Information System (ISIS), log the SP into ISIS, and direct the SP to the stadiometer. The

anthropometry component requires no formal or standard script. However, the examiner will provide a brief introduction to the examination, such as:

“In this room we will take a number of body measurements such as height and weight. We will also measure the length of your arm and leg, the thickness of your abdomen, and take some circumference measurements.”

IMPORTANT: Prior to initiating the first measurement **ask the SP to remove any items from his or her pockets**. Set these and other belongings on the infantometer or in a basket located on the bottom shelf of the exam table.

3.3 General Guidelines for Measuring and Recording

Follow the guidelines below when taking anthropometric measurements and subsequently recording the data into ISIS:

1. **Always tell the SP what you are going to do before you do it.** Explain what you are doing and why, such as when locating the leg tendon in the groin area to measure the upper leg length; or before adjusting the pants down to measure the waist circumference. **Do not comment about the SP's body in any way.** Maintain professionalism at all times.
2. **Measure the right side of the body.** If the SP has a physical disability or abnormality on the right side, the examiner should still attempt to measure the right side. **Only** take measurements on the left side when the SP has a cast, prosthesis, or amputation on the appropriate right limb; or for some other reason the measurement cannot be taken accurately on the right side. If a measurement is obtained on the left side, submit an Unusual Field Occurrence (UFO) as documentation (refer to the *UFO Utility Manual* and *Equipment Tracking System User Guide* for details).
3. **Turn the SP in the direction needed for a given measure.** This promotes efficiency during the examination by saving time and avoiding unnecessary movement on the part of the examiner. In other words, do not move yourself around the SP.
4. **Position the zero end of the measuring tape below the measurement value.** With respect to circumference measures, do not take any measurement readings with the zero end of the tape placed above the section of the tape with the result.
5. **Avoid parallax when taking measurement readings.** Parallax describes the phenomenon where an observer reads a different value on a measuring device depending on the angle from which it is viewed. Parallax is a common cause of data error especially for measurements obtained using the abdominal calipers and measurement tape. The

examiner should read the measurement with his or her line of sight directly in front of the value rather than at an angle or from even slightly off to the side.

6. **Record all measurements to the nearest tenth of a centimeter (0.1 cm).** For quality control purposes, the computer will read each number aloud immediately following data entry. ISIS will also alert the recorder to any values that are outside a predetermined limit. This warning serves as an alert for possible data entry and measurement errors. Always verify the result before advancing to the next measure.

3.4 Examination Procedures

This section describes the anthropometry examination procedures. As previously shown in Table 3-1, the protocol includes a total of nine body measures. Exam staff will collect a minimum of three and a maximum of seven measures, depending on the age of the participant.

3.4.1 Recumbent Length

The anthropometry protocol requires a stature measurement in the form of recumbent length for all children less than 4 years of age (birth to 47 months). Recumbent length is measured using an infantometer with a fixed head piece and horizontal backboard, and an adjustable foot piece.

1. **Position the SP:** Lay the child on a Chux pad on the infantometer with the feet toward the foot piece and the head against the fixed head piece. If the child is not wearing a MEC examination gown, ask the parent or guardian to remove the child's clothes except for diapers or underpants. The parent can set the child on a Chux pad on top of the exam table as a changing area.

Placing infants and small children in a recumbent position often generates a sense of insecurity and consequently invokes a crying response. To help comfort the child, the parent or guardian should be encouraged to stand between the examiner and recorder, make eye contact, and talk to the child throughout the procedure.

The **recorder supports the child's head** while the **examiner positions the feet** and ensures that the head lies in the Frankfort horizontal plane described in Section 3.4.3. Apply gentle traction to bring the top of the head in contact with the fixed head piece. Secure the child's head in the proper alignment by lightly cupping the palms of your hands over the ears (Exhibit 3-1). Align the child's legs by placing one hand gently but with mild pressure over the knees. With the other hand, slide the foot piece to rest firmly at the child's heels (Exhibit 3-2). The toes must point directly upward with both soles of the feet flexed perpendicular against the acrylic foot piece. To encourage the child to flex the feet, run the tip of your finger down the inside of the foot.

NOTE: If you are unable to achieve both legs outstretched in the correct position, make certain at least one leg is straight with the foot flexed against the foot piece. However, only position with one leg as an **exception** for extremely fussy children, making sure that the child's body remains straight in the infantometer.

2. **Capture the result:** When the child is correctly positioned, click the “Get” button on the screen to capture the result in ISIS. Release the child's feet as you hold the foot piece in position. Wait for the computer to repeat the measurement aloud. After verifying the correct value, have the parent or guardian remove the child from the infantometer. Slide the foot piece to the end of the measurement column in preparation for the next participant.

In the event of a power outage or if the infantometer malfunctions, position the child as described above and obtain the recumbent length using the tape measure mounted on the right side of the measurement table. Call the result to the recorder, who will manually enter this number in the appropriate ISIS field.

Exhibit 3-1. Recumbent length head position



Exhibit 3-2. Recumbent length feet position**3.4.2 Head Circumference**

The circumference of the head is measured on children from birth through 6 months of age. Follow the steps below to obtain the head circumference measurement:

1. **Position the SP:** Instruct the parent or guardian to stand holding the child over the parent's left shoulder or else sit on the blue box with the child in the parent's lap. Ask the parent to remove any of the child's hair ornaments or braids.
2. **Take the measurement:** Place the head circumference tape around the child's head so that the tape lies across the frontal bones of the skull; slightly above the eyebrows; perpendicular to the long axis of the face; above the ears; and over the occipital prominence at the back of the head (Exhibit 3-3). Move the tape up and down over the back of the head to locate the maximal circumference. Tighten the insertion tape so that it fits snugly around the head and compresses the hair and underlying soft tissues. Measure the circumference to the nearest 0.1 cm. Since the head circumference tape shows both centimeters and inches, check that you take the measurement using the **metric** scale.
3. **Record the result:** Call the result to the recorder, who will enter this number on the ISIS screen. Remove the head circumference tape. Proceed to the next measure for SPs in this age group (birth through 6 months), the upper arm length.

Exhibit 3-3. Head circumference tape position**3.4.3 Standing Height**

Standing height is an assessment of maximum vertical size. This stature measurement is collected on all SPs aged 2 years and older who are able to stand unassisted. Standing height is measured using a stadiometer with a fixed vertical backboard and an adjustable head piece.

1. **Position the SP:** Direct the SP to the stadiometer platform. Ask him or her to remove any hair ornaments, jewelry, buns, or braids from the top of the head. Exhibit 3-4 depicts the correct position for the measurement of standing height. First, have the SP stand up straight against the backboard with the body weight evenly distributed and both feet flat on the platform. Instruct the SP to stand with the **heels together and toes apart**. The toes should point slightly outward at approximately a 60° angle. Check that the back of the **head, shoulder blades, buttocks, and heels make contact with the backboard** (Exhibit 3-4).

NOTE: Depending on the overall body conformation of the individual, all four contact points—head, shoulders, buttocks, and heels—may not touch the stadiometer backboard. For example, elderly SPs may frequently have **kyphosis**, a forward curvature of the spine that appears as a hump at the upper back. In particular, dowager’s hump is a form of kyphosis that creates a hump at the back of the neck. Additionally, some overweight SPs cannot stand straight while touching all four contact points to the backboard. In such instances it is important to obtain the best measurement possible according to the protocol. If you cannot ensure that the SP’s trunk remains vertical above the waist, the arms and shoulders are relaxed, and the head lies in the Frankfort plane, then call “NS”

to the recorder who will capture the measurement and add the “Not Straight” comment beside the appropriate stature measure in ISIS.

Exhibit 3-4. Standing height position

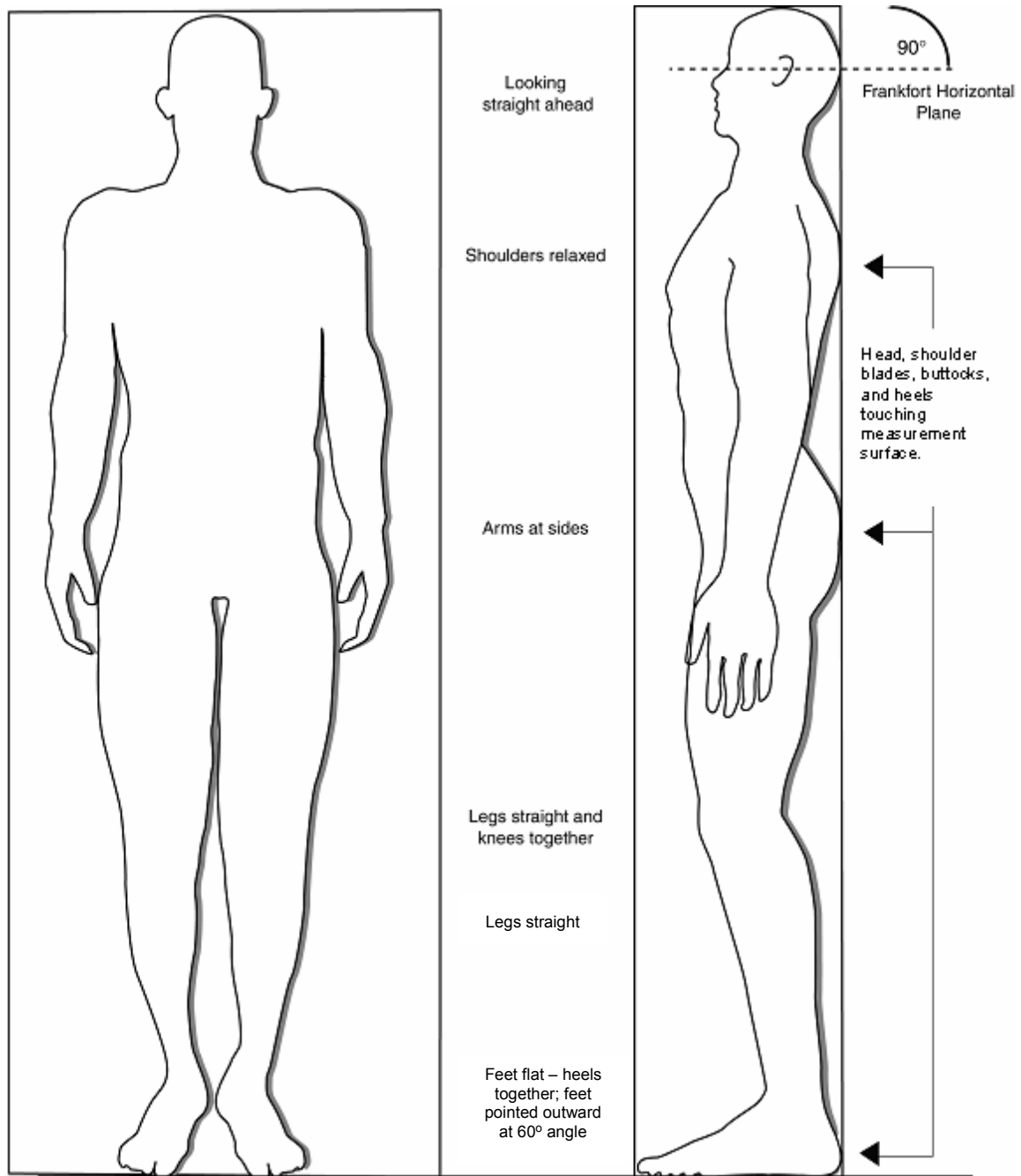

Second, align the head in the **Frankfort horizontal plane**. The head is in the Frankfort plane when the **horizontal** line from the ear canal to the lower border of the orbit of the eye is parallel to the floor and perpendicular to the vertical backboard (Exhibit 3-5). Many people will assume this position naturally, but for some SPs the examiner may need to gently tilt the head up or down to achieve the proper alignment. Instruct the SP to look straight ahead.

Next, lower the stadiometer head piece so that it rests firmly on top of the participant's head, with sufficient pressure to compress the hair. Instruct the SP to stand as tall as possible, **take a deep breath**, and hold this position. The act of taking a deep breath helps straighten the spine to yield a more consistent and reproducible stature measurement. Notice that the inhalation will cause the head piece to rise slightly.

NOTE: Some SPs have hair styles such as a barrette, bun, or braid that will interfere with the placement of the stadiometer head piece. Other SPs may refuse to remove their shoes for the height measurement. In these cases, while the SP remains positioned on the stadiometer platform, the examiner will measure the hair piece and/or the shoe heel with the 15-cm height adjustment ruler. The recorder will enter this number in the Height Correction Above/Below Waist field on the screen. ISIS will use this correction factor to automatically calculate an adjusted height value.

2. **Capture the result:** While the SP is correctly positioned and holding the breath, call "Get" to the recorder, who will click the Get button on the ISIS screen to capture the result. Tell the SP to release the breath as you hold the head piece in position. Wait for the computer to repeat the measurement aloud. After verifying the correct value, have the SP relax and step away from the stadiometer. Slide the head piece to the top of the measurement column and secure it in place with the brake lever, in preparation for the next participant.

NOTE: In the event of a power outage or if the stadiometer malfunctions, slide the head piece to the top of the measurement column and obtain the height using the tape measure mounted on the right side of the measurement column. Call the result to the recorder, who will manually enter this number in the appropriate ISIS field.

Exhibit 3-5. Frankfort horizontal plane

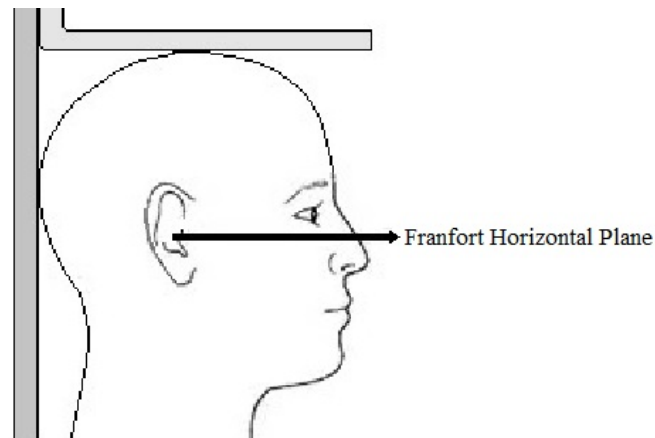

3.4.4 Weight

Participants will be weighed in kilograms using a digital weight scale. At the end of the examination, ISIS will display the weight in both kilograms and pounds for the recorder to share with the SP if he or she wants to know the result. Participants should wear the standard MEC examination gown, which consists of a disposable shirt, pants, and slippers. SPs should wear only underpants beneath the gown. Infants should wear only diapers. The procedures for obtaining the weight measurement are as follows:

1. **Position the SP:** After the examiner briefly introduces the exam to the SP, the recorder will direct the SP to stand in the center of the scale platform, hands at sides, and looking straight ahead.
2. **Capture the result:** After the SP is correctly positioned and the readout on the digital measurement device becomes stable, the recorder will click the “Get Weight” button on the screen to capture the result into ISIS.

In addition, exam staff should follow the procedures described below when applicable:

- **Small children:** Infants and toddlers who cannot stand alone on the scale will be weighed with the assistance of an adult. The parent, guardian, or the examiner will stand alone on the scale while the recorder clicks the **Tare** button on the ISIS screen. This sets the scale readout to zero. The child is then handed to the adult on the scale. In this way the scale will read only the child’s weight. The recorder will click Get Weight to transfer this result to ISIS, and Reset to undo the tare setting.
- **Casts or prostheses:** If you successfully obtained the weight, but the SP had a cast or medical prostheses, add the Medical Appliance (MA) code in ISIS.

- **Street clothes:** If you successfully obtained the weight but the SP wore street clothes instead of the MEC examination gown, add the Clothing (CL) code in ISIS. Do not use this code for infants wearing diapers, one-piece, or a T-shirt.

Weight data collected with the SP wearing **shoes** on the scale will be considered invalid. Therefore, if the SP wears shoes to the exam ask him or her to remove them before stepping on the scale. If the SP refuses to remove his or her shoes in order to step on the scale, code the weight measure as Could Not Obtain (CNO).

- **Portable scales:** Each MEC has two portable scales that are kept in the cabinet drawers. Turn on the scale on by pressing the “On” button, and position the SP on the portable scale in the same manner as for the digital weight scale. Call the weight to the recorder, who will manually enter the number into the Weight field on the ISIS screen. Use the portable scales in the following situations:

If the examinee weighs more than 600 lb (note that the digital weight scale can accurately weigh up to a maximum of 600 lb), obtain the weight using two portable scales:

- Have the SP stand with one foot on each portable scale.
- Combine the two results to approximate the weight.
- Manually enter the total in the Weight field on the screen.
- If the SP exceeds the capacity of both portable scales (440 lb each), code the weight measure as Exceeds Capacity (EC) in ISIS.

Or, if the **digital weight scale malfunctions** or in the event of a power outage, obtain the weight using two portable scales.

3.4.5 Upper Leg Length

Following the weight and height measures, the length of the upper leg will be collected on participants aged 8 years and older. This section describes the procedures to obtain the upper leg length measurement:

1. **Position the SP:** Ask the SP to sit on the blue box with the right knee bent at a 90° angle (Exhibit 3-6). Tell the SP that you are going to cut the right sleeve and pant leg of the examination gown. Assure him or her that you will tape these areas closed at the end of the exam. Using the blunt-edge scissors, cut the right sleeve to the edge of the shoulder and the pant leg to the edge of the pocket.

Exhibit 3-6. Upper leg length measurement position

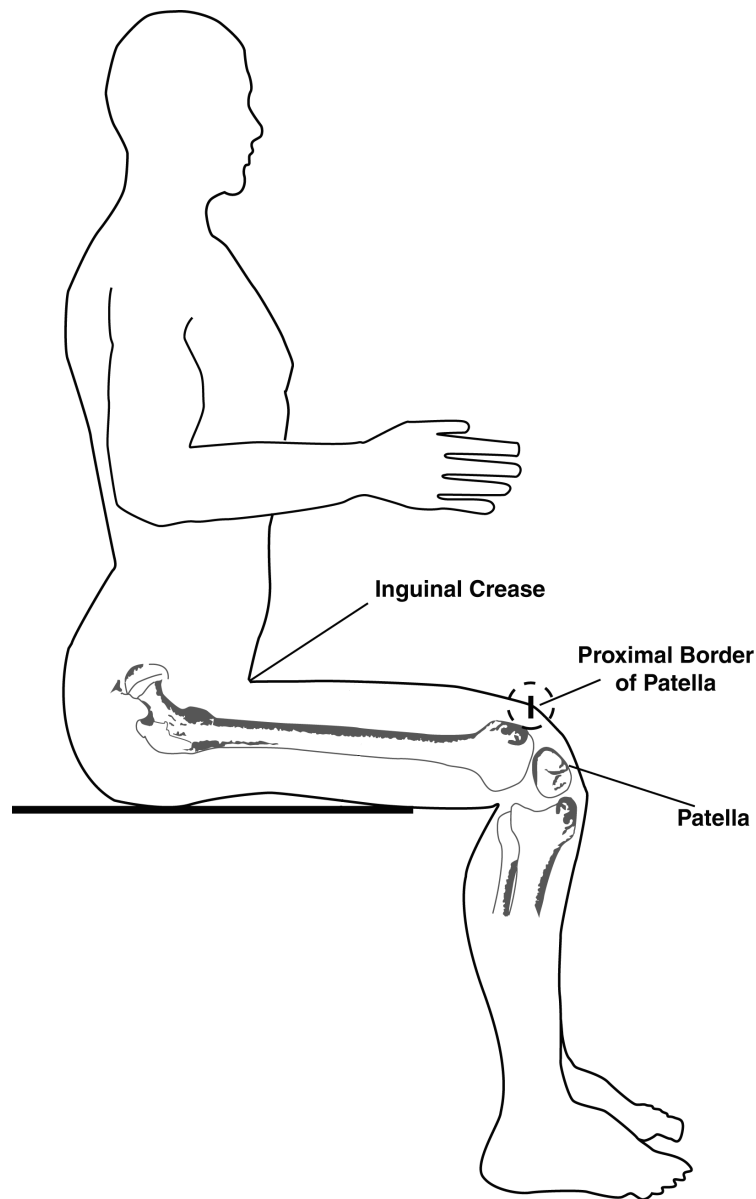

2. **Mark the measurement site:** Hand the scissors to the recorder in exchange for the knee caliper. **Position the knee caliper as if you were measuring the breadth of the patella** (Exhibit 3-7). At the distal end of the femur place the caliper blades on either side of the patella, not to be confused with the femoral condyles. The horizontal bar of the caliper should touch or lie close to the anterior surface of the thigh, proximal to the patella. Try to position the caliper as vertical as possible, but it may need to sit somewhat slanted or at an angle depending on the SP. With a cosmetic pencil mark a line along the proximal border of the patella on the anterior surface of the thigh. Use the edge of the horizontal bar of the caliper as a guide.

Exhibit 3-7. Knee caliper positioned on edges of patella

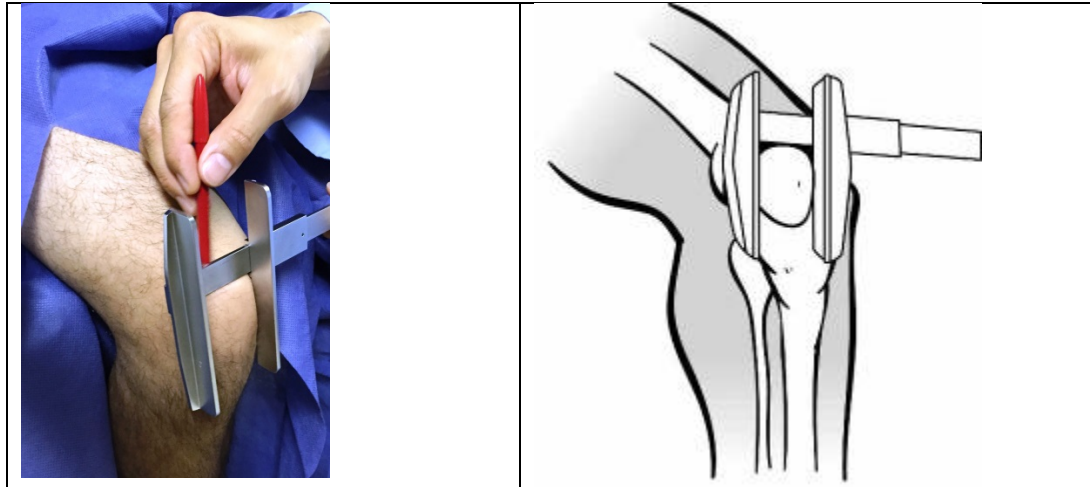

3. **Take the measurement:** Instruct the SP to sit up straight and tell him or her what you will do next. For example, say that you are going to locate the muscle tendon where the leg meets the rest of the body (Exhibit 3-8). Place the zero end of the steel measuring tape at the **inguinal crease**, just below the anterior superior iliac spine (Exhibit 3-9). Depending on the SP, the examiner may need to lift folds of fat tissue in order to locate this crease. Check that the zero end of the tape is properly positioned: place your thumb firmly over the zero end of the tape and ask the SP to lift the thigh slightly off the box. If the tape is in the correct position at the inguinal crease, you will feel a definite tightening of the tendon. **Apply sufficient pressure on the zero end to make certain that the zero end is on the tendon in the crease.** Pull the pant leg slightly to smooth out any gathers. Ask the SP to relax the right leg and remind him or her to sit up straight. Starting from the inguinal crease, extend the tape down the anterior midline of the thigh to the cosmetic pencil mark. Take the measurement to the nearest 0.1 cm.
4. **Record the result:** Call the result to the recorder, who will enter this number on the ISIS screen. Instruct the SP to come off the box, stand on the floor, and turn to face away from you.

Exhibit 3-8. Upper leg length mark

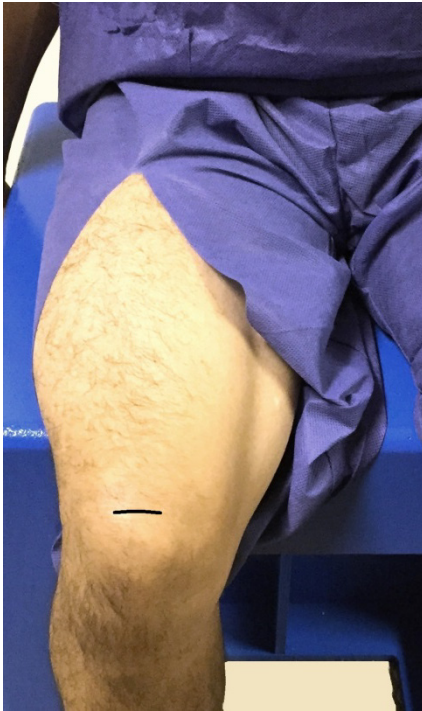
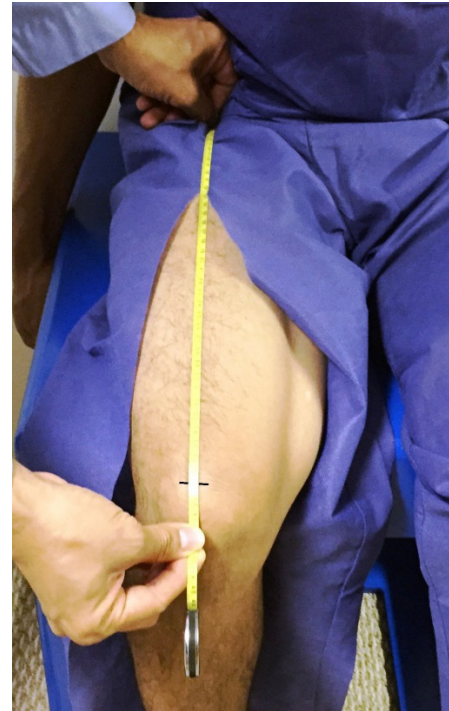

Exhibit 3-9. Upper leg length tape position



3.4.6 Upper Arm Length

In this study, the length of the upper arm is measured to obtain reliable arm circumference (Sections 3.4.7). Exam staff will measure the upper arm length on participants aged 2 months and older.

1. **Position the SP:** Direct the SP to turn away from you. Ask him or her to stand upright with the weight evenly distributed on both feet; the right arm bent 90° at the elbow, and the right palm facing up. Demonstrate the correct position if necessary (Exhibit 3-10).
2. **Mark the measurement site:** Locate the end of the spine of the right scapula by following the scapula out to the arm until it makes a sharp V-turn to the front of the body (Exhibit 3-11). Using the cosmetic pencil, make a horizontal line on the **uppermost edge of the posterior border** of the spine extending from the acromion process (see Exhibit 3-12).
3. **Take the measurement:** Hold the zero end of the measuring tape at this mark and extend the tape down the **center** of the posterior surface of the arm to the tip of the olecranon process, the bony part of the mid-elbow (Exhibit 3-13). Exhibit 3-14 shows this measurement on an infant. Take the measurement to the nearest 0.1 cm.

IMPORTANT: The tape must be centered on the posterior surface of the arm. Exhibit 3-15 shows the correct placement of the measuring tape centered on the posterior surface of the arm, whereas Exhibit 3-16 shows the measuring tape placed incorrectly.

Exhibit 3-10. SP position for upper arm length and midpoint

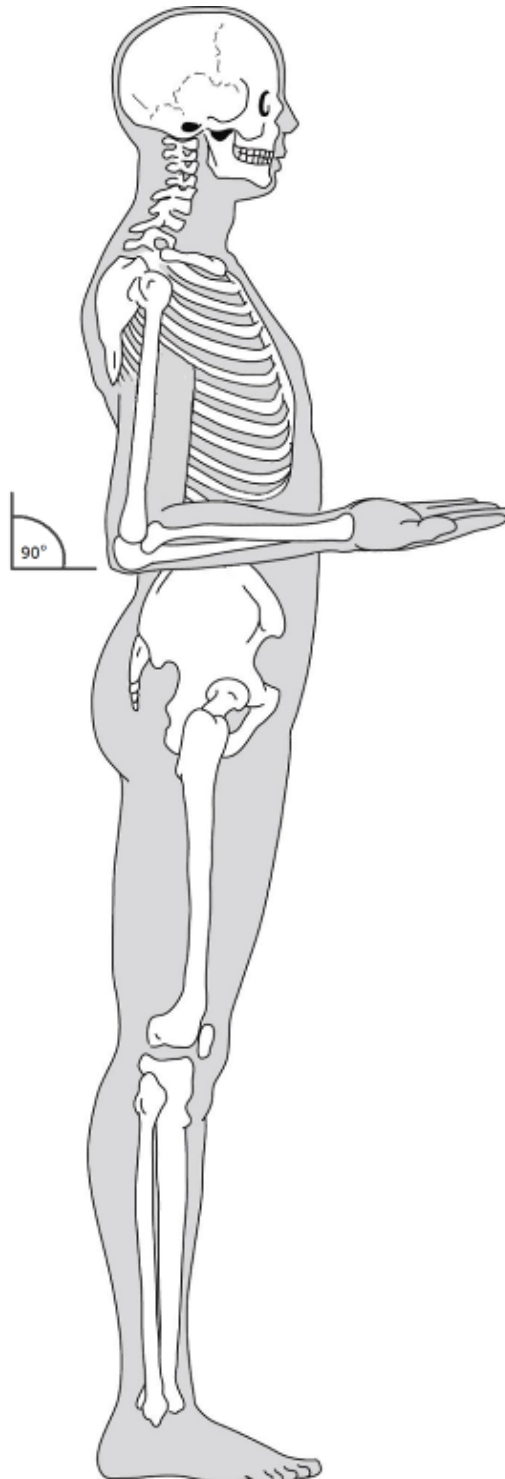

Exhibit 3-11. Upper arm bony landmarks

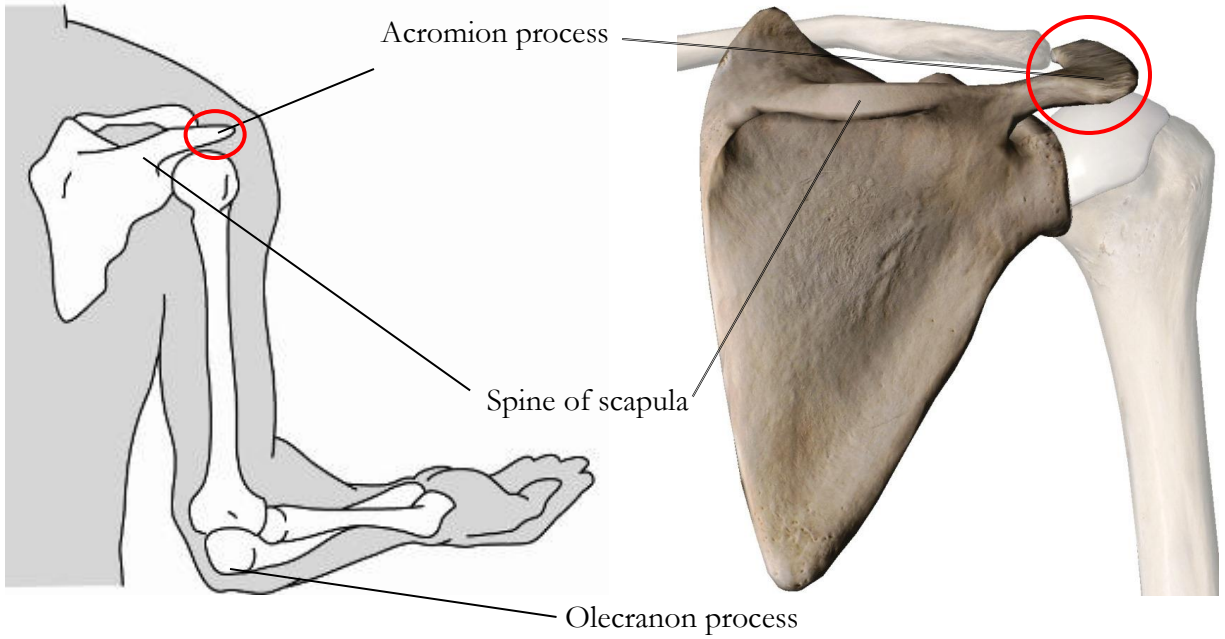

Exhibit 3-12. Marking spine extending from acromion process



Exhibit 3-13. Marking upper arm length midpoint

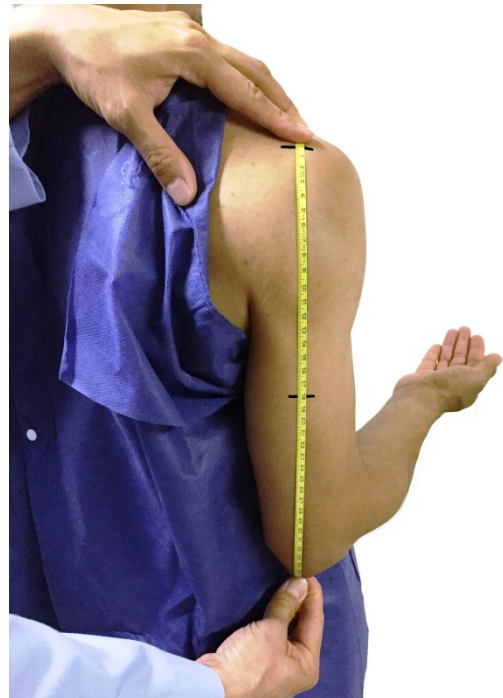
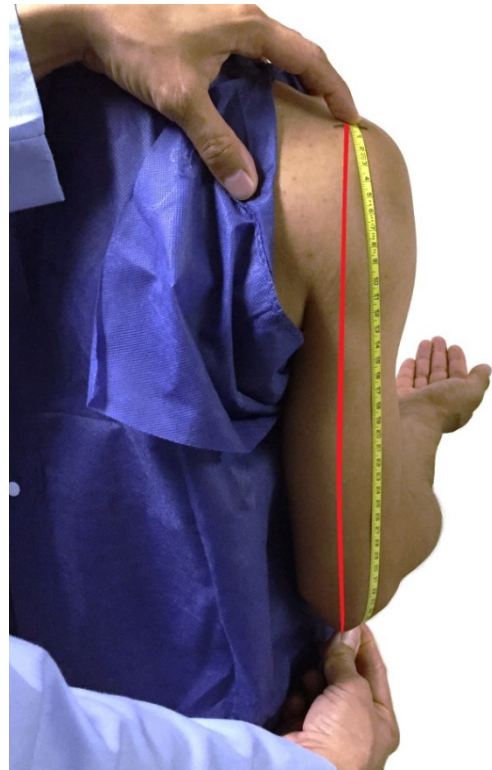

Exhibit 3-14. Infant upper arm length

Exhibit 3-15. **CORRECT** tape placement for upper arm lengthExhibit 3-16. **INCORRECT** tape placement for upper arm length

4. **Record the result:** Call the result to the recorder, who will enter this number on the ISIS screen. Keep the measuring tape in position.

Mark the midpoint: After the recorder enters the result, the application will divide the value in half to calculate the midpoint of the measured length. A computer-generated voice will repeat the measurement aloud and call out the midpoint. While the examiner holds the tape in place, the recorder will make a horizontal mark at the midpoint and cross this mark with a **perpendicular line centered** on the posterior surface of the arm (see Exhibit 3-13). This mark defines the site at which the arm circumference will be measured. Thus the examiner may need to remove the tape to allow the recorder to complete the appropriate cross mark. Finally, tell the SP to relax the right arm. Proceed to the arm circumference measure.

3.4.7 Arm Circumference

The anthropometry protocol calls for two circumference measures: arm circumference on participants aged 2 months and older and abdominal, or waist, circumference on participants 2 years and older. The arm circumference is measured on the right arm at the level of the upper arm mid-point mark. The examiner makes this mark on the posterior surface of the arm immediately after measuring the upper arm length. The procedures for making the mid-arm circumference mark are explained in Section 3.4.6, Upper Arm Length shown earlier. This section describes the procedures for measuring the arm circumference:

1. **Position the SP:** Ask the SP to turn so that you stand **facing** his or her right side. Have the participant stand upright with the weight evenly distributed on both feet, the shoulders relaxed, and the right arm hanging loosely at the sides. Flexing or tightening the arm muscles will yield an inaccurate measurement.
2. **Take the measurement:** Continue to stand **facing the right side** of the SP. Do not stand behind the SP for this measurement. Wrap the measuring tape around the arm at the level of the upper arm mid-point mark. Position the tape **perpendicular** to the long axis of the upper arm. Pull the two ends of the overlapping tape together so that the zero end sits below the measurement value and the result lies on the lateral aspect of the arm (not the posterior surface). Check that the tape fits snugly around the arm but does not compress the skin. Exhibits 3-17 and 3-18 show the arm circumference measurement on an adult and infant, respectively. Take the measurement to the nearest 0.1 cm.
3. **Record the result:** Call the result to the recorder, who will enter this number on the ISIS screen. Remove the tape measure. Proceed to the next circumference measure.

Exhibit 3-17. Adult arm circumference



Exhibit 3-18. Infant arm circumference



3.4.8 Abdominal (Waist) Circumference

The second circumference measure consists of the abdominal or waist circumference. Exam staff will collect the waist circumference on participants aged 2 years and older. Follow the procedures below to obtain this measure:

1. **Position the SP:** Instruct the SP to gather the shirt gown above the waist and clip it on the front so it will not interfere with the measurements. Instruct the participant to cross his or her arms and place his or her hands on opposite shoulders. Demonstrate the desired position of the arms. It may help to tell SPs to think of giving themselves a hug. Feel the SP's right and left iliac crest and, if necessary, lower the waistband of the pants and underclothing to expose the iliac crest. Again, always tell the SP what you are going to do before you do it.
2. **Mark the measurement site:** Stand on the participant's right side. Palpate the hip area to locate the right ilium of the pelvis. With the cosmetic pencil draw a horizontal line just above the uppermost lateral border of the right ilium. Cross this mark at the midaxillary line, which extends from the armpit down the side of the torso.

NOTE: If it is difficult to find the iliac crest, such as on SPs with larger waists, then begin inferior to the midaxillary line (toward the SP's front) and palpate the ilium upward to the midaxillary line until you find the uppermost part of the bone. Exhibit 3-19 shows the measurement site correctly marked for the waist circumference.

3. **Take the measurement:** Extend the measuring tape around the waist. Position the tape in a horizontal plane at the level of the measurement mark (Exhibit 3-20). Use the wall mirror to ensure the horizontal alignment of the tape. While the examiner remains on the SP's right side, the recorder will come around to the SP's left side to check the placement of the tape. Check that the tape sits parallel to the floor and lies snug but does not compress the skin. Always position the zero end of the tape below the section containing the measurement value. Take the measurement to the nearest 0.1 cm at the end of the SP's normal expiration.
4. **Record the result:** Call the result to the recorder, who will enter this number on the ISIS screen. Remove the tape measure and erase the cosmetic pencil mark from the SP's skin with a few drops of baby oil on a piece of gauze.

NOTE: It is important to remove the pencil mark from the uppermost lateral border of the right ilium before the SAD measurements (Section 3.4.9). Often the location of the lateral border of the right ilium shifts slightly due to the position of the SP, standing for waist circumference and supine for SAD.

Exhibit 3-19. Waist circumference mark

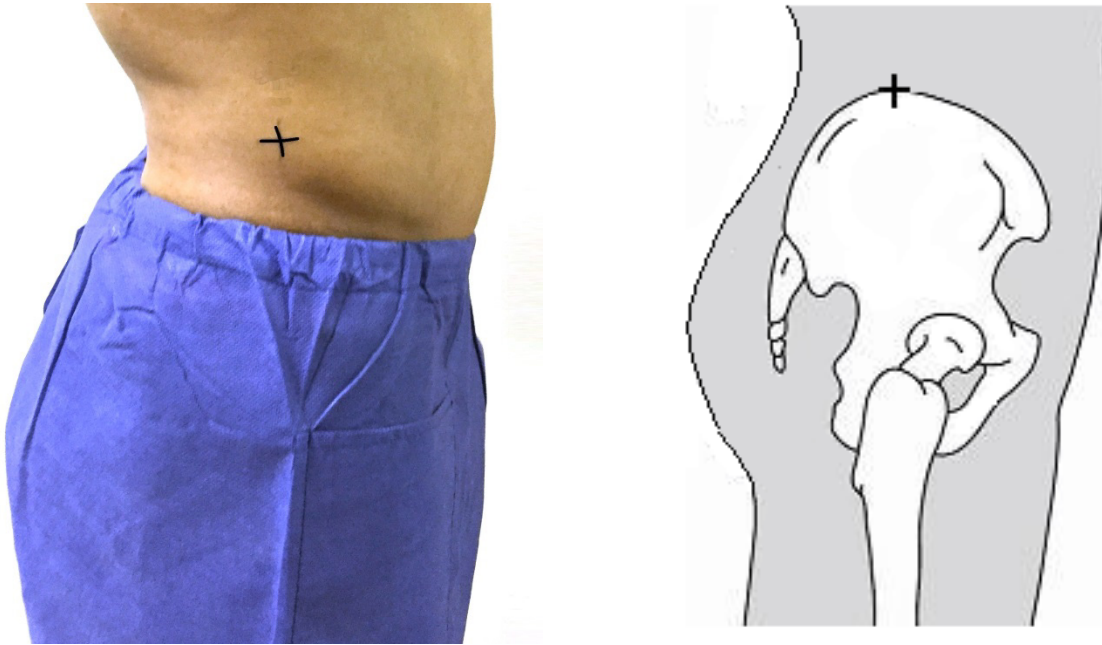
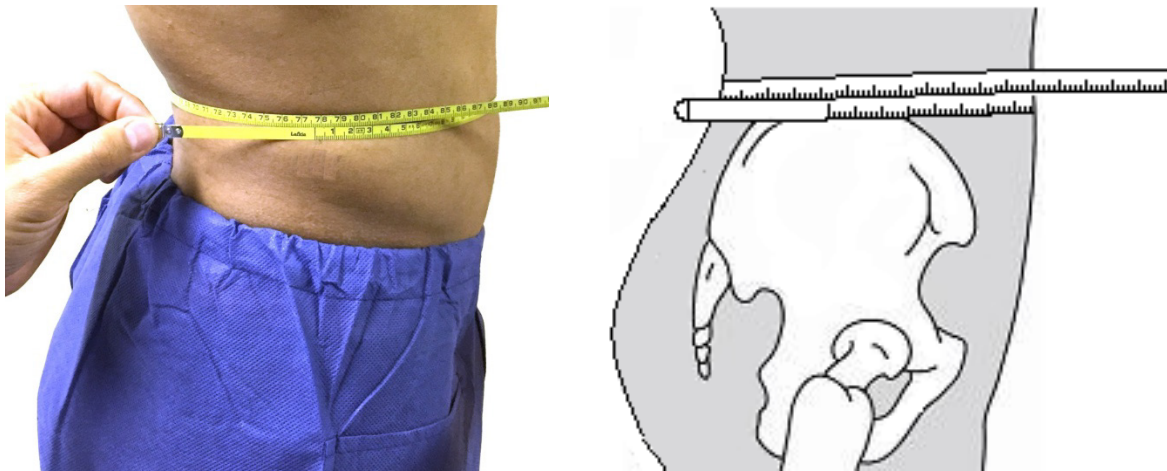

Exhibit 3-20. Measuring tape position for waist circumference



3.4.9 Sagittal Abdominal Diameter (SAD) Measurement

The sagittal abdominal diameter will be measured when the SP is in the supine position on the examination table. Participants aged 8 years and older (except for pregnant women) will have this measurement taken. An abdominal caliper will be used to establish the external distance between the front of the abdomen and the small of the back at the iliac level line. Before the measurement, the examiner will provide a brief introduction to this measurement, such as:

“Next, I am going to take a measurement on your abdomen. I will ask you to lie down on the table with your knees bent and feet flat. After I make a mark on your front abdomen, I will use a caliper to measure the distance between your back and your upper abdomen.”

1. **Position the SP:** Direct the SP to lie down on the table with the head facing the back mirror and the feet toward the wall. The SP can use a step stool to get on the table. Ask the SP to bend his or her knees at a 90° angle, feet resting flat on the table and arms crossed over the chest (Exhibit 3-21). A small head pillow is available if it makes the SP more comfortable.

Exhibit 3-21. SP positioned at table



2. **Mark the measurement site:** Locate the right iliac crest at the point where it intersects the midaxillary line. With a cosmetic pencil draw a line perpendicular to the table on the uppermost lateral border of the right ilium (Exhibit 3-22).

Exhibit 3-22. Marking right iliac crest



Locate the left iliac crest where it also intersects the midaxillary line and extend the measuring tape over the abdomen without compressing the skin from the left iliac crest to the mark on the right iliac crest. The arc of this extended tape should be aligned perpendicular to the table. The recorder will draw a horizontal line, around 5 cm long, on the abdomen along the iliac level line. The line should be drawn on the top left edge of the tape (Exhibit 3-23).

Exhibit 3-23. Marking the iliac level line

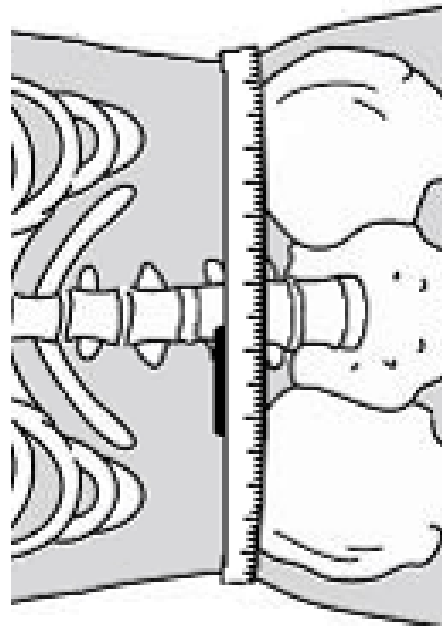

3. **Take the measurement:** At least two SAD measurements are conducted. Select a proper size abdominal caliper based on the estimated SP's abdominal diameter. Ask the SP to briefly raise his or her hips and insert the caliper's lower arm under the small of the back making sure the caliper's upper arm exceeds the SP's abdominal diameter. Check that the caliper's lower arm is in contact with the SP's back. If a gap is present, place a positioning cushion under the caliper so the SP's back touches the caliper. If necessary ask the SP to lower his or her waistband to ensure that it does not interfere with the caliper's lower arm. Grasp the shaft of the caliper with one hand and adjust it in a vertical position (confirmed by the bubble in the spirit level). Using the other hand, slide the caliper's upper arm down to about 2 cm above the abdomen with the edge aligned with the iliac level line mark but without touching the abdomen (Exhibit 3-24).

Exhibit 3-24. Align upper arm to iliac level line



Instruct the SP to **slowly take in a gentle breath, slowly let the air out and then pause** (rest, relax). Promptly slide down the caliper's upper arm letting it lightly touch the abdomen but without compressing it. This descent of the sliding arm should be rapid enough so that the SP does not resume breathing or feel out of breath. Take the measurement when the SP is in the resting phase and the caliper's shaft is in the vertical position (the bubble in the spirit level is in the center of the circle or as close to the center as possible Exhibit 3-25).

NOTE: Do not take the measurement if the left edge of the caliper's upper arm is about 2.0 cm or more from the iliac level line mark. Adjust the caliper in a proper position and repeat the previous steps.

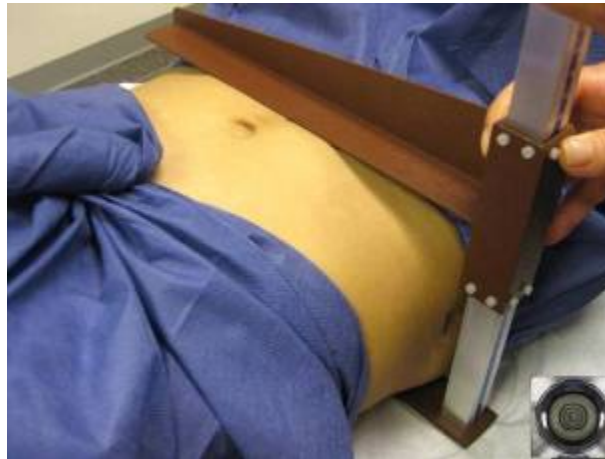
Exhibit 3-25. Take measurement

4. **Read the measurement:** Read the measurement (to the nearest 0.1 cm) on the shaft of the caliper. The ruler on the shaft goes from 0 at the bottom to 36.2 cm on the top in a standard size caliper or to 51.0 cm on the top in a larger size caliper. When the examiner reads the measurement, the integer number in centimeters to be read may not be visible, but the millimeter lines will be easily seen. That means that the example in Exhibit 3-26 is read as 25.5 cm even though the integer 25 cannot be seen. The examiner needs to pay careful attention so the correct value is read. Keep in mind that the integer visible on the scale is probably higher than the integer you will report.

Exhibit 3-26. Reading the caliper

To conduct the second measurement, raise the caliper's upper arm from the abdomen, provide breathing instruction to the SP, and follow the same steps to take the measure. If the difference between the first and second measurement is greater than 0.5 cm, a third and fourth measurement will be conducted following the same procedures.

NOTE: The spirit level should be as close to the center as possible but it is acceptable if it is slightly off center. Please see below (Exhibit 3-27) for acceptable and unacceptable level positions.

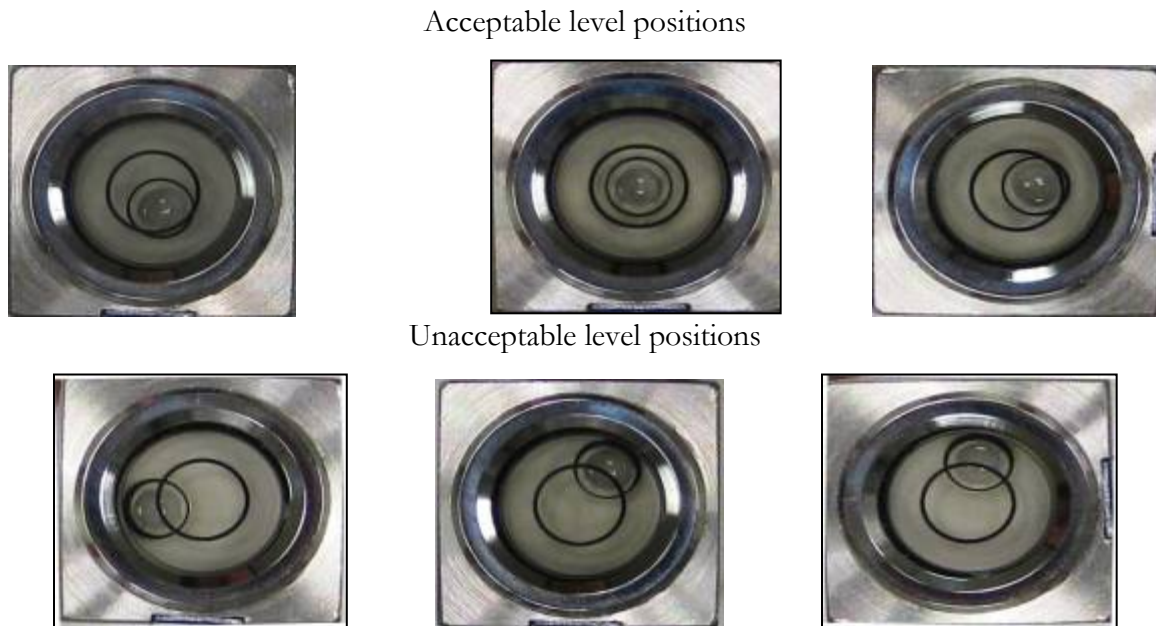
Exhibit 3-27. Acceptable and unacceptable spirit level positions

NOTE: To determine which caliper size the SP needs, check on the wall marking when the SP is in the supine position. Use a large size caliper only if the SP's abdomen exceeds the wall marking. Otherwise use the standard caliper. Most participants will need the standard size caliper.

Record the measurement: Call the result to the recorder, who will enter this number on the ISIS screen. Remove the caliper from the SP. Assist SP to get down from the table.

At the end of the exam, remove the cosmetic pencil marks with baby oil. Remove the paper from the table and wipe it with wipes. Place a new sheet of paper for the next SP and clean the caliper's arm with wipes.

3.4.10 Comment Screen

A comment screen is available to provide information regarding any factors that affected the SAD measurement. These comments are applicable for all SPs who are eligible for the SAD exam regardless of the status of the measurement (completed and CNO). The items are the following:

- SP unable to comply;
- SP discomfort;

- Scar or navel interfering with measure;
- Problem handling/reading caliper;
- Use of positioning cushion; and
- Other, specify.

Check all that apply. If you encounter any problems let the recorder know and she or he will check the appropriate comment(s); otherwise the recorder will advance to the next screen.

3.4.11 Special Circumstances

In the case that SPs are unable to lie still to conduct the SAD measurement, it should be coded as CNO for the 1st measurement with exam comment code of “Unable to lie flat on the exam table.” SPs that have a medical appliance or cast or artifact that impedes access to their back, should be coded as CNO for the 1st measurement with exam comment code of “medical appliance.” In addition, EC (exceeds capacity) and BMIN (below the minimum) codes are available for use.

3.5 Special Considerations

Obtaining complete and accurate body measurement data can be more challenging under some circumstances. The following situations may require certain modifications to the procedures that would be followed under routine conditions.

3.5.1 SPs in Street Clothes

Some SPs refuse to change into the shirt and/or pants provided to them as part of the standard survey examination gown. If a participant enters the exam room wearing his or her street clothes, complete as many anthropometric measurements as possible. For example, the weight and height measures can easily be obtained. Exam staff can also collect the upper arm length and arm circumference if the SP has a loose fitting or sleeveless shirt. For infants, ask the parent or guardian to undress the child leaving only the diaper and T-shirt.

Perform the weight measurement procedures described in Section 3.4.4 with the following caveats:

- **Shoes.** Ask the SP to remove his or her shoes before stepping on the scale. If the SP refuses to remove the shoes in order to step on the scale, code Could Not Obtain (CNO) for the weight measure in ISIS. **Weight data collected with the SP wearing shoes on the scale will be considered invalid.**
- **Clothes.** On the ISIS screen select Clothes (CL) from the Comments box beside the Weight field. This code indicates that the SP wore street clothes while standing on the scale. Do not use the CL code for infants wearing diapers or a T-shirt.
- **Medical appliance.** If you successfully obtained the weight but the SP wore a medical appliance that could not be removed, such as a cast or prosthesis, add the Medical Appliance (MA) code from the ISIS Comments box.

3.5.2 Children

The procedures for performing anthropometric measures on children must take into account their smaller size as well as extra safety precautions:

- **Weight.** When an infant or toddler SP cannot stand unassisted on the digital weight scale, collect the weight following the Tare procedures described in Section 4.2.2. In ISIS be sure to select the Clothes (CL) code beside the weight field for a child wearing street clothes but not for an infant wearing a diaper and T-shirt.
- **Recumbent length.** Exam staff must carefully **hold small children on the infantometer at all times** because they can quickly flip themselves over or easily fall. Move the screen cursor to the GET button **before** positioning the child, in order to capture the measurement immediately after the child assumes the correct position.
- **Upper arm length and circumferences.** For toddlers and small children up to roughly 6 or 7 years of age, the examiner may opt to stand the child on the blue sitting box. In this position the examiner can better control the child's movements and take measurements at eye level for data accuracy. Ensure that the box sits against the wall and ask the child to hold the safety bar for balance. If the child cannot stand alone on the box, take the measurements with the child sitting in the parent's lap. Ask parents to place infants over their left shoulder.

3.5.3 SPs in Wheelchairs

Provided the SP is willing and able to participate, exam staff should attempt to collect the following subset of anthropometric measurements on SPs who are in wheelchairs:

- Upper arm length; and
- Arm circumference.

To prepare the SP for these measurements, direct him or her to the right side of the wheelchair so that the arm of the chair does not restrict the right arm. Ensure that the SP can extend the right arm without interference from the chair. **As with ambulatory participants, DO NOT try to lift the SP or bear his or her weight in order to facilitate the examination protocol.**

3.5.4 Amputees

For SPs who have any part of a limb on the right side amputated, collect the required measurement data on the SP's **left side**. For example, if the SP has part of his or her right arm missing, obtain the upper arm length measurement and mark the midpoint on the left arm. Measure the arm circumference on the left arm as well. Enter CNO in the Comment box only if both arms are amputated or for some other reason you cannot obtain these three measurements.

During the exam, carefully observe whether the SP has any amputations. For data quality purposes it is important to take amputations into account, for example in relation to the measured weight. The anthropometry protocol does not require the examiner or recorder to ask the SP outright if he or she has any amputations. Amputations may be obvious on many SPs, especially amputations of the arms and the leg that is measured as part of the exam. However, if the exam staff has doubts or difficulty determining this information based on observation alone, then ask the SP directly: "Do you have any amputations?"

Record all amputation-related information on the ISIS Amputations screen prior to finishing the exam. Specifically, ISIS will ask you to record whether or not the SP has any amputations. If so, ISIS will prompt you to record more details: the particular extremity or extremities affected (i.e., upper or lower, right or left) and where the amputation lies (i.e., above or below the elbow or knee).

3.5.5 Comprehension or Language Difficulties

Some SPs may have difficulty understanding the examination instructions. Exam staff should use extreme caution when attempting to conduct the anthropometry component on these participants. If the SP cannot understand your instructions due to a developmental disability or other type of physical or mental impairment, ask if a family member or friend accompanied the SP to the MEC who can help explain your directions to the SP. Regardless, if you believe the SP cannot comprehend well enough for you to safely and accurately carry out the examination protocol, then on the ISIS screen code the appropriate measure(s) as Could Not Obtain (CNO) and select “Communication Problem” as the reason for the Partial or Not Done exam status.

For many SPs, language barriers are a common cause of difficulty in understanding examination instructions. For Spanish-speaking SPs, if the examiner is not English-Spanish bilingual, a Spanish interpreter will be assigned to interpret for the SP and the examiner during the exam. In most cases the coordinator will assign a bilingual recorder to conduct the component with the examiner. If the SP speaks a language other than English or Spanish, arrangements will be made ahead of the anthropometry exam to identify an appropriate interpreter. Nevertheless, as in the case of other forms of comprehension difficulties, if you cannot safely and accurately perform the exam on the SP, then code the affected measure(s) as Could Not Obtain (CNO) on the ISIS screen and select “Communication Problem” as the reason for the Partial or Not Done exam status. See the *NHANES Interpretation Guidelines* for procedures related to the interpretation of MEC examination components and working with interpreters.

3.6 Post-Examination Procedures

At the end of the examination remove any remaining cosmetic pencil marks from the SP’s skin with a few drops of baby oil on a piece of gauze. Tape the SP’s pant leg and sleeve where they were cut during the exam. The recorder will assist the examiner as follows: hand the gauze pads with baby oil and strips of masking tape to the examiner; return the SP’s jewelry, wallet, purse, or other belongings that may have been set aside; and put away equipment and supplies in preparation for the next examination.

To end the component, the recorder will click the Finish button on the ISIS screen. This signals the coordinator to make the next assignment for that SP. **Do not click Finish until the SP is**

completely ready to be escorted out of the room. Wait for a message from the coordinator indicating where to direct the SP. Thank the SP for participating and accompany him or her to the next exam room or to the reception area.

4.1 General Screen Information

When the coordinator assigns a survey participant (SP) to the Anthropometry or Body Measures room, a communication dialog box will appear on the Integrated Survey Information System (ISIS) computer screen. This will inform you that an SP has been assigned to this component. Click the Close button to remove the dialog box from the screen.

To begin the examination, click the “Logon SP” icon, the first icon on the left in the standard toolbar. ISIS will present a dialog box that asks for the name and password of the examiner and the recorder. Wand the bar code on the SP’s identification bracelet or type the SP’s ID number to log the SP into the component. This will activate a dialog box (Exhibit 4-1) containing descriptive information about the SP (i.e., name, SP ID, age, etc.). Verify that the correct participant name appears on the screen. Contact the coordinator and MEC manager for assistance if the information in ISIS appears incorrect. Otherwise, click OK to initiate the examination.

Exhibit 4-1. Logon SP screen

The screenshot shows a dialog box titled "SP Login" with the following fields and values:

- Sample Person ID: 719924
- Sample Person Name: 719924 - Clock
- Last Name: CLOCK
- First Name: LISA
- Date of Birth: 09/01/1985
- Gender: Female
- Age at Interview: 25 years

Buttons at the bottom include "Retrieve", "OK", and "Cancel".

All ISIS screens have similar characteristics. As shown below (Exhibit 4-2), at the very top of the screen is a title bar containing the component name (Anthropometry Subsystem), stand number, session number, and session date and time. Below this are the menu bar and standard toolbar icons, which provide software application commands and shortcuts. Under the standard toolbar sits a second title bar that identifies the examination component (Body Measures), stand number, session number, and session date and time. Below the second title bar is the SP ID, name, age, gender, and current date and time. The component screen name lies in the upper left of the main window area.

Exhibit 4-2. ISIS screen characteristics

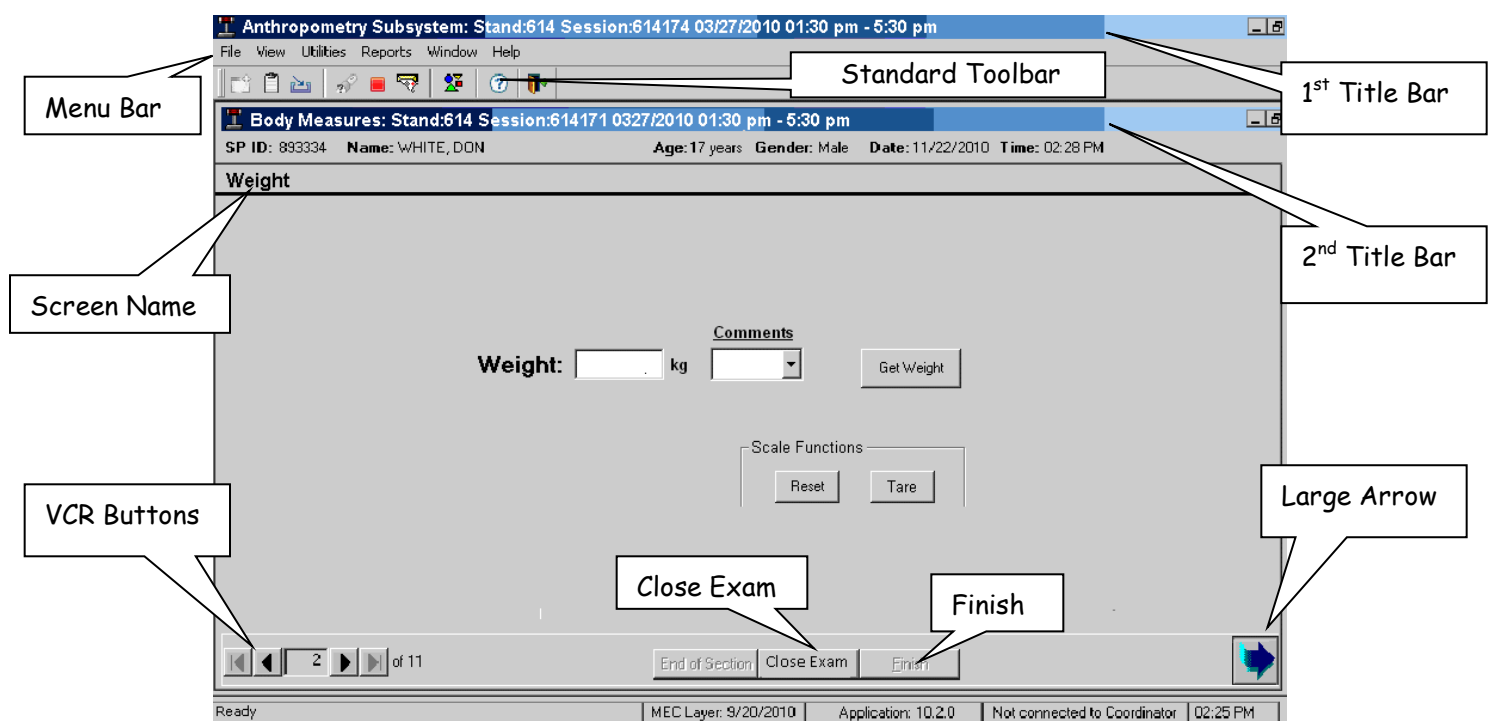

At the bottom left corner of the screen is the ISIS screen number and a set of arrow buttons for navigating the screens: The far left button moves to the first screen and the far right button moves to the last screen. Directly beside the screen number, the left button moves to the previous screen and the right button moves to the next screen. At the bottom right corner of the screen is a large arrow. **Always click on the large arrow to advance to the next screen.**

In the middle of the bottom of the screen are two buttons: Close Exam and Finish. Clicking Close Exam will delete any data captured on the current screen, terminate the exam, and code the exam status as Partial or Not Done. **NEVER click the Close Exam button unless the exam must be discontinued and there is no other appropriate means to exit the application.** Click the Finish

button at the end of an exam. This sends a signal to the coordinator that the SP is available for the next assignment.

As you proceed through the examination, certain ISIS entries will activate an Edit Check box (Exhibit 4-3). This window appears if the recorder enters a number that ISIS determines to be out of the acceptable range. Specifically, ISIS identifies numeric data entries as out of range as those that are less than the 1st percentile or greater than the 99th percentile for the SP's age and gender. In these cases, the Edit Check box will present the message, "Check that measure." ISIS will also identify numeric data entries that exceed the capacity of the equipment, and display an Edit Check box with the message "The Measurement exceeded the device limitation." **The recorder must prompt the examiner to review the measurement for accuracy and follow his or her instructions before proceeding with the exam.**

Exhibit 4-3. Edit Check box

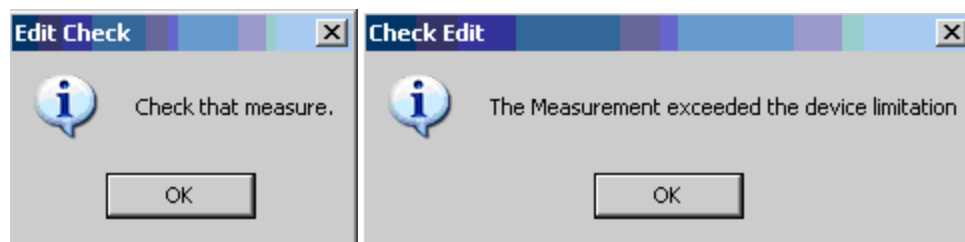

4.2 Pregnancy Screen

If the pregnancy status has not been determined in a previous component, female SPs between the ages of 12-49 will be asked the pregnancy question (Exhibit 4-4).

Exhibit 4-4. Pregnancy question

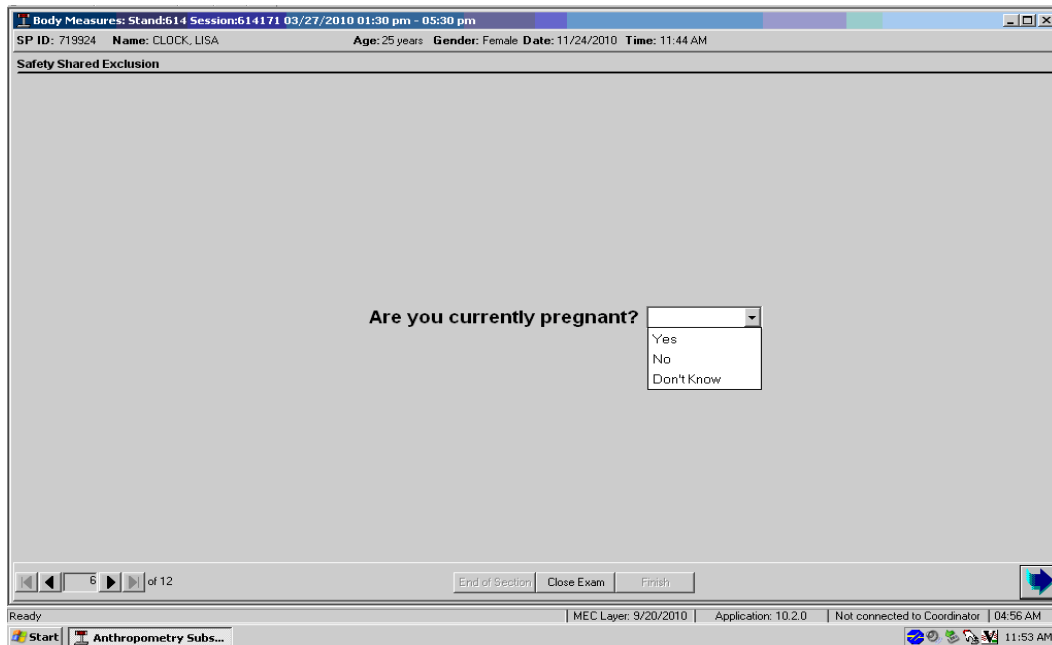

The screenshot shows a software window titled "Body Measures: Stand:614 Session:614171 03/27/2010 01:30 pm - 05:30 pm". The window contains a header with patient information: "SP ID: 719924 Name: CLOCK, LISA Age: 25 years Gender: Female Date: 11/24/2010 Time: 11:44 AM". Below the header is a "Safety Shared Exclusion" section. The main area of the window displays the question "Are you currently pregnant?" followed by a dropdown menu with three options: "Yes", "No", and "Don't Know". At the bottom of the window, there are navigation buttons: "End of Section", "Close Exam", and "Finish". The Windows taskbar at the bottom shows the Start button, an open application "Anthropometry Subs...", and the system tray with the date "9/20/2010", application version "10.2.0", and status "Not connected to Coordinator". The time in the taskbar is "04:56 AM".

4.3 Stature Screen

The next screen in the ISIS anthropometry application is the Stature screen (Exhibit 4-5 through Exhibit 4-8). In accordance with the anthropometry protocol, the screen will reflect different measurement fields depending on the age of the SP:

1. SPs aged 0-6 months: Recumbent length and head circumference (Exhibit 4-5)
2. SPs aged 7-23 months: Recumbent length (Exhibit 4-6)
3. SPs aged 24-47 months: Recumbent length and standing height (Exhibit 4-7)
4. SPs aged 4 years and older: Standing height (Exhibit 4-8)

Click the “Get” button to transfer the recumbent length and standing height measurement directly from the infantometer and stadiometer, respectively, to ISIS. These measurements may also be manually entered. The head circumference measurement can only be entered manually. After each measure is successfully captured in ISIS, a computer-generated voice will repeat the number aloud. Always verify that this is the correct number.

Exhibit 4-5. Stature screen—SPs 0-6 months

Body Measures: Stand:253 Session:253261 05/03/2009 01:30 pm - 05:30 pm
 SP ID: 461407 Name: PETERSON, CHLOE Age: 1 months Gender: Female Date: 11/24/2010 Time: 12:03 PM

Stature

Get

Height Correction:	Above Waist:	<input type="text" value=".0"/>	cm
	Below Waist:	<input type="text" value=".0"/>	cm
Recumbent Length:	Measured	<input type="text"/>	cm
	Adjusted	<input type="text"/>	cm
Head Circumference:	Measured	<input type="text"/>	cm
	Adjusted	<input type="text"/>	cm
			Comments
			<input type="text"/>

1 of 8 End of Section Close Exam Finish

Ready MEC Layer: 9/20/2010 Application: 10.2.0 Not connected to Coordinator 04:56 AM

Exhibit 4-6. Stature screen—SPs 7-23 months

Body Measures: Stand:253 Session:253261 05/03/2009 01:30 pm - 05:30 pm
 SP ID: 461407 Name: PETERSON, CHLOE Age: 1 year Gender: Female Date: 11/24/2010 Time: 12:03 PM

Stature

Get

Height Correction:	Above Waist:	<input type="text" value=".0"/>	cm
	Below Waist:	<input type="text" value=".0"/>	cm
Recumbent Length:	Measured	<input type="text"/>	cm
	Adjusted	<input type="text"/>	cm
			Comments
			<input type="text"/>

1 of 8 End of Section Close Exam Finish

Ready MEC Layer: 9/20/2010 Application: 10.2.0 Not connected to Coordinator 04:56 AM

Start Anthropometry Subs... 12:03 PM

Exhibit 4-7. Stature screen – SPs 24-47 months

Body Measures: Stand:253 Session:253261 05/03/2009 01:30 pm - 05:30 pm
 SP ID: 461407 Name: PETERSON, CHLOE Age: 2 years Gender: Female Date: 11/24/2010 Time: 12:03 PM

Stature

Get

Height Correction:	Above Waist:	<input type="text" value=".0"/> cm
	Below Waist:	<input type="text" value=".0"/> cm
Recumbent Length:	Measured	<input type="text"/> cm
	Adjusted	<input type="text"/> cm
Standing Height:	Measured	<input type="text"/> cm
	Adjusted	<input type="text"/> cm
	Comments	<input type="text"/>

1 of 8 End of Section Close Exam Finish

Ready MEC Layer: 9/20/2010 Application: 10.2.0 Not connected to Coordinator 04:56 AM

Exhibit 4-8. Stature screen – SPs 4 years and older

Body Measures: Stand:614 Session:614171 03/27/2010 01:30 pm - 05:30 pm
 SP ID: 893334 Name: WHITE, DON Age: 17 years Gender: Male Date: 11/22/2010 Time: 02:28 PM

Stature

Get

Height Correction:	Above Waist:	<input type="text"/> cm
	Below Waist:	<input type="text"/> cm
Standing Height:	Measured	<input type="text"/> cm
	Adjusted	<input type="text"/> cm
	Comments	<input type="text"/>

1 of 11 End of Section Close Exam Finish

Ready MEC Layer: 9/20/2010 Application: 10.2.0 Not connected to Coordinator 02:25 PM

4.3.1 Height Correction

The top portion of the Stature screen offers two fields for Height Correction: Above Waist and Below Waist (Exhibit 4-9). Using the designated height adjustment ruler, the exam staff will make corrections to the SPs height in two cases:

1. **Above waist.** The SP refuses (or is unable) to remove a hairpiece such as a barrette, bun, or braids that would otherwise prevent an accurate stature measurement. The technologist measures the hairpiece with the ruler and the recorder enters this number in the Height Correction: Above Waist field.
2. **Below waist.** The SP refuses (or is unable) to remove his or her shoes for the stature measurement. The technologist measures the height of the shoe heel with the ruler and the recorder enters this number in the Height Correction: Below Waist field.

The Stature screen also displays two columns associated with corrections to the recumbent length and standing height measurements:

1. **Measured.** The uncorrected height measurement captured or entered into ISIS from the infantometer or stadiometer.
2. **Adjusted.** The adjusted height measurement, taking into account the height correction. ISIS automatically calculates the adjusted height by subtracting the height correction number entered in the Above Waist and/or Below Waist field from the uncorrected height measurement value.

Exhibit 4-9. Stature screen—height correction

Height Correction:	Above Waist: <input type="text" value="1.0"/> cm						
	Below Waist: <input type="text" value=".0"/> cm						
	<table border="1"> <thead> <tr> <th><u>Measured</u></th> <th><u>Adjusted</u></th> <th><u>Comments</u></th> </tr> </thead> <tbody> <tr> <td>Standing Height: <input type="text" value="161.0"/> cm</td> <td><input type="text" value="160.0"/> cm</td> <td><input type="text"/></td> </tr> </tbody> </table>	<u>Measured</u>	<u>Adjusted</u>	<u>Comments</u>	Standing Height: <input type="text" value="161.0"/> cm	<input type="text" value="160.0"/> cm	<input type="text"/>
<u>Measured</u>	<u>Adjusted</u>	<u>Comments</u>					
Standing Height: <input type="text" value="161.0"/> cm	<input type="text" value="160.0"/> cm	<input type="text"/>					

4.3.2 Stature Comments

Beside the Measured and Adjusted columns is a Comments column for specific notes regarding recumbent length and standing height measurements. The Comment box provides the following codes in a drop-down list: EC, CNO, and NS.

1. **EC = Exceeds Capacity.** Select EC if you cannot capture or manually enter the height because the SP is too tall or long to be measured by the stadiometer or infantometer, respectively.
2. **CNO = Could Not Obtain.** Select CNO if you cannot obtain the stature measurement for a reason other than EC.
3. **NS = Not Straight.** Select NS to code an inaccurate stature measurement if the SP's posture was not straight.

The drop-down list changes depending on whether or not a value is entered. Specifically, if the height and/or length value is zero, the drop-down list will provide the options CNO or EC (Exhibit 4-10). When a non-zero value is entered in the height and/or length, the drop-down list will consist of only NS (Exhibit 4-11).

Exhibit 4-10. Stature screen—recumbent length blank comments

Body Measures: Stand:253 Session:253261 05/03/2009 01:30 pm - 05:30 pm
 SP ID: 461407 Name: PETERSON, CHLOE Age: 1 year Gender: Female Date: 11/24/2010 Time: 12:03 PM

Stature

Get

Height Correction:	Above Waist:	<input type="text" value=".0"/> cm
	Below Waist:	<input type="text" value=".0"/> cm
Recumbent Length:	Measured	<input type="text"/> cm
	Adjusted	<input type="text"/> cm
	Comments	<input type="text" value="EC"/> <input type="text" value="CNO"/>

Ready | MEC Layer: 9/20/2010 | Application: 10.2.0 | Not connected to Coordinator | 04:56 AM

Exhibit 4-11. Stature screen—standing height value comments

Body Measures: Stand:614 Session:614171 03/27/2010 01:30 pm - 05:30 pm
 SP ID: 893334 Name: WHITE, DON Age: 17 years Gender: Male Date: 11/22/2010 Time: 02:28 PM

Stature

Get

Height Correction:	Above Waist:	<input type="text" value=".0"/> cm
	Below Waist:	<input type="text" value=".0"/> cm
Standing Height:	Measured	<input type="text" value="160.0"/> cm
	Adjusted	<input type="text" value="160.0"/> cm
	Comments	<input type="text" value="NS"/>

Ready | MEC Layer: 9/20/2010 | Application: 10.2.0 | Not connected to Coordinator | 02:25 PM

4.4 Weight Screen

The second data entry screen is the Weight screen (Exhibit 4-12). Weight in kilograms is collected on all SPs.

When you open this screen, the cursor will automatically appear in the Weight field. After the SP steps on the digital weight scale and the weight appears on the measurement device, click the “Get Weight” button on the screen. ISIS will capture the SP’s weight directly from the scale and display the number in the Weight field.

If the digital weight scale was set to pounds (lb) instead of kilograms (kg), when you click “Get Weight,” ISIS will present a warning message asking you to change the display to kg and click Get Weight again (Exhibit 4-13). In this case, click OK to the warning message, change the scale setting to kg, and retry capturing the weight into ISIS.

Exhibit 4-12. Weight screen

The screenshot shows a software window titled "Body Measures: Stand:614 Session:614171 03/27/2010 01:30 pm - 05:30 pm". The window contains the following information and controls:

- Header: SP ID: 893334 Name: WHITE, DON Age: 17 years Gender: Male Date: 11/22/2010 Time: 02:28 PM
- Section Title: Weight
- Weight Input: A text field labeled "Weight:" followed by a unit selector set to "kg".
- Comments: A dropdown menu labeled "Comments".
- Action: A "Get Weight" button.
- Scale Functions: A group box containing "Reset" and "Tare" buttons.
- Navigation: A bottom bar with navigation arrows, a page indicator "2 of 11", and buttons for "End of Section", "Close Exam", and "Finish".
- Status Bar: "Ready | MEC Layer: 9/20/2010 | Application: 10.2.0 | Not connected to Coordinator | 02:25 PM"

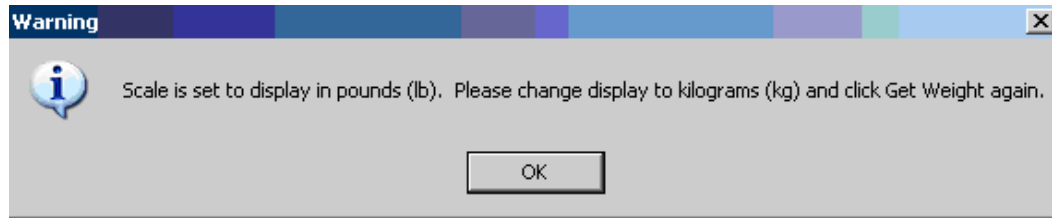
Exhibit 4-13. Weight screen—lb/kg warning message

4.4.1 Weight Comments

Beside the Weight field, a Comments box provides the following codes in a drop-down list: EC, CNO, CL, and MA (Exhibit 4-14).

1. **EC = Exceeds Capacity.** Select EC if you cannot capture or manually enter the weight because (1) the SP exceeds the capacity of the digital weight scale; **and** (2) the SP exceeds the capacity of two portable scales when standing with one foot on each scale.
2. **CNO = Could Not Obtain.** Select CNO if you cannot obtain the weight for a reason other than EC.
3. **CL = Clothing.** Select CL if you successfully obtained the weight, but the SP wore street clothes instead of the standard MEC shirt and pant gown. Do not select CL for infants wearing diapers or a T-shirt.

NOTE. If the SP wears shoes to the exam, ask him or her to remove them before stepping on the scale. If the SP refuses to remove the shoes in order to step on the scale, code the weight as CNO. Weight data collected with the SP wearing shoes on the scale will be considered invalid.

4. **MA = Medical Appliance.** Select MA if you successfully obtained the weight but the SP wore a medical appliance that could not be removed, such as a cast or prosthesis.

Exhibit 4-14. Weight screen— comments list

Body Measures: Stand:514 Session:614171 03/27/2010 01:30 pm - 05:30 pm

SP ID: 893334 Name: WHITE, DON Age: 17 years Gender: Male Date: 11/22/2010 Time: 02:28 PM

Weight

Weight: kg

Comments

- CNO
- EC
- CL
- MA

Get Weight

Functions

Reset Tare

2 of 11

End of Section Close Exam Finish

4.4.2 Tare and Reset

Use the Tare and Reset scale functions on the Weight screen when an infant or toddler SP cannot stand unassisted on the digital weight scale. In these cases an adult will assist in weighing the child. First, either the child’s guardian or the examiner will stand alone on the scale while the recorder clicks the Tare button on the screen. This sets the reading on the scale measurement device to zero. Next, the child is handed to the person on the scale. The measurement device will now read only the weight of the child. As soon as the scale measures this weight, the recorder will click “Get Weight” to transfer the number to ISIS. After the child’s weight is successfully captured on the screen, the recorder will click “Reset” to undo the tare function (Exhibit 4-15).

Following the weight screen, the recorder will manually enter the remaining anthropometry measurements into ISIS.

Exhibit 4-15. Weight screen—tare and reset functions

Body Measures: Stand:615 Session:615431 10/08/2010 01:30 pm - 05:30 pm
SP ID: 161248 Name: 3, SP Age: 1 year Gender: Male Date: 10/07/2015 Time: 09:57 AM

Weight

Weight: 10.5 kg

Comments

Get Weight

Scale Functions

Reset Tare

2 of 7

End of Section Close Exam Finish

4.5 Sitting Measures Screen

The next screen is titled Sitting Measures (Exhibit 4-16). This screen displays the Upper Leg Length measure, which is collected on SPs aged 8 years and older. After the recorder enters the upper leg length, ISIS will repeat the number aloud for confirmation.

If you cannot obtain the measure for some reason, e.g., SP refusal or physical limitation, select CNO (Could Not Obtain) from the Comment box located beside the measurement field.

Exhibit 4-16. Sitting measures screen

Body Measures: Stand:614 Session:614171 03/27/2010 01:30 pm - 05:30 pm

SP ID: 833334 Name: WHITE, DDN Age: 17 years Gender: Male Date: 11/22/2010 Time: 02:28 PM

Sitting Measures

Upper Leg Length: cm

3 of 11

End of Section Close Exam Finish

4.6 Upper Arm Length Screen

Following Upper Leg Length is the Upper Arm Length screen (Exhibit 4-17). This screen is displayed for all SPs aged 2 months and older. After the recorder enters the upper arm length, ISIS will call out both the number entered and the midpoint of this measurement.

If you cannot obtain the measure for some reason, e.g., SP refusal or physical limitation, select CNO (Could Not Obtain) from the corresponding Comment box.

Exhibit 4-17. Upper arm length screen

Body Measures: Stand:614 Session:614171 03/27/2010 01:30 pm - 05:30 pm

SP ID: 893334 Name: WHITE, DON Age: 17 years Gender: Male Date: 11/22/2010 Time: 02:28 PM

Upper Arm Length

Upper Arm Length: 40.0 cm

Midpoint of upper arm length: 20.0 cm

4 of 11

End of Section Close Exam Finish

4.7 Circumference Measures Screen

The next screen in the ISIS anthropometry application is the Circumference Measures screen. In accordance with the anthropometry protocol, the screen will reflect different measurement fields depending on the age of the SP.

1. SPs aged 2-23 months: Arm circumference (Exhibit 4-18)
2. SPs aged 24 months–19 years: Arm and waist circumference (Exhibit 4-19)
3. SPs aged 20 years and older have two screens: Arm circumference (Exhibit 4-20) and Waist circumference (Exhibit 4-21)

To move the screen cursor from one measurement field to the next, press Enter or Tab on the keyboard or click the cursor on the desired field. After the recorder enters each measurement, ISIS will repeat the number aloud for confirmation. If you cannot obtain the measure for some reason, e.g., SP refusal or physical limitation, select CNO (Could Not Obtain) from the corresponding Comment box.

Exhibit 4-18. Circumference Measures screen—arm circumference (SPs 2–23 months)

Body Measures: Stand:616 Session:616021 01/26/2011 01:30 pm - 05:30 pm
SP ID: 906837 Name: MA, S12_AUDIO S Age: 1 year Gender: Male Date: 09/09/2015 Time: 02:24 PM

Circumference Measures

Arm Circumference: cm

5 of 11 End of Section Close Exam Finish

Exhibit 4-19. Circumference Measures screen—arm and waist circumference (SPs 24 months to 19 years)

Body Measures: Stand:615 Session:615431 10/08/2010 01:30 pm - 05:30 pm
SP ID: 161248 Name: 3, SP Age: 6 years Gender: Male Date: 10/07/2015 Time: 09:57 AM

Circumference Measures

Arm Circumference: cm

Waist Circumference: cm

4 of 7 End of Section Close Exam Finish

Exhibit 4-20. Circumference Measures screen—arm circumference (SPs 20 years and older)

Body Measures: Stand:615 Session:615810 11/15/2010 08:30 am - 12:30 pm

SP ID: 767995 Name: NAME, LAST M Age: 22 years Gender: Male Date: 04/03/2015 Time: 10:14 AM

Arm Circumference Measure

Arm Circumference: .0 cm

5 of 15 End of Section Close Exam Finish

Exhibit 4-21. Circumference Measures screen—waist circumference (SPs 20 years and older)

Body Measures: Stand:616 Session:616021 01/26/2011 01:30 pm - 05:30 pm

SP ID: 906837 Name: MA, S12_AUDIO S Age: 21 years Gender: Male Date: 09/09/2015 Time: 02:24 PM

Circumference Measures

NHANES

Waist Circumference: .0 cm

5 of 11 End of Section Close Exam Finish

In addition to the NHANES waist circumference, SPs 20 years and older will have three additional waist circumference screens; one for the World Health Organization (WHO) protocol and two for the Multi-Ethnic Study of Atherosclerosis (MESA) protocol. For detailed information regarding the WHO and MESA protocols, refer to the Waist Circumference Measures Methodology Study Procedures Manual.

4.8 Sagittal Abdominal Diameter (SAD) Measures Screen

Following the Circumference Measures screen are the SAD measures screens. These screens are displayed for all SPs aged 8 and older. Two exclusions are in place for this measurement—if an SP is over 600 lb or if a female SP is pregnant.

Up to four SAD measurements will be conducted using a Holtain-Kahn caliper. The top portions of the SAD measures screens offer a field for caliper selection. The examiner needs to check which caliper was used—standard size or larger (custom) size (Exhibits 4-22 and 4-24).

Exhibit 4-22. First set of SAD measures screen

Body Measures: Stand:614 Session:614171 03/27/2010 01:30 pm - 05:30 pm
SP ID: 893334 Name: WHITE, DON Age: 17 years Gender: Male Date: 11/22/2010 Time: 02:28 PM
Sagittal Abdominal Diameter (SAD) 1

Which caliper was used for this measurement?

Data entry for 1st measurement cm
Data entry for 2nd measurement cm

6 of 11

The first set of SAD measures screens also displays a comment column associated with the first measurement. The Comment box provides the following codes in a drop-down list: CNO, EC, BMIN (Exhibit 4-23).

1. **CNO = Could Not Obtain.** Select CNO if you cannot obtain the SAD measure.
2. **EC = Exceeds Capacity.** Select EC if you cannot capture the measure due to equipment limitation.
3. **BMIN = Below Minimum.** Select BMIN if the SP's abdomen is below the minimum width of the caliper.
4. Don't select EC if you cannot capture the measure when using a standard caliper. Reselect a large size caliper for the SAD measurement.
5. If any of these codes, CNO, EC, or BMIN are used for the first measurement, then a second measurement is not needed. The application will gray it out.

Exhibit 4-23. First set of SAD measures—comments for first measurement

The screenshot shows a software window titled "Body Measures: Stand:614 Session:614171 03/27/2010 01:30 pm - 05:30 pm". The patient information at the top includes "SP ID: 893334", "Name: WHITE, DDN", "Age: 17 years", "Gender: Male", "Date: 11/22/2010", and "Time: 02:28 PM". The main heading is "Sagittal Abdominal Diameter (SAD) 1". The form contains the following fields and controls:

- "Which caliper was used for this measurement?" with a dropdown menu.
- "Data entry for 1st measurement" with a text input field, a "cm" unit label, and a dropdown menu.
- "Data entry for 2nd measurement" with a text input field, a "cm" unit label, and a dropdown menu.

The dropdown menu for the second measurement is open, showing the options "CNO", "EC", and "BMIN". At the bottom of the window, there are navigation controls: "End of Section", "Close Exam", and "Finish" buttons, along with a status bar showing "6 of 11" and a blue arrow icon.

If the difference between the first and second measurements is greater than 0.5 cm, the application will ask to conduct a second set for the measurements (Exhibit 4-24).

Exhibit 4-24. Second set of SAD measures screen

Body Measures: Stand:614 Session:614171 03/27/2010 01:30 pm - 05:30 pm
SP ID: 893334 Name: WHITE, DDN Age: 17 years Gender: Male Date: 11/22/2010 Time: 02:28 PM
Sagittal Abdominal Diameter (SAD) 2

Which caliper was used for this measurement?

Data entry for 3rd measurement cm

Data entry for 4th measurement cm

7 of 11 End of Section Close Exam Finish

ISIS will display an edit check message “Check that measure” if a value entered falls outside a predetermined range (Exhibit 4-25). The recorder must read the edit check message aloud to prompt the examiner to review the measurement for accuracy. If SAD is an accurate measurement, review the waist circumference value. If original values are correct, retain both waist circumference and SAD values. If a measurement or recording error was made, take the measure and/or record the correct value.

ISIS will display a hard edit alert “The Measurement of SAD is out of range” if the value entered exceeds the capacity of the selected caliper (Exhibit 4-25). The recorder must read the edit check message aloud to prompt the examiner to review both SAD and waist circumference measurements for accuracy.

Exhibit 4-25. SAD measures—edit check screen

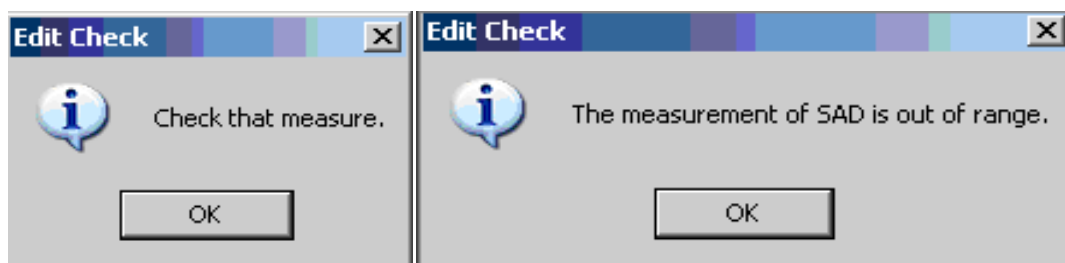

ISIS will display a remind message “Please enter 2nd Measurement” or “Please enter 4th Measurement” (Exhibit 4-26) if the second or fourth measurement is missing. The recorder must read the remind message aloud to prompt the examiner to complete the measurements.

Exhibit 4-26. SAD measures—remind screen

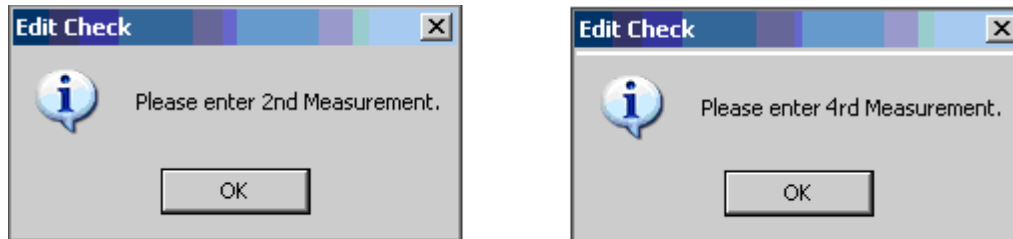

A comment screen (Exhibit 4-27) will be displayed either after the first or second set of SAD measures. This screen allows the examiner to check any, all, or none of the comments.

Exhibit 4-27. SAD measures — Comments screen

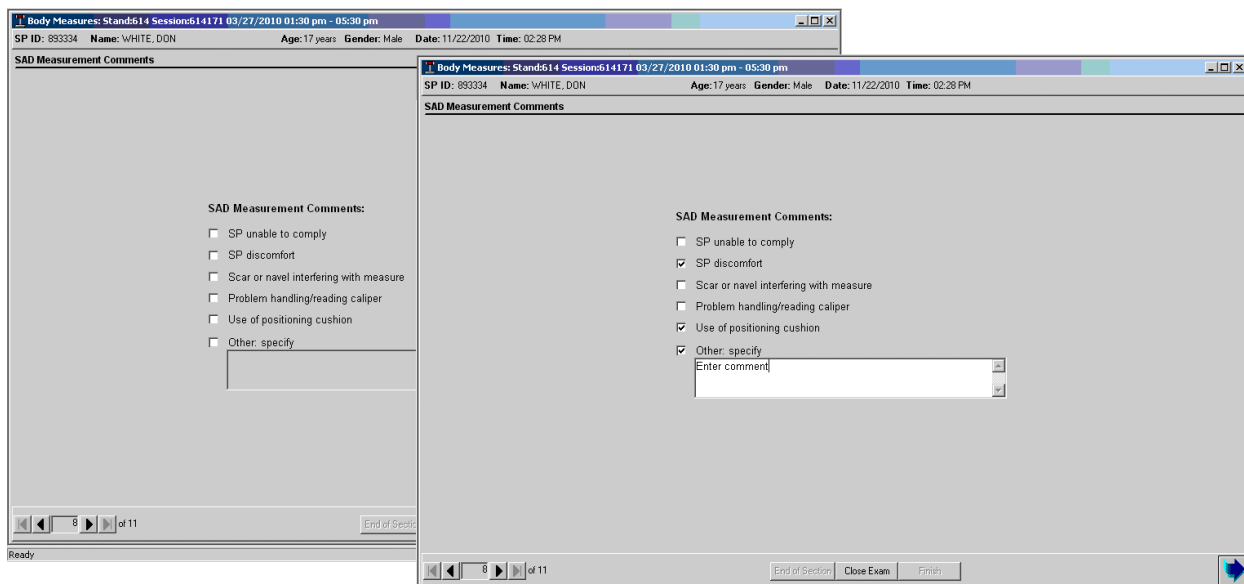

4.9 SP Information Screen

Following the measurement screens, ISIS will present the SP Information screen (Exhibit 4-28), which offers the question, “Do you want to know your height and weight?” The recorder will read the question to the SP and click the “Yes” or “No” radio button. This will trigger the following responses:

1. **YES.** ISIS will show two boxes: Weight in both pounds and kilograms, and height in both English and metric equivalents.
2. **NO.** ISIS will be ready to advance to the next screen.

Exhibit 4-28. SP Information screen

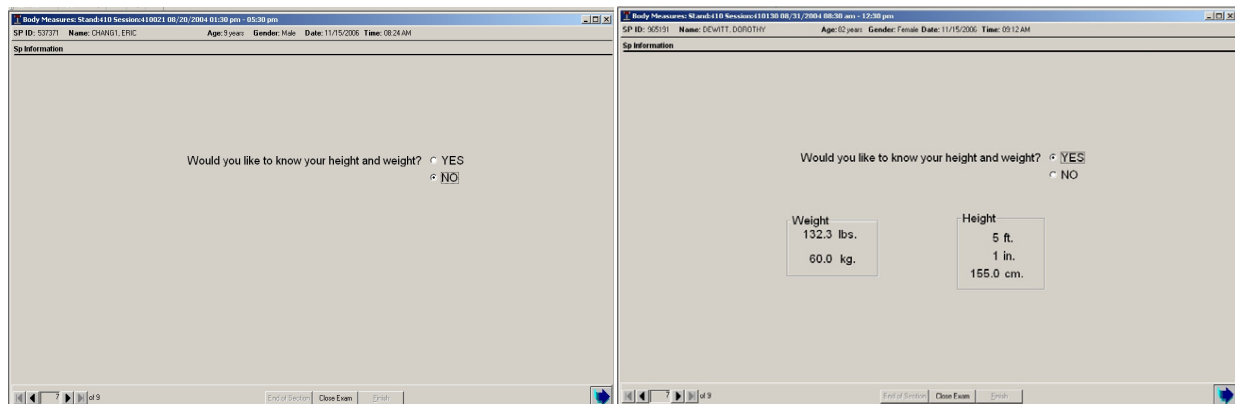

4.10 Amputations Screen

The Amputations screen (Exhibit 4-29) is an observation screen for the exam staff to complete without asking the SP directly. The recorder will mark the appropriate Yes or No radio button beside “Amputations?” This will trigger the following responses:

1. **Amputations: YES.** ISIS will add four questions to the screen, which the recorder must answer by clicking Yes, No, or Could Not Obtain for each:
 - Upper right extremity?
 - Upper left extremity?
 - Lower right extremity?
 - Lower left extremity?
2. **Upper extremities: Yes.** Clicking Yes to either of the upper extremities will prompt ISIS to add two more questions: Above Elbow? Below Elbow? The recorder must mark the Yes or No radio buttons beside each.
3. **Lower extremities: Yes.** Clicking Yes to either of the lower extremities will prompt ISIS to add two more questions: Above Knee? Below Knee? The recorder must mark the Yes or No radio buttons beside each.
4. **Amputations: No.** ISIS will be ready to advance to the next screen.

Exhibit 4-29. Amputations screens

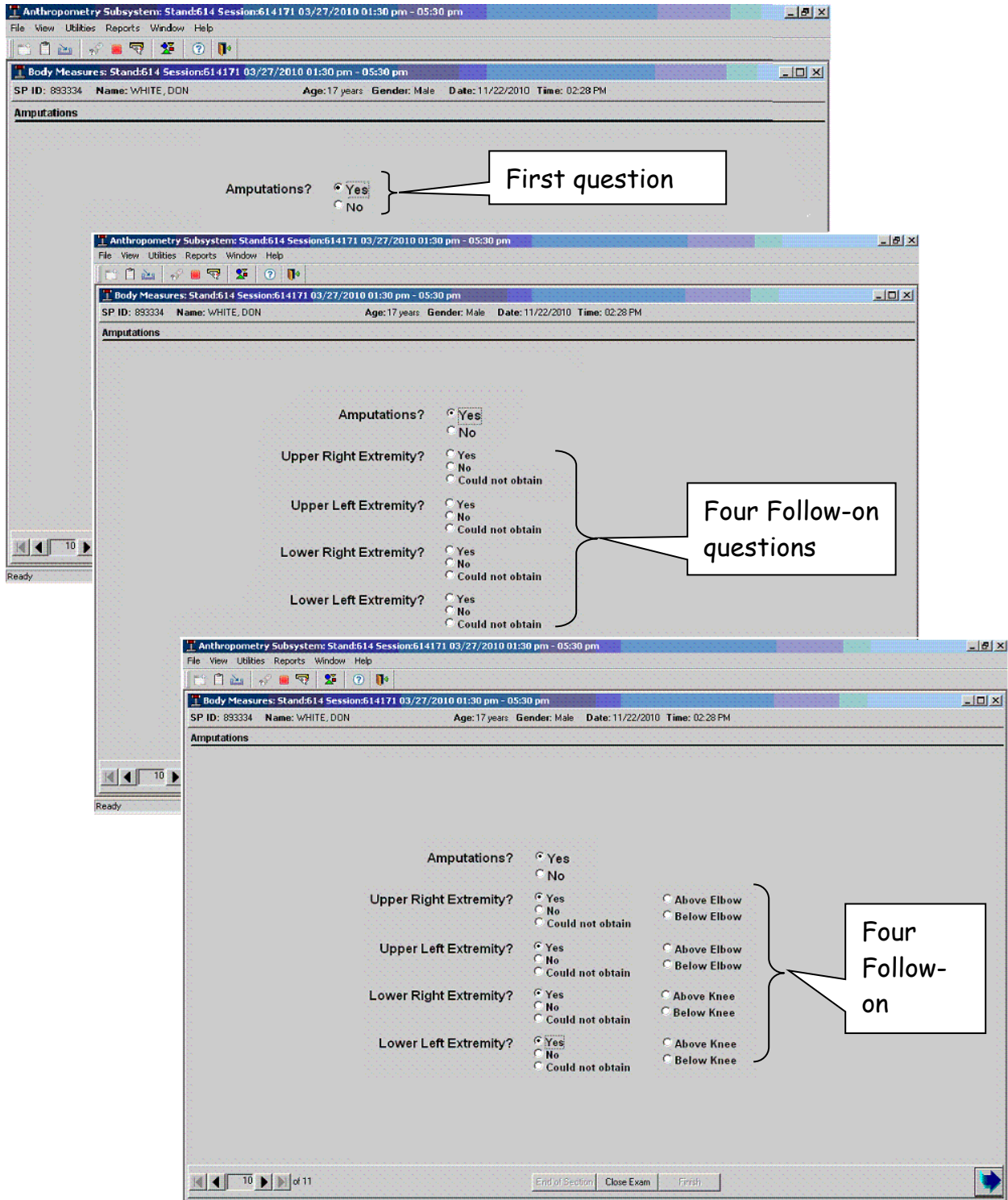

4.11 Anthropometry Component Status Screen

The Anthropometry Component Status (Exhibits 4-30 and 4-31) marks the final ISIS screen. The purpose of this screen is to document the overall status of the anthropometry examination: Complete, Partial, and Not Done. As with all other MEC exam components, ISIS will automatically default to one of these codes.

- **Complete.** All required measures were captured in ISIS.
- **Partial.** One or more required measures were NOT captured in ISIS.
- **Not Done.** No required measures were captured in ISIS.

Exhibit 4-30. Anthropometry component status screen—Complete

Body Measures: Stand:614 Session:614171 03/27/2010 01:30 pm - 05:30 pm
SP ID: 893334 Name: WHITE, DON Age: 17 years Gender: Male Date: 11/22/2010 Time: 02:28 PM
Body Measurement component Status

Status

Complete
 Partial
 Not Done

Comments

Other text

End of Section Close Exam Finish

For Partial and Not Done exams, use the drop-down menu beside the Comments box to select from a list of reasons that include safety exclusion, SP refusal, no time, physical limitation, communication problem, equipment failure, SP ill/emergency, interrupted, medical appliance, unable to lie flat, and other, specify. If you choose the “other, specify” comment you must enter a description. Be as brief as possible. Only select “other, specify” if the comment does not fit into one of the defined comments. Two new codes have been added for Not Done and Partial exams. The codes are “medical appliance” (if SP has a medical device that prevents access to the back), and “unable to lie flat” (if SP cannot lie down on the exam table).

The following are some common scenarios regarding reasons for Partial status exams:

- **Partial status example #1:** If Could Not Obtain (CNO) or Exceeds Capacity (EC) was entered for one of the measures because it was physically impossible for the examiner to obtain the measurement, then ISIS will code the exam status as Partial and the recorder should code the reason as physical limitation.
- **Partial status example #2:** If CNO was entered for one of the measures because the SP refused to allow the examiner to obtain the measurement, then ISIS will code the exam status as Partial and the recorder should code the reason as SP Refusal.
- **Partial status example #3:** If CNO was entered for the SAD measurement because the SP had a medical device that prevented access to the back, then ISIS will code the exam status as Partial and the recorder should code the reason as medical appliance.
- **Partial status example #4:** If CNO was entered for the SAD measurement because the SP could not lie down on the exam table, then ISIS will code the exam status as Partial and the recorder should code the reason as unable to lie flat.

Exhibit 4-31. Anthropometry component status screen—Partial

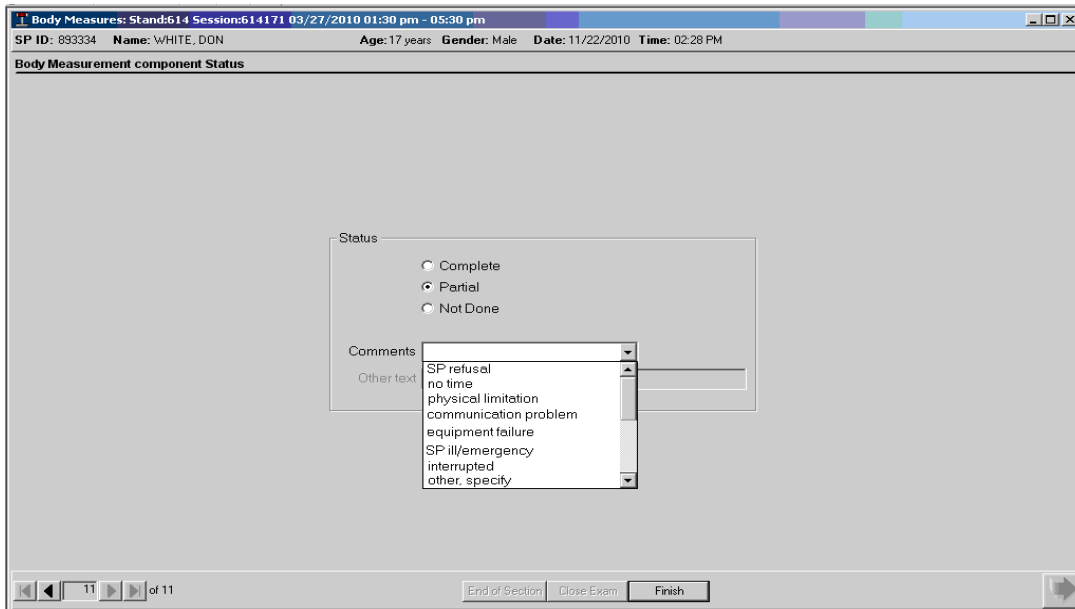

The screenshot displays the 'Body Measurement component Status' window. At the top, it shows session information: 'Stand:614 Session:614171 03/27/2010 01:30 pm - 05:30 pm'. Below this, patient details are listed: 'SP ID: 893334 Name: WHITE, DON Age: 17 years Gender: Male Date: 11/22/2010 Time: 02:28 PM'. The main area is titled 'Body Measurement component Status'. A 'Status' section contains three radio buttons: 'Complete', 'Partial' (which is selected), and 'Not Done'. Below this is a 'Comments' section with a dropdown menu. The dropdown is open, showing a list of reasons: 'SP refusal', 'no time', 'physical limitation', 'communication problem', 'equipment failure', 'SP ill/emergency', 'interrupted', and 'other, specify'. At the bottom of the window, there are navigation buttons: 'End of Section', 'Close Exam', and 'Finish'. A status bar at the very bottom indicates '11 of 11'.

Lastly, click Finish to end the examination. Wait for a message from the coordinator indicating where to direct the SP. Thank the SP for participating and escort him or her to the next exam room or to the coordinator.

5.1 Introduction to Quality Control for Anthropometry

Quality control procedures ensure the collection and documentation of accurate, reliable data. The NHANES anthropometry data are among the most widely used data collected in the study. Your role as an examiner or recorder is crucial to the success of this component. The anthropometry protocol requires the examiner and recorder to work together as a team (see Chapter 3, Examination Protocol).

In anthropometrics, the most common errors involve body positioning, locating and marking body landmarks, reading measurement results, and recording examination results in ISIS. The methods used in NHANES were developed to minimize inter-examiner variability, reduce error, and ensure data quality. In addition to the standardized examination protocol, the anthropometry component incorporates specific quality control procedures.

5.2 Equipment Calibrations

Routine calibrations of the anthropometry equipment ensure that the equipment produces accurate measures. The following pieces of equipment require calibration at specific points during a stand: digital weight scale, portable scales, stadiometer, infantometer, and abdominal calipers. Table 5-1 summarizes the calibration schedule and requirements for these equipment pieces.

Sections 5.2.1–5.2.6 detail the required calibration procedures for the equipment listed in Table 5-1. The technologist will record the results of all calibrations on the ISIS screen titled, “Body Measures Quality Control Checks.” To access this screen, select the quality control option from the main Utilities menu. The Body Measures Quality Control Checks dialog box (Exhibit 5-1) contains individual tabs designated for the start of stand, daily, middle of stand, end of stand, and equipment swap calibration procedures.

Table 5-1. Anthropometry equipment calibrations

Calibration schedule	Equipment	Calibration requirements
Start of stand	Digital weight scale	15 10-kg weights, acceptable range: 149.85 – 150.15kg
	Portable scales	11 10-kg weights, acceptable range: 109.50 – 110.50kg
	Stadiometer	100-cm rod
	Infantometer	Foot piece to headboard, 0.0 cm
	Abdominal calipers	25.0-cm rod, acceptable range: 24.9-25.1
	Skinfold Calipers	Refer to the Waist Circumference Methodology Study Procedures Manual for detail information.
Daily	Digital weight scale	5, 10-kg weights, acceptable range: 49.70 – 50.30kg
	Portable scales	5, 10-kg weights, acceptable range: 49.70 – 50.30kg
	Stadiometer	100-cm rod
	Infantometer	Foot piece to headboard, 0.0 cm
	Abdominal calipers	25.00-cm rod, acceptable range: 24.9-25.1
	Skinfold Calipers	Refer to the Waist Circumference Methodology Study Procedures Manual for detail information.
Mid-stand	Digital weight scale	15 10-kg weights, acceptable range: 149.85 – 150.15kg
End of stand	Digital weight scale	15 10-kg weights, acceptable range: 149.85 – 150.15kg

Exhibit 5-1. Body measures quality control check box

To exit the Body Measures Quality Control Checks dialog box, click OK. If any required procedures are not checked as “Done,” ISIS will present a pop-up reminder window to indicate that not all of the quality control (QC) items were done (Exhibit 5-2).

Exhibit 5-2. Not all QC Done message box

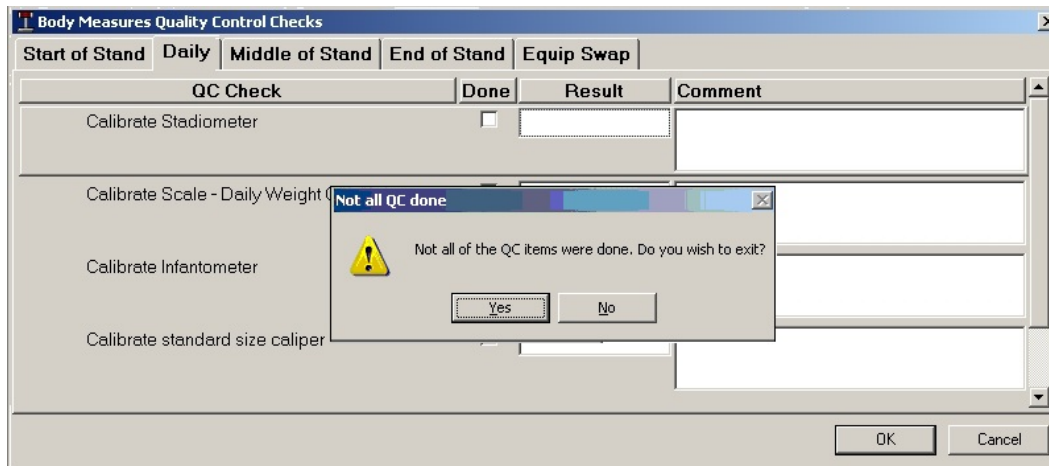

To return to the QC dialog box, click “Cancel,” perform the required procedure(s), and check the corresponding “Done” box. If it is time to perform Middle of Stand QC, when you attempt to exit the QC dialog box, ISIS will present a similar pop-up window that includes a reminder to perform the mid-stand QC procedure, Calibrate Scale – Full (Exhibit 5-3).

Exhibit 5-3. Time to do Mid-Stand QC message box

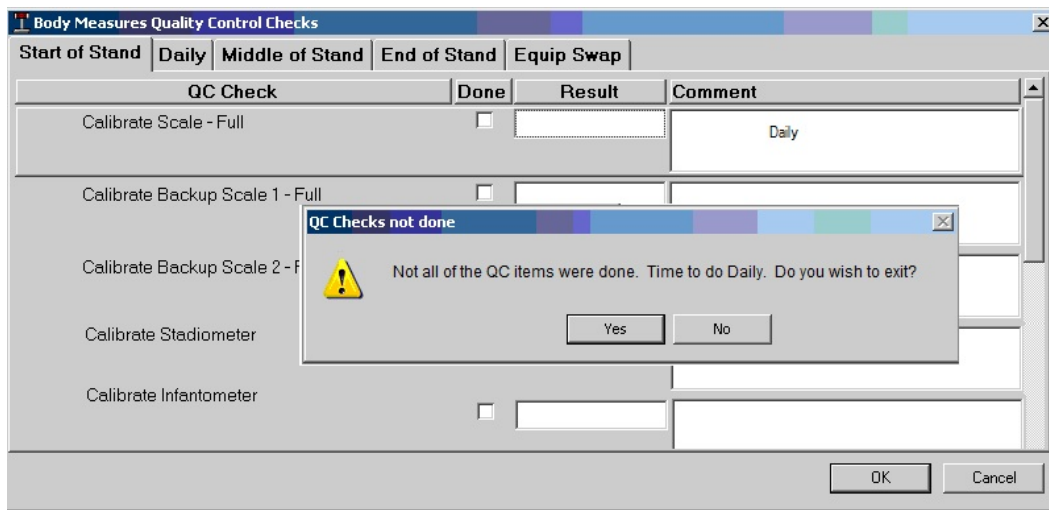

Finally, if you need to exit the Body Measures QC utility without completing all of the required procedures listed in the QC dialog box, click OK to close the dialog box and click OK to close the pop-up reminder window. ISIS will then return you to the main component screen.

5.2.1 Digital Weight Scale

Full calibration of the digital weight scale is required at the start, middle, and end of a stand. In addition, a rough calibration must be done daily prior to the first exam session.

Full Calibration: Start, Middle, End of Stand

- Carefully place all 15 of the 10-kilogram calibration weights on the scale. To ensure an accurate measurement reading, the weights must be placed evenly distributed over the center area of the scale.
- Click on the appropriate tab (i.e., Start of Stand, Middle of Stand, or End of Stand) in the ISIS QC Checks dialog box (Exhibit 5-4).

Exhibit 5-4. Digital weight scale full calibration

QC Check	Done	Result	Comment
Calibrate Scale - Full	<input checked="" type="checkbox"/>	150.00	
Calibrate Backup Scale 1 - Full	<input type="checkbox"/>		
Calibrate Backup Scale 2 - Full	<input type="checkbox"/>		
Calibrate Stadiometer	<input type="checkbox"/>		

- Click the “Done” box beside “Calibrate Scale – Full” to capture the value directly into ISIS under the Result field.
- The acceptable calibration weight range for 15 10-kilogram calibration weights on the digital weight scale is 149.85 – 150.15 kg.
- If the result falls outside the acceptable range, notify the chief technologist, MEC manager, and home office component specialist to have the scale recalibrated by the NCHS engineer or a service representative. Document the issue in the UFO system.
- If the scale is recalibrated at a later date, record the new calibration results under the Equipment Swap tab of the QC Checks dialog box (see Section 5.2.6).

Rough Calibration: Daily

- Carefully place 5 of the 10 kilogram calibration weights on the scale. To ensure an accurate measurement reading, the weights must be placed evenly distributed over the center area of the scale.
- Click on the Daily tab in the ISIS QC Checks dialog box (Exhibit 5-5).

Exhibit 5-5. Digital weight scale daily calibration

QC Check	Done	Result	Comment
Calibrate Stadiumeter	<input type="checkbox"/>		
Calibrate Scale - Daily Weight Check	<input checked="" type="checkbox"/>	50.00	
Calibrate Infantometer	<input type="checkbox"/>		
Calibrate standard size caliper	<input type="checkbox"/>		

- Click the “Done” box beside “Calibrate Scale – Daily Weight Check” to capture the value directly into ISIS under the Result field.
- The acceptable calibration weight range for 5, 10 kilogram calibration weights on the digital weight scale is 49.70 – 50.30 kg.
- If the result falls outside the acceptable range, perform the full calibration procedures described above to determine if the scale remains out of calibration. If the result lies within the acceptable range for the full calibration, repeat the daily calibration procedures with the five weights. If the result still lies outside the acceptable range, notify the chief technologist, MEC manager, and home office component specialist to have the scale recalibrated by the NCHS engineer or a service representative. Document the issue in the UFO system.
- If the scale is recalibrated at a later date, record the new calibration results under the Equipment Swap tab of the QC Checks dialog box (see Section 5.2.6).

5.2.1.1 Digital Measurement Device: Pounds (lb) vs. Kilograms (kg)

The measurement device for the digital weight scale is situated on the wall below the computer monitor (Exhibit 5-6).

Exhibit 5-6. Digital scale measurement device



The device contains a row of five buttons. The second button from the left has two arrows that toggle the display from pound to kilogram units. Above this buttons is the weighing display that shows the weight unit as “kg” or “lb.” Keep the display toggled to kg at all times.

If the digital measurement device is set to pounds instead of kilograms, when you click “Done” to capture the full or daily scale calibration reading into ISIS, the following warning message will appear (Exhibits 5-7 to 5-10).

Exhibit 5-7. Digital weight scale full calibration—scale set to lb

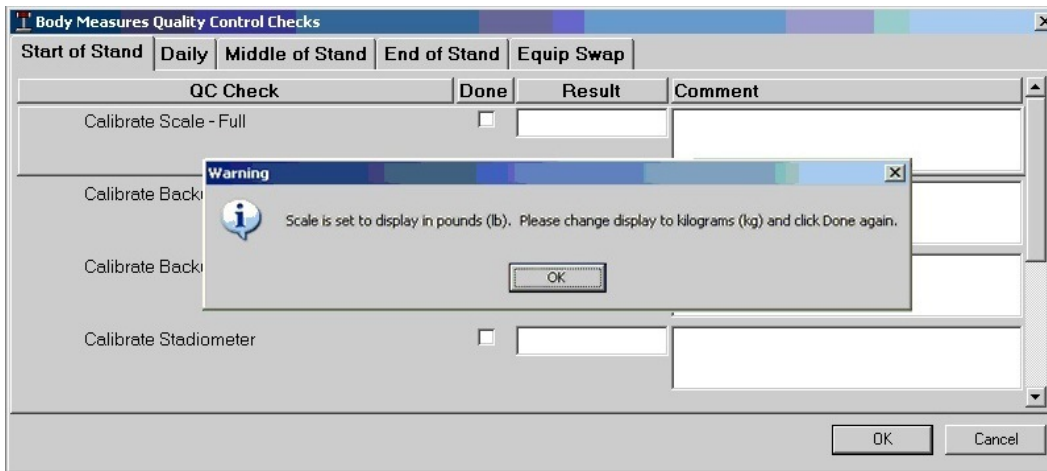
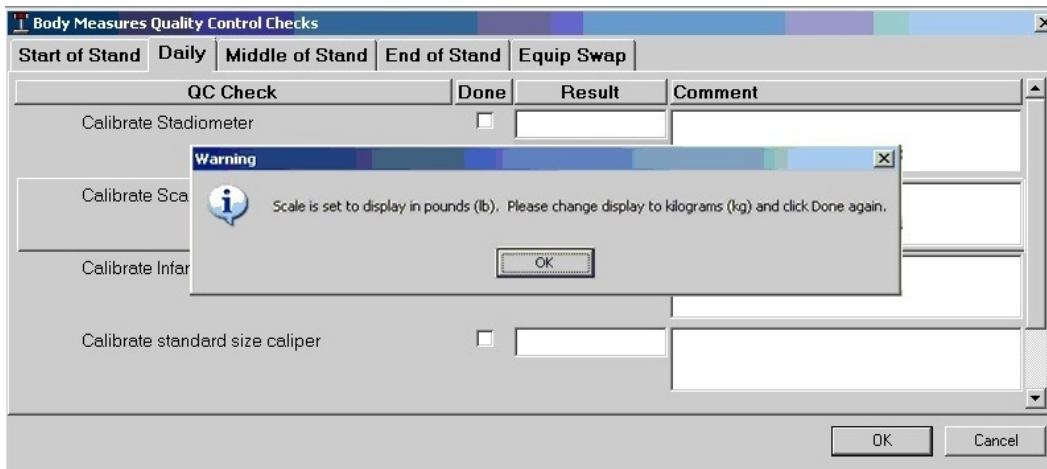

Exhibit 5-8. Digital weight scale daily calibration—scale set to lb



Click OK to this message. Next, the following error message will appear:

Exhibit 5-9. Digital weight scale full calibration—lb setting error message

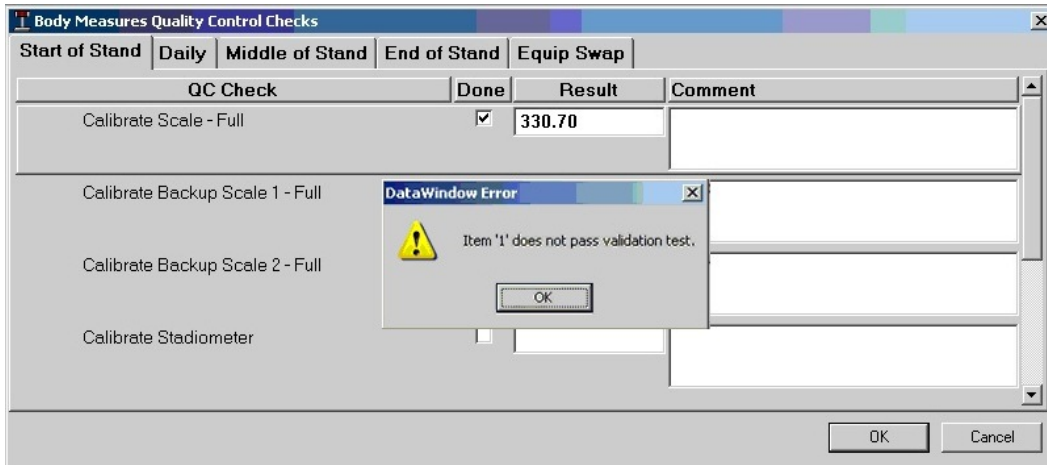
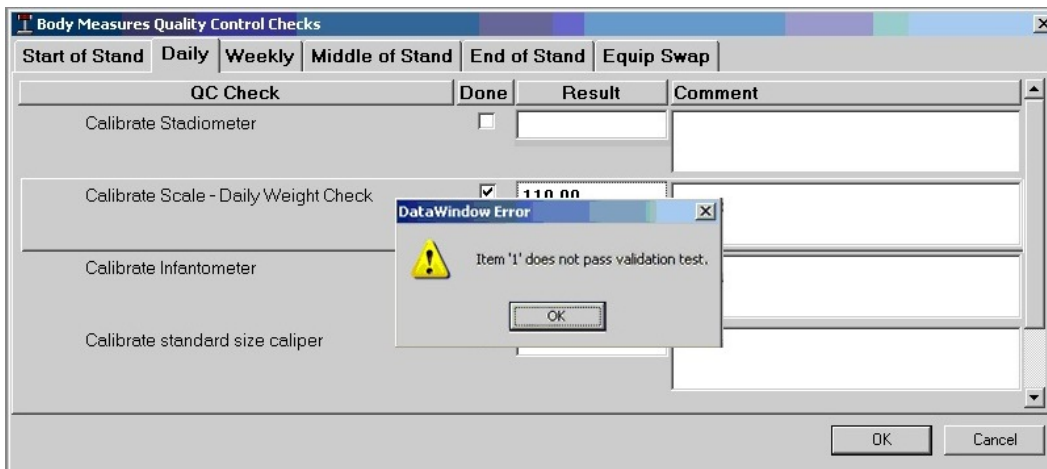

Exhibit 5-10. Digital weight scale daily calibration—lb setting error message



Click OK to this message to uncheck the “Done” box beside the corresponding “Calibrate Scale – Full” or “Calibrate Scale – Daily Weight Check” QC item.

Change the setting on the digital measurement device to kilograms and retry capturing the kg value into ISIS.

5.2.2 Portable Scales

Calibration: Start of Stand

- Place the portable scale on the floor and activate it by lightly touching the surface with your foot.
- Verify that the scale is set to measure weight in kilograms by checking the switch on the back of the scale.
- Wait for the display to read 0.0.
- Carefully place 11 of the 10 kilogram weights on the scale.
- Click on the Start of Stand tab in the ISIS QC Checks dialog box (Exhibit 5-11).

Exhibit 5-11. Portable scales calibration

QC Check	Done	Result	Comment
Calibrate Scale - Full	<input type="checkbox"/>		
Calibrate Backup Scale 1 - Full	<input checked="" type="checkbox"/>	110.00	
Calibrate Backup Scale 2 - Full	<input checked="" type="checkbox"/>	110.00	
Calibrate Stadiometer	<input type="checkbox"/>		

- Click the “Done” box beside “Calibrate Backup Scale 1 – Full.”
- When the scale display has stabilized, record the value in the Result field.
- Record the manufacturer serial number in the Comment field.
- The acceptable calibration weight range for 11 10-kilogram calibration weights on the portable scale is 109.50 – 110.50 kg.
- If the result falls outside the acceptable range, inform the chief technologist, MEC manager, and home office component specialist in order to have the scale replaced. Document the issue in the UFO system.

- Follow the above calibration procedures for the second portable scale, under “Calibrate Backup Scale 2 – Full.”
- If either scale is replaced at a later date, record the calibration results under the Equipment Swap tab of the QC Checks dialog box.

5.2.3 Stadiometer

Calibration: Start of Stand, Daily

- Place one end of the 100-cm calibration rod on the stadiometer base.
- Lower the stadiometer head piece to rest firmly against the top end of the calibration rod. Ensure that the rod stands perpendicular to the base.
- Check the result displayed on the digital measurement device. When calibrated, the result should read 100.0 cm.
- Click on the appropriate tab (i.e., Start of Stand or Daily) in the ISIS QC Checks dialog box (Exhibit 5-12).

Exhibit 5-12. Stadiometer calibration: In calibration

QC Check	Done	Result	Comment
Calibrate Scale - Full	<input type="checkbox"/>		
Calibrate Backup Scale 1 - Full	<input type="checkbox"/>		
Calibrate Backup Scale 2 - Full	<input type="checkbox"/>		
Calibrate Stadiometer	<input checked="" type="checkbox"/>	100.0	

OK Cancel

- Click the “Done” box beside “Calibrate Stadiometer” to capture the value directly into ISIS under the Result field.
- If the digital measurement device result was not 100.0 cm, recalibrate the device by pressing the + or – button until the display reads 100.0 cm. Record “Recalibrated to 100.0” in the Comment field (Exhibit 5-13).

Exhibit 5-13. Stadiometer calibration: Out of calibration—recalibrated

QC Check	Done	Result	Comment
Calibrate Scale - Full	<input type="checkbox"/>		
Calibrate Backup Scale 1 - Full	<input type="checkbox"/>		
Calibrate Backup Scale 2 - Full	<input type="checkbox"/>		
Calibrate Stadiometer	<input checked="" type="checkbox"/>	99.3	Recalibrated to 100.0

5.2.4 Infantometer

Calibration: Start of Stand, Daily

- Slide the foot piece as far as it will go toward the headboard of the infantometer.
- Check the result displayed on the digital measurement device, the result in all three MECs should read 0.0 cm.
- Click on the appropriate tab (i.e., Start of Stand or Daily) in the ISIS QC Checks dialog box (Exhibit 5-14).
- Click the “Done” box beside “Calibrate Infantometer” to capture the value directly into ISIS under the Result field.

Exhibit 5-14. Infantometer calibration: In calibration

The screenshot shows a software window titled "Body Measures Quality Control Checks" with a close button (X) in the top right corner. Below the title bar are five tabs: "Start of Stand", "Daily", "Middle of Stand", "End of Stand", and "Equip Swap". The "Daily" tab is selected. The main area contains a table with four rows, each representing a different QC check. The columns are "QC Check", "Done", "Result", and "Comment".

QC Check	Done	Result	Comment
Calibrate Stadiometer	<input type="checkbox"/>		
Calibrate Scale - Daily Weight Check	<input type="checkbox"/>		
Calibrate Infantometer	<input checked="" type="checkbox"/>	0.0	
Calibrate standard size caliper	<input type="checkbox"/>		

At the bottom right of the window are two buttons: "OK" and "Cancel".

- If the digital measurement device result was not 0.0 cm, recalibrate the device by pressing the Datum Key or the + or the – button until the display reads 0.0 cm. Record “Recalibrated to 0.0” in the Comment field (Exhibit 5-15).

Exhibit 5-15. Infantometer calibration: Out of calibration—recalibrated

The screenshot shows the same software window as Exhibit 5-14, but with the "Calibrate Infantometer" row updated. The "Done" checkbox is checked, the "Result" field now contains "0.5", and the "Comment" field contains "Recalibrated to 0.0".

QC Check	Done	Result	Comment
Calibrate Stadiometer	<input type="checkbox"/>		
Calibrate Scale - Daily Weight Check	<input type="checkbox"/>		
Calibrate Infantometer	<input checked="" type="checkbox"/>	0.5	Recalibrated to 0.0
Calibrate standard size caliper	<input type="checkbox"/>		

At the bottom right of the window are two buttons: "OK" and "Cancel".

5.2.5 Abdominal Calipers

Calibration: Start of Stand, Daily

- Place the calibration rod in between the caliper's lower and upper arm so it is parallel to the vertical shaft.
- Check that the calibration rod is at least 20 cm from the sliding hub.
- Click on the appropriate tab (i.e., "Start of Stand" or "Daily") in the ISIS QC Checks dialog box (Exhibit 5-16).
- Click the "Done" box beside "Calibrate standard size caliper."
- Record the measurement taken.
- Click the "Done" box beside "Calibrate larger size caliper."
- Record the measurement taken.
- The acceptable calibration range for both calipers is 24.9 cm to 25.1 cm.
- If the result falls outside the acceptable range, inform the chief technologist, MEC manager, and home office component specialist in order to have the caliper replaced. Document the issue in the UFO system.
- If the calipers are replaced at a later date, record the calibration results under the Equipment Swap tab of the QC Check dialog box.

Exhibit 5-16. Abdominal caliper calibration: In calibration

QC Check	Done	Result	Comment
Calibrate Stadiometer	<input type="checkbox"/>		
Calibrate Scale - Daily Weight Check	<input type="checkbox"/>		
Calibrate Infantometer	<input type="checkbox"/>		
Calibrate standard size caliper	<input checked="" type="checkbox"/>	25.0	

5.2.6 Equipment Swap

If any equipment requires recalibration or replacement outside of the regularly scheduled calibrations (i.e., start of stand, daily, or middle of stand), record the new calibrations under the Equipment Swap tab of the ISIS Body Measures Quality Control Checks screen.

- Click the Equipment Swap tab in the Quality Control Checks dialog box (Exhibit 5-17).
- Click the “Done” box beside the equipment piece that will be recalibrated or replaced.
- For each equipment piece(s) to be recalibrated or replaced, complete the Result and/or Comment field with the new calibration information in accordance with the calibration procedures described in Sections 5.2.1 to 5.2.6.
- When you are finished entering the new calibrations, click OK to exit the QC screen.
- ISIS will automatically save the equipment swap information permanently to the study database. However, similar to the daily QC process, when the tech opens a new session the Equipment Swap tab will appear blank, as shown in Exhibit 5-17. This means ISIS is ready for additional calibrations to be entered if necessary.

Exhibit 5-17. Equipment swap screen

The screenshot shows a software window titled "Body Measures Quality Control Checks" with a tabbed interface. The "Equip Swap" tab is selected. The window contains a table with four rows of calibration checks. Each row has a "QC Check" column, a "Done" checkbox, a "Result" text input field, and a "Comment" text area. The "Done" checkboxes are all unchecked. At the bottom right of the window are "OK" and "Cancel" buttons.

QC Check	Done	Result	Comment
Calibrate Stadiometer	<input type="checkbox"/>		
Calibrate Scale - Daily Weight Check	<input type="checkbox"/>		
Calibrate Infantometer	<input type="checkbox"/>		
Calibrate standard size caliper	<input type="checkbox"/>		

5.3 ISIS Examination Screens

The ISIS Anthropometry Examination screens are designed to be user friendly and at the same time ensure the collection of accurate data. Quality control features of the ISIS anthropometry application include:

- The weight, length, and height measurement data are transmitted directly from the equipment into ISIS by clicking the “Get” button.
- The application will not permit advancement to the next screen unless a number or a comment is entered in every required field.
- When the application advances to the next screen, the cursor will automatically appear in the appropriate field awaiting data entry.
- Each measurement number entered is verified using a computer-generated voice that repeats the measure aloud immediately following data capture.
- The risk of measurement and recording errors is reduced through the use of pre-programmed edit ranges. For example, if data captured in ISIS does not fall within the 1st or 99th percentile based on the NHANES 1999-2010 data set, an “out of range” message will appear on the screen. Although some data collected (i.e., from very small or very large SPs) may truly fall outside of the “normal” ranges, the examiner and recorder must always verify the measurement if prompted by ISIS.
- Data entry errors are also minimized by limits set on the placement of decimal points and the number of digits entered. For instance, if the number entered for a measurement exceeds the allowable digits, ISIS will not permit the number to be entered.

5.4 Observations, Replication, and Review

A consulting anthropometry expert will visit each MEC team twice per year at minimum. These visits will serve to verify that the anthropometry protocol is being implemented properly and consistently. While at the MEC, the expert will meet with the technologists to review any problems or variations in the standard procedures. Following the site visit, the consultant will summarize all of the issues encountered during the visit in a final report to Westat. The Westat component specialist will forward a copy of the consultant’s Site Visit Report to the appropriate NCHS project officer.

Besides the observation of anthropometry examinations, a critical function of the body measures consultant is to serve as the “gold standard” anthropometry examiner. In this role, the consultant will conduct a repeat anthropometry examination on each SP immediately following the examination performed by the technologist. These gold standard replicate exams will be used to compare measurements between the expert consultant and the individual technologists. Gold standard examinations thus constitute an essential aspect of quality control for the anthropometry component. Appendix B explains the procedures for conducting anthropometry gold standard replicate examinations.

In addition to observations and gold standard exams completed by the anthropometry consultant, NCHS personnel and Westat component staff will visit the MEC teams at regular intervals to observe anthropometry examinations. To further monitor the quality of data collection, Westat component staff will generate reports from the ISIS intraweb. The number of anthropometry examinations and examination times: cumulative and sorted by session, by age group, and by technologist, as well as the reason for not done and partial examinations, will be analyzed for each stand.

Finally, retraining sessions will be arranged by the Westat component specialist in coordination with the NCHS project officer and the anthropometry consultant when major protocol changes are introduced, or when a lack of standardization is observed among the technologists.

Appendix A

Body Measures Recording Form

Appendix A

Body Measures Recording Form

Body Measures Recording Form

SP ID: _____ Stand #: _____ Session/Date: _____
 Technologist: _____ Recorder: _____

MEASURES		BIRTH +	2MO+	7MO+	2YR+	4YR+	8YR+
(BMXWT)	Weight						
(BMXRECUM)	Recum Length						
(BMXHEAD)	Head Circ						
(BMXHT)	Height						
(BMXHTCRA)	Ht Correction: Above Waist						
(BMXHTCRB)	Ht Correction: Below Waist						
(BMXLEG)	Leg Length						
(BMXARML)	Upper Arm Length						
	<i>Mid-point of Upper Arm Length</i>						
(BMXARMC)	Arm Circ						
(BMXWAIST)	Waist Circ						
(BMXSAD1)	SAD First reading						
(BMXSAD2)	SAD Second reading						
(BMXSACS1)	Which Caliper was used? Standard/Large						
	If the difference between the 1 st and 2 nd SAD measurements is > 0.5 cm, obtain a 3 rd and 4 th measurement.						
(BMXSAD3)	SAD Third reading						
(BMXSAD4)	SAD Fourth reading						
(BMXSACS2)	Which Caliper was used? Standard/Large						

Key: N/A

Body Measures Recording Form (continued)

MEASURES	BIRTH +	2MO+	7MO+	2YR+	4YR+	8YR+
(BMXAMP) Amputations? Yes/No						
If Yes:						
(BMXUREXT) Upper R Extremity? Yes/No						
(BMXUPREL) Upper R. Above/Below Elbow?						
(BMXULEXT) Upper L Extremity? Yes/No						
(BMXUPLEL) Upper L Above/Below Elbow?						
(BMXLOREX) Lower R Extremity? Yes/No						
(BMXLORKN) Lower R. Above/Below Knee?						
(BMXLLEXT) Lower L Extremity? Yes/No						
(BMXLLKNE) Lower L. Above/Below Knee?						

Appendix B

Procedures for Conducting Anthropometry Gold Standard Replicate Examinations

Appendix B

Procedures for Conducting Anthropometry Gold Standard Replicate Examinations

Gold standard examinations are an essential quality control measure for the anthropometry component. These replicate exams are used to compare differences in measurement results obtained by the expert consultant to those obtained by the individual technologists. Below are instructions for conducting gold standard replicate examinations at the MEC.

At the start of the session during which gold standard replicate exams will be conducted, activate the Gold Standard software application:

- In the ISIS Anthropometry application, under the Utilities menu, go to “Gold Standard.”
- Click on “Gold Standard” so that a checkmark appears beside it, indicating the application is on.
- If rebooting the computer becomes necessary during a session, the Gold Standard application must be reactivated.

To use the Gold Standard application, the technologists should conduct exams as usual, with one person examining and a second person recording. Following the primary examination, the Gold Standard recruitment screen will appear with two questions:

1. Do you want to conduct a gold standard examination on this SP?
2. Does the SP consent to a gold standard examination?

If a gold standard examination will not be conducted at this time, answer “No” to the first question; the second question will remain deactivated. If “Yes” is answered to the first question, ISIS will activate the second question. In order to repeat the examination, verbal consent must then be obtained from the SP:

“In order to assure the high quality of our data we sometimes repeat the exam. Would you mind if we repeat the exam?”

If the SP does not give consent, or if for some other reason a gold standard exam will not be conducted at this time, simply advance to the next screen, the status screen, and end the gold

standard exam. If the SP gives consent, enter “Yes” to the second recruitment question and select the appropriate name under the Gold Standard Examiner and Gold Standard Recorder drop-downs.

For the gold standard exam, the anthropometry consultant will serve as the examiner and the original examiner should record for the gold standard exam. If this is not possible, the recorder from the primary exam can continue to record for the gold standard exam. In preparation for the gold standard exam, the cosmetic pencil marks should be erased completely prior to the gold standard exam.

In ISIS the gold standard application screens are identical to the primary exam screens, except that the SAD measurements are first and the SP information screen and amputation questions will not appear. Also, the status of gold standard exams will always default to “Complete” regardless of whether the actual status of this section was partial or not done. This is designed to prevent the status of the gold standard section from affecting the overall status of the component.

The ISIS anthropometry application is also designed with the capability to provide the results of gold standard examinations as compared to the results obtained in the primary examination. This allows the gold standard examiner and the MEC staff to review and discuss on the spot any relevant measurement errors or discrepancies. Gold standard comparison reports can be generated from ISIS in two ways:

1. ISIS anthropometry application: In the main menu bar, under the tab entitled “Reports” select “Gold Standard.” Then choose the desired results by Stand, Session, and/or SP(s).
2. ISIS IntraWeb: Select MEC Operations, Operations Reports, Anthropometry Gold Standard Report. Then choose the desired results by Stand, Session, and/or SP(s).

The gold standard reports include the results obtained for individual SPs as well as a display of the absolute and percent difference between the values obtained by the gold standard examiner compared to the technologist. The major difference between generating the report from the application vs. the IntraWeb is that the IntraWeb report additionally offers a cumulative summary of the number of gold standard examinations performed for each examiner.

Finally, ensuring that SPs complete their primary exams at the MEC remains a top priority. If conducting gold standard replicate exams will impede the flow of SPs through the MEC, the anthropometry consultant can instead observe the primary exams or act as the recorder. By freeing

up other staff, this may allow replicate exams to resume. Communication among all members of the MEC team will promote a smooth work flow to this end.