



# PowerFlex 520-Series Adjustable Frequency AC Drive

Catalog Number 25A series B, 25B



**Allen-Bradley**

by ROCKWELL AUTOMATION

User Manual

Original Instructions

## Important User Information

Read this document and the documents listed in the additional resources section about installation, configuration, and operation of this equipment before you install, configure, operate, or maintain this product. Users are required to familiarize themselves with installation and wiring instructions in addition to requirements of all applicable codes, laws, and standards.

Activities including installation, adjustments, putting into service, use, assembly, disassembly, and maintenance are required to be carried out by suitably trained personnel in accordance with applicable code of practice.

If this equipment is used in a manner not specified by the manufacturer, the protection provided by the equipment may be impaired.

In no event will Rockwell Automation, Inc. be responsible or liable for indirect or consequential damages resulting from the use or application of this equipment.

The examples and diagrams in this manual are included solely for illustrative purposes. Because of the many variables and requirements associated with any particular installation, Rockwell Automation, Inc. cannot assume responsibility or liability for actual use based on the examples and diagrams.

No patent liability is assumed by Rockwell Automation, Inc. with respect to use of information, circuits, equipment, or software described in this manual.

Reproduction of the contents of this manual, in whole or in part, without written permission of Rockwell Automation, Inc., is prohibited.

Throughout this manual, when necessary, we use notes to make you aware of safety considerations.



**WARNING:** Identifies information about practices or circumstances that can cause an explosion in a hazardous environment, which may lead to personal injury or death, property damage, or economic loss.

---



**ATTENTION:** Identifies information about practices or circumstances that can lead to personal injury or death, property damage, or economic loss. Attentions help you identify a hazard, avoid a hazard, and recognize the consequence.

---

**IMPORTANT** Identifies information that is critical for successful application and understanding of the product.

---

Labels may also be on or inside the equipment to provide specific precautions.



**SHOCK HAZARD:** Labels may be on or inside the equipment, for example, a drive or motor, to alert people that dangerous voltage may be present.

---



**BURN HAZARD:** Labels may be on or inside the equipment, for example, a drive or motor, to alert people that surfaces may reach dangerous temperatures.

---



**ARC FLASH HAZARD:** Labels may be on or inside the equipment, for example, a motor control center, to alert people to potential Arc Flash. Arc Flash will cause severe injury or death. Wear proper Personal Protective Equipment (PPE). Follow ALL Regulatory requirements for safe work practices and for Personal Protective Equipment (PPE).

---

**Preface**

About This Publication ..... 9  
 Download Firmware, AOP, EDS, and Other Files ..... 9  
 Summary of Changes..... 9  
 Who Should Use this Manual..... 10  
 Additional Resources ..... 10  
 Download Files ..... 10  
 Manual Conventions ..... 11  
 Drive Frame Sizes..... 12  
 General Precautions..... 13  
     Catalog Number Explanation ..... 14

**Chapter 1**

**Installation/Wiring**

Mounting Considerations ..... 15  
     Minimum Mounting Clearances ..... 16  
     Ambient Operating Temperatures..... 17  
     Current Derating Curves ..... 17  
     Debris Protection..... 18  
     Storage ..... 18  
 AC Supply Source Considerations ..... 19  
     Ungrounded Distribution Systems ..... 19  
     Input Power Conditioning..... 20  
 General Grounding Requirements..... 20  
     Ground Fault Monitoring ..... 20  
     Safety Ground - (PE) ..... 21  
     Network Ground ..... 21  
     Motor Ground..... 21  
     Shield Termination - SHLD..... 21  
     RFI Filter Grounding..... 22  
 Fuses and Circuit Breakers..... 22  
     Fusing..... 22  
     Circuit Breakers ..... 22  
     Fuses and Circuit Breakers for PowerFlex 520-Series Drives ..... 24  
 Power and Control Module..... 28  
 Control Module Cover ..... 30  
 Power Module Terminal Guard..... 31  
 Power Wiring..... 32  
     Motor Cable Types Acceptable for 100...600 Volt Installations .... 32  
     Reflected Wave Protection..... 34  
     Output Disconnect ..... 34  
 Power Terminal Block ..... 35  
 Common Bus/Precharge Notes..... 35  
 I/O Wiring ..... 36  
     Motor Start/Stop Precautions..... 36  
     Signal and Control Wire Types..... 36  
     Maximum Control Wire Recommendations..... 37

	Control I/O Terminal Block .....	37
	PowerFlex 523 Control I/O Terminal Block .....	37
	PowerFlex 525 Control I/O Terminal Block .....	41
	I/O Wiring Examples .....	43
	Start and Speed Reference Control .....	48
	Start Source and Speed Reference Selection .....	48
	Accel/Decel Selection .....	49
	CE Conformity .....	51
	Low Voltage Directive (2014/35/EU) .....	51
	EMC Directive (2014/30/EU) .....	51
	Machinery Directive (2006/42/EC) .....	51
	ATEX Directive (2014/34/EU) .....	51
	General Considerations .....	52
	 <b>Chapter 2</b>	
<b>Start Up</b>	Prepare for Drive Startup .....	57
	Drive Startup Task List .....	57
	Start, Stop, Direction, and Speed Control .....	59
	Variable Torque Fan/Pump Applications .....	59
	Display and Control Keys .....	59
	Control and Navigation Keys .....	60
	Viewing and Editing Parameters .....	61
	Drive Programming Tools .....	62
	Language Support .....	62
	Smart Startup with Basic Program Group Parameters .....	63
	LCD Display with QuickView Technology .....	65
	Using the USB Port .....	65
	MainsFree Programming .....	65
	Using Drive Startup in CCW or Logix Designer application .....	66
	 <b>Chapter 3</b>	
<b>Programming and Parameters</b>	About Parameters .....	69
	Parameter Groups .....	71
	AppView Parameter Groups .....	74
	CustomView Parameter Group .....	75
	Basic Display Group .....	76
	Basic Program Group .....	82
	Terminal Block Group .....	88
	Communications Group .....	100
	Logic Group .....	106
	Advanced Display Group .....	109
	Advanced Program Group .....	114
	Network Parameter Group .....	142
	Modified Parameter Group .....	142
	Fault and Diagnostic Group .....	142
	AppView Parameter Groups .....	150
	CustomView Parameter Group .....	151
	Parameter Cross Reference by Name .....	152

<b>Troubleshooting</b>	<b>Chapter 4</b>	
	Drive Status .....	157
	Faults .....	157
	Fault Indication .....	158
	Manually Clearing Faults .....	158
	Automatically Clearing Faults .....	158
	Auto Restart (Reset/Run) .....	158
	Fault Descriptions .....	159
	Common Symptoms and Corrective Actions .....	162
<b>Supplemental Drive Information</b>	<b>Appendix A</b>	
	Certifications .....	165
	Environmental Specifications .....	166
	Technical Specifications .....	167
	Power Specifications .....	170
<b>Accessories and Dimensions</b>	<b>Appendix B</b>	
	Product Selection .....	173
	Product Dimensions .....	184
	Adapter Plate Dimensions .....	197
	Optional Accessories and Kits .....	200
	Installing a Communication Adapter .....	200
	Removing a Communication Adapter .....	201
<b>RS485 (DSI) Protocol</b>	<b>Appendix C</b>	
	Network Wiring .....	203
	Parameter Configuration .....	205
	Supported Modbus Function Codes .....	205
	Writing (06) Logic Command Data .....	205
	Writing (06) Comm Frequency Command .....	207
	Reading (03) Logic Status Data .....	208
	Reading (03) Drive Error Codes .....	209
	Reading (03) Drive Operational Values .....	210
	Reading (03) and Writing (06) Drive Parameters .....	210
	Additional Information .....	210
<b>Velocity StepLogic, Basic Logic and Timer/Counter Functions</b>	<b>Appendix D</b>	
	Velocity StepLogic Using Timed Steps .....	212
	Velocity StepLogic Sequence .....	212
	Velocity StepLogic Using Basic Logic Functions .....	212
	Timer Function .....	213
	Counter Function .....	214
	Velocity StepLogic Parameters .....	215
<b>Encoder/Pulse Train Usage and Position StepLogic Application</b>	<b>Appendix E</b>	
	Encoder and Pulse Train Usage .....	217
	Encoder Interface .....	217

HTL/TTL DIP Switches . . . . .	218
Wiring Notes . . . . .	219
Determine Encoder Pulse Per Revolution (PPR) Specification Based on Speed Resolution . . . . .	219
Positioning Overview . . . . .	220
Common Guidelines for All Applications . . . . .	220
Positioning Operation . . . . .	221
Homing Routine . . . . .	224
Encoder and Position Feedback . . . . .	225
Use Over Communications . . . . .	226
Setup Notes . . . . .	227

## Appendix F

### PID Set Up

PID Loop . . . . .	229
Exclusive Control . . . . .	229
Trim Control . . . . .	230
PID Reference and Feedback . . . . .	231
Analog PID Reference Signals . . . . .	232
Scale Function . . . . .	232
Invert Function . . . . .	232
PID Deadband . . . . .	232
PID Preload . . . . .	233
PID Limits . . . . .	233
PID Gains . . . . .	233
Guidelines for Adjusting the PID Gains . . . . .	234

## Appendix G

### Safe Torque Off Function

PowerFlex 525 Safe-Torque-Off Overview . . . . .	237
EC Type Examination Certification . . . . .	238
EMC Instructions . . . . .	238
Using PowerFlex 525 Safe-Torque-Off . . . . .	239
Safety Concept . . . . .	239
Important Safety Considerations . . . . .	239
Functional Proof Test . . . . .	240
PFD and PFH Data . . . . .	240
Safety Reaction Time . . . . .	240
Enabling PowerFlex 525 Safe-Torque-Off . . . . .	241
Wiring . . . . .	241
PowerFlex 525 Safe-Torque-Off Operation . . . . .	242
Verify Operation . . . . .	242
Discrepancy Time of the Safety Inputs . . . . .	242
Connection Examples . . . . .	243
Example 1 – Safe-Torque-Off Connection with Coast-to-Stop Action, SIL 2/PL d . . . . .	243
Example 2 – Safe-Torque-Off Connection with Controlled Stop Action, SIL 2/PL d . . . . .	245
Example 3 – Safe-Torque-Off Connection with Coast-to-Stop Action Using External +24V supply, SIL 3/PL e . . . . .	246
PowerFlex 525 Certification for Safe-Torque-Off . . . . .	246

<b>EtherNet/IP</b>	<b>Appendix H</b>	
	Establishing A Connection With EtherNet/IP . . . . .	247
	Ground Connections for EtherNet/IP Networks . . . . .	248
<b>Control Diagrams</b>	<b>Appendix I</b>	
	Induction Motor Tuning Diagrams . . . . .	249
	Adjusting Speed Control Parameters . . . . .	250
<b>PowerFlex 525 PM Motor Configuration</b>	<b>Appendix J</b>	
	Motor Control . . . . .	252
	Motor Data . . . . .	252
	Feedback . . . . .	253
	Stop Mode/Brake Type . . . . .	253
	Direction Test . . . . .	254
	Auto Tune . . . . .	254
	Manual Configuration Using Drive Keypad . . . . .	256
	Additional PM Motor Configuration . . . . .	257
	Additional Setup for Open Loop PM Motor . . . . .	257
	Additional Setup for Closed Loop PM Motor . . . . .	259
	Optional Parameter Adjustments for Optimum Performance . . . . .	261
<b>PowerFlex 525 Synchronous Reluctance Motor Configuration</b>	<b>Appendix K</b>	
	SynRM Structure . . . . .	263
	Control Diagram . . . . .	263
	SynRM Control Configuration . . . . .	264
	<b>Index</b>	

**Notes:**



## About This Publication

The purpose of this manual is to provide you with the basic information needed to install, start-up and troubleshoot the PowerFlex® 520-Series Adjustable Frequency AC Drive.

Topic	Page
Summary of Changes	9
Additional Resources	10
Manual Conventions	11
Drive Frame Sizes	12
General Precautions	13
Catalog Number Explanation	14

## Download Firmware, AOP, EDS, and Other Files

Download firmware, associated files (such as AOP, EDS, and DTM), and access product release notes from the Product Compatibility and Download Center at [rok.auto/pcdc](http://rok.auto/pcdc).

See [Download Files on page 10](#) to download the files for your PowerFlex 525 drive.

## Summary of Changes

This publication contains the following new or updated information. This list includes substantive updates only and is not intended to reflect all changes.

Topic	Page
Updated to new template	throughout
Updated and corrected parameter values (see the corresponding change bars for details)	throughout
Moved and updated downloading files procedure	10
Changed Circuit Breakers Bulletin 140M-C2E-C16 to 140M-D8E-C16 for 380...480V 3-Phase Input Protection Devices	26
Corrected PCR with ID 774 on designation of the R3 terminal	39
Updated CE conformity directives	51
Updated AOP version to 5.07 and moved related information to Chapter 2 from Appendix J	66
Added synchronous reluctance motor control parameters to [P039] options	83, 140
Corrected PCR with ID 1076 on parameter description for A434 and A435	116
Corrected PCR with ID 1055 and 872 on parameter values from 150% to 65%	133
Corrected PCR with ID 742. Changed "password" to "access code"	133, 240
Updated Certifications table	165
Added new drives jumper and communication adapter spare kits	177
Added PowerFlex 4/40/40P to PowerFlex 520-series drives product selection table for the mounting plate	178, 179, 180
Added Bulletin 160 to PowerFlex 520-series mounting adapter plate dimensions	197
Added PowerFlex 4/40/40P to PowerFlex 520-series mounting adapter plate dimensions	198
Added new feature HTL/TTL DIP switches for 25-ENC-1 encoder card	218
Updated information on PowerFlex 525 PM motor (see corresponding change bars for details)	251
Added new appendix and related parameters for synchronous reluctance motor	72, 140, 263

## Who Should Use this Manual

This manual is intended for qualified personnel. You must be able to program and operate Adjustable Frequency AC Drive devices. In addition, you must have an understanding of the parameter settings and functions.

## Additional Resources

All recommended documentation that is listed in this section is available online at [rok.auto/literature](http://rok.auto/literature).

The following publications provide general drive information:

Title	Publication
Wiring and Grounding Guidelines for Pulse Width Modulated (PWM) AC Drives	<a href="#">DRIVES-IN001</a>
Preventive Maintenance of Industrial Control and Drive System Equipment	<a href="#">DRIVES-TD001</a>
Safety Guidelines for the Application, Installation, and Maintenance of solid-state Control	<a href="#">SGI-1.1</a>
Guarding Against Electrostatic Damage	<a href="#">8000-SB001</a>

The following publications provide specific PowerFlex 520-Series information on drive installation, features, specifications, and service:

Title	Publication
PowerFlex 520-Series AC Drive Specifications	<a href="#">520-TD001</a>
PowerFlex Dynamic Braking Resistor Calculator	<a href="#">PFLEX-ATO01</a>
PowerFlex AC Drives in Common Bus Configurations	<a href="#">DRIVES-ATO02</a>

The following publications provide specific Network Communications information:

Title	Publication
PowerFlex 525 Embedded EtherNet/IP Adapter	<a href="#">520COM-UM001</a>
PowerFlex 25-COMM-D DeviceNet Adapter	<a href="#">520COM-UM002</a>
PowerFlex 25-COMM-E2P Dual-Port EtherNet/IP Adapter	<a href="#">520COM-UM003</a>
PowerFlex 25-COMM-P PROFIBUS DPV1 Adapter	<a href="#">520COM-UM004</a>

## Download Files

Follow these steps to download the files for your PowerFlex 525 drive.

1. Go to the Rockwell Automation Product Compatibility and Download Center at [rok.auto/pcdc](http://rok.auto/pcdc).

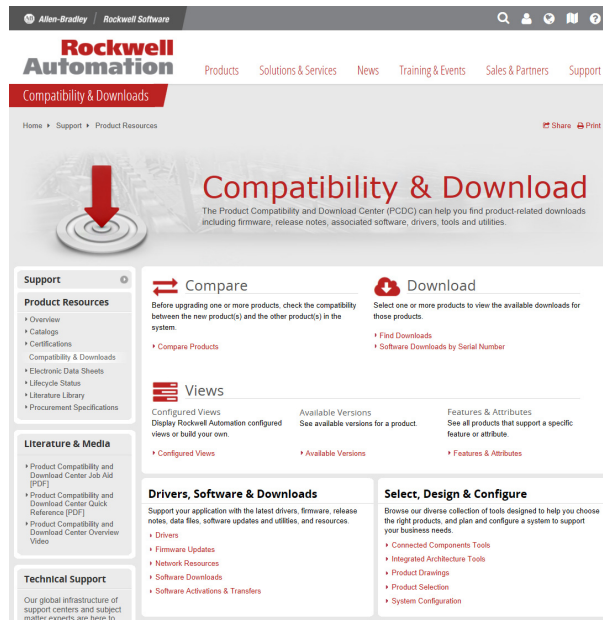

**IMPORTANT** You must sign in to the Rockwell Automation website before downloading a firmware revision.

2. Click the Find Downloads link.
3. Enter “PowerFlex 525” into the Product Search field. The results appears in the box below.

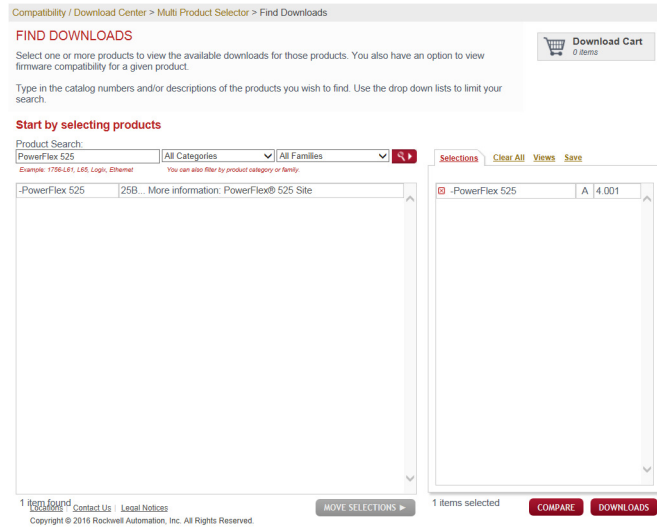

4. Select the entry and the firmware revision, then click **Downloads**.

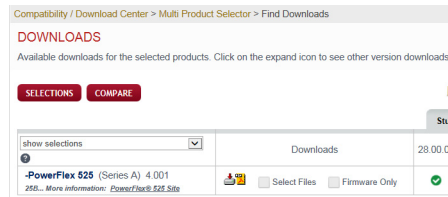

5. Click the Show Downloads  icon, then click the links to download the firmware revision and AOP files to your computer.

## Manual Conventions

- In this manual we refer to PowerFlex 520-Series Adjustable Frequency AC Drive as; drive, PowerFlex 520-series, PowerFlex 520-series drive or PowerFlex 520-series AC drive.
- Specific drives within the PowerFlex 520-series may be referred to as:
  - PowerFlex 523, PowerFlex 523 drive or PowerFlex 523 AC drive.
  - PowerFlex 525, PowerFlex 525 drive or PowerFlex 525 AC drive.

- Parameter numbers and names are shown in this format:

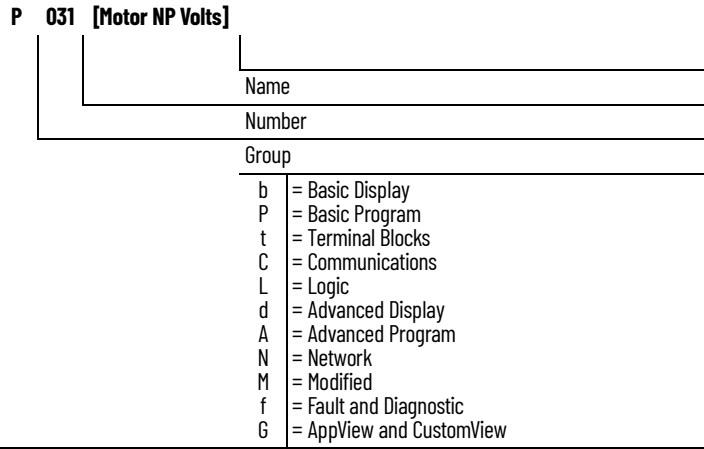

- The following words are used throughout the manual to describe an action:

Words	Meaning
Can	Possible, able to do something
Cannot	Not possible, not able to do something
May	Permitted, allowed
Must	Unavoidable, you must do this
Shall	Required and necessary
Should	Recommended
Should Not	Not Recommended

- The Studio 5000<sup>®</sup> Engineering and Design Environment combines engineering and design elements into a common environment. The first element in the Studio 5000 environment is the Logix Designer application. The Studio 5000 Logix Designer<sup>®</sup> application is the rebranding of RSLogix 5000<sup>®</sup> software and will continue to be the product to program Logix 5000<sup>™</sup> controllers for discrete, process, batch, motion, safety, and drive-based solutions. The Studio 5000 environment is the foundation for the future of Rockwell Automation<sup>®</sup> engineering design tools and capabilities. It is the one place for design engineers to develop all the elements of their control system.

## Drive Frame Sizes

Similar PowerFlex 520-series drive sizes are grouped into frame sizes to simplify spare parts ordering, dimensioning, and so on. A cross-reference of drive catalog numbers and their respective frame sizes is provided in [Appendix B](#).

## General Precautions



**ATTENTION:** The drive contains high voltage capacitors which take time to discharge after removal of mains supply. After power has been removed from the drive, wait three minutes to make sure DC bus capacitors are discharged. After three minutes, verify AC voltage L1, L2, L3 (Line to Line and Line to Ground) to ensure mains power has been disconnected. Measure DC voltage across DC- and DC+ bus terminals to verify DC Bus has discharged to zero volts. Measure DC voltage from L1, L2, L3, T1, T2, T3 DC - and DC+ terminals to ground and keep the meter on the terminals until the voltage discharges to zero volts. The discharge process may take several minutes to reach zero volts. Darkened display LEDs is not an indication that capacitors have discharged to safe voltage levels.

**ATTENTION:** Only qualified personnel familiar with adjustable frequency AC drives and associated machinery should plan or implement the installation, start-up and subsequent maintenance of the system. Failure to comply may result in personal injury and/or equipment damage.

**ATTENTION:** This drive contains ESD (Electrostatic Discharge) sensitive parts and assemblies. Static control precautions are required when installing, testing, servicing or repairing this assembly. Component damage may result if ESD control procedures are not followed. If you are not familiar with static control procedures, reference A-B publication 8000-4.5.2, "Guarding Against Electrostatic Damage" or any other applicable ESD protection handbook.

**ATTENTION:** An incorrectly applied or installed drive can result in component damage or a reduction in product life. Wiring or application errors, such as undersizing the motor, incorrect or inadequate AC supply, or excessive ambient temperatures may result in malfunction of the system.

**ATTENTION:** The bus regulator function is extremely useful for preventing nuisance overvoltage faults resulting from aggressive decelerations, overhauling loads, and eccentric loads. However, it can also cause either of the following two conditions to occur.

1. Fast positive changes in input voltage or imbalanced input voltages can cause uncommanded positive speed changes;
2. Actual deceleration times can be longer than commanded deceleration times. However, a "Stall Fault" is generated if the drive remains in this state for 1 minute. If this condition is unacceptable, the bus regulator must be disabled (see parameter A550 [Bus Reg Enable]). In addition, installing a properly sized dynamic brake resistor will provide proper stopping requirements based on braking resistor sizing.

**ATTENTION:** Risk of injury or equipment damage exists. Drive does not contain user-serviceable components. Do not disassemble drive chassis.

## Catalog Number Explanation

1-3	4	5	6-8	9	10	11	12	13	14
<b>25B</b>	-	<b>B</b>	<b>2P3</b>	<b>N</b>	<b>1</b>	<b>1</b>	<b>4</b>	-	-
Drive	Dash	Voltage Rating	Rating	Enclosure	Reserved	Emission Class	Reserved	Dash	Dash

Code	Type
25A	PowerFlex 523
25B	PowerFlex 525

Code	Voltage	Phase
V	120V AC	1
A	240V AC	1
B	240V AC	3
D	480V AC	3
E	600V AC	3

Code	Interface Module
1	Standard

Code	Enclosure
N	IP20 NEMA / Open

Code	EMC Filter
0	No Filter
1	Filter

Code	Braking
4	Standard

Output Current @ 1 Phase, 100...120V Input						
Code	Amps	Frame	ND		HD	
			HP	kW	HP	kW
1P6 <sup>(1)</sup>	1.6	A	0.25	0.2	0.25	0.2
2P5	2.5	A	0.5	0.4	0.5	0.4
4P8	4.8	B	1.0	0.75	1.0	0.75
6P0	6.0	B	1.5	1.1	1.5	1.1

Output Current @ 1 Phase, 200...240V Input						
Code	Amps	Frame	ND		HD	
			HP	kW	HP	kW
1P6 <sup>(1)</sup>	1.6	A	0.25	0.2	0.25	0.2
2P5	2.5	A	0.5	0.4	0.5	0.4
4P8	4.8	A	1.0	0.75	1.0	0.75
8P0	8.0	B	2.0	1.5	2.0	1.5
011	11.0	B	3.0	2.2	3.0	2.2

Output Current @ 3Phase, 200...240V Input						
Code	Amps	Frame	ND		HD	
			HP	kW	HP	kW
1P6 <sup>(1)</sup>	1.6	A	0.25	0.2	0.25	0.2
2P5	2.5	A	0.5	0.4	0.5	0.4
5P0	5.0	A	1.0	0.75	1.0	0.75
8P0	8.0	A	2.0	1.5	2.0	1.5
011	11.0	A	3.0	2.2	3.0	2.2
017	17.5	B	5.0	4.0	5.0	4.0
024	24.0	C	7.5	5.5	7.5	5.5
032	32.2	D	10.0	7.5	10.0	7.5
048 <sup>(2)</sup>	48.3	E	15.0	11.0	10.0	7.5
062 <sup>(2)</sup>	62.1	E	20.0	15.0	15.0	11.0

Output Current @ 3 Phase, 380...480V Input						
Code	Amps	Frame	ND		HD	
			HP	kW	HP	kW
1P4	1.4	A	0.5	0.4	0.5	0.4
2P3	2.3	A	1.0	0.75	1.0	0.75
4P0	4.0	A	2.0	1.5	2.0	1.5
6P0	6.0	A	3.0	2.2	3.0	2.2
010	10.5	B	5.0	4.0	5.0	4.0
013	13.0	C	7.5	5.5	7.5	5.5
017	17.0	C	10.0	7.5	10.0	7.5
024	24.0	D	15.0	11.0	15.0	11.0
030 <sup>(2)</sup>	30.0	D	20.0	15.0	15.0	11.0
037 <sup>(2)</sup>	37.0	E	25.0	18.5	20.0	15.0
043 <sup>(2)</sup>	43.0	E	30.0	22.0	25.0	18.5

Output Current @ 3 Phase, 525...600V Input						
Code	Amps	Frame	ND		HD	
			HP	kW	HP	kW
0P9	0.9	A	0.5	0.4	0.5	0.4
1P7	1.7	A	1.0	0.75	1.0	0.75
3P0	3.0	A	2.0	1.5	2.0	1.5
4P2	4.2	A	3.0	2.2	3.0	2.2
6P6	6.6	B	5.0	4.0	5.0	4.0
9P9	9.9	C	7.5	5.5	7.5	5.5
012	12.0	C	10.0	7.5	10.0	7.5
019	19.0	D	15.0	11.0	15.0	11.0
022 <sup>(2)</sup>	22.0	D	20.0	15.0	15.0	11.0
027 <sup>(2)</sup>	27.0	E	25.0	18.5	20.0	15.0
032 <sup>(2)</sup>	32.0	E	30.0	22.0	25.0	18.5

(1) This rating is only available for PowerFlex 523 drives.  
 (2)   Normal and Heavy-Duty ratings are available for this drive.

## Installation/Wiring

This chapter provides information on mounting and wiring the PowerFlex 520-series drives.

Topic	Page
Mounting Considerations	15
AC Supply Source Considerations	19
General Grounding Requirements	20
Fuses and Circuit Breakers	22
Power and Control Module	28
Control Module Cover	30
Power Module Terminal Guard	31
Power Wiring	32
Power Terminal Block	35
Common Bus/Precharge Notes	35
I/O Wiring	36
Control I/O Terminal Block	37
Start and Speed Reference Control	48
CE Conformity	51

Most startup difficulties are the result of incorrect wiring. Every precaution must be taken to assure that the wiring is done as instructed. All items must be read and understood before the actual installation begins.



**ATTENTION:** The following information is merely a guide for proper installation. Rockwell Automation cannot assume responsibility for the compliance or the noncompliance to any code, national, local or otherwise for the proper installation of this drive or associated equipment. A hazard of personal injury and/or equipment damage exists if codes are ignored during installation.

### Mounting Considerations

- Mount the drive upright on a flat, vertical, and level surface.

Frame	Screw Size	Screw Torque
A	M5 (#10...24)	1.56...1.96 N•m (14...17 lb•in)
B	M5 (#10...24)	1.56...1.96 N•m (14...17 lb•in)
C	M5 (#10...24)	1.56...1.96 N•m (14...17 lb•in)
D	M5 (#10...24)	2.45...2.94 N•m (22...26 lb•in)
E	M8 (5/16 in.)	6.0...7.4 N•m (53...65 lb•in)

- Protect the cooling fan by avoiding dust or metallic particles.
- Do not expose to a corrosive atmosphere.
- Protect from moisture and direct sunlight.

## Minimum Mounting Clearances

See [Product Dimensions on page 184](#) for mounting dimensions.

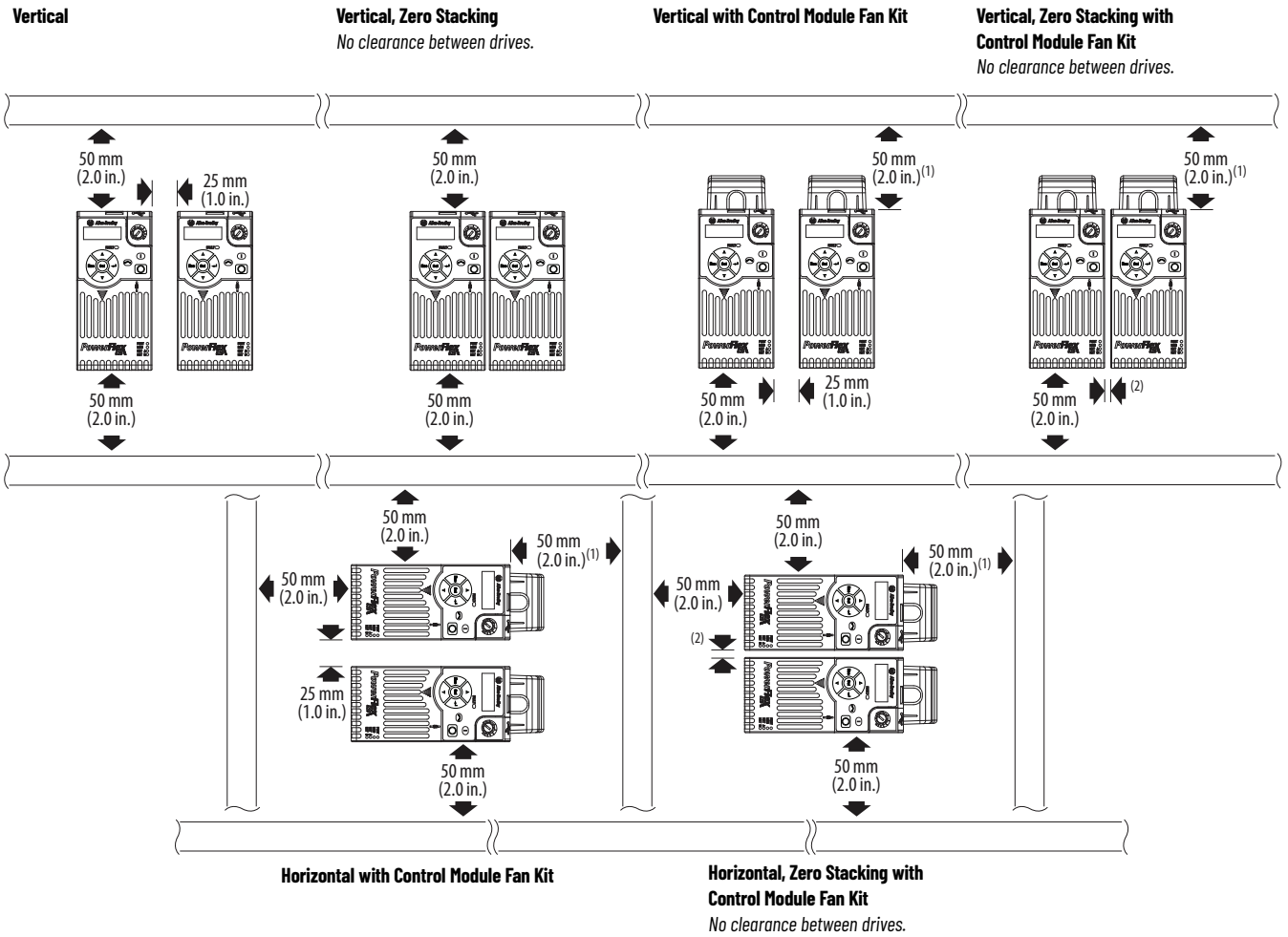

(1) For Frame E with Control Module Fan Kit only, clearance of 95 mm (3.7 in.) is required.  
 (2) For Frame E with Control Module Fan Kit only, clearance of 12 mm (0.5 in.) is required.



## Ambient Operating Temperatures

For optional accessories and kits, see [Accessories and Dimensions on page 173](#).

Mounting	Enclosure Rating <sup>(1)</sup>	Ambient Temperature			
		Minimum	Maximum (No Derate)	Maximum (Derate) <sup>(2)</sup>	Maximum with Control Module Fan Kit (Derate) <sup>(3)(5)</sup>
Vertical	IP 20/Open Type	-20 °C (-4 °F)	50 °C (122 °F)	60 °C (140 °F)	70 °C (158 °F)
	IP 30/NEMA 1/UL Type 1		45 °C (113 °F)	55 °C (131 °F)	-
Vertical, Zero Stacking	IP 20/Open Type		45 °C (113 °F)	55 °C (131 °F)	65 °C (149 °F)
	IP 30/NEMA 1/UL Type 1		40 °C (104 °F)	50 °C (122 °F)	-
Horizontal with Control Module Fan Kit <sup>(4)(5)</sup>	IP 20/Open Type		50 °C (122 °F)	-	70 °C (158 °F)
Horizontal, Zero Stacking with Control Module Fan Kit <sup>(4)(5)</sup>	IP 20/Open Type		45 °C (113 °F)	-	65 °C (149 °F)

(1) IP 30/NEMA 1/UL Type 1 rating requires installation of the PowerFlex 520-Series IP 30/NEMA 1/UL Type 1 option kit, catalog number 25-JBAx.

(2) For catalogs 25x-D1P4N104 and 25x-E0P9N104, the temperature listed under the Maximum (Derate) column is reduced by 5 °C (9 °F) for all mounting methods.

(3) For catalogs 25x-D1P4N104 and 25x-E0P9N104, the temperature listed under the Maximum with Control Module Fan Kit (Derate) column is reduced by 10 °C (18 °F) for vertical and vertical with zero stacking mounting methods only.

(4) Catalogs 25x-D1P4N104 and 25x-E0P9N104 cannot be mounted using either of the horizontal mounting methods.

(5) Requires installation of the PowerFlex 520-Series Control Module Fan Kit, catalog number 25-FANx-70C.

## Current Derating Curves

### Vertical Mounting

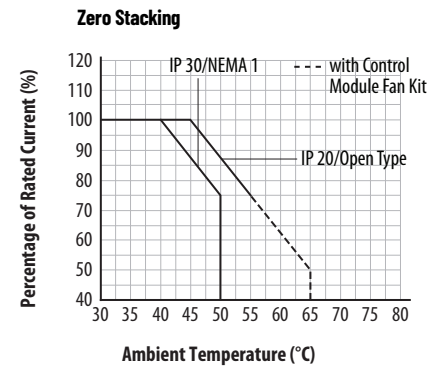
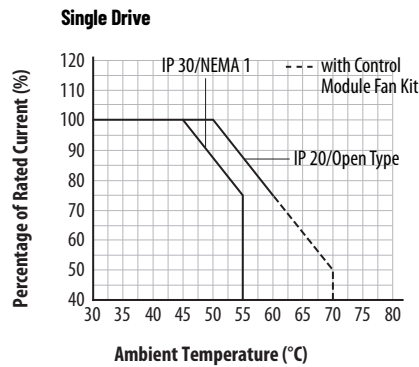

### Horizontal/Floor Mounting

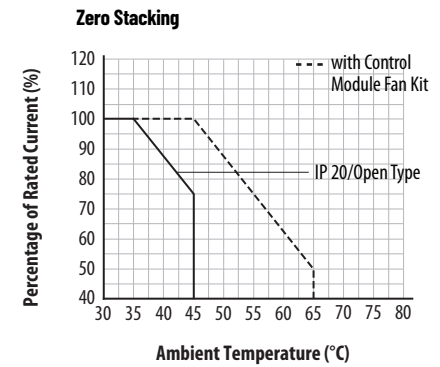
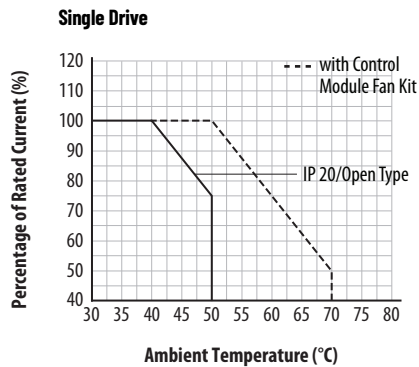

### Derating Guidelines for High Altitude

The drive can be used without derating at a maximum altitude of 1000 m (3300 ft). If the drive is used above 1000 m (3300 ft):

- Derate the maximum ambient temperature by 5 °C (9 °F for every additional 1000 m (3300 ft), subject to limits listed in the [Altitude Limit \(Based on Voltage\)](#) table below.
- Or
- Derate the output current by 10% for every additional 1000 m (3300 ft), up to 3000 m (9900 ft), subject to limits listed in the [Altitude Limit \(Based on Voltage\)](#) table below.

#### Altitude Limit (Based on Voltage)

Drive Rating	Center Ground (Wye Neutral)	Corner Ground, Impedance Ground, or Ungrounded
100...120V 1-Phase	6000 m	6000 m
200...240V 1-Phase	2000 m	2000 m
200...240V 3-Phase	6000 m	2000 m
380...480V 3-Phase	4000 m	2000 m
525...600V 3-Phase	2000 m	2000 m

#### High Altitude

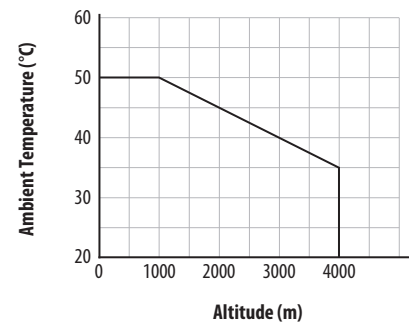
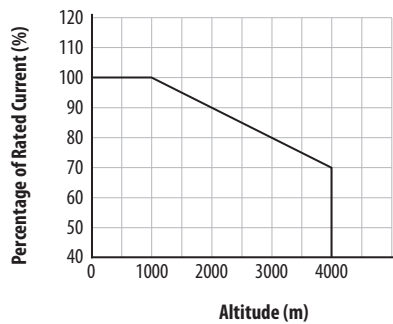

### Debris Protection

Take precautions to prevent debris from falling through the vents of the drive housing during installation.

### Storage

- Store within an ambient temperature range of -40...85 °C<sup>(1)</sup>.
- Store within a relative humidity range of 0...95%, noncondensing.
- Do not expose to a corrosive atmosphere.

(1) The maximum ambient temperature for storing a Frame E drive is 70 °C.

## AC Supply Source Considerations

### Ungrounded Distribution Systems



**ATTENTION:** PowerFlex 520-series drives contain protective MOVs that are referenced to ground. These devices must be disconnected if the drive is installed on an ungrounded or resistive grounded distribution system.

**ATTENTION:** Removing MOVs in drives with an embedded filter will also disconnect the filter capacitor from earth ground.

#### Disconnecting MOVs

To prevent drive damage, the MOVs connected to ground shall be disconnected if the drive is installed on an ungrounded distribution system (IT mains) where the line-to-ground voltages on any phase could exceed 125% of the nominal line-to-line voltage. To disconnect these devices, remove the jumper shown in the diagrams below.

1. Turn the screw counterclockwise to loosen.
2. Pull the jumper completely out of the drive chassis.
3. Tighten the screw to keep it in place.

#### Jumper Location (Typical)

Power Module

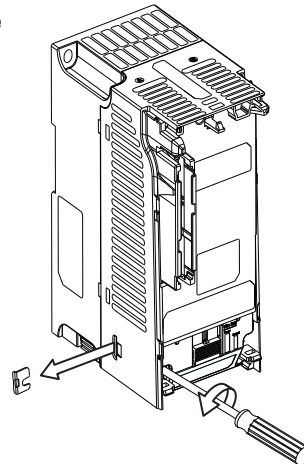

**IMPORTANT** Tighten screw after jumper removal.

#### Phase to Ground MOV Removal

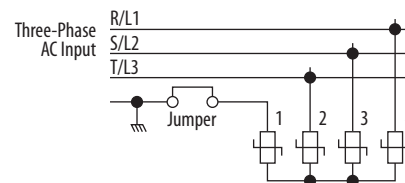

## Input Power Conditioning

The drive is suitable for direct connection to input power within the rated voltage of the drive (see [page 167](#)). Listed in the [Input Power Conditions](#) table below are certain input power conditions which may cause component damage or reduction in product life. If any of these conditions exist, install one of the devices listed under the heading Corrective Action on the line side of the drive.

**IMPORTANT** Only one device per branch circuit is required. It should be mounted closest to the branch and sized to handle the total current of the branch circuit.

### Input Power Conditions

Input Power Condition	Corrective Action
Low Line Impedance (less than 1% line reactance)	<ul style="list-style-type: none"> <li>• Install Line Reactor<sup>(1)</sup></li> <li>• or Isolation Transformer</li> </ul>
Greater than 120 kVA supply transformer	
Line has power factor correction capacitors	<ul style="list-style-type: none"> <li>• Install Line Reactor<sup>(1)</sup></li> <li>• or Isolation Transformer</li> </ul>
Line has frequent power interruptions	
Line has intermittent noise spikes in excess of 6000V (lightning)	
Phase to ground voltage exceeds 125% of normal line-to-line voltage	<ul style="list-style-type: none"> <li>• Remove MOV jumper to ground.</li> <li>• or Install Isolation Transformer with grounded secondary if necessary.</li> </ul>
Ungrounded distribution system	
B-phase grounded distribution system	
240V open delta configuration (stinger leg) <sup>(2)</sup>	<ul style="list-style-type: none"> <li>• Install Line Reactor<sup>(1)</sup></li> </ul>

(1) See [Appendix B](#) for accessory ordering information.

(2) For drives applied on an open delta with a middle phase grounded neutral system, the phase opposite the phase that is tapped in the middle to the neutral or earth is referred to as the "stinger leg," "high leg," "red leg," etc. This leg should be identified throughout the system with red or orange tape on the wire at each connection point. The stinger leg should be connected to the center Phase B on the reactor. See [Bulletin 1321-3R Series Line Reactors on page 183](#) for specific line reactor part numbers.

## General Grounding Requirements

The drive Safety Ground - (PE) must be connected to system ground. Ground impedance must conform to the requirements of national and local industrial safety regulations and/or electrical codes. The integrity of all ground connections should be periodically checked.

### Typical Grounding

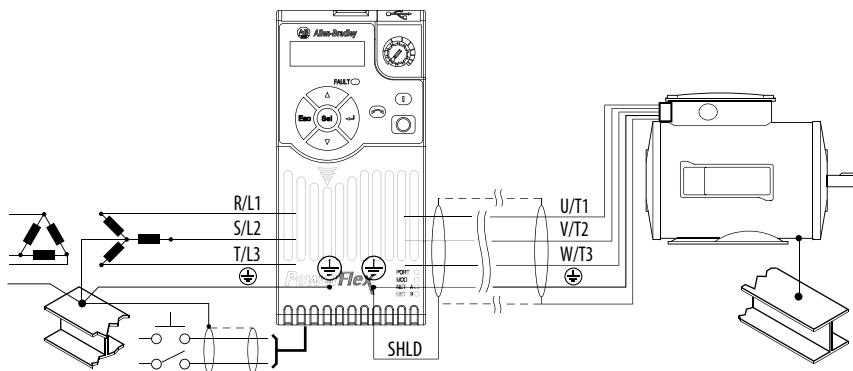

## Ground Fault Monitoring

If a system ground fault monitor (RCD) is to be used, only Type B (adjustable) devices should be used to avoid nuisance tripping.

## Safety Ground - ⊕ (PE)

This is the safety ground for the drive that is required by code. One of these points must be connected to adjacent building steel (girder, joist), a floor ground rod or bus bar. Grounding points must comply with national and local industrial safety regulations and/or electrical codes.

## Network Ground

Connect terminal C1 to a clean earth ground when using a network with a star topology (EtherNet/IP™) or daisy-chain (RS485). It is acceptable to ground both C1 and C2 terminals.

Note: Grounding C1 and C2 helps noise immunity for non-network applications.

Connect terminal CS1 or CS2 to a clean ground when using a network with a ring topology (EtherNet/IP).

For more information on EtherNet/IP networks, see [Ground Connections for EtherNet/IP Networks on page 248](#).

For more information on RS485 networks, see [Network Wiring on page 203](#).

## Motor Ground

The motor ground must be connected to one of the ground terminals on the drive.

## Shield Termination - SHLD

Either of the safety ground terminals located on the power terminal block provides a grounding point for the motor cable shield. The **motor cable** shield connected to one of these terminals (drive end) should also be connected to the motor frame (motor end). Use a shield terminating or EMI clamp to connect the shield to the safety ground terminal. The earthing plate or conduit box option may be used with a cable clamp for a grounding point for the cable shield.

When shielded cable is used for **control and signal wiring**, the shield should be grounded at the source end only, not at the drive end.

## RFI Filter Grounding

Using a drive with filter may result in relatively high ground leakage currents. Therefore, the **filter must only be used in installations with grounded AC supply systems and be permanently installed and solidly grounded** (bonded) to the building power distribution ground. Ensure that the incoming supply neutral is solidly connected (bonded) to the same building power distribution ground. Grounding must not rely on flexible cables and should not include any form of plug or socket that would permit inadvertent disconnection. Some local codes may require redundant ground connections. The integrity of all connections should be periodically checked.

## Fuses and Circuit Breakers

The PowerFlex 520-series drive does not provide branch short circuit protection. This product should be installed with either input fuses or an input circuit breaker. National and local industrial safety regulations and/or electrical codes may determine additional requirements for these installations.

The tables found on pages [24...27](#) provide recommended AC line input fuse and circuit breaker information. See Fusing and Circuit Breakers below for UL and IEC requirements. Sizes listed are the recommended sizes based on 40 °C (104 °F) and the U.S. N.E.C. Other country, state or local codes may require different ratings.

### Fusing

The recommended fuse types are listed in the tables found on pages [24...27](#). If available current ratings do not match those listed in the tables provided, choose the next higher fuse rating.

- IEC – BS88 (British Standard) Parts 1 & 2<sup>(a)</sup>, EN60269-1, Parts 1 & 2, type GG or equivalent should be used.
- UL – UL Class CC, T, RK1, or J should be used.

### Circuit Breakers

The “non-fuse” listings in the tables found on pages [24...27](#) include inverse time circuit breakers, instantaneous trip circuit breakers (motor circuit protectors) and 140M self-protected combination motor controllers. If one of these is chosen as the desired protection method, the following requirements apply:

- IEC – Both types of circuit breakers and 140M self-protected combination motor controllers are acceptable for IEC installations.
- UL – Only inverse time circuit breakers and the specified 140M self-protected combination motor controllers are acceptable for UL installations.

(a) Typical designations include, but may not be limited to the following; Parts 1 & 2: AC, AD, BC, BD, CD, DD, ED, EFS, EF, FF, FG, GF, GG, GH.

*Bulletin 140M (Self-Protected Combination Controller)/UL489 Circuit Breakers*

When using Bulletin 140M or UL489 rated circuit breakers, the guidelines listed below must be followed in order to meet the NEC requirements for branch circuit protection.

- Bulletin 140M can be used in single motor applications.
- Bulletin 140M can be used up stream from the drive **without** the need for fuses.

## Fuses and Circuit Breakers for PowerFlex 520-Series Drives

### 100...120V 1-Phase Input Protection Devices – Frames A...B

Catalog No.	Output Ratings						Input Ratings		Frame Size	Catalog No.	IEC Applications (Non-UL)			UL Applications		
	PF 525		HD		Amps		KVA	Max Amps <sup>(1)</sup>			Fuses (Rating)	Circuit Breakers	Fuses (Max. Rating)	Circuit Breakers	Min. Enclosure Vol. (in. <sup>3</sup> )	
	ND	HP	KW	HP	KW	HP										Class / Catalog No.
25A-V1P6N104	0.25	0.2	0.25	0.2	1.6	0.8	6.4	A	100-C09	10	16	140U-D6D2-B80	140M-C2E-B63	140U-D6D2-B80	140M-C2E-B63	-
25A-V2P5N104	0.5	0.4	0.5	0.4	2.5	1.3	9.6	A	100-C12	16	20	140U-D6D2-C12	140M-C2E-C10	140U-D6D2-C12	140M-C2E-C10	-
25A-V4P8N104	1.0	0.75	1.0	0.75	4.8	2.5	19.2	B	100-C23	25	40	140U-D6D2-C25	140M-D8E-C20	140U-D6D2-C25	140M-D8E-C20	-
25A-V6P0N104	1.5	1.1	1.5	1.1	6.0	3.2	24.0	B	100-C23	32	50	140U-D6D2-C30	140M-F8E-C25	140U-D6D2-C30	140M-F8E-C25	-

### 200...240V 1-Phase Input Protection Devices – Frames A...B

Catalog No.	Output Ratings						Input Ratings		Frame Size	Catalog No.	IEC Applications (Non-UL)			UL Applications		
	PF 525		HD		Amps		KVA	Max Amps <sup>(1)</sup>			Fuses (Rating)	Circuit Breakers	Fuses (Max. Rating)	Circuit Breakers	Min. Enclosure Vol. (in. <sup>3</sup> )	
	ND	HP	KW	HP	KW	HP										Class / Catalog No.
25A-A1P6N104	0.25	0.2	0.25	0.2	1.6	1.4	5.3	A	100-C09	6	10	140U-D6D2-C10	140M-C2E-B63	140U-D6D2-C10	140M-C2E-B63	-
25A-A1P6N114	0.25	0.2	0.25	0.2	1.6	1.4	5.3	A	100-C09	6	10	140U-D6D2-C10	140M-C2E-B63	140U-D6D2-C10	140M-C2E-B63	-
25A-A2P5N104	0.5	0.4	0.5	0.4	2.5	1.7	6.5	A	100-C09	10	16	140U-D6D2-C10	140M-C2E-C10	140U-D6D2-C10	140M-C2E-C10	-
25A-A2P5N114	0.5	0.4	0.5	0.4	2.5	1.7	6.5	A	100-C09	10	16	140U-D6D2-C10	140M-C2E-C10	140U-D6D2-C10	140M-C2E-C10	-
25A-A4P8N104	1.0	0.75	1.0	0.75	4.8	2.8	10.7	A	100-C12	16	25	140U-D6D2-C15	140M-C2E-C16	140U-D6D2-C15	140M-C2E-C16	-
25A-A4P8N114	1.0	0.75	1.0	0.75	4.8	2.8	10.7	A	100-C12	16	25	140U-D6D2-C15	140M-C2E-C16	140U-D6D2-C15	140M-C2E-C16	-
25A-A8P0N104	2.0	1.5	2.0	1.5	8.0	4.8	18.0	B	100-C23	25	40	140U-D6D2-C25	140M-F8E-C25	140U-D6D2-C25	140M-F8E-C25	-
25A-A8P0N114	2.0	1.5	2.0	1.5	8.0	4.8	18.0	B	100-C23	25	40	140U-D6D2-C25	140M-F8E-C25	140U-D6D2-C25	140M-F8E-C25	-
25A-A011N104	3.0	2.2	3.0	2.2	11.0	6.0	22.9	B	100-C37	32	50	140G-66C3-C35	140M-F8E-C25	_(5)	140M-F8E-C25	-
25A-A011N114	3.0	2.2	3.0	2.2	11.0	6.0	22.9	B	100-C37	32	50	140G-66C3-C35	140M-F8E-C25	_(5)	140M-F8E-C25	-

(1) When the drive is controlling motors with lower amp ratings, refer to the drive nameplate for drive input current rating.  
 (2) The AIC ratings of the Bulletin 140M Motor Protector Circuit Breakers may vary. See the Use of Motor Protection Circuit Breakers with Variable-Frequency Drives Application Techniques, publication [140M-A100Z](#).  
 (3) Bulletin 140M with adjustable current range should have the current trip set to the minimum range that the device will not trip.  
 (4) Manual Self-Protected (Type E) Combination Motor Controller, UL listed for use on 480V/277 and 600V/547 AC input. Not UL listed for use on 480V or 600V Delta/Delta, corner ground, or high-resistance ground systems.  
 (5) Circuit breaker selection is not available for this drive rating.



200...240V 3-Phase Input Protection Devices – Frames A...E

Catalog No. (1)		Output Ratings				Input Ratings		Frame Size		IEC Applications (Non-UL)		UL Applications		
PF 523	PF 525	ND	HD		kVA	Max Amps(2)	Catalog No.	Fuses (Rating)	Circuit Breakers		Fuses (Max. Rating)	Circuit Breakers		Min. Enclosure Vol. (in. 3)
			HP	KW					HP	KW		140M/140G	140M	
25A-B1P9N104	-	0.25	0.2	0.25	0.2	1.6	100-C09	3	140U-D6D3-B30	140M-C2E-B25	CLASS RK5, CC, J, or T / DLS-R-15	140U-D6D3-B30	140M-C2E-B25	-
25A-B2P5N104	25B-B2P5N104	0.5	0.4	0.5	0.4	2.5	100-C09	6	140U-D6D3-B40	140M-C2E-B40	CLASS RK5, CC, J, or T / DLS-R-6	140U-D6D3-B40	140M-C2E-B40	-
25A-B5P0N104	25B-B5P0N104	1.0	0.75	1.0	0.75	5.0	100-C09	10	140U-D6D3-B80	140M-C2E-B83	CLASS RK5, CC, J, or T / DLS-R-15	140U-D6D3-B80	140M-C2E-B83	-
25A-B8P0N104	25B-B8P0N104	2.0	1.5	2.0	1.5	8.0	100-C12	16	140U-D6D3-C10	140M-C2E-C10	CLASS RK5, CC, J, or T / DLS-R-20	140U-D6D3-C10	140M-C2E-C10	-
25A-B011N104	25B-B011N104	3.0	2.2	3.0	2.2	11.0	100-C23	20	140U-D6D3-C15	140M-C2E-C16	CLASS RK5, CC, J, or T / DLS-R-30	140U-D6D3-C15	140M-C2E-C16	-
25A-B017N104	25B-B017N104	5.0	4.0	5.0	4.0	17.5	100-C23	32	140U-D6D3-C25	140M-F8E-C25	CLASS CC, J, or T / 45	140U-D6D3-C25	140M-F8E-C25	-
25A-B024N104	25B-B024N104	7.5	5.5	7.5	5.5	24.0	100-C37	35	140G-66C3-C35	140M-F8E-C32	CLASS CC, J, or T / 60	- (7)	140M-F8E-C32	-
25A-B032N104	25B-B032N104	10.0	7.5	10.0	7.5	32.2	100-C43	45	140G-66C3-C60	140M-F8E-C45	CLASS RK5, CC, J, or T / DLS-R-70	- (7)	140M-F8E-C45	-
25A-B048N104	25B-B048N104	15.0	11.0	10.0	7.5	48.3	100-C60	63	140G-66C3-C70	140M-F8E-C45	CLASS CC, J, or T / 90	- (7)	140M-F8E-C45	1416.0(6)
25A-B062N104	25B-B062N104	20.0	15.0	15.0	11.0	62.1	100-C72	70	140G-66C3-C90	- (7)	CLASS CC, J, or T / 125	- (7)	- (7)	-

- (1) Normal Duty (ND) and Heavy Duty (HD) ratings are available for this drive.
- (2) When the drive is controlling motors with lower amp ratings, refer to the drive nameplate for drive input current rating.
- (3) The AIC ratings of the Bulletin 140M Motor Protector Circuit Breakers may vary. See the Use of Motor Protection Circuit Breakers with Variable-Frequency Drives Application Techniques, publication 140M-A100Z.
- (4) Bulletin 140M with adjustable current range should have the current trip set to the minimum range that the device will not trip.
- (5) Manual Self-Protected (Type E) Combination Motor Controller, UL listed for 480V/277 and 600V/347 AC input. Not UL listed for use on 480V or 600V Delta/Delta, corner ground, or high-resistance ground systems.
- (6) When using a Manual Self-Protected (Type E) Combination Motor Controller with this drive power rating, the drive must be installed in a ventilated or non-ventilated enclosure with the minimum volume specified in this column. Application specific thermal considerations may require a larger enclosure.
- (7) Circuit breaker selection is not available for this drive rating.

380...480V 3-Phase Input Protection Devices – Frames A...E

Catalog No. (1)		Output Ratings				Input Ratings		Frame Size		IEC Applications (Non-UL)		UL Applications				
		ND	HP	KW	HD	KVA	Max Amps (2)	Contactor No.	Fuses (Rating)	Circuit Breakers	Fuses (Max. Rating)	Circuit Breakers	Min. Enclosure Vol. (in. 3)			
PF 523	PF 525	HP	KW	KW	HP	Amps	A	Min.	Max.	140M	Class / Catalog No.	140M/140G	140M/140G	140M/140G	140M/140G	140M/140G
25A-D1P4N104	25B-D1P4N104	0.5	0.4	0.4	0.5	1.4	A	3	6	140M-C2E-B25	CLASS RK5, CC, J, or T / DLS-R-6	140M-C2E-B25	140M-C2E-B25	140M-C2E-B25	-	-
25A-D1P4N114	25B-D1P4N114	0.5	0.4	0.4	0.5	1.4	A	3	6	140M-C2E-B25	CLASS RK5, CC, J, or T / DLS-R-6	140M-C2E-B25	140M-C2E-B25	140M-C2E-B25	-	-
25A-D2P3N104	25B-D2P3N104	1.0	0.75	0.75	1.0	2.3	A	6	10	140M-C2E-B40	CLASS RK5, CC, J, or T / DLS-R-10	140M-C2E-B40	140M-C2E-B40	140M-C2E-B40	-	-
25A-D2P3N114	25B-D2P3N114	1.0	0.75	0.75	1.0	2.3	A	6	10	140M-C2E-B40	CLASS RK5, CC, J, or T / DLS-R-10	140M-C2E-B40	140M-C2E-B40	140M-C2E-B40	-	-
25A-D4P0N104	25B-D4P0N104	2.0	1.5	1.5	2.0	4.0	A	10	16	140M-C2E-B63	CLASS RK5, CC, J, or T / DLS-R-15	140M-C2E-B63	140M-C2E-B63	140M-C2E-B63	-	-
25A-D4P0N114	25B-D4P0N114	2.0	1.5	1.5	2.0	4.0	A	10	16	140M-C2E-B63	CLASS RK5, CC, J, or T / DLS-R-15	140M-C2E-B63	140M-C2E-B63	140M-C2E-B63	-	-
25A-D6P0N104	25B-D6P0N104	3.0	2.2	2.2	3.0	6.0	A	10	16	140M-C2E-C10	CLASS RK5, CC, J, or T / DLS-R-15	140M-C2E-C10	140M-C2E-C10	140M-C2E-C10	-	-
25A-D6P0N114	25B-D6P0N114	3.0	2.2	2.2	3.0	6.0	A	10	16	140M-C2E-C10	CLASS RK5, CC, J, or T / DLS-R-15	140M-C2E-C10	140M-C2E-C10	140M-C2E-C10	-	-
25A-D010N104	25B-D010N104	5.0	4.0	4.0	5.0	10.5	B	20	32	140M-C2E-C16	CLASS RK5, CC, J, or T / DLS-R-30	140M-C2E-C16	140M-D8E-C16	140M-D8E-C16	-	-
25A-D010N114	25B-D010N114	5.0	4.0	4.0	5.0	10.5	B	20	32	140M-C2E-C16	CLASS RK5, CC, J, or T / DLS-R-30	140M-C2E-C16	140M-D8E-C16	140M-D8E-C16	-	-
25A-D013N104	25B-D013N104	7.5	5.5	5.5	7.5	13.0	C	20	35	140M-D8E-C20	CLASS CC, J, or T / 35	140M-D8E-C20	140M-D8E-C20	140M-D8E-C20	-	-
25A-D013N114	25B-D013N114	7.5	5.5	5.5	7.5	13.0	C	20	35	140M-D8E-C20	CLASS CC, J, or T / 35	140M-D8E-C20	140M-D8E-C20	140M-D8E-C20	-	-
25A-D017N104	25B-D017N104	10.0	7.5	7.5	10.0	16.8	C	25	40	140M-D8E-C25	CLASS CC, J, or T / 40	140M-D8E-C25	140M-D8E-C25	140M-D8E-C25	-	-
25A-D017N114	25B-D017N114	10.0	7.5	7.5	10.0	16.8	C	25	40	140M-D8E-C25	CLASS CC, J, or T / 40	140M-D8E-C25	140M-D8E-C25	140M-D8E-C25	-	-
25A-D024N104	25B-D024N104	15.0	11.0	11.0	15.0	24.0	D	35	63	140G-66C3-C40	CLASS CC, J, or T / 60	140M-F8E-C32	140M-F8E-C32	140M-F8E-C32	656.7(6)	656.7(6)
25A-D024N114	25B-D024N114	15.0	11.0	11.0	15.0	24.0	D	35	63	140G-66C3-C40	CLASS CC, J, or T / 60	140M-F8E-C32	140M-F8E-C32	140M-F8E-C32	656.7(6)	656.7(6)
25A-D030N104	25B-D030N104	20.0	15.0	15.0	20.0	30.2	D	45	70	140G-66C3-C50	CLASS CC, J, or T / 70	140M-F8E-C45	140M-F8E-C45	140M-F8E-C45	656.7(6)	656.7(6)
25A-D030N114	25B-D030N114	20.0	15.0	15.0	20.0	30.2	D	45	70	140G-66C3-C50	CLASS CC, J, or T / 70	140M-F8E-C45	140M-F8E-C45	140M-F8E-C45	656.7(6)	656.7(6)
25A-D037N114	25B-D037N114	25.0	18.5	18.5	25.0	37.0	E	45	70	140G-66C3-C50	CLASS CC, J, or T / 70	140M-F8E-C45	140M-F8E-C45	140M-F8E-C45	-	-
25A-D043N114	25B-D043N114	30.0	22.0	18.5	30.0	43.0	E	50	80	140G-66C3-C60	CLASS CC, J, or T / 80	140M-F8E-C45	140M-F8E-C45	140M-F8E-C45	-	-

(1) Normal Duty (ND) and Heavy Duty (HD) ratings are available for this drive.

(2) When the drive is controlling motors with lower amp ratings, refer to the drive nameplate for drive input current rating.

(3) The AIC ratings of the Bulletin 140M Motor Protector Circuit Breakers may vary. See the Use of Motor Protection Circuit Breakers with Variable-Frequency Drives Application Techniques, publication 140M-A1002.

(4) Bulletin 140M with adjustable current range should have the current trip set to the minimum range that the device will not trip.

(5) Manual Self-Protected (Type E) Combination Motor Controller, UL listed for 480Y/277 and 600Y/347 AC input. Not UL listed for use on 480V or 600V Delta/Delta, corner ground, or high-resistance ground systems.

(6) When using a Manual Self-Protected (Type E) Combination Motor Controller with this drive power rating, the drive must be installed in a ventilated or non-ventilated enclosure with the minimum volume specified in this column. Application specific thermal considerations may require a larger enclosure.

(7) Circuit breaker selection is not available for this drive rating.

525...600V 3-Phase Input Protection Devices – Frames A...E

Catalog No. (1)		Output Ratings				Input Ratings		IEC Applications (Non-UL)		UL Applications					
PF 523	PF 525	ND	HD		kVA	Max Amps <sup>(2)</sup>	Frame Size	Catalog No.	Fuses (Rating)	Circuit Breakers		Fuses (Max. Rating)	Circuit Breakers		Min. Enclosure Vol. (in. <sup>3</sup> )
			kW	HP						kW	HP		140M	140U/140G	
25A-E0P9N104	25B-E0P9N104	0.5	0.4	0.5	0.4	0.9	A	100-C09	3	140M-C2E-B25	140M-C2E-B25	CLASS RK5, CC, J, or T / DLS-R-6	(6)	140M-C2E-B25	-
25A-E1P7N104	25B-E1P7N104	1.0	0.75	1.0	0.75	1.7	A	100-C09	3	140U-D603-B30	140M-C2E-B25	CLASS RK5, CC, J, or T / DLS-R-6	(6)	140M-C2E-B25	-
25A-E3P0N104	25B-E3P0N104	2.0	1.5	2.0	1.5	3.0	A	100-C09	6	140U-D603-B50	140M-C2E-B40	CLASS RK5, CC, J, or T / DLS-R-10	(6)	140M-C2E-B40	-
25A-E4P2N104	25B-E4P2N104	3.0	2.2	3.0	2.2	4.2	A	100-C09	10	140U-D603-B80	140M-C2E-B63	CLASS RK5, CC, J, or T / DLS-R-15	(6)	140M-D8E-B63	-
25A-E8P6N104	25B-E8P6N104	5.0	4.0	5.0	4.0	6.6	B	100-C09	10	140U-D603-C10	140M-C2E-C10	CLASS RK5, CC, J, or T / DLS-R-20	(6)	140M-D8E-C10	-
25A-E9P9N104	25B-E9P9N104	7.5	5.5	7.5	5.5	9.9	C	100-C16	16	140U-D603-C15	140M-C2E-C16	CLASS RK5, CC, J, or T / DLS-R-25	(6)	140M-D8E-C16 <sup>(6)</sup>	-
25A-E012N104	25B-E012N104	10.0	7.5	10.0	7.5	12.0	C	100-C23	20	140U-D603-C20	140M-C2E-C16	CLASS RK5, CC, J, or T / DLS-R-30	(6)	140M-D8E-C16	-
25A-E019N104	25B-E019N104	15.0	11.0	15.0	11.0	19.0	D	100-C30	32	140G-66C3-C30	140M-F8E-C25	CLASS CC, J, or T / 50	(6)	140M-F8E-C25	656.7 <sup>(7)</sup>
25A-E022N104	25B-E022N104	20.0	15.0	20.0	15.0	22.0	D	100-C30	35	140G-66C3-C35	140M-F8E-C32	CLASS CC, J, or T / 60	(6)	140M-F8E-C32	656.7 <sup>(7)</sup>
25A-E027N104	25B-E027N104	25.0	18.5	25.0	18.5	27.0	E	100-C30	35	140G-66C3-C35	140M-F8E-C32	CLASS CC, J, or T / 50	(6)	140M-F8E-C32	1416.0 <sup>(7)</sup>
25A-E032N104	25B-E032N104	30.0	22.0	30.0	22.0	33.4	E	100-C37	40	140G-66C3-C50	140M-F8E-C32	CLASS CC, J, or T / 60	(6)	140M-F8E-C32	1416.0 <sup>(7)</sup>

- (1) Normal Duty (ND) and Heavy Duty (HD) ratings are available for this drive.
- (2) When the drive is controlling motors with lower amp ratings, refer to the drive nameplate for drive input current rating.
- (3) The AIC ratings of the Bulletin 140M Motor Protector Circuit Breakers may vary. See the Use of Motor Protection Circuit Breakers with Variable-Frequency Drives Application Techniques, publication [140M-A100Z](#).
- (4) Bulletin 140M with adjustable current range should have the current trip set to the minimum range that the device will not trip.
- (5) Manual Self-Protected (Type E) Combination Motor Controller, UL listed for 480V/277 and 600V/347 AC input. Not UL listed for use on 480V or 600V Delta/Delta, corner ground, or high-resistance ground systems.
- (6) When used with the 140M circuit breaker, the 25A-E9P9104 must be installed in a ventilated or non-ventilated enclosure with the minimum size of 457.2 x 457.2 x 269.8 mm (18 x 18 x 10.62 in.).
- (7) When using a Manual Self-Protected (Type E) Combination Motor Controller with this drive power rating, the drive must be installed in a ventilated or non-ventilated enclosure with the minimum volume specified in this column. Application specific thermal considerations may require a larger enclosure.
- (8) Circuit breaker selection is not available for this drive rating.

## Power and Control Module

PowerFlex 520-series drives consist of a Power Module and Control Module.

### Separating the Power and Control Module



**ATTENTION:** Perform this action only when drive is NOT powered.

1. Press and hold down the catch on both sides of the frame cover, then pull out and swing upwards to remove (Frames B...E only).

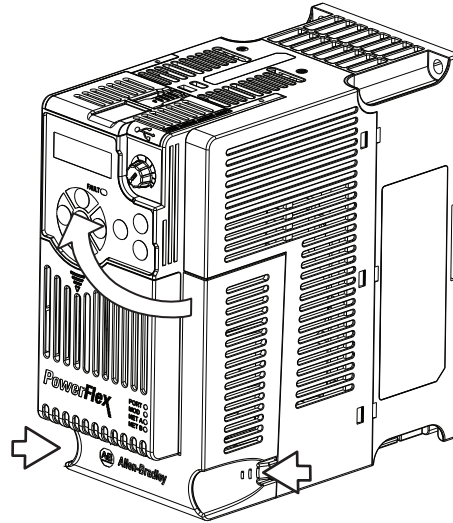

2. Press down and slide out the top cover of the Control Module to unlock it from the Power Module.

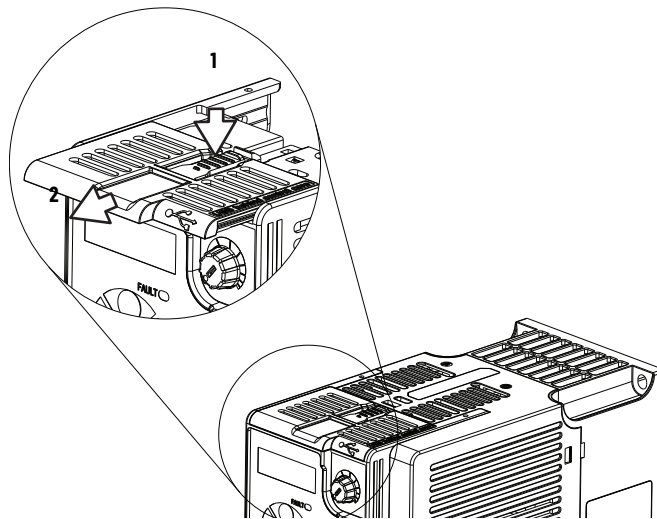

3. Hold the sides and top of the Control Module firmly, then pull out to separate it from the Power Module.

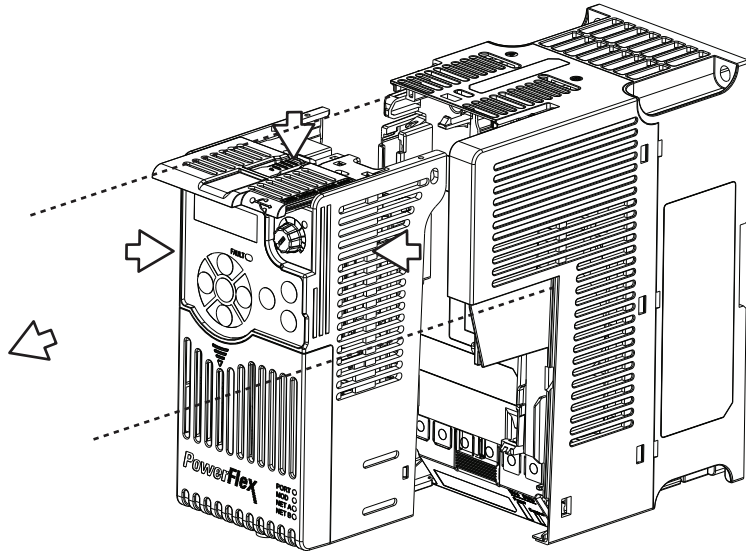

#### Connecting the Power and Control Module

1. Align the connectors on the Power Module and Control Module, then push the Control Module firmly onto the Power Module.

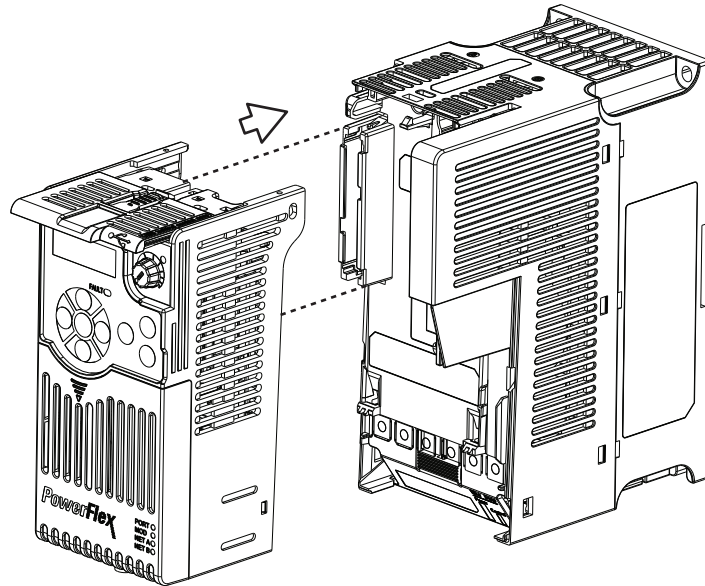

2. Push the top cover of the Control Module towards the Power Module to lock it.

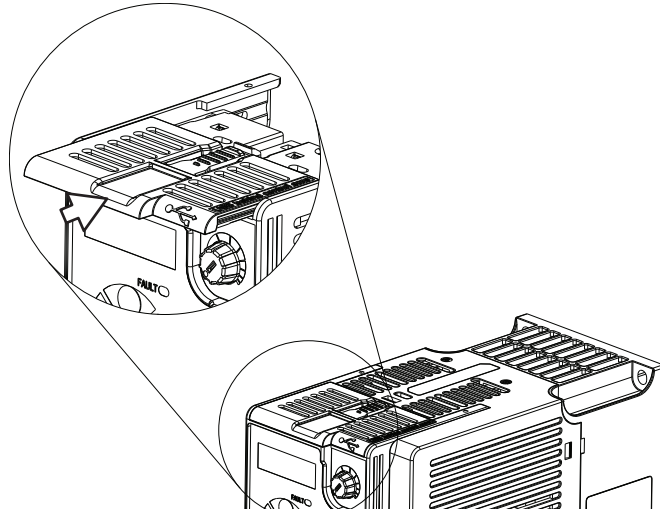

3. Insert the catch at the top of the frame cover into the Power Module, then swing the frame cover to snap the side catches onto the Power Module (Frames B...E only).

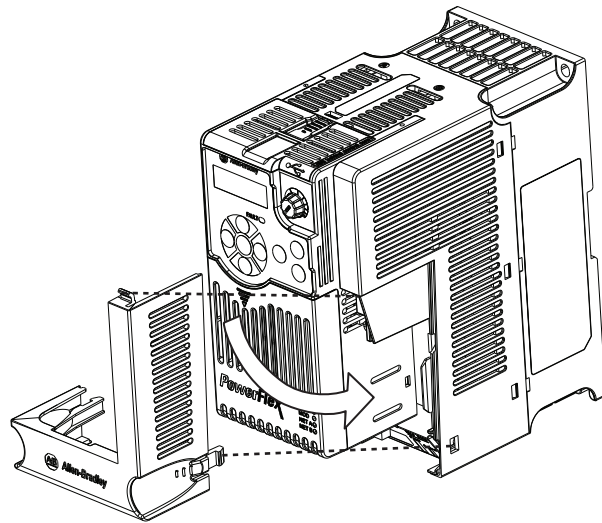

## Control Module Cover

To access the control terminals, DSI port, and Ethernet port, the front cover must be removed. To remove:

1. Press and hold down the arrow on the front of the cover.

- Slide the front cover down to remove from the Control Module.

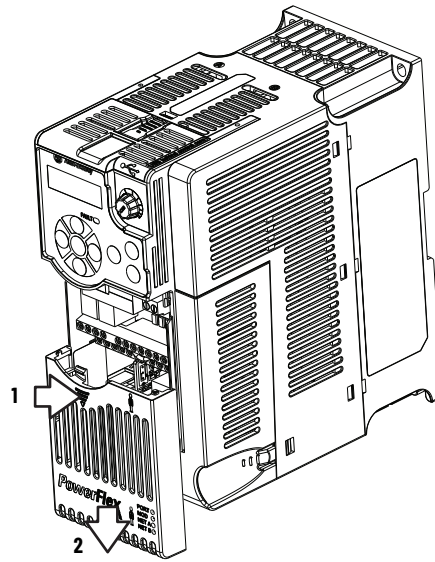

Re-attach the front cover when wiring is complete.

## Power Module Terminal Guard

To access the power terminals, the terminal guard must be removed. To remove:

- Press and hold down the catch on both sides of the frame cover, then pull out and swing upwards to remove (Frames B...E only).

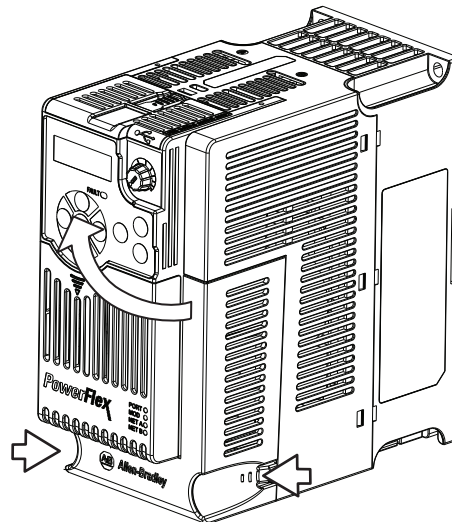

- Press and hold down the locking tab on the terminal guard.

- Slide the terminal guard down to remove from the Power Module.

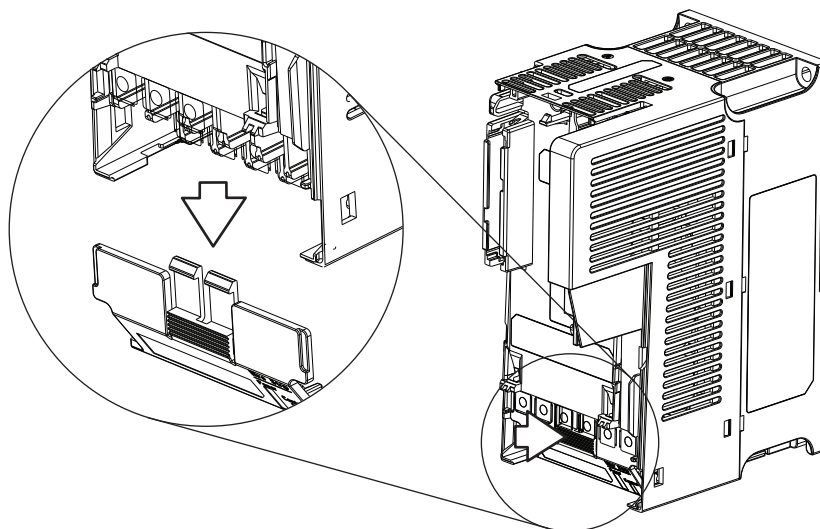

Re-attach the terminal guard when wiring is complete.

To access the power terminals for Frame A, you need to separate the Power and Control Modules. See [Separating the Power and Control Module on page 28](#) for instructions.

## Power Wiring



**ATTENTION:** National Codes and standards (NEC, VDE, BSI, etc.) and local codes outline provisions for safely installing electrical equipment. Installation must comply with specifications regarding wire types, conductor sizes, branch circuit protection and disconnect devices. Failure to do so may result in personal injury and/or equipment damage.

**ATTENTION:** To avoid a possible shock hazard caused by induced voltages, unused wires in the conduit must be grounded at both ends. For the same reason, if a drive sharing a conduit is being serviced or installed, all drives using this conduit should be disabled. This will help minimize the possible shock hazard from “cross coupled” power leads.

### Motor Cable Types Acceptable for 100...600 Volt Installations

A variety of cable types are acceptable for drive installations. For many installations, unshielded cable is adequate, provided it can be separated from sensitive circuits. As an approximate guide, allow a spacing of 0.3 m (1 ft) for every 10 m (32.8 ft) of length. In all cases, long parallel runs must be avoided. Do not use cable with an insulation thickness less than 15 mils (0.4 mm/0.015 in.). Do not route more than three sets of motor leads in a single conduit to minimize “cross talk”. If more than three drive/motor connections per conduit are required, shielded cable must be used.

UL installations above 50 °C ambient must use 600V, 90 °C wire.

UL installations in 50 °C ambient must use 600V, 75 °C or 90 °C wire.

UL installations in 40 °C ambient should use 600V, 75 °C or 90 °C wire.



Use copper wire only. Wire gauge requirements and recommendations are based on 75 °C. Do not reduce wire gauge when using higher temperature wire.



**WARNING:** The distance between the drive and motor must not exceed the maximum cable length stated in the Motor Cable Length Restrictions Tables in “Wiring and Grounding Guide, (PWM) AC Drives,” publication [DRIVES-IN001](#).

### *Unshielded*

THHN, THWN or similar wire is acceptable for drive installation in dry environments provided adequate free air space and/or conduit fill rates limits are provided. Any wire chosen must have a minimum insulation thickness of 15 mils and should not have large variations in insulation concentricity.



**ATTENTION:** Do not use THHN or similarly coated wire in wet areas.

### *Shielded/Armored Cable*

Shielded cable contains all of the general benefits of multi-conductor cable with the added benefit of a copper braided shield that can contain much of the noise generated by a typical AC Drive. Strong consideration for shielded cable should be given in installations with sensitive equipment such as weigh scales, capacitive proximity switches and other devices that may be affected by electrical noise in the distribution system. Applications with large numbers of drives in a similar location, imposed EMC regulations or a high degree of communications / networking are also good candidates for shielded cable.

Shielded cable may also help reduce shaft voltage and induced bearing currents for some applications. In addition, the increased impedance of shielded cable may help extend the distance that the motor can be located from the drive without the addition of motor protective devices such as terminator networks. See Reflected Wave in “Wiring and Grounding Guide, (PWM) AC Drives,” publication [DRIVES-IN001](#).

Consideration should be given to all of the general specifications dictated by the environment of the installation, including temperature, flexibility, moisture characteristics, and chemical resistance. In addition, a braided shield should be included and be specified by the cable manufacturer as having coverage of at least 75%. An additional foil shield can greatly improve noise containment.

A good example of recommended cable is Belden 295xx (xx determines gauge). This cable has four XLPE insulated conductors with a 100% coverage foil and an 85% coverage copper braided shield (with drain wire) surrounded by a PVC jacket.

Other types of shielded cable are available, but the selection of these types may limit the allowable cable length. Particularly, some of the newer cables twist 4 conductors of THHN wire and wrap them tightly with a foil shield. This construction can greatly increase the cable charging current required and reduce the overall drive performance. Unless specified in the individual

distance tables as tested with the drive, these cables are not recommended and their performance against the lead length limits supplied is not known.

### Recommended Shielded Wire

Location	Rating/Type	Description
Standard (Option 1)	600V, 90 °C (194 °F) XHHW2/RHW-2 Anixter B209500-B209507, Belden 29501-29507, or equivalent	<ul style="list-style-type: none"> <li>• Four tinned copper conductors with XLPE insulation.</li> <li>• Copper braid/aluminum foil combination shield and tinned copper drain wire.</li> <li>• PVC jacket.</li> </ul>
Standard (Option 2)	Tray rated 600V, 90 °C (194 °F) RHH/RHW-2 Anixter OLF-7xxxx or equivalent	<ul style="list-style-type: none"> <li>• Three tinned copper conductors with XLPE insulation.</li> <li>• 5 mil single helical copper tape (25% overlap min) with three bare copper grounds in contact with shield.</li> <li>• PVC jacket.</li> </ul>
Class I & II; Division I & II	Tray rated 600V, 90 °C (194 °F) RHH/RHW-2 Anixter 7V-7xxx-3G or equivalent	<ul style="list-style-type: none"> <li>• Three bare copper conductors with XLPE insulation and impervious corrugated continuously welded aluminum armor.</li> <li>• Black sunlight resistant PVC jacket overall.</li> <li>• Three copper grounds on #10 AWG and smaller.</li> </ul>

### Reflected Wave Protection

The drive should be installed as close to the motor as possible. Installations with long motor cables may require the addition of external devices to limit voltage reflections at the motor (reflected wave phenomena). See Reflected Wave in “Wiring and Grounding Guide, (PWM) AC Drives,” publication [DRIVES-IN001](#).

The reflected wave data applies to all carrier frequencies 2...16 kHz.

For 240V ratings and lower, reflected wave effects do not need to be considered.

### Output Disconnect

The drive is intended to be commanded by control input signals that will start and stop the motor. A device that routinely disconnects then reapplies output power to the motor for the purpose of starting and stopping the motor should not be used. If it is necessary to disconnect power to the motor with the drive outputting power, an auxiliary contact should be used to simultaneously disable drive (Aux Fault or Coast to Stop).

## Power Terminal Block

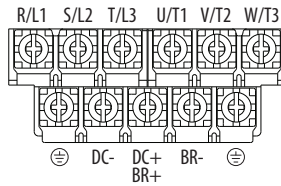

### Power Terminal Block

#### Frame A, B, C & D

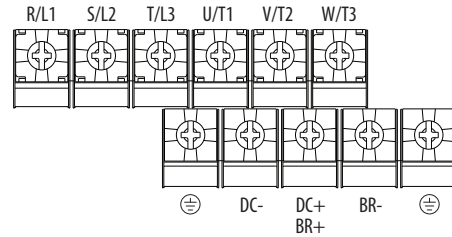

#### Frame E



Terminal	Description
R/L1, S/L2	1-Phase Input Line Voltage Connection
R/L1, S/L2, T/L3	3-Phase Input Line Voltage Connection
U/T1, V/T2, W/T3	Motor Phase Connection =  Switch any two motor leads to change forward direction.
DC+, DC-	DC Bus Connection (except for 110V 1-Phase)
BR+, BR-	Dynamic Brake Resistor Connection
	Safety Ground - PE

**IMPORTANT** Terminal screws may become loose during shipment. Ensure that all terminal screws are tightened to the recommended torque before applying power to the drive.

### Power Terminal Block Wire Specifications

Frame	Maximum Wire Size <sup>(1)</sup>	Minimum Wire Size <sup>(1)</sup>	Torque
A	5.3 mm <sup>2</sup> (10 AWG)	0.8 mm <sup>2</sup> (18 AWG)	1.76...2.16 N•m (15.6...19.1 lb•in)
B	8.4 mm <sup>2</sup> (8 AWG)	2.1 mm <sup>2</sup> (14 AWG)	1.76...2.16 N•m (15.6...19.1 lb•in)
C	8.4 mm <sup>2</sup> (8 AWG)	2.1 mm <sup>2</sup> (14 AWG)	1.76...2.16 N•m (15.6...19.1 lb•in)
D	13.3 mm <sup>2</sup> (6 AWG)	5.3 mm <sup>2</sup> (10 AWG)	1.76...2.16 N•m (15.6...19.1 lb•in)
E	26.7 mm <sup>2</sup> (3 AWG)	8.4 mm <sup>2</sup> (8 AWG)	3.09...3.77 N•m (27.3...33.4 lb•in)

(1) Maximum/minimum sizes that the terminal block will accept - these are not recommendations.

## Common Bus/Precharge Notes

If drives are used with a disconnect switch to the common DC bus, then an auxiliary contact on the disconnect must be connected to a digital input of the drive. The corresponding input (parameter [to62](#), [to63](#), [to65...to68](#) [DigIn TermBlk xx]) must be set to 30, "Precharge En" This provides the proper precharge interlock, guarding against possible damage to the drive when connected to a common DC bus. For more information, see Drives in Common Bus Configurations, publication [DRIVES-AT002](#).

## I/O Wiring

### Motor Start/Stop Precautions



**ATTENTION:** A contactor or other device that routinely disconnects and reapplies the AC line to the drive to start and stop the motor can cause drive hardware damage. The drive is designed to use control input signals that will start and stop the motor. If used, the input device must not exceed one operation per minute or drive damage can occur.

**ATTENTION:** The drive start/stop control circuitry includes solid-state components. If hazards due to accidental contact with moving machinery or unintentional flow of liquid, gas or solids exist, an additional hardwired stop circuit may be required to remove the AC line to the drive. When the AC line is removed, there will be a loss of any inherent regenerative braking effect that might be present - the motor will coast to a stop. An auxiliary braking method may be required. Alternatively, use the drive's safety input function.

Important points to remember about I/O wiring:

- Always use copper wire.
- Wire with an insulation rating of 600V or greater is recommended.

Control and signal wires should be separated from power wires by at least 0.3 m (1 ft).

**IMPORTANT** I/O terminals labeled "Common" are not referenced to the safety ground (PE) terminal and are designed to greatly reduce common mode interference.



**ATTENTION:** Driving the 4...20 mA analog input from a voltage source could cause component damage. Verify proper configuration prior to applying input signals.

### Signal and Control Wire Types

Recommendations are for 50 °C ambient temperature.

75 °C wire must be used for 60 °C ambient temperature.

90 °C wire must be used for 70 °C ambient temperature.

#### Recommended Signal Wire

Signal Type/ Where Used	Belden Wire Type(s) <sup>(1)</sup> (or equivalent)	Description	Min. Insulation Rating
Analog I/O & PTC	8760/9460	0.750 mm <sup>2</sup> (18 AWG), twisted pair, 100% shield with drain <sup>(2)</sup>	300V, 60 °C (140 °F)
Remote Pot	8770	0.750 mm <sup>2</sup> (18 AWG), 3 conductor, shielded	
Encoder/Pulse I/O	9728/9730	0.196 mm <sup>2</sup> (24 AWG), individually shielded pairs	

(1) Stranded or solid wire.

(2) If the wires are short and contained within a cabinet which has no sensitive circuits, the use of shielded wire may not be necessary, but is always recommended.

#### Recommended Control Wire for Digital I/O

Type	Wire Type(s)	Description	Min. Insulation Rating
Unshielded	Per US NEC or applicable national or local code	-	300V, 60 °C (140 °F)
Shielded	Multi-conductor shielded cable such as Belden 8770 (or equivalent)	0.750 mm <sup>2</sup> (18 AWG), 3 conductor, shielded.	

## Maximum Control Wire Recommendations

Do not exceed control wiring length of 30 m (100 ft). Control signal cable length is highly dependent on electrical environment and installation practices. To improve noise immunity, the I/O terminal block Common may be connected to ground terminal/protective earth.

## Control I/O Terminal Block

### Control I/O Terminal Block Wire Specifications

Frame	Maximum Wire Size <sup>(1)</sup>	Minimum Wire Size <sup>(1)</sup>	Torque
A...E	1.3 mm <sup>2</sup> (16 AWG)	0.13 mm <sup>2</sup> (26 AWG)	0.71...0.86 N•m (6.2...7.6 lb•in)

(1) Maximum/minimum sizes that the terminal block will accept - these are not recommendations.

## PowerFlex 523 Control I/O Terminal Block

### PowerFlex 523 Series A Control I/O Wiring Block Diagram

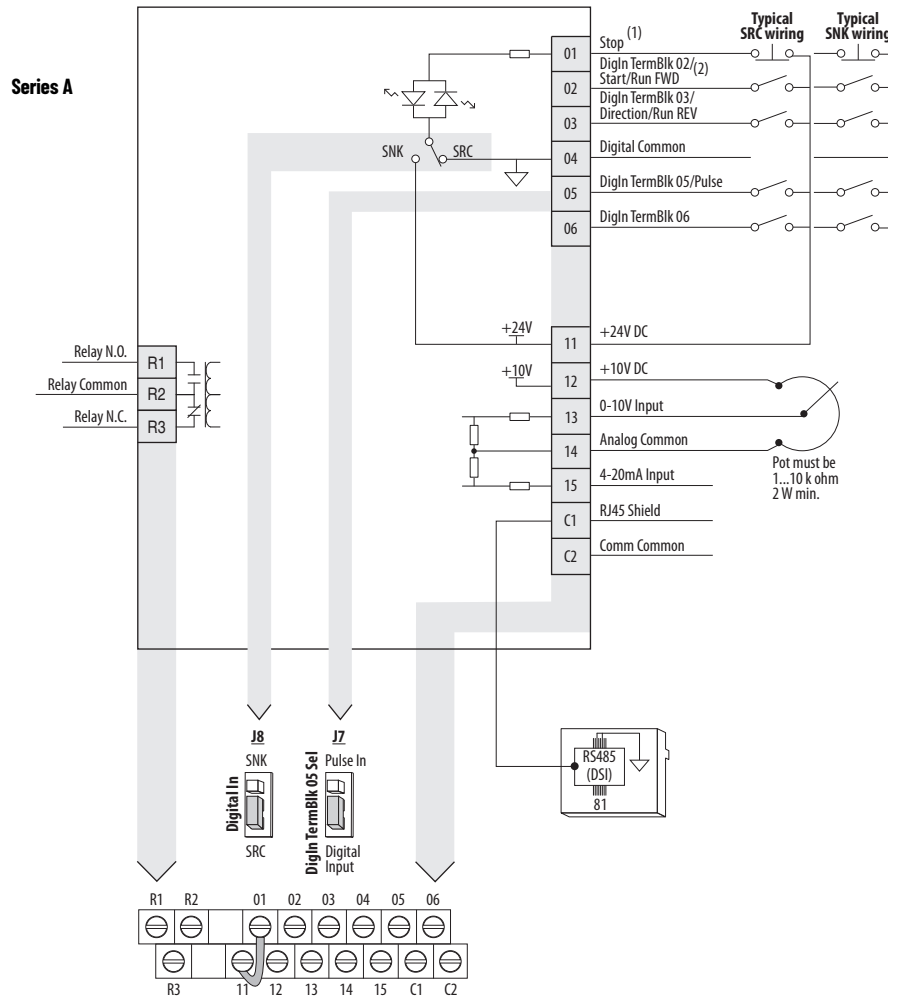

PowerFlex 523 Series B Control I/O Wiring Block Diagram

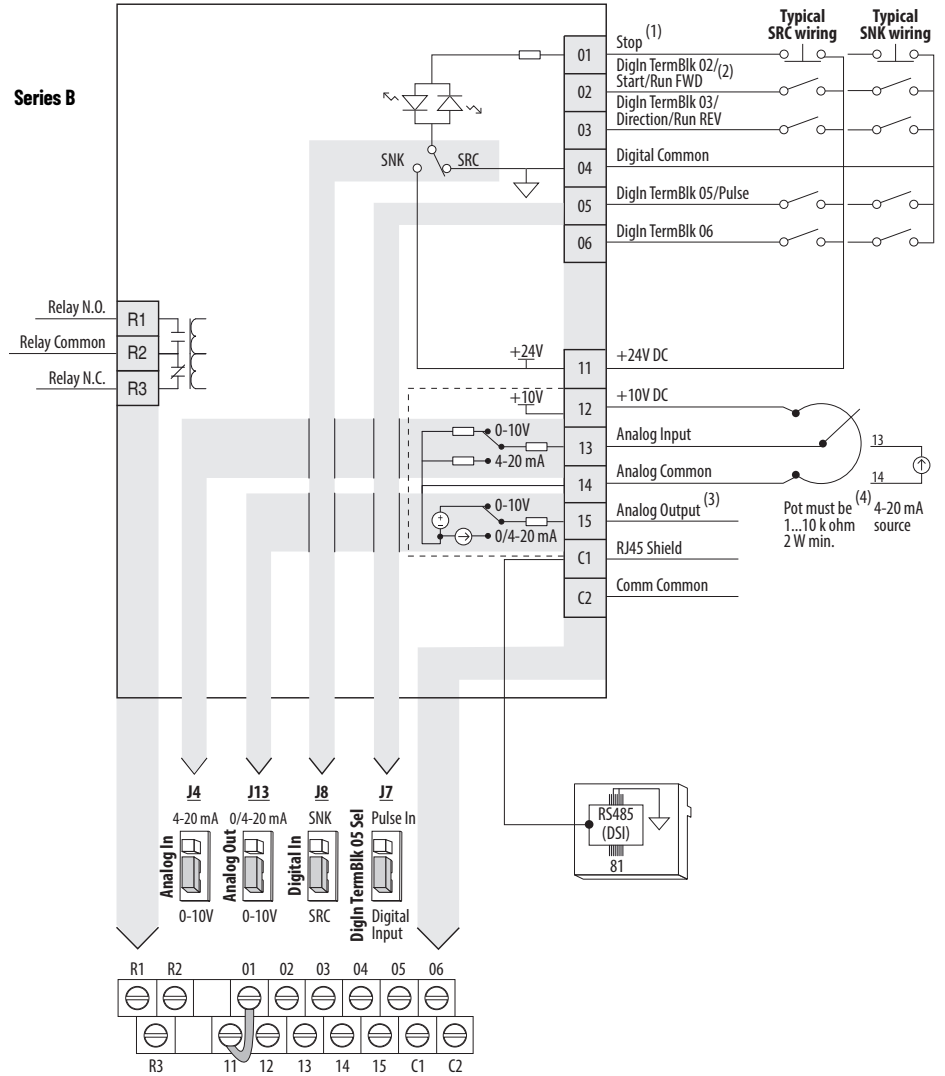

Control I/O Wiring Block Diagram Notes

(1) See [Digital Input Selection for Start Source on page 49](#) for more information on configuring the digital inputs.

**IMPORTANT** I/O Terminal 01 is always a stop input. The stopping mode is determined by the drive setting. See the tables below for more information.

Start Method	Stop Method	
<b>P046, P048, P050 [Start Source x]</b>	<b>I/O Terminal 01 Stop</b>	<b>Normal Stop</b>
1 "Keypad"	Coast	Per P045 [Stop Mode]
2 "DigIn TrmBlk"	See <a href="#">t062, t063 [DigIn TrmBlk xx]</a> below	
3 "Serial/DSI"	Coast	
4 "Network Opt"	Coast	
5 "EtherNet/IP" (1)	Coast	

(1) Setting is specific to PowerFlex 525 drives only.

Start Method	Stop Method	
t062, t063 [DigIn TermBlk xx]	I/O Terminal 01 Stop	Normal Stop
48 "2-Wire FWD"	t064 [2-Wire Mode] is set to: • 0, 1, or 2 = Coast • 3 = per P045 [Stop Mode]	Per P045 [Stop Mode]
49 "3-Wire Start"	Per P045 [Stop Mode]	
50 "2-Wire REV"	t064 [2-Wire Mode] is set to: • 0, 1, or 2 = Coast • 3 = per P045 [Stop Mode]	
51 "3-Wire Dir"	Per P045 [Stop Mode]	

**IMPORTANT** The drive is shipped with a jumper installed between I/O Terminals 01 and 11. Remove this jumper when using I/O Terminal 01 as a stop or enable input.

- (2) Two wire control shown. For three wire control use a momentary input  $\overline{\text{---}}$  on I/O Terminal 02 to command a start. Use a maintained input  $\text{---}$  for I/O Terminal 03 to change direction.
- (3) Analog output (terminal 15) is only available on PowerFlex 523 series B drive, and requires firmware 3.001 and later to configure the analog output parameters (t088, t089, and t090).
- (4) Potentiometer connection is only applicable when the 0...10V setting (default) is selected for jumper J4.
- (5) Only one analog frequency source may be connected at a time. If more than one reference is connected at the same time, an undetermined frequency reference will result.

### Control I/O Terminal Designations

No.	Signal	Default	Description	Parameter
R1	Relay N.O.	Fault	Normally open contact for output relay.	
R2	Relay Common	Fault	Common for output relay.	t076
R3	Relay N.C.	Fault	Normally closed contact for output relay.	
01	Stop	Coast	Three wire stop. However, it functions as a stop under all input modes and cannot be disabled.	P045 <sup>(1)</sup>
02	DigIn TermBlk 02/ Start/Run FWD	Run FWD	Used to initiate motion and also can be used as a programmable digital input. It can be programmed with t062 [DigIn TermBlk 02] as three wire (Start/Dir with Stop) or two wire (Run FWD/Run REV) control. Current consumption is 6 mA.	P045, P046, P048, P050, A544, t062
03	DigIn TermBlk 03/ Dir/Run REV	Run REV	Used to initiate motion and also can be used as a programmable digital input. It can be programmed with t063 [DigIn TermBlk 03] as three wire (Start/Dir with Stop) or two wire (Run FWD/Run REV) control. Current consumption is 6 mA.	t063
04	Digital Common	-	Return for digital I/O. Electrically isolated (along with the digital I/O) from the rest of the drive.	-
05	DigIn TermBlk 05/ Pulse In	Preset Freq	Program with t065 [DigIn TermBlk 05]. Also functions as a Pulse Train input for reference or speed feedback. Requires an NPN pulse input. The maximum frequency is 100 kHz. Current consumption is 6 mA.	t065
06	DigIn TermBlk 06	Preset Freq	Program with t066 [DigIn TermBlk 06]. Current consumption is 6 mA.	t066
11	+24V DC	-	Referenced to Digital Common. Drive supplied power for digital inputs. Maximum output current is 100 mA.	-
12	+10V DC	-	Referenced to Analog Common. Drive supplied power for 0...10V external potentiometer. Maximum output current is 15 mA.	P047, P049

## Control I/O Terminal Designations (Continued)

No.	Signal	Default	Description	Parameter
13	<b>For Series A</b> 0...10V In <sup>(2)</sup>	Not Active	For external 0...10V (unipolar) input supply or potentiometer wiper. Input impedance: Voltage source = 100 kΩ Allowable potentiometer resistance range = 1...10 kΩ	<a href="#">P047</a> , <a href="#">P049</a> , <a href="#">t062</a> , <a href="#">t063</a> , <a href="#">t065</a> , <a href="#">t066</a> , <a href="#">t093</a> , <a href="#">A459</a> , <a href="#">A471</a>
	<b>For Series B</b> Analog Input	Not Active	External analog input supply, selectable by Analog Input jumper. Default is 0...10V (unipolar) input supply or potentiometer wiper. Input impedance: Voltage source = 100 kΩ Allowable potentiometer resistance range = 1...10 kΩ Change Analog Input jumper to 4...20 mA for external 4...20 mA input supply. Input impedance = 250 Ω	<a href="#">P047</a> , <a href="#">P049</a> , <a href="#">t062</a> , <a href="#">t063</a> , <a href="#">t065</a> , <a href="#">t066</a> , <a href="#">t093</a> , <a href="#">A459</a> , <a href="#">A471</a>
14	Analog Common	-	Return for the analog I/O. Electrically isolated (along with the analog I/O) from the rest of the drive.	-
15	<b>For Series A</b> 4...20 mA In <sup>(2)</sup>	Not Active	For external 4...20 mA input supply. Input impedance = 250 Ω	<a href="#">P047</a> , <a href="#">P049</a> , <a href="#">t062</a> , <a href="#">t063</a> , <a href="#">t065</a> , <a href="#">t066</a> , <a href="#">A459</a> , <a href="#">A471</a>
	<b>For Series B</b> Analog Output	OutFreq 0...10	The default analog output is 0...10V. To convert a current value, change the Analog Output jumper to 0...20 mA. Program with t088 [Analog Out Sel]. Maximum analog value can be scaled with t089 [Analog Out High]. Maximum Load: 4...20 mA = 525 Ω (10.5V) 0...10V = 1 kΩ (10 mA)	<a href="#">t088</a> , <a href="#">t089</a>
C1	C1	-	This terminal is tied to the RJ-45 port shield. Tie this terminal to a clean ground in order to improve noise immunity when using external communication peripherals.	-
C2	C2	-	This is the signal common for the communication signals.	-

(1) Setting is specific to PowerFlex 525 drives only.

(2) Only one analog frequency source may be connected at a time. If more than one reference is connected at the same time, an undetermined frequency reference will result.



# PowerFlex 525 Control I/O Terminal Block

PowerFlex 525 Control I/O Wiring Block Diagram

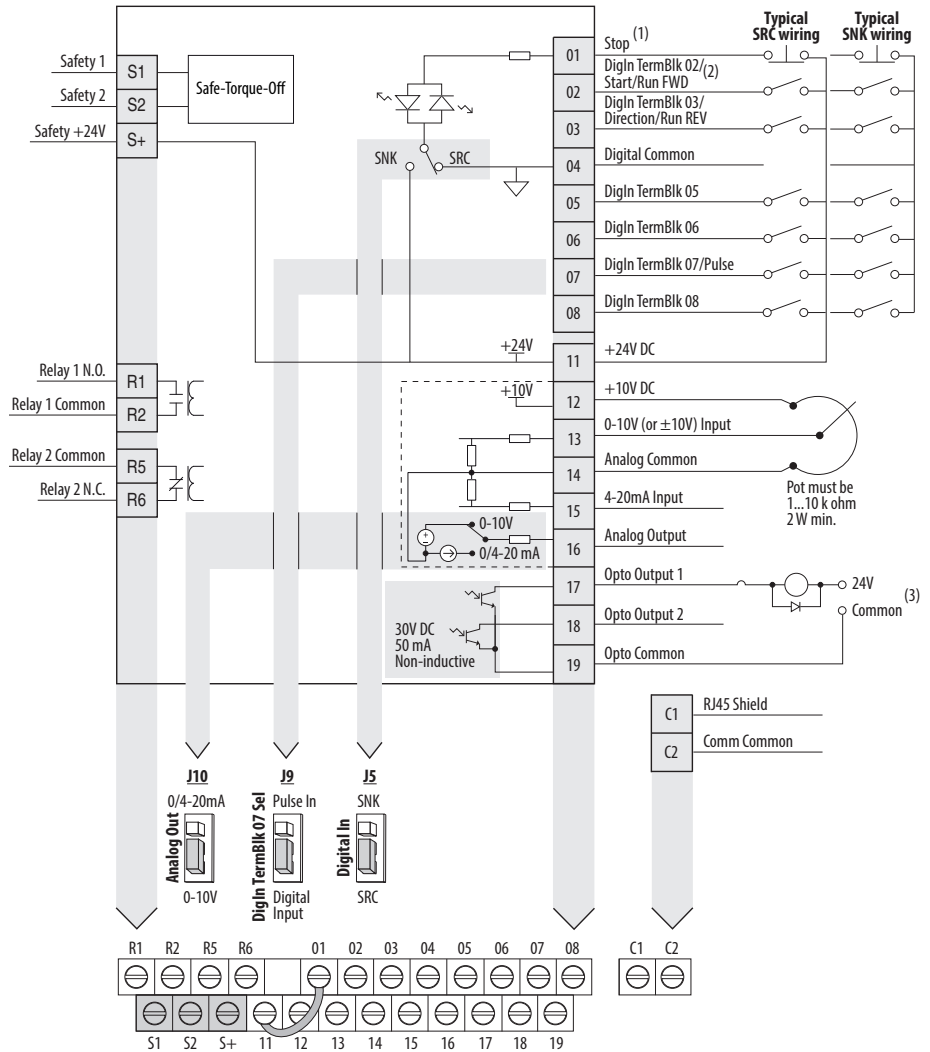

## Control I/O Wiring Block Diagram Notes



(1) See [Digital Input Selection for Start Source on page 49](#) for more information on configuring the digital inputs.

**IMPORTANT** I/O Terminal 01 is always a stop input. The stopping mode is determined by the drive setting. See the tables below for more information.

Start Method	Stop Method	Normal Stop
<b>P046, P048, P050 [Start Source x]</b>	<b>I/O Terminal 01 Stop</b>	Per P045 [Stop Mode]
1 "Keypad"	Coast	
2 "DigIn TrmBlk"	See <a href="#">t062, t063 [DigIn TermBlk xx]</a> below	
3 "Serial/DSI"	Coast	
4 "Network Opt"	Coast	
5 "EtherNet/IP"	Coast	

Start Method	Stop Method	
t062, t063 [DigIn TermBlk xx]	I/O Terminal 01 Stop	Normal Stop
48 "2-Wire FWD"	t064 [2-Wire Mode] is set to: • 0, 1, or 2 = Coast • 3 = per P045 [Stop Mode]	Per P045 [Stop Mode]
49 "3-Wire Start"	Per P045 [Stop Mode]	
50 "2-Wire REV"	t064 [2-Wire Mode] is set to: • 0, 1, or 2 = Coast • 3 = per P045 [Stop Mode]	
51 "3-Wire Dir"	Per P045 [Stop Mode]	

**IMPORTANT** The drive is shipped with a jumper installed between I/O Terminals 01 and 11. Remove this jumper when using I/O Terminal 01 as a stop or enable input.

- (2) Two wire control shown. For three wire control use a momentary input  on I/O Terminal 02 to command a start. Use a maintained input  for I/O Terminal 03 to change direction.
- (3) When using an opto output with an inductive load such as a relay, install a recovery diode parallel to the relay as shown, to prevent damage to the output.

### Control I/O Terminal Designations

No.	Signal	Default	Description	Parameter
R1	Relay 1 N.O.	Fault	Normally open contact for output relay.	t076
R2	Relay 1 Common	Fault	Common for output relay.	
R5	Relay 2 Common	Motor Running	Common for output relay.	t081
R6	Relay 2 N.C.	Motor Running	Normally closed contact for output relay.	
01	Stop	Coast	Three wire stop. However, it functions as a stop under all input modes and cannot be disabled.	P045 <sup>(1)</sup>
02	DigIn TermBlk 02/ Start/Run FWD	Run FWD	Used to initiate motion and also can be used as a programmable digital input. It can be programmed with t062 [DigIn TermBlk 02] as three wire (Start/Dir with Stop) or two wire (Run FWD/Run REV) control. Current consumption is 6 mA.	P045, P046, P048, P050, A544, t062
03	DigIn TermBlk 03/ Dir/Run REV	Run REV	Used to initiate motion and also can be used as a programmable digital input. It can be programmed with t063 [DigIn TermBlk 03] as three wire (Start/Dir with Stop) or two wire (Run FWD/Run REV) control. Current consumption is 6 mA.	t063
04	Digital Common	-	Return for digital I/O. Electrically isolated (along with the digital I/O) from the rest of the drive.	-
05	DigIn TermBlk 05	Preset Freq	Program with t065 [DigIn TermBlk 05]. Current consumption is 6 mA.	t065
06	DigIn TermBlk 06	Preset Freq	Program with t066 [DigIn TermBlk 06]. Current consumption is 6 mA.	t066
07	DigIn TermBlk 07/ Pulse In	Start Source 2 + Speed Reference2	Program with t067 [DigIn TermBlk 07]. Also functions as a Pulse Train input for reference or speed feedback. Requires an NPN pulse input. Maximum frequency is 100 kHz. Current consumption is 6 mA.	t067
08	DigIn TermBlk 08	Jog Forward	Program with t068 [DigIn TermBlk 08]. Current consumption is 6 mA.	t068
C1	C1	-	This terminal is tied to the RJ-45 port shield. Tie this terminal to a clean ground in order to improve noise immunity when using external communication peripherals.	-
C2	C2	-	This is the signal common for the communication signals.	-
S1	Safety 1	-	Safety input 1. Current consumption is 6 mA.	-
S2	Safety 2	-	Safety input 2. Current consumption is 6 mA.	-
S+	Safety +24V	-	+24V supply for safety circuit. Internally tied to the +24V DC source (Pin 11).	-
11	+24V DC	-	Referenced to Digital Common. Drive supplied power for digital inputs. Maximum output current is 100 mA.	-

## Control I/O Terminal Designations (Continued)

No.	Signal	Default	Description	Parameter
12	+10V DC	-	Referenced to Analog Common. Drive supplied power for 0...10V external potentiometer. Maximum output current is 15 mA.	<a href="#">P047</a> , <a href="#">P049</a>
13	±10V In	Not Active	For external 0...10V (unipolar) or ±10V (bipolar) input supply or potentiometer wiper. Input impedance: Voltage source = 100 kΩ Allowable potentiometer resistance range = 1...10 kΩ	<a href="#">P047</a> , <a href="#">P049</a> , <a href="#">t062</a> , <a href="#">t063</a> , <a href="#">t065</a> , <a href="#">t066</a> , <a href="#">t093</a> , <a href="#">A459</a> , <a href="#">A471</a>
14	Analog Common	-	Return for the analog I/O. Electrically isolated (along with the analog I/O) from the rest of the drive.	-
15	4...20mA In	Not Active	For external 4...20 mA input supply. Input impedance = 250 Ω	<a href="#">P047</a> , <a href="#">P049</a> , <a href="#">t062</a> , <a href="#">t063</a> , <a href="#">t065</a> , <a href="#">t066</a> , <a href="#">A459</a> , <a href="#">A471</a>
16	Analog Output	OutFreq 0...10	The default analog output is 0...10V. To convert a current value, change the Analog Output jumper to 0...20 mA. Program with <a href="#">t088</a> [Analog Out Sel]. Maximum analog value can be scaled with <a href="#">t089</a> [Analog Out High]. Maximum Load: 4...20 mA = 525 Ω (10.5V) 0...10V = 1 kΩ (10 mA)	<a href="#">t088</a> , <a href="#">t089</a>
17	Opto Output 1	Motor Running	Program with <a href="#">t069</a> [Opto Out1 Sel]. Each Opto-Output is rated 30V DC 50 mA (Non-inductive).	<a href="#">t069</a> , <a href="#">t070</a> , <a href="#">t075</a>
18	Opto Output 2	At Frequency	Program with <a href="#">t072</a> [Opto Out1 Sel]. Each Opto-Output is rated 30V DC 50 mA (Non-inductive).	<a href="#">t072</a> , <a href="#">t073</a> , <a href="#">t075</a>
19	Opto Common	-	The emitters of the Optocoupler Outputs (1 and 2) are tied together at Optocoupler Common. Electrically isolated from the rest of the drive.	-

(1) Setting is specific to PowerFlex 525 drives only.

## I/O Wiring Examples

I/O	Connection Example
	<a href="#">P047</a> [Speed Reference1] = 5 "0-10V Input"
<p><b>Potentiometer</b> 1...10 kΩ Pot. Recommended (2 W minimum)</p>	

## I/O Wiring Examples (Continued)

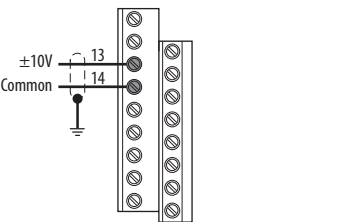
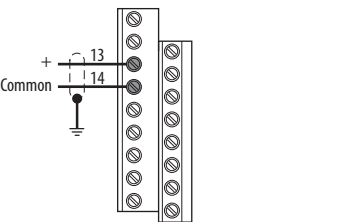
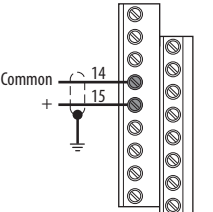
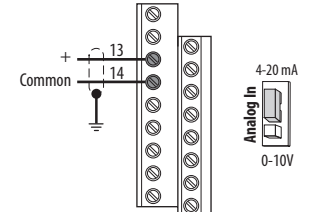
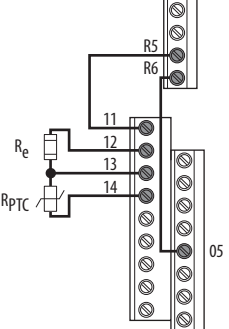
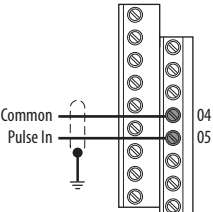
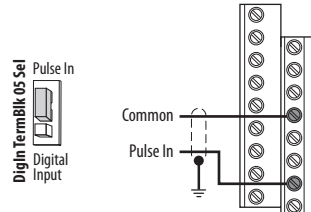
I/O (Continued)	Connection Example	
<p><b>Analog Input</b>                      0...10V, 100k Ω impedance                      4...20 mA, 250 Ω impedance</p>	<p>Bipolar  <a href="#">P047</a> [Speed Reference1] = 5 "0-10V Input"                      and <a href="#">t093</a> [10V Bipolar Enbl] = 1 "Bi-Polar In"</p>	<p>Unipolar (Voltage)  <a href="#">P047</a> [Speed Reference1] = 5 "0-10V Input"</p>
		
	<p>Unipolar (Current)  <a href="#">P047</a> [Speed Reference1] = 6 "4-20mA Input"</p>	
<p><b>Analog Input, PTC</b>                      For Drive Fault</p>	<div style="display: flex; justify-content: space-around;"> <div data-bbox="784 594 1003 867"> <p>PowerFlex 523 Series A, PowerFlex 525</p>  </div> <div data-bbox="1011 594 1328 867"> <p>PowerFlex 523 Series B</p>  </div> </div>	
	<p>Wire the PTC and External Resistor (typically matched to the PTC Hot Resistance) to I/O Terminals 12, 13, 14.                      Wire R2/R3 Relay Output (SRC) to I/O Terminals 5 &amp; 11.  <a href="#">t065</a> [DigIn TermBlk 05] = 12 "Aux Fault"  <a href="#">t081</a> [Relay Out 2 Sel] = 10 "Above Anlg V"  <a href="#">t082</a> [Relay Out 2 Level] = % Voltage Trip</p>	
<p>Pulse Train Input                      PowerFlex 523  <a href="#">t065</a> [DigIn TermBlk 05] = 52                      PowerFlex 525  <a href="#">t067</a> [DigIn TermBlk 07] = 52</p> <p>Use <a href="#">P047</a>, <a href="#">P049</a> and <a href="#">P051</a> [Speed Referencex] to select pulse input. Jumper for DigIn TermBlk 05 or 07 Sel must be moved to Pulse In.</p>	 <div style="border: 1px solid black; padding: 5px; margin: 10px auto; width: fit-content;"> <math display="block">\%V_{Trip} = \frac{R_{PTC} (hot)}{R_{PTC} (hot) + R_e} \times 100</math> </div>	
	<div style="display: flex; justify-content: space-around;"> <div data-bbox="784 1392 1003 1644"> <p>PowerFlex 523</p>  </div> <div data-bbox="1011 1392 1328 1644"> <p>PowerFlex 525</p>  </div> </div> <p>The device connected to terminal 5 (for PowerFlex 523) or terminal 7 (for PowerFlex 525) needs to be NPN or push-pull output driver.</p>	

## I/O Wiring Examples (Continued)

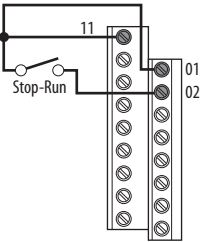
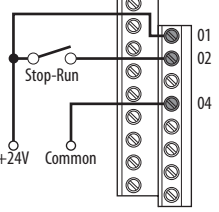
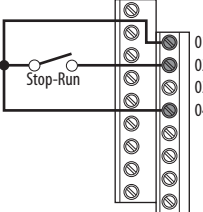
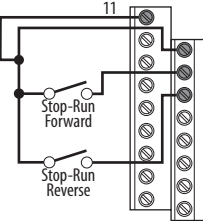
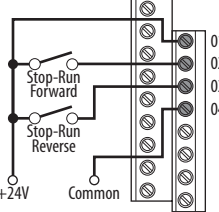
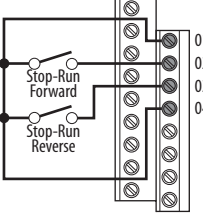
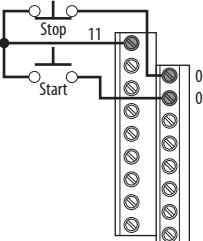
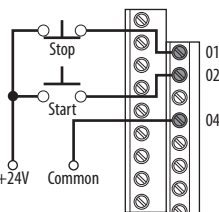
I/O (Continued)	Connection Example	
<p><b>2 Wire SRC Control - Non-Reversing</b>                      P046 [Start Source 1] = 2 and t062 [DigIn TermBlk 02] = 48                      Input must be active for the drive to run. When input is opened, the drive will stop as specified by P045 [Stop Mode].                      If desired, a User Supplied 24V DC power source can be used. See the "External Supply (SRC)" example.</p>	<p>Internal Supply (SRC)</p> 	<p>External Supply (SRC)</p>  <p>Each digital input draws 6 mA.</p>
<p><b>2 Wire SNK Control - Non-Reversing</b></p>	<p>Internal Supply (SNK)</p> 	
<p><b>2 Wire SRC Control - Run FWD/Run REV</b>                      P046 [Start Source 1] = 2, t062 [DigIn TermBlk 02] = 48 and t063 [DigIn TermBlk 03] = 50                      Input must be active for the drive to run. When input is opened, the drive will stop as specified by P045 [Stop Mode].                      If both Run Forward and Run Reverse inputs are closed at the same time, an undetermined state could occur.</p>	<p>Internal Supply (SRC)</p> 	<p>External Supply (SRC)</p>  <p>Each digital input draws 6 mA.</p>
<p><b>2 Wire SNK Control - Run FWD/Run REV</b></p>	<p>Internal Supply (SNK)</p> 	
<p><b>3 Wire SRC Control - Non-Reversing</b>                      P046 [Start Source 1] = 2, t062 [DigIn TermBlk 02] = 49 and t063 [DigIn TermBlk 03] = 51                      A momentary input will start the drive. A stop input to I/O Terminal 01 will stop the drive as specified by P045 [Stop Mode].</p>	<p>Internal Supply (SRC)</p> 	<p>External Supply (SRC)</p>  <p>Each digital input draws 6 mA.</p>

## I/O Wiring Examples (Continued)

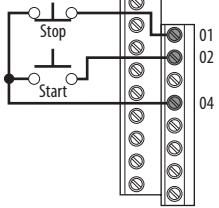
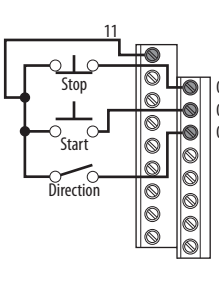
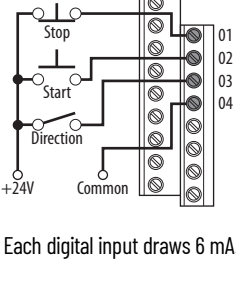
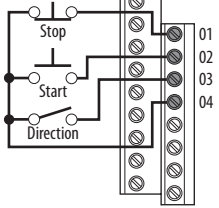
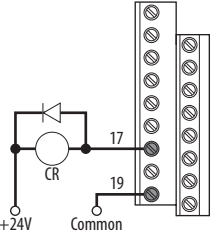
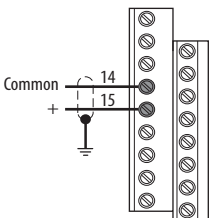
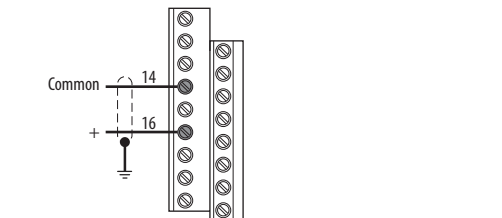
I/O (Continued)	Connection Example	
<p><b>3 Wire SNK Control - Non-Reversing</b></p>	<p>Internal Supply (SNK)</p> 	
<p><b>3 Wire SRC Control - Reversing</b>                      P046 [Start Source 1] = 2, t062 [DigIn TermBlk 02] = 49 and t063 [DigIn TermBlk 03] = 51                      A momentary input will start the drive. A stop input to I/O Terminal 01 will stop the drive as specified by P045 [Stop Mode]. I/O Terminal 03 determines direction.</p>	<p>Internal Supply (SRC)</p> 	<p>External Supply (SRC)</p>  <p>Each digital input draws 6 mA.</p>
<p><b>3 Wire SNK Control - Reversing</b></p>	<p>Internal Supply (SNK)</p> 	
<p><b>Opto Output (1 &amp; 2)<sup>(1)</sup></b>                      t069 [Opto Out1 Sel] determines Opto-Output 1 (I/O Terminal 17) operation.                      t072 [Opto Out2 Sel] determines Opto-Output 2 (I/O Terminal 18) operation.                      When using Opto-Output with an inductive load such as a relay, install a recovery diode parallel to the relay as shown, to prevent damage to the output.</p>	<p>Opto-Output 1</p>  <p>Each Opto-Output is rated 30V DC 50 mA (Non-inductive).</p>	
<p><b>Analog Output<sup>(2)</sup></b>                      t088 [Analog Out Sel] determines analog output type and drive conditions.                      0...10V, 1k Ω min                      0...20 mA/4...20 mA, 525 Ω                      0...20 mA/4...20 mA, 525 Ω max</p>	<p>t088 [Analog Out Sel] = 0...23                      The Analog Output Select jumper must be set to match the analog output signal mode set in t088 [Analog Out Sel].</p> <div style="display: flex; justify-content: space-around;"> <div data-bbox="781 1564 998 1822"> <p>PowerFlex 523 Series B</p>  </div> <div data-bbox="1003 1564 1502 1822"> <p>PowerFlex 525</p>  </div> </div>	

(1) Feature is specific to PowerFlex 525 drives only.  
 (2) Feature is not applicable to PowerFlex 523 series A drives.

## Typical Multiple Drive Connection Examples

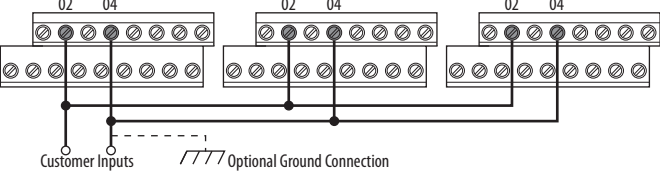
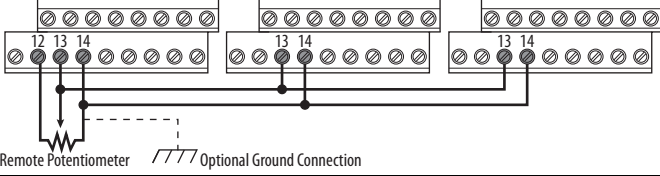
Input/Output	Connection Example
<p><b>Multiple Digital Input Connections</b> Customer Inputs can be wired per External Supply (SRC).</p>	 <p>When connecting a single input such as Run, Stop, Reverse or Preset Speeds to multiple drives, it is important to connect I/O Terminal 04 common together for all drives. If they are to be tied into another common (such as earth ground or separate apparatus ground) only one point of the daisy chain of I/O Terminal 04 should be connected.</p> <p><b>ATTENTION:</b> I/O Common terminals should <b>not</b> be tied together when using SNK (Internal Supply) mode. In SNK mode, if power is removed from one drive, inadvertent operation of other drives that share the same I/O Common connection may occur.</p>
<p><b>Multiple Analog Connections</b></p>	 <p>When connecting a single potentiometer to multiple drives it is important to connect I/O Terminal 14 common together for all drives. I/O Terminal 14 common and I/O Terminal 13 (potentiometer wiper) should be daisy chained to each drive. All drives must be powered up for the analog signal to be read correctly.</p>

# Start and Speed Reference Control

## Start Source and Speed Reference Selection

The start and drive speed command can be obtained from a number of different sources. By default, start source is determined by [PO46](#) [Start Source 1] and drive speed source is determined by [PO47](#) [Speed Reference1]. However, various inputs can override this selection, See below for the override priority.

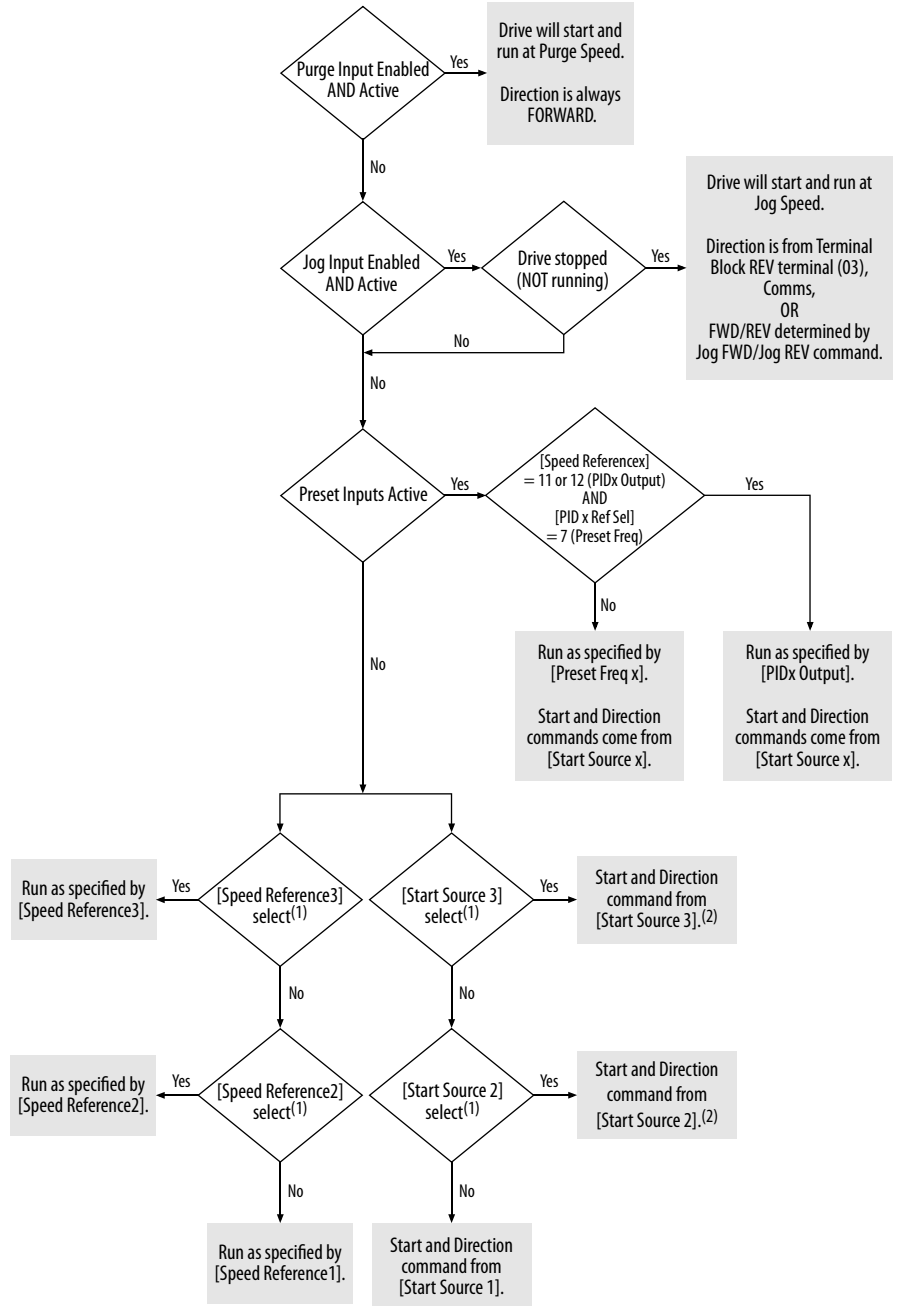

(1) [Start Source 2/3] and [Speed Reference2/3] can be selected by the control terminal block or communication commands.  
 (2) See [Digital Input Selection for Start Source on page 49](#) for information on selecting the correct digital input.



### Digital Input Selection for Start Source

If [PO46](#), [PO48](#) or [PO50](#) [Start Source x] has been set to 2, “DigIn TermBlk”, then [tO62](#) and [tO63](#) [DigIn TermBlk xx] must be configured for 2-Wire or 3-Wire control for the drive to function properly.

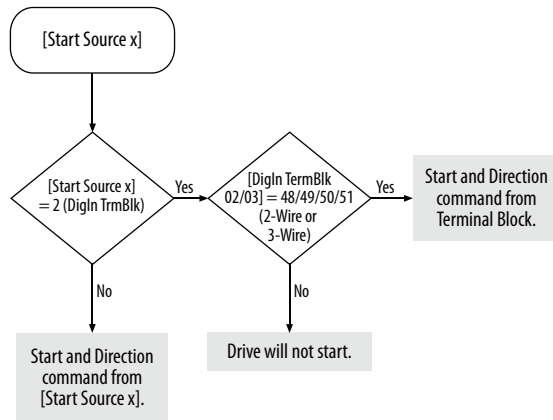

### Accel/Decel Selection

The Accel/Decel rate can be obtained by a variety of methods. The default rate is determined by [PO41](#) [Accel Time 1] and [PO42](#) [Decel Time 1].

Alternative Accel/Decel rates can be made through digital inputs, communications and/or parameters. See below for the override priority.

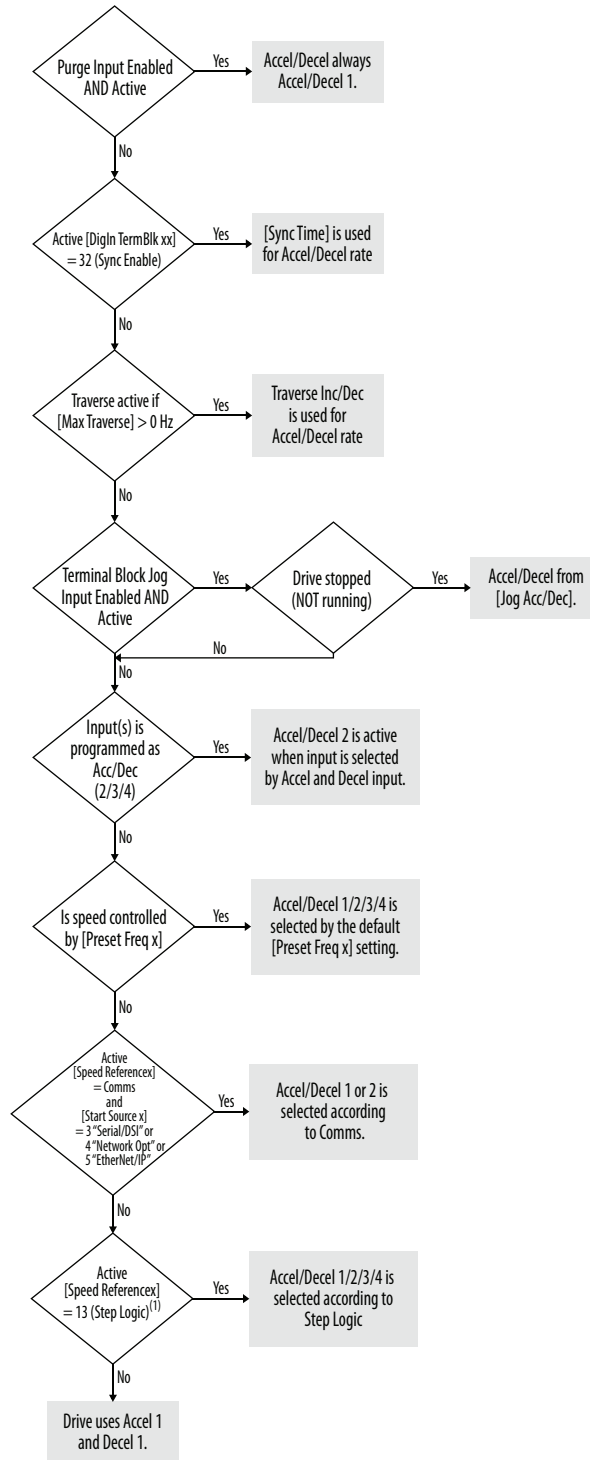

(1) Setting is specific to PowerFlex 525 drives only.

## CE Conformity

Compliance with the Low Voltage Directive and Electromagnetic Compatibility Directive has been demonstrated using harmonized European Norm (EN) standards published in the Official Journal of the European Communities. PowerFlex 520-series drives comply with the EN standards listed below when installed according to the installation instructions in this manual.

CE Declarations of Conformity are available online at:

[rok.auto/certifications](http://rok.auto/certifications).

### Low Voltage Directive (2014/35/EU)

- EN 61800-5-1 Adjustable speed electrical power drive systems – Part 5-1: Safety requirements – Electrical, thermal, and energy.

#### Pollution Degree Ratings According to EN 61800-5-1

Pollution Degree	Description
1	No pollution or only dry, non-conductive pollution occurs. The pollution has no influence.
2	Normally, only non-conductive pollution occurs. Occasionally, however, a temporary conductivity caused by condensation is to be expected, when the drive is out of operation.

### EMC Directive (2014/30/EU)

- EN 61800-3 – Adjustable speed electrical power drive systems - Part 3: EMC requirements and specific test methods

### Machinery Directive (2006/42/EC)

- EN ISO 13849-1 – Safety of machinery – Safety related parts of control systems -Part 1: General principles for design
- EN 62061 – Safety of machinery – Functional safety of safety-related electrical, electronic and programmable electronic control systems
- EN 60204-1 – Safety of machinery – Electrical equipment of machines - Part 1: General requirements
- EN 61800-5-2 – Adjustable speed electrical power drive systems - Part 5-2: Safety requirement – Functional

See [Appendix G](#) for installation consideration related to Machinery Directive.

### ATEX Directive (2014/34/EU)

- EN 50495 – Safety devices required for the safe functioning of equipment with respect to explosion risks.

## General Considerations

- For CE compliance, drives must satisfy installation requirements related to both EN 61800-5-1 and EN 61800-3 provided in this document.
- PowerFlex 520-series drives must be installed in a pollution degree 1 or 2 environment to be compliant with the CE LV Directive. See [Pollution Degree Ratings According to EN 61800-5-1 on page 51](#) for descriptions of each pollution degree rating.
- PowerFlex 520-series drives comply with the EMC requirements of EN 61800-3 when installed according to good EMC practices and the instructions provided in this document. However, many factors can influence the EMC compliance of an entire machine or installation, and compliance of the drive itself does not ensure compliance of all applications.
- PowerFlex 520-series drives are not intended to be used on public low-voltage networks which supply domestic premises. Without additional mitigation, radio frequency interference is expected if used on such a network. The installer is responsible for taking measures such as a supplementary line filter and enclosure (see [Connections and Grounding on page 54](#)) to prevent interference, in addition to the installation requirements of this document.



**ATTENTION:** NEMA/UL Open Type drives must either be installed in a supplementary enclosure or equipped with a “NEMA Type 1 Kit” to be CE compliant with respect to protection against electrical shock.

- PowerFlex 520-series drives generate harmonic current emissions on the AC supply system. When operated on a public low-voltage network it is the responsibility of the installer or user to ensure that applicable requirements of the distribution network operator have been met. Consultation with the network operator and Rockwell Automation may be necessary.
- If the optional NEMA 1 kit is not installed, the drive must be installed in an enclosure with side openings less than 12.5 mm (0.5 in.) and top openings less than 1.0 mm (0.04 in.) to maintain compliance with the LV Directive.
- The motor cable should be kept as short as possible in order to avoid electromagnetic emission as well as capacitive currents.
- Use of line filters in ungrounded systems is not recommended.
- In CE installations, input power must be a Balanced Wye with Center Ground configuration for EMC compliance.

### *Installation Requirements Related to EN 61800-5-1 and the Low Voltage Directive*

- 600V PowerFlex 520-series drives can only be used on a “center grounded” supply system for altitudes up to and including 2000 m (6562 ft).
- When used at altitudes above 2000 m (6562 ft) up to a maximum of 4800 m (15,748 ft), PowerFlex 520-series drives of voltage classes up to 480V may not be powered from a “corner-earthed” supply system in order to maintain compliance with the CE LV Directive. See [Derating Guidelines for High Altitude on page 18](#).

- PowerFlex 520-series drives produce leakage current in the protective earthing conductor which exceeds 3.5 mA AC and/or 10 mA DC. The minimum size of the protective earthing (grounding) conductor used in the application must comply with local safety regulations for high protective earthing conductor current equipment.



**ATTENTION:** PowerFlex 520-series drives produce DC current in the protective earthing conductor which may reduce the ability of RCD's (residual current-operated protective devices) or RCM's (residual current-operated monitoring devices) of type A or AC to provide protection for other equipment in the installation. Where an RCD or RCM is used for protection in case of direct or indirect contact, only an RCD or RCM of Type B is allowed on the supply side of this product.

#### *Installation Requirements Related to EN 61800-3 and the EMC Directive*

- The drive must be earthed (grounded) as described in [Connections and Grounding on page 54](#). See [General Grounding Requirements on page 20](#) for additional grounding recommendations.
- Output power wiring to the motor must employ cables with a braided shield providing 75% or greater coverage, or the cables must be housed in metal conduit, or equivalent shield must be provided. Continuous shielding must be provided from the drive enclosure to the motor enclosure. Both ends of the motor cable shield (or conduit) must terminate with a low-impedance connection to earth.  
Drive Frames A...E: At the drive end of the motor, either
  - a. The cable shield must be clamped to a properly installed “EMC Plate” for the drive. Kit number 25-EMC1-Fx.  
or
  - b. The cable shield or conduit must terminate in a shielded connector installed in an EMC plate, conduit box, or similar.
- At the motor end, the motor cable shield or conduit must terminate in a shielded connector which must be properly installed in an earthed motor wiring box attached to the motor. The motor wiring box cover must be installed and earthed.
- All control (I/O) and signal wiring to the drive must use cable with a braided shield providing 75% or greater coverage, or the cables must be housed in metal conduit, or equivalent shielding must be provided. When shielded cable is used, the cable shield should be terminated with a low impedance connection to earth at only one end of the cable, preferably the end where the receiver is located. When the cable shield is terminated at the drive end, it may be terminated either by using a shielded connector in conjunction with a conduit plate or conduit box, or the shield may be clamped to an “EMC plate.”
- Motor cabling must be separated from control and signal wiring wherever possible.
- Maximum motor cable length must not exceed the maximum length indicated in [PowerFlex 520-Series RF Emission Compliance and Installation Requirements on page 54](#) for compliance with radio frequency emission limits for the specific standard and installation environment.

Connections and Grounding

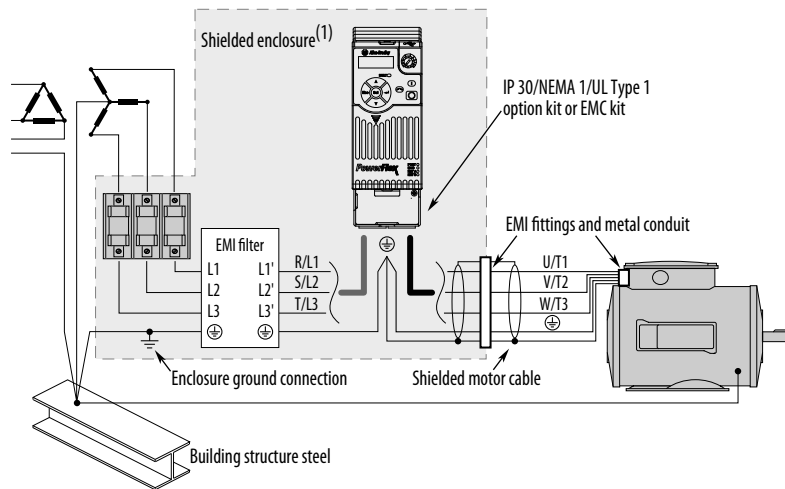

(1) Some installations require a shielded enclosure. Keep wire length as short as possible between the enclosure entry point and the EMI filter.

PowerFlex 520-Series RF Emission Compliance and Installation Requirements

Filter Type	Standard/Limits		
	EN61800-3 Category C1 EN61000-6-3 CISPR11 Group 1 Class B	EN61800-3 Category C2 EN61000-6-4 CISPR11 Group 1 Class A (Input power ≤ 20 kVA)	EN61800-3 Category C3 (I ≤ 100 A) CISPR11 Group 1 Class A (Input power > 20 kVA)
Internal	-	10 m (33 ft)	20 m (66 ft)
External <sup>(1)</sup>	30 m (16 ft)	100 m (328 ft)	100 m (328 ft)

(1) See [EMC Line Filters on page 175](#) and [page 195](#) for more information on optional external filters.

Additional Installation Requirements

This section provides information on additional requirements for category C1 and C2 installation, such as enclosures and EMC cores.

**IMPORTANT** EMC cores are included with:

- drives that have an internal EMC filter (25x-xxxxN114)
- external EMC filter accessory kit (25-RFxxx)

**IMPORTANT** An enclosure, shielded input cable, and EMC cores are not required to meet category C3 requirements.

Additional Installation Requirements

Frame Size	Category C1			Category C2		
	Enclosure	Conduit or Shielded Cable @ Input	EMC Cores Required (Included with product)	Enclosure	Conduit or Shielded Cable @ Input	EMC Cores Required (Included with product)
<b>100...120V AC (-15%, +10%) - 1-Phase Input with External EMC Filter, 0...120V 1-Phase Output</b>						
A	No	No	No	No	No	No
B	No	No	No	No	No	No
<b>200...240V AC (-15%, +10%) - 1-Phase Input with External EMC Filter, 0...230V 3-Phase Output</b>						
A	Yes	Yes	No	No	No	Input/Output
B	Yes	Yes	Output only	No	No	Input/Output
<b>200...240V AC (-15%, +10%) - 1-Phase Input with Internal EMC Filter, 0...230V 3-Phase Output<sup>(1)</sup></b>						
A	*	*	*	Yes	No	No
B	*	*	*	Yes	No	No

**Additional Installation Requirements (Continued)**

Frame Size	Category C1			Category C2		
	Enclosure	Conduit or Shielded Cable @ Input	EMC Cores Required (Included with product)	Enclosure	Conduit or Shielded Cable @ Input	EMC Cores Required (Included with product)
<b>200...240V AC (-15%, +10%) - 3-Phase Input with External EMC Filter, 0...230V 3-Phase Output</b>						
A	Yes	Yes	Output only	No	No	Input/Output
B	Yes	Yes	Output only	No	No	Input/Output
C	Yes	Yes	Output only	No	No	Input/Output
D	Yes	Yes	No	No	No	Input only
E	Yes	Yes	Output only	No	No	Input only
<b>380...480V AC (-15%, +10%) - 3-Phase Input with External EMC Filter, 0...460V 3-Phase Output</b>						
A	Yes	Yes	No	No	No	Input/Output
B	Yes	Yes	No	No	No	Input/Output
C	Yes	Yes	No	No	No	Input only
D	Yes	Yes	Output only	No	No	Input/Output
E	Yes	Yes	No	Yes	No	Input/Output
<b>380...480V AC (-15%, +10%) - 3-Phase Input with Internal EMC Filter, 0...460V 3-Phase Output(1)</b>						
A	*	*	*	No	No	Input/Output
B	*	*	*	No	No	Input/Output
C	*	*	*	No	No	Input/Output
D	*	*	*	No	No	Input/Output
E	*	*	*	No	No	Input/Output
<b>525...600V AC (-15%, +10%) - 3-Phase Input with External EMC Filter, 0...575V 3-Phase Output</b>						
A	Yes	Yes	No	No	No	Input/Output
B	Yes	Yes	No	No	No	Input/Output
C	Yes	Yes	No	No	No	Input/Output
D	Yes	Yes	No	No	No	Input/Output
E	Yes	Yes	No	Yes	No	No

(1) An (\*) indicates that EMC requirements are not met.

**Recommended Placement of EMC Cores**

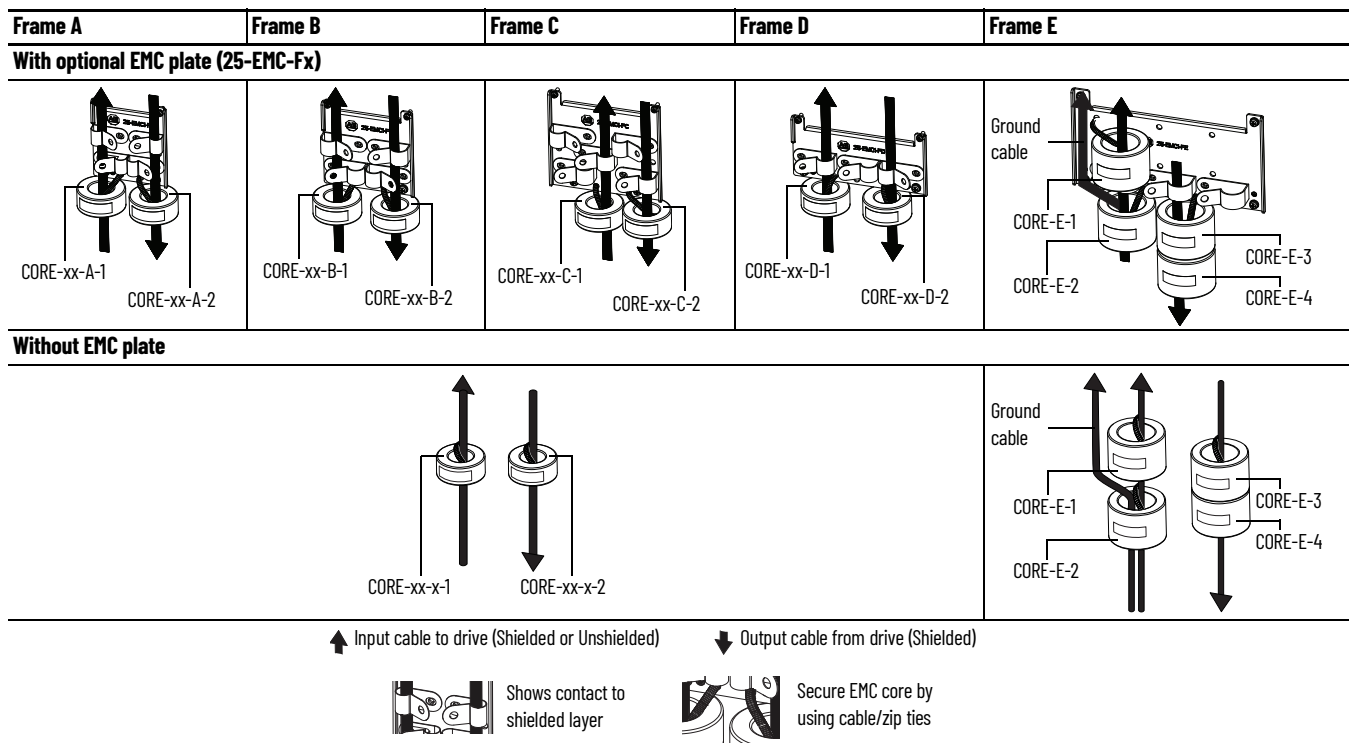

- IMPORTANT** The ground cable/shield for both input and output must pass through the EMC core(s), except for the following:
- Frame E drives with internal filters where the grounded input cable must not pass through EMC CORE-E-1.
  - 600V drives with external filters where the grounded output cable must not pass through the EMC core(s).
- 

### Recommended Placement of EMC Cores Relative to External Filter

---

All Frame sizes

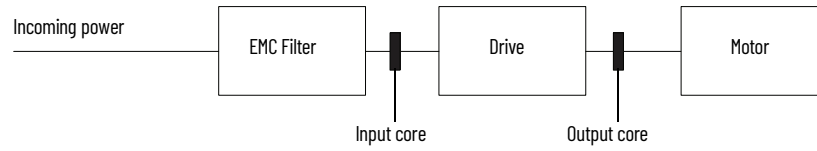



## Start Up

This chapter describes how to start up the PowerFlex 520-series drive. To simplify drive setup, the most commonly programmed parameters are organized in a single Basic Program Group.

Topic	Page
Prepare for Drive Startup	57
Display and Control Keys	59
Viewing and Editing Parameters	61
Drive Programming Tools	62
Smart Startup with Basic Program Group Parameters	63
LCD Display with QuickView Technology	65
Using the USB Port	65

**IMPORTANT** Read the [General Precautions on page 13](#) section before proceeding.



**ATTENTION:** Power must be applied to the drive to perform the following start-up procedures. Some of the voltages present are at incoming line potential. To avoid electric shock hazard or damage to equipment, only qualified service personnel should perform the following procedure. Thoroughly read and understand the procedure before beginning. If an event does not occur while performing this procedure, **Do Not Proceed.** **Remove All Power** including user supplied control voltages. User supplied voltages may exist even when main AC power is not applied to the drive. Correct the malfunction before continuing.

## Prepare for Drive Startup

### Drive Startup Task List

1. Disconnect and lock out power to the machine.
2. Verify that AC line power at the disconnect device is within the rated value of the drive.
3. If replacing a drive, verify the current drive's catalog number. Verify all options installed on the drive.
4. Verify that any digital control power is 24 volts.
5. Inspect grounding, wiring, connections, and environmental compatibility.
6. Verify that the Sink (SNK)/Source (SRC) jumper is set to match your control wiring scheme. See the [PowerFlex 523 Control I/O Terminal Block on page 37](#) and [PowerFlex 525 Control I/O Terminal Block on page 41](#) for location.

**IMPORTANT** The default control scheme is Source (SRC). The Stop terminal is jumpered to allow starting from the keypad or comms. If the control scheme is changed to Sink (SNK), the jumper must be removed from I/O Terminals 01 and 11 and installed between I/O Terminals 01 and 04.

7. Wire I/O as required for the application.

8. Wire the power input and output terminals.
9. Confirm that all inputs are connected to the correct terminals and are secure.
10. Collect and record motor nameplate and encoder or feedback device information. Verify motor connections.
  - Is the motor uncoupled?
  - What direction will the motor need to turn for the application?
11. Verify the input voltage to the drive. Verify if the drive is on a grounded system. Ensure the MOV jumpers are in the correct position. See [AC Supply Source Considerations on page 19](#) for more information.
12. Apply power and reset the drive and communication adapters to factory default settings. To reset the drive, see parameter [P053](#) [Reset to Defaults]. To reset the communication adapters, see the user manual of the adapter for more information.
13. Configure the basic program parameters related to the motor. See [Smart Startup with Basic Program Group Parameters on page 63](#).
14. Complete the autotune procedure for the drive. See parameter [P040](#) [Autotune] for more information.
15. If you are replacing a drive and have a backup of the parameter settings obtained using the USB utility application, use the USB utility application to apply the backup to the new drive. See [Using the USB Port on page 65](#) for more information.

Otherwise, set the necessary parameters for your application using the LCD keypad interface, Connected Components Workbench™ software, or RSLogix™, or Studio 5000 Logix Designer application if using an Add-on Profile through EtherNet/IP.

- Configure the communication parameters needed for the application (node number, IP address, Datalinks in and out, communication rate, speed reference, start source, and so on). Record these settings for your reference.
  - Configure the other drive parameters needed for the drive analog and digital I/O to work correctly. Verify the operation. Record these settings for your reference.
16. Verify the drive and motor perform as specified.
    - Verify that the Stop input is present or the drive will not start.

---

**IMPORTANT** If I/O Terminal 01 is used as a stop input, the jumper between I/O Terminals 01 and 11 must be removed.

---

- Verify the drive is receiving the speed reference from the correct place and that the reference is scaled correctly.
  - Verify the drive is receiving start and stop commands correctly.
  - Verify input currents are balanced.
  - Verify motor currents are balanced.
17. Save a backup of the drive settings using the USB utility application. See [Using the USB Port on page 65](#) for more information.

## Start, Stop, Direction, and Speed Control

Factory default parameter values allow the drive to be controlled from the keypad. No programming is required to start, stop, change direction and control speed directly from the keypad.

---

**IMPORTANT** To disable reverse operation, see A544 [Reverse Disable].

---

If a fault appears on power-up, see [Fault Descriptions on page 159](#) for an explanation of the fault code.

## Variable Torque Fan/Pump Applications

For improved motor and drive performance, tune the motor in SVC mode using parameter P040 [Autotune]. If V/Hz mode is selected, use parameter A530 [Boost Select] to adjust the boost.

## Display and Control Keys

PowerFlex 523

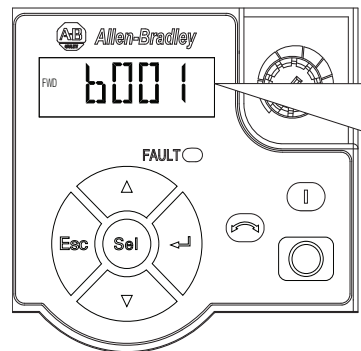

PowerFlex 525

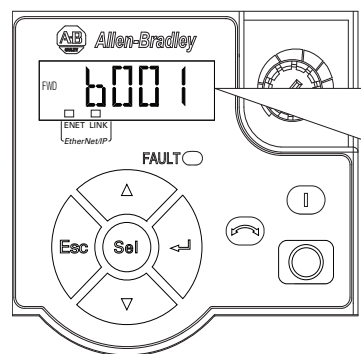









Menu	Parameter Group and Description
<b>b</b>	<b>Basic Display</b> Commonly viewed drive operating conditions.
<b>P</b>	Basic Program Commonly used programmable functions.
<b>t</b>	Terminal Blocks Programmable terminal functions.
<b>C</b>	Communications Programmable communication functions.
<b>L</b>	Logic (PowerFlex 525 only) Programmable logic functions.
<b>d</b>	Advanced Display Advanced drive operating conditions.
<b>A</b>	<b>Advanced Program</b> Remaining programmable functions.
<b>N</b>	Network Network functions that are shown only when a comm card is used.
<b>M</b>	Modified Functions from the other groups with values changed from default.
<b>f</b>	<b>Fault and Diagnostic</b> Consists of list of codes for specific fault conditions.
<b>G</b>	AppView and CustomView Functions from the other groups organized for specific applications.

## Control and Navigation Keys

Display	Display State	Description
ENET (PowerFlex 525 only)	Off	Adapter is not connected to the network.
	Steady	Adapter is connected to the network and drive is controlled through Ethernet.
	Flashing	Adapter is connected to the network but drive is not controlled through Ethernet.
LINK (PowerFlex 525 only)	Off	Adapter is not connected to the network.
	Steady	Adapter is connected to the network but not transmitting data.
	Flashing	Adapter is connected to the network and transmitting data.

LED	LED State	Description
FAULT	Flashing Red	Indicates drive is faulted.

Key	Name	Description
	Up Arrow Down Arrow	Scroll through user-selectable display parameters or groups. Increment values.
	Escape	Back one step in programming menu. Cancel a change to a parameter value and exit Program Mode.
	Select	Advance one step in programming menu. Select a digit when viewing parameter value.
	Enter	Advance one step in programming menu. Save a change to a parameter value.
	Reverse	Used to reverse direction of the drive. Default is active. Controlled by parameters P046, P048, and P050 [Start Source x] and A544 [Reverse Disable].
	Start	Used to start the drive. Default is active. Controlled by parameters P046, P048, and P050 [Start Source x].
	Stop	Used to stop the drive or clear a fault. This key is always active. Controlled by parameter P045 [Stop Mode].
	Potentiometer	Used to control speed of drive. Default is active. Controlled by parameters P047, P049, and P051 [Speed Referencex].

## Viewing and Editing Parameters

The following is an example of basic integral keypad and display functions. This example provides basic navigation instructions and illustrates how to program a parameter.

Step	Key	Example Display
1. When power is applied, the last user-selected Basic Display Group parameter number is briefly displayed with flashing characters. The display then defaults to that parameter's current value. (Example shows the value of b001 [Output Freq] with the drive stopped.)		
2. Press Esc to display the Basic Display Group parameter number shown on power-up. The parameter number will flash.		
3. Press Esc to enter the parameter group list. The parameter group letter will flash.		
4. Press the Up Arrow or Down Arrow to scroll through the group list (b, P, t, C, L, d, A, f and Gx).	or	
5. Press Enter or Sel to enter a group. The right digit of the last viewed parameter in that group will flash.	or	
6. Press the Up Arrow or Down Arrow to scroll through the parameter list.	or	
7. Press Enter to view the value of the parameter. Or Press Esc to return to the parameter list.		
8. Press Enter or Sel to enter Program Mode and edit the value. The right digit will flash and the word Program on the LCD display will light up.	or	
9. Press the Up Arrow or Down Arrow to change the parameter value.	or	
10. If desired, press Sel to move from digit to digit or bit to bit. The digit or bit that you can change will flash.		
11. Press Esc to cancel a change and exit Program Mode. Or Press Enter to save a change and exit Program Mode. The digit will stop flashing and the word Program on the LCD display will turn off.	or	
12. Press Esc to return to the parameter list. Continue to press Esc to back out of the programming menu. If pressing Esc does not change the display, then b001 [Output Freq] is displayed. Press Enter or Sel to enter the group list again.		

## Drive Programming Tools

Some features in the PowerFlex 520-series drive are not supported by older configuration software tools. It is strongly recommended that customers using such tools migrate to RSLogix 5000 software (version 17.0 or greater) or Studio 5000 Logix Designer (version 21.0 or greater) application with Add-on Profile (AOP), or Connected Components Workbench software version 5.0 or later to enjoy a richer, full-featured configuration experience. For Automatic Device Configuration (ADC) support, RSLogix 5000 software version 20.0 or greater is required.

Description	Catalog Number/Release Version
Connected Components Workbench <sup>(1)</sup> software	Version 5.0 or later
Logix Designer application	Version 21.0 or later
RSLogix 5000 software	Version 17.0 or later
Built-in USB software tool	-
Serial Converter Module <sup>(2)</sup>	22-SCM-232
USB Converter Module <sup>(2)</sup>	1203-USB
Remote Panel Mount, LCD Display <sup>(2)</sup>	22-HIM-C2S
Remote Handheld, LCD Display <sup>(2)</sup>	22-HIM-A3

(1) Available to download at [rok.auto/ccw](http://rok.auto/ccw).

(2) Does not support the new dynamic parameter groups (AppView<sup>®</sup>, CustomView<sup>™</sup>), and CopyCat functionality is limited to the linear parameter list.

## Language Support

Language	Keypad/LCD Display	RSLogix 5000/ Logix Designer application	Connected Components Workbench software
English	Y	Y	Y
French	Y	Y	Y
Spanish	Y	Y	Y
Italian	Y	Y	Y
German	Y	Y	Y
Japanese	-	Y	-
Portuguese	Y	Y	-
Chinese Simplified	-	Y	Y
Korean	-	Y	-
Polish <sup>(1)</sup>	Y	-	-
Turkish <sup>(1)</sup>	Y	-	-
Czech <sup>(1)</sup>	Y	-	-

(1) Due to a limitation of the LCD Display, some of the characters for Polish, Turkish, and Czech will be modified.

## Smart Startup with Basic Program Group Parameters

The PowerFlex 520-series drive is designed so that start up is simple and efficient. The Basic Program Group contains the most commonly used parameters. See [Programming and Parameters on page 69](#) for detailed descriptions of the parameters listed here and the full list of available parameters.

### Basic Program Group Parameters



= Stop drive before changing this parameter.



= Parameter is specific to PowerFlex 525 drives only.

No.	Parameter	Min/Max	Display/Options	Default
P030	[Language]	1/15	1 = English 2 = Français 3 = Español 4 = Italiano 5 = Deutsch 6 = Reserved 7 = Português 8 = Reserved 9 = Reserved 10 = Reserved 11 = Reserved 12 = Polish 13 = Reserved 14 = Turkish 15 = Czech	1
	Selects the language displayed. <b>Important:</b> The setting takes effect after the drive is power cycled.			
P031	[Motor NP Volts]	10V (for 200V Drives), 20V (for 400V Drives), 25V (for 600V Drives)/Drive Rated Volts	1V	Based on Drive Rating
P031	[Motor NP Volts]	10V (for 200V Drives), 20V (for 400V Drives), 25V (for 600V Drives)/Drive Rated Volts	1V	Based on Drive Rating
	Sets the motor nameplate rated volts.			
P032	[Motor NP Hertz]	15/500 Hz	1 Hz	60 Hz
P032	[Motor NP Hertz]	Sets the motor nameplate rated frequency.		
P033	[Motor OL Current]	0.0/(Drive Rated Amps x 2)	0.1 A	Based on Drive Rating
	Sets the motor nameplate overload current.			
P034	[Motor NP FLA]	0.0/(Drive Rated Amps x 2)	0.1 A	Drive Rated Amps
	Sets the motor nameplate FLA.			
P035	[Motor NP Poles]	2/40	1	4
	Sets the number of poles in the motor.			
P036	[Motor NP RPM]	0/24000 rpm	1 rpm	1750 rpm
	[Motor NP RPM]	Sets the rated nameplate rpm of motor.		
P037	[Motor NP Power]	0.00/Drive Rated Power	0.01 kW	Drive Rated Power
	[Motor NP Power]	Sets the motor nameplate power. Used in PM regulator.		
P039	[Torque Perf Mode]	0/4	0 = "V/Hz" 1 = "SVC" 2 = "Economize" 3 = "Vector" <sup>(1)</sup> 4 = "PM Control" <sup>(1)(2)(3)</sup> 5 = "SynRM"	1
	Selects the motor control mode. (1) Setting is specific to PowerFlex 525 drives only. (2) Setting is available in PowerFlex 525 FRN 5.xxx and later. (3) When P039 [Torque Perf Mode] is set to 4 and A535 [Motor Fdbk Type] is set to 0, 1, 2 or 3, the drive is in open loop PM motor control mode. When P039 [Torque Perf Mode] is set to 4 and A535 [Motor Fdbk Type] is set to 4 or 5, the drive is in closed loop PM motor control mode.			
P040	[Autotune]	0/2	0 = "Ready/Idle" 1 = "Static Tune" 2 = "Rotate Tune"	0
	[Autotune]	Enables a static (not spinning) or dynamic (motor spinning) autotune.		
P041	[Accel Time 1]	0.00/600.00 s	0.01 s	10.00 s
P041	Sets the time for the drive to accel from 0 Hz to [Maximum Freq].			

Basic Program Group Parameters (Continued)

 = Stop drive before changing this parameter.  
 [PF 525] = Parameter is specific to PowerFlex 525 drives only.

No.	Parameter	Min/Max	Display/Options	Default
P042	[Decel Time 1]	0.00/600.00 s	0.01 s	10.00 s
	Sets the time for the drive to decel from [Maximum Freq] to 0 Hz.			
P043	[Minimum Freq]	0.00/500.00 Hz	0.01 Hz	0.00 Hz
	Sets the lowest frequency the drive outputs.			
P044	[Maximum Freq]	0.00/500.00 Hz	0.01 Hz	60.00 Hz
	Sets the highest frequency the drive outputs.			
P045	[Stop Mode]	0/11	0= "Ramp, CF" <sup>(1)</sup> 1= "Coast, CF" <sup>(1)</sup> 2= "DC Brake, CF" <sup>(1)</sup> 3= "DCBrkAuto,CF" <sup>(1)</sup> 4= "Ramp" 5= "Coast" 6= "DC Brake" 7= "DC BrakeAuto" 8= "Ramp+EM B,CF" <sup>(1)</sup> 9= "Ramp+EM Brk" 10= "PointStp,CF" <sup>(1)</sup> 11= "PointStop"	0
	Stop command for normal stop. <b>Important:</b> I/O Terminal O1 is always a stop input. The stopping mode is determined by the drive setting. <b>Important:</b> The drive is shipped with a jumper installed between I/O Terminals O1 and 11. Remove this jumper when using I/O Terminal O1 as a stop or enable input. (1) Stop input also clears active fault.			
P046, P048, P050	[Start Source 1]	1/5	1 = "Keypad" <sup>(1)</sup> 2 = "DigIn TrmBlk" <sup>(2)</sup> 3 = "Serial/DSI" 4 = "Network Opt" 5 = "EtherNet/IP" <sup>(3)</sup>	P046 = 1 P048 = 2 P050 = 3 (PowerFlex 523) 5 (PowerFlex 525)
	Sets the default control scheme used to start the drive unless overridden by P048 [Start Source 2] or P050 [Start Source 3]. (1) When active, the Reverse key is also active unless disabled by A544 [Reverse Disable]. (2) If "DigIn TrmBlk" is selected, ensure that the digital inputs are properly configured. (3) Setting is specific to PowerFlex 525 drives only.			
P047, P049, P051	[Speed Reference1]	1/16	1= "Drive Pot" 2= "Keypad Freq" 3= "Serial/DSI" 4= "Network Opt" 5= "0-10V Input" 6= "4-20mA Input" 7= "Preset Freq" 8= "Anlg In Mult" <sup>(1)</sup> 9= "MOP" 10= "Pulse Input" 11= "PID1 Output" 12= "PID2 Output" 13= "Step Logic" <sup>(1)</sup> 14= "Encoder" <sup>(1)</sup> 15= "EtherNet/IP" <sup>(1)</sup> 16= "Positioning" <sup>(1)</sup>	P047 = 1 P049 = 5 P051 = 3 (PowerFlex 523) 15 (PowerFlex 525)
	Sets the default speed command of the drive unless overridden by P049 [Speed Reference2] or P051 [Speed Reference3]. (1) Setting is specific to PowerFlex 525 drives only.			
P052	[Average kWh Cost]	0.00/655.35	0.01	0.00
	Sets the average cost per kWh.			
P053	[Reset To Defaults]	0/4	0 = "Ready/Idle" 1 = "Param Reset" 2 = "Factory Reset" 3 = "Power Reset" 4 = "Module Reset" <sup>(1)(2)(3)</sup>	0
	Resets parameters to their factory defaults values. After a Reset command, the value of this parameter returns to zero. (1) Power cycle of the drive, <b>NO</b> parameters are reset. (2) Setting is available in PowerFlex 525 FRN 5.xxx and later. (3) Setting is available in PowerFlex 523 FRN 3.xxx and later.			



## LCD Display with QuickView Technology

QuickView® technology enables text to scroll across the LCD display of the PowerFlex 520-series drive. This allows you to easily configure parameters, troubleshoot faults and view diagnostic items without using a separate device.

Use parameter [A556](#) [Text Scroll] to set the speed at which the text scrolls across the display. Select o “Off” to turn off text scrolling. See [Language Support on page 62](#) for the languages supported by the PowerFlex 520-series drive.

## Using the USB Port

The PowerFlex 520-series drive has a USB port that connects to a PC for the purpose of upgrading drive firmware or uploading/downloading a parameter configuration.

---

**IMPORTANT** PowerFlex 525 with firmware revision 7.001 and later supports the USB application with Windows® 8 and 10.

---

## MainsFree Programming

The MainsFree™ programming feature allows you to quickly configure your PowerFlex 520-series drive without having to power up the control module or install additional software. Simply connect the control module to your PC with a USB Type B cable and you can download a parameter configuration to your drive. You can also easily upgrade your drive with the latest firmware.

### Connecting a PowerFlex 520-series drive to a PC

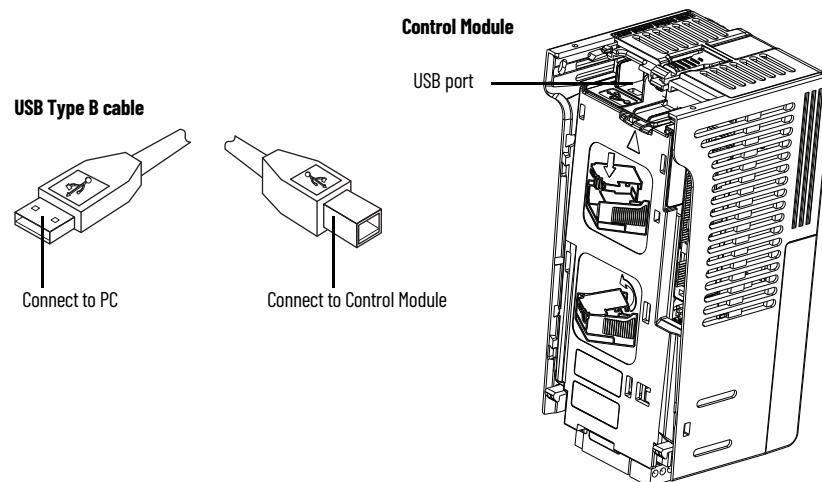

When connected, the drive appears on the PC and contains two files:

- **GUIDE.PDF**  
This file contains links to relevant product documentation and software downloads.
-  **PF52XUSB.EXE**  
This file is an application to flash upgrade firmware or upload/download a parameter configuration.

It is not possible to delete these files or add more to the drive.

Double-click the PF52XUSB.EXE file to launch the USB utility application. The main menu is displayed. Follow the program instructions to upgrade the firmware or upload/download configuration data.

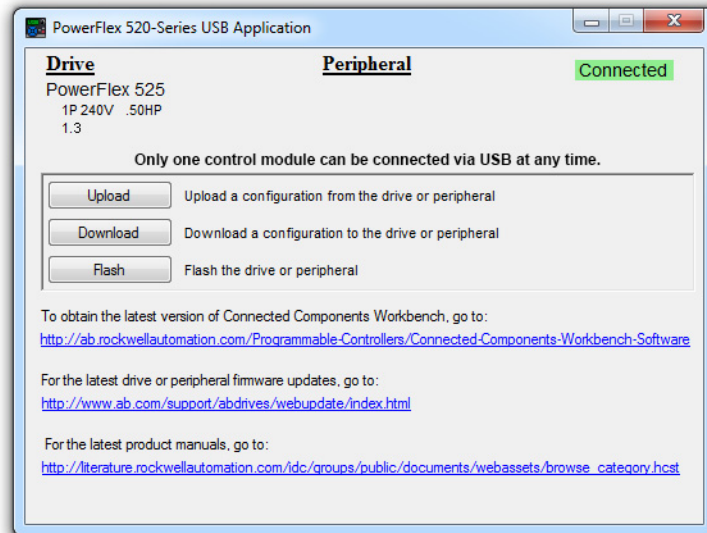

---

**IMPORTANT** Make sure your PC is powered by an AC power outlet or has a fully charged battery before starting any operation. This prevents the operation from terminating before completion due to insufficient power.

---

### Limitation in Downloading .pf5 Configuration Files with the USB Utility Application

Before downloading a .pf5 configuration file using the USB utility application, parameter C169 [MultiDrv Sel] in the destination drive must match the incoming configuration file. If it does not, set the parameter manually to match and then cycle drive power. Also, the drive type of the .pf5 file must match the drive.

This means you cannot apply a multi-drive configuration using the USB utility application to a drive in single mode (parameter C169 [MultiDrv Sel] set to 0 “Disabled”), or apply a single mode configuration to a drive in multi-drive mode.

## Using Drive Startup in CCW or Logix Designer application

To use the PowerFlex 525 Startup Wizard in Connected Components Workbench software to automatically configure the parameters, make sure you have installed the following:

- PowerFlex 525 drive firmware revision 5.001 or later.
- PowerFlex 525 drive Add-on Profile 5.07 or later.
- Latest drive database for Connected Components Workbench software.

For instructions, see [Using Drive Startup in CCW or Logix Designer application on page 66](#).

Alternatively, you can manually configure the parameters by using the drive keypad. For instructions, see [Manual Configuration Using Drive Keypad on page 256](#).

1. From Connected Components Workbench software, click the Wizard Browser icon.

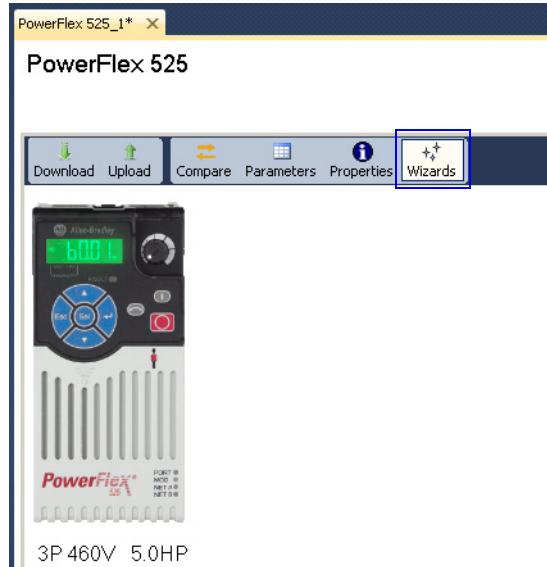

2. In the Available Wizards dialog box, click PowerFlex 525 Startup Wizard, then click Select.

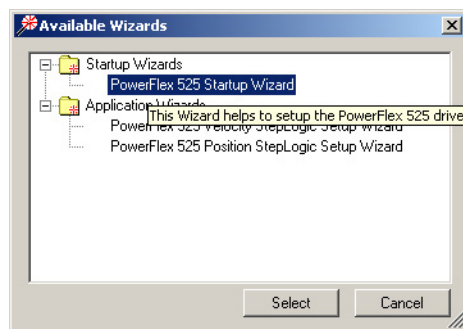

3. Before tuning the drive, it is recommended to reset all parameters to their default values. Select the option shown below.

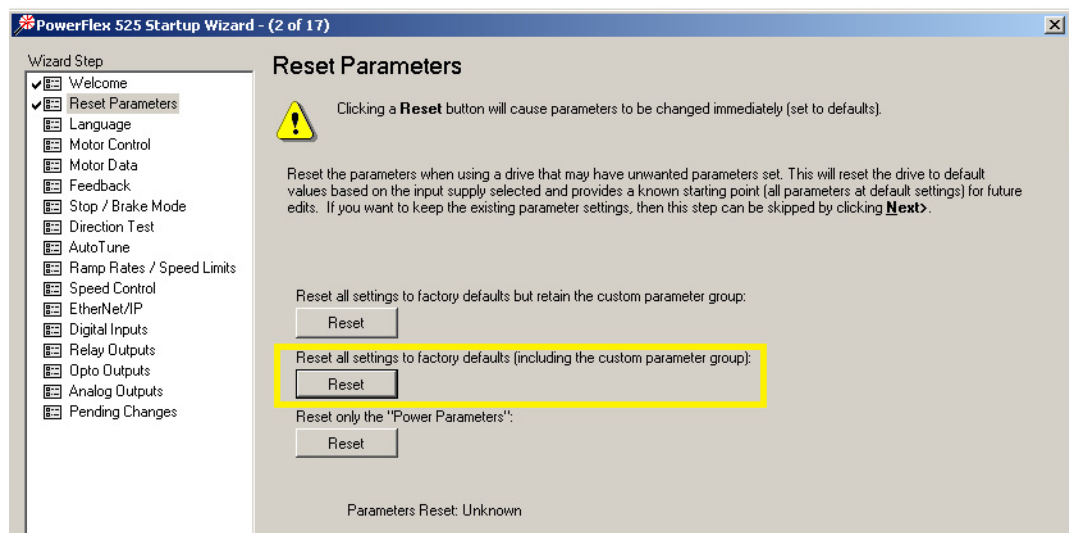

4. Complete each step in the Startup Wizard to configure the drive.

---

**IMPORTANT** Follow the Startup Wizard steps exactly. If not, unexpected results can occur.

---

**Notes:**

## Programming and Parameters

This chapter provides a complete listing and description of the PowerFlex 520-series drive parameters. Parameters are programmed (viewed/edited) using either the drive's built-in keypad, RSLogix 5000 software version 17.0 or greater, Studio 5000 Logix Designer application version 21.0 or greater, or Connected Components Workbench software version 5.0 or later. The Connected Components Workbench software can be used offline (through USB) to upload parameter configurations to the drive or online (through Ethernet connection).

Limited functionality is also available when using the Connected Components Workbench software online (through DSI and serial converter module), a legacy external HIM, or legacy software online (DriveTools™ SP). When using these methods, the parameter list can only be displayed linearly, and there is no access to communications option card programming.

Topic	Page
About Parameters	69
Parameter Groups	71
Basic Display Group	76
Basic Program Group	82
Terminal Block Group	88
Communications Group	100
Logic Group	106
Advanced Display Group	109
Advanced Program Group	114
Network Parameter Group	142
Modified Parameter Group	142
Fault and Diagnostic Group	142
AppView Parameter Groups	150
CustomView Parameter Group	151
Parameter Cross Reference by Name	152

### About Parameters

To configure a drive to operate in a specific way, drive parameters may have to be set. Three types of parameters exist:

- **ENUM**  
ENUM parameters allow a selection from two or more items. Each item is represented by a number.
- **Numeric Parameters**  
These parameters have a single numerical value (0.1V).
- **Bit Parameters**  
Bit parameters have five individual digits associated with features or conditions. If the digit is 0, the feature is off or the condition is false. If the digit is 1, the feature is on or the condition is true.

Some parameters are marked as follows.

 = Stop drive before changing this parameter.

 = 32 bit parameter.

 = Parameter is specific to PowerFlex 525 drives only.

### 32-bit Parameters

Parameters marked 32-bit will have two parameter numbers when using RS485 communications and programming software. For example, parameters bo10 [Process Display] and bo11 [Process Fract] are scaled and displayed as follows.

- P043 [Minimum Freq] = 0 Hz
- P044 [Maximum Freq] = 60 Hz
- A481 [Process Display Lo] = 0
- A482 [Process Display Hi] = 10

Using the formula

$$\text{Scaled Process Value (PV)} = \frac{([\text{Process Disp Hi}] - [\text{Process Disp Lo}]) \times ([\text{Output Freq}] - [\text{Minimum Freq}])}{[\text{Maximum Freq}] - [\text{Minimum Freq}]}$$

when the drive is running at 10 Hz, the Process Value will be 1.66.

On the drive LCD display, only parameter bo10 [Process Display] is shown.



In Connected Components Workbench software, parameter bo10 [Process Display] and bo11 [Process Fract] are shown separately.

#	Name	Value	Units	Internal Value	Default	Min	Max
1	Output Freq	10.00	Hz	1000	0.00	0.00	500.00
2	Commanded Freq	10.00	Hz	1000	0.00	0.00	500.00
3	Output Current	0.04	A	4	0.00	0.00	9.60
4	Output Voltage	37.0	V	370	0.0	0.0	999.9
5	DC Bus Voltage	333	VDC	333	0	0	1200
6	Drive Status	00000000 00000011		3	00000000 0000...	0	31
7	Fault 1 Code	81		81	0	0	127
8	Fault 2 Code	4		4	0	0	127
9	Fault 3 Code	81		81	0	0	127
10	Process Display	1		1	0	0	9999
11	Process Fract	0.66		66	0.00	0.00	0.99

# Parameter Groups

For an alphabetical listing of parameters, see [Parameter Cross Reference by Name on page 152](#).

## Parameters List



	<b>Basic Display</b>		Output Voltage	b004	Process Fract	b011	Power Saved	b018	Accum Cost Sav	b025
	Output Freq	b001	DC Bus Voltage	b005	Control Source	b012	Elapsed Run Time	b019	Accum CO2 Sav	b026
	Commanded Freq	b002	Drive Status	b006	Contrl In Status	b013	Average Power	b020	Drive Temp	b027
	Output Current	b003	Fault 1 Code	b007	Dig In Status	b014	Elapsed kWh	b021	Control Temp	b028
			Fault 2 Code	b008	Output RPM	b015	Elapsed MWh	b022	Control SW Ver	b029
			Fault 3 Code	b009	Output Speed	b016	Energy Saved	b023		
			Process Display	b010	Output Power	b017	Accum kWh Sav	b024		
	<b>Basic Program</b>		Motor NP Hertz	P032	Torque Perf Mode	P039	Stop Mode	P045	Speed Reference3	P051
	Language	P030	Motor OL Current	P033	Autotune	P040	Start Source 1	P046	Average kWh Cost	P052
	Motor NP Volts	P031	Motor NP FLA	P034	Accel Time 1	P041	Speed Reference1	P047	Reset To Defaults	P053
			Motor NP Poles	P035	Decel Time 1	P042	Start Source 2	P048	Display Param	P054
			Motor NP RPM	P036	Minimum Freq	P043	Speed Reference2	P049		
			Motor NP Power <sup>(1)</sup>	P037	Maximum Freq	P044	Start Source 3	P050		
	<b>Terminal Blocks</b>		Opto Out1 Sel <sup>(1)</sup>	t069	Relay 1 Off Time	t080	Anlg In 0-10V Lo	t091	Sleep Time	t102
	DigIn TermBlk 02	t062	Opto Out1 Level <sup>(1)</sup>	t070	Relay Out2 Sel <sup>(1)</sup>	t081	Anlg In 0-10V Hi	t092	Wake Level	t103
	DigIn TermBlk 03	t063	Opto Out1 LevelF	t071	Relay Out2 Level <sup>(1)</sup>	t082	10V Bipolar Enbl <sup>(1)</sup>	t093	Wake Time	t104
	2-Wire Mode	t064	Opto Out2 Sel <sup>(1)</sup>	t072	Relay Out2 LevelF <sup>(1)</sup>	t083	Anlg In V Loss	t094	Safety Open En <sup>(1)</sup>	t105
	DigIn TermBlk 05	t065	Opto Out2 Level <sup>(1)</sup>	t073	Relay 2 On Time <sup>(1)</sup>	t084	Anlg In4-20mA Lo	t095	SafetyFlt RstCfg <sup>(1)(3)</sup>	t106
	DigIn TermBlk 06	t066	Opto Out2 LevelF	t074	Relay 2 Off Time <sup>(1)</sup>	t085	Anlg In4-20mA Hi	t096		
	DigIn TermBlk 07 <sup>(1)</sup>	t067	Opto Out Logic <sup>(1)</sup>	t075	EM Brk Off Delay	t086	Anlg In mA Loss	t097		
	DigIn TermBlk 08 <sup>(1)</sup>	t068	Relay Out1 Sel	t076	EM Brk On Delay	t087	Anlg Loss Delay	t098		
			Relay Out1 Level	t077	Analog Out Sel <sup>(2)</sup>	t088	Analog In Filter	t099		
			Relay Out1 LevelF	t078	Analog Out High <sup>(2)</sup>	t089	Sleep-Wake Sel	t100		
			Relay 1 On Time	t079	Anlg Out Setpt <sup>(2)</sup>	t090	Sleep Level	t101		
	<b>Communications</b>		EN Addr Sel <sup>(1)</sup>	C128	EN Gateway Cfg 3 <sup>(1)</sup>	C139	EN Data In 1 <sup>(1)</sup>	C153	Opt Data In 4	C164
	Comm Write Mode	C121	EN IP Addr Cfg 1 <sup>(1)</sup>	C129	EN Gateway Cfg 4 <sup>(1)</sup>	C140	EN Data In 2 <sup>(1)</sup>	C154	Opt Data Out 1	C165
	Cmd Stat Select <sup>(1)</sup>	C122	EN IP Addr Cfg 2 <sup>(1)</sup>	C130	EN Rate Cfg <sup>(1)</sup>	C141	EN Data In 3 <sup>(1)</sup>	C155	Opt Data Out 2	C166
	RS485 Data Rate	C123	EN IP Addr Cfg 3 <sup>(1)</sup>	C131	EN Comm Flt Actn <sup>(1)</sup>	C143	EN Data In 4 <sup>(1)</sup>	C156	Opt Data Out 3	C167
	RS485 Node Addr	C124	EN IP Addr Cfg 4 <sup>(1)</sup>	C132	EN Idle Flt Actn <sup>(1)</sup>	C144	EN Data Out 1 <sup>(1)</sup>	C157	Opt Data Out 4	C168
	Comm Loss Action	C125	EN Subnet Cfg 1 <sup>(1)</sup>	C133	EN Flt Cfg Logic <sup>(1)</sup>	C145	EN Data Out 2 <sup>(1)</sup>	C158	MultiDrv Sel	C169
	Comm Loss Time	C126	EN Subnet Cfg 2 <sup>(1)</sup>	C134	EN Flt Cfg Ref <sup>(1)</sup>	C146	EN Data Out 3 <sup>(1)</sup>	C159	Drv 1 Addr	C171
	RS485 Format	C127	EN Subnet Cfg 3 <sup>(1)</sup>	C135	EN Flt Cfg DL 1 <sup>(1)</sup>	C147	EN Data Out 4 <sup>(1)</sup>	C160	Drv 2 Addr	C172
			EN Subnet Cfg 4 <sup>(1)</sup>	C136	EN Flt Cfg DL 2 <sup>(1)</sup>	C148	Opt Data In 1	C161	Drv 3 Addr	C173
			EN Gateway Cfg 1 <sup>(1)</sup>	C137	EN Flt Cfg DL 3 <sup>(1)</sup>	C149	Opt Data In 2	C162	Drv 4 Addr	C174
			EN Gateway Cfg 2 <sup>(1)</sup>	C138	EN Flt Cfg DL 4 <sup>(1)</sup>	C150	Opt Data In 3	C163	DSI I/O Cfg	C175
	<b>Logic<sup>(1)</sup></b>		Stp Logic 4	L184	Stp Logic Time 4	L194	Step Units 1	L202	Step Units 5	L210
	Stp Logic 0	L180	Stp Logic 5	L185	Stp Logic Time 3	L193	Step Units F 1	L203	Step Units F 5	L211
	Stp Logic 1	L181	Stp Logic 6	L186	Stp Logic Time 4	L194	Step Units 2	L204	Step Units 6	L212
	Stp Logic 2	L182	Stp Logic 7	L187	Stp Logic Time 5	L195	Step Units F 2	L205	Step Units F 6	L213
	Stp Logic 3	L183	Stp Logic Time 0	L190	Stp Logic Time 6	L196	Step Units 3	L206	Step Units 7	L214
			Stp Logic Time 1	L191	Stp Logic Time 7	L197	Step Units F 3	L207	Step Units F 7	L215
			Stp Logic Time 2	L192	Step Units 0	L200	Step Units 4	L208		
			Stp Logic Time 3	L193	Step Units F 0	L201	Step Units F 4	L209		
	<b>Advanced Display</b>		Counter Status	d364	Speed Feedback F	d377	PID2 Fdbk Disp <sup>(1)</sup>	d385	Fiber Status	d390
	Analog In 0-10V	d360	Timer Status	d365	Encoder Speed <sup>(2)</sup>	d378	PID2 Setpnt Disp <sup>(1)</sup>	d386	Stp Logic Status <sup>(1)</sup>	d391
	Analog In 4-20mA	d361	Timer StatusF	d366	Encoder Speed F	d379	Position Status <sup>(1)</sup>	d387		
	Elapsed Time-hr	d362	Drive Type	d367	DC Bus Ripple	d380	Units Traveled H <sup>(1)</sup>	d388		
	Elapsed Time-min	d363	Testpoint Data	d368	Output Powr Fctr	d381	Units Traveled L <sup>(1)</sup>	d389		
			Motor OL Level	d369	Torque Current	d382	RdyBit Mode Act <sup>(2)(4)</sup>	d392		
			Slip Hz Meter	d375	PID1 Fdbk Disp	d383	Drive Status 2 <sup>(2)(3)</sup>	d393		
			Speed Feedback	d376	PID1 Setpnt Disp	d384	Dig Out Status <sup>(2)(3)</sup>	d394		

Parameters List (Continued)

Advanced Program										
	Preset Freq 0	A410	Decel Time 2	A443	Process Disp Lo	A481	Freq 1 Ki <sup>(1)</sup>	A522	Counts Per Unit <sup>(1)</sup>	A559
	Preset Freq 1	A411	Accel Time 3	A444	Process Disp Hi	A482	Freq 2 Kp <sup>(1)</sup>	A523	Enh Control Word <sup>(1)</sup>	A560
	Preset Freq 2	A412	Decel Time 3	A445	Testpoint Sel	A483	Freq 2 Ki <sup>(1)</sup>	A524	Home Save <sup>(1)</sup>	A561
	Preset Freq 3	A413	Accel Time 4	A446	Current Limit 1	A484	Freq 3 Kp <sup>(1)</sup>	A525	Find Home Freq <sup>(1)</sup>	A562
	Preset Freq 4	A414	Decel Time 4	A447	Current Limit 2 <sup>(1)</sup>	A485	Freq 3 Ki <sup>(1)</sup>	A526	Find Home Dir <sup>(1)</sup>	A563
	Preset Freq 5	A415	Skip Frequency 1	A448	Shear Pin1 Level	A486	PM FWKn 1 Kp <sup>(1)(3)</sup>	A527	Encoder Pos Tol <sup>(1)</sup>	A564
	Preset Freq 6	A416	Skip Freq Band 1	A449	Shear Pin 1 Time	A487	PM FWKn 2 Kp <sup>(1)(3)</sup>	A528	Pos Reg Filter <sup>(1)</sup>	A565
	Preset Freq 7	A417	Skip Frequency 2	A450	Shear Pin2 Level <sup>(1)</sup>	A488	PM Control Cfg <sup>(1)(3)</sup>	A529	Pos Reg Gain <sup>(1)</sup>	A566
	Preset Freq 8 <sup>(1)</sup>	A418	Skip Freq Band 2	A451	Shear Pin 2 Time <sup>(1)</sup>	A489	Boost Select	A530	Max Traverse	A567
	Preset Freq 9 <sup>(1)</sup>	A419	Skip Frequency 3 <sup>(1)</sup>	A452	Load Loss Level <sup>(1)</sup>	A490	Start Boost	A531	Traverse Inc	A568
	Preset Freq 10 <sup>(1)</sup>	A420	Skip Freq Band 3 <sup>(1)</sup>	A453	Load Loss Time <sup>(1)</sup>	A491	Break Voltage	A532	Traverse Dec	A569
	Preset Freq 11 <sup>(1)</sup>	A421	Skip Frequency 4 <sup>(1)</sup>	A454	Stall Fault Time	A492	Break Frequency	A533	P Jump	A570
	Preset Freq 12 <sup>(1)</sup>	A422	Skip Freq Band 4 <sup>(1)</sup>	A455	Motor OL Select	A493	Maximum Voltage	A534	Sync Time	A571
	Preset Freq 13 <sup>(1)</sup>	A423	PID 1 Trim Hi	A456	Motor OL Ret	A494	Motor Fdbk Type <sup>(2)</sup>	A535	Speed Ratio	A572
	Preset Freq 14 <sup>(1)</sup>	A424	PID 1 Trim Lo	A457	Drive OL Mode	A495	Encoder PPR <sup>(1)</sup>	A536	Mtr Options Cfg <sup>(2)(5)</sup>	A573
	Preset Freq 15 <sup>(1)</sup>	A425	PID 1 Trim Sel	A458	IR Voltage Drop	A496	Pulse In Scale	A537	RdyBit Mode Cfg <sup>(2)(4)</sup>	A574
	Keypad Freq	A426	PID 1 Ref Sel	A459	Flux Current Ref	A497	Ki Speed Loop <sup>(2)</sup>	A538	Flux Braking En <sup>(2)(3)</sup>	A575
	MOP Freq	A427	PID 1 Fdbk Sel	A460	Motor Rr <sup>(1)</sup>	A498	Kp Speed Loop <sup>(2)</sup>	A539	Phase Loss Level <sup>(2)(3)</sup>	A576
	MOP Reset Sel	A428	PID 1 Prop Gain	A461	Motor Lm <sup>(1)</sup>	A499	Var PWM Disable	A540	Current Loop BW <sup>(1)(3)</sup>	A580
	MOP Preload	A429	PID 1 Integ Time	A462	Motor Lx <sup>(1)</sup>	A500	Auto Rstrt Tries	A541	PM Stable 1 Freq <sup>(1)(3)</sup>	A581
MOP Time	A430	PID 1 Diff Rate	A463	PM IR Voltage <sup>(1)(3)</sup>	A501	Auto Rstrt Delay	A542	PM Stable 2 Freq <sup>(1)(3)</sup>	A582	
Jog Frequency	A431	PID 1 Setpoint	A464	PM IXq Voltage <sup>(1)(3)</sup>	A502	Start At PowerUp	A543	PM Stable 1 Kp <sup>(1)(3)</sup>	A583	
Jog Accel/Decel	A432	PID 1 Deadband	A465	PM IXq Voltage <sup>(1)(3)</sup>	A503	Reverse Disable	A544	PM Stable 2 Kp <sup>(1)(3)</sup>	A584	
Purge Frequency	A433	PID 1 Preload	A466	PM BEMF Voltage <sup>(1)(3)</sup>	A504	Flying Start En	A545	PM Stable Brk Pt <sup>(1)(3)</sup>	A585	
DC Brake Time	A434	PID 1 Invert Err	A467	Speed Reg Sel <sup>(1)</sup>	A509	FlyStrt CurLimit	A546	PM Stepload Kp <sup>(1)(3)</sup>	A586	
DC Brake Level	A435	PID 2 Trim Hi <sup>(1)</sup>	A468	Freq 1 <sup>(1)</sup>	A510	Compensation	A547	PM 1 Efficiency <sup>(1)(3)</sup>	A587	
DC Brk Time@Strt	A436	PID 2 Trim Lo <sup>(1)</sup>	A469	Freq 1 BW <sup>(1)</sup>	A511	Power Loss Mode	A548	PM 2 Efficiency <sup>(1)(3)</sup>	A588	
DB Resistor Sel	A437	PID 2 Trim Sel <sup>(1)</sup>	A470	Freq 2 <sup>(1)</sup>	A512	Half Bus Enable	A549	PM Algor Sel <sup>(1)(3)</sup>	A589	
DB Threshold	A438	PID 2 Ref Sel <sup>(1)</sup>	A471	Freq 2 BW <sup>(1)</sup>	A513	Bus Reg Enable	A550	SYNRM SW Freq	A590	
S Curve %	A439	PID 2 Fdbk Sel <sup>(1)</sup>	A472	Freq 3 <sup>(1)</sup>	A514	Fault Clear	A551	SYNRM Flux Cur	A591	
PWM Frequency	A440	PID 2 Prop Gain <sup>(1)</sup>	A473	Freq 3 BW <sup>(1)</sup>	A515	Program Lock	A552	SYNRM Freq1 Volt	A592	
Droop Hertz@ FLA <sup>(1)</sup>	A441	PID 2 Integ Time <sup>(1)</sup>	A474	PM Initial Sel <sup>(1)(3)</sup>	A516	Program Lock Mod	A553	SYNRM Freq1 Kp	A593	
Accel Time 2	A442	PID 2 Diff Rate <sup>(1)</sup>	A475	PM DC Inject Cur <sup>(1)(3)</sup>	A517	Drv Ambient Sel	A554	SYNRM Freq1 Comp	A594	
		PID 2 Setpoint <sup>(1)</sup>	A476	PM Align Time <sup>(1)(3)</sup>	A518	Reset Meters	A555	SYNRM Freq2 BW	A595	
		PID 2 Deadband <sup>(1)</sup>	A477	PM HIFI NS Cur <sup>(1)(3)</sup>	A519	Text Scroll	A556	SYNRM Freq2 Kp	A596	
		PID 2 Preload <sup>(1)</sup>	A478	PM Bus Reg Kd <sup>(1)(3)</sup>	A520	Out Phas Loss En	A557			
		PID 2 Invert Err <sup>(1)</sup>	A479	Freq 1 Kp <sup>(1)</sup>	A521	Positioning Mode <sup>(1)</sup>	A558			



## Parameters List (Continued)

<b>Network</b>		This group contains parameters for the network option card that is installed. See the network option card's user manual for more information on the available parameters.							
									
<b>Modified</b>		This group contains parameters that have their values changed from the factory default. When a parameter has its default value changed, it is automatically added to this group. When a parameter has its value changed back to the factory default, it is automatically removed from this group.							
									
<b>Fault and Diagnostic</b>		This group contains parameters for fault and diagnostic information.							
									
Fault 4 Code	F604	Fault 5 Time-min	F625	Fault10 Current <sup>(1)</sup>	F650	EN Rate Act <sup>(1)</sup>	F685	Drv 1 Reference	F710
Fault 5 Code	F605	Fault 6 Time-min <sup>(1)</sup>	F626	Fault 1 BusVolts	F651	DSI I/O Act	F686	Drv 1 Logic Sts	F711
Fault 6 Code	F606	Fault 7 Time-min <sup>(1)</sup>	F627	Fault 2 BusVolts	F652	HW Addr 1 <sup>(1)</sup>	F687	Drv 1 Feedback	F712
Fault 7 Code	F607	Fault 8 Time-min <sup>(1)</sup>	F628	Fault 3 BusVolts	F653	HW Addr 2 <sup>(1)</sup>	F688	Drv 2 Logic Cmd	F713
Fault 8 Code	F608	Fault 9 Time-min <sup>(1)</sup>	F629	Fault 4 BusVolts	F654	HW Addr 3 <sup>(1)</sup>	F689	Drv 2 Reference	F714
Fault 9 Code	F609	Fault10 Time-min <sup>(1)</sup>	F630	Fault 5 BusVolts	F655	HW Addr 4 <sup>(1)</sup>	F690	Drv 2 Logic Sts	F715
Fault10 Code	F610	Fault 1 Freq	F631	Fault 6 BusVolts <sup>(1)</sup>	F656	HW Addr 5 <sup>(1)</sup>	F691	Drv 2 Feedback	F716
Fault 1 Time-hr	F611	Fault 2 Freq	F632	Fault 7 BusVolts <sup>(1)</sup>	F657	HW Addr 6 <sup>(1)</sup>	F692	Drv 3 Logic Cmd	F717
Fault 2 Time-hr	F612	Fault 3 Freq	F633	Fault 8 BusVolts <sup>(1)</sup>	F658	EN IP Addr Act 1 <sup>(1)</sup>	F693	Drv 3 Reference	F718
Fault 3 Time-hr	F613	Fault 4 Freq	F634	Fault 9 BusVolts <sup>(1)</sup>	F659	EN IP Addr Act 2 <sup>(1)</sup>	F694	Drv 3 Logic Sts	F719
Fault 4 Time-hr	F614	Fault 5 Freq	F635	Fault10 BusVolts <sup>(1)</sup>	F660	EN IP Addr Act 3 <sup>(1)</sup>	F695	Drv 3 Feedback	F720
Fault 5 Time-hr	F615	Fault 6 Freq <sup>(1)</sup>	F636	Status @ Fault 1	F661	EN IP Addr Act 4 <sup>(1)</sup>	F696	Drv 4 Logic Cmd	F721
Fault 6 Time-hr <sup>(1)</sup>	F616	Fault 7 Freq <sup>(1)</sup>	F637	Status @ Fault 2	F662	EN Subnet Act 1 <sup>(1)</sup>	F697	Drv 4 Reference	F722
Fault 7 Time-hr <sup>(1)</sup>	F617	Fault 8 Freq <sup>(1)</sup>	F638	Status @ Fault 3	F663	EN Subnet Act 2 <sup>(1)</sup>	F698	Drv 4 Logic Sts	F723
Fault 8 Time-hr <sup>(1)</sup>	F618	Fault 9 Freq <sup>(1)</sup>	F639	Status @ Fault 4	F664	EN Subnet Act 3 <sup>(1)</sup>	F699	Drv 4 Feedback	F724
Fault 9 Time-hr <sup>(1)</sup>	F619	Fault10 Freq <sup>(1)</sup>	F640	Status @ Fault 5	F665	EN Subnet Act 4 <sup>(1)</sup>	F700	EN Rx Overruns <sup>(1)</sup>	F725
Fault10 Time-hr <sup>(1)</sup>	F620	Fault 1 Current	F641	Status @ Fault 6 <sup>(1)</sup>	F666	EN Gateway Act 1 <sup>(1)</sup>	F701	EN Rx Packets <sup>(1)</sup>	F726
Fault 1 Time-min	F621	Fault 2 Current	F642	Status @ Fault 7 <sup>(1)</sup>	F667	EN Gateway Act 2 <sup>(1)</sup>	F702	EN Rx Errors <sup>(1)</sup>	F727
Fault 2 Time-min	F622	Fault 3 Current	F643	Status @ Fault 8 <sup>(1)</sup>	F668	EN Gateway Act 3 <sup>(1)</sup>	F703	EN Tx Packets <sup>(1)</sup>	F728
Fault 3 Time-min	F623	Fault 4 Current	F644	Status @ Fault 9 <sup>(1)</sup>	F669	EN Gateway Act 4 <sup>(1)</sup>	F704	EN Tx Errors <sup>(1)</sup>	F729
Fault 4 Time-min	F624	Fault 5 Current	F645	Status @ Fault10 <sup>(1)</sup>	F670	Drv 0 Logic Cmd	F705	EN Missed IO Pkt <sup>(1)</sup>	F730
		Fault 6 Current <sup>(1)</sup>	F646	Comm Sts - DSI	F681	Drv 0 Reference	F706	DSI Errors	F731
		Fault 7 Current <sup>(1)</sup>	F647	Comm Sts - Opt	F682	Drv 0 Logic Sts	F707		
		Fault 8 Current <sup>(1)</sup>	F648	Com Sts-Emb Enet <sup>(1)</sup>	F683	Drv 0 Feedback	F708		
		Fault 9 Current <sup>(1)</sup>	F649	EN Addr Src <sup>(1)</sup>	F684	Drv 1 Logic Cmd	F709		

(1) Parameter is specific to PowerFlex 525 drives only.

(2) Parameter is also available in PowerFlex 523 FRN 3.xxx and later.

(3) Parameter is available in PowerFlex 525 FRN 5.xxx and later.

(4) Parameter is available in PowerFlex 525 FRN 3.xxx and later.

(5) Parameter is available in PowerFlex 525 FRN 2.xxx and later.



## AppView Parameter Groups

PowerFlex 520-series drives include various AppView parameter groups that group certain parameters together for quick and easy access based on different types of applications. See [AppView Parameter Groups on page 150](#) for more information.

### Parameters Group

<b>Conveyor</b>  Language P030 Output Freq b001 Commanded Freq b002	Motor NP Volts	P031	Decel Time 1	P042	DigIn TermBlk 03	t063	Anlg In mA Loss	t097
	Motor NP Hertz	P032	Minimum Freq	P043	Opto Out1 Sel	t069	Slip Hz Meter	d375
	Motor OL Current	P033	Maximum Freq	P044	Relay Out1 Sel	t076	Preset Freq 0	A410
	Motor NP FLA	P034	Stop Mode	P045	Anlg In 0-10V Lo	t091	Jog Frequency	A431
	Motor NP Poles	P035	Start Source 1	P046	Anlg In 0-10V Hi	t092	Jog Accel/Decel	A432
	Autotune	P040	Speed Reference1	P047	Anlg In4-20mA Lo	t095	S Curve %	A439
	Accel Time 1	P041	DigIn TermBlk 02	t062	Anlg In4-20mA Hi	t096	Reverse Disable	A544
<b>Mixer</b>  Language P030 Output Freq b001	Commanded Freq	b002	Motor NP Poles	P035	Stop Mode	P045	Anlg In4-20mA Lo	t095
	Output Current	b003	Autotune	P040	Start Source 1	P046	Anlg In4-20mA Hi	t096
	Motor NP Volts	P031	Accel Time 1	P041	Speed Reference1	P047	Anlg In mA Loss	t097
	Motor NP Hertz	P032	Decel Time 1	P042	Relay Out1 Sel	t076	Preset Freq 0	A410
	Motor OL Current	P033	Minimum Freq	P043	Anlg In 0-10V Lo	t091	Stall Fault Time	A492
	Motor NP FLA	P034	Maximum Freq	P044	Anlg In 0-10V Hi	t092		
<b>Compressor</b>  Language P030 Output Freq b001 Commanded Freq b002 Motor NP Volts P031	Motor NP Hertz	P032	Maximum Freq	P044	Anlg In 0-10V Lo	t091	Start At PowerUp	A543
	Motor OL Current	P033	Stop Mode	P045	Anlg In 0-10V Hi	t092	Reverse Disable	A544
	Motor NP FLA	P034	Start Source 1	P046	Anlg In4-20mA Lo	t095	Power Loss Mode	A548
	Motor NP Poles	P035	Speed Reference1	P047	Anlg In4-20mA Hi	t096	Half Bus Enable	A549
	Autotune	P040	Relay Out1 Sel	t076	Anlg In mA Loss	t097		
	Accel Time 1	P041	Analog Out Sel	t088	Preset Freq 0	A410		
	Decel Time 1	P042	Analog Out High	t089	Auto Rstrt Tries	A541		
	Minimum Freq	P043	Anlg Out Setpt	t090	Auto Rstrt Delay	A542		
<b>Centrifugal Pump</b>  Language P030 Output Freq b001 Commanded Freq b002 Motor NP Volts P031 Motor NP Hertz P032	Motor OL Current	P033	Start Source 1	P046	Anlg In4-20mA Hi	t096	PID 1 Diff Rate	A463
	Motor NP FLA	P034	Speed Reference1	P047	Anlg In mA Loss	t097	PID 1 Setpoint	A464
	Motor NP Poles	P035	Relay Out1 Sel	t076	Preset Freq 0	A410	PID 1 Deadband	A465
	Autotune	P040	Analog Out Sel	t088	PID 1 Trim Hi	A456	PID 1 Preload	A466
	Accel Time 1	P041	Analog Out High	t089	PID 1 Trim Lo	A457	Auto Rstrt Tries	A541
	Decel Time 1	P042	Anlg Out Setpt	t090	PID 1 Ref Sel	A459	Auto Rstrt Delay	A542
	Minimum Freq	P043	Anlg In 0-10V Lo	t091	PID 1 Fdbck Sel	A460	Start At PowerUp	A543
	Maximum Freq	P044	Anlg In 0-10V Hi	t092	PID 1 Prop Gain	A461	Reverse Disable	A544
	Stop Mode	P045	Anlg In4-20mA Lo	t095	PID 1 Integ Time	A462		
<b>Blower/Fan</b>  Language P030 Output Freq b001 Commanded Freq b002 Motor NP Volts P031 Motor NP Hertz P032	Motor OL Current	P033	Start Source 1	P046	Anlg In4-20mA Hi	t096	PID 1 Diff Rate	A463
	Motor NP FLA	P034	Speed Reference1	P047	Anlg In mA Loss	t097	PID 1 Setpoint	A464
	Motor NP Poles	P035	Relay Out1 Sel	t076	Preset Freq 0	A410	PID 1 Deadband	A465
	Autotune	P040	Analog Out Sel	t088	PID 1 Trim Hi	A456	PID 1 Preload	A466
	Accel Time 1	P041	Analog Out High	t089	PID 1 Trim Lo	A457	Auto Rstrt Tries	A541
	Decel Time 1	P042	Anlg Out Setpt	t090	PID 1 Ref Sel	A459	Auto Rstrt Delay	A542
	Minimum Freq	P043	Anlg In 0-10V Lo	t091	PID 1 Fdbck Sel	A460	Start At PowerUp	A543
	Maximum Freq	P044	Anlg In 0-10V Hi	t092	PID 1 Prop Gain	A461	Reverse Disable	A544
	Stop Mode	P045	Anlg In4-20mA Lo	t095	PID 1 Integ Time	A462	Flying Start En	A545

## Parameters Group (Continued)

<b>Extruder</b> 	Motor NP Hertz	P032	Stop Mode	P045	Anlg In4-20mA Lo	t095	Motor Fdbk Type	A535
	Motor OL Current	P033	Start Source 1	P046	Anlg In4-20mA Hi	t096	Encoder PPR	A536
	Motor NP FLA	P034	Speed Reference1	P047	Anlg In mA Loss	t097	Pulse In Scale	A537
	Motor NP Poles	P035	Relay Out1 Sel	t076	Slip Hz Meter	d375	Ki Speed Loop	A538
	Language	P030	Autotune	P040	Speed Feedback	d376	Kp Speed Loop	A539
	Output Freq	b001	Accel Time 1	P041	Speed Feedback F	d377	Power Loss Mode	A548
	Commanded Freq	b002	Decel Time 1	P042	Encoder Speed	d378	Half Bus Enable	A549
	Output Current	b003	Minimum Freq	P043	Preset Freq 0	A410		
	Motor NP Volts	P031	Maximum Freq	P044	Stall Fault Time	A492		
<b>Positioning</b> <sup>(1)</sup> 	Stop Mode	P045	Stp Logic 5	L185	Step Units 6	L212	Jog Accel/Decel	A432
	Start Source 1	P046	Stp Logic 6	L186	Step Units 7	L214	DB Threshold	A438
	Speed Reference1	P047	Stp Logic 7	L187	Slip Hz Meter	d375	S Curve %	A439
	DigIn TermBlk 02	t062	Stp Logic Time 0	L190	Speed Feedback	d376	Motor Fdbk Type	A535
	DigIn TermBlk 03	t063	Stp Logic Time 1	L191	Encoder Speed	d378	Encoder PPR	A536
	DigIn TermBlk 05	t065	Stp Logic Time 2	L192	Units Traveled H	d388	Pulse In Scale	A537
	DigIn TermBlk 06	t066	Stp Logic Time 3	L193	Units Traveled L	d389	Ki Speed Loop	A538
	Opto Out1 Sel	t069	Stp Logic Time 4	L194	Preset Freq 0	A410	Kp Speed Loop	A539
	Opto Out2 Sel	t072	Stp Logic Time 5	L195	Preset Freq 1	A411	Bus Reg Enable	A550
	Relay Out1 Sel	t076	Stp Logic Time 6	L196	Preset Freq 2	A412	Positioning Mode	A558
	EM Brk Off Delay	t086	Stp Logic Time 7	L197	Preset Freq 3	A413	Counts Per Unit	A559
	EM Brk On Delay	t087	Step Units 0	L200	Preset Freq 4	A414	Enh Control Word	A560
	Stp Logic 0	L180	Step Units 1	L202	Preset Freq 5	A415	Find Home Freq	A562
	Stp Logic 1	L181	Step Units 2	L204	Preset Freq 6	A416	Find Home Dir	A563
	Stp Logic 2	L182	Step Units 3	L206	Preset Freq 7	A417	Encoder Pos Tol	A564
Stp Logic 3	L183	Step Units 4	L208	Preset Freq 8	A418	Pos Reg Filter	A565	
Stp Logic 4	L184	Step Units 5	L210	Jog Frequency	A431	Pos Reg Gain	A566	
<b>Textile/Fiber</b> 	Motor NP FLA	P034	DigIn TermBlk 02	t062	Slip Hz Meter	d375	Max Traverse	A567
	Motor NP Poles	P035	DigIn TermBlk 03	t063	Fiber Status	d390	Traverse Inc	A568
	Autotune	P040	Opto Out1 Sel	t069	Preset Freq 0	A410	Traverse Dec	A569
	Accel Time 1	P041	Opto Out2 Sel	t072	Jog Frequency	A431	P Jump	A570
	Language	P030	Relay Out1 Sel	t076	Jog Accel/Decel	A432	Sync Time	A571
	Output Freq	b001	Anlg In 0-10V Lo	t091	S Curve %	A439	Speed Ratio	A572
	Commanded Freq	b002	Anlg In 0-10V Hi	t092	Reverse Disable	A544		
	Motor NP Volts	P031	Stop Mode	P045	Power Loss Mode	A548		
	Motor NP Hertz	P032	Start Source 1	P046	Half Bus Enable	A549		
	Motor OL Current	P033	Speed Reference1	P047	Bus Reg Enable	A550		

(1) This AppView parameter group is specific to PowerFlex 525 drives only.

## CustomView Parameter Group

PowerFlex 520-series drives include a CustomView parameter group for you to store frequently used parameters for your application. See [CustomView Parameter Group on page 151](#) for more information.

### Custom Group



This group can store up to 100 parameters.

## Basic Display Group

### b001 [Output Freq]

Related Parameter(s): [b002](#), [b010](#), [b011](#), [P043](#), [P044](#), [P048](#), [P050](#), [P052](#)

Output frequency present at T1, T2 & T3 (U, V & W). Does not include slip frequency.

	Default:	Read Only
<b>Values</b>	Min/Max:	0.00/[Maximum Freq]
	Display:	0.01 Hz

### b002 [Commanded Freq]

Related Parameter(s): [b001](#), [b013](#), [P043](#), [P044](#), [P048](#), [P050](#), [P052](#)

Value of the active frequency command even if the drive is not running.

**IMPORTANT** The frequency command can come from a number of sources. See [Start and Speed Reference Control on page 48](#) for more information.

	Default:	Read Only
<b>Values</b>	Min/Max:	0.00/[Maximum Freq]
	Display:	0.01 Hz

### b003 [Output Current]

Output current present at T1, T2 & T3 (U, V & W).

	Default:	Read Only
<b>Values</b>	Min/Max:	0.00/(Drive Rated Amps x 2)
	Display:	0.01 A

### b004 [Output Voltage]

Related Parameter(s): [P031](#), [A530](#), [A534](#)

Output voltage present at T1, T2 & T3 (U, V & W).

	Default:	Read Only
<b>Values</b>	Min/Max:	0.0/Drive Rated Volts
	Display:	0.1V

### b005 [DC Bus Voltage]

Filtered DC bus voltage level of the drive.

	Default:	Read Only
<b>Values</b>	Min/Max:	0/1200V DC
	Display:	1V DC

### b006 [Drive Status]

Related Parameter(s): [A544](#)

Present operating condition of the drive.

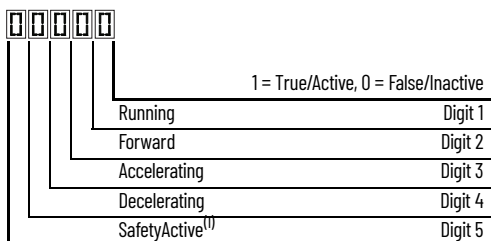

(1) Setting is specific to PowerFlex 525 drives only.

	Default:	Read Only
<b>Values</b>	Min/Max:	00000/11111
	Display:	00000

## Basic Display Group (continued)

**b007 [Fault 1 Code]**  
**b008 [Fault 2 Code]**  
**b009 [Fault 3 Code]**

Related Parameter(s): [F604-F610](#)

A code that represents a drive fault. Codes appear in these parameters in the order they occur ([b007](#) [Fault 1 Code] = the most recent fault). Repetitive faults are only recorded once.

See [Fault and Diagnostic Group](#) for more information.

	Default:	Read Only
<b>Values</b>	Min/Max:	F0/F127
	Display:	F0

**b010 [Process Display]**

Related Parameter(s): [b001](#), [A481](#), [A482](#)

 32 bit parameter.

Output frequency scaled by [A481](#) [Process Disp Lo] and [A482](#) [Process Disp Hi].

Scaled Process Value (PV) =  $\frac{([Process\ Disp\ Hi] - [Process\ Disp\ Lo]) \times ([Output\ Freq] - [Minimum\ Freq])}{([Maximum\ Freq] - [Minimum\ Freq])}$

	Default:	Read Only
<b>Values</b>	Min/Max:	0/9999.00
	Display:	0.01

**b011 [Process Fract]**

Related Parameter(s): [b001](#), [A481](#), [A482](#)

 32 bit parameter.

Output frequency scaled by [A481](#) [Process Disp Lo] and [A482](#) [Process Disp Hi].

Scaled Process Value (PV) =  $\frac{([Process\ Disp\ Hi] - [Process\ Disp\ Lo]) \times ([Output\ Freq] - [Minimum\ Freq])}{([Maximum\ Freq] - [Minimum\ Freq])}$

	Default:	Read Only
<b>Values</b>	Min/Max:	0.00/0.99
	Display:	0.01

### Basic Display Group (continued)

**b012 [Control Source]**

Related Parameter(s): [P046](#), [P047](#), [P048](#), [P049](#), [P050](#), [P051](#), [t062](#), [t063](#), [t065-t068](#), [L180-L187](#), [A410-A425](#)

Active source of the Start Command and Frequency Command. Normally defined by the settings of [P046](#), [P048](#), [P050](#) [Start Source x] and [P047](#), [P049](#), [P051](#) [Speed Referencex]. See [Start and Speed Reference Control on page 48](#) for more information.

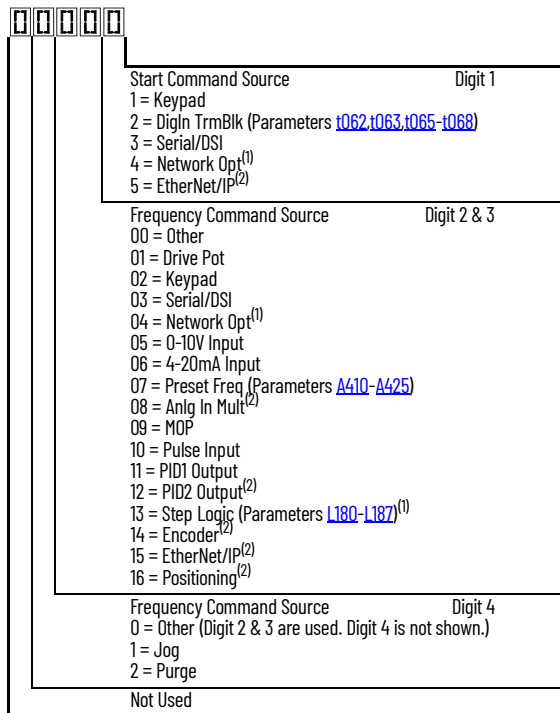

**Example**

Display reads...	Description
2004	Start source comes from Network Opt and Frequency source is Purge.
113	Start source comes from Serial/DSI and Frequency source comes from PID1 Output.
155	Start source and Frequency source comes from EtherNet/IP.
052	Start source comes from DigIn TrmBlk and Frequency source from 0...10V Input.
011	Start source comes from Keypad and Frequency source comes from Drive Pot.

- (1) Select this setting if using the optional PowerFlex 25-COMM-E2P, 25-COMM-D, or 25-COMM-P adapters as the Start source and/or Frequency source.
- (2) Setting is specific to PowerFlex 525 drives only.

Default:	Read Only
<b>Values</b> Min/Max:	0000/2165
Display:	0000

**b013 [Contrl In Status]**

Related Parameter(s): [b002](#), [P044](#), [P045](#)

State of the digital terminal blocks 1...3 and DB transistor.

**IMPORTANT** Actual control commands may come from a source other than the control terminal block.

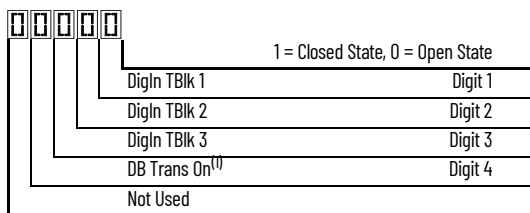

- (1) The DB Transistor "on" indication must have a 0.5 s hysteresis. It will turn on and stay on for at least 0.5 s every time the DB transistor is turned on.

Default:	Read Only
<b>Values</b> Min/Max:	0000/1111
Display:	0000

## Basic Display Group (continued)

**b014 [Dig In Status]**Related Parameter(s): [t065-t068](#)

State of the programmable digital inputs.

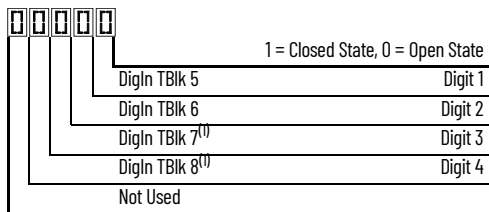

(1) Setting is specific to PowerFlex 525 drives only.

	Default:	Read Only
<b>Values</b>	Min/Max:	0000/1111
	Display:	0000

**b015 [Output RPM]**Related Parameter(s): [P035](#)Current output frequency in rpm. Scale is based on [P035](#) [Motor NP Poles].

	Default:	Read Only
<b>Values</b>	Min/Max:	0/24000 rpm
	Display:	1 rpm

**b016 [Output Speed]**Related Parameter(s): [P044](#)Current output frequency in %. Scale is 0% at 0.00 Hz to 100% at [P044](#) [Maximum Freq].

	Default:	Read Only
<b>Values</b>	Min/Max:	0.0/100.0%
	Display:	0.1%

**b017 [Output Power]**Related Parameter(s): [b018](#)

Output power present at T1, T2 &amp; T3 (U, V &amp; W).

	Default:	Read Only
<b>Values</b>	Min/Max:	0.00/(Drive Rated Power x 2)
	Display:	0.01 kW

**b018 [Power Saved]**Related Parameter(s): [b017](#)

Instantaneous power savings of using this drive compared to an across the line starter.

	Default:	Read Only
<b>Values</b>	Min/Max:	0.00/655.35 kW
	Display:	0.01 kW

**b019 [Elapsed Run time]**Related Parameter(s): [A555](#)

Accumulated time drive is outputting power. Time is displayed in 10 hour increments.

	Default:	Read Only
<b>Values</b>	Min/Max:	0/65535 x 10 hr
	Display:	1 = 10 hr

## Basic Display Group (continued)

**b020 [Average Power]**Related Parameter(s): [A555](#)

Average power used by the motor since the last reset of the meters.

	Default:	Read Only
<b>Values</b>	Min/Max:	0.00/(Drive Rated Power x 2)
	Display:	0.01 kW

**b021 [Elapsed kWh]**Related Parameter(s): [b022](#)Accumulated output energy of the drive. When the maximum value of this parameter is reached, it resets to zero and [b022](#) [Elapsed MWh] is incremented.

	Default:	Read Only
<b>Values</b>	Min/Max:	0.0/100.0 kWh
	Display:	0.1 kWh

**b022 [Elapsed MWh]**Related Parameter(s): [b021](#)

Accumulated output energy of the drive.

	Default:	Read Only
<b>Values</b>	Min/Max:	0.0/6553.5 MWh
	Display:	0.1 MWh

**b023 [Energy Saved]**Related Parameter(s): [A555](#)

Total energy savings of using this drive compared to an across the line starter since the last reset of the meters.

	Default:	Read Only
<b>Values</b>	Min/Max:	0.0/6553.5 kWh
	Display:	0.1 kWh

**b024 [Accum kWh Sav]**Related Parameter(s): [b025](#)

Total approximate accumulated energy savings of the drive compared to using an across the line starter.

	Default:	Read Only
<b>Values</b>	Min/Max:	0.0/6553.5 kWh
	Display:	0.1 = 10 kWh

**b025 [Accum Cost Sav]**Related Parameter(s): [b024](#), [P052](#), [A555](#)

Total approximate accumulated cost savings of the drive compared to using an across the line starter.

[Accum Cost Sav] = [Average kWh cost] x [Accum kWh Sav]

	Default:	Read Only
<b>Values</b>	Min/Max:	0.0/6553.5
	Display:	0.1

**b026 [Accum CO2 Sav]**Related Parameter(s): [A555](#)

Total approximate accumulated CO2 savings of the drive compared to using an across the line starter.

	Default:	Read Only
<b>Values</b>	Min/Max:	0.0/6553.5 kg
	Display:	0.1 kg



### Basic Display Group *(continued)*

#### b027 [Drive Temp]

Present operating temperature of the drive heatsink (inside module).

	Default:	Read Only
<b>Values</b>	Min/Max:	0/120 °C
	Display:	1 °C

#### b028 [Control Temp]

Present operating temperature of the drive control.

	Default:	Read Only
<b>Values</b>	Min/Max:	0/120 °C
	Display:	1 °C

#### b029 [Control SW Ver]

Current drive firmware version.

	Default:	Read Only
<b>Values</b>	Min/Max:	0.000/65.535
	Display:	0.001

## Basic Program Group

### P030 [Language]

Selects the language displayed. A reset or power cycle is required after selection is made.

### Language Support

		Keypad/ LCD Display	RSLogix 5000/Logix Designer application	Connected Components Workbench software
	1 English (Default)	Y	Y	Y
	2 Français	Y	Y	Y
	3 Español	Y	Y	Y
	4 Italiano	Y	Y	Y
	5 Deutsch	Y	Y	Y
	6 Japanese	-	Y	-
	7 Português	Y	Y	-
<b>Options</b>	8 Chinese Chinese Simplified	-	Y	Y
	9 Reserved			
	10 Reserved			
	11 Korean	-	Y	-
	12 Polish <sup>(1)</sup>	Y	-	-
	13 Reserved			
	14 Turkish <sup>(1)</sup>	Y	-	-
	15 Czech <sup>(1)</sup>	Y	-	-

(1) Due to a limitation of the LCD Display, some of the characters for Polish, Turkish, and Czech will be modified.

### P031 [Motor NP Volts]

Related Parameter(s): [b004](#), [A530](#), [A531](#), [A532](#), [A533](#)

 Stop drive before changing this parameter.

Sets the motor nameplate rated volts.

	Default:	Drive Rated Volts
<b>Values</b>	Min/Max:	10V (for 230V Drives), 20V (for 460V Drives), 25V (for 600V Drives)/Drive Rated Volts
	Display:	1V

### P032 [Motor NP Hertz]

Related Parameter(s): [A493](#), [A530](#), [A531](#), [A532](#), [A533](#)

 Stop drive before changing this parameter.

Sets the motor nameplate rated frequency.

	Default:	60 Hz
<b>Values</b>	Min/Max:	15/500 Hz
	Display:	1 Hz

### P033 [Motor OL Current]

Related Parameter(s): [t069](#), [t072](#), [t076](#), [t081](#), [A484](#), [A485](#), [A493](#)

Sets the motor nameplate overload current. Used to determine motor overload conditions and can be set from 0.1 A to 200% of drive rated current.

**IMPORTANT** The drive will fault on an F007 "Motor Overload" if the value of this parameter is exceeded based on class 10 motor overload protection according to NEC article 430 and motor over-temperature protection according to NEC article 430.126 (A) (2). UL 508C File 29572

	Default:	Drive Rated Amps
<b>Values</b>	Min/Max:	0.0/(Drive Rated Amps x 2)
	Display:	0.1 A

## Basic Program Group *(continued)*

### P034 [Motor NP FLA]

Related Parameter(s): [P040](#)

Sets the motor nameplate FLA. Used to assist the Autotune routine and motor control.

	Default:	Based on Drive Rating
<b>Values</b>	Min/Max:	0.1/(Drive Rated Amps x 2)
	Display:	0.1 A

### P035 [Motor NP Poles]

Related Parameter(s): [b015](#)

Sets the number of poles in the motor.

	Default:	4
<b>Values</b>	Min/Max:	2/40
	Display:	1

### P036 [Motor NP RPM]

 Stop drive before changing this parameter.

Sets the rated nameplate rpm of the motor. Used to calculate the rated slip of the motor. To reduce the slip frequency, set this parameter closer to the motor synchronous speed.

	Default:	1750 rpm
<b>Values</b>	Min/Max:	0/24000 rpm
	Display:	1 rpm

### P037 [Motor NP Power]

[PF 525](#) PowerFlex 525 only.

Sets the motor nameplate power. Used in PM regulator.

	Default:	Drive Rated Power
<b>Values</b>	Min/Max:	0.00/Drive Rated Power
	Display:	0.01 kW

### P039 [Torque Perf Mode]

Related Parameter(s): [P040](#), [A530](#), [A531](#), [A532](#), [A533](#), [A535](#)
 Stop drive before changing this parameter.

Selects the motor control mode.

The PowerFlex 523 and PowerFlex 525 drives are capable of performing with the following motor control modes.

	0	"V/Hz"	
	1	"SVC" (Default)	
	2	"Economize"	
<b>Options</b>	3	"Vector" <sup>(1)</sup>	Voltage Vector only (cannot control torque). It is recommended to use with an encoder when using VVC mode.
	4	"PM Control" <sup>(1) (2)</sup>	When P039 [Torque Perf Mode] is set to 4 and <a href="#">A535</a> [Motor Fdbk Type] is set to 0, 1, 2 or 3, the drive is in open loop PM motor control mode. When P039 [Torque Perf Mode] is set to 4 and <a href="#">A535</a> [Motor Fdbk Type] is set to 4 or 5, the drive is in closed loop PM motor control mode.
	5	"SynRM" <sup>(3)</sup>	Set P039 [Torque Perf Mode] to 5 to enable the use of Synchronous Reluctance Motor control.

(1) Setting is specific to PowerFlex 525 drives only.

(2) Setting is available in PowerFlex 525 FRN 5.xxx and later.

(3) Setting is available in PowerFlex 525 FRN 7.xxx and later.

### Basic Program Group *(continued)*

**P040 [Autotune]**

Related Parameter(s): [P034](#), [P039](#), [A496](#), [A497](#)

 Stop drive before changing this parameter.

Enables a static (not spinning) or dynamic (motor spinning) autotune to automatically set the motor parameters. Set the parameter value to a one or two, then issue a valid "Start" command to begin the routine. After the routine is complete the parameter resets to a zero. A failure (such as if a motor is not connected) results in an Autotune Fault.

It is recommended to perform a full rotate tune when using VVC mode.

**IMPORTANT** All motor parameters in the Basic Program group must be set before running the routine. If a start command is not given (or a stop command is given) within 30 s, the parameter automatically returns to a zero and an Autotune Fault occurs.



**ATTENTION:** Rotation of the motor in an undesired direction can occur during this procedure. To guard against possible injury and/or equipment damage, it is recommended that the motor be disconnected from the load before proceeding.

0	"Ready/Idle" (Default)	
1	"Static Tune"	A temporary command that initiates a non-rotational motor stator resistance test for the best possible automatic setting of <a href="#">A496</a> [IR Voltage Drop]. A start command is required following initiation of this setting. The parameter returns to 0 "Ready/Idle" following the test, at which time another start transition is required operate the drive in normal mode. Used when motor cannot be uncoupled from the load.
<b>Options</b>		
2	"Rotate Tune"	A temporary command that initiates a "Static Tune" followed by a rotational test for the best possible automatic setting of <a href="#">A497</a> [Flux Current Ref]. A start command is required following initiation of this setting. The parameter returns to 0 "Ready/Idle" following the test, at which time another start transition is required to operate the drive in normal mode. Important: Used when motor is uncoupled from the load. Results may not be valid if a load is coupled to the motor during this procedure. If [P039 = 5], it is the same with "Static Tune"

**P041 [Accel Time 1]**

Related Parameter(s): [P044](#), [A439](#)

Sets the time for the drive to accelerate from 0 Hz to [P044](#) [Maximum Freq].  
 Accel Rate = [Maximum Freq] / [Accel Time x]

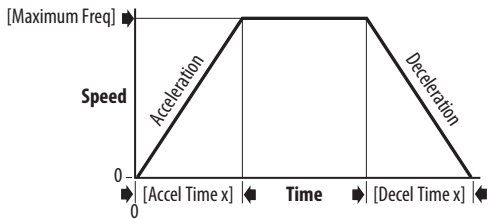

Default:	10.00 s
<b>Values</b>	
Min/Max:	0.00/600.00 s
Display:	0.01 s

**P042 [Decel Time 1]**

Related Parameter(s): [P044](#), [A439](#)

Sets the time for the drive to decelerate from [P044](#) [Maximum Freq] to 0 Hz.  
 Decel Rate = [Maximum Freq] / Decel Time x

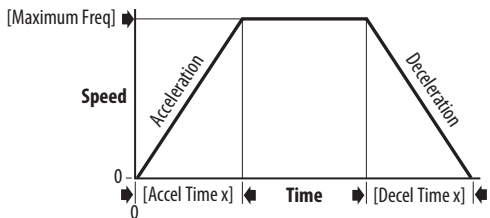

Default:	10.00 s
<b>Values</b>	
Min/Max:	0.00/600.00 s
Display:	0.01 s

## Basic Program Group (continued)

**P043 [Minimum Freq]**Related Parameter(s): [b001](#), [b002](#), [b013](#), [P044](#), [A530](#), [A531](#) Stop drive before changing this parameter.

Sets the lowest frequency the drive outputs.

	Default:	0.00 Hz
<b>Values</b>	Min/Max:	0.00/500.00 Hz
	Display:	0.01 Hz

**P044 [Maximum Freq]**Related Parameter(s): [b001](#), [b002](#), [b013](#), [b016](#), [P043](#), [A530](#), [A531](#) Stop drive before changing this parameter.

Sets the highest frequency the drive outputs.

**IMPORTANT** This value must be greater than the value set in P043 [Minimum Freq].

	Default:	60.00 Hz
<b>Values</b>	Min/Max:	0.00/500.00 Hz
	Display:	0.01 Hz

**P045 [Stop Mode]**Related Parameter(s): [t086](#), [t087](#), [A434](#), [A435](#), [A550](#)

Determines the stopping mode used by the drive when a stop is initiated.

	0	"Ramp, CF" (Default)	Ramp to Stop. Stop command clears active fault.
	1	"Coast, CF"	Coast to Stop. Stop command clears active fault.
	2	"DC Brake, CF"	DC Injection Braking Stop. Stop command clears active fault.
	3	"DC BrkAuto,CF"	DC Injection Braking Stop with Auto Shutoff. <ul style="list-style-type: none"> <li>Standard DC Injection Braking for value set in <a href="#">A434</a> [DC Brake Time].</li> <li>OR</li> <li>Drive shuts off if the drive detects that the motor is stopped.</li> </ul> Stop command clears active fault.
	4	"Ramp"	Ramp to Stop.
	5	"Coast"	Coast to Stop.
	6	"DC Brake"	DC Injection Braking Stop.
	7	"DC BrakeAuto"	DC Injection Braking Stop with Auto Shutoff. <ul style="list-style-type: none"> <li>Standard DC Injection Braking for value set in <a href="#">A434</a> [DC Brake Time].</li> <li>OR</li> <li>Drive shuts off if the drive detects that the motor is stopped.</li> </ul>
<b>Options</b>	8	"Ramp+EM B,CF"	Ramp to Stop with EM Brake Control. Stop command clears active fault.
	9	"Ramp+EM Brk"	Ramp to Stop with EM Brake Control.
	10	"PointStp,CF"	PointStop. Stop command clears active fault.
	11	"PointStop"	Provides a method to stop at a constant distance instead of a fixed rate. When a Stop command is given, the distance required for the machine to travel to standstill based on the programmed maximum speed and deceleration time is calculated. If the drive is running slower than the maximum speed, the function will apply a calculated deceleration time that allows the machine to travel to standstill in the same distance based on the current speed. It is recommended to use braking resistors or set <a href="#">A550</a> [Bus Reg Enable] to 0 "Disabled" for better performance.

PointStop.

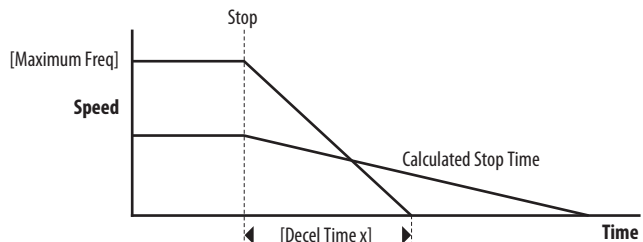

### Basic Program Group (continued)

**P046 [Start Source 1]**  
**P048 [Start Source 2]**  
**P050 [Start Source 3]**

Related Parameter(s): [b012](#), [t064](#), [c125](#)

 Stop drive before changing this parameter.

Configures the start source of the drive. Changes to these inputs take effect as soon as they are entered. P046 [Start Source 1] is the factory default start source unless overridden.

See [Start and Speed Reference Control on page 48](#) for more information.

**IMPORTANT** For all settings except when t064 [2-Wire Mode] is set to 1 “Level Sense”, the drive must receive a leading edge from the start input for the drive to start after a stop input, loss of power, or fault condition.

	1	“Keypad”	[Start Source 1] default
	2	“DigIn TrmBlk”	[Start Source 2] default
<b>Options</b>	3	“Serial/DSI”	[Start Source 3] default for PowerFlex 523
	4	“Network Opt” <sup>(1)</sup>	
	5	“EtherNet/IP” <sup>(2)</sup>	[Start Source 3] default for PowerFlex 525

(1) Select this setting if using the optional PowerFlex 25-COMM-E2P, 25-COMM-D, or 25-COMM-P adapters as the start source.

(2) Setting is specific to PowerFlex 525 drives only.

**P047 [Speed Reference1]**  
**P049 [Speed Reference2]**  
**P051 [Speed Reference3]**

Related Parameter(s): [c125](#)

Selects the source of speed command for the drive. Changes to these inputs take effect as soon as they are entered. P047 [Speed Reference1] is the factory default speed reference unless overridden.

See [Start and Speed Reference Control on page 48](#) for more information.

	1	“Drive Pot”	[Speed Reference1] default
	2	“Keypad Freq”	
	3	“Serial/DSI”	[Speed Reference3] default for PowerFlex 523
	4	“Network Opt” <sup>(1)</sup>	
	5	“0-10V Input”	[Speed Reference2] default
	6	“4-20mA Input”	
	7	“Preset Freq”	
<b>Options</b>	8	“Anlg In Mult” <sup>(2)</sup>	
	9	“MOP”	
	10	“Pulse Input”	
	11	“PID1 Output”	
	12	“PID2 Output” <sup>(2)</sup>	
	13	“Step Logic” <sup>(2)</sup>	
	14	“Encoder” <sup>(2)</sup>	
	15	“EtherNet/IP” <sup>(2)</sup>	[Speed Reference3] default for PowerFlex 525
	16	“Positioning” <sup>(2)</sup>	Referencing from <a href="#">A558</a> [Positioning Mode]

(1) Select this setting if using the optional PowerFlex 25-COMM-E2P, 25-COMM-D, or 25-COMM-P adapters as the speed reference.

(2) Setting is specific to PowerFlex 525 drives only.

**P052 [Average kWh Cost]**

Related Parameter(s): [b025](#)

Sets the average cost per kWh.

	Default:	0.00
<b>Values</b>	Min/Max:	0.00/655.35
	Display:	0.01

## Basic Program Group (continued)

### P053 [Reset To Defaults]

 Stop drive before changing this parameter.

Resets all parameters to their factory default values. After a Reset command, the value of this parameter returns to zero.

#### Parameters that are NOT Reset when P053 = 1

Parameter	Parameter	Parameter
P030 [Language]	C138 [EN Gateway Cfg 2]	C159 [EN Data Out 3]
C121 [Comm Write Mode]	C139 [EN Gateway Cfg 3]	C160 [EN Data Out 4]
C122 [Cmd Stat Select]	C140 [EN Gateway Cfg 4]	C161 [Opt Data In 1]
C123 [RS485 Data Rate]	C141 [EN Rate Cfg]	C162 [Opt Data In 2]
C124 [RS485 Node Addr]	C143 [EN Comm Flt Actn]	C163 [Opt Data In 3]
C124 [Comm Loss Action]	C144 [EN Idle Flt Actn]	C164 [Opt Data In 4]
C126 [Comm Loss Time]	C145 [EN Flt Cfg Logic]	C165 [Opt Data Out 1]
C127 [RS485 Format]	C146 [EN Flt Cfg Ref]	C166 [Opt Data Out 2]
C128 [EN Addr Sel]	C147 [EN Flt Cfg DL 1]	C167 [Opt Data Out 3]
C129 [EN IP Addr Cfg 1]	C148 [EN Flt Cfg DL 2]	C168 [Opt Data Out 4]
C130 [EN IP Addr Cfg 2]	C149 [EN Flt Cfg DL 3]	C169 [MultiDrv Sel]
C131 [EN IP Addr Cfg 3]	C150 [EN Flt Cfg DL 4]	C171 [Drv 1 Addr]
C132 [EN IP Addr Cfg 4]	C153 [EN Data In 1]	C172 [Drv 2 Addr]
C133 [EN Subnet Cfg 1]	C154 [EN Data In 2]	C173 [Drv 3 Addr]
C134 [EN Subnet Cfg 2]	C155 [EN Data In 3]	C174 [Drv 4 Addr]
C135 [EN Subnet Cfg 3]	C156 [EN Data In 4]	C175 [DSI I/O Cfg]
C136 [EN Subnet Cfg 4]	C157 [EN Data Out 1]	GC [Parameters in Custom Group]
C137 [EN Gateway Cfg 1]	C158 [EN Data Out 2]	

#### Parameters that are Reset when P053 = 3

Parameter Name
P031 [Motor NP Volts]
P033 [Motor OL] Current
P034 [Motor NP FLA]
P035 [Motor NP Poles]
A435 [DC Brake Level]
A484 [Current Limit 1]
A485 [Current Limit 2]
A486 [Shear Pin1 Level]
A488 [Shear Pin2 Level]
A490 [Load Loss Level]
A496 [IR Voltage Drop]
A497 [Flux Current Ref]
A530 [Boost Select]
A531 [Start Boost]
A532 [Break Voltage]
A533 [Break Frequency]
A534 [Maximum] Voltage

	0	"Ready/Idle" (Default)	
	1	"Param Reset"	Does not reset custom groups, parameter P030 [Language], and communication parameters.
<b>Options</b>	2	"Factory Rset"	Restore drive to factory condition.
	3	"Power Reset"	Resets only power parameters. Can be used when swapping power modules.
	4	"Module Reset" <sup>(1) (2)</sup>	Power cycle of the drive, <b>NO</b> parameters are reset.

(1) Setting is available in PowerFlex 525 FRN 5.xxx and later.

(2) Setting is available in PowerFlex 523 FRN 3.xxx and later.

### P054 [Display Param]

Related Parameter(s): [b001](#)

Sets the parameter to display on the drive LCD display when the drive powers up.

	0	"Keypad Disp" (Default)	Without ADC = shows last selected display parameter With ADC = shows parameter <a href="#">b001</a> [Output Freq]
<b>Options</b>	1	"Output Freq"	Basic Display group parameters

# Terminal Block Group

## Programmable Digital Inputs

t062 [DigIn TermBlk 02] t063 [DigIn TermBlk 03]  
 t065 [DigIn TermBlk 05] t066 [DigIn TermBlk 06]

Related Parameter(s): [b012](#), [b013](#), [b014](#), [P045](#), [P046](#), [P048](#), [P049](#), [P050](#), [P051](#), [t064](#), [t086](#), [A410-A425](#), [A427](#), [A431](#), [A432](#), [A433](#), [A434](#), [A435](#), [A442](#), [A443](#), [A488](#), [A535](#), [A560](#), [A562](#), [A563](#), [A567](#), [A571](#)

t067 [DigIn TermBlk 07] t068 [DigIn TermBlk 08]  
 [PF 525] PowerFlex 525 only.

 Stop drive before changing this parameter.

Programmable digital input. Changes to these inputs takes effect as soon as they are entered. If a digital input is set for a selection that is only usable on one input, no other input can be set for the same selection.

0	"Not Used"	Terminal has no function but can be read over network communications with <a href="#">b013</a> [Contrl In Status] and <a href="#">b014</a> [Dig In Status].
1	"Speed Ref 2"	Selects <a href="#">P049</a> [Speed Reference2] as drive's speed command.
2	"Speed Ref 3"	Selects <a href="#">P051</a> [Speed Reference3] as drive's speed command.
3	"Start Src 2"	Selects <a href="#">P048</a> [Start Source 2] as control source to start the drive.
4	"Start Src 3"	Selects <a href="#">P050</a> [Start Source 3] as control source to start the drive.
5	"Spd + Strt 2"	[DigIn TermBlk 07] default. Selects combination of <a href="#">P049</a> [Speed Reference2] and <a href="#">P048</a> [Start Source 2] as speed command with control source to start the drive.
6	"Spd + Strt 3"	Selects combination of <a href="#">P051</a> [Speed Reference3] and <a href="#">P050</a> [Start Source 3] as speed command with control source to start the drive.
7	"Preset Freq"	[DigIn TermBlk 05] and [DigIn TermBlk 06] default. <ul style="list-style-type: none"> <li>Selects a preset frequency in Velocity mode (<a href="#">P047</a>, <a href="#">P049</a>, <a href="#">P051</a> [Speed Reference<math>x</math>] = 1...15). See <a href="#">A410...A425</a> [Preset Freq <math>x</math>].</li> <li>Selects a preset frequency and position in Positioning mode (<a href="#">P047</a>, <a href="#">P049</a>, <a href="#">P051</a> [Speed Reference<math>x</math>] = 16). See <a href="#">L200...L214</a> [Step Units <math>x</math>] (only for PowerFlex 525 drives).</li> </ul>

**IMPORTANT** Digital Inputs have priority for frequency control when programmed as Preset Speed and are active. See [Start Source and Speed Reference Selection on page 48](#) for more information.

### Options

8	"Jog"	<ul style="list-style-type: none"> <li>When input is present, drive accelerates according to the value set in <a href="#">A432</a> [Jog Accel/Decel] and ramps to the value set in <a href="#">A431</a> [Jog Frequency].</li> <li>When input is removed, drive ramps to a stop according to the value set in <a href="#">A432</a> [Jog Accel/Decel].</li> <li>A valid Start command will override this input.</li> </ul>
9	"Jog Forward"	[DigIn TermBlk 08] default. Drive accelerates to <a href="#">A431</a> [Jog Frequency] according to <a href="#">A432</a> [Jog Accel/Decel] and ramps to a stop when input becomes inactive. A valid Start command will override this input.
10	"Jog Reverse"	Drive accelerates to <a href="#">A431</a> [Jog Frequency] according to <a href="#">A432</a> [Jog Accel/Decel] and ramps to a stop when input becomes inactive. A valid Start command will override this input.
11	"Acc/Dec Sel2" <sup>(1)</sup>	If active, determines which Accel/Decel time will be used for all ramp rates except jog. Can be used with option 29 "Acc/Dec Sel3" for additional Accel/Decel times. See <a href="#">A442</a> [Accel Time 2] for more information.
12	"Aux Fault"	When enabled, an <a href="#">F002</a> "Auxiliary Input" fault will occur when the input is removed.
13	"Clear Fault"	When active, clears an active fault.
14	"RampStop,CF"	Causes drive to immediately ramp to a stop regardless of how <a href="#">P045</a> [Stop Mode] is set.
15	"CoastStop,CF"	Causes drive to immediately coast to a stop regardless of how <a href="#">P045</a> [Stop Mode] is set.
16	"DCInjStop,CF"	Causes drive to immediately begin a DC Injection stop regardless of how <a href="#">P045</a> [Stop Mode] is set.
17	"MOP Up"	Increases the value of <a href="#">A427</a> [MOP Freq] at the rate set in <a href="#">A430</a> [MOP Time].
18	"MOP Down"	Decreases the value of <a href="#">A427</a> [MOP Freq] at the rate set in <a href="#">A430</a> [MOP Time].
19	"Timer Start" <sup>(1)</sup>	Clears and starts the timer function. May be used to control the relay or opto outputs.
20	"Counter In" <sup>(1)</sup>	Starts the counter function. May be used to control the relay or opto outputs.
21	"Reset Timer"	Resets the internal active timer, <a href="#">d365</a> [Timer Status]. For more information, see <a href="#">Timer Function on page 213</a> .
22	"Reset Counter"	Resets the count in the accumulated internal active counter, <a href="#">d364</a> [Counter Status]. For more information, see <a href="#">Counter Function on page 214</a> .
23	"Rset Tim&Cnt"	Resets both the internal active timer and accumulated internal active counter.



## Programmable Digital Inputs (Continued)

24 "Logic In 1" <sup>(1)(2)</sup>	Logic function input number 1. May be used to control the relay or opto outputs ( <a href="#">t076</a> , <a href="#">t081</a> [Relay Outx Sel] and <a href="#">t069</a> , <a href="#">t072</a> [Opto Outx Sel], options 11...14). May be used in conjunction with StepLogic parameters <a href="#">L180</a> ... <a href="#">L187</a> [Stp Logic x].
25 "Logic In 2" <sup>(1)(2)</sup>	Logic function input number 2. May be used to control the relay or opto outputs ( <a href="#">t076</a> , <a href="#">t081</a> [Relay Outx Sel] and <a href="#">t069</a> , <a href="#">t072</a> [Opto Outx Sel], options 11...14). May be used in conjunction with StepLogic parameters <a href="#">L180</a> ... <a href="#">L187</a> [Stp Logic x].
26 "Current Lmt2" <sup>(2)</sup>	When active, <a href="#">A485</a> [Current Limit 2] determines the drive current limit level.
27 "Anlg Invert"	Inverts the scaling of the analog input levels set in <a href="#">t091</a> [Anlg In 0-10V Lo] and <a href="#">t092</a> [Anlg In 0-10V Hi] or <a href="#">t095</a> [Anlg In4-20mA Lo] and <a href="#">t096</a> [Anlg In4-20mA Hi].
28 "EM Brk Rlse"	If EM brake function is enabled, this input releases the brake. See <a href="#">t086</a> [EM Brk Off Delay] for more information.



**ATTENTION:** If a hazard of injury due to movement of equipment or material exists, an auxiliary mechanical braking device must be used.

29 "Acc/Dec Sel3" <sup>(1)</sup>	If active, determines which Accel/Decel time is used for all ramp rates except jog. Used with option 11 "Acc/Dec Sel2" for the Accel/Decel times listed in this table.
----------------------------------	--

Option		Description
29	11	
0	0	Acc/Dec 1
0	1	Acc/Dec 2
1	0	Acc/Dec 3
1	1	Acc/Dec 4

30 "Precharge En"	Forces drive into precharge state. Typically controlled by auxiliary contact on the disconnect at the DC input to the drive. If this input is assigned, it must be energized for the pre-charge relay to close and for the drive to run. If it is de-energized, the pre-charge relay opens and the drive coasts to a stop.
31 "Inertia Dcel"	Forces drive into Inertia Ride-Through state. The drive attempts to regulate the DC bus at the current level.
32 "Sync Enable"	Must be used in order to hold the existing frequency when Sync Time is set to enable speed synchronization. When this input is released the drive accelerates to the commanded frequency in <a href="#">A571</a> [Sync Time].
<b>Options</b> 33 "Traverse Dis"	When an input is programmed the traverse function is disabled while this input is active. See <a href="#">A567</a> [Max Traverse].
34 "Home Limit" <sup>(2)</sup>	In Positioning mode, indicates the drive is at the home position. See <a href="#">Appendix E</a> for more information on Positioning.
35 "Find Home" <sup>(2)</sup>	In Positioning mode, causes the drive to return to the Home position when a Start command is issued. Uses <a href="#">A562</a> [Find Home Freq] and <a href="#">A563</a> [Find Home Dir] until the "Home Limit" input is activated. If it passes this point, it then runs in the reverse direction at 1/10th the frequency of [Find Home Freq] until the "Home Limit" is activated again. As long as this input is active, any start command causes the drive to enter the homing routine. Only functions if in Positioning mode. Once the Find Home routine has finished, the drive stops. See <a href="#">Appendix E</a> for more information on Positioning.
36 "Hold Step" <sup>(2)</sup>	In Positioning mode, overrides other inputs and causes the drive to remain at its current step (running at zero speed once it reaches its position) until released. While in "Hold", the drive ignores any input command which would normally result in a move to a new step. Timers continue to run. Therefore, when the Hold is removed, the drive must see any required digital inputs transition (even if they already transitioned during the hold), but it does not reset any timer. See <a href="#">Appendix E</a> for more information on Positioning.
37 "Pos Redefine" <sup>(2)</sup>	In Positioning mode, resets the home position to the current position of the machine. See <a href="#">Appendix E</a> for more information on Positioning.
38 "Force DC"	If the drive is not running, causes the drive to apply a DC Holding current ( <a href="#">A435</a> [DC Brake Level], ignoring <a href="#">A434</a> [DC Brake Time]) while the input is applied.
39 "Damper Input"	When active, drive is allowed to run normally. When inactive, drive is forced into sleep mode and is prevented from accelerating to command speed.
40 "Purge" <sup>(1)</sup>	Starts the drive at <a href="#">A433</a> [Purge Frequency] regardless of the selected control source. Supersedes the keypad Control function as well as any other control command to take control of the drive. Purge can occur, and is operational, at any time whether the drive is running or stopped regardless of the selected logic source selection. If a valid stop (other than from comms or SW enable) is present, the drive will not start on the purge input transition.



**ATTENTION:** If a hazard of injury due to movement of equipment or material exists, an auxiliary mechanical braking device must be used.

41 "Freeze-Fire"	When inactive, will cause an immediate <a href="#">F094</a> "Function Loss" fault. Use to safely bypass the drive with an external switching device.
42 "SW Enable"	Works like an interlock that has to be active for the drive to run.

Programmable Digital Inputs (Continued)

	43 "ShearPin1 Dis"	Disables shear pin 1 but leaves shear pin 2 active. If <a href="#">A488</a> [Shear Pin 2 Level] is greater than 0.0 A, shear pin 2 is enabled.
	44 Reserved	
	45 Reserved	
	46 Reserved	
	47 Reserved	
	48 "2-Wire FWD" (only for DigIn TermBlk 02)	[DigIn TermBlk 02] default. Select 2-Wire FWD for this input. Select this option and set <a href="#">P046</a> , <a href="#">P048</a> or <a href="#">P050</a> [Start Source x] to 2 "DigIn TrmBlk" to configure [Start Source x] to a 2-wire run forward mode. Also see <a href="#">t064</a> [2-Wire Mode] for level trigger settings.
	49 "3-Wire Start" (only for DigIn TermBlk 02)	Select 3-Wire Start for this input. Select this option and set <a href="#">P046</a> , <a href="#">P048</a> or <a href="#">P050</a> [Start Source x] to 2 "DigIn TrmBlk" to configure [Start Source x] to a 3-wire start mode.
Options	50 "2-Wire REV" (only for DigIn TermBlk 03)	[DigIn TermBlk 03] default. Select 2-Wire REV for this input. Select this option and set <a href="#">P046</a> , <a href="#">P048</a> or <a href="#">P050</a> [Start Source x] to 2 "DigIn TrmBlk" to configure [Start Source x] to a 2-wire run reverse mode. Also see <a href="#">t064</a> [2-Wire Mode] for level trigger settings. For PowerFlex 523 drives, this setting will be disabled if [DigIn TermBlk 03] is set to 7 "Preset Freq".
	51 "3-Wire Dir" (only for DigIn TermBlk 03)	Select 3-Wire Dir for this input. Select this option and set <a href="#">P046</a> , <a href="#">P048</a> or <a href="#">P050</a> [Start Source x] to 2 "DigIn TrmBlk" to change the direction of [Start Source x]. For PowerFlex 523 drives, this setting will be disabled if [DigIn TermBlk 03] is set to 7 "Preset Freq".
	52 "Pulse Train"  (PF523: only for DigIn TermBlk 05) (PF525: only for DigIn TermBlk 07)	Select pulse train for this input. Use <a href="#">P047</a> , <a href="#">P049</a> and <a href="#">P051</a> [Speed Reference x] to select pulse input. Jumper for DigIn TermBlk 05 or 07 Sel must be moved to Pulse In.

Drive Start Condition Matrix for t062 and t063

	t062 Setting	
t063 Setting	3-Wire Start	2-Wire FWD
2-Wire REV	Drive will not start	OK
3-Wire Dir	OK	Drive will not start

- (1) This function may be tied to one input only.
- (2) Setting is specific to PowerFlex 525 drives only.

**t064 [2-Wire Mode]**

Related Parameter(s): [P045](#), [P046](#), [P048](#), [P050](#), [t062](#), [t063](#)

 Stop drive before changing this parameter.

Programs the mode of trigger only for [t062](#) [DigIn TermBlk 02] and [t063](#) [DigIn TermBlk 03] when 2-wire option is being selected as [P046](#), [P048](#) or [P050](#) [Start Source x].

0	"Edge Trigger" (Default)	Standard 2-Wire operation.
1	"Level Sense"	<ul style="list-style-type: none"> <li>I/O Terminal 01 "Stop" = Coast to stop. Drive will restart after a Stop command when:                             <ul style="list-style-type: none"> <li>Stop is removed and</li> <li>Start is held active</li> </ul> </li> <li>I/O Terminal 03 "Run REV"</li> </ul>



**ATTENTION:** Hazard of injury exists due to unintended operation. When t064 [2-Wire Mode] is set to option 1, and the Run input is maintained, the Run inputs do not need to be toggled after a Stop input for the drive to run again. A Stop function is provided only when the Stop input is active (open).

Options



**ATTENTION:** When operating in 2-Wire Level Sense (Run Level), the PowerFlex 523 and PowerFlex 525 drive should only be controlled from the Digital Input Terminal Blocks. This should NOT be used with any other DSI or Network device.

2	"Hi-Spd Edge"	<p><b>IMPORTANT</b> There is greater potential voltage on the output terminals when using this option.</p> <ul style="list-style-type: none"> <li>Outputs are kept in a ready-to-run state. The drive will respond to a Start command within 10 ms.</li> <li>I/O Terminal 01 "Stop" = Coast to stop.</li> <li>I/O Terminal 03 "Run REV"</li> </ul>
3	"Momentary"	<ul style="list-style-type: none"> <li>Drive will start after a momentary input from either the Run FWD input (I/O Terminal 02) or the Run REV input (I/O Terminal 03).</li> <li>I/O Terminal 01 "Stop" = Stop according to the value set in <a href="#">P045</a> [Stop Mode].</li> </ul>

## Programmable Digital Outputs

**t069** [Opto Out1 Sel]  
**t072** [Opto Out2 Sel]

Related Parameter(s): [P046](#), [P048](#), [P050](#), [t070](#), [t073](#), [t077](#), [t082](#),  
[t086](#), [t087](#), [t093](#), [t094](#), [t097](#), [A541](#), [A564](#)

(PF 525) PowerFlex 525 only.

Determines the operation of the programmable digital outputs.

Options	Setting Output Changes State When...	Hysteresis
0 "Ready/Fault"	Opto outputs are active when power is applied. Indicates that the drive is ready for operation. Opto outputs are inactive when power is removed or a fault occurs.	None
1 "At Frequency"	Drive reaches commanded frequency.	0.5 Hz above; 1.0 Hz below
2 "MotorRunning"	Motor is receiving power from the drive.	None
3 "Reverse"	Drive is commanded to run in reverse direction.	None
4 "Motor Overld"	Motor overload condition exists.	100 ms time delay on or off
5 "Ramp Req"	Ramp regulator is modifying the programmed accel/decel times to avoid an overcurrent or overvoltage fault from occurring.	100 ms time delay on or off
6 "Above Freq"	Drive exceeds the frequency (Hz) value set in <a href="#">t070</a> or <a href="#">t073</a> [Opto Outx Level].	100 ms time delay on or off
7 "Above Cur"	Drive exceeds the current (% Amps) value set in <a href="#">t070</a> or <a href="#">t073</a> [Opto Outx Level].  <div style="border: 1px solid black; padding: 5px; text-align: center;"> <b>IMPORTANT</b> Value for <a href="#">t070</a> or <a href="#">t073</a> [Opto Outx Level] must be entered in percent of drive rated output current.         </div>	100 ms time delay on or off
8 "Above DCVolt"	Drive exceeds the DC bus voltage value set in <a href="#">t070</a> or <a href="#">t073</a> [Opto Outx Level].	100 ms time delay on or off
9 "Retries Exst"	Value set in <a href="#">A541</a> [Auto Rstrt Tries] is exceeded.	None
10 "Above Anlg V"	Analog input voltage (0...10V input) exceeds the value set in <a href="#">t070</a> or <a href="#">t073</a> [Opto Outx Level].  <div style="border: 1px solid black; padding: 5px; text-align: center;"> <b>IMPORTANT</b> Do not use if <a href="#">t093</a> [10V Bipolar Enbl] is set to 1 "Bi-Polar In".         </div>	100 ms time delay on or off
11 "Above PF Ang"	Power Factor angle exceeds the value set in <a href="#">t070</a> or <a href="#">t073</a> [Opto Outx Level].	100 ms time delay on or off
12 "Anlg In Loss"	Analog input loss has occurred. Program <a href="#">t094</a> [Anlg In V Loss] or <a href="#">t097</a> [Anlg In mA Loss] for desired action when input loss occurs.	On, 2 mA / ±1V Off, 3 mA / ±1.5V
13 "ParamControl"	Output is directly controlled by the state of the <a href="#">t070</a> or <a href="#">t073</a> [Opto Outx Level]. A value of 0 causes the output to turn off. A value of 1 or greater in this parameter causes the output to turn on.	None
14 "NonRec Fault"	<ul style="list-style-type: none"> <li>• Value set in <a href="#">A541</a> [Auto Rstrt Tries] is exceeded or</li> <li>• <a href="#">A541</a> [Auto Rstrt Tries] is not enabled or</li> <li>• A non-resettable fault has occurred.</li> </ul>	None
15 "EM Brk Cntrl"	EM Brake is energized. Program <a href="#">t087</a> [EM Brk On Delay] and <a href="#">t086</a> [EM Brk Off Delay] for desired action.	None
16 "Thermal OL"	Relay energizes when thermal Motor overload counter is above the value set in <a href="#">t077</a> or <a href="#">t082</a> [Relay Outx Level]. It also energizes if the drive is within 5 °C of the drive overheat trip point.	None
17 "Amb OverTemp"	Relay energizes when control module over temperature occurs.	None
18 "Local Active"	Active when drive <a href="#">P046</a> , <a href="#">P048</a> or <a href="#">P050</a> [Start Source x] is in local keypad control.	None
19 "Comm Loss"	Active when communication is lost from any comm source with reference or control.	None
20 "Logic In 1"	An input is programmed as "Logic Input 1" and is active.	None
21 "Logic In 2"	An input is programmed as "Logic Input 2" and is active.	None
22 "Logic 1 & 2"	Both Logic inputs are programmed and active.	None
23 "Logic 1 or 2"	One or both Logic inputs are programmed and one or both is active.	None
24 "StpLogic Out"	Drive enters StepLogic step with Command Word set to enable Logic output.	None
25 "Timer Out"	Timer has reached the value set in <a href="#">t070</a> or <a href="#">t073</a> [Opto Outx Level] or not timing.	None
26 "Counter Out"	Counter has reached the value set in <a href="#">t070</a> or <a href="#">t073</a> [Opto Outx Level] or not counting.	None
27 "At Position"	Drive is in Positioning mode and has reached the commanded position. Tolerance is adjusted with <a href="#">A564</a> [Encoder Pos Tol].	-
28 "At Home"	Drive is in Positioning mode and has reached the home position. Tolerance is adjusted with <a href="#">A564</a> [Encoder Pos Tol].	-
29 "Safe-Off"	Both safe-off inputs are active.	-
30 "SafeTqPermit" <sup>(1)</sup>	Both safe-off inputs are inactive (closed).	-
31 "AutoRst Ctdn" <sup>(1)</sup>	Drive is counting down to an automatic restart.	-

(1) Setting is available in FRN 5.xxx and later.

### Programmable Digital Outputs (Continued)

<b>Values</b>	Default:	2
	Opto Out1 Sel:	1
	Opto Out2 Sel:	0/31
	Display:	1

**t070 [Opto Out1 Level]**

Related Parameter(s): [t069](#), [t072](#)

**t073 [Opto Out2 Level]**



32 bit parameter.

**PF 525** PowerFlex 525 only.

Determines the on/off point for the digital outputs when [t069](#) or [t072](#) [Opto Outx Sel] is set to the values shown below.

Min/Max Value Range Based On [Opto Outx Sel] Setting					
6:	0...500 Hz	10:	0...100%	16:	0.1...9999 s
				20:	0/1
7:	0...180%	11:	0/1	17:	1...9999 counts
				26:	0...150%
8:	0...815V	13:	0...800	18:	0...180°
				-	

<b>Values</b>	Default:	0.0
	Min/Max:	0.0/9999.0
	Display:	0.1

**t075 [Opto Out Logic]**

**PF 525** PowerFlex 525 only.

Determines the logic (Normally Open/NO or Normally Closed/NC) of the digital outputs only.

Setting	Digital Out 1 Logic	Digital Out 2 Logic
0	NO	NO
1	NC	NO
2	NO	NC
3	NC	NC

<b>Values</b>	Default:	0
	Min/Max:	0/3
	Display:	1

## Programmable Relay Outputs

### t076 [Relay Out1 Sel]

Related Parameter(s): [P046](#), [P048](#), [P050](#), [t070](#), [t073](#), [t077](#), [t082](#), [t086](#), [t087](#), [t093](#), [t094](#), [t097](#), [A541](#), [A564](#)

### t081 [Relay Out2 Sel]

PF 525 PowerFlex 525 only.

Determines the operation of the programmable output relay.

Options	Output Relay Changes State When...	Hysteresis
0 "Ready/Fault"	Relay changes state when power is applied. Indicates that the drive is ready for operation. Relay returns drive to shelf state when power is removed or a fault occurs.	None
1 "At Frequency"	Drive reaches commanded frequency.	0.5 Hz above; 1.0 Hz below
2 "MotorRunning"	Motor is receiving power from the drive.	None
3 "Reverse"	Drive is commanded to run in reverse direction.	None
4 "Motor Overld"	Motor overload condition exists.	100 ms time delay on or off
5 "Ramp Reg"	Ramp regulator is modifying the programmed accel/ decel times to avoid an overcurrent or overvoltage fault from occurring.	100 ms time delay on or off
6 "Above Freq"	Drive exceeds the frequency (Hz) value set in <a href="#">t077</a> or <a href="#">t082</a> [Relay Outx Level].	100 ms time delay on or off
7 "Above Cur"	Drive exceeds the current (% Amps) value set in <a href="#">t077</a> or <a href="#">t082</a> [Relay Outx Level].  <b>IMPORTANT</b> Value for <a href="#">t077</a> or <a href="#">t082</a> [Relay Outx Level] must be entered in percent of drive rated output current.	100 ms time delay on or off
8 "Above DCVolt"	Drive exceeds the DC bus voltage value set in <a href="#">t077</a> or <a href="#">t082</a> [Relay Outx Level].	100 ms time delay on or off
9 "Retries Exst"	Value set in <a href="#">A541</a> [Auto Rstrt Tries] is exceeded.	None
10 "Above Anlg V"	Analog input voltage (0...10V input) exceeds the value set in <a href="#">t077</a> or <a href="#">t082</a> [Relay Outx Level].  <b>IMPORTANT</b> Do not use if <a href="#">t093</a> [10V Bipolar Enbl] is set to 1 "Bi-Polar In".	100 ms time delay on or off
11 "Above PF Ang"	Power Factor angle exceeds the value set in <a href="#">t077</a> or <a href="#">t082</a> [Relay Outx Level].	100 ms time delay on or off
12 "Anlg In Loss"	Analog input loss has occurred. Program <a href="#">t094</a> [Anlg In V Loss] or <a href="#">t097</a> [Anlg In mA Loss] for desired action when input loss occurs.	On, 2 mA / ±1V Off, 3 mA / ±1.5V
13 "ParamControl"	Output will be directly controlled by the state of the <a href="#">t077</a> or <a href="#">t082</a> [Relay Outx Level]. A value of 0 causes the output to turn off. A value of 1 or greater in this parameter causes the output to turn on.	None
14 "NonRec Fault"	<ul style="list-style-type: none"> <li>Value set in <a href="#">A541</a> [Auto Rstrt Tries] is exceeded or</li> <li><a href="#">A541</a> [Auto Rstrt Tries] is not enabled or</li> <li>A non-resettable fault has occurred.</li> </ul>	None
15 "EM Brk Cntr"	EM Brake is energized. Program <a href="#">t087</a> [EM Brk On Delay] and <a href="#">t086</a> [EM Brk Off Delay] for desired action.	None
16 "Thermal OL"	Relay energizes when thermal Motor overload counter is above the value set in <a href="#">t077</a> or <a href="#">t082</a> [Relay Outx Level]. It also energizes if the drive is within 5 °C of the drive overheat trip point.	None
17 "Amb OverTemp"	Relay energizes when control module over temperature occurs.	None
18 "Local Active"	Active when drive <a href="#">P046</a> , <a href="#">P048</a> or <a href="#">P050</a> [Start Source x] is in local keypad control.	None
19 "Comm Loss"	Active when communication is lost from any comm source with reference or control.	None
20 "Logic In 1 <sup>(1)</sup> "	An input is programmed as "Logic Input 1" and is active.	None
21 "Logic In 2 <sup>(1)</sup> "	An input is programmed as "Logic Input 2" and is active.	None
22 "Logic 1 & 2 <sup>(1)</sup> "	Both Logic inputs are programmed and active.	None
23 "Logic 1 or 2 <sup>(1)</sup> "	One or both Logic inputs are programmed and one or both is active.	None
24 "StpLogic Out <sup>(1)</sup> "	Drive enters StepLogic step with Command Word set to enable Logic output.	None
25 "Timer Out"	Timer has reached the value set in <a href="#">t077</a> or <a href="#">t082</a> [Relay Outx Level] or not timing.	None
26 "Counter Out"	Counter has reached the value set in <a href="#">t077</a> or <a href="#">t082</a> [Relay Outx Level] or not counting.	None
27 "At Position" <sup>(1)</sup>	Drive is in Positioning mode and has reached the commanded position. Tolerance is adjusted with <a href="#">A564</a> [Encoder Pos Tol].	-
28 "At Home" <sup>(1)</sup>	Drive is in Positioning mode and has reached the home position. Tolerance is adjusted with <a href="#">A564</a> [Encoder Pos Tol].	-
29 "Safe-Off" <sup>(1)</sup>	Both safe-off inputs are active.	-
30 "SafeTqPermit" <sup>(1)(2)</sup>	Both safe-off inputs are inactive (closed).	-
31 "AutoRst Ctdn" <sup>(1)(2)</sup>	Drive is counting down to an automatic restart.	-

(1) Setting is specific to PowerFlex 525 drives only.

(2) Setting is available in FRN 5.xxx and later.

### Programmable Relay Outputs (Continued)

<b>Values</b>	Default:	
	Relay Out1 Sel:	0
	Relay Out2 Sel:	2
	Min/Max:	0/31
	Display:	1

Related Parameter(s): [t076](#), [t081](#)

**t077 [Relay Out1 Level]**

**t082 [Relay Out2 Level]**

(PF 525) PowerFlex 525 only.

$\nabla^{32}$  32 bit parameter.

Determines the on/off point for the output relay when [t076](#) or [t081](#) [Relay Outx Sel] is set to the values shown below.

Min/Max Value Range Based On [Relay Outx Sel] Setting					
6:	0...500 Hz	10:	0...100%	16:	0.1...9999 s
7:	0...180%	11:	0/1	17:	1...9999 counts
8:	0...815V	13:	0...800	18:	0...180 °C
				20:	0/1
				26:	0...150%
				-	

<b>Values</b>	Default:	0.0
	Min/Max:	0.0/9999.0
	Display:	0.1

**t079 [Relay 1 On Time]**

**t084 [Relay 2 On Time]**

(PF 525) PowerFlex 525 only.

Sets the delay time before Relay energizes after required condition is met.

<b>Values</b>	Default:	0.0 s
	Min/Max:	0.0/600.0 s
	Display:	0.1 s

**t080 [Relay 1 Off Time]**

**t085 [Relay 2 Off Time]**

(PF 525) PowerFlex 525 only.

Sets the delay time before Relay de-energizes after required condition ceases.

<b>Values</b>	Default:	0.0 s
	Min/Max:	0.0/600.0 s
	Display:	0.1 s

**t086 [EM Brk Off Delay]**

Related Parameter(s): [P045](#)

Sets the time the drive remains at minimum frequency before ramping up to the commanded frequency (and engaging the brake coil relay) if Electromechanical (EM) Brake Control Mode is enabled with [P045](#) [Stop Mode].

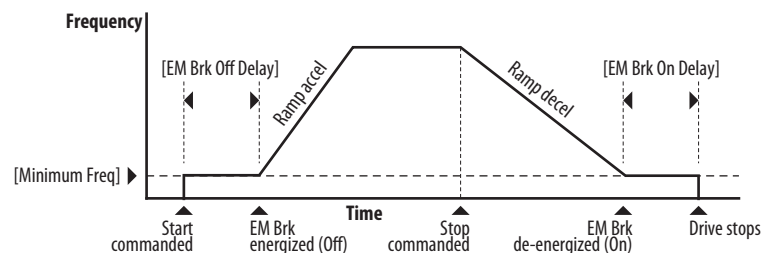

<b>Values</b>	Default:	2.00 s
	Min/Max:	0.00/10.00 s
	Display:	0.01 s

## Terminal Block Group (continued)

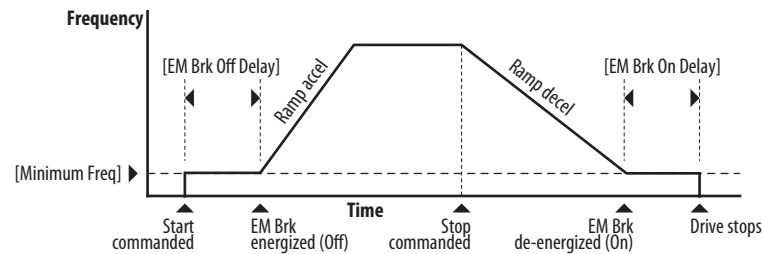
**t087 [EM Brk On Delay]**Related Parameter(s): [P045](#)Sets the time the drive remains at minimum frequency (after releasing the brake coil relay) before stopping if EM Brake Control Mode is enabled with [P045](#) [Stop Mode].

Default: 2.00 s

<b>Values</b>	Min/Max:	0.00/10.00 s
---------------	----------	--------------

	Display:	0.01 s
--	----------	--------

**t088 [Analog Out Sel]**Related Parameter(s): [t090](#)The 0...10V, 0...20 mA or 4...0 mA analog output can be used to provide a signal proportional to several drive conditions. This parameter also selects which analog calibration parameters to use.<sup>(1)</sup>

Options	Output Range	Minimum Output Value	Maximum Output Value = <a href="#">t089</a> [Analog Out High]	Filter <sup>(1)</sup>	Related Parameter
0 "OutFreq 0-10"	0-10V	0V = 0 Hz	[Maximum Freq]	None	<a href="#">b001</a>
1 "OutCurr 0-10"	0-10V	0V = 0 A	200% Drive Rated Current	Filter A	<a href="#">b003</a>
2 "OutVolt 0-10"	0-10V	0V = 0V	120% Drive Rated Output Volts	None	<a href="#">b004</a>
3 "OutPowr 0-10"	0-10V	0V = 0 kW	200% Drive Rated Power	Filter A	<a href="#">b017</a>
4 "OutTorq 0-10"	0-10V	0V = 0 A	200% Drive Rated Current	Filter A	<a href="#">d382</a>
5 "TstData 0-10"	0-10V	0V = 0000	65535 (Hex FFFF)	None	-
6 "Setpnt 0-10"	0-10V	0V = 0%	100.0% Setpoint setting	None	<a href="#">t090</a>
7 "DCVolt 0-10"	0-10V	0V = 0V	100.0% of trip value	None	<a href="#">b005</a>
8 "OutFreq 0-20"	0-20 mA	0 mA = 0 Hz	[Maximum Freq]	None	<a href="#">b001</a>
9 "OutCurr 0-20"	0-20 mA	0 mA = 0 A	200% Drive Rated Current	Filter A	<a href="#">b003</a>
10 "OutVolt 0-20"	0-20 mA	0 mA = 0V	120% Drive Rated Output Volts	None	<a href="#">b004</a>
11 "OutPowr 0-20"	0-20 mA	0 mA = 0 kW	200% Drive Rated Power	Filter A	<a href="#">b017</a>
12 "OutTorq 0-20"	0-20 mA	0 mA = 0 A	200% Drive Rated Current	Filter A	<a href="#">d382</a>
13 "TstData 0-20"	0-20 mA	0 mA = 0000	65535 (Hex FFFF)	None	-
14 "Setpnt 0-20"	0-20 mA	0 mA = 0%	100.0% Setpoint setting	None	<a href="#">t090</a>
15 "DCVolt 0-20"	0-20 mA	0 mA = 0V	100.0% of trip value	None	<a href="#">b005</a>
16 "OutFreq 4-20"	4-20 mA	4 mA = 0 Hz	[Maximum Freq]	None	<a href="#">b001</a>
17 "OutCurr 4-20"	4-20 mA	4 mA = 0 A	200% Drive Rated Current	Filter A	<a href="#">b003</a>
18 "OutVolt 4-20"	4-20 mA	4 mA = 0V	120% Drive Rated Output Volts	None	<a href="#">b004</a>
19 "OutPowr 4-20"	4-20 mA	4 mA = 0 kW	200% Drive Rated Power	Filter A	<a href="#">b017</a>
20 "OutTorq 4-20"	4-20 mA	4 mA = 0 A	200% Drive Rated Current	Filter A	<a href="#">d382</a>
21 "TstData 4-20"	4-20 mA	4 mA = 0000	65535 (Hex FFFF)	None	-
22 "Setpnt 4-20"	4-20 mA	4 mA = 0%	100.0% Setpoint setting	None	<a href="#">t090</a>
23 "DCVolt 4-20"	4-20 mA	4 mA = 0V	100.0% of trip value	None	<a href="#">b005</a>

<sup>(1)</sup> Filter A is a single pole digital filter with a 162 ms time constant. Given a 0...100% step input from a steady state, the output of Filter A takes 500 ms to get to 95% of maximum, 810 ms to get to 99%, and 910 ms to get to 100%.

Default: 0

<b>Values</b>	Min/Max:	0/23
---------------	----------	------

	Display:	1
--	----------	---

<sup>(1)</sup> Parameter is also available in PowerFlex 523 FRN 3.xxx and later. PowerFlex 523 series B drive is required.

## Terminal Block Group (continued)

**t089 [Analog Out High]**

Scales the maximum output value (V or mA) when the source setting is at maximum.<sup>(1)</sup>

	Default:	100%
<b>Values</b>	Min/Max:	0/800%
	Display:	1%

(1) Parameter is also available in PowerFlex 523 FRN 3.xxx and later. PowerFlex 523 series B drive is required.

**t090 [Anlg Out Setpt]**

Related Parameter(s): [t088](#)

Sets the percentage of output desired when [t088](#) [Analog Out Sel] is set to 6, 14 or 22 "Analog Setpoint".<sup>(1)</sup>

	Default:	0.0%
<b>Values</b>	Min/Max:	0.0/100.0%
	Display:	0.1%

(1) Parameter is also available in PowerFlex 523 FRN 3.xxx and later. PowerFlex 523 series B drive is required.

**t091 [Anlg In 0-10V Lo]**

Related Parameter(s): [P043](#), [t092](#), [t093](#)

 Stop drive before changing this parameter.

Sets the percentage (based on 10V) of input voltage applied to the 0...10V analog input used to represent [P043](#) [Minimum Freq]. Analog inversion can be accomplished by setting this value larger than [t092](#) [Anlg In 0-10V Hi]. If [t093](#) [10V Bipolar Enbl] is set to 1 "Bi-Polar In", this parameter is ignored.

	Default:	0.0%
<b>Values</b>	Min/Max:	0.0/200.0%
	Display:	0.1%

**t092 [Anlg In 0-10V Hi]**

Related Parameter(s): [P044](#), [t091](#), [t093](#)

 Stop drive before changing this parameter.

Sets the percentage (based on 10V) of input voltage applied to the 0...10V analog input used to represent [P044](#) [Maximum Freq]. Analog inversion can be accomplished by setting this value smaller than [t091](#) [Anlg In 0-10V Lo]. If [t093](#) [10V Bipolar Enbl] is set to 1 "Bi-Polar In", the same value applies to positive and negative voltage.

	Default:	100.0%
<b>Values</b>	Min/Max:	0.0/200.0%
	Display:	0.1%

**t093 [10V Bipolar Enbl]**

Related Parameter(s): [t091](#), [t092](#)

(PF 525) PowerFlex 525 only.

Enables/disables bi-polar control. In bi-polar mode direction is commanded by the polarity of the voltage. If bi-polar control is enabled, [P043](#) [Minimum Freq] and [t091](#) [Anlg In 0-10V Lo] are ignored.

<b>Options</b>	0 "Uni-Polar In" (Default)	0...10V only
	1 "Bi-Polar In"	±10V



## Terminal Block Group (continued)

**t094 [Anlg In V Loss]**Related Parameter(s): [P043](#), [P044](#), [A426](#), [A427](#)

Sets the response to a loss of input. When the 0...10V input (or -10 to +10V) is used for any reference, any input less than 1V is reported as a signal loss. Input must exceed 1.5V for the signal loss condition to end.

If enabled, this function affects any input that is being used as a speed reference, PID reference or PID setpoint in the drive.

	0	"Disabled" (Default)
	1	"Fault (F29)"
	2	"Stop"
	3	"Zero Ref"
<b>Options</b>	4	"Min Freq Ref"
	5	"Max Freq Ref"
	6	"Key Freq Ref"
	7	"MOP Freq Ref"
	8	"Continu Last"

**t095 [Anlg In4-20mA Lo]**Related Parameter(s): [P043](#), [t095](#)

 Stop drive before changing this parameter.

Sets the percentage (based on 4...20 mA) of input current applied to the 4...20 mA analog input used to represent [P043](#) [Minimum Freq]. Analog inversion can be accomplished by setting this value larger than [t096](#) [Anlg In4-20mA Hi].

	Default:	0.0%
<b>Values</b>	Min/Max:	0.0/200.0%
	Display:	0.1%

**t096 [Anlg In4-20mA Hi]**Related Parameter(s): [P044](#), [t095](#)

 Stop drive before changing this parameter.

Sets the percentage (based on 4...20 mA) of input current applied to the 4...20 mA analog input used to represent [P044](#) [Maximum Freq]. Analog inversion can be accomplished by setting this value smaller than [t095](#) [Anlg In4-20mA Lo].

	Default:	100.0%
<b>Values</b>	Min/Max:	0.0/200.0%
	Display:	0.1%

**t097 [Anlg In mA Loss]**Related Parameter(s): [P043](#), [P044](#), [A426](#), [A427](#)

Sets the response to a loss of input. When the 4...20 mA input is used for any reference, any input less than 2 mA is reported as a signal loss. Input must exceed 3 mA for the signal loss condition to end.

If enabled, this function affects any input that is being used as a speed reference or PID reference or PID setpoint in the drive.

	0	"Disabled" (Default)
	1	"Fault (F29)"
	2	"Stop"
	3	"Zero Ref"
<b>Options</b>	4	"Min Freq Ref"
	5	"Max Freq Ref"
	6	"Key Freq Ref"
	7	"MOP Freq Ref"
	8	"Continu Last"

## Terminal Block Group (continued)

**t098 [Anlg Loss Delay]**Related Parameter(s): [t094](#), [t097](#)

Sets the length of time after power-up during which the drive detects no analog signal loss. Response to an analog signal loss is set in [t094](#) or [t097](#) [Analog In x Loss].

	Default:	0.0 s
<b>Values</b>	Min/Max:	0.0 /20.0 s
	Display:	0.1 s

**t099 [Analog In Filter]**

Sets the level of additional filtering of the analog input signals. A higher number increases filtering and decreases bandwidth. Each setting doubles the applied filtering (1 = 2x filter, 2 = 4x filter, and so on).

	Default:	0
<b>Values</b>	Min/Max:	0/14
	Display:	1

**t100 [Sleep-Wake Sel]**Related Parameter(s): [t101](#), [t102](#), [t103](#)

Drive "sleeps" if the appropriate analog input drops below the set [t101](#) [Sleep Level] for the time set in [t102](#) [Sleep Time] and the drive is running. When entering sleep mode the drive ramps to zero and the run indicator on the keypad display flashes to indicate the drive is in "sleep" mode. When the appropriate analog input rises above the set [Wake Level], the drive "wakes" and ramps to the commanded frequency. Inversion can be accomplished by setting [Sleep Level] to a higher setting than [t103](#) [Wake Level].



**ATTENTION:** Enabling the Sleep-Wake function can cause unexpected machine operation during the Wake mode. Equipment damage and/or personal injury can result if this parameter is used in an inappropriate application. In addition, all applicable local, national and international codes, standards, regulations or industry guidelines must be considered.

	0	"Disabled" (Default)
<b>Options</b>	1	"0-10V Input" Sleep enabled from 0...10V Analog Input 1
	2	"4-20mA Input" Sleep enabled from 4...20 mA Analog Input 2
	3	"Command Freq" Sleep enabled based on drive commanded frequency

**t101 [Sleep Level]**

Sets the analog input level the drive must reach to enter sleep mode.

	Default:	10.0%
<b>Values</b>	Min/Max:	0.0/100.0%
	Display:	0.1%

**t102 [Sleep Time]**

Sets the analog input time the drive must stay below to enter sleep mode.

	Default:	0.0 s
<b>Values</b>	Min/Max:	0.0/600.0 s
	Display:	0.1 s

**t103 [Wake Level]**

Sets the analog input level the drive must reach to wake from sleep mode.

	Default:	15.0%
<b>Values</b>	Min/Max:	0.0/100.0%
	Display:	0.1%

## Terminal Block Group *(continued)*

### t104 [Wake Time]

Sets the analog input time the drive must stay above to wake from sleep mode.

	Default:	0.0 s
<b>Values</b>		0.0/600.0 s
	1 "FaultDisable"	0.1 s

### t105 [Safety Open En]

PF 525 PowerFlex 525 only.

Sets the action when both safety inputs (Safety 1 and Safety 2) are disabled (de-energized - no power is applied).

<b>Options</b>	0 "FaultEnable" (Default)
	1 "FaultDisable"

### t106 [SafetyFit RstCfg]

PF 525 PowerFlex 525 only.

(With FRN 5.xxx and later.)

Sets the method of resetting fault F111 "Safety Hardware" either by means of a power cycle or fault clear operation.

<b>Options</b>	0 "PwrCycleRset" (Default)	Reset fault F111 using power cycle.
	1 "FltClr Rset"	Reset fault F111 using fault clear mechanism without power cycle.

## Communications Group

### C121 [Comm Write Mode]

Saves parameter values in active drive memory (RAM) or in drive non-volatile memory (EEPROM).



**ATTENTION:** If Automatic Drive Configuration (ADC) is used, this parameter must remain at its default value of 0 "Save".

**IMPORTANT** Parameter values set prior to setting 1 "RAM only" are saved in RAM.

<b>Options</b>	0	"Save" (Default)
	1	"RAM only"

### C122 [Cmd Stat Select]

(PF 525) PowerFlex 525 only.

Selects velocity-specific or position/fibers-specific Command and Status Word bit definitions for use over a communication network. See [Writing \(06\) Logic Command Data on page 205](#) for more information. This parameter cannot be changed when an I/O connection is established through the communication adapter or the drive's embedded EtherNet/IP port.

<b>Options</b>	0	"Velocity" (Default)
	1	"Position"

### C123 [RS485 Data Rate]

Sets the communications baud rate (bits/second) for the RS485 port. A reset or power cycle is required after selection is made.

<b>Options</b>	0	"1200"
	1	"2400"
	2	"4800"
	3	"9600" (Default)
	4	"19,200"
	5	"38,400"

### C124 [RS485 Node Addr]

Sets the Modbus drive node number (address) for the RS485 port if using a network connection. A reset or power cycle is required after selection is made.

<b>Values</b>	Default:	100
	Min/Max:	1/247
	Display:	1

### C125 [Comm Loss Action]

Related Parameter(s): [P045](#)

Sets the drive's response to a loss of connection or excessive communication errors on the RS485 port.

<b>Options</b>	0	"Fault" (Default)	
	1	"Coast Stop"	Stops drive using "Coast to stop".
	2	"Stop"	Stops drive using <a href="#">P045</a> [Stop Mode] setting.
	3	"Continu Last"	Drive continues operating at communication commanded speed saved in RAM.

### C126 [Comm Loss Time]

Related Parameter(s): [C125](#)

Sets the time that the drive remains in communication loss with the RS485 port before taking the action specified in [C125](#) [Comm Loss Action]. See [Appendix C](#) for more information.

**IMPORTANT** This setting is effective only if I/O that controls the drive is transmitted through the RS485 port.

<b>Values</b>	Default:	5.0 s
	Min/Max:	0.1/60.0 s
	Display:	0.1 s

## Communications Group *(continued)*

### C127 [RS485 Format]

Determines the details related to the specific Modbus protocol used by the drive. A reset or power cycle is required after selection is made.

	0	"RTU 8-N-1" (Default)
	1	"RTU 8-E-1"
	2	"RTU 8-O-1"
<b>Options</b>	3	"RTU 8-N-2"
	4	"RTU 8-E-2"
	5	"RTU 8-O-2"

### C128 [EN Addr Sel]

Related Parameter(s): [C129-C132](#), [C133-C136](#), [C137-C140](#)

(PF 525) PowerFlex 525 only.

Enables the IP address, subnet mask and gateway address to be set with a BOOTP server. Identifies the connections that would be attempted on a reset or power cycle. A reset or power cycle is required after selection is made.

<b>Options</b>	1	"Parameters"
	2	"BOOTP" (Default)

### C129 [EN IP Addr Cfg 1]

Related Parameter(s): [C128](#)

### C130 [EN IP Addr Cfg 2]

### C131 [EN IP Addr Cfg 3]

### C132 [EN IP Addr Cfg 4]

(PF 525) PowerFlex 525 only.

Sets the bytes in the IP address. A reset or power cycle is required after selection is made.

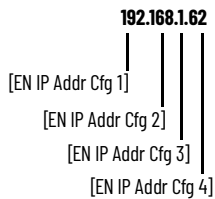

**IMPORTANT** C128 [EN Addr Sel] must be set to 1 "Parameters".

	Default:	0
<b>Values</b>	Min/Max:	0/255
	Display:	1

### C133 [EN Subnet Cfg 1]

Related Parameter(s): [C128](#)

### C134 [EN Subnet Cfg 2]

### C135 [EN Subnet Cfg 3]

### C136 [EN Subnet Cfg 4]

(PF 525) PowerFlex 525 only.

Sets the bytes of the subnet mask. A reset or power cycle is required after selection is made.

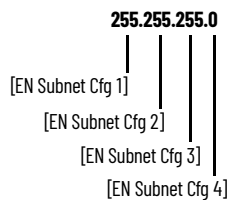

**IMPORTANT** C128 [EN Addr Sel] must be set to 1 "Parameters".

	Default:	0
<b>Values</b>	Min/Max:	0/255
	Display:	1

### Communications Group *(continued)*

Related Parameter(s): [C128](#)

- C137 [EN Gateway Cfg 1]**
- C138 [EN Gateway Cfg 2]**
- C139 [EN Gateway Cfg 3]**
- C140 [EN Gateway Cfg 4]**

PF 525 PowerFlex 525 only.

Sets the bytes of the gateway address. A reset or power cycle is required after selection is made.

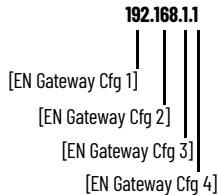

<b>IMPORTANT</b> C128 [EN Addr Sel] must be set to 1 "Parameters".	
<b>Values</b>	Default: 0
	Min/Max: 0/255
	Display: 1

**C141 [EN Rate Cfg]**

PF 525 PowerFlex 525 only.

Sets the network data rate at which EtherNet/IP communicates. A reset or power cycle is required after selection is made.

	0 "Auto detect" (Default)
	1 "10Mbps Full"
<b>Options</b>	2 "10Mbps Half"
	3 "100Mbps Full"
	4 "100Mbps Half"

**C143 [EN Comm Flt Actn]**

Related Parameter(s): [P045](#), [C145](#), [C146](#), [C147-C150](#)

PF 525 PowerFlex 525 only.

Sets the action that the EtherNet/IP interface and drive takes if the EtherNet/IP interface detects that Ethernet communications have been disrupted.

**IMPORTANT** This setting is effective only if I/O that controls the drive is transmitted through the EtherNet/IP interface.



**ATTENTION:** Risk of injury or equipment damage exists. Parameter C143 [EN Comm Flt Actn] lets you determine the action of the EtherNet/IP interface and connected drive if communications are disrupted. By default, this parameter faults the drive. You can set this parameter so that the drive continues to run. Precautions should be taken to ensure that the setting of this parameter does not create a risk of injury or equipment damage. When commissioning the drive, verify that your system responds correctly to various situations (for example, a disconnected drive).

	0 "Fault" (Default)	
	1 "Stop"	Drive stops per P045 [Stop Mode] setting.
<b>Options</b>	2 "Zero Data"	Note: The Reference and Datalink values transmitted to the drive will be set to "0".
	3 "Hold Last"	Note: The Logic Command, Reference, and Datalink values transmitted to the drive will be held at their last value.
	4 "Send Flt Cfg"	Note: The Logic Command, Reference, and Datalink values will be transmitted to the drive as configured in C145, C146, and C147...C150.

## Communications Group *(continued)*

### C144 [EN Idle Flt Actn]

 Related Parameter(s): [P045](#), [C145](#), [C146](#), [C147-C150](#)

(PF 525) PowerFlex 525 only.

Sets the action that the EtherNet/IP interface and drive takes if the EtherNet/IP interface detects that the scanner is idle because the controller was switched to program mode.



**ATTENTION:** Risk of injury or equipment damage exists. Parameter C144 [EN Idle Flt Actn] lets you determine the action of the EtherNet/IP interface and connected drive if the scanner is idle. By default, this parameter faults the drive. you can set this parameter so that the drive continues to run. Precautions should be taken to ensure that the setting of this parameter does not create a risk of injury or equipment damage. When commissioning the drive, verify that your system responds correctly to various situations (for example, a disconnected drive).

	0	"Fault" (Default)	
	1	"Stop"	Drive stops per P045 [Stop Mode] setting.
<b>Options</b>	2	"Zero Data"	Note: The Reference and Datalink values transmitted to the drive will be set to "0".
	3	"Hold Last"	Note: The Logic Command, Reference, and Datalink values transmitted to the drive will be held at their last value.
	4	"Send Flt Cfg"	Note: The Logic Command, Reference, and Datalink values will be transmitted to the drive as configured in C145, C146, and C147...C150.

### C145 [EN Flt Cfg Logic]

 Related Parameter(s): [C143](#), [C144](#)

(32) 32 bit parameter.

(PF 525) PowerFlex 525 only.

Sets the Logic Command data that is sent to the drive if any of the following is true:

- [C143](#) [EN Comm Flt Actn] is set to 4 "Send Flt Cfg" and communications are disrupted.
- [C144](#) [EN Idle Flt Actn] is set to 4 "Send Flt Cfg" and the scanner is put into Program or Test mode.

See [Writing \(06\) Logic Command Data on page 205](#) for more information.

	Default:	0000
<b>Values</b>	Min/Max:	0000/FFFF
	Display:	0000

### C146 [EN Flt Cfg Ref]

 Related Parameter(s): [C143](#), [C144](#)

(32) 32 bit parameter.

(PF 525) PowerFlex 525 only.

Sets the Reference data that is sent to the drive if any of the following is true:

- [C143](#) [EN Comm Flt Actn] is set to 4 "Send Flt Cfg" and communications are disrupted.
- [C144](#) [EN Idle Flt Actn] is set to 4 "Send Flt Cfg" and the scanner is put into Program or Test mode.

	Default:	0
<b>Values</b>	Min/Max:	0/50000
	Display:	1

### C147 [EN Flt Cfg DL 1]

### C148 [EN Flt Cfg DL 2]

### C149 [EN Flt Cfg DL 3]

### C150 [EN Flt Cfg DL 4]

(PF 525) PowerFlex 525 only.

Sets the Ethernet Datalink Input data that is sent to the drive if any of the following is true:

- [C143](#) [EN Comm Flt Actn] is set to 4 "Send Flt Cfg" and communications are disrupted.
- [C144](#) [EN Idle Flt Actn] is set to 4 "Send Flt Cfg" and the scanner is put into Program or Test mode.

	Default:	0
<b>Values</b>	Min/Max:	0/65535
	Display:	1

## Communications Group *(continued)*

**C153 [EN Data In 1]**  
**C154 [EN Data In 2]**  
**C155 [EN Data In 3]**  
**C156 [EN Data In 4]**

(PF 525) PowerFlex 525 only.

Datalink parameter number whose value is written from the embedded EtherNet/IP data table. This parameter cannot be changed when an I/O connection is established through the drive's embedded EtherNet/IP port.

	Default:	0
<b>Values</b>	Min/Max:	0/800
	Display:	1

**C157 [EN Data Out 1]**  
**C158 [EN Data Out 2]**  
**C159 [EN Data Out 3]**  
**C160 [EN Data Out 4]**

(PF 525) PowerFlex 525 only.

Datalink parameter number whose value is read from the embedded EtherNet/IP data table. This parameter cannot be changed when an I/O connection is established through the drive's embedded EtherNet/IP port.

	Default:	0
<b>Values</b>	Min/Max:	0/800
	Display:	1

**C161 [Opt Data In 1]**  
**C162 [Opt Data In 2]**  
**C163 [Opt Data In 3]**  
**C164 [Opt Data In 4]**

Datalink parameter number whose value is written from the High Speed Drive Serial Interface (HSDSI) data table. This parameter cannot be changed when an I/O connection is established through the communication adapter.

	Default:	0
<b>Values</b>	Min/Max:	0/800
	Display:	1

**C165 [Opt Data Out 1]**  
**C166 [Opt Data Out 2]**  
**C167 [Opt Data Out 3]**  
**C168 [Opt Data Out 4]**

Datalink parameter number whose value is read from the HSDSI data table. This parameter cannot be changed when an I/O connection is established through the communication adapter.

	Default:	0
<b>Values</b>	Min/Max:	0/800
	Display:	1

**C169 [MultiDrv Sel]**

Sets the configuration of the drive that is in multi-drive mode. A reset or power cycle is required after selection is made.

<b>Options</b>	0 "Disabled" (Default)	No multi-drive master from the internal network option module or embedded Ethernet port. The drive can still function as a multi-drive slave or as a single drive (no multi-drive used).
	1 "Network Opt"	Multi-drive is enabled with the internal network option as a multi-drive master. The host drive is "Drive 0" and up to four slave drives can be daisy-chained from its RS485 port.
	2 "EtherNet/IP" <sup>(1)</sup>	Multi-drive is enabled with the embedded Ethernet port as the multi-drive master. The host drive is "Drive 0" and up to four slave drives can be daisy-chained from its RS485 port.

(1) Setting is specific to PowerFlex 525 drives only.



## Communications Group *(continued)*

**C171 [Drv 1 Addr]**  
**C172 [Drv 2 Addr]**  
**C173 [Drv 3 Addr]**  
**C174 [Drv 4 Addr]**

Related Parameter(s): [C169](#)

Sets the corresponding node addresses of the daisy-chained drives when [C169 \[MultiDrv Sel\]](#) is set to 1 "Network Opt" or 2 "EtherNet/IP". A reset or power cycle is required after selection is made.

<b>Values</b>	Default:	
	Drv 1 Addr:	2
	Drv 2 Addr:	3
	Drv 3 Addr:	4
	Drv 4 Addr:	5
	Min/Max:	1/247
	Display:	1

### **C175 [DSI I/O Cfg]**

Sets the configuration of the Drives that are active in the multi-drive mode. Identifies the connections that would be attempted on a reset or power cycle. A reset or power cycle is required after selection is made.

<b>Options</b>	0	"Drive 0" (Default)
	1	"Drive 0-1"
	2	"Drive 0-2"
	3	"Drive 0-3"
	4	"Drive 0-4"

# Logic Group

## StepLogic Inputs

<b>L180</b> [Stp Logic 0]	<b>L181</b> [Stp Logic 1]
<b>L182</b> [Stp Logic 2]	<b>L183</b> [Stp Logic 3]
<b>L184</b> [Stp Logic 4]	<b>L185</b> [Stp Logic 5]
<b>L186</b> [Stp Logic 6]	<b>L187</b> [Stp Logic 7]

Related Parameter(s):

 Stop drive before changing this parameter.

 PowerFlex 525 only.

	Default:	00F1
<b>Values</b>	Min/Max:	0000/FAFF
	Display	0001

See [Appendix D](#) and [Appendix E](#) for more information on applying StepLogic® function and Position StepLogic application.

Parameters L180...L187 are only active if [P047](#), [P049](#), or [P051](#) [Speed Referencex] is set to 13 “Step Logic” or 16 “Positioning”. These parameters can be used to create a custom profile of frequency commands. Each “step” can be based on time, status of a Logic input or a combination of time and the status of a Logic input.

Digits 1...4 for each [Stp Logic x] parameter must be programmed according to the desired profile. A Logic input is established by setting a digital input, parameters [t062](#), [t063](#), [t065](#)...[t068](#) [DigIn TermBlk xx] to 24 “Logic In 1” and/or 25 “Logic In 2” or by using Bits 6 and 7 of [A560](#) [Enh Control Word].

A time interval between steps can be programmed using parameters [L190](#)...[L197](#) [Stp Logic Time x]. See the table below for related parameters.

The speed for any step is programmed using parameters [A410](#)...[A417](#) [Preset Freq x].

Step	StepLogic Parameter	Related Preset Frequency Parameter (Can be activated independent of StepLogic Parameters)	Related StepLogic Time Parameter (Active when L180...L187 Digit 1 or 2 are set to 1, b, C, d or E)
0	L180 [Stp Logic 0]	A410 [Preset Freq 0]	L190 [Stp Logic Time 0]
1	L181 [Stp Logic 1]	A411 [Preset Freq 1]	L191 [Stp Logic Time 1]
2	L182 [Stp Logic 2]	A412 [Preset Freq 2]	L192 [Stp Logic Time 2]
3	L183 [Stp Logic 3]	A413 [Preset Freq 3]	L193 [Stp Logic Time 3]
4	L184 [Stp Logic 4]	A414 [Preset Freq 4]	L194 [Stp Logic Time 4]
5	L185 [Stp Logic 5]	A415 [Preset Freq 5]	L195 [Stp Logic Time 5]
6	L186 [Stp Logic 6]	A416 [Preset Freq 6]	L196 [Stp Logic Time 6]
7	L187 [Stp Logic 7]	A417 [Preset Freq 7]	L197 [Stp Logic Time 7]

The position for any step is programmed using parameters [L200](#)...[L214](#) [Step Units x].

Step	StepLogic Position Parameter
0	L200 [Step Units 0] & L201 [Step Units F 0]
1	L202 [Step Units 1] & L203 [Step Units F 1]
2	L204 [Step Units 2] & L205 [Step Units F 2]
3	L206 [Step Units 3] & L207 [Step Units F 3]
4	L208 [Step Units 4] & L209 [Step Units F 4]
5	L210 [Step Units 5] & L211 [Step Units F 5]
6	L212 [Step Units 6] & L213 [Step Units F 6]
7	L214 [Step Units 7] & L215 [Step Units F 7]

### How StepLogic Works

The StepLogic sequence begins with a valid start command. A normal sequence always begins with L180 [Stp Logic 0].

#### Digit 1: Logic for next step

This digit defines the logic for the next step. When the condition is met the program advances to the next step. Step 0 follows Step 7. Example: Digit 1 is set to 3. When “Logic In 2” becomes active, the program advances to the next step.

#### Digit 2: Logic to jump to a different step

For all settings other than F, when the condition is met, the program overrides Digit 0 and jumps to the step defined by Digit 3.

#### Digit 3: Different step to jump

When the condition for Digit 2 is met, this digit setting determines the next step or to end the program.

#### Digit 4: Step settings

This digit defines additional characteristics of each step.

Any StepLogic parameter can be programmed to control a relay or opto output, but you can not control different outputs based on the condition of different StepLogic commands.

## StepLogic Inputs (Continued)

### StepLogic Settings

The logic for each function is determined by the four digits for each StepLogic parameter. The following is a listing of the available settings for each digit. See [Appendix D](#) for more information.

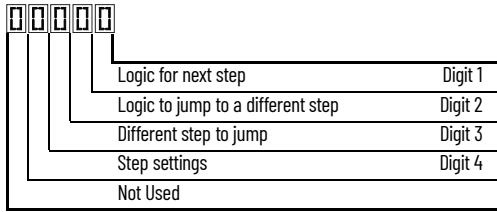

### Velocity Control Settings (Digit 4)

Required Setting	Accel/Decel Param. Used	StepLogic Output State	Commanded Direction
0	Accel/Decel 1	Off	FWD
1	Accel/Decel 1	Off	REV
2	Accel/Decel 1	Off	No Output
3	Accel/Decel 1	On	FWD
4	Accel/Decel 1	On	REV
5	Accel/Decel 1	On	No Output
6	Accel/Decel 2	Off	FWD
7	Accel/Decel 2	Off	REV
8	Accel/Decel 2	Off	No Output
9	Accel/Decel 2	On	FWD
A	Accel/Decel 2	On	REV
b	Accel/Decel 2	On	No Output

### Positioning Settings (Digit 4)

Required Setting	Accel/Decel Param. Used	StepLogic Output State	Direction From Home	Type of Command
0	Accel/Decel 1	Off	FWD	Absolute
1	Accel/Decel 1	Off	FWD	Incremental
2	Accel/Decel 1	Off	REV	Absolute
3	Accel/Decel 1	Off	REV	Incremental
4	Accel/Decel 1	On	FWD	Absolute
5	Accel/Decel 1	On	FWD	Incremental
6	Accel/Decel 1	On	REV	Absolute
7	Accel/Decel 1	On	REV	Incremental
8	Accel/Decel 2	Off	FWD	Absolute
9	Accel/Decel 2	Off	FWD	Incremental
A	Accel/Decel 2	Off	REV	Absolute
b	Accel/Decel 2	Off	REV	Incremental
C	Accel/Decel 2	On	FWD	Absolute
d	Accel/Decel 2	On	FWD	Incremental
E	Accel/Decel 2	On	REV	Absolute
F	Accel/Decel 2	On	REV	Incremental

### Settings (Digit 3)

Setting	Description
0	Jump to Step 0
1	Jump to Step 1
2	Jump to Step 2
3	Jump to Step 3
4	Jump to Step 4
5	Jump to Step 5
6	Jump to Step 6
7	Jump to Step 7
8	End Program (Normal Stop)
9	End Program (Coast to Stop)
A	End Program and Fault (F2)

### Settings (Digit 2 and 1)

Setting	Description
0	Skip Step (Jump Immediately)
1	Step Based on [Stp Logic Time x]
2	Step if "Logic In 1" is Active
3	Step if "Logic In 2" is Active
4	Step if "Logic In 1" is Not Active
5	Step if "Logic In 2" is Not Active
6	Step if either "Logic In 1" or "Logic In 2" is Active
7	Step if both "Logic In 1" and "Logic In 2" are Active
8	Step if neither "Logic In 1" nor "Logic In 2" is Active
9	Step if "Logic In 1" is Active and "Logic In 2" is Not Active
A	Step if "Logic In 2" is Active and "Logic In 1" is Not Active
b	Step after [Stp Logic Time x] and "Logic In 1" is Active
C	Step after [Stp Logic Time x] and "Logic In 2" is Active
d	Step after [Stp Logic Time x] and "Logic In 1" is Not Active
E	Step after [Stp Logic Time x] and "Logic In 2" is Not Active
F	Do Not Step/Ignore Digit 2 Settings

**Logic Group** *(continued)*

- L190 [Stp Logic Time 0]    L191 [Stp Logic Time 1]
- L192 [Stp Logic Time 2]    L193 [Stp Logic Time 3]
- L194 [Stp Logic Time 4]    L195 [Stp Logic Time 5]
- L196 [Stp Logic Time 6]    L197 [Stp Logic Time 7]

PF 525 PowerFlex 525 only.

Sets the time to remain in each step if the corresponding command word is set to "Step based on time".

	Default:	30.0 s
<b>Values</b>	Min/Max:	0.0/999.9 s
	Display:	0.1 s

- L200 [Step Units 0]        L202 [Step Units 1]
- L204 [Step Units 2]        L206 [Step Units 3]
- L208 [Step Units 4]        L210 [Step Units 5]
- L212 [Step Units 6]        L214 [Step Units 7]

32 32 bit parameter.

PF 525 PowerFlex 525 only.

Sets the position in user-defined units the drive must reach at each step.

	Default:	0.00
<b>Values</b>	Min/Max:	0.00/6400.00
	Display:	0.01

## Advanced Display Group

### d360 [Analog In 0-10V]

Related Parameter(s): [t091](#), [t092](#)

Displays the 0...10V analog input as a percent of full scale.

	Default:	Read Only
<b>Values</b>	Min/Max:	0.0/100.0%
	Display:	0.1%

### d361 [Analog In 4-20mA]

Related Parameter(s): [t095](#), [t096](#)

Displays the 4...20 mA analog input as a percent of full scale.

	Default:	Read Only
<b>Values</b>	Min/Max:	0.0/100.0%
	Display:	0.1%

### d362 [Elapsed Time-hr]

Related Parameter(s): [A555](#)

Displays the total elapsed powered-up time (in hours) since timer reset. The timer stops when it reaches the maximum value.

	Default:	Read Only
<b>Values</b>	Min/Max:	0/32767 hr
	Display:	1 hr

### d363 [Elapsed Time-min]

Related Parameter(s): [d362](#), [A555](#)Displays the total elapsed powered-up time (in minutes) since timer reset. Resets to zero when maximum value is reached and increments [d362](#) [Elapsed Time-hr] by one.

	Default:	Read Only
<b>Values</b>	Min/Max:	0.0/60.0 min
	Display:	0.1 min

### d364 [Counter Status]

Displays the current value of the counter if enabled.

	Default:	Read Only
<b>Values</b>	Min/Max:	0/65535
	Display:	1

### d365 [Timer Status]

 32 bit parameter.

Displays the current value of the timer if enabled.

	Default:	Read Only
<b>Values</b>	Min/Max:	0.0/9999.0 s
	Display:	0.1 s

### d366 [Timer Status]

 32 bit parameter.

Displays the current value of the timer if enabled.

	Default:	Read Only
<b>Values</b>	Min/Max:	0.0/0.9 s
	Display:	0.1 s

## Advanced Display Group *(continued)*

### d367 [Drive Type]

Displays the Drive type setting. Used by Rockwell Automation field service personnel (not write accessible by non Rockwell Automation technical personnel).

	Default:	Read Only
<b>Values</b>	Min/Max:	0/65535
	Display:	1

### d368 [Testpoint Data]

Related Parameter(s): [A483](#)

Displays the present value of the function selected in [A483](#) [Testpoint Sel].

	Default:	Read Only
<b>Values</b>	Min/Max:	0/FFFF
	Display:	1

### d369 [Motor OL Level]

Displays the motor overload counter.

	Default:	Read Only
<b>Values</b>	Min/Max:	0.0/150.0%
	Display:	0.1%

### d375 [Slip Hz Meter]

Related Parameter(s): [P032](#)

Displays the current amount of slip or droop (absolute value) being applied to the motor frequency. Drives applies slip based on the setting for [P032](#) [Motor NP Hertz].

	Default:	Read Only
<b>Values</b>	Min/Max:	0.0/25.0 Hz
	Display:	0.1 Hz

### d376 [Speed Feedback]

 32 bit parameter.

Displays the value of the actual motor speed whether measured by encoder/pulse train feedback or estimated.

	Default:	Read Only
<b>Values</b>	Min/Max:	0.0/64000.0 rpm
	Display:	0.1 rpm

### d377 [Speed Feedback F]

 32 bit parameter.

Displays the value of the actual motor speed whether measured by encoder/pulse train feedback or estimated.

	Default:	Read Only
<b>Values</b>	Min/Max:	0.0/0.9 rpm
	Display:	0.1 rpm

### d378 [Encoder Speed]

 32 bit parameter.

Provides a monitoring point that reflects the speed measured from the feedback device. This shows the encoder or pulse train speed even if not used directly to control motor speed.<sup>(1)</sup>

	Default:	Read Only
<b>Values</b>	Min/Max:	0.0/64000.0 rpm
	Display:	0.1 rpm

(1) Parameter is also available in PowerFlex 523 FRN 3.xxx and later.

## Advanced Display Group (continued)

### d379 [Encoder Speed F]

 32 bit parameter.

Provides a monitoring point that reflects the speed measured from the feedback device. This shows the encoder or pulse train speed even if not used directly to control motor speed.

	Default:	Read Only
<b>Values</b>	Min/Max:	0.0/0.9 rpm
	Display:	0.1 rpm

### d380 [DC Bus Ripple]

Displays the real-time value of the DC bus ripple voltage.

	Default:	Read Only
<b>Values</b>	Min/Max:	0/410V DC for 230V AC drives; 820V DC for 460V AC drives; 1025V DC for 600V AC drives
	Display:	1V DC

### d381 [Output Powr Fctr]

Displays the angle in electrical degrees between motor voltage and motor current.

	Default:	Read Only
<b>Values</b>	Min/Max:	0.0/180.0 deg
	Display:	0.1 deg

### d382 [Torque Current]

Displays the current value of the motor torque current measured by the drive.

	Default:	Read Only
<b>Values</b>	Min/Max:	0.00/(Drive Rated Amps x 2)
	Display:	0.01 A

### d383 [PID1 Fdbk Displ]

#### d385 [PID2 Fdbk Displ]

 PowerFlex 525 only.

Displays the active PID Feedback value.

	Default:	Read Only
<b>Values</b>	Min/Max:	0.0/100.0%
	Display:	0.1%

### d384 [PID1 Setpnt Disp]

#### d386 [PID2 Setpnt Disp]

 PowerFlex 525 only.

Displays the active PID Setpoint value.

	Default:	Read Only
<b>Values</b>	Min/Max:	0.0/100.0%
	Display:	0.1%

### Advanced Display Group (continued)

#### d387 [Position Status]

**PF 525** PowerFlex 525 only.

Displays the present operating condition of the drive. When in Positioning mode, Bit 1 indicates positive or negative position in relation to Home.

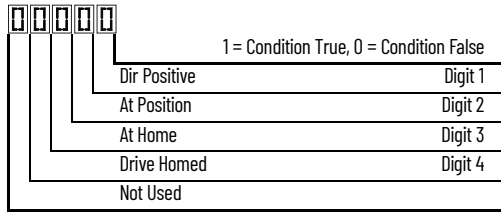

	Default:	Read Only
<b>Values</b>	Min/Max:	0000/1111
	Display:	0000

#### d388 [Units Traveled H]

Related Parameter(s): [d387](#)

Stop drive before changing this parameter.  
 32 bit parameter.

**PF 525** PowerFlex 525 only.

Displays the number of user-defined units traveled from the home position. See [d387](#) [Position Status] for direction of travel.

	Default:	Read Only
<b>Values</b>	Min/Max:	0/64000
	Display:	1

#### d389 [Units Traveled L]

Related Parameter(s): [d387](#)

Stop drive before changing this parameter.  
**PF 525** PowerFlex 525 only.

Displays the number of user-defined units traveled from the home position. See [d387](#) [Position Status] for direction of travel.

	Default:	Read Only
<b>Values</b>	Min/Max:	0.00/0.99
	Display:	0.01

#### d390 [Fiber Status]

Present status of the Fibers features.

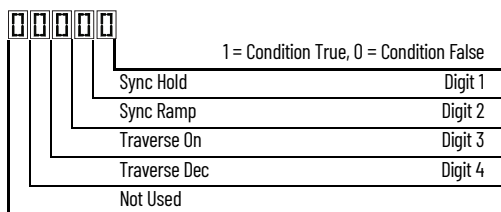

	Default:	Read Only
<b>Values</b>	Min/Max:	0000/1111
	Display:	0000

#### d391 [Stp Logic Status]

Related Parameter(s): [P047](#), [L180-L187](#)

**PF 525** PowerFlex 525 only.

Displays the current step of the StepLogic profile as defined by parameters [L180...L187](#) [Step Logic x] when [P047](#) [Speed Reference1] is set to 13 "Step Logic" or 16 "Positioning".

	Default:	Read Only
<b>Values</b>	Min/Max:	0/8
	Display:	1



### Advanced Display Group (continued)

#### d392 [RdyBit Mode Act]

Related Parameter(s): [A574](#)

(With PowerFlex 525 FRN 3.xxx and later.)  
 (With PowerFlex 523 FRN 3.xxx and later.)  
 Displays the value of [A574](#) [RdyBit Mode Cfg].

	Default:	Read Only
<b>Values</b>	Min/Max:	0/1
	Display:	1

#### d393 [Drive Status 2]

(With PowerFlex 525 FRN 5.xxx and later.)  
 (With PowerFlex 523 FRN 3.xxx and later.)  
 Displays the present operating condition of the drive.

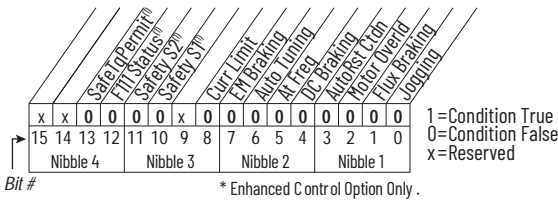

(1) Bit status is specific to PowerFlex 525 drives only.

	Default:	Read Only
<b>Values</b>	Min/Max:	0/65535
	Display:	1

#### d394 [Dig Out Status]

(With PowerFlex 525 FRN 5.xxx and later.)  
 (With PowerFlex 523 FRN 3.xxx and later.)  
 Displays relay output and opto output status.

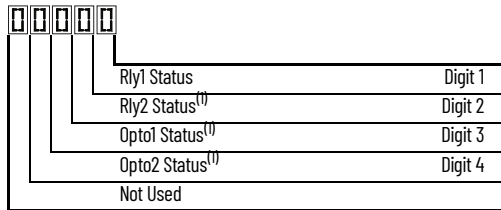

Status	Bit Value = 0	Bit Value = 1
Relay 1 status (Normally Open)	Not activated (Relay 1 open)	Activated (Relay 1 closed)
Relay 2 status (Normally Closed)	Not activated (Relay 2 closed)	Activated (Relay 2 open)
Opto 1 status	Not activated	Activated
Opto 2 status	Not activated	Activated

(1) Setting is specific to PowerFlex 525 drives only.

	Default:	Read Only
<b>Values</b>	Min/Max:	0/15
	Display:	1

# Advanced Program Group

A410 [Preset Freq 0]      A411 [Preset Freq 1]  
 A412 [Preset Freq 2]      A413 [Preset Freq 3]  
 A414 [Preset Freq 4]      A415 [Preset Freq 5]  
 A416 [Preset Freq 6]      A417 [Preset Freq 7]

A418 [Preset Freq 8]      A419 [Preset Freq 9]  
 A420 [Preset Freq 10]      A421 [Preset Freq 11]  
 A422 [Preset Freq 12]      A423 [Preset Freq 13]  
 A424 [Preset Freq 14]      A425 [Preset Freq 15]

(PF 525) PowerFlex 525 only.

Sets the frequency of the drive outputs to the programmed value when selected.

**For PowerFlex 525**

	Default Accel/Decel Used	Preset Input 1 (DigIn TermBlk 05)	Preset Input 2 (DigIn TermBlk 06)	Preset Input 3 (DigIn TermBlk 07)	Preset Input 4 (DigIn TermBlk 08)
Preset Setting 0 <sup>(1)</sup>	1	0	0	0	0
Preset Setting 1	1	1	0	0	0
Preset Setting 2	2	0	1	0	0
Preset Setting 3	2	1	1	0	0
Preset Setting 4	1	0	0	1	0
Preset Setting 5	1	1	0	1	0
Preset Setting 6	2	0	1	1	0
Preset Setting 7	2	1	1	1	0
Preset Setting 8	1	0	0	0	1
Preset Setting 9	1	1	0	0	1
Preset Setting 10	2	0	1	0	1
Preset Setting 11	2	1	1	0	1
Preset Setting 12	1	0	0	1	1
Preset Setting 13	1	1	0	1	1
Preset Setting 14	2	0	1	1	1
Preset Setting 15	2	1	1	1	1

**For PowerFlex 523**

	Default Accel/Decel Used	Preset Input 1 (DigIn TermBlk 05)	Preset Input 2 (DigIn TermBlk 06)	Preset Input 3 (DigIn TermBlk 03)	-
Preset Setting 0 <sup>(1)</sup>	1	0	0	0	
Preset Setting 1	1	1	0	0	
Preset Setting 2	2	0	1	0	
Preset Setting 3	2	1	1	0	
Preset Setting 4	1	0	0	1	
Preset Setting 5	1	1	0	1	
Preset Setting 6	2	0	1	1	
Preset Setting 7	2	1	1	1	

(1) Preset Setting 0 is only available if P047, P049 or P051 [Speed Referencex] is set to 7 "Preset Freq".

<b>Values</b>	Defaults:	
	Preset Freq 0:	0.00 Hz
	Preset Freq 1:	5.00 Hz
	Preset Freq 2:	10.00 HZ
	Preset Freq 3:	20.00 Hz
	Preset Freq 4:	30.00 Hz
	Preset Freq 5:	40.00 Hz
	Preset Freq 6:	50.00 Hz
	Preset Freq 7...15:	60.00 Hz
	Min/Max:	0.00/500.00 Hz
Display:	0.01 Hz	

## Advanced Program Group (continued)

### A426 [Keypad Freq]

Related Parameter(s): [P047](#), [P049](#), [P051](#)

Provides the drive frequency command using the built-in keypad navigation. When [P047](#), [P049](#) or [P051](#) [Speed Reference] selects 2 "Keypad Freq", the value set in this parameter controls the frequency of the drive. The value of this parameter can also be changed when navigating with the keypad by pressing the Up or Down arrow keys.

	Default:	60.00 Hz
<b>Values</b>	Min/Max:	0.00/500.00 Hz
	Display:	0.01 Hz

### A427 [MOP Freq]

Provides the drive frequency command using the built-in Motor Operated Potentiometer (MOP).

**IMPORTANT** Frequency is not written to non-volatile storage until drive is powered-down. If both MOP Up and MOP Down are applied at the same time, the inputs are ignored and the frequency is unchanged.

	Default:	60.00 Hz
<b>Values</b>	Min/Max:	0.00/500.00 Hz
	Display:	0.01 Hz

### A428 [MOP Reset Sel]

Determines if the current MOP reference command is saved on power down.

<b>Options</b>	0	"Zero MOP Ref"	Resets the MOP frequency to zero on power down and stop.
	1	"Save MOP Ref" (Default)	

### A429 [MOP Preload]

Determines the operation of the MOP function.

<b>Options</b>	0	"No preload" (Default)	
	1	"Preload"	Bumpless Transfer: whenever MOP mode is selected, the current output value of the speed is loaded.

### A430 [MOP Time]

Sets the rate of change of the MOP reference.

	Default:	10.0 s
<b>Values</b>	Min/Max:	0.1/600.0 s
	Display:	0.1 s

### A431 [Jog Frequency]

Related Parameter(s): [P044](#)

Sets the output frequency when a jog command is issued.

	Default:	10.00 Hz
<b>Values</b>	Min/Max:	0.00/[Maximum Freq]
	Display:	0.01 Hz

### A432 [Jog Accel/Decel]

Sets the acceleration and deceleration time used when in jog mode.

	Default:	10.00 s
<b>Values</b>	Min/Max:	0.01/600.00 s
	Display:	0.01 s

### Advanced Program Group (continued)

#### A433 [Purge Frequency]

Related Parameter(s): [t062](#), [t063](#), [t065-t068](#)

Provides a fixed frequency command value when [t062](#), [t063](#), [t065-t068](#) [DigIn TermBlk xx] is set to 40 "Purge".

	Default:	5.00 Hz
<b>Values</b>	Min/Max:	0.00/500.00 Hz
	Display:	0.01 Hz

#### A434 [DC Brake Time]

Related Parameter(s): [P045](#), [A435](#)

Sets the length of time that DC brake current is "injected" into the motor when [P045](#) [Stop Mode] is set to 10 "PointStp,CF" and 11 "PointStop" or 0 "Ramp,CF" and 4 "Ramp".

	Default:	0.0 s
<b>Values</b>	Min/Max:	0.0/99.9 s
	Display:	0.1 s

#### A435 [DC Brake Level]

Related Parameter(s): [P045](#)

Defines the maximum DC brake current, in amps, applied to the motor when [P045](#) [Stop Mode] is set to either 0 "Ramp,CF", 2 "DC Brake, CF", 4 "Ramp", 6 "DC Brake", 10 "PointStp,CF", or 11 "PointStop".

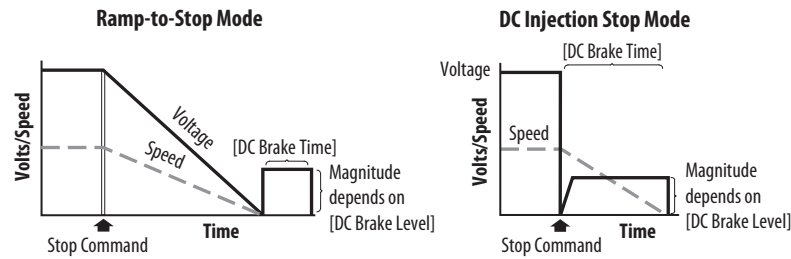

**ATTENTION:** If a hazard of injury due to movement of equipment or material exists, an auxiliary mechanical braking device must be used. This feature should not be used with synchronous motors. Motors may be demagnetized during braking.

	Default:	Drive Rated Amps x 0.05
<b>Values</b>	Min/Max:	0.00/(Drive Rated Amps x 1.80)
	Display:	0.01 A

#### A436 [DC Brk Time@Strt]

Related Parameter(s): [P045](#), [A435](#)

Sets the length of time that DC brake current is "injected" into the motor after a valid start command is received.

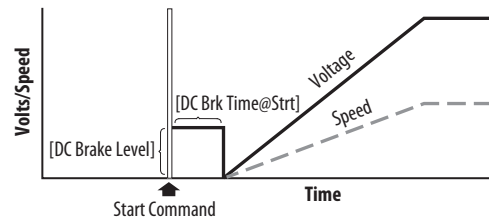

	Default:	0.0 s
<b>Values</b>	Min/Max:	0.0/99.9 s
	Display:	0.1 s

## Advanced Program Group (continued)

**A437 [DB Resistor Sel]**Related Parameter(s): [A438](#), [A550](#)
 Stop drive before changing this parameter.

Enables/disables external dynamic braking and selects the level of resistor protection.

**IMPORTANT** When A437 [DB Resistor Sel] is set to a value greater than "0", the value set in parameter [A550](#) [Bus Reg Enable] will not take effect.

<b>Options</b>	0	"Disabled" (Default)	
	1	"Norml RA Res"	5%
	2	"NoProtection"	100%
	3..99	"3..99% DutyCycle"	

**A438 [DB Threshold]**Related Parameter(s): [A437](#)

Sets the DC bus voltage threshold for Dynamic Brake operation. If DC bus voltage rises above this level, Dynamic Brake turns on. Lower values makes the dynamic braking function more responsive but may result in nuisance Dynamic Brake activation (IGBT can modulate continuously).



**ATTENTION:** Equipment damage may result if this parameter is set to a value that causes the dynamic braking resistor to dissipate excessive power. Parameter settings less than 100% should be carefully evaluated to ensure that the Dynamic Brake resistor's wattage rating is not exceeded. In general, values less than 90% are not needed. This parameter's setting is especially important if parameter A437 [DB Resistor Sel] is set to 2 "NoProtection".

<b>Values</b>	Default:	100.0%
	Min/Max:	10.0/110.0%
	Display:	0.1%

**A439 [S Curve %]**

Enables a fixed shape S-Curve that is applied to the acceleration and deceleration ramps (including jog).

S-Curve Time = (Accel or Decel Time) x (S-Curve Setting in percentage)

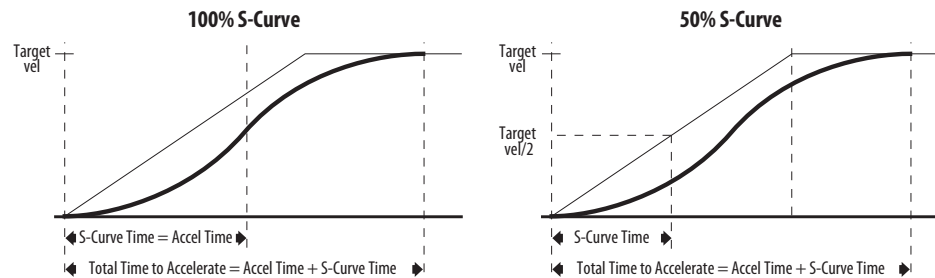
**Example:**

Accel Time = 10 s  
 S-Curve Setting = 30%  
 S-Curve Time = 10 x 0.3 = 3 s

<b>Values</b>	Default:	0%
	Min/Max:	0/100%
	Display:	1%

### Advanced Program Group (continued)

#### A440 [PWM Frequency]

Related Parameter(s): [A540](#)

Sets the carrier frequency for the PWM output waveform. The chart below provides derating guidelines based on the PWM frequency setting.

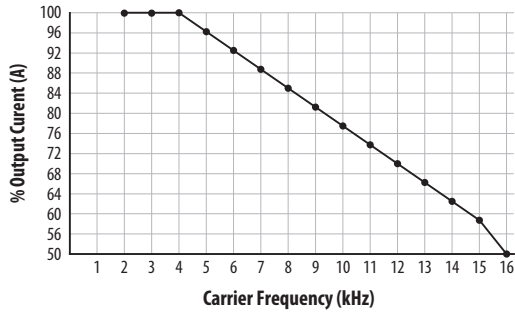

Note: If Vector mode (open loop) is selected and 16 kHz is selected, the drive will forcibly reduce the carrier frequency to 8 kHz.

**IMPORTANT** Ignoring derating guidelines can cause reduced drive performance. The drive may automatically reduce the PWM carrier frequency at low output speeds, unless prevented from doing so by A540 [Var PWM Disable].

<b>Values</b>	Default:	4.0 kHz
	Min/Max:	2.0/16.0 kHz
	Display:	0.1 kHz

#### A441 [Droop Hertz@ FLA]

(PF 525) PowerFlex 525 only.

Reduces the frequency based on current. This frequency is subtracted from the commanded output frequency. Generally Slip and Droop would not both be used, but if both are enabled they simply subtract from each other. Typically used in load sharing schemes.

<b>Values</b>	Default:	0.0 Hz
	Min/Max:	0.0/10.0 Hz
	Display:	0.1 Hz

#### A442 [Accel Time 2]

Related Parameter(s): [P044](#)

Time for the drive to ramp from 0.0 Hz to [P044](#) [Maximum Freq] if Accel Time 2 is selected.  
 Accel Rate = [Maximum Freq] / [Accel Time]

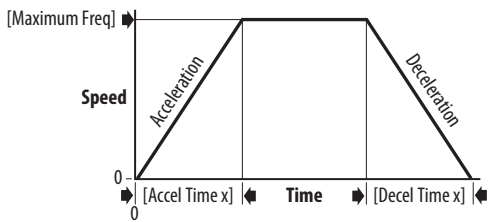

<b>Values</b>	Default:	10.00 s
	Min/Max:	0.00/600.00 s
	Display:	0.01 s

#### A443 [Decel Time 2]

Related Parameter(s): [P044](#)

Time for the drive to ramp from [P044](#) [Maximum Freq] to 0.0 Hz if Decel Time 2 is selected.  
 Decel Rate = [Maximum Freq] / [Decel Time]

<b>Values</b>	Default:	10.00 s
	Min/Max:	0.00/600.00 s
	Display:	0.01 s

## Advanced Program Group (continued)

### A444 [Accel Time 3] A446 [Accel Time 4]

Sets the rate of acceleration for all speed increases when selected by digital inputs.

	Default:	10.00 s
<b>Values</b>	Min/Max:	0.00/600.00 s
	Display:	0.01 s

### A445 [Decel Time 3] A447 [Decel Time 4]

Sets the rate of deceleration for all speed decreases when selected by digital inputs.

	Default:	10.00 s
<b>Values</b>	Min/Max:	0.00/600.00 s
	Display:	0.01 s

### A448 [Skip Frequency 1] A450 [Skip Frequency 2]

Related Parameter(s): [A449](#), [A451](#), [A453](#), [A455](#)

### A452 [Skip Frequency 3] A454 [Skip Frequency 4]

PF 525 PowerFlex 525 only.

Works in conjunction with [A449](#), [A451](#), [A453](#) and [A455](#) [Skip Freq Band x] creating a range of frequencies at which the drive does not operate continuously.

	Default:	0.0 Hz (Disabled)
<b>Values</b>	Min/Max:	0.0/500.0 Hz
	Display:	0.1 Hz

### A449 [Skip Freq Band 1] A451 [Skip Freq Band 2]

Related Parameter(s): [A448](#), [A450](#), [A452](#), [A454](#)

### A453 [Skip Freq Band 3] A455 [Skip Freq Band 4]

PF 525 PowerFlex 525 only.

Determines the band around [A448](#), [A450](#), [A452](#) and [A454](#) [Skip Frequency x].

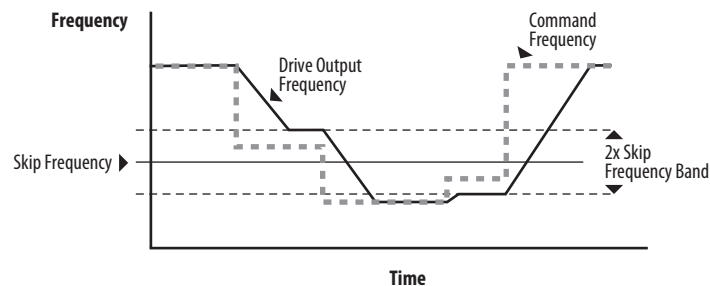

	Default:	0.0 Hz
<b>Values</b>	Min/Max:	0.0/30.0 Hz
	Display:	0.1 Hz

## Advanced Program Group (continued)

**A456 [PID 1 Trim Hi]****A468 [PID 2 Trim Hi]**

(PF 525) PowerFlex 525 only.

Scales the upper value of the trim frequency when trim is active.

	Default:	60.0 Hz
<b>Values</b>	Min/Max:	0.0/500.0 Hz
	Display:	0.1 Hz

**A457 [PID 1 Trim Lo]****A469 [PID 2 Trim Lo]**

(PF 525) PowerFlex 525 only.

Scales the lower value of the trim frequency when trim is active.

	Default:	0.0 Hz
<b>Values</b>	Min/Max:	0.0/500.0 Hz
	Display:	0.1 Hz

**A458 [PID 1 Trim Sel]****A470 [PID 2 Trim Sel]**

(PF 525) PowerFlex 525 only.



Stop drive before changing this parameter.

Sets the PID output as trim to the source reference.

	0	"Disabled" (Default)	PID Trim is disabled.
	1	"TrimOn Pot"	
	2	"TrimOn Keypd"	
	3	"TrimOn DSI"	
	4	"TrimOn NetOp"	
	5	"TrimOn 0-10V"	
<b>Options</b>	6	"TrimOn 4-20"	
	7	"TrimOn Prset"	
	8	"TrimOn AnMlt" <sup>(1)</sup>	
	9	"TrimOn MOP"	
	10	"TrimOn Pulse"	
	11	"TrimOn Slgic" <sup>(1)</sup>	
	12	"TrimOn Encdr" <sup>(1)</sup>	
	13	"TrimOn ENet" <sup>(1)</sup>	

(1) Setting is specific to PowerFlex 525 drives only.



## Advanced Program Group (continued)

**A459 [PID 1 Ref Sel]****A471 [PID 2 Ref Sel]**

(PF 525) PowerFlex 525 only.



Stop drive before changing this parameter.

Selects the source of the PID reference.

	0	"PID Setpoint" (Default)
	1	"Drive Pot"
	2	"Keypad Freq"
	3	"Serial/DSF"
	4	"Network Opt"
	5	"0-10V Input"
<b>Options</b>	6	"4-20mA Input"
	7	"Preset Freq"
	8	"AnlgIn Multi" <sup>(1)</sup>
	9	"MOP Freq"
	10	"Pulse Input"
	11	"Step Logic" <sup>(1)</sup>
	12	"Encoder" <sup>(1)</sup>
	13	"EtherNet/IP" <sup>(1)</sup>

(1) Setting is specific to PowerFlex 525 drives only.

**A460 [PID 1 Fdback Sel]****A472 [PID 2 Fdback Sel]**

(PF 525) PowerFlex 525 only.

Selects the source of the PID feedback.

	0	"0-10V Input" (Default)	Note: PID does not function with bipolar input. Negative voltages are ignored and treated as zero.
	1	"4-20mA Input"	
	2	"Serial/DSF"	
<b>Options</b>	3	"Network Opt"	
	4	"Pulse Input"	
	5	"Encoder" <sup>(1)</sup>	
	6	"EtherNet/IP" <sup>(1)</sup>	

(1) Setting is specific to PowerFlex 525 drives only.

**A461 [PID 1 Prop Gain]**Related Parameter(s): [A459](#), [A471](#)**A473 [PID 2 Prop Gain]**

(PF 525) PowerFlex 525 only.

Sets the value for the PID proportional component when the PID mode is enabled.

	Default:	0.01
<b>Values</b>	Min/Max:	0.00/99.99
	Display:	0.01

## Advanced Program Group (continued)

**A462 [PID 1 Integ Time]**Related Parameter(s): [A459](#), [A471](#)**A474 [PID 2 Integ Time]****(PF 525)** PowerFlex 525 only.

Sets the value for the PID integral component when PID mode is enabled.

	Default:	2.0 s
<b>Values</b>	Min/Max:	0.0/999.9 s
	Display:	0.1 s

**A463 [PID 1 Diff Rate]**Related Parameter(s): [A459](#), [A471](#)**A475 [PID 2 Diff Rate]****(PF 525)** PowerFlex 525 only.

Sets the value (in 1/second) for the PID differential component when PID mode is enabled.

	Default:	0.00
<b>Values</b>	Min/Max:	0.00/99.99
	Display:	0.01

**A464 [PID 1 Setpoint]**Related Parameter(s): [A459](#), [A471](#)**A476 [PID 2 Setpoint]****(PF 525)** PowerFlex 525 only.

Provides an internal fixed value for process setpoint when PID mode is enabled.

	Default:	0.0%
<b>Values</b>	Min/Max:	0.0/100.0%
	Display:	0.1%

**A465 [PID 1 Deadband]****A477 [PID 2 Deadband]****(PF 525)** PowerFlex 525 only.

Sets a range, in percent above and below the PID Reference, that the PID output will ignore.

	Default:	0.0%
<b>Values</b>	Min/Max:	0.0/10.0%
	Display:	0.1%

**A466 [PID 1 Preload]****A478 [PID 2 Preload]****(PF 525)** PowerFlex 525 only.

Sets the value used to preload the integral component on start or enable.

	Default:	0.0 Hz
<b>Values</b>	Min/Max:	0.0/500.0 Hz
	Display:	0.1 Hz

**A467 [PID 1 Invert Err]****A479 [PID 2 Invert Err]****(PF 525)** PowerFlex 525 only.

Changes the sign of the PID error.

<b>Options</b>	0	"Normal" (Default)
	1	"Inverted"

## Advanced Program Group *(continued)*

### A481 [Process Disp Lo]

Related Parameter(s): [b010](#), [P043](#)Sets the value displayed in [b010](#) [Process Display] when the drive is running at [P043](#) [Minimum Freq].

	Default:	0.00
<b>Values</b>	Min/Max:	0.00/99.99
	Display:	0.01

### A482 [Process Disp Hi]

Related Parameter(s): [b010](#), [P044](#)Sets the value displayed in [b010](#) [Process Display] when the drive is running at [P044](#) [Maximum Freq].

	Default:	0.00
<b>Values</b>	Min/Max:	0.00/99.99
	Display:	0.01

### A483 [Testpoint Sel]

Used by Rockwell Automation field service personnel.

	Default:	400
<b>Values</b>	Min/Max:	0/FFFF
	Display:	1

### A484 [Current Limit 1]

Related Parameter(s): [P033](#)

Maximum output current allowed before current limiting occurs.

	Default:	Drive Rated Amps x 1.1 (Normal Duty); Drive Rated Amps x 1.5 (Heavy Duty)
<b>Values</b>	Min/Max:	0.0/Drive Rated Amps x 1.5 (Normal Duty); Drive Rated Amps x 1.8 (Heavy Duty)
	Display:	0.1 A

### A485 [Current Limit 2]

Related Parameter(s): [P033](#)(PF 525) PowerFlex 525 only.

Maximum output current allowed before current limiting occurs.

	Default:	Drive Rated Amps x 1.1
<b>Values</b>	Min/Max:	0.0/Drive Rated Amps x 1.5 (Normal Duty); Drive Rated Amps x 1.8 (Heavy Duty)
	Display:	0.1 A

### A486 [Shear Pin1 Level]

Related Parameter(s): [A487](#), [A489](#)

#### A488 [Shear Pin2 Level]

(PF 525) PowerFlex 525 only.Sets the value of current at which the shear pin fault occurs after the time set in [A487](#), [A489](#) [Shear Pin x Time]. Setting the value at 0.0 A disables this function.

	Default:	0.0 A (Disabled)
<b>Values</b>	Min/Max:	0.0/(Drive Rated Amps x 2)
	Display:	0.1 A

### A487 [Shear Pin 1 Time]

Related Parameter(s): [A486](#), [A488](#)

#### A489 [Shear Pin 2 Time]

(PF 525) PowerFlex 525 only.Sets the continuous time the drive must be at or above the value set in [A486](#), [A488](#) [Shear Pinx Level] before a shear pin fault occurs.

	Default:	0.00 s
<b>Values</b>	Min/Max:	0.00/30.00 s
	Display:	0.01 s

### Advanced Program Group (continued)

#### A490 [Load Loss Level]

Related Parameter(s): [A491](#)

(PF 525) PowerFlex 525 only.

Provides a software trip (Load Loss fault) when the current drops below this level for the time specified in [A491](#) [Load Loss Time].

	Default:	0.0 A
<b>Values</b>	Min/Max:	0.0/Drive Rated Amps
	Display:	0.1 A

#### A491 [Load Loss Time]

Related Parameter(s): [A490](#)

(PF 525) PowerFlex 525 only.

Sets the required time for the current to be below [A490](#) [Load Loss Level] before a Load Loss fault occurs.

	Default:	0 s
<b>Values</b>	Min/Max:	0/9999 s
	Display:	1 s

#### A492 [Stall Fault Time]

Sets the time that the drive remains in stall mode before a fault is issued.

	0	"60 Seconds" (Default)
	1	"120 Seconds"
<b>Options</b>	2	"240 Seconds"
	3	"360 Seconds"
	4	"480 Seconds"
	5	"Flt Disabled"

#### A493 [Motor OL Select]

Related Parameter(s): [P032](#), [P033](#)

Drive provides Class 10 overload protection. Settings 0...2 select the derating factor for the I<sup>2</sup>t overload function.

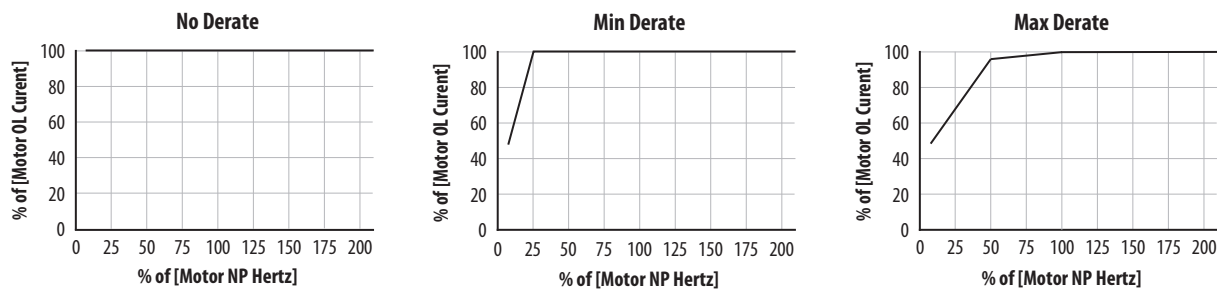

	0	"No Derate" (Default)
<b>Options</b>	1	"Min. Derate"
	2	"Max. Derate"

#### A494 [Motor OL Ret]

Selects whether the motor overload counter is saved on power-down or reset on power-up.

	0	"Reset" (Default)
<b>Options</b>	1	"Save"

## Advanced Program Group (continued)

### A495 [Drive OL Mode]

Determines how the drive handles overload conditions that would otherwise cause the drive to fault.

<b>Options</b>	0	“Disabled”
	1	“Reduce CLim”
	2	“Reduce PWM”
	3	“Both-PWM 1st” (Default)

### A496 [IR Voltage Drop]

Related Parameter(s): [P040](#)

Value of volts dropped across the resistance of the motor stator (autotune) for induction motor.

<b>Values</b>	Default:	Based on Drive Rating
	Min/Max:	0.0/600.0VAC
	Display:	0.1VAC

### A497 [Flux Current Ref]

Related Parameter(s): [P040](#)

This is the current necessary for full motor flux. The value should be set to the full speed no-load current of the motor.

<b>Values</b>	Default:	Based on Drive Rating
	Min/Max:	0.00/(Drive Rated Amps x 1.4)
	Display:	0.01 A

### A498 [Motor Rr]

(PF 525) PowerFlex 525 only.

Rotor resistance of induction motor. The value of this parameter will populate when a full rotate tune is performed.

<b>Values</b>	Default:	Based on Drive Rating
	Min/Max:	0.00/655.35 ohm
	Display:	0.01 ohm

### A499 [Motor Lm]

(PF 525) PowerFlex 525 only.

Mutual Inductance of induction motor. The value of this parameter will populate when a full rotate tune is performed.

<b>Values</b>	Default:	Based on Drive Rating
	Min/Max:	0.0/6553.5 mH
	Display:	0.1 mH

### A500 [Motor Lx]

(PF 525) PowerFlex 525 only.

Leakage Inductance of induction motor. The value of this parameter will populate when a full rotate tune is performed.

<b>Values</b>	Default:	Based on Drive Rating
	Min/Max:	0.0/6553.5 mH
	Display:	0.1 mH

### A501 [PM IR Voltage]

(PF 525) PowerFlex 525 only.

(With FRN 5.xxx and later.)

Voltage across the stator resistance of the PM or SynRM motor at the rated motor current displayed in line-to-line rms value.

<b>Values</b>	Default:	11.50V
	Min/Max:	0.00/655.35V
	Display:	0.01V

## Advanced Program Group (continued)

**A502 [PM IXd Voltage]**

(PF 525) PowerFlex 525 only.

(With FRN 5.xxx and later.)

Voltage across the d-axis stator inductance of the PM or SynRM motor at the rated motor current and the rated motor frequency displayed in line-to-line rms value.

	Default:	17.91V
<b>Values</b>	Min/Max:	0.00/655.35V
	Display:	0.01V

**A503 [PM IXq Voltage]**

(PF 525) PowerFlex 525 only.

(With FRN 5.xxx and later.)

Voltage across the q-axis stator inductance of the PM or SynRM motor at the rated motor current and the rated motor frequency displayed in line-to-line rms value.

	Default:	53.21V
<b>Values</b>	Min/Max:	0.00/655.35V
	Display:	0.01V

**A504 [PM BEMF Voltage]**

(PF 525) PowerFlex 525 only.

(With FRN 5.xxx and later.)

Back electromotive force (EMF) voltage of the PM or SynRM motor.

	Default:	328.0 V - PM, 164.0 V - SynRM
<b>Values</b>	Min/Max:	0.0/1200.0 V
	Display:	0.1V

**A509 [Speed Reg Sel]**Related Parameter(s): [A521](#), [A522](#), [A523](#), [A524](#), [A525](#), [A526](#)

(PF 525) PowerFlex 525 only.

Determines if PI gain of the "Vector" control mode speed regulator is set automatically or manually. Parameters [A521](#)...[A526](#) are set automatically by this parameter.

<b>Options</b>	0	"Automatic" (Default)
	1	"Manual"

**A510 [Freq 1]****A512 [Freq 2]****A514 [Freq 3]**

(PF 525) PowerFlex 525 only.

Sets the "Vector" control mode frequency.

	Default:	
<b>Values</b>	Freq 1:	8.33%
	Freq 2:	15.00%
	Freq 3:	20.00%
	Min/Max:	0.00/200.00%
	Display:	0.01%

**A511 [Freq 1 BW]****A513 [Freq 2 BW]****A515 [Freq 3 BW]**

(PF 525) PowerFlex 525 only.

Speed control loop bandwidth for "Vector" control mode.

	Default:	10 Hz
<b>Values</b>	Min/Max:	0/40 Hz
	Display:	1 Hz

## Advanced Program Group (continued)

### A516 [PM Initial Sel]

(PF 525) PowerFlex 525 only.

(With FRN 5.xxx and later.)  
PM initial angle detect.

	0	"Align" (Default)	
<b>Options</b>	1	"HFI"	High Frequency Injection to detect initial angle.
	2	"Six Pulse"	

### A517 [PM DC Inject Cur]

(PF 525) PowerFlex 525 only.

(With FRN 5.xxx and later.)  
Maximum DC current in amps applied to the motor in order to reset the rotor position of a PM motor.

	Default:	30%
<b>Values</b>	Min/Max:	0/300%
	Display:	1%

### A518 [PM Align Time]

(PF 525) PowerFlex 525 only.

(With FRN 5.xxx and later.)  
Magnetic pole reorientation time.

	Default:	0.7 s
<b>Values</b>	Min/Max:	0.0/60.0 s
	Display:	0.1 s

### A519 [PM HFI NS Cur]

(PF 525) PowerFlex 525 only.

(With FRN 5.xxx and later.)  
High Frequency Injection (HFI) North South Current to detect N/S Magnet.

	Default:	100%
<b>Values</b>	Min/Max:	0/300%
	Display:	1%

### A520 [PM Bus Reg Kd]

(PF 525) PowerFlex 525 only.

(With FRN 5.xxx and later.)  
Derivative gain for bus regulator.

	Default:	2
<b>Values</b>	Min/Max:	0/500
	Display:	1

### A521 [Freq 1 Kp]

### A523 [Freq 2 Kp]

### A525 [Freq 3 Kp]

(PF 525) PowerFlex 525 only.

Sets P-gain of "Vector" control mode when in frequency region 1, 2 or 3 for faster speed response during dynamic-state where motor is still accelerating. If [A509](#) [Speed Reg Sel] is set to 1 "Manual", these parameters can be changed.

	Default:	100.0%
<b>Values</b>	Min/Max:	0.0/500.0%
	Display:	0.1%

Related Parameter(s): [A509](#), [A510](#)

### Advanced Program Group (continued)

Related Parameter(s): [A509](#), [A510](#)

**A522 [Freq 1 Ki]**  
**A524 [Freq 2 Ki]**  
**A526 [Freq 3 Ki]**

(PF 525) PowerFlex 525 only.

Sets I-gain of “Vector” control mode when in frequency region 1, 2 or 3 for faster speed response during steady-state where motor is at its rated speed. If [A509](#) [Speed Reg Sel] is set to 1 “Manual”, these parameters can be changed.

	Default:	0.100 s
<b>Values</b>	Min/Max:	0.000/10.000 s
	Display:	0.001 s

**A527 [PM FWKn 1 Kp]**

(PF 525) PowerFlex 525 only.

(With FRN 5.xxx and later.)

The gain to ensure good performance in field weakening region.

	Default:	350%
<b>Values</b>	Min/Max:	0/2000%
	Display:	1%

**A528 [PM FWKn 2 Kp]**

(PF 525) PowerFlex 525 only.

(With FRN 5.xxx and later.)

The gain to ensure robustness under step load in weakening region.

	Default:	300%
<b>Values</b>	Min/Max:	100/8000%
	Display:	1%

**A529 [PM Control Cfg]**

(PF 525) PowerFlex 525 only.

(With FRN 5.xxx and later.)

Control configuration for Feed Forward Decouple (FFD), Maximum Torque Per Amp (MTPA), and Load Disturbance Observer (LDOB).

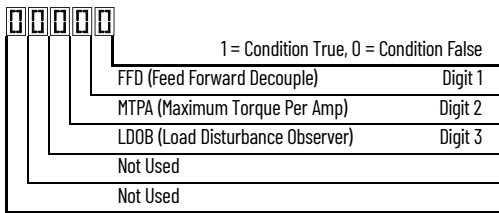

	Default:	00111
<b>Values</b>	Min/Max:	00000/00111
	Display:	00000



### Advanced Program Group (continued)

#### A530 [Boost Select]

Related Parameter(s): [b004](#), [P031](#), [P032](#), [P039](#)

Sets the boost voltage (% of [P031](#) [Motor NP Volts]) and redefines the V/Hz curve. Only used for V/Hz control modes.

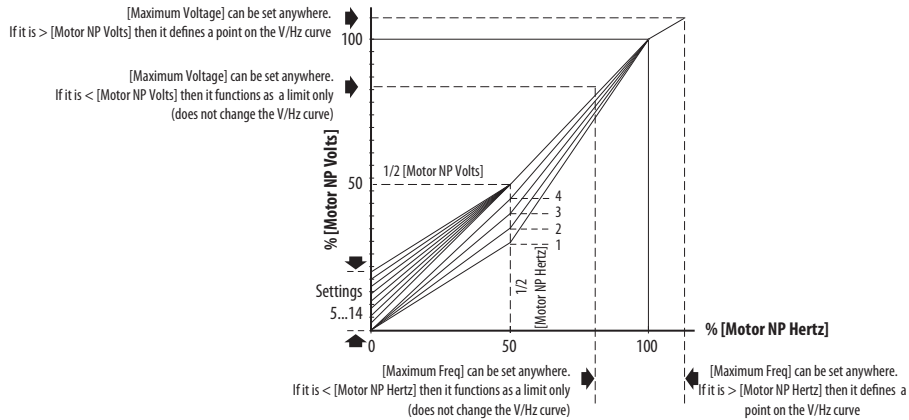

	0	"Custom V/Hz"	
	1	"30.0, VT"	
	2	"35.0, VT"	Fan/Pump Curves (Variable Torque)
	3	"40.0, VT"	
	4	"45.0, VT"	
	5	"0.0, no IR"	
	6	"2.5, CT" (Default for 400V and 600V drives, 5 HP and above)	
<b>Options</b>	7	"2.5, CT" (Default for 200V drives, 5 HP and above)	
	8	"5.0, CT" (Default for drives below 5 HP)	Boost Voltage (% of Base) (Constant Torque)
	9	"7.5, CT"	
	10	"10.0, CT"	
	11	"12.5, CT"	
	12	"15.0, CT"	
	13	"17.5, CT"	
	14	"20.0, CT"	

### Advanced Program Group (continued)

**A531 [Start Boost]**

Related Parameter(s): [P031](#), [P032](#), [P039](#), [A530](#)

Sets the boost voltage (% of [P031](#) [Motor NP Volts]) and redefines the V/Hz curve when [A530](#) [Boost Select] = 0 "Custom V/Hz" and [P039](#) [Torque Perf Mode] = 0 "V/Hz".

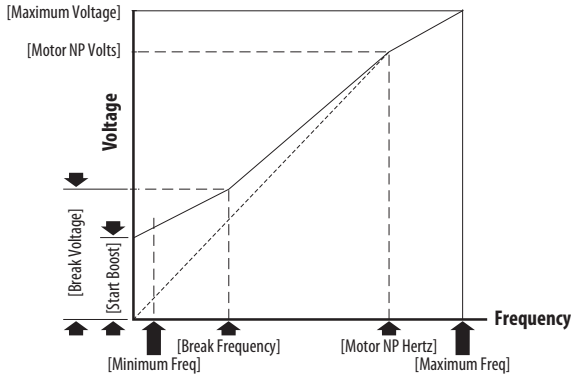

	Default:	2.5%
<b>Values</b>	Min/Max:	0.0/25.0%
	Display:	0.1%

**A532 [Break Voltage]**

Related Parameter(s): [P031](#), [P032](#), [P039](#), [A530](#), [A533](#)

Sets the voltage (in percent of [Base Frequency]) at the [A533](#) [Break Frequency] if [A530](#) [Boost Select] is set to 0 "Custom V/Hz".

	Default:	25.0%
<b>Values</b>	Min/Max:	0.0/100.0%
	Display:	0.1%

**A533 [Break Frequency]**

Related Parameter(s): [P031](#), [P032](#), [P039](#), [A530](#), [A532](#)

Sets the frequency where [A532](#) [Break Voltage] is applied if [A530](#) [Boost Select] is set to 0 "Custom V/Hz".

	Default:	15.0 Hz
<b>Values</b>	Min/Max:	0.0/500.0 Hz
	Display:	0.1 Hz

**A534 [Maximum Voltage]**

Related Parameter(s): [b004](#)

Sets the highest voltage the drive outputs.

	Default:	Drive Rated Volts
<b>Values</b>	Min:	10V AC (on 230V AC Drives); 20V AC (on 460V AC Drives); 25V AC (on 600V AC Drives)
	Max:	255V AC (on 230V AC Drives); 510V AC (on 460V AC Drives); 637.5V AC (on 600V AC Drives)
	Display:	1V AC

## Advanced Program Group (continued)

**A535 [Motor Fdbk Type]**Related Parameter(s): [P039](#), [A537](#)
 Stop drive before changing this parameter.
Selects the encoder type.<sup>(1)</sup>

**ATTENTION:** The loss of analog input, encoder or other feedback may cause unintended speed or motion. Take appropriate precautions to guard against possible unintended speed or motion.

	Allowable Control Modes (See <a href="#">P039</a> [Torque Perf Mode])	Hardware Inputs
0 "None" (Default)	V/Hz, SVC, Economize, Vector, PM Control	-
1 "Pulse Train"	V/Hz, SVC, Economize, PM Control	[DigIn TermBlk 05] for PowerFlex 523 [DigIn TermBlk 07] for PowerFlex 525
<b>Options</b> 2 "Single Chan" <sup>(2)</sup>	V/Hz, SVC, Economize, PM Control	
3 "Single Check" <sup>(2)</sup>	V/Hz, SVC, Economize, PM Control	
4 "Quadrature" <sup>(2)</sup>	V/Hz, SVC, Economize, Vector, PM Control	Optional incremental encoder card (catalog number 25-ENC-1)
5 "Quad Check" <sup>(2)</sup>	V/Hz, SVC, Economize, Vector, PM Control	

(1) Parameter is also available in PowerFlex 523 FRN 3.xxx and later.

(2) Setting is specific to PowerFlex 525 drives only.

**A536 [Encoder PPR]**[PF 525](#) PowerFlex 525 only.

Specifies the encoder Pulses Per Revolution (PPR) when an encoder is used.

To achieve speed range/accuracy for SVC and VVC closed loop control, a minimum of 1024 PPR encoder is recommended. The maximum encoder pulse is 250 kHz.

For more information, see [Determine Encoder Pulse Per Revolution \(PPR\) Specification Based on Speed Resolution on page 219](#).

	Default:	1024 PPR
<b>Values</b>	Min/Max:	1/20000 PPR
	Display:	1 PPR

**A537 [Pulse In Scale]**Related Parameter(s): [t065](#), [t067](#), [A535](#)Sets the scale factor/gain for the Pulse Input when [t065](#) [DigIn TermBlk 05] or [t067](#) [DigIn TermBlk 07] is set to 52 "Pulse Train", or [A535](#) [Motor Fdbk Type] is set to 1 "Pulse Train".  
Input frequency (Hz) / Pulse in Scale = Output frequency (Hz)

	Default:	64
<b>Values</b>	Min/Max:	0/20000
	Display:	1

**A538 [Ki Speed Loop]**Sets the I-gain used in the PI calculation of the speed loop when feedback is used. Applicable to V/Hz and SVC modes in closed loop control only.<sup>(1)</sup>

	Default:	2.0
<b>Values</b>	Min/Max:	0.0/400.0
	Display:	0.1

(1) Parameter is also available in PowerFlex 523 FRN 3.xxx and later.

**A539 [Kp Speed Loop]**Sets the P-gain used in the PI calculation of the speed loop when feedback is used. Applicable to V/Hz and SVC modes in closed loop control only.<sup>(1)</sup>

	Default:	0.5
<b>Values</b>	Min/Max:	0.0/200.0
	Display:	0.1

(1) Parameter is also available in PowerFlex 523 FRN 3.xxx and later.

## Advanced Program Group (continued)

**A540 [Var PWM Disable]**Related Parameter(s): [A440](#) Stop drive before changing this parameter.Enables/disables a feature that varies the carrier frequency for the PWM output waveform defined by [A440](#) [PWM Frequency].

<b>Options</b>	0	"Enabled" (Default)
	1	"Disabled"

**A541 [Auto Rstrt Tries]**Related Parameter(s): [A542](#)Sets the maximum number of times the drive attempts to reset a fault and restart. See [Chapter 4](#) for more information on faults and fault codes.**Clear a Type 1 fault and restart the drive.**

1. Set A541 [Auto Rstrt Tries] to a value other than "0".
2. Set [A542](#) [Auto Rstrt Delay] to a value other than "0".

**Clear an OverVoltage, UnderVoltage or Heatsink OvrTmp fault without restarting the drive.**

1. Set A541 [Auto Rstrt Tries] to a value other than "0".
2. Set [A542](#) [Auto Rstrt Delay] to "0".

**ATTENTION:** Equipment damage and/or personal injury may result if this parameter is used in an inappropriate application. Do not use this function without considering applicable local, national and international codes, standards, regulations or industry guidelines.

<b>Values</b>	Default:	0
	Min/Max:	0/9
	Display:	1

**A542 [Auto Rstrt Delay]**Related Parameter(s): [A541](#)Sets the time between restart attempts if [A541](#) [Auto Rstrt Tries] is not zero.

<b>Values</b>	Default:	1.0 s
	Min/Max:	0.0/120.0 s
	Display:	0.1 s

**A543 [Start At PowerUp]** Stop drive before changing this parameter.

Enables/disables drive start on power up without a Run command being cycled. Requires a digital input configured for Run and a valid run signal.

**ATTENTION:** Equipment damage and/or personal injury may result if this parameter is used in an inappropriate application. Do not use this function without considering applicable local, national and international codes, standards, regulations or industry guidelines.

<b>Options</b>	0	"Disabled" (Default)
	1	"Enabled"

**A544 [Reverse Disable]**Related Parameter(s): [b006](#) Stop drive before changing this parameter.

Enables/disables the function that allows the direction of motor rotation to be changed.

<b>Options</b>	0	"Rev Enabled" (Default)
	1	"Rev Disabled"

**A545 [Flying Start En]**

Sets the condition that allows the drive to reconnect to a spinning motor at actual RPM.

<b>Options</b>	0	"Disabled" (Default)
	1	"Enabled" Catch and ramp to commanded speed at every drive start.

## Advanced Program Group (continued)

### A546 [FlyStrt CurLimit]

Used to determine when the drive has matched the motor frequency if flying start is enabled.

	Default:	65%
<b>Values</b>	Min/Max:	30/200%
	Display:	1%

### A547 [Compensation]

Enables/disables correction options that may improve problems with motor instability.

<b>Options</b>	0	"Disabled"	No compensation.
	1	"Electrical" (Default)	Some drive/motor combinations have inherent instabilities which are exhibited as non-sinusoidal motor currents. This setting attempts to correct this condition
	2	"Mechanical"	Some motor/load combinations have mechanical resonances which can be excited by the drive current regulator. This setting slows down the current regulator response and attempts to correct this condition.
	3	"Both"	

### A548 [Power Loss Mode]

Sets the reaction to a loss of input power.

<b>Options</b>	0	"Coast" (Default)	Drive faults and motor coasts to a stop.
	1	"Decel"	Drive decelerates and attempts to keep the DC bus voltage above the undervoltage level.

### A549 [Half Bus Enable]

Enables/disables the power ride through function which allows the drive to maintain power to the motor at 50% drive input voltage during short-term power sag conditions.



**ATTENTION:** To guard against drive damage, a minimum line impedance must be provided to limit inrush current when the power line recovers. The input impedance should be equal or greater than the equivalent of a 5% transformer with a VA rating 6 times the drive's input VA rating if Half Bus is enabled.

<b>Options</b>	0	"Disabled" (Default)
	1	"Enabled"

### A550 [Bus Reg Enable]

Related Parameter(s): [A437](#)

Enables/disables the bus regulator.

<b>Options</b>	0	"Disabled"
	1	"Enabled" (Default)

### A551 [Fault Clear]



Stop drive before changing this parameter.

Resets a fault and clears the fault queue.

<b>Options</b>	0	"Ready/Idle" (Default)	
	1	"Reset Fault"	Resets the active fault but does not clear any fault buffer.
	2	"Clear Buffer"	Resets the active fault and clears all fault buffers to "0".

### A552 [Program Lock]

Related Parameter(s): [A553](#)

Protects parameters against change by unauthorized personnel with a 4-digit access code.

	Default:	0000
<b>Values</b>	Min/Max:	0000/9999
	Display:	1111

## Advanced Program Group (continued)

### A553 [Program Lock Mod]

Related Parameter(s): [A552](#)

Determines the lock mode used in parameter [A552](#) [Program Lock]. When set to 2 or 3, A552 [Program Lock] is added to the custom group to allow unlocking of parameters.

	0	"Full Lock" (Default)	All parameters are locked except [Program Lock].
	1	"Keypad Lock"	All parameters are locked except [Program Lock] from keypad access but can still be accessed over communications.
<b>Options</b>	2	"Custom Only"	All parameters are locked and hidden except custom group and [Program Lock].
	3	"KeyPd Custom"	All parameters are locked and hidden except custom group and [Program Lock] from keypad access but can still be accessed over communications.

### A554 [Drv Ambient Sel]

Sets the maximum expected ambient of the drive when used above 50 °C. When ambient temperature is above 50 °C, the drive will apply necessary current derating.

	0	"Normal" (Default)	
	1	"55C"	
<b>Options</b>	2	"60C"	
	3	"65C +Fan Kit"	Fan kit required.
	4	"70C +Fan Kit"	

### A555 [Reset Meters]

Related Parameter(s): [b019](#), [b021](#), [b022](#), [b023](#), [b024](#),  
[b025](#), [b026](#), [d362](#), [d363](#)

Resets the values stored in the parameters that track fault times and energy usage.

	0	"Ready/Idle" (Default)	
<b>Options</b>	1	"Reset Meters"	Resets kWh, MWh, Accum kWh, Cost, and CO2 Sav parameter values.
	2	"Reset Time"	Resets min, hr, and x10 hr.

### A556 [Text Scroll]

Sets the scrolling speed of the text in the LCD display.

	0	"Off"	No scroll.
<b>Options</b>	1	"Low Speed"	
	2	"Mid Speed" (Default)	
	3	"High Speed"	

### A557 [Out Phas Loss En]

Enable/disable output phase loss detection.



**ATTENTION:** Equipment damage and/or personal injury may result if this parameter is used in an inappropriate application. Do not use this function without considering applicable local, national and international codes, standards, regulations or industry guidelines.

<b>Options</b>	0	"Disable" (Default)	
	1	"Enable"	

### A558 [Positioning Mode]



Stop drive before changing this parameter.

(PF 525) PowerFlex 525 only.

Defines the positioning transition mode used for the position steps.

	0	"Time Steps" (Default)	Steps based on time.
	1	"Preset Input"	Preset inputs directly commands a given step.
<b>Options</b>	2	"Step Logic"	Use StepLogic Commands. Always start from Step 0.
	3	"Preset StpL"	Use Preset Inputs to determine starting step then StepLogic commands.
	4	"StpLogic-Lst"	Use StepLogic commands from last Step Logic step at last drive stop.

## Advanced Program Group (continued)

### A559 [Counts Per Unit]

(PF 525) PowerFlex 525 only.

Sets the number of encoder counts equal to one user-defined unit.

	Default:	4096
<b>Values</b>	Min/Max:	1/32000
	Display:	1

### A560 [Enh Control Word]

Related Parameter(s): [t062](#), [t063](#), [t065](#) - [t068](#), [A571](#)

(PF 525) PowerFlex 525 only.

Allows control of positioning and other functions through parameter control for use over comms. The functions replicate the digital input options and function in the same way.

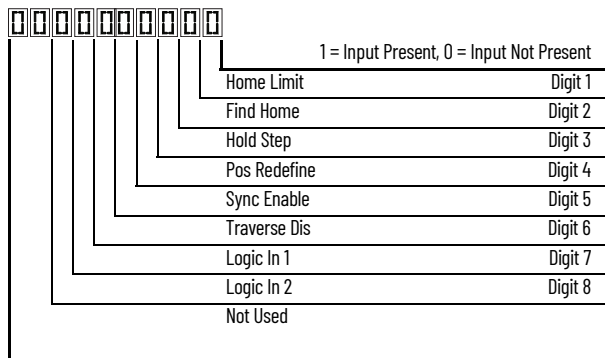

	Default:	0000 0000
<b>Values</b>	Min/Max:	0000 0000/1111 1111
	Display:	0000 0000

	0	“Home Limit”	In Positioning mode, this indicates the drive is at the home position
	1	“Find Home”	When set, the next start command causes the drive to find home. Set this bit to 0 after completing the homing routine.
	2	“Hold Step”	In Positioning mode, this input over-rides other inputs and causes the drive to remain at its current step (running at zero speed once it reaches its position) until released.
	3	“Pos Redefine”	In Positioning mode, this input resets the home position to the current position of the machine. Set this bit to 0 after completing the homing routine.
<b>Digits</b>	4	“Sync Enable”	Must be used in order to hold the existing frequency when Sync Time is set to enable speed synchronization. When this bit is reset to zero the drive accelerates to the new commanded frequency based on <a href="#">A571</a> [Sync Time] setting.
	5	“Traverse Dis”	When set the traverse function is disabled.
	6	“Logic In 1”	This provides an identical function as the “Logic In1” Digital Input option. This bit is logically ORed with a digital input <a href="#">t062</a> , <a href="#">t063</a> , <a href="#">t065-t068</a> [DigIn TermBlk xx] set to 24 “Logic In1”. It can be used to move through the Step-Logic functions (speed or position) using comms control without requiring actual digital input transitions.
	7	“Logic In 2”	This provides an identical function as the “Logic In2” Digital Input option. This bit is logically ORed with a digital input <a href="#">t062</a> , <a href="#">t063</a> , <a href="#">t065-t068</a> [DigIn TermBlk xx] set to 25 “Logic In2”. It can be used to move through the Step-Logic functions (speed or position) using comms control without requiring actual digital input transitions.

### A561 [Home Save]

(PF 525) PowerFlex 525 only.

Determines whether the current position is saved on power down.

<b>Options</b>	0	“Home Reset” (Default)	Position resets to zero on power up.
	1	“Home Saved”	

## Advanced Program Group *(continued)*

### A562 [Find Home Freq]

 PowerFlex 525 only.

Sets the maximum frequency the drive uses when "Find Home" is issued.

	Default:	10.0 Hz
<b>Values</b>	Min/Max:	0.1/500.0 Hz
	Display:	0.1 Hz

### A563 [Find Home Dir]

 Stop drive before changing this parameter.

 PowerFlex 525 only.

Sets the direction the drive commands when "Find Home" is issued.

<b>Options</b>	0	"Forward" (Default)
	1	"Reverse"

### A564 [Encoder Pos Tol]

 PowerFlex 525 only.

Sets the "At Position" and the "At Home" tolerance around the encoder count. The value is added to and subtracted from the target encoder unit value to create the tolerance range.

	Default:	100
<b>Values</b>	Min/Max:	1/50000
	Display:	1

### A565 [Pos Reg Filter]

 PowerFlex 525 only.

Sets the error signal filter in the position regulator.

	Default:	8
<b>Values</b>	Min/Max:	0/15
	Display:	1

### A566 [Pos Reg Gain]

 PowerFlex 525 only.

Sets the gain adjustment for the position regulator.

	Default:	3.0
<b>Values</b>	Min/Max:	0.0/200.0
	Display:	0.1



## Advanced Program Group (continued)

### A567 [Max Traverse]

Sets the amplitude of triangle wave speed modulation.

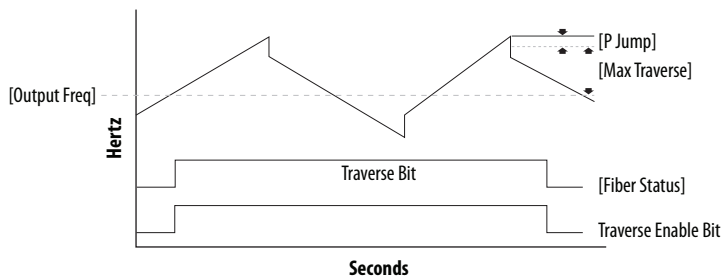

	Default:	0.00 Hz
<b>Values</b>	Min/Max:	0.00/300.00 Hz
	Display:	0.01 Hz

### A568 [Traverse Inc]

Related Parameter(s): [A567](#)

Sets the time required for the Traverse function to accelerate from the minimum to the maximum traverse frequency. See the diagram at [A567](#) [Max Traverse].

	Default:	0.00 s
<b>Values</b>	Min/Max:	0.00/300.00 s
	Display:	0.01 s

### A569 [Traverse Dec]

Related Parameter(s): [A567](#)

Sets the time required for the Traverse function to decelerate from the maximum to the minimum traverse frequency. See the diagram at [A567](#) [Max Traverse].

	Default:	0.00 s
<b>Values</b>	Min/Max:	0.00/300.00 s
	Display:	0.01 s

### A570 [P Jump]

Related Parameter(s): [A567](#)

Sets the frequency amplitude that is added to or subtracted from the commanded frequency. See the diagram at [A567](#) [Max Traverse].

	Default:	0.00 Hz
<b>Values</b>	Min/Max:	0.00/300.00 Hz
	Display:	0.01 Hz

### A571 [Sync Time]

Related Parameter(s): [t062](#), [t063](#), [t065](#) - [t068](#), [A560](#)

Enables the function that holds the drive at the current frequency even if the commanded frequency changes. Used with [t062](#), [t063](#), [t065-t068](#) [DigIn TermBlk xx] 32 "Sync Enable".

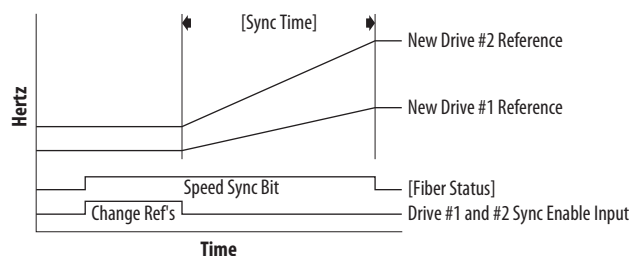

	Default:	0.0 s
<b>Values</b>	Min/Max:	0.0/3200.0 s
	Display:	0.1 s

### Advanced Program Group (continued)

#### A572 [Speed Ratio]

 Stop drive before changing this parameter.

Scales the drive speed command.

	Default:	1.00
<b>Values</b>	Min/Max:	0.01/99.99
	Display:	0.01

#### A573 [Mtr Options Cfg]

(With PowerFlex 525 FRN 2.xxx and later.)

(With PowerFlex 523 FRN 3.xxx and later.)

Sets the configuration of the motor option.

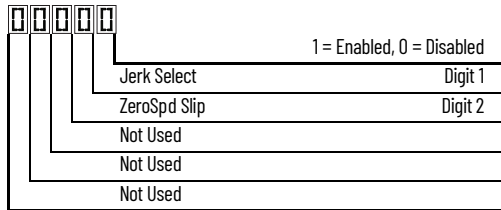

Options	Description
Jerk Select	Limits the rate of change to the velocity reference for improved current limiting. Set to 0 "Disabled" for positioning type applications with fast Accel or Decel times.
ZeroSpd Slip	Sets slip compensation to 0.0 Hz when the following conditions are met: <ul style="list-style-type: none"> <li>• Commanded speed = 0.00 Hz</li> <li>• Status of drive = "At speed"</li> <li>• ZeroSpd Slip = 1 "Enabled"</li> </ul>

	Default:	11
<b>Values</b>	Min/Max:	00/11
	Display:	00

#### A574 [RdyBit Mode Cfg]

Related Parameter(s): [d392](#)

 Stop drive before changing this parameter.

(With PowerFlex 525 FRN 3.xxx and later.)

(With PowerFlex 523 FRN 3.xxx and later.)

Determines which Stop conditions causes the drive's Ready bit (Network Logic Status bit 1) to go low (0). A reset or power cycle is required after selection is made.

Stop Conditions	Ready Bit Status <sup>(1)</sup>	
	Standard	Enhanced
Drive fault	0	0
Stop digital input terminal 01/11 open	1	0
Holding down the drive's keypad or the Remote DSI HIM Stop button	1	0
Stop commanded through Comms (Stop bit = 1)	1	0
Software (SW) Enable digital input terminal open	1	0
Safe-Torque-Off (STO) condition with value of t105 [Safety Open En] set to 1 "FaultDisabled" <sup>(2)</sup>	0	0

(1) 1 = Active, 0 = Inactive

(2) Condition is specific to PowerFlex 525 drives only.

<b>Options</b>	0 "Standard" (Default)
	1 "Enhanced"

#### A575 [Flux Braking En]

Related Parameter(s): [A550](#)

(With PowerFlex 525 FRN 5.xxx and later.)

(With PowerFlex 523 FRN 3.xxx and later.)

Enables/disables flux braking.

<b>Options</b>	0 "Disable" (Default)
	1 "Enable"

## Advanced Program Group (continued)

### A576 [Phase Loss Level]

(With PowerFlex 525 FRN 5.xxx and later.)

(With PowerFlex 523 FRN 3.xxx and later.)

Output Phase Loss Level. Sets the threshold level which is used to determine an output phase loss condition. Each motor phase must exceed this value. Decreasing this parameter's value lowers sensitivity.

	Default:	25.0% for Induction motor; 4.0% for PM motor
<b>Values</b>	Min/Max:	0.0/100.0%
	Display:	0.1%

### A580 [Current Loop BW]

PF 525 PowerFlex 525 only.

(With FRN 5.xxx and later.)

Current loop bandwidth (0 = Automatically calculate the control gain of current loop).

	Default:	0 Hz
<b>Values</b>	Min/Max:	0/65535 Hz
	Display:	1 Hz

### A581 [PM Stable 1 Freq]

PF 525 PowerFlex 525 only.

(With FRN 5.xxx and later.)

The start frequency for stabilization loop [P032](#) [Motor NP Hertz] x A581 [PM Stable 1 Freq].

	Default:	0%
<b>Values</b>	Min/Max:	0/100%
	Display:	1%

### A582 [PM Stable 2 Freq]

PF 525 PowerFlex 525 only.

(With FRN 5.xxx and later.)

Stabilization function will return to normal output after this frequency [P032](#) [Motor NP Hertz] x A582 [PM Stable 2 Freq].

	Default:	45%
<b>Values</b>	Min/Max:	0/100%
	Display:	1%

### A583 [PM Stable 1 Kp]

PF 525 PowerFlex 525 only.

(With FRN 5.xxx and later.)

Percentage of the gain for stabilization loop. The gain is set in [A584](#) [PM Stable 2 Kp].

	Default:	40%
<b>Values</b>	Min/Max:	0/100%
	Display:	1%

### A584 [PM Stable 2 Kp]

PF 525 PowerFlex 525 only.

(With FRN 5.xxx and later.)

The gain for stabilization loop.

	Default:	250%
<b>Values</b>	Min/Max:	0/2000%
	Display:	1%

## Advanced Program Group (continued)

**A585 [PM Stable Brk Pt]**

(PF 525) PowerFlex 525 only.

(With FRN 5.xxx and later.)

Percentage of rated power [P037](#) [Motor NP Power] for the gain of ([A584](#) [PM Stable 2 Kp] x [A583](#) [PM Stable 1 Kp]).

	Default:	40%
<b>Values</b>	Min/Max:	0/100%
	Display:	1%

**A586 [PM Stepload Kp]**

(PF 525) PowerFlex 525 only.

(With FRN 5.xxx and later.)

The gain to ensure robustness under step load in low speed region.

	Default:	0%
<b>Values</b>	Min/Max:	0/1000%
	Display:	1%

**A587 [PM 1 Efficiency]**

(PF 525) PowerFlex 525 only.

(With FRN 5.xxx and later.)

Reduce full load current.

	Default:	120%
<b>Values</b>	Min/Max:	0/2000%
	Display:	1%

**A588 [PM 2 Efficiency]**

(PF 525) PowerFlex 525 only.

(With FRN 5.xxx and later.)

Reduce no load current.

	Default:	500%
<b>Values</b>	Min/Max:	0/2000%
	Display:	1%

**A589 [PM Algor Sel]**Related Parameter(s): [A550](#) Stop drive before changing this parameter.

(PF 525) PowerFlex 525 only.

(With FRN 5.xxx and later.)

Selects the algorithm to use with your motor. Check with the manufacturer of your motor to determine whether it is an iPM or sPM motor.

	0 "Algorithm 1" (Default)	Suggested for most motors.
<b>Options</b>	1 "Algorithm 2"	Enable an embedded algorithm to reduce oscillation in output waveform (use with sPM motor only, do not enable for iPM motor).

**A590 [SYNRM SW Freq]**

Related Parameter(s):

(PF 525) PowerFlex 525 only.

(With FRN 7.xxx and later.)

Switching Frequency point from Low-Speed Observer (Freq1) to High-Speed Observer (Freq2).

	Default:	10 Hz
<b>Values</b>	Min/Max:	0/600 Hz

## Advanced Program Group (continued)

**A591 [SYNRM Flux Cur]**

Related Parameter(s):

(PF 525) PowerFlex 525 only.

(With FRN 7.xxx and later.)

SynRM Field Excitation Current.

Increasing the setting enhances no loading performance but has poor efficiency.

Decreasing the setting reduces no loading performance but good efficiency.

<b>Values</b>	Default:	35%
	Min/Max:	0/150%

**A592 [SYNRM Freq1 Volt]**

Related Parameter(s):

(PF 525) PowerFlex 525 only.

(With FRN 7.xxx and later.)

The Amplitude of Injected Signal of Low-Speed Observer (Freq1).

Increasing the setting enhances the loading performance during Freq1 operation.

<b>Values</b>	Default:	30%
	Min/Max:	0/100%

**A593 [SYNRM Freq1 Kp]**

Related Parameter(s):

(PF 525) PowerFlex 525 only.

(With FRN 7.xxx and later.)

The Scaling of Band Width At Low-Speed Observer (Freq1).

Increasing the setting enhances the loading performance during low-speed (Freq1) operation but too high causes motor vibration.

Decreasing the setting causes the motor to stall during startup and low-speed (Freq1) operation.

When the motor running speed is lower than the switching frequency [A590](#) adjust the setting.

<b>Values</b>	Default:	1.00
	Min/Max:	0.01/5.00

**A594 [SYNRM Freq1 Comp]**

Related Parameter(s):

(PF 525) PowerFlex 525 only.

(With FRN 7.xxx and later.)

The Scaling of Mutual Inductance Compensation At Low-Speed Observer (Freq1).

Increasing or decreasing the setting enhances the loading performance during Freq1 operation depending on the motor.

<b>Values</b>	Default:	1.00
	Min/Max:	0/10.00

**A595 [SYNRM Freq2 BW]**

Related Parameter(s):

(PF 525) PowerFlex 525 only.

(With FRN 7.xxx and later.)

The Band Width At High-Speed Observer (Freq2).

Increasing the setting enhances the loading performance during high-speed (Freq2) operation but too high causes vibration.

Decreasing the setting causes the motor to stall during startup and high-speed (Freq2) operations.

When the motor running speed is higher than the switching frequency [A590](#), adjust the setting.

<b>Values</b>	Default:	10 Hz
	Min/Max:	0/50 Hz

**A596 [SYNRM Freq2 Kp]**

Related Parameter(s):

(PF 525) PowerFlex 525 only.

(With FRN 7.xxx and later.)

The Scaling of Magnetic linkage estimator At High-Speed Observer (Freq2).

To fine tune the setting when motor is still not stable after adjustment [A595](#).

Increasing the motor setting enhances the loading performance during high-speed (Freq2) operation but too high causes vibration.

Decreasing the setting causes the motor to stall during startup and high-speed (Freq2) operations.

When the motor running speed is higher than the switching frequency [A590](#), adjust the setting.

<b>Values</b>	Default:	1.00
	Min/Max:	0.1/10.00

## Network Parameter Group

This group contains parameters for the network option card that is installed.

Refer to the network option card’s user manual for more information on the available parameters.

## Modified Parameter Group

This group contains parameters that have their values changed from the factory default.

When a parameter has its default value changed, it is automatically added to this group. When a parameter has its value changed back to the factory default, it is automatically removed from this group.

## Fault and Diagnostic Group

- F604 [Fault 4 Code]
- F605 [Fault 5 Code]
- F606 [Fault 6 Code]
- F607 [Fault 7 Code]
- F608 [Fault 8 Code]
- F609 [Fault 9 Code]
- F610 [Fault10 Code]

Related Parameter(s): [b007-b009](#)

A code that represents a drive fault. The codes appear in these parameters in the order they occur (b007 [Fault 1 Code] = the most recent fault). Repetitive faults are only recorded once.

	Default:	Read Only
<b>Values</b>	Min/Max:	F0/F127
	Display:	F0

- F611 [Fault 1 Time-hr]      F612 [Fault 2 Time-hr]
- F613 [Fault 3 Time-hr]      F614 [Fault 4 Time-hr]
- F615 [Fault 5 Time-hr]

Related Parameter(s): [d362](#)

F616 [Fault 6 Time-hr]      F617 [Fault 7 Time-hr]
F618 [Fault 8 Time-hr]      F619 [Fault 9 Time-hr]
F620 [Fault10 Time-hr]
<small>(PF 525) PowerFlex 525 only.</small>

Displays the value of [d362](#) [Elapsed Time-hr] when the fault occurs.

	Default:	Read Only
<b>Values</b>	Min/Max:	0/32767 hr
	Display:	1 hr

- F621 [Fault 1 Time-min]      F622 [Fault 2 Time-min]
- F623 [Fault 3 Time-min]      F624 [Fault 4 Time-min]
- F625 [Fault 5 Time-min]

Related Parameter(s): [d363](#)

F626 [Fault 6 Time-min]      F627 [Fault 7 Time-min]
F628 [Fault 8 Time-min]      F629 [Fault 9 Time-min]
F630 [Fault10 Time-min]
<small>(PF 525) PowerFlex 525 only.</small>

Displays the value of [d363](#) [Elapsed Time-min] when the fault occurs.

	Default:	Read Only
<b>Values</b>	Min/Max:	0.0/320.0 min
	Display:	0.1 min

Fault and Diagnostic Group *(continued)*

F631 [Fault 1 Freq]  
F633 [Fault 3 Freq]  
F635 [Fault 5 Freq]

F632 [Fault 2 Freq]  
F634 [Fault 4 Freq]

Related Parameter(s): [b001](#)

F636 [Fault 6 Freq]      F637 [Fault 7 Freq]  
F638 [Fault 8 Freq]      F639 [Fault 9 Freq]  
F640 [Fault10 Freq]

PF 525 PowerFlex 525 only.

Displays and stores the value of [b001](#) [Output Freq] with the most recent 10 faults occurred.  
[Fault 1 Freq] stores the most recent fault, [Fault 2 Freq] stores the second most recent fault and [Fault 3 Freq] stores the third most recent fault.

	Default:	Read Only
<b>Values</b>	Min/Max:	0.00/500.00 Hz
	Display:	0.01 Hz

F641 [Fault 1 Current]  
F643 [Fault 3 Current]  
F645 [Fault 5 Current]

F642 [Fault 2 Current]  
F644 [Fault 4 Current]

Related Parameter(s): [b003](#)

F646 [Fault 6 Current]      F647 [Fault 7 Current]  
F648 [Fault 8 Current]      F649 [Fault 9 Current]  
F650 [Fault10 Current]

PF 525 PowerFlex 525 only.

Displays and stores the value of [b003](#) [Output Current] with the most recent 10 faults occurred.  
[Fault 1 Current] stores the most recent fault, [Fault 2 Current] stores the second most recent fault and [Fault 3 Current] stores the third most recent fault.

	Default:	Read Only
<b>Values</b>	Min/Max:	0.00/(Drive Rated Amps x 2)
	Display:	0.01 A

F651 [Fault 1 BusVolts]  
F653 [Fault 3 BusVolts]  
F655 [Fault 5 BusVolts]

F652 [Fault 2 BusVolts]  
F654 [Fault 4 BusVolts]

Related Parameter(s): [b005](#)

F656 [Fault 6 BusVolts]      F657 [Fault 7 BusVolts]  
F658 [Fault 8 BusVolts]      F659 [Fault 9 BusVolts]  
F660 [Fault10 BusVolts]

PF 525 PowerFlex 525 only.

Displays and stores the value of [b005](#) [DC Bus Voltage] with the most recent 10 faults occurred.  
[Fault 1 BusVolts] stores the most recent fault, [Fault2 BusVolts] stores the second most recent fault and [Fault 3 BusVolts] stores the third most recent fault.

	Default:	Read Only
<b>Values</b>	Min/Max:	0/1200V DC
	Display:	1V DC

### Fault and Diagnostic Group *(continued)*

Related Parameter(s): [b006](#)

**F661 [Status @ Fault 1]**    **F662 [Status @ Fault 2]**  
**F663 [Status @ Fault 3]**    **F664 [Status @ Fault 4]**  
**F665 [Status @ Fault 5]**

**F666 [Status @ Fault 6]**    **F667 [Status @ Fault 7]**  
**F668 [Status @ Fault 8]**    **F669 [Status @ Fault 9]**  
**F670 [Status @ Fault 10]**

(PF 525) PowerFlex 525 only.

Displays the value of [b006](#) [Drive Status] with the most recent 10 faults occurred.  
 [Status @ Fault 1] stores the most recent fault, [Status @ Fault 2] stores the second most recent fault and [Status @ Fault 3] stores the third most recent fault.

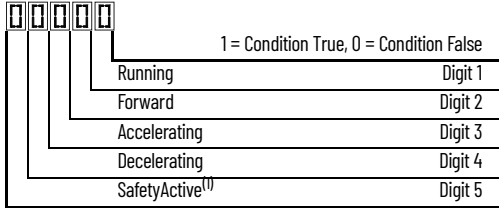

(1) Setting is specific to PowerFlex 525 drives only.

	Default:	Read Only
<b>Values</b>	Min/Max:	0/0x1F
	Display:	1

#### F681 [Comm Sts - DSI]

Displays the status of the RS485 serial (DSI) port to the drive.

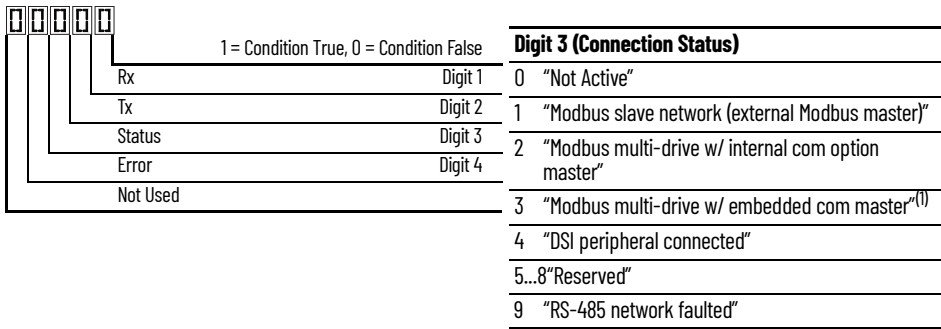

(1) Setting is specific to PowerFlex 525 drives only.

	Default:	Read Only
<b>Values</b>	Min/Max:	0000/1911
	Display:	0000

#### F682 [Comm Sts - Opt]

Displays the status of the internal communication to the drive.

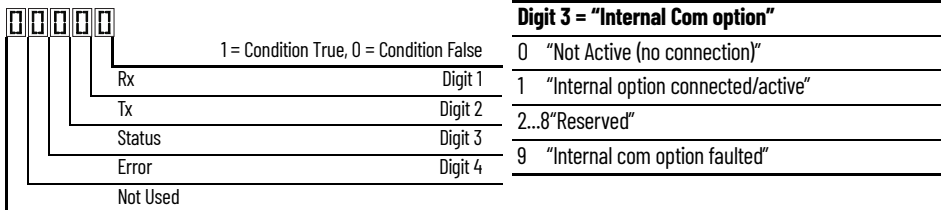

	Default:	Read Only
<b>Values</b>	Min/Max:	0000/1911
	Display:	0000



## Fault and Diagnostic Group (continued)

### F683 [Com Sts-Emb Enet]

**PF 525** PowerFlex 525 only.

Displays the status of the embedded EtherNet/IP interface to the drive.

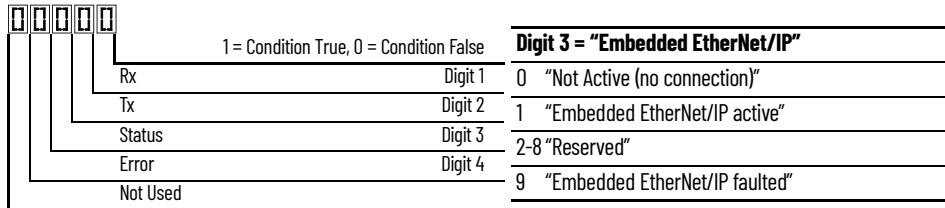

	Default:	Read Only
<b>Values</b>	Min/Max:	0000/1911
	Display:	0000

### F684 [EN Addr Src]

**PF 525** PowerFlex 525 only.

Displays the actual source of the Ethernet configuration (IP address, subnet mask, and gateway address).

<b>Options</b>	1 "Parameters"	Read Only
	2 "BOOTP"	

### F685 [EN Rate Act]

**PF 525** PowerFlex 525 only.

Displays the network data rate currently used by the embedded EtherNet/IP interface.

	0 "No Link"	
	1 "10Mbps Full"	
	2 "10Mbps Half"	
<b>Options</b>	3 "100Mbps Full"	Read Only
	4 "100Mbps Half"	
	5 "Dup IP Addr"	
	6 "Disabled"	

### F686 [DSI I/O Act]

Displays the Drives that are active in Multi-Drive mode.

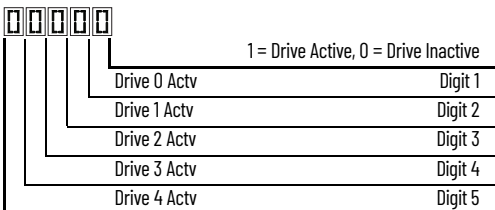

	Default:	Read Only
<b>Value</b>	Min/Max:	00000/11111
	Display:	00000

### Fault and Diagnostic Group *(continued)*

- F687 [HW Addr 1]**
- F688 [HW Addr 2]**
- F689 [HW Addr 3]**
- F690 [HW Addr 4]**
- F691 [HW Addr 5]**
- F692 [HW Addr 6]**

(PF 525) PowerFlex 525 only.

Shows the MAC address for the embedded EtherNet/IP interface.

	Default:	Read Only
<b>Values</b>	Min/Max:	0/255
	Display:	1

- F693 [EN IP Addr Act 1]**
- F694 [EN IP Addr Act 2]**
- F695 [EN IP Addr Act 3]**
- F696 [EN IP Addr Act 4]**

(PF 525) PowerFlex 525 only.

Shows the actual IP address used by the embedded EtherNet/IP interface at the time. This indicates 0 if no address is set.

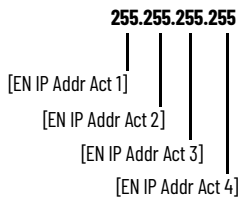

	Default:	Read Only
<b>Values</b>	Min/Max:	0/255
	Display:	1

- F697 [EN Subnet Act 1]**
- F698 [EN Subnet Act 2]**
- F699 [EN Subnet Act 3]**
- F700 [EN Subnet Act 4]**

(PF 525) PowerFlex 525 only.

Shows the actual subnet mask used by the embedded EtherNet/IP interface at the time. This will indicate 0 if no address is set.

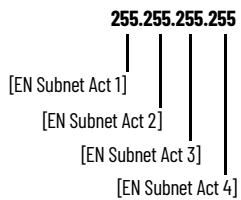

	Default:	Read Only
<b>Values</b>	Min/Max:	0/255
	Display:	1

## Fault and Diagnostic Group *(continued)*

**F701 [EN Gateway Act 1]**  
**F702 [EN Gateway Act 2]**  
**F703 [EN Gateway Act 3]**  
**F704 [EN Gateway Act 4]**

(PF 525) PowerFlex 525 only.

Shows the actual gateway address used by the embedded EtherNet/IP interface at the time. This will indicate 0 if no address is set.

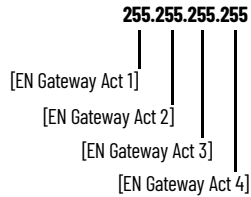

	Default:	Read Only
<b>Values</b>	Min/Max:	0/255
	Display:	1

**F705 [Drv 0 Logic Cmd]**  
**F709 [Drv 1 Logic Cmd]**  
**F713 [Drv 2 Logic Cmd]**  
**F717 [Drv 3 Logic Cmd]**  
**F721 [Drv 4 Logic Cmd]**

In multi-drive mode, this is the logic command being transmitted to drive 0/1/2/3/4.

In single-drive mode, this is the logic command being used by the drive (whether HS-DSI, EtherNet/IP, or DSI) at the time. If comms control is NOT being used, and the drive is in single-drive mode, then this parameter will show 0.

	Default:	Read Only
<b>Values</b>	Min/Max:	0/FFFF
	Display:	1

**F706 [Drv 0 Reference]**  
**F710 [Drv 1 Reference]**  
**F714 [Drv 2 Reference]**  
**F718 [Drv 3 Reference]**  
**F722 [Drv 4 Reference]**

In multi-drive mode, this is the reference being transmitted to drive 0/1/2/3/4.

In single-drive mode, this is the reference being used by the drive (whether HS-DSI, EtherNet/IP, or DSI) at the time. If comms control is NOT being used, and the drive is in single-drive mode, then this parameter will show 0.

	Default:	Read Only
<b>Values</b>	Min/Max:	0.00/5000.00 Hz
	Display:	0.01 Hz

**F707 [Drv 0 Logic Sts]**  
**F711 [Drv 1 Logic Sts]**  
**F715 [Drv 2 Logic Sts]**  
**F719 [Drv 3 Logic Sts]**  
**F723 [Drv 4 Logic Sts]**

In multi-drive mode, this is the logic status being received from drive 0/1/2/3/4.

In single-drive mode, this is the logic status of the drive at the time.

	Default:	Read Only
<b>Values</b>	Min/Max:	0/FFFF
	Display:	1

## Fault and Diagnostic Group *(continued)*

**F708 [Drv 0 Feedback]**  
**F712 [Drv 1 Feedback]**  
**F716 [Drv 2 Feedback]**  
**F720 [Drv 3 Feedback]**  
**F724 [Drv 4 Feedback]**

In multi-drive mode, this is the feedback being received from drive 0/1/2/3/4.  
 In single-drive mode, this is the feedback of the drive at the time.

	Default:	Read Only
<b>Values</b>	Min/Max:	0.00/5000.00 Hz
	Display:	0.01 Hz

### **F725 [EN Rx Overruns]**

(PF 525) PowerFlex 525 only.

A count of the number of receive overrun errors reported by the embedded EtherNet/IP interface.

	Default:	Read Only
<b>Values</b>	Min/Max:	0/65535
	Display:	1

### **F726 [EN Rx Packets]**

(PF 525) PowerFlex 525 only.

A count of the number of receive packets reported by the embedded EtherNet/IP interface.

	Default:	Read Only
<b>Values</b>	Min/Max:	0/65535
	Display:	1

### **F727 [EN Rx Errors]**

(PF 525) PowerFlex 525 only.

A count of the number of receive errors reported by the embedded EtherNet/IP interface.

	Default:	Read Only
<b>Values</b>	Min/Max:	0/65535
	Display:	1

### **F728 [EN Tx Packets]**

(PF 525) PowerFlex 525 only.

A count of the number of transmitted packets reported by the embedded EtherNet/IP interface.

	Default:	Read Only
<b>Values</b>	Min/Max:	0/65535
	Display:	1

### **F729 [EN Tx Errors]**

(PF 525) PowerFlex 525 only.

A count of the number of transmit errors reported by the embedded EtherNet/IP interface.

	Default:	Read Only
<b>Values</b>	Min/Max:	0/65535
	Display:	1

**Fault and Diagnostic Group** *(continued)***F730 [EN Missed IO Pkt]**PF 525 PowerFlex 525 only.

The number of I/O packets missed.

---

	Default:	Read Only
<b>Values</b>	Min/Max:	0/65535
	Display:	1

---

**F731 [DSI Errors]**

The number of total DSI errors.

---

	Default:	Read Only
<b>Values</b>	Min/Max:	0/65535
	Display:	1

---

## AppView Parameter Groups







AppView parameter groups provide a simple starting point for using the PowerFlex 520-series drives by grouping certain commonly used parameters based on different types of applications. Use these parameter groups to quickly and easily setup the PowerFlex 520-series drive for your application.

AppView parameter groups are available for the following applications:

- Conveyor
- Mixer
- Compressor
- Centrifugal Pump
- Blower/Fan
- Extruder
- Positioning (PowerFlex 525 only)
- Textile/Fiber

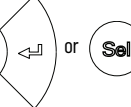
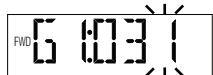
You cannot add or remove parameters to or from the AppView parameter groups. If you require quick access to additional parameters to what is already included in the different AppView parameter groups, use the CustomView parameter group instead.



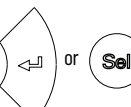
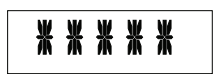



The parameters in the AppView parameter groups can be quickly added to the CustomView parameter group by doing the following:

Step	Key(s)	Example Displays
1. Press the Up Arrow or Down Arrow to scroll to an AppView group (G1...G8).	 or 	
2. Press Enter or Sel to enter a group. The right most digit of the last viewed parameter in that group will flash.	 or <b>Sel</b>	
3. Press the Up Arrow or Down Arrow to scroll to the command G1->GC.	 or 	
4. Press Enter or Sel to add all the parameters in this AppView group to the CustomView group. The LCD display will show a confirmation.	 or <b>Sel</b>	



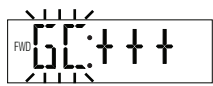
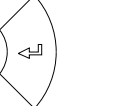



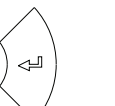
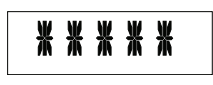



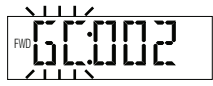
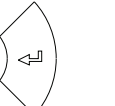

## CustomView Parameter Group

CustomView allows you to quickly access only the parameters needed for your application by storing them in a custom parameter group. Add your frequently used parameters to this group, then hide all other parameters with [A552](#) [Program Lock] to simplify your drive configuration process.

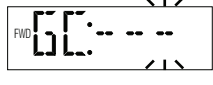
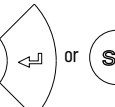
Up to 100 parameters can be stored in the CustomView parameter group. You can copy one entire AppView parameter group to the CustomView parameter group as shown on [page 150](#) or add individual parameters as show below.

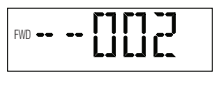
Step	Key(s)	Example Displays
1. Press the Up Arrow or Down Arrow to scroll to the CustomView group (GC).	 or 	
2. Press Enter to view the parameters that can be added to the CustomView group.		
3. Press the Up Arrow or Down Arrow to scroll through the list of parameters.	 or 	
4. Press Enter to add the parameter to the CustomView group. The LCD display will show a confirmation.		

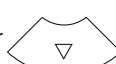
To delete parameters from the CustomView parameter group:

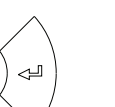
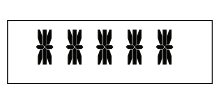
Step	Key(s)	Example Displays
1. Press the Up Arrow or Down Arrow to scroll to the CustomView group (GC).	 or 	
2. Press Enter to view the parameters that are in the CustomView group.		
3. Press the Up Arrow or Down Arrow to scroll to the command GC---.	 or 	
4. Press Enter or Sel to view the parameters that are stored in the CustomView group.	 or 	
5. Press the Up Arrow or Down Arrow to scroll through the list of parameters.	 or 	
6. Press Enter to delete the parameter from the CustomView group. The LCD display will show a confirmation.		



The Connected Components Workbench software can be used to speed up this process with drag and drop functionality.

## Parameter Cross Reference by Name

### Parameters

Parameter Name	No.	Parameter Name	No.	Parameter Name	No.
10V Bipolar Enbl <sup>(1)</sup>	093	Current Loop BW <sup>(1)(2)</sup>	580	Drv 4 Logic Sts	723
2-Wire Mode	064	DB Resistor Sel	437	Drv 4 Reference	722
Accel Time 1	041	DB Threshold	438	Drv Ambient Sel	554
Accel Time 2	442	DC Brake Level	435	DSI Errors	731
Accel Time 3	444	DC Brake Time	434	DSI I/O Act	686
Accel Time 4	446	DC Brk Time@Strt	436	DSI I/O Cfg	175
Accum C02 Sav	026	DC Bus Ripple	380	Elapsed kWh	021
Accum Cost Sav	025	DC Bus Voltage	005	Elapsed MWh	022
Accum kWh Sav	024	Decel Time 1	042	Elapsed Run Time	019
Analog In 0-10V	360	Decel Time 2	443	Elapsed Time-hr	362
Analog In 4-20mA	361	Decel Time 3	445	Elapsed Time-min	363
Analog In Filter	099	Decel Time 4	447	EM Brk Off Delay	086
Analog Out High <sup>(3)</sup>	089	Dig In Status	014	EM Brk On Delay	087
Analog Out Sel <sup>(2)</sup>	088	Dig Out Status <sup>(2)(3)</sup>	394	EN Addr Sel <sup>(1)</sup>	128
Anlg In 0-10V Hi	092	DigIn TermBlk 02	062	EN Addr Src <sup>(1)</sup>	684
Anlg In 0-10V Lo	091	DigIn TermBlk 03	063	EN Comm Fit Actn <sup>(1)</sup>	143
Anlg In mA Loss	097	DigIn TermBlk 05	065	EN Data In 1 <sup>(1)</sup>	153
Anlg In V Loss	094	DigIn TermBlk 06	066	EN Data In 2 <sup>(1)</sup>	154
Anlg In4-20mA Hi	096	DigIn TermBlk 07 <sup>(1)</sup>	067	EN Data In 3 <sup>(1)</sup>	155
Anlg In4-20mA Lo	095	DigIn TermBlk 08 <sup>(1)</sup>	068	EN Data In 4 <sup>(1)</sup>	156
Anlg Loss Delay	098	Drive OL Mode	495	EN Data Out 1 <sup>(1)</sup>	157
Anlg Out Setpt <sup>(2)</sup>	090	Drive Status	006	EN Data Out 2 <sup>(1)</sup>	158
Auto Rstrt Delay	542	Drive Status 2 <sup>(2)(3)</sup>	393	EN Data Out 3 <sup>(1)</sup>	159
Auto Rstrt Tries	541	Drive Temp	027	EN Data Out 4 <sup>(1)</sup>	160
Autotune	040	Drive Type	367	EN Flt Cfg DL 1 <sup>(1)</sup>	147
Average kWh Cost	052	Droop Hertz@ FLA <sup>(1)</sup>	441	EN Flt Cfg DL 2 <sup>(1)</sup>	148
Average Power	020	Drv 0 Feedback	708	EN Flt Cfg DL 3 <sup>(1)</sup>	149
Boost Select	530	Drv 0 Logic Cmd	705	EN Flt Cfg DL 4 <sup>(1)</sup>	150
Break Frequency	533	Drv 0 Logic Sts	707	EN Flt Cfg Logic <sup>(1)</sup>	145
Break Voltage	532	Drv 0 Reference	706	EN Flt Cfg Ref <sup>(1)</sup>	146
Bus Reg Enable	550	Drv 1 Addr	171	EN Gateway Act 1 <sup>(1)</sup>	701
Cmd Stat Select <sup>(1)</sup>	122	Drv 1 Feedback	712	EN Gateway Act 2 <sup>(1)</sup>	702
Com Sts-Emb Enet <sup>(1)</sup>	683	Drv 1 Logic Cmd	709	EN Gateway Act 3 <sup>(1)</sup>	703
Comm Loss Action	125	Drv 1 Logic Sts	711	EN Gateway Act 4 <sup>(1)</sup>	704
Comm Loss Time	126	Drv 1 Reference	710	EN Gateway Cfg 1 <sup>(1)</sup>	137
Comm Sts - DSI	681	Drv 2 Addr	172	EN Gateway Cfg 2 <sup>(1)</sup>	138
Comm Sts - Opt	682	Drv 2 Feedback	716	EN Gateway Cfg 3 <sup>(1)</sup>	139
Comm Write Mode	121	Drv 2 Logic Cmd	713	EN Gateway Cfg 4 <sup>(1)</sup>	140
Commanded Freq	002	Drv 2 Logic Sts	715	EN Idle Flt Actn <sup>(1)</sup>	144
Compensation	547	Drv 2 Reference	714	EN IP Addr Act 1 <sup>(1)</sup>	693
Contrl In Status	013	Drv 3 Addr	173	EN IP Addr Act 2 <sup>(1)</sup>	694
Control Source	012	Drv 3 Feedback	720	EN IP Addr Act 3 <sup>(1)</sup>	695
Control SW Ver	029	Drv 3 Logic Cmd	717	EN IP Addr Act 4 <sup>(1)</sup>	696



## Parameters (Continued)

Parameter Name	No.	Parameter Name	No.	Parameter Name	No.
Control Temp	028	Drv 3 Logic Sts	719	EN IP Addr Cfg 1 <sup>(1)</sup>	129
Counter Status	364	Drv 3 Reference	718	EN IP Addr Cfg 2 <sup>(1)</sup>	130
Counts Per Unit <sup>(1)</sup>	559	Drv 4 Addr	174	EN IP Addr Cfg 3 <sup>(1)</sup>	131
Current Limit 1	484	Drv 4 Feedback	724	EN IP Addr Cfg 4 <sup>(1)</sup>	132
Current Limit 2 <sup>(1)</sup>	485	Drv 4 Logic Cmd	721	EN Missed IO Pkt <sup>(1)</sup>	730
EN Rate Act <sup>(1)</sup>	685	Fault 6 BusVolts <sup>(1)</sup>	656	Half Bus Enable	548
EN Rate Cfg <sup>(1)</sup>	141	Fault 6 Code <sup>(1)</sup>	606	Home Save <sup>(1)</sup>	561
EN Rx Errors <sup>(1)</sup>	727	Fault 6 Current <sup>(1)</sup>	646	HW Addr 1 <sup>(1)</sup>	687
EN Rx Overruns <sup>(1)</sup>	725	Fault 6 Freq <sup>(1)</sup>	636	HW Addr 2 <sup>(1)</sup>	688
EN Rx Packets <sup>(1)</sup>	726	Fault 6 Time-hr <sup>(1)</sup>	616	HW Addr 3 <sup>(1)</sup>	689
EN Subnet Act 1 <sup>(1)</sup>	697	Fault 6 Time-min <sup>(1)</sup>	626	HW Addr 4 <sup>(1)</sup>	690
EN Subnet Act 2 <sup>(1)</sup>	698	Fault 7 BusVolts <sup>(1)</sup>	657	HW Addr 5 <sup>(1)</sup>	691
EN Subnet Act 3 <sup>(1)</sup>	699	Fault 7 Code <sup>(1)</sup>	607	HW Addr 6 <sup>(1)</sup>	692
EN Subnet Act 4 <sup>(1)</sup>	700	Fault 7 Current <sup>(1)</sup>	647	IR Voltage Drop	496
EN Subnet Cfg 1 <sup>(1)</sup>	133	Fault 7 Freq <sup>(1)</sup>	637	Jog Accel/Decel	432
EN Subnet Cfg 2 <sup>(1)</sup>	134	Fault 7 Time-hr <sup>(1)</sup>	617	Jog Frequency	431
EN Subnet Cfg 3 <sup>(1)</sup>	135	Fault 7 Time-min <sup>(1)</sup>	627	Keypad Freq	426
EN Subnet Cfg 4 <sup>(1)</sup>	136	Fault 8 BusVolts <sup>(1)</sup>	658	Ki Speed Loop <sup>(2)</sup>	538
EN Tx Errors <sup>(1)</sup>	729	Fault 8 Code <sup>(1)</sup>	608	Kp Speed Loop <sup>(2)</sup>	539
EN Tx Packets <sup>(1)</sup>	728	Fault 8 Current <sup>(1)</sup>	648	Language	30
Encoder Pos Tol <sup>(1)</sup>	564	Fault 8 Freq <sup>(1)</sup>	638	Load Loss Level <sup>(1)</sup>	490
Encoder PPR <sup>(1)</sup>	536	Fault 8 Time-hr <sup>(1)</sup>	618	Load Loss Time <sup>(1)</sup>	491
Encoder Speed <sup>(2)</sup>	378	Fault 8 Time-min <sup>(1)</sup>	628	Max Traverse	567
Energy Saved	023	Fault 9 BusVolts <sup>(1)</sup>	659	Maximum Freq	044
Enh Control Word <sup>(1)</sup>	560	Fault 9 Code <sup>(1)</sup>	609	Maximum Voltage	534
Fault 1 BusVolts	651	Fault 9 Current <sup>(1)</sup>	649	Minimum Freq	043
Fault 1 Code	007	Fault 9 Freq <sup>(1)</sup>	639	MOP Freq	427
Fault 1 Current	641	Fault 9 Time-hr <sup>(1)</sup>	619	MOP Preload	429
Fault 1 Freq	631	Fault 9 Time-min <sup>(1)</sup>	629	MOP Reset Sel	428
Fault 1 Time-hr	611	Fault Clear	551	MOP Time	430
Fault 1 Time-min	621	Fault10 BusVolts <sup>(1)</sup>	660	Motor Fdbk Type <sup>(2)</sup>	535
Fault 2 BusVolts	652	Fault10 Code <sup>(1)</sup>	610	Motor Lm <sup>(1)</sup>	499
Fault 2 Code	008	Fault10 Current <sup>(1)</sup>	650	Motor Lx <sup>(1)</sup>	500
Fault 2 Current	642	Fault10 Freq <sup>(1)</sup>	640	Motor NP FLA	034
Fault 2 Freq	632	Fault10 Time-hr <sup>(1)</sup>	620	Motor NP Hertz	032
Fault 2 Time-hr	612	Fault10 Time-min <sup>(1)</sup>	630	Motor NP Poles	035
Fault 2 Time-min	622	Fiber Status	390	Motor NP Power <sup>(1)</sup>	037
Fault 3 BusVolts	653	Find Home Dir <sup>(1)</sup>	563	Motor NP RPM	036
Fault 3 Code	009	Find Home Freq <sup>(1)</sup>	562	Motor NP Volts	031
Fault 3 Current	643	Flux Braking En <sup>(2)(3)</sup>	575	Motor OL Current	033
Fault 3 Freq	633	Flux Current Ref	497	Motor OL Level	369
Fault 3 Time-hr	613	Flying Start En	545	Motor OL Ret	494
Fault 3 Time-min	623	FlyStrt CurLimit	546	Motor OL Select	493
Fault 4 BusVolts	654	Freq 1 <sup>(1)</sup>	510	Motor Rr <sup>(1)</sup>	498

Parameters (Continued)

Parameter Name	No.
Fault 4 Code	604
Fault 4 Current	644
Fault 4 Freq	634
Fault 4 Time-hr	614
Fault 4 Time-min	624
Fault 5 BusVolts	655
Fault 5 Code	605
Fault 5 Current	645
Fault 5 Freq	635
Fault 5 Time-hr	615
Fault 5 Time-min	625
Opto Out1 Level <sup>(1)</sup>	070
Opto Out1 Sel <sup>(1)</sup>	069
Opto Out2 Level <sup>(1)</sup>	073
Opto Out2 Sel <sup>(1)</sup>	072
Out Phas Loss En	557
Output Current	003
Output Freq	001
Output Power	017
Output Powr Fctr	381
Output RPM	015
Output Speed	016
Output Voltage	004
P Jump	570
Phase Loss Level <sup>(2)(3)</sup>	576
PID 1 Deadband	465
PID 1 Diff Rate	463
PID 1 Fdback Sel	460
PID 1 Integ Time	462
PID 1 Invert Err	467
PID 1 Preload	466
PID 1 Prop Gain	461
PID 1 Ref Sel	459
PID 1 Setpoint	464
PID 1 Trim Hi	456
PID 1 Trim Lo	457
PID 1 Trim Sel	458
PID1 Fdbk Displ	383
PID1 Setpnt Disp	384
PID 2 Deadband <sup>(1)</sup>	477
PID 2 Diff Rate <sup>(1)</sup>	475
PID 2 Fdback Sel <sup>(1)</sup>	472
PID 2 Integ Time <sup>(1)</sup>	474
PID 2 Invert Err <sup>(1)</sup>	479

Parameter Name	No.
Freq 1 BW <sup>(1)</sup>	511
Freq 1 Ki <sup>(1)</sup>	522
Freq 1 Kp <sup>(1)</sup>	521
Freq 2 <sup>(1)</sup>	512
Freq 2 BW <sup>(1)</sup>	513
Freq 2 Ki <sup>(1)</sup>	524
Freq 2 Kp <sup>(1)</sup>	523
Freq 3 <sup>(1)</sup>	514
Freq 3 BW <sup>(1)</sup>	515
Freq 3 Ki <sup>(1)</sup>	526
Freq 3 Kp <sup>(1)</sup>	525
PM FWKn 1 Kp <sup>(1)(3)</sup>	527
PM FWKn 2 Kp <sup>(1)(3)</sup>	528
PM HIFI NS Cur <sup>(1)(3)</sup>	519
PM Initial Sel <sup>(1)(3)</sup>	516
PM IR Voltage <sup>(1)(3)</sup>	501
PM IXd Voltage <sup>(1)(3)</sup>	502
PM IXq Voltage <sup>(1)(3)</sup>	503
PM Stable 1 Freq <sup>(1)(3)</sup>	581
PM Stable 1 Kp <sup>(1)(3)</sup>	583
PM Stable 2 Freq <sup>(1)(3)</sup>	582
PM Stable 2 Kp <sup>(1)(3)</sup>	584
PM Stable Brk Pt <sup>(1)(3)</sup>	585
PM Stepload Kp <sup>(1)(3)</sup>	586
Pos Reg Filter <sup>(1)</sup>	565
Pos Reg Gain <sup>(1)</sup>	566
Position Status <sup>(1)</sup>	387
Positioning Mode <sup>(1)</sup>	558
Power Loss Mode	548
Power Saved	018
Preset Freq 0	410
Preset Freq 1	411
Preset Freq 2	412
Preset Freq 3	413
Preset Freq 4	414
Preset Freq 5	415
Preset Freq 6	416
Preset Freq 7	417
Preset Freq 8 <sup>(1)</sup>	418
Preset Freq 9 <sup>(1)</sup>	419
Preset Freq 10 <sup>(1)</sup>	420
Preset Freq 11 <sup>(1)</sup>	421
Preset Freq 12 <sup>(1)</sup>	422
Preset Freq 13 <sup>(1)</sup>	423

Parameter Name	No.
Mtr Options Cfg <sup>(2)(4)</sup>	573
MultiDrv Sel	169
Opt Data In 1	161
Opt Data In 2	162
Opt Data In 3	163
Opt Data In 4	164
Opt Data Out 1	165
Opt Data Out 2	166
Opt Data Out 3	167
Opt Data Out 4	168
Opto Out Logic <sup>(1)</sup>	075
Relay 2 On Time <sup>(1)</sup>	084
Relay Out2 Level <sup>(1)</sup>	082
Relay Out2 Sel <sup>(1)</sup>	081
Reset Meters	555
Reset to Defaults	053
Reverse Disable	544
RS485 Data Rate	123
RS485 Format	127
RS485 Node Addr	124
S Curve %	439
Safety Open En <sup>(1)</sup>	105
SafetyFit RstCfg <sup>(1)(3)</sup>	106
Shear Pin 1 Time	487
Shear Pin1 Level	486
Shear Pin 2 Time <sup>(1)</sup>	489
Shear Pin2 Level <sup>(1)</sup>	488
Skip Freq Band 1	449
Skip Freq Band 2	451
Skip Freq Band 3 <sup>(1)</sup>	453
Skip Freq Band 4 <sup>(1)</sup>	455
Skip Frequency 1	448
Skip Frequency 2	450
Skip Frequency 3 <sup>(1)</sup>	452
Skip Frequency 4 <sup>(1)</sup>	454
Sleep Level	101
Sleep Time	102
Sleep-Wake Sel	100
Slip Hz Meter	375
Speed Feedback	376
Speed Ratio	572
Speed Reference1	047
Speed Reference2	049
Speed Reference3	051

## Parameters (Continued)

Parameter Name	No.
PID 2 Preload <sup>(1)</sup>	478
PID 2 Prop Gain <sup>(1)</sup>	473
PID 2 Ref Sel <sup>(1)</sup>	471
PID 2 Setpoint <sup>(1)</sup>	476
PID 2 Trim Hi <sup>(1)</sup>	468
PID 2 Trim Lo <sup>(1)</sup>	469
PID 2 Trim Sel <sup>(1)</sup>	470
PID2 Fdbk Disp <sup>(1)</sup>	385
PID2 Setpnt Disp <sup>(1)</sup>	386
PM 1 Efficiency <sup>(1)(3)</sup>	587
PM 2 Efficiency <sup>(1)(3)</sup>	588
PM Algor Sel <sup>(1)(3)</sup>	589
PM Align Time <sup>(1)(3)</sup>	518
PM BEMF Voltage <sup>(1)(3)</sup>	504
PM Bus Reg Kd <sup>(1)(3)</sup>	520
PM Control Cfg <sup>(1)(3)</sup>	529
PM DC Inject Cur <sup>(1)(3)</sup>	517
Step Units 0 <sup>(1)</sup>	200
Step Units 1 <sup>(1)</sup>	202
Step Units 2 <sup>(1)</sup>	
Step Units 3 <sup>(1)</sup>	204
Step Units 4 <sup>(1)</sup>	206
Step Units 5 <sup>(1)</sup>	208
Step Units 6 <sup>(1)</sup>	210
Step Units 7 <sup>(1)</sup>	212
Stop Mode	214
Stp Logic 0 <sup>(1)</sup>	045
Stp Logic 1 <sup>(1)</sup>	180
Stp Logic 2 <sup>(1)</sup>	181
Stp Logic 3 <sup>(1)</sup>	182
Stp Logic 4 <sup>(1)</sup>	183
Stp Logic 5 <sup>(1)</sup>	185
Stp Logic 6 <sup>(1)</sup>	186
Stp Logic 7 <sup>(1)</sup>	187

Parameter Name	No.
Preset Freq 14 <sup>(1)</sup>	424
Preset Freq 15 <sup>(1)</sup>	425
Process Disp Hi	482
Process Disp Lo	481
Process Display	010
Program Lock	552
Program Lock Mod	553
Pulse In Scale	537
Purge Frequency	433
PWM Frequency	440
RdyBit Mode Act <sup>(2)(5)</sup>	392
RdyBit Mode Cfg <sup>(2)(4)</sup>	574
Relay 1 Off Time	080
Relay 1 On Time	079
Relay Out1 Level	077
Relay Out1 Sel	076
Relay 2 Off Time <sup>(1)</sup>	085
Stp Logic Status <sup>(1)</sup>	391
Stp Logic Time 0 <sup>(1)</sup>	190
Stp Logic Time 1 <sup>(1)</sup>	191
Stp Logic Time 2 <sup>(1)</sup>	192
Stp Logic Time 3 <sup>(1)</sup>	193
Stp Logic Time 4 <sup>(1)</sup>	194
Stp Logic Time 5 <sup>(1)</sup>	195
Stp Logic Time 6 <sup>(1)</sup>	196
Stp Logic Time 7 <sup>(1)</sup>	197
Sync Time	571
SynRM SW Freq	590
SynRM Flux Cur	591
SynRM Freq1 Volt	592
SynRM Freq1 Kp	593
SynRM Freq1 Comp	594
SynRM Freq2 BW	595
SynRM Freq2 Kp	596

Parameter Name	No.
Speed Reg Sel <sup>(1)</sup>	509
Stall Fault Time	492
Start At PowerUp	543
Start Boost	531
Start Source 1	046
Start Source 2	048
Start Source 3	050
Status @ Fault 1	661
Status @ Fault 2	662
Status @ Fault 3	663
Status @ Fault 4	664
Status @ Fault 5	665
Status @ Fault 6 <sup>(1)</sup>	666
Status @ Fault 7 <sup>(1)</sup>	667
Status @ Fault 8 <sup>(1)</sup>	668
Status @ Fault 9 <sup>(1)</sup>	669
Status @ Fault10 <sup>(1)</sup>	670
Testpoint Sel	483
Text Scroll	556
Testpoint Data	368
Timer Status	365
Timer StatusF	366
Torque Current	382
Torque Perf Mode	039
Traverse Dec	569
Traverse Inc	568
Units Traveled H <sup>(1)</sup>	388
Units Traveled L <sup>(1)</sup>	389
Var PWM Disable	540
Voltage Class	038
Wake Level	103
Wake Time	104

(1) Parameter is specific to PowerFlex 525 drives only.

(2) Parameter is available in PowerFlex 525 FRN 5.xxx and later.

(3) Parameter is also available in PowerFlex 523 FRN 3.xxx and later.

(4) Parameter is available in PowerFlex 525 FRN 2.xxx and later.

(5) Parameter is available in PowerFlex 525 FRN 3.xxx and later.

**Notes:**

## Troubleshooting

This chapter provides information to guide you in troubleshooting the PowerFlex 520-series drive. Included is a listing and description of drive faults with possible solutions, when applicable.

Topic	Page
Drive Status	157
Faults	157
Fault Descriptions	159
Common Symptoms and Corrective Actions	162



**ATTENTION:** Risk of injury or equipment damage exists. Drive does not contain user-serviceable components. Do not disassemble drive chassis.

### Drive Status

The condition or state of your drive is constantly monitored. Any changes will be indicated through the integral LCD display.

See [Display and Control Keys on page 59](#) for information on drive status indicators and controls.

### Faults

A fault is a condition that stops the drive. There are two fault types.

#### Fault Types

Type	Fault Description	
1	Auto-Reset/Run	When this type of fault occurs, and <a href="#">A541</a> [Auto Rstrt Tries] is set to a value greater than "0," a user-configurable timer, <a href="#">A542</a> [Auto Rstrt Delay], begins. When the timer reaches zero, the drive attempts to automatically reset the fault. If the condition that caused the fault is no longer present, the fault will be reset and the drive will be restarted.
2	Non-Resettable	This type of fault may require drive or motor repair, or is caused by wiring or programming errors. The cause of the fault must be corrected before the fault can be cleared.

## Fault Indication

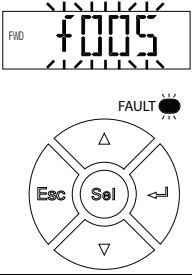
Condition	Display
<p><b>Drive is indicating a fault.</b>                      The integral LCD display provides visual notification of a fault condition by displaying the following.</p> <ul style="list-style-type: none"> <li>• Flashing fault number</li> <li>• Flashing fault indicator (LED)</li> </ul> <p>Press the Esc key to regain control of the display.</p>	

## Manually Clearing Faults

Step	Key(s)
<ol style="list-style-type: none"> <li>1. Press Esc to acknowledge the fault. The fault information will be removed so that you can use the integral keypad.                      Access <a href="#">b007</a> [Fault 1 Code] to view the most recent fault information.</li> <li>2. Address the condition that caused the fault.                      The cause must be corrected before the fault can be cleared. See <a href="#">Fault Types, Descriptions, and Actions on page 159</a>.</li> <li>3. After corrective action has been taken, clear the fault by one of these methods.                             <ul style="list-style-type: none"> <li>• Press Stop if <a href="#">P045</a> [Stop Mode] is set to a value between "0" and "3".</li> <li>• Cycle drive power.</li> <li>• Set <a href="#">A551</a> [Fault Clear] to 1 "Reset Fault" or 2 "Clear Buffer".</li> <li>• Cycle digital input if <a href="#">t062</a>, <a href="#">t063</a>, <a href="#">t065...t068</a> [DigIn TermBlk xx] is set to 13 "Clear Fault".</li> </ul> </li> </ol>	

## Automatically Clearing Faults

Option/Step	
<p><b>Clear a Type 1 fault and restart the drive.</b></p> <ol style="list-style-type: none"> <li>1. Set <a href="#">A541</a> [Auto Rstrt Tries] to a value other than "0".</li> <li>2. Set <a href="#">A542</a> [Auto Rstrt Delay] to a value other than "0".</li> </ol> <p><b>Clear an OverVoltage, UnderVoltage or Heatsink OvrTmp fault without restarting the drive.</b></p> <ol style="list-style-type: none"> <li>1. Set <a href="#">A541</a> [Auto Rstrt Tries] to a value other than "0".</li> <li>2. Set <a href="#">A542</a> [Auto Rstrt Delay] to "0".</li> </ol>	



**ATTENTION:** Equipment damage and/or personal injury may result if these parameters are used in an inappropriate application. Do not use this function without considering applicable local, national and international codes, standards, regulations or industry guidelines.

## Auto Restart (Reset/Run)

The Auto Restart feature provides the ability for the drive to automatically perform a fault reset followed by a start attempt without user or application intervention. This allows remote or "unattended" operation. Only certain faults are allowed to be reset. Certain faults (Type 2) that indicate possible drive component malfunction are not resettable. Fault types are listed in the table [Fault Types on page 157](#). See [Fault Descriptions on page 159](#) for more information.

Use caution when enabling this feature, since the drive will attempt to issue its own start command based on user selected programming.

## Fault Descriptions

### Fault Types, Descriptions, and Actions

No.	Fault	Type <sup>(1)</sup>	Description	Action
F000	No Fault	–	No fault present.	–
F002	Auxiliary Input	1	External trip (Auxiliary) input.	<ul style="list-style-type: none"> <li>• Check remote wiring.</li> <li>• Verify communications programming for intentional fault.</li> </ul>
F003	Power Loss	2	Single phase operation detected with excessive load.	<ul style="list-style-type: none"> <li>• Monitor the incoming AC line for low voltage or line power interruption.</li> <li>• Check input fuses.</li> <li>• Reduce load.</li> </ul>
F004	UnderVoltage	1	DC bus voltage fell below the min value.	Monitor the incoming AC line for low voltage or line power interruption.
F005	OverVoltage	1	DC bus voltage exceeded max value.	Monitor the AC line for high line voltage or transient conditions. Bus overvoltage can also be caused by motor regeneration. Extend the decel time or install dynamic brake option.
F006	Motor Stalled	1	Drive is unable to accelerate or decelerate motor.	<ul style="list-style-type: none"> <li>• Increase <a href="#">P041</a>, <a href="#">A442</a>, <a href="#">A444</a>, <a href="#">A446</a> [Accel Time x] or reduce load so drive output current does not exceed the current set by parameter <a href="#">A484</a>, <a href="#">A485</a> [Current Limit x] for too long.</li> <li>• Check for overhauling load.</li> </ul>
F007	Motor Overload	1	Internal electronic overload trip.	<ul style="list-style-type: none"> <li>• An excessive motor load exists. Reduce load so drive output current does not exceed the current set by parameter <a href="#">P033</a> [Motor OL Current].</li> <li>• Verify <a href="#">A530</a> [Boost Select] setting.</li> </ul>
F008	Heatsink OvrTmp	1	Heatsink/Power Module temperature exceeds a predefined value.	<ul style="list-style-type: none"> <li>• Check for blocked or dirty heat sink fins. Verify that ambient temperature has not exceeded the rated ambient temperature.</li> <li>• Check fan.</li> </ul>
F009	CC OvrTmp	1	Control module temperature exceeds a predefined value.	<ul style="list-style-type: none"> <li>• Check product ambient temperature.</li> <li>• Check for airflow obstruction.</li> <li>• Check for dirt or debris.</li> <li>• Check fan.</li> </ul>
F012	HW OverCurrent	2	The drive output current has exceeded the hardware current limit.	Check programming. Check for excess load, improper <a href="#">A530</a> [Boost Select] setting, DC brake volts set too high or other causes of excess current.
F013	Ground Fault	1 <sup>(2)</sup>	A current path to earth ground has been detected at one or more of the drive output terminals.	Check the motor and external wiring to the drive output terminals for a grounded condition.
F015 <sup>(3)</sup>	Load Loss	2	The output torque current is below the value programmed in <a href="#">A490</a> [Load Loss Level] for a time period greater than the time programmed in <a href="#">A491</a> [Load Loss Time].	<ul style="list-style-type: none"> <li>• Verify connections between motor and load.</li> <li>• Verify level and time requirements</li> </ul>
F021	Output Ph Loss	1	Output Phase Loss (if enabled). Configure with <a href="#">A557</a> [Out Phas Loss En].	<ul style="list-style-type: none"> <li>• Verify motor wiring.</li> <li>• Verify motor.</li> </ul>

## Fault Types, Descriptions, and Actions (Continued)

No.	Fault	Type <sup>(1)</sup>	Description	Action
F029	Analog In Loss	1	An analog input is configured to fault on signal loss. A signal loss has occurred. Configure with <a href="#">t094</a> [Anlg In V Loss] or <a href="#">t097</a> [Anlg In mA Loss].	<ul style="list-style-type: none"> <li>• Check for broken/loose connections at inputs.</li> <li>• Check parameters.</li> </ul>
F033	Auto Rstrt Tries	2	Drive unsuccessfully attempted to reset a fault and resume running for the programmed number of <a href="#">A541</a> [Auto Rstrt Tries].	Correct the cause of the fault and manually clear.
F038	Phase U to Gnd	2	A phase to ground fault has been detected between the drive and motor in this phase.	<ul style="list-style-type: none"> <li>• Check the wiring between the drive and motor.</li> <li>• Check motor for grounded phase.</li> <li>• Replace drive if fault cannot be cleared.</li> </ul>
F039	Phase V to Gnd			
F040	Phase W to Gnd			
F041	Phase UV Short	2	Excessive current has been detected between these two output terminals.	<ul style="list-style-type: none"> <li>• Check the motor and drive output terminal wiring for a shorted condition.</li> <li>• Replace drive if fault cannot be cleared.</li> </ul>
F042	Phase UW Short			
F043	Phase VW Short			
F048	Params Defaulted	1	The drive was commanded to write default values to EEPROM.	<ul style="list-style-type: none"> <li>• Clear the fault or cycle power to the drive.</li> <li>• Program the drive parameters as needed.</li> </ul>
F059 <sup>(3)</sup>	Safety Open	1	Both of the safety inputs (Safety 1, Safety 2) are not enabled. Configure with <a href="#">t104</a> [Safety Open En].	<ul style="list-style-type: none"> <li>• Check safety input signals. If not using safety, verify and tighten jumper for I/O terminals S1, S2, and S+.</li> </ul>
F063	SW OverCurrent	1	Programmed <a href="#">A486</a> , <a href="#">A488</a> [Shear Pinx Level] has been exceeded for a time period greater than the time programmed in <a href="#">A487</a> , <a href="#">A489</a> [Shear Pin x Time].	<ul style="list-style-type: none"> <li>• Verify connections between motor and load.</li> <li>• Verify level and time requirements.</li> </ul>
F064	Drive Overload	2	Drive overload rating has been exceeded.	Reduce load or extend Accel Time.
F070	Power Unit	2	Failure has been detected in the drive power section.	<ul style="list-style-type: none"> <li>• Check max ambient temperature has not been exceeded.</li> <li>• Cycle power.</li> <li>• Replace drive if fault cannot be cleared.</li> </ul>
F071	DSI Net Loss	2	Control over the Modbus or DSI communication link has been interrupted.	<ul style="list-style-type: none"> <li>• Cycle power.</li> <li>• Check communications cabling.</li> <li>• Check Modbus or DSI setting.</li> <li>• Check Modbus or DSI status.</li> </ul>
F072	Opt Net Loss	2	Control over the network option card's remote network has been interrupted.	<ul style="list-style-type: none"> <li>• Cycle power.</li> <li>• Check communications cabling.</li> <li>• Check network adapter setting.</li> <li>• Check external network status.</li> </ul>
F073 <sup>(3)</sup>	EN Net Loss	2	Control through the embedded EtherNet/IP adapter has been interrupted.	<ul style="list-style-type: none"> <li>• Cycle power.</li> <li>• Check communications cabling.</li> <li>• Check EtherNet/IP setting.</li> <li>• Check external network status.</li> </ul>
F080	Autotune Failure	2	The autotune function was either cancelled by the user or failed.	Restart procedure.
F081	DSI Comm Loss	2	Communications between the drive and the Modbus or DSI master device have been interrupted.	<ul style="list-style-type: none"> <li>• Cycle power.</li> <li>• Check communications cabling.</li> <li>• Check Modbus or DSI setting.</li> <li>• Check Modbus or DSI status.</li> <li>• Modify using <a href="#">C125</a> [Comm Loss Action].</li> <li>• Connecting I/O terminals C1 and C2 to ground may improve noise immunity.</li> <li>• Replace wiring, Modbus master device, or control module.</li> </ul>



## Fault Types, Descriptions, and Actions (Continued)

No.	Fault	Type <sup>(1)</sup>	Description	Action
F082	Opt Comm Loss	2	Communications between the drive and the network option card have been interrupted.	<ul style="list-style-type: none"> <li>• Cycle power.</li> <li>• Reinstall option card in drive.</li> <li>• Modify using <a href="#">C125</a> [Comm Loss Action].</li> <li>• Replace wiring, port expander, option card, or control module.</li> </ul>
F083 <sup>(3)</sup>	EN Comm Loss	2	Internal communications between the drive and the embedded EtherNet/IP adapter have been interrupted.	<ul style="list-style-type: none"> <li>• Cycle power.</li> <li>• Check EtherNet/IP setting.</li> <li>• Check drive's Ethernet settings and diagnostic parameters.</li> <li>• Modify using <a href="#">C125</a> [Comm Loss Action].</li> <li>• Replace wiring, Ethernet switch, or control module.</li> </ul>
F091 <sup>(3)</sup>	Encoder Loss	2	Requires differential encoder. One of the 2 encoder channel signals is missing.	<ul style="list-style-type: none"> <li>• Check Wiring.</li> <li>• If <a href="#">P047</a>, <a href="#">P049</a>, <a href="#">P051</a> [Speed Reference] = 16 "Positioning" and <a href="#">A535</a> [Motor Fdbk Type] = 5 "Quad Check", swap the Encoder channel inputs or swap any two motor leads.</li> <li>• Replace encoder.</li> </ul>
F094	Function Loss	2	"Freeze-Fire" (Function Loss) input is inactive, input to the programmed terminal is open.	Close input to the terminal and cycle power.
F100	Parameter Chksum	2	Drive parameter non-volatile storage is corrupted.	Set <a href="#">P053</a> [Reset To Defaults] to 2 "Factory Rset".
F101	External Storage	2	External non-volatile storage has failed.	Set <a href="#">P053</a> [Reset To Defaults] to 2 "Factory Rset".
F105	C Connect Err	2	Control module was disconnected while drive was powered.	Clear fault and verify all parameter settings. Do not remove or install the control module while power is applied.
F106	Incompat C-P	2	The PowerFlex 525 control module does not support power modules with 0.25 HP power rating.	<ul style="list-style-type: none"> <li>• Change to a different power module.</li> <li>• Change to a PowerFlex 523 control module.</li> </ul>
F107	Replaced C-P	2	The control module could not recognize the power module. Hardware failure.	<ul style="list-style-type: none"> <li>• Change to a different power module.</li> <li>• Replace control module if changing power module does not work.</li> </ul>
F109	Mismatch C-P	2	The control module was mounted to a different drive type power module.	Set <a href="#">P053</a> [Reset To Defaults] to 3 "Power Reset".
F110	Keypad Membrane	2	Keypad membrane failure / disconnected.	<ul style="list-style-type: none"> <li>• Cycle power.</li> <li>• Replace control module if fault cannot be cleared.</li> </ul>
F111 <sup>(3)</sup>	Safety Hardware	2	Safety input enable hardware malfunction. One of the safety inputs is not enabled.	<ul style="list-style-type: none"> <li>• Check safety input signals. If not using safety, verify and tighten jumper for I/O terminals S1, S2, and S+.</li> <li>• Replace control module if fault cannot be cleared.</li> </ul>
F114	uC Failure	2	Microprocessor failure.	<ul style="list-style-type: none"> <li>• Cycle power.</li> <li>• Verify grounding requirements. See <a href="#">General Grounding Requirements on page 20</a> for more information.</li> <li>• Replace control module if fault cannot be cleared.</li> </ul>
F122	I/O Board Fail	2	Failure has been detected in the drive control and I/O section.	<ul style="list-style-type: none"> <li>• Cycle power.</li> <li>• Replace drive or control module if fault cannot be cleared.</li> </ul>

## Fault Types, Descriptions, and Actions (Continued)

No.	Fault	Type <sup>(1)</sup>	Description	Action
F125	Flash Update Req	2	The firmware in the drive is corrupt, mismatched, or incompatible with the hardware.	Perform a firmware flash update operation to attempt to load a valid set of firmware.
F126	NonRecoverablErr	2	A non-recoverable firmware or hardware error was detected. The drive was automatically stopped and reset.	<ul style="list-style-type: none"> <li>Clear fault or cycle power to the drive.</li> <li>Replace drive or control module if fault cannot be cleared.</li> </ul>
F127	DSIFlashUpdatReq	2	A critical problem with the firmware was detected and the drive is running using backup firmware that only supports DSI communications.	Perform a firmware flash update operation using DSI communications to attempt to load a valid set of firmware.

(1) See [Fault Types](#) for more information.

(2) This fault may be cleared by the auto-restart routine and will be attempted only once. It ignores the value set in parameter A541 [Auto Rstrt Tries].

(3) This fault is not applicable to PowerFlex 523 drives.

## Common Symptoms and Corrective Actions

The drive is designed to start from the keypad when shipped. For a basic test of drive operation:

1. Remove all user I/O wire.
2. Verify safety terminals (S1, S2, and S+) jumper is in place and tightened.
3. Verify wire jumper is in place between I/O terminals 01 and 11.
4. Verify that the three jumpers are in their proper default positions on the control board. See [PowerFlex 525 Control I/O Terminal Block on page 41](#) for more information.
5. Reset default parameter values by setting [P053](#) [Reset Defaults] to 2 "Factory Rset".
6. If safe to do so for your application, press Start on drive keypad. Drive will run according to the speed potentiometer.

### Motor does not Start

Cause(s)	Indication	Corrective Action
No output voltage to the motor.	None	Check the power circuit. <ul style="list-style-type: none"> <li>Check the supply voltage.</li> <li>Check all fuses and disconnects.</li> </ul> Check the motor. <ul style="list-style-type: none"> <li>Verify that the motor is connected properly.</li> </ul> Check the control input signals. <ul style="list-style-type: none"> <li>Verify that a Start signal is present. If 2-Wire control is used, verify that either the Run Forward or Run Reverse signal is active, but not both.</li> <li>Verify that I/O Terminal 01 is active.</li> <li>Verify that <a href="#">P046</a>, <a href="#">P048</a>, <a href="#">P050</a> [Start Source x] matches your configuration.</li> <li>Verify that <a href="#">A544</a> [Reverse Disable] is not prohibiting movement.</li> <li>Verify that safety inputs (Safety 1 and Safety 2) are active.</li> </ul>
Improper boost setting at initial startup.	None	Set <a href="#">A530</a> [Boost Select] to 2 "35.0, VT".
Drive is Faulted	Flashing red status light	Clear fault. <ul style="list-style-type: none"> <li>Press Stop if <a href="#">P045</a> [Stop Mode] is set to a value between "0" and "3".</li> <li>Cycle drive power.</li> <li>Set <a href="#">A551</a> [Fault Clear] to 1 "Reset Fault" or 2 "Clear Buffer".</li> <li>Cycle digital input if <a href="#">t062</a>, <a href="#">t063</a>, <a href="#">t065</a>...<a href="#">t068</a> [DigIn TermBlk xx] is set to 13 "Clear Fault".</li> </ul>

**Motor does not Start (Continued)**

Cause(s) (Continued)	Indication	Corrective Action
Incorrect programming. • <a href="#">P046</a> , <a href="#">P048</a> , <a href="#">P050</a> [Start Source x] is set incorrectly.	None	Check setting for <a href="#">b012</a> [Control Source].
Incorrect input wiring. See <a href="#">page 43</a> for wiring examples. • 2 wire control requires Run Forward, Run Reverse or Jog input. • 3 wire control requires Start and Stop inputs • Stop input is always required.	None	<ul style="list-style-type: none"> <li>• Wire inputs correctly and/or install jumper.</li> <li>• If the PowerFlex 525 Safe Torque Off function is used, verify that inputs are active.</li> <li>• If 2-wire or 3-wire mode is used, verify that <a href="#">t062</a> [DigIn TermBlk 02] and <a href="#">t063</a> [DigIn TermBlk 03] are set properly.</li> </ul>
Incorrect sink/source jumper setting.	None	Set switch to match wiring scheme.

**Drive does not Start from Start or Run Inputs wired to the terminal block**

Cause(s)	Indication	Corrective Action
Drive is Faulted	Flashing red status light	Clear fault. <ul style="list-style-type: none"> <li>• Press Stop if <a href="#">P045</a> [Stop Mode] is set to a value between "0" and "3".</li> <li>• Cycle drive power.</li> <li>• Set <a href="#">A551</a> [Fault Clear] to 1 "Reset Fault" or 2 "Clear Buffer".</li> <li>• Cycle digital input if <a href="#">t062</a>, <a href="#">t063</a>, <a href="#">t065</a>...<a href="#">t068</a> [DigIn TermBlk xx] is set to 13 "Clear Fault".</li> </ul>
Incorrect programming. • <a href="#">P046</a> , <a href="#">P048</a> , <a href="#">P050</a> [Start Source x] is set incorrectly. • <a href="#">t062</a> , <a href="#">t063</a> [DigIn TermBlk 02/03] is set incorrectly.	None	Check parameter settings.
Incorrect input wiring. See <a href="#">page 43</a> for wiring examples. • 2 wire control requires Run Forward, Run Reverse or Jog input. • 3 wire control requires Start and Stop inputs • Stop input is always required.	None	<ul style="list-style-type: none"> <li>• Wire inputs correctly and/or install jumper.</li> <li>• If the PowerFlex 525 Safe Torque Off function is used, verify that inputs are active.</li> </ul>
Incorrect sink/source jumper setting.	None	Set switch to match wiring scheme.

**Drive does not respond to changes in speed command**

Cause(s)	Indication	Corrective Action
No value is coming from the source of the command.	The drive "Run" indicator is lit and output is 0 Hz.	<ul style="list-style-type: none"> <li>• Check <a href="#">b012</a> [Control Source] for correct source.</li> <li>• If the source is an analog input, check wiring and use a meter to check for presence of signal.</li> <li>• Check <a href="#">b002</a> [Commanded Freq] to verify correct command.</li> </ul>
Incorrect reference source is being selected by remote device or digital inputs.	None	<ul style="list-style-type: none"> <li>• Check <a href="#">b012</a> [Control Source] for correct source.</li> <li>• Check <a href="#">b014</a> [Dig In Status] to see if inputs are selecting an alternate source. Verify settings for <a href="#">t062</a>, <a href="#">t063</a>, <a href="#">t065</a>-<a href="#">t068</a> [DigIn TermBlk xx].</li> <li>• Check <a href="#">P047</a>, <a href="#">P049</a>, <a href="#">P051</a> [Speed Referencex] for the source of the speed reference. Reprogram as necessary.</li> <li>• Review the Speed Reference Control chart on <a href="#">page 48</a>.</li> <li>• Verify communications if used.</li> </ul>

**Motor and/or drive will not accelerate to commanded speed**

Cause(s)	Indication	Corrective Action
Acceleration time is excessive.	None	Reprogram <a href="#">P041</a> , <a href="#">A442</a> , <a href="#">A444</a> , <a href="#">A446</a> [Accel Time x].
Excess load or short acceleration times force the drive into current limit, slowing or stopping acceleration.	None	<ul style="list-style-type: none"> <li>• Compare <a href="#">b003</a> [Output Current] with <a href="#">A484</a>, <a href="#">A485</a> [Current Limit x].</li> <li>• Remove excess load or reprogram <a href="#">P041</a>, <a href="#">A442</a>, <a href="#">A444</a>, <a href="#">A446</a> [Accel Time x].</li> <li>• Check for improper <a href="#">A530</a> [Boost Select] setting.</li> </ul>
Speed command source or value is not as expected.	None	<ul style="list-style-type: none"> <li>• Verify <a href="#">b002</a> [Commanded Freq].</li> <li>• Check <a href="#">b012</a> [Control Source] for the proper Speed Command.</li> </ul>
Programming is preventing the drive output from exceeding limiting values.	None	<ul style="list-style-type: none"> <li>• Check <a href="#">P044</a> [Maximum Freq] to ensure that speed is not limited by programming.</li> <li>• Verify programming of <a href="#">A572</a> [Speed Ratio].</li> </ul>
Torque performance does not match motor characteristics.	None	<ul style="list-style-type: none"> <li>• Set motor nameplate full load amps in parameter <a href="#">P034</a> [Motor NP FLA].</li> <li>• Perform <a href="#">P040</a> [Autotune] "Static Tune" or "Rotate Tune" procedure.</li> <li>• Set <a href="#">P039</a> [Torque Perf Mode] to 0 "V/Hz".</li> </ul>

**Motor operation is unstable**

Cause(s)	Indication	Corrective Action
Motor data was incorrectly entered.	None	<ol style="list-style-type: none"> <li>1. Correctly enter motor nameplate data into <a href="#">P031</a>, <a href="#">P032</a> and <a href="#">P033</a>.</li> <li>2. Enable <a href="#">A547</a> [Compensation].</li> <li>3. Use <a href="#">A530</a> [Boost Select] to reduce boost level.</li> </ol>

**Drive will not reverse motor direction**

Cause(s)	Indication	Corrective Action
Reverse is disabled.	None	Check <a href="#">A544</a> [Reverse Disable].
Digital input is not selected for reversing control.	None	Check [DigIn TermBlk xx] (See <a href="#">page 88</a> ). Choose correct input and program for reversing mode.
Digital input is incorrectly wired.	None	Check input wiring (See <a href="#">page 43</a> ).
Motor wiring is improperly phased for reverse.	None	Switch two motor leads.

**Drive does not power up**

Cause(s)	Indication	Corrective Action
No input power to drive.	None	<ul style="list-style-type: none"> <li>• Check the power circuit.</li> <li>• Check the supply voltage.</li> <li>• Check all fuses and disconnects.</li> </ul>
Control module is not connected properly to power module.	None	<ol style="list-style-type: none"> <li>1. Remove power.</li> <li>2. Verify that the control module is properly and fully installed on the power module.</li> <li>3. Reapply power.</li> </ol>





**Motor is rotating at zero Hz or slip frequency is not correct**

Cause(s)	Indication	Corrective Action
Incorrect speed calculation.	Improper speed.	<ul style="list-style-type: none"> <li>• Verify <a href="#">P032</a> [Motor NP Hertz].</li> <li>• Reduce boost with <a href="#">A530</a> [Boost Select].</li> <li>• Set <a href="#">P036</a> [Motor NP RPM] to motor synchronous speed.</li> </ul>

## Supplemental Drive Information

Topic	Page
Certifications	165
Environmental Specifications	166
Technical Specifications	167
Power Specifications	170

### Certifications

Certifications	PowerFlex 523	PowerFlex 525
<b>c-UL-us</b> 	Listed to UL508C and CAN/CSA-C22.2 No. 14-05.	
<b>RCM</b> 	Australian Communications and Media Authority In conformity with the following: Radiocommunications Act: 1992 (including amendments up to 2018) Radiocommunications Standard: 2017 Radiocommunications Labelling Notice: 2017 Standards applied: EN 61800-3	
	In conformity with the following European Directives: 2014/35/EU Low Voltage Directive (LVD) 2014/30/EU EMC Directive (EMC) 2014/34/EU ATEX Directive (ATEX) 2006/42/EC Machinery Directive (MD) 2011/65/EU RoHS Directive (RoHS) Standards applied: EN 61800-3 EN 61800-5-1	
<b>Functional Safety</b> 	(Applicable to PowerFlex 525 drives only) TÜV Rheinland Standards applied: EN ISO 13849-1 EN 61800-5-2 EN 61508 PARTS 1-7 EN 62061 EN 60204-1 Certified to ISO 13849-1 SIL2/PLd with embedded Safe-Torque-Off function Meets Functional Safety (FS) when used with embedded Safe-Torque-Off function	
<b>ATEX</b>  <b>II (2) G D</b> <b>TUV 12 ATEX 7199 X</b>	(Applicable to PowerFlex 525 drives only) Certified to ATEX Directive 2014/34/EU Group II Category (2) GD Applications with ATEX Approved Motors	
<b>KCC</b>	Korean Registration of Broadcasting and Communications Equipment Compliant with the following standards: Article 58-2 of Radio Waves Act, Clause 3	
<b>EAC</b>	Standards applied: Low Voltage TP TC 004/2011 EMC TP TC 020/2011	
<b>AC 156</b>	Tested by Trentec to be compliant with AC156 Acceptance Criteria for Seismic Qualification Testing of Nonstructural Components and 2003 International Building Code for worst-case seismic level for USA excluding site class F	

## Environmental Specifications

Certifications	PowerFlex 523	PowerFlex 525
<b>SEMI F47</b>	Certified compliant with the following standards: SEMI F47 IEC 61000-4-11 IEC 61000-4-34	
<b>Lloyds Register</b>	(Applicable to PowerFlex 525 drives only) Lloyd's Register Type Approval Certificate 12/10068(E1)	
<b>RoHS</b>	Compliant with the European "Restriction of Hazardous Substances" 2011/65/EU Directive	

The drive is also designed to meet the appropriate portions of the following specifications:  
 NFPA 70 - US National Electrical Code  
 NEMA ICS 7.1 - Safety standards for Construction and Guide for Selection, Installation and Operation of Adjustable Speed Drive Systems.

Specifications	PowerFlex 523	PowerFlex 525
Altitude: Without derating: With derating:	See <a href="#">Current Derating Curves on page 17</a> for derating guidelines. 1000 m (3300 ft) max. Up to 4000 m (13,200 ft) max., with the exception of 600V drives at 2000 m (6600 ft) max.	
Max. Surrounding Air Temperature Without derating: With derating:	See <a href="#">Current Derating Curves on page 17</a> for derating guidelines. -20...+50 °C (-4...+122 °F) -20...+60 °C (-4...+140 °F) or -20...+70 °C (-4...+158 °F) with optional Control Module Fan kit.	
Storage Temperature: Frame A...D: Frame E:	-40...+85 °C (-40...+185 °F) -40...+70 °C (-40...+158 °F)	
Atmosphere:		

**IMPORTANT** Drive **must not** be installed in an area where the ambient atmosphere contains volatile or corrosive gas, vapors or dust. If the drive is not going to be installed for a period of time, it must be stored in an area where it will not be exposed to a corrosive atmosphere.

Relative Humidity:	0...95% noncondensing
Shock: Vibration:	Complies with IEC 60068-2-27 Complies with IEC 60068-2-6:1995

Frame Size	Operating and Nonoperating		Nonoperating (Transportation)	
	Force (Shock/Vibration)	Mounting Type	Force (Shock/Vibration)	Mounting Type
A	15 g / 2 g	DIN rail or screw	30 g / 2.5 g	Screw only
B	15 g / 2 g	DIN rail or screw	30 g / 2.5 g	Screw only
C	15 g / 2 g	DIN rail or screw	30 g / 2.5 g	Screw only
D	15 g / 2 g	Screw only	30 g / 2.5 g	Screw only
E	15 g / 1.5 g	Screw only	30 g / 2.5 g	Screw only

Conformal Coating:	Complies with: IEC 60721-3-3 to level 3C2 (chemical and gases only)
Surrounding Environment Pollution Degree Pollution Degree 1 & 2:	See <a href="#">Pollution Degree Ratings According to EN 61800-5-1 on page 51</a> for descriptions. All enclosures acceptable.
Sound Pressure Level (A-weighted) Frame A & B: Frame C: Frame D: Frame E:	Measurements are taken 1 m from the drive. Maximum 53 dBA Maximum 57 dBA Maximum 64 dBA Maximum 68 dBA

## Technical Specifications

### Protection

Specifications	PowerFlex 523	PowerFlex 525
Bus Overvoltage Trip 100...120V AC Input: 200...240V AC Input: 380...480V AC Input: 525...600V AC Input:	405V DC bus (equivalent to 150V AC incoming line) 405V DC bus (equivalent to 290V AC incoming line) 810V DC bus (equivalent to 575V AC incoming line) 1005V DC bus (equivalent to 711V AC incoming line)	
Bus Undervoltage Trip 100...120V AC Input: 200...240V AC Input: 380...480V AC Input:	190V DC bus (equivalent to 75V AC incoming line) 190V DC bus (equivalent to 150V AC incoming line) 390V DC bus (equivalent to 275V AC incoming line)	
Power Ride-Thru:	100 ms	
Logic Control Ride-Thru:	0.5 s minimum, 2 s typical	
Electronic Motor Overload Protection:	Provides class 10 motor overload protection according to NEC article 430 and motor over-temperature protection according to NEC article 430.126 (A) (2). UL 508C File 29572.	
Overcurrent:	200% hardware limit, 300% instantaneous fault	
Ground Fault Trip:	Phase-to-ground on drive output	
Short Circuit Trip:	Phase-to-phase on drive output	

### Electrical

Specifications	PowerFlex 523	PowerFlex 525
Voltage Tolerance:	-15% / +10%	
Frequency Tolerance:	47...63 Hz	
Input Phases:	Three-phase input provides full rating. Single-phase input provides 35% rating on three-phase drives.	
Displacement Power Factor:	0.98 across entire speed range	
Maximum Short Circuit Rating:	100,000 Amps Symmetrical	
Actual Short Circuit Rating:	Determined by AIC Rating of installed fuse/circuit breaker	
Transistor Type:	Isolated Gate Bipolar Transistor (IGBT)	
Internal DC Bus Choke 200...240V AC Input: 380...480V AC Input: 525...600V AC Input:	Only for Frame E drive ratings 11 kW (15 HP) 15...18.5 kW (20...25 HP) - Heavy Duty 15...18.5 kW (20...25 HP) - Heavy Duty	

### Control

Specifications	PowerFlex 523	PowerFlex 525
Method	Sinusoidal PWM, Volts/Hertz, Sensorless Vector Control, Economizer SVC motor control, Closed Loop Velocity Vector Control, Surface Mount and Interior Permanent Magnet Motor (without encoder), Interior Permanent Magnet Motor (with encoder) (Closed Loop Velocity Vector Control, PM motor control, and SynRM are not applicable to PowerFlex 523 drives)	
Carrier Frequency	2...16 kHz, Drive rating based on 4 kHz	
Frequency Accuracy	Within ±0.05% of set output frequency	
Digital Input:	Within 0.5% of maximum output frequency, 10-Bit resolution	
Analog Input:	±2% of full scale, 10-Bit resolution	
Analog Output:		
Performance	V/Hz (Volts per Hertz): ±1% of base speed across a 60:1 speed range SVC (Sensorless Vector): ±0.5% of base speed across a 100:1 speed range SVC Economizer: ±0.5% of base speed across a 100:1 speed range  VVC (Velocity Vector Control): (Applicable to PowerFlex 525 drives only) ±0.5% of base speed across a 60:1 speed range PM Motor <sup>(1)</sup> : ±0.5% of base speed, up to a 20:1 speed range	
Performance with Encoder	SVC (Sensorless Vector): (Applicable to PowerFlex 525 drives only) ±0.1% of base speed across a 100:1 speed range <sup>(2)</sup> SVC Economizer: ±0.1% of base speed across a 100:1 speed range <sup>(2)</sup> VVC (Velocity Vector Control): ±0.1% of base speed across a 1000:1 speed range <sup>(2)</sup> PM Motor (iPM motor, 10 HP rating and below) <sup>(1)</sup> : ±0.1% of base speed, up to a 60:1 speed range	
Output Voltage Range:	0V to rated motor voltage	
Output Frequency Range:	0...500 Hz (programmable)	
Efficiency:	97.5% (typical)	
Stop Modes:	Multiple programmable stop modes including – Ramp, Coast, DC-Brake, and Ramp-to-Stop	
Accel/Decel:	Four independently programmable accel and decel times. Each time may be programmed from 0...600 s in 0.01 s increments.	
Intermittent Overload	110% Overload capability for up to 60 s, 150% for up to 3 s	
Normal Duty:	Applies for power rating above 15 kW (20 HP) only. Based on 480V drive rating.	
Heavy Duty:	150% Overload capability for up to 60 s, 180% for up to 3 s (200% programmable)	

(1) For details on specific motor performance, see Knowledge Base article "PowerFlex 525 PM Motor Performance Testing Summary".

(2) For more information, see [Determine Encoder Pulse Per Revolution \(PPR\) Specification Based on Speed Resolution on page 219](#).

### Control Inputs

Specifications	PowerFlex 523	PowerFlex 525	
Digital	Bandwidth:	10 Rad/s for open and closed loop	
	Quantity:	(1) Dedicated for stop (4) Programmable	(1) Dedicated for stop (6) Programmable
	Current:	6 mA	
	Type		
	Source Mode (SRC): Sink Mode (SNK):	18...24V = ON, 0...6V = OFF 0...6V = ON, 18...24V = OFF	
Pulse Train	Quantity:	(1) Shared with one of the programmable digital input terminals.	
	Input Signal: Input Frequency: Current Consumption:	Transistor contact (open collector) 0...100 kHz 7 mA @ 24V DC maximum	
Analog:	Quantity:	(1) Isolated, 0...10V and 4...20mA	(2) Isolated, -10...10V and 4...20mA
	Specification		
	Resolution:	10-bit	
	0...10V DC Analog: 4...20mA Analog: External Pot:	100k ohm input impedance 250 ohm input impedance 1...10k ohm, 2 W minimum	



## Control Outputs

Specifications		PowerFlex 523	PowerFlex 525
Relay:	Quantity:	(1) Programmable Form C	(2) 1 Programmable Form A and 1 Programmable Form B
	Specification Resistive Rating: Inductive Rating:	3.0 A @ 30V DC, 3.0 A @ 125V, 3.0 A @ 240V AC 0.5 A @ 30V DC, 0.5 A @ 125V, 0.5 A @ 240V AC	
Opto:	Quantity:	-	(2) Programmable
	Specification:		30V DC, 50 mA Non-inductive
Analog	Quantity:	(1) Non-Isolated 0...10V or 4...20 mA <sup>(1)</sup>	
	Specification Resolution: 0...10V DC Analog: 4...20 mA Analog:	10-bit 1 k ohm minimum 525 ohm maximum	

(1) Feature is not applicable to PowerFlex 523 series A drives.

## Encoder

Specifications	PowerFlex 523	PowerFlex 525
Type:		Incremental, dual channel
Supply:		12V, 250 mA
Quadrature:		90 °, ±27 ° @ 25 °C
Duty Cycle:		50%, +10%
Requirements:	-	Encoders must be line driver type, quadrature (dual channel) or pulse (single channel), 3.5...26V DC output, single-ended or differential and capable of supplying a minimum of 10 mA per channel. Allowable input is DC up to a maximum frequency of 250 kHz. The encoder I/O automatically scales to allow 5V, 12V and 24V DC nominal voltages.

## Power Specifications

### Watts Loss

Voltage	Output Current (A)	Total Watts Loss
100...120V, 50/60 Hz 1-Phase	1.6	20.0
	2.5	27.0
	4.8	53.0
	6.0	67.0
200...240V, 50/60 Hz 1-Phase	1.6	20.0
	2.5	29.0
	4.8	50.0
	8.0	81.0
200...240V, 50/60 Hz 1-Phase w/ EMC Filter	1.6	20.0
	2.5	29.0
	4.8	53.0
	8.0	84.0
200...240V, 50/60 Hz 3-Phase	1.6	20.0
	2.5	29.0
	5.0	50.0
	8.0	79.0
	11.0	107.0
	17.5	148.0
	24.0	259.0
	32.2	323.0
380...480V, 50/60 Hz 3-Phase	48.3	584.0
	62.1	708.0
	1.4	27.0
	2.3	37.0
	4.0	62.0
	6.0	86.0
	10.5	129.0
	13.0	170.0
380...480V, 50/60 Hz 3-Phase w/ EMC Filter	17.0	221.0
	24.0	303.0
	30.0	387.0
	1.4	27.0
	2.3	37.0
	4.0	63.0
	6.0	88.0
	10.5	133.0
13.0	175.0	
380...480V, 50/60 Hz 3-Phase w/ EMC Filter	17.0	230.0
	24.0	313.0
	30.0	402.0
	37.0	602.0
	43.0	697.0

*Watts Loss (Continued)*

Voltage	Output Current (A)	Total Watts Loss
525...600V, 50/60 Hz 3-Phase	0.9	22.0
	1.7	32.0
	3.0	50.0
	4.2	65.0
	6.6	95.0
	9.9	138.0
	12.0	164.0
	19.0	290.0
	22.0	336.0
	27.0	466.0
	32.0	562.0

*Input Current Scaling (Optional)*

You can use a higher drive rating by scaling the input current based on the output current required for your application. You can use a lower input current rating based upon the motor FLA rating. For example, if the motor has an FLA rating of 1.6, the input rating will be 6.4 amps. See the [PowerFlex 520-Series Input Current Rating Scaled by the Motor FLA on page 171](#) table for more information.

**PowerFlex 520-Series Input Current Rating Scaled by the Motor FLA**

PowerFlex 523 Catalog Number	PowerFlex 525 Catalog Number	Output Current: Motor FLA				Input Drive Current Rating			
		1	2	3	4	5	6	7	8
<b>100...120V AC (-15%, +10%) - 1-Phase Input, 0...230V 3-Phase Output</b>									
25A-V1P6N104	-	1.6	1.3	1.0	0.8	6.4	5.2	4.0	3.2
25A-V2P5N104	25B-V2P5N104	2.5	2.0	1.6	1.3	9.6	7.7	6.2	4.8
25A-V4P8N104	25B-V4P8N104	4.8	3.8	3.1	2.4	19.2	15.4	12.5	9.6
25A-V6P0N104	25B-V6P0N104	6.0	4.8	3.9	3.0	24.0	19.2	15.6	12.0
<b>200...240V AC (-15%, +10%) - 1-Phase Input, 0...230V 3-Phase Output</b>									
25A-A1P6N104	-	1.6	1.3	1.0	0.8	5.3	4.3	3.4	2.7
25A-A2P5N104	25B-A2P5N104	2.5	2.0	1.6	1.3	6.5	5.2	4.2	3.3
25A-A4P8N104	25B-A4P8N104	4.8	3.8	3.1	2.4	10.7	8.6	7.0	5.4
25A-A8P0N104	25B-A8P0N104	8.0	6.4	5.2	4.0	18.0	14.4	11.7	9.0
25A-A011N104	25B-A011N104	11.0	8.8	7.2	5.5	22.9	18.3	14.9	11.5
<b>200...240V AC (-15%, +10%) - 1-Phase Input with EMC Filter, 0...230V 3-Phase Output</b>									
25A-A1P6N114	-	1.6	1.3	1.0	0.8	5.3	4.3	3.4	2.7
25A-A2P5N114	25B-A2P5N114	2.5	2.0	1.6	1.3	6.5	5.2	4.2	3.3
25A-A4P8N114	25B-A4P8N114	4.8	3.8	3.1	2.4	10.7	8.6	7.0	5.4
25A-A8P0N114	25B-A8P0N114	8.0	6.4	5.2	4.0	18.0	14.4	11.7	9.0
25A-A011N114	25B-A011N114	11.0	8.8	7.2	5.5	22.9	18.3	14.9	11.5
<b>200...240V AC (-15%, +10%) - 3-Phase Input, 0...230V 3-Phase Output</b>									
25A-B1P6N104	-	1.6	1.3	1.0	0.8	1.9	1.5	1.2	1.0
25A-B2P5N104	25B-B2P5N104	2.5	2.0	1.6	1.3	2.7	2.2	1.8	1.4
25A-B5P0N104	25B-B5P0N104	5.0	4.0	3.2	2.5	5.8	4.6	3.8	2.9
25A-B8P0N104	25B-B8P0N104	8.0	6.4	5.2	4.0	9.5	7.6	6.2	4.8
25A-B011N104	25B-B011N104	11.0	8.8	7.2	5.5	13.8	11.0	9.0	6.9
25A-B017N104	25B-B017N104	17.5	14.0	11.4	8.8	21.1	16.9	13.7	10.6
25A-B024N104	25B-B024N104	24.0	19.2	15.6	12.0	26.6	21.3	17.3	13.3
25A-B032N104	25B-B032N104	32.2	25.8	20.9	16.1	34.8	27.8	22.6	17.4
25A-B048N104	25B-B048N104	48.3	38.6	31.4	24.2	44.0	35.2	28.6	22.0

## PowerFlex 520-Series Input Current Rating Scaled by the Motor FLA (Continued)

PowerFlex 523 Catalog Number	PowerFlex 525 Catalog Number	Output Current: Motor FLA				Input Drive Current Rating			
		1	2	3	4	5	6	7	8
25A-B062N104	25B-B062N104	62.1	49.7	40.4	31.1	56.0	44.8	36.4	28.0
<b>380...480V AC (-15%, +10%) - 3-Phase Input, 0...460V 3-Phase Output</b>									
25A-D1P4N104	25B-D1P4N104	1.4	1.1	0.9	0.7	1.9	1.5	1.2	1.0
25A-D2P3N104	25B-D2P3N104	2.3	1.8	1.5	1.2	3.2	2.6	2.1	1.6
25A-D4PON104	25B-D4PON104	4.0	3.2	2.6	2.0	5.7	4.6	3.7	2.9
25A-D6PON104	25B-D6PON104	6.0	4.8	3.9	3.0	7.5	6.0	4.9	3.8
25A-D010N104	25B-D010N104	10.5	8.4	6.8	5.3	13.8	11.0	9.0	6.9
25A-D013N104	25B-D013N104	13.0	10.4	8.5	6.5	15.4	12.3	10.0	7.7
25A-D017N104	25B-D017N104	17.0	13.6	11.1	8.5	18.4	14.7	12.0	9.2
25A-D024N104	25B-D024N104	24.0	19.2	15.6	12.0	26.4	21.1	17.2	13.2
25A-D030N104	25B-D030N104	30.0	24.0	19.5	15.0	33.0	26.4	21.5	16.5
<b>380...480V AC (-15%, +10%) - 3-Phase Input with EMC Filter, 0...460V 3-Phase Output</b>									
25A-D1P4N114	25B-D1P4N114	1.4	1.1	0.9	0.7	1.9	1.5	1.2	1.0
25A-D2P3N114	25B-D2P3N114	2.3	1.8	1.5	1.2	3.2	2.6	2.1	1.6
25A-D4PON114	25B-D4PON114	4.0	3.2	2.6	2.0	5.7	4.6	3.7	2.9
25A-D6PON114	25B-D6PON114	6.0	4.8	3.9	3.0	7.5	6.0	4.9	3.8
25A-D010N114	25B-D010N114	10.5	8.4	6.8	5.3	13.8	11.0	9.0	6.9
25A-D013N114	25B-D013N114	13.0	10.4	8.5	6.5	15.4	12.3	10.0	7.7
25A-D017N114	25B-D017N114	17.0	13.6	11.1	8.5	18.4	14.7	12.0	9.2
25A-D024N114	25B-D024N114	24.0	19.2	15.6	12.0	26.4	21.1	17.2	13.2
25A-D030N114	25B-D030N114	30.0	24.0	19.5	15.0	33.0	26.4	21.5	16.5
25A-D037N114	25B-D037N114	37.0	29.6	24.1	18.5	33.7	27.0	21.9	16.9
25A-D043N114	25B-D043N114	43.0	34.4	28.0	21.5	38.9	31.1	25.3	19.5
<b>525...600V AC (-15%, +10%) - 3-Phase Input, 0...575V 3-Phase Output</b>									
25A-E0P9N104	25B-E0P9N104	0.9	0.7	0.6	0.5	1.2	1.0	0.8	0.6
25A-E1P7N104	25B-E1P7N104	1.7	1.4	1.1	0.9	2.3	1.8	1.5	1.2
25A-E3PON104	25B-E3PON104	3.0	2.4	2.0	1.5	3.8	3.0	2.5	1.9
25A-E4P2N104	25B-E4P2N104	4.2	3.4	2.7	2.1	5.3	4.2	3.4	2.7
25A-E6P6N104	25B-E6P6N104	6.6	5.3	4.3	3.3	8.0	6.4	5.2	4.0
25A-E9P9N104	25B-E9P9N104	9.9	7.9	6.4	5.0	11.2	9.0	7.3	5.6
25A-E012N104	25B-E012N104	12.0	9.6	7.8	6.0	13.5	10.8	8.8	6.8
25A-E019N104	25B-E019N104	19.0	15.2	12.4	9.5	24.0	19.2	15.6	12.0
25A-E022N104	25B-E022N104	22.0	17.6	14.3	11.0	27.3	21.8	17.7	13.7
25A-E027N104	25B-E027N104	27.0	21.6	17.6	13.5	24.7	19.8	16.1	12.4
25A-E032N104	25B-E032N104	32.0	25.6	20.8	16.0	29.2	23.4	19.0	14.6

## Accessories and Dimensions

### Product Selection

#### Catalog Number Description

<b>25B</b>	<b>-</b>	<b>V</b>	<b>2P5</b>	<b>N</b>	<b>1</b>	<b>0</b>	<b>4</b>
Drive		Voltage Rating	Rating	Enclosure	HIM	Emission Class	Version

#### PowerFlex 520-Series Drive Ratings

Output Ratings					Input Voltage Range	Frame Size	PowerFlex 523	PowerFlex 525
Normal Duty		Heavy Duty		Output Current (A)			Catalog No.	Catalog No.
HP	kW	HP	kW					
<b>100...120V AC (-15%, +10%) - 1-Phase Input, 0...230V 3-Phase Output</b>								
0.25	0.2	0.25	0.2	1.6	85...132	A	25A-V1P6N104 <sup>(1)</sup>	-
0.5	0.4	0.5	0.4	2.5	85...132	A	25A-V2P5N104	25B-V2P5N104
1.0	0.75	1.0	0.75	4.8	85...132	B	25A-V4P8N104	25B-V4P8N104
1.5	1.1	1.5	1.1	6.0	85...132	B	25A-V6P0N104	25B-V6P0N104
<b>200...240V AC (-15%, +10%) - 1-Phase Input, 0...230V 3-Phase Output</b>								
0.25	0.2	0.25	0.2	1.6	170...264	A	25A-A1P6N104 <sup>(1)</sup>	-
0.5	0.4	0.5	0.4	2.5	170...264	A	25A-A2P5N104	25B-A2P5N104
1.0	0.75	1.0	0.75	4.8	170...264	A	25A-A4P8N104	25B-A4P8N104
2.0	1.5	2.0	1.5	8.0	170...264	B	25A-A8P0N104	25B-A8P0N104
3.0	2.2	3.0	2.2	11.0	170...264	B	25A-A011N104	25B-A011N104
<b>200...240V AC (-15%, +10%) - 1-Phase Input with EMC Filter, 0...230V 3-Phase Output</b>								
0.25	0.2	0.25	0.2	1.6	170...264	A	25A-A1P6N114	-
0.5	0.4	0.5	0.4	2.5	170...264	A	25A-A2P5N114	25B-A2P5N114
1.0	0.75	1.0	0.75	4.8	170...264	A	25A-A4P8N114	25B-A4P8N114
2.0	1.5	2.0	1.5	8.0	170...264	B	25A-A8P0N114	25B-A8P0N114
3.0	2.2	3.0	2.2	11.0	170...264	B	25A-A011N114	25B-A011N114
<b>200...240V AC (-15%, +10%) - 3-Phase Input, 0...230V 3-Phase Output</b>								
0.25	0.2	0.25	0.2	1.6	170...264	A	25A-B1P6N104 <sup>(1)</sup>	-
0.5	0.4	0.5	0.4	2.5	170...264	A	25A-B2P5N104	25B-B2P5N104
1.0	0.75	1.0	0.75	5.0	170...264	A	25A-B5P0N104	25B-B5P0N104
2.0	1.5	2.0	1.5	8.0	170...264	A	25A-B8P0N104	25B-B8P0N104
3.0	2.2	3.0	2.2	11.0	170...264	A	25A-B011N104	25B-B011N104
5.0	4.0	5.0	4.0	17.5	170...264	B	25A-B017N104	25B-B017N104
7.5	5.5	7.5	5.5	24.0	170...264	C	25A-B024N104	25B-B024N104
10.0	7.5	10.0	7.5	32.2	170...264	D	25A-B032N104	25B-B032N104
15.0	11.0	10.0	7.5	48.3	170...264	E	25A-B048N104	25B-B048N104
20.0	15.0	15.0	11.0	62.1	170...264	E	25A-B062N104	25B-B062N104
<b>380...480V AC (-15%, +10%) - 3-Phase Input, 0...460V 3-Phase Output<sup>(2)</sup></b>								
0.5	0.4	0.5	0.4	1.4	323...528	A	25A-D1P4N104 <sup>(1)</sup>	25B-D1P4N104 <sup>(1)</sup>
1.0	0.75	1.0	0.75	2.3	323...528	A	25A-D2P3N104	25B-D2P3N104
2.0	1.5	2.0	1.5	4.0	323...528	A	25A-D4P0N104	25B-D4P0N104

## PowerFlex 520-Series Drive Ratings (Continued)

Output Ratings					Input Voltage Range	Frame Size	PowerFlex 523	PowerFlex 525
Normal Duty		Heavy Duty		Output Current (A)			Catalog No.	Catalog No.
HP	kW	HP	kW					
3.0	2.2	3.0	2.2	6.0	323...528	A	25A-D6PON104	25B-D6PON104
5.0	4.0	5.0	4.0	10.5	323...528	B	25A-D010N104	25B-D010N104
7.5	5.5	7.5	5.5	13.0	323...528	C	25A-D013N104	25B-D013N104
10.0	7.5	10.0	7.5	17.0	323...528	C	25A-D017N104	25B-D017N104
15.0	11.0	15.0	11.0	24.0	323...528	D	25A-D024N104	25B-D024N104
20.0	15.0	15.0	11.0	30.0	323...528	D	25A-D030N104	25B-D030N104
<b>380...480V AC (-15%, +10%) - 3-Phase Input with EMC Filter, 0...460V 3-Phase Output</b>								
0.5	0.4	0.5	0.4	1.4	323...528	A	25A-D1P4N114	25B-D1P4N114
1.0	0.75	1.0	0.75	2.3	323...528	A	25A-D2P3N114	25B-D2P3N114
2.0	1.5	2.0	1.5	4.0	323...528	A	25A-D4PON114	25B-D4PON114
3.0	2.2	3.0	2.2	6.0	323...528	A	25A-D6PON114	25B-D6PON114
5.0	4.0	5.0	4.0	10.5	323...528	B	25A-D010N114	25B-D010N114
7.5	5.5	7.5	5.5	13.0	323...528	C	25A-D013N114	25B-D013N114
10.0	7.5	10.0	7.5	17.0	323...528	C	25A-D017N114	25B-D017N114
15.0	11.0	15.0	11.0	24.0	323...528	D	25A-D024N114	25B-D024N114
20.0	15.0	15.0	11.0	30.0	323...528	D	25A-D030N114	25B-D030N114
25.0	18.5	20.0	15.0	37.0	323...528	E	25A-D037N114	25B-D037N114
30.0	22.0	25.0	18.5	43.0	323...528	E	25A-D043N114	25B-D043N114
<b>525...600V AC (-15%, +10%) - 3-Phase Input, 0...575V 3-Phase Output</b>								
0.5	0.4	0.5	0.4	0.9	446...660	A	25A-E0P9N104 <sup>(1)</sup>	25B-E0P9N104 <sup>(1)</sup>
1.0	0.75	1.0	0.75	1.7	446...660	A	25A-E1P7N104	25B-E1P7N104
2.0	1.5	2.0	1.5	3.0	446...660	A	25A-E3PON104	25B-E3PON104
3.0	2.2	3.0	2.2	4.2	446...660	A	25A-E4P2N104	25B-E4P2N104
5.0	4.0	5.0	4.0	6.6	446...660	B	25A-E6P6N104	25B-E6P6N104
7.5	5.5	7.5	5.5	9.9	446...660	C	25A-E9P9N104	25B-E9P9N104
10.0	7.5	10.0	7.5	12.0	446...660	C	25A-E012N104	25B-E012N104
15.0	11.0	15.0	11.0	19.0	446...660	D	25A-E019N104	25B-E019N104
20.0	15.0	15.0	11.0	22.0	446...660	D	25A-E022N104	25B-E022N104
25.0	18.5	20.0	15.0	27.0	446...660	E	25A-E027N104	25B-E027N104
30.0	22.0	25.0	18.5	32.0	446...660	E	25A-E032N104	25B-E032N104

(1) These drive ratings do not come with a heatsink cooling fan and are in accordance with design specifications.

(2) A non-filtered drive is not available for 380...480V AC 25 HP (18.5 kW) and 30 HP (22.0 kW) ratings. Filtered drives are available, however you must verify that the application will support a filtered drive.

## Dynamic Brake Resistors

Drive Ratings			Minimum Resistance $\Omega \pm 10\%$	Resistance $\Omega \pm 5\%$	Catalog No. <sup>(1)(2)</sup>
Input Voltage		HP			
100...120V 50/60 Hz 1-Phase	0.25	0.2	56	91	AK-R2-091P500
	0.5	0.4	56	91	AK-R2-091P500
	1.0	0.75	56	91	AK-R2-091P500
	1.5	1.1	41	91	AK-R2-091P500
200...240V 50/60 Hz 1-Phase	0.25	0.2	56	91	AK-R2-091P500
	0.5	0.4	56	91	AK-R2-091P500
	1.0	0.75	56	91	AK-R2-091P500
	2.0	1.5	41	91	AK-R2-091P500
	3.0	2.2	32	47	AK-R2-047P500

## Dynamic Brake Resistors (Continued)

Drive Ratings			Minimum Resistance $\Omega \pm 10\%$	Resistance $\Omega \pm 5\%$	Catalog No. (1)(2)
Input Voltage	HP	kW			
200...240V 50/60 Hz 3-Phase	0.25	0.2	56	91	AK-R2-091P500
	0.5	0.4	56	91	AK-R2-091P500
	1.0	0.75	56	91	AK-R2-091P500
	2.0	1.5	41	91	AK-R2-091P500
	3.0	2.2	32	47	AK-R2-047P500
	5.0	4.0	18	47	AK-R2-047P500
	7.5	5.5	16	30	AK-R2-030P1K2
	10.0	7.5	14	30	AK-R2-030P1K2
	15.0	11.0	14	15	AK-R2-030P1K2 <sup>(3)</sup>
	20.0	15.0	10	15	AK-R2-030P1K2 <sup>(3)</sup>
380...480V 50/60 Hz 3-Phase	0.5	0.4	89	360	AK-R2-360P500
	1.0	0.75	89	360	AK-R2-360P500
	2.0	1.5	89	360	AK-R2-360P500
	3.0	2.2	89	120	AK-R2-120P1K2
	5.0	4.0	47	120	AK-R2-120P1K2
	7.5	5.5	47	120	AK-R2-120P1K2
	10.0	7.5	47	120	AK-R2-120P1K2
	15.0	11.0	43	60	AK-R2-120P1K2 <sup>(3)</sup>
	20.0	15.0	43	60	AK-R2-120P1K2 <sup>(3)</sup>
	30.0	22.0	27	40	AK-R2-120P1K2 <sup>(4)</sup>
525...600V 50/60 Hz 3-Phase	0.5	0.4	112	360	AK-R2-360P500
	1.0	0.75	112	360	AK-R2-360P500
	2.0	1.5	112	360	AK-R2-360P500
	3.0	2.2	112	120	AK-R2-120P1K2
	5.0	4.0	86	120	AK-R2-120P1K2
	7.5	5.5	59	120	AK-R2-120P1K2
	10.0	7.5	59	120	AK-R2-120P1K2
	15.0	11.0	59	60	AK-R2-120P1K2 <sup>(3)</sup>
	20.0	15.0	59	60	AK-R2-120P1K2 <sup>(3)</sup>
	30.0	22.0	34	40	AK-R2-120P1K2 <sup>(4)</sup>

(1) The resistors listed in this tables are rated for 5% duty cycle.

(2) Use of Rockwell Automation resistors is always recommended. The resistors listed have been carefully selected for optimizing performance in a variety of applications. Alternative resistors may be used, however, care must be taken when making a selection. See the PowerFlex Dynamic Braking Resistor Calculator, publication [PFLEX-AT001](#).

(3) Requires two resistors wired in parallel.

(4) Requires three resistors wired in parallel.

## EMC Line Filters

## Short Circuit Current Rating = 100 kA

Drive Ratings				Frame Size	Catalog No.
Input Voltage	HP	kW	Current (A)		
100...120V 50/60 Hz 1-Phase	0.25	0.2	1.6	A	25-RF011-AL
	0.5	0.4	2.5	A	25-RF011-AL
	1.0	0.75	4.8	B	25-RF023-BL
	1.5	1.1	6.0	B	25-RF023-BL

### EMC Line Filters (Continued)

Short Circuit Current Rating = 100 kA

Drive Ratings				Frame Size	Catalog No.	
Input Voltage	HP	kW	Current (A)			
200...240V 50/60 Hz 1-Phase	0.25	0.2	1.6	A	25-RF011-AL	
	0.5	0.4	2.5	A	25-RF011-AL	
	1.0	0.75	4.8	A	25-RF011-AL	
	2.0	1.5	8.0	B	25-RF023-BL	
	3.0	2.2	11.0	B	25-RF023-BL	
200...240V 50/60 Hz 3-Phase	0.25	0.2	1.6	A	25-RF014-AL	
	0.5	0.4	2.5	A	25-RF014-AL	
	1.0	0.75	5.0	A	25-RF014-AL	
	2.0	1.5	8.0	A	25-RF014-AL	
	3.0	2.2	11.0	A	25-RF014-AL	
	5.0	4.0	17.5	B	25-RF021-BL	
	7.5	5.5	24.0	C	25-RF027-CL	
	10.0	7.5	32.2	D	25-RF035-DL	
	15.0	11.0	48.3	E	25-RF056-EL	
380...480V 50/60 Hz 3-Phase	0.5	0.4	1.4	A	25-RF7P5-AL	
	1.0	0.75	2.3	A	25-RF7P5-AL	
	2.0	1.5	4.0	A	25-RF7P5-AL	
	3.0	2.2	6.0	A	25-RF7P5-AL	
	5.0	4.0	10.5	B	25-RF014-BL	
	7.5	5.5	13.0	C	25-RF018-CL	
	10.0	7.5	17.0	C	25-RF018-CL	
	15.0	11.0	24.0	D	25-RF033-DL	
	20.0	15.0	30.0	D	25-RF033-DL	
	25.0	18.5	37.0	E	25-RF039-EL	
	30.0	22.0	43.0	E	25-RF039-EL <sup>(1)</sup>	
	525...600V 50/60 Hz 3-Phase	0.5	0.4	0.9	A	25-RF8P0-BL <sup>(2)</sup>
		1.0	0.75	1.7	A	25-RF8P0-BL <sup>(2)</sup>
2.0		1.5	3.0	A	25-RF8P0-BL <sup>(2)</sup>	
3.0		2.2	4.2	A	25-RF8P0-BL <sup>(2)</sup>	
5.0		4.0	6.6	B	25-RF8P0-BL	
7.5		5.5	9.9	C	25-RF014-CL	
10.0		7.5	12.0	C	25-RF014-CL	
15.0		11.0	19.0	D	25-RF027-DL	
20.0		15.0	22.0	D	25-RF027-DL	
25.0		18.5	27.0	E	25-RF029-EL	
30.0		22.0	32.0	E	25-RF029-EL <sup>(1)</sup>	

(1) EMC Line Filter size is based on the input current of the drive. See the tables on page 26 and page 27 for more information.  
 (2) This 600V drive rating must be matched with a frame B EMC Line Filter.

### EMC Plates

Item	Description	Frame Size	Catalog No.
EMC Plate	Optional grounding plate for shielded cables.	A	25-EMC1-FA
		B	25-EMC1-FB
		C	25-EMC1-FC
		D	25-EMC1-FD
		E	25-EMC1-FE



## Human Interface Module (HIM) Option Kits and Accessories

Item	Description	Catalog No.
LCD Display, Remote Panel Mount	Digital speed control CopyCat capable IP66 (NEMA Type 4X/12) indoor use only Includes 2.0 meter cable	22-HIM-C2S
LCD Display, Remote Handheld	Digital speed control Full numeric keyboard CopyCat capable IP 30 (NEMA Type 1) Includes 1.0 meter cable Panel mount with optional Bezel Kit	22-HIM-A3
Bezel Kit	Panel mount for LCD Display, Remote Handheld unit, IP 30 (NEMA Type 1) Includes 2.0 m DSI cable	22-HIM-B1
DSI HIM Cable (DSI HIM to RJ45 cable)	1.0 m (3.3 ft)	22-HIM-H10
	2.9 m (9.51 ft)	22-HIM-H30

## IP 30/NEMA 1/UL Type 1 Kit

Item	Description	Frame Size	Catalog No.
IP 30/NEMA 1/UL Type 1 Kit	Field installed kit. Converts drive to IP 30/NEMA 1/UL Type 1 enclosure. Includes conduit box with mounting screws and plastic top panel.	A	25-JBAA
		B	25-JBAB
		C	25-JBAC
		D	25-JBAD
		E	25-JBAE

## Control Module Fan Kit

Item	Description	Frame Size	Catalog No.
Control Module Fan Kit	For use with drive in environments with ambient temperatures up to 70 °C or horizontal mounting.	A...D	25-FAN1-70C
		E	25-FAN2-70C

## Incremental Encoder Input Option

Item	Description	Catalog No.
Incremental Encoder	Incremental encoder input option board.	25-ENC-1



**WARNING:** Only the 25-ENC-1 Encoder will work properly in the PowerFlex 525 drive. Installing an incorrect encoder card, such as the PowerFlex 527 25-ENC-2 will cause damage to the PowerFlex 525 drive.

## PowerFlex 520-Series Drives Jumper Spare Kit

Item	Description	Catalog No.
<ul style="list-style-type: none"> <li>Wire Jumper</li> <li>MOV Jumper</li> <li>Protective Jumper (Control I/O terminal block)</li> <li>Analog/Signal Configuration Jumper</li> </ul>	Replace the Protective Jumper from your Power module, drive Terminals Safety 1, Safety 2 and Safety +24V (S1, S2, S+) of the Control Module.	25-ACCS-Drive

## PowerFlex 520 Series Communication Adapter Spare Kit

Item	Description	Catalog No.
<ul style="list-style-type: none"> <li>PowerFlex 525 Encoder card removable Terminal Block</li> <li>PowerFlex 523/525 Communication Adapter interface connector</li> </ul>	Communication adapter spare kits	25-ACCS-COMM

**Bulletin 160 to PowerFlex 520-Series Mounting Adapter Plate**

Item	Description	B160 Frame Size	Catalog No.
Mounting Adapter Plate	For use with drive when replacing Bulletin 160 drives in existing installations to a PowerFlex 520-Series drive. Select the catalog number based on the frame size of your Bulletin 160 drive.	A	25-MAP-FA
		B	25-MAP-FB

**Mounting Adapter Plate for PowerFlex 4 AC Drive to PowerFlex 520-Series**

Drive Ratings			PowerFlex 4		PowerFlex 520-series		
Input Voltage	HP	kW	Catalog No.	Frame Size	Catalog No.	Catalog No. with external EMC Filter <sup>(1)</sup>	
100 ...120V, Single-Phase, 50/60 Hz	0.3	0.2	22A-V1P5N104	A	25-APO-FA	25-AP1-FA	
	0.5	0.4	22A-V2P3N104	A			
	1.0	0.8	22A-V4P5N104	B	25-APO-FB	25-AP1-FB	
	1.5	1.1	22A-V6P0N104	B			
200...240V, Single-Phase, 50/60 Hz	0.3	0.2	22A-A1P5N104	A	25-APO-FA	25-AP1-FA	
	0.5	0.4	22A-A2P3N104	A			
	1.0	0.8	22A-A4P5N104	A			
	2.0	1.5	22A-A8P0N104	B	25-APO-FB	25-AP1-FB	
	<b>No Brake IGBT</b>						
	0.3	0.2	22A-A1P4N103	A	25-APO-FA	25-AP1-FA	
	0.5	0.4	22A-A2P1N103	A			
	1.0	0.8	22A-A3P6N103	A			
	2.0	1.5	22A-A6P8N103	B	25-APO-FB	25-AP1-FB	
	3.0	2.2	22A-A9P6N103	B			
200...240V, Single-Phase, 50/60 Hz, with integral EMC Filter	0.3	0.2	22A-A1P5N114	A	25-APO-FA	25-AP1-FA	
	0.5	0.4	22A-A2P3N114	A			
	1.0	0.8	22A-A4P5N114	A			
	2.0	1.5	22A-A8P0N114	B	25-APO-FB	25-AP1-FB	
	<b>No Brake IGBT</b>						
	0.3	0.2	22A-A1P4N113	A	25-APO-FA	25-AP1-FA	
	0.5	0.4	22A-A2P1N113	A			
	1.0	0.8	22A-A3P6N113	A			
	2.0	1.5	22A-A6P8N113	B	25-APO-FB	25-AP1-FB	
	3.0	2.2	22A-A9P6N113	B			
200...240V, Three-Phase, 50/60 Hz	0.3	0.2	22A-B1P5N104	A	25-APO-FA	25-AP1-FA	
	0.5	0.4	22A-B2P3N104	A			
	1.0	0.8	22A-B4P5N104	A			
	2.0	1.5	22A-B8P0N104	A	25-APO-FB	25-AP1-FB	
	3.0	2.2	22A-B012N104	B			
	5.0	3.7	22A-B017N104	B			
380...480V, Three-Phase 50/60 Hz	0.5	0.4	22A-D1P4N104	A	25-APO-FA	25-AP1-FA	
	1.0	0.8	22A-D2P3N104	A			
	2.0	1.5	22A-D4P0N104	A			
	3.0	2.2	22A-D6P0N104	B	25-APO-FB	25-AP1-FB	
	5.0	3.7	22A-D8P7N104	B			

(1) The adapter plate catalogs starting with 25-AP1-Fx are used to replace PowerFlex 4/40/40P IP20 drives with external EMC filter to PowerFlex 520-series drives with external EMC filter only.

## Mounting Adapter Plate for PowerFlex 40 AC Drive to PowerFlex 520-Series

Drive Ratings			PowerFlex 40		PowerFlex 520-series	
Input Voltage	HP	kW	Catalog No.	Frame Size	Catalog No.	Catalog No. with external EMC Filter <sup>(1)</sup>
100 ...120V, Single-Phase, 50/60 Hz	0.5	0.4	22B-V2P3N104	B	25-APO-FB	25-API-FB
	1.0	0.8	22B-V5P0N104	B		
	1.5	1.1	22B-V6P0N104	B		
200...240V, Single-Phase, 50/60 Hz	0.5	0.4	22B-A2P3N104	B	25-APO-FB	25-API-FB
	1.0	0.8	22B-A5P0N104	B		
	2.0	1.5	22B-A8P0N104	B		
	3.0	2.2	22B-A012N104	C	25-APO-FC	25-API-FC
200...240V, Single-Phase, 50/60 Hz, with integral EMC Filter	0.5	0.4	22B-A2P3N114	B	25-APO-FB	25-API-FB
	1.0	0.8	22B-A5P0N114	B		
	2.0	1.5	22B-A8P0N114	B		
	3.0	2.2	22B-A012N114	C	25-APO-FC	25-API-FC
200...240V, Three-Phase, 50/60 Hz	0.5	0.4	22B-B2P3N104	B	25-APO-FB	25-API-FB
	1.0	0.8	22B-B5P0N104	B		
	2.0	1.5	22B-B8P0N104	B		
	3.0	2.2	22B-B012N104	B		
	5.0	3.7	22B-B017104	B		
	7.5	5.5	22B-B024N104	C	25-APO-FC	25-API-FC
	10.0	7.5	22B-B033N104	C	25-APO-FD	_(2)
380...480V, Three-Phase 50/60 Hz	0.5	0.4	22B-D1P4N104	B	25-APO-FB	25-API-FB
	1.0	0.8	22B-D2P3N104	B		
	2.0	1.5	22B-D4P0N104	B		
	3.0	2.2	22B-D6P0N104	B		
	5.0	3.7	22B-D010N104	B		
	7.5	5.5	22B-D012N104	C	25-APO-FC	25-API-FC
	10.0	7.5	22B-D017N104	C	25-APO-FC	25-API-FC
	15.0	11.0	22B-D024N104	C	25-APO-FD	_(2)
525...600V, Three-Phase 50/60 Hz	1.0	0.8	22B-E1P7N104	B	25-APO-FB	25-API-FB
	2.0	1.5	22B-E3P0N104	B		
	3.0	2.2	22B-E4P2N104	B		
	5.0	3.7	22B-E6P6N104	B		
	7.5	5.5	22B-E9P9N104	C	25-APO-FC	25-API-FC
	10.0	7.5	22B-E012N104	C	25-APO-FC	25-API-FC
	15.0	11.0	22B-E019N104	C	25-APO-FD	_(2)

(1) The adapter plate catalogs starting with 25-API-Fx are used to replace PowerFlex 4/40/40P IP20 drives with external EMC filter to PowerFlex 520-series drives with external EMC filter only.

(2) Mounting Adapter Plate is not required for the following ratings, as it comes with matching footprint and mounting holes.

- Three-Phase 200...240V: 7.5 kW/10 HP
- Three-Phase 380...480V: 11 kW/15 HP
- Three-Phase 500...600V: 11 kW/15 HP

### Mounting Adapter Plate for PowerFlex 40P AC Drive to PowerFlex 520-Series

Drive Ratings			PowerFlex 40P		PowerFlex 520-series	
Input Voltage	HP	kW	Catalog No.	Frame Size	Catalog No.	Catalog No. with external EMC Filter <sup>(1)</sup>
200...240V, Three-Phase, 50/60 Hz	0.5	0.4	22D-B2P3N104	B	25-APO-FB	25-API-FB
	1.0	0.8	22D-B5P0N104	B		
	2.0	1.5	22D-B8P0N104	B		
	3.0	2.2	22D-B012N104	B		
	5.0	3.7	22D-B017N104	B		
	7.5	5.5	22D-B024N104	C	25-APO-FC	25-API-FC
	10.0	7.5	22D-B033N104	C	25-APO-FD	_(2)
380...480V, Three-Phase 50/ 60 Hz	0.5	0.4	22D-D1P4N104	B	25-APO-FB	25-API-FB
	1.0	0.8	22D-D2P3N104	B		
	2.0	1.5	22D-D4P0N104	B		
	3.0	2.2	22D-D6P0N104	B		
	5.0	3.7	22D-D010N104	B		
	7.5	5.5	22D-D012N104	C	25-APO-FC	25-API-FC
	10.0	7.5	22D-D017N104	C	25-APO-FD	_(2)
	15.0	11.0	22D-D024N104	C	25-APO-FD	_(2)
525...600V, Three-Phase 50/ 60 Hz	1.0	0.8	22D-E1P7N104	B	25-APO-FB	25-API-FB
	2.0	1.5	22D-E3P0N104	B		
	3.0	2.2	22D-E4P2N104	B		
	5.0	3.7	22D-E6P6N104	B		
	7.5	5.5	22D-E9P9N104	C	25-APO-FC	25-API-FC
	10.0	7.5	22D-E012N104	C	25-APO-FD	_(2)
	15.0	11.0	22D-E019N104	C	25-APO-FD	_(2)

(1) The adapter plate catalogs starting with 25-API-Fx are used to replace PowerFlex 4/40/40P IP20 drives with external EMC filter to PowerFlex 520-series drives with external EMC filter only.

(2) Mounting Adapter Plate is not required for the following ratings, as it comes with matching footprint and mounting holes.

- Three-Phase 200...240V: 7.5 kW/10 HP
- Three-Phase 380...480V: 11 kW/15 HP
- Three-Phase 500...600V: 11 kW/15 HP

### Replacement Parts

#### PowerFlex 520-Series Power Module

Item	Description
PowerFlex 520-Series Power Module	Replacement power module for use with PowerFlex 520-Series drives. Includes: <ul style="list-style-type: none"> <li>• Power Module</li> <li>• Power Module Front Cover</li> <li>• Power Terminal Guard</li> <li>• Heatsink Fan</li> </ul>

Output Ratings					Input Voltage Range	Frame Size	Catalog No.
Normal Duty		Heavy Duty		Output Current (A)			
HP	kW	HP	kW				
<b>100...120V AC (-15%, +10%) - 1-Phase Input, 0...230V 3-Phase Output</b>							
0.25	0.2	0.25	0.2	1.6	85...132	A	25-PM1-V1P6
0.5	0.4	0.5	0.4	2.5	85...132	A	25-PM1-V2P5
1.0	0.75	1.0	0.75	4.8	85...132	B	25-PM1-V4P8
1.5	1.1	1.5	1.1	6.0	85...132	B	25-PM1-V6P0
<b>200...240V AC (-15%, +10%) - 1-Phase Input, 0...230V 3-Phase Output</b>							
0.25	0.2	0.25	0.2	1.6	170...264	A	25-PM1-A1P6
0.5	0.4	0.5	0.4	2.5	170...264	A	25-PM1-A2P5

Output Ratings (Continued)					Input Voltage Range	Frame Size	Catalog No.
Normal Duty		Heavy Duty		Output Current (A)			
HP	kW	HP	kW				
1.0	0.75	1.0	0.75	4.8	170...264	A	25-PM1-A4P8
2.0	1.5	2.0	1.5	8.0	170...264	B	25-PM1-A8P0
3.0	2.2	3.0	2.2	11.0	170...264	B	25-PM1-A011
<b>200...240V AC (-15%, +10%) - 1-Phase Input with EMC Filter, 0...230V 3-Phase Output</b>							
0.25	0.2	0.25	0.2	1.6	170...264	A	25-PM2-A1P6
0.5	0.4	0.5	0.4	2.5	170...264	A	25-PM2-A2P5
1.0	0.75	1.0	0.75	4.8	170...264	A	25-PM2-A4P8
2.0	1.5	2.0	1.5	8.0	170...264	B	25-PM2-A8P0
3.0	2.2	3.0	2.2	11.0	170...264	B	25-PM2-A011
<b>200...240V AC (-15%, +10%) - 3-Phase Input, 0...230V 3-Phase Output</b>							
0.25	0.2	0.25	0.2	1.6	170...264	A	25-PM1-B1P6
0.5	0.4	0.5	0.4	2.5	170...264	A	25-PM1-B2P5
1.0	0.75	1.0	0.75	5.0	170...264	A	25-PM1-B5P0
2.0	1.5	2.0	1.5	8.0	170...264	A	25-PM1-B8P0
3.0	2.2	3.0	2.2	11.0	170...264	A	25-PM1-B011
5.0	4.0	5.0	4.0	17.5	170...264	B	25-PM1-B017
7.5	5.5	7.5	5.5	24.0	170...264	C	25-PM1-B024
10.0	7.5	10.0	7.5	32.2	170...264	D	25-PM1-B032
15.0	11.0	10.0	7.5	48.3	170...264	E	25-PM1-B048
20.0	15.0	15.0	11.0	62.1	170...264	E	25-PM1-B062
<b>380...480V AC (-15%, +10%) - 3-Phase Input, 0...460V 3-Phase Output</b>							
0.5	0.4	0.5	0.4	1.4	323...528	A	25-PM1-D1P4
1.0	0.75	1.0	0.75	2.3	323...528	A	25-PM1-D2P3
2.0	1.5	2.0	1.5	4.0	323...528	A	25-PM1-D4P0
3.0	2.2	3.0	2.2	6.0	323...528	A	25-PM1-D6P0
5.0	4.0	5.0	4.0	10.5	323...528	B	25-PM1-D010
7.5	5.5	7.5	5.5	13.0	323...528	C	25-PM1-D013
10.0	7.5	10.0	7.5	17.0	323...528	C	25-PM1-D017
15.0	11.0	15.0	11.0	24.0	323...528	D	25-PM1-D024
20.0	15.0	15.0	11.0	30.0	323...528	D	25-PM1-D030
<b>380...480V AC (-15%, +10%) - 3-Phase Input with EMC Filter, 0...460V 3-Phase Output</b>							
0.5	0.4	0.5	0.4	1.4	323...528	A	25-PM2-D1P4
1.0	0.75	1.0	0.75	2.3	323...528	A	25-PM2-D2P3
2.0	1.5	2.0	1.5	4.0	323...528	A	25-PM2-D4P0
3.0	2.2	3.0	2.2	6.0	323...528	A	25-PM2-D6P0
5.0	4.0	5.0	4.0	10.5	323...528	B	25-PM2-D010
7.5	5.5	7.5	5.5	13.0	323...528	C	25-PM2-D013
10.0	7.5	10.0	7.5	17.0	323...528	C	25-PM2-D017
15.0	11.0	15.0	11.0	24.0	323...528	D	25-PM2-D024
20.0	15.0	15.0	11.0	30.0	323...528	D	25-PM2-D030
25.0	18.5	20.0	15.0	37.0	323...528	E	25-PM2-D037
30.0	22.0	25.0	18.5	43.0	323...528	E	25-PM2-D043
<b>525...600V AC (-15%, +10%) - 3-Phase Input, 0...575V 3-Phase Output</b>							
0.5	0.4	0.5	0.4	0.9	446...660	A	25-PM1-E0P9
1.0	0.75	1.0	0.75	1.7	446...660	A	25-PM1-E1P7
2.0	1.5	2.0	1.5	3.0	446...660	A	25-PM1-E3P0
3.0	2.2	3.0	2.2	4.2	446...660	A	25-PM1-E4P2
5.0	4.0	5.0	4.0	6.6	446...660	B	25-PM1-E6P6
7.5	5.5	7.5	5.5	9.9	446...660	C	25-PM1-E9P9
10.0	7.5	10.0	7.5	12.0	446...660	C	25-PM1-E012
15.0	11.0	15.0	11.0	19.0	446...660	D	25-PM1-E019

Output Ratings (Continued)					Input Voltage Range	Frame Size	Catalog No.
Normal Duty		Heavy Duty		Output Current (A)			
HP	kW	HP	kW				
20.0	15.0	15.0	11.0	22.0	446...660	D	25-PM1-E022
25.0	18.5	20.0	15.0	27.0	446...660	E	25-PM1-E027
30.0	22.0	25.0	18.5	32.0	446...660	E	25-PM1-E032

**PowerFlex 520-Series Control Module**

Item	Description	Frame Size	Catalog No.
PowerFlex 523 Control Module	Replacement control module for use with PowerFlex 520-Series drives. Includes: <ul style="list-style-type: none"> <li>Control Module</li> <li>Control Module Front Cover</li> </ul>	A...E	25A-CTM1
PowerFlex 525 Control Module			25B-CTM1

**Other Parts**

Item	Description	Frame Size	Catalog No.
PowerFlex 523 Control Module Front Cover	Replacement cover for the control module I/O terminals, EtherNet/IP, and DSI ports.	A...E	25A-CTMFC1
PowerFlex 525 Control Module Front Cover			25B-CTMFC1
PowerFlex 520-Series Power Module Front Cover	Replacement cover for the PowerFlex 520-Series power module.	B	25-PMFC-FB
		C	25-PMFC-FC
		D	25-PMFC-FD
		E	25-PMFC-FE
PowerFlex 520-Series Power Terminal Guard	Replacement finger guard for power terminals.	A	25-PTG1-FA
		B	25-PTG1-FB
		C	25-PTG1-FC
		D	25-PTG1-FD
		E	25-PTG1-FE
PowerFlex 520-Series Heatsink Fan Kit	Replacement fan for drive power module.	A	25-FAN1-FA
		B	25-FAN1-FB
		C	25-FAN1-FC
		D	25-FAN1-FD
		E	25-FAN1-FE
PowerFlex 520-Series EMC Cores	Replacement EMC cores	A	25-CORE-A
			25-CORE-RF-A
		B	25-CORE-B
			25-CORE-RF-B
		C	25-CORE-C
			25-CORE-RF-C
		D	25-CORE-D
			25-CORE-RF-D
		E	25-CORE-E
			25-CORE-RF-E

## Communication Option Kits and Accessories

Item	Description	Catalog No.
Communication Adapters	Embedded communication options for use with the PowerFlex 520-Series drives: <ul style="list-style-type: none"> <li>• DeviceNet®</li> <li>• Dual-port EtherNet/IP</li> <li>• PROFIBUS DP-V1</li> </ul>	25-COMM-D 25-COMM-E2P 25-COMM-P 25-ACCS-COMM
Compact I/O™ Module	Three channels	1769-SM2
Universal Serial Bus (USB) Converter Module	Provides serial communication with DF1 protocol for use with Connected Components Workbench software. Includes: <ul style="list-style-type: none"> <li>• 2 m USB cable (1)</li> <li>• 20-HIM-H10 cable (1)</li> <li>• 22-HIM-H10 cable (1)</li> </ul>	1203-USB
Serial Converter Module (RS485 to RS232)	Provides serial communication with DF1 protocol for use with Connected Components Workbench software. Includes: <ul style="list-style-type: none"> <li>• DSI to RS232 serial converter (1)</li> <li>• 1203-SFC serial cable (1)</li> <li>• 22-RJ45CBL-C20 cable (1)</li> </ul>	22-SCM-232
DSI Cable	2.0 m RJ45 to RJ45 cable, male to male connectors.	22-RJ45CBL-C20
Serial Cable	2.0 m serial cable with a locking low profile connector to connect to the serial converter and a 9-pin sub-miniature D female connector to connect to a computer.	1203-SFC
Splitter Cable	RJ45 one to two port splitter cable (Modbus only)	AK-U0-RJ45-SC1
Terminating Resistors	RJ45 120 Ohm resistors (2 pieces)	AK-U0-RJ45-TR1
Terminal Block	RJ45 Two position terminal block (5 pieces)	AK-U0-RJ45-TB2P
Connected Components Workbench Software (Download via the Software Subscription Portal or DVD-ROM) <a href="http://rok.auto/ccw">rok.auto/ccw</a>	Windows-based software packages for programming and configuring Allen-Bradley® drives and other Rockwell Automation products. Compatibility: Windows XP, Windows Vista and Windows 7	<a href="http://rok.auto/ccw">rok.auto/ccw</a>

## Bulletin 1321-3R Series Line Reactors

Output Ratings <sup>(1)</sup>				Input Line Reactor <sup>(2)(4)</sup>		Output Line Reactor <sup>(2)(3)</sup>	
Normal Duty		Heavy Duty		IP00 (Open Style)	IP11 (NEMA/UL Type 1)	IP00 (Open Style)	IP11 (NEMA/UL Type 1)
HP	kW	HP	kW	Catalog No.	Catalog No.	Catalog No.	Catalog No.
<b>200...240V 50/60 Hz 1-Phase<sup>(4)</sup></b>							
0.25	0.2	0.25	0.2	1321-3R4-A	1321-3RA4-A	1321-3R2-D	1321-3RA2-D
0.5	0.4	0.5	0.4	1321-3R8-A	1321-3RA8-A	1321-3R2-D	1321-3RA2-D
1.0	0.75	1.0	0.75	1321-3R8-A	1321-3RA8-A	1321-3R4-A	1321-3RA4-A
2.0	1.5	2.0	1.5	1321-3R18-A	1321-3RA18-A	1321-3R8-A	1321-3RA8-A
3.0	2.2	3.0	2.2	1321-3R18-A	1321-3RA18-A	1321-3R12-A	1321-3RA12-A
<b>200...240V 50/60 Hz 3-Phase</b>							
0.25	0.2	0.25	0.2	1321-3R2-D	1321-3RA2-D	1321-3R2-D	1321-3RA2-D
0.5	0.4	0.5	0.4	1321-3R2-D	1321-3RA2-D	1321-3R2-D	1321-3RA2-D
1.0	0.75	1.0	0.75	1321-3R4-A	1321-3RA4-A	1321-3R4-A	1321-3RA4-A
2.0	1.5	2.0	1.5	1321-3R8-A	1321-3RA8-A	1321-3R8-A	1321-3RA8-A
3.0	2.2	3.0	2.2	1321-3R12-A	1321-3RA12-A	1321-3R12-A	1321-3RA12-A
5.0	4.0	5.0	4.0	1321-3R18-A	1321-3RA18-A	1321-3R18-A	1321-3RA18-A
7.5	5.5	7.5	5.5	1321-3R25-A	1321-3RA25-A	1321-3R25-A	1321-3RA25-A
10.0	7.5	10.0	7.5	1321-3R35-A	1321-3RA35-A	1321-3R35-A	1321-3RA35-A
15.0	11.0	10.0	7.5	1321-3R45-A	1321-3RA45-A	1321-3R45-A	1321-3RA45-A
20.0	15.0	15.0	11.0	1321-3R55-A (ND) 1321-3R45-A (HD)	1321-3RA55-A (ND) 1321-3RA45-A (HD)	1321-3R55-A (ND) 1321-3R45-A (HD)	1321-3RA55-A (ND) 1321-3RA45-A (HD)
<b>380...480V 50/60 Hz 3-Phase</b>							

**Bulletin 1321-3R Series Line Reactors (Continued)**

Output Ratings <sup>(1)</sup>				Input Line Reactor <sup>(2)(4)</sup>		Output Line Reactor <sup>(2)(3)</sup>	
Normal Duty		Heavy Duty		IP00 (Open Style)	IP11 (NEMA/UL Type 1)	IP00 (Open Style)	IP11 (NEMA/UL Type 1)
HP	kW	HP	kW	Catalog No.	Catalog No.	Catalog No.	Catalog No.
0.5	0.4	0.5	0.4	1321-3R2-B	1321-3RA2-B	1321-3R2-B	1321-3RA2-B
1.0	0.75	1.0	0.75	1321-3R4-C	1321-3RA4-C	1321-3R4-C	1321-3RA4-C
2.0	1.5	2.0	1.5	1321-3R4-B	1321-3RA4-B	1321-3R4-B	1321-3RA4-B
3.0	2.2	3.0	2.2	1321-3R8-C	1321-3RA8-C	1321-3R8-C	1321-3RA8-C
5.0	4.0	5.0	4.0	1321-3R12-B	1321-3RA12-B	1321-3R12-B	1321-3RA12-B
7.5	5.5	7.5	5.5	1321-3R12-B	1321-3RA12-B	1321-3R12-B	1321-3RA12-B
10.0	7.5	10.0	7.5	1321-3R18-B	1321-3RA18-B	1321-3R18-B	1321-3RA18-B
15.0	11.0	15.0	11.0	1321-3R25-B	1321-3RA25-B	1321-3R25-B	1321-3RA25-B
20.0	15.0	15.0	11.0	1321-3R35-B (ND) 1321-3R25-B (HD)	1321-3RA35-B (ND) 1321-3RA25-B (HD)	1321-3R35-B (ND) 1321-3R25-B (HD)	1321-3RA35-B (ND) 1321-3RA25-B (HD)
25.0	18.5	20.0	15.0	1321-3R35-B	1321-3RA35-B	1321-3R35-B	1321-3RA35-B
30.0	22.0	25.0	18.5	1321-3R45-B (ND) 1321-3R35-B (HD)	1321-3RA45-B (ND) 1321-3RA35-B (HD)	1321-3R45-B (ND) 1321-3R35-B (HD)	1321-3RA45-B (ND) 1321-3RA35-B (HD)
<b>525...600V 50/60 Hz 3-Phase</b>							
0.5	0.4	0.5	0.4	1321-3R1-C	1321-3RA1-C	1321-3R1-C	1321-3RA1-C
1.0	0.75	1.0	0.75	1321-3R2-B	1321-3RA2-B	1321-3R2-B	1321-3RA2-B
2.0	1.5	2.0	1.5	1321-3R4-C	1321-3RA4-C	1321-3R4-C	1321-3RA4-C
3.0	2.2	3.0	2.2	1321-3R4-B	1321-3RA4-B	1321-3R4-B	1321-3RA4-B
5.0	4.0	5.0	4.0	1321-3R8-C	1321-3RA8-C	1321-3R8-C	1321-3RA8-C
7.5	5.5	7.5	5.5	1321-3R12-B	1321-3RA12-B	1321-3R12-B	1321-3RA12-B
10.0	7.5	10.0	7.5	1321-3R12-B	1321-3RA12-B	1321-3R12-B	1321-3RA12-B
15.0	11.0	15.0	11.0	1321-3R18-B	1321-3RA18-B	1321-3R18-B	1321-3RA18-B
20.0	15.0	15.0	11.0	1321-3R25-B (ND) 1321-3R18-B (HD)	1321-3RA25-B (ND) 1321-3RA18-B (HD)	1321-3R25-B (ND) 1321-3R18-B (HD)	1321-3RA25-B (ND) 1321-3RA18-B (HD)
25.0	18.5	20.0	15.0	1321-3R35-C (ND) 1321-3R25-C (HD)	1321-3RA35-C (ND) 1321-3RA25-C (HD)	1321-3R35-C (ND) 1321-3R25-C (HD)	1321-3RA35-C (ND) 1321-3RA25-C (HD)
30.0	22.0	25.0	18.5	1321-3R35-C (ND) 1321-3R25-B (HD)	1321-3RA35-C (ND) 1321-3RA25-B (HD)	1321-3R35-C (ND) 1321-3R25-B (HD)	1321-3RA35-C (ND) 1321-3RA25-B (HD)

- (1) Normal Duty and Heavy-Duty ratings for 15 HP (11 kW) and below are identical except for 200...240V 3-Phase 15 HP (11 kW) drive.
- (2) Catalog numbers listed are for 3% impedance at 60 Hz. 5% impedance reactor types are also available. See publication [1321-TD001](#).
- (3) Input line reactors were sized based on the NEC fundamental motor amps. Output line reactors were sized based on the VFD rated output currents.
- (4) Standard 3-phase reactors can be used for 1-phase applications by routing each of the two supply conductors through an outside coil and leaving the center open.

**Product Dimensions**

The PowerFlex 520-series drive is available in five frame sizes. See the [PowerFlex 520-Series Drive Ratings on page 173](#) for information on power ratings.

**PowerFlex 520-Series Drive Weight**

Frame Size	Weight (kg/lb)
A	1.1 / 2.4
B	1.6 / 3.5
C	2.3 / 5.0
D	3.9 / 8.6
E	12.9 / 28.4



### IP 20/Open Type - Frame A

Dimensions are in millimeters and (inches)

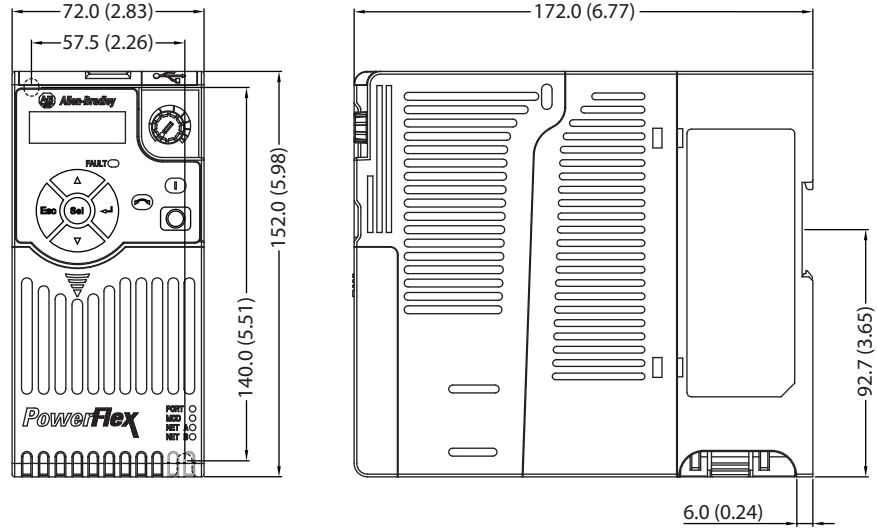

### IP 20/Open Type - Frame B

Dimensions are in millimeters and (inches)

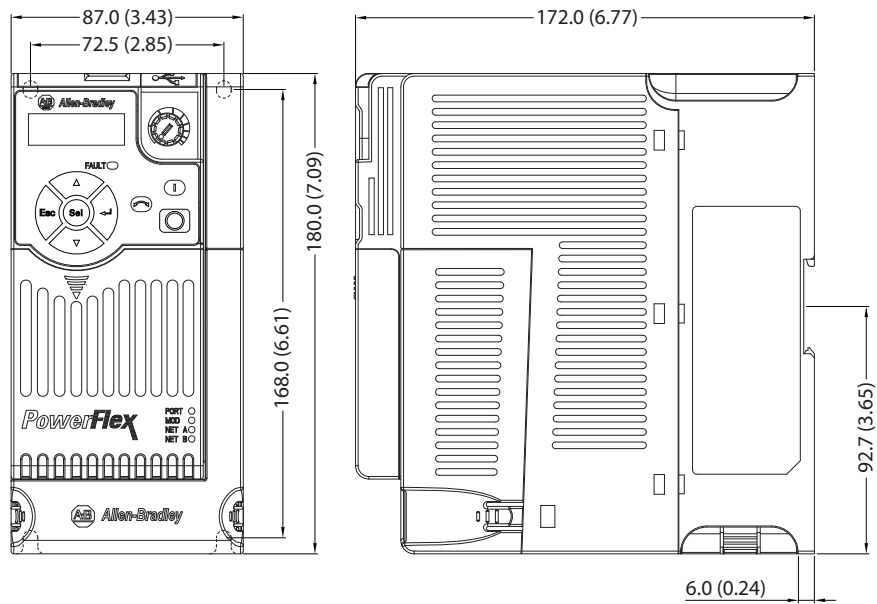

### IP 20/Open Type - Frame C

Dimensions are in millimeters and (inches)

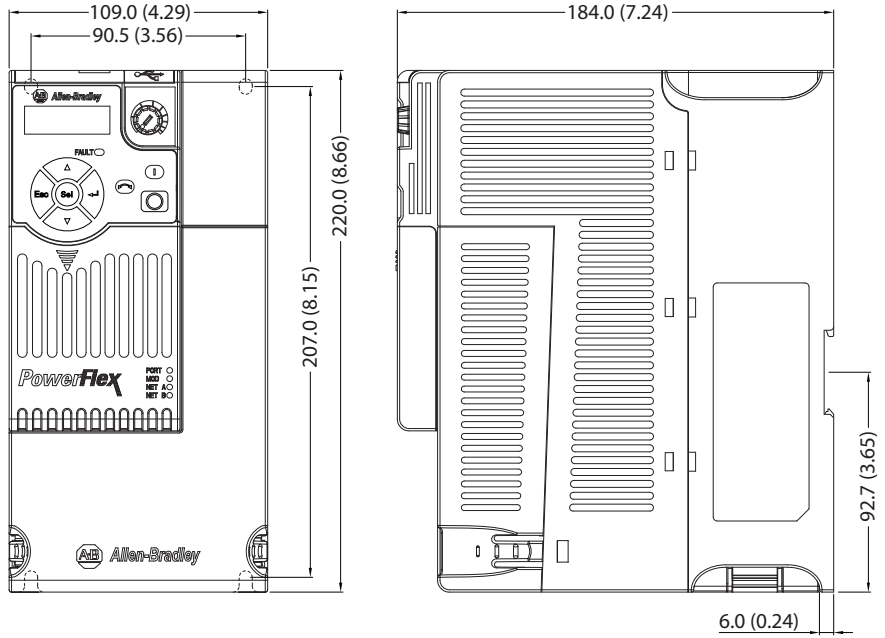

### IP 20/Open Type - Frame D

Dimensions are in millimeters and (inches)

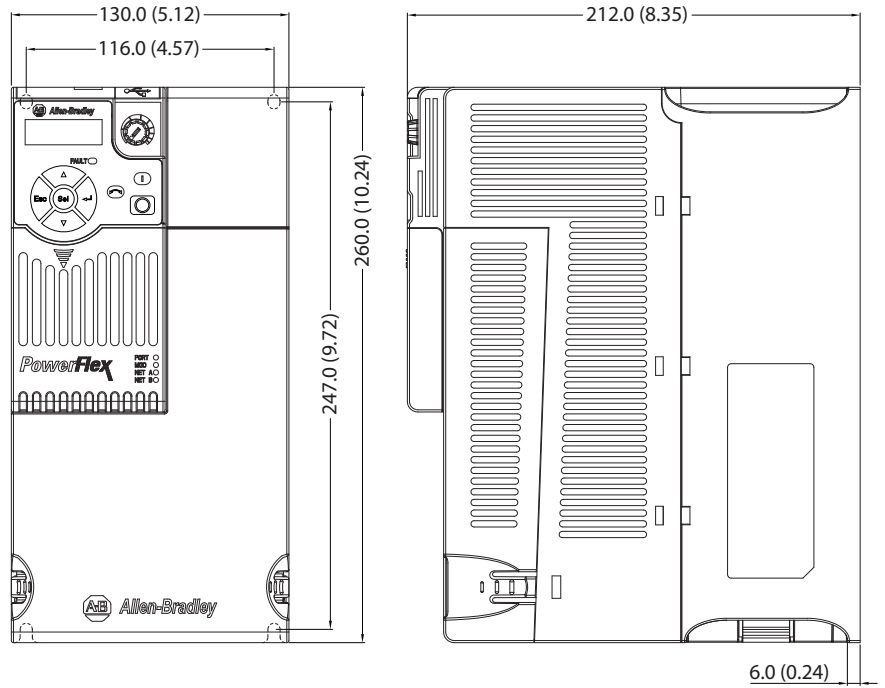

### IP 20/Open Type - Frame E

Dimensions are in millimeters and (inches)

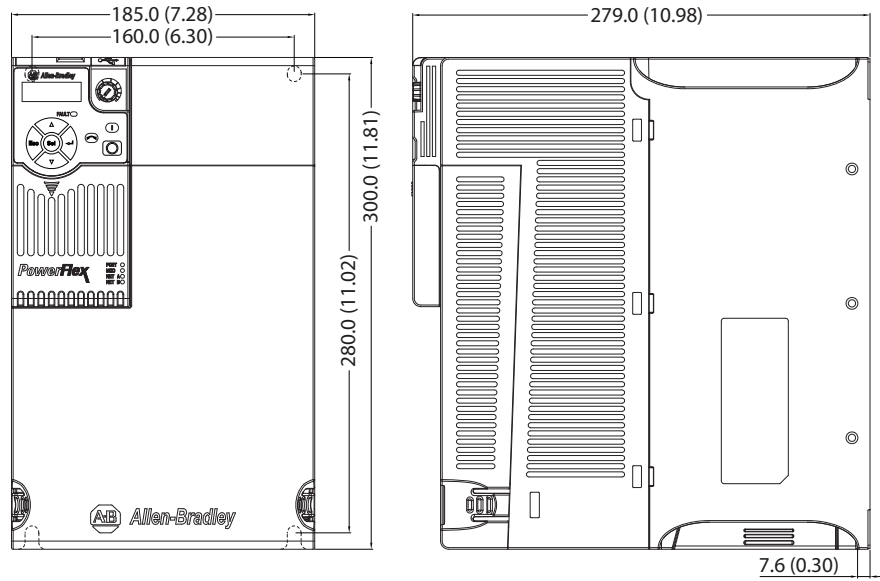

### Control Module Fan Kit

25-FAN1-70C

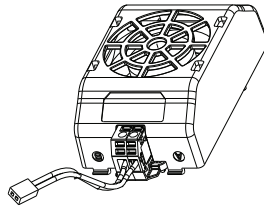

25-FAN2-70C

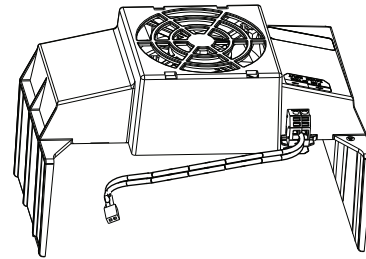

Specifications	25-FAN1-70C	25-FAN2-70C
Rated Voltage	24V DC	
Operation Voltage	14...27.6V DC	
Input Current	0.1 A	0.15 A
Speed (Reference)	7000 rpm	4500 ± 10% rpm
Air Flow (At zero static pressure) max	0.575 m <sup>3</sup> /min	1.574 m <sup>3</sup> /min
Air Pressure (At zero air flow) min	7.70 mm H <sub>2</sub> O	9.598 mm H <sub>2</sub> O
Acoustical Noise	40.5 dB-A	46.0 dB-A
Insulation Type	UL Class A	
Frame Size	Frame A...D	Frame E
Wire Size	0.32 mm <sup>2</sup> (22 AWG)	
Torque	0.29...0.39 N•m (2.6...3.47 lb•in)	

IP 20/Open Type with Control Module Fan Kit - Frame A...C

Dimensions are in millimeters and (inches)

Frame A

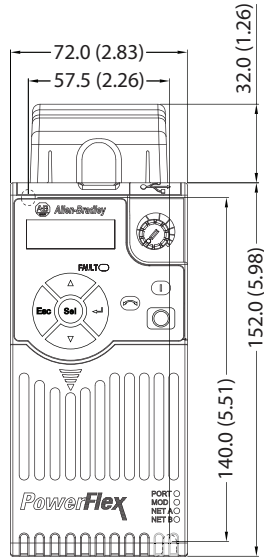

Frame B

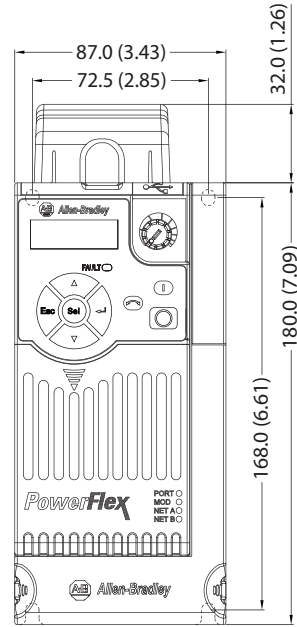

Frame C

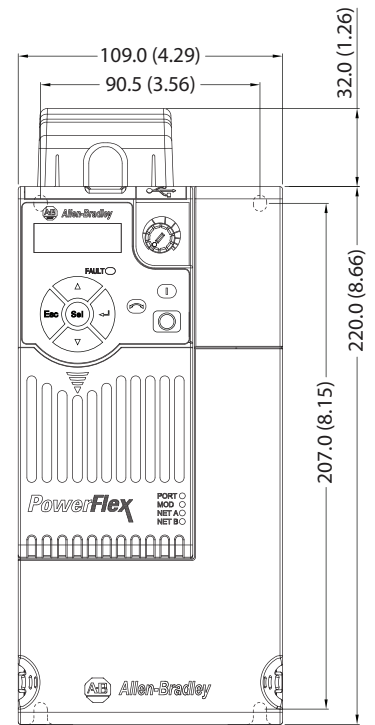

**IMPORTANT** An external 24V DC power source is required when using the Control Module Fan Kit with drive frames A, B, and C.

IP 20/Open Type with Control Module Fan Kit - Frame D...E

Dimensions are in millimeters and (inches)

Frame D

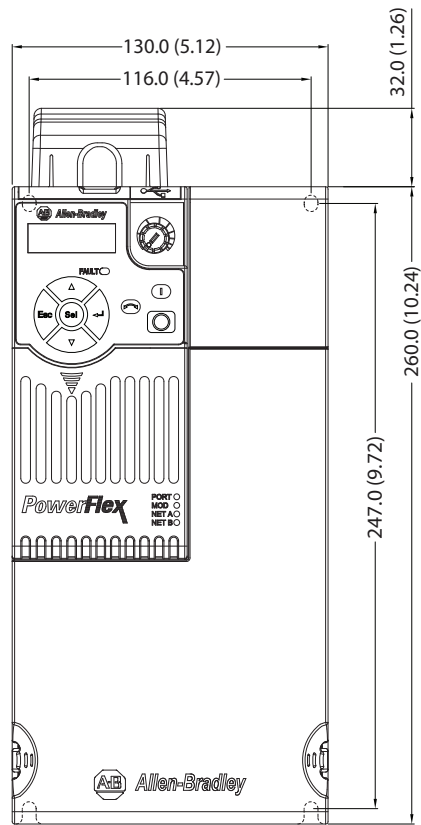

Frame E

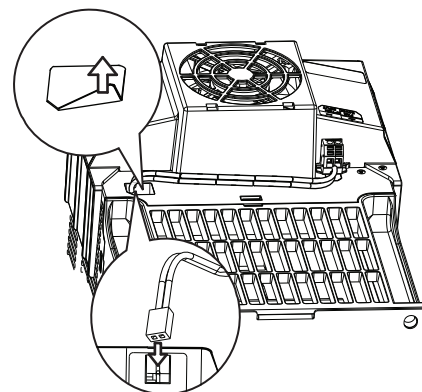
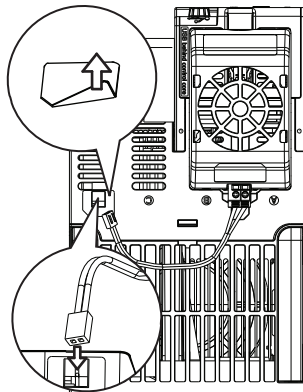
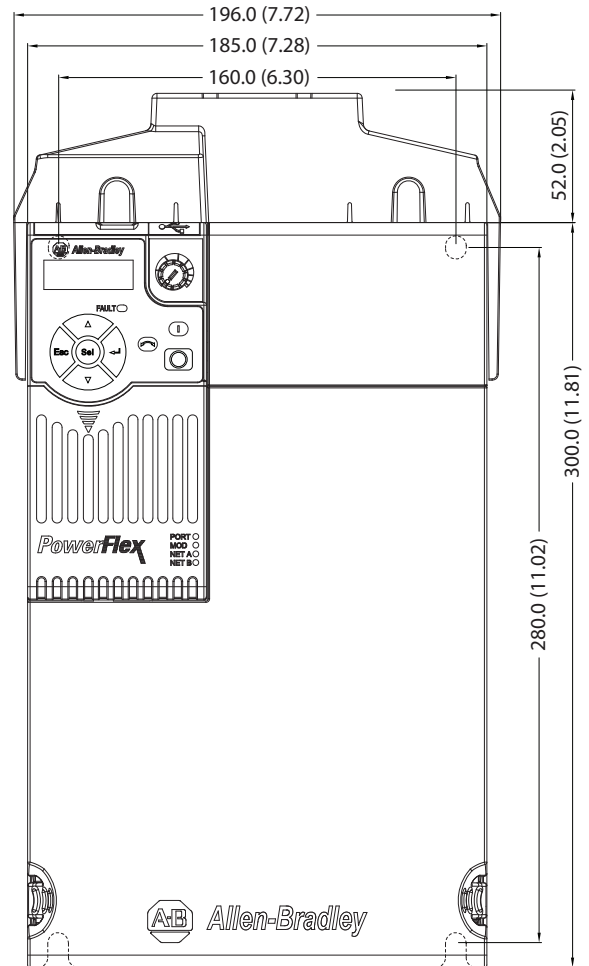

**IMPORTANT** Remove the label to access the built-in 24V supply on drive frames D and E for use with the Control Module Fan Kit.

IP 30/NEMA 1/UL Type 1 – Frame A

Dimensions are in millimeters and (inches)

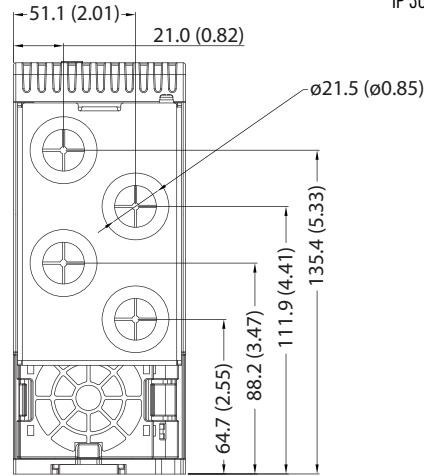
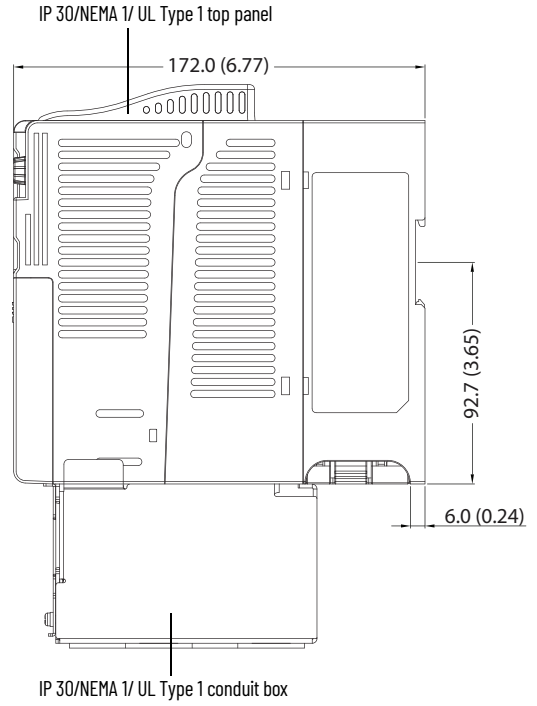
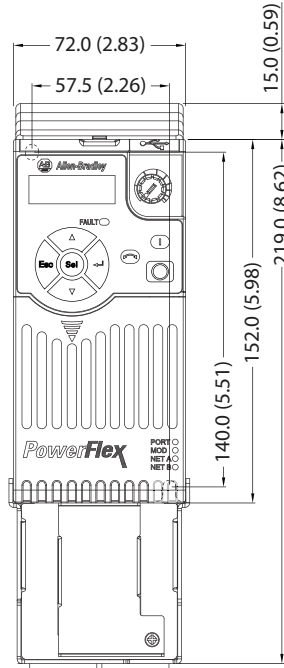

### IP 30/NEMA 1/UL Type 1 – Frame B

Dimensions are in millimeters and (inches)

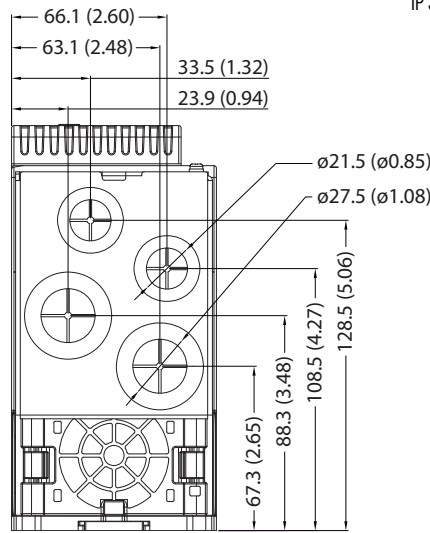
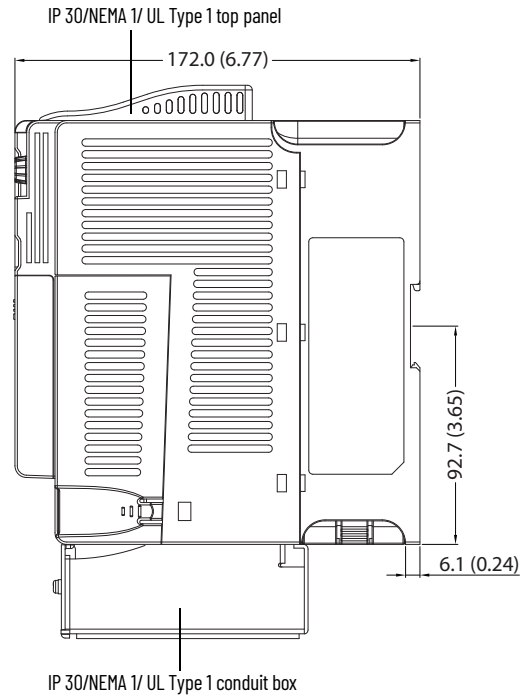
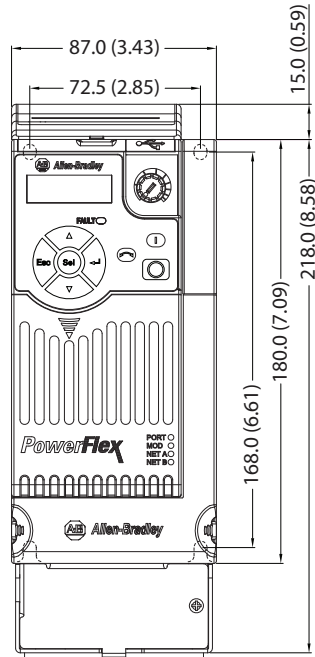

IP 30/NEMA 1/UL Type 1 - Frame C

Dimensions are in millimeters and (inches)

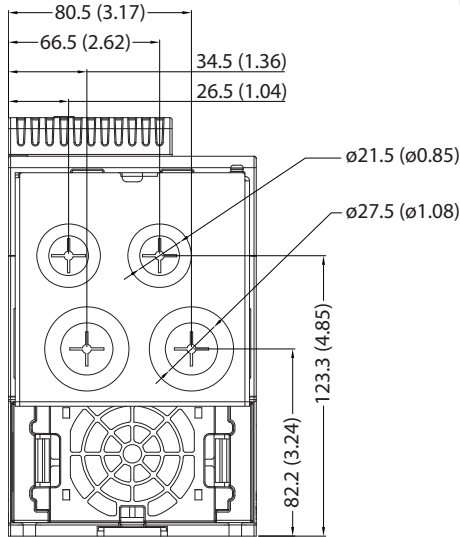
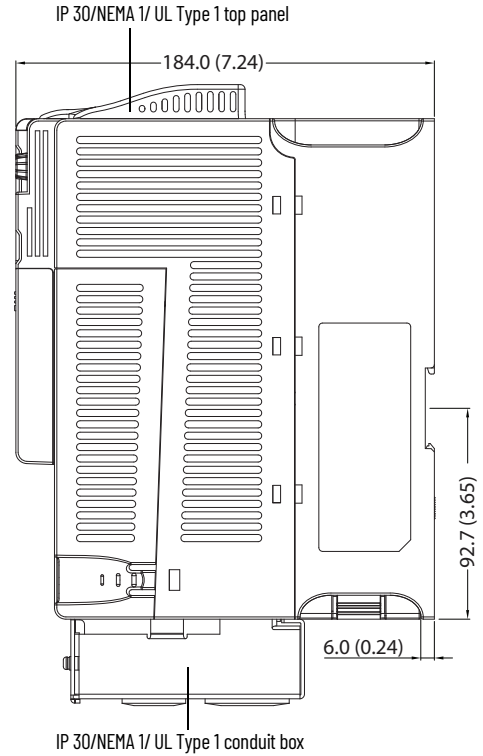
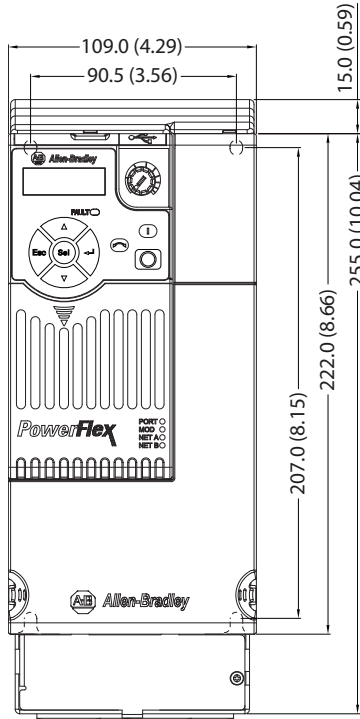



### IP 30/NEMA 1/UL Type 1 - Frame D

Dimensions are in millimeters and (inches)

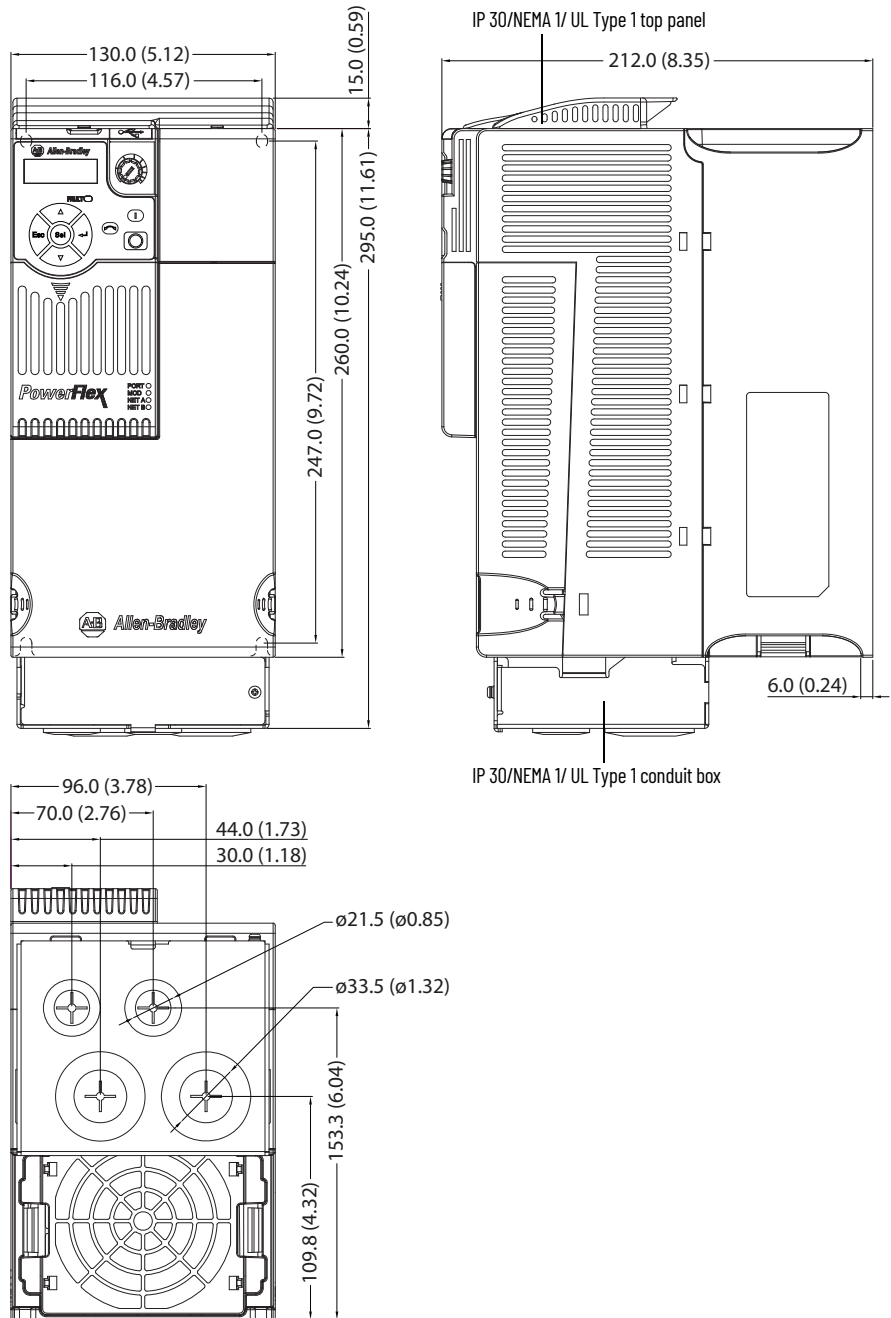

### IP 30/NEMA 1/UL Type 1 – Frame E

Dimensions are in millimeters and (inches)

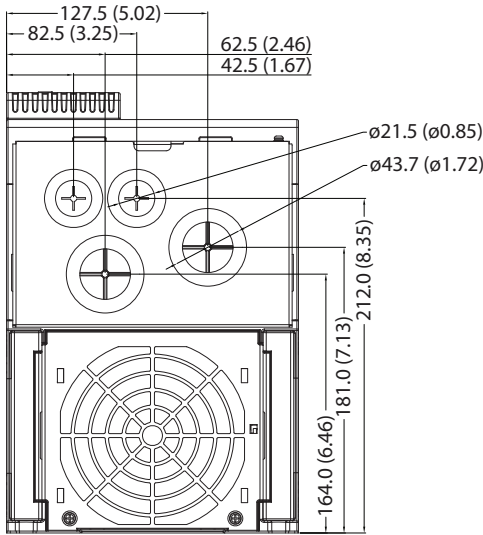
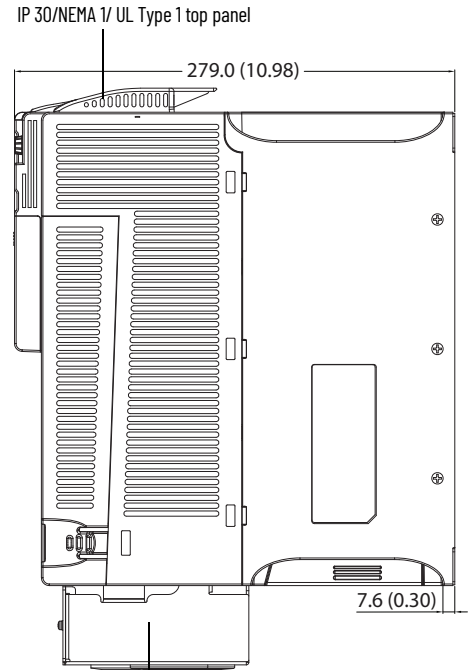
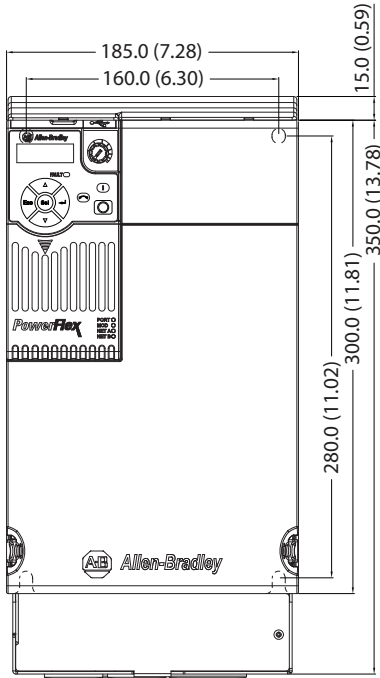

### EMC Line Filter – Frame A

Dimensions are in millimeters and (inches)

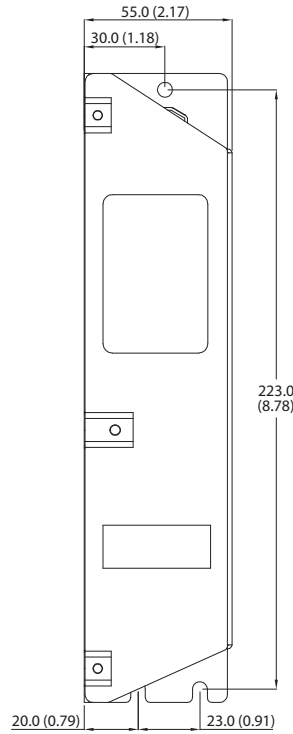

Filter can be mounted onto the back of the drive.

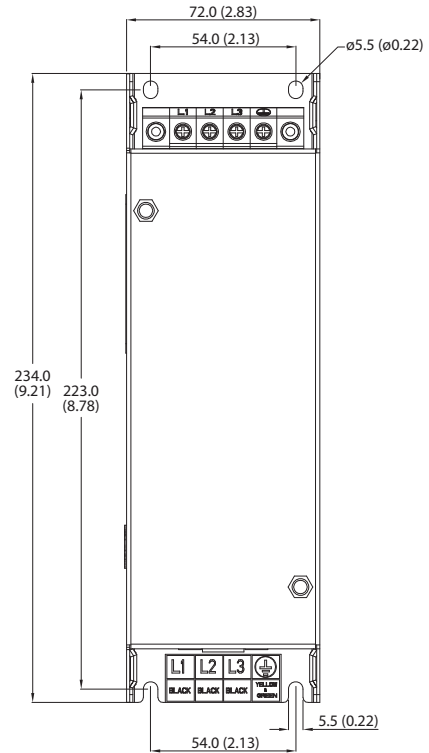

### EMC Line Filter – Frame B

Dimensions are in millimeters and (inches)

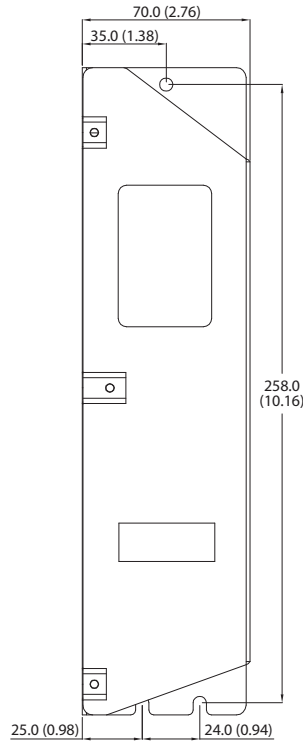

Filter can be mounted onto the back of the drive.

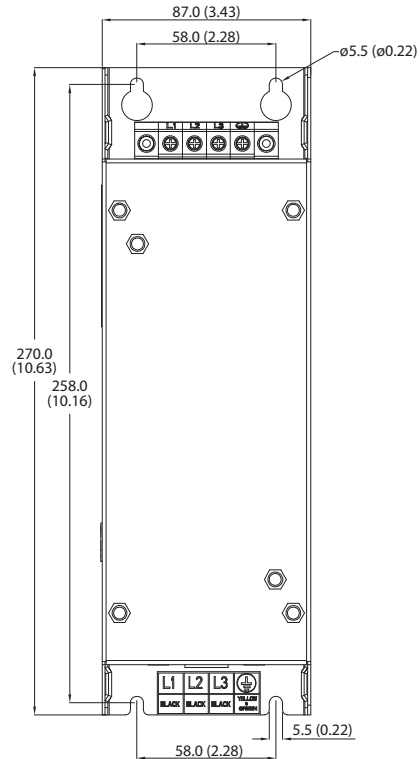

### EMC Line Filter – Frame C

Dimensions are in millimeters and (inches)

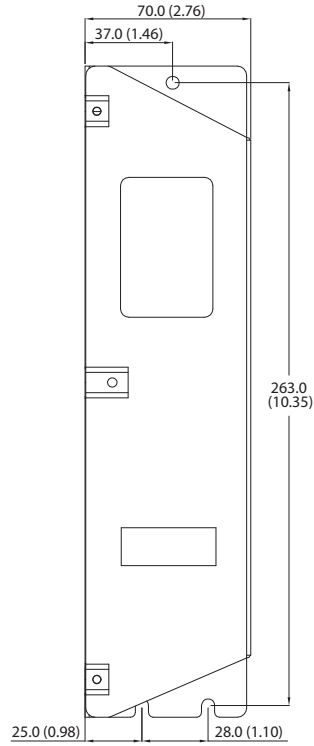

Filter can be mounted onto the back of the drive.

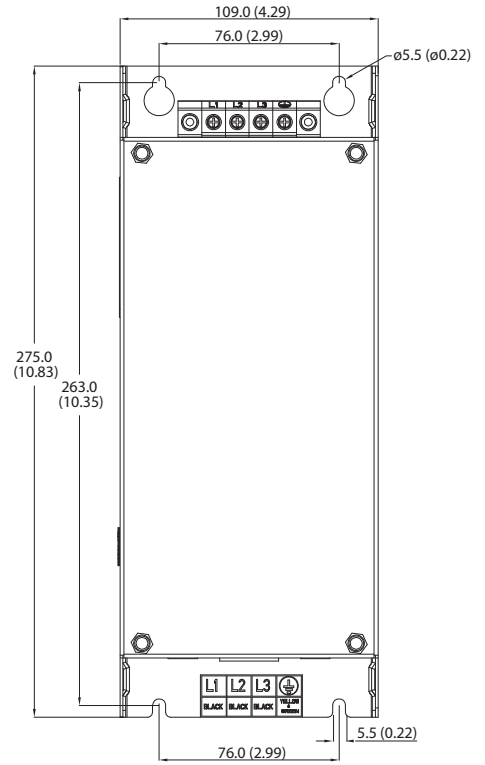

### EMC Line Filter – Frame D

Dimensions are in millimeters and (inches)

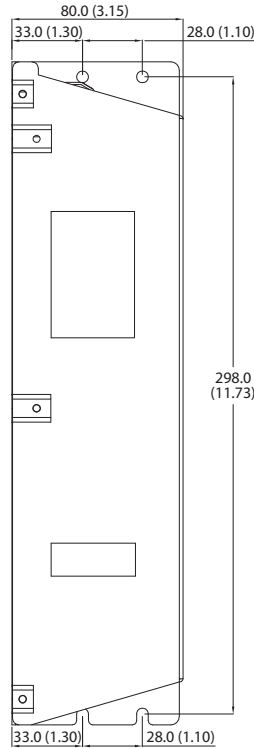

Filter can be mounted onto the back of the drive.

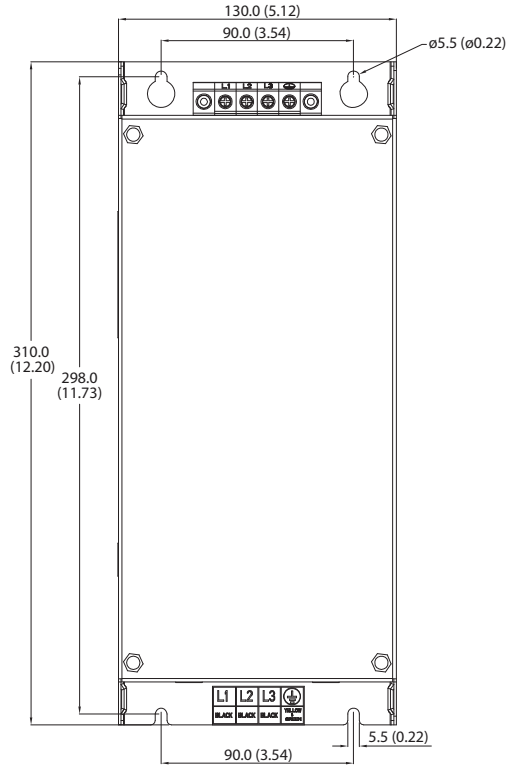

### EMC Line Filter – Frame E

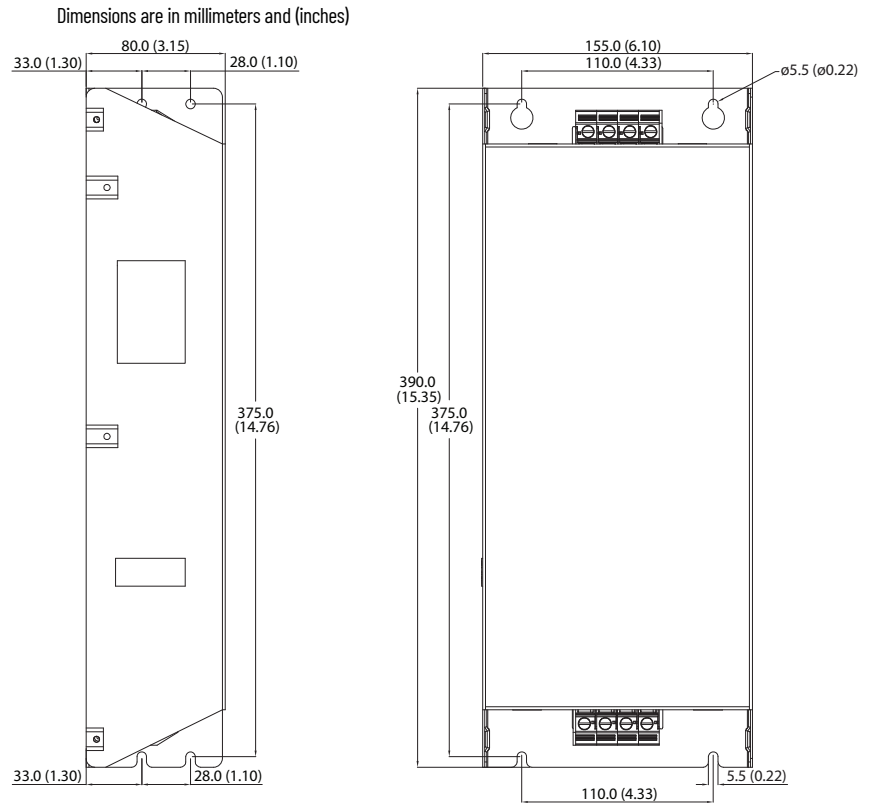

### Adapter Plate Dimensions

#### Bulletin 160 to PowerFlex 520-Series Mounting Adapter Plate Dimensions

Dimensions are in millimeters and (inches)

**Frame A**  
**25-MAP-FA**

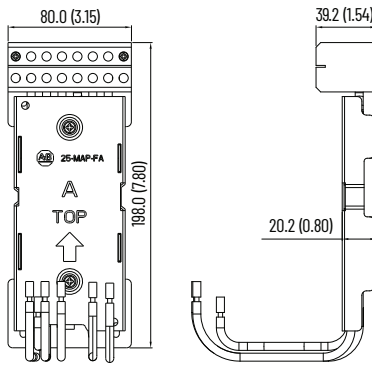

**Frame B**  
**25-MAP-FB**

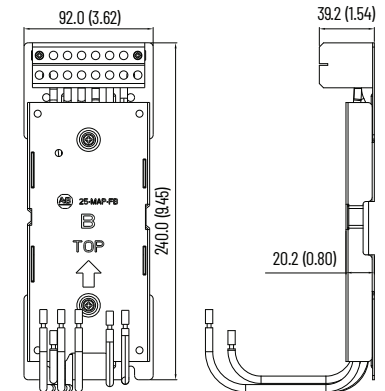

PowerFlex 4/40/40P to PowerFlex 520-Series Mounting Adapter Plate Dimension

Adapter Plate - Frame A

Dimensions are in millimeters and (inches)

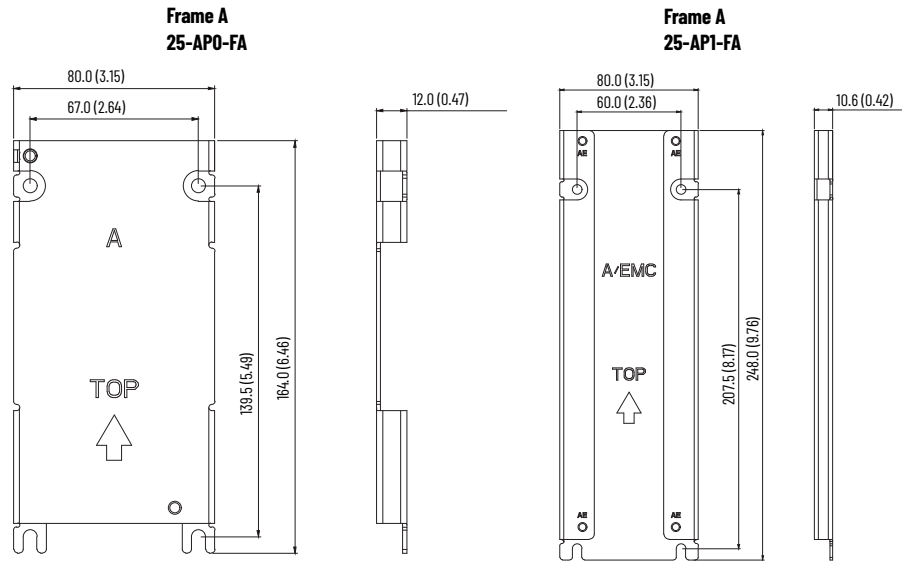

Adapter Plate - Frame B

Dimensions are in millimeters and (inches)

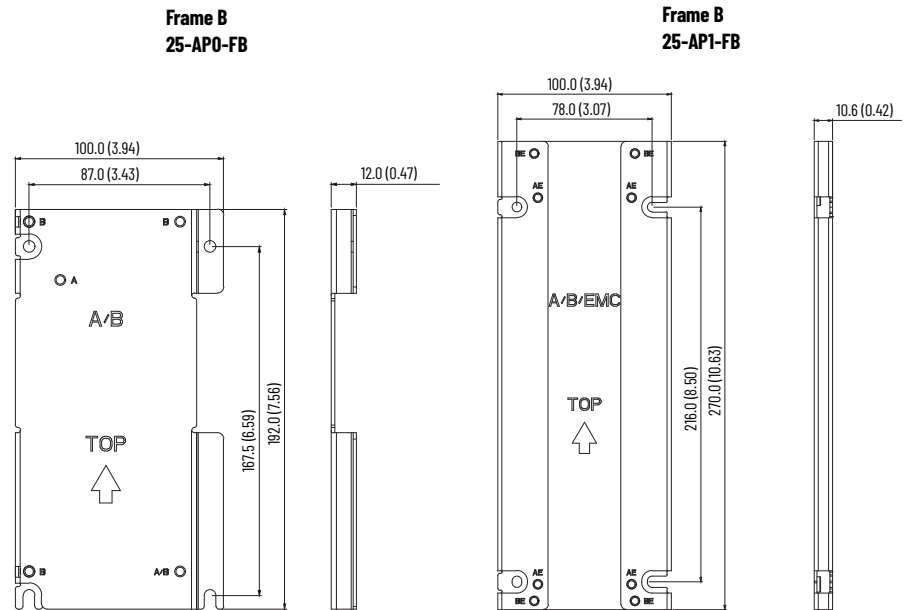

### Adapter Plate - Frame C

Dimensions are in millimeters and (inches)

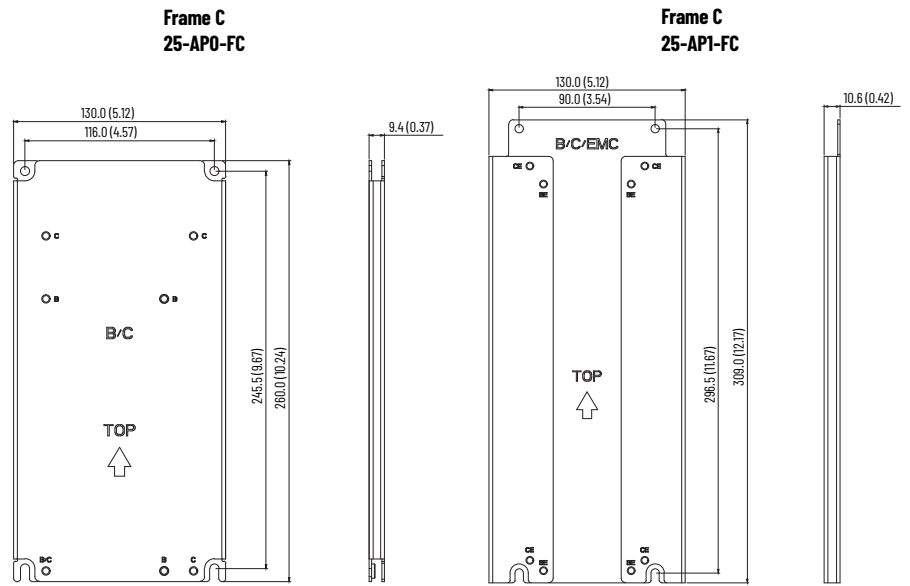

### Adapter Plate - Frame D

Dimensions are in millimeters and (inches)

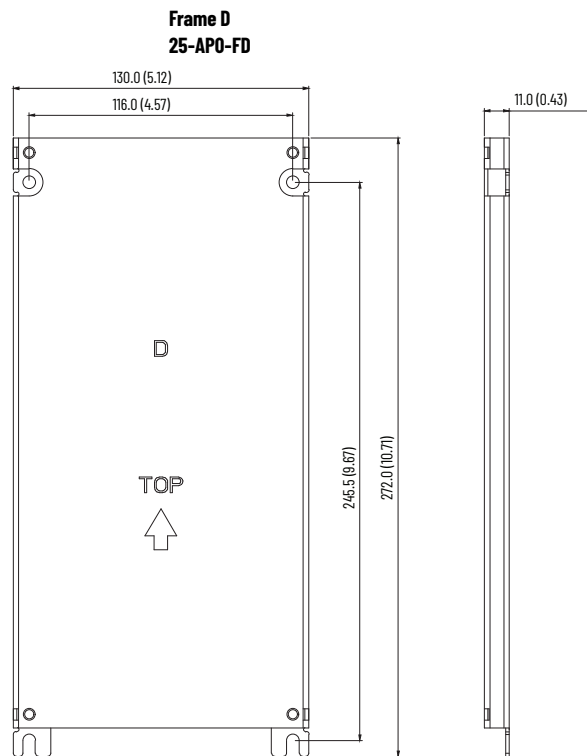

## Optional Accessories and Kits

### Installing a Communication Adapter

1. Insert the communication adapter interface connector into the Control Module. Make sure the indicator line on the connector is aligned with the surface of the Control Module.

#### For PowerFlex 523

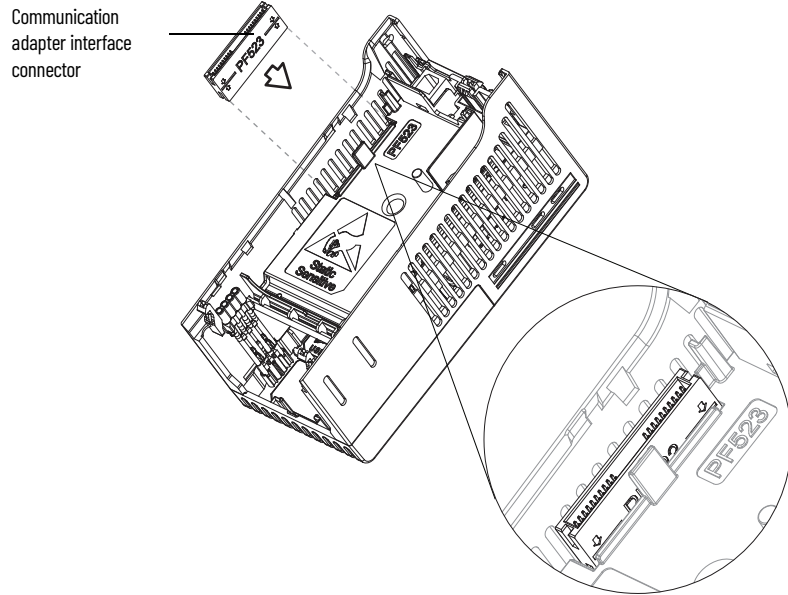

#### For PowerFlex 525

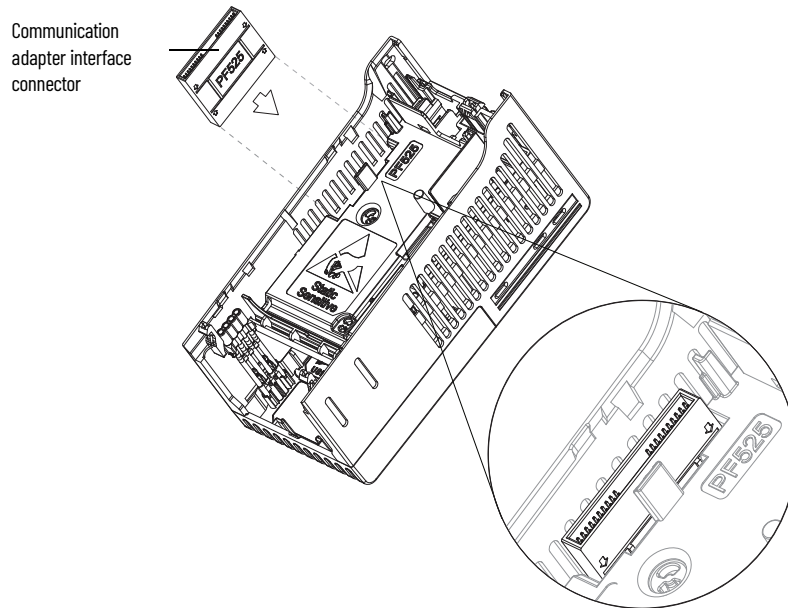

2. Align the connectors on the communication adapter to the communication adapter interface connector, then push the back cover down.



3. Press along the edges of the back cover until it snaps firmly into place.

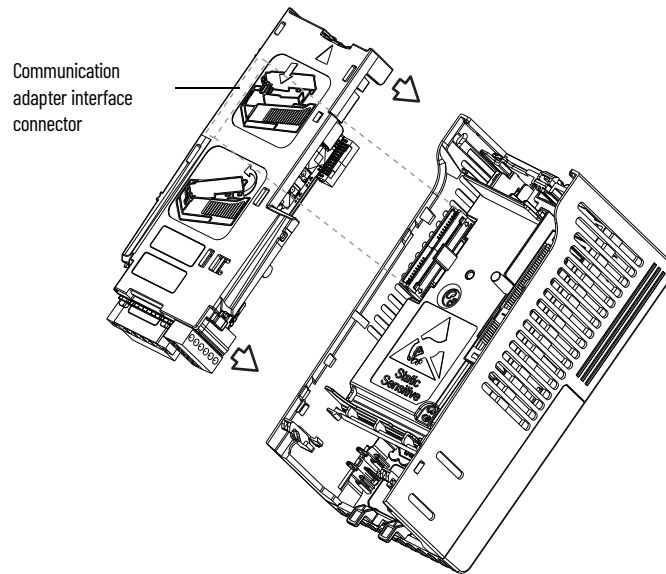

### Removing a Communication Adapter

1. Insert a finger into the slot at the top of the back cover. Lift to separate the back cover from the Control Module.

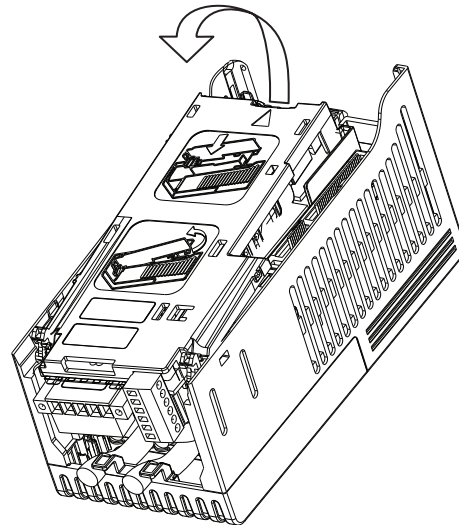

**Notes:**

## RS485 (DSI) Protocol

PowerFlex 520-series drives support the RS485 (DSI) protocol to allow efficient operation with Rockwell Automation peripherals. In addition, some Modbus functions are supported to allow simple networking. PowerFlex 520-series drives can be multi-dropped on an RS485 network using Modbus protocol in RTU mode.

### PowerFlex 520-Series Drive Network

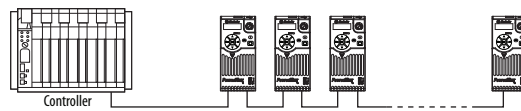

For information regarding EtherNet/IP or other communication protocols, refer to the appropriate user manual.

## Network Wiring

Network wiring consists of a shielded 2-conductor cable that is daisy-chained from node to node.



**ATTENTION:** Never attempt to connect a Power over Ethernet (PoE) cable to the RS485 port. Doing so may damage the circuitry.

**Network Wiring Diagram Example**

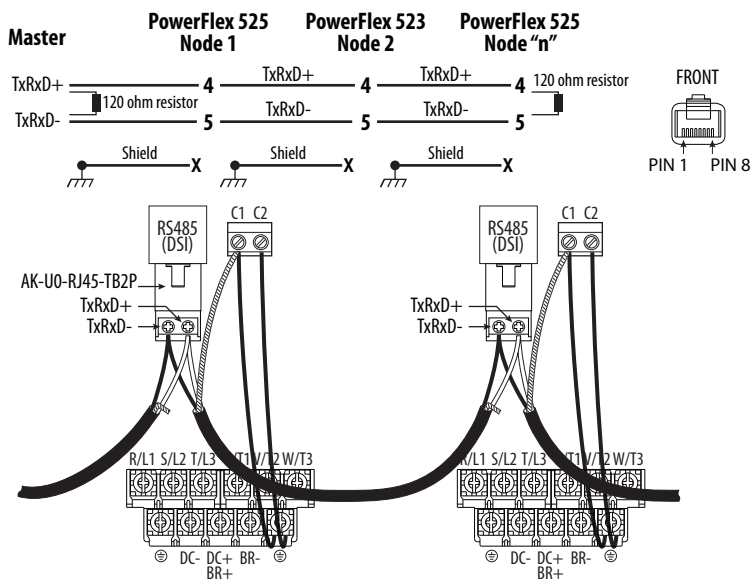

**IMPORTANT** The shield is connected at ONLY ONE end of each cable segment.

Only pins 4 and 5 on the RJ45 plug should be wired. The other pins on the PowerFlex 520-series drive’s RJ45 socket must not be connected because they contain power, etc. for other Rockwell Automation peripheral devices.

Wiring terminations on the master controller will vary depending on the master controller used and “TxRxD+” and “TxRxD-” are shown for illustration purposes only. Refer to the master controller’s user manual for network terminations. Note that there is no standard for the “+” and “-” wires, and consequently Modbus device manufacturers interpret them differently. If you have problems with initially establishing communications, try swapping the two network wires at the master controller.

Standard RS485 wiring practices apply.

- Termination resistors need to be applied at each end of the network cable.
- RS485 repeaters may need to be used for long cable runs, or if greater than 32 nodes are needed on the network.
- Network wiring should be separated from power wires by at least 0.3 meters (1 foot).
- Network wiring should only cross power wires at a right angle.

I/O Terminal C1 (RJ45 Shield) for the Ethernet and DSI network cables on the PowerFlex 520-series drive must also be connected to PE ground (there are two PE terminals on the drive). The shield for the network cables should be connected to PE ground at one end only.

I/O Terminal C2 (Comm Common) is internally tied to Network Common for the network signals, and NOT to RJ45 Shield. Tying I/O Terminal C2 to PE ground may improve noise immunity in some applications.

See I/O Control Terminal Designations on [page 39](#) and [page 42](#) for more information.

## Parameter Configuration

The following PowerFlex 520-series drive parameters are used to configure the drive to operate on a DSI network.

### Configuring Parameters for DSI Network

Parameter	Details	Reference
<a href="#">P046</a> [Start Source 1]	Set to 3 "Serial/DSI" if Start is controlled from the network.	<a href="#">page 86</a>
<a href="#">P047</a> [Speed Reference]	Set to 3 "Serial/DSI" if the Speed Reference is controlled from the network.	<a href="#">page 86</a>
<a href="#">C123</a> [RS485 Data Rate]	Sets the data rate for the RS485 (DSI) Port. All nodes on the network must be set to the same data rate.	<a href="#">page 100</a>
<a href="#">C124</a> [RS485 Node Addr]	Sets the node address for the drive on the network. Each device on the network requires a unique node address.	<a href="#">page 100</a>
<a href="#">C125</a> [Comm Loss Action]	Selects the drive's response to communication problems.	<a href="#">page 100</a>
<a href="#">C126</a> [Comm Loss Time]	Sets the time that the drive will remain in communication loss before the drive implements <a href="#">C125</a> [Comm Loss Action].	<a href="#">page 100</a>
<a href="#">C127</a> [Comm Format]	Sets the transmission mode, data bits, parity, and stop bits for the RS485 (DSI) Port. All nodes on the network must be set to the same setting.	<a href="#">page 101</a>
<a href="#">C121</a> [Comm Write Mode]	Set to 0 "Save" when programming drive. Set to 1 "RAM only" to only write to volatile memory.	<a href="#">page 100</a>

## Supported Modbus Function Codes

The Drive Serial Interface (DSI) used on PowerFlex 520-series drives supports some of the Modbus function codes.

### Supported Modbus Function Codes

Modbus Function Code (Decimal)	Command
03	Read Holding Registers
06	Preset (Write) Single Register
16 (10 Hexadecimal)	Preset (Write) Multiple Registers

**IMPORTANT** Modbus devices can be 0-based (registers are numbered starting at 0) or 1-based (registers are numbered starting at 1). Depending on the Modbus Master used, the register addresses listed on the following pages may need to be offset by +1. For example, Logic Command may be register address 8192 for some master devices (for example, ProSoft 3150-MCM SLC™ Modbus scanner) and 8193 for others (for example, PanelView™).

## Writing (06) Logic Command Data

The PowerFlex 520-series drive can be controlled through the network by sending Function Code 06 writes to register address 2000H (Logic Command). [P046](#) [Start Source 1] must be set to 3 "Serial/DSI" in order to accept the commands. PowerFlex 523 drives support only Velocity bit definitions. PowerFlex 525 drives can use Parameter [C122](#) [Cmd Stat Select] to select either Velocity or Position bit definitions.



Powerup/Reset the drive after selecting an option for [C122](#) [Cmd Stat Select] for the change to take effect.

### Velocity Bit Definitions

Comm Logic Command - C122 = 0 "Velocity"			
Address (Decimal)	Bit(s)	Description	
2000H (8192)	0	1 = Stop, 0 = Not Stop	
	1	1 = Start, 0 = Not Start	
	2	1 = Jog, 0 = No Jog	
	3	1 = Clear Faults, 0 = Not Clear Faults	
	5, 4	00	No Command
		01	Forward Command
		10	Reverse Command
		11	No Command
	6	1 = Force Keypad Control, 0 = Not Force Keypad Control	
	7	1 = MOP Increment, 0 = Not Increment	
	9, 8	00	No Command
		01	Accel Rate 1 Enable
		10	Accel Rate 2 Enable
		11	Hold Accel Rate Selected
	11, 10	00	No Command
		01	Decel Rate 1 Enable
		10	Decel Rate 2 Enable
		11	Hold Decel Rate Selected
	14, 13, 12	000	No Command
		001	Freq. Source = P047 [Speed Reference1]
010		Freq. Source = P049 [Speed Reference2]	
011		Freq. Source = P051 [Speed Reference3]	
100		A410 [Preset Freq 0]	
101		A411 [Preset Freq 1]	
110		A412 [Preset Freq 2]	
111		A413 [Preset Freq 3]	
15	1 = MOP Decrement, 0 = Not Decrement		

## Position Bit Definitions

Comm Logic Command - C122 = 1 "Position"			
Address (Decimal)	Bit(s)	Description	
2000H (8192)	0	1 = Stop, 0 = Not Stop	
	1	1 = Start, 0 = Not Start	
	2	1 = Jog, 0 = No Jog	
	3	1 = Clear Faults, 0 = Not Clear Faults	
	5, 4	00	No Command
		01	Forward Command
		10	Reverse Command
		11	No Command
	6	1 = Logic In 1	
	7	1 = Logic In 2	
	10, 9, 8	000	Freq. and Position Step 0
		001	Freq. and Position Step 1
		010	Freq. and Position Step 2
		011	Freq. and Position Step 3
		100	Freq. and Position Step 4
101		Freq. and Position Step 5	
110		Freq. and Position Step 6	
111	Freq. and Position Step 7		
11	1 = Find Home		
12	1 = Hold Step		
13	1 = Pos Redefine		
14	1 = Sync Enable		
15	1 = Traverse Disable		

## Writing (06) Comm Frequency Command

The PowerFlex 520-series drive Comm Frequency Command can be controlled through the network by sending Function Code 06 writes to register address 2001H (Comm Frequency Command).

### Comm Frequency Command

Reference	
Address (Decimal)	Description
2001H (8193)	Used by internal comm modules to control the reference of the drive. In units of 0.01 Hz.

## Reading (03) Logic Status Data

The PowerFlex 520-series drive Logic Status data can be read through the network by sending Function Code 03 reads to register address 2100H (Logic Status). PowerFlex 523 drives support only Velocity bit definitions. PowerFlex 525 drives can use Parameter [C122](#) [Cmd Stat Select] to select either Velocity or Position bit definitions.

### Velocity Bit Definitions

Comm Logic Status - C122 = 0 "Velocity"		
Address (Decimal)	Bit(s)	Description
2100H (8448)	0	1 = Ready, 0 = Not Ready
	1	1 = Active (Running), 0 = Not Active
	2	1 = Cmd Forward, 0 = Cmd Reverse
	3	1 = Rotating Forward, 0 = Rotating Reverse
	4	1 = Accelerating, 0 = Not Accelerating
	5	1 = Decelerating, 0 = Not Decelerating
	6	Not Used
	7	1 = Faulted, 0 = Not Faulted
	8	1 = At Reference, 0 = Not At Reference
	9	1 = Main Freq Controlled by Active Comm
	10	1 = Operation Cmd Controlled by Active Comm
	11	1 = Parameters have been locked
	12	Digital Input 1 Status (DigIn TermBlk 05)
	13	Digital Input 2 Status (DigIn TermBlk 06)
	14	Digital Input 3 Status (DigIn TermBlk 07)
	15	Digital Input 4 Status (DigIn TermBlk 08)

### Position Bit Definitions

Comm Logic Status - C122 = 1 "Position"		
Address (Decimal)	Bit(s)	Description
2100H (8448)	0	1 = Ready, 0 = Not Ready
	1	1 = Active (Running), 0 = Not Active
	2	1 = Cmd Forward, 0 = Cmd Reverse
	3	1 = Rotating Forward, 0 = Rotating Reverse
	4	1 = Accelerating, 0 = Not Accelerating
	5	1 = Decelerating, 0 = Not Decelerating
	6	1 = Forward Travel Position, 0 = Reverse Travel Position
	7	1 = Faulted, 0 = Not Faulted
	8	1 = At Reference, 0 = Not At Reference
	9	1 = At Position, 0 = Not At Position
	10	1 = At Home, 0 = Not At Home
	11	1 = Drive Homed, 0 = Not Drive Homed
	12	1 = Sync Hold, 0 = Not Sync Hold
	13	1 = Sync Ramp, 0 = Not Sync Ramp
	14	1 = Traverse On, 0 = Traverse Off
	15	1 = Traverse Decel, 0 = Not Traverse Decel



## Reading (03) Drive Error Codes

The PowerFlex 520-series Error Code data can be read through the network by sending Function Code 03 reads to register address 2101H (Drive Error Codes).

### Drive Error Codes

Logic Status			
Address (Decimal)	Value (Decimal)	Description	
2101H (8449)	0	No Fault	
	2	Auxiliary Input	
	3	Power Loss	
	4	Undervoltage	
	5	Overvoltage	
	6	Motor Stalled	
	7	Motor Overload	
	8	Heatsink Overtemperature	
	9	Control Module Overtemperature	
	12	HW Overcurrent (300%)	
	13	Ground Fault	
	15	Load Loss	
	21	Output Phase Loss	
	29	Analog Input Loss	
	33	Auto Restart Tries	
	38	Phase U to Ground Short	
	39	Phase V to Ground Short	
	40	Phase W to Ground Short	
	41	Phase UV Short	
	42	Phase UW Short	
	43	Phase VW Short	
	48	Parameters Defaulted	
	59	Safety Open	
	63	Software Overcurrent	
	64	Drive Overload	
	70	Power Unit Fail	
	71	DSI Network Loss	
	72	Option Card Network Loss	
	73	Embedded EtherNet/IP Adapter Network Loss	
	80	AutoTune Fail	
	81	DSI Communication Loss	
	82	Option Card Communication Loss	
	83	Embedded EtherNet/IP Adapter Communication Loss	
	91	Encoder Loss	
	94	Function Loss	
	100	Parameter Checksum Error	
	101	External Storage	
	105	Control Module Connect Error	
	106	Incompatible Control-Power Module	
	107	Unrecognized Control-Power Module	
	109	Mismatched Control-Power Module	
	110	Keypad Membrane	
	111	Safety Hardware	
	114	Microprocessor Failure	
	122	I/O Board Fail	
	2101H (8449)	125	Flash Update Required
		126	Non Recoverable Error
127		DSI Flash Update Required	

## Reading (03) Drive Operational Values

The PowerFlex 520-series Drive Operational Values can be read through the network by sending Function Code 03 reads to register addresses 2102H...210AH.

### Drive Operational Values

Reference	
Address (Decimal)	Description
2102H (8450)	Frequency Command (xxx.xx Hz)
2103H (8451)	Output Frequency (xxx.xx Hz)
2104H (8452)	Output Current (xxx.xx A)
2105H (8453)	DC-BUS Voltage (xxxV)
2106H (8454)	Output Voltage (xxx.xV)

## Reading (03) and Writing (06) Drive Parameters

To access drive parameters, the Modbus register address equals the parameter number. For example, a decimal “1” is used to address Parameter 0001 [Output Freq] and decimal “41” is used to address Parameter P041 [Accel Time 1].

## Additional Information

See <https://www.ab.com/drives> for additional information.

## Velocity StepLogic, Basic Logic and Timer/Counter Functions

Four PowerFlex 520-series logic functions provide the capability to program simple logic functions without a separate controller.

- Velocity StepLogic Function (specific to PowerFlex 525 drives only)

Steps through up to eight preset speeds based on programmed logic. Programmed logic can include conditions that need to be met from digital inputs programmed as “Logic In 1” and “Logic In 2” before stepping from one preset speed to the next. A timer is available for each of the eight steps and is used to program a time delay before stepping from one preset speed to the next. The status of a digital output can also be controlled based on the step being executed.

- Basic Logic Function (specific to PowerFlex 525 drives only)

Up to two digital inputs can be programmed as “Logic In 1” and/or “Logic In 2”. A digital output can be programmed to change state based on the condition of one or both inputs based on basic logic functions such as AND, OR, NOR. The basic logic functions can be used with or without StepLogic.

- Timer Function

A digital input can be programmed for “Timer Start”. A digital output can be programmed as a “Timer Out” with an output level programmed to the desired time. When the timer reaches the time programmed into the output level the output will change state. The timer can be reset with a digital input programmed as “Reset Timer”.

- Counter Function

A digital input can be programmed for “Counter In”. A digital output can be programmed as “Counter Out” with an output level programmed to the desired number of counts. When the counter reaches the count programmed into the output level the output will change state. The counter can be reset with a digital input programmed as “Reset Counter”.



Use the Wizard in Connected Components Workbench software to simplify setup instead of manually configuring the parameters.

## Velocity StepLogic Using Timed Steps

---

**IMPORTANT** This function is specific to PowerFlex 525 drives only.

---

To activate this function, set one of the three speed reference sources, parameter PO47, PO49, or PO51 [Speed Referencex] to 13 “Step Logic” and activate that speed reference source. Three parameters are used to configure the logic, speed reference and time for each step.

- Logic is defined using parameters L180...L187 [Stp Logic x].
- Preset Speeds are set with parameters A410...A417 [Preset Freq o...7].
- Time of operation for each step is set with parameters L190...L197 [Stp Logic Time x].

The direction of motor rotation can be forward or reverse.

### Using Timed Steps

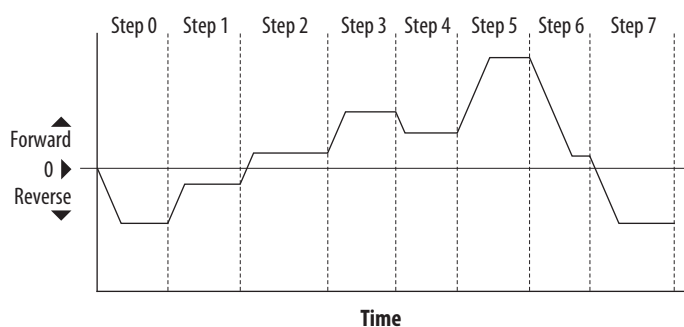

### Velocity StepLogic Sequence

- Sequence begins with a valid start command.
- A normal sequence begins with Step 0 and transition to the next step when the corresponding StepLogic time has expired.
- Step 7 is followed by Step 0
- Sequence repeats until a stop is issued or a fault condition occurs.

## Velocity StepLogic Using Basic Logic Functions

---

**IMPORTANT** This function is specific to PowerFlex 525 drives only.

---

Digital input and digital output parameters can be configured to use logic to transition to the next step. Logic In 1 and Logic In 2 are defined by programming parameters to62...to63, to65...to68 [DigIn TermBlk xx] to 24 “Logic In 1” or 25 “Logic In 2”.

### Example

- Run at Step 0.
- Transition to Step 1 when Logic In 1 is true. Logic senses the edge of Logic In 1 when it transitions from off to on. Logic In 1 is not required to remain “on”.
- Transition to Step 2 when both Logic In 1 and Logic In 2 are true. The drive senses the level of both Logic In 1 and Logic In 2 and transitions to Step 2 when both are on.

- Transition to Step 3 when Logic In 2 returns to a false or off state. Inputs are not required to remain in the “on” condition except under the logic conditions used for the transition from Step 2 to Step 3.

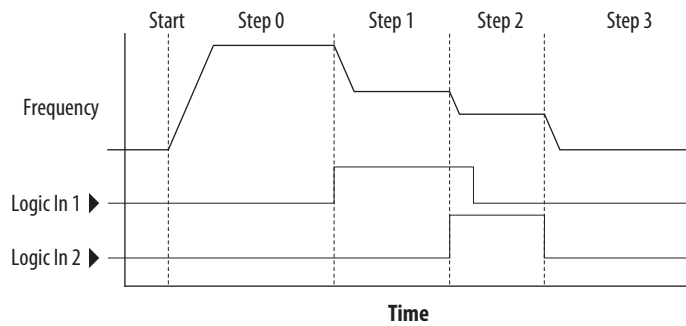

The step time value and the basic logic may be used together to satisfy machine conditions. For instance, the step may need to run for a minimum time period and then use the basic logic to trigger a transition to the next step.

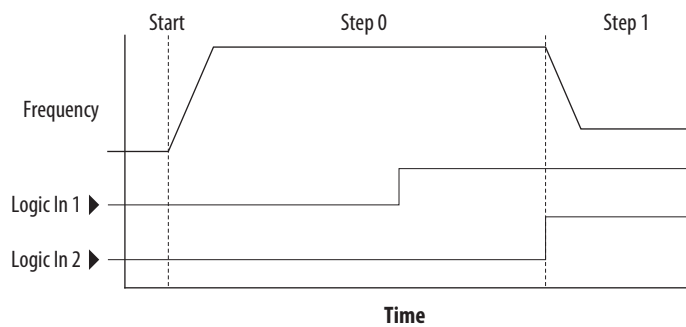

## Timer Function

Digital inputs and outputs control the timer function and are configured with parameters to62...to63, to65...to68 [DigIn TermBlk xx] set to 19 “Timer Start” and 21 “Reset Timer”.

Digital outputs (relay and opto type) define a preset level and indicate when the level is reached. Level parameters to77 [Relay Out1 Level], to82[Relay Out2 Level], to70 [Opto Out1 Level] and to73 [Opto Out2 Level] are used to set the desired time in seconds.

Parameters to76 [Relay Out1 Sel], to81 [Relay Out2 Sel], to69 [Opto Out1 Sel] and to72 [Opto Out2 Sel] are set to 25 “Timer Out” and causes the output to change state when the preset level is reached.

### Example

- Drive starts up and accelerates to 30 Hz.
- After 30 Hz has been maintained for 20 seconds, a 4...20 mA analog input becomes the reference signal for speed control.
- The timer function is used to select a preset speed with a 20 second run time that overrides the speed reference while the digital input is active.
- Parameters are set to the following options:
  - Po47 [Speed Reference1] = 6 “4-20mA Input”
  - Po49 [Speed Reference2] = 7 “Preset Freq”
  - to62 [DigIn TermBlk o2] = 1 “Speed Ref 2”
  - to63 [DigIn TermBlk o3] = 19 “Timer Start”

- t076 [Relay Out1 Sel] = 25 “Timer Out”
- t077 [Relay Out1 Level] = 20.0 seconds
- A411 [Preset Freq 1] = 30.0 Hz
- The control terminal block is wired such that a start command will also trigger the timer start.
- The relay output is wired to I/O Terminal o2 (DigIn TermBlk o2) so that it forces the input on when the timer starts.
- After the timer is complete, the output is turned off releasing the preset speed command. The drive defaults to following the analog input reference as programmed.

Note that a “Reset Timer” input is not required for this example since the “Timer Start” input both clears and starts the timer.

## Counter Function

Digital inputs and outputs control the counter function and are configured with parameters t062...t063, t065...t068 [DigIn TermBlk xx] set to 20 “Counter In” and 22 “Reset Counter”.

Digital outputs (relay and opto type) define a preset level and indicate when the level is reached. Level parameters t077 [Relay Out1 Level], t082 [Relay Out2 Level], t070 [Opto Out1 Level] and t073 [Opto Out2 Level] are used to set the desired count value.

Parameters t076 [Relay Out1 Sel], t081 [Relay Out2 Sel], t069 [Opto Out1 Sel] and t072 [Opto Out2 Sel] are set to 26 “Counter Out” which causes the output to change state when the level is reached.

### Example

- A photo eye is used to count packages on a conveyor line.
- An accumulator holds the packages until 5 are collected.
- A diverter arm redirects the group of five packages to a bundling area.
- The diverter arm returns to its original position and triggers a limit switch that resets the counter.
- Parameters are set to the following options:
  - t065 [DigIn TermBlk 05] = 20 “Counter In”
  - t066 [DigIn TermBlk 06] = 22 “Reset Counter”
  - t076 [Relay Out1 Sel] = 26 “Counter Out”
  - t077 [Relay Out1 Level] = 5.0 Counts

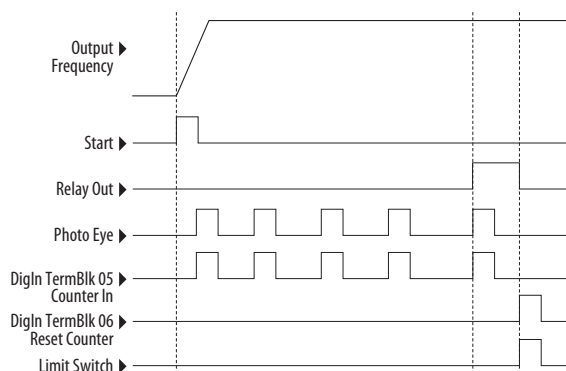

# Velocity StepLogic Parameters

## Code Descriptions for Parameters L180...L187

Digit 4	Digit 3	Digit 2	Digit 1
0	0	F	1

### Digit 4 - Defines the action during the step currently executing

Setting	Accel/Decel Parameter Used	StepLogic Output State	Commanded Direction
0	1	Off	FWD
1	1	Off	REV
2	1	Off	No Output
3	1	On	FWD
4	1	On	REV
5	1	On	No Output
6	2	Off	FWD
7	2	Off	REV
8	2	Off	No Output
9	2	On	FWD
A	2	On	REV
b	2	On	No Output

### Digit 3 - Defines what step to jump to or how to end program when the logic conditions specified in Digit 2 are met

Setting	Logic
0	Jump to Step 0
1	Jump to Step 1
2	Jump to Step 2
3	Jump to Step 3
4	Jump to Step 4
5	Jump to Step 5
6	Jump to Step 6
7	Jump to Step 7
8	End Program (Normal Stop)
9	End Program (Coast to Stop)
A	End Program and Fault (F002)

### Digit 2 - Defines what logic must be met to jump to a step other than the very next step

Setting	Description	Logic
0	Skip Step (jump immediately)	SKIP
1	Step based on the time programmed in the respective [Stp Logic Time x] parameter.	TIMED
2	Step if "Logic In 1" is active (logically true)	TRUE
3	Step if "Logic In 2" is active (logically true)	TRUE
4	Step if "Logic In 1" is not active (logically false)	FALSE
5	Step if "Logic In 2" is not active (logically false)	FALSE
6	Step if either "Logic In 1" or "Logic In 2" is active (logically true)	OR
7	Step if both "Logic In 1" and "Logic In 2" is active (logically true)	AND
8	Step if neither "Logic In 1" or "Logic In 2" is active (logically true)	NOR
9	Step if "Logic In 1" is active (logically true) and "Logic In 2" is not active (logically false)	XOR
A	Step if "Logic In 2" is active (logically true) and "Logic In 1" is not active (logically false)	XOR
b	Step after [Stp Logic Time x] and "Logic In 1" is active (logically true)	TIMED AND
C	Step after [Stp Logic Time x] and "Logic In 2" is active (logically true)	TIMED AND

**Digit 2 - Defines what logic must be met to jump to a step other than the very next step**

Setting	Description	Logic
d	Step after [Stp Logic Time x] and "Logic In 1" is not active (logically false)	TIMED OR
E	Step after [Stp Logic Time x] and "Logic In 2" is not active (logically false)	TIMED OR
F	Do not step OR no "jump to", so use Digit 0 logic	IGNORE

**Digit 1 - Defines what logic must be met to jump to the very next step**

Setting	Description	Logic
0	Skip Step (jump immediately)	SKIP
1	Step based on the time programmed in the respective [Stp Logic Time x] parameter.	TIMED
2	Step if "Logic In 1" is active (logically true)	TRUE
3	Step if "Logic In 2" is active (logically true)	TRUE
4	Step if "Logic In 1" is not active (logically false)	FALSE
5	Step if "Logic In 2" is not active (logically false)	FALSE
6	Step if either "Logic In 1" or "Logic In 2" is active (logically true)	OR
7	Step if both "Logic In 1" and "Logic In 2" is active (logically true)	AND
8	Step if neither "Logic In 1" or "Logic In 2" is active (logically true)	NOR
9	Step if "Logic In 1" is active (logically true) and "Logic In 2" is not active (logically false)	XOR
A	Step if "Logic In 2" is active (logically true) and "Logic In 1" is not active (logically false)	XOR
b	Step after [Stp Logic Time x] and "Logic In 1" is active (logically true)	TIMED AND
C	Step after [Stp Logic Time x] and "Logic In 2" is active (logically true)	TIMED AND
d	Step after [Stp Logic Time x] and "Logic In 1" is not active (logically false)	TIMED OR
E	Step after [Stp Logic Time x] and "Logic In 2" is not active (logically false)	TIMED OR
F	Use logic programmed in Digit 1	IGNORE



## Encoder/Pulse Train Usage and Position StepLogic Application

### Encoder and Pulse Train Usage

The PowerFlex 520-series drives include a pulse train input built into the terminal block. PowerFlex 525 drives also support an optional encoder card. The pulse train and encoder can be used for many of the same functions, but the pulse train supports up to 100 kHz at 24V, and uses the drive built-in terminal block. The encoder supports up to 250 kHz dual channel at 5, 12V or 24V and requires the optional encoder board to be installed. When [A535](#) [Motor Fdbk Type] is set to a value other than zero, the drive is set to use an encoder or pulse train. The drive will use the encoder or pulse train in several ways depending on the settings of other parameters. The drive will use the encoder or pulse train as shown below (listed in order of priority):

1. If enabled by [Po47](#), [Po49](#), or [Po51](#) [Speed Reference], the encoder or pulse train will be used directly as a commanded speed (normally used with a pulse train) or as a position reference (normally used with a quadrature encoder).
2. If not enabled by the Speed Reference parameters, the encoder or pulse train can be used with the PID function if enabled by [A459](#) or [A471](#) [PID x Ref Sel], or [A460](#) or [A472](#) [PID x Fdbk Sel].
3. If not enabled by the Speed Reference or PID function parameters, the encoder or pulse train can be used with [A535](#) [Motor Fdbk Type] for direct feedback and trim of the speed command. The normal slip compensation is not used in this case. Instead the drive will use the encoder or pulse train to determine actual output frequency and adjust the output frequency to match the command. Parameters [A538](#) [Ki Speed Loop] and [A539](#) [Kp Speed Loop] are used in this control loop. The primary benefit of this mode is increased speed accuracy when compared to open-loop slip compensation. It does not provide speed bandwidth improvement.

---

**IMPORTANT** The encoder usage, and position StepLogic application covered in this chapter is specific to PowerFlex 525 drives only.

---

### Encoder Interface

The incremental encoder option card can source 5 volt or 12 volt power and accept 5, 12 or 24 volts single ended or differential inputs. See [Appendix B](#) for ordering information.

---

**IMPORTANT** Only the 25-ENC-1 Encoder will work properly in the PowerFlex 525 drive. Installing an incorrect encoder card, such as the PowerFlex 527 25-ENC-2 will cause damage to the PowerFlex 525 drive.

---

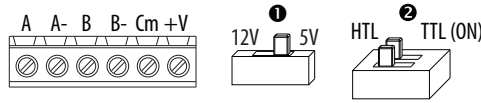

No.	Signal	Description
+V	5...12V Power <sup>(1)(2)</sup>	Internal power source 250 mA (isolated).
Cm	Power Return	
B-	Encoder B (NOT)	Quadrature B input.
B	Encoder B	
A-	Encoder A (NOT)	Single channel, pulse train or quadrature A input.
A	Encoder A	
①	Output	DIP switch selects 12 or 5 volt power supplied at terminals "+V" and "Cm" for the encoder.
②	HTL/TTL DIP switches	Set the position of the DIP switches based on the type of encoder signal used. You must set all switches to the same position.

(1) When using 12V Encoder power, 24V I/O power, maximum output current at I/O Terminal 11 is 50 mA.  
 (2) If Encoder requires 24V power, it must be supplied by an external power source.

### Encoder Wiring Examples

I/O	Connection Example	I/O	Connection Example
<b>Encoder Power - Internal Drive Power</b>  Internal (drive) 12V DC, 250 mA		<b>Encoder Power - External Power Source</b>	
<b>Encoder Signal - Single-Ended, Dual Channel</b>		<b>Encoder Signal - Differential, Dual Channel</b>	

### HTL/TTL DIP Switches

This feature is available on 25-ENC-1 encoder. Set the two switches to HTL (default) or TTL (On) based on the type of encoder signal you are using in your application. You must set all switches to the same position.

### Compatible Encoder Output Voltage

Switch Position	Low Level (UL)	High Level (UH)
TTL	<1.5V	>2.5V
HTL	<3.5V	>5V

**IMPORTANT** Only the 25-ENC-1 Encoder will work properly in the PowerFlex 525 drive. Installing an incorrect encoder card, such as the PowerFlex 527 25-ENC-2 will cause damage to the PowerFlex 525 drive.

## Wiring Notes

The encoder option card can supply 5V or 12V power (250 mA maximum) for an encoder. Be sure the DIP switch is set properly for the encoder. In general, 12V will provide higher noise immunity.

The encoder can handle 5V, 12V, or 24V inputs, but the pulse train can handle only 24V inputs. The inputs will automatically adjust to the voltage applied and no additional drive adjustment is necessary. If a single-channel input is used, it must be wired between the A (signal) and A- (signal common) channels.

---

**IMPORTANT** A quadrature encoder provides rotor speed and direction. Therefore, the encoder must be wired such that the forward direction matches the motor forward direction. If the drive is reading encoder speed but the position regulator or other encoder function is not working properly, remove power to the drive, then do one of the following:

- Swap the A and A (NOT) encoder channels.
- Swap the B and B (NOT) encoder channels.
- Swap any two motor leads.

Drives will fault when an encoder is incorrectly wired and [A535](#) [Motor Fdbk Type] is set to 5 "Quad Check".

---

## Determine Encoder Pulse Per Revolution (PPR) Specification Based on Speed Resolution

Use the following formula to determine the encoder pulse per revolution (PPR) specification based on the speed resolution.

$$\text{Speed resolution (Hz)} = \frac{\left( \frac{1}{\text{encoder pulse number} \times 4} \right) \times \text{pole pairs}}{10^{-3} \text{ sec}}$$



The operating speed range will depend on the motor control mode selected (SVC or VVC). For more information, see [Performance with Encoder on page 168](#).

### Example 1

To determine the PPR for quadrature encoder, to achieve 0.06 Hz of speed resolution on a 4-pole motor (2-pole pair) with a base speed of 60 Hz:

$$\begin{aligned} 0.06 \text{ Hz} &= \frac{\left( \frac{1}{\text{encoder pulse number} \times 4} \right) \times 2}{10^{-3} \text{ sec}} \\ &= \sim 8333 \text{ pulse} \end{aligned}$$

Therefore, select 8333 PPR or higher for the quadrature encoder to achieve the desired speed resolution of 0.06 Hz.

### Example 2

To determine the speed resolution, using a 1024 PPR quadrature incremental encoder on a 4-pole (2-pole pair) motor:

$$\begin{aligned} \text{Speed resolution (Hz)} &= \frac{\left( \frac{1}{1024 \times 4} \right) \times 2}{10^{-3} \text{ sec}} \\ &= 0.49 \text{ Hz} \end{aligned}$$

Therefore, using a 1024 PPR quadrature encoder will give a speed resolution of 0.49 Hz.

## Positioning Overview

The PowerFlex 525 drive includes a simple position regulator which can be used in a variety of position applications without the need for multiple limit switches or photo-eyes. This can be used as a standalone controller for simple applications (up to 8 positions) or in conjunction with a controller for more flexibility.

Please note that this is not intended to replace high end servo controllers or any application that needs high bandwidth or very high torque at low speeds.

## Common Guidelines for All Applications

The position regulator can be configured for operation appropriate for a variety of applications. Certain parameters will need to be adjusted in all cases.

[P047](#) [Speed Reference1] must be set to 16 “Positioning”.

[A535](#) [Motor Fdbk Type] must be set to match the feedback device. Positioning mode must use [A535](#) [Motor Fdbk Type] option 4.

### [A535](#) [Motor Fdbk Type] Options

o **“None”** indicates no encoder is used. This can not be used for positioning.

**1 “Pulse Train”** is a single channel input, no direction, speed feedback only. This should not be used for positioning. The Single Channel selection is similar to a Pulse Train, but uses the standard encoder scaling parameters.

**2 “Single Chan”** is a single channel input, no direction, speed feedback only. This should not be used for positioning. Single channel uses the standard encoder scaling parameters.

**3 “Single Check”** is a single channel input with encoder signal loss detection. The drive will fault if it detects that the input pulses do not match the expected motor speed. This should not be used for positioning.

**4 “Quadrature”** is a dual channel encoder input with direction and speed from the encoder. This may be used for positioning control.

**5 “Quad Check”** is a dual channel encoder with encoder signal loss detection. The drive will fault if it detects that the encoder speed does not match the expected motor speed.

[A544](#) [Reverse Disable] should be set to o “Rev Enabled” to allow bidirectional movement necessary for position control.

[P039](#) [Torque Perf Mode] default setting is 1 “SVC”. However, any mode can be used to improve the low speed torque for positioning applications. For best

results, tune the application first. The autotune routine can be completed to further improve the drive-motor performance.

[A550](#) [Bus Reg Enable] default setting is 1 “Enabled”. If the deceleration time is too short, the drive may overshoot the desired position. For best results, a longer deceleration time may be necessary. [A550](#) [Bus Reg Enable] can be disabled to provide precise stopping movements, but the deceleration time will need to be manually tuned so that it is long enough to avoid Foos “OverVoltage” faults.

[A437](#) [DB Resistor Sel] default setting is 0 “Disabled”. If improved deceleration performance is required a Dynamic Brake resistor can be used. If used, this parameter should be set to the appropriate setting for the resistor selected.

[P035](#) [Motor NP Poles] must be set to match the number of motor poles on the motor driven by the PowerFlex 520-series drive.

[A536](#) [Encoder PPR] must be set to match the number of pulses per revolution of the encoder used (i.e., 1024 PPR Encoder).

[A559](#) [Counts Per Unit] sets the number of encoder counts that will be used to define one position unit. This allows the encoder positions to be defined in terms of units important to the application. For example, if 1 cm of travel on a conveyor belt requires 0.75 turns of the motor, the motor encoder is 1024 PPR, and the Motor Feedback type is set to Quadrature, then this parameter would need to be set to  $(4 \times 1024 \times 0.75) = 3072$  counts for 1 cm of travel. Then all other positions could be setup in units of “cm”.

[A564](#) [Encoder Pos Tol] indicates the desired position tolerance for the system. This will determine how close the drive must be to the commanded position before the drive will indicate “At Home” or “At Position” in units of raw encoder pulses. This has no effect on the actual positioning control of the motor.

## Positioning Operation

Parameter [A558](#) [Positioning Mode] must be set to properly match the desired operation of the positioning function.

### [A558](#) [Positioning Mode] Options

0 “Time Steps” uses Step Logic times. This mode ignores the Step Logic settings and moves through the steps (Step 0 to Step 7 and back to Step 0) based on the times programmed into [L190...L197](#) [Stp Logic Time x]. This can be used when the desired position is based only on time. In addition, this mode only accepts absolute positions in a positive direction from “home”. This option provides an easy way to implement a simple positioning program or to test the basic positioning setup. For additional flexibility one of the other settings should be used.

1 “Preset Input” directly commands movement to any step based on the status of the digital inputs programmed for “Preset Freq”. This setting ignores the StepLogic Commands settings and instead the

drive will move directly to whatever step is currently commanded by [A410...A425](#) [Preset Freq x] and [L200...L214](#) [Step Units x]. This is useful when an application needs direct access to any position step based on discrete inputs. This mode moves in the forward direction from Home and is an absolute move.

---

**IMPORTANT** Advanced StepLogic options such as incremental move are not available in this mode.

---

**2 “Step Logic”** provides a highly flexible mode of operation. This can be used to move through the steps (Step 0 to Step 7 and back to Step 0) or can jump to a different step at any time based on time or the status of digital inputs or communication commands. In this mode the drive always starts at Step 0 of the StepLogic profile.

**3 “Preset StpL”** is identical to 2 “Step Logic” except the drive will use the current status of the Preset Inputs to determine which Step Logic step to begin. This only affects the initial step. After start, the drive will move through the steps in the same manner as if setting 2 was selected.

**4 “StpLogic-Lst”** is identical to 2 “Step Logic” except the drive will use the step prior to its last stop command to determine which Step Logic step to begin. This only affects the initial step. After start, the drive will move through the steps in the same manner as if setting 2 was selected. This allows a process to be stopped and then restarted at the position where it stopped.

In all position modes, the following parameters will control the characteristics at each step:

[L200](#), [L202](#), [L204](#), [L206](#), [L208](#), [L210](#), [L212](#) and [L214](#) [Step Units x] are the number value to the left of the decimal (whole number) of the 8 positions desired for an application, beginning with Step 0 (L200) and continuing with each step until Step 7 (L214). For example, enter 2 into this parameter if you would like a commanded position of 2.77.

[L201](#), [L203](#), [L205](#), [L207](#), [L209](#), [L211](#), [L213](#), and [L215](#) [Step Units F x] are the number value to the right of the decimal (the portion less than 1) of the 8 positions desired for an application, beginning with Step 0 (L201) and continuing with each step until Step 7 (L215). For example, enter 0.77 into this parameter if you would like a commanded position of 2.77.

[A410...A417](#) [Preset Freq x] are the parameters that define the maximum frequency the drive will run at during the corresponding step. For example, if [Preset Freq 2] is set to 40 Hz, the drive will accelerate to 40 Hz maximum when moving to Position 2.

Frequency Source	Step Source	Position Source
<a href="#">A410</a> [Preset Freq 0]	<a href="#">L180</a> [Stp Logic 0]	<a href="#">L200</a> [Step Units 0]
<a href="#">A411</a> [Preset Freq 1]	<a href="#">L181</a> [Stp Logic 1]	<a href="#">L202</a> [Step Units 1]
<a href="#">A412</a> [Preset Freq 2]	<a href="#">L182</a> [Stp Logic 2]	<a href="#">L204</a> [Step Units 2]
<a href="#">A413</a> [Preset Freq 3]	<a href="#">L183</a> [Stp Logic 3]	<a href="#">L206</a> [Step Units 3]
<a href="#">A414</a> [Preset Freq 4]	<a href="#">L184</a> [Stp Logic 4]	<a href="#">L208</a> [Step Units 4]

Frequency Source	Step Source	Position Source
<a href="#">A415</a> [Preset Freq 5]	<a href="#">L185</a> [Stp Logic 5]	<a href="#">L210</a> [Step Units 5]
<a href="#">A416</a> [Preset Freq 6]	<a href="#">L186</a> [Stp Logic 6]	<a href="#">L212</a> [Step Units 6]
<a href="#">A417</a> [Preset Freq 7]	<a href="#">L187</a> [Stp Logic 7]	<a href="#">L214</a> [Step Units 7]

**IMPORTANT** The default value for [A410](#) [Preset Freq 0] is 0.00 Hz. This value needs to be changed or the drive will not be able to move during Step 0.

[L190...L197](#) [Stp Logic Time x] are the parameters that define the time the drive will remain in each corresponding step if that step is time-based. For example, if [L192](#) [Stp Logic Time 2] is set to 5.0 seconds and that step is time-based, the drive will remain in Step 2 for 5.0 seconds. Note that this is the total time in that step, not the time at that position. Therefore, it will include the time needed to accelerate, run, and decelerate to that position.

[L180...L187](#) [Stp Logic x] are the parameters that allow additional flexibility and control various aspects of each step when a positioning mode is selected that utilizes the StepLogic functions. Note that in Positioning mode these parameters have a different function than when used for normal velocity Step Logic. Each of the 4 digits controls one aspect of the each position step. The following is a listing of the available settings for each digit:

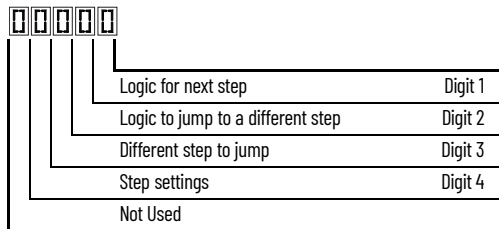

### Velocity Control Settings (Digit 4)

Required Setting	Accel/Decel Param. Used	StepLogic Output State	Commanded Direction
0	Accel/Decel 1	Off	FWD
1	Accel/Decel 1	Off	REV
2	Accel/Decel 1	Off	No Output
3	Accel/Decel 1	On	FWD
4	Accel/Decel 1	On	REV
5	Accel/Decel 1	On	No Output
6	Accel/Decel 2	Off	FWD
7	Accel/Decel 2	Off	REV
8	Accel/Decel 2	Off	No Output
9	Accel/Decel 2	On	FWD
A	Accel/Decel 2	On	REV
b	Accel/Decel 2	On	No Output

### Settings (Digit 3)

Setting	Description
0	Jump to Step 0
1	Jump to Step 1
2	Jump to Step 2
3	Jump to Step 3
4	Jump to Step 4
5	Jump to Step 5
6	Jump to Step 6
7	Jump to Step 7
8	End Program (Normal Stop)
9	End Program (Coast to Stop)
A	End Program and Fault (F2)

## Positioning Settings (Digit 4)

Required Setting	Accel/Decel Param. Used	StepLogic Output State	Direction From Home	Type of Command
0	Accel/Decel 1	Off	FWD	Absolute
1	Accel/Decel 1	Off	FWD	Incremental
2	Accel/Decel 1	Off	REV	Absolute
3	Accel/Decel 1	Off	REV	Incremental
4	Accel/Decel 1	On	FWD	Absolute
5	Accel/Decel 1	On	FWD	Incremental
6	Accel/Decel 1	On	REV	Absolute
7	Accel/Decel 1	On	REV	Incremental
8	Accel/Decel 2	Off	FWD	Absolute
9	Accel/Decel 2	Off	FWD	Incremental
A	Accel/Decel 2	Off	REV	Absolute
b	Accel/Decel 2	Off	REV	Incremental
C	Accel/Decel 2	On	FWD	Absolute
d	Accel/Decel 2	On	FWD	Incremental
E	Accel/Decel 2	On	REV	Absolute
F	Accel/Decel 2	On	REV	Incremental

## Settings (Digit 2 and 1)

Setting	Description
0	Skip Step (Jump Immediately)
1	Step Based on [Stp Logic Time x]
2	Step if "Logic In 1" is Active
3	Step if "Logic In 2" is Active
4	Step if "Logic In 1" is Not Active
5	Step if "Logic In 2" is Not Active
6	Step if either "Logic In 1" or "Logic In 2" is Active
7	Step if both "Logic In 1" and "Logic In 2" are Active
8	Step if neither "Logic In 1" nor "Logic In 2" is Active
9	Step if "Logic In 1" is Active and "Logic In 2" is Not Active
A	Step if "Logic In 2" is Active and "Logic In 1" is Not Active
b	Step after [Stp Logic Time x] and "Logic In 1" is Active
C	Step after [Stp Logic Time x] and "Logic In 2" is Active
d	Step after [Stp Logic Time x] and "Logic In 1" is Not Active
E	Step after [Stp Logic Time x] and "Logic In 2" is Not Active
F	Do Not Step/Ignore Digit 2 Settings



Use the Wizard in Connected Components Workbench software to simplify setup instead of manually configuring the parameters.

Note: Incremental move commands will cause the drive to move the amount specified based on the current position. Absolute commands are always with reference to "Home".

[A565](#) [Pos Reg Filter] provides a low pass filter at the input of the position regulator.

[A566](#) [Pos Reg Gain] is a single adjustment for increasing or decreasing the responsiveness of the position regulator. For faster response, the filter should be reduced and/or the gain should be increased. For smoother response with less overshoot, the filter should be increased and/or the gain should be reduced. In general, the gain will have a larger effect on most systems than the filter.

## Homing Routine

This drive supports incremental encoders only. Therefore, when the drive powers up it will reset the current position to zero. If this is known to be correct the position routine can be started without further adjustment. However, in most applications the drive will need to be "homed" after each power-up and prior to starting the position routine.

This can be accomplished in one of the following two ways:

1. Manual Homing—Program the following drive parameters:

[to62](#), [to63](#), [to65...to68](#) [DigIn TermBlk xx] = 37 "Pos Redefine"

Program one of the digital inputs to 37 "Pos Redefine". Then, move the system into the home position with a run command, a jog command,



or by manually moving the system into the home position. Then, toggle the “Pos Redefine” input. This will set the drive to “Home” at its current position and [d388](#) [Units Traveled H] and [d389](#) [Units Traveled L] are set to zero. Alternately, the “Pos Redefine” bit in [A560](#) [Enh Control Word] can be toggled instead of utilizing a digital input.

---

**IMPORTANT** The “Pos Redefine” input or bit must be returned to inactive before starting the position routine. Otherwise the drive will continuously read a position of “0” (home) and the position routine will not function correctly.

---

- Automatic Homing to Limit Switch—Program the following drive parameters:

[t062](#), [t063](#), [t065...t068](#) [DigIn TermBlk xx] = 35 “Find Home”  
Program one of the digital inputs to 35 “Find Home”.

[t062](#), [t063](#), [t065...t068](#) [DigIn TermBlk xx] = 34 “Home Limit”  
Program one of the digital inputs to 34 “Home Limit”. Normally, the “Home Limit” input would be wired to a proximity switch or photo-eye and will indicate the system is in the home position.

[A562](#) [Find Home Freq] sets the frequency the drive will use while it is moving to the home position during the automatic homing routine.

[A563](#) [Find Home Dir] sets the direction the drive will use while it is moving to the home position during the automatic homing routine.

To begin the automatic homing routine, activate the “Find Home” input and then initiate a valid start command. The drive will then ramp to the speed set in [A562](#) [Find Home Freq] and in the direction set in [A563](#) [Find Home Dir] until the digital input defined as “Home Limit” is activated. If the drive passes this point too quickly it will then reverse direction at 1/10th [A562](#) [Find Home Freq] to the point where the Home Limit switch reactivates. Approximately one second after the routine finds home the drive will stop. Alternately, the “Find Home Freq” and/or “Home Limit” bits in [A560](#) [Enh Control Word] can be activated instead of utilizing a digital input. The inputs or bits should be returned to inactive after the routine is complete.

---

**IMPORTANT** After the position is reached the drive will stop. If the Find Home is removed before the homing is complete, the drive will begin running the position routine without the proper home. In this case Home will not be reset and the position will be in relation to the power up position.

---

## Encoder and Position Feedback

[d376](#) [Speed Feedback] indicates the measured speed feedback or the calculated speed feedback when no feedback device is selected. Parameter [d376](#) [Speed Feedback] is the number value to the left of the decimal (whole number) and [d377](#) [Speed Feedback F] is the value to the right of the decimal (the portion less than 1).

[d378](#) [Encoder Speed] indicates the measured speed of the feedback device. This is useful if the encoder is not used for motor speed control. However, the encoder must be used for some purpose in order for [d378](#) [Encoder Speed] to indicate a value. Parameter [d378](#) [Encoder Speed] is the number value to the

left of the decimal (whole number) and [d379](#) [Encoder Speed F] is the number to the right of the decimal (the portion less than 1).

[d388](#), [d389](#) [Units Traveled x] indicate the current position of the system in terms of units away from Home. Parameter [d388](#) [Units Traveled H] is the number value to the left of the decimal (whole number) and [d389](#) [Units Traveled L] is the number to the right of the decimal (the portion less than 1).

[d387](#) [Position Status] indicates the status of the positioning functions. The indication bits are:

**Bit 0 “Dir Positive”** indicates the current direction the drive has moved from Home.

**Bit 1 “At Position”** indicates whether the drive is at its commanded position. If the drive is within [A564](#) [Encoder Pos Tol] of the commanded position, this bit will be active.

**Bit 2 “At Home”** indicates whether the drive is at Home. If the drive is within [A564](#) [Encoder Pos Tol] of “Home”, this bit will be active.

**Bit 3 “Drive Homed”** indicates whether the drive has been homed since power up. This bit will be active once the drive has been homed either manually or automatically. It will remain active until the next power down.

## Use Over Communications

If 8 steps are not adequate for the application or if dynamic program changes are required, many of the positioning functions can be controlled through an active communication network. The following parameters will allow this control.

[C121](#) [Comm Write Mode]

Repeated writes to parameters over a communication network can cause damage to the drive EEPROM. This parameter allows the drive to accept parameter changes without writing to the EEPROM.

---

**IMPORTANT** Parameter values set prior to setting 1 “RAM only” are saved in RAM.

---

[C122](#) [Cmd Stat Select]

Selects velocity-specific or position/fibers-specific Command and Status Word bit definitions for use over a communication network.

[A560](#) [Enh Control Word]

This parameter allows many of the positioning functions to be completed through parameter control using an explicit message. This allows the operation over communications instead of with hardware inputs. The bits have the same functions as the digital input options of the same name. Options relating to positioning are:

**Bit 0 “Home Limit”** indicates the drive is at the home position.

**Bit 1 “Find Home”** causes the drive to find home at the next start command. Deactivate this bit after completing the homing routine.

**Bit 2 “Hold Step”** overrides other inputs and causes the drive to remain at its current step (running at zero speed once it reaches its position) until released.

**Bit 3 “Pos Redefine”** resets the home position to the current position of the machine. Deactivate this bit after completing the homing routine.

**Bit 4 “Sync Enable”** holds the existing frequency when A571 [Sync Time] is set to enable speed synchronization. When this bit is deactivated the drive will accelerate to the new commanded frequency based on A571 [Sync Time].

**Bit 5 “Traverse Dis”** disables the traverse function when this bit is active.

**Bit 6 “Logic In 1”** provides an identical function and is logically ORed with setting 24 “Logic In 1” for [t062](#), [t063](#), [t065...t068](#) [DigIn TermBlk xx]. It can be used to move through the StepLogic functions (speed or position) using comms control without requiring actual digital input transitions.

**Bit 7 “Logic In 2”** provides an identical function and is logically ORed with setting 25 “Logic In 2” for [t062](#), [t063](#), [t065...t068](#) [DigIn TermBlk xx]. It can be used to move through the StepLogic functions (speed or position) using comms control without requiring actual digital input transitions.

[L200...L214](#) [Step Units x]

All of the position steps can be written to while the drive is running. The changes will take place at the next move. For example, if step 0 is over-written while the drive is moving to step 0, the drive will move to the previous commanded position at step 0. The next time the drive is commanded to return to step 0 it will proceed to the new position. One possible use of this capability is when an application requires full control of the movement by a controller external to the drive. The StepLogic program might be written to jump from step 0 back to step 0 when Input 1 is active. The controller could write any desired position to step 0 and then toggle the input 1 bit of [A560](#) [Enh Control Word] to cause the drive to move to the new position. This allows almost unlimited flexibility and can be used with absolute or incremental moves.

## Setup Notes

The RA computer tool (Connected Components Workbench software) can make setup of the positioning functions much easier. See the latest versions for additional tools or wizards, which can aid in the setup.

**Notes:**

## PID Set Up

### PID Loop

The PowerFlex 520-series drive features built-in PID (proportional, integral, derivative) control loops. The PID loop is used to maintain a process feedback (such as pressure, flow or tension) at a desired set point. The PID loop works by subtracting the PID feedback from a reference and generating an error value. The PID loop reacts to the error, based on the PID Gains, and outputs a frequency to try to reduce the error value to 0.

To enable the PID loop, [Po47](#), [Po49](#) or [Po51](#) [Speed Reference] must be set to 11 “PID1 Output” or 12 “PID2 Output”, and the corresponding speed reference activated.

---

**IMPORTANT** PowerFlex 523 has one PID control loop.  
PowerFlex 525 has two PID control loops, of which only one can be in use at any time.

---

Exclusive Control and Trim Control are two basic configurations where the PID loop may be used.

### Exclusive Control

In Exclusive Control, the Speed Reference becomes 0, and the PID Output becomes the entire Freq Command. Exclusive Control is used when [A458](#) or [A470](#) [PID x Trim Sel] is set to option 0. This configuration does not require a master reference, only a desired set point, such as a flow rate for a pump.

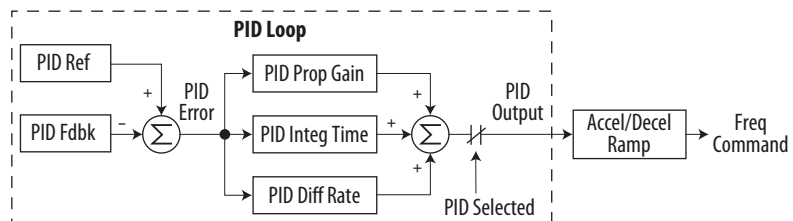

### Example

- In a pumping application, the PID Reference equals the Desired System Pressure set point.
- The Pressure Transducer signal provides PID Feedback to the drive. Fluctuations in actual system pressure, due to changes in flow, result in a PID Error value.
- The drive output frequency increases or decreases to vary motor shaft speed to correct for the PID Error value.
- The Desired System Pressure set point is maintained as valves in the system are opened and closed causing changes in flow.

- When the PID Control Loop is disabled, the Commanded Speed is the Ramped Speed Reference.

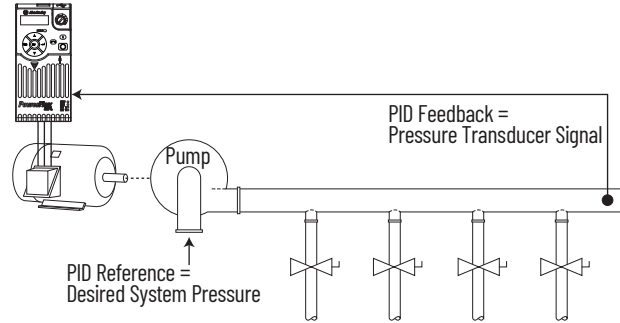

### Trim Control

In Trim Control, the PID Output is added to the Speed Reference. In Trim mode, the output of the PID loop bypasses the accel/decel ramp as shown. Trim Control is used when [A458](#) or [A470](#) [PID x Trim Sel] is set to any option other than 0.

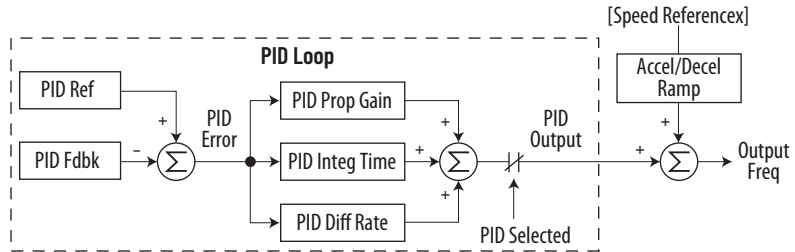

### Example

- In a winder application, the PID Reference equals the Equilibrium set point.
- The Dancer Pot signal provides PID Feedback to the drive. Fluctuations in tension result in a PID Error value.
- The Master Speed Reference sets the wind/unwind speed.
- As tension increases or decreases during winding, the Speed Reference is trimmed to compensate. Tension is maintained near the Equilibrium set point.

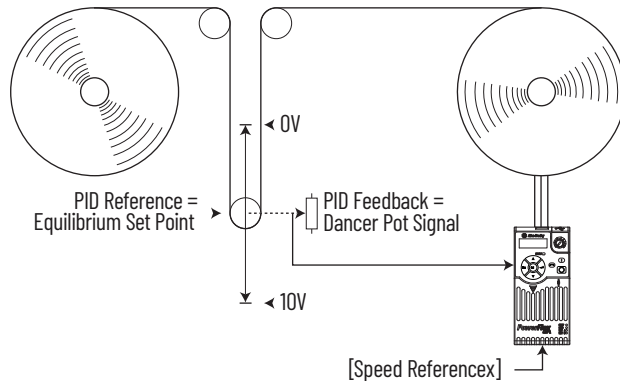

## PID Reference and Feedback

PID mode is enabled by setting [Po47](#), [Po49](#) or [Po51](#) [Speed Reference<sub>x</sub>] to 11 “PID1 Output” or 12 “PID2 Output”, and activating the corresponding speed reference.

---

**IMPORTANT** PowerFlex 523 has one PID control loop.  
PowerFlex 525 has two PID control loops, of which only one can be in use at any time.

---

If [A459](#) or [A471](#) [PID x Ref Sel] is not set to 0 “PID Setpoint”, PID can still be disabled by select programmable digital input options (parameters [t062](#), [t063](#), [t065...t068](#) [DigIn TermBlk xx]) such as “Purge”.

### A459, A471 [PID x Ref Sel] Options

Options	Description
0”PID Setpoint”	A464 or A476 [PID x Setpoint] will be used to set the value of the PID Reference.
1”Drive Pot”	The drive potentiometer will be used to set the value of the PID Reference.
2”Keypad Freq”	The drive keypad will be used to set the value of the PID Reference.
2”Serial/DSI”	The reference word from the Serial/DSI communication network becomes the PID Reference.
4”Network Opt”	The reference word from a communication network option becomes the PID Reference.
5”0-10V Input”	Selects the 0...10V Input. The PID will not function with a bipolar analog input. It will ignore any negative voltages and treat them like a zero.
6”4-20mA Input”	Selects the 4...20 mA Input.
7”Preset Freq”	A410...A425 [Preset Freq <sub>x</sub> ] will be used as an input for the PID Reference.
8”AnlgIn Multi <sup>(1)</sup> ”	The product of the 0...10V and 4...20mA Inputs will be used as an input for the PID Reference.
9”MOP Freq”	A427 [MOP Freq] will be used as an input for the PID Reference.
10”Pulse Input”	Pulse train will be used as an input for the PID Reference.
11”Step Logic <sup>(1)</sup> ”	Step Logic will be used as an input for the PID Reference.
12”Encoder <sup>(1)</sup> ”	Encoder will be used as an input for the PID Reference.
13”EtherNet/IP <sup>(1)</sup> ”	The reference word from the EtherNet/IP communication network becomes the PID Reference.

(1) Setting is specific to PowerFlex 525 drives only.

[A460](#) and [A472](#) [PID x Fdbck Sel] are used to select the source of the PID feedback.

### A460, A472 [PID x Fdbck Sel] Options

Options	Description
0”0-10V Input”	Selects the 0...10V Input (default setting). The PID will not function with a bipolar analog input. It will ignore any negative voltages and treat them like a zero.
1”4-20mA Input”	Selects the 4...20 mA Input.
2”Serial/DSI”	Serial/DSI will be used as an input for the PID Feedback.
3”Network Opt”	The reference word from a communication network option becomes the PID Reference.
4”Pulse Input”	Pulse train will be used as an input for the PID Feedback.
5”Encoder <sup>(1)</sup> ”	Encoder will be used as an input for the PID Feedback.
6”EtherNet/IP <sup>(1)</sup> ”	EtherNet/IP will be used as an input for the PID Feedback.

(1) Setting is specific to PowerFlex 525 drives only.

## Analog PID Reference Signals

Parameters [t091](#) [Anlg In 0-10V Lo] and [t092](#) [Anlg In 0-10V Hi] are used to scale or invert an analog PID Reference or PID Feedback.

### Scale Function

For a 0...5V signal, the following parameter settings are used so that a 0V signal = 0% PID Reference and a 5V signal = 100% PID Reference.

- [t091](#) [Anlg In 0-10V Lo] = 0.0%
- [t092](#) [Anlg In 0-10V Hi] = 50.0%
- [A459](#) [PID 1 Ref Sel] = 5 “0-10V Input”

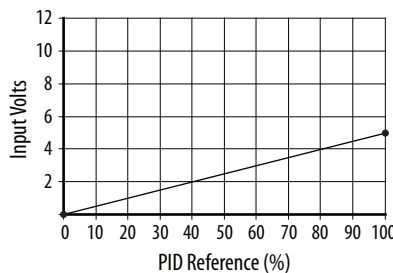

### Invert Function

For a 4...20 mA signal, the following parameter settings are used so that a 20 mA signal = 0% PID Reference and a 4 mA signal = 100% PID Reference.

- [t095](#) [Anlg In4-20mA Lo] = 100.0%
- [t096](#) [Anlg In4-20mA Hi] = 0.0%
- [A459](#) [PID 1 Ref Sel] = 6 “4-20mA Input”

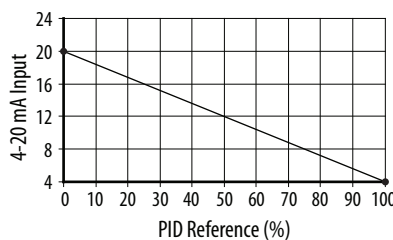

### PID Deadband

Parameters [A465](#) and [A477](#) [PID x Deadband] are used to set a range, in percent, of the PID Reference that the drive will ignore.

#### Example

- [A465](#) [PID 1 Deadband] = 5.0%
- The PID Reference is 25.0%
- The PID Regulator will not act on a PID Error that falls between 20.0 and 30.0%



## PID Preload

The value set in [A466](#) or [A478](#) [PID x Preload], in Hz, will be pre-loaded into the integral component of the PID at any start or enable. This will cause the drive's frequency command to initially jump to that preload frequency, and the PID loop starts regulating from there.

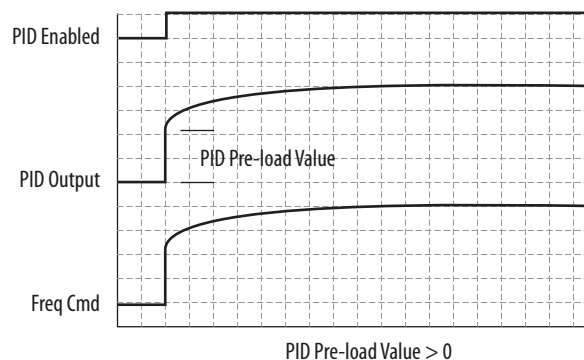

## PID Limits

[A456](#) and [A468](#) [PID x Trim Hi] and [A457](#) and [A469](#) [PID x Trim Lo] are used to limit the PID output and are only used in trim mode. [PID x Trim Hi] sets the maximum frequency for the PID output in trim mode. [PID x Trim Lo] sets the reverse frequency limit for the PID output in trim mode. Note that when the PID reaches the Hi or Lo limit, the PID regulator stops integrating so that windup does not occur.

## PID Gains

The proportional, integral, and differential gains make up the PID regulator.

- [A461](#) and [A473](#) [PID x Prop Gain]  
The proportional gain (unitless) affects how the regulator reacts to the magnitude of the error. The proportional component of the PID regulator outputs a speed command proportional to the PID error. For example, a proportional gain of 1 would output 100% of max frequency when the PID error is 100% of the analog input range. A larger value for [PID x Prop Gain] makes the proportional component more responsive, and a smaller value makes it less responsive. Setting [PID x Prop Gain] to 0.00 disables the proportional component of the PID loop.
- [A462](#) and [A474](#) [PID x Integ Time]  
The integral gain (units of seconds) affects how the regulator reacts to error over time and is used to get rid of steady state error. For example, with an integral gain of 2 seconds, the output of the integral gain component would integrate up to 100% of max frequency when the PID error is 100% for 2 seconds. A larger value for [PID x Integ Time] makes the integral component less responsive, and a smaller value makes it more responsive. Setting [PID x Integ Time] to 0.0 disables the integral component of the PID loop.
- [A463](#) and [A475](#) [PID x Diff Rate]  
The Differential gain (units of 1/seconds) affects the rate of change of the PID output. The differential gain is multiplied by the difference between the previous error and current error. Thus, with a large error the D has a large effect and with a small error the D has less of an effect. This

parameter is scaled so that when it is set to 1.00, the process response is 0.1% of [Po44](#) [Maximum Freq] when the process error is changing at 1% / second. A larger value for [PID x Diff Rate] makes the differential term have more of an effect and a small value makes it have less of an effect. In many applications, the D gain is not needed. Setting [PID x Diff Rate] to 0.00 (factory default) disables the differential component of the PID loop.

### Guidelines for Adjusting the PID Gains

1. Adjust the proportional gain. During this step it may be desirable to disable the integral gain and differential gain by setting them to 0. After a step change in the PID Feedback:
  - If the response is too slow increase A461 or A473 [PID x Prop Gain].
  - If the response is too quick and/or unstable (see [Unstable Response on page 234](#)), decrease A461 or A473 [PID x Prop Gain].
  - Typically, A461 or A473 [PID x Prop Gain] is set to some value below the point where the PID begins to go unstable.
2. Adjust the integral gain (leave the proportional gain set as in Step 1). After a step change in the PID Feedback:
  - If the response is too slow (see [Slow Response – Over Damped on page 234](#)), or the PID Feedback does not become equal to the PID Reference, decrease A462 or A474 [PID x Integ Time].
  - If there is a lot of oscillation in the PID Feedback before settling out (see [Oscillation – Under Damped on page 235](#)), increase A462 or A474 [PID x Integ Time].
3. At this point, the differential gain may not be needed. However, if after determining the values for A461 or A473 [PID x Prop Gain] and A462 or A474 [PID x Integ Time]:
  - Response is still slow after a step change, increase A463 or A475 [PID x Diff Rate].
  - Response is still unstable, decrease A463 or A475 [PID x Diff Rate].

The following figures show some typical responses of the PID loop at different points during adjustment of the PID Gains.

#### Unstable Response

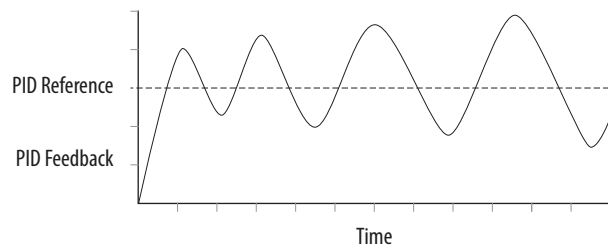

#### Slow Response - Over Damped

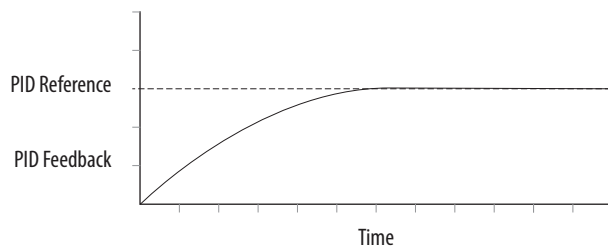

### Oscillation - Under Damped

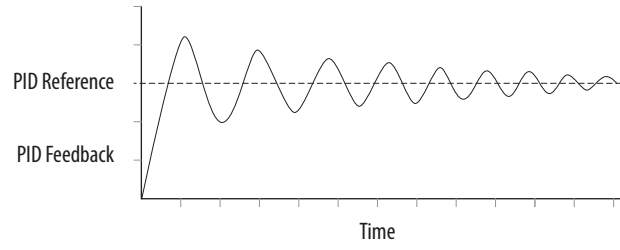

### Good Response - Critically Damped

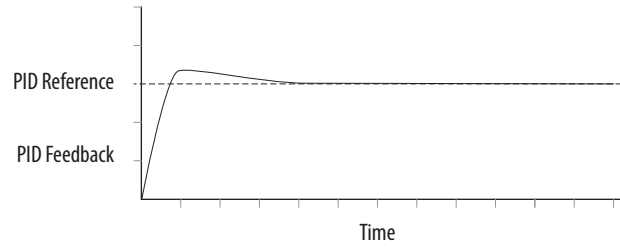

**Notes:**

## Safe Torque Off Function

The PowerFlex 525 Safe-Torque-Off function, when used with other safety components, helps provide protection according to EN ISO 13849 and EN62061 for safe-off and protection against restart. The PowerFlex 525 Safe-Torque-Off function is just one component in a safety control system. Components in the system must be chosen and applied appropriately to achieve the desired level of operator safeguarding.

Topic	Page
PowerFlex 525 Safe-Torque-Off Overview	237
EC Type Examination Certification	238
EMC Instructions	238
Using PowerFlex 525 Safe-Torque-Off	239
Enabling PowerFlex 525 Safe-Torque-Off	241
Wiring	241
Verify Operation	242
PowerFlex 525 Safe-Torque-Off Operation	242
Connection Examples	243
PowerFlex 525 Certification for Safe-Torque-Off	246

**IMPORTANT** The Safe-Torque-Off function covered in this chapter is specific to PowerFlex 525 drives only.

### PowerFlex 525 Safe-Torque-Off Overview

The PowerFlex 525 Safe-Torque-Off function:

- Provides the Safe-Torque-Off (STO) function defined in EN 61800-5-2.
- Blocks gate-firing signals from reaching the Insulated Gate Bipolar Transistor (IGBT) output devices of the drive. This prevents the IGBTs from switching in the sequence necessary to generate torque in the motor.
- Can be used in combination with other safety devices to fulfill the requirements of a system “safe torque off” function which satisfies

Category 3 / PL (d) according to EN ISO 13849-1 and SIL CL2 according to EN 62061, IEC 61508, and EN 61800-5-2.

---

**IMPORTANT** The function is suitable for performing mechanical work on the drive system or affected area of a machine only. It does not provide electrical safety.

---



**ATTENTION:** Electric Shock Hazard. Verify that all sources of AC and DC power are de-energized and locked out or tagged out in accordance with the requirements of ANSI/NFPA 70E, Part II.

To avoid an electric shock hazard, verify that the voltage on the bus capacitors has discharged before performing any work on the drive. Measure the DC bus voltage at the +DC and -DC terminals or test points (refer to your drive's User Manual for locations). The voltage must be zero.

In safe-off mode, hazardous voltages may still be present at the motor. To avoid an electric shock hazard, disconnect power to the motor and verify that the voltage is zero before performing any work on the motor.

---

## EC Type Examination Certification

TÜV Rheinland has certified the PowerFlex 525 Safe-Torque-Off function compliant with the requirements for machines defined in Annex I of the EC Directive 2006/42/EC, and that it complies with the requirements of the relevant standards listed below:

- EN ISO 13849-1 Safety of machinery – Safety related parts of control systems – Part 1: General principles for design. (PowerFlex 525 STO achieves Category 3 / PL(d))
- EN 61800-5-2 Adjustable speed electrical power drive systems – Part 5-2 Safety requirements – Functional. (PowerFlex 525 STO achieves SIL CL 2)
- EN 62061 Safety of machinery – Functional safety of safety-related electrical, electronic and programmable electronic control systems.
- IEC 61508 Part 1-7 Functional safety of electrical/electronic/programmable electronic safety-related systems – Parts 1-7.

TÜV also certifies that the PowerFlex 525 STO may be used in applications up to Category 3/ PL(d) according to EN ISO 13849-1 and SIL 2 according to EN 62061 / EN 61800-5-2 / IEC 61508.

The TÜV Rheinland certificate may be found at: [rok.auto/certifications](http://rok.auto/certifications).

## EMC Instructions

PowerFlex 525 Safe-Torque-Off function requires CE Conformity as described on [page 51](#).

## Using PowerFlex 525 Safe-Torque-Off

The PowerFlex 525 Safe-Torque-Off function is intended to be part of the safety related control system of a machine. Before use, a risk assessment should be performed that compares the PowerFlex 525 Safe-Torque-Off function specifications and all foreseeable operational and environmental characteristics of the machine to which it is to be fitted.

A safety analysis of the machine section controlled by the drive is required to determine how often the safety function should be tested for proper operation during the life of the machine.



**ATTENTION:** The following information is merely a guide for proper installation. Rockwell Automation cannot assume responsibility for the compliance or the noncompliance to any code, national, local or otherwise for the proper installation of this equipment. A hazard of personal injury and/or equipment damage exists if codes are ignored during installation.

**ATTENTION:** In safe-off mode, hazardous voltages may still be present at the motor. To avoid an electric shock hazard, disconnect power to the motor and verify that the voltage is zero before performing any work on the motor.

**ATTENTION:** In the event of the failure of two output IGBTs in the drive, when the PowerFlex 525 Safe-Torque-Off has controlled the drive outputs to the off state, the drive may provide energy for up to 180° of rotation in a 2-pole motor before torque production in the motor ceases.

## Safety Concept

The PowerFlex 525 Safe-Torque-Off function is suitable for use in safety applications up to and including Category 3 / PL(d) according to EN ISO 13849-1 and SIL 2 according to EN 62061 / EN 61800-5-2 / IEC 61508.

In addition, the PowerFlex 525 STO may be used together with other components in a safety application to achieve an overall Category 3 / PL(e) according to EN ISO 13849-1 and SIL 3 according to EN 62061 and IEC 61508. This is illustrated in Example 3 in this appendix.

Safety requirements are based on the standards current at the time of certification.

The PowerFlex 525 Safe-Torque-Off function is intended for use in safety-related applications where the de-energized state is considered to be the safe state. All of the examples in this manual are based on achieving de-energization as the safe state for typical Machine Safety and Emergency Shutdown (ESD) systems.

## Important Safety Considerations

The system user is responsible for:

- the set-up, safety rating, and validation of any sensors or actuators connected to the system.
- completing a system-level risk assessment and reassessing the system any time a change is made.
- certification of the system to the desired safety performance level.
- project management and proof testing.

- programming the application software and the safety option configurations in accordance with the information in this manual.
- access control to the system, including access code handling.
- analyzing all configuration settings and choosing the proper setting to achieve the required safety rating.

---

**IMPORTANT** When applying Functional Safety, restrict access to qualified, authorized personnel who are trained and experienced.

---



**ATTENTION:** When designing your system, consider how personnel will exit the machine if the door locks while they are in the machine. Additional safeguarding devices may be required for your specific application.

---

## Functional Proof Test

The PFD and PFH values provided in the table below are contingent upon the Proof Test Interval (PTI). Before the end of the PTI specified in the table below, a proof test of the STO safety function must be performed in order for the specified PFD and PFH values to remain valid.

## PFD and PFH Data

PFD and PFH calculations are based on the equations from Part 6 of EN 61508.

This table provides data for a 20-year proof test interval and demonstrates the worst-case effect of various configuration changes on the data.

### PFD and PFH for 20-year Proof Test Interval

Attribute	Value
PFD	6.62E-05 (MTTF = 3593 years)
PFH <sub>D</sub>	8.13E-10
SFF	83%
DC	62.5%
CAT	3
HFT	1 (1002)
PTI	20 YEARS
Hardware Type	Type A

## Safety Reaction Time

The safety reaction time is the amount of time from a safety-related event as input to the system until the system is in the Safe State.

The safety reaction time from an input signal condition that triggers a safe stop, to the initiation of safe-torque-off, is 100 ms (maximum).



## Enabling PowerFlex 525 Safe-Torque-Off

1. Remove all power to the drive.



**ATTENTION:** To avoid an electric shock hazard, verify that the voltage on the bus capacitors has discharged before performing any work on the drive. Measure the DC bus voltage at the +DC and -DC terminals or test points (refer to your drive's user manual for the location of the terminals). The voltage must be zero.

2. Loosen the screw of terminals Safety 1, Safety 2 and Safety +24V (S1, S2, S+) on the control I/O terminal block.
3. Remove the protective jumper.

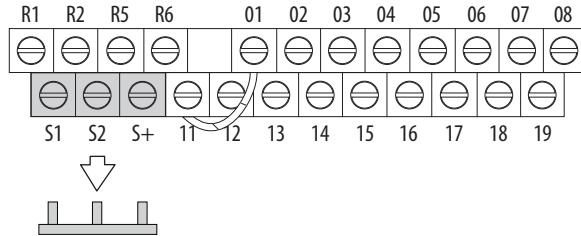

4. Safe-Torque-Off function is now enabled and the terminals are ready to function as safety inputs.

## Wiring

Important points to remember about wiring:

- Always use copper wire.
- Wire with an insulation rating of 600V or greater is recommended.
- Control wires should be separated from power wires by at least 0.3 m (1 ft).

### Recommended Wire

Type	Wire Type <sup>(1)</sup>	Description	Min Insulation Rating
Shielded	Multi-conductor shielded cable such as Belden 8770 (or equiv.)	0.750 mm <sup>2</sup> (18 AWG), 3 conductor, shielded.	300V, 60 °C (140 °F)

(1) Recommendations are for 50 °C ambient temperature.  
75 °C wire must be used for 60 °C ambient temperature.  
90 °C wire must be used for 70 °C ambient temperature.

See [I/O Wiring on page 36](#) for wiring recommendations and [Control I/O Terminal Designations on page 42](#) for terminal descriptions.

If Safety Inputs S1 and S2 are powered by an external +24V source, apply it only in SELV system, PELV system or low voltage Class 2 circuit.

## PowerFlex 525 Safe-Torque-Off Operation

The PowerFlex 525 Safe-Torque-Off function disables the drive's output IGBT's by breaking the link with the drive microcontroller. When used in combination with a safety input device, the system satisfies the requirements of EN ISO 13849 and EN62061 for safe-torque-off and helps protect against restart.

Under normal drive operation, both safety inputs (Safety 1 and Safety 2) are energized, and the drive is able to run. If either input is de-energized, the gate control circuit becomes disabled. To meet EN ISO 13849 operation, both safety channels must be de-energized. See the following examples for more information.

---

**IMPORTANT** By itself, the Safe-Torque-Off function initiates a coast to stop action. Additional protective measures will need to be applied when an application requires a change to the stop action.

---

## Verify Operation

Test the safety function for proper operation after the initial setup of the PowerFlex 525 Safe-Torque-Off function. Retest the safety function at the intervals determined by the safety analysis described on [page 239](#).

Verify that both safety channels are functioning according to the table below.

### Channel Operation and Verification

Safety Function Status	Drive In Safe State	Drive In Safe State	Drive In Safe State	Drive Able To Run
Drive Status	Configured by t105 [Safety Open En]	Fault F111 (Safety Hardware)	Fault F111 (Safety Hardware)	Ready/Run
<b>Safety Channel Operation</b>				
Safety Input S1	No Power Applied	Power Applied	No Power Applied	Power Applied
Safety Input S2	No Power Applied	No Power Applied	Power Applied	Power Applied

---

**IMPORTANT** If an external fault is present on the wiring or circuitry controlling the Safety 1 or Safety 2 inputs for a period of time, the Safe-Torque-Off function may not detect this condition. When the external fault condition is removed the Safe-Torque-Off function will allow an enable condition. Fault in the external wiring shall either be detected by external logic, or excluded (wiring must be protected by cable ducting or armoring), according to EN ISO 13849-2.

---

## Discrepancy Time of the Safety Inputs

For example, if S1 is disabled and S2 did not follow after the discrepancy time, fault F111 "Safety Hardware" will occur. However, if S1 is disable and S2 follows before the discrepancy time, fault F059 "Safety Open" will occur.

The discrepancy time is one second for PowerFlex 525 FRN 5.xxx and later. The discrepancy time is 10 milliseconds for PowerFlex 525 FRN 4.xxx and earlier.

# Connection Examples

## Example 1 - Safe-Torque-Off Connection with Coast-to-Stop Action, SIL 2/PL d

### Stop Category 0 - Coast

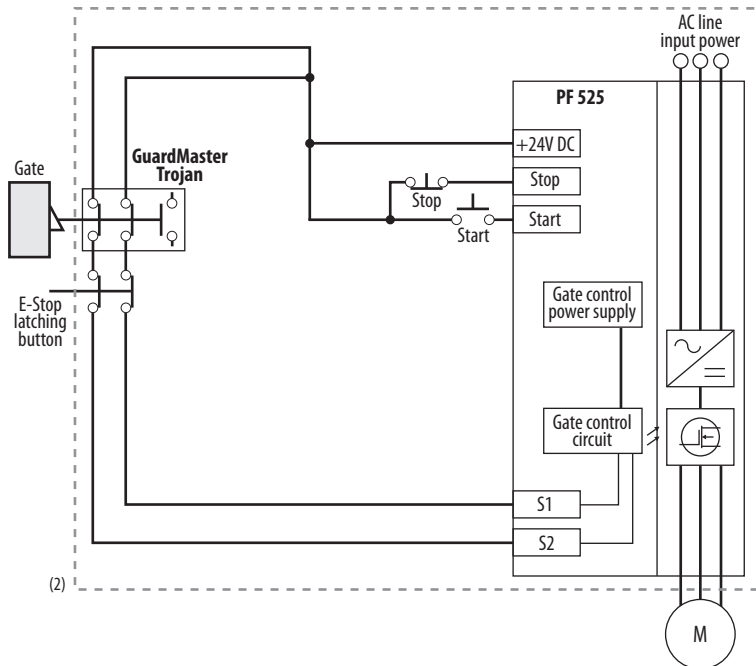
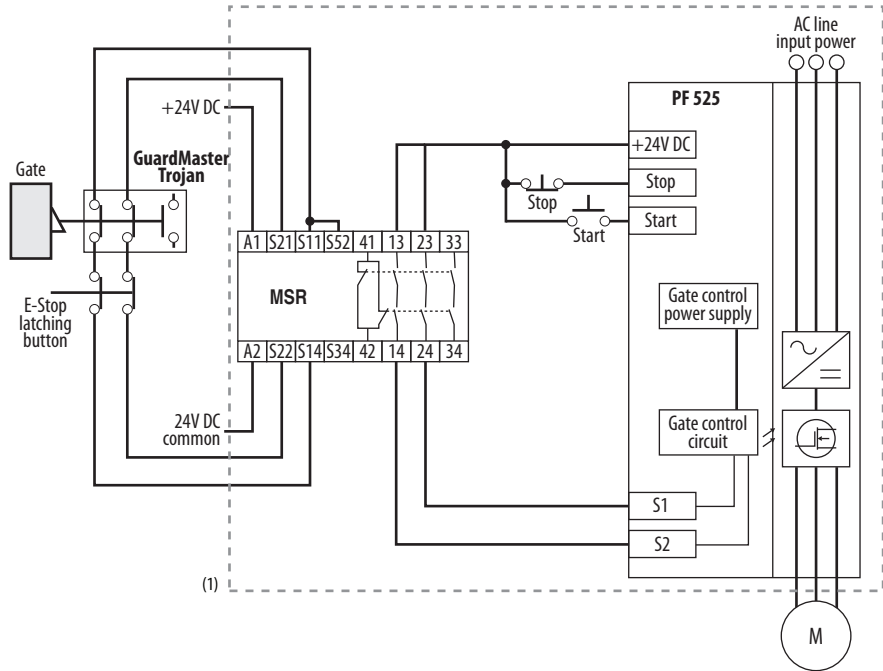

- (1) Enclosure Recommended. Note: External wiring failure modes must be considered as described in EN ISO 13849-2. Enclosure or other measure to exclude these failure modes should be used.
- (2) In some situations, a safety relay is not required if both the switch and PowerFlex 525 are installed in the same enclosure.

Stop Category 0 – Coast with Two PowerFlex 525 Drives

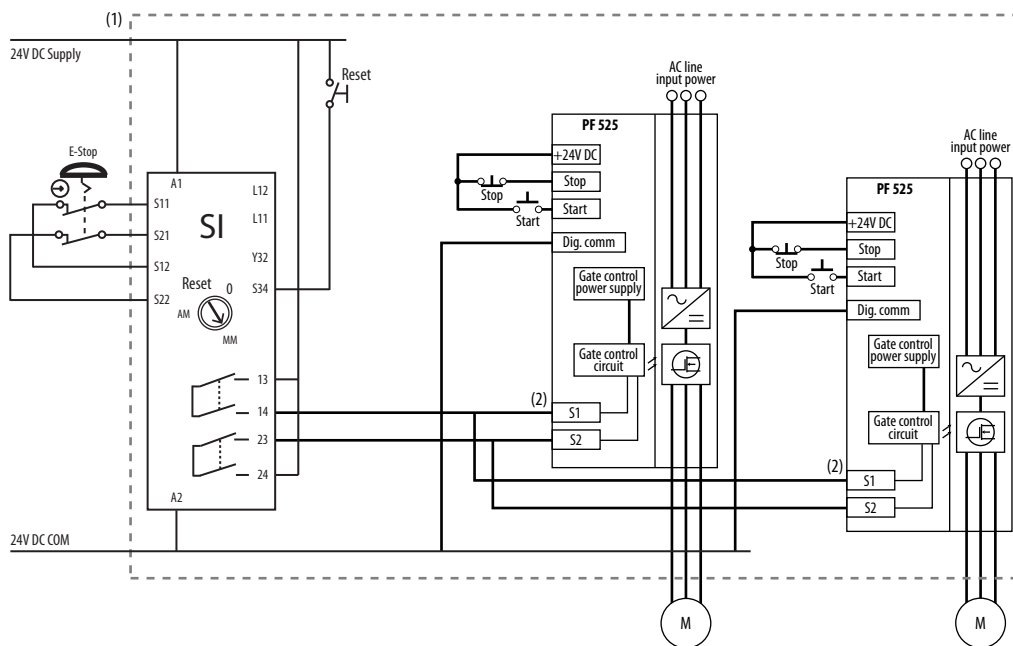

- (1) Enclosure Recommended. Note: External wiring failure modes must be considered as described in EN ISO 13849-2. Enclosure or other measure to exclude these failure modes should be used.
- (2) Each safety input draws 6 mA from the supply.

Circuit Status

Circuit shown with guard door closed and system ready for normal drive operation.

Operating Principle

This is a dual channel system with monitoring of the Safe-Torque-Off circuit and drive. Opening the guard door will switch the input circuits (S13-S14 & S21-S22) to the Minotaur™ monitoring safety relay unit. The output circuits (13-14 & 23-24) will cause the Safe-Torque-Off Enable circuit to trip and the motor will coast to stop. To restart the drive, the Minotaur safety relay must first be reset followed by a valid start command to the drive.

Fault Detection

A single fault detected on the Minotaur safety input circuits will result in the lock-out of the system at the next operation and will not cause loss of the safety function.

A single fault detected on the PowerFlex 525 safety enable redundant inputs will result in the lock-out of the drive and will not cause loss of the safety function.

## Example 2 - Safe-Torque-Off Connection with Controlled Stop Action, SIL 2/PL d

### Stop Category 1 - Controlled

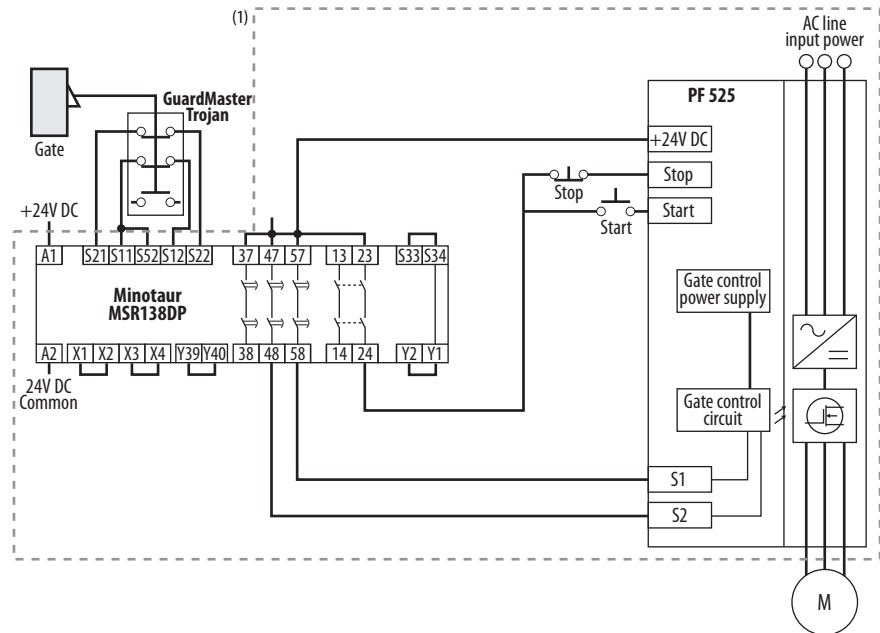

(1) Enclosure Recommended. External wiring failure modes must be considered as described in EN ISO 13849-2. Enclosure or other measure to exclude these failure modes should be used.

### Circuit Status

Circuit shown with guard door closed and system ready for normal drive operation.

### Operating Principle

This is a dual channel system with monitoring of the Safe-Torque-Off circuit and drive. Opening the guard door will switch the input circuits (S11-S12 & S21-S22) to the Minotaur monitoring safety relay unit. The output circuits (13-14) will issue a Stop command to the drive and cause a controlled deceleration. After the programmed delay, the timed output circuits (47-48 & 57-58) will cause the Safe-Torque-Off Enable circuit to trip. If the motor is rotating when the trip occurs, it will coast to stop. To restart the drive, the Minotaur safety relay must first be reset followed by a valid start command to the drive.

### Fault Detection

A single fault detected on the Minotaur safety input circuits will result in the lock-out of the system at the next operation and will not cause loss of the safety function.

A single fault detected on the PowerFlex 525 safety enable redundant inputs will result in the lock-out of the drive and will not cause the loss of the safety function.

### Example 3 - Safe-Torque-Off Connection with Coast-to-Stop Action Using External +24V supply, SIL 3/PL e

#### Stop Category 0 - Coast

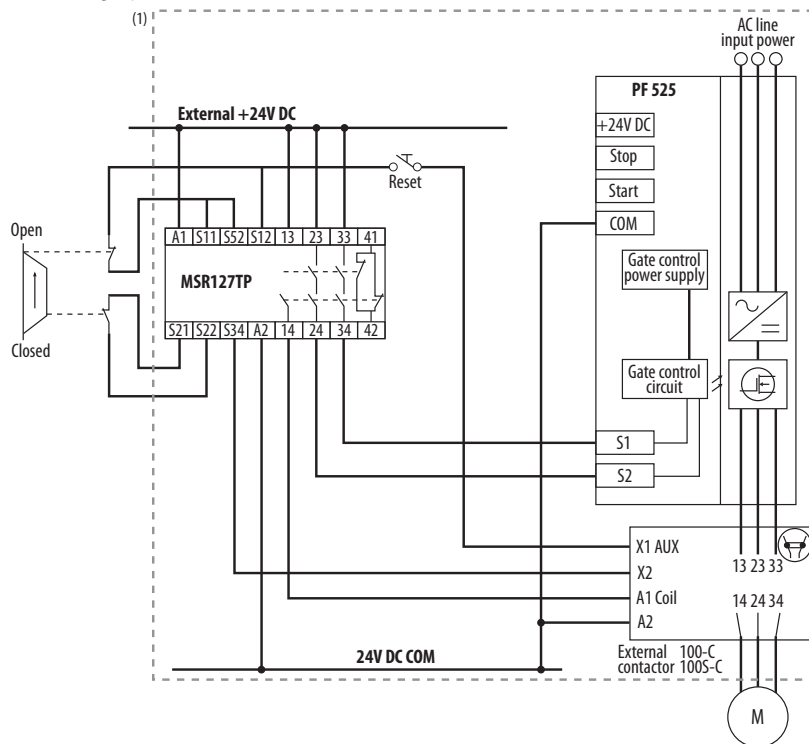

(1) Enclosure Recommended. External wiring failure modes must be considered as described in EN ISO 13849-2. Enclosure or other measure to exclude these failure modes should be used.

#### Circuit Status

Circuit shown with guard door closed and system ready for normal drive operation.

#### Operating Principle

This is a dual channel system with monitoring of the Safe-Torque-Off circuit and drive. Opening the guard door will switch the input circuits (S11-S12 & S21-S22) to the Minotaur monitoring safety relay unit. The output circuits (13-14 & 23-24 & 33-34) will cause the output contact and Safe-Torque-Off Enable circuit to trip and the motor will coast to stop. To restart the drive, the Minotaur safety relay must first be reset followed by a valid start command to the drive.

#### Fault Detection

A single fault detected on the Minotaur safety input circuits will result in the lock-out of the system at the next operation and will not cause loss of the safety function.

### PowerFlex 525 Certification for Safe-Torque-Off

Certification information can be viewed at [rok.auto/certifications](http://rok.auto/certifications).

## EtherNet/IP

This section contains only basic information to setup an EtherNet/IP connection with your PowerFlex 520-series drive. For comprehensive information about EtherNet/IP (single and dual-port) and how to use it, see the following publications:

- PowerFlex 525 Embedded EtherNet/IP Adapter User Manual, publication [520COM-UM001](#).
- PowerFlex 25-COMM-E2P Dual-Port EtherNet/IP Adapter User Manual, publication [520COM-UM003](#).



**ATTENTION:** PowerFlex 523 drives support only the 25-COMM-E2P dual-port EtherNet/IP adapter. PowerFlex 525 drives support both the embedded EtherNet/IP adapter and the 25-COMM-E2P dual-port EtherNet/IP adapter.

It is recommended to use Allen-Bradley Ethernet RJ45 cables, shielded or unshielded (catalog number 1585J-M8xBJM-x), for connecting your PowerFlex 520-series drive to an EtherNet/IP network.

### Establishing A Connection With EtherNet/IP

There are three methods for configuring the Ethernet IP address:

- **BootP Server** – Use BootP if you prefer to control the IP addresses of devices using a server. The IP address, subnet mask, and gateway addresses will then be provided by the BootP server.
- **Adapter Parameters** – Use adapter parameters when you want more flexibility in setting up the IP address, or need to communicate outside the control network using a gateway. The IP address, subnet mask, and gateway addresses will then come from the adapter parameters you set.
- **DHCP (Dynamic Host Configuration Protocol)** (only with PowerFlex 25-COMM-E2P adapter) – Use DHCP when you want additional flexibility and ease-of-use compared to BOOTP in configuring the IP address, subnet mask, and gateway address for the adapter using a DHCP server.

**IMPORTANT** If you are setting your network addresses manually using parameters, you must set the appropriate drive or 25-COMM-E2P adapter parameter value to 1 "Parameters". See the respective EtherNet/IP adapter user manual for more information.

**IMPORTANT** Regardless of the method used to set the adapter IP address, each node on the EtherNet/IP network must have a unique IP address. To change an IP address, you must set the new value and then remove and reapply power to (or reset) the adapter.

# Ground Connections for EtherNet/IP Networks

Connect terminal C1 to a clean ground when using a network with a star topology. It is acceptable to ground both C1 and C2 terminals.

## PowerFlex 525 Embedded Ethernet/IP Adapter

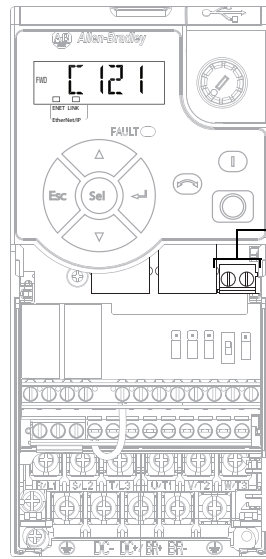

Terminal	Description
C1	This terminal is tied to the RJ-45 port shield. Tie this terminal to a clean ground in order to improve noise immunity when using external communication peripherals.
C2	This is the signal common for the communication signals.

Connect terminal CS1 or CS2 to a clean ground when using a network with a ring topology.

## PowerFlex 25-COMM-E2P Dual-Port EtherNet/IP Adapter

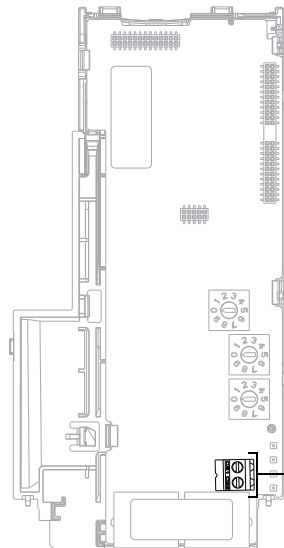

Terminal	Description
CS1/CS2	Provides a clean ground for the communication bus cable shields. CS1 or CS2 should be connected to a clean ground or PE ground on the drive.



# Control Diagrams

This chapter contains various diagrams on the PowerFlex 520-series drive functions and behaviors.

## Induction Motor Tuning Diagrams

[Speed Reg Sel] Diagrams For Motor Tuning

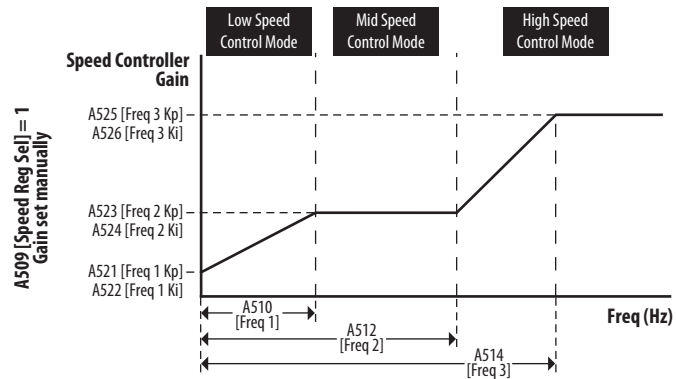
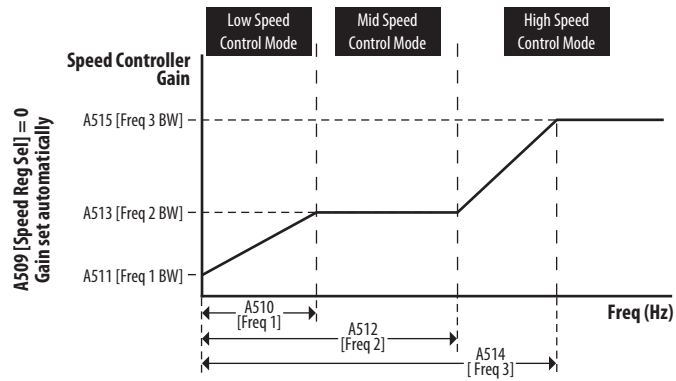

# Adjusting Speed Control Parameters

These settings show how to adjust the speed control for motor tuning.

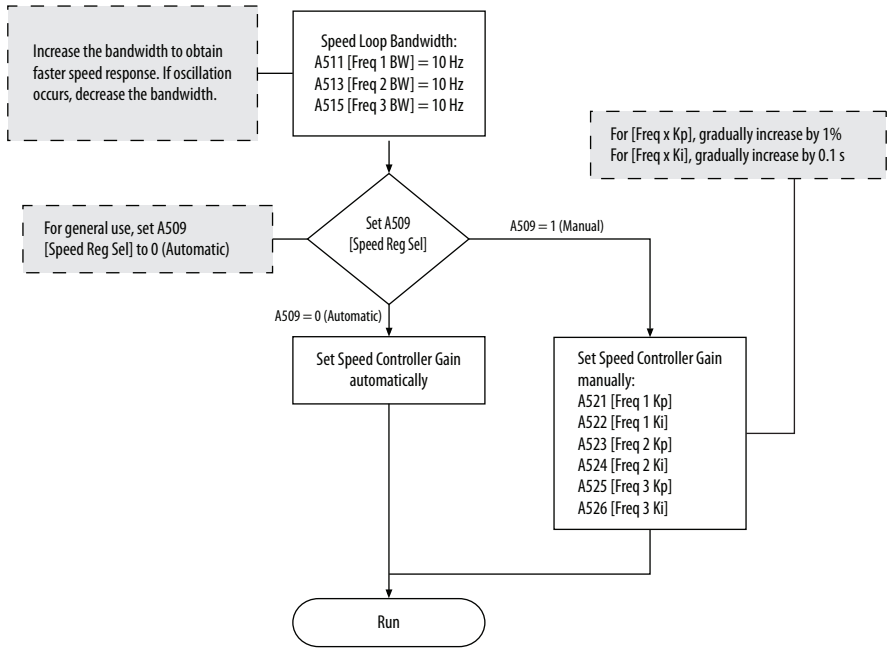

## PowerFlex 525 PM Motor Configuration

This chapter contains instructions and diagrams on configuring the PowerFlex 525 drive for use with a PM motor. For more information, see the PowerFlex 525 Configuration with Permanent Magnet Motors Application Technique, publication [520-AT001](#).

Topic	Page
Manual Configuration Using Drive Keypad	256
Additional PM Motor Configuration	257
Optional Parameter Adjustments for Optimum Performance	261



**ATTENTION:** It is the responsibility of the startup engineer / end user to use proper safety precautions with any equipment used during this startup. In no event will Rockwell Automation, Inc. be responsible or liable for indirect or consequential damages resulting from the use or application of this equipment. The examples and diagrams in this document are included solely for illustrative purposes. Because of the many variables and requirements associated with any particular installation, Rockwell Automation cannot assume responsibility or liability of actual use based on the examples and diagrams.

No patent liability is assumed by Rockwell Automation, Inc. with respect to the information, circuits, equipment. Or software described in this document. Rockwell Automation reserves the right to make changes to this document without prior notice. When using examples in this document the user recognizes that Rockwell Automation cannot be made liable for any damage or claims. Because there are many application-specific variables, users **MUST** ensure that products are correctly used and the appropriate architecture is deployed. Reproduction of the contents of this document, in whole or in part, without written permission of Rockwell Automation, Inc. is prohibited.

To use PM motor control, you need to install the PowerFlex 525 drive firmware revision 5.001 or later. If you wish to perform PM motor tuning by using the PowerFlex 525 Startup Wizard in Connected Components Workbench software, and update to the latest drive database.

## Motor Control

From the Torq Perf Mode drop-down list, select “PM Motor”.

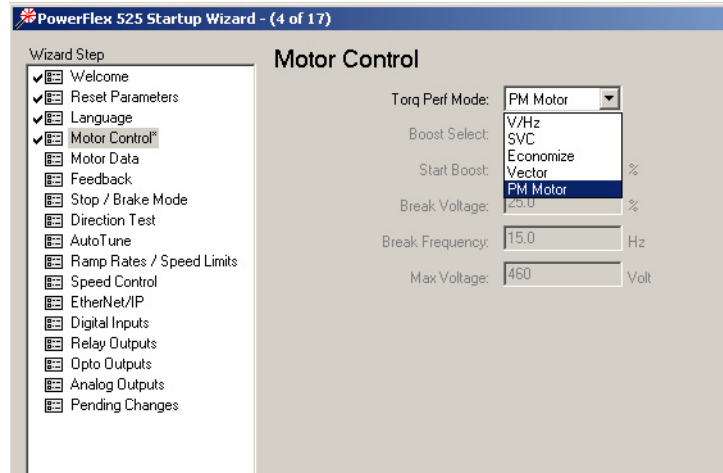

This configuration can also be done by setting parameter P039 [Torq Perf Mode] to 4 “PM Motor”.

## Motor Data

Key in the details of your Motor Nameplate.

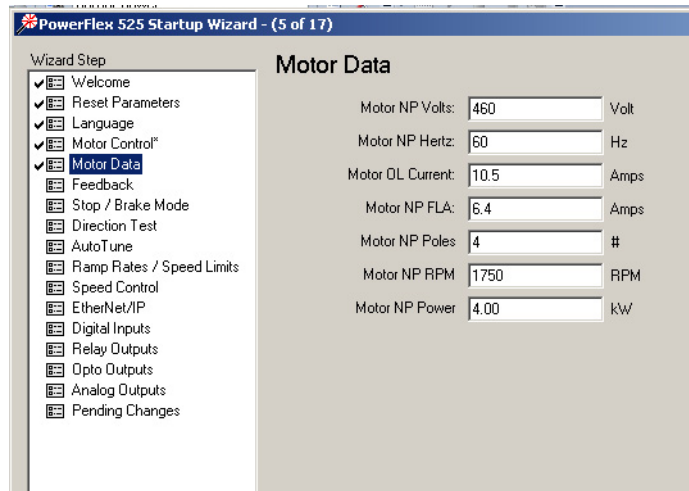

## Feedback

If you are configuring a closed loop PM motor control, key in the details of your incremental encoder.

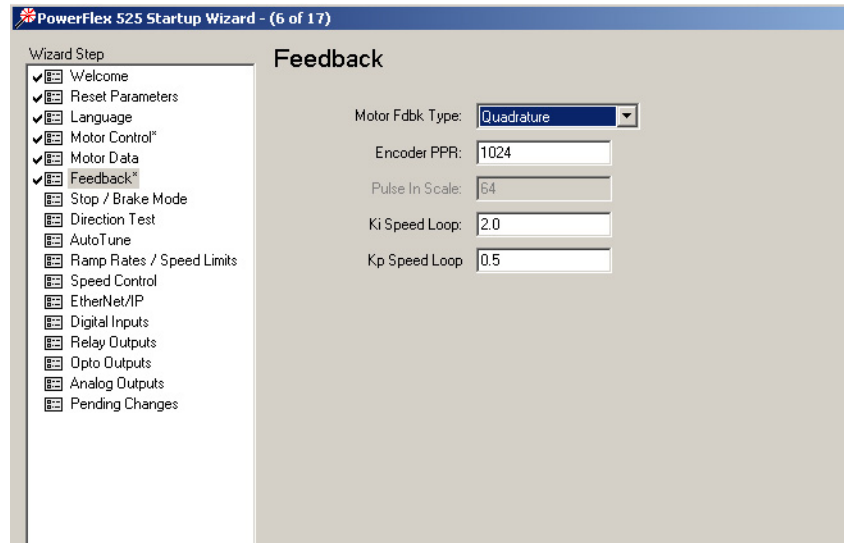

**IMPORTANT** Note the following:

- PowerFlex 525 drive only supports incremental AB encoder (25-ENC-1).
- Motor Feedback Type can be “Quadrature” or “Quad Check”.
- Only Interior Permanent magnet motor (iPM) is supported for closed loop control.

## Stop Mode/Brake Type

Key in the details of your configuration.

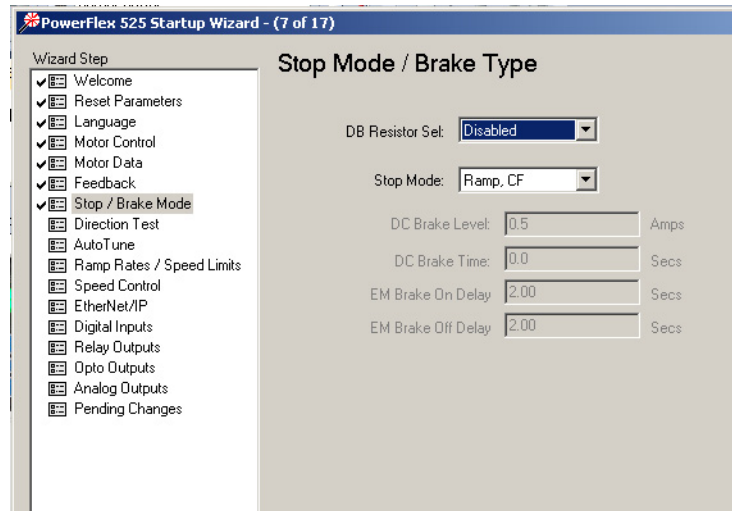

## Direction Test

**IMPORTANT** When configuring a PM motor or using an encoder, it is required to perform a Direction Test before proceeding to the next step (Auto Tune).

Perform a Direction Test. The direction test can be performed with or without the load attached. Consider your application requirements when deciding to have the load attached or removed from the motor. This test runs in V/Hz mode to verify the motor polarity relative to the feedback polarity. The test confirms motor rotation and feedback polarity. After the test is completed, a change can be made, if necessary.

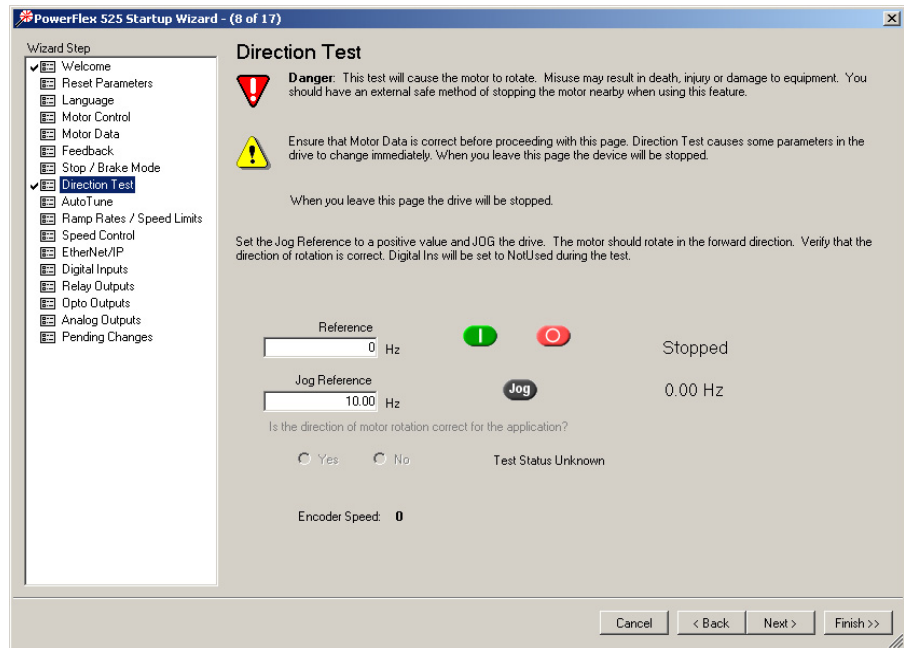

**IMPORTANT** If the drive was never operated before (new installation), verify that safeguards are in place to remove power safely from the drive during an unstable situation where the drive can produce undesired motion.

## Auto Tune

Ensure the load is uncoupled and perform a Rotate Tune test.

Run the drive with Po40 [Autotune] = 2 “Rotate Tune” configured to complete the autotune process. This process measures and configures the following:

- A501 [PM IR Voltage]
- A502 [PM IXd Voltage]
- A503 [PM IXq Voltage]
- A504 [PM BEMF Voltage]

The Auto Tune is used to identify the correct motor flux and stator electrical properties, including the following:

- IR volt drop, which is voltage drop over resistance.
- IXd volt drop, which is voltage drop over inductance.

- Flux current (estimated in Static Tune and measured in Rotate Tune test).
- Slip RPM, which is calculated from motor nameplate data. If an encoder is used, the Slip RPM becomes a measured value using the encoder.

### Auto Tune Window

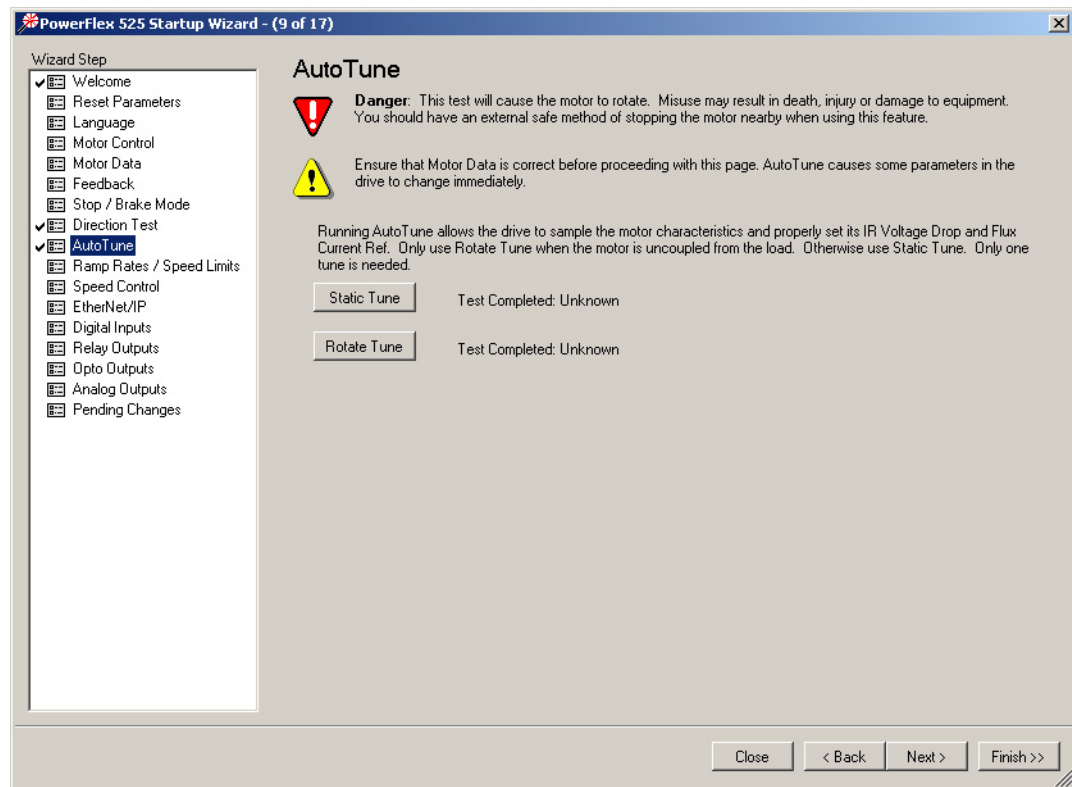

A properly tested motor and drive helps ensure higher starting torque and better performance at low speeds. Conversely, an improperly performed Auto Tune can cause the motor to exhibit instability at low speeds, uneven performances when running through the motor speed range, and can generate unnecessary faults such as overcurrent and overvoltage faults.

#### *Static Tune*

This test is used when the motor is connected to a high friction load and cannot easily be uncoupled from the motor, or when the load cannot be rotated due to mechanical constraints or a limited range of movement. The Static Tune test does not generate any motor movement. The Static tune test results may not be as accurate as the Rotate Tune test.

#### *Rotate Tune (preferred for PM motor tuning)*

This test is used when the motor is not coupled to the load or the load is low friction. Rotate tune is generally used to better identify motor flux and stator electrical properties, which are used to automatically tune the torque current loop. The Rotate Tune test causes motor rotation at different speeds while it is executing.



**ATTENTION:** If the drive was never operated before (new installation), verify that safeguards are in place to remove power safely from the drive during an unstable situation where the drive can produce undesired motion.

After completing the configuration and running the Auto Tune test, you may need to perform additional configuration depending on whether you have an open loop or closed loop system.

For an open loop system (A535 [Motor Fdbk Type] = 0 “None”), you may need to adjust two parameters if you encounter momentary reverse startup after a Start command is issued.

For a closed loop system (A535 [Motor Fdbk Type] = 4 “Quadrature” or 5 “Quad Check”, you must perform an angle alignment after the Auto Tune test before running the motor normally.

See [Additional PM Motor Configuration on page 257](#) for instructions.

## Manual Configuration Using Drive Keypad

Besides using the PowerFlex 525 Startup Wizard in Connected Components Workbench software, you can also manually configure the parameters by using the drive keypad. Make sure you have installed the PowerFlex 525 drive firmware revision 5.001 or later.

To configure the parameters, do the following:

1. Reset all parameters to their default values.  
Set P053 [Reset to Defaults] = 2 “Factory Rset”
2. Select the Control Mode  
Set P039 [Torque Perf Mode] = 4 “PM Control”
3. Enter Motor nameplate data
  - Set P031 [Motor NP Volts]
  - Set P032 [Motor NP Hertz]
  - Set P033 [Motor OL Current]
  - Set P034 [Motor NP FLA]
  - Set P035 [Motor NP Poles]
  - Set P036 [Motor NP RMP]
  - Set P037 [Motor NP Power]
  - Set P043 [Minimum Freq]
  - Set P044 [Maximum Freq]
4. Set A440 [PWM Frequency] = 4.0 kHz (default)
5. Set A535 [Motor Fdbk Type]
  - = 4 “Quadrature” or 5 “Quad Check” (for Closed Loop PM)  
or
  - = 0 “None” (for Open Loop PM)
  - A536 [Encoder PPR]
6. Enter Stop mode and dynamic brake data, if any.
  - P045 [Stop Mode]
  - A437 [DB Resistor Sel]
7. Ensure the load is uncoupled and perform a Rotate Tune test  
Set P040 [Autotune] = 2 “Rotate Tune”



Press the Start button (Take note of your Start Source settings PO46, PO48, and PO50. Default setting of PO46 = 1 “Keypad”)



**ATTENTION:** If the drive was never operated before (new installation), verify that safeguards are in place to remove power safely from the drive during an unstable situation where the drive can produce undesired motion.

After completing the configuration and running the Auto Tune test, you may need to perform additional configuration depending on whether you have an open loop or closed loop system.

For an open loop system (A535 [Motor Fdbk Type] = 0 “None”), you may need to adjust two parameters if you encounter momentary reverse startup after a Start command is issued.

For a closed loop system (A535 [Motor Fdbk Type] = 4 “Quadrature” or 5 “Quad Check”), you must perform an angle alignment after the Auto Tune test before running the motor normally.

See [Additional PM Motor Configuration on page 257](#) for instructions.

## Additional PM Motor Configuration

After completing the initial configuration, there are additional steps that need to be performed to complete the whole PM motor setup.

For an open loop PM motor (iPM and sPM) control, some parameters need to be adjusted to prevent reverse startup. For a closed loop PM motor (iPM), an angle alignment procedure needs to be performed before the motor is run normally.

### Additional Setup for Open Loop PM Motor

After performing an autotune on an open loop PM motor, a momentary “reverse startup” may occur. To prevent this from occurring, perform the following steps:

1. Set A516 [PM Initial Sel] = 1 “HFI”.
2. Increase the value of A519 [PM HFI NS Cur] by 10%.
3. Perform a test run at a reference speed and check if the motor reverses.
4. If the motor reverses, repeat steps 2 and 3.
5. If A519 [PM HFI NS Cur] has reached its maximum value (200%):
  - reset the value to the default (100%)
  - set A516 [PM Initial Sel] = 2 “Six Pulse”
6. Perform a test run at a reference speed and check if the motor reverses.
7. If the motor reverses, repeat steps 2 and 3.
8. If A519 [PM HFI NS Cur] has reached its maximum value again and a reverse motor startup still occurs, the motor setup has failed.

Flowchart for Open Loop PM Motor (iPM and sPM) Setup

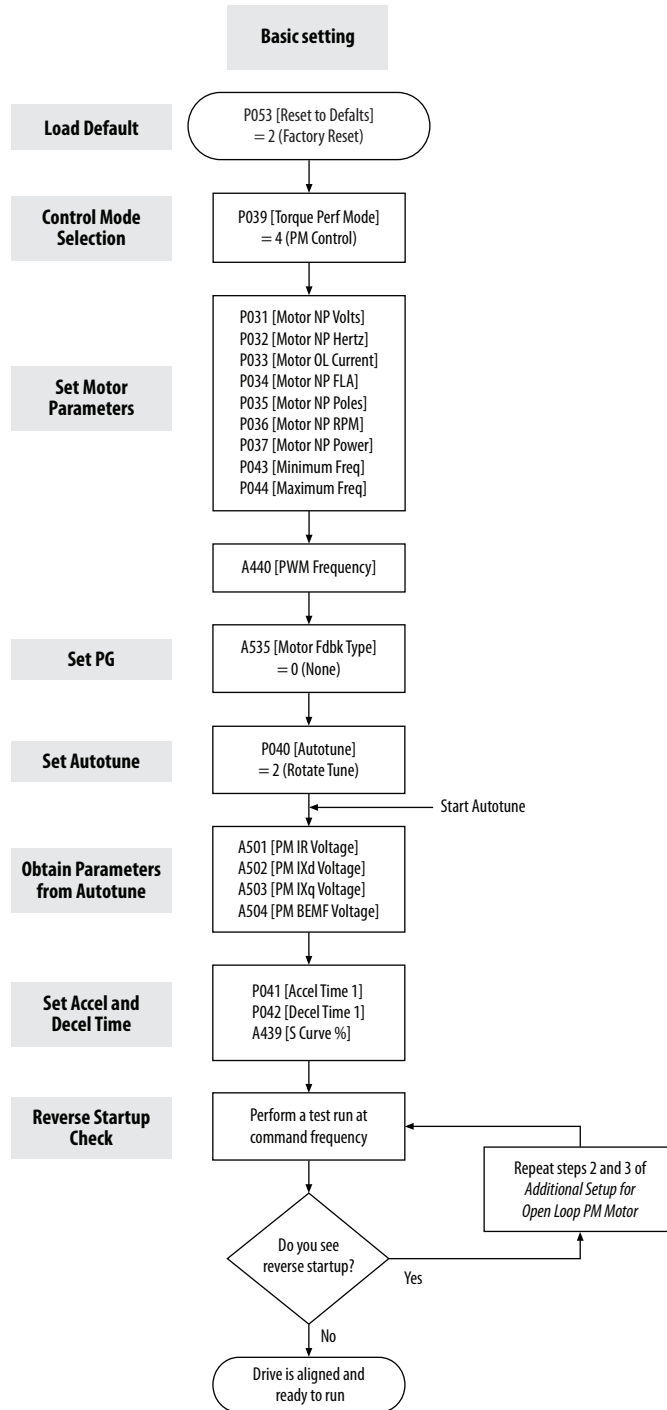

## Additional Setup for Closed Loop PM Motor

After performing an autotune on an closed loop PM motor, a PM angle alignment needs to be performed to complete the setup.

### *Align the PM Angle*

To align the PM angle, do the following:

1. Uncouple the load.
2. Set these parameters to the recommended value:
  - A517 [PM DC Inject Cur] = 60% (default is 30%)
  - A518 [PM Align Time] = 5.8 s (default is 0.7 s)
  - A580 [Current Loop BW] = 300 Hz (default is 0 Hz)
3. Set the desired speed (10...40 Hz recommended).  
Check the setting for P047 [Speed Reference 1]. Speed reference can be from POT, control panel of Connected Components Workbench software, and so on.
4. Set the Start Source.  
Check the setting for P046 [Start Source 1]. Start source can be from POT, control panel of Connected Components Workbench software, and so on.
5. Start the drive to run at the desired speed.
6. Drive will begin to align itself (move forward and reverse) and run to the desired speed.
7. Stop the drive. The drive is now aligned.



The PM angle alignment only needs to be performed once unless the drive is power cycled or re-tuned.

---

**IMPORTANT** The PM angle alignment has failed when fault F012 (HW Overcurrent) or F013 (Ground Fault) is observed during acceleration and deceleration.

---

### *Adjustments if PM Angle Alignment has Failed*

If the PM angle alignment has failed, do the following:

1. Cycle drive power or set A535 [Motor Fdbk Type] = 0 “None”, then set back to 4 “Quadrature” or 5 “Quad Check”.
2. Increase A517 [PM DC Inject Cur] by 50%.
3. Increase A518 [PM Align Time] by 0.2 s.
4. Repeat the [Align the PM Angle](#) instructions again, beginning from step 3.

### Flowchart for Closed Loop PM Motor (iPM) Setup

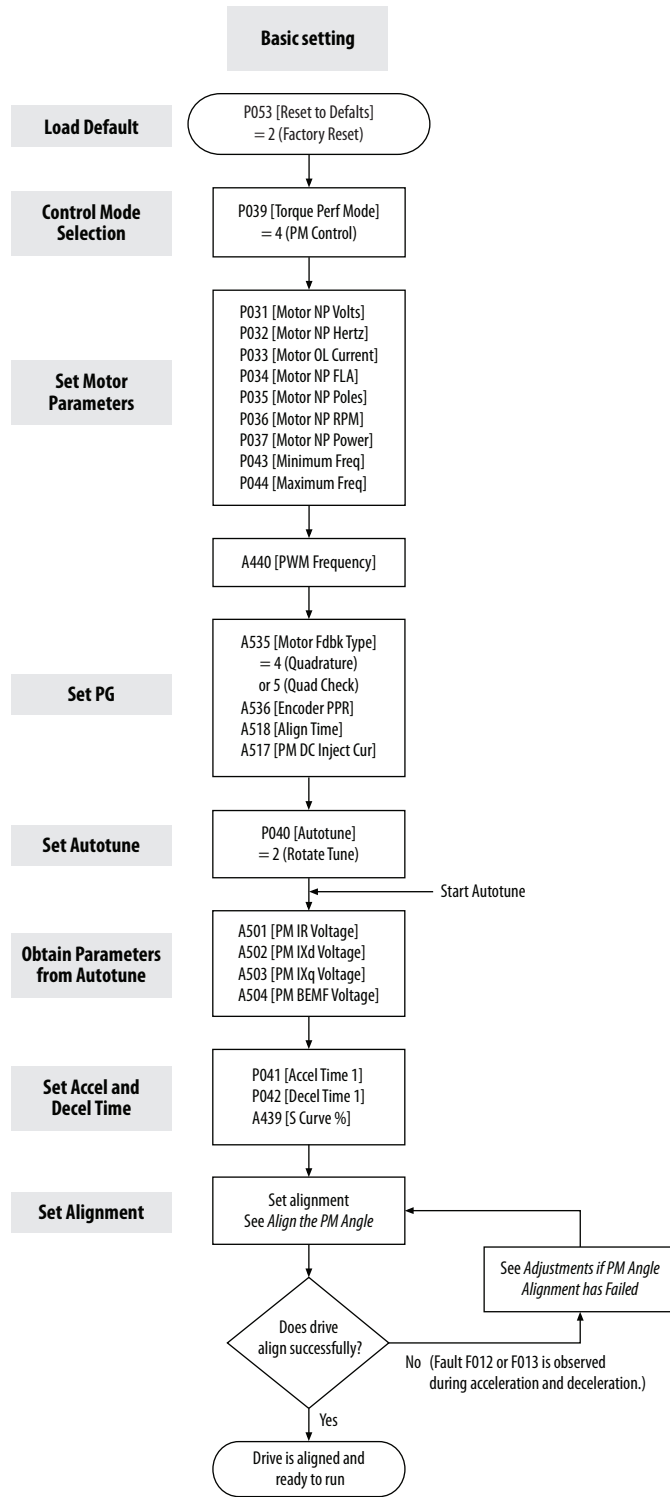

## Optional Parameter Adjustments for Optimum Performance

There are a few parameters that you can use to obtain optimum performance during the test run. Usually, the default value of these parameters work well, but you may need to adjust them under different conditions.

### 1. A517 [PM DC Inject Cur]

Maximum DC current in amps applied to the motor in order to reset the rotor position of a PM motor.

Alignment has failed when fault Fo12 (HW Overcurrent) or Fo13 (Ground Fault) is observed during acceleration and deceleration.

Default = 30%

Increase 50 of A517 [PM DC Inject Cur] for each trial when PM speed response is slow after adding load.

### 2. A518 [PM Align Time]

Magnetic pole reorientation time.

Alignment failed when fault Fo12 (HW Overcurrent) or Fo13 (Ground Fault) is observed during acceleration and deceleration.

Default = 0.7 s

Increase A518 [PM Align Time] to > 4.7 s.

### 3. A527 [PM FWKn 1 Kp]

The gain to ensure good performance in field weakening region.

Default = 450%

Increase 100 of A527 [PM FWKn 1Kp] for each trial when PM speed response is slow after adding load.

Decrease 100 of A527 [PM FWKn 1Kp] for each trial when speed vibration is observed after adding load.

### 4. A580 [Current loop BW]

Current loop bandwidth (0 = Auto calculate the control gain of current loop)

Default = 0 Hz

Increase 50 of A580 [Current Loop BW] for each trial when PM speed response is slow after adding load.

Decrease 50 of A580 [Current Loop BW] for each trial when speed instability is observed after adding load.

### 5. A584 [PM Stable 2 Kp]

The gain for stabilization loop.

Default = 250%

Increase 100 of A584 [PM Stable 2 Kp] for each trial if fault Fo64 (Drive overload) is experienced at high load.

Applicable to open loop tuning especially for sPM motor. In most cases, the default value will work.

**Notes:**

## PowerFlex 525 Synchronous Reluctance Motor Configuration

This chapter contains instructions and diagrams on configuring the PowerFlex 525 drive for use with a Synchronous Reluctance Motor (SynRM) control.

Topic	Page
SynRM Structure	263
SynRM Control Configuration	264

PowerFlex 525 drive is enhanced with SynRM control that allows an option to pair with PF525 SynRM for energy efficiency and low effort in motor maintenance.

### SynRM Structure

### Control Diagram

With PowerFlex 525 drive firmware revision 7.001, SynRM control can only be configured manually using the keypad.

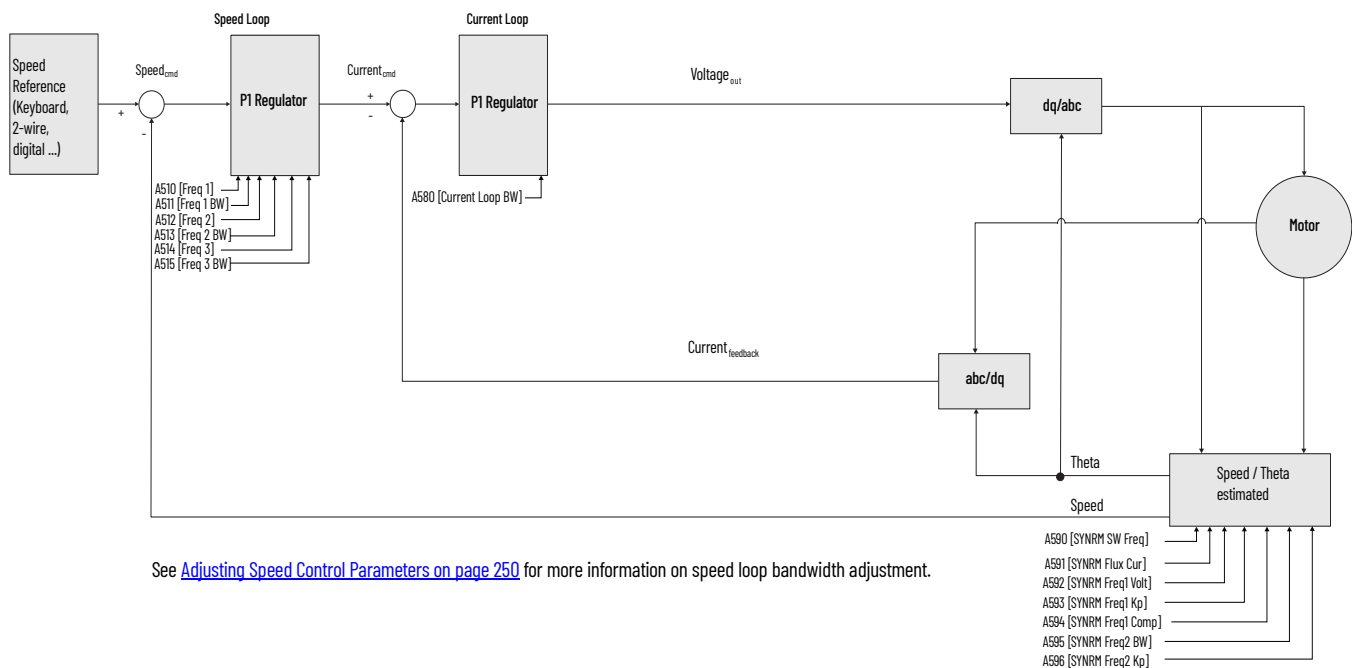

## SynRM Control Configuration

To run the motor test, make sure you have installed the PowerFlex 525 drive firmware revision 7.001 or later. For instructions, see [Download Files on page 10](#).

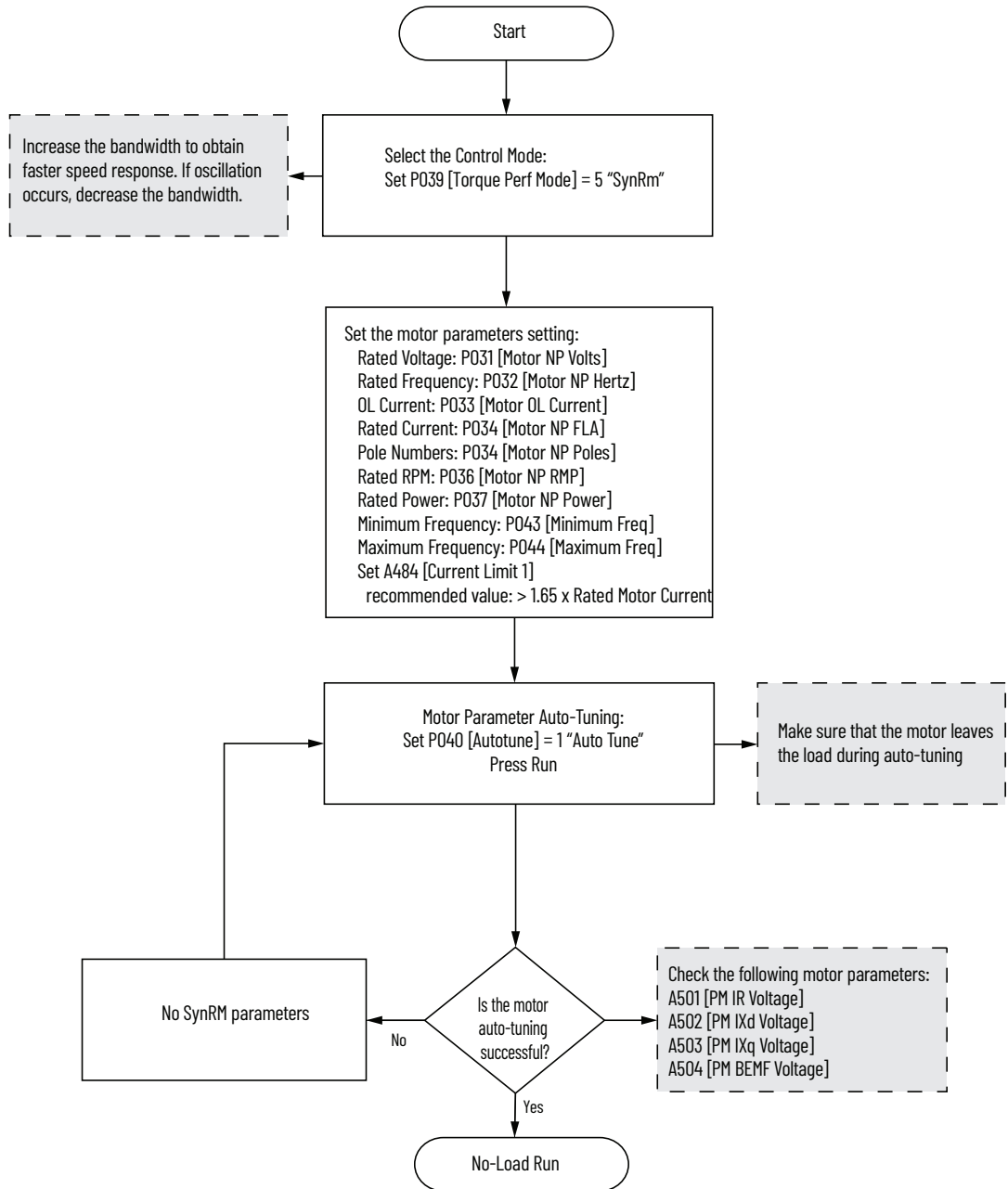



Startup with No-Load adjustment procedure

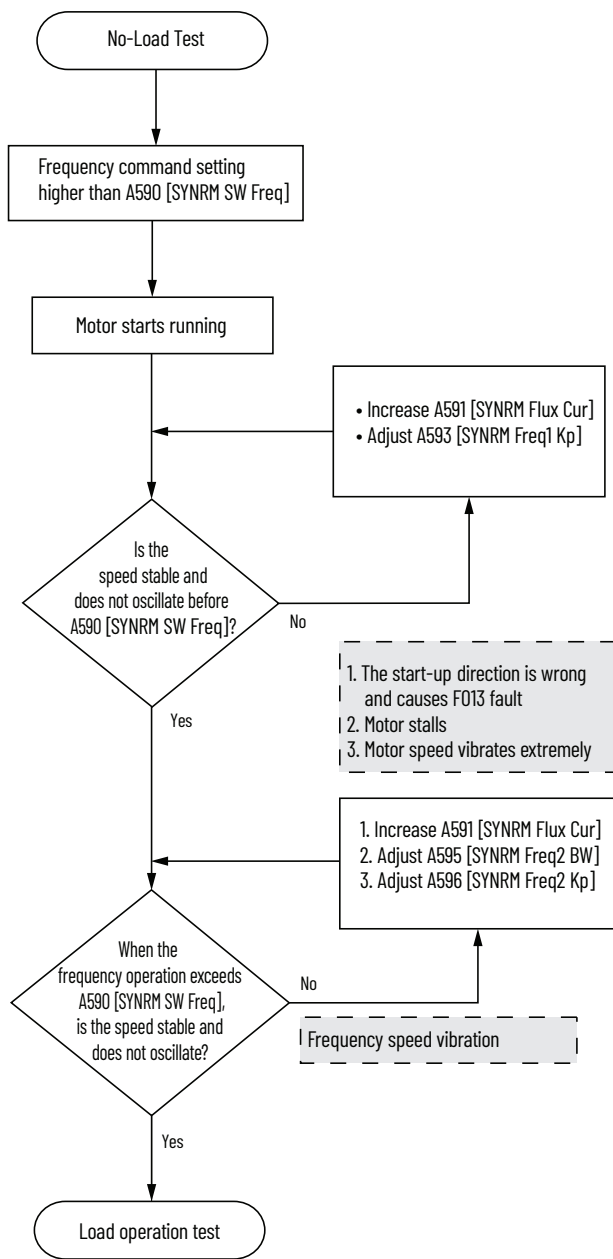

Startup with Load adjustment procedure

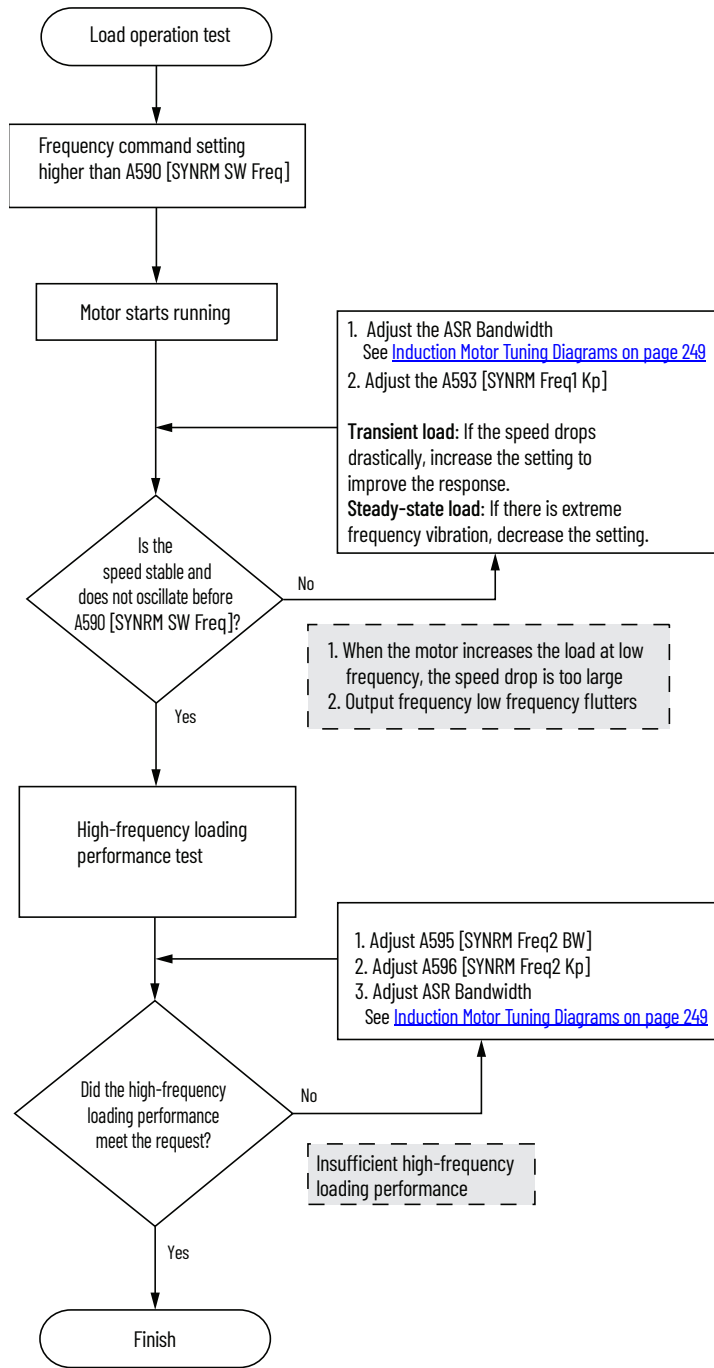

## Numerics

### 2-wire

inputs 49

### 3-wire

inputs 49

## A

### accel

override priority 50  
selecting 49

### accessing

control terminals 30  
power terminals 31

### applications

safety 239

### auxiliary contact

drive 34, 35

## B

### basic operation 63

drive 58, 63, 162  
programming 63  
safety 242

## C

### circuit breakers

inputs 22  
ratings 23

### common bus

drive 35

### communications

positioning 226

### configuring

RS485(DSI) 205

### control terminals

accessing 30

### counter

programming 211, 214

## D

### decel

override priority 50  
selecting 49

### derating

factor 124  
temperature 17

### digital inputs

selecting 49  
start source 49

### dimensions

mounting 16, 184

### disconnect

output 34

### drive

auxiliary contact 34, 35  
basic operation 58, 63, 162  
common bus 35  
mount 15  
programming 59, 62  
safety 242

### drive damage

preventing 19  
ungrounded distribution systems 19

## E

### encoder

programming 217  
wiring 219

### environment

storage 18

### Ethernet

programming 247

## F

### fault monitoring

ground 20

### fuses

rating 22

## G

### ground

fault monitoring 20  
motor 21  
RFI filter 22  
safety 21  
shielding 21

## H

### homing

automatic 225  
manual 224  
programming 224

## I

### inputs

2-wire 49  
3-wire 49  
circuit breakers 22  
power 20

## L

### logic

basic 211, 212  
timed steps 211, 212

**M**

- Modbus**
  - reading 208, 209, 210
  - writing 205, 207, 210
- motor**
  - ground 21
  - start 34
  - stop 34
- mount**
  - drive 15
- mounting**
  - dimensions 16, 184

**N**

- noise immunity**
  - wiring 37, 204

**O**

- output**
  - disconnect 34
- override priority**
  - accel 50
  - decel 50
  - speed reference 48
  - start source 48

**P**

- parameters**
  - AppView 74, 150
  - CustomView 151
  - programming 61, 65
- PID**
  - programming 231
- positioning**
  - communications 226
  - programming 220, 221
- power**
  - inputs 20
- power and control module**
  - separating 28
- power terminals**
  - accessing 31
- preventing**
  - drive damage 19
- programming** 63
  - basic logic 211, 212
  - counter 211, 214
  - drive 59, 62
  - encoder 217
  - Ethernet 247
  - homing 224
  - parameters 61, 65
  - PID 231
  - positioning 220, 221
  - pulse train 217
  - timed steps 211, 212
  - timer 211, 213
  - tools 62
- pulse train**
  - programming 217

**R**

- rating**
  - fuses 22
- ratings**
  - circuit breakers 23
- reading**
  - Modbus 208, 209, 210
- recommended**
  - wiring 36, 241
- reflected**
  - wave protection 34
- RFI filter**
  - ground 22
- RS485(DSI)**
  - configuring 205

**S**

- safety**
  - applications 239
  - basic operation 242
  - drive 242
  - ground 21
  - testing 240
  - wiring 241
- selecting**
  - accel 49
  - decel 49
  - digital inputs 49
  - speed reference 48
  - start source 48
- separating**
  - power and control module 28
- shielded**
  - wiring 33
- shielding**
  - ground 21
- speed reference**
  - override priority 48
  - selecting 48
- start**
  - motor 34
- start source**
  - digital inputs 49
  - override priority 48
  - selecting 48
- stop**
  - motor 34
- storage**
  - environment 18

**T**

- temperature**
  - derating 17
  - wiring 32
- testing**
  - safety 240
- timer**
  - programming 211, 213
- tools**
  - programming 62

**U****unshielded**

wiring 33

**V****voltage reflections**

wiring 34

**W****wave protection**

reflected 34

**wiring**

encoder 219

noise immunity 37, 204

recommended 36, 241

RS485 (DSI) 203

safety 241

shielded 33

temperature 32

unshielded 33

voltage reflections 34

**writing**

Modbus 205, 207, 210

**Notes:**



# Rockwell Automation Support

Use these resources to access support information.

<b>Technical Support Center</b>	Find help with how-to videos, FAQs, chat, user forums, and product notification updates.	<a href="http://rok.auto/support">rok.auto/support</a>
<b>Knowledgebase</b>	Access Knowledgebase articles.	<a href="http://rok.auto/knowledgebase">rok.auto/knowledgebase</a>
<b>Local Technical Support Phone Numbers</b>	Locate the telephone number for your country.	<a href="http://rok.auto/phonesupport">rok.auto/phonesupport</a>
<b>Literature Library</b>	Find installation instructions, manuals, brochures, and technical data publications.	<a href="http://rok.auto/literature">rok.auto/literature</a>
<b>Product Compatibility and Download Center (PCDC)</b>	Download firmware, associated files (such as AOP, EDS, and DTM), and access product release notes.	<a href="http://rok.auto/pcdc">rok.auto/pcdc</a>

## Documentation Feedback

Your comments help us serve your documentation needs better. If you have any suggestions on how to improve our content, complete the form at [rok.auto/docfeedback](http://rok.auto/docfeedback).

## Waste Electrical and Electronic Equipment (WEEE)



At the end of life, this equipment should be collected separately from any unsorted municipal waste.

Rockwell Automation maintains current product environmental compliance information on its website at [rok.auto/pec](http://rok.auto/pec).





Allen-Bradley, AppView, Compact I/O, Connected Components Workbench, CustomView, DriveTools, expanding human possibility, FactoryTalk, Logix 5000, MainsFree, Minotaur, PanelView, PowerFlex, QuickView, Rockwell Automation, RSLogix, RSLogix 5000, SLC, StepLogic, Studio 5000, Studio 5000 Logix Designer, and TechConnect are trademarks of Rockwell Automation, Inc.

EtherNet/IP and DeviceNet are trademarks of ODVA, Inc.

Windows is a trademark of Microsoft Corporation

Trademarks not belonging to Rockwell Automation are property of their respective companies

Rockwell Otomasyon Ticaret A.Ş. Kar Plaza İş Merkezi E Blok Kat:6 34752, İçerenköy, İstanbul, Tel: +90 (216) 5698400 EEE Yönetmeliğine Uygundur

Connect with us.    

**rockwellautomation.com** ————— **expanding human possibility™**

AMERICAS: Rockwell Automation, 1201 South Second Street, Milwaukee, WI 53204-2496 USA, Tel: (1) 414.382.2000, Fax: (1) 414.382.4444

EUROPE/MIDDLE EAST/AFRICA: Rockwell Automation NV, Pegasus Park, De Kleetlaan 12a, 1831 Diegem, Belgium, Tel: (32) 2 663 0600, Fax: (32) 2 663 0640

ASIA PACIFIC: Rockwell Automation, Level 14, Core F, Cyberport 3, 100 Cyberport Road, Hong Kong, Tel: (852) 2887 4788, Fax: (852) 2508 1846