



an EnerSys® company

Cordex® 24-400W Rectifier Shelf System

Technical Guide: 9400021-J0

Effective: 07/2020



Cordex[®] 24-400W Rectifier Shelf System Manual

NOTE: Photographs contained in this manual are for illustrative purposes only. These photographs may not match your installation.

NOTE: Operator is cautioned to review the drawings and illustrations contained in this manual before proceeding. If there are questions regarding the safe operation of this powering system, contact Alpha Technologies or your nearest Alpha representative.

NOTE: Alpha shall not be held liable for any damage or injury involving its enclosures, power supplies, generators, batteries, or other hardware if used or operated in any manner or subject to any condition inconsistent with its intended purpose, or if installed or operated in an unapproved manner, or improperly maintained.

For technical support, contact Alpha Technologies:

Canada and USA: **1-888-462-7487**

International: **+1-604-436-5547**

Copyright

Copyright © 2020 Alpha Technologies Ltd. All rights reserved. Alpha is a registered trademark of Alpha Technologies.

No part of this documentation shall be reproduced, stored in a retrieval system, translated, transcribed, or transmitted in any form or by any means manual, electric, electronic, electromechanical, chemical, optical, or other-wise without prior explicit written permission from Alpha Technologies.

This document, the software it describes, and the information and know-how they contain constitute the proprietary, confidential and valuable trade secret information of Alpha Technologies, and may not be used for any unauthorized purpose, or disclosed to others without the prior written permission of Alpha Technologies.

The material contained in this document is for information only and is subject to change without notice. While reasonable efforts have been made in the preparation of this document to assure its accuracy, Alpha Technologies assumes no liability resulting from errors or omissions in this document, or from the use of the information contained herein. Alpha Technologies reserves the right to make changes in the product design without reservation and without notification to its users.

Contents

- List of Figures..... 4
- List of Tables.....5
- 1. Safety..... 6**
- 2. Introduction..... 9**
 - 2.1. Scope.....9
 - 2.2. Product Overview..... 9
- 3. Features..... 11**
 - 3.1. Rectifier..... 11
 - 3.2. Overview of the CXCi HP..... 14
 - 3.3. Overview of the CXCi+..... 16
 - 3.4. Controller Input and Output..... 18
- 4. Inspection..... 20**
- 5. Installation..... 21**
 - 5.1. Safety Precautions..... 21
 - 5.2. Shelf Preparation/Mounting.....21
 - 5.3. Module Insertion and Removal..... 22
 - 5.4. Removing a CXRC Rectifier..... 22
 - 5.5. Removing the CXCi HP and CXCi+ Controller.....22
- 6. Wiring and Connections..... 24**
 - 6.1. Safety Precautions..... 24
 - 6.2. Tools Required..... 24
 - 6.3. Power System Chassis Ground and DC Ground..... 24
 - 6.4. AC Feeder Protection/Sizing.....24
 - 6.5. AC Input..... 25
 - 6.6. Calculating Output Wire Size Requirements..... 25
 - 6.7. DC Output..... 26
 - 6.8. CAN Ports..... 27
 - 6.9. Network Connection and Remote Communications via the Controller..... 27
 - 6.10. Signal Wiring Connections.....27
- 7. Operation..... 31**
 - 7.1. Main Rectifier States..... 31
 - 7.2. Main Rectifier Modes..... 32

- 7.3. CAN Bus Communication..... 33
- 7.4. Factory Ranges and Defaults..... 33
- 8. System Startup..... 34**
 - 8.1. Check System Connections..... 34
 - 8.2. Verify AC and Power the Shelf..... 34
 - 8.3. Check Battery Polarity and Connect..... 34
 - 8.4. Controller Reset - CXCI+..... 34
 - 8.5. Controller Reset - CXCI HP..... 35
- 9. Maintenance..... 36**
 - 9.1. Replacing a CXCI+ Controller..... 36
 - 9.2. Replacing a CXCI HP Controller..... 38
- 10. Warranty and Service Information..... 39**
- 11. Certification..... 40**
- 12. Glossary..... 41**
- 13. Specifications..... 43**
 - 13.1. 2RU, 24-400W, 19", 4 Module System..... 43
 - 13.2. 2RU, 24-400W, 19", 5 Module System..... 44
 - 13.3. Cordex 24-400W Switched Mode Rectifier..... 45
 - 13.4. CXCI HP Controller..... 48
 - 13.5. CXCI+ Controller..... 50

List of Figures

Figure 1: Four Module System, 030-763-20-XXX.....	10
Figure 2: Five Module System, 030-773-20-XXX.....	10
Figure 3: Rectifier Front Panel.....	11
Figure 4: CXCI HP Controller.....	14
Figure 5: In-Shelf Controller Dashboard Screens.....	15
Figure 6: In-Shelf Controller Menu.....	15
Figure 7: In-Shelf Controller Buttons.....	16
Figure 8: Cordex CXCI+ model system controller front panel.....	17
Figure 9: Packing Materials and Environmental Codes.....	20
Figure 10: Digital Input Connection Method.....	29
Figure 11: Relay Connections.....	30
Figure 12: Removing the CXCI HP.....	38

List of Tables

Table 1: In-Shelf Controller Full Menu.....	15
Table 2: Recommended AC Supply Configuration.....	25
Table 3: Wiring Connections for the CXCi Series of Controllers.....	27
Table 4: Voltage Level Definitions for Digital Inputs.....	30
Table 5: Output Voltage Modes.....	32
Table 6: Output Current/Power Modes.....	32
Table 7: Factory Ranges and Defaults.....	33
Table 8: Sample Maintenance Log.....	36
Table 9: Specifications: 24-400W 19", 4 Module System.....	43
Table 10: Specifications: 24-400W 19", 5 Module System.....	44
Table 11: Specifications: Cordex 24-400W, Switched Mode Rectifier.....	45
Table 12: Specifications: CXCi HP Controller.....	48
Table 13: Specifications: CXCi+ Controller.....	50

1. Safety

SAVE THESE INSTRUCTIONS: This manual contains important safety instructions that must be followed during the installation, servicing, and maintenance of the product. Keep it in a safe place. Review the drawings and illustrations contained in this manual before proceeding. If there are any questions regarding the safe installation or operation of this product, contact Alpha Technologies or the nearest Alpha representative.

Safety Wording/Symbols

To reduce the risk of injury or death, and to ensure the continued safe operation of this product, the following symbols have been placed throughout this manual. Where these symbols appear, use extra care and attention.

 **Attention:** *The use of attention indicates specific regulatory/code requirements that may affect the placement of equipment and /or installation procedures.*

 **Note:** *Notes provide additional information to help complete a specific task or procedure.*

 **CAUTION:** *Cautions indicate safety information intended to PREVENT DAMAGE to material or equipment.*

 **Warning:** *Warnings present safety information to PREVENT INJURY OR DEATH to personnel.*

 **Note:** *HOT! The use of Hot presents safety information to PREVENT BURNS to the technician or user.*

General Warning and Cautions

 **Warning:**

You must read and understand the following warnings before installing the system and its components. Failure to do so could result in personal injury or death.

- Read and follow all instructions included in this manual.
- Only trained personnel are qualified to install or replace this equipment and its components.
- Use proper lifting techniques whenever handling equipment, parts, or batteries.
- To be installed in a restricted access location that is inaccessible to the general public.

Electrical Safety

 **Warning:**

Hazardous voltages are present at the input of power systems. The DC output from some rectifiers and batteries can have high voltage and high short-circuit current capacity that may cause severe burns and electrical arcing.

Before working with any live battery or power system, follow these precautions:

- Remove all metallic jewelry, such as watches, rings, metal rimmed glasses, or necklaces.
- Wear safety glasses with side shields at all times during the installation.
- Use OSHA approved insulated hand tools. Do not rest tools on top of batteries.

 **Warning:**

Lethal voltages are present within the power system. Always assume that an electrical connection or conductor is energized. Check the circuit with a voltmeter with respect to the grounded portion of the enclosure (both AC and DC) before performing any installation or removal procedure.

- Do not work alone under hazardous conditions.
- A licensed electrician is required to install permanently wired equipment. Input voltages can range up to 240Vac. Ensure that the utility power is disconnected and locked out before performing any installation or removal procedure.
- Ensure that no liquids or wet clothes come into contact with internal components.
- Hazardous electrically live parts inside this unit are energized from the batteries even when the AC input power is disconnected.
- The enclosure which contains the DC or AC power system along with customer installed equipment must remain locked at all times, except when authorized service personnel are present.
- Always assume electrical connections or conductors are live. Turn off all circuit breakers and double-check with a voltmeter before performing installation or maintenance.
- Place a warning label on the utility panel to warn emergency personnel that a reserve battery source is present which will power the loads in a power outage condition or if the AC disconnect breaker is turned off.
- At high ambient temperature conditions, the internal temperature can be hot so use caution when touching the equipment.

 **Warning:**

*The intra-building ports (Ethernet, CAN, Alarm relays) of the equipment or subassembly are suitable for connection to intra-building or unexposed wiring or cabling only. The intra-building ports of the equipment or subassembly **MUST NOT** be metallically connected to interfaces that connect to the OSP or its wiring. These interfaces are designed for use as intra-building interfaces only (Type 2 or Type 4 ports) and require isolation from the exposed OSP cabling. The addition of Primary Protectors is not sufficient protection in order to connect these interfaces metallically to OSP wiring.*

 **Warning:**

Controller Ethernet port is not designed to withstand lightning and AC power cross surges according to the NEBS requirements in GR-1089-CORE. Ensure that any Ethernet cable used (not provided by Alpha) does not exceed a maximum length of 6 meters.

Battery Safety

- Never transport an enclosure with batteries installed. Batteries must **ONLY** be installed after the enclosure has been securely set in place at its permanent installation location. Transporting the

unit with batteries installed may cause a short circuit, fire, explosion, and/or damage to the battery pack, enclosure and installed equipment.

- Servicing and connection of batteries must be performed by, or under the direct supervision of, personnel knowledgeable of batteries and the required safety precautions.
- Batteries contain or emit chemicals known to cause cancer and birth defects or other reproductive harm. Battery post terminals and related accessories contain lead and lead compounds. Wash your hands after handling batteries.

 **Warning:**

Follow battery manufacturer's safety recommendations when working around battery systems. Do not smoke or introduce an open flame when batteries (especially vented batteries) are charging. When charging, batteries vent hydrogen gas, which can explode.

- Batteries are hazardous to the environment and should be disposed at a recycling facility. Consult the battery manufacturer for recommended local authorized recyclers.

2. Introduction

2.1. Scope

This manual explains the installation, interconnection, and operation of the following Alpha Technologies shelf systems:

- Cordex[®] 24-400W integrated 19" 2RU shelf system with up to 1600W output power and distribution.
- Cordex[®] 24-400W integrated 19" 2RU shelf system with up to 2000W bulk output power.
- Operation of the Cordex[®] 24-400W rectifier.

2.2. Product Overview

A complete Cordex[®] rectifier system consists of a controller with one or more power modules in a common shelf enclosure. The shelf has connections for AC inputs, DC output, and system communications.

Cordex rectifier modules use a high frequency, switched mode conversion technique to provide a fully regulated and isolated DC output from the AC mains. The rectifier input is wide range to allow use on 120/208/220/240Vac 50/60Hz electrical service.

Rectifier power modules are “hot swappable” meaning they can be inserted or removed from the shelf without cutting power to or from the system or the load.

Additional power modules can be included with the system at the time of ordering or added after the shelf has been installed.

The shelf rectifier system is designed to operate with the Alpha CXCI series of controllers (includes CXCI+ and CXCI HP), which is built into the rectifier system shelf.

All models of the controller allow the user to set up, control and monitor the entire power system and its components from one central, easy-to-use source: your web browser. The CXCI series of controllers do not have a touch screen display, system setup and management is performed exclusively with the web interface. Details of controller operation are provided in the current version software manual.

The following figures are examples of:

1. Cordex 48-400W integrated 19" 2RU shelf system: four rectifiers, controller, and breaker distribution.
2. Cordex 48-400W integrated 19" 2RU shelf system: five rectifiers and controller.

Figure 1. Four Module System, 030-763-20-XXX



Figure 2. Five Module System, 030-773-20-XXX



3. Features

3.1. Rectifier

The Cordex[®] CXRC series of 24V 400W rectifier modules employ an advanced resonant power conversion technology featuring high power conversion efficiency. All internal semiconductor devices operate under “soft-switching” conditions and exhibit very low power loss. The reduced power loss leads to lower thermal stress on the semiconductors and thus improves reliability.

Rectifier Front Panel

Figure 3. Rectifier Front Panel

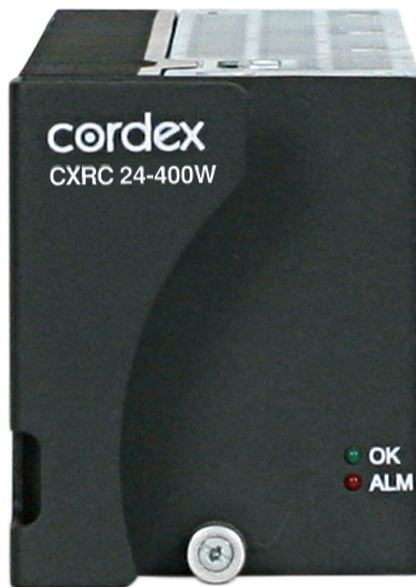

LEDs

The front panel LEDs provide rectifier status summary and help to locate a specific module with the controller.

OK

The top LED (green) is on when AC is within valid range and the rectifier is delivering power to the load. The LED will flash (~2Hz) when AC is outside the nominal range – AC voltage is invalid if the AC Mains Low or AC Mains High alarm is active. The LED turns off when AC has failed (or no AC power is present).

Alarm

The bottom LED (red) is on continuously in the event of an active Module Fail alarm. The LED flashes (~2Hz) when a minor alarm is detected. The LED remains off in the absence of an alarm.

LED Activity During “Locate Module” Command from Controller

When the “locate module” command has been received from the controller, the LEDs behave in a distinctly different way so that the rectifier is easier to visually identify among adjacent rectifiers.

This state is entered when commanded via the controller. The LEDs flash in a distinct pattern repeating every two seconds.

LED Activity During Firmware Upload

When a rectifier firmware upload is in progress, the LEDs behave in the same way as the locate module command described above.

Mechanical

A thumbscrew is provided to secure the rectifier into the shelf. During normal operation the rectifier shall be locked into position. A handle (or grip) is incorporated into the front panel to facilitate the removal of the rectifier from the shelf. No special tools are required.

True Module Fail Alarm

The power modules have a “true” fail alarm. This provides a true indication of the power module’s ability to source current. When the module’s output current drops below 2.5% of the rated output a low output current condition is detected and the Module Fail detection circuit is activated. This circuit momentarily ramps up the output voltage to determine if the module will source current. If no increase in current is detected, the Module Fail alarm is activated. The module will test once every 60 seconds for the condition until current is detected. Output voltage ramping will cease upon detection of current¹. A minimum 2.5% load is required to avoid the Ramp Test Fail alarm; this can typically be provided with the parallel system battery. Activation of this alarm could indicate a failed module or a failed load.

 **Note:** For rectifier systems without batteries (or with a very light load; below 2.5% of rated output) it is recommended that the ramp test be disabled to avoid nuisance alarms. The Ramp Test feature is enabled/disabled via the controller. Refer to the software manual for detailed information.

Heat Dissipation

Heat dissipation is achieved through natural (bottom to top) convection cooling

Over Temperature Protection

Each rectifier module is protected in the event of an excessive increase in temperature due to component failure or cooling airflow blockage. During over temperature conditions, the rectifier limits the output power as well as the output current. If temperature continues to increase, a shutdown of the rectifier is initiated. The rectifier shall restart automatically if the temperature has returned to a safe level.

1. Under normal conditions, a battery connected to the output of the rectifier will draw current when the voltage ramp occurs. Therefore the rectifier fail alarm will not be generated with a battery connected.

Wide AC Range

A minor alarm is generated when the AC input voltage drops below specification. The unit will deliver derated output power down to 60Vac.

-  **Note:** Output power is reduced linearly between 90Vac to 60Vac to 0% of the rated output power. At a lower voltage the module will shutdown and will not restart until the AC is greater than 65Vac. For voltages between 276Vac and 320Vac, the rectifier may not be operational but shall not suffer any damage.

AC Inrush/Transient Suppression

An external surge suppressor is not required at the AC input, modules are protected from input lightning and transient surges in accordance with IEEE/ANSI C62.41 Category B3.

Soft Start

To eliminate an instantaneous demand on the AC source, a soft start feature is employed. Soft Start, sometimes referred to as “current walk-in”, works by gradually (up to five seconds) ramping the current limit up from zero to the actual or defined customer setting. The rectifier output voltage is ramped up from the minimum voltage to the float voltage.

Start Delay

The rectifier modules are equipped with a delay timer in order to stagger start a series of modules to prevent excessive loading of generators upon start up. The built-in timer delays the start up of the module depending on the value selected (up to 120 seconds on CXCI and 250 seconds on CXCI HP) via the controller. A minimum one-second delay is preset to allow charging of the input capacitors.

Current Limit/Short Circuit Protection

The current limit function determines the maximum output current limit of the rectifier module, regardless of output voltage or power. Maximum output current is limited to a constant value down to short circuit condition. Current limiting can be used to mate the rectifier output current ampacity to the needs of the load and parallel battery to minimize excessive battery recharge current.

The rectifier will sustain a short circuit at the output terminals indefinitely. The maximum short circuit current cannot exceed 105% of the rated full load current.

Power Limiting

Each rectifier module is designed to limit power output to the module specification. This enables more current to be supplied at lower output voltages, and allows matching of output to the demand of constant power loads, normally seen with telecom equipment.

This feature may also be used for a faster recharge of flooded batteries paralleled with the load.

-  **Note:** Current limiting overrides the power-limiting feature.

High Voltage Shutdown (HVSD)

This feature provides protection to the load from over voltage conditions originating from the rectifiers. It operates by shutting down the offending rectifier module when a high output voltage condition occurs. Indication is through the red Alarm (Module Fail) LED. Modules will restart automatically; however, if more than three over voltage conditions occur in one minute, the module will latch off and remain shut down until it is reset.

Battery Eliminator Operation

Rectifier modules maintain all specifications (except where indicated) with or without a battery attached in parallel to the output; however, if a battery or another module supplying DC voltage in parallel is not present, there will be no monitoring or control activity if there is an AC power failure or input fuse failure.

3.2. Overview of the CXCI HP

The CXC HP in-shelf controllers have a small organic LED (OLED) display. This display shows 30 characters total (five lines high, six characters wide) and the controller has three navigation buttons and one reset button.

The in-shelf display has three main operating modes: dashboard, menu and screen saver. After 20 minutes with no activity, the in-shelf controller goes into screen saver mode and the display shuts off. From screen saver mode, press any of the three navigation buttons to re-activate the screen and enter dashboard mode.

Figure 4. CXCI HP Controller

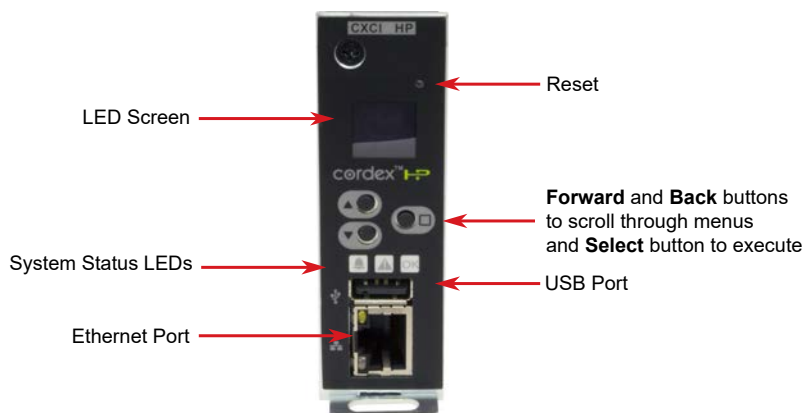

Display

In dashboard mode, the in-shelf display shows the key operating parameters of a system. For example, output voltage and load current. If more than one system is defined, you can cycle between systems using the **Forward** and **Back** buttons. With multiple systems, you can specify a default system, which is then displayed first.

Refer to the software manual for set up.

The following figure below shows examples of the screens.

Figure 5. In-Shelf Controller Dashboard Screens

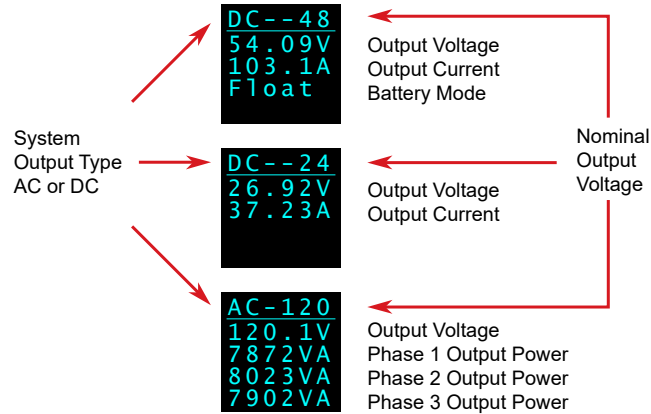

In-Shelf Display: Menu

From the OLED dashboard, use the **Select** button to enter a menu. From the menu, the OLED display lets you execute a set of commands much like the LCD screens on the CXC HP.

When you enter a menu, the top item is highlighted. To go to another menu scroll through using the **Forward** and **Back** buttons. To execute a highlighted menu item, press the **Select** button.

To exit a menu and return to the main OLED dashboard, scroll to the **Back** command, and then press the **Select** button. The figure below shows an example of the menu screen. The following table provides a full list of menus available via the in-shelf display.

Figure 6. In-Shelf Controller Menu



Table 1. In-Shelf Controller Full Menu

Menu Label	Description
ALCO	Perform the alarm cut-off command
Reset	Perform a software reset of the controller
IPv4	Display the IPv4 address, subnet and gateway for this controller
IPv6	Display the IPv6 addresses assigned to this controller

Table 1. In-Shelf Controller Full Menu (continued)

Menu Label	Description
Backup	Backup the controller application and configuration to a file on a USB device
Restore	Restore the controller application and configuration from a file on a USB device
Upgra...	Upgrade the controller application from a file on a USB device
OS Upg	Upgrade the controller's operating system from a file on a USB device
Info	Display controller information including serial number, part number, software and hardware version
Rotate	Rotate the in-shelf controller display information by 90 degrees
Back	Exit the menu and return to the OLED dashboard

In-Shelf Controller Buttons

The following figure shows how the buttons are interpreted.

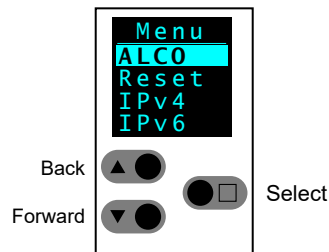
Figure 7. In-Shelf Controller Buttons

3.3. Overview of the CXCI+

The CXCI+ has a 4-digit display for monitoring system voltage (V) and current (A). A pushbutton toggle switch allows the user to alternate the display reading.

Figure 8. Cordex CXCI+ model system controller front panel

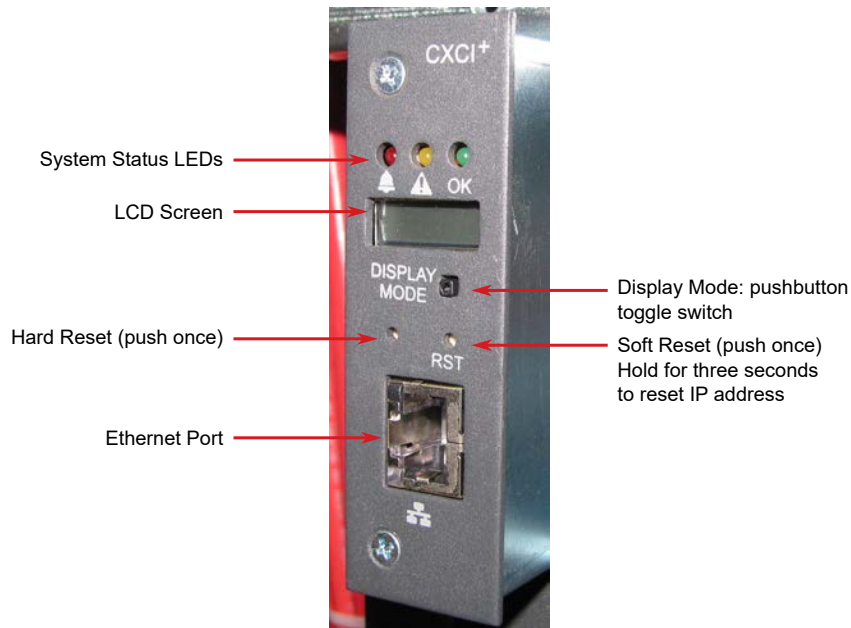

LEDs

The controller has three LEDs to display the alarm status of the power system, controller progress and status during startup, files transfers and lamp tests.

Alarm Conditions

The CXC illuminates the LED that corresponds to the alarm status. Only one LED is illuminated at a time during alarm conditions:

- **Green:** OK, no alarms present
- **Yellow:** Minor alarm is present (no major alarms)
- **Red:** Major alarm is present.

Progress and Status Indication

The LEDs are also used in the following situations:

- **Base unit validation:** All three LEDs on simultaneously
- **File transfer:** Red LED illuminates when recovering from invalid firmware application
- **Lamp Test:** All three LEDs flash in sync for two seconds

Reset (CXCI+ only)

A reset button is located on the front panel for restarting the controller. During reset, the controller may occasionally need to run a defragmentation cycle. This can be recognized by the LEDs cycling on

the front panel. A full defragmentation may take up to 20 minutes to perform, do not power down the controller during this time.

 **Note:** Refer also to the software manual – always select the Reset menu item before pressing the reset button.

3.4. Controller Input and Output

The inputs and outputs refer to both the CXCI+ and the CXCI HP controllers.

Ethernet Port

The Ethernet port is designed for connection to a user supplied network (TCP/IP secured by user) via a front panel RJ-45 jack and a standard network cable. Local access (e.g. laptop computer) is also possible from the Ethernet port connection using a standard network cable.

Analog Input Channels

The controller is provided with analog input channels for voltage, current, and temperature.

Voltage Inputs

Two voltage input channels, V1 and V2, provide monitoring of discharge and charge voltage. The controller software is pre-configured to monitor V1 for battery voltage and V2 for load voltage.

V2 is wired internally to the rectifier shelf to provide a reference for rectifier float voltage, low voltage disconnect (LVD), system high voltage alarm, and system low voltage alarm.

Wire V1 to battery to monitor battery voltage or change battery setting from V1 to V2 in **Signals > Configure Signals**.

Current Inputs

The controller software is pre-configured to monitor I1 for load current wired internally to the load current shunt.

Temperature Inputs

Two temperature input channels, T1 and T2, provide monitoring of battery temperature and temperature compensation (temp comp) or room/ambient temperature. A voltage is supplied to these terminals to power the temperature sensors.

Digital Input Channels

The controller can accommodate up to two channels and can monitor digital alarm/control signals from rectifiers, converters and many other types of equipment.

Alarm and Control Output Relays

The controller contains four Form C digital alarm output relays to extend alarms and control external apparatus. Each internally generated alarm or control signal may be mapped to any one of the relays, or, several signals may be mapped to just one relay or none at all.

Network Connection and Remote Communication

The Cordex® system can be set up, monitored and tested via an Ethernet connection. The communication protocol supports a web interface. All alarming and control of the rectifiers is accomplished with a controller via a CAN bus.

A step-by-step connection wizard – provided to establish remote communications with your controller – is available via the Alpha website (<http://www.alpha.ca/downloads>).

Controller Connections

Located on the rear of the shelf are terminal block connections for the system control I/O; such as, digital signals, analog inputs, and alarm relay outputs.

USB Port (CXCi HP Only)

A USB 2.0 port is located on the front of the CXCi HP controller. It is used for upgrading operating system software.

4. Inspection

The inventory included with your shipment is dependent upon the options you have ordered. The options are clearly marked on the shipping container labels and on the bill of materials (BOM).







Check for Damage

Prior to unpacking the product, note any damage to the shipping container. Unpack the product and inspect the exterior for damage. If any damage is observed contact the carrier immediately. Continue the inspection for any internal damage. In the unlikely event of internal damage, inform the carrier and contact Alpha Technologies for advice on the impact of any damage.

Packing Materials

Alpha is committed to providing products and services that meet our customers' needs and expectations in a sustainable manner, while complying with all relevant regulatory requirements. As such Alpha strives to follow our quality and environmental objectives from product supply and development through to the packaging for our products. Rectifiers, UPSs, and batteries are shipped on individual pallets and are packaged according to the manufacturer's guidelines. Almost all of Alpha's packaging material is from sustainable resources and or is recyclable. See the following table for the material and its environmental codes.

Figure 9. Packing Materials and Environmental Codes

 PAP/PCB	 PET	 PE-LD	 PS	 FE	 ALU	 NW
Cardboard	Polyethylene Terephthalate	Low Density Polyethylene	Polystyrene	Steel	Aluminum	Wood
Packing boxes Caps	Flexible film Packaging	Bubble wrap Shrink wrap Plastic bags	Foam	Strapping on pallets	Strapping on pallets	Pallets Lumber

Returns for Service

Save the original shipping container. If the product needs to be returned for service, it should be packaged in its original shipping container. If the original container is unavailable, make sure that the product is packed with at least three inches of shock-absorbing material to prevent shipping damage. Alpha Technologies is not responsible for damage caused by improper packaging of returned products.

If you have any questions before you proceed, call Alpha Technologies: 1 888 462-7487.

5. Installation

This chapter is provided for qualified personnel to install the product. Mount the unit horizontally in a clean and dry environment.

 **Note:** Drawings are located at the rear of the manual.

 **Warning:** This system is designed to be installed in a restricted access location that is inaccessible to the general public.

5.1. Safety Precautions

 **Warning:** Hazardous voltages are present at the input of power systems. The DC output from the rectifiers and battery system, though not dangerous in voltage, has a high short circuit current capacity that may cause severe burns and electrical arcing.

Before working with any live battery or power system/distribution center, follow these precautions:

- Remove all metallic jewelry; e.g., watches, rings, metal rimmed glasses, necklaces.
- Wear safety glasses with side shields (and prescription lenses if necessary) at all times during installation.
- Use insulated hand tools.

The installer should follow all applicable local rules and regulations for electrical and battery installations; e.g., CSA, UL, CEC, NEC, OSHA, and local fire codes.

5.2. Shelf Preparation/Mounting

 **Warning:** This system is designed to be installed in a restricted access location that is inaccessible to the general public.

 **Note:** The shelf is designed for mounting in a clean and dry environment. Allow at least 1.75" (44mm, 1 RU) of free space above and below the unit for unrestricted cooling airflow. 3.5" (89mm, 2RU) is recommended.

Each shelf has been designed for flush or offset mounting in a 19" (483mm) or 23" (584mm) rack. See drawings at the end of this manual.

Mounting brackets accommodate either 1" (25.4mm) or 1.75" (44mm) rack spacing. Mount the shelf to the rack using at least two #12 – 24 x 1/2" (12.7mm) screws in each bracket. Use Phillips-type screws and screwdriver to eliminate the possibility of slippage and scratching of the unit's exterior.

An electrical conducting path must exist between the unit's chassis and the metalwork of the enclosure in which it is mounted or a grounding conductor. The electrical continuity requirement can be met by the use of thread-forming type unit mounting screws and star washers that remove any paint or non-conductive coatings and establish metal-to-metal contact.

5.3. Module Insertion and Removal

The rectifier is plug and play. When a rectifier module is added to the system, the controller will detect and update the inventory automatically. Replacing an installed rectifier requires a manual **Inventory Update** at the controller to clear the removed rectifier from its current list of rectifiers.

Insert rectifiers by placing the module on the shelf bottom and sliding the module into the rear connector (inside of the shelf). Apply pressure on the front of the module to engage the rear connector in the shelf receptacle. A thumbscrew is provided to secure the rectifier into the shelf.

 **Note:** Do not force a module into position if it does not seat properly. All modules are keyed to ensure that the correct module (polarity/voltage) type is used.

5.4. Removing a CXRC Rectifier

1. To remove a module, loosen the screw on the bottom of the faceplate.



2. Grasp the handle and pull out, sliding the module away from the rear connector and out of the shelf.
3. Place the new rectifier module on the shelf bottom and slide the module into the rear connector (inside the shelf).
4. Apply pressure to the module front panel to engage the rear connector in the shelf receptacle.
5. Tighten the thumb screw to secure the rectifier to the shelf.
6. Refer to the respective controller software manual to perform an inventory update or module assignment.

5.5. Removing the CXCi HP and CXCi+ Controller

To remove the controller:

1. Remove at minimum the left most rectifier adjacent to the controller.
2. Remove the controller mounting screws as highlighted in figure below.

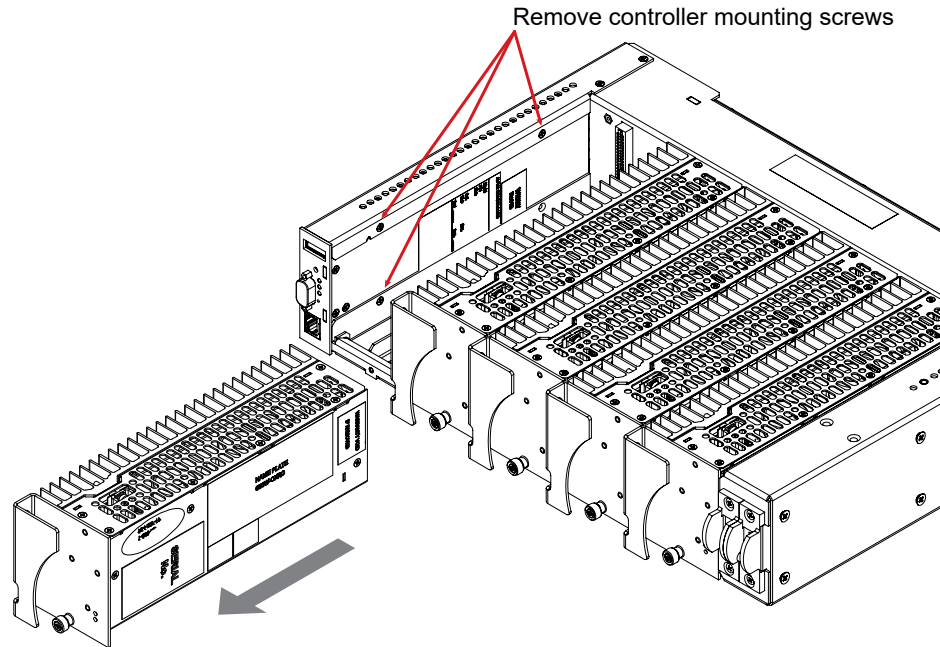

3. Pull from the location noted in the following image to remove the controller.



⚠ CAUTION: When removing the controller in a live system that has an LVD, ensure that the LVD override jumper is set to correct position to avoid possible service disruption. Refer to the wiring and connections section of the manual and the connection drawings.

6. Wiring and Connections

6.1. Safety Precautions

 **Warning:** Hazardous AC voltages may be present. Ensure power at the AC service panel is off before attempting work on the AC connections. Use a voltmeter to verify the absence of voltage. Clearly mark the correct polarity of the battery leads before commencing work on DC connections.

Refer to the chapter on Installation for additional safety precautions.

6.2. Tools Required

Various tools are essential for product installation. Insulated tools are recommended. Use this list as a guide:

- Slot head screwdrivers (blade sizes: 1/4", 1/8", 1/16")
- Phillips head screwdriver, #2 (tip size 3/16")
- Digital voltmeter equipped with test leads
- Adjustable 24/48Vdc load (optional)
- Cutters and wire strippers
- Crimping tool (optional for large gauge wire)
- Socket and ratchet set (Imperial measure)
- Anti-static wrist strap
- Computer (laptop) with web browser
- Standard network cable (for access using the Ethernet port)

6.3. Power System Chassis Ground and DC Ground

 **Warning:** For safety reasons, ensure the system is properly bonded to the building's ground.

Both the shelf chassis ground (via power system chassis ground) and common return (DC ground) shall be connected to the site ground to ensure correct operation of the system and to prevent drifting floating analog (especially current) readings.

6.4. AC Feeder Protection/Sizing

To maximize system reliability, the AC feed divides the rectifiers into groups to be supplied by separate feeds. See customer connections drawing (modules are numbered left to right).

- Shelves with integrated distribution have TB3 feed modules 1 and 2 while TB4 feeds modules 3 and 4.
- Shelves with bulk outputs have TB3 feed modules 1 and 2 while TB4 feeds modules 3, 4 and 5.

It is recommended, for each feed, to use a dedicated protection feeder breaker located at the AC distribution panel. The feeder breaker can also act as the disconnect device for the connected modules.

Table 2. Recommended AC Supply Configuration

AC Input (Vac)	Number of Rectifiers on AC Feed	Circuit Breaker, Exact Value to Use (A)	90° C Wire Gauge to use at 30° C ambient (AWG)
120/240	1	10 or 15	14
120/240	2	20	12
120/240	3	20	12

An external surge protection device is not required. The rectifiers are protected by internal MOVs.

6.5. AC Input

⚠ CAUTION: Route the AC input wires in flexible or rigid conduit as far away as possible from the DC power wires to minimize EMI disturbances.

1. If the shelf is factory-equipped with a line cord, proceed to the next section.
2. Refer to the -08 customer connections drawings (rear view – back cover removed).
3. Remove the metal cover from the rear of the shelf to expose the wire-way for the input terminal blocks.
4. Attach the conduit retainers to the wire-way hole(s) and route the AC cables through.
5. Secure the wires to the AC input and chassis ground terminals as required. Tighten the cable connector to the AC cable (conduit similar).
6. Replace rear cover once all connections have been completed.

6.6. Calculating Output Wire Size Requirements

Wire size is calculated by first determining the appropriate maximum voltage drop requirement. Using the formula below calculate the CMA wire size requirement. Determine the size and number of conductors required to satisfy the CMA requirement.

$CMA = (A \times LF \times K) / AVD$, where:

- CMA: Cross section of wire in circular MIL area
- A: Ultimate drain in amps
- LF: Conductor loop feet
- K: 11.1 constant factor for commercial (TW type) copper wire
- AVD: Allowable voltage drop

Check again that the ampacity rating of the cable meets the requirement for the installation application. Consult local electrical codes (NEC, CEC, etc.) for guidelines. If required, increase the size of the cable to meet the code.

Example:

A = 40A

LF = 20 feet

K = 11.1

AVD = 0.5V

$CMA = (A \times LF \times K) / AVD$

$CMA = (40A \times 20ft \times 11.1) / 0.5A$

CMA = 17,760

In this example the technician would need to use a 7 AWG or larger. This value can be found from a standard AWG table.

6.7. DC Output

⚠ Warning: Leave cables disconnected at battery and verify output polarity using a voltmeter. Make battery connections only after all other wiring is completed.

DC output wire must be UL approved XHHW or RHH/RHW (for Canadian users RW90; for European users, must be EN or IEC approved wire). Control and sense wires must be UL approved 1015 (for Canadian users TEW type; for European users, must be EN or IEC approved wire).

Circuit Breaker Distribution

Four Module shelf: equipped with four AM-style bullet type breakers, factory configurable as four load breakers or two load breakers plus two battery breakers, or three load breakers plus one battery breaker.

Five Module shelf: bulk output only.

📄 Note: Battery breakers should be series-trip to ensure effective alarm operation; service personnel must reset the breaker to clear the alarm.

📄 Note: When there is no AC power to the rectifiers and there is only one battery circuit breaker, there will be no alarm if the circuit breaker trips.

Secure the positive and negative cable leads to the shelf output terminal blocks of the correct polarity; i.e., +V_{cable} to +V_{post}.

The common output leg of the rectifier system should be connected to ground. This is typically done at the load common termination point. For the output terminal block configurations, refer to the schematics drawings at the rear of this manual.

6.8. CAN Ports

Four Module shelf: one CAN OUT port located at the rear of the shelf.

Five Module shelf: one CAN IN and one CAN OUT port. Located at the back of the shelf.

Daisy-chain from node to node (CAN OUT of one node to CAN IN of another) as necessary and ensure that only the last node is terminated.

 **Note:** This system can accommodate up to a maximum of 12 Cordex® small convection cooled rectifiers (650W, 400W, 250W). The individual rectifiers do not provide their own CAN bus power and must draw it from the controller.

6.9. Network Connection and Remote Communications via the Controller

The Cordex® rectifier shelf systems can be set up, monitored and tested via modem or Ethernet 10/100 Base-T serial data connection. The communication protocol supports a web interface. Some standard scenarios are described in the following sections.

Ethernet Port for Network Connection

The Ethernet port is designed for controller connection to a user supplied network (TCP/IP secured by user) via a front panel RJ-45 jack.

Connect to the controller using a standard network cable. Pinouts are shown in the connection drawings.

Ethernet Port for Local Connection

Local access (e.g. laptop computer) is also possible from the Ethernet port connection using a standard network cable.

 **Note:** Older CXCi models must use a crossover Ethernet cable for direct connection to a computer.

6.10. Signal Wiring Connections

For terminal block connections, the recommended wire sizes are #16 to #26 AWG (1.5 to 0.129mm²). Control and sense wires shall be UL approved Style 1015 (for Canadian users, TEW type; for European users, EN or IEC approved wire).

 **CAUTION:** To reduce the risk of fire, use only #26 AWG (0.129mm²) or thicker wire.

Table 3. Wiring Connections for the CXCi Series of Controllers

Terminal	Description	Default Name	Signal Type	Range
1, 2, 3*	LVD Control (internal)	K1, Relay 1	NO/COM/NC	60VDC / 1A
4, 5, 6*	Alarm Output 2	K2, Relay 2	NO/COM/NC	60VDC / 1A

Table 3. Wiring Connections for the CXCi Series of Controllers (continued)

Terminal	Description	Default Name	Signal Type	Range
7, 8, 9*	Alarm Output 3	K3, Relay 3	NO/COM/NC	60VDC / 1A
10, 11, 12*	Alarm Output 4	K4, Relay 4	NO/COM/NC	60VDC / 1A
13, 14**	Digital Input 1 (internal)	D1, Digital 1	Pos (+) or Neg (-)	0—60VDC
15, 16**	Digital Input 2	D2, Digital 2	Pos (+) or Neg (-)	0—60VDC
17, 18***	Voltage Input 1	V1, Load Voltage	Pos (+) / Neg (-)	0—60VDC
19, 20***	Temp Probe 1	T1, Analog Input T1	Pos (+) / Neg (-)	0—5VDC
21, 22***	Temp Probe 2	T2, Analog Input T2	Pos (+) / Neg (-)	0—5VDC
23	Battery -48V	Batt Hot	Neg (-)	20—60VDC
24, 25	Current Input 1 (internal)	I1, Load Current	Pos (+) / Neg (-)	±50mV

* NO and NC Form C contacts available. Can be configured to de-energize on alarm (DOA) or energize on alarm (EOA).** See [Table 4: Voltage Level Definitions for Digital Inputs \(on page 30\)](#) for definitions of logic and system.*** Voltage (Input) is 0—60VDC, Temp Probe is 0—5VDC with power source.

 **Note:** To aid the user with installation, frequent reference is made to drawings located at the rear of this manual. Custom configurations may be detailed within the Alpha power system documentation package.

Bundle the signal cables together and route them through the entry holes of the shelf.

Analog Inputs

 **CAUTION:** Ensure the correct polarity is used for all input cable terminations.

The analog input channels are used to monitor various types of electrical signals. The Voltage Input is -60 to +60Vdc. The Temperature Input (designed for Alpha supplied temp sensor only) is 0 to 5Vdc with power source.

Voltage

Voltage Input #1 terminals on the shelf provide connections to an optional secondary voltage input. Voltage Input #2 is wired internally to the rectifier output voltage of the shelf. This is used as the reference for Voltage regulation of rectifiers, system alarming (such as high voltage) and control (such as LVD).

See the software manual for information on configuring Alarms and LVD control. The battery should be connected at the battery system voltage terminal for redundant power feed to the CXCi series controller when a battery disconnect device is used. It is critical to controller operation as it ensures an auxiliary source of power to the controller should the disconnect device open the circuit.

Current

Current input #1 is wired internally to the system current shunt for shelves with integrated distribution, and wired to an external shunt for bulk distribution shelves.

Temperature Sensor

Temperature Probe input channels provide connections for up to two temperature sensors. A voltage is supplied to these terminals for sensor measurements. Temperature sensors are available from Alpha in various lengths.

Digital Inputs

The digital input channels are used to monitor various alarm and control signals. All input channels are voltage activated and accept a bipolar (i.e. negative or positive) DC signal directly.

For shelf modules with integrated distribution, D1 is wired internally for CB/fuse trip. D2 is available for customer connections as required.

Connection Method

Typical Alpha systems use the “reset with Hot and trigger with Ground” connection. The digital input is wired in such a way that the Hot is wired directly into one of the input terminals:

- positive input for +12V and +24V systems
- negative input for -48V systems

The other input terminal is wired to the Ground (common) of the system through a relay (dry contact – usually located on the equipment requiring monitoring). This method allows the digital input to receive (or not receive) a Ground signal on an alarm.

Figure 10. Digital Input Connection Method

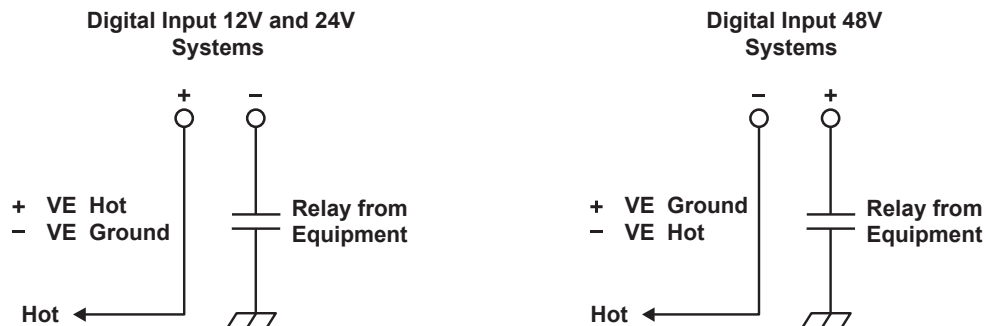

Programming the Digital Input

The digital input channels can be programmed for “active high” or “active low. Active high indicates, “alarm on the presence of a ground signal” and active low indicates, “alarm on the removal of a ground signal.” See controller software manual for detailed instruction on programming.

Table 4. Voltage Level Definitions for Digital Inputs

V	Voltage Level (Vdc), Considered As "0" (Off)	Voltage Level (Vdc), Considered As "1" (On)
0 - 60 (System Voltage Setting)	0 to 3V	9 to 60V

Alarm Relay Outputs

Terminals provide contacts for extending various alarm or control signals. Each relay output can be wired for NO or NC operation during an alarm or control condition.

Figure 11. Relay Connections

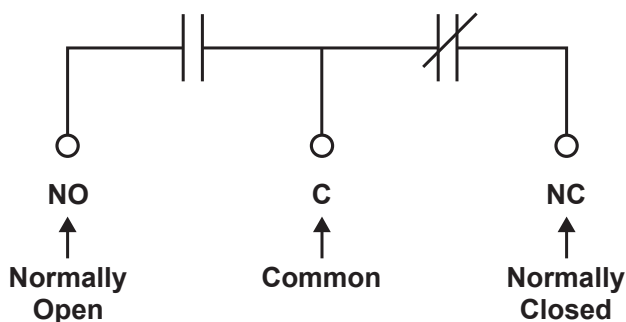

Relays can be programmed to energize or de-energize during an alarm condition (see controller software manual). When the controller reset button is pressed or power is lost, all relays de-energize.

These relays could be used for additional external LVD contactor control; however, this would not provide the redundant LVD control as with the assigned output pins described below.

LVD Control (Load Disconnect or Battery Disconnect)

The disconnect option is controlled by and connected internally to relay K1, when applicable.

LVD Inhibit

Should it be necessary to remove a CXCI series controller, the customer connection board (on the rear of the shelf) provides shorting pins (JP2) to inhibit (or override) the LVD Control function.

See the customer connections drawings.

If the LVD is controlled on NC contacts (factory default for LVD option), then JP2 pins 1 and 2 must be shorted together to maintain LVD operation. If the LVD is controlled on NO contacts, then pins 2 and 3 must be shorted together. For normal operation, the factory-supplied shorting jumper should be left on pins 3 and 4.

LVD Control Alternative

The LVD Control functions can be hardwired directly from an alarm output relay to an external LVD contactor (or panel). See Controls Menu Defaults in the controller software manual.

7. Operation

7.1. Main Rectifier States

Rectifier operation has five main states; each state is distinct and necessary for the operation of the rectifier.

- Off
- Start Delay
- Soft Start
- Normal Operation
- Turning Off

Off

The rectifier is in the Off state immediately after power is applied to the rectifier or after a rectifier shutdown (remote or local shutdown, AC shutdown, OVP or thermal shutdown).

In this state the DC-DC converter is turned off and the controller monitors its inputs for the proper conditions to begin the start up sequence.

When the conditions have been met for the rectifier to start up, it transitions to the Start Delay state.

Start Delay

When the rectifier is in the Start Delay state, the DC-DC converter is held off and still not sourcing power, waiting for a given amount of time before transitioning to the next state.

The controller continues to monitor its inputs.

After the Start Delay state the rectifier transitions to the Soft Start state.

 **Note:** *Soft start, or current walk-in, gradually increases the voltage and current output of the rectifier upon startup. This is done to reduce the instantaneous load on the AC source.*

Soft Start

When the Soft Start state is entered, the rectifier is turned on and the output voltage and output current gradually increased. If a load is present, the rectifier begins to source power.

When the voltage and current limit ramps have finished, the rectifier will transition to the Normal Operation state.

Normal Operation

The Normal Operation state is the state that the rectifier will be in performing all of the rectifier functions and features specified herein.

From this state, the only valid transition is to the Turning Off state. This transition will happen if the rectifier is required to shut down.

Turning Off

The Turning Off state is entered because a short delay is required before the rectifier actually turns off to take care of any initialization requirements.

When this short delay has elapsed, a transition to the Off state is made.

7.2. Main Rectifier Modes

In addition to main rectifier states, there is a set of main rectifier modes. These modes are divided into two categories:

Output Voltage Modes

Voltage modes, under software control, can directly adjust the output voltage. Situations, such as the rectifier being in current limit, can change the output voltage with no software control.

The following table describes the five output voltage modes.

Table 5. Output Voltage Modes

Output Voltage Modes	Active when...
Float	Output voltage is set to the float voltage setting.
Equalize	Output voltage is set to the equalize voltage setting.
Battery Test	Output voltage is set to the battery test voltage setting.
Safe	Output voltage is set to the safe mode voltage setting.
Manual Test	Output voltage can be manually adjusted outside of the standard adjustment ranges.

Output Current/Power Modes

These four output current/power modes directly affect the output current and power:

Table 6. Output Current/Power Modes

Output Current/Power Mode	Output current and power limit have been reduced due to:
Temperature foldback mode	High temperature of the heatsink or internal ambient temperature sensor.
AC foldback mode	Low AC input voltage.  Note: Reduces the risk of tripping an AC breaker due to increased AC current draw as the AC voltage decreases.
Short circuit foldback mode	Short circuit at the output.
Internal fault foldback mode	Internal fault.

7.3. CAN Bus Communication

The CAN bus is used for commands and data transfer between the rectifier and controller to configure the rectifier with system settings and to monitor rectifier status.

7.4. Factory Ranges and Defaults

The following table lists the rectifier controller settings/ranges/defaults. These settings are for a 24V system.

Table 7. Factory Ranges and Defaults

Setting	Range (minimum to maximum)	Default
Float (FL) Voltage	23.75 – 29.30V	27.00V
Equalize (EQ) Voltage	24.90 – 29.30V	27.50V
Battery Test (BT) Voltage	22.00 – 26.00V	23.00V
Over Voltage Protection (OVP)	See note below – 30.30V	28.50V
Current Limit (CL)	23 – 100%	100%
Power Limit (PL)	0 – 100%	100%
Module Start Delay	0 – 250s	1s
System Start Delay	0 – 600s	0s
Low Voltage Alarm (LVA)	21.00 – 26.00V	22.00V
High Voltage Alarm (HVA)	26.00 – 30.30V	27.75V
Equalization (EQ) Timeout	1 – 2399h	30h
Battery Test (BT) Timeout	1 – 250h	8h
Softstart Ramp-rate	Normal/Fast	Normal
Current Limit / Power Limit Alarm	Enable/Disable	Enable
Remote Shutdown	Enable/Disable	Enable
Ramp Test	Enable/Disable	Enable

 **Note:** OVP cannot be set below the present system/FL/EQ/BT voltage setting or the safe mode voltage of 25.7V.

8. System Startup

8.1. Check System Connections

- Ensure AC is off, battery is disconnected, and all power modules are removed from the shelf.
- Verify the polarity of all connections.

8.2. Verify AC and Power the Shelf

- Install one power module.
- Verify AC input voltage is correct and turn on the corresponding AC input feeder breaker.
- The power module OK LED should illuminate after a preset start delay.
- Using the controller, test functionality of various module alarms and controls.

8.3. Check Battery Polarity and Connect

- Verify correct battery polarity using a voltmeter (ensuring no cells or batteries are reversed).
- Connect battery as required to the output of the system or turn on battery breaker.
- Install remaining power modules.
- On the controller, set Float and Equalize voltage to the levels specified by the battery manufacturer.
- For some systems, the default setting for low AC voltage alarming is 180Vac. For nominal 120Vac operation, it is recommended to reset this value to 100Vac.
- Using the controller, test the functionality of various module alarms and controls. In addition, perform a load test with the system using a resistive load box as needed.

8.4. Controller Reset - CXCI+

Soft Reset

⚠ CAUTION: Before removing a CXCI+ from a live system or performing controller maintenance, and external LVD inhibit (or override) is required to avoid a disruption of service.

The reset button located on the front panel of the CXCI+ is for restarting the microprocessor. When pressed momentarily, the unit beeps twice then resets. The front-panel LEDs illuminate temporarily, and then extinguish after the system has finished its 15-second self-test.

⚠ CAUTION: During a reset the controller may need to run a defragmentation cycle. Cycling LEDs in the front panel indicate that defragmentation is in progress. All full defragmentation can take up to 20 minutes to perform. DO NOT power down the controller during this time.

IP Address Reset

To reset the IP address, press and hold the front panel soft reset button for three seconds. The CXCi+ unit beeps three times, IP address resets to 10.10.10.201 and DHCP is disabled. The settings are saved and the unit then resets.

This reset allows local access; e.g., with a laptop and a standard network cable. See current version software manual for details.

Hard Reset

A hard reset of the controller can be performed by pressing the front panel hard reset button. This procedure will restart the microprocessor if the front panel (soft) reset button fails to operate.

 **CAUTION:** Move the LVD control jumper to the override position before unplugging the controller. The load and batteries are still connected. Use of hard reset may cause loss of data.

8.5. Controller Reset - CXCi HP

Soft Reset

 **CAUTION:** Ensure that a backup has been performed before starting this process. Use the Backup feature accessed through the LCD at **Shortcuts > Backup**.

 **Note:** When the controller is being reset, the DC output voltage is maintained. Temperature compensation, user inputs, and relay controls are not available until the controller has finished restarting.

1. From the main dashboard, go to **Controller > Controller Status**.
2. Click the **Reset Controller** button. The **Controller Restart** window displays progress via a blue bar.
3. The controller screen goes black, and the LEDs lights cycle while restart is in progress.

Hard Reset

A hard reset of the controller can be performed by pressing the front panel hard reset button. This procedure will restart the microprocessor if the front panel (soft) reset button fails to operate.

 **CAUTION:** Move the LVD control jumper to the override position before unplugging the controller. The load and batteries are still connected. Use of hard reset may cause loss of data.

9. Maintenance

Although very little maintenance is required with Alpha systems, routine checks and adjustments are recommended to ensure optimum system performance. Qualified service personnel should do repairs.

The following table lists a few maintenance procedures for this system. These procedures should be performed at least once a year.

 **Warning:** ***HIGH VOLTAGE AND SHOCK HAZARD.** Use extreme care when working inside the shelf while the system is energized. Do not make contact with live components or parts.*

 **Important:** *Circuit cards can be damaged by static electricity. Always wear a grounded wrist strap when handling or installing circuit cards.*

Table 8. Sample Maintenance Log

Procedure	Date Completed
Clean ventilation openings	
Inspect all system connections (re-torque as necessary)	
Verify alarm/control settings	
Verify alarm relay operation	

9.1. Replacing a CXCI+ Controller

This procedure is for replacing a CXCI+ controller.

Write down the controller communication information: dynamic or static IP, IP address, and gateway.

1. Connect a laptop to controller per software manual; standard network cable to the Ethernet port.
2. Save the CXC configuration file (see software manual Logs and Files > Manage Configuration File > Save Full Site Configuration).
3. Save the CXC text file if necessary: **Logs and Files > Manage Editable Text Files > Save Dynamic Text File.** If applicable, bypass the system LVD:
 - a. Locate JP2 on the back of CXCI+ system shelf (see below).

Customer Connection Board Detail

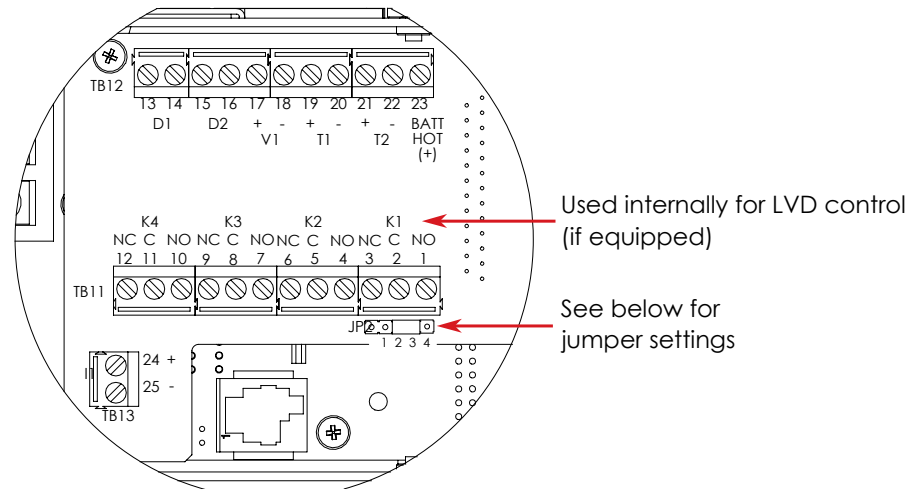

- b. If the LVD is controlled on NC contacts (factory default for LVD option), then JP2 pins 1 and 2 must be shorted together to maintain LVD operation.
- c. If the LVD is controlled on NO contacts, then JP2 pins 2 and 3 must be shorted together.
- 4. Gently pull the controller from the slot.
- 5. Place the new CXCI+ controller on the shelf bottom and slide into the rear connector at the back of the slot.



- 6. Log on to the controller and go to **Logs and Files > Manage Configuration File > Upload Site Configuration** and select the saved *.cfg file. After the upload do a Submit Changes. Make sure the site information is checked to save it, and click **Accept**.
- 7. **Go to Logs and Files > Manage Editable Text Files > Upload Dynamic Text File** and select the saved *.tfg file. You do not need to submit changes; it is already saved.

8. Use a meter to verify the bus voltage and current shunt. Recalibrate as required due to differences in the new CXCI+.
9. Replace rectifiers and remove LVD bypass.

9.2. Replacing a CXCI HP Controller

This procedure is for replacing a CXCI HP controller.

Write down the controller communication information: dynamic or static IP, IP address, and gateway.

Figure 12. Removing the CXCI HP



1. Login to the web user interface.
2. From the main dashboard go to **Controller > Advanced Functions > Configuration File**.
3. Click on the **Export Controller Clone** button to save the configuration file. Save the configuration file in a location easily accessed as it will be uploaded into the new controller.
4. Gently pull the controller from the slot.
5. Place the new controller on the shelf bottom and slide in the rear connector at the back of the slot.
6. Log back into the web user interface.
7. From the main dashboard go to **Controller > Advanced Functions > Configuration File**.
8. Press the **Import** button to upload the last saved configuration file.

10. Warranty and Service Information

Technical Support

In Canada and the USA, call toll free 1-888-462-7487.

Customers outside Canada and the USA, call +1-604-436-5547.

Warranty Statement

For full information details review Alpha's online Warranty Statement at www.alpha.ca.

Product Warranty

Alpha warrants that for a period of two (2) years from the date of shipment its products shall be free from defects under normal authorized use consistent with the product specifications and Alpha's instructions, the terms of the manual will take precedence. The warranty provides for repairing, replacing or issuing credit (at Alpha's discretion) for any equipment manufactured by it and returned by the customer to the factory or other authorized location during the warranty period. There are limitations to this warranty coverage. The warranty does not provide to the customer or other parties any remedies other than the above. It does not provide coverage for any loss of profits, loss of use, costs for removal or installation of defective equipment, damages or consequential damages based upon equipment failure during or after the warranty period. No other obligations are expressed or implied. Warranty also does not cover damage or equipment failure due to cause(s) external to the unit including, but not limited to, environmental conditions, water damage, power surges or any other external influence. The customer is responsible for all shipping and handling charges. Where products are covered under warranty Alpha will pay the cost of shipping the repaired or replacement unit back to the customer.

Battery Warranty

Note that battery warranty terms and conditions vary by battery and by intended use. Contact your Alpha sales representative or the Technical Support team at the above number to understand your entitlements under Battery Warranty.

Warranty Claims

Any claim under this Limited Warranty must be made in writing to Alpha BEFORE sending material back. Alpha will provide Product return instructions upon approval of return request. A Service Repair Order (SRO) and / or Return Authorization (RA) number will be issued ensuring that your service needs are handled promptly and efficiently. Claims must be made online at: www.alpha.ca.

Service Information

For a list of international service centers, visit: www.alpha.ca.

11. Certification

CSA (Canadian Standards Association also known as CSA Group) was established in 1919 as an independent testing laboratory in Canada. CSA received its recognition as an NRTL (Nationally Recognized Testing Laboratory) in 1992 from OSHA (Occupational Safety and Health Administration) in the United States of America (Docket No. NRTL-2-92).

When these marks appear with the indicator “C and US” or “NRTL/C” it means that the product is certified for both the US and Canadian markets, to the applicable US and Canadian standards. (1)

As part of the reciprocal, US/Canada agreement regarding testing laboratories, the Standards Council of Canada (Canada’s national accreditation body) granted Underwriters Laboratories (UL) authority to certify products for sale in Canada. (2) Only Underwriters Laboratories may grant a license for the use of this mark, which indicates compliance with both Canadian and US requirements.(3)



NRTL’s Capabilities

NRTLs are third party organizations recognized by OSHA, US Department of Labor, under the NRTL program. The testing and certifications are based on product safety standards developed by US based standards developing organizations and are often issued by the American National Standards Institute (ANSI). (4) The NRTL determines that a product meets the requirements of an appropriate consensus-based product safety standard either by successfully testing the product itself, or by verifying that a contract laboratory has done so, and the NRTL certifies that the product meets the requirements of the product safety standard. (4)

Governance of NRTL

The NRTL Program is both national and international in scope with foreign labs permitted.

(1) www.csagroup.org

(2) www.scc.ca

(3) www.ulc.ca

(4) www.osha.gov

12. Glossary

AC	Alternating Current
ACCT	Alternating Current Current Transducer
ADIO	Analog-digital input-output
Alarm	An alarm has user configurable fields like a name, priority and it can is able to sent SNMP or email notifications when it becomes active or cleared
ALCO	Alarm cutoff
Alert	An alert is status information about a module like a converter or rectifier. For example, "Module Fail" or "Current Limit"
CAN	Controller Area Network
CT	Current Transducer
CX	Cordex series; e.g. CXC for Cordex [®] System Controller
CXC	Cordex [®] Controller
CXC HP	Cordex [®] Controller High Performance
CXD	Cordex [®] DC-DC Converter
CXR	Cordex [®] Rectifier
DC	Direct current
DCCT	Direct Current Current Transducer
DHCP	Dynamic Host Configuration Protocol
DOD	Depth of discharge
FCC	Federal Communications Commission
GUI	Graphical User Interface
Hint	A hint is information about the state of the system or possible configuration problems.
ICMP	Internet control message protocol
IEC	International Electrotechnical Commission
IETF	Internet Engineering Task Force
IP	Internet Protocol
IPv4	Internet Protocol version 4
IPv6	Internet Protocol version 6
ISO	International Organization for Standardization
LCD	Liquid Crystal Display
LED	Light Emitting Diode
LVD	Low voltage disconnect
LVBD	Low voltage battery disconnect

MAC	Media Access Control; e.g. MAC address
MIB	Management Information Base; a database of entities most often associated with SNMP
MOV	Metal Oxide Varistor
MUX	Multiplexer
NEBS	Network Equipment-Building System; a set of safety, spatial and environmental guidelines for telecom
OLED	Organic LED, in-shelf controller display
RFC	Request For Comments; a formal document (or standard) from the Internet Engineering Task Force (IETF)
SCI	Serial Communication Interface
SELV	Safety Extra Low Voltage
SMTP	Simple Mail Transfer Protocol
SNMP	Simple Network Management Protocol
SNTP	Simple Network Time Protocol
SOC	State of Charge
TCP/IP	Transmission Control Protocol / Internet Protocol
Trap	An unsolicited SNMP event notification

13. Specifications

13.1. 2RU, 24-400W, 19", 4 Module System

Table 9. Specifications: 24-400W 19", 4 Module System

Specifications: 24-400W 19", 4 Module System	
Basic Unit: Shelf	
Maximum Output:	53A, 30VDC
Recommended Feed Breaker, Single Phase:	20A, #12 AWG per feed
Mechanical	
Dimensions:	88mm H x 444mm W x 307mm D, rectifier front panel 18mm D (3.5" H x 17.5" W x 12.1" D, rectifier front panel 0.7" D)
Mounting:	19" or 23" rack, flush or 5" offset or 6" offset
Weight:	6.39kg (15.2lb)
Connections	
AC Input:	Dual feed terminal blocks, 4 to 6mm ² (#12 to #10 AWG)
Chassis ground:	M4 studs
Communications:	CAN bus out RJ-12 offset
DC Output:	Terminal blocks #6 AWG (16mm ²) maximum.
Signal wiring:	Terminal blocks #26 to #18 AWG (0.14 to 0.75mm ²)
Compliance	
EN 60950:	Rectifier output shall be rated SELV suitable for connections to TNV-1 circuits
UL:	UL 60950-1-2014
CSA:	CAN/CSA C22.2 No.60950-1-07, +A1:2011 +A2:2014
CE IEC/EN:	EN 60950-1:2006 / A11:2009 / A1:2010 / A12:2011 / A2:2013, CB Scheme 2014/35/EU Low Voltage Directive 2014/30/EC EMC Directive
* See drawings at the rear of this manual. The above information is valid at the time of publication. Consult factory for up-to-date ordering information. Specifications are subject to change without notice.	

13.2. 2RU, 24-400W, 19", 5 Module System

Table 10. Specifications: 24-400W 19", 5 Module System

Specifications: 24-400W 19", 5 Module System	
Basic Unit: Shelf	
Maximum Output:	67A, 30VDC
Recommended Feed Breaker, Single Phase:	20A, #12 AWG per feed
Mechanical	
Dimensions:	88mm H x 444mm W x 307mm D, rectifier front panel 18mm D (3.5" H x 17.5" W x 12.1" D, rectifier front panel 0.7" D)
Mounting:	19" or 23" rack, flush or 5" offset or 6" offset
Weight:	8.5kg (18.7lb)
Connections	
AC Input:	Dual feed terminal blocks, 4 to 6mm ² (#12 to #10 AWG)
Chassis ground:	M4 studs
Communications:	CAN bus out RJ-12 offset
DC Output:	1/4 - 20 x 5/8 inch studs
Signal wiring:	Terminal blocks #26 to #18 AWG (0.14 to 0.75mm ²)
Compliance	
EN 60950:	Rectifier output shall be rated SELV suitable for connections to TNV-1 circuits
UL:	UL 60950-1-2014
CSA:	CAN/CSA C22.2 No.60950-1-07, +A1:2011 +A2:2014
CE IEC/EN:	EN 60950-1:2006 / A11:2009 / A1:2010 / A12:2011 / A2:2013, CB Scheme 2014/35/EU Low Voltage Directive 2014/30/EC EMC Directive
* See drawings at the rear of this manual. The above information is valid at the time of publication. Consult factory for up-to-date ordering information. Specifications are subject to change without notice.	

13.3. Cordex 24-400W Switched Mode Rectifier

Table 11. Specifications: Cordex 24-400W, Switched Mode Rectifier

Specifications: Cordex 24-400W, Switched Mode Rectifier	
Power Module Output	
Voltage:	21 to 30Vdc within rated limits
Power:	380W continuous/module @ 90-276Vac nominal
Current:	15A maximum @ 24Vdc
Static Load Regulation:	Better than $\pm 1\%$ for any load change within rated limits
Static Line Regulation:	Better than $\pm 0.1\%$ for any change in input voltage within rated limits
Dynamic Load Regulation:	Better than $\pm 5\%$ for 40% - 90% - 40% (50% load step) [output shall recover to static limits within 30ms]
Dynamic Line Regulation:	Better than $\pm 1\%$ for any change in input voltage within rated limits (output voltage shall recover to static limits within 2ms)
Hold up Time:	>20ms @ 100% load 208-240Vac
Time Stability:	$\leq 0.2\%$ per year
Temperature Stability:	100ppm/ $^{\circ}\text{C}$ over the operating range
Heat Dissipation:	200 BTU Max @ 100% load 90Vac; <151 BTU @ 208-240Vac
Electrical Noise:	$\leq 32\text{dBn}$ voice band (25Hz to 10kHz) $\leq 10\text{mV}$ wide band (RMS to 10kHz) $\leq 100\text{mV}$ wide band (p-p to 100MHz)
In accordance with FCC requirements, we provide the following statement as specified in the FCC guidelines for conformance to Part 15, Class B:	
<p> Note: This equipment has been tested and found to comply with the limits for a Class B digital device, pursuant to part 15 of the FCC Rules. These limits are designed to provide reasonable protection against harmful interference in a residential installation. This equipment generates, uses, and can radiate radio frequency energy and, if not installed and used in accordance with the instructions, may cause harmful interference to radio communications. However, there is no guarantee that interference will not occur in a particular installation. If this equipment does cause harmful interference to radio or television reception, which can be determined by turning the equipment off and on, the user is encouraged to try to correct the interference by one or more of the following measures:</p> <ul style="list-style-type: none"> • Reorient or relocate the receiving antenna • Increase the separation between the equipment and receiver. • Connect the equipment into an outlet on a circuit different from that to which the receiver is connected. • Consult the dealer or an experienced radio/TV technician for help. 	

Table 11. Specifications: Cordex 24-400W, Switched Mode Rectifier (continued)

Specifications: Cordex 24-400W, Switched Mode Rectifier	
Any changes or modifications to this equipment not expressly described in this manual could void the FCC compliance.	
Power Module Input	
Voltage:	Nominal: 208-240Vac Extended: 90-276Vac Extended Low: 60-90Vac (derated linearly to 0% output power) Extended High: 276-320Vac (derated input power factor)
Frequency:	50/60Hz nominal (45 to 66Hz)
Current:	1.7 to 2.0A (208-240Vac), 5.2A maximum @ 90Vac
Power Factor:	>0.98 at 208-240Vac and 50-100% load
Protection:	1.5kA-interrupting capacity fuses in active and neutral lines
Efficiency:	>87% at 208-240Vac and 50-100% load 92.2% peak
Inrush current:	≤ full load steady state current of the rectifier within rated limits
Start-up Ready Time:	<5 seconds (excluding soft start) to complete inrush limit routine and ac measurement (for OK signal)
Start-up Delay:	Programmable up to 120 seconds to enable stagger-start of multiple rectifiers and to minimize the effect on a supply source
Soft Start:	User adjustable to at least 5 seconds (not including start-up delay time) and is determined by output current limit ramp-up
THD (Current):	<6% at 100% load 208-240Vac
Input Leakage Current:	<3.5mA @ 265Vac 60Hz for up to two rectifiers
Environmental	
Operating Temperature:	-40 to +50°C (derated linearly to 0 watts @ 70°C) -40 to +122°F (derated linearly to 0 watts @ 158°F)
Storage Temperature:	-40 to +85°C (-40 to 185°F)
Humidity:	0 to 95% RH non-condensing
Elevation:	-500 to 3000m (-1640 feet to 9843ft)
Mechanical	
MTBF:	>405,000 hours

Table 11. Specifications: Cordex 24-400W, Switched Mode Rectifier (continued)

Specifications: Cordex 24-400W, Switched Mode Rectifier	
Dimensions:	88.1mm H x 71.6mm W x 242mm D (excluding connector) [3.47" H x 2.82" W x 9.5" D]
Weight:	1.6kg (3.5lb.)
Compliance	
EN 61000-6-2:2005	EMC - Part 6-5: Generic standards - Immunity for equipment used in power station and substation environment
EN 61000-6-4:2007/A1:2011	EMC Part 6-4: Generic standards - Emission standard for industrial environments
EN 61000-3-2:	Harmonic Current Emissions
EN 61000-3-3:	Voltage Fluctuations and Flicker
EN 61000-4-2:	ESD Immunity
EN 61000-4-3:	Radiated Electromagnetic Immunity
EN 61000-4-4:	Electrical Fast Transient/Burst Immunity
EN 61000-4-5:	Power Line Surge Immunity
EN 61000-4-6:	Conducted Electromagnetic Immunity
EN 61000-4-8:	Power Frequency Magnetic Field
EN 61000-4-11	Voltage Dips, Short Interruptions and Variations
ETS 300 019-1-1	Environmental Conditions; Storage
ETS 300 019-1-2	Environmental Conditions; Transportation
ETS 300 132-2	Power Supply Interface at the Input to Telecommunications Equipment; Operated by Direct Current (DC)
ETS 300 753	Acoustic Noise Emissions
IEC 60950	Safety of Information Technology Equipment, Including Electrical Business Equipment (IECUL/CSA 60950-1 Ed. 2)
Input Transient Suppression:	Meets ANSI/IEEE C62.41 Category B3

The above information is valid at the time of publication. Consult factory for up-to-date ordering information. Specifications are subject to change without notice.

13.4. CXCI HP Controller

Table 12. Specifications: CXCI HP Controller



Specifications: Basic Unit, CXCI HP	
Input Voltage:	12 to 60Vdc within rated limits
Current:	<200mA @ 52Vdc, <400mA @ 26.5Vdc, <800mA @ 13.2Vdc
MTBF:	95,000 hours (10.9 years), with display off OLED 84,000 hours @ 10% usage, 9,800 atv100% usage, at 25°C
EMC:	<p>The unit meets requirements of:</p> <ul style="list-style-type: none"> • EN 300 386-2 EMC and EMR, Telecommunications Network Equipment <p>Emissions:</p> <ul style="list-style-type: none"> • EN 55022 Class B (CISPR 22) • CFR47 (FCC) Part 15 Class B <p>Immunity:</p> <ul style="list-style-type: none"> • EN 61000-4-2 ESD EN 61000-4-3 • Radiated EN 61000-4-4 EFT /Burst • EN 61000-4-6 Conducted <p>Environmental:</p> <ul style="list-style-type: none"> • ETS 300 019-1-1 Environmental Conditions, Storage • ETS 300 019-1-2 Environmental Conditions, Transportation
In accordance with FCC requirements, we provide the following statement as specified in the FCC guidelines for conformance to Part 15, Class B:	
<p> Note: This equipment has been tested and found to comply with the limits for a Class B digital device, pursuant to part 15 of the FCC Rules. These limits are designed to provide reasonable protection against harmful interference when the equipment is operated in a commercial environment. This equipment generates, uses, and can radiate radio frequency energy and, if not installed and used in accordance with the instruction manual, may cause harmful interference to radio communications. Operation of this equipment in a residential area is likely to cause harmful interference in which case the user will be required to correct the interference at his own expense.</p>	
Any changes or modifications to this equipment not expressly described in this manual could void the FCC compliance.	
Environmental	

Table 12. Specifications: CXCI HP Controller (continued)

Specifications: Basic Unit, CXCI HP	
Temperature:	-40 to 65°C (-40 to 149°F) operating -40 to 80°C (-40 to 176°F) storage
Humidity:	5% to 95% RH non-condensing
Elevation:	-500 to +4000m (-1640 to +13124ft)
Hardware: CXCI HP	
Hardware	
CPU:	ARM A8
RAM:	128MB
Flash:	256MB
Display:	5-line, LED matrix
Front Panel Controls:	Menu up and down, home and select buttons
LED's:	System OK (Green) Power System Minor Alarm (Yellow) Power System Major Alarm / Controller Fail (Red)
Audio:	Built-in speaker for alarm and popup message tones 70dbl
Dimensions:	44mm H x 88mm W x 318mm D (1.73" H x 3.5" W x 12.5" D)
Weight:	0.62kg (1.36lb.)
Mounting:	Modular on Cordex series shelves
Relay Outputs:	Four (4) Form C, 60Vdc 1A maximum
Digital Inputs:	Two (2), ±60Vdc
Analog Inputs:	Two DC voltage, 0 to 60Vdc, One DC current, compatible with ±25mV to ±200mV shunts, Two temperature, 0 to 5Vdc with power source
Communication Ports:	Ethernet RJ-45, USB 2.0, CAN (see shelf specifications)
Recommended Signal Wire Sizes	
Wire Size Range:	#16 to #26 AWG (1.5 to 0.14mm ²)
Temperature Rating:	90°C (194°F)
<p> CAUTION: <i>TO REDUCE RISK OF FIRE, USE ONLY #26 AWG (0.14mm²) OR LARGER WIRE.</i></p>	
<p>The above information is valid at the time of publication. Consult factory for up-to-date ordering information. Specifications are subject to change without notice.</p>	

13.5. CXCI+ Controller

Table 13. Specifications: CXCI+ Controller

Specifications: Basic Unit, CXCI+	
Input Voltage:	10 to 65Vdc within rated limits
Current:	<100mA @ 48Vdc
	<200mA @ 24Vdc
MTBF:	1,500,000 hrs @30°C (86°F) ambient
EMC:	<p>Radiated and Conducted Emissions:</p> <p>North America Regions</p> <ul style="list-style-type: none"> • CFR 47, Part 15 Subpart B, Class B • ICES-003 Issue 2, Rev 1, Class <p>European Regions</p> <ul style="list-style-type: none"> • EN 55022 Class B • EN 300 386-2 • EN61000-3-2; Harmonics • EN61000-3-3; Flicker <p>Immunity:</p> <ul style="list-style-type: none"> • EN 300 386-2 • EN61000-4-2:2005, ESD ± 8 kV Air, ± 6 kV Contact • EN61000-4-3:2005, RF Immunity 10 V/m • EN61000-4-4:2005, EFT, 1kV/0.5kV • EN61000-4-5:2005, Surge; 2 kV line to line, 1 kV line to earth • EN61000-4-6:2005, Conducted Susceptibility, 10 Vrms • EN61000-4-11: Voltage Dips and Interruptions
<p>In accordance with FCC requirements, we provide the following statement as specified in the FCC guidelines for conformance to Part 15, Class B:</p>	
<p>⚠ Warning: <i>The CXCI+ has been tested and found to comply with the limits for a Class B digital device, pursuant to part 15 of the FCC Rules. These limits are designed to provide reasonable protection against harmful interference in a residential installation. This equipment generates, uses, and can radiate radio frequency energy and, if not installed and used in accordance with the instructions, may cause harmful interference to radio communications. However, there is no guarantee that interference will not occur in a particular installation. If this equipment does cause harmful interference to radio or television reception, which can be determined by turning the equipment off and on, the user is encouraged to try to correct the interference by one or more of the following measures:</i></p>	

Table 13. Specifications: CXCi+ Controller (continued)

Specifications: Basic Unit, CXCi+	
<ul style="list-style-type: none"> • Reorient or relocate the receiving antenna. • Increase the separation between the equipment and receiver. • Connect the equipment into an outlet on a circuit different from that to which the receiver is connected. • Consult the dealer or an experienced radio/TV technician for help. 	
Any changes or modifications to this equipment not expressly described in this manual could void the FCC compliance.	
Environmental	
Temperature:	-40 to 65°C (-40 to 149°F) standard @ 3000m (9843ft), derate to 55°C (131°F) @ 4000m (13124ft)
Humidity:	0 to 95% non-condensing
Elevation:	-500 to +4000m (-1640 to +13124ft)
Hardware Specifications	
CPU:	Coldfire
Display:	4 digit LCD
Front Panel Controls:	Display pushbutton toggle switch for voltage (V) or current (A), Reset switch (soft reset button; hold for 3 seconds to reset IP)
LEDs:	System OK (Green), Power System Minor Alarm (Yellow), Power System Major Alarm / Controller Fail (Red)
Audio:	Built-in speaker for alarm and popup message tones
Dimensions:	88mm H x 26mm W x 280mm D (3.5" H x 1" W x 11" D)
Weight:	0.34kg (0.75lb.)
Mounting:	Integrated on Cordex 2RU series 19" and 23" shelves
Relay Outputs:	Four (4) Form C, 60Vdc 1A maximum
Digital Inputs:	Two (2), 0 to 60Vdc
Analog Inputs:	One (1) DC voltage, 0 to 60Vdc One (1) DC current, ±50mV Two (2) temperature, self-powered Alpha sensor (max 12Vdc)
Communication Ports:	Ethernet RJ-45, CAN [see shelf specifications]
Recommended Signal Wire Sizes (as per UL/CSA)	
Wire Size Range:	#16 to #26 AWG (1.5 to 0.14mm ²)
Temperature Rating:	90°C (194°F)

Table 13. Specifications: CXCi+ Controller (continued)

Specifications: Basic Unit, CXCi+	
	CAUTION: TO REDUCE RISK OF FIRE, USE ONLY #26 AWG (0.14mm ²) OR LARGER WIRE.
The above information is valid at the time of publication. Consult factory for up-to-date ordering information. Specifications are subject to change without notice.	

REV.	REVISION	DATE	BY	CHK
B	REDESIGNED	08/15/93	ML	ML
C	DESIGNED BY TERRY W. BROWN	08/23/93	ML	ML
D	DESIGNED BY TERRY W. BROWN	08/23/93	ML	ML
E	DESIGNED BY TERRY W. BROWN	08/23/93	ML	ML

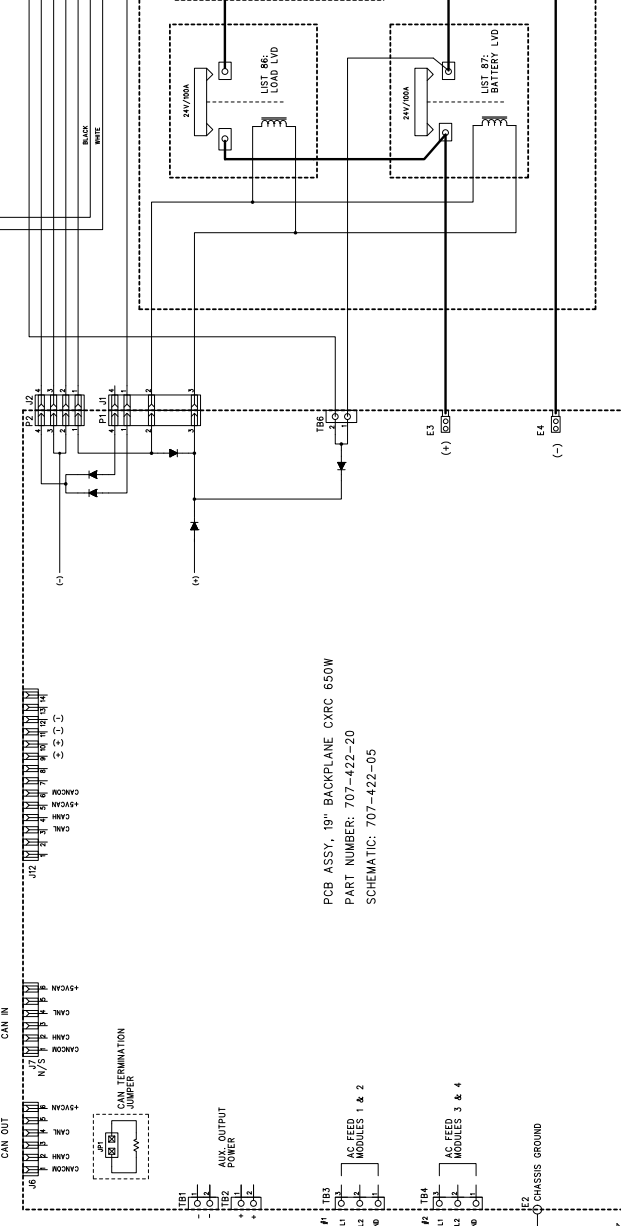
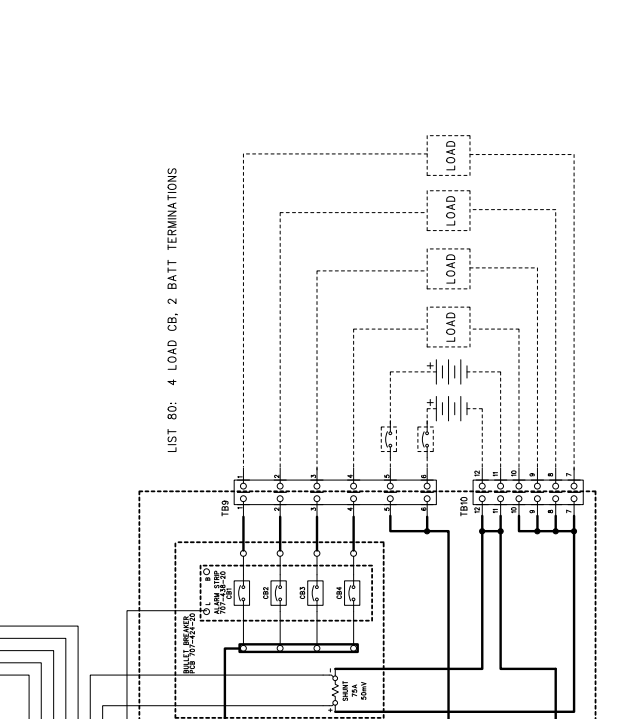

REV	DESCRIPTION	DATE	BY	CHK
B	REDESIGNED	08/15/93	ML	ML
C	DESIGNED BY TERRY W. BROWN	08/23/93	ML	ML
D	DESIGNED BY TERRY W. BROWN	08/23/93	ML	ML
E	DESIGNED BY TERRY W. BROWN	08/23/93	ML	ML

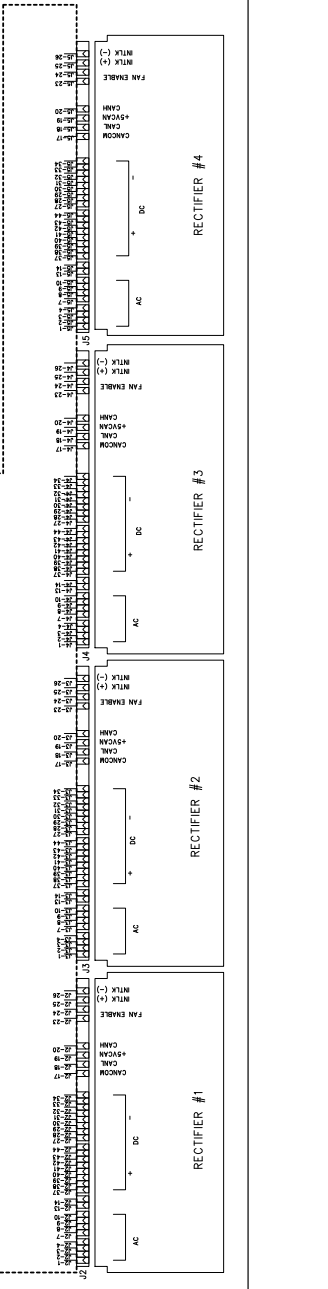
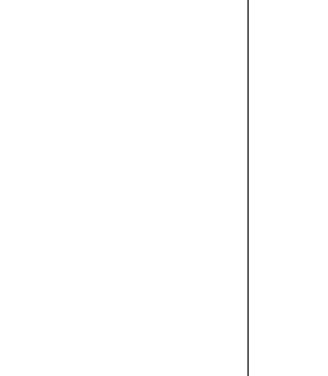

REV	DESCRIPTION	DATE	BY	CHK
B	REDESIGNED	08/15/93	ML	ML
C	DESIGNED BY TERRY W. BROWN	08/23/93	ML	ML
D	DESIGNED BY TERRY W. BROWN	08/23/93	ML	ML
E	DESIGNED BY TERRY W. BROWN	08/23/93	ML	ML

1/1

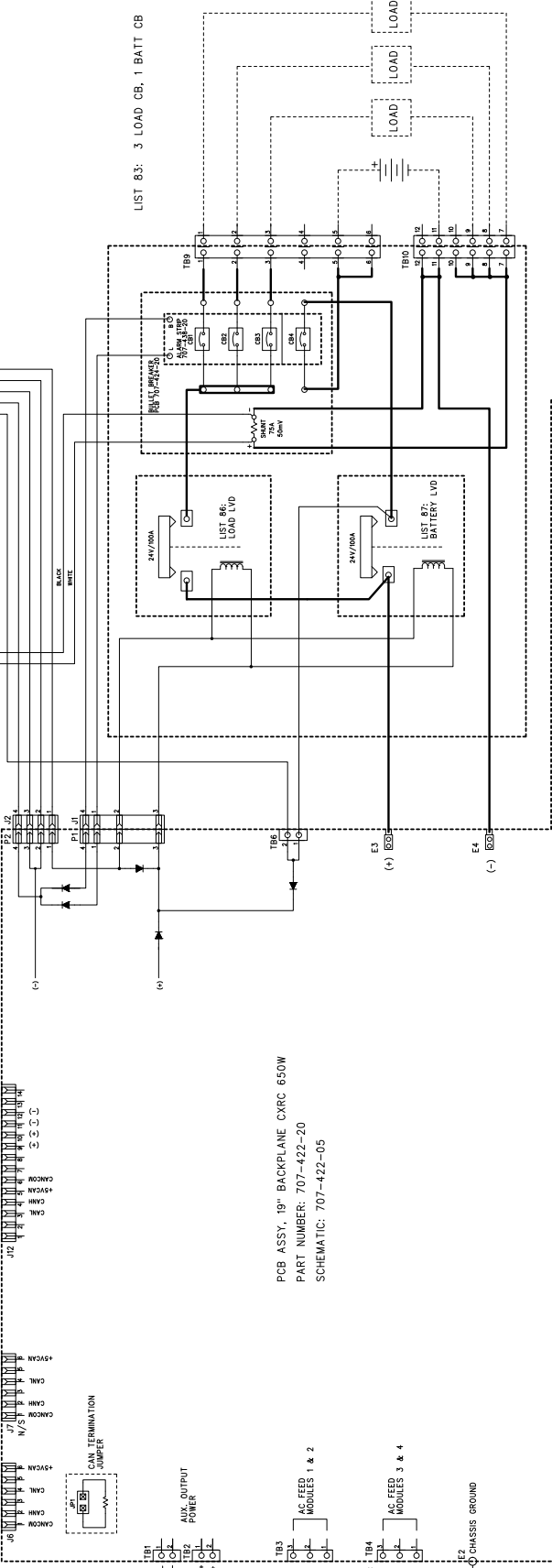
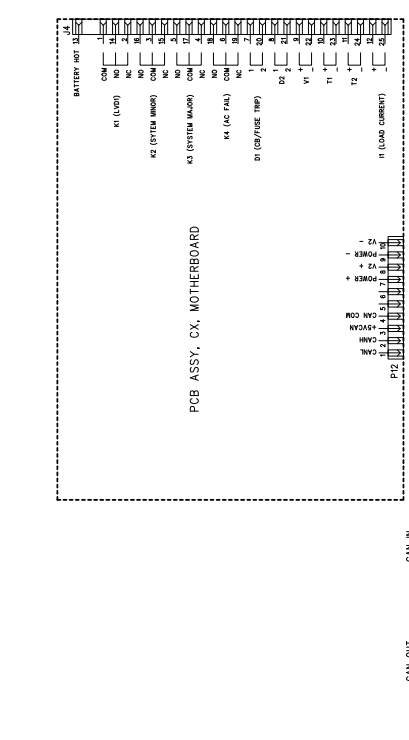
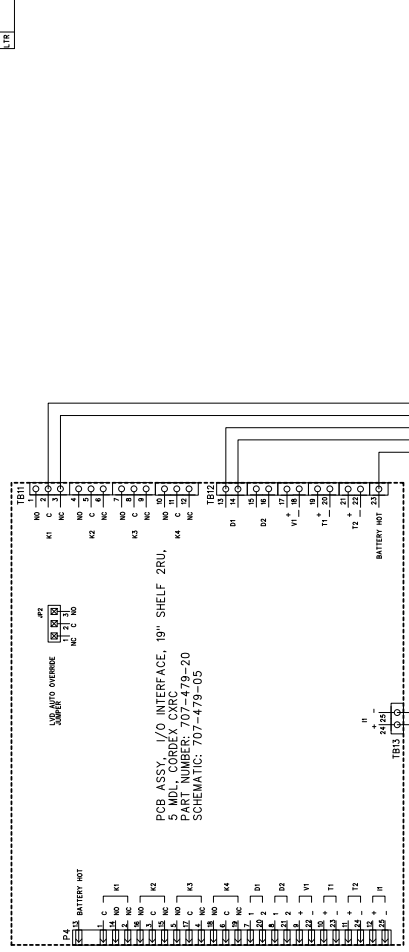

PCB ASSY, 19" BACKPLANE CXRC 650W
PART NUMBER: 707-422-20
SCHEMATIC: 707-422-05

ALPHA TECHNOLOGIES

THESE DESIGN AND SPECIFICATIONS ARE CONFIDENTIAL AND NOT TO BE COPIED OR USED WITHOUT ITS WRITTEN CONSENT.

DESIGN J.A. 10/05/94 CHECKED J.A. 10/05/94
DRAWN J.A. 10/05/94 APPROVED J.A. 10/05/94

TITLE SCHEMATIC, SHELF,
19" FLUSH, 2RU, 4 MDL,
CXRC, DISTRN. 24V-400W

ISSUE SHEET 2 of 3
SIZE B
HWG NO. 030-763-05
REV E

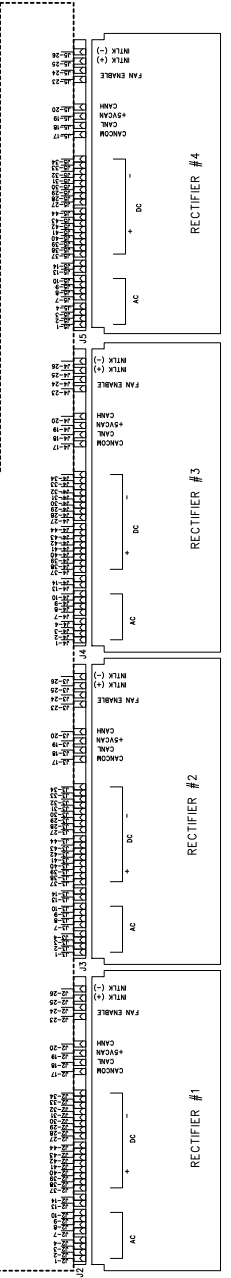

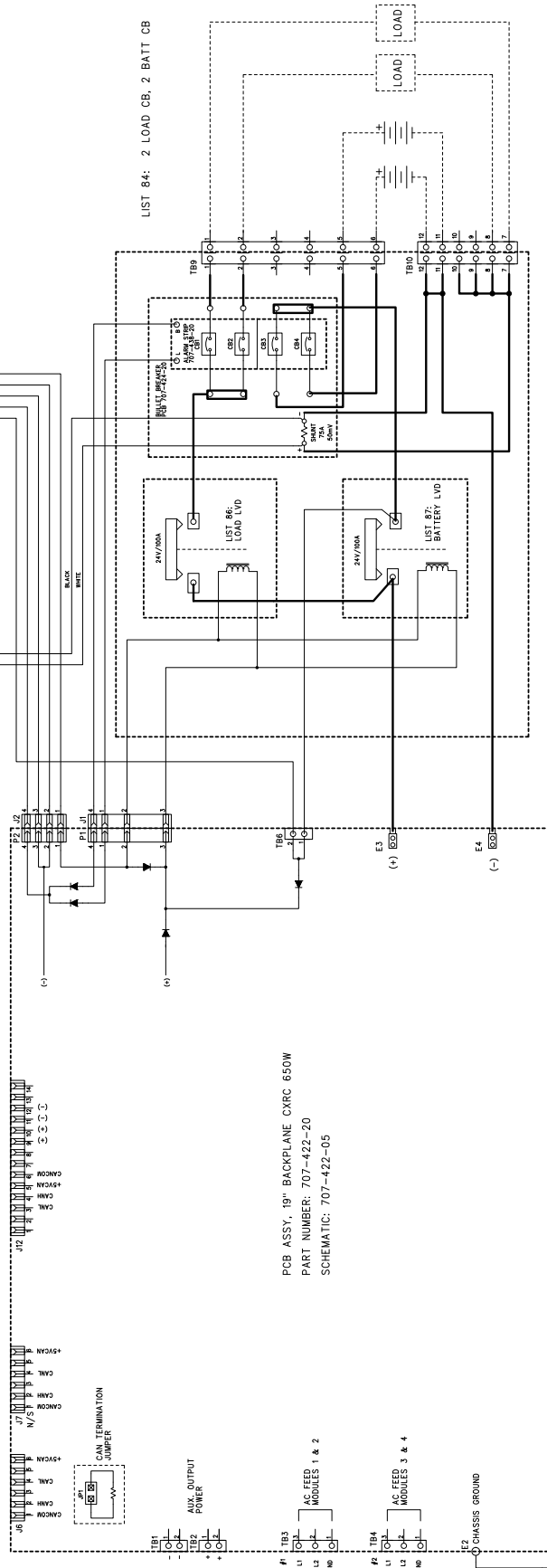
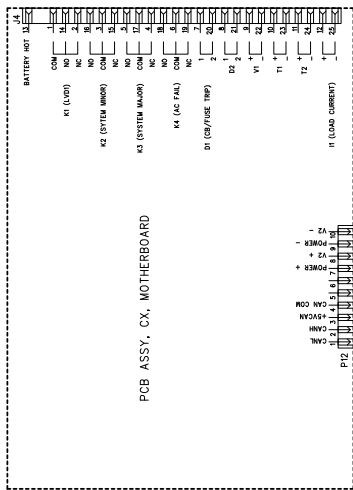
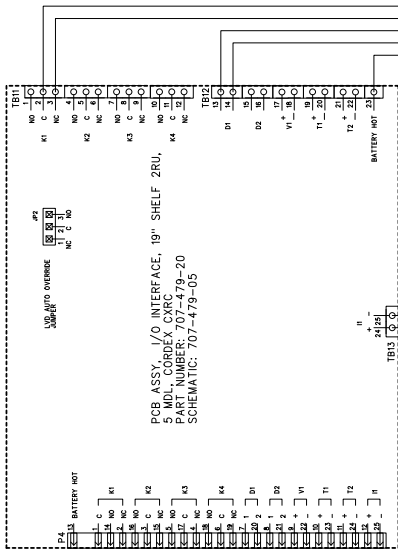

LIST 84: 2 LOAD CB, 2 BATT CB

PCB ASSY, 19" BACKPLANE CXRC 650W
PART NUMBER: 707-422-20
SCHEMATIC: 707-422-05

ALPHA TECHNOLOGIES

THESE DESIGN AND SPECIFICATIONS ARE CONFIDENTIAL. ALL RIGHTS ARE RESERVED. THIS DOCUMENT SHALL NOT BE COPIED OR USED WITHOUT ITS WRITTEN CONSENT.

DESIGN J.A. 10/05/04 CHECKED J.A. 10/05/04
DRAWN J.A. 10/05/04 APPROVED J.A. 10/05/04

TITLE SCHEMATIC, SHELF,
19" FLUSH, 2RU, 4 MDL,
CXRC, DISTRN. 24V-400W

ISSUE SHEET 3 of 3
SIZE B DWG NO. 030-763-05 REV E

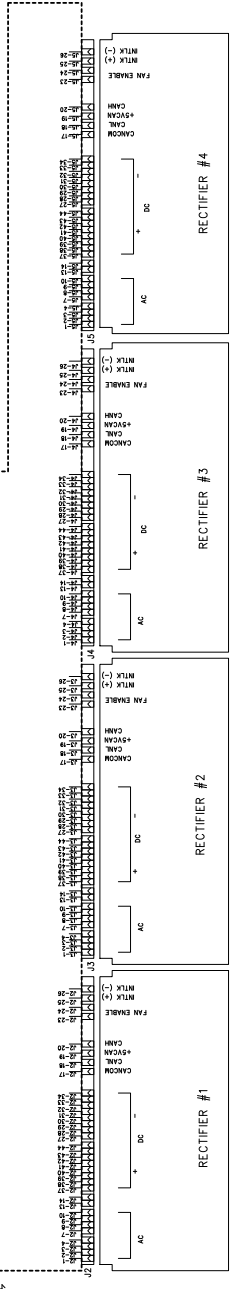

REV	DATE	BY	CHK	APP
1	02/01/00	WJ	WJ	WJ
2	02/02/00	WJ	WJ	WJ

REV	DESCRIPTION
1	ISSUED FOR FAB
2	ISSUED FOR FAB

REV	DATE	BY	CHK	APP
1	02/01/00	WJ	WJ	WJ
2	02/02/00	WJ	WJ	WJ

REV	DESCRIPTION
1	ISSUED FOR FAB
2	ISSUED FOR FAB



PCB ASSY, I/O INTERFACE, 19" SHELF 2RU,
5 MDL, CORDEK CXRC
PART NUMBER: 707-479-20
SCHEMATIC: 707-479-05

PCB ASSY, CX, MOTHERBOARD

PCB ASSY, 19" 2RU BACKPLANE,
5 MDL, POS GND, CORDEK CXRC
PART NUMBER: 707-461-20
SCHEMATIC: 707-461-05



THESE CONNECTIONS REQUIRED
WHEN LVD CONTROLLED OUTPUT
IS USED FOR BATTERY

CUSTOMER
BREAKERS

ALPHA TECHNOLOGIES

ALPHA TECHNOLOGIES
19" 5 MDL CXCI,
CXRC 24-400W

ISSUE	DATE	BY
B	03/01/00	WJ
C	03/02/00	WJ

SIZE	SCALE	REV
B	1:1	C

ISSUE	DATE	BY
B	03/01/00	WJ
C	03/02/00	WJ

REV	DESCRIPTION
B	ISSUED FOR FAB
C	ISSUED FOR FAB

REV	DESCRIPTION
B	ISSUED FOR FAB
C	ISSUED FOR FAB

REV	DESCRIPTION
B	ISSUED FOR FAB
C	ISSUED FOR FAB

REV	DESCRIPTION
B	ISSUED FOR FAB
C	ISSUED FOR FAB

REV	DESCRIPTION
B	ISSUED FOR FAB
C	ISSUED FOR FAB

REV	DESCRIPTION
B	ISSUED FOR FAB
C	ISSUED FOR FAB

REV	DESCRIPTION
B	ISSUED FOR FAB
C	ISSUED FOR FAB

REV	DESCRIPTION
B	ISSUED FOR FAB
C	ISSUED FOR FAB

REV	DESCRIPTION
B	ISSUED FOR FAB
C	ISSUED FOR FAB

REV	DESCRIPTION
B	ISSUED FOR FAB
C	ISSUED FOR FAB

REV	DESCRIPTION
B	ISSUED FOR FAB
C	ISSUED FOR FAB

REV	DESCRIPTION
B	ISSUED FOR FAB
C	ISSUED FOR FAB

REV	DESCRIPTION
B	ISSUED FOR FAB
C	ISSUED FOR FAB

REV	DESCRIPTION
B	ISSUED FOR FAB
C	ISSUED FOR FAB

REV	DESCRIPTION
B	ISSUED FOR FAB
C	ISSUED FOR FAB

REV	DESCRIPTION
B	ISSUED FOR FAB
C	ISSUED FOR FAB

REV	DESCRIPTION
B	ISSUED FOR FAB
C	ISSUED FOR FAB

REV	DESCRIPTION
B	ISSUED FOR FAB
C	ISSUED FOR FAB

REV	DESCRIPTION
B	ISSUED FOR FAB
C	ISSUED FOR FAB

REV	DESCRIPTION
B	ISSUED FOR FAB
C	ISSUED FOR FAB

REV	DESCRIPTION
B	ISSUED FOR FAB
C	ISSUED FOR FAB

REV	DESCRIPTION
B	ISSUED FOR FAB
C	ISSUED FOR FAB

REV	DESCRIPTION
B	ISSUED FOR FAB
C	ISSUED FOR FAB

REV	DESCRIPTION
B	ISSUED FOR FAB
C	ISSUED FOR FAB

REV	DESCRIPTION
B	ISSUED FOR FAB
C	ISSUED FOR FAB

REV	DESCRIPTION
B	ISSUED FOR FAB
C	ISSUED FOR FAB

REV	DESCRIPTION
B	ISSUED FOR FAB
C	ISSUED FOR FAB

REV	DESCRIPTION
B	ISSUED FOR FAB
C	ISSUED FOR FAB

REV	DESCRIPTION
B	ISSUED FOR FAB
C	ISSUED FOR FAB

REV	DESCRIPTION
B	ISSUED FOR FAB
C	ISSUED FOR FAB

REV	DESCRIPTION
B	ISSUED FOR FAB
C	ISSUED FOR FAB

REV	DESCRIPTION
B	ISSUED FOR FAB
C	ISSUED FOR FAB

REV	DESCRIPTION
B	ISSUED FOR FAB
C	ISSUED FOR FAB

REV	DESCRIPTION
B	ISSUED FOR FAB
C	ISSUED FOR FAB

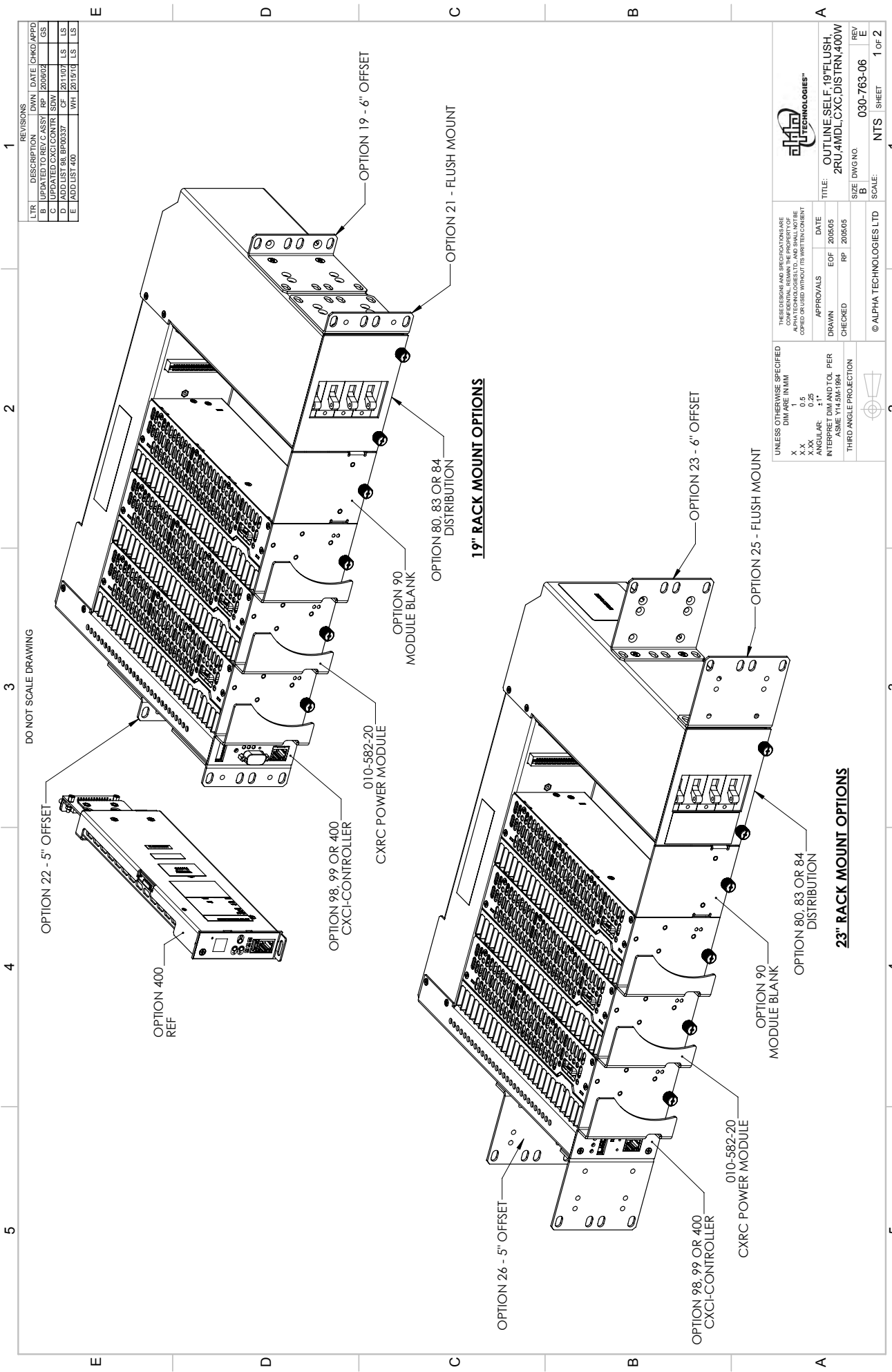

REVISIONS			
LTR	DESCRIPTION	DMN	DATE
A	UPD. PART CLASS	200605	GS
B	UPD. PART CLASS	200605	GS
C	UPD. PART CLASS	200605	GS
D	ADD LIST 88, BR00337	CF	201107 LS
E	ADD LIST 400	WH	201511 LS

DO NOT SCALE DRAWING

THESE DESIGNS AND SPECIFICATIONS ARE CONFIDENTIAL. REMAIN THE PROPERTY OF ALPHA TECHNOLOGIES. NOT TO BE REPRODUCED, COPIED OR USED WITHOUT ITS WRITTEN CONSENT.	
APPROVALS DRAWN: EOP CHECKED: RP	DATE: 200605 EOP: 200605 RP: 200605
TITLE: OUTLINE SELF 19" FLUSH 23" RACK MOUNT OPTIONS	
SIZE: DWG NO. 030-763-06 SHEET 1 OF 2	© ALPHA TECHNOLOGIES LTD

UNLESS OTHERWISE SPECIFIED DIM ARE IN MM	
X	0.5
X	0.25
X	0.125
ANGULAR: ±1°	
INTERPRETATION: PER ISO 10301	
THIRD ANGLE PROJECTION	



NTS TECHNOLOGIES™

TITLE: OUTLINE SELF 19" FLUSH
2RU, 4MID, CXC, DISTRN, 400W

SIZE DWG NO. 030-763-06 REV E

SCALE: NTS SHEET 2 OF 2

1 2 3 4 5

DO NOT SCALE DRAWING

LR	DESCRIPTION	DAWN	DATE	CHKD	APPD
B	UPDATED TO REV C ASY	RP	2006/03	GS	GS
C	CORRECTED QRT IN P/B LABELING	RP	2006/03	GS	GS
D	CORRECTED DETAIL ON SHEET	JU	2006/06	GS	GS
E	CORRECTED RJ45 DETAIL	SDW	2006/08	GS	GS
F	UPDATED CXC SUPERVISORY	SDW	2006/09	JK	JK
G	UPDATED CXC SUPERVISORY	MP	2007/04	GS	GS
H	CORRECTED DETAIL ON SHEET	MP	2007/04	GS	GS
I	CORRECTED DETAIL ON SHEET	MP	2007/04	GS	GS
J	UPDATED NOTES	SDW	2008/01	JK	JK
K	ADD LIST 98 (SHT 2), BR00337	CF	2011/07	LS	LS
L	ADD Option 400	WH	2015/10	LS	LS

OPTION 99 ONLY

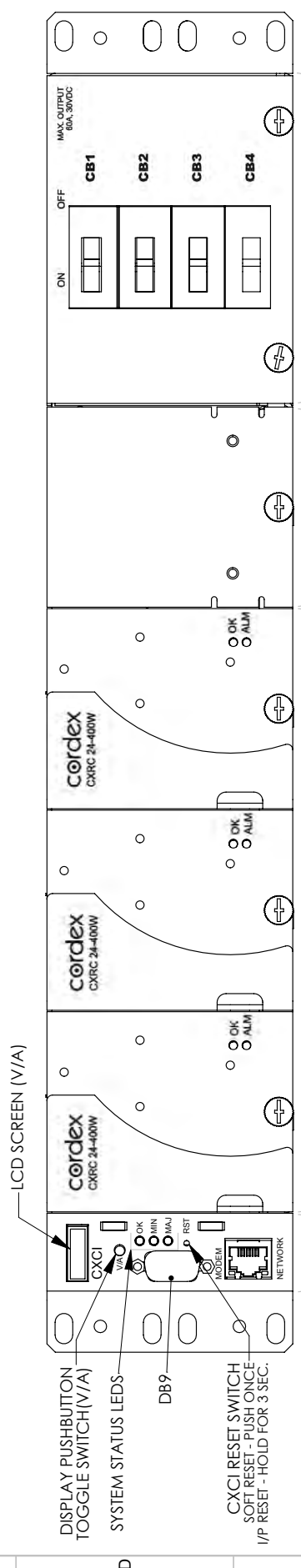

CX SUPERVISORY

CORDEX 400W MODULES

MODULE BLANK

4 CB POSITION DISTRIBUTION

DB9 FOR ARGUS DC MODEM USE ONLY

1. DCD
2. RX
3. TX
4. DTR
5. COM
6. DSR
7. RTS
8. CTS
9. RI

ETHERNET RJ45

1. TX+
2. TX-
3. RX+
4. NOT CONNECTED
5. NOT CONNECTED
6. RX-
7. NOT CONNECTED
8. NOT CONNECTED

OPTION 99

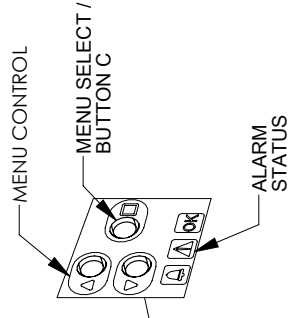
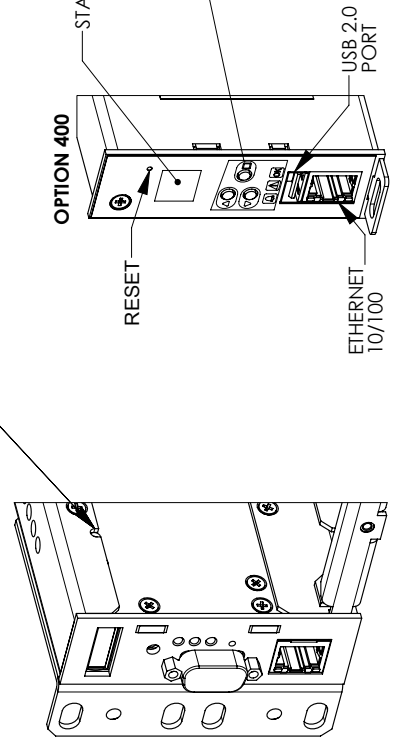

UNLESS OTHERWISE SPECIFIED DIM ARE IN MM		THESE DESIGN AND SPECIFICATIONS ARE ALPHA TECHNOLOGIES LTD. AND SHALL NOT BE COPIED OR USED WITHOUT ITS WRITTEN CONSENT.	
X X X	1 0 5	APPROVALS	DATE
ANGULAR:	3:1*	DRAWN	EDF 2005/05
INTERPRET DIM AND TOL PER	ASME Y14.5M-1994	CHECKED	RP 2006/05
THIRD ANGLE PROJECTION		© ALPHA TECHNOLOGIES LTD	
TITLE:		CUSTOMER CONNECTION	
DRAWN		2RU, 4MDL, CXC, DIS, TRN, 400W	
CHECKED		SIZE	
DRAWN		DWG. NO.	
CHECKED		030-763-08	
DATE		REV	
EDF 2005/05		L	
RP 2006/05		1 OF 4	
SCALE:		NTS	
SHEET		1	

1 2 3 4 5

E

D

C

B

A

1 2 3 4 5

DO NOT SCALE DRAWING

LIST 98 ONLY

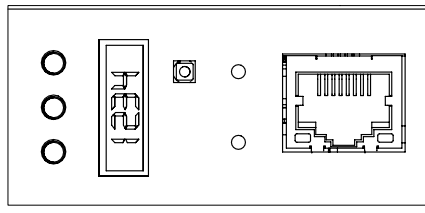
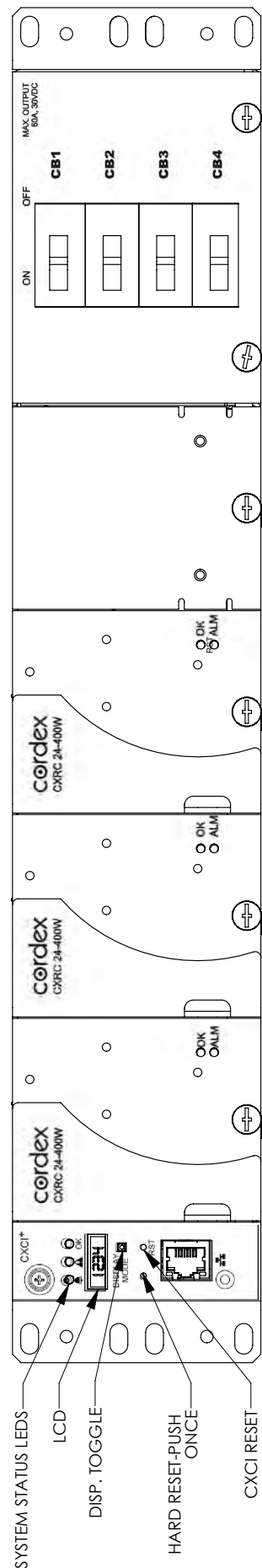

ETHERNET RJ45

- 1. TX+
- 2. TX-
- 3. RX+
- 4. NOT CONNECTED
- 5. NOT CONNECTED
- 6. RX-
- 7. NOT CONNECTED
- 8. NOT CONNECTED

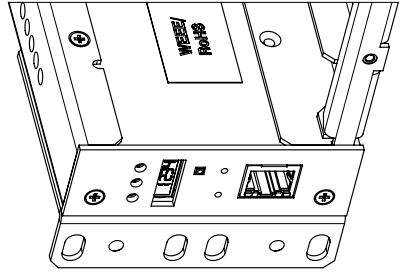

TITLE: CUSTOMER CONNECTION
2RU,4MDL,CXC,DIS,TRN,400W

SIZE	DWG. NO.	REV
NTS	030-763-08	L

SCALE: NTS SHEET 2 OF 4

1 2 3 4 5

DO NOT SCALE DRAWING

DC OUTPUT TERMINAL BLOCKS
(MAX. WIRE GAUGE #6 AWG)

TB3 FEEDS MODULES 1 AND 2
TB4 FEEDS MODULES 3 AND 4

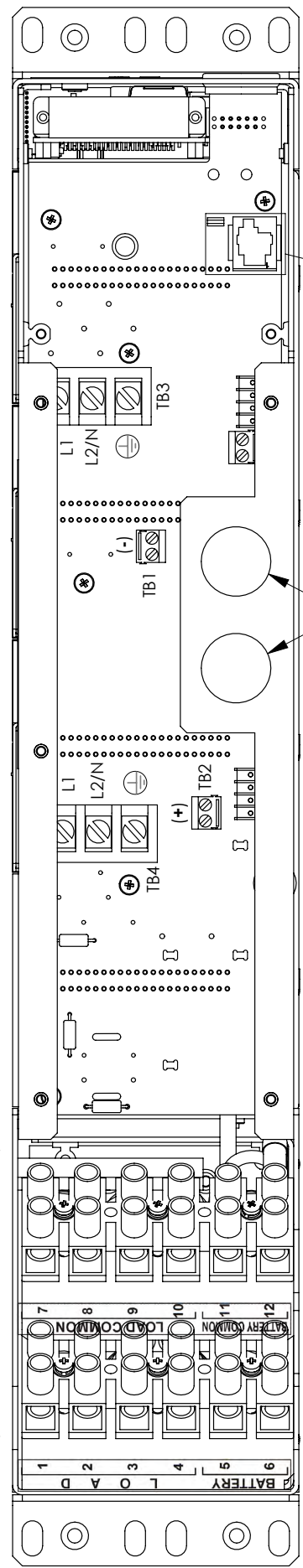

REAR VIEW

(BACK COVER REMOVED)
(CUSTOMER CONNECTION BOARD NOT SHOWN)

CAN OUT RJ12
PIN OUT (J6)

1. CAN COM
2. CAN H
3. NOT CONNECTED
4. CAN L
5. NOT CONNECTED
6. +5 V CAN

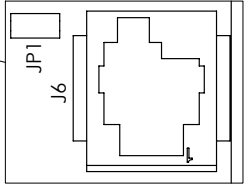

JUMPER SETTINGS FOR JP1

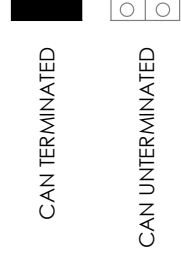

E D C B A

ALPHATECH TECHNOLOGIES™

TITLE: CUST_CONN_2RU_4MDL,
CXC-DISTRN_400W

SIZE DWG NO. 030-763-08 REV L

SCALE: NTS SHEET 3 OF 4

1 2 3 4 5

A

B

C

D

E

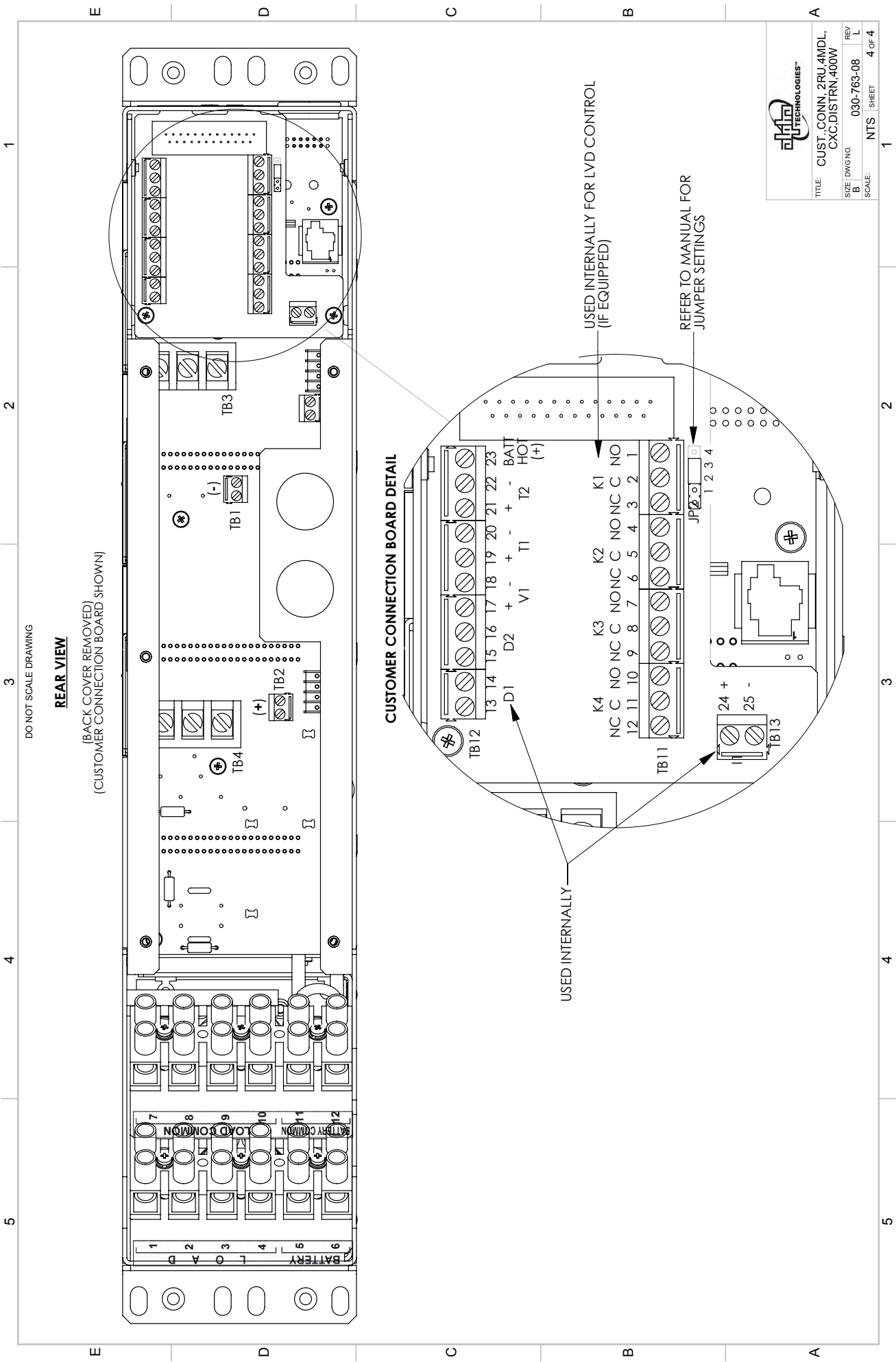

1

2

3

4

5

REVISIONS			
LTR	DESCRIPTION	DWN	DATE
B	UPDATED CXRC CONTROLLER	JU	2006/10
C	UPDATED CXRC POWER MODULE	SDW	2006/12
D	ADDED OPTION 400	WH	2017/05

DO NOT SCALE DRAWING

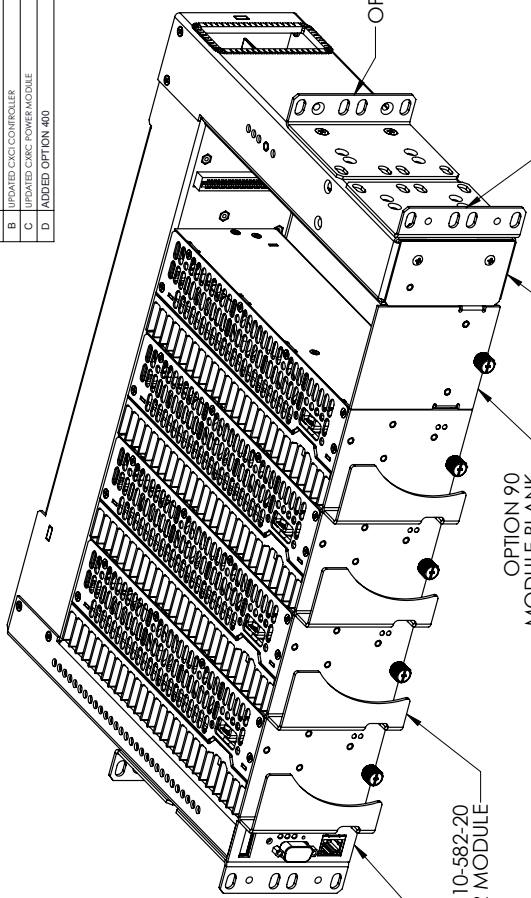

19" RACK MOUNT OPTIONS

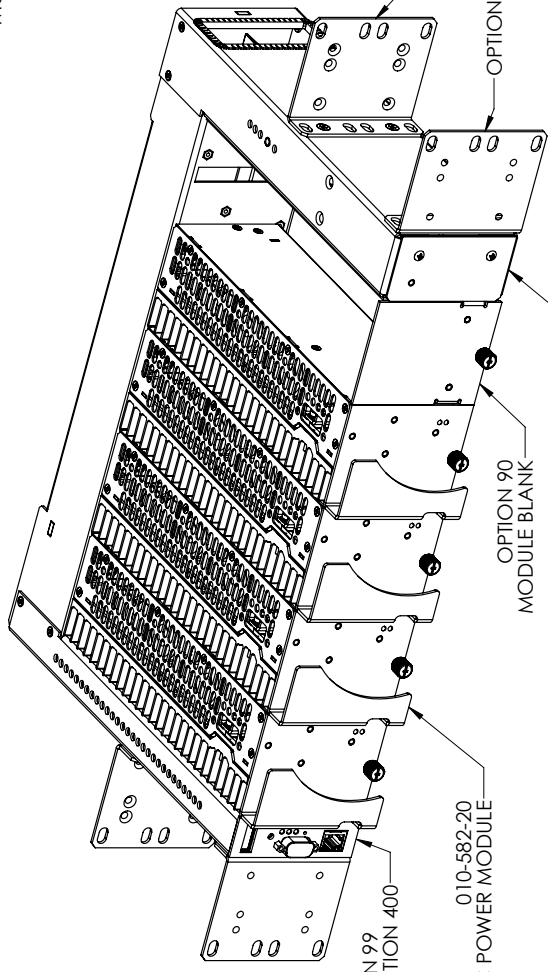

23" RACK MOUNT OPTIONS

UNLESS OTHERWISE SPECIFIED
DIM ARE IN MM

X .X
X.X
X.XX
ANGULAR: ±1°
INTERSECTING DIM AND CL PER
SIZE 180

THIRD ANGLE PROJECTION

© ALPHA TECHNOLOGIES LTD

SCALE: N.T.S. SHEET 1 OF 2

THESE DESIGNS AND SPECIFICATIONS ARE
CONFIDENTIAL. REMAIN THE PROPERTY OF
ALPHA TECHNOLOGIES LTD. AND SHALL NOT
BE COPIED OR USED WITHOUT ITS WRITTEN CONSENT

APPROVALS

DRAWN: RP 2006/04
CHECKED: GS 2006/04

DATE: 2006/04

TITLE: OUTL. SHELF, 19" 5 MDL,
CXRC, CXRC 24-400W

SIZE: DWG NO. 030-773-06
REV: D
REV: 1

A

A

E

E

D

D

C

C

B

B

1

1

2

2

3

3

4

4

5

5



DO NOT SCALE DRAWING

TITLE: OUTL., SHELF, 19" 5 MDL, CXG1, CXRC 24-400W	
SIZE	DWG NO.
B	030-773-06
SCALE:	N.T.S.
SHEET	2 OF 2

23" RACK MOUNT OPTIONS

19" RACK MOUNT OPTIONS

DO NOT SCALE DRAWING

REVISIONS			
LTR	DESCRIPTION	DWN	DATE
D	CHANGED AD I/P FROM L2 TO L2IN	MP	2007/04
E	CORRECTED JP2 PINOUT (SHT. 3)	JK	2007/10
F	UPDATED NOTES	SWD	2008/01
G	ADDED CXCI+ MODULE	FC	2013/12
H	ADDED CXCI HP	WH	2015/11

LTR	DESCRIPTION	DWN	DATE	CHK
D	CHANGED AD I/P FROM L2 TO L2IN	MP	2007/04	JK
E	CORRECTED JP2 PINOUT (SHT. 3)	JK	2007/10	JK
F	UPDATED NOTES	SWD	2008/01	JK
G	ADDED CXCI+ MODULE	FC	2013/12	JK
H	ADDED CXCI HP	WH	2015/11	LS

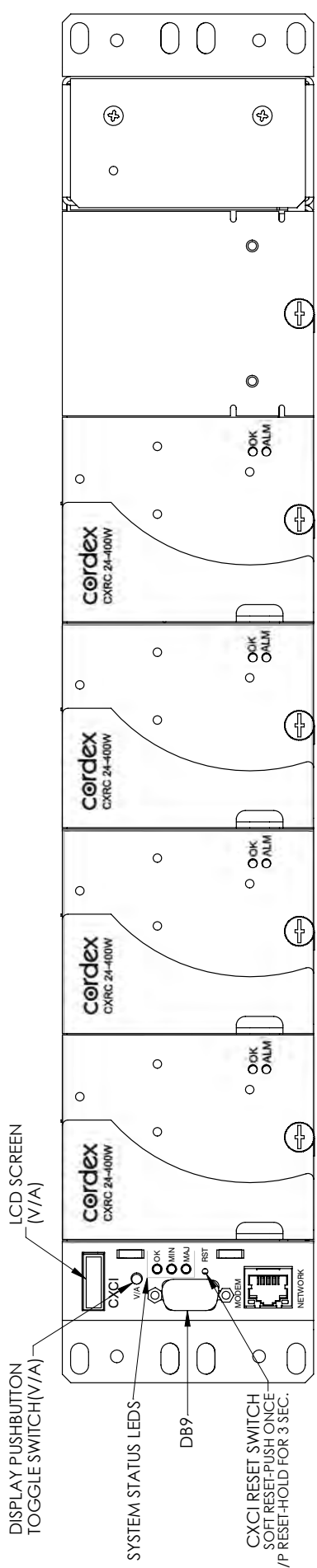

CXCI SUPERVISORY

CORDEX 400W MODULES

MODULE BLANK

LIST 80

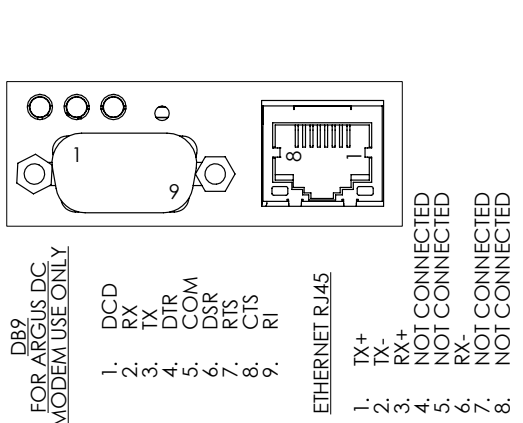
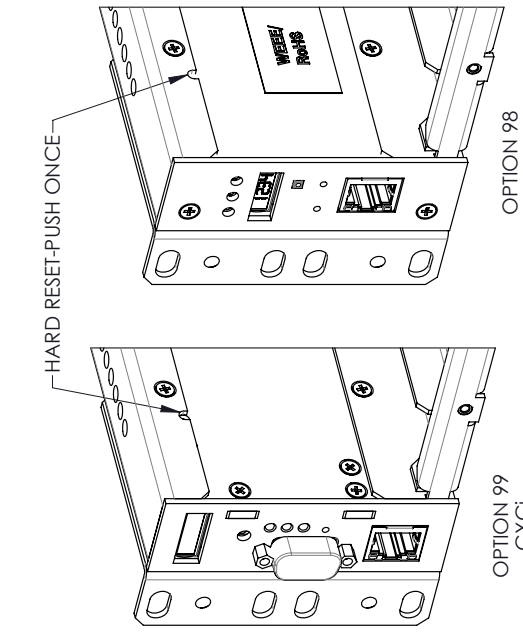
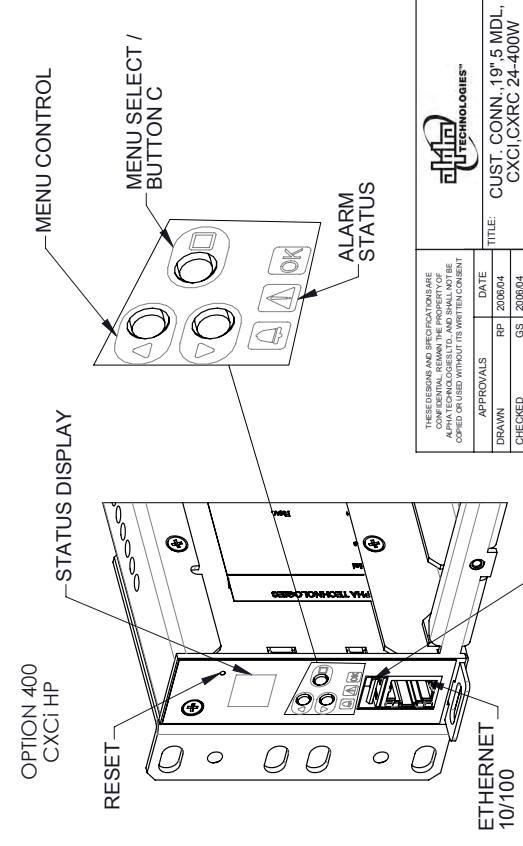

- DB9 FOR ARGUS DC MODEM USE ONLY**
1. DCD
 2. RX
 3. TX
 4. DTR
 5. COM
 6. DSR
 7. RTS
 8. CTS
 9. RI

- ETHERNET RJ45**
1. TX+
 2. TX-
 3. RX+
 4. RX-
 5. NOT CONNECTED
 6. NOT CONNECTED
 7. NOT CONNECTED
 8. NOT CONNECTED

<small>THESE DESIGNS AND SPECIFICATIONS ARE CONFIDENTIAL. REMAIN THE PROPERTY OF ALPHA TECHNOLOGIES LTD. AND ARE NOT TO BE COPIED OR USED WITHOUT ITS WRITTEN CONSENT.</small>	TITLE: CUST. CONN. 19" 5 MDL, CXCI, CXRC 24-400W
APPROVALS DRAWN: RP 200604 CHECKED: GS 200604	DATE: RP 200604 GS 200604
SCALE: NTS	SIZE DWG NO.: 030-775-08
© ALPHA TECHNOLOGIES LTD	REVISIONS SHEET: 1 OF 3

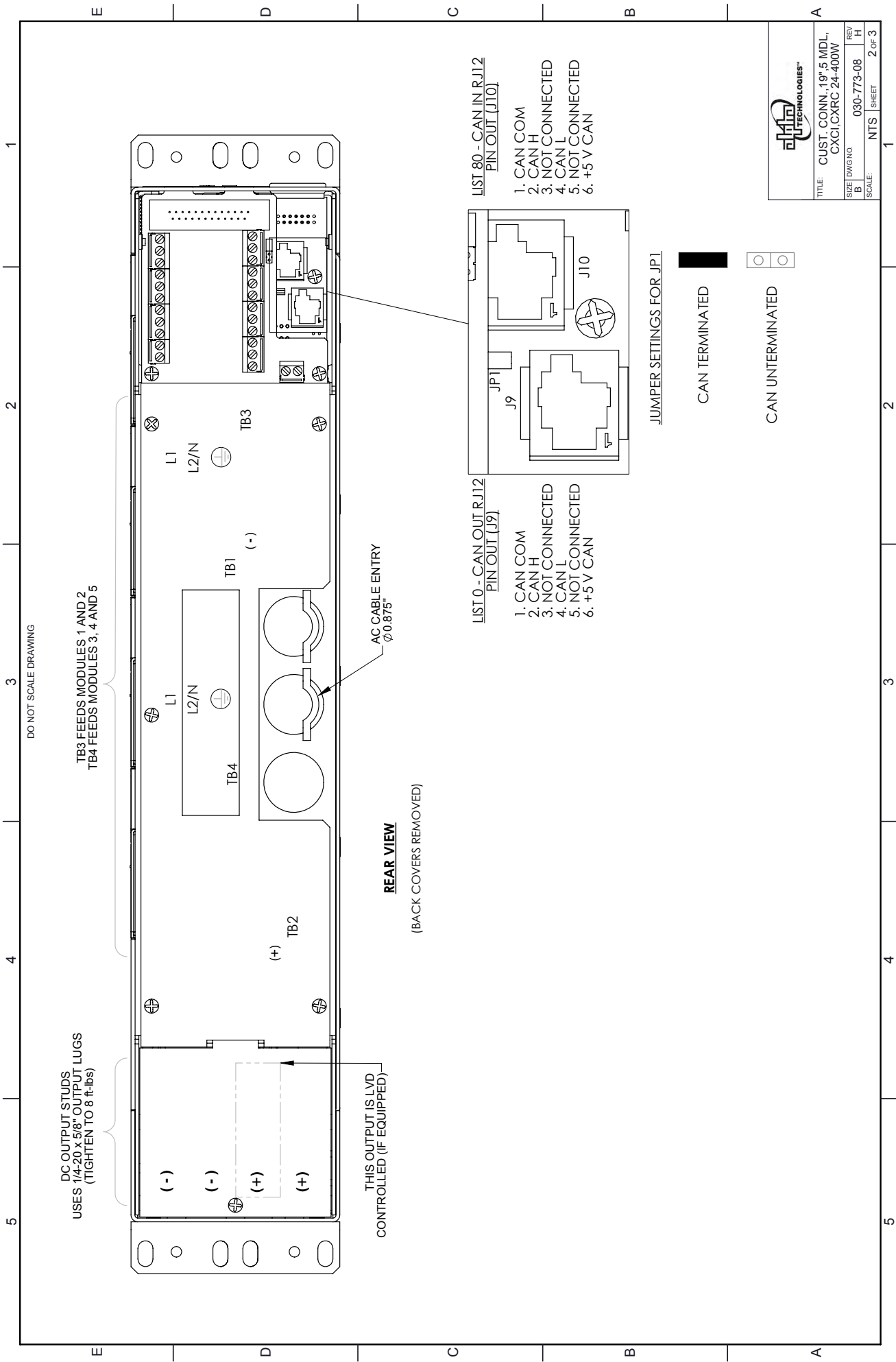

DO NOT SCALE DRAWING

DC OUTPUT STUDS
USES 1/4-20 x 5/8" OUTPUT LUGS
(TIGHTEN TO 8 ft-lbs)

TB3 FEEDS MODULES 1 AND 2
TB4 FEEDS MODULES 3, 4 AND 5

(-) (-) (+) (+)
THIS OUTPUT IS LVD
CONTROLLED (IF EQUIPPED)

L1 L2/N TB1 (-) TB2 (+)
L1 L2/N TB3 TB4

AC CABLE ENTRY
Ø0.875"

REAR VIEW

(BACK COVERS REMOVED)

**LIST 0 - CAN OUT R.J12
PIN OUT (J9)**

1. CAN COM
2. CAN H
3. NOT CONNECTED
4. CAN L
5. NOT CONNECTED
6. +5V CAN

**LIST 80 - CAN IN R.J12
PIN OUT (J10)**

1. CAN COM
2. CAN H
3. NOT CONNECTED
4. CAN L
5. NOT CONNECTED
6. +5V CAN

JUMPER SETTINGS FOR J9



CAN TERMINATED

CAN UNTERMINATED

NTS TECHNOLOGIES

TITLE: CUST. CONN., 19" 5 MDL,
CXCI, CXRC 24-400W

SIZE DWG NO. 030-773-08 REV H

SCALE: NTS SHEET 2 OF 3

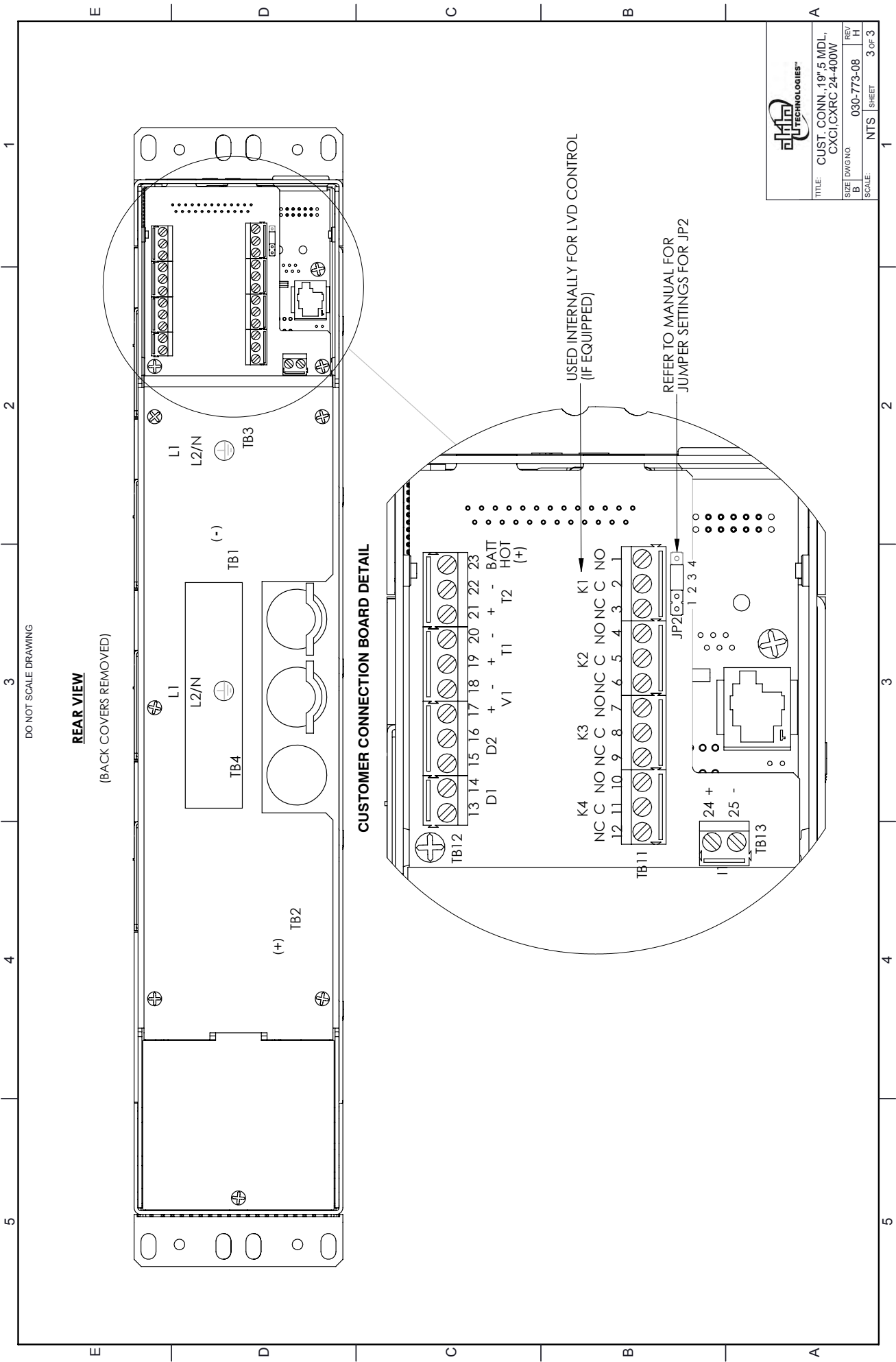

DO NOT SCALE DRAWING

REAR VIEW
(BACK COVERS REMOVED)

CUSTOMER CONNECTION BOARD DETAIL

USED INTERNALLY FOR LVD CONTROL
(IF EQUIPPED)

REFER TO MANUAL FOR
JUMPER SETTINGS FOR JP2

ALPHATECH TECHNOLOGIES™	
TITLE: CUST. CONN. 19" 5 MDL, CXG1,CXRC 24-400W	
SIZE DWG NO. B	REV H
SCALE: NTS	SHEET 3 OF 3



Alpha Technologies Ltd. | 7700 Riverfront Gate, Burnaby, BC V5J 5M4 CANADA

Tel.: Toll Free North America: +1 800 667 8743 | Outside North America +1 604 436 5547 | Technical Support +1 888 462 7487

For more information visit our website at: www.alpha.com

© 2020 Alpha Technologies Ltd. All Rights Reserved. Trademarks and logos are the property of Alpha Technologies Ltd. and its affiliates unless otherwise noted. Subject to revisions without prior notice. E. & O.E.

www.alpha.com

#9400021-J0 REV B (07/2020)