

# Galanz

## Installation Guide

Model# GLOMJA17S2B-10  
GLOMJA17S3B-10  
GLOMJB19S2SWZ-10  
GLOMJB17S2ASWZ-10



Thank you for purchasing a Galanz product. Please read this manual carefully for correct usage and safety, and keep for future reference. For service, support and warranty information, call 1-800-562-0738.

# CONTENTS

IMPORTANT SAFETY INSTRUCTIONS .....	3
Introduction .....	3
Before You Begin .....	3
Electrical Requirements .....	3
PACKAGE CONTENTS .....	4
Parts .....	4
Hardware .....	4
BEFORE YOU INSTALL .....	5
Tools and materials needed .....	5
Mounting requirements .....	6
Exhaust requirements .....	7
REMOVING YOUR MICROWAVE .....	9
INSTALLING YOUR MICROWAVE .....	10
Step 1: Find the wall studs .....	10
Step 2: Align the rear wall template .....	11
Step 3: Select a ventilation type .....	13
Step 4: Option A - Attach the mounting plate to the wall .....	14
Step 5: Option A - Preparing the top cabinet .....	16
Step 6: Option A - Insert the exhaust adapter .....	18
Step 7: Option A - Mount the microwave .....	19
Step 8: Option A - Connecting ductwork .....	21
Step 4: Option B - Cutting a vent opening .....	22
Step 5: Option B - Attach the mounting plate to the wall .....	23
Step 6: Option B - Preparing the top cabinet .....	25
Step 7: Option B - Adapt the microwave blower for outside back exhaust .....	27
Step 8: Option B - Mount the microwave .....	30
Step 4: Option C - Attach the mounting plate to the wall .....	32
Step 5: Option C - Preparing the top cabinet .....	34
Step 6: Option C - Adapting blower for recirculation .....	36
Step 7: Option C - Mount the microwave .....	39
BEFORE USING YOUR MICROWAVE .....	41
Specifications .....	41
TEMPLATE DIMENSIONS .....	42
Rear wall template dimensions .....	42
Top cabinet template dimensions .....	43

# IMPORTANT SAFETY INSTRUCTIONS

## Introduction

Congratulations on your purchase of a high-quality Galanz product. Your GLOMJA17S2B-10 represents the state of the art in microwave design and is designed for reliable and trouble-free performance. This installation guide will show you how to install your new over-the-range microwave.

## BEFORE YOU BEGIN

Read these instructions completely and carefully.

- **IMPORTANT** – Save these instructions for local inspector's use.
- **IMPORTANT** – Observe all governing codes and ordinances.
- **Note to Installer** – Be sure to leave these instructions with the consumer.
- **Note to Consumer** – Keep these instructions for future reference.
- **Skill level** – Installation of this appliance requires basic mechanical and electrical skills.
- **Proper installation** is the responsibility of the installer.
- **Product failure** due to improper installation is not covered under the Warranty.

## IMPORTANT SAFETY INSTRUCTIONS

**IMPORTANT—PLEASE READ CAREFULLY. FOR PERSONAL SAFETY, THIS APPLIANCE MUST BE PROPERLY GROUNDED TO AVOID SEVERE OR FATAL SHOCK.**

This product requires a three-prong, properly grounded outlet for safe operation. If not properly grounded, or if the outlet box does not meet electrical requirements noted (under ELECTRICAL REQUIREMENTS), a qualified electrician should be employed to correct any deficiencies.

The power cord of this appliance is equipped with a three-prong (grounding) plug which mates with a standard three-prong (grounding) wall receptacle to minimize the possibility of electric shock hazard from this appliance.

You should have the wall receptacle and circuit checked by a qualified electrician to make sure that the receptacle is properly grounded.

Where a standard two-prong wall receptacle is encountered, it is very important to have it replaced with a properly grounded three-prong wall receptacle installed by a qualified electrician.

**DO NOT, UNDER ANY CIRCUMSTANCES, CUT, DEFORM, OR REMOVE ANY OF THE PRONGS FROM THE POWER CORD. DO NOT USE WITH AN EXTENSION CORD.**

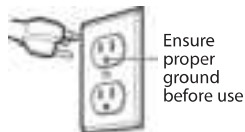

**Note:** For easier installation and personal safety, we recommend that two people install this product because of the weight. We highly recommend professional installation if any electrical or carpentry work is required.

## CAUTION

For personal safety, remove the house fuse or open the circuit breaker before beginning installation to avoid severe or fatal shock injury.

For personal safety, the mounting surface must be capable of supporting the cabinet load, in addition to the added weight of this 54 pound (24 kilogram) product, plus additional oven loads of up to 50 pounds (22 kilograms) for a total weight of 104 pounds (47 kilograms).

For personal safety, this product cannot be installed in cabinet arrangements such as an island or a peninsula. It must be mounted to BOTH a top cabinet AND a wall.

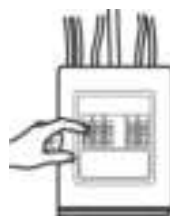

## ELECTRICAL REQUIREMENTS

The product rating of your microwave is 120 volts AC, 60 Hertz, 14 amps, and 1.5 kilowatts. This product must be connected to a supply circuit of the proper voltage and frequency. Wire size must conform to the requirements of the National Electrical Code or the prevailing local code for this kilowatt rating. The power supply cord and plug should be brought to a separate 20 ampere branch circuit single grounded outlet. The outlet box should be located in the cabinet above the microwave oven. The outlet box and supply circuit should be installed by a qualified electrician and conform to the National Electrical Code or the prevailing local code.

# PACKAGE CONTENTS

## Package contents

- 1.7 and 1.9 cu.ft over-the-range microwave
- Turntable (with ring)
- Installation parts ("Parts" on page 4)
- Installation hardware (see "Hardware" on page 4)
- Mounting templates (2)
- Installation Guide
- User Manual

## Parts

Make sure that you have all the parts necessary to install your new microwave.



Mounting plate (Qty. 1)

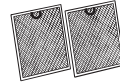







Grease filters (Qty. 2)



Exhaust adapter (Qty. 1)

## Hardware

HARDWARE	QTY.
 Washers	2
 Sheet metal screws	2
 Wood screws (1/4" x 2")	2

HARDWARE	QTY.
 Toggle bolts with wing nuts (3/16" x 3")	2
 Self-aligning machine screws (20-1/4" x 3")	2
 Nylon grommet	1

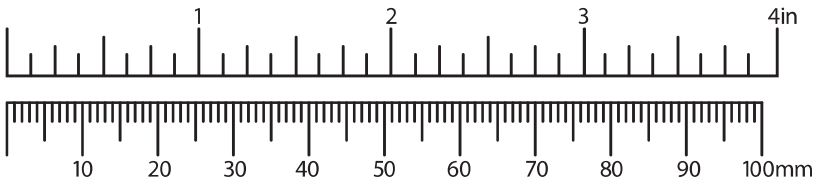

# BEFORE YOU INSTALL

## Before you install

Read these instructions completely before installing your microwave. Make sure that your space meets the mounting requirements and that you've gathered all needed tools and materials.

### Tools and materials needed



Ducts (if venting outside)  
See "Exhaust requirements" on page 7



Filler blocks or scrap wood pieces  
(for top cabinet spacing in recessed  
bottom cabinet installations, if needed)



#1 and #2 Phillips screwdrivers



Pencil



Edge-to-edge stud finder



Ruler or tape measure



Carpenter square  
(optional)



Level



Duct tape

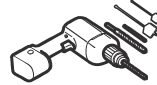

Electric drill with 3/16", 1/2", and 5/8" bits



Saw  
(saber, hole, or keyhole)



Tin snips  
(to cut damper, if needed)



Scissors  
(to cut template, if needed)



Gloves



Safety goggles

# BEFORE YOU INSTALL

## Mounting requirements

- The space between the cabinets must be 30 in. (76.2 cm) wide. If the space between the cabinets is more than 30 in. (76.2 cm), you'll need filler material to fill the gap between the microwave and cabinets.
- This microwave is for installation over ranges up to 36 in. (91.4 cm) wide.
- If installing the microwave beneath smooth, flat cabinets, make sure that you leave enough space for the power cord clearance.
- If you are going to vent your exhaust to the outside, see "Exhaust requirements" on page 7 for exhaust duct preparation.

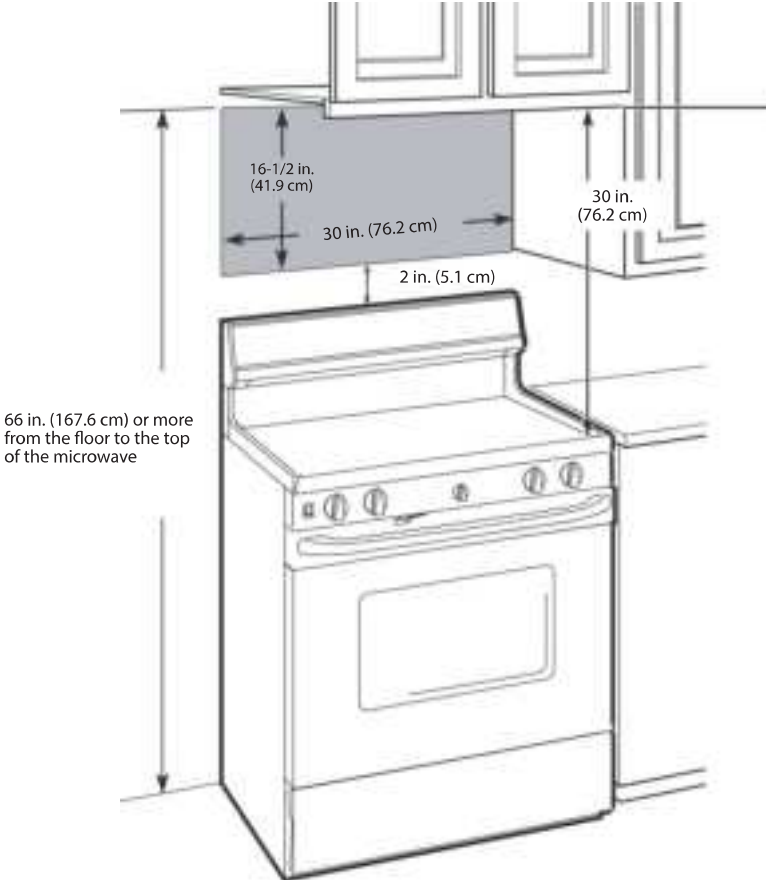

# BEFORE YOU INSTALL

## Exhaust requirements

Use this section if you plan to vent your microwave outside (top or back exhaust). If you plan to recirculate the air back into the room, skip to "Removing your microwave" on page 9.

When installing exhaust vents:



- Use the most direct route with as few elbows/transitions as possible. This helps prevent blockages and ensures that the exhaust is being vented correctly.
- Your microwave is designed to mate with a standard 3-1/4" x 10" rectangular duct. If a round duct is required, a rectangular-to-round transition adapter must be used. Do not use a duct with a diameter less than 6".

**Note:** If a rectangular-to-round transition adapter is used, you must cut the bottom corners of the damper with tin snips to let the damper have free movement.

- Elbows, transitions, and wall/roof caps add resistance to airflow. Each of these pieces are equivalent to a section of straight duct that is longer than their actual physical size. When calculating your duct length, add the equivalent lengths of all the pieces together. For proper airflow, the equivalent airflow should not exceed 140 ft. For example:

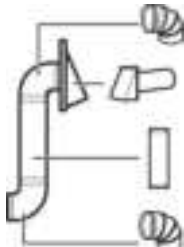
Example setup:



Duct Pieces	Equivalent Length	×	Number Used	=	Total Equivalent Length
 Roof cap	40 ft.	×	( 1 )	=	40 ft.
 90° elbow	10 ft.	×	( 2 )	=	20 ft.
 Straight duct 6" round OR 3-1/4" x 10" rectangular	3 ft.	×	( 1 )	=	3 ft.
<b>Total ductwork =</b>					<b>63 ft.</b>

↑  
For proper airflow,  
this number should  
not exceed 140 ft.

Use the "Equivalent duct length table" on page 8 to calculate the equivalent ductwork length for your setup.









**Note:** Equivalent lengths of duct pieces are based on actual tests and reflect requirements for good venting performance with any vent hood.

# BEFORE YOU INSTALL

## Equivalent duct length table

To calculate your equivalent duct length:

- 1 Write the number of sections used for each of the duct pieces.
- 2 Multiply the number used by the equivalent length for each duct piece.
- 3 Add the total equivalent lengths together. This number must be less than 140 ft.

Duct Pieces	Equivalent Length	×	Number Used	=	Total Equivalent Length
 Rectangular-to-round transition adapter	5 ft.	×	(     )	=	ft.
 Wall cap	40 ft.	×	(     )	=	ft.
 90° elbow	10 ft.	×	(     )	=	ft.
 45° elbow	5 ft.	×	(     )	=	ft.
 90° elbow	25 ft.	×	(     )	=	ft.
 45° elbow	5 ft.	×	(     )	=	ft.
 Roof cap	24 ft.	×	(     )	=	ft.
 Straight duct 6" round OR 3-1/4" × 10" rectangular	1 ft.	×	(     )	=	ft.
<b>Total ductwork =</b>					<b>ft.</b> (For proper airflow, this number should not exceed 140 ft.)

# REMOVING YOUR MICROWAVE

## Removing your microwave

- 1 Remove the upper foam from the box. Keep all the accessories.
- 2 Pull the microwave out of the box.
- 3 Remove and throw away the plastic bags.

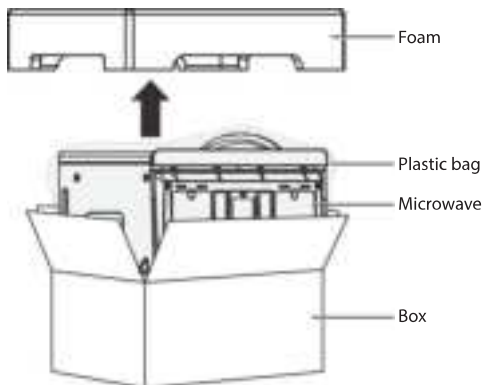

- 4 Remove the mounting plate from the upper foam.

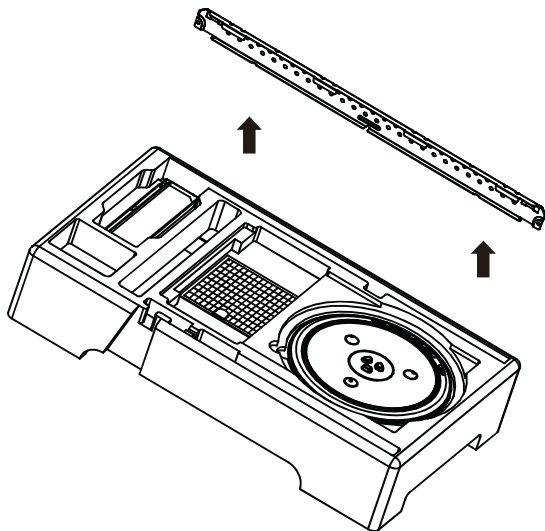

# INSTALLING YOUR MICROWAVE

## Installing your microwave

### Step 1: Find the wall studs

**WARNING:** Your microwave must be connected to at least one wall stud.

- 1 Using an edge-to-edge stud finder, locate the edges of the wall stud(s) within the opening.

**WARNING:** The center of any adjacent wall studs should be 16" or 24" from this mark.

- 2 Mark the center of each stud, and then draw a vertical line down the center of each stud.

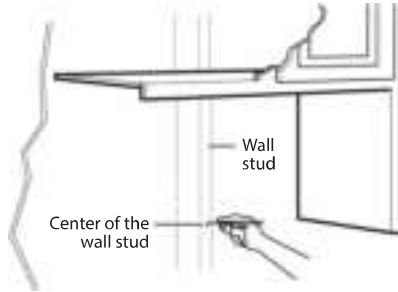

### You'll need:



Edge-to-edge stud finder



Ruler or tape measure



Pencil

# INSTALLING YOUR MICROWAVE

## Step 2: Align the rear wall template

**Note:** If the rear wall template is damaged or unusable, measure and mark the wall with the dimensions at the end of this step.

- 1 Use a level to make sure that the bottom of the cabinet is level.
- 2 Draw a vertical line down the center of the wall in the mounting space. This is where the center of your template will be.

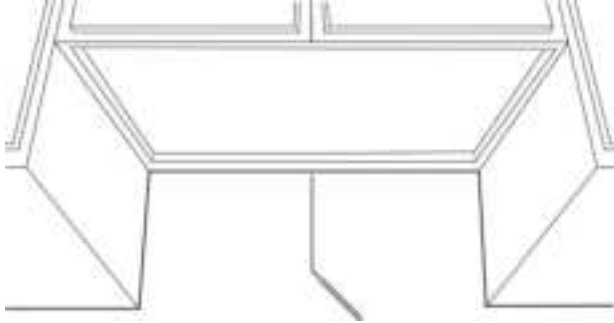

- 3 Draw a horizontal line at the height of the front of your cabinet. This is where the top of your template will be. If the bottom of your cabinet is flat, make sure that you leave space for the power cord.

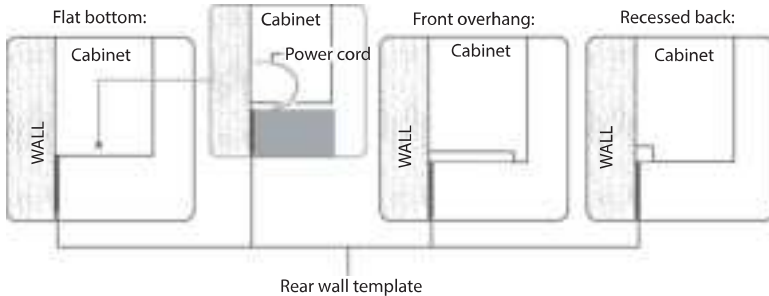

**Notes:**

- If installing the microwave beneath smooth, flat cabinets, make sure that you leave enough space for the power cord clearance.
- If cabinets have decorative trim that interferes with the microwave installation, remove the trim to install the microwave properly and to make sure that it is level.

- 4 Trim the rear wall template along the dotted line.

# INSTALLING YOUR MICROWAVE

- 5 Tape the template in place so that it is centered on the vertical line and the top edge is aligned with the horizontal line.

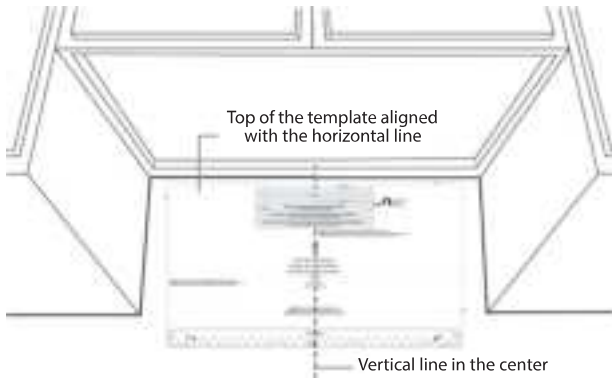

- 6 Mark points **A** and **B** on the wall with a pencil.
- 7 If the stud is on the center line, mark point **C** on the wall with a pencil.  
OR  
If the stud is not on the center line, mark two holes on either side of point **C** that align with the studs.
- 8 Drill holes through the template at points you marked. If the hole lines up with a stud, drill a 3/16" hole. Otherwise, drill a 5/8" hole for the toggle bolts.



**Note:** Depending on your stud locations, your installation may look different. You should mount to at least one stud.

**Note:** At least three holes must be used for mounting.

## You'll need:



Ruler or tape measure



Level



Pencil



Electric drill with 3/16" and 5/8" bits



Duct tape



Rear wall template

# INSTALLING YOUR MICROWAVE

## Step 3: Select a ventilation type

This microwave is designed for three types of ventilation. Select the type of ventilation you want to use, then go to the corresponding page.

**Note:** This microwave is shipped assembled for top exhaust ventilation.

**Option A - Outside top exhaust (vertical duct):** See page 14

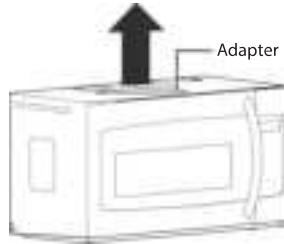

**Option B - Outside back exhaust (horizontal duct):** See page 22



**Note:** If a wall stud is within 6 in. (15.2 cm) of the vertical center line, you cannot use this installation option.

**Option C - Recirculating (non-vented/ductless):** See page 32



\*Requires a charcoal filter (included)

# INSTALLING YOUR MICROWAVE

## Step 4: Option A - Attach the mounting plate to the wall

**Note:** Depending on your stud locations, your installation may look different. You should insert toggle bolts into drywall and wood screws into studs.

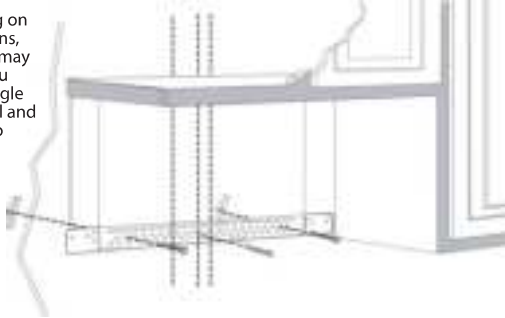

- 1 Remove the rear wall template.
- 2 Remove the mounting plate from the upper foam.

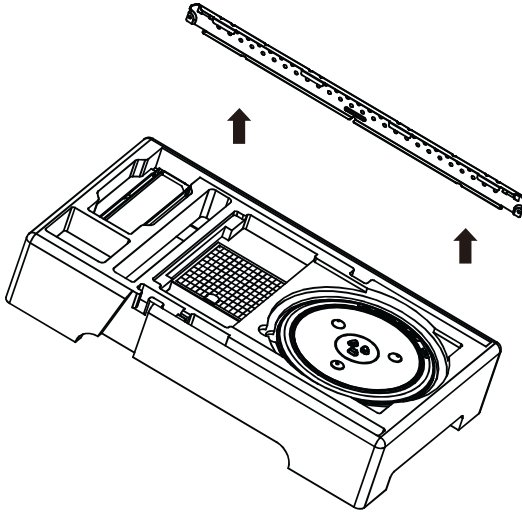

- 3 Insert the toggle bolt(s) through the front of the mounting plate into the hole(s) that are not going into a stud, and then attach the toggle wings  $\frac{3}{4}$ " onto each bolt. Hold your mounting plate up to holes in your wall to identify the correct position.

**Note:** The top of the mounting plate is indicated with an arrow. The mounting plate's hooks are on the front.

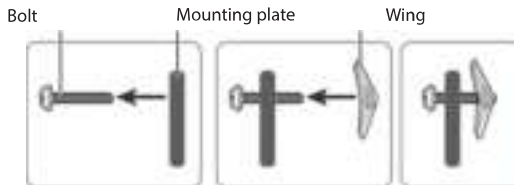

- 4 Place the mounting plate against the wall and insert the toggle wings into the holes you drilled in the drywall. Pull the mounting plate away from the wall to help tighten the toggle wings.

# INSTALLING YOUR MICROWAVE

- 5 Insert wood screw(s) through the mounting plate and into the hole(s) drilled in the stud(s), then tighten both the wood screw(s) and toggle bolt(s) with a Phillips screwdriver to mount the plate. Make sure that the plate is centered before tightening fully.

**CAUTION:** Be careful to avoid pinching your fingers between the back of the mounting plate and the wall.

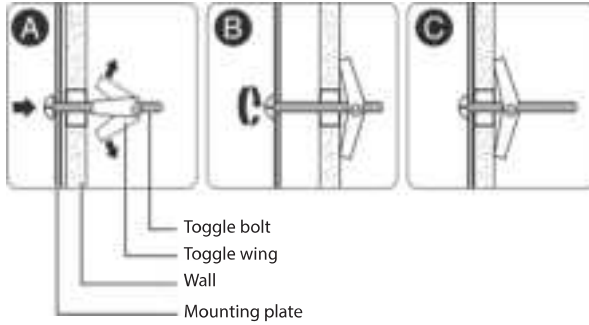

## You'll need:



Toggle bolts



Wood screws

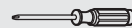

Phillips screwdrivers



Mounting plate (Qty. 1)

# INSTALLING YOUR MICROWAVE

## Step 5: Option A - Preparing the top cabinet

You need to drill holes for the top support screws, a hole large enough for the power cord to fit through, and a cutout large enough for the exhaust adapter.

- 1 Turn off the power to the outlet in the cabinet.
- 2 Remove everything from the cabinet.
- 3 Trim the **Top Cabinet Template** along the dotted line.
- 4 If the bottom of your cabinet is recessed and the template is too large, trim the edges to fit. Your template should fit snugly inside the space with no overhang.

### Notes:

- Make sure that you keep the left and right sides even. For example, if you need to trim the sides by 1", cut 1/2" from the left side and 1/2" from the right side.
- Some cabinets have a small bracket or glue block between the overhang and the underside of the cabinet bottom. Cut the template to fit around these so it lies flat on the bottom of the cabinet.

### 5 To position the **Top Cabinet Template**

- Align the center line on the template with the center line that you drew on the wall.
- Align the back edge of the template to the rear wall (smooth or flat bottom cabinets) or to the back of the recess (recessed cabinets) to make sure that the holes cut into the upper cabinet align with the holes in the top of the microwave.

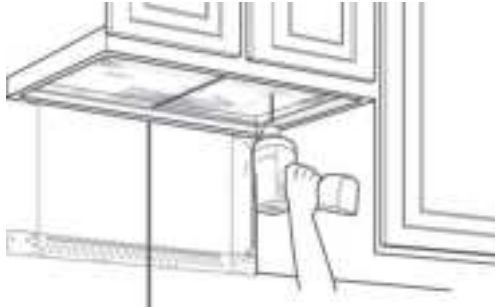

Center line

- 6 Tape the template to the bottom of the cabinet.
- 7 Drill 1/2" holes through the template at points **D** and **E**.

**CAUTION:** Wear safety goggles when drilling holes in the cabinet bottom.

- 8 Cut a 2" diameter hole at point **F** for the power cord.
- 9 Cut out the shaded area **I** through the cabinet bottom.
- 10 Remove the template.

# INSTALLING YOUR MICROWAVE

## 11 If you have recessed cabinets:

- Make two filler blocks out of scrap wood pieces the size of shaded areas **G** and **H**. They must be as thick as the depth of the cabinet recess.
- Drill 5/8" holes in the filler blocks to align with points **D** and **E**.
- Align the blocks with the corresponding holes in the cabinet. They should be at the same level as the bottom edge of the cabinet frame.

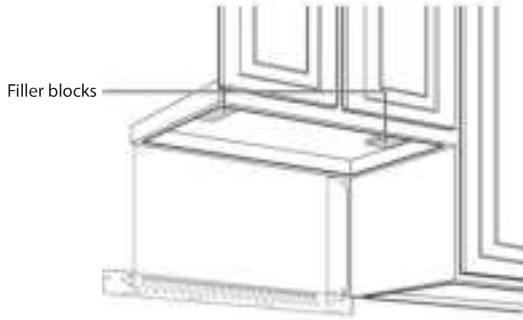

## You'll need:



Electric drill with 1/2" and 5/8" bits



Duct tape



Scissors  
(recessed cabinets only)



Safety goggles



Ruler or tape measure



Saw  
(saber, hole, or keyhole)



Filler blocks or scrap wood pieces  
(for recessed cabinets only)

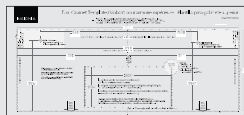

Top Cabinet Template

# INSTALLING YOUR MICROWAVE

## Step 6: Option A - Insert the exhaust adapter

- 1 Set the microwave in its upright position, with the top facing up.
- 2 Remove any tape securing the damper and make sure that the damper pivots easily.

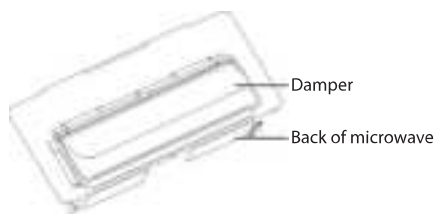

- 3 Insert the exhaust adapter into the slots next to the ventilation and secure with a sheet metal screw.

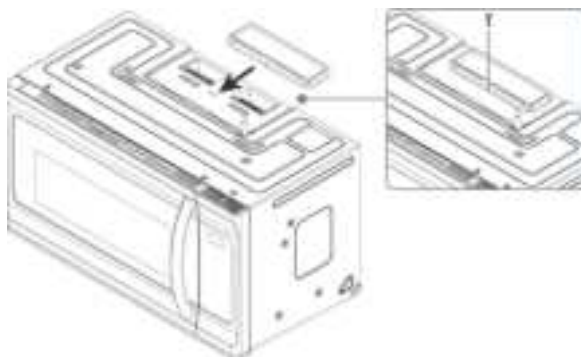

### You'll need:



Exhaust adapter



Sheet metal screw

# INSTALLING YOUR MICROWAVE

## Step 7: Option A - Mount the microwave

### CAUTIONS:

- For easier installation and personal safety, we recommend that two people install this product because of the weight. We highly recommend professional installation if any electrical or carpentry work is required.
- Do not grip or use the handle during installation.
- To keep the power cord tight while mounting the microwave oven, thread the power cord through the hole in the bottom of the cabinet.

- 1 If your cabinet is metal, insert the nylon grommet into the power cord hole to prevent cutting the cord.
- 2 Lift the microwave, tilt it forward, and hook the slots on the back bottom edge onto the four lower tabs of the mounting plate. Rotate the front of the microwave up against the bottom of the cabinet.

### Notes:

- We recommend using filler blocks if the front of the cabinet hangs below the cabinet's bottom shelf.
- If filler blocks are not used, damage may occur from over-tightening the screws.
- Be sure to keep the power cord tight.
- Do not pinch the cord, especially when mounting flush to the bottom of the cabinet.

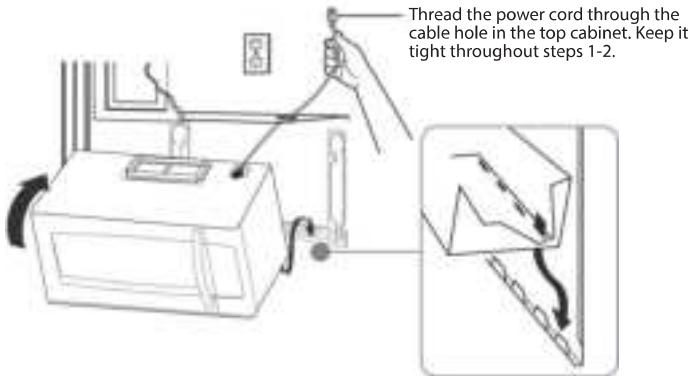

- 3 To attach the microwave oven to the top cabinet, insert two self-aligning machine screws through the holes you drilled in the bottom of the cabinet. Turn each screw at least two full turns (they will be fully tightened later).

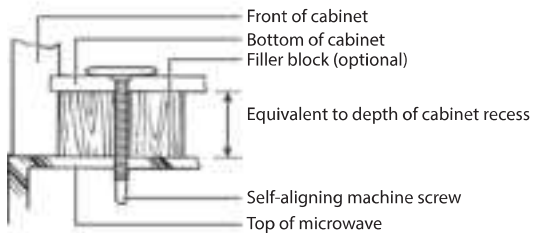

# INSTALLING YOUR MICROWAVE

- 4 While holding the microwave up against the wall and cabinet fully tighten the outer two screws.



- 5 Fit the two grease filters into the openings underneath your microwave.



BOTTOM

## You'll need:



Nylon grommet  
(for metal cabinets)



Self-aligning machine  
screws



Grease filters



Phillips screwdrivers

# INSTALLING YOUR MICROWAVE

## Step 8: Option A - Connecting ductwork

- 1 Open the cabinet and slide the exhaust adapter front-to-back or side-to-side to adjust.

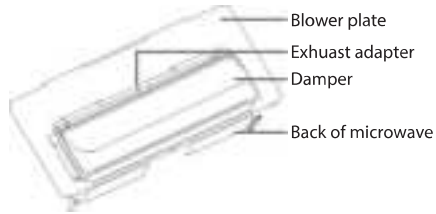

- 2 Extend the house duct down to connect to the exhaust adapter.
- 3 Seal the exhaust duct joints with duct tape.



- 4 You're finished! Skip to "[Before using your microwave](#)" on page 41.

### You'll need:



Duct tape

# INSTALLING YOUR MICROWAVE

## Step 4: Option B - Cutting a vent opening

- 1 Use a saber or keyhole saw to cut out the shaded area **K** through the rear wall.

**Note:** If a wall stud is within 6 in. (15.2 cm) of the vertical center line, you cannot use this installation option.



- 2 Remove the rear wall template.

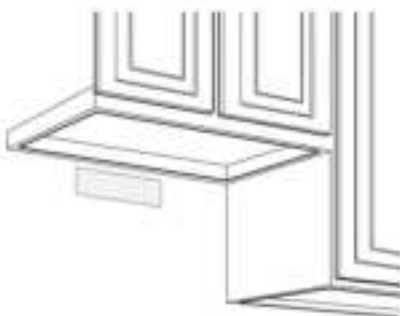

## You'll need:

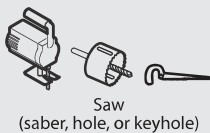

# INSTALLING YOUR MICROWAVE

## Step 5: Option B - Attach the mounting plate to the wall

**Note:** Depending on your stud locations, your installation may look different. You should insert toggle bolts into drywall and wood screws into studs.

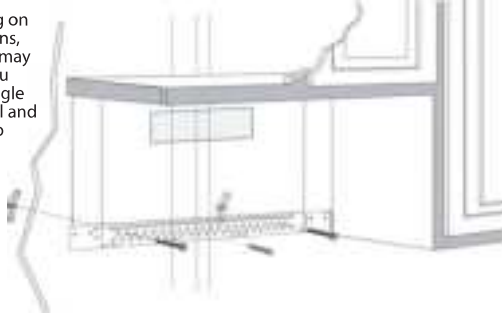

- 1 Remove the rear wall template.
- 2 Remove the mounting plate from the upper foam.

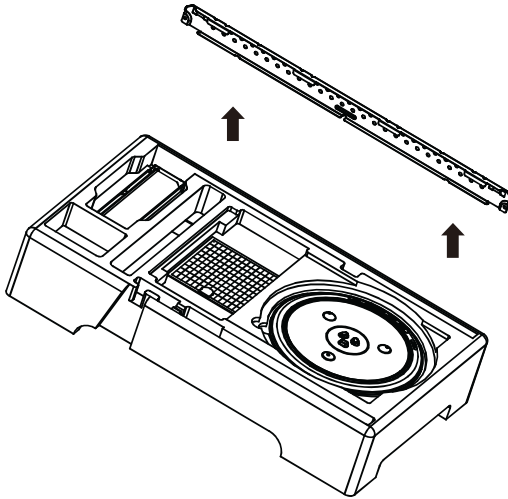

- 3 Insert the bolt(s) through the front of the mounting plate into the hole(s) that are not going into a stud, and then reattach the toggle wings  $\frac{3}{4}$ " onto each bolt. Hold your mounting plate up to holes in your wall to identify the correct position.

**Note:** The top of the mounting plate is indicated with an arrow. The mounting plate's hooks are on the front.

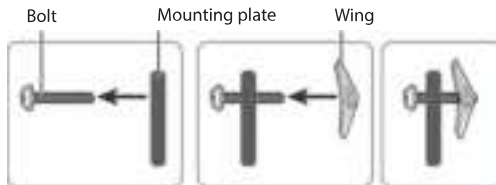

- 4 Place the mounting plate against the wall and insert the toggle wings into the holes you drilled in the drywall. Pull the mounting plate away from the wall to help tighten the toggle wings.

# INSTALLING YOUR MICROWAVE

- 5 Insert wood screw(s) through the mounting plate and into the hole(s) drilled in the stud(s), then tighten both the wood screw(s) and toggle bolt(s) with a Phillips screwdriver to mount the plate. Make sure that the plate is centered before tightening fully.

**CAUTION:** Be careful to avoid pinching your fingers between the back of the mounting plate and the wall.

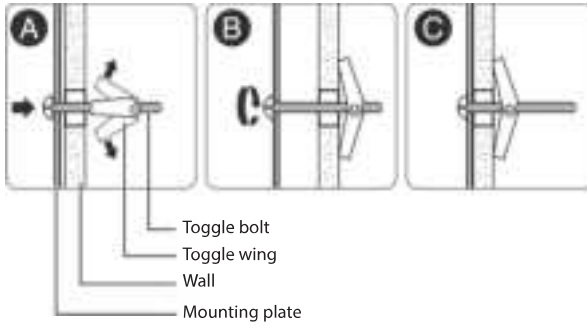

## You'll need:



# INSTALLING YOUR MICROWAVE

## Step 6: Option B - Preparing the top cabinet

You need to drill holes for the top support screws and a hole large enough for the power cord to fit through.

- 1 Turn off the power to the outlet in the cabinet.
- 2 Remove everything from the cabinet.
- 3 Trim the **Top Cabinet Template** along the dotted line.
- 4 If the bottom of your cabinet is recessed and the template is too large, trim the edges to fit. Your template should fit snugly inside the space with no overhang.

### Notes:

- Make sure that you keep the left and right sides even. For example, if you need to trim the sides by 1", cut 1/2" from the left side and 1/2" from the right side.
- Some cabinets have a small bracket or glue block between the overhang and the underside of the cabinet bottom. Cut the template to fit around these so it lies flat on the bottom of the cabinet.

### 5 To position the **Top Cabinet Template**

- Align the center line on the template with the center line that you drew on the wall.
- Align the back edge of the template to the rear wall (smooth or flat bottom cabinets) or to the back of the recess (recessed cabinets) to make sure that the holes cut into the upper cabinet align with the holes in the top of the microwave.

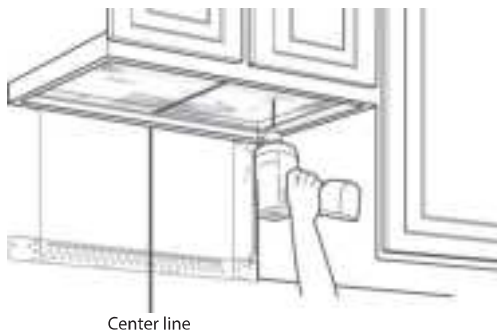

- 6 Tape the template to the bottom of the cabinet.
- 7 Drill 1/2" holes through the template at points **D** and **E**.

**CAUTION:** Wear safety goggles when drilling holes in the cabinet bottom.

- 8 Cut a 2" diameter hole at point **F** for the power cord.
- 9 Remove the template.

# INSTALLING YOUR MICROWAVE

## 10 If you have recessed cabinets:

- Make two filler blocks out of scrap wood pieces the size of shaded areas **G** and **H**. They must be as thick as the depth of the cabinet recess.
- Drill 5/8" holes in the filler blocks to align with points **D** and **E**.
- Align the blocks with the corresponding holes in the cabinet. They should be at the same level as the bottom edge of the cabinet frame.



## You'll need:



Electric drill with 1/2" and 5/8" bits



Duct tape



Scissors  
(recessed cabinets only)



Safety goggles



Ruler or tape measure



Saw  
(saber, hole, or keyhole)



Filler blocks or scrap wood pieces  
(for recessed cabinets only)



Top Cabinet Template

# INSTALLING YOUR MICROWAVE

## Step 7: Option B - Adapt the microwave blower for outside back exhaust

- 1 Remove and save the five screws that hold the blower unit in the microwave.

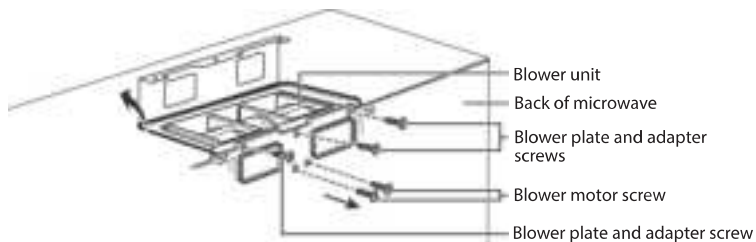

- 2 Carefully pull out the blower unit. The wires will extend far enough to let you adjust the blower unit. Do not disconnect the wires.

**WARNING:** Do not pull or stretch the blower unit wiring. Make sure that the wires are not pinched.

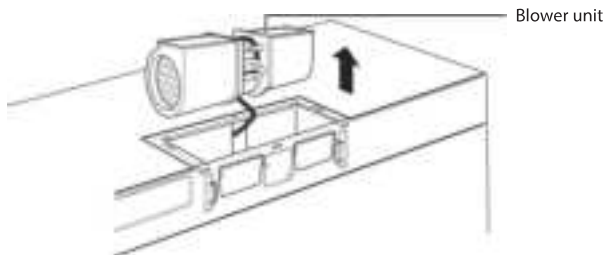

- 3 Cut out the vent holes with tin snips.

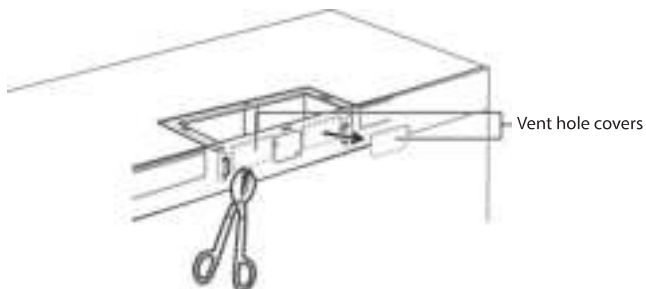

# INSTALLING YOUR MICROWAVE

- 4 Turn the blower unit 180° so that the fan blade openings are facing out the back of the microwave.

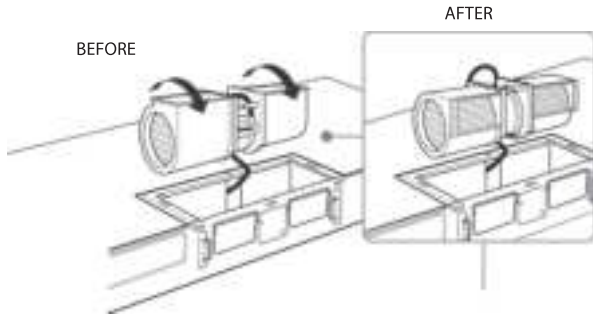

- 5 Place the blower unit back into the opening. The blower unit exhaust openings should match the exhaust openings on back of the microwave.

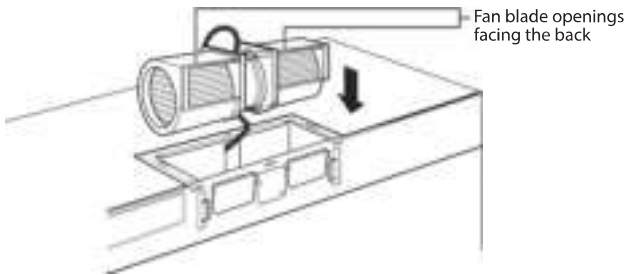

- 6 Slide the exhaust adapter into the guides on the back of the microwave and push in until it is aligned with the blower motor screw holes, then secure with the blower motor screws.

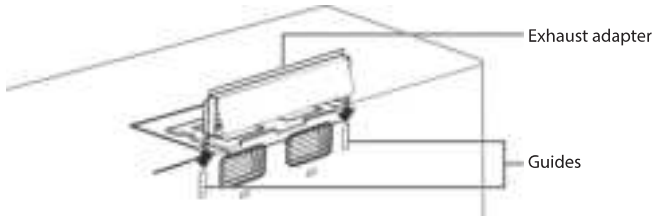

- 7 Secure the blower unit in the microwave with two of the screws you previously removed.

**Note:** Make sure that the damper hinge is at the top and that it can swing freely.

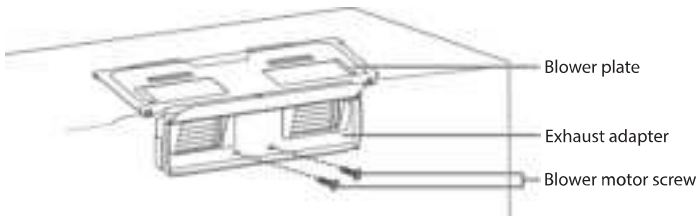

# INSTALLING YOUR MICROWAVE

- 8 Secure the blower plate and exhaust adapter with the remaining screws you removed previously.

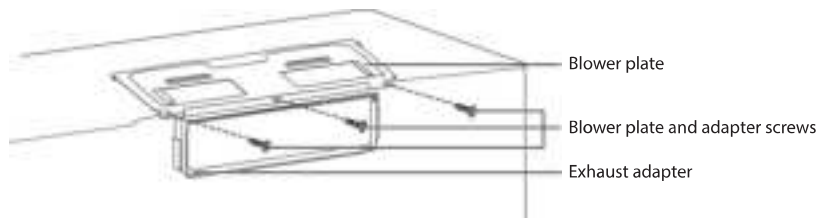

## You'll need:

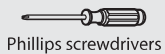

# INSTALLING YOUR MICROWAVE

## Step 8: Option B - Mount the microwave

### CAUTIONS:

- For easier installation and personal safety, we recommend that two people install this product because of the weight. We highly recommend professional installation if any electrical or carpentry work is required.
- Do not grip or use the handle during installation.
- To keep the power cord tight while mounting the microwave oven, thread the power cord through the hole in the bottom of the top cabinet.

- 1 If your cabinet is metal, insert the nylon grommet into the power cord hole to prevent cutting the cord.
- 2 Lift the microwave, tilt it forward, and hook the slots on the back bottom edge onto the four lower tabs of the mounting plate. Rotate the front of the microwave up against the bottom of the cabinet.

### Notes:

- We recommend using filler blocks if the front of the cabinet hangs below the cabinet's bottom shelf.
- If filler blocks are not used, damage may occur from over-tightening the screws.
- Be sure to keep the power cord tight.
- Do not pinch the cord, especially when mounting flush to the bottom of the cabinet.

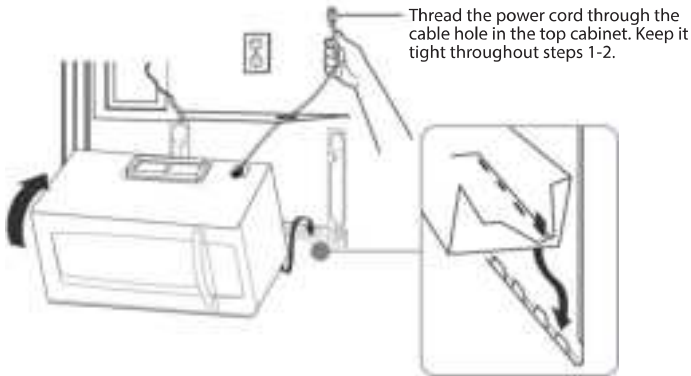

- 3 To attach the microwave oven to the top cabinet, insert two self-aligning machine screws through the holes you drilled in the bottom of the cabinet. Turn each screw at least two full turns (they will be fully tightened later).

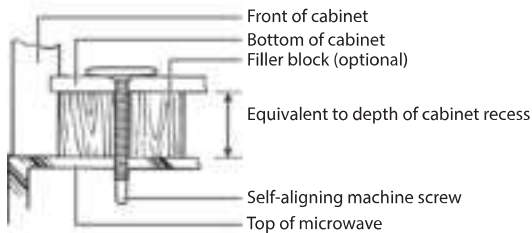

# INSTALLING YOUR MICROWAVE

- 4 While holding the microwave up against the wall and cabinet fully tighten the outer two screws.



- 5 Fit the two grease filters into the openings underneath your microwave.

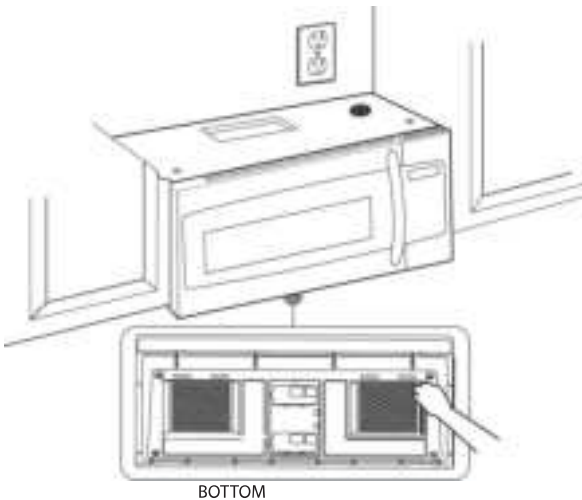

- 6 You're finished! See "Before using your microwave" on page 41

## You'll need:



Nylon grommet  
(for metal cabinets)



Self-aligning machine  
screws



Grease filters



Phillips screwdrivers

# INSTALLING YOUR MICROWAVE

## Step 4: Option C - Attach the mounting plate to the wall

**Note:** Depending on your stud locations, your installation may look different. You should insert toggle bolts into drywall and wood screws into studs.

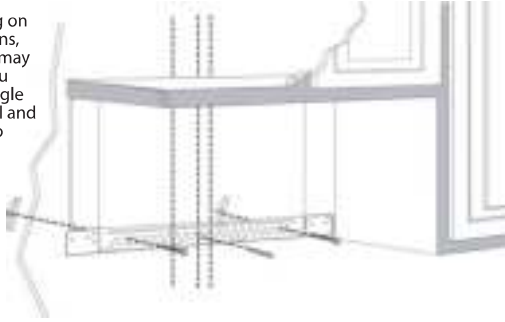

- 1 Remove the rear wall template.
- 2 Remove the mounting plate from the upper foam.

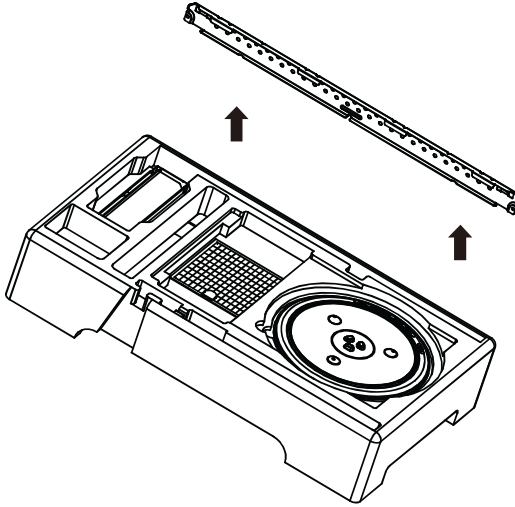

- 3 Insert the bolt(s) through the front of the mounting plate into the hole(s) that are not going into a stud, and then reattach the toggle wings  $\frac{3}{4}$ " onto each bolt. Hold your mounting plate up to holes in your wall to identify the correct position.

**Note:** The top of the mounting plate is indicated with an arrow. The mounting plate's hooks are on the front.

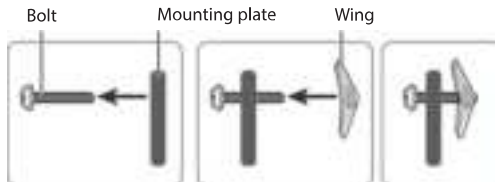

# INSTALLING YOUR MICROWAVE

- 4 Place the mounting plate against the wall and insert the toggle wings into the holes you drilled in the drywall. Pull the mounting plate away from the wall to help tighten the toggle wings.
- 5 Insert wood screw(s) through the mounting plate and into the hole(s) drilled in the stud(s), then tighten both the wood screw(s) and toggle bolt(s) with a Phillips screwdriver to mount the plate. Make sure that the plate is centered before tightening fully.

**Note:** Be careful to avoid pinching your fingers between the back of the mounting plate and the wall.

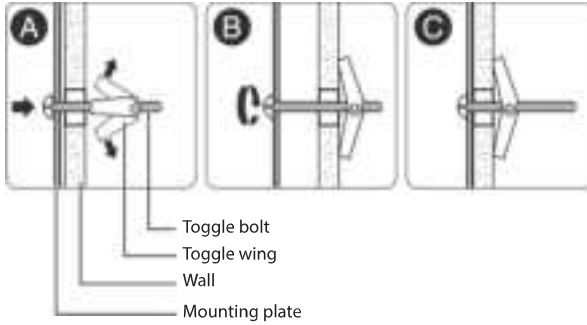

## You'll need:

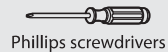

# INSTALLING YOUR MICROWAVE

## Step 5: Option C - Preparing the top cabinet

You need to drill holes for the top support screws and a hole large enough for the power cord to fit through.

- 1 Turn off the power to the outlet in the cabinet.
- 2 Remove everything from the cabinet.
- 3 Trim the **Top Cabinet Template** along the dotted line.
- 4 If the bottom of your cabinet is recessed and the template is too large, trim the edges to fit. Your template should fit snugly inside the space with no overhang.

### Notes:

- Make sure that you keep the left and right sides even. For example, if you need to trim the sides by 1", cut 1/2" from the left side and 1/2" from the right side.
- Some cabinets have a small bracket or glue block between the overhang and the underside of the cabinet bottom. Cut the template to fit around these so it lies flat on the bottom of the cabinet.

### 5 To position the Top Cabinet Template

- Align the center line on the template with the center line that you drew on the wall.
- Align the back edge of the template to the rear wall (smooth or flat bottom cabinets) or to the back of the recess (recessed cabinets) to make sure that the holes cut into the upper cabinet align with the holes in the top of the microwave.

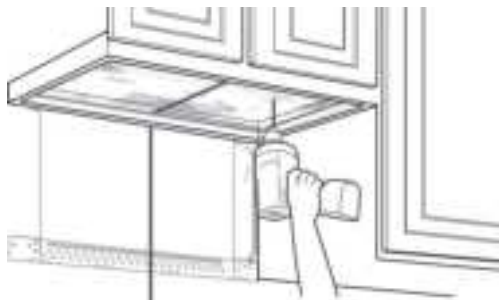

Center line

- 6 Tape the template to the bottom of the cabinet.
- 7 Drill 1/2" holes through the template at points **D** and **E**.

**CAUTION:** Wear safety goggles when drilling holes in the cabinet bottom.

- 8 Cut a 2" diameter hole at point **F** for the power cord.
- 9 Remove the template.

# INSTALLING YOUR MICROWAVE

## 10 If you have recessed cabinets:

- Make two filler blocks out of scrap wood pieces the size of shaded areas **G** and **H**. They must be as thick as the depth of the cabinet recess.
- Drill 5/8" holes in the filler blocks to align with points **D** and **E**.
- Align the blocks with the corresponding holes in the cabinet. They should be at the same level as the bottom edge of the cabinet frame.

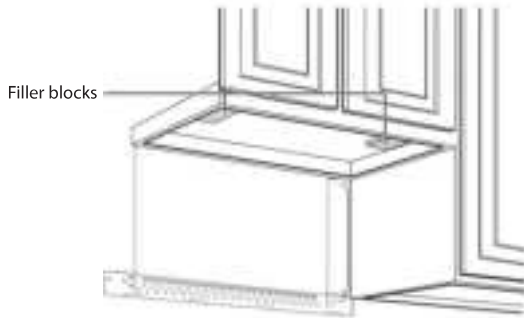

## You'll need:



Electric drill with 1/2" and 5/8" bits



Duct tape



Scissors  
(recessed cabinets only)



Safety goggles



Ruler or tape measure



Saw  
(saber, hole, or keyhole)



Filler blocks or scrap wood pieces  
(for recessed cabinets only)

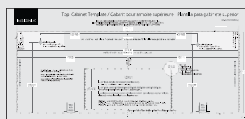

Top Cabinet Template

# INSTALLING YOUR MICROWAVE

## Step 6: Option C - Adapting blower for recirculation

- 1 Remove and save the five screws that hold the blower unit in the microwave.

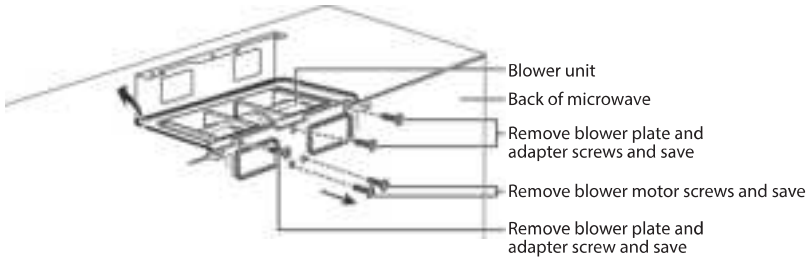

- 2 Carefully pull out the blower unit. The wires will extend far enough to let you adjust the blower unit. Do not disconnect the wires.

**WARNING:** Do not pull or stretch the blower unit wiring. Make sure that the wires are not pinched.

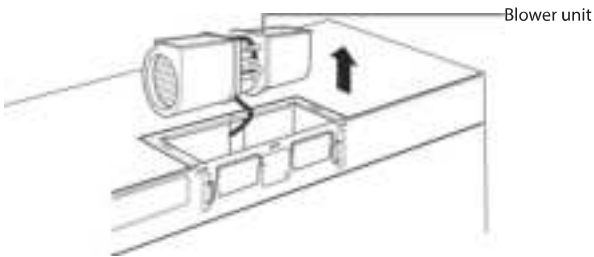

- 3 Turn the blower unit 90° so that the fan blade openings are facing the front of the microwave.

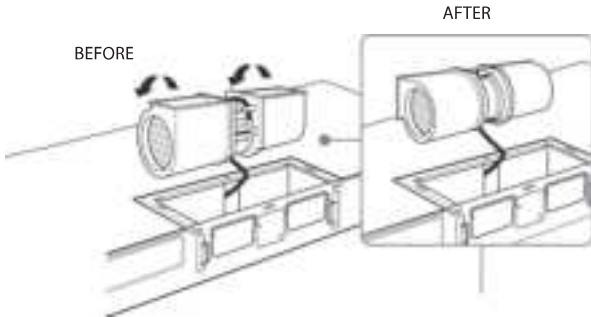

# INSTALLING YOUR MICROWAVE

- 4 Place the blower unit back into the opening. The blower unit exhaust openings should match the exhaust openings toward the front of the microwave.

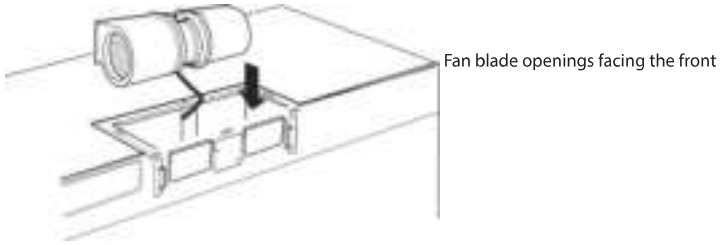

# INSTALLING YOUR MICROWAVE

- 5 Secure the blower unit in the microwave with the remaining screws you previously removed.

**Note:** Make sure that the damper hinge is at the top and that it can swing freely.

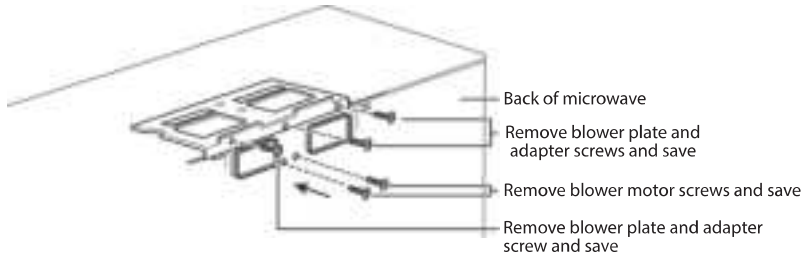

## You'll need:



Phillips screwdrivers

# INSTALLING YOUR MICROWAVE

## Step 7: Option C - Mount the microwave

### CAUTIONS:

- For easier installation and personal safety, we recommend that two people install this product because of the weight. We highly recommend professional installation if any electrical or carpentry work is required.
- Do not grip or use the handle during installation.
- To keep the power cord tight while mounting the microwave oven, thread the power cord through the hole in bottom of the top cabinet.

- 1 If your cabinet is metal, insert the nylon grommet into the power cord hole to prevent cutting the cord.
- 2 Lift the microwave, tilt it forward, and hook the slots on the back bottom edge onto the four lower tabs of the mounting plate. Rotate the front of the microwave up against the bottom of the cabinet.

### Notes:

- We recommend using filler blocks if the front of the cabinet hangs below the cabinet's bottom shelf.
- If filler blocks are not used, damage may occur from over-tightening the screws.
- Be sure to keep the power cord tight.
- Do not pinch the cord, especially when mounting flush to the bottom of the cabinet.

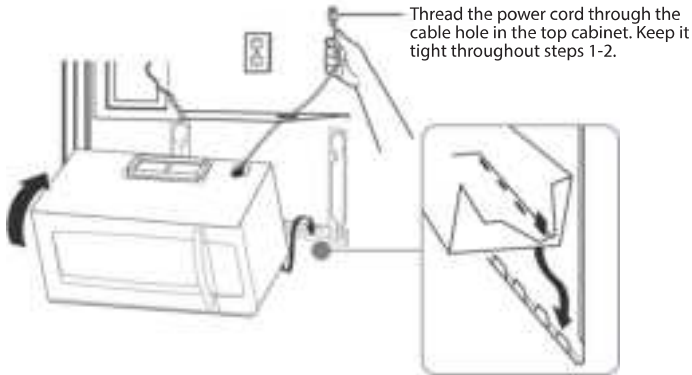

- 3 To attach the microwave oven to the top cabinet, insert two self-aligning machine screws through the holes you drilled in the bottom of the cabinet. Turn each screw at least two full turns (they will be fully tightened later).

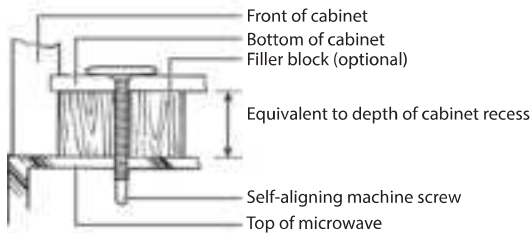

# INSTALLING YOUR MICROWAVE

- 4 While holding the microwave up against the wall and cabinet fully tighten the outer two screws.



- 5 Fit the two grease filters into the openings underneath your microwave.

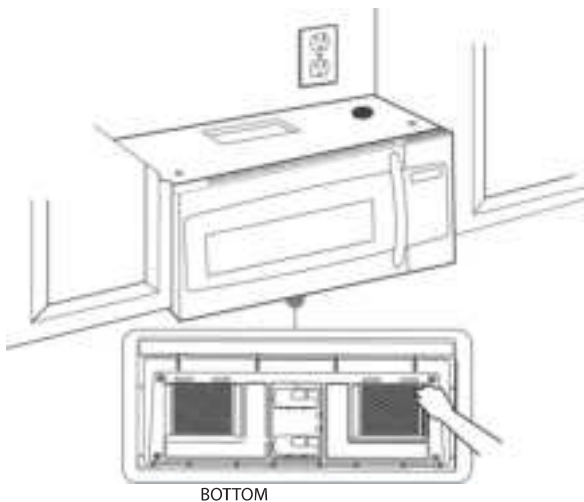

- 6 You're finished! Skip to "Before using your microwave" on page 41.

## You'll need:



Nylon grommet  
(for metal cabinets)



Self-aligning machine  
screws



Grease filters



Phillips screwdrivers

# BEFORE USING YOUR MICROWAVE

**Note:** Keep these installation instructions for the local inspector's use.

- 1 Make sure that all packing material has been removed from the microwave.
- 2 Install the turntable and ring inside your microwave. See your **User Manual** for more information.
- 3 Plug the power cord into a dedicated 20 amp electrical outlet.
- 4 Turn your circuit breaker back on.

## Specifications

Model	GLOMJA17S2B-10	GLOMJA17S3B-10
Rated Voltage	120V/60Hz	120V/60Hz
Rated Input Power	1500W	1500W
Rated Output Power	1000W	1000W
Microwave Capacity	1.7 cu.ft	1.7 cu.ft
Turntable Diameter	12.4 in.(31.5 cm)	12.4 in.(31.5cm)
External Dimensions(H×W×D)	16.9 × 29.9 × 17.3 in.(42.9 × 75.9 × 44.1 cm)	16.9 × 29.9 × 17.3 in.(42.9 × 75.9 × 44.1 cm)
Internal Dimensions(H×W×D)	10.2 × 21.1 × 14.6 in.(25.9 × 54.1 × 37.1 cm)	10.2 × 21.1 × 14.6 in.(25.9 × 54.1 × 37.1 cm)
Certifications	UL approved	UL approved
Power Cord Length	39.8 in.(101 cm)	39.8 in.(101 cm)

Model	GLOMJB19S2SWZ-10	GLOMJB17S2ASWZ-10
Rated Voltage	120V/60Hz	120V/60Hz
Rated Input Power	1500W	1550W
Rated Output Power	1000W	1000W
Microwave Capacity	1.9 cu.ft	1.7 cu.ft
Turntable Diameter	14.2 in.(36.0 cm)	12.8 in.(32.5 cm)
External Dimensions(H×W×D)	16.9 × 29.9 × 17.5 in.(42.9 × 75.9 × 44.4 cm)	16.9 × 29.9 × 17.5 in.(42.9 × 75.9 × 44.4 cm)
Internal Dimensions(H×W×D)	10.9 × 22.3 × 14.9 in.(27.9 × 56.6 × 37.8 cm)	10.6 × 21.5 × 14.1 in.(26.8 × 54.5 × 35.9 cm)
Certifications	UL approved	UL approved
Power Cord Length	39.8 in.(101 cm)	39.8 in.(101 cm)

# TEMPLATE DIMENSIONS

## Rear wall template dimensions

If your rear wall template is unusable, drill using the dimensions below:

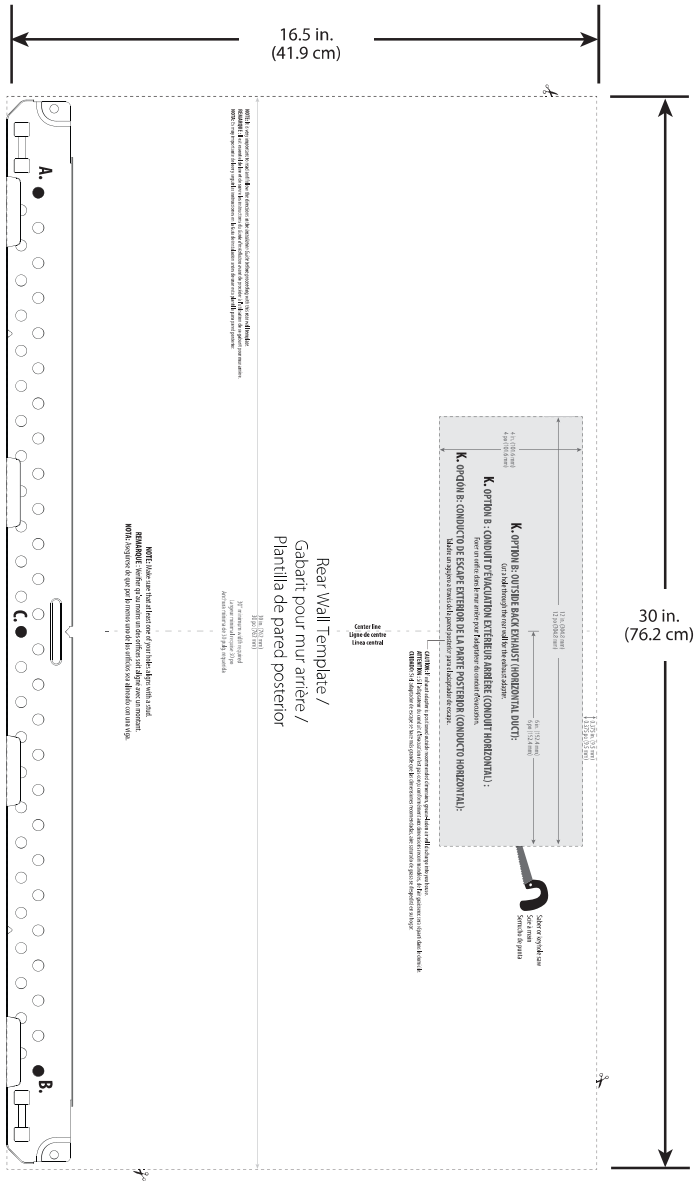

# TEMPLATE DIMENSIONS

## Top cabinet template dimensions

If your top cabinet template is unusable, drill using the dimensions below:

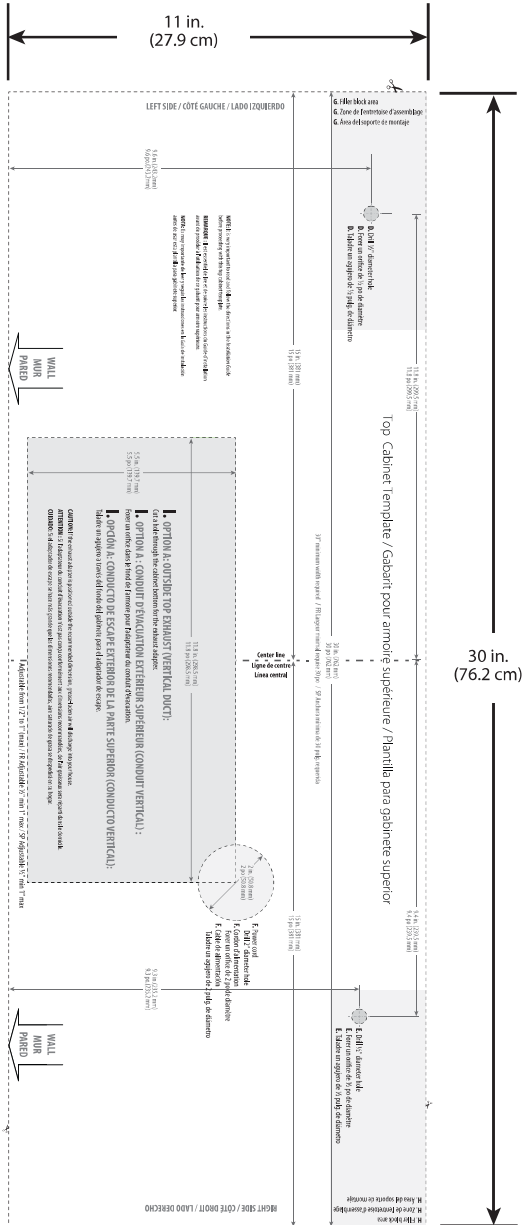

# Galanz