

Nikon

DIGITAL CAMERA

COOLPIX S70

User's Manual

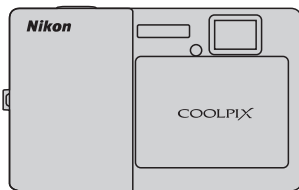

En

Trademark Information

- Microsoft, Windows and Windows Vista are either registered trademarks or trademarks of Microsoft Corporation in the United States and/or other countries.
- Macintosh, Mac OS, and QuickTime are trademarks of Apple Inc.
- Adobe and Acrobat are registered trademarks of Adobe Systems Inc.
- The SD logo is a trademark of the SD Card Association.
- PictBridge is a trademark.
- All other trade names mentioned in this manual or the other documentation provided with your Nikon product are trademarks or registered trademarks of their respective holders.

Introduction

First Steps



Basic Photography and Playback: Easy Auto Mode

More on Shooting

More on Playback

Editing Pictures



Movies

Connecting to Televisions, Computers and Printers

Setup Menu

Technical Notes

For Your Safety

To prevent damage to your Nikon product or injury to yourself or to others, read the following safety precautions in their entirety before using this equipment. Keep these safety instructions where all those who use the product will read them.



This icon marks warnings, information that should be read before using this Nikon product, to prevent possible injury.

WARNINGS

Turn off in the event of malfunction

Should you notice smoke or an unusual smell coming from the camera or AC adapter, unplug the AC adapter and remove the battery immediately, taking care to avoid burns. Continued operation could result in injury. After removing or disconnecting the power source, take the equipment to a Nikon-authorized service representative for inspection.

Do not disassemble

Touching the internal parts of the camera or AC adapter could result in injury. Repairs should be performed only by qualified technicians. Should the camera or AC adapter break open as the result of a fall or other accident, take the product to a Nikon-authorized service representative for inspection, after unplugging the product and/or removing the battery.

Do not use the camera or AC adapter in the presence of flammable gas

Do not use electronic equipment in the presence of flammable gas, as this could result in explosion or fire.

Handle the camera strap with care

Never place the strap around the neck of an infant or child.

Keep out of reach of children

Particular care should be taken to prevent infants from putting the battery or other small parts into their mouths.

Observe caution when handling the battery

The battery may leak or explode if improperly handled. Observe the following precautions when handling the battery for use in this product:

- Before replacing the battery, turn the product off. If you are using the AC adapter (available separately), be sure to unplug the AC adapter from an electrical outlet.
- Use only a Rechargeable Li-ion Battery EN-EL12 (supplied). Charge the battery inserted into the camera by connecting the Charging AC Adapter EH-68P/EH-68P (AR) (supplied).
- When inserting the battery, do not attempt to insert it upside down or backwards.
- Do not short or disassemble the battery or attempt to remove or break the battery insulation or casing.
- Do not expose the battery to flame or to excessive heat.
- Do not immerse in or expose to water.
- Replace the terminal cover when transporting the battery. Do not transport or store with metal objects such as necklaces or hairpins.
- The battery is prone to leakage when fully discharged. To avoid damage to the product, be sure to remove the battery when no charge remains.

- Discontinue use immediately should you notice any change in the battery, such as discoloration or deformation.
- If liquid from the damaged battery comes in contact with clothing or skin, rinse immediately with plenty of water.

Observe the following precautions when handling the Charging AC Adapter

- Keep dry. Failure to observe this precaution could result in fire or electric shock.
- Dust on or near the metal parts of the plug should be removed with a dry cloth. Continued use could result in fire.
- Do not handle the cable or go near the Charging AC Adapter during lightning storms. Failure to observe this precaution could result in electric shock.
- Do not damage, modify, forcibly tug or bend the cable, place it under heavy objects, or expose it to heat or flames. Should the insulation be damaged and the wires become exposed, take it to a Nikon-authorized service representative for inspection. Failure to observe these precautions could result in fire or electric shock.

For Your Safety

- Do not handle the plug or Charging AC Adapter with wet hands. Failure to observe this precaution could result in electric shock.
- Do not use with travel converters or adapters designed to convert from one voltage to another or with DC-to-AC inverters. Failure to observe this precaution could damage the product or cause overheating or fire.

Use appropriate cables

When connecting cables to the input and output jacks, use only the cables provided or sold by Nikon for the purpose, to maintain compliance with product regulations.

Handle moving parts with care

Be careful that your fingers or other objects are not pinched by the slide cover or other moving parts.

CD-ROMs

The CD-ROMs supplied with this device should not be played back on audio CD equipment. Playing CD-ROMs on an audio CD player could cause hearing loss or damage the equipment.

Observe caution when using the flash

Using the flash close to your subject's eyes could cause temporary visual impairment. Particular care should be observed if photographing infants, when the flash should be no less than one meter (3 ft. 4 in.) from the subject.

Do not operate the flash with the flash window touching a person or object

Failure to observe this precaution could result in burns or fire.

Do not apply pressure to the monitor

Should the monitor break, care should be taken to avoid injury caused by broken glass.

Turn the power off when using inside an airplane or the hospital

Turn the power off while inside the airplane during take off or landing. Follow the instructions of the hospital when using while in a hospital. The electromagnetic waves given out by this camera may disrupt the electronic systems of the airplane or the instruments of the hospital.

Notices

Notice for Customers in the U.S.A.

Federal Communications Commission (FCC) Radio Frequency Interference Statement

This equipment has been tested and found to comply with the limits for a Class B digital device, pursuant to Part 15 of the FCC rules. These limits are designed to provide reasonable protection against harmful interference in a residential installation. This equipment generates, uses, and can radiate radio frequency energy and, if not installed and used in accordance with the instructions, may cause harmful interference to radio communications. However, there is no guarantee that interference will not occur in a particular installation. If this equipment does cause harmful interference to radio or television reception, which can be determined by turning the equipment off and on, the user is encouraged to try to correct the interference by one or more of the following measures:

- Reorient or relocate the receiving antenna.
- Increase the separation between the equipment and receiver.
- Connect the equipment into an outlet on a circuit different from that to which the receiver is connected.
- Consult the dealer or an experienced radio/television technician for help.



Nikon
COOLPIX S70

CAUTIONS

Modifications

The FCC requires the user to be notified that any changes or modifications made to this device that are not expressly approved by Nikon Corporation may void the user's authority to operate the equipment.

Interface Cables

Use the interface cables sold or provided by Nikon for your equipment. Using other interface cables may exceed the limits of Class B Part 15 of the FCC rules.

Notice for customers in the State of California

WARNING

Handling the cord on this product will expose you to lead, a chemical known to the State of California to cause birth defects or other reproductive harm.

Wash hands after handling.

Nikon Inc.,
1300 Walt Whitman Road
Melville, New York 11747-3064
USA
Tel: 631-547-4200

Notice for customers in Canada

CAUTION

This Class B digital apparatus complies with Canadian ICES-003.

ATTENTION

Cet appareil numérique de la classe B est conforme à la norme NMB-003 du Canada.

Notice for customers in Europe

This symbol indicates that this product is to be collected separately.



The following apply only to users in European countries:

- This product is designated for separate collection at an appropriate collection point. Do not dispose of as household waste.
- For more information, contact the retailer or the local authorities in charge of waste management.

This symbol on the battery indicates that the battery is to be collected separately.



The following apply only to users in European countries:

- All batteries, whether marked with this symbol or not, are designated for separate collection at an appropriate collection point. Do not dispose of as household waste.
- For more information, contact the retailer or the local authorities in charge of waste management.

Table of Contents

















| | |
|---|----|
| For Your Safety | ii |
| WARNINGS | ii |
| Notices | v |
| Introduction | 1 |
| About This Manual | 1 |
| Information and Precautions | 2 |
| Parts of the Camera | 4 |
| The Camera Body | 4 |
| Basic Operations of the Shutter-Release Button | 4 |
| Attaching the Camera Strap | 5 |
| Operating the Touch Panel | 6 |
| Tapping | 6 |
| Dragging | 6 |
| Spreading/pinching | 7 |
| Main Display of the Monitor/Touch Panel and Basic Operations | 8 |
| Information and Controls Display | 8 |
| Shooting (Operation Controls) | 10 |
| Shooting (Other Indicators) | 11 |
| Playback (Operation Controls) | 12 |
| Playback (Information Display) | 13 |
| HOME Screen Controls | 14 |
| Setup Menu | 15 |
| Help Display | 15 |
| First Steps | 16 |
| Inserting the Battery | 16 |
| Removing the Battery | 17 |
| Charging the Battery | 18 |
| Turning On and Off the Camera | 21 |
| Setting Display Language, Date and Time | 22 |
| Inserting Memory Cards | 24 |
| Removing Memory Cards | 24 |
|  Basic Photography and Playback: Easy Auto Mode | 26 |
| Step 1 Turn the Camera On and Select  Easy Auto Mode | 26 |
| Indicators Displayed in  (Easy Auto) Mode | 27 |
| Step 2 Frame a Picture | 28 |
| Using the Zoom | 29 |
| Step 3 Focus and Shoot | 30 |
| Step 4 Playing Back and Deleting Pictures | 32 |
| Playing Back Pictures (Playback Mode) | 32 |
| Deleting Pictures | 32 |
| Easy Auto Mode | 34 |

Table of Contents

| | |
|--|-----------|
| More on Shooting | 35 |
| Selecting a Shooting Mode | 35 |
| Shooting in  (Auto) Mode | 37 |
| Shooting Suited to Scenes | 38 |
| Selecting a Scene Mode | 38 |
| Features | 39 |
| Using the Draw Option | 45 |
| Shooting for a Panorama | 46 |
| Adjusting the Camera Settings in Shooting Mode | 48 |
| Setting Options | 48 |
| Camera Settings that Can Be Adjusted in Each Shooting Mode | 49 |
| Adjusting Shooting Settings | 50 |
|  Tapping the Monitor to Release the Shutter (Touch Shutter) | 51 |
|  Tapping the Monitor to Focus (Touch AF/AE) | 53 |
|  Focusing on a Moving Subject (Subject Tracking) | 56 |
|  Taking Pictures with the Self-timer | 58 |
|  Automatic Shooting of a Smiling Face (Smile Timer) | 60 |
|  Using the Flash | 62 |
|  Image Mode (Image Quality/Image Size) | 64 |
|  Changing Brightness Using Exposure Compensation | 66 |
|  Macro Mode Setting | 67 |
|  Continuous | 68 |
|  WB White Balance | 70 |
|  ISO ISO Sensitivity | 73 |
|  DATE Imprinting Time and Date (Date Imprint) | 74 |
| Camera Settings That cannot be Applied Simultaneously | 75 |
| More on Playback | 77 |
| Selecting Playback Mode | 77 |
| Sorting Favorite Pictures (Favorite Pictures Mode) | 78 |
| Preparing an Album (Assigning an Icon) | 79 |
| Adding Pictures to Albums | 80 |
| Viewing Pictures in an Album | 81 |
| Removing Pictures from Albums | 82 |
| Operations in Favorite Pictures Mode | 82 |
| Finding Pictures in Auto Sort Mode | 84 |
| Viewing Pictures in Auto Sort Mode | 84 |
| Operations in Auto Sort Mode | 86 |
| Playing Back Pictures Taken on a Same Day (List by Date Mode) | 87 |
| Selecting a Date in List by Date Mode | 87 |
| Operations in List by Date Mode | 88 |
| Operations in Full-frame Playback Mode | 89 |
| Taking a Closer Look: Playback Zoom | 91 |
| Viewing Multiple Pictures: Thumbnail Playback | 93 |













| | |
|--|------------|
| Deleting Multiple Pictures | 95 |
| Deleting Pictures by Album, Category, or Shooting Date | 96 |
| Playback Options | 97 |
| Setting Options | 97 |
| Enjoying Slide Shows | 98 |
| Protecting Important Pictures (Protect) | 99 |
| Protecting One Picture | 99 |
| Protecting Multiple Pictures | 100 |
| Creating a DPOF Print Order: Print Set | 101 |
| Creating a Print Order for One Picture | 101 |
| Creating a Print Order for Multiple Pictures | 102 |
| Creating a Print Order by Album, Category, or Shooting Date | 104 |
| Rotate Image | 106 |
| Voice Memos: Recording and Playback | 107 |
| Recording Voice Memos | 107 |
| Playing Voice Memos | 108 |
| Deleting Voice Memos | 108 |
| <hr/> | |
| Editing Pictures | 109 |
| Editing Functions | 109 |
| Picture Editing | 111 |
|  Paint Pictures: Paint | 111 |
|  Enhancing Contrast and Saturation: Quick Retouch | 114 |
|  Enhancing Brightness and Contrast: D-Lighting | 115 |
|  Modifying Color Tones: Color Options | 116 |
|  Resizing Pictures: Small Picture | 117 |
|  Stretching Pictures: Stretch | 118 |
|  Adjust a Sense of Perspective: Perspective Control | 119 |
|  Softening Skin Tones: Skin Softening | 120 |
|  Creating a Cropped Copy: Crop | 121 |
| <hr/> | |
| Movies | 122 |
| Recording Movies | 122 |
| Movie Recording Settings | 123 |
|  Selecting Movie Options | 123 |
|  Autofocus Mode | 124 |
|  Macro Mode Setting | 124 |
| Movie Playback | 125 |
| Deleting Movie Files | 125 |
| <hr/> | |
| Connecting to Televisions, Computers and Printers | 126 |
| Connecting to a TV | 126 |

Table of Contents

| | |
|---|------------|
| Connecting to a Computer | 127 |
| Before Connecting the Camera..... | 127 |
| Transferring Pictures from the Camera to a Computer | 128 |
| Charging While Connecting to a Computer | 131 |
| Connecting to a Printer | 132 |
| Connecting the Camera to a Printer..... | 133 |
| Printing Pictures One at a Time..... | 135 |
| Printing Multiple Pictures | 136 |
| <hr/> | |
| Setup Menu | 139 |
| Basic Camera Setup: The Setup Menu | 139 |
| Operating the Setup Menu | 140 |
| HOME Display | 141 |
| Welcome Screen | 142 |
| Date..... | 143 |
| Monitor Settings..... | 146 |
| Date Imprint | 146 |
| Vibration Reduction | 147 |
| AF Assist..... | 148 |
| Digital Zoom | 148 |
| Sound Settings..... | 149 |
| Auto Off | 149 |
| Format Memory/Format Card..... | 150 |
| Language..... | 151 |
| Video Mode | 151 |
| Charge by Computer..... | 152 |
| Blink Warning | 153 |
| Reset All | 154 |
| Copy..... | 156 |
| Firmware Version | 157 |
| <hr/> | |
| Technical Notes | 158 |
| Optional Accessories | 158 |
| Approved Memory Cards | 158 |
| Image/Sound File and Folder Names | 159 |
| Caring for the Camera | 160 |
| Cleaning | 162 |
| Storage..... | 162 |
| Error Messages | 163 |
| Troubleshooting | 167 |
| Specifications | 173 |
| Supported Standards | 176 |
| Index | 177 |

About This Manual

Thank you for your purchase of a Nikon COOLPIX S70 digital camera. This manual was written to help you enjoy taking pictures with your Nikon digital camera. Read this manual thoroughly before use, and keep it where all those who use the product will read it.

Symbols and Conventions

To make it easier to find the information you need, the following symbols and conventions are used:



This icon marks cautions, information that should be read before use, to prevent damage to the camera.



This icon marks tips, additional information that may be helpful when using the camera.



This icon marks notes, information that should be read before using the camera.



This icon indicates that more information is available elsewhere in this manual.

Notations

- A Secure Digital (SD) memory card is referred to as a “memory card.”
- The setting at the time of purchase is referred to as the “default setting.”
- The names of menu items displayed in the camera monitor, and the names of buttons or messages displayed on a computer monitor appear in bold.

Screen Samples

In this manual, images are sometimes omitted from monitor display samples so that monitor indicators can be more clearly shown.

Illustrations and Screen Display

Illustrations and text displays shown in this manual may differ from actual display.

Internal Memory and Memory Cards

Pictures taken with this camera can be stored in the camera’s internal memory or on removable memory cards. If a memory card is inserted, all new pictures will be stored on the memory card and delete, playback and format operations will apply only to the pictures on the memory card. The memory card must be removed before the internal memory can be formatted or accessed for picture storage, deletion, or viewing.

Information and Precautions

Life-Long Learning

As part of Nikon's "Life-Long Learning" commitment to ongoing product support and education, continually updated information is available online at the following sites:

- For users in the U.S.A.: <http://www.nikonusa.com/>
- For users in Europe and Africa: <http://www.europe-nikon.com/support/>
- For users in Asia, Oceania, and the Middle East: <http://www.nikon-asia.com/>

Visit these sites to keep up-to-date with the latest product information, tips, answers to frequently asked questions (FAQs), and general advice on digital imaging and photography. Additional information may be available from the Nikon representative in your area. Visit the site below for contact information.

URL below for contact information:

<http://imaging.nikon.com/>

Use Only Nikon Brand Electronic Accessories

Nikon COOLPIX cameras are designed to the highest standards and include complex electronic circuitry. Only Nikon brand electronic accessories (including battery charger, batteries, Charging AC Adapter and AC adapters) certified by Nikon specifically for use with this Nikon digital camera are engineered and proven to operate within the operational and safety requirements of this electronic circuitry.

THE USE OF NON-NIKON ELECTRONIC ACCESSORIES COULD DAMAGE THE CAMERA AND MAY VOID YOUR NIKON WARRANTY.

The use of third-party rechargeable Li-ion batteries not bearing the Nikon holographic seal could interfere with normal operation of the camera or result in the batteries overheating, igniting, rupturing, or leaking.

For more information about Nikon brand accessories, contact a local authorized Nikon dealer.



Holographic seal:

Identifies this device as an authentic Nikon product.

Before Taking Important Pictures

Before taking pictures on important occasions (such as at weddings or before taking the camera on a trip), take a test shot to ensure that the camera is functioning normally. Nikon will not be held liable for damages or lost profits that may result from product malfunction.

About the Manuals

- No part of the manuals included with this product may be reproduced, transmitted, transcribed, stored in a retrieval system, or translated into any language in any form, by any means, without Nikon's prior written permission.
- Nikon reserves the right to change the specifications of the hardware and software described in these manuals at any time and without prior notice.
- Nikon will not be held liable for any damages resulting from the use of this product.
- While every effort was made to ensure that the information in these manuals is accurate and complete, we would appreciate it were you to bring any errors or omissions to the attention of the Nikon representative in your area (address provided separately).

Notice Concerning Prohibition of Copying or Reproduction

Note that simply being in possession of material that was digitally copied or reproduced by means of a scanner, digital camera or other device may be punishable by law.

- **Items prohibited by law from being copied or reproduced**

Do not copy or reproduce paper money, coins, securities, government bonds or local government bonds, even if such copies or reproductions are stamped "Sample." The copying or reproduction of paper money, coins, or securities which are circulated in a foreign country is prohibited. Unless the prior permission of the government was obtained, the copying or reproduction of unused postage stamps or post cards issued by the government is prohibited. The copying or reproduction of stamps issued by the government and of certified documents stipulated by law is prohibited.

- **Cautions on certain copies and reproductions**

The government has issued cautions on copies or reproductions of securities issued by private companies (shares, bills, checks, gift certificates, etc.), commuter passes or coupon tickets, except when a minimum of necessary copies are to be provided for business use by a company. Also, do not copy or reproduce passports issued by the government, licenses issued by public agencies and private groups, ID cards and tickets, such as passes and meal coupons.

- **Comply with copyright notices**

The copying or reproduction of copyrighted creative works such as books, music, paintings, woodcut prints, maps, drawings, movies and photographs is governed by national and international copyright laws. Do not use this product for the purpose of making illegal copies or to infringe copyright laws.

Disposing of Data Storage Devices

Please note that deleting images or formatting data storage devices such as memory cards or built-in camera memory does not completely erase the original image data. Deleted files can sometimes be recovered from discarded storage devices using commercially available software, potentially resulting in the malicious use of personal image data. Ensuring the privacy of such data is the user's responsibility.

Before discarding a data storage device or transferring ownership to another person, erase all data using commercial deletion software, or format the device and then completely refill it with images containing no private information (for example, pictures of empty sky). Be sure to also replace any pictures selected for the **Photograph** option in the **HOME display** setting (📖 141) or the **Select an image** option in the **Welcome screen** setting (📖 142). Care should be taken to avoid injury or damage to property when physically destroying data storage devices.

Parts of the Camera

The Camera Body

Introduction

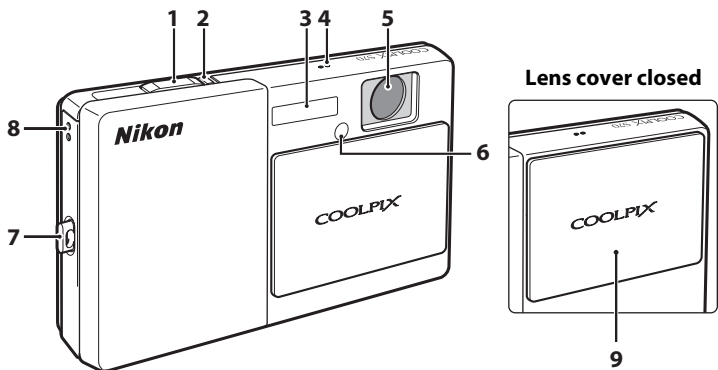

| | | | |
|--------------------------------------|------------------|--|---------|
| 1 Shutter-release button..... | 30 | 6 Self-timer lamp..... | 58, 60 |
| 2 Power-on lamp..... | 19, 21, 131, 149 | 7 AF-assist illuminator..... | 31, 148 |
| 3 Built-in flash..... | 62 | 8 Eyelet for camera strap..... | 5 |
| 4 Microphone..... | 107, 122 | 9 Slide cover (power switch)..... | 21 |
| 5 Lens..... | 162, 173 | | |

Basic Operations of the Shutter-Release Button

The camera features a two-stage shutter-release button. To set focus and exposure, press the shutter-release button halfway, stopping when you feel resistance. Focus and exposure lock while the shutter-release button is held in this position. To release the shutter and take a picture, press the shutter-release button the rest of the way down. Do not use force when pressing the shutter-release button, as this may result in camera shake and blurred pictures.



Press the shutter-release button halfway to set focus and exposure.

Press the shutter-release button the rest of the way down to take a picture.

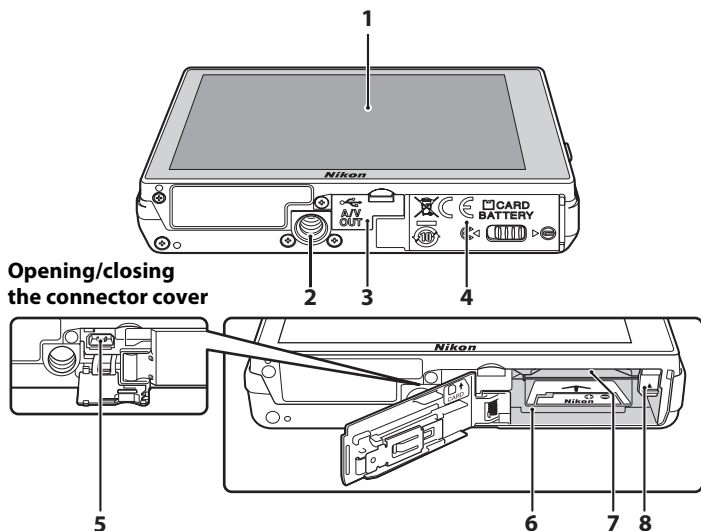

Opening/closing the connector cover

| | |
|----------|---|
| 1 | OLED monitor (monitor)*/ touch panel.....6, 8 |
| 2 | Tripod socket |
| 3 | Connector cover18, 126, 128, 133 |
| 4 | Battery-chamber/ memory card slot cover.....16, 24 |

| | |
|----------|---------------------------------------|
| 5 | Cable connector.....18, 126, 128, 133 |
| 6 | Battery chamber16 |
| 7 | Memory card slot.....24 |
| 8 | Battery latch16, 17 |

* Referred to simply as the “monitor” in this manual.

Attaching the Camera Strap

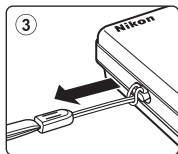
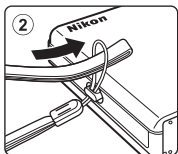
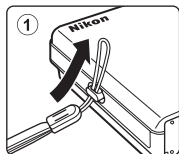

Operating the Touch Panel

The monitor on the COOLPIX S70 is a touch panel display operated by touch. Use the method described below.

Introduction

Tapping

Tap the touch panel.

Use this operation to select a control or picture.

The shutter can also be released by tapping the monitor (📖 51).

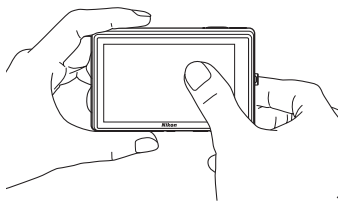

Dragging

Drag your finger across the touch panel.

Use this operation to view the previous or subsequent picture during playback.

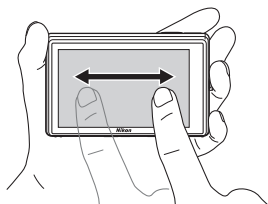

Use two fingers to forward or backward pictures more rapidly.

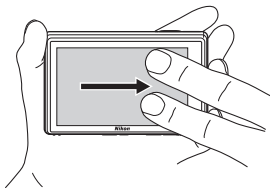

Spreading/pinching

Spread two fingers apart/pinch two fingers together

Place two fingers on the monitor and spread them apart to zoom in on a picture (📖 91) in playback mode. Pinch two fingers together to zoom out or to display picture thumbnails (📖 93).

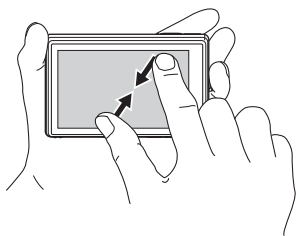
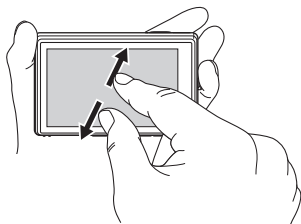

✔ Notes on the Touch Panel

- This camera utilizes a static touch panel. Therefore, it may not respond when touched with fingernails or gloved fingers.
- Do not press on the touch panel with pointed objects.
- Do not apply unnecessary pressure to the touch panel.
- The touch panel may not respond to touch if a commercially available protecting film is applied.

📌 Auto Monitor Boost

The camera automatically increases monitor brightness outdoors and under extremely bright lighting to make the monitor display easier to see and read (when **Brightness** (📖 146) in the setup menu (📖 139) is set to **4** or less).

Main Display of the Monitor/Touch Panel and Basic Operations

Information and Controls Display

Tap **INFO** to toggle the information display setting in the following order.

Shooting

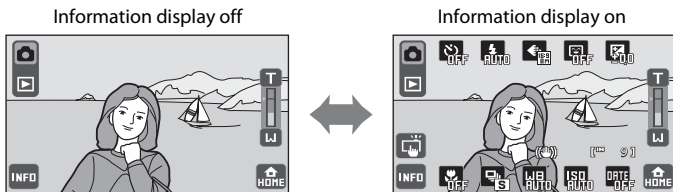

Shooting information such as the number of exposures remaining and operation controls are displayed.

Playback

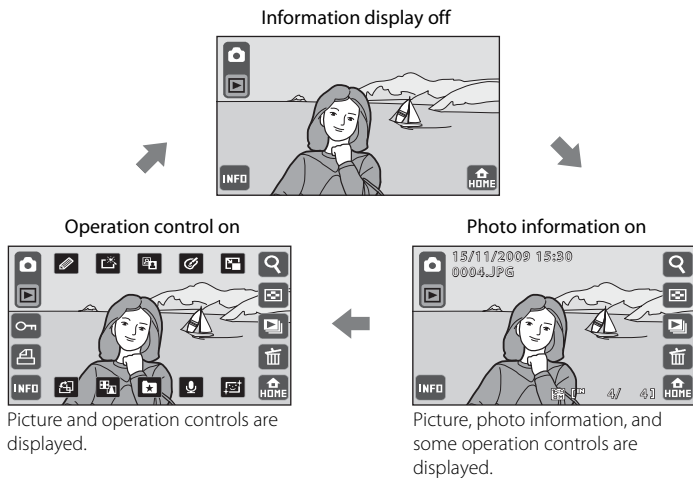

Shooting (Operation Controls)

Tap the following controls to change settings.

- The controls available and the setting status displayed vary depending upon the information display setting (📖 8), shooting mode, and the current camera settings.

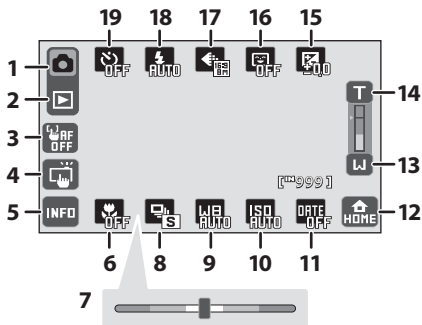

| | |
|---|---|
| <p>1 Shooting mode.....26, 37, 38, 60, 122</p> <p>2 Switch to playback mode..... 32</p> <p>3 Touch AF/AE cancellation 53</p> <p>4 Touch shutter 51 Touch AF/AE 53 Subject tracking 56</p> <p>5 Information display setting.....8</p> <p>6 Macro mode*67</p> <p>7 Scene effect adjustment slider 39</p> <p>8 Continuous shooting mode, BSS* 68</p> <p>9 White balance mode* 70</p> | <p>10 ISO sensitivity*63, 73</p> <p>11 Date imprint*74</p> <p>12 Switch to the HOME screen..... 14</p> <p>13 Wide zoom29</p> <p>14 Tele zoom29</p> <p>15 Exposure compensation*66</p> <p>16 Smile timer*60</p> <p>17 Image mode*64 Movie options* 123</p> <p>18 Flash mode*62</p> <p>19 Self-timer*58</p> |
|---|---|

* The current camera setting is displayed at the bottom of a control.

Shooting (Other Indicators)

The following monitor display shows the focus area as well as the number of exposures remaining.

- The indicators displayed vary depending upon the information display setting (8), shooting mode, and the current camera settings.

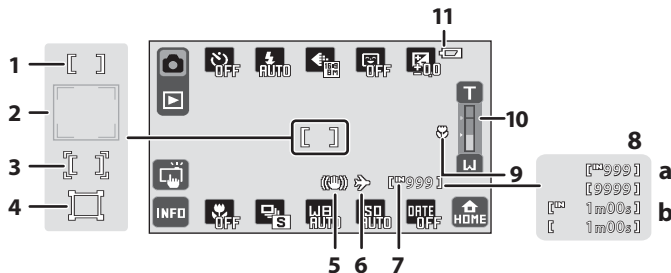

| | | |
|----------|-------------------------------------|-----|
| 1 | Focus area | 30 |
| 2 | Focus area (face priority) | 30 |
| 3 | Focus area (touch AF/AE) | 53 |
| 4 | Focus area (subject tracking) | 56 |
| 5 | Vibration reduction | 147 |
| 6 | Date not set | 163 |
| | Travel destination | 143 |

| | | |
|-----------|--|--------|
| 7 | Internal memory indicator | 27 |
| a | Number of exposures remaining (still pictures) | 27 |
| 8 | b Movie recording time remaining | 123 |
| 9 | Macro mode | 67 |
| 10 | Zoom indicator | 29, 67 |
| 11 | Battery level indicator | 26 |

Monitor Display in Portrait (“Tall”) Orientation

When the camera is held in portrait (“tall”) orientation, the controls and indicators are also displayed in portrait (“tall”) orientation. Controls and indicators may not be appropriately rotated when the camera is pointing up or down.

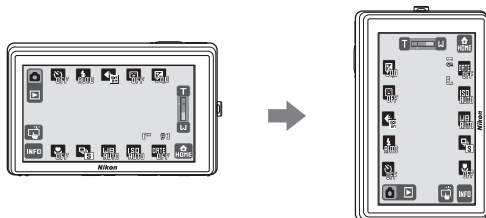

Playback (Operation Controls)

Tap the following controls to switch between monitor displays, or delete or edit pictures.

- The controls available displayed vary depending upon the information display setting (8), the displayed picture, and the current camera settings.

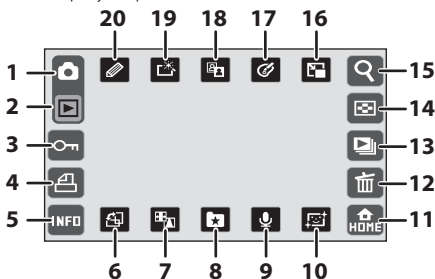

| | | | | | |
|----|--|--|----|--|-----------------------------------|
| 1 | | Switch to shooting mode26, 38, 122 | 11 | | Switch to the HOME screen..... 14 |
| 2 | | Playback mode32, 78, 84, 87 | 12 | | Delete32 |
| 3 | | Protect 99 | 13 | | Slide show98 |
| 4 | | Print-order101 | 14 | | Thumbnail display 93 |
| 5 | | Volume control.....98, 108, 125 | 15 | | Playback zoom91 |
| 6 | | Rotate image 106 | 16 | | Movie playback125 |
| 7 | | Stretch.....118 | 17 | | Small picture117 |
| 8 | | Perspective control.....119 | 18 | | Color options116 |
| 9 | | Add pictures to albums 80 | 19 | | D-Lighting.....115 |
| 10 | | Voice memo107 | 20 | | Quick retouch.....114 |
| | | Skin softening.....120 | | | Paint.....111 |

Playback (Information Display)

When **INFO** is tapped and the photo information is turned on (📖 9), the following information is displayed.

- The indicators displayed vary depending upon the displayed picture and the current camera settings.

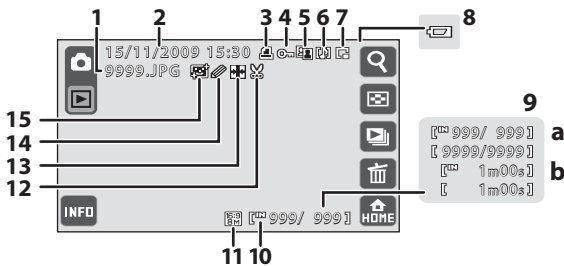

| | | | | | |
|----------|--------------------------------|-----|-----------|--|-----|
| 1 | File number and type | 159 | 9 | a Current frame number/ total number of frames | 32 |
| 2 | Date/time of recording..... | 22 | b | Movie length..... | 125 |
| 3 | Print-order icon | 101 | 10 | Internal memory indicator..... | 32 |
| 4 | Protect icon..... | 99 | | Image mode..... | 64 |
| 5 | Quick retouch icon | 114 | 11 | Movie options | 123 |
| 6 | D-Lighting icon..... | 115 | 12 | Crop icon | 121 |
| 7 | Color options icon | 116 | 13 | Stretch icon | 118 |
| 8 | Voice memo icon | 107 | 14 | Perspective control icon..... | 119 |
| | Small picture icon..... | 117 | 15 | Paint icon..... | 111 |
| | Battery level indicator* | 26 | | Skin softening icon..... | 120 |

* Displayed when the battery level is low, regardless of the photo information display setting.

Picture Display

When the camera is rotated, the picture and controls displayed are also rotated as indicated below.

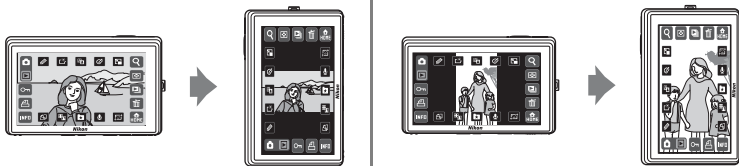

Pictures and controls may not be appropriately rotated when the camera is pointing up or down.

HOME Screen Controls

Tap  displayed at lower right corner in the monitor, in shooting or playback mode (📖 10, 12) to switch to the HOME screen.

Selecting shooting and playback modes are available, and the setup menu can be displayed from the HOME screen.

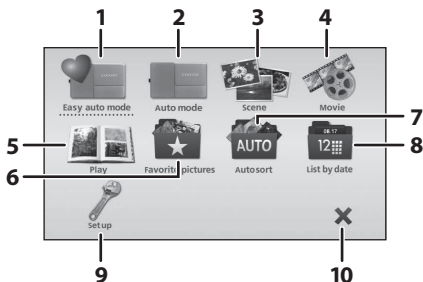

| | | | | | |
|----------|-------------------------------|-----|-----------|--|-----|
| 1 | Switch to easy auto mode..... | 26 | 6 | Switch to favorite pictures mode..... | 78 |
| 2 | Switch to auto mode..... | 37 | 7 | Switch to auto sort mode | 84 |
| 3 | Switch to scene mode | 38 | 8 | Switch to list by date mode..... | 87 |
| 4 | Switch to movie mode..... | 122 | 9 | Display the setup menu to adjust basic camera setup options..... | 139 |
| 5 | Switch to playback mode | 32 | 10 | Return to shooting or playback mode | |

HOME Screen Display Design

The display design for the HOME screen can be changed from the **HOME display** option (📖 141) in the setup menu (📖 139).

Setup Menu

Tap the **Set up** control in the HOME screen to display the setup menu screen. When the menu item is tapped in the setup menu screen, the setting screen for the selected menu item is displayed.

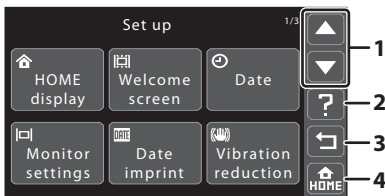

- 1 : Display the previous or subsequent page.
- 2 : Display the help selection screen. Tap a menu item to view a description of that feature.
- 3 : Return display to the previous screen.
- 4 : Exit the menu and return to the HOME screen.

Help Display

Tap to display a description of the feature to be applied or adjusted (help screen).

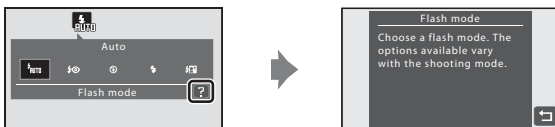

Tap to return to the previous screen.

- See "Selecting a Scene Mode" (📖 38) for more information on displaying descriptions of the features of each scene mode.
- See "Operating the Setup Menu" (📖 140) for more information on displaying the help screen for each setup menu item.

Inserting the Battery

Insert a Rechargeable Li-ion Battery EN-EL12 (supplied) into the camera.

- Charge the battery before the first use or when the battery is running low (📖 16).

1 Open the battery-chamber/memory card slot cover.

Slide the cover latch to  side (①) and open the cover (②).

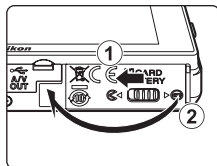

2 Insert the battery.

Confirm that the battery's positive (+) and negative (-) terminals are oriented correctly as shown on the label at the battery chamber opening, and insert the battery.

Use the battery to push the orange battery latch up (①) as the battery is inserted (②).

The battery latch will spring back into place when the battery is fully inserted.

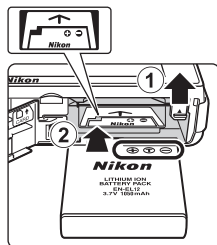

Inserting the Battery

Inserting the battery upside down or backwards

could damage the camera. Be sure to check that the battery is in the correct orientation.

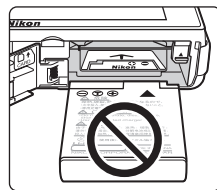

3 Close the battery-chamber/memory card slot cover.

Close the cover (①) and slide the cover latch (②) to  side.

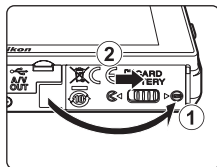

Removing the Battery

Close the slide cover to turn the camera off (📖 21) and be sure that the power-on lamp and the monitor have turned off before opening the battery-chamber/memory card slot cover.

To eject the battery, open the battery-chamber/memory card slot cover and slide the orange battery latch in the direction indicated by the arrow (①). The battery can then be removed by hand (②).

- Note that the battery may become hot during use; observe due caution when removing the battery.

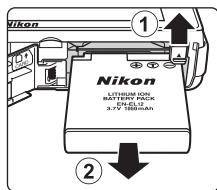

✓ Notes on the Battery

- Be sure to read and follow the warnings for the battery on page iii and the section, “The Battery” (📖 161), before use.
- If the battery will not be used for an extended period, recharge it at least once every six months and run it flat before returning it to storage.

Charging the Battery

Charge the supplied Rechargeable Li-ion Battery EN-EL12 inserted into the camera, by connecting the supplied Charging AC Adapter EH-68P to the camera via the supplied USB Cable UC-E6, and then plugging the Charging AC Adapter into an electrical outlet.

1 Prepare the Charging AC Adapter EH-68P.

If a plug adapter* is included, attach the plug adapter to the plug on the Charging AC Adapter. Push the plug adapter firmly until it is securely held in place. Once the two are connected, attempting to forcibly remove the plug adapter could damage the product.

* The shape of the plug adapter varies according to the country or region in which the camera was purchased.

For Customers in Argentina

If the camera was purchased in Argentina, the shape of the Charging AC Adapter EH-68P (AR) differs from that supplied in other countries, and a plug adapter is not included. Proceed to step 2.

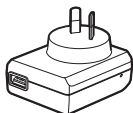
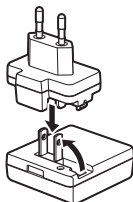
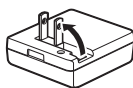

EH-68P (AR)

2 Be sure that the power-on lamp and the monitor are off.

Be sure to insert the battery into the camera (📖 16) and turn off the camera (📖 21).

3 Use the supplied USB cable to connect the Charging AC Adapter to the camera.

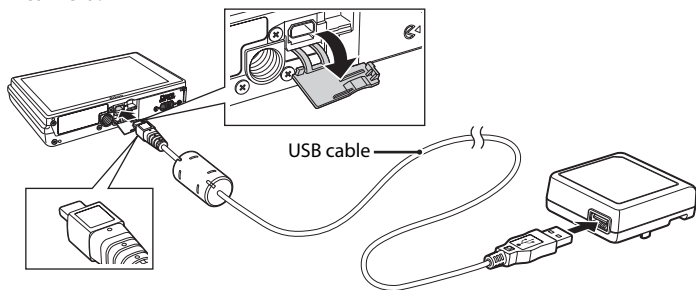

✓ Connecting the Cable

When connecting the cable, be sure that the connector is properly oriented. Do not use force when connecting the cable to the camera. When disconnecting the cable, do not pull the connector at an angle.

4 Plug the Charging AC Adapter into an electrical power outlet.

The power-on lamp slowly blinks orange to indicate that the battery is charging.

About four hours are required to charge a fully exhausted battery.

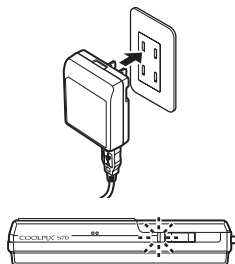

The following chart explains power-on lamp status when the camera is plugged into the electrical power outlet.

| Power-on lamp | Description |
|------------------------|---|
| Blinks slowly (orange) | Battery charging. |
| Off | Battery not charging. When charging is complete, the power-on lamp stops blinking orange and turns off. |
| Flickers (orange) | <ul style="list-style-type: none"> The ambient temperature is not suited to charging. Charge the battery indoors with an ambient temperature of 5 °C to 35 °C (41 °F to 95 °F). A USB cable is not correctly connected, nor is a Charging AC Adapter correctly plugged, or the battery is faulty. Disconnect the USB cable or unplug the Charging AC Adapter and correctly connect it again, or change the battery. |

5 Disconnect the Charging AC Adapter from the electrical outlet and then disconnect the USB cable.

Charging the Battery

Notes on Charging AC Adapter

- The Charging AC Adapter EH-68P is for use only with compatible devices. Do not use with another make or model of device.
- Be sure to read and follow the warnings for the Charging AC Adapter on page iii and the section, "The Battery" (📖 161), before use.
- The Charging AC Adapter EH-68P can be used with AC power sources of 50/60 Hz and 100-240 V. To use the charging AC adapter abroad, be sure to use a power adapter (available commercially) where necessary. Check beforehand with your travel agent regarding the necessity for power adapter plugs.
- The Charging AC Adapter EH-68P is for charging the battery inserted into the camera. When the Charging AC adapter is connected to the camera, the camera cannot be turned on.
- Do not, under any circumstances, use another make or model of AC adapter other than Charging AC Adapter EH-68P or USB-AC adapter. Failure to observe this precaution could result in overheating or in damage to the camera.

AC Power Source

- If the AC Adapter EH-62F (available separately; 📖 158) is used, power is supplied to the camera from an electrical outlet and taking pictures and playing back pictures are available with this camera.
- Do not, under any circumstances, use another make or model of AC adapter other than EH-62F. Failure to observe this precaution could result in overheating or in damage to the camera.

Charging Using Computer or Battery Charger

- Connecting the COOLPIX S70 to a computer also charges the Rechargeable Li-ion Battery EN-EL12 (📖 127, 131).
- Rechargeable Li-ion Battery EN-EL12 can also be charged using the Battery Charger MH-65 (available separately; 📖 158).

Turning On and Off the Camera

To turn on the camera, open the slide cover.

After the power-on lamp (green) lights for a moment, the monitor will turn on.

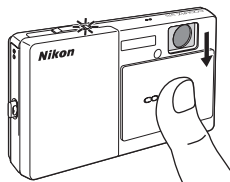

To turn off the camera, close the slide cover.

When the camera turns off, both the power-on lamp and monitor will turn off.

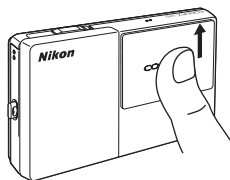

✔ Note on Opening the Slide Cover

Be sure to keep your fingers away from the lens when opening the slide cover.

🔍 Auto Power Off in Shooting Mode (Standby Mode)

If no operations are performed for about a minute (default setting), the monitor will turn off automatically and the camera will enter standby mode (the auto off function).

- Pressing the shutter-release button, while the monitor is off (the power-on lamp is blinking) in standby mode will reactivate the monitor.
- The time allowed to elapse before the camera enters standby mode can be changed from the **Auto off** option (📖 149) in the setup menu (📖 139).
- When the AC Adapter EH-62F (available separately, 📖 162) is connected, a screen saver function is activated to prevent screen burn when no operations are performed for about a minute (default setting, 📖 149).

Setting Display Language, Date and Time

A language-selection dialog is displayed the first time the camera is turned on.

1 Open the slide cover to turn on the camera.

The power-on lamp (green) will light for a moment and the monitor will turn on.

When the COOLPIX welcome screen is displayed, tap the monitor or press the shutter-release button.

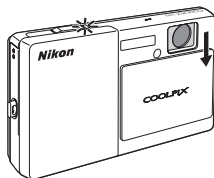

2 Tap the desired language.

If the desired language is not displayed, tap or to view other language options.

For more information about operating the touch panel, see "Operating the Touch Panel" (📖 6).



3 Tap Yes.

If **No** is tapped, the date and time will not be set.

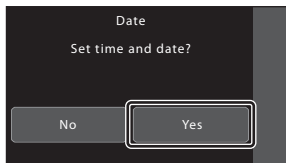

4 Tap or to select your home time zone (📖 145) and tap .

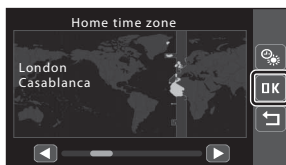

Daylight Saving Time

If daylight saving time is in effect, tap in the time zone selection screen displayed in step 4 to turn on the daylight saving time function.

When the daylight saving time function is enabled, is displayed at the top of the monitor.

To turn off the daylight saving time function, tap again.

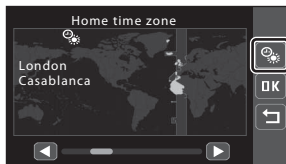

- 5** Tap ▲ or ▼ to choose the order in which the day, month and year are displayed.

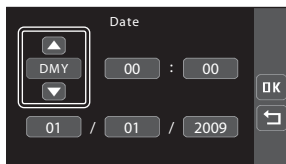

- 6** Edit the date and time.

Tap the desired item and ▲ or ▼ to edit the highlighted item.

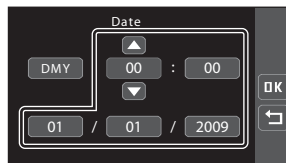

- 7** Tap OK.

The settings are applied and monitor display exits to shooting mode.

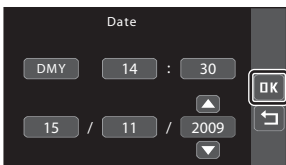

Changing the Date and Time

- Select **Date** from the **Date** item (📖 143) in the setup menu (📖 139) to change the current date and time and follow the procedure described from step 5.
- Select **Time zone** from the **Date** item (📖 143) in the setup menu to change the time zone and daylight saving time settings.

Inserting Memory Cards

Recorded data are stored in the camera's internal memory (approximately 20 MB) or on removable Secure Digital (SD) memory cards (available separately;  158).

If a memory card is inserted in the camera, data are automatically stored on the memory card and data recorded to the memory card can be played back, deleted or transferred. Remove the memory card to store data in the internal memory, or play back, delete or transfer data from the internal memory.

- 1 Be sure that the power-on lamp and the monitor are off and open the battery-chamber/memory card slot cover.

Be sure to turn off the camera before opening the battery-chamber/memory card slot cover.



- 2 Insert the memory card.

Slide the memory card in the correct orientation shown at right until it clicks into place.

Close the battery-chamber/memory card slot cover.

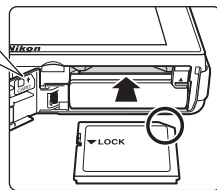

Inserting Memory Cards

Inserting the memory card upside down or backwards could damage the camera or the memory card. Be sure that the memory card is in the correct orientation.

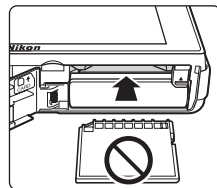

Removing Memory Cards

Before removing memory cards, close the slide cover to turn the camera off and be sure that the power-on lamp and monitor are off. Open the battery-chamber/memory card slot cover and press the card in (1) to partially eject the card. The card can then be removed by hand (2). Do not attempt to remove the card at an angle.

- Note that the memory card may become hot during use; observe due caution when removing the memory card.

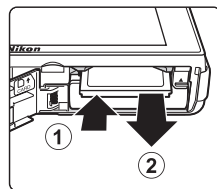

✓ Formatting Memory Cards

If the message at right is displayed when the camera is turned on, the memory card must be formatted before use (📖 150). Note that **formatting permanently deletes all pictures and other data on the memory card**. Be sure to make copies of any pictures you wish to keep before formatting the memory card.

Tap **Yes** to format. When the confirmation dialog is displayed, tap **Yes**. To start formatting, tap **OK**.

- Do not turn the camera off or open the battery-chamber/memory card slot cover until formatting is complete.
- Be sure to use this camera to format memory cards previously used in other devices the first time they are inserted into the COOLPIX S70 (📖 150).

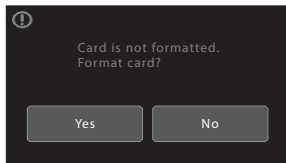

✓ The Write Protect Switch

Memory cards are equipped with a write protect switch. When this switch is in the “lock” position, data cannot be written to, or deleted from, the memory card. If the switch is in the “lock” position, unlock it by sliding the switch to the “write” position to record or delete pictures, or to format the memory card.

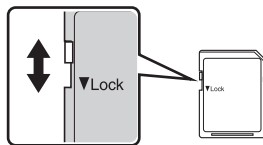

Write protect switch



✓ Memory Cards

- Use only Secure Digital memory cards.
- Do not perform the following during formatting, while data is being written to or deleted from the memory card, or during data transfer to a computer. Failure to observe this precaution could result in the loss of data or in damage to the camera or memory card:
 - Take out the battery or memory card
 - Turn off the camera
 - Disconnect the AC adapter
- Do not use a computer to format the memory card.
- Do not disassemble or modify.
- Do not drop, bend, or expose to water or strong physical shock.
- Do not touch the metal terminals with your fingers or metal objects.
- Do not affix labels or stickers to the memory card.
- Do not leave in direct sunlight, closed vehicles or areas exposed to high temperatures.
- Do not expose to humidity, dust, or corrosive gases.

Step 1 Turn the Camera On and Select Easy Auto Mode

In  (easy auto) mode, the camera automatically selects the optimum shooting mode by framing a picture, allowing you to easily take pictures using a shooting mode that suits the scene ( 34).

1 Open the slide cover to turn on the camera.

The power-on lamp (green) will light for a moment and the monitor will turn on.

 (easy auto) mode is initially activated at the time of purchase. Proceed to step 4.

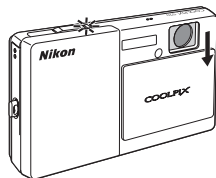

2 Tap the shooting mode control.

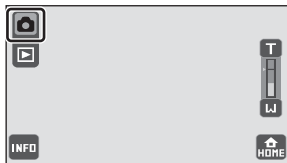

3 Tap .

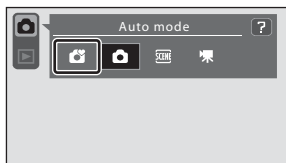

The camera enters  (easy auto) mode.

A shooting mode can also be selected from the HOME screen ( 14).



4 Check the battery level.



Battery Level

| Monitor | Description |
|---|---|
| NO INDICATOR | Battery fully charged. |
|  | Battery low. Prepare to charge or replace the battery. |
|  Battery exhausted. | Cannot take pictures. Recharge or replace with a fully charged battery. |

Battery level indicator



Indicators Displayed in (Easy Auto) Mode

To display the number of exposures remaining and shooting settings, tap  displayed at lower left in the monitor to turn on shooting information ( 8).

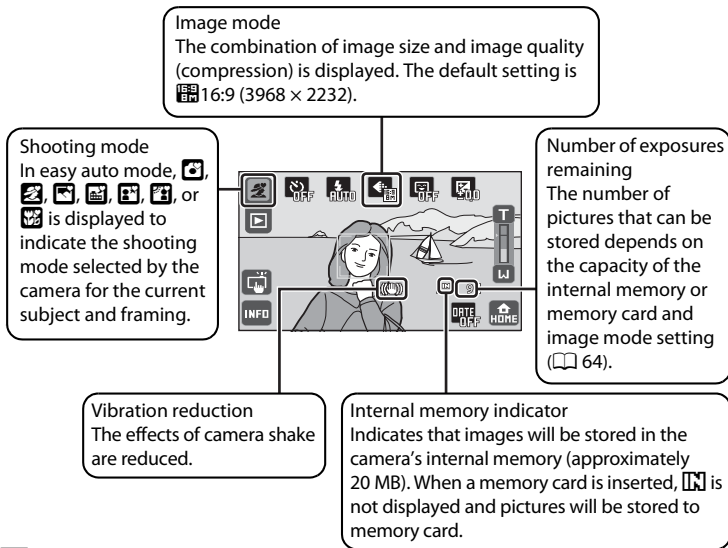



Note on Touch Shutter

At the default setting, the shutter can be released by simply tapping a subject in the monitor ( 51). Take care that you do not release the shutter accidentally.



Note on Printing Pictures

When printing pictures taken at an  **Image mode** setting of  **16:9 (3968)** (default setting), the edges of pictures may be cropped, preventing printing of complete pictures ( 132).

Functions Available in Easy Auto Mode

- When the camera is pointed at a human face, the face priority function which the camera automatically recognizes that face and focus on it, activates. See “Easy Auto Mode” ( 34) for more information.
- Shooting settings ( 48) can be changed when  is tapped to display the operation controls.

Vibration Reduction

- See “Vibration Reduction” ( 147) in the setup menu ( 139) for more information.
- Set **Vibration reduction** to **Off** when using a tripod to stabilize the camera during shooting.

Step 2 Frame a Picture

1 Ready the camera.

Hold the camera steadily in both hands, keeping your fingers and other objects away from the lens, flash, AF-assist illuminator, and microphone.

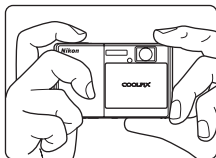

When taking pictures in portrait ("tall") orientation, turn the camera so that the built-in flash is above the lens.

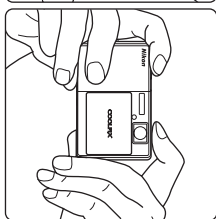

2 Frame the picture.

When the camera automatically selects the optimum scene mode, the shooting mode control will be changed (📖 34).

When the camera recognizes a human face, that face will be framed by a yellow double border (focus area).

Up to 12 faces can be recognized. If more than one face is recognized, the face closest to the camera will be framed by a double border, and the others by a single border.

When taking pictures of subjects other than people, or framing a subject with which no face is recognized, a focus area will not be displayed. Frame the picture so that the intended subject is at or near the center of the frame.

Shooting mode control



✓ Notes on Easy Auto Mode

- The desired scene mode may not be selected in certain condition. In this case, select another shooting mode.
- When digital zoom is in effect, shooting mode is 📷.

Using the Zoom

Tap **T** or **W** to activate optical zoom. Tap **T** to zoom in so that the subject fills a larger area of the frame, or **W** to zoom out, increasing the area visible in the frame.

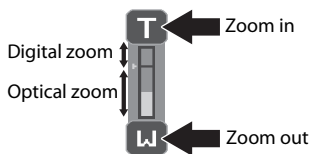

Digital Zoom

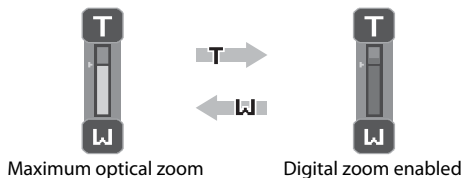

When the camera is zoomed in to the maximum optical zoom position, touching and holding **T** triggers digital zoom. The subject is magnified up to 4x the maximum optical zoom ratio.

The camera focuses at the center of the frame and the focus area is not displayed when digital zoom is in effect. The touch shutter (📖 51) and touch AF/AE (📖 53) functions are not available.



Digital Zoom and Interpolation

Unlike optical zoom, digital zoom uses a digital imaging process known as interpolation to magnify images, resulting in slight deterioration of picture quality.

Interpolation is applied at zoom positions beyond . When zoom is increased beyond the  position, interpolation is initiated and the zoom indicator turns yellow to indicate that interpolation is being applied. The position of  moves to the top as image size decreases, allowing for confirmation of the zoom positions at which shooting without interpolation is possible at the current image mode setting (📖 64).

Digital zoom can be disabled from the **Digital zoom** option (📖 148) in the setup menu (📖 139).

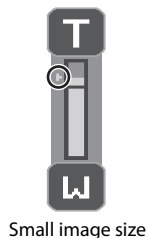

Step 3 Focus and Shoot

1 Press the shutter-release button halfway (📖 4).

Focus is locked when the shutter-release button is pressed halfway. When focus is locked, the active focus area turns green.

When a face is recognized:



Shutter speed Aperture

When digital zoom is used, the focus area is not displayed and the camera focuses at the center of the frame. Once focus has been acquired, the focus indicator will glow green.

When no face is recognized:



Focus indicator



The shutter speed and aperture value are displayed when the shutter-release button is pressed halfway.

The focus and exposure remain locked while the shutter-release button is pressed halfway.

When the camera detects subject movement or camera shake and increases shutter speed, the shutter speed indicator will turn green (Motion detection; 📖 34).

When the shutter-release button is pressed halfway, and then the focus area or the focus indicator may blink red, the camera is unable to focus. Modify the composition and press the shutter-release button halfway again.

2 Press the shutter-release button the rest of the way down.

The shutter is released and the picture will be recorded to the memory card or internal memory.



During Recording

While pictures are being recorded, the number of exposures remaining will blink. **Do not open the battery-chamber/memory card slot cover** while pictures are being recorded. Cutting power or removing the memory card in these circumstances could result in loss of data or in damage to the camera or card.

Autofocus

Autofocus may not perform as expected in the following situations. In some rare cases, the subject may not be in focus despite the fact that the focus area or the focus indicator glows green.

- Subject is very dark
- Objects of sharply differing brightness are included in the frame (e.g. the sun behind the subject makes that subject appear very dark)
- No contrast between the subject and surroundings (e.g. a portrait subject, wearing a white shirt, is standing in front a white wall)
- Several objects are at different distances from the camera (e.g. the subject is inside a cage)
- Subject is moving rapidly

In the situations noted above, try pressing the shutter-release button halfway to refocus several times, or focus on another subject (📖 55). When focusing on another subject, be sure that the alternate subject is at the same distance from the camera as the intended subject while the shutter-release button is pressed halfway.

Note on Face Priority

See “Notes on Face Priority” (📖 34) for more information.

Touch Shutter

At the default setting, the shutter can be released by simply tapping a subject in the monitor (📖 51) rather than by pressing the shutter-release button. The **Touch shutter** option can be changed to the  **Touch AF/AE** option, with which the camera locks focus and exposure without releasing the shutter, when a subject is tapped (📖 53).

AF-assist Illuminator and Flash

If the subject is poorly lit, the AF-assist illuminator (📖 148) may light when the shutter-release button is pressed halfway, or the flash (📖 62) may fire when the shutter-release button is pressed all the way down.

Step 4 Playing Back and Deleting Pictures

Playing Back Pictures (Playback Mode)

Tap .

Shooting

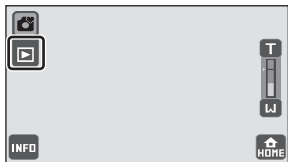





Playback



The last picture taken will be displayed in full-frame playback mode.

Drag the current picture to display previous or subsequent picture. Use two fingers to forward or backward pictures more rapidly.

Tap the shooting mode control  displayed at upper left in the monitor or press the shutter-release button to return to shooting mode.

Tap  displayed at lower left in the monitor to turn on photo information ( 9) and check picture file numbers.  is displayed when pictures stored in the camera's internal memory are played back.

When a memory card is inserted in the camera,  is not displayed and pictures stored on the memory card are played back.

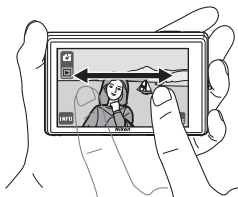

Internal memory indicator
File number/total number of frames

Deleting Pictures

1 Play back a picture to be deleted and tap  to display  at the right side of the monitor ( 9).



2 Tap .

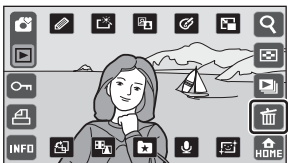

3 Tap Yes.

Note that deleted pictures cannot be recovered.

To exit without deleting the picture, tap **No**.

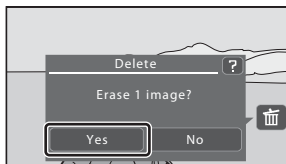
**Options Available in Playback Mode**

When is tapped in full-frame playback mode and photo information is turned on (9), the following operations are available using operation controls.

| Option | Tap | Description | |
|----------------------------------|-----------------------|---|----|
| Playback zoom | | Enlarge view of picture currently displayed in the monitor up to about 10x. Pictures can also be enlarged by placing two fingers on the picture currently displayed and spreading them apart. Tap to return to full-frame playback. | 91 |
| View thumbnails | | Display 6, 12, or 20 picture thumbnails. Picture thumbnails can also be displayed by placing two fingers on the picture currently displayed and pinching them together. | 93 |
| Play back pictures in slide show | | Play back pictures, stored in the internal memory or on a memory card, one by one. | 98 |
| Switch to shooting mode | Shooting mode control | Tap the shooting mode control displayed at upper left in the monitor (10). The shutter-release button can also be pressed to switch to shooting mode. | – |
| Switch to the HOME screen | | Shooting or playback mode can be selected and the setup menu can be displayed from the HOME screen. | 14 |

Viewing Pictures

- Pictures stored in the internal memory can only be viewed if no memory card is inserted.
- Pictures taken in portrait (“tall”) orientation will be rotated automatically (13). The rotating direction can be changed from the **Rotate image** option (106). When the camera is rotated, the picture displayed is also rotated (13).
- When the monitor has turned off in standby mode to save power, press the shutter-release button to reactivate it (149).







Deleting Multiple Pictures

- When is tapped in thumbnail playback mode, multiple pictures can be deleted (95).
- When is tapped in the album list in favorite pictures (81) or in the category list in auto sort (84) mode, all pictures added to a particular album or sorted to a particular category can be deleted (96).
- When is tapped in the shooting date list screen in list by date mode (87), all pictures taken on a particular date can be deleted (96).



Easy Auto Mode

Automatic Scene Selection

The camera automatically selects one of the following scenes when pointing the camera at a subject.

-  Auto mode (general use)
-  Portrait (📖 39)
-  Landscape (📖 40)
-  Night landscape (📖 42)
-  Night portrait (📖 40)
-  Backlight (📖 44)
-  Close-up (📖 42)

Focusing in Easy Auto Mode

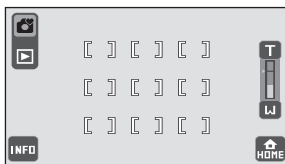

When the shutter-release button is pressed halfway while the shooting mode control  or  is displayed, the camera automatically selects the focus area (one of nine) containing the subject closest to the camera.



Notes on Face Priority





- The camera may be unable to recognize faces in the following situations:
 - When faces are partially hidden by sunglasses or other obstructions
 - When faces take up too much or too little of the frame
- When the frame includes more than one face, the faces recognized by the camera and the face on which the camera focuses depend upon a variety of factors, including the direction in which the faces are looking.
- In some cases, including those noted in "Autofocus" (📖 31), autofocus may not perform as expected, and the subject may not be in focus despite the fact that the double border glows green. Should this occur, refocus on another subject positioned at the same distance from the camera as the actual portrait subject (📖 55).

Motion Detection

In  (easy auto) mode or  (auto) mode, when the camera detects subject movement or camera shake, ISO sensitivity and shutter speed is increased to reduce blurring. In this case, the shutter speed indicator will turn green.

- Motion detection may be unable to completely eliminate the effects of subject movement and camera shake in some situations.
- Motion detection may not function if the subject exhibits significant movement or is too dark.
- The pictures taken using motion detection may be somewhat "grainy" in appearance.

Selecting a Shooting Mode



Select a shooting mode from  (easy auto),  (auto),  (scene), and  (movie) modes.

1 Tap the shooting mode control in shooting mode.

The shooting mode selection controls are displayed.



2 Tap the desired shooting mode control.

Tap  (scene) to display scene selection controls. Tap the desired scene control ( 38).

The selected shooting mode is enabled and the monitor display returns to shooting mode.

When the shooting mode control displayed at upper left in the monitor is tapped or the shutter-release button is pressed with the shooting mode selection controls displayed, monitor display returns to shooting mode without switching shooting modes.

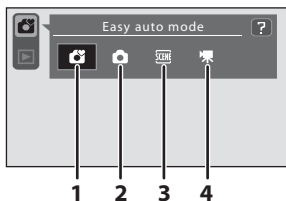

1 Easy auto mode 26

By simply framing a picture, the camera automatically selects the optimum shooting mode.

2 Auto mode 37

Pictures can be taken with your own shooting settings such as flash mode or macro mode setting. The continuous setting and the subject tracking option with which a focus area follows the selected subject can also be applied.

3 Scene mode 38

Camera settings are automatically optimized for the selected scene.

4 Movie mode 122

Shoot movies with sound recorded via the built-in microphone.

Selecting a Shooting Mode

Selecting a Shooting Mode from the HOME Screen

A different shooting mode can also be selected from the HOME screen (📖 14). Tap  , displayed at lower right in the monitor in shooting and playback modes, to display the HOME screen.

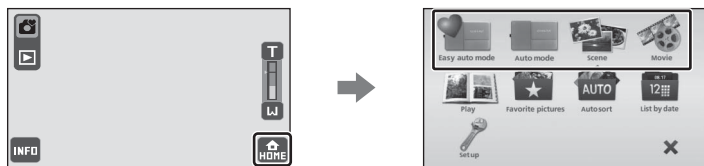



Adjusting Shooting Settings

When  is tapped in shooting mode, operation controls are displayed and shooting settings can be adjusted. The settings that can be adjusted vary by shooting mode (📖 49).

Shooting in (Auto) Mode

Shooting settings such as flash mode and macro mode can be changed or applied. The **Continuous** setting and the **Subject tracking** option, with which the active focus area follows the selected subject, can also be applied.

- 1 Tap the shooting mode control in shooting mode to display the shooting mode selection controls, and then tap .

The camera enters  (auto) mode. A shooting mode can also be selected from the HOME screen ( 14).

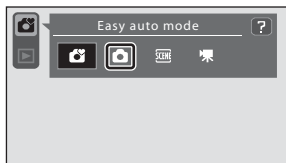

- 2 Tap  to display the operation controls.

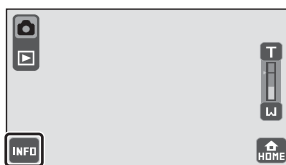

- 3 Check or adjust the setting.

Tap an operation control to adjust the setting. See "Adjusting the Camera Settings in Shooting Mode" ( 48) for more information.



- 4 Frame the subject and take a picture.

When the camera recognizes a face, a yellow double border (focus area) is displayed around that face. When the shutter-release button is pressed halfway, the camera focuses on that face framed by a double border ( 28, 34).

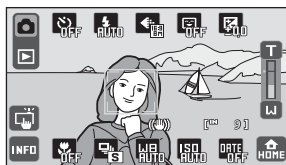

When taking pictures of subjects other than people, or framing a subject with which no face is recognized, the camera selects the focus area (one of nine) containing the subject closest to the camera ( 34) by pressing the shutter-release button halfway.

A picture is taken when the shutter-release button is pressed all the way down.

At the default setting, the shutter can be released by simply tapping a subject in the monitor ( 51) rather than by pressing the shutter-release button. The **Touch shutter** option can be changed to the  **Touch AF/AE** option, with which the camera locks focus and exposure without releasing the shutter, when a subject is tapped ( 53).

More Information

See "Autofocus" ( 31) and "Notes on Face Priority" ( 34) for more information.

Shooting Suited to Scenes

Camera settings are automatically optimized for the selected subject type. The following scene modes are available.

| | | | | |
|------------|-----------------|----------------|-----------------|--------------|
| Portrait | Landscape | Sports | Night portrait | Party/indoor |
| Beach/snow | Sunset | Dusk/dawn | Night landscape | Close-up |
| Food | Museum | Fireworks show | Copy | Draw |
| Backlight | Panorama assist | | | |

Selecting a Scene Mode

- 1 Tap the shooting mode control in shooting mode to display the shooting mode selection controls, and then tap .

The scene selection controls will be displayed. A shooting mode can also be selected from the HOME screen (📖 14).

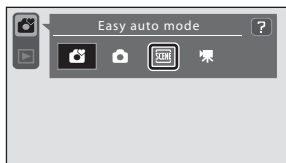

- 2 Tap the desired scene control.

See "Features" (📖 39) for more information.

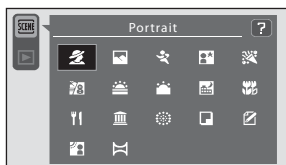

- 3 Frame the subject and take a picture.

A scene effect adjustment slider is displayed in some scene modes when the information display is enabled by tapping . The degree of effect applied to pictures taken in the selected scene mode can be adjusted (📖 39).

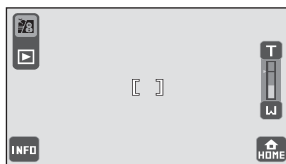

Tap to display the operation controls and adjust the shooting settings (📖 48).

Displaying the Help Screen in Scene Mode

When is tapped in step 2, the help selection screen is displayed. Tap a scene control to display a description of the features of that mode. Tap to return to the help selection screen.

- Tap in the help selection screen to return to the monitor display shown in step 2.

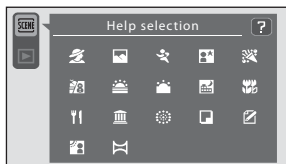

Adjusting Scene Effect

The scene effect adjustment slider is displayed in the scene modes listed below when the information display is enabled by tapping **INFO**. Tap the scene effect adjustment slider to adjust the degree of effect to be applied to pictures taken in the selected scene mode.



Scene effect adjustment slider

| | |
|--|---|
| Portrait, Night portrait, Beach/snow, Night landscape, Backlight | <p>Darker Brighter</p> |
| Food | <p>More blue More red</p> |
| Landscape, Close-up | <p>Less vivid More vivid</p> |
| Sunset, Dusk/dawn | <p>More blue More red</p> |

Features

Portrait



Use this mode for portraits.

- The camera detects and focuses on a face (📖 28, 34).
- If no faces are recognized, the camera focuses on the subject at the center of the frame by pressing the shutter-release button halfway.
- The camera smoothes skin tones (in up to three faces) by applying the skin softening function before recording pictures (📖 120).
- Digital zoom is not available.
- The default setting for flash mode is **Auto with red-eye reduction**.
- Use the scene effect adjustment slider (📖 39) to adjust picture brightness.



Landscape



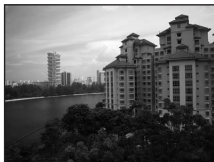

Use this mode for vivid landscapes and cityscapes.

- Camera focuses at infinity. The focus area or focus indicator () always glows green when the shutter-release button is pressed halfway. Note, however, that objects in the foreground may not always be in focus.
- The flash does not fire and the flash mode is disabled.
- The AF-assist illuminator does not light ( 148).
- Use the scene effect adjustment slider () to adjust picture saturation.



Sports

Use this mode for dynamic action shots that freeze the action in a single shot and record motion in a series of pictures.



- The camera focuses continuously until focus is locked by pressing the shutter-release button halfway.
- While the shutter-release button is held down, up to 6 pictures are taken at a rate of about 1 frame per second (fps) when image mode is set to  **16:9 (3968)**.
- The maximum frame rate with continuous shooting may vary depending upon the current image mode setting, the memory card used, or shooting condition.
- Continuous shooting is disabled and only one picture can be taken at a time when the shutter is released using the  **Touch shutter** function ( 51).
- The flash does not fire and the flash mode is disabled.
- The AF-assist illuminator does not light ( 148).



Night portrait



Use this mode for portraits taken at sunset or at night. The flash fires to light the portrait subject while preserving background lighting to achieve a natural balance between the main subject and background ambience.

- The camera detects and focuses on a face ( 28, 34).
- If no faces are recognized, the camera focuses on the subject at the center of the frame by pressing the shutter-release button halfway.
- The camera smooths skin tones (in up to three faces) by applying the skin softening function before recording pictures ( 120).
- Digital zoom is not available.
- The flash mode setting is fixed at fill flash with slow sync with red-eye reduction.
- Use the scene effect adjustment slider () to adjust picture brightness.





Use of a tripod is recommended in scene modes with which  is indicated. Set **Vibration reduction** () to **Off** when using a tripod to stabilize the camera.

Noise reduction is automatically performed in scene modes with which  is indicated. More time than usual is required to record pictures to which noise reduction is applied.

Party/indoor

Captures the effects of candlelight and other indoor background lighting.

- Camera focuses on the subject at the center of the frame.
- The default setting for flash mode is  **Auto with red-eye reduction**. The flash mode setting may automatically switch to slow sync with red-eye reduction.
- As pictures are easily affected by camera shake, hold the camera steadily. In dark surroundings, the use of a tripod is recommended. Set **Vibration reduction** ( 147) to **Off** when using a tripod to stabilize the camera.



Beach/snow

Captures the brightness of such subjects as snowfields, beaches, or sunlit expanses of water.



- Camera focuses on the subject at the center of the frame.
- Use the scene effect adjustment slider ( 39) to adjust picture brightness.



Sunset



Preserves the deep hues seen in sunsets and sunrises.



- Camera focuses on the subject at the center of the frame.
- The default setting for flash mode is  **Off**.
- Use the scene effect adjustment slider ( 39) to adjust picture color.



Dusk/dawn



Preserves the colors seen in the weak natural light before sunrise or after sunset.



- Camera focuses at infinity. The focus area or focus indicator ( 30) always glows green when the shutter-release button is pressed halfway. Note, however, that objects in the foreground may not always be in focus.
- The flash does not fire and the flash mode is disabled.
- The AF-assist illuminator does not light ( 148).
- Use the scene effect adjustment slider ( 39) to adjust picture color.



Night landscape









Slow shutter speeds are used to produce stunning night landscapes.

- Camera focuses at infinity. The focus area or focus indicator ( 30) always glows green when the shutter-release button is pressed halfway. Note, however, that objects in the foreground may not always be in focus.
- The flash does not fire and the flash mode is disabled.
- The AF-assist illuminator does not light ( 148).
- Use the scene effect adjustment slider ( 39) to adjust picture brightness.





Close-up

Photograph flowers, insects and other small objects at close range.

-  **Macro mode** ( 67) is enabled and the camera automatically zooms to the closest position at which it can focus.
- The camera can focus on the subject as close as 3 cm (1.2 in.) at the zoom position at which  and the zoom indicator glow green (the zoom indicator is positioned under ). The closest possible shooting distance may vary according to zoom position.
- Note that the flash may be unable to light entire subject at distances of less than 30 cm (1 ft.).
- The camera focuses continuously until focus is locked by pressing the shutter-release button halfway.
- As pictures are easily affected by camera shake, be sure that **Vibration reduction** ( 147) is enabled and hold the camera steadily.
- Use the scene effect adjustment slider ( 39) to adjust picture saturation.





Use of a tripod is recommended in scene modes with which  is indicated. Set **Vibration reduction** ( 147) to **Off** when using a tripod to stabilize the camera.

Noise reduction is automatically performed in scene modes with which  is indicated. More time than usual is required to record pictures to which noise reduction is applied.

🍴 Food

Useful when taking pictures of food.

- **Macro mode** (📖 67) is enabled and the camera automatically zooms to the closest position at which it can focus.
- The camera can focus on the subject as close as 3 cm (1.2 in.) at the zoom position at which  and the zoom indicator glow green (the zoom indicator is positioned under ). The closest possible shooting distance may vary according to zoom position.
- The flash does not fire and the flash mode is disabled.
- Use the scene effect adjustment slider to adjust the influence lighting has on the color of the subject (📖 39). Scene effect adjustments applied in **Food** scene mode are stored in the camera's memory even after the camera is turned off and reapplied the next time camera is turned on.



🏛️ Museum

Use indoors where flash photography is prohibited (for example, in museums and art galleries) or in other situations in which you do not want to use the flash.

- Camera focuses on the subject at the center of the frame.
- BSS (best shot selector) (📖 68) can be enabled when shooting.
- BSS is disabled and only one picture can be taken at a time when the shutter is released using the  **Touch shutter** function (📖 51).
- As pictures are easily affected by camera shake, be sure that **Vibration reduction** (📖 147) is enabled and hold the camera steadily.
- The flash does not fire and the flash mode is disabled.
- The AF-assist illuminator does not light (📖 148).



🎆 Fireworks show



Slow shutter speeds are used to capture the expanding burst of light from a firework.



- Camera focuses at infinity. The focus area or focus indicator (📖 30) always glows green when the shutter-release button is pressed halfway. Note, however, that objects in the foreground may not always be in focus.
- The flash does not fire and the flash mode is disabled.
- The AF-assist illuminator does not light (📖 148).



Shooting Suited to Scenes

Copy

Provides clear pictures of text or drawings on a white board or in print.

- Camera focuses on the subject at the center of the frame.
- Use macro mode ( 67) to focus at short ranges.
- Colored text and drawings may not show up well.
- The default setting for flash mode is  **Off**.





Draw

Write a memo or draw a picture on the touch panel display and save it as an image. See “Using the Draw Option” ( 45) for more information.

Backlight

Use when light is coming from behind the subject, throwing features or details into shadow. The flash fires automatically to “fill in” (illuminate) shadows.

- Camera focuses on the subject at the center of the frame.
- The flash mode setting is fixed at  **Fill flash**.
- Use the scene effect adjustment slider ( 39) to adjust picture brightness.



Panorama assist



Use when taking a series of pictures that will later be joined to form a single panorama using the supplied Panorama Maker software. See “Shooting for a Panorama” ( 46) for more information.

- The default setting for flash mode is  **Off**.

Using the Draw Option

Write a memo or draw a picture on the touch panel display and save it as an image. The image is saved at an image size setting of **TV screen** (640 × 480).

- 1 Tap the shooting mode control in shooting mode to display the shooting mode selection controls, and then tap **SCENE**.

The scene selection controls will be displayed.



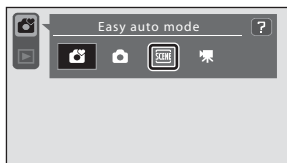

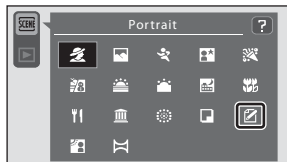

A shooting mode can also be selected from the HOME screen (📖 14).





- 2 Tap .



- 3 Write a memo or draw pictures.

Tap  to enlarge picture display by 3x, the optimum display size for writing memos and drawing pictures. Tap , , , or  to change the portion of the picture in the monitor. Tap  to return to the original display size.

Tap  (pen) to write text or draw pictures (📖 112), and tap  (eraser) to erase lines (📖 112).



- 4 Tap **OK**.

Tap **OK**, before tapping , to undo the last operation applied using the pen or erase tool (up to the last five operations can be undone).



- 5 Tap **Yes**.

The memo is saved.

To exit without saving the memo, tap **No**.



Shooting for a Panorama

The camera focuses on the subject at the center of the frame. Use a tripod for best results. Set **Vibration reduction** (📖 147) to **Off** from the setup menu (📖 139) when using a tripod to stabilize the camera.

- 1 Tap the shooting mode control in shooting mode to display the shooting mode selection controls, and then tap **SCENE**.

The scene selection controls will be displayed.

A shooting mode can also be selected from the HOME screen (📖 14).

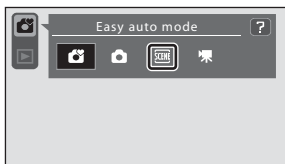

- 2 Tap .

The panorama direction icons are displayed to show the direction in which pictures will be joined.

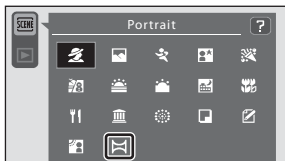

- 3 Tap a direction icon.

Select the direction in which picture will be joined in the completed panorama; right (▶), left (◀), up (▲), or down (▼).

A different direction can be selected by tapping a different panorama direction icon.

Change shooting settings (📖 48) before the first picture is taken in the next step.



- 4 Frame the first portion of the panorama scene and take the first picture.

One third of the picture will be displayed as translucent.



5 Take the next picture.

Frame the next picture so that one-third of the frame overlaps the previous picture.

Repeat this process until the necessary number of pictures have been taken to complete the scene.



6 Tap **X** when shooting is completed.

The camera returns to step 3.



✓ Notes on Panorama Assist

- Apply or adjust shooting settings (📖 48) before releasing the shutter for the first picture. Shooting settings cannot be changed after the first picture is taken. Picture cannot be deleted, nor can zoom be adjusted until the series is finalized.
- The panorama series is terminated if the camera enters standby mode with the auto off function (📖 149) during shooting. Setting the time allowed to elapse before the auto off function is enabled to a longer setting is recommended.

💡 AE/AF/L Indicator

In **Panorama assist** scene mode, exposure, white balance, and focus for all pictures in a panorama are fixed at the values for the first picture in each series.

When the first picture is taken, **AE/AF/L** is displayed to indicate that exposure, white balance, and focus are locked.



📷 Panorama Maker

Install Panorama Maker from the supplied Software Suite CD.

Transfer pictures to a computer (📖 127) and use Panorama Maker (📖 130) to join them in a single panorama.

📷 More Information

See "Image/Sound File and Folder Names" (📖 159) for more information.

Adjusting the Camera Settings in Shooting Mode

Setting Options

The camera settings described below can be applied or adjusted depending upon shooting conditions and purposes.

- The settings that can be applied or adjusted vary depending upon shooting mode. See “Camera Settings that Can Be Adjusted in Each Shooting Mode” (📖 49) for more information.

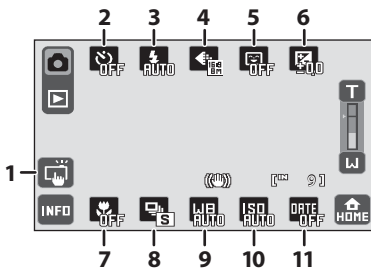

More on Shooting



| | | | |
|-----------|----------------------------|----|--|
| 1 | Touch shooting | | |
| | Touch shutter..... | 51 | |
| | Touch AF/AE..... | 53 | |
| | Subject tracking..... | 56 | |
| 2 | Self-timer..... | 58 | |
| 3 | Flash mode..... | 62 | |
| 4 | Image mode..... | 64 | |
| 5 | Smile timer..... | 60 | |
| 6 | Exposure compensation..... | 66 | |
| 7 | Macro mode..... | 67 | |
| 8 | Continuous..... | 68 | |
| 9 | WB White balance..... | 70 | |
| 10 | ISO ISO sensitivity..... | 73 | |
| 11 | DATE Date imprint..... | 74 | |

Camera Settings that Can Be Adjusted in Each Shooting Mode

The following camera settings can be adjusted in each shooting mode. ✓: Can be adjusted

| Function | Shooting mode | | | | | | | | | | | | |
|--|--|--|--|--|--|--|--|--|--|--|--|--|--|
| |  51 |  53 |  56 |  58 |  62 |  64 |  60 |  66 |  67 |  68 |  70 |  73 |  74 |
| Easy auto mode | ✓ | ✓ | | ✓ | ✓ ² | ✓ | ✓ | ✓ | | | | | ✓ |
|  (auto) mode | ✓ ³ | ✓ ³ | ✓ ³ | ✓ | ✓ ³ | ✓ | ✓ | ✓ ³ | ✓ ³ | ✓ ³ | ✓ ³ | ✓ ³ | ✓ |
| Scene mode | Portrait | ✓ | ✓ | | ✓ | ✓ | ✓ | ✓ | | | | | ✓ |
| | Landscape | | | | ✓ | | ✓ | | | | | | ✓ |
| | Sports | ✓ | ✓ | | | | ✓ | ✓ | | | | | |
| | Night portrait | ✓ | ✓ | | ✓ | | ✓ | ✓ | | | | | ✓ |
| | Party/indoor | ✓ | ✓ | | ✓ | ✓ | ✓ | | ✓ | | | | ✓ |
| | Beach/snow | ✓ | ✓ | | ✓ | ✓ | ✓ | | ✓ | | | | ✓ |
| | Sunset | | | | ✓ | ✓ | ✓ | | ✓ | | | | ✓ |
| | Dusk/dawn | | | | ✓ | | ✓ | | ✓ | | | | ✓ |
| | Night landscape | | | | ✓ | | ✓ | | ✓ | | | | ✓ |
| | Close-up | ✓ | ✓ | | ✓ | ✓ | ✓ | | ✓ | | | | ✓ |
| | Food | ✓ | ✓ | | ✓ | | ✓ | | ✓ | | | | ✓ |
| | Museum | ✓ | ✓ | | ✓ | | ✓ | | ✓ | ✓ | | | |
| | Fireworks show | | | | | | ✓ | | | | | | ✓ |
| | Copy | ✓ | ✓ | | ✓ | ✓ | ✓ | | ✓ | ✓ | | | ✓ |
| | Draw | | | | | | | | | | | | |
| Backlight | ✓ | ✓ | | ✓ | | ✓ | | ✓ | | | | ✓ | |
| Panorama assist | | | | ✓ | ✓ | ✓ | | ✓ | ✓ | | | | |

1 Changes made to this setting apply to all shooting modes (except movie mode).

2 Only  **Auto Auto** and  **Off** flash modes can be specified. When  **Auto Auto** is applied, the camera automatically selects the optimum flash mode for the scene mode it has selected.

3 The settings applied are stored in the camera's memory even after the camera is turned off, and reapplied the next time the camera is turned on.

Camera Settings That cannot be Applied Simultaneously

Some shooting settings cannot be used with other functions. See "Camera Settings That cannot be Applied Simultaneously" (□ 75) for more information.

Adjusting Shooting Settings

- 1 Tap **INFO** in shooting mode.

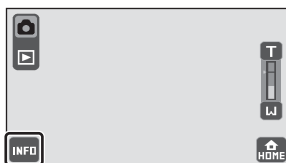

- 2 Tap the desired operation control.

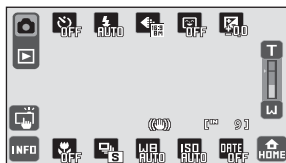

- 3 Tap the desired setting item.

Setting status is displayed at the bottom of operation controls, except the touch shooting control. The touch shooting control differs according to the current setting.

To exit to shooting mode without adjusting shooting setting, tap the operation control or press the shutter-release button halfway while the selection controls are displayed.



Tapping the Monitor to Release the Shutter (Touch Shutter)

When the  **Touch shutter** option (default setting) is selected for the touch shooting setting, the shutter is released when the monitor is tapped.

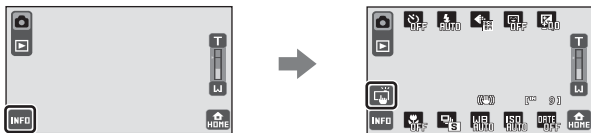

Tap the touch shooting control displayed at the left side of the monitor in shooting mode to adjust a setting.

1 Tap (touch shutter).

 is displayed at the left side of the monitor in shooting mode.

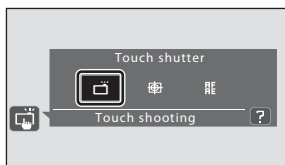

2 Tap the desired subject to take a picture.

Do not use force when tapping the monitor as this may cause slight movement of the camera, resulting in blurred pictures.

When digital zoom is in effect, the touch shutter function is not available.

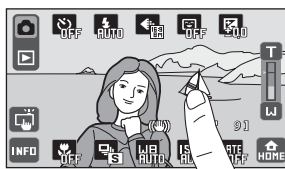

Touch shutter operation differs, according to the current shooting mode, as follows.

| Shooting mode | Touch shutter operation |
|--|--|
|  (easy auto) mode | <ul style="list-style-type: none"> When the camera recognizes a face, focus and exposure are set by tapping the double border. When the camera recognizes more than one face, tap a face framed by a single border to set focus and exposure for that face. When no face is recognized, focus is set for the area tapped. |

Adjusting the Camera Settings in Shooting Mode

| Shooting mode | Touch shutter operation |
|---|--|
| (auto) mode, Sports , Party/indoor , Beach/snow , Close-up , Food , Museum , Copy , and Backlight scene modes | Tap the intended subject. Focus and exposure are set for the area tapped. When the camera recognizes more than one face, tap a face framed by a single border to set focus and exposure for that face. |
| Portrait and Night portrait scene modes | The shutter is released only when a border displayed by the face priority function is tapped. |
| Landscape , Sunset , Dusk/dawn , Night landscape , Fireworks show , and Panorama assist scene modes | Focus and exposure are set for the same focus area used when pictures are taken by pressing the shutter-release button. See “Features” (📖 39) for more information. |

The shutter-release button can also be used when the touch shutter option is selected.

If is displayed when the monitor is tapped, the shutter cannot be released. Tap an area within or a border displayed when the camera recognizes a face.



✓ Notes on Touch Shutter

- When taking pictures with **Continuous** or **BSS** enabled, or in **Sports** or **Museum** scene mode, use the shutter-release button to take pictures. Only one picture can be taken at a time using the touch shutter function.
- Prevent shooting with accidental tapping of the monitor in (easy auto) mode, (auto) mode, and some scene modes by changing the touch shooting setting to **Touch AF/AE** (📖 53). At this setting, the shutter is not released when the monitor is tapped.
- In some rare cases, shooting subjects with which autofocus may not perform as expected, the subject may not be in focus (📖 31).
- There may be functions with which this setting cannot be enabled. See “Camera Settings That cannot be Applied Simultaneously” (📖 75) for more information.



Touch Shutter Function When Recording Movies

Touch shutter is also available in movie mode. Movie recording can be initiated or stopped by tapping the monitor (📖 122).

Touch Shooting Setting

The touch shooting setting applied in (auto) mode is stored in the camera's memory even after the camera is turned off, and reapplied the next time (auto) mode is selected.

Tapping the Monitor to Focus (Touch AF/AE)

The touch shooting setting can be changed from  **Touch shutter** (default setting) to  **Touch AF/AE**.

Tap a subject in the monitor to select the area at which the camera focuses. Press the shutter-release button halfway to lock focus and exposure for the area tapped, and press the shutter-release button the rest of the way down to take the picture.



Tap the touch shooting control displayed at the left side of the monitor in shooting mode to adjust a setting.

1 Tap .

 is displayed at the left side of the monitor in shooting mode.

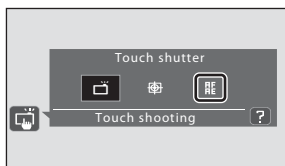



2 Tap the subject at which the camera focuses.

 or a double border will be displayed at the area tapped.

When digital zoom is in effect, the touch AF/AE function is not available.

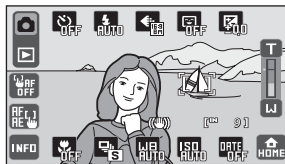
Touch AF/AE operation differs, according to the current shooting mode, as follows.



| Shooting mode | Touch AF/AE operation |
|--|---|
|  (easy auto) mode | <ul style="list-style-type: none"> When the camera recognizes a face, only a face framed by a border can be selected. When the camera recognizes more than one face, tap a face framed by a single border to set focus and exposure for that face. The single border changes to a double border. When no face is recognized, only the focus is set for the area tapped. |

Adjusting the Camera Settings in Shooting Mode

| Shooting mode | Touch AF/AE operation |
|--|---|
| (auto) mode, Sports, Party/indoor, Beach/snow, Close-up, Food, Museum, Copy, and Backlight scene modes | Focus and exposure are set for the area tapped. |
| Portrait and Night portrait scene modes | Only a border displayed by the face priority function can be selected. When the camera recognizes more than one face, tap a face framed by a single border to set focus and exposure for that face. The single border changes to a double border. |

To disable the focus area selection, tap displayed at the left side of the monitor.

If a position at which focus cannot be acquired is tapped, will be displayed in the monitor. Tap another position inside .

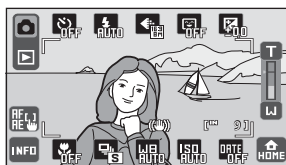

3 Press the shutter-release button to take a picture.

Press the shutter-release button halfway to acquire focus and exposure and press it all the way down to release the shutter.



Notes on Touch AF/AE



- Touch AF/AE is disabled in Landscape, Sunset, Dusk/dawn, Night landscape, Fireworks show, and Panorama assist scene modes. The touch shooting setting is fixed at Touch shutter.
- In some rare cases, shooting subjects with which autofocus may not perform as expected, the subject may not be in focus (31).
- There may be functions with which this setting cannot be enabled. See “Camera Settings That cannot be Applied Simultaneously” (75) for more information.

Touch Shooting Setting

The touch shooting setting applied in (auto) mode is stored in the camera's memory even after the camera is turned off, and reapplied the next time (auto) mode is selected.



Taking Pictures of Subjects with Which Autofocus may not Perform as Expected

When taking pictures of subjects with which autofocus may not perform as expected, try pressing the shutter-release button halfway to refocus several times, or try the following techniques.

- Switch to  (auto) mode and select  **Touch AF/AE** for the touch shooting setting.
 -  is displayed at the left side of the monitor in shooting mode.
- Tap another subject that is as far from the camera as the desired subject.
- Press the shutter-release button halfway.
 - Confirm that the focus area glows green.
 - Exposure is locked for the subject on which focus is acquired when the shutter-release button is pressed halfway.
- Continue holding down the shutter-release button halfway and recompose the picture.
 - Be sure to maintain the same distance between the camera and the subject while the shutter-release button is pressed halfway.
- Press the shutter-release button the rest of the way down to take the picture.



Focusing on a Moving Subject (Subject Tracking)

In  (auto) mode, the touch shooting setting can be changed from  **Touch shutter** (default setting) to  **Subject tracking**. Use this option to take pictures of moving subjects. Tap the subject on which the camera will focus. The focus area will automatically move to track the subject.

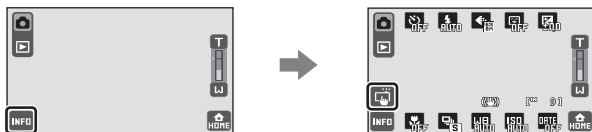

Switch to  (auto) mode and tap the touch shooting control displayed at the left side of the monitor to adjust a setting.

1 Tap (subject tracking).

 is displayed at the left side of the monitor in shooting mode.

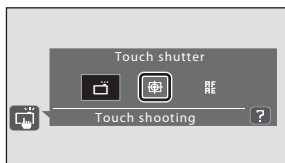

2 Select a subject.

Tap the desired tracking subject.

When the camera recognizes a face, it is framed by a border. When that face is tapped, the camera begins tracking the face. If more than one face was recognized, the borders framing faces other than the one selected for subject tracking disappear.

When the subject other than a face is selected, a yellow focus area is displayed around that subject and the camera begins tracking the subject.

When the camera is unable to focus on the subject, the focus area will glow red. Change the composition and tap the tracking subject again.

Tap another subject to change a subject to follow.

The camera focuses continuously as it tracks the subject. Therefore, the sound of lens drive movement can be heard.

If the camera cannot track the selected subject anymore, the focus area will disappear and the selection will be cancelled. Select the subject again.

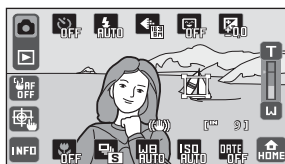
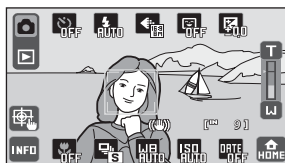

3 Press the shutter-release button to take a picture.

The camera focuses on the focus area framed by a border when the shutter-release button is pressed halfway. The focus area will glow green and focus will be locked.

When the camera is unable to focus, the focus area will blink. Press the shutter-release button halfway again to focus.

If the shutter-release button is pressed halfway while the focus area is not displayed, the camera automatically selects the focus area (one of nine) containing the subject closest to the camera.

Press the shutter-release button all the way down to release the shutter.



✓ Notes on Subject Tracking Mode

- Adjust zoom and shooting settings (📖 48) before selecting the subject. If zoom or any other setting is adjusted after the subject has been selected, subject selection will be cancelled.
- It may be impossible to select the desired subject, or the camera may be unable to track the selected subject or may begin tracking a different subject, if the subject is moving rapidly, if there is a significant amount of camera shake, or if the camera recognizes a similar subject. The camera's ability to accurately track the selected subject is also dependent upon the size and brightness of the subject.
- Digital zoom is not available.
- In some rare cases, shooting subjects with which autofocus may not perform as expected, the subject may not be in focus (📖 31).
- There may be functions with which this setting cannot be enabled. See "Camera Settings That cannot be Applied Simultaneously" (📖 75) for more information.

✍ Touch Shooting Setting

The touch shooting setting applied in 📷 (auto) mode is stored in the camera's memory even after the camera is turned off, and reapplied the next time 📷 (auto) mode is selected.

🕒 Taking Pictures with the Self-timer

The camera is equipped with a ten-second and two-second timer for self-portraits. This feature is useful for reducing the effects of camera shake that occurs when pressing the shutter-release button. When using the self-timer, use of a tripod is recommended. Set **Vibration reduction** (📖 147) to **Off** from the setup menu (📖 139) when using a tripod to stabilize the camera.

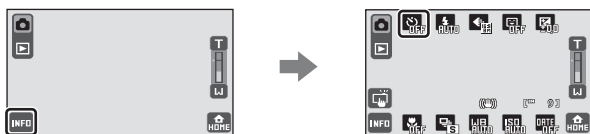

Tap  in shooting mode to adjust the setting.

- 1 Tap the desired time until the shutter is released.

 **10s** (ten seconds): Use on important occasions, such as weddings.

 **2s** (two seconds): Use to prevent camera shake.

The selected self-timer mode is displayed.



- 2 Frame the picture and press the shutter-release button halfway.

Focus and exposure will be locked.



3 Press the shutter-release button the rest of the way down.

The self-timer starts, and the number of seconds remaining before the shutter is released is displayed in the monitor. The self-timer lamp blinks while the timer is counting down. About one second before the shutter is released, the lamp stops blinking and glows steadily.

When the shutter is released, the self-timer turns off.

To stop the timer before a picture is taken, press the shutter-release button again.

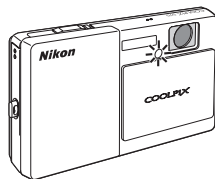

Note on Self-timer

There may be functions with which this setting cannot be enabled. See “Camera Settings That cannot be Applied Simultaneously” (📖 75) for more information.

Automatic Shooting of a Smiling Face (Smile Timer)

The camera detects smiles on the recognized faces and the shutter is automatically released.



Tap  in shooting mode to adjust the setting.

1 Tap ON.

The smile timer is enabled.

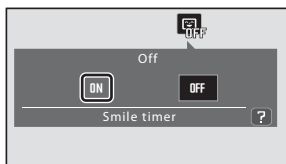

2 Frame a picture.

When the camera recognizes a human face, a yellow double border (focus area) is displayed around that face. When focus is acquired on that face, the double border will glow green for a moment and focus is locked.

Up to three faces can be recognized. When the camera detects more than one face, the double border is displayed around the face closest to the center of the frame, and single border around the others. When a face framed by a single border is tapped, the single border changes to a double border and the camera will focus on that face.



3 The shutter is automatically released.

If the camera detects that the face framed by the double border is smiling, the shutter is automatically released.

When the camera recognizes a face, the self-timer lamp (📖 4) blinks. Immediately after the shutter is released with detection of a smiling face, the self-timer lamp flickers.

Each time the shutter is released, the camera again initiates face priority function and smile detection operations for continuous automatic shooting.

The camera smoothes skin tones (in up to three faces) by applying the skin softening function before recording pictures (📖 120).

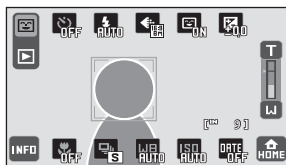

4 Tap and **OFF** to exit smile timer mode.

Shooting also stops in the following situations:

- When 12 pictures have been taken
- When no smile is detected for five minutes



Notes on Smile Timer

- When the shutter-release button is pressed all the way down while the smile timer is enabled, the shutter is released and the camera exits smile timer mode.
- The focus area can be changed only when the double or single border displayed around a face recognized with the face priority function is tapped.
- Digital zoom is not available.
- There may be functions with which this option cannot be enabled. See “Camera Settings That cannot be Applied Simultaneously” (📖 75) for more information.



Face Priority Function and Smiling Detection Feature

When a face is framed while the smile timer is enabled, the camera automatically recognizes that face (face priority) and then detects smiles on that face.

- Under some shooting conditions, the camera may be unable to recognize faces or detect smiles.
- See “Notes on Face Priority” (📖 34) for more information.

⚡ Using the Flash

The flash has a range of approx. 0.3 to 3.5 m (1 to 11 ft.) when the camera is zoomed out all the way. With maximum optical zoom applied, the range is approx. 0.5 to 2.5 m (1 to 8 ft.) when **ISO sensitivity** is set to **Auto**.



Note that in  (easy auto) mode ( 26), only **⚡AUTO Auto** (default setting) and  **Off** are available.



Tap  in shooting mode to adjust the setting.

Auto

Flash fires automatically when lighting is poor.

In  (easy auto) mode ( 26), the camera automatically selects the optimum flash mode for the scene mode it has selected.

Auto with red-eye reduction

Suited to pictures of people, this option reduces the “red-eye” phenomenon ( 63).

Off

Flash will not fire even when lighting is poor.

Fill flash



Flash fires whenever a picture is taken. Use to “fill-in” (illuminate) shadows and back-lit subjects.

Slow sync

 **AUTO** (auto) is combined with slow shutter speed.

Suited to evening and night portraits that include background scenery. Flash illuminates main subject; slow shutter speeds are used to capture background at night or under dim lighting.

Notes on Flash

- When using the flash, reflections from dust particles in the air may appear as bright spots in pictures. To reduce these reflections, set the flash setting to  **Off**.
- There may be functions with which this setting cannot be enabled. See “Camera Settings That cannot be Applied Simultaneously” ( 75) for more information.

✓ Shooting When the Flash is Disabled (🚫) or Lighting is Poor

- Use of a tripod is recommended to stabilize the camera during shooting. Set **Vibration reduction** (📖 147) to **Off** from the setup menu (📖 139) when using a tripod to stabilize the camera.
- Pictures taken when the ISO sensitivity is increased may be slightly mottled.
- Noise reduction may be performed for pictures taken at slow shutter speeds. More time than usual is required to record pictures to which noise reduction is applied.

🔪 The Flash Indicator

The flash indicator shows flash status when the shutter-release button is pressed halfway.

- **On:** Flash will fire when picture is taken.
- **Blinks:** Flash charging. Wait a few seconds and try again.
- **Off:** Flash will not fire when picture is taken.

If the battery is low, the monitor will turn off, and remain off, while the flash charges.



🔪 Flash Mode Setting

The flash mode setting applied in 📷 (auto) mode is stored in the camera's memory even after the camera is turned off, and reapplied the next time 📷 (auto) mode is selected.

🔪 Red-eye Reduction









This camera uses advanced red-eye reduction ("In-Camera Red-Eye Fix"). The flash fires repeatedly at low intensity before the main flash, reducing red-eye. The camera then analyzes the picture; if red-eye is detected, the affected area will be processed to further reduce red-eye before the picture is saved. Note that because there is a slight lag between the shutter-release button being pressed and the picture being taken, this mode is not recommended when a quick shutter response is required. The time until the picture is stored also increases slightly. Advanced red-eye reduction may not produce the desired results in all situations. In extremely rare instances, areas not subject to red-eye may be affected by advanced red-eye reduction processing; in these cases, choose another flash mode setting and try again.

Image Mode

The image mode setting applied is stored in the camera's memory even after the camera is turned off, and reapplied the next time the camera is turned on. Changes made to this setting apply to all shooting modes (except movie mode).

Number of Exposures Remaining

The following table lists the approximate number of pictures that can be stored in internal memory and on a 512 MB memory card. Note that the number of pictures that can be stored will differ depending on the composition of the picture (due to JPEG compression). In addition, this number may vary depending upon the make of memory card, even when the memory cards have the same specified capacity.

| Setting | Internal memory (approx. 20 MB) | Memory card ¹ (512 MB) | Print size ² (cm/in.) |
|--|------------------------------------|--------------------------------------|----------------------------------|
|  High (4000★) | 3 | Approx. 80 | Approx. 34 × 25/13.4 × 9.8 |
|  Normal (4000) | 7 | Approx. 165 | Approx. 34 × 25/13.4 × 9.8 |
|  Normal (3264) | 10 | Approx. 245 | Approx. 28 × 21/11 × 8.3 |
|  Normal (2592) | 16 | Approx. 385 | Approx. 22 × 16.5/8.6 × 6.4 |
|  Normal (2048) | 25 | Approx. 605 | Approx. 17 × 13/6.7 × 5.1 |
|  PC screen (1024) | 87 | Approx. 2060 | Approx. 9 × 7/3.5 × 2.7 |
|  TV screen (640) | 163 | Approx. 3865 | Approx. 5 × 4/1.9 × 1.5 |
|  16:9 (3968) | 9 | Approx. 220 | Approx. 34 × 19/13.4 × 7.5 |

¹ If the number of exposures remaining is 10,000 or more, the number of exposures remaining display shows "9999".

² Print size at an output resolution of 300 dpi. Print sizes are calculated by dividing the number of pixels by printer resolution (dpi) and multiplying by 2.54 cm (1 in.). However, at the same image size, pictures printed at higher resolutions will print smaller than the size indicated, and those printed at lower resolutions will print larger than the size indicated.

Image Mode Setting and Monitor Display

Monitor display in shooting and playback modes varies as indicated below according to the image mode setting.

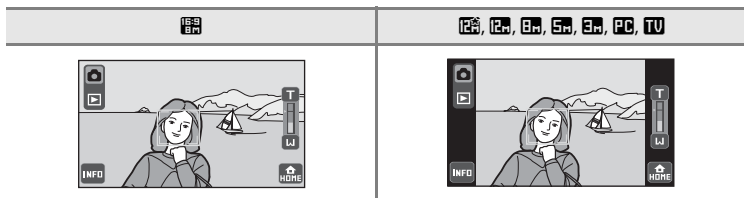

Changing Brightness Using Exposure Compensation

Exposure compensation is used to alter exposure from the value suggested by the camera to make pictures brighter or darker.

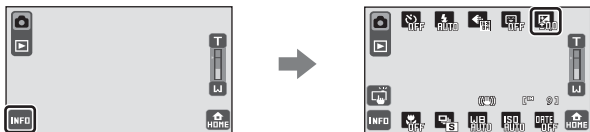

Tap  in shooting mode to adjust the setting.

1 Tap a slider, or or .

When the picture is too dark, apply positive (+) exposure compensation.

When the picture is too bright, apply negative (-) exposure compensation.

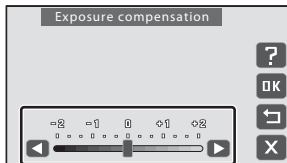

Exposure compensation can be set to values between -2.0 and +2.0 EV.

Tap  to close the guide and return to shooting display without changing the exposure compensation value.





2 Tap .

The setting is applied.

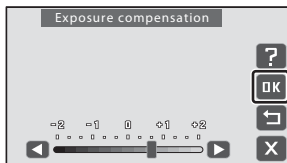
To reset exposure compensation, tap  to display the slider and set the exposure compensation value to 0 using the slider, and then tap .



Exposure Compensation Value

The exposure compensation value applied in  (auto) mode is stored in the camera's memory even after the camera is turned off, and reapplied the next time  (auto) mode is selected.

Using Exposure Compensation

The camera tends to reduce exposure when the frame is dominated by brightly lit objects and to increase exposure when the frame is mostly dark. *Positive* (+) compensation may therefore be required to capture the brilliancy of very bright objects that fill the frame (for example, sunlit expanses of water, sand, or snow) or when the background is much brighter than the main subject. *Negative* (-) compensation may be called for when large areas of the frame contain very dark objects (for example, a swath of dark green leaves) or when the background is much darker than the main subject.

Macro Mode Setting

Macro mode is used for taking pictures of objects as close as 3 cm (1.2 in.). Note that the flash may be unable to light the entire subject at distances of less than 30 cm (1 ft.).

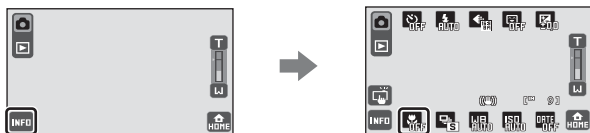



Tap  in shooting mode to adjust the setting.

1 Tap ON.

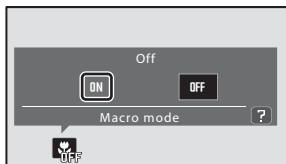
The macro mode icon () is displayed.



2 Tap or and frame the picture.

The camera can focus at a distance of 3 cm (1.2 in.) at the zoom position at which  glows green (the zoom indicator is positioned under )

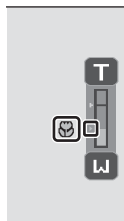

Note on Macro Mode Setting

There may be functions with which this setting cannot be enabled. See “Camera Settings That cannot be Applied Simultaneously” (📖 75) for more information.

Autofocus

In macro mode, the camera focuses continuously until the shutter-release button is pressed halfway to lock focus and exposure. Therefore, the sound of lens drive movement can be heard.

Recording Movies in Macro Mode

Macro mode setting can be also applied in movie mode (📖 124).

The Macro Mode Setting

The macro mode setting applied in  (auto) mode is stored in the camera's memory even after the camera is turned off, and reapplied the next time  (auto) mode is selected.

Continuous

Enable continuous shooting or BSS (best shot selector). The flash is disabled when **Continuous**, **BSS** or **Multi-shot 16** is selected, and focus, exposure and white balance are fixed at the values determined with the first picture in each series.

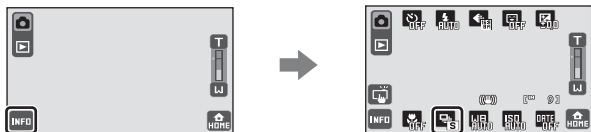

Tap  in shooting mode to adjust the setting.

The following options are available.

Single (default setting)

One picture is taken each time the shutter-release is released.

Continuous

While the shutter-release button is held down, up to 6 pictures are taken at a rate of about 1 frame per second (fps) when **Image mode** is set to  **16:9 (3968)**.

BSS (Best Shot Selector)

The “best shot selector” is recommended when shooting with the flash off or the camera zoomed in, or in other situations in which inadvertent motion can result in blurred pictures. When BSS is on, the camera takes up to ten pictures while the shutter-release button is held down. The sharpest picture in the series is automatically selected and saved.

Multi-shot 16

Each time the shutter-release button is pressed, camera takes 16 pictures at about 7 frames per second (fps) and arranges them in a single image.

- Pictures are recorded at an image mode setting of  **Normal (2592)**. This setting cannot be changed.
- Digital zoom is not available.

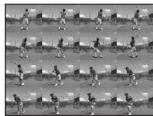

Notes on Continuous Shooting

- The maximum frame rate with continuous shooting may vary depending upon the current image mode setting, the memory card used, or shooting condition.
- There may be functions with which this setting cannot be enabled. See “Camera Settings That cannot be Applied Simultaneously” ( 75) for more information.



Note on BSS

BSS is effective when taking pictures of still subjects. BSS may not produce the desired results if the subject moves or the composition changes while the shutter-release button is held down.



Note on Multi-shot 16

Smear (📖 162) visible in the monitor when shooting with **Multi-shot 16** enabled will be recorded with images. Avoiding bright objects such as the sun, reflections of the sun, and electric lights when shooting with **Multi-shot 16** enabled is recommended.

Note on Touch Shutter

 **Continuous** or  **BSS** is disabled and only one picture can be taken at a time when the shutter is released using the touch shutter function.

Continuous Setting

The continuous setting applied in  (auto) mode is stored in the camera's memory even after the camera is turned off, and reapplied the next time  (auto) is selected.

WB White Balance

The color of light reflected from an object varies with the color of the light source. The human brain is able to adapt to changes in the color of the light source, with the result that white objects appear white whether seen in the shade, direct sunlight, or under incandescent lighting. Digital cameras can mimic this adjustment by processing images according to the color of the light source. This is known as “white balance.” For natural coloration, choose a white balance setting that matches the light source before shooting. Although the default setting, **AUTO**, can be used under most types of lighting, the white balance setting suited to a particular light source can be specified manually to achieve more accurate results.



Tap **WB** in shooting mode to adjust the setting.

The following white balance settings are available.

AUTO Auto (default setting)

White balance automatically adjusted to suit lighting conditions. Best choice in most situations.

PRE Preset manual

Neutral-colored object used as reference to set white balance under unusual lighting conditions. See “Preset Manual” for more information (📖 72).

☀️ Daylight

White balance adjusted for direct sunlight.

💡 Incandescent

Use under incandescent lighting.

💡 Fluorescent

Use under fluorescent lighting.

☁️ Cloudy

Use when taking pictures under overcast skies.



🔦 Flash

Use with the flash.



✔ Note on White Balance Setting

There may be functions with which this setting cannot be enabled. See “Camera Settings That cannot be Applied Simultaneously” (📖 75) for more information.

✔ Flash Mode

Set the flash mode to  **Off** (📖 62) at white balance settings other than  (**Auto**) or  (**Flash**).

📌 White Balance Setting

The white balance setting applied in  (auto) mode is stored in the camera's memory even after the camera is turned off, and reapplied the next time  (auto) is selected.

Preset Manual

Preset manual is effective with mixed lighting or to compensate for light sources with a strong color cast (for example, to make pictures taken under a lamp with a red shade look as though they had been taken under white light).

1 Place a white or gray reference object under the lighting that will be used during shooting.

2 Tap **INFO** to display the operation controls and tap **WB**.

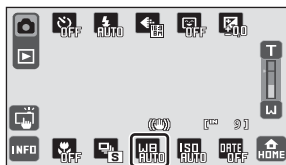

3 Tap **PRE**.

The camera zooms in.



4 Frame the reference object in the measuring window.

To apply the most recently measured value for preset manual, tap **Cancel**.

Measuring window

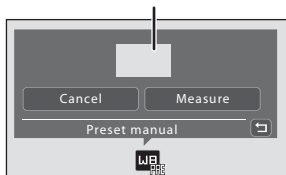

5 Tap **Measure** to measure a value for preset manual.

The shutter is released and the new white balance value is set. No picture is recorded.

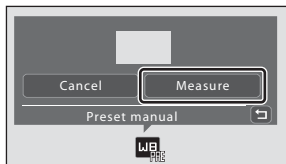

✓ Note on Preset Manual

Regardless of the flash mode selected, the flash will not fire when **Measure** is tapped in step 5. Therefore, it is impossible to measure a value for preset manual that takes flash lighting into account. When using flash, select **Auto** or **Flash** for the white balance setting.

ISO ISO Sensitivity

Sensitivity is a measure of the camera's response to light. The higher the sensitivity, the less light is needed to expose an image. Although high ISO sensitivity settings are suited to pictures of moving subjects or those taken under dim lighting, high sensitivity settings are often associated with "noise" - randomly spaced, brightly colored pixels - concentrated in dark portions of images.



Tap **ISO** in shooting mode to adjust the setting.

The following options are available.

AUTO Auto (default setting)

Sensitivity is ISO 80 when there is sufficient lighting; the camera compensates by raising sensitivity to a maximum of ISO 800 when lighting is poor.

ISO Fixed range auto

Choose the range in which the camera automatically adjusts ISO sensitivity, from **ISO 80-200** or **ISO 80-400**. The camera will not raise sensitivity beyond the maximum value in the selected range. Set the maximum value for ISO sensitivity for effective control over the amount of "grain" that appears in images.

80, 100, 200, 400, 800, 1600, 3200, 6400

Sensitivity is locked at the specified value.

When the ISO sensitivity setting is set to any option other than **AUTO Auto**, motion detection (📖 34) is disabled.

✔ **Note on ISO Setting**

There may be functions with which this setting cannot be enabled. See "Camera Settings That cannot be Applied Simultaneously" (📖 75) for more information.

✔ **Notes on ISO Sensitivity 3200 and 6400**

- When **ISO ISO sensitivity** is set to **3200** or **6400**, **Image mode** settings are limited to **Normal (2048)**, **PC screen (1024)**, and **TV screen (640)**.
- When **ISO ISO sensitivity** is set to **3200** or **6400**, the image mode control is displayed in red during shooting.

✔ **ISO Sensitivity Setting**

The ISO sensitivity setting applied in **(A)** (auto) mode is stored in the camera's memory even after the camera is turned off, and reapplied the next time **(A)** (auto) is selected.

DATE Imprinting Time and Date (Date Imprint)

The date and time of shooting are imprinted on pictures as they are recorded, allowing the information to be printed even from printers that do not support date printing (📖 103).

The **Date imprint** setting can also be adjusted from the setup menu (📖 146).

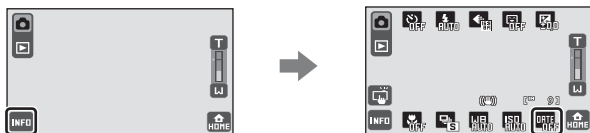

Tap **DATE** in shooting mode to adjust the setting.

The following options are available.

OFF Off (default setting)

Date and time are not imprinted on pictures.

DATE Date

Date is imprinted on pictures taken.



DATE Date and time

Date and time are imprinted on pictures.



✓ Notes on Date Imprint

- Imprinted dates form a permanent part of image data and cannot be deleted. The date and time cannot be imprinted on pictures after they have been taken.
- Dates imprinted at an **Image mode** setting (📖 64) of **TV TV screen (640)** may be difficult to read. Choose an **Image mode** setting of **PC screen (1024)** or larger when using date imprint.
- The date is recorded using the format selected in the setup menu's **Date** item (📖 22, 143).
- The date cannot be imprinted in the following situations:
 - Pictures taken in **Sports** (📖 40), **Museum** (📖 43), or **Panorama assist** (📖 44) scene mode
 - Pictures taken with **Continuous** or **BSS** selected for the **Continuous** setting (📖 68)
 - Movies (📖 122)
 - When shooting with **Vibration reduction** (📖 147) set to **On (hybrid)**, **Date imprint** is automatically set to **Off**.
- The shooting date decoration can also be added to existing pictures using the **Paint** function (📖 111).

Date Imprint and Print Set



















When printing from DPOF-compatible printers that support the printing of shooting date and photo information, the date and information can be printed without imprinting this information on them using settings in the **Print set** option (📖 101).

Date Imprint Setting















Changes made to the date imprint setting apply to all other shooting modes except  **Sports**,  **Museum**, and  **Panorama assist** scene modes and movie mode, which do not support date imprinting. The current date imprint setting is stored in the camera's memory even after the camera is turned off and reapplied the next time the camera is turned on.

Camera Settings That cannot be Applied Simultaneously





Some shooting settings cannot be used with other functions.

| Restricted function | Setting | Description |
|--|----------------------------|--|
| Touch shooting:  Touch shutter (📖 51)  Touch AF/AE (📖 53)  Subject tracking (📖 56) | Smile timer (📖 60) | When the camera recognizes more than one face, a face framed by a single border can be tapped to focus on that face. The touch shutter and subject tracking functions are not available. |
| | Self-timer (📖 58) | When Self-timer is enabled, the touch shutter function is not available. |
|  Self-timer (📖 58) | Subject tracking (📖 56) | When Touch shooting is set to  Subject tracking , Self-timer is disabled. |
| | Smile timer (📖 60) | When Smile timer is enabled, Self-timer is disabled. |
|  Flash mode (📖 62) | Continuous (📖 68) | When  Continuous ,  BSS , or  Multi-shot 16 is selected, flash is disabled. |
| | Continuous (📖 68) | When  Multi-shot 16 is selected, the image mode setting is fixed at  Normal (2592) . |
|  Image mode (📖 64) | ISO sensitivity (📖 73) | When 3200 or 6400 is selected for ISO ISO sensitivity , the image mode setting of only  Normal (2048) ,  PC screen (1024) , or  TV screen (640) can be selected. If any image mode setting other than above is selected, the image mode setting is automatically changed to  Normal (2048) when ISO ISO sensitivity is set to 3200 or 6400 . |
| | Continuous (📖 68) | When  Multi-shot 16 is selected, the image mode setting is fixed at  Normal (2592) . |

Adjusting the Camera Settings in Shooting Mode

| Restricted function | Setting | Description |
|--|-----------------------------------|---|
|  Smile timer (book 60) | Self-timer (book 58) | When taking a picture using Self-timer , Smile timer is disabled. |
|  Macro mode (book 67) | Subject tracking (book 56) | When Touch shooting is set to  Subject tracking , Macro mode is disabled. |
| | Smile timer (book 60) | When Smile timer is enabled, macro mode is disabled. |
|  Continuous (book 68) | Self-timer (book 58) |  Continuous ,  BSS , and  Multi-shot 16 cannot be used. |
| | Smile timer (book 60) | |
|  White balance (book 70) | Smile timer (book 60) | When Smile timer is enabled, the white balance setting is fixed at AUTO Auto . |
|  ISO sensitivity (book 73) | Smile timer (book 60) | When Smile timer is enabled, the ISO sensitivity setting is fixed at AUTO Auto . |
| | Continuous (book 68) | When  Multi-shot 16 is selected for the Continuous setting, the ISO sensitivity setting is fixed at AUTO Auto . |
|  Date imprint (book 74) | Continuous (book 68) | When  Continuous or  BSS is selected for the Continuous setting, date imprint is disabled. |
| | Vibration reduction (book 147) | The On (hybrid) option for Vibration reduction and Date imprint cannot be enabled simultaneously. When shooting with Vibration reduction set to On (hybrid) , Date imprint is automatically set to Off . |
| Digital zoom (book 29) | Subject tracking (book 56) | When Touch shooting is set to  Subject tracking , digital zoom is not available. |
| | Smile timer (book 60) | When Smile timer is enabled, digital zoom is not available. |
| | Continuous (book 68) | When  Multi-shot 16 is selected, digital zoom is not available. |

Selecting Playback Mode

Select a playback mode from  (playback),  (favorite pictures),  (auto sort), and  (list by date) modes.

1 Tap the playback mode control in playback mode.



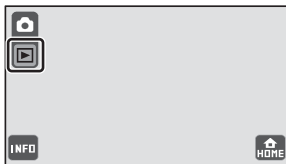



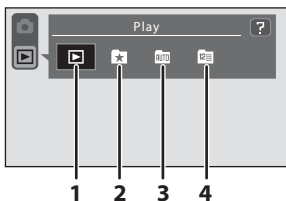

The playback mode selection controls are displayed.





2 Tap the desired playback mode control.

The camera enters the selected playback mode. When the playback control displayed at upper left in the monitor is tapped with the playback mode selection controls displayed, the monitor display returns to the last playback mode selected without switching the playback mode.



- | | | |
|---|---|--|
| 1 |  Playback mode |  32 |
| 2 |  Favorite pictures mode |  78, 81 |
| 3 |  Auto sort mode |  84 |
| 4 |  List by date mode |  87 |
- Play back all pictures.
- Play back pictures added to albums.
- Play back pictures and movies automatically sorted to the selected category with shooting.
- Play back pictures taken on the selected date.

Selecting a Playback Mode from the HOME Screen

A different playback mode can also be selected from the HOME screen ( 14). Tap , displayed at lower right in the monitor in shooting and playback mode, to display the HOME screen.

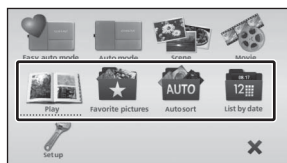

Sorting Favorite Pictures (Favorite Pictures Mode)

Pictures can be added to album for specific events, such as vacations or weddings, or themes. When viewing albums, only the pictures sorted to the current album are displayed. Individual pictures can be added to multiple albums.

Sorting/Playback Procedures

Preparing album (📖 79)

Play back pictures
Pictures can be added from playback mode (📖 32),
auto sort mode (📖 84), and list by date mode (📖 87).

Adding pictures to album (📖 80)

Viewing pictures in an album (📖 81)

More on Playback

Preparing an Album (Assigning an Icon)

The icon assigned to an album can be changed to reflect the theme of pictures included in the album. Album icons can be applied or changed even after pictures are added to albums.

- 1 Tap the playback mode control in playback mode to display the playback mode selection controls, and then tap .

Album list is displayed.

A playback mode can also be selected from the HOME screen ( 14).

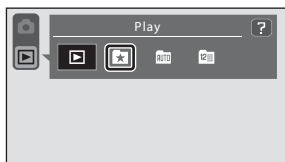

- 2 Tap .

The album selection screen is displayed.

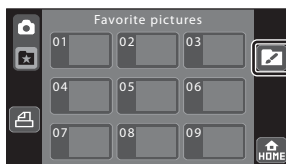

- 3 Tap the desired album.

The album icon and icon color selection screen is displayed.

To return to the list of albums without adjusting the settings, tap .

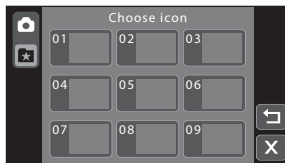

- 4 Tap the desired icon and color, and then tap .

The icon is changed and monitor display returns to the display of album list shown in step 2.

To return to the album selection screen without adjusting the settings, tap .

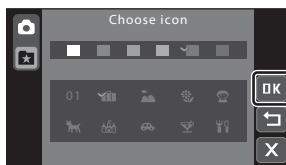

Notes on Icons for Albums

- Choose icons for albums separately for the internal memory and for every memory card used.
- To change the icon for an album containing pictures stored in the internal memory, remove the memory card from the camera.
- A number (default setting) is displayed in place of an icon for albums for which an icon has not been specified, whether the albums contain pictures stored in the internal memory or on a memory card.

Adding Pictures to Albums

Pictures can be sorted by adding them to albums. Adding pictures to albums makes it faster and easier to find specific pictures.

1 Display a picture to be added to an album full-frame in playback mode (📖 32), auto sort mode (📖 84), or list by date mode (📖 87).

2 Tap **INFO** to display the operation control, and then tap **+**.

The favorite pictures screen is displayed.

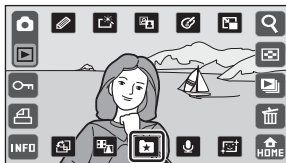

3 Tap the desired album.

The picture is added to the selected album.

When **+** is tapped, the camera returns to playback mode without adding pictures to the album.

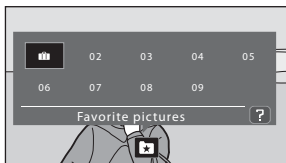

✓ Notes on Adding Favorite Pictures

- An album can contain up to 200 pictures.
- If the selected picture has already been added to an album, the icon for the album to which it has been added will be turned yellow.
- Individual pictures can be added to multiple albums.
- When pictures are added to albums, they are not physically copied to albums or moved from the folder (📖 159) to which they were originally recorded (📖 83).
- Movies cannot be added to albums.

🔍 More Information

See "Removing Pictures from Albums" (📖 82) for more information.

Viewing Pictures in an Album

Pictures can be displayed by selecting the album to which they were added in “ favorite pictures mode”. In full-frame playback mode, just as with normal playback mode, picture display can be enlarged, pictures can be displayed as thumbnails, and edited. In addition, only the pictures added to the same album can be played back in a slide show.

- 1 Tap the playback mode control in playback mode to display the playback mode selection controls, and then tap .

A list of albums is displayed.

If the pictures have been added to an album, a picture in the album is displayed.

A playback mode can also be selected from the HOME screen ( 14).

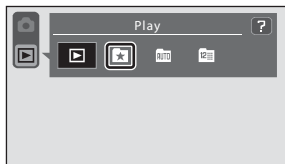

- 2 Tap the desired album.

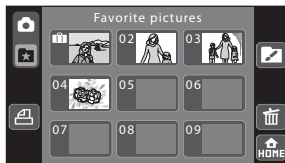

The picture in the selected album will be displayed in full-frame playback mode ( 89).

Repeat steps 1 and 2 to select a different album.



Removing Pictures from Albums

To remove a picture from an album without permanently deleting it, follow the procedures described below.

Select the desired picture in full-frame display in step 2 in favorite pictures mode (📖 81) and tap . When  is tapped, the confirmation dialog is displayed.

- Tap **Yes** to remove the picture from the album. To exit without removing the picture, tap **No**.

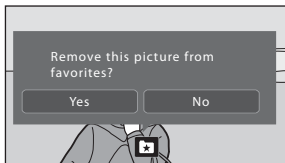





Note on Deleting Picture in Favorite Pictures Mode

Note that deleting a picture played back in favorite picture mode permanently deletes the original picture from the internal memory or memory card (📖 83).

Operations in Favorite Pictures Mode

The following operations are available with display of album list.

| Option | Tap | Description |  |
|---------------------------------------|--|---|---|
| Change album icon |  | Change the icon assigned to an album. | 79 |
| Delete pictures by the selected album |  | Delete all pictures added to the selected album. | 96 |
| Create print orders |  | Create print orders for all pictures added to the selected album. | 104 |
| Switch to another playback mode |  | Display the playback mode selection controls. | 77 |
| Switch to shooting mode | Shooting mode control | Tap the shooting mode control displayed at upper left in the monitor or press the shutter-release button. | – |

Adding/Viewing Favorite Pictures

When pictures are added to an album, they are not physically copied to the album or moved from the folder to which they were originally recorded (📖 159). Only the file names of pictures are added to albums. In favorite pictures mode, pictures with file names that have been added to the specified album are played back.

Note that deleting a picture played back in favorite picture mode permanently deletes the original picture from the internal memory or memory card.

Adding Pictures to Albums

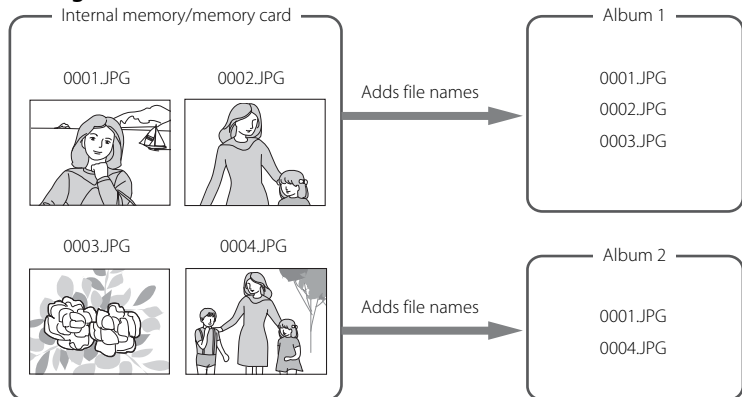





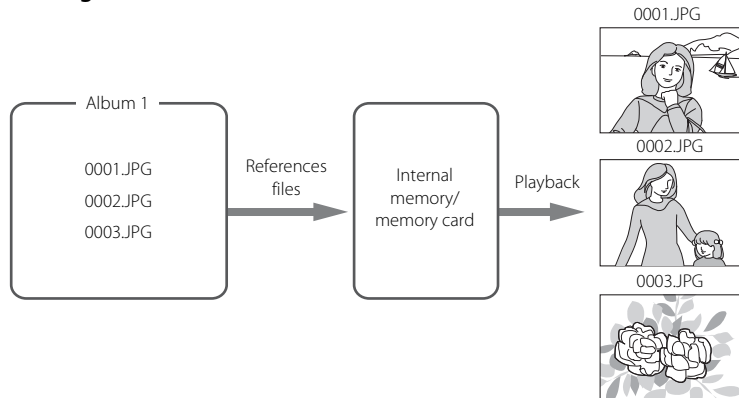





More on Playback

Viewing Pictures in Albums



Finding Pictures in Auto Sort Mode

Pictures and movies are automatically sorted to any of the following category with shooting. If “ auto sort mode” is selected, pictures and movies can be viewed by selecting the category to which they were sorted.

| | | |
|---|--|--|
|  Smile |  Portraits |  Food |
|  Landscape |  Dusk to dawn |  Close-ups |
|  Movie |  Retouched copies |  Other scenes |

In full-frame playback mode, just as with normal playback mode, picture display can be enlarged, pictures can be displayed as thumbnails, edited, and movies can be played back. Pictures can be added to an album. In addition, only the pictures sorted to the same category can be played back in a slide show.

Viewing Pictures in Auto Sort Mode

- 1 Tap the playback mode control in playback mode to display the playback mode selection controls, and then tap .

Category list is displayed.

If the pictures have been sorted to a category, a picture in the category is displayed.

A playback mode can also be selected from the HOME screen ( 14).

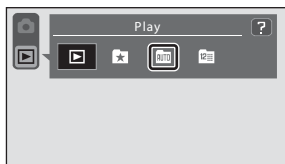

- 2 Tap the desired category.







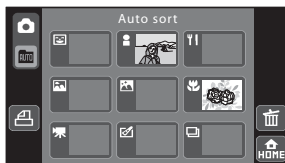

























For more information on categories, see “Auto Sort Mode Categories” ( 85).

The picture in the selected category will be displayed in full-frame playback mode ( 89).

Repeat steps 1 and 2 to select a different category.



Auto Sort Mode Categories

| Category | Description |
|--|--|
|  Smile | Pictures automatically taken with the  Smile timer . |
|  Portraits* | Pictures taken when the camera selects  Portrait,  Night portrait, or  Backlight in  (easy auto) mode (📖 26). Pictures taken using the face priority function in  (auto) mode (📖 37), or those taken in  Portrait ,  Night Portrait ,  Party/indoor , or  Backlight scene mode (📖 38). |
|  Landscape | Pictures taken when the camera selects  Landscape in  (easy auto) mode (📖 26), or those taken in  Landscape scene mode (📖 38). |
|  Dusk to dawn | Pictures taken when the camera selects  Night landscape in  (easy auto) mode (📖 26), or those taken in  Night landscape ,  Sunset ,  Dusk/dawn , or  Fireworks show scene mode (📖 38). |
|  Close-ups | Pictures taken when the camera selects  Close-up in  (easy auto) mode (📖 26), or those taken with macro mode (📖 67) enabled in  (auto) mode. Pictures taken in  Close-up scene mode (📖 38). |
|  Food | Pictures taken in  Food scene mode (📖 38). |
|  Movie | Movies (📖 122). |
|  Retouched copies | Copies created using editing functions (📖 109). |
|  Other scenes | All other pictures that cannot be defined by the categories described above. |





* Except pictures automatically taken with  **Smile timer**.

Notes on Auto Sort Mode

- Up to 999 pictures and movie files can be sorted to each category in auto sort mode. If 999 pictures or movies have already been sorted to a specific category, new pictures and movies cannot be sorted to that category nor can they be displayed in auto sort mode. Display pictures and movies that could not be sorted to a category in normal playback mode (📖 32) or list by date mode (📖 78).
- Pictures or movies copied from the internal memory or the memory card or vice versa (📖 156) cannot be displayed in auto sort mode.
- Pictures or movies recorded by a camera other than the COOLPIX S70 cannot be displayed in auto sort mode.

Operations in Auto Sort Mode

The following operations are available with display of category list.

| Option | Tap | Description |  |
|--|---|---|---|
| Delete pictures by the selected category |  | Delete all pictures sorted to the selected category. | 96 |
| Create print orders |  | Create print orders for all pictures sorted in the selected category. | 104 |
| Switch to another playback mode |  | Display the playback mode selection controls. | 77 |
| Switch to shooting mode | Shooting mode control | Tap the shooting mode control displayed at the upper left in the monitor or press the shutter-release button. | – |

Playing Back Pictures Taken on a Same Day (List by Date Mode)

In “ list by date mode”, pictures taken on a same date can be played back. In full-frame playback mode, just as with normal playback mode, picture display can be enlarged, pictures can be displayed as thumbnails, edited, and movies can be played back. Pictures can be added to an album. In addition, only the pictures taken on the same shooting date can be played back in a slide show.

Selecting a Date in List by Date Mode

- 1 Tap the playback mode control in playback mode to display the playback mode selection controls, and then tap .

Dates for which pictures exist are listed.

A playback mode can also be selected from the HOME screen ( 14).

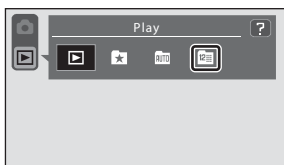

- 2 Tap the desired date.

The camera lists up to 29 dates. If pictures exist for more than 29 dates, all pictures recorded earlier than most recent 29 dates will be combined under **Others**.

The first picture taken on the selected date will be displayed full frame ( 89).

Repeat steps 1 and 2 to select a different shooting date.







Notes on List by Date Mode

- Up to 9,000 of the most recently recorded pictures can be displayed in list by date mode. If more pictures exist, “*” is displayed next to the number of pictures for folder(s) containing pictures older than the most recent 9,000.
- Pictures taken before the date and time have been set are recognized as having been taken on 01/01/2009.

Operations in List by Date Mode

The following operations are available in the shooting date selection screen.

| Option | Tap | Description |  |
|--------------------------------------|---|---|---|
| Scroll display |  | Scroll display. | – |
| Delete pictures by the selected date |  | Delete all pictures taken on the selected date. | 96 |
| Create print orders |  | Create print orders for all pictures taken on the selected date. | 104 |
| Switch to another playback mode |  | Display the playback mode selection controls. | 77 |
| Switch to shooting mode | Shooting mode control | Tap the shooting mode control displayed at the upper left in the monitor or press the shutter-release button. | – |

Operations in Full-frame Playback Mode



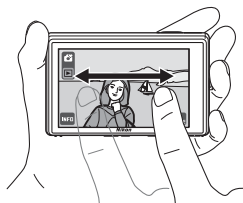

Drag the current picture to display previous or subsequent picture in full-frame playback mode. Drag two of your fingers to view pictures more rapidly.

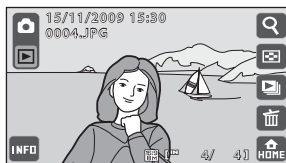









When **INFO** is tapped in full-frame playback mode and the photo information is turned on (8), the following operations are available using the operation controls.



| Option | Tap | Description | |
|----------------------------------|-----|--|----|
| Playback zoom | | Enlarge view of picture currently displayed in the monitor up to about 10x. Pictures can also be enlarged by placing two fingers on the picture currently displayed and spreading them apart. Tap X to return to full-frame playback. | 91 |
| View thumbnails | | Display 6, 12, or 20 picture thumbnails. Picture thumbnails can also be displayed by placing two fingers on the picture currently displayed and pinching them together. | 93 |
| Play back pictures in slide show | | Play back pictures, stored in the internal memory or on the memory card, one by one. | 98 |
| Delete pictures | | Delete the picture currently displayed. | 32 |
| Switch to the HOME screen | | Shooting or playback mode can be selected and the setup menu can be displayed from the HOME screen. | 14 |

| Option | Tap | Description |  |
|-------------------------|---|---|---|
| Switch monitor display |  | Each time  is tapped, monitor display switches in the following order (three displays): photo information on → operation controls on → photo information off Display operation controls for adjusting playback settings ( 97) and editing picture ( 109). | 9 |
| Switch to shooting mode | Shooting mode control | Tap the shooting mode control displayed at upper left in the monitor. The shutter-release button can also be pressed to switch to shooting mode. | – |
| Select playback mode | Playback mode control | Display the playback mode selection controls. | 77 |

Viewing Pictures

- Pictures stored in the internal memory can only be viewed if no memory card is inserted.
- In favorite pictures (, 82), auto sort (, 86), or list by date (, 88) mode, only the pictures in the selected album, category, or date are displayed.
- Pictures taken in portrait (“tall”) orientation will be rotated automatically (, 13). The rotating direction can be changed from the  **Rotate image** option (, 106). When the camera is rotated, the picture displayed is also rotated (, 13).
- When the monitor has turned off in standby mode to save power, press the shutter-release button to reactivate it (, 149).

Taking a Closer Look: Playback Zoom

Placing two fingers on the monitor in full-frame playback mode (📖 89) and spreading them apart enlarges display of the picture currently displayed.

The guide displayed in the bottom right of the monitor shows the portion of the image currently displayed.

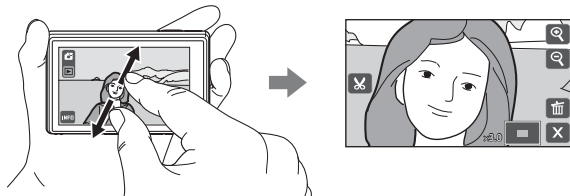



- Pictures can also be enlarged by tapping in full-frame playback mode. If is not displayed, tap .

The following operations can be performed while picture display is enlarged.





| To | Tap | Description | |
|-------------------------------|-----|---|-----|
| Zoom in | | Tap to enlarge view of picture currently displayed in monitor, up to about 10x. Pictures can also be zoomed in by placing two fingers on the picture currently displayed and spreading them apart. | – |
| Zoom out | | Tap . When the magnification ratio reaches 1x, the display returns to full-frame playback mode. Pictures can also be zoomed out by placing two fingers on the picture currently displayed and pinching them together. | – |
| Change the display area | – | The area of the picture currently displayed can be changed by dragging the picture. | – |
| Delete pictures | | Delete the picture currently displayed. | 32 |
| Switch to full-frame playback | | Tap . | 89 |
| Create a cropped copy (crop) | | Create a cropped copy with only the enlarged portion save the copy as a separate file. | 121 |
| Switch to shooting mode | – | Press the shutter-release button. | – |

Pictures Taken with Face Priority Function

When zooming in (playback zoom) on a picture by tapping  in full-frame playback mode taken with the face priority function (📖 28), the picture will be enlarged with the face recognized with shooting at the center of the monitor (except pictures taken when ).

Continuous, **BSS**, or **Multi-shot 16** (📖 68) was selected).





- If more than one face was detected, the picture will be enlarged with the face on which focus was acquired at the center of the monitor. Tap  or  to display other recognized faces.
- When  or  is tapped to adjust the zoom ratio, the center of the picture (normal playback zoom display), rather than the face, is displayed at the center of the monitor.



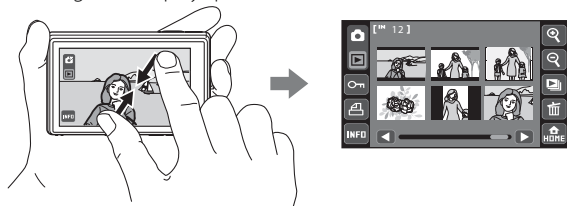









Viewing Multiple Pictures: Thumbnail Playback

Placing two fingers on the monitor in full-frame playback mode (📖 89) and pinching them together displays pictures in “contact sheets” of thumbnail images.



- Pictures can also be displayed as thumbnails by tapping  in full-frame playback mode. If  is not displayed, tap .

The following operations can be performed while thumbnails are displayed

| To | Tap | Description |  |
|---|---|---|---|
| Scroll display |   | Tap  or  , or drag the slider at the bottom of the monitor. | - |
| Increase number of picture thumbnails displayed |  | Increase number of picture thumbnails displayed: 6 → 12 → 20 Placing two fingers on the picture currently displayed and pinching them together also increases the number of picture thumbnails displayed. | - |
| Decrease number of picture thumbnails displayed |  | Decrease number of picture thumbnails displayed: 20 → 12 → 6 → 1 Placing two fingers on the picture currently displayed and spreading them apart also decreases the number of picture thumbnails displayed. | - |
| Protect pictures |  | Protect multiple pictures. | 100 |
| Create print orders |  | Create a print order for multiple pictures at the same time. | 102 |
| Play back pictures in slide show |  | Play back pictures, stored in the internal memory or on a memory card, one by one. | 98 |
| Delete pictures |  | Delete multiple pictures at the same time. | 95 |
| Switch to full-frame playback | - | Tap a picture to display it full-frame. | - |
| Switch to the HOME screen |  | Tap  to switch to the HOME screen. | 14 |

Viewing Multiple Pictures: Thumbnail Playback

| To | Tap | Description |  |
|-------------------------|-----------------------|--|---|
| Switch to shooting mode | Shooting mode control | Tap the shooting mode control or press the shutter-release button. | - |
| Select playback mode | Playback mode control | Display the playback mode selection controls. | 77 |

More on Playback

Thumbnail Playback for Movies

Movies are displayed as film frames.

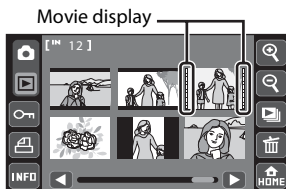

Deleting Multiple Pictures

Multiple pictures can be deleted at a time.

- 1 Switch to thumbnail playback mode (📖 93) and tap 🗑️.

The monitor display switches to **Erase selected images** screen.



- 2 Tap the desired picture(s) to be deleted.

When a picture is selected, a check mark is displayed. To cancel the selection, tap the picture again.

Tap 🔍 or 🗨️ to change the number of pictures displayed.

Tap ALL to delete all pictures. In favorite pictures, auto sort, or list by date mode, all pictures in the selected album or category, or taken on the selected date, are deleted.



- 3 Tap OK.

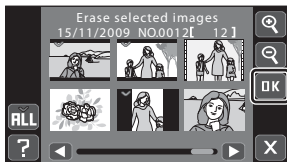

- 4 Tap Yes.

The selected pictures are deleted.

To exit without deleting pictures, tap No.





✓ Notes on Deleting Pictures



- Once deleted, pictures cannot be recovered. Transfer important pictures to a computer before deleting them.
- Pictures marked with the protect icon are protected and cannot be deleted.
- Note that deleting a picture played back in favorite picture mode permanently deletes the original picture from the internal memory or memory card (📖 83).

Deleting Pictures by Album, Category, or Shooting Date

Delete pictures by album in favorite pictures mode, category in auto sort mode, or date in list by date mode.

- 1 Tap  while the album list, auto sort category list, or date selection screen is displayed.

Tap  while the album list is displayed ( 81) to delete all pictures added to the selected album.

Tap  while the auto sort category list is displayed ( 84) to delete all pictures sorted to the selected category.

Tap  while the date selection screen is displayed ( 87) to delete all pictures taken on the selected date.



- 2 Tap an album, category, or date from which pictures will be deleted and tap .

The selected album, category, or date can be recognized by the check mark.



- 3 Tap **Yes**.

The selected pictures are deleted.

To exit without deleting pictures, tap **No**.

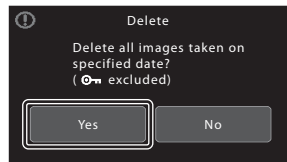

Playback Options

Setting Options

When operation controls are displayed by tapping **INFO** in playback mode, picture settings can be applied and pictures can be edited.

- The controls available and monitor display vary depending upon the current picture and camera settings.

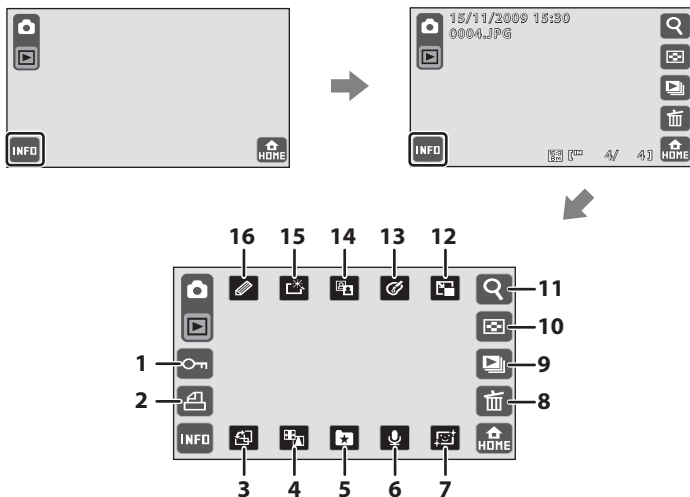



| | | |
|---|--|-----|
| 1 | Protect..... | 99 |
| 2 | DPOF print order..... | 101 |
| 3 | Rotate image..... | 106 |
| 4 | Stretch..... | 118 |
| | Perspective control..... | 119 |
| 5 | Add pictures to albums (except in favorite pictures mode)..... | 80 |
| | Remove pictures from albums (in favorite pictures mode)..... | 82 |
| 6 | Voice memo..... | 107 |
| 7 | Skin softening..... | 120 |

| | | |
|----|------------------------|-----|
| 8 | Delete..... | 32 |
| 9 | Slide show..... | 98 |
| 10 | Thumbnail display..... | 93 |
| 11 | Playback zoom..... | 91 |
| 12 | Small picture..... | 117 |
| 13 | Color options..... | 116 |
| 14 | D-Lighting..... | 115 |
| 15 | Quick retouch..... | 114 |
| 16 | Paint..... | 111 |

Enjoying Slide Shows

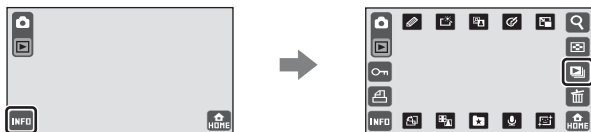

Play back pictures, stored in the internal memory or on a memory card, one by one in an automated “slide show.”



Tap  in playback mode to adjust the setting.

1 Tap Start.

To repeat the slide show automatically, enable **Loop** by tapping **Start**. A check mark (✓) will be added to the loop option when enabled.

Tap  to play back sample images stored in the camera with an automatic loop function. Tap  to return to playback display without playing back pictures in a slide show.











2 The slide show begins.



Tap the monitor to display operation controls and  to hide them.

The following operations are available during slide show.





| To | Tap | Description |
|--|---|---|
| Volume |  | Adjust the volume of background music. |
| Rewind slide show one frame at a time |  | Rewind slide show one frame at a time. Touch and hold  for continuous frame-by-frame rewind. |
| Advance slide show one frame at a time |  | Advance slide show one frame at a time. Touch and hold  for continuous frame-by-frame advance. |
| Pause |  | Pause playback. |
| Resume playback |  | Resume playback. |
| End |  | End slide show. |

✓ Notes on Slide Show

- Only the first frame of movies ( 125) included in a slide show is displayed.
- The maximum playback time is up to 30 minutes even if **Loop** is enabled ( 149).

Protecting Important Pictures (Protect)

Protect selected pictures from accidental deletion. Protected pictures are recognized by the  icon in playback mode when photo information is on ( 13).

Protecting One Picture

- 1 Select the desired picture to be protected in full-frame playback mode and tap .



- 2 Tap .

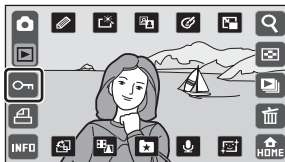

- 3 Tap **On**.

The selected picture is protected.

To exit without protecting the picture, tap **Off**.

When  is tapped, the camera returns to playback display without adjusting the protect setting.



Protecting Multiple Pictures

Multiple pictures can be protected at a time.

- 1 Switch to thumbnail playback mode (📖 93) and tap .

The monitor display switches to the picture selection screen for protection.



- 2 Tap the desired pictures to be protected.

When a picture is selected, a check mark is displayed. To cancel the selection, tap the picture again.

Tap  or  to change the number of pictures displayed.



- 3 Tap .

The selected pictures are protected.

To exit without protecting pictures, tap .

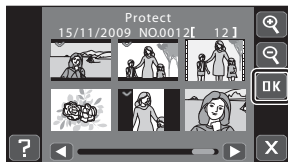

Note on Protecting Pictures

Note that formatting the camera's internal memory or the memory card will permanently delete protected files (📖 150).

Creating a DPOF Print Order: Print Set

The **Print set** option is used to create digital “print orders” for printing from DPOF-compatible devices (📖 176). Print orders can also be used to specify pictures to be printed when the memory card containing the pictures is taken to a digital photo lab. A single print order can be created for up to 99 pictures, with up to nine copies of each picture specified.

When the camera is connected to a PictBridge-compatible printer, pictures can be printed from the printer according to the DPOF print order you have created for pictures on the memory card. If the memory card is removed from the camera, a DPOF print order can be created for pictures stored in the internal memory.

Creating a Print Order for One Picture

- 1 Select the desired picture in full-frame playback mode and tap **INFO**.



- 2 Tap **PRINT**.

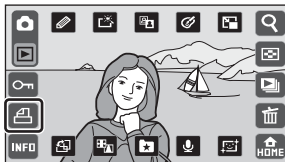

- 3 Tap the desired number of copies and tap **OK**.

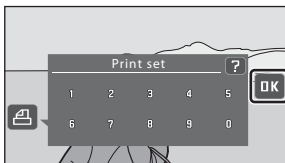

If the total number of the pictures in a print order, including pictures just added, exceeds 99, the screen shown at right will be displayed.

- Tap **Yes** to remove pictures previously added from the print order and restrict the print order to pictures just marked.
- Tap **Cancel** to remove the pictures just added from the print order and restrict the print order to pictures previously marked.

When **PRINT** is tapped, the camera returns to playback display without creating a print order.

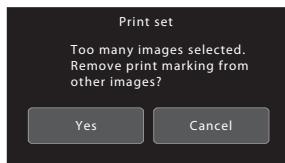

4 Choose whether or not to print shooting date and photo information.

Tap **Date** to print shooting date on a picture in the print order.

Tap **Info** to print photo information (shutter speed and aperture) on a picture in the print order.

Tap **OK** to complete the print order.

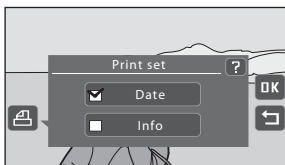

Creating a Print Order for Multiple Pictures



1 Switch to thumbnail playback mode (93) and tap .

The monitor display switches to the print set screen.



2 Tap the desired pictures to print (up to 99) and tap or to specify the number of copies (up to nine) for each.

Pictures selected for printing can be recognized by the check mark () and the numeral indicating the number of copies to be printed.

Tap  or  to change the number of pictures displayed.

Tap **RESET** to remove print marking from all pictures and cancel the print order.

Tap **OK** when setting is complete.



3 Choose whether or not to print shooting date and photo information.

Tap **Date** to print the shooting date on all pictures in the print order.

Tap **Info** to print photo information (shutter speed and aperture) on all pictures in the print order.

Tap **OK** to complete the print order.

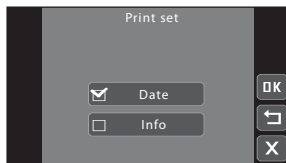

Canceling Existing Print Order

When the confirmation dialog is displayed by tapping **RESET**, tap **Yes** to remove print marking from all pictures and cancel the print order.

Note on Printing Pictures

When printing pictures taken at an **Image mode** setting of **16:9 (3968)** (default setting), the edges of pictures may be cropped, preventing printing of complete pictures (132).

Notes on Printing with Shooting Date and Photo Information

When the **Date** and **Info** settings are enabled in the print set option, shooting date and photo information are printed on pictures when a DPOF-compatible (176) printer which supports printing of shooting date and photo information is used.

- Photo information cannot be printed when the camera is connected directly to a printer, via the supplied USB cable, for DPOF printing (138).
- Note that **Date** and **Info** settings are reset when the print set option is displayed.
- The printed date is the one that has been set when a picture is taken. Although the date is changed using the **Date** option in the setup menu after a picture has been taken, the printed date will not be reflected.

Print Order Pictures

Pictures selected for printing are recognized in playback mode when photo information is on (13).



Date Imprint



When date and time of recording are imprinted on pictures using the **DATE Date imprint** option (74, 146), pictures are recorded with shooting date and time imprinted on the picture when they are taken. Pictures with the date imprinted on them can be printed from printers that do not support printing of the date on pictures. Only the **Date imprint** date and time on pictures will be printed, even if **Print set** is enabled with **Date** selected in the print set screen.



Creating a Print Order by Album, Category, or Shooting Date

Create a print order by album in favorite pictures mode, category in auto sort mode, or date in list by date mode.

- 1 Tap  while the album list, auto sort category list, or shooting date list is displayed.



Tap  while the album list is displayed ( 81) to create a print order for all pictures added to the selected album.

Tap  while the auto sort category list is displayed ( 84) to create a print order for all pictures sorted to the selected category.

Tap  while the shooting date list is displayed ( 87) to create a print order for all pictures taken on the selected date.



- 2 Specify the desired album, category, or shooting date and the number of prints of each picture (up to nine).

Tap the desired album, category, or date, and then tap  or  to specify the number of copies for each.

The album, category, or date selected for printing can be recognized by the check mark and numeral, indicating the number of copies to be printed, displayed with check mark. If no copies have been specified for pictures, the selection is canceled.

If the selected album, category, or shooting date folder contains more than 100 pictures, the print order will contain the oldest 99 pictures.

Tap  when setting is complete.



The screen shown at right is displayed when pictures other than those in the selected album, category, or shooting date have been marked for printing.

- Tap **Yes** to add pictures in the selected album or category, or taken on the selected shooting date, to the existing print order.
- Tap **No** to remove print marking from previously marked pictures and restrict the print order to pictures in the selected album or category, or taken on the selected shooting date.

If the total number of the pictures in a print order exceeds 99, the screen shown at right will be displayed.

- Tap **Yes** to remove pictures previously added from the print order and restrict the print order to pictures just marked.
- Tap **Cancel** to remove the pictures just added from the print order and restrict the print order to pictures previously marked.

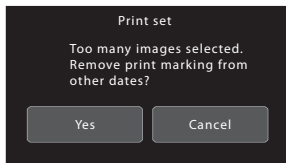
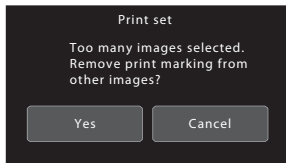
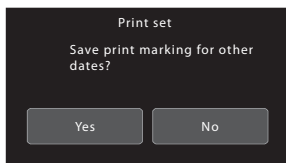
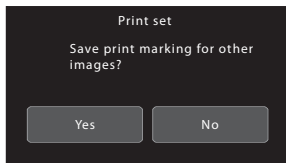

3 Choose whether or not to print shooting date and photo information.

Tap **Date** to print the shooting date on all pictures in the print order.

Tap **Info** to print photo information (shutter speed and aperture) on all pictures in the print order.

Tap **OK** to complete the print order.

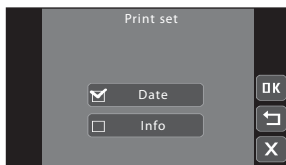

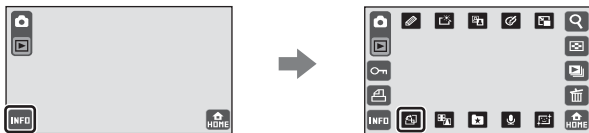

Rotate Image

Specify the orientation in which recorded pictures are displayed with playback. Still pictures can be rotated 90 degrees clockwise or 90 degrees counterclockwise. Pictures that were recorded in portrait (“tall”) orientation can be rotated up to 180 degrees in either direction.



Tap  in playback mode to adjust the setting.

Tap  or  to rotate the picture 90 degrees.



Rotate 90 degrees
counterclockwise



Rotate 90 degrees
clockwise

Tap  to finalize display orientation and save the orientation information with the picture.

Voice Memos: Recording and Playback



Use the camera's built-in microphone to record voice memos for pictures.

Recording Voice Memos



Tap  in playback mode to adjust the setting.

Tap  to record a voice memo.

- Recording ends after 20 seconds.
- Do not touch the built-in microphone during recording.
- During recording, **REC** blinks in the monitor.
- When  is tapped during recording, recording ends.
- When recording ends, the voice memo playback screen is displayed. Tap  to playback a voice memo (108).
- Tap  to return to full-frame playback mode.





More on Playback

More Information

See "Image/Sound File and Folder Names" (159) for more information.



Playing Voice Memos

Pictures for which voice memos have been recorded are indicated with the  icon in playback mode when photo information is on ( 13).



Tap  in playback mode to adjust the setting.

Tap  to play the voice memo.

- Tap  to stop playback.
- Tap the volume control to adjust playback volume.
- Tap  to return to full-frame playback mode.



Volume control

Deleting Voice Memos

Tap  in the voice memo playback screen.

Tap **Yes** to delete only the voice memo.

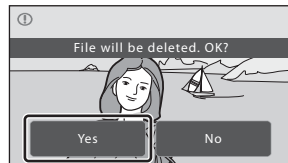









Notes on Voice Memos

- When a picture with a voice memo attached is deleted, both the picture and its voice memo are deleted.
- If a voice memo already exists for the current picture, it must be deleted before a new voice memo can be recorded.
- The COOLPIX S70 is not able to record a voice memo for pictures taken with another make or model of digital camera.

Editing Functions

Use the COOLPIX S70 to edit pictures in-camera and store them as separate files (📖 159). The editing functions described below are available.

| Editing function | Description |
|---|--|
|  Paint (📖 111) | Draw on pictures, or add decorations, to pictures. |
|  Quick retouch (📖 114) | Easily create retouched copies in which contrast and saturation have been enhanced. |
|  D-Lighting (📖 115) | Create a copy of the current picture with enhanced brightness and contrast, brightening dark portions of the picture. |
|  Color options (📖 116) | Make colors more vivid or record pictures in monochrome. |
|  Small picture (📖 117) | Create a small copy of pictures suitable for use as e-mail attachments. |
|  Stretch (📖 118) | Stretch the current picture horizontally to make the subject appear thinner or wider. |
|  Perspective control (📖 119) | Adjust the perspective of picture taken in landscape orientation. Apply perspective control similar to that available with shift lenses. This function is suited to pictures of buildings or architecture. |
|  Skin softening (📖 120) | Make facial skin tones softer. |
|  Crop (📖 121) | Crop a portion of the picture. Use to zoom in on a subject or arrange a composition. |

Notes on Picture Editing

- The editing functions of this camera cannot be used for pictures taken with another make or model of digital camera.
- Edited copies created with this camera may not be displayed properly on another make or model of digital camera. It may also be impossible to transfer them to a computer using another make or model of digital camera.
- Editing functions are not available when there is not enough free space in the internal memory or on the memory card to store the edited copies.
- If no face is recognized in a picture, a copy cannot be created using the skin softening function (📖 120).
- Images created in  (Draw) scene mode (📖 45) can be edited only with the paint, small picture, or crop function.



Restrictions on Picture Editing

When an edited copy is further modified with another editing function, check the following restrictions.

| Editing function used | Editing function to add |
|--|---|
| Paint | The paint, small picture, or crop function can be added. |
| Quick retouch D-Lighting Color options Stretch Perspective control | The paint, small picture, skin softening, or crop function can be added. |
| Small picture | Another editing function cannot be added. |
| Skin softening | The editing functions other than the skin softening can be added. |
| Crop | Another editing function cannot be added except to copies with an aspect ratio of 16:9 and copies saved with the image size of 640 × 480 or larger. |

- Copies created with editing functions other than the paint function cannot be further edited with the same function used to create them.
- When combining the small picture or crop function and another editing function, use the small picture and crop functions after other editing functions have been applied.

Original and Edited Pictures

- Copies created with editing functions are not deleted if the original pictures are deleted. The original pictures are not deleted if copies created with editing functions are deleted.
- Edited copies are stored with the same recording date and time as the original.
- Print marking ( 101) and protect settings ( 99) do not remain effective in edited copies.

Picture Editing

Paint Pictures: Paint

Draw on pictures or decorate them. Shooting date decoration can also be added. Painted copies are stored as separate files.







Tap  in playback mode to edit a picture.

1 Use the , , , , and tools to paint pictures.



For more information about using each tool, see "Using the Paint Tools" (📖 112).

Tap  to enlarge picture display

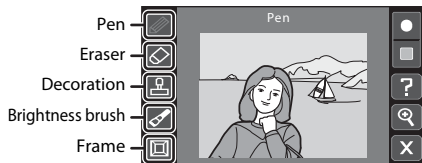
by 3x, the optimum display size for painting pictures. Tap , , , or  to change the portion of the picture in the monitor. Tap  to return to the original display size.





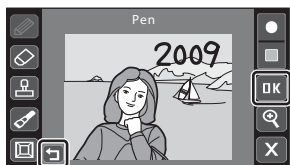

2 Tap .

Tap  before tapping  to undo the last operation applied using the pen, eraser, decoration, or brightness brush tool (up to the last five operations can be undone).



3 Tap Yes.

A new, painted copy is created.

Copies created with pictures taken at an image mode setting of  **16:9 (3968)** are saved at the image size of 1,920 × 1,080. Copies created with pictures taken at an image mode setting of  **Normal (2048)** or larger are saved at the image size of 2,048 × 1,536. Copies created with pictures taken at an image mode setting of  **PC screen (1024)** and  **TV screen (640)** are saved at the image size of 640 × 480.

To exit without saving the copy, tap **No**.

Copies created with the painted function can be recognized by the  icon displayed in playback mode when photo information is on (📖 13).

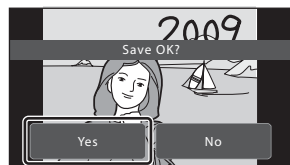

Using the Paint Tools

Write and Draw on Pictures

Tap  to write or draw on pictures.

- Tap the thickness control to choose the weight of pen strokes.
- Tap the color control to choose a color.

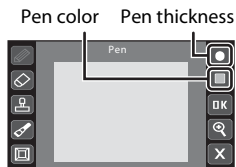

Erase Paint Tool Additions



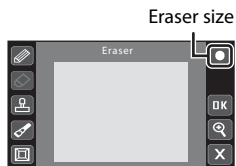

Tap  to erase additions to pictures using the paint or decoration tool.

- Tap the eraser size control to choose the size of the eraser.



Add Decorations

Tap  to add a decoration.

- Tap the decoration type control to choose one of 14 decorations. Select  to add shooting date decoration.
- Tap the decoration size control to choose the size of the decorations. When  is selected for the decoration type,  (day, month, year) and  (day, month, year, time) options are available.

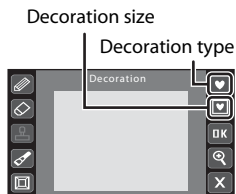

Change Picture Brightness Partially

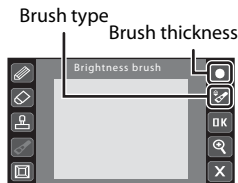

Tap  and then tap the monitor to change the brightness of the position tapped brighter or darker. Tap the same position several times to make more effect.

- Tap the brush thickness control to choose the thickness of the brightness brush.
- Tap the brush type control to choose the brightening brush or the darkening brush.





Add a Frame

Tap  to add a frame around the picture.

- Tap  or  to display seven different frames one at a time. Tap  to select a frame.



Notes on Shooting Date Decoration

- When the shooting date decoration is added to pictures taken at an  **Image mode** setting (📖 64) of **TV TV screen (640)**, the shooting date may be difficult to read. Add the shooting date decoration pictures to pictures taken at an  **Image mode** setting (📖 64) of **PC PC screen (1024)** or larger.
- The date added with the shooting date decoration uses the format selected in the setup menu's **Date** item (📖 22, 143).
- The date added with the shooting date decoration is the date on which the picture was taken. The date added with the shooting date decoration cannot be changed.

More Information

See "Image/Sound File and Folder Names" (📖 159) for more information.

Enhancing Contrast and Saturation: Quick Retouch

Quick retouch can be used to easily create retouched copies in which contrast and saturation have been enhanced. Copies created with the quick retouch function are stored as separate files.



Tap  in playback mode to edit a picture.



- 1 Choose the degree of enhancement performed and tap .



- 2 Tap **Yes**.

A new, edited copy is created (it may take several seconds to create the copy).

To exit without saving the copy, tap **No**.

Copies created with the quick retouch function can be recognized by the  icon displayed in playback mode when photo information is on ( 13).

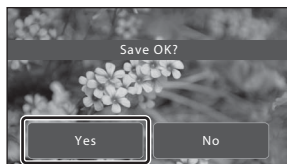



More Information

See "Image/Sound File and Folder Names" ( 159) for more information.

Enhancing Brightness and Contrast: D-Lighting

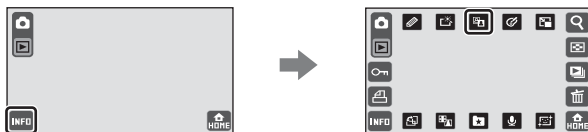
D-Lighting can be used to create copies with enhanced brightness and contrast, brightening dark portions of a picture. Enhanced copies are stored as separate files.



Tap  in playback mode to edit a picture.

1 Tap .

To cancel D-Lighting, tap .

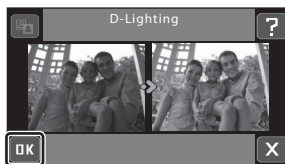

2 Tap **Yes**.

A new, edited copy is created.

To exit without saving the copy, tap **No**.

Copies created with the D-Lighting function can be recognized by the  icon displayed in playback mode when photo information is on (📖 13).

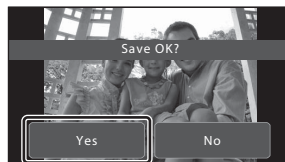



More Information

See "Image/Sound File and Folder Names" (📖 159) for more information.

Modifying Color Tones: Color Options

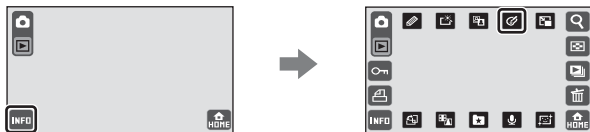



Modify color tones. Copies created with which color tone has been modified are stored as separate files.

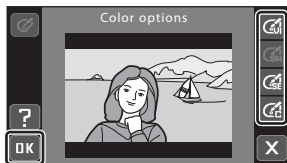

Tap  in playback mode to edit a picture.

- 1 Tap the desired color option control and tap .



| Options | Description |
|---|---|
|  Vivid color | Use to achieve a vivid, "photo print" effect. |
|  Black-and-white | Record black-and-white copies. |
|  Sepia | Record copies with sepia tones. |
|  Cyanotype | Record cyan-blue monochrome copies. |

- 2 Tap **Yes**.

A new copy with modified color tones is created.

To exit without saving the copy, tap **No**.

Copies created with the color options function can be recognized by the  icon displayed in playback mode when photo information is on (📖 13).



More Information

See "Image/Sound File and Folder Names" (📖 159) for more information.

Resizing Pictures: Small Picture



Create a small copy of the current picture. Small copies are stored as JPEG files with a compression ratio of 1:16.





Tap  in playback mode to edit a picture.

- 1 Tap the desired small copy size control and tap .







| Option | Description |
|---|--|
|  640×480 | Suited to television playback. |
|  320×240 | Suited to display on Web pages. |
|  160×120 | Suited to use as for e-mail attachments. |

A small picture size cannot be selected for pictures taken at an image mode setting of  **16:9 (3968)**. The size of the small copy will be 1,920 × 1,080. Tap  and proceed to step 2.

- 2 Tap **Yes**.

A new, small copy is created.

To exit without saving the copy, tap **No**.

The copy is displayed with a gray frame. Copies created with the small picture function can be recognized by the , , or  icon displayed when photo information is on ( 13).

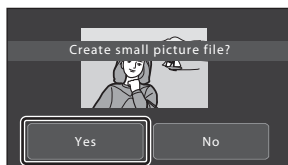

More Information

See "Image/Sound File and Folder Names" ( 159) for more information.

Stretching Pictures: Stretch

Stretch pictures horizontally. Stretched copies are stored as separate files.



Tap  in playback mode to edit a picture.

1 Tap .

When  is tapped, the camera returns to playback display without editing the picture.

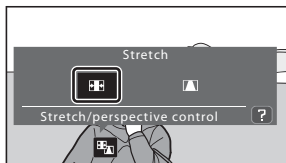

2 Drag the slider to adjust stretch effects.

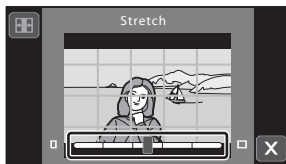

3 Tap .

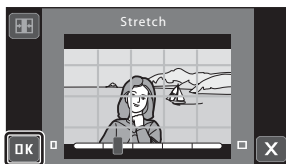

4 Tap **Yes**.

A new, edited copy is created.

To exit without saving the copy, tap **No**.

Copies created with the stretch function can be recognized by the  icon displayed in playback mode when photo information is on (📖 13).

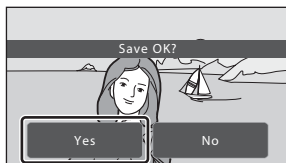

More Information

See "Image/Sound File and Folder Names" (📖 159) for more information.

Adjust a Sense of Perspective: Perspective Control

Adjust the sense of perspective in the picture taken in landscape orientation.

Copies created with the perspective control function are stored as separate files.



Tap  in playback mode to edit a picture.

1 Tap .

When  is tapped, the camera returns to playback display without editing the picture.

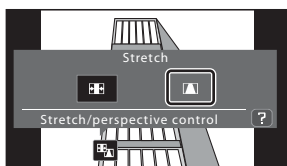

2 Drag the slider to adjust perspective control.

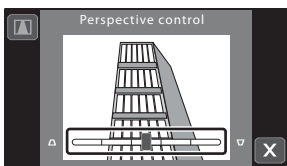

3 Tap .

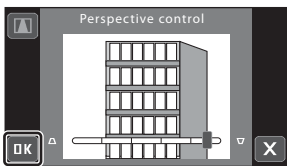

4 Tap **Yes**.

A new, edited copy is created.

To exit without saving the copy, tap **No**.

Copies created with the perspective control function can be recognized by the  icon displayed in playback mode when photo information is on (📖 13).

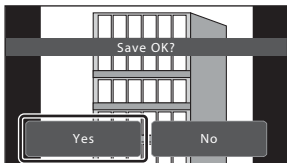



More Information

See "Image/Sound File and Folder Names" (📖 159) for more information.

Softening Skin Tones: Skin Softening

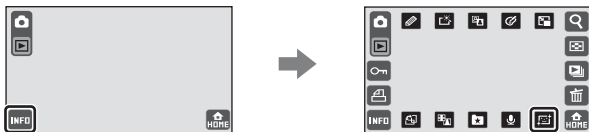
The camera recognizes faces in pictures and creates a copy with softer facial skin tones. Copies created using the skin softening function are stored as separate files. If no faces are recognized in the picture, an alert is displayed and the camera returns to full-frame playback mode.



Tap  in playback mode to edit a picture.

1 Select a degree of softening and tap .

The confirmation dialog is displayed and the portion of the picture containing the softened face is enlarged.



2 Check the preview of the copy.

Skin tones in up to 12 faces, in the order of that closest to the center of the frame, are softened.

When more than one softened face is displayed, tap  or  to display other faces.

Tap  to adjust the degree of softening. The monitor display returns to that shown in step 1.

When  is tapped, a new, edited copy is created.

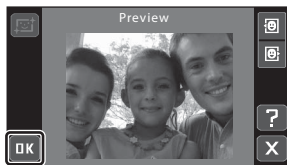

Copies created with the skin softening function can be recognized by the  icon displayed in playback mode when photo information is on ( 13).

Note on Skin Softening

The skin softening function may not perform as expected, even when faces were recognized with shooting. The camera's ability to accurately detect faces in pictures and then edit those faces depends on a variety of factors, including the brightness of the faces in the picture and the direction in which the faces are looking.

More Information

See "Image/Sound File and Folder Names" ( 159) for more information.

✂ Creating a Cropped Copy: Crop

Create a copy containing only the portion visible in the monitor with playback zoom (📖 91) enabled. Cropped copies are stored as separate files.

1 Enlarge the desired picture in full-frame playback mode (📖 91).

Enlarge picture display until 🗂 is displayed at left in the monitor.

2 Refine copy composition.

Tap 🔍 or 🔍 to adjust the zoom ratio.

Drag the picture so that only the portion to be copied is visible in the monitor.

Pictures taken at an image mode setting of 📷

16:9 (3968) can be cropped at ratios of 2.0x or less.



3 Tap 🗂.

Pictures taken at an image mode setting of 📷 **16:9 (3968)** are cropped with an aspect ratio of 16:9. Pictures taken at an image mode setting other than 📷 **16:9 (3968)** are cropped with an aspect ratio of 4:3.



4 Tap Yes.

A cropped copy is created.

To exit without saving the copy, tap **No**.

Cropped copies can be recognized by the 🗂 icon displayed in playback mode when photo information is on (📖 13).



✔ Notes on Crop

- When playback zoom is applied to a picture taken in portrait orientation, the enlarged picture is displayed in landscape orientation.
- Picture aspect ratio cannot be changed and pictures cannot be cropped in portrait orientation.

📏 Image Size

As the area to be saved is reduced, the image size (pixels) of the cropped copy is also reduced.

When the image size of the cropped copy is 320 × 240 or 160 × 120, the small picture icon 📷 or 📷 is displayed in the left of the monitor in playback mode when photo information is on (📖 13).

📖 More Information

See "Image/Sound File and Folder Names" (📖 159) for more information.

Recording Movies

Record movies with sound recorded via the built-in microphone.

- 1 Tap the shooting mode control during shooting to display the shooting mode selection controls, and then tap .

The maximum recording time for a single movie is 25 minutes, or a file size of 2 GB, even when there is enough free space in the internal memory or on the memory card.

The maximum movie length that can be recorded is displayed in the monitor ( 123).

A shooting mode can also be selected from the HOME screen ( 14).

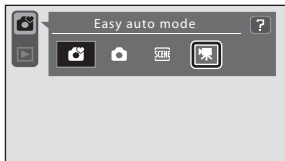

- 2 Press the shutter-release button all the way down to start recording.

The camera focuses on the subject at center of the frame.

A progress bar shows the amount of recording time remaining.

To end recording, press the shutter-release button all the way down again.

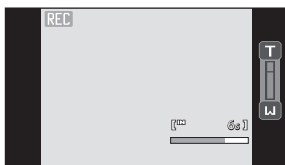

Movie recording can also be initiated or stopped by tapping the monitor.

Recording stops automatically when the maximum movie length that can be recorded has run out.

Recording Movies

Optical zoom cannot be adjusted once movie recording begins. Digital zoom cannot be applied before movie recording begins. However, digital zoom (up to 2x) can be applied while movies are being recorded.



Note on Recording Movies

After a movie has been recorded, the movie is being recorded to the internal memory or memory card until the monitor returns to shooting display. **Do not open the battery-chamber/memory card slot cover** while movies are being recorded. Removing the memory card while movies are being recorded could result in loss of data or in damage to the camera or card.

Adjusting Movie Settings

 Movie options,  Autofocus mode, and  Macro mode can be applied or changed in movie mode. These settings cannot be applied or changed while movies are being recorded. Apply or change settings before movie recording begins.

Movie Recording Settings

⏪ Movie options,  Autofocus mode, and  Macro mode can be applied or changed in movie mode.





Tap the control before movie recording begins to adjust settings.

⏪ Selecting Movie Options





Select the desired movie option to record.



Tap  in movie mode to adjust the setting.

| Option | Image size and frame rate |
|--|--|
|  HD 720p | Image size: 1,280 × 720 pixels Frame rate: 30 frames per second |
|  TV movie 640★ (default setting) | Image size: 640 × 480 pixels Frame rate: 30 frames per second |
|  TV movie 640 | Image size: 640 × 480 pixels Frame rate: 15 frames per second |
|  Small size 320★ | Image size: 320 × 240 pixels Frame rate: 30 frames per second |
|  Small size 320 | Image size: 320 × 240 pixels Frame rate: 15 frames per second |

Movie Options and Maximum Movie Length and Frames

| Option | Internal memory (approx. 20 MB) | Memory card (512 MB) |
|--|---------------------------------|----------------------|
|  HD 720p | 6 s | 2 min 30 s |
|  TV movie 640★ (default setting) | 18 s | 7 min 20 s |
|  TV movie 640 | 35 s | 14 min 10 s |
|  Small size 320★ | 35 s | 14 min 10 s |
|  Small size 320 | 1 min 7 s | 25 min |

* All figures are approximate. The maximum recording time may vary with make of memory card. The maximum recording time for a single movie is 25 minutes, or a file size of 2 GB, even when there is enough free space in the internal memory or on the memory card. The maximum movie length that can be recorded for a single movie is displayed during recording.

More Information

See "Image/Sound File and Folder Names" (📖 159) for more information.

Autofocus Mode

Select how the camera focuses in movie mode.



Tap  in movie mode to adjust the setting.



Single AF (default setting)

Focus is locked when the shutter-release button is pressed.



Full-time AF

Camera focuses continuously until focus is acquired and locked.

To prevent sound of camera focusing from interfering with recording, use of **Single AF** is recommended.

Macro Mode Setting

Macro mode is used for recording movies of objects as close as 3 cm (1.2 in.).



Tap  in movie mode to adjust the setting.



On

Macro mode setting is enabled. See page 67 for more information.



Off (default setting)

Macro mode setting is disabled.

Movie Playback

Switch to playback mode (📖 32) and display the desired movie full-frame. Tap **INFO** to display operation controls and then tap **▶** displayed at upper right in the monitor to start movie playback.

Movie playback can also be initiated by tapping the monitor.

Tap the volume control during playback to display the volume setting control, and adjust playback volume.

Playback controls are displayed at the right side of the monitor. The operations described below are available during movie playback.



During playback

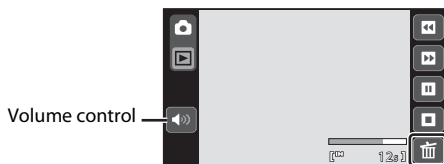

| To | Tap | Description |
|---------|-----------------------------|---|
| Rewind | ⏮ | Touch and hold ⏮ to rewind movie. |
| Advance | ⏭ | Touch and hold ⏭ to advance movie. |
| Pause | ⏸ | Pause playback. The following operations can be performed while playback is paused using the controls displayed in the right of the monitor. |
| | | ⏮ Rewind movie back one frame. Touch and hold ⏮ for continuous frame-by-frame rewind. |
| | | ⏭ Advance movie forward one frame. Touch and hold ⏭ for continuous frame-by-frame advance. |
| | ▶ Resume playback. | |
| End | ⏹ | End playback and return to full-frame display. |

Deleting Movie Files

Tap **🗑** in full-frame playback mode (📖 89) or during movie playback. A confirmation dialog is displayed. Tap **Yes** to delete the movie, or tap **No** to exit without deleting the movie.

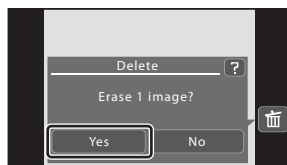

Connecting to a TV

Connect the camera to a television using the supplied audio/video cable to play back pictures full-frame or in a slide show, or to play back movies, on a television.

- 1 Close the slide cover to turn off the camera.

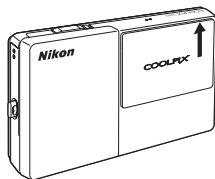

- 2 Connect the camera to the TV using the supplied A/V cable.

Connect the yellow plug to the video-in jack, and the white plug to the audio-in jack on the TV.

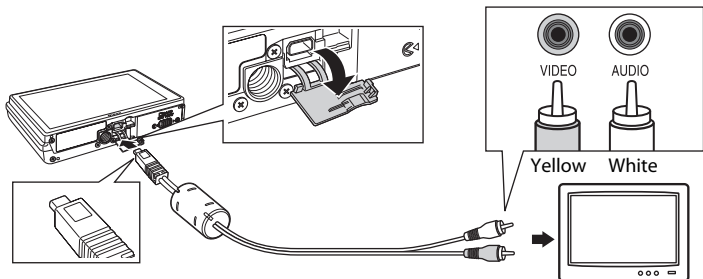

- 3 Tune the television to the video channel.

See the documentation provided with your television for details.

- 4 Open the slide cover to turn on the camera.

Tap  to switch to playback mode. Pictures are displayed in the camera monitor and on the television.

Pictures cannot be displayed on the television when the camera is in shooting mode or the setup menu is displayed in camera monitor.

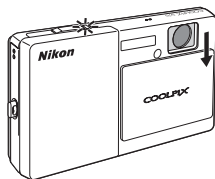

✓ Connecting the Cable

When connecting the cable, be sure that the camera connector is properly oriented. Do not use force when connecting the cable. When disconnecting the cable, do not pull the connector at an angle.

✓ Video Mode

Be sure that the camera's video mode setting conforms to the standard used by your television.

The video mode setting is specified from the **Video mode** (📖 151) option in the setup menu (📖 139).

Connecting to a Computer

Connect the camera to a computer using the supplied USB cable to copy (transfer) pictures to a computer with the supplied Nikon Transfer software.

Before Connecting the Camera

Install the Software

Before connecting the camera to a computer, software, including Nikon Transfer, ViewNX for viewing transferred pictures, and Panorama Maker for creating panorama images, must be installed from the supplied Software Suite CD.

For more information on installing the software, refer to the *Quick Start Guide*.

Compatible Operating Systems

Windows

Preinstalled versions of Windows Vista Service Pack 1 (32-bit Home Basic/Home Premium/Business/Enterprise/Ultimate editions),

Windows XP Service Pack 3 (Home Edition/Professional)

Macintosh

Mac OS X (version 10.3.9, 10.4.11, 10.5.6)

Refer to the Nikon website for the latest information on operating system compatibility.

Note on Computer Connection

Disconnect other USB devices such as commercial USB chargers from the computer. Simultaneous connection of the camera and other USB devices to the computer could result in operation malfunction or excessive supply of power to the camera, causing damage to the camera or memory card. Refer to the documentation supplied with other USB devices for more information.

Notes on Power Source

- When connecting the camera to a computer to transfer pictures, use a fully charged battery to prevent the camera from turning off unexpectedly.
- When the camera is connected to a computer via the supplied USB cable with **Auto** (default setting) selected for the **Charge by computer** option in the setup menu, the battery inserted into the camera is automatically charged using power supplied by the computer (152). Pictures can be transferred while the battery is charging.
- If the AC Adapter EH-62F is used, power can be supplied to the COOLPIX S70 from an electrical power outlet. Do not, under any circumstances, use another make or model of AC adapter other than EH-62F. Failure to observe this precaution could result in overheating or in damage to the camera.

Transferring Pictures from the Camera to a Computer

- 1 Start the computer to which Nikon Transfer was installed.
- 2 Be sure that the camera is off.
- 3 Connect the camera to the computer using the supplied USB cable.

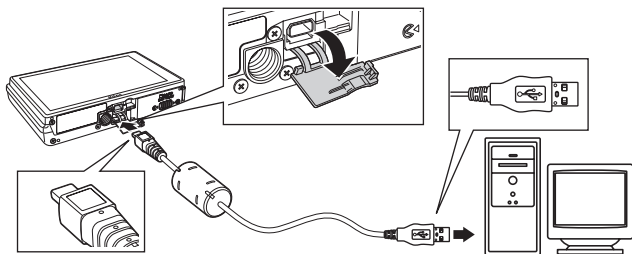

- 4 The camera is automatically turned on.

The power-on lamp will light or blink ( 131).

The camera monitor remains off.

If charge for the battery inserted into the camera is low, the computer may not recognize the camera. If the camera is not recognized, pictures will not be transferred. When battery charging starts automatically using power supplied by the computer, wait until battery charge has reached a sufficient level to begin transfer.

Windows Vista

When the AutoPlay dialog is displayed, click **Copy pictures to a folder on my computer using Nikon Transfer**. Nikon Transfer will start. To bypass this dialog in the future, check **Always do this for this device**.

Windows XP

When the action selection dialog is displayed, select **Nikon Transfer Copy pictures to a folder on my computer** and click **OK**. Nikon Transfer will start.

To bypass this dialog in the future, check **Always use this program for this action**.

Mac OS X

Nikon Transfer will start automatically if **Yes** was selected in the Auto-Launch setting dialog when Nikon Transfer was first installed.

- 5** Confirm that the source device is displayed in the transfer options **Source** panel and click **Start Transfer**.

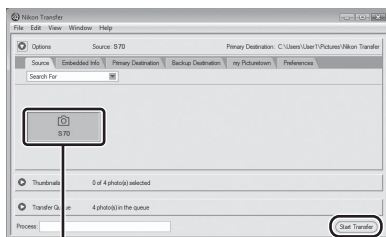

Source device

Start Transfer button

At the Nikon Transfer default settings, all pictures are transferred to the computer. At the Nikon Transfer default settings, ViewNX starts automatically when transfer is complete and transferred pictures can be viewed.

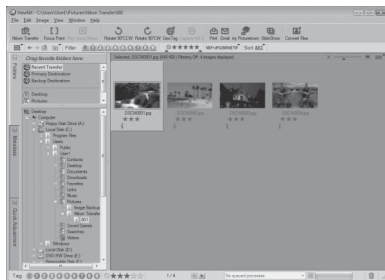

For more information on using Nikon Transfer or ViewNX, refer to help information contained in Nikon Transfer or ViewNX (130).

Disconnecting the camera

Do not turn off the camera or disconnect the camera from the computer during transfer.

When transfer is complete, open and close the slide cover to turn off the camera and disconnect the USB cable.

The camera turns off automatically if there is no communication with the computer for 30 minutes while the camera is connected via the USB cable.

Connecting the USB Cable

- Be sure that connectors are properly oriented. Do not attempt to insert connectors at an angle, and do not use force when connecting or disconnecting the USB cable.
- The connection may not be recognized if the camera is connected to a computer via a USB hub.

Charging the Battery

The power-on lamp slowly blinks orange while the battery inserted into the camera is charging (📖 131).

Using a Card Reader

The pictures stored on the memory card inserted into a card reader or similar device can also be transferred to the computer using Nikon Transfer.

- If the memory card has a capacity greater than 2 GB, or is SDHC-compliant, the intended device must support these features of the memory card.
- Insert a memory card into the card reader or similar device, and refer to steps 4 and 5 (📖 128) to transfer pictures.
- To transfer pictures stored in the camera's internal memory to the computer, the pictures must first be copied to a memory card using the camera (📖 156).

Starting Nikon Transfer or ViewNX Manually

Windows

Choose **Start menu>All Programs>Nikon Transfer>Nikon Transfer** (or **All Programs>ViewNX>ViewNX**).

Double-clicking the Nikon Transfer or ViewNX shortcut icon on the desktop will also start Nikon Transfer or ViewNX.

Mac OS X

Open **Applications** and double-click **Nikon Software>Nikon Transfer>Nikon Transfer** (or **Nikon Software>ViewNX>ViewNX**).

Clicking the Nikon Transfer or ViewNX icon on the Dock will also start Nikon Transfer or ViewNX.

Viewing Nikon Transfer and ViewNX Help Information

For more information on Nikon Transfer or ViewNX, start Nikon Transfer or ViewNX and select **Nikon Transfer Help** or **ViewNX Help** from the **Help** menu.

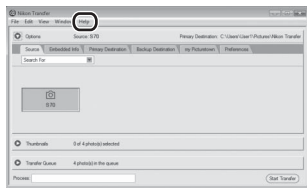

Panorama Creation with Panorama Maker

- Use a series of pictures taken in **Panorama assist** scene mode (📖 44) to create a single panorama photo with Panorama Maker.
- Panorama Maker can be installed on a computer using the supplied Software Suite CD.
- After installation is complete, follow the procedure described below to start Panorama Maker.

Windows

Choose **Start menu>All Programs>ArcSoft Panorama Maker 4>Panorama Maker 4**.

Macintosh

Open **Applications** and double-click the **Panorama Maker 4** icon.

- For more information on using Panorama Maker, refer to the on-screen instructions and help information contained in Panorama Maker.

Image File Names and Folder Names

See "Image/Sound File and Folder Names" (📖 159) for more information.

Charging While Connecting to a Computer

When connecting the camera to a computer via the supplied USB cable while **Auto** (default setting) is selected for the **Charge by computer** option (📖 152) in the setup menu, the battery inserted into the camera is automatically charged using power supplied by the computer.

See “Before Connecting the Camera” (📖 127) and “Transferring Pictures from the Camera to a Computer” (📖 128) for more information on connecting the camera to a computer.

Power-on Lamp

The following chart explains power-on lamp status when the camera is connected to a computer.

| Power-on lamp | Description |
|------------------------|---|
| Blinks slowly (orange) | Battery charging. |
| Glow (green) | <ul style="list-style-type: none"> Battery not charging. Charging is complete when the power-on lamp stops blinking orange and glows green. When the camera is connected to a computer with Off selected for the Charge by computer option, the power-on lamp remains lit but the battery inserted into the camera is not charged. |
| Flickers (orange) | <ul style="list-style-type: none"> Charge the battery indoors with an ambient temperature of 5 °C to 35 °C (41 °F to 95 °F). A USB cable is not correctly connected or the battery is faulty. Reconnect the USB cable correctly or replace the battery. Computer is in sleep mode and does not supply power. Reboot a computer. The battery cannot be charged as computer's specifications or settings does not support power supply to the camera. |

✓ Notes on Charging with Connection to a Computer

- The battery cannot be charged, nor can data be transferred, when the camera is connected to a computer before the camera's date and time have been set (📖 22). If the camera's clock battery (📖 144) has been exhausted, the date and time must be reset before the battery can be charged or images can be transferred with connection to a computer. In this case, use the Charging AC Adapter EH-68P (📖 18) to charge the battery and then set the camera's date and time.
- If the camera is turned off by opening and closing the slide cover, charging will also stop.
- If a computer enters sleep mode while charging, charging will stop and the camera may be turned off.
- When disconnecting the camera from a computer, turn the camera off by opening and closing the slide cover and then disconnect the USB cable.
- About seven hours are required to charge a fully exhausted battery. Charging time increases when images are transferred while the battery is charging.
- When the camera is connected to a computer, an application installed on the computer, such as Nikon Transfer, may start. If the camera was connected to the computer for the sole purpose of charging the battery, exit the application.
- The camera turns off automatically if there is no communication with the computer for 30 minutes after the battery has finished charging.
- Depending upon computer specifications, settings, and power supply and allocation, it may be impossible to charge the battery inserted into the camera via computer connection.

Connecting to a Printer

Users of PictBridge-compatible (📖 176) printers can connect the camera directly to the printer and print pictures without using a computer.

Follow the procedures below to print pictures.

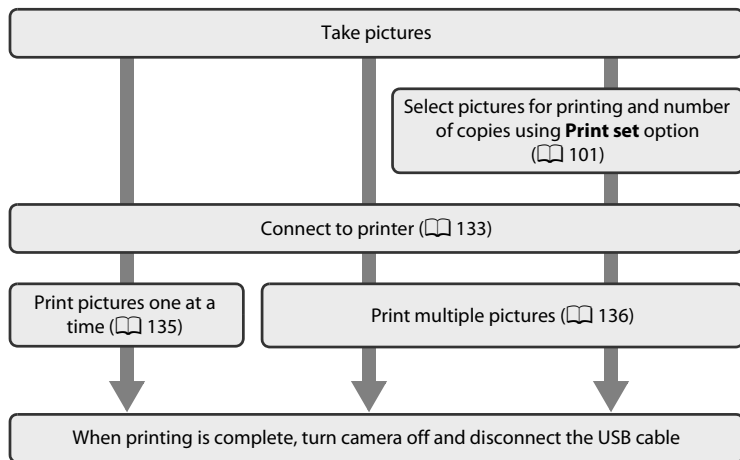

✔ Notes on Power Source

- When connecting the camera to a printer, use a fully charged battery to prevent the camera from turning off unexpectedly.
- If the AC Adapter EH-62F (available separately) is used, COOLPIX S70 can be powered from a home electrical outlet. Do not use any other AC adapters as it will cause the camera to heat up or malfunction.

✔ Note on Printing Pictures

When printing pictures taken at an **Image mode** setting of **16:9 (3968)** (default setting), the edges of pictures may be cropped, preventing printing of complete pictures.

It may be possible to print complete pictures if settings on the printer are applied so that borders are printed around pictures (borderless printing not enabled).

Refer to the documentation supplied with the printer or consult the digital photo lab for further details to make sure that the printer supports printing at an aspect ratio of 16:9.

Printing Pictures

In addition to printing pictures transferred to a computer from your personal printer and printing over a direct camera-to-printer connection, the following options are also available for printing pictures stored on the memory card:

- Insert a memory card into a DPOF-compatible printer's card slot
- Take a memory card to a digital photo lab

To print pictures using either of these methods, use your camera's **Print set** option (📖 101) to select the pictures, and the desired number of prints each, from those recorded to a memory card.

Connecting the Camera to a Printer

- 1 Close the slide cover to turn off the camera.

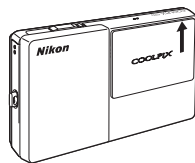

- 2 Turn on the printer.

Check printer settings.

- 3 Connect the camera to the printer using the supplied USB cable.

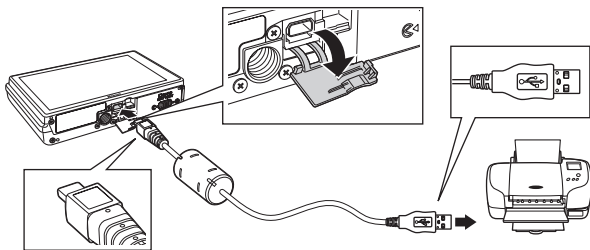

- 4 The camera is automatically turned on.

When properly connected, the **PictBridge** startup screen (①) will be displayed in the camera monitor, followed by the print selection screen (②).

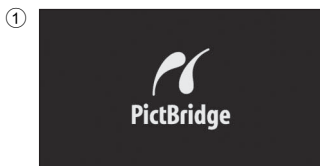
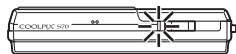

✔ **Notes on Connecting/Disconnecting Cable**

- Be sure that connectors are properly oriented. Do not attempt to insert connectors at an angle, and do not use force when connecting or disconnecting the USB cable.
- Open and close the slide cover to turn off the camera before disconnecting the USB cable.

✔ **If the PictBridge Startup Screen is not Displayed**



Turn the camera off and disconnect the USB cable. Set the **Charge by computer** option (📖 152) in the camera's setup menu to **Off** and reconnect the cable again.

Printing Pictures One at a Time

After properly connecting the camera to the printer (📖 133), follow the procedures described below to print a picture.

- 1 Tap  or  to choose the desired picture, and tap .

Previous or subsequent picture can also be viewed by tapping the scroll bar.

Tap  to display 12 thumbnails, and  to switch back to full-frame playback.

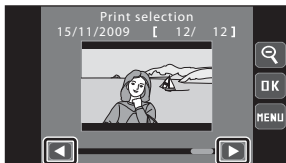

- 2 Tap **Copies**.

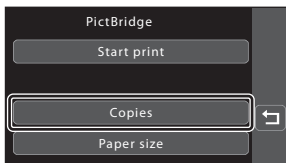

- 3 Tap the desired number of copies.



Up to nine copies can be specified.

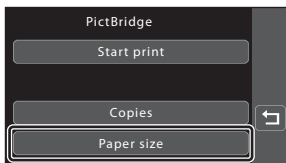

- 4 Tap **Paper size**.



- 5 Tap the desired paper size.

Paper sizes supported by the printer are displayed (📖 138). Tap  or  to display additional options.

To specify paper size using settings on the printer, tap **Default** in the paper size option.

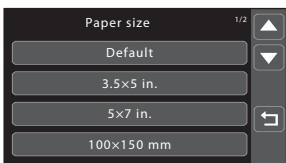

6 Tap **Start print**.



7 Printing begins.

Monitor display returns to the print selection screen shown in step 1 when printing is complete.

To cancel printing before all copies have been printed, tap **Cancel**.

Current number of copies/
total number of copies

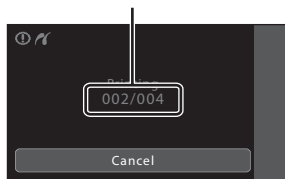

Printing Multiple Pictures

After properly connecting the camera to the printer (📖 133), follow the procedures described below to print multiple pictures.

1 When the print selection screen is displayed, tap **MENU**.

The print menu is displayed.

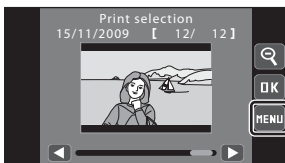

2 Tap **Paper size**.



3 Tap the desired paper size.

Paper sizes supported by the printer are displayed (📖 138). Tap ▲ or ▼ to display additional options.

To specify paper size using settings on the printer, tap **Default** in the paper size option.

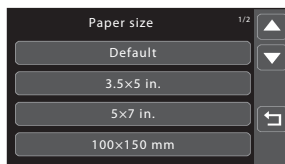

4 Tap **Print selection**, **Print all images** or **DPOF printing**.



Print selection

Choose pictures (up to 99) and the number of copies (up to nine) of each.

- Tap the desired pictures and tap or to specify the number of copies to be printed.
- Pictures selected for printing can be recognized by the check mark () and the numeral indicating the number of copies to be printed.
- Tap to switch back to full-frame playback, and to display 12 thumbnails.
- Tap to remove print marking from all pictures.
- Tap when setting is complete.
- When the screen shown at right is displayed, tap **Start print** to print.
- To return to the print menu, tap **Cancel**.

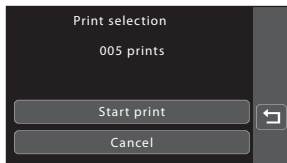
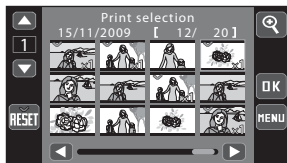

Print all images

One copy each of all pictures stored in the internal memory, or on the memory card, is printed.

- When the screen shown at right is displayed, tap **Start print** to print.
- To return to the print menu, tap **Cancel**.

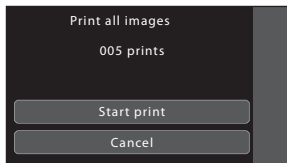

DPOF printing

Print pictures for which a print order was created using the **Print set** option (101).

- When the screen shown at right is displayed, tap **Start print** to print.
- To view the current print order, tap **View images**. To print pictures, tap **OK**.

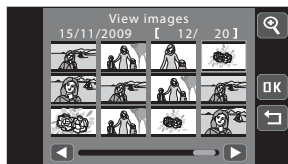

5 Printing begins.

Monitor display returns to the print menu shown in step 2 when printing is complete.

To cancel printing before all copies have been printed, tap **Cancel**.

Current number of copies/
total number of copies

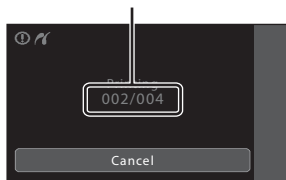

Paper Size

The camera supports the following paper sizes: **Default** (the default paper size for the printer connected to the camera), **3.5 × 5 in.**, **5 × 7 in.**, **100 × 150 mm**, **4 × 6 in.**, **8 × 10 in.**, **Letter**, **A3**, and **A4**. Only sizes supported by the printer will be displayed. To specify paper size using printer settings, choose **Default** in the **Paper Size** option.

Basic Camera Setup: The Setup Menu

The setup menu contains the following options.

| | |
|---|-----|
| HOME display | 141 |
| Choose a display format for the HOME screen. | |
| Welcome screen | 142 |
| Select screen displayed when camera is turned on. | |
| Date | 143 |
| Set camera clock and choose home and destination time zones. | |
| Monitor settings | 146 |
| Adjust post-shooting image review and monitor brightness settings. | |
| Date imprint | 146 |
| Imprint shooting date and time on pictures. | |
| Vibration reduction | 147 |
| Choose whether or not vibration reduction is enabled. | |
| AF assist | 148 |
| Enable or disable AF-assist illuminator. | |
| Digital zoom | 148 |
| Enable or disable digital zoom. | |
| Sound settings | 149 |
| Adjust sound and volume when operating the camera. | |
| Auto off | 149 |
| Set time before camera enters standby mode. | |
| Format memory/Format card | 150 |
| Format internal memory or memory card. | |
| Language | 151 |
| Choose the language used for camera monitor display. | |
| Video mode | 151 |
| Adjust settings necessary for connection to television. | |
| Charge by computer | 152 |
| Choose whether or not to charge the camera battery when connecting to a computer via the USB cable. | |
| Blink warning | 153 |
| Specify whether or not the camera detects human faces that have blinked with shooting using face priority (📖 28). | |
| Reset all | 154 |
| Restore camera settings to default values. | |
| Copy | 156 |
| Copy files between memory card and internal memory. | |
| Firmware version | 157 |
| Display camera firmware version. | |

Operating the Setup Menu

- 1 Tap  in shooting or playback mode.

The HOME screen is displayed.





- 2 Tap the **Set up** control.

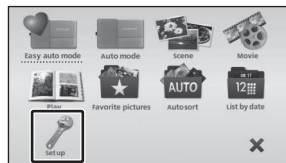

The setup menu is displayed.



- 3 Tap the desired option.

Tap  or  to display previous or subsequent page.

Tap  to return to the previous screen.

When  is displayed in a screen, tap  to apply the setting.

To exit the setup menu, tap the desired shooting or playback mode control in the HOME screen, displayed by tapping  (14).

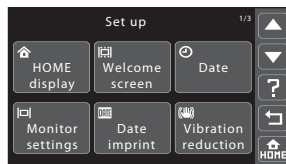

Displaying the Help Screen in Setup Menu

When  is tapped in setup menu, the help selection screen is displayed. Tap a setup menu item to display a description of the function of that item.

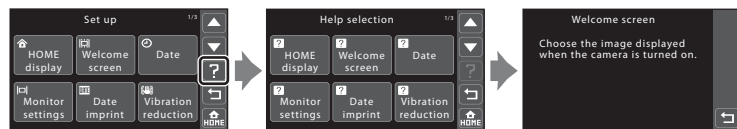

Tap  to return to the help selection screen.

Tap  in the help selection screen to return to the setup menu.



HOME display

Tap  → Setup menu (📖 140) → HOME display

Choose a display format for the HOME screen.

Photograph

Select a picture from the internal memory or a memory card for display format of the HOME screen. Choose a picture from the picture selection screen and tap .

- In the picture selection screen, tap  to switch to full-frame playback and tap  to switch back to 12-thumbnail display.
- As the selected picture is stored in the camera, it will be displayed when the camera is turned on even if the original picture is deleted.
- Copies created at a size of 320 × 240 or smaller using the crop (📖 121) or small picture (📖 117) function, cannot be selected.



Clip art (default setting)

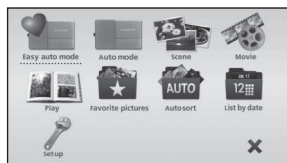

Craft

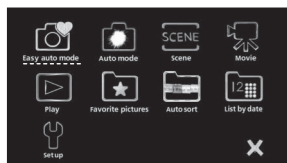

Welcome Screen

Tap  → Setup menu (📖 140) → Welcome screen

Select the welcome screen to be displayed when the camera is turned on.

None (default setting)



No welcome screen is displayed.

COOLPIX

Displays a welcome screen.

Select an image

Select a picture from the internal memory or a memory card for display as the welcome screen. Choose a picture from the picture selection screen and tap .

- In the picture selection screen, tap  to switch to full-frame playback and tap  to switch back to 12-thumbnail display.
- As the selected picture is stored in the camera, it will be displayed when the camera is turned on even if the original picture is deleted.
- Copies created at a size of 320 × 240 or smaller using the crop (📖 121) or small picture (📖 117) function, cannot be selected.



Date

Tap  → Setup menu (📖 140) → Date

Set the camera clock.

Date

Set camera clock to current date and time.

When the date and time setting screen is displayed, repeat from step 5 of the section, “Setting Display Language, Date and Time” (📖 23).

Time zone

Home time zone (🏠) can be specified and daylight saving time is enabled or disabled from **Time zone** options. When destination time zone (✈️) is selected, local time (📖 145) is automatically calculated and shooting date and time in the selected region are recorded with pictures. Useful when travelling.

Selecting Travel Destination Time Zone

1 Tap **Time zone**.

The time zone screen is displayed.

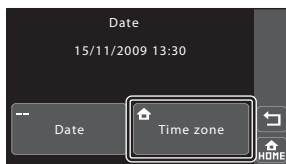

2 Tap **Travel destination**.

The date and time displayed in the monitor changes according to the region currently selected.

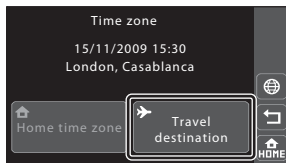

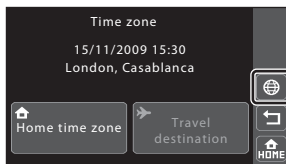

3 Tap .

The travel destination screen is displayed.



4 Tap or to choose the travel destination time zone and tap .

If daylight saving time is in effect, tap  to enable daylight saving time function.  is displayed at the top of the monitor and the camera clock is advanced one hour. Tapping  toggles the daylight saving time function on and off.

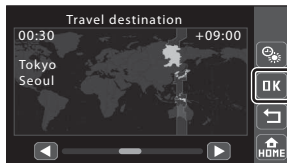

While the travel destination time zone is selected, the  icon will be displayed in the monitor when the camera is in shooting mode.

Note on the Clock Backup Battery

The camera clock is powered by the clock backup battery. The clock battery charges when the main battery is inserted or an AC adapter is connected, and can provide several days of backup power after about ten hours of charging.



Home Time Zone

- To switch to the home time zone, tap **Home time zone** in step 2.
- To change the home time zone, tap **Home time zone** in step 2, and complete steps 3 and 4.

Daylight Saving Time

When daylight saving time starts or ends, turn the daylight saving time function on or off from the time zone selection screen displayed in step 4.

Imprinting Date on Pictures

Enable date imprint in shooting mode ( 74) after the date and time have been set or from the **Date imprint** option ( 146) in the setup menu. When the **Date imprint** option is enabled, pictures will be recorded with shooting date imprinted on them.

 **Time Zones (📖 22)**

The camera supports the time zones listed below.

For time zones not listed below, set the camera clock to local time from the **Date** option.

| UTC +/- | Location | UTC +/- | Location |
|---------|--|---------|---|
| -11 | Midway, Samoa | +1 | Madrid, Paris, Berlin |
| -10 | Hawaii, Tahiti | +2 | Athens, Helsinki, Ankara |
| -9 | Alaska, Anchorage | +3 | Moscow, Nairobi, Riyadh, Kuwait, Manama |
| -8 | PST (PDT): Los Angeles, Seattle, Vancouver | +4 | Abu Dhabi, Dubai |
| -7 | MST (MDT): Denver, Phoenix | +5 | Islamabad, Karachi |
| -6 | CST (CDT): Chicago, Houston, Mexico City | +5.5 | New Delhi |
| -5 | EST (EDT): New York, Toronto, Lima | +6 | Colombo, Dhaka |
| -4 | Caracas, Manaus | +7 | Bangkok, Jakarta |
| -3 | Buenos Aires, Sao Paulo | +8 | Beijing, Hong Kong, Singapore |
| -2 | Fernando de Noronha | +9 | Tokyo, Seoul |
| -1 | Azores | +10 | Sydney, Guam |
| ±0 | London, Casablanca | +11 | New Caledonia |
| | | +12 | Auckland, Fiji |

Monitor Settings

Tap  → Setup menu (📖 140) → Monitor settings

Adjust post-shooting image review and monitor brightness settings.

Image review

On (default setting): Picture is automatically displayed in the monitor immediately after it is taken and the monitor display returns to shooting mode.

Off: Picture is not displayed after it is taken.

Brightness

Choose from five settings for monitor brightness. The default setting is **3**.

Auto Monitor Boost

The camera automatically increases monitor brightness outdoors and under extremely bright lighting to make the monitor display easier to see and read (when **Brightness** is set to **4** or less).

Date Imprint

Tap  → Setup menu (📖 140) → Date imprint

The shooting date and time can be imprinted on the pictures with shooting, allowing the information to be printed even from printers that do not support date printing (📖 103).

Off (default setting)

Date and time are not imprinted on pictures.

Date

Date is imprinted on pictures.

Date and time

Date and time are imprinted on pictures.

Date imprint can be enabled in shooting mode. For more information on date imprint, see “**DATE** Imprinting Time and Date (Date Imprint)” (📖 74).

Vibration Reduction

Tap  → Setup menu (📖 140) → Vibration reduction



Select the vibration reduction option for shooting.

Vibration reduction effectively reduces blur, caused by slight hand movement known as camera shake, which commonly occurs when shooting with zoom applied or at slow shutter speeds. The effects of camera shake are reduced when recording movies, in addition to when taking still pictures.

Set **Vibration reduction** to **Off** when using a tripod to stabilize the camera during shooting.

On (hybrid)

The effects of camera shake are reduced optically only using a lens-shift method. Additional image processing with electronic vibration reduction is applied to further reduce the effects of camera shake with recording of still pictures taken under the following conditions.

- when flash is disabled.
- when a shutter speed slower than 1/60 seconds is used.
- when  **Self-timer** is disabled.
- when  **Single** is selected for the  **Continuous** setting.
- when ISO sensitivity is set to 200 or less.

On (default setting)

Vibration reduction is enabled when taking pictures and recording movies using lens-shift method.

Off

Vibration reduction is not enabled.

The current vibration reduction setting can be confirmed in the camera monitor with shooting when photo information is on (📖 11, 27). When **Off** is selected, no icon is displayed.

✓ Notes on Vibration Reduction

- Vibration reduction may take a few seconds to activate after the power is turned on, or the camera enters shooting mode from playback mode. Wait until the image of the monitor stabilizes before shooting.
- Due to characteristics of the vibration reduction function, images displayed in the camera's monitor immediately after shooting may be displayed blurry.
- Vibration reduction may be unable to completely eliminate the effects of camera shake in some situations.
- Image processing with electronic vibration reduction may not perform as expected with very slight or extreme camera shake, even when **On (hybrid)** is selected.
- Image processing with electronic vibration reduction is not enabled at fast or extremely slow shutter speeds, even when **On (hybrid)** is selected.
- The **On (hybrid)** option for **Vibration reduction** and **Date imprint** (📖 74, 146) cannot be enabled simultaneously. When shooting with **Vibration reduction** set to **On (hybrid)**, **Date imprint** is automatically set to **Off**.
- When **On (hybrid)** is selected and electronic vibration reduction is activated, the shutter is automatically released twice when a picture is taken to allow for image processing. Therefore, the time required to record pictures increases. **Shutter sound** (📖 149) can be heard only when the shutter is released the first time and a single picture will be recorded.

AF Assist

Tap  → Setup menu (📖 140) → AF assist

Enable or disable AF-assist illuminator.

Auto (default setting)

AF-assist illuminator will be used to assist the focus operation when the subject is poorly lit. The illuminator has a range of about 5 m (16 ft.). Note that for some scene modes, AF-assist illuminator turns off automatically (📖 39).

Off

Disable this function. The camera may be unable to focus under poor lighting.

Digital Zoom

Tap  → Setup menu (📖 140) → Digital zoom

Enable or disable digital zoom.





On (default setting)

When the camera is zoomed in to the maximum optical zoom position, tapping  triggers digital zoom (📖 29).

Off

Digital zoom will not be activated (except when recording movies).

Notes on Digital Zoom

- The camera focuses on the subject at the center of the frame when digital zoom is in effect (📖 29).
- Digital zoom cannot be used in the following situations:
 - When  **Portrait**, or  **Night portrait** scene mode is selected
 - When taking pictures with the smile timer
 -  **Subject tracking** is selected for the touch shooting setting
 - When  **Multi-shot 16** is selected for the  **Continuous** setting
 - Before movie recording begins (however, digital zoom of up to 2x can be applied while movies are being recorded)

Sound Settings

Tap  → Setup menu (📖 140) → Sound settings

Adjust the following sound settings.

Button sound

Turn button sound **On** (default setting) or **Off**. When **On** (default setting) is selected, beep will sound once when operations are completed successfully, twice when the camera acquires focus on the subject, and three times when an error is detected. Start-up sound will also play when the camera is turned on.

Shutter sound

Choose shutter sound from **On** (default setting) or **Off**.

Auto Off

Tap  → Setup menu (📖 140) → Auto off

When the camera is on and a period of time passes without any operations having been performed, the monitor will be turned off and the camera will enter standby mode (📖 21) to save power. Once the camera has entered standby mode, the power-on lamp will blink.

Choose the time allowed to elapse before the camera enters standby mode if no operations are performed from **30 s**, **1 min** (default setting), **5 min**, and **30 min**. Press the shutter-release button to cancel standby mode.

✓ Notes on Auto Off

Regardless of the option selected, the monitor will remain on as follows:

- When the HOME screen or setup menu is displayed: three minutes
- During slide show playback: up to 30 minutes
- When the AC adapter is connected: 30 minutes (auto off does not function while the camera is connected to a TV)

✓ Notes on AC Adapter Connection

- When the AC Adapter EH-62F (available separately; 📖 158) is connected, a screen saver function is activated to prevent screen burn if no operations are performed for the time selected for the **Auto off** option. If no operations are performed for an additional 30 minutes, the monitor turns off. Press the shutter-release button to reactivate the monitor.
- The screen saver function is not activated when **30 min** is selected for **Auto off**.
- The images used for the screen saver are the same as those displayed when  is tapped with slide show display (📖 98), though no background music is played.
- The screen saver function is not activated, even when no operations are performed for an extended period of time, and the monitor does not turn off when the camera is connected to a TV or printer.

Format Memory/Format Card

Tap  → Setup menu (📖 140) → Format memory/Format card

Use this option to format the internal memory or a memory card.

Formatting the Internal Memory

To format the internal memory, remove the memory card from the camera.

The **Format memory** option is displayed in the setup menu.

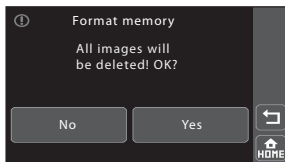

Formatting a Memory Card

When a memory card is inserted in the camera, the **Format card** option is displayed in the setup menu and the memory card is formatted.

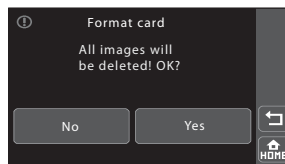

✔ Formatting Internal Memory and Memory Cards

- **Formatting the internal memory or memory cards permanently deletes all data.** Be sure to transfer important pictures to a computer before formatting.
- Formatting the internal memory or memory card restores album icon settings (📖 79) to the default setting (displayed as number).
- Do not turn the camera off or open the battery-chamber/memory card slot cover during formatting.
- Be sure to use this camera to format memory cards previously used in other devices the first time they are inserted into the COOLPIX S70.

Language

Tap  → Setup menu (📖 140) → Language

Choose one of 24 languages for display of camera menus and messages.

| | |
|------------|-------------------|
| Čeština | Czech |
| Dansk | Danish |
| Deutsch | German |
| English | (default setting) |
| Español | Spanish |
| Ελληνικά | Greek |
| Français | French |
| Indonesia | Indonesian |
| Italiano | Italian |
| Magyar | Hungarian |
| Nederlands | Dutch |
| Norsk | Norwegian |



| | |
|-----------|---------------------|
| Polski | Polish |
| Português | Portuguese |
| Русский | Russian |
| Suomi | Finnish |
| Svenska | Swedish |
| Türkçe | Turkish |
| عربي | Arabic |
| 中文简体 | Simplified Chinese |
| 中文繁體 | Traditional Chinese |
| 日本語 | Japanese |
| 한글 | Korean |
| ภาษาไทย | Thai |

Video Mode

Tap  → Setup menu (📖 140) → Video mode

Adjust settings for connection to a television. Choose from **NTSC** and **PAL**.

Charge by Computer

Tap  → Setup menu ( 140) → Charge by computer

Choose whether or not the battery inserted into the camera is charged when the camera is connected to a computer via the USB cable ( 131).

Auto (default setting)

When the camera is connected to a computer that is running, the battery inserted into the camera is automatically charged using power supplied by the computer.

Off

The battery inserted into the camera is not charged when the camera is connected to a computer.

Notes on Connecting the Camera to a Printer

- The battery cannot be charged with connection to a printer, even if the printer complies with the PictBridge standard.
- When **Auto** is selected for **Charge by computer**, it may be impossible to print pictures with direct connection of the camera to some printers. If the **PictBridge** startup screen is not displayed in the monitor after the camera is connected to a printer and turned on, turn the camera off and disconnect the USB cable. Set **Charge by computer** to **Off** and reconnect the camera to the printer.

Blink Warning

Tap → Setup menu (📖 140) → Blink warning

Specify whether or not the camera detects human subjects that have blinked with shooting using face priority (📖 28).

On

When the camera detects that one or more human subjects may have blinked in a picture taken using face priority, the blink warning screen is displayed in the monitor. The face of the human subject that may have blinked when the shutter was released is framed by a yellow border. Should this occur, check the picture and determine whether or not another picture should be taken.

Off (default setting)

Blink warning is not enabled.

Operating the Blink Warning Screen

When the blink warning screen shown at right is displayed in the monitor, the operations described below are available.

If no operations are performed within a few seconds, the camera automatically returns to shooting mode.



| Option | Tap | Description |
|---------------------------|-----|---|
| Enlarge the detected face | | Tap . If the camera detects that more than one human subject blinked, tap or to switch display to another face. Tap to return to the blink warning screen. |
| Delete pictures | | Tap . |
| Switch to shooting mode | | Tap the monitor or tap . The shutter-release button can also be pressed to return to shooting mode. |

Note on Blink Warning

Blink detection does not function with shooting in the following situations:





- when **Smile timer** is enabled
- when **Continuous**, **BSS**, or **Multi-shot 16** is selected for the **Continuous** setting

Reset All



Tap  → Setup menu (📖 140) → Reset all

When **Reset** is selected, the camera's settings will be restored to their default values.

Shooting Settings

| Option | Default value |
|--------------------------------------|---|
| Touch shooting (📖 51, 53, 56) |  Touch shutter |
| Self-timer (📖 58) | Off |
| Flash mode (📖 62) |  AUTO Auto |
| Image mode (📖 64) |  16:9 (3968) |
| Smile timer (📖 60) | Off |
| Exposure compensation (📖 66) | 0.0 |
| Macro mode (📖 67) | Off |
| Continuous (📖 68) |  Single |
| White balance (📖 70) | Auto |
| ISO sensitivity (📖 73) | Auto |
| Date imprint (📖 74) | Off |
| Scene selection in scene mode (📖 38) |  Portrait |
| Scene effect adjustment (📖 39) | Center |

Movie Settings

| Option | Default value |
|------------------------|---|
| Movie options (📖 123) |  TV movie 640★ |
| Autofocus mode (📖 124) |  Single AF |
| Macro mode (📖 124) | Off |

Setup Menu

| Option | Default value |
|-----------------------------|---------------|
| Choose HOME display (📖 141) | Clip art |
| Welcome screen (📖 142) | None |
| Image review (📖 146) | On |
| Brightness (📖 146) | 3 |
| Date imprint (📖 146) | Off |
| Vibration reduction (📖 147) | On |
| AF assist (📖 148) | Auto |
| Digital zoom (📖 148) | On |
| Button sound (📖 149) | On |
| Shutter sound (📖 149) | On |
| Auto off (📖 149) | 1 min |
| Charge by computer (📖 152) | Auto |
| Blink warning (📖 153) | Off |

Others

| Option | Default value |
|-----------------------------------|-----------------|
| Information display setting (📖 8) | Information off |
| Paper size (📖 135, 136) | Default |

- Selecting **Reset** also clears the current file number (📖 159) from memory. Numbering will continue from the lowest number available. To reset file numbering to "0001", delete all pictures stored in the internal memory or on the memory card (📖 95) before selecting **Reset**.
- The following settings will remain unaffected even when **Reset all** is set to **Reset**.

Shooting settings: Preset manual data (📖 72) acquired for **White balance Setup menu:** Pictures selected for **HOME display** (📖 141) and **Welcome screen** (📖 142), **Date** (📖 143), **Language** (📖 151), and **Video mode** (📖 151)

Copy

Tap → Setup menu (📖 140) → Copy

Copy pictures between the internal memory and a memory card.

- 1 Tap a destination option to which pictures are copied in the copy screen.

: Copy pictures from internal memory to memory card.

: Copy pictures from memory card to internal memory.

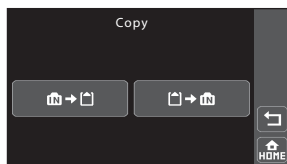

- 2 Tap a copy option.

Selected images: Copy pictures selected. Proceed to step 3.

All images: Copy all pictures. When a confirmation dialog is displayed, tap **Yes**. Pictures are copied. To return to the setup menu without copying, tap **No**.

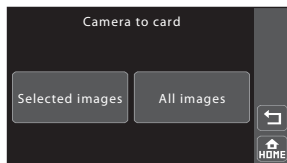

- 3 Tap the pictures to be copied and tap .

When a picture is selected, a check mark is displayed. To cancel the selection, tap the picture again. A check mark is removed.

Tap to switch to full-frame playback and tap to switch back to 12-thumbnail display.

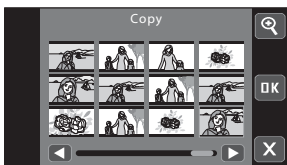

- 4 Tap .

When a confirmation dialog is displayed, tap **Yes**. Pictures are copied. To return to the setup menu without copying, tap **No**.

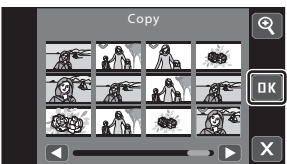

✓ Notes on Copying Pictures

- JPEG-, AVI-, and WAV-format files can be copied. Files recorded in any other format cannot be copied.
- If voice memos (📖 107) are attached to pictures selected for copying, voice memos are copied with the pictures.
- Operation is not guaranteed with pictures taken with another make of camera or that have been modified on a computer.
- When pictures selected for a print order (📖 101) are copied, print marking is not copied with pictures (copies will not be included in the print order). When protected pictures (📖 99) are copied, the copies are also protected.
- Pictures copied from the internal memory or a memory card cannot be displayed in auto sort mode (📖 84).
- When a picture that has been added to an album (📖 80) is copied, information specifying the album to which the original picture was added is not copied.

✎ Memory contains no images. Message

If there are no pictures stored on the memory card when playback mode is applied, the message **Memory contains no images.** will be displayed. Switch to the HOME screen to display the setup menu. Select **Copy** from the setup menu to copy pictures stored in the camera's internal memory to the memory card.

💡 More Information

See "Image/Sound File and Folder Names" (📖 159) for more information.

Firmware Version

Tap  → Setup menu (📖 140) → Firmware version

View the current camera firmware version.



Firmware version

Optional Accessories

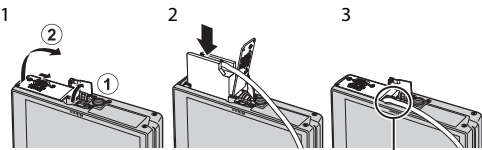
| | |
|----------------------|--|
| Rechargeable battery | Rechargeable Li-ion Battery EN-EL12 |
| Battery charger | Battery Charger MH-65 |
| Charging AC adapter | Charging AC Adapter EH-68P*, EH-68P (AR)* |
| AC adapter | <p>AC Adapter EH-62F</p> <p>Connecting the EH-62F</p>  <p>Be sure that the AC adapter cord has been properly aligned in the grooves of the AC adapter and the battery chamber before closing the battery-chamber/memory card slot cover. If the cord is not properly aligned in the groove, the cover may be damaged when it is closed.</p> |
| USB cable | USB Cable UC-E6 |
| A/V cable | Audio/Video Cable EG-CP14 |

* To use the charging AC adapter abroad, be sure to use a power adapter (available commercially) where necessary. Check beforehand with your travel agent regarding the necessity for power adapter plugs.

Approved Memory Cards

The following Secure Digital (SD) memory cards have been tested and approved for use in this camera.

All cards of the designated make and capacity can be used, regardless of speed.

| | |
|-----------|--|
| SanDisk | 512 MB, 1 GB, 2 GB ¹ , 4 GB ² , 8 GB ² , 16 GB ² |
| TOSHIBA | 512 MB, 1 GB, 2 GB ¹ , 4 GB ² , 8 GB ² , 16 GB ² |
| Panasonic | 512 MB, 1 GB, 2 GB ¹ , 4 GB ² , 8 GB ² , 16 GB ² |
| Lexar | 1 GB, 2 GB ¹ , 4 GB ² , 8 GB ² |

¹ If the memory card will be used with a card reader or similar device, check that device supports 2 GB cards.

²  SDHC-compliant.

 If the memory card will be used with a card reader or similar device, check that device supports SDHC.

Operation is not guaranteed with other makes of card. Contact the manufacturer for details on the above cards.

Image/Sound File and Folder Names

Pictures, movies, or voice memos are assigned file names as follows.

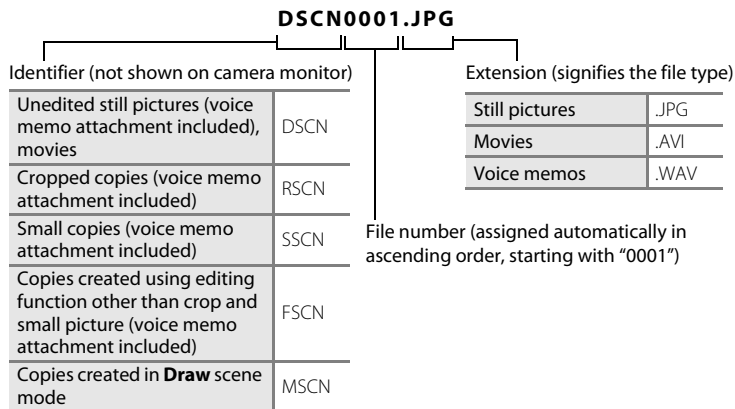

- Files are stored in folders named with a folder number followed by an identifier: "P_" plus a three-digit sequential number for pictures taken in **Panorama assist** scene mode (e.g. "101P_001"; 📖 46), and "NIKON" for all other pictures (e.g. "100NIKON"). When the number of files within a folder reaches 9999, a new folder will be created. File numbers will be assigned automatically starting with "0001."
- Files copied using **Copy>Selected images** are copied to the current folder, where they are assigned new file numbers in ascending order starting from the largest file number in memory. **Copy>All images** copy all folders from the source medium; file names do not change but new folder numbers are assigned in ascending order, starting from the largest folder number on the destination medium (📖 156).
- A single folder can hold up to 200 pictures; if the current folder already contains 200 pictures, a new folder, named by adding one to the current folder name, will be created the next time a picture is taken. If the current folder is numbered 999 and contains 200 pictures, or a picture is numbered 9999, no further pictures can be taken until the internal memory or memory card is formatted (📖 150), or a new memory card is inserted.

Caring for the Camera

To ensure continued enjoyment of this Nikon product, observe the following precautions when using or storing the device.

Keep Dry

The device will be damaged if immersed in water or subjected to high humidity.

Do not Drop

The product may malfunction if subjected to strong shock or vibration.

Handle the Lens and All Moving Parts with Care

Do not apply force to the lens, monitor, memory card slot or battery-chamber. These parts are easily damaged. Applying force to the lens cover could result in camera malfunction or damage to the lens. Should the monitor break, care should be taken to avoid injury caused by broken glass.

Do not Point the Lens at Strong Light Sources for Extended Periods

Avoid pointing the lens at the sun or other strong light sources for extended periods when using or storing the camera. Intense light may cause deterioration of the CCD image sensor, producing a white blur effect in photographs.

Keep Away from Strong Magnetic Fields

Do not use or store this device in the vicinity of equipment that generates strong electromagnetic radiation or magnetic fields. Strong static charge or the magnetic fields produced by equipment such as radio transmitters could interfere with the monitor, damage data stored on the memory card, or affect the product's internal circuitry.

Avoid Sudden Changes in Temperature

Sudden changes in temperature, such as when entering or leaving a heated building on a cold day, can cause condensation to form inside the device. To prevent condensation, place the device in a carrying case or a plastic bag before exposing it to sudden changes in temperature.

Turn the Product Off before Removing or Disconnecting the Power Source

Do not remove the battery while the product is on, or while images are being recorded or deleted. Forcibly cutting power in these circumstances could result in loss of data or in damage to product memory or internal circuitry.

 **The Battery**

- Check the battery level before using the camera and replace or charge the battery if necessary. Do not continue charging once the battery is fully charged as this will result in reduced battery performance. Whenever possible, carry a fully charged spare battery when taking pictures on important occasions.
- Do not use the battery at ambient temperatures below 0 °C (32 °F) or above 40 °C (104 °F).
- Charge the battery indoors with an ambient temperature of 5 °C to 35 °C (41 °F to 95 °F) before use.
- When charging the COOLPIX S70 using the Charging AC adapter EH-68P or a computer, the charge capacity may decrease at ambient temperatures 45 °C to 60 °C (113 °F to 140 °F).
- The battery is not charged at ambient temperatures below 0 °C (32 °F) or above 60 °C (140 °F).
- Note that the battery may become hot during use; wait for the battery to cool before charging. Failure to observe these precautions could damage the battery, impair its performance or prevent it from charging normally.
- On cold days, the capacity of batteries tends to decrease. Be sure that the battery is fully charged before heading outside to take pictures in cold weather. Keep spare batteries in a warm place and exchange as necessary. Once warmed, a cold battery may recover some of its charge.
- Dirt on the battery terminals can prevent the camera from functioning. Should the battery terminals become dirty, wipe them off with a clean, dry cloth before use.
- If the battery will not be used for some time, insert it in the camera and run it flat before removing it for storage. The battery should be stored in a cool location with an ambient temperature of 15 to 25 °C (59 to 77 °F). Do not store the battery in hot or extremely cold locations.
- Always remove the battery from the camera or Charging AC Adapter when it is not being used. When inserted, minute amounts of current are drawn from the battery even when not in use. This may result in excessive draining of the battery and complete loss of function. Turning the camera on or off while the battery is exhausted can result in reduced battery life.
- Recharge the battery at least once every six months and completely exhaust it before returning it to storage.
- After removing the battery from the camera or Charging AC Adapter, replace the supplied terminal cover and store in a cool place.
- A marked drop in the time a fully-charged battery retains its charge, when used at room temperature, indicates that the battery needs to be replaced. Purchase a new EN-EL12 battery.
- Replace the battery when it no longer holds a charge. Used batteries are a valuable resource. Please recycle used batteries in accordance with local regulations.

Cleaning

| | |
|---------|---|
| Lens | Avoid touching glass parts with your fingers. Remove dust or lint with a blower (typically a small device with a rubber bulb attached to one end that is pumped to produce a stream of air out the other end). To remove fingerprints or other stains that cannot be removed with a blower, wipe the lens with a soft cloth, using a spiral motion that starts at the center of the lens and working toward the edges. If this fails, clean the lens using a cloth lightly dampened with commercial lens cleaner. |
| Monitor | Remove dust or lint with a blower. To remove fingerprints and other stains, clean the monitor with a soft, dry cloth, being careful not to apply pressure. |
| Body | Use a blower to remove dust, dirt or sand, then wipe gently with a soft, dry cloth. After using the camera at the beach or other sandy or dusty environment, wipe off any sand, dust or salt with a dry cloth lightly dampened with fresh water and dry thoroughly. Note that foreign matter inside the camera could cause damage not covered by the warranty. |

Do not use alcohol, thinner, or other volatile chemicals.

Storage

Turn the camera off when not in use. Be sure that the power-on lamp is off before putting the camera away. Remove the battery if the camera will not be used for an extended period. Do not store the camera with naphtha or camphor moth balls, or in any of the following locations:

- Next to equipment that produces strong electromagnetic fields, such as televisions or radios
- Exposed to temperatures below -10°C (14°F) or above 50°C (122°F)
- Places that are poorly ventilated or subject to humidity of over 60%











To prevent mold or mildew, take the camera out of storage at least once a month. Turn the camera on and release the shutter a few times before putting the camera away again.

Notes on the Monitor

- The monitor may contain a few pixels that are always lit or that do not light. This does not indicate a malfunction. Images recorded using the product will not be affected.
- Due to the general characteristics of OLED monitors, prolonged or repeated display of the same screen or image may result in screen burn. Screen burn can be recognized by decreased brightness in portions of the monitor or mottled display. In some cases, screen burn may become permanent. However, pictures are in no way affected by screen burn.
To prevent screen burn, do not set monitor brightness higher than necessary and do not display the same screen or image for an extended period of time.
- White or colored streaks of light may be visible in the monitor with framing of bright subjects. This phenomenon, known as “smear,” occurs when extremely bright light strikes the image sensor. This is due to characteristics of the image sensor and does not indicate a malfunction. Smear may also cause partial discoloration in monitor display with shooting.
Smear does not affect recorded images except when shooting with **Continuous** set to **Multi-shot 16** and when recording movies. When shooting in these modes, avoiding bright objects such as the sun, reflections of the sun, and electric lights is recommended.
- Images in the monitor may be difficult to see under bright lighting.
- The monitor is lit by an LED backlight. Should the monitor begin to dim or flicker, contact your Nikon-authorized service representative.

Error Messages

The following table lists the error messages and other warnings displayed in the monitor, as well as the solutions for dealing with them.

| Display | Problem | Solution |  |
|---|---|--|---|
|  (blinks) | Clock not set. | Set date and time. | 143 |
|  | Battery running low. | Prepare to charge or replace battery. | 16 |
|  Battery exhausted. | Battery exhausted. | Charge or replace battery. | 16 |
|  Battery temperature high | Battery temperature is high. | Turn off camera, and allow battery to cool down before resuming use. After five seconds, this message will disappear, the monitor will turn off, and the power-on lamp and flash indicator will blink rapidly. | 18 |
|  ● (● blinks red) | Camera cannot focus. | <ul style="list-style-type: none"> • Refocus. • Use focus lock. | 30, 31 55 |
|  Please wait for the camera to finish recording. | Camera cannot perform other operations until recording is complete. | Wait until message clears from display automatically when recording is complete. Do not open the battery-chamber/memory card slot cover during recording. | – |
|  Memory card is write protected. | Write-protect switch is in “lock” position. | Slide write-protect switch to “write” position. | 25 |
|  This card cannot be used. | Error accessing memory card. | <ul style="list-style-type: none"> • Use approved card. • Check that terminals are clean. • Confirm that memory card is correctly inserted. | 158 24 |
|  This card cannot be read. | | | 24 |
|  Card is not formatted. Format card? Yes No | Memory card has not been formatted for use in COOLPIX S70. | Formatting deletes all data stored on the memory card. Be sure to select No and make copies of any pictures which need to be kept before formatting the memory card. Tap Yes to format. | 25 |

Error Messages

| Display | Problem | Solution |  |
|--|---|--|---|
| i Out of memory. | Memory card is full. | <ul style="list-style-type: none"> Choose smaller image size. Delete pictures. Insert new memory card. Remove memory card and use internal memory. | 64 32, 95, 125 24 24 |
| i Image cannot be saved. | Error occurred while recording picture. | Format internal memory or memory card. | 150 |
| | Camera has run out of file numbers. | <ul style="list-style-type: none"> Insert new memory card. Format internal memory or memory card. | 24 150 |
| | Picture cannot be used for the HOME screen or welcome screen. | Choose a small picture or cropped copy of 640x480 pixels or larger, or picture taken with the COOLPIX S70. | 117, 121 |
| | Insufficient space to save a copy. | Delete pictures from destination. | 156 |
| i Album is full. No further pictures can be added. | 200 pictures have already been added to album. | <ul style="list-style-type: none"> Remove some pictures from album. Add to other albums. | 82 80 |
| i Image cannot be modified. | Cannot edit selected picture. | Select pictures that support editing functions. | 109 |
| i Cannot record movie. | Time out error while recording movie on the memory card. | Choose memory card with faster write speed. | 158 |

| Display | Problem | Solution |  |
|--|---|---|---|
| i Memory contains no images. | No pictures in the internal memory or memory card. | <ul style="list-style-type: none"> Remove the memory card from the camera to play back pictures stored in the camera's internal memory. Display the HOME screen to copy pictures from the camera's internal memory to the memory card. Display the setup menu and select Copy. | 24 156 |
| | No pictures are contained in the category selected in auto sort mode. | Select the category containing the sorted pictures. | 86 |
| | No pictures can be played back in auto sort mode. | Play back pictures in playback mode or list by date mode. | 87 |
| | The picture has not been added to album. | <ul style="list-style-type: none"> Add pictures to album. Choose the album to which picture was added. | 80 81 |
| i The camera will turn off to prevent overheating. | Inside of the camera or the memory card has become hot. The camera turns off automatically. | Leave the camera off until the inside of the camera or the memory card has cooled and then turn it on again. | – |
| i File contains no image data. | File not created with COOLPIX S70. | Use the computer or other device with which the file was created or edited for playback. | – |
| i All images are hidden. | No pictures available for a slide show. | – | – |
| i Travel destination is in the current time zone. | Destination in same time zone as home. | – | 143 |

Error Messages

| Display | Problem | Solution |  |
|--|--|---|---|
| Lens cover error  | Lens error. | Turn camera off and then on again. If error persists, contact retailer or Nikon-authorized service representative. | 26 |
|  Initializing lens. Cannot focus. | The camera cannot focus. | Wait for the camera to recover automatically. | – |
|  Communications error | Error occurs during communication with a printer. | Turn camera off, reconnect USB cable. | 133 |
| System error  | Error has occurred in camera's internal circuitry. | Turn camera off, remove and reinsert battery, and turn camera on. If error persists, contact retailer or Nikon-authorized service representative. | 16, 26 |
|  Printer error: check printer status. | Printer error. | Check printer. After solving the problem, tap Resume to resume printing.* | – |
|  Printer error: check paper | Specified size of paper is not loaded in printer. | Load the specified paper, and tap Resume to resume printing.* | – |
|  Printer error: paper jam | Paper has jammed in the printer. | Eject the jammed paper, and tap Resume to resume printing.* | – |
|  Printer error: out of paper | No paper is loaded in printer. | Load the specified paper, and tap Resume to resume printing.* | – |
|  Printer error: check ink | Ink error. | Check ink, and tap Resume to resume printing.* | – |
|  Printer error: out of ink | Ink cartridge is empty. | Replace ink, and tap Resume to resume printing.* | – |
|  Printer error: file corrupt | An error caused by the image file has occurred. | Tap Cancel to cancel printing. | – |

* See the documentation provided with your printer for further guidance and information.

Troubleshooting

If the camera fails to function as expected, check the list of common problems below before consulting your retailer or Nikon-authorized service representative.

Display, Settings and Power Supply











| Problem | Cause/Solution |  |
|--|--|---|
| Monitor is blank | <ul style="list-style-type: none">• Camera is off.• Battery is exhausted.• Standby mode for saving power: press the shutter-release button halfway.• When connecting to an electrical outlet using a Charging AC Adapter, the camera cannot be turned on.• Camera and computer are connected via the USB cable. | 26 26 21, 30 18 128 |
| Monitor is hard to read/has darkened | <ul style="list-style-type: none">• Adjust monitor brightness.• When the internal temperature of the camera is high, the monitor darkens to reduce heat generation. When internal temperature cools, the monitor brightens again.• When the power-on lamp is covered after the camera has automatically increased monitor brightness, the monitor may darken.• Monitor is dirty. Clean monitor. | 146 – – 160 |
| Camera turns off without warning | <ul style="list-style-type: none">• Battery is exhausted.• If connecting the Charging AC Adapter while the camera is on, the camera is turned off.• The USB cable for the camera to a computer or printer has been disconnected. Reconnect the USB cable.• The internal temperature of the camera or the memory card is high. Allow the camera and memory card to cool and turn on the camera again.• Battery is cold. | 26 18 128, 133 165 161 |
| Date and time of recording are not correct | <ul style="list-style-type: none">• Pictures recorded before clock has been set will have time stamp of "00/00/0000 00:00". "Date not set" indicator blinks during shooting; movies will be dated "01/01/2009 00:00." Set the correct time and date from the Date option in the setup menu.• Check camera clock regularly against more accurate timepieces and reset as required. | 22 143 |
| No indicators displayed in monitor | Tap  to switch the information display setting. | 146 |



















| Problem | Cause/Solution |  |
|---|--|---|
| Date imprint not available | <ul style="list-style-type: none"> • Camera clock has not been set. • Another function that does not support date imprint is enabled. | 22, 143 76 |
| Date not imprinted on pictures even when Date imprint is enabled | Date is not imprinted in the following situations: <ul style="list-style-type: none"> • Selected shooting mode does not support date imprint • Another function that does not support date imprint is enabled • Recording movies | 74 75 122 |
| Camera settings reset | Backup battery is exhausted; all settings were restored to their default values. | 144 |
| Monitor turns off, and the power-on lamp blinks green rapidly. | Battery temperature is high. Turn off camera and allow battery to cool down before resuming use. | 21 |
| Battery inserted into the camera is not charged when the camera is connected to a computer. | <ul style="list-style-type: none"> • The battery is not charged when the camera is turned off. • Charging stops if the computer enters sleep mode while the battery is charging. The camera may be turned off. • Depending upon computer specifications, settings, and status, it may be impossible to charge the battery inserted into the camera via computer connection. | 131 131 131 |

Electronically Controlled Cameras

In extremely rare instances, unusual characters may appear in the monitor and the camera may stop functioning. In most cases, this phenomenon is caused by a strong external static charge. Turn the camera off, remove and replace the battery, then turn the camera on again. In the event of continued malfunction, contact your retailer or Nikon-authorized service representative. Note that disconnecting the power source as described above may result in the loss of any data not recorded to internal memory or the memory card at the time the problem occurred. Data already recorded will not be affected.

Shooting

| Problem | Cause/Solution |  |
|---|---|---|
| No picture taken. | <ul style="list-style-type: none"> When camera is in playback mode or the setup menu is displayed, press the shutter-release button. Battery is exhausted. When flash indicator blinks, flash is charging. | 32 26 63 |
| Camera cannot focus. | <ul style="list-style-type: none"> The intended subject is one with which autofocus does not perform well. Set AF assist in the setup menu to Auto. Turn camera off and then on again. | 31 148 26 |
| Pictures are blurred. | <ul style="list-style-type: none"> Use flash. Increase ISO sensitivity value. Enable vibration reduction. Use BSS (Best Shot Selector). Use tripod and self-timer. | 62 73 147 68 58 |
| Bright specks appear in pictures taken with flash. | Flash is reflecting off particles in air. Set the  Flash mode setting to  Off . | 62 |
| Streaks of light or partial discoloration are visible in the monitor. | Smear occurs when extremely bright light strikes the image sensor. When shooting with Continuous set to Multi-shot 16 and when recording movies, avoiding bright objects, such as the sun, reflections of the sun, and electric lights is recommended. | 162 |
| Flash does not fire. | <ul style="list-style-type: none"> The  Flash mode setting is set to  Off. Scene mode with which the flash does not fire is selected. Another function that restricts flash is enabled. | 62 39 75 |
| Optical zoom cannot be used. | Optical zoom cannot be used while recording movies. | 122 |
| Digital zoom cannot be used. | <ul style="list-style-type: none"> Digital zoom is set to Off in the setup menu. Digital zoom is not available in the following situations. <ul style="list-style-type: none"> When  Portrait or  Night portrait scene mode is selected Touch shooting is set to  Subject tracking. When shooting with the smile timer Before movie recording begins (however, digital zoom of up to 2x can be applied while movies are being recorded) When  Multi-shot 16 is selected for the  Continuous setting | 148 39, 40 56 60 122 68 |

| Problem | Cause/Solution |  |
|---|--|---|
|  Image mode not available. | Another function that restricts the  Image mode option is enabled. | 75 |
| No sound when the shutter is released. | <ul style="list-style-type: none"> • Off is selected for Sound settings>Shutter sound in the setup menu. •  Continuous,  Multi-shot 16 or  BSS is selected for the  Continuous setting. •  Sports or  Museum scene mode is selected. •  mode is selected. • The speaker is blocked. Do not cover the speaker. | 149 68 40, 43 122 4 |
| AF-assist illuminator does not light. | <ul style="list-style-type: none"> • Off is selected for the AF assist option in the setup menu. • AF-assist illuminator turns off automatically in some scene modes. | 148 39-44 |
| Pictures appear smeared. | Lens is dirty. Clean lens. | 160 |
| Colors are unnatural. | White balance does not match light source. | 70 |
| Randomly spaced bright pixels ("noise") appear in image. | Shutter speed too slow or ISO sensitivity is high as the subject is dark. Noise can be reduced by: <ul style="list-style-type: none"> • Using flash • Specifying a lower ISO sensitivity setting • Using a scene mode which has noise reduction ability. | 62 73 39-44 |
| Pictures are too dark (underexposed). | <ul style="list-style-type: none"> • The  Flash mode setting is set to  Off. • Flash window is blocked. • Subject is beyond flash range. • Adjust exposure compensation. • Increase the ISO sensitivity. • Subject is backlit. Select  Backlight scene mode or set the  Flash mode setting to  Fill flash. | 62 28 62 66 73 44, 62 |
| Pictures are too bright (overexposed). | Adjust exposure compensation. | 66 |
| Unexpected results when flash set to  Auto with red-eye reduction . | When taking pictures with  Auto with red-eye reduction or fill flash with slow sync and red-eye reduction in  Night portrait scene mode, In-Camera Red-Eye Fix may be applied to areas not affected by red-eye. Use any scene mode other than  Night portrait , and change the flash mode to any setting other than  Auto with red-eye reduction and try taking a picture again. | 40, 62 |

Playback

| Problem | Cause/Solution |  |
|--|---|---|
| File cannot be played back. | File or folder was overwritten or renamed by computer or other make of camera. | – |
| Cannot zoom in on picture. | Playback zoom cannot be used with movies, small pictures, or pictures that have been cropped to a size of 320 × 240 or smaller. | – |
| Cannot record or play back voice memo. | <ul style="list-style-type: none"> • Voice memos cannot be attached to movies. • Voice memos cannot be attached to pictures taken with other cameras. Voice memos attached to pictures using another camera cannot be played back on this camera. | 125 108 |
| Cannot edit pictures. | <ul style="list-style-type: none"> • These options cannot be used with movies. • Select pictures that support editing functions. • Pictures taken with another make or model of camera cannot be edited. • Pictures edited with this camera may not be displayed correctly on other cameras and cannot be transferred to computers from other cameras. | 125 109 109 109 |
| Pictures not displayed on television. | <ul style="list-style-type: none"> • Choose the correct Video mode. • Choose pictures that can be displayed on a television. • Memory card contains no pictures. Replace memory card. Remove memory card to play back pictures recorded in the internal memory. | 151 126 24 |
| Album icon restored to default settings, or pictures added to album not displayed in favorite pictures playback. | Data in the memory card may not be played back correctly if overwritten by a computer. | – |
| The recorded pictures are not displayed in auto sort mode. | <ul style="list-style-type: none"> • The desired picture was sorted to a category other than the category currently displayed. • Pictures recorded by a camera other than the COOLPIX S70 and pictures copied using the Copy option cannot be displayed in auto sort mode. • Pictures recorded in the internal memory or on the memory card may not be played back correctly if overwritten by a computer. • Up to 999 pictures and movies in total can be added to each category. If the desired category already contains 999 pictures or movies in total, new pictures or movies cannot be added. | 85 156 – 85 |

Specifications

Nikon COOLPIX S70 Digital Camera

| | |
|--------------------------------|--|
| Type | Compact digital camera |
| Effective pixels | 12.1 million |
| Image sensor | $\frac{1}{2.3}$ -in. CCD; total pixels: approx. 12.39 million |
| Lens | 5 \times optical zoom, NIKKOR lens |
| Focal length | 5.0-25.0mm (equivalent with 35mm [135] format picture angle: 28-140mm) |
| f/-number | f/3.9-5.8 |
| Construction | 13 elements in 9 groups |
| Digital zoom | Up to 4 \times (equivalent with 35mm [135] format picture angle: approx. 560mm) |
| Vibration reduction | Combination lens-shift and electronic VR |
| Autofocus (AF) | Contrast-detect AF |
| Focus range (from lens) | <ul style="list-style-type: none">• Approx. 30 cm (1 ft.) to ∞ (W); approx. 50 cm (1 ft. 8 in.) to ∞ (T)• Macro mode: 3 cm (1.2 in.) (wide-angle zoom position) to ∞ |
| Focus-area selection | Face priority, center, Auto (9-area automatic selection), manual (focus area can be selected using the touch panel) |
| Monitor | 3.5-in., widescreen, OLED (touch panel), approx. 288k-dot 5-level brightness adjustment |
| Frame coverage (shooting mode) | Image mode setting of 16:9 (3968) : approx. 92% horizontal and 98% vertical (Compared to actual picture) Image mode setting other than 16:9 (3968) : approx. 98% horizontal and 98% vertical (Compared to actual picture) |
| Frame coverage (playback mode) | Image mode setting of 16:9 (3968) : approx. 94% horizontal and 100% vertical (Compared to actual picture) Image mode setting other than 16:9 (3968) : approx. 100% horizontal and 100% vertical (Compared to actual picture) |
| Storage | |
| Media | <ul style="list-style-type: none">• Internal memory (approx. 20 MB)• SD (Secure Digital) memory cards |
| File system | DCF, Exif 2.2, and DPOF compliant |
| File formats | Compressed: JPEG-Baseline compliant Movies: AVI (Motion-JPEG compliant) Sound files: WAV |
| Image size (pixels) | <ul style="list-style-type: none">• 4,000 \times 3,000 High (4000★)/Normal (4000)• 3,264 \times 2,448 Normal (3264)• 2,592 \times 1,944 Normal (2592)• 2,048 \times 1,536 Normal (2048)• 1,024 \times 768 PC screen (1024)• 640 \times 480 TV screen (640)• 3,968 \times 2,232 16:9 (3968) |

Specifications

| | |
|---|--|
| ISO sensitivity (Standard output sensitivity) | ISO 80, 100, 200, 400, 800, 1600, 3200, 6400, Auto (auto gain from ISO 80 to 800), Fixed range auto (ISO 80 to 200, ISO 80 to 400) |
| Exposure | |
| Metering | 256-segment matrix, center-weighted (digital zoom less than 2x), spot (digital zoom 2x or more) |
| Exposure control | Programmed auto exposure with motion detection and exposure compensation (–2.0 to +2.0 EV in steps of $\frac{1}{3}$ EV) |
| Range (ISO 100) | [W]: 1.1 to 16.9 EV [T]: 2.2 to 18 EV |
| Shutter | Mechanical and charge-coupled electronic shutter |
| Speed | $\frac{1}{1500}$ –2 s, 4 s (🎆 Fireworks show scene mode) |
| Aperture | Electronically-controlled ND filter (–2AV) insertion |
| Range | 2 steps (f/3.9 and f/7.8 [W]) |
| Self-timer | Can be selected from 10 and 2 second duration, or smile timer |
| Built-in flash | |
| Range (ISO sensitivity: Auto) | [W]: 0.3 to 3.5 m (1 to 11 ft.) [T]: 0.5 to 2.5 m (1 to 8 ft.) |
| Flash control | TTL auto flash with monitor preflashes |
| Interface | Hi-Speed USB |
| Video output | Can be selected from NTSC and PAL |
| I/O terminal | Multi connector (USB, audio/video output, DC input) |
| Supported languages | Arabic, Chinese (Simplified and Traditional), Czech, Danish, Dutch, English, Finnish, French, Greek, German, Hungarian, Indonesian, Italian, Japanese, Korean, Polish, Portuguese, Norwegian, Russian, Spanish, Swedish, Thai, Turkish |
| Power sources | One EN-EL12 Rechargeable Li-ion Battery (supplied) AC Adapter EH-62F (available separately) |
| Charging time | Approx. 4 hours (Charging AC Adapter EH-68P) Approx. 7 hours (Charge by computer) When battery is fully discharged |
| Battery life* | Approx. 200 shots (EN-EL12) |
| Dimensions (W × H × D) | Approx. 96.5 × 60.5 × 20 mm (3.8 × 2.4 × 0.8 in.) (excluding projections) |
| Weight | Approx. 140 g (4.9 oz) (without battery and SD memory card) |
| Operating environment | |
| Temperature | 0 to 40 °C (32 to 104 °F) |
| Humidity | Less than 85% (no condensation) |

- Unless otherwise stated, all figures are for a camera with a fully-charged Rechargeable Li-ion Battery EN-EL12 operated at an ambient temperature of 25 °C (77 °F).
- * Based on Camera and Imaging Products Association (CIPA) standards for measuring the life of camera batteries. Measured at 23 °C (73 °F); zoom adjusted with each shot, flash fired with every other shot, image mode set to  **16:9 (3968)**. Battery life may vary depending upon shooting interval and length of time menus and images are displayed.

Rechargeable Li-ion Battery EN-EL12

| | |
|------------------------|--|
| Type | Rechargeable lithium-ion battery |
| Rated capacity | DC 3.7 V, 1050 mAh |
| Operating temperature | 0 to 40 °C (32 to 104 °F) |
| Dimensions (W × H × D) | Approx. 32 × 43.8 × 7.9 mm (1.3 × 1.7 × 0.3 in.) (excluding projections) |
| Weight | Approx. 22.5 g (0.8 oz) (excluding terminal cover) |

Charging AC Adapter EH-68P/EH-68P (AR)

| | |
|------------------------|--|
| Rated input | AC 100-240 V, 50/60 Hz, 0.065-0.04 A |
| Rated capacity | 6.5-9.6 VA |
| Rated output | DC 5.0 V, 0.5 A |
| Applicable batteries | Rechargeable Li-ion Battery EN-EL12 |
| Operating temperature | 0 to 40 °C (32 to 104 °F) |
| Dimensions (W × H × D) | |
| EH-68P | Approx. 55 × 22 × 65 mm (2.2 × 0.9 × 2.6 in.) (excluding plug adapter) |
| EH-68P (AR) | Approx. 55 × 51.6 × 66 mm (2.2 × 2.0 × 2.6 in.) |
| Weight | |
| EH-68P | Approx. 60 g (2.1 oz) (excluding plug adapter) |
| EH-68P (AR) | Approx. 65 g (2.3 oz) |

Specifications

Nikon will not be held liable for any errors this manual may contain. The appearance of this product and its specifications are subject to change without notice.

Supported Standards

- **DCF:** Design Rule for Camera File System is a standard widely used in the digital camera industry to ensure compatibility among different makes of camera.
- **DPOF:** Digital Print Order Format is an industry-wide standard that allows pictures to be printed from print orders stored on memory cards.
- **Exif version 2.2:** This camera supports Exchangeable Image File Format for Digital Still Cameras (Exif) version 2.2 for digital still cameras, a standard that allows information stored with photographs to be used for optimal color reproduction when images are output from Exif-compliant printers.
- **PictBridge:** A standard developed cooperatively by the digital camera and printer industries, allowing photographs to be output directly to a printer without connecting the camera to a computer.

Index

Symbols

AE/AF-L 47

Vibration reduction 147

(tele) 29

(wide) 29

Playback zoom 91

Thumbnail playback 93

Easy auto mode 26

Auto mode 26, 37

Scene mode 38

Movie mode 122

Playback mode 32

Favorite pictures mode 78

Auto sort mode 84

List by date mode 87

Delete 32, 95, 96, 125

A

A/V cable 126

AC adapter 158

AF-assist illuminator 4, 31, 148

Audio/video cable 127, 128, 133

Audio-in/Video-in jack 126

Auto flash 62

Auto mode 26, 37

Auto off 149

Auto sort mode 84

Autofocus mode 124

AVI 159

B

Back light 44

Battery 16, 18, 144

Battery charger 158

Battery latch 5

Battery level 26

Battery-chamber 5

Battery-chamber/memory card slot cover
5, 16

Beach/snow 41

Best Shot Selector 68

Blink warning 153

Brightness 146

BSS 68

Built-in flash 4

Built-in microphone 4

Button sound 149

C

Cable connector 5, 126, 127

Charge by computer 152

Charging AC Adapter EH-68P 18

Clip art 141

Close-up 42

Cloudy 70

Computer 127, 127–130

copying pictures to 127–130

Copy 44

Craft 141

Crop 121

D

Date 143

Date counter 147

Date imprint 146

Daylight 70

Daylight saving time 22, 144

Delete 95

Digital zoom 29, 148

Direct print 132

D-Lighting 115

DPOF 176

printing 138

Drag 6

Draw 44, 45

Dusk/dawn 41

E

Easy auto mode 26

EN-EL12 16, 18









Exposure compensation 66

Extension 159

Eyelet for camera strap 4

F

Face priority 34

- File names 159
- Fill flash 62
- Fireworks show  43
- Firmware version 157
- Fixed range auto 73
- Flash 62
- Flash indicator 63
- Flash off 62
- Fluorescent 70
- Focus 4
 - area 30
- Folder name 159
- Food  43
- Format 25, 150
- Format memory card 25, 150
- Formatting internal memory 150
- H**
- Halfway 4
- HOME screen 14
 - display design 141
- I**
- Identifier 159
- Image mode 65
- Image size 64
- Incandescent 70
- ISO sensitivity 73
- J**
- JPG 159
- L**
- Language 151
- Lens 4, 173
- Li-ion rechargeable battery 16
- List by date mode 87
- M**
- Macro mode 124
- Memory capacity 27, 65
- Memory card 24, 158
- Memory card slot 5, 24
- Monitor 5, 162
- Monitor settings 146
- Movie menu 123
- Movie playback 125
- Movie settings 123
- Multi connector 133
- Multi-shot 16 68
- Museum  43
- N**
- Night landscape  42
- Night portrait  40
- Nikon Transfer 127, 128
- Number of exposures remaining 27, 65
- O**
- Optional accessories 158
- P**
- Paint 111
- Panorama assist  44, 46
- Paper size 135
- Party/indoor  41
- Perspective control 119
- Photo info 146
- Photograph 141
- PictBridge 132
- Playback 33, 77, 91
- Playback zoom 91
- Portrait  39
- Power 22, 26
- Power switch 4, 26
- Power-on lamp 4, 19, 21, 131, 149
- Print 101, 135, 136
- Print set 101
- Printer 132
- Q**
- Quick retouch 114
- R**
- Rechargeable battery 158
- Rechargeable Li-ion battery 16
- Record orientation 149
- Recording movies 122
- Red-eye reduction 62, 63
- Reset all 154

S

- Scene mode 39
- Self-timer lamp 4, 59
- Setup menu 139
- Shooting 26, 28, 30
- Shutter sound 149
- Shutter-release button 4, 30
- Single 68
- Skin softening 120
- Slide cover (power switch) 4
- Slow Sync 62
- Small picture 117
- Sound settings 149
- Speaker 4
- Sports 🏊 40
- Strap 5
- Stretch 118
- Subject tracking 56
- Sunset 🌅 41

T

- Tap 6
- Thumbnail playback 93
- Time zone 143, 145
- Touch AF/AE 53
- Touch shooting 48
- Touch shutter 51
- Transfer 128
- Tripod socket 5
- TV 126
- TV movie 123

U

- USB cable 18, 127, 128, 133

V

- Video mode 126, 151
- ViewNX 127
- Voice memo 107
- Volume 125

W

- WAV 159
- Welcome screen 142

Nikon

No reproduction in any form of this manual, in whole or in part (except for brief quotation in critical articles or reviews), may be made without written authorization from NIKON CORPORATION.



NIKON CORPORATION

Fuji Bldg., 2-3 Marunouchi 3-chome,
Chiyoda-ku, Tokyo 100-8331, Japan

© 2009 Nikon Corporation

Printed in Japan
YP9H02(11)
6MM71111-02