

3040c

DIGITAL Scan Tool



OWNER'S MANUAL

The easiest and best way to
troubleshoot 1996 and newer
OBD2 vehicles!



Table of Contents

INTRODUCTION	
WHAT IS OBD?	1
YOU CAN DO IT!	2
SAFETY PRECAUTIONS	
SAFETY FIRST!	3
ABOUT THE SCAN TOOL	
VEHICLES COVERED	4
CONTROLS AND INDICATORS	5
DISPLAY FUNCTIONS	6
INITIAL ADJUSTMENTS	8
ONBOARD DIAGNOSTICS	
COMPUTER ENGINE CONTROLS	9
DIAGNOSTIC TROUBLE CODES (DTCs)	14
OBD2 MONITORS	17
PREPARATION FOR TESTING	
BEFORE YOU BEGIN	29
VEHICLE SERVICE MANUALS	30
USING THE SCAN TOOL	
CODE RETRIEVAL PROCEDURE	31
VIEWING FREEZE FRAME DATA	37
VIEWING ENHANCED DTCs	38
VIEWING ABS DTCs	48
ERASING DIAGNOSTIC TROUBLE CODES (DTCs)	50
ABOUT REPAIRSOLUTIONS®	52
I/M READINESS TESTING	56
LIVE DATA MODE	
VIEWING LIVE DATA	62
CUSTOMIZING LIVE DATA (PIDs)	63
ADDITIONAL FUNCTIONS	
BATTERY/ALTERNATOR MONITOR	66
VIEWING VEHICLE INFORMATION	67
VIEWING THE FIRMWARE VERSION	70
THE TOOL LIBRARY	70
ADJUSTMENTS AND SETTINGS	73
GENERIC (GLOBAL) OBD2 PID LIST	77
VEHICLE APPLICATIONS - ABS	
VEHICLE APPLICATIONS – MAKES COVERED	82
WARRANTY AND SERVICING	
LIMITED ONE YEAR WARRANTY	85
SERVICE PROCEDURES	85

WHAT IS OBD?

The Scan Tool is designed to work on all OBD2 compliant vehicles. All 1996 and newer vehicles (cars, light trucks and SUVs) sold in the United States are OBD2 compliant.

One of the most exciting improvements in the automobile industry was the addition of on-board diagnostics (OBD) on vehicles, or in more basic terms, the computer that activates the vehicle's "CHECK ENGINE" light. OBD1 was designed to monitor manufacturer-specific systems on vehicles built from 1981 to 1995. Then came the development of OBD2, which is on all 1996 and newer vehicles sold in the U.S. Like its predecessor, OBD2 was adopted as part of a government mandate to lower vehicle emissions. But what makes OBD2 unique is its universal application for all late model cars and trucks - domestic and import. This sophisticated program in the vehicle's main computer system is designed to detect failures in a range of systems, and can be accessed through a universal OBD2 port, which is usually found under the dashboard. For all OBD systems, if a problem is found, the computer turns on the "CHECK ENGINE" light to warn the driver, and sets a Diagnostic Trouble Code (DTC) to identify where the problem occurred. A special diagnostic tool, such as the Scan Tool, is required to retrieve these codes, which consumers and professionals use as a starting point for repairs.



The Scan Tool provides the additional ability to retrieve *enhanced* DTCs from most Chrysler/Jeep, Ford/Mazda, GM/Isuzu, Honda/Acura and Toyota/Lexus vehicles, as well as Anti-Lock Brake System (ABS) DTCs and vehicle information. The types of enhanced data available depends on the vehicle make.

To learn more about vehicle Computer Control Systems and OBD2, see COMPUTER ENGINE CONTROLS on page 8.



You Can Do It!

EASY TO USE - EASY TO VIEW - EASY TO DEFINE

Easy To Use

- Connect the Scan Tool to the vehicle's test connector.
- Turn the ignition key "On." DO NOT start the engine.
- The Scan Tool will automatically link to the vehicle's computer.

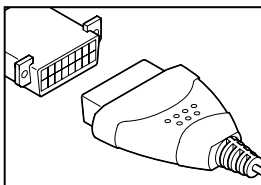

Easy To View

- The Scan Tool retrieves stored codes, Freeze Frame data System Status.
- Codes, System Status and Freeze Frame data are displayed on the Scan Tool's display screen. System status is indicated by LED indicators.

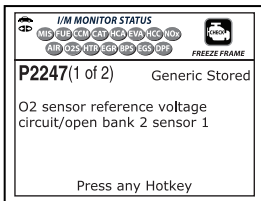

Easy To Define

- Read code definitions from the Scan Tool's display
- View Freeze Frame data.
- View Live Data.
- View Anti-Lock Brake System (ABS) DTCs.

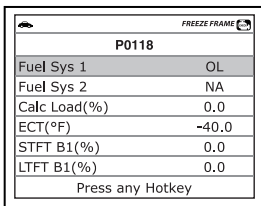

SAFETY FIRST!

This manual describes common test procedures used by experienced service technicians. Many test procedures require precautions to avoid accidents that can result in personal injury, and/or damage to your vehicle or test equipment. Always read your vehicle's service manual and follow its safety precautions before and during any test or service procedure. **ALWAYS** observe the following general safety precautions:



When an engine is running, it produces carbon monoxide, a toxic and poisonous gas. To prevent serious injury or death from carbon monoxide poisoning, operate the vehicle **ONLY** in a **well-ventilated** area.



To protect your eyes from propelled objects as well as hot or caustic liquids, **always** wear **approved** safety eye protection.



When an engine is running, many parts (such as the coolant fan, pulleys, fan belt etc.) turn at high speed. To avoid serious injury, always be aware of moving parts. Keep a safe distance from these parts as well as other potentially moving objects.



Engine parts become very hot when the engine is running. To prevent severe burns, avoid contact with hot engine parts.



Before starting an engine for testing or trouble-shooting, make sure the parking brake is engaged. Put the transmission in **park** (for automatic transmission) or **neutral** (for manual transmission). Block the drive wheels with suitable blocks.



Connecting or disconnecting test equipment when the ignition is **ON** can damage test equipment and the vehicle's electronic components. Turn the ignition **OFF** before connecting the Code Reader to or disconnecting the Code Reader from the vehicle's Data Link Connector (DLC).



To prevent damage to the on-board computer when taking vehicle electrical measurements, always use a digital multimeter with at least 10 MegOhms of impedance.



The vehicle's battery produces highly flammable hydrogen gas. To prevent an explosion, keep all sparks, heated items and open flames away from the battery.



Don't wear loose clothing or jewelry when working on an engine. Loose clothing can become caught in the fan, pulleys, belts, etc. Jewelry is highly conductive, and can cause a severe burn if it makes contact between a power source and ground.

VEHICLES COVERED

The Scan Tool is designed to work on all OBD2 compliant vehicles. All 1996 and newer vehicles (cars and light trucks) sold in the United States are OBD2 compliant. This includes all Domestic, Asian and European vehicles.

Some 1994 and 1995 vehicles are OBD2 compliant. To find out if a 1994 or 1995 vehicle is OBD2 compliant, check the following:

1. **The Vehicle Emissions Control Information (VECI) Label.** This label is located under the hood or by the radiator of most vehicles. If the vehicle is OBD2 compliant, the label will state **“OBD II Certified.”**

VEHICLE EMISSION CONTROL INFORMATION			
VEHICLE MANUFACTURER	ENGINE FAMILY	EFN2.6YBT2BA	OBD II CERTIFIED
	DISPLACEMENT	2.6L	
THIS VEHICLE CONFORMS TO U.S. EPA AND STATE OF CALIFORNIA REGULATIONS APPLICABLE TO 1999 MODEL YEAR NEW TLEV PASSENGER CARS.			
REFER TO SERVICE MANUAL FOR ADDITIONAL INFORMATION TUNE-UP CONDITIONS: NORMAL OPERATING ENGINE TEMPERATURE, ACCESSORIES OFF, COOLING FAN OFF, TRANSMISSION IN NEUTRAL			
EXHAUST EMISSIONS STANDARDS		STANDARD CATEGORY	
CERTIFICATION IN-USE		TLEV TLEV INTERMEDIATE	
SPARK PLUG TYPE NGK BPRE-11 GAP: 1.1MM	CATALYST		

**OBD II
CERTIFIED**

2. Government Regulations require that all OBD2 compliant vehicles must have a “common” sixteen-pin **Data Link Connector (DLC)**.

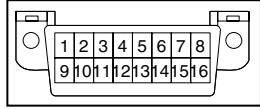

Some 1994 and 1995 vehicles have 16-pin connectors but are not OBD2 compliant. Only those vehicles with a Vehicle Emissions Control Label stating “OBD II Certified” are OBD2 compliant.

Data Link Connector (DLC) Location

The 16-pin DLC is usually located under the instrument panel (dash), within 12 inches (300 mm) of center of the panel, on the driver’s side of most vehicles. It should be easily accessible and visible from a kneeling position outside the vehicle with the door open.

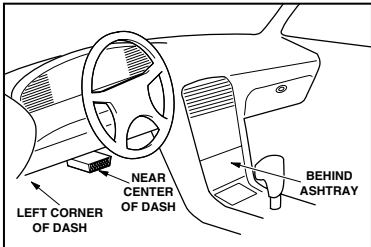

On some Asian and European vehicles the DLC is located behind the “ashtray” (the ashtray must be removed to access it) or on the far left corner of the dash. If the DLC cannot be located, consult the vehicle’s service manual for the location.

CONTROLS AND INDICATORS

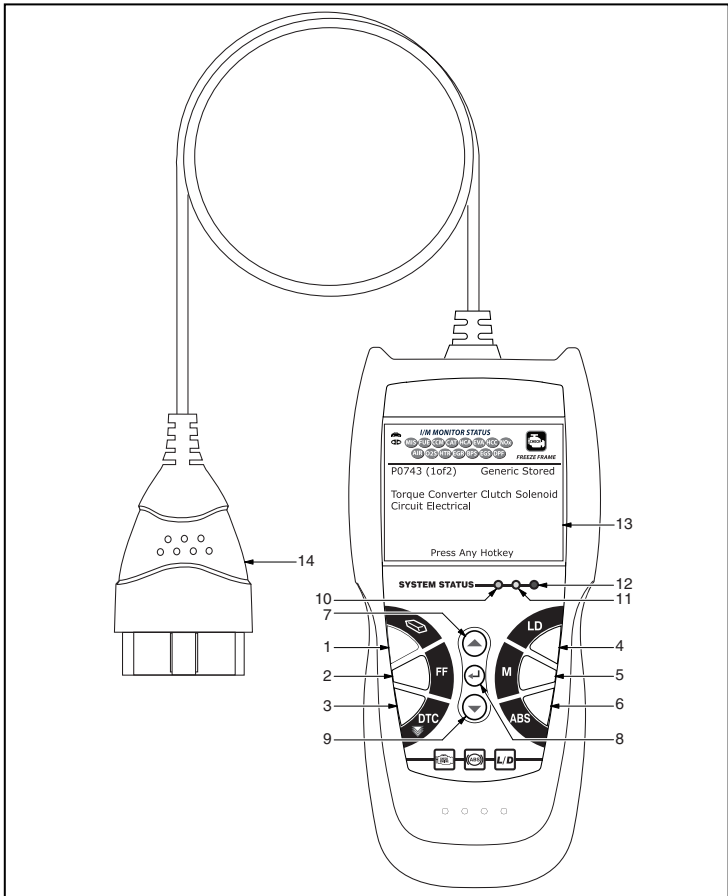



Figure 1. Controls and Indicators

See Figure 1 for the locations of items 1 through 14, below.

1.  **ERASE button** - Erases Diagnostic Trouble Codes (DTCs) and "Freeze Frame" data from your vehicle's computer, and resets Monitor status.
2. **FF button** - When retrieving and viewing DTCs, displays Freeze Frame data for the highest priority code.
3. **DTC button** - Displays the DTC View screen and/or scrolls the display when more than one DTC is present.
4. **LD button** - When linked to a vehicle, places the Scan Tool in "Live Data" mode.

- M (Menu) button** – When pressed while linked to a vehicle, displays the “Main Menu.”
- ABS button** – When pressed, links the diagnostic tool to the vehicle’s ABS control module to retrieve diagnostic data from the computer’s memory.
- UP button** – When in MENU mode, scrolls UP through the menu and submenu selection options. When LINKED to a vehicle, scrolls UP through the current display screen to display any additional data.
- ENTER button** - When in Menu mode, confirms the selected option or value.
- DOWN button** - When in MENU mode, scrolls down through the menu and submenu selection options. When LINKED to a vehicle, scrolls down through the current display screen to display any additional data.
- GREEN LED** - Indicates that all engine systems are running normally (all Monitors on the vehicle are active and performing their diagnostic testing, and no DTCs are present).
- YELLOW LED** - Indicates there is a possible problem. A “Pending” DTC is present and/or some of the vehicle’s emission monitors have not run their diagnostic testing.
- RED LED** - Indicates there is a problem in one or more of the vehicle’s systems. The red LED is also used to show that DTC(s) are present. DTCs are shown on the Scan Tool’s LCD display. In this case, the Multifunction Indicator (“Check Engine”) lamp on the vehicle’s instrument panel will light steady on.
- LCD Display** - Displays test results, Scan Tool functions and Monitor status information. See DISPLAY FUNCTIONS, below, for details.
- CABLE** - Connects the Scan Tool to the vehicle’s Data Link Connector (DLC).

DISPLAY FUNCTIONS

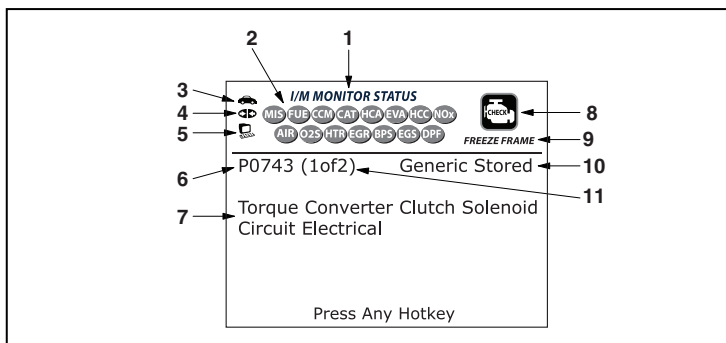





Figure 2. Display Functions

See Figure 2 for the locations of items 1 through 11, below.

1. **I/M MONITOR STATUS field** – Identifies the I/M Monitor status area.
2. **Monitor icons** - Indicates which Monitors are supported by the vehicle under test, and whether or not the associated Monitor has run its diagnostic testing (Monitor status). When a Monitor icon is solid green, it indicates that the associated Monitor has completed its diagnostic testing. When a Monitor icon is flashing red, it indicates that the vehicle supports the associated Monitor, but the Monitor has not yet run its diagnostic testing.
3.  **Vehicle icon** - Indicates whether or not the Scan Tool is being properly powered through the vehicle's Data Link Connector (DLC). A visible icon indicates that the Scan Tool is being powered through the vehicle's DLC connector.
4.  **Link icon** - Indicates whether or not the Scan Tool is communicating (linked) with the vehicle's on-board computer. When visible, the Scan Tool is communicating with the computer. If the Link icon is not visible, the Scan Tool is not communicating with the computer.
5.  **Computer icon** - When this icon is visible it indicates that the Scan Tool is linked to a personal computer. Optional "PC Link" software is available that makes it possible to upload retrieved data to a personal computer.
6. **DTC Display Area** - Displays the Diagnostic Trouble Code (DTC) number and definition. Each fault is assigned a code number that is specific to that fault.
7. **Test Data Display Area** – Displays DTC definitions, Freeze Frame data, and other pertinent rest information messages.
8. **MIL icon** - Indicates the status of the Malfunction Indicator Lamp (MIL). The MIL icon is visible only when a DTC has commanded the MIL on the vehicle's dashboard to light.
9. **FREEZE FRAME icon** - Indicates that "Freeze Frame" data has been stored in the vehicle's computer for the currently displayed DTC.
10. **Code Type** – Indicates whether the code is "generic" or "manufacturer-specific" and shows the type of code; **Stored, Pending** or **Permanent**.
11. **Code Number Sequence** – Shows the number of the currently displayed code and the total number of codes retrieved from the vehicle's computer. The Diagnostic Tool assigns a sequence number to each DTC that is present in the computer's memory, starting with "1." Code number "1" is always the highest priority code, and the one for which "Freeze Frame" data has been stored.



If "01" is a "Pending" code, there may or may not be "Freeze Frame" data stored in memory.

INITIAL ADJUSTMENTS

The first time the unit is connected to a vehicle, the Select Language screen displays. You must select the desired display language (English, French or Spanish) and unit of measurement (USA or Metric) as follows:

1. Use the **UP** (▲) and **DOWN** (▼) buttons, as necessary, to highlight the desired display language.
2. When the desired display language is selected, press the **ENTER** (↵) button to confirm your selection.
 - The Select Unit screen displays.
3. Use the **UP** (▲) and **DOWN** (▼) buttons, as necessary, to highlight the desired unit of measurement.
4. When the desired unit of measurement is selected, press the **ENTER** (↵) button to confirm your selection.

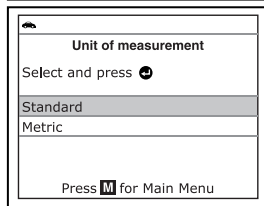
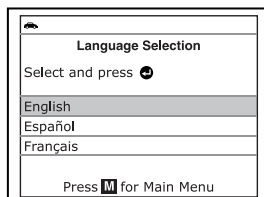

After the initial language and unit of measurement selections are performed, these, as well as other settings, can be changed as desired. Proceed to “ADJUSTMENTS AND SETTINGS” on page 70 for further instructions.

COMPUTER ENGINE CONTROLS

The Introduction of Electronic Engine Controls

Electronic Computer Control Systems make it possible for vehicle manufacturers to comply with the tougher emissions and fuel efficiency standards mandated by State and Federal Governments.

As a result of increased air pollution (smog) in large cities, such as Los Angeles, the California Air Resources Board (**CARB**) and the Environmental Protection Agency (**EPA**) set new regulations and air pollution standards to deal with the problem. To further complicate matters, the energy crisis of the early 1970s caused a sharp increase in fuel prices over a short period. As a result, vehicle manufacturers were not only required to comply with the new emissions standards, they also had to make their vehicles more fuel-efficient. Most vehicles were required to meet a miles-per-gallon (MPG) standard set by the U.S. Federal Government.



Precise fuel delivery and spark timing are needed to reduce vehicle emissions. Mechanical engine controls in use at the time (such as ignition points, mechanical spark advance and the carburetor) responded too slowly to driving conditions to properly control fuel delivery and spark timing. This made it difficult for vehicle manufacturers to meet the new standards.

A new Engine Control System had to be designed and integrated with the engine controls to meet the stricter standards. The new system had to:

- Respond instantly to supply the proper mixture of air and fuel for any driving condition (idle, cruising, low-speed driving, high-speed driving, etc.).
- Calculate instantly the best time to “ignite” the air/fuel mixture for maximum engine efficiency.
- Perform both these tasks without affecting vehicle performance or fuel economy.

Vehicle Computer Control Systems can perform millions of calculations each second. This makes them an ideal substitute for the slower mechanical engine controls. By switching from mechanical to electronic engine controls, vehicle manufacturers are able to control fuel delivery and spark timing more precisely. Some newer Computer Control Systems also provide control over other vehicle functions, such as transmission, brakes, charging, body, and suspension systems.

The Basic Engine Computer Control System

The Computer Control System consists of an on-board computer and several related control devices (sensors, switches, and actuators).

The on-board computer is the heart of the Computer Control System. The computer contains several programs with preset reference values for air/fuel ratio, spark or ignition timing, injector pulse width, engine speed, etc. Separate values are provided for various driving conditions, such as idle, low speed driving, high-speed driving, low load, or high load. The preset reference values represent the ideal air/fuel mixture, spark timing, transmission gear selection, etc., for any driving condition. These values are programmed by the vehicle manufacturer, and are specific to each vehicle model.



Most on-board computers are located inside the vehicle behind the dashboard, under the passenger's or driver's seat, or behind the right kick panel. However, some manufacturers may still position it in the engine compartment.

Vehicle sensors, switches, and actuators are located throughout the engine, and are connected by electrical wiring to the on-board computer. These devices include oxygen sensors, coolant temperature sensors, throttle position sensors, fuel injectors, etc. Sensors and switches are **input devices**. They provide signals representing current engine operating conditions to the computer. Actuators are **output devices**. They perform actions in response to commands received from the computer.

The on-board computer receives information inputs from sensors and switches located throughout the engine. These devices monitor critical engine conditions such as coolant temperature, engine speed, engine load, throttle position, air/fuel ratio etc.

The computer compares the values received from these sensors with its preset reference values, and makes corrective actions as needed so that the sensor values always match the preset reference values for the current driving condition. The computer makes adjustments by commanding other devices such as the fuel injectors, idle air control, EGR valve or Ignition Module to perform these actions.

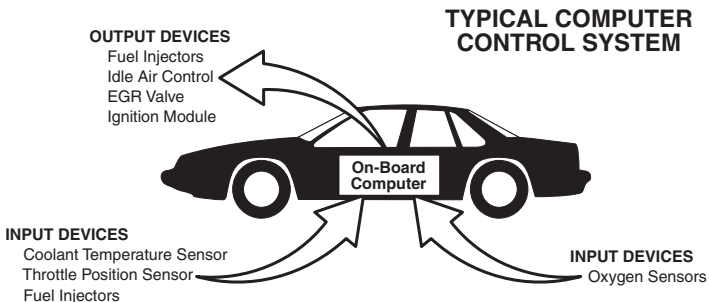

Vehicle operating conditions are constantly changing. The computer continuously makes adjustments or corrections (especially to the air/fuel mixture and spark timing) to keep all the engine systems operating within the preset reference values.

On-Board Diagnostics - First Generation (OBD1)

With the exception of some 1994 and 1995 vehicles, most vehicles from 1982 to 1995 are equipped with some type of first generation On-Board Diagnostics.



Beginning in 1988, California's Air Resources Board (**CARB**), and later the Environmental Protection Agency (**EPA**) required vehicle manufacturers to include a self-diagnostic program in their on-board computers. The program would be capable of identifying emissions-related faults in a system. The first generation of Onboard Diagnostics came to be known as **OBD1**.

OBD1 is a set of self-testing and diagnostic instructions programmed into the vehicle's on-board computer. The programs are specifically designed to detect failures in the sensors, actuators, switches and wiring of the various vehicle emissions-related systems. If the computer detects a failure in any of these components or systems, it lights an indicator on the dashboard to alert the driver. The indicator lights **only** when an emissions-related problem is detected.

The computer also assigns a numeric code for each specific problem that it detects, and stores these codes in its memory for later retrieval. These codes can be retrieved from the computer's memory with the use of a "Code Reader" or a "Scan Tool."

On-Board Diagnostics - Second Generation (OBD2)

In addition to performing all the functions of the OBD1 System, the OBD2 System has been enhanced with new Diagnostic Programs. These programs closely monitor the functions of various emissions-related components and systems (as well as other systems) and make this information readily available (with the proper equipment) to the technician for evaluation.

The OBD2 System is an enhancement of the OBD1 System.

The California Air Resources Board (**CARB**) conducted studies on OBD1 equipped vehicles. The information that was gathered from these studies showed the following:

- A large number of vehicles had deteriorating or degraded emissions-related components. These components were causing an increase in emissions.



- Because OBD1 systems only detect failed components, the degraded components were not setting codes.
- Some emissions problems related to degraded components only occur when the vehicle is being driven under a load. The emission checks being conducted at the time were not performed under simulated driving conditions. As a result, a significant number of vehicles with degraded components were passing Emissions Tests.
- Codes, code definitions, diagnostic connectors, communication protocols and emissions terminology were different for each manufacturer. This caused confusion for the technicians working on different make and model vehicles.

To address the problems made evident by this study, CARB and the EPA passed new laws and standardization requirements. These laws required that vehicle manufacturers to equip their new vehicles with devices capable of meeting all of the new emissions standards and regulations. It was also decided that an enhanced on-board diagnostic system, capable of addressing all of these problems, was needed. This new system is known as **“On-Board Diagnostics Generation Two (OBD2).”** The primary objective of the OBD2 system is to comply with the latest regulations and emissions standards established by CARB and the EPA.

The Main Objectives of the OBD2 System are:

- To detect degraded and/or failed emissions-related components or systems that could cause tailpipe emissions to exceed by 1.5 times the Federal Test Procedure (FTP) standard.
- To expand emissions-related system monitoring. This includes a set of computer run diagnostics called Monitors. Monitors perform diagnostics and testing to verify that all emissions-related components and/or systems are operating correctly and within the manufacturer’s specifications.
- To use a standardized Diagnostic Link Connector (DLC) in all vehicles. (Before OBD2, DLCs were of different shapes and sizes.)
- To standardize the code numbers, code definitions and language used to describe faults. (Before OBD2, each vehicle manufacturer used their own code numbers, code definitions and language to describe the same faults.)
- To expand the operation of the Malfunction Indicator Lamp (MIL).
- To standardize communication procedures and protocols between the diagnostic equipment (Scan Tools, Code Readers, etc.) and the vehicle’s on-board computer.

OBD2 Terminology

The following terms and their definitions are related to OBD2 systems. Read and reference this list as needed to aid in the understanding of OBD2 systems.

- **Powertrain Control Module (PCM)** - The PCM is the OBD2 accepted term for the vehicle's "on-board computer." In addition to controlling the engine management and emissions systems, the PCM also participates in controlling the powertrain (transmission) operation. Most PCMs also have the ability to communicate with other computers on the vehicle (ABS, ride control, body, etc.).
- **Monitor** - Monitors are "diagnostic routines" programmed into the PCM. The PCM utilizes these programs to run diagnostic tests, and to monitor operation of the vehicle's emissions-related components or systems to ensure they are operating correctly and within the vehicle's manufacturer specifications. Currently, up to fifteen Monitors are used in OBD2 systems. Additional Monitors will be added as the OBD2 system is further developed.



Not all vehicles support all fifteen Monitors.

- **Enabling Criteria** - Each Monitor is designed to test and monitor the operation of a specific part of the vehicle's emissions system (EGR system, oxygen sensor, catalytic converter, etc.). A specific set of "conditions" or "driving procedures" must be met before the computer can command a Monitor to run tests on its related system. These "conditions" are known as "**Enabling Criteria.**" The requirements and procedures vary for each Monitor. Some Monitors only require the ignition key to be turned "**On**" for them to run and complete their diagnostic testing. Others may require a set of complex procedures, such as, starting the vehicle when cold, bringing it to operating temperature, and driving the vehicle under specific conditions before the Monitor can run and complete its diagnostic testing.
- **Monitor Has/Has Not Run** - The terms "Monitor has run" or "Monitor has not run" are used throughout this manual. "**Monitor has run,**" means the PCM **has** commanded a particular Monitor to perform the required diagnostic testing on a system to ensure the system is operating correctly (within factory specifications). The term "**Monitor has not run**" means the PCM **has not** yet commanded a particular Monitor to perform diagnostic testing on its associated part of the emissions system.
- **Trip** - A Trip for a particular Monitor requires that the vehicle is being driven in such a way that all the required "Enabling Criteria" for the Monitor to run and complete its diagnostic testing are met. The "Trip Drive Cycle" for a particular Monitor begins when the ignition key is turned "**On.**" It is successfully completed when all the "Enabling Criteria" for the Monitor to run and complete its diagnostic testing are met by the time the ignition key is turned "**Off.**" Since each of the fifteen monitors is designed to run diagnostics and testing on a different part of the engine or emissions system, the "Trip Drive Cycle" needed for each individual Monitor to run and complete varies.

- **OBD2 Drive Cycle** - An OBD2 Drive Cycle is an extended set of driving procedures that takes into consideration the various types of driving conditions encountered in real life. These conditions may include starting the vehicle when it is cold, driving the vehicle at a steady speed (cruising), accelerating, etc. An OBD2 Drive Cycle begins when the ignition key is turned "On" (when cold) and ends when the vehicle has been driven in such a way as to have all the "Enabling Criteria" met for all its applicable Monitors. Only those trips that provide the Enabling Criteria for all Monitors applicable to the vehicle to run and complete their individual diagnostic tests qualify as an OBD2 Drive Cycle. OBD2 Drive Cycle requirements vary from one model of vehicle to another. Vehicle manufacturers set these procedures. Consult your vehicle's service manual for OBD2 Drive Cycle procedures.



Do not confuse a "Trip" Drive Cycle with an OBD2 Drive Cycle. A "Trip" Drive Cycle provides the "Enabling Criteria" for one specific Monitor to run and complete its diagnostic testing. An OBD2 Drive Cycle must meet the "Enabling Criteria" for all Monitors on a particular vehicle to run and complete their diagnostic testing.

- **Warm-up Cycle** - Vehicle operation after an engine off period where engine temperature rises at least 40°F (22°C) from its temperature before starting, and reaches at least 160°F (70°C). The PCM uses warm-up cycles as a counter to automatically erase a specific code and related data from its memory. When no faults related to the original problem are detected within a specified number of warm-up cycles, the code is erased automatically.

DIAGNOSTIC TROUBLE CODES (DTCs)

Diagnostic Trouble Codes (DTCs) are meant to guide you to the proper service procedure in the vehicle's service manual. **DO NOT** replace parts based only on DTCs without first consulting the vehicle's service manual for proper testing procedures for that particular system, circuit or component.

Diagnostic Trouble Codes (DTCs) are codes that identify a specific problem area.

DTCs are alphanumeric codes that are used to identify a problem that is present in any of the systems that are monitored by the on-board computer (PCM). Each trouble code has an assigned message that identifies the circuit, component or system area where the problem was found.

OBD2 diagnostic trouble codes are made up of five characters:

- The 1st character is a **letter** (B, C, P or U). It identifies the "main system" where the fault occurred (Body, Chassis, Powertrain, or Network).
- The 2nd character is a **numeric digit** (0 thru 3). It identifies the "type" of code (Generic or Manufacturer-Specific).



Generic DTCs are codes that are used by all vehicle manufacturers. The standards for generic DTCs, as well as their definitions, are set by the Society of Automotive Engineers (SAE).





Manufacturer-Specific DTCs are codes that are controlled by the vehicle manufacturers. The Federal Government does not require vehicle manufacturers to go beyond the standardized generic DTCs in order to comply with the new OBD2 emissions standards. However, manufacturers are free to expand beyond the standardized codes to make their systems easier to diagnose.

- The 3rd character is a **letter** or a **numeric digit** (0 thru 9, A thru F). It identifies the specific system or sub-system where the problem is located.
- The 4th and 5th characters are **letters** or **numeric digits** (0 thru 9, A thru F). They identify the section of the system that is malfunctioning.

OBD2 DTC EXAMPLE

P0201 - Injector Circuit Malfunction, Cylinder 1

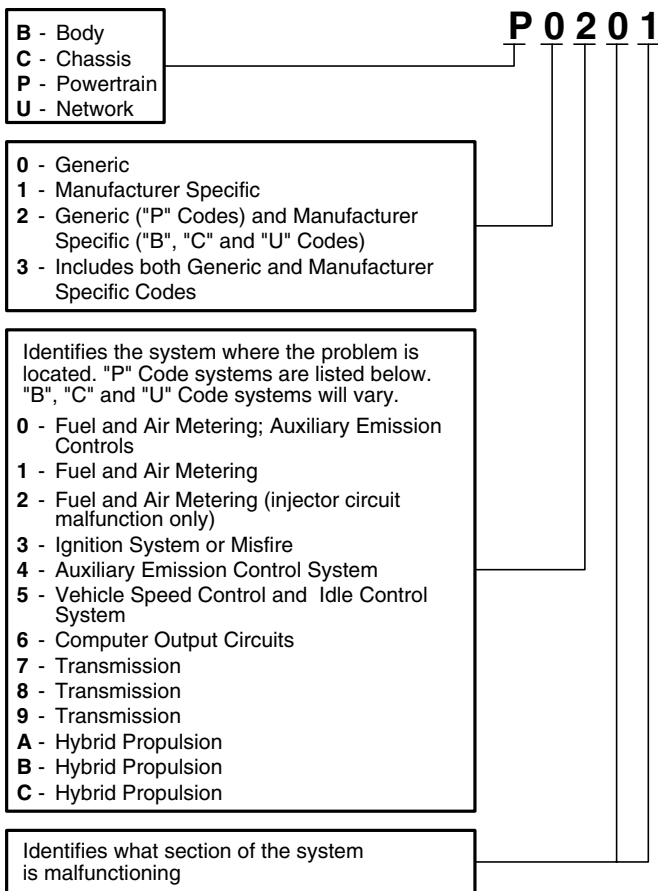

DTCs and MIL Status

When the vehicle's on-board computer detects a failure in an emissions-related component or system, the computer's internal diagnostic program assigns a diagnostic trouble code (DTC) that points to the system (and subsystem) where the fault was found. The diagnostic program saves the code in the computer's memory. It records a "Freeze Frame" of conditions present when the fault was found, and lights the Malfunction Indicator Lamp (MIL). Some faults require detection for two trips in a row before the MIL is turned on.



The "Malfunction Indicator Lamp" (MIL) is the accepted term used to describe the lamp on the dashboard that lights to warn the driver that an emissions-related fault has been found. Some manufacturers may still call this lamp a "Check Engine" or "Service Engine Soon" light.

There are two types of DTCs used for emissions-related faults: Type "A" and Type "B." Type "A" codes are "One-Trip" codes; Type "B" DTCs are usually Two-Trip DTCs.

When a **Type "A"** DTC is found on the First Trip, the following events take place:

- The computer commands the MIL "On" when the failure is first found.
- If the failure causes a severe misfire that may cause damage to the catalytic converter, the MIL "flashes" **once per second**. The MIL continues to flash as long as the condition exists. If the condition that caused the MIL to flash is no longer present, the MIL will light "steady" On.
- A DTC is saved in the computer's memory for later retrieval.
- A "Freeze Frame" of the conditions present in the engine or emissions system when the MIL was ordered "On" is saved in the computer's memory for later retrieval. This information shows fuel system status (closed loop or open loop), engine load, coolant temperature, fuel trim value, MAP vacuum, engine RPM and DTC priority.

When a **Type "B"** DTC is found on the First Trip, the following events take place:

- The computer sets a Pending DTC, but the MIL is not ordered "On." "Freeze Frame" data may or may not be saved at this time depending on manufacturer. The Pending DTC is saved in the computer's memory for later retrieval.
- If the failure **is found** on the second consecutive trip, the MIL is ordered "On." "Freeze Frame" data is saved in the computer's memory.
- If the failure **is not found** on the second Trip, the Pending DTC is erased from the computer's memory.

The MIL will stay lit for both Type "A" and Type "B" codes until one of the following conditions occurs:

- If the conditions that caused the MIL to light are no longer present for the next three trips in a row, the computer automatically turns the MIL “Off” if no other emissions-related faults are present. However, the DTCs remain in the computer’s memory as a history code for 40 warm-up cycles (80 warm-up cycles for fuel and misfire faults). The DTCs are automatically erased if the fault that caused them to be set is not detected again during that period.
- Misfire and fuel system faults require three trips with “similar conditions” before the MIL is turned “Off.” These are trips where the engine load, RPM and temperature are similar to the conditions present when the fault was first found.



After the MIL has been turned off, DTCs and Freeze Frame data stay in the computer’s memory.

- Erasing the DTCs from the computer’s memory can also turn off the MIL. See ERASING DIAGNOSTIC TROUBLE CODES (DTCs) on page 50, before erasing codes from the computer’s memory. If a Diagnostic Tool or Scan Tool is used to erase the codes, Freeze Frame data will also be erased.

OBD2 MONITORS

To ensure the correct operation of the various emissions-related components and systems, a diagnostic program was developed and installed in the vehicle’s on-board computer. The program has several procedures and diagnostic strategies. Each procedure or diagnostic strategy is made to monitor the operation of, and run diagnostic tests on, a specific emissions-related component or system. These tests ensure the system is running correctly and is within the manufacturer’s specifications. On OBD2 systems, these procedures and diagnostic strategies are called “Monitors.”

Currently, fifteen Monitors are supported by OBD2 systems. Additional monitors may be added as a result of Government regulations as the OBD2 system grows and matures. Not all vehicles support all fifteen Monitors. Additionally, some Monitors are supported by “spark ignition” vehicles only, while others are supported by “compression ignition” vehicles only.

Monitor operation is either “**Continuous**” or “**Non-Continuous**,” depending on the specific monitor.







Continuous Monitors

Three of these Monitors are designed to constantly monitor their associated components and/or systems for proper operation. Continuous Monitors run constantly when the engine is running. The Continuous Monitors are:

- **CCM** Comprehensive Component Monitor (CCM)
- **MIS** Misfire Monitor
- **FUE** Fuel System Monitor





Non-Continuous Monitors

The other twelve Monitors are “non-continuous” Monitors. “Non-continuous” Monitors perform and complete their testing once per trip. The “non-continuous” Monitors are:

-  O2S Oxygen Sensor Monitor
-  HTR Oxygen Sensor Heater Monitor
-  CAT Catalyst Monitor
-  HCA Heated Catalyst Monitor
-  EGR EGR System Monitor
-  EVA EVAP System Monitor
-  AIR Secondary Air System Monitor



The following Monitors will be standard beginning in 2010. The majority of vehicles produced before this time will not support these Monitors

-  HCC NMHC Monitor
-  NOx NOx Adsorber Monitor
-  BPS Boost Pressure System Monitor
-  EGS Exhaust Gas Sensor Monitor
-  DPF PM Filter Monitor

The following provides a brief explanation of the function of each Monitor:



Comprehensive Component Monitor (CCM) - This Monitor continuously checks all inputs and outputs from sensors, actuators, switches and other devices that provide a signal to the computer. The Monitor checks for shorts, opens, out of range value, functionality and “rationality.”



Rationality: Each input signal is compared against all other inputs and against information in the computer’s memory to see if it makes sense under the current operating conditions. Example: The signal from the throttle position sensor indicates the vehicle is in a wide-open throttle condition, but the vehicle is really at idle, and the idle condition is confirmed by the signals from all other sensors. Based on the input data, the computer determines that the signal from the throttle position sensor is not rational (does not make sense when compared to the other inputs). In this case, the signal would fail the rationality test.

The CCM is supported by both “spark ignition” vehicles and “compression ignition” vehicles. The CCM may be either a “One-Trip” or a “Two-Trip” Monitor, depending on the component.



Fuel System Monitor

This Monitor uses a Fuel System Correction program, called Fuel Trim, inside the on-board computer. Fuel Trim is a set of positive and negative values that represent adding or subtracting fuel from the engine. This program is used to correct for a lean (too much air/not enough fuel) or rich (too much fuel/not enough air) air-fuel mixture. The program is designed to add or subtract fuel, as needed, up to a certain percent. If the correction needed is too large and exceeds the time and percent allowed by the program, a fault is indicated by the computer.

The Fuel System Monitor is supported by both “spark ignition” vehicles and “compression ignition” vehicles. The Fuel System Monitor may be a “One-Trip” or “Two-Trip” Monitor, depending on the severity of the problem.



Misfire Monitor

This Monitor continuously checks for engine misfires. A misfire occurs when the air-fuel mixture in the cylinder does not ignite. The misfire Monitor uses changes in crankshaft speed to sense an engine misfire. When a cylinder misfires, it no longer contributes to the speed of the engine, and engine speed decreases each time the affected cylinder(s) misfire. The misfire Monitor is designed to sense engine speed fluctuations and determine from which cylinder(s) the misfire is coming, as well as how bad the misfire is. There are three types of engine misfires, Types 1, 2, and 3.

- Type 1 and Type 3 misfires are two-trip monitor faults. If a fault is sensed on the first trip, the computer temporarily saves the fault in its memory as a Pending Code. The MIL is not commanded on at this time. If the fault is found again on the second trip, under similar conditions of engine speed, load and temperature, the computer commands the MIL “On,” and the code is saved in its long term memory.
- Type 2 misfires are the most severe type of misfire. When a Type 2 misfire is sensed on the first trip, the computer commands the MIL to light when the misfire is sensed. If the computer determines that a Type 2 misfire is severe, and may cause catalytic converter damage, it commands the MIL to “flash” once per second as soon as the misfire is sensed. When the misfire is no longer present, the MIL reverts to steady “On” condition.

The Misfire Monitor is supported by both “spark ignition” vehicles and “compression ignition” vehicles.



Catalyst Monitor

The catalytic converter is a device that is installed downstream of the exhaust manifold. It helps to oxidize (burn) the unburned fuel (hydrocarbons) and partially burned fuel (carbon monoxide) left over from the combustion process. To accomplish this, heat and catalyst materials inside the converter react with the exhaust gases to burn the remaining fuel. Some materials inside the catalytic converter also have the ability to store oxygen, and release it as needed to oxidize hydrocarbons and carbon monoxide. In the process, it reduces vehicle emissions by converting the polluting gases into carbon dioxide and water.

The computer checks the efficiency of the catalytic converter by monitoring the oxygen sensors used by the system. One sensor is located before (upstream of) the converter; the other is located after (downstream

of) the converter. If the catalytic converter loses its ability to store oxygen, the downstream sensor signal voltage becomes almost the same as the upstream sensor signal. In this case, the monitor fails the test.

The Catalyst Monitor is supported by "spark ignition" vehicles only. The Catalyst Monitor is a "Two-Trip" Monitor. If a fault is found on the first trip, the computer temporarily saves the fault in its memory as a Pending Code. The computer does not command the MIL on at this time. If the fault is sensed again on the second trip, the computer commands the MIL "On" and saves the code in its long-term memory.



Heated Catalyst Monitor - Operation of the "heated" catalytic converter is similar to the catalytic converter. The main difference is that a heater is added to bring the catalytic converter to its operating temperature more quickly. This helps reduce emissions by reducing the converter's down time when the engine is cold. The Heated Catalyst Monitor performs the same diagnostic tests as the catalyst Monitor, and also tests the catalytic converter's heater for proper operation.

The Heated Catalyst Monitor is supported by "spark ignition" vehicles only. This Monitor is also a "Two-Trip" Monitor.



Exhaust Gas Recirculation (EGR) Monitor - The Exhaust Gas Recirculation (EGR) system helps reduce the formation of Oxides of Nitrogen during combustion. Temperatures above 2500°F cause nitrogen and oxygen to combine and form Oxides of Nitrogen in the combustion chamber. To reduce the formation of Oxides of Nitrogen, combustion temperatures must be kept below 2500°F. The EGR system recirculates small amounts of exhaust gas back into the intake manifold, where it is mixed with the incoming air/fuel mixture. This reduces combustion temperatures by up to 500°F. The computer determines when, for how long, and how much exhaust gas is recirculated back to the intake manifold. The EGR Monitor performs EGR system function tests at preset times during vehicle operation.

The EGR Monitor is supported by both "spark ignition" vehicles and "compression ignition" vehicles. The EGR Monitor is a "Two-Trip" Monitor. If a fault is found on the first trip, the computer temporarily saves the fault in its memory as a Pending Code. The computer does not command the MIL on at this time. If the fault is sensed again on the second trip, the computer commands the MIL "On," and saves the code in its long-term memory.



Evaporative System (EVAP) Monitor - OBD2 vehicles are equipped with a fuel Evaporative system (EVAP) that helps prevent fuel vapors from evaporating into the air. The EVAP system carries fumes from the fuel tank to the engine where they are burned during combustion. The EVAP system may consist of a charcoal canister, fuel tank cap, purge solenoid, vent solenoid, flow monitor, leak detector and connecting tubes, lines and hoses.

Fumes are carried from the fuel tank to the charcoal canister by hoses or tubes. The fumes are stored in the charcoal canister. The computer controls the flow of fuel vapors from the charcoal canister to the engine via a purge solenoid. The computer energizes or de-energizes the purge

solenoid (depending on solenoid design). The purge solenoid opens a valve to allow engine vacuum to draw the fuel vapors from the canister into the engine where the vapors are burned. The EVAP Monitor checks for proper fuel vapor flow to the engine, and pressurizes the system to test for leaks. The computer runs this Monitor once per trip.

The EVAP Monitor is supported by “spark ignition” vehicles only. The EVAP Monitor is a “Two-Trip” Monitor. If a fault is found on the first trip, the computer temporarily saves the fault in its memory as a Pending Code. The computer does not command the MIL on at this time. If the fault is sensed again on the second trip, the PCM commands the MIL “On,” and saves the code in its long-term memory.



Oxygen Sensor Heater Monitor - The Oxygen Sensor Heater

Monitor tests the operation of the oxygen sensor's heater. There are two modes of operation on a computer-controlled vehicle: “open-loop” and “closed-loop.” The vehicle operates in open-loop when the engine is cold, before it reaches normal operating temperature. The vehicle also goes to open-loop mode at other times, such as heavy load and full throttle conditions. When the vehicle is running in open-loop, the oxygen sensor signal is ignored by the computer for air/fuel mixture corrections. Engine efficiency during open-loop operation is very low, and results in the production of more vehicle emissions.

Closed-loop operation is the best condition for both vehicle emissions and vehicle operation. When the vehicle is operating in closed-loop, the computer uses the oxygen sensor signal for air/fuel mixture corrections.

In order for the computer to enter closed-loop operation, the oxygen sensor must reach a temperature of at least 600°F. The oxygen sensor heater helps the oxygen sensor reach and maintain its minimum operating temperature (600°F) more quickly, to bring the vehicle into closed-loop operation as soon as possible.

The Oxygen Sensor Heater Monitor is supported by “spark ignition” vehicles only. The Oxygen Sensor Heater Monitor is a “Two-Trip” Monitor. If a fault is found on the first trip, the computer temporarily saves the fault in its memory as a Pending Code. The computer does not command the MIL on at this time. If the fault is sensed again on the second trip, the computer commands the MIL “On,” and saves the code in its long-term memory.



Oxygen Sensor Monitor - The Oxygen Sensor monitors how

much oxygen is in the vehicle's exhaust. It generates a varying voltage of up to one volt, based on how much oxygen is in the exhaust gas, and sends the signal to the computer. The computer uses this signal to make corrections to the air/fuel mixture. If the exhaust gas has a large amount of oxygen (a lean air/fuel mixture), the oxygen sensor generates a “low” voltage signal. If the exhaust gas has very little oxygen (a rich mixture condition), the oxygen sensor generates a “high” voltage signal. A 450mV signal indicates the most efficient, and least polluting, air/fuel ratio of 14.7 parts of air to one part of fuel.

The oxygen sensor must reach a temperature of at least 600-650°F, and the engine must reach normal operating temperature, for the computer to enter into closed-loop operation. The oxygen sensor only

functions when the computer is in closed-loop. A properly operating oxygen sensor reacts quickly to any change in oxygen content in the exhaust stream. A faulty oxygen sensor reacts slowly, or its voltage signal is weak or missing.

The Oxygen Sensor Monitor is supported by “spark ignition” vehicles only. The Oxygen Sensor Monitor is a “Two-Trip” monitor. If a fault is found on the first trip, the computer temporarily saves the fault in its memory as a Pending Code. The computer does not command the MIL on at this time. If the fault is sensed again on the second trip, the computer commands the MIL “On,” and saves the code in its long-term memory.



Secondary Air System Monitor - When a cold engine is first started, it runs in open-loop mode. During open-loop operation, the engine usually runs rich. A vehicle running rich wastes fuel and creates increased emissions, such as carbon monoxide and some hydrocarbons. A Secondary Air System injects air into the exhaust stream to aid catalytic converter operation:

1. It supplies the catalytic converter with the oxygen it needs to oxidize the carbon monoxide and hydrocarbons left over from the combustion process during engine warm-up.
2. The extra oxygen injected into the exhaust stream also helps the catalytic converter reach operating temperature more quickly during warm-up periods. The catalytic converter must heat to operating temperature to work properly.

The Secondary Air System Monitor checks for component integrity and system operation, and tests for faults in the system. The computer runs this Monitor once per trip.

The Secondary Air System Monitor is a “Two-Trip” monitor. If a fault is found on the first trip, the computer temporarily saves this fault in its memory as a Pending Code. The computer does not command the MIL on at this time. If the fault is sensed again on the second trip, the computer commands the MIL “On,” and saves the code in its long-term memory.



Non-Methane Hydrocarbon Catalyst (NMHC) Monitor - The non-methane hydrocarbon catalyst is a type of catalytic converter. It helps to remove non-methane hydrocarbons (NMH) left over from the combustion process from the exhaust stream. To accomplish this, heat and catalyst materials react with the exhaust gases to convert NMH to less harmful compounds. The computer checks the efficiency of the catalyst by monitoring the quantity of NMH in the exhaust stream. The monitor also verifies that sufficient temperature is present to aid in particulate matter (PM) filter regeneration.

The NMHC Monitor is supported by “compression ignition” vehicles only. The NMHC Monitor is a “Two-Trip” Monitor. If a fault is found on the first trip, the computer temporarily saves the fault in its memory as a Pending Code. The computer does not command the MIL on at this time. If the fault is sensed again on the second trip, the computer commands the MIL “On,” and saves the code in its long-term memory.

NOx **NOx Aftertreatment Monitor** - NOx aftertreatment is based on a catalytic converter support that has been coated with a special washcoat containing zeolites. NOx Aftertreatment is designed to reduce oxides of nitrogen emitted in the exhaust stream. The zeolite acts as a molecular "sponge" to trap the NO and NO₂ molecules in the exhaust stream. In some implementations, injection of a reactant before the aftertreatment purges it. NO₂ in particular is unstable, and will join with hydrocarbons to produce H₂O and N₂. The NOx Aftertreatment Monitor monitors the function of the NOx aftertreatment to ensure that tailpipe emissions remain within acceptable limits.

The NOx Aftertreatment Monitor is supported by "compression ignition" vehicles only. The NOx Aftertreatment Monitor is a "Two-Trip" Monitor. If a fault is found on the first trip, the computer temporarily saves the fault in its memory as a Pending Code. The computer does not command the MIL on at this time. If the fault is sensed again on the second trip, the computer commands the MIL "On," and saves the code in its long-term memory.

BPS **Boost Pressure System Monitor** - The boost pressure system serves to increase the pressure produced inside the intake manifold to a level greater than atmospheric pressure. This increase in pressure helps to ensure complete combustion of the air-fuel mixture. The Boost Pressure System Monitor checks for component integrity and system operation, and tests for faults in the system. The computer runs this Monitor once per trip.

The Boost Pressure System Monitor is supported by "compression ignition" vehicles only. The Boost Pressure System Monitor is a "Two-Trip" Monitor. If a fault is found on the first trip, the computer temporarily saves the fault in its memory as a Pending Code. The computer does not command the MIL on at this time. If the fault is sensed again on the second trip, the computer commands the MIL "On," and saves the code in its long-term memory.

EGS **Exhaust Gas Sensor Monitor** - The exhaust gas sensor is used by a number of systems/monitors to determine the content of the exhaust stream. The computer checks for component integrity, system operation, and tests for faults in the system, as well as feedback faults that may affect other emission control systems.

The Exhaust Gas Sensor Monitor is supported by "compression ignition" vehicles only. The Exhaust Gas Sensor Monitor is a "Two-Trip" Monitor. If a fault is found on the first trip, the computer temporarily saves the fault in its memory as a Pending Code. The computer does not command the MIL on at this time. If the fault is sensed again on the second trip, the computer commands the MIL "On," and saves the code in its long-term memory.



PM Filter Monitor - The particulate matter (PM) filter removes particulate matter from the exhaust stream by filtration. The filter has a honeycomb structure similar to a catalyst substrate, but with the channels blocked at alternate ends. This forces the exhaust gas to flow through the walls between the channels, filtering the particulate matter out. The filters are self-cleaning by periodic modification of the exhaust gas concentration in order to burn off the trapped particles (oxidizing the particles to form CO₂ and water). The computer monitors the efficiency of the filter in trapping particulate matter, as well as the ability of the filter to regenerate (self-clean).

The PM Filter Monitor is supported by “compression ignition” vehicles only. The PM Filter Monitor is a “Two-Trip” Monitor. If a fault is found on the first trip, the computer temporarily saves the fault in its memory as a Pending Code. The computer does not command the MIL on at this time. If the fault is sensed again on the second trip, the computer commands the MIL “On,” and saves the code in its long-term memory.

OBD2 Reference Table

The table below lists current OBD2 Monitors, and indicates the following for each Monitor:

- A. Monitor Type (how often does the Monitor run; Continuous or Once per trip)
- B. Number of trips needed, with a fault present, to set a pending DTC
- C. Number of consecutive trips needed, with a fault present, to command the MIL “On” and store a DTC
- D. Number of trips needed, with no faults present, to erase a Pending DTC
- E. Number and type of trips or drive cycles needed, with no faults present, to turn off the MIL
- F. Number of warm-up periods needed to erase the DTC from the computer’s memory after the MIL is turned off

Name of Monitor	A	B	C	D	E	F
Comprehensive Component Monitor	Continuous	1	2	1	3	40
Misfire Monitor (Type 1 and 3)	Continuous	1	2	1	3 - similar conditions	80
Misfire Monitor (Type 2)	Continuous		1		3 - similar conditions	80
Fuel System Monitor	Continuous	1	1 or 2	1	3 - similar conditions	80
Catalytic Converter Monitor	Once per trip	1	2	1	3 trips	40
Oxygen Sensor Monitor	Once per trip	1	2	1	3 trips	40
Oxygen Sensor Heater Monitor	Once per trip	1	2	1	3 trips	40
Exhaust Gas Recirculation (EGR) Monitor	Once per trip	1	2	1	3 trips	40
Evaporative Emissions Controls Monitor	Once per trip	1	2	1	3 trips	40
Secondary Air System (AIR) Monitor	Once per trip	1	2	1	3 trips	40
NMHC Monitor	Once per trip	1	2	1	3 trips	40
NOx Adsorber Monitor	Once per trip	1	2	1	3 trips	40
Boost Pressure System Monitor	Once per trip	1	2	1	3 trips	40
Exhaust Gas Sensor Monitor	Once per trip	1	2	1	3 trips	40
PM Filter Monitor	Once per trip	1	2	1	3 trips	40

PRELIMINARY VEHICLE DIAGNOSTIC WORKSHEET

The purpose of this form is to help you gather preliminary information on your vehicle before you retrieve codes. By having a complete account of your vehicle's current problem(s), you will be able to systematically pinpoint the problem(s) by comparing your answers to the fault codes you retrieve. You can also provide this information to your mechanic to assist in diagnosis and help avoid costly and unnecessary repairs. It is important for you to complete this form to help you and/or your mechanic have a clear understanding of your vehicle's problems.

NAME:

DATE:

VIN*:

YEAR:

MAKE:

MODEL:

ENGINE SIZE:

VEHICLE MILEAGE:

*VIN: Vehicle Identification Number, found at the base of the windshield on a metallic plate, or at the driver door latch area (consult your vehicle owner's manual for location).

TRANSMISSION:

- Automatic
- Manual

Please check all applicable items in each category.

DESCRIBE THE PROBLEM:

WHEN DID YOU FIRST NOTICE THE PROBLEM:

- Just Started
- Started Last Week
- Started Last Month
- Other:

LIST ANY REPAIRS DONE IN THE PAST SIX MONTHS:

PROBLEMS STARTING

- No symptoms
- Will not crank
- Cranks, but will not start
- Starts, but takes a long time

ENGINE QUITS OR STALLS

- No symptoms
- Right after starting
- When shifting into gear
- During steady-speed driving
- Right after vehicle comes to a stop
- While idling
- During acceleration
- When parking

IDLING CONDITIONS

- No symptoms
- Is too slow at all times
- Is too fast
- Is sometimes too fast or too slow
- Is rough or uneven
- Fluctuates up and down

RUNNING CONDITIONS

- No symptoms
- Runs rough
- Lacks power
- Bucks and jerks
- Poor fuel economy
- Hesitates or stumbles on accelerations
- Backfires
- Misfires or cuts out
- Engine knocks, pings or rattles
- Surges
- Dieseling or run-on

AUTOMATIC TRANSMISSION PROBLEMS (if applicable)

- | | |
|---|---|
| <input type="checkbox"/> No symptoms | <input type="checkbox"/> Vehicle does not move when in gear |
| <input type="checkbox"/> Shifts too early or too late | <input type="checkbox"/> Jerks or bucks |
| <input type="checkbox"/> Changes gear incorrectly | |

PROBLEM OCCURS

- | | | |
|----------------------------------|------------------------------------|----------------------------------|
| <input type="checkbox"/> Morning | <input type="checkbox"/> Afternoon | <input type="checkbox"/> Anytime |
|----------------------------------|------------------------------------|----------------------------------|

ENGINE TEMPERATURE WHEN PROBLEM OCCURS

- | | | |
|-------------------------------|-------------------------------|------------------------------|
| <input type="checkbox"/> Cold | <input type="checkbox"/> Warm | <input type="checkbox"/> Hot |
|-------------------------------|-------------------------------|------------------------------|

DRIVING CONDITIONS WHEN PROBLEM OCCURS

- | | |
|--|---|
| <input type="checkbox"/> Short - less than 2 miles | <input type="checkbox"/> With headlights on |
| <input type="checkbox"/> 2 - 10 miles | <input type="checkbox"/> During acceleration |
| <input type="checkbox"/> Long - more than 10 miles | <input type="checkbox"/> Mostly driving downhill |
| <input type="checkbox"/> Stop and go | <input type="checkbox"/> Mostly driving uphill |
| <input type="checkbox"/> While turning | <input type="checkbox"/> Mostly driving level |
| <input type="checkbox"/> While braking | <input type="checkbox"/> Mostly driving curvy roads |
| <input type="checkbox"/> At gear engagement | <input type="checkbox"/> Mostly driving rough roads |
| <input type="checkbox"/> With A/C operating | |

DRIVING HABITS

- | | |
|---|---|
| <input type="checkbox"/> Mostly city driving | <input type="checkbox"/> Drive less than 10 miles per day |
| <input type="checkbox"/> Highway | <input type="checkbox"/> Drive 10 to 50 miles per day |
| <input type="checkbox"/> Park vehicle inside | <input type="checkbox"/> Drive more than 50 miles per day |
| <input type="checkbox"/> Park vehicle outside | |

GASOLINE USED

- | | |
|------------------------------------|--|
| <input type="checkbox"/> 87 Octane | <input type="checkbox"/> 91 Octane |
| <input type="checkbox"/> 89 Octane | <input type="checkbox"/> More than 91 Octane |

WEATHER CONDITIONS WHEN PROBLEM OCCURS

- | | |
|--|--|
| <input type="checkbox"/> 32 - 55° F (0 - 13° C) | <input type="checkbox"/> Above 55° F (13° C) |
| <input type="checkbox"/> Below freezing (32° F / 0° C) | |

CHECK ENGINE LIGHT / DASH WARNING LIGHT

- | | | |
|---------------------------------------|------------------------------------|-----------------------------------|
| <input type="checkbox"/> Sometimes ON | <input type="checkbox"/> Always ON | <input type="checkbox"/> Never ON |
|---------------------------------------|------------------------------------|-----------------------------------|

PECULIAR SMELLS

- | | |
|--|--------------------------------------|
| <input type="checkbox"/> "Hot" | <input type="checkbox"/> Gasoline |
| <input type="checkbox"/> Sulfur ("rotten egg") | <input type="checkbox"/> Burning oil |
| <input type="checkbox"/> Burning rubber | <input type="checkbox"/> Electrical |

STRANGE NOISES

- | | |
|---------------------------------|---------------------------------|
| <input type="checkbox"/> Rattle | <input type="checkbox"/> Squeak |
| <input type="checkbox"/> Knock | <input type="checkbox"/> Other |

BEFORE YOU BEGIN

The diagnostic tool aids in monitoring electronic- and emissions-related faults in your vehicle and retrieving fault codes related to malfunctions in these systems. Mechanical problems such as low oil level or damaged hoses, wiring or electrical connectors can cause poor engine performance and may also cause a fault code to set. Fix any known mechanical problems before performing any test. See your vehicle's service manual or a mechanic for more information.



Check the following areas **before** starting any test:

- Check the engine oil, power steering fluid, transmission fluid (if applicable), engine coolant and other fluids for proper levels. Top off low fluid levels if needed.
- Make sure the air filter is clean and in good condition. Make sure all air filter ducts are properly connected. Check the air filter ducts for holes, rips or cracks.
- Make sure all engine belts are in good condition. Check for cracked, torn, brittle, loose or missing belts.
- Make sure mechanical linkages to engine sensors (throttle, gearshift position, transmission, etc.) are secure and properly connected. See your vehicle's service manual for locations.
- Check all rubber hoses (radiator) and steel hoses (vacuum/fuel) for leaks, cracks, blockage or other damage. Make sure all hoses are routed and connected properly.
- Make sure all spark plugs are clean and in good condition. Check for damaged, loose, disconnected or missing spark plug wires.
- Make sure the battery terminals are clean and tight. Check for corrosion or broken connections. Check for proper battery and charging system voltages.
- Check all electrical wiring and harnesses for proper connection. Make sure wire insulation is in good condition, and there are no bare wires.
- Make sure the engine is mechanically sound. If needed, perform a compression check, engine vacuum check, timing check (if applicable), etc.

VEHICLE SERVICE MANUALS

Always refer to the manufacturer's service manual for your vehicle before performing any test or repair procedures. Contact your local car dealership, auto parts store or bookstore for availability of these manuals. The following companies publish valuable repair manuals:

- **Haynes Publications**
861 Lawrence Drive
Newbury Park, California 91320
Phone: 800-442-9637
Web: www.haynes.com

- **Mitchell 1**
14145 Danielson Street
Poway, California 92064
Phone: 888-724-6742
Web: www.m1products.com

- **Motor Publications**
5600 Crooks Road, Suite 200
Troy, Michigan 48098
Phone: 800-426-6867
Web: www.motor.com

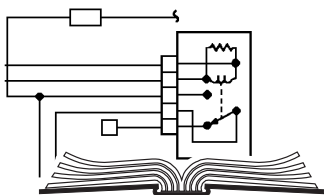

FACTORY SOURCES

Ford, GM, Chrysler, Honda, Isuzu, Hyundai and Subaru Service Manuals

- **Helm Inc.**
14310 Hamilton Avenue
Highland Park, Michigan 48203
Phone: 800-782-4356
Web: www.helminc.com

CODE RETRIEVAL PROCEDURE

Never replace a part based only on the DTC definition. Each DTC has a set of testing procedures, instructions and flow charts that must be followed to confirm the location of the problem. This information is found in the vehicle's service manual. Always refer to the vehicle's service manual for detailed testing instructions.



*Check your vehicle thoroughly before performing any test. See **Preparation for Testing** on page 26 for details.*



ALWAYS observe safety precautions whenever working on a vehicle. See **Safety Precautions** on page 3 for more information.

1. Turn the ignition off.
2. Locate the vehicle's 16-pin Data Link Connector (DLC). See page 4 for connector location.
3. Connect the Scan Tool's cable connector to the vehicle's DLC. The cable connector is keyed and will only fit one way.

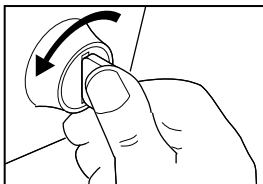

- If you have problems connecting the cable connector to the DLC, rotate the connector 180° and try again.

If you still have problems, check the DLC on the vehicle and on the Scan Tool. Refer to your vehicle's service manual to properly check the vehicle's DLC.

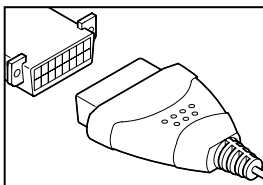

- After the Scan Tool's test connector is properly connected to the vehicle's DLC, the Vehicle icon  should display to confirm a good power connection.
4. Turn the ignition on. **DO NOT** start the engine.
 5. When the Scan Tool's cable connector is properly connected to the vehicle's DLC, The Scan Tool will automatically turn ON.

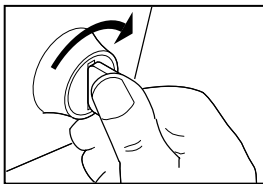

- If the unit does not power on automatically when connected to the vehicle's DLC connector, it usually indicates there is no power present at the vehicle's DLC connector. Check your fuse panel and replace any burned-out fuses.
- If replacing the fuse(s) does not correct the problem, consult your vehicle's repair manual to identify the proper computer (PCM) fuse/circuit, and perform any necessary repairs before proceeding.



- The Scan Tool will automatically start a check of the vehicle's computer to determine which type of communication protocol it is using. When the Scan Tool identifies the computer's communication protocol, a communication link is established. The protocol type used by the vehicle's computer is shown on the display.

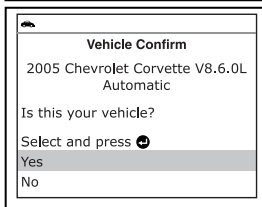
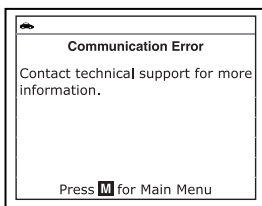
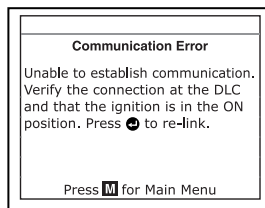

A **PROTOCOL** is a set of rules and procedures for regulating data transmission between computers, and between testing equipment and computers. As of this writing, five different types of protocols (ISO 9141, Keyword 2000, J1850 PWM, J1850 VPW and CAN) are in use by vehicle manufacturers. The Scan Tool automatically identifies the protocol type and establishes a communication link with the vehicle's computer.

- If the Scan Tool fails to link to the vehicle's computer, a "Communication Error" message shows on the Scan Tool's display.
 - Ensure your vehicle is OBD2 compliant. See **VEHICLES COVERED** on page 4 for vehicle compliance verification information.
 - Verify the connection at the DLC, and verify the ignition is ON.
 - Turn the ignition OFF, wait 5 seconds, then back ON to reset the computer.
 - Press the **ENTER**  button to continue.
 - If the Scan Tool **cannot** link to the vehicle's computer after three attempts, the message "Contact Technical Support" displays.
 - Press the **M** button to return to the Main Menu.
 - Turn the ignition off, and disconnect the Scan Tool.
 - Contact Technical Support for assistance.
- If the Scan Tool can decode the Vehicle Identification Number (VIN) for the vehicle under test, the Vehicle Information screen displays.



- If the information shown is correct for the vehicle under test, use the **UP**  and **DOWN**  buttons, as necessary, to highlight **Yes**, then press the **ENTER**  button. Proceed to step 10.

- If the information shown is not correct for the vehicle under test, or if you wish to manually select the vehicle, use **UP** (▲) and **DOWN** (▼) buttons, as necessary, to highlight **No**, then press the **ENTER** (↵) button. Proceed to step 8.
- If the Scan Tool **cannot** decode the Vehicle Identification Number (VIN) for the vehicle under test, the Select Vehicle screen displays. Proceed to step 8.

8. When **No** is selected from the Vehicle information screen, the Select Vehicle screen displays. The Select Vehicle screen lists the three most recently tested vehicles.

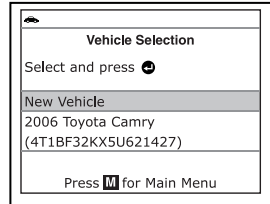

- To select a previously tested vehicle, use the **UP** (▲) and **DOWN** (▼) buttons, as necessary, to highlight the desired vehicle, then press the **ENTER** (↵) button. Proceed to step 10.

- To select a new vehicle, use the **UP** (▲) and **DOWN** (▼) buttons, as necessary, to highlight **New Vehicle**, then press the **ENTER** (↵) button. Proceed to step 9.

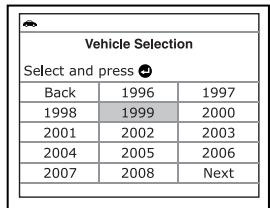

9. When **New Vehicle** is chosen from the Select Vehicle screen, the Select Year screen displays.

- Use the **UP** (▲) and **DOWN** (▼) buttons, as necessary, to highlight the desired vehicle model year, then press the **ENTER** (↵) button to continue. If necessary, select **Next** to view additional options.

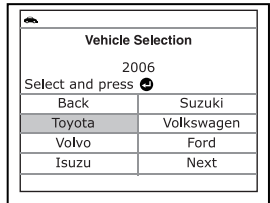

- The Select Make screen displays.

- Use the **UP** (▲) and **DOWN** (▼) buttons, as necessary, to highlight the desired vehicle make, then press the **ENTER** (↵) button to continue. If necessary, select **Next** to view additional options.

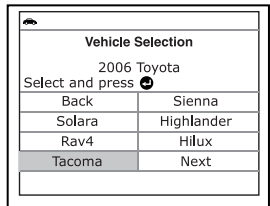

- The Select Model screen displays.

- Use the **UP** (▲) and **DOWN** (▼) buttons, as necessary, to highlight the desired vehicle model, then press the **ENTER** (↵) button to continue. If necessary, select **Next** to view additional options.

- The Select Engine screen displays.

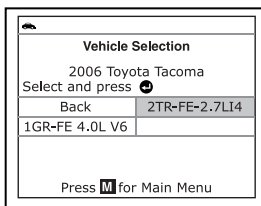

- Use the **UP** (▲) and **DOWN** (▼) buttons, as necessary, to highlight the desired vehicle engine size, then press the **ENTER** (↵) button to continue. If necessary, select **Next** to view additional options.

- The Select Transmission screen displays.

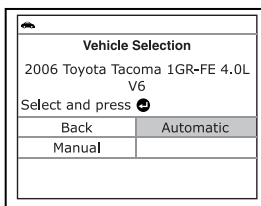

- Use the **UP** (▲) and **DOWN** (▼) buttons, as necessary, to highlight the desired transmission type, then press the **ENTER** (↵) button to continue. If necessary, select **ENTER** (↵) to view additional options. The Vehicle Information screen displays.

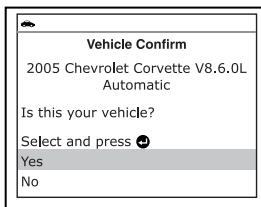

- If the information shown is correct for the vehicle under test, use the **UP** (▲) and **DOWN** (▼) buttons, as necessary, to highlight **Yes**, then press the **ENTER** (↵) button. Proceed to step 10.
- If the information shown is not correct for the vehicle under test, or if you wish to reselect the vehicle, use **UP** (▲) and **DOWN** (▼) buttons, as necessary, to highlight **No**, then press the **ENTER** (↵) button to return to the Select Year screen.

10. After approximately 10~60 seconds, the Scan Tool will **retrieve** and **display** any Diagnostic Trouble Codes, Monitor Status and Freeze Frame Data retrieved from the vehicle's computer memory.

- The Scan Tool will display a code only if codes are present in the vehicle's computer memory. If no codes are present, a "No DTC's or Freeze Frame data presently stored in the vehicle's computer" message is displayed.

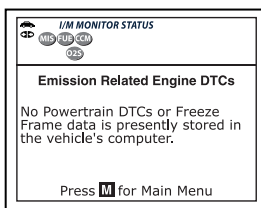

- The Scan Tool is capable of retrieving and storing up to 32 codes in memory, for immediate or later viewing.

11. To read the display:



Refer to **DISPLAY FUNCTIONS** on page 6 for a description of display elements.

- A visible icon indicates that the Scan Tool is being powered through the vehicle's DLC connector.
- A visible icon indicates that the Scan Tool is linked to (communicating with) the vehicle's computer.
- The I/M Monitor Status icons indicate the type and number of Monitors the vehicle supports, and provides indications of the current status of the vehicle's Monitors. A **solid green** Monitor icon indicates the associated Monitor **has run** and completed its testing. A **blinking red** Monitor icon indicates the associated Monitor **has not run** and completed its testing.
- The display shows the number of the code currently being displayed, the total number of codes retrieved, and whether or not the displayed code commanded the MIL on. If the code being displayed is a PENDING code, the PENDING icon is shown. If the code being displayed is a PERMANENT code, the PERMANENT icon is shown.
- The Diagnostic Trouble Code (DTC) and related code definition are shown in the lower section of the display.

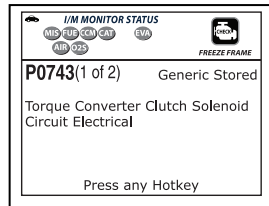

In the case of long code definitions, or when viewing Freeze Frame Data, a small arrow is shown in the upper/lower right-hand corner of the Scan Tool display area to indicate the presence of additional information. Use the **UP** and **DOWN** buttons, as necessary, to view the additional information.



If a definition for the currently displayed code is not available, an advisory message shows on the Scan Tool's display.

12. Read and interpret the Diagnostic Trouble Codes using the LCD display and the green, yellow and red LEDs.



The green, yellow and red LEDs are used (with the LCD display) as visual aids to make it easier to determine engine system conditions.

- **Green LED** - Indicates that all engine systems are "OK" and running normally. All monitors on the vehicle are active and are performing their diagnostic testing, and no trouble codes are present. A zero will show on the Scan Tool's display, and all Monitor icons will be solid.

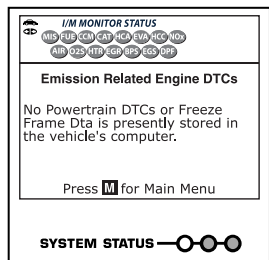

- **Yellow LED** - Indicates one of the following conditions:

PENDING CODE PRESENT - If the yellow LED is lit, it may indicate the existence of a pending code. Check the Scan Tool's LCD display for confirmation. A pending code is confirmed by the presence of a numeric code and the word PENDING on the Scan Tool's LCD display.

MONITOR STATUS - If the Scan Tool's LCD display shows a zero (indicating there are no DTCs present in the vehicle's computer), but the yellow LED is lit, it indicates a "Monitor Has Not Run" status. This means that some of the Monitors on the vehicle have not yet finished their diagnostic self-testing. This condition is confirmed by one or more **blinking** Monitor icons on the LCD display. A **blinking** Monitor icon means the Monitor has not yet run and finished its diagnostic self-testing. All Monitor icons that are **solid** have completed their diagnostic self-testing.

- **Red LED** - Indicates there is a problem with one or more of the vehicle's systems. The red LED is also used to show that DTC(s) are present (displayed on the Scan Tool's LCD display). In this case, the Malfunction Indicator (Check Engine) lamp on the vehicle's instrument panel will light steady on.
- DTC's that start with "P0", "P2" and some "P3" are considered Generic (Universal). All Generic DTC definitions are the same on all OBD2 equipped vehicles. The Scan Tool automatically displays the code definitions (if available) for Generic DTC's.
- DTC's that start with "P1" and some "P3" are Manufacturer specific codes and their code definitions vary with each vehicle manufacturer.

13. If more than one DTC was retrieved, and to view Freeze Frame Data, press and release the **DTC** button, as necessary.

- Each time the **DTC** button is pressed and released, the Scan Tool will scroll and display the next DTC in sequence until all DTCs in its memory have displayed.

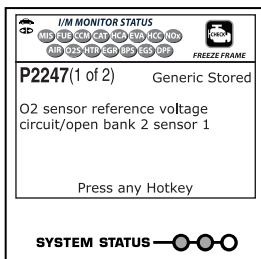
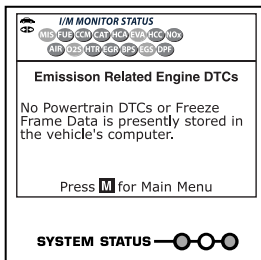
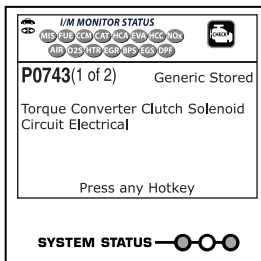

- Freeze Frame Data (if available) can be viewed at any time by pressing the **FF** button.
- In OBD2 systems, when an emissions-related engine malfunction occurs that causes a DTC to set, a record or snapshot of engine conditions at the time that the malfunction occurred is also saved in the vehicle's computer memory. The record saved is called Freeze Frame data. Saved engine conditions include, but are not limited to: engine speed, open or closed loop operation, fuel system commands, coolant temperature, calculated load value, fuel pressure, vehicle speed, air flow rate, and intake manifold pressure. See VIEWING FREEZE FRAME DATA on page 37.

FREEZE FRAME	
P0118	
Fuel Sys 1	OL
Fuel Sys 2	NA
Calc Load(%)	0.0
ECT(°F)	-40.0
STFT B1(%)	0.0
LTFT B1(%)	0.0
Press any Hotkey	



If more than one malfunction is present that causes more than one DTC to be set, only the code with the highest priority will contain Freeze Frame data. The code designated "01" on the Scan Tool display is referred to as the PRIORITY code, and Freeze Frame data always refers to this code. The priority code is also the one that has commanded the MIL on.



Retrieved information can be uploaded to a Personal Computer (PC) with the use of the optional "PC Link" software. (see instructions included with PC-Link program for more information).

14. When the last retrieved DTC has been displayed and the **DTC** button is pressed, the screen returns to the first retrieved DTCs.
15. Determine engine system(s) condition by viewing the Scan Tool's display for any retrieved Diagnostic Trouble Codes, code definitions, Freeze Frame data and Live Data, interpreting the green, yellow and red LEDs.
 - If DTC's were retrieved and you are going to perform the repairs yourself, proceed by consulting the Vehicle's Service Repair Manual for testing instructions, testing procedures, and flow charts related to retrieved code(s).
 - To prolong battery life, the Scan Tool automatically shuts "Off" approximately three minutes after it is disconnected from the vehicle. The DTCs retrieved, captured Live Data Information, Monitor Status and Freeze Frame data (if any) will remain in the Scan Tool's memory, and may be viewed at any time by turning the unit "On". If the Scan Tool's batteries are removed, or if the Scan Tool is re-linked to a vehicle to retrieve codes/data, any prior codes/data in its memory are automatically cleared.

VIEWING FREEZE FRAME DATA

In OBD2 systems, when an emissions-related engine malfunction occurs that causes a DTC to set, a record or snapshot of engine conditions at the time that the malfunction occurred is also saved in the vehicle's computer memory. The record saved is called Freeze Frame data.

1. While linked to the vehicle, press and release the **FF** button.

- The Freeze Frame screen displays.
- Saved engine conditions include but are not limited to: engine speed, open or closed loop operation, fuel system commands, coolant temperature, calculated load value, fuel pressure, vehicle speed, air flow rate and intake manifold pressure.

FREEZE FRAME	
P1639 Generic Stored	
Fuel Sys 1	OL
Fuel Sys 2	NA
Calc Load(%)	0.0
ECT(°F)	-40.0
STFT B1(%)	0.0
LTFT B1(%)	0.0
Press any Hotkey	



*If more than one malfunction is present that causes more than one DTC to be set, only the code with the highest priority will contain Freeze Frame data. The code designated "01" on the Scan Tool's display is referred to as the **PRIORITY** code, and Freeze Frame data always refers to this code. The priority code is also the one that has commanded the MIL on.*

- Use the **UP** (▲) and **DOWN** (▼) buttons, as necessary, to view all available Freeze Frame data.



*If Freeze Frame data is not presently stored in the vehicle's computer, an advisory message displays. Press the **M** button to return to the OBD2 DTC screen.*

Freeze Frame Data	
No Freeze Frame Data is presently stored in the vehicle's computer	
Press M for Main Menu	

2. When finished, press and release the **M** button to return to the Main Menu screen.

VIEWING ENHANCED DTCs

The "enhanced" mode provides the ability to retrieve OEM enhanced DTCs from most Chrysler/Jeep, Ford/Mazda, GM/Isuzu, Honda/Acura and Toyota/Lexus vehicles. The types of enhanced data available depends on the vehicle make.

To view Enhanced DTCs:

1. With the Scan Tool on the Code Retrieval screen, press and release the **M** button.
 - The Main Menu displays.
2. Use the **UP** (▲) and **DOWN** (▼) buttons, as necessary, to highlight **OEM Enhanced**, then press the **ENTER** (↵) button.

Main Menu	
Select and press (Ⓜ)	
Global OBD2	
OEM Enhanced	
Battery/Alternator Monitor	
Vehicle Information	
Press any Hotkey	

- If enhanced communication is not supported by the vehicle under test, an advisory message displays. Press the **POWER/LINK**  button to re-link to the vehicle's computer. Enhanced functionality is not available for your vehicle.

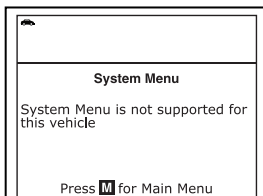

Refer to the appropriate paragraph to view enhanced DTCs for your vehicle:

- Chrysler/Jeep Enhanced DTCspage 39
- Ford/Mazda Enhanced DTCspage 41
- GM/Isuzu Enhanced DTCspage 43
- Honda/Acura Enhanced DTCspage 45
- Toyota/Lexus Enhanced DTCs.....page 47

Chrysler/Jeep Enhanced DTCs

When **OEM Enhanced** is chosen from the Main Menu, (and **Chrysler** is selected when prompted), the Scan Tool retrieves OEM enhanced DTCs from the vehicle's computer.

1. A "One moment please" message displays while the Scan Tool retrieves the selected DTCs.

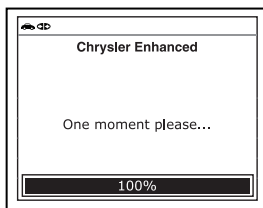

- If the Scan Tool fails to link to the vehicle's computer, a "Communication Error" message shows on the Scan Tool's display.

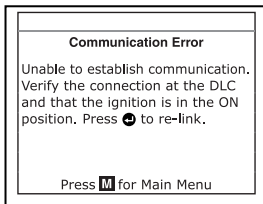

- Ensure your vehicle is OBD2 compliant. See **VEHICLES COVERED** on page 4 for vehicle compliance verification information.
- Verify the connection at the DLC, and verify the ignition is ON.
- Turn the ignition OFF, wait 5 seconds, then back ON to reset the computer.
- Press the **ENTER**  button to continue.

- If the Scan Tool **cannot** link to the vehicle's computer after three attempts, the message "Contact Technical Support" displays.

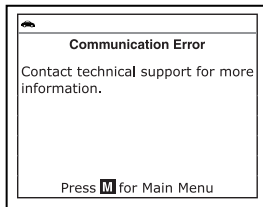

- Press the **M** button to return to the Main Menu.
- Turn the ignition off, and disconnect the Scan Tool.
- Contact Technical Support for assistance.

2. To read the display:



Refer to **DISPLAY FUNCTIONS** on page 6 for a description of LCD display elements.

- A visible icon indicates that the Scan Tool is being powered through the vehicle's DLC connector.
- A visible icon indicates that the Scan Tool is linked to (communicating with) the vehicle's computer.
- The display shows the number of the code currently being displayed, the total number of codes retrieved.
- The Diagnostic Trouble Code (DTC) and related code definition are shown in the lower section of the LCD display.

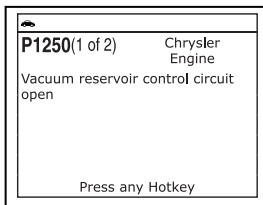

If the definition for the currently displayed code is not available, an advisory message shows on the Scan Tool's LCD display.



I/M MONITOR STATUS icons are not displayed when viewing enhanced DTCs.

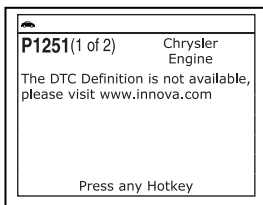

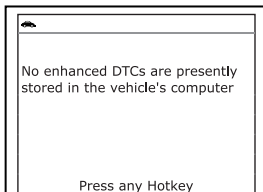

In the case of long code definitions, or when viewing Freeze Frame data, a small arrow is shown in the upper/lower right-hand corner of the code display area to indicate the presence of additional information. Use **UP** and **DOWN** buttons, as necessary, to view the additional information.

- The Scan Tool will display a code only if codes are present in the vehicle's computer memory. If no codes are present, a "No Enhanced DTC's are presently stored in the vehicle's computer" is displayed. Press the **M** button to return to the Main Menu.



3. If more than one code was retrieved press the **DTC** button, as necessary, to display additional codes one at a time.
4. When the last retrieved DTC has been displayed and the **DTC** button is pressed, the Scan Tool returns to the "Priority" code.
 - To view *additional* enhanced DTCs, repeat steps 1 through 4, above.

- To exit the enhanced mode, press the **M** button to return to the Main Menu. Use the **UP**  and **DOWN**  buttons, as necessary, to highlight **Global OBD**, then press the **ENTER**  button to return to the Global OBD2 mode.



Ford/Mazda Enhanced DTCs

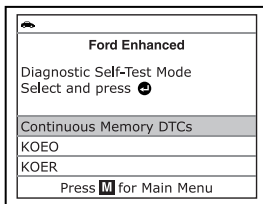

Mazda Enhanced DTCs are available for Mazda-branded Ford vehicles only.

When **OEM Enhanced** is chosen from the Main Menu (and **Ford** is selected when prompted), the Ford Enhanced menu displays. You may view DTCs for either the “Continuous Memory Test”, “KOEO (Key On Engine Off) Test” or “KOER (Key On Engine Running) Test.”



1. Use the **UP**  and **DOWN**  buttons, as necessary, to highlight the desired option, then press the **ENTER**  button.

- If **KOER** is selected, an advisory message shows on the Scan Tool's display.

- Start and warm the engine to normal operating temperature, then press the **ENTER**  button. Proceed to step 3.

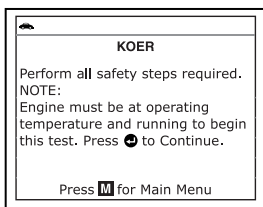

2. If **KOEO** or **Continuous Memory** is selected, an “instructional” message shows on the Scan Tool's display.

- Turn the ignition OFF, then back ON. Press the **ENTER**  button. Proceed to step 3.

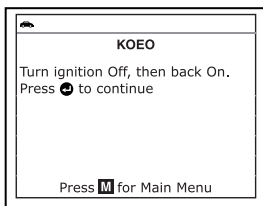

3. A “One moment please” message displays while the test is in progress.

- If the Scan Tool fails to link to the vehicle's computer, a “Communication Error” message shows on the Scan Tool's display.

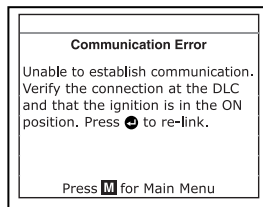

- Ensure your vehicle is OBD2 compliant. See **VEHICLES COVERED** on page 4 for vehicle compliance verification information.
- Verify the connection at the DLC, and verify the ignition is ON.
- Turn the ignition OFF, wait 5 seconds, then back ON to reset the computer.
- Press the **ENTER**  button to continue.



- If the Scan Tool **cannot** link to the vehicle's computer after three attempts, the message "Contact Technical Support" displays.
 - Press the **M** button to return to the Main Menu.
 - Turn the ignition off, and disconnect the Scan Tool.
 - Contact Technical Support for assistance.
 - If the KOER Test was selected, and the vehicle's engine *is not* running, an advisory message shows on the Scan Tool's display.
 - Press the **M** button to return to the Main Menu.
 - If the KOEO Test was selected, and the vehicle's engine *is running*, an advisory message shows on the Scan Tool's display.
 - Press the **M** button to return to the Main Menu.
4. If the KOER test was selected, an "instructional" message shows on the Scan Tool's display.
- Turn the steering wheel to the right, then release.
 - Press and release the brake pedal.
 - Cycle the overdrive switch (if equipped).
 - A "One moment please" message displays while the test is in progress.
5. To read the display:



Refer to **DISPLAY FUNCTIONS** on page 6 for a description of LCD display elements.

- A visible  icon indicates that the Scan Tool is being powered through the vehicle's DLC connector.
- A visible  icon indicates that the Scan Tool is linked to (communicating with) the vehicle's computer.
- The display shows the number of the code currently being displayed, the total number of codes retrieved.

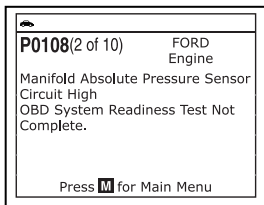
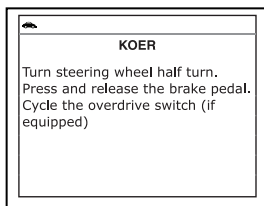
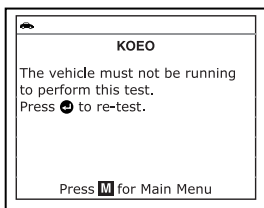
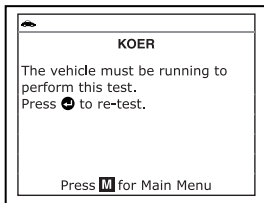
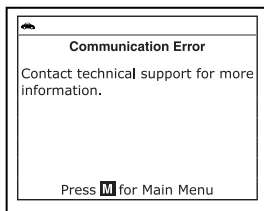

- The Diagnostic Trouble Code (DTC) and related code definition are shown in the lower section of the LCD display.



I/M MONITOR STATUS icons are not displayed when viewing enhanced DTCs.



*In the case of long code definitions, or when viewing Freeze Frame data, a small arrow is shown in the upper/lower right-hand corner of the code display area to indicate the presence of additional information. Use the **UP** (▲) and **DOWN** (▼) buttons, as necessary, to view the additional information.*

- For additional help with a displayed DTC, use the **UP** (▲) and **DOWN** (▼) buttons, as necessary, to highlight **Help**, then press the **ENTER** (↵) button.
 - The Scan Tool will display a code only if codes are present in the vehicle's computer memory. If no codes are present, a "System Pass" message is displayed. Press the **M** button to return to the Main Menu.
6. If more than one code was retrieved press the **DTC** button, as necessary, to display additional codes one at a time.
 7. When the last retrieved DTC has been displayed and the **DTC** button is pressed, the Scan Tool returns to the "Priority" code.
 - To view *additional* enhanced DTCs, repeat steps 1 through 6, above.
 - To exit the enhanced mode, press the **M** button to return to the Main Menu. Use the **UP** (▲) and **DOWN** (▼) buttons, as necessary, to highlight **Global OBD**, then press the **ENTER** (↵) button to return to the Global OBD2 mode.

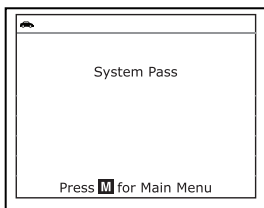

General Motors/Isuzu Enhanced DTCs

When **OEM Enhanced** is chosen from the Main Menu, (and **GM** is selected when prompted), the Scan Tool retrieves OEM enhanced DTCs from the vehicle's computer.

1. A "One moment please" message displays while the Scan Tool retrieves the selected DTCs.
 - If the Scan Tool fails to link to the vehicle's computer, a "Communication Error" message shows on the Scan Tool's display.

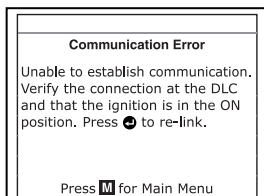
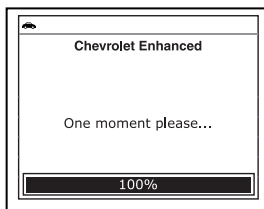

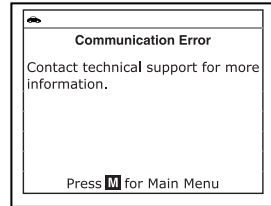

- Ensure your vehicle is OBD2 compliant. See VEHICLES COVERED on page 4 for vehicle compliance verification information.
- Verify the connection at the DLC, and verify the ignition is ON.
- Turn the ignition OFF, wait 5 seconds, then back ON to reset the computer.
- Press the **ENTER** (↵) button to continue.
- If the Scan Tool **cannot** link to the vehicle's computer after three attempts, the message "Contact Technical Support" displays.
 - Press the **M** button to return to the Main Menu.
 - Turn the ignition off, and disconnect the Scan Tool.
 - Contact Technical Support for assistance.



2. To read the display:



Refer to **DISPLAY FUNCTIONS** on page 6 for a description of LCD display elements.

- A visible  icon indicates that the Scan Tool is being powered through the vehicle's DLC connector.
- A visible  icon indicates that the Scan Tool is linked to (communicating with) the vehicle's computer.
- The display shows the number of the code currently being displayed, the total number of codes retrieved.
- The Diagnostic Trouble Code (DTC) and related code definition are shown in the lower section of the LCD display.

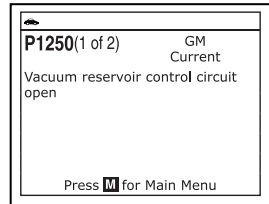

If the definition for the currently displayed code is not available, an advisory message shows on the Scan Tool's LCD display.



I/M MONITOR STATUS icons are not displayed when viewing enhanced DTCs.

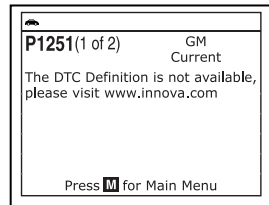

In the case of long code definitions, or when viewing Freeze Frame data, a small arrow is shown in the upper/lower right-hand corner of the code display area to indicate the presence of additional information. Use the **UP** (↑) and **DOWN** (↓) buttons, as necessary, to view the additional information.

- The Scan Tool will display a code only if codes are present in the vehicle's computer memory. If no codes are present, a "No Enhanced DTC's are presently stored in the vehicle's computer" is displayed. Press the **M** button to return to the Main Menu.

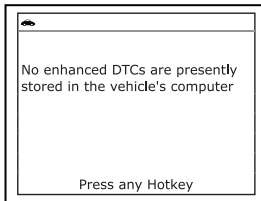

3. If more than one code was retrieved press the **DTC** button, as necessary, to display additional codes one at a time.
4. When the last retrieved DTC has been displayed and the **DTC** button is pressed, the Scan Tool returns to the "Priority" code.
 - To view *additional* enhanced DTCs, repeat steps 1 through 4, above.
 - To exit the enhanced mode, press the **M** button to return to the Main Menu. Use the **UP** (⬆) and **DOWN** (⬇) buttons, as necessary, to highlight **Global OBD**, then press the **ENTER** (⊞) button to return to the Global OBD2 mode.

Honda/Acura Enhanced DTCs

When **OEM Enhanced** is chosen from the Main Menu, (and **Honda** is selected when prompted), the Scan Tool retrieves OEM enhanced DTCs from the vehicle's computer.

1. A "One moment please" message displays while the Scan Tool retrieves the selected DTCs.

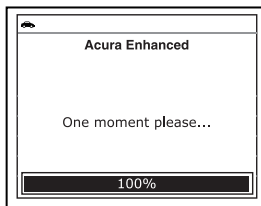

- If the Scan Tool fails to link to the vehicle's computer, a "Communication Error" message shows on the Scan Tool's display.

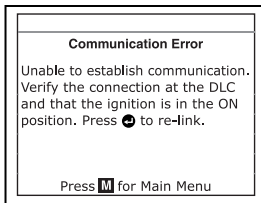

- Ensure your vehicle is OBD2 compliant. See **VEHICLES COVERED** on page 4 for vehicle compliance verification information.
- Verify the connection at the DLC, and verify the ignition is ON.
- Turn the ignition OFF, wait 5 seconds, then back ON to reset the computer.
- Press the **ENTER** (⊞) button to continue.

- If the Scan Tool **cannot** link to the vehicle's computer after three attempts, the message "Contact Technical Support" displays.

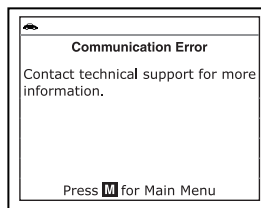

- Press the **M** button to return to the Main Menu.

- Turn the ignition off, and disconnect the Scan Tool.
- Contact Technical Support for assistance.

2. To read the display:



Refer to **DISPLAY FUNCTIONS** on page 6 for a description of LCD display elements.

- A visible icon indicates that the Scan Tool is being powered through the vehicle's DLC connector.
- A visible icon indicates that the Scan Tool is linked to (communicating with) the vehicle's computer.
- The display shows the number of the code currently being displayed, the total number of codes retrieved.
- The Diagnostic Trouble Code (DTC) and related code definition are shown in the lower section of the LCD display.

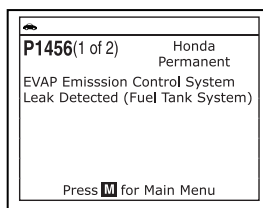

If the definition for the currently displayed code is not available, an advisory message shows on the Scan Tool's LCD display.



I/M MONITOR STATUS icons are not displayed when viewing enhanced DTCs.

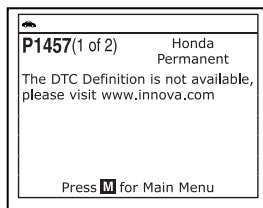

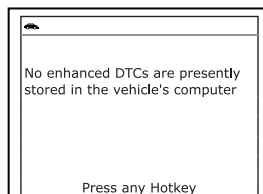

In the case of long code definitions, or when viewing Freeze Frame data, a small arrow is shown in the upper/lower right-hand corner of the code display area to indicate the presence of additional information. Use the **UP** and **DOWN** buttons, as necessary, to view the additional information.

- The Scan Tool will display a code only if codes are present in the vehicle's computer memory. If no codes are present, a "No Enhanced DTC's are presently stored in the vehicle's computer" is displayed. Press the **M** button to return to the Main Menu.



3. If more than one code was retrieved press the **DTC** button, as necessary, to display additional codes one at a time.
4. When the last retrieved DTC has been displayed and the **DTC** button is pressed, the diagnostic tool returns to the "Priority" code.
 - To view *additional* enhanced DTCs, repeat steps 1 through 4, above.

- To exit the enhanced mode, press the **M** button to return to the Main Menu. Use the **UP**  and **DOWN**  buttons, as necessary, to highlight **Global OBD**, then press the **ENTER**  button to return to the Global OBD2 mode.

Toyota/Lexus Enhanced DTCs

When **OEM Enhanced** is chosen from the Main Menu, (and **Toyota** is selected when prompted), the Scan Tool retrieves OEM enhanced DTCs from the vehicle's computer.

1. A "One moment please" message displays, while the Scan Tool retrieves the selected DTCs.

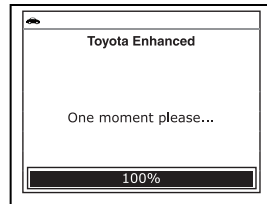

- If the Scan Tool fails to link to the vehicle's computer, a "Communication Error" message shows on the Scan Tool's display.
 - Ensure your vehicle is OBD2 compliant. See **VEHICLES COVERED** on page 4 for vehicle compliance verification information.
 - Verify the connection at the DLC, and verify the ignition is ON.
 - Turn the ignition OFF, wait 5 seconds, then back ON to reset the computer.
 - Press the **ENTER**  button to continue.

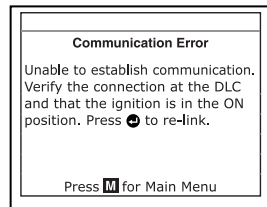

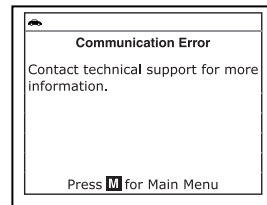

- If the Scan Tool **cannot** link to the vehicle's computer after three attempts, the message "Contact Technical Support" displays.
 - Press the **M** button to return to the Main Menu.
 - Turn the ignition off, and disconnect the Scan Tool.
 - Contact Technical Support for assistance.



2. To read the display:



*Refer to **DISPLAY FUNCTIONS** on page 6 for a description of LCD display elements.*

- A visible  icon indicates that the Scan Tool is being powered through the vehicle's DLC connector.
- A visible  icon indicates that the Scan Tool is linked to (communicating with) the vehicle's computer.

- The display shows the number of the code currently being displayed, the total number of codes retrieved.
- The Diagnostic Trouble Code (DTC) and related code definition are shown in the lower section of the LCD display.



If the definition for the currently displayed code is not available, an advisory message shows on the Scan Tool's LCD display.



I/M MONITOR STATUS icons are not displayed when viewing enhanced DTCs.



*In the case of long code definitions, or when viewing Freeze Frame data, a small arrow is shown in the upper/lower right-hand corner of the code display area to indicate the presence of additional information. Use the **UP** (▲) and **DOWN** (▼) buttons, as necessary, to view the additional information.*

- The Scan Tool will display a code only if codes are present in the vehicle's computer memory. If no codes are present, a "No Enhanced DTC's are presently stored in the vehicle's computer" is displayed. Press the **M** button to return to the Main Menu.

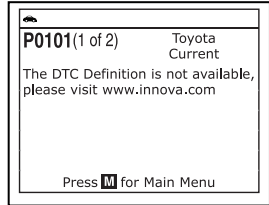
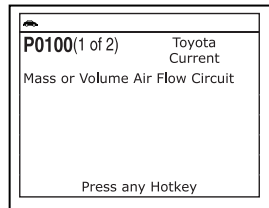

3. If more than one code was retrieved press the **DTC** button, as necessary, to display additional codes one at a time.
4. When the last retrieved DTC has been displayed and the **DTC** button is pressed, the Scan Tool returns to the "Priority" code.
 - To view *additional* enhanced DTCs, repeat steps 1 through 4, above.
 - To exit the enhanced mode, press the **M** button to return to the Main Menu. Use the **UP** (▲) and **DOWN** (▼) buttons, as necessary, to highlight **Global OBD**, then press the **ENTER** (↵) button to return to the Global OBD2 mode.

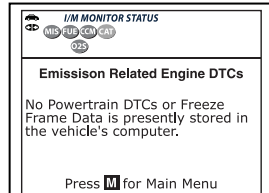

VIEWING ABS DTCs



Refer to Vehicle Applications - ABS on page 82 for vehicle makes covered. For a complete list of vehicle's covered, please visit www.innova.com.

Reading ABS DTCs

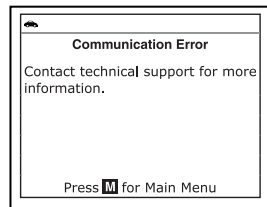
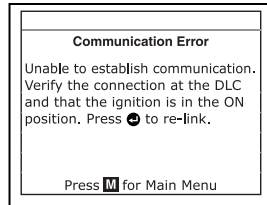
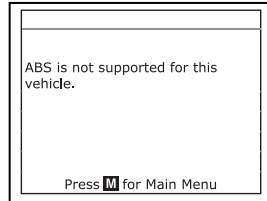
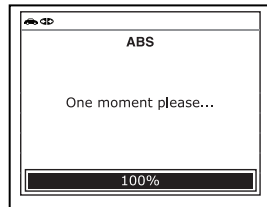

- From the OBD2 DTC screen or OEM enhanced DTC screen, press the **ABS** button.
- A "One moment please" message displays while the Scan Tool retrieves the selected DTCs.
 - If the vehicle does not support ABS communication, an advisory message shows on the Scan Tool's display. Press the **M** button to return to the Main Menu.
 - If the Scan Tool fails to link to the vehicle's computer, a "Linking Failed" message shows on the Scan Tool's display.
 - Verify the connection at the DLC, and verify the ignition is ON.
 - Turn the ignition OFF, wait 5 seconds, then turn back ON to reset the computer.
 - Press the **ENTER**  button to continue.
 - If the Scan Tool **cannot** link to the vehicle's computer after three attempts, the message "Contact Technical Support" displays.
 - Press the **M** button to return to the Main Menu.
 - Turn the ignition off, and disconnect the Scan Tool.
 - Contact Technical Support for assistance.



- To read the display:



Refer to **DISPLAY FUNCTIONS** on page 6 for a description of LCD display elements.

- A visible  icon indicates that the diagnostic tool is being powered through the vehicle's DLC connector.
- A visible  icon indicates that the diagnostic tool is linked to (communicating with) the vehicle's computer.
- The display shows the number of the code currently being displayed, the total number of codes retrieved.

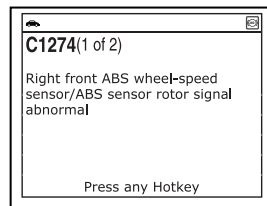

- The Diagnostic Trouble Code (DTC) and related code definition are shown in the lower section of the LCD display.



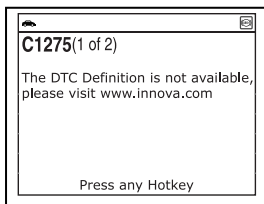

If the definition for the currently displayed code is not available, an advisory message shows on the Scan Tool's display.



I/M MONITOR STATUS icons are not displayed when viewing ABS DTCs.



In the case of long code definitions, a small arrow is shown in the upper/lower right-hand corner of the code display area to indicate the presence of additional information. Use the **UP**  and **DOWN**  buttons, as necessary, to view the additional information.

- The Scan Tool will display a code only if codes are present in the vehicle's computer memory. If no codes are present, a "No ABS DTC's are presently stored in the vehicle's computer" is displayed. Press the **M** button to return to the Main Menu.

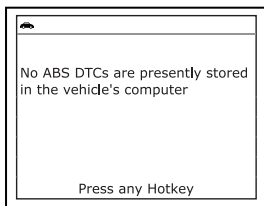

4. If more than one code was retrieved press the **DTC** button, as necessary, to display additional codes one at a time.
5. When the last retrieved DTC has been displayed and the **DTC** button is pressed, the diagnostic tool returns to the "Priority" code.
 - To exit the enhanced mode, press the **M** button. The Scan Tool returns to the Main Menu.

ERASING DIAGNOSTIC TROUBLE CODES (DTCs)



When the Scan Tool's ERASE function is used to erase the DTCs from the vehicle's on-board computer, "Freeze Frame" data and manufacturer-specific enhanced data are also erased.

If you plan to take the vehicle to a Service Center for repair, **DO NOT** erase the codes from the vehicle's computer. If the codes are erased, valuable information that might help the technician troubleshoot the problem will also be erased.

Erase DTCs from the computer's memory as follows:







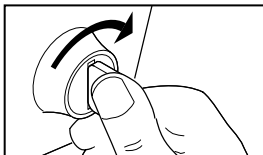
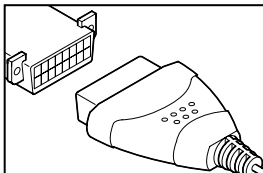

When DTCs are erased from the vehicle's computer memory, the I/M Readiness Monitor Status program resets status of all the Monitors to a not run "flashing" condition. To set all of the Monitors to a DONE status, an OBD2 Drive Cycle must be performed. Refer to your vehicle's service manual for information on how to perform an OBD2 Drive Cycle for the vehicle under test.

1. If not connected already, connect the Scan Tool to the vehicle's DLC. (If the Scan Tool is already connected and linked to the vehicle's computer, proceed directly to step 3. If not, continue to step 2.)
2. Perform the Code Retrieval procedure as described on page 31.



- **To erase OBD2 DTCs:** Wait until the codes are displayed on the Scan Tool's LCD and then proceed to step 3.
- **To erase OEM enhanced or ABS DTCs:** Perform the Code Retrieval procedure for OEM enhanced DTCs as described on page 38 or for ABS DTCs as described on page 48. Wait until the codes are displayed on the diagnostic tool's LCD and then proceed to step 3.

3. Press and release the **ERASE**  button. A confirmation message shows on the display.

- If you are sure you want to proceed, use the **UP**  and **DOWN**  buttons, as necessary, to highlight **YES**, then press the **ENTER**  button to erase DTCs from the vehicle's computer.
- If you do not want to continue with the erase process, use the **UP**  and **DOWN**  buttons, as necessary, to highlight **NO**, then press the **ENTER**  button to exit the erase mode.

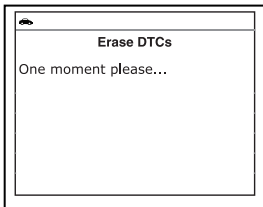
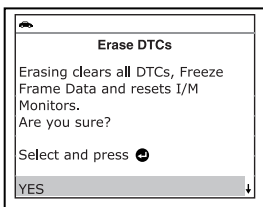

4. If you chose to erase DTCs, a "One moment please..." message displays while the erase function is in progress.



*If the vehicle's engine is running, an advisory message shows on the diagnostic tool's display. Turn the engine OFF, then turn the ignition back to ON. DO NOT start the engine. Press the **ENTER**  button to continue.*

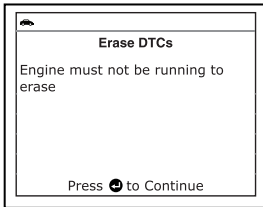

- If the erase was successful, a confirmation message shows on the display. Press the **M** button to return to the Main Menu.

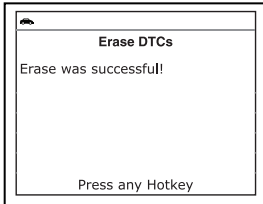

- If the erase was not successful, an advisory message shows on the display indicating the erase request was sent to the vehicle's computer. Press the **M** button to return to the Main Menu.

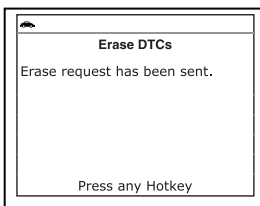

Erasing DTCs does not fix the problem(s) that caused the code(s) to be set. If proper repairs to correct the problem that caused the code(s) to be set are not made, the code(s) will appear again (and the check engine light will illuminate) as soon as the vehicle is driven long enough for its Monitors to complete their testing.

ABOUT REPAIRSOLUTIONS®

RepairSolutions® is a web-based service that provides you with the tools and information you need to quickly and accurately diagnose and repair today's vehicles. RepairSolutions® lets you view, save, and email the diagnostic data retrieved from a vehicle's on-board computer(s) using an Innova Scan Tool. At the core of RepairSolutions® is an extensive knowledge database, developed by compiling and analyzing years worth of "real world" vehicle service data. RepairSolutions® builds on manufacturer-recommended diagnostic and repair information by providing verified, vehicle-specific fixes supplied by ASE technicians across the country. The basic RepairSolutions® account is free, and is available immediately upon purchase of your Innova tool and a one-time software download. Certain "value added" premium information is available on demand at nominal charge or through "premium" subscription.

The RepairSolutions® Diagnostic Report

The RepairSolutions® Diagnostic Report provides you with detailed information for diagnosing and repairing vehicle issues. The Diagnostic Report gives you the following information:



Some features are available only with a "premium" subscription to RepairSolutions®.

- **Summary** – The **Summary** page shows the current status of your vehicle's emissions, engine/transmission, supplemental restraint (airbag) and anti-lock brake systems, and provides a summary of the issues associated with your vehicle.
- **Verified Fixes** – The **Verified Fixes** page lists the most likely repair(s) needed by your vehicle based on the DTCs retrieved. It includes cost estimates for the repair(s) based on your geographic location, provides access to detailed instructions for performing the repair(s), and includes links to supplemental information (including articles and videos) related to the affected component or system.

- **Diagnostic Data** – The **Diagnostic Data** page provides detailed information related to the DTCs retrieved from your vehicle's computer. It includes descriptions of the retrieved DTCs including the conditions under which each DTC was set, the probable causes for the issue and recommendations for verifying the problem. You can also view Freeze Frame data for the "priority" DTC (the DTC that caused the MIL to illuminate) and current I/M Monitor status.
- **TSBs / Recalls** - Even with the exhaustive testing a vehicle undergoes before being made available to the public, some issues are discovered only under "real world" driving conditions. Depending on the severity of the problem, the vehicle manufacturer may issue a Technical Service Bulletin describing the problem, and providing the procedures necessary to correct it. For safety related problems, vehicle manufacturers are required to issue vehicle recalls to correct the problem. The **TSBs / Recalls** page lists three main categories for issues related to your vehicle: Factory Technical Service Bulletins (TSBs), Factory Recalls, and Government-mandated NHTSA Safety Recalls. This information can help you identify a problem before it occurs, and ensure your vehicle meets Federal safety standards.
- **Maintenance** - The **Maintenance** page provides information to help keep your vehicle in top running condition. The page uses your vehicle's year, make, model and current mileage to provide a list of manufacturer-recommended periodic maintenance procedures that should be performed during its next scheduled service. These maintenance items are highly recommended and should be performed to best protect against premature failure. The page also includes additional recommended service procedures based on analysis of component failures reported by the RepairSolutions® network of technicians for vehicles of your make, model and mileage. All procedures include estimates of cost and level of difficulty.
- **Warranty** – Warranties are the vehicle manufacturer's promise to cover certain repair/replacement costs for a specific amount of time or until the vehicle has been driven for a specific number of miles. The **Warranty** page provides an estimation of the current state of your vehicle's warranties (whether they are active, expired, and/or transferable). This information is intended for reference only. It is based on manufacturer published data available at the time the data was gathered and may not fully reflect your actual warranty coverage.
- **Predicted Repairs** – Solving a problem before it becomes a problem can reduce out-of-pocket cost and minimize personal inconvenience. Through detailed analysis of historical repair information supplied by technician across the country, RepairSolutions® is able to provide highly accurate predictions of potential service and repair requirements based on your vehicle's year, make, model and mileage. The **Predicted Repairs** page provides a list of predicted repairs for your vehicle over the next 12 months. The predicted repairs are weighted by probability (high, moderate or low) and include cost estimates.
- **Vehicle History Reports** – Thinking of buying a vehicle? RepairSolutions® provides "one click" access for the purchase of a vehicle history report.

The Portal Page

The **Portal** page gives you an overview of your RepairSolutions® account. It shows your Account Status and provides access to the reports you have most recently generated using a registered Innova tool.

Innova Account

The **Innova Account** section lets you manage the vehicles and tools you've registered with your account and manage your personal information.

- **My Garage** – Your RepairSolutions® account can be used for multiple vehicles. The **My Garage** page you add, view and edit vehicles for your account.
- **Report History** – Each report you create through RepairSolutions® is retained through the lifetime of your membership, giving you an overview of the health of your vehicles. The **Report History** page lets you browse a list of all reports created through RepairSolutions® for all vehicles registered to your account, and view any report listed. You can also search the list based on the criteria (report #, VIN, etc.) you specify.
- **Registered Devices** – You can register all of your Innova tools with your RepairSolutions® account. The **Registered Devices** page shows all the tools registered to your account along with the date on which the device was activated.
- **Order History** – You can purchase “premium” access to RepairSolutions® on a monthly or annual basis. The **Order History** page lists all subscriptions you've purchased for your account.
- **Profile and Reset Password** – These pages let you update and maintain your personal account information and change the password you use to log in to RepairSolutions®.

Tools

The RepairSolutions® **Tools** section provides access to several databases offering maintenance and repair instruction, “tech tips,” safety information and general reference data.

- **How-To Videos** – With the complexity of today's vehicles, repair tasks can seem daunting even to the seasoned do-it-yourselfer. RepairSolutions® offers a rich selection of **How-To Videos** that provide step-by-step instruction for a variety of tasks, including general maintenance, diagnosis and troubleshooting, and detailed repair information. The “basic” membership provides access to a selection of available videos, while the “premium” subscription allows access to the complete video library.
- **Recalls** – Even with the exhaustive testing a vehicle undergoes before being made available to the public, some issues are discovered only under “real world” driving conditions. When an issue that affects personal safety is found, or if a vehicle does not meet Federal safety standards, the Government mandates that the vehicle manufacturer issue a “safety recall.” Safety recalls are official notices that describe known vehicle issues as well as the

related safety concerns. Repairs performed to address a safety recall are provided free of cost by the vehicle manufacturer's dealership. The **Recalls** database helps you ensure the safety of your vehicle. You can search for safety recalls by entering a vehicle's year, make and model.

- **DTC Library** – Diagnostic Trouble Codes (DTCs) are the starting point for identifying, troubleshooting and repairing vehicle issues. The **DTC Library** contains definitions for “generic” and “manufacturer-specific” OBD2 DTCs as well as OBD1 codes. Currently, the database provides code definitions for 43 different vehicle makes. Select the desired make and enter the DTC to retrieve the specific definition for your vehicle. Because OBD2 is an evolving system, the **DTC Library** is continuously updated to include additional “manufacturer-specific” definitions as the system matures.
- **DLC Locator** – The key to unlocking the wealth of information available through OBD2 is the Data Link Connector (DLC), the doorway to your vehicle's computer. The **DLC Locator** is a comprehensive database of DLC locations for all OBD2-certified vehicles. Simply enter a Vehicle Identification Number (VIN), or select the desired year, make and model, and the **DLC Locator** will return a description and photo illustration of the DLC location.
- **Tech Tips** – Updated quarterly, RepairSolutions® **Tech Tips** are designed to provide basic solutions to everyday vehicle issues, explain how to perform much needed maintenance, and provide basic information on how to take care of your vehicle. All **Tech Tips** are prepared, reviewed and approved with the support of ASE Certified Technicians.
- **Shop Locator** – Whether you want to purchase parts to make a repair yourself or find a local repair shop, the **Shop Locator** will return a list facilities near your location based on the Zip Code you provide.

Hardware Requirements:

- Innova Scan Tool
- Mini USB Cable (included with tool)

Minimum System Operating Requirements:

- Windows®

OS Requirements

- Windows® XP / Windows® Vista (32/64-bit editions) / Windows® 7 (32/64-bit editions) / Windows® 8 / Windows® 8.1

Minimum Hardware Requirements

- 50 MB free disk space
- 128 MB RAM
- Pentium processor or better
- One available USB port (USB 2.0 preferred)

Other Requirements

- Internet Connection
- Internet Explorer 5.5, Netscape 7.0 or Firefox 2.0 browser or newer

■ MAC®

OS Requirements

- Mac OS 10.4.4 and newer

Minimum Hardware Requirements

- 100 MB free disk space
- 256 MB of RAM
- Intel processor running at 700 MHz or greater
- One available USB port

Other Requirements

- Internet Connection
- Safari 3.0, Netscape 7.2 or Firefox 3.0 browser or newer

Accessing RepairSolutions®

1. Link your Scan Tool to a vehicle and retrieve diagnostic data.
2. Visit www.innova.com, download and install the latest PC-Link software for your Scan Tool. Select the **Support** tab, then choose **Manuals and Software**. Use the drop-down menu provided to select your tool Category and tool Model to download the latest PC-Link software.
3. Connect the Scan Tool to your PC using a Mini USB cable (cable included).
 - Your default web browser launches automatically and connects to the www.innova.com website.
4. Login to your RepairSolutions® account using your registered **Email Address** and **Password**.



If you have not yet established an account, you must register for a FREE RepairSolutions® account before proceeding.

I/M READINESS TESTING

I/M is an Inspection and Maintenance program legislated by the Government to meet federal clean-air standards.

The program requires that a vehicle be taken periodically to an Emissions Station for an "Emissions Test" or "Smog Check," where the emissions-related components and systems are inspected and tested for proper operation. Emissions Tests are generally performed once a year, or once every two years.

On OBD2 systems, the I/M program is enhanced by requiring vehicles to meet stricter test standards. One of the tests instituted by the Federal Government is called I/M 240. On I/M 240, the vehicle under test is driven under different speeds and load conditions on a dynamometer for 240 seconds, while the vehicle's emissions are measured.



Emissions tests vary depending on the geographic or regional area in which the vehicle is registered. If the vehicle is registered in a highly urbanized area, the I/M 240 is probably the type of test required. If the vehicle is registered in a rural area, the stricter "dynamometer type" test may not be required.

I/M Readiness Monitors

I/M Readiness shows whether the various emissions-related systems on the vehicle are operating properly and are ready for Inspection and Maintenance testing.

State and Federal Governments enacted Regulations, Procedures and Emission Standards to ensure that all emissions-related components and systems are **continuously** or **periodically** monitored, tested and diagnosed whenever the vehicle is in operation. It also requires vehicle manufacturers to automatically detect and report any problems or faults that may increase the vehicle's emissions to an unacceptable level.

The vehicle's emissions control system consists of several components or sub-systems (Oxygen Sensor, Catalytic Converter, EGR, Fuel System, etc.) that aid in reducing vehicle emissions.

To have an efficient Vehicle Emission Control System, all the emissions-related components and systems must work correctly whenever the vehicle is in operation.

To comply with State and Federal Government regulations, vehicle manufacturers designed a series of special computer programs called "Monitors" that are programmed into the vehicle's computer. Each of these Monitors is specifically designed to run tests and diagnostics on a specific emissions-related component or system (Oxygen Sensor, Catalytic Converter, EGR Valve, Fuel System, etc.) to ensure their proper operation. Currently, there are a maximum of fifteen Monitors available for use.

To learn more about Emissions Inspection and Maintenance (I/M) Readiness Monitors, see OBD2 MONITORS on page 16.



Each Monitor has a specific function to test and diagnose only its designated emissions-related component or system. The names of the Monitors (Oxygen Sensor Monitor, Catalyst Monitor, EGR Monitor, Misfire Monitor, etc.) describe which component or system each Monitor is designed to test and diagnose.



Emissions Inspection and Maintenance (I/M) Readiness

Monitor Status Information

I/M Readiness Monitor Status shows which of the vehicle's Monitors have run and completed their diagnosis and testing, and which ones have not yet run and completed testing and diagnosis of their designated sections of the vehicle's emissions system.

- If a Monitor was able to meet all the conditions required to enable it to perform the self-diagnosis and testing of its assigned engine system, it means the monitor "HAS RUN."
- If a Monitor has not yet met all the conditions required for it to perform the self-diagnosis and testing of its assigned engine system; it means the Monitor "HAS NOT RUN."



The Monitor Run/Not Run status does not show whether or not a problem exists in a system. Monitor status only indicates whether a particular Monitor has or has not run and performed the self-diagnosis and testing of its associated system.

Performing I/M Readiness Quick Check



When a vehicle first comes from the factory, all Monitors indicate a "HAVE RUN" status. This indicates that all Monitors have run and completed their diagnostic testing. The "HAVE RUN" status remains in the computer's memory, unless the Diagnostic Trouble Codes are erased or the vehicle's computer memory is cleared.

The Scan Tool allows you to retrieve Monitor/System Status Information to help you determine if the vehicle is ready for an Emissions Test (Smog Check). In addition to retrieving Diagnostic Trouble Codes, the Scan Tool also retrieves Monitor Run/Not Run status. This information is very important since different areas of the state/country have different emissions laws and regulations concerning Monitor Run/Not Run status.

Before an Emissions Test (Smog Check) can be performed, your vehicle must meet certain rules, requirements and procedures legislated by the Federal and state (country) governments where you live.

1. In most areas, one of the requirements that must be met before a vehicle is allowed to be Emissions Tested (Smog Checked) is that the vehicle does not have any Diagnostic Trouble Codes present (with the exception of PENDING Diagnostic Trouble Codes).
2. In addition to the requirement that no Diagnostic Trouble Codes be present, some areas also require that all the Monitors that a particular vehicle supports indicate a "Has Run" status condition before an Emissions Check may be performed.
3. Other areas may only require that some (but not all) Monitors indicate a "Has Run" status before an Emissions Test (Smog Check) may be performed.



Monitors with a "Has Run" status indicate that all the required conditions they needed to perform diagnosis and testing of their assigned engine area (system) have been met, and all diagnostic testing has completed successfully.



Monitors with a "Has Not Run" status have not yet met the conditions they need to perform diagnosis and testing of their assigned engine area (system), and have not been able to perform diagnostic testing on that system.

The green, yellow and red LEDs provide a quick way to help you determine if a vehicle is ready for an Emissions Test (Smog Check). Follow the instructions below to perform the Quick Check.

Perform the CODE RETRIEVAL PROCEDURE as described on page 31, then interpret the LED indications as follows:

Interpreting I/M Readiness Test Results

1. **GREEN LED** - Indicates that all engine systems are "OK" and operating normally (all Monitors supported by the vehicle have run and performed their self-diagnostic testing). The vehicle is ready for an Emissions Test (Smog Check), and there is a good possibility that it can be certified.

2. **YELLOW LED** - Determine from the CODE RETRIEVAL PROCEDURE (page 31) which of the two possible conditions is causing the yellow LED to light.

- If a "PENDING" Diagnostic Trouble Code is causing the yellow LED to light, it is possible that the vehicle will be allowed to be tested for emissions and certified. Currently, most areas (states / countries) will allow an Emissions Test (Smog Check) to be performed if the only code in the vehicle's computer is a "PENDING" Diagnostic Trouble Code.

- If the illumination of the Yellow LED is being caused by monitors that "have not run" their diagnostic testing, then the issue of the vehicle being ready for an Emissions Test (Smog Check) depends on the emissions regulations and laws of your local area.

- Some areas require that all Monitors indicate a "Has Run" status before they allow an Emissions Test (Smog Check) to be performed. Other areas only require that some, but not all, Monitors have run their self-diagnostic testing before an Emissions Test (Smog Check) may be performed.

From the code retrieval procedure, determine the status of each Monitor (a solid Monitor icon shows Monitor "Has Run" status, a flashing Monitor icon indicates "Has Not Run" status). Take this information to an emissions professional to determine (based on your test results) if your vehicle is ready for an Emissions Test (Smog Check).

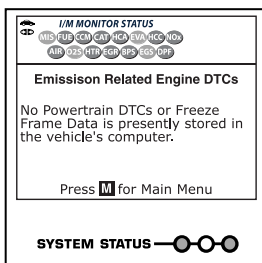
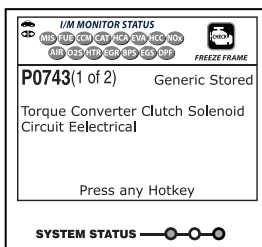
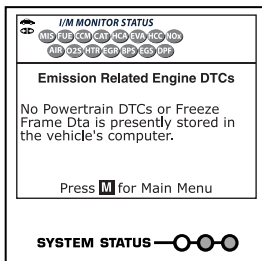

- RED LED** - Indicates there is a problem with one or more of the vehicle's systems. A vehicle displaying a red LED is definitely not ready for an Emissions Test (Smog Check). The red LED is also an indication that there are Diagnostic Trouble Code(s) present (displayed on the Scan Tool's screen). The Multifunction Indicator (Check Engine) Lamp on the vehicle's instrument panel will light steady. The problem that is causing the red LED to light must be repaired before an Emissions Test (Smog Check) can be performed. It is also suggested that the vehicle be inspected/repaired before driving the vehicle further.
- Flashing Red and Yellow LEDs** – Indicates that a "permanent" code has been set, and one or more of the vehicle's monitors has failed its diagnostic testing. A "permanent" DTC can be cleared *only* by the vehicle's computer following successful completion of the monitor that caused the fault to set.

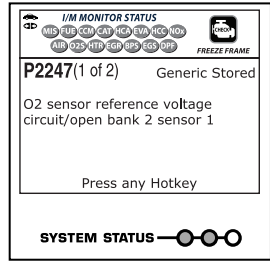

If the Red LED or flashing RED and YELLOW LEDs were obtained, there is a definite problem present in the system(s). In these cases, you have the following options.

- Repair the vehicle yourself. If you are going to perform the repairs yourself, proceed by reading the vehicle service manual and following all its procedures and recommendations.
- Take the vehicle to a professional to have it serviced. The problem(s) causing the red LED to light must be repaired before the vehicle is ready for an Emissions Test (Smog Check).

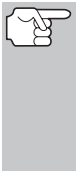

On some vehicle models, the computer will store non-emission related DTCs. These DTCs will not command the MIL on since they are not emission related. If the Scan Tool retrieves one of these types of codes, the MIL will not be commanded on, and the Yellow LED on the Scan Tool will be illuminated. In most cases, these types of codes will not prevent the Emissions Test from being performed.

Using the I/M Readiness Monitor Status to Confirm a Repair

The I/M Readiness Monitor Status function can be used (after repair of a fault has been performed) to confirm that the repair has been performed correctly, and/or to check for Monitor Run Status. Use the following procedure to determine I/M Readiness Monitor Status:

1. Using retrieved Diagnostic Trouble Codes (DTCs) and code definitions as a guide, and following manufacturer's repair procedures, repair the fault or faults as instructed.
2. After the fault or faults have been repaired, connect the Scan Tool to the vehicle's DLC and erase the code or codes from the vehicle's computer memory.
 - See page 50 for procedures for ERASING DIAGNOSTIC TROUBLE CODES (DTCs) from the vehicle's on-board computer.

- Write the codes down on a piece of paper for reference before erasing.
3. After the erase procedure is performed, most of the Monitor icons on the Scan Tool's LCD display will be flashing. Leave the Scan Tool connected to the vehicle, and perform a Trip Drive Cycle for each "flashing" Monitor:



Misfire, Fuel and Comprehensive Component Monitors run continuously and their icons will always be on solid, even after the erase function is performed.

- Each DTC is associated with a specific Monitor. Consult the vehicle's service manual to identify the Monitor (or Monitors) associated with the faults that were repaired. Follow the manufacturer's procedures to perform a Trip Drive Cycle for the appropriate Monitors.
- While observing the Monitor icons on the Scan Tool's LCD display, perform a Trip Drive Cycle for the appropriate Monitor or Monitors.



If the vehicle needs to be driven in order to perform a Trip Drive Cycle, ALWAYS have a second person help you. One person should drive the vehicle while the other person observes the Monitor icons on the Scan Tool for Monitor RUN status. Trying to drive and observe the Scan Tool at the same time is dangerous, and could cause a serious traffic accident.

4. When a Monitor's Trip Drive Cycle is performed properly, the Monitor icon on the Scan Tool's LCD display changes from "flashing" to "solid," indicating that the Monitor has run and finished its diagnostic testing.
- If, after the Monitor has run, the MIL on the vehicle's dash is not lit, and no stored or pending codes associated with that particular Monitor are present in the vehicle's computer, the repair was successful.
 - If, after the Monitor has run, the MIL on the vehicle's dash lights and/or a DTC associated with that Monitor is present in the vehicle's computer, the repair was unsuccessful. Refer to the vehicle's service manual and recheck repair procedures.

The Scan Tool is a special tool that communicates with the vehicle's computer. The Scan Tool lets you view and/or "capture" (record) "real-time" Live Data. This information includes values (volts, rpm, temperature, speed etc.) and system status information (open loop, closed loop, fuel system status, etc.) generated by the various vehicle sensors, switches and actuators.

In effect the Scan Tool lets you view, in "real time", the same signal values generated by the sensors, actuators, switches and/or vehicle system status information used by the vehicle's computer when calculating and conducting system adjustments and corrections.

The real time (Live Data) vehicle operating information (values/status) that the computer supplies to the Scan Tool for each sensor, actuator, switch, etc. is called Parameter Identification (PID) Data.

Each PID (sensor, actuator switch, status, etc.) has a set of operating characteristics and features (parameters) that serve to identify it. The Scan Tool displays this information for each sensor, actuator, switch or status that is supported by the vehicle under test.



WARNING: If the vehicle must be driven in order to perform a troubleshooting procedure, **ALWAYS** have a second person help you. One person should drive the vehicle while the other person observes the Scan Tool data. Trying to drive and operate the Scan Tool at the same time is dangerous, and could cause a serious traffic accident.

VIEWING LIVE DATA

1. While linked to the vehicle, start the engine, then press and release the **LD** button.
2. A "One moment please . . ." message displays while the Scan Tool establishes communication with the vehicle.
 - If the Scan Tool fails to establish communication with the vehicle, a "Communication Error" message is shown on the Scan Tool's display.
 - Ensure your vehicle is OBD2 compliant. See **VEHICLES COVERED** on page 4 for vehicle compliance verification information.
 - Verify the connection at the DLC, and verify the ignition is ON.
 - Turn the ignition OFF, wait 5 seconds, then back ON to reset the computer.
 - Press the **ENTER**  button to continue.
3. Real-time Live Data (PID) information supported by the vehicle under test displays.

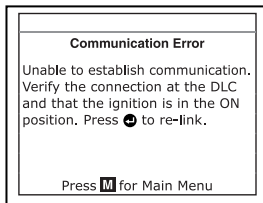
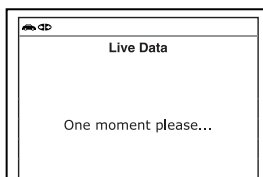

Powertrain Live Data

PCM PID	1/38
Fuel Sys 1	OL
Fuel Sys 2	NA
Calc Load(%)	0.0
ECT(°F)	-40.0
STFT B1(%)	0.0

Press  for LD menu

- If Live Data is not supported by the vehicle under test, an advisory message displays. Press the **M** button to return to the Main Menu. Live Data is not available for your vehicle.



Remember, what you are viewing is "real-time" Live Data. The values (volts, rpm, temperature, vehicle speed, system status etc) for the various PIDs displayed may change as the vehicle's operating conditions change.

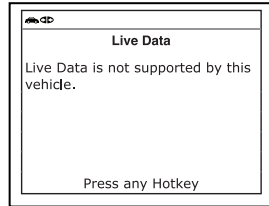

4. A vehicle usually supports several PIDs, however, only a limited amount of PID data can be displayed on the screen at one time. If additional PID data is available, a small arrow will be shown on the display. Use the **UP** (▲) and **DOWN** (▼) buttons, as necessary, to scroll up or down to view all available PID data.

- If communication with the vehicle is lost while viewing Live Data, a "Communication Lost" message shows on the Scan Tool's display.

5. Press and hold the **ENTER** (↵) button to view the "expanded" definition for the currently selected PID. Release the **ENTER** (↵) button to return to the PID list.

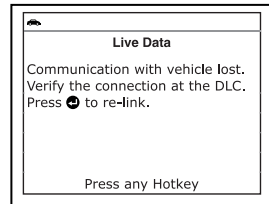

6. If you experience vehicle problems, view and/or compare the Live Data (PID) information displayed on the Scan Tool to specifications in the vehicle's repair manual.



*If desired, you can "customize" the Live Data display to show only those PIDs you are interested in viewing. See **Customizing Live Data (PIDs)** below for details.*

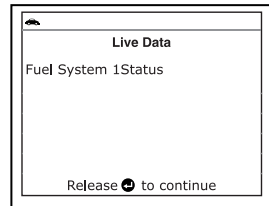

CUSTOMIZING LIVE DATA (PIDs)

This feature lets you customize the Scan Tool display to show only those PIDs that are of interest at the current time. You can customize the Live Data display by placing the Scan Tool in "Custom Live Data" mode and selecting only the PIDs that you wish to display. To customize the Live Data display, proceed as follows:

1. With the Scan Tool in Live Data mode (see **VIEWING LIVE DATA** on page 62), press and hold the **LD** button until the Live Data Menu displays, then release the **LD** button.

2. Use the **UP** (▲) and **DOWN** (▼) buttons, as necessary, to highlight **Custom Live Data**, then press the **ENTER** (↵) button.

- If the Scan Tool fails to establish communication with the vehicle, a “Communication Error” message is shown on the Scan Tool’s display.

- Ensure your vehicle is OBD2 compliant. See **VEHICLES COVERED** on page 4 for vehicle compliance verification information.

- Verify the connection at the DLC, and verify the ignition is ON.

- Turn the ignition OFF, wait 5 seconds, then back ON to reset the computer.

- Press the **ENTER** (↵) button to continue.

- If Live Data is not supported by the vehicle under test, an advisory message displays. Press the **M** button to return to the Main Menu. Live Data is not available for your vehicle.

- If custom Live Data was previously selected, the Select PIDs to Use screen displays.

- To use the *existing* custom Live data selections, use the **UP** (▲) and **DOWN** (▼) buttons, as necessary, to highlight **Use existing PIDs**, then press the **ENTER** (↵) button. Proceed to step 5.

- To select *new* custom Live Data, use the **UP** (▲) and **DOWN** (▼) buttons, as necessary, to highlight **Select new PIDs**, then press the **ENTER** (↵) button. The Custom Live Data menu displays, with the first PID in the menu highlighted. Proceed to step 3.

- If custom Live Data was not previously selected, the Custom Live Data menu displays, with the first PID in the menu highlighted. Proceed to step 3.

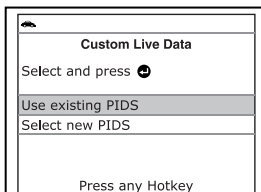
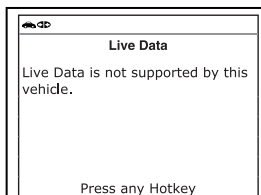
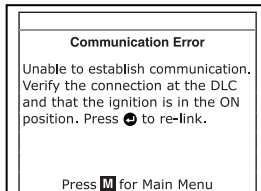
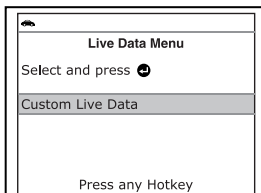

3. Use the **UP** (▲) and **DOWN** (▼) buttons to scroll through the available PIDs. When the PID you wish to display is highlighted, press the **ENTER** (↵) button to select it (a "checkmark" will show in the checkbox to the right of the PID to confirm your selection). Repeat the procedure until only the PIDs you want to display have all been selected.

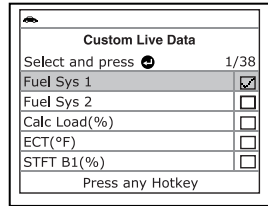

- To deselect a currently selected PID, highlight the PID, then press the **ENTER** (↵) button. The checkmark will be removed from the checkbox.

4. When you are finished making your selection(s), scroll to the end of the PID list and highlight the word **Done**, then press the **ENTER** (↵) button.

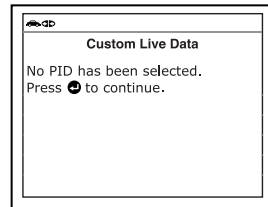

- If *no PIDs* have been selected, an advisory message displays. Press the **M** button to return to the Custom Live Data menu.

5. The Scan Tool is now in "Custom Live Data" mode. Only the PIDs you selected are shown on the Scan Tools display.

- To add *additional* PIDs to the current custom Live Data selections, use the **UP** (▲) and **DOWN** (▼) buttons, as necessary, to highlight **More PIDs**, then press the **ENTER** (↵) button to return to the Custom Live Data menu. Repeat step 4.

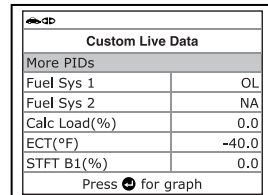

6. To exit the "Custom Live Data" mode, press the **M** button to return to the Main Menu.

BATTERY/ALTERNATOR MONITOR

The Scan Tool can perform a check of the vehicle's battery and alternator system to ensure the system is operating within acceptable limits. You can perform a battery check *only*, or an alternator system (battery and alternator) check.

To perform a battery check ONLY:

1. With the Scan Tool on the Code Retrieval screen, press and release the **M** button.

- The Main Menu displays.

2. Use the **UP** (▲) and **DOWN** (▼) buttons, as necessary, to highlight **Battery/Alternator Monitor**, then press the **ENTER** (↵) button.

- The Battery/Alternator Monitor Menu displays.

3. Use the **UP** (▲) and **DOWN** (▼) buttons, as necessary, to highlight **Battery Monitor**, then press the **ENTER** (↵) button.

- A "One moment please" message displays, while the Scan Tool retrieves the requested information.

4. When the battery check is complete, a results screen displays the current **Battery Voltage**, and indicates whether or not the voltage is within acceptable limits. The System Status LEDs provide a PASS/FAIL indication, as follows:

- Green = PASS
- Yellow = Caution/LOW
- Red = FAIL

5. Press the **M** button to return to the Main Menu.

To perform an alternator system check:

1. With the Scan Tool on the Code Retrieval screen, press and release the **M** button.

- The Main Menu displays.

2. Use the **UP** (▲) and **DOWN** (▼) buttons, as necessary, to highlight **Battery/Alternator Monitor**, then press the **ENTER** (↵) button.

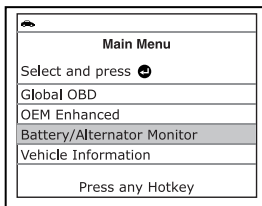
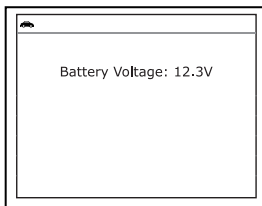
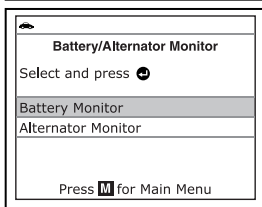
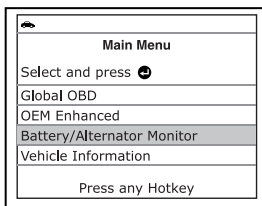

- The Battery/Alternator Monitor Menu displays.
3. Use the **UP** (▲) and **DOWN** (▼) buttons, as necessary, to highlight **Alternator Monitor**, then press the **ENTER** (↵) button.
 - A “One moment please” message displays, while the Scan Tool retrieves the requested information.
 4. When the battery check is complete, a results screen displays the current Battery Voltage.
 5. Press the **ENTER** (↵) button to perform the alternator check.
 - An instructional screen displays.
 6. Press the accelerator pedal to raise engine speed to 1500~1700 RPM, and maintain the engine speed for 10 seconds.
 - When engine speed is within the required range, the alternator test begins. A progress screen shows the **Engine RPM** and **Count down** (time remaining until the test is complete).
 7. When the alternator check is complete, a results screen displays the current **Alternator Voltage**, and indicates whether or not the voltage is within acceptable limits. The System Status LEDs provide a PASS/FAIL indication, as follows:
 - Green = PASS
 - Yellow = Caution/LOW
 - Red = FAIL
 - If the alternator voltage is less than 9 V, the red, yellow and green **SYSTEM STATUS** LEDs will flash on and off.
 8. Press the **M** button to return to the Main Menu.

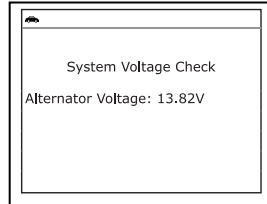
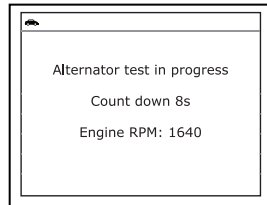
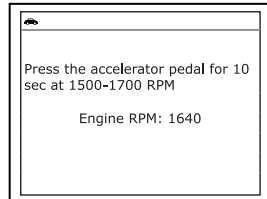
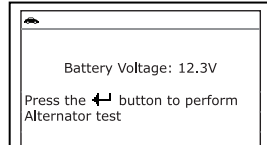
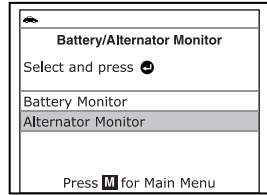

VIEWING VEHICLE INFORMATION

The Scan Tool offers three options for retrieving reference information for the vehicle under test; **Vehicle ID**, **Available Modules** and **IPT** (In-use Performance Tracking).

Retrieving Vehicle ID Information



The **Vehicle ID** function is applicable to model year 2000 and newer OBD2-compliant vehicles.

The Scan Tool can retrieve a list of information (provided by the vehicle manufacturer), unique to the vehicle under test, from the vehicle's on-board computer. This information may include:

- The vehicle's VIN number
 - The control module identification number
 - The vehicle's calibration ID(s). These IDs uniquely identify the software version(s) for the vehicle's control module(s).
 - The Vehicle's Calibration Verification Number(s) (CVNs) required by OBD2 regulations. CVNs are used to determine if emission-related calibrations for the vehicle under test have been changed. One or more CVNs may be returned by the vehicle's computer.
1. While linked to a vehicle, press the **M** button.
 - The "Main Menu" displays.
 2. Use the **UP** (▲) and **DOWN** (▼) buttons, as necessary, to highlight **Vehicle Info**, then press the **ENTER** (⊕) button.
 - The Vehicle Information menu displays.
 3. Use the **UP** (▲) and **DOWN** (▼) buttons, as necessary, to highlight **Vehicle ID**, then press the **ENTER** (⊕) button.
 4. A "One moment please..." message displays while the requested information is retrieved from the vehicle's computer.

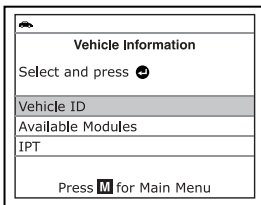
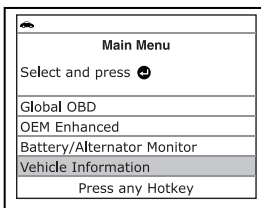

The first time the **Vehicle ID** function is used, it may take several minutes to retrieve the information from the vehicle's computer.

5. When the retrieval process is completed, the vehicle ID information is shown on the Scan Tool's display. Use the **UP** (▲) and **DOWN** (▼) buttons, as necessary, to view the entire list.
6. When you have finished viewing the retrieved vehicle ID information, press the **M** button to exit.

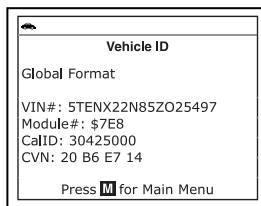

Viewing Available Modules

The Scan Tool can retrieve a list of modules supported by the vehicle under test.

1. While linked to a vehicle, press the **M** button.

- The "Main Menu" displays.
2. Use the **UP** (▲) and **DOWN** (▼) buttons, as necessary, to highlight **Vehicle Information**, then press the **ENTER** (↵) button.
 - The Vehicle Information menu displays.
3. Use the **UP** (▲) and **DOWN** (▼) buttons, as necessary, to highlight **Available Modules**, then press the **ENTER** (↵) button.
4. A "One moment please..." message displays while the requested information is retrieved from the vehicle's computer.
5. When the retrieval process is completed, a complete list of modules supported by the vehicle under test is shown on the Scan Tool's display. Use the **UP** (▲) and **DOWN** (▼) buttons, as necessary, to view the entire list.
6. When you have finished viewing the list of available modules, press the **M** button to exit.

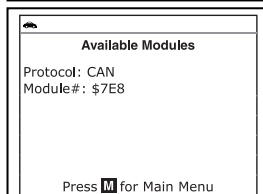
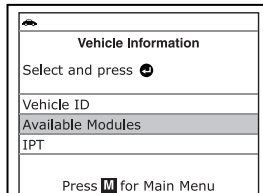
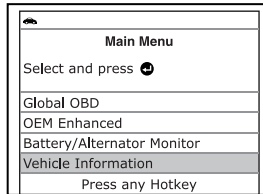

Viewing In-use Performance Tracking (IPT)

The Scan Tool can retrieve In-use Performance Tracking (IPT) statistics for monitors supported by the vehicle under test. Two values are returned for each monitor; the number of times that all conditions necessary for a specific monitor to detect a malfunction have been encountered (XXXCOND), and the number of times that the vehicle has been operated under the specific conditions for the monitor (XXXCOMP). Statistics are also provided for the number of times the vehicle has been operated in OBD monitoring conditions (OBDCOND), and the number of times the vehicle's engine has been started (IGNCNTR).

1. While linked to a vehicle, press the **M** button.
 - The "Main Menu" displays.
2. Use the **UP** (▲) and **DOWN** (▼) buttons, as necessary, to highlight **Vehicle Information**, then press the **ENTER** (↵) button.
 - The Vehicle Information menu displays.
3. Use the **UP** (▲) and **DOWN** (▼) buttons, as necessary, to highlight **IPT**, then press the **ENTER** (↵) button.

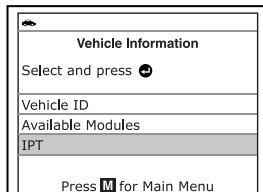
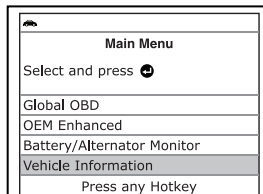

- When the retrieval process is completed, In-use Performance Tracking statistics for monitors supported by the vehicle under test are shown on the Scan Tool's display. Use the **UP** (▲) and **DOWN** (▼) buttons, as necessary, to view the entire list.
- When you have finished viewing the statistics, press the **M** button to exit.

IPT	
	1/16
OBDCOND	0
IGNCNTR	0
CATCOMP1	0
CATCOND1	0
CATCOMP2	0
Press M for Main Menu	

VIEWING THE FIRMWARE VERSION

- While linked to a vehicle, press and release the **M** button.
 - The Main Menu displays.
- Use the **UP** (▲) and **DOWN** (▼) buttons, as necessary, to highlight **Firmware Version** in the Main Menu, then press the **ENTER** (↵) button.
 - The Firmware Version screen displays.
 - The screen shows the diagnostic tool's current firmware version, bootloader version and database version.
- Press the **M** button to return to the Main Menu.

Main Menu	
Select and press M	
Vehicle Information	
Firmware Version	
Tool Library	
Tool Settings	
Press any Hotkey	

Scan Tool	
Firmware Version: V01.00.44	
Bootloader Version: V01.00.07	
Database Version: V01.00.35	
Copyright 2014 IEC	
All Rights Reserved	

THE TOOL LIBRARY

The Tool Library contains valuable reference information for the Scan Tool. The following functions are available:





- Monitor Icon** – Shows the full names for the **I/M MONITOR STATUS** icons shown on the diagnostic tool's display.
 - DTC Library** – Provides access to a library of OBD2 DTC definitions.
 - LED Meaning** – Provides descriptions of the meaning of the Scan Tool **SYSTEM STATUS** LEDs.
- While linked to the vehicle, press the **M** button.
 - The Main Menu displays.
 - Use the **UP** (▲) and **DOWN** (▼) buttons, as necessary, to highlight **Tool Library**, then press the **ENTER** (↵) button.
 - The Tool Library menu displays.

Main Menu	
Select and press M	
Vehicle Information	
Firmware Version	
Tool Library	
Tool Settings	
Press any Hotkey	

Tool Library	
Select and press M	
Monitor Icon	
DTC Library	
LED Meaning	
Press M for Main Menu	







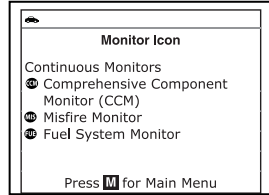

Viewing Monitor Icon Descriptions

The **I/M MONITOR STATUS** icons on the Scan Tool's LCD display provide an indication of the "Completed / Not Complete" status for all I/M Monitors supported by the vehicle under test. The **Monitor Icon** function displays the full name for each Monitor icon.

1. From the Tool Library menu, use the **UP**  and **DOWN**  buttons, as necessary, to highlight **Monitor Icon**, then press the **ENTER**  button.
 - The Monitor Icon screen displays.
 - The screen shows a list of the 15 Monitor icons, along with the full name for each icon. Use the **UP**  and **DOWN**  buttons, as necessary, to scroll the list.
2. When you have finished viewing the Monitor icon descriptions, press the **M** button to return to the Main Menu.



Using the DTC Library

1. From the Tool Library menu, use the **UP**  and **DOWN**  buttons, as necessary, to highlight **DTC Library**, then press the **ENTER**  button.
 - The Enter DTC screen displays. The screen shows the code "P0001", with the "P" highlighted.
2. Use the **UP**  and **DOWN**  buttons, as necessary, to scroll to the desired DTC type (P=Powertrain, U=Network, B=Body, C=Chassis), then press the **DTC** button.
 - The selected character displays "solid", and the next character is highlighted.
3. Select the remaining characters in the DTC in the same way, pressing the **DTC** button to confirm each character. When you have selected all the DTC characters, press the **ENTER**  button to view the DTC definition.
 - The Select Manufacturer screen displays.
4. Use the **UP**  and **DOWN**  buttons, as necessary, to highlight the desired vehicle manufacturer, then press the **DTC** button.

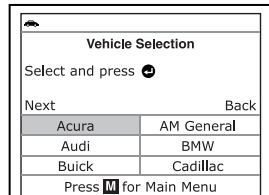
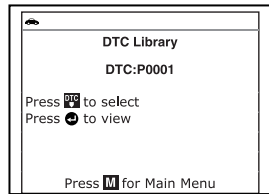
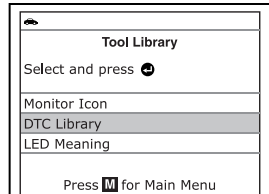

- A confirmation message shows on the LCD display.

- If the correct manufacturer is not shown, use the **UP** (▲) and **DOWN** (▼) buttons, as necessary, to highlight **No**, then press the **ENTER** (↵) button to return to the list of vehicle manufacturers.

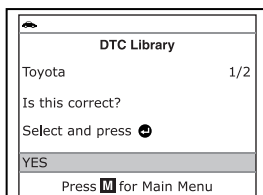

- If the correct manufacturer is shown, use the **UP** (▲) and **DOWN** (▼) buttons, as necessary, to highlight **Yes**, then press the **ENTER** (↵) button to view the DTC definition.

5. When you have finished viewing the DTC definition, use the **UP** (▲) and **DOWN** (▼) buttons, as necessary, to highlight **Back**, then press the **ENTER** (↵) button to return to the Enter DTC screen and enter additional DTCs; or, press the **M** button to return to the Main Menu.

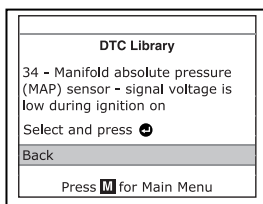

*If a definition for the DTC you entered is not available, an advisory message shows on the diagnostic tool's display. Use the **UP** (▲) and **DOWN** (▼) buttons, as necessary, to highlight **Back**, then press the **ENTER** (↵) button to return to the Enter DTC screen and enter additional DTCs; or, press the **M** button to return to the Main Menu.*

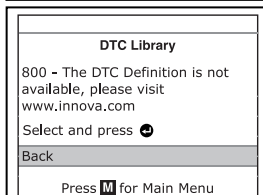

Viewing the LED Meaning

The **SYSTEM STATUS** LEDs on the Scan Tool provide a visual indication of the I/M Readiness status of the vehicle under test. The **LED Meaning** function provides a description of the meanings of the green, yellow and red **SYSTEM STATUS** LEDs.

1. From the Tool Library menu, use the **UP** (▲) and **DOWN** (▼) buttons, as necessary, to highlight **LED Meaning**, then press the **ENTER** (↵) button.

- The LED Meaning screen displays.
- The screen provides a description of the meanings of the green, yellow and red **SYSTEM STATUS** LEDs. Use the **UP** (▲) and **DOWN** (▼) buttons, as necessary, to scroll the display.

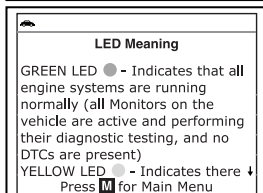
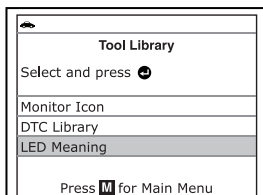

- When you have finished viewing the LED meanings, press the **M** button to return to the Main Menu.

ADJUSTMENTS AND SETTINGS

You can access the Adjustments and Settings MENU while the Scan Tool is in “Live Data” mode. The Scan Tool lets you make several adjustments and settings to configure the Scan Tool for your particular needs. The following adjustments and settings are available:

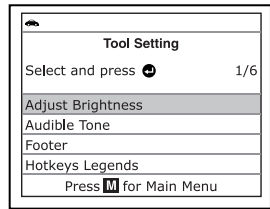

- **Footer:** Turns the navigational “footers” at the bottom of most display screens “on” and “off.”
- **Adjust Brightness:** Adjusts the brightness of the display screen.
- **Audible Tone:** Turns the Scan Tool’s audible tone “on” and “off.” When turned “on,” a tone sounds each time a button is pressed.
- **Select Language:** Sets the display language for the Scan Tool to English, French or Spanish.
- **Unit of Measurement:** Sets the Unit of Measurement for the Scan Tool’s display to USA or Metric.
- **Hotkeys Legends:** Shows functional descriptions for the diagnostic tool’s hotkeys.

Accessing the Adjustments and Settings Menu

- While linked to the vehicle, press and release the **M** button.
 - The “Main Menu” displays.
- Use the **UP** (▲) and **DOWN** (▼) buttons, as necessary, to highlight **Tool Settings**, then press the **ENTER** (↵) button.
 - The Tool Setting Menu displays.
- Make adjustments and settings as described in the following paragraphs.

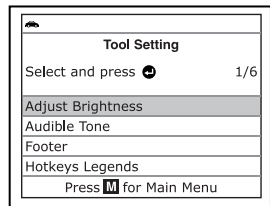
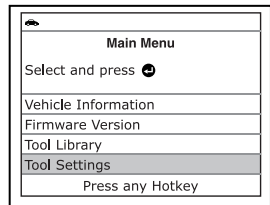

Disabling Navigational Footers



Navigational “footers” are shown at the bottom of most display screens. They show which hotkey to press to return to the topmost menu for the current function.

1. Use the **UP** (▲) and **DOWN** (▼) buttons, as necessary, to highlight **Footer** in the Tool Settings menu, then press the **ENTER** (↵) button.
 - The Footer screen displays.
2. Use the **UP** (▲) and **DOWN** (▼) buttons, as necessary, to highlight **On** of **Off** as desired.
3. When the desired option is selected, press the **ENTER** (↵) button to save your changes and return to the Tool Settings menu.



To exit the Footer screen and return to the Main Menu without making changes, press the **M** button.

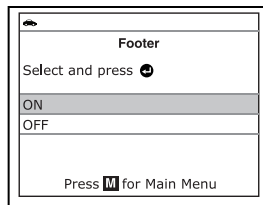
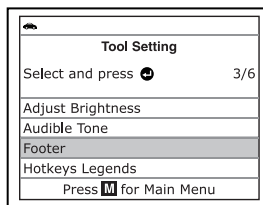

Adjusting Display Brightness

1. Use the **UP** (▲) and **DOWN** (▼) buttons, as necessary, to highlight **Adjust Brightness** in the Menu, then press the **ENTER** (↵) button.
 - The Adjust Brightness screen displays.
 - The **Adjust Brightness** field shows the current brightness setting, from 1 - 4.
2. Press the **UP** (▲) button to decrease the brightness of the display (make the display darker).
3. Press the **DOWN** (▼) button to increase the brightness of the display (make the display lighter).
4. When the desired brightness is obtained, press the **ENTER** (↵) button to save your changes and return to the Tool Settings Menu.



To exit the Adjust Brightness screen and return to the Tool Settings Menu without making changes, press the **M** button.

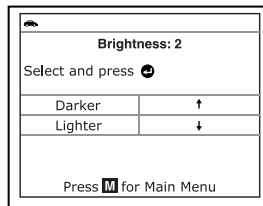
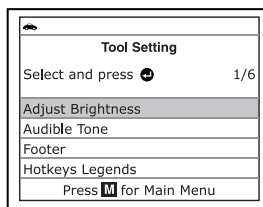

Enabling the Audible Tone

1. Use the **UP** (▲) and **DOWN** (▼) buttons, as necessary, to highlight **Audible Tone** in the Tool Settings Menu, then press the **ENTER** (↵) button.

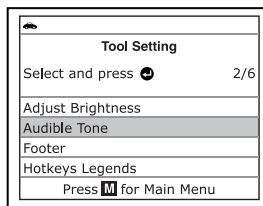

- The Audible Tone screen displays.
2. Use the **UP** (▲) and **DOWN** (▼) buttons, as necessary, to highlight **ON** or **OFF** as desired.
 3. When the desired option is selected, press the **ENTER** (↵) button to save your changes and return to the Tool Settings Menu.

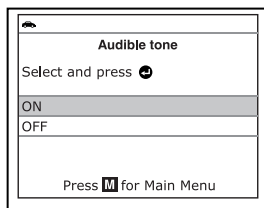

To exit the Audible Tone screen and return to the Tool Settings Menu without making changes, press the **M** button.

Selecting the Display Language

1. Use the **UP** (▲) and **DOWN** (▼) buttons, as necessary, to highlight **Language Selection** in the Tool Settings menu, then press the **ENTER** (↵) button.
 - The Select Language screen displays.
 - The currently selected display language is highlighted.
2. Use the **UP** (▲) and **DOWN** (▼) buttons, as necessary, to highlight the desired display language.
3. When the desired display language is highlighted, press the **ENTER** (↵) button to save your changes and return to the Tool Settings Menu (shown in the selected display language).

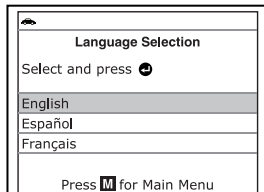
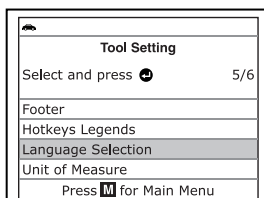

To exit the Select Language screen and return to the Tool Settings Menu without making changes, press the **M** button.

Setting the Unit of Measurement

1. Use the **UP** (▲) and **DOWN** (▼) buttons, as necessary, to highlight **Unit of Measurement** in the Tool Settings Menu, then press the **ENTER** (↵) button.
 - The Unit of Measurement screen displays.
 - The currently selected **Unit of Measurement** is highlighted.
2. Use the **UP** (▲) and **DOWN** (▼) buttons, as necessary, to highlight the desired **Unit of Measurement**.

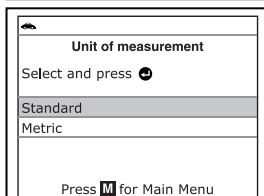
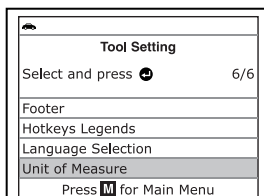





- When the desired **Unit of Measurement** value is selected, press the **ENTER**  button to save your changes and return to the Tool Settings Menu.



To exit the Unit of Measurement screen and return to the Tool Settings Menu without making changes, press the **M** button.

Viewing Hotkey Legends

- Use the **UP**  and **DOWN**  buttons, as necessary, to highlight **Hotkey Legends** in the Tool Settings menu, then press the **ENTER**  button.
 - The Hotkey Legends screen displays.
 - The screen shows a functional description of each of the diagnostic tool's hotkeys.
- When you have finished viewing the Hotkey Legends, press the **ENTER**  button to return to the Tool Settings menu.

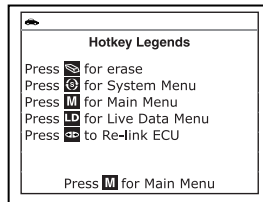
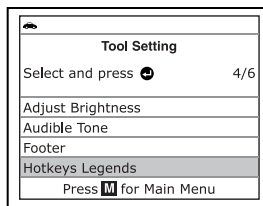

Exiting the Tool Settings Menu

- Press the **M** button to return to the Main Menu.

Generic (Global) OBD2 PID List

The following is a list of Generic (Global) PIDs and their descriptions.

Tool Display	Unit	Value	PID Description
ACC Pedal D	%	XXX.X	Accelerator Pedal Position D
ACC Pedal E	%	XXX.X	Accelerator Pedal Position E
ACC Pedal F	%	XXX.X	Accelerator Pedal Position F
Air Status	-	UPS, DNS, OFF	Commanded Secondary Air Status
Ambient	*C / *F	XXX	Ambient Air Temperature
Aux Input Status	-	On / Off	Auxiliary Input Status
BARO	kPa /inHg	XXX / XX.X	Barometric Pressure
Calc LOAD	%	XXX.X	Calculated LOAD Value
CAT Temp 11	*C / *F	XXXX.X	Catalyst Temperature Bank 1- Sensor 1
CAT Temp 12	*C / *F	XXXX.X	Catalyst Temperature Bank 1- Sensor 2
CAT Temp 21	*C / *F	XXXX.X	Catalyst Temperature Bank 2- Sensor 1
CAT Temp 22	*C / *F	XXXX.X	Catalyst Temperature Bank 2- Sensor 2
Command EGR	%	XXX.X	Commanded EGR
Command EVAP	%	XXX.X	Commanded Evaporative Purge
Command TAC	%	XXX.X	Commanded Throttle Actuator
Dist DTC Clr	km /mile	XXXXX	Distance since DTC Cleared
Dist MIL ON	km /mile s	XXXXX	Distance Traveled while MIL ON
ECT	*C / *F	XXX / XXX	Engine Coolant Temp
ECU Volts	V	XX.XXX	Control Module Voltage
EGR Error	%	XXX.X	EGR Error
Eng RPM	min	XXXXXX	Engine RPM
EQ Ratio	-	X.XXX	Commanded Equivalence Ratio
EQ Ratio 11	-	X.XXX	Bank 1 - Sensor 1 Equivalence Ratio
EQ Ratio 12	-	X.XXX	Bank 1 - Sensor 2 Equivalence Ratio
EQ Ratio 13	-	X.XXX	Bank 1 - Sensor 3 Equivalence Ratio

Generic (Global) OBD2 PID List

Tool Display	Unit	Value	PID Description
EQ Ratio 14	-	X.XXX	Bank 1 - Sensor 4 Equivalence Ratio
EQ Ratio 21	-	X.XXX	Bank 2 - Sensor 1 Equivalence Ratio
EQ Ratio 22	-	X.XXX	Bank 2 - Sensor 2 Equivalence Ratio
EQ Ratio 23	-	X.XXX	Bank 2 - Sensor 3 Equivalence Ratio
EQ Ratio 24	-	X.XXX	Bank 2 - Sensor 4 Equivalence Ratio
EVAP Press	Pa /in H ₂ O	XXXX.XX /XX.XXX	Evap System Vapor Pressure
FP / Vac	kPa /PSI	XXXX.XXX /XXX.X	Fuel Rail Pressure relative to Vacuum
Fuel Level	%	XXX.X	Fuel Level Input
Fuel Press	kPa /PSI	XXX / XX.X	Fuel Rail Pressure
Fuel Press	kPa /PSI	XXXXX /XXXX.X	Fuel Rail Pressure
Fuel Sys 1	-	OL	Fuel System 1 Status
Fuel Sys 1	-	CL	Fuel System 1 Status
Fuel Sys 1	-	OL-Drive	Fuel System 1 Status
Fuel Sys 1	-	OL-Fault	Fuel System 1 Status
Fuel Sys 1	-	CL-Fault	Fuel System 1 Status
Fuel Sys 2	-	OL	Fuel System 2 Status
Fuel Sys 2	-	CL	Fuel System 2 Status
Fuel Sys 2	-	OL-Drive	Fuel System 2 Status
Fuel Sys 2	-	OL-Fault	Fuel System 2 Status
Fuel Sys 2	-	CL-Fault	Fuel System 2 Status
IAT	*C / *F	XXX / XXX	Intake Air Temperature
LOAD Value	%	XXX.X	Absolute Load Value
LTFT B1	%	XXX.X	Long Term Fuel Trim-Bank 1
LTFT B2	%	XXX.X	Long Term Fuel Trim-Bank 2
LTFT B3	%	XXX.X	Long Term Fuel Trim-Bank 3
LTFT B4	%	XXX.X	Long Term Fuel Trim-Bank 4
MAF	g/s ;l b/min	XXX.XX /XXXX.X	Air Flow Rate from Mass Air Flow Sensor
MAP	kPa /PSI	XXX / XX.X	Intake Manifold Absolute Pressure
MIL On Time	hrs, min	XXXX, XX	Engine Run Time while MIL ON
Monitor Status	-	ICONS on Display	Monitor Status this Driving Cycle
O2S B1 S1	V	X.XXX	Bank 1 - Sensor 1

Generic (Global) OBD2 PID List

Tool Display	Unit	Value	PID Description
O2S B1 S1 mA	mA	X.XXX	Bank 1 - Sensor 1 O2S Current
O2S B1 S1 V	V	X.XXX	Bank 1 - Sensor 1 O2S Voltage
O2S B1 S2	V	X.XXX	Bank 1 - Sensor 2
O2S B1 S2 mA	mA	X.XXX	Bank 1 - Sensor 2 O2S Current
O2S B1 S2 V	V	X.XXX	Bank 1 - Sensor 2 O2S Voltage
O2S B1 S3	V	X.XXX	Bank 1 - Sensor 3
O2S B1 S3 mA	mA	X.XXX	Bank 1 - Sensor 3 O2S Current
O2S B1 S3 V	V	X.XXX	Bank 1 - Sensor 3 O2S Voltage
O2S B1 S4	V	X.XXX	Bank 1 - Sensor 4
O2S B1 S4 mA	mA	X.XXX	Bank 1 - Sensor 4 O2S Current
O2S B1 S4 V	V	X.XXX	Bank 1 - Sensor 4 O2S Voltage
O2S B2 S1	V	X.XXX	Bank 2 - Sensor 1
O2S B2 S1 mA	mA	X.XXX	Bank 2 - Sensor 1 O2S Current
O2S B2 S1 V	V	X.XXX	Bank 2 - Sensor 1 O2S Voltage
O2S B2 S2	V	X.XXX	Bank 2 - Sensor 2
O2S B2 S2 mA	mA	X.XXX	Bank 2 - Sensor 2 O2S Current
O2S B2 S2 V	V	X.XXX	Bank 2 - Sensor 2 O2S Voltage
O2S B2 S3	V	X.XXX	Bank 2 - Sensor 3
O2S B2 S3 mA	mA	X.XXX	Bank 2 - Sensor 3 O2S Current
O2S B2 S3 V	V	X.XXX	Bank 2 - Sensor 3 O2S Voltage
O2S B2 S4	V	X.XXX	Bank 2 - Sensor 4
O2S B2 S4 mA	mA	X.XXX	Bank 2 - Sensor 4 O2S Current
O2S B2 S4 V	V	X.XXX	Bank 2 - Sensor 4 O2S Voltage
O2S Location	-	O2S11	Oxygen Sensor, Bank 1, Sensor 1
O2S Location	-	O2S12	Oxygen Sensor, Bank 1, Sensor 2
O2S Location	-	O2S13	Oxygen Sensor, Bank 1, Sensor 3
O2S Location	-	O2S14	Oxygen Sensor, Bank 1, Sensor 4
O2S Location	-	O2S21	Oxygen Sensor, Bank 2, Sensor 1
O2S Location	-	O2S22	Oxygen Sensor, Bank 2, Sensor 1
O2S Location	-	O2S23	Oxygen Sensor, Bank 2, Sensor 3
O2S Location	-	O2S24	Oxygen Sensor, Bank 2, Sensor 4
O2S Location	-	O2S11	Oxygen Sensor, Bank 1, Sensor 1
O2S Location	-	O2S12	Oxygen Sensor, Bank 1, Sensor 2
O2S Location	-	O2S21	Oxygen Sensor, Bank 2, Sensor 1
O2S Location	-	O2S22	Oxygen Sensor, Bank 2, Sensor 2
O2S Location	-	O2S31	Oxygen Sensor, Bank 3, Sensor 1
O2S Location	-	O2S32	Oxygen Sensor, Bank 3, Sensor 2
O2S Location	-	O2S41	Oxygen Sensor, Bank 4, Sensor 1

Generic (Global) OBD2 PID List

Tool Display	Unit	Value	PID Description
O2S Location	-	O2S42	Oxygen Sensor, Bank 4, Sensor 2
OBD Support	-	OBD2	OBD Requirements
OBD Support	-	OBD	OBD Requirements
OBD Support	-	OBD and OBD2	OBD Requirements
OBD Support	-	OBD1	OBD Requirements
OBD Support	-	No OBD	OBD Requirements
OBD Support	-	EOBD	OBD Requirements
OBD Support	-	EOBD and OBD2	OBD Requirements
OBD Support	-	EOBD and OBD	OBD Requirements
OBD Support	-	EOBD, OBD and OBD2	OBD Requirements
OBD Support	-	JOBD	OBD Requirements
OBD Support	-	JOBD and OBD2	OBD Requirements
OBD Support	-	JOBD and EOBD	OBD Requirements
OBD Support	-	JOBD, EOBD and OBD2	OBD Requirements
PTO Status	-	On / Off	Power Take Off Status
Rel TPS	%	XXX.X	Relative Throttle Position
Spark Adv	deg	XX	Ignition Timing Advance #1 Cylinder
STFT B1	%	XXX.X	Short Term Fuel Trim-Bank 1
STFT B1 S1	%	XXX.X	Bank 1 - Sensor 1
STFT B1 S2	%	XXX.X	Bank 1 - Sensor 2
STFT B1 S3	%	XXX.X	Bank 1 - Sensor 3
STFT B1 S4	%	XXX.X	Bank 1 - Sensor 4
STFT B2	%	XXX.X	Short Term Fuel Trim-Bank 2
STFT B2 S1	%	XXX.X	Bank 2 - Sensor 1
STFT B2 S2	%	XXX.X	Bank 2 - Sensor 2
STFT B2 S3	%	XXX.X	Bank 2 - Sensor 3
STFT B2 S4	%	XXX.X	Bank 2 - Sensor 4
STFT B3	%	XXX.X	Short Term Fuel Trim-Bank 3
STFT B4	%	XXX.X	Short Term Fuel Trim-Bank 4
Time DTC Clr	hrs, min	XXXX, XX	Time since DTC Cleared
Time Since Start	sec	XXXX	Time Since Engine Start
TPS	%	XXX.X	Absolute Throttle Position
TPS B	%	XXX.X	Absolute Throttle Position B
TPS C	%	XXX.X	Absolute Throttle Position C

Generic (Global) OBD2 PID List

Tool Display	Unit	Value	PID Description
Veh Speed	km/h / mph	XXX / XXX	Vehicle Speed Sensor
Warm-up DTC Clr	-	XXX	# Warm-ups since DTC Cleared

VEHICLE APPLICATIONS – MAKES COVERED

The diagnostic tool has the ability to retrieve and erase ABS codes. Vehicle Makes supported by the diagnostic tool are shown below. Please visit www.innova.com for a complete list of vehicles covered.

ACURA	JEEP
AM GENERAL	LEXUS
BUICK	LINCOLN
CADILLAC	MERCURY
CHEVROLET	OLDSMOBILE
CHRYSLER	PLYMOUTH
DAEWOO	PONTIAC
DODGE	RAM
FORD	SATURN
GENERAL MOTORS	SCION
GEO	SRT
GMC	TOYOTA
HONDA	
HUMMER	

INTRODUCTION

This Glossary contains definitions for abbreviations and terms you may find in this manual or in your vehicle service manual.

GLOSSARY OF TERMS AND ABBREVIATIONS

CARB – California Air Resources Board

CCM – Central Control Module

Computer Control System – An electronic control system, consisting of an on-board computer and related sensors, switches and actuators, used to ensure peak performance and fuel efficiency while reducing pollutants in the vehicle's emissions.

DIY – Do-It-Yourself

DLC – Data Link Connector

Drive Cycle – An extended set of driving procedures that takes into consideration the various types of driving conditions encountered in real life.

Driving Condition – A specific environmental or operation condition under which a vehicle is operated; such as starting the vehicle when cold, driving at steady speed (cruising), accelerating, etc.

DTC(s) – Diagnostic Trouble Code(s)

EGR – Exhaust Gas Recirculation

System Status – An indication of whether or not a vehicle's emissions-related system are operating properly and are ready for Inspection and Maintenance testing.

EPA – Environmental Protection Agency

EVAP – Evaporative Emissions System

Fault Code – See DTCs

Freeze Frame – A digital representation of engine and/or emissions system conditions present when a fault code was recorded.

FTP – Fuel Tank Pressure

Generic Code – A DTC that applies to all OBD2 compliant vehicles.

I/M Test / Emissions Test / Smog Check – A functional test of a vehicle to determine if tailpipe emissions are within Federal/State/Local requirements.

LCD – Liquid Crystal Display

LED – Light Emitting Diode

LTFT – Long Term Fuel Trim, is a program in the vehicle's computer designed to add or subtract fuel from the vehicle to compensate for operating conditions that vary from the ideal A/F ratio (long term).

Manufacturer Specific Code – A DTC that applies only to OBD2 compliant vehicles made by a specific manufacturer.

MIL – Malfunction Indicator Lamp (also referred to as “Check Engine” light)

OBD1 – On-Board Diagnostics Version 1 (also referred to as “OBD I”)

OBD2 – On-Board Diagnostics Version 2 (also referred to as “OBD II”)

On-Board Computer – The central processing unit in the vehicle’s computer control system.

PCM – Powertrain Control Module

Pending Code – A code recorded on the “first trip” for a “two-trip” code. If the fault that caused the code to be set is not detected on the second trip, the code is automatically erased.

STFT – Short Term Fuel Trim, is a program in the vehicle’s computer designed to add or subtract fuel from the vehicle to compensate for operating conditions that vary from the ideal A/F ratio. The vehicle uses this program to make minor fuel adjustments (fine tune) on a short-term basis.

Trip Drive Cycle – Vehicle operation that provides the necessary driving condition to enable a vehicle Monitor to run and complete its diagnostic testing.

VECI – Vehicle Emission Control Information Decal

LIMITED ONE YEAR WARRANTY

The Manufacturer warrants to the original purchaser that this unit is free of defects in materials and workmanship under normal use and maintenance for a period of one (1) year from the date of original purchase.

If the unit fails within the one (1) year period, it will be repaired or replaced, at the Manufacturer's option, at no charge, when returned prepaid to the Service Center with Proof of Purchase. The sales receipt may be used for this purpose. Installation labor is not covered under this warranty. All replacement parts, whether new or remanufactured, assume as their warranty period only the remaining time of this warranty.

This warranty does not apply to damage caused by improper use, accident, abuse, improper voltage, service, fire, flood, lightning, or other acts of God, or if the product was altered or repaired by anyone other than the Manufacturer's Service Center.

The Manufacturer, under no circumstances shall be liable for any consequential damages for breach of any written warranty of this unit. This warranty gives you specific legal rights, and you may also have rights, which vary from state to state. This manual is copyrighted with all rights reserved. No portion of this document may be copied or reproduced by any means without the express written permission of the Manufacturer. **THIS WARRANTY IS NOT TRANSFERABLE.** For service, send via U.P.S. (if possible) prepaid to Manufacturer. Allow 3-4 weeks for service/repair.

SERVICE PROCEDURES

If you have any questions, require technical support or information on UPDATES and OPTIONAL ACCESSORIES, please contact your local store, distributor or the Service Center.

USA & Canada:

(800) 544-4124 (6:00AM-6:00PM, Monday through Saturday)

All others: (714) 241-6802 (6:00AM-6:00PM, Monday through Saturday)

FAX: (714) 241-3979 (24 hr.)

Web: www.innova.com



SERVICE IN USA
WE EMPLOY TECHNICIANS CERTIFIED BY ASE ONLY.
LET US SHOW YOU THEIR CREDENTIALS.
www.innova.com

INNOVA[®]
ELECTRONICS CORPORATION

Innova Electronics Corp.
17352 Von Karman Ave.
Irvine, CA 92614

Instruction MRP #93-0257 Rev. B
Copyright © 2015 IEC. All Rights Reserved.



WARNING:

This product may contain chemicals known to the state of California to cause cancer and birth defects or other reproductive harm.

