

# **GENERAL LOCK**

## **2021 Product Catalog**

# *Superior Quality Exceptional Value*



**866-407-7597** ♦ **info@GeneralLock.com** ♦ **GeneralLock.com**

info@northernvideo.com ♦ techsupport@northernvideo.com ♦ www.northernvideo.com ♦ 855-388-7422

# GENERAL LOCK

## 2021 Product Catalog

### Contents

<b>GENERAL INFO</b> .....	<b>3 - 4</b>	<b>CYLINDERS, CORES, HOUSINGS, &amp; KEYS</b> .....	<b>21 - 31</b>	<b>PADLOCKS</b> .....	<b>44 - 47</b>
Finish, Handing, and Functions .....	3	Custom Cylinders .....	22	Brass Body KLC Rekeyable .....	44
Warranty, Certifications, and Terms .....	4	Restricted Key Systems .....	23	Steel Body SFIC Padlocks .....	45
<b>GRADE 1 LEVERS</b> .....	<b>5 - 7</b>	Mortise Cylinders .....	24	Brass & Brass/Chrome Body SFIC Padlocks.....	45
L100 Series Clutched Levers .....	5	KLC, Rim, Dummy & T-Turn Cylinders .....	25	Brass Body LFIC Padlocks.....	45
L100 Series Clutched LFIC Levers.....	6	SFIC Cores .....	26	PL451/452/453 Padlock Parts .....	45
L100 Series Clutched SFIC Levers.....	6	SFIC Housings .....	27	Hidden Shackle Padlocks & Hasps .....	46
L100 Series Clutched Curved Levers.....	6	LFIC SCHL Cores & Housings .....	28	Rekeyable - Steel - Round Body Padlocks.....	46
LX100 Series Rigid Levers .....	6	Cylinder Parts.....	29	Steel Body Rekeyable .....	46
LX100 Series Rigid SFIC Levers.....	6	Key Blanks .....	30	Steel Body Padlock Parts .....	46
L100 Series Clutched Electrified Levers .....	7	Custom Coined Keys .....	31	Discus Padlocks .....	47
<b>GRADE 1 PARTS</b> .....	<b>8</b>	<b>BUILDER'S HARDWARE</b> .....	<b>32 - 34</b>	Resettable Combo .....	47
Grade 1 Lever and Knob Parts.....	8	Filler Plates .....	33	Laminated Steel Padlocks.....	47
<b>GRADE 1 EXTERIOR ENTRY MORTISE LOCKS</b>		Hole Filler Plates.....	33	Brass Non-rekeyable Padlocks.....	47
GM9100 Series Mortise Locks .....	9	Scar Plate.....	33	<b>SAFES</b> .....	<b>48</b>
<b>GRADE 2 LEVERS</b> .....	<b>10 - 13</b>	Hinges.....	33	Depository Safes .....	48
L200S Series Clutched Levers .....	11 - 12	Push, Pull & Kick Plates.....	34	Hotel Safe .....	48
L200N Series Clutched Levers.....	12	Wrap Arouds .....	34	Safe - Parts & Components .....	48
L200N Series Clutched SFIC Levers .....	12	<b>EXIT DEVICES</b> .....	<b>35 - 37</b>	<b>TOOLS &amp; SUPPLIES</b> .....	<b>49</b>
LX200S Series Rigid Levers .....	13	ED1000 Series - Storefront.....	35	<b>NORTHERN VIDEO</b> .....	<b>50 - 63</b>
LX200N Series Rigid Levers .....	13	ED1000 Series Parts .....	35	<b>IP &amp; HD ANALOG RECORDERS &amp; CAMERAS</b>	
<b>GRADE 1 KNOBSETS</b> .....	<b>14</b>	ED2300 Series Std. Duty Exit Device.....	36	<b>MONITORS &amp; POWER SUPPLIES</b> .....	<b>50 - 54</b>
K100 Series Cylindrical Knobsets.....	14	ED2300 Series Trims & Parts.....	37	Northern IP-POE NVRs & 4MP Cameras.....	51
<b>GRADE 2 KNOBSETS</b> .....	<b>14 - 16</b>	<b>STOREFRONT</b> .....	<b>38 - 39</b>	Northern 2MP Outdoor IR PTZ Cameras	
K200 Series Cylindrical Knobsets.....	15 - 16	Storefront Locks.....	39	Accessories and Surveillance Products .....	52
<b>GRADE 2 PARTS</b> .....	<b>17</b>	Storefront Hardware & Lock Parts.....	39	Northern Hybrid HD Analog DVR's	
Grade 2 Lever and Knob Parts.....	17	Storefront Hardware - Pivots.....	39	& HD-TVI Cameras.....	53
<b>GRADE 1 DEADBOLTS</b> .....	<b>18</b>	<b>DOOR CLOSERS</b> .....	<b>40 - 43</b>	Monitors, Mounts, Power Supplies,	
D660 Series Grade 1 Deadbolt.....	18	C3600 Fixed Power Overhead Concealed.....	40	Cables & Connectors .....	54
<b>GRADE 2 DEADBOLTS</b> .....	<b>19</b>	CX3700 Adjust. Power Overhead Concealed .....	40	<b>STRUCTURED CABLING SOLUTIONS</b> .....	<b>55 - 63</b>
D160 Series Grade 2 Deadbolt.....	19	Overhead Concealed Door Closer Parts .....	40	Structured Cabling System .....	56
<b>GRADE 1 &amp; 2 DEADBOLT PARTS</b> .....	<b>20</b>	CX5000 Series Surface Door Closers .....	41	Faceplates, SMB's, Patch Panels	
		CX5000 Parts.....	41	& Patch Cords .....	57
		CX7000 Series Surface Door Closers .....	42	Relay Rack & Hinged Wall Bracket Solutions .....	58
		CX7000 Parts.....	42	22 Gauge Multiconductor Cable .....	59
		CX9000 Series Surface Door Closers .....	43	Fire Alarm Cable .....	60
		CX9000 Parts.....	43	Alarm & Signal Cable .....	61
				Access Control Cables .....	62
				Fiber Jumper Cable .....	63

### Finish Code Numbers:



605 / US3  
Bright Brass

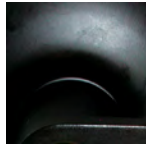

613 / US10B  
Oil Rubbed Bronze

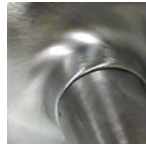

626 / US26D  
Satin Chrome

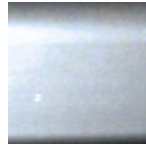

628 / US28  
Anodized Aluminum



630 / US32D  
Satin Stainless Steel

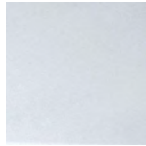

689  
Painted Aluminum

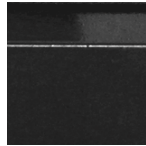

695  
Painted Dark  
Bronze

ALUM = Aluminum  
DURO = Duranodic

BP = Brass Plated  
PC = Prime Coat  
SL = Silver

US4 - Satin Brass

313 = Duranodic  
609 / US5 Antique Brass  
606 / US4 Satin Brass

### Handing Chart:

Standing on the outside (Keyhole side) of the door

**LEFT HAND**  
Hinges on  
Left Opens  
Inward



**RIGHT HAND**  
Hinges on  
Right Opens  
Inward



**LEFT HAND  
REVERSE**  
Hinges on  
Left Opens  
Outward



**RIGHT HAND  
REVERSE**  
Hinges on  
Right Opens  
Outward



### Functions:

**10 - Passage Set** **F75 ANSI**  
Latch bolt operated by knob/lever, from either side at all times.



**40 - Privacy Lock** **F76 ANSI**  
Latch bolt operated by knob/lever from either side. Outside knob/lever is locked by push button or other locking device inside and unlocked by emergency release outside, operating inside knob/lever or closing door.



**53 - Entrance Lock** **F109 ANSI**  
Dead locking latch bolt operated by knob/lever from either side except when outside knob/lever is locked by the push or turn button inside. Key outside or operating inside knob/lever releases push or turn button unlocking outside knob/lever except when push or turn button has been rotated to keep outside knob/lever locked. Inside push or turn button must be manually operated to unlock outside knob/lever. Inside knob/lever always operates latch bolt.



**70 - Classroom Lock** **F84 ANSI**  
Dead locking latch bolt operated by knob/lever from either side except when outside knob/lever is locked from outside by key. Inside knob/lever always operative.



**75 - Classroom Security Lock** **F110 ANSI**  
Dead locking latch bolt operated by lever from either side. Key either inside or outside locks or unlocks outside lever. Inside lever always operates latch bolt.



**80 - Storeroom Lock** **F86 ANSI**  
Dead locking latch bolt operated by key in outside knob/lever, or by operating inside knob/lever. Outside knob/lever is always inoperable.



**82 - Asylum/Institutional Lock** **F87 ANSI**  
Dead locking latch bolt operated by key in knobs/levers, from either side. Both knobs/levers always inoperable.



**Electrically Unlocked (Fail Secure - FSE)**  
Dead locking latch bolt operated by outside lever when outside lever is unlocked by electric current, by key in outside lever, or by operating inside lever

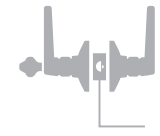

**Electrically locked (Fail Safe - FSA)**  
Deadlocking latch bolt operated by outside lever when power fails, by key in outside lever, or by operating inside lever

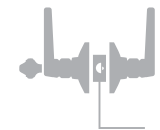

**Single Cylinder Deadbolt - Deadbolt**  
thrown or retracted by key on the outside or by inside turn unit. Bolt automatically deadlocks when fully thrown.



**Double Cylinder Deadlock - Deadbolt**  
thrown or retracted by key on either side. Bolt automatically deadlocks when fully thrown.



## No Hassle Warranty Replacement

For Warranty, Replacements\*

Call General Lock Customer Service: **866-407-7597**



**“If it breaks under warranty, we will send out a replacement. It’s as simple as that!”**

### All General Lock Products - Except Door Closers

- Customer provides invoice# of original purchase and Anixter account# for sales history verification.
- General Lock Customer Service verifies that the product is under Warranty.
- A warranty replacement is sent out at no charge
- Defective product returns are not required in most cases.

### All General Lock Surface and Concealed Door Closers

- Customer provides invoice# of original purchase and Anixter account# for sales history verification.
- Customer provides invoice # of original purchase and Anixter account # for sales history verification.
- Customer emails a picture of the defective closer showing the manufacture date on closer body
- General Lock Customer Service email - [info@generallock.com](mailto:info@generallock.com)
- General Lock Customer Service verifies that the product is under warranty
- A warranty replacement is sent out at no charge
- Defective product returns are not required in most cases.

\* For Credit Refunds contact your Anixter sales rep directly

### Certifications:

Many products sold by General Lock are independently tested and comply with ANSI and UL standards. Field modification or disassembly beyond normal installation will void certification. Please see UL and ANSI web sites for details on certifications mentioned in this catalog.

ANSI

Underwriters Laboratories, Inc.

Federal Specifications

ADA

California Fire Marshal Code



### Terms and Warranty:

Copyright: ©2017 General Lock, a division of Anixter Inc. All text, graphics, photographs, and any selection, coordination, and arrangement of such materials contained herein is copyrighted and owned by General Lock. No material from this catalog may be copied, reproduced, republished, uploaded, posted, transmitted, or distributed in any way unless permission has been expressly granted by General Lock and any reproduction of this catalog, in whole or in part, and/or any information or materials contained in it is prohibited without the express authorization of General Lock. General Lock is a trademark or registered trademark of General Lock. ANY MATERIALS OR INFORMATION PROVIDED BY GENERAL LOCK IN THIS CATALOG IS PROVIDED “AS IS” WITHOUT WARRANTY OF ANY KIND. GENERAL LOCK ASSUMES NO RESPONSIBILITY FOR ERRORS OR OMISSIONS IN THIS CATALOG, OR OTHER PUBLICATION OR OTHER DOCUMENTS, WHICH ARE REFERENCED BY THIS PUBLICATION. All other brand names or product names, including Arrow, Best, Corbin-Russwin, Falcon, Kwikset, KSP, Sargent, Schlage, Weiser, and Yale, referenced herein are trademarks, registered trademarks, service marks, or trade names of the respective manufacturers of such products and are owned by their respective holders. General Lock reserves the right to make changes in designs and specifications, to make addition or improvements on its products or to discontinue products without incurring any obligation. General Lock is not responsible for modification, addition or alteration to our products by others. Products may not appear as depicted. General Lock warrants only to Buyer that the products will be free from defects in material and workmanship for a period of 12 months from the date of shipment of the products unless a longer period is specified. This warranty does not cover wear and tear and shall be ineffective and shall not apply to products that have been subjected to misuse or abuse, neglect, accident, damage, or improper installation, or maintenance. Buyer’s sole and exclusive remedy under these warranties will be limited to, at General Lock’s sole option and expense, refund of the purchase price of, or the repair or replacement for of, the products or parts thereof which General Lock reasonably determines do not conform with these warranties. Buyer will inspect the products upon delivery and will promptly notify General Lock in writing of any defect in the products. Proof of purchase is required. **DISCLAIMER OF WARRANTIES: THE FOREGOING WARRANTIES ARE EXCLUSIVE AND IN LIEU OF, AND GENERAL LOCK DISCLAIMS, AND BUYER WAIVES, ALL OTHER WARRANTIES OF MERCHANTABILITY, FITNESS FOR A PARTICULAR PURPOSE AND OF ANY OTHER TYPE, WHETHER EXPRESS OR IMPLIED, ARISING BY LAW (STATUTORY OR OTHERWISE) AND WHETHER OR NOT OCCASIONED BY GENERAL LOCK’S NEGLIGENCE. LIMITATION OF LIABILITY: IN NO EVENT SHALL GENERAL LOCK BE LIABLE FOR LOST PROFITS OR ANY SPECIAL, INCIDENTAL, INDIRECT, PUNITIVE, OR CONSEQUENTIAL DAMAGES, INCLUDING ANY DAMAGES OCCASIONED BY GENERAL LOCK’S NEGLIGENCE. IN ADDITION, GENERAL LOCK’S LIABILITY ON ANY CLAIMS FOR DAMAGES OR CLAIMS ARISING OUT OF OR CONNECTED WITH THIS AGREEMENT OR THE SALE, DELIVERY OR USE OF THE PRODUCTS SHALL NOT EXCEED THE PURCHASE PRICE OF THE PRODUCTS AND/OR SERVICES DELIVERED. IN THE EVENT THIS DISCLAIMER OF WARRANTY STATEMENT IS DISALLOWED BY APPLICABLE LAW, SUCH EXPRESS OR IMPLIED WARRANTIES SHALL BE LIMITED IN DURATION TO THE WARRANTY PERIOD (OR THE MINIMUM PERIOD REQUIRED BY THE APPLICABLE LAW).**

### Grade 1 Levers

Super heavy-duty commercial leverset designed for high traffic interior and exterior doors.

- ◆ Meets ANSI A156.2 Grade 1 Standards
- ◆ Designed for ADA Barrier Free Applications



#### SPECIFICATIONS:

Certifications	ANSI A156.2 Grade 1, UL Listed 3 Hour Fire, ADA Compliant
Finishes	Satin Chrome (626), Oil Rubbed Bronze (613), Bright Brass (605)
Lever Designs	R-Lever (Straight), C-Lever (Curved) L-Clutched or LX-Rigid Mechanism
Keyways	LFIC-SCHL Prep
Backset	Standard - 2-3/4 Optional - 2-3/8", 3-3/4", & 5"
Strike	ANSI - 1-1/4" x 4-7/8"
Door Thickness	1-3/8" to 2"
Warranty	Lifetime Mechanical / 5 Year Finish / 1 Year Electrical

#### L100 Series Clutched Levers - Schlage C Keyway

ANX#	Part#	Function	Finish	Keyway	Backset
CS338534	L110R 605 234 S ANSI	Passage	US3		2-3/4"
CS338535	L110R 613 234 S ANSI	Passage	US10B		2-3/4"
CS338536	L110R 626 234 S ANSI	Passage	US26D		2-3/4"
CS338537	L140R 605 234 S ANSI	Privacy	US3		2-3/4"
CS338538	L140R 613 234 S ANSI	Privacy	US10B		2-3/4"
CS338539	L140R 626 234 S ANSI	Privacy	US26D		2-3/4"
CS338524	L153R 605 C 234 S ANSI	Entry	US3	SCHL-C	2-3/4"
CS338528	L153R 613 C 234 S ANSI	Entry	US10B	SCHL-C	2-3/4"
CS338529	L153R 626 C 234 S ANSI	Entry	US26D	SCHL-C	2-3/4"
CS338510	L170R-360 605 C 234 S ANSI	Classroom	US3	SCHL-C	2-3/4"
CS480944	L170R-360 613 C 234 S ANSI	Classroom	US10B	SCHL-C	2-3/4"
CS480946	L170R-360 626 C 234 S ANSI	Classroom	US26D	SCHL-C	2-3/4"
CS123192	L175R 613 C 234 S ANSI	Classroom Security	US10B	SCHL-C	2-3/4"
CS117212	L175R 626 C 234 S ANSI	Classroom Security	US26D	SCHL-C	2-3/4"
CS338540	L180R 605 C 234 S ANSI	Storeroom	US3	SCHL-C	2-3/4"
CS338541	L180R 613 C 234 S ANSI	Storeroom	US10B	SCHL-C	2-3/4"
CS338542	L180R 626 C 234 S ANSI	Storeroom	US26D	SCHL-C	2-3/4"
CS415926	L182R 626 C 234 S ANSI	Institution	US26D	SCHL-C	2-3/4"



### Grade 1 Levers

#### L100 Series Clutched LFIC Levers (sold less core)

ANX#	Part#	Function	Finish	Keyway	Backset
CS123179	L153R 626 LFIC 234 S ANSI	Entry	US26D	LFIC	2-3/4"
CS123181	L180R 626 LFIC 234 S ANSI	Storeroom	US26D	LFIC	2-3/4"



#### L100 Series Clutched SFIC Levers (sold less core)

ANX#	Part#	Function	Finish	Keyway	Backset
CS338530	L153R 605 IC 234 S ANSI	Entry	US3	SFIC	2-3/4"
CS338532	L153R 613 IC 234 S ANSI	Entry	US10B	SFIC	2-3/4"
CS338533	L153R 626 IC 234 S ANSI	Entry	US26D	SFIC	2-3/4"
CS495798	L170R-360 605 IC 234 S ANSI	Classroom	US3	SFIC	2-3/4"
CS480945	L170R-360 613 IC 234 S ANSI	Classroom	US10B	SFIC	2-3/4"
CS480947	L170R-360 626 IC 234 S ANSI	Classroom	US26D	SFIC	2-3/4"
CS117219	L175R 626 IC 234 S ANSI	Classroom Security	US26D	SFIC	2-3/4"
CS338543	L180R 605 IC 234 S ANSI	Storeroom	US3	SFIC	2-3/4"
CS338544	L180R 613 IC 234 S ANSI	Storeroom	US10B	SFIC	2-3/4"
CS338545	L180R 626 IC 234 S ANSI	Storeroom	US26D	SFIC	2-3/4"



#### L100 Series Clutched Curved Levers - Schlage C Keyway

ANX#	Part#	Function	Finish	Keyway	Backset
CS440635	L110C 626 234 S ANSI	Passage	US26D		2-3/4"
CS440636	L140C 626 234 S ANSI	Privacy	US26D		2-3/4"
CS440637	L153C 626 C 234 S ANSI	Entry	US26D	SCHL-C	2-3/4"
CS480943	L170C-360 626 C 234 S ANSI	Classroom	US26D	SCHL-C	2-3/4"
CS440639	L180C 626 C 234 S ANSI	Storeroom	US26D	SCHL-C	2-3/4"



#### LX100 Series Rigid Levers - Schlage C Keyway

ANX#	Part#	Function	Finish	Keyway	Backset
CS432741	LX140R 626 234 S ANSI	Privacy	US26D		2-3/4"
CS432742	LX153R 613 C 234 S ANSI	Entry	US10B	SCHL-C	2-3/4"
CS432743	LX153R 626 C 234 S ANSI	Entry	US26D	SCHL-C	2-3/4"
CS432747	LX170R 613 C 234 S ANSI	Classroom	US10B	SCHL-C	2-3/4"
CS432749	LX170R 626 C 234 S ANSI	Classroom	US26D	SCHL-C	2-3/4"
CS432754	LX180R 613 C 234 S ANSI	Storeroom	US10B	SCHL-C	2-3/4"
CS432756	LX180R 626 C 234 S ANSI	Storeroom	US26D	SCHL-C	2-3/4"

#### LX100 Series Rigid SFIC Levers (sold less core)

ANX#	Part#	Function	Finish	Keyway	Backset
CS432745	LX153R 626 IC 234 S ANSI	Entry	US26D	SFIC	2-3/4"
CS432752	LX170R 626 IC 234 S ANSI	Classroom	US26D	SFIC	2-3/4"
CS432757	LX180R 626 IC 234 S ANSI	Storeroom	US26D	SFIC	2-3/4"

## Grade 1 Levers - Electrified

### L100 Series Clutched Electrified Levers - Continuous Duty - Fail Secure

ANX#	Part#	Voltage	Finish	Keyway	REX
CS106132	L180CE FSE 12VDC 626 C REX - CURVED LEVER	12VDC	US26D	SCHL-C	Yes
CS101869	L180RE FSE 12VDC 613 C REX	12VDC	US10B	SCHL-C	Yes
CS101870	L180RE FSE 12VDC 626 C REX	12VDC	US26D	SCHL-C	Yes
CS101874	L180RE FSE 12VDC 613 SFIC REX	12VDC	US10B	SFIC	Yes
CS101875	L180RE FSE 12VDC 626 SFIC REX	12VDC	US26D	SFIC	Yes
CS106131	L180CE FSE 12VDC 613 C REX - CURVED LEVER	12VDC	US10B	SCHL-C	Yes
CS106140	L180CE FSE 24VDC 613 C REX - CURVED LEVER	24VDC	US10B	SCHL-C	Yes
CS103715	L180CE FSE 24VDC 626 C REX - CURVED LEVER	24VDC	US26D	SCHL-C	Yes
CS101871	L180RE FSE 24VDC 613 C REX	24VDC	US10B	SCHL-C	Yes
CS101872	L180RE FSE 24VDC 626 C REX	24VDC	US26D	SCHL-C	Yes
CS112489	L180CE FSE 24VDC 626 SFIC REX 2-3/8" BACKSET	24VDC	US26D	SFIC	Yes
CS101876	L180RE FSE 24VDC 613 SFIC REX	24VDC	US10B	SFIC	Yes
CS101877	L180RE FSE 24VDC 626 SFIC REX	24VDC	US26D	SFIC	Yes



### L100 Series Clutched Electrified Levers - Continuous Duty - Fail Safe

ANX#	Part#	Voltage	Finish	Keyway	REX
CS110370	L180RE FSA 24VDC 626 C REX	24VDC	US26D	SCHL-C	Yes

### L100 Series Clutched Electrified Levers - Intermittent Duty - Dual Voltage

ANX#	Part#	Voltage	Finish	Keyway	REX
CS418648	L180RE FSE 626 C 234 S ANSI S	12/24VDC	US26D	SCHL-C	No

### Wiring Guide for Electrified Levers Single voltage Locks



### L180 Electrified Specifications:

FSE	Fail Secure
FSA	Fail Safe
12VDC	Single Voltage / Continuous Duty - 320mA
24VDC	Single Voltage / Continuous Duty - 160mA
12VDC/24VDC	Dual Voltage / Intermittent Duty - 12VDC - 600mA / 24VDC - 300mA
REX	Form "B" - Normally Closed

### Dual Voltage Locks

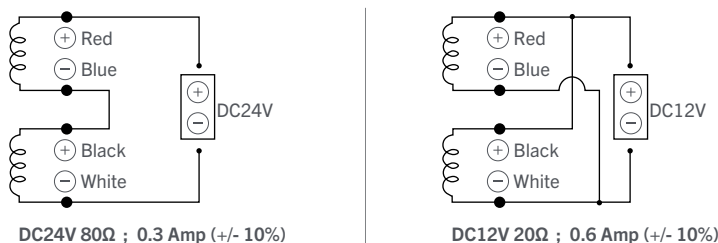

### REX Switch

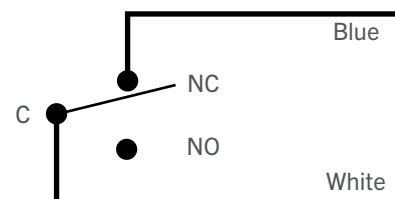

## Grade 1 Lever and Knob Parts

### Grade 1 Cylindrical Lock Parts

ANX#	Part#	Description	Finish	Backset	Type
CS342518	1DL 605 234 S	Dead Latch	US3	2-3/4"	Square Corner
CS342517	1DL 605 238 S	Dead Latch	US3	2-3/8"	Square Corner
CS342520	1DL 613 234 S	Dead Latch	US10B	2-3/4"	Square Corner
CS342519	1DL 613 238 S	Dead Latch	US10B	2-3/8"	Square Corner
CS342522	1DL 626 234 S	Dead Latch	US26D	2-3/4"	Square Corner
CS342521	1DL 626 238 S	Dead Latch	US26D	2-3/8"	Square Corner
CS498905	1DL EXT LINK FOR 3-3/4"	Extension Link		3-3/4"	
CS436459	1DL EXT LINK FOR 5"	Extension Link		5"	
CS342524	1SL 605 234 S	Spring Latch	US3	2-3/4"	Square Corner
CS342523	1SL 605 238 S	Spring Latch	US3	2-3/8"	Square Corner
CS342526	1SL 613 234 S	Spring Latch	US10B	2-3/4"	Square Corner
CS342525	1SL 613 238 S	Spring Latch	US10B	2-3/8"	Square Corner
CS342528	1SL 626 234 S	Spring Latch	US26D	2-3/4"	Square Corner
CS342527	1SL 626 238 S	Spring Latch	US26D	2-3/8"	Square Corner
CS113694	AS 605 W/SCREWS	ASA Strike	US3		Square Corner
CS126391	AS 613 W/SCREWS	ASA Strike	US10B		Square Corner
CS113697	AS 630 W/SCREWS	ASA Strike	US32D		Square Corner
CS101551	L1 INSERT	Black Plastic Lever Insert			
CS105041	L1 RS	Lever Return Spring			
CS498918	L1 SP 605	Screw Pack	US3		
CS498917	L1 SP 613	Screw Pack	US10B		
CS498916	L1 SP 626	Screw Pack	US26D		
CS502181	L1 TB	Through Bolts			
CS103100	L1 TP	C-Lever Tailpiece			
CS129435	L1 LFIC TP	LFIC Tailpiece			
CS104397	L1-IC-TP-53-80	SFIC Tailpiece			
CS112493	L1R-LEV-EXT SFIC	Ext. SFIC Lever	US26D		R Lever
CS112492	L1R-LEV-INT-CL	Int. Clsrn Lever	US26D		R Lever
CS103102	L195 TP	Classroom Security TP			
CS106654	LK12 CYL CAP	G1&2 Cyl. Cap			





### Grade 1 Exterior Entry Mortise Locks



Super heavy-duty commercial mortise lock with deadbolt designed for exterior doors.

- ◆ Meets ANSI A156.13 Grade 1 Standards
- ◆ Designed for ADA Barrier Free Applications
- ◆ Field Reversible Handing
- ◆ Rose & Escutcheon Trim Designs - Stainless Steel Finish
- ◆ No exposed mounting screws

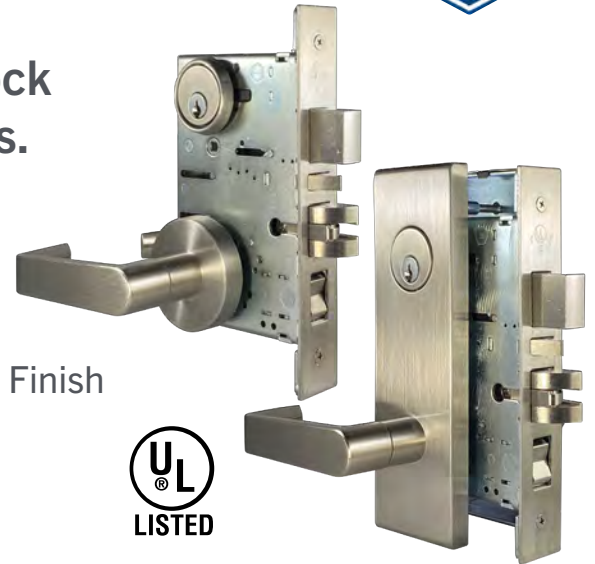

#### SPECIFICATIONS:

Certifications	ANSI/BHMA A156.13 Grade 1, UL Listed 3 Hour Fire, UL10C, ADA Compliant
Finishes	Satin Stainless Steel (630)
Lever Designs	Clutched - R-Lever (Straight)
Keyway	SCHL-C
Backset	Standard - 2-3/4" Lever to Cylinder - 3-7/8" CTC
Bolt and Latch	Stainless Steel - Bolt - 1", Latch - 3/4"
Door Thickness	1-3/4"
Warranty	Lifetime Mechanical / 3 Year Finish

#### GM9100 Series Mortise Locks

ANX#	Part#	Description
CS129358	GM9153 RR 630 C	Rose Trim - Straight Lever
CS129349	GM9153 RE 630 C	Escutcheon Trim - Straight Lever

### Grade 2 Levers

Heavy-duty commercial leverset designed for moderate to heavy traffic interior doors.

- ◆ Meets ANSI A156.2 Grade 2 Standards
- ◆ Designed for ADA Barrier Free Applications
- ◆ Schlage “C” and SFIC Prep
- ◆ 6 Functions and 3 Finishes
- ◆ 2 Lever Designs – Clutched and Rigid Mechanism

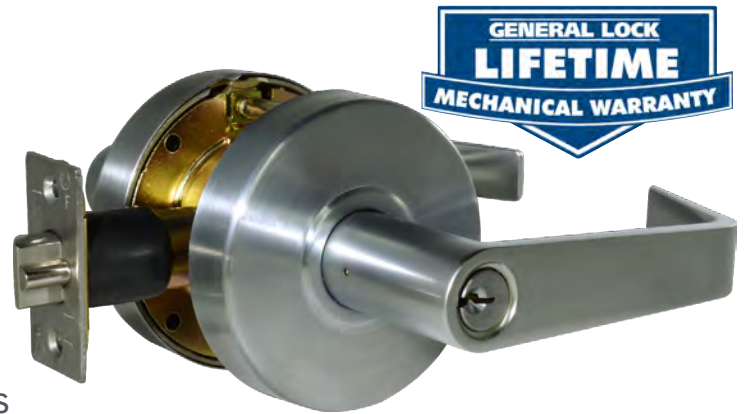

#### SPECIFICATIONS:

Certifications	ANSI A156.2 Grade 2, UL Listed 3 Hour Fire, ADA Compliant
Finishes	Satin Chrome (626), Oil Rubbed Bronze (613), Bright Brass (605)
Lever Designs	S-Lever (Straight), N-Lever (Curved) L-Clutched and LX-Rigid Mechanism
Keyways	SCHL-C, SFIC Prep
Backset	Standard - 2-3/4" Optional - 2-3/8", 3-3/4" & 5"
Strike	ANSI - 1-1/4" x 4-7/8" – Optional - T-Strike
Door Thickness	1-3/8" to 2"
Warranty	Lifetime Mechanical / 5 Year Finish

### Grade 2 Levers

**COST =  
SAME AS  
COMPLETE  
LOCK**

#### √ BUILD-A-LOCK

Less Latch Lock + Required Backset = Complete Lock

#### L200S Series Clutched Levers - Schlage C Keyway

ANX#	Part#	Function	Finish	Keyway	Backset	√	Lock ANX #	Latch ANX#
CS402356	L210S 605 234 S ANSI	Passage	US3		2-3/4"	√	CS303053	CS324180
CS303053	L210S 605 LL ANSI	Passage	US3		Less Latch			
CS390183	L210S 613 234 S ANSI	Passage	US10B		2-3/4"	√	CS303054	CS324181
CS390184	L210S 613 238 S ANSI	Passage	US10B		2-3/8"	√	CS303054	CS322895
CS303054	L210S 613 LL ANSI	Passage	US10B		Less Latch			
CS288614	L210S 626 234 S ANSI	Passage	US26D		2-3/4"			
CS390186	L210S 626 238 S ANSI	Passage	US26D		2-3/8"	√	CS303056	CS322899
CS303056	L210S 626 LL ANSI	Passage	US26D		Less Latch			
CS288619	L240S 605 234 S ANSI	Privacy	US3		2-3/4"	√	CS303083	CS324180
CS303083	L240S 605 LL ANSI	Privacy	US3		Less Latch			
CS390187	L240S 613 234 S ANSI	Privacy	US10B		2-3/4"	√	CS303086	CS324181
CS303086	L240S 613 LL ANSI	Privacy	US10B		Less Latch			
CS288621	L240S 626 234 S ANSI	Privacy	US26D		2-3/4"			
CS390190	L240S 626 238 S ANSI	Privacy	US26D		2-3/8"	√	CS303089	CS322899
CS303089	L240S 626 LL ANSI	Privacy	US26D		Less Latch			
CS288602	L253S 605 C 234 S ANSI	Entry	US3	SCHL-C	2-3/4"			
CS302996	L253S 605 C LL ANSI	Entry	US3	SCHL-C	Less Latch			
CS288603	L253S 613 C 234 S ANSI	Entry	US10B	SCHL-C	2-3/4"			
CS390192	L253S 613 C 238 ANSI	Entry	US10B	SCHL-C	2-3/8"	√	CS302999	CS288317
CS302999	L253S 613 C LL ANSI	Entry	US10B	SCHL-C	Less Latch			
CS288604	L253S 626 C 234 S ANSI	Entry	US26D	SCHL-C	2-3/4"			
CS390194	L253S 626 C 238 S ANSI	Entry	US26D	SCHL-C	2-3/8"	√	CS303002	CS288318
CS303002	L253S 626 C LL ANSI	Entry	US26D	SCHL-C	Less Latch			
CS480962	L270S-360 605 C 234 S ANSI	Classroom	US3	SCHL-C	2-3/4"			
CS480964	L270S-360 613 C 234 S ANSI	Classroom	US10B	SCHL-C	2-3/4"			
CS480965	L270S-360 626 C 234 S ANSI	Classroom	US26D	SCHL-C	2-3/4"			
CS480966	L270S-360 626 C LL ANSI	Classroom	US26D	SCHL-C	Less Latch			
CS402359	L280S 605 C 234 S ANSI	Storeroom	US3	SCHL-C	2-3/4"	√	CS303188	CS288321
CS303188	L280S 605 C LL ANSI	Storeroom	US3	SCHL-C	Less Latch			
CS390195	L280S 613 C 234 S ANSI	Storeroom	US10B	SCHL-C	2-3/4"	√	CS303189	CS288322
CS303189	L280S 613 C LL ANSI	Storeroom	US10B	SCHL-C	Less Latch			
CS288628	L280S 626 C 234 S ANSI	Storeroom	US26D	SCHL-C	2-3/4"			
CS390198	L280S 626 C 238 S ANSI	Storeroom	US26D	SCHL-C	2-3/8"	√	CS303191	CS288318
CS303191	L280S 626 C LL ANSI	Storeroom	US26D	SCHL-C	Less Latch			

### Grade 2 Levers

#### L200S Series Clutched SFIC Levers (sold less core)

ANX#	Part#	Function	Finish	Keyway	Backset
CS343671	L253S 605 IC 234 S ANSI S	Entry	US3	SFIC	2-3/4"
CS246338	L253S 613 IC 234 S ANSI S	Entry	US10B	SFIC	2-3/4"
CS246339	L253S 626 IC 234 S ANSI S	Entry	US26D	SFIC	2-3/4"
CS480963	L270S-360 605 IC 234 S ANSI S	Classroom	US3	SFIC	2-3/4"
CS495797	L270S-360 613 IC 234 S ANSI S	Classroom	US10B	SFIC	2-3/4"
CS480967	L270S-360 626 IC 234 S ANSI S	Classroom	US26D	SFIC	2-3/4"
CS343674	L280S 605 IC 234 S ANSI S	Storeroom	US3	SFIC	2-3/4"
CS246343	L280S 613 IC 234 S ANSI S	Storeroom	US10B	SFIC	2-3/4"
CS246344	L280S 626 IC 234 S ANSI S	Storeroom	US26D	SFIC	2-3/4"



#### L200S Series Clutched Levers - Posts - 70mm CTC

ANX#	Part#	Function	Finish	Keyway	Backset
CS104086	L210S-70 626 234 S ANSI	Passage	US26D		2-3/4"
CS104087	L240S-70 626 234 S ANSI	Privacy	US26D		2-3/4"
CS104088	L253S-70 626 C 234 S ANSI	Entry	US26D	SCHL-C	2-3/4"
CS104089	L253S-70 626 IC 234 S ANSI S	Entry	US26D	SFIC	2-3/4"
CS104090	L270S-70-360 626 C 234 S ANSI	Classroom	US26D	SCHL-C	2-3/4"
CS104095	L270S-70-360 626 IC 234 S ANSI	Classroom	US26D	SFIC	2-3/4"
CS104096	L280S-70 626 C 234 S ANSI	Storeroom	US26D	SCHL-C	2-3/4"

L200S Series available with **70mm** through-bolts to match templating of additional brands.

example: **L253S-70 626 C 234**

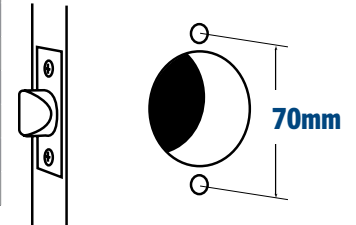

#### L200N Series Clutched Levers - Schlage C Keyway

ANX#	Part#	Function	Finish	Keyway	Backset
CS101879	L2170N 626	Dummy	US26D		2-3/4"
CS101878	L210N 626 234 S ANSI	Passage	US26D		2-3/4"
CS101880	L240N 626 234 S ANSI	Privacy	US26D		2-3/4"
CS101882	L253N 626 C 234 S ANSI	Entry	US26D	SCHL-C	2-3/4"
CS104044	L253N 626 C 238 S ANSI	Entry	US26D	SCHL-C	2-3/8"
CS101885	L270N-360 626 C 234 S ANSI	Classroom	US26D	SCHL-C	2-3/4"
CS101887	L280N 626 C 234 S ANSI	Storeroom	US26D	SCHL-C	2-3/4"



**COST =  
SAME AS  
COMPLETE  
LOCK**

#### ✓ BUILD-A-LOCK

Less Latch Lock + Required Backset = Complete Lock

✓	Lock ANX #	Latch ANX#
✓	CS101882	CS288318

#### L200N Series Clutched SFIC Levers (sold less core)

ANX#	Part#	Function	Finish	Keyway	Backset
CS101884	L253N 626 IC 234 S ANSI S	Entry	US26D	SFIC	2-3/4"
CS101888	L280N 626 IC 234 S ANSI S	Storeroom	US26D	SFIC	2-3/4"



### Grade 2 Levers

**COST =  
SAME AS  
COMPLETE  
LOCK**

#### √ BUILD-A-LOCK

Less Latch Lock + Required Backset = Complete Lock

#### LX200S Series Rigid Levers - Schlage C Keyway

ANX#	Part#	Function	Finish	Keyway	Backset
CS402360	LX253S 605 C 234 S ANSI	Entry	US3	SCHL-C	2-3/4"
CS303004	LX253S 605 C LL ANSI	Entry	US3	SCHL-C	Less Latch
CS390202	LX253S 613 C 234 S ANSI	Entry	US10B	SCHL-C	2-3/4"
CS303007	LX253S 613 C LL ANSI	Entry	US10B	SCHL-C	Less Latch
CS288607	LX253S 626 C 234 S ANSI	Entry	US26D	SCHL-C	2-3/4"
CS390206	LX253S 626 C 238 S ANSI	Entry	US26D	SCHL-C	2-3/8"
CS303016	LX253S 626 C LL ANSI	Entry	US26D	SCHL-C	Less Latch
CS288592	LX270S 605 C 234 S ANSI	Classroom	US3	SCHL-C	2-3/4"
CS302965	LX270S 605 C LL ANSI	Classroom	US3	SCHL-C	Less Latch
CS102510	LX270S-360 613 C 234 S ANSI	Classroom	US10B	SCHL-C	2-3/4"
CS102513	LX270S-360 613 C 238 S ANSI	Classroom	US10B	SCHL-C	2-3/8"
CS102520	LX270S-360 613 C LL ANSI	Classroom	US10B	SCHL-C	Less Latch
CS102530	LX270S-360 626 C 234 S ANSI	Classroom	US26D	SCHL-C	2-3/4"
CS102539	LX270S-360 626 C 238 S ANSI	Classroom	US26D	SCHL-C	2-3/8"
CS102540	LX270S-360 626 C LL ANSI	Classroom	US26D	SCHL-C	Less Latch
CS288629	LX280S 605 C 234 S ANSI	Storeroom	US3	SCHL-C	2-3/4"
CS390211	LX280S 613 C 234 S ANSI	Storeroom	US10B	SCHL-C	2-3/4"
CS303193	LX280S 613 C LL ANSI	Storeroom	US10B	SCHL-C	Less Latch
CS288631	LX280S 626 C 234 S ANSI	Storeroom	US26D	SCHL-C	2-3/4"
CS303194	LX280S 626 C LL ANSI	Storeroom	US26D	SCHL-C	Less Latch

√	Lock ANX #	Latch ANX#
√	CS303004	CS288321
√	CS303007	CS288322
√	CS303016	CS288318
√	CS102520	CS288322
√	CS102520	CS288317
√	CS102540	CS288323
√	CS102540	CS288318
√	CS303193	CS288322

#### LX200S Series Rigid SFIC Levers (sold less core)

ANX#	Part#	Function	Finish	Keyway	Backset
CS243397	LX253S 613 IC 234 S ANSI	Entry	US10B	SFIC	2-3/4"
CS243399	LX253S 626 IC 234 S ANSI	Entry	US26D	SFIC	2-3/4"
CS246347	LX280S 626 IC 234 S ANSI	Storeroom	US26D	SFIC	2-3/4"



#### LX200N Series Rigid Levers - Schlage C Keyway

ANX#	Part#	Function	Finish	Keyway	Backset
CS101890	LX253N 626 C 234 S ANSI	Entry	US26D	SCHL-C	2-3/4"
CS101892	LX270N-360 626 C 234 S ANSI	Classroom	US26D	SCHL-C	2-3/4"
CS101893	LX280N 626 C 234 S ANSI	Storeroom	US26D	SCHL-C	2-3/4"



#### LX200N Series Rigid SFIC Levers (sold less core)

ANX#	Part#	Function	Finish	Keyway	Backset
CS101891	LX253N 626 IC 234 S ANSI	Entry	US26D	SFIC	2-3/4"
CS101894	LX280N 626 IC 234 S ANSI	Storeroom	US26D	SFIC	2-3/4"

### Grade 1 Knobsets

Super heavy-duty commercial knobset designed for high traffic interior and exterior doors.



SPECIFICATIONS:	
Certifications	ANSI A156.2 Grade 1, UL Listed 3 Hour Fire
Finishes	Stainless Steel (630)
Door Thickness	1-3/8" to 2"
Backset	Standard - 2-3/4" Optional Latches - 2-3/8", 3-3/4", & 5"
Strike	ANSI - 1-1/4" x 4-7/8"
Keyways	SCHL-C
Knob Designs	B-Knob (Ball)
Warranty	Lifetime Mechanical / 5 Year Finish



#### K100 Series Grade 1 Cylindrical Knobsets

ANX#	Part#	Function	Finish	Keyway	Backset
CS123185	K153B 630 C 234 S ANSI	Entry	US32D	SCHL-C	2-3/4"
CS123186	K180B 630 C 234 S ANSI	Storeroom	US32D	SCHL-C	2-3/4"

### Grade 2 Knobsets

Heavy-duty commercial knobset designed for moderate traffic doors.

- ◆ Meets ANSI A156.2 Grade 2 Standards
- ◆ Schlage "C" and SFIC Prep



SPECIFICATIONS:	
Certifications	ANSI A156.2 Grade 2, UL Listed 3 Hour Fire
Finishes	Bright Brass (605), Oil Rubbed Bronze (613), Satin Stainless Steel (630)
Door Thickness	1-3/8" to 1-3/4"
Backset	Standard - 2-3/4" or 2-3/8" Optional - 3-3/4", & 5"
Strike	ANSI - 1-1/4" x 4-7/8" — Optional - T-Strike
Keyways	SCHL-C, SFIC Prep
Knob Designs	B-Knob (Ball), P-Knob (Plymouth)
Warranty	Lifetime Mechanical / 5 Year Finish



## Grade 2 Knobsets



**COST =  
SAME AS  
COMPLETE  
LOCK**

### ✓ BUILD-A-LOCK

Less Latch Lock + Required Backset = Complete Lock

### K200 Series Grade 2 Cylindrical Knobsets - Ball Knob Design

ANX#	Part#	Function	Finish	Keyway	Backset	✓	Lock ANX #	Latch ANX#
CS402341	K210B 605 234 S ANSI	Passage	US3		2-3/4"	✓		
CS402369	K210B 605 238 S ANSI	Passage	US3		2-3/8"	✓	CS303018	CS324180
CS303018	K210B 605 LL ANSI	Passage	US3		Less Latch	✓	CS303018	CS322890
CS390215	K210B 613 234 S ANSI	Passage	US10B		2-3/4"	✓	CS303019	CS324181
CS390216	K210B 613 238 S ANSI	Passage	US10B		2-3/8"	✓	CS303019	CS322895
CS303019	K210B 613 LL ANSI	Passage	US10B		Less Latch			
CS288286	K210B 630 234 S ANSI	Passage	US32D		2-3/4"			
CS390218	K210B 630 238 S ANSI	Passage	US32D		2-3/8"	✓	CS303029	CS322899
CS303029	K210B 630 LL ANSI	Passage	US32D		Less Latch			
CS402343	K240B 605 234 S ANSI	Privacy	US3		2-3/4"	✓	CS303057	CS324180
CS402371	K240B 605 238 S ANSI	Privacy	US3		2-3/8"	✓	CS303057	CS322890
CS303057	K240B 605 LL ANSI	Privacy	US3		Less Latch			
CS288296	K240B 613 234 S ANSI	Privacy	US10B		2-3/4"	✓	CS303059	CS324181
CS390220	K240B 613 238 S ANSI	Privacy	US10B		2-3/8"	✓	CS303059	CS322895
CS303059	K240B 613 LL ANSI	Privacy	US10B		Less Latch			
CS390221	K240B 630 234 S ANSI	Privacy	US32D		2-3/4"	✓	CS303063	CS324182
CS390222	K240B 630 238 S ANSI	Privacy	US32D		2-3/8"	✓	CS303063	CS322899
CS303063	K240B 630 LL ANSI	Privacy	US32D		Less Latch			
CS402344	K253B 605 C 234 S ANSI	Entry	US3	SCHL-C	2-3/4"	✓	CS302982	CS288321
CS402375	K253B 605 C 238 S ANSI	Entry	US3	SCHL-C	2-3/8"	✓	CS302982	CS288316
CS302982	K253B 605 C LL ANSI	Entry	US3	SCHL-C	Less Latch			
CS442388	K253B 605 IC 234 S ANSI	Entry	US3	SFIC	2-3/4"			
CS390223	K253B 613 C 234 S ANSI	Entry	US10B	SCHL-C	2-3/4"	✓	CS302987	CS288322
CS390224	K253B 613 C 238 S ANSI	Entry	US10B	SCHL-C	2-3/8"	✓	CS302987	CS288317
CS302987	K253B 613 C LL ANSI	Entry	US10B	SCHL-C	Less Latch			
CS288278	K253B 630 C 234 S ANSI	Entry	US32D	SCHL-C	2-3/4"			
CS390226	K253B 630 C 238 S ANSI	Entry	US32D	SCHL-C	2-3/8"	✓	CS302988	CS288318
CS302988	K253B 630 C LL ANSI	Entry	US32D	SCHL-C	Less Latch			
CS411210	K253B 630 IC 234 S ANSI	Entry	US32D	SFIC	2-3/4"			
CS288268	K270B 613 C 234 S ANSI	Classroom	US10B	SCHL-C	2-3/4"	✓	CS302957	CS288322
CS390228	K270B 613 C 238 S ANSI	Classroom	US10B	SCHL-C	2-3/8"	✓	CS302957	CS288317
CS302957	K270B 613 C LL ANSI	Classroom	US10B	SCHL-C	Less Latch			
CS390229	K270B 630 C 234 S ANSI	Classroom	US32D	SCHL-C	2-3/4"	✓	CS302959	CS288323
CS390230	K270B 630 C 238 S ANSI	Classroom	US32D	SCHL-C	2-3/8"	✓	CS302959	CS288318
CS302959	K270B 630 C LL ANSI	Classroom	US32D	SCHL-C	Less Latch			
CS402350	K280B 605 C 234 S ANSI	Storeroom	US3	SCHL-C	2-3/4"	✓	CS303175	CS288321
CS402399	K280B 605 C 238 S ANSI	Storeroom	US3	SCHL-C	2-3/8"	✓	CS303175	CS288316
CS303175	K280B 605 C LL ANSI	Storeroom	US3	SCHL-C	Less Latch			
CS390231	K280B 613 C 234 S ANSI	Storeroom	US10B	SCHL-C	2-3/4"	✓	CS303176	CS288322
CS390232	K280B 613 C 238 S ANSI	Storeroom	US10B	SCHL-C	2-3/8"	✓	CS303176	CS288317
CS303176	K280B 613 C LL ANSI	Storeroom	US10B	SCHL-C	Less Latch			
CS288303	K280B 630 C 234 S ANSI	Storeroom	US32D	SCHL-C	2-3/4"			
CS390234	K280B 630 C 238 S ANSI	Storeroom	US32D	SCHL-C	2-3/8"	✓	CS303177	CS288318
CS303177	K280B 630 C LL ANSI	Storeroom	US32D	SCHL-C	Less Latch			
CS411209	K280B 630 IC 234 S ANSI	Storeroom	US32D	SFIC	2-3/4"			

### Grade 2 Knobsets

**COST =  
SAME AS  
COMPLETE  
LOCK**

#### √ BUILD-A-LOCK

Less Latch Lock + Required Backset = Complete Lock

#### K200 Series Grade 2 Cylindrical Knobsets - P Knob Design - Standard Rose

ANX#	Part#	Function	Finish	Keyway	Backset
CS478000	K240P 605 234 S ANSI	Privacy	US3		2-3/4"
CS478001	K240P 605 238 S ANSI	Privacy	US3		2-3/8"
CS303065	K240P 605 LL ANSI	Privacy	US3		Less Latch
CS478005	K270P 605 C 234 S ANSI	Classroom	US3	SCHL-C	2-3/4"
CS478009	K270P 605 C 238 S ANSI	Classroom	US3	SCHL-C	2-3/8"
CS477957	K270P 605 C LL ANSI 5P KA4	Classroom	US3	SCHL-C	Less Latch

√	Lock ANX #	Latch ANX#
√	CS303065	CS324180
√	CS303065	CS322890
√	CS477957	CS288321
√	CS477957	CS288316

#### K200 Series Grade 2 Cylindrical Knobsets - PSR Knob Design (SR = Small Rose)

ANX#	Part#	Function	Finish	Keyway	Backset
CS113309	K210PSR 605 238 S TF	Passage	US3		2-3/8"
CS125643	K210PSR 613 234 S TF	Passage	US10B		2-3/4"
CS113327	K210PSR 630 234 S TF	Passage	US32D		2-3/4"
CS113314	K240PSR 605 238 S TF	Privacy	US3		2-3/8"
CS125644	K240PSR 613 234 S TF	Privacy	US10B		2-3/4"
CS113328	K240PSR 630 234 S TF	Privacy	US32D		2-3/4"
CS129074	K253PSR 605 C 238 S TF 5P KA	Entry	US3	SCHL-C	2-3/8"
CS113318	K253PSR 605 C 238 S TF	Entry	US3	SCHL-C	2-3/8"
CS125646	K253PSR 613 C 234 S TF	Entry	US10B	SCHL-C	2-3/4"
CS113329	K253PSR 630 C 234 S TF	Entry	US32D	SCHL-C	2-3/4"
CS113323	K280PSR 605 C 238 S TF	Storeroom	US3	SCHL-C	2-3/8"
CS125661	K280PSR 613 C 234 S TF	Storeroom	US10B	SCHL-C	2-3/4"
CS113330	K280PSR 630 C 234 S TF	Storeroom	US32D	SCHL-C	2-3/4"
CS113331	K282PSR 630 C 234 S TF	Institution	US32D	SCHL-C	2-3/4"





## Grade 2 Lever and Knob Parts

### Grade 2 Cylindrical Lock Parts

ANX#	Part#	Description	Finish	Backset	Type
CS288310	2DL 234 D	Dead Latch		2-3/4"	Drive-in
CS288309	2DL 238 D	Dead Latch		2-3/8"	Drive-in
CS288313	2DL 605 234 R	Dead Latch	US3	2-3/4"	Radius Corner
CS288321	2DL 605 234 S	Dead Latch	US3	2-3/4"	Square Corner
CS288312	2DL 605 238 R	Dead Latch	US3	2-3/8"	Radius Corner
CS288316	2DL 605 238 S	Dead Latch	US3	2-3/8"	Square Corner
CS288322	2DL 613 234 S	Dead Latch	US10B	2-3/4"	Square Corner
CS322885	2DL 613 238 R	Dead Latch	US10B	2-3/8"	Radius Corner
CS288317	2DL 613 238 S	Dead Latch	US10B	2-3/8"	Square Corner
CS288314	2DL 626 234 R	Dead Latch	US26D	2-3/4"	Radius Corner
CS118690	2DL 626 234 R 1"	Dead Latch	US26D	2-3/4"	1" Radius Corner
CS288323	2DL 626 234 S	Dead Latch	US26D	2-3/4"	Square Corner
CS118688	2DL 626 234 S 1"	Dead Latch	US26D	2-3/4"	1" Square Corner
CS322886	2DL 626 238 R	Dead Latch	US26D	2-3/8"	Radius Corner
CS288318	2DL 626 238 S	Dead Latch	US26D	2-3/8"	Square Corner
CS360919	2DL EXT LINK FOR 3-3/4"	Extension Link		3-3/4"	
CS413156	2DL EXT LINK FOR 5"	Extension Link		5"	
CS322888	2SL 234 D	Spring Latch		2-3/4"	Drive-in
CS322887	2SL 238 D	Spring Latch		2-3/8"	Drive-in
CS322893	2SL 605 234 R	Spring Latch	US3	2-3/4"	Radius Corner
CS324180	2SL 605 234 S	Spring Latch	US3	2-3/4"	Square Corner
CS322889	2SL 605 238 R	Spring Latch	US3	2-3/8"	Radius Corner
CS322890	2SL 605 238 S	Spring Latch	US3	2-3/8"	Square Corner
CS322896	2SL 613 234 R	Spring Latch	US10B	2-3/4"	Radius Corner
CS324181	2SL 613 234 S	Spring Latch	US10B	2-3/4"	Square Corner
CS322894	2SL 613 238 R	Spring Latch	US10B	2-3/8"	Radius Corner
CS322895	2SL 613 238 S	Spring Latch	US10B	2-3/8"	Square Corner
CS322900	2SL 626 234 R	Spring Latch	US26D	2-3/4"	Radius Corner
CS324182	2SL 626 234 S	Spring Latch	US26D	2-3/4"	Square Corner
CS322897	2SL 626 238 R	Spring Latch	US26D	2-3/8"	Radius Corner
CS322899	2SL 626 238 S	Spring Latch	US26D	2-3/8"	Square Corner
CS498925	K2 IC TP	Tailpiece SFIC Knob			
CS498924	K2 SP 605	Screwpack - Knob	US3		
CS498923	K2 SP 613	Screwpack - Knob	US10B		
CS498922	K2 SP 630	Screwpack - Knob	US26D		
CS502181	L1L2 TB	Through bolts G1/G2			
CS101552	L2 INSERT	Black Plastic Lever Insert			
CS498921	L2 SP 605	Screwpack - Lever	US3		
CS498920	L2 SP 613	Screwpack - Lever	US10B		
CS498919	L2 SP 626	Screwpack - Lever	US26D		
CS463244	L2-IC-TP2	Tailpiece SFIC Lever			
CS117315	L2K2 TP-TB	Tailpiece - Thin Base			
CS106654	LK12 CYL CAP	Cyl Cap G1/G2			
CS342529	TS 605 S	T-Strike	US3		Square Corner
CS342530	TS 613 S	T-Strike	US10B		Square Corner
CS342531	TS 626 S	T-Strike	US26D		Square Corner



2DL 626

2SL 626



K2 IC TP



L2K2 TP-TB



L2 IC TP2



TS 626 S

### Grade 1 Deadbolts

Super heavy-duty commercial deadbolt  
Designed for high security applications  
on interior or exterior doors.

- ◆ Meets ANSI A156.36 Grade 1 Standards
- ◆ Schlage “C” and SFIC Prep



#### SPECIFICATIONS:

Certifications	ANSI A156.36 Grade 1, UL Listed 3 Hour Fire, ADA Compliant
Finishes	Satin Chrome (626), Oil Rubbed Bronze (613), Bright Brass (605)
Door Thickness	1-9/16" to 2"
Backset	2-3/4" - Square Corner, 2-3/8" Bolt - Optional
Strike	Steel Strike Plate - 2-3/4" x 1-1/8" with 3" Installation Screws
Function	Single and Double Cylinder
Keyways	SCHL-C, SFIC Prep
Warranty	Lifetime Mechanical / 5 Year Finish

#### D660 Series Grade 1 Deadbolt - Schlage C Keyway

ANX#	Part#	Function	Finish	Backset	Keyway
CS359455	D660 626 234 C	Single Cylinder	US26D	2-3/4"	SCHL-C
CS359446	D662 626 234 C	Double Cylinder	US26D	2-3/4"	SCHL-C



#### D660 Series Grade 1 Deadbolt - SFIC Prep

ANX#	Part#	Function	Finish	Backset	Keyway
CS359452	D660 605 234 IC	Single Cylinder	US3	2-3/4"	SFIC
CS359456	D660 626 234 IC	Single Cylinder	US26D	2-3/4"	SFIC
CS359442	D662 605 234 IC	Double Cylinder	US3	2-3/4"	SFIC
CS359445	D662 613 234 IC	Double Cylinder	US10B	2-3/4"	SFIC
CS359447	D662 626 234 IC	Double Cylinder	US26D	2-3/4"	SFIC



### Grade 2 Deadbolts

Heavy-duty commercial deadbolt designed for medium security applications on interior or exterior doors.

- ◆ Meets ANSI A156.36 Grade 2 Standards
- ◆ Schlage “C” and SFIC Prep



SPECIFICATIONS:	
Certifications	ANSI A156.36 Grade 2, UL Listed 3 Hour Fire, ADA Compliant
Finishes	Satin Chrome (626), Oil Rubbed Bronze (613), Bright Brass (605), Satin Stainless Steel (630)
Door Thickness	“C” Keyway = 1-3/8” to 1-3/4” SFIC Prep = 1-9/16” to 2”
Backset	6-Way Bolt - 2-3/8”, 2-3/4” - Square Corner, Radius Corner and Drive-in
Strike	Steel Strike Plate - 2-3/4” x 1-1/8” with 3” Installation Screws
Function	Single and Double Cylinder
Keyways	SCHL-C, SFIC Prep
Warranty	Lifetime Mechanical / 5 Year Finish

#### D160 Series Grade 2 Deadbolt - Schlage C Keyway

ANX#	Part#	Function	Finish	Backset	Keyway
CS257037	D160 605 6WL C	Single Cylinder	US3	6-Way Adj.	SCHL-C
CS477954	D160 605 6WL C 5P KA4	Single Cylinder	US3	6-Way Adj.	SCHL-C
CS473505	D160 609 6WL C	Single Cylinder	US5	6-Way Adj.	SCHL-C
CS257038	D160 613 6WL C	Single Cylinder	US10B	6-Way Adj.	SCHL-C
CS257039	D160 626 6WL C	Single Cylinder	US26D	6-Way Adj.	SCHL-C
CS103126	D160 630 6WL C	Single Cylinder	US32D	6-Way Adj.	SCHL-C
CS257031	D162 605 6WL C	Double Cylinder	US3	6-Way Adj.	SCHL-C
CS477956	D162 605 6WL C 5P KA4	Double Cylinder	US3	6-Way Adj.	SCHL-C
CS485779	D162 609 6WL C	Double Cylinder	US5	6-Way Adj.	SCHL-C
CS257032	D162 613 6WL C	Double Cylinder	US10B	6-Way Adj.	SCHL-C
CS257033	D162 626 6WL C	Double Cylinder	US26D	6-Way Adj.	SCHL-C
CS103130	D162 630 6WL C	Double Cylinder	US32D	6-Way Adj.	SCHL-C



#### D160 Series Grade 2 Deadbolt - SFIC Prep

ANX#	Part#	Function	Finish	Backset	Keyway
CS359448	D160 605 6WL IC	Single Cylinder	US3	6-Way Adj.	SFIC
CS359449	D160 613 6WL IC	Single Cylinder	US10B	6-Way Adj.	SFIC
CS359450	D160 626 6WL IC	Single Cylinder	US26D	6-Way Adj.	SFIC
CS103129	D160 630 6WL IC	Single Cylinder	US32D	6-Way Adj.	SFIC
CS359437	D162 605 6WL IC	Double Cylinder	US3	6-Way Adj.	SFIC
CS359438	D162 613 6WL IC	Double Cylinder	US10B	6-Way Adj.	SFIC
CS359439	D162 626 6WL IC	Double Cylinder	US26D	6-Way Adj.	SFIC
CS103132	D162 630 6WL IC	Double Cylinder	US32D	6-Way Adj.	SFIC



## Deadbolt Parts

### Deadbolt - Bolts

ANX#	Part#	Description	Grade	Finish	Type	Backset
CS263356	DB-234 605	Dead Bolt	Grade 1	US3	Square Corner	2-3/4"
CS263357	DB-234 626	Dead Bolt	Grade 1	US26D	Square Corner	2-3/4"
CS259372	DB-238 605	Dead Bolt	Grade 1	US3	Square Corner	2-3/8"
CS259375	DB-238 626	Dead Bolt	Grade 1	US26D	Square Corner	2-3/8"
CS447836	DB-6WL-605	Dead Bolt	Grade 2	US3	6-Way Adj.	2-3/8" to 2-3/4"
CS447838	DB-6WL-626	Dead Bolt	Grade 2	US26D	6-Way Adj.	2-3/8" to 2-3/4"
CS429309	DBA-605	Dead Bolt	Grade 1&2	US3	Square Corner	2-3/8" to 2-3/4"
CS429311	DBA-626	Dead Bolt	Grade 1&2	US26D	Square Corner	2-3/8" to 2-3/4"



### Deadbolt - Parts

ANX#	Part#	Description	Grade	Finish	Type
CS101940	D1-SR-605	Adapter Ring	Grade 1	US3	2 Per Lock Req.
CS102053	D1-SR-626	Adapter Ring	Grade 1	US26D	2 Per Lock Req.
CS102931	D2-SR-605	Adapter Ring	Grade 2	US3	2 Per Lock Req.
CS102933	D2-SR-613	Adapter Ring	Grade 2	US10B	2 Per Lock Req.
CS102166	1DB DC SP 626	Screwpack	Grade 1	US26D	Double Cyl.
CS102167	1DB SC SP 626	Screwpack	Grade 1	US26D	Single Cyl.
CS102158	2DB DC SP 605	Screwpack	Grade 2	US3	Double Cyl.
CS102161	2DB DC SP 613	Screwpack	Grade 2	US10B	Double Cyl.
CS102164	2DB DC SP 626	Screwpack	Grade 2	US26D	Double Cyl.
CS101533	2DB SC SP 605	Screwpack	Grade 2	US3	Single Cyl.
CS101534	2DB SC SP 613	Screwpack	Grade 2	US10B	Single Cyl.
CS101535	2DB SC SP 626	Screwpack	Grade 2	US26D	Single Cyl.
CS105928	D162-1WS 626	Screwpack - 1Way	Grade 2	US26D	Double Cyl.
CS498913	D1D2 DC C TP - EX	Tailpiece - Exterior	Grade 1&2		Double Cyl.
CS498912	D1D2 DC C TP - IN	Tailpiece - Interior	Grade 1&2		Double Cyl.
CS498915	D1D2 DC IC TP	Tailpiece - SFIC	Grade 1&2		Double Cyl.
CS498914	D1D2 SC IC TP	Tailpiece - SFIC	Grade 1&2		Single Cyl.
CS498906	D1D2 SC C TP	Tailpiece - STD.	Grade 1&2		Single Cyl.
CS468938	D1D2-DC-TDK-214 605	Thick Door Kit	Grade 1&2	US3	Double Cyl.
CS483539	D1D2-DC-TDK-214 613	Thick Door Kit	Grade 1&2	US10B	Double Cyl.
CS468941	D1D2-DC-TDK-214 626	Thick Door Kit	Grade 1&2	US26D	Double Cyl.
CS468939	D1D2-SC-TDK-214 605	Thick Door Kit	Grade 1&2	US3	Single Cyl.
CS483537	D1D2-SC-TDK-214 613	Thick Door Kit	Grade 1&2	US10B	Single Cyl.
CS468943	D1D2-SC-TDK-214 626	Thick Door Kit	Grade 1&2	US26D	Single Cyl.
CS502184	D1D2 SC IC TDK 214 605	Thick Door Kit - SFIC	Grade 1&2	US3	Single Cyl.
CS502183	D1D2 SC IC TDK 214 613	Thick Door Kit - SFIC	Grade 1&2	US10B	Single Cyl.
CS502182	D1D2 SC IC TDK 214 626	Thick Door Kit - SFIC	Grade 1&2	US26D	Single Cyl.

## OEM compatible cylinders to integrate with existing key systems

- ◆ KLC Cylinders
- ◆ Mortise Cylinders
- ◆ T-Turns & Dummy
- ◆ Rim Cylinders
- ◆ SFIC Cores
- ◆ SFIC Housings
- ◆ LFIC Cores & Housings
- ◆ Cylinder Part
- ◆ Key Blanks



### SPECIFICATIONS:

Mortise Cylinders	1" – 5-Pin, 1-1/8" & 1-1/4" – 6-Pin, 26D, 10B and US3 Finish
Rim Cylinders	6-Pin, 26D, 10B and US3 Finish
KLC Cylinders	6-Pin, Multiple Tailpieces for leversets, knobsets and deadbolts, 26D & US4 Finish
SC-LFIC Cylinders	6-Pin — 26D ~ Control Key Included
SFIC Cores	6-Pin & 7-Pin — Best Style Capping
Key Blanks	Neuter Bow, Brass

## Custom Cylinders

**Build your brand and generate repeat business by using cylinders crisply emblazoned with your logo!**

- Available in most standard General Lock Mortise and Rim Cylinders
- Minimum order quantity – **50 per item and 200 per order**, with a \$120 one-time tooling charge on the first order.
- Tooling fee will be waived if order is 500 cylinders or more
- Reorders must be **50 per item and 200 per order minimum**
- Lead time 16 – 18 weeks on first order

*\*branding not available for interchangeable core core housings or restricted keyway products.*



**GENERAL LOCK**  
General Lock Custom-Branded Cylinder Order Form

Step 1 - Order Form

Item Number <small>(refer to example orders on previous page)</small>	Quantity	Label Price	Notes

Step 2 - Imprint on Cylinder Face

**Text**  
Example: Company Name & Phone Number

If you require (and incl.) clear's beneath it here:

First Line:

Second Line:

... Check back if you would like the (first line cut out)

**Custom Logo**  
Attach provided by you.

**Custom Logo**  
If you need a logo emblazoned on this cylinder face, submit your clear back and white artwork with the following: **Backed, sized and approved by GL.** You will receive confirmation and a mock-up of this image back for your approval and signature.

Stamping guidelines: Avoid too much information for the space available on the cylinder for best readability.

Mock up:

Mock up Approval (Signature): \_\_\_\_\_ Approval Date: \_\_\_\_\_

GeneralLock.com • 1 (866) 407-7597

**Custom-Branded Cylinder Order Form**

<https://www.anixter.com/content/dam/anixter/resources/promotions/180605-GL-Custom-Cylinders-Order-Form-Apr-2019.pdf>

Call your local Anixter Security Branch to place your order today  
**1 (844) 522-5275.**

### Restricted Key Systems

Cost effective commercial key control solution to prevent unauthorized key duplication

- ◆ Managed Restricted Cylinders & Keyblanks
- ◆ Written Contract Required to Ensure Key Control Integrity
- ◆ 6 Restricted standard format keyways
  - Mortise, Rim and KLC cylinders
  - Uses Schlage depths & spacing
  - Neuter Bow Do Not Duplicate - Standard
  - Custom Coined Neuter Bow - Option
- ◆ 2 Restricted SFIC Keyways
  - 6-Pin and 7-Pin Cores
  - Uses Best depths & spacing and pins & caps



SPECIFICATIONS:	
Mortise Cylinders	6-Pin, 1-1/8" and 1-1/4" Length. 26D, 10B and US3 Finish
Rim Cylinders	6-Pin, 26D, 10B and US3 Finish
KLC Cylinders	Multiple tailpieces for leversets, knobsets and deadbolts, 26D & US4 Finish
SFIC Cylinders	6-Pin and 7-Pin. Best Style Capping 6-Pin - 26D & US4, 7-Pin - 26D
Key Blanks — Std.	Neuter bow, Do Not Duplicate, Nickel Silver - Custom coining available
Key Blanks — SFIC	Square Bow, Do Not Duplicate, Brass
Std. Depths and Spacing	Schlage Depths and Spacing (HPC - C45 Card)
SFIC Depths and Spacing	Best Spacing - A2, A3 or A4 Systems
Warranty	Cylinder Warranty - 10 Years

Call your local Anixter Security Branch for more information  
**1 (844) 522-5275.**

## Cylinders

### Mortise Cylinders

ANX#	Part#	Pin	Length	Keyway	Finish	Cam
CS256627	MC100 AA 10B AR KA2	5-pin	1"	Arrow	US10B	Adamsrite
CS256628	MC100 AA 26D AR KA2	5-pin	1"	Arrow	US26D	Adamsrite
CS256631	MC100 KS 10B AR KA2	5-pin	1"	Kwikset	US10B	Adamsrite
CS256636	MC100 KS 26D AR KA2	5-pin	1"	Kwikset	US26D	Adamsrite
CS256630	MC100 KS 3 AR KA2	5-pin	1"	Kwikset	US3	Adamsrite
CS256639	MC100 SC 10B AR KA2	5-pin	1"	SCHL-C	US10B	Adamsrite
CS256640	MC100 SC 26D AR KA2	5-pin	1"	SCHL-C	US26D	Adamsrite
CS256638	MC100 SC 3 AR KA2	5-pin	1"	SCHL-C	US3	Adamsrite
CS256642	MC100 SX 10B AR KA2	5-pin	1"	SCHL-Composite	US10B	Adamsrite
CS256644	MC100 SX 26D AR KA2	5-pin	1"	SCHL-Composite	US26D	Adamsrite
CS256646	MC100 WA 26D AR KA2	5-pin	1"	Weiser	US26D	Adamsrite
CS256648	MC100 YA 10B AR KA2	5-pin	1"	Yale 8	US10B	Adamsrite
CS256649	MC100 YA 26D AR KA2	5-pin	1"	Yale 8	US26D	Adamsrite
CS256647	MC100 YA 3 AR KA2	5-pin	1"	Yale 8	US3	Adamsrite
CS428250	MC118 60 26D ST/AR KA2	6-pin	1-1/8"	Corbin 60	US26D	Standard/Adamsrite
CS256692	MC118 AA 26D ST/AR KA2	6-pin	1-1/8"	Arrow	US26D	Standard/Adamsrite
CS256693	MC118 GA 10B ST/AR KA2	6-pin	1-1/8"	Sargent LA	US10B	Standard/Adamsrite
CS256694	MC118 GA 26D ST/AR KA2	6-pin	1-1/8"	Sargent LA	US26D	Standard/Adamsrite
CS286172	MC118 GA 3 ST/AR KA2	6-pin	1-1/8"	Sargent LA	US3	Standard/Adamsrite
CS256696	MC118 KS 10B ST/AR KA2	6-pin	1-1/8"	Kwikset	US10B	Standard/Adamsrite
CS256697	MC118 KS 26D ST/AR KA2	6-pin	1-1/8"	Kwikset	US26D	Standard/Adamsrite
CS256695	MC118 KS 3 ST/AR KA2	6-pin	1-1/8"	Kwikset	US3	Standard/Adamsrite
CS256701	MC118 RB 10B ST/AR KA2	6-pin	1-1/8"	Russwin D1	US10B	Standard/Adamsrite
CS256703	MC118 RB 26D ST/AR KA2	6-pin	1-1/8"	Russwin D1	US26D	Standard/Adamsrite
CS256699	MC118 RB 3 ST/AR KA2	6-pin	1-1/8"	Russwin D1	US3	Standard/Adamsrite
CS256706	MC118 SC 10B ST/AR KA2	6-pin	1-1/8"	SCHL-C	US10B	Standard/Adamsrite
CS256707	MC118 SC 26D ST/AR KA2	6-pin	1-1/8"	SCHL-C	US26D	Standard/Adamsrite
CS437331	MC118 SC 26D ST/AR KA2 ABPR	6-pin	1-1/8"	SCHL-C	US26D	Standard/Adamsrite
CS256705	MC118 SC 3 ST/AR KA2	6-pin	1-1/8"	SCHL-C	US3	Standard/Adamsrite
CS124648	MC118E SC123 26D ST/AR 0B	6-pin	1-1/8"	SCHL-C123	US26D	Standard/Adamsrite
CS256708	MC118 SE 10B ST/AR KA2	6-pin	1-1/8"	SCHL-E	US10B	Standard/Adamsrite
CS256709	MC118 SE 26D ST/AR KA2	6-pin	1-1/8"	SCHL-E	US26D	Standard/Adamsrite
CS256712	MC118 SX 10B ST/AR KA2	6-pin	1-1/8"	SCHL-Composite	US10B	Standard/Adamsrite
CS256716	MC118 SX 26D ST/AR KA2	6-pin	1-1/8"	SCHL-Composite	US26D	Standard/Adamsrite
CS256711	MC118 SX 3 ST/AR KA2	6-pin	1-1/8"	SCHL-Composite	US3	Standard/Adamsrite
CS256717	MC118 WA 26D ST/AR KA2	6-pin	1-1/8"	Weiser	US26D	Standard/Adamsrite
CS256720	MC118 YA 26D ST/AR KA2	6-pin	1-1/8"	Yale 8	US26D	Standard/Adamsrite
CS256719	MC118 YA 3 ST/AR KA2	6-pin	1-1/8"	Yale 8	US3	Standard/Adamsrite
CS256740	MC114 SC 10B ST KA2	6-pin	1-1/4"	SCHL-C	US10B	Standard
CS256742	MC114 SC 26D ST KA2	6-pin	1-1/4"	SCHL-C	US26D	Standard
CS256738	MC114 SC 3 ST KA2	6-pin	1-1/4"	SCHL-C	US3	Standard
CS256746	MC114 SX 10B ST KA2	6-pin	1-1/4"	SCHL-Composite	US10B	Standard
CS256750	MC114 SX 26D ST KA2	6-pin	1-1/4"	SCHL-Composite	US26D	Standard
CS256744	MC114 SX 3 ST KA2	6-pin	1-1/4"	SCHL-Composite	US3	Standard





## KLC, Rim, Dummy & T-Turn Cylinders

### Thumb Turns

ANX#	Part#	Length	Type	Finish	Cam
CS256816	MC100TT 10B AR	1"	Mortise	US10B	Adamsrite
CS256817	MC100TT 26D AR	1"	Mortise	US26D	Adamsrite
CS256815	MC100TT 3 AR	1"	Mortise	US3	Adamsrite
CS256819	MC118TT 10B ST/AR	1-1/8"	Mortise	US10B	Standard/Adamsrite
CS256821	MC118TT 26D ST/AR	1-1/8"	Mortise	US26D	Standard/Adamsrite
CS256818	MC118TT 3 ST/AR	1-1/8"	Mortise	US3	Standard/Adamsrite
CS256824	MC114TT 26D ST	1-1/4"	Mortise	US26D	Standard
CS256823	MC114TT 3 ST	1-1/4"	Mortise	US3	Standard



### Dummy Cylinders

ANX#	Part#	Length	Type	Finish
CS256610	MC100DC 10B	1"	Mortise	US10B
CS256611	MC100DC 26D	1"	Mortise	US26D
CS256609	MC100DC 3	1"	Mortise	US3
CS256613	MC118DC 10B	1-1/8"	Mortise	US10B
CS256614	MC118DC 26D	1-1/8"	Mortise	US26D
CS256612	MC118DC 3	1-1/8"	Mortise	US3
CS287326	RCDC 26D		Rim	US26D

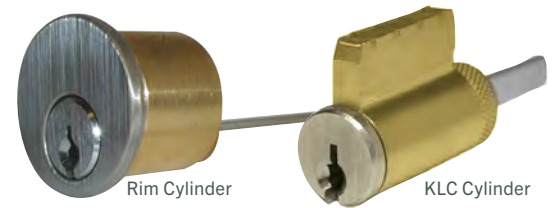

### Rim Cylinders

ANX#	Part#	Length	Type	Finish
CS256763	RC6 AA 26D KA2	6-pin	Arrow	US26D
CS256768	RC6 AA 26D KD	6-pin	Arrow	US26D
CS256758	RC6 AA 3 KA2	6-pin	Arrow	US3
CS256769	RC6 GA 26D KD	6-pin	Sargent LA	US26D
CS256778	RC6 KS 10B KD	6-pin	Kwikset	US10B
CS256779	RC6 KS 26D KA2	6-pin	Kwikset	US26D
CS256781	RC6 KS 26D KD	6-pin	Kwikset	US26D
CS256771	RC6 KS 3 KA2	6-pin	Kwikset	US3
CS256774	RC6 KS 3 KD	6-pin	Kwikset	US3
CS256784	RC6 RB 26D KA2	6-pin	Russwin D1	US26D
CS256790	RC6 SC 10B KA2	6-pin	SCHL-C	US10B
CS256792	RC6 SC 10B KD	6-pin	SCHL-C	US10B
CS256793	RC6 SC 26D KA2	6-pin	SCHL-C	US26D
CS256794	RC6 SC 26D KD	6-pin	SCHL-C	US26D
CS256788	RC6 SC 3 KA2	6-pin	SCHL-C	US3
CS256789	RC6 SC 3 KD	6-pin	SCHL-C	US3
CS124649	RC6E SC123 26D OB	6-pin	SCHL-C123	US26D
CS256796	RC6 SE 26D KA2	6-pin	SCHL-E	US26D
CS256799	RC6 SX 26D KA2	6-pin	SCHL-Composite	US26D
CS256800	RC6 SX 26D KD	6-pin	SCHL-Composite	US26D
CS256797	RC6 SX 3 KD	6-pin	SCHL-Composite	US3
CS256803	RC6 WA 26D KA2	6-pin	Weiser	US26D
CS256807	RC6 YA 10B KD	6-pin	Yale 8	US10B
CS256808	RC6 YA 26D KA2	6-pin	Yale 8	US26D
CS256810	RC6 YA 26D KD	6-pin	Yale 8	US26D
CS256804	RC6 YA 3 KA2	6-pin	Yale 8	US3

### Key-in-Lever / Knob Cylinders

ANX#	Part#	Length	Type	Finish
CS256570	KLC1599 AA 26D KD	6-pin	Arrow	US26D
CS256571	KLC1599 AA 26D OB	6-pin	Arrow	US26D
CS256568	KLC1599 AA 4 OB	6-pin	Arrow	US4
CS256574	KLC1599 CA 26D KD	6-pin	Corbin 60	US26D
CS256576	KLC1599 CA 26D OB	6-pin	Corbin 60	US26D
CS256573	KLC1599 CA 4 OB	6-pin	Corbin 60	US4
CS256578	KLC1599 GA 26D KD	6-pin	Sargent LA	US26D
CS483431	KLC1599 GA 26D OB	6-pin	Sargent LA	US26D
CS256580	KLC1599 KS 26D KD	6-pin	Kwikset	US26D
CS256581	KLC1599 KS 26D OB	6-pin	Kwikset	US26D
CS256579	KLC1599 KS 4 OB	6-pin	Kwikset	US4
CS256583	KLC1599 RB 26D KD	6-pin	Russwin D1	US26D
CS256584	KLC1599 RB 26D OB	6-pin	Russwin D1	US26D
CS256582	KLC1599 RB 4 OB	6-pin	Russwin D1	US4
CS437330	KLC1599 SC 26D ABPR	6-pin	SCHL-C - Bump Resistant	US26D
CS256586	KLC1599 SC 26D KD	6-pin	SCHL-C	US26D
CS256588	KLC1599 SC 26D OB	6-pin	SCHL-C	US26D
CS256585	KLC1599 SC 4 OB	6-pin	SCHL-C	US4
CS124645	KLC1599E SC123 26D OB	6-pin	SCHL-C123	US26D
CS256592	KLC1599 SE 26D KD	6-pin	SCHL-E	US26D
CS256595	KLC1599 SE 26D OB	6-pin	SCHL-E	US26D
CS256590	KLC1599 SE 4 OB	6-pin	SCHL-E	US4
CS256597	KLC1599 SX 26D KD	6-pin	SCHL-Composite	US26D
CS256598	KLC1599 SX 26D OB	6-pin	SCHL-Composite	US26D
CS256596	KLC1599 SX 4 OB	6-pin	SCHL-Composite	US4
CS256601	KLC1599 WA 26D KD	6-pin	Weiser	US26D
CS256602	KLC1599 WA 26D OB	6-pin	Weiser	US26D
CS256600	KLC1599 WA 4 OB	6-pin	Weiser	US4
CS256605	KLC1599 YA 26D KD	6-pin	Yale 8	US26D
CS256606	KLC1599 YA 26D OB	6-pin	Yale 8	US26D
CS256604	KLC1599 YA 4 OB	6-pin	Yale 8	US4

## SFIC Cores

### SFIC Cores 6-Pin - Uncombined

ANX#	Part#	Keyway	Finish
CS275719	IC6B A 26D	A	US26D
CS275718	IC6B A 4	A	US4*
CS275723	IC6B B 26D	B	US26D
CS275721	IC6B B 4	B	US4*
CS275726	IC6B C 26D	C	US26D
CS275725	IC6B C 4	C	US4*
CS275734	IC6B D 26D	D	US26D
CS275731	IC6B D 4	D	US4*
CS275747	IC6B E 26D	E	US26D
CS275745	IC6B E 4	E	US4*
CS275749	IC6B F 26D	F	US26D
CS275748	IC6B F 4	F	US4*
CS275754	IC6B G 26D	G	US26D
CS275753	IC6B G 4	G	US4*
CS275757	IC6B H 26D	H	US26D
CS275755	IC6B H 4	H	US4*
CS275759	IC6B J 26D	J	US26D
CS275758	IC6B J 4	J	US4*
CS275766	IC6B K 26D	K	US26D
CS275763	IC6B K 4	K	US4*
CS275771	IC6B L 26D	L	US26D
CS275769	IC6B L 4	L	US4*
CS275775	IC6B M 26D	M	US26D
CS275773	IC6B M 4	M	US4*
CS275777	IC6B Q 26D	Q	US26D
CS275776	IC6B Q 4	Q	US4*

\*Special Order Only - Min. 100 pcs

US4 FINISH SPECIAL ORDER ONLY MIN. 100 PCS.



### SFIC Cores 7-Pin - Uncombined

ANX#	Part#	Keyway	Finish
CS275778	IC7B A 26D	A	US26D
CS275779	IC7B B 26D	B	US26D
CS275780	IC7B C 26D	C	US26D
CS275781	IC7B D 26D	D	US26D
CS275783	IC7B E 26D	E	US26D
CS275784	IC7B F 26D	F	US26D
CS275785	IC7B G 26D	G	US26D
CS275786	IC7B H 26D	H	US26D
CS275787	IC7B J 26D	J	US26D
CS275788	IC7B K 26D	K	US26D
CS275789	IC7B L 26D	L	US26D
CS275790	IC7B M 26D	M	US26D
CS275791	IC7B Q 26D	Q	US26D

### SFIC Cores 6-Pin - Keyed

ANX#	Part#	Keyway	Finish	Keying
CS477208	IC6B G 26D KA	G	US26D	Keyed Alike
CS477209	IC6B G 26D KD	G	US26D	Keyed Different
CS106628	IC6B M 26D KA	M	US26D	Keyed Alike
CS106630	IC6B M 26D KD	M	US26D	Keyed Different
CS120954	IC6B J 26D MKD KD	J	US26D	Master Keyed

### SFIC Cores 6-Pin - Keyed - Cut Key

ANX#	Part#	Keyway	Description
CS477968	1A1G1 434750 CONTROL	G	G Keyway - KA Cores
CS477967	1A1G1 452510 CONTROL	G	G Keyway - KD Cores
CS106632	1A1M1 569476 CONTROL	M	M Keyway - KA Cores
CS106634	1A1M1 439639 CONTROL	M	M Keyway - KD Cores
CS120955	1A1J1 684941 CONTROL	J	J Keyway - MKD Cores
CS120956	1A1J1 395016 MASTER	J	J Keyway - MKD Cores

## Housings

### Mortise Housings - SFIC

ANX#	Part#	Length	Pin	Finish	Cam
CS256547	MC-IC6-AR 10B	1-1/4"	6-pin	US10B	Adamsrite
CS256548	MC-IC6-AR 26D	1-1/4"	6-pin	US26D	Adamsrite
CS256549	MC-IC6-CL 26D	1-1/4"	6-pin	US26D	Cloverleaf
CS465477	MC-IC6-SL 10B	1-1/4"	6-pin	US10B	Schlage
CS465474	MC-IC6-SL 26D	1-1/4"	6-pin	US26D	Schlage
CS256550	MC-IC6-ST 26D	1-1/4"	6-pin	US26D	Standard
CS256551	MC-IC7-AR 10B	1-3/8"	7-pin	US10B	Adamsrite
CS256552	MC-IC7-AR 26D	1-3/8"	7-pin	US26D	Adamsrite
CS256553	MC-IC7-CL 26D	1-3/8"	7-pin	US26D	Cloverleaf
CS256554	MC-IC7-SA 26D	1-3/8"	7-pin	US26D	Sargent
CS463694	MC-IC7-SL 10B	1-3/8"	7-pin	US10B	Schlage
CS256555	MC-IC7-SL 26D	1-3/8"	7-pin	US26D	Schlage
CS463692	MC-IC7-SL 3	1-3/8"	7-pin	US26D	Schlage
CS256556	MC-IC7-ST 10B	1-3/8"	7-pin	US10B	Standard
CS256557	MC-IC7-ST 26D	1-3/8"	7-pin	US26D	Standard
CS463696	MC-IC7-ST 3	1-3/8"	7-pin	US3	Standard
CS256558	MCT-IC6-AR 26D	3/4"	6-pin	Tapered - US26D	Adamsrite
CS256559	MCT-IC7-AR 10B	3/4"	7-pin	Tapered - US10B	Adamsrite
CS256560	MCT-IC7-AR 26D	3/4"	7-pin	Tapered - US26D	Adamsrite



### Rim Housings - SFIC

ANX#	Part#	Pin	Finish
CS120147	RC-IC6-10B	6-pin	US10B
CS256561	RC-IC6 26D	6-pin	US26D
CS256563	RC-IC7 10B	7-pin	US10B
CS256564	RC-IC7 26D	7-pin	US26D
CS256562	RC-IC7 3	7-pin	US3
CS435390	RC-IC7-LZ 26D	7-pin	Lazy - US26D



## Large Format Interchangeable Cores (LFIC)

### Mortise Housings - SCHL-LFIC

ANX#	Part#	Length	Finish	Cam
CS105711	MC-LF-ST/SL 10B	1-1/2"	US10B	Standard/Schlage
CS105716	MC-LF-ST/SL 26D	1-1/2"	US26D	Standard/Schlage
CS105709	MC-LF-ST/SL 3	1-1/2"	US3	Standard/Schlage



### Rim Housings - SCHL-LFIC

ANX#	Part#		Finish	
CS105755	RC-LF 10B		US10B	
CS105756	RC-LF 26D		US26D	
CS105752	RC-LF 3		US3	



### LFIC Cores - 6-Pin

ANX#	Part#	Finish	Keyway
CS105681	IC6S SC 26D 0-BIT	US26D	SCHL-C
CS105680	IC6S SC 4 0-BIT	US4	SCHL-C
CS105686	IC6S SC123 26D 0-BIT	US26D	SCHL-C123
CS114006	IC6S SC145 26D 0-BIT	US26D	SCHL-C145
CS105687	IC6S SE 26D 0-BIT	US26D	SCHL-E
CS124430	IC6S SX 26D 0-BIT	US26D	SCHL-Composite
CS121259	KB SC1 CNTL BR	Control Key Blank	SCHL-C



### LFIC Cores - 6-Pin - Keyed

ANX#	Part#	Keyway	Finish	Keying
CS115219	IC6S SC 26D KA W/C	SCHL-C	US26D	Keyed Alike
CS115221	IC6S SC 26D KD W/C	SCHL-C	US26D	Keyed Different

## Cylinder Parts



### Cams

ANX#	Part#	Cylinder Type	Cam Type
CS269981	CL CAM	Standard Cylinder	Cloverleaf
CS269979	AR CAM	Standard Cylinder	Adamsrite
CS269984	SA CAM	Standard Cylinder	Sargent
CS269988	SL CAM	Standard Cylinder	Schlage
CS269990	ST CAM	Standard Cylinder	Standard
CS105762	CL-LF CAM	SCHL-LFIC Cylinder	Cloverleaf
CS105757	AR-LF CAM	SCHL-LFIC Cylinder	Adamsrite
CS105768	SA-LF CAM	SCHL-LFIC Cylinder	Sargent
CS105769	SL-LF CAM	SCHL-LFIC Cylinder	Schlage
CS105770	ST-LF CAM	SCHL-LFIC Cylinder	Standard
CS269982	CL-IC CAM	SFIC Cylinder	Cloverleaf
CS269980	AR-IC CAM	SFIC Cylinder	Adamsrite
CS269986	SA-IC CAM	SFIC Cylinder	Sargent
CS269989	SL-IC CAM	SFIC Cylinder	Schlage
CS269992	ST-IC CAM	SFIC Cylinder	Standard
CS124638	CL-E CAM	SCHL-E Type Cylinder	Cloverleaf
CS124637	AR-E CAM	SCHL-E Type Cylinder	Adamsrite
CS124640	SA-E CAM	SCHL-E Type Cylinder	Sargent
CS124641	SL-E CAM	SCHL-E Type Cylinder	Schlage
CS124643	ST-E CAM	SCHL-E Type Cylinder	Standard

### Collars

ANX#	Part#	Size	Finish
CS270420	CR-1 10B	5/32"	US10B
CS270421	CR-1 26D	5/32"	US26D
CS270417	CR-1 3	5/32"	US3
CS270423	CR-2 10B	1/8"	US10B
CS270424	CR-2 26D	1/8"	US26D
CS270422	CR-2 3	1/8"	US3
CS270427	CR-3 10B	1/4" Adjustable	US10B
CS270429	CR-3 26D	1/4" Adjustable	US26D
CS270425	CR-3 3	1/4" Adjustable	US3

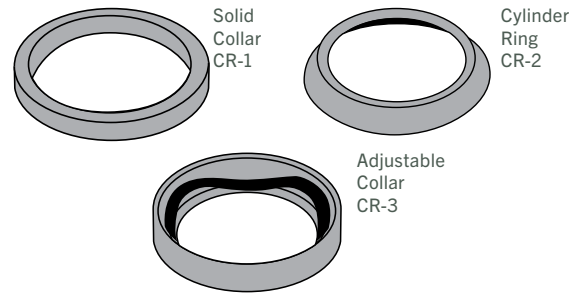

### Misc. Cylinder Parts

ANX#	Part#	Size
CS127058	KLC-1599- CAP PIN-100	KLC Cylinder Cap Pin - 100 Pk.
CS127059	KLC-1599-CAP SPRING-100	KLC Cylinder Cap Spring- 100 Pk.
CS127060	MC-CAM SCREWS-100	Mort. Cyl. Cam Screws- 100 Pk.
CS127061	RC-BACK PLATE	Rim Cyl Back Plate
CS127062	RC-MOUNTING SCREWS-2	Rim Cyl. Mounting Screws- 2 Pk.
CS471691	RCTP	Rim Cyl. Tailpiece
CS106542	RCTP-IC	SFIC Rim Cyl. Tailpiece
CS321778	IC-SP1	6 to 7 Pin SFIC Spacer

## Key Blanks

- ◆ Door Cylinder Key Blanks
  - Brass - Neuter Bow Do Not Duplicate
  - Manufactured to OEM Specifications
  - All Popular Keyways
  - Sold in Box Quantity
- ◆ Padlock Key Blanks
  - Fits General Lock Padlocks
- ◆ Safe Key Blanks
  - Fits General Lock SDFB & SDFC Inner Compartments



### Neuter Bow DND Key Blank

ANX#	Part#	Keyway	Length
CS459471	KB C087 DND BR	Corbin 1Z-60	5-Pin
CS459472	KB C088 DND BR	Corbin 1Z-60	6-Pin
CS459474	KB KW1 DND BR	Kwikset	5-Pin
CS106544	KB KW10 DND BR	Kwikset	6-Pin
CS459475	KB RU45 DND BR	Russwin D1	5-Pin
CS459476	KB RU46 DND BR	Russwin D1	6-Pin
CS459473	KB S22 DND BR	Sargent LA	6-Pin
CS459477	KB SC1 DND BR	Schlage C	5-Pin
CS459478	KB SC4 DND BR	Schlage C	6-Pin
CS459479	KB SC9 DND BR	Schlage E	6-Pin
CS459480	KB WR5 DND BR	Weiser	5-Pin
CS459481	KB Y1 DND BR	Yale 8	5-Pin
CS121259	KB SC1 CNTL BR - STD BOW	SCHL-C Control	6-Pin

### Padlock Keyblank

ANX#	Part#	GL Padlock Series
CS513975	KB AM3 S BR	PL456S, PL635S
CS513976	KB AM4 S BR	PL730
CS511031	KB200 NP	PL200B
CS511032	KB300/400 NP	PL300B & PL400B
CS511033	KB700 NP	PL700SS, PL40LP, PL44LP
CS121242	KB-PL201	PL201
CS121243	KB-PL301	PL301
CS121244	KB-PL401	PL401
CS121250	KB-PL41-43	PL41LP, PL43LP
CS121245	KB-PL501	PL501B
CS121249	KB-PL701	PL701SS

### Safe Keyblank

ANX#	Part#	GL Padlock Series
CS126824	KB-MJWA-WTS-01	SDFB / SDFC Inner Compartment

### Custom Coined Keys

#### Build your Brand and Generate Repeat Business with Custom Coined Keys.

- Keys are coined – Raised Letters
- Minimum order quantity - **3,000**
- Minimum line quantity - **3,000**
- Tooling cost per side: **\$120** for simple design, or **\$160** for complex designs.
- 5-pin and 6-pin Neuter Bow
- Lead time 16 – 18 weeks on the first order



#### Available Keyways

5-Pin	6-Pin
AR1	AR4
C087	C088
KW1	KW10
RU45	RU46
SC1	S22
WR5	SC4
Y1	SC9

#### Custom-Branded Coined Keys Order Form

<https://www.anixter.com/content/dam/anixter/resources/promotions/180605-GL-Custom-Coined-Keys-Order-Form-Apr-2019.pdf>

Call your local Anixter Security Branch to place your order today  
**1 (844) 522-5275.**

## Builder's Hardware

Builder's hardware specifically used to increase security and to protect the finish on metal or wood interior and exterior doors.

- ◆ Filler Plates
- ◆ Hole Filler & Scar Plates
- ◆ Hinges
- ◆ Push, Pulls, & Kick Plates
- ◆ Wrap Arounds

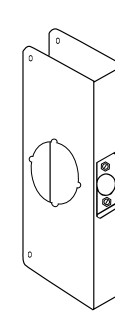
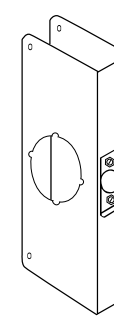
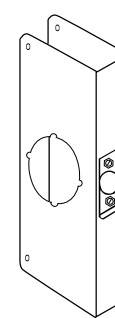
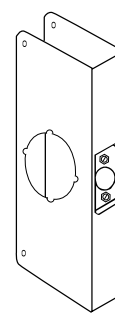
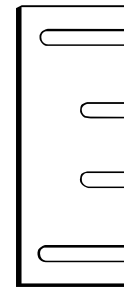
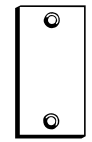
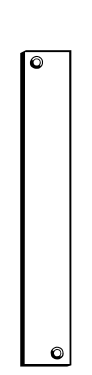
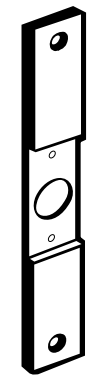
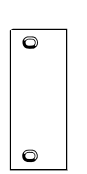
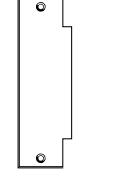
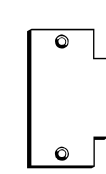
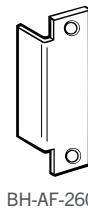
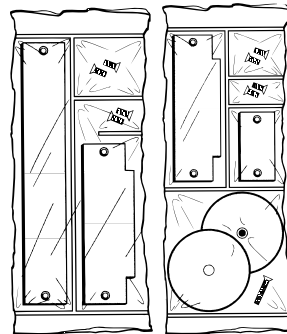
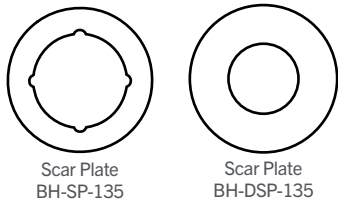
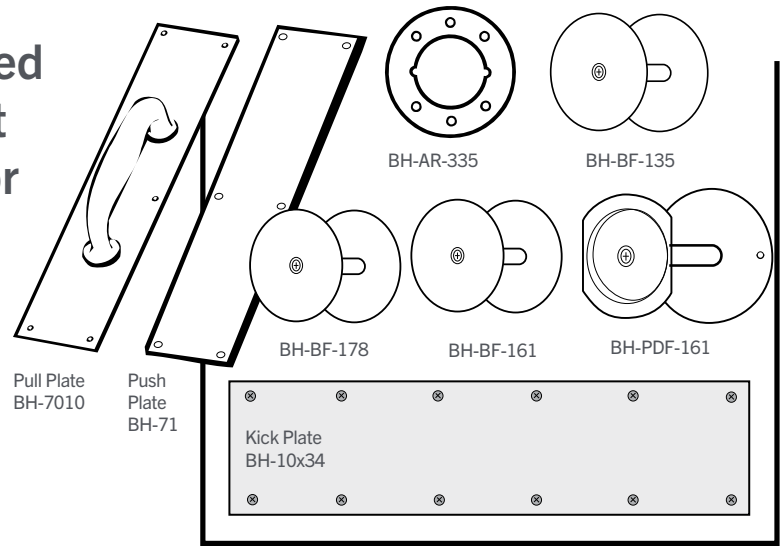

BH-CV-86  
Converts 86  
cut out to 161

BH-EF-634  
Flush bolt  
cut out

BH-EF-86  
86 cut out

BH-EF-160  
160 cut out  
BH-EF-161  
161 cut out

BH-HF-45  
BH-SHF-45  
Door hinge  
cut out

BH-HS-060  
16 (.060) Gauge  
hinge shim

BH-1-PB-CW  
BH-1-S-CW

BH-2-PB-CW  
BH-2-S-CW

BH-3-PB-CW  
BH-3-S-CW

BH-4-PB-CW  
BH-4-S-CW

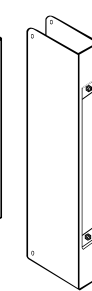
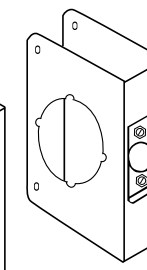
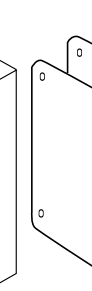
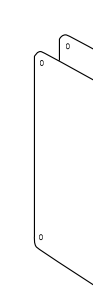
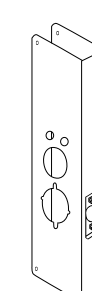
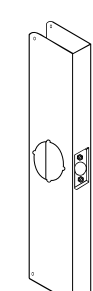
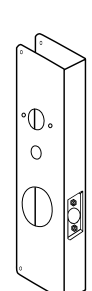
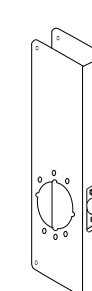
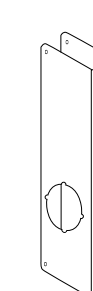
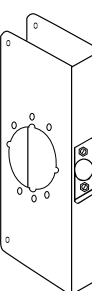
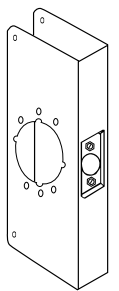

BH-4-S-2-CW

BH-12-2-S-CW

BH-14-S-CW

BH-14-2-S-CW

BH-15-S-CW

BH-20-S-CW

BH-27-S-CW

BH-40-S-CW

BH-80-S-CW

BH-51-PB-CW  
BH-61-PB-CW  
BH-81-PB-CW  
BH-81-S-CW

BH-504-S-CW



## Builder's Hardware

### Filler Plates

ANX#	Part#	Type	Size	Finish
CS422257	BH-AF-260-SL	Electric Strike Filler - Blank	4-7/8"x1-1/4"	Painted Silver
CS422258	BH-AF-261-SL	Electric Strike Filler - Strike	4-7/8"x1-1/4"	Painted Silver
CS422272	BH-BTS-160-PC	T-Strike	2-3/4" x 1-1/8"	Prime Coated
CS422281	BH-CV-86	Mortise to Cylindrical	8" x 1-1/4"	Prime Coated
CS422284	BH-EF-160	Latch/Bolt	2-1/4" x 1"	Prime Coated
CS422285	BH-EF-161	Latch/Bolt	2-1/4" x 1-1/8"	Prime Coated
CS422286	BH-EF-161-S	Latch/Bolt	2-3/4" x 1-1/8"	Prime Coated
CS422287	BH-EF-634	Flush Bolt	6-3/4" x 1"	Prime Coated
CS422288	BH-EF-86	Mortise 86	8" x 1-1/4" x 3/16"	Prime Coated
CS422292	BH-FF-45	Frame Hinge	4-1/2" x 1-5/8"	Prime Coated
CS422293	BH-FPK-161	Cylindrical Filler Plate Kit		Prime Coated
CS422294	BH-FPK-86	Mortise Filler Plate Kit		Prime Coated
CS422295	BH-FS-260-PC	ASA Strike	4-7/8"x1-1/4"	Prime Coated
CS422296	BH-HF-45	Hinge	4-1/2" x 1-3/4"	Prime Coated
CS422297	BH-HS-060	16 Ga. Hinge Shim	4-1/2"	Prime Coated
CS422298	BH-HS-090	13 Ga. Hinge Shim	4-1/2"	Prime Coated
CS422341	BH-SHF-45	Hinge	4-1/2" x 1-1/2"	Prime Coated



BH-AF-261

### Hole Filler Plates

ANX#	Part#	Type	Size	Finish
CS422261	BH-AR-335-613	Lever Spacer F/ 1-3/8" Door	3-1/2" Dia	Dark Bronze
CS422262	BH-AR-335-630	Lever Spacer F/ 1-3/8" Door	3-1/2" Dia	Stainless Steel
CS422263	BH-BF-135-PC	Round Hole Cover	3-3/4" Dia. Hole	Prime Coated
CS422264	BH-BF-161-BP	Round Hole Cover - 2-5/8"	2-1/8" Dia. Hole	Brass Plated
CS422265	BH-BF-161-PC	Round Hole Cover - 2-5/8"	2-1/8" Dia. Hole	Prime Coated
CS422266	BH-BF-161-SL	Round Hole Cover - 2-5/8"	2-1/8" Dia. Hole	Painted Silver
CS422267	BH-BF-178-PC	Round Hole Cover - 1-7/8"	1-1/2" Dia. Hole	Prime Coated
CS422268	BH-BF-178-SL	Round Hole Cover - 1-7/8"	1-1/2" Dia. Hole	Painted Silver
CS422322	BH-PDF-161-PC	Under Rim Device Cover	2-1/8" Dia. Hole	Prime Coated

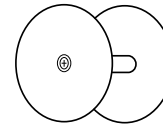

BH-BF-135

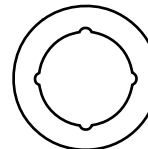

Scar Plate  
BH-SP-135

### Scar Plate

ANX#	Part#	Type	Size	Finish
CS422282	BH-DSP-135-605	Dead Bolt	2-3/8" to 2-3/4" B.S.	Bright Brass
CS422283	BH-DSP-135-630	Dead Bolt	2-3/8" to 2-3/4" B.S.	Stainless Steel
CS422344	BH-SP-135-605	Knobset	2-3/8" to 2-3/4" B.S.	Bright Brass
CS422345	BH-SP-135-609	Knobset	2-3/8" to 2-3/4" B.S.	Antique Brass
CS422346	BH-SP-135-630	Knobset	2-3/8" to 2-3/4" B.S.	Stainless Steel

### Hinges

ANX#	Part#	Type	Size	Finish
CS115206	BH-BB4545 652 626 AWS/WMS	Removable Pin	4-1/2" x 4-1/2"	US26D
CS115207	BH-BB4545NRP 652 626 AWS/WMS	Non-Removable Pin	4-1/2" x 4-1/2"	US26D

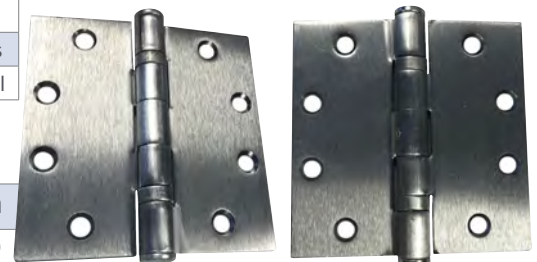

BH-BB4545 652  
626 AWS/WMS

BH-BB4545NRP  
652 626 AWS/WMS

## Builder's Hardware

### Push, Pull & Kick Plates

ANX#	Part#	Type	Size	Finish
CS422256	BH-8X34-630	Kick Plate	8"x34"	Stainless Steel
CS121931	BH 10X30-630	Kick Plate	10"x30"	Stainless Steel
CS422226	BH-10X34-630	Kick Plate	10"x34"	Stainless Steel
CS422323	BH-7010-605	Pull Plate	3.5"x15"	Bright Brass
CS422324	BH-7010-613	Pull Plate	3.5"x15"	Dark Bronze
CS422247	BH-7010-628	Pull Plate	3.5"x15"	Aluminum
CS422325	BH-7010-630	Pull Plate	3.5"x15"	Stainless Steel
CS422329	BH-70-605	Push Plate	3.5"x15"	Bright Brass
CS422331	BH-70-613	Push Plate	3.5"x15"	Dark Bronze
CS422248	BH-70-628	Push Plate	3.5"x15"	Aluminum
CS422332	BH-70-630	Push Plate	3.5"x15"	Stainless Steel
CS422249	BH-7110-630	Pull Plate	4"x16"	Stainless Steel
CS422250	BH-7116-630	Pull Plate	4"x16"	Stainless Steel
CS422251	BH-71-628	Push Plate	4"x16"	Aluminum
CS422252	BH-71-630	Push Plate	4"x16"	Stainless Steel

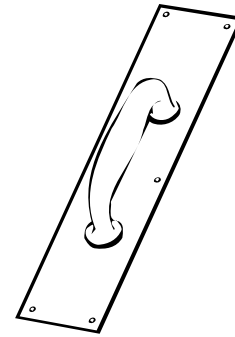

Pull Plate  
BH-7010

### Wrap Arounds

ANX#	Part#	Type	Door	Backset	Size	Finish
CS422232	BH-1-PB-CW	Knobset	1-3/8"	2-3/8"	4" x 9"	Bright Brass
CS422233	BH-1-S-CW	Knobset	1-3/8"	2-3/8"	4" x 9"	Stainless Steel
CS422236	BH-2-PB-CW	Knobset	1-3/4"	2-3/8"	4" x 9"	Bright Brass
CS422237	BH-2-S-CW	Knobset	1-3/4"	2-3/8"	4" x 9"	Stainless Steel
CS422239	BH-3-PB-CW	Knobset	1-3/8"	2-3/4"	4-1/4" x 9"	Bright Brass
CS422241	BH-4-PB-CW	Knobset	1-3/4"	2-3/4"	4-1/4" x 9"	Bright Brass
CS422242	BH-4-S-2-CW	Leverset	1-3/4"	2-3/4"	4-3/4" x 9"	Stainless Steel
CS422243	BH-4-S-CW	Knobset	1-3/4"	2-3/4"	4-1/4" x 9"	Stainless Steel
CS422227	BH-12-2-S-CW	Leverset	1-3/4"	2-3/4"	4-3/4" x 12"	Stainless Steel
CS422228	BH-14-2-S-CW	Leverset	1-3/4"	2-3/4"	5" x 14"	Stainless Steel
CS422230	BH-14-S-CW	Knobset	1-3/4"	2-3/4"	5" x 14"	Stainless Steel
CS422231	BH-15-S-CW	Simplex 1000	1-3/4"	2-3/4"	5" x 15"	Stainless Steel
CS422234	BH-20-S-CW	Knobset	1-3/4"	2-3/4"	5" x 20"	Stainless Steel
CS422235	BH-27-S-CW	Alarmlock	1-3/4"	2-3/4"	5" x 15"	Stainless Steel
CS422240	BH-40-S-CW	Blank	1-3/4"	Blank	4-1/4" x 9"	Stainless Steel
CS422244	BH-504-S-CW	Mortise	1-3/4"	Blank	5" x 12"	Stainless Steel
CS422245	BH-51-PB-CW	Knobset	1-3/8"	2-3/8"	4" x 4-1/2"	Bright Brass
CS422246	BH-61-PB-CW	Knobset	1-3/4"	2-3/8"	4" x 4-1/2"	Bright Brass
CS422253	BH-80-S-CW	Blank	1-3/4"	Blank	4-1/2" x 4-1/2"	Stainless Steel
CS422254	BH-81-PB-CW	Knobset	1-3/4"	2-3/4"	4-1/4" x 4-1/2"	Bright Brass
CS422255	BH-81-S-CW	Knobset	1-3/4"	2-3/4"	4-1/4" x 4-1/2"	Stainless Steel

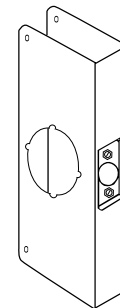

BH-2-PB-CW  
BH-2-S-CW

### Storefront Exit Devices

For use on a single door or double doors with or without mullion. For use as a new installation on single or double storefront glass doors or replacement for Jackson exit devices.

- ◆ UL Listed
- ◆ Rim device is handed. CVR device is reversible
- ◆ Replacement for Jackson 1085/1095
- ◆ Cylinder Pad sold separately



ED1048CV

#### SPECIFICATIONS:

Certifications	UL Listed
Sizes	48" - cut to size
Handing	Rim-Handed - CVR-Non-handed
Strike	Panic Rim Device Furnished with Roller Strike
Cylinder	Cylinder Sold Separately
Trim	Cylinder Pad Sold Separately
Materials	Aluminum
Mounting Hardware	Included
Warranty	1 Year

## ED1000 Series

#### ED1000 Series Narrow Stile Exit Device

ANX#	Part#	Type	Size	Hand	Finish
CS428867	ED1048CV-313	Concealed Vertical Rod	48" x 84"		Duronodic
CS428868	ED1048CV-628	Concealed Vertical Rod	48" x 84"		Aluminum
CS428869	ED1048R-LHR-313	Rim	48"	Left Hand Reverse	Duronodic
CS428870	ED1048R-LHR-628	Rim	48"	Left Hand Reverse	Aluminum
CS428904	ED1048R-RHR-313	Rim	48"	Right Hand Reverse	Duronodic
CS428906	ED1048R-RHR-628	Rim	48"	Right Hand Reverse	Aluminum

#### ED1000 Series Parts

ANX#	Part#	Type	Size
CS452143	ED10CES 313	Mortise Cyl. Pad	Duronodic
CS452145	ED10CES 628	Mortise Cyl. Pad	Aluminum

### Standard Duty Exit Devices

For use on a single door or double doors with or without mullion. For 1-3/4" (44 mm) thick standard RHR or LHR hollow metal doors and wood doors. All devices and accessories are to be used on a 1-3/4" standard door.

- ◆ Meets ANSI A156.3 Grade 1 Standards
- ◆ Non-handed
- ◆ Trim sold separately

## ED2300 Series



#### SPECIFICATIONS:

Certifications	ANSI A156.3 Grade 1, UL Listed Panic Device, UL Listed 3-hour Fire Device
Sizes	36" and 48"
Handing	Non-handed
Strike	Panic Rim Device Furnished with Roller Strike
Cylinder	Cylinder Sold Separately
Trim	Trim Sold Separately
Materials	Steel or Stainless Steel (All Springs Stainless Steel)
Mounting Hardware	Machine Screws, Sex Nuts and Bolts

#### ED2300 Series Exit Device

ANX#	Part#	Type	Size	Finish
CS380439	ED2300R-P 689 36"	Rim	36"	Aluminum
CS380442	ED2300R-P 689 48"	Rim	48"	Aluminum
CS380444	ED2300R-P 695 36"	Rim	36"	Dark Bronze
CS410995	ED2300R-P 695 48"	Rim	48"	Dark Bronze
CS106521	ED2300R-P 630 36"	Rim	36"	Stainless Steel
CS380429	ED2300R-F 689 36"	Rim - Fire Rated	36"	Aluminum
CS380433	ED2300R-F 695 36"	Rim - Fire Rated	36"	Dark Bronze
CS380475	ED2300V-P 689 36"	Surface Vertical Rod	36" x 84"	Aluminum
CS380476	ED2300V-P 695 36"	Surface Vertical Rod	36" x 84"	Dark Bronze
CS380472	ED2300V-F 689 36"	Surface Vertical Rod - Fire Rated	36" x 84"	Aluminum

36" PANIC RATED EXIT DEVICE CAN BE CUT DOWN TO 25.5".

36" FIRE RATED EXIT DEVICE CAN BE CUT DOWN TO 23.5".

48" PANIC RATED EXIT DEVICE CAN BE CUT DOWN TO 30.5".

48" FIRE RATED EXIT DEVICE CAN BE CUT DOWN TO 28.5".

### ED2300 Series Trims & Parts

#### ED2300 Series Trims

ANX#	Part#	Type	Size
CS480213	ED23T-KIK-CLS 630	Key-In-Knob - Classroom - C-Kwy	US32D
CS480214	ED23T-KIK-NL-630	Key-In-Knob - Storeroom - C-Kwy	US32D
CS380481	ED23T-KIL-CLS 626	Key-In-Lever - Classroom - C-Kwy	US26D
CS101056	ED23T-KIL-CLS 626 IC	Key-In-Lever - Storeroom - SFIC	US26D
CS402392	ED23T-KIL-CLS 695	Key-In-Lever - Classroom - C-Kwy	Dark Bronze
CS450557	ED23T-KIL-NL 626	Key-In-Lever - Storeroom - C-Kwy	US26D
CS101057	ED23T-KIL-NL 626 IC	Key-In-Lever - Storeroom - SFIC	US26D
CS450558	ED23T-KIL-NL 695	Key-In-Lever - Storeroom - C-Kwy	Dark Bronze
CS125521	ED23T-KIL-PASSAGE-626	Key-In-Lever - PASSAGE	US26D
CS448442	ED23T-LET-CLS 626	Escutcheon/Lever - Classroom	US26D
CS448443	ED23T-LET-CLS 695	Escutcheon/Lever - Classroom	Dark Bronze
CS449351	ED23T-LET-NL 626	Escutcheon/Lever - Storeroom	US26D
CS449352	ED23T-LET-NL 695	Escutcheon/Lever - Storeroom	Dark Bronze
CS125522	ED23T-LET-PASSAGE-626	Escutcheon/Lever - PASSAGE	US26D
CS480203	ED23T-FP01-NL 689	Finger Pull	Aluminum
CS480207	ED23T-FP01-NL 695	Finger Pull	Dark Bronze
CS380483	ED23T-P01 689	Pull Plate - Blank	Aluminum
CS380484	ED23T-P01 695	Pull Plate - Blank	Dark Bronze
CS380486	ED23T-P01-NL 689	Pull Plate - Cylinder Hole	Aluminum
CS380487	ED23T-P01-NL 695	Pull Plate - Cylinder Hole	Dark Bronze
CS480215	ED23T-PET-NL-630	Escutcheon/Pull - Cyl. Hole	US32D
CS505977	ED23T-PET-NL-695	Escutcheon/Pull - Cyl. Hole	Dark Bronze
CS480217	ED23T-PET-TP-630	Escutcheon/Thumb Piece - Classroom	US32D
CS505978	ED23T-PET-TP-695	Escutcheon/Thumb Piece - Classroom	Dark Bronze



ED23T-KIK-CLS-630



ED23T-KIL-CLS-626



ED23T-P01 689



ED23T-LET-630



ED23T-PET-TP 630



ED23T-PET-NL 630



ED23-DOGGING KEY



ED23T-CRC

#### ED2300 Series Parts

ANX#	Part#	Type	Size
CS395553	ED S 237 630	Double Door Strike	US32D
CS444016	ED232-RP	Roller Strike & Shim - ED2300R-P	US32D
CS444017	ED233-RF	Roller Strike & Shim - ED2300R-F	US32D
CS446241	ED23-TOP STRIKE	Top Strike for ED2300V	US32D
CS446238	ED23-BOTTOM STRIKE	Bottom Strike for ED2300V	US32D
CS102465	ED23-DOGGING KEY	Hex Dogging Key	
CS102955	ED23-DOGGING MECH	Dogging Mechanism	
CS444019	ED23-ECS 689	End Cap Set	Aluminum
CS444020	ED23-ECS 695	End Cap Set	Dark Bronze
CS415269	ED23ER-12 689	12" Vertical Extension Rod	Aluminum
CS448072	ED23ER-12 695	12" Vertical Extension Rod	Dark Bronze
CS444021	ED23-LBA 689	Bottom Latch Assy. & Cover	Aluminum
CS444025	ED23-LBA 695	Bottom Latch Assy. & Cover	Dark Bronze
CS444026	ED23-LTA 689	Top Latch Assy. & Cover	Aluminum
CS444027	ED23-LTA 695	Top Latch Assy. & Cover	Dark Bronze
CS444028	ED23-RBA 689	Bottom Rod Assy.	Aluminum
CS444029	ED23-RBA 695	Bottom Rod Assy.	Dark Bronze
CS444030	ED23-RTA78 689	Top Rod Assy. 7' to 8'	Aluminum
CS444031	ED23-RTA78 695	Top Rod Assy. 7' to 8'	Dark Bronze
CS444032	ED23-SNB 689	Sex Nuts & Bolts	Aluminum
CS444033	ED23-SNB 695	Sex Nuts & Bolts	Dark Bronze
CS485412	ED23T-CRC	Cyl. Retaining Cup	

### Storefront

Swingbolt / hookbolt or deadlatch locks and hardware for all your storefront needs.

- ◆ Locks
- ◆ Hardware & Lock Parts
- ◆ Pivots
- ◆ Narrow Stile Exits (see exit section)
- ◆ Overhead Closers (see closer section)



ADB118 AL      AHB118 AL



ADL118 shown with cylinder and AL1 lever

ADL118 AL

ADB, AHB, and ADL locks each come with four different faceplates.



APV-8

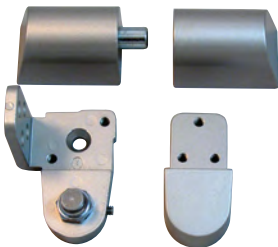

APV-10 (RH shown)



AHDB-DD



ATDB



AHDB118



AFB-AL



ADLS-LS2H



ADLS-SS1H



AEXIN-AL

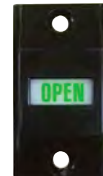

AEXIN-DU



LOCKED



LOCKED

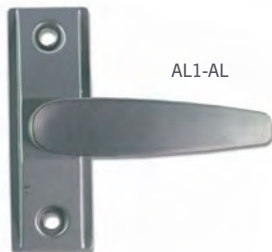

AL1-AL



AP1 AL



ACD



AMCRS-95



AP1RS

**THIS DOOR TO REMAIN UNLOCKED**

**WHEN THE BUILDING IS OCCUPIED**

AHS 1 of 2 signs  
Other sign states:  
THIS DOOR TO REMAIN UNLOCKED  
DURING BUSINESS HOURS

### Storefront

#### Storefront Locks

ANX#	Part#	Description	Backset	Finish
CS103072	ADB2P *	Two Point Header/Threshold Deadbolt		US26D
CS418625	ADB118 AL/DU	Swingbolt - 4 Faceplates, Flat/Radiused	1-1/8"	628/313
CS418626	ADB3132 AL/DU	Swingbolt - 4 Faceplates, Flat/Radiused	31/32"	628/313
CS418639	ADL118 AL/DU	Deadlatch - 4 Faceplates, Flat/Radiused	1-1/8"	628/313
CS418643	ADL3132 AL/DU	Deadlatch - 4 Faceplates, Flat/Radiused	31/32"	628/313
CS418619	AHB118 AL/DU	Hookbolt - 4 Faceplates, Flat/Radiused	1-1/8"	628/313
CS418624	AHB3132 AL/DU	Hookbolt - 4 Faceplates, Flat/Radiused	31/32"	628/313

\*SPECIAL ORDER ONLY - MIN. 100 PCS



ADL118 AL

#### Storefront Hardware & Lock Parts

ANX#	Part#	Description	Finish
CS479614	ACD	Cam Disc Plug f/ Paddle & Lever	
CS101794	ADLS-LS2H	Deadlatch Strike - Long, 2-hole	US32D
CS101795	ADLS-SS1H	Deadlatch Strike - Short, 1-hole	US32D
CS428843	AEXIN-AL	Lock/Unlock Indicator	628
CS428844	AEXIN-DU	Lock/Unlock Indicator	313
CS428846	AFB14-AL	Flushbolt - 1/4" Backset, CTC-5-7/32"	628
CS428851	AFB14-DU	Flushbolt - 1/4" Backset, CTC-5-7/32"	313
CS428852	AFB18-AL	Flushbolt - 1/8" Backset, CTC-5-7/32"	628
CS428853	AFB18-DU	Flushbolt - 1/8" Backset, CTC-5-7/32"	313
CS101792	AHDB118	Header Bolt - Active Door	
CS101791	AHDB-DD	Header Bolt - Inactive Door	
CS448071	AHS	2 Signs: "THIS DOOR TO REMAIN UNLOCKED WHEN THE BUILDING IS OCCUPIED" and "THIS DOOR TO REMAIN UNLOCKED DURING BUSINESS HOURS"	
CS418584	AL1-AL	Lever - RH/LH	628
CS418588	AL1-DU	Lever - RH/LH	313
CS104890	AMCRS-95	Cylinder Set Screw	
CS418602	AP1-AL	Paddle Push/Pull	628
CS418605	AP1-DU	Paddle Push/Pull	313
CS105067	AP1RS	Paddle Return Spring Kit	
CS101793	ATDB	Threshold Bolt	



ACD

#### Storefront Hardware - Pivots

ANX#	Part#	Description	Finish
CS103108	APV-8 DU	Offset Pivot	628
CS103107	APV-8 AL	Offset Pivot	313
CS103113	APV-10 RH DU	3/4" Offset Pivot - Lefthand	628
CS103112	APV-10 RH AL	3/4" Offset Pivot - Lefthand	313
CS103111	APV-10 LH DU	3/4" Offset Pivot - Righthand	628
CS103110	APV-10 LH AL	3/4" Offset Pivot - Righthand	313
CS109680	36/3700-GE	Bottom Pivot Set F/ OHC Closers	



APV-8

### Overhead Concealed C3600 / CX3700 Series Door Closers

Heavy-Duty concealed overhead door closer for easy drop in replacements into existing storefronts.



#### SPECIFICATIONS:

Handed	Non-handed
Hung	Center hung
Included	Closer Body with mounting brackets; Side load arm and pivot set also included (except PT model in which a 7/8" end load arm and pivot set are included)
Material	Cast iron body, hardened steel internal springs, closer fluid non-gumming and non-freezing
Spring Power	Medium - Size 3 (C3600), Adjustable - Size 1-4 (CX3700)
Warranty	10-year warranty

#### C3600 Fixed Power Overhead Concealed Closers - Size 3

ANX#	Part#	Description	Back Stop	Hold Open
CS109061	C3600-OH-105-HO BODY ONLY	Body Only/No Hardware	105°	Yes
CS421968	C3600-OH-105-HO-S	Incl. Mounting Hardware & Side Load Arm	105°	Yes
CS109062	C3600-OH-105-NHO BODY ONLY	Body Only/No Hardware	105°	No
CS421969	C3600-OH-105-NHO-S	Incl. Mounting Hardware & Side Load Arm	105°	No
CS428907	C3600-OH-90-HO-S	Incl. Mounting Hardware & Side Load Arm	90°	Yes
CS428908	C3600-OH-90-NHO-S	Incl. Mounting Hardware & Side Load Arm	90°	No

#### CX3700 Adjustable Power Overhead Concealed Closers - Size 1-4

ANX#	Part#	Description	Back Stop	Hold Open
CS125532	CX3700-OH-105-HO BODY ONLY	Body Only/No Hardware	105°	Yes
CS125535	CX3700-OH-105-HO-S	Incl. Mounting Hardware & Side Load Arm	105°	Yes
CS125536	CX3700-OH-105-NHO BODY ONLY	Body Only/No Hardware	105°	No
CS125537	CX3700-OH-105-NHO-PT	Incl. Mounting Hardware & End Load Arm	105°	No
CS125538	CX3700-OH-105-NHO-S	Incl. Mounting Hardware & Side Load Arm	105°	No
CS125539	CX3700-OH-90-HO-S	Incl. Mounting Hardware & Side Load Arm	90°	Yes
CS125548	CX3700-OH-90-NHO-S	Incl. Mounting Hardware & Side Load Arm	90°	No

#### Overhead Concealed Door Closer Parts

ANX#	Part#	Description
CS109679	36/3700-DP	Bottom Pivot Set - Dual Purpose
CS109681	36/3700-FS	Anchor Set/ Closer Mounting Bracket Set
CS109680	36/3700-GE	Threshold Mount Bottom Pivot Set
CS502241	36/3700-JOXAL-9/16	Offset Arm - 9/16" Top Rail Depth - 628
CS502242	36/3700-JOXDU-9/16	Offset Arm - 9/16" Top Rail Depth - 313

ANX#	Part#	Description
CS502246	36/3700-VOXAL-7/8	Offset Arm - 7/8" Top Rail Depth - 628
CS502249	36/3700-VOXDU-7/8	Offset Arm - 7/8" Top Rail Depth - 313
CS502239	36/3700-K-5/8	"K" Type End Loading Arm - 5/8" Top Rail Depth
CS502240	36/3700-PT-7/8	"PT" Type End Loading Arm - 7/8" Top Rail Depth
CS502238	36/3700-A-1	"A" Type End Loading Arm - 1" Top Rail Depth
CS502236	36/3700-S	Side Load Arm



### CX5000 Series Surface Door Closers

Standard duty commercial surface door closer designed for moderate traffic applications on interior or exterior doors.



#### SPECIFICATIONS:

Certifications	UL/UL10C Listed, Meets Grade 1 Standards
Finishes	Aluminum (689), Duronodic (695)
Sizing	Adjustable Sizing 1 to 6 - ADA Compliant (sized to 1)
Adjustments	Sweep, Latch, Back Check and Power
Mounting	Regular, Top Jamb and Parallel Arm Mount
Body	Cast Aluminum
Fasteners	Wood Screws, Self Tapping Screws and Sex Nuts & Bolts
Warranty	Lifetime Mechanical Warranty

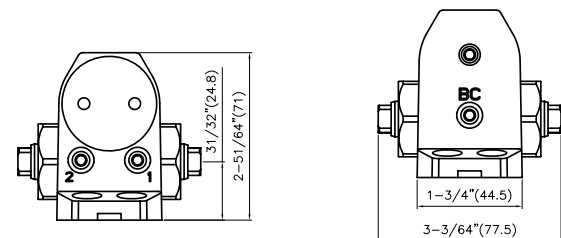
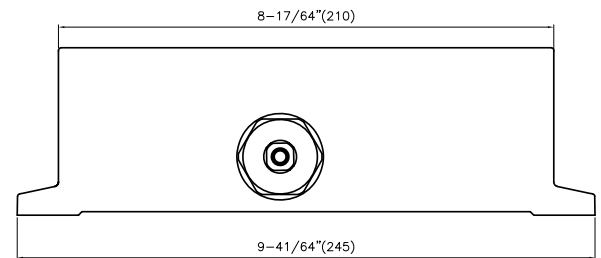
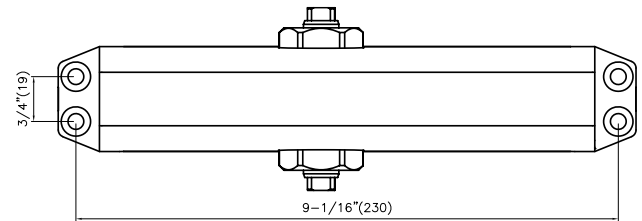

#### CX5000 Series Surface Closers - Standard Duty

ANX#	Part#	Description	Finish
CS124908	CX5016 689	Tri-Pack Mounting, Adjustable 1-6	Aluminum
CS124910	CX5016 695	Tri-Pack Mounting, Adjustable 1-6	Dark Bronze

#### CX5000 Parts

ANX#	Part#	Description	Finish
CS124962	CX5000/CX7000-FH 689	Friction Hold Open Arm	Aluminum
CS124965	CX5000/CX7000-FH 695	Friction Hold Open Arm	Dark Bronze
CS124967	CX5000-ARM 689	Regular Arm	Aluminum
CS124968	CX5000-ARM 695	Regular Arm	Dark Bronze
CS124952	CX5000-C 689	Slim Cover	Aluminum
CS124954	CX5000-C 695	Slim Cover	Dark Bronze
CS124960	CX5000-DP 3in1 689	Drop Plate (REG, TJ and PA)	Aluminum
CS124961	CX5000-DP 3in1 695	Drop Plate (REG, TJ and PA)	Dark Bronze
CS124950	CX5000-SP 689	Screw Pack	Aluminum
CS124951	CX5000-SP 695	Screw Pack	Dark Bronze

### CX7000 Series Surface Door Closers

Heavy duty commercial surface door closer designed for high traffic applications on interior or exterior doors.



#### SPECIFICATIONS:

Certifications	ANSI/BHMA A156.4 Grade 1, UL/UL10C and UL228 Listed
Finishes	Aluminum (689), Duronodic (695)
Sizing	Adjustable Sizing 1 to 6 - ADA Compliant (sized to 1)
Adjustments	Sweep, Latch, Back Check and Power
Mounting	Regular, Top Jamb and Parallel Arm Mount
Body	Cast Aluminum
Fasteners	Wood Screws, Self Tapping Screws and Sex Nuts & Bolts
Warranty	Lifetime Mechanical Warranty

#### CX7300 Series - Slim Cover - Heavy Duty

ANX#	Part#	Description	Finish
CS124920	CX7316 689	Tri-Pack Mounting, Adjustable 1-6, Slim Cover	Aluminum
CS124921	CX7316 695	Tri-Pack Mounting, Adjustable 1-6, Slim Cover	Dark Bronze

#### CX7500 Series - Full Cover - Heavy Duty

ANX#	Part#	Description	Finish
CS124923	CX7516 689	Tri-Pack Mounting, Adjustable 1-6, Full Cover	Aluminum
CS124942	CX7516 695	Tri-Pack Mounting, Adjustable 1-6, Full Cover	Dark Bronze

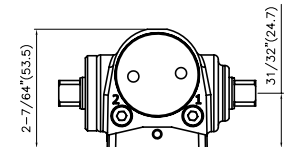

#### CX7000 Series Surface Door Closer Parts

ANX#	Part#	Description	Finish
CS124962	CX5000/CX7000-FH 689	Friction Hold Open Arm	Aluminum
CS124965	CX5000/CX7000-FH 695	Friction Hold Open Arm	Dark Bronze
CS124996	CX7000-ARM 689	Regular Arm	Aluminum
CS124999	CX7000-ARM 695	Regular Arm	Dark Bronze
CS124976	CX7000-DP 689	Drop Plate - Regular and Top Jamb	Aluminum
CS124979	CX7000-DP 695	Drop Plate - Regular and Top Jamb	Dark Bronze
CS124985	CX7000-DP-PA 689	Drop Plate - Parallel Arm	Aluminum
CS124986	CX7000-DP-PA 695	Drop Plate - Parallel Arm	Dark Bronze
CS126180	CX7000-SP 689	Screw Pack	Aluminum
CS126181	CX7000-SP 695	Screw Pack	Dark Bronze
CS125006	CX7300-C 689	Slim Cover	Aluminum
CS125014	CX7300-C 695	Slim Cover	Dark Bronze
CS125016	CX7500-C 689	Full Cover	Aluminum
CS125019	CX7500-C 695	Full Cover	Dark Bronze

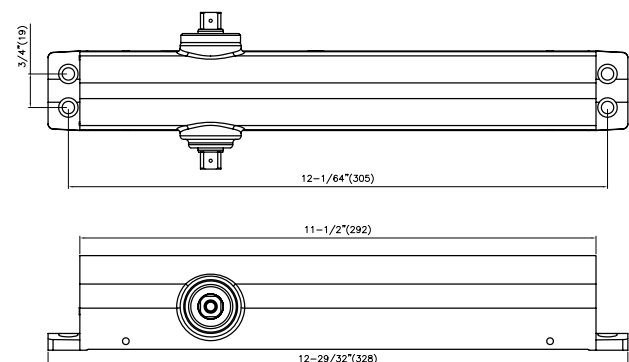

### CX9000 Series Surface Door Closers

Super heavy duty commercial surface door closer designed for heavy traffic applications on interior or exterior doors.



#### SPECIFICATIONS:

Certifications	ANSI/BHMA A156.4 Grade 1, ANSI A117.1 ADA ~ UL/UL10C and UL228 Listed
Finishes	Aluminum (689), Durodnic (695)
Sizing	Adjustable Sizing 1 to 6 - ADA Compliant (sized to 1)
Adjustments	Sweep, Latch, Back Check, Power and Delay Action - All Adjustments on Closer Face
Mounting	Regular, Top Jamb and Parallel Arm Mount
Body	Cast Iron - 1 Piece Construction
Fasteners	Wood Screws, Self Tapping Screws and Sex Nuts & Bolts
Warranty	Lifetime Mechanical Warranty

#### CX9000 Series Surface Closers - Super Heavy Duty

ANX#	Part#	Description	Finish
CS124945	CX9016 689	Tri-Pack Mounting, Adjustable 1-6, Full Cover	Aluminum
CS124946	CX9016 695	Tri-Pack Mounting, Adjustable 1-6, Full Cover	Dark Bronze

#### CX9000 Series Surface Door Closer Parts

ANX#	Part#	Description	Finish
CS125060	CX9000-ARM 689	Regular Arm	Aluminum
CS125061	CX9000-ARM 695	Regular Arm	Dark Bronze
CS125053	CX9000-FH 689	Friction Hold Open Arm	Aluminum
CS125055	CX9000-FH 695	Friction Hold Open Arm	Dark Bronze
CS125056	CX9000-MH 689	Mechanical Hold Open Arm	Aluminum
CS125057	CX9000-MH 695	Mechanical Hold Open Arm	Dark Bronze
CS125058	CX9000-CS 689	Cush Stop Arm	Aluminum
CS125059	CX9000-CS 695	Cush Stop Arm	Dark Bronze
CS125036	CX9000-DP 689	Drop Plate - Regular	Aluminum
CS125045	CX9000-DP 695	Drop Plate - Regular	Dark Bronze
CS125048	CX9000-DP PA 689	Drop Plate - Parallel Arm	Aluminum
CS125052	CX9000-DP PA 695	Drop Plate - Parallel Arm	Dark Bronze
CS126147	CX9000-DP TJ 689	Drop Plate - Top Jamb	Aluminum
CS126148	CX9000-DP TJ 695	Drop Plate - Top Jamb	Dark Bronze
CS125028	CX9000-C 689	Full Cover	Aluminum
CS125032	CX9000-C 695	Full Cover	Dark Bronze
CS125064	CX9000-SP 689	Screw Pack	Aluminum
CS125065	CX9000-SP 695	Screw Pack	Dark Bronze
CS126460	CX9000-SBS 689	Sex Nuts and Bolts - Only	Aluminum
CS126461	CX9000-SBS 695	Sex Nuts and Bolts - Only	Dark Bronze

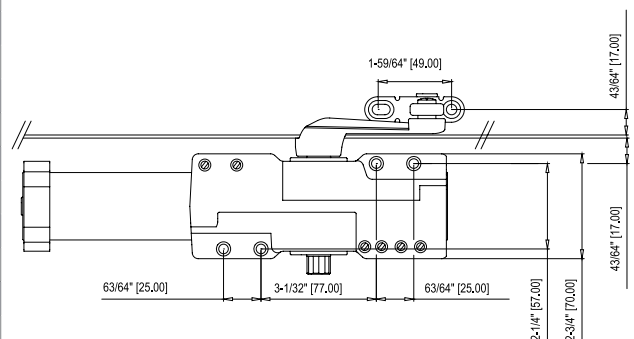
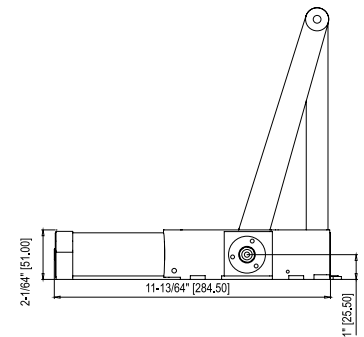

## Padlocks



### Brass Body Rekeyable - Door Cyl. Padlocks - 5/16" Dia. Shackle

ANX#	Part#	Keyway	Shackle Length
CS121134	PL451B10S RK LESS CYL KR/NKR	No Cylinder	1"
CS121137	PL451B10S RK KW OBIT KR/NKR	Kwikset	1"
CS121141	PL451B10S RK SC OBIT KR/NKR	Schl-C	1"
CS121145	PL451B10S RK SX OBIT KR/NKR	Schl-C-K	1"

### Brass Body LFIC Padlocks - 5/16" Dia. Shackle

ANX#	Part#	Keyway	Shackle Length
CS114043	PL452B15S LFSC	SCHL-LFIC	1-1/2"

### Brass & Brass/Chrome Body SFIC Padlocks - 5/16" Dia. Shackle

ANX#	Part#	Keyway	Shackle Length
CS121176	PL453B10S SFIC (Brass Body)	SFIC 6pin or 7pin	1"
CS121177	PL453B20S SFIC (Brass Body)	SFIC 6pin or 7pin	2"
CS121181	PL453BC10S SFIC (Brass/Chrome)	SFIC 6pin or 7pin	1"

### PL451/PL452B/PL453 - 5/16" Replacement Shackles

ANX#	Part#	Shackle Length
CS121207	SH-PL451/PL452B/PL453-7S	3/4"
CS121208	SH-PL451/PL452B/PL453-10S	1"
CS121210	SH-PL451/PL452B/PL453-15S	1-1/2"
CS121221	SH-PL451/PL452B/PL453-20S	2"
CS121222	SH-PL451/PL452B/PL453-30S	3"
CS121225	SH-PL451/PL452B/PL453-40S	4"

### PL451/PL452B/PL453 - 5/16" Parts

ANX#	Part#	Desc.
CS129335	PL451 - Cyl. Rotation Limiter	Cylinder Rotation Limiter
CS129433	PL451-DVR-MED	Driver for Medeco 20200S1 Cyl.
CS126911	PL451 - Cylinder Bible Cover	Cylinder Retainer Housing
CS126913	PL451 - Cyl. Bible Cover Screw	Housing Fixing Screw
CS126915	PL451 - Cylinder Driver	Cylinder Cam Connector

**NO SPECIAL TOOLS REQUIRED**

### QUICK CHANGE SHACKLE

Replacement shackles are easily switched out without disassembling the padlock



## Padlocks

### Brass/Chrome Body SFIC Padlocks - 1/4" Dia. Shackle

ANX#	Part#	Cylinder Prep	Shackle Length
CS121178	PL353BC15S SFIC	SFIC 6pin or 7pin	1-1/2"

## Padlocks Parts

### PL353 - 1/4" Replacement Shackles

ANX#	Part#	Shackle Length
CS121199	SH-PL353-7S	3/4"
CS121200	SH-PL353-10S	1"
CS121201	SH-PL353-15S	1-1/2"
CS121202	SH-PL353-20S	2"
CS121203	SH-PL353-30S	3"
CS121204	SH-PL353-40S	4"



PL353BC15S SFIC

### Steel Body SFIC Padlocks - 5/16" Dia. Shackle

ANX#	Part#	Cylinder Prep	Shackle Length
CS510101	PL452S10S SFIC	SFIC 6pin or 7pin	1"
CS510102	PL452S20S SFIC	SFIC 6pin or 7pin	2"

### PL452S - 5/16" Replacement Shackles

ANX#	Part#	Cylinder Prep
CS511046	PL452S/456S MOLY SHACKLE 2	2" Replacement Shackle
CS511047	PL452S/456S MOLY SHACKLE 3	3" Replacement Shackle

### Brass & Brass/Chrome Body SFIC Padlocks - 5/16" Dia. Shackle

ANX#	Part#	Cylinder Prep	Shackle Length
CS121176	PL453B10S SFIC	SFIC 6pin or 7pin	1"
CS121177	PL453B20S SFIC	SFIC 6pin or 7pin	2"
CS121181	PL453BC10S SFIC	SFIC 6pin or 7pin	1"

### PL451/PL452B/PL453 - 5/16" Replacement Shackles & Parts

ANX#	Part#	Shackle Length
CS121207	SH-PL451/PL452B/PL453-7S	3/4"
CS121208	SH-PL451/PL452B/PL453-10S	1"
CS121210	SH-PL451/PL452B/PL453-15S	1-1/2"
CS121221	SH-PL451/PL452B/PL453-20S	2"
CS121222	SH-PL451/PL452B/PL453-30S	3"
CS121225	SH-PL451/PL452B/PL453-40S	4"



PL453B10S SFIC



PL452S20S SFIC



PL553BC15S SFIC

### Brass/Chrome Body SFIC Padlocks - 3/8" Dia. Shackle

ANX#	Part#	Cylinder Prep
CS121190	PL553BC15S SFIC	SFIC 6pin or 7pin

### PL553 - 3/8" Replacement Shackles

ANX#	Part#	Shackle Length
CS121227	SH-PL553-7S	3/4"
CS121228	SH-PL553-10S	1"
CS121231	SH-PL553-15S	1-1/2"
CS121233	SH-PL553-20S	2"
CS121234	SH-PL553-30S	3"
CS121236	SH-PL553-40S	4"

### Brass Body LFIC Padlocks - 5/16" Dia. Shackle

ANX#	Part#	Cylinder Prep	Shackle Length
CS114043	PL452B15S LFSC	SCHL-LFIC	1-1/2"

## Padlocks



PL730



PL730 HASP

### Hidden Shackle (Hockey Puck) Padlocks & Hasps

ANX#	Part#	Keying
CS510143	PL730 A6 KA GX00001	Keyed Alike - GX00001
CS510173	PL730 A6 KA GX13033	Keyed Alike - GX13033
CS121198	PL730 A6 KD	Keyed Different
CS510182	PL730 HASP	Hasp f/ PL730 Padlock



PL635S10S



PL635S20S



PL456S

### Rekeyable - Steel - Round Body Padlocks - 7/16" Dia. Shackle

ANX#	Part#	Keying	Shackle Length
CS510118	PL635S10S A5/6 KA GA53282	Keyed Alike - GA53282	1"
CS121195	PL635S10S A5/6 KD	Keyed Different	1"
CS510120	PL635S10S A5/6 KD - VIS PACK	Keyed Different	1"
CS510127	PL635S20S A5/6 KA GA53282	Keyed Alike - GA53282	2"
CS121196	PL635S20S A5/6 KD	Keyed Different	2"
CS510141	PL635S20S A5/6 KD - VIS-PACK	Keyed Different	2"

### Rekeyable - Steel Padlocks - 5/16" Dia. Shackle

ANX#	Part#	Keying	Shackle Length
CS510104	PL456S10S A5/6 KA GA22286	Keyed Alike - GA22286	1"
CS510105	PL456S10S A5/6 KA GA36253	Keyed Alike - GA36253	1"
CS121194	PL456S10S A5/6 KD	Keyed Different	1"
CS510108	PL456S20S A5/6 KA GA36253	Keyed Alike - GA36253	2"
CS510109	PL456S20S A5/6 KA GA53254	Keyed Alike - GA53254	2"

## Padlocks Parts

### PL452S/PL456/PL635/PL730 Padlock Parts

ANX#	Part#	Description
CS511035	PL CYL A5 PLUG RETAIN CLIP	Plug Retaining Clip f/ A5/6 Cyl.
CS511036	PL CYL A5/6 0B	A5/6 Padlock Cylinder - 0-Bit
CS511037	PL CYL A5/6 KA GA42537	A5/6 Padlock Cylinder - Keyed Alike
CS511044	PL452S CAM & TP	Cam and Tailpiece
CS511045	PL452S LIMIT PLATE SCREW	Rotation Limit Plate Screw
CS511046	PL452S/456S MOLY SHACKLE 2	2" Replacement Shackle
CS511050	PL452S/456S SHACKLE RET SCRWB	Shackle Retaining Screw
CS511051	PL452S/456S SHACKLE SPRING	Shackle Spring
CS511052	PL456S CYL RETAIN COV PLT	Cylinder Armor Plate
CS511053	PL456S CYL RETAIN PLT SCRWB	Armor Plate Screw
CS511054	PL456S CYL RETAIN SEC NUT	Armor Plate Sex Bolt
CS511056	PL635 CYL RETAIN COVER PLATE	Cylinder Armor Plate
CS511057	PL635 MOLY SHACKLE ONLY 2	2" Replacement Shackle
CS511058	PL635 SHACKLE RETAIN SCREW	Shackle Retaining Screw
CS511059	PL635 SHACKLE SPRING	Shackle Spring
CS511060	PL730 CYL A6 KA GX00002	PL730 Cylinder - KA
CS511061	PL730 CYL RETAIN SCREW	Cylinder Retaining Screw
CS511062	PL730 PLUG RET SCREW	Plug Retaining Screw

### PL740 Padlock

ANX#	Part#	Keying
CS128031	PL740 SC 0-BIT	Schlage C Keyway - 6-pin



PL740 SC 0-BIT



PL456S10S

PL456S20S

## Padlocks

### Discus Padlocks - 2-3/4" Dia. 3/8" Dia Shackle

ANX#	Part#	Keying
CS121151	PL701SS KA-F005	Keyed Alike - F005
CS121150	PL701SS KA-F007	Keyed Alike - F007
CS121146	PL701SS KD	Keyed Different



### Resettable Combo - Brass Padlocks - 5/16" Dia. Shackle

ANX#	Part#		Shackle Length
CS121191	PL510PB10S	4 Wheel - 10,000 Combinations	1-1/8"
CS121193	PL510PB20S	4 Wheel - 10,000 Combinations	2-3/16"



### Laminated Steel Padlocks - 9/32" Dia. Shackle

ANX#	Part#	Keying	Shackle Length
CS121163	PL43LP10S KA-M143801	Keyed Alike - M143801	1"
CS121165	PL43LP10S KA-M143802	Keyed Alike - M143802	1"
CS121162	PL43LP10S KD	Keyed Different	1"
CS121174	PL43LP20S KA-M143801	Keyed Alike - M143801	1-1/2"
CS121175	PL43LP20S KA-M143802	Keyed Alike - M143802	1-1/2"
CS121170	PL43LP20S KD	Keyed Different	1-1/2"



### Non-Rekeyable - Brass Padlocks

ANX#	Part#	Keying	Body Width	Shackle Size
CS121103	PL201 KA-M351	Keyed Alike - M351	7/8"	1/8" x 7/16"
CS121104	PL201 KA-M352	Keyed Alike - M352	7/8"	1/8" x 7/16"
CS121102	PL201 KD	Keyed Different	7/8"	1/8" x 7/16"
CS121111	PL301 KA-M41161	Keyed Alike - M41161	1-1/8"	3/16" x 3/4"
CS121116	PL301 KA-M41162	Keyed Alike - M41162	1-1/8"	3/16" x 3/4"
CS121106	PL301 KD	Keyed Different	1-1/8"	3/16" x 3/4"
CS121125	PL401 KA-M57551	Keyed Alike - M57551	1-1/2"	1/4" x 7/8"
CS121124	PL401 KA-M57614	Keyed Alike - M57614	1-1/2"	1/4" x 7/8"
CS121123	PL401 KD	Keyed Different	1-1/2"	1/4" x 7/8"



## Safes

A variety of options to help secure valuables.

- ◆ Depository Safes
- ◆ Wall Safes
- ◆ Hotel Safes
- ◆ Safe Keyblanks
- ◆ Safe Parts & Components



### Depository Safes

ANX#	Part#	Description
CS110458	SDFB-281620-XX-BLACK	B-Rated, Front Load Mail Box Drop, Electronic Lock

### Hotel Safe

ANX#	Part#	Description
CS119047	23KM	9"h x 17"w x 14.5"d, Electronic Resettable Lock

### Safe Keyblank

ANX#	Part#	Description
CS126824	KB-MJWA-WTS-01	SDFB & SDFC Inner Compartment

### Safe - Parts & Components

ANX#	Part#	Description
CS121043	23KM-KPD	Replacement Keypad f/ 23KM
CS121038	23KM-PCB	Replacement Control Board f/ 23KM
CS118965	CEU	HANDHELD AUDIT & PWR TOOL f/ 23KM
CS110470	S-SECURAM-COMPLETE	Complete Electronic Lock f/ SDFB & SDFC
CS110473 / CS110471	S-SECURAM-KEYPAD / S-SECURAM-LOCK	Kit: Replacement Keypad f/ SDFB & SDFC, Replacement Electronic Lock f/ SDFB & SDFC
CS110467	S-SHELF-CLIP	Shelf Clip f/ SDFB & SDFC
CS110461	SDFC-282020-SHELF	Shelf f/SDFC
CS110468	S-DF-HANDLE	Replacement Handle f/ SDFB & SDFC



## Tools & Supplies

### Tools and Supplies

ANX#	Part#	Description
CS113760	C-NUTWRENCH	Nut Wrench for C Series Friction HO Arms
CS119434	CSS-100	Cap Saver Strips - 100 Pack
CS125528	PFT-500	.500 Plug Follower Tool
CS354979	GENERAL LOCK CATALOG	2021 General Lock Catalog
CS120840	GL-MKS-B-A2-SFIC	Masterkey Sys. Best A-2 SFIC 7-Pin 1MK/256 CK
CS120839	GL-MKS-SCHL-S	Masterkey Sys. Schlage Std. 6-Pin 1MK/256 CK
CS100036	GLS 2 HOLE DISPLAY MOUNT	2 Hole Mount 2-3/4" B.S. Lever/DB
CS123209	KRT-1.5MM	Padlock Key Retaining Set Screw Tool
CS484317	PL ALLEN WRENCH 1/16"	Padlock Key Retaining Set Screw Tool - No Handle
CS511034	PL ALLEN WRENCH 2.5MM	Padlock Shackle Set Screw Tool - No Handle



# Northern<sup>★</sup>

The Professional's Choice for Cable and Connectivity Products

*IP & HD Analog  
Recorders & Cameras  
Monitors & Power Supplies*

## N2 Series NVRs with POE



### 4, 8 & 16 Channel NVR's with Built-in POE

- Real-Time 30FPS/Ch Recording @ 1080p
- Up to 8MP Recording
- H.265 & H.264 Recording Compression
- NorthernView Mobile App for iPhone, iPad, & Android
- Free NorthernView CMS
- Supports P2P Operation
- Up to 8TB Storage Capacity (4Ch)
- Up to 16TB Storage Capacity (8Ch & 16Ch)
- Integrated 40W/80W/120W POE Switch (4/8/16Ch)
- Simultaneous HDMI & VGA Outputs (4Ch)
- Independent HDMI & VGA Outputs (8 & 16Ch)
- Accepts ONVIF Protocols



**NORTHERN VIEW**  
Free Mobile App for iPhone, iPad, Android™ & Android™ Tablets



### 32 Channel NVR with 16 Channel Built-in POE

- Real-Time 30FPS/Ch Recording @ 1080p
- Up to 12MP Recording
- H.265 & H.264 Recording Compression
- NorthernView Mobile App for iPhone, iPad, & Android
- Free NorthernView CMS
- Supports P2P Operation
- Up to 24TB Storage Capacity
- Integrated 160W POE Switch
- Independent HDMI & VGA Outputs
- Accepts ONVIF Protocols

Part#	ANX#	Channels	HDD Size
N2NVR4POE2T	9955159	4	2TB
N2NVR8POE2T	9955161	8	2TB
N2NVR16POE2T	9955163	16	2TB
N2NVR3216POE	9955164	32	No Storage

## Northern N2 Series Camera Features

- True 120dB Wide Dynamic Range
- Up to 4MP - 2592 x 1520 Resolution
- Free NorthernView App & CMS Software
- ONVIF Profile S/G/Q Compliant
- Mechanical IR Cut Filters
- Full HD 1080p Real Time Video

## N2 Series IP Cameras



### 4MP IP Outdoor Bullet

- 2.8mm Fixed IR Lens
- 4 IR LED's • 100' Range • IP67



### 4MP IP Outdoor Dome Camera

- 2.8mm or 4mm Fixed IR Lens
- 2 IR LED's • 100' Range
- Audio Line In/Out • IP67/IK10



### 4MP IP Outdoor Wedge Camera

- 2.8mm Fixed IR Lens
- 12 IR LED's • 30' Range
- Built-in Microphone • IP66



### 4MP IP Outdoor Turret Camera

- 2.8mm Fixed IR Lens
- 1 IR LED • 100' Range • IP67



### 4MP IP Outdoor Autofocus Bullet Camera

- 2.7~13.5 Varifocal Autofocus IR Lens
- 4 IR LED's • 120' Range
- Audio Line In/Out • IP67



### 4MP IP Outdoor Autofocus Dome Camera

- 2.7~13.5 Varifocal Autofocus IR Lens
- 15 IR LED's • 120' Range
- Audio Line In/Out • IP67/IK10



Part#	ANX#
N2IP4B	9955152
N2IP4D	9955153
N2IP4D4MM	9955154
N2IP4W	9955151
N2IP4T	9955150
N2IP4AFB	9955156
N2IP4AFD	9955155

## Northern 2MP Outdoor IR PTZ Cameras Accessories and Surveillance Products

### N2 Series 2MP IP Outdoor IR PTZ with POE

#### 1080P IP IR Outdoor PTZ Camera

- True 120dB Wide Dynamic Range
- Full HD 1080p Real Time Video
- 30X (4.5-135mm) Optical Zoom
- True D/N Mechanical IR Cut Filter
- 10 IR LED's 600' IR Range
- Free NorthernView App & CMS Software
- Hi-POE & 24VAC Power
- Included Hi-POE Injector
- Built in Heater & Fan
- -40°F Operating Temp
- ONVIF Compliant – IP66
- Includes Wall Mount



N2IPPTZ30X

Part#	ANX#	Description
N2IPPTZ30X	9955157	IP IR PTZ Cam

### N2 Series 2MP HD Analog Outdoor IR PTZ

#### TVI/CVI/AHD & 960H IR Outdoor PTZ Camera

- Full HD 1080p Resolution
- True 120dB Wide Dynamic Range
- STARLIGHT 0.005 Low Lux Level
- 32X (4.8-153mm) Optical Zoom Level
- Included 24VAC Power Supply
- 6 IR LED's – 450' IR Range
- UTC & RS-485 Controllable
- Built-in Heater & Fan
- -22° Operating Temp
- IP66 Rated



HDPTZ32XIR

#### Wall Mount & Junction Box for HDPTZ32XIR



IPTVIWMT



IPTVIJB

Part#	ANX#	Description
HDPTZ32XIR	988688	HD Analog IR PTZ Cam
IPTVIWMT	CS109668	HDPTZ Wall Mount
IPTVIJB	CS109669	Junction box for IPTVIJB

### N2 Series HD Analog DVR Kits

#### 4 Channel, 4 Camera 1080p Kit

- 4Ch. 1080p DVR with 2TB Storage
- 4x 1080p Outdoor Eyeball Cameras with 60' IR
- UTC – P2P – NorthernView App & CMS Software



N2HVR4KIT4C

#### 8 Channel, 6 Camera 1080p Kit

- 8Ch. 1080p DVR with 2TB Storage
- 6x 1080p Outdoor Eyeball Cameras with 60' IR
- UTC – P2P – NorthernView App & CMS Software

Part#	ANX#
N2HVR4KIT4C	9955178
N2HVR8KIT6C	9955179



N2HVR8KIT6C

## Northern Hybrid HD Analog DVR's & HD-TVI Cameras

### 4-in-1 HD Analog 1080p Cameras



### 1080p Indoor Varifocal Bullet & Turret Cameras

- Multi Format (TVI, CVI, AHD, 960H)
- True 120dB Wide Dynamic Range
- True D/N Mechanical IR Cut Filter
- 60'/90' IR Range (Bullet/Turret)
- 2.8mm Fixed IR Lens
- 12 Volt DC Power
- UTC & Joystick Controllable
- IP67 Rated



HDBIR60WD



HDTIR90WD

Part#	ANX#	Description
HDBIR60WD	9955169	Bullet Cam
HDTIR90WD	9955168	Turret Cam

### HD-TVI/960H Cameras

### 1080p Indoor Varifocal Dome Camera

- True 120dB Wide Dynamic Range
- STARLIGHT – 0.003 Low Lux Level
- 2.8~12mm Semi Autofocus IR Lens
- 3-Axis Wall or Ceiling Mountable
- 2 IR LED's – 120' IR Range
- TVI & 960H Main Video Outputs
- 12VDC/24VAC Dual Voltage Power
- Indoor Only



TVID212IR2

### 1080p Outdoor Varifocal Cameras

- True 120dB Wide Dynamic Range
- STARLIGHT – 0.003 Low Lux Level
- 2.8~12mm Semi Autofocus IR Lens
- 3-Axis Wall or Ceiling Mountable
- 2/6 IR LED's – 120' IR Range (Dome/Bullet)
- TVI & 960H Main Video Outputs
- 12VDC/24VAC Dual Voltage Power
- IP66 Rated



TVIVFDIR120



TVIVFBIR120

Part#	ANX#	Description
TVID212IR2	961272	Indoor Dome
TVIVFDIR120	970585	Outdoor Dome
TVIVFBIR120	970380	Outdoor Bullet

### N2 Series Hybrid HD Analog DVR's



### 4, 8 & 16 Channel Hybrid HD Analog DVR's

- Multi Format (TVI, CVI, AHD, 960H)
- Up to 5MP Lite Analog Recording at 10FPS
- Up to 1080p Recording at 15FPS
- Full Hybrid – All Channels Analog or IP
- Up to 1080P IP Camera Recording
- Up to 16TB Storage Capacity
- NorthernView App & CMS Software



**NORTHERN VIEW**  
Free Mobile App for iPhone, iPad, Android™ & Android™ Tablets

Part#	ANX#	Channels	HDD Size
N2HVR42T	9955171	4	2TB
N2HVR82T	9955173	8	2TB
N2HVR162T	9955175	16	2TB

### 4-in-1 HD Analog 1080P Cameras

### Outdoor 1080p Eyeball Cameras

- Multi Format (TVI, CVI, AHD, 960H)
- 3.6mm IR Lens
- UTC & Joystick OSD Control
- True D/N IR Cut Filters
- D-WDR DNR IP66 12 Volt DC



HDDWMIR / HDDWMIRW

### Outdoor Varifocal 1080p Eyeball Cameras

- Multi Format (TVI, CVI, AHD, 960H)
- 2.8-12mm Varifocal IR Lens
- UTC & Joystick OSD Control
- True D/N IR Cut Filters
- D-WDR - DNR - IP66 - 12 Volt DC



HDDWMVFIR / HDDWMVFIRW

Part#	ANX#	Description
HDDWMIR	cs113611	Gray / 60' IR
HDDWMIRW	cs113618	White / 60' IR
HDDWMVFIR	cs113619	Gray / 90' IR
HDDWMVFIRW	cs113620	White / 90' IR

## Monitors, Mounts, Power Supplies, Cables & Connectors

### HD Security Monitors & Wall Mounts

#### Northern Wide Screen LED Security Monitors

- HDMI, VGA, BNC & AUDIO INPUTS
- HDMI & VGA Cables Included
- 3D Comb Filter & 3D De-Interlace
- 1360 x 768 (18")
- 1920 x 1080 (22", 24", 27" & 32")
- VESA Mounting
- UL Approved



LED22R

#### LCD / LED Wall Mounts

- VESA 75 x 75mm & 100 x 100mm
- 180° Rotation, 40° Tilt, 20° Pivot
- Fits Most 13" - 23" Monitors
- 33 Pound Maximum Load Capacity
- 3-Axis Adjustment
- Cable Management (MONWM3)



MONWM2

MONWM3

Part#	ANX#	Description
LED18	695913	18.5" Monitor
LED22R	923193	21.5" Monitor
LED24R	923194	24" Monitor
LED27R	923195	27" Monitor
LED32R	923196	32" Monitor
MONWM2	695917	Extends 2.5" - 4"
MONWM3	675803	Extends 2.5" - 13"

### Cables & Connectors

#### UL Listed 3', 6' and 15' HDMI Cables

- Gold Plated Connectors
- PVC Jacket, Version 2.0



HDMI3UL

HDMI6UL

HDMI15UL

#### 10 Pack – DC Power Connectors

- Center Pin Positive
- Sold in 10 Packs



12VDCCORD10PK

12VDCCON10PKF

Part#	ANX#	Description
HDMI3UL	9808390	3' Length
HDMI6UL	9808392	6' Length
HDMI15UL	9808391	15' Length
12VDCCORD10PK	cs102369	Male, 12" Bare Lead
12VDCCON10PKF	695946	Female Screw Terminal

### Video Test Monitors

#### 7" IP, TVI, CVI, AHD & 960H Test Monitor

- 7" Touch Screen • POE Power for Cameras
- Supports ONVIF IP Camera Testing
- UTC Compatible for HD Analog Cameras
- 10-Hour Lithium Ion Battery



IP7TM2

Part#	ANX#	Description
IP7TM2	986963	7" Test Monitor

### UL Listed Power Supplies

#### Regulated 12 Volt DC Power Supplies

- Class II, UL Listed, Level VI Efficiency
- Center Pin Positive
- 1 or 2 Amp Output



12VDC1AMP

12VDC2AMP

#### 4 Channel 5 Amp 12 Volt DC Power Supply

- Number of Outputs: 4
- Output Current: 5 Amp
- Input Voltage: AC 100V-240V
- Adjustable Output Voltage: 12 ~ 13.8 Volts DC



PSMINI4C5AUL

#### 9 & 18 Channel 12VDC, PTC Fused Multi-Channel Power Supplies

- 10 Amp Total Output
- 1.1 Amp/Channel (9 Ch)
- 560mA/Channel (18 Ch)
- PTC Resettable Fuse Protection
- LED Channel Indicator
- UL Listed



DC9C10AUL

#### 24 Volt AC Plug-in Transformer

- 2 Amp / 50VA Output
- Class II, UL Listed
- Screw Terminal Connection



AC2450VA

Part#	ANX#	Description
12VDC1AMP	cs102366	1 Amp Output
12VDC2AMP	695944	2 Amp Output
PSMINI4C5AUL	cs102417	12 ~ 13.8 Volts DC out
DC9C10AUL	675788	9 Channel, 10 AMP
DC18C10AUL	675789	18 Channel, 10 AMP
AC2450VA	cs102370	24VAC, 50VA



The Professional's Choice for Cable and Connectivity Products

*Structured  
Cabling  
Solutions*

# Structured Cabling System

## Category Cable

### CATEGORY 6A, CATEGORY 6E, CATEGORY 6, CATEGORY 5E



#### FEATURES:

- ETL Certified To ANSI/TIA 568 D.2
- NEC Article 800 Compliant CMR or CMP
- Solid Bare Copper Conductors
- Made In America

See Individual Spec Sheets For More Information

CATEGORY 6A 500 MHZ 23GA/4PR(1)*		
CMR	CMP	
N6ARBL1RL	N6APBL1RL	—
N6ARWH1RL	N6APWH1RL	—

CATEGORY 6E 550 MHZ 23GA/4PR(1) BC*		
CMR	CMP	DIRECT BURIAL
N6ERBL1BX	N6EPBL1BX	N/A SEE CATEGORY 6
N6ERWH1BX	N6EPWH1BX	—

CATEGORY 6 250 MHZ 23GA/4PR(1) BC*		
CMR	CMP	DIRECT BURIAL
N/A SEE 6E	N6PBL1BX	N6DB1RL
—	N6WH1BX	—

CATEGORY 5E 350 MHZ 24GA/4PR(1) BC *		
CMR	CMP	DIRECT BURIAL
N5ERBL1BX	N5EPBL1BX	N5EDB1RL
NRERWH1BX	N5EPWH1BX	—

## Jacks

### 90°, 180°, Shielded 90°

#### FEATURES:

- ANSI/TIA-568-D.2 Component Requirements
- For Connecting Hardware
- ISO 11801
- 110 IDC
- PoE

See Individual Spec Sheets For More Information



NJK6CC



NJK6CCHD

CATEGORY JACKS		
90° *	180°	SHIELDED 90°
NJK6ABL	NJK6ABLHD	NJK6ASH
NJK6BL	NJK6BLHD	NJK6SH
NJK5EBL	NJK5EBLHD	NJK5ESH

## Rapid Punch Termination Tools

### Compatible with Northern Performance Jacks

#### FEATURES:

- Handle Lock
- Speeds Termination
- Cuts All 8 Wires to Length with 1 Squeeze



NJKCRIMP90

TERMINATION TOOLS		
90° *	180°	SHIELDED 90°
NJKCRIMP90	NJKCRIMPHD	NJKCRMP90

\*CABLE AND JACK COLORS; SUBJECT TO AVAILABILITY AND OR SPECIAL ORDER

BLUE (BL), BLACK(BK), GREEN(GN), GRAY(GY), IVORY(IV), ORANGE(OR), PURPLE(PR), RED(RD), YELLOW(YL), WHITE(WH)



# Faceplates, SMB's, Patch Panels & Patch Cords

## Faceplates & Surface Mount Boxes

### FEATURES:

- UL 94 V.0 Plastics
- Accept Northern Keystone Jacks

AVAILABLE COLORS:  
WHITE(WH), IVORY(IV),  
LIGHT ALMOND (LA)\*

\*Special Order



NFP1WH



NFP1WHID



NSMB2WH

NON ID SINGLE GANG FACE PLATES	ID FACE PLATES SINGLE GANG	SUFACEMONT BOXES
NFP1WH	NFP1WHID	NSMB1WH
NFP2WH	NFP2WHID	NSMB2WH
NFP3WH	NFP3WHID	NSMB4WH
NFP4WH	NFP4WHID	—
NFP6WH	NFP6WHID	—

## Patch Panels

### 16 Gauge Steel Construction

### FEATURES:

- Modular Patch Panel Accepts Northern Jacks
- 24P = 1U / 48P = 2U RMS
- 12P Uses 89B Bracket



NPP612PM



NPPMOD24P



NPP648P

CATEGORY 6	CATEGORY 5E	MODULAR
NPP612PM	NPP5E12PM	NPPMOD12PM*
NPP624P	NPP5E24P	NPPMOD24P*
NPP648P	NPP5E48P	NPPMOD48P*

\* Use Modular Panels For 6A Requirements

## Patch Cords

### ANSI/TIA 568 D.2 Component Tested



NPC5E1WH

Note: Specification subject to change without notice

PATCH CORDS		
CATEGORY 6A	CATEGORY 6	CATEGORY 5E
NPC6A1BL	NPC61BL	NPC5E1BLBB
NPC6A2BL	NPC62BL	NPC5E2BLBB
NPC6A3BL	NPC63BL	NPC5E3BLBB
NPC6A5BL	NPC65BL	NPC5E5BLBB
NPC6A7BL	NPC67BL	NPC5E7BLBB
NPC6A10BL	NPC610BL	NPC5E10BLBB
NPC6A15BL	NPC615BL	NPC5E15BLBB
NPC6A20BL	NPC620BL	NPC5E20BLBB
NPC6A25BL	NPC625BL	NPC5E25BLBB

### FEATURES:

- Snagless Boots
  - Male Ends Comply ANSI/TIA 1096-A
  - 24 Gauge Stranded BC Conductors
  - ANSI/TIA 568 D.2 Component Tested
  - ISO/IEC 11801
  - PoE
  - UL 3rd Party Listed & Verified
- See Individual Spec Sheets For More Information

### PATCH CORD COLOR KEY:

BLUE (BL), BLACK(BK), GREEN(GN), GRAY(GY), IVORY(IV), ORANGE(OR), PURPLE(PR), RED(RD), YELLOW(YL), WHITE(WH)  
OTHER LENGHTS AND COLORS AVAILABLE, CALL SALES WITH INQUIRY

# Relay Rack & Hinged Wall Bracket Solutions

## 19" Wide Hinged Wall Mount Brackets

**FEATURES:**

- EIA 310 1224 Screw Pattern
- Hinged To Get To Back Side Of Patch Panels
- Can Be Used To Mount Active Equipment



NHWB2U6BK

19" WIDE X 6" DEEP		19" WIDE X 15" DEEP	
NHWB1U6BK	<b>HINGED WALLMOUNT BRACKET 1U</b>	NHWB2U15BK	
NHWB2U6BK	<b>HINGED WALLMOUNT BRACKET 2U</b>	NHWB4U15BK	
NHWB3U6BK	<b>HINGED WALLMOUNT BRACKET 3U</b>	NHWB6BKU15BK	
NHWB4U6BK	<b>HINGED WALLMOUNT BRACKET 4U</b>	NHWB8U15	
NHWB6U6BK	<b>HINGED WALLMOUNT BRACKET 6U</b>	NHBEK15BK	

## Swing Gate Racks

**FEATURES:**

- EIA 310 1224 Screw Pattern
- 19" Width X 18' Depth
- Swing Gate Rack Allows Access To Back Side Of Rack



NRRSWM1924

## Fixed Wall Mount Racks

**FEATURES:**

- EIA 310 1224 Screw Pattern
- 19" Width X 18' Depth
- Economical Wallmount Rack Solution

SWING GATE RACKS	
NRRSWM1924	<b>WALL RACK 24"HX19"WX18"D</b>
NRRSWM1936	<b>WALL RACK 36"HX19"WX18"D</b>
NRRSWM1948	<b>WALL RACK 48"HX19"WX18"D</b>

FIXED WALL MOUNT RACKS	
NWMRR241918	<b>WALLMOUNT RACK 24"HX19"WX18"D</b>
NWMRR361918	<b>WALLMOUNT RACK 36"HX19"WX18"D</b>
NWMRR481918	<b>WALLMOUNT RACK 48"HX19"WX18"D</b>



NRR45U4PSRBK

## Relay Racks

**2 POST FEATURES:**

- EIA 310 1224 Screw Pattern

2 POST RACK	
NRR45U2PBK	<b>45U, 7' X 19" RELAY RACK</b>

**4 POST FEATURES:**

- EIA 310 1224 Screw Pattern
- Available With Cage Nut Rails

4 POST ADJUSTABLE RACK	
NRR45U4PSRBK	<b>45U, 7'H X 19" WIDE X 24" - 36" DEPTH</b>

## Racks & Cable Management

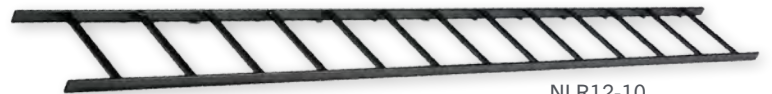

NLR12-10

LADDER RACKS & ACCESSORIES			
NLR12-10	<b>12" W x 10' LADDER RACK</b>	NLREC	<b>LADDER RACK END CAP PR</b>
NLRHB12	<b>12" LADDER RACK, HORIZ BEND</b>	NLRRRTP12	<b>12" RACK TO RUNWAY PLATE</b>
NLRUVB12	<b>12" UNIV RADIUS BEND LADDER</b>	NLR8RPK	<b>8" RETAINING POST KIT</b>
NLRBSK	<b>BUTT SPLICE KIT - STRAIGHT PR</b>	NLRSSK	<b>LADDER RACK STANDOFF SUPPORT KIT</b>
NLRGSK-ANG	<b>BUTT SPLICE KIT - 90 OR 45 PR</b>	NLRTBKT	<b>T JUNCTION BRACKET KIT</b>
NLRCRDC12	<b>12" CABLE RADIUS DROP</b>	NLRWASK12	<b>12" TRIANGLE WALL SUPPORT</b>
NLRCRDS	<b>RADIUS DROP SIDE/STRINGER</b>	NLRWAB12	<b>12" WALL ANGLE SUPPORT BRACKET</b>

# 22 Gauge Multiconductor Cable

## 22/2, 22/4, 22/6 Multiconductor

### APPLICATION:

Indoor Usage for Intercom, Security, Sound and Audio Systems, Control Circuits Smoke Detectors, Door Controllers

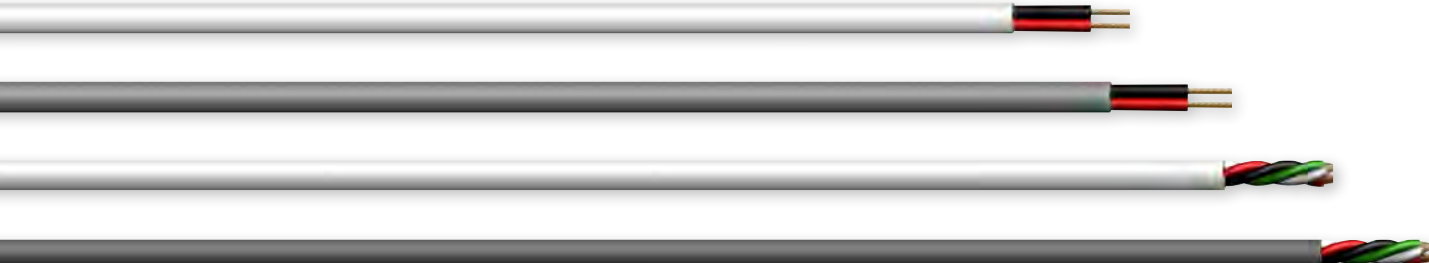

### OTHER COLORS AVAILABLE:

BEIGE (15) BLACK (02), BLUE (06), BROWN (07), GREEN (04), GRAY (09), ORANGE (08), PURPLE (10), RED (03), YELLOW (05) WHITE (01)

### PUT UP CODE:

1000' BOX (10), 1000' REEL (11), 500' BOX (50), 500' REEL (51), 500' COIL PACK (52)

### CMR CABLE FEATURES:

- NEC ARTICLE 725
- NEC ARTICLE 800
- UL 13 TYP CL2R
- UL 444 CMR

### CMP CABLE FEATURES:

- NEC ARTICLE 725
- NEC ARTICLE 800
- UL 13 TYPE CL2P
- UL 444 CMP
- RoHS

CMR GRAY	PRODUCT DESCRIPTION	CMP WHITE
N2202-1006-0110	22/2(7)BC 1000' BOX	N2202-1008-0110
N2202-1006-0111	22/2(7)BC 1000' REEL	N2202-1008-0111
N2202-1006-0150	22/2(7)BC 500' BOX	N2202-1008-0150
N2202-1006-0152	22/2(7)BC 500' Coil Pack	N2202-1008-0152
N2202-1016-0910	22/2(1)BC 1000' BOX	N2202-1018-0110
N2202-1016-0911	22/2(1)BC 1000' REEL	N2202-1018-0111
N2202-1016-0950	22/2(1)BC 500' BOX	N2202-1018-0150
N2202-1016-0952	22/2(1)BC 500' Coil Pack	N2202-1018-0152
N2202-1106-0910	22/2(7)BC OAS 1000' BOX	N2202-1108-0110
N2202-1106-0911	22/2(7)BC OAS 1000' REEL	N2202-1108-0111
N2204-1006-0910	22/4(7)BC 1000' BOX	N2204-1008-0110
N2204-1006-0911	22/4(7)BC 1000' REEL	N2204-1008-0111
N2204-1006-0950	22/4(7)BC 500' BOX	N2204-1008-0150
N2204-1006-0952	22/4(7)BC 500' Coil Pack	N2204-1008-0152
NN2204-1016-0910	22/4(1)BC 1000' BOX	NN2204-1018-0110
NN2204-1016-0911	22/4(1)BC 1000' REEL	NN2204-1018-0111
NN2204-1016-0950	22/4(1)BC 500' BOX	NN2204-1018-0150
NN2204-1016-0952	22/4(1)BC 500' Coil Pack	NN2204-1018-0152
N2204-1106-0910	22/4(7)BC OAS 1000' BOX	N2204-1108-0110
N2204-1106-0911	22/4(7)BC OAS 1000' REEL	N2204-1108-0111
N2206-1006-0910	22/6(7)BC 1000' BOX	N2206-1008-0110
N2206-1006-0950	22/6(7)BC 500' BOX	N2206-1008-0150
N2206-1106-0910	22/6(7)BC OAS 1000' BOX	N2206-1108-0110
N2206-1106-0950	22/6(7)BC OAS 500' BOX	N2206-1108-0150

22/2 CONDUCTOR STRANDED BARE COPPER

22/2 CONDUCTOR SOLID BARE COPPER

22/2 CONDUCTOR STRANDED BARE COPPER ALUMINUM MYLAR SHIELD AND DRAIN

22/4 CONDUCTOR STRANDED BARE COPPER

22/4 CONDUCTOR SOLID BARE COPPER

22/4 CONDUCTOR STRAND BARE COPPER ALUMINUM MYLAR SHIELD AND DRAIN

22/6 CONDUCTOR STRANDED BARE COPPER

22/6 CONDUCTOR STRANDED BARE COPPER ALUMINUM MYLAR SHIELD AND DRAIN



# Fire Alarm Cable

## FPLR / FPLP

### APPLICATION:

Fire Alarm Systems and Control Circuits



### FPLR SPECIFICATION:

- NEC ARTICLE 725
- NEC ARTICLE 760
- UL13 TYPE CL3R
- UL 1424 FPLR
- UL 444 CMR
- RoHS COMPLIANT

### FPLP SPECIFICATION:

- NEC ARTICLE 725
- NEC ARTICLE 760
- UL 13 TYPE CL3P
- UL 1424 FPLP
- EU 2001/65/EU
- RoHS

FPLR	PRODUCT DESCRIPTION	FPLP
N1802-7016-0310	18/2(1)BC RED 1000' BOX	N1802-7018-0310
N1802-7016-0311	18/2(1)BC RED 1000' REEL	N1802-7018-0311
N1802-7016-0350	18/2(1)BC RED 500' BOX	N1802-7018-0350
N1802-7016-0351	18/2(1)BC RED 500' REEL	N1802-7018-0351
N1804-7016-0310	18/4(1)BC RED 1000' BOX	N1804-7018-0310
N1804-7016-0311	18/4(1)BC RED 1000' REEL	N1804-7018-0311
N1804-7016-0350	18/4(1)BC RED 500' BOX	N1804-7018-0350
N1804-7016-0351	18/4(1)BC RED 500' REEL	N1804-7018-0351
N1602-7016-0310	16/2(1)BC RED 1000' BOX	N1602-7018-0310
N1602-7016-0311	16/2(1)BC RED 1000' REEL	N1602-7018-0311
N1602-7016-0350	16/2(1)BC RED 500' BOX	N1602-7018-0350
N1602-7016-0351	16/2(1)BC RED 500' REEL	N1602-7018-0351
N1604-7016-0310	16/4(1)BC RED 1000' BOX	N1604-7018-0310
N1604-7016-0311	16/4(1)BC RED 1000' REEL	N1604-7018-0311
N1604-7016-0350	16/4(1)BC RED 500' BOX	N1604-7018-0350
N1604-7016-0351	16/4(1)BC RED 500' REEL	N1604-7018-0351
N1402-7016-0310	14/2(1)BC RED 1000' BOX	N1402-7018-0310
N1402-7016-0311	14/2(1)BC RED 1000' REEL	N1402-7018-0311
N1402-7016-0350	14/2(1)BC RED 500' BOX	N1402-7018-0350
N1402-7016-0351	14/2(1)BC RED 500' REEL	N1402-7018-0351
N1404-7016-0310	14/4(1)BC RED 1000' BOX	N1404-7018-0310
N1404-7016-0311	14/4(1)BC RED 1000' REEL	N1404-7018-0311
N1404-7016-0350	14/4(1)BC RED 500' BOX	N1404-7018-0350
N1404-7016-0351	14/4(1)BC RED 500' REEL	N1404-7018-0351
N1202-7016-0310	12/2(1)BC RED 1000' BOX	N1202-7018-0310
N1202-7016-0311	12/2(1)BC RED 1000' REEL	N1202-7018-0311
N1202-7016-0350	12/2(1)BC RED 500' BOX	N1202-7018-0350
N1202-7016-0351	12/2(1)BC RED 500' REEL	N1202-7018-0351

### OTHER COLORS AVAILABLE:

BEIGE (15) BLACK (02), BLUE (06), BROWN (07), GREEN (04), GRAY (09), ORANGE (08), PURPLE (10), RED (03), YELLOW (05) WHITE (01)

### PUT UP CODE:

1000' BOX (10), 1000' REEL (11), 500' BOX (50), 500' REEL (51)

# Alarm & Signal Cable

## 18 - 12 Gauge Multiconductor

### APPLICATION:

Indoor Intercom, Security, Sound and Audio Systems, Control Circuits Smoke Detectors, Door Controllers

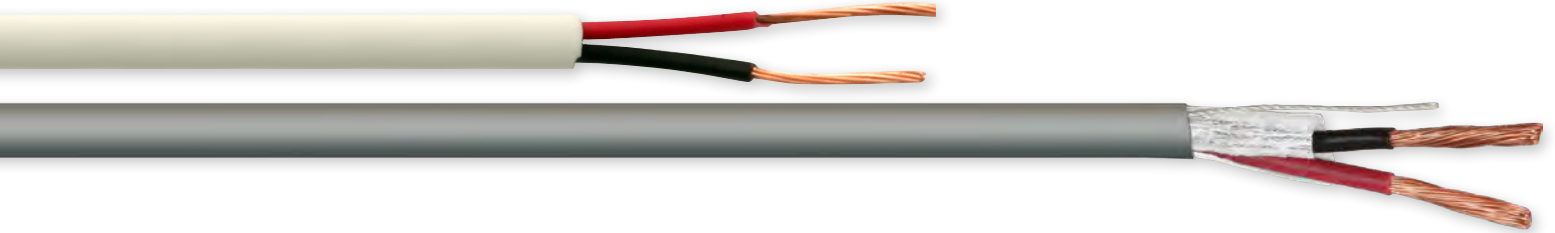

CMR GRAY	PRODUCT DESCRIPTION	CMP WHITE
N1802-1006-0910	18/2(7)BC CMR 1M BX	N1802-1008-0110
N1802-1016-0910	18/2(1)BC CMR 1M BX	N1802-1018-0110
N1802-1106-0910	18/2(7)BC OAS CMR/CL3R 1BX	N1802-1108-0110
N1802-1108-0110	18/2(7)BC OAS CMP WHITE 1M BX	N1802-1108-0110
N1804-1006-0910	18/4(7)BC CMR 1M BX	N1804-1008-0110
N1804-1016-0910	18/4(1)BC CMR 1M BX	N1804-1018-0110
N1804-1106-0910	18/4(7)BC OAS CMR/CL3R 1BX	N1804-1108-0110
N1806-1006-0910	18/6(7)BC CMR 1M BX	N1806-1008-0110
N1806-1016-0910	18/6 CMR 1M BX	N1806-1018-0110
N1806-1106-0910	18/6(7)BC OAS CMR/CL3R 1BX	N1806-1108-0110
N1602-1006-0910	16/2(19)BC CMR 1M BX	N1602-1008-0110
N1602-1016-0910	16/2(1)BC CMR 1M BX	N1602-1018-0110
N1602-1106-0910	16/2(19)BC OAS CMR/CL3R 1BX	N1602-1108-0110
N1604-1006-0910	16/4(19)BC CMR 1M BX	N1604-1008-0110
N1604-1016-0910	16/4(1)BC CMR 1M BX	N1604-1018-0110
N1604-1106-0910	16/4(19)BC OAS CMR/CL3R 1BX	N1604-1108-0110
N1604-1108-0110	16/4(19)BC OAS CMP WHITE 1M BX	–
N1402-1006-0910	14/2(19)BC CMR CL3R 1M BX	N1402-1008-0110
N1404-1006-0910	14/4(19)BC CMR CL3R 1M BX	N1404-1008-0110
N1202-1006-0911	12/2(19)BC CMR CL3R 1M' REEL	N1202-1008-0111

**CMR CABLE FEATURES:**

- CMR, CL3R, FPLR, FT4
- NEC 725/760
- UL 1424

**CMP CABLE FEATURES:**

- CMP, CL3P, FPLP, FT6
- NEC 725/760
- UL 1424

**OTHER COLORS AVAILABLE:**

BEIGE (15) BLACK (02), BLUE (06), BROWN (07), GREEN (04), GRAY (09), ORANGE (08), PURPLE (10), RED (03), YELLOW (05) WHITE (01)

18/2 Conductor  
18/4 Conductor  
18/6 Conductor  
16/2 Conductor  
16/4 Conductor  
14/2 Conductor  
14/4 Conductor  
12/2 Conductor

## Audio Cables

### MID FLEX AUDIO APPLICATION:

- Home & Commercial Speaker Cable

### AUDIO CABLE FEATURES:

- NEC 725 & 800
- UL 444 CMR CSA FT4
- RoHS

### HIGH FLEX AUDIO APPLICATION:

- Pro Audio & High End Home Audio Systems

MID FLEX AUDIO CABLES		HIGH FLEX AUDIO CABLE	
N1602-1206-0150	16/2(26)BC MIDFLEX CMR 500' BOX WHITE	N1602-1306-0150	16/2(65)BC HIGH FLEX CMR 500' BOX WHITE
N1604-1206-0150	16/4(26)BC MIDFLEX CMR 500' BOX WHITE	N1604-1306-0550	16/4(65)BC HIGH FLEX CMR 500' BOX YELLOW
N1402-1206-0550	14/2(41)BC MIDFLEX CMR 500' BOX WHITE	N1402-1306-0150	14/2(105)BC HIGH FLEX CMR 500' BOX WHITE
N1404-1206-0150	14/4(41)BC MIDFLEX CMR 500' BOX WHITE	N1404-1306-0151	14/4(105)BC HIGH FLEX CMR 500' BOX WHITE
N1202-1206-0150	12/2(65)BC MIDFLEX CMR 500' BOX WHITE	–	–

# Access Control Cables

## FPLR / FPLP

### SPECIFICATION:

Each Member Is Stranded Bare Copper And Individually Jacketed Available With An Overall Yellow Jacket Or "SW" Which Is A Nylong String Wrap Binding The 4 Members Together.

This Cable Is Offered With Two Different 22/6 Conductor Options (\*, \*\*)

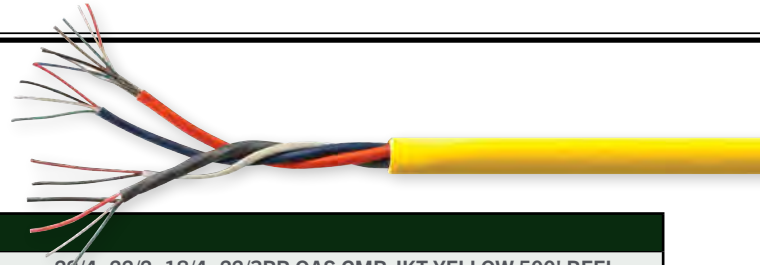

CMR/FT4	
NCOMB-3306-0551	22/4+22/2+18/4+22/3PR OAS CMR JKT YELLOW 500' REEL
NCOMB-3206-0551	22/4+22/2+18/4+22/6 OAS CMR JKT YELLOW 500' REEL
NCOMB-3106-SW51	22/4+22/2+18/4+22/3PR OAS SPEED WRAP 500' REEL
NCOMB-3006-SW51	22/4+22/2+18/4+22/6 OAS SPEED WRAP 500' REEL
CMP/FT6	
NCOMB-3308-0551	22/4+22/2+18/4+22/3PR OAS CMP JKT YELLOW 500' REEL
NCOMB-3208-0551	22/4+22/2+18/4+22/6 OAS CMP JKT YELLOW 500' REEL
NCOMB-3108-SW51	22/4+22/2+18/4+22/3PR SPEED WRAP 500' REEL
NCOMB-3008-SW51	22/4+22/2+18/4+22/6 OAS SPEED WRAP 500' REEL

\* 22/6(7)BC With An Over All Aluminum Mylar Shield and Drain, Jacketed

\*\* 22/3PR(7)BC Over All Aluminum Mylar Shield and Drain, Jacketed

## COAX and Siamese Cable

### APPLICATION: CATV Systems

Quad shield: aluminum mylar tape/60% aluminum braid/aluminum mylar tape/ 40% aluminum braid

Rg6 Dual Shield  
(60% Alumium Braid Over Aluminum Mylar Shield)



CMR B&W	CATV	CMP WHITE
NRG6U-4206-0210	RG6U CCSDUAL SHLD 60% BLACK 1000' BOX	—
NRG6U-4206-0110	RG6U CCSDUAL SHLD 60% WHITE 1000' BOX	NRG6U-4208-0110
NRG6U-4206-0250	RG6U CCSDUAL SHLD 60% BLACK 500' BOX	—
NRG6U-4206-0150	RG6U CCSDUAL SHLD 60% WHITE 500' BOX	NRG6U-4208-0150
NRG6Q-4406-0210	RG6U CCS QUAD SHLD BLACK 1000' BOX	—
NRG6Q-4406-0110	RG6U CCS QUAD SHLD WHITE 1000' BOX	NRG6Q-4408-0110
NRG6Q-4406-0250	RG6U CCS QUAD SHLD BLACK 500' BOX	—
NRG6Q-4406-0150	RG6U CCS QUAD SHLD WHITE 500' BOX	NRG6Q-4408-0150

## CCTV Coax

### APPLICATION: CCTV & Video Surveillance

Cctv Coax: Bc Center Conductor  
95% Bare Copper Braid



CMR B&W	CCTV COAX	CMP WHITE
NRG59-5026-0210	RG59 BC 95% BC SHLD BLACK 1000' BOX	NRG59-5028-0210
NRG6U-4226-0210	RG6 BC 95% BC BRAID BLACK 1000' BOX	NRG6U-4228-0110

## Siamese Cable - CCTV

### APPLICATION: CCTV Video & Power

Coax: bare copper center conductor / and 95% bare copper braid paired with 18/2(7) bare copper

Coax: bare copper center conductor / and 95% cca (copper clad aluminum) braid paired with 18/2(7) bare copper

Coax: bare copper center conductor / and 95% cca (copper clad aluminum) braid paired with 18/2(7) cca (copper clad aluminum)  
Only c12 listed



CMR B&W	SIAMESE CABLE- CCTV	CMP WHITE
NSIAM-5196-0210	RG59 18/2 BC COND AND BRAID BLACK 1000' BOX	NSIAM-5198-0210
NSIAM-5196-0250	RG59 18/2 BC COND AND BRAID BLACK 500' BOX	NSIAM-5198-0250
NSIAM-5196-0110	RG59 18/2 BC COND AND BRAID WHITE 1000' BOX	NSIAM-5198-0110
NSIAM-5196-0150	RG59 18/2 BC COND AND BRAID WHITE 500' BOX	NSIAM-5198-0150
NSIAM-5296-0210	RG59 18/2 BC COND CCA BRAID BC BLACK 1000' BOX	NSIAM-5298-0210
NSIAM-5296-0250	RG59 18/2 BC COND CCA BRAID BC BLACK 500' BOX	NSIAM-5298-0250
NSIAM-5296-0110	RG59 18/2 BC COND CCA BRAID BC WHITE 1000' BOX	NSIAM-5298-0110
NSIAM-5296-0150	RG59 18/2 BC COND CCA BRAID BC WHITE 500' BOX	NSIAM-5298-0150
NSIAM-5396-0210	RG59 18/2 CCA COND CCA BRAID BC BLACK 1000' BOX	NSIAM-5398-0210
NSIAM-5396-0250	RG59 18/2 CCA COND CCA BRAID BC BLACK 500' BOX	NSIAM-5398-0250
NSIAM-5396-0110	RG59 18/2 CCA COND CCA BRAID BC WHITE 1000' BOX	NSIAM-5398-0110
NSIAM-5396-0150	RG59 18/2 CCA COND CCA BRAID BC WHITE 500' BOX	NSIAM-5398-0150

\* NOTE: Reels Available 1000' Reel (11), 500' Reel (51)

# Fiber Jumper Cable

## Duplex Fiber Optic Jumpers ISO/IEC 11801, ETL Type cETLus, OFNR

### SPECIFICATION:

Northern fiber patch cords are factory terminated resulting in un-compromised performance compared to field terminated cables. Available in 1, 2, 3, 4, 5, 7 & 10 meter lengths Custom sizes available by special order.

### FEATURES:

Singlemode and Multimode • Multiple Connector Types

Connector's design complies with TIA-604-3-B (SC), TIA-604-10-B (LC), IEC 61754-4 (SC) and IEC 61754-20 (LC) standards

2MM OFNR Jacket • Multiple Lengths

Materials are compliant with RoHS 3 (2015/863), REACH (SVHC list release of January 15, 2019) and UL 94 V-0

Qualified to Telcordia GR-326-CORE issue 4 and IEC 61300 standards

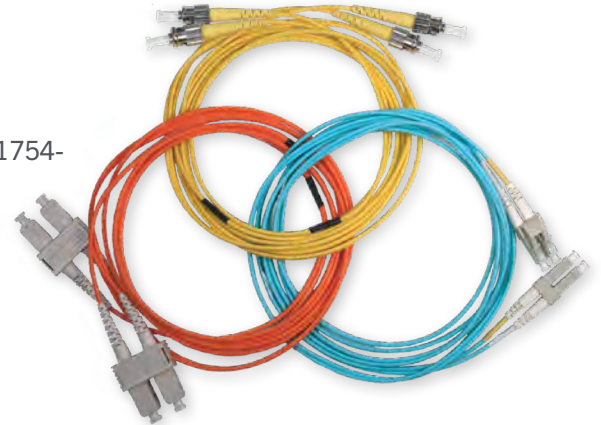

### PART NUMBER EXAMPLE:

## NFJ8803C2RA3M

Northern Fiber Jumper, LC-LC, OM3 2.0mm, Dup 2F, Riser, Aqua, 3 Meter

NORTHERN BRAND	FIBER JUMPER	CONNECTOR	CONNECTOR	BOOT	FIBER TYPE	JACKET THICKNESS	DUPLEX CABLE TYPE	FLAME RATING	JACKET COLOR	METER LENGTH
N	FJ	8 = LC	8 = LC	0 = STRAIGHT	0 = OS2	C = 2mm	2 = 2F ZIP	R = OFNR	5 = YELLOW (OS2)	1M
		6 = SC	6 = SC		1 = OM1				8 = ORANGE (OM1)	2M
		5 = ST	5 = ST		3 = OM3				A = AQUA (OM3)	3M
										4M
									5M	
										7M
										10M

## Duplex Fiber Jumpers

CONNECTOR TYPE	OS2 SINGLE MODE	OM3 MULTIMODE
ST to ST	NFJ5500C2R51M	NFJ5503C2RA1M
ST to ST	NFJ5500C2R53M	NFJ5503C2RA3M
ST to ST	NFJ5500C2R510M	NFJ5503C2RA10M
SC to SC	NFJ6600C2R51M	NFJ5603C2RA1M
SC to SC	NFJ6600C2R52M	
SC to SC	NFJ6600C2R53M	NFJ5603C2RA3M
SC to SC	NFJ6600C2R510M	NFJ5603C2RA10M
LC to LC	NFJ8800C2R51M	NFJ8803C2RA1M
LC to LC	NFJ8800C2R52M	NFJ8803C2RA2M
LC to LC	NFJ8800C2R53M	NFJ8803C2RA3M
LC to LC	NFJ8800C2R54M	NFJ8803C2RA4M
LC to LC	NFJ8800C2R55M	NFJ8803C2RA5M
LC to LC	NFJ8800C2R57M	NFJ8803C2RA7M
LC to LC	NFJ8800C2R510M	NFJ8803C2RA10M

## Duplex Gender Changer Fiber Jumpers

CONNECTOR TYPE	OS2 SINGLE MODE	OM3 MULTIMODE
SC to ST	NFJ5600C2R51M	NFJ5603C2RA1M
SC to ST	NFJ5600C2R53M	NFJ5603C2RA3M
SC to ST	NFJ5600C2R510M	NFJ5603C2RA10M
LC to ST	NFJ5800C2R51M	NFJ5803C2RA1M
LC to ST	NFJ5800C2R53M	NFJ5803C2RA3M
LC to ST	NFJ5800C2R510M	NFJ5803C2RA10M
LC to SC	NFJ6800C2R51M	NFJ6803C2RA1M
LC to SC	NFJ6800C2R52M	NFJ6803C2RA2M
LC to SC	NFJ6800C2R53M	NFJ6803C2RA3M
LC to SC	NFJ6800C2R55M	
LC to SC	NFJ6800C2R510M	NFJ6803C2RA10M

# **GENERAL LOCK**

## **2021 Product Catalog**

# *Superior Quality Exceptional Value*



**866-407-7597** ♦ **info@GeneralLock.com** ♦ **GeneralLock.com**

info@northernvideo.com ♦ techsupport@northernvideo.com ♦ www.northernvideo.com ♦ 855-388-7422