



APX TWO-WAY RADIOS

APX 5500, APX 6500, APX 6500Li, APX 7500, APX 8500

APX MOBILE 05 CONTROL HEAD USER GUIDE

JANUARY 2021

© 2021 Motorola Solutions, Inc. All rights reserved



6875947M01-HP



Contents

| | |
|---|-----------|
| List of Tables..... | 10 |
| Software Version..... | 11 |
| Chapter 1: Read Me First..... | 12 |
| 1.1 Notations Used in This Manual..... | 12 |
| 1.2 Radio Care..... | 12 |
| 1.2.1 Cleaning the External Surface of the Radio..... | 13 |
| 1.3 Additional Performance Enhancement..... | 13 |
| 1.3.1 ASTRO 25 Enhanced Data..... | 13 |
| 1.3.2 Dynamic System Resilience..... | 13 |
| 1.3.3 CrossTalk Prevention..... | 13 |
| 1.3.4 Encrypted Integrated Data..... | 13 |
| 1.3.5 SecureNet..... | 14 |
| 1.3.6 Over-the-Air Rekeying..... | 14 |
| 1.3.7 P25 Digital Vehicular Repeater System..... | 14 |
| 1.3.8 Conventional Talkgroup and Radio Scan Enhancements..... | 14 |
| 1.4 What Your Dealer/System Administrator Can Tell You..... | 15 |
| Chapter 2: Preparing Your Radio for Use..... | 16 |
| 2.1 Turning On the Radio | 16 |
| 2.2 Adjusting the Volume..... | 16 |
| 2.3 Validating Compatibility During Power Up..... | 16 |
| Chapter 3: Radio Controls..... | 18 |
| 3.1 O5 Control Head and Microphone..... | 18 |
| 3.2 Keypad..... | 20 |
| 3.3 Programmable Features..... | 21 |
| 3.3.1 Assignable Radio Functions..... | 21 |
| 3.3.2 Assignable Settings or Utility Functions..... | 23 |
| Chapter 4: Status Indicators..... | 25 |
| 4.1 LED Indications..... | 25 |
| 4.2 Status Icons..... | 25 |
| 4.3 TMS Status Icons..... | 28 |
| 4.4 Call Type Icons..... | 28 |
| 4.5 Intelligent Lighting Indicators..... | 29 |
| 4.6 Alert Tones | 29 |
| Chapter 5: General Radio Operation..... | 32 |
| 5.1 Selecting a Zone..... | 32 |

| | |
|---|-----------|
| 5.2 Selecting a Radio Channel..... | 32 |
| 5.3 Selecting a Channel by using Channel Search Button..... | 32 |
| 5.4 Mode Select Feature..... | 33 |
| 5.4.1 Saving a Zone and a Channel to a Softkey..... | 33 |
| 5.4.2 Saving a Zone and a Channel to a Button..... | 33 |
| 5.5 Receiving and Responding to a Radio Call..... | 34 |
| 5.5.1 Receiving and Responding to a Talkgroup Call..... | 34 |
| 5.5.2 Receiving and Responding to a Private Call (Trunking Only)..... | 35 |
| 5.5.3 Receiving and Responding to a Telephone Call (Trunking Only)..... | 35 |
| 5.6 Methods to Make a Radio Call..... | 35 |
| 5.6.1 Making a Talkgroup Call | 36 |
| 5.6.2 Making a Private Call (Trunking Only)..... | 36 |
| 5.6.3 Making a Telephone Call (Trunking Only)..... | 37 |
| 5.7 Switching Between Repeater or Direct Operation Button..... | 37 |
| 5.8 Monitor Feature..... | 37 |
| 5.8.1 Monitoring a Channel..... | 38 |
| 5.8.2 Monitoring Conventional Mode..... | 38 |
| Chapter 6: Advanced Features..... | 39 |
| 6.1 ViQi..... | 39 |
| 6.1.1 Using ViQi Virtual Partner..... | 40 |
| 6.2 Advanced Call Features..... | 40 |
| 6.2.1 Calling a Phone Not in the List..... | 40 |
| 6.2.2 Selective Call (ASTRO Conventional Only)..... | 41 |
| 6.2.2.1 Receiving a Selective Call..... | 41 |
| 6.2.2.2 Making a Selective Call..... | 41 |
| 6.2.3 Talkgroup Call Feature (Conventional Only)..... | 42 |
| 6.2.3.1 Selecting a Talkgroup..... | 42 |
| 6.2.4 Sending a Status Call..... | 42 |
| 6.2.5 Making a Priority Dispatch Calls..... | 43 |
| 6.2.6 Dynamic Regrouping (Trunking Only)..... | 43 |
| 6.2.6.1 Classification of Regrouped Radios..... | 43 |
| 6.2.6.2 Requesting a Reprogram (Trunking Only)..... | 44 |
| 6.2.7 Dynamic Zone Programming..... | 44 |
| 6.2.7.1 Entering the Dynamic Zone to Select a Dynamic Channel..... | 44 |
| 6.2.7.2 Saving a Channel in the Dynamic Zone from List Selection..... | 45 |
| 6.2.7.3 Deleting a Channel in the Dynamic Zone..... | 45 |
| 6.3 Multiple Control Head Features..... | 45 |
| 6.3.1 Setting the ID of the Initial Control Head..... | 46 |
| 6.3.2 All Active Mode..... | 46 |

| | | |
|---------|---|----|
| 6.3.3 | Activating and Deactivating Intercom in All Active Mode..... | 46 |
| 6.3.4 | One Active Mode..... | 47 |
| 6.4 | Remote Monitor..... | 48 |
| 6.5 | Contacts..... | 48 |
| 6.5.1 | Making a Private Call from Contacts..... | 48 |
| 6.5.2 | Adding a New Contact Entry..... | 49 |
| 6.5.3 | Deleting a Contact Entry..... | 50 |
| 6.5.4 | Adding a Contact to a Call List..... | 50 |
| 6.5.5 | Methods of Contact Editing in a Call List..... | 50 |
| 6.5.5.1 | Editing an Entry Alias..... | 50 |
| 6.5.5.2 | Editing as Entry ID..... | 51 |
| 6.5.5.3 | Editing a Call Type..... | 51 |
| 6.6 | Scan Lists..... | 52 |
| 6.6.1 | Intelligent Priority Scan..... | 52 |
| 6.6.2 | Viewing a Scan List..... | 52 |
| 6.6.3 | Editing the Scan List..... | 52 |
| 6.6.4 | Changing the Scan List Status..... | 53 |
| 6.6.5 | Viewing and Changing the Priority Status..... | 53 |
| 6.7 | Scan..... | 54 |
| 6.7.1 | Turning Scan On or Off..... | 54 |
| 6.7.2 | Turning Scan On While Disregarding the Squelch Code (Conventional Channels Only)..... | 54 |
| 6.7.3 | Deleting a Nuisance Channel..... | 54 |
| 6.7.4 | Restoring a Nuisance Channel..... | 55 |
| 6.7.5 | Changing Priorities Status While Scan is On..... | 55 |
| 6.7.6 | Restoring Priorities in a Scan List..... | 55 |
| 6.7.7 | Using the Hang Up Box (HUB)..... | 55 |
| 6.8 | Call Alert Paging..... | 56 |
| 6.8.1 | Receiving a Call Alert Page..... | 56 |
| 6.8.2 | Sending a Call Alert Page..... | 56 |
| 6.9 | Recent Calls..... | 57 |
| 6.9.1 | Viewing Recent Calls..... | 58 |
| 6.9.2 | Instant Recall..... | 58 |
| 6.9.2.1 | Saving and Playback Calls..... | 58 |
| 6.10 | In-Call User Alert..... | 59 |
| 6.10.1 | Enabling and Disabling In-Call User Alert..... | 60 |
| 6.11 | Quick Call II | 60 |
| 6.11.1 | Initiating a Quick Call II Transmission..... | 60 |
| 6.12 | Emergency Operation..... | 61 |
| 6.12.1 | Special Considerations for Emergency Operation..... | 61 |

| | | |
|-----------|--|----|
| 6.12.2 | Emergency Keep-Alive..... | 61 |
| 6.12.3 | Exiting Emergency Operation..... | 62 |
| 6.12.4 | Exiting Emergency as Supervisor (Trunking Only)..... | 62 |
| 6.12.5 | Sending an Emergency Alarm..... | 62 |
| 6.12.6 | Sending an Emergency Call (Trunking Only)..... | 63 |
| 6.12.7 | Sending An Emergency Call With Hot Mic (Trunking Only)..... | 63 |
| 6.12.8 | Sending an Emergency Alarm with Emergency Call..... | 64 |
| 6.12.9 | Sending An Emergency Alarm and Call with Hot Mic..... | 64 |
| 6.12.10 | Sending a Silent Emergency Alarm..... | 65 |
| 6.12.11 | Impact Detection..... | 65 |
| 6.12.11.1 | Detecting Impact..... | 65 |
| 6.12.11.2 | Exiting Impact Detected Condition..... | 66 |
| 6.13 | Sending Evacuation Tone..... | 66 |
| 6.14 | Automatic Registration Service..... | 66 |
| 6.14.1 | Selecting or Changing the ARS Mode..... | 67 |
| 6.14.2 | User Login Feature..... | 67 |
| 6.14.2.1 | Logging In as a User..... | 68 |
| 6.14.2.2 | Logging Out..... | 69 |
| 6.15 | Text Messaging Service..... | 69 |
| 6.15.1 | Accessing the Messaging Features..... | 69 |
| 6.15.2 | Composing and Sending a New Text Message..... | 70 |
| 6.15.3 | Sending a Quick Text Message..... | 70 |
| 6.15.4 | Priority Status and Request Reply of a New Text Message..... | 71 |
| 6.15.4.1 | Appending a Priority Status to a Text Message..... | 72 |
| 6.15.4.2 | Removing a Priority Status from a Text Message..... | 72 |
| 6.15.4.3 | Appending a Request Reply to a Text Message..... | 72 |
| 6.15.4.4 | Removing a Request Reply from a Text Message..... | 72 |
| 6.15.4.5 | Appending a Priority Status and a Reply Request to a Text Message.... | 73 |
| 6.15.4.6 | Removing a Priority Status and a Reply Request from a Text Message..... | 73 |
| 6.15.4.7 | Receiving a Text Message..... | 73 |
| 6.15.4.8 | Viewing a Text Message from the Inbox..... | 74 |
| 6.15.4.9 | Replying to a Received Text Message..... | 74 |
| 6.15.4.10 | Accessing the Drafts Folder..... | 75 |
| 6.15.4.11 | Sent Text Messages..... | 75 |
| 6.15.4.12 | Deleting Text Messages..... | 76 |
| 6.16 | Secure Operations..... | 77 |
| 6.16.1 | Enabling Secure Transmission..... | 77 |
| 6.16.2 | Accessing the Secure Feature..... | 77 |
| 6.16.3 | Managing Encryption..... | 77 |

| | |
|--|----|
| 6.16.3.1 Loading Encryption Keys..... | 77 |
| 6.16.3.2 Multikey Feature..... | 78 |
| 6.16.3.3 Selecting Encryption Keys..... | 78 |
| 6.16.3.4 Selecting Keysets..... | 79 |
| 6.16.3.5 Erasing Encryption Keys..... | 79 |
| 6.16.3.6 Requesting an Over-the-Air Rekey..... | 80 |
| 6.16.3.7 MDC OTAR (Conventional Only)..... | 80 |
| 6.16.3.8 Infinite UKEK Retention..... | 80 |
| 6.16.3.9 Hear Clear..... | 80 |
| 6.17 Radio Lock..... | 81 |
| 6.17.1 Enabling or Disabling Radio Lock (Secure Radios Only)..... | 81 |
| 6.17.2 Changing the Radio Lock Password..... | 82 |
| 6.17.3 Changing the Tactical Inhibit Password..... | 82 |
| 6.18 Radio Stun and Kill..... | 83 |
| 6.18.1 Radio Stun..... | 83 |
| 6.18.1.1 Using Radio Stun..... | 83 |
| 6.18.2 Radio Kill..... | 83 |
| 6.18.2.1 Using Remote Kill to Kill Another Radio..... | 84 |
| 6.18.2.2 Using Direct Kill to Kill Your Own Radio..... | 84 |
| 6.19 Radio Inhibit..... | 85 |
| 6.20 Global Positioning System/Global Navigation Satellite System..... | 85 |
| 6.20.1 GPS Performance Enhancement..... | 85 |
| 6.20.2 The Outdoor Location Feature (Using GPS)..... | 85 |
| 6.20.3 Location Format..... | 86 |
| 6.20.4 Accessing the Outdoor Location Feature..... | 86 |
| 6.20.5 Turning Off GPS..... | 87 |
| 6.20.6 Saving a Waypoint..... | 87 |
| 6.20.7 Viewing a Saved Waypoint..... | 88 |
| 6.20.8 Editing the Alias of a Waypoint..... | 88 |
| 6.20.9 Editing the Coordinates of a Waypoint..... | 89 |
| 6.20.10 Deleting a Single Saved Waypoint..... | 90 |
| 6.20.11 Deleting All Saved Waypoints..... | 90 |
| 6.20.12 Measuring the Distance and Bearing from a Saved Waypoint..... | 90 |
| 6.20.13 Location Feature in Emergency Mode..... | 91 |
| 6.20.14 Peer-Location on the Display (ASTRO Conventional)..... | 91 |
| 6.21 Mission Critical Geofence (ASTRO 25 Trunking)..... | 92 |
| 6.21.1 Entering the Geofence Area..... | 92 |
| 6.21.2 Mission Critical Geofence..... | 93 |
| 6.21.3 Entering Mission Critical Geofence..... | 93 |

| | |
|--|-----|
| 6.21.4 Exiting Mission Critical Geofence..... | 93 |
| 6.22 Trunking System Controls..... | 93 |
| 6.22.1 Operating in Failsoft System..... | 93 |
| 6.22.2 Out-of-Range Radio..... | 94 |
| 6.22.3 SmartConnect..... | 94 |
| 6.22.4 SmartZone..... | 94 |
| 6.22.5 Site Trunking Feature..... | 95 |
| 6.22.6 Locking and Unlocking a Site..... | 95 |
| 6.22.7 Viewing the Current Site..... | 95 |
| 6.22.8 Changing the Current Site..... | 95 |
| 6.22.9 Trunked Announcement..... | 96 |
| 6.22.9.1 Initiating an Announcement..... | 96 |
| 6.23 Ignition Switch Options..... | 96 |
| 6.23.1 Using Emergency Power Up..... | 97 |
| 6.24 ASTRO 25 (P25) Programming Over Project 25 (POP25)..... | 97 |
| 6.24.1 Responding to the Notification of Upgrade..... | 98 |
| 6.25 Voice Announcement | 98 |
| 6.26 Site Selectable Alerts (ASTRO 25 Trunking)..... | 98 |
| 6.26.1 Sending SSA Notification to Single Site..... | 99 |
| 6.26.2 Sending SSA Notification to Single Site by Manual Entry..... | 99 |
| 6.26.3 Sending SSA Notification to All Sites..... | 100 |
| 6.26.4 Sending SSA Notification to All Available Sites..... | 100 |
| 6.26.5 Stopping SSA Notification of a Single Site..... | 101 |
| 6.26.6 Stopping SSA Notification of a Single Site by Manual Entry..... | 102 |
| 6.26.7 Stopping SSA Notification of All Sites..... | 102 |
| 6.26.8 Stopping SSA Notification of All Available Sites..... | 103 |
| 6.27 Channel Change on Off-Hook..... | 103 |
| 6.28 Low Voltage Threshold Warning..... | 104 |
| 6.29 Wi-Fi..... | 104 |
| 6.29.1 Turning Wi-Fi On or Off..... | 104 |
| 6.29.2 Selecting WiFi Network..... | 104 |
| 6.29.3 Checking the Wi-Fi Configuration and Status of the Radio..... | 105 |
| 6.30 Utilities..... | 105 |
| 6.30.1 Selecting the Power Level..... | 106 |
| 6.30.2 Selecting a Radio Profile..... | 106 |
| 6.30.3 Controlling the Display Backlight..... | 107 |
| 6.30.4 Turning the Keypad Tones On or Off..... | 107 |
| 6.30.5 Turning Voice Mute On or Off..... | 107 |
| 6.30.6 Using the Time-Out Timer..... | 108 |

| | |
|---|------------|
| 6.30.7 Conventional Squelch Operation..... | 108 |
| 6.30.7.1 Using Conventional Squelch Operation Features..... | 109 |
| 6.30.8 Using the PL Defeat Feature..... | 109 |
| 6.30.9 Digital PTT ID Support..... | 109 |
| 6.30.10 Smart PTT (Conventional Only)..... | 110 |
| 6.30.11 Transmit Inhibit..... | 110 |
| 6.30.11.1 Enabling Transmit Inhibition..... | 110 |
| 6.30.11.2 Disabling Transmit Inhibition..... | 111 |
| 6.30.12 External Alarms (Horn and Lights)..... | 111 |
| 6.30.12.1 Using Non-Permanent Horn and Lights..... | 111 |
| 6.30.12.2 Using Permanent Horn and Lights..... | 112 |
| 6.30.12.3 Changing the Selected Alarms..... | 112 |
| 6.30.12.4 Receiving a Call While Alarms are Turned On..... | 112 |
| 6.30.12.5 Turning Off Non-Rearmable External Alarms..... | 112 |
| 6.30.12.6 Turning Off Rearmable External Alarms..... | 113 |
| 6.30.13 Front Panel Programming..... | 113 |
| 6.30.13.1 Initiating the FPP Feature..... | 113 |
| 6.30.13.2 Changing Password (Optional)..... | 114 |
| 6.30.13.3 Selecting a Channel within a Zone..... | 114 |
| 6.30.13.4 Changing a Channel Parameter..... | 115 |
| 6.30.13.5 Editing Parameters..... | 115 |
| Chapter 7: Accessories..... | 117 |
| Legal and Compliance Statements..... | 118 |
| Disclaimer..... | 118 |
| Copyrights..... | 118 |
| Declaration of Conformity..... | 119 |
| Important Safety Information..... | 120 |
| Notice to Users (FCC) | 120 |
| FCC Licensing Information..... | 120 |
| Applying for Canadian License..... | 121 |
| Maritime Radio Use in the VHF Frequency Range..... | 122 |
| Special Channel Assignments..... | 122 |
| Emergency Channel..... | 122 |
| Non-Commercial Call Channel..... | 122 |
| Operating Frequency Requirements..... | 122 |
| Declaration of Compliance for the Use of Distress and Safety Frequencies..... | 125 |
| Technical Parameters for Interfacing External Data Sources..... | 125 |
| Limited Warranty..... | 126 |
| MOTOROLA SOLUTIONS COMMUNICATION PRODUCTS..... | 126 |

| | |
|---|------------|
| I. WHAT THIS WARRANTY COVERS AND FOR HOW LONG:..... | 126 |
| II. GENERAL PROVISIONS:..... | 127 |
| III. STATE LAW RIGHTS:..... | 127 |
| IV. HOW TO GET WARRANTY SERVICE:..... | 127 |
| V. WHAT THIS WARRANTY DOES NOT COVER:..... | 127 |
| VI. PATENT AND SOFTWARE PROVISIONS:..... | 128 |
| VII. GOVERNING LAW:..... | 128 |
| VIII. For Australia Only..... | 129 |
| SERVICE..... | 129 |
| Glossary..... | 130 |

List of Tables

| | |
|---|-----|
| Table 1: O5 Control Head and Microphone | 18 |
| Table 2: Text Entry Modes | 20 |
| Table 3: Keypad Characters | 20 |
| Table 4: LED Indications | 25 |
| Table 5: TMS Status Icons | 28 |
| Table 6: Call Type Icons | 28 |
| Table 7: ViQi Virtual Partner Queries | 39 |
| Table 8: Emergency Operation Scenarios | 61 |
| Table 9: Parameter Editing Keys | 115 |
| Table 10: VHF Marine Channel List | 123 |

Software Version

All the features described in the following sections are supported by the software version **R22.00.00** or later.

See [Accessing the Radio Information](#) to determine the software version of your radio.

Contact your system administrator for more details of all the supported features.

Chapter 1

Read Me First

This User Guide covers the basic operation of the radio. However, your dealer or system administrator may have customized your radio for your specific needs. Check with your dealer or system administrator for more information.

1.1

Notations Used in This Manual

Notations such as **Warning**, **Caution**, and **Notice** are used throughout the text in this publication. These notations are used to emphasize that safety hazards exist, and the care that must be taken or observed.



WARNING: An operational procedure, practice, or condition and so on, which may result in injury or death if not carefully observed.





CAUTION: An operational procedure, practice, or condition and so on, which may result in damage to the equipment if not carefully observed.



NOTICE: An operational procedure, practice, or condition and so on, which is essential to emphasize.

The following special notations identify certain items.

| Example | Description |
|---|--|
| Home button or  | Buttons and keys are shown in bold print or as an icon. |
| PHONE Phone | Menu entries are shown similar to the way they appear on the display of the radio. |
|  | This means “Press the right side of the 4-Way Navigation Button”. |

1.2

Radio Care

Proper radio usage and care ensure efficient operation and long life of the product.

The following are suggestions to assist you in troubleshooting possible operating problems.



CAUTION: The cables that connect to the rear of the radio could have live voltage on some of their pins. Do not remove or reconnect these cables. Only a qualified radio technician should perform this task. Service performed by unauthorized personnel may cause the radio to transmit an emergency alarm even if the unit is turned off.

If your radio is locked up or the display shows `FAIL 01/09`, power cycle the radio. If this does not correct the condition, take the radio to a qualified radio technician for service.

If radio operation is intermittent, check with other persons using the system for similar problems before taking the radio in for service. Similar problems indicate a system malfunction rather than a radio failure.

If symptoms persist or if your unit exhibits other problems, contact a qualified radio technician.

1.2.1

Cleaning the External Surface of the Radio

Prerequisites:



CAUTION: Do **not** use solvents to clean your radio. Spirits may permanently damage the radio housing.
Do **not** submerge the radio in detergent solution.

Procedure:

- 1 Combine 1 teaspoon of mild dishwashing detergent to 1 gallon of water (0.5% solution).
- 2 Apply the solution sparingly with a stiff, non-metallic, short-bristled brush, ensuring that excess detergent does not get entrapped near the connectors, controls, or crevices.
- 3 Dry the radio thoroughly with a soft, absorbent, lint-free cloth.
- 4 Ensure that no water remains entrapped near the connectors, cracks, or crevices.

1.3

Additional Performance Enhancement

The following performance enhancements are some of the latest creations designed to enhance the security, quality, and efficiency of the radios.

1.3.1

ASTRO 25 Enhanced Data

ASTRO 25 Enhanced Data is optimized to handle different message sizes and variable update rates from different applications of the radio. To improve data channel efficiency and enable denser network traffic, add Enhanced Data to the Integrated Data system with a software installation.

1.3.2

Dynamic System Resilience

Dynamic System Resilience (DSR) ensures that the radio system is seamlessly switched to a backup master site dynamically during a system failure. DSR also provides indications such as failure detection, fault recovery, and redundancy within the system. DSR also supports mechanisms related to the Integrated Voice and Data (IV&D) or data centric.

1.3.3

CrossTalk Prevention

CrossTalk Prevention feature prevents crosstalk scenarios and allows the adjustment of the internal SSI clock rate of the radio. This reduces the possibility of radio frequency interfering spurs.

1.3.4

Encrypted Integrated Data

Encrypted Integrated Data (EID) provides security encryption and authentication of Integrated Voice and Data (IV&D) data bearer service communication between the radio and the Customer Enterprise Network.

1.3.5

SecureNet

SecureNet allows you to perform secured communications on an Analog or Motorola Data Communication (MDC) channel. The MDC Over-the-Air Rekeying (OTAR) feature allows you to perform OTAR activities on an MDC channel.

1.3.6

Over-the-Air Rekeying

The Over-the-Air Rekeying (OTAR) feature allows the dispatcher to remotely reprogram encryption keys in the radio after a rekey request.

Single-system OTAR

Single-system OTAR allows a radio to be rekeyed by only one Key Management Facility (KMF) or Key Management Controller (KMC).

Multi-system OTAR

Multi-system OTAR allows a radio to be rekeyed by multiple KMFs. After an initial programming, the radio is able to seamlessly move to different secure systems associated to a newly selected channel.



NOTICE: This feature must be preprogrammed by a qualified radio technician. Contact your system administrator for more information.

1.3.7

P25 Digital Vehicular Repeater System

Motorola Solutions offers an MSI Certified APX compatible, third party, P25 Digital Vehicular Repeater System (DVRS) that provides low-cost portable radio coverage in areas where only mobile radio coverage is available and portable radio coverage is either intermittent or non-existent.

The system sends DVRS firmware and configuration updates over-the-air. The following scenarios occur during the update:

- If the update is accepted, the display shows `UPDATING DVRS`.
- If the update fails, the display shows `DVRS UPDT FAILED`. Contact your system administrator for more information.



NOTICE: Portable subscriber units enabled in the system for Radio Authentication shall be able to authenticate regardless of whether they are communicating directly on the system or by using a DVRS.

DVRS can also work with SmartConnect to use broadband coverage for the in-vehicle mobile. Portable radios communicate through the in-vehicle mobile to the system through the LTE, Satellite or Wi-Fi connection. This extends the system coverage when you are away from the vehicle.

1.3.8

Conventional Talkgroup and Radio Scan Enhancements

Enhancements have been made to the Conventional Talkgroup at the system to improve the Scan feature operation significantly when multiple agencies are using a single conventional radio frequency channel.

These enhancements allow you to use Selective Squelch to operate on only the subset of talkgroups that are relevant to the users rather than all talkgroups on the channel.

The enhancements support the following Scan mode:

- Mixed Vote Scan.

- Standard Conventional Scan.
- Priority Operation.

Up to 30 different talkgroups can be supported using conventional channels. A maximum of four talkgroups can be supported when Vote Scan channels are being used.

Smart PTT is supported with this enhancement as Smart PTT prevents you from transmitting while other users are on the channel.



NOTICE: User Selectable Talkgroups are not compatible with this Conventional Talkgroup Enhancement.

1.4

What Your Dealer/System Administrator Can Tell You

If the radio is to be operated in extreme temperatures (less than -30 °C or more than +60 °C), check with your system administrator for the correct radio settings.

You can consult your dealer or system administrator about the following:

- Is your radio programmed with any preset conventional channels?
- Which buttons have been programmed to access other features?
- What optional accessories may suit your needs?



NOTICE: Specifications may vary for different radio models. Contact your system administrator for more information.

Chapter 2

Preparing Your Radio for Use

This section provides simple instructions to prepare your radio for use.

2.1

Turning On the Radio

Procedure:

- 1 Press the **Power On/Off Button** briefly to power on the radio.

After a short time, the red, yellow, and green LEDs light up. The display shows the following:

- Current zone and channel text
- Menu items on the home screen

The backlight turns on to the last selected dim level.



NOTICE:

If `Fail ##/##` appears on the display, the radio is unable to function until the condition is corrected.

If `Error ##/##` appears, some non-critical data has been changed. If the display goes blank, or if the unit appears to be locked up, see [Radio Care on page 12](#) for more information.

If `Ch mismatch` appear, either the Control Head is connected to an incompatible transceiver, or vice versa.

If your radio does not power up, contact your system administrator.

- 2 To turn off the radio, press the **Power On/Off** button after the LEDs light up.

2.2

Adjusting the Volume

Procedure:

- 1 To increase the volume, rotate the **Volume Knob** clockwise.
- 2 To decrease the volume, rotate the knob counterclockwise.

2.3

Validating Compatibility During Power Up

The radio validates and updates the software and hardware of your control head(s) during power-up. During validation, the display shows `MAINTENANCE MODE REMOTE DEVICE`; promptly followed by other maintenance statuses.

Procedure:

Press the **Power On/Off** Button to reset when the display shows UPDATE DONE PLEASE RESET upon completion, or when the display shows UPDATE FAILED PLEASE RESET when it fails to update.

If the updates are incomplete, the radio runs the Maintenance Mode and the display shows MAINTENANCE MODE REMOTE DEVICE; promptly followed by other maintenance statuses again.



NOTICE: If SW INCOMPLETE appears, use Flashport Recovery Tool to update the control heads before you power on the radio again.

Chapter 3

Radio Controls

This chapter explains the buttons and functions to control the radio.

3.1

O5 Control Head and Microphone

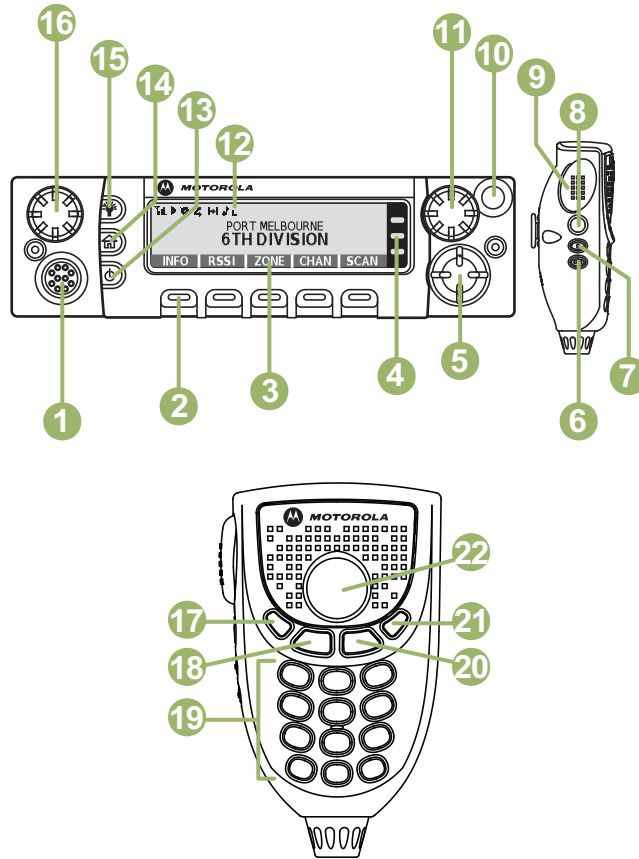

NOTICE: The microphone is not part of the radio. It is an optional accessory.

Table 1: O5 Control Head and Microphone

| Number | Description |
|--------|--|
| 1 | Accessory Port (Microphone) |
| 2* | Menu Select Buttons Press to enter the menu corresponding to the menu entry. |
| 3 | Menu Entries |
| 4 | LED Indicators |

* These radio controls/buttons are programmable.

| Number | Description |
|---------------|--|
| 5 | Navigation Button Use these buttons for list scrolling and navigating around the menu hierarchy. |
| 6* | Accessory 2-Dot Button Use this programmable button to access a preprogrammed function or enable or disable a feature. |
| 7* | Accessory 1-Dot Button Use this programmable button to access a preprogrammed function or enable or disable a feature. |
| 8* | Accessory No-Dot Button (Purple) Use this programmable button to access a preprogrammed function or enable or disable a feature. |
| 9 | Push-to-Talk (PTT) Button Press and hold to talk in simplex calls or to initiate a group call, release it to listen. |
| 10* | Orange Button This button is usually programmed as the Emergency button. |
| 11 | Mode Knob Rotate this knob to scroll through the channel list. |
| 12 | Screen Display |
| 13 | Power On/Off Button Press and hold to turn on/off your radio. |
| 14 | Home Button Press to return to the Home screen. |
| 15 | Dimmer Button Press to adjust the display brightness. Press and hold to toggle between day and night mode. |
| 16 | Volume Knob Rotate clockwise to increase the volume. Rotate counterclockwise to decrease the volume. |
| 17* | Data Feature Button Press to enter the Text Messaging Service feature screen. Press and hold to enter the Inbox menu. |
| 18 | Home Button (Microphone) Press to return to the Home screen. |
| 19 | Keypad Buttons Use the keypad to enter alphanumeric characters for dialing, contact entries, and text messages. |
| 20 | Okay/Select Button Press to select the option that appears on the screen. |
| 21 | Cancel Button Press to cancel the current operation and return to the previous screen. |

| Number | Description |
|--------|---|
| 22 | Navigation Button (Microphone) Use these buttons for list scrolling and navigating around the menu hierarchy. |

3.2 Keypad

Use the keypad to enter alphanumeric text on your radio.

Your radio uses icons to indicate the selected text entry mode. Refer to the following table for the supported modes.

Table 2: Text Entry Modes

| Icon | Description |
|------|---|
| HEX | Text entry is in hexadecimal mode. |
| 123 | Text entry is in numeric mode. |
| Ab↑ | The first character of the text entry is capitalized. |
| Abc | Text entry is in normal text mode. |
| ABC | Text entry is in uppercase mode. |
| abc | Text entry is in lowercase mode. |
| xT9 | Text entry is in lowercase with predicted words shown at the bottom of the screen. |
| Xt9 | Text entry is in mixed case and with predicted words shown at the bottom of the screen. |
| XT9 | Text entry is in uppercase with predicted words shown at the bottom of the screen. |

Depending on the selected mode, each key press generates a different character of the alphabet. The following table shows the characters generated by each key in their supported modes.

Table 3: Keypad Characters

| Key | Mode | Output |
|-------|-----------------------------|--|
| 1 key | Numeric/Uppercase/Lowercase | 1 . , ? ! ; @ _ - * # & \$ / + = \ " ' () |
| | Hexadecimal Mode | 1 |
| 2 key | Numeric | 2 |
| | Uppercase | A B C |
| | Lowercase | a b c |
| | Hexadecimal | 2 A B C |
| 3 key | Numeric | 3 |
| | Uppercase | D E F |
| | Lowercase | d e f |
| | Hexadecimal | 3 D E F |

| Key | Mode | Output |
|-------|-----------------------------|---|
| 4 key | Numeric | 4 |
| | Uppercase | G H I |
| | Lowercase | g h i |
| 5 key | Numeric | 5 |
| | Uppercase | J K L |
| | Lowercase | j k l |
| 6 key | Numeric | 6 |
| | Uppercase | M N O |
| | Lowercase | m n o |
| 7 key | Numeric | 7 |
| | Uppercase | P Q R S |
| | Lowercase | p q r s |
| 8 key | Numeric | 8 |
| | Uppercase | T U V |
| | Lowercase | t u v |
| 9 key | Numeric | 9 |
| | Uppercase | W X Y Z |
| | Lowercase | w x y z |
| 0 key | Numeric/Hexadecimal | 0 |
| | Uppercase/Lowercase | Toggle between mixed case mode, uppercase mode, and lowercase mode. |
| * key | Numeric/Uppercase/Lowercase | Space |
| # key | Numeric/Uppercase/Lowercase | Toggle between numeric and letter mode. |

3.3

Programmable Features

Your system administrator can program the programmable buttons as shortcuts to radio functions or preset channels/groups depending on the duration of a button press. Some functions can also be programmed to the radio switches.

3.3.1

Assignable Radio Functions

Call Alert

Allows your radio to function like a pager, or to verify if a radio is active on the system.

Call Response

Allows you to answer a private call or phone call.

Channel

Selects a channel.

Contacts

Allows you to access the **Contacts** menu.

Dynamic ID (Conventional Only)

Allows you to edit the ASTRO Individual ID and/or MDC Primary ID of the radio.



NOTICE:

- If the Dynamic ID menu key is not pre-programmed in the radio, use dongle to display the menu key. Press the menu key and enter the password to view or edit the ASTRO Individual ID and/or MDC Primary ID of the radio.
- If the password is not pre-programmed, press the menu key to directly view or edit the ASTRO Individual ID and/or MDC Primary ID of the radio.

Dynamic Priority (Conventional Only)

Allows any channel in a Scan List (except for a Priority-One channel) to temporarily replace the Priority-Two channel.

Emergency

Depending on the programming, initiates or cancels an emergency alarm or call.

In-Call User Alert

Allows the radio to remain muted to affiliated talkgroup calls while operating on the current Trunking Personality or conventional channel.

Intercom

Enables users of multiple control heads to talk to each other using the control heads in a multi-control head setup.

Internet Protocol Address

Displays the Internet Protocol (IP) address, device name, and status of the radio.

Location

Displays the current location (latitude, longitude, time, and date), and also the distance and bearing to another location, or toggles GPS/Location between on and off.

Message

Allows you to access the message list.

Monitor (Conventional Only)

Monitors a selected channel for all radio traffic until the function is disabled.

Multiple Private Line (Conventional Only)

Allows you to access the Multiple Private Line lists.

Nuisance Delete

Temporarily removes an unwanted channel, except for priority channels and the designated transmit channel from the scan list.

Phone Call

Allows you to make and receive calls similar to standard phone calls.

Private Call (Trunking Only)

Allows a call from one individual radio to another.

Priority Dispatch

Allows you to call the dispatcher on a different talkgroup.

Radio Profiles

Allows you to access a set of preprogrammed visual and audio settings of the radio.

Recent Calls

Allows you to view the recent call history of your radio.

Rekey Request

Notifies the dispatcher that a new encryption key is needed.

Remote Monitor

Enables the system administrator to remotely command a targeted radio.

Repeater Access Button (RAB) (Conventional Only)

Allows you to manually send a repeater access codeword.

Reprogram Request (Trunking Only)

Notifies the dispatcher that a new dynamic regrouping assignment is needed.

Request-To-Talk (Conventional Only)

Notifies the dispatcher that you want to send a voice call.

Scan

Short press – Toggles the scan function between on and off.

Long press – Enables Scan List Programming and selects the scan list for editing.

Secure/Clear

Toggles secure transmission between on and off.

Selective Call (Conventional Only)

Calls an assigned radio.

Siren

Turns different Siren Tones on or off.

Site Display/Search (Trunking Only)

Short press – Displays the current site ID and Received Signal Strength Indicator (RSSI) value.

Long press – Performs site search for Automatic Multiple Site Select (AMSS) or SmartZone operation (long press).

Site Lock/Unlock (Trunking Only)

Allows your radio to lock onto a specific site.

Status (Trunking Only)

Sends data calls to the dispatcher about a predefined status.

Talkaround/Direct (Conventional Only)

Toggles between using a repeater or communicating directly with another radio.

Talkgroup (Conventional Only)

Initiates a call to a preprogrammed group of radios.

Text Messaging Service (TMS)

Allows you to access the **Text Messaging Service (TMS)** menu.

TMS Quick Text

Selects a predefined message.

User

Allows you to log on to the server with a personally identifiable user name.

Virtual Partner

Enables the Virtual Partner feature and allows you to perform queries using ViQi.

Zone Down

Toggles downward through the zones in the radio.

Zone Select

Selects a zone from the switch.

Zone Up

Toggles upward through the zones in the radio.

3.3.2

Assignable Settings or Utility Functions

Dim

Short Press changes the display brightness, while Long Press toggle between day/night mode.

Front/Rear

Toggles between one of the two control heads.

Horns/Lights

Toggles the horns and lights feature on and off.

Low Power

Toggles the transmit power level between high and low.

Voice Announcement

Audibly indicates the current feature mode, zone, or channel that you have been assigned to.

Chapter 4

Status Indicators

This section explains the status indicators of the radio.

4.1

LED Indications

The Status LED shows the operational status of your radio.



Table 4: LED Indications











| Indication | Status |
|----------------------|---|
| Solid red | Radio is transmitting. |
| Double blinking red | Radio is transmitting an emergency alarm or call. |
| Rapid blinking red | Radio has failed the self-test upon powering up or encountered a fatal error. |
| Solid yellow | Channel is busy in conventional mode. |
| Blinking yellow | Radio is receiving a secured transmission. |
| Solid green | Radio is powering up or is on a non-priority channel while in the Scan List Programming mode. |
| Blinking green | Radio is receiving an individual or telephone call or is on a Priority-Two channel while in the Scan List Programming mode. |
| Rapid blinking green | Radio is on a Priority-One channel while in the Scan List Programming mode. |











4.2

Status Icons

The liquid crystal display (LCD) of your radio shows the radio status, text entries, and menu entries. The following are the icons that appear on the display of the radio.

| Icon | Description |
|---|---|
|  | Radio is receiving a call or data. |
|  | Radio is transmitting a call or data. |
|  | The number of bars displayed represents the received signal strength for the current site (trunking only). The more stripes in the icon, the stronger the signal. |
| | The radio has roamed to and is currently registered to a foreign system. |
| | Direct |

| Icon | Description |
|--|---|
| | <p>On Radio is configured for direct radio-to-radio communication (during conventional operation only).</p> <p>Off Radio is connected with other radios through a repeater.</p> |
| | <p>Selected channel is being monitored (during conventional operation only).</p> |
|  | <p>In-Call User Alert feature is enabled. Voice muting of the affiliated trunking talkgroup or selected conventional channel is activated.</p> |
| <p>or</p>   | <p>When the radio displays L, the radio is set at Low power. When the radio displays H, the radio is set at High power.</p> |
|  | <p>Radio is scanning a scan list.</p> |
|  | <p>Blinking dot Radio detects activity on channel designated as Priority-One.</p> <p>Steady dot Radio detects activity on channel designated as Priority-Two.</p> |
|  | <p>The vote scan feature is enabled.</p> |
|  | <p>On Secure operation.</p> <p>Off Clear operation.</p> <p>Blinking Receiving an encrypted voice call.</p> |
|  | <p>On AES secure operation.</p> <p>Off Clear operation.</p> <p>Blinking Receiving an encrypted voice call.</p> |
|  | <p>On Feature is enabled and GPS signal is available.</p> <p>Blinking Feature is enabled, but no GPS signal is available.</p> |
|  | <p>User Login Indicator (IP Packet Data)</p> <p>On User is associated with the radio.</p> |









| Icon | Description |
|---|---|
| | <p>Blinking Device registration or user registration with the server failed due to an invalid username or pin.</p> <p>Inverted User successfully logged in to the secured IP Packet Data.</p> |
|  | Data activity is present. |
|  | <p>Steady – LTE system is available and connected.</p> <p>Blinking – ARS user login failed while in LTE system.</p> |
|  | The radio is receiving LTE signal. |
|  | The radio is transmitting LTE signal. |
|  | The radio is receiving and transmitting LTE signal. |
|  | Indicating ARS user logged in successfully with LTE system. |
|  | The radio is receiving LTE signal with ARS user logged in. |
|  | The radio is transmitting LTE signal with ARS user logged in. |
|  | The radio is receiving and transmitting LTE signal with ARS user logged in. |
|  | The radio Wi-Fi® network is connected. The number of bars displayed represents the signal strength of the Wi-Fi signal. |
|  | <p>On The current channel supports SmartConnect.</p> <p>Inverted The current channel is connected through the SmartConnect feature.</p> |

4.3

TMS Status Icons

The following icons appear on the radio display when you send and receive text messages.

Table 5: TMS Status Icons





| Icon | Description |
|---|---|
|  | The Inbox is full. |
|  | The text message is sent. |
|  | The text message cannot be sent. |
|  | The selected text message in the Inbox is not read. |
|  | The selected text message in the Inbox is read. |
|  | Compose a message with normal priority and without a request for a reply. |
|  | Toggle on the “Request Reply” feature before sending the message. |
|  | Toggle on the “Priority” feature before sending the message. |
|  | Compose a message with a priority status and a request for a reply. |
| 3/6 | Indicates the index of the current message that you are viewing. |



4.4

Call Type Icons

When you make or receive a call, or view selected call lists, call icons appear on the radio main display to indicate the different call types associated with an alias or ID.

Table 6: Call Type Icons

| Icon | Description |
|---|-------------------------------------|
|  | Radio number. |
|  | Radio number added to a Call List. |
|  | Mobile number. |
|  | Mobile number added to a Call List. |
|  | Landline phone number. |

| Icon | Description |
|---|---|
|  | Landline phone number added to a Call List. |
|  | Incoming call or data. |
|  | Outgoing call or data. |

4.5

Intelligent Lighting Indicators

This feature temporarily changes the display backlight color and the alert text background color of the radio to help signal that a radio event has occurred.

| Backlight and Bar Color | Notification | When |
|-------------------------|------------------|---|
| Orange | Emergency Alerts | The radio initiates an emergency alarm or call. |
| | | The radio receives an emergency alarm or call. |
| Red | Critical Alerts | The radio is out of range. |
| | | The radio enters Failsoft mode. |
| | | The radio is unable to establish a full connection with the system. |
| Green | Call Alerts | The radio is unable to authenticate or register with the system. |
| | | The radio receives a private call. |
| | | The radio receives a phone call. |
| | | The radio receives a call alert. |
| | | The radio receives a selective call. |
| | | The radio enters Geofence. |

4.6

Alert Tones

Your radio uses alert tones to inform you of the condition of your radio. The following table lists these tones and when they occur.

| You Hear | Tone Name | Heard |
|--------------------------------|-------------------------------------|--|
| Short, Low-Pitched Tone | Radio Self-Test Fail | When radio fails its power-up self-test. |
| | Reject | When an unauthorized request is made. |
| | Time-Out Timer Warning | Four seconds before time-out. |
| | No ACK Received | When radio fails to receive an acknowledgment. |
| | Individual Call Warning Tone | When radio is in an individual call for greater than six seconds without any activity. |

| You Hear | Tone Name | Heard |
|---|-----------------------------------|--|
| Long, Low-Pitched Tone | Time-Out Timer Timed Out | After time-out. |
| | Talk Prohibit/PTT Inhibit | (When PTT button is pressed) transmissions are not allowed. |
| | Lack of Voice PTT Time-Out | When the radio ends your call after it detected there are lack of voice for five seconds after the PTT is pressed and hold. Your radio ends the call to enable your radio to receive calls from other radio users. |
| | Out of Range | (When PTT button is pressed) the radio is out of range of the system. |
| | Invalid Mode | When radio is on an unprogrammed channel. |
| A Group of Low-Pitched Tones | Busy | When system is busy. |
| Short, Medium-Pitched Tone | Valid Key-Press | When a correct key is pressed. |
| | Radio Self-Test Pass | When radio passes its power-up self-test. |
| | Clear Voice | At beginning of a non-coded communication. |
| | Priority Channel Received | When activity on a priority channel is received. |
| | Emergency Alarm/Call Entry | When entering the emergency state. |
| | Central Echo | When central controller has received a request from a radio. |
| Long, Medium-Pitched Tone | Volume Set | When volume is changed on a quiet channel. |
| | Emergency Exit | When exiting the emergency state. |
| A Group of Medium-Pitched Tones | Failsoft | When the trunking system fails. |
| | Automatic Call Back | When voice channel is available from previous request. |
| | Keyfail | When encryption key has been lost. |
| | Console Acknowledge | When status, emergency alarm, or reprogram request ACK is received. |
| | Received Individual Call | When Call Alert or Private Call is received. |
| | Call Alert Sent | When the target radio receives the Call Alert. |
| | Site Trunking | When a SmartZone trunking system fails. |
| Short, High-Pitched Tone (Chirp) | Low-Battery Chirp | When battery is below preset threshold value. |
| Two High-Pitched Tones | GPS Fails | When the GPS fails or loses signal. |

| You Hear | Tone Name | Heard |
|-----------------------------------|----------------------------|---|
| Ringing | Fast Ringing | When system is searching for the target of the Private Call. |
| | Enhanced Call Sent | When waiting for the target of the Private Call to answer the call. |
| | Phone Call Received | When a land-to-mobile phone call is received. |
| Gurgle | Dynamic Regrouping | (When PTT button is pressed) a dynamic ID has been received. |
| | Talk Permit | (When PTT button is pressed) is verifying with the system for accepting its transmissions. |
| Unique, Low-Pitched Chirp | New Message | When a new message is received. |
| Unique, High-Pitched Chirp | Priority Status | When a priority message is received. |

Chapter 5

General Radio Operation





This chapter explains the general operations of your radio.

5.1

Selecting a Zone

When and where to use: A zone is a group of channels. Do one of the following to select a radio channel. You can use these options interchangeably depending on your preference and the programmed functions.

Procedure:





- Select a zone using the radio menu `Zone`:
 - a.  or  to `Zone` and press the **Menu Select** button directly below `Zone`.
 - b.  or  to the required zone, or use the keypad to enter the zone number.
 - c. Press  or the **PTT** button to confirm the selected zone number.

5.2

Selecting a Radio Channel

When and where to use: A channel is a group of radio characteristics, such as transmit/receive frequency pairs. Do one of the following to select a radio channel. You can use the options interchangeably depending on your preference and the programmed functions.

Procedure:

- Select a channel using the **Mode knob**:
 - a. Rotate the **Mode knob** until the display shows the desired channel.
- Select a channel using the radio menu `CHAN`:
 - a.  or  to `CHAN`.
 - b. Press the **Menu Select** button directly below `CHAN`.
 - c.  or  to the required channel.
 - d. Press the **Menu Select** button directly below `SEL` to confirm the selected channel.

5.3

Selecting a Channel by using Channel Search Button

This feature allows you to do a quick search for a specific channel in your radio by keying in the alias of the channel.

Procedure:

- 1 Perform one of the following actions:
 - Press the preprogrammed **Channel Search** button.

-  or  to `CHSR` and press the **Menu Select** button directly below `CHSR`.

A blinking cursor appears on the **Channel Search** screen.

- 2 Use the **keypad** to type or edit your channel name.
- 3 To initiate searching, press the **Menu Select** button directly below `CHSR` once the entry is done.

To exit this procedure, press the **Menu Select** button directly below `CNCL`.

One of the following scenarios occurs:

- The display shows `SEARCHING`. Once found, the display shows the matched channel name and the radio changes its transmission to the selected channel.
- If the radio is triggered to search for an empty entry, the display shows `INVALID ENTRY`. Repeat [step 2](#) to search again.
- If the entry does not match, the display shows `CHANNEL NAME NOT FOUND`. Repeat [step 2](#) to search again; or press  or the **Menu Select** button directly below `EXIT` to exit.

5.4

Mode Select Feature

Mode Select allows a long press to save the current zone and channel of your radio to a programmable button, keypad button, or a softkey. Once programmed, the short-press of that button or softkey changes the transmission to the saved zone and channel.





NOTICE: Your radio must be preprogrammed for you to use this feature.

5.4.1

Saving a Zone and a Channel to a Softkey

When and where to use: Five softkeys are available for you to save the frequently used zone and channel.

Procedure:

- 1 Toggle from your current zone and channel to the required zone and channel.
- 2  or  to `MS1`, `MS2` ... or `MS5`.
- 3 Press and hold the **Menu Select** button directly below one of the softkeys (`MS1–MS5`).

You hear a short, medium-pitched tone when the zone and channel is saved.



NOTICE: To change the programmed zone and channel, repeat this procedure. Short press of the programmed softkey changes your current transmission to the zone and channel programmed in this softkey.

5.4.2

Saving a Zone and a Channel to a Button

When and where to use: You can save the frequently used zone and channel to the programmable buttons and keypad digit 0 to 9 buttons.

Procedure:

- 1 Toggle from your current zone and channel to the required zone and channel.

- 2 Press and hold the button you desire to program.

You hear a short, medium-pitched tone when the zone and channel is saved.



NOTICE:

Short press of the programmed button changes your current transmission to the zone and channel programmed in this button.

5.5

Receiving and Responding to a Radio Call

Once you have selected the required channel and/or zone, you can proceed to receive and respond to calls.

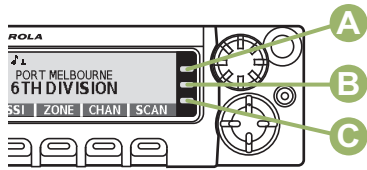

| | |
|---|------------|
| A | Red LED |
| B | Yellow LED |
| C | Green LED |

The radio shows different indicators based on the system the radio is configured.

- The LED lights up solid red while the radio is transmitting.
- In conventional mode, the LED lights up solid yellow when the radio is receiving a transmission.
- In trunking mode, there is no LED indication when the radio receives a transmission.
- If the radio is receiving a secure transmission, the LED blinks yellow.

5.5.1

Receiving and Responding to a Talkgroup Call

When and where to use:When you receive a talkgroup call (while on the Home screen) the radio displays the following depending on the system your radio is configured to:

- For ASTRO Conventional system, the LED lights up solid yellow. The display shows the talkgroup alias or ID, and the caller alias or ID.
- For Trunking system, the display shows the caller alias or ID.

Procedure:

- 1 Hold the microphone vertically 1 to 2 inches (2.5 to 5.0 cm) from your mouth.
- 2 Press the **PTT** button to respond to the call.
The LED lights up solid red.
- 3 Release the **PTT** button to listen.

5.5.2

Receiving and Responding to a Private Call (Trunking Only)

A Private Call is a call from one individual radio to another. Other users in the current talkgroup cannot hear the one-to-one call between the two radios. The calling radio automatically verifies that the receiving radio is active on the system and can display the caller ID.

When and where to use:

When you receive a Private Call, you hear two alert tones and the LED blinks green. The display shows `CALL RECEIVED` and the caller alias or ID.

Procedure:

- 1 Press the **Menu Select** button directly below `RESP` within 20 seconds after the call indicators begin.
If the caller alias is in the call list, the display shows the caller alias during the call.
If the caller name is not in the call list, the display shows the caller ID.
- 2 Press and hold the **PTT** button to talk. Release the **PTT** button to listen.
- 3 Press  to hang up and return to the Home screen.



NOTICE: If you press **PTT** button before pressing the **Menu Select** button directly below `RESP`, your conversation will be heard by all members of the talk group.
If 20 seconds pass before you press the **Menu Select** button directly below the `RESP`, you will not respond privately to the call just received. Instead, you initiate a Private Call.

5.5.3

Receiving and Responding to a Telephone Call (Trunking Only)

This feature allows you to receive calls similar to standard phone calls from a landline phone.

When and where to use:

When you receive a Telephone Call, you hear a telephone-type ringing and the LED blinks green. The backlight of the screen turns green. The display shows `PHONE CALL` and the call received icon blinks.

Procedure:

- 1 Press the **Menu Select** button directly below `RESP`.
- 2 Press and hold the **PTT** button to talk. Release the **PTT** button to listen.
- 3 Press  or the **Menu Select** button directly below `EXIT` to hang up and return to the Home screen.

5.6

Methods to Make a Radio Call

You can select a zone, channel, subscriber ID, or talkgroup by using:

- The preprogrammed Zone menu.
- The **Mode Knob**.
- A preprogrammed button.
- The Contacts list (see [Contacts on page 48](#)).

5.6.1

Making a Talkgroup Call

Procedure:

- 1 Perform one of the following actions:
 - ◀ or ▶ to **TGRP** and press the **Menu Select** button directly below **TGRP**. The display shows the last-selected talkgroup. Press the **Menu Select** button directly below **SEL**.
 - Use the **Mode Knob** to select the channel with the desired talkgroup.
- 2 Hold the microphone vertically 1 to 2 inches (2.5 to 5.0 cm) from your mouth.
- 3 Press the **PTT** button to make the call.

The radio shows different indicators based on the system the radio is configured.

- For ASTRO Conventional system, the LED lights up solid red. The display shows the talkgroup alias or ID.
 - For Trunking system, the LED lights up solid red.
- 4 Speak clearly into the microphone.
 - 5 Release the **PTT** button to listen.

5.6.2

Making a Private Call (Trunking Only)

When and where to use: This feature allows you to send an individual Call Alert or page if there is no answer from the target radio. See [Sending a Call Alert Page on page 56](#) for more information.

Procedure:

- 1 Perform one of the following actions:
 - To access this feature using a preprogrammed button, press the preprogrammed **Private Call** button to dial the preprogrammed ID (number) and initiate the Private Call. Proceed to [step 4](#).
 - ◀ or ▶ to **CALL**, and press the **Menu Select** button directly below **CALL**. The display shows the last transmitted or received ID.
- 2 To select the required ID, perform one of the following actions:
 - Press the **Menu Select** button directly below **CNTS** to scroll through and select the required ID.
 - Press the **Menu Select** button directly below **LIST** to go to the first number of the call list.
 - ◀ or ▶ to the required ID.
 - Use the **keypad** to enter the required ID.
- 3 Press the **PTT** button to initiate the Private Call.

If the receiving unit is in service, a telephone-type ringing sounds. The display shows **CALLING... <NUMBER>** or **CALLING... <ALIAS>**.

- 4 Hold the microphone vertically 1 to 2 inches (2.5 to 5.0 cm) from your mouth.

When you are connected, the display shows the ID of the target radio.

If no acknowledgment is received, the display shows **NO ACKNOWLEDGE**.

If the target radio does not respond before the time out, the display shows **NO ANSWER**.





- 5 Press and hold the **PTT** button to talk.

5.6.3

Making a Telephone Call (Trunking Only)

This feature allows you to make calls similar to standard phone calls to a mobile or landline phone.

Procedure:

- 1 Perform one of the following actions:
 - To access this feature using a preprogrammed button, press the preprogrammed **Phone Call** button to dial the preprogrammed phone number. Proceed to [step 4](#).
 -  or  to **PHON**, and press the **Menu Select** button directly below **PHON**. The display shows the last transmitted or received ID.
- 2 To select the required ID, perform one of the following actions:
 - Press the **Menu Select** button directly below **CNTS** to scroll through and select the required ID.
 - Press the **Menu Select** button directly below **LIST** to go to the first number of the call list.
 -  or  to the required phone number.
 - Use the keypad to enter the required phone number.
- 3 Press the **PTT** button to dial the phone number.
- 4 Hold the microphone vertically 1 to 2 inches (2.5 to 5.0 cm) from your mouth.
- 5 When your call is answered, press and hold the **PTT** button to talk. Release the **PTT** button to listen.
- 6 Press  to return to the **Home** screen.



See [Alert Tones on page 29](#) for more information if your call is not answered.

5.7

Switching Between Repeater or Direct Operation Button

The Repeater Operation increases the radio coverage area by connecting with other radios through a repeater. The transmit and receive frequencies are different. The Direct or “talkaround operation” allows you to bypass the repeater and connect directly to another radio. The transmit and receive frequencies are the same.

Procedure:

- Perform one of the following actions:
- Press the preprogrammed **Repeater/Direct** switch to toggle between talkaround and repeater mode.
 -  or  to **DIR** and press the **Menu Select** button directly below **DIR**.

5.8

Monitor Feature

The monitor feature ensures that a channel is clear before transmitting.

The lack of static on a digital channel when the users switch from analog to digital radios is not an indication that the radio is malfunctioning. Digital technology quiets the transmission by removing the noise from the signal and allows only the clear voice or data information to be heard.

5.8.1

Monitoring a Channel

Procedure:

- Monitoring a Channel in Conventional Modes:
 - a. Lift the microphone off the hook.
 - b. Listen for activity on that channel.
 - c. Adjust the **Volume Knob** if necessary.
 - d. If you hear no activity, press and hold the **PTT** button to start your conversation.
- Monitoring a Channel in Trunked Modes:
 - a. Lift the microphone off the hook.
 - b. Press the **PTT** button.
 - c. If you hear two, short, high-pitched tones, or if you hear no tone and the  indicator lights steadily, then proceed with your message.
 - d. Release the **PTT** button to receive transmission.

If you are not in the range of the system, you may hear a continuous low-pitched tone and the display shows `OUT OF RANGE`.



5.8.2

Monitoring Conventional Mode

This feature allows you to monitor channel traffic on conventional channels by defeating the coded squelch. Thus, you can listen to another active user on the channel. This way, you may be prevented from taking over the conversation of another user.

When and where to use: Your radio may be preprogrammed to receive Private-Line® (PL) calls.

Procedure:

- 1 To activate monitoring, perform one of the following actions:
 - At Home mode where the default zone and channel are being displayed,  or  to `MON` and press the **Menu Select** button directly below `MON` momentarily.
 - Take the control head off the hook.

The display shows `MONITOR ON`. You hear all channel traffic.

- 2 Press the **Menu Select** button again to deactivate the monitoring.

The display shows `MONITOR OFF`.

Pressing the **Menu Select** button again turns monitor off and you do not hear all channel traffic. If you try to transmit on a receive-only channel, you hear an invalid tone until you release the **PTT** button.

Chapter 6

Advanced Features

This chapter explains the operations of the features available in your radio.

6.1

ViQi

ViQi is a virtual assistant that helps you manage your radio and perform information lookups using voice commands. This feature is purpose-built for public safety and is active when you press the assigned **ViQi** button on the radio, Remote Speaker Microphone (RSM), or compatible mobile microphone.



NOTICE: This feature is a selling feature.

ViQi Virtual Partner



ViQi Virtual Partner helps you to look up information such as license plate, driver's license, and Vehicle ID Number (VIN), and she responds with a result to your query.

Table 7: ViQi Virtual Partner Queries

The following table shows the queries supported by the ViQi Virtual Partner feature and their respective commands. Use the following commands followed by the supported query instructions to initiate ViQi Virtual Partner:

- "Look up..."
- "Check..."
- "Run a..."

| Query | Examples |
|-------------------------------|--|
| License plate | "Run a <State> license plate <Alphanumeric String>" "Check a <State> license plate" "Look up <State> license plate <Alphanumeric String>" |
| Driver's license | "Run a <State> driver's license <Alphanumeric String>" "Check the state of <State> driver's license <Alphanumeric String>" "Look up <State> driver's license <Alphanumeric String>" |
| Vehicle Identification Number | "Check Vehicle Identification Number <Alphanumeric String>" "VIN check <Alphanumeric String>" "Run a VIN"  NOTICE: You can use variations such as <Vehicle Identification Number>, <VIN>, and <Vehicle Number>. |
| Own Location | "Where am I?" |

| Query | Examples |
|-----------------|---|
| | "Can I get my exact location?" "Am I still at the <Location>?"  NOTICE: ViQi will ask for more information to complete the query. |
| Target Location | "Where is <Unit Name>?" "Tell me where <Unit Name> is."  NOTICE: ViQi will ask for more information to complete the query. |

6.1.1

Using ViQi Virtual Partner

Prerequisites: See [ViQi on page 39](#) for the queries supported by this feature. To perform queries you are required to log in to CommandCentral. See [Logging In to CommandCentral \(Subsequent Login\)](#).

Procedure:

- 1 Press and hold the assigned **ViQi** button.
- 2 After you hear a tone, speak your request into the microphone.
- 3 Release the assigned programmable button and wait for ViQi to respond.
- 4 Throughout your session, repeat steps [step 1](#) through [step 3](#) when responding to ViQi. Depending on your query, you can also say the following requests:
 - To play the available results, say "Play results".
 - To request for more details, say "More details".
 - To complete the Virtual Partner session, say "Complete".

6.2





Advanced Call Features

This chapter explains the operations of the call features available in your radio.

6.2.1

Calling a Phone Not in the List

Procedure:

- 1  or  to PHON.
- 2 Press the **Menu Select** button directly below PHON.
- 3 Enter the desired phone number on the keypad.
The display updates as the numbers are entered.
- 4 Press the  button or the **PTT** button on the keypad microphone to make the call.
- 5 Press and hold the **PTT** button to talk. Release the **PTT** button to listen.
- 6 Press  or **Menu Select** button directly below PHON to exit.

6.2.2

Selective Call (ASTRO Conventional Only)

A Selective Call is a call from an individual radio to another individual radio with privacy.

6.2.2.1

Receiving a Selective Call

When and where to use: When you receive a Selective Call, you hear two alert tones and the yellow LED illuminates while the green LED blinks. The call received icons blink and the display alternates between `CALL RECEIVED` and the home display.

The speaker unmutes.

Procedure:

- 1 Hold the microphone vertically 1 to 2 inches (2.5 to 5.0 cm) from your mouth.
- 2 Press and hold the **PTT** button to talk. Release the **PTT** button to listen.



NOTICE: If you press **PTT** button before pressing the **Menu Select** button directly below `CALL`, your conversation is heard by all members of the talk group.

If 20 seconds pass before you press the **Menu Select** button directly below the `CALL`, you are not responding privately to the call just received. Instead, you initiate a Selective Call. See [Making a Selective Call on page 41](#).

6.2.2.2

Making a Selective Call

Prerequisites: Your radio must be preprogrammed for you to use this feature.

Procedure:

- 1 Perform one of the following actions:
 - To access this feature by using a preprogrammed button, press the preprogrammed **Selective Call** button to dial the preprogrammed ID. Proceed to [step 3](#).
 - **◀** or **▶** to `CALL`, and press the **Menu Select** button directly below `CALL`. The display shows the last transmitted or received ID.
- 2 To select the required ID, perform one of the following actions:
 - Press the **Menu Select** button directly below `CNTS` to scroll through and select the required ID.
 - Press the **Menu Select** button directly below `LIST` to go to the last number dialed.
 - **◀** or **▶** to the required ID.
 - Use the keypad to enter the required ID.
- 3 Hold the microphone vertically 1 to 2 inches (2.5 to 5.0 cm) from your mouth.
- 4 Press and hold the **PTT** button to start the Selective Call.

The display shows the ID of the target radio.

- 5 Release the **PTT** button to listen.
- 6 Press  to return to the **Home** screen.

If you do not press  button to hang up, your radio remains in Selective Call state with the other unit. You will miss all subfleet traffic and incoming phone calls.

6.2.3

Talkgroup Call Feature (Conventional Only)

This feature allows you to define a group of conventional system users so that they can share the use of a conventional channel.



NOTICE: Encryption keys are associated to talkgroups. When talkgroups are associated, encryption keys are changed by changing the active talkgroup. See [Secure Operations on page 77](#) for more information.

6.2.3.1

Selecting a Talkgroup

Procedure:

- 1 Press **◀** or **▶** to `TGRP` and press the **Menu Select** button directly below `TGRP`.

The display shows the last talkgroup that was selected and stored.

- 2 Perform one of the following actions:

- Press **◀** or **▶** to `PSET` for the preset preprogrammed Talkgroup.
- Press **◀** or **▶** to the required Talkgroup.

- 3 Press the **Menu Select** button directly below `SEL` to save the currently selected talkgroup and return to the **Home** screen.

If the encryption key associated to the new Talkgroup is erased, you hear a momentary key fail tone and the display shows `KEY FAIL`.

If the encryption key that is associated to the new Talkgroup is not allowed, you hear a momentary key fail tone and the display shows `ILLEGAL KEY`.

- 4 Press **🏠** to return to the **Home** screen.

6.2.4

Sending a Status Call

This feature allows you to send data calls to the dispatcher about a predefined status. Each status can have up to a 14-character name. A maximum of eight status conditions is possible.

Procedure:

- 1 Perform one of the following actions:

- Press the preprogrammed **Status** button.
- Press **◀** or **▶** to `STS` and press the **Menu Select** button directly below `STS`.

The display shows the last acknowledged status call, or the first status in the list.

- 2 Perform one of the following actions:

- Press **◀** or **▶** to the required status.
- Use the **keypad** to enter a number corresponding to the location in the status list.

- 3 Press the **PTT** button to send the status.

When the dispatcher acknowledges, you hear four tones and the display shows `ACK RECEIVED`. The radio returns to normal dispatch operation.

If no acknowledgment is received, you hear a low-pitched tone and the display shows **NO ACKNOWLEDGE**.

- 4 Press  to return to the **Home** screen.

No traffic is heard on trunked channels while Status Call is selected. If the radio detects no Status Call activity for six seconds, an alert tone sounds until you press  or the **PTT** button.

6.2.5

Making a Priority Dispatch Calls

If a talkgroup is congested, the Priority Dispatch feature allows you to call the dispatcher on a different talkgroup. This talkgroup is called the Priority Talkgroup. Each trunking talkgroup can have its own assigned Priority Talkgroup. Priority Dispatch is not available during Emergency operations. Scan feature is suspended when Priority Dispatch is initiated.

Prerequisites: Dispatch console that supports this feature must be preprogrammed to use this feature. Check with your dealer or system administrator for more information on dispatch console supporting this feature.

Procedure:

- 1 Press the preprogrammed **Priority Dispatch** button.
A tone sounds and the radio enters Priority Dispatch mode. The radio exits this mode when the Priority Dispatch Time Out Timer expires.
- 2 Before the Priority Dispatch Time Out Timer expires, press and hold the **PTT** button to transmit.
The display shows the Priority Talkgroup alias.
- 3 Release the **PTT** button to listen.
The radio exits Priority Dispatch mode, returns to its original talkgroup, and displays the home channel alias.

6.2.6

Dynamic Regrouping (Trunking Only)

This feature allows the dispatcher to temporarily reassign selected radios to a particular channel to communicate with each other.

When your radio is dynamically regrouped, it receives a dynamic regrouping command and automatically switches to the dynamically regrouped channel. You hear a tone and the display shows the name of the dynamically regrouped channel.

When the dispatcher cancels dynamic regrouping, the radio automatically returns to the previous zone and channel.

If you access a zone or channel that has been reserved as a dynamically regrouped mode for other users, you hear an invalid tone.

6.2.6.1

Classification of Regrouped Radios

The dispatcher can classify regrouped radios into Select Enabled or Select Disabled categories.

Select Enabled

Select-enabled radios are free to change to any available channel, including the dynamic-regrouping channel, once you have selected the dynamic-regrouping position.

Select Disabled

Select-disabled radios cannot change channels while dynamically regrouped. The radio is forced to remain on the dynamic-regrouping channel.

The Scan and Private Call features are unavailable when your radio is Select Disabled.

6.2.6.2

Requesting a Reprogram (Trunking Only)

This feature allows you to notify the dispatcher when you want a new dynamic regrouping assignment.

Procedure:

Perform one of the following actions:

- Press the preprogrammed **Reprogram Request** button to send reprogram request to the dispatcher.
- **◀** or **▶** to `RPGM` then press the **Menu Select** button directly below `RPGM` to send reprogram request to the dispatcher.

The display shows `REPROGRAM RQST` and `PLEASE WAIT`.

If you hear five beeps, the dispatcher has acknowledged the reprogram request. The display shows `ACK RECEIVED` and the radio returns to the **Home** screen.

If the dispatcher does not acknowledge the reprogram request within six seconds, you hear a low-pitched alert tone and the display shows `NO ACKNOWLEDGE`. Try again or press **🏠** to cancel and return to the **Home** screen.

6.2.7

Dynamic Zone Programming

Dynamic Zone Programming (DZP) provides one or more Dynamic Zones to store frequently used channels for conventional or trunking.



NOTICE: Your radio must be preprogrammed for you to use this feature. At least one zone in the radio must be a non-dynamic zone.

6.2.7.1

Entering the Dynamic Zone to Select a Dynamic Channel

Procedure:

- 1 **◀** or **▶** to `Zone` then press the **Menu Select** button directly below `Zone`.

The display shows the **Zone** screen.

- 2 **◀** or **▶** to `<# Dynamic Zone Channels>`.

- 3 Perform one of the following actions:

- Press the **Menu Select** button below `Sel` to select.
- Press the **Menu Select** button below `Exit` to exit.

If you have selected one of the Dynamic Zone Channels list, the display returns to **Home** screen with the selected `<# Dynamic Zone Channels>` shown on the screen.

If you have selected Exit without selecting any Dynamic Zone Channels list, the display returns to **Home** screen without any changes.

6.2.7.2

Saving a Channel in the Dynamic Zone from List Selection

Prerequisites:To perform this operation, the radio must be in the Dynamic Zone.

Procedure:

- 1 ◀ or ▶ to `ZnPr`. Press the **Menu Select** button directly below `ZnPr` to enter the **Program Zone** screen.
- 2 Press the **Menu Select** button directly below `Edit`.
The display shows **Search Options** screen.
- 3 ◀ or ▶ to `List Selection`. Press the **Menu Select** button directly below `SEL`.
The display shows **Select Zone** screen.
- 4 ◀ or ▶ to the required zone. Press the **Menu Select** button directly below `SEL`.
The display shows **Select Chan** screen.
- 5 ◀ or ▶ to the required channel. Press the **Menu Select** button directly below `SEL`.
The display shows `Channel updated`.
- 6 Press the **Menu Select** button directly below `Exit` to return to **Home** screen.

6.2.7.3

Deleting a Channel in the Dynamic Zone

Prerequisites:To perform this operation, the radio must be in the Dynamic Zone.

Procedure:

- 1 ◀ or ▶ to `ZnPr` then press the **Menu Select** button directly below `ZnPr` to enter **Program Zone** screen.
The display shows the dynamic channels list.
- 2 ◀ or ▶ to the saved dynamic channel then press the **Menu Select** button directly below `Del`.
The display shows **Channel deleted** screen.
- 3 Press the **Menu Select** button below `Exit` to return to **Home** screen.
The **Home** screen shows `<Dynamic Zone Channels>`.
If the channel deleted is the Home channel, the **Home** screen shows `<Zone Name>"Blank"`.

6.3

Multiple Control Head Features

This feature allows your transceiver to control the combinations of control heads on APX Mobile.

You can use the Controller Area Network (CAN) cables to connect in any configuration that does not exceed 131 feet. For further information, refer to the following Installation Manuals:

- *6878215A01 APX Mobile Radios and Control Heads Installation Manual*
- *MN003109A01 APX 8500 Mobile Radio Installation Manual*
- *MN005720A01 Enhanced Single Band Mobile Radio Installation Manual*

The Multiple Control Head (MCH) feature consists of two modes that can be programmed through Customer Programming Software (CPS):

- All Active mode
- One Active mode



NOTICE: If two or more control heads are connected to the system before enabling the MCH feature in the CPS, the radio displays `EXTRA CH` or `CH ID # ERR`. Both errors are Fatal.

6.3.1

Setting the ID of the Initial Control Head

When and where to use: This feature allows you to set up the control head in the **Front Panel Programming (FPP)** mode. During the setup, the control heads are defined as Control Head Number 1, Control Head Number 2, Control Head Number 3, and Control Head Number 4.

Procedure:

- 1 Power off the radio by pressing the **Power** button.
- 2 Press and hold the left-most **Menu Select** button and the emergency button simultaneously.
- 3 While continuing to depress these two buttons, press the **Power** button to power on the radio and the control head.

The radio and the control head powers on into **FPP** mode. The display shows the ID number of the control head.
- 4 Turn the **Mode** knob to change the ID number of the control head.
- 5 Press the **Power** button to power off the radio and exit **FPP** mode.
- 6 Repeat [step 1](#) to [step 5](#) to set the ID number for the rest of the attached control heads.

6.3.2

All Active Mode

The All Active mode enables all connected control heads attached to the radio to operate concurrently with each other. When you activate a feature on one control head, the rest of the control heads have the same activated features and indicators on their respective display.



NOTICE: The multiple control head feature allows only control heads of the same type to be connected. Upon power-up, if a control head of a different type is connected to the radio, the display of all the attached control heads shows the FATAL error `CH MISMATCH`.

6.3.3

Activating and Deactivating Intercom in All Active Mode

Prerequisites: This feature only applies to control heads in the All Active mode.

When and where to use: The intercom feature allows one control head user to talk to another control head user in a MCH configuration. At any given time, when a control head being operated has priority

for the intercom call, all other control heads are blocked until the active control head releases **PTT** button.

Procedure:

- 1 Press the **Menu Select** button directly below `INTC` to activate the intercom feature of any of the control heads.
- 2 Press the **PTT** button to initiate an intercom transmission.
All control heads that are attached will receive the same intercom call. The display of the control heads receiving the intercom call shows the alias/ID number of the transmitting control head.
- 3 Press  or the **Menu Select** button directly below `EXIT` to deactivate the intercom feature.
The intercom feature also deactivates when you initiate a mode change. If the radio is on an emergency channel, pressing of the **Emergency** button or the emergency footswitch button on any control head also deactivates the intercom feature.

6.3.4

One Active Mode

One Active mode enables only one control head to be visibly active at a time in a two control head system.



NOTICE: In the One Active mode, if more than two control heads are present upon power up, the radio shows a **FATAL** error `EXTRA CH` on the display of all attached control heads.

The active control head commands the system normally while the inactive control head is in remote mode with its display shows `REMOTE`.

The **Volume** knob, **DIM** button, **Front/Rear (F/R)** softkey, **Emergency**, the Emergency footswitch, and VIP inputs remain active on the inactive control head, while all other controls are disabled.

The VIP input control head is configurable in the CPS and VIP should be attached to the control head selected in the CPS.

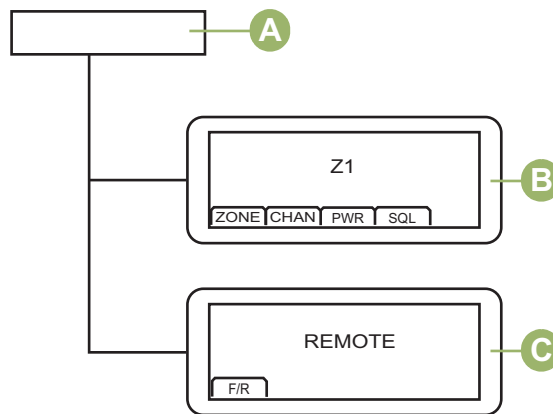

| Item | Description |
|------|------------------|
| A | Transceiver |
| B | Active Radio |
| C | Non-Active Radio |

You can change the command between the two control heads by pressing the **Menu Select** button directly below `F/R`, or the **Menu Select** button on the keypad microphone.

6.4

Remote Monitor

This feature allows the system administrator to turn on the microphone of a targeted radio with a subscriber alias or ID.

When remote monitor feature is activated, the audio transmission can be configured in CPS to route the audio to the radio internal microphone, wired RSM microphone, or Bluetooth wireless microphone.

In life-threatening or critical situations, the system administrator can remotely monitor any audible activity surrounding the targeted radio.

6.5

Contacts

This feature provides “address-book” capabilities on your radio. Each entry corresponds to an alias (name) and ID (number) that you use to initiate a call. Contact entries are alphabetically sorted according to the entry alias.

Also, each entry, depending on context (conventional, trunking, or phone), associates with one or up to five IDs according to the following types of calls:

- Phone Call
- Private Call
- Selective Call
- Call Alert

Each entry within Contacts contains the following information:

- Call Alias (Name)
- Call ID (Number)
- Call Type (Icon)
- WACN ID (ASTRO 25 Trunking IDs only)
- System ID



NOTICE: Your radio must be preprogrammed to allow you to add, edit, or delete the contact entries.

Your radio also supports a maximum of 50 call lists. Each list can store up to 100 IDs.



NOTICE: Your radio is preprogrammed with a few contacts per Call Lists. Check with your dealer or system administrator for more information.

6.5.1

Making a Private Call from Contacts

Prerequisites: Your radio must be preprogrammed to allow you to use this feature.

Procedure:

- 1 or to CNTS and press the **Menu Select** button directly below CNTS.
The entries are alphabetically sorted.
- 2 or to the required subscriber alias.
- 3 Press the **Menu Select** button directly below OPTN and proceed to the next step.
- 4 or to CALL and press the **Menu Select** button directly below SEL.

- 5 ◀ or ▶ to select the call type.
- 6 Hold the microphone vertically 1 to 2 inches (2.5 to 5.0 cm) from your mouth.
- 7 Press the **PTT** button to initiate the call.
During the call, the display shows the subscriber alias.
- 8 Press and hold the **PTT** button to talk. Release the **PTT** button to listen.
The LED lights up solid red when the **PTT** button is pressed.

If there is no voice activity for a preprogrammed period, the call ends.

If the call reaches the maximum ring time, the call ends.

6.5.2

Adding a New Contact Entry

Procedure:

- 1 ◀ or ▶ to **CNTS** and press the **Menu Select** button directly below **CNTS** .
The entries are alphabetically sorted.
- 2 ◀ or ▶ to **[NEW CONTACT]** and press the **Menu Select** button directly below **SEL** .
The display shows **NAME**.
- 3 Press the **Menu Select** button directly below **EDIT**.
- 4 Use the **keypad** to enter the name and press the **Menu Select** button directly below **OK** once you have entered the name.
To cancel this operation, press the **Menu Select** button directly below **CNCL** to return to the previous screen.
- 5 ◀ or ▶ to **[ADD NUMBER]** and press the **Menu Select** button directly below **SEL** .
The display shows **TYPE 1 <DEFAULT TYPE>**.
- 6 Press the **Menu Select** button directly below **EDIT** .
- 7 ◀ or ▶ to the required channel and press the **Menu Select** button directly below **OK**.
- 8 ◀ or ▶ to **NUMBER 1** and press the **Menu Select** button directly below **EDIT** .
The display shows **NUMBER 1** and a blinking cursor appears.
- 9 Use the **keypad** to enter the number and press the **Menu Select** button directly below **OK** once you have entered the number.
To cancel this operation, press the **Menu Select** button directly below **CNCL** to return to the previous screen.
- 10 Press the **Menu Select** button directly below **DONE** once you have finished.
The display shows **<ENTRY> STORED**, confirming that the contact entry has been added.
The radio returns to the main **Contacts** screen.

6.5.3

Deleting a Contact Entry

Procedure:

- 1 ◀ or ▶ to CNTS and press the **Menu Select** button directly below CNTS .
The entries are alphabetically sorted.
- 2 ◀ or ▶ to the entry you want to delete and press the **Menu Select** button directly below OPTN .
- 3 ◀ or ▶ to DEL and press the **Menu Select** button directly below SEL .
The display shows <ENTRY> CONFIRM DEL?.
- 4 Select the **Menu Select** button directly below YES to delete the entry, or NO to cancel and return to the main screen of Contacts.
The display shows <ENTRY> DELETED and the radio returns to the main screen of Contacts.

6.5.4

Adding a Contact to a Call List

Procedure:

- 1 ◀ or ▶ to CNTS and press the **Menu Select** button directly below CNTS .
The entries are alphabetically sorted.
- 2 ◀ or ▶ to the entry you want to add and press the **Menu Select** button directly below OPTN .
- 3 ◀ or ▶ to ADD TO CALLST or ADD TO PHONLST and press the **Menu Select** button directly below SEL .
- 4 Perform one of the following actions:
 - ◀ or ▶ until the display shows [AVAILABLE] and press the **Menu Select** button directly below ADD to add as a new entry.
 - ◀ or ▶ until the display shows <ENTRY> and its associated number and press the **Menu Select** button directly below RPLC to replace the existing entry.The display shows <ENTRY> ADDED, confirming the addition of the contact to the list.

The radio returns to the main display of **Contacts**.

6.5.5

Methods of Contact Editing in a Call List

This feature allows you to edit contacts in a call list.

6.5.5.1

Editing an Entry Alias

Procedure:

- 1 ◀ or ▶ to CNTS and press the **Menu Select** button directly below CNTS .
The entries are alphabetically sorted.

- 2 ◀ or ▶ to the entry you want to edit and press the **Menu Select** button directly below `OPTN` .
- 3 ◀ or ▶ to `EDIT` and press the **Menu Select** button directly below `SEL` .
- 4 ◀ or ▶ to the entry alias you wish to change and press the **Menu Select** button directly below `EDIT` .
A blinking cursor appears.
- 5 Use the **keypad** to edit the name and press the **Menu Select** button directly below `OK` once you have finished.
The display returns to the **Edit Contact** screen.
- 6 Press the **Menu Select** button directly below `DONE` to save your changes and return to the main screen of **Contacts**.

6.5.5.2

Editing as Entry ID

Procedure:



- 1 ◀ or ▶ to `CNTS` and press the **Menu Select** button directly below `CNTS` .
The entries are alphabetically sorted.
- 2 ◀ or ▶ to the entry you want to edit and press the **Menu Select** button directly below `OPTN` .
- 3 ◀ or ▶ to `EDIT` and press the **Menu Select** button directly below `SEL` .
- 4 ◀ or ▶ to the entry ID you wish to change and press the **Menu Select** button directly below `EDIT` .
A blinking cursor appears.
- 5 Use the keypad to edit the number and press the **Menu Select** button directly below `OK` once you have finished.
The display returns to the **Edit Contact** screen.
- 6 Press the **Menu Select** button directly below `DONE` to save your changes and return to the main screen of **Contacts**.

6.5.5.3

Editing a Call Type

Procedure:

- 1 ◀ or ▶ to `CNTS` and press the **Menu Select** button directly below `CNTS` .
The entries are alphabetically sorted.
- 2 ◀ or ▶ to the entry you want to edit and press the **Menu Select** button directly below `OPTN` .
- 3 ◀ or ▶ to `EDIT` and press the **Menu Select** button directly below `SEL` .
- 4 ◀ or ▶ to `TYPE` and press the **Menu Select** button directly below `EDIT` .

- 5  or  to choose from the list of call types given and press the **Menu Select** button directly below **OK** .
The display returns to the **Edit Contact** screen.
- 6 Press the **Menu Select** button directly below **DONE** to save your changes and return to the main screen of **Contacts**.

6.6 Scan Lists

Scan lists are created and assigned to individual channels/groups. Your radio scans for voice activity by cycling through the channel/group sequence specified in the scan list for the current channel/group.

Your radio supports different types of Scan Lists:

- Conventional Scan List
- Multi-System Talkgroup Scan
- Trunking Priority Monitor Scan List
- Voting Scan List

A maximum of 200 Scan Lists can be programmed in your radio. These lists must be preprogrammed by a qualified radio technician.





6.6.1 Intelligent Priority Scan

Intelligent Priority Scan feature allows you to add or delete conventional channels and trunking talkgroups from multiple system into the priority scan lists.

When the radio locks onto a channel in the Intelligent Priority Scan list, radio scans for higher priority member within the same Trunking or Conventional system.

6.6.2 Viewing a Scan List





Procedure:

- 1  or  to **SCNL** and press the **Menu Select** button directly below **SCNL** .
- 2  or  to view the members on the list.
- 3 Press  to exit the current display and return to the Home screen.

6.6.3 Editing the Scan List

When and where to use: This feature allows you to change scan list members and priorities.

Procedure:

- 1  or  to **SCNL** and press the **Menu Select** button directly below **SCNL** .
The display shows the lists that can be changed.
- 2  or  to the entry you want to edit.
- 3 Perform one of the following actions:

- Press the **Menu Select** button directly below **SEL** to add and/or change the priority of the currently displayed channel in the scan list.
 - Press the **Menu Select** button directly below **DEL** to delete the currently displayed channel from the scan list.
 - Press the **Menu Select** button directly below **RCL** to view the next member of the scan list.
- 4 Perform one of the following actions to select another channel that you want to add or delete then repeat [step 3](#). Otherwise, proceed to the next step.
- ◀ or ▶ to the desired channel.
 - Use the keypad to enter the desired channel name.
 - Use the **Mode Knob** to select the channel.
- 5 Press  to exit scan list programming and return to the Home screen.

See [Viewing and Changing the Priority Status on page 53](#) for more information on how to add and/or change the priority of the currently displayed channel in the scan list.

6.6.4

Changing the Scan List Status

Procedure:

- 1 Long press the preprogrammed **Scan** side button.
- 2 ◀ or ▶ to the member you want to edit.
- 3 Perform one of the following actions:
 - Press the **Select** button once to add the currently displayed channel to the scan list.
 - Press the **Select** button one or more times to change the scan list status icon of the currently displayed channel.
- 4 Perform one of the following actions:
 - ◀ or ▶ to select more list members whose scan status you want to change.
 - Use the **Mode Knob** to select another scan list member.
- 5 Press  to exit scan list programming and return to the Home screen.

6.6.5

Viewing and Changing the Priority Status

Procedure:

Perform one of the following actions:

- Press the **Menu Select** button directly below **SEL** one or more times to change the priority status of the current displayed channel.
- Press the **Select** button one or more times to toggle between different status of the Scan List status icon of the current displayed channel.

The radio shows one of following priority status icons and scenarios:

- A **Scan** icon indicates that the current channel is in the scan list as a non-priority channel. The LED lights up solid green.

- A **Priority-One Channel Scan** icon indicates that the current channel is in the scan list as the Priority-One channel. The LED rapidly blinks green. You hear all traffic on the Priority-One channel, regardless of traffic on non-priority channels.
- A **Priority-Two Channel Scan** icon indicates that the current channel is in the scan list as the Priority-Two channel. The LED blinks green.
- No icon indicates that the current channel is deleted from the scan list.

6.7

Scan

This feature allows you to monitor traffic on different channels by scanning a preprogrammed list of channels. Scanning is halted if you initiate a call and resumes when the call has ended.

6.7.1

Turning Scan On or Off

Procedure:

Perform one of the following actions:

- Press the preprogrammed **Scan** button to initiate or stop scan.
- ◀ or ▶ to **SCAN** and press the **Menu Select** button directly below **SCAN**.

If the scan is enabled, the display shows **SCAN ON** and the scan status icon.

If the scan is disabled, the display shows **SCAN OFF**.

The radio returns to the Home screen.

6.7.2

Turning Scan On While Disregarding the Squelch Code (Conventional Channels Only)

When and where to use: You can still receive fleetwide, system-wide, dynamic regrouping, incoming telephone interconnect, and Private Conversation/Call Alert calls while scanning for activity.

You may respond to these types of calls as you would normally on the selected channel. However, when scanning different channels while in talkgroup scan, incoming Private Conversation/Call Alert calls may be missed.

Procedure:

- ◀ or ▶ to **MON** and press the **Menu Select** button directly below **MON**.

The brief **MONITOR ON** display indicates that the radio is disregarding the squelch code.

6.7.3

Deleting a Nuisance Channel

When and where to use:

If a channel continually generates unwanted calls or noise (termed “nuisance” channel), you can temporarily remove the unwanted channel from the scan list.

This capability does not apply to priority channels or the designated transmit channel.

Procedure:

When the radio is locked onto the channel to be deleted, ◀ or ▶ to **NUIS** and press the **Menu Select** button directly below **NUIS**.

The radio continues scanning the remaining channels in the list.

6.7.4

Restoring a Nuisance Channel

Procedure:

To restore the deleted nuisance channel, perform one of the following actions:

- Stop and restart a scan.
- Mode change to another channel and back to the original channel.
- Turn off the radio and then turn it on again.

6.7.5

Changing Priorities Status While Scan is On

When and where to use:

While the radio is scanning, the dynamic priority change feature allows you to temporarily change any channel in a scan list (except for the Priority-One channel) to the Priority-Two channel.

This change remains in effect until scan is turned off. Scan then reverts to the preprogrammed (original) setting.

Procedure:

- 1 Press the **Menu Select** button directly below **DYNP** to change the priority of a non-priority channel in the scan list to Priority-Two.
- 2 Press  momentarily to exit the scan list and resume scanning.

6.7.6

Restoring Priorities in a Scan List

Procedure:

To restore the original channel priorities in a scan list, perform one of the following actions:

- Turn scan off, and then on.
- Change channels.
- Turn off the radio, and then turn it back on.

6.7.7

Using the Hang Up Box (HUB)

Procedure:

- 1 To temporarily suspend Scan Mode operation, remove the microphone from the Hang Up Box (HUB).

You are allowed to use the control head while scan is suspended. However, Priority Member scanning is not suspended. This feature applies to all Scan Lists and Scan Types. Scan is

resumed once the control head is returned to the holding clip and the preprogrammed hangtime has elapsed.



NOTICE: Priority Scan List members are continuously scanned only when the Scan List, **Designated Tx Member** field is set to “Talkback” in the radio programming. Otherwise, all scan mode operation is suspended.

6.8

Call Alert Paging

This feature allows your radio to work like a pager.

If other users are away from their radios or if they are unable to hear their radios, you can send them an individual call alert page. You can also verify if a radio is active on the system.

Depending on how your radio is programmed, if there is no answer after the maximum ring time or when you press the **PTT** button for an Enhanced Private Call, the radio automatically sends a call alert page.



NOTICE: This feature must be preprogrammed by a qualified radio technician.

6.8.1

Receiving a Call Alert Page

When and where to use: When you receive a Call Alert page, you hear four repeating alert tones and the LED blinks green. If Call Alert Tone Auto Reset is enabled, you hear one alert tone and the LED blinks green. The call received icons blinks and the display shows `PAGE RECEIVED`.

Procedure:

Press the **PTT** button to answer or press any button to clear the Call Alert page.

See [Making a Talkgroup Call on page 36](#) or [Making a Private Call \(Trunking Only\) on page 36](#) for more information on returning the call.

6.8.2

Sending a Call Alert Page

When and where to use:

Do one of the following to send a call alert page:



NOTICE: If the feature inactivity timer is enabled, your radio automatically exits the feature when your radio is left idle long enough for the time to expire. You hear the Menu Inactive Exit Tone upon feature exit.

Procedure:

- Sending a call alert page using the preprogrammed **Call Alert Paging** button:
 - a. Press the preprogrammed **Call Alert Paging** button to send a page to the preprogrammed ID.

The display shows `PAGING . . . <NUMBER> or <ALIAS>`.

If the call alert page is sent successfully, you hear four high-pitched tones and the display shows `ACK RECEIVED`. The radio returns to the Home screen.

If the call alert page is not acknowledged, you hear a low tone and the display shows **NO ACKNOWLEDGE**. Press the **Menu Select** button directly below **OK** to return to the main screen for **Contacts**.

- Sending a call alert page using the radio menu **PAGE** :
 - a. ◀ or ▶ to **PAGE** .
 - b. Press the **Menu Select** button directly below **PAGE** .
 - c. ◀ or ▶ to select the required ID.
 - d. Press the **PTT** button to send the page.

The display shows **PAGING . . . <NUMBER> or <ALIAS>**.

If the call alert page is sent successfully, you hear four high-pitched tones and the display shows **ACK RECEIVED**. The radio returns to the Home screen.

If the call alert page is not acknowledged, you hear a low tone and the display shows **NO ACKNOWLEDGE**. Press the **Menu Select** button directly below **OK** to return to the main screen of **Contacts**.

- Sending a call alert page using the radio menu **CALL** :
 - a. ◀ or ▶ to **CALL** .
 - b. Press the **Menu Select** button directly below **CALL** .
 - c. ◀ or ▶ to select the alias or ID, and press the **PTT** button to initiate the call.

If the target radio does not respond after a preprogrammed period of time, the display shows **SEND PAGE?**.
 - d. To send the call alert page, press the **Menu Select** button directly below **YES** . To exit the screen without sending the call alert page, press the **Menu Select** button directly below **NO** .

The display shows **PAGING . . . <ALIAS>**.

If the call alert page is sent successfully, you hear four high-pitched tones and the display shows **ACK RECEIVED**. The radio returns to the Home screen.

If the call alert page is not acknowledged, you hear a low tone and the display shows **NO ACKNOWLEDGE**. Press the **Menu Select** button directly below **OK** to return to the main screen of **Contacts**.

6.9

Recent Calls

Recent call menu allows you to view the recent incoming and outgoing call information.

You can view the information of the following type of calls:

- Call Alert
- Selective Call
- Private Call
- Phone Call (Outgoing Only)

- Emergency Call (Incoming Only)



NOTICE: The Log Dispatch Calls Enable field need to be enabled in CPS for your radio to log the dispatch call.

6.9.1

Viewing Recent Calls

Procedure:

- Viewing recent calls using the radio menu:
 - a. ◀ or ▶ to RCNT.
 - b. Press the **Menu Select** button directly below RCNT to access the RECENT CALLS feature screen.
 - c. ◀ or ▶ to scroll through the list.
 - d. To view the recent Emergency calls, press the **Menu Select** button directly below Emer. Press the **Menu Select** button directly below All to view back all recent calls.
 - e. To return to the Home screen, press the **Menu Select** button directly below BACK, , or the PTT button.

6.9.2

Instant Recall

This feature allows you to playback the recent received calls and save them in your radio. Check with your system administrator for the duration of the recorded calls that your radio supports. All saved calls are removed upon radio power cycle.

6.9.2.1

Saving and Playback Calls





When and where to use:

Perform one of the following to save and play back the recorded calls. You can use the options interchangeably depending on your preference and the programmed functions.

Procedure:

- Playback and saving the recorded calls using the radio menu:
 - a. Press the **Menu Select** button directly below RCNT.
 - b. ◀ or ▶ to RECENT CONVS and press the **Menu Select** button directly below SEL to view the recent conversations.
 - c. ◀ or ▶ to the required call and press the **Menu Select** button directly below PLAY.
Radio playback the selected call and auto playback the recorded calls in chronological order.
 - d. Press the **Menu Select** button directly below STOP to stop the radio playback.
 - e. ◀ or ▶ to the required call and press the **Menu Select** button directly below SAVE.
Radio displays Audio Saved momentarily.
 - f. To return to the previous screen, press the **Menu Select** button directly below BACK.
 - g. To return to the Home screen, press the **Menu Select** button directly below EXIT.

Recent calls are lost after radio power cycle if the calls are not saved.

- Playback the saved calls using the radio menu:
 - a. Press the **Menu Select** button directly below `RCNT`.
 - b.  or  to `SAVED CONVS` and press the **Menu Select** button directly below `SEL` to view the recent conversations.
 - c.  or  to the required call and press the **Menu Select** button directly below `PLAY`.
Radio playback the selected call and auto playback the saved calls in chronological order.
 - d. Press the **Menu Select** button directly below `STOP` to stop the radio playback.
 - e. To return to the previous screen, press the **Menu Select** button directly below `BACK`.
 - f. To return to the Home screen, press the **Menu Select** button directly below `EXIT`.
- Saving the recorded calls using the preprogrammed **Record Playback** button:
 - a. Long press the preprogrammed **Record Playback** button to save the recorded calls.

Radio displays `AUDIO SAVED` momentarily.

Radio plays the saved call automatically if call saving is successful.

A tone sounds if call saving is not successful.

- Playback the saved calls using the preprogrammed **Record Playback** button:
 - a. Short press the preprogrammed **Record Playback** button to playback the saved calls.
 - b. Short press the preprogrammed **Record Playback** button again to skip to the next saved call. If there is only a single saved call, the playback skips to the end of the call.

Radio auto playback the most recent incoming call followed by saved calls in chronological order.

Radio displays the playback status.



NOTICE:

Received call overwrites the ongoing record playback. User can short press the programmable button within three seconds to continue the playback and ignore the receiving call.

User can short press the programmable button to trigger playback when the radio is receiving call to overwrite the receiving call.

Playback can be halted by any tone and button press except for specific buttons. Check with your dealer or system administrator for more information.

6.10

In-Call User Alert

This feature allows the radio to remain muted to affiliated talkgroup calls or dispatch calls while operating on the current Trunking Personality or conventional channel respectively.

Group and individual Pages unmute the radio for the alert tone to sound. The radio also unmutes to individual radio-to-radio calls. This feature is very useful when a radio-user prefers to not hear affiliated talkgroup or dispatch calls traffic, but needs-to remain in radio contact. For an In-Call User Alert enabled channel, the Voice Mute button-press or the Voice Mute menu-selection allows the radio-user to toggle on and off Voice Mute functionality.



6.10.1

Enabling and Disabling In-Call User Alert

This feature allows you to mute the voice transmission of the current zone and channel.

Prerequisites: Make sure you are in Home mode where the default zone and mode are being displayed.

Procedure:

- 1  or  to scroll to the `VMUT` and press the **Menu Select** button directly below `VMUT`.

Voice transmission is muted.

- 2 To turn the feature off, press the **Menu Select** button directly below `VMUT` or the `VMut` preprogrammed button again.

Pressing the **Menu Select** button directly below `VMUT` or the **VMut** programmed button momentarily toggles between Voice mute on and Voice mute off. `VOICE MUTE ON` shown on the display indicates that the radio is muted to all conventional dispatch calls and affiliated trunking group calls.

6.11

Quick Call II

This feature allows you to broadcast a series of distinct, recognizable tones before a voice transmission from the dispatcher or a radio.

The broadcasting dispatcher or radio user can select this pre-programmed Quick Call II tone transmission to be sent to an individual talkgroup or over the entire system. Each tone is distinctive to indicate different situation or different broadcaster.







NOTICE: The receiving radio must be configured with the matching Quick Call II tone from the transmitting radio, in order for the receiving radio to sound the selected tone followed by the pre-configured alert tone.

6.11.1

Initiating a Quick Call II Transmission

Prerequisites: The broadcasting or transmitting radio must be pre-programmed to see the tone in the Quick Call II tone list. The receiving radio must also be pre-programmed to decode the tone to broadcast.

Procedure:

- 1  or  to `QCII`, and press the **Menu Select** button directly below `QCII`.
- 2  or  to select the tone to broadcast.
- 3 Press the **PTT** to broadcast the selected tone, or press and hold the **PTT** to broadcast the selected tone and transmit with your vocal transmission.
You hear the radio sounds the selected tone. You can begin your call after the tone ends.
- 4 Release **PTT** to listen.

6.12

Emergency Operation

The Emergency feature is used to indicate a critical situation. An emergency signal overrides any other communication over the selected channel.

Your radio supports the following Emergency modes:

- Emergency Alarm
- Emergency Call
- Emergency Alarm with Emergency Call
- Silent Emergency Alarm

Only one of the Emergency modes can be assigned to the **Emergency** button or the **Emergency** footswitch.

Your radio is also programmed to operate in one of the following conditions:

Tactical/Non-Revert

The radio sends an emergency alarm and/or makes an emergency call on the current channel.

Non-Tactical/Revert for Conventional System

The radio reverts to the preprogrammed emergency channel to send an alarm and/or make an emergency call.

Contact your system administrator for more information.

6.12.1

Special Considerations for Emergency Operation

The following scenarios apply during Emergency operation:

Table 8: Emergency Operation Scenarios

| If... | Then... |
|---|---|
| If you press the Emergency button while in a channel that has no Emergency capability, | a low-pitched tone sounds. |
| If you change to a channel/mode with no Emergency capability while in Emergency operation, | the following occurs: <ul style="list-style-type: none"> • The display shows NO EMERGENCY. • A continuous low-pitched tone sounds until you select a valid Emergency channel/mode or until you disable the Emergency operation. |
| If you change to a channel/mode with Emergency capability while in Emergency operation, | the Emergency Alarm and/or Emergency Call continues on the new channel/mode. |
| If the radio is out-of-range of the system or the emergency alarm is not acknowledged, | a tone sounds and the display shows No acknowledgement. |

6.12.2

Emergency Keep-Alive

This feature prevents the radio from being turned off when it is in Emergency mode. If this feature is enabled, you are required to exit Emergency mode before turning off your radio.

6.12.3

Exiting Emergency Operation

If an Emergency operation is triggered on your radio, the dispatch console or radios configured as Supervisor can also exit the Emergency operation.

Procedure:

To exit Emergency operation, press and hold the preprogrammed **Emergency** button.

6.12.4

Exiting Emergency as Supervisor (Trunking Only)

Radios configured as Supervisor are able to cancel emergency mode of other radios. The dispatch console must be preprogrammed to use this feature. Check with your dealer or system administrator for more information on dispatch console supporting this feature.

Procedure:

- 1 Perform one of the following actions:

| If... | Then... |
|---|---|
| If the emergency mode is initiated by other radios, | press and hold the Accy No-Dot Button (Purple) button and press the Emergency button. |
| If the emergency mode is initiated by the Supervisor, | Perform one of the following actions: <ul style="list-style-type: none">• Press and hold the Emergency button.• Press and hold the Accy No-Dot Button (Purple) and press the Emergency button.• Wait for console to clear emergency. |



NOTICE: The following buttons combinations are supported:

- Radio **Accy No-Dot Button (Purple)** and **Emergency** button.
- Radio **Accy No-Dot Button (Purple)** and accessory **Orange** button.
- Accessory **1-Dot Button** and radio **Emergency** button.
- Accessory **1-Dot Button** and accessory **Orange** button.

6.12.5

Sending an Emergency Alarm

When and where to use: This feature allows you to send a data transmission, which identifies the radio sending the emergency, to the dispatcher.

Procedure:

- 1 Press the preprogrammed **Emergency** button.

A tone sounds and the display alternates **EMERGENCY** and the home display. A dispatcher acknowledgment **ACK RECEIVED** display follows. For trunking system, the radio also sounds a high-pitched tone that indicates the alarm has been received by the trunked system's central controller.

- 2 Press and hold the **Emergency** button or the **PTT** button to return to normal operation.

6.12.6

Sending an Emergency Call (Trunking Only)

When and where to use: This feature gives your radio priority access to a talkgroup.

Procedure:

- 1 Press the preprogrammed **Emergency** button.
One of the following scenarios occurs:
 - A tone sounds and the display alternates `EMERGENCY` and the home display.
 - You hear a short low-pitched tone to indicate that the selected channel does not support emergency and rejects to launch emergency mode.
- 2 Hold the microphone vertically 1 to 2 inches (2.0 to 2.5 cm) from your mouth.
- 3 Press and hold the **PTT** button. Speak clearly into the microphone.
- 4 Release the **PTT** button to end the transmission and wait for a response from the dispatcher.
- 5 To exit Emergency Call, press and hold the preprogrammed **Emergency** button for about a second.

6.12.7

Sending An Emergency Call With Hot Mic (Trunking Only)

This feature allows you to send an Emergency Call with hot mic to a group of radios.

When and where to use:

Your radio must be programmed for this type of operation.

Your radio microphone is automatically activated, allowing you to communicate with the group of radios without pressing the **PTT** button. This activated microphone state is also known as hot mic. The hot mic applies to the first voice transmission from your radio during the Emergency call. For subsequent transmissions in the same Emergency call, you must press the **PTT** button.

When indirect PTT such as Hot Mic is activated, the audio transmission can be configured in CPS to route the audio to the radio internal microphone, wired RSM microphone, or Bluetooth wireless microphone.

Follow the procedure to send Emergency Call with hot mic on your radio.

Procedure:

- 1 Press the preprogrammed **Emergency** button.
One of the following scenarios occurs:
 - The display shows `EMERGENCY` on the current zone and channel. A tone sounds and the LED blinks red momentarily.
 - A tone sounds to indicate that the selected channel does not support emergency and rejects to launch emergency mode.
- 2 The microphone remains active for the hot mic time specified in the radio's codeplug programming.
- 3 To exit Emergency Call, press and hold the preprogrammed **Emergency** button.

6.12.8

Sending an Emergency Alarm with Emergency Call

When and where to use:

This feature gives your radio priority access on a channel for conventional system, and to a talkgroup for trunking system.

If the radio has both emergency call and alarm features enabled, it automatically proceeds to the call mode after the alarm is acknowledged.

Procedure:

- 1 Press the preprogrammed **Emergency** button.
The display alternates `EMERGENCY` and the home display. A high-pitched tone sounds, indicating that the trunked system central controller has received the alarm. A dispatcher acknowledgment (four high-pitched tones) follows, accompanied by an `ACK RECEIVED` display.
- 2 Hold the radio vertically 1 to 2 inches (2.5 to 5.0 cm) from your mouth.
- 3 Press and hold the **PTT** button. Speak clearly into the microphone.
- 4 Release the **PTT** button to end the transmission and wait for a response from the dispatcher.
- 5 To exit Emergency Call, press and hold the preprogrammed **Emergency** button for about a second.
Turning off the radio also cancels the emergency state.

6.12.9

Sending An Emergency Alarm and Call with Hot Mic

This feature allows you to send an Emergency Alarm and Call with hot mic to a group of radios.

When and where to use: Your radio must be programmed for this type of operation.

When indirect PTT such as Hot Mic is activated, the audio transmission can be configured in CPS to route the audio to the radio internal microphone, wired RSM microphone, or Bluetooth wireless microphone.

Follow the procedure to send Emergency Alarms and Call with hot mic on your radio.

Procedure:

- 1 Press the preprogrammed **Emergency** button.

If successful, the display shows `EMERGENCY` on the current zone and channel. A tone sounds and the LED blinks red momentarily.
The radio exits Emergency Alarm and enters the Emergency Call state when one of the following scenarios occur:
 - You receive the dispatcher acknowledgment. The display shows `ACK RECEIVED`.
 - You receive no acknowledgment. The display shows `NO ACKNOWLEDGE`.If unsuccessful, a tone sounds to indicate that the selected channel does not support emergency and rejects to launch emergency mode.
- 2 The microphone remains active for the hot mic time specified in your radio's codeplug programming.
- 3 To exit Emergency Call, press and hold the preprogrammed **Emergency** button.
Turning off the radio also cancels the emergency state.

6.12.10

Sending a Silent Emergency Alarm

When and where to use: This feature allows you to send an Emergency Alarm to the system without triggering any audio or visual indicators.

This activated microphone state is also known as “hot mic”.



NOTICE: If you press the **PTT** button during hot mic, and continue to press it after the hot mic duration expires, the radio continues to transmit until you release the **PTT** button.

Procedure:

- 1 Press the preprogrammed **Emergency** button.
The display shows no changes, the LED does not light up, and you hear no tones. The silent emergency state continues until you perform the next step.
- 2 Press and hold the emergency button until a tone sounds to exit the silent alarm mode.
If silent emergency alarm is used with emergency call, pressing the **PTT** button exits the silent mode and initiates the emergency call.

6.12.11

Impact Detection

This feature activates Emergency mode when the radio detects a force of gravity impact or orientation changes on the vehicle in the event of a vehicle crash or rollover. The radio automatically activates Impact Detected condition when the impact event meets or exceeds a predefined threshold.

The radio must stay in this condition for a preprogrammed amount of time before the Emergency Alarm or Call is activated. This feature also sends out the location-based information if the GPS feature is enabled.

In the event of hardware failure or malfunction, the radio alternatively displays `Impact HW` and `Error` and a tone sounds when the radio power-up. Any button press of the radio or accessory except the programmed button for volume and backlighting functionality ceases the error message and sound.

The following scenarios affect the Emergency feature activation:

- Pressing a preprogrammed `Emergency` button cancels the Impact Detection sequence and enters the Emergency mode.
- Pressing the **PTT** button does not suspend the Impact Detection sequence.
- Pressing the **PTT** button, the **CLR** menu button, or the preprogrammed **Clear** button when the radio displays the Impact Detected display alert, exits the Impact Detected condition.

6.12.11.1

Detecting Impact

Procedure:

- 1 Radio detects the impact on the vehicle and the impact event meets or exceeds the predefined threshold.

One of the following scenarios occur:

- Radio enters Impact Detected condition. Radio sounds alert tone and displays `IMPACT` on the screen, and Post-Alert Timer is initiated.

- Impact Detected condition continues for the time duration defined in the Post-Alert Timer field. When the timer expires, radio enters into Emergency mode. Radio displays **EMERGENCY** on the screen.
- Radio enters Emergency mode immediately and displays **EMERGENCY** on the screen.



NOTICE:

If the radio is programmed with Silent Emergency, the radio inhibits the alert tone and visual alert associated with the emergency feature.

If the radio is programmed in Surveillance Mode, the radio inhibits all tones and lights on the radio.

- 2 Press the preprogrammed **CLR** menu button or the preprogrammed **CLEAR** button to exit the Impact Detected condition.

6.12.11.2

Exiting Impact Detected Condition

When and where to use: If there is a false alarm or you do not want to enter into Emergency mode, you can exit the Impact Detected condition and prevent emergency from going off. Returning to normal operations resets the Impact Detected condition.

Procedure:

Perform one of the following actions:

- Press the preprogrammed **CLEAR** button to exit.
- Press the **Menu Select** button below **CLR** to exit.

6.13

Sending Evacuation Tone

This feature enables the evacuation tone to be heard on the transmitting radio and on any radio that is able to receive the tone instruction.

Procedure:

Press and hold the **PTT** button on the radio keypad mic and short press the **Orange** button on the radio control head.

Once the tone begins to sound, if the orange button is released the tone continues to alarm on all radios within the talkgroup, until the **PTT** button is released.



NOTICE: Radio does not transmit evacuation tone if the radio is in secure mode.

6.14

Automatic Registration Service

Automatic Registration Service (ARS) provides an automated data application registration for the radio. When you turn on the radio, the device automatically registers with the server. Data applications within the fixed network determine the presence of a device on the system and send data to the device.

The ARS for the radio consists of two modes:

- ARS Server Mode (default mode)
- ARS Non-server Mode



6.14.1

Selecting or Changing the ARS Mode

When and where to use:

The following methods are options on how to select or change the ARS Mode. The result of all the methods is the same. You can use the options interchangeably depending on your preference and the programmed functions.

Procedure:

- Selecting or Changing the ARS mode using the radio menu:
 - a. Press and hold ◀ or ▶ to CHAN .
 - b. Press the **Menu Select** button directly below CHAN .
The display shows the current zone is not blinking, and the channel is blinking.
 - c. ◀ or ▶ or rotate the **Mode Knob** to the desired channel.
 - d. Press  to confirm the displayed zone and channel.
One of the following scenarios occur:
 - In ARS Server Mode, the display shows the User Login Indicator icon, the zone, and ARS server channel.
 - In ARS Non-Server Mode, the display shows the User Login Indicator icon, the zone, and ARS non-server channel.
 - If the channel or mode selected is unprogrammed, the display shows UNPROGRAMMED.
- Selecting the ARS mode using the **Mode Knob** :
 - a. After the zone you want is displayed, toggle until the display shows the required channel.
The display shows that the current zone is not blinking, and the channel is blinking.
 - b. ◀ or ▶ or rotate the **Mode Knob** to the desired channel.
One of the following scenarios occur:
 - In ARS Server Mode, the display shows the User Login Indicator icon, the zone, and ARS server channel.
 - In ARS Non-Server Mode, the display shows the User Login Indicator icon, the zone, and ARS non-server channel.
 - If the channel or mode selected is unprogrammed, the display shows UNPROGRAMMED.
 - c. Press  to confirm the displayed zone and channel.

6.14.2

User Login Feature

This feature allows you to take on a friendly username for (Example: Text Messaging Service).

You can still send text messages without logging in as a user. The user login feature only enables the recipient of your message to identify you as the sender by assigning a username to your message.



NOTICE: Valid characters for a username entry are capital letters (A–Z), small letters (a–z), numbers (0–9), symbols (*, #, -, /), and the space character.









The maximum length for a username is eight characters. Usernames are not case-sensitive in server mode but are case-sensitive in non-server mode.

A predefined username may sometimes be invalid because the programming software that is used to set predefined usernames allows you to set usernames comprising of eight characters or more.

6.14.2.1

Logging In as a User

Procedure:

- 1  or  to `USER` and press the **Menu Select** button directly below `USER`.
The display shows the User Login screen.
- 2 Perform one of the following actions:
 -  or  to `[ID Entry]` and press the **Menu Select** button directly below `Edit` to enter ID. A blinking cursor appears on the screen. Use the **keypad** to type or edit a user name. Press the **Menu Select** button directly below `Ok` to submit.
 -  or  to scroll through the list of predefined user names. Press the **Menu Select** button directly below `SEL` to select the predefined user name.
 - Press and hold  or  to scroll through the list of predefined user names at a fast scroll rate. Press the **Menu Select** button directly below `LOGN` to select the predefined user name.

If the selected predefined username has more than eight (8) characters, or an invalid character in it, the display momentarily shows `INVALID ID`.
- 3 Press the **Menu Select** button directly below `PIN`.
A blinking cursor appears beside `PIN`.
- 4 Enter your Personal Identification Number (PIN) number.
The maximum PIN length is four digits. The PIN number appears as asterisks.
- 5 Press the **Menu Select** button directly below `LOGN`.
One of the following scenarios occurs:
 - In ARS Server Mode, the display shows the User Login Indicator icon, the ID, and `IN PROGRESS, with CNCL`.
 - In ARS Non-Server Mode, the display shows the User Login Indicator icon, the ID, and `LOGGED IN, with LOGT and EXIT`.
 - In non-ARS enabled mode, the display shows `OFFLINE, with LOGT and EXIT`.

One of the following scenarios occurs:

- If the user name is invalid, login fails and the user login failure indicator (IP indicator) icon blinks. The display also shows momentary `LOGIN FAILED`.
- If the PIN is invalid, login fails and the user login failure indicator (IP indicator) icon blinks. The display also shows momentary `LOGIN FAILED`.

- Wait for the logged in confirmation screen. If the login process is successful, the display shows the successful user login indicator (IP indicator) icon and `LOGGED IN`, with `LOGT` and `EXIT`.



NOTICE: To cancel the login process and return to the initial user login screen, press the **Menu Select** button directly below `CNCL`.

6.14.2.2

Logging Out

Prerequisites: Once the data application registration is completed, you can log out.

When and where to use:



NOTICE: Private data refers to all messages in the text messaging **Inbox**, **Draft**, and **Sent** folder. The next user is able to access the **Inbox**, **Draft**, and **Sent** messages if private data is not deleted.

Procedure:

- 1 ◀ or ▶ to `LOGT` and press the **Menu Select** button directly below `LOGT`.

The display shows the User Login Indicator icon and `CLEAR PRIVATE DATA?`.

- 2 Perform one of the following actions:
 - Select `YES` to clear all your private data. The display shows momentary `PRIVATE DATA CLEARED`.
 - Select `NO` to keep your private data.

6.15

Text Messaging Service

Text Messaging Service (TMS) allows you to send and receive messages and run database queries directly from your radios. The maximum number of characters allowed for a text message is 200 characters.

The types of text messages available are:

- A new text message (free form message).
- A predefined message (quick text message).
- An edited quick text message.
- A query (ASTRO 25 Advanced Messaging Solution).



NOTICE: Query is only supported in the ASTRO 25 Advanced Messaging Solution. For more information, see [ASTRO 25 Advanced Messaging Solution](#) and [Two-Factor Authentication](#).

6.15.1

Accessing the Messaging Features

Procedure:

- 1 Perform one of the following actions:
 - Press the **Data Feature** button or the preprogrammed **TMS Feature** button to access the TMS feature screen.
 - Press and hold the **Data Feature** button or the preprogrammed **TMS Feature** button to access the Inbox.

- Follow the procedure described next to access this feature using the radio menu.
- 2 ◀ or ▶ to TMS.
 - 3 Press the **Menu Select** button directly below TMS to access the TMS feature screen.
 - 4 ◀ or ▶ to scroll through the main menu options.

6.15.2

Composing and Sending a New Text Message

Procedure:

- 1 ◀ or ▶ to TMS.
- 2 Press the **Menu Select** button directly below TMS to access the TMS feature screen.
- 3 Press the **Menu Select** button directly below COMP to see the compose options.
- 4 Press the **Menu Select** button directly below NEW to compose a new message.
A blinking cursor appears on the COMPOSE screen.
- 5 Use the keypad to type or edit your message.
- 6 Press the **Menu Select** button directly below OPTN once the message is composed.
- 7 Perform one of the following actions:
 - ◀ or ▶ to scroll through the address list and select the required address.
 - ◀ or ▶ to [OTHER RECPNT] and press the **Menu Select** button below EDIT. When a blinking cursor appears in the ENTER ADDRESS screen, use the **keypad** to type the address entry.
- 8 Press the **Menu Select** button directly below SEND or press the PTT button to send the message.

The display shows the SEND MESSAGE screen and SENDING MSG.

If the message is sent, you hear a tone and the display shows MSG SENT.

If the message is not sent, you hear a low tone, the display shows SEND FAILED and returns to the main TMS screen.



NOTICE: You can append a priority status and/or a request reply to your message. See [Priority Status and Request Reply of a New Text Message on page 71](#) for more information.

You can also select the DRFT option to save your message in the Drafts folder to send it at a later time. See [Accessing the Drafts Folder on page 75](#) for more information.

6.15.3

Sending a Quick Text Message

When and where to use:

Quick Text messages are messages that are predefined and usually consist of messages that are used most frequently.

Each Quick Text message has a maximum length of 50 characters.

Procedure:

- 1 Perform one of the following actions:

- To access this feature using the preprogrammed button, press the preprogrammed **Quick Text** button and proceed to [step 4](#).
 - To access this feature using the menu, proceed to the next step.
- 2 ◀ or ▶ to TMS and press the **Menu Select** button directly below TMS to access the TMS feature screen.
 - 3 Perform one of the following actions:
 - Press the **Menu Select** button directly below COMP to see the compose options.
 - Press the **Menu Select** button directly below EXIT to return to the Home screen.
 - 4 Press the **Menu Select** button directly below LIST to see the quick text list.
 - 5 ◀ or ▶ to scroll through the list of messages and press the **Menu Select** button directly below SEL to select the required message.

The message appears on the COMPOSE screen, with a blinking cursor at the end of it. Use the keypad to edit the message, if required.
 - 6 Press the **Menu Select** button directly below OPTN .
 - 7 Press the **Menu Select** button directly below SEND .
 - 8 Perform one of the following actions to send the message:
 - ◀ or ▶ to scroll through the address list and select the required address. The message is sent after the address is selected.
 - ◀ or ▶ to [OTHER RECPNT] and press the **Menu Select** button below EDIT. When a blinking cursor appears on the ENTER ADDRESS screen. Use the keypad to type the address entry. Proceed to [step 10](#) to send the message.
 - 9 ◀ or ▶ to scroll through the address list and select the required address.

The message is sent after the address is selected.
 - 10 Press the **Menu Select** button directly below SEND or press the PTT button to send the message.

The display shows the SEND MESSAGE screen and SENDING MSG.

If the message is sent, you hear a tone and the display shows MSG SENT.

If the message is not sent, you hear a low tone, the display shows SEND FAILED and returns to the main TMS screen.



NOTICE: You can append a priority status and/or a request reply to your message. See [Priority Status and Request Reply of a New Text Message on page 71](#) for more information.

6.15.4

Priority Status and Request Reply of a New Text Message

Before sending your message, you can append a priority status and/or a request reply to your message.

6.15.4.1

Appending a Priority Status to a Text Message

Prerequisites: Ensure that an outgoing message is composed to allow you to perform this procedure. See [Composing and Sending a New Text Message on page 70](#) for more information.

When and where to use:



NOTICE: The Priority Status icon on a message does not imply that the message gets higher priority over the other messages when it is being transmitted. It is just an indication that can be embedded into a message to let the receiver know that the message is important.

Procedure:

- 1 Press the **Menu Select** button directly below `OPTN`.
- 2 **◀** or **▶** to `IMPT` and press the **Menu Select** button directly below `IMPT` to indicate the message as important.

The priority status icon appears beside the normal message icon on the label bar.

6.15.4.2

Removing a Priority Status from a Text Message

Prerequisites: Ensure there is an outgoing message composed to allow you to perform this procedure. See [Composing and Sending a New Text Message on page 70](#) for more information.

Procedure:

- 1 Press the **Menu Select** button directly below `OPTN`.
- 2 Press the **Menu Select** button directly below `IMPT` to remove the priority status icon.

The display shows the normal message icon on the label bar.

6.15.4.3

Appending a Request Reply to a Text Message

Prerequisites: Ensure that an outgoing message is composed to allow you to perform this procedure. See [Composing and Sending a New Text Message on page 70](#) for more information.

Procedure:

- 1 Press the **Menu Select** button directly below `OPTN`.
- 2 Press the **Menu Select** button directly below `RQRP` to request for a reply.

The request reply icon appears beside the normal message icon on the label bar.

6.15.4.4

Removing a Request Reply from a Text Message

Prerequisites: Ensure that an outgoing message is composed to allow you to perform this procedure. See [Composing and Sending a New Text Message on page 70](#) for more information.

Procedure:

- 1 Press the **Menu Select** button directly below `OPTN`.
- 2 Press the **Menu Select** button directly below `RQRP` to remove the reply status icon.

The display shows the normal message icon on the label bar.

6.15.4.5

Appending a Priority Status and a Reply Request to a Text Message

Prerequisites: Ensure that an outgoing message is composed to allow you to perform this procedure. See [Composing and Sending a New Text Message on page 70](#) for more information.

Procedure:

- 1 Press the **Menu Select** button directly below `OPTN`.
- 2 Press the **Menu Select** button directly below `IMPT` to indicate the message as important.
- 3 Press the **Menu Select** button directly below `RQRP` to request for a reply.

The priority status and request reply icons appear beside the normal message icon on the label bar.

6.15.4.6

Removing a Priority Status and a Reply Request from a Text Message

Prerequisites: Ensure that an outgoing message is composed to allow you to perform this procedure. See [Composing and Sending a New Text Message on page 70](#) for more information.

Procedure:

- 1 Press the **Menu Select** button directly below `OPTN`.
- 2 Press the **Menu Select** button directly below `IMPT` to remove the priority status icon.
- 3 Press the **Menu Select** button directly below `RQRP` to remove the reply status icon.

The display shows the normal message icon on the label bar.

6.15.4.7

Receiving a Text Message

When and where to use:



NOTICE: When you receive a message that is flagged with the Request Reply icon, you must manually respond to the sender that you have received the message. The system does not automatically send a notification to acknowledge that the message was received.

Procedure:

Do one of the following to receive a text message. You can use the options interchangeably depending on your preference and the programmed functions.

- Receiving a text message using the **Data Feature** button or the **TMS Feature** button:
When you receive a message, press and hold the preprogrammed **Data Feature** button or the **TMS Feature** button to access the Inbox.
- Receiving a text message using the radio menu:
When the new message icon appears and the display shows momentary `NEW MSG`, press the **Menu Select** button directly below `TMS` to access the Inbox.

The display shows a list of aliases or IDs, with the sender of the latest received message on top.

6.15.4.8

Viewing a Text Message from the Inbox

When and where to use: The Inbox can hold up to 30 messages.



NOTICE: ◀ or ▶ to read the message if the content fills more than one screen.

Procedure:

- 1 Perform one of the following actions:
 - Press the preprogrammed **Data Feature** button or the **TMS Feature** button to access the TMS feature screen. Press the **Menu Select** button directly below **INBX**.
 - Press and hold the preprogrammed **Data Feature** button or the **TMS Feature** button to access the Inbox.
 - ◀ or ▶ to **TMS** and press the **Menu Select** button directly below **TMS** to access the TMS feature screen. Press the **Menu Select** button directly below **INBX**.

The display shows the latest received message.

- 2 While on the view message screen, press the **Menu Select** button directly below **RPLY**, **DEL**, or **BACK** to access the option.
 - Select **RPLY** to reply the message.
 - Select **DEL** to delete the message.
 - Select **BACK** to return to the previous screen.



NOTICE: The icon at the top right corner of the screen indicates the status of the message. See [Status Indicators on page 25](#) for more information.

6.15.4.9

Replying to a Received Text Message

When and where to use:



NOTICE: The original date and time stamp, address, and message content is automatically appended to the reply message.

Procedure:

- 1 Press the **Menu Select** button directly below **RPLY** to reply to a message.
- 2 Perform one of the following actions:
 - Press the **Menu Select** button directly below **NEW** to compose a new message.
 - Press the **Menu Select** button directly below **LIST** to select a predefined message.
 - ◀ or ▶ to scroll through the list of predefined messages and press the **Menu Select** button directly below **SEL** to select the required message.

One of the following scenarios occurs:

- A blinking cursor appears on the **Compose** screen.
- The predefined message appears on the **Compose** screen, with a blinking cursor at the end of it.

- 3 Use the keypad to type or edit your message.
- 4 Press the **Menu Select** button directly below `OPTN` once you have completed the message.
- 5 Press the **Menu Select** button directly below `SEND` to send the message.

The display shows the `Send Message` screen and `SENDING MSG`.



NOTICE:

Press the **Menu Select** button directly below `BACK` at any time to return to the previous screen.

You can append a priority status and/or a request reply to your message. See [Priority Status and Request Reply of a New Text Message on page 71](#) for more information.

6.15.4.10

Accessing the Drafts Folder

When and where to use: This folder stores the messages that were saved previously. The Drafts folder can hold up to 10 messages. The oldest draft in the folder is deleted when the 11th message comes in.

Procedure:

- 1 ◀ or ▶ to `TMS`.
- 2 Press the **Menu Select** button directly below `TMS` to access the TMS feature screen.
- 3 Press the **Menu Select** button below `DRAFT`.

The display shows the latest drafted text message.

- 4 ◀ or ▶ to the required text message and press the **Menu Select** button below `SEL` to view the message.
 - Select `EDIT` to edit the message before sending it.
 - Select `DEL` to delete the message.
 - Select `BACK` to return to the previous screen.

6.15.4.11

Sent Text Messages

Sent messages is saved in the Sent folder.

The Sent folder stores a maximum of 10 messages. The oldest message in the folder is deleted when the 11th message comes in.

6.15.4.11.1

Viewing a Sent Text Message

Procedure:

- 1 Perform one of the following actions:
 - Press the preprogrammed **Data Feature** button or the **TMS Feature** button to access the TMS feature screen.
 - ◀ or ▶ to `TMS` and press the **Menu Select** button directly below `TMS` to access the TMS feature screen.

- 2 Press the **Menu Select** button below `SENT`.

The display shows the latest sent message.

- 3 While on the view message screen, press the **Menu Select** button directly below `OPTN`, `DEL`, or `BACK` to access the option.
 - Select `OPTN` to configure the message settings.
 - Select `DEL` to delete the message.
 - Select `BACK` to return to the previous screen.



NOTICE: The icon at the top right corner of the screen indicates the status of the message. See [Status Icons on page 25](#) for more information.

6.15.4.11.2

Sending a Sent Text Message

Procedure:

- 1 Press the **Menu Select** button directly below `OPTN` while viewing the message.
- 2 Press the **Menu Select** button directly below `SEND`.
- 3 Perform one of the following actions:
 - `◀` or `▶` to scroll through the address list and select the required address.
 - `◀` or `▶` to `[OTHER RECPNT]` and press the **Menu Select** button below `EDIT`. When a blinking cursor appears in the `ENTER ADDRESS` screen, use the **keypad** to type the address entry.
- 4 Press the **Menu Select** button below `SEND` or the **PTT** button to send the message.

The display shows the `SEND MESSAGE` screen and `SENDING MSG`.



NOTICE: Press the **Menu Select** button directly below `BACK` at any time to return to the previous screen.

You can append a priority status and/or a request reply to your message. See [Priority Status and Request Reply of a New Text Message on page 71](#) for more information.

6.15.4.12

Deleting Text Messages

Procedure:

- 1 From the Inbox, Draft, or Sent screen, `◀` or `▶` to scroll through the messages.
- 2 Press the **Menu Select** button directly below `DEL` to view the delete options.
- 3 Perform one of the following actions:
 - Press the **Menu Select** button directly below `CURR` to delete the current message.
 - Press the **Menu Select** button directly below `ALL` to delete all the messages.

6.16

Secure Operations

Secure radio operation provides the highest commercially available level of voice security on both trunked and conventional channels.

By default, the radio automatically enters the encrypted environment without having to manually select or clear the secure transmission.

6.16.1

Enabling Secure Transmission

Procedure:

- 1 ◀ or ▶ to **SEC** and press the **Menu Select** button directly below **SEC**.

The display shows  and the current key if multi-key has been enabled.

- 2 Monitor the mode to ensure that it is not in use.
- 3 Press **PTT** button to transmit.



NOTICE: If the selected channel is preprogrammed for clear-only operation – when you press the **PTT** button, an invalid mode tone sounds and the display shows **CLEAR TX** only.

The radio does not transmit until you disable the secure mode.

The radio can be configured to ignore the clear voice or unsecured transmission when the radio is in secured transmission. Check with your agent for details.

6.16.2

Accessing the Secure Feature

Procedure:

- 1 ◀ or ▶ to **SEC**.
- 2 Press and hold the **Menu Select** button directly below **SEC** to display Secure feature screen.

The display shows the **Secure** screen.

6.16.3

Managing Encryption

This chapter explains the encryption feature on your radio.

6.16.3.1

Loading Encryption Keys

Prerequisites:

- Refer to the *Key Variable Loader (KVL) manual* for equipment connections and setup.

Procedure:

- 1 Attach the KVL to your radio.

The display shows **Keyloading** and all other radio functions, except for power down, backlight, and volume, are locked out.

The display shows `KEYLOADING` and all other radio functions, except for power down, backlight, and volume, are locked out.



NOTICE:

If the Multi-system Over-the-Air Rekeying feature is in use, the ASTRO profile name is displayed below `Keyloading`.

If the Multi-system Over-the-Air Rekeying feature is in use, the ASTRO profile name is displayed below `KEYLOADING`.

- 2 Press **Target**→**Load**.
- 3 Perform one of the following actions:
 - For single key, select **Key**.
 - For multikey, select **Group**.
- 4 Select the required keys and press **Load** on the KVL.

The KVL indicates that keyload is successful.

6.16.3.2

Multikey Feature

This feature allows the radio to be equipped with different encryption keys and supports the DES-OFB algorithm.

There are two types of encryption keys:

Conventional Multikey

The encryption keys are strapped on a one-per-channel basis, through CPS. In addition, you can have operator-selectable keys, operator-selectable keysets, and operator-selectable key erasure. If talkgroups are enabled in conventional, then the encryption keys are strapped to the talkgroups.

Trunked Multikey

If the radio is used for both conventional and trunked applications, strap the encryption keys for trunking on a per-talkgroup or announcement-group basis. In addition, a different key can be strapped to other features, such as dynamic regrouping, failsoft, or emergency talkgroup. You can have operator-selectable key erasure.

6.16.3.3

Selecting Encryption Keys

Procedure:

- 1 **◀** or **▶** to `KEY`.
- 2 Press the **Menu Select** button directly below `KEY`.

The display shows the last user-selected and stored encryption key, and the available menu selections. If the Multi-system Over-the-Air Rekeying feature is in use, the list of keys displayed is only for the current secure profile of the selected channel.
- 3 **◀** or **▶** to scroll through the encryption keys or use the keypad to enter the number of the desired key.
- 4 Perform one of the following actions:
 - Press the **Menu Select** button directly below `SEL` to save the newly selected key and return to the **Home** screen.
 - Press **🏠**, the **PTT** button, or the **Menu Select** button directly below `EXIT`.

- Turn the **16-Position Select** knob to exit.



NOTICE: When the selected key is erased, you hear a momentary keyfail tone and the display shows `KEY FAIL`.

When the selected key is not allowed, you hear a momentary illegal key tone and the display shows `ILLEGAL KEY`.

6.16.3.4

Selecting Keysets

When and where to use: This feature allows you to select one or more groups of several encryption keys from among the available keys stored in the radio.

For example, you could have a group of three keys structured to one keyset, and another group of three different keys structured to another keyset; by changing keysets, you would automatically switch from one set of keys to the other.

Every channel to which one of the original keys was tied now has the equivalent new key instead.

Procedure:

- 1 ◀ or ▶ to `KSET` and press the **Menu Select** button directly below `KSET`.

The display shows the last user-selected and stored keyset, and the available keyset menu selections. If the Multi-system Over-the-Air Rekeying feature is in use, the displayed keysets are only for the current secure profile of the selected channel.

- 2 ◀ or ▶ to scroll through the keysets or use the keypad to enter the number of the desired keyset.
- 3 Press the **Menu Select** button directly below `SEL` to save the newly selected keyset.

The radio exits keyset selection and returns to the **Home** screen.



NOTICE: Press , the **PTT** button, or the `EXIT` menu selection to exit this menu at any time without changing the keyset selection.

6.16.3.5

Erasing Encryption Keys

Do one of the following to erase the selected encryption keys. You can use the options interchangeably depending on your preference and the programmed functions.

If the Multi-system Over-the-Air Rekeying feature is in use, the keys erased are only for the current secure profile of the selected channel. The erase all option operates as configured by the dealer or system administrator. Erasing all keys using the Top (Orange) button and the Top Side (Select) button erases all keys in all keylists in the radio.

Procedure:

- Erasing the selected encryption keys using the radio menu:

- a. ◀ or ▶ to `ERAS` and press the **Menu Select** button directly below `ERAS`.

The display shows the last user-selected and stored encryption key, and the available menu selections.

- b. ◀ or ▶ to the desired encryption key or use the keypad to enter the number of the desired key.
- c. Press the **Menu Select** button directly below `ALL` to delete all keys, or press the **Menu Select** button directly below `SNGL` to delete current shown key.

You can abort this screen and return to Home screen by pressing the **Menu Select** button directly below **ABRT**.



6.16.3.6

Requesting an Over-the-Air Rekey

If the Multi-system Over-the-Air Rekeying feature is in use, the rekey request is only for the current selected secure profile.

Prerequisites: Ensure that the Unique Key Encryption Key (UKEK) or Unique Shadow Key (USK) is loaded into the radio with the Key Variable Loader (KVL) before the rekey request can be sent. Refer to your local key management supervisor for more information.

Procedure:

- 1  or  to **REKY**.
- 2 Press the **Menu Select** button directly below **REKY**.
- 3 Perform one of the following actions:
 - Press the **PTT** button to send the rekey request.
 - Press the **PTT** button again, or the  or **Emergency** button, to exit the feature and transmit in normal mode.

If the rekey operation fails, you hear a bad-key tone and the display shows **REKEY FAIL**.



NOTICE: The rekey operation failure indicates that your radio does not contain the UKEK or USK.

6.16.3.7

MDC OTAR (Conventional Only)

This feature allows you to view or define the Motorola Data Communications (MDC) Over-the-Air Rekeying (OTAR) features. It is applied only when operating in secure encrypted mode. In addition to Rekey Requests, OTAR transmissions include Delayed Acknowledgments, and Power-up Acknowledgments.

Some of the selected options require configuration at the Key Management Controller (KMC) site to work properly.



NOTICE: This feature must be preprogrammed by a qualified radio technician. Contact your system administrator for more information.

6.16.3.8

Infinite UKEK Retention

This feature enables Unique Key Encryption Key (UKEK) to be permanently stored in the radio even when all the encryption keys are erased. Without this UKEK key, the radio cannot be rekeyed over the air. The Infinite UKEK Retention settings can be different for each secure profile.



NOTICE: This feature must be preprogrammed by a qualified radio technician. Check with your dealer or system administrator for more information.

6.16.3.9

Hear Clear

Hear-Clear is a noise reduction system which composed of Companding and Random FM Noise Canceller.

Comping

Reduces the channel noise, such as OTA transmission that is predominantly present in UHF2 and 900 MHz channel with the following features.

Compressor

Reduces the background noise flow and the speech signal at transmitting radio.

Expander

Expands the speech while the noise flow remains the same at receiving radio.

Random FM Noise Canceller (Flutter Fighter)

Reduces the unwanted effects of random FM noise pulses caused by channel fading under high Signal-to-Noise (S/N) conditions such as in a moving transportation. The fading effects, heard as audio pops and clicks, are canceled without affecting the desired audio signal.

The Random FM Noise Canceller operates only in receive mode.



NOTICE: This feature must be preprogrammed by a qualified radio technician. Check with your dealer or system administrator for more information.

6.17

Radio Lock

This feature requires you to enter a password to unlock the radio when it powers on. The default password is 0123456789.

Your service provider determines the following requirements:

- Number of characters for a password (maximum 10 characters)
- Number of attempts for password entry

If you are prompted to change the password, enter a new password as reusing the default password is not allowed.

If you exhaust all attempts at entering the correct password, the radio is deadlocked. Restart the radio to start over.



NOTICE:

Depending on the configuration, the radio might carry over the number of attempts remaining even after a power cycle. If you exhaust all attempts in this configuration, the following occurs:

- The radio remains inhibited
- All encryptions and secure keys are erased

6.17.1

Enabling or Disabling Radio Lock (Secure Radios Only)

Procedure:

- 1  or  to LOGF.
- 2 Press the **Menu Select** button directly below LOGF.





One of the following results occur:

- The display shows `PSWD ENABLED`, indicating that the radio lock feature is enabled.
- The display shows `PSWD DISABLED`, indicating that the radio lock feature is disabled.

6.17.2

Changing the Radio Lock Password

Procedure:

- 1  or  to PSWD.
- 2 Press the **Menu Select** button directly below PSWD.
The display shows **Change Password** screen.
- 3  or  to UNLOCK PSWD.
- 4 Press the **Menu Select** button directly below SEL .
- 5 Enter the old password.
- 6 Press the **Menu Select** button directly below OK .
- 7 Enter the new password.
- 8 Press the **Menu Select** button directly below OK .
- 9 Re-enter the new password.
- 10 Press the **Menu Select** button directly below OK .

The password is updated.

If the two passwords do not match, repeat [step 5](#) through [step 10](#).







NOTICE: If you enter three incorrect old passwords, the radio exits the password feature. You cannot access this feature again until you turn the radio off and on.

6.17.3

Changing the Tactical Inhibit Password

The Tactical Inhibit Password is required for the Radio Stun and Radio Kill features. You can set up to eight characters for this password.

Procedure:

- 1  or  to PSWD.
- 2 Press the **Menu Select** button directly below PSWD.
The display shows **Change Password** screen.
- 3  or  to TACTICAL INH ENCODE PSWD.
- 4 Press the **Menu Select** button directly below SEL .
- 5 Enter the old password.
- 6 Press the **Menu Select** button directly below OK .
- 7 Enter the new password.
- 8 Press the **Menu Select** button directly below OK .
- 9 Re-enter the new password.
- 10 Press the **Menu Select** button directly below OK .

The password is updated.

If the two passwords do not match, repeat [step 5](#) through [step 10](#).



NOTICE: If you enter three incorrect passwords, the radio exits the password feature. You cannot access this feature again until you turn the radio off and on.

6.18

Radio Stun and Kill

This chapter explains the radio stun and kill features.

6.18.1

Radio Stun

This feature allows you to stun another radio by sending an over-the-air command using the menu on your radio. This feature prevents an unauthorized user from using the radio. Once the radio is stunned, a password is required to re-activate the stunned radio.

6.18.1.1

Using Radio Stun

Procedure:

- 1 or to STUN.
- 2 Press the **Menu Select** button directly below STUN.
The display shows ENTER PASSWORD.
- 3 Use the **keypad** to enter your Tactical Inhibit Encode Password.
- 4 Press the **Menu Select** button directly below OK .
The display shows radio Contact IDs.
- 5 Perform one of the following actions:
 - or to the required ID.
 - Press the **Menu Select** button directly below LNUM to go to the last number dialed.
 - Use the **keypad** to enter the required ID.
 - Press the **Menu Select** button directly below SEND to initiate command.

If the receiving radio received the command, your radio display shows ACK RECEIVED.

If the receiving radio does not have encryption key to decrypt the received encrypted command, your radio display shows DEC FAIL.

If the receiving radio is powered off or already killed, your radio display shows NO ACKNOWLEDGE.

Once the receiving radio received the command, its screen locked and request for password.

6.18.2

Radio Kill

This feature allows you to render your radio or another radio inoperable if the radio is misplaced or lost. When a radio is killed, the display turns blank and all functions of the radio are not usable.

The killed radio can only be recovered with a special device. Consult an authorized and qualified technician for details.

6.18.2.1

Using Remote Kill to Kill Another Radio

When and where to use: Remote Kill allows you to render another radio inoperable by sending an over-the-air command using the menu on your radio.

Procedure:

- 1 **◀** or **▶** to `KILL`.
- 2 Press the **Menu Select** button directly below `KILL`.
The display shows `ENTER PASSWORD`.
- 3 Use the keypad to enter your Tactical Inhibit Encode Password.
- 4 Press the **Menu Select** button directly below `OK`.
The display shows the radio Contact IDs.
- 5 Perform one of the following actions:
 - **◀** or **▶** to the required ID.
 - Press the **Menu Select** button directly below `LNUM` to go to the last number dialed.
 - Use the **keypad** to enter the required ID.
 - Press the **Menu Select** button directly below `SEND` to initiate command.

If the receiving radio received the command, your radio display shows `ACK RECEIVED`.

If the receiving radio does not have encryption key to decrypt the received encrypted command, your radio display shows `DEC FAIL`.

If the receiving radio is powered off or already killed, your radio display shows `NO ACKNOWLEDGE`.

Once the receiving radio received the command, its screen turns blank, the killed radio is inoperable.

6.18.2.2

Using Direct Kill to Kill Your Own Radio

When and where to use: Direct Kill allows you to make your own radio inoperable.

Procedure:

Press and hold the programmable button (2-dot) on the keypad microphone then press the **Orange** button until the display turns blank and becomes inoperable.

6.19

Radio Inhibit

This feature allows the system administrator to put a radio into a non-functional state when the radio is missing or in an unknown hand. The radio stays in this state regardless of its power changes.



NOTICE:

If the radio has Inter-system roaming capability, the system administrator is able to put the radio into a non-functional state when the missing radio roams to another system.

The radio can only be uninhibited by receiving an uninhibited command from the system administrator.

6.20

Global Positioning System/Global Navigation Satellite System



NOTICE: This feature is addressed as GPS across the manual as the naming convention of the buttons and strings remain the same as the legacy feature of GPS.

The availability and accuracy of this location information (and the amount of time that it takes to calculate it) varies depending on the environment in which you are using the GPS feature. For example, GPS location fixes are difficult to obtain indoors, in covered locations, between high buildings, or in situations where you have not established a clear broad view of the sky.

If adequate signals from multiple satellites are available, your GPS feature only provides an approximate location, usually within 10 meters from your actual location, but sometimes farther away.

6.20.1

GPS Performance Enhancement

Sometimes, the GPS feature may be unable to complete a location calculation successfully. You then see a message indicating that your radio cannot connect to enough visible satellites.

To maximize the ability of your radio to determine a fix, take note of the following guidelines:

- For your initial fix, hold the radio in the face position.
- Stay in the open. The GPS feature works best where there is nothing between your radio and the open sky.

6.20.2

The Outdoor Location Feature (Using GPS)

This feature allows you to determine your current location using a location menu, and your current distance and bearing in relation to another location. Radio location may be requested and reported over-the-air.

Your radio stores up to a maximum of 60 programmable location coordinates, also known as waypoints. When the memory is full, the next waypoint automatically replaces the oldest waypoints in the radio.

The radio also stores four preprogrammed waypoints. These coordinates cannot be deleted.

The following table shows the differences between programmable waypoints and preprogrammed waypoints.

| Programmable Waypoints | Preprogrammed Waypoints |
|---|-----------------------------|
| User-configurable location coordinates. | Fixed location coordinates: |

| Programmable Waypoints | Preprogrammed Waypoints |
|---|---|
| | <ul style="list-style-type: none"> • Home • Emergency • Last Known Location • Destination |
| Only the alias is editable, not the coordinates. | The Home and Destination coordinates are editable. |
| Coordinates can be deleted one at a time, or all at once. | Coordinates cannot be deleted. |

6.20.3

Location Format

This feature allows you to select different display formats of GPS location.

The following GPS location formats are available:

- Lat/Long(DD)
- Lat/Long(DDM)
- Lat/Long(DMS)
- UTM/UCS
- SLD99
- MGRS



NOTICE: When you send your location to another radio, the receiving radio displays the location in its selected format.

6.20.4





Accessing the Outdoor Location Feature

When and where to use:



NOTICE: An **ON** radio menu may be present on the Location menu screen if it is preprogrammed by the dealer or system administrator.

Procedure:

- 1  or  to **LOC**.
- 2 Press the **Menu Select** button directly below **LOC**.
The display shows **LOCATION OFF <LATITUDE>**.
- 3 Press the **Menu Select** button directly below **On** to turn on the GPS.
The display shows **PREVIOUS LOC <LATITUDE>**.
- 4  or  to check the longitude, time and date of the last successful location fix.
- 5 To obtain a new location fix, press the **Menu Select** button directly below **RFSH**.
The top line temporarily displays **PLEASE WAIT** while the new location is being determined. While the new location is being determined, the location signal can be a solid or blinking icon.







The location coordinates are updated automatically every 5 seconds while the location signal is present.

- 6 To return to the **Home** screen, press , the **PTT** button, or the **Menu Select** button directly below **EXIT**.

6.20.5

Turning Off GPS

Procedure:







- 1  or  to **LOC**.
- 2 Press the **Menu Select** button directly below **LOC**.
The display shows **PREVIOUS LOC <LATITUDE>**.
- 3  or  to check the time and date of the last successful location fix.
- 4 Press the **Menu Select** button directly below **OPTN**.
- 5  or  to **TURN OFF GPS** (if preprogrammed).
- 6 Press the **Menu Select** button directly below **SEL** to turn off the GPS.
The display shows **LOCATION OFF**.
- 7 To return to the **Home** screen, press , the **PTT** button, or the **Menu Select** button directly below **EXIT**.

6.20.6

Saving a Waypoint

Prerequisites: Ensure that your radio shows the current location on the screen.

Procedure:

- 1 Press the **Menu Select** button directly below **OPTN**.
- 2 Perform one of the following actions:
 -  or  to **SAVE AS WAYPT** and press the **Menu Select** button directly below **SEL**.
 -  or  to **SAVE AS HOME** and press the **Menu Select** button directly below **SEL** and proceed to [step 5](#).
 -  or  to **SAVE AS DEST.** and press the **Menu Select** button directly below **SEL** and proceed to [step 5](#).

A blinking cursor appears on the screen.

- 3 Use the **keypad** to edit the auto-generated waypoint, if required, or press the **Menu Select** button directly below **CNCL** to return to the Location main screen.
- 4 Press the **Menu Select** button directly below **OK** once you are done.
One of the following scenarios occur:
 - The display shows **SAVED AS <WAYPOINT NAME>**.
 - The display shows **SAVED AS HOME**.









- The display shows `SAVED AS DEST..`
- 5 To return to the Home screen, press  , the **PTT** button, the preprogrammed **GPS** button or the **Menu Select** button directly below `EXIT`.

6.20.7

Viewing a Saved Waypoint

Prerequisites: Ensure your radio shows the current location on the screen.

Procedure:







- 1 Press the **Menu Select** button directly below `OPTN`.
- 2  or  to `WAYPOINTS` and press the **Menu Select** button directly below `SEL`.
The display shows a list of waypoints.
- 3 Perform one of the following actions:
 -  or  to scroll through the list.
 -  or  to select a waypoint to view the location information in full.
- 4 Press the **Menu Select** button directly below `OPTN`.
- 5 To view the longitude, time and date of the selected waypoint,  or  to `VIEW` and press the **Menu Select** button directly below `SEL`.
- 6 To return to the previous screen, press the **Menu Select** button directly below `BACK`, or to return to the Home screen, press  or the **PTT** button.

6.20.8

Editing the Alias of a Waypoint

Prerequisites: Ensure your radio shows the current location on the screen.

Procedure:

- 1 Press the **Menu Select** button directly below `OPTN`.
- 2  or  to `WAYPOINTS` and press the **Menu Select** button directly below `SEL`.
The display shows a list of waypoints.
- 3  or  to the required saved waypoint, and press the **Menu Select** button directly below `OPTN`.
- 4  or  to `EDIT NAME` and press the **Menu Select** button directly below `SEL`.
A blinking cursor appears in the `EDIT NAME` screen.
- 5 Use the **keypad** to edit the alias.
- 6 Perform one of the following actions:
 - Press the **Menu Select** button directly below `OK` once you are done.
 - Press the **Menu Select** button directly below `CNCL` to return to the Waypoints main screen.
- 7 The display shows `<WAYPOINT NAME> UPDATED` and the radio returns to the Waypoints main screen.
- 8 Perform one of the following actions:

- Press the **Menu Select** button directly below **BACK** to return to the previous screen.
- Press  or the **PTT** button to return to the Home screen.

6.20.9

Editing the Coordinates of a Waypoint











When and where to use:



NOTICE: You can only edit preprogrammed coordinates of Home and Destination.

Ensure that your radio shows the current location on the screen.

Procedure:

- 1 Press the **Menu Select** button directly below **OPTN**.
- 2  or  to **WAYPOINTS** and press the **Menu Select** button directly below **SEL**.
The display shows a list of waypoints.
- 3 Perform one of the following actions:
 - or to **[HOME]** and press the **Menu Select** button directly below **OPTN**.
 - or to **[DESTINATION]** and press the **Menu Select** button directly below **OPTN**.
- 4  or  to **EDIT LOCATION** and press the **Menu Select** button directly below **SEL**.
The first number blinks.
- 5 Utilize the following control buttons to select the number/coordinates if required, then press the **Menu Select** button directly below **EDIT** to change the number/coordinates.
 - Press  to move to the previous number/coordinates.
 - Press  to move to the next number/coordinates.
 - Press  or  to change the North (N), South (S), East (E), or West (W) direction.A blinking cursor appears in the **EDIT LOCATION** screen.
- 6 Utilize the following control buttons or menu to change the number/coordinates if required then press the **Menu Select** button directly below **OK** once.
 - Press  to move one space to the left.
 - Press  to move one space to the right.
 - Press the **Menu Select** button directly below **DEL** to delete any unwanted characters.
 - Press the **Menu Select** button directly below **CNCL** to return to the previous screen
- 7 Press the **Menu Select** button directly below **OK** once complete setting up the new Home or Destination.
One of the following scenarios occurs:
 - The display shows **[HOME] UPDATED** and the radio returns to the Waypoints main screen.
 - The display shows **[DESTINATION] UPDATED** and the radio returns to the Waypoints main screen.

6.20.10

Deleting a Single Saved Waypoint

Prerequisites: Ensure your radio shows the current location on the screen.

Procedure:

- 1 Press the **Menu Select** button directly below `OPTN`.
- 2 **◀** or **▶** to `WAYPOINTS` and press the **Menu Select** button directly below `SEL`.
The display shows a list of waypoints.
- 3 Perform one of the following actions:
 - **◀** or **▶** to the required saved waypoint, and press the **Menu Select** `OPTN`. **◀** or **▶** to `Edit name` and press the **Menu Select** button directly below `Del`.
 - Press the **Menu Select** button directly below `Del`.
- 4 The display shows `<WAYPOINT NAME> CONFIRM DEL?`.
- 5 Press the **Menu Select** button directly below `YES` to delete the waypoint or press the **Menu Select** button directly below `NO` to return to the Waypoints main screen.

The display shows `<WAYPOINT NAME> DELETED`.

6.20.11

Deleting All Saved Waypoints

Prerequisites: Ensure your radio shows the current location on the screen.

When and where to use:



NOTICE: You cannot delete any of the preprogrammed waypoints.

Procedure:

- 1 Press the **Menu Select** button directly below `OPTN`.
- 2 **◀** or **▶** to `WAYPOINTS` and press the **Menu Select** button directly below `SEL`.
The display shows a list of waypoints.
- 3 **◀** or **▶** to the required saved waypoint, and press the **Menu Select** button directly below `OPTN`.
- 4 **◀** or **▶** to `DELETE ALL` and press the **Menu Select** button directly below `SEL`.
The display shows `ALL SAVED WAYP CONFIRM DEL?`.
- 5 Press the **Menu Select** button directly below `YES` to delete all waypoints or press the **Menu Select** button directly below `NO` to return to the Waypoints main screen.





The display shows `ALL SAVED WAYP DELETED`.

6.20.12

Measuring the Distance and Bearing from a Saved Waypoint

Prerequisites: Ensure your radio shows the current location on the screen.

Procedure:

- 1 Press the **Menu Select** button directly below `OPTN`.
- 2  or  to `DIST FRM HERE` and press the **Menu Select** button directly below `SEL` .
The display shows a list of waypoints.
- 3  or  to the required waypoint and press the **Menu Select** button directly below `SEL` .

The display shows the distance and bearing from the current to the selected coordinates.

6.20.13

Location Feature in Emergency Mode

When the Emergency feature is activated, the radio exits the Location menu and returns to the Home screen for you to view the channel that triggers the emergency signal. You may re-enter the Location menu while still in Emergency mode as long as Silent Emergency is not activated.

If you have disabled the Location feature on your radio, it automatically turns back on when Emergency mode is activated.

If there is a solid location signal during Emergency operation, the current location and the location information received is saved as Emergency and Last Known Location waypoints respectively.

6.20.14

Peer-Location on the Display (ASTRO Conventional)

This feature is only available for radio-to-radio voice transmissions, dispatch call and selective call.

Both the transmitting radio and receiving radio must be configured to enable them to send and receive the GPS coordinates.



NOTICE: If the receiving radio is operating in a Mixed Mode channel, only if its voice transmission is through conventional ASTRO system then the radio can receive the location coordinates of the peers.

This feature is also operable in a Scan Active channel or Scan Talkback channel.

After receiving a voice transmission with GPS coordinates enabled on the receiving radio, the display shows the coordinates available in full or in short coordinates.

Full location coordinates

- PTT ID (optional)
- Longitude and latitude
- Relative distance or direction

Short location coordinates

- PTT ID (optional)
- Longitude and latitude



NOTICE: If the transmitting radio is stale at the location after a period, the receiving radio display shows the last known location. If the transmitting radio does not have GPS or the receiving radio could not decode the GPS signal of the received signal, the receiving radio display shows the location as unknown.

6.21

Mission Critical Geofence (ASTRO 25 Trunking)

This feature allows the radio to use the GPS receiver to determine its location at frequent intervals and evaluate if the radio is within the Geofence area in real time. Geofence is a virtual perimeter based on the GPS to define a geographical area on earth.

When the radio enters the predefined Geofence area, your radio receives the Dynamic Regroup command from the system and immediately connects to a Dynamic Regroup talkgroup. The radio display shows the new selected Dynamic Regrouped talkgroup with green intelligent light for your attention. Voice Announcement is also available to support this feature.

Any new text messages received at Geofence is displayed immediately on the radio display.



NOTICE:

If the radio is set up in DVRS, only mobile radio is supported for this feature.

6.21.1

Entering the Geofence Area

Prerequisites: The Voice Announcement and TMS display in this feature are optional. They must be configured to enable you to hear and see these indicators.

When and where to use: When the radio enters a Geofence area, the radio immediately sends a message ACK back to the system.

The radio searches the current zone for the channel with same talkgroup assigned as the Dynamic Talkgroup and also with same system ID of current trunk system. Once matched, the radio display shows the first matched and connected channel alias.

If there is no channel with matching Talkgroup ID and trunk system ID, the radio display shows the channel alias of <DYNAMIC talkgroup>.

Once the radio is connected, you hear a dynamic regroup tone, the radio display shows <DYNAMIC channel> with the temporary green color intelligent backlight and you hear a Voice Announcement.



NOTICE:

When the radio loses the GPS signal, the GPS icon blinks and the radio sounds two high-pitched tones repetitively to indicate that the GPS has failed to operate. The radio display shows the red intelligent light.

If the first matched channel is not configured with Voice Announcement, no Voice Announcement is played.

The system sends a message to your radio. The radio display shows a direct text message content without any user operation. This message indicates that you are currently present in a Geofence area. This TMS remains open on the display until user presses exit/home to exit this screen.



NOTICE: If there is another incoming text message before you exit the previous message, the message screen is refreshed to show the latest message.

The following procedure guides you to exit the text message received.

Procedure:

Press the **Menu Select** button below EXIT or  to return to **Home** screen.

The other operations are the same as normal dynamic regroup command.

When the radio exits the Geofence area, your radio reverts to original channel or newly assigned talkgroup. The radio display shows the new channel together with Voice Announcement to indicate the changes. Voice Announcement of the new channel only works if that channel is configured with Voice Announcement.

6.21.2

Mission Critical Geofence

This feature allows the radio to use the GPS receiver to determine radio location at frequent intervals and evaluate if the radio is within the Geofence area in real time

Check with your dealer or qualified technician to program the geofence coordinates and actions.

6.21.3

Entering Mission Critical Geofence

When and where to use:

When the radio enters the predefined Geofence area, the radio displays <Geofence Alias> with the intelligent backlight and you hear a Voice Announcement. Zone and channel alias of the Geofence area is displayed. If the radio is set to manual, you can choose either to proceed with zone and channel change or cancel the change.

The radio then connects to the designated talkgroup. The radio displays the talkgroup alias and dynamic regroup tone sounds. The transmit power level changes and the radio shows a direct text message content without any user operation.



NOTICE:

The availability of the Voice Announcement (VA), TMS display, Intelligent Backlight, and Transmit Power Level alerts depend on your radio configuration. The VA can be programmed to alert continuously or momentarily.

If Site Selectable Alert (SSA) is enabled, the radio mutes any alert that is received when entering the Geofence area and unmutes when exiting.

6.21.4

Exiting Mission Critical Geofence

When and where to use:

When the radio exits the Geofence area, the radio reverts to the original transmit power level, intelligent lighting, channel, or newly assigned talkgroup. Voice announcement is canceled or you hear a preprogrammed VA tone. The radio displays the new channel and a message is received to indicate the changes.

6.22

Trunking System Controls

This chapters explain the trunking system control features in your radio.

6.22.1

Operating in Failsoft System

When and where to use:

The failsoft system ensures continuous radio communication during a trunked system failure. If a trunking system fails completely, the radio goes into failsoft operation and automatically switches to its failsoft channel.

During failsoft operation, your radio transmits and receives in conventional operation on a predetermined frequency. You hear a medium-pitched tone and the display shows FAILSOFT.

When the trunking system returns to normal operation, your radio automatically leaves failsoft operation and returns to trunked operation.

To continue in Failsoft and to communicate with other talkgroups, refer to the following procedure.

Procedure:

- 1 Rotate the **16-Position Select Knob** to change to a different repeater frequency.
- 2 Press the **PTT** button to talk, and release the button to listen.

6.22.2

Out-of-Range Radio

When your radio goes out of the range of the system, it can no longer lock onto a control channel.

You hear a low-pitched tone and/or the display shows the currently selected zone/channel combination and Out of range notification. Your radio remains in this out-of-range condition until it locks onto a control channel or failsoft channel, or if it is turned off.

6.22.3

SmartConnect

SmartConnect allows your radio to maintain voice communication when LMR is out of range by switching to a Wi-Fi, LTE through Tethered Data Modem and Satellite through Ethernet.

Before switching broadband connections, your radio compares the relative signal strength of the various broadband connection types to one another, as well as LMR. Your radio remains or returns to LMR connection when the other broadband connections fall below the quality threshold. In addition, a radio operating on a lower priority broadband connection returns to the higher priority or quality connection while idle on SmartConnect.



NOTICE: This feature must be preprogrammed by a qualified radio technician. Contact your system administrator for more details of supported radio models.

Your radio can connect through a fixed Wi-Fi access point in buildings or in-vehicle Broadband modem such as the following modems:

- Motorola Solutions VML750
- Sierra Wireless MP70
- Sierra Wireless GX450

Your radio displays the SmartConnect capable icon  on the SmartConnect enabled channel, once the device is connected to an available network, the radio displays SmartConnect connection icon



Your radio displays `Out of Range` when both LMR and SmartConnect are unavailable.

6.22.4

SmartZone

The SmartZone™ feature extends communications beyond the reach of a single-trunked site (antenna location) when operating in a SmartZone system. SmartZone units provide expanded wide-area coverage.

SmartZone automatically switches the radio to a different site when the current site signal becomes unacceptable. This usually happens when the vehicle in which the radio is located is driven out of the range of one site, and into the range of another.

Under normal conditions, a SmartZone-enabled radio functions invisibly to the operator. However, the operator does have some manual controls on the Control Head—the **RSSI** menu entry. This button can be used to check, or change, the SmartZone operation.

6.22.5

Site Trunking Feature

If the Zone Controller loses communication with any site, that site reverts to site trunking. When this occurs, you can communicate only with the radios within your trunking site.

The display shows the currently selected zone/channel and the Site Trunking message.

6.22.6

Locking and Unlocking a Site

When and where to use: This feature allows your radio to lock onto a specific site and not roam among wide-area talkgroup sites. This feature should be used with caution, since it inhibits roaming to another site in a wide-area system.

You can toggle the lock state between locked and unlocked by pressing the preprogrammed **Site Lock/Unlock** button.

Follow the procedure to lock and unlock a site using the radio menu.

Procedure:

- 1 ◀ or ▶ to **SITE**.
- 2 Press the **Menu Select** button directly below **SITE**.
- 3 Perform one of the following actions:
 - To lock the site, press the **Menu Select** button directly below **LOCK**. The display shows **SITE LOCKED**.
 - To unlock the site, press the **Menu Select** button directly below **UNLK**. The display shows **SITE UNLOCKED**.

The radio saves the new site lock state and returns to the Home screen.

6.22.7

Viewing the Current Site

Procedure:

Perform one of the following actions:

- Press the preprogrammed **Site Search** button.
- ◀ or ▶ to **RSSI** and press the **Menu Select** button directly below **RSSI**.

The display shows momentarily the name of the current site and its corresponding received **RSSI**.

6.22.8

Changing the Current Site

Procedure:

Perform one of the following actions:

- Press and hold down the preprogrammed **Site Search** button.

- Press and hold down the **Menu Select** button directly below **RSSI**.
You hear a tone and the display shows momentary **SCANNING SITE**.

When the radio finds a new site, it returns to the Home screen.

6.22.9

Trunked Announcement

The announcement capability allows you to make announcements to the entire user group, monitor talkgroup calls, and other announcements.

Announcement calls are handled in two different ways, ruthless and non-ruthless preemption.

Ruthless Preemption

When a ruthless preemption announcement call is initiated, the requesting radio begins transmitting immediately. All associated talkgroup calls taking place on other channels are immediately halted, and the radios are steered to the announcement call.

Transmitting radios continue to transmit until the **PTT** button is released, and unmute for the announcement call.

Non-Ruthless Preemption

When a non-ruthless preemption announcement is initiated, the initiating unit receives a telephone-type busy tone, followed by a callback when all associated talkgroup conversations end.

6.22.9.1

Initiating an Announcement

Prerequisites: Ensure your radio has been programmed to allow announcement calls.

Procedure:

- 1 Turn the **Mode Knob** to locate the announcement-group mode.
- 2 Press the **PTT** button to initiate the announcement.

6.23

Ignition Switch Options

The Ignition Switch Options feature is configured in the Customer Programming Software (CPS) and it determines the functionality of the radio based on the ignition state of the vehicle.

The available options are:

Blank

This option allows you to turn on/off the radio through the **Power** button regardless of the current state of the ignition.

Transmit Inhibit

This option allows you to turn on/off the radio through the **Power** button regardless of the current state of the ignition. If the ignition is not present, all transmissions are inhibited. This includes receiving any trunking dispatch communications as the radio is not affiliated with the trunking systems.

PTT Transmit Inhibit

This option allows you to turn on/off the radio through the **Power** button regardless of the current state of the ignition. If the ignition is not present, all **PTT** button transmissions are inhibited. However, the radio is able to affiliate with the trunking systems.

Required

This option allows you to turn on the radio only if ignition is present. The radio turns off either through a **Power** button press or when the ignition is lost. If the radio turns off due to ignition being removed, it automatically turns on when the ignition is present.

If the radio is configured with the Auto Power Off Timer, it automatically turns off after being inactive for a period (with or without ignition).

Soft Power Off

This option allows you to turn on the radio either through the **Power** button or when the ignition is detected. Meanwhile, if the **Power** button is pressed or the ignition is removed, the radio turns off.

If the radio is configured with the Auto Power Off Timer, it automatically turns off after being inactive for a period (with or without ignition).

Ignition Only Power Up

In this option, the radio turns on only when ignition is detected and turns off when ignition is removed. It does not turn on/off with the **Power** button press.

If the radio is configured with the Auto Power Off Timer, it automatically turns off after being inactive for a period (with or without ignition).



NOTICE:

If the radio is turned on with an Emergency Power Up footswitch-press, you are required to press the **Power** button to turn off the radio even if ignition is not present.

If the radio is previously turned off due to the Auto Power Off Timer, you are required to press the **Power** button to turn on the radio even if ignition is present.

6.23.1

Using Emergency Power Up

When and where to use: This feature allows you to power on the radio and automatically transmits an emergency mode transmission on personalities with emergency enabled, with the use of a footswitch. This feature is not available if the Ignition Switch option is set to either Tx Inhibit or PTT Tx Inhibit.

Procedure:

Press the footswitch to turn on the radio and launch Emergency.

A tone sounds and the display shows *Emergency*.

6.24

ASTRO 25 (P25) Programming Over Project 25 (POP25)

Also called Over-the-Air Programming, this feature allows configuration data and firmware to be upgraded to your radio over-the-air. Full use of the radio is retained during the data transfer without interrupting communication.

If the upgrade happens on the ASTRO 25 and ASTRO Conventional systems, the upgrade pauses to give priorities to voice call, and continues after the voice call ended. If the upgrade happens on a Wi-Fi network, the upgrade process runs concurrently with voice calls.

Once a configuration upgrade is downloaded to your radio, you can install new changes immediately or delay changes to be installed on the radio when it is being powered up.

6.24.1

Responding to the Notification of Upgrade

Procedure:

- 1 The display shows `Upgrade?` and two short, medium-pitched tones sound every 30 seconds until the user makes a choice of either accepting, delaying, or rejecting the request.
- 2 Perform one of the following actions:

One of the following scenarios occurs:

- If you choose to accept, the display shows `Programming Dont power off` to indicate the upgrade is about to begin. The radio resets to install the upgrade. In the case of configuration data upgrade, the process only takes a few seconds. In the case of firmware upgrade, the installation takes several minutes.



NOTICE: The radio cannot be used while the upgrade is being installed. Therefore, make sure to only accept the upgrade at a convenient time when immediate radio use is not required.

- If you choose to delay, a configuration data upgrade is installed automatically at the next power up. However, in the case of a firmware upgrade, the radio prompts `Upgrade?` again at the next power up.
- If you choose to reject, the display shows `Upg Aborted`. The radio continues to function with the current configuration until it gets reprogrammed.



NOTICE: If your radio has problems upgrading over-the-air, consult a qualified technician for details.

6.25

Voice Announcement

This feature enables the radio to audibly indicate the current feature mode, zone, or channel assigned to the user.

The available voice announcement priority options are:

High

Voice announcement is enabled even when the radio is receiving calls.

Low

Voice announcement is disabled when the radio is receiving calls.

6.26

Site Selectable Alerts (ASTRO 25 Trunking)

A Site Selectable Alert (SSA) is an Intelligent Lighting indicator with audio alert sent to radios at sites to notify the users when there is a special situation that they need to be aware of.

Your radio supports up to 250 site aliases. Only authorized radios are enabled to send SSA.



NOTICE:

The alert alias, alert tone, and alert period is configured in the Customer Programming Software. Contact your system administrator for more information.

When mixing SSA with received voice audio, the SSA alert is reduced in volume to ensure that the voice message is still heard clearly. It is important that the SSA audio files are created with clear loud audio to ensure audio clarity at reduced levels.

6.26.1

Sending SSA Notification to Single Site

Procedure:

- 1 ◀ or ▶ to SSA.
2 Press the **Menu Select** button directly below SSA.
The display shows the **Site Alert** screen.
- 3 ◀ or ▶ to START ALERT and press the **Menu Select** button directly below SEL.
The display shows the **Select Site** screen.
- 4 ◀ or ▶ to the desired Site Alias. Press the **Menu Select** button directly below SEL.
The display shows the **Select Alert** screen.
- 5 ◀ or ▶ to select the desired Alert Alias and press the **Menu Select** button directly below SEND.
The display shows SENDING REQ.
If radio is out of range, roaming to a foreign system or in a failsoft situation, the display shows REQ FAILED.
If the request is successful, the display shows REQ SUCCESSFUL.
If the site is not available, the display shows <SITE ALIAS> NOT AVAILABLE.
If the site does not exist, the display shows <SITE ALIAS> DOES NOT EXIST.
- 6 To return to the Home screen, press the **Menu Select** button directly below EXIT.

If you are at the site designated to receive this alert, you can hear an alert tone repeated periodically. The display shows the <ALERT ALIAS> with the intelligent lighting at Home screen.

6.26.2

Sending SSA Notification to Single Site by Manual Entry

Procedure:

- 1 ◀ or ▶ to SSA.
2 Press the **Menu Select** button directly below SSA.
The display shows the **Site Alert** screen.
- 3 ◀ or ▶ to START ALERT and press the **Menu Select** button directly below SEL.
The display shows the **Select Site** screen.
- 4 ◀ or ▶ to [SITEID ENTRY] to send alert through the manual entry. Press the **Menu Select** button directly below EDIT.
The display shows the **Enter SiteID** screen.
- 5 Key in the desired Site ID and press the **Menu Select** button directly below OK.
If a correct Site ID is entered, the display shows the **Select Alert** screen.
If a wrong Site ID is entered, the display shows INVALID ID and prompts to enter the Site ID again.

- 6 ◀ or ▶ to select the desired Alert Alias and press the **Menu Select** button directly below `SEND`.

The display shows `SENDING REQ`.

If radio is out of range, roaming to a foreign system or in a failsoft situation, the display shows `REQ FAILED`.

If the request is successful, the display shows `REQ SUCCESSFUL`.

If the site is not available, the display shows `<SITE ID> NOT AVAILABLE`.

If the site does not exist, the display shows `<SITE ID> DOES NOT EXIST`.

- 7 To return to the Home screen, press the **Menu Select** button directly below `EXIT`.

If you are at the site designated to receive this alert, you can hear an alert tone repeated periodically. The display shows the `<ALERT ALIAS>` with the intelligent lighting at Home screen.

6.26.3

Sending SSA Notification to All Sites

Procedure:

- 1 ◀ or ▶ to `SSA`.
- 2 Press the **Menu Select** button directly below `SSA`.
The display shows the **Site Alert** screen.
- 3 ◀ or ▶ to `START ALERT` and press the **Menu Select** button directly below `SEL`.
The display shows the **Select Site** screen.
- 4 ◀ or ▶ to `[All SITES]` and press the **Menu Select** button directly below `SEL`.
The display shows the **Select Alert** screen.
- 5 ◀ or ▶ to select the desired `<Alert Alias>` and press the **Menu Select** button directly below `SEND`.
The display shows `SENDING REQ`.
If radio is out of range, roaming to a foreign system or in a failsoft situation, the display shows `REQ FAILED`.
If the request is successful, the display shows `REQ SUCCESSFUL`.
If one or more sites are unavailable, the display shows `NOT ALL SITES AVAILABLE`. Repeat [step 3](#).
- 6 To return to the Home screen, press the **Menu Select** button directly below `EXIT`.

If you are at the site designated to receive this alert, you can hear an alert tone repeated periodically. The display shows the `<ALERT ALIAS>` with the intelligent lighting at Home screen.

6.26.4

Sending SSA Notification to All Available Sites

Procedure:

- 1 ◀ or ▶ to `SSA`.

- 2 Press the **Menu Select** button directly below `SSA`.
The display shows the **Site Alert** screen.
- 3 ◀or▶ to `START ALERT` and press the **Menu Select** button directly below `SEL`.
The display shows the **Select Site** screen.
- 4 ◀or▶ to `[All AVAIL]` and press the **Menu Select** button directly below `SEL`.
The display shows the **Select Alert** screen.
- 5 ◀or▶ to select the desired `<Alert Alias>` and press the **Menu Select** button directly below `SEND`.
The display shows `SENDING REQ`.
If radio is out of range, roaming to a foreign system or in a failsoft situation, the display shows `REQ FAILED`.
If the request is successful, the display shows `REQ SUCCESSFUL`.
- 6 To return to the Home screen, press the **Menu Select** button directly below `EXIT`.

If you are at the site designated to receive this alert, you can hear an alert tone repeated periodically. The display shows the `<ALERT ALIAS>` with the intelligent lighting at Home screen.

6.26.5

Stopping SSA Notification of a Single Site

Procedure:

- 1 ◀or▶ to `SSA`.
- 2 Press the **Menu Select** button directly below `SSA`.
The display shows the **Site Alert** screen.
- 3 ◀or▶ to `STOP ALERT` and press the **Menu Select** button directly below `SEL`.
The display shows the **Select Site** screen.
- 4 ◀or▶ to select the desired Site Alias and press the **Menu Select** button directly below `SEND`.
The display shows `SENDING REQ`.
If radio is out of range, roaming to a foreign system or in a failsoft situation, the display shows `REQ FAILED`.
If the request is successful, the display shows `REQ SUCCESSFUL`.
If the site is not available, the display shows `<SITE ALIAS> NOT AVAILABLE`.
If the site does not exist, the display shows `<SITE ALIAS> DOES NOT EXIST`.
- 5 To return to the Home screen, press the **Menu Select** button directly below `EXIT`.

The SSA Alert for the designated site stops.

6.26.6

Stopping SSA Notification of a Single Site by Manual Entry

Procedure:

- 1 ◀ or ▶ to SSA.
- 2 Press the **Menu Select** button directly below SSA.
The display shows the **Site Alert** screen.
- 3 ◀ or ▶ to STOP ALERT and press the **Menu Select** button directly below SEL.
The display shows the **Select Site** screen.
- 4 ◀ or ▶ to [SITEID ENTRY] and press the **Menu Select** button directly below EDIT.
The display shows the **Enter SiteID** screen.
- 5 Key in the required Site ID and press the **Menu Select** button directly below SEND.

One of the following scenarios occur:

- If a wrong Site ID is entered, the display shows INVALID ID and prompts to enter the Site ID again.
- If a correct Site ID is entered, the display shows SENDING REQ.
- If the request is successful, the display shows REQ SUCCESSFUL.
- If the single site is not available, the display shows <SITE ID> NOT AVAILABLE.
- If the single site does not exist, the display shows <SITE ID> DOES NOT EXIST.

- 6 To return to the Home screen, press the **Menu Select** button directly below EXIT.

The SSA Alert for the designated site stops.

6.26.7

Stopping SSA Notification of All Sites

Procedure:

- 1 ◀ or ▶ to SSA.
- 2 Press the **Menu Select** button directly below SSA.
The display shows the **Site Alert** screen.
- 3 ◀ or ▶ to STOP ALERT and press the **Menu Select** button directly below SEL.
The display shows the **Select Site** screen.
- 4 ◀ or ▶ to [ALL SITES] and press the **Menu Select** button directly below SEND.
The display shows SENDING REQ.
If radio is out of range, roaming to a foreign system or in a failsoft situation, the display shows REQ FAILED.
If the request is successful, the display shows REQ SUCCESSFUL.

If one or more sites are not available, the display shows `NOT ALL SITES AVAILABLE`. Repeat [step 3](#).

- 5 To return to the Home screen, press the **Menu Select** button directly below `EXIT`.

The SSA Alert for all sites stop.

6.26.8

Stopping SSA Notification of All Available Sites

Procedure:

- 1 ◀ or ▶ to `SSA`.
- 2 Press the **Menu Select** button directly below `SSA`.
The display shows the **Site Alert** screen.
- 3 ◀ or ▶ to `STOP ALERT` and press the **Menu Select** button directly below `SEL`.
The display shows the **Select Site** screen.
- 4 ◀ or ▶ to `[ALL AVAIL]` and press the **Menu Select** button directly below `SEND`.
The display shows `SENDING REQ`.
If radio is out of range, roaming to a foreign system or in a failsoft situation, the display shows `REQ FAILED`.
If the request is successful, the display shows `REQ SUCCESSFUL`.
- 5 To return to the Home screen, press the **Menu Select** button directly below `EXIT`.

The SSA Alert for all available sites stop.

6.27

Channel Change on Off-Hook

This feature determines the mode of the radio based on the Hub on/off-hook state of all the control heads.

Whenever the radio goes off-hook, it changes to a preprogrammed zone channel assigned for off-hook state. While in off-hook state, you can change the mode manually. When you return the radio to on-hook state, it reverts to its previous channel zone before the radio goes off-hook.



NOTICE: If the radio is operating on Tone Private Line (PL) Defeat or Suspend Scan operations during on-hook state, the radio is converted to work in a new channel and the Channel Change on Off-Hook feature is suspended until these conditions end.

During Dynamic Regroup channel selector lock state, Emergency, Transmit Inhibit, radio lock, or when an external key loader is attached to the radio, the Channel Change on Off-Hook feature is suspended until the following conditions end.

The Off-Hook State for APX Dual-Radio Setup

For Dual-Radio, the state of the Hub on the unselected radio is always considered as on-hook. When the Hub is in off-hook state, the selected radio changes the channel according to the configuration of the Customer Programming Software (CPS), and the unselected radio does not trigger a channel change.

With Channel Change on Off-Hook enabled, when the Hub is placed off-hook and radio switch happens, the new selected radio moves to the target channel zone of its off-hook state. The new unselected radio reverts to the last user selected channel before the off-hook state.

The Off-Hook State for Multiple Radios Setup

When multiple control heads are connected, the states of these Hubs reflect the state of the active control head(s). Any Hub placed off-hook by the active control head(s) makes the radio goes into off-hook state. The radio can be in on-hook state only when all Hubs are placed on-hook.



NOTICE: Familiarize yourself with the functionality of this feature as removing the microphone easily triggers a mode change on the radio.

6.28

Low Voltage Threshold Warning

A specific external device is attached to the radio to monitor the automobile voltage. When the car battery went lower than a pre-defined threshold, the external device asserts the Vehicular Interface Port (VIP) input to the radio.

When the VIP switch turns on, the VIP asserts input to the radio. The radio immediately initiates a 15 seconds of low Voltage Pre-alert Timer. If the status of the VIP changed before this time-out timer ends, the radio returns to normal operation.

If the status from the VIP remains unchanged when the time-out timer ends, the radio shows Low Battery message on the display and low alert tone. The radio sounds a high-pitched tone immediately after the **PTT** button is released.



NOTICE: If the mobile radio does not have a control head connected, the bricks can only alert the user with battery alert tone and the transmit chirp.

6.29

Wi-Fi

You can connect your radio to a Wi-Fi network for wireless programming. Your service administrator preprograms the Wi-Fi Service Set Identifier (SSID) or network name that your radio can connect to.

6.29.1

Turning Wi-Fi On or Off

Procedure:

- Turning Wi-Fi on or off using the preprogrammed button:
 - a. To toggle the Wi-Fi on or off, press the preprogrammed **Wi-Fi** button.
This button must be preprogrammed by a qualified radio technician. Check with your dealer or system administrator for more information.
- Turning Wi-Fi on or off using the radio menu button:
 - a. **◀** or **▶** to `WiFi` and press the **Menu Select** button directly below `WiFi`.
 - If the display shows `WiFi Status` being `Off`, press the **Menu Select** button directly below `On`.
 - If the display shows `WiFi Status` as `Searching`, `Connecting`, `Connected` or `No Service`, press the **Menu Select** button directly below `Off` to turn off Wi-Fi.

6.29.2

Selecting WiFi Network

This feature allows you to view and select the available WiFi network.

Procedure:

- 1 Press the **Menu Select** button directly below `WiFi` to enter WiFi screen.
- 2 Press the **Menu Select** button directly below `On` to turn on the WiFi.
Radio starts searching for available network.
- 3 Press the **Menu Select** button directly below `List`.

Radio displays available network selection and the network signal strength.

If the radio displays `No network available`, press the **Menu Select** button directly below `REFSH` to search for available networks.

- 4 Press `◀` or `▶` to scroll through the list and press **Menu Select** button directly below `SEL` to connect to the selected network.

Radio displays the WiFi status, the selected network, and the signal strength.



NOTICE: The **List** and `REFSH` buttons are not available when WiFi is searching or connecting to network.

6.29.3

Checking the Wi-Fi Configuration and Status of the Radio

Procedure:

- 1 Perform one of the following actions:
 - Long press the preprogrammed **Wi-Fi** button.
 - `◀` or `▶` to `WiFi` and press the **Menu Select** button directly below `WiFi`.

The display shows the current status of the Wi-Fi as described next.

Searching

Looking for available Wi-Fi networks that have been preprogrammed into the radio.

Connecting

In the process of connecting to a found Wi-Fi network.

Connected

Connected to one of the preprogrammed Wi-Fi networks.

No Service

No available networks or connection with one of the networks failed.

If the radio is Wi-Fi connected, you see a Wi-Fi signal strength indicator,  on the display. In addition, the WiFi menu shows `Connected` under the connection Status heading, what network you are connected to under the Network heading, and the signal strength to that network under the Sig Strength heading.

- 2 Press  to exit.

6.30

Utilities

This chapter explains the operations of the utility functions available in your radio.

6.30.1

Selecting the Power Level

Prerequisites:



NOTICE: This feature must be preprogrammed by a qualified radio technician.

When and where to use: This feature enables you to reduce the transmit power level for specific case that requires a lower power level. You can select the power level at which your radio transmits. The radio always turns on to the default setting.

Power level **LOW** enables a shorter transmitting distance and to conserve power. Power level **HIGH** enables a longer transmitting distance.

Do one of the following to select the power level. You can use the options interchangeably depending on your preference and the programmed functions.

Procedure:

- Selecting the Power Level using the **Transmit Power Level** switch:
 - a. Use the preprogrammed **Transmit Power Level** switch to toggle the power level between low and high power.
- Selecting the Power Level using the radio menu:
 - a. ◀ or ▶ to **PWR**.
 - b. Press the **Menu Select** button directly below **PWR**.

The display shows **LOW POWER** and the low power icon or the display shows **HIGH POWER** and the high power icon.

6.30.2

Selecting a Radio Profile

When and where to use: This feature allows you to manually switch the visual and audio settings of the radio. The display, backlight, alert tones, and audio settings are defined according to the preprogrammed radio settings of each radio profile.

Refer to a qualified technician for more information.

Do one of the following to select a radio profile. You can use the options interchangeably depending on your preference and the programmed functions.

Procedure:

- Selecting a radio profile using the preprogrammed **Profile** button:
 - a. Press the preprogrammed **Profile** button.
 - b. ◀ or ▶ to scroll through the menu selections.
 - c. Press the **Menu Select** button directly below **SEL** to select the required radio profile, or press the **Menu Select** button directly below **EXIT** to exit the screen without making any changes.

The radio returns to the Home screen. The profile name on the Home screen indicates the current selected radio profile.

- Selecting a radio profile using the radio menu:
 - a. ◀ or ▶ to **PRFL** and press the **Menu Select** button directly below **PRFL** to access the **Profiles** feature screen.
 - b. ◀ or ▶ to scroll through the menu selections.

- c. Press the **Menu Select** button directly below `SEL` to select the required radio profile, or press the **Menu Select** button directly below `EXIT` to exit the screen without making any changes.

The radio returns to the Home screen. The profile name on the Home screen indicates the current selected radio profile.

6.30.3

Controlling the Display Backlight

When and where to use: You can enable or disable the radio display backlight as needed, if poor light conditions make the display or keypad difficult to read.

Depending on how your radio is preprogrammed, you can also maintain a minimum backlight level on the radio front display.

Procedure:

Perform one of the following actions:

- To toggle the backlight on or off, press the **DIM** button.
- To turn the backlight on, press any key of the keypad, the **Menu Select** or **Menu Navigation** buttons, or any programmable radio controls or buttons

6.30.4

Turning the Keypad Tones On or Off

When and where to use: You can enable and disable keypad tones as needed.

Procedure:

- Turning the tones on or off using the preprogrammed **Keypad Mute** button:
 - a. To turn the tones off or on, press the preprogrammed **Keypad Mute** button.
- Turning the tones on or off using the radio menu:
 - a. **◀** or **▶** to `MUTE`.
 - b. Press the **Menu Select** button directly below `MUTE`.

The display shows momentary `TONES OFF`, indicating that the tones are disabled or the display shows momentary `TONES ON`, and you hear a short tone indicating that the tones are enabled.

6.30.5

Turning Voice Mute On or Off

This feature allows you to mute the voice transmission of the current zone and channel.

When and where to use:

Procedure:

- Turning Voice Mute off or on using the preprogrammed **Voice Mute** button:
 - a. To turn the feature off or on, press the preprogrammed **Voice Mute** button.
- Turning Voice Mute on or off using the radio menu:

- a. ◀ or ▶ to **VMUT** and press the **Menu Select** button directly below **VMUT**.

The display shows momentary **VOICE MUTE OFF**, and you hear a short tone, indicating that the feature is disabled or the display shows momentary **VOICE MUTE ON**, and you hear a short tone, indicating that the feature is enabled.

6.30.6

Using the Time-Out Timer

When and where to use: This feature turns off the transmitter of your radio. You cannot transmit longer than the preset timer setting.

If you attempt to do so, the radio automatically stops your transmission, and you hear a talk-prohibit tone.

The timer is defaulted at 60 seconds, but it can be preprogrammed from 15 to 465 seconds, in 15-second intervals, or it can be disabled entirely for each radio mode, by a qualified radio technician.



NOTICE: You hear a brief, low-pitched, warning tone four seconds before the transmission times out.

Procedure:

- 1 Hold down the **PTT** button longer than the preprogrammed time.
You hear a continuous talk prohibit tone. The transmission is cut off and the LED goes out.
- 2 Release the **PTT** button.
The timer resets.
- 3 To re-transmit, press the **PTT** button.
The time-out timer restarts and the LED lights up solid red.

6.30.7

Conventional Squelch Operation

This feature filters out unwanted calls with low signal strength or channels that have a higher than normal background noise.

Analog Options

Tone Private Line, Digital Private-Line, and carrier squelch is available (preprogrammed) per channel.

| Option | Result |
|---|---|
| Carrier squelch | You hear all traffic on a channel. |
| Tone Private Line or Digital Private-Line | The radio responds only to your messages. |

Digital Options

One or more of the following options may be preprogrammed in your radio. Contact your system administrator for more information.

| Option | Result |
|----------------------------------|-------------------------------|
| Digital Carrier-Operated Squelch | You hear all digital traffic. |

| Option | Result |
|------------------|--|
| Normal Squelch | You hear any digital traffic having the correct network access code. |
| Selective Switch | You hear any digital traffic having the correct network access code and correct talkgroup. |

6.30.7.1

Using Conventional Squelch Operation Features

Procedure:

- 1 Press **◀** or **▶** to SQL.
- 2 Press the **Menu Select** button directly below SQL.
The display shows SQUELCH XX, where XX is the value for the current squelch.
- 3 Perform one of the following actions:
 - Press the **Menu Select** button directly below “+” to increase the squelch volume.
 - Press the **Menu Select** button directly below “-” to decrease the squelch volume.
- 4 Press **⏠** to return to the selected channel.

6.30.8

Using the PL Defeat Feature

This feature allows you to override any coded squelch that preprogrammed to a channel. The radio also unmutes to any digital activity on a digital channel. When this feature is active, the Carrier Squelch status indicator is displayed.

Procedure:

Place the preprogrammed **PL Defeat** switch in the PL Defeat position.

One of the following occurs:

- The radio plays the active transmission on the channel.
- If no activity is present, the radio is muted

6.30.9

Digital PTT ID Support

This feature allows you to see the radio ID (number) of the radio from whom you are currently receiving a transmission. The receiving radio and the dispatcher can view the ID, which consists of up to a maximum of eight characters.

The ID number of your radio is also automatically sent every time you press the **PTT** button. This feature is preprogrammed per channel. For digital voice transmissions, the ID of your radio is sent continuously during the voice message.

6.30.10

Smart PTT (Conventional Only)

Smart PTT is a per-personality, programmable feature used to keep radio users from talking over other radio conversations. When Smart PTT is enabled in your radio, you cannot transmit on an active channel.

The following table shows the variations of Smart PTT.

| Mode | Description |
|--|---|
| Transmit Inhibit on Busy Channel with Carrier | You cannot transmit if traffic is detected on the channel. |
| Transmit Inhibit on Busy Channel with Wrong Squelch Code | You cannot transmit on an active channel with a squelch code or (if secure-equipped) encryption key other than your own. If the PL code is the same as yours, the transmission is not prevented. |
| Quick-Key Override | Your radio must be preprogrammed to allow you to use Quick-Key Override. This feature works with either one of the two above variations. You can override the transmit-inhibit state by quick-keying the radio (press PTT button twice within the preprogrammed time limit). |

6.30.11

Transmit Inhibit

This feature allows you to stop all transmission including voice and data. The radio can receive messages but not able to reply the acknowledgment request of the received message.

This feature is available for APCO 25 trunking, Type II trunking and Conventional operations for all APX radios.

You can physically control the transmission of the radio especially during operation in hazardous environments. An environment is considered hazardous if radio transmission could initiate an explosion or other dangerous reactions.

6.30.11.1

Enabling Transmit Inhibition

Procedure:

Perform one of the following actions:

- ◀ or ▶ to TXIN. Press the **Menu Select** button below TXIN.
- Turn off the ignition through Ignition Sense Line.

The display shows **TX INHIBIT ON**. You hear a sequence of short, low-high tones to indicate that transmission is inhibited.

Pressing **PTT** triggers the radio sounds a constant short, low-pitched tone (reject tone).



NOTICE: The status of the Transmit Inhibit does not change after the radio powers up. The softkey **TXIN** is created to ease the user of inhibition transmission besides relying solely on Ignition Sense Line. Only if the Ignition Sense Line is on, the softkey **TXIN** works. If the Ignition Sense Line is on, user can always turn on or off the Transmit Inhibition using the softkey **TXIN**; but when the Ignition Sense Line is off, function of softkey **TXIN** is suspended, and the Transmit Inhibition function is always off.



If **PTT TX Inhibit** is enabled, when using multi-control head with one active configuration, with the **PTT** pressed on the active control head, any press on the programmable button of the other control head which meant for that control head to be active control head causes an unstoppable long low-pitched tone (Talk Prohibit Tone). The display shows **TX INHIBIT**. This behavior can be stopped by pressing **PTT** button again on the active control head.

6.30.11.2

Disabling Transmit Inhibition

Procedure:

Perform one of the following actions:

-  or  to **TXIN**. Press the **Menu Select** button below **TXIN**.
- Turn on the ignition through Ignition Sense Line.

The display shows **TX INHIBIT OFF**. You hear a sequence of short, high-low tone (Transmit Inhibit Off tone) to indicate that the transmission is back to normal operation.

6.30.12

External Alarms (Horn and Lights)

Your service administrator may configure the control heads with external alarms (horn and lights) that are activated when a Call Alert Page, Private Call, or Phone Call is received. The radio always powers up with the horn and lights feature enabled.

6.30.12.1

Using Non-Permanent Horn and Lights

Procedure:

- 1 Press the **Menu Select** button directly below **H/L** momentarily.

The last selected alarm(s) are enabled, and the display shows the enabled alarm(s) alternating with the selected mode, until it is turned off.

- 2 Press the **Menu Select** button directly below **H/L** momentarily to turn off the alarm(s).

The display shows **HORN/LITES OFF**.

6.30.12.2

Using Permanent Horn and Lights

When and where to use: If Permanent Horn and Lights is enabled, horn and lights will automatically turn on when the radio powers up.

Procedure:

- 1 Press the **Menu Select** button directly below **H/L** once to turn off the alarm(s).
- 2 Press the **Menu Select** button directly below **H/L** momentarily to enable the last selected alarm(s).

The display briefly shows the enabled alarms, and then reverts to the selected mode.

6.30.12.3

Changing the Selected Alarms

Procedure:

- 1 Press the **Menu Select** button directly below **H/L** until the display shows the required alarm.
- 2 Perform one of the following actions:
 - Press the **Menu Select** button directly below **H+L** to turn on both horn and lights.
 - Press the **Menu Select** button directly below **Lgts** to turn on the lights.
 - Press the **Menu Select** button directly below **Horn** to turn on the horn.

One of the following scenarios occurs:

- If you choose **H+L**, the display shows **HORN/LITES ON**.
- If you choose **LGTS**, the display shows **LIGHTS ON**.
- If you choose **HORN**, the display shows **HORN ON**.

An **OFF** entry is shown at the softkey when one of the alarms is active. Selecting **OFF** deactivates the current active alarm.

6.30.12.4

Receiving a Call While Alarms are Turned On

When and where to use: When you receive a call with the Alarms turned on, the vehicle horn sounds for 4 seconds, and/or the car lights turn on for 60 seconds.

The display shows the type of call received (**CALL**, **PAGE**, or **PHONE**) and the selected mode name.

The time interval can be modified by a qualified radio technician.

6.30.12.5

Turning Off Non-Rearmable External Alarms

Procedure:

- 1 Perform one of the following actions:
 - Press the **Menu Select** button directly below **CALL**, **PAGE** or **PHON** to turn off the external alarm(s) and access that feature.
 - Press the **PTT** button or any control-head button to turn off the external alarm(s).

The **Volume Knob** and the **DIM** button have no effect on the state of the external alarm(s).

- 2 Press the **Menu Select** button directly below H/L momentarily to rearm the horn and lights feature.

6.30.12.6

Turning Off Rearmable External Alarms

Procedure:

Perform one of the following actions:

- Press the **Menu Select** button directly below CALL, PAGE or PHON to turn off the external alarm(s) and access that feature. The external alarm(s) is turned off and automatically rearmed so that when you exit the entry, the external alarm(s) will automatically turn on.
- Press the **PTT** button or any control head button other than the **Menu Select** button directly below H/L to turn off the external alarm(s). The external alarm(s) is turned off and automatically rearmed so that when you exit the entry, the external alarm(s) will automatically turn on.
- Press the **Menu Select** button directly below H/L to turn off the external alarm(s) and exit the Horn and Lights feature. Press the **Menu Select** button directly below H/L momentarily to rearm the horn and lights feature.

The **Volume Knob** and the **DIM** button have no effect on the state of the external alarm(s).

6.30.13

Front Panel Programming

You are able to customize certain feature parameters in Front Panel Programming (FPP) to enhance the use of your radio.

The radio can be programmed in two ways:

- Front Panel Programming (FPP) using the front panel controls of the radio.
- Customer Programming Software (CPS), with the radio connected to a PC computer.

There are two methods to program a channel within a zone. Either:

- Select the zone and channel through the radio interface, and then initiate the FPP feature. Or,
- initiate the FPP feature, and then select the zone and channel.



NOTICE: When any of the Rx parameters such as Rx frequency, Rx PL, Rx DPL, and Rx NAC is changed, FPP automatically copies these Rx parameter values to the equivalent Direct operation (also known as Talkaround operation) parameters. If you use FPP to change the Rx frequency to be the same as the Tx frequency and subsequently use the CPS to read then write to the radio, Direct/Talkaround mode will operate differently from when a receive channel parameter value is changed through FPP (as described in the above note). Refer to the CPS help files for a description of Direct/ Talkaround Mode operation, in respect to a CPS write to the radio.

6.30.13.1

Initiating the FPP Feature

Prerequisites: Before using this feature, you should:

- Familiarize yourself with the your radio.
- Remove the universal connector seal or any other accessories if it is attached to the radio.

Procedure:

- 1 Press **◀** or **▶** to FPP.
- 2 Press the **Menu Select** button directly below FPP.
 - If you are going to program zones which are not password protected (only supported in Federal FPP), go to [step 4](#).
 - If you are going to program a set of zones, of which one or more are password protected, go to [step 3](#). The radio displays Password.
- 3 Key in the password.
The radio displays Password: *****.
- 4 Press **OK**.
The radio displays Radio Param and Zn/Ch Param.

6.30.13.2

Changing Password (Optional)

Prerequisites: Radios from the Motorola Solutions factory are provisioned with a blank password. In this case, press the **OK** softkey immediately at the Enter Old password: prompt to change the password, to access the protected channels.

Procedure:

- 1 Press **EDIT**.
The radio displays Enter Old password.
- 2 Key in the old password and press **OK** to accept the entry.
The screen displays Enter New password.
- 3 Key in the new password and press **OK** to accept the entry.
The screen displays Re-enter New password.
- 4 Key in the new password again and press **OK** to accept the entry.

6.30.13.3

Selecting a Channel within a Zone

Procedure:

- 1 Press **◀** or **▶** to FPP and press the **Menu Select** button directly below FPP.
The radio displays the Enter password screen
- 2 Enter the password and press the **Menu Select** button directly below Ok.
- 3 Press **◀** or **▶** to select Zn/Ch.
- 4 Press **◀** or **▶** to select the required zone and press **SEL** to view the channels.
- 5 Press **◀** or **▶** to select the required channel and press **SEL** to access the channel parameter.
The radio displays the channel parameter screen.
- 6 Press **◀** or **▶** to select the required channel parameter.

6.30.13.4

Changing a Channel Parameter

Procedure:

- 1 Press **◀** or **▶** to **FPP** and press the **Menu Select** button directly below **FPP**.
The radio displays the **Enter password** screen
- 2 Enter the password and press the **Menu Select** button directly below **Ok**.
- 3 **◀** or **▶** to scroll through the various information.
- 4 Press **EDIT** to edit the channel parameter.
- 5 Change the parameter value.
- 6 Press **OK** to accept the parameter change and return to view mode.
- 7 Perform one of the following actions and proceed to the next step:
 - **◀** or **▶** to select other channel parameters.
 - Press **BACK** to access a different channel and make any necessary programming changes.
- 8 Press **BACK** to return to **Zone List Selector**.
- 9 Press **BACK** to return to **FPP** main menu.
- 10 Press **🏠** to return to the Home screen.

6.30.13.5

Editing Parameters

When and where to use: Use the keypad to enter the numeric digits. Each key can generate different characters of the alphabet through multiple presses of the same key. For all parameters except **Chan Name**, **Zone Name**, **Top Chan Name** and **Top Zone Name** the **◀** or **▶** buttons increment or decrement the selected value by scrolling through the valid entries.

Procedure:

- 1 Perform the following actions based on the type of the parameter:

Table 9: Parameter Editing Keys

| Parameter | Editing Keys | Value |
|-----------|--|-------|
| Tx | Perform one of the following: | |
| Rx | <ul style="list-style-type: none"> • ◀ or ▶ to increment entry and to move cursor. • Use keypad to directly enter the desired value. | |
| Tx PL | Perform one of the following: | |
| Rx PL | <ul style="list-style-type: none"> • ◀ or ▶ to increment entry and to move cursor. | |
| Tx DPL | <ul style="list-style-type: none"> • Use keypad to directly enter the desired value. | |
| Rx DPL | <p>DEL to delete the parameter value of PL entered.</p> <p>In addition, for Tx DPL and Rx DPL, the INVT softkey switches INVERT on and off.</p> | |

| Parameter | Editing Keys | Value |
|---------------|--|----------------------------------|
| Tx NAC | ◀ or ▶ to increment or decrement entry and to move cursor within parameter value. Use keypad to enter hexadecimal numbers: <ul style="list-style-type: none"> • Plus, multiple press 2 to scroll through A, B, C, 2. • Plus, multiple press 3 to scroll through D, E, F, 3. | |
| Rx NAC | | |
| Rx Type | Perform one of the following: <ul style="list-style-type: none"> • or to toggle between valid entries. | ANALOG/ DIGITAL/ MIXED |
| Tx Type | <ul style="list-style-type: none"> • Press the keypad digits for quick access to locations in the list. | ANALOG/ DIGITAL |
| Bandwidth | | 25kHz/ 20kHz/ 12.5kHz |
| Protect | | ON/OFF |
| Tx Deviation | | 5.0 kHz/4.0 kHz/2.5 kHz |
| Power Level | | High/Low |
| Hot Keypad | | ON/OFF |
| Busy LED | | ON/OFF |
| Low Batt LED | | ON/OFF |
| MPL Enable | | Disabled/Rx /Tx/All |
| Scan List | | None/Scan List 1, 2, 3,... |
| Zone Name | Use keypad to enter numbers and alphabet characters. For more information, see Keypad on page 20 . | |
| Top Chan Name | | |
| Top Zone Name | | |
| Chan Name | | |



NOTICE:

To edit **Tx PL**, **Rx PL**, **Tx DPL**, and **Rx DPL**, the PL Setting must be set to **Disabled**.

If PL setting is set to **ALL**, **Rx** or **Tx**, there is no **Edit** selection available to change the codes for **Tx PL**, **Rx PL**, **Tx DPL**, or **Rx DPL**.

If PL setting is set to **Rx**, you can only edit **Tx PL** and **Tx DPL** codes.

If PL setting is set to **Tx**, you can only edit **Rx PL** and **Rx DPL** codes.

Chapter 7

Accessories

Not all accessories are FCC certified to operate with all radio models and/or bandsplits. Refer to the radio price pages for a list of FCC certified accessories or contact your sales representative for accessory compatibility.

Visit <http://www.motorolasolutions.com> to know more about the accessories supported by this radio.



NOTICE: GPS only antenna is used in either a single band UHF or 700/800 MHz application where the Public Safety Microphone (PSM) is used with the corresponding PSM antenna. This antenna is only for GPS reception and cannot be used for receive/transmit operation at UHF, VHF, or 700/800. Do not use this antenna on the PSM.

Legal and Compliance Statements

Disclaimer

The information in this document is carefully examined, and is believed to be entirely reliable. However, no responsibility is assumed for inaccuracies.

Furthermore, Motorola Solutions reserves the right to change any products to improve readability, function, or design. Motorola Solutions does not assume any liability arising out of the applications or use of any product or circuit described herein; nor does it cover any license under its patent rights, nor the rights of others.

Copyrights

The Motorola Solutions products described in this document may include copyrighted Motorola Solutions computer programs. Laws in the United States and other countries preserve for Motorola Solutions certain exclusive rights for copyrighted computer programs. Accordingly, any copyrighted Motorola Solutions computer programs contained in the Motorola Solutions products described in this document may not be copied or reproduced in any manner without the express written permission of Motorola Solutions.

© 2021 Motorola Solutions, Inc. All Rights Reserved

No part of this document may be reproduced, transmitted, stored in a retrieval system, or translated into any language or computer language, in any form or by any means, without the prior written permission of Motorola Solutions, Inc.

Furthermore, the purchase of Motorola Solutions products shall not be deemed to grant either directly or by implication, estoppel or otherwise, any license under the copyrights, patents or patent applications of Motorola Solutions, except for the normal non-exclusive, royalty-free license to use that arises by operation of law in the sale of a product.

Disclaimer

Please note that certain features, facilities, and capabilities described in this document may not be applicable to or licensed for use on a specific system, or may be dependent upon the characteristics of a specific mobile subscriber unit or configuration of certain parameters. Please refer to your Motorola Solutions contact for further information.

Trademarks

MOTOROLA, MOTO, MOTOROLA SOLUTIONS, and the Stylized M Logo are trademarks or registered trademarks of Motorola Trademark Holdings, LLC and are used under license. All other trademarks are the property of their respective owners.

Open Source Content

This product contains Open Source software used under license. Refer to the product installation media for full Open Source Legal Notices and Attribution content.

European Union (EU) Waste of Electrical and Electronic Equipment (WEEE) directive



■ The European Union's WEEE directive requires that products sold into EU countries must have the crossed out trash bin label on the product (or the package in some cases).

As defined by the WEEE directive, this cross-out trash bin label means that customers and end-users in EU countries should not dispose of electronic and electrical equipment or accessories in household waste.

Customers or end-users in EU countries should contact their local equipment supplier representative or service centre for information about the waste collection system in their country.

Declaration of Conformity

Per FCC CFR 47 Part 2 Section 2.1077(a)



Responsible Party

Name: Motorola Solutions, Inc.

Address: 2000 Progress Pkwy, Schaumburg, IL 60196-1078, U.S.A.

Phone Number: 1-800-927-2744

Hereby declares that **APX Mobile** conforms to FCC Part 15, subpart B, section 15.107(a), 15.107(d), and section 15.109(a)

Class B Digital Device

As a personal computer peripheral, this device complies with Part 15 of the FCC Rules. Operation is subject to the following two conditions:

- 1 This device may not cause harmful interference, and
- 2 This device must accept any interference received, including interference that may cause undesired operation.



NOTICE:

This equipment has been tested and found to comply with the limits for a Class B digital device, pursuant to part 15 of the FCC Rules. These limits are designed to provide reasonable protection against harmful interference in a residential installation. This equipment generates, uses, and can radiate radio frequency energy and, if not installed and used in accordance with the instructions, may cause harmful interference to radio communications. However, there is no guarantee that interference will not occur in a particular installation.

If this equipment does cause harmful interference to radio or television reception, which can be determined by turning the equipment off and on, the user is encouraged to try to correct the interference by one or more of the following measures:

- Reorient or relocate the receiving antenna.
- Increase the separation between the equipment and receiver.
- Connect the equipment into an outlet on a circuit different from that to which the receiver is connected.
- Consult the dealer or an experienced radio or TV technician for help.

Important Safety Information

RF Energy Exposure and Product Safety Guide for Mobile Two-Way Radios

CAUTION:

This radio is restricted to Occupational use only.

Before using the radio, read the RF Energy Exposure and Product Safety Guide for Mobile Two-Way Radios which contains important operating instructions for safe usage and RF energy awareness and control for Compliance with applicable standards and Regulations.

For a list of Motorola Solutions-approved antennas and other accessories, visit:

<http://www.motorolasolutions.com>

Any modification to this device, not expressly authorized by Motorola Solutions, may void your authority to operate this device.

Under Industry Canada regulations, this radio transmitter may only operate using an antenna of a type and maximum (or lesser) gain approved for the transmitter by Industry Canada. To reduce potential radio interference to other users, the antenna type and its gain should be so chosen that the equivalent isotropically radiated power (e.i.r.p.) is not more than that necessary for successful communication.

This radio transmitter is approved by Industry Canada to operate with a Motorola Solutions-approved antenna with the maximum permissible gain and required antenna impedance for each antenna type indicated. Antenna types not included in this list, having a gain greater than the maximum gain indicated for that type, are strictly prohibited for use with this device.



NOTICE: Setting up the radio as an RF Modem takes complete control of the radio. In this mode, the radio no longer responds to button and **PTT** presses nor will it unmute to voice activity. This mode is designed to receive and pass formatted over-the-air data to a tethered computer with RF modem enabled applications. This mode can only be exit by reprogramming the radio with Customer Programming Software (CPS) to not operate in RF modem mode and cycling power.

Notice to Users (FCC)

This device complies with Part 15 of the FCC rules per the following conditions:

- This device may not cause harmful interference.
- The device must accept any interference received, including interference that may cause undesired operation.
- Changes or modifications made to this device, not expressly approved by Motorola Solutions, could void the authority of the user to operate this equipment.

FCC Licensing Information

This device complies with Parts 90 and 15 of the Federal Communications Commission (FCC) Rules.

Operation is subject to the condition that this device does not cause harmful interference. The radio operates on radio frequencies that are regulated by the Federal Communications Commission (FCC). To transmit on these frequencies, you are required to have a license issued by the FCC. Application is made available on FCC Form 601 and Schedules D, H, and Remittance Form 159.

To obtain these FCC forms, request document 000601 which includes all forms and instructions. If you wish to have the document faxed, mailed or have questions, use the following contact information.

Fax

Contact the Fax-On-Demand system at 1-202-418-0177

Mail

Call the FCC forms hotline at 1-800-418-FORM or 1-800-418-3676

Contact

For questions regarding FCC license, contact 1-888-CALL-FCC, 1-888-225-5322, or <http://www.fcc.gov>.

Before filling out your application, you must decide which frequency you can operate on. For questions on determining the radio frequency, call Motorola Solutions Product Services at: 1-800-448- 6686. Changes or modifications not expressly approved by Motorola Solutions may void the user authority granted by the FCC to operate this radio and should not be made. To comply with FCC requirements, transmitter adjustments should be made only by or under the supervision of a person certified as technically qualified to perform transmitter maintenance and repairs in the private land mobile and fixed services as certified by an organization representative of the user of those services.

Replacement of any transmitter component such as crystal, semiconductor, and others not authorized by the FCC equipment authorization for this radio could violate FCC rules.



NOTICE: Use of this radio outside the country where it was intended to be distributed is subject to government regulations and may be prohibited.

Applying for Canadian License

The operation of your Motorola Solutions radio is subject to the Radio communications Act and must comply with rules and regulations of the Federal Government's department of Industry Canada. Industry Canada requires that all operators using Private Land Mobile frequencies obtain a radio license before operating their equipment.

Prerequisites: Obtain the latest Canadian License Application form at http://www.ic.gc.ca/ic_wp-pa.htm.

Procedure:

- 1 Fill in the items as per the instructions. Be sure to print legibly.
If you need additional space for any item, use the reverse side of the application.
- 2 Make a copy of your files.
- 3 Prepare a cheque or money order payable to the "Receiver General for Canada", for an amount for each radio purchased.
The license is renewed on April 1st each year, and issued for a period of 12 months.
- 4 Mail your completed application along with your cheque or money order to the closest Industry Canada District office.

Maritime Radio Use in the VHF Frequency Range

Special Channel Assignments

Emergency Channel

If you are in imminent and grave danger at sea and require emergency assistance, use VHF Channel 16 to send a distress call to nearby vessels and the United States Coast Guard. Transmit the following information, in this order:

- 1 "MAYDAY, MAYDAY, MAYDAY."
- 2 "THIS IS _____, CALL SIGN _____." State the name of the vessel in distress 3 times, followed by the call sign or other identification of the vessel, stated 3 times.
- 3 Repeat "MAYDAY" and the name of the vessel.
- 4 "WE ARE LOCATED AT _____." State the position of the vessel in distress, using any information that will help responders to locate you, e.g.:
 - latitude and longitude
 - bearing (state whether you are using true or magnetic north)
 - distance to a well-known landmark
 - vessel course, speed or destination
- 5 State the nature of the distress.
- 6 Specify what kind of assistance you need.
- 7 State the number of persons on board and the number needing medical attention, if any.
- 8 Mention any other information that would be helpful to responders, such as type of vessel, vessel length and/or tonnage, hull color, etc.
- 9 "OVER."
- 10 Wait for a response.
- 11 If you do not receive an immediate response, remain by the radio and repeat the transmission at intervals until you receive a response. Be prepared to follow any instructions given to you.

Non-Commercial Call Channel

For non-commercial transmissions, such as fishing reports, rendezvous arrangements, repair scheduling, or berthing information, use **VHF Channel 9**.

Operating Frequency Requirements

A radio designated for shipboard use must comply with Federal Communications Commission Rule Part 80 as follows:

- on ships subject to Part II of Title III of the Communications Act, the radio must be capable of operating on the 156.800 MHz frequency.
- on ships subject to the Safety Convention, the radio must be capable of operating:
 - in the simplex mode on the ship station transmitting frequencies specified in the 156.025–157.425 MHz frequency band, and

- in the semiduplex mode on the two frequency channels specified in the table below.



NOTICE:

Simplex channels 3, 21, 23, 61, 64, 81, 82, and 83 cannot be lawfully used by the general public in US waters.

Additional information about operating requirements in the Maritime Services can be obtained from the full text of FCC Rule Part 80 and from the US Coast Guard.

Table 10: VHF Marine Channel List

| Channel Number | Frequency (MHz) | |
|----------------|-----------------|---------|
| | Transmit | Receive |
| 1 | 156.050 | 160.650 |
| 2 | 156.100 | 160.700 |
| * | 156.150 | 160.750 |
| 4 | 156.200 | 160.800 |
| 5 | 156.250 | 160.850 |
| 6 | 156.300 | — |
| 7 | 156.350 | 160.950 |
| 8 | 156.400 | — |
| 9 | 156.450 | 156.450 |
| 10 | 156.500 | 156.500 |
| 11 | 156.550 | 156.550 |
| 12 | 156.600 | 156.600 |
| 13** | 156.650 | 156.650 |
| 14 | 156.700 | 156.700 |
| 15** | 156.750 | 156.750 |
| 16 | 156.800 | 156.800 |
| 17** | 156.850 | 156.850 |
| 18 | 156.900 | 161.500 |
| 19 | 156.950 | 161.550 |
| 20 | 157.000 | 161.600 |
| * | 157.050 | 161.650 |
| 22 | 157.100 | 161.700 |
| * | 157.150 | 161.750 |
| 24 | 157.200 | 161.800 |
| 25 | 157.250 | 161.850 |
| 26 | 157.300 | 161.900 |
| 27 | 157.350 | 161.950 |
| 28 | 157.400 | 162.000 |
| 60 | 156.025 | 160.625 |

6875947M01-HP
 Maritime Radio Use in the VHF Frequency Range

| | | |
|------|---------|---------|
| * | 156.075 | 160.675 |
| 62 | 156.125 | 160.725 |
| 63 | 156.175 | 160.775 |
| * | 156.225 | 160.825 |
| 65 | 156.275 | 160.875 |
| 66 | 156.325 | 160.925 |
| 67** | 156.375 | 156.375 |
| 68 | 156.425 | 156.425 |
| 69 | 156.475 | 156.475 |
| 71 | 156.575 | 156.575 |
| 72 | 156.625 | – |
| 73 | 156.675 | 156.675 |
| 74 | 156.725 | 156.725 |
| 75 | *** | *** |
| 76 | *** | *** |
| 77** | 156.875 | – |
| 78 | 156.925 | 161.525 |
| 79 | 156.975 | 161.575 |
| 80 | 157.025 | 161.625 |
| * | 157.075 | 161.675 |
| * | 157.125 | 161.725 |
| * | 157.175 | 161.775 |
| 84 | 157.225 | 161.825 |
| 85 | 157.275 | 161.875 |
| 86 | 157.325 | 161.925 |
| 87 | 157.375 | 161.975 |
| 88 | 157.425 | 162.025 |



NOTICE:

* Simplex channels 3, 21, 23, 61, 64, 81, 82, and 83 cannot be **lawfully used** by the general public in US waters.

** Low power (1 W) only.

*** Guard band.



NOTICE: A – in the Receive column indicates that the channel is transmit only.

Declaration of Compliance for the Use of Distress and Safety Frequencies

The radio equipment does not employ a modulation other than the internationally adopted modulation for maritime use when it operates on the distress and safety frequencies specified in RSS-182 Section 7.3.

Technical Parameters for Interfacing External Data Sources

| | RS232 | USB | SB9600 |
|---|---------------|-------------|---------------|
| Input Voltage (Volts Peak-to-peak) | 18 V | 3.6 V | 5 V |
| Max Data Rate | 115 Kbps | 12 Mbps | 9.6 Kbps |
| Impedance | 5000 Ω | 90 Ω | 120 Ω |

Limited Warranty

MOTOROLA SOLUTIONS COMMUNICATION PRODUCTS

I. WHAT THIS WARRANTY COVERS AND FOR HOW LONG:

MOTOROLA SOLUTIONS, INC. ("MOTOROLA") warrants the MOTOROLA SOLUTIONS manufactured Communication Products listed below ("Product") against defects in material and workmanship under normal use and service for a period of time from the date of purchase as scheduled below:

| | |
|-------------------------|--------------|
| ASTRO APX Mobile Radios | One (1) Year |
| Product Accessories | One (1) Year |

MOTOROLA SOLUTIONS, at its option, will at no charge either repair the Product (with new or reconditioned parts), replace it (with a new or reconditioned Product), or refund the purchase price of the Product during the warranty period provided it is returned in accordance with the terms of this warranty. Replaced parts or boards are warranted for the balance of the original applicable warranty period. All replaced parts of Product shall become the property of MOTOROLA SOLUTIONS.

This express limited warranty is extended by MOTOROLA SOLUTIONS to the original end user purchaser only and is not assignable or transferable to any other party. This is the complete warranty for the Product manufactured by MOTOROLA SOLUTIONS. MOTOROLA SOLUTIONS assumes no obligations or liability for additions or modifications to this warranty unless made in writing and signed by an officer of MOTOROLA SOLUTIONS.

Unless made in a separate agreement between MOTOROLA SOLUTIONS and the original end user purchaser, MOTOROLA SOLUTIONS does not warrant the installation, maintenance or service of the Product.

MOTOROLA SOLUTIONS cannot be responsible in any way for any ancillary equipment not furnished by MOTOROLA SOLUTIONS which is attached to or used in connection with the Product, or for operation of the Product with any ancillary equipment, and all such equipment is expressly excluded from this warranty. Because each system which may use the Product is unique, MOTOROLA SOLUTIONS disclaims liability for range, coverage, or operation of the system as a whole under this warranty.

MOTOROLA SOLUTIONS offers the following optional extended service contracts.

DEVICE MANAGED SERVICES (DMS) ACCIDENTAL DAMAGE

Provides for extended hardware repair coverage INCLUDING CHEMICAL, LIQUID, FIRE, AND OTHER PHYSICAL DAMAGE. Accidental damage coverage is available in conjunction with MOTOROLA SOLUTIONS'S standard Commercial Warranty and starts from the FIRST DAY the radio is put into use. Service performed under this plan consists of repair or replacement of the covered equipment as set forth in the terms and conditions. Repairs will be made only at the designated MOTOROLA SOLUTIONS repair depot. Local services are not included. MOTOROLA SOLUTIONS will pay the inbound shipping charges only with use of the MOTOROLA SOLUTIONS designated delivery service. MOTOROLA SOLUTIONS will pay for outbound shipping via MOTOROLA SOLUTIONS'S normal shipping methods.

DEVICE MANAGED SERVICES (DMS) STANDARD HARDWARE

Provides extended hardware normal wear and tear repair coverage beginning AFTER MOTOROLA SOLUTIONS'S standard Commercial Warranty period expires. Service performed under this plan consists of repair of the covered equipment as set forth in the terms and conditions. Repairs will be

made only at the designated MOTOROLA SOLUTIONS repair depot. Local services are not included. MOTOROLA SOLUTIONS will pay for outbound shipping via MOTOROLA SOLUTIONS'S normal shipping methods.

II. GENERAL PROVISIONS:

This warranty sets forth the full extent of MOTOROLA SOLUTIONS'S responsibilities regarding the Product. Repair, replacement or refund of the purchase price, at MOTOROLA SOLUTIONS's option, is the exclusive remedy. THIS WARRANTY IS GIVEN IN LIEU OF ALL OTHER EXPRESS WARRANTIES. IMPLIED WARRANTIES, INCLUDING WITHOUT LIMITATION, IMPLIED WARRANTIES OF MERCHANTABILITY AND FITNESS FOR A PARTICULAR PURPOSE, ARE LIMITED TO THE DURATION OF THIS LIMITED WARRANTY. IN NO EVENT SHALL MOTOROLA SOLUTIONS BE LIABLE FOR DAMAGES IN EXCESS OF THE PURCHASE PRICE OF THE PRODUCT, FOR ANY LOSS OF USE, LOSS OF TIME, INCONVENIENCE, COMMERCIAL LOSS, LOST PROFITS OR SAVINGS OR OTHER INCIDENTAL, SPECIAL OR CONSEQUENTIAL DAMAGES ARISING OUT OF THE USE OR INABILITY TO USE SUCH PRODUCT, TO THE FULL EXTENT SUCH MAY BE DISCLAIMED BY LAW.

III. STATE LAW RIGHTS:

SOME STATES DO NOT ALLOW THE EXCLUSION OR LIMITATION OF INCIDENTAL OR CONSEQUENTIAL DAMAGES OR LIMITATION ON HOW LONG AN IMPLIED WARRANTY LASTS, SO THE ABOVE LIMITATION OR EXCLUSIONS MAY NOT APPLY.

This warranty gives specific legal rights, and there may be other rights which may vary from state to state.

IV. HOW TO GET WARRANTY SERVICE:

You must provide proof of purchase (bearing the date of purchase and Product item serial number) in order to receive warranty service and, also, deliver or send the Product item, transportation and insurance prepaid, to an authorized warranty service location. Warranty service will be provided by MOTOROLA SOLUTIONS through one of its authorized warranty service locations. If you first contact the company which sold you the Product (e.g., dealer or communication service provider), it can facilitate your obtaining warranty service. You can also call MOTOROLA SOLUTIONS at 1-800-927-2744 US/Canada.

V. WHAT THIS WARRANTY DOES NOT COVER:

- 1 Defects or damage resulting from use of the Product in other than its normal and customary manner.
- 2 Defects or damage from misuse, accident, water, or neglect.
- 3 Defects or damage from improper testing, operation, maintenance, installation, alteration, modification, or adjustment.
- 4 Breakage or damage to antennas unless caused directly by defects in material workmanship.
- 5 A Product subjected to unauthorized Product modifications, disassembles or repairs (including, without limitation, the addition to the Product of non-MOTOROLA SOLUTIONS supplied equipment) which adversely affect performance of the Product or interfere with MOTOROLA SOLUTIONS's normal warranty inspection and testing of the Product to verify any warranty claim.
- 6 Product which has had the serial number removed or made illegible.
- 7 Rechargeable batteries if:
 - any of the seals on the battery enclosure of cells are broken or show evidence of tampering.

- the damage or defect is caused by charging or using the battery in equipment or service other than the Product for which it is specified.
- 8 Freight costs to the repair depot.
 - 9 A Product which, due to illegal or unauthorized alteration of the software/firmware in the Product, does not function in accordance with MOTOROLA SOLUTIONS's published specifications or the FCC certification labeling in effect for the Product at the time the Product was initially distributed from MOTOROLA SOLUTIONS.
 - 10 Scratches or other cosmetic damage to Product surfaces that does not affect the operation of the Product.
 - 11 Normal and customary wear and tear.

VI. PATENT AND SOFTWARE PROVISIONS:

MOTOROLA SOLUTIONS will defend, at its own expense, any suit brought against the end user purchaser to the extent that it is based on a claim that the Product or parts infringe a United States patent, and MOTOROLA SOLUTIONS will pay those costs and damages finally awarded against the end user purchaser in any such suit which are attributable to any such claim, but such defense and payments are conditioned on the following:

- 1 that MOTOROLA SOLUTIONS will be notified promptly in writing by such purchaser of any notice of such claim,
- 2 that MOTOROLA SOLUTIONS will have sole control of the defense of such suit and all negotiations for its settlement or compromise, and
- 3 should the Product or parts become, or in MOTOROLA SOLUTIONS's opinion be likely to become, the subject of a claim of infringement of a United States patent, that such purchaser will permit MOTOROLA SOLUTIONS, at its option and expense, either to procure for such purchaser the right to continue using the Product or parts or to replace or modify the same so that it becomes non-infringing or to grant such purchaser a credit for the Product or parts as depreciated and accept its return. The depreciation will be an equal amount per year over the lifetime of the Product or parts as established by MOTOROLA SOLUTIONS.

MOTOROLA SOLUTIONS will have no liability with respect to any claim of patent infringement which is based upon the combination of the Product or parts furnished hereunder with software, apparatus or devices not furnished by MOTOROLA SOLUTIONS, nor will MOTOROLA SOLUTIONS have any liability for the use of ancillary equipment or software not furnished by MOTOROLA SOLUTIONS which is attached to or used in connection with the Product. The foregoing states the entire liability of MOTOROLA SOLUTIONS with respect to infringement of patents by the Product or any parts thereof.

Laws in the United States and other countries preserve for MOTOROLA SOLUTIONS certain exclusive rights for copyrighted MOTOROLA SOLUTIONS software such as the exclusive rights to reproduce in copies and distribute copies of such MOTOROLA SOLUTIONS software. MOTOROLA SOLUTIONS software may be used in only the Product in which the software was originally embodied and such software in such Product may not be replaced, copied, distributed, modified in any way, or used to produce any derivative thereof. No other use including, without limitation, alteration, modification, reproduction, distribution, or reverse engineering of such MOTOROLA SOLUTIONS software or exercise of rights in such MOTOROLA SOLUTIONS software is permitted. No license is granted by implication, estoppel or otherwise under MOTOROLA SOLUTIONS patent rights or copyrights.

VII. GOVERNING LAW:

This Warranty is governed by the laws of the State of Illinois, U.S.A.

VIII. For Australia Only

This provision applies to products and services supplied by Motorola Solutions to consumers within the meaning of the Australian Consumer Law. This warranty is given by Motorola Solutions Australia Pty Limited (ABN16 004 742 312) of Tally Ho Business Park, 10 Wesley Court, Burwood East, Victoria. Our goods come with guarantees that cannot be excluded under the Australia Consumer Law. For major failures with the service, you are entitled:

- To cancel your service contract with us: and
- To a refund for the unused portion, or to compensation for its reduced value.

You are entitled to choose a replacement or refund for a major failure with goods. If a failure with the goods or service does not amount to a major failure, you are entitled to have the failure rectified in a reasonable time. If this is not done you are entitled to a refund for the goods and to cancel the contract for the service and obtain a refund of any unused portion. You are also entitled to be compensated for any other reasonably foreseeable loss or damage from a failure in the goods or service. If you have any queries, please call Motorola Solutions Australia at 1800 457 439. You may also visit our website: https://www.motorolasolutions.com/en_xa/support.html for current warranty terms.

SERVICE

Proper repair and maintenance procedures will assure efficient operation and long life for this product. A Motorola Solutions maintenance agreement will provide expert service to keep this and all other communication equipment in perfect operating condition. A nationwide service organization is provided by Motorola Solutions to support maintenance services. Through its maintenance and installation program, Motorola Solutions makes available the finest service to those desiring reliable, continuous communications on a contract basis. For a contract service agreement, please contact your nearest Motorola Solutions service or sales representative, or an authorized Motorola Solutions dealer.

Express Service Plus (ESP) is an optional extended service coverage plan, which provides for the repair of this product for a period of three years from the date of shipment from the factory, or the date of delivery if purchased from an authorized Motorola Solutions two-way radio dealer. For more information about ESP, contact the Motorola Solutions Radio Support Center, 2204 Galvin Drive, Elgin, IL 60123, 1-800-227-6772.

Glossary

This glossary contains an alphabetical listing of terms and their definitions that are applicable to portable and mobile subscriber radio products.

ACK

Acknowledgment of communication.

Active Channel

A channel that has traffic on it.

Analog Signal

An RF signal that has a continuous nature rather than a pulsed or discrete nature.

ARS

Automatic Registration Service

ASTRO 25

Motorola Solutions standard for wireless digital trunked communications.

ASTRO conventional

Motorola Solutions standard for wireless analog or digital conventional communications.

Autoscan

A feature that allows the radio to automatically scan the members of a scan list.

AUX CH

Auxiliary Control Head.

Call Alert

Privately paging an individual by sending an audible tone.

Carrier Squelch

Feature that responds to the presence of an RF carrier by opening or unmuting (turning on) a receiver audio circuit. A squelch circuit silences the radio when no signal is being received so that the user does not have to listen to “noise.”

Central Controller

A software-controlled, computer-driven device that receives and generates data for the trunked radios assigned to it. It Monitors and directs the operations of the trunked repeaters.

Channel

A group of characteristics, such as transmit/receive frequency pairs, radio parameters, and encryption encoding.

CHIB

Control Head Interface Board.

Control Channel

In a trunking system, one of the channels that is used to provide a continuous, two-way/data-communications path between the central controller and all radios on the system.

Conventional

Typically refers to radio-to-radio communications, sometimes through a repeater. Frequencies are shared with other users without the aid of a central controller to assign communications channels.

Conventional Scan List

A scan list that includes only conventional channels.

Cursor

A visual tracking marker (a blinking line) that indicates a location on a display.

Deadlock

Displayed by the radio after three failed attempts to unlock the radio. The radio must be powered off and on prior to another attempt.

Digital Private Line (DPL)

A type of digital communications that utilizes privacy call, as well as memory channel and busy channel lock out to enhance communication efficiency.

Digital Signal

An RF signal that has a pulsed, or discrete, nature, rather than a continuous nature.

Dispatcher

An individual who has radio-system management duties and responsibilities.

Digital Signal Processor

A microcontroller specifically designed for performing the mathematics involved in manipulating analog information, such as sound, that has been converted into a digital form. DSP also implies the use of a data compression technique.

Dynamic Regrouping

A feature that allows the dispatcher to temporarily reassign selected radios to a single special channel so they can communicate with each other.

DVRS

Digital Vehicular Repeater System.

ESN

Electrical Serial Number.

Failsoft

A backup system that allows communication in a non-trunked, conventional mode if the trunked system fails.

FCC

Federal Communications Commission.

Hang up

Disconnect.

Key Variable Loader (KVL) A portable, handheld, rugged device used to transfer encryption keys to a target device. Encryption keys can be entered manually by the KVL user, auto-generated by the KVL, obtained from or shared with another KVL, or downloaded from a Key Management Facility (KMF).

Liquid-Crystal Display (LCD)

An LCD uses two sheets of polarizing material with a liquid-crystal solution between them. An electric current passed through the liquid causes the crystals to align so that light cannot pass through them.

Light Emitting Diode (LED)

An electronic device that lights up when current is passed through it.

MCHB

Millennium Control Head Board.

MDC

Motorola Solutions Digital Communications.

Menu Entry

A software-activated feature shown at the bottom of the display. Selection of a feature is controlled by the programming of the buttons on the side of the radio.

Monitor

Check channel activity by pressing the Monitor button. If the channel is clear, you hear static. If the channel is in use, you hear conversation. It also serves as a way to check the volume level of the radio, since the radio "opens the squelch" when the monitor button is pressed.

Multi-System Talkgroup Scan List

A scan list that can include both talkgroups (trunked) and channels (conventional).

Network Access Code

Network Access Code (NAC) operates on digital channels to reduce voice channel interference between adjacent systems and sites.

Non-tactical/revert

The user will talk on a preprogrammed emergency channel. The emergency alarm is sent out on this same channel.

Over-The-Air Rekeying

Allows the dispatcher to remotely reprogram the encryption keys in the radio.

Page

A one-way alert with audio and/or display messages.

Personality

A set of unique features specific to a radio.

PIN

Personal Identification Number.

Preprogrammed

A software feature that has been activated by a qualified radio technician.

Private (Conversation) Call

A feature that lets you have a private conversation with another radio user in the group.

Private Line (PL)

A sub-audible tone that is transmitted such that only receivers decoding the tone receives it.

Programmable

A radio control that can have a radio feature assigned to it.

Push-to-Talk

PTT-The switch or button usually located on the left side of the radio which, when pressed, causes the radio to transmit. When the PTT is released, the unit returns to receive operation.

Radio Frequency

RF-The portion of the electromagnetic spectrum between audio sound and infrared light (approximately 10 kHz to 10 GHz).

Repeater

Remote transmit/receive facility that re-transmits received signals in order to improve communications range and coverage (conventional operation).

Selective Call

A feature that allows you to call a selected individual, intended to provide privacy and to eliminate the annoyance of having to listen to conversations of no interest to you.

selective switch

Any digital P25 traffic having the correct Network Access Code and the correct talkgroup.

Squelch

Muting of audio circuits when received signal levels fall below a pre-determined value. With carrier squelch, all channel activity that exceeds the preset squelch level can be heard.

Synchronous Serial Interface (SSI)

DSP interface to peripherals that consists of a clock signal line, a frame synchronization signal line, and a data line.

Standby

An operating condition whereby the radio's speaker is muted but still continues to receive data.

Status Calls

Pre-defined text messages that allow the user to send a conditional message without talking.

Tactical/non-revert

The user will talk on the channel that was selected before the radio entered the emergency state.

TalkAround

Bypassing a repeater and talking directly to another unit for local unit-to-unit communications.

Talkgroup

An organization or group of radio users who communicate with each other using the same communications path.

TMS

Text Messaging Service.

Trunking

The automatic sharing of communications paths between a large number of users. Allows users to share a smaller number of frequencies because a repeater or communications path is assigned to a talkgroup for the duration of a conversation.

Trunking Priority Monitor scan list

A scan list that includes talkgroups that are all from the same trunking system.

USK

Unique shadow key.

UTC

Coordinated Universal Time. The international time standard (formerly Greenwich Mean Time, or GMT). Zero hours UTC is midnight in Greenwich, England, which is located at 0 degrees longitude. Everything east of Greenwich (up to 180 degrees) is later in time; everything west is earlier. There are 42 time authorities around the world that are constantly synchronizing with each other. Abbreviated as UTC (English backronym = Universal Time, Coordinated), it is also known as Zulu (Z) Time.

VRS

Vehicular Repeater System.

Zone

A grouping of channels.