

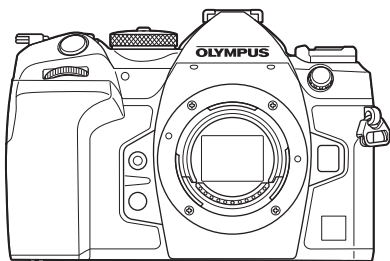

DIGITAL CAMERA

# OM SYSTEM OM-1

## Instruction Manual



### Table of Contents

1. Preparation
2. Shooting
3. Using the Menu
4. Shooting Settings
5. Playback
6. Customizing the Camera
7. Setting Up the Camera  
Connecting the Camera to  
External Devices
8. External Devices
9. Cautions
10. Information
11. SAFETY PRECAUTIONS

Model No. : IM027

- Thank you for purchasing our digital camera. Before you start to use your new camera, please read these instructions carefully to enjoy optimum performance and a longer service life.
- Be sure you have read and understood the contents of "11. SAFETY PRECAUTIONS", before using this product. Keep these instructions available for future reference.
- We recommend that you take test shots to get accustomed to your camera before taking important photographs.
- The screen and camera illustrations shown in this manual were produced during the development stages and may differ from the actual product.
- If there are additions and/or modifications of functions due to firmware update for the camera, the contents will differ. For the latest information, please visit our website.

# Before You Begin

## **Read and Follow Safety Precautions**

To prevent incorrect operation resulting in fire or other damage to property or harm to yourself or to others, read “11. SAFETY PRECAUTIONS” (P. 332) in its entirety before using the camera.

While using the camera, consult this manual to ensure safe and correct operation. Be sure to keep the manual in a safe place once it is read.

Our company will not be held liable for violations of local regulations arising from use of this product outside the country or region of purchase.

## **Wireless LAN and Bluetooth®**

The camera features built-in wireless LAN and **Bluetooth®**. Use of these features outside the country or region of purchase may violate local wireless regulations; be sure to check with local authorities before use. Our company will not be held liable for the user's failure to comply with local regulations.

Disable wireless LAN and **Bluetooth®** in areas where their use is prohibited.

 “Disabling the camera's wireless communication (Airplane Mode)” (P. 260)

## ■ User Registration

Visit our website for information on registering your products.

## ■ Installing PC Software/Apps

### **OM Workspace**

This computer application is used to download and view photos and movies recorded with the camera. It can also be used to update the camera firmware. The software can be downloaded from our website. Be prepared to provide the camera serial number when downloading the software.

### **OM Image Share**

You can load images in the camera that have been marked for sharing (P. 195) to a smartphone.

You can also operate the camera remotely and take pictures from a smartphone.

Visit our website for information about the application.

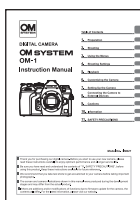

## Instruction Manual (this pdf)

A how-to guide to the camera and its features. The Instruction Manual can be downloaded from our website or directly using the “OM Image Share” smartphone app.

# About This Manual

## How to find what you want to know

You can use the following methods to find what you want to know in this manual.

Search method	Where to look	
Search based on what you want to do	▶ Table of Contents	P. 6
Search based on names of buttons and parts of the camera	▶ Names of parts	P. 15
Search based on menus and terms displayed on the monitor	▶ Default Settings	P. 311
Search based on words	▶ Index	P. 337

## How to read this manual

### ■ Shooting modes in which the function is available

In each explanation of a shooting function, the shooting modes in which the function can be used are shown at the beginning. The shooting modes in which the function can be used are shown in black. The shooting modes in which the function cannot be used are shown in gray.

**Taking Pictures Using the Shooting Modes**

**Letting the camera choose aperture and shutter speed**

The camera chooses the optimal aperture and shutter speed according to subject brightness.

1 Rotate the mode dial to P.



2 **Shooting**







Availability of the function in each shooting mode

### ■ How to set the function





The procedures for setting each function is described at the beginning of the explanation of the function. For details, see “How to operate the menus” (P. 63) and “How to change the shooting settings (Direct buttons/Super Control Panel)” (P. 66).

**Choosing how the camera measures brightness (Metering)**

PASMB

Button	AF  button  
Super Control Panel	 Metering
Menu	MENU   5. Metering  Metering

	<p><b>Digital ESP metering</b></p> <p>Suited to most scenes, including back-ill subjects. The camera meters 324 areas of the frame and calculates optimal exposure taking into consideration the nature of the scene.</p>
	<p><b>Center weighted averaging metering</b></p> <p>Suited to compositions that place the main subject at the center of the frame. The camera sets exposure based on the average light level for the entire frame while assigning the greatest weight to the area in the center.</p>
<input type="checkbox"/>	<p><b>Spot metering</b></p> <p>Use a specific area of the subject meter exposure. The camera meters a small portion (approximately 2%) of the frame.</p>
	<p><b>Spot metering (highlight)</b></p> <p>Increases spot metering exposure. Ensures bright subjects appear bright.</p>
	<p><b>Spot metering (shadow)</b></p> <p>Lowens spot metering exposure. Ensures dark subjects appear dark.</p>









① The spot metering position can be set at the selected AF target. ② "Metering the Focus"

4 **Shooting Settings**

How to set the function

## ■ Symbols in this manual

The following symbols are used throughout this manual.

	Symbols designating the buttons (respectively the up, down, left, and right arrow buttons) to press on the arrow pad.
	Represents operation of the front dial.
	Represents operation of the rear dial.
	Represents placing a finger lightly on the multi selector and pivoting it in the desired direction.
	Represents pressing down on the center of the multi selector much as you would a button.
	Cautions and limitations.
	Tips and other helpful information for using the camera.
	References to other pages in this manual.

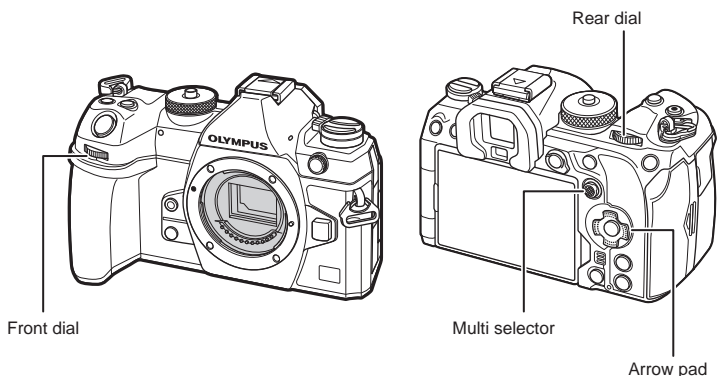

## ■ About the screen illustrations in this manual

The camera monitor displays the super control panel (P. 69) by default. The screen illustrations in this manual, however, show the live view display.

See “Switching between displays” (P. 37) for how to display the shooting screen on the monitor.

# Table of Contents

<b>Before You Begin</b>	<b>2</b>	<b>Initial setup</b> .....	<b>31</b>
<b>Product Manuals</b>	<b>3</b>	<b>What to Do If You Can't Read the Display</b> .....	<b>33</b>
<b>About This Manual</b>	<b>4</b>		
How to find what you want to know .....	4		
How to read this manual.....	4		
<b>Names of parts</b>	<b>15</b>		
<b>1. Preparation</b>	<b>17</b>	<b>2. Shooting</b>	<b>34</b>
<b>Unpacking the box contents</b> .....	<b>17</b>	<b>Information displays while shooting</b> .....	<b>34</b>
<b>Attaching the Strap</b> .....	<b>18</b>	<b>Switching between displays</b> .....	<b>37</b>
<b>Attaching Cable Protectors</b> .....	<b>19</b>	Switching the information display .....	38
<b>Inserting and removing the battery</b> .....	<b>20</b>	<b>Shooting still pictures</b> .....	<b>39</b>
Inserting the battery.....	20	Types of shooting modes .....	39
Removing the battery .....	21	Shooting with touch screen operations.....	41
<b>Charging the Battery using the supplied USB-AC adapter</b> .....	<b>22</b>	Photo Review (Image Review).....	42
<b>Charging the Battery using a USB Device</b> .....	<b>23</b>	<b>Taking Pictures Using the Shooting Modes</b> .....	<b>43</b>
<b>Inserting and removing the card</b> .....	<b>24</b>	Letting the camera choose aperture and shutter speed ( <b>P</b> : Program AE).....	43
Inserting the card.....	24	Choosing aperture ( <b>A</b> : Aperture-Priority AE).....	45
Removing the card .....	25	Choosing shutter speed ( <b>S</b> : Shutter-Priority AE) .....	47
Using Two Memory Cards .....	25	Choosing aperture and shutter speed ( <b>M</b> : Manual Exposure).....	49
Usable cards .....	25	Long Exposures ( <b>B</b> : Bulb/Time).....	51
<b>Attaching and removing lenses</b> .....	<b>26</b>	Lighten Blending ( <b>B</b> : Live Composite Photography).....	54
Attaching a lens to the camera.....	26	<b>Saving Custom Settings to the Mode Dial (C1/C2/C3/C4 Custom Modes)</b> .....	<b>56</b>
Removing Lenses.....	28	Saving Settings (Assign to Custom Mode).....	56
<b>Using the monitor</b> .....	<b>29</b>	Using Custom Modes (C1/C2/C3/C4) .....	57
<b>Turning the camera on</b> .....	<b>30</b>	<b>Recording Movies</b> .....	<b>59</b>
Sleep Mode .....	30	Recording movies in movie mode (  ) .....	59

Recording movies in photo shooting modes .....	61
Touch Controls (Silent Controls)...	62

### 3. Using the Menus 63

- What you can do with menus.....63
- How to operate the menus .....

### 4. Shooting Settings 66

- How to change the shooting settings (Direct buttons/Super Control Panel).....66
  - Direct Buttons.....66
  - The Super Control Panel/LV Super Control Panel.....69
- Basic functions for focusing.....72
  - Choosing a focus mode (AF Mode / AF Mode).....72
  - Choosing a Focus Target (AF Target Point).....76
  - Choosing an AF Target Mode (AF Target Mode).....77
  - Setting the options for AF target modes (AF Target Mode Settings).....79
  - Zoom frame AF/Zoom AF (Super Spot AF).....80
- Functions for configuring how to focus .....
- Combined Auto and Manual Focus (AF+MF).....82
- Configuring the AF operation when the shutter button is pressed (AF by half-pressing).....83
- Autofocus using the AF-ON button .....
- Using Autofocus in Manual Focus Mode (AF-ON in MF mode).....84
- Configuring camera operation when it cannot focus on the subject (Release Priority).....84

Changing the settings of Starry Sky AF (Starry Sky AF Setting) ....	85
---	----

### ■ Functions for customizing AF operation to fit the subject .....86

C-AF Center Target Priority (C-AF Center Priority) .....	86
C-AF Tracking Sensitivity (C-AF Sensitivity / C-AF Sensitivity) .....	87
C-AF Focus Speed (C-AF Speed).....	87
Face priority AF/Eye priority AF (Face & Eye Detection) .....	88
Tracking Focus on Selected Subjects (Subject Detection) .....	90
Configuring the frame displays for detected eyes (Eye Detection Frame) .....	91

### ■ Functions for changing camera operation regarding focus.....92

Lens Focus Range (AF Limiter) .....	92
C-AF Lens Scanning (AF Scanner).....	94
Fine-Tuning Autofocus (AF Focus Adjustment) .....	95
AF Illuminator Autofocus Assist (AF Illuminator).....	96
AF Target Display Mode (AF Area Pointer).....	96







### ■ Functions for setting the focusing position .....



























Matching AF Target Selection to Camera Orientation (Orientation Linked [::]).....	97
Choosing the AF Home Position ([::] Set Home).....	98
AF Target Selection ([::]Select Screen Settings).....	99
Enabling AF Target Selection Wrap ([::] Loop Settings) .....	100
Touch AF Target Selection for Viewfinder Photography (AF Targeting Pad) .....	101











<b>Other functions that are useful when focusing</b> .....	<b>102</b>
Manual Focus Assist (MF Assist) .....	102
Focus Peaking Options (Peaking Settings) .....	103
Choosing a Focus Distance for Preset MF (Preset MF distance) .....	104
Disabling the MF Clutch (MF Clutch) .....	104
Lens Focus Direction (Focus Ring) .....	104
Resetting the Lens Position at Shutdown (Reset Lens) .....	105
<b>Metering and Exposure</b> .....	<b>106</b>
Controlling exposure (Exposure Compensation) .....	106
EV Steps for Exposure Control (EV Step) .....	107
Fine-Tuning Exposure (Exposure Shift) .....	107
Reducing Flicker Under LED Lighting (Flicker Scan / Flicker Scan) .....	108
Choosing how the camera measures brightness (Metering) .....	109
Locking the exposure (AE Lock) .....	109
AE Lock Exposure Metering (Metering during <b>[AEL]</b> ) .....	110
Releasing AE Lock after shooting ( <b>[AEL]</b> Auto Reset) .....	110
Locking exposure when the shutter button is pressed halfway (AEL by half-pressing <b>[AEL]</b> ) .....	111
Setting metering options for sequential shooting (Metering during <b>[M]</b> ) .....	112
Metering the Focus Target ( <b>[*]</b> Spot Metering) .....	112
Changing ISO sensitivity (ISO) .....	113
EV Steps for ISO Sensitivity Control (ISO Step) .....	114
Setting the range of ISO sensitivity values selected in [Auto] mode (ISO-A Upper/Default / ISO-A Upper/Default) .....	114
Setting the shutter speed at which the camera automatically raises ISO sensitivity (ISO-A Lowest S/S) .....	115
Choosing the modes in which [Auto] can be used for ISO sensitivity (ISO-Auto / ISO-Auto) .....	115
High ISO Noise Reduction Options (Noise Filter / Noise Filter) .....	116
Image Processing Options (Low ISO Processing) .....	116
Long Exposure Noise Reduction Options (Noise Reduction) .....	117
<b>Flash photography</b> .....	<b>118</b>
Using a flash (Flash photography) .....	118
Choosing a Flash Mode (Flash Mode) .....	120
Configuring flash modes (Flash Mode Settings) .....	123
Adjusting flash output (Flash Exposure Comp.) .....	123
Wireless Remote Flash Control (RC Mode) .....	124
Choosing a Flash Sync Speed (X-Sync) .....	124
Choosing the Minimum Shutter Speed (Slow Limit) .....	124
Flash and Exposure Compensation ( <b>[+]</b> <b>[+]</b> ) .....	124
Setting the exposure balance for TTL metering (Balanced Flash Metering) .....	125
<b>Sequential Shooting/ Self-Timer</b> .....	<b>126</b>
Performing the sequential/self-timer shooting .....	126



Configuring the sequential shooting functions (Sequential Shooting Settings) ...	128
Configuring the self-timer functions (Self-timer Settings) ....	130
Shooting without the vibration caused by shutter button operations (Anti-Shock[♦] Settings).....	131
Shooting without shutter sound (Silent[♥] Settings) .....	132
Shooting without a release time lag (Pro Capture shooting) .....	133
Reducing Flicker in Photographs (Anti-Flicker Shooting).....	135
<b>Image Stabilization.....</b>	<b>136</b>
Reducing camera shake (📷 Image Stabilizer / 📷 Image Stabilizer) .....	136
Image stabilization options (📷 IS Level) .....	137
Half-press image stabilization (= Image Stabilizer) .....	138
Burst mode image stabilization (📷 Image Stabilizer).....	138
Displaying camera motion on the monitor (Handheld Assist) .....	139
Image Stabilization for IS Lenses (Lens I.S. Priority).....	139
<b>Color and Quality .....</b>	<b>140</b>
Setting the Quality of Photos and Movies (📷 ⏪ / 📷 ⏩).....	140
Combinations of JPEG image sizes and compression rates (📷 ⏪- Detailed Settings).....	143
Choosing the codec for recording movies (📷 Video Codec).....	144
Setting the image aspect (Image Aspect) .....	144
Peripheral illumination (Shading Comp.) .....	144
Processing options (📷 Picture Mode / 📷 Picture Mode) .....	145
Choosing which options are displayed when selecting a picture mode (📷 Picture Mode Settings) .....	149
Adjusting color (WB (white balance)).....	150
Locking the white balance in movie mode (📷 Button Function: <sup>WB</sup> AutoLock) ....	153
Making fine adjustments to white balance (📷 All <sup>WB</sup> / 📷 All <sup>WB</sup> ) .....	153
Preserving the warm tones of incandescent lighting when in WB Auto mode (📷 <sup>WB</sup> Auto Keep Warm Color / 📷 <sup>WB</sup> Auto Keep Warm Color).....	154
Flash White Balance (⚡ +WB) ...	154
Setting the color reproduction format (Color Space) .....	155
Preview Options for Movie Picture Modes (📷 📷 View Assist) .....	155
<b>Special shooting modes (Computational Modes) .....</b>	<b>156</b>
Shooting still pictures in a higher resolution (High Res Shot) .....	156
Slowing the Shutter in Bright Light (Live ND Shooting) .....	158
Increasing Depth of Field (Focus Stacking) .....	160
Taking HDR (High Dynamic Range) images (HDR).....	162
Recording multiple exposures in a single image (Multiple Exposure) .....	163
Digital Zoom (📷 Digital Tele-converter / 📷 Digital Tele-converter).....	166
Shooting automatically with a fixed interval (Interval Shooting).....	167
Keystone correction and perspective control (Keystone Comp.) .....	170
Correcting Fisheye Distortion (Fisheye Compensation) .....	171



Configuring BULB/TIME/COMP Settings (BULB/TIME/COMP Settings) .....	173
Recording a series of shots with varied exposure (AE BKT).....	174
Recording pictures with varied white balance (WB BKT) .....	175
Recording pictures with varied flash level (FL BKT).....	175
Recording pictures with varied ISO sensitivity (ISO BKT) .....	176
Recording copies of one picture with different art filters applied (ART BKT) .....	177
Recording pictures with different focus positions (Focus BKT) .....	178
<b>Functions that are only available in movie mode .....</b>	<b>180</b>
Sound Recording Options (Sound Recording Settings) .....	180
Adjusting the headphone volume (Headphone Volume) .....	181
Time Codes (Time Code Settings) .....	181
HDMI Output (  HDMI Output) .....	182
Displaying a + mark in the center of the screen while recording movies (Center Marker).....	183
Displaying zebra patterns over high luminance areas while recording movies (Zebra Pattern Settings) .....	184
Displaying a red frame while recording movies (Red Frame during  REC) .....	185
<b>5. Playback .....</b>	<b>186</b>
<b>Information display during playback .....</b>	<b>186</b>
Playback image information .....	186
Switching the information display .....	187
<b>Viewing photographs and movies .....</b>	<b>188</b>
Viewing photographs.....	188
Watching movies .....	189
Finding Pictures Quickly (Index and Calendar Playback) ..	189
Zooming In (Playback Zoom) .....	190
<b>Playback Using Touch Controls.....</b>	<b>191</b>
Full-frame playback.....	191
Index/Calendar playback.....	191
Other functions.....	192
<b>Setting playback functions.....</b>	<b>193</b>
Rotating Pictures (Rotate) .....	193
Protecting Pictures (  ) .....	193
Copying an image (Copy).....	193
Copying all images on a card (Copy All).....	194
Deleting Pictures (Erase) .....	194
Deleting All Pictures (Erase All) ..	194
Disabling Deletion Confirmation (Quick Erase) .....	195
RAW+JPEG Deletion Options (RAW+JPEG Erase).....	195
Selecting Pictures for Sharing (Share Order) .....	195
Selecting RAW+JPEG Pictures for Sharing (RAW+JPEG  ) .....	196
Rating Pictures (Rating) .....	196
Selecting the numbers of stars to be used for rating (Rating Settings).....	197
Selecting Multiple Pictures (Share Order Selected, Rating Selected,  , Copy Select, Erase Selected).....	197
Print order (DPOF) .....	198
Resetting all protection/share orders/print orders/ratings (Reset All Images) .....	198
Adding Audio to Pictures (  ).....	199
Retouching Pictures (Edit).....	200

Combining Pictures (Image Overlay).....	203
Trimming movies (Movie Trimming).....	204
Creating Movie Stills (In-Movie Image Capture) .....	204
Changing the role of the  (✓) button during playback (   Function).....	205
Changing the roles of the front and rear dials during playback (  Dial Function).....	205
Choosing the Playback Zoom Ratio (   Default Setting).....	205
Automatically rotating portrait- orientation pictures for playback (  ).....	205
Choosing the information displayed during playback (  Info Settings).....	206
Choosing the information displayed during magnified playback (   Info Settings).....	206
Configuring the index display (  Settings).....	207
<b>6. Customizing the Camera</b>	
<b>208</b>	
<b>Functions for Configuring Camera Controls .....</b>	<b>208</b>
Changing the roles of buttons (Button Settings).....	208
Assigning Roles to the Front and Rear Dials (  Dial Function /  Dial Function) .....	216
Changing the Dial Direction (Dial Direction).....	218
Changing the Functions of the Multi Selector (Multi Selector Settings) .....	218
Customizing the Fn Lever (Fn Lever Settings).....	219
Power Zoom Lenses (Electronic Zoom Settings).....	222
Locking the  Button (  Lock) ..	223
Choosing What Happens When the Shutter Button Is Pressed During Live View Zoom (LV Close Up Mode).....	223
Choosing the Behavior of the Control Used for Depth-of-Field Preview (  Lock).....	224
Button Hold Options (Press-and-hold Time).....	224
<b>Functions for adjusting the live view display .....</b>	<b>225</b>
Changing the look of the display (  LV Mode).....	225
Making the display easier to see in dark places (  Night Vision).....	225
Viewfinder Display Rate (Frame Rate).....	225
Art Filter Preview (Art LV Mode) .....	226
Reducing Flicker in Live View (Anti-Flicker LV).....	226
Selfie Assist (Selfie Assist) .....	227
<b>Functions for Configuring Information Display .....</b>	<b>228</b>
Selecting the display style of the viewfinder (EVF Style).....	228
Shooting Indicators (  Info Settings /  Info Settings).....	230
Configuring the display for when the shutter button is pressed halfway (Info by half-pressing  ).....	231
Viewfinder Info Display Options (   Info Settings).....	232
Displaying the Level Gauge when the shutter button is pressed halfway (   Level Gauge).....	233
Framing Guide Options (  Grid Settings /  Grid Settings) .....	234

Viewfinder Framing Grid Options (  Grid Settings) .....	235
Choosing the Settings Available via Multi-Fn (Multi Function Settings).....	236
Histogram Exposure Warning (Histogram Settings).....	236
<b>Settings related to operation and display of menus.....</b>	<b>237</b>
Configuring the cursor on the menu screen (Menu Cursor Settings) .....	237
Choosing how to move between pages with the rear dial (  Loop in Menu Tab) .....	238
[Yes]/[No] Default (Priority Set) .....	238
<b>“My Menu” Settings .....</b>	<b>239</b>
Using “My Menu” .....	239
<b>7. Setting Up the Camera 241</b>	
<b>Card/Folder/File Settings.....</b>	<b>241</b>
Formatting the card (Card Formatting) .....	241
Setting the card to record to (  Card Slot Settings /  Card Slot Settings) .....	242
Specifying a folder to save images in (Assign Save Folder).....	244
File Naming Options (File Name).....	244
Naming Files (Edit Filename) .....	245
<b>User information.....</b>	<b>246</b>
Saving lens info (Lens Info Settings) .....	246
Output Resolution (dpi Settings) .....	247
Adding Copyright Information (Copyright Info.).....	247
<b>Monitor/Sound/Connection Settings .....</b>	<b>249</b>
Disabling Touch Controls (Touchscreen Settings).....	249
Monitor Brightness and Hue (Monitor Adjust) .....	249
Viewfinder Brightness and Hue (EVF Adjust) .....	250
Configuring the eye sensor (Eye Sensor Settings) .....	250
Disabling the Focus Beep (  ) .....	251
External Monitor Display Options (HDMI Settings).....	251
Choosing a USB Connection Mode (USB Settings).....	252
<b>Battery/Sleep Settings .....</b>	<b>253</b>
Displaying Battery Status (  Battery Status).....	253
Setting which Battery Is Used First (  Battery Priority).....	253
Changing the battery level display during movie recording (  Display Pattern) .....	253
Dimming the Backlight (Backlit LCD) .....	254
Setting Sleep (Power Saving) Options (Sleep) .....	254
Setting Auto Power Off Options (Auto Power Off).....	254
Reducing Power Consumption (Quick Sleep Mode).....	255
<b>Reset/Clock/Language/Others Settings .....</b>	<b>257</b>
Restoring Default Settings (Reset/Initialize Settings).....	257
Setting the Camera Clock (  Settings).....	257
Choosing a Language (  ).....	257
Calibrating the Level Gauge (Level Adjust).....	258
Image Processing Check (Pixel Mapping) .....	258
Viewing the Firmware Version (Firmware Version) .....	258

Viewing Certificates (Certification).....	258
--	-----

## 8. Connecting the Camera to External Devices 259



<b>Precautions for Using Wi-Fi and Bluetooth® .....</b>	<b>259</b>
Disabling the camera's wireless communication (Airplane Mode).....	260
<b>Connecting the camera to a smartphone.....</b>	<b>260</b>
Pairing the Camera and Smartphone (Wi-Fi Connection) .....	261
Wireless Connection Standby Setting for When the Camera Is On (Bluetooth).....	262
Wireless Settings for When the Camera Is Off (Power-off Standby) .....	263
Transferring images to a smartphone .....	264
Automatically uploading images while the camera is off.....	264
Shooting remotely with a smartphone (Live View).....	265
Shooting remotely with a smartphone (Remote Shutter).....	265
Adding position information to images.....	266
Resetting smartphone connection settings (Reset  Settings).....	266
Changing the password (  Connection Password) .....	267
<b>Connecting to Computers via Wi-Fi.....</b>	<b>267</b>
Installing Software .....	267
Readying the Computer (Windows) .....	268
Pairing the Computer with the Camera (New Link) .....	269
Adjusting Wi-Fi Settings (Wi-Fi Connection) .....	271

Uploading Pictures as They Are Taken.....	276
Ending the Connection .....	278

## Using the Remote Control.....279

Names of parts.....	279
Connection .....	279
Shooting from the remote control.....	281
MAC address of the remote control.....	282
Precautions for using the remote control.....	282

## Connecting to Computers via USB.....283

Installing Software.....	283
Uploading Pictures as They Are Taken (  RAW/Control) .....	284
Connecting the Camera for High-Speed RAW Processing (  RAW/Control) .....	285
Copying Pictures to the Computer (Storage/MTP).....	286

## Powering the Camera via USB (USB Power Delivery).....287

## Connecting to TVs or External Displays via HDMI.....288







Viewing Pictures on a TV (HDMI).....	288
---	-----

## 9. Cautions 289

<b>Information about Dust and Water Resistant Features .....</b>	<b>289</b>
<b>Battery and charger .....</b>	<b>290</b>
<b>Using your charger abroad .....</b>	<b>290</b>

## 10. Information 291

<b>Interchangeable lenses.....</b>	<b>291</b>
<b>MF Clutch Lenses.....</b>	<b>292</b>
<b>Camera Displays for Lens SET and CALL Functions .....</b>	<b>293</b>
<b>Optional Accessories.....</b>	<b>294</b>

Using the charger (BCX-1).....	294
HLD-10 Power Battery Holder....	295
Notes on using this product.....	296
Designated External Flash Units .....	297
Wireless remote control flash photography .....	298
Other external flash units .....	300
Principal Accessories .....	301
<b>System chart.....</b>	<b>302</b>
<b>Cleaning and storing the camera.....</b>	<b>304</b>
Cleaning the camera .....	304
Storage.....	304
Cleaning and checking the image pickup device.....	305
Pixel Mapping - Checking the image processing functions.....	305
<b>Shooting tips and information</b>	<b>306</b>
<b>Error codes .....</b>	<b>309</b>
<b>Default Settings .....</b>	<b>311</b>
Super Control Panel.....	311
 1 Tab.....	313
 2 Tab.....	316
AF Tab .....	317
 Tab .....	319
 Tab.....	320
 Tab.....	321
 Tab.....	325
<b>Memory Card Capacity .....</b>	<b>327</b>
<b>Specifications .....</b>	<b>329</b>
<b>11. SAFETY PRECAUTIONS</b>	
	<b>332</b>
<b>SAFETY PRECAUTIONS .....</b>	<b>332</b>
<b>Index</b>	<b>337</b>

# Names of parts

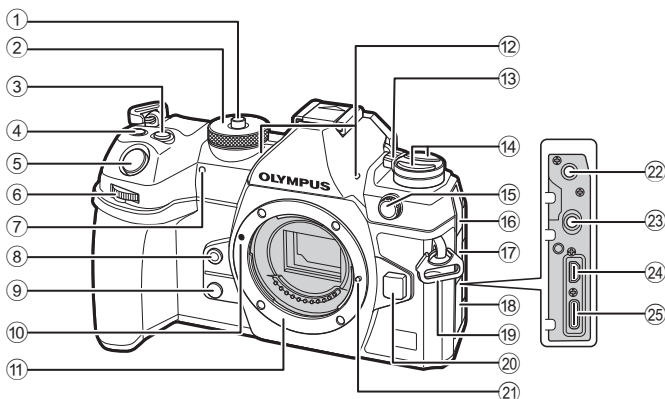

- |  |   |
|--|---|
| ① Mode dial lock.....P. 39                               | ⑭  button.....P. 223  |
| ② Mode dial.....P. 39                                    | AF  (AF/metering mode) button   |
| ③  (Exposure compensation) button                        | .....P. 109   |
| .....P. 43, 45, 47, 50, 106                              | (Sequential shooting/self-timer/flash) button.....P. 120, 126                     |
| ④  (Movie)/  (High Res Shot)/                            | ⑮ External flash terminal.....P. 119  |
| (selection) button                                       | ⑯ Microphone jack cover   |
| .....P. 59/P. 156/P. 197                                 | ⑰ Cover for headphone jack.....P. 181   |
| ⑤ Shutter button.....P. 39                               | ⑱ Connector cover   |
| ⑥ Front dial   | ⑲ Strap eyelet.....P. 18  |
| .....P. 43–50, 63, 188, 205, 216, 218                    | ⑳ Lens release button.....P. 28   |
| ⑦ Self-timer lamp/AF illuminator                         | ㉑ Lens lock pin   |
| .....P. 126/P. 96  | ㉒ Microphone jack (ø3.5 mm stereo mini-jack for third-party microphones)...P. 180 |
| ⑧  (One-touch white balance) button                      | ㉓ Headphone jack (ø3.5 mm stereo mini-jack for third-party headphones)...P. 181   |
| .....P. 152  | ㉔ HDMI connector (Type D)   |
| ⑨  (Preview) button.....P. 224                           | .....P. 182, P. 288   |
| ⑩ Lens attachment mark.....P. 26                         | ㉕ USB connector (Type C)  |
| ⑪ Mount (Remove the body cap before attaching the lens.) | .....P. 22, 23, 283, 287  |
| ⑫ Stereo microphone.....P. 180, 199                      |   |
| ⑬ ON/OFF lever.....P. 30                                 |   |

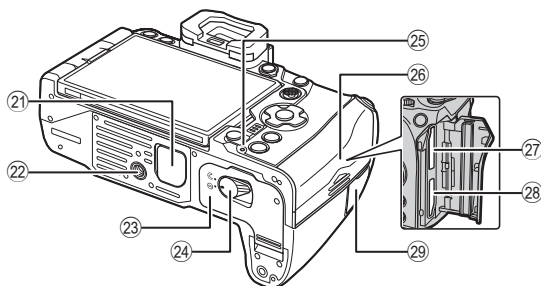
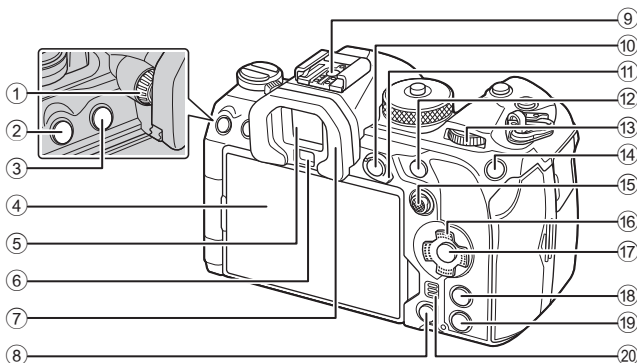

- |  |  |
|--|--|
| ① Diopter adjustment dial.....P. 37                      | ⑮ Multi selector (●/○) .....P. 76, 218                               |
| ② MENU button.....P. 63                                  | ⑯ Arrow pad (△ ▽ ◀ ▶).....P. 188                                     |
| ③ I/O (LV) button.....P. 37                              | ⑰ OK button .....P. 63, 69, 188                                      |
| ④ Monitor (Touch screen)<br>.....P. 34, 37, 41, 101, 191 | ⑱ INFO button .....P. 38, P. 65, 187                                 |
| ⑤ Viewfinder.....P. 37, 228                              | ⑲ [▶] (Playback) button.....P. 188                                   |
| ⑥ Eye sensor   | ⑳ Speaker  |
| ⑦ Eyecup.....P. 301                                      | ㉑ Power battery holder (PBH) cover<br>.....P. 295                    |
| ⑧ [Erase] button .....P. 194                             | ㉒ Tripod socket  |
| ⑨ Hot shoe .....P. 119, 300                              | ㉓ Battery compartment cover.....P. 20                                |
| ⑩ AEL / [Protect] button<br>.....P. 109/P. 193           | ㉔ Battery compartment lock.....P. 20                                 |
| ⑪ Fn lever.....P. 43–49, 219                             | ㉕ Battery charge lamp.....P. 23                                      |
| ⑫ AF-ON button .....P. 83, P. 84                         | ㉖ Card compartment cover .....P. 24                                  |
| ⑬ Rear dial (☺)  | ㉗ Card slot 1 .....P. 24   |
| .....P. 43–50, 63, 188, 205, 216, 218                    | ㉘ Card slot 2 .....P. 24   |
| ⑭ ISO / [★] (Rating) button<br>.....P. 113/P. 196        | ㉙ Remote cable terminal cover<br>(Remote cable terminal) .....P. 279 |



# 1 Preparation

## Unpacking the box contents

At purchase, the package contains the camera and the following accessories. If anything is missing or damaged, contact the dealer from whom you purchased the camera.



Camera



Body cap\*



EP-18 eyecup\*



Hot shoe cover\*



Strap

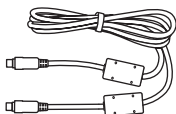

CB-USB13 USB cable

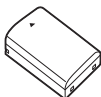

BLX-1 rechargeable lithium-ion battery

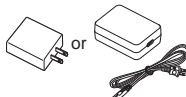

USB-AC adapter F-7AC



CC-1 cable clip



CP-2 cable protector



Basic Manual

- Warranty Card

\* The body cap, eyecup, and hot shoe cover attached to or inserted in the camera.

⚠ Contents may vary depending on purchase location.

⚠ The battery will not be fully charged at the time of purchase. Charge the battery before use (P. 22).

## Attaching the Strap

1

Preparation

- 1 Before attaching the strap, remove the end from the keeper loop and loosen the strap as shown.

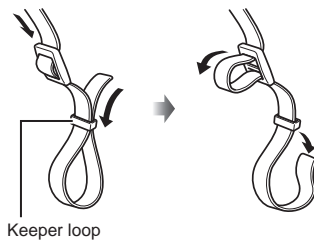

- 2 Pass the end of the strap through the strap eyelet and back through the keeper loop.

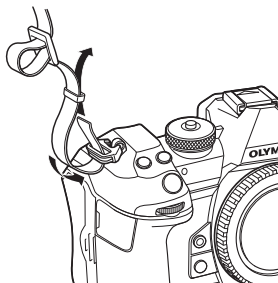

- 3 Pass the end of the strap through the buckle and tighten as shown.

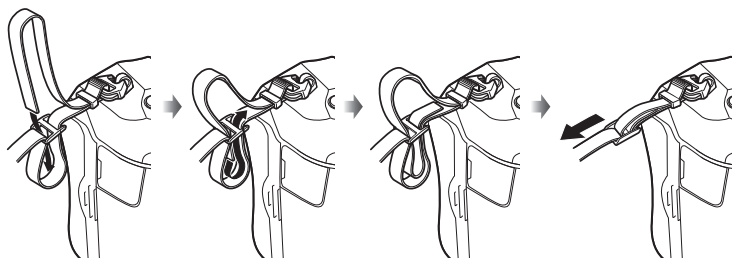

- Attach the other end of the strap to the other eyelet.
- After attaching the strap, pull on it firmly to ensure that it will not come loose.

## Attaching Cable Protectors

Attach the supplied cable protectors when connecting the supplied USB and HDMI cables. This prevents accidental disconnection and damage to the connectors.

- 1 Mount the cable protector on the camera.

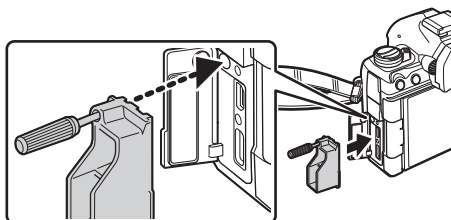

- 2 Tighten the screw.

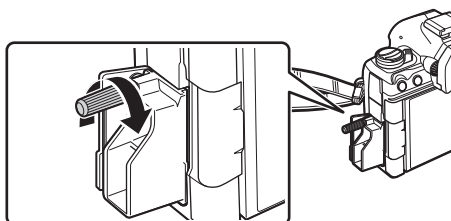

- 3 Clip the cable clip to the cable and attach the clip to the strap.
  - The clip attaches to the buckle.

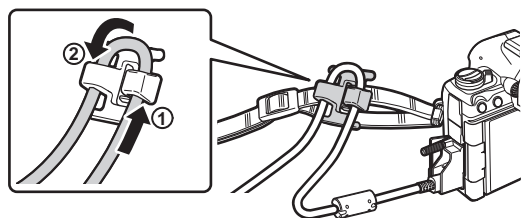

## Inserting and removing the battery

### Inserting the battery

- 1 Confirm that the ON/OFF lever is in the OFF position.

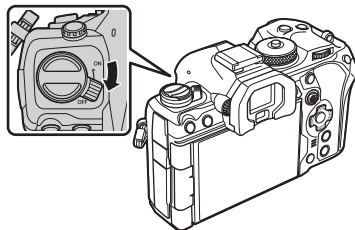

- 2 Open the battery compartment cover.

Battery compartment cover

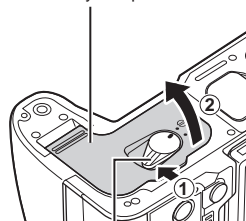

Battery compartment lock

- 3 Loading the battery.

- ⓘ Use only BLX-1 batteries (P. 17, 331).

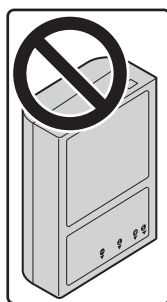

Direction indicating mark

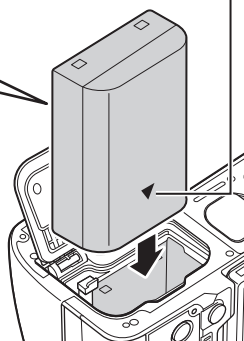

#### 4 Close the battery compartment cover.

- ⓘ Be sure the battery compartment cover is closed before using the camera.

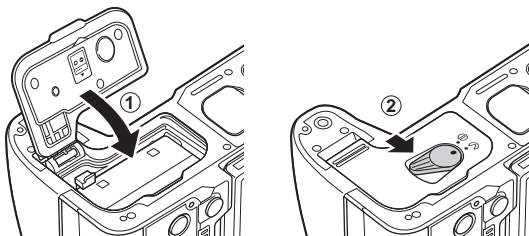

ⓘ It is recommended to set aside a backup battery for prolonged shooting in case the battery in use drains.

ⓘ Also read "Battery and charger" (P. 290).

### Removing the battery

Turn off the camera before opening or closing the battery compartment cover. To remove the battery, first push the battery lock knob in the direction of the arrow and then remove.

- ⓘ Never remove batteries or memory cards while the memory card access indicator (P. 34) is displayed.
- ⓘ Contact an authorized distributor or service center if you are unable to remove the battery. Do not use force.

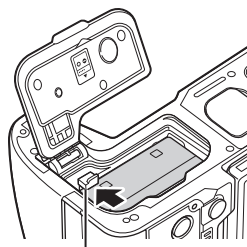

Battery lock knob

## Charging the Battery using the supplied USB-AC adapter

ⓘ The battery will not be fully charged at the time of purchase. Charge the battery before use.

1 Check that the battery is in the camera, and connect the USB cable and USB-AC adapter.

- When attaching the USB cable, use the supplied cable protector and cable clip to prevent damage to the connectors.  “Attaching Cable Protectors” (P. 19)
- ⚠ Refrain from using anything other than the USB cable (CB-USB13) supplied with the camera or sold separately.

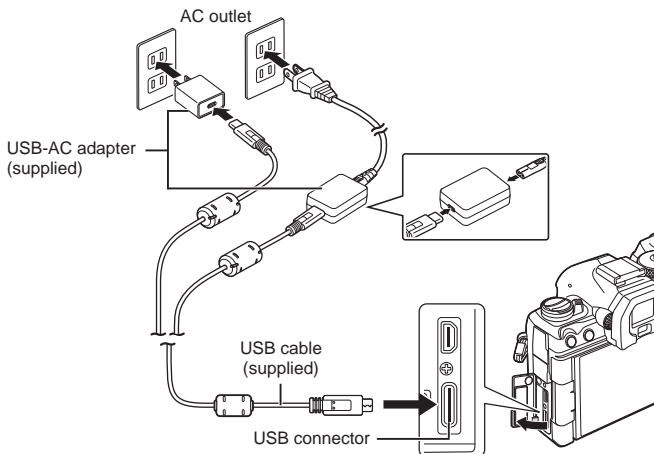

- The battery charge lamp lights during charging. Charging with the camera turned off takes about 2 hours 30 minutes. The lamp goes out as the batteries reach full charge. Remove the USB cable from the camera.

ⓘ If a charging error occurs, the battery charge lamp will blink. Disconnect and reconnect the USB cable.

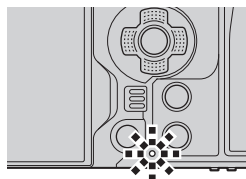

⚠ The battery will be charged regardless of whether the camera is turned on or off. The charging time will be longer if the camera is on.

⚠ Charging stops when the battery temperature is too high. It will resume after the battery temperature falls.

⚠ A charger (BCX-1; sold separately) can be used to charge the battery (P. 294).

⚠ For safety reasons, charging may take longer, or the battery may not reach full charge, when the battery is charged in a high-temperature environment.

ⓘ The USB-AC Adapter

- Be sure to unplug the USB-AC adapter for cleaning. Leaving the USB-AC adapter plugged in during cleaning could result in injury or electric shock.

## Charging the Battery using a USB Device

The battery inserted in the camera will charge when the camera is connected via a USB cable to a USB PD-compliant USB device.

### ■ Charging via USB

- 1 Confirm that the ON/OFF lever is in the OFF position.

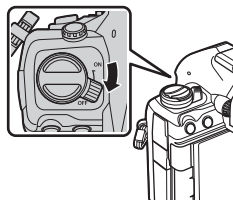

- 2 Connect the camera to the USB device using a USB cable.

- When attaching the USB cable, use the supplied cable protector and cable clip to prevent damage to the connectors.  "Attaching Cable Protectors" (P. 19)

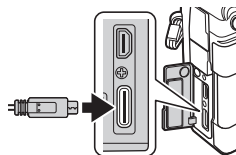

- The battery charge lamp lights during charging. Charging times vary with the output of the USB device. The lamp goes out as the batteries reach full charge.

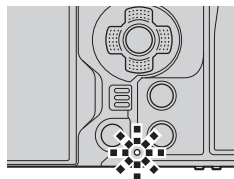

- ⓘ If a charging error occurs, the battery charge lamp will blink. Disconnect and reconnect the USB cable.
- 🔌 The supply of power ends when the battery is charged. Disconnect and reconnect the USB cable to resume charging.
- 🔌 The camera can be powered using mobile batteries or similar devices connected via USB. For more information, see "Powering the Camera via USB (USB Power Delivery)" (P. 287).

## Inserting and removing the card

1

Preparation

### Inserting the card

In this manual, all storage devices are referred to as "cards."

The camera uses third-party SD, SDHC, or SDXC memory cards conforming to the SD (Secure Digital) standard.

Cards must be formatted with this camera before first use or after being used with other cameras or computers. ➡ "Formatting the card (Card Formatting)" (P. 241)

- The camera has two card slots.

- 1 Confirm that the ON/OFF lever is in the OFF position.

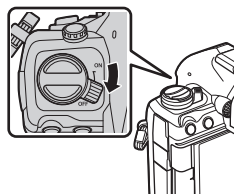

- 2 Open the card compartment cover.

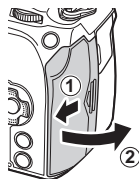

- 3 Insert the card.

- Slide the card in until it locks into place.
- ⓘ Do not forcibly insert a damaged or deformed card. Doing so may damage the card slot.

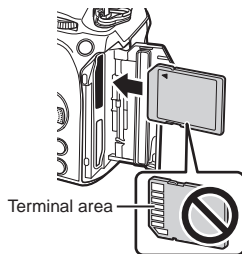

- 4 Close the card compartment cover.

  - Close it securely until you hear it click.

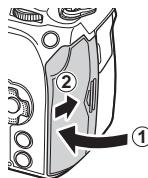



## Removing the card

Press the card in to eject it. Pull out the card.

- ⚠ Never remove batteries or memory cards while the memory card access indicator (P. 34) is displayed.

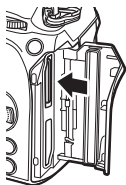

## Using Two Memory Cards

When two memory cards are inserted, you can choose how each card is used according to your goals. [ ] "Setting the card to record to ( [ ] Card Slot Settings / [ ] Card Slot Settings)" (P. 242)

- Record only to a selected card
- Record to a selected card until it is full, then record to the second card
- Record pictures with different sizes or compression ratios to different cards
- Record copies of each picture to both cards

## Usable cards

In this manual, all storage devices are referred to as "cards". The following types of SD memory card (commercially available) can be used with this camera: SD, SDHC, and SDXC. For the latest information, please visit our website.



### SD card write protect switch

The SD card body has a write protect switch. Setting the switch to "LOCK" prevents data being written to the card. Return the switch to the unlock position enable writing.



- ⚠ When recording movies, use an SD card that supports an SD speed class of 10 or higher.
- ⚠ A UHS-II or UHS-I card with a UHS speed class of 3 or better is required when:
  - a movie resolution of [4K] or [C4K] is selected in the [ ] menu or a Motion Compensation of [A-I] (All-Intra) is selected in the [ ] menu
- ⚠ The data in the card will not be erased completely even after formatting the card or deleting the data. When discarding, destroy the card to prevent leakage of personal information.
- ⚠ Access to some playback functions and the like may be restricted when the write-protect switch is in the "LOCK" position.

## Attaching and removing lenses

1

Preparation

### Attaching a lens to the camera

- See page 291 for information on compatible lenses.

- 1 Confirm that the ON/OFF lever is in the OFF position.

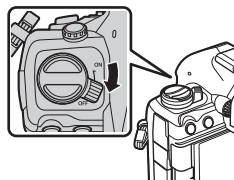

- 2 Remove the rear cap of the lens and the body cap of the camera.

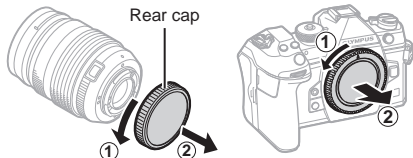

- 3 Align the lens attachment mark (red) on the camera with the alignment mark (red) on the lens, then insert the lens into the camera's body.

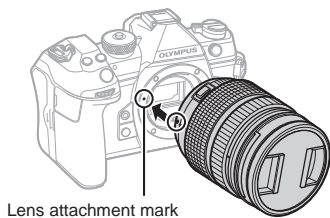

- 4 Rotate the lens clockwise until you hear it click.
  - ⚠ Do not press the lens release button.
  - ⚠ Do not touch internal portions of the camera.

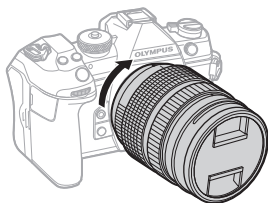

**5** Remove the front lens cap.

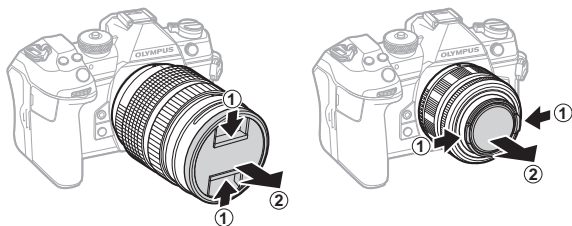

## Removing Lenses

1

Preparation

- 1 Confirm that the ON/OFF lever is in the OFF position.

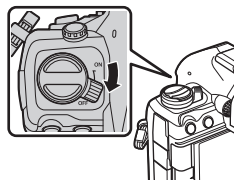

- 2 Hold the lens release button and rotate the lens as shown.

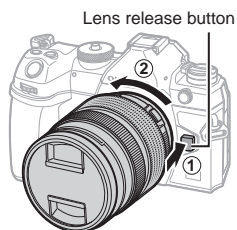

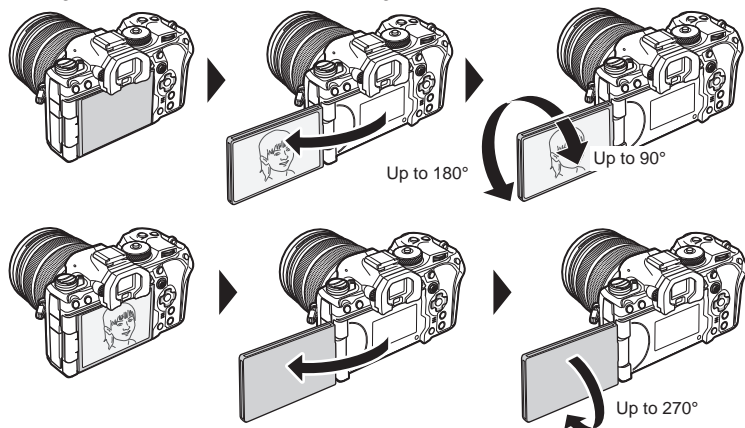

## Using the monitor

Rotate the monitor for ease of viewing. The angle of the monitor can be adjusted according to conditions at the time of shooting.

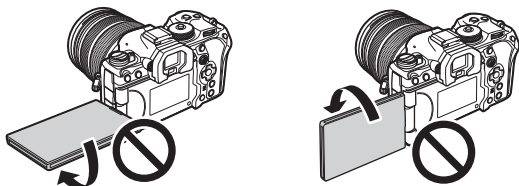

- Gently rotate the monitor within its range of motion. Attempting to rotate the monitor beyond the limits shown below could damage the connectors.



- The camera can be configured to display a mirror image of the view through the lens or automatically zoom power zoom lenses all the way out when the monitor is rotated for self portraits.  "Selfie Assist (Selfie Assist)" (P. 227)

## Turning the camera on

1

Preparation

### 1 Set the ON/OFF lever to the ON position.

- When the camera is turned on, the monitor will turn on and display the super control panel (P. 69).  
The viewfinder turns on when you put your eye to the viewfinder. When the viewfinder is lit up, the monitor turns off.  
See P. 37 for information on how to switch between the viewfinder and the monitor.
- To turn the camera off, return the lever to the OFF position.

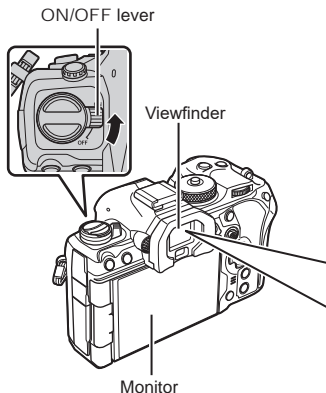

### Battery level

The camera displays the level of the battery currently in use. The battery level is shown as percentages.

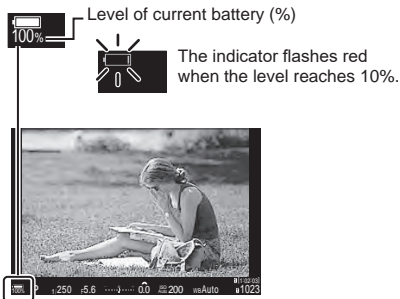

The Fn lever can be configured to turn the camera on and off using the [Fn Lever/Power Lever] option. "Configuring [Fn Lever/Power Lever]" (P. 222)

## Sleep Mode

If no controls are used for a set period, the camera will automatically enter suspend operation to reduce the drain on the batteries. This is referred to as "sleep mode".

- When the camera enters sleep mode, the monitor will turn off and operation will be suspended. Pressing the shutter or button reactivates the camera.
- If no operations are performed for a set period after the camera enters sleep mode, the camera will turn off automatically. The camera can be reactivated by turning it on again.
- ⓘ The camera may require additional time to recover from sleep mode when [On] (enabled) is selected for [Settings] > [Power-off Standby]. "Wireless Settings for When the Camera Is Off (Power-off Standby)" (P. 263)
- ⓘ The delay before the camera goes to sleep or turns off automatically can be selected in the menu. "Setting Sleep (Power Saving) Options (Sleep)" (P. 254), "Setting Auto Power Off Options (Auto Power Off)" (P. 254)

## Initial setup

After turning the camera on for the first time, perform the initial setup by choosing a language and setting the camera clock.

ⓘ The file name is also included with the date and time information. Be sure to set the correct date and time before using the camera. Some functions cannot be used if the date and time have not been set.

1 Press the **OK** button when the initial setup dialog is displaying prompting you to choose a language.



2 Highlight the desired language using the front or rear dial or the **△** **▽** **<** **>** buttons.

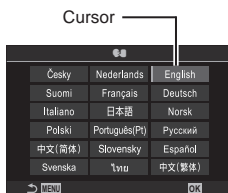

3 Press the **OK** button when the desired language is highlighted.

- If you press the shutter button before pressing the **OK** button, the camera will exit to shooting mode and no language will be selected. You can perform the initial setup by turning the camera off and then on again to display the initial setup dialog and repeating the process from Step 1.
- The language can be changed at any time from the menu. "What to Do If You Can't Read the Display" (P. 33)



- 4** Set the date, time, and date format.
- Use the <|> buttons to highlight items.
  - Use the Δ ▽ buttons to change the highlighted item.
  - The clock can be adjusted at any time from the menu.
- ☞ “Setting the Camera Clock (⌚ Settings)” (P. 257)

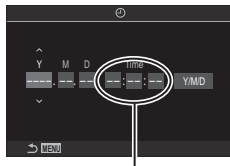

The time is displayed using a 24-hour clock.

- 5** Press the OK button.
- 6** Highlight a time zone using the Δ ▽ buttons and press the OK button.
- Press the INFO button to enable or disable daylight saving time.
- 7** Press the OK button to set the clock.

- ☞ Date and time information is recorded on the card together with the images.
- ☞ If the battery is removed from the camera and the camera is left for a while, the date and time may be reset. If this happens, set the date and time using the menu. ☞ “Setting the Camera Clock (⌚ Settings)” (P. 257)
- ☞ You may also need to adjust the frame rate before shooting movies. ☞ “Setting the Quality of Photos and Movies (📷 / 🎥)” (P. 140)



## What to Do If You Can't Read the Display

If you see unfamiliar characters or words in other languages, you may not have selected the language you intended. Follow the steps below to choose another language.

- 1 Press the MENU button to view the menus.

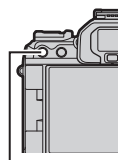

MENU button

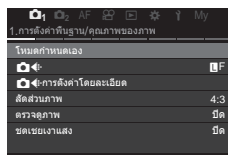

- 2 Highlight the (setup) tab using the front dial.

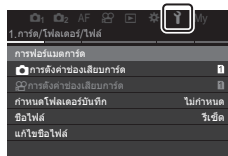

- 3 Select a screen on which appears using the buttons or the rear dial.

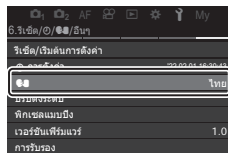

- 4 Highlight using the buttons and press the button.



- 5 Highlight the desired language using the buttons and press the button.



# 2 Shooting

## Information displays while shooting





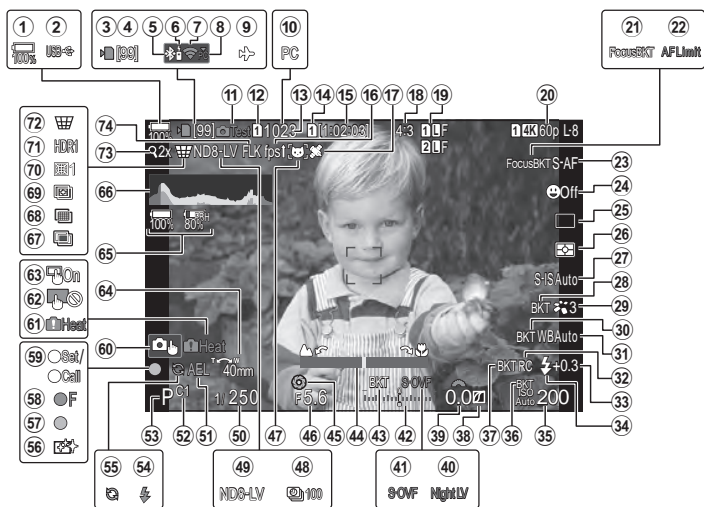



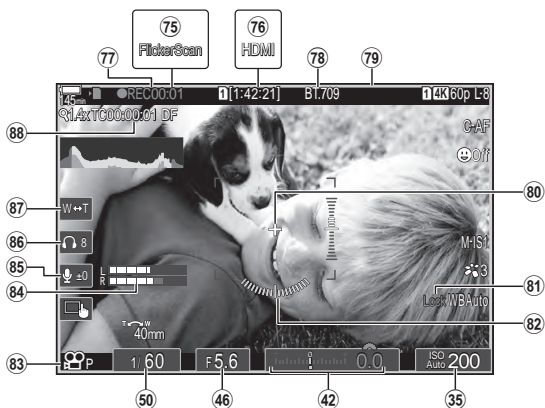

For information on the super control panel, which appears on the monitor by default, see P. 71.

### Monitor display during still photography



### Monitor display during movie mode



- ① Battery level .....P. 30
- ② USB PD .....P. 287
- ③ Card write indicator.....P. 21, 25
- ④ Maximum number of continuous shots  
.....P. 128
- ⑤ Active **Bluetooth**<sup>®</sup> connection  
.....P. 260, 280
- ⑥ Remote control .....P. 280
- ⑦ Wireless LAN connection.....P. 261, 267
- ⑧ Active connection to computer (Wi-Fi)  
.....P. 267
- ⑨ Airplane Mode.....P. 260
- ⑩ Active connection to computer (USB)<sup>\*1</sup>  
.....P. 284
- ⑪ Test Picture.....P. 210
- ⑫  Save settings.....P. 243
- ⑬ Number of storable still pictures ...P. 327
- ⑭  Save slot .....P. 243
- ⑮ Available recording time .....P. 327
- ⑯ Frame rate .....P. 225
- ⑰ Bluetooth position information .....P. 266
- ⑱ Aspect ratio.....P. 144
- ⑲  Image quality .....P. 140
- ⑳  Image quality .....P. 141
- ㉑ Focus BKT .....P. 178
- ㉒ AF Limiter .....P. 92
- ㉓ AF mode .....P. 72
- ㉔ Face priority/Eye priority .....P. 88
- ㉕ Drive mode (single-frame/sequential  
shooting/self-timer/vibration reduction/  
silent photography/Pro Capture)  
.....P. 126
- ㉖ Metering mode.....P. 109
- ㉗ Image stabilizer.....P. 136
- ㉘ ART BKT.....P. 177
- ㉙ Picture mode.....P. 145
- ㉚ WB BKT .....P. 175
- ㉛ White balance .....P. 150
- ㉜ RC mode.....P. 124
- ㉝ Flash intensity control .....P. 123
- ㉞ Flash mode .....P. 120
- ㉟ ISO sensitivity .....P. 113
- ㊱ ISO BKT.....P. 176
- ㊲ FL BKT.....P. 175
- ㊳ Highlight & shadow control .....P. 215
- ㊴ Exposure compensation value.....P. 106
- ㊵ Night Vision.....P. 225
- ㊶ LV Mode.....P. 225
- ㊷ Exposure compensation .....P. 106
- ㊸ AE BKT .....P. 174
- ㊹ Focus Indicator .....P. 102
- ㊺ Preview .....P. 224
- ㊻ Aperture value .....P. 43, 45
- ㊼ Subject Detection.....P. 90
- ㊽ Time lapse shooting.....P. 167
- ㊾ Live ND filter photography .....P. 158
- ㊿ Shutter speed .....P. 43, 47
- ① AE lock.....P. 109
- ② Custom mode .....P. 56
- ③ Shooting mode.....P. 43
- ④ Flash .....P. 118  
(blinks: charging in progress, lights up:  
charging completed)
- ⑤ Pro Capture active .....P. 133
- ⑥ Dust reduction.....P. 305
- ⑦ AF confirmation mark.....P. 40
- ⑧  SH2 Aperture warning.....P. 126
- ⑨ SET function/CALL function.....P. 293
- ⑩ Touch operation .....P. 41
- ⑪ Internal temperature warning.....P. 309
- ⑫ Disable touch operation.....P. 101
- ⑬ Touch operation .....P. 41
- ⑭ Zoom operation direction/Focal length
- ⑮ All Battery Information .....P. 30, 295
- ⑯ Histogram .....P. 38
- ⑰ Multiple exposure.....P. 163
- ⑱ High Res Shot.....P. 156
- ⑲ Focus Stacking .....P. 160
- ㉑ Fisheye compensation.....P. 171
- ㉒ HDR.....P. 162
- ㉓  Keystone compensation .....P. 170
- ㉔ Digital Tele-converter .....P. 166
- ㉕ Anti-flicker shooting .....P. 135
- ㉖ Flicker scan.....P. 108
- ㉗  HDMI Output .....P. 182
- ㉘ Recording time (displayed during  
recording).....P. 59
- ㉙  View assist.....P. 155
- ㉚ Red frame during movie recording  
.....P. 185
- ㉛ Center marker.....P. 183
- ㉜  Lock .....P. 153
- ㉝ Level gauge .....P. 38
- ㉞  mode (movie exposure mode)  
.....P. 60
- ㉟ Recording level meter.....P. 62

- Ⓢ5 Audio recording level .....P. 62
- Ⓢ6 Headphone volume .....P. 62
- Ⓢ7 Electronic Zoom.....P. 62
- Ⓢ8 Time code .....P. 181

\*1 Displayed when the camera is connected to OM Capture in [📷📷RAW/Control] mode and the computer is the sole save location of images (P. 284).

## Switching between displays

The camera uses an eye sensor to automatically switch between the viewfinder and monitor display (super control panel/live view) also show information on camera settings. Options are available for controlling display switching and choosing the information shown.

The camera monitor displays the super control panel (P. 69) by default.

### Framing photos in the viewfinder

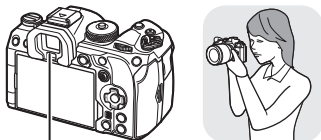

Viewfinder



The viewfinder turns on automatically when you bring it to your eye. When the viewfinder is lit up, the monitor turns off.

### Framing photos in the monitor

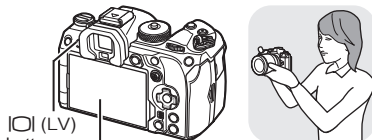

Monitor

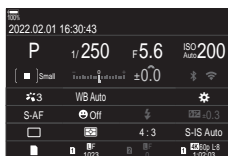

The monitor shows the super control panel. It changes to live view when you press the IOI (LV) button.

IOI (LV) button



- If the viewfinder is not in focus, put your eye to the viewfinder and focus the display by rotating the diopter adjustment dial.

Diopter adjustment dial

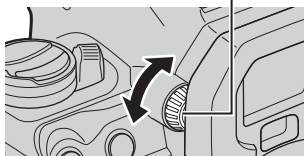

Display switching and viewfinder display options are available.

“Selecting the display style of the viewfinder (EVF Style)” (P. 228), “Configuring the eye sensor (Eye Sensor Settings)” (P. 250)

## Switching the information display





PASMB 

You can switch the information displayed in the monitor during shooting using the INFO button.

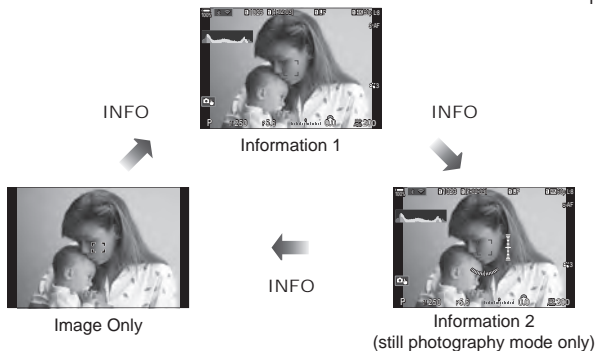

INFO button



- The information display screens can be switched in either direction by rotating the dial while pressing the INFO button.
- The information shown in still photography mode and the information shown in movie mode can be set individually.  "Shooting Indicators ( Info Settings /  Info Settings)" (P. 230)
- You can choose whether or not to display information when the shutter button is pressed halfway.  "Configuring the display for when the shutter button is pressed halfway (Info by half-pressing )" (P. 231)

### Histogram display

A histogram showing the distribution of brightness in the image is displayed. The horizontal axis gives the brightness, the vertical axis the number of pixels of each brightness in the image. Areas above the upper limit at shooting are displayed in red, those below the lower limit in blue, and those within the spot metering range in green. You can choose the upper and lower limits.  "Histogram Exposure Warning (Histogram Settings)" (P. 236)

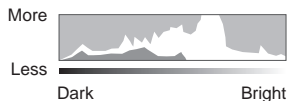

### Highlights and Shadows

Highlights and shadows, defined according to the upper and lower limits for the histogram display, are shown in red and blue. You can choose the upper and lower limits.  "Histogram Exposure Warning (Histogram Settings)" (P. 236)

### Level gauge display

The orientation of the camera is indicated. The "tilt" direction is indicated on the vertical bar and the "horizon" direction on the horizontal bar.

- The level gauge is intended as a guide only.
- Calibrate the gauge if you find it is no longer truly plumb or level.  "Calibrating the Level Gauge (Level Adjust)" (P. 258)

## Shooting still pictures

PASMB 

Use the mode dial to select the shooting mode, and then shoot the image.

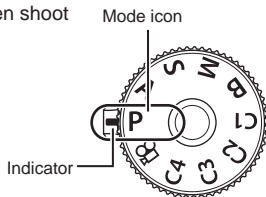

2

Shooting

### Types of shooting modes

For how to use the various shooting modes, see the following.

<b>P</b>	Program AE (P. 43)
<b>A</b>	Aperture-priority AE (P. 45)
<b>S</b>	Shutter-priority AE (P. 47)
<b>M</b>	Manual exposure (P. 49)
<b>B</b>	Bulb/time (P. 51)
	Live composite (P. 54)
C1/C2/C3/C4	Custom (P. 57)

 For information on  on the mode dial, see P. 59.

**1** Press the mode dial lock to unlock it, and then turn to set the mode you wish to use.

- When the mode dial lock has been pressed down, the mode dial is locked. Each time you press the mode dial lock, it switches between locked/released.

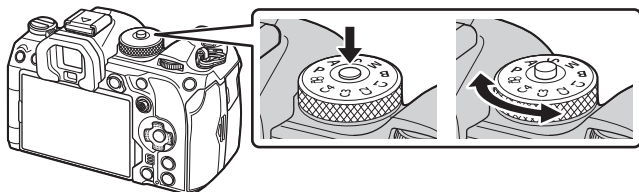

**2** Frame the shot.

- ① Be careful that your fingers or the camera strap do not obstruct the lens or AF illuminator.

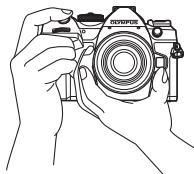

Landscape position

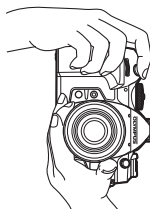

Portrait position



### 3 Adjust the focus.

- Lightly press the shutter button down to the first position (press the shutter button halfway).

The AF confirmation mark (●) will be displayed, and a green frame (AF target) will be displayed in the focus location.

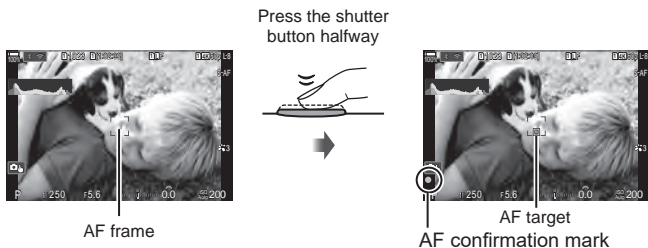
 You can also focus by pressing the AF-ON button. (P. 83)





-  If the camera is unable to focus, the AF confirmation mark will flash (P. 306).
-  The AF frame varies with the option chosen for AF-target mode. Change the area (P. 77) and position (P. 76) of the AF target as required.
-  The AF frame is not displayed when [All] is chosen for AF-target mode (P. 77).

### 4 Release the shutter.

- Press the shutter button all the way (fully).
- The camera will release the shutter and take a picture.

Press the rest of the way down



 You can focus and take pictures using touch controls.  "Shooting with touch screen operations" (P. 41)



## Shooting with touch screen operations

PASMB

You can tap the subject to focus and take a photograph.

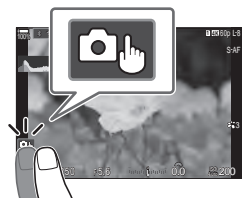

2

Shooting

	Tap a subject to focus and automatically release the shutter. This option is not available in mode <b>B</b> (bulb), in  (movie) mode, or when [AF] or [AF MF] is selected for AF mode (P. 72).
	Shooting with touch screen operations is disabled.
	Tap to display an AF target and focus on the subject in the selected area. You can use the touch screen to choose the position and size of the focus frame. Photographs can be taken by pressing the shutter button.
	Tap to choose the subject used for focus when multiple portrait subjects are detected.  is displayed when an option other than [Off] is selected for [Face & Eye Detection] (P. 88). Subject selection is not available when a frame rate of [FHD 120/60p L-8] (high-speed movie recording) is selected in  (movie) mode (P. 141).

- Tapping an icon switches the settings.
- ⚠ Do not touch the display with your fingernails or other sharp objects.
- ⚠ Gloves or monitor covers may interfere with touch screen operation.

### ■ Previewing the subject (

#### 1 Tap the subject in the display.

- An AF target will be displayed.
- Use the slider to choose the size of the frame.
- Tap to turn off the display of the AF target.



#### 2 Use the slider to adjust the size of the AF target, and then tap to zoom in at the frame position.

- Use your finger to scroll the display when the picture is zoomed in.
- Tap to cancel the zoom display.

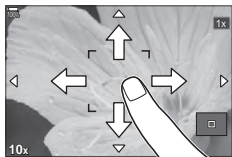

- The situations in which touch screen operations are not available include the following.
  - When buttons or dials are in use
- You can disable the touch screen operation. “Disabling Touch Controls (Touchscreen Settings)” (P. 249)





Pictures are displayed immediately after shooting. This gives you a chance to quickly review the shot. You can choose how long pictures are displayed or disable photo review altogether.

To end photo review and resume shooting at any time, press the shutter button halfway.

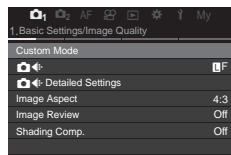

<b>0.3–20sec</b>	Choose how long photos are displayed.
<b>Off</b>	Photo review disabled. The camera continues to display the view through the lens after shooting.
<b>Auto</b> 	Switch to playback after shooting. You can delete images and perform other playback operations.

- 1 Press the MENU button to display the menus.
- 2 Highlight the  tab using the front dial.

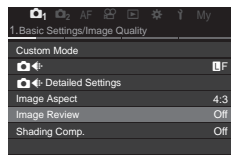

- 3 Highlight [1. Basic Settings/Image Quality] using the   buttons or the rear dial.
- 4 Highlight [Image Review] using the   buttons and press the  button.



- 5 Change the setting using the   buttons and press the  button.

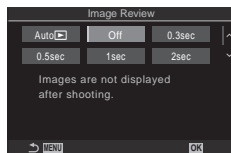

- 6 Press the MENU button to exit the menus.

## Taking Pictures Using the Shooting Modes

### Letting the camera choose aperture and shutter speed

(P: Program AE)



P A S M B 

The camera chooses the optimal aperture and shutter speed according to subject brightness.

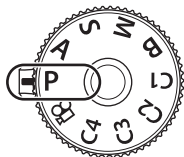
- 1 Rotate the mode dial to **P**.









- 2 Focus and check the display.

- Use the front and rear dials to adjust the following settings.  
Front dial: Exposure compensation (P. 106)  
Rear dial: Program shift (P. 44)
- The shutter speed and aperture chosen by the camera are displayed.
- Exposure compensation can also be adjusted using the  button. Press the  button and then rotate the front or rear dial.





Shutter speed  
Aperture  
Shooting mode



- 3 Take pictures.

-  You can choose the functions performed by the front and rear dials.  “Assigning Roles to the Front and Rear Dials ( Dial Function /  Dial Function)” (P. 216)
-  You can use the Fn lever to reverse the roles of the front and rear dials. The lever can also be assigned other roles.  “Customizing the Fn Lever (Fn Lever Settings)” (P. 219)

### Subject Too Dark or Too Bright

If the camera is unable to achieve optimal exposure, the shutter-speed and aperture displays will flash as shown.

Display	Problem/solution
Large aperture (low f/-number)/ slow shutter speed 	The subject is too dark. <ul style="list-style-type: none"> <li>Use a flash.</li> </ul>
Small aperture (high f/-number)/ fast shutter speed 	Subject is too bright. <ul style="list-style-type: none"> <li>The limits of the camera metering system have been exceeded. Use a third-party ND (Neutral Density) filter to reduce the amount of light entering the camera.</li> <li>Shutter speeds as fast as 1/32000 s are available in [♥] (silent) mode.  "Shooting without shutter sound (Silent[♥] Settings)" (P. 132), "Performing the sequential/self-timer shooting" (P. 126)</li> </ul>

 When [ISO] is not set to [Auto], optimal exposure may be achieved by changing the setting.  "Changing ISO sensitivity (ISO)" (P. 113)

 The aperture value shown when the displays flash varies with the lens and focal length.

### ■ Program Shift



Without changing exposure, you can choose from different combinations of aperture and shutter speed selected automatically by the camera. This is known as program shift.

1 Rotate the rear dial until the camera displays the desired combination of aperture and shutter speed.

- The shooting mode indicator in the display changes from **P** to **Ps** while program shift is in effect. To end program shift, rotate the rear dial in the opposite direction until **Ps** is no longer displayed.



Program shift

 You can choose whether the display reflects the effects of exposure compensation or maintains a constant brightness for ease of viewing.  "Changing the look of the display ([LV Mode])" (P. 225)

In this mode, you choose the aperture (f/-number) and the camera automatically sets the shutter speed for optimal exposure according to subject brightness. Lower aperture values (larger apertures) reduce the depth of the area that appears to be in focus (depth of field), blurring the background. Higher aperture values (smaller apertures) increase the depth of the area that appears to be in focus in front of and behind the subject.



## 1 Rotate the mode dial to **A**.

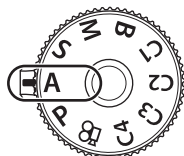

## 2 Choose an aperture.

- Use the front and rear dials to adjust the following settings.  
Front dial: Exposure compensation (P. 106)  
Rear dial: Aperture
- The shutter speed selected automatically by the camera will appear in the display.
- Exposure compensation can also be adjusted using the button. Press the button and then rotate the front or rear dial.





Aperture value



## 3 Take pictures.

- You can choose the functions performed by the front and rear dials. "Assigning Roles to the Front and Rear Dials ( Dial Function / Dial Function)" (P. 216)
- You can use the Fn lever to reverse the roles of the front and rear dials. The lever can also be assigned other roles. "Customizing the Fn Lever (Fn Lever Settings)" (P. 219)
- You can choose whether the display reflects the effects of exposure compensation or maintains a constant brightness for ease of viewing. "Changing the look of the display ( LV Mode)" (P. 225)
- You can stop aperture down to the selected value and preview depth of field. "Changing the roles of buttons (Button Settings)" (P. 208)

**Subject Too Dark or Too Bright**

If the camera is unable to achieve optimal exposure, the shutter-speed display will flash as shown.

Display	Problem/solution
Slow shutter speed 	Underexposure. <ul style="list-style-type: none"> <li>Choose a lower aperture value.</li> </ul>
Fast shutter speed 	Overexposure. <ul style="list-style-type: none"> <li>Choose a higher aperture value.</li> <li>If the subject is still overexposed at the higher value, the limits of the camera metering system have been exceeded. Use a third-party ND (Neutral Density) filter to reduce the amount of light entering the camera.</li> <li>Shutter speeds as fast as 1/32000 s are available in [♥] (silent) mode.  "Shooting without shutter sound (Silent[♥] Settings)" (P. 132), "Performing the sequential/self-timer shooting" (P. 126)</li> </ul>

 When [ISO] is not set to [Auto], optimal exposure may be achieved by changing the setting.  "Changing ISO sensitivity (ISO)" (P. 113)

In this mode, you choose the shutter speed and the camera automatically sets aperture for optimal exposure according to subject brightness. Faster shutter speeds appear to “freeze” fast-moving subjects. Slower shutter speeds add blur to moving objects, lending them a sense of motion for a dynamic effect.

### Slower shutter speeds...

60" ← [blurred bars] 15 ← [blurred bars] 30 ← [blurred bars] 60

...produce dynamic shots with a sense of motion.

### Faster shutter speeds...

125 → [sharp bars] 250 → [sharp bars] 8000

...“freeze” the motion of fast-moving subjects.

## 1 Rotate the mode dial to S.

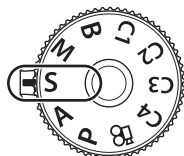

## 2 Choose a shutter speed.

- Use the front and rear dials to adjust the following settings.  
Front dial: Exposure compensation (P. 106)  
Rear dial: Shutter speed
- Shutter speed can be set to values between 1/8000 and 60 s.
- Shutter speeds as fast as 1/32000 s are available in [♥] (silent) mode. “Shooting without shutter sound (Silent[♥] Settings)” (P. 132), “Performing the sequential/self-timer shooting” (P. 126)
- The aperture selected automatically by the camera will appear in the display.
- Exposure compensation can also be adjusted using the button. Press the button and then rotate the front or rear dial.





Shutter speed

## 3 Take pictures.

- You can choose the functions performed by the front and rear dials. “Assigning Roles to the Front and Rear Dials ( Dial Function / Dial Function)” (P. 216)
- You can use the Fn lever to reverse the roles of the front and rear dials. The lever can also be assigned other roles. “Customizing the Fn Lever (Fn Lever Settings)” (P. 219)
- You can choose whether the display reflects the effects of exposure compensation or maintains a constant brightness for ease of viewing. “Changing the look of the display ( LV Mode)” (P. 225)
- To achieve the effect of a slow shutter in brightly-lit settings in which slow shutter speeds are not otherwise available, use the live ND filter. “Slowing the Shutter in Bright Light (Live ND Shooting)” (P. 158)
- Depending on the shutter speed selected, you may notice banding in the display caused by flicker from fluorescent or LED light sources. The camera can be configured to reduce the effects of flicker during live view or when pictures are taken. “Reducing Flicker in Photographs (Anti-Flicker Shooting)” (P. 135), “Reducing Flicker Under LED Lighting ( Flicker Scan / Flicker Scan)” (P. 108)

**Subject Too Dark or Too Bright**

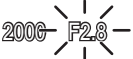
If the camera is unable to achieve optimal exposure, the aperture display will flash as shown.

Display	Problem/solution
Low aperture value 	Underexposure. <ul style="list-style-type: none"> <li>Choose a slower shutter speed.</li> </ul>
High aperture value 	Overexposure. <ul style="list-style-type: none"> <li>Choose a faster shutter speed. Shutter speeds as fast as 1/32000 s are available in silent mode.</li> <li>If the subject is still overexposed at the higher speed, the limits of the camera metering system have been exceeded. Use a third-party ND (Neutral Density) filter to reduce the amount of light entering the camera.</li> </ul>

🔊 When [ISO] is not set to [Auto], optimal exposure may be achieved by changing the setting. 📖 “Changing ISO sensitivity (ISO)” (P. 113)

🔊 The aperture value shown when the display flashes varies with the lens and focal length.



## Choosing aperture and shutter speed (M: Manual Exposure)

PASMB

In this mode, you choose the aperture and shutter speed. You can adjust settings according to your goals, for example by combining fast shutter speeds with small apertures (high f-numbers) for increased depth of field.

### 1 Rotate the mode dial to M.

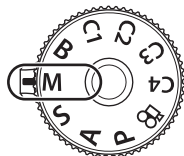

### 2 Adjust aperture and shutter speed.

- Use the front and rear dials to adjust the following settings.

Front dial: Aperture

Rear dial: Shutter speed

- Choose from shutter speeds of 1/8000–60 s.
- Shutter speeds as fast as 1/32000 s are available in silent mode. “Shooting without shutter sound (Silent[♥] Settings)” (P. 132)
- The display shows the difference between the exposure produced by the selected aperture and shutter speed and the optimal exposure metered by the camera. The display will flash if the difference exceeds  $\pm 3$  EV.
- When [Auto] is selected for [ISO], ISO sensitivity will automatically be adjusted for optimal exposure at the selected exposure settings. [ISO] defaults to [Auto]. “Changing ISO sensitivity (ISO)” (P. 113)



Difference from optimal exposure

### 3 Take pictures.



- You can choose the functions performed by the front and rear dials. “Assigning Roles to the Front and Rear Dials (Dial Function / Dial Function)” (P. 216)
- You can use the Fn lever to reverse the roles of the front and rear dials. The lever can also be assigned other roles. “Customizing the Fn Lever (Fn Lever Settings)” (P. 219)
- Depending on the shutter speed selected, you may notice banding in the display caused by flicker from fluorescent or LED light sources. The camera can be configured to reduce the effects of flicker during live view or when pictures are taken. “Reducing Flicker in Photographs (Anti-Flicker Shooting)” (P. 135), “Reducing Flicker Under LED Lighting (Flicker Scan / Flicker Scan)” (P. 108)
- You can choose whether the display reflects the effects of exposure compensation or maintains a constant brightness for ease of viewing. “Changing the look of the display (LV Mode)” (P. 225)

2

Shooting

**Subject Too Dark or Too Bright**

If the camera is unable to achieve optimal exposure with [Auto] selected for [📷 ISO], the ISO sensitivity display will flash as shown.

Display	Problem/solution
	Overexposure. <ul style="list-style-type: none"> <li>Choose a higher aperture value or faster shutter speed.</li> </ul>
	Underexposure. <ul style="list-style-type: none"> <li>Choose a lower aperture value or slower shutter speed.</li> <li>If the warning does not clear from the display, choose a higher value for ISO sensitivity. 📖 “Changing ISO sensitivity (ISO)” (P. 113), “Setting the range of ISO sensitivity values selected in [Auto] mode (📷 ISO-A Upper/Default / 📷 ISO-A Upper/Default)” (P. 114)</li> </ul>

**■ Using Exposure Compensation in Mode M**

In mode **M**, exposure compensation is available when [Auto] is selected for [📷 ISO]. Because exposure compensation is performed by adjusting ISO sensitivity, aperture and shutter speed are not affected. 📖 “Changing ISO sensitivity (ISO)” (P. 113), “Setting the range of ISO sensitivity values selected in [Auto] mode (📷 ISO-A Upper/Default / 📷 ISO-A Upper/Default)” (P. 114)

**1** Hold the  button and rotate the front or rear dial.

- Exposure compensation is added to the exposure difference shown in the display.

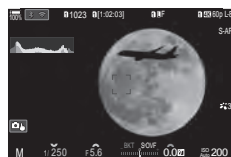

Exposure compensation plus exposure difference

Exposure compensation

Select this mode to leave the shutter open for a long exposure. You can preview the photo in live view and end the exposure when the desired results have been achieved. Use when long exposures are required, for example when photographing night scenes or fireworks.

ⓘ For long exposure shooting, it is recommended that you fix the camera securely on a tripod and set [Image Stabilizer] (P. 136) to [S-IS Off].

### “Bulb” and “Live Bulb” Photography

The shutter remains open while the shutter button is pressed. Releasing the button ends the exposure.

- The amount of light entering the camera increases the longer the shutter is open.
- When live bulb photography is selected, you can check the results in the live view display and end exposure when you want to.

### “Time” and “Live Time” Photography

The exposure begins when the shutter button is pressed all the way down. To end the exposure, press the shutter button all the way down a second time.

- The amount of light entering the camera increases the longer the shutter is open.
- When live time photography is selected, you can check the results in the live view display and end exposure when you want to.

**1** Rotate the mode dial to **B**.

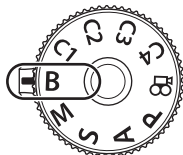

**2** Select [Bulb] (for bulb photography) or [Time] (time photography).

- At default settings, the selection is made with the rear dial.



Bulb or time photography

- 3 Press the MENU button.
- You will be prompted to choose the interval at which the preview is updated.

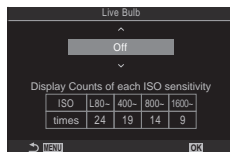

- 4 Highlight an interval using  $\Delta$   $\nabla$ .
- 5 Press the  $\odot$  button to select the highlighted option.
- The menu will be displayed.
- 6 Press the MENU button repeatedly to exit the menus.
- If an option other than [Off] is selected, [Live Bulb] or [Live Time] will appear in the display.
- 7 Adjust aperture.
- At default settings, aperture can be adjusted using the front dial.

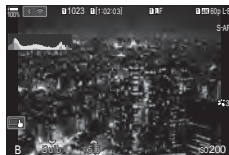

Aperture

- 8 Take pictures.
- In bulb and live bulb modes, keep the shutter button pressed. The exposure ends when the button is released.
  - During live time photography, you can refresh the preview by pressing the shutter button halfway.
  - In time and live time modes, press the shutter button all the way down once to start the exposure and again to end it.
  - The exposure ends automatically when the time selected for [Bulb/Time Timer] is reached. "Configuring BULB/TIME/COMP Settings (BULB/TIME/COMP Settings)" (P. 173)
  - [Noise Reduction] is applied after shooting. The display shows the time remaining until the process is complete. You can choose the conditions under which noise reduction is performed (P. 117).
- Some limitations apply to the choice of ISO sensitivity settings available.
- Bulb photography is used in place of live bulb photography when multiple exposure, keystone compensation, or fisheye correction is in effect.
- Time photography is used in place of live time photography when multiple exposure, keystone compensation, or fisheye correction is in effect.
- During shooting, there are limits on the settings for the following functions.  
Sequential shooting, self-timer shooting, time lapse shooting, AE bracket shooting, flash bracketing, focus bracketing, Focus Stacking, etc.
- Depending on camera settings, the temperature, and the situation, you may notice noise or bright spots in the monitor. These may sometimes appear in pictures even when [Noise Reduction] (P. 117) is enabled.
- Starry sky AF can be used for shots of the night sky. "Choosing a focus mode (AF Mode / AF Mode)" (P. 72), "Changing the settings of Starry Sky AF (Starry Sky AF Setting)" (P. 85)

- ☞ Display brightness can be adjusted during bulb/time photography. ☞☞ “Configuring BULB/TIME/COMP Settings (BULB/TIME/COMP Settings)” (P. 173)
- ☞ In mode **B** (bulb), you can adjust focus manually while the exposure is in progress. This allows you to defocus during the exposure or focus at the end of the exposure. ☞☞ “Configuring BULB/TIME/COMP Settings (BULB/TIME/COMP Settings)” (P. 173)

## ☞ Noise

While shooting at slow shutter speeds, noise may appear on screen. These phenomena occur when the temperature rises in the image pickup device or image pickup device internal drive circuit, causing current to be generated in those sections of the image pickup device that are not normally exposed to light. This can also occur when shooting with a high ISO setting in a high-temperature environment. To reduce this noise, the camera activates the noise reduction function. ☞☞ “Long Exposure Noise Reduction Options (Noise Reduction)” (P. 117)

Leave the shutter open for a long exposure. You can view the light trails left by fireworks or stars and photograph them without changing the exposure of the background. The camera combines multiple shots and records them as a single photograph.

ⓘ For live composite photography, it is recommended that you fix the camera securely on a tripod and set [Image Stabilizer] (P. 136) to [S-IS Off].

1 Rotate the mode dial to **B**.

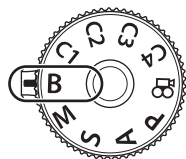

2 Select [Live Comp].

- At default settings, the selection is made with the rear dial.

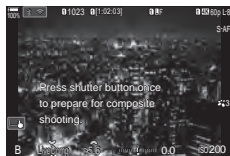
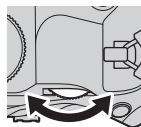

Live composite photography

3 Press the MENU button.

- The [Composite Settings] menu will be displayed.

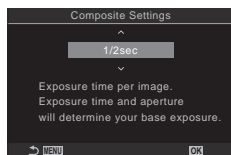

4 Highlight an exposure time using  $\Delta$   $\nabla$ .

- Choose an exposure time of from 1/2 to 60 s.

5 Press the  $\odot$  button to select the highlighted option.

- The menus will be displayed.

6 Press the MENU button repeatedly to exit the menus.

7 Adjust aperture.

- At default settings, aperture can be adjusted using the front dial.

**8** Press the shutter button all the way down to ready the camera.

- The camera is ready to shoot when [Ready for composite shooting] is displayed.

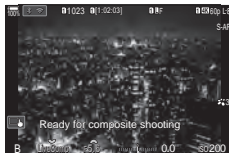

**9** Press the shutter button to start shooting.

- Live composite photography will start. The display will be updated after each exposure.

**10** Press the shutter button again to end shooting.

- Shooting ends automatically after the time selected for [Live Composite Timer] (P. 173). Other options can be selected.
- The maximum recording time available varies with battery level and shooting conditions.

ⓘ Some limitations apply to the choice of ISO sensitivity settings available.

ⓘ Limitations apply to some features during shooting, including: sequential shooting, the self-timer, interval timer photography, AE bracketing, flash bracketing, focus bracketing, High Res Shot, HDR photography, Focus Stacking, multiple exposure, keystone compensation, the live ND filter, and fisheye correction.

👉 Stary sky AF can be used for shots of the night sky. 📖 “Choosing a focus mode (AF Mode / AF Mode)” (P. 72), “Changing the settings of Stary Sky AF (Stary Sky AF Setting)” (P. 85)

👉 Display brightness can be adjusted during live composite photography. 📖 “Configuring BULB/TIME/COMP Settings (BULB/TIME/COMP Settings)” (P. 173)



👉 The exposure time for each exposure made during live composite photography can be chosen in advance using the menus. 📖 “Configuring BULB/TIME/COMP Settings (BULB/TIME/COMP Settings)” (P. 173)

## Saving Custom Settings to the Mode Dial (C1/C2/C3/C4 Custom Modes)







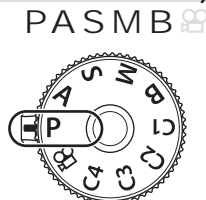

Frequently-used settings and shooting modes can be saved as custom modes and recalled as needed simply by rotating the mode dial. Saved settings can also be recalled from the menus.

- Save settings to positions C1 through C4.



### Saving Settings (Assign to Custom Mode)

- 1 Choose a mode other than  and adjust settings as desired.
  - For information on the settings that can be saved, see the menu list (P. 311).
- 2 Press the MENU button to display the menus.
- 3 Highlight the  tab using the front dial.

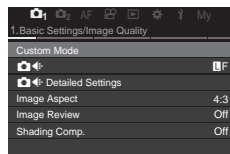

- 4 Highlight [1. Basic Settings/Image Quality] using the   buttons or the rear dial.
- 5 Highlight [Custom Mode] using the   buttons and press the  button.
- 6 Highlight the desired custom mode ([C1]–[C4]) using   buttons and press the  button.
  - The menu for the selected custom mode will be displayed.



- 7 Highlight [Assign] using the   buttons and press the  button.

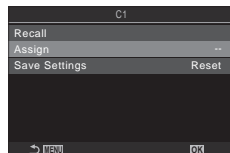
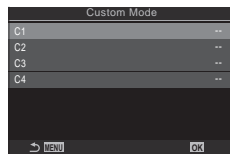



**8** Highlight [Set] using the  $\Delta$   $\nabla$  buttons and press the  $\odot$  button.

- Any existing settings will be overwritten.
- To restore default settings for the selected custom mode, highlight [Reset] and press the  $\odot$  button.

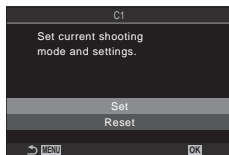

**9** Press the MENU button to exit the menus.

Custom modes can be updated automatically to reflect any changes made to settings (C1, C2, C3, or C4) during shooting. “Saving the Changes Made to Settings while in Custom Modes” (P. 57)

## Using Custom Modes

(C1/C2/C3/C4)

PASMB

To recall all saved settings, including the shooting mode:

**1** Rotate the mode dial to the desired custom mode (C1, C2, C3, or C4).

- The camera will be set to the settings for the selected mode.

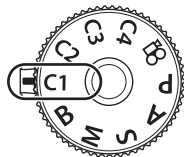

By default, changes made after recall will not be applied to the stored settings. The saved settings will be restored when next you select the custom mode with the mode dial.

### ■ Saving the Changes Made to Settings while in Custom Modes

You can save the changes made to settings while in custom modes in the camera. The changed settings remain even if you rotate the mode dial. You can use the custom modes just like the P/A/S/M/B modes.

**1** Press the MENU button to display the menus.

**2** Highlight the 1 tab using the front dial.

**3** Highlight [1. Basic Settings/Image Quality] using the  $\triangleleft$   $\triangleright$  buttons or the rear dial.

**4** Highlight [Custom Mode] using the  $\Delta$   $\nabla$  buttons and press the  $\odot$  button.

**5** Highlight the desired custom mode ([C1]–[C4]) using  $\Delta$   $\nabla$  buttons and press the  $\odot$  button.

**6** Highlight [Save Settings] using the  $\Delta$   $\nabla$  buttons and press the  $\odot$  button.

**7** Highlight [Hold] using the  $\triangleleft$   $\triangleright$  buttons and press the  $\odot$  button.







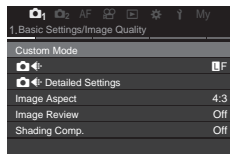

**8** Press the MENU button to exit the menus.

## ■ Recalling Saved Settings



In modes other than , you can recall the settings stored in custom modes [C1] through [C4].

- 1 Press the MENU button to display the menus.
- 2 Highlight the  tab using the front dial.



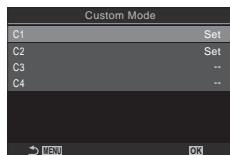

- 3 Highlight [1. Basic Settings/Image Quality] using the   buttons or the rear dial.
- 4 Highlight [Custom Mode] using the   buttons and press the  button.
- 5 Highlight the desired custom mode ([C1]–[C4]) using   buttons and press the  button.

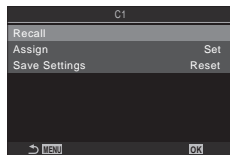

- 6 Highlight [Recall] using the   buttons and press the  button.



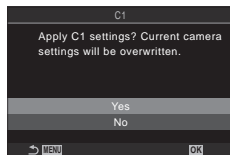

- 7 Highlight [Yes] using the   buttons and press the  button.



- 8 Press the MENU button to exit the menus.

 When you recall a setting while the mode dial is set to C1, C2, C3, or C4, the shooting mode also changes to the saved mode.

 Settings recalled by pressing a button to which [C1] - [C4] (Custom Mode C1 - 4) has been assigned in  Button Function] (P. 208) cease to apply when you:

- Turn the camera off
- Rotate the mode dial to another setting
- Press the MENU button during shooting
- Perform a reset
- Save or recall custom settings

## Recording Movies

- ⓘ When recording movies, use an SD card that supports an SD speed class of 10 or higher.
- ⓘ A UHS-II or UHS-I card with a UHS speed class of 3 or better is required when:
  - a movie resolution of [4K] or [C4K] is selected in the [ ] menu or a Motion Compensation of [A-I] (All-Intra) is selected in the [ ] menu

### Recording movies in movie mode ( )

PASMB

Rotate the mode dial to ( ) (movie mode) to record movies using the effects available in **P**, **A**, **S**, and **M** modes (P. 60).

**1** Rotate the mode dial to ( ).

**2** Press the ( ) button to begin recording.

- A beep does not sound when the camera focuses in movie mode.
- Movie you are recording will be displayed on the monitor.
- If you put your eye to the viewfinder, movie you are recording will be displayed in the viewfinder.
- A red frame is displayed during movie recording (P. 185).
- You can change the focus location by tapping the screen while recording.
- The camera will start the recording count and display the recording time.

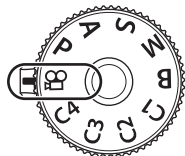

**3** Press the ( ) button again to end recording.

- ⓘ When the camera is used continuously for extended periods, the temperature of the image sensor will rise and noise and color splotches may be visible in the display. Should this occur, turn the camera off and wait for it to cool. Noise and color splotches are particularly likely to occur at high ISO sensitivities. If the temperature of the sensor increases further, the camera will turn off automatically.
- ⓘ When using a Four Thirds system lens, the AF will not operate while recording movies.
- ⓘ When high-speed movie recording is selected for [ ], movies shot with [I-Enhance] or an art filter selected for picture mode will be recorded in [Natural] mode.
- ⓘ The sound of touch operations and button operations may be recorded.
- ⓘ CMOS image sensors of the type used in the camera generate a so-called "rolling shutter" effect that can cause distortion in pictures of moving objects. This distortion is a phenomenon that occurs in pictures of fast-moving subjects or if the camera is moved during shooting. It is particularly noticeable in pictures taken at long focal lengths.
- ⓘ When an SDXC card is used, movies up to 3 hours long can be recorded. Movies over 3 hours are recorded over multiple files (depending on shooting conditions, the camera may start recording to a new file before the 3-hour limit is reached).
- ⓘ When an SD/SDHC card is used, movies over 4 GB in size are recorded over multiple files (depending on shooting conditions, the camera may start recording to a new file before the 4 GB limit is reached).
- 👉 You can also begin recording movies by pressing the shutter button. 📷 "Recording a movie by pressing the shutter button ( ) Shutter Function" (P. 216)
- 👉 Divided movie files can be played back as a single movie. 📷 "Playing back separated movies" (P. 189)

## ■ Choosing an Exposure Mode (📷 Mode (Movie Exposure Modes))

You can create movies that take advantage of the effects available in **P**, **A**, **S**, and **M** modes.

- 1 Press the MENU button to display the menus.
- 2 Highlight the 📷 tab using the front dial.
- 3 Highlight [1. Basic Settings/Image Quality] using the ◀▶ buttons or the rear dial.
- 4 Highlight [📷Mode] using the △▽ buttons and press the Ⓞ button.
- 5 Highlight the desired mode using △▽ buttons and press the Ⓞ button.

<b>P</b>	Optimal aperture is set automatically according to the brightness of the subject. Use the front dial or rear dial to adjust exposure compensation.
<b>A</b>	Depiction of background is changed by setting the aperture. Use the front dial to adjust exposure compensation and rear dial to adjust aperture.
<b>S</b>	Shutter speed affects how the subject appears. Use the front dial to adjust exposure compensation and rear dial to adjust shutter speed. Shutter speed can be set to values between 1/24 s and 1/32000 s.
<b>M</b>	<p>Freely adjust both aperture and shutter speed. Use the front dial to select aperture value and the rear dial to select shutter speed.</p> <ul style="list-style-type: none"> <li>• Choose from shutter speeds of 1/24–1/32000 s. Values of ISO 200–12800 are available using the [📷 ISO] manual sensitivity control options.</li> <li>• The display shows the difference between the exposure produced by the selected aperture and shutter speed and the optimal exposure metered by the camera. The display will flash if the difference exceeds ±3 EV.</li> <li>• The option chosen for [📷M ISO-A Upper/Default] (P. 114) takes effect.</li> </ul>

📷 The low end of the shutter speed changes according to the frame rate of the movie record mode.

- 6 Press the MENU button to exit the menus.

📷 [📷Mode] can also be set from the super control panel. 📷 “The Super Control Panel/LV Super Control Panel” (P. 69)

## Recording movies in photo shooting modes

Movies can be recorded in program AE mode even when the mode dial is not in the  position.

- ① [●REC] must be assigned to a button using [📷Button Function] (P. 208).
- ① The AF target takes on the shape selected for movie mode (P. 59). Rotate the mode dial to  (movie mode) and choose target shape in the AF target selection display (P. 77).

- 1 Press the button, to which [●REC] has been assigned, to begin recording.
  - During recording, “●REC”, recording time, and a red frame (P. 185) will be displayed on the monitor.
  - If you put your eye to the viewfinder, movie you are recording will be displayed in the viewfinder.
  - You can change the focus location by tapping the screen while recording.



- 2 Press the button again to end recording.
    - “●REC”, recording time, and the red frame (P. 185) disappear when you end recording.
- ① Even if you press a button to which [●REC] has been assigned, you cannot record movies in the following instances:
- During a multiple exposure (still photography also ends), while the shutter button is pressed halfway, during sequential shooting, time-lapse photography, keystone compensation, or fish-eye correction, or while the live ND filter is in use

## Touch Controls

## (Silent Controls)

PASMB

You can prevent the camera from recording operating sounds that occur due to camera operations while shooting. After tapping an item, tap the displayed arrows to select the settings.

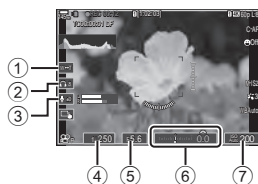

① power zoom	Zoom power zoom lenses in or out.
② headphone volume	Adjust volume when using headphones.
③ recording level	Choose the recording level.
④ shutter speed	Adjust shutter speed when [S] (shutter-priority AE) or [M] (manual) is selected for [Movie Mode] (movie exposure mode) (P. 60).
⑤ aperture	Adjust aperture when [A] (aperture-priority AE) or [M] (manual) is selected for [Movie Mode] (movie exposure mode) (P. 60).
⑥ exposure compensation	Adjust exposure compensation. If [M] is selected for [Movie Mode] (movie exposure mode) (P. 60), exposure compensation is available when [Auto] is selected for [ISO] (P. 113).
⑦ ISO sensitivity	Adjust [ISO] (P. 113). This option is available when [M] is selected for [Movie Mode] (movie exposure mode) (P. 60).

ⓘ Silent controls are not available during high-speed movie recording (P. 142).

🔊 You can configure the camera so that silent controls using the touch panel can also be used during still photography. 📖 "Configuring Info Settings" (P. 231)

# 3 Using the Menus

## What you can do with menus

In addition to shooting and playback options, the menus contain options that let you customize the operation and display of the camera, and set up the camera.

There are several tabs which represent function categories, and related functions are contained in each page.

For information on tab categories and functions on each page, see "Default Settings" (P. 311).

## How to operate the menus

- Front dial : Select a tab.
- ◀▶/Rear dial : Select a page.
- △ ▽ : Move the cursor.
- OK button : Confirm the setting/proceed to the next screen.
- MENU button : Cancel operation/return to previous screen.

The following explanation uses [AE BKT] as an example.

- 1 Press the MENU button to display the menus.

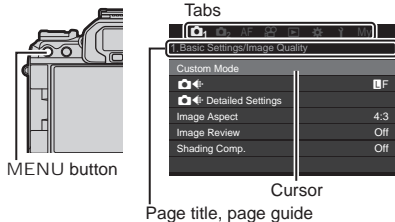

- 2 Use the front dial to select the desired tab.
  - [AE BKT] is on the tab. Rotate the front dial until the tab is highlighted.

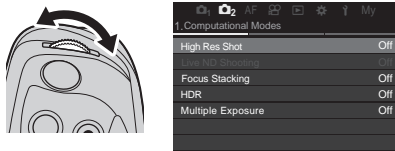

3 Use  $\triangleleft$   $\triangleright$  or the rear dial to select the desired page.

- [AE BKT] is on the 3rd page: [3. Bracketing]. Operate the  $\triangleleft$   $\triangleright$  buttons or the rear dial until the [3. Bracketing] page is highlighted.

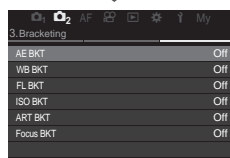
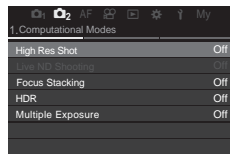

4 Use  $\triangle$   $\nabla$  to select [AE BKT] and press the  $\text{OK}$  button.

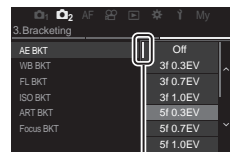
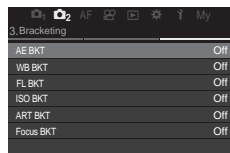

This appears next to the currently selected option.

5 Use  $\triangle$   $\nabla$  to highlight an option and press the  $\text{OK}$  button to select.

- The setting is confirmed.
- Pressing the MENU button closes the menu.
- The procedure after selecting an item and pressing the  $\text{OK}$  button varies depending on the menu item.
- Some menu items require further settings after you select an option in step 5. For operation, see the explanation of each function.

In this manual, the procedure for selecting a menu items is shown as follows.

Menu	MENU $\Rightarrow$ $\text{M2}$ $\Rightarrow$ 3. Bracketing $\Rightarrow$ AE BKT
------	---

$\text{M}$  You can use the multi selector in place of  $\triangle$   $\nabla$   $\triangleleft$   $\triangleright$  when operating menus.

$\text{M}$  To cancel menu operation, press the MENU button.

$\text{M}$  For information on each menu function and default settings, see "Default Settings" (P. 311).



### ■ Displaying the description of a menu item

When you press the INFO button while a menu item is selected, the description of the menu is displayed.

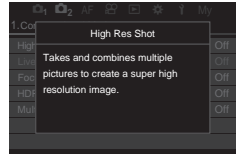
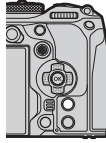

### ■ Items shown in gray

If an item is currently unavailable due to the condition of the camera or other settings, it is shown in gray.

When you press the **OK** button while a gray item is highlighted, the reason it is not available is displayed.

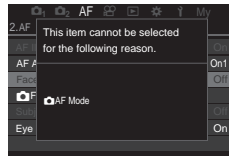
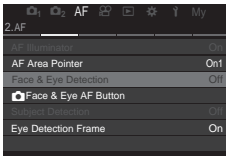

# 4 Shooting Settings

## How to change the shooting settings (Direct buttons/ Super Control Panel)

The camera offers many photography-related functions. Depending on how often you use them, you can access settings via buttons or icons in the display.





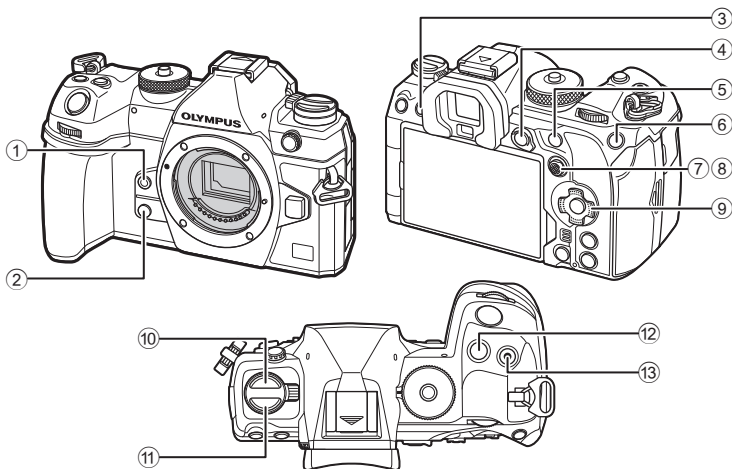







### Direct Buttons

Frequently-used photographic functions are assigned to buttons. These are referred to as "direct buttons". The buttons to which functions can be assigned are listed below.













Buttons excluding ⑩ (Power button) and ⑪ (AF button) can be assigned different roles.  "Changing the roles of buttons (Button Settings)" (P. 208)

## ■ Direct buttons during photo shooting

Direct button	Assigned function	
①  button	One-touch white balance	P. 152
②  button	Preview	P. 224
③  (LV) button	Display (monitor/viewfinder) selection	P. 37
④ AEL button	AEL	P. 109
⑤ AF-ON button	AF-ON	P. 83, 84
⑥ ISO button	ISO sensitivity	P. 113
⑦ Multi selector (  )	[  ] (AF target position)	P. 76
⑧ Multi selector (  )	Off*	-
⑨ Arrow pad (  )	Off*	-
⑩  button	Sequential/self-timer shooting/flash	P. 120, 126
⑪ AF (  ) button	AF/metering mode	P. 72, 109
⑫  button	Exposure compensation	P. 106
⑬  button	High Res Shot	P. 156

\* No function is assigned by default.

## ■ Direct buttons during movie recording

Direct button	Assigned function	
①  button	Peaking	P. 152
②  button	Magnify	P. 80
③  (LV) button	Display (monitor/viewfinder) selection	P. 37
④ AEL button	AEL	P. 109
⑤ AF-ON button	AF-ON	P. 83, 84
⑥ ISO button	ISO sensitivity	P. 113
⑦ Multi selector (  )	[  ] (AF target position)	P. 76
⑧ Multi selector (  )	Off*	-
⑨ Arrow pad (  )	Off*	-
⑪ AF (  ) button	AF/metering mode	P. 72, 109
⑫  button	Exposure compensation	P. 106
⑬  button	Movie recording	P. 59

\* No function is assigned by default.

For information on how each direct button function works, see the explanation page of each function.

This section explains how to operate when a selection menu is displayed, using [AF Mode] as an example.

**1** Press the button of the function you want to use.

- Press the AF  button
- A selection menu appears.



Selection menu

**2** Rotate the front/rear dial so select a setting.

- You can also use the  $\Delta$   $\nabla$   $\triangleleft$   $\triangleright$  buttons.  
If setting values appear at the top and bottom of the display when you press the button in step 1, use the following buttons.

$\Delta$   $\nabla$ : Selects items displayed at the top.

$\triangleleft$   $\triangleright$ : Selects items displayed at the bottom.

- In this example, rotate the rear dial to set [AF Mode].
- Pressing the shutter button halfway to exit to the shooting display.
- You can also return to the shooting display by pressing the button you pressed in step 1.
- With some functions, further detailed settings are available after selecting the setting in step 2. For information on how to operate, see the explanation of each function.

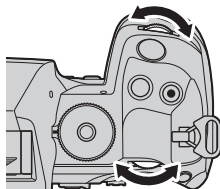

In this manual, the procedure for changing a setting using a direct button is shown as follows.

Button	AF  button $\Rightarrow$ 
--------	---

**Quickly changing the setting while keeping the button pressed**

Some settings can be changed by rotating the front/rear dial while keeping the button of the function pressed.

The setting screen closes when you release the button.

## The Super Control Panel/LV Super Control Panel

The super control panel/LV super control panel lists shooting settings and their current values. Use the super control panel when framing shots in the viewfinder, the LV super control panel when framing shots in the monitor (“live view”).

- In photo shooting mode, pressing the  (LV) button switches between viewfinder photography and live view photography.

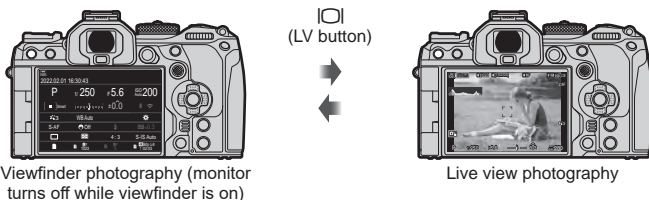

### Super Control Panel (Viewfinder Photography)

When you frame subjects in the viewfinder, the super LV control panel will be displayed in the monitor at all times. Press the  button to activate the cursor.



### LV Super Control Panel (Live View Photography)

To display the LV super control panel in the monitor, press the  button during live view.



This section explains how to operate super control panel/LV super control panel using [Face & Eye Detection] as an example.

#### 1 Press the button.

- If you press the button during live view, the LV super control panel will be displayed in the monitor.
- The last setting used will be highlighted.

#### Cursor



- 2 Highlight an item using  $\triangle \nabla \leftarrow \rightarrow$ .
- The selected setting will be highlighted.
  - You can also highlight items by tapping them in the display.

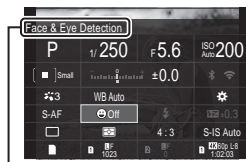

The name of the selected function appears.

- 3 Rotate the front/rear dial to change the highlighted setting.

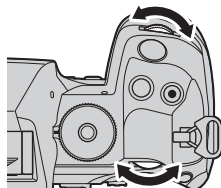

- Press the shutter button halfway to save the current setting and exit to the shooting display.

In this manual, the procedure for changing a setting using a direct button is shown as follows.

Super Control Panel	OK	➔	Face & Eye Detection
---------------------	----	---	----------------------

### Additional Options

Pressing the  $\text{OK}$  button in Step 2 displays options for the highlighted setting. In some cases, additional options can be configured.

$\text{OK}$  button

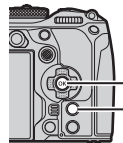

INFO button



LV Super Control Panel/  
Super Control Panel  
display

$\text{OK}$



Selection menu display

INFO



Detailed setting display

## ■ Settings Available in the Super Control/LV Super Control Panel

### Photo shooting mode

#### LV super control panel

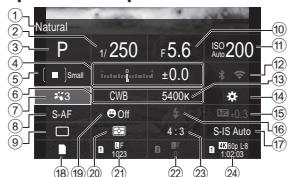

- ① Name of the currently selected option
- ② Shutter speed .....P. 43, 47
- ③ Shooting mode.....P. 43
- ④ Exposure compensation .....P. 106
- ⑤ AF target.....P. 77
- ⑥ White balance.....P. 150
- ⑦ Picture mode .....P. 145
- ⑧ AF mode .....P. 72
- ⑨ Drive mode (sequential shooting/self-timer).....P. 126
- ⑩ Aperture value .....P. 43, 45
- ⑪ ISO sensitivity.....P. 113
- ⑫ Wi-Fi/Bluetooth .....P. 261
- ⑬ Color temperature .....P. 150

#### Super control panel

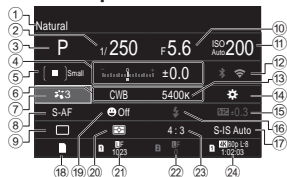

- ⑭ Button function assignment....P. 208
- ⑮ Manual flash output .....P. 123
- ⑯ Flash mode.....P. 120
- ⑰ Image stabilizer .....P. 136
- ⑱ Storage options .....P. 243
- ⑲ Face & Eye Detection.....P. 88
- ⑳ Metering mode.....P. 109
- ㉑ Slot 1: Image quality, number of storable still pictures .....P. 140
- ㉒ Slot 2: Image quality, number of storable still pictures .....P. 140
- ㉓ Aspect ratio.....P. 144
- ㉔ Image quality, Available recording time .....P. 141

### Movie recording mode

#### LV Super control panel



- ① Name of the currently selected option
- ② Shutter speed .....P. 60
- ③ mode (movie exposure mode) .....P. 60
- ④ Exposure compensation .....P. 106
- ⑤ AF target.....P. 77
- ⑥ White balance .....P. 150
- ⑦ Picture mode .....P. 145
- ⑧ AF mode .....P. 72
- ⑨ Sound Recording Level .....P. 62
- ⑩ Aperture value .....P. 60

- ⑪ ISO sensitivity .....P. 113
- ⑫ Wi-Fi/Bluetooth .....P. 261
- ⑬ Color temperature .....P. 150
- ⑭ Button function assignment....P. 208
- ⑮ Image quality, Available recording time .....P. 141
- ⑯ Image stabilizer .....P. 136
- ⑰ Headphone Volume .....P. 62
- ⑱ Face & Eye Detection.....P. 88
- ⑲ Recording level meter.....P. 62









## Basic functions for focusing

### Choosing a focus mode

( AF Mode /  AF Mode)



PASMB 









You can select a focusing method (focus mode).

Button	AF  button →   
Super Control Panel	 →  AF Mode /  AF Mode
Menu	MENU → AF → 1. AF →  AF Mode MENU → AF → 4. Movie AF →  AF Mode









<b>S-AF</b> (Single AF)	The camera focuses once when the shutter button is pressed halfway or the AF-ON button is pressed. When the focus is locked in still photography mode, a beep sounds, and the AF confirmation mark and the AF target mark light up. When the focus is locked in movie recording mode, the AF confirmation mark and the AF target are displayed. This mode is suitable for taking pictures of still subjects or subjects with limited movement.
<b>C-AF</b> (Continuous AF)	In photo shooting mode, the camera repeats measuring the distance between the subject and the camera and focusing while the shutter button remains pressed halfway or while the AF-ON button is pressed. When the subject is in focus, the AF confirmation mark lights up on the monitor and the beep sounds when the focus is locked at the first time. In movie recording mode, the camera repeats focusing both before and during recording. This mode is suitable when the distance to the subject keeps changing.
<b>MF</b> (Manual focus)	This function allows you to manually focus on any position by operating the focus ring on the lens.  Focus ring
<b>S-AF MF</b>	The camera focuses in S-AF mode. You can adjust the focus position by operating the focus ring on the lens.



<b>C-AF+TR</b> (AF tracking)	<p>Press the shutter button halfway or press the AF-ON button to focus; the camera then tracks and maintains focus on the current subject while the button is held in position.</p> <p>In movie recording mode, the camera keeps continues AF tracking even if you release the button before you start recording. To stop it, press the  button.</p> <p>When you start recording a movie while the camera is tracking the subject, it will continue tracking.</p> <ul style="list-style-type: none"> <li>• The AF target is displayed in red if the camera can no longer track the subject. Release the button and then frame the subject again and press the shutter button halfway or press the AF-ON button.</li> <li>• Autofocus does not work while the AF target is displayed in red even if the camera is tracking the subject.</li> <li>• Tracking AF cannot be used with: keystone compensation, High Res Shot, focus bracketing, focus stacking, interval-timer photography, HDR photography, the live ND filter, or fisheye correction.</li> </ul>
<b>PreMF</b> (Preset MF)	<p>The camera automatically focuses on the preset focus point when shooting.</p>
 <b>AF</b> (Starry Sky AF) (only during photo shooting)	<p>Choose this mode for pictures of stars in the night sky. Press the AF-ON button to focus on the stars.  "Using Starry Sky AF" (P. 74)</p>

- ⓘ [S-AF **MF**] only appears in  [AF Mode]. To focus manually during autofocus when taking pictures, use  [AF+MF].  "Combined Auto and Manual Focus ( AF+MF)" (P. 82)
- ⓘ The camera may be unable to focus if the subject is poorly lit, obscured by mist or smoke, or lacks contrast.
- ⓘ When using a Four Thirds system lens, AF will not be available during movie recording.
- ⓘ [AF Mode] selection is not available (P. 292) when the lens focus ring is in the MF position and [Operative] is selected for [MF Clutch] (P. 104).
- 👉 The Fn lever can be used to quickly switch the AF mode.  "Customizing the Fn Lever (Fn Lever Settings)" (P. 219)
- 👉 You can choose whether to focus when the shutter button is pressed halfway.  
 "Configuring the AF operation when the shutter button is pressed ( AF by half-pressing )" (P. 83)

## Using Starry Sky AF

- 1 Select [AF] for AF mode.
- 2 Press the AF-ON button to initiate starry sky AF.
  - To interrupt starry sky AF, press the AF-ON button again.
  - You can configure the camera so that starry sky AF starts when the shutter button is pressed halfway.  “Changing the settings of Starry Sky AF (Starry Sky AF Setting)” (P. 85)
  - The camera displays [Starry Sky AF is Running] during starry sky AF. The in-focus indicator (●) is displayed for about two seconds after the camera focuses; if the camera is unable to focus, the in-focus indicator will instead flash for about two seconds.
- 3 Press the shutter button all the way down to take the picture.
  - ⓘ The camera will not be able to focus in bright locations.
  - ⓘ Starry sky AF cannot be used with Pro Capture.
  - ⓘ  Orientation Linked [::] (P. 97), [L::] Loop Settings] (P. 100),  AF Limiter] (P. 92), [AF Illuminator] (P. 96), [Face & Eye Detection] (P. 88), and  AF Scanner] (P. 94) are fixed at [Off] and [Frame Rate] (P. 225) is fixed at [Normal].
  - ⓘ Manual focus is selected when a Four Thirds lens is attached.
  - ⓘ Starry sky AF is available with Micro Four Thirds lenses made by OM Digital Solutions or OLYMPUS. It cannot, however, be used with lenses with a maximum aperture over f/5.6. For more information, visit our website.
  -  The [Starry Sky AF Setting] (P. 85) item offers a choice of [Accuracy] and [Speed]. Mount the camera on a tripod before taking photographs with [Accuracy] selected.
  -  Your choice of AF target modes (P. 77) is restricted to [■] Small, [■] Mid, and [■] Large.
  -  The camera automatically focuses at infinity when starry sky AF is selected.
  -  When [On] is selected for [Release Priority], the shutter can be released even when the subject is not in focus.

### Setting a focus position for Pre-MF

- 1 Select [Pre-MF] with the AF-ON button, and press INFO button.
- 2 Press the shutter button halfway to focus.
  - Focus can be adjusted by rotating the focus ring.
- 3 Press the OK button.

☞ The distance for the preset focus point can be set with [Preset MF distance] (P. 104).

- ☞ The camera also focuses at the preset distance:
- when turned on and
  - when you exit the menus to the shooting display.

### Adjusting Focus Manually During Autofocus

- Before proceeding, select [On] for [AF+MF] (P. 82). MF will be displayed in [S-AF], [C-AF], [C-AF+TR], and [AF+MF] modes.
- 1 Choose a focus mode marked with an MF icon (P. 72).
    - When recording movies, choose [S-AF MF].
  - 2 Press the shutter button halfway to focus using autofocus.
    - In [AF+MF] mode, press the AF-ON button to initiate starry sky AF.
  - 3 Keeping the shutter button pressed halfway, rotate the focus ring to adjust focus manually.
    - To refocus using autofocus, release the shutter button and press it halfway again.
    - Manual focus adjustment during autofocus is not available in [AF+MF] mode.
    - Manual focus adjustment during autofocus is available via the focus ring on M.ZUIKO PRO (Micro Four Thirds PRO) lenses. For information on other lenses, see our website.
  - 4 Press the shutter button the rest of the way down to take the picture.

The frame showing the location of the focus point is referred to as the “AF target”. You can position the target over your subject. At default settings, the multi selector is used to position the AF target.

**1** Use the multi selector to position the AF target.

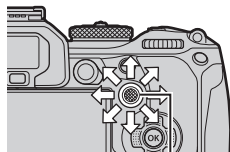





Multi selector

- The AF target is displayed at the start of the operation.
- To select the center AF target, press the multi selector or press and hold the  button.
- You can choose whether AF target selection “wraps around” the edges of the display (P. 100).



AF target

**2** Take pictures.

- The AF target selection display will clear from the monitor when the shutter button is pressed halfway.
  - The AF frame is displayed in place of the selected AF target.
-  You can reposition the AF target during focusing when [C-AF] or [C-AF **MF**] is selected in still photography mode.
-  You can also reposition the AF target during movie recording.
-  The size and number of the AF target changes depending on shooting settings.
-  When [On] is selected for [AF Targeting Pad] (P. 101), you can reposition the AF target using monitor touch controls while framing your subject in the viewfinder.

Button	(kept pressed) and
Super Control Panel	→ AF Target Mode

- 1 Keep the multi selector pressed while rotating the front or rear dial.

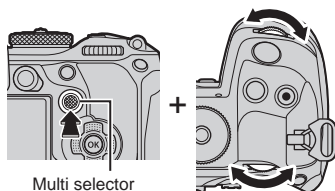

- The camera cycles through AF target modes as shown.

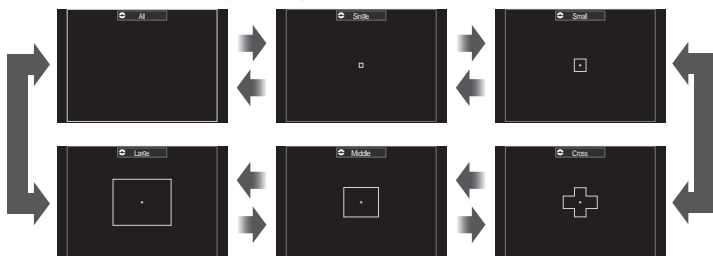

- The only options available when AF is selected are Small, Middle, and Large.
- The only options available during movie recording are Small, Middle, Large, and All.
- The AF target modes to be displayed can be selected in AF Target Mode Settings (P. 79).

## All

The camera chooses the target used for focus from all available targets.

- The camera chooses from 1053 (39 × 27) targets during still photography and from 741 (39 × 19) targets in movie mode.

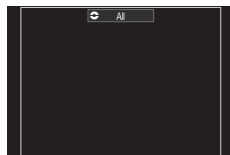

## Single

Select a single focus target.

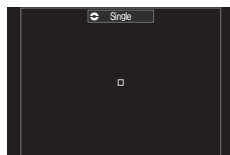

**[ ] Small**

Select a small-sized group of targets. The camera chooses the target used for focus from within the selected group.

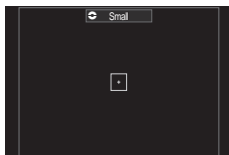
**[ # ] Cross**

Select a group of targets arranged in a cross. The camera chooses the target used for focus from within the selected group.

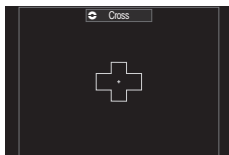
**[ ] Middle**

Select a middle-sized group of targets. The camera chooses the target used for focus from within the selected group.

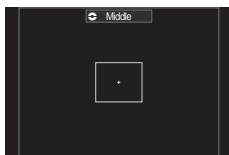
**[ ] Large**

Select a large-sized group of targets. The camera chooses the target used for focus from within the selected group.

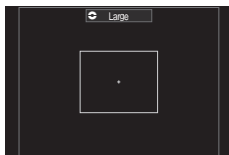
**[ ] C1 - [ ] C4 Custom Target**

You can change the size of the AF target and the step (the distance it moves at one time). Custom target modes can be selected when there is a check (✓) next to a custom target in [AF Target Mode Settings] (P. 79).

**2 Release the multi selector when the desired mode is displayed.**

- AF target mode options will no longer be displayed.
- ☞ The number of AF targets available may be reduced depending on shooting settings.
- ☞ The AF target display can be accessed by pressing the multi selector. The multi selector can be configured using [Center Button] (P. 218).
- ☞ Separate AF target modes can be selected according to camera orientation.
  - ☞ "Matching AF Target Selection to Camera Orientation (Orientation Linked [::])" (P. 97)
- ☞ The following focus settings can be recalled simultaneously using the Fn lever. Separate settings can be assigned to Positions 1 and 2. Use this option to quickly adjust settings according to shooting conditions.
  - [AF Mode] (P. 72), [AF Target Mode] (P. 77), and [AF Target Point] (P. 76)
  - The Fn lever can be configured using the [Fn Lever Function] item (P. 220) or the [Fn Lever Function] item (P. 220).
- ☞ You can adjust AF target settings for [C-AF].
  - ☞ [C-AF Center Priority] (P. 86)
- ☞ Separate options can be selected for still photography and movie mode.

## Setting the options for AF target modes

### (📷 AF Target Mode Settings)

## PASMB 📷

Specify which options are displayed when setting the 📷 AF Target Mode.

Menu	MENU ➔ AF ➔ 5. AF Target Settings & Operations ➔ 📷 AF Target Mode Settings
------	--

- Select the AF target modes that you want to have displayed as options and put a check (✔) next to each of them.
  - Select an option using  $\Delta$   $\nabla$  and press the  $\odot$  button to put a check (✔) next to it. To remove the check, press the  $\odot$  button again.

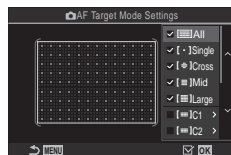

📷 AF Target Mode Settings screen

[ ] All			
[ ] Single			
[ ] Cross	If you put a check (✔) next to an option, it will be displayed as the option when selecting the AF target.		
[ ] Mid			
[ ] Large			
[ ] C1 - [ ] C4	If you put a check (✔) next to an option, it will be displayed as the option when selecting the AF target mode. Press $\triangleright$ to configure the size of the AF target and the step (the distance it moves at one time).		
	Item	Horizontal	Vertical
	Size	12 types (1 / 3 / 5 / 7 / 9 / 11 / 15 / 19 / 23 / 27 / 33 / 39) Switch using $\triangleleft$ $\triangleright$ or the front dial.	10 types (1 / 3 / 5 / 7 / 9 / 11 / 15 / 19 / 23 / 27) Switch using $\Delta$ $\nabla$ or the rear dial.
	Step	8 types (1 to 8) Switch using $\triangleleft$ $\triangleright$ or the front dial.	5 types (1 to 5) Switch using $\Delta$ $\nabla$ or the rear dial.
	Press the INFO button to switch between Size and Step.		

You can zoom in on the display during shooting. For greater precision during focusing, zoom in on the focus area. At higher zoom ratios, you can focus on areas smaller than the standard focus target. You can reposition the focus area as desired during zoom.

Button	A button to which <b>Q</b> has been assigned
--------	--

- ⓘ Before you will be able to use Super Spot AF, you must use [Button Settings] (P. 208) to assign [**Q**] (P. 210) to a camera control.

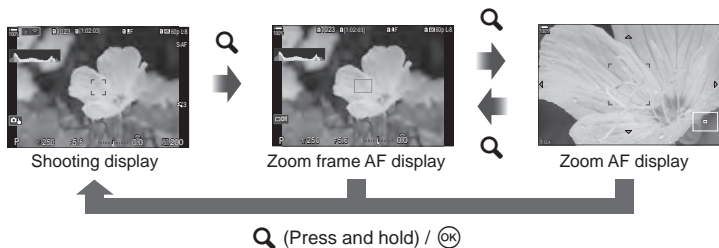

- 1** Press the button to which [**Q**] (magnify) is assigned.

- The zoom frame will be displayed.



- 2** Position the frame using the multi selector.

- To re-center the frame, press the multi selector or press and hold the **OK** button.
- The frame can also be positioned using the arrow pad (**Δ** **∇** **◀** **▶**).



- 3** Adjust the size of the zoom frame to choose the zoom ratio.

- Press the **INFO** button and then use the **Δ** **∇** buttons or the front or rear dial to adjust the size of the zoom frame.
- Press the **OK** button to accept and exit.





#### 4 Press the button to which [Q] is assigned once more.

- The camera will zoom the selected area in to fill the display.
- Use the front or rear dial to zoom in or out.
- Use the multi selector to scroll the display.
- Use  $\Delta \nabla \triangleleft \triangleright$  to scroll the display.
- If the shooting mode is **M** (manual) or **B** (bulb) and [ISO Auto] is not selected, you can press the INFO button during zoom to choose aperture or shutter speed.
- Press the **Q** button to return to the zoom frame.
- Press the  $\odot$  button to end focus zoom.
- You can also end focus zoom by pressing and holding the **Q** button.



Exposure adjustment display for modes **M** and **B**

- ⓘ Focus zoom applies to the display only. Pictures taken with the camera are not affected.
- ⓘ Zoom AF does not work during zoom display and when using a Four Thirds system lens.
- ⓘ When [Digital Tele-converter] is [On] in movie recording mode, camera cannot zoom.
- 👉 Pictures can also be taken during zoom frame AF display and zoom AF display.
- 👉 Touch controls can be used for focus zoom. 📖 “Shooting with touch screen operations” (P. 41)
- 👉 You can configure the camera to exit focus zoom when the shutter button is pressed halfway to focus. 📖 “Choosing What Happens When the Shutter Button Is Pressed During Live View Zoom (LV Close Up Mode)” (P. 223)

## Functions for configuring how to focus

### Combined Auto and Manual Focus

(📷 AF+MF)

PASMB 📷

After focusing using autofocus, you can adjust focus manually by keeping the shutter button pressed halfway and rotating the focus ring. Switch from auto to manual focus at will or fine-tune focus manually after focusing with autofocus.

🔗 The procedure varies with the AF mode selected.

Menu	MENU ➔ AF ➔ 1. AF ➔ 📷 AF+MF
------	-----------------------------

On	<p>Enable manual focus adjustment in autofocus mode. <b>MF</b> is displayed next to [S-AF], [C-AF], [C-AF+TR], or [📷 AF].</p> <ul style="list-style-type: none"><li>• When [S-AF <b>MF</b>] is selected, you can keep the shutter button pressed halfway or keep the AF-ON button pressed after focusing using single AF and adjust focus manually. Alternatively, you can switch to manual focus by rotating the focus ring while the camera is focusing. Focus can also be adjusted manually while the shutter is open and during burst photography.</li><li>• When [C-AF <b>MF</b>] or [C-AF+TR <b>MF</b>] is selected, you can switch to manual focus by rotating the focus ring while the camera is focusing in continuous AF and continuous tracking AF modes. Press the shutter button halfway or press the AF-ON button a second time to refocus using autofocus. Focus can also be adjusted manually while the shutter is open and during burst photography.</li><li>• When [📷 AF <b>MF</b>] is selected, you can focus manually after focusing or before initiating focus using autofocus.</li></ul>
Off	Manual focus adjustment disabled during autofocus.

🔗 Manual focus is not available during burst photography in [📷 SH1] or [ProCap SH1] mode.

🔗 Autofocus with manual focus is also available when autofocus is assigned to other camera controls. 📷 “Changing the roles of buttons (Button Settings)” (P. 208)

🔗 The lens focus ring can be used to interrupt autofocus only when M.ZUIKO PRO (Micro Four Thirds PRO) lenses are used. For information on other lenses, visit our website.

🔗 In **B** (bulb) mode, manual focus is controlled by the option selected for [Bulb/Time Focusing] (P. 173).

## Configuring the AF operation when the shutter button is pressed

( AF by half-pressing )

PASMB

You can choose whether the camera focuses when the shutter button is pressed halfway.

Menu	MENU $\Rightarrow$ AF $\Rightarrow$ 1. AF $\Rightarrow$ AF by half-pressing
<b>S-AF</b>	Set the AF operation for when the AF mode is [S-AF]. [No]: The camera does not start AF operation when the shutter button is pressed halfway. [Yes]: The camera starts AF operation when the shutter button is pressed halfway. If you press the shutter button halfway while pressing the AF-ON button, autofocus will be continued.
<b>C-AF/C-AF+TR</b>	Set the AF operation for when the AF mode is [C-AF] or [C-AF+TR]. [No]: The camera does not start AF operation when the shutter button is pressed halfway. [Yes]: The camera starts AF operation when the shutter button is pressed halfway. If you press the shutter button halfway while pressing the AF-ON button, autofocus will be continued.

## Autofocus using the AF-ON button

PASMB

The camera starts AF operation when you press the AF-ON button. Autofocus ends when you release the AF-ON button. When you press the AF-ON button while the camera is performing autofocus because the shutter button has been pressed halfway, autofocus will be continued.

Button	AF-ON button
--------	--------------

If [C-AF] is selected for [ AF Mode], the camera operates in S-AF mode when the AF-ON button is pressed during movie recording. If [C-AF+TR] is selected, the camera performs AF tracking when the AF-ON button is pressed.

## Using Autofocus in Manual Focus Mode

(**AF-ON** in MF mode)

PASMB 

You can configure the camera so that it focuses with autofocus when you press the AF-ON button, even if the AF mode is [MF] or [Pre MF].

Menu	MENU ➔ AF ➔ 1. AF ➔ <b>AF-ON</b> in MF mode
No	If the AF mode is [MF] or [Pre MF], the camera does not focus with autofocus even when the AF-ON button is pressed.
Yes	If the AF mode is [MF] or [Pre MF], the camera focuses with autofocus in [S-AF] mode when the AF-ON button is pressed.

## Configuring camera operation when it cannot focus on the subject

(Release Priority)

PASMB 







You can choose whether the camera takes a picture when it cannot focus on the subject with autofocus.

Menu	MENU ➔ AF ➔ 1. AF ➔ Release Priority
S-AF	Set the camera operation for when the AF mode is [S-AF] and it cannot focus on the subject with autofocus. <b>[Off]:</b> If the camera cannot focus on the subject with autofocus, the shutter cannot be released even when the shutter button is pressed fully. If the flash is configured to fire, the shutter cannot be released until the flash is charged. <b>[On]:</b> The shutter is released when the shutter button is pressed fully, even if the camera cannot focus on the subject with autofocus.
C-AF/C-AF+TR	Set the camera operation for when the AF mode is [C-AF] or [C-AF+TR] and it cannot focus on the subject with autofocus. <b>[Off]:</b> If the camera cannot focus on the subject with autofocus, the shutter cannot be released even when the shutter button is pressed fully. If the flash is configured to fire, the shutter cannot be released until the flash is charged. <b>[On]:</b> The shutter is released when the shutter button is pressed fully, even if the camera cannot focus on the subject with autofocus.

## Changing the settings of Starry Sky AF (Starry Sky AF Setting)

PASMB 

You can configure the operation of the Starry Sky AF function.

Menu	MENU ➔ AF ➔ 1. AF ➔ Starry Sky AF Setting
AF Priority	[Accuracy]: Prioritize focus accuracy over speed. Use a tripod. [Speed]: Prioritize focus speed over accuracy.
AF Operation	[  ]: Focuses with autofocus while the shutter button is pressed halfway. [  ]: Focuses with autofocus while the AF-ON button is pressed. [  ]: Focusing starts when the AF-ON button is pressed. Press again to stop focusing.
Release Priority	[Off]: If [AF Operation] is set to [  ], the shutter cannot be released even when the shutter button is pressed fully, unless the camera is in focus. If [AF Operation] is set to [  ] and the AF-ON button is pressed, the shutter cannot be released even when the shutter button is pressed fully, unless the camera is in focus. If the AF-ON button is not pressed, you can start shooting at any time by pressing the shutter button fully. If [AF Operation] is set to [  ] and Starry Sky AF is being executed, shooting does not start even when the shutter button is pressed fully. If Starry Sky AF is not being executed, you can start shooting at any time by pressing the shutter button fully. [On]: Shooting starts when the shutter button is pressed fully, regardless of the setting of [AF Operation].

## Functions for customizing AF operation to fit the subject

### C-AF Center Target Priority

( C-AF Center Priority)

PASMB

When focusing using group-target AF in [C-AF] and [C-AF MF] modes, the camera always assigns priority to the center target in the selected group for a repeated series of focus operations. Only if the camera is unable to focus using the center focus target will it focus using the surrounding targets in the selected focus group. This helps you track subjects that are moving quickly but relatively predictably. Center priority is recommended in most situations.

Menu MENU ⇒ AF ⇒ 3. AF ⇒ C-AF Center Priority

- 1 Select an AF target mode for which the camera always assigns priority to the center target for a repeated series of focus operations and put a check (✓) next to it.

- Select an option using  $\Delta$   $\nabla$  and press the  $\odot$  button to put a check (✓) next to it.  
To remove the check, press the  $\odot$  button again.

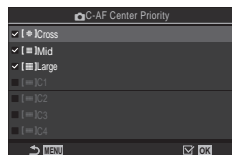





C-AF Center Priority setting screen

[] Cross	
[] Mid	If you put a check (✓) next to an option, the camera always assigns priority to the center target for a repeated series of focus operations when the AF target mode is used.
[] Large	
[] C1 - [] C4	
[] C1 - [] C4	



- [] C1 - [] C4 can only be checked (✓) when either the horizontal or vertical [Size] specified in [ AF Target Mode Settings] (P. 79) is 5 or larger.

## C-AF Tracking Sensitivity ( C-AF Sensitivity / C-AF Sensitivity)

PASMB 

Choose how rapidly the camera responds to changes in the distance to the subject while focusing with [C-AF], [C-AF ], [C-AF+TR] or [C-AF+TR ] selected for [ AF Mode], or with [C-AF] or [C-AF+TR] selected for [ AF Mode]. This can help autofocus track a quickly-moving subject or prevent the camera refocusing when an object passes between the subject and the camera.

Menu	MENU $\Rightarrow$ AF $\Rightarrow$ 1. AF $\Rightarrow$  C-AF Sensitivity MENU $\Rightarrow$ AF $\Rightarrow$ 4. Movie AF $\Rightarrow$  C-AF Sensitivity
------	--

- Choose from five levels ( C-AF Sensitivity) / three levels ( C-AF Sensitivity) of tracking sensitivity.
- The higher the value, the higher the sensitivity. Choose positive values for subjects that suddenly enter the frame, that are moving rapidly away from the camera, or that change speed or stop suddenly while moving toward or away from the camera.
- The lower the value, the lower the sensitivity. Choose negative values to prevent the camera refocusing when the subject is briefly obscured by other objects or to prevent the camera focusing on the background when you are unable to keep the subject in the AF target.

## C-AF Focus Speed ( C-AF Speed)

PASMB 

Choose how quickly the camera responds to changes to the distance to subject when [C-AF] or [C-AF+TR] is selected for focus mode. This can be used to adjust the time the camera takes to refocus when, for example, you switch subjects.

Menu	MENU $\Rightarrow$ AF $\Rightarrow$ 4. Movie AF $\Rightarrow$  C-AF Speed
------	--

- Choose from three focus speed levels.
- Refocusing is quicker at +1 and slower at -1. Choose -1 to refocus slowly when shifting to a new subject.

## Face priority AF/Eye priority AF (Face & Eye Detection)

The camera automatically detects and focuses on the faces or eyes of portrait subjects.

Super Control Panel	OK ➔ Face & Eye Detection
Menu	MENU ➔ AF ➔ 2. AF ➔ Face & Eye Detection

☺ <b>Face Detection On</b>	The camera detects and focuses on faces.
<b>Off</b>	Face priority AF off.
☺i <b>Face &amp; Eye Detection On</b>	The camera detects faces and focuses on the eye closest to the camera.
☺iL <b>Face &amp; Left Eye Detection On</b>	The camera detects faces and focuses on the left eye.
☺iR <b>Face &amp; Right Eye Detection On</b>	The camera detects faces and focuses on the right eye.

### ■ Selecting a face to focus on

#### 1 Point the camera at your subject.

- When the camera detects faces, a white frame appears on the face which is focused on. Gray frames appear on other faces. On the face which is focused on, an additional frame appears surrounding the white frame.
- When eye priority is on, white frames also appear on the eyes of the face which is focused on. The frames on the eyes can be hidden from the menu (P. 91).
- When faces/eyes of multiple persons are detected, choose the face to focus on by pressing the button to which [☺Face Selection] (P. 212) has been assigned in [Button Settings] (P. 208). When you press the button, a face that is closest to the AF target is selected. Switch faces by rotating the front or rear dial while holding the button pressed. Release the button to finalize your choice.
- The face used for focus can also be selected via touch controls (P. 41).

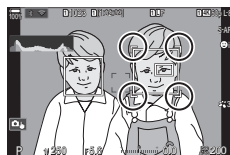

The face chosen for focus is indicated by white double brackets.

#### 2 Press the shutter button halfway to focus.







- ☞ You can also press the AF-ON button to focus (P. 83).
- The area of the subject used for focus is indicated by a green border.
- If the camera detects the subject's eyes, it will focus on an eye.
- Face and eye priority are also available in [MF] (P. 72). Faces and eyes detected by the camera are indicated by white frames. Exposure will be set according to the value metered for the center of the face.





### 3 Press the shutter button the rest of the way down to shoot.

- When set to  (Digital ESP metering) (P. 109), metering is performed with priority given to faces.



- ⓘ You may be unable to use [Face & Eye Detection] depending on the setting of [Subject Detection] (P. 90). Set [Subject Detection] to [Off].
- ⓘ Depending on the subject and the art filter setting, the camera may not be able to correctly detect the face.
- ⓘ This function is disabled when the AF target mode (P. 77) is  Single or  Small, the metering mode (P. 109) is  and  Spot Metering] (P. 112) is being used.
- ⓘ This function is disabled when the  AF Mode] (P. 72) is set to  AF] or  AF MF].
- 🔊 We recommend selecting [Off] when photographing non-portrait subjects using [C-AF] or [C-AF MF] in still photography mode.

### ■ Assigning focus priority to buttons ( Face & Eye AF Button)

PASMB 





You can configure the camera so that pressing the shutter button halfway or pressing the AF-ON button does not make the camera focus on faces and eyes even when  Face & Eye AF Button] is set to a setting other than [Off].





Menu	MENU ➔ AF ➔ 2. AF ➔  Face & Eye AF Button
------	--

	Select the AF operation for when the shutter button is pressed halfway. <b>[☉ Priority]:</b> When the camera detects faces and/or eyes, it focuses on faces and/or eyes. <b>[[::]] Priority:</b> Even when the camera detects faces and/or eyes, the camera focuses giving priority to the selected AF target positions.
	Select the AF operation for when the AF-ON button is pressed. <b>[☉ Priority]:</b> When the camera detects faces and/or eyes, it focuses on faces and/or eyes. <b>[[::]] Priority:</b> Even when the camera detects faces and/or eyes, the camera focuses giving priority to the selected AF target positions.

The camera can detect subjects of specific types when focusing. You may find it hard to focus on the driver or cockpit of a fast-moving subject such as a race car or airplane. This feature detects and focuses on specific elements of such subjects.

Menu	MENU ➔ AF ➔ 2. AF ➔ Subject Detection
------	---------------------------------------

	The camera detects cars or motorcycles. It tracks focus on such elements as the chassis (chiefly of types used in motor sports) or driver.
	The camera detects planes and helicopters. It tracks focus on such elements as the fuselage or cockpit.
	The camera detects trains. It tracks focus on such elements as the cars or driver's compartment.
	The camera detects birds. It tracks focus on such elements as the head or eyes.
	The camera detects cats, dogs and similar animals. It tracks focus on such elements as the head or eyes.
Off	Tracking subject selection disabled.

- ⓘ When you set this to a setting other than [Off], [Face & Eye Detection] is set to [Off].
- ⓘ During photo shooting, this function is disabled when [ AF Mode] is set to [ AF] or [ MF].  
During movie recording, this function is available only when [ AF Mode] is set to [ C-AF+TR].

## ■ Taking Pictures Using [Subject Detection]

- 1 Select the [📷 AF Mode] or the [👁️ AF Mode].
  - For photo shooting, select a setting other than [📷 AF] or [📷 AF MF].
  - For movie recording, select [C-AF+TR].

- 2 Point the camera at your subject.

- When the camera detects subjects, a white frame appears on the subject which is focused on. Gray frames appear on other subjects. On the subject which is focused on, an additional frame appears surrounding the white frame.
- If the white frame indicating a subject to be focused on does not appear, change the size and/or position of the AF target so that it covers the subject. When the AF target mode is [📷 All], the subject closest to the center of the display is focused on.
- When the camera further detects specific elements such as the driver or the cockpit, smaller white frames also appears on them. These frames can be hidden from the menu (P. 91).

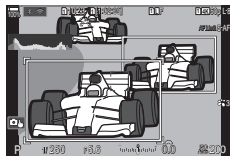

- 3 Press the shutter button halfway to focus.

- You can also press the AF-ON button to focus (P. 83).
- When the camera focuses on a subject, a green frame appears on the focus position.
- When the camera detects specific elements such as the driver or the cockpit, it focuses on them.

- 4 Press the shutter button the rest of the way down to take the picture.

- ⚠ The camera may fail to detect the subject depending on the subject or art filter selected.
- ⚠ The camera may fail to detect the subject depending on its type or on shooting conditions.

## Configuring the frame displays for detected eyes

(Eye Detection Frame)

P A S M B 📷

You can choose whether to display small frames when the camera detects small parts such as the eyes and cockpits.

Menu	MENU ➔ AF ➔ 2. AF ➔ Eye Detection Frame
Off	Frames are not displayed on small parts such as the eyes or cockpits.
On	Frames are displayed on small parts such as the eyes or cockpits.

- Even if [Eye Detection Frame] is set to [Off], the camera focuses on the eyes or specific elements such as the cockpit when they are detected.

## Functions for changing camera operation regarding focus

### Lens Focus Range

( AF Limiter)

PASMB

Choose the range in which the camera will focus using autofocus. This is effective in situations in which an obstacle presents itself between the subject and the camera during the focus operation, causing drastic changes in focus. You can also use it to prevent the camera focusing on foreground objects when shooting through a fence, window, or the like.

- Using the settings saved in [AF Limiter]

Menu	MENU → AF → 3. AF →  AF Limiter
------	---------------------------------

- 1 Select [AF Limiter] using  $\Delta$   $\nabla$  and press the button.
- 2 Select [On1] / [On2] / [On3] using  $\Delta$   $\nabla$  and press the button.

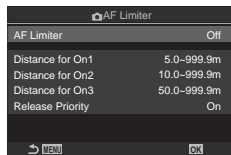

AF Limiter setting screen

<b>Off</b>	The camera does not use the saved range of focusing distances.
<b>On1</b>	The camera uses the range saved in [Distance for On1].
<b>On2</b>	The camera uses the range saved in [Distance for On2].
<b>On3</b>	The camera uses the range saved in [Distance for On3].

- 3 Return to the AF Limiter setting screen.

- ① AF Limiter is not available in the following cases.
  - When the focus limiter is enabled on the lens
  - When using focus bracketing
  - While in the movie mode or recording a movie
  - When [ AF] or [ AF MF] is selected for focus mode

## ■ Configuring [AF Limiter]

### 1 Configure options.

- Select an option using  $\Delta$   $\nabla$  and press the  $\text{OK}$  button to display the setting menu.
- Press the  $\text{OK}$  button again to return to the  $\text{AF Limiter}$  setting screen.

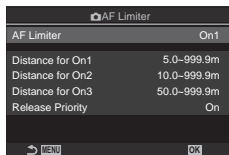

<b>Distance for On1</b>	Set the range of focusing distances to be used when [On1] is selected. Change the number with $\Delta$ $\nabla$ . Use $\langle \triangleright \rangle$ to move between digits. <b>[000.0] – [999.9 m/ft]</b>
<b>Distance for On2</b>	Set the range of focusing distances to be used when [On2] is selected. Change the number with $\Delta$ $\nabla$ . Use $\langle \triangleright \rangle$ to move between digits. <b>[000.0] – [999.9 m/ft]</b>
<b>Distance for On3</b>	Set the range of focusing distances to be used when [On3] is selected. Change the number with $\Delta$ $\nabla$ . Use $\langle \triangleright \rangle$ to move between digits. <b>[000.0] – [999.9 m/ft]</b>
<b>Release Priority</b>	<b>[Off]</b> : Complies to the [Release Priority] (P. 84) setting. <b>[On]</b> : The shutter can still be released if the camera is unable to focus when a setting other than [Off] is selected for [AF Limiter].

- ⓘ The figures displayed in [Distance for On1] - [Distance for On3] are intended as guides only.

Choose whether the camera performs a focus scan. If the camera is unable to focus, it will scan for the focus position by cycling the lens from the minimum focus distance to infinity. You can limit the scanning operation if desired. This option takes effect when [C-AF], [C-AF+TR], [C-AF MF], or [C-AF+TR MF] is selected for [AF Mode] (P. 72).



Menu	MENU ➔ AF ➔ 3. AF ➔  AF Scanner
------	--

Off	The camera will not scan if unable to focus. This prevents focus changing to such an extent that you lose sight of your subject when attempting to track small objects and the like.
On	When unable to focus, the camera scans only once. The camera will not scan again as long as the focus operation continues.



- Regardless of the option selected, the camera will scan once if unable to focus when [S-AF] or [S-AF MF] is selected for [AF Mode].

Fine-tune phase-detection autofocus. Focus can be fine-tuned by up to  $\pm 20$  steps.

Menu	MENU $\Rightarrow$ AF $\Rightarrow$ 3. AF $\Rightarrow$  AF Focus Adjustment
------	---

-  Normally there is no need to fine-tune autofocus using this item. Fine-tuning focus may prevent the camera focusing normally.
-  Focus fine-tuning has no effect in [S-AF] and [S-AF MF] modes.

■ Using the saved focus adjustment value

- 1 Select [AF Focus Adjustment] using  $\Delta$   $\nabla$  and press the  button.
- 2 Select [On] using  $\Delta$   $\nabla$  and press the  button.

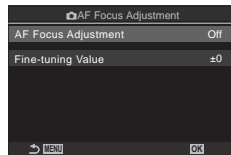



 AF Focus Adjustment setting screen

Off	The camera does not use the saved focus adjustment value.
On	The camera uses the saved focus adjustment value.



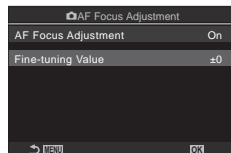

- 3 Return to the  AF Focus Adjustment setting screen.

### ■ Configuring [AF Focus Adjustment]

- 1 Configure the option.
  - Select an option using  $\Delta$   $\nabla$  and press the  button to display the setting menu.
  - Press the  button again to return to the  AF Focus Adjustment setting screen.



Fine-tuning Value	Adjusts focus for all lenses. Focus can be fine-tuned by up to $\pm 20$ steps. [-20] – [±0] – [+20]
-------------------	--

-  You can zoom in on the display by using the front dial or  button to check the results.
-  You can take a test picture to check the results by pressing the shutter button before pressing the  button.

## AF Illuminator Autofocus Assist

(AF Illuminator)

PASMB 

The AF illuminator lights to assist the focus operation when lighting is poor.

Menu	MENU ➔ <b>AF</b> ➔ 2. AF ➔ AF Illuminator
------	---

<b>On</b>	The illuminator lights during autofocus if the subject is poorly lit.
<b>Off</b>	The illuminator does not light even if the subject is poorly lit.

 To use the AF illuminator during silent photography, you will need to change the option selected for [Silent[▼] Settings] (P. 132).

## AF Target Display Mode

(AF Area Pointer)

PASMB 

In autofocus mode, the position of the subject on which the camera has focused is shown by a green focus target. This item controls the display of the focus target.

Menu	MENU ➔ <b>AF</b> ➔ 2. AF ➔ AF Area Pointer
------	--

<b>Off</b>	The focus target is not displayed.
<b>On1</b>	The focus target is displayed only briefly after the camera focuses.
<b>On2</b>	After the camera focuses, cluster AF targeting is enabled and the camera will display AF targets for all areas that are in focus while the shutter button is pressed halfway or the AF-ON button is pressed.



## Functions for setting the focusing position

### Matching AF Target Selection to Camera Orientation

 Orientation Linked [:::]

PASMB 

The camera can be configured to change the AF target position and AF target mode automatically when it detects that it has been rotated between landscape (wide) or portrait (tall) orientations. Rotating the camera changes the composition and consequently also the position of the subject in the frame. The camera can store the AF target mode and AF target position separately according to camera orientation. When this option is active, [ [:::] Set Home] (P. 98) can be used to store separate home positions for landscape and portrait orientations.

Menu	MENU $\Rightarrow$ AF $\Rightarrow$ 5. AF Target Settings & Operations $\Rightarrow$  Orientation Linked [:::]
------	--

- 1 Select a function with which you want to save different settings for landscape and portrait orientations, and put a check (✓) next to it.
  - Select an option using  $\Delta$   $\nabla$  and press the  $\odot$  button to put a check (✓) next to it.  
To remove the check, press the  $\odot$  button again.

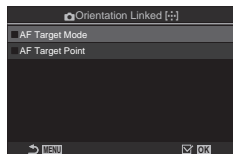

 Orientation Linked [:::]  
setting screen

<b>AF Target Mode</b>	When you put a check (✓) next to this, the camera saves separate AF target modes (e.g.,  All, [ # ] Small) for landscape and portrait orientations.
<b>AF Target Point</b>	When you put a check (✓) next to this, the camera saves separate AF target positions for landscape and portrait orientations.

- 2 The display returns to the  Orientation Linked [:::] setting screen.
- 3 Press the MENU button to return to shooting screen.
- 4 Choose the AF target mode or target position with the camera first in one orientation and then the other.
  - Separate settings are stored for landscape orientation, portrait orientation with the camera rotated to the right, and portrait orientation with the camera rotated to the left.

Choose the home position for the [::]Home feature. The [::]Home feature lets you recall a previously-saved "home position" for AF target at the touch of a button. This item is used to choose the home position.

Menu	MENU ➔ AF ➔ 5. AF Target Settings & Operations ➔  [::] Set Home
------	---

**1** Select a setting you wish to store with the home position and put a check (✓) next to it.

- Select an option using  $\Delta$   $\nabla$  and press the  $\odot$  button to put a check (✓) next to it. To remove the check, press the  $\odot$  button again.

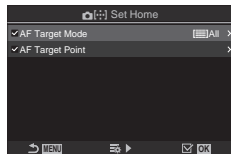

<b>AF Target Mode</b>	Choose the home position AF target mode. Only options selected for  AF Target Mode Settings] (P. 79) are available.
<b>AF Target Point</b>	Choose the home position focus target position.

**2** Press  $\triangleright$  to configure options for the selected item.









- Choose settings for the home position
- When Orientation Linked [::] is active, you will be prompted to select landscape or portrait (camera rotated left/camera rotated right) orientation before pressing the  $\odot$  button to display options.

### ■ Using the [::]Home function

The [::]Home function can be used in the following ways.







- In Button Function] (P. 208), assign [::]Home to a button. The AF target moves to the saved home position when you press the button.
- Select [::]JHP for Center Button] (P. 218). The AF target moves to the saved home position when you press the multi selector.

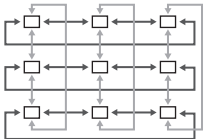
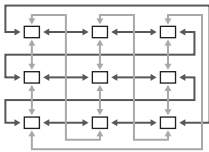

Choose the roles played by the front and rear dials or arrow pad during AF target selection. The controls used can be selected according to how the camera is used or personal taste.

Menu	MENU ➔ <b>AF</b> ➔ 5. AF Target Settings & Operations ➔ [::]Select Screen Settings
 dial	Assign roles to the front and rear dials. <b>[Off]</b> : None. <b>[Pos]</b> : Position the AF target (P. 76). <b>[Mode]</b> : Choose the AF target mode (e.g.,  All, [ # ]Small) (P. 77).
 button	Assign roles to     .
	<b>[Off]</b> : None. <b>[Pos]</b> : Position the AF target (P. 76). <b>[Mode]</b> : Choose the AF target mode (e.g.,  All, [ # ]Small) (P. 77).

You can choose whether AF target selection “wraps around” the edges of the display. You can also choose whether you have the option of selecting All (all targets) before AF target selection “wraps around” to the opposite border of the display.

Menu	MENU ➔ AF ➔ 5. AF Target Settings & Operations ➔ [::] Loop Settings
------	---

<p><b>[::] Loop Selection</b></p>	<p>[Off]: Wrap disabled. Target selection stays within the borders of the display.</p> <p>[Loop 1]: If you continue to press the multi selector in the same direction after reaching the border of the display, the target in the same row or column on the opposite border will be selected.</p> <p>[Loop 2]: If you continue to press the multi selector in the same direction after reaching the border of the display, the target in the next row or column on the opposite border will be selected.</p> <div style="text-align: center;">  <p>“Loop 1”</p>  <p>“Loop 2”</p> </div>
<p><b>Via All</b></p>	<p>[No]: Target selection does not pass through All (all targets) before wrapping around.</p> <p>[Yes]: If [Loop 1] or [Loop 2] is chosen for [::] Loop Selection, target selection will pass through All (all targets) before wrapping around to the opposite border.</p> <ul style="list-style-type: none"> <li>• Hiding All (all targets) in AF Target Mode Settings] fixes [Via All] at [No].</li> </ul>

ⓘ [::] Loop Settings] is fixed at [Off] during movie recording and when AF or AF MF] is selected for focus mode.



## Touch AF Target Selection for Viewfinder Photography

(AF Targeting Pad)

PASMB 

Use touch controls in the monitor to select the AF target during viewfinder photography. Glide a finger over the monitor to position the focus target while viewing your subject in the viewfinder.

Menu	MENU ➔ AF ➔ 5. AF Target Settings & Operations ➔ AF Targeting Pad
------	---

Off	Monitor touch controls cannot be used for AF target selection during viewfinder photography.
On	Monitor touch controls can be used for AF target selection during viewfinder photography. Gently tap the monitor twice to enable or disable touch AF target selection. When the target reaches the edge of the display and you lift and glide your finger again, the AF target moves to the other side or becomes  All (all target) mode depending on the [  Loop Selection] setting (P. 100).

 When [On] is selected, touch controls can also be used to position the zoom frame (P. 80).

## Other functions that are useful when focusing



### Manual Focus Assist







(MF Assist)

PASMB 

This is a focus assist function for MF. When the focus ring is rotated, the edge of the subject is enhanced or a portion of the screen display is magnified. When you stop operating the focus ring, the screen returns to the original display.

Menu	MENU ➔ AF ➔ 6. MF ➔ MF Assist
------	-------------------------------

<b>Magnify</b>	Magnifies a portion of the screen. [Off]: Normal display. [On]: Magnifies a portion of the screen. The portion to be magnified can be set in advance using AF target.  "Choosing a Focus Target (AF Target Point)" (P. 76)
<b>Peaking</b>	Displays clearly defined outlines with edge enhancement. [Off]: Normal display. [On]: Displays clearly defined outlines with edge enhancement. You can select the enhancement color and intensity.  "Focus Peaking Options (Peaking Settings)" (P. 103)
<b>Focus Indicator</b>	Rotating the focus ring during manual focus displays an indicator showing the direction and approximate amount of rotation required to bring the subject into focus. [Off]: Normal display. [On]: Rotating the focus ring during manual focus displays an indicator showing the direction and approximate amount of rotation required to bring the subject into focus.

-  When Peaking is in use, the edges of small subjects tend to be enhanced more strongly. This is no guarantee of accurate focusing.
-  Focus zoom is not available in the following instances:  
During movie recording / when [C-AF MF] or [C-AF+TR MF] is selected for focus mode / during a multiple exposure / when  Digital Tele-converter] is set to [On] in movie recording mode
-  When using third-party lenses with focus clutch mechanism, the direction of focus and the display of Focus Indicator may be reversed. If this happens, change the setting of [Focus Ring] (P. 104).
-  Focus Indicator cannot be displayed when using a Four-Thirds system lens.
-  Rotate the front or rear dial to zoom in or out during focus zoom.
-  Press the INFO button to change the color and intensity when Peaking is displayed.

Highlight objects using color outlines. This makes objects that are in focus easier to see during manual focus and the like.





Button	A button to which [Peaking] has been assigned ➔ INFO button
Menu	MENU ➔ AF ➔ 6. MF ➔ Peaking Settings

Peaking Color	Choose the focus peaking color. [White] / [Black] / [Red] / [Yellow]
Highlight Intensity	Choose the focus peaking level. [Low] / [Normal] / [High]
Image Brightness Adj.	Adjust background brightness to make focus peaking easier to see. [Off]: Normal display. [On]: Adjusts background brightness.

- When [On] is selected for [Image Brightness Adj.], the live view display may be brighter or darker than the final photograph.

#### ■ Using Focus Peaking

The following options are available for using focus peaking.

- Assigning [Peaking Settings] to a control using [Button Function] or [Button Function]: Focus peaking can be assigned to a control by selecting [Peaking] for [Button Function] (P. 208) or [Button Function] (P. 208). Pressing the button enables focus peaking. [Peaking] can also be selected for [Multi Function] (P. 215).
- Using [Peaking] for [MF Assist]:  
If [Peaking] is selected for [MF Assist], focus peaking will activate automatically when the lens focus ring is rotated.

 Press the INFO button to view peaking options.

## Choosing a Focus Distance for Preset MF (Preset MF distance)

P A S M B

Set the focusing position for Preset MF.  
Specify the number and unit (m or ft).

Menu	MENU ➔ AF ➔ 6. MF ➔ Preset MF distance
------	--

- ⓘ If the lens is equipped with a focus limiter, disable it before proceeding.
- ⓘ The figures displayed are intended as guides only.

## Disabling the MF Clutch (MF Clutch)

P A S M B

Disable the manual focus clutch, which is found on some lenses. This can prevent autofocus being disabled by the focus ring being rotated accidentally.

Menu	MENU ➔ AF ➔ 6. MF ➔ MF Clutch
------	-------------------------------

<b>Operative</b>	The camera responds to the position of the lens focus ring.
<b>Inoperative</b>	The camera focuses according to the option selected for [AF Mode] / [AF Mode], regardless of the position of the lens focus ring.

- ⓘ Manual focus using the lens focus ring is not available when [Inoperative] is selected for [MF Clutch], even if the lens focus ring is in the manual focus position.
- 🔍 For details about lenses equipped with MF clutch, see P. 292.

## Lens Focus Direction (Focus Ring)

P A S M B

Choose the direction in which the focus ring is rotated to adjust focus.

Menu	MENU ➔ AF ➔ 6. MF ➔ Focus Ring
------	--------------------------------

	Rotate the ring counterclockwise to increase the focus distance.
	Rotate the ring clockwise to increase the focus distance.



## Resetting the Lens Position at Shutdown (Reset Lens)

PASMB 

You have the option of not restoring the lens to the reset focus position when the camera is turned off. This lets you turn the camera off without changing the focus position.

Menu	MENU ➔ <b>AF</b> ➔ 6. MF ➔ Reset Lens
------	---------------------------------------



<b>Off</b>	The lens focus position is not reset when the camera is turned off. Power zoom lenses also return to the zoom position they were in before the camera was turned off.
<b>On</b>	The lens focus position is reset when the camera is turned off.

## Metering and Exposure

### Controlling exposure (Exposure Compensation)

PASMB 

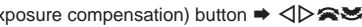

The exposure selected automatically by the camera can be altered to suit your artistic intent. Choose positive values to make pictures brighter, negative values to make them darker.

Button*	 (Exposure compensation) button → 
Super Control Panel	 → Exposure Comp.

\* When using in M mode, rotate the front or rear dial while pressing the  (Exposure compensation) button.

 To enable exposure compensation in mode **M**, select [Auto] for  ISO (P. 113).



- During photo shooting, exposure compensation can be adjusted by up to  $\pm 5.0$  EV. The viewfinder and live view show the effects of values not exceeding  $\pm 3.0$  EV. The exposure bar flashes when the value exceeds  $\pm 3.0$  EV.
- During movie recording, exposure compensation can be adjusted by  $\pm 3.0$  EV.
- To preview the effects of exposure compensation in live view, select [Standard] for  LV Mode (P. 225) and [Off] for  Night Vision (P. 225).

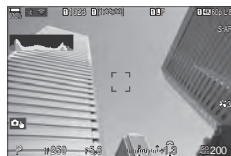

Exposure bar      Exposure compensation

- The front and rear dials or touch controls can be used to adjust exposure during movie recording.

## ■ Adjusting Exposure Compensation

### Modes P, A, and S

In movie mode, exposure compensation can be adjusted when [P], [A], or [S] is selected for [Mode] (movie exposure mode) (P. 60).

- 1 Rotate the front dial to adjust exposure compensation.
  - You can also choose a value by pressing the  button and using  $\triangleleft \triangleright$ .
- 2 Take pictures.

### Mode M

In movie mode, exposure compensation can be adjusted when [M] is selected for [Mode] (movie exposure mode). You must first however select [On] for [M ISO-Auto] (P. 115) and [Auto] for [ISO] (P. 113).

- 1 Press the  button and then rotate the front dial or rear dial to adjust exposure compensation.
- 2 Take pictures.

## ■ Resetting Exposure Compensation

To reset exposure compensation, press and hold the  button.

## EV Steps for Exposure Control (EV Step)

P A S M B 

Choose the size of the increments used when adjusting shutter speed, aperture, exposure compensation, and other exposure-related settings. Choose from 1/3, 1/2, and 1 EV.

Menu	MENU $\Rightarrow$  1 $\Rightarrow$ 4. Exposure $\Rightarrow$ EV Step
------	--







## Fine-Tuning Exposure (Exposure Shift)

P A S M B 

Fine-tune exposure. Use this option if you want the results of auto exposure to be consistently brighter or darker.

- ① Fine-tuning is not normally required. Use only as necessary. In normal circumstances, exposure can be adjusted using exposure compensation (P. 106).
- ① Fine-tuning exposure reduces the amount of exposure compensation available in the direction (+ or -) exposure was fine-tuned.



Menu	MENU $\Rightarrow$  1 $\Rightarrow$ 4. Exposure $\Rightarrow$ Exposure Shift
------	---



 (digital ESP)	Set the fine-tuning amount for when the metering method is  . [-1] – [±0] – [+1]
 (center-weighted averaging)	Set the fine-tuning amount for when the metering method is  . [-1] – [±0] – [+1]
 (spot)	Set the fine-tuning amount for when the metering method is  . [-1] – [±0] – [+1]

## Reducing Flicker Under LED Lighting

( Flicker Scan /  Flicker Scan)





P A S M B 

Banding may occur in photographs taken under LED lighting. Use [ Flicker Scan] / [ Flicker Scan] to optimize shutter speed while viewing banding in the display.

 : This item can be used in **S**, **M**, and silent mode and with Pro Capture shooting.

: This item can be used when [ Mode] (movie exposure mode) is [**S**] or [**M**].

 The range of available shutter speeds is reduced.

Menu	MENU →  → 4. Exposure →  Flicker Scan
	MENU →  → 1. Basic Settings/Image Quality →  Flicker Scan

- When set to [On], "FlickerScan" will be displayed.



 Focus peaking and the LV super control panel are not available in the flicker scan display. To view these items, first press the INFO button to exit the flicker scan display.

### ■ Choosing the Shutter Speed

- Choose a shutter speed using the front or rear dial or the  $\Delta$   $\nabla$  buttons. If desired, the shutter speed can be selected by keeping  $\Delta$   $\nabla$  pressed.
- You can also rotate the front dial to adjust shutter speed in the exposure increments selected for [EV Step] (P. 107).
- Continue adjusting shutter speed until banding is no longer visible in the display. Magnifying the display (P. 80) makes it easier to check for banding.
- Press the INFO button; the display will change and the "FlickerScan" will no longer be displayed. You can adjust aperture and exposure compensation. Do so using the front or rear dial or the arrow pad.
- Press the INFO button repeatedly to return to the flicker scan display.

## Choosing how the camera measures brightness (Metering)

PASMB

You can choose how the camera meters subject brightness.

Button	AF  button →
Super Control Panel	→ Metering
Menu	MENU →  1 → 5. Metering → Metering

<b>Digital ESP metering</b>	Suited to most scenes, including back-lit subjects. The camera meters 324 areas of the frame and calculates optimal exposure taking into consideration the nature of the scene.	
<b>Center weighted averaging metering</b>	Suited to compositions that place the main subject at the center of the frame. The camera sets exposure based on the average light level for the entire frame while assigning the greatest weight to the area in the center.	
<b>Spot metering</b>	Use a specific area of the subject meter exposure. The camera meters a small portion (approximately 2%) of the frame.	
<b>Spot metering (highlight)</b>	Increases spot metering exposure. Ensures bright subjects appear bright.	
<b>Spot metering (shadow)</b>	Lowers spot metering exposure. Ensures dark subjects appear dark.	

The spot metering position can be set at the selected AF target. “Metering the Focus Target ([::]Spot Metering)” (P. 112)

## Locking the exposure (AE Lock)

PASMB

You can lock the exposure by pressing the AEL button. Use this when you want to adjust the focus and exposure separately or when you want to shoot several images at the same exposure.

Button	AEL button
--------	------------

The camera can be configured to automatically release the lock after shooting. [AEL] [Auto Reset] (P. 110)

- If the AEL button has been assigned a different role, you will need to assign [AEL] (P. 213) to a control using [Button Function] (P. 208).
- If you press the AEL button once, the exposure is locked and “AEL” is displayed.
- Press the button once again to release the AE Lock.
- The lock will be released if you operate the mode dial, MENU button, or button.

## AE Lock Exposure Metering

(Metering during **(AEL)**)

PASMB 

Choose the metering method used to meter exposure when exposure is locked using the AEL button.

Menu	MENU ➔  1 ➔ 5. Metering ➔ Metering during <b>(AEL)</b>
------	---

- For more information on AE lock, see P. 109.

<b>Auto</b>	Exposure is metered using the method selected for [Metering] (P. 109).
<input checked="" type="checkbox"/> (center-weighted averaging)	The camera sets exposure based on the average light level for the entire frame while assigning the greatest weight to the area in the center.
<input type="checkbox"/> (spot metering)	The camera meters a small portion (approximately 2%) of the frame.
<input type="checkbox"/> Hi (spot highlight metering)	Brightens the spot metering area, brightening highlights.
<input type="checkbox"/> Sh (spot shadow metering)	Darkens the spot metering area, darkening highlights.

## Releasing AE Lock after shooting

(**(AEL)** Auto Reset)

PASMB 

Configure the camera so that it automatically releases the lock after shooting when exposure is locked using the AEL button.

Menu	MENU ➔  1 ➔ 5. Metering ➔ <b>(AEL)</b> Auto Reset
------	--



<b>No</b>	Exposure remains locked after shooting. Press the AEL button to release the lock.
<b>Yes</b>	Exposure lock is released after shooting.



-  When multiple photos are taken using such functions like sequential shooting, custom self-timer or interval shooting, exposure lock will be released after a series of photos have been taken.





## Locking exposure when the shutter button is pressed halfway (AEL by half-pressing )

### PASMB

Configure the camera so that it locks exposure when the shutter button is pressed halfway.

Menu	MENU $\Rightarrow$  1 $\Rightarrow$ 5. Metering $\Rightarrow$ AEL by half-pressing 
------	---



<b>No</b>	Exposure is not locked when the shutter button is pressed halfway. Exposure is determined based on the shooting conditions when the shutter button is pressed fully.
<b>Yes</b>	Exposure is locked when the shutter button is pressed halfway.
<b>S-AF Only</b>	Exposure is locked when the shutter button is pressed halfway only when the AF mode is [S-AF], [S-AF MF], [  ]AF or [  ]AF MF].

-  If exposure is locked by pressing the AEL button, it remains locked when you press the shutter button halfway regardless of this setting.
-  If you configure the camera so that it does not lock exposure when the shutter button is pressed halfway, you can choose whether the camera meters brightness for each frame during sequential shooting.  “Setting metering options for sequential shooting (Metering during 4



## Setting metering options for sequential shooting

(Metering during )

PASMB 

Menu	MENU →  5. Metering → Metering during 
------	--

No	The camera meters exposure when capturing the first frame and exposure is locked during sequential shooting.
Yes	The camera meters brightness and determines exposure for each frame.



- ⓘ If exposure is locked by pressing the AEL button (P. 109) or pressing the shutter button halfway (P. 111), exposure remains locked during sequential shooting even when [Metering during ] is set to [Yes].
- ⓘ When [SH1] or [ProCap SH1] is set, [Metering during ] is fixed at [No].





## Metering the Focus Target



([]Spot Metering)



PASMB 

Choose whether the camera meters the current AF target when [] is selected for [Metering]. Settings can be adjusted separately for spot, spot highlight, and spot shadow metering.

Menu	MENU →  5. Metering → [  ]Spot Metering
------	---

- 1 Select a metering method with which you want the camera to meter the current AF target, and put a check (✓) next to it.
  - Select an option using   and press the  button to put a check (✓) next to it. To remove the check, press the  button again.

Spot	Applied when [Metering] is [  ] (spot metering).
Spot Hilight	Applied when [Metering] is [  Hi] (spot highlight metering).
Spot Shadow	Applied when [Metering] is [  Sh] (spot shadow metering).

- ⓘ [Face & Eye Detection] turns off automatically.
- ⓘ The selected option takes effect when []Single or []Small is selected as the AF target mode (P. 77).
- ⓘ The camera zooms in on the selected AF target during focus zoom (P. 80).



Select a value according to subject brightness. Higher values let you photograph darker scenes but also increase image "noise" (mottling). Select [Auto] to let the camera adjust sensitivity according to lighting conditions.

Button	ISO button →
Super Control Panel	→ ISO

ⓘ ISO sensitivity is fixed at [Auto] during movie recording when [P], [A], or [S] is selected for Mode] (movie exposure mode). Setting Mode] to [M] allows other options to be selected. "Assigning Roles to the Front and Rear Dials ( Dial Function / Dial Function)" (P. 216)

<b>Auto</b>	<p>Sensitivity is adjusted automatically according to shooting conditions. During still photography, you can choose the maximum and standard values for ISO sensitivity. ( ISO-A Upper/Default) (P. 114)) You can change the shutter speed at which ISO sensitivity starts to rise in P and A modes. ( ISO-A Lowest S/S) (P. 115))</p> <p>ⓘ During movie recording, ISO sensitivity will be set to values of from ISO 200 to 12800. When [M] is selected for  Mode] (movie exposure mode), auto ISO sensitivity control can be enabled by selecting [On] for  ISO-Auto]. You can also choose maximum and standard values for ISO sensitivity.</p> <p> "Setting the shutter speed at which the camera automatically raises ISO sensitivity ( ISO-A Lowest S/S)" (P. 115)</p>
<b>L80, L100, 200–102400</b> (still photography)	<p>Choose a value for ISO sensitivity. ISO 200 offers a good balance between noise and dynamic range. Choose [L100] or [L80] for larger apertures (higher f-numbers) or slower shutter speeds. [L80] is equivalent to ISO 80, [L100] to ISO 100.</p> <p>ⓘ [L80] and [L100] are available at all exposure step values.</p> <p>ⓘ [L80] and [L100] reduce dynamic range.</p>
<b>200–12800</b> (movie recording)	<p>Choose a value for ISO sensitivity. ISO 200 offers a good balance between noise and dynamic range.</p>

- ⓘ Combining values over ISO 16000 with settings that use an electronic shutter (for example, silent mode or focus bracketing) sets the flash sync speed to 1/50 s.
- ⓘ Regardless of the value selected for ISO sensitivity, the flash sync speed for photos taken using ISO bracketing in silent mode is 1/50 s.
- ⓘ When [M] is selected for Mode] (movie exposure mode), ISO sensitivity can be adjusted during recording using touch controls (P. 62) or by rotating the front or rear dial.
- ⓘ If [Dramatic Tone] or [Watercolor] is chosen for picture mode during still photography, sensitivity will not exceed ISO 1600 when [Auto] is selected.

ⓘ The following restrictions apply when [M] is selected for [Mode] (movie exposure mode) depending on the picture mode:

- [2 OM-Log400] / [3 HLG]:
  - If the frame rate selected for [Frame Rate] is 23.98p, 24.00p, 25.00p, or 29.97p, [Auto] is restricted to sensitivities of ISO 400–6400.
  - If the frame rate selected for [Frame Rate] is 50.00p or 59.94p, [Auto] is restricted to sensitivities of ISO 400–12800.
  - The lowest value that can be selected manually is ISO 400.
- [Dramatic Tone] / [Watercolor]:
  - [Auto] is restricted to sensitivities of ISO 200–3200.
- Art filters other than [Dramatic Tone] / [Watercolor]:
  - If the frame rate selected for [Frame Rate] is 23.98p, 24.00p, 25.00p, or 29.97p, [Auto] is restricted to sensitivities of ISO 200–3200.
  - If the frame rate selected for [Frame Rate] is 50.00p or 59.94p, [Auto] is restricted to sensitivities of ISO 200–6400.
- Other picture modes:
  - If the frame rate selected for [Frame Rate] is 23.98p, 24.00p, 25.00p, or 29.97p, [Auto] is restricted to sensitivities of ISO 200–6400.

## EV Steps for ISO Sensitivity Control (ISO Step)

P A S M B

Choose the size of the increments used when adjusting ISO sensitivity. Choose from 1/3 and 1 EV.

Menu	MENU →  1 → 3. ISO/Noise Reduction → ISO Step
------	---

## Setting the range of ISO sensitivity values selected in [Auto] mode

( ISO-A Upper/Default / ISO-A Upper/Default)

P A S M B

Choose the range of ISO sensitivity values selected by the camera when [Auto] is selected for [ ISO] or [ ISO].

Menu	MENU →  1 → 3. ISO/Noise Reduction →  ISO-A Upper/Default MENU →  3. ISO/Noise Reduction →  ISO-A Upper/Default
------	--



<b>Upper Limit</b>	Choose the maximum sensitivity selected automatically by the camera. Set the value using $\Delta$ $\nabla$ or the front/rear dials.
<b>Default</b>	Choose the default sensitivity. Set the value using $\Delta$ $\nabla$ or the front/rear dials.

- Switch between [Upper Limit] and [Default] using  $\triangleleft$   $\triangleright$ .
- ⓘ The upper limit and the default settings differ between [ ISO] and [ ISO]. If the optimal exposure cannot be achieved under the aperture and shutter speed conditions, a lower sensitivity is applied.

## Setting the shutter speed at which the camera automatically raises ISO sensitivity ISO-A Lowest S/S

P A S M B 





Choose the shutter speed at which the camera starts raising the ISO sensitivity when [Auto] is selected for  ISO.

Menu	MENU $\Rightarrow$  1 $\Rightarrow$ 3. ISO/Noise Reduction $\Rightarrow$  ISO-A Lowest S/S
Auto	The camera sets it automatically.
1/8000 – 60"	The camera starts raising the ISO sensitivity at the specified shutter speed. Press the  button and set the shutter speed using $\Delta$ $\nabla$ .

## Choosing the modes in which [Auto] can be used for ISO sensitivity ISO-Auto / M ISO-Auto

P A S M B 



Choose the modes in which [Auto] can be used for ISO sensitivity.

Menu	MENU $\Rightarrow$  1 $\Rightarrow$ 3. ISO/Noise Reduction $\Rightarrow$  ISO-Auto MENU $\Rightarrow$  M $\Rightarrow$ 3. ISO/Noise Reduction $\Rightarrow$  M ISO-Auto
------	--

### ISO-Auto

P/A/S	[Auto] can be used for ISO sensitivity when the shooting mode is P, A, or S.
P/A/S/M	[Auto] can be used for ISO sensitivity when the shooting mode is P, A, S, or M.

### M ISO-Auto





Off	[Auto] cannot be used for ISO sensitivity when  Mode] (P. 60) is [M].
On	[Auto] can be used for ISO sensitivity when  Mode] (P. 60) is [M].

## High ISO Noise Reduction Options

( Noise Filter /  Noise Filter)

PASMB 

Reduce image artifacts (“noise”) in footage filmed at high ISO sensitivities. This can help reduce “graininess” in footage filmed under low light. You can choose the amount of noise reduction performed.

Menu	MENU ➔  ➔ 3. ISO/Noise Reduction ➔  Noise Filter MENU ➔  ➔ 3. ISO/Noise Reduction ➔  Noise Filter
Off	Noise reduction disabled.
Low / Standard / High	Choose the amount of noise reduction performed.

## Image Processing Options

(Low ISO Processing)

PASMB 

Choose the type of processing applied to photographs taken at low ISO sensitivities using sequential shooting.

Menu	MENU ➔  ➔ 3. ISO/Noise Reduction ➔ Low ISO Processing
Drive Priority	Image processing is adapted so as not to curtail the number of pictures that can be taken in a single burst.
Detail Priority	Image processing prioritizes image quality.

 Photographs taken in single shooting are processed in [Detail Priority] mode even if [Drive Priority] is selected.

## Long Exposure Noise Reduction Options (Noise Reduction)

PASMB 

Choose whether to process photos taken at slow shutter speeds to reduce image artifacts (“noise”). At slow shutter speeds, noise is caused by the heat generated from the camera itself. After each photo is taken, the camera captures a second image for noise reduction, causing a delay equal to the selected shutter speed before the next photo can be taken.

Menu	MENU ➔  1 ➔ 3. ISO/Noise Reduction ➔ Noise Reduction
------	---

<b>Off</b>	Noise reduction not performed.
<b>On</b>	Noise reduction is performed at all shutter speeds.
<b>Auto</b>	Noise reduction is performed automatically when the camera's internal temperature is elevated.

- ⓘ During noise reduction, the camera displays the time remaining until the process is complete.
- ⓘ During sequential shooting, [Off] is selected automatically and noise reduction is not performed.
- ⓘ Noise reduction may not produce the desired effects depending on the subject and shooting conditions.
- 🔊 To use this function in silent mode, it is required that you configure the [Silent[♥] Settings] setting (P. 132).

## Flash photography

### Using a flash

### (Flash photography)

When using a flash unit designed for use with the camera, you can choose from various shooting modes to meet your needs.

#### ■ Flash units designed for use with the camera

Choose a flash unit to suit your needs, taking into consideration such factors as the output required and whether the unit supports macro photography. Flash units designed to communicate with the camera support a variety of flash modes, including TTL auto and super FP. Flash units can be mounted on the camera hot shoe or connected using a cable (available separately) and flash bracket. The camera also supports the following wireless flash control systems:

#### **Radio-Controlled Flash Photography: CMD, ⚡CMD, RCV, and X-RCV Modes**

The camera controls one or more remote flash units by means of radio signals. The range of locations in which flash units can be placed increases. Flash units can control other compatible units or be fitted with radio commander/receivers to allow the use of units that do not otherwise support radio flash control.

#### **Wireless Remote-Control Flash Photography: RC Mode**

The camera controls one or more remote flash units by means of optical signals. The flash mode can be selected using camera controls (P. 124).

#### ■ Features Available with Compatible Flash Units

Flash unit	Supported flash control modes	GN (Guide Number, ISO 100)	Supported wireless systems
FL-700WR	TTL-AUTO, MANUAL, FP TTL AUTO, FP MANUAL, MULTI, RC, SL MANUAL	GN 42 (75/150 mm <sup>*1</sup> ) GN 21 (12/24 mm <sup>*1</sup> )	CMD, ⚡CMD, RCV, X-RCV, RC
FL-900R	TTL-AUTO, AUTO, MANUAL, FP TTL AUTO, FP MANUAL, MULTI, RC, SL AUTO, SL MANUAL	GN 58 (100/200 mm <sup>*1</sup> ) GN 27 (12/24 mm <sup>*1</sup> )	RC
STF-8	TTL-AUTO, MANUAL, RC <sup>*2</sup>	GN 8.5	RC <sup>*2</sup>
FL-LM3	Varies with camera settings.	GN 9.1 (12/24 mm <sup>*1</sup> )	RC <sup>*2</sup>

\*1 Maximum lens focal length at which unit can provide flash coverage (figures following slashes are 35 mm format equivalent focal lengths).

\*2 Functions as commander (transmitter) only.

## ■ Attaching Compatible Flash Units

The methods used to attach and operate external flash units vary with the unit. See the documentation provided with the unit for details. The instructions here apply to the FL-LM3.

⚠ Confirm that both the camera and flash unit are off. Attaching or removing a flash unit while either the camera or flash unit is on could damage the equipment.

### 1 Remove the hot shoe cover and attach the flash.

- Slide the flash in until the foot clicks into place at the back of the shoe.

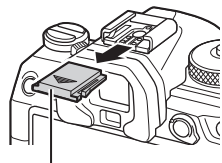

Hot shoe cover

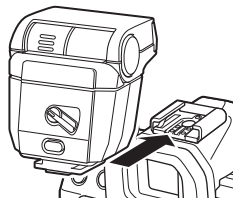

### 2 Position the flash head for bounce-flash photography or direct lighting.

- The flash head can be rotated up and left or right.
- Note that flash output may be insufficient for correct exposure when bounce flash lighting is used.

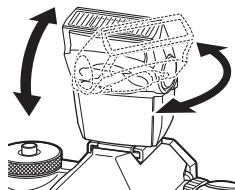

### 3 Rotate the flash ON/OFF lever to the ON position.

- Rotate the lever to the OFF position when the flash is not in use.

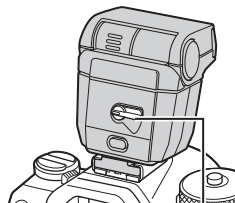

ON/OFF lever

## ■ Removing Flash Units

- 1 Keeping the UNLOCK button pressed, slide the flash unit from the hot shoe.

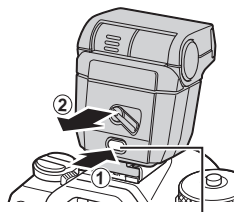

UNLOCK button

## Choosing a Flash Mode

(Flash Mode)

Button	button →
Super Control Panel	→ Flash Mode

## ■ Flash Modes

Flash modes that are displayed vary depending on the configuration of [Flash Mode Settings] (P. 123).

<b>Fill In</b>	<p>Enable the flash.</p> <p>① Shutter speed can be set to values between that selected for [ Slow Limit] (P. 124) and [ X-Sync.] (P. 124).</p>
<b>Flash Off</b>	<p>Disable the flash.</p> <p>① The flash will not fire even if the unit is on.</p>
<b>Slow Slow</b>	<p>Slow shutter speeds are used to capture both the main subject and the background.</p> <p>① Shutter speed is set according to the exposure value metered by the camera and is not restricted by the option selected for [ Slow Limit].</p>
<b>Manual Manual</b>	<p>The flash fires at the selected level.</p> <p>Appears only when the FL-LM3 is attached.</p>



## ■ Flash Mode and Shutter Speed

The range of shutter speeds available varies with the flash mode. The range of available speeds can be further restricted using the options in the menu.

[X-Sync.] (P. 124), [ Slow Limit] (P. 124)

Exposure mode	Flash mode	[Reduce Red-eye] (P. 123)	[Synchro Settings] (P. 123)	Super control panel	Red-eye reduction	Flash timing	Shutter speed
P/A	Fill flash	[No]	[First Curtain]		No	Front-curtain sync	60 - 1/250 s
			[Second Curtain]	2		Rear-curtain sync	
		[Yes]	[First Curtain]		Yes	Front-curtain sync	
			[Second Curtain]	2		Rear-curtain sync	
	Slow	[No]	[First Curtain]	Slow	No	Front-curtain sync	
			[Second Curtain]	Slow2		Rear-curtain sync	
		[Yes]	[First Curtain]	Slow	Yes	Front-curtain sync	
			[Second Curtain]	Slow2		Rear-curtain sync	
	Manual value*1	(regardless of setting)	(regardless of setting)	Manual	No	Front-curtain sync	
	Flash off	(regardless of setting)	(regardless of setting)	3	—	—	

Exposure mode	Flash mode	[Reduce Red-eye] (P. 123)	[Synchro Settings] (P. 123)	Super control panel	Red-eye reduction	Flash timing	Shutter speed
S/M	Fill flash	[No]	[First Curtain]		No	Front-curtain sync	60 - 1/250 s
			[Second Curtain]			Rear-curtain sync	
		[Yes]	[First Curtain]		Yes	Front-curtain sync	
			[Second Curtain]			Rear-curtain sync	
	Manual value*1	(regardless of setting)	(regardless of setting)		No	Front-curtain sync	
	Flash off	(regardless of setting)	(regardless of setting)		—	—	
B	Fill flash	[No]	[First Curtain]		No	Front-curtain sync	—
			[Second Curtain]			Rear-curtain sync*2	—
		[Yes]	[First Curtain]		Yes	Front-curtain sync	—
			[Second Curtain]			Rear-curtain sync*2	—
	Manual value*1	(regardless of setting)	(regardless of setting)		No	Front-curtain sync	—
	Flash off	(regardless of setting)	(regardless of setting)		—	—	—

\*1 This is displayed only when the FL-LM3 is attached. You can select the value by selecting [Manual Value] from the super control panel.

\*2 When [Live Comp] (P. 54) is selected, flash operates in [First Curtain] mode even when [Second Curtain] is selected.

- In red-eye reduction mode, the shutter will be released approximately one second after the initial red-eye reduction pre-flash. Do not move the camera until shooting is complete. Also note that red-eye reduction may not produce the desired results in some conditions.
- The fastest shutter speed available when the flash fires is 1/250 s. Bright backgrounds in pictures taken with the flash may be overexposed.

- The flash sync speed for silent modes (P. 132), High Res Shot (P. 156), and focus bracketing (P. 178) is 1/100 s. Setting [ ISO ] to a value over ISO 16000 when using an option that requires the electronic shutter (for example, silent mode or focus bracketing) sets the flash sync speed to 1/50 s. The flash sync speed is also set to 1/50 s during ISO bracketing (P. 176).
- Even the minimum available flash output may be too bright at short range. To prevent overexposure in pictures taken at short range, select mode **A** or **M** and choose a smaller aperture (higher f-number) or choose a lower setting for [ ISO ].

## Configuring flash modes (Flash Mode Settings)

### P A S M B

Choose which modes are displayed on the flash mode selection screen.

Menu	MENU →  1 → 6. Flash → Flash Mode Settings	
<b>Reduce Red-eye</b>	Reduce “red-eye” in portrait photos. <b>[No]:</b> The camera does not display Reduce Red-eye modes. <b>[Yes]:</b> The camera displays Reduce Red-eye modes.	
<b>Synchro Settings</b>	Choose when the flash fires. <b>[First Curtain]:</b> The flash fires when the shutter is fully open. <b>[Second Curtain]:</b> The flash fires immediately before the shutter closes. Moving objects appear to leave trails of light behind them.	

## Adjusting flash output (Flash Exposure Comp.)

### P A S M B

Flash output can be adjusted if you find that your subject is over- or under-exposed even though the exposure in the rest of the frame is appropriate.

Flash compensation is available in modes other than manual.

Super Control Panel	→ Flash Exposure Comp.
---------------------	------------------------

- Changes to flash intensity made with the external flash unit are added to those made with the camera.

## Wireless Remote Flash Control

 RC Mode

 P A S M B 

Adjust settings for wireless remote flash control. Remote control is available with optional flash units that support wireless remote control (“wireless RC flash”). For information on using wireless remote flash control, see P. 298.

Menu	MENU →  1 → 6. Flash →  RC Mode
------	---

Off	Wireless remote flash control disabled.
On	Wireless remote flash control enabled. The camera displays settings for wireless remote flash control.

- Selecting [On] displays the RC mode super control panel in the camera monitor. To view the regular super control panel, press the INFO button.

## Choosing a Flash Sync Speed

 X-Sync.)

 P A S M B 





Choose the fastest shutter speed available for flash photography. Choose the fastest shutter speed available for flash photography, irrespective of subject brightness.

Menu	MENU →  1 → 6. Flash →  X-Sync.
------	---

## Choosing the Minimum Shutter Speed

 Slow Limit)

 P A S M B 

Choose the slowest shutter speed available for flash photography in P/A modes. This item is used to select the slowest setting available to the camera when selecting the shutter speed automatically during flash photography, regardless of how dark the subject may be. It does not take effect in slow-sync ( Slow,  Slow2,  Slow and  Slow2) modes.

- Available values: 60 s to value selected for [ X-Sync.]

Menu	MENU →  1 → 6. Flash →  Slow Limit
------	--

## Flash and Exposure Compensation

 + 

 P A S M B 

Choose whether exposure compensation is added to the value for flash compensation. For information on flash compensation, see P. 123.

Menu	MENU →  1 → 6. Flash →  + 
------	---

Off	Flash and exposure compensation are set independently.
On	The value for exposure compensation is added to the value for flash compensation.

## Setting the exposure balance for TTL metering

(Balanced Flash Metering)

PASMB 

Set the exposure balance to be used when using an external flash in TTL metering mode.

Menu	MENU ➔  1 ➔ 6. Flash ➔ Balanced Flash Metering
------	---

<b>Off</b>	Gives priority to the subject during metering.
<b>On</b>	Gives priority to the balance between the subject and the background during metering.

 When selecting [On], it is recommended that you set [ ISO] to [Auto].

## Sequential Shooting/Self-Timer

### Performing the sequential/self-timer shooting



PASMB

Adjust settings for burst or self-timer photography. Choose an option according to your subject. Other options, including anti-shock and silent modes, are also available.



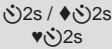

① Fix the camera securely on a tripod for self-timer shooting.



Button	button →
Super Control Panel	→ Drive
Menu	MENU →  → 7. Drive Mode → Drive



<b>Single</b>	Single-frame advance. The camera takes one photo each time the shutter button is pressed all the way down.
<b>Sequential</b>	The camera takes photos at up to about 20 fps while the shutter button is held all the way down. When [ AF Mode] (P. 72) is set to [C-AF], [C-AF <b>MF</b> ], [C-AF+TR], or [C-AF+TR <b>MF</b> ], the camera will focus before each shot. When [Metering during ] (P. 112) is set to [Yes], the camera will meter the brightness and determines the exposure before each shot.
<b>High-speed Sequential SH1</b>	The camera takes photos at up to about 120 fps while the shutter button is held all the way down. Focus, exposure, and white balance are locked at the values for the first shot in each series.
<b>High-speed Sequential SH2</b>	The camera takes photos at up to about 50 fps while the shutter button is held all the way down. When [ AF Mode] (P. 72) is set to [C-AF], [C-AF <b>MF</b> ], [C-AF+TR], or [C-AF+TR <b>MF</b> ], the camera will focus before each shot. When [Metering during ] (P. 112) is set to [Yes], the camera will meter the brightness and determines the exposure before each shot.
ProCap ProCap SH1 ProCap SH2 <b>Pro Capture</b>	Capture starts when the shutter button is pressed halfway. The camera starts recording pictures, including those captured while the button was pressed halfway, when the button is pressed all the way down (P. 133). Focus and exposure during each ProCap mode are the same as [] (♥Sequential), [] (♥High-speed Sequential SH1) and [] (♥High-speed Sequential SH2).

 <b>Self-timer 12 sec</b>	<p>The shutter is released 12 seconds after the shutter button is pressed all the way down. The self-timer lamp will light for about 10 seconds and then start to flash about 2 seconds before the shutter is released. The camera focuses when the shutter button is pressed halfway.</p>
 <b>Self-timer 2 sec</b>	<p>When the shutter button is pressed all the way down, the self-timer lamp will start to flash and a photo will be taken after about 2 seconds. The camera focuses when the shutter button is pressed halfway.</p>
 <b>Custom Self-timer</b>	<p>Adjust self-timer settings, including the self-timer delay and the number of shots taken when the timer expires (P. 130).</p>







 You can choose the frame advance rate and the maximum number of shots in each series (P. 128).





















 Items marked with  allows you to take pictures with the small amount of blur caused by operation of the shutter reduced. Use this option when even slight camera motion can cause blur, for example during macro or telephoto photography. This option is available when [Anti-Shock[]] is set to [On] in [Anti-Shock[]] Settings] (P. 131).

 Items marked with  use the electronic shutter. Use these with shutter speeds faster than 1/8000 seconds, or in settings where the sound of the shutter would be unwelcome.

  SH2 and ProCap SH2 can only be used with specific lenses. Visit our website for details.

 To cancel the activated self-timer, press .

 In , , and  and ProCap modes, the camera displays the view through the lens during shooting. In  SH1,  SH2, ProCap SH1, and ProCap SH2 modes, it displays the shot immediately preceding the current frame.

-  When using  SH2 or ProCap SH2 with [C-AF], [C-AF], [C-AF+TR] or [C-AF+TR] selected for [ AF Mode] (P. 72) and an aperture value larger than F8, the focus accuracy will decrease.  F will be displayed.
-  In  SH1 and ProCap SH1 modes, the lower limit of the shutter speed is 1/15 s.
-  In  SH2 and ProCap SH2 modes, the lower limit of the shutter speed is 1/640 s when [Max fps] under [Sequential Shooting Settings] is set to 50 and 1/320 s when it is set to 25.
-  Shooting speed will be lower when [ ISO] is 16000 or higher.
-  When [ ISO] set to 16000 or higher in  mode, the flash sync speed will be 1/50 s and the shooting speed will be limited to a maximum of 10 fps.
-  If you stand in front of the camera to press the shutter button when using the self-timer, the picture may be out of focus.
-  The speed of sequential shooting varies depending on the lens you are using and the focus of the zoom lens.
-  During sequential shooting, if the battery level icon blinks due to low battery, the camera stops shooting. The camera may not save all of the pictures depending on how much battery power remains.
-  Photographs taken in silent and pro-capture modes may be distorted if the subject or camera moves quickly during shooting.
-  To use the flash in silent shooting modes (P. 132), select [Allow] for [Flash Mode] in [Silent[]] Settings] (P. 132).

ⓘ Shooting speed may be lower when shooting in a dark place. You may be able to increase shooting speed by setting [Night Vision] to [Off]. ⓘ “Making the display easier to see in dark places (Night Vision)” (P. 225)

#### ■ Number of pictures that can be taken

The camera displays the number of pictures that can be stored in the remaining buffer in the following instances:

When the shutter button is pressed halfway, when the shutter button is pressed fully, when writing to SD card

When it becomes [00] (red), the camera will be unable to record the next picture. When the images in the buffer are written to the card, the number will increase and the will be able to record pictures.

ⓘ It is not displayed when there is no card in the camera.

ⓘ It may not be displayed depending on the functions that are in use.

ⓘ The number is approximate and not exact. It may change depending on the shooting conditions.



## Configuring the sequential shooting functions

### (Sequential Shooting Settings)

P A S M B

You can choose which types of sequential shooting modes are displayed when you press the button, and the maximum speed/number of frames for each sequential shooting mode.

Menu	MENU →  → 7. Drive Mode → Sequential Shooting Settings
------	--

1 Select a sequential shooting mode that you want to have displayed, and put a check (✓) next to it.

- Select an option using  $\Delta$   $\nabla$  and press the  $\text{OK}$  button to put a check (✓) next to it.

To remove the check, press the  $\text{OK}$  button again.

ⓘ [] is displayed when [Anti-Shock[ $\blacklozenge$ ]] is set to [On] in [Anti-Shock[ $\blacklozenge$ ]] Settings) (P. 131).

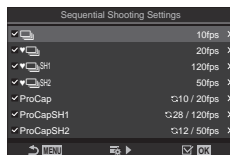



Sequential Shooting Settings screen

2 Press  $\blacktriangleright$ .

3 Configure options.

Max fps	<p>Set the shooting speed for sequential shooting. The numbers indicate the approximate maximum speeds.</p> <p>/<math>\blacklozenge</math>: 1 – 10 fps  : 5, 10, 15, 20 fps  SH1: 60, 100, 120 fps  SH2: 25, 50 fps  ProCap: 5, 10, 15, 20 fps  ProCap SH1: 60, 100, 120 fps  ProCap SH2: 25, 50 fps</p>
---------	--



<b>Pre-shutter Frames (ProCap/ProCap SH1/ProCap SH2 only)</b>	Set the number of frames to be captured before the shutter button is pressed fully from between 0 and 70.
<b>Frame Count Limiter</b>	<p>Set the total number of frames from 2 to 99 (including the pre-shutter frames) to be captured. You can limit the number of frames that are captured after you press the shutter button fully. Shooting stops automatically when the limit is reached.</p> <ul style="list-style-type: none"> <li>• Select [Off] if you do not want to put a limit on the number of frames.</li> <li>• To put a limit on the number of frames, select the number and press the  button. The setting screen appears. You can change the number with <math>\Delta</math> <math>\nabla</math>.</li> <li>• For Pro Capture shooting, the number of frames includes the pre-shutter frames.  "Shooting without a release time lag (Pro Capture shooting)" (P. 133)</li> </ul>





- ① When [HDR], [Focus Stacking] or [Focus BKT] is enabled, [Frame Count Limiter] will be [Off].
- ① When using  SH2 or ProCap SH2, shooting speed can only be configured with specific lenses. For compatible lenses, visit our Website.

You can choose which types of self-timer modes are displayed when you press the  button, and change the self-timer settings such as the time the camera waits before taking a picture, and the number of frames it captures.

Menu MENU →  → 7. Drive Mode → Self-timer Settings



- Select a self-timer mode that you want to have displayed, and put a check (✓) next to it.

  - Select an option using  $\Delta$   $\nabla$  and press the  $\text{OK}$  button to put a check (✓) next to it.  
To remove the check, press the  $\text{OK}$  button again.

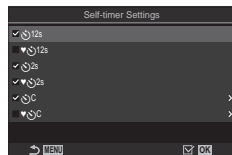
 [♦  12s] / [♦  2s] / [♦  C] are displayed when [Anti-Shock[♦]] is set to [On] in [Anti-Shock[♦] Settings] (P. 131).



Self-timer Settings screen

- When setting Custom Self-timer, select [ C] / [♦  C] / [♥  C] and press  $\triangleright$ .
- Configure options.

<b>Number of Frames</b>	Choose the number of shots taken when the timer expires.
<b> Timer</b>	Choose how long the camera waits to begin shooting after the shutter button is pressed all the way down.
<b>Interval Length</b>	If the number of shots is 2 or more, choose the interval between the shots taken when the timer expires.
<b>Every Frame AF</b>	[Off]: If the number of shots is 2 or more, focus is locked when the first shot is taken. [On]: The camera focuses before each shot.





## Shooting without the vibration caused by shutter button operations (Anti-Shock[◆] Settings)

PASMB 

Anti-shock shooting modes can be used to reduce the slight blur caused by shutter motion.

Use this option when even slight camera motion can cause blur, for example during macro or telephoto photography.

Menu	MENU ➔  1 ➔ 7. Drive Mode ➔ Anti-Shock[◆] Settings
------	---





<b>Anti-Shock[◆]</b>	[Off]: Anti-shock shooting modes ([◆□], [◆  , etc.) are not displayed on the drive mode selection screen. Normal shooting modes ([□], [  , etc.) are displayed. [On]: Anti-shock shooting modes ([◆□], [◆  , etc.) are displayed on the drive mode selection screen. Normal shooting modes ([□], [  , etc.) are not displayed.
<b>Waiting Time</b>	Choose how long the camera waits to begin shooting after the shutter button is pressed all the way down when shooting in anti-shock shooting modes. <b>[0sec], [1/8sec], [1/4sec], [1/2sec], [1sec], [2sec], [4sec], [8sec], [15sec], [30sec]</b>

- Be sure there is a check (✓) next to a sequential shooting mode with ◆ in [Sequential Shooting Settings] (P. 128).
- Select a mode with ◆ (P. 126), press the  button, then take pictures. After the specified time elapses, the shutter will be released and pictures will be taken.

In situations where the shutter sound is a problem, you can use the silent shooting modes to shoot without making a sound. An electronic shutter is used to reduce the minuscule camera shake caused by the motion of the mechanical shutter, much as is the case for anti-shock photography.

Menu	MENU ➔  1 ➔ 7. Drive Mode ➔ Silent[♥] Settings
------	---

<b>Waiting Time</b>	Choose how long the camera waits to begin shooting after the shutter button is pressed all the way down when shooting in silent shooting modes. <b>[0sec], [1/8sec], [1/4sec], [1/2sec], [1sec], [2sec], [4sec], [8sec], [15sec], [30sec]</b>
<b>Noise Reduction</b>	<b>[Off]</b> : Shoots normally. <b>[Auto]</b> : Reduces image "noise" in long exposures during silent photography. The sound of the shutter may be audible when noise reduction is active.
	Choose whether to allow the beep to sound as specified (P. 251).
<b>AF Illuminator</b>	Choose whether to allow AF Illuminator to work as specified (P. 96).
<b>Flash Mode</b>	Choose whether the flash works as specified.

- ⓘ During High Res Shot shooting (P. 156), , [AF Illuminator], and [Flash Mode] work in [Allow] mode even if they are set to [Not Allow].  
When [High Res Shot] is set to [On , however, [Flash Mode] is fixed at [Flash Off].
- Be sure there is a check (♥) next to a sequential shooting mode with ♥ in [Sequential Shooting Settings] (P. 128).
- Select a mode with ♥ (P. 126), press the  button, then take pictures. The monitor turns dark for a short while when the shutter is released. The shutter does not sound.
- ⓘ The desired results may not be achieved under flickering light sources such as fluorescent or LED lamps or if the subject moves abruptly during shooting.
- ⓘ The fastest available shutter speed is 1/32000 s.
- ⓘ The flash sync speed will be 1/50 s when [ISO] is 16000 or higher.

Capture starts when the shutter button is pressed halfway; the moment the button is pressed the rest of the way down, the camera will start saving the last  $n$  captured pictures to the memory card, where  $n$  is a number selected before shooting begins. If the button is held all the way down, shooting will continue until the selected number of pictures is recorded. Use this option to capture moments you might otherwise miss due to your subject's reactions or shutter lag.

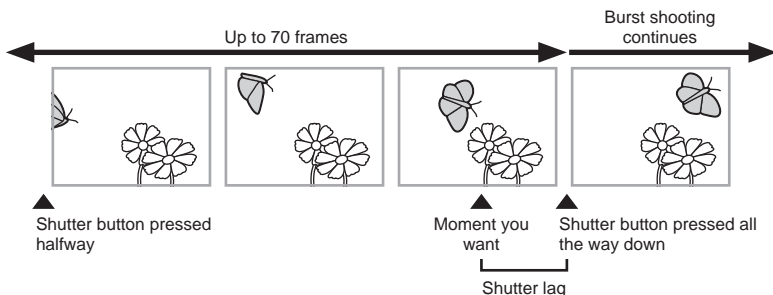

### Pro Capture (ProCap)

Choose this option if you anticipate that the distance to the subject will change during shooting. The camera shoots at up to 20 fps. A maximum of 70 frames can be captured before the shutter button is pressed all the way down. If [C-AF], [C-AF MF], [C-AF+TR], or [C-AF+TR MF] is selected for [AF Mode] (P. 72), the camera will focus before each shot.

### Pro Capture SH1 (ProCap SH1)

Choose this option if the distance to the subject is unlikely to change very much during shooting. The camera shoots at up to 120 fps. A maximum of 70 frames can be captured before the shutter button is pressed all the way down. The camera will use [S-AF] when [C-AF] or [C-AF+TR] is selected for [AF Mode] (P. 72) and [S-AF MF] when [C-AF MF] or [C-AF+TR MF] is selected.

### Pro Capture SH2 (ProCap SH2)

The camera shoots at up to 50 fps. A maximum of 70 frames can be captured before the shutter button is pressed all the way down. If [C-AF], [C-AF MF], [C-AF+TR], or [C-AF+TR MF] is selected for [AF Mode] (P. 72), the camera will focus before each shot.

- ⓘ This option can only be used with specific lenses. Visit our website for details
- ⓘ When using ProCap SH2 with [C-AF], [C-AF MF], [C-AF+TR] or [C-AF+TR MF] selected for [AF Mode] (P. 72) and an aperture value larger than F8, the focus accuracy will decrease. ● F will be displayed.
- ⓘ In ProCap SH1 mode, the lower limit of the shutter speed is 1/15 s.
- ⓘ In ProCap SH2 mode, the lower limit of the shutter speed is 1/640 s when [Max fps] under [Sequential Shooting Settings] is set to 50 and 1/320 s when it is set to 25.

Button	button →
Super Control Panel	→ Drive
Menu	MENU →  → 7. Drive Mode → Drive

- 1 Select ProCap, ProCap SH1, or ProCap SH2 and press the button.
- 2 Press the shutter button halfway to start capturing.

- When the shutter button is pressed halfway, a capture icon () will be displayed. If the button is kept pressed halfway for over a minute, capture will end and the icon will clear from the display. Press the shutter button halfway again to resume shooting.
- Shooting will continue while the shutter button is pressed all the way down, up to the number of shots selected for [Frame Count Limiter].



Capture icon

[Max fps], [Pre-shutter Frames], and [Frame Count Limiter] can be adjusted in [Sequential Shooting Settings] (P. 128).

- 3 Press the shutter button all the way down to start saving pictures to the memory card.
  - Pro Capture is not available while the camera is connected to a smartphone (Wi-Fi).
  - Flickering occurred by fluorescent lights or the large movement of the subject, etc. may cause distortions in images.
  - During capture, the monitor will not go dark and the sound of the shutter will not be heard.
  - The slowest shutter speed is limited.
  - Depending on subject brightness and the options selected for [ISO] and exposure compensation, the display frame rate may drop below that selected for [Frame Rate] (P. 225).

## Reducing Flicker in Photographs (Anti-Flicker Shooting)

PASMB 

You may notice uneven exposure in photos taken under flickering light. When this option is enabled, the camera will detect the flicker frequency and adjust the timing of the shutter release accordingly.

Menu **MENU**  **7. Drive Mode**  **Anti-Flicker Shooting**

- “FLK” appears in the display when [On] is selected.



- ⓘ The camera may be unable to detect flicker at some settings. Normal release timing will be used if flicker is not detected.
- ⓘ Normal release timing is used at slow shutter speeds.
- ⓘ Enabling flicker reduction may cause release lag, slowing the frame advance rate during burst photography.

## Image Stabilization

### Reducing camera shake (📷 Image Stabilizer / 📹 Image Stabilizer) P A S M B 📷

You can reduce the amount of camera shake that can occur when shooting in low light situations or shooting with high magnification.

Super Control Panel	OK → 📷 Image Stabilizer / 📹 Image Stabilizer
Menu	MENU → 📷 1 → 8. Image Stabilizer → 📷 Image Stabilizer MENU → 📹 4 → 4. Image Stabilizer → 📹 Image Stabilizer

#### 📷 Image Stabilizer

<b>S-IS Off (Still-I.S. Off)</b>	Image stabilization disabled. Select this option when using a tripod.
<b>S-IS Auto (Auto I.S.)</b>	Image stabilization applies to motion on all axes. If panning motion is detected, the camera will automatically suspend image stabilization on that axis.
<b>S-IS1 (All Direction Shake I.S.)</b>	Image stabilization applies to motion on all axes.
<b>S-IS2 (Vertical Shake I.S.)</b>	Image stabilization applies to vertical motion. Use when panning the camera horizontally.
<b>S-IS3 (Horizontal Shake I.S.)</b>	Image stabilization applies to horizontal motion. Use when panning the camera vertically.

#### 📹 Image Stabilizer

<b>M-IS Off (Movie-I.S. Off)</b>	Image stabilizer is off.
<b>M-IS1 (All Direction Shake I.S.)</b>	Electronic image stabilization combined with VCM-controlled image sensor movement.
<b>M-IS2 (All Direction Shake I.S.)</b>	VCM-controlled image sensor movement only.



## ■ Setting the detailed option of image stabilizer

When using lenses other than Micro Four Thirds or Four Thirds system lenses, input the focal length of the lens.

- 1 Press the INFO button while configuring [Image Stabilizer] or [Image Stabilizer]. Input the focal length using  $\Delta$   $\nabla$   $\triangleleft$   $\triangleright$  and then press the OK button.

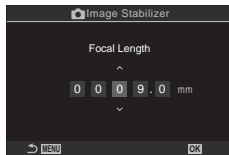

<b>Focal Length</b>	Set the lens focal length. Input the number that is printed on the lens. [0.1] – [1000.0] mm
---------------------	---

- ⓘ Image stabilization may be unable to compensate for excessive camera motion or very slow shutter speeds. Use a tripod in these cases.
- ⓘ You may notice noise or vibration while image stabilization is in effect.
- ⓘ The setting selected with the lens image stabilization switch, if any, takes priority over that selected with the camera. This can be changed. "Image Stabilization for IS Lenses (Lens I.S. Priority)" (P. 139)
- ⓘ [S-IS Auto] functions as [S-IS1] when [On] is selected for [Lens I.S. Priority] (P. 139).
- ⓘ When you select [S-IS Auto] or [S-IS1] with SH2/ProCap SH2 selected as the drive mode (P. 126), the image stabilization will be suitable for camera moves in the depth direction, compared to when used with other sequential shooting modes.
- ⓘ You can choose whether image stabilization will be performed while the shutter button is pressed halfway. "Half-press image stabilization (=Image Stabilizer)" (P. 138)
- ⓘ The selected value is not reset when you select [Reset Shooting Settings] in [Reset/Initialize Settings] ("Restoring Default Settings (Reset/Initialize Settings)" (P. 257)).

## Image stabilization options (IS Level)

PASMB

Choose the amount of image stabilization applied during movie recording.

Menu	MENU $\Rightarrow$ $\Rightarrow$ 4. Image Stabilizer $\Rightarrow$ IS Level
+1	Choose for static hand-held shots.
$\pm 0$	Recommended in most situations.
-1	Choose for hand-held panning, tilting, or tracking shots.

## Half-press image stabilization (=)

PASMB 

Choose whether image stabilization applies while the shutter button is pressed halfway. An example of a situation in which you might want to suspend image stabilization would be when using the level gauge to keep the camera level while framing photographs.

Menu	MENU ➔  1 ➔ 8. Image Stabilizer ➔ = 
------	--

On	Image stabilization is performed while the shutter button is pressed halfway.
Off	Image stabilization is not performed while the shutter button is pressed halfway.

## Burst mode image stabilization ()

PASMB 

Choose the type of image stabilization applied during burst shooting. To maximize the effects of image stabilization during burst shooting, the camera centers the image sensor for every shot. This slightly reduces the frame advance rate.

Menu	MENU ➔  1 ➔ 8. Image Stabilizer ➔ 
------	--

IS Priority	Priority is given to image stabilization. The frame advance rate drops slightly.
Fps Priority	Priority is given to the frame advance rate. Image stabilization may be slightly less effective under some conditions.



## Displaying camera motion on the monitor (Handheld Assist)

PASMB 

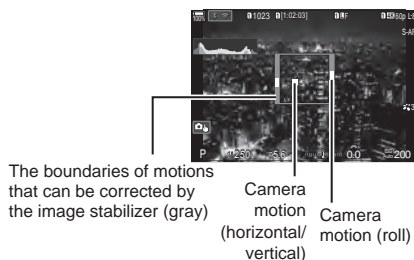
You can configure the camera to display the motion of the camera and the boundaries of motions that can be corrected by the image stabilizer when the shutter button is pressed halfway and during exposure. This is useful when you want to reduce camera motion during long exposure with the camera held by hand.



Menu	MENU ➔  1 ➔ 8. Image Stabilizer ➔ Handheld Assist
Off	Camera motion is not displayed on the monitor.
On	Camera motion is displayed on the monitor when the shutter button is pressed halfway and during exposure.

- ⓘ There is no guarantee that the picture will be without blurs, even if the camera motion indicator stays within the gray frame.
- ⓘ Camera motion cannot be displayed correctly when the camera is close to the subject.
- ⓘ Camera motion is not displayed if [ Image Stabilizer] is set to [Off] or if you are using third-party lenses, with which only the lens image stabilizer operates.
- ⓘ If [ Image Stabilizer] is set to [Off], camera motion is only displayed during exposure.

## Image Stabilization for IS Lenses (Lens I.S. Priority)

PASMB 

When using a third-party lens with an on-board image stabilizer, choose whether image stabilization gives priority to the camera or the lens.

- ⓘ This option has no effect if the lens is equipped with an IS switch that can be used to enable or disable image stabilization.

Menu	MENU ➔  1 ➔ 8. Image Stabilizer ➔ Lens I.S. Priority
On	Priority is given to lens image stabilization.
Off	Priority is given to camera image stabilization.

## Color and Quality

### Setting the Quality of Photos and Movies



You can set the image quality modes for photos and movies. Select a quality suitable for the application (such as for processing on PC, use on website etc.).

Super Control Panel	→  /
Menu	MENU →  → 1. Basic Settings/Image Quality → MENU →  → 1. Basic Settings/Image Quality →

#### ■ Setting

Option	Image size	Compression ratio	File format
	5184 × 3888	SuperFine (1/2.7)	JPG
	5184 × 3888	Fine (1/4)	JPG
	5184 × 3888	Normal (1/8)	JPG
	3200 × 2400	Normal (1/8)	JPG
<b>RAW</b>	5184 × 3888	Lossless compression	ORF
<b>RAW+JPEG</b>	RAW plus the JPEG option selected above		

- The image size/compression combinations available can be selected in the menus. “Combinations of JPEG image sizes and compression rates ( Detailed Settings)” (P. 143)
- During the high resolution shooting (P. 156), you can select between F, F, F, F+RAW, F+RAW, and F+RAW.
- When [Standard], [Dual Same↓], or [Dual Same↑], or [Auto Switch] is selected for [ Save Settings] (P. 242), the selected option applies to the cards in both slots and .
- F and F+RAW are unavailable when [On] is selected for High Res Shot (P. 156).
- Selecting High Res Shot (P. 156) changes the image quality option selected; be sure to check the image quality setting before shooting.
- RAW files store raw image data in an unprocessed state. Choose this format (extension “.ORF”) for pictures that will later be enhanced.
  - Cannot be viewed on other cameras
  - Can be viewed on computers using OM Workspace Digital Photo Managing software
  - Can be saved in JPEG format using the [RAW Data Edit] (P. 200) retouch option in the camera menus

## ■ Setting

- To change the settings of each image quality mode, press  while an image quality mode is selected.

### The Movie Quality Icon

Changes to settings are reflected in the   icon as shown below. Up to three combinations can be saved.

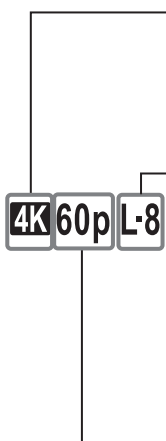



**Movie Resolution**

<b>4K</b>	4K	4K	3840x2160
<b>FHD</b>	FHD	Full HD	1920x1080
<b>C4K</b>	C4K	4K Digital Cinema	4096x2160

**Motion Compensation**

<b>I-8</b>	A-I	ALL-Intra*
<b>L-8</b>	L-GOP	LongGOP

- Fixed to [L-GOP] when [Movie Resolution] is [4K] or [C4K].

When  [Video Codec] (P. 144) is [H.264]: "-8"  
When  [Video Codec] (P. 144) is [H.265]: "-10"

\* When ALL-Intra is used, the movie will be recorded without interframe compression. It is suitable for editing, but the data will be large.







**Playback Frame Rate**

60p	59.94p	59.94fps
50p	50.00p	50.00fps
30p	29.97p	29.97fps
25p	25.00p	25.00fps
24.00p	24.00p	24.00fps
24p	23.98p	23.98fps

- [24.00p] can only be selected when [Movie Resolution] is [C4K].

**Slow or Fast Motion**

-	Off
-	Number (rate)

- Large rate means fast recording and small rate means slow recording.
- Because the movies are played back at the designated speed, they will look like slow motion/fast motion movies.
-  Sound is not recorded.
-  Art filters selected in [Picture Mode] are disabled.
-  Slow recording and/or fast recording may be unavailable depending on the   setting.
-  Only 1/24 or higher shutter speed is available. Availability depends on the [Frame Rate] setting.

- ⓘ Depending on the card used, recording may end before the maximum length is reached.
- ⓘ Motion Compensation selection may be unavailable at some settings.
- ⓘ Movies are recorded at an aspect ratio of 16:9. C4K movies are recorded at an aspect ratio of 17:9.

### Filming High-Speed Movies

Film at high frame rates. Movies are filmed at 100 - 240 fps and play back at 23.98 - 59.94 fps. Stretching playback to 2x - 10x the recording time lets you view in slow motion movements that in real life took only the blink of an eye.

A high-speed movie option can be included in the movie image quality menu. Your choice of playback frame rate determines the playback speed multiplier. Limitations apply to combination of the Sensor Frame Rate and Playback Frame Rate.

Changes to settings are reflected in the movie quality icon as shown.

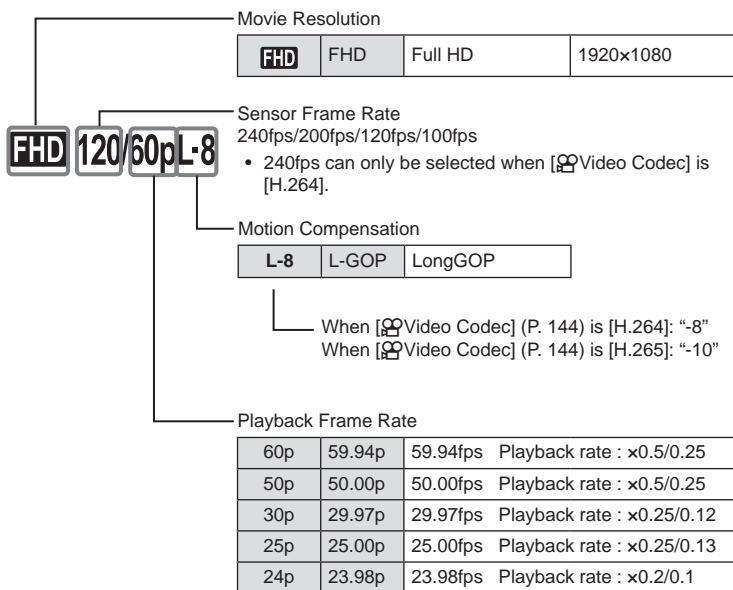

- To change the settings for high-speed movies, press  $\blacktriangleright$  while an image quality mode is selected.

- ⓘ When an SD/SDHC card is used, the size of one file is limited to 4 GB.  
When an SDXC card is used, recording stops before the playback time reaches 3 hours.
- ⓘ Focus, exposure, and white balance lock during recording.
- ⓘ Sound is not recorded.
- ⓘ The picture angle is slightly reduced.
- ⓘ Aperture, shutter speed, exposure compensation, and ISO sensitivity cannot be changed during recording.
- ⓘ Time codes cannot be recorded or displayed.
- ⓘ Brightness may change if zoom is adjusted during recording.
- ⓘ High-speed movie recording is not available while the camera is connected to an HDMI device.
- ⓘ When recording high-speed movies, [All] cannot be selected for AF target mode.
- ⓘ [M-IS1] cannot be selected for [Image Stabilizer] (P. 136).
- ⓘ [i-Enhance], and art filter picture modes (P. 145) are not available.
- ⓘ [Gradation] (P. 147) is fixed at [Gradation Normal].
- ⓘ High-speed movie recording is not available during remote photography when the camera is connected to a smartphone.

## Combinations of JPEG image sizes and compression rates

  Detailed Settings

PASMB 

You can set the JPEG image quality by combining image size and compression rate.



Menu	MENU →  1 → 1. Basic Settings/Image Quality →   Detailed Settings
------	--

Image size		Compression rate			Application
Name	Pixel Count	SF (Super Fine)	F (Fine)	N (Normal)	
<b>L</b> (Large)	5184×3888	<b>L</b> SF	<b>L</b> F	<b>L</b> N	Select for the print size
<b>M1</b> (Middle)	3200×2400	<b>M1</b> SF	<b>M1</b> F	<b>M1</b> N	
<b>M2</b> (Middle)	1920×1440	<b>M2</b> SF	<b>M2</b> F	<b>M2</b> N	
<b>S1</b> (Small)	1280×960	<b>S1</b> SF	<b>S1</b> F	<b>S1</b> N	For small prints and use on a website
<b>S2</b> (Small)	1024×768	<b>S2</b> SF	<b>S2</b> F	<b>S2</b> N	

## Choosing the codec for recording movies

(Video Codec)

PASMB

Choose the codec to be used when recording movies.

Menu	MENU →  → 1. Basic Settings/Image Quality →  Video Codec
------	--

H.264	Records 8-bit movies using H.264, which is a versatile codec. Use this setting for general use.
H.265	Records 10-bit movies using the H.265 codec. This setting is primarily for movies that are intended to be edited on a computer.

- ⓘ When [H.265] is selected, only [ 2 OM-Log400] and [ 3 HLG] are available for [ Picture Mode] (P. 146). For playback with the correct color and brightness, a TV or a display compatible with 10-bit input is required. When outputted to a HDMI device compatible with 10-bit input, the colors of icons may look different from the way they usually look.

## Setting the image aspect

(Image Aspect)

PASMB

Choose the ratio of width to height for pictures according to your intent or your goals for printing or the like. In addition to the standard aspect (width-to-height) ratio of [4:3], the camera offers settings of [16:9], [3:2], [1:1], and [3:4].

Super Control Panel	→ Aspect
Menu	MENU →  → 1. Basic Settings/Image Quality → Image Aspect

- JPEG images are recorded at the selected aspect ratio. RAW images are the same size as the image sensor and are recorded at an aspect ratio of 4:3 with a tag indicating the aspect ratio selected. A crop indicating the selected aspect ratio is displayed when images are played back.

## Peripheral illumination

(Shading Comp.)

PASMB

Compensate for the drop in brightness at the edges of the frame due to the optical characteristics of the lens. Some lenses may exhibit a drop in brightness at the edges of the frame. The camera can compensate for this by making the edges brighter.

Menu	MENU →  → 1. Basic Settings/Image Quality → Shading Comp.
------	---

Off	Shading compensation disabled.
On	The camera detects and compensates for reduced peripheral illumination.

- ⓘ [On] has no effect when a teleconverter or extension tube is attached.
- ⓘ Noise may be more noticeable at the edges of the frame at high ISO sensitivities.



Choose how pictures are processed during shooting to enhance color, tone, and other properties. Choose from preset picture modes according to your subject or artistic intent. Contrast, sharpness, and other settings can be adjusted separately for each mode. You can also add artistic effects using art filters. Art filters give you the option of added frame effects and the like. Adjustments to individual parameters are stored separately for each picture mode and art filter.

Super Control Panel	[OK] ➔ Picture Mode
Menu	MENU ➔ [📷]1 ➔ 2. Picture Mode/WB ➔ [📷]Picture Mode MENU ➔ [👤]2 ➔ 2. Picture Mode/WB ➔ [👤]Picture Mode

① When in movie mode with the camera configured as follows, you can set the same setting as the [📷]Picture Mode] (P. 146) setting by selecting [👤]Picture Mode] from the super control panel.







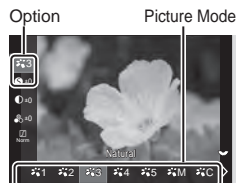



- [👤]Video Codec] is set to [H.264] and [👤]Picture Mode] is set to [Same as 📷]

■ Setting  Picture Mode

1 Select a picture mode using the rear dial or  .



Picture Mode setting screen





 1	<b>i-Enhance</b>	The camera adjusts colors and contrast for optimal results according to the type of subject.
 2	<b>Vivid</b>	Choose for vivid colors.
 3	<b>Natural</b>	Choose for natural colors.
 4	<b>Muted</b>	Choose for pictures that will later be retouched.
 5	<b>Portrait</b>	Enhance skin tones.
 M	<b>Monochrome</b>	Record pictures in monochrome. You can apply color filter effects and choose a tint.
 C	<b>Custom</b>	Adjust picture mode parameters to create a custom version of a selected picture mode.
	<b>Underwater</b>	Process pictures to preserve the vivid colors seen under water. <ul style="list-style-type: none"> <li>• We recommend choosing [Off] for [+WB] (P. 154) when this option is selected.</li> </ul>
	<b>Color Creator</b>	Adjust hue and color to suit your creative intent.
ART 1 ART 2 ART 3 ART 4 ART 5 ART 6 ART 7 ART 8 ART 9 ART 10 ART 11 ART 12 ART 13 ART 14 ART 15 ART 16	<b>Pop Art</b> <b>Soft Focus</b> <b>Pale&amp;Light Color</b> <b>Light Tone</b> <b>Grainy Film</b> <b>Pin Hole</b> <b>Diorama</b> <b>Cross Process</b> <b>Gentle Sepia</b> <b>Dramatic Tone</b> <b>Key Line</b> <b>Watercolor</b> <b>Vintage</b> <b>Partial Color</b> <b>Bleach Bypass</b> <b>Instant Film</b>	Uses Art Filter settings. Art effects can also be used. Available effects differ depending on the art filter.

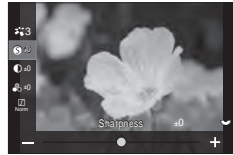

■ Setting detailed options of a  Picture Mode

1 Press  $\Delta$   $\nabla$  on the Picture Mode setting screen (P. 146) to select the option you want to set.

- Available settings vary depending on the selected picture mode.



<p> <b>Sharpness</b></p>	<p>Adjust image sharpness. Outlines can be emphasized for a sharp, clear picture. [-2] – [±0] – [+2]</p>
<p> <b>Contrast</b></p>	<p>Adjust image contrast. Increasing contrast heightens the difference between bright and dark areas for a harder, more well-defined picture. [-2] – [±0] – [+2]</p>
<p> <b>Saturation</b></p>	<p>Adjust color saturation. Increasing saturation makes pictures more vivid. [-2] – [±0] – [+2]</p>
<p> <b>Gradation</b></p>	<p>Adjust color brightness and shading. Bring pictures closer to what you envisage by, for example, brightening the entire picture. [Shadow Adj]: Divides the image into detailed regions and adjusts the brightness separately for each region. This is effective for images with areas of large contrast in which the whites appear too bright or the blacks appear too dark. [Gradation Normal]: Optimal shading. Recommended in most circumstances. [Gradation High Key]: Uses a tone suitable for a bright subject. [Gradation Low Key]: Uses a tone suitable for a dark subject.</p>
<p><b>Effect Effect</b></p>	<p>Choose the strength of i-Enhance. [Effect: Low]: Adds a low effect to images. [Effect: Standard]: Adds an effect between "low" and "high" to images. [Effect: High]: Adds a high effect to images.</p>
<p><b>Filter Color Filter</b></p>	<p>Color filter effects can be added to monochrome picture modes. Depending on the color of the subject, color filter effects can make subjects brighter or enhance contrast. Orange adds more contrast than yellow, red more contrast than orange. Green is a good choice for portraits and the like. [N:None]: No filter effect. [Ye:Yellow]: Reproduces clearly defined white cloud with natural blue sky. [Or:Orange]: Slightly brings out blue skies or the light of the setting sun. [R:Red]: Further brings out blue skies or autumn foliage. [G:Green]: Adds warmth to skin tones in portraits. The green filter also emphasizes the reds in lipstick.</p>





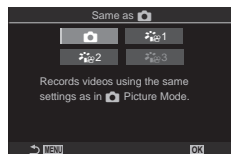

<b>Color</b> <b>Monochrome Color</b>	Add a tint to pictures when using monochrome picture modes. <b>[N:Normal]</b> : Creates a normal black and white image. <b>[S:Sepia]</b> : Shoot in sepia-tinted monochrome. <b>[B:Blue]</b> : Shoot in blue-tinted monochrome. <b>[P:Purple]</b> : Shoot in purple-tinted monochrome. <b>[G:Green]</b> : Shoot in green-tinted monochrome.
 <b>Picture Mode</b>	Choose a picture mode you want to adjust when using <b>[Custom]</b> . <b>[i-Enhance]</b> , <b>[Vivid]</b> , <b>[Natural]</b> , <b>[Muted]</b> , <b>[Portrait]</b> , <b>[Monochrome]</b>
<b>Color Creator</b>	Rotate the front dial to adjust hue. Rotate the rear dial to adjust saturation. To restore default values, press and hold the  button.
<b>Add Effects</b>	Add effects to an art filter. The effects that can be added differ depending on the art filter. With some art filters, Color Filter and Monochrome Color can be adjusted.
<b>Color</b> <b>Partial Color</b>	Selects the art filter "partial color".

- Art filters apply only to the JPEG copy. [RAW+JPEG] is automatically selected for image quality in place of [RAW].
- ⓘ Depending on the scene, the effects of some settings may not be visible, while in other cases tone transitions may be ragged or the image rendered more "grainy".
- 🔧 You can choose whether to show or hide each picture mode using the  Picture Mode Settings] menu (P. 149).

## ■ Setting Picture Mode

- 1 Select [ Picture Mode] from the menu.
- 2 Select an option using  $\Delta$   $\nabla$   $\triangleleft$   $\triangleright$ .





 Same as 	Movies are recorded using the same setting as configured in [  Picture Mode].
 1 Flat	Movies are recorded using a tone curve adapted to color grading.
 2 OM-Log400	Movies are recorded using a log tone curve for greater freedom during color grading.
 3 HLG	Movies are recorded with a high dynamic range, reproducing images as seen with the naked eye when played back using compatible equipment.



ⓘ [ 3 HLG] cannot be selected when [ Video Codec] (P. 144) is set to [H.264].

ⓘ [] and [ 1 Flat] cannot be selected when [ Video Codec] (P. 144) is set to [H.265].





## Choosing which options are displayed when selecting a picture mode

( Picture Mode Settings)  
PASMB 

You can display only the options you need when selecting a picture mode.

- For details on picture modes, see "Processing options ( Picture Mode /  Picture Mode)" (P. 145).

Menu	MENU $\Rightarrow$  1 $\Rightarrow$ 2. Picture Mode/WB $\Rightarrow$  Picture Mode Settings
------	---

- 1 Select a picture mode that you want to have displayed, and put a check () next to it.
  - Select an option using  $\Delta$   $\nabla$  and press the  button to put a check () next to it. To remove the check, press the  button again.

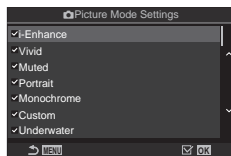

 Picture Mode Settings screen

White balance (WB) ensures that white objects in images recorded by the camera appear white. [Auto] is suitable in most circumstances, but other values can be selected according to the light source when [Auto] fails to produce the desired results or you wish to introduce a deliberate color cast into your images.

## ■ Setting the white balance

Super Control Panel	OK → WB
Menu	MENU →  1 → 2. Picture Mode/WB →  WB MENU →  → 2. Picture Mode/WB →  WB

- 1 Select a WB mode using the rear dial or <math>\triangleleft \triangleright</math>.
- 2 To set the detailed options of the selected picture mode, select an option using  $\triangle \nabla$ .

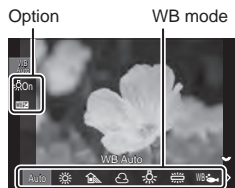

WB setting screen

WB Auto <b>WB Auto</b>	Most normal scenes (scenes containing objects that are white or close to white) <ul style="list-style-type: none"> <li>• This mode is recommended in most situations.</li> <li>• You can choose the white balance used under incandescent lighting (P. 154).</li> </ul>
<b>Sunny 5300K</b>	Sunlit outdoor scenes, sunsets, fireworks <ul style="list-style-type: none"> <li>• Color temperature is set to 5300K.</li> </ul>
<b>Shadow 7500K</b>	Daylight shots of subjects in the shade <ul style="list-style-type: none"> <li>• Color temperature is set to 7500K.</li> </ul>
<b>Cloudy 6000K</b>	Shots taken in daylight under overcast skies <ul style="list-style-type: none"> <li>• Color temperature is set to 6000K.</li> </ul>
<b>Incandescent 3000K</b>	Subjects under incandescent lighting <ul style="list-style-type: none"> <li>• Color temperature is set to 3000K.</li> </ul>
<b>Fluorescent 4000K</b>	Subjects under fluorescent lighting <ul style="list-style-type: none"> <li>• Color temperature is set to 4000K.</li> </ul>
<b>WB</b> <b>Underwater</b>	Underwater photography
<b>WB Flash 5500K</b>	Light sources with the same color temperature as flash lighting <ul style="list-style-type: none"> <li>• Color temperature is set to 5500K.</li> </ul>
<b>One-touch WB 1-4</b>	Situations in which you want to set white balance for a specific subject <ul style="list-style-type: none"> <li>• Color temperature is set to a value metered from a white object under the lighting what will be used in the final photograph (P. 152).</li> </ul>

<b>CWB</b> <b>Custom WB</b>	<p>Situations in which you can identify the appropriate color temperature</p> <ul style="list-style-type: none"> <li>Choose a color temperature.</li> </ul>
-----------------------------	---

### ■ Making fine adjustments to white balance of each WB mode

You can fine-tune the white balance settings. Adjustments can be made separately.

#### 1 Configure options.

- Press  $\Delta \nabla$  on the WB setting screen (P. 150) to select the option to adjust.



<b>WB AUTO</b> <b>Keep Warm Color</b> (only when WB Auto is used)	<p><b>[Off]:</b> The camera suppresses the warm tones produced by incandescent lighting when WB Auto is used.</p> <p><b>[On]:</b> The camera preserves the warm tones produced by incandescent lighting when WB Auto is used.</p>
<b>WBZ</b> (WB Compensation)	<p>Use the front dial or <math>\triangleleft \triangleright</math> to adjust the (amber–blue) axis. When the pointer (<math>\rightarrow</math>) gets closer to A, a red cast is added and when it gets closer to B, a blue cast is added.</p> <p>Use the rear dial or <math>\Delta \nabla</math> to adjust the (green–magenta) axis. When the pointer (<math>\rightarrow</math>) gets closer to G, a green cast is added and when it gets closer to M, a magenta cast is added.</p> <p>Adjustments made will be reset when you press and hold the <math>\text{OK}</math> button.</p> <p>You can adjust the settings for all white balance modes at once.</p> <p><math>\text{INFO}</math> <b>[All WBZ]</b> (P. 153)</p>
<b>Kelvin</b> (only for Custom WB)	<p>You can set the color temperature.</p> <p><b>[2000K] - [14000K]</b></p>

$\text{WBZ}$  When  $\text{WBZ}$  (WB Compensation) is done, a mark (\*) appears next to the WB mode icon.

## ■ One-touch white balance

Measure white balance by framing a piece of paper or other white object under the lighting that will be used in the final photograph. Use this option to fine-tune white balance when you find it hard to obtain the desired results with white balance compensation or preset white balance options such as ☀ (sunlight) or ☁ (overcast). The camera stores the metered value for quick recall as required. Settings for still photography and movie recording can be stored individually.

- 1 After selecting [WB1], [WB2], [WB3], or [WB4] (one-touch white balance 1, 2, 3, or 4) on the WB setting screen, press the **OK** button followed by the INFO button.
- 2 Select [Set].
- 3 Photograph a piece of colorless (white or gray) paper.
  - Frame the piece of paper so that it fills the display. Ensure that it is free of shadows.
  - Press the INFO button.
  - The one-touch white balance screen appears.
- 4 Select [Yes] and press the **OK** button.
  - The new value is saved as a preset white balance option.
  - The new value is stored until one-touch white balance is measured again. Turning the power off does not erase the data.

### Metering White Balance with the One-Touch White Balance Button (Ⓢ)

Assigning [Ⓢ] to a button allows the control to be used to measure white balance. By default, the **OK** button can be used to measure white balance during still photography. To measure white balance during movie recording, you must first assign one-touch white balance to a control using [Ⓢ Button Function] (P. 208).

- 1 Frame a piece of colorless (white or gray) paper in the center of the display.
  - Frame the piece of paper so that it fills the display. Ensure that it is free of shadows.
- 2 Hold the button to which One-Touch White Balance is assigned and press the shutter button all the way down.
  - When recording movies, press the one-touch white balance button to proceed to Step 3.
  - You will be prompted to choose the one-touch white balance option that will be used to store the new value.

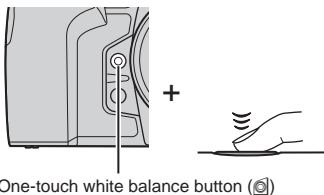

- 3 Highlight a one-touch white balance setting using **△** **▽** and press the **OK** button.
  - The new value will be saved as the value for the selected setting and the camera will exit to the shooting display.

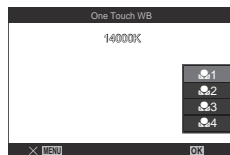





## Locking the white balance in movie mode

( Button Function:  Lock)

PASMB 

When the camera is in movie mode and the white balance is set to [WB Auto], you can lock the white balance to prevent it from changing even if the subject or the lighting changes.

 It is required that you assign [ Lock] to a button using [ Button Function] (P. 208).

Button	A button to which [  Lock] has been assigned
--------	---

When you press the button, white balance is locked with the currently selected settings and “Lock” appears to the left of “WBAuto”. Lock is released when you press the button again.







Lock





## Making fine adjustments to white balance



( All  /  All 

PASMB 

Fine-tune white balance of all white balance modes at once.

Menu	MENU $\Rightarrow$  1 $\Rightarrow$ 2. Picture Mode/WB $\Rightarrow$  All  MENU $\Rightarrow$  2. Picture Mode/WB $\Rightarrow$  All 
------	--



 All  /  All 	Use the front dial or $\triangleleft \triangleright$ to adjust the (amber–blue) axis. When the pointer ( $\oplus$ ) gets closer to A, a red cast is added and when it gets closer to B, a blue cast is added. Use the rear dial or $\triangle \nabla$ to adjust the (green–magenta) axis. When the pointer ( $\oplus$ ) gets closer to G, a green cast is added and when it gets closer to M, a magenta cast is added. Adjustments made will be reset when you press and hold the $\text{OK}$ button.
---	---

 When [ All ] / [ All ] is done, a mark (\*) appears next to each WB mode icon.



## Preserving the warm tones of incandescent lighting when in WB Auto mode

PASMB 

Choose how the camera adjusts white balance for pictures taken using auto white balance under incandescent lighting.

Menu	MENU →  1 → 2. Picture Mode/WB →  WB AUTO Keep Warm Color MENU →  2. Picture Mode/WB →  WB AUTO Keep Warm Color
------	--

Off	The camera suppresses the warm tones produced by incandescent lighting.
On	The camera preserves the warm tones produced by incandescent lighting.



 This can also be set from the WB setting screen.  “Making fine adjustments to white balance of each WB mode” (P. 151).

## Flash White Balance

PASMB 

Choose the white balance used for photos taken with a flash. Instead of using a setting adapted to flash lighting, you can opt to prioritize the value selected for non-flash photography. Use this option to automatically switch from one white balance setting to another when you find yourself frequently enabling and disabling the flash.

Menu	MENU →  1 → 2. Picture Mode/WB →  +WB
------	---

Off	The camera uses the value currently selected for white balance.
WBAuto	The camera uses auto white balance ([WB Auto]).
WB  5500K	The camera uses flash white balance ([WB  ]).

You can select a format to ensure that colors are correctly reproduced when shot images are regenerated on a monitor or using a printer.



Menu	MENU $\Rightarrow$  1 $\Rightarrow$ 2. Picture Mode/WB $\Rightarrow$ Color Space
------	---

<b>sRGB</b>	The color space standardized by an international standards organization. It is widely supported across displays, printers, digital cameras, and computer applications. This setting is recommended in most circumstances.
<b>AdobeRGB</b>	It can reproduce a wider gamut of colors than sRGB. Accurate color reproduction is available only with software and devices (displays, printers, and the like) that support this standard. An underscore ("_") appears at the beginning of the file name (e.g., "_xxx0000.jpg").

⚠ [AdobeRGB] is not available in HDR or movie () mode or when an art filter is selected for picture mode.

## Preview Options for Movie Picture Modes



(View Assist)



The display can be adjusted for ease of viewing when a movie-only picture mode option ([ 1 Flat] or [ 2 OM-Log400]) is selected (P. 149).

Menu	MENU $\Rightarrow$  $\Rightarrow$ 2. Picture Mode/WB $\Rightarrow$  View Assist
------	---

<b>On</b>	Adjust the picture for ease of viewing. The indicators in the display may change color.
<b>Off</b>	Do not adjust the picture for ease of viewing.

⚠ This option applies only to the display, not to the actual movie files.

⚠ This option does not apply when movies recorded using [ 1 Flat] or [ 2 OM-Log400] are played back on the camera. It also does not apply when the movies are viewed on a TV.

 The histogram (P. 38) and zebra pattern (P. 184) are processed based on the picture before  View Assist is applied.



## Special shooting modes (Computational Modes)



The camera combines images or processes them digitally to create special effects that cannot be achieved in normal shooting modes.

### Shooting still pictures in a higher resolution (High Res Shot)





P A S M B 

Shoot at resolutions higher than that of the image sensor. The camera takes a series of shots while moving the image sensor and combines them to create a single high-resolution photo. Use this option to capture details that normally would not be visible even at high zoom ratios.

When High Res Shot is enabled, the image quality mode for High Res Shot can be selected using   (P. 140).



Button	 button
Menu	MENU $\rightarrow$  $\rightarrow$ 1. Computational Modes $\rightarrow$ High Res Shot

#### ■ Enabling High Res Shot

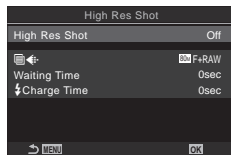



- 1 Use  $\Delta$   $\nabla$  to select [High Res Shot] and press the  button.
- 2 Use  $\triangleleft$   $\triangleright$  to select [On ] (tripod) or [On ] (handheld) and press the  button.



High Res Shot setting screen

Off	High Res Shot is disabled.
On 	Shoot with the camera fixed to a tripod. The RAW picture is recorded in 80M (10368 x 7776).
On 	Shoot with the camera in your hands. The RAW picture is recorded in 50M (8160 x 6120).

#### 3 The display returns to the High Res Shot setting screen.

-  When setting from the button, you can turn this function on and off using the  button. You can also switch between [On ] (tripod) and [On ] (handheld) by rotating the front or rear dial while pressing the  button.

## ■ Configuring High Res Shot

### 1 Configure options.

- Press  $\Delta \nabla$  to select an item and press the  $\odot$  button to display the setting menu.
- After configuring options, press the  $\odot$  button to return to High Res Shot setting screen.

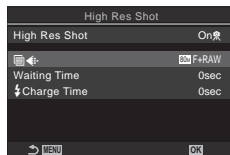

	Choose the image quality of High Res Shot shooting (P. 140).
<b>Waiting Time</b>	Set how long the camera waits before releasing the shutter after you press the shutter button fully. Use this to prevent the effect of camera shake caused by the pressing of the shutter button.
<b>Charge Time</b>	Choose how long the camera waits for the flash to charge between shots when using a flash unit not specifically designated for use with the camera. [0.5 sec] / [0.2 sec] / [0.1 sec] / [0 sec]

## ■ Shooting

### 1 Press the MENU button to close the High Res Shot setting screen and return to shooting screen.

- A icon will be displayed. The icon will flash if the camera is not steady. The icon stops flashing when the camera is steady and ready to shoot.
- After enabling High Res Shot, check the option selected for image quality. Image quality can be adjusted in the super control panel.



Camera readying for High Res Shot (flashes)

### 2 Take pictures.

- Shooting is complete when the green icon clears from the display.
- The camera will automatically create the composite image when shooting is complete. A message will be displayed during this process.
- Choose from JPEG (8000 F, 5000 F, or 2500 F) and RAW+JPEG modes. When image quality is set to RAW+JPEG, the camera saves a single RAW image (extension “.ORI”) before combining it with the high resolution shooting. Pre-combination RAW images can be played back using the latest version of OM Workspace.
- ⚠ 8000 F and 8000 F+RAW are unavailable when [On] (handheld) is selected as the shooting method.
- ⚠ [S-IS Off] is automatically selected for [Image Stabilizer] (P. 136) when [On] (tripod) is chosen, [S-IS Auto] when [On] (handheld) is selected.
- ⚠ The maximum wait time for [On] (handheld) is 1 second.
- ⚠ During RC flash photography, the maximum flash wait time is 4 seconds and the flash control mode is fixed at MANUAL.
- ⚠ The following cannot be used:  
multiple exposure, keystone compensation, bracketing, focus stacking, fisheye correction, and HDR.
- ⚠ When [High Res Shot] is set to [On] (tripod), [Time Lapse Movie] becomes [Off].

- ① When High Res Shot is enabled, [Drive ] is set to []. [12s] (Silent self-timer 12s), [2s] (Silent self-timer 2s) and [C] (Silent custom self-timer) can be set.
- ① Pictures taken with an art filter selected for picture mode will be recorded in [Natural] mode.
- ① Image quality may drop under flickering light sources such as fluorescent or LED lamps.
- ① If the camera is unable to record a composite image due to blur or other factors, only the first shot will be recorded. If [JPEG] is selected for image quality, the shot will be recorded in JPEG format, while if [RAW+JPEG] is selected, the camera will record two copies, one in RAW (.ORF) and the other in JPEG format.

## Slowing the Shutter in Bright Light (Live ND Shooting)

P A S M B

The camera makes a series of exposures and combines to create a single photo that appears to have been taken at a slow shutter speed.

- Changing exposure compensation or shutter speed resets the [LV Simulation] display.

### ■ Enabling Live ND Shooting

Menu	MENU →  2 → 1. Computational Modes → Live ND Shooting
------	---

- 1 Use to select [Live ND Shooting] and press the button.
- 2 Use to select [On] and press the button.

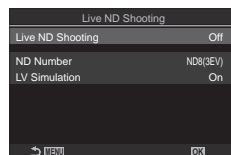

Live ND Shooting setting screen

Off	Pictures are taken without using this function.
On	Pictures are taken with the slow shutter effect enabled.

- 3 The display returns to the Live ND Shooting setting screen.

## ■ Configuring Live ND Shooting

### 1 Configure options.

- Press  $\Delta \nabla$  to select an item and press the  $\odot$  button to display the setting menu.
- After configuring options, press the  $\odot$  button to return to Live ND Shooting setting screen.

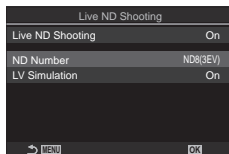

<b>ND Number</b>	Choose an ND filter type; the camera will convert it to an exposure value and reduce exposure by that amount. Options are available in increments of 1 EV: [ND2 (1EV)], [ND4 (2EV)], [ND8 (3EV)], [ND16 (4EV)], [ND32 (5EV)], [ND64 (6EV)]
<b>LV Simulation</b>	Choose whether to preview the effect of the selected filter at the current shutter speed. [Off]: Use the standard shooting display. [On]: The effects of shutter speed are shown in the display.

## ■ Shooting

### 1 Press the MENU button to close the Live ND Shooting setting screen and return to shooting screen.

- If you selected [On] for [Live ND Shooting], live ND filter photography will now start.
- An icon appears in the display when the live ND filter is enabled.
- To end live ND filter photography, select [Off] in the [Live ND Shooting] display shown in Step 2.

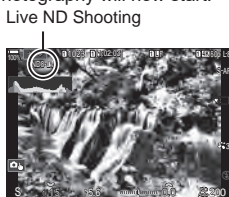

### 2 Adjust shutter speed while previewing the results in the display.

- Adjust shutter speed using the rear dial.
- The slowest shutter speed available varies with the ND filter selected.

[ND2 (1EV)]: 1/60 s	[ND16 (4EV)]: 1/8 s
[ND4 (2EV)]: 1/30 s	[ND32 (5EV)]: 1/4 s
[ND8 (3EV)]: 1/15 s	[ND64 (6EV)]: 1/2 s

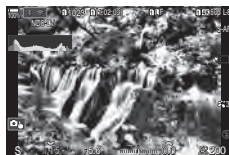

- If [On] is selected for [LV Simulation], the effects of changes to shutter speed can be previewed in the display.
- The camera requires a length of time equivalent to the selected shutter speed to produce [LV Simulation] results similar to the final image.
- When the time equivalent to the selected shutter speed passes, the "LV" part of the icon on the screen turns green. When the icon is green, the display is similar to the final image.

### 3 Take pictures.

- ① [Frame Rate] will be [Normal] during live ND photography.
- ① The upper limit for [ISO] during live ND photography is ISO 800. This also applies when [Auto] is selected for [ISO].
- ① The following cannot be used:  
HDR, High Res Shot, multiple exposure, keystone compensation, bracketing, focus stacking, interval-timer photography, flicker scan, flickerless photography, and fisheye correction.
- ① When Live ND Shooting is enabled, [Drive] is set to [Silent]. [Silent self-timer 12s], [Silent self-timer 2s] and [Silent custom self-timer] can be set.
- ① Unlike physical ND filters, the live ND filter does not reduce the amount of light reaching the image sensor, and consequently very bright subjects may be overexposed.

## Increasing Depth of Field

## (Focus Stacking)

### PASMB

Combine multiple images for a depth of field greater than can be obtained with a single shot. The camera takes a series of shots at focus distances both in front of and behind the current focus position and creates a single image from the areas that are in focus in each shot.

Choose this option if you want all areas of the subject in focus in photographs taken at short ranges or wide apertures (low f-numbers). The pictures are taken in silent mode using the electronic shutter.

- ① The composite image is recorded in JPEG format, regardless of the option selected for image quality.
- ① The composite image is enlarged 7% horizontally and vertically.
- ① Shooting will end if focus or zoom is adjusted after the shutter button has been pressed all the way down to start focus stacking photography.
- ① If focus stacking fails, the camera will record the selected number of photos without creating a composite image.
- ① This option is available only with lenses that support focus stacking. See our website for information on compatible lenses.
- ① Pictures taken with an art filter selected for picture mode are recorded in [Natural] mode.

Menu	MENU →  → 1. Computational Modes → Focus Stacking
------	---

### ■ Enabling Focus Stacking

- 1 Use  $\Delta$   $\nabla$  to select [Focus Stacking] and press the  $\text{OK}$  button.
- 2 Use  $\Delta$   $\nabla$  to select [On] and press the  $\text{OK}$  button.

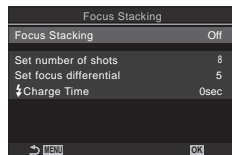

Focus Stacking setting screen

Off	Pictures are taken without using this function.
On	Pictures are taken with increased depth of field.



3 The display returns to the Focus Stacking setting screen.

## ■ Configuring Focus Stacking

1 Configure options.

- Press  $\Delta$   $\nabla$  to select an item and press the  $\odot$  button to display the setting menu.
- After configuring options, press the  $\odot$  button to return to Focus Stacking setting screen.

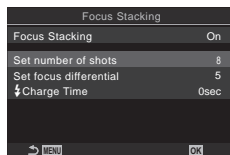

<b>Set number of shots</b>	Choose the number of shots to be taken with varied focus positions. <b>[3] – [15]</b>
<b>Set focus differential</b>	Choose the amount the camera varies focus with each shot. <b>[1] – [10]</b>
<b>⚡ Charge Time</b>	Choose how long the camera waits for the flash to charge between shots when using a flash unit not specifically designated for use with the camera. <b>[0 sec] / [0.1 sec] / [0.2 sec] / [0.5 sec] / [1 sec] / [2 sec] / [4 sec] / [8 sec] / [15 sec] / [30 sec]</b>

## ■ Shooting

1 Press the MENU button to close the Focus Stacking setting screen and return to shooting screen.

- $\text{[MENU]}$  appears on the screen.
- Picture mode will be set to [Natural].
- A frame indicating the final crop will be shown in the display. Compose the shot with your subject in the frame.



2 Take pictures.

- The camera will automatically take the selected number of shots when the shutter button is pressed all the way down.

ⓘ When [Focus Stacking] is set to [On], [Flash Mode] in [Silent[♥] Settings] (P. 132) becomes [Allow].

ⓘ The flash sync speed is set to 1/100 s. Selecting a value over ISO 16000 for [📷ISO] sets the flash sync speed to 1/50 s.

🔧 We recommend using a remote control (P. 279) to reduce blur caused by camera shake. In [Silent[♥] Settings] (P. 132), you can choose how long the camera will wait to release the shutter after the shutter button is pressed all the way down.

The camera varies exposure over a series of shots, selects from each tone range with the highest level of detail, and combines them to create a single picture with a wide dynamic range. If the photo features a high-contrast subject, details that would otherwise be lost in shadows or highlights will be preserved.

① Use a tripod or take similar measures to fix the camera in place.

Menu	MENU ⇒  2 ⇒ 1. Computational Modes ⇒ HDR
------	---

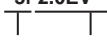
<b>Off</b>	HDR is disabled.
<b>HDR1</b>	Each time you take a photo, the camera will take a series of shots while varying exposure and combine them into a single picture. Choose [HDR1] for natural-looking results, [HDR2] for a more painterly effect. <ul style="list-style-type: none"> <li>• [ ISO] is fixed at ISO 200.</li> </ul>
<b>HDR2</b>	<ul style="list-style-type: none"> <li>• Shutter speeds can be as slow as 4 s. Shooting will continue for up to 15 s.</li> <li>• Picture mode is fixed at [Natural] and color space at [sRGB].</li> <li>• The combined picture is saved in JPEG format. If [RAW] is selected for image quality, it will instead be recorded in RAW + JPEG format.</li> </ul>
<b>3f 2.0EV</b>	<div style="text-align: center;"> <p><b>3f 2.0EV</b></p>  <p>Number of shots      Exposure range</p> </div>
<b>5f 2.0EV</b>	
<b>7f 2.0EV</b>	
<b>3f 3.0EV</b>	
<b>5f 3.0EV</b>	

- "HDR" appears on the screen.

HDR



## 1 Take pictures.

- Each time you press the shutter button, the camera will take the selected number of shots.
- In [HDR1] and [HDR2] modes, the camera will automatically combine the shots into a single picture.
- Exposure compensation is available in modes **P**, **A**, and **S**.

- ⓘ The image displayed in the monitor or viewfinder during shooting differs from the final HDR picture.
- ⓘ Noise may appear in the final picture when a slower shutter speed is selected in [HDR1] or [HDR2] mode.
- ⓘ When [HDR1] or [HDR2] is enabled, [Drive ] is set to []. [12s] (Silent self-timer 12s), [2s] (Silent self-timer 2s) and [C] (Silent custom self-timer) can be set.
- ⓘ The following cannot be used:  
flash photography, bracketing, focus stacking, multiple exposure, interval-timer photography, keystone compensation, the live ND filter, fisheye correction, and High Res Shot.

## Recording multiple exposures in a single image (Multiple Exposure)

PASMB

Take two shots and combine them into a single picture. Alternatively, you can take a shot and combine it with an existing picture stored on the memory card.

The combined image is recorded at current image quality settings. Only RAW pictures can be selected for multiple exposures that include an existing image.

If you record a multiple exposure with RAW selected for [], you can then select it for subsequent multiple exposures using [Overlay], allowing you to create multiple exposures combining three or more photographs.

Menu	MENU → 2 → 1. Computational Modes → Multiple Exposure
------	---

### ■ Enabling Multiple Exposure

- 1 Use  $\Delta \nabla$  to select [Multiple Exposure] and press the button.
- 2 Use  $\Delta \nabla$  to select [On] and press the button.

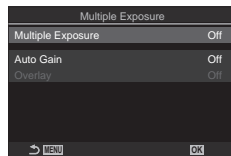

Multiple Exposure setting screen

<b>Off</b>	Pictures are taken without using this function.
<b>On</b>	Create a multiple exposure from 2 pictures.

- 3 The display returns to the Multiple Exposure setting screen.

## ■ Configuring Multiple Exposure

### 1 Configure options.

- Press  $\Delta$   $\nabla$  to select an item and press the  $\odot$  button to display the setting menu.
- After configuring options, press the  $\odot$  button to return to Multiple Exposure setting screen.

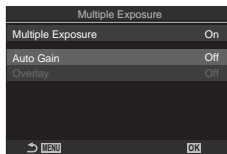

<b>Auto Gain</b>	<p><b>[Off]:</b> Do not adjust brightness the brightness of the pictures in the multiple exposure.</p> <p><b>[On]:</b> Halve the brightness of each picture in the multiple exposure.</p>
<b>Overlay</b>	<p><b>[Off]:</b> Create a multiple exposure from the next 2 pictures taken.</p> <p><b>[On]:</b> Shoot a multiple exposure that includes an existing RAW image stored on the memory card.</p> <ul style="list-style-type: none"> <li>• [Overlay] is only available when [On] is selected for [Multiple Exposure].</li> </ul>





## ■ Shooting

### 1 Press the MENU button to close the Multiple Exposure setting screen and return to shooting screen.

- A  icon will be displayed.



### 2 Take pictures.

- The first shot will be visible superimposed on the view through the lens as you compose the next shot.
- The  icon turns green.
- Normally, a multiple exposure will be created after the second shot is taken.
- Pressing the  button allows you to retake the first shot.
- Press the MENU button or press the  button to end multiple exposure photography.
- The  icon clears from the display when multiple exposure photography ends.

## ■ When [Overlay] is set

When [On] is selected for [Overlay], a list of pictures is displayed.

- 1 Highlight a picture using  $\Delta$   $\nabla$   $\triangleleft$   $\triangleright$  and press the  $\text{OK}$  button.
    - Only RAW images can be selected.
  - 2 Press the MENU button to close the menu.
    - A  $\text{OK}$  icon will be displayed.
    - The selected picture is overlaid on the screen.
  - 3 Take pictures.
    - You can take additional pictures that will be overlaid on the previously-chosen photograph.
- ⓘ The camera will not enter sleep mode during multiple exposure photography.
  - ⓘ Pictures taken with other cameras cannot be used for multiple exposures.
  - ⓘ RAW pictures taken using High Res Shot cannot be used for multiple exposures.
  - ⓘ The RAW pictures listed in the image-selection display when [On] is selected for [Overlay] are those processed using the settings in effect at the time the photograph was taken.
  - ⓘ Exit multiple exposure mode before adjusting shooting settings. Some settings cannot be adjusted while multiple exposure mode is in effect.
  - ⓘ Performing any of the following operations after the first shot is taken ends multiple exposure photography:
    - turning the camera off, pressing the  $\text{▶}$  or MENU button, choosing a different shooting mode, or connecting cables of any type. Multiple exposure is also canceled when the battery is exhausted.
  - ⓘ The image-selection display for [Overlay] shows the JPEG copies of photographs taken with RAW + JPEG selected for image quality.
  - ⓘ Live composite photography ([Live Comp]) is not available in mode **B**.
  - ⓘ The following are not available in multiple exposure mode:
    - HDR, bracketing, focus stacking, interval-timer photography, keystone compensation, the live ND filter, fisheye correction, and High Res Shot.
  - 🔊 Pictures taken with RAW selected for [ $\text{RAW}$   $\text{▶}$ ] can also be overlaid during playback.
    - 🔊 “Combining Pictures (Image Overlay)” (P. 203)

This option takes a crop at the center of the frame the same dimensions as the size option currently selected for image quality and zooms it in to fill the display. This allows you to zoom in past the lens' maximum focal length, making it a good choice when you are unable to switch lenses or find it difficult to get any closer to your subject.

Menu	MENU ➔ 📷2 ➔ 2. Other Shooting Functions ➔ 📷 Digital Tele-converter MENU ➔ 📺 ➔ 1. Basic Settings/Image Quality ➔ 📺 Digital Tele-converter
------	---

<b>Off</b>	Pictures are taken without using this function.
<b>On</b>	Images are recorded enlarged (Still pictures: 2x, Movies: 1.4x).

- When [On] is selected, an icon is displayed and, when live view is enabled, it is enlarged.
- The size of the AF targets ("Choosing an AF Target Mode (AF Target Mode)" (P. 77)) increases and their number decreases.
- JPEG images are recorded at the selected zoom ratio. In the case of RAW images, a frame shows the zoom crop. A frame showing the zoom crop is displayed on the image during playback.

Digital teleconverter



- ⚠ In still photography mode, the following cannot be used: multiple exposure, keystone compensation, and fish-eye correction.
- ⚠ In movie mode, this function cannot be used during high-speed movie recording.
- ⚠ This function cannot be used when outputting HDMI signals in RAW mode (P. 182).
- ⚠ You cannot zoom in on the display (P. 41, P. 80, P. 102) when [📺 Digital Tele-converter] is enabled.

## Shooting automatically with a fixed interval (Interval Shooting)

PASMB

You can set the camera to shoot automatically with a set time lapse. The shot frames can also be recorded as into a single movie.

Menu	MENU →  → 2. Other Shooting Functions → Interval Shooting
------	---

### ■ Enabling Interval Shooting

- 1 Use  $\Delta \nabla$  to select [Interval Shooting] and press the  $\text{OK}$  button.
- 2 Use  $\Delta \nabla$  to select [On] and press the  $\text{OK}$  button.

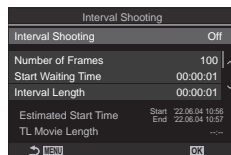

Interval Shooting setting screen

Off	Pictures are taken without using this function.
On	Pictures are taken at specified interval.

- 3 The display returns to the Interval Shooting setting screen.

### ■ Configuring Interval Shooting

- 1 Configure options.
  - Press  $\Delta \nabla$  to select an item and press the  $\text{OK}$  button to display the setting menu.
  - After configuring options, press the  $\text{OK}$  button to return to Interval Shooting setting screen.

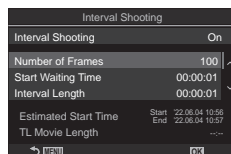

<b>Number of Frames</b>	Choose the number of frames shot. <b>[002] – [9999]</b>
<b>Start Waiting Time</b>	Choose how long the camera waits before starting interval timer photography and taking the first shot. <b>[00:00:00] – [24:00:00]</b>
<b>Interval Length</b>	Choose how long the camera waits between shots once shooting has begun. <b>[00:00:01] – [24:00:00]</b>
<b>Interval Mode</b>	Choose whether to put priority on the interval time or the number of frames. <b>[Time Priority] / [Frames Priority]</b> If [Time Priority] is selected, the previous shooting may be still in progress even when it is time to shoot the next shot. When the selected [Interval Length] is short or when using long exposure, the number of recorded frames may be smaller than the number selected for [Number of Frames].

<b>Exposure Smoothing</b>	Choose whether to smooth the exposure settings for all frames. The change of exposure will be smooth in the time lapse movie. <b>[Off]</b> / <b>[On]</b>
<b>Time Lapse Movie</b>	Choose whether to record a time-lapse movie. <b>[Off]</b> : The camera saves the individual shots but does not use them to create a time-lapse movie. <b>[On]</b> : The camera records the individual shots and also uses them to create a time-lapse movie.
<b>Movie Settings</b>	Choose the frame size ([Movie Resolution]) and frame rate ([Frame Rate]) for movies created using [Time Lapse Movie]. Choose the frame size from the following options. <b>[4K]</b> / <b>[FullHD]</b> / <b>[HD]</b> Choose the frame rate from the following options. <b>[30fps]</b> / <b>[15fps]</b> / <b>[10fps]</b> / <b>[5fps]</b>

ⓘ [Start Waiting Time], [Interval Length] and [Estimated Time] may change depending on shooting settings. Use these as guidelines only.

## ■ Shooting



1 Press the MENU button to close the Interval Shooting setting screen and return to shooting screen.

- An  icon and the selected number of frames appear on the shooting screen.

Interval-timer photography



2 Take pictures.

- The specified number of frames will be shot automatically.
- The  icon will turn green and the number of shots remaining will be displayed.
- Time lapse shooting will be canceled if any of the following is operated: Mode dial, MENU button,  button, lens release button, or connection to a computer using a USB cable.
- Turning the camera off ends interval-timer photography.
- ⓘ Frames are shot even if the image is not in focus after AF. If you wish to fix the focus position, shoot in MF.
- ⓘ [Image Review] (P. 42) is fixed at 0.5 seconds.
- ⓘ If the time until shooting or the shooting interval is 1 minute 31 seconds or longer, the monitor will go dark and the camera will enter sleep mode if no operations are performed for 1 minute. The camera and monitor will reactivate automatically 10 seconds before a picture is taken, and can be reactivated manually by pressing the shutter button.
- ⓘ The camera automatically selects [S-AF] for AF mode (P. 72) in place of [C-AF] and [C-AF+TR], and [S-AF MF] in place of [C-AF MF] and [C-AF+TR MF].
- ⓘ When  is selected as the AF mode (P. 72), focus to initiate shooting, then lock focus and start recording.
- ⓘ Touch operations are disabled during time lapse shooting.
- ⓘ Time-lapse shooting cannot be combined with HDR, bracketing, focus stacking, multiple exposure, or the live ND filter.





- ⚠ The flash will not work if the flash charging time is longer than the interval between shots.
- ⚠ When 1000 or a larger number is selected for [Number of Frames], [Time Lapse Movie] will be set to [Off].
- ⚠ When [High Res Shot] is set to [On📷] (tripod), [Time Lapse Movie] becomes [Off].
- ⚠ If any of still pictures are not recorded correctly, the time lapse movie will not be generated.
- ⚠ If there is insufficient space on the card, the time lapse movie will not be recorded.
- ⚠ If there is not enough charge left on the battery, the shooting may end partway through. Use a sufficiently charged battery or connect the supplied USB-AC adapter (P. 17) or a mobile battery conforming to the USB-PD standard to the camera when shooting.

## Keystone correction and perspective control (Keystone Comp.)

PASMB

Keystone distortion due to the influence of lens focal length and proximity to the subject can be corrected, or enhanced to exaggerate the effects of perspective. Keystone compensation can be previewed in the monitor during shooting. The corrected image is created from a smaller crop, slightly increasing the effective zoom ratio.

Menu	MENU →  → 2. Other Shooting Functions → Keystone Comp.
Off	Pictures are taken without using this function.
On	Pictures are taken with keystone compensation applied.

- When you select [On], a  icon is displayed and sliders appear on the monitor.

Keystone compensation



- 1 Frame the shot and adjust keystone compensation while viewing your subject in the display.
  - Rotate the front dial to make horizontal adjustments and the rear dial to make vertical adjustments.
  - Use  $\Delta$   $\nabla$   $\triangleleft$   $\triangleright$  to position the crop. The direction in which the crop can be moved is shown by an arrow ( $\Delta$ ).
  - To cancel changes, press and hold the  $\text{OK}$  button.
- 2 To adjust aperture, shutter speed, and other shooting settings, press the INFO button.
  - Standard shooting indicators will be displayed.
  - A  icon is displayed while keystone compensation is enabled. The icon is displayed in green if adjustments have been made to keystone compensation settings.
  - To return to the keystone compensation display shown in Step 1, press the INFO button repeatedly.
- 3 Take pictures.
  - ① Pictures may seem “grainy” depending on the amount of compensation performed. The amount of compensation also determines the amount the picture will be enlarged when cropped and whether the crop can be moved.
  - ① Depending on the amount of compensation, you may be unable to reposition the crop.
  - ① Depending on the amount of compensation performed, the selected AF target may not be visible in the display. If the AF target is outside the frame, its direction is indicated by a  $\uparrow$ ,  $\downarrow$ ,  $\leftarrow$ , or  $\rightarrow$  icon in the display.

- ⓘ Pictures taken with [RAW] for image quality are recorded in RAW + JPEG format.
- ⓘ The following cannot be used:
  - live composite photography, burst photography, bracketing, focus stacking, HDR, multiple exposure, the live ND filter, fish-eye correction, the digital teleconverter, movie recording, [C-AF], [C-AF MF], [C-AF+TR], and [C-AF+TR MF] AF modes, art filter picture modes, the custom self-timer, and High Res Shot.
- ⓘ Lens converters may not produce the desired results.
- ⓘ Be sure to provide [Image Stabilizer] data for lenses that are not part of the Four Thirds or Micro Four Thirds family (P. 136).
  - Where applicable, keystone compensation will be performed using the focal length supplied for [Image Stabilizer] (P. 136) or [Lens Info Settings] (P. 246).

## Correcting Fisheye Distortion (Fisheye Compensation)

P A S M B 

Correct distortion caused by fisheye lenses to give photos the appearance of pictures taken with a wide-angle lens. The amount of correction can be selected from three different levels. You can also opt simultaneously to correct distortion in photos taken under water.

- This option is only available with compatible fisheye lenses.
  - As of February 2022, it could be used with the M.ZUIKO DIGITAL ED 8mm F1.8 Fisheye PRO.

### ■ Enabling Fisheye Compensation

Menu	MENU ➔  2 ➔ 2. Other Shooting Functions ➔ Fisheye Compensation
------	---

- 1 Use  $\Delta$   $\nabla$  to select [Fisheye Compensation] and press the  $\odot$  button.
- 2 Use  $\Delta$   $\nabla$  to select [On] and press the  $\odot$  button.



Fisheye Compensation setting screen

Off	Pictures are taken without using this function.
On	Pictures are taken with fisheye compensation applied.

- 3 The display returns to the Fisheye Compensation setting screen.

## ■ Configuring Fisheye Compensation

### 1 Configure options.

- Press  $\Delta$   $\nabla$  to select an item and press the  $\odot$  button to display the setting menu.
- After configuring options, press the  $\odot$  button to return to Fisheye Compensation setting screen.



<b>Angle</b>	When fisheye correction is performed, the picture is cropped to eliminate blacked-out areas. Choose from three different crops. <b>[1] / [2] / [3]</b>
<b>Correction</b>	Choose whether to correct distortion in photos taken under water in addition to the correction performed using [Angle]. <b>[Off] / [On]</b>

### ■ Shooting

### 1 Press the MENU button to close the Fisheye Compensation setting screen and return to shooting screen.

- When fisheye compensation is enabled, a  $\text{F}$  icon will be displayed together with the selected crop.

Fisheye compensation



### 2 Take pictures.

- ⓘ Pictures taken with [RAW] selected for image quality are recorded in RAW + JPEG format. Fisheye compensation is not applied to the RAW image.
- ⓘ Focus peaking is not available in the fisheye compensation display.
- ⓘ AF target selection is restricted to [ ■ ]Single and [ # ]Small target modes.
- ⓘ The following cannot be used:  
live composite photography, burst photography, bracketing, focus stacking, HDR, multiple exposure, the live ND filter, keystone compensation, the digital teleconverter, movie recording, [C-AF], [C-AF **MF**], [C-AF+TR], and [C-AF+TR **MF**] AF modes, art filter picture modes, the custom self-timer, and High Res Shot.

## Configuring BULB/TIME/COMP Settings

### (BULB/TIME/COMP Settings)

PASMB 

Set items related to bulb/time/composite photography.

Menu	MENU →  → 2. Other Shooting Functions → BULB/TIME/COMP Settings
------	--

#### 1 Configure options.

- Press  $\Delta$   $\nabla$  to select an item and press the  button to display the setting menu.

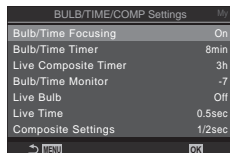

BULB/TIME/COMP Settings	
Bulb/Time Focusing	On
Bulb/Time Timer	8min
Live Composite Timer	3h
Bulb/Time Monitor	-7
Live Bulb	Off
Live Time	0.5sec
Composite Settings	1/2sec

<b>Bulb/Time Focusing</b>	Allows manual focusing in <b>B</b> (bulb) mode. You can take pictures using techniques such as putting the subject out of focus during exposure or focusing at the end of exposure. [Off]: Disables manual focusing during exposure. [On]: Enables manual focusing during exposure.
<b>Bulb/Time Timer</b>	Specify the maximum length of bulb/time photography. [30min] / [25min] / [20min] / [15min] / [8min] / [4min] / [2min] / [1min]
<b>Live Composite Timer</b>	Specify the maximum length of live composite photography. [6h] / [5h] / [4h] / [3h] / [2h] / [1h] / [30min] / [25min] / [20min] / [15min] / [8min] / [4min]
<b>Bulb/Time Monitor</b>	Specify the display brightness in <b>B</b> (bulb) mode. [-7] – [±0] – [+7]
<b>Live Bulb</b>	Choose the display interval during bulb photography. The number of update times is limited. Choose [Off] to disable the display. [60sec] / [30sec] / [15sec] / [8sec] / [4sec] / [2sec] / [1sec] / [0.5sec] / [Off]
<b>Live Time</b>	Choose the display interval during time photography. The number of update times is limited. Choose [Off] to disable the display. [60sec] / [30sec] / [15sec] / [8sec] / [4sec] / [2sec] / [1sec] / [0.5sec] / [Off]
<b>Composite Settings</b>	Set an exposure time to be the reference in composite photography. [60sec] / [50sec] / [40sec] / [30sec] / [25sec] / [20sec] / [15sec] / [13sec] / [10sec] / [8sec] / [6sec] / [5sec] / [4sec] / [3.2sec] / [2.5sec] / [2sec] / [1.6sec] / [1.3sec] / [1sec] / [1/1.3sec] / [1/1.6sec] / [1/2sec]

## Recording a series of shots with varied exposure (AE BKT)

PASMB 



Vary exposure over a series of shots. You choose the amount of variation and the number of shots. The camera takes a series of shots with different exposure settings. The camera will take pictures while the shutter button is pressed all the way down, ending when the selected number of shots has been taken.

Menu	MENU $\Rightarrow$  2 $\Rightarrow$ 3. Bracketing $\Rightarrow$ AE BKT
------	---

<b>Off</b>	Pictures are taken without using this function.
<b>3f 0.3EV</b>	3 pictures are taken with the bracketing amount of 0.3 EV.
<b>3f 0.5EV</b>	3 pictures are taken with the bracketing amount of 0.5 EV.
<b>3f 0.7EV</b>	3 pictures are taken with the bracketing amount of 0.7 EV.
<b>3f 1.0EV</b>	3 pictures are taken with the bracketing amount of 1.0 EV.
<b>5f 0.3EV</b>	5 pictures are taken with the bracketing amount of 0.3 EV.
<b>5f 0.5EV</b>	5 pictures are taken with the bracketing amount of 0.5 EV.
<b>5f 0.7EV</b>	5 pictures are taken with the bracketing amount of 0.7 EV.
<b>5f 1.0EV</b>	5 pictures are taken with the bracketing amount of 1.0 EV.
<b>7f 0.3EV</b>	7 pictures are taken with the bracketing amount of 0.3 EV.
<b>7f 0.5EV</b>	7 pictures are taken with the bracketing amount of 0.5 EV.
<b>7f 0.7EV</b>	7 pictures are taken with the bracketing amount of 0.7 EV.

“BKT” is displayed in green until all the shots in the bracketing sequence have been taken. The first shot is taken at current exposure settings, followed first by the shots with reduced exposure and then by the shots with increased exposure.

The settings used to alter exposure vary with the shooting mode.

<b>P</b> (program AE)	Both aperture and shutter speed
<b>A</b> (aperture-priority AE)	Shutter speed
<b>S</b> (shutter-priority AE)	Aperture
<b>M</b> (manual)	<ul style="list-style-type: none"> <li>• Shutter speed (when [ ISO] is not set to [Auto])</li> <li>• ISO sensitivity (when [ ISO] is set to [Auto])</li> </ul>

- If exposure compensation is enabled before shooting begins, the camera will vary exposure around the selected value.
  - Changing the option selected for [EV Step] (P. 107) changes the options available for bracketing amount.
-  Exposure bracketing cannot be combined with flash bracketing (P. 175) or focus bracketing (P. 178).

## Recording pictures with varied white balance (WB BKT)

PASMB 

The camera varies white balance to record a series of pictures. You choose the color axis and the bracketing amount.

Shooting ends after a single shot. The camera takes one picture when the shutter button is pressed all the way down and automatically processes it to record the pictures.

Menu	MENU $\Rightarrow$  2 $\Rightarrow$ 3. Bracketing $\Rightarrow$ WB BKT
------	---

A-B	Select the bracketing amount for the A-B (amber–blue) axis. [Off] / [3f 2Step] / [3f 4Step] / [3f 6Step]
G-M	Select the bracketing amount for the G-M (green–magenta) axis. [Off] / [3f 2Step] / [3f 4Step] / [3f 6Step]

Three pictures are created for each color axis.

The first copy is recorded at current white balance settings, the second using a negative value for compensation, and the third using a positive value.

- If white balance fine-tuning is enabled before shooting begins, the camera will vary white balance around the selected value.
-  White balance bracketing cannot be combined with art filter bracketing (P. 177) or focus bracketing (P. 178).

## Recording pictures with varied flash level (FL BKT)



PASMB 

The camera varies flash level (output) over a series of shots. You choose the amount of variation. The camera takes a shot at a new flash level each time the shutter button is pressed all the way down. Bracketing ends after the required number of shots has been taken. In burst shooting modes, the camera will take pictures while the shutter button is pressed all the way down, ending when the required number of shots has been taken.

Menu	MENU $\Rightarrow$  2 $\Rightarrow$ 3. Bracketing $\Rightarrow$ FL BKT
------	---

Off	Pictures are taken without using this function.
3f 0.3EV	3 pictures are taken with the bracketing amount of 0.3 EV.
3f 0.5EV	3 pictures are taken with the bracketing amount of 0.5 EV.
3f 0.7EV	3 pictures are taken with the bracketing amount of 0.7 EV.
3f 1.0EV	3 pictures are taken with the bracketing amount of 1.0 EV.

“BKT” is displayed in green until all the shots in the bracketing sequence have been taken. The first shot is taken at current flash settings, followed first by the shot with reduced flash output and then by the shot with increased flash output.

-  If you change the [EV Step] setting (P. 107), the bracketing amount of flash also changes.
- If flash compensation is enabled before shooting begins, the camera will vary flash output around the selected value.
-  Flash bracketing cannot be combined with exposure bracketing (P. 174) or focus bracketing (P. 178).

The camera varies ISO sensitivity to record a series of pictures. You choose the bracketing amount. Shooting ends after a single shot. The camera takes one picture when the shutter button is pressed all the way down and automatically processes it to record the required number of shots.

Menu	MENU →  2 → 3. Bracketing → ISO BKT
------	--

<b>Off</b>	Pictures are taken without using this function.
<b>3f 0.3EV</b>	3 pictures are taken with the bracketing amount of 0.3 EV.
<b>3f 0.7EV</b>	3 pictures are taken with the bracketing amount of 0.7 EV.
<b>3f 1.0EV</b>	3 pictures are taken with the bracketing amount of 1.0 EV.

The first copy is recorded at the current ISO sensitivity setting, the second with sensitivity reduced by the selected amount, and the third with ISO sensitivity increased by the selected amount.

- If shutter speed or aperture have been changed to modify exposure from the value selected by the camera, the camera will vary ISO sensitivity around the current exposure value.
- ⓘ The maximum sensitivity selected for [ ISO-A Upper/Default] does not apply.
- ⓘ During silent photography, the flash sync speed is set to 1/50 s.
- ⓘ Changing the option selected for [ISO Step] (P. 114) does not change the options available for bracketing amount.
- ⓘ ISO sensitivity bracketing cannot be combined with art filter bracketing (P. 177) or focus bracketing (P. 178).





## Recording copies of one picture with different art filters applied (ART BKT)

# PASMB

Create multiple pictures of each picture, each with a different art filter applied.

### ■ Enabling art filter bracketing

Menu	MENU →  2 → 3. Bracketing → ART BKT
------	--

- 1 Use  $\Delta$   $\nabla$  to select [ART BKT] and press the  button.
- 2 Use  $\Delta$   $\nabla$  to select [On] and press the  button.

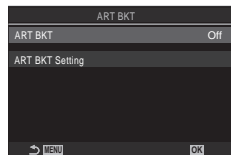





ART BKT setting screen

Off	Pictures are taken without using this function.
On	Pictures are taken with multiple art filters applied.

- 3 The display returns to the ART BKT setting screen.

### ■ Configuring art filter bracketing

- 1 Select [ART BKT Setting] on the ART BKT setting screen and press the  button.
- 2 Select an art filter that you want to apply, and put a check () next to it.
  - Select an option using  $\Delta$   $\nabla$  and press the  button to put a check () next to it.
  - To remove the check, press the  button again.

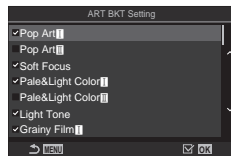

ART BKT Setting	Select the art filters that you want to apply. Picture modes such as [Vivid], [Natural] and [Flat] can also be selected.
-----------------	--

- ⓘ When there is a large number of art filters to be applied, it may take a long time to record the pictures after shooting.
- ⓘ With the exceptions of exposure bracketing (P. 174) and flash bracketing (P. 175), art filter bracketing cannot be combined with other forms of bracketing.

### ■ Shooting

- 1 Press the MENU button to close the ART BKT setting screen and return to shooting screen.
- 2 The camera takes one picture when the shutter button is pressed all the way down and automatically creates multiple copies, each with a different art filter applied.

## Recording pictures with different focus positions (Focus BKT)

PASMMB

The camera varies focus over a series of pictures. You choose the amount and the number of shots. The entire series is shot with a single press of the shutter button. Each time the shutter button is pressed all the way down, the camera takes the selected number of shots, varying focus with each shot. The pictures are taken in silent mode using the electronic shutter.

### ■ Enabling focus bracketing

Menu	MENU →  → 3. Bracketing → Focus BKT
------	-------------------------------------

- 1 Use  $\Delta$   $\nabla$  to select [Focus BKT] and press the  $\odot$  button.
- 2 Use  $\Delta$   $\nabla$  to select [On] and press the  $\odot$  button.

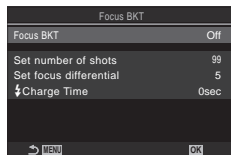

Focus BKT setting screen

Off	Pictures are taken without using this function.
On	Pictures are taken with varied focus positions.

- 3 The display returns to the Focus BKT setting screen.

### ■ Configuring focus bracketing

- 1 Configure options.
  - Press  $\Delta$   $\nabla$  to select an item and press the  $\odot$  button to display the setting menu.
  - After configuring options, press the  $\odot$  button to return to Focus BKT setting screen.

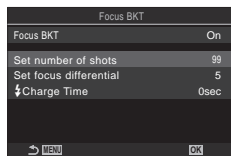

Set number of shots	Choose the number of shots to be taken with varied focus positions. [003] – [999]
Set focus differential	Choose the amount the camera varies focus with each shot. [1] – [10]
Charge Time	Choose how long the camera waits for the flash to charge between shots when using a flash unit not specifically designated for use with the camera. [0 sec] / [0.1 sec] / [0.2 sec] / [0.5 sec] / [1 sec] / [2 sec] / [4 sec] / [8 sec] / [15 sec] / [30 sec]

## ■ Shooting





- 1** Press the MENU button to close the Focus BKT setting screen and return to shooting screen.
  - 2** Press the shutter button all the way down.
    - Shooting will continue until the selected number of shots has been taken.
    - To interrupt bracketing, press the shutter button all the way down a second time.
    - The camera varies the focus distance by the amount selected for Set focus differential with each shot. Shooting will end if the focus distance reaches infinity.
- ⓘ Shooting will end if focus or zoom is adjusted after the shutter button has been pressed all the way down to start bracketing.
- ⓘ When [Focus BKT] is set to [On], [Flash Mode] in [Silent[♥] Settings] (P. 132) becomes [Allow].
- ⓘ Focus bracketing is not available with Four Thirds system lenses.
- ⓘ Focus bracketing cannot be combined with other forms of bracketing.
- ⓘ The flash sync speed is set to 1/100 s. Selecting a value over ISO 16000 for [📷ISO] sets the flash sync speed to 1/50 s.





## Functions that are only available in movie mode







### Sound Recording Options (Sound Recording Settings)

PASMB 

Adjust settings for recording sound during filming. You can also access settings for use when an external microphone or recorder is connected.

Menu	MENU    5. Sound Recording/Connection  Sound Recording Settings
------	---

<b>Recording Volume</b>	Adjust microphone sensitivity. Choose separate values for the built-in stereo microphone and external microphones. <b>[Built-In </b> ]: Adjust the sensitivity of the camera's built-in stereo microphone. <b>[-10] - [0] - [+10]</b> <b>[MIC </b> ]: Adjust the sensitivity of external microphones connected to the microphone jack. <b>[-10] - [0] - [+10]</b>
<b> Volume Limiter</b>	The camera puts a limit on the volume of sounds recorded by the microphone. Use this option to automatically reduce the level of sounds above a certain volume. <b>[Off]</b> : Does not put a limit on the volume of sounds recorded by the microphone. <b>[On]</b> : Puts a limit on the volume of sounds recorded by the microphone.
<b>Wind Noise Reduction</b>	Reduce wind noise during audio recording. <b>[Off]</b> : Does not reduce wind noise during audio recording. <b>[Low] / [Standard] / [High]</b> : Set the level of wind noise reduction.
<b>Recording Rate</b>	Choose an audio recording format. <b>[96kHz/24bit]</b> : High-quality audio. <b>[48kHz/16bit]</b> : Standard-quality audio.
<b> Plug-in Power</b>	Adjust settings for use with condenser microphones and other devices that draw power from the camera. <b>[Off]</b> : For devices that do not require power from the camera (general-purpose dynamic microphones). <b>[On]</b> : For devices that require power from the camera (condenser microphones).

-  Sound is not recorded:
  - with high-speed or slow- or fast-motion movies or when ART 7  / ART 7  (diorama) is selected for picture mode.
-  Audio can only be played on devices that support the option selected for [Recording Rate].
-  Operation sounds of the lens and camera may be recorded in a movie. To prevent it from recording, reduce the operation sounds by setting [ AF Mode] (P. 72) to [S-AF], [MF], or [Pre  ], or by minimizing the button operations of the camera.

## Adjusting the headphone volume (Headphone Volume)

PASMB 

Menu	MENU →  → 5. Sound Recording/Connection → Headphone Volume
------	---

<b>Headphone Volume</b>	Adjust the volume of audio output to the headphones.
-------------------------	--

## Time Codes (Time Code Settings)

PASMB 

Adjust time code settings. Time codes are used to synchronize picture and sound during editing and the like. Choose from the following options.

Menu	MENU →  → 5. Sound Recording/Connection → Time Code Settings
------	---

<b>Time Code Mode</b>	Choose a time code recording option. Use time codes where precise timing is required. <b>[Drop Frame]:</b> Drop-frame time codes. The time code is adjusted to compensate for deviations from the recording time. <b>[Non-DF]:</b> Non-drop-frame time codes. The time code is not adjusted to compensate for deviations from the recording time.
<b>Count Up</b>	Choose how the time count is incremented. <b>[Rec Run]:</b> The count is incremented only during recording. <b>[Free Run]:</b> The count is incremented continuously, including when recording is not in progress or the camera is off.
<b>Starting Time</b>	Choose the starting time code. <b>[Reset]:</b> Reset the time code to 00:00:00 <b>[Manual Input]:</b> Enter the time code manually. <b>[Current Time]:</b> Set the time code to the current time, frame 00.

- ⓘ When setting [Starting Time] to [Current Time], be sure that the camera shows the correct time.  “Setting the Camera Clock (⌚ Settings)” (P. 257)
- ⓘ Time codes are not recorded on high-speed movies (P. 142).

Adjust settings for output to HDMI devices. Options are available for controlling HDMI recorders from the camera or adding time codes for use during movie editing.

Menu	MENU →  → 5. Sound Recording/Connection →  HDMI Output
------	--

<b>Output Mode</b>	<p><b>[Monitor]:</b> The HDMI device functions as an external monitor. The camera outputs both images and indicators to the display. Output settings can be adjusted using the [HDMI Settings] option (P. 251).</p> <p><b>[Record]:</b> The HDMI device functions as an external recorder. Only images are output to the device. Frame size and sound settings are adjusted using camera controls.</p> <p><b>[RAW]:</b> Images are output to the HDMI device in RAW format. Images are not recorded on the card in the camera. Frame size and sound settings are adjusted using camera controls.</p> <ul style="list-style-type: none"> <li>The camera operates in [Monitor] when the mode dial is set to <b>P/A/S/M/B</b> or when the menu is displayed, or when playing back an image.</li> </ul>
<b>REC Bit</b>	<p>The camera and the external device start and stop recording at the same time.</p> <ul style="list-style-type: none"> <li>This option is only available with compatible devices.</li> </ul> <p><b>[Off]:</b> Does not use this function.</p> <p><b>[On]:</b> Controls the external device.</p>
<b>Time Code</b>	<p>Output time codes to the external device. Time code settings can be adjusted using [Time Code Settings] (P. 181).</p> <p><b>[Off]:</b> Does not output time codes to the external device.</p> <p><b>[On]:</b> Output time codes to the external device.</p>

### ■ About [RAW]

When [RAW] is selected, the raw images, to which shooting settings such as exposure compensation and white balance have not been applied, can be recorded.

Visit our website for information on HDMI devices compatible with [RAW].

- When [RAW] is selected, "HDMI" will appear on the camera monitor while outputting signals to an HDMI device.
- The images output from the camera when [RAW] is selected are recorded in ProRes RAW format.
- When [RAW] is selected and a compatible HDMI device is connected, [ Picture Mode] will be set to [ 2 OM-Log400].
- The following limitations apply when [RAW] is selected.
  - Only [C4K] and [4K] can be selected. Slow- or fast-motion movies are not available.
  - Only [M-IS Off] and [M-IS2] can be selected.
  - will be set to [Off].
  - when using a Four Thirds system lens: Only [MF] and [PreMF] can be selected.

## Displaying a + mark in the center of the screen while recording movies (Center Marker)

PASMB 

During movie recording, you can display a “+” mark which enables you to understand where the center of the screen is.



+ mark

Menu	MENU ➔  ➔ 6. Shooting Assist ➔ Center Marker
Off	The + mark is not displayed.
On	The + mark is displayed in the center of the screen during movie recording and when in movie recording ready mode.

## Displaying zebra patterns over high luminance areas while recording movies (Zebra Pattern Settings)

PASMB 

During movie recording, you can display zebra patterns (stripes) over the areas where the luminance levels exceed the predetermined thresholds. You can specify two thresholds and zebra patterns with different angles will be displayed.





### ■ Displaying zebra patterns

Menu	MENU →  → 6. Shooting Assist → Zebra Pattern Settings
------	--

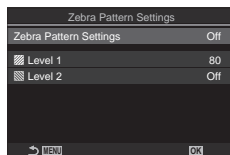
- 1 Use  $\Delta$   $\nabla$  to select [Zebra Pattern Settings] and press the  $\text{OK}$  button.
- 2 Use  $\Delta$   $\nabla$  to select [On] and press the  $\text{OK}$  button.



Zebra Pattern Settings setting screen

<b>Off</b>	Zebra patterns will not be displayed.
<b>On</b>	During movie recording, zebra patterns (stripes) will be displayed over the areas where the luminance levels exceed the predetermined thresholds. A  pattern will be displayed where the luminance level exceeds [Level 1]. A  pattern will be displayed where the luminance level exceeds [Level 2]. The  pattern will be displayed where they overlap.

- 3 The display returns to the Zebra Pattern Settings setting screen.





## ■ Configuring Zebra Pattern Settings

### 1 Configure options.

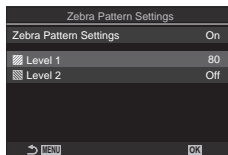
- Press  $\Delta \nabla$  to select an item and press the  $\odot$  button to display the setting menu.
- After configuring options, press the  $\odot$  button to return to Interval Shooting setting screen.



<b>Level 1</b>	A  pattern will be displayed where the luminance level exceeds the specified value.
<b>Level 2</b>	A  pattern will be displayed where the luminance level exceeds the specified value. Set this to [Off] if you want to display only one type of zebra pattern.

## Displaying a red frame while recording movies

(Red Frame during  $\odot$ REC)

PASMB 

You can display a red outer frame on the screen to make it easier to see whether the camera is recording a movie.



Menu	MENU $\Rightarrow$  $\Rightarrow$ 6. Shooting Assist $\Rightarrow$ Red Frame during $\odot$ REC
<b>Off</b>	The camera will not display a red frame.
<b>On</b>	The camera will display a red frame during movie recording.

# 5 Playback

## Information display during playback

### Playback image information

#### Basic display

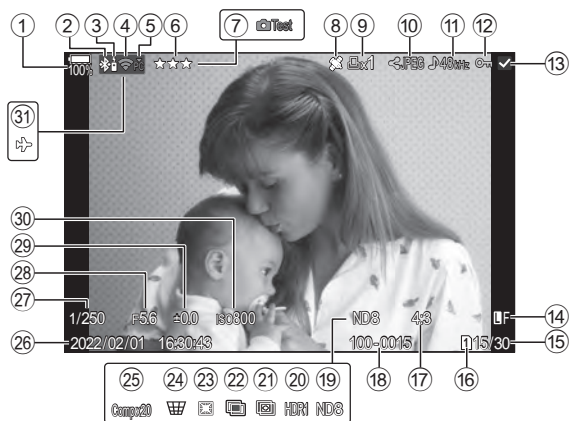

#### Overall display

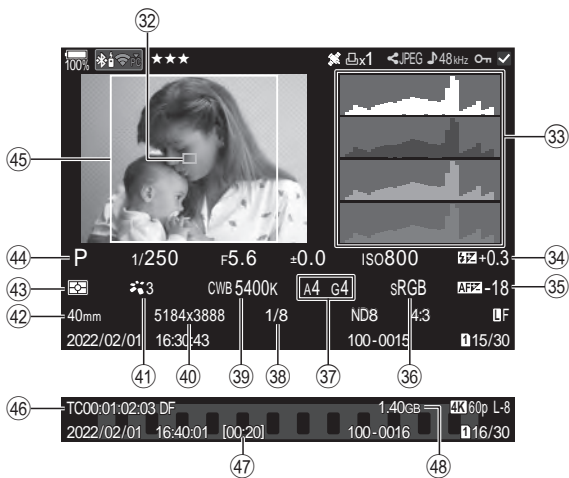

- ① Battery level.....P. 30
  - ② Active Bluetooth® connection  
.....P. 260, 280
  - ③ Remote control .....P. 280
  - ④ Wireless LAN connection.....P. 261, 267
  - ⑤ Active connection to computer (Wi-Fi)  
.....P. 267
  - ⑥ Rating .....P. 196
  - ⑦ Test Picture.....P. 210
  - ⑧ GPS data indicator.....P. 266
  - ⑨ Print order  
Number of prints .....P. 198
  - ⑩ Share order.....P. 195
  - ⑪ Sound record.....P. 199
  - ⑫ Protect .....P. 193
  - ⑬ Image selected .....P. 197
  - ⑭ Image quality .....P. 140, 141
  - ⑮ Frame number/total number of frames
  - ⑯ Playback slot.....P. 242
  - ⑰ Aspect ratio.....P. 144
  - ⑱ File number.....P. 244
  - ⑲ Live ND filter .....P. 158
  - ⑳ HDR image .....P. 162
  - ㉑ Focus stacking.....P. 160
  - ㉒ Multiple Exposure .....P. 163
  - ㉓ Fisheye Compensation.....P. 171
  - ㉔ Keystone Compensation.....P. 170
  - ㉕ Composite shooting  
Number of combined shots.....P. 54
  - ㉖ Date and time .....P. 257
  - ㉗ Shutter speed .....P. 43, 47
  - ㉘ Aperture value .....P. 43, 45
  - ㉙ Exposure compensation .....P. 106
  - ㉚ ISO sensitivity .....P. 113
  - ㉛ Airplane Mode.....P. 260
  - ㉜ AF target display.....P. 77
  - ㉝ Histogram .....P. 38
  - ㉞ Flash intensity control.....P. 123
  - ㉟ Focus adjustment .....P. 95
  - ㊱ Color space.....P. 155
  - ㊲ White balance compensation ....P. 151, 153
  - ㊳ Compression rate .....140
  - ㊴ White balance .....P. 150
  - ㊵ Pixel count .....P. 140
  - ㊶ Picture mode.....P. 145
  - ㊷ Focal length
  - ㊸ Metering mode.....P. 109
  - ㊹ Shooting mode.....P. 43
  - ㊺ Aspect border .....P. 144
  - ㊻ Time Code .....P. 181
  - ㊼ Movie recording time .....P. 328
  - ㊽ Movie file size .....P. 328
- \* ㊼ to ㊽ are only displayed when playing back movies.

## Switching the information display

Button	INFO button
--------	-------------

You can switch the information displayed during playback by pressing the INFO button.

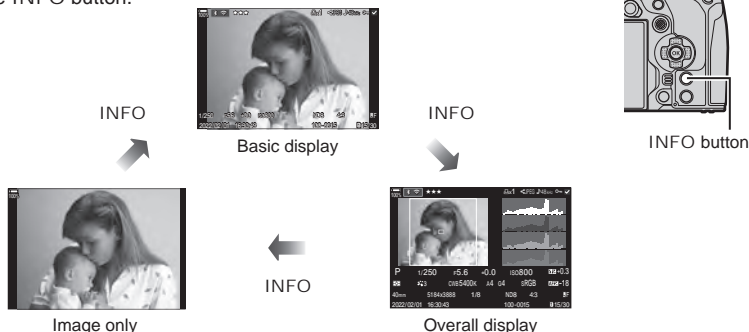

☞ You can choose whether or not to display each of three display types. ☞ “Choosing the information displayed during playback (▶Info Settings)” (P. 206)

## Viewing photographs and movies

### Viewing photographs

#### 1 Press the button.



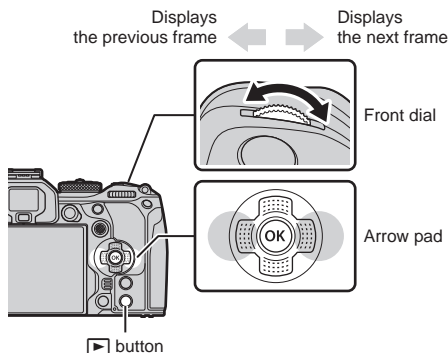















- Your most recent photograph or movie will be displayed.
- Select the desired photograph or movie using the front dial or arrow pad.
- Press the shutter button halfway to return to shooting mode.





Still image





Movie

<b>Rear dial</b> (  )	Zoom in (  ) / Index (  )
<b>Front dial</b> (  )	Previous (  ) / Next (  ) Operation also available during magnified playback.
<b>Arrow pad</b> (  ) / <b>multi selector</b> (  )	Single-frame playback: Next (  ) / previous (  ) / playback volume (  ) Playback zoom: Press  to display a zoom frame. Press it again to zoom in on the frame. You can scroll the image by pressing  during playback zoom. Index/calendar playback: Highlight image  • The operations performed using  can also be performed by pressing the multi selector up, down, left, or right.
<b>INFO button</b>	View image info
 <b>button</b>	Select picture (P. 197)
<b>★ button</b>	Assign rating stars to picture (P. 196)
 <b>button</b>	Protect picture (P. 193)
 <b>button</b>	Delete picture (P. 194)
 <b>button</b>	View menus (in calendar playback, press this button to exit to single-frame playback)





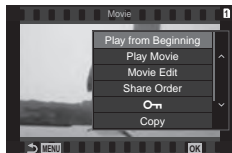

#### ■ Switching cards while viewing photographs

- The  button can be used to switch between cards while playback is in progress. To choose a card, hold the  button and rotate the front or rear dial. This does not change option selected for [📷 Card Slot Settings] > [▶ Slot] (P. 242).

## Watching movies



- 1 Press the  button.
  - The most recent picture will be displayed.
- 2 Select a movie and press the  button.
  - The playback menu will be displayed.
- 3 Select [Play Movie] and press the  button.
  - Movie playback begins.





Fast-forward and rewind using  . Press the  button again to pause playback. While playback is paused, use  to view the first frame and  to view the last frame. Use  or the front dial to view previous or next frame. Press the MENU button to end playback.

### Playing back separated movies



Long movies are automatically recorded over multiple files when the file size exceeds 4 GB or the recording time exceeds 3 hours (P. 59). The files can be played back as a single movie.

- 1 Press the  button.
  - The most recent picture will be displayed.
- 2 Display a long movie you want to view and press the  button.
  - The following options will be displayed.
 



[Play from Beginning]:	Plays back a split movie all the way through
[Play Movie]:	Plays back files separately
[Delete entire  ]:	Deletes all parts of a split movie
[Erase]:	Deletes files separately

- ⓘ We recommend using the latest version of OM Workspace to play back movies on a computer (P. 267). Before launching the software for the first time, connect the camera to the computer.
- ⓘ Movies recorded with [ Video Codec] (P. 144) set to [H.265] cannot be played back using OM Workspace.

## Finding Pictures Quickly (Index and Calendar Playback)

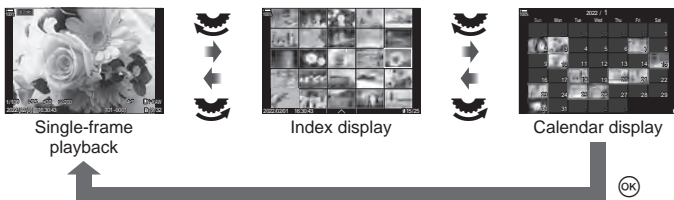
- In single-frame playback, rotate the rear dial to  for index playback. Rotate further for calendar playback.
- Turn the rear dial to  to return to single-frame playback.



- You can change the number of frames for index display.  "Configuring the index display ( Settings)" (P. 207)

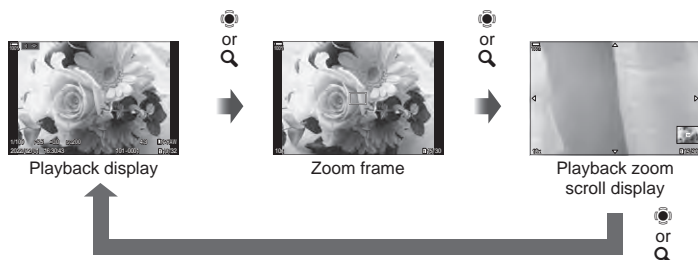

When you press or a button to which [Q] (magnify) has been assigned (P. 208), a zoom frame will be displayed over the part of the picture that was in focus or the part where the subject was detected. Press the button again to zoom in on the zoom frame. Press or to scroll the image during playback zoom.

- You can change the settings of the zoom frame and image scroll. “Choosing the information displayed during magnified playback ( Info Settings)” (P. 206)
- You can change the zoom ratio using the rear dial.
- Playback zoom ends when you press the button.
- If [Face & Eye Detection] is enabled, pressing the INFO button while the zoom frame is displayed moves the zoom frame to the detected face. During close-up playback, the detected face will be enlarged.

## Playback Using Touch Controls

Use touch controls to zoom pictures in and out, scroll pictures, or choose the picture displayed.

- ⚠ Do not tap the display with your fingernails or other sharp objects.
- ⚠ Gloves or monitor covers may interfere with touch screen operation.

### Full-frame playback

#### ■ Displaying the previous or next image

- Slide your finger to the left to view the next image, and right to view the previous image.



#### ■ Magnify

- Lightly tap the screen to display the slider and . Lightly tap the screen twice to magnify the image at the ratio specified in [Q Default Setting] (P. 205).
- Slide the bar up or down to zoom in or out.
- Slide your finger to scroll the display when the picture is zoomed in.
- Tap to display index playback.
- Tap for calendar playback.



#### ■ Movie playback

- Tap to begin playback.
- Tap the lower part of the screen to display the control bar which allows you to end playback and change the playback volume.
- Tap the center of the screen to pause playback. Tap again to resume playback.
- By sliding the bar at the bottom of the screen during playback pause, you can change the position from which the movie will be played when playback is resumed.
- Tap to end playback.



### Index/Calendar playback

#### ■ Displaying the previous or next page

- Slide your finger up to view the next page, and down to view the previous page.
- The touch control menu will be displayed when you tap during index playback. Tap or to switch the number of images displayed. Tap "Configuring the index display (Settings)" (P. 207)
- Tap several times to return to single-frame playback.

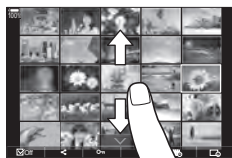











#### ■ Viewing images

- Tap an image to view it full frame.

## Other functions

Lightly tap the screen during single-frame playback or tap  during index playback to display the touch menu. You can then perform the desired operation by tapping the icons in the touch menu.

	Select an image. You can select multiple images and delete them collectively.  "Selecting Multiple Pictures (Share Order Selected, Rating Selected,  , Copy Select, Erase Selected)" (P. 197)
	Images you want to share with a smartphone can be set.  "Selecting Pictures for Sharing (Share Order)" (P. 195)
	Assign rating stars to an image.  "Rating Pictures (Rating)" (P. 196)
	Protects an image.  "Protecting Pictures (  )" (P. 193)



## Setting playback functions

### Rotating Pictures (Rotate)

Choose whether to rotate photographs.

- 1 Play the photograph back and press the **OK** button.
- 2 Select [Rotate] and press the **OK** button.
- 3 Press **△** to rotate the image counterclockwise, **▽** to rotate it clockwise; the image rotates each time the button is pressed.
  - Press the **OK** button to save settings and exit.
  - Movies and protected images cannot be rotated.

The camera can be configured to automatically rotate portrait-orientation pictures during playback. “Automatically rotating portrait-orientation pictures for playback (f)” (P. 205)

[Rotate] is not available when [Off] is selected for [f].

### Protecting Pictures (Protect)

Protect images from accidental deletion.

(protect) icon

- 1 Display the image you want to protect and press the button.
  - (protection icon) appears on the image. Press the button again to cancel protection.
  - When an unprotected image is displayed, you can hold the button and rotate the front or rear dial to protect all images displayed while the dial is rotated. Any previously-protected images displayed while the dial is rotated will be unaffected.
  - When a protected image is displayed, you can hold the button and rotate the front or rear dial to remove protection from all images displayed while the dial is rotated. Any previously-unprotected images displayed while the dial is rotated will be unaffected.
  - The same operations can be performed during playback zoom or when a picture is selected in the index display.



You can also protect multiple selected images. “Selecting Multiple Pictures (Share Order Selected, Rating Selected, , Copy Select, Erase Selected)” (P. 197.)

Formatting the card erases all data including protected images.

### Copying an image (Copy)

When there are cards with available space in both slots 1 and 2, you can copy an image to the other card.

- 1 Display an image you want to copy and press the **OK** button.
- 2 Highlight [Copy] and press the **OK** button.
- 3 Choose whether to specify the destination folder.
  - If you select [Assign], choose a destination folder.
  - If a folder has already been specified, the name of the folder is displayed. To select a different folder, press **▷**.

- 4** Highlight [Yes] and press the **OK** button.
- The picture will be copied to the other card.

You can also copy all images on a card to the other card at a time. [Copy All] (P. 194)

## Copying all images on a card (Copy All)

All images can be copied between the cards inserted in the camera (card slot 1 and 2).

Menu	MENU    1. File  Copy All
------	---------------------------

<b>1</b> → <b>2</b>	All images are copied from the card in card slot 1 to the card in card slot 2.
<b>2</b> → <b>1</b>	All images are copied from the card in card slot 2 to the card in card slot 1.

- Copying ends when the destination card is full.
- If the destination card is an SD card or an SDHC card, movie files exceeding 4 GB will not be copied.

## Deleting Pictures (Erase)

- Display an image you want to delete and press the button.
- Select [Yes] and press the **OK** button.
  - The image will be deleted.

- You can erase images without the confirmation step by changing the button settings. “Disabling Deletion Confirmation (Quick Erase)” (P. 195)

You can choose whether deleting pictures recorded in RAW+JPEG image quality modes deletes both copies, only the JPEG copy, or only the RAW copy. “RAW+JPEG Deletion Options (RAW+JPEG Erase)” (P. 195)

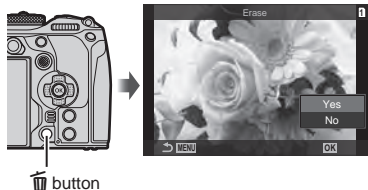

## Deleting All Pictures (Erase All)

Delete all pictures. Protected pictures will not be deleted. You can also exclude the pictures which have been assigned rating stars (P. 196) and delete all other pictures.

Menu	MENU    1. File  Erase All
------	----------------------------



<b>Erase</b>	Delete all pictures including those with rating stars assigned.
<b>Save</b>	Keep the pictures with rating stars assigned, and delete all other pictures.

- If memory cards are inserted in both slots, you will be prompted to choose a slot. Choose a slot and press the **OK** button.
- If you choose [Save] and execute [Erase All], it may take some time depending on the speed class of the card and the number of pictures on the card.

## Disabling Deletion Confirmation (Quick Erase)

If this option is enabled when the  button is pressed to delete photos or movies, the camera will not display a confirmation dialog but will instead delete the images immediately.

Menu	MENU    2. Operations  Quick Erase
------	--

Off	A confirmation dialog is displayed when the  button is pressed.
On	No confirmation dialog will be displayed when the  button is pressed.

## RAW+JPEG Deletion Options (RAW+JPEG Erase)

Choose operation performed when [RAW+JPEG] images are deleted one at a time.







Menu	MENU    2. Operations  RAW+JPEG Erase
------	---

JPEG	Only the JPEG copy is deleted.
RAW	Only the RAW copy is deleted.
RAW+JPEG	Both the RAW and JPEG copies are deleted.



 When [RAW+JPEG] pictures are erased using [Erase All] (P. 194) or [Erase Selected] (P. 197), both the RAW and the JPEG copies will be deleted.





## Selecting Pictures for Sharing (Share Order)



You can select images you want to transfer to a smartphone in advance.

- 1 Display an image you want to transfer and press the  button.
  - The playback menu will be displayed.
- 2 Select [Share Order] and press the  button. Then, press  or .
  - The image is marked for sharing. A  icon and the file type will be displayed.
  - Up to 200 pictures on each slot can be marked for sharing at a time.
  - To cancel a share order, press  or .

 A movie file whose file size exceeds 4GB cannot be marked for sharing.

 You can select images you want to transfer in advance and set a share order all at once.  “Selecting Multiple Pictures (Share Order Selected, Rating Selected, , Copy Select, Erase Selected)” (P. 197), “Transferring images to a smartphone” (P. 264)

 You can also mark images for sharing by assigning  to a button in [  Function] (P. 205).

Press the  button when an unmarked image is displayed during single frame display/index display/playback zoom. When you hold the  button and rotate the front or rear dial, all images displayed while the dial is rotated will be marked for sharing. Any previously-marked images displayed while the dial is rotated will be unaffected.



When you hold the  button and rotate the front or rear dial while a marked image is displayed, all images displayed while the dial is rotated will be unmarked. Any unmarked images displayed while the dial is rotated will be unaffected.

## Selecting RAW+JPEG Pictures for Sharing (RAW+JPEG )

In the case of pictures recorded with [RAW+JPEG] for image quality, you can choose to share only the JPEG copies, only the RAW copies, or both the JPEG and RAW copies.

Menu	MENU    2. Operations  RAW+JPEG 
------	---

<b>JPEG</b>	Only the JPEG copies will be marked for sharing.
<b>RAW</b>	Only the RAW copies will be marked for sharing.
<b>RAW+JPEG</b>	Both RAW and JPEG copies will be marked for sharing.

-  Changing the option selected for [RAW+JPEG ] does not affect pictures already marked for sharing.
-  Regardless of the option selected, removing share marking removes the marking from both copies.

## Rating Pictures (Rating)

Assign one to five rating stars to a picture.





This can be helpful when arranging and searching for pictures using OM Workspace or other utilities.

Button	 button
--------	--

If you press the  button when the selected picture has no rating stars assigned, rating stars will be assigned to the picture. The number of stars will be the same as the previously set number.

If you press the  button when the selected picture has rating stars assigned, rating stars will be cleared.

You can change the number of stars by rotating the front or rear dial while holding the  button.

-  Rating stars can only be assigned to still images.
-  If the picture was recorded with [RAW+JPEG], the same rating will be applied to both the RAW and JPEG files.
-  Rating stars cannot be assigned to protected images.
-  Rating stars cannot be assigned to pictures that were taken with a different camera.

## Selecting the numbers of stars to be used for rating

(Rating Settings)

You can select the numbers of stars that will be displayed as options for rating.

Menu	MENU → [▶] → 3. Displays → Rating Settings
------	--

**1** Select the number of stars that you want to display as an option when rating pictures, and put a check (✓) next to it.

- Select an option using  $\Delta$   $\nabla$  and press the  $\text{OK}$  button to put a check (✓) next to it. To remove the check, press the  $\text{OK}$  button again.

- ① When there is no item with a check (✓) next to it, you cannot assign rating stars to pictures.
- ① Changing the settings of [Rating Settings] does not affect the ratings of pictures that have already been assigned.

## Selecting Multiple Pictures (Share Order Selected, Rating Selected, $\text{OK}$ , Copy Select, Erase Selected)

You can select multiple images for [Share Order Selected], [Rating Selected], [ $\text{OK}$ ], [Copy Select] or [Erase Selected].

**1** Display an image you want to select and press the  $\text{OK}$  button.

- The image will be selected and ✓ will be displayed.  
To cancel selection, press the button again.
- You can select an image during single-frame playback and index playback.





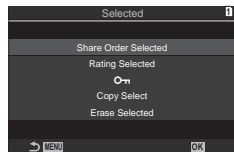



**2** Press the  $\text{OK}$  button to display the menu and select [Share Order Selected], [Rating Selected], [ $\text{OK}$ ], [Copy Select] or [Erase Selected].

- When an unmarked image is displayed, you can hold the  $\text{OK}$  button and rotate the front or rear dial to select all images displayed while the dial is rotated. Any previously-marked images displayed while the dial is rotated will be unaffected.
- When a marked image is displayed, you can hold the  $\text{OK}$  button and rotate the front or rear dial to deselect all images displayed while the dial is rotated. Any previously-unmarked images displayed while the dial is rotated will be unaffected.



You can save digital “print orders” to the memory card listing the pictures to be printed and the number of copies of each print. You can then have the pictures printed at a print shop that supports DPOF. A memory card is required when creating a print order.

### ■ Configuring print orders

Menu	MENU →  → 1. File → 
	<p>Press   to select the frame that you want to set as print reservation, then press   to set the number of prints. To set print reservation for several pictures, repeat this step. Press the  button when all the desired pictures have been selected, and then select the date and time format.</p> <p><b>[No]:</b> The pictures are printed without the date and time.  <b>[Date]:</b> The pictures are printed with the shooting date.  <b>[Time]:</b> The pictures are printed with the shooting time.</p>
 ALL	<p>Select this when you want to set print orders to all of the pictures. Select the date and time format.</p> <p><b>[No]:</b> The pictures are printed without the date and time.  <b>[Date]:</b> The pictures are printed with the shooting date.  <b>[Time]:</b> The pictures are printed with the shooting time.</p>

 When printing images, the setting cannot be changed between the images.

### ■ Setting print orders

Set	Print orders will be set. Settings will be reflected on the pictures saved on the currently selected card.
Cancel	Print orders will not be set.

 The camera cannot be used to modify print orders created with other devices. Creating a new print order deletes any existing print orders created with other devices.

 Print orders cannot include RAW images or movies.

### Resetting all protection/share orders/print orders/ratings

(Reset All Images)

You can reset all protection/share orders/print orders/ratings from pictures on a card in one slot at once.

Menu	MENU →  → 1. File → Reset All Images
Reset Print Orders	Resets all print orders.
Reset Protect	Resets all protection.
Reset share Order	Resets all share orders.
Reset Ratings	Resets all ratings.

• If memory cards are inserted in both slots, you will be prompted to choose a slot. Choose a slot and press the  button. Then the confirmation screen will be displayed.

 When there are a lot of rated pictures, [Reset Ratings] will take a long time.

## Adding Audio to Pictures



You can record audio using the built-in stereo microphone or an optional external microphone and add it to pictures. The recorded audio provides a simple replacement for written notes about the pictures. Audio recordings can be up to 30 s long.

- 1 Display the image to which you want to add audio and press the **OK** button.
  - Audio recording is not available with protected images.
- 2 Select **[M]** and press the **OK** button.
  - To exit without adding audio, select [No].
- 3 Select **[M Start]** and press the **OK** button to begin recording.
- 4 Press the **OK** button to end recording.
  - Pictures with audio are indicated by icons and indicators showing the recording rate.
  - To delete recorded audio, select [Erase] in Step 3.

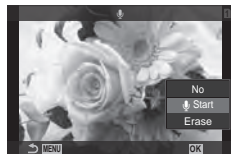

Audio is recorded at the rate selected for movies. The rate can be selected using [Sound Recording Settings] (P. 180).

### ■ Audio Playback

Playback begins automatically when a picture with audio is displayed. To adjust the volume:

- 1 Display the picture whose audio you want to play back.
- 2 Press **Δ** or **∇**.
  - **Δ** button: Raise volume.
  - **∇** button: Lower volume.



Create retouched copies of pictures. In the case of RAW pictures, you can adjust the settings in effect at the time the picture was taken, such as white balance and picture mode (art filters included). With JPEG pictures, you can make simple edits such as cropping and resizing.

<b>RAW Data Edit</b>	<p>Retouch pictures and save the resulting copies in JPEG format (P. 200). The following options are available:</p> <p><b>[Current]:</b> Save the picture at the settings currently selected with the camera.</p> <p><b>[Custom1]/[Custom2]:</b> Adjust settings while previewing the results in the display. The settings are saved as [Custom1] or [Custom2].</p> <p><b>[ART BKT]:</b> The camera creates multiple JPEG copies of each image, one for each art filter selected. Select one or more filters and apply them to one or more images.</p>
<b>JPEG Edit</b>	<p>Retouch JPEG pictures and save the resulting copies in JPEG format (P. 201).</p>

### Retouching RAW Pictures (RAW Data Edit)

[RAW Data Edit] can be used to adjust the following settings. These are also the settings applied when you select [Current].

Image quality	Mid-tones
Picture mode	Highlights
Color/saturation (Color Creator)	Aspect ratio
Color (Partial Color)	High ISO noise reduction
White balance	Color space
Color temperature	Keystone compensation
Exposure compensation	
Shadows	

⚠ [Color Space] is fixed at [sRGB] when an art filter is selected for picture mode.

⚠ RAW pictures cannot be retouched if:

there is not enough space on the memory card or if the picture was created with a different camera

**1** Display an image you want to edit and press the **OK** button.



**2** Use **Δ**/**▽** to select [RAW Data Edit] and press the **OK** button.

- The editing menu will be displayed.

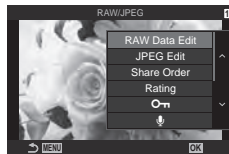



### 3 Highlight items using $\Delta \nabla$ .

- To apply current camera settings, highlight [Current] and press the  $\odot$  button. Current settings will be applied.
  - Use  $\Delta \nabla$  to select [Yes] and press the  $\odot$  button to record the developed image.
- For [Custom1] or [Custom2], highlight the desired option and press  $\triangleright$ , then edit settings as follows:
  - Retouch options will be displayed. Highlight items using  $\Delta \nabla$  and use  $\triangleleft \triangleright$  to choose settings. Repeat until all the desired settings have been chosen. Press the  $\odot$  button to preview the results.
    - Press the  $\odot$  button to confirm the settings. The processing will be applied to the image.
    - Use  $\Delta \nabla$  to select [Yes] and press the  $\odot$  button to record the developed image.
- Highlighting [ART BKT] and pressing  $\triangleright$  displays a list of art filters. Highlight art filters and press the  $\odot$  button to select or deselect; selected filters are marked with a  $\checkmark$ . Press the MENU button to return to the previous display once all the desired filters have been selected.
  - Press the  $\odot$  button to record the image after processing with the selected art filter.









### 4 To create additional copies from the same original, highlight [Reset] and press the $\odot$ button. To exit without creating more copies, highlight [No] and press the $\odot$ button.

- Selecting [Reset] displays editing options. Repeat the process from Step 3.

#### Retouching JPEG Pictures (JPEG Edit)

The [JPEG Edit] menu contains the following options.

<b>Shadow Adj</b>	Brighten back-lit subjects.
<b>Red-eye Fix</b>	Reduce "red-eye" in pictures taken with a flash.
	Crop pictures. Size the crop with the front or rear dial and position it with $\Delta \nabla \triangleleft \triangleright$ .
<b>Aspect</b>	Change the aspect ratio from the standard 4:3 to [3:2], [16:9], [1:1], or [3:4]. After choosing an aspect ratio, use the arrow pad to position the crop.
<b>Black &amp; White</b>	Create a black-and-white copy of the current picture.
<b>Sepia</b>	Create a sepia copy of the current picture.
<b>Saturation</b>	Adjust the vividness of colors. The results can be previewed in the display.
	Create a resized copy 1280 x 960, 640 x 480, or 320 x 240 pixels in size. Pictures with an aspect ratio other than the standard 4:3 are resized to dimensions as close as possible to the selected option.

-  Red-eye correction may not work depending on the image.
-  Editing of a JPEG image is not possible in the following cases:
  - When an image is processed on a PC, when there is not enough space in the card memory, or when an image is recorded on another camera.
-  The image cannot be resized () to the larger size than the original size.
-  Some images can not be resized.

① [ ] (trimming) and [Aspect] can only be used to edit images with an aspect ratio of 4:3 (standard).

1 Display an image you want to edit and press the **OK** button.



2 Use  $\Delta$   $\nabla$  to select [JPEG Edit] and press the **OK** button.

- The editing menu will be displayed.



3 Highlight items using  $\Delta$   $\nabla$  and press the **OK** button.

- The effect can be previewed in the display. If multiple options are listed for the selected item, use  $\Delta$   $\nabla$  to choose the desired option.
- When [ ] is selected, you can size the crop using the dials and position it using  $\Delta$   $\nabla$   $\triangleleft$   $\triangleright$ .
- When [Aspect] is selected, you can select an option using  $\Delta$   $\nabla$ , and then set the position using  $\Delta$   $\nabla$   $\triangleleft$   $\triangleright$ .



4 Highlight [Yes] using  $\Delta$   $\nabla$  and press the **OK** button.

- The new copy will be saved at the selected settings and the camera will return to the playback display.

Overlay existing RAW photos and to create a new picture. Up to 3 pictures can be included in the overlay.

The results can be modified by adjusting brightness (gain) separately for each picture.















- The overlay is saved in the format currently selected for image quality. Overlays created with [RAW] selected for image quality are saved in RAW format and in JPEG format using the image quality option selected for [◀:2] (P. 140).
- Overlays saved in RAW format can in turn be combined with other RAW images to create overlays containing 4 or more pictures.

- 1 Display an image you want to edit and press the **OK** button.
- 2 Use **△ ▽** to select [Image Overlay] and press the **OK** button.
- 3 Select the number of images to be overlaid and press the **OK** button.
- 4 Use **△ ▽ <|>** to select the RAW images to be overlaid.
  - Selected pictures are marked with a **✓**. To deselect, press the **OK** button again.
  - The overlaid image will be displayed if images of the number specified in step 3 are selected.
- 5 Adjust the gain for each image to be overlaid.
  - Use **<|>** to select an image and **△ ▽** to adjust gain.
  - Gain can be adjusted in the range 0.1–2.0. Check the results in the monitor.
- 6 Press the **OK** button to display the confirmation dialog.
  - Select [Yes] and press the **OK** button.



Cut selected footage from movies. Movies can be trimmed repeatedly to create files containing only footage you want to preserve.

 This option is available only with movies recorded with the camera.











- 1 Display a movie you want to edit and press the  button.
- 2 Select [Movie Edit] and press the  button.
- 3 Use   to select [Movie Trimming] and press the  button.
  - You will be prompted to choose how you want to save the edited movie.  
[New File]: Save the trimmed movie in a new file.  
[Overwrite]: Overwrite the existing movie.  
[No]: Exit without trimming the movie.
  - If the movie is protected, you cannot select [Overwrite].
- 4 Highlight the desired option and press the  button.
  - You will be presented with an edit display.
- 5 Trim the movie.
  - Use the  button to skip to the first frame and the  button to skip to the last frame.
  - Using the front or rear dial or the  button, highlight the first frame of the footage you want to delete and press the  button.
  - Using the front or rear dial or the  button, highlight the last frame of the footage you want to delete and press the  button.
- 6 Highlight [Yes] and press the  button.
  - The edited movie will be saved.
  - To select different footage, highlight [No] and press the  button.
  - If you selected [Overwrite], you will be prompted to choose whether to trim additional footage from the movie. To trim additional footage, highlight [Continue] and press the  button.

## Creating Movie Stills

## (In-Movie Image Capture)

Save a still copy of a selected frame.

 This option is available only with [4K] movies recorded with the camera.

- 1 Display a movie you want to edit and press the  button.
- 2 Select [Movie Edit] and press the  button.
- 3 Use   to select [In-Movie Image Capture] and press the  button.
- 4 Use   to select a frame to be saved as a still image and press the  button.
  - The camera will save a still copy of the selected frame.
  - Use the  button to go back and the  button to skip ahead.  
How much it goes back or skips ahead differ depending on the length of the movie.

## Changing the role of the button during playback (Function)

Choose the role played by the  button during playback.

Menu	MENU →  → 2. Operations →  Function
------	---

 Function	 : Create or modify a "share order" by marking pictures for upload to a smartphone.  : Select multiple pictures.
--	---

## Changing the roles of the front and rear dials during playback (Dial Function)

Choose the roles played by the front and rear dials during playback.

Menu	MENU →  → 2. Operations →  Dial Function
------	--

	Zoom in or out or switch to the index display during playback.
Prev/Next	View the next or previous image during playback.

## Choosing the Playback Zoom Ratio (Default Setting)

Choose the starting zoom ratio for playback zoom (close-up playback).

Menu	MENU →  → 2. Operations →  Default Setting
------	--

Recently	Zoom in to the most recently selected zoom ratio.
Equally Value	Images are displayed at a zoom ratio of 1:1. A  icon appears in the monitor.
x2, x3, x5, x7, x10, x14	Choose the starting zoom ratio.

## Automatically rotating portrait-orientation pictures for playback ()

Choose whether pictures shot in portrait orientation are automatically rotated for display on the camera.

Menu	MENU →  → 3. Displays → 
------	--

On	Pictures are automatically rotated for display during playback.
Off	Pictures are not automatically rotated for display during playback.

## Choosing the information displayed during playback

(▶ Info Settings)

Choose the information displayed during playback. Pressing the INFO button during playback will switch the display between the selected displays.

Menu	MENU → ▶ → 3. Displays → ▶ Info Settings
------	--

1 Select the display type, and put a check (✓) next to it.

- Select an option using  $\Delta$   $\nabla$  and press the  $\odot$  button to put a check (✓) next to it. To remove the check, press the  $\otimes$  button again.

<b>Image Only</b>	Only the image is shown.
<b>Basic</b>	Minimum information is shown.
<b>Overall</b>	Full information including the shooting conditions and histogram is shown (P. 186).

## Choosing the information displayed during magnified playback

(▶ Q Info Settings)

Choose the display when you magnify the picture by pressing  $\odot$  or a button to which [Q] (magnify) has been assigned (P. 208).

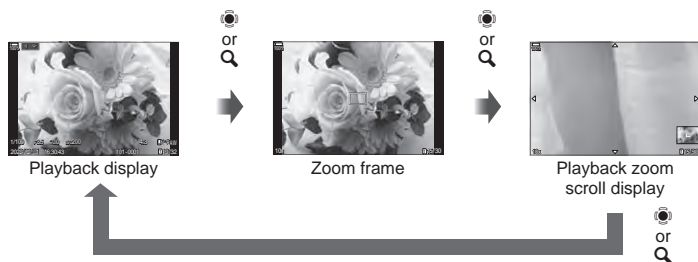

ⓘ If you remove the checks from all options, you will not be able to magnify the image using  $\odot$  or a button to which [Q] (magnify) has been assigned.

Menu	MENU → ▶ → 3. Displays → ▶ Q Info Settings
------	--

1 Select the display type, and put a check (✓) next to it.

- Select an option using  $\Delta$   $\nabla$  and press the  $\odot$  button to put a check (✓) next to it. To remove the check, press the  $\otimes$  button again.

<b>Magnify Frame</b>	Displays the zoom frame.
<b>Magnify Scroll</b>	Allows you to scroll the display during magnified playback.



## Configuring the index display





( Settings)

You can change the number of frames to be displayed on the index display and whether to use the calendar display.

Menu	MENU →  → 3. Displays →  Settings
------	---

**1** Select the display type, and put a check (✓) next to it.

- Select an option using  $\Delta$   $\nabla$  and press the  button to put a check (✓) next to it. To remove the check, press the  button again.

 4] / [  9] / [  25] / [  100]	Choose the number of frames to be displayed on the index display.
Calendar	Pictures are displayed on a calendar.































## Functions for Configuring Camera Controls

### Changing the roles of buttons (Button Settings) P A S M B



Other roles can be assigned to buttons in place of their existing functions.

The functions assigned using [ Button Function] take effect only during still photography. The functions assigned using [ Button Function] take effect in  (movie) mode.

#### ■ Customizable Controls

Icon	Button	Default role	
			
	 button	 (exposure compensation)	
	 button	 (High Res Shot)	 REC (movie recording)
	ISO button	ISO sensitivity	
	AF-ON button	AF-ON	
	AEL button	AEL	
	 button	 (display selection)	
	Arrow pad	Off*1	
	Arrow pad  (right)*2	 (AF/MF toggle)	
	Arrow pad  (down)*2	 (white balance)	
	One-touch white balance button	 (one-touch white balance)	Peaking
	Preview button	Preview	Magnify
PBH 	 button on the optional power battery holder	 (exposure compensation)	
PBH 	ISO button on the optional power battery holder	ISO sensitivity	
PBH 	AF-ON button on the optional power battery holder	AF-ON	
	Fn button on the lens	AF Stop	

\*1 No function is assigned to the arrow pad by default.

\*2 To use  and  on the arrow pad in their assigned roles, select [Direct Function] for [] (arrow pad).



Super Control Panel	→  Button Function /  Button Function
Menu	MENU →  → 1. Operations → Button Settings →  Button Function MENU →  → 1. Operations → Button Settings →  Button Function

- 1 Highlight the desired control using  $\Delta$   $\nabla$  and press the button.
- 2 Highlight a function using  $\Delta$   $\nabla$   $\langle$   $\triangleright$  and press the button to assign it to the selected control.



























#### ■ Available Roles











only": This role is only available in the [ Button Function] menu.





only": This role is only available in the [ Button Function] menu.

The options available vary from button to button.



Role	Function
REC (movie recording)	The control functions as a movie-record button. Press to start or stop recording.
Preview () ( only)	Stop aperture down to the selected value. This lets you preview depth of field. Aperture stops down to the currently-selected value while the button is pressed. Preview options can be selected using [ Lock] (P. 224).
(one-touch white balance)	Measure a value for one-touch white balance (P. 152). To measure white balance during still photography, frame a reference object (a piece of white paper or the like) in the display, then press and hold the control and press the shutter button. A list of one-touch white balance options will be displayed, from which you can choose the location to which the new value will be saved. To measure white balance during movie recording, frame a reference object (a piece of white paper or the like) in the display and press the button. A list of one-touch white balance options will be displayed, from which you can choose the location to which the new value will be saved.
AF Area Select ([::])	You can choose the AF target mode (P. 77) and position (P. 76). Press the control to view the AF target selection display. Use the front or rear dial to choose AF target mode and the multi selector or arrow pad to position the AF target. <ul style="list-style-type: none"> <li>• You can choose the controls used for this operation.  "AF Target Selection ([::]Select Screen Settings)" (P. 99)</li> </ul>
[::]Home ([::]JHP) (AF home position) ( only)	Recall previously-saved [AF Target Mode], and [AF Target Point] "home position" settings. Home position settings are saved using [ [::] Set Home] (P. 98). <ul style="list-style-type: none"> <li>• You can save separate home positions for landscape and portrait orientations.  "Matching AF Target Selection to Camera Orientation ( Orientation Linked [::])" (P. 97)</li> </ul>
MF () (AF/MF toggle)	Switch between AF and MF. Press once to select MF and again to return to the previous mode. The focus mode can also be selected by holding the button and rotating a dial.

Role	Function
<b>RAW</b>  <b>(RAW quality)</b>  only)	If you press the button when [  ] is set to JPEG, it changes to RAW+JPEG. When [  ] is set to RAW or RAW+JPEG, the setting does not change. You can also choose an image quality setting by holding the button and rotating a dial.
<b>Test Picture</b>  <b>Test</b>  only)	Take a test shot. You can view the effects of selected settings in an actual photograph. If you keep the control pressed while pressing the shutter button, you will be able to view the results but the picture will not be saved to the memory card.
<b>Custom Mode</b> <b>C1–C4</b>  only)	Recall settings for the selected custom mode. Press the control once to recall saved settings, a second time to restore the settings previously in effect (P. 58). The control continues to perform this function when a custom mode is selected with the mode dial.
<b>Exposure Comp.</b> 	Adjust exposure settings. Hold the control and rotate the front or rear dial. Alternatively, you can press the button to activate settings and then rotate the dials. The adjustments available vary with the shooting mode: [P]: Use the front or rear dial or <img alt="Left arrow" data-bbox="305 365 332 382"/> for exposure compensation. Use the   buttons for program shift. [A]: Use the front or rear dial or <img alt="Left arrow" data-bbox="305 395 332 412"/> for exposure compensation. Use the   buttons for aperture. [S]: Use the front or rear dial or <img alt="Left arrow" data-bbox="305 425 332 442"/> for exposure compensation. Use the   buttons for shutter speed. [M]*: Use the rear dial or   for shutter speed. Use the front dial or the <img alt="Left arrow" data-bbox="305 475 332 492"/> buttons for aperture. [B]: Use rear dial or   to switch between bulb/time and live composite photography. Use the front dial or <img alt="Left arrow" data-bbox="305 505 332 522"/> buttons to choose the aperture. * For information on adjusting exposure settings when [Auto] is selected for [ISO] (P. 113), see “Adjusting Exposure Compensation” (P. 107).
<b>Digital Tele-converter</b>  <b>Q2x / :</b> <b>Q1.4x)</b>	Turn the digital teleconverter on or off (P. 166). Press once to zoom in and again to zoom out. You can turn it on/off even when you are recording a movie. During movie recording, a frame indicating the area that will be magnified by the digital teleconverter is displayed.
<b>Keystone Comp.</b>   only)	Press the control to view keystone compensation settings (P. 170). After adjusting settings, press the control again to exit. To cancel keystone compensation, press and hold the control.
<b>Fisheye Compensation</b>   only)	Enable fisheye correction (P. 171). Press once to enable fisheye correction. Press again to disable. Hold the button and rotate the front or rear dial to choose from [Angle] options 1, 2, and 3.
<b>Magnify</b> 	Press the control once to display the zoom frame and again to zoom in (P. 80). Press the control a third time to exit zoom; to hide the zoom frame, press and hold the control. Use the multi selector, touch controls, or   <img alt="Left arrow" data-bbox="305 845 332 862"/> to position the zoom frame.

Role	Function
<b>HDR</b> (  only)	Enable HDR (P. 162). Press once to enable HDR. Press again to disable. Hold the button and rotate the front or rear dial to adjust HDR settings, including HDR bracketing.
<b>ISO</b>	Adjust [ISO] settings (P. 113). Hold the control and rotate the front or rear dial. Alternatively, you can press the button to activate settings and then rotate the dials. Use the front or rear dial or  to adjust settings.
<b>WB (white balance)</b>	Adjust [WB] settings (P. 150). Hold the control and rotate the front or rear dial. Alternatively, you can press the button to activate settings and then rotate the dials. Use the front or rear dial or  to adjust settings.
<b>Multi Function (Multi Fn)</b>	Configure the control for use as a multi-function button (P. 215). Hold the control and rotate the front or rear dial to choose the function performed. The selected function can be performed by pressing the control.
<b>Peaking (Peak)</b>	Toggle focus peaking on or off (P. 103). Press the control once to turn peaking on and again to turn it off. When peaking is on, peaking options (color, amount) can be displayed by pressing the INFO button.
 <b>Level Disp</b> (  )	Display the digital level gauge. The exposure bar display in the viewfinder functions as a level gauge. Press the control again to exit. This option takes effect when [  Style 1] or [  Style 2] is selected for [EVF Style] (P. 228).
 <b>View Selection (View Selection)</b> (display selection)	Switch between viewfinder photography and live view. If [Off] is selected for [EVF Auto Switch] (P. 250), the display will switch between the viewfinder and the monitor. Press and hold the control to display [EVF Auto Switch] options.
<b>LV Mode (S-OVF)</b> (  only)	Switches [LV Mode] (P. 225) between [Standard] and [S-OVF].
<b>AF Limiter (AFLimit)</b> (  only)	Enable the AF limiter (P. 92). Press once to enable [AF Limiter]. Press again to disable. Hold the button and rotate the front or rear dial to choose from three stored settings.
<b>Preset MF (Pre MF)</b>	Set [AF Mode] to [Pre MF] (P. 72). Press the control once to enable preset MF and again to restore the previous focus mode. Alternatively, you can choose the [AF Mode] by holding the control and rotating a dial.
<b>Lens Info Settings (Exif Lens)</b>	Recall previously-saved lens data (P. 246). Recall saved data for the current lens after changing lenses or the like.
<b>IS Mode (IS)</b>	Toggle [Image Stabilizer] on or off (P. 136). Press once to select [Off] and again to turn image stabilization on. Hold the control and rotate the front or rear dial to access [Image Stabilizer] options.
<b>Flicker Scan (Flicker Scan)</b>	Adjust settings for [Flicker Scan] (P. 108). Press the control to select [On]. You can adjust shutter speed for best results while viewing banding in the display. Press the control again to display shooting information and access other settings. Press and hold the control to select [Off] for [Flicker Scan].

Role	Function
<b>Live ND Shooting (ND)</b> (📷 only)	Enable the live ND filter (P. 158). Press once to enable [Live ND Shooting]. Press again to disable. Hold the button and rotate the front or rear dial to adjust [Live ND Shooting] settings.
<b>Off</b>	The control is not used.
<b>Flash Mode</b> (⚡) (📷 only)	Adjust flash settings (P. 120). Press once to display flash options and again select the highlighted option and exit. Highlight settings using the front or rear dial or <math>\triangleleft/\triangle></math>. <ul style="list-style-type: none"> <li>This function can be assigned to the <math>\triangleright</math> and <math>\nabla</math> buttons only. You must first set [<math>\blacktriangleleft/\blacktriangleright</math>] to [Direct Function].</li> </ul>
 (sequential shooting/self-timer) (📷 only)	Choose a drive (sequential shooting/self-timer) mode (P. 126). Press the button to display drive mode options and then choose a mode using the front or rear dial or the $\triangleleft/\triangle>$ buttons. <ul style="list-style-type: none"> <li>This function can be assigned to the <math>\triangleright</math> and <math>\nabla</math> buttons only. You must first set [<math>\blacktriangleleft/\blacktriangleright</math>] to [Direct Function].</li> </ul>
 <b>Lock (touch control lock)</b>	Lock touch controls. Press and hold the button once to lock touch controls and again to unlock. <ul style="list-style-type: none"> <li>This function can be assigned to the <math>\triangleright</math> and <math>\nabla</math> buttons only. You must first set [<math>\blacktriangleleft/\blacktriangleright</math>] to [Direct Function].</li> </ul>
<b>Electronic Zoom (W↔T)</b>	Zoom power zoom lenses in or out. After pressing the control, use the arrow pad to zoom in or out. Use $\triangle$ or $\triangleright$ to zoom in and $\nabla$ or $\triangleleft$ to zoom out. <ul style="list-style-type: none"> <li>This function can be assigned to the <math>\triangleright</math> and <math>\nabla</math> buttons only. You must first set [<math>\blacktriangleleft/\blacktriangleright</math>] to [Direct Function].</li> </ul>
<b>AF Stop</b>	Suspend autofocus. Focus locks and autofocus is suspended while the control is pressed. Applies only to lens <b>L-Fi</b> buttons.
 <b>Face Selection</b> (👤)	Select the face used for focus when the camera detects multiple portrait subjects. Pressing the button selects the face closest to the current AF target. If  All (all targets) is selected for AF-target mode, pressing the button will instead select the face closest to the center of the frame. To focus on a different face, hold the button and rotate the front or rear dial. This option can also be used during movie recording.
<b>Face &amp; Eye Detection</b> (☺)	Pressing the button when an option other than [Off] is selected for [Face & Eye Detection] (P. 88) selects [Off]; to restore the previous setting, press the button again. To change the option displayed in the [Face & Eye Detection] menu, hold the button and rotate the front or rear dial.
<b>Focus Ring Lock</b> (🔒)	Press the control once to disable, and again to enable, the lens focus ring. This option is available when [S-AF MF], [C-AF MF], [MF], [C-AF+TR MF], [Pre MF], or [ $\blacktriangleleft/\blacktriangleright$ AF MF] is selected for [AF Mode]. The MF portion of the AF mode indicator is displayed gray while the ring is disabled. In the case of lenses equipped with an MF (manual focus) clutch, pressing the button has no effect when the focus ring is in the MF position (closer to the camera body). Focus ring lock ends when you perform an operation such as turning the camera off or attaching a different lens.

Role	Function
<b>Night Vision (Night LV)</b> (📷 only)	Pressing the button when [Off] is selected for [📷Night Vision] (P. 225) selects [On]. If [On] is selected, pressing the button selects [Off].
<b>AEL (AE lock)</b>	Press the button to lock exposure. Press again to release it.
<b>AF-ON</b>	The camera focuses with autofocus while the button is pressed (P. 83). The camera stops focusing when the button is released.
<b>AE BKT</b> (📷 only)	Pressing the button when [Off] is selected for [AE BKT] selects the setting selected under [AE BKT]. If an option other than [Off] is selected, pressing the button selects [Off]. To choose an option for [AE BKT], hold the button and rotate the front or rear dial.
<b>WB BKT</b> (📷 only)	Pressing the button when [Off] is selected for [WB BKT] selects the setting selected under [WB BKT]. If an option other than [Off] is selected, pressing the button selects [Off]. To choose an option for [WB BKT], hold the button and rotate the front or rear dial.
<b>FL BKT</b> (📷 only)	Pressing the button when [Off] is selected for [FL BKT] selects the setting selected under [FL BKT]. If an option other than [Off] is selected, pressing the button selects [Off]. To choose an option for [FL BKT], hold the button and rotate the front or rear dial.
<b>ISO BKT</b> (📷 only)	Pressing the button when [Off] is selected for [ISO BKT] selects the setting selected under [ISO BKT]. If an option other than [Off] is selected, pressing the button selects [Off]. To choose an option for [ISO BKT], hold the button and rotate the front or rear dial.
<b>ART BKT</b> (📷 only)	Toggle [ART BKT] on or off. To choose an option for [ART BKT], press and hold the button.
<b>Focus BKT</b> (📷 only)	Toggle [Focus BKT] on or off. To choose an option for [Focus BKT], press and hold the button.
<b>Focus Stacking</b> (📷 only)	Toggle [Focus Stacking] on or off. To choose an option for [Focus Stacking], press and hold the button.
<b>High Res Shot</b> (📷 only)	Pressing the button when [Off] is selected for [High Res Shot] selects the setting selected under [High Res Shot]. If an option other than [Off] is selected, pressing the button selects [Off]. To choose an option for [High Res Shot], hold the button and rotate the front or rear dial.
<b>Subject Detection</b> (📷)	Pressing the button when [Off] is selected for [Subject Detection] selects the setting selected under [Subject Detection]. If an option other than [Off] is selected, pressing the button selects [Off]. To choose an option for [Subject Detection], hold the button and rotate the front or rear dial.
<b>Direct Function</b> (📷/⏏/⏏/⏏)	Assign roles to the buttons on the arrow pad (△ ▽ ◀ ▶). The following roles can be assigned: ◀ button: [⏏] (AF-target selection) △ button: [📷] (exposure compensation) ▶ button: [MF] (AF/MF toggle) ▽ button: [WB] (white balance) • The ▶ and ▽ buttons can be assigned other functions.
<b>WB AUTO Lock (Lock WB AUTO)</b> (📷 only)	When recording a movie with the white balance set to [AUTO], pressing the button locks the white balance. Pressing it again releases the lock.

Role	Function
<b>View Assist (BT.709)</b>  only	Toggle [View Assist] on or off. You can change the setting even when you are recording a movie.
<b>Zebra Pattern Settings</b>  <b>Zebra</b>  only	Toggle [Zebra Pattern Settings] on or off. You can change the setting even when you are recording a movie.

## 6

### Customizing the Camera

## ■ Using multi function options (Multi Function)

Assign multiple roles to a single button.



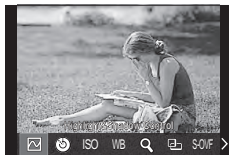

☞ To use the multi function feature, you must first assign [Multi Function] to a camera control using [Button Settings] (P. 208).

### Choosing a function

- 1 Hold the button to which [Multi Function] is assigned and rotate the front or rear dial.
  - Rotate the dial until the desired feature is highlighted.  
Release the button to select the highlighted feature.
- 2 Press the button to which [Multi Function] is assigned.
- 3 Adjust settings.



The multi-function button can be used to:

<b>Highlight&amp;Shadow Control</b>	Adjust brightness using the front or rear dial. Press the INFO button to choose the tone range (highlights, shadows, or mid-tones).
<b>Color Creator</b>	Use the front dial to adjust hue and the rear dial to adjust saturation.
 <b>ISO</b>  <b>ISO</b>	Choose a setting using the front or rear dial.
 <b>WB</b>  <b>WB</b>	
<b>Magnify</b>	The zoom frame will be displayed.
<b>Image Aspect</b>	Choose a setting using the front or rear dial.
 <b>LV Mode</b>	Press the button to switch between [Standard] and [S-OVF].
<b>Peaking</b>	Press the button to turn the feature on or off.

- You can choose the options displayed. ☞ [Multi Function Settings] (P. 236)
- ☞ During shooting, [Highlight&Shadow Control] can also be set by pressing the  (Exposure compensation) and then pressing the INFO button.

- Recording a movie by pressing the shutter button (📷Shutter Function)

PASMB📷

Configure the shutter button as a Ⓜ (movie record) button. An optional remote control can then be used to start or stop recording when the mode dial is rotated to 📷 (movie).

Menu	MENU ➔ ⚙ ➔ 1. Operations ➔ 📷Shutter Function
Off	The shutter button cannot be used to record movies.
Ⓜ REC	Press the shutter button all the way down to start or stop movie recording.

ⓘ The Ⓜ button cannot be used for movie recording when [Ⓜ REC] is selected.

## Assigning Roles to the Front and Rear Dials

(📷Dial Function / 📷Dial Function)

PASMB📷

Choose the roles performed by the front and rear dials.

Menu	MENU ➔ ⚙ ➔ 1. Operations ➔ Dial Settings ➔ 📷Dial Function MENU ➔ ⚙ ➔ 1. Operations ➔ Dial Settings ➔ 📷Dial Function
------	--

1 Choose an item to set, and press the Ⓜ button.

- Choose a dial using the ◀▶ buttons and use the ▲▼ buttons to choose a role.
- Press the INFO button to move between lever positions.
- Press the Ⓜ button when settings are complete.

ⓘ When [📷Fn Lever Function] / [📷Fn Lever Function] is set to a setting other than [mode1], the functions assigned to lever 1 is enabled even if the lever is in position 2.



The functions that can be assigned in [📷Dial Function] are listed below.

Role	Function	Shooting mode				
		P	A	S	M	B
Ps	Program shift (P. 44).	✓	—	—	—	—
Shutter	Choose the shutter speed.	—	—	✓	✓	✓*
FNo.	Adjust aperture.	—	✓	—	✓	✓
☒	Adjust exposure compensation.	✓	✓	✓	✓	✓
☒	Adjust flash compensation.	✓	✓	✓	✓	✓
ISO	Adjust ISO sensitivity.	✓	✓	✓	✓	✓
WB	Adjust white balance.	✓	✓	✓	✓	✓
CWB Kelvin	Choose a color temperature when CWB (custom) is selected for white balance.	✓	✓	✓	✓	✓
Off	None.	✓	✓	✓	✓	✓

\* Switch between bulb, time, and live composite.



The functions that can be assigned in [Dial Function] are listed below.

Role	Function	mode (movie exposure mode)			
		P	A	S	M
<b>Shutter</b>	Choose the shutter speed.	—	—	✓	✓
<b>FNo.</b>	Adjust aperture.	—	✓	—	✓
	Adjust exposure compensation.	✓	✓	✓	✓
<b>ISO</b>	Adjust ISO sensitivity.	—	—	—	✓
<b>WB</b>	Adjust white balance.	✓	✓	✓	✓
<b>CWB Kelvin</b>	Choose a color temperature when CWB (custom) is selected for white balance.	✓	✓	✓	✓
 VOL	Adjust the recording level.	✓	✓	✓	✓
 VOL	Adjust headphone volume.	✓	✓	✓	✓
<b>Off</b>	None.	✓	✓	✓	✓

## Changing the Dial Direction

(Dial Direction)

PASMB 

Choose the direction in which the dials are rotated to set exposure.





Menu	MENU ➔  ➔ 1. Operations ➔ Dial Settings ➔ Dial Direction
Exposure	Choose the direction the dials are rotated to set aperture and shutter speed in A, S, M, and B modes.
Ps	Choose the direction the dials are rotated for program shift (mode P).

## Changing the Functions of the Multi Selector

(Multi Selector Settings)







PASMB 

Choose the direction in which the dials are rotated to set exposure.

Menu	MENU ➔  ➔ 1. Operations ➔ Multi Selector Settings
 Center Button	Choose the operation performed by pressing the multi selector. The multi selector can then function as a button. [Off]: No role assigned. Pressing the multi selector has no effect. [[::]]: Press the multi selector to adjust settings for AF target selection or AF target mode. The arrow pad or front and rear dials can be used according to the setting selected for [[::]]Select Screen Settings] (P. 99). [[::]]HP]: The multi selector performs the function selected for  Button Function] > [[::]]Home] (P. 98).  This option applies in still photography modes only.
 Direction Key	Choose the operation performed by tilting the multi selector. The multi selector is normally used to position the AF target, but this function can be disabled to prevent unintended operation. [Off]: No function is assigned. [[::]]: The multi selector can be used to position the AF-target.

Menu	MENU ➔ ⚙ ➔ 1. Operations ➔ Fn Lever Settings
------	--

### ■ How to configure the Fn lever

 Fn Lever Function	<p>Choose the role played by the Fn lever in still photography modes. The Fn lever can be used to choose the roles of the front and rear dials or to recall focus settings. It can also be used to select movie mode.</p> <p>This setting takes effect in modes P, A, S, M, and B (still photography modes). The option selected using [ Fn Lever Function] takes effect in  (movie) mode.</p>
 Fn Lever Function	<p>Choose the role played by the Fn lever in  (movie) mode. The Fn lever can be used to choose the roles of the front and rear dials or to recall focus settings.</p> <p>The role assigned to the Fn lever using this item takes effect in  (movie) mode.</p> <p>In P, A, S, M, and B (still photography) modes, the Fn lever performs the role selected in [ Fn Lever Function].</p>
<b>Fn Lever/Power Lever</b>	<p>The Fn lever can be used as an on/off lever. Use this feature if you would like to use your right hand to turn the camera on or off during shooting.</p>

## ■ Configuring [Fn Lever Function]

- 1 Select [Fn Lever Function] on the [Fn Lever Settings] screen and press the **OK** button.

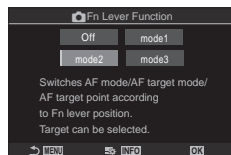

Fn Lever Function screen

<b>Off</b>	Changing the position of the Fn lever has no effect.
<b>mode1</b>	Switch the functions of the front and rear dials. The functions for Positions 1 and 2 conform to the setting selected for [Dial Function] (P. 216).
<b>mode2</b>	Switch between two groups of settings previously selected for [AF Mode], [AF Target Mode], and [AF Target Point]. Press the INFO button and put a check (✓) next to a setting that you want to recall with the Fn lever. To remove the check, press the <b>OK</b> button again. [AF Mode]: S-AF, C-AF, etc. [AF Target Mode]: [·]Single, [All]All, etc. [AF Target Point]: The position of AF target.
<b>mode3</b>	Toggle the shooting mode. You can switch to [movie] mode without rotating the mode dial.

ⓘ When [mode3] is selected, [Fn Lever Function] cannot be used (P. 221).

ⓘ This function cannot be used in the following cases.

- [Fn Lever/Power Lever] (P. 222) is set to [ON/OFF] or [OFF/ON].

## ■ Configuring [Fn Lever Function]

- 1 Select [Fn Lever Function] on the [Fn Lever Settings] screen and press the **OK** button.

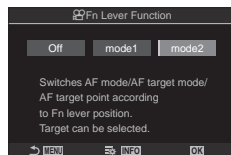

Fn Lever Function screen

<b>Off</b>	Changing the position of the Fn lever has no effect.
<b>mode1</b>	Switch the functions of the front and rear dials. The functions for Positions 1 and 2 conform to the setting selected for [Dial Function] (P. 216).
<b>mode2</b>	Switch between two groups of settings previously selected for [AF Mode], [AF Target Mode], and [AF Target Point]. Press the INFO button and put a check (✓) next to a setting that you want to recall with the Fn lever. To remove the check, press the <b>OK</b> button again. [AF Mode]: S-AF, C-AF, etc. [AF Target Mode]: [≠]Small, [All]All, etc. [AF Target Point]: AF-target position

⚠ This function cannot be used in the following cases.

- [mode3] is selected for [Fn Lever Function] (P. 220).
- [Fn Lever/Power Lever] (P. 222) is set to [ON/OFF] or [OFF/ON].

■ Using [mode2] of [Fn Lever Function] / [Fn Lever Function]

When [mode2] is selected for [Fn Lever Function] / [Fn Lever Function], the camera will store separate focus settings for Positions 1 and 2.

**1** Rotate the Fn lever to Position 1 and set the AF settings.

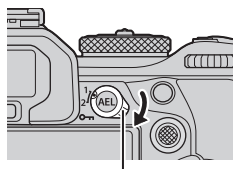

- The camera can store the settings that have been checked (✓) in:

[AF Mode]: S-AF, C-AF, etc.  
[AF Target Mode]: [ · ] Small, [ ] All, etc.  
[AF Target Point]: AF-target position

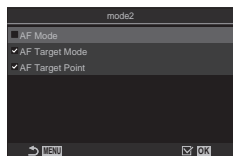

**2** Repeat the process for Position 2.

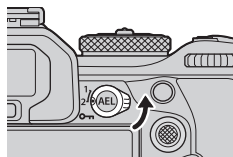

**3** Rotate the lever to the desired position to recall the saved settings.

## ■ Configuring [Fn Lever/Power Lever]

- 1 Select [Fn Lever/Power Lever] on the [Fn Lever Settings] screen and press the **OK** button.



<b>Fn</b>	The lever functions according to the options selected for [ <b>Fn</b> Fn Lever Function] and [ <b>Fn</b> Fn Lever Function] (P. 221).
<b>ON/OFF</b>	The lever functions as an on/off lever. Position 1 is on and Position 2 is off.
<b>OFF/ON</b>	The lever functions as an on/off lever. Position 1 is off and Position 2 is on.

- ⓘ The ON/OFF lever cannot be used to turn the camera off when [ON/OFF] or [OFF/ON] is selected. [**Fn** Fn Lever Function] and [**Fn** Fn Lever Function] are similarly unavailable.

## Power Zoom Lenses (Electronic Zoom Settings)

### P A S M B

Choose the speed at which power zoom lenses zoom in or out when the zoom ring is rotated. Adjust zoom speed if it is so quick that you find it hard to frame your subject.

Menu	MENU ➔  ➔ 1. Operations ➔ Electronic Zoom Settings
------	--

<b>Elec. Zoom Speed</b>	Sets the zoom speed for  (still photography) mode. <b>[Low]:</b> Slow zoom. A good choice when precise adjustments are needed. <b>[Normal]:</b> Normal zoom speed. <b>[High]:</b> Fast zoom.
<b>Elec. Zoom Speed</b>	Sets the zoom speed for  (movie) mode. <b>[Low]:</b> Slow zoom. A good choice when precise adjustments are needed. <b>[Normal]:</b> Normal zoom speed. <b>[High]:</b> Fast zoom.





- ⓘ Although the same options are displayed for (still photography) mode and (movie) mode, the actual zoom speeds are different.

## Locking the Button

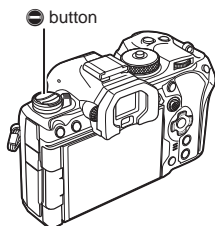
 (Lock)  
P A S M B 

You can disable the  button.



Menu	MENU ➔  ➔ 1. Operations ➔ 
Off	The  button can be used.
On	The  button cannot be used.

## Choosing What Happens When the Shutter Button Is Pressed During Live View Zoom (LV Close Up Mode)

P A S M B 

Choose display options for use with focus zoom.

Menu	MENU ➔  ➔ 2. Operations ➔ LV Close Up Mode
------	---

- For information on live view zoom options, see the explanation on P. 80.

<b>LV Close Up Mode</b>	Choose what happens if the shutter button is pressed halfway during focus zoom. <b>[mode1]:</b> Focus zoom ends. You can check the composition after focusing using focus zoom. <b>[mode2]:</b> Focus zoom remains in effect while the camera focuses. Compose the shot before focusing, then zoom in for precise focus and take a picture without ever ending zoom.
-------------------------	--

## Choosing the Behavior of the Control Used for Depth-of-Field Preview

( Lock)

PASMB 

Choose the behavior of the control used for depth-of-field preview.

Menu	MENU  2. Operations 
------	--











 Lock	Choose the behavior of the control used for depth-of-field preview. <b>[Off]</b> : Aperture stops down while the control is pressed. <b>[On]</b> : Aperture stops down when the control is pressed; to end depth-of-field preview, press the control a second time.
--	---

## Button Hold Options (Press-and-hold Time)

PASMB 

Choose how long buttons must be pressed to perform resets and other similar functions for various features. For ease of use, button hold times can be set separately for different features.

Menu	MENU  2. Operations  Press-and-hold Time
------	--

End LVQ	Set the button hold time for each function. [0.5sec] - [3.0sec]
Reset LVQ Frame	
Reset 	
Reset 	
Reset 	
Reset 	
Reset 	
Reset 	
Reset [:::]	
Call EVF Auto Switch	
Reset 	
End 	
Switch  Lock	
End Flicker Scan	
Call WB BKT Setting	
Call ART BKT Setting	
Call Focus BKT Setting	
Call  Setting	



## Functions for adjusting the live view display

### Changing the look of the display

( LV Mode)

PASMB

Increase dynamic range of the viewfinder display, increasing the amount of detail visible in highlights and shadows in a manner similar to optical viewfinders. This setting takes effect on the viewfinder, the monitor and HDMI output.

Menu	MENU $\Rightarrow$ $\Rightarrow$ 3. Live View $\Rightarrow$ LV Mode
------	---

<b>Standard</b>	The effects of exposure, color and other shooting settings are visible in the viewfinder display.
<b>S-OVF</b>	The effects of exposure, white balance, art filters and other shooting settings are not visible in the display.

- “S-OVF” appears on the display when [S-OVF] is selected.

### Making the display easier to see in dark places

( Night Vision)

PASMB

Increase brightness of the display to make it easier to see in dark places.

Menu	MENU $\Rightarrow$ $\Rightarrow$ 3. Live View $\Rightarrow$ Night Vision
------	--

<b>Off</b>	Normal display.
<b>On</b>	Brightness is adjusted for ease of viewing. The brightness and colors of the preview differs from the final photograph.

- “Night LV” appears on the display when [On] is selected.
- [Frame Rate] will be set to [Normal] when [On] is selected.

### Viewfinder Display Rate

(Frame Rate)

PASMB

Choose the viewfinder display refresh rate.

Menu	MENU $\Rightarrow$ $\Rightarrow$ 3. Live View $\Rightarrow$ Frame Rate
------	--

<b>Normal</b>	The standard frame rate. This is the preferred choice in most situations.
<b>High</b>	Smooth the motion of fast-moving subjects. Fast-moving subjects are easier to track. This setting reverts to [Normal] automatically if the internal temperature of the camera rises during shooting.

You can preview the effects of art filters in the monitor or viewfinder during shooting. Some filters may cause subject movement to appear jerky, but this can be minimized so as to not influence photography.

Menu	MENU ➔  ➔ 3. Live View ➔ Art LV Mode
------	---

<b>mode1</b>	The effects of art filters can be previewed during shooting.
<b>mode2</b>	While the shutter button is pressed halfway, the camera gives priority to maintaining the display rate and reduces the effects of art filters on the preview display. Motion is smooth.

## Reducing Flicker in Live View

(Anti-Flicker LV)

P A S M B 

Reduce flicker under fluorescent lighting and the like. Choose this option if flicker makes the display difficult to view.

Menu	MENU ➔  ➔ 3. Live View ➔ Anti-Flicker LV
------	---

<b>Auto</b>	The camera detects and reduces flicker.
<b>50Hz</b>	Reduce flicker under workplace or outdoor lighting powered by alternating current with a frequency of 50 Hz.
<b>60Hz</b>	Reduce flicker under workplace or outdoor lighting powered by alternating current with a frequency of 60 Hz.
<b>Off</b>	Flicker reduction off. <ul style="list-style-type: none"> <li>• This option is not available when [On] is selected for [Anti-Flicker Shooting] (P. 135).</li> </ul>

## Selfie Assist

(Selfie Assist)  
PASM B 

Choose the display used when the monitor is reversed for self-portraits.

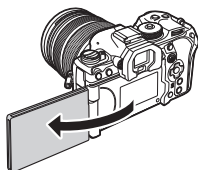

Menu	MENU ➔  ➔ 3. Live View ➔ Selfie Assist
------	---





<b>Off</b>	The display does not change when the monitor is reversed.
<b>On</b>	When reversed for self-portraits, the monitor shows a mirror image of the view through the lens.

## Functions for Configuring Information Display

### Selecting the display style of the viewfinder (EVF Style)

PASMB 

Menu	MENU →  → 4. Information → EVF Style
------	---

 Style 1 / Style 2	Similar to film camera viewfinder displays.	
 Style 3	The same as the monitor display.	

## ■ Viewfinder display when shooting using the viewfinder (Style 1/Style 2)

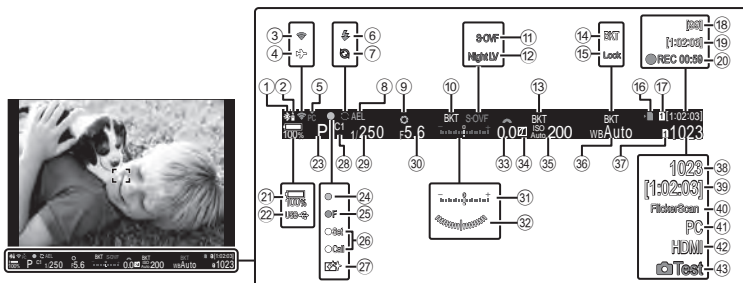

- |   |   |
|---|---|
| ① Active <b>Bluetooth</b> ® connection .....P. 260, 280                             | ②① Battery level.....P. 30                            |
| ② Remote control .....P. 280  | ②② Powered via USB PD.....P. 287                      |
| ③ Wireless LAN connection .....P. 261, 267  | ②③ Shooting mode.....P. 43                            |
| ④ Airplane Mode.....P. 260  | ②④ AF confirmation mark.....P. 40                     |
| ⑤ Active connection to computer (Wi-Fi) .....P. 267                                 | ②⑤  SH2 Aperture warning.....P. 126                   |
| ⑥ Flash.....P. 118<br>(blinks: charging in progress, lights up: charging completed) | ②⑥ SET and CALL functions.....P. 293                  |
| ⑦ Pro Capture active .....P. 133  | ②⑦ Dust reduction.....P. 305                          |
| ⑧ AE lock.....P. 109  | ②⑧ Custom mode .....P. 56                             |
| ⑨ Preview .....P. 224   | ②⑨ Shutter speed .....P. 43, 47                       |
| ⑩ AE BKT .....P. 174  | ③⑩ Aperture value .....P. 43, 45                      |
| ⑪  LV Mode .....P. 225  | ③① Exposure compensation .....P. 106                  |
| ⑫  Night Vision .....P. 225   | ③② Level gauge *1 .....P. 233                         |
| ⑬ ISO BKT.....P. 176  | ③③ Exposure compensation value.....P. 106             |
| ⑭ WB BKT .....P. 175  | ③④ Highlight & shadow control .....P. 215             |
| ⑮  WB AutoLock .....P. 153  | ③⑤ ISO sensitivity .....P. 113                        |
| ⑯ Card write indicator.....P. 21, 25  | ③⑥ White balance.....P. 150                           |
| ⑰  Save slot .....P. 243  | ③⑦  Save settings.....P. 243                          |
| ⑱ Maximum number of continuous shots .....P. 128                                    | ③⑧ Number of storable still pictures ...P. 327        |
| ⑲ Available recording time .....P. 327  | ③⑨ Available recording time .....P. 327               |
| ⑳ Recording time (displayed during recording).....P. 59                             | ④⑩ Flicker scan.....P. 108                            |
|   | ④① Active connection to computer (USB) *2 .....P. 284 |
|   | ④②  HDMI Output .....P. 182                           |
|   | ④③ Test Picture .....P. 210                           |

\*1 Displayed when the shutter button is pressed halfway. [Level Gauge] (P. 233)

\*2 Displayed only when connected to OM Capture and the computer is currently selected in the [ RAW/Control] menu as the sole destination for new pictures (P. 276).

Choose the indicators listed in the live view display.

You can display or hide shooting setting indicators. Use this option to choose the icons that appear in the display.

You can configure three sets of display settings for still photography mode and two sets for movie recording mode.

Menu	MENU → ⚙ → 4. Information → Info Settings MENU → ⚙ → 4. Information → Info Settings
------	--

### ■ Configuring Info Settings

- 1 Select an indicator you wish to display when the INFO button is pressed, and put a check (✓) next to it.

- Select an option using  $\Delta$   $\nabla$  and press the  $\text{OK}$  button to put a check (✓) next to it. To remove the check, press the  $\text{OK}$  button again.

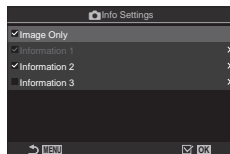

Info Settings setting screen

<b>Image Only</b>	No information will be displayed.
<b>Information 1</b>	Select an option using $\Delta$ $\nabla$ and press the $\text{OK}$ button to put a check (✓) next to it.
<b>Information 2</b>	To remove the check, press the $\text{OK}$ button again. To set the details of an item to be displayed, press $\triangleright$ . The following items can be set.
<b>Information 3</b>	[] / [Highlight&Shadow] / [Level Gauge] / [All Battery Information] / [Silent  Operation]

The set that is currently in use cannot be disabled, but the items to be displayed can be configured.

## ■ Configuring Info Settings

1 Select an indicator you wish to display when the INFO button is pressed, and put a check (✓) next to it.

- Select an option using  $\Delta$   $\nabla$  and press the  $\odot$  button to put a check (✓) next to it. To remove the check, press the  $\odot$  button again.

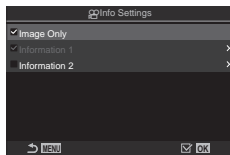

Info Settings setting screen

<b>Image Only</b>	No information will be displayed.
<b>Information 1</b>	Select an option using $\Delta$ $\nabla$ and press the $\odot$ button to put a check (✓) next to it. To remove the check, press the $\odot$ button again. To set the details of an item to be displayed, press $\triangleright$ . The following items can be set.
<b>Information 2</b>	<b>[Level Gauge] / [All Battery Information] / [Image Stabilizer] / [Picture Mode] / [WB] / [AF Mode] / [Face &amp; Eye Detection] / [Sound Recording Level Meter] / [Headphone Volume] / [Time Code] / [Silent Operation] / [Grid]</b>

The set that is currently in use cannot be disabled, but the items to be displayed can be configured.

## ■ Choosing a Display

Press the INFO button during shooting to cycle through the selected displays.

“Switching the information display” (P. 38)

## Configuring the display for when the shutter button is pressed halfway (Info by half-pressing)

PASMB

You can configure the display for when the shutter button is pressed halfway.

<b>Menu</b>	MENU $\Rightarrow$ $\ast$ $\Rightarrow$ 4. Information $\Rightarrow$ Info by half-pressing
<b>Off</b>	No information is displayed while the shutter button is pressed halfway.
<b>On1</b>	Only the following exposure-related items are displayed while the shutter button is pressed halfway. <ul style="list-style-type: none"> <li>• Shutter speed</li> <li>• Aperture value</li> <li>• Exposure compensation value</li> <li>• Difference from optimal exposure</li> <li>• ISO sensitivity</li> </ul>
<b>On2</b>	The display does not change even when the shutter button is pressed halfway.

Choose the information that can be viewed by pressing the INFO button in the viewfinder display. Just as you can with the monitor, you can display a histogram or level gauge in the viewfinder by pressing the INFO button. This item is used to choose the types of display available. It takes effect when the camera is in still photography mode and [Style 1] or [Style 2] is selected for [EVF Style] (P. 228). The option selected for [Info Settings] takes effect in [P] mode (P. 231).

Menu MENU → ⚙ → 4. Information →  Info Settings

- 1 Select an indicator you wish to display when the INFO button is pressed, and put a check (✓) next to it.

- Select an option using  $\Delta$   $\nabla$  and press the  $\text{OK}$  button to put a check (✓) next to it. To remove the check, press the  $\text{OK}$  button again.

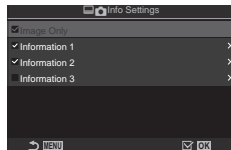

 Info Settings setting screen



<b>Image Only</b>	No information will be displayed.
<b>Information 1</b>	Select an option using $\Delta$ $\nabla$ and press the $\text{OK}$ button to put a check (✓) next to it. To remove the check, press the $\text{OK}$ button again. To set the details of an item to be displayed, press $\triangleright$ . The following items can be set. <b>[Histogram]</b> : A histogram superimposed on the display in the viewfinder. <b>[Highlight&amp;Shadow]</b> : Tints applied to over- and under-exposed areas. <b>[Level Gauge]</b> : The level gauge. <b>[All Battery Information]</b> : Information on all batteries.
<b>Information 2</b>	
<b>Information 3</b>	

 The set that is currently in use cannot be disabled, but the items to be displayed can be configured.





## Displaying the Level Gauge when the shutter button is pressed halfway (Level Gauge)

PASMB 

Choose whether the level gauge can be displayed in the viewfinder by pressing the shutter button halfway when [ Style 1] or [ Style 2] is selected for [EVF Style] (P. 228).



Display when shutter button is pressed halfway

Menu	MENU →  → 4. Information →  = Level Gauge
On	The level gauge is displayed in the viewfinder while the shutter button is pressed halfway. The level gauge appears in place of the exposure bar.
Off	The level gauge is not displayed.



Menu	MENU ➔ ⚙ ➔ 5. Grid/Other Displays ➔ 📷 Grid Settings MENU ➔ ⚙ ➔ 5. Grid/Other Displays ➔ 🎞 Grid Settings
------	--









<b>Display Color</b>	Choose the displayed color. <b>[Preset 1]:</b> The settings of [Color of Preset 1] are used. <b>[Preset 2]:</b> The settings of [Color of Preset 2] are used.
<b>Exclusive for 🎞 (🎞 Grid Settings only)</b>	Choose whether to use a movie-exclusive setting when displaying guides in 🎞 (movie) mode. <b>[Off]:</b> Use the same setting as when in still photography mode. <b>[On]:</b> Use the settings dedicated to movie recording mode.
<b>Displayed Grid</b>	Select the type of guides displayed. Choose from: <b>[Off]</b> / [📷] / [📷] / [📷] / [📷] / [📷] / [📷] (📷 Grid Settings only) • When [📷] is selected, the guides are adjusted for a 16:9 movie frame when movies are shot in still photography mode. Depending on the option selected for [📷 ←:], the guides may be displayed with an aspect ratio of 17:9.
<b>Color of Preset 1</b>	<b>[R]:</b> Increase the number to emphasize the red tint. <b>[G]:</b> Increase the number to emphasize the green tint. <b>[B]:</b> Increase the number to emphasize the blue tint.
<b>Color of Preset 2</b>	<b>[α]:</b> Increase the number to make the color of the guides deeper.

ⓘ The guides configured here are not displayed during Focus Stacking (P. 160).

🎞 The settings made here are also used when [📷 Style 3] is selected for [EVF Style].

Choose whether to display a framing grid in the viewfinder. You can also choose guide color and type. It takes effect when the camera is in still photography mode and [Style 1] or [Style 2] is selected for [EVF Style] (P. 228). The option selected for [Info Settings] takes effect in  mode (P. 231).

Menu	MENU →  → 5. Grid/Other Displays →  Grid Settings
------	---

<b>Exclusive for</b> 	Choose whether to use a viewfinder-exclusive setting when displaying guides on the viewfinder. <b>[Off]:</b> Use the same setting as when using the monitor. <b>[On]:</b> Use the setting dedicated to the viewfinder.
<b>Display Color</b>	Choose the displayed color. <b>[Preset 1]:</b> The settings of [Color of Preset 1] are used. <b>[Preset 2]:</b> The settings of [Color of Preset 2] are used.
<b>Displayed Grid</b>	Select the type of guides displayed. Choose from: <b>[Off]</b> /  /  /  /  /  /  <ul style="list-style-type: none"> <li>When  is selected, the guides are adjusted for a 16:9 movie frame when movies are shot in still photography mode. Depending on the option selected for , the guides may be displayed with an aspect ratio of 17:9.</li> </ul>
<b>Color of Preset 1</b>	<b>[R]:</b> Increase the number to emphasize the red tint. <b>[G]:</b> Increase the number to emphasize the green tint. <b>[B]:</b> Increase the number to emphasize the blue tint.
<b>Color of Preset 2</b>	<b>[α]:</b> Increase the number to make the color of the guides deeper.

## Choosing the Settings Available via Multi-Fn





(Multi Function Settings)

P A S M B 

Choose the settings that can be accessed via multi-function buttons.

Menu	MENU ➔  ➔ 5. Grid/Other Displays ➔ Multi Function Settings
------	---

- 1 Select an indicator you wish to display when the INFO button is pressed, and put a check (✔) next to it.
  - Select an option using  $\Delta$   $\nabla$  and press the  button to put a check (✔) next to it. To remove the check, press the  button again.

<b>Highlight&amp;Shadow Control</b>	Change the setting using the front and rear dials. Press the INFO button to change the area (highlight, midtone, shadow) to be configured.
<b>Color Creator</b>	Use the front dial to adjust hue and the rear dial to adjust saturation.
 ISO  ISO	Change the setting using the front and rear dials.
 WB  WB	
<b>Magnify</b>	A zoom frame will be displayed.
<b>Image Aspect</b>	Change the setting using the front and rear dials.
 LV Mode	The setting switches between [Standard] and [S-OVF] with each press of the button.
<b>Peaking</b>	Turns on and off with each press of the button.

## Histogram Exposure Warning

(Histogram Settings)

P A S M B 

Choose the brightness levels that the histogram shows as overexposed (highlights) or underexposed (shadows). These levels are used for exposure warnings in the histogram displays during shooting and photo playback.

- The areas shown in red or blue in the monitor and viewfinder [Highlight&Shadow] displays are also selected according to the values chosen for this option.

Menu	MENU ➔  ➔ 5. Grid/Other Displays ➔ Histogram Settings
------	--

<b>Highlight</b>	Choose the minimum brightness for the highlight warning. [245] – [255]
<b>Shadow</b>	Choose the maximum brightness for the shadow warning. [0] – [10]

## Settings related to operation and display of menus

### Configuring the cursor on the menu screen (Menu Cursor Settings)

PASMB 

Choose where the cursor will be displayed when you open the menu or move to a different page.

Menu	MENU ➔  ➔ 2. Operations ➔ Menu Cursor Settings
------	---

<b>Page Cursor Position</b>	<p><b>[Save]:</b> When you move to a different page, the cursor appears where it was the last time the page was opened.</p> <p><b>[Reset]:</b> Each time you move to a different page, the cursor appears at the top of the page.</p>
<b>Menu Start Position</b>	<p><b>[Recently]:</b> When you open the menu, the last used tab, page, and cursor position are recalled.</p> <p><b>[O<sub>1</sub>]:</b> When you open the menu, the first page of the [O<sub>1</sub>] tab is displayed.</p> <p><b>[My]:</b> When you open the menu, the first page of the [My] tab is displayed.</p>
<b>Shortcut to B Mode Settings</b>	<p>The camera can be configured to open the mode-specific menu when you press the MENU button in B mode.</p> <p><b>[Off]:</b> The menu opens according to the setting of [Menu Start Position].</p> <p><b>[On]:</b> [Live Bulb] (P. 173), [Live Time] (P. 173), or [Composite Settings] (P. 173) opens, depending on the selected mode.</p>

## Choosing how to move between pages with the rear dial

(Loop in Menu Tab)

PASMB

Choose whether to switch the pages only within the same menu tab when the rear dial is turned.

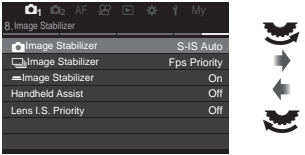
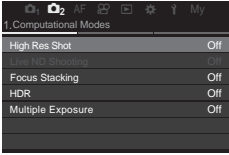
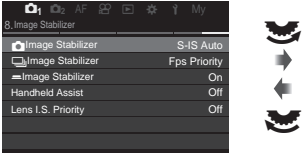
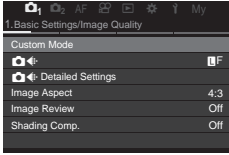
Menu	MENU → ⚙️ → 1. Operations → Dial Settings → Loop in Menu Tab
No	<p>When you move to the last page by turning the rear dial and turn it further, the first page of the next tab is displayed. When you move to the first page by turning the rear dial and turn it further, the last page of the previous tab is displayed.</p>  
Yes	<p>When you move to the last page by turning the rear dial and turn it further, the first page of the current tab is displayed. When you move to the first page by turning the rear dial and turn it further, the last page of the current tab is displayed.</p>  

⚙️ This settings is effective only when the rear dial is operated. When you use <> to switch pages, it always works in the same way as when [No] is selected.

[Yes]/[No] Default

(Priority Set)

PASMB

Choose the option highlighted by default when a [Yes]/[No] confirmation is displayed.

Menu	MENU → ⚙️ → 2. Operations → Priority Set
No	[No] is highlighted by default.
Yes	[Yes] is highlighted by default.

## “My Menu” Settings

### Using “My Menu”

You can use “My Menu” to create a personalized menu tab containing only items you select. “My Menu” can contain up to 5 pages of 7 items each. You can delete items or change the page or item order.

At purchase, “My Menu” contains no items.

**1** Press the MENU button to display the menus.

**2** Highlight an item for inclusion in “My Menu”.

- Any item in the menus **1** through **7** can be added to “My Menu” if it appears on the screen with tabs displayed.
- Some other menu items can also be added to “My Menu”. If the menu item can be added, “My” is displayed at the top right corner of the display.

**3** Press the **OK** button.

- You will be prompted to choose a page. Use **▲**/**▼** on the arrow pad to choose the “My Menu” page to which the item will be added.

Item can be added to  
“My Menu”

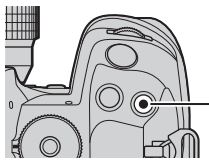
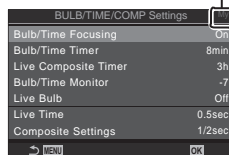

**OK** button

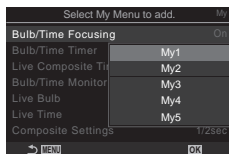

#### 4 Press the **OK** button to add the item to the selected page.

- The camera will display a message stating that the item has been added to "My Menu".

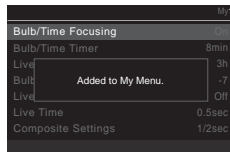

- Items that have been added to "My Menu" are indicated by the number of the "My Menu" page.
- Items can be removed from "My Menu" by pressing the **OK** button. A confirmation dialog will be displayed; to proceed, highlight [Yes] and press the **OK** button.

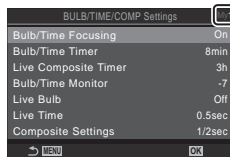

- Items saved to "My Menu" are added to the My ("My Menu") tab.

My ("My Menu") tab

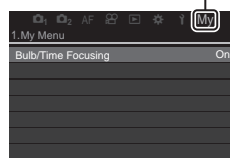

#### 5 To access "My Menu", select the "My" tab.

You can make the camera display "My Menu" first when you press the MENU button.

"Configuring the cursor on the menu screen (Menu Cursor Settings)" (P. 237)

#### ■ Managing "My Menu"

You can reorder items in "My Menu", move them between pages, or remove them from "My Menu" altogether.

##### 1 Press the MENU button to display the menus.

##### 2 Display the "My Menu" page you want to edit and press the **OK** button.

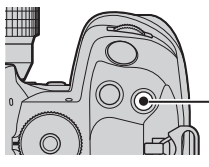

**OK** button

- The options below will be displayed.

[Rearrange Order]: Change the order of items or pages. Use the arrow pad (**△ ▽ < ▷**) to choose the new location.

[Remove this item]: Remove the highlighted item from "My Menu". Highlight [Yes] and press the **OK** button.

[Remove this page]: Remove from "My Menu" all items on the current page. Highlight [Yes] and press the **OK** button.

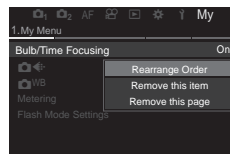



# 7 Setting Up the Camera

## Card/Folder/File Settings

### Formatting the card (Card Formatting) P A S M B

Cards must be formatted with this camera before first use or after being used with other cameras or computers.

All data stored on the card, including protected images, is erased when the card is formatted.

When formatting a used card, confirm there are no images that you still want to keep on the card. “Usable cards” (P. 25)

Menu	MENU    1. Card/Folder/File  Card Formatting
------	--

<b>Format Card</b>	<b>[Yes]:</b> The card will be formatted. <b>[No]:</b> Formatting will be cancelled.
<b>No</b>	Formatting will be cancelled.

- When there are cards in both slots 1 and 2, card slot selection appears. Select a card slot and press the button.

## Setting the card to record to

( Card Slot Settings / Card Slot Settings)

P A S M B

When there are cards in both slots 1 and 2, you can select which card to record still images and movies to.









Super Control Panel	⇒  Save Settings
Menu	MENU ⇒  ⇒ 1. Card/Folder/File ⇒  Card Slot Settings MENU ⇒  ⇒ 1. Card/Folder/File ⇒  Card Slot Settings

### ■ Configuring Card Slot Settings

Save Settings	Choose the recording method for still images (P. 243). [0] / [1] / [↓0/0] / [↑0/0] / [↓0=0] / [↑0=0]
Save Slot	Choose the card used to record photographs. This option takes effect when [0] or [1] is selected for [ Save Settings]. [1]: Photographs are recorded on the card in slot 1. [2]: Photographs are recorded on the card in slot 2.
Slot	Choose the card used for still image playback when [ Save Settings] is set to [↓0/0], [↑0/0], [↓0=0], or [↑0=0]. [1]: Photographs on the card in slot 1 are played back. [2]: Photographs on the card in slot 2 are played back.

You can also choose a card for playback using the button. Hold the button and rotate the front or rear dial to switch cards while playback is in progress. This does not change the option selected for [ Slot].

## ■ Configuring Save Settings

 <b>Standard</b>	Pictures are recorded to the memory card in the slot selected for [  Save Slot] (P. 242). Shooting ends when the card is full.
 <b>Auto Switch</b>	Pictures are recorded to the memory card in the slot selected for [  Save Slot] (P. 242). Pictures will be recorded to the remaining card when the card in the selected slot fills. This setting automatically reverts to [Standard] when only one memory card is inserted.
 <b>Dual Independent</b> ↓	Each picture is recorded twice, once in each of two different image quality formats. Choose an image quality for each slot (P. 140). Shooting ends when either card is full. Image quality is set separately for each slot; after changing the option selected, check the current image quality setting.
 <b>Dual Independent</b> ↑	Each picture is recorded twice, once in each of two different image quality formats. Choose an image quality for each slot (P. 140). Recording continues to the card in the remaining slot when either card fills. Image quality is set separately for each slot; after changing the option selected, check the current image quality setting.
 <b>Dual Same</b> ↓	Each picture is recorded twice, once to each card, using the option currently selected for image quality. Shooting ends when either card is full. This setting automatically reverts to [Standard] when only one memory card is inserted.
 <b>Dual Same</b> ↑	Each picture is recorded twice, once to each card, using the option currently selected for image quality. Recording continues to the card in the remaining slot when either card fills. This setting automatically reverts to [Standard] when only one memory card is inserted.

ⓘ The image quality mode may change if you change the option selected for [ Save Settings] or replace a memory card with one that can contain a different amount of additional photographs. Check the image quality mode before taking photographs.

⚙ When [] (Auto Switch) is selected for [ Save Settings], the camera will automatically switch between the last picture on the first card and the first picture on the second card.

## ■ Configuring Card Slot Settings

①	Movies are recorded on the card in slot 1.
②	Movies are recorded on the card in slot 2.

## Specifying a folder to save images in (Assign Save Folder)

PASMB 

Specify the folder on the card in which the images will be saved.

Menu	MENU $\Rightarrow$ $\gamma$ $\Rightarrow$ 1. Card/Folder/File $\Rightarrow$ Assign Save Folder
------	--

Assign *	<b>[New Folder]:</b> Specify a 3-digit folder number. 1st digit: <b>[0] - [9]</b> 2nd digit: <b>[0] - [9]</b> 3rd digit: <b>[0] - [9]</b> <b>[Existing Folder]:</b> Select an existing folder using $\Delta$ $\nabla$ . The first two frames and the last frame in the folder are displayed.
Do not assign	The folder in which the images will be saved is not specified. If a folder has already been specified, selection will be cancelled.

\* If a folder has already been specified, the name of the folder is displayed. To select a different folder, press  $\triangleright$ .

## File Naming Options (File Name)

PASMB 

Choose how the camera names files when saving photos or movies to memory cards. File names consist of a four-character prefix and a four-digit number. Use this option to choose how file numbers are assigned.

Menu	MENU $\Rightarrow$ $\gamma$ $\Rightarrow$ 1. Card/Folder/File $\Rightarrow$ File Name
------	---

 When two cards are inserted, the camera may create new folders or fail to number files consecutively depending on the file and folder numbers currently in use on each card.

Auto	When a new memory card is inserted, file numbering continues from the last number used. If the card already contains a file with the same or a higher number, numbering will continue from the highest number.
Reset	Folder numbering is reset to 100 and file numbering to 0001 when a new card is inserted. If the card already contains images, numbering will continue from the highest number.

Change the file names the camera uses when saving photos and movies to memory cards.

Menu	MENU ➡  1. Card/Folder/File ➡ Edit Filename
------	--

sRGB	<p><b>[Date (mdd)]:</b> The 2nd to 4th digits will be made up of the numbers corresponding to the month and day of the recording date (A to C will be used for October to December). You can set the 1st digit as you wish.</p> <p><b>[Directory Number]:</b> The 2nd to 4th digits will be made up of the number of the destination folder ("100" – "999"). You can set the 1st digit as you wish.</p> <p><b>[Manual]:</b> You can set the first four digits as you wish using alphanumeric characters.</p>
AdobeRGB	<p><b>[Date (mdd)]:</b> The 2nd to 4th digits will be made up of the numbers corresponding to the month and day of the recording date (A to C will be used for October to December). The 1st digit cannot be changed from "_".</p> <p><b>[Directory Number]:</b> The 2nd to 4th digits will be made up of the number of the destination folder ("100" – "999"). The 1st digit cannot be changed from "_".</p> <p><b>[Manual]:</b> You can set the 2nd to 4th digits as you wish using alphanumeric characters. The 1st digit cannot be changed from "_".</p>

## User information

### Saving lens info

### (Lens Info Settings)

PASMB

The camera can store information for up to 10 lenses that do not conform to the Micro Four Thirds or Four Thirds system standards. These data also supply the focal length used for the image stabilization and keystone compensation features. The data are saved as Exif tags.

Menu	MENU → <b>Y</b> → 2. Information Record → Lens Info Settings
------	--

<b>Create Lens Information</b>	Register the lens information. <b>[Lens Name]:</b> Input the name of the lens. <b>[Focal Length]:</b> Input the focal length. [0.1] – [1000.0] mm <b>[Aperture Value]:</b> Input the aperture value. [00.00] – [99.99] <b>[Set]:</b> Save the lens information you have inputted.
<b>Lens01 (registered name) – Lens10 (registered name)</b>	Edit the registered lens information. <b>[Edit]:</b> Edit the registered lens information. Edit [Lens Name], [Focal Length], and [Aperture Value]. <b>[Delete]:</b> Delete the registered lens information.

#### Entering characters

- 1) Press the INFO button to switch between uppercase, lowercase and symbols.
- 2) Select a character using  $\Delta$   $\nabla$   $\triangleleft$   $\triangleright$  and press the **OK** button.
  - The selected character appears in the character entry area.
  - To delete a character, press the **Del** button.
- 3) To delete a character in the character entry area, move the cursor using the front and rear dials.
  - Select a character and press the **Del** button to delete it.
- 4) When you have finished entering, select [End] and press the **OK** button.

#### Character entry area



#### Character selection area

- The lens will be added to the lens info menu.
- When a lens that does not supply info automatically is attached, the info used is indicated by checks (✓). Highlight lenses to which you want to add checks (✓) and press the **OK** button.

## Output Resolution

(dpi Settings)

PASMB 

Choose the output resolution information (in dots per inch, or dpi) stored with photo image files. The selected resolution will be used when the images are printed. The dpi setting is stored as an Exif tag.

Menu	MENU →  → 2. Information Record → dpi Settings
------	---

## Adding Copyright Information

(Copyright Info.)

PASMB 

Choose the copyright information stored with photos when they are saved. Copyright information is stored as Exif tags.

Menu	MENU →  → 2. Information Record → Copyright Info.
------	--

 We will not be held liable for any disputes or damages arising from use of the [Copyright Info.] feature. Use at your own risk.

 To delete the copyright information you have entered, delete the characters on the entry screen of each item (P. 248).

■ Enabling Copyright Info.

1 Use  $\Delta$   $\nabla$  to select [Copyright Info.] and press the  button.

2 Use  $\Delta$   $\nabla$  to select [On] and press the  button.

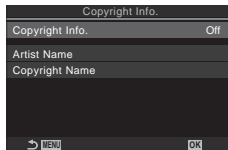

Copyright Info. setting screen

Off	Do not add Exif tags naming the photographer and/or copyright holder.
On	Add Exif tags naming the photographer and/or copyright holder.

3 The display returns to the Copyright Info. setting screen.

## ■ Configuring Copyright Info.

### 1 Configure options.

- Press  $\Delta \nabla$  to select an item and press the  $\text{OK}$  button to display the setting menu.
- After configuring options, press the  $\text{OK}$  button to return to Copyright Info. setting screen.



Artist Name	Enter the name of the photographer.
Copyright Name	Enter the name of the copyright holder.

### Entering characters

- 1) Press the INFO button to switch between uppercase, lowercase and symbols.
- 2) Select a character using  $\Delta \nabla \langle \rangle$  and press the  $\text{OK}$  button.
  - The selected character appears in the character entry area.
  - To delete a character, press the  $\text{Trash}$  button.
- 3) To delete a character in the character entry area, move the cursor using the front and rear dials.
  - Select a character and press the  $\text{Trash}$  button to delete it.
- 4) When you have finished entering, select [End] and press the  $\text{OK}$  button.

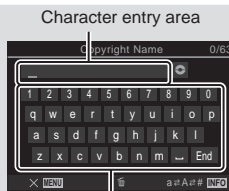

Character selection area



## Monitor/Sound/Connection Settings

### Disabling Touch Controls (Touchscreen Settings)

PASMB 

Enable or disable touch controls.











Menu	MENU →  → 3. Monitor/Sound/Connection → Touchscreen Settings
Off	Disable touch controls.
On	Enable touch controls.



### Monitor Brightness and Hue (Monitor Adjust)

PASMB 

Adjust monitor color temperature and brightness. This option applies in both still photography and movie modes.

Menu	MENU →  → 3. Monitor/Sound/Connection → Monitor Adjust
------	---

 (Color temperature)	Adjust color temperature. Use the front dial or   to adjust the “amber–blue” axis. Moving the pointer (  ) closer to A adds a red cast and moving it closer to B adds a blue cast. Use the rear dial or   to adjust the “green–magenta” axis. Moving the pointer (  ) closer to G adds a green cast and moving it closer to M adds a magenta cast.
 (Brightness)	Adjust brightness. Use   to choose a setting. [-7] – [±0] – [+7]

- Press the INFO button to switch between color temperature and brightness and set each item.
- You can reset the setting by pressing and holding the  button.
- In B mode, the monitor uses the brightness selected in [Bulb/Time Monitor].  
 “Configuring BULB/TIME/COMP Settings (BULB/TIME/COMP Settings)” (P. 173)















## Viewfinder Brightness and Hue

(EVF Adjust)

PASMB 

Adjust viewfinder brightness and hue. The display switches to the viewfinder while these settings are being adjusted.

Menu	MENU →  → 3. Monitor/Sound/Connection → EVF Adjust
------	---

 (Color temperature)	Adjust color temperature. Use the front dial or   to adjust the “amber–blue” axis. Moving the pointer (  ) closer to A adds a red cast and moving it closer to B adds a blue cast. Use the rear dial or   to adjust the “green–magenta” axis. Moving the pointer (  ) closer to G adds a green cast and moving it closer to M adds a magenta cast.
 (Brightness)	<b>[EVF Auto Luminance Off] / [EVF Auto Luminance On]:</b> Viewfinder brightness and indicator contrast adapt automatically to ambient lighting conditions. Change the setting using   . <b>[]:</b> Adjust brightness. Use   to choose a setting. <b>[-7] – [±0] – [+7]</b>  Brightness cannot be changed when <b>[EVF Auto Luminance On]</b> is selected.

- Press the INFO button to switch between color temperature and brightness and set each item.
- You can reset the setting by pressing and holding the  button.

## Configuring the eye sensor

(Eye Sensor Settings)

PASMB 

You can specify how the camera operates when you put your eye to the viewfinder.

Menu	MENU →  → 3. Monitor/Sound/Connection → Eye Sensor Settings
------	--

<b>EVF Auto Switch</b>	<b>[Off]:</b> The display does not switch when you put your eye to the viewfinder. To switch the display, press the  button. <b>[On]:</b> The viewfinder automatically turns on when you put your eye to the viewfinder.
<b>Behavior when switched</b>	Choose what will be displayed when the display automatically switches to the viewfinder. <b>[Maintain Screen]:</b> The screen that was shown on the monitor will be shown in the viewfinder. <b>[Shooting Screen]:</b> The viewfinder shows the live view even if the playback screen or a menu was shown on the monitor.

<b>When Monitor is Opened</b>	<p><b>[Operative]:</b> When <b>[EVF Auto Switch]</b> is <b>[On]</b> and you put your eye to the viewfinder, the display switches to the viewfinder even if the monitor is open.</p> <p><b>[Inoperative]:</b> When <b>[EVF Auto Switch]</b> is <b>[On]</b> and you put your eye to the viewfinder, the display does not switch to the viewfinder if the monitor is open.</p>
-------------------------------	---

The **[EVF Auto Switch]** setting screen appears when you press and hold the button.

## Disabling the Focus Beep (■|||)

PASMB

Disable the beep that sounds when the camera focuses.

Menu	MENU $\Rightarrow$ $\Rightarrow$ 3. Monitor/Sound/Connection $\Rightarrow$ (■   )
------	---

<b>On</b>	A beep sounds after successful autofocus operations. The beep sounds only when the camera first focuses using [C-AF].
<b>Off</b>	A beep does not sound after successful autofocus operations.

You may need to adjust settings in the [Silent(♥) Settings] menu in order to enable the focus beep during silent shooting (P. 132).

## External Monitor Display Options (HDMI Settings)

PASMB

Choose the signal output to external monitors connected via HDMI. Adjust the frame rate, movie frame size, and other settings according to monitor specifications.

Menu	MENU $\Rightarrow$ $\Rightarrow$ 3. Monitor/Sound/Connection $\Rightarrow$ HDMI Settings
------	--



<b>Output Size</b>	<p>Choose the type of signal output to the HDMI connector.</p> <p><b>[C4K]:</b> The signal is output in 4K digital cinema (4096 x 2160) format.</p> <p><b>[4K]:</b> If possible, the signal is output in 4K (3840 x 2160).</p> <p><b>[1080p]:</b> If possible, the signal is output in Full HD (1080p).</p> <p><b>[720p]:</b> If possible, the signal is output in HD (720p).</p>
<b>Output Frame Rate</b>	<p>Choose the signal frame rate according to whether the device supports NTSC or PAL.</p> <p><b>[60p Priority]:</b> Frame rate for areas supporting NTSC.</p> <p><b>[50p Priority]:</b> Frame rate for areas supporting PAL.</p>

- [Output Frame Rate] cannot be changed when the camera is connected to a device via HDMI.
- Sound will not be played back unless the connected device is compatible with the sound format.
- You can configure detailed options for when outputting signals to an HDMI device in movie mode. "HDMI Output ( HDMI Output)" (P. 182)

Choose how the camera functions when connected to external devices via USB.

Menu	MENU ➔  ➔ 3. Monitor/Sound/Connection ➔ USB Settings
------	---

<b>USB Mode</b>	<p><b>[Select]:</b> The menu for selecting the connection mode appears each time a USB cable is connected..</p> <p><b>[Storage]:</b> The camera functions as an external storage device. The data on the camera memory card can be copied to the computer.</p> <p><b>[MTP]:</b> The pictures on the memory card can be viewed or copied to the computer using computer software (P. 286).</p> <p><b>[RAW/Control]:</b> Employing computer controls available via OM Workspace, process pictures using the camera's high-speed image processing engine. Also, by using OM Capture, you can shoot and transfer images to a computer and control the camera from a computer. For details, see "Connecting to Computers via USB" (P. 283).</p> <p><b>[USB PD]:</b> Select this when you do not want the camera to be powered automatically when connected to a USB PD-compliant device.</p>
<b>Power Supply from USB</b>	<p>Choose whether to power the camera when connecting to a computer via USB.</p> <p><b>[Yes]:</b> The camera will be powered when the camera and computer are connected via USB.</p> <p><b>[No]:</b> The camera will not be powered when the camera and computer are connected via USB.</p>

 When you connect the camera to a computer via USB while [Storage], [MTP], or [RAW/Control] is selected, you can use the camera while powering it.

## Battery/Sleep Settings

### Displaying Battery Status

PASMB 

View the status of the batteries inserted in the camera. Status of the battery in the camera and of the battery in the power battery holder are displayed individually.



Menu	MENU →  → 5. Battery/Sleep → 
------	---

 Some items are not displayed when the camera is powered from the supplied USB-AC adapter or a USB PD-compliant USB device.

### Setting which Battery Is Used First

PASMB 

Choose which battery to use first when there are batteries in both the camera and the optional power battery holder (P. 295).

Menu	MENU →  → 5. Battery/Sleep → 
------	---

<b>Body Battery</b>	The battery in the camera is used first.
<b>PBH Battery</b>	The battery in the optional power battery holder is used first.

### Changing the battery level display during movie recording

PASMB 

Choose a format for the battery level display. Battery level can be displayed as a percentage or as the amount of shooting time remaining.

- The shooting time display is intended as a guide only.

Menu	MENU →  → 5. Battery/Sleep → 
------	---

<b>%</b>	Battery level is shown as a percentage.
<b>min</b>	Battery level is shown as the shooting time remaining. In still photography modes, the battery level is displayed only while recording movies.

## Dimming the Backlight

(Backlit LCD)

PASMB 

Choose the length of time before the monitor backlight dims when no operations are performed. Dimming the backlight reduces the drain on the battery.

Menu	MENU →  → 5. Battery/Sleep → Backlit LCD
------	---

8sec / 30sec / 1min	The monitor backlight dims after the specified time.
Hold	The monitor backlight does not dim.

## Setting Sleep (Power Saving) Options

(Sleep)

PASMB 

Choose the delay before the camera enters sleep mode when no operations are performed. In sleep mode, camera operations are suspended and the monitor turns off.

Menu	MENU →  → 5. Battery/Sleep → Sleep
------	---

Off	The camera does not enter sleep mode.
1min / 3min / 5min	The camera enters sleep mode after the specified time.

- Normal operation can be restored by pressing the shutter button halfway.
- ① The camera will not enter sleep mode in the following situations:
  - while a multiple exposure is in progress, while connected to an HDMI device, while connected to a smartphone via Wi-Fi, while connected to a computer via Wi-Fi or USB, while connected to a remote control wirelessly, or while being powered via USB.

## Setting Auto Power Off Options

(Auto Power Off)

PASMB 

The camera will turn off automatically if no operations are performed for a set time after it has entered sleep mode. This option is used to choose the delay before the camera turns off automatically.

Menu	MENU →  → 5. Battery/Sleep → Auto Power Off
------	--

Off	The camera does not turn off automatically.
5min / 30min / 1h / 4h	The camera turns off after the specified time.

- ② To reactivate the camera after it has turned off automatically, turn the camera on using the ON/OFF lever.



Further reduce power consumption during viewfinder photography. The delay before the backlight turns off or the camera enters sleep mode can be shortened.

 Power saving is not available:

during live view photography, while the viewfinder is on, while multiple exposure or interval timer photography is in progress, while connected to an HDMI device, while connecting to a smartphone via Wi-Fi, while connecting to a computer via Wi-Fi or USB, or while Bluetooth is enabled

Menu	MENU →  → 5. Battery/Sleep → Quick Sleep Mode
------	--

### ■ Enabling Quick Sleep Mode

- 1 Use  $\Delta$   $\nabla$  to select [Quick Sleep Mode] and press the  button.
- 2 Use  $\Delta$   $\nabla$  to select [On] and press the  button.

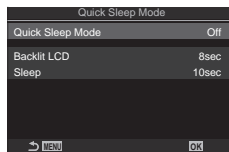



Quick Sleep Mode setting screen

Off	The camera does not enter power-saving mode.
On	The camera is quick to enter power-saving mode. When power-saving is in effect and the super control panel is displayed (P. 37), "ECO" is displayed on the monitor.

- 3 The display returns to the Quick Sleep Mode setting screen.

### ■ Configuring Quick Sleep Mode

- 1 Configure options.
  - Press  $\Delta$   $\nabla$  to select an item and press the  button to display the setting menu.
  - After configuring options, press the  button to return to Quick Sleep Mode setting screen.

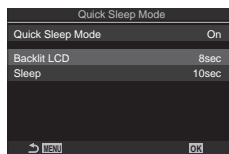

Backlit LCD	Choose the length of time before the monitor backlight dims when no operations are performed. <b>3sec / 5sec / 8sec</b>
Sleep	Choose the delay before the camera enters sleep mode when no operations are performed. <b>3sec / 5sec / 8sec / 10sec / 15sec / 30sec / 1min</b>

- When power-saving is in effect and the super control panel is displayed (P. 37), "ECO" is displayed on the monitor.



## 7

### Setting Up the Camera



## Reset/Clock/Language/Others Settings

### Restoring Default Settings (Reset/Initialize Settings)

PASMB 

Reset the camera to factory default settings. You can opt to reset almost all settings or only those directly related to photography.

Menu	MENU →  → 6. Reset/Clock/Language/Others → Reset/Initialize Settings
------	---

<b>Reset Shooting Settings</b>	Reset photography-related settings only.
<b>Initialize All Settings</b>	Reset all settings with a few exceptions, such as the clock and language.

 See "Default Settings" (P. 311) for information on the settings that are reset.

 Settings can be saved using OM Workspace or OM Image Share. For more information, visit our website.

### Setting the Camera Clock (⌚ Settings)

PASMB 

Set the camera clock.

Menu	MENU →  → 6. Reset/Clock/Language/Others → ⌚ Settings
------	--

	Set the date, time, and date format. Use the < > buttons to highlight items and use the Δ ▽ buttons to change the highlighted item.
<b>Time Zone</b>	Set the time zone and daylight saving time. Use the Δ ▽ buttons to change the time zone. Pressing the INFO button allows you to set the daylight saving time. It switches on and off each time the INFO button is pressed.

### Choosing a Language (🗨️)

PASMB 

Choose a language for camera menus and tool tips.

Menu	MENU →  → 6. Reset/Clock/Language/Others → 🗨️
------	--

## Calibrating the Level Gauge

(Level Adjust)

PASMB

Correct deviation in the level gauge. Calibrate the gauge if you find it is no longer truly plumb or level.

Menu	MENU ➔  6. Reset/Clock/Language/Others ➔ Level Adjust
------	--

Reset	Reset the gauge to factory default settings.
-------	--

Adjust	Choose the reference (zero) point. Calibrate the level gauge after positioning the camera appropriately.
--------	--

## Image Processing Check

(Pixel Mapping)

PASMB

Check the image sensor and image processing functions simultaneously. For best results, end shooting and playback and wait at least a minute before performing proceeding.

 Be sure to perform the check again if you accidentally turn the camera off while the check is in progress.

Menu	MENU ➔  6. Reset/Clock/Language/Others ➔ Pixel Mapping
------	---

## Viewing the Firmware Version

(Firmware Version)

PASMB

View the versions of the firmware for the camera and any lenses or other peripherals currently connected. You may need this information when contacting customer support or performing firmware updates.

Menu	MENU ➔  6. Reset/Clock/Language/Others ➔ Firmware Version
------	--

## Viewing Certificates

(Certification)

PASMB

Display the compliance certificates for some of the standards with which the camera complies. The remaining certificates can be found on the camera itself or in the camera manual.

Menu	MENU ➔  6. Reset/Clock/Language/Others ➔ Certification
------	---

A number of tasks can be accomplished by connecting the camera to an external device such as a computer or smartphone. Choose a connection type and software according to your goals.

### Precautions for Using Wi-Fi and Bluetooth®

Disable wireless LAN and **Bluetooth®** in countries, regions, or locations in which their use is prohibited.







The camera is equipped with wireless LAN and **Bluetooth®**. Use of these features in countries outside the region of purchase may violate local wireless regulations.

Some countries and regions may prohibit the acquisition of location data without prior governmental permission. In some sales areas, the camera may consequently ship with location data displays disabled.

Each country and region has its own laws and regulations. Check them before traveling and observe them while abroad. Our company assumes no liability for any failure on the part of the user to observe local laws and regulations.

Disable Wi-Fi on airplanes and in other locations where their use is prohibited.

 "Disabling the camera's wireless communication (Airplane Mode)" (P. 260)

-  Wireless transmissions are vulnerable to interception by third parties. Use wireless features with this in mind.
-  The wireless transceiver is located in the camera grip. Keep it as far away as practicable from metal objects.
-  When transporting the camera in a bag or other container, be aware that the contents of the container or the materials of which it is constructed may interfere with wireless transmissions, which can prevent the camera connecting to a smartphone.
-  Wi-Fi connections increase the drain on the batteries. The connection may be lost during use if the batteries are low.
-  Devices such as microwave ovens and cordless phones that generate radio-frequency emissions, magnetic fields, or static electricity may slow or otherwise interfere with wireless data transmission.
-  Some wireless LAN features are unavailable when the memory card write-protect switch is in the "LOCK" position.

## Disabling the camera's wireless communication (Airplane Mode)

PASMB 

You can disable the wireless communication (Wi-Fi/**Bluetooth**<sup>®</sup>) of the camera.

Menu	MENU →  → 4. Wi-Fi/Bluetooth → Airplane Mode
------	---

<b>Off</b>	Wireless communication is enabled.
<b>On</b>	Wireless communication is disabled. You cannot use it until you change the setting to <b>[Off]</b> .  appears when you select <b>[On]</b> .

 Communication with the Wireless Radiowave Commander FC-WR is possible even if you select **[On]**.

## Connecting the camera to a smartphone

Use the camera's wireless LAN (Wi-Fi) and **Bluetooth**<sup>®</sup> features to connect to a smartphone, where you can use the dedicated app to enhance your enjoyment of the camera both before and after shooting. Once a connection has been established, you can download and take pictures remotely and add position information to images.

- Operation is not guaranteed on all smartphones.

### Things you can do with the specified app, OM Image Share



- Download images from the camera to the smartphone  
You can load images in the camera that have been marked for sharing (P. 195) to a smartphone.  
You can also use the smartphone to select images for download from the camera.
- Remote shooting from a smartphone  
You can remotely operate the camera and shoot using a smartphone.
- Beautiful image processing  
Use intuitive controls to apply impressive effects to images downloaded to your smartphone.
- Addition of GPS tags to camera images  
Using the smartphone's GPS function, you can add position information when taking pictures with the camera.

For details, visit our website.

## Pairing the Camera and Smartphone (Wi-Fi Connection)

Follow the steps below when connecting the devices for the first time.





- Adjust pairing settings using OM Image Share, not the settings app that is part of the smartphone operating system.

Super Control Panel	
Menu	MENU →  → 4. Wi-Fi/Bluetooth → Wi-Fi Connection

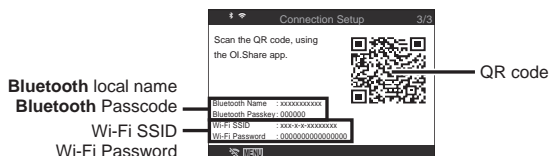
- You can also connect by tapping  in the live view display.

- Launch the copy of the dedicated OM Image Share app previously installed on your smartphone.
- Select [Device Connection] and press the  button.
- Follow the on-screen guide to adjust Wi-Fi/**Bluetooth**® settings.
  - The **Bluetooth** local name and passcode, the Wi-Fi SSID and password, and a QR code are displayed in the monitor.







- Tap the camera icon at the bottom of the OM Image Share display.
  - An [Easy Setup] tab will be displayed.
- Follow the on-screen instructions in OM Image Share to scan the QR code and adjust connection settings.
  - If you are unable to scan the QR code, follow the on-screen instructions in OM Image Share to adjust settings manually.
    - Bluetooth**®: To connect, select the local name and enter the passcode displayed in the camera monitor into the **Bluetooth** settings dialog in OM Image Share.
    - Wi-Fi: To connect, enter the SSID and password displayed on the camera monitor into the Wi-Fi settings dialog in OM Image Share.
  -  on the screen will turn green when pairing is complete.
  - The **Bluetooth**® icon indicates the status as follows:
    - : The camera is emitting wireless signal.
    - : Wireless connection has been established.
- To end the Wi-Fi connection, press MENU on the camera or tap  MENU on the monitor screen.
  - You can also turn the camera off and end the connection from OM Image Share.
  - At default settings, **Bluetooth**® connection is kept active even after Wi-Fi connection is terminated, allowing you to shoot remotely with a smartphone. To set the camera to also terminate **Bluetooth**® connection when terminating Wi-Fi connection, set [Bluetooth] to [Off].

## Wireless Connection Standby Setting for When the Camera Is On (Bluetooth)

You can choose whether the camera will be on standby for wireless connection with the smartphone or the optional remote control when the power is on.



 Complete the pairing of camera and smartphone or the optional remote control beforehand. [Bluetooth] cannot be selected unless the pairing has been completed.

Menu	MENU ➡ 4. Wi-Fi/Bluetooth ➡ Bluetooth
Off	The camera will not be on standby for wireless connection and wireless signal will not be emitted even when the power is on.
On 	When the camera is on, it will emit wireless signal and be on standby for wireless connection. You can connect the camera and the smartphone through operation of OM Image Share and shoot remotely or transfer images.
On 	When the camera is on, it will emit wireless signal and be on standby for wireless connection with the optional remote control (P. 279) if it has already been paired with the camera.

 When [On ] is selected and the OM Image Share app is recording GPS logs, the camera receives position information and adds it to the picture taken.

## Wireless Settings for When the Camera Is Off (Power-off Standby)

You can choose whether the camera will maintain a wireless connection to the smartphone when off.

<b>Menu</b>	MENU ➔  ➔ 4. Wi-Fi/Bluetooth ➔  Settings ➔ Power-off Standby
<b>Select</b>	When you turn the camera off, you will be prompted to choose whether to maintain the wireless connection to the smartphone.
<b>Off</b>	Turning the camera off terminates the wireless connection to the smartphone.
<b>On</b>	When the camera is turned off, the connection to the smartphone remains active and the smartphone can still be used to download or view the pictures on the camera.

### ■ “Select”

When [Select] is chosen for [Power-off Standby], a confirmation dialog will be displayed before the camera turns off if all the following conditions are met:

- [Off] is selected for [Airplane Mode]
- The camera is currently connected with a smartphone (P. 261)
- The memory card is correctly inserted

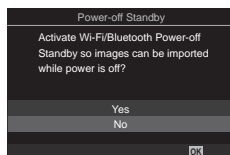

<b>Yes</b>	Turn the camera off but leave the wireless smartphone connection active.
<b>No</b>	Turn the camera off and terminate the wireless smartphone connection.

- ⚠ If no operations are performed about a minute after the confirmation dialog is displayed, the camera will end the wireless connection to the smartphone and turn off automatically.
- ⚠ If left active, the wireless connection will automatically terminate if:
  - the connection remains inactive for 12 hours
  - the memory card is removed
  - the battery is replaced
  - a charging error occurs during on-board battery charging

The connection can be restored by turning the camera on.

- 📌 Note that if [On] is selected for [Power-off Standby], camera may not turn on immediately when the ON/OFF lever is rotated to ON.

## Transferring images to a smartphone

You can select images in the camera and load them to a smartphone. You can also use the camera to select images you want to share in advance.  “Selecting Pictures for Sharing (Share Order)” (P. 195)

- If [Bluetooth] (P. 262) is set to [Off] or [On\*], set it to [On\*].
  - If [Bluetooth] (P. 262) is set to [On\*], the camera will be on standby for wireless connection.
- 1 Tap [Import Photos] in OM Image Share on the smartphone.
    - ① Depending on the smartphone, a confirmation screen for Wi-Fi connection may appear. Follow the on-screen guidance to connect the smartphone and the camera.
    - The images in the camera are displayed in a list.
  - 2 Select the pictures you want to transfer and tap the Save button.
    - When saving is completed, you can turn off the camera from the smartphone.
    - Even if [Bluetooth] (P. 262) is set to [Off] or [On\*], [Import Photos] can be used by starting [Wi-Fi Connection] ➔ [Device Connection] on the camera.

## Automatically uploading images while the camera is off

To configure the camera to automatically upload images to a smartphone while off:

- Mark images for sharing (P. 195)
  - Enable power-off standby (P. 263)
  - If you are using an iOS device, launch OM Image Share
- When you mark an image for sharing on the camera and turn the camera off, a notification appears in OM Image Share. When you tap the notification, images are automatically transferred to the smartphone.



## Shooting remotely with a smartphone (Live View)

You can shoot remotely by operating the camera with a smartphone while checking the live view on the smartphone screen.

- The camera shows the connection screen and all operations are performed from the smartphone.
- If [Bluetooth] (P. 262) is set to [Off] or [On $\frac{1}{2}$ ], set it to [On $\frac{3}{4}$ ].
- If [Bluetooth] (P. 262) is set to [On $\frac{3}{4}$ ], the camera will be on standby for wireless connection.

**1** Launch OM Image Share and tap [Remote Control].

**2** Tap [Live View].

**3** Tap the shutter button to shoot.

- The image taken is saved on the memory card in the camera.

- Even if [Bluetooth] (P. 262) is set to [Off] or [On $\frac{1}{2}$ ], [Live View] can be used by starting [Wi-Fi Connection] ➔ [Device Connection] on the camera.
- Available shooting options are partially limited.

## Shooting remotely with a smartphone (Remote Shutter)

You can shoot remotely by operating the camera with a smartphone (Remote Shutter).

- All operations are available on the camera. In addition, you can shoot pictures and record movies using the shutter button displayed on the smartphone screen.
- If [Bluetooth] (P. 262) is set to [Off] or [On $\frac{1}{2}$ ], set it to [On $\frac{3}{4}$ ].
- If [Bluetooth] (P. 262) is set to [On $\frac{3}{4}$ ], the camera will be on standby for wireless connection.

**1** Launch OM Image Share and tap [Remote Control].

**2** Tap [Remote Shutter].





**3** Tap the shutter button to shoot.

- The image taken is saved on the memory card in the camera.

- Even if [Bluetooth] (P. 262) is set to [Off] or [On $\frac{1}{2}$ ], [Remote Shutter] can be used by starting [Wi-Fi Connection] ➔ [Device Connection] on the camera.

## Adding position information to images

Using the smartphone's GPS function, you can add position information when taking pictures with the camera.

- If [Bluetooth] (P. 262) is set to [Off] or [On $\frac{1}{2}$ ], set it to [On $\frac{1}{1}$ ].
  - If [Bluetooth] (P. 262) is set to [On $\frac{1}{2}$ ], the camera will be on standby for wireless connection.
- 1 Before taking pictures with the camera, launch OM Image Share and switch on the position information addition function.
    - When you are prompted to synchronize the clocks of the smartphone and the camera, follow the guides displayed in OM Image Share.
  - 2 Take pictures with the camera.
    - When it is possible to add position information,  will be lit on the shooting screen. When the camera cannot acquire position information,  blinks.
    - It may take some time before the camera is ready to add position information when it has been turned on or it has resumed from sleep mode.
    - Position information will be added to pictures taken while  is displayed on the screen.
    -  is displayed on the screen when you view a picture that has position information.
    - Position information is not added to movies.
  - 3 When you have finished shooting, switch off the position information addition function in OM Image Share.

## Resetting smartphone connection settings (Reset Settings)

You can restore smartphone connection settings to default values.

Menu	MENU $\Rightarrow$  $\Rightarrow$ 4. Wi-Fi/Bluetooth $\Rightarrow$  Settings $\Rightarrow$ Reset  Settings
------	---

 The following menu items will be reset.

 Connection Password] (P. 267) / [Power-off Standby] (P. 263)

 To connect to a smartphone, start [Device Connection] again (P. 261).

## Changing the password (Connection Password)



To change the Wi-Fi/Bluetooth® passwords:

Menu	MENU → ȳ → 4. Wi-Fi/Bluetooth → Settings → Connection Password
------	--

1 Follow the operation guide and press the  button.

- A new password will be set.

 Both the Wi-Fi connection password and **Bluetooth**® connection passcode can be changed.

 Reconnect to the smartphone after changing passwords.  "Pairing the Camera and Smartphone (Wi-Fi Connection)" (P. 261)

## Connecting to Computers via Wi-Fi

Connect the camera and computer via Wi-Fi. Using Wi-Fi, the camera can connect via a router to a computer on a household network or the like.

### Installing Software

Use "OM Capture" to connect the camera and computer via Wi-Fi.

#### **OM Capture**

Use "OM Capture" to automatically download and view pictures taken with a camera connected via Wi-Fi to the same network as the computer. To learn more or to download the software, visit our website. When downloading the software, be prepared to provide the camera serial number.

Follow the on-screen instructions to install the software. System requirements and installation instructions are available at our website.

## Readying the Computer (Windows)

If Windows is unable to detect a camera connected via a router or access point, follow the steps below to register the device manually.

- 1 Click the [Start] button on the computer desktop to display the Start menu.
- 2 Click  (Settings) to display [Windows Settings] options.



- 3 Click [Devices] to display options for [Bluetooth & other devices].



- 4 Click [Add Bluetooth or other devices].
- 5 Click [+ Everything else].
  - An [Add a device] window will open and [OM-1] will be displayed after a short pause.
- 6 Click [OM-1].
  - When a message is displayed stating the preparation is complete, click [Done].

The camera and computer must be paired in order to connect. Up to four computers can be paired with the camera at a time. To pair a computer with the camera, connect it via USB. Pairing need only be performed once per computer.

**1** After confirming that the camera is off, connect it to the computer using the USB cable.

- When attaching the USB cable, use the supplied cable protector and cable clip to prevent damage to the connectors.  "Attaching Cable Protectors" (P. 19)

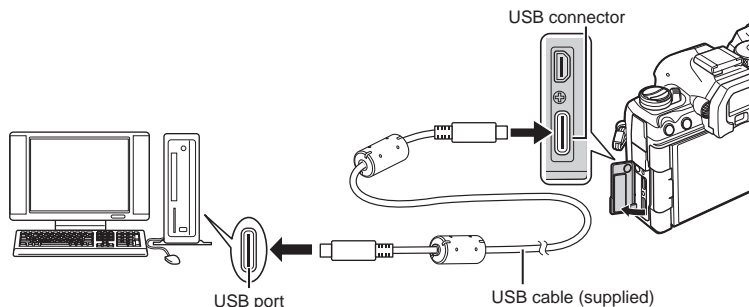



- The locations of USB ports vary from computer to computer. See the documentation provided with the computer for information on USB ports.
- If the USB port on the computer is Type A port, use the optional CB-USB11 cable.

**2** Turn the camera on.

- The camera will display a message prompting you to identify the device to which the USB cable is connected.

 If the message is not displayed, select [Select] for [USB Mode] (P. 252).

 If the batteries are very low, the camera will not display a message when connecting to a computer. Be sure the batteries are charged.

**3** Highlight [ RAW/Control] using  $\Delta$   $\nabla$  on the arrow pad and press the  button.

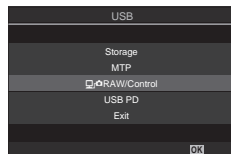

**4** Launch the copy of "OM Capture" installed on the computer.

- After starting up, "OM Capture" will prompt you to choose the connection type.



**5** Click the [+] to the right of [Create new link].

- If nothing happens, reconnect the camera.



- Enter the name that will be used on the camera to identify the computer. The default is the computer's "Computer Name".
- The name used on the camera can be up to 15 characters long.



**6** Click [Settings] in "OM Capture".

- When a message is displayed stating that pairing is complete, disconnect the camera as instructed.



- Repeat the above steps to pair the camera with each additional computer.
- The pairing information stored on the camera can be viewed and deleted using "OM Capture".

Adjust settings for connection to the network to which the paired computer belongs.

Before the camera can connect to the computer via Wi-Fi, it must be configured for connection to the network via the Wi-Fi router or access point. Multiple network profiles can be stored on the camera and recalled as desired. [Wi-Fi Connection] settings can be adjusted via the following methods:

<b>Connect by WPS</b>	Configure the camera for automatic connection (P. 272). To connect using a WPS router or access point, simply press the device's WPS button. [PBC Method]: Connect using only the router WPS button. The camera connects automatically when the button is pressed. [PIN Method]: The camera connects in PIN mode. Enter the camera PIN on the router to connect.
<b>Connect from ((W)) List</b>	Choose the network from a list (P. 274). The camera will search for available networks; to connect, select a network from the list and enter the network password.
<b>Connect manually</b>	Adjust connection settings manually (P. 273). To connect, enter the network name (SSID) and other settings.

- WPS connections require a WPS-compatible router or access point.
- Connecting via WPS in PIN mode requires that the router itself be connected to a administrator computer from which the PIN can be entered.
- Manual connection requires that you have information on the network to which you are connecting.
- The camera can connect via routers or access points of the following types:
  - Standard: IEEE802.11a/b/g/n/ac
  - Band: 2.4 GHz or 5 GHz
  - Security: WPA2, WPA3
- The camera can store settings for up to eight networks. The camera will automatically connect to networks to which it has previously connected.
- Each new connection after the eighth overwrites settings for the connection that has been left unused for the longest period of time.
- Adding a network profile for an access point with the same MAC address as existing profile overwrites the settings for the existing profile.
- For information on using routers or access points, see the documentation provided with the device.
- Network profiles are not reset when you select [Initialize All Settings] for [Reset/Initialize Settings] (P. 257). To reset network settings, use [Wi-Fi PC Settings] (P. 276) > [Reset Wi-Fi PC Settings].

## ■ Enabling Camera Wi-Fi

Before connecting to a network via Wi-Fi, you will need to enable Wi-Fi on the camera. If [Airplane Mode] (P. 260) is set to [On], set it to [Off].

## ■ Connecting via WPS (Connect by WPS)

Connect using the WPS feature on the router or access point.

Menu	MENU ➔  ➔ 4. Wi-Fi/Bluetooth ➔ Wi-Fi Connection
------	--

- 1 Highlight [PC Connection] using the  $\Delta$   $\nabla$  buttons and press the  $\text{OK}$  button.
  - [PC Connection] options will be displayed.
- 2 Highlight [Connect by WPS] using the  $\Delta$   $\nabla$  buttons and press the  $\text{OK}$  button.
- 3 Highlight an option using the  $\Delta$   $\nabla$  buttons and press the  $\text{OK}$  button.
  - If you selected [PBC Method], press the WPS button on the router or access point.
  - Press the camera  $\text{OK}$  button to start the connection.
  - Some time may be required for connection after the button is pressed.
  - If you selected [PIN Method], the camera will display a PIN; enter it on the router or access point. Press the camera  $\text{OK}$  button when the router is ready to connect.
- 4 If the camera is able to connect, the network will be displayed with a check ( $\checkmark$ ) next to the network name.

- If the camera has been paired with more than one computer, you will be prompted to choose a computer before the network is displayed. Highlight the desired computer using the  $\Delta$   $\nabla$  buttons and press the  $\text{OK}$  button.
- The camera can be used only with the selected computer. To select a different computer, you must first terminate the current connection.
- If the connection fails, the camera will display a message to that effect, followed by the options shown in Step 3. Repeat Steps 3–4.

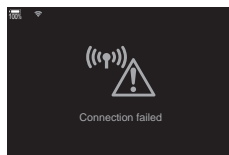
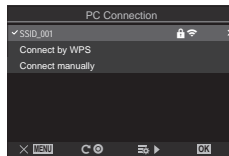

- 5 Press the  $\text{OK}$  button to exit to the shooting display.
  - The camera will return to the standard shooting display.  on the screen will turn green.





## ■ Connecting Manually (Connect manually)

Adjust network settings manually. You will need to provide:

Menu	MENU ➡ <b>Y</b> ➡ 4. Wi-Fi/Bluetooth ➡ Wi-Fi Connection
------	---

<b>SSID</b>	The network name (SSID).
<b>Authentication</b>	The type of security used on the network.
<b>Password</b>	The password for connection to a secured network.
<b>IP Address Assign</b>	Choose whether the camera IP address is assigned automatically by the network DHCP server.
<b>IP Address</b>	These fields are required when the IP address is assigned manually. The settings used vary with the network.
<b>Subnet Mask</b>	
<b>Default Gateway</b>	
<b>DNS</b>	

- 1 Highlight [PC Connection] using the  $\Delta$   $\nabla$  buttons and press the **OK** button.
  - [PC Connection] options will be displayed.
- 2 Highlight [Connect manually] using the  $\Delta$   $\nabla$  buttons and press the **OK** button.
- 3 Highlight items using the  $\Delta$   $\nabla$  buttons and press the **OK** button.
  - Options for the selected item will be displayed.

<b>SSID</b>	Enter the network SSID.
<b>Authentication</b>	Select the type of security used on the network. Choose from [None], [WPA2/WPA3] and [WPA3].
<b>Password</b>	If you selected [WPA2/WPA3] or [WPA3] for [Authentication], enter the network password.
<b>IP Address Assign</b>	Choose from [Auto(DHCP)] and [Manual]. Automatic IP address assignment requires a network with a DHCP server configured to supply IP addresses automatically.
<b>IP Address</b>	These fields are required when [Manual] is selected for [IP Address Assign].
<b>Subnet Mask</b>	
<b>Default Gateway</b>	
<b>DNS</b>	

- 4 Highlight [Start Connection] using the  $\Delta$   $\nabla$  buttons and press the **OK** button.

**5** If the camera is able to connect, the network will be displayed with a check (✔) next to the network name.

- If the camera has been paired with more than one computer, you will be prompted to choose a computer before the network is displayed. Highlight the desired computer using the  $\Delta$   $\nabla$  buttons and press the  $\text{OK}$  button.
- The camera can be used only with the selected computer. To select a different computer, you must first terminate the current connection.
- If the connection fails, the camera will display a message to that effect, followed by the options shown in Step 4. Repeat Steps 4–5.

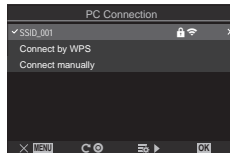

**6** Press the  $\text{OK}$  button to exit to the shooting display.

- Standard shooting indicators will be displayed.  $\text{Wi-Fi}$  on the screen will turn green.

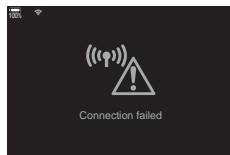

#### ■ Choosing a Network from a List (Connect from Access Point List)

The camera will search for available networks and display them in a list from which you can choose the network to which you wish to connect.

Menu	MENU $\Rightarrow$ $\gamma$ $\Rightarrow$ 4. Wi-Fi/Bluetooth $\Rightarrow$ Wi-Fi Connection
------	---

**1** Highlight [PC Connection] using the  $\Delta$   $\nabla$  buttons and press the  $\text{OK}$  button.

- [PC Connection] options will be displayed.

**2** Highlight [Connect from ((Wi-Fi)) List] using the  $\Delta$   $\nabla$  buttons and press the  $\text{OK}$  button.

- A list of available networks will be displayed.

**3** Highlight the desired network using the  $\Delta$   $\nabla$  buttons and press the  $\text{OK}$  button.

- If the network is password-protected, you will be prompted to enter a password. Enter the password and press the  $\text{OK}$  button.
- Press the  $\triangleright$  button to display [Detail Settings] for the highlighted network. You can enter an IP address and adjust other settings manually.
- Press the  $\text{Wi-Fi}$  button to repeat the search and update the network list.

**4** If the camera is able to connect, the network will be displayed with a check mark (✓) next to the network name.

- Password-protected networks are indicated by a lock icon.
- If the camera has been paired with more than one computer, you will be prompted to choose a computer before the network is displayed. Highlight the desired computer using the  $\Delta$   $\nabla$  buttons and press the  $\odot$  button.
- The camera can be used only with the selected computer. To select a different computer, you must first terminate the current connection.
- If the connection fails, the camera will display a message to that effect, followed by the options shown in Step 3. Repeat Steps 3–4.

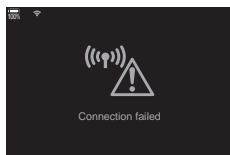

**5** Press the  $\odot$  button to exit to the shooting display.

- Standard shooting indicators will be displayed.  $\odot$  on the screen will turn green.



### Connecting to Previously-Selected Networks

- The camera will automatically reconnect to previously-selected networks when you select [PC Connection] via the  $\odot$   $\odot$  icon. You will not be required to supply a password.
- If multiple networks are available, the camera will connect first to the most recently-used network.
- Once the camera has connected, it will display a list of available networks with the current network shown by a check mark ✓.
- To connect to a different network, highlight it in the list and press the  $\odot$  button.
- If the camera has been paired with more than one computer on the network, you will be prompted to choose a computer before the network list is displayed. Highlight the desired computer using the  $\Delta$   $\nabla$  buttons and press the  $\odot$  button.

## ■ Displaying the MAC address / Resetting Wi-Fi settings for PC connection (Wi-Fi PC Settings)

You can display the camera's MAC address for Wi-Fi connection and reset the Wi-Fi settings used for connection to a computer.

Menu	MENU ⇒  ⇒ 4. Wi-Fi/Bluetooth ⇒ Wi-Fi PC Settings
Wi-Fi MAC Address	Display the camera's MAC address for Wi-Fi connection.
Reset Wi-Fi PC Settings	Delete the information about computers the camera has paired with and access points the camera has connected to.

## Uploading Pictures as They Are Taken

Take pictures and upload them to a computer on the same network as the camera. Before proceeding, connect the camera and computer as described in "Pairing the Computer with the Camera (New Link)" (P. 269).

### 1 Launch "OM Capture" on destination computer.

- If prompted to choose a connection type, click [Wi-Fi Connection].
- The computer will display the message, [Camera connected] when the camera is detected.



[Wi-Fi Connection]

- The camera will display the message shown at right when a connection is established.

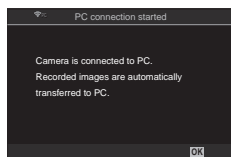

### 2 Configure "OM Capture" to automatically download pictures as they are taken.

- Select the source card slot (1 or 2) and the type of pictures (JPEG photos, RAW photos, or movies) to be downloaded.
- Choose a destination for the downloaded pictures.



The "OM Capture" control window

### 3 Take pictures using camera controls.

- The pictures will be uploaded to the computer after they are saved to the camera memory card.
- A PC (“image upload”) icon will be displayed while upload is in progress.
- The camera will upload only photos and movies recorded while the camera and computer are connected. Any pictures taken before Wi-Fi was enabled on the camera will not be uploaded.
- The upload queue for each card can contain no more than 3000 pictures.

Image upload



☞ While the camera is connected to a network:

- Sleep mode is disabled
- Interval-timer photography is not available
- Some restrictions apply to the options available during playback

☞ [PC connection ended] options will be displayed when the camera's connection to the network ends. Upload of any remaining data will resume when the connection is re-established. Note, however, that remaining data will not be uploaded if:

- The Wi-Fi connection is ended using camera controls
- The camera is turned off
- The source memory card is removed

☞ If “OM Capture” displays the message [This application is unable to find a camera in the camera control mode.], check:

- that the camera has been paired with the computer,
- that you selected the correct computer when connecting to the network, and
- that the camera is registered with the computer (Windows only). ☞ “Readying the Computer (Windows)” (P. 268)

## Ending the Connection

End the Wi-Fi connection. The use of Wi-Fi may be prohibited in some countries or regions, in which case Wi-Fi should be disabled.

### ■ Ending the Current Connection

1 Tap  in the camera monitor.

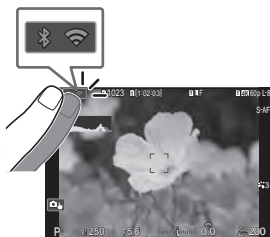

- You will be prompted to confirm whether you wish to disconnect.
- The network SSID is shown in the display.

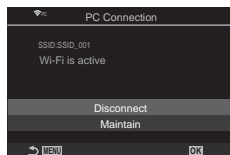

- 2 Highlight [Disconnect] using  $\Delta$   $\nabla$  and press the  $\text{OK}$  button.
- The camera will terminate the connection and exit to the shooting display.
  - A confirmation dialog will be displayed if data remain to be uploaded. To terminate the connection, highlight [Yes] and press the  $\text{OK}$  button.
- 3 To reconnect, tap  or select [Wi-Fi Connection] > [PC Connection] and press the  $\text{OK}$  button.
- The camera will automatically reconnect to previously-selected networks.
  - To connect to a new network, highlight [Maintain] in Step 2 and press the  $\text{OK}$  button. Choose from a list of available networks and adjust settings as described in "Choosing a Network from a List (Connect from Access Point List)" (P. 274).
  - If you turn the camera off while upload is in progress, you will be prompted to choose whether to power the camera down and terminate the Wi-Fi connection immediately or to power the camera down only after upload is complete.

### ■ Disabling Wi-Fi/Bluetooth®



Set [Airplane Mode] (P. 260) to [On]. Wireless communication will be disabled.

## Using the Remote Control

You can control the camera from the optional remote control (RM-WR1) and take pictures.

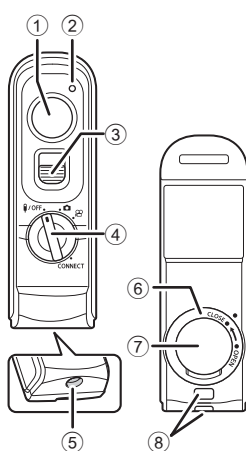
### Names of parts



- ① Shutter button
- ② Data transfer indicator
- ③ Shutter button lock
- ④ Mode dial (OFF /  /  / CONNECT)
- ⑤ Cable connector
- ⑥ Battery-compartment lid
- ⑦ Battery-compartment cover
- ⑧ Strap eyelet

### Connection

#### ■ Wired connection

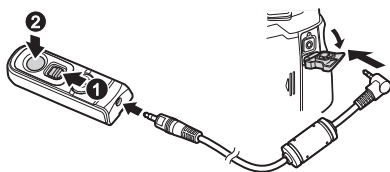

Rotate the mode dial of the remote control to OFF and connect the remote control to the camera via the supplied cable.

Photographs can be taken by pressing the shutter button.



To record movies, set [Shutter Function] (P. 216) to [REC] beforehand.

ⓘ Wireless remote control is not available while the cable is connected.

🔍 Bulb photography or the like is available by sliding the shutter button lock up and pressing the shutter button (1, 2).



## ■ Wireless connection

For wireless connection, you must pair the camera and the remote control first.

Menu	MENU ➔  ➔ 4. Wi-Fi/Bluetooth ➔ Wireless Shutter Setting
Start Pairing	Follow the on-screen instructions. When pairing is complete, [Bluetooth] will be set to [On  ].
Delete Pairing	If you select [Yes] and press the  button, the paired device will be deleted.

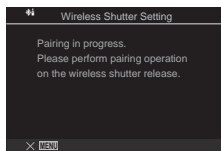
- 1 Select [Start Pairing] and press the  button.
- 2 When a message indicating pairing is in progress is displayed, rotate the mode dial of the remote control to CONNECT and keep it in the position.
  - Pairing starts when it is kept 3 seconds. Keep it in the CONNECT position until pairing is complete. If you rotate the mode dial before it is complete, the data transfer indicator flashes rapidly.
  - The data transfer indicator lights when pairing starts.



- 3 When a message indicating pairing is complete is displayed, press the  button.
    - The data transfer indicator goes out when pairing is complete.
    - [Bluetooth] (P. 262) will be set to [On ] when pairing is complete.
- ① If you rotate the mode dial of the remote control or press the MENU button of the camera before the pairing completion message is displayed, the pairing process ends. Paired device information will be reset. Perform pairing again.
  - ① If you rotate the mode dial of a remote control that is not currently paired to CONNECT and keep it 3 seconds, or when pairing fails, the pairing information from previous connections will be reset. Perform pairing again.

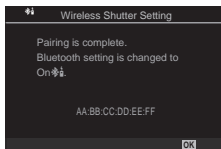





## ■ Deleting pairing



- 1 Select [Delete Pairing] and press the **OK** button.
- 2 Select [Yes] and press the **OK** button.

ⓘ When you have paired the camera with a remote control, you have to perform [Delete Pairing] to reset pairing information before you pair the camera with a new remote control.

## Shooting from the remote control



PASMB 

To connect the camera and remote control wirelessly, be sure that [Bluetooth] (P. 262) is set to [On ]. When set to [On ],  is displayed and the camera will be on standby for wireless communication with the remote control as soon as it is turned on.

- 1 Rotate the mode dial of the remote control to  or .



- 2 Press the shutter button on the remote control to take pictures.

- When the mode dial of the remote control is set to  (still photography mode): When you lightly press the shutter button of the remote control down to the first position (press the shutter button halfway), the AF confirmation mark (●) will be displayed, and a green frame (AF target) will be displayed in the focus location.
- When the mode dial of the remote control is set to  (movie recording mode): When you press the shutter button of the remote control, movie recording starts. Press the shutter button of the remote control again to stop movie recording.



Shutter button

## ■ Data transfer indicator of the remote control

<b>Lights once</b>	Remote control operation is sent to the camera correctly.
<b>Flashes rapidly (1 second)</b>	Remote control operation is not sent to the camera correctly. Shorten the distance between the camera and the remote control. If the problem is not solved, check the setting of the camera.
<b>Flashes rapidly (3 seconds)</b>	There is a problem regarding the pairing of the camera and remote control. Pair the devices again.
<b>Does not light</b>	This may occur in the following situations. <ul style="list-style-type: none"><li>• The battery in the remote control is dead.</li><li>• The mode dial of the remote control is in the <b>OFF</b> position.</li><li>• The camera and remote control are connected with a cable</li></ul>

- ⓘ Even if [Bluetooth] (P. 262) is set to [On], you can connect the camera to a smartphone by starting [Device Connection] on the camera. However, you cannot control the camera from the remote control when it is connected to a smartphone.
- ⓘ Pairing devices and remote shooting are not available when [Airplane Mode] (P. 260) is [On].
- ⓘ The camera does not enter sleep mode when a remote control is connected wirelessly.
- ⓘ If you rotate the mode dial of the remote control to the **OFF** position, the camera enters sleep mode according to the setting of [Sleep] (P. 254).  
When [Bluetooth] (P. 262) is set to [On], the camera does not enter sleep mode unless you rotate the mode dial of the remote control to the **OFF** position.
- ⓘ If you operate the remote control while the camera is in sleep mode, it may take a longer time for the camera to resume operation.
- ⓘ The camera cannot be controlled from the remote control while it is waking from sleep. Operate the remote control after the camera has resumed operation.
- ⓘ Rotate the mode dial of the remote control to the **OFF** position when you have finished using the remote control.

## MAC address of the remote control

The MAC address of the remote control is printed on the warranty card provided with the remote control.

## Precautions for using the remote control

- Do not tug on the battery-compartment cover or use it to turn the battery-compartment lid.
- Do not pierce batteries with sharp objects.
- Do not drop or swing the remote control while holding the cable.
- Moisture on the cable or remote control connectors could interfere with wireless control and render wired connections unreliable.
- Confirm that the battery-compartment lid is free of foreign matter before closing it.
- Rotate the mode dial to **OFF** before connecting or disconnecting cables.

## Connecting to Computers via USB

Connect the camera to a computer using the USB cable.

### Installing Software

Install the following software to access the camera while it is connected directly to the computer via USB.

#### **OM Capture**

Use “OM Capture” to automatically download and view pictures as they are taken or control the camera remotely. To learn more or to download the software, visit our website. When downloading the software, be prepared to provide the camera serial number.

Follow the on-screen instructions to install the software. System requirements and installation instructions are available at our website.

#### **OM Workspace**

This computer application is used to download, view, and manage photos and movies recorded with the camera. When editing RAW data in the OM Workspace, high-speed processing using the camera engine has been enabled. It can also be used to update the camera firmware. The software can be downloaded from our website. Be prepared to provide the camera serial number when downloading the software.

Follow the on-screen instructions to install the software. System requirements and installation instructions are available at our website.

Connect the camera to a computer via USB to upload pictures as they are taken. You can take pictures using the controls on the camera body or while controlling the camera remotely from the computer.

**1** After confirming that the camera is off, connect it to the computer using the USB cable.

- When attaching the USB cable, use the supplied cable protector and cable clip to prevent damage to the connectors. “Attaching Cable Protectors” (P. 19)

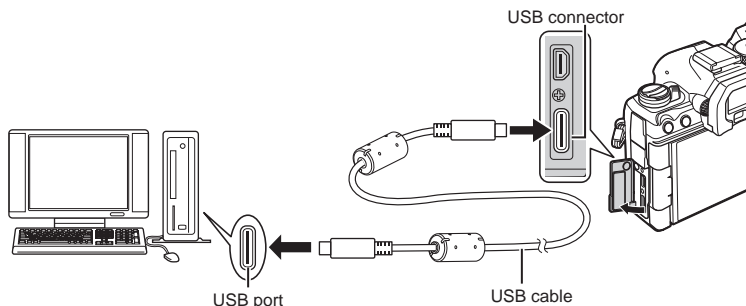

- The locations of USB ports vary from computer to computer. See the documentation provided with the computer for information on USB ports.
- If the USB port on the computer is Type A port, use the optional CB-USB11 cable.

**2** Turn the camera on.

- The camera will display a message prompting you to identify the device to which the USB cable is connected.

If the message is not displayed, select [Select] for [USB Mode] (P. 252).

If the batteries are very low, the camera will not display a message when connecting to a computer. Be sure the batteries are charged.

**3** Highlight [ RAW/Control] using  $\Delta$   $\nabla$  and press the button.

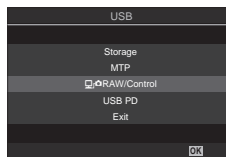

**4** Launch the copy of “OM Capture” installed on the computer.

- When prompted to choose the connection type, click [USB Connection].





[USB Connection]

- 5 Configure “OM Capture” for download.
  - Choose a destination for the downloaded pictures.
- 6 Take pictures using camera or computer controls.
  - The pictures will be downloaded to the computer according to the options chosen.
  - See online help for more information on using the software.
  - The computer cannot be used to change the camera shooting mode.
  - The computer cannot be used to delete pictures from the memory cards inserted in the camera.
  - The camera display frame rate may drop if the view through the camera lens is displayed simultaneously both on the computer and in the camera monitor.
  - The connection to the computer will end if you:
    - exit “OM Capture”,
    - insert or remove memory cards, or
    - turn the camera off.

## Connecting the Camera for High-Speed RAW Processing

( RAW/Control)

When you edit RAW data with the camera and computer connected, processing will be faster than when done with the computer only.

- 1 After confirming that the camera is off, connect it to the computer using the USB cable.
- 2 Turn the camera on.
  - The camera will display a message prompting you to identify the device to which the USB cable is connected.
  - If the message is not displayed, select [Select] for [USB Mode] (P. 252).
  - If the batteries are very low, the camera will not display a message when connecting to a computer. Be sure the batteries are charged.
- 3 Highlight [ RAW/Control] using  $\Delta$   $\nabla$  and press the  button.

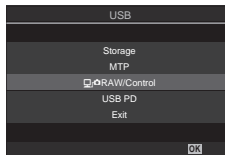

- 4 Launch the copy of “OM Workspace” installed on the computer.
- 5 Choose the picture to be processed.
  - Only the pictures that were taken using the connected camera can be chosen.
  - You can not choose pictures on the SD card in the connected camera.

## 6 Process RAW images.

- Adjustments can be made to the shooting settings available on the camera and RAW pictures processed accordingly.
- The processed copies will be saved in JPEG format.
- Enabling USB RAW data editing cancels any changes previously made in the edit window.
- USB RAW data editing is not available when two or more cameras are connected.
- See online help for more information on using the software.

## Copying Pictures to the Computer (Storage/MTP)

When connected to a computer, the camera can function as external storage in much same way as a hard drive or other external storage device. Data can be copied from the camera to the computer.

- 1 After confirming that the camera is off, connect it to the computer using the USB cable.
- 2 Turn the camera on.
  - The camera will display a message prompting you to identify the device to which the USB cable is connected.
  - If the message is not displayed, select [Select] for [USB Mode] (P. 252).
  - If the batteries are very low, the camera will not display a message when connecting to a computer. Be sure the batteries are charged.

- 3 Highlight [Storage] or [MTP] using  $\Delta$   $\nabla$  and press the  $\odot$  button.

[Storage]: The camera functions as a card reader.

[MTP]: The camera functions as a portable device.

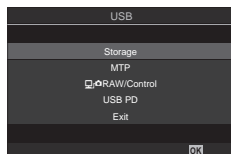

- 4 The camera will connect to the computer as new storage device.

- ① Data transfer is not guaranteed in the following environments, even if your computer is equipped with a USB port.

Computers with a USB port added by means of an extension card, etc., computers without a factory-installed OS, or home-built computers

- ① Camera functions cannot be used while the camera is connected to the computer.
- ① If the computer fails to detect the camera, disconnect and reconnect the USB cable.
- ① When [MTP] is selected, movies exceeding 4 GB cannot be copied to the computer.

## Powering the Camera via USB (USB Power Delivery)

Mobile batteries or USB AC adapters conforming to the USB Power Delivery (USB PD) standard can be used to power the camera. The devices must:

Standard: Conform to the USB Power Delivery (USB PD) standard

Output: Be rated for an output of 27 W (9 V 3 A, 15 V 2 A, or 15 V 3 A) or more

- 1 After confirming that the camera is off, use the USB cable to connect it to the device.

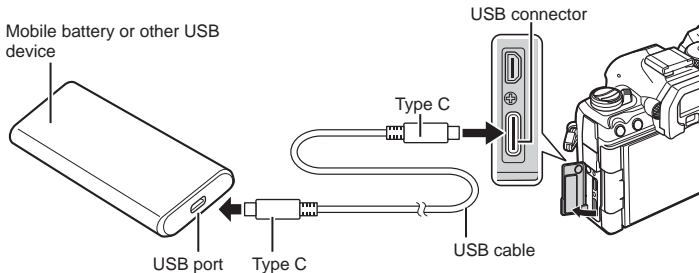

- The method used for connection varies from device to device. See the documentation provided with the device for details.
- You may be unable to use USB Power Delivery (USB PD) with some USB devices. See the manual supplied with the USB device.

- 2 Turn the camera on.

- The camera will draw power from the connected USB device.
- If the camera displays a message prompting you to identify the device to which the USB cable is connected, select [USB PD].
- If the batteries are very low, the display will remain blank when the camera is connected to the USB device. Be sure the batteries are charged.
- "USB " is displayed while the camera draws power from the USB device.





# 9 Cautions

## Information about Dust and Water Resistant Features

- This camera has a water resistant specification of IPX3 (when used in combination with an IPX3 or higher water resistant lens supplied by our company).
- This camera has a dust resistant specification of IP5X (under our company's test conditions).

### ■ Precautions

- Dust and water resistant capabilities may be lost when the camera is subjected to shock.
- Check the following parts for foreign material including dirt, dust or sand: packing parts of the battery compartment cover, card compartment cover, connector covers, and the parts that come in contact with them, and the parts that come in contact when attaching the lens and the power battery holder. Wipe off foreign material with a clean cloth that does not produce textile waste.
- To ensure dust and water resistant capabilities, close the covers firmly and attach the lens before use.
- Do not operate the camera, open/close the covers, or attach/remove the lens when they are wet.
- Water resistant feature is ensured only when compatible lenses/accessories are attached. Check the compatibility.  
For compatible accessories, visit our website.

### ■ Maintenance

- Wipe off water thoroughly with a dry cloth.
- Remove foreign materials such as dirt, dust or sand thoroughly.

## Battery and charger

- This camera uses one of our lithium-ion batteries. Use the specified genuine battery.
- The camera's power consumption varies widely with usage and other conditions.
- As the following consume a lot of power even without shooting, the battery will be drained quickly.
  - Performing auto focus repeatedly by pressing the shutter button halfway in shooting mode.
  - Displaying images on the monitor for a prolonged period.
  - When connected to a computer (except when powering the camera via USB).
  - Leaving wireless LAN/**Bluetooth**<sup>®</sup> enabled.
- When using a drained battery, the camera may turn off without the low battery warning being displayed.
- The battery will not be fully charged at the time of purchase. Charge the battery before use.
- Remove the batteries before putting the camera into storage for periods of a month or more. Leaving the batteries in the camera for extended periods shortens their lives, potentially rendering them unusable.
- The normal charging time using the supplied USB-AC adapter is approximately 2 hours 30 minutes (estimated).
- Do not attempt to use USB-AC adapters or chargers not specifically designated for use with the supplied battery, or to use batteries not specifically designated for use with the supplied USB-AC adapter.
- There is a risk of explosion if the battery is replaced with the incorrect battery type.
- Dispose of the used battery following the instructions "CAUTION" (P. 334) in the instruction manual.

## Using your charger abroad

- The USB-AC adapter can be used in most home electrical sources within the range of 100V to 240V AC (50/60Hz) around the world. However, depending on the country or area you are in, the AC wall outlet may be shaped differently and the charger may require a plug adapter to match the wall outlet.
- Do not use commercially available travel adapters as the USB-AC adapter may malfunction.

## Interchangeable lenses

Choose a lens according to the scene and your creative intent. Use lenses designed exclusively for the Micro Four Thirds system and bearing the M.ZUIKO DIGITAL label or the symbol shown at right. With an adapter, you can also use Four Thirds System lenses. The optional adapter is required.



- When you attach or remove the body cap and lens from the camera, keep the lens mount on the camera pointed downward. This helps prevent dust and other foreign matter from getting inside the camera.
- Do not remove the body cap or attach the lens in dusty places.
- Do not point the lens attached to the camera toward the sun. This may cause the camera to malfunction or even ignite due to the magnifying effect of sunlight focusing through the lens.
- Be careful not to lose the body cap and rear cap.
- Attach the body cap to the camera to prevent dust from getting inside when no lens is attached.

### ■ Lens and camera combinations

Lens	Camera	Attachment	AF	Metering
Micro Four Thirds system lens	Micro Four Thirds system camera	Yes	Yes	Yes
Four Thirds system lens		Attachment possible with mount adapter	Yes*1	Yes

\*1 Not available during enlarged display, movie recording or starry sky AF.

## MF Clutch Lenses

The “MF clutch” (manual focus clutch) mechanism on MF clutch lenses can be used to switch between auto and manual focus simply by repositioning the focus ring.

- Check the position of the MF clutch before shooting.
- Sliding the focus ring to the AF/MF position at the end of the lens selects autofocus, while sliding it to the MF position closer to the camera body selects manual focus, regardless of the focus mode chosen with the camera.

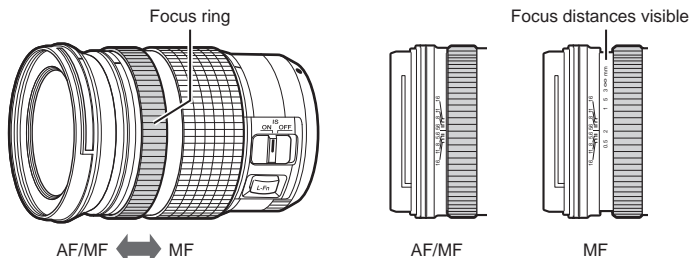

- Selecting [Inoperative] for [MF Clutch] (P. 104) disables manual focus even when the MF clutch is in the MF position.

## Camera Displays for Lens SET and CALL Functions

The camera displays “●Set” when the focus position is saved using the SET option and “●Call” when a saved focus position is restored using the CALL option. For more information on SET and CALL, see the lens manual.



## Optional Accessories

### Using the charger (BCX-1)

Two batteries can be inserted. It can also be used with only one battery inserted.

#### 1 Charge the battery.

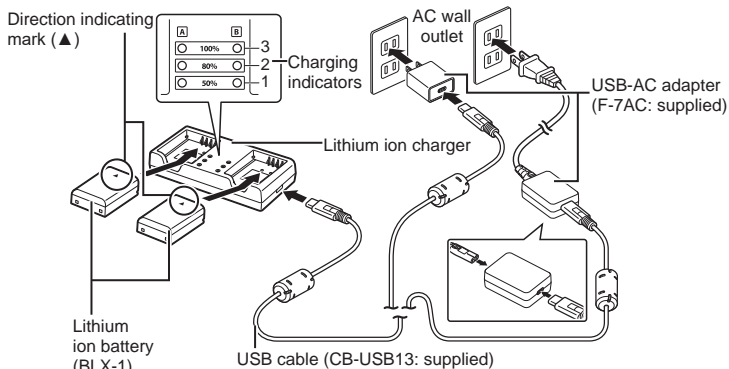

- Charging time is approximately 2 hours 30 minutes. See the table below for status of the charging indicators and battery charge.

\* Charging time does not change even when you charge two batteries at the same time.

Charging indicator	Battery charge	
Indicator 1: Blinks	Charging in progress	Less than 50%
Indicator 1: Lights up, Indicator 2: Blinks		50% or more Less than 80%
Indicators 1 and 2: Light up, Indicator 3: Blinks		80% or more Less than 100%
All indicators: Unlit	Charging complete	
All indicators: Blinking	Charging error	

## HLD-10 Power Battery Holder

An optional HLD-10 battery holder can be used to power the camera for extended periods.

⚠ Make sure to turn the camera off when attaching and removing the holder.

### ■ Part names

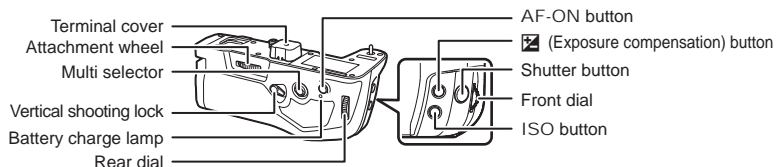

### ■ Attaching the holder

Remove the power battery holder (PBH) cover on the bottom of the camera and the terminal cover of HLD-10 before attaching the HLD-10. Once attached, make sure the HLD-10 removal knob is tightly secured. When not using the HLD-10, make sure to attach the power battery holder (PBH) cover to the camera and the terminal cover to the HLD-10.

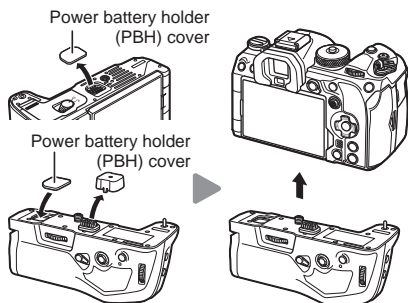

Store the Power battery holder (PBH) cover in the HLD-10.

### ■ Loading the battery

Use BLX-1 battery. Once you load the battery, make sure to lock the battery cover.

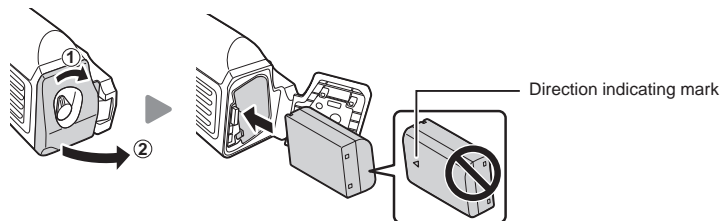



🔊 The monitor battery-level indicator (P. 30) shows "PBH" when the camera is powered by the battery in the HLD-10.





## ■ Charging the battery in the power battery holder

To charge the battery in the power battery holder, load a battery in the holder and attach the holder to the camera. Charge the battery in the same way as described on P. 22. The charge lamp of the holder lights during charging.

## ■ Using the buttons

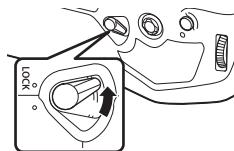
Slide the vertical shooting lock of the HLD-10 in the direction of the arrow. The roles performed by the  (Exposure compensation) button, ISO button and AF-ON button on the HLD-10 can be selected using the [Button Settings] item.  “Changing the roles of buttons (Button Settings)” (P. 208)



 Buttons on the HLD-10 cannot be used when the vertical shooting lock is in the LOCK position.

## Notes on using this product

- Use only the designated battery. Failure to do so could result in injury, damage to the product, and fire.
- Do not use your nail to turn the attachment wheel. Doing so could result in injury.
- Only use the camera within the guaranteed operating temperature range.
- Do not use or store the product in dusty or humid areas.
- Do not touch the electrical contacts.
- Use a dry, soft cloth to clean the terminals. Do not clean the product with a damp cloth, thinner, benzine, or any other organic solvents.
- Remove the batteries from the camera and power battery holder before putting the camera into storage for periods of a month or more. Leaving the batteries in the camera for extended periods shortens their lives, potentially rendering them unusable.



## Designated External Flash Units

When using an optional flash unit designed for use with the camera, you can choose the flash mode using camera controls and take pictures with the flash. See the documentation provided with the flash unit for information on flash features and their use.

Choose a flash unit to suit your needs, taking into consideration such factors as the output required and whether the unit supports macro photography. Flash units designed to communicate with the camera support a variety of flash modes, including TTL auto and super FP. Flash units can be mounted on the camera hot shoe or connected using a cable (available separately) and flash bracket. The camera also supports the following wireless flash control systems:

### **Radio-Controlled Flash Photography: CMD, ⚡CMD, RCV, and X-RCV Modes**

The camera controls one or more remote flash units by means of radio signals. The range of locations in which flash units can be placed increases. Flash units can control other compatible units or be fitted with radio commander/receivers to allow the use of units that do not otherwise support radio flash control.

### **Wireless Remote-Control Flash Photography: RC Mode**

The camera controls one or more remote flash units by means of optical signals. The flash mode can be selected using camera controls (P. 298).

#### ■ Features Available with Compatible Flash Units

Flash unit	Supported flash control modes	GN (Guide Number, ISO 100)	Supported wireless systems
<b>FL-700WR</b>	TTL-AUTO, MANUAL, FP TTL AUTO, FP MANUAL, MULTI, RC, SL MANUAL	GN 42 (75/150 mm <sup>*1</sup> ) GN 21 (12/24 mm <sup>*1</sup> )	CMD, ⚡CMD, RCV, X-RCV, RC
<b>FL-900R</b>	TTL-AUTO, AUTO, MANUAL, FP TTL AUTO, FP MANUAL, MULTI, RC, SL AUTO, SL MANUAL	GN 58 (100/200 mm <sup>*1</sup> ) GN 27 (12/24 mm <sup>*1</sup> )	RC
<b>STF-8</b>	TTL-AUTO, MANUAL, RC <sup>*2</sup>	GN 8.5	RC <sup>*2</sup>
<b>FL-LM3</b>	Varies with camera settings.	GN 9.1 (12/24 mm <sup>*1</sup> )	RC <sup>*2</sup>

\*1 Maximum lens focal length at which unit can provide flash coverage (figures following slashes are 35 mm format equivalent focal lengths).

\*2 Functions as commander (transmitter) only.

Wireless flash photography is available with compatible flash units that support wireless remote control (RC). The remote flash units are controlled via a unit mounted on the camera hot shoe. Settings can be adjusted separately for the units in up to three other groups.

RC mode must be enabled on both the master and remote flash units (P. 297).

- 1 Set the remote flash units to RC mode and place them as desired.
  - Turn the external flash units on, press the MODE button, and select RC mode.
  - Select a channel and group for each external flash unit.
- 2 Select [On] for [ RC Mode] (P. 124).
  - The camera will exit to the shooting display.
  - “RC” will be displayed.



- 3 Press the  button.
  - The RC mode super control panel will be displayed.
  - The standard LV super control panel can be displayed by pressing the INFO button. The display will change each time the INFO button is pressed.



RC mode super control panel

#### 4 Adjust flash settings.

- Highlight items using the  $\Delta$   $\nabla$   $\langle$   $\rangle$  buttons and rotate the front dial to choose settings.

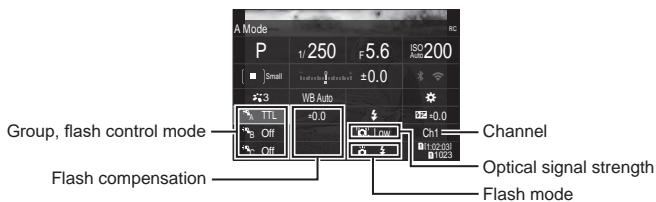

<b>Group</b>	Choose a group. Changes to settings apply to all units in the selected group. The unit mounted on the camera works as a member of Group A.
<b>Flash control mode</b>	Choose a flash mode.
<b>Flash compensation</b>	Adjust flash output. When [Manual] is selected for flash mode, you can a value for manual flash output.
<b>Optical signal strength</b>	Choose the brightness of the optical control signals emitted by the flash units. Choose [High] if you have placed flash units at close to the maximum distance from the camera. This setting applies to all groups.
<b>Flash mode</b>	Choose $\text{⚡}$ (standard) or FP (super FP). Choose super FP for shutter speeds faster than the flash sync speed. This setting applies to all groups.
<b>Channel</b>	Choose the channel used for flash control. Change the channel if you find that other light sources in the area are interfering with remote flash control.

#### 5 Set the unit mounted on the camera to [TTL AUTO].

- Flash control settings for the FL-LM3 can only be adjusted using the camera.

- ⓘ Position the wireless units with the remote sensors facing the camera.
- ⓘ Take pictures after confirming that the flash units are charged.

## ■ Wireless Flash Control Range

The illustration is intended as a guide only. The flash control range varies with the type of flash mounted on the camera and the conditions in the surrounding area.

### Flash Control Range for Camera-Mounted FL-LM3 Flash Units

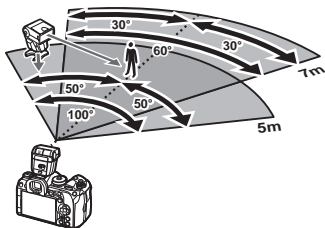

- We recommend that each group contain no more than 3 flash units.
- Wireless flash photography is not available in anti-shock mode or in rear-curtain slow sync mode when a shutter speed slower than 4 s is selected.
- Start wait times longer than 4 s cannot be selected in anti-shock and silent modes.
- Flash control signals may interfere with exposure if subject is too close to the camera. This can be mitigated by reducing the brightness of the camera flash, for example by using a diffuser.

### Other external flash units

Third-party flash units can be mounted on the hot shoe or connected via a sync cable. Be sure to replace the cap on the external flash connector when it is not in use. Note the following when using a third-party flash unit mounted on the camera hot shoe:

- Using obsolete flash units that apply currents of more than about 250 V to the X-contact will damage the camera.
- Connecting flash units with signal contacts that do not conform to our specifications may damage the camera.
- Select mode **M**, choose a shutter speed no faster than the flash sync speed, and set [ISO] to a setting other than [Auto].
- Flash control can only be performed by manually setting the flash to the ISO sensitivity and aperture values selected with the camera. Flash brightness can be adjusted by adjusting either ISO sensitivity or aperture.
- Use a flash with an angle of illumination suited to the lens. Angle of illumination is usually expressed using 35-mm format equivalent focal lengths.

## Principal Accessories

### ■ Converter lenses

Converter lenses attach to the camera lens for quick and easy fish-eye or macro photography. See our website for information on the lenses that can be used.

### ■ Eyecup (EP-18)

#### Removal

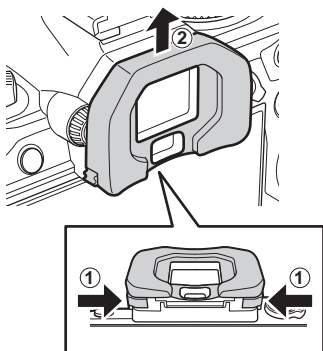

Push both levers inward and lift the eyecup.

## System chart

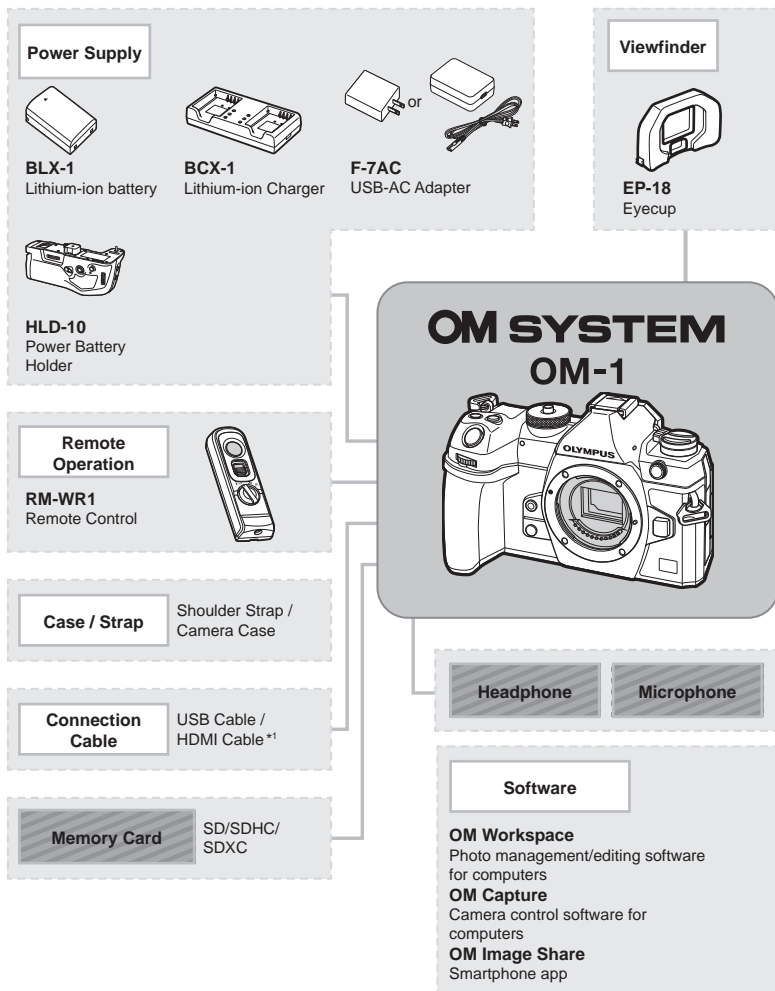

 : OM-1 compatible products

 : Commercially available products

For the latest information, please visit our website.

\*1 HDMI cables are available from third-party suppliers.

\*2 There are restrictions on the lenses that can be used with the adapter. Visit our website for details.

\*3 Visit our website for information on compatible lenses.

## Lens



Micro Four Thirds system lenses



MMF-2/MMF-3<sup>2</sup>  
Four Thirds Adapter



Four Thirds system  
lenses

## Converter Lens<sup>43</sup>

MC-20  
Teleconverter

MC-14  
Teleconverter

FCON-P01  
Fisheye

MCON-P02  
Macro

## Flash



FL-LM3  
Electronic Flash



FL-900R  
Electronic Flash

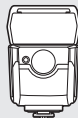

FL-700WR  
Electronic Flash

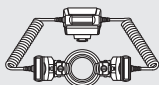

STF-8  
Macro Flash



FC-WR  
Wireless Radiowave  
Commander



FR-WR  
Wireless Radiowave  
Receiver

## Cleaning and storing the camera

### Cleaning the camera

Turn off the camera and remove the battery before cleaning the camera.

- Do not use strong solvents such as benzene or alcohol, or a chemically treated cloth.

#### Exterior:

- Wipe gently with a soft cloth. If the camera is very dirty, soak the cloth in mild soapy water and wring well. Wipe the camera with the damp cloth and then dry it with a dry cloth. If you have used the camera at the beach, use a cloth soaked in clean water and well wrung.

#### Monitor:

- Wipe gently with a soft cloth.

#### Lens:

- Blow dust off the lens with a commercially available blower. For the lens, wipe gently with a lens cleaning paper.

### Storage

- When not using the camera for a prolonged period, remove the battery and card. Store the camera in a cool, dry place that is well ventilated.
- Insert the battery periodically and test the camera's functions.
- Remove dust and other foreign matter from the body and rear caps before attaching them.
- Attach the body cap to the camera to prevent dust from getting inside when no lens is attached. Be sure to replace the front and rear lens caps before putting the lens away.
- Clean the camera after use.
- Do not store with insect repellent.
- Avoid storing the camera in places where chemicals are treated, in order to protect the camera from corrosion.
- Mold may form on the lens surface if the lens is left dirty.
- Check each part of the camera before use if it has not been used for a long time. Before taking important pictures, be sure to take a test shot and check that the camera works properly.



## Cleaning and checking the image pickup device

This camera incorporates a dust reduction function to keep dust from getting on the image pickup device and to remove any dust or dirt from the image pickup device surface with ultrasonic vibrations. The dust reduction function operates when the camera is turned on.

The dust reduction function operates at the same time as the pixel mapping, which checks the image pickup device and image processing circuitry. Since dust reduction is activated every time the camera's power is turned on, the camera should be held upright for the dust reduction function to be effective.

## Pixel Mapping - Checking the image processing functions

The pixel mapping feature allows the camera to check and adjust the image pickup device and image processing functions. For best results, wait at least a minute after shooting and playback have ended before performing pixel mapping.

- 1 Select [Pixel Mapping] (P. 258).
  - 2 Select [Yes], then press the **OK** button.
    - The [Busy] bar is displayed when pixel mapping is in progress. When pixel mapping is finished, the menu is restored.
- If you accidentally turn the camera off during pixel mapping, start again from Step 1.

## Shooting tips and information

### The camera does not turn on even when a battery is loaded

#### The battery is not fully charged

- Charge the battery with the USB-AC adapter.

#### The battery is temporarily unable to function because of the cold

- Battery performance drops at low temperatures. Remove the battery and warm it by putting it in your pocket for a while.

### A dialog prompting you to choose a language is displayed

The dialog is displayed in the following situations.

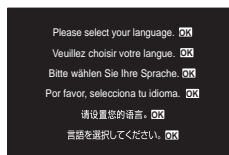

- The camera is turned on for the first time.
- You have not chosen a language.

See "Initial setup" (P. 31) and choose a language.



### No picture is taken when the shutter button is pressed

#### The camera has turned off automatically

- If [On] is selected for [Quick Sleep Mode] (P. 255), the camera will enter sleep mode if no operations are performed for a set period. Press the shutter button halfway to exit the sleep mode.
- The camera automatically enters sleep mode to reduce the drain on the battery if no operations are performed for a set period of time.  [Sleep] (P. 254)  
If no operations are performed for a set time after the camera has entered sleep mode, the camera will turn off automatically.  [Auto Power Off] (P. 254)

#### The flash is charging

- On the monitor, the  mark blinks when charging is in progress. Wait for the blinking to stop, then press the shutter button.

#### Unable to focus

- The camera cannot focus on subjects that are too close to the camera or that are not suited to autofocus (the AF confirmation mark will blink in the monitor). Increase the distance to the subject or focus on a high contrast object at the same distance from the camera as your main subject, compose the shot, and shoot.

#### Subjects that are difficult to focus on

It may be difficult to focus with auto focus in the following situations.

AF confirmation mark is blinking. These subjects are not focused.

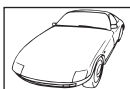

Subject with low contrast



Excessively bright light in center of frame

AF confirmation mark lights up but the subject is not focused.



Subjects at different distances

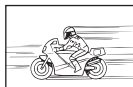

Fast-moving subject





Subject not inside AF area

### Noise reduction is activated

- When shooting night scenes, shutter speeds are slower and noise tends to appear in images. The camera activates the noise-reduction process after shooting at slow shutter speeds. During which, shooting is not allowed. You can set [Noise Reduction] to [Off].  
☞ [Noise Reduction] (P. 117)

### The number of AF targets is reduced

The size and number of the AF target changes depending on the [Digital Tele-converter] (P. 166), [Aspect] (P. 144), group target (P. 77), [Drive ] and [Image Stabilizer] settings.

### The date and time has not been set

#### The camera is used with the settings at the time of purchase

- The date and time of the camera is not set when purchased. Set the date and time before using the camera. ☞ “Initial setup” (P. 31)

#### The battery has been removed from the camera

- The date and time settings will be returned to the factory default settings if the camera is left without the battery for approximately 1 day (in-house measurements). The settings will be canceled more quickly if the battery was only loaded in the camera for a short time before being removed. Before taking important pictures, check that the date and time settings are correct.

### Set functions are restored to their factory default settings

Settings adjusted in custom modes (modes C1–C4) will be reset to saved values when another shooting mode is selected or the camera is turned off. If [Hold] is selected for [Save Settings] when a custom mode is selected, changes to settings will automatically be saved to the selected mode. ☞ “Saving the Changes Made to Settings while in Custom Modes” (P. 57)

### Image taken appears whitish

This may occur when the picture is taken in backlight or semi-backlight conditions. This is due to a phenomenon called flare or ghosting. As far as possible, consider a composition where strong light source is not taken in the picture. Flare may occur even when a light source is not present in the picture. Use a lens hood to shade the lens from the light source. If a lens hood does not have effect, use your hand to shade the lens from the light.  
☞ “Interchangeable lenses” (P. 291)

### Unknown bright dot(s) appear on the subject in the picture taken

This may be due to stuck pixel(s) on the image pickup device. Perform [Pixel Mapping]. If the problem persists, repeat pixel mapping a few times. ☞ “Pixel Mapping - Checking the image processing functions” (P. 305)

## Functions that cannot be selected from menus

When you open the menu, items that cannot be set are displayed in gray.

If you press the  button while selecting a gray item, the reason it cannot be set will be displayed.

Refer to the on-screen instructions and check the settings (P. 65).

## Functions that cannot be set from the super control panel

Some functions may be unavailable depending on the current shooting settings. Check if the same function is displayed in gray in the menus (P. 65).

## The subject appears distorted

The following functions use an electronic shutter:



movie recording (P. 59), silent mode (P. 132), Pro Capture shooting (P. 133), High Res Shot (P. 156), focus bracketing (P. 178), focus stacking (P. 160), the live ND filter (P. 158), HDR (P. 162)

This may cause distortion if the subject is moving rapidly or the camera is moved abruptly. Avoid moving the camera abruptly during shooting or use standard sequential shooting.

## Lines appear in photographs

The following functions use an electronic shutter, which may result in lines due to flicker and other phenomena associated with fluorescent and LED lighting, an effect that can sometimes be reduced by choosing slower shutter speeds:

movie recording (P. 59), silent mode (P. 132), Pro Capture shooting (P. 133), High Res Shot (P. 156), focus bracketing (P. 178), focus stacking (P. 160), the live ND filter (P. 158), HDR (P. 162)

Flicker can be reduced by choosing slower shutter speeds. You can also reduce flicker using flicker scan.  [Flicker Scan],  [Flicker Scan] (P. 108)

## Only the subject is displayed and no information is shown

The display has been switched to [Image Only]. Press the INFO button and switch to another display mode.

## Focus mode cannot be changed from MF (manual focus)

The lens you are using may be equipped with the MF clutch mechanism. In this case, manual focus is selected when the focus ring is slid to the camera body side. Check the lens.









 "MF Clutch Lenses" (P. 292)









## Nothing is displayed on the monitor

When something, e.g. your face, hand or strap, comes close to the viewfinder, the monitor turns off and the viewfinder turns on.

 "Switching between displays" (P. 37)

## Error codes

Monitor indication	Possible cause	Corrective action
 No Card	The card is not inserted, or it cannot be recognized.	Insert a card. Or reinsert the card properly.
 ① Card Error	There is a problem with the memory card in Slot 1.	Remove and reinsert the memory card. If this does not solve the problem, format the card. If formatting fails, the card cannot be used.
 ② Card Error	There is a problem with the memory card in Slot 2.	
 ① Write Protect	The memory card in Slot 1 is write-protected ("locked").	The memory card write-protect switch is in the "LOCK" position. Return the switch to the unlocked position (P. 25).
 ② Write Protect	The memory card in Slot 2 is write-protected ("locked").	
 ① Card Full	<ul style="list-style-type: none"> <li>Shooting disabled; the memory card in Slot 1 does not have space for additional pictures.</li> <li>Shooting disabled; the memory card in Slot 1 is full.</li> </ul>	Insert another memory or delete pictures. Before deleting pictures, be sure any pictures you wish to keep have been copied to a computer. If [↓□/□], [↑□/□], [↓□=□] or [↑□=□] is selected for [Save Settings] (P. 242), choose a different setting.
 ② Card Full	<ul style="list-style-type: none"> <li>Shooting disabled; the memory card in Slot 2 does not have space for additional pictures.</li> <li>Shooting disabled; the memory card in Slot 2 is full.</li> </ul>	
 ① No Picture	Playback unavailable; the memory card in Slot 1 contains no pictures.	The selected memory card contains no pictures. Take pictures before choosing playback mode.
 ② No Picture	Playback unavailable; the memory card in Slot 2 contains no pictures.	

Monitor indication	Possible cause	Corrective action
 ① Picture Error	The selected file is damaged and cannot be played back. Alternatively, the picture is in a format that is not supported by the camera.	View the picture using computer imaging software or the like. If the picture cannot be displayed on a computer, the file may be corrupt.
 ② Picture Error		
 ① The Image Cannot Be Edited	Camera retouch features cannot be applied to pictures recorded with other devices.	Retouch the picture on a computer or other device.
 ② The Image Cannot Be Edited		
Y/M/D	The clock is not set.	Set the clock (P. 257).
 Heat	The internal temperature of the camera has risen due to sequential shooting.	Turn off the camera and wait for the internal temperature to cool.
 Internal camera temperature is too high. Please wait for cooling before camera use.		Wait a moment for the camera to turn off automatically. Allow the internal temperature of the camera to cool before resuming operations.
 Battery Empty	The battery is drained.	Charge the battery.
 No Connection	The camera is not correctly connected to a computer, HDMI display, or other device.	Reconnect the camera.
The lens is locked. Please extend the lens.	The lens of the retractable lens stays retracted.	Extend the lens.
Please check the status of a lens.	An abnormality has occurred between the camera and the lens.	Turn off the camera, check the connection with the lens, and turn the power on again.

## Default Settings

\*1: Can be added to [Assign].

\*2: Default can be restored by selecting [Initialize All Settings] for [Reset/Initialize Settings].

\*3: Default can be restored by selecting [Reset Shooting Settings] for [Reset/Initialize Settings].

## Super Control Panel

Shooting mode	Function	Default	*1	*2	*3	
P/A/S/M/B	Shooting Mode	P	—	—	—	43
	Shutter Speed	1/250 (When set to S/M), Bulb (When set to B)	✓	✓	✓	47
	Aperture Value	F5.6	✓	✓	✓	45
	ISO	ISO Auto	✓	✓	✓	113
	AF Target Mode	[ = ]Small	✓	✓	✓	77
	Exposure Comp.	±0.0	✓	✓	✓	106
	Wi-Fi/Bluetooth	—	—	—	—	261
	Picture Mode	Natural	✓	✓	✓	145
	WB	WB Auto	✓	✓	✓	150
	Kelvin	5400K (When [ WB] is set to [CWB])	✓	✓	—	150
	Button Function	—	✓	✓	—	208
	AF Mode	S-AF	✓	✓	✓	72
	Face & Eye Detection	☺Off	✓	✓	—	88
	Flash Mode		✓	✓	✓	120
	Flash Exposure Comp.	±0.0	✓	✓	✓	123
	Manual Value	Full (When [Flash Mode] is set to [ Manual])	✓	✓	✓	121
	Drive		✓	✓	✓	126
	Metering		✓	✓	✓	109
	Aspect	4:3	✓	✓	✓	144
	Image Stabilizer	S-IS Auto	✓	✓	✓	136
	Card Slot Settings	Standard	✓	✓	—	242
		L F (when High Res Shot is set:  F+RAW)	✓	✓	✓	140
		L F (when High Res Shot is set:  F+RAW)	✓	✓	✓	140
	4K60p L-8	✓	✓	✓	141	

Shooting mode	Function	Default	*1	*2	*3	
(movie)	Mode	P	—	✓	—	59
	Shutter Speed	1/250	—	✓	✓	47
	Aperture Value	F5.6	—	✓	✓	45
	ISO	ISO Auto	—	✓	✓	113
	AF Target Mode	[  ] Middle	—	✓	✓	77
	Exposure Comp.	±0.0	✓	✓	✓	106
	Wi-Fi/Bluetooth	—	—	—	—	261
	Picture Mode	3 Natural	✓	✓	✓	149
	WB	WB Auto	—	✓	✓	150
	Kelvin	5400K (When [  WB ] is set to [CWB])	—	✓	—	150
	Button Function	—	—	✓	—	208
	AF Mode	C-AF	✓	✓	✓	72
	Face & Eye Detection	☹ Off	✓	✓	—	88
	Image Stabilizer	M-IS1	—	✓	✓	136
		4K60p L-8	✓	✓	✓	141
	Sound Recording Level	±0	—	✓	—	62
	Headphone Volume	8	—	✓	—	62
RC mode	Shooting Mode	P	—	—	—	43
	Shutter Speed	1/250 (When set to S/M), Bulb (When set to B)	✓	✓	✓	47
	Aperture Value	F5.6	✓	✓	✓	45
	ISO	ISO Auto	✓	✓	✓	113
	AF Target Mode	[  ] Small	✓	✓	✓	77
	Exposure Comp.	±0.0	✓	✓	✓	106
	Wi-Fi/Bluetooth	—	—	—	—	261
	Picture Mode	3 Natural	✓	✓	✓	145
	WB	WB Auto	✓	✓	✓	150
	Kelvin	5400K (When [  WB ] is set to [CWB])	✓	✓	—	150
	Button Function	—	✓	✓	—	208
	A mode	TTL	✓	✓	✓	298
	B mode	Off	✓	✓	✓	
	C mode	Off	✓	✓	✓	
	Flash compensation	Off	✓	✓	✓	
	Flash output	±0.0 (when set to TTL/Auto)	✓	✓	✓	
	Flash Mode	1/1 (when in Manual mode)	✓	✓	✓	
	/FP	(Normal)	✓	✓	✓	
	optical signal strength	Low	✓	✓	✓	
	Channel	Ch1	✓	✓	✓	



Page	Function	Default	*1	*2	*3					
<b>1. Basic Settings/Image Quality</b>										
Custom Mode	C1	Recall	—	—	—	56				
		Assign	Shooting Mode: P Image quality: <b>L</b> F+RAW	—	—		—			
		Save Settings	Reset	—	✓		—			
	C2	Recall	—	—	—		56			
		Assign	Shooting Mode: P Image quality: <b>L</b> F+RAW	—	—			—		
		Save Settings	Reset	—	✓			—		
	C3	Recall	—	—	—			56		
		Assign	Shooting Mode: P Image quality: <b>L</b> F+RAW	—	—				—	
		Save Settings	Reset	—	✓				—	
	C4	Recall	—	—	—				56	
		Assign	Shooting Mode: P Image quality: <b>L</b> F+RAW	—	—					—
		Save Settings	Reset	—	✓					—
		<b>L</b> F	✓	✓	✓	140				
Detailed Settings	1	Pixel Count: <b>L</b> Compression: SF	✓	✓	—	140				
	2	Pixel Count: <b>L</b> Compression: F	✓	✓	—					
	3	Pixel Count: <b>L</b> Compression: N	✓	✓	—					
	4	Pixel Count: <b>M</b> Compression: N	✓	✓	—					
Image Aspect		4:3	✓	✓	✓	144				
Image Review		Off	✓	✓	—	42				
Shading Comp.		Off	✓	✓	✓	144				
<b>2. Picture Mode/WB</b>										
Picture Mode		<b>3</b> Natural	✓	✓	✓	145				
Picture Mode Settings		All items: ✓	✓	✓	—	149				
WB		WB Auto	✓	✓	✓	150				
All WB	A-B	0	✓	✓	—	153				
	G-M	0	✓	✓	—					
<sup>WB</sup> <sub>AUTO</sub> Keep Warm Color		On	✓	✓	✓	154				
+WB		Off	✓	✓	—	154				
Color Space		sRGB	✓	✓	✓	155				

Page	Function		Default	*1	*2	*3	
3. ISO/Noise Reduction							
	ISO-A	Upper Limit	25600	✓	✓	✓	114
	Upper/Default	Default	200	✓	✓	✓	
	ISO-A Lowest S/S		Auto	✓	✓	✓	115
	ISO-Auto		P/A/S/M	✓	✓	—	115
	ISO Step		1/3EV	✓	✓	✓	114
	Noise Filter		Standard	✓	✓	✓	116
	Low ISO Processing		Drive Priority	✓	✓	✓	116
	Noise Reduction		Auto	✓	✓	✓	117
4. Exposure							
	Flicker Scan		Off	✓	✓	✓	108
	EV Step		1/3EV	✓	✓	✓	107
Exposure Shift			±0	✓	✓	—	107
			±0	✓	✓	—	
			±0	✓	✓	—	
5. Metering							
	Metering			✓	✓	✓	109
	Metering during <b>(AEL)</b>		Auto	✓	✓	✓	110
	<b>(AEL)</b> Auto Reset		No	✓	✓	✓	110
	AEL by half-pressing		S-AF Only	✓	✓	✓	111
	Metering during		Yes	✓	✓	✓	112
	<b>[:::]</b> Spot Metering		All items: ✓	✓	✓	✓	112
6. Flash							
	RC Mode		Off	✓	✓	✓	124
	X-Sync.		1/250sec	✓	✓	✓	124
	Slow Limit		1/60sec	✓	✓	✓	124
			Off	✓	✓	✓	124
	Balanced Flash Metering		Off	✓	✓	✓	125
Flash Mode Settings	Reduce Red-eye		No	✓	✓	✓	123
	Synchro Settings		First Curtain	✓	✓	✓	

Page	Function	Default	*1	*2	*3	
7.	Drive Mode					
	Drive	<input type="checkbox"/>	✓	✓	✓	126
	Anti-Flicker Shooting	Off	✓	✓	✓	135
	Sequential Shooting Settings	✓	✓	✓	—	128
	Max fps	10fps	✓	✓	✓	
	Frame Count Limiter	Off	✓	✓	✓	
		✓	✓	✓	—	
	Max fps	20fps	✓	✓	✓	
	Frame Count Limiter	Off	✓	✓	✓	
	SH1	✓	✓	✓	—	
	Max fps	120fps	✓	✓	✓	
	Frame Count Limiter	Off	✓	✓	✓	
	SH2	✓	✓	✓	—	
	Max fps	50fps	✓	✓	✓	
	Frame Count Limiter	Off	✓	✓	✓	
	ProCap	✓	✓	✓	—	
	Max fps	20fps	✓	✓	✓	
	Pre-shutter Frames	10	✓	✓	✓	
	Frame Count Limiter	50	✓	✓	✓	
	ProCap SH1	✓	✓	✓	—	
	Max fps	128fps	✓	✓	✓	
	Pre-shutter Frames	28	✓	✓	✓	
	Frame Count Limiter	50	✓	✓	✓	
	ProCap SH2	✓	✓	✓	—	
	Max fps	50fps	✓	✓	✓	
	Pre-shutter Frames	12	✓	✓	✓	
	Frame Count Limiter	50	✓	✓	✓	
	Self-timer Settings	✓	✓	✓	—	130
	12	<input type="checkbox"/> (without ✓)	✓	✓	—	
	2	✓	✓	✓	—	
	2	✓	✓	✓	—	
	C	✓	✓	✓	—	
	Number of Frames	3f	✓	✓	✓	
	Timer	1sec	✓	✓	✓	
	Interval Length	0.5sec	✓	✓	✓	
	Every Frame AF	Off	✓	✓	✓	
	C	<input type="checkbox"/> (without ✓)	✓	✓	—	
	Number of Frames	3f	✓	✓	✓	
	Timer	1sec	✓	✓	✓	
	Interval Length	0.5sec	✓	✓	✓	
	Every Frame AF	Off	✓	✓	✓	
	Anti-Shock	Off	✓	✓	—	131
	Settings Waiting Time	0sec	✓	✓	—	
	Silent  Settings	Waiting Time	0sec	✓	✓	132
	Noise Reduction	Off	✓	✓	—	
		Not Allow	✓	✓	—	
	AF Illuminator	Not Allow	✓	✓	—	
	Flash Mode	Not Allow	✓	✓	—	

Page	Function	Default	*1	*2	*3	
8. Image Stabilizer						
	Image Stabilizer	S-IS Auto	✓	✓	✓	136
	Image Stabilizer	Fps Priority	✓	✓	✓	138
	Image Stabilizer	On	—	✓	✓	138
	Handheld Assist	Off	✓	✓	✓	139
	Lens I.S. Priority	Off	✓	✓	✓	139

## 2 Tab

Page	Function	Default	*1	*2	*3	
1. Computational Modes						
High Res Shot	High Res Shot	Off	✓	✓	✓	156
		F+RAW	✓	✓	✓	
	Waiting Time	0sec	✓	✓	—	
		0sec	✓	✓	—	
Live ND Shooting	Live ND Shooting	Off	✓	✓	✓	158
	ND Number	ND8(3EV)	✓	✓	—	
	LV Simulation	On	✓	✓	—	
Focus Stacking	Focus Stacking	Off	✓	✓	✓	160
	Set number of shots	8	✓	✓	—	
	Set focus differential	5	✓	✓	—	
		0sec	✓	✓	—	
HDR		Off	✓	✓	✓	162
Multiple Exposure	Multiple Exposure	Off	—	✓	✓	163
	Auto Gain	Off	—	✓	✓	
	Overlay	Off	—	✓	✓	
2. Other Shooting Functions						
	Digital Tele-converter	Off	✓	✓	✓	166
Interval Shooting	Interval Shooting	Off	—	✓	✓	167
	Number of Frames	100	—	✓	✓	
	Start Waiting Time	00:00:01	—	✓	✓	
	Interval Length	00:00:01	—	✓	✓	
	Interval Mode	Time Priority	—	✓	✓	
	Exposure Smoothing	On	—	✓	✓	
	Time Lapse Movie	Off	—	✓	✓	
	Movie Settings	Movie Resolution	FullHD	—	✓	
	Frame Rate	10fps	—	✓	✓	
Keystone Comp.		Off	✓	✓	✓	170
Fisheye Compensation	Fisheye Compensation	Off	✓	✓	✓	171
	Angle	1	✓	✓	—	
		Correction	Off	✓	✓	
BULB/TIME/COMP Settings	Bulb/Time Focusing	On	✓	✓	✓	173
	Bulb/Time Timer	8min	✓	✓	✓	
	Live Composite Timer	3h	✓	✓	✓	
	Bulb/Time Monitor	-7	✓	✓	—	
	Live Bulb	Off	✓	✓	—	
	Live Time	0.5sec	✓	✓	—	
	Composite Settings	1/2sec	✓	✓	—	

Page	Function		Default	*1	*2	*3	
3. Bracketing							
	AE BKT		Off	✓	✓	✓	174
	WB BKT	A-B	Off	✓	✓	✓	175
		G-M	Off	✓	✓	✓	
	FL BKT		Off	✓	✓	✓	175
	ISO BKT		Off	✓	✓	✓	176
	ART BKT	ART BKT	Off	✓	✓	✓	177
		ART BKT Setting	ART only: ✓ (ART with multiple types: only the  type is checked ✓.)	✓	✓	✓	
	Focus BKT	Focus BKT	Off	✓	✓	✓	178
		Set number of shots	99	✓	✓	✓	
		Set focus differential	5	✓	✓	✓	
		Charge Time	0sec	✓	✓	✓	

## AF Tab

Page	Function		Default	*1	*2	*3	
1. AF							
	AF Mode		S-AF	✓	✓	✓	72
	AF+MF		Off	✓	✓	✓	82
	Starry Sky AF Setting	AF Priority	Speed	✓	✓	✓	85
		AF Operation	Start/Stop	✓	✓	✓	
		Release Priority	Off	✓	✓	✓	
	AF by half-pressing	S-AF	Yes	✓	✓	✓	83
		C-AF/C-AF+TR	Yes	✓	✓	✓	
	in MF mode		No	✓	✓	✓	84
	Release Priority	S-AF	Off	✓	✓	✓	84
		C-AF/C-AF+TR	On	✓	✓	✓	
2. AF							
	AF Illuminator		On	✓	✓	✓	96
	AF Area Pointer		On1	✓	✓	✓	96
	Face & Eye Detection		Off	✓	✓	—	88
	Face & Eye AF Button		Priority	✓	✓	✓	89
			Priority	✓	✓	✓	
	Subject Detection		Off	✓	✓	—	90
	Eye Detection Frame		On	✓	✓	—	91

Page	Function	Default	*1	*2	*3		
3. AF							
	C-AF Sensitivity	±0	✓	✓	✓	87	
	C-AF Center Priority	Cross	✓	✓	✓	86	
		Mid	✓	✓	✓		
		Large	✓	✓	✓		
		C1	<input type="checkbox"/> (without ✓)	✓	✓		
		C2	<input type="checkbox"/> (without ✓)	✓	✓		
		C3	<input type="checkbox"/> (without ✓)	✓	✓		
		C4	<input type="checkbox"/> (without ✓)	✓	✓		
	AF Limiter	AF Limiter	Off	✓	✓	✓	92
		Distance for On1	5.0 - 999.9m	✓	✓	✓	
		Distance for On2	10.0 - 999.9m	✓	✓	✓	
		Distance for On3	50.0 - 999.9m	✓	✓	✓	
		Release Priority	On	✓	✓	✓	
	AF Scanner		On	✓	✓	✓	94
	AF Focus Adjustment	AF Focus Adjustment	Off	✓	✓	—	95
		Fine-tuning Value	±0	—	—	—	
4. Movie AF							
	AF Mode	C-AF		✓	✓	✓	72
	C-AF Speed		±0	✓	✓	✓	87
	C-AF Sensitivity		±0	✓	✓	✓	87
5. AF Target Settings & Operations							
	AF Target Mode Settings	All	✓	✓	✓	—	79
		Single	✓	✓	✓	—	
		Cross	✓	✓	✓	—	
		Mid	✓	✓	✓	—	
		Large	✓	✓	✓	—	
		C1	<input type="checkbox"/> (without ✓)	✓	✓	—	
		C2	<input type="checkbox"/> (without ✓)	✓	✓	—	
		C3	<input type="checkbox"/> (without ✓)	✓	✓	—	
		C4	<input type="checkbox"/> (without ✓)	✓	✓	—	
	Orientation Linked	AF Target Mode	<input type="checkbox"/> (without ✓)	✓	✓	—	97
		AF Target Point	<input type="checkbox"/> (without ✓)	✓	✓	—	
	[::] Set Home	AF Target Mode	✓ ( All)	✓	✓	✓	98
		AF Target Point	✓	✓	✓	✓	
	[::] Select Screen Settings	dial button	[::] Mode	✓	✓	✓	99
		button	Pos	✓	✓	✓	
	[::] Loop Settings	[::] Loop Selection	Off	✓	✓	✓	100
		Via  All	No	✓	✓	✓	
		AF Targeting Pad	Off	✓	✓	✓	101
6. MF							
	MF Assist	Magnify	Off	✓	✓	—	102
		Peaking	Off	✓	✓	—	
		Focus Indicator	Off	✓	✓	—	
	Peaking Settings	Peaking Color	Red	✓	✓	—	103
		Highlight Intensity	Normal	✓	✓	—	
		Image Brightness Adj.	Off	✓	✓	—	
		Preset MF distance	999.9m	✓	✓	✓	104
		MF Clutch	Operative	✓	✓	✓	104
		Focus Ring	C	✓	✓	—	104
		Reset Lens	Off	✓	✓	—	105

Page	Function	Default	*1	*2	*3	
1. Basic Settings/Image Quality						
	Video Codec	H.264	✓	✓	✓	144
	Resolution	4K60p L-8	✓	✓	✓	141
	Mode	P	—	✓	—	59
	Flicker Scan	Off	—	✓	✓	108
	Digital Tele-converter	Off	—	✓	✓	166
2. Picture Mode/WB						
	Picture Mode	Same as	✓	✓	✓	145
	View Assist	Off	—	✓	—	155
	WB	WB Auto	—	✓	✓	150
	All	A-B	0	—	✓	153
		G-M	0	—	✓	—
	Keep Warm Color	On	—	✓	✓	154
3. ISO/Noise Reduction						
	ISO-A	Upper Limit	12800	—	✓	114
		Upper/Default	200	—	✓	
	ISO-Auto	On	—	✓	—	115
	Noise Filter	Standard	—	✓	✓	116
4. Image Stabilizer						
	Image Stabilizer	M-IS1	—	✓	✓	136
	IS Level	±0	—	✓	✓	137
5. Sound Recording/Connection						
Sound Recording Settings	Recording Volume	Built-In  / MIC	±0	—	✓	180
	Volume Limiter		On	—	✓	
	Wind Noise Reduction		Off	—	✓	
	Recording Rate		48kHz/16bit	—	✓	
	Plug-in Power		Off	—	✓	
Headphone Volume			8	—	✓	181
Time Code Settings	Time Code Mode		Drop Frame	—	✓	181
	Count Up		Rec Run	—	✓	
	Starting Time		—	—	✓	
HDMI Output	Output Mode		Monitor	—	✓	182
	REC Bit		Off	—	✓	
	Time Code		On	—	✓	
6. Shooting Assist						
	Center Marker		Off	—	✓	183
Zebra Pattern Settings	Zebra Pattern Settings		Off	—	✓	184
	Level 1		80	—	✓	
	Level 2		Off	—	✓	
	Red Frame during  REC		On	—	✓	185

## ▶ Tab

Page	Function	Default	*1	*2	*3	
1. File						
		—	—	—	—	198
	Reset All Images	—	—	—	—	198
	Copy All	—	—	—	—	194
	Erase All	—	—	✓	—	194
2. Operations						
	Function	<input checked="" type="checkbox"/>	—	✓	—	205
	Dial Function	/	—	✓	—	205
	Default Setting	Recently	—	✓	—	205
	Quick Erase	Off	—	✓	✓	195
	RAW+JPEG Erase	RAW+JPEG	—	✓	—	195
	RAW+JPEG	JPEG	—	✓	—	196
3. Displays						
		On	—	✓	✓	205
	Info Settings	All items: ✓	—	✓	✓	206
	Info Settings	All items: ✓	—	✓	—	206
	Settings	[25] and [Calendar]: ✓	—	✓	—	207
	Rating Settings	All items: ✓	—	✓	—	196



# ☼ Tab





Page	Function	Default	*1	*2	*3			
1. Operations								
Button Settings	☼ Button Function		Exposure Comp.	✓	✓	—	208	
			High Res Shot	✓	✓	—		
			ISO	✓	✓	—		
			AF-ON	✓	✓	—		
			AEL	✓	✓	—		
			View Selection	✓	✓	—		
			Off	✓	✓	—		
			Off	✓	✓	—		
			Off	✓	✓	—		
			Preview	✓	✓	—		
			PBH Exposure Comp.	✓	✓	—		
			PBH Exposure Comp.	✓	✓	—		
			PBH ISO	✓	✓	—		
			PBH AF-ON	✓	✓	—		
		PBH AF-ON	✓	✓	—			
		PBH AF-ON	✓	✓	—			
		L-Fn AF Stop	✓	✓	—			
	☼ Button Function	☼ Button Function		Exposure Comp.	—	✓	—	208
				REC	—	✓	—	
				ISO	—	✓	—	
			AF-ON	—	✓	—		
			AEL	—	✓	—		
			View Selection	—	✓	—		
			Off	—	✓	—		
			Off	—	✓	—		
			Off	—	✓	—		
			Peaking	—	✓	—		
			Magnify	—	✓	—		
			PBH Exposure Comp.	—	✓	—		
			PBH ISO	—	✓	—		
			PBH AF-ON	—	✓	—		
	PBH AF-ON	—	✓	—				
	L-Fn AF Stop	—	✓	—				
	☼ Shutter Function	Off	—	✓	—	216		

Page	Function		Default	*1	*2	*3					
Dial Settings	Dial Function	P	Level 1	: Exposure Comp. : Ps	✓	✓	—	216			
			Level 2	: ISO : WB							
		A	Level 1	: Exposure Comp. : Aperture Value							
			Level 2	: ISO : WB							
		S	Level 1	: Exposure Comp. : Shutter Speed							
			Level 2	: ISO : WB							
		M/B	Level 1	: Aperture Value : Shutter Speed nnnn							
			Level 2	: Exposure Comp. : ISO							
		Dial Function	P	Level 1	: Exposure Comp. : Exposure Comp.	—	✓		—	216	
				Level 2	: VOL : VOL						
			A	Level 1	: Exposure Comp. : Aperture Value						
				Level 2	: VOL : VOL						
	S		Level 1	: Exposure Comp. : Shutter Speed							
			Level 2	: VOL : VOL							
	M		Level 1	: Aperture Value : Shutter Speed							
			Level 2	: VOL : ISO							
	Loop in Menu Tab			No	—	✓	—	238			
	Dial		Exposure	Dial1	✓	✓	—	218			
	Direction	Ps	Dial1	✓	✓	—					

Page	Function	Default	*1	*2	*3		
Multi Selector Settings	Center Button	Off	✓	✓	—	218	
	Direction Key	[.:.]	✓	✓	—		
	Fn Lever Settings	Fn Lever Function	mode2	—	✓	—	220
		Fn Lever Function	mode2	—	✓	—	220
		Fn Lever/Power Lever	Fn	—	✓	—	222
	Electronic Zoom Settings	Elec. Zoom Speed	Normal	✓	✓	—	222
Elec. Zoom Speed		Normal	—	✓	—		
Lock		Off	✓	✓	—	223	
<b>2. Operations</b>							
	LV Close Up Mode	mode2	✓	✓	—	223	
	Lock	Off	✓	✓	—	224	
	Priority Set	No	—	✓	—	238	
Menu Cursor Settings	Page Cursor Position	Reset	—	✓	—	237	
	Menu Start Position	Recently	—	✓	—		
	Shortcut to B Mode Settings	On	✓	✓	—		
Press-and-hold Time	End LV  Q	0.7sec	✓	✓	—	224	
	Reset LV  Q Frame	0.7sec	✓	✓	—		
	Reset  Z	0.7sec	✓	✓	—		
	Reset  Z	0.7sec	✓	✓	—		
	Reset  WB	0.7sec	✓	✓	—		
	Reset  I	0.7sec	✓	✓	—		
	Reset  C	0.7sec	✓	✓	—		
	Reset  S	0.7sec	✓	✓	—		
	Reset [.:.]	0.7sec	✓	✓	—		
	Call EVF Auto Switch	0.7sec	✓	✓	—		
	Reset  WB	0.7sec	✓	✓	—		
	End  WB	0.7sec	✓	✓	—		
	Switch  Lock	0.7sec	✓	✓	—		
	End Flicker Scan	0.7sec	✓	✓	—		
	Call WB BKT Setting	0.7sec	✓	✓	—		
	Call ART BKT Setting	0.7sec	✓	✓	—		
Call Focus BKT Setting	0.7sec	✓	✓	—			
Call  Setting	0.7sec	✓	✓	—			
<b>3. Live View</b>							
	LV Mode	Standard	✓	✓	—	225	
	Night Vision	Off	✓	✓	—	225	
	Frame Rate	Normal	✓	✓	—	225	
	Art LV Mode	mode1	✓	✓	—	226	
	Anti-Flicker LV	Off	✓	✓	—	226	
	Selfie Assist	On	—	✓	—	227	

Page	Function	Default	*1	*2	*3	
4. Information						
	EVF Style	Style 2	—	✓	—	228
	Info Settings	[Image Only], [Information 1] and [Information 2]: ✓	✓	✓	—	230
	Info by half-pressing	On2	✓	✓	—	231
	Info Settings	[Image Only], [Information 1] and [Information 2]: ✓	✓	✓	—	232
	Level Gauge	On	✓	✓	—	233
	Info Settings	[Image Only] and [Information 1]: ✓	—	✓	—	231
5. Grid/Other Displays						
Grid Settings	Display Color	Preset 1	✓	✓	—	234
	Displayed Grid	Off	✓	✓	—	
	Color of Preset 1	R/G/B: 38 α: 75%	✓	✓	—	
	Color of Preset 2	R: 180 G/B: 0 α: 75%	✓	✓	—	
Grid Settings	Exclusive for	Off	✓	✓	—	235
	Display Color	Preset 1	✓	✓	—	
	Displayed Grid	Off	✓	✓	—	
	Color of Preset 1	R/G/B: 38 α: 75%	✓	✓	—	
	Color of Preset 2	R: 180 G/B: 0 α: 75%	✓	✓	—	
Grid Settings	Exclusive for	Off	—	✓	—	234
	Display Color	Preset 1	—	✓	—	
	Displayed Grid	Off	—	✓	—	
	Color of Preset 1	R/G/B: 38 α: 75%	—	✓	—	
	Color of Preset 2	R: 180 G/B: 0 α: 75%	—	✓	—	
Multi Function Settings		All items except ISO: ✓	✓	✓	—	236
Histogram Settings	Highlight	255	✓	✓	—	236
	Shadow	0	✓	✓	—	

Page	Function	Default	*1	*2	*3																		
1. Card/Folder/File																							
	Card Formatting	—	—	—	—	241																	
	<div style="display: flex; justify-content: space-between;"> <div style="width: 20%;">  Card Slot Settings                 </div> <div style="width: 60%;"> <div style="display: flex; justify-content: space-between;"> <div style="width: 30%;">  Save Settings   Save Slot   Slot                     </div> <div style="width: 70%;"> <table border="1"> <tr> <td>Standard</td> <td>✓</td> <td>✓</td> <td>—</td> </tr> <tr> <td>1</td> <td>✓</td> <td>✓</td> <td>—</td> </tr> <tr> <td>1</td> <td>✓</td> <td>✓</td> <td>—</td> </tr> </table> </div> </div> </div> </div>	Standard	✓	✓	—	1	✓	✓	—	1	✓	✓	—	242									
Standard	✓	✓	—																				
1	✓	✓	—																				
1	✓	✓	—																				
	<div style="display: flex; justify-content: space-between;"> <div style="width: 20%;">  Card Slot Settings                 </div> <div style="width: 80%;"> <table border="1"> <tr> <td>Assign Save Folder</td> <td>Do not assign</td> <td>—</td> <td>✓</td> <td>—</td> </tr> <tr> <td>File Name</td> <td>Reset</td> <td>—</td> <td>✓</td> <td>—</td> </tr> <tr> <td rowspan="2">Edit Filename</td> <td>sRGB</td> <td>M D D</td> <td>—</td> <td>✓</td> <td>—</td> </tr> <tr> <td>Adobe RGB</td> <td>M D D</td> <td>—</td> <td>✓</td> <td>—</td> </tr> </table> </div> </div>	Assign Save Folder	Do not assign	—	✓	—	File Name	Reset	—	✓	—	Edit Filename	sRGB	M D D	—	✓	—	Adobe RGB	M D D	—	✓	—	243
Assign Save Folder	Do not assign	—	✓	—																			
File Name	Reset	—	✓	—																			
Edit Filename	sRGB	M D D	—	✓	—																		
	Adobe RGB	M D D	—	✓	—																		
	Assign Save Folder	Do not assign	—	✓	—	244																	
	File Name	Reset	—	✓	—	244																	
	Edit Filename	sRGB	M D D	—	✓	—	245																
		Adobe RGB	M D D	—	✓	—																	
2. Information Record																							
	Lens Info Settings	Off	—	✓	—	246																	
	dpi Settings	350dpi	✓	✓	—	247																	
	Copyright Info.	Copyright Info.	Off	✓	✓	—	247																
		Artist Name	—	—	—	—																	
		Copyright Name	—	—	—	—																	
3. Monitor/Sound/Connection																							
	Touchscreen Settings	On	—	✓	—	249																	
	Monitor Adjust	±0	✓	✓	—	249																	
	EVF Adjust	⌘ (Color temperature)	A0, G0	✓	✓	—																	
		⌘ (Color temperature)	Auto	✓	✓	—	250																
	Eye Sensor Settings	EVF Auto Switch	On	—	✓	—	250																
		Behavior when switched	Maintain Screen	—	✓	—																	
		When Monitor is Opened	Inoperative	—	✓	—																	
	HDMI Settings	Output Size	On	✓	✓	—	251																
		Output Frame Rate	4K	—	✓	—	251																
	USB Settings	USB Mode	60p Priority	—	—	—																	
		Power Supply from USB	Select	—	✓	—	252																
		Yes	—	✓	—																		
4. Wi-Fi/Bluetooth																							
	Airplane Mode	Off	—	✓	—	260																	
	Bluetooth	Off	—	✓	—	262																	
	Wireless Shutter Setting	—	—	—	—	279																	
	Wi-Fi Connection	—	—	✓	—	271																	
	Settings	Power-off Standby	Off	—	✓	—	263																
		Connection Password	—	—	—	—	267																
		Reset Settings	—	—	—	—	266																
	Wi-Fi PC Settings	Wi-Fi MAC Address	—	—	—	276																	
		Reset Wi-Fi PC Settings	—	—	—																		
5. Battery/Sleep																							
	Battery Status	—	—	—	—	253																	
	Battery Priority	PBH Battery	—	✓	—	253																	
	Display Pattern	min	—	✓	—	253																	
	Backlit LCD	Hold	✓	✓	—	254																	
	Sleep	1min	✓	✓	—	254																	
	Auto Power Off	4h	✓	✓	—	254																	
	Quick Sleep Mode	Quick Sleep Mode	Off	✓	✓	—	255																
		Backlit LCD	8sec	✓	✓	—																	
		Sleep	10sec	✓	✓	—																	

Page	Function		Default	*1	*2	*3	
6. Reset/Clock/Language/Others							
	Reset/	Reset Shooting Settings	—	—	—	—	257
	Initialize Settings	Initialize All Settings	—	—	—	—	
	 Settings		—	—	—	—	257
		Time Zone	—	—	—	—	
			—	—	—	—	257
	Level Adjust		—	—	✓	—	258
	Pixel Mapping		—	—	—	—	258
	Firmware Version		—	—	—	—	258
	Certification		—	—	—	—	258

## Memory Card Capacity

### Memory Card Capacity: Photos

Figures are for a 64 GB SDXC card used to record photos with an aspect ratio of 4:3.

Record mode	Image size (Pixel Count)	Compression ratio	File format	File size (MB) (approx.)	Number of storable still pictures
80M F+RAW	(Tripod) 10368x7776	Loss-less compression	ORF	(Tripod) 183.6	(Tripod) 323
	10368x7776	1/4	JPEG		
	5184x3888	Loss-less compression	ORI		
50M F+RAW	(Tripod) 10368x7776	Loss-less compression	ORF	(Tripod) 170.4	(Tripod) 350
	(Handheld) 8160x6120				
	8160x6120	1/4	JPEG	(Handheld) 122.9	(Handheld) 483
	5184x3888	Loss-less compression	ORI		
25M F+RAW	(Tripod) 10368x7776	Loss-less compression	ORF	(Tripod) 159.7	(Tripod) 376
	(Handheld) 8160x6120				
	5760x4320	1/4	JPEG	(Handheld) 112.2	(Handheld) 534
	5184x3888	Loss-less compression	ORI		
80M F	10368x7776	1/4	JPEG	35.2	1564
50M F	8160x6120	1/4	JPEG	22	2503
25M F	5760x4320	1/4	JPEG	11.2	4882
RAW	5184x3888	Loss-less compression	ORF	22.4	2727
L SF		1/2.7	JPEG	13.4	4103
L F		1/4		9.2	5954
L N		1/8		4.9	11355
M1 SF	3200x2400	1/2.7	JPEG	5.4	10172
M1 F		1/4		3.8	14360
M1 N		1/8		2.2	24413
M2 SF	1920x1440	1/2.7	JPEG	2.3	24413
M2 F		1/4		1.7	32551
M2 N		1/8		1.1	48827
S1 SF	1280x960	1/2.7	JPEG	1.3	40689
S1 F		1/4		1.1	48827
S1 N		1/8		0.4	122067
S2 SF	1024x768	1/2.7	JPEG	1.1	54252
S2 F		1/4		0.5	122067
S2 N		1/8		0.3	162756

- The number of storable still pictures may change according to the subject, whether or not print reservations have been made, and other factors. In certain instances, the number of storable still pictures displayed on the monitor will not change even when you take pictures or erase stored images.
- The actual file size varies according to the subject.
- The maximum number of storable still pictures displayed on the monitor is 9999.

### Memory Card Capacity: Movies

Figures are for a 64 GB SDXC memory card.

Frame size	Motion compensation	Playback frame rate	Capacity (approx.)	
			When [Video Codec] is set to [H.264]	When [Video Codec] is set to [H.265]
C4K	—	59.94p	41 minutes	54 minutes
		50.00p	41 minutes	54 minutes
		29.97p	81 minutes	108 minutes
		25.00p	81 minutes	108 minutes
		24.00p	81 minutes	108 minutes
		23.98p	81 minutes	108 minutes
4K	—	59.94p	41 minutes	54 minutes
		50.00p	41 minutes	54 minutes
		29.97p	81 minutes	108 minutes
		25.00p	81 minutes	108 minutes
		23.98p	81 minutes	108 minutes
		23.98p	81 minutes	108 minutes
FHD	A-I	29.97p	41 minutes	101 minutes
		25.00p	41 minutes	101 minutes
		23.98p	41 minutes	101 minutes
	L-GOP	59.94p	160 minutes	199 minutes
		50.00p	160 minutes	199 minutes
		29.97p	312 minutes	384 minutes
		25.00p	312 minutes	384 minutes
		23.98p	312 minutes	384 minutes
		23.98p	312 minutes	384 minutes

- Figures are for footage recorded at the maximum frame rate. The actual bit rate varies with the frame rate and scene recorded.
- When an SDXC card is used, movies over 3 hours are recorded over multiple files (depending on shooting conditions, the camera may start recording to a new file before the 3-hour limit is reached).
- When an SD/SDHC card is used, movies over 4 GB in size are recorded over multiple files (depending on shooting conditions, the camera may start recording to a new file before the 4 GB limit is reached).



## Specifications

### ■ Camera

Product type	
Product type	Digital camera with interchangeable Micro Four Thirds Standard lens system
Lens	M.ZUIKO DIGITAL, Micro Four Thirds System Lens
Lens mount	Micro Four Thirds mount
Equivalent focal length on a 35 mm film camera	Approx. twice the focal length of the lens
Image pickup device	
Product type	4/3" Live MOS sensor
Total no. of pixels	Approx. 22.93 million pixels
No. of effective pixels	Approx. 20.37 million pixels
Screen size	17.4 mm (H) × 13.0 mm (V)
Aspect ratio	1.33 (4:3)
Viewfinder	
Type	Electronic viewfinder with eye sensor
No. of pixels	Approx. 5.76 million dots
Magnification	100%
Eye point	Approx. 21 mm (-1 m <sup>-1</sup> )
Live view	
Sensor	Uses Live MOS sensor
Magnification	100%
Monitor	
Product type	3.0" TFT color LCD, Vari-angle, touch screen
Total no. of pixels	Approx. 1.62 million dots (aspect ratio 3:2)
Shutter	
Product type	Computerized focal-plane shutter
Shutter speed	1/8000 - 60 sec., bulb photography, time photography
Flash sync speed	Up to 1/250 sec.
Auto focus	
Product type	Hi-Speed Imager AF
Focusing points	1053 points
Selection of focusing point	Auto, Optional
Exposure control	
Metering system	TTL metering system (imager metering) Digital ESP metering/Center weighted averaging metering/Spot metering
Metered range	-2 to 20 EV (f/2.8, ISO 100 equivalent)
Shooting modes	<b>P</b> : Program AE (program shift available); <b>A</b> : Aperture priority AE; <b>S</b> : Shutter-priority AE; <b>M</b> : Manual; <b>B</b> : Bulb (bulb, time, and composite); C1/C2/C3/C4: Custom Modes; <b>MOV</b> : Movie
ISO sensitivity	L80; L100; 200 - 25600 in steps of 1/3 or 1 EV
Exposure compensation	±5.0 EV (1/3, 1/2, 1 EV step)

<b>White balance</b>	
Mode setting	Auto/Preset WB (7 settings)/Customized WB/One-touch WB (camera can store up to 4 settings)
<b>Recording</b>	
Memory	SD, SDHC and SDXC UHS-II compatible
Recording system	Digital recording, JPEG (DCF2.0), RAW Data
Applicable standards	Exif 2.31, Digital Print Order Format (DPOF)
Sound with still pictures	Wave format
Movie	MOV (H.264/MPEG-4 AVC, H.265/HEVC)
Audio	Stereo linear PCM, 16 bit; sampling frequency 48 kHz (wave format) Stereo linear PCM, 24 bit; sampling frequency 96 kHz (wave format)
<b>Playback</b>	
Display format	Single-frame playback/Close-up playback/Index display/Calendar display
<b>Drive</b>	
Drive mode	Single frame; sequential; anti-shock; silent; Pro Capture; self-timer
Sequential shooting	Up to 10 fps (📷) Up to 20 fps (♥📷/ProCap) Up to 50 fps (♥📷/ProCap SH2) Up to 120 fps (♥📷/ProCap SH1)
Self-timer	Operation time: 12 sec./2 sec./Customized
Energy saving function	Switch to sleep mode: 1 minute, Power OFF: 4 hours (This function can be customized.)
<b>Flash</b>	
Flash control mode	TTL-AUTO (TTL pre-flash mode)/MANUAL
X-Sync.	1/250 s or slower
<b>Wireless LAN</b>	
Compatible standard	IEEE 802.11a/b/g/n/ac*
<b>Bluetooth®</b>	
Compatible standard	Bluetooth Version 4.2 BLE
<b>External connector</b>	
USB (Type C); HDMI micro connector (type D); external flash; remote cable (ø2.5 mm mini-jack); microphone jack (ø3.5 mm stereo mini-jack); headphone jack (ø3.5 mm stereo mini-jack)	
<b>Power supply</b>	
Battery	Lithium-ion Battery x1
<b>Dimensions/weight</b>	
Dimensions	Approx. 134.8 mm (W) x 91.6 mm (H) x 72.7 mm (D) (5.4" x 3.7" x 2.9") (excluding protrusions)
Weight	Approx. 599 g (1.3 lb.) (including battery and memory card)
<b>Operating environment</b>	
Temperature	-10 °C - 40 °C (14 °F - 104 °F) (operation)/ -20 °C - 60 °C (-4 °F - 140 °F) (storage)
Humidity	30% - 90% (operation)/10% - 90% (storage)
Water resistance	Type: IEC Standard publication 60529 IPX3 (applies if camera is used with our IPX3 or higher water-resistant lens)

\* Note that cameras have been developed in line with the different standards of the countries.

### ■ Flash

MODEL NO.	FL-LM3
Guide number	9.1 (ISO100•m) 12.7 (ISO200•m)
Firing angle	Covers the picture angle of a 12 mm lens (equivalent to 24 mm in 35 mm format)
Dimensions	Approx. 43.6 mm (W) × 49.4 mm (H) × 39 mm (D) (1.7" × 1.9" × 1.5")
Weight	Approx. 51 g (1.8 oz.)
Splash resistance	Type Equivalent to IEC Standard publication 60529 IPX1

### ■ Lithium-ion battery

MODEL NO.	BLX-1
Type	Rechargeable Lithium-ion battery
Nominal voltage	DC 7.2 V
Nominal capacity	2280 mAh
No. of charge and discharge times	Approx. 500 times (varies with usage conditions)
Ambient temperature	0 °C - 40 °C (32 °F - 104 °F) (charging)
Dimensions	Approx. 40 mm (W) × 22 mm (H) × 55 mm (D) (1.6" × 0.9" × 2.2")
Weight	Approx. 86 g (3.1 oz.)

### ■ USB-AC adapter

MODEL NO.	F-7AC-1/F-7AC-2
Rated input	AC 100 V - 240 V (50/60Hz)
Rated output	DC 5V, 3 A DC 9V, 3 A
Ambient temperature	0 °C - 40 °C (32 °F - 104 °F) (operation)/ -20 °C - 60 °C (-4 °F - 140 °F) (storage)

- The appearance and specifications of this product are subject to change without notice or obligation on the part of the manufacturer.
- Visit our website for the latest specifications.

The terms HDMI and HDMI High-Definition Multimedia Interface, and the HDMI Logo are trademarks or registered trademarks of HDMI Licensing Administrator, Inc. in the United States and other countries.

**HDMI**™  
HIGH-DEFINITION MULTIMEDIA INTERFACE

## SAFETY PRECAUTIONS



**CAUTION**  
RISK OF ELECTRIC SHOCK  
DO NOT OPEN



**CAUTION: TO REDUCE THE RISK OF ELECTRICAL SHOCK, DO NOT REMOVE COVER (OR BACK). NO USER-SERVICEABLE PARTS INSIDE. REFER SERVICING TO QUALIFIED SERVICE PERSONNEL.**



An exclamation mark enclosed in a triangle alerts you to important operating and maintenance instructions in the documentation provided with the product.

**WARNING**

If the product is used without observing the information given under this symbol, serious injury or death may result.

**CAUTION**

If the product is used without observing the information given under this symbol, injury may result.

**NOTICE**

If the product is used without observing the information given under this symbol, damage to the equipment may result.

**WARNING!**

**TO AVOID THE RISK OF FIRE OR ELECTRICAL SHOCK, NEVER DISASSEMBLE, EXPOSE THIS PRODUCT TO WATER OR OPERATE IN A HIGH HUMIDITY ENVIRONMENT.**

**General Precautions**

**Read All Instructions** — Before you use the product, read all operating instructions. Save all manuals and documentation for future reference.

**Power Source** — Connect this product only to the power source described on the product label.

**Foreign Objects** — To avoid personal injury, never insert a metal object into the product.

**Cleaning** — Always unplug this product from the wall outlet before cleaning. Use only a damp cloth for cleaning. Never use any type of liquid or aerosol cleaner, or any type of organic solvent to clean this product.

**Heat** — Never use or store this product near any heat source such as a radiator, heat register, stove, or any type of equipment or appliance that generates heat, including stereo amplifiers.

**Lightning** — If a lightning storm occurs while using a USB-AC adapter, remove it from the wall outlet immediately.

**Attachments** — For your safety, and to avoid damaging the product, use only accessories recommended by our company.

**Location** — To avoid damage to the product, mount the product securely on a stable tripod, stand, or bracket.

**WARNING**

- **Do not use the camera near flammable or explosive gases.**
- **Rest your eyes periodically when using the viewfinder.**

Failure to observe this precaution could result in eyestrain, nausea, or sensations similar to motion sickness. The length and frequency of the required rest varies with the individual; use your own judgement. If you feel tired or unwell, avoid using the viewfinder and if necessary consult a physician.

- **Do not use the flash and LED (including AF illuminator) on people (infants, small children, etc.) at close range.**
  - You must be at least 1 m (3 ft.) away from the faces of your subjects. Firing the flash too close to the subject's eyes could cause a momentary loss of vision.

- **Do not look at the sun or strong lights with the camera.**
- **Keep young children, infants away from the camera.**
  - Always use and store the camera out of the reach of young children and infants to prevent the following dangerous situations which could cause serious injury:
    - Becoming entangled in the camera strap, causing strangulation.
    - Accidentally swallowing the battery, cards or other small parts.
    - Accidentally firing the flash into their own eyes or those of another child.
    - Accidentally being injured by the moving parts of the camera.
- **If you find that the USB-AC adapter or charger is extremely hot or notice any unusual odors, noise, or smoke around it, unplug the power plug from wall outlet immediately and stop using it. Then, contact an authorized distributor or service center.**
- **Stop using the camera immediately if you notice any unusual odors, noise, or smoke around it.**
  - Never remove the batteries with bare hands, which may cause a fire or burn your hands.
- Never hold or operate the camera with wet hands. This may cause overheating, exploding, burning, electrical shocks, or malfunctions.
- **Do not leave the camera in places where it may be subject to extremely high temperatures.**
  - Doing so may cause parts to deteriorate and, in some circumstances, cause the camera to catch fire. Do not use the charger or USB-AC adapter if it is covered (such as a blanket). This could cause overheating, resulting in fire.
- **Handle the camera with care to avoid getting a low temperature burn.**
  - When the camera contains metal parts, overheating can result in a low-temperature burn. Pay attention to the following:
    - When used for a long period, the camera will get hot. If you hold on to the camera in this state, a low-temperature burn may be caused.
    - In places subject to extremely cold temperatures, the temperature of the camera's body may be lower than the environmental temperature. If possible, wear gloves when handling the camera in cold temperatures.
- To protect the high-precision technology contained in this product, never leave the camera in the places listed below, no matter if in use or storage:
  - Places where temperatures and/or humidity are high or go through extreme changes. Direct sunlight, beaches, locked cars, or near other heat sources (stove, radiator, etc.) or humidifiers.
  - In sandy or dusty environments.
  - Near flammable items or explosives.
  - In wet places, such as bathrooms or in the rain.
  - In places prone to strong vibrations.
- The camera uses a lithium ion battery specified by our company. Charge the battery with the specified USB-AC adapter or charger. Do not use any other USB-AC adapters or chargers.
- Never incinerate or heat batteries in microwaves, on hot plates, or in pressure vessels, etc.
- Never leave the camera on or near electromagnetic devices. This may cause overheating, burning, or exploding.
- Do not connect terminals with any metallic objects.
- Take precautions when carrying or storing batteries to prevent them from coming into contact with any metal objects such as jewelry, pins, fasteners, keys, etc. The short circuit may cause overheating, exploding, or burning, which burn or damage you.
- To prevent causing battery leaks or damaging their terminals, carefully follow all instructions regarding the use of batteries. Never attempt to disassemble a battery or modify it in any way, solder, etc.
- If battery fluid gets into your eyes, flush your eyes immediately with clear, cold running water and seek medical attention immediately.
- If you cannot remove the battery from the camera, contact an authorized distributor or service center. Do not try to remove the battery by force. Damage to the battery exterior (scratches, etc.) may produce heat or an explosion.
- Always store batteries out of the reach of small children and pets. If they accidentally swallow a battery, seek medical attention immediately.
- To prevent batteries from leaking, overheating, or causing a fire or explosion, use only batteries recommended for use with this product.

- If rechargeable batteries have not been recharged within the specified time, stop charging them and do not use them.
- Do not use batteries with scratches or damage to the casing, and do not scratch the battery.
- Never subject batteries to strong shocks or continuous vibration by dropping or hitting. This may cause exploding, overheating, or burning.
- If a battery leaks, has unusual odor, becomes discolored or deformed, or becomes abnormal in any other way during operation, stop using the camera, and keep away from fire immediately.
- If a battery leaks fluid onto your clothing or skin, remove the clothing and flush the affected area with clean, running cold water immediately. If the fluid burns your skin, seek medical attention immediately.
- Never use lithium-ion batteries in a low-temperature environment. Doing so may cause generation of heat, ignition, or explosion.
- The lithium-ion battery is designed to be used only for the digital camera. Do not use the battery to other devices.
- **Do not allow children or animals/pets to handle or transport batteries (prevent dangerous behaviour such as licking, putting in mouth or chewing).**
- Keep batteries dry at all times.
- The battery may become hot during prolonged use. To avoid minor burns, do not remove it immediately after using the camera.
- This camera uses one of our lithium-ion batteries. Use the specified genuine battery. There is a risk of explosion if the battery is replaced with the incorrect battery type.
- Please recycle batteries to help save our planet's resources. When you throw away dead batteries, be sure to cover their terminals and always observe local laws and regulations.

## NOTICE

- **Do not use or store the camera in dusty or humid places.**
- **Use SD/SDHC/SXDC memory cards only. Never use other types of cards.**  
If you accidentally insert another type of card into the camera, contact an authorized distributor or service center. Do not try to remove the card by force.
- Regularly back up important data to a computer or other storage device to prevent accidental loss.
- Our company accepts no liability for any loss of data associated with this device.
- Be careful with the strap when you carry the camera. It could easily catch on stray objects and cause serious damage.
- Before transporting the camera, remove a tripod and all other accessories made by other companies.
- Never drop the camera or subject it to severe shocks or vibrations.
- When attaching the camera to or removing it from a tripod, rotate the tripod screw, not the camera.
- Do not touch electric contacts on cameras.
- Do not leave the camera pointed directly at the sun. This may cause lens or shutter curtain damage, color failure, ghosting on the image pickup device, or may possibly cause fires.
- Do not leave the viewfinder exposed to a strong light source or direct sunlight. The heat may damage the viewfinder.
- Do not push or pull severely on the lens.
- Be sure to remove any water droplets or other moisture from the product before replacing the battery or opening or closing covers.
- Before storing the camera for a long period, remove the batteries. Select a cool, dry location for storage to prevent condensation or mold from forming inside the camera. After storage, test the camera by turning it on and pressing the shutter button to make sure that it is operating normally.

## Use Only Dedicated Rechargeable Battery, Battery Charger and USB-AC adapter

We strongly recommend that you use only the genuine rechargeable battery, battery charger, and USB-AC adapter specified by our company with this camera. Using a non-genuine rechargeable battery, battery charger and/or USB-AC adapter may result in fire or personal injury due to leakage, heating, ignition or damage to the battery. Our company does not assume any liability for accidents or damage that may result from the use of a battery, battery charger, and/or USB-AC adapter that are not specified genuine accessories.

## CAUTION

- **Do not cover the flash with a hand while firing.**
- The included USB-AC adapter F-7AC is designed to be used only with this camera. Other cameras cannot be charged with this USB-AC adapter.
- Do not connect the included USB-AC adapter F-7AC to equipment other than this camera.
- Never store batteries where they will be exposed to direct sunlight, or subjected to high temperatures in a hot vehicle, near a heat source, etc.

- The camera may malfunction if it is used in a location where it is subject to a magnetic/ electromagnetic field, radio waves, or high voltage, such as near a TV set, microwave, video game, loud speakers, large monitor unit, TV/radio tower, or transmission towers. In such cases, turn the camera off and on again before further operation.
- Always observe the operating environment restrictions described in the camera's manual.
- Insert the battery carefully as described in the operating instructions.
- Before loading, always inspect the battery carefully for leaks, discoloration, warping, or any other abnormality.
- Always unload the battery from the camera before storing the camera for a long period.
- When storing the battery for a long period, select a cool location for storage.
- For plug-in type USB-AC adapter: Connect the plug-in type USB-AC adapter F-7AC correctly by plugging it vertically into the wall outlet.
- As the main plug of AC adapter is used to disconnect the AC adapter from the mains, connect it to an easily accessible AC outlet.
- Power consumption by the camera varies depending on which functions are used.
- During the conditions described below, power is consumed continuously and the battery becomes exhausted quickly.
  - The zoom is used repeatedly.
  - The shutter button is pressed halfway repeatedly in shooting mode, activating the auto focus.
  - A picture is displayed on the monitor for an extended period of time.
- Using an exhausted battery may cause the camera to turn off without displaying the battery level warning.
- If the battery's terminals get wet or greasy, camera contact failure may result. Wipe the battery well with a dry cloth before use.
- Always charge a battery when using it for the first time, or if it has not been used for a long period.
- When operating the camera with battery power at low temperatures, try to keep the camera and spare battery as warm as possible. A battery that has run down at low temperatures may be restored after it is warmed at room temperature.
- Before going on a long trip, and especially before traveling abroad, purchase extra batteries. A recommended battery may be difficult to obtain while traveling.

## Using the wireless LAN/ Bluetooth® functions

- **Turn off the camera in hospitals and other locations where medical equipment is present.**  
The radio waves from the camera may adversely affect medical equipment, causing a malfunction that results in an accident. Be sure to disable wireless LAN/**Bluetooth**® functions in the vicinity of medical equipment (P. 260).
- **Turn off the camera when onboard aircraft.**  
Using wireless devices onboard may hinder safe operation of the aircraft. Be sure to disable wireless LAN/**Bluetooth**® functions onboard aircraft (P. 260).
- **Do not use this product where it may interfere with nearby radar systems.**

## Monitor

- Do not push the monitor forcibly; otherwise the image may become vague, resulting in a playback mode failure or damage to the monitor.
- A strip of light may appear on the top/bottom of the monitor, but this is not a malfunction.
- When a subject is viewed diagonally in the camera, the edges may appear zigzagged on the monitor. This is not a malfunction; it will be less noticeable in playback mode.
- In places subject to low temperatures, the monitor may take a long time to turn on or its color may change temporarily.  
When using the camera in extremely cold places, it is a good idea to occasionally place it in a warm place. The monitor exhibiting poor performance due to low temperatures will recover in normal temperatures.
- The monitor of this product is manufactured with high-quality accuracy, however, there may be a stuck or dead pixel on the monitor. These pixels do not have any influence on the image to be saved. Because of the characteristics, the unevenness of the color or brightness may also be found depending on the angle, but this is due to the structure of the monitor. This is not a malfunction.

## Legal and Other Notices

- Our company makes no representations or warranties regarding any damages, or benefit expected by using this unit lawfully, or any request from a third person, which are caused by the inappropriate use of this product.
- Our company makes no representations or warranties regarding any damages or any benefit expected by using this unit lawfully which are caused by erasing picture data.

## Disclaimer of Warranty

- Our company makes no representations or warranties, either expressed or implied, by or concerning any content of these written materials or software, and in no event shall be liable for any implied warranty of merchantability or fitness for any particular purpose or for any consequential, incidental or indirect damages (including but not limited to damages for loss of business profits, business interruption and loss of business information) arising from the use or inability to use these written materials or software or equipment. Some countries do not allow the exclusion or limitation of liability for consequential or incidental damages or of the implied warranty, so the above limitations may not apply to you.
- Our company reserves all rights to this manual.

## Warning

Unauthorized photographing or use of copyrighted material may violate applicable copyright laws. Our company assumes no responsibility for unauthorized photographing, use or other acts that infringe upon the rights of copyright owners.

## Copyright Notice

All rights reserved. No part of these written materials or this software may be reproduced or used in any form or by any means, electronic or mechanical, including photocopying and recording or the use of any type of information storage and retrieval system, without the prior written permission of our company. No liability is assumed with respect to the use of the information contained in these written materials or software, or for damages resulting from the use of the information contained therein. Our company reserves the right to alter the features and contents of this publication or software without obligation or advance notice.

## Trademarks

- Microsoft and Windows are registered trademarks of Microsoft Corporation.
- SDXC Logo is a trademark of SD-3C, LLC.
- Apical logo is a registered trademark of Apical Limited.



- Micro Four Thirds, Four Thirds, and the Micro Four Thirds and Four Thirds logos are trademarks or registered trademarks of the OM Digital Solutions Corporation in Japan, the United States, the countries of the European Union, and other countries.
- Wi-Fi is a registered trademark of the Wi-Fi Alliance.
- The **Bluetooth**<sup>®</sup> word mark and logos are registered trademarks owned by the Bluetooth SIG, Inc. and any use of such marks by OM Digital Solutions Corporation is under license.
- The standards for camera file systems referred to in this manual are the "Design Rule for Camera File System/DCF" standards stipulated by the Japan Electronics and Information Technology Industries Association (JEITA).
- All other company and product names are registered trademarks and/or trademarks of their respective owners.

THIS PRODUCT IS LICENSED UNDER THE AVC PATENT PORTFOLIO LICENSE FOR THE PERSONAL AND NONCOMMERCIAL USE OF A CONSUMER TO (i) ENCODE VIDEO IN COMPLIANCE WITH THE AVC STANDARD ("AVC VIDEO") AND/OR (ii) DECODE AVC VIDEO THAT WAS ENCODED BY A CONSUMER ENGAGED IN A PERSONAL AND NON-COMMERCIAL ACTIVITY AND/OR WAS OBTAINED FROM A VIDEO PROVIDER LICENSED TO PROVIDE AVC VIDEO. NO LICENSE IS GRANTED OR SHALL BE IMPLIED FOR ANY OTHER USE. ADDITIONAL INFORMATION MAY BE OBTAINED FROM MPEG LA, L.L.C. SEE [HTTP://WWW.MPEGLA.COM](http://www.mpegla.com)

The software in this camera may include third party software. Any third party software is subject to the terms and conditions, imposed by the owners or licensors of that software, under which software is provided to you.

Those terms and other third party software notices, if any, may be found in the software notice PDF file stored at <https://cs.olympus-imaging.jp/en/support/imgsg/digicamera/download/notice/notice.cfm>



# Index

## Symbols

+WB .....	154
RC Mode.....	298
Slow Limit.....	124
X-Sync .....	124
(Protect) .....	193
(Uploading Pictures).....	284
.....	251
Image stabilizer.....	138
Auto Reset.....	110
Connection Password .....	267
in MF mode .....	84
Loop in Menu Tab.....	238
Settings .....	207
Image stabilizer.....	138
Detailed Settings .....	143
JMode Settings .....	78
Set Home .....	98
AF+MF .....	82
AF by half-pressing .....	83
AF Focus Adjustment .....	95
AF Limiter .....	92
AF Scanner .....	94
AF Target Mode Settings.....	79
C-AF Center Priority .....	86
Face & Eye AF Button.....	89
ISO-A Lowest S/S .....	115
LV Mode .....	225
Night Vision .....	225
Orientation Linked [::] .....	97
Picture Mode Settings .....	149
Save Settings .....	243
Display Pattern.....	253
C-AF Speed .....	87
HDMI Output .....	182
Mode (Movie exposure modes.....	60
(Movie recording) .....	59
Shutter Function.....	216
[::] Loop Settings.....	100
[::] Select Screen Settings .....	99
[::] Spot Metering .....	112
Battery Priority .....	253
Battery Status .....	253
Function .....	205
Default Setting.....	205
Dial Function .....	205
Info Settings .....	206
(automatic rotation) .....	205
Lock .....	223
Grid Settings.....	235
Info Settings.....	232
Level Gauge.....	233
Keep Warm Color .....	257
Movie .....	154
Still image .....	154
WB AUTO Lock .....	153
WB+WB .....	124
Settings.....	257
Lock .....	224

## A

A (Aperture priority AE) .....	45
Accessories .....	301
AdobeRGB .....	155
AEL by half-pressing .....	111
AE lock .....	109
AF Area Pointer .....	96
AF Illuminator .....	96
AF Mode .....	
Movie .....	72
Still image .....	72
AF-ON button .....	83
AF Targeting Pad.....	101
AF Target Mode .....	77
AF Target Point.....	76
AF tracking (C-AF+TR).....	73
Airplane Mode .....	260
All  .....	153
Movie .....	153
Still image .....	153
Anti-Flicker LV .....	226

Anti-Flicker Shooting .....	135
Anti-shock[  ] settings.....	131
Aperture-Priority AE .....	45
Art LV Mode.....	226
Assign Save Folder .....	244, 246
Assign to Custom Mode .....	56
Audio Playback.....	199
Audio recording .....	199
Auto Power Off .....	254

## B

B (Long Exposures) .....	51
Backlit LCD.....	254
Balanced flash metering .....	125
Battery charge .....	22, 23
Battery level.....	30
Battery level display.....	253
Bluetooth .....	262
Bluetooth®.....	260
Bracketing (BKT)	
AE BKT .....	174
ART BKT.....	177
FL BKT.....	175
Focus BKT.....	178
ISO BKT.....	176
WB BKT .....	175
Bulb .....	51
BULB/TIME/COMP Settings.....	173
Button Function	
Movie .....	208
Still image .....	208

## C

Cable clip.....	19
Cable protector .....	19
C-AF+TR (AF tracking).....	73
C-AF (Continuous AF) .....	72
C-AF Sensitivity	
Movie .....	87
Still image .....	87
Calendar display.....	191
Calendar playback.....	189
CALL function .....	293
Card.....	24

Card Formatting.....	241
Card Slot Settings	
Movie .....	242
Still image .....	242
Center marker.....	183
Certification.....	258
Charger.....	294
Charging via USB.....	22, 23
Color Space.....	155
Compatible flash units .....	118
Composite Settings .....	54
Compression rate .....	140, 327
Connection	
Computer.....	267, 283
Smartphone .....	260
Continuous AF .....	72
Continuous AF (C-AF) .....	72
Copy	
Copy .....	193
Copy All.....	194
Copyright Info.....	247
Copy Select .....	197
Custom Mode (C1/C2/C3/C4).....	56

## D

Dial Direction .....	218
Dial Function	
Movie .....	216
Still image .....	216
Digital Tele-converter	
Movie .....	166
Still image .....	166
Diopter adjustment .....	37
Direct button .....	66
dpi Settings.....	247
DPOF.....	198

## E

Edit	
JPEG .....	201
RAW.....	200
Edit Filename.....	245
Electronic Zoom.....	212
Electronic Zoom Settings.....	222

Erase .....	194
Erase All .....	194
Erase Selected .....	197
EVF Adjust.....	250
EVF Style.....	228
EV Step .....	107
Exposure compensation .....	106
Exposure shift.....	107
Eyecup.....	301
Eye detection frame.....	90
Eye Sensor Settings .....	250

## F

Face & Eye Detection.....	88
Face Priority .....	212
File format.....	140, 327
File Name .....	244
File size .....	327
Firmware Version.....	258
Fisheye Compensation.....	171
Flash.....	118, 297
Flash Exposure Comp.....	123
Flash mode settings .....	123
Flash photography.....	118
Flicker scan	
Movie .....	108
Still image .....	108
Fn Lever	
Movie .....	219
Still image .....	219
Focus Ring .....	104
Focus Ring Lock.....	212
Focus Stacking.....	160
Frame Rate.....	225
Movie .....	328
Frame size.....	328

## G

Grid Settings	
Movie .....	234
Still image .....	234

## H

Handheld assist.....	139
HDMI .....	288
HDMI Settings .....	251
HDR (High Dynamic Range) .....	162
High Res Shot (High resolution shooting) .....	156
High-speed movie.....	142
Histogram display .....	38
Histogram Settings .....	236

## I

Image aspect.....	144
Image Overlay .....	203
Image quality	
Movie .....	141
Still image .....	140
Image Review.....	42
Image size .....	140, 327
Image stabilizer	
Movie .....	136
Still image .....	136
Index display.....	191
Index playback.....	189
INFO button.....	38, 65, 187
Info by half-pressing  .....	231
Information display	
Playback .....	186
Info Settings	
Movie .....	230
Still image .....	230
In-Movie Image Capture.....	204
Interchangeable lenses .....	291
Interval Shooting.....	167
ISO-A Upper/Default	
Movie .....	114
Still image .....	114
ISO-Auto	
Movie .....	115
Still image .....	115
ISO-Auto Set	
Still image .....	113
ISO sensitivity.....	113
ISO step.....	114



<b>K</b>	
Keystone Comp.....	170
<b>L</b>	
Language.....	33, 257
Lens Info Settings.....	246
Lens I.S. Priority.....	139
Level Adjust.....	258
Level Disp.....	211
Level gauge display.....	38
Lighten Blending (B: Live composite photography).....	54
Live Bulb.....	51
Live ND shooting.....	158
Live Time.....	51
Location data.....	259
Long exposures (B: Bulb/Time).....	51
Low ISO Processing.....	116
LV Close Up Mode.....	223
LV super control panel.....	69, 311
LV Super control panel.....	311
<b>M</b>	
M (Manual Exposure).....	49
Manual Exposure.....	49
Manual focus (MF).....	72
Menu.....	63, 241, 311
Menu Cursor Settings.....	237
Metering.....	109
Metering during <b>[AEL]</b> .....	110
Metering during  .....	112
MF (AF/MF toggle).....	209
MF Assist.....	102
MF Clutch.....	104, 292
MF (Manual focus).....	72
Monitor Adjust.....	249
Motion compensation.....	141, 142, 328
Movie exposure mode.....	60
Movie playback.....	189
Movie recording.....	59, 61
Movie resolution.....	141, 142
Movie Trimming.....	204
Multi Function.....	215
Multi Function Settings.....	236

Multiple Exposure.....	163
Multi Selector	
Settings.....	218
My Menu.....	239
Add.....	239
Manage.....	240
<b>N</b>	
Noise filter	
Movie.....	116
Still image.....	116
Noise reduction.....	117
<b>O</b>	
One-touch white balance.....	152
<b>P</b>	
P (Program AE).....	43
Peaking Settings.....	103
Picture mode	
Movie.....	145
Picture Mode	
Still image.....	145
Pixel Mapping.....	258, 305
Playback	
Movie.....	189
Still image.....	188
Playback frame rate.....	141, 142
Playback zoom ( <b>Q</b> ).....	190
Position information.....	266
Power Battery Holder.....	295
Power-off Standby.....	263
Preset MF distance.....	104
Preset MF (PreMF).....	73
Press-and-hold Time.....	224
Print order.....	198
Priority Set.....	238
Pro Capture shooting.....	133
Program AE.....	43
Program shift (Ps).....	44
Protect.....	193
Protect selected.....	197
Ps (Program shift).....	44

## Q

Quick Erase .....	195
Quick Sleep Mode .....	255

## R

Rating .....	196
Rating Selected .....	197
Rating Settings .....	197
RAW+JPEG  .....	196
RAW+JPEG Erase .....	194, 195
RAW image .....	140
RC mode .....	298
Recall from Custom Mode .....	58
Red Frame during  REC .....	185
Release Priority .....	84
Remote Control .....	279
Remote shooting	
Live View .....	265
Remote Shutter .....	265

Reset All Images .....	198
Reset/Initialize Settings .....	257
Reset Lens .....	105
Rotate .....	193

## S

S (Shutter priority AE) .....	47
S-AF (Single AF) .....	72
Save Settings .....	246
Save Slot .....	246
Selfie Assist .....	227
Self-timer .....	126
Self-timer settings .....	130
Sensor frame rate .....	327
Sequential shooting .....	126
Sequential shooting settings .....	128
SET function .....	293
Shading Comp. ....	144
Share Order .....	195
Share Order Selected .....	197
Shooting Menu .....	313
Shooting modes .....	39
Shutter-Priority AE .....	47
Silent [  ] Settings .....	132

Silent controls .....	62
Single AF (S-AF) .....	72
Sleep .....	30, 254
Sound Recording Settings .....	180
sRGB .....	155
Starry Sky AF (  AF) .....	74
Starry Sky AF Setting .....	85
Storage .....	286
Subject detection .....	90
Super control panel .....	69
Super Spot AF .....	80

## T

Test Picture .....	210
Time .....	51
Touch screen	
Playback .....	191
Shooting .....	41
Touchscreen Settings .....	249



## U

USB Power Delivery .....	287
USB Settings .....	252
User registration .....	2

## V

View Assist (  ) View Assist .....	155
---	-----

## W

White balance .....	150
Wi-Fi/Bluetooth Settings .....	272
Wi-Fi Connection .....	271
Computer .....	267
Smartphone .....	261
Wi-Fi PC Settings .....	276
Wireless remote control flash (  RC Mode) .....	298
Wireless Remote Flash Control (  RC Mode) .....	124

## Z

Zebra Pattern Settings .....	184
Zoom frame .....	206
Zoom frame AF/Zoom AF .....	80

date of issue 2022.02.



<https://om-digitalsolutions.com/>