



PixBlasterTM

User Guide



Catalog No. 1-08070-00



**AMERICAN
PRINTING
HOUSE**

Table of Contents

Introduction	5
Safety Instructions	5
System Compatibility	6
Getting PixBlaster Ready for Use	7
In the Box	7
Unpacking the Box	7
Setting Up Embosser for Initial Use	9
Powering on the Embosser	9
Connecting to USB, LAN, and Audio Ports	10
Installing the Software	11
Registering for the Software	14
Managing Software Seats	15
Removing the Printer Driver and Devices	15
Setting Printer Properties and Preferences	16
Making Use of the PixBlaster Properties Window	17
Device Settings Tab	17
Service Tab	24
Utilizing the Advanced Printer Configuration	26
Calibration Tab	26
Network Tab	28
Usage Tab	28
Utilizing Printing Preferences Window	29
Layout Tab	30
Paper/Media Tab	32
Tiger Tab	36
Utilizing the Operator Panel	39
Button Functions	40
PixBlaster User Guide	3

Operator Panel Menu	41
Receiving Machine Status and Alerts	44
Loading Paper Into the Embosser	46
Inserting Paper into Tractor Mechanism	46
Resolving Paper Jams	47
Utilizing Braille Transcription Software	51
BrailleBlaster	51
Setting up PixBlaster in BrailleBlaster®	52
ViewPlus Tiger Software Suite (TSS)	53
Printing Graphics and Braille	53
Selecting Braille Fonts	54
Creating Braille Math Documents	54
Printing Documents	55
Accessing Training, Maintenance, Support, and Warranty Information	56
Accessing Training Resources	56
Monitoring Maintenance of Embosser	56
Contacting APH Customer Service	57
Locating Warranty Information	57
Considering Extended Warranty Options	57
Appendices	58
Appendix A: Compliance Statements	58
Appendix B: Embosser Specifications	61
Appendix C: TigerPlus Technology	63
Appendix D: Proper Trademark Notice and Attributions	64

Introduction

Welcome to the APH's PixBlaster™ embosser (Catalog No. 1-08070-00) that provides double-sided embossing for braille text with capabilities to include single-sided high-quality tactile graphics.

The PixBlaster embosser uses the standard Windows printer driver to mix text and graphics in mainstream Windows® software like Microsoft Word and Microsoft Excel. Use the computer to adjust settings and preferences. Print documents exactly as they appear on the screen.

The PixBlaster embosser is compatible with APH's BrailleBlaster®, Tiger Software Suite, and third party products such as Duxbury, Braille2000, and RTFC braille translation software, which can be used to print braille from braille notetakers.

Use the Tiger Software Suite (TSS) to take braille translation and tactile graphics to a new level. The Tiger® Braille Formatter is a Microsoft add-in that gives you advanced tools for translation and embossing. Tiger Designer enables basic editing of documents for quick drawing and braille needs. Translator serves as a basic translation tool for almost any Windows software—including PowerPoint® and CorelDRAW® Graphics Suite 2020.

Updates and additional information can be found on the APH PixBlaster webpage at <https://www.aph.org/product/pixblaster>.

Safety Instructions

IMPORTANT: Please read the safety instructions before using the embosser. In addition, abide by all warnings and instructions marked on the embosser itself.

- Do not place the embosser on an unstable surface.
- Do not place the embosser near a radiator or heat source.
- Do not block or cover slots and openings in the embosser's cabinet; do not insert objects through slots.
- Use only the type of power source indicated on the embosser's label.
- Connect all equipment to properly grounded electrical outlets.
- Do not use frayed or damaged power cords.
- The use of an extension cord with the embosser is not recommended.
- Unplug the embosser before cleaning it; only use a damp cloth to clean it.
- Do not spill liquid into the embosser.
- Except as specifically explained in the user guide, do not attempt to service the embosser by yourself.
- Only adjust those controls that are covered by the operating instructions.
- Detach the embosser from the power source and refer to qualified service personnel under the following conditions:
 - If the power cord or plug is damaged.
 - If liquid has entered the embosser.
 - If the embosser has been dropped or the cabinet is damaged.
 - If the embosser does not operate properly or exhibits a distinct change in performance.

System Compatibility

The Windows driver for PixBlaster is compatible with Windows Vista® through current versions of Windows operating systems, both 32- and 64-bit systems. The Windows driver

allows printing to PixBlaster from virtually any program in the Windows operating system. Read more about the Windows printer driver installation in the section [Installing the Software](#).

A macOS® 10.9 printer driver is also available for the PixBlaster embosser.

Getting PixBlaster Ready for Use

In the Box

- PixBlaster embosser
- PIXie box (for wireless connectivity)
- PIXie power adapter
- Speaker and USB-A to Mini-B power cord (in separate box)
- USB-A to USB-B printer cable
- PixBlaster USB flash drive (includes driver, user guide, and software)
- PIXie USB flash drive (includes PIXie reset file)
- Print and braille versions of the Quick-Start Guide
- Hardcopy tactile graphic/braille samples

Unpacking the Box

1. Remove the embosser and all accessories from the packaging.
2. Inspect the embosser and the packaging for any damage. If noticeable damage occurred during shipping, please report to your APH product supplier immediately.

NOTE: Save the packing material and box. The packing material must be used to ship the PixBlaster for warranty maintenance service and to settle any insurance claim.

3. Remove the shipping bolt by opening the top lid of the embosser and removing the shipping bolt as indicated in Image 1.



Image 1: Shows the shipping bolt and location

4. Store the shipping bolt in the plastic retaining loops on the inside frame, indicated in Image 2.

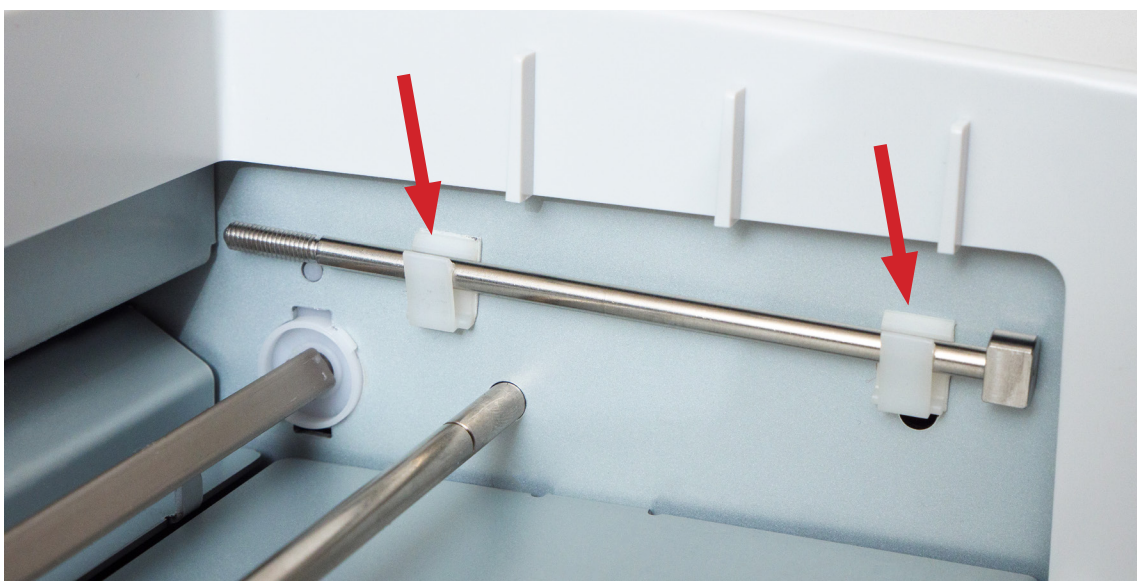

Image 2: Shows proper storage of the shipping bolt

IMPORTANT: Before packing up the PixBlaster embosser for shipping, **please make sure to reinstall the shipping bolt.** You may need to tilt the embosser gently to the side with the buttons until you hear a sliding sound to allow complete insertion of the shipping bolt. Screw and tighten the shipping bolt securely. Replace the tape to hold the lid on the embosser. Reinsert the PixBlaster into the original plastic bag and add the side-specific foam end caps to the embosser. These shipping instructions are mandatory otherwise the warranty is voided.

Setting Up Embosser for Initial Use

Powering on the Embosser

Facing the back of the embosser, in the lower-right corner, there is a power module with a power socket, an On/Off switch, and a compartment holding one fuse (see Image 3). A sticker above the power module indicates the specific fuse required for the embosser. If the embosser does not power on, it may be necessary to replace the fuse.



Image 3: Shows the power module in the back of the embosser

Insert the power cable plug into the PixBlaster power socket and the other end into a grounded outlet or a surge protector (recommended).

The Power switch is labeled with a circle (○) for Off and a horizontal bar (—) for On. Press the Power switch to the On position, which is to the left when facing the embosser from the front.

Connecting to USB, LAN, and Audio Ports

Facing the front of the embosser, on the right-side panel are three ports (see Image 4). From right to left they are the LAN port, the USB port, and the audio jack.

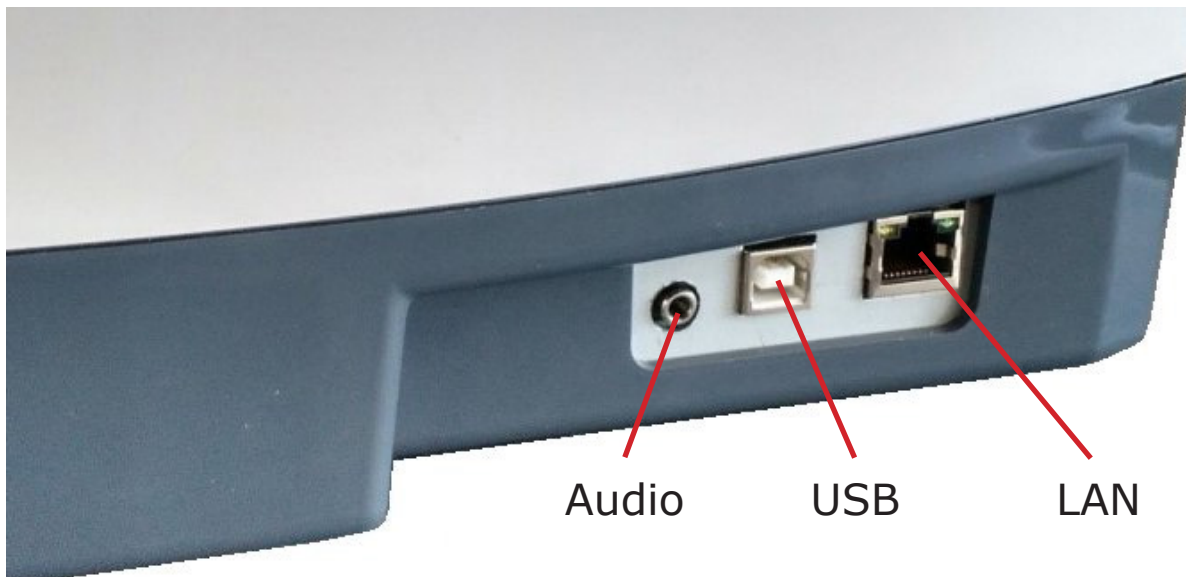

Image 4: Shows three ports on the right-hand side of the embosser

IMPORTANT: Install the Printer Driver software located on the PixBlaster flash drive **BEFORE** connecting PixBlaster to a computer. See the [Installing the Software](#) section.

USB: To connect the embosser for printing, insert the square end of the USB printer cable into the center (USB) port and the rectangular end into the host computer USB port.

LAN: To connect the embosser to your network, you need a LAN cable (not included in box). Attach one end of a LAN cable to the (LAN) port furthest to the right and the other end to a network data port.

AUDIO: For audio, connect your powered speaker to embosser using the audio jack on the far left of the three ports. Audio messages include status messages, device menu items and commands, error messages, and so on. The speaker must be powered since there is no onboard audio amplifier. To learn more about powering the speaker, refer to the instructions provided with the speaker.

Installing the Software

Included with your PixBlaster embosser is a PixBlaster USB flash drive, which contains the Windows printer driver and the ViewPlus Tiger Software Suite (TSS).

IMPORTANT: Do not connect your PixBlaster to the computer during the installation of the Windows printer driver.

Run the driver setup from the USB flash drive, or download the current PixBlaster driver from the APH webpage, <https://www.aph.org/product/pixblaster/>. Follow the instructions from the installation program.

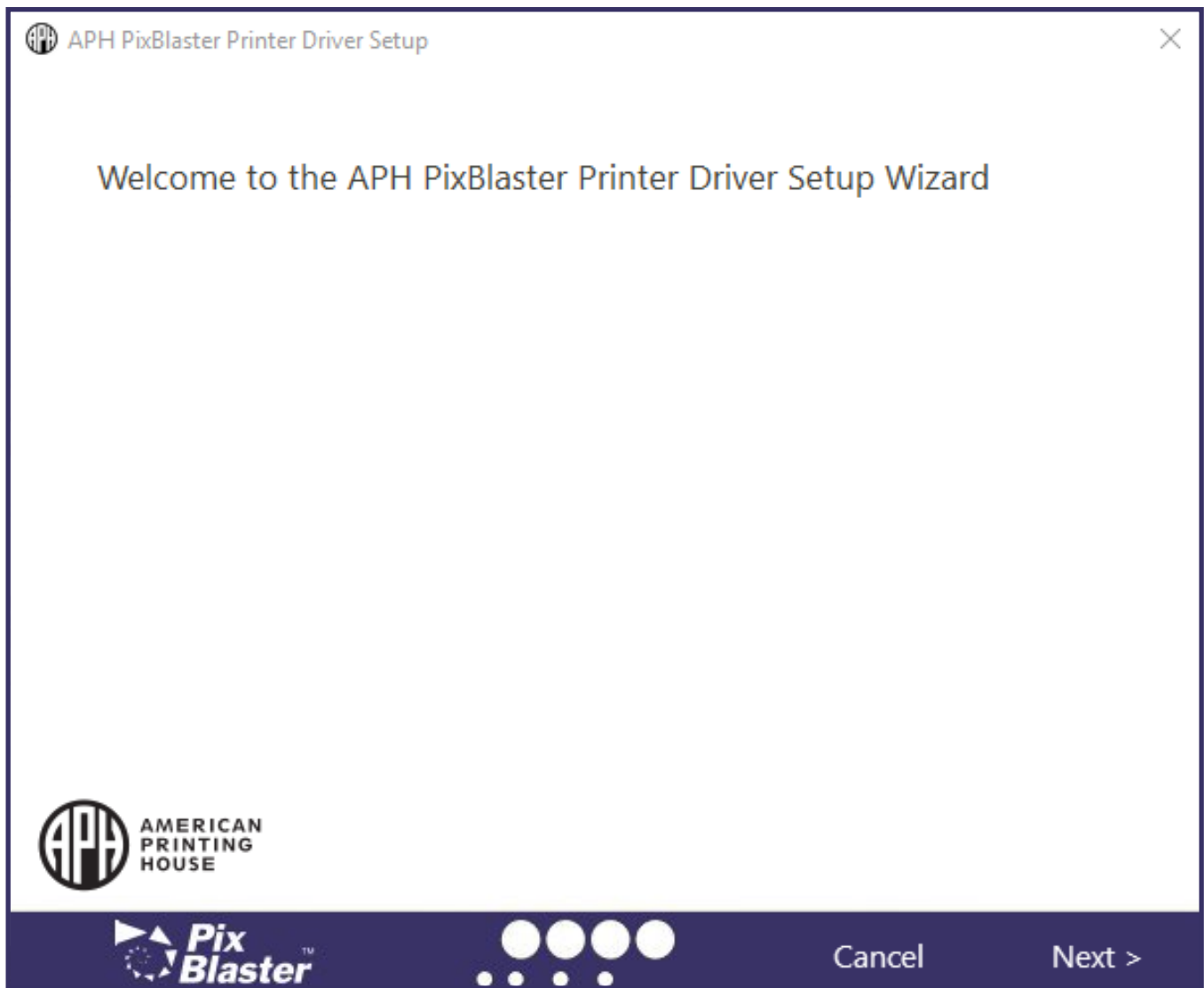

Image 5: Shows printer driver installation welcome screen

If network installation of the PixBlaster embosser IS desired, please pause at the screen with the Run the Network Installation Utility checkbox. DO NOT click Finish until the printer is connected and switched On (see Image 6).

If network installation IS NOT desired, click Finish to complete the driver installation (see Image 6).

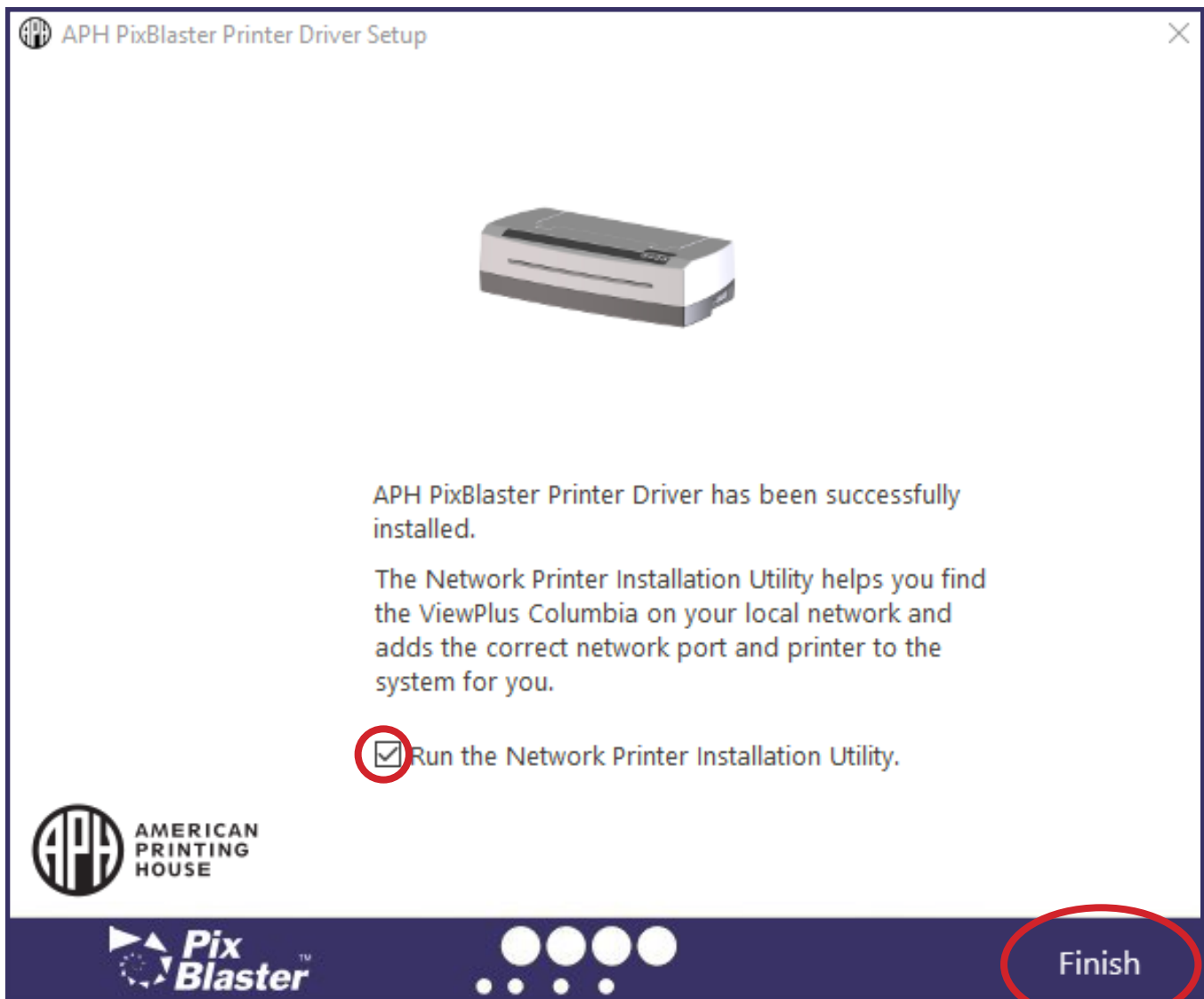

Image 6: Shows printer driver network installation screen

At this point, (in both cases) connect the PixBlaster embosser to the computer using the USB printer cable and turn it On. The system automatically detects the embosser and adds it to the system control panel under Devices and Printers.

Troubleshooting: If Windows does not detect the printer, try unplugging the USB flash drive and plugging it back into the same USB port of your computer. If Windows still does not detect the embosser, try a different USB port.

To continue network installation:

1. Connect a LAN local network cable to the PixBlaster embosser after the printer has been locally detected via the USB flash drive.
2. Make sure the Run the Network Printer Installation Utility checkbox is checked.
3. Click Finish.

The network connection for the device installs automatically.

The Network Printer Installation Utility can also be run outside the printer driver installation from the Windows Start menu, under the APH program folder.

After successful installation, you may also install ViewPlusTiger Software Suite (TSS) from the PixBlaster USB flash drive. For installation, please follow the instructions from the setup program. For use of the Tiger Software Suite (TSS) please refer to the [TSS User Manual](#).

Registering for the Software

IMPORTANT: To obtain your Tiger Software Suite (TSS) license number, visit the [ViewPlus American Printing House warranty page](#) and complete the registration form. You will be asked to enter the purchased embosser's serial number, the Order Number, and your email address. A 16-digit license number will be emailed to you from ViewPlus Technologies, Inc. – within 1 to 2 business days. The TSS works for 30 days without a license. We recommend that you complete the license registration form during those first 30 days to avoid any gap in usage of the embosser.

Managing Software Seats

Every PixBlaster comes with a license for Tiger Software Suite (TSS) that is good for two “seats” or installations on two separate computers. License Administrators will want to be careful how they manage these installations because they are tied to the PixBlaster embosser. A seat can be disabled by following the uninstall process and disassociating your seat. You can remotely disable a seat by contacting ViewPlus Customer Service. For installation, please follow the instructions from the setup program. For use of the Tiger Software Suite (TSS), please refer to the [TSS User Manual](#). You may also view the [Tiger Software Suite 7 Webinar](#).

Removing the Printer Driver and Devices

If you wish to remove the APH PixBlaster printer driver application from your computer, you can either run the printer driver setup program again, which gives you the option to remove the driver, or use Windows uninstall option under Programs and Features in the system control panel.

Deleting the PixBlaster device appearance under Devices and Printers in the system control panel does not remove the printer driver installation from your computer entirely, only the instance of the device assigned to a specific port.

Troubleshooting: Sometimes, Windows automatically adds instances of the same device under Devices and Printers and suddenly, you have Copy 1 or further available from your printer. If this is not desired, and you have trouble assigning your print jobs to the correct printer device name, do the following:

1. Unplug the PixBlaster embosser.
2. Remove all PixBlaster printer devices under Devices and Printers in the system control panel.
3. Plug the PixBlaster embosser back in.

Windows automatically adds one instance of the printer again, which is assigned to the correct port.

Setting Printer Properties and Preferences

The APH printer driver uses a standard Windows printer driver interface to provide user access to setting options on the APH PixBlaster embosser from a local or networked computer. The printer properties are accessible through Devices and Printers in the Windows system control panel.

Select the APH PixBlaster in the list of printers and Printer Properties from the Context menu. The printer properties contain general device settings, such as connectivity, sharing, and security, but also APH specific settings for Legacy Mode operation and service procedures on the APH PixBlaster embosser. Note that these options are only activated when your APH PixBlaster is currently connected to your computer and switched On.

Always click on the Apply button to have changes submitted to the device.

Making Use of the PixBlaster Properties Window

Device Settings Tab

The device settings are properties that are stored within the internal memory of the embosser. To activate any changes, the embosser needs to be connected and turned On. Always click on the Apply button when finished making changes to the settings. The embosser beeps once to confirm the receiving of the changed settings.

Legacy settings control the embosser's output when printing to the PixBlaster from programs that do not use the Windows printer driver, including some braille programs and notetaker devices. Some of these Legacy settings are also available through the embosser Operator Panel controls to make them accessible without having to have a Windows computer connected. See [Utilizing the Operator Panel](#) section for further explanation on the Operator Panel menu.

The screenshot of the PixBlaster Printer Properties window showing the Device Settings tab in Image 7 displays the list of descriptions available to make your selections.

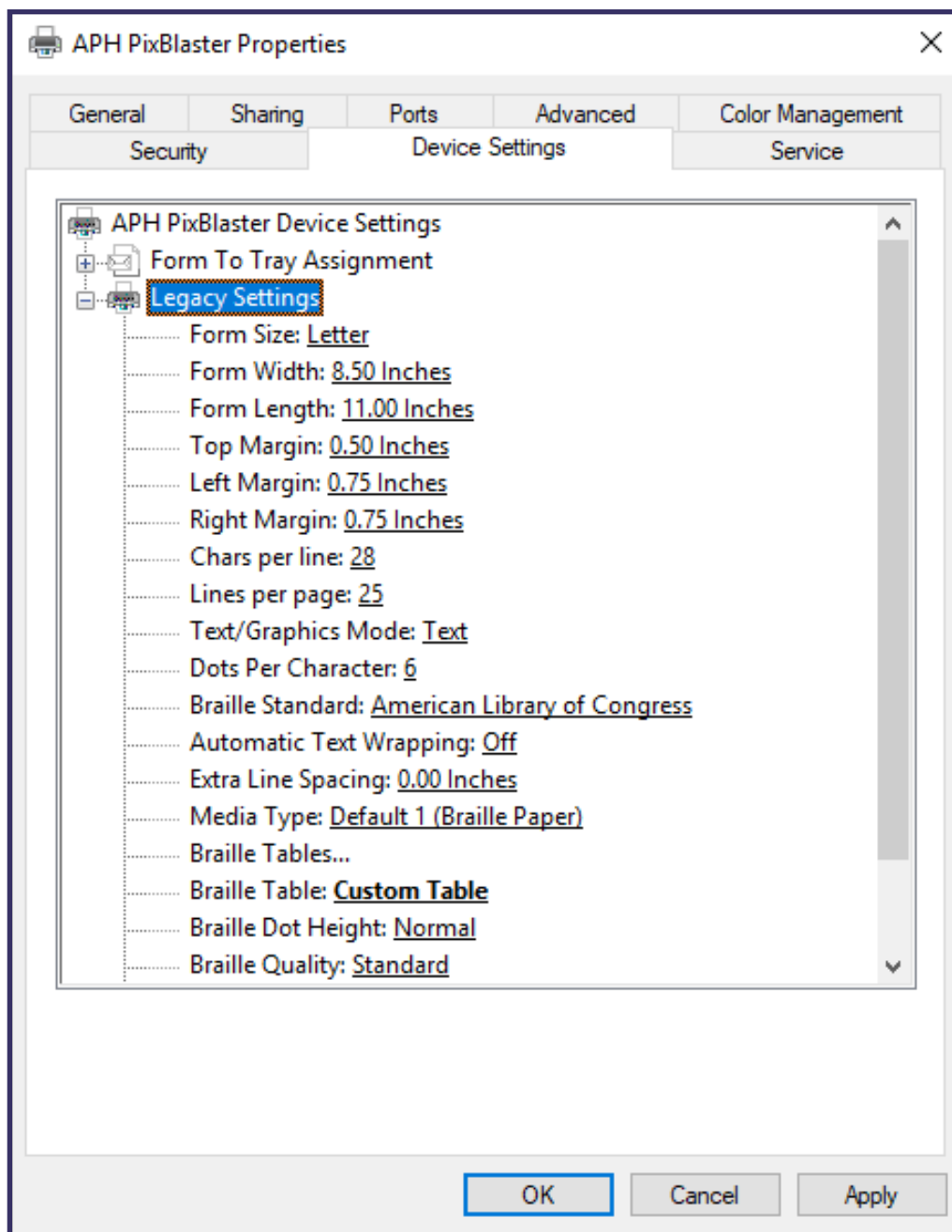

Image 7: Shows Device Settings Tab in the PixBlaster Printer Properties window

Form To Tray Assignment

Tractor Feed: The first section of the Device Settings tab shows the PixBlaster's Tray Assignment. This is a Windows default item that cannot be hidden and does not have any relevance for your printing.

Legacy Settings

Form Size: Select a standard page size, or select Custom to set the page size manually.

Form Width: Shows the page width. For standard page sizes, this field is informational only. If the Form Size is set to Custom, this field is editable.

Form Length: Shows the page length. For standard page sizes, this field is informational only. If the Form Size is set to Custom, this field is editable.

Top Margin: Set the top margin to be used when printing in Legacy mode.

NOTE: If you are printing from an application that sends margin information with the print job, set the top margin to 0.

Left Margin: Set the left margin to be used when printing in Legacy mode.

NOTE: If you are printing from an application that sends margin information with the print job, set the left margin to 0.

Right Margin: Set the right margin to be used when printing in Legacy mode.

NOTE: When embossing double-sided, adjust the left and right margin settings according to the requirements for the front side of the page. If the left and right margins are set differently, the margins are applied as binding margins, meaning they are mirrored to the back of the page, with the result that the same amount of margin is applied to the same edge of the paper on both sides.

Text/Graphics Mode: Select Text mode if your legacy document contains text. If the document is a graphic, select Graphics mode to remove the space between

braille lines so that dots may be printed in an even grid.

Dots Per Character: Select 6 or 8 dots per character.

Braille Standard: Select a Standard for braille dot spacing. The drop-down list contains Marburg, American Library of Congress, American National Library of the Blind, Japanese Standard (Microbraille), Korean Standard, and Jumbo. Dot spacing of the embossed output follows named Standards, or in case of Jumbo it is 1.5 times the size of Marburg.

Automatic Text Wrapping: Select On if lines in the document are longer than what fits on one printed line and you do not wish the lines to be truncated. Select Off if the document is formatted correctly for the page size and margins you are using, or if you do not wish to have long lines wrapped to the next line.

Extra Line Spacing: Set the amount of extra space desired between braille lines. This setting can only be set in multiples of 0.05 inches and is added to the normal single line spacing.

Media Type: The media type setting defines the hammer force that is applied when forming the dots in the paper (media). The stronger the media, the higher the punch force needs to be to form readable dots.

A list of presets for certain media types is available, but a Custom setting is also possible if the presets yield satisfactory embossing results. The media type that you choose here is saved to the embosser's internal memory and referred to as Printer Setting within media type selection of the Windows Printing Preferences.

Custom Media Lowest Force: Enter the hammer force value to be used for the lowest dots on a custom media type. See also Media Types in the section [Utilizing the Advanced Printer Configuration](#) on how to determine the correct value.

Custom Media Highest Force: Enter the hammer force value to be used for the highest dots on a custom media type. See also Media Types in the section [Utilizing the Advanced Printer Configuration](#) on how to determine the correct value.

Braille Table...: The PixBlaster has some braille tables stored onboard, and a custom braille table can be loaded additionally. Click on Properties to open a dialog as shown in Image 8a.

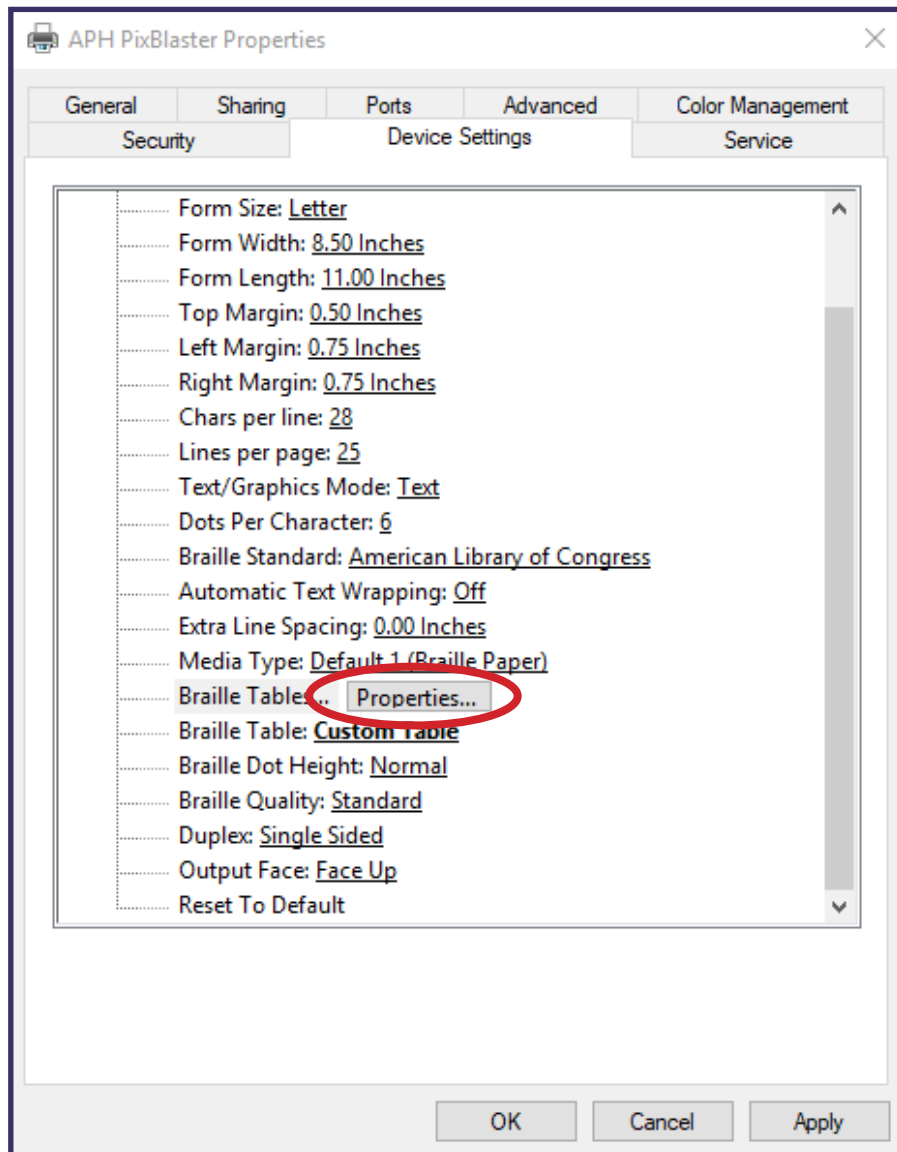

Image 8a: Shows the Properties button for Braille Tables

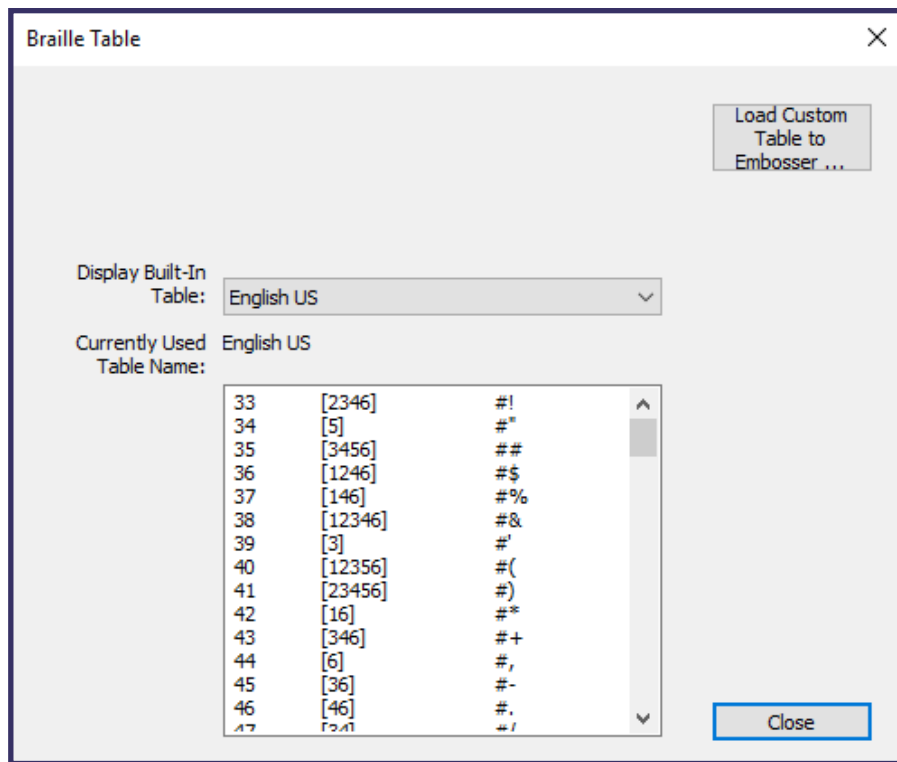

Image 8b: Shows Braille Table Properties in Device Settings

The dialog offers two basic functions. The lower section offers a display for onboard braille tables that the APH PixBlaster provides, including the current custom table. Choose the braille table name from the drop-down list to display the associated table as illustrated in Image 8b.

The second function of this dialog is provided through the button at the upper right. This opens a file browser dialog to choose a Custom Braille Table that is written to the printer. The braille table written to the printer last is referred to as a Custom table and stays onboard as a Custom table until another file is written to the printer, taking the place of the previous Custom table.

The Custom Braille Table can be chosen as file type .bct, .dis, or .rbt. The file browser dialog defaults to the location of the braille tables being used within the Tiger Software Suite (TSS). Choose one of those tables, or browse to the location of your own braille table to be loaded to the embosser (see Image 9).

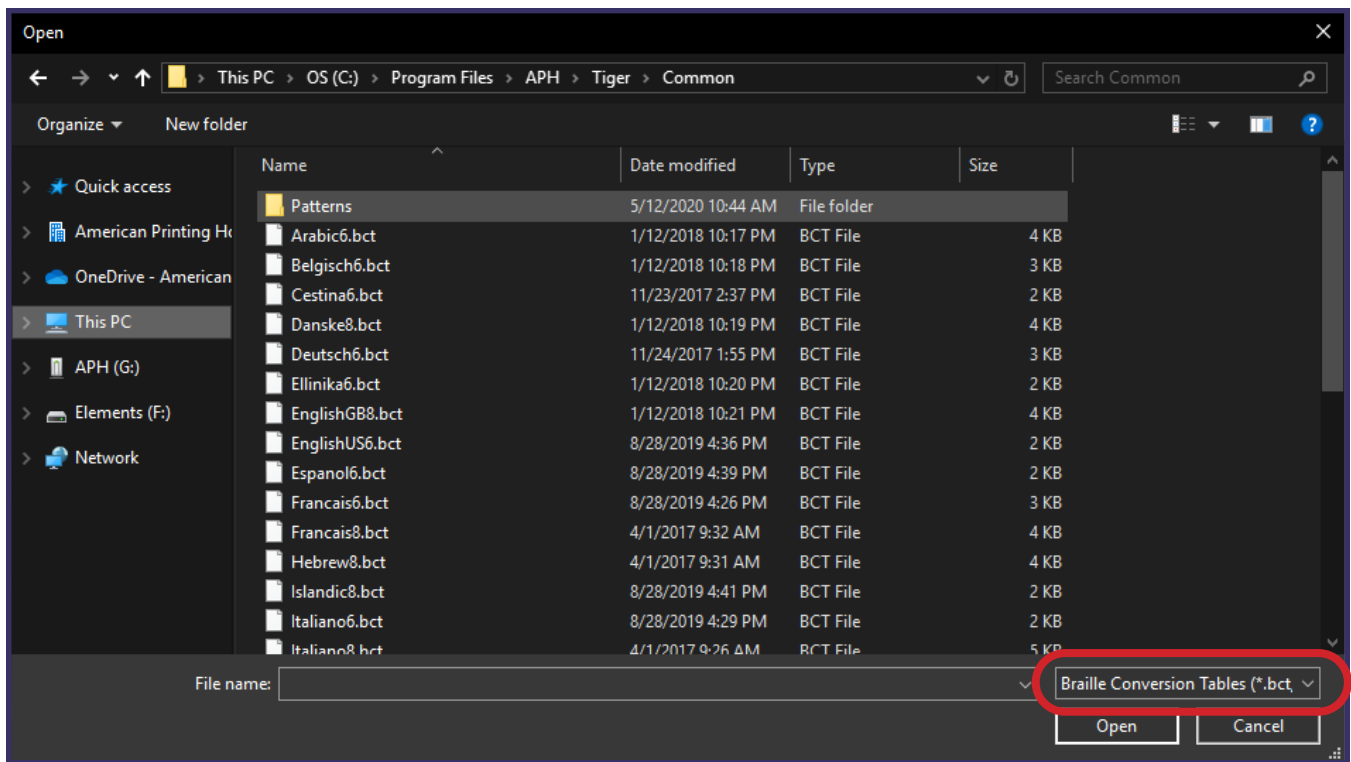

Image 9: Shows Custom Braille Table file selection

Braille Table: From the drop-down list, select which braille table to use when printing. If the previously loaded Custom table should be used for text-to-braille conversion, select Custom Table here (see Image 10).

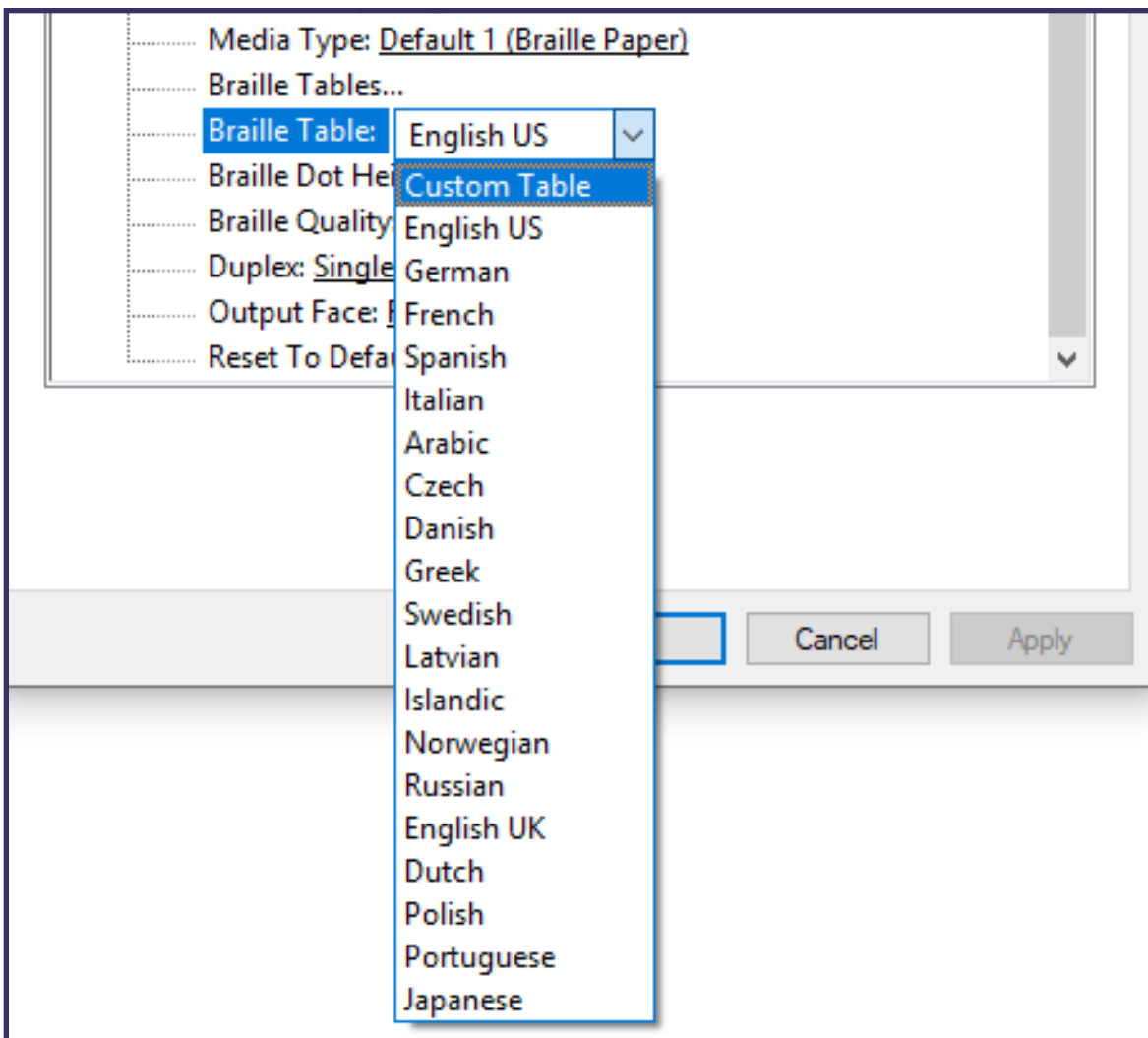

Image 10: Shows selection of active Braille Table

Braille Dot Height: Select Low, Normal, or High to control how tall the braille dots emboss.

Duplex: Choose whether to print single-sided or double-sided (interpoint).

Service Tab

The Service tab of the Printer Properties dialog window provides information about the connected APH PixBlaster at the bottom left. When contacting APH Support [<https://www.aph.org/contact-us/>], please have the driver version, printer serial number, and firmware version available, shown in Image 11.

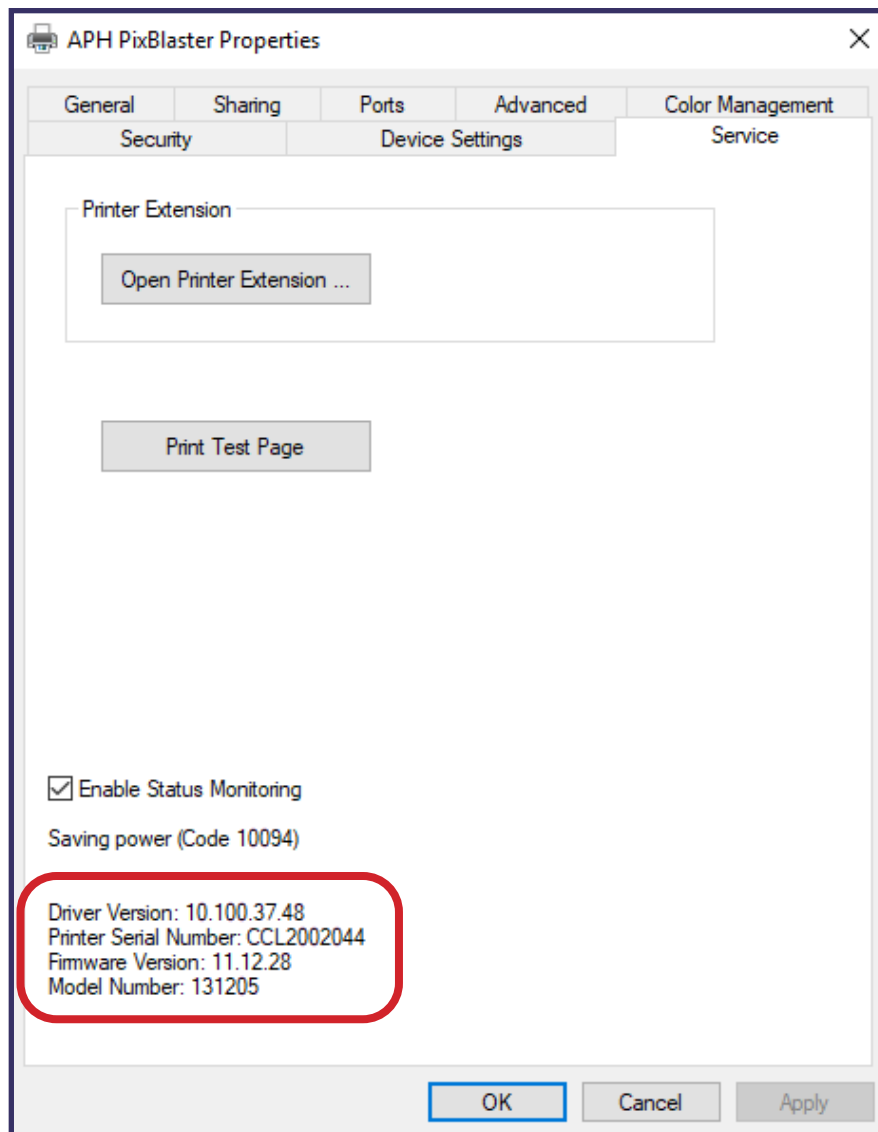

Image 11: Shows Printer Properties Service Tab

Open Printer Extension...

A separate program opens to provide extended access to onboard device settings.

Print Test Page

This action initiates the printing of an onboard test page from the embosser. Make sure the embosser is properly connected to your computer and paper is loaded when trying to print a test page.

Enable Status Monitoring

Status messages of the embosser are displayed and updated permanently as long as the checkbox is checked and the embosser is properly communicating with the computer.

Utilizing the Advanced Printer Configuration

As implied, Advanced Printer Configuration is not typically used for day-to-day print jobs. Its intended use is for advanced print jobs only.

Calibration Tab

Your embosser is calibrated before you receive it. If you have any issues while embossing, such as torn paper or light dots, it may be useful to adjust calibration through this toolbox. Adjusting calibration should only be attempted after [contacting APH Customer Service](#).

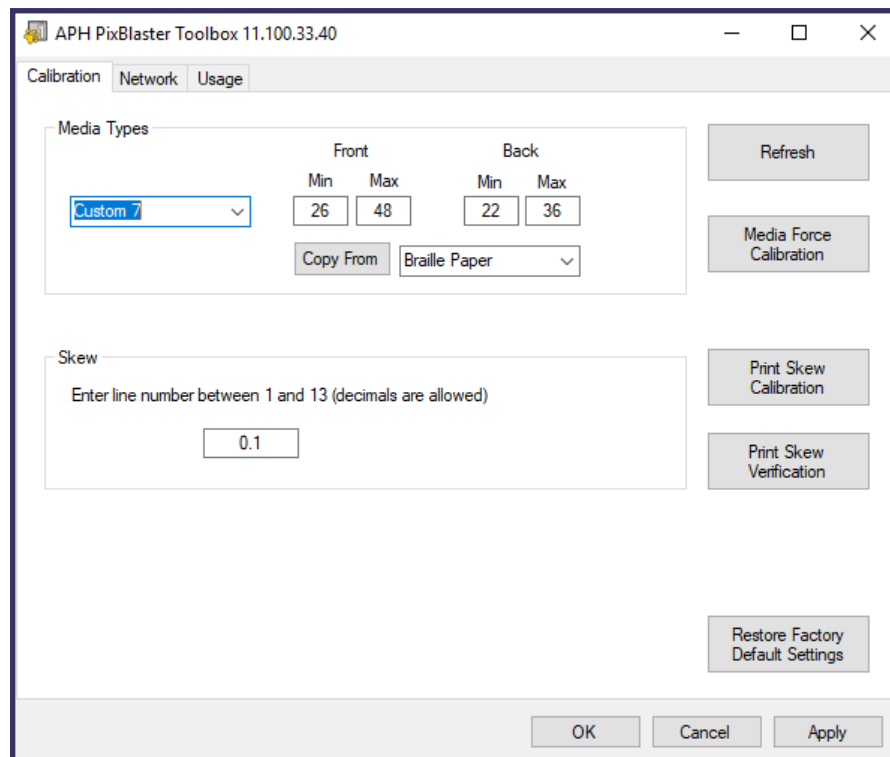

Image 12: Shows Calibration tab of PixBlaster Toolbox window

Selecting Media Types

In addition to preset media types, you have the opportunity to select media type Custom within the Printer Properties Device settings. The hammer punch forces applied when embossing media type Custom is determined from the Min and Max settings. These are the same values as the custom media lowest and highest force settings described in the Printer Properties [Device Settings Tab](#) section.

Adjusting Skew Settings

If dots 1, 2, 3, or 4, 5, 6 do not appear in a straight-line underneath each other on embossed braille text, this could be caused by a wrong Skew setting. In this case, do the following:

1. Make sure to have paper loaded in the embosser, and initiate a test print by clicking the Print Skew Calibration button.
2. From the printed test patterns, choose the one that has the straightest vertical lines, counting the separated pattern sections from top to bottom starting with 1.
3. Enter the number of the corresponding pattern in the edit box.
4. Press Apply.

After pressing Apply and hearing the confirmation beep from the embosser, you may print the skew verification pattern using the Print Skew Verification button to see if further adjustment is necessary.

Network Tab

If using the APH PixBlaster via a network connection, this tab gives an opportunity to check network address settings or manually enter static IP addresses, as shown in Image 13.

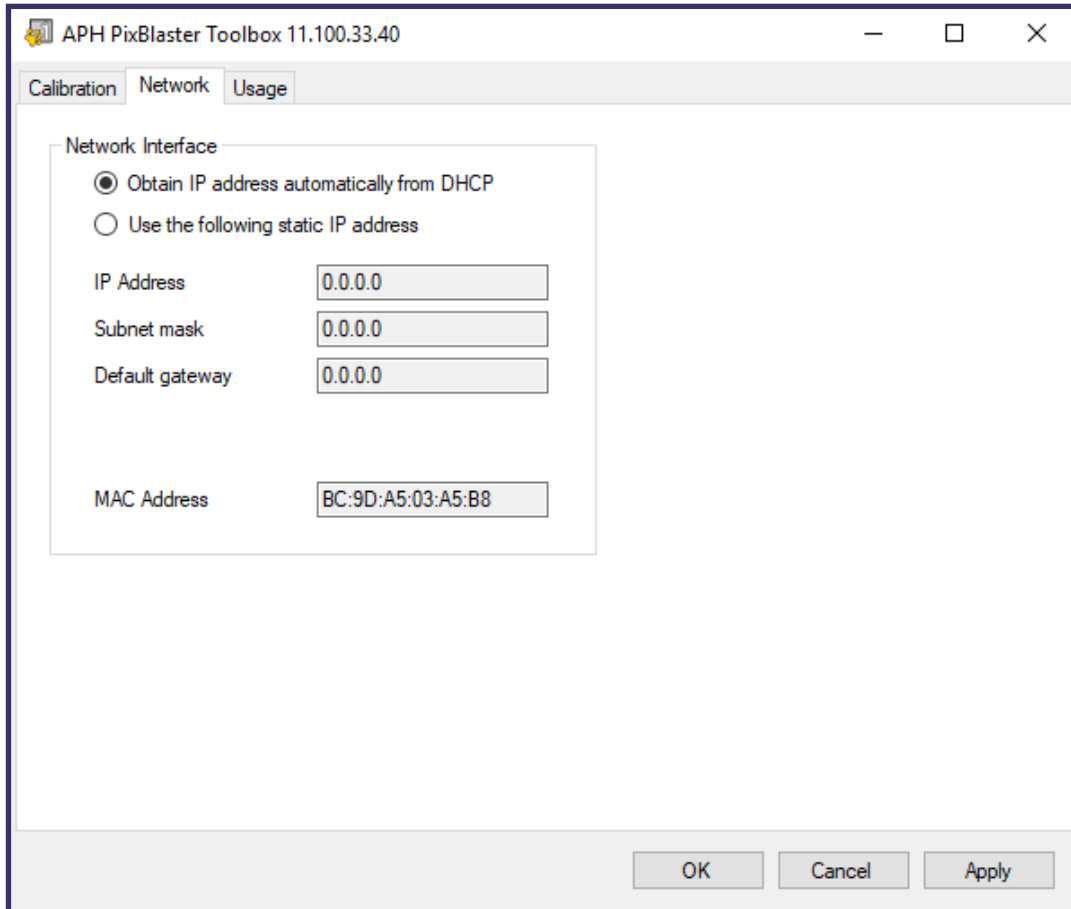

Image 13: Shows Network tab of PixBlaster Toolbox window

The MAC address of your embosser is also displayed, as well as given on the bar code sticker on the back of the embosser.

Usage Tab

This tab displays embosser usage information. It includes the average lifetime remaining for each of the two carriages in the embosser, as well as the number of pages that have been printed, and the number of hours of use, as shown in Image 14.

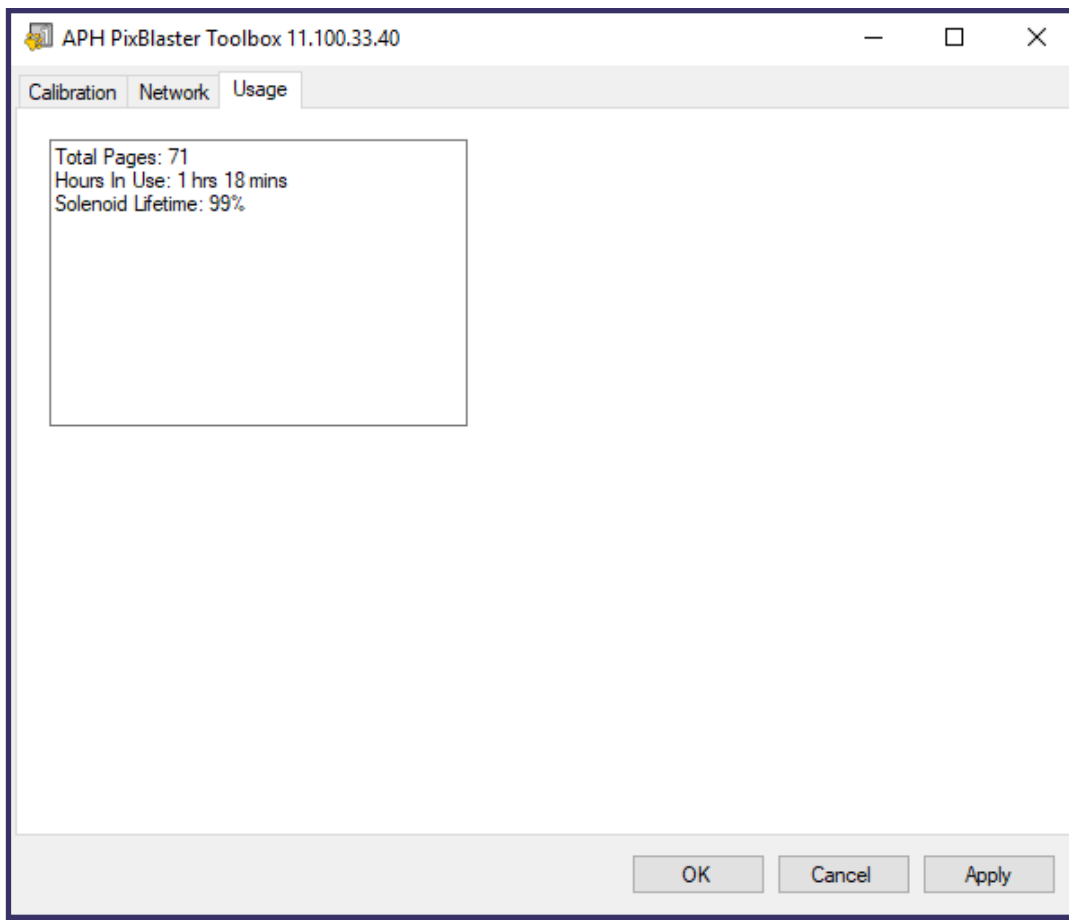

Image 14: Shows Usage Tab of PixBlaster Toolbox window

Utilizing Printing Preferences Window

The Printing Preferences contain settings for printing from Windows programs to your APH PixBlaster, which affects the output of individual print jobs. To open the printing preferences dialog, choose the Preferences... button on the General tab of the Printer Properties dialog.

In Devices and Printers under Windows system control panel, choose the Printing Preferences... option from the context menu of the APH PixBlaster device as shown in Image 15.

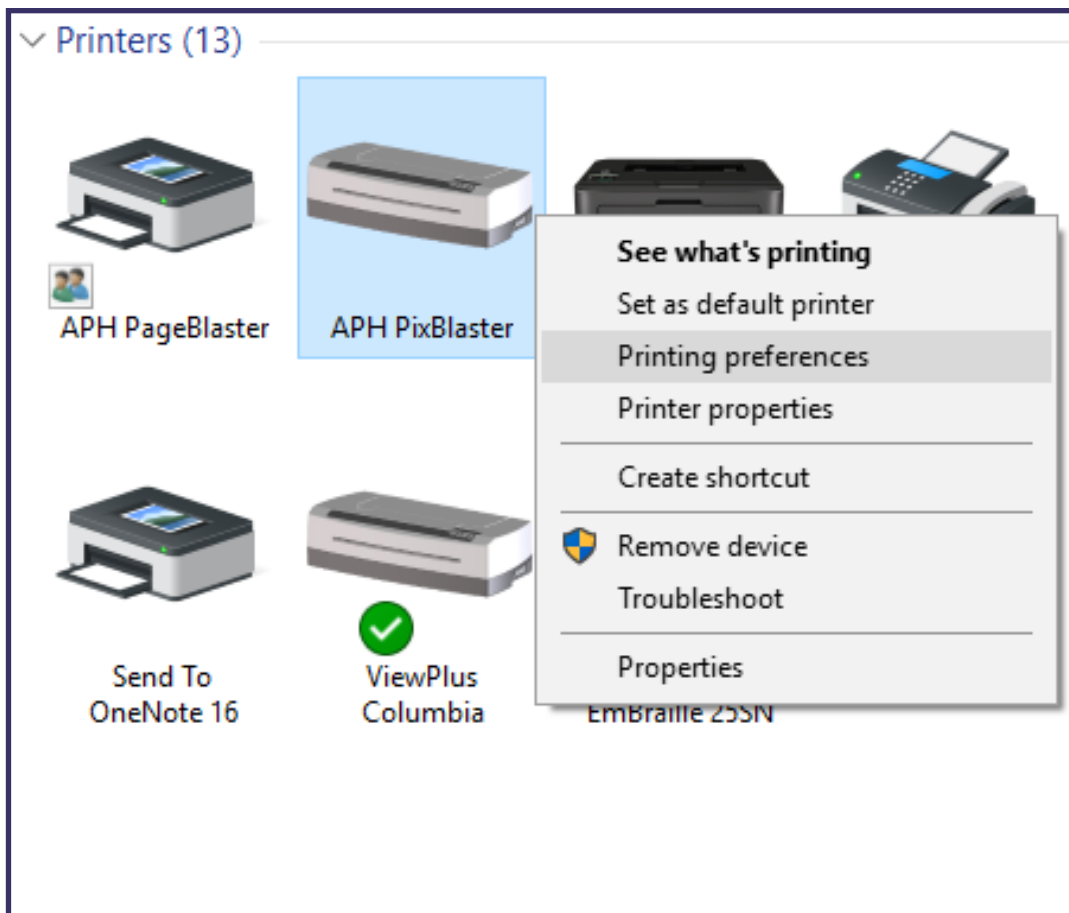

Image 15: Use the context menu options for APH PixBlaster embosser to access Printing Preferences

In addition, the printing preferences are accessible next to the printer selection box on the standard Windows print dialog when printing from most programs.

Layout Tab

The printing preferences options are organized into three tabs. The Layout tab contains options pertaining to the page layout of the document to be printed, as shown in Image 16. Use the descriptions of the options on the Layout tab to help make the appropriate selections for the document.

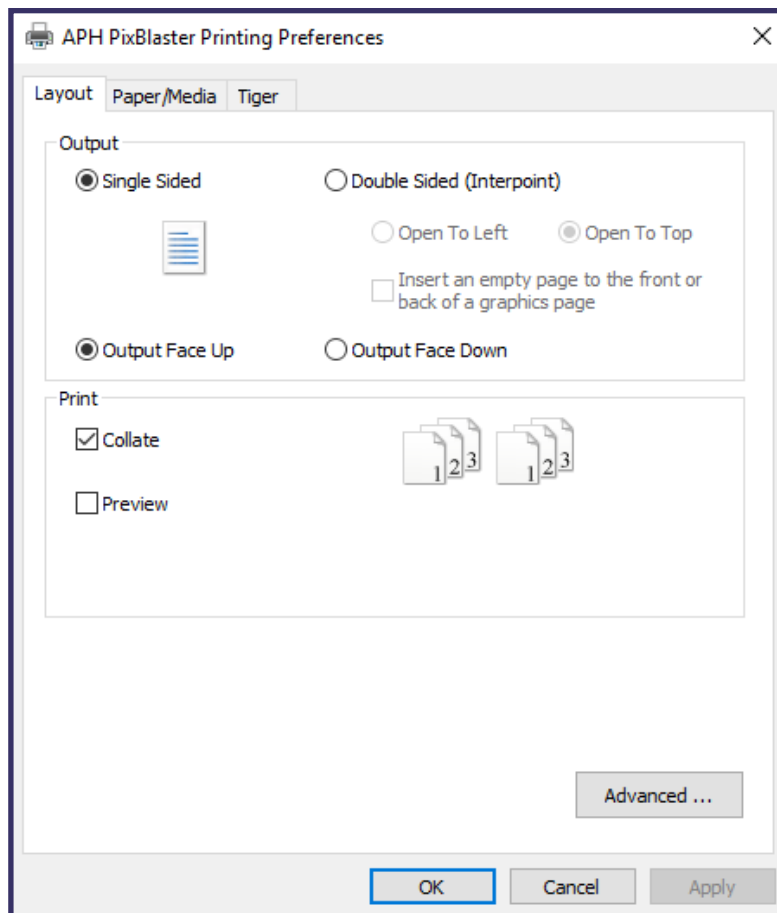

Image 16: Shows Layout Tab of Printing Preferences window

Output

Single-sided: Select this option if you only want to print on one side of the page.

Double-sided (Interpoint): Select this option if you want to print on both the front and the back of the page. If Double-sided (Interpoint) is selected, the following option also becomes available:

- **Insert an empty page to the front or back of a graphics page:** If selected, a blank page is inserted automatically on the back of every page that contains graphics for the embossed output. Do not select this option if you have already inserted blank pages after graphics pages in your document within the application.

Print

Collate: When the collate box is checked and multiple copies of a document are printed, one complete document is embossed at a time. If the collate box is not checked, all copies of each page are embossed before embossing all copies of the next page of the document.

Preview: If this option is checked, a preview of how the document prints and embosses is shown in Tiger Print Preview. If you are satisfied with the preview, choose the print option again within Tiger Print Preview to send the print job to the embosser. Tiger Print Preview also gives the option to save the print file, or to cancel the print.

Advanced

This button opens a dialog box containing advanced user options. In this case, there is only one option:

Orientation - Rotated Landscape: When checked, this option rotates pages into landscape orientation by 180 degrees. It is generally only used for spreadsheets, where it is helpful for the information to emboss as it appears on the screen when printed on continuous (tractor fed) paper.

Paper/Media Tab

The Paper/Media tab contains options related to the type of paper or media being used for printing, as shown in Image 17. Select the desired options for your media.

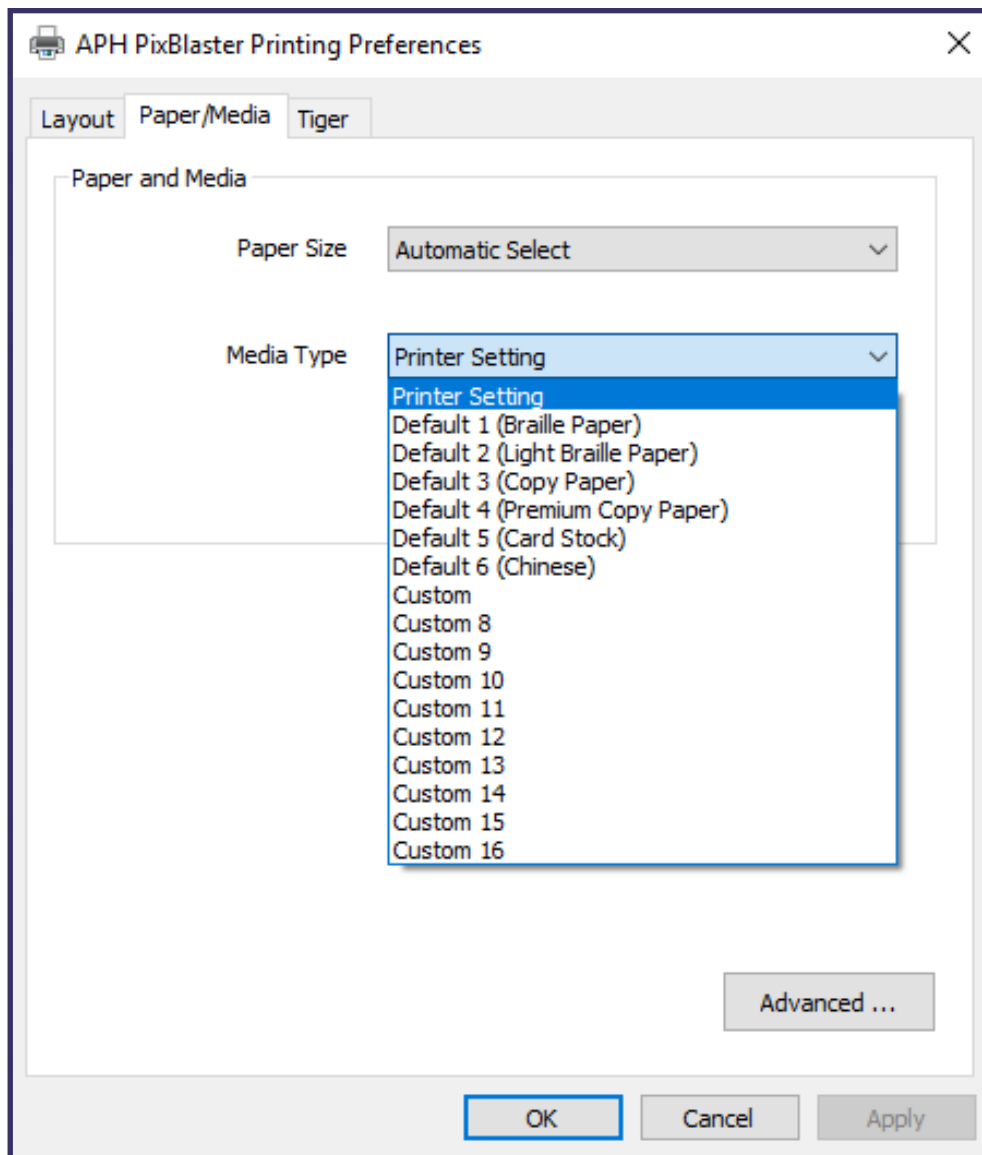

Image 17: Shows Paper/Media Tab of Printing Preferences window

Selecting Paper and Media

Paper size: Select the paper size you are using from the list, or leave the setting at Automatic Select to allow the paper size setting from the application you are printing from to be applied.

Media Type: Select the type of media you are using. The media type setting determines the hammer punch force that is applied during embossing.

- Default 1-5: The type of media indicated in parentheses for default setting 1 through 5 is an example of the correctly embossed media when applying this setting. If none of the default settings yield satisfactory results, refer to the Advanced... option to find out about custom media type setting.
- Printer Setting applies the media type setting from the Printer Properties Device Settings tab.

Advanced ...: The Advanced... button brings up another dialog, which allows you to create and manage custom media types and paper sizes, as shown in Image 18.

The drop-down list shows all media types currently available. This list can be edited using the buttons underneath.

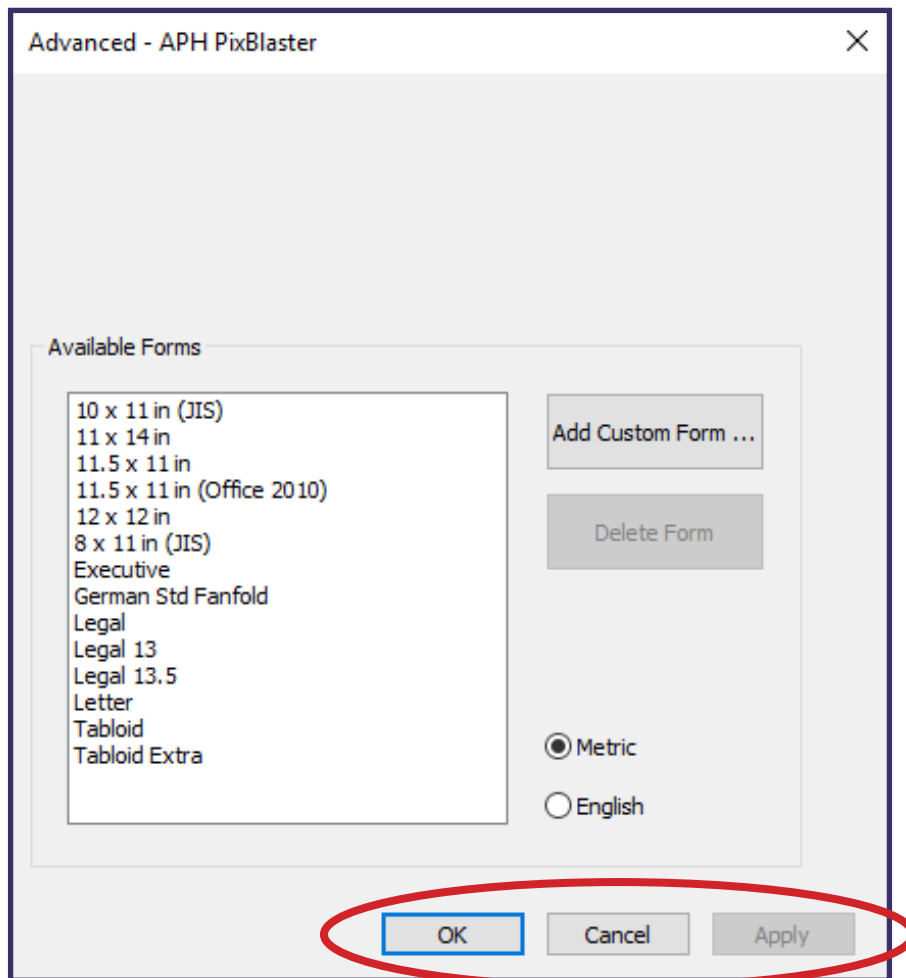

Image 18: Shows Advanced options in Paper/Media setting

Defining Media Type

Add: Allows you to define a new custom media type within the Add Form dialog box, shown in Image 19.

Edit the name of your new custom media type if desired. Then choose a hammer force value for the highest dots to be embossed, and the lowest dots to be embossed on your outputs.

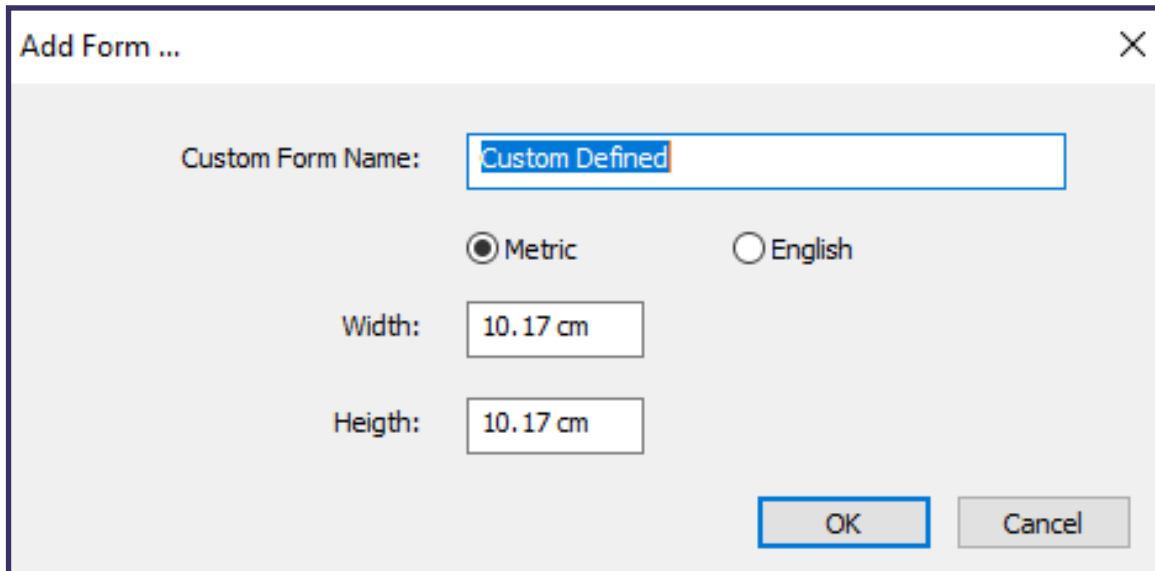

Image 19: Shows Add Form dialog box

Edit: Opens up the same dialog as Add (Image 19), but with the constraint to editing the Lowest and Highest Dot Value only for an existing custom media type from the list. **NOTE:** Default media types cannot be edited.

Remove: Select a media type from the drop-down list and choose Remove to delete it. **NOTE:** Default media types cannot be removed.

Formatting Documents Using Available Forms

All forms that are available for Windows document formatting when printing to the APH PixBlaster are listed in the display box, and dimensions of these forms are shown on the right upon selection of the form name.

Add Custom Form...: This button opens a new dialog where you have the opportunity to enter a new custom form name and define width and height for that form in either metric or English units of measure. **NOTE:** Paper sizes wider than 12 inches may not be added.

Delete Form: If the selected form from the list is a custom size, the Delete Form button removes the selected form.

Metric/English: Select either one of these systems to show dimensions of forms in corresponding units of measure.

Tiger Tab

The Tiger tab contains controls for braille and print output options as shown in Image 20.

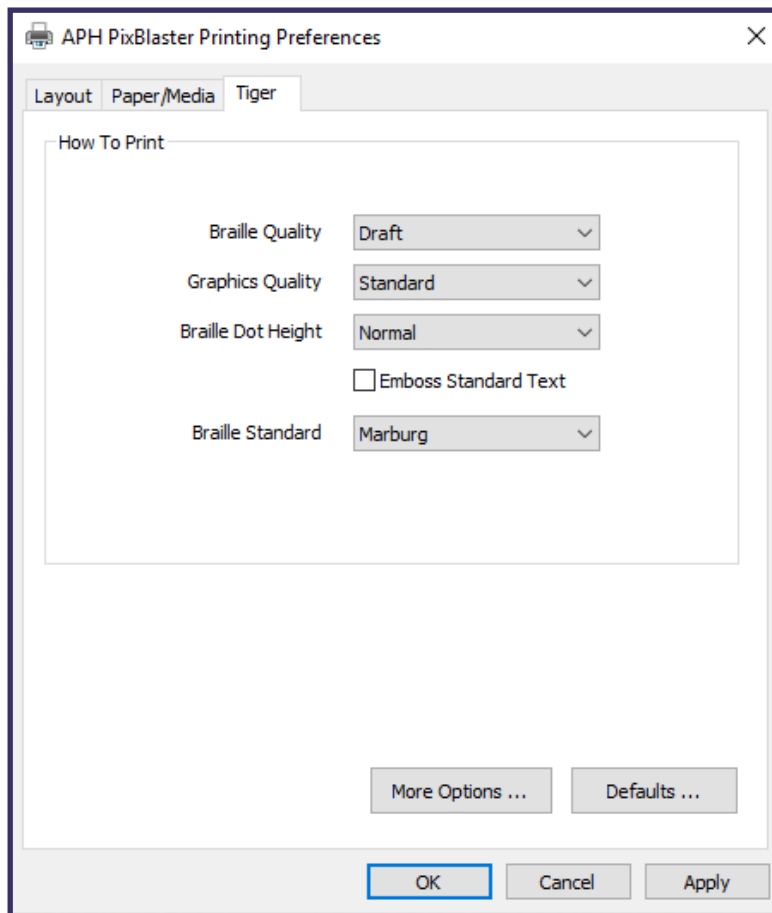

Image 20: Shows Tiger Tab in Printing Preferences window

Adjusting Aspects of Braille Text

Dot Quality: Select Draft, Standard, or Best. Printing with draft dot quality is the faster option. Standard or best dot quality produces rounder, smoother dots, but slows down the printing process.

Braille Height: Select Low, Normal, or High braille dot height. Normal dot height sets the braille dots to the same height as the highest graphics dots. Adjust the braille dot height higher or lower to suit the reader.

Emboss Standard Text: When checked, standard text that is not translated to braille is embossed as an image of the characters. This is helpful when used with a large font to print raised letters. When doing so, it is recommended to change the font color to grey instead of black since the paper could get torn embossing solid black.

Braille Standard: Choose from five different standards to define dot spacing for braille text.

More Options ... : This button brings up a new dialog box, as shown in Image 21.

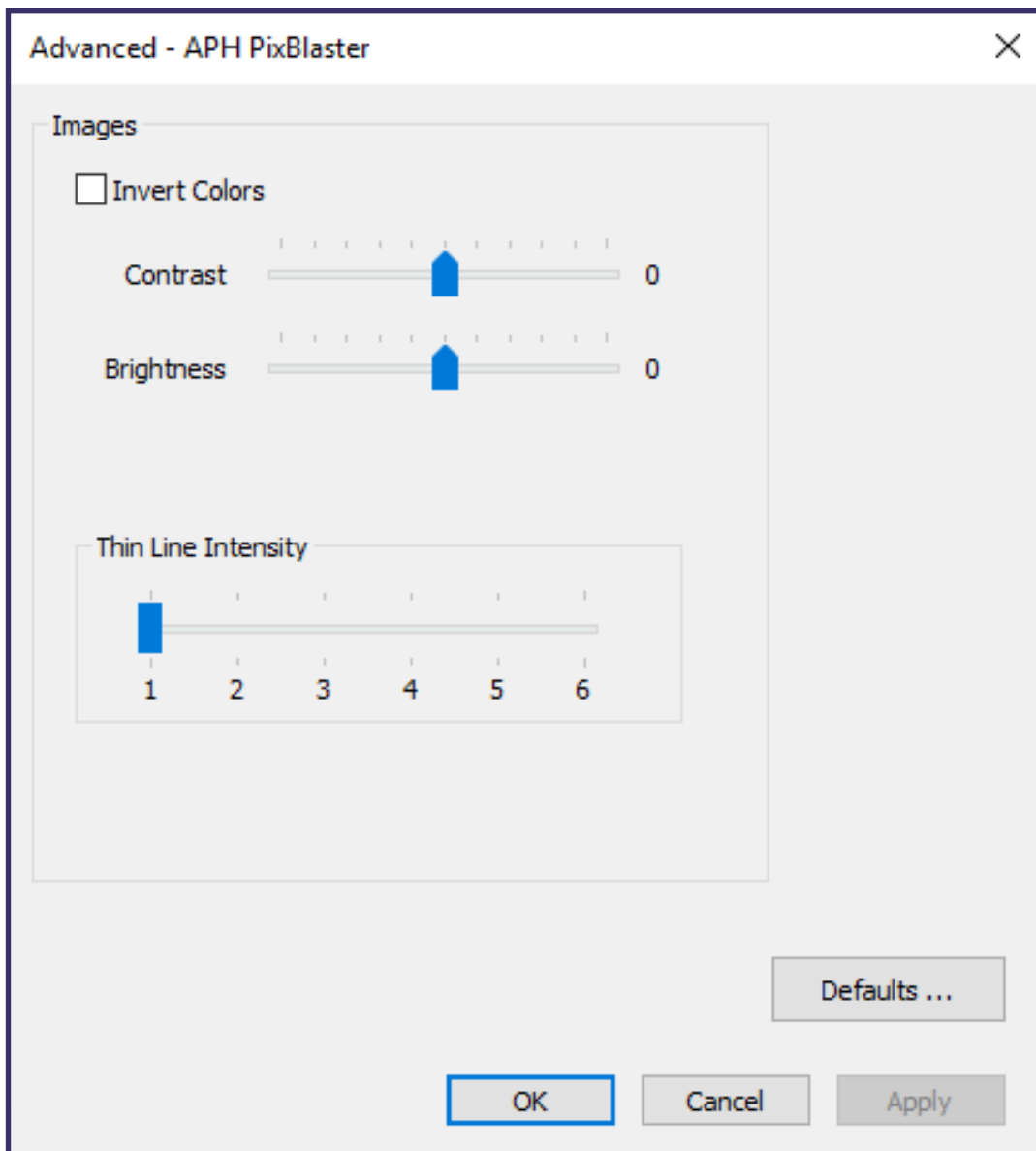

Image 21: Shows the More Options dialog box

Adjusting Aspects of Embossed Images

Invert Colors: Check this option if you want colors to emboss inverted, meaning lighter colors emboss in higher dots, and darker colors emboss in lower dots.

Contrast: The default setting is 0. The range is -100–100. Increasing the contrast increases the dot height difference in respect to the color difference that the dots refer to. So the dot height difference of two similar colors increases.

Brightness: The default setting is 0. The range is -100–100. Increasing the brightness can be useful to increase the intensity of all the colors. This option is most often used with images in which lines are thin and light.

Thin Line Intensity: In general, line thickness should be at least 1.5 pt. If lines in graphics are too thin to emboss correctly, try using a higher thin line intensity by sliding the indicator to the right.

Defaults ...: Restores all settings to their default values.

Utilizing the Operator Panel

The Operator panel is located on the top edge of the embosser, in the front-right corner (closest to you). The panel consists of three rows of four items each. From top to bottom, they are the 4 Menu symbols, 4 round buttons, and 4 LED lights, as shown in Image 22.

From left to right the Menu symbols key includes:

Menu: Indicated by four horizontal raised lines

Up: Indicated by a raised arrow pointing up

Down: Indicated by a raised arrow pointing down

Cancel: Indicated by a raised X

The buttons below the Menu symbols key relate to the symbol directly above it. Notice that the Cancel button has a small raised dot on it, where the other buttons do not.

From left to right, the LED lights are:

LED1: Red - Offline

LED2: Green

LED3: Yellow

LED4: Yellow

For more information about the LED lights, please see the section [Receiving Machine Status and Alerts](#).

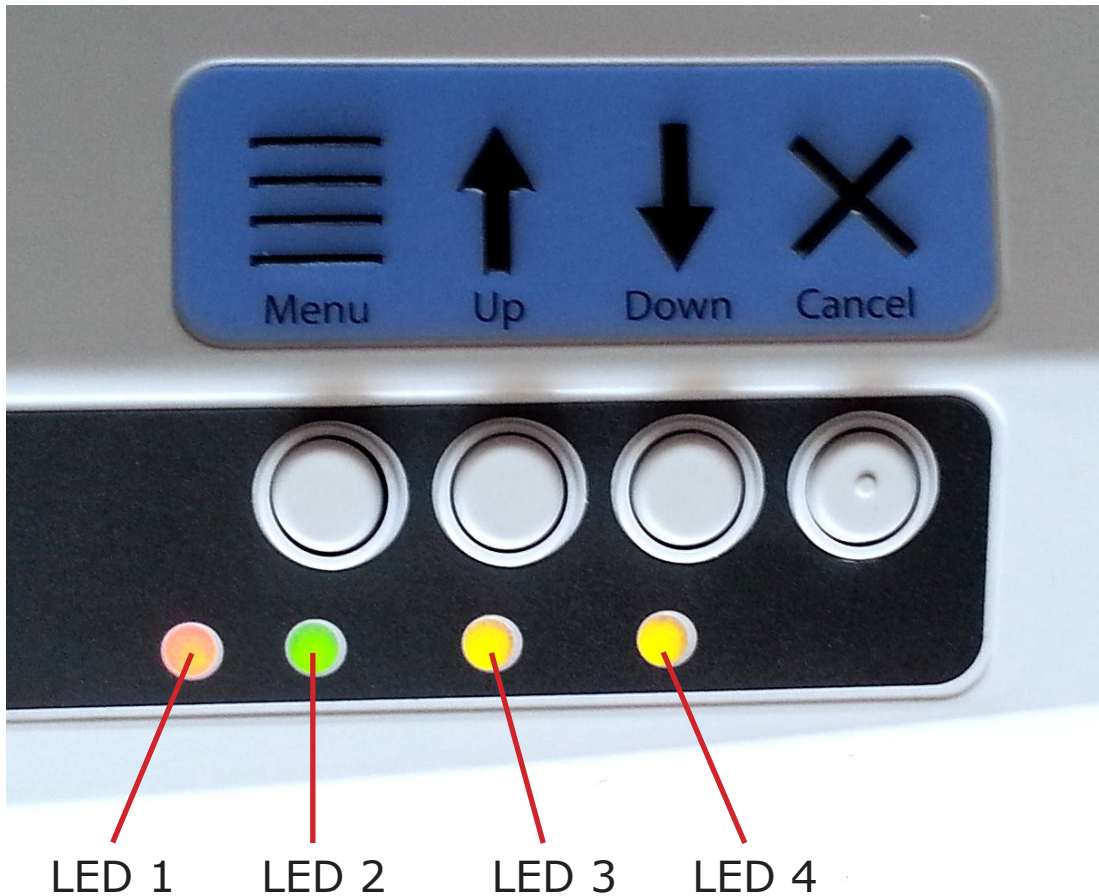

Image 22: Shows the Operator panel with LED lights

Button Functions

Menu: In offline state, press this button to enter the onboard Settings menu to adjust settings for printing in Legacy mode, such as when printing from a notetaker instead of a Windows PC. To be able to follow the menu, it is necessary to have a powered speaker connected through the audio output jack. Please see section [Operator Panel Menu](#) for further information on the onboard Settings menu.

Up: Outside the onboard Settings menu, tapping this button backs up the paper for a certain distance, attempting to bring the paper back to the loading position. Holding the button continuously moves paper back for as long as the button is held.

Within the onboard Settings menu, this button is used for navigation as described in section [Operator Panel Menu](#).

Down: Outside the onboard Settings menu, tapping this button moves paper forward for a certain distance, attempting to bring paper to top-of-form position for printing, or to paper tear-off position depending on the current situation. Holding the button moves the paper forward continuously for as long as the button is held.

Within the onboard Settings menu, this button is used for navigation as described in section [Operator Panel Menu](#).

When running out of paper during printing, use this button to continue printing after the new paper has been loaded to the embosser.

Cancel: Holding this button during power On of the embosser yields to embossing a demo page. During printing, pressing this button stops the print job or clears error status.

During stand-by, this button switches the embosser between Online and Offline modes.

Operator Panel Menu

The APH PixBlaster provides an onboard Settings menu to adjust device settings without connecting the embosser to a Windows computer. This is useful for adjusting settings prior to printing in Legacy mode such as from a notetaker device.

To enter the onboard Settings menu:

1. Make sure the embosser is in Offline mode. This is indicated by the red LED light.
2. Use the Cancel button to toggle between Online and Offline mode.
3. Press the Menu button to enter the menu accompanied by audio messaging.

Note: To be able to listen to the messages, it is necessary to have a powered speaker connected through the audio output jack on the right side of the machine.

In the menu, use the Up and Down Arrow buttons to navigate through the menu items.

Once the menu is entered, the Menu button switches between the Change Setting mode and Continue Navigation mode. In the Change Setting mode, the setting of the current menu item can be changed using the Up and Down Arrow buttons. In Continue Navigation mode, the Up and Down Arrow buttons can be used to continue navigating through menu items.

When in the menu, pressing the Menu button for any menu item activates the audio. The audio message states the name of the menu item plus the current value. Now the Up and Down Arrow buttons change the value. At any value, pressing the Menu button brings you back to the upper menu level either with a changed value, or with no change. The Cancel button always returns you to the upper menu level with no change.

A value is saved when confirmed with the Menu button, and the confirmed message appears accompanied by a beep of the embosser.

The Cancel button backs up one menu level at any state. If the message No Change appears, the current menu item in focus was not changed prior to exiting the menu, but all changes that were confirmed are saved.

Table 1 shows all menu items and their value range.

Menu item	Description	Values
Form Size	Paper form size	11.5x11 inches, letter, custom, German standard fanfold
Language	Menu language	English
IP address	States IP address, but no change possible	No change
Double-sided interpoint	Set double-sided or single-sided print mode	Short edge, long edge (both for double-sided embossing), single-sided
Dots per Character	Number of dots per braille character	6, 8
Dot Quality	Quality setting for embossed dots	Draft, best, normal
Braille Dot Height	Adjust hammer punch force for braille dots	Heavy, normal, light
Word Wrap	Truncate lines if word wrap is Off, or set to On to have words wrap to next line if too long for the current line	On, Off

Menu item	Description	Values
Extra Line Spacing	Extra line spacing is added to normal single line spacing between braille lines	0–1 inch, 0.05 inch increments
Braille Standard	Dot spacing in braille text following the Standard that is selected	Marburg, Jumbo Braille, Korean, Micro Braille, US National Library, Library of Congress
	Orientation of paper	Landscape, Portrait, Inverse Landscape, Inverse Portrait
Right Margin	Right margin setting	0–5 inches, 0.05 inch increments
Left Margin	Left margin setting	0–5 inches, 0.05 inch increments
Top Margin	Top margin setting	0–5 inches, 0.05 inch increments
Form Width	Select a form width	11.5 inches, 8.5 inches, custom
Form Length	Select a form length	12 inches, 11 inches, custom

Table 1: Operator Panel Menu Items, Descriptions, and Values

Receiving Machine Status and Alerts

As long as the embosser is online and connected properly to the computer, you are able to receive status messages and codes through the Printer Properties Service tab, as well as status indications through audio alerts and LED lights.

Table 2 shows machine status and corresponding alerts from the embosser.

Status description	Status code	Audio alert	LED lights indication
Online/Standby	10094	Online	LED2 on
Offline	10002	Offline	LED1 on
Embossing	10098		LED2 on, LED4 blinking
Paper load error	41100		LED2 on, LED3 and LED4 blinking
Invalid data			All LEDs blinking
Hardware error			All LEDs blinking
Network error	30027		
SD card error	30900 40083		
SD card missing	40100		
Power fault, or Machine temperature out of valid range			No lights at all

Table 2: Embosser Status and Alerts (Description, Code, Audio alert, and LED indication)

Troubleshooting: If one of the following events should occur, please follow these instructions:

Paper load error: This error message could have several meanings:

- There is not paper present when the embosser is trying to start printing.

- Paper ran out before the print job was completed.
- The paper path is blocked and no top of form could be found to start a new page.

In any of these cases, make sure to have paper loaded properly and press the Down Arrow button to begin or continue printing.

To cancel the print job at this point and clear the error, press the Cancel button. Any print jobs waiting in the queue, begin printing after the error is cleared.

Paper Jam: Remove the jammed paper according to the instructions in [Resolving Paper Jams](#) section, and press Cancel to clear the error status. Any print jobs not completed before the error occurred are re-sent.

Print data error: If you notice wrong data output from the embosser, press Cancel and send the print job again.

Carriage stall: If the carriage stalls, turn the embosser Off and see if the paper path is clear following instructions in the [Resolving Paper Jams](#) section to remove jammed paper. Turn the embosser back On. If this does not clear the error status, contact [APH Support](#).

Any failure that can't be identified: Turn the embosser Off and contact [APH Support](#).

Loading Paper Into the Embosser

Inserting Paper into Tractor Mechanism

Your APH PixBlaster comes with a tractor mechanism, feeding paper from the back of the embosser. To load tractor-feed paper, complete the following steps:

1. Open the paper cover by lifting the back edge of the housing top and rotating it towards the front of the printer.
2. Lift the tractor flaps on both sides to reveal the tractor teeth.
3. Facing the printer from the back, place the left side of the paper into the left tractor. Do not adjust the left tractor position. Close the tractor flap if there is no need to adjust the right tractor position. If you need to adjust the right tractor position to fit into the right side of the paper, do the following:
 - a. Release the locking lever on the side of the tractor.
 - b. Slide the tractor to a position so it lines up with the holes in the paper.
 - c. Insert the paper into the tractor and close the flap.
 - d. Adjust the tractor so that the paper is tight.
 - e. Engage the locking lever.
4. Close the paper cover.

Resolving Paper Jams

Occasionally, you may encounter a paper jam. To correct it, do the following:

1. Tear off the paper at the closest perforation to the embosser, for both the paper input and output, as shown in Images 23 and 24.

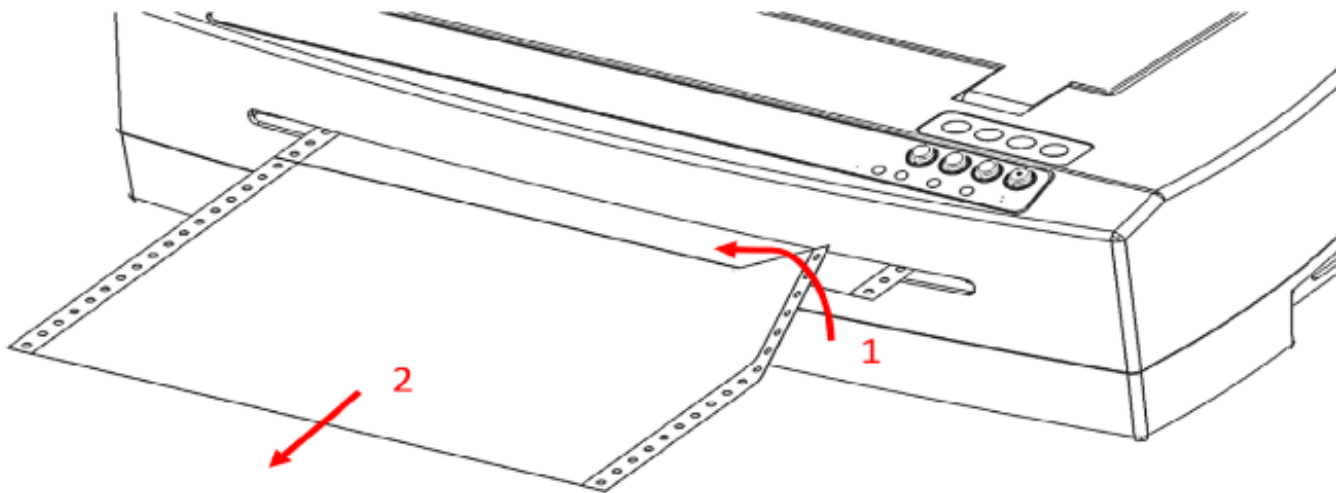
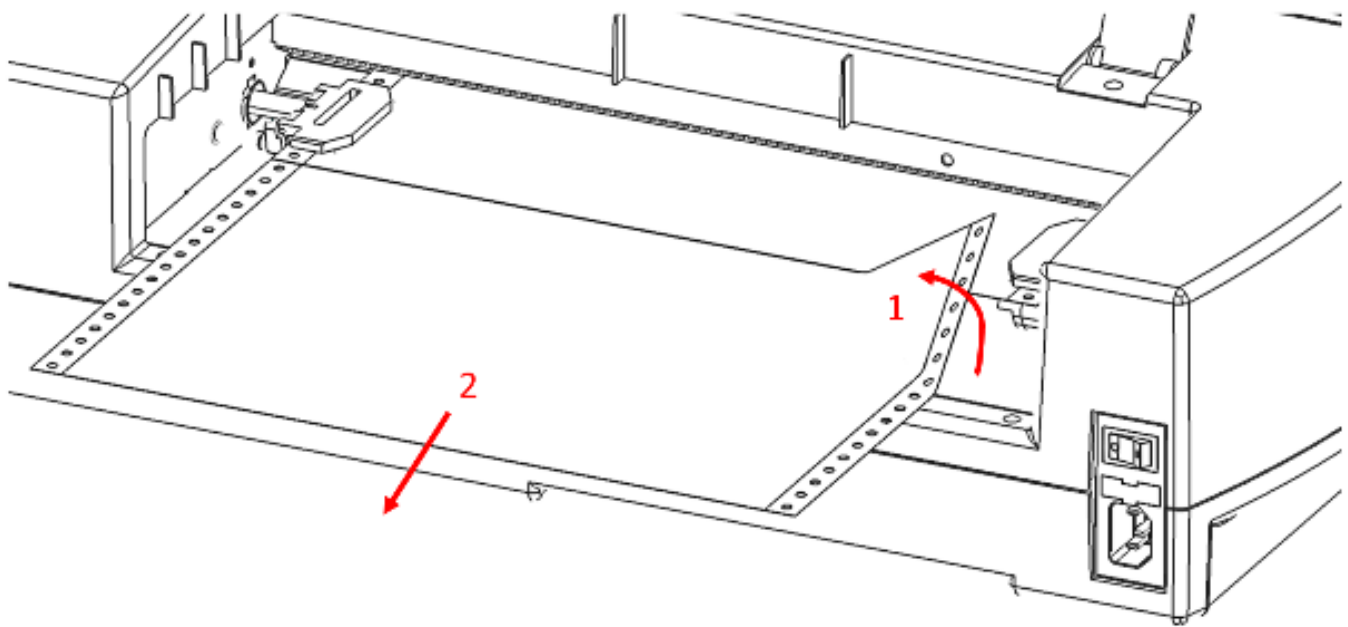

Images 23 and 24: Shows paper input and output

2. Open the tractor feeder lid and release paper from the tractor pins if still engaged, shown in Image 25.

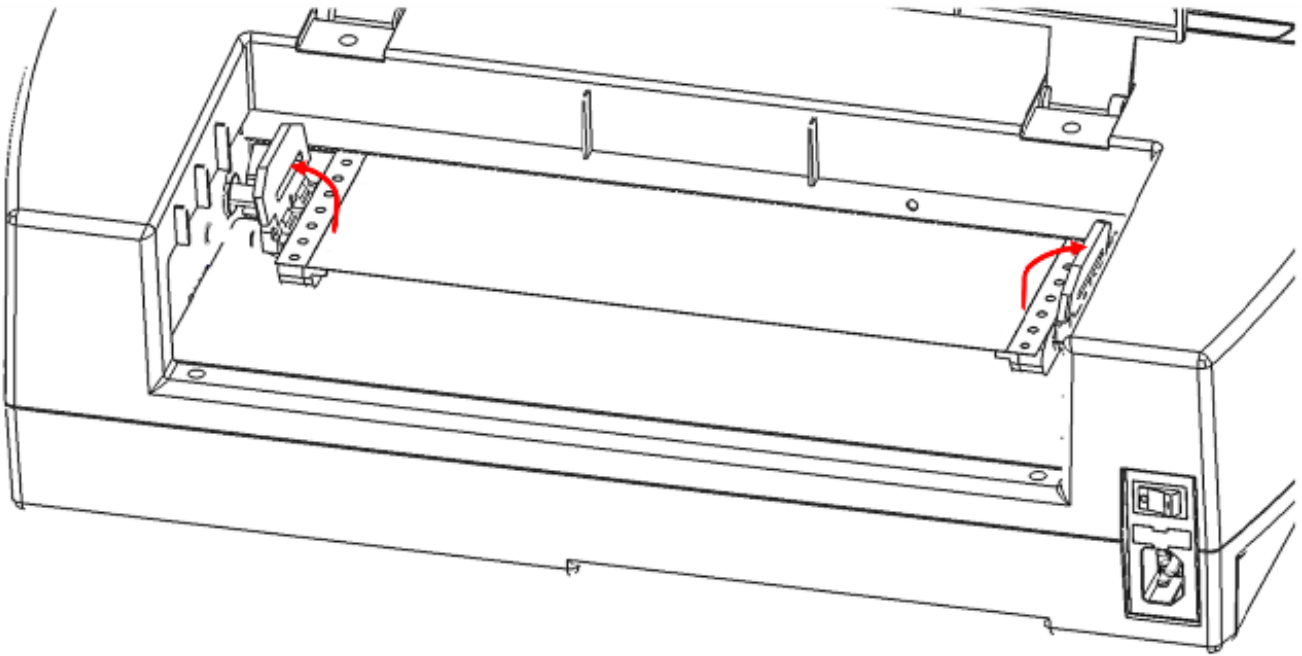

Image 25: Shows the paper release mechanisms

3. Pull on visible paper on the output (front) side of the machine; take care to distribute pulling force evenly across the paper to prevent tearing, shown in Image 26.

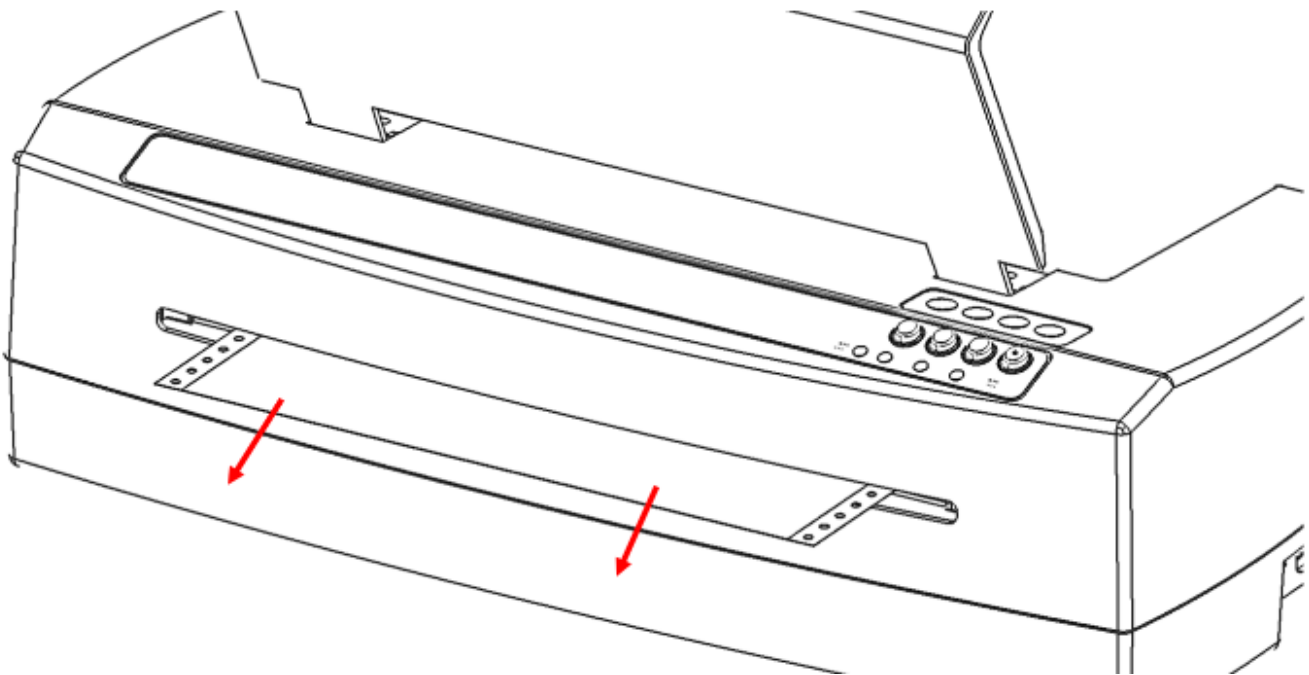

Image 26: Shows where to pull the paper from the front

4. If the paper does not completely pull out the front, remove any remaining paper from the rear of the embosser; take care to distribute pulling force evenly across the paper to prevent tearing, shown in Image 27.

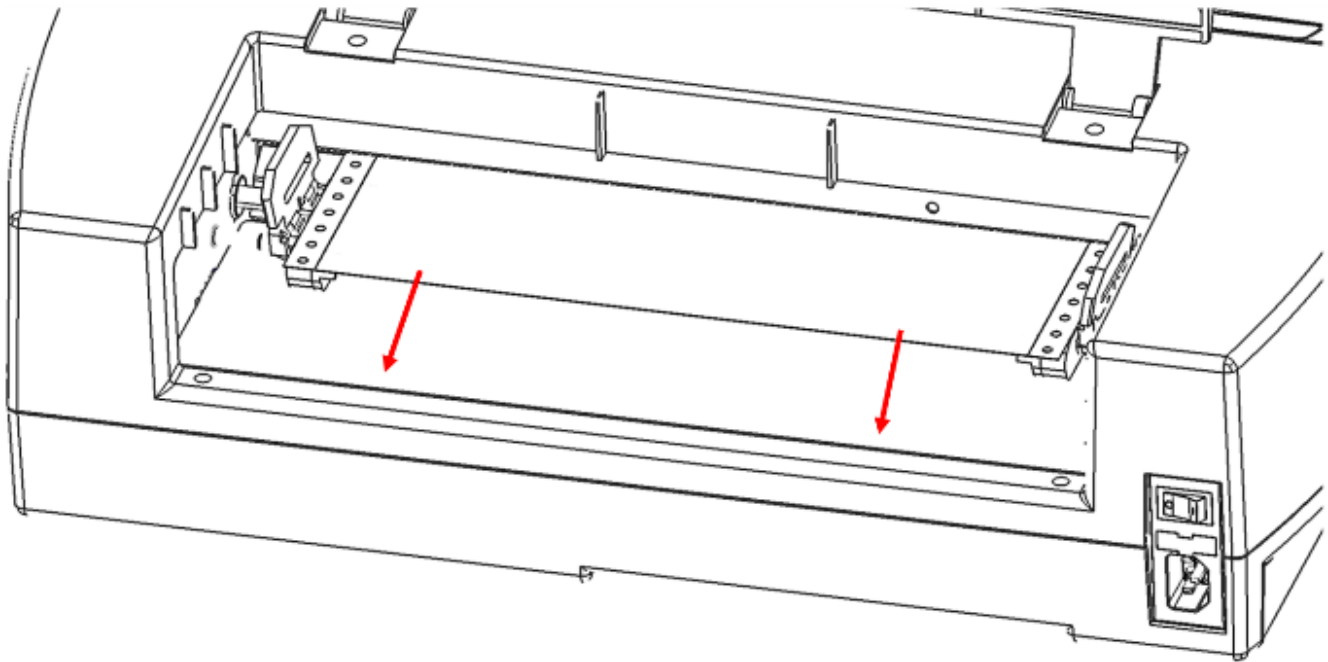

Image 27: Shows where to pull the paper from the back

5. (Alternative step) You may also try the Up and Down Arrow buttons on the Operating panel to support paper moving out of the machine.
6. In the rare event, there are still scraps of paper left behind in the embosser, fold a thick sheet of paper in half, insert the sheet into the embosser over the tractor feed, and move the sheet from side to side to free paper remnants, shown in Image 28.

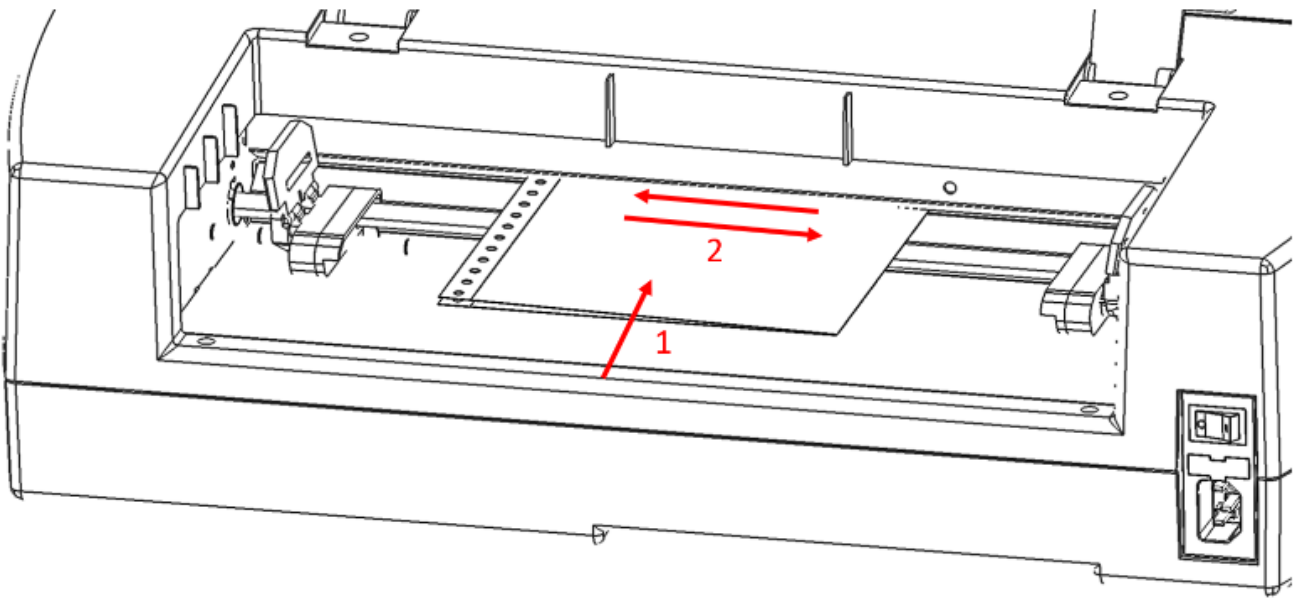

Image 28: Shows how to free additional paper remnants

Once the paper jam is clear, insert paper again, engage tractors, close the lid, and reprint the document.

Utilizing Braille Transcription Software

The PixBlaster embosser is compatible with APH's BrailleBlaster[®], Tiger Software Suite, and third party products such as Duxbury, Braille2000, and RTFC braille translation software, which can be used to print braille from braille notetakers.

BrailleBlaster

BrailleBlaster is a free braille translation software app developed by APH to help transcribers provide braille textbooks on the first day of class. BrailleBlaster relies on [Liblouis](#), a well-known open-source braille translator, for translating text and mathematics to braille. Go to brailleblaster.org to download the app and for more information about this software.

BrailleBlaster supports the following:

- Braille in grade 1 (literary) and 2 (contracted)
- EBAE, UEB, UEB with Nemeth, Spanish US, Cherokee
- Uncontracted versions of UEB and EBAE tables
- Word (*.doc) files
- Word XML (*.docx) files
- PDF (*.pdf) files
- Text (*.txt) files
- Page numbering
- Volume handling (for braille books)
- APH embossers

Setting up PixBlaster in BrailleBlaster®

BrailleBlaster can be configured to work with this embosser by going to Settings > Embosser Settings. Select “Add” to create a new embosser profile. This opens the Edit embosser configuration dialog.

In this dialog, find your PixBlaster embosser in the dropdown list labeled Embosser device. This lists all available printers and embossers that you have communicating with your computer. Then select “APH” from the dropdown Embosser manufacturer. Finally, select the model “PixBlaster” from the dropdown Embosser model. Once finished, select OK to create this embosser profile.

For more information on using BrailleBlaster, visit brailleblaster.org.

Image 29 shows the Edit embosser configuration dialog from BrailleBlaster. Here, you name your embosser, choose your embosser device, choose the manufacturer, and choose the model.

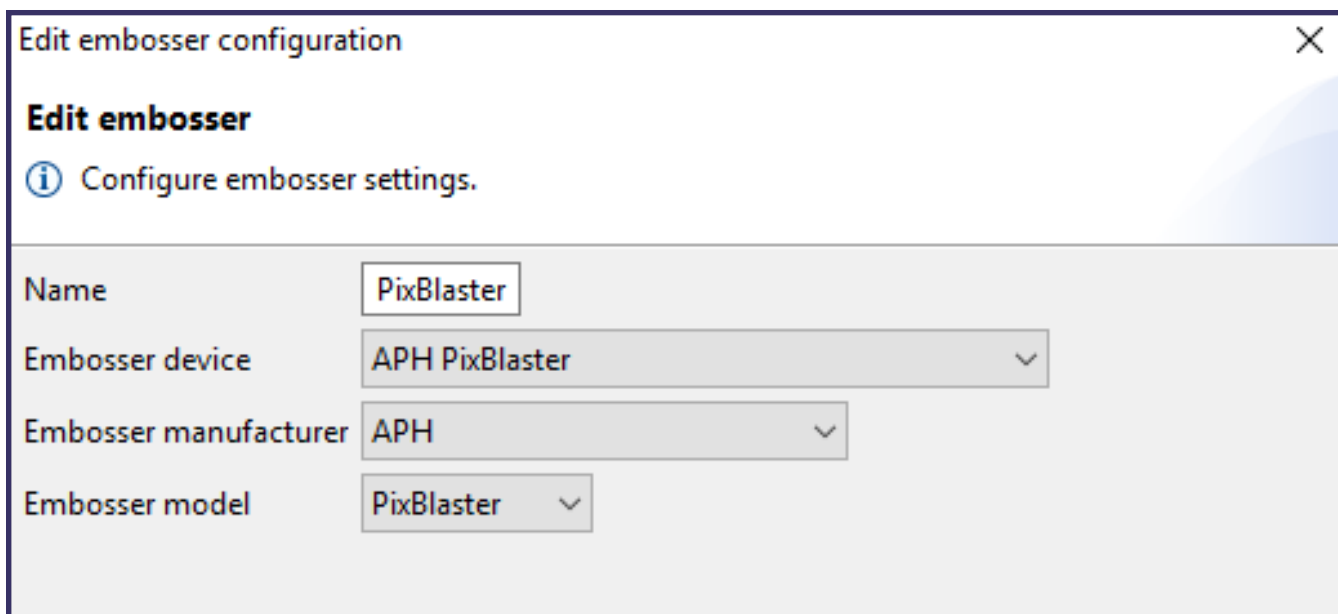

Image 29: BrailleBlaster embosser configuration dialog

ViewPlus Tiger Software Suite (TSS)

Within Microsoft Word and Excel the ViewPlus Tiger Software Suite (TSS) provides direct tools for text-to-braille translation in numerous languages and contraction grades. TSS includes easy translation of charts and graphs in Microsoft Excel and provides further tools to easily create and edit tactile graphics originating from other Windows applications.

Please visit <https://viewplus.com/product/tiger-software-suite/> for further information about the ViewPlus Tiger Software Suite solutions, including the [TSS User Manual](#).

Printing Graphics and Braille

In general, the embossing technology creates a tactile representation of the screen image where darker colors result in higher tactile dots and lighter colors in lower tactile dots.

Text only prints in braille after it has been translated to braille code and can be recognized as braille text from the printer driver. In Windows applications, if the text is recognized as

true text and not embedded as an image, a non-contracted braille output can be created by simply formatting the text to a braille font as further described in the section [Selecting Braille Fonts](#).

Selecting Braille Fonts

Braille and Tiger screen fonts are braille fonts that install with the installation of the APH PixBlaster embosser driver. They can be chosen from any Windows program that includes Windows font selection. However, text has to be handled as true text, and not as embedded images, such as may be the case in some PDF Editor programs.

Braille and Tiger screen fonts appear as standard text characters on the screen and emboss in braille dot patterns. When applying these fonts, each print character is converted to one braille character that corresponds to the ASCII code of that print character. There are no contractions or translation of symbols in the braille output.

It is very important to use the correct font size for the correct dot spacing to be printed for braille fonts. For 8-dot braille fonts, such as Computer braille, the point size needs to be set to 43. Other braille fonts, indicated through a 29 in their font name, need to be set to point size 29.

Characters or text that is not translated to braille embosses as graphic images of the visual appearance of standard text if the Emboss Standard Text option is checked within the Tiger tab of the printing preferences.

Creating Braille Math Documents

Create braille math documents using Tiger Software Suite (TSS) with MathType from Design Science. Insert text, graphics, and math equations directly into a Microsoft Word document and translate to braille in one easy step.

Equations appear in both braille and print allowing sighted readers to follow along.

Printing Documents

Once the printer driver is installed and the printer properties are accessible, you are ready to emboss from any Windows program. For a general printing test of Microsoft Word follow these easy steps:

1. Open the document to be printed in Microsoft Word.
2. Open the program's File menu and choose Print.
3. On the Print dialog, make sure the APH PixBlaster is selected.

The default embosser properties settings should be fine, but if you want to make changes:

1. Click the Printer Properties button and adjust settings such as paper size and PixBlaster printing options.
2. Click OK in the Printer Properties dialog box when finished.
3. Click OK in the Print dialog box to start the print job.

When the embosser is finished, it advances the paper automatically to a position where it can be torn off. You can leave the paper at this position for the embosser to automatically move it back and find top of form again for the next print job.

In general, PixBlaster follows the WYSWIG principle: What you see is what you get. The screen image is converted to tactile resolution and colors are converted to different dot heights on the embossed output, where darker colors are embossed with higher dots (black = highest dot), and lighter colors are embossed with lower dots (white = no dot).

A knowledge base and tutorials on how to use PixBlaster on various applications can be found under <https://viewplus.com/viewplus-support/>.

Accessing Training, Maintenance, Support, and Warranty Information

Please consult the APH webpage <https://www.aph.org/product/pixblaster/> or contact your APH sales representative for additional information about training, maintenance, and support.

Accessing Training Resources

APH provides two training methods:

1. Video tutorials/documentation downloadable from the PixBlaster webpage <https://www.aph.org/product/pixblaster/>, and
2. Live online training sessions with an APH Support Specialist.

Monitoring Maintenance of Embosser

It is important to follow the safety instructions as stated under I.C. (International Compliance).

Dot quality should be monitored; poor alignment of the hammer tips to the receiving dies can cause permanent damage to the PixBlaster embosser.

Updates can be downloaded from the PixBlaster webpage <https://www.aph.org/product/pixblaster/>. Please check the webpage occasionally for our latest developments.

Contacting APH Customer Service

In addition to support material available on the [PixBlaster webpage](#), please do not hesitate to contact American Printing House (APH) for your technical support questions.

- E-mail to cs@aph.org; or
- Call APH Customer Service at +1 (800) 223-1839.

Locating Warranty Information

For information on your product warranty, please visit <https://viewplus.com/viewplus-support/warranty-details/>.

Considering Extended Warranty Options

For extended warranty options, please contact sales@viewplus.com.

Appendices

Appendix A: Compliance Statements

FCC Compliance Statement (USA)

This equipment has been tested and found to comply with the limits for a Class A digital device, pursuant to Part 15 of the FCC Rules. Operation is subject to the following two conditions: (1) this device may not cause harmful interference, and (2) this device must accept any interference received, including interference that may cause undesired operation. If this equipment does cause harmful interference to radio or television reception, which can be determined by turning the equipment off and on, the user is encouraged to try to correct the interference by one or more of the following measures:

- Reorient or relocate the receiving antenna.
- Increase the separation between the equipment and receiver.
- Connect the equipment to an outlet on a circuit different from that to which the receiver is connected.
- Consult the dealer or an experienced radio/TV technician for help.

FCC Warning: Changes or modifications not expressly approved by the party responsible for compliance could void the user's authority to operate the equipment.

Note the following:

- The use of a non-shielded interface cable with the referenced device is prohibited.
- The length of the power cord must be 3 meters (10 feet) or less.

This unit is also intended for connection to IT distribution systems.

Compliance Statement (Canada)

This digital apparatus is in conformity with standard ICES-003 of Canada.

Cet appareil numérique est conforme à la norme NMB-003 du Canada.

Compliance Statement (Germany)

Bescheinigung des Herstellers/Importeurs:
Hiermit wird bescheinigt, dass der Drucker der Maschinenlärminformationsverordnung 3. GSGV, 18.01.1991 entspricht: Der höchste Schalldruckpegel beträgt 70 dB(A) oder weniger gemäß EN27779-1991.

Compliance Statement (Europe)

Warning: This product meets the interference requirements of EN 55032. In a domestic environment, this product may cause radio interference in which case, the user may be required to take adequate measures.

Compliance Statement (Korea)

This apparatus complies with CISPR32 requirements.

International Compliance



Rule Number	Component
EN 55032:2012 Class B	Emissions series
EN 55024:2010	Immunity characteristics
EN 61000-3-2:2014	Power line harmonics
EN 61000-3-3:2013	Power line flicker
EN 55024:2010	Electrostatic discharge
EN 55024:2010	Radiated immunity
EN 55024:2010	Electrical fast transient/burst
EN 55024:2010	Surge
EN 55024:2010	Conducted immunity
EN 55024:2010	Magnetic Field Immunity
EN 55024:2010	Input voltage interruptions/DIPS

Appendix B: Embosser Specifications

Component	APH PixBlaster Embosser
Print Speed	Up to 120 CPS, double-sided 400 pph (A4 paper size)
Tactile Resolution	100 DPI
Embossed Dot Density	Up to 17 DPI
Braille Dot Spacing	Selectable from 5 international Standards
Tactile Graphic Dot Heights	7 steps for color representation
Braille Dot Heights	Adjustable in 3 heights
Paper Feed Method	Tractor feed from the back
Paper Width	7 to 11.5 inches (176 to 292mm)
Paper Weight	Adjustable for different media from 90 g/m ² (Copy paper) to 200 g/m ² (heavy braille paper)
Power Supply	Voltage: 100 to 240 VAR (\pm 10%) Frequency: 50/60 Hz (\pm 3%)
Power Consumption	Standby: 10 W Average Embossing: <130 W Heavy Embossing: <185 W
Fuse	5 A, 250 V slow blow long time lag 5x20mm

Component	APH PixBlaster Embosser
Embosser Dimensions:	
Width	21.9 (557 mm)
Depth	10.8 (275 mm)
Height	6.2 (158 mm)
Weight	19.8 lbs (9 kg)
Connectivity	USB and Ethernet
Operating Conditions:	
Operating Temperature	59 to 95 °F (15 to 35 °C)
Storage Temperature	-4 to 158 °F (-40 to 70 °C)
Relative Humidity	20 to 80% RH (non-condensing)
Acoustics	<= 70 dBA per ISO 7779

Appendix C: TigerPlus Technology

The TigerPlus Braille system, which is implemented with APH's PixBlaster, places dots on tactile prints with an accuracy of up to 100 DPI. The physical size of each dot allows placing dots as close to each other as 17 DPI. However, the resolution of actual dot placement may vary to yield the best possible representation of shapes in tactile print.

The advantage of the TigerPlus Braille system versus the traditional Tiger Braille system is the capability of placing dots in variable distances with a resolution of 100 DPI. This allows the selection of a special setting with this embosser that is not available with other embosser models. The setting of the braille dot spacing to one of the five following international braille standards:

- Marburg Medium (German), equivalent to traditional Tiger Braille system
- American Library of Congress
- American National Library of the Blind
- Japanese Standard (Micro Braille)
- Korean Standard

Additional to these braille standards, Jumbo Braille can be created when using Tiger Software Suite (TSS) in Microsoft Word, or Microsoft Excel. Or, when printing to a notetaker in Legacy mode, Jumbo Braille can be selected in braille spacing options of the [Device Settings Tab](#).

Appendix D: Proper Trademark Notice and Attributions

BrailleBlaster is a registered trademark of American Printing House for the Blind; PixBlaster is a trademark of American Printing House for the Blind.

CorelDRAW is a registered trademark of Corel Corporation.

macOS is a registered trademark of Apple Inc.

Tiger is a registered trademark of ViewPlus Technologies, Inc.

Word is a trademark of Microsoft Corporation; Excel, PowerPoint, and Windows Vista are registered trademarks of Microsoft Corporation.

All other trademarks are the property of their respective owners.

PixBlaster

Catalog No. 1-08070-00

Copyright © 2021



1839 Frankfort Avenue

Louisville, KY 40206

502-895-2405

info@aph.org

www.aph.org