

Easy to Read and  
Easy to Understand

RFID

Technical Guide



# Table of Contents

What is RFID? .....	3
Types of RFID .....	6
OMRON's RFID Products: Features .....	10
Precautions for Use .....	15

# 1 What is RFID?

## ► What is RFID?

Automatic identification (auto ID) is a process where people and things are automatically identified. Some familiar examples are barcodes used to identify products and fingerprint authentication used by smartphones to identify users.

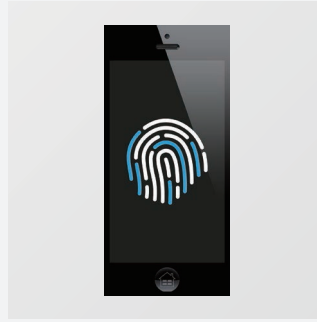

Radio frequency identification, or RFID, is an auto ID technology whereby reader/writers use radio waves to capture information recorded on RF tags.



## ► Strong Points

RFID has the following advantages over barcodes and other auto ID technologies.

1. Relatively stain-resistant.
2. RF tags can be read from or written to even when they are not in close proximity to the reader/writer (as long as they are within the reach of the radio energy used for communication).
3. Data can be rewritten.

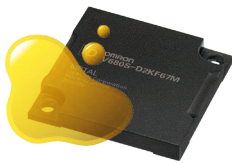

Stain-resistant

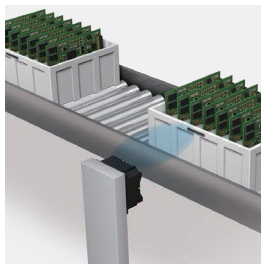

Tags can be read from/  
written to if within communication range

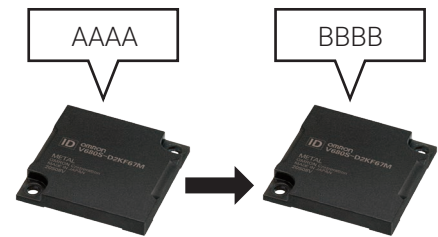

Rewritable

## ▶ Common Applications of RFID

RFID has many applications that take advantage of the technology's strong points.

### 1. Railway ticket gates

Transit fare cards (e.g. Suica) use RF tags.

Information encoded in the card is read to control ticket gate operation.

The tags are rewritable, making them perfect for storing balance and other information.

### 2. Cafeteria checkout counter

RF tags are attached to all tableware used at the cafeteria to enable an unmanned automatic checkout system.

### 3. Store product management

A major clothing manufacturer attaches RF tags to their products to streamline inventory management.

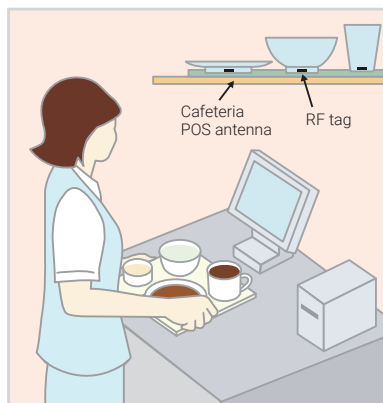
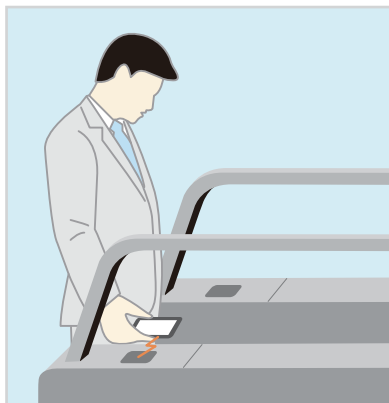

With the Ministry of Economy, Trade and Industry (METI) of Japan planning to attach RF tags to all products sold in convenience stores by 2025, RFID is sure to become even more pervasive in our daily lives.

Reference: METI website

[https://www.meti.go.jp/english/press/2017/0418\\_003.html](https://www.meti.go.jp/english/press/2017/0418_003.html)

# 2 Types of RFID

## ► Categorized by Frequency Band

The chart below groups RFID according to the frequency band used for communication. Each type has its strong and weak points, and so should be selected according to purpose.

Transmission method	Electromagnetic induction		Radio wave	
	135 kHz or lower	13.56 MHz	920 MHz	2.4 GHz
Used frequencies	135 kHz or lower	13.56 MHz	920 MHz	2.4 GHz
Communication range	Fair A few to a few dozen cm		Good A few meters	Good A few to a few dozen meters
Oil/chemical resistance (impact of moisture)	Good (no impact)		Fair (substantial impact)	Fair (substantial impact)
Application	Relatively limited range of usage	Widely used in a vast range of applications (virtually unaffected by all substances except metals and therefore highly versatile)	Warehouse gates (because it can communicate over long distances)	Mostly active RFID

### Electromagnetic induction

Uses magnetic fields for coupling.  
 Suited for short-range communication, for drop off in field strength is inversely proportional to the distance squared.  
 Magnetic fields are virtually unaffected by water

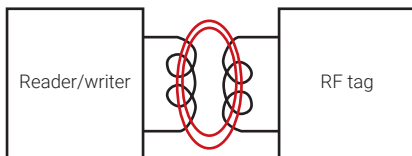

### Radio wave

Uses radio waves for coupling.  
 Can communicate over long distances, for drop off in field strength is inversely proportional to the distance.  
 Greatly affected by water

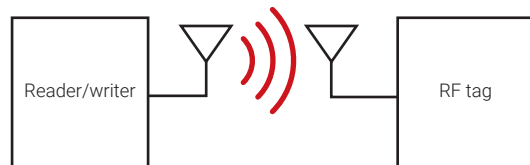

## ► Categorized by Power Supply

RFID can also be grouped into three groups according to how tags are powered: passive, semi-passive, and active.

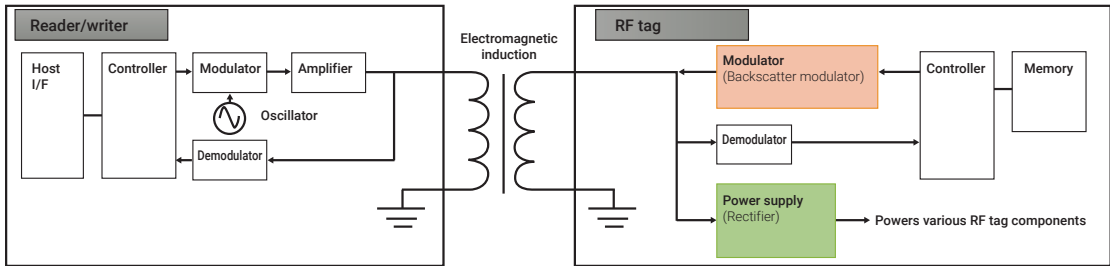
	Passive RFID
<b>Features</b>	<p>The most distinguishing feature of passive RFID is that its RF tags have no batteries. This allows for a low-cost, maintenance-free system, which would not be possible with other wireless technologies (e.g. Wi-Fi and Bluetooth), suited for tasks that require the identification of a large number of subjects, such as inventory management and production management.</p> <p>The RF tags do not emit radio waves but talk back to reader/writers using backscatter modulation.</p>
<b>RF tag battery</b>	<p><b>None</b></p> <p>The tag harvests its internal operating power by rectifying high-frequency signals it receives from the reader/writer (using power supply shown in green in block diagram), which means its internal circuit operates only when it is within communication range of the reader/writer.</p>
<b>Communication method</b>	<p><b>Backscatter</b></p> <p>RF tag does not need its own oscillator to signal to the reader/writer, and this reduces power consumption (modulator shown in orange in block diagram).</p>
<b>Mechanism</b>	<p>Block diagram</p>  <p>The diagram illustrates the communication mechanism between a Reader/writer and an RF tag. The Reader/writer side includes a Host I/F, Controller, Modulator, Amplifier, and Demodulator, with an Oscillator connected to the Modulator. The RF tag side includes a Modulator (Backscatter modulator), Demodulator, Controller, and Memory. A Power supply (Rectifier) is connected to the Demodulator and provides power to various RF tag components. The two sides are connected via Electromagnetic induction, represented by a transformer symbol.</p>

	<b>Semi-passive RFID</b>
<b>Features</b>	In a semi-passive RFID system, the method of communication between RF tags and reader/writers is the same as in a passive RFID system. The difference is that RF tags in a semi-passive system have batteries to enable functions that are not possible in a passive RFID system. Some representative examples of sensing without receiving power from reader/writers are temperature data logging during transport, and long-distance communication that passive RFID systems would not be able to provide.
<b>RF tag battery</b>	<b>Built-in battery</b> RFID components are powered by battery, so internal circuits can operate even when tag is outside reader/writer communication range (sensor is shown in blue in block diagram).
<b>Communication method</b>	<b>Backscatter</b> RF tag does not need its own oscillator to signal to the reader/writer, and this reduces power consumption (modulator shown in orange in block diagram).
<b>Mechanism</b>	Block diagram 

	<b>Active RFID</b>
<b>Features</b>	Unlike passive and semi-passive RFID tags, active RFID tags generate their own radio frequency signals, enabling long-distance communication. Because the tags are battery-powered, it is critical that information is delivered efficiently with minimum power consumption. Active RFID is used, for example, to monitor electricity meters and gas meters, and for managing sea freight containers at ports.
<b>RF tag battery</b>	<b>Built-in battery</b> RFID parts are powered by battery, so internal circuits can operate even when tag is outside reader/writer communication range (sensor is shown in blue in block diagram).
<b>Communication method</b>	<b>Each equipment have Continuous Wave (CW) oscillator</b>
<b>Mechanism</b>	Block diagram 



## ► Supplement: How Does Backscatter Communication Work?

This section explains how backscatter communication, used in passive and semi-passive RFID, works.

In passive and semi-passive RFID, energy from the reader/writer cannot sufficiently power an oscillator circuit inside the RF tag. The backscatter technique enables tags to talk back to reader/writers without an oscillator circuit.

Changing the impedance of the load modulation circuit in the RF tag from  $Z_1$  to  $Z_2$  while continuous waves (CW) are being transmitted from the reader/writer changes the amplitude of the CW signals that reflect off the tag. Passive and semi-passive RF tags apply this principle by switching their circuit impedance between  $Z_1$  and  $Z_2$  to translate their response signals (0/1) into changes in the amplitude of the CW signals reflected off of them, a technique known as backscatter modulation.

The reader/writer then demodulates the modulated RF waves.

In using this method, the RF tags themselves do not emit RF waves and so are not considered as radio equipment under Japanese Radio Law.

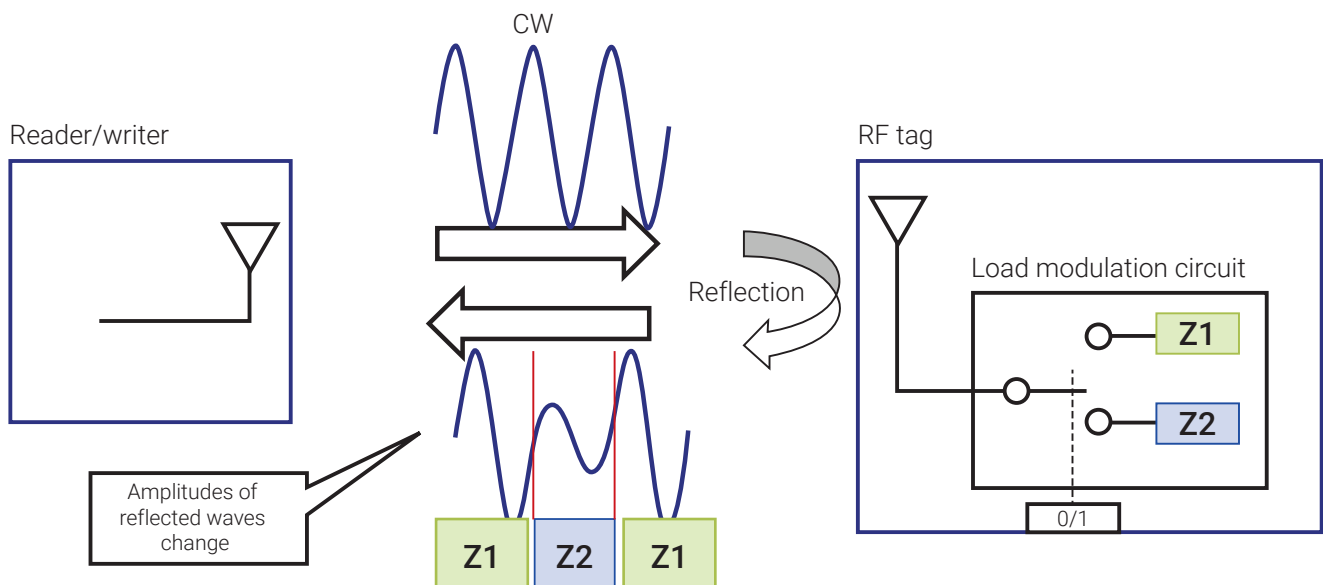

# 3

## OMRON's RFID Products: Features

OMRON's RFID products boast an extensive on-the-ground track record in the field of factory automation over more than 30 years. In keeping with this proud history, we continue to strive to develop RFID technologies our customers can rely on.

### 1. Guaranteed Communication Range (V600/V680/V680S Series)

The communication range of an RFID system may fluctuate due to a range of factors, such as equipment temperature and variation among different units.

In electromagnetic induction RFID systems, tags and reader/writers communicate via the connection between their coils. Increasing the Q-factors of the coils can increase the communication range, but this comes with the risk of increasing communication range fluctuation as well.

At OMRON, we define a guaranteed communication range for each of our RFID products that takes these points into consideration.

We also test to make sure that there are no blind spots in the designated range, ensuring reliability as long as the units are used within its limits.

#### Sample communication range specifications (guaranteed range)

Amplifier	Antenna	RF tag	Communication range	
V680-HA63B	V680-HS51	V680-D2KF52M	Read	0.5 to 5.5 mm (axis offset $\pm 2$ mm)
			Write	0.5 to 5.5 mm (axis offset $\pm 2$ mm)
	V680-HS51	V680-D2KF52M (Embedded in metal (iron))	Read	0.5 to 3.5 mm (axis offset $\pm 2$ mm)
			Write	0.5 to 3.5 mm (axis offset $\pm 2$ mm)
	V680-HS52	V680-D2KF52M	Read	0 to 8.0 mm (axis offset $\pm 2$ mm)
			Write	0 to 8.0 mm (axis offset $\pm 2$ mm)
	V680-HS52	V680-D2KF52M (Embedded in metal (iron))	Read	0 to 3.0 mm (axis offset $\pm 2$ mm)
			Write	0 to 3.0 mm (axis offset $\pm 2$ mm)
	V680-HS63	V680-D2KF52M	Read	0 to 9.5 mm (axis offset $\pm 2$ mm)
			Write	0 to 9.5 mm (axis offset $\pm 2$ mm)

#### Sample communication range diagram (reference)

##### V680-HS52 (embedded in non-metal material) + V680-D2KF52M

• Read/write

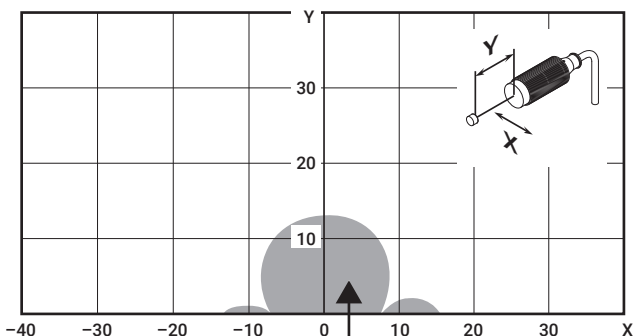

No blind spots within designated range

## 2. Visualization (V680S/V780)

Because magnetic fields and RF waves are not visible to the naked eye, it is impossible for humans to visibly verify whether reader/writers and RF tags are communicating with sufficient leeway.

Installing or configuring the system without allowing for a generous margin may cause abrupt communication failure in the midst of operations or make it difficult to determine the cause of such failures.

OMRON's RFID products come equipped with various visualization tools that incorporate feedback from engineers who have actually configured systems on the ground, ensuring reliability for a wide range of users, from those in charge of installation to those tasked with maintenance.

### Status visualization by reader/writer LEDs

#### Visualization of communications status

LEDs on reader/writer allow for on-site, at-a-glance view of communications status. High-brightness LEDs used for indicators make them readily visible even from a great distance.

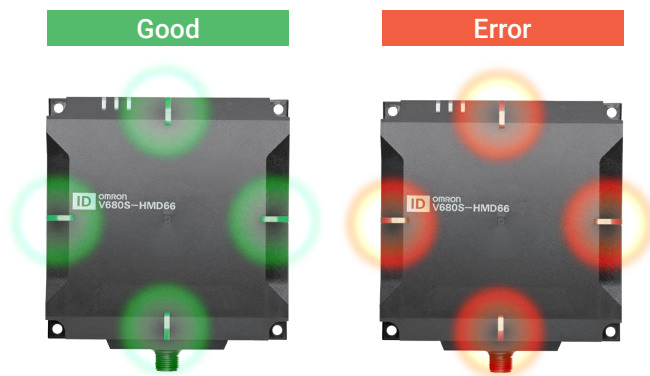

Also...

Communications status visible from five directions

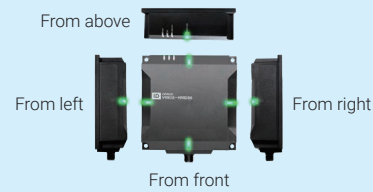

#### Diagnosis of Communications

The reader/writer measures the communications signal and ambient noise levels to diagnose its stability, then indicates in LED and report to host system.

Easily and quickly checks the proper installation of the system, and helps to reduce startup time. This can be used for preventing errors during operation.

#### Warning

Indicates "Warning" states communication in yellow

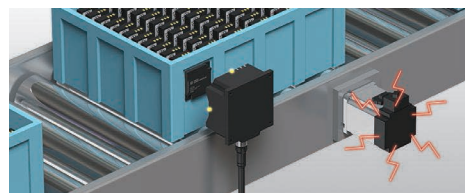
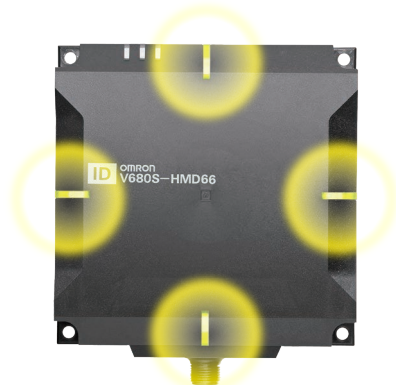

- Note: 1. Communication Diagnostic feature is disabled by default.  
2. Enabling the Communication Diagnostic feature increases communication time.  
For details, refer to the User's Manual (Cat. No. Z339 or Z353).

## Status visualization by web browser interface

### Web Browser I/F

Enable all parameter settings, execute RF tag communications, and check the operation log anywhere by just connecting the computer.

### Easy Troubleshooting

Up to 2,000 communication results are stored and guidance for the "Warning" results is provided. Can be quickly recovered from trouble without expert knowledge.

#### List display

Displays diagnostic logs for the past 2,048 communication sessions between the reader/writer and RF tags.

No.	Time	Query	Result	Diagnosis	Detail
80	01:01:00	DataRead	Warning	VX Voltage lock	Show
81	01:01:01	DataRead	Warning	VX Voltage lock	Show
82	01:01:02	DataRead	Error	RF Tag missing error	Show
83	01:01:03	DataRead	Warning	VX Voltage lock	Show
84	01:01:04	DataRead	Good		Show
85	01:01:05	DataRead	Good		Show
86	01:01:06	DataRead	Warning	VX Voltage lock	Show
87	01:01:07	DataRead	Error	RF Tag missing error	Show

#### Guidance window

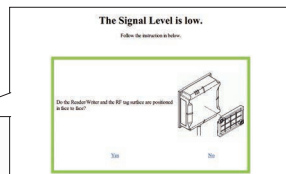

Troubleshoot is also available in the "Warning" results.

#### Charts

Diagnostic results can be shown by the graph. Analysis time required to identify the cause of unstable communication can be reduced by checking the time-series signal and noise levels. The results can be output to CSV files.

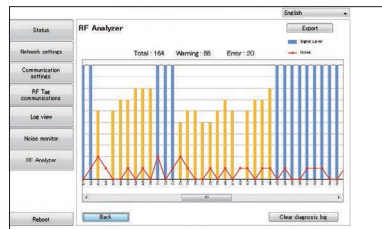

## 3. Compliance to Radio Laws in Different Countries

Different countries have different radio laws, which means that equipment needs to be approved for use specifically in the country where it is installed.

OMRON's RFID products are approved for use in 51 countries\*1 across the globe—virtually any country of your choice.

Japan

Europe

Americas (United States, Canada, Mexico, Brazil)

Asia (China, South Korea, Taiwan, Hong Kong, Philippines, Vietnam, Thailand, Singapore, Indonesia, Malaysia, India)

Oceania (Australia, New Zealand)

\*1: Some models are not approved for use in some countries. See our website (<http://www.ia.omron.com/>) for details.

## 4. Technology for Preventing Excessive Reading (V780)

UHF RFID products, which can communicate over long distances, may, by their nature, accidentally detect RF tags placed at distant locations that are not intended for detection.

In other words, these products sometimes “excessively” read targets.

Our long-range RFID products come equipped with features that prevent such “excessive” reading, ensuring reliability.

### Focus Mode prevents excessive reading and reads only target tags **PATENT PENDING\*1**

Even when two or more RF tags exist in the communication range, the reader/writer can read the target tag just in front of it.

It reads RF tags in the order in which they are conveyed while ignoring RF tags on pallets around the line.

(Only when communication mode is set to “Focus”)

\*1. PATENT PENDING/PATENTED means that the patent was applied for or the patent was granted. (As of August 2019)

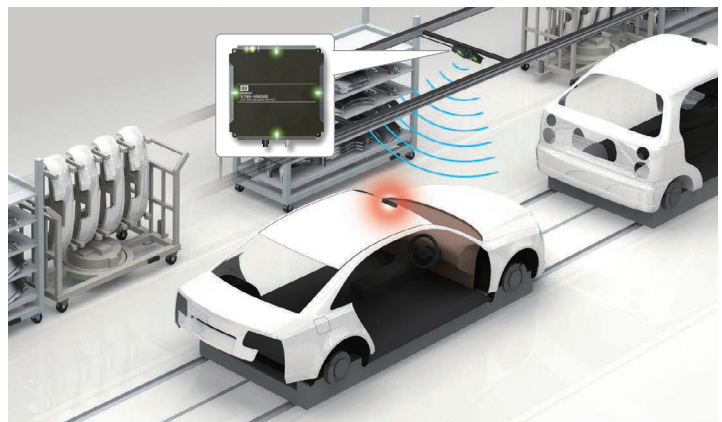

Below is an outline of the technology behind this feature.

For more details, read the full technical paper on our technical paper site.

<https://www.omron.com/global/en/technology/omrontechnics/vol51/007.html>

## Stable reading for UHF RFID

### Technique for preventing erroneous detection of non-target RF tag Hidekatsu Nogami

In the automotive industry, the increasing number of recalls is a major issue. Individual identification technologies, which can help companies handle recalls of their products more quickly by pinpointing when and where each and every component was manufactured, are therefore becoming more and more important. Of the many individual identification technologies, RFID has the advantage of being resistant to dirt, oil, and dust. It can be categorized into two groups according to communication distance: HF RFID for short-range communication, and UHF RFID for long-range communication. The accuracy of UHF RFID, however, can be impacted by radio waves reflected off of surrounding structures.

To counter this issue, we developed an algorithm that can distinguish between target and non-target RF tags by detecting changes in the electrical power radiated from the tags, based on how RF tags move at the production site. With this technique, a highly reliable long-distance individual identification system can be achieved.

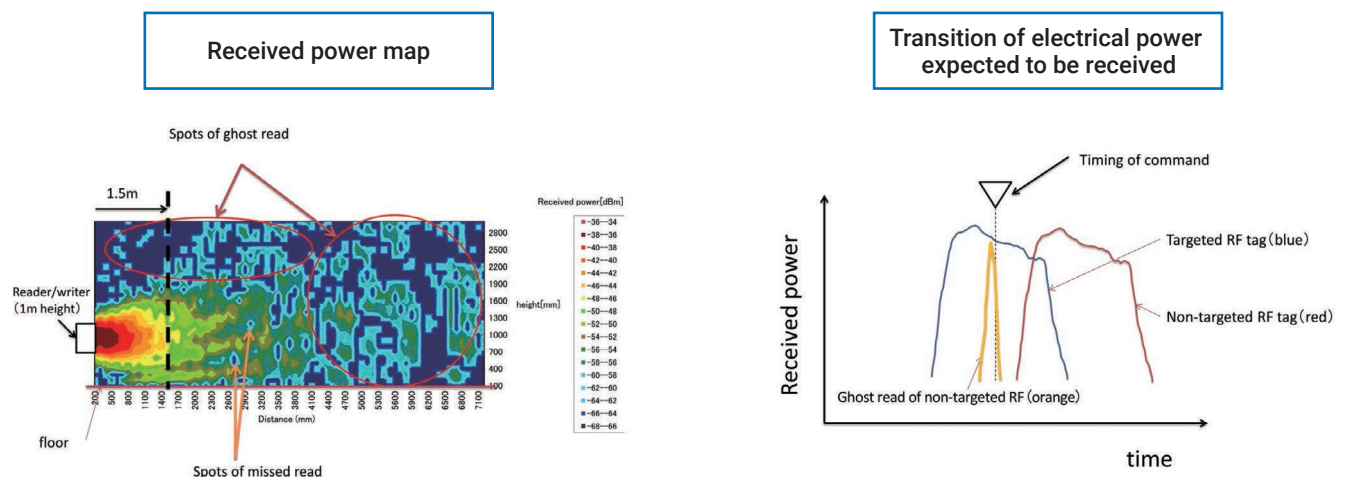

See our website for more.

# 4 Precautions for Use

## 1. Installing Reader/Writers and RF Tags

Communication range may be impacted by metal surrounding the equipment, its installation angle, and mutual interference. Specific data can be found in the product manual. Please refer to them upon installation.

**Example:**  
When installing V680S-HMD63-ETN

### ■ Impact of metal surrounding the reader/writer

Reader/writers can be mounted to the surface or, optionally, embedded in metal to protect them from collision with other objects, in which case there should be a distance of at least 80 mm between the metal and the reader/writer. Placing the metal any closer to the reader/writer will significantly reduce its communication range. The height of the metal should not exceed the height of the reader/writer.

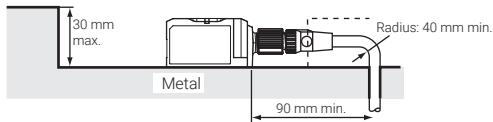

Provide a cable bending radius of 40 mm or more.



The communication range will be reduced significantly if the reader/writer is installed closer than 80 mm to metal surfaces.

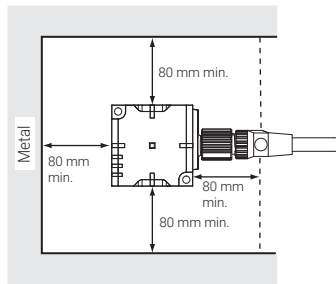

## 2. Communication Time

Communication time may vary due to factors such as the type of RF tag being read or the amount of processing data. Refer to your manual and make sure to set your communication time with ample margin.

In noisy environments, retries may cause communication to take longer than indicated in the manual. Make sure to sufficiently test your installation before operation.

**Example:**  
Communication time between V680S-HMD6□-ETN and V680-D1K□□

The communication time is the time from when the Reader/Writer turns ON the RF signal until it receives the last bit of the response from the RF Tag.

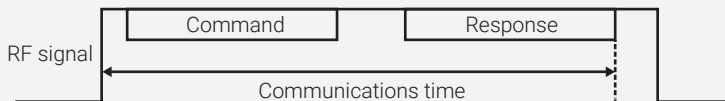

- RF signal : The radio wave that the Reader/Writer transmits to the RF Tag. The Reader/Writer turns ON this RF signal and then sends the command to start communications with the RF Tag. When the communications end, the Reader/Writer turns OFF the RF signal.
- Command : The command that the Reader/Writer sends to the RF Tag.
- Response : The response that the RF Tag returns to the Reader/Writer.



Enabling the Communication Diagnostic feature increases communication time by up to 200 ms.

V680S-HMD6□-ETN and V680-D1K□□  
There are no differences between  
Communication speed: "normal" and "high".

Query	Communication time [ms] N: No. of bytes processed
Read	$T = 1.0N + 20.1$
Write (with verification)	$T = 1.8N + 45.2$
Write (without verification)	$T = 1.5N + 41.4$

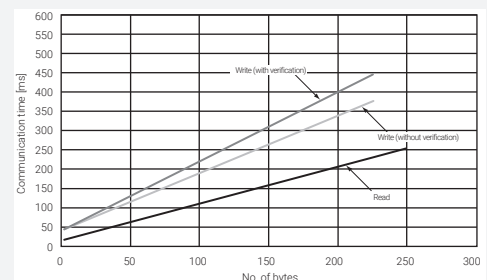

### 3. Applying for a Premises Radio Station License (V780)

Under Japanese law, V780 is deemed a "premises radio station," which requires a license for operation. Follow the instructions in your manual to apply for your license. For reference, below is an outline of what the process looks like in Japan. Similar procedures are required in Russia, Singapore, and Thailand, but not in most other countries.

V780-HMD68-EIP-JP/V780-HMD68-ETN-JP-S is a wireless facility of premises radio station to differentiate moving object using the 920-MHz band. The licensing procedures of the premises radio station must be performed before use. Be sure to perform the licensing procedures before use.

#### Introduction

As for the licensing procedures of the premises radio station, check the information regarding the latest procedures, and the documents necessary for the procedures on the Website of the Regional Bureau of Telecommunications.

The licensing procedures involve the submission of an application for a license at the local Regional Bureau of Telecommunications. A Regional Bureau of Telecommunications falls under the jurisdiction of each district. Please confirm your Regional Bureau of Telecommunications to perform the procedures.

For details on the Regional Bureau of Telecommunications in each district where you can perform the licensing procedures, refer to the Radio Use Website of the Ministry of Internal Affairs and Communications (<http://www.tele.soumu.go.jp/e/ref/material/commtab1/index.htm>).

Example) For the Kanto area (Ibaraki, Tochigi, Gunma, Saitama, Chiba, Tokyo, Kanagawa and Yamanashi) Contact the Kanto Bureau of Telecommunications (Website URL: <http://www.soumu.go.jp/soutsu/kanto/>).

For details on the licensing procedures system, refer to the Radio Use Website of the Ministry of Internal Affairs and Communications (<http://www.tele.soumu.go.jp/e/adm/proc/type/index.htm>). The URL described above is effective as of July 2019.

#### Flow of Licensing Procedures (Overview)

The licensing procedures involve the submission of an application for a license in order to set up a radio station. When an application for a license is submitted, a license is issued. Once the license is received, the procedures are complete. The flow of the licensing procedures is shown below.

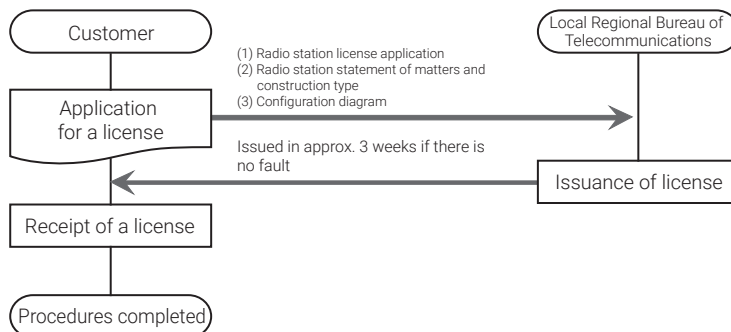

- \* Please enclose a self-addressed return envelope for receipt of your license when applying for a license.
- \* The license is effective for a period of 5 years (you will have to apply again for a license after 5 years.)
- \* In case of any changes in the license contents or establishment report contents, you will have to perform change procedures.
- \* If the license is no longer in use, please submit a discard report.
- \* If there are any changes in the contact address, or the address for sending the radio use charges payment notice, or any changes in the station location, you will have to perform change procedures. You are requested to do the needful.





**Note: Do not use this document to operate the Unit.**

**OMRON Corporation Industrial Automation Company**  
Kyoto, JAPAN

**Contact: [www.ia.omron.com](http://www.ia.omron.com)**

**Regional Headquarters**

**OMRON EUROPE B.V.**

Wegalaan 67-69, 2132 JD Hoofddorp  
The Netherlands  
Tel: (31)2356-81-300/Fax: (31)2356-81-388

**OMRON ELECTRONICS LLC**

2895 Greenspoint Parkway, Suite 200  
Hoffman Estates, IL 60169 U.S.A.  
Tel: (1) 847-843-7900/Fax: (1) 847-843-7787

**OMRON ASIA PACIFIC PTE. LTD.**

No. 438A Alexandra Road # 05-05/08 (Lobby 2),  
Alexandra Technopark,  
Singapore 119967  
Tel: (65) 6835-3011/Fax: (65) 6835-2711

**OMRON (CHINA) CO., LTD.**

Room 2211, Bank of China Tower,  
200 Yin Cheng Zhong Road,  
PuDong New Area, Shanghai, 200120, China  
Tel: (86) 21-5037-2222/Fax: (86) 21-5037-2200

**Authorized Distributor:**

© OMRON Corporation 2020 All Rights Reserved.  
In the interest of product improvement,  
specifications are subject to change without notice.

**Cat. No. Q288-E1-01**

0320 (0320)