



Metra[®]



Jeep[®] Accessories





**THE POWER
OF METRA'S
FIT GUIDE
ANYTIME.
ANYWHERE.**



- Enables an easy search of all Metra products.
- Allows dealers and customers to browse and filter parts by vehicle specifics such as make, model, year and trim.
- Lets dealers quickly place orders for parts - no online payment needed, Metra does the rest.

Download it FREE at the
App Store or Google Play



Scan for App Store



Scan for Google Play

CONTENTS



UNIVERSAL

Headlight Replacements	2-7
Fog Lights	4-5, 8

WRANGLER JL/GLADIATOR JT 2018-UP*

Radio Kits & Harnessing	9
Speaker Pods	10
Digital Signal Processor	10-11
Turn / Running / Taillight	12-13
Brackets	12-13

WRANGLER JK 2007-2018

Radio Kits & Harnessing	14
Digital Signal Processor	15
Camera Interface	16-17
Brackets	18-19
Turn / Running / Taillight	20-21

WRANGLER TJ 1997-2006

1997-2006 Radio Kits & Harnessing	22
1997-2005 Radio Kits & Harnessing	23
Brackets	24
Taillights	24

WRANGLER YJ 1986-1995

Radio Kits & Harnessing	25
Brackets	25

CHEROKEE 1984-2019

2014-2019 Radio Kits & Harnessing	26-27
1984-2001 Radio Kits & Harnessing	28

COMANCHE 1985-1996

Radio Kits & Harnessing	29
-----------------------------------	----

COMMANDER 2006-2010

Radio Kits & Harnessing	29-30
-----------------------------------	-------

COMPASS 2007-2019

Radio Kits & Harnessing	30-32
-----------------------------------	-------

GRAND CHEROKEE 1993-2017

2011-2019 Radio Kits & Harnessing	33
2005-2013 Radio Kits & Harnessing	34
1993-2004 Radio Kits & Harnessing	34-35

GRAND WAGONEER 1986-1995

Radio Kits & Harnessing	36
-----------------------------------	----

LIBERTY 2002-2017

Radio Kits & Harnessing	36-37
-----------------------------------	-------

PATRIOT 2007-2017

Radio Kits & Harnessing	37-38
-----------------------------------	-------

RENEGADE 2015-2019

Radio Kits & Harnessing	39
-----------------------------------	----

WAGONEER 1984-1996

Radio Kits & Harnessing	40
-----------------------------------	----

UNIVERSAL

Headlight Replacement Fit Guide	41
Fog Light Replacement Fit Guide	42
Accessory Bulb Replacement Fit Guide	43
RGB / RGBW Accent Lights	44-45
Lights	46-52
Switches & Panels	53-54
Cabling	55-58
Ammo Style Vehicle Antennas	59-60
Monitors & Mirrors	61

Merchandise	62-63
-----------------------	-------

Terms and Conditions	64
--------------------------------	----

Jeep® Accessories



WARNING: This catalog does not advise whether a State of California Proposition 65 warning is required for a particular item of merchandise. To learn whether a particular item of merchandise requires a California Proposition 65 warning, please be sure to look up and read the particular merchandise's listing on Metra's website www.MetraOnline.com, as well as read the particular merchandise's packaging. When a California Proposition 65 warning is present on Metra's website listing for the particular merchandise, or on the particular merchandise's packaging, a compliant California Proposition 65 warning is to be provided to the purchasing California consumer prior to the sale of the particular merchandise.



LED HEADLIGHT PAIR

JP-701B

7" LIGHT

9 LED

- (9) 5-watt LEDs
- 45W each
- 3600lm @ high beam
2400lm @ low beam
- Matching fog light JP-701FLB
- Die-cast aluminum housing
- Polycarbonate lens
- Standard H4 connector
- LED color temp 6500K



LED HEADLIGHT PAIR

JP-701S

7" LIGHT

9 LED

- (9) 5-watt LEDs
- 45W each
- 3600lm @ high beam
2400lm @ low beam
- Matching fog light JP-701FLS
- Die-cast aluminum housing
- Polycarbonate lens
- Standard H4 connector
- LED color temp 6500K



LED HEADLIGHT PAIR WITH FULL HALO

JP-702B

7" LIGHT

9 LED

- (9) 5-watt LEDs
- 45W each
- 3600lm @ high beam
2400lm @ low beam
- Matching fog light JP-702FLB
- Die-cast aluminum housing
- Polycarbonate lens
- Standard H4 connector
- LED color temp 6500K



LED HEADLIGHT PAIR WITH FULL HALO

JP-702S

7" LIGHT

9 LED

- (9) 5-watt LEDs
- 45W each
- 3600lm @ high beam
2400lm @ low beam
- Complementing fog light JP-701FLS
- Die-cast aluminum housing
- Polycarbonate lens
- Standard H4 connector
- LED color temp 6500K



LED HEADLIGHT PAIR WITH PARTIAL HALO

JP-703B

7" LIGHT

6 LED

- (6) 10-watt LEDs
- 60W each
- 3000lm @ high beam
2000lm @ low beam
- Complementing fog light
JP-702FLB
- Die-cast aluminum housing
- Polycarbonate lens
- Standard H4 connector
- LED color temp 6500K



LED HEADLIGHT PAIR WITH PARTIAL HALO

JP-703S

7" LIGHT

6 LED

- (6) 10-watt LEDs
- 60W each
- 3000lm @ high beam
2000lm @ low beam
- Complementing fog light
JP-701FLS
- Die-cast aluminum housing
- Polycarbonate lens
- Standard H4 connector
- LED color temp 6500K



LED HEADLIGHT PAIR WITH PARTIAL HALO

JP-704B

7" LIGHT

21 LED

- (21) 5-watt LEDs
- 105W each
- 5500lm @ high beam
3000lm @ low beam
- Complementing fog light
JP-701FLB
- Die-cast aluminum housing
- Polycarbonate lens
- Standard H4 connector
- LED color temp 6500K



7" LED HEADLIGHT PAIR

JP-705B

7" LIGHT

2 LED

- 7" LED headlights
- (2) 10-watt LEDs
- 20W each
- 1600lm @ high beam
1000lm @ low beam
- Complementing fog light
JP-701FLS
- Die-cast aluminum housing
- Polycarbonate lens
- Standard H4 connector
- LED color temp 6500K





RGB BACKLIT LED HEADLIGHT PAIR



JP-704RGB

7" LIGHT

RGB

- (15) 5-watt LEDs
- 75W each
- 4000lm @ high beam
2200lm @ low beam
- Requires RGB-CB1 controller (sold separately)
- Polycarbonate lens cover is virtually unbreakable

RGB BACKLIT LED FOG LIGHT PAIR



JP-704RGBFL

4" LIGHT

15 LED

NEW!

- Number of white LEDs (per light): (15) 2-watt LEDs
- Wattage (per light): 30W
- Lumen output for white LEDs (per light/set): 800lm /1600lm
- Die-cast aluminum housing
- Polycarbonate lens
- Standard 9145 connector
- LED color temp 6500K
- Number of RGB LEDs (per light): (6) 0.2-watt LEDs
- Number of halo LEDs (per light): (12) 0.2-watt LEDs
- RGB-CB1 control box required for operation (sold separately)



RGB CONTROL BOX



RGB-CB1

FOR HEISE RGB AND 704RGB HEADLIGHTS/FOG LIGHTS

- App controlled Android™ / iOS®
- Wireless BLE control
- 16 million color options
- Group multiple devices
- Camera color capture
- Sync lighting to your music
- Rainbow, water and fire patterns
- Fade, blink and pulsating transitions
- 4 programmable triggers
- Handles up to 10 amps of lights





LED HEADLIGHT PAIR WITH RGB HALO



HE-PBHL702RGB

7" LIGHT

6 LED

- (6) 10-watt LEDs
- 60W each
- 3000lm @ high beam
2000lm @ low beam
- Polycarbonate lens
- Standard H4 connector
- LED color temp 6500K
- RGB-CB3 control box required for operation (sold separately)

LED FOG LIGHT PAIR WITH RGB HALO



HE-JWBFL02RGB

4" LIGHT

3 LED

- (3) 10-watt LEDs
- 30W each
- 1200lm (set)
- Die-cast aluminum housing
- Polycarbonate lens
- Standard 9145 connector
- LED color temp 6500K
- RGB-CB3 control box required for operation (sold separately)



RGB CONTROL BOX



RGB-CB3

FOR 702RGB HEADLIGHTS/FOG LIGHTS

- Heise RGB Control Box
- Used for part # HE-PBHL702RGB HL and HE-JWBFL02RGB
- App controlled Android™ / iOS®
- Wireless BLE control
- 16 million color options
- Group multiple devices
- Camera color capture
- Sync lighting to your music
- Rainbow, water and fire patterns
- Fade, blink and pulsating transitions
- 4 programmable triggers
- Handles up to 10 amps
- Flat 4-pin





IP67 RATED



UNIVERSAL



H4 CONNECTOR

RGB LED HEADLIGHT PAIR + 4" RGB LED FOG LIGHT PAIR



JP-706RGBKT

COMBO

9 LED

- Addressable LEDs
- 120 color changing patterns
- DIY pattern function
- Music sync function
- App controlled (Car-lights app)
- Compatible with Android™ and iOS®
- Includes RGB controller

7" Headlight

- (9) 5-watt LEDs
- 45W each
- 3600lm @ high beam
- 2400lm @ low beam

4" Fog lights

- (6) 5-watt LEDs
- 30W (set)
- 1440lm



Download the Car-Lights App Here



iOS®



Android™



5"x 7" LED HEADLIGHT PAIR

HE-5X7B1

17 LED

- Wattage: (17) 3-watt LEDs for a total of 85 watts
- 2400lm low beam, draws 4.3A @ 13.8V
- 3500lm high beam, draws 6.2A @ 13.8V
- H4 style connector
- Set of two lights

5"x 7" LED HEADLIGHT PAIR

HE-5X7S1

17 LED

- Wattage: (17) 3-watt LEDs for a total of 85 watts
- 2400lm low beam, draws 4.3A @ 13.8V
- 3500lm high beam, draws 6.2A @ 13.8V
- H4 style connector
- Set of two lights



4"x 6" LED HEADLIGHT PAIR

HE-4X6B1

18 LED

- Wattage: (18) 3-watt LEDs for a total of 60 watts
- 2400lm low beam, draws 2.9A @ 13.8V
- 3500lm high beam, draws 4.3A @ 13.8V
- H4 style connector
- Set of two lights

4"x 6" LED HEADLIGHT PAIR

HE-4X6S1

18 LED

- Wattage: (18) 3-watt LEDs for a total of 60 watts
- 2400lm low beam, draws 2.9A @ 13.8V
- 3500lm high beam, draws 4.3A @ 13.8V
- H4 style connector
- Set of two lights





LED FOG LIGHT PAIR

JP-701FLS

4" LIGHT

6 LED

- (6) 5-watt LEDs
- 30W each
- 1440lm (set)
- Die-cast aluminum housing
- Polycarbonate lens
- Standard 9145 connector
- LED color temp 6500K



LED FOG LIGHT PAIR

JP-701FLB

4" LIGHT

6 LED

- (6) 5-watt LEDs
- 30W each
- 1440lm (set)
- Die-cast aluminum housing
- Polycarbonate lens
- Standard 9145 connector
- LED color temp 6500K



LED FOG LIGHT PAIR

JP-702FLB

4" LIGHT

6 LED

- (6) 5-watt LEDs
- 30W each
- 1440lm (set)
- Die-cast aluminum housing
- Polycarbonate lens
- Standard 9145 connector
- LED color temp 6500K



ADAPTER HARNESS FOR FOG LIGHTS

JP-JWFLAH

PLUG-N-PLAY

2 PACK

- Adapter harness for fog lights
- Adapts 9145 connector to PSX24W connector
- Use with fog lights JP-701FLS, JP-701FLB, JP-702FLB or JP-706RGBFL
- Makes connections plug-n-play

H4 CONNECTOR TO H13 CONNECTOR

JP-H4H13DE

FOR 7" LIGHTS

2 PACK

- Includes CANBUS decoder to eliminate "bulb out" light and flickering of headlights
- Use with any of the 7" headlights in 2007 and newer Jeep Wranglers
- Comes as a set: (2) adapters (2) CANBUS decoders



LED HEADLIGHT AND FOG LIGHT BULB KITS

SEE HEADLIGHT & FOG LIGHT FIT GUIDE PAGE 41-43



DASH KIT

2018-UP*

107-CH3B

DASH KIT

- Designed for most shallow mount radios like the Alpine iLX-W650 (refer to radio manufacturer for current models)
- Special brackets included for Pioneer modular radios DMH-C2550NEX and DMHC2500NEX (refer to radio manufacturer for current models)
- Painted scratch-resistant matte black to match the factory finish

INTERFACE FOR JEEP WRANGLER JL / GLADIATOR

2018-UP*

AXVI-6524

PRE-WIRED AXSWC INTERFACE

- Provides accessory power (12-volt 10-amp)
- Retains R.A.P. (Retained Accessory Power)
- Provides NAV outputs (parking brake, reverse and speed sense)
- Pre-wired AXSWC harness (AXSWC sold separately)
- Retains the factory backup camera (if applicable)
- Retains the 3.5mm AUX-IN jack and balance and fade
- Using custom Bluetooth® app, allows ability to manipulate vehicle's customization settings that are usually lost when adding aftermarket radio (Android™ only at this time)
- Micro "B" USB updatable



ANTENNA ADAPTER

2018-UP*

40-EU10

EUROPEAN ANTENNA ADAPTER

- European factory antenna with mini-style plug to aftermarket radio



SPEAKER HARNESS

2007-2018

72-6514

SPEAKER HARNESS

- Sold as a pair



* Visit MetraOnline.com for up-to-date vehicle applications



SPEAKER PODS



2018-UP*

JP-1014

REPLACEMENT SPEAKER PODS

- Designed for 6.5" to 6.75" speaker
- Replaces original speaker pods
- ABS housing utilizing factory mounting locations for a secure fit
- Speaker adapter harnesses included
- One pair of pods in each package

2018-UP*

JP-1015

OVERHEAD SPEAKER ADAPTERS JL/GLADIATOR SOUNDBAR

NEW!

- Retains the factory soundbar
- Allows provision for 6.5" speakers and a spot for a tweeter
- Hardware and speaker harnesses included
- Cutting of the interior material of the soundbar needed (template provided)



DIGITAL SIGNAL PROCESSOR

DSP PACKAGE WITH AXDSP-X, T-HARNESS AND AMP BYPASS HARNESS

2018-UP*

AXDSPX-CH5

NEW!

- Package includes AXDSP-X and vehicle T-harness
- 31-band graphic EQ
- 6 inputs, 10 individually assignable outputs
- Independent equalization on each output
- Independent high pass, low pass and band pass filters
- Each channel can be delayed independently up to 10ms
- Easy behind the radio installation
- Can be used with OE and aftermarket radios
- Chime control for Chrysler vehicles
- Clipping detection and limiting circuits
- Bass knob included
- Retains OE voice prompts (SYNC® and OnStar®)
- Retains factory chimes including parking sensor chimes
- Settings adjusted via Bluetooth® in a smart device application (tablet or mobile phone), compatible with both
- Android™ and iOS® devices
- Read, write and store your configuration for future recall
- Password protect feature available in the mobile app
- Micro "B" USB updatable



* Visit MetraOnline.com for up-to-date vehicle applications

DSP PACKAGE WITH AXDSP-L, T-HARNESS AND AMP BYPASS HARNESS 2018-UP*

AXDSPL-CH5

NEW!

- Package includes AXDSP-L and vehicle T-harness
- 15-band graphic EQ
- 4 inputs and 6 outputs, including front, rear and subwoofer
- Independent equalization for front, rear and subwoofer
- Independent crossover for front, rear and subwoofer
- Selectable slope (12, 24, 36, or 48db per octave)
- Front and rear channels can be delayed independently up to 10ms
- Easy behind the radio installation in most applications
- Can be used with OE and aftermarket radios
- Chime control for Chrysler vehicles
- Clipping detection and limiting circuits
- Internal header port for adding interface modules
- Bass knob included
- Retains Uconnect® voice prompts
- Retains factory chimes including parking sensor and cross path detection alerts
- Settings adjusted via Bluetooth® in a smart device application (tablet or mobile phone), compatible with both
- Android™ and iOS® devices
- Read, write and store configurations for future recall
- Password protect feature available in the mobile app
- Micro "B" USB updatable



AMP BYPASS HARNESS 2018-UP*

AXABH-CH4

NEW!

- Allows the factory amplifier to be bypassed without altering the factory wiring
- 20 gauge wires
- Length - 12 inches



* Visit MetraOnline.com for up-to-date vehicle applications



TURN/RUNNING/TAILLIGHT



2018-UP*

JP-SML2 LED SIDE MARKER LIGHT 13.5 WATTS **NEW!**

- (27) 0.5-watt LEDs
- Smoked crystalline lens
- Amber LED
- Multi-angle internal reflector
- Intergrated anti-flicker
- Plug and play with factory connector
- IP67
- Fits Jeep Wrangler JL/Gladiator JT 2018-UP*



BRACKETS

HEADLIGHT REPLACEMENTS

SEE UNIVERSAL LED HEADLIGHT SETS FOR COMPATIBLE LIGHTING SOLUTIONS ON PAGES 2-6



2018-UP*

JP-JLB7 7" LED HEADLIGHT ADAPTER BRACKET PAIR

- Allows 7" LED headlights to fit into Jeep Wrangler JL/ Gladiator JT 2018-UP*
- Includes factory to H4 wiring adapters
- Solid steel construction
- 3 points of beam adjustment
- Gaskets included
- Sold as a set of 2 brackets with 2 harnesses
- Headlights sold separately

FOG LIGHTS

SEE UNIVERSAL LED FOG LIGHT SETS FOR COMPATIBLE LIGHTING SOLUTIONS ON PAGE 7-8



2018-UP*

JP-JFOG FOG LIGHT BRACKET PAIR

- Fits: • 2018 - UP* Jeep Wrangler JL Rubicon
- 2009- 2018 Jeep Wrangler JK Hard Rock, Rubicon X, 10th Anniversary Edition



2018-UP*

JP-JFOG2 FOG LIGHT BRACKET PAIR **NEW!**

- Fits: • 2018 - UP* Jeep Wrangler JL Sport

* Visit MetraOnline.com for up-to-date vehicle applications



2018-UP*

JP-JLAPB

PILLAR LIGHT BRACKET

PAIR

NEW!

- Designed for 50" straight lightbar
- Two optional mounting locations for cubes or work lights
- 5-gauge, powder coated steel
- Includes gaskets, mounting hardware and anti-sway stabilization hardware



2018-UP*

JP-JLPMLB

POST MOUNT BRACKET

PAIR

NEW!

- Fits a cube, work or driving light
- Mount cubes on top and sides with 6 mounting locations
- 5-gauge, powder coated steel
- Includes gaskets and mounting hardware



For monitors and mirror see page 61

CAMERA REPLACEMENT



CAMERA REPLACEMENT BRACKET FOR JEEP WRANGLER JL

2018-UP JEEP WRANGLER JL MODELS

JP-JLKT

CAMERA REPLACEMENT BRACKET

NEW!

- Cost effective replacement for the OEM LVDS camera
- RCA output for aftermarket radios or monitors
- Can be viewed while driving with compatible monitor
- Improved power circuit
- Resolution: 550 TV Lines
- Viewing angle: 160 degrees
- Direct OE replacement
- Selectable parking lines
- Water-resistant: IP68

BRAKE LIGHTS



2018-UP*

JP-TTL3T

LED THIRD BRAKE LIGHT

2.5 WATTS

NEW!



- (5) 0.5-watt LEDs
- Polycarbonate lens
- Plug-n-play with factory connector
- IP67
- Fits Jeep Wrangler JL 2018-UP*



JP-STL

SPARE TIRE BRAKE LIGHT

85 WATTS

- (85) 1-watt LEDs
- Brake light
- Fits Jeep Wrangler JL 2018-UP*



TURBOKIT 8-INCH RADIO KIT FOR PIONEER

2011-2018

108-CH1B

TURBOKIT 8-INCH RADIO KIT

- Designed specifically for the Pioneer DMH-C5500NEX 8-inch radio
- Cutting template included for necessary dash modifications
- Painted scratch-resistant matte black



JEEP MULTI-KIT

2007-2018

95-6511

JEEP DOUBLE-DIN MULTI-KIT

- New design allows for better fit of standard Double-DIN radios and includes secondary parts for short-nosed radio faces
- For classic design, use 95-6511-17
- For Single-DIN installation, use 99-6511
- See multi-kit guide or application chart at MetraOnline.com

CAN INTERFACE

2007-2018



DIRECT
CONNECT



MICRO B USB
UPDATABLE

AXVI-6522

CAN INTERFACE

NEW!

- Provides accessory power (12-volt 10-amp)
- Retains R.A.P. (Retained Accessory Power)
- Used in non-amplified systems or when replacing amplified system
- Provides NAV outputs (parking brake, reverse and speed sense)
- Pre-wired AXSWC harness (AXSWC sold separately)
- Retains audible blind spot detection system
- Micro "B" USB updatable



ANTENNA ADAPTER

2007-2018

40-EU10

EUROPEAN ANTENNA ADAPTER

- European factory antenna with mini-style plug to aftermarket radio



SPEAKER HARNESS

2007-2018

72-6514

SPEAKER HARNESS

- Sold as a pair



* Visit MetraOnline.com for up-to-date vehicle applications

DSP PACKAGE WITH AXDSP-L, T-HARNESS AND AMP BYPASS HARNESS

2007-2018

AXDSPL-CH4

NEW!

- Package includes AXDSP-L and vehicle T-harness
- 15-band graphic EQ
- 4 inputs and 6 outputs, including front, rear and subwoofer
- Independent equalization for front, rear and subwoofer
- Independent crossover for front, rear and subwoofer
- Selectable slope (12, 24, 36 or 48db per octave)
- Front and rear channels can be delayed independently up to 10ms
- Easy behind the radio installation in most applications
- Can be used with OE and aftermarket radios
- Chime control for Chrysler vehicles
- Clipping detection and limiting circuits
- Internal header port for adding interface modules
- Bass knob included
- Retains Uconnect® voice prompts
- Retains factory chimes including parking sensor and cross path detection alerts
- Settings adjusted via Bluetooth® in a smart device application (tablet or mobile phone), compatible with both
- Android™ and iOS® devices
- Read, write and store configurations for future recall
- Password protect feature available in the mobile app
- Micro "B" USB updatable



AMP BYPASS HARNESS

2007 - 2018

AXABH-CH2

NEW!



- Allow the factory amplifier to be bypassed without altering the factory wiring
- 20 gauge wires
- Length - 12 inches

ADJUSTABLE BRACKET + BACKUP CAMERA

2007-2018

TE-JPKT

KIT

- Kit includes: 1 bracket and 1 camera
- Bracket mounts to studs of spare wheel mount
- Selectable parking lines



MULTI-ADJUSTABLE BRACKET + BACKUP CAMERA

2007-2018 (with in-dash display)

TE-AJPKT

KIT

- Kit includes: 1 adjustable bracket and 1 camera
- Bracket mounts to studs of spare wheel mount
- Selectable parking lines

See monitors on page 61 to pair along with these camera kits



PLUG-N-PLAY BACKUP CAMERA SOLUTION

2007-2018 (with in-dash display)

TE-JEEP-BU-1

KIT WITH INTERFACE

- Kit includes: 1 bracket, 1 camera, AXAC-CH4 and vehicle specific wiring
- Bracket mounts to studs of spare wheel mount
- Selectable parking lines



PLUG-N-PLAY BACKUP CAMERA SOLUTION

2007-2018 (with in-dash display)

TE-JEEP-BU-2

KIT WITH INTERFACE

- Kit includes: 1 adjustable bracket, 1 camera, AXAC-CH4 and vehicle specific wiring
- Bracket mounts to studs of spare wheel mount
- Selectable parking lines

2007-UP*
JP-JFOG
FOG LIGHT BRACKET
PAIR

- Fits:
 - 2018 - UP* Jeep Wrangler JL Rubicon
 - 2009- 2018 Jeep Wrangler JK Hard Rock, Rubicon X, 10th Anniversary Edition
- 7-gauge, powder coated steel
- Includes mounting hardware

2007-2018
JP-JKGR1
GRILLE MOUNT
PAIR

- Designed for 20" straight lightbar
- 7-gauge, powder coated steel
- Includes gaskets and mounting hardware

2007-2018
JP-JKHM1
HOOD MOUNT BRACKET
PAIR

- Designed for 10" straight lightbar
- 7-gauge, powder coated steel
- Includes mounting hardware
- Excludes special edition models with raised hoods

2007-2018
JP-JKHM2
HOOD MOUNT BRACKET
PAIR

- Designed for 20" straight lightbar
- 7-gauge, powder coated steel
- Excludes special edition models with raised hoods

2007-2018
JP-JKHMB
HOOD MOUNT BRACKET
PAIR

- Designed for 22" straight lightbar
- 7-gauge, powder coated steel
- Includes gaskets and mounting hardware
- Excludes special edition models with raised hoods

2007-2018
JP-JKHM03
HOOD BRACKET
SINGLE

- Mount locations for 4 cube lights
- 7-gauge, powder coated steel
- Includes gasket and mounting hardware
- Excludes special edition models with raised hoods

* Visit MetraOnline.com for up-to-date vehicle applications



SEE UNIVERSAL
LIGHTBARS & CUBES FOR
COMPATIBLE LIGHTING
SOLUTIONS ON PAGES 46-52

2007-2018**JP-JKPMLB****POST MOUNT BRACKET****PAIR**

- Fits a cube, work or driving light
- 7-gauge, powder coated steel
- Includes gaskets and mounting hardware

**2007-2018****JP-JKPMWS****POST MOUNT CUBE BRACKET****PAIR**

- Fits a cube, work or driving light
- 7-gauge, powder coated steel
- Includes gaskets and mounting hardware

**2007-2018****JP-JKPM2****DUAL-STACKED POST MOUNT****PAIR**

- Mounts 2 sets of cube lights in post location
- 7-gauge, powder coated steel
- Includes gaskets and mounting hardware

**2007-2018****JP-JKAPB****A-PILLAR BRACKET****PAIR**

- Designed for 50" straight lightbar
- 7-gauge, powder coated steel
- Includes gaskets and mounting hardware

**2007-2018****JP-JKWIP****WHIP MOUNT BRACKET****SINGLE**

- Mount 1 LED whip light to spare wheel carrier
- 7-gauge, powder coated steel
- Includes gasket and mounting hardware



SEE UNIVERSAL
LIGHTBARS & CUBES FOR
COMPATIBLE LIGHTING
SOLUTIONS ON PAGES 46-52



LED SIDE MIRROR COVERS

2007-2018

JP-JKMR

29 WATTS

11 LED

- (9) 3-watt white LEDs and (2) 1-watt amber LEDs each
- Integrated running lights and turn signals



LED SIDE MARKER WITH HALO

2007-2018

JP-SML1

4 WATTS

8 LED

- (8) 0.5-watt amber LEDs each
- Color temperature: 2000K



LED TURN SIGNAL WITH HALO

2007-2018

JP-TSL1

4 WATTS

8 LED

- (8) 0.5-watt amber LEDs each
- Color temperature: 2000K



LED THIRD TAILLIGHT

2007-2018

JP-TTL

6 WATTS

6 LED

- (6) 1-watt CREE LEDs
- Replaces the OEM third taillight
- Smoked lens



LED THIRD TAILLIGHT WITH REVERSE

2007-2018

JP-TTL2

6 WATTS

6 LED

- (6) 1-watt CREE LEDs
- Replaces the OEM third taillight
- Smoked lens

COMMON FEATURES

- OEM FIT
- PLUGS INTO OEM HARNESS
- POLYCARBONATE LENS



LED GRID TAILLIGHT

2007-2018

JP-TL01T	38 WATTS	32 LED
----------	----------	--------

- Turn signal (14) 1-watt LEDs, brake light (6) .5-watt LEDs and running light (12) .2-watt LEDs (each)
- Transparent lens



LED GRID TAILLIGHT

2007-2018

JP-TL01S	38 WATTS	32 LED
----------	----------	--------

- Turn signal (14) 1-watt LEDs, brake light (6) .5-watt LEDs and running light (12) .2-watt LEDs (each)
- Smoked lens



LED BAR TAILLIGHT

2007-2018

JP-TL02T	38 WATTS	29 LED
----------	----------	--------

- Turn signal (10) 1-watt LEDs, brake light (2) 3-watt LEDs and running light (17) 1-watt LEDs (each)



LED LUX TAILLIGHT

2007-2018

JP-TL03T	42 WATTS	21 LED
----------	----------	--------

- Turn signal, brake light and running light (21) 1-watt LEDs (each)
- 30-watt high-output reverse light
- Gives your Jeep Wrangler a rugged look



COMMON FEATURES

- OEM FIT
- PLUGS INTO OEM HARNESS
- POLYCARBONATE LENS



JP-STL	85 WATTS	85 LED
--------	----------	--------

- (85) 1-watt LEDs
- Brake light
- Fits Jeep Wrangler JK 2007 - 2018 and JL 2018-UP*





MULTI-KIT FOR JEEP MODELS

2003-2006

95-6541

DOUBLE-DIN MULTI-KIT

- Replacement of the center panel allows for a Double-DIN installation
- No custom work or cutting of the factory bezel required
- Textured for a clean factory appearance
- See multi-kit guide or application chart at MetraOnline.com for vehicle specific applications and Single-DIN kit options

WIRING HARNESS

2002-2006

70-6502

- Plugs into car harness at radio
- Provides power - 4-speaker connection



ANTENNA ADAPTER

2002-UP*

40-CR10

- Chrysler factory antenna with snap-lock to aftermarket radio



1997-2006

82-1011

SPEAKER ADAPTER

- Designed for 4"x6" aftermarket speaker installation
- One pair of adapters included in each package

1997-2006

82-1012

SPEAKER ADAPTER

- Designed for 4" aftermarket speaker installation
- One pair of adapters included in each package

1997-2006

82-1013

SPEAKER ADAPTER

- Designed for 5.25" aftermarket speaker installation
- One pair of adapters included in each package

SPEAKER HARNESS

2003-2006

72-6514

- Sold as a pair



WIRING HARNESS

1997-2005

70-1817

- Plugs into car harness at radio
- Provides power - 4-speaker connection

**MULTI-KIT FOR JEEP MODELS**

1997-2002

99-6500**MULTI-KIT**

- Includes alignment pins for fast, positive installation in Chrysler, Plymouth and Dodge vehicles
- See multi-kit guide or application chart at MetraOnline.com for vehicle specific applications

**MULTI-KIT FOR JEEP MODELS**

1997-2002

95-6549**DOUBLE-DIN MULTI-KIT**

- Replacement of the center panel allows for a Double-DIN installation
- Storage pocket or blank plate options for added customization
- Textured for a clean factory appearance
- See multi-kit guide or application chart at MetraOnline.com for vehicle specific applications and Single-DIN kit options

**SPEAKER HARNESS**

1997-2002

72-6512

- Sold as a pair





BRACKETS

SEE UNIVERSAL LIGHTBARS & CUBES FOR COMPATIBLE LIGHTING SOLUTIONS ON PAGES 46-52



1997-2006

JP-TJHMB

HOOD MOUNT BRACKET

PAIR

- Designed for 22" straight lightbar
- 7-gauge, powder coated steel
- Includes gaskets and mounting hardware



1997-2006

JP-TJPMLB

POST MOUNT BRACKET

PAIR

- Fits a cube, work or driving light
- 7-gauge, powder coated steel
- Includes gaskets and mounting hardware



1997-2006

JP-TJAPB

A-PILLAR BRACKET

PAIR

- Designed for 50" straight lightbar
- 7-gauge, powder coated steel
- Includes gaskets and mounting hardware



TAILLIGHTS

1998-2006

JP-TL04T

46 WATTS

23 LED

- Turn signal, reverse light, brake light and running light
- Built-in license plate light





MULTI-KIT FOR JEEP MODELS

1986 - 1995

99-5510

MULTI-KIT

- Professional Installer Series TurboKit offers quick conversion from 2-shaft to DIN
- OEM-style rear support included

WIRING HARNESS

1988-1995

70-1002

- Plugs into car harness at radio
- Provides power - 4-speaker connection



SEE UNIVERSAL LIGHTBARS & CUBES FOR COMPATIBLE LIGHTING SOLUTIONS ON PAGES 46-52

BRACKETS



1987-1995

JP-YJAPB

A-PILLAR BRACKET

PAIR

- Designed for 50" straight lightbar
- 7-gauge, powder coated steel
- Includes gaskets and mounting hardware

1987-1995

JP-YJPMLB

POST MOUNT BRACKET

PAIR

- Fits a cube, work or driving light
- 7-gauge, powder coated steel
- Includes gaskets and mounting hardware

ANTENNA REPLACEMENT

1987-1995

44-US502

- Side mount for (4) hole applications
- 46" (119cm) 3-section removable mast
- 60" (152cm) detachable cable



ANTENNA REPLACEMENT

1987-1995

44-US51B

- Side mount for universal (4) hole application
- 31" (79cm) 1-section removable black mast
- 60" (152cm) detachable cable



**DASH KIT
2014-2017**
99-6518B
DASH KIT

- ISO DIN radio provision with pocket
- Painted matte black
- Note: Modifications to factory radio cavity are required for this installation

**RADIO REPLACEMENT DATA INTERFACE WITH SWC
2014-2017**
AXDIS-CH5
RADIO REPLACEMENT DATA INTERFACE WITH SWC

- Provides accessory power (12-volt 10-amp)
- Retains R.A.P. (Retained Accessory Power)
- Provides NAV outputs (parking brake, reverse and speed sense)
- Retains audio controls on the steering wheel
- Retains the factory backup camera (if through the factory radio)
- Retains the factory 3.5mm AUX-IN jack
- High level speaker input
- Can be used in non-amplified or amplified systems
- Micro "B" USB updatable



ADD-ON MULTIPLE CAN ACTIVATED CAMERAS FOR CHRYSLER 2014-2017

AXAC-CH5
ADD-ON MULTIPLE CAN ACTIVATED CAMERAS

- To be used when adding cameras to an OEM screen
- 4 camera inputs
- Programmable 12V 5-amp switched output (configured through the Axxess Updater program)
- Reverse signal trigger generated via CAN bus communication of the vehicle
- Turn signal trigger generated via CAN bus communication of the vehicle
- 4 programmable camera control wires (configured through the Axxess Updater program)
- Can also be manually controlled and used along with an aftermarket radio
- VSS (Vehicle Speed Sense) input and output
- Retains backup camera
- Micro "B" USB updatable



ANTENNA ADAPTER

2014-2019
40-EU55

- Powered version of 40-EU10
- Mini-style plug to aftermarket radio



SPEAKER HARNESS

2014-2017
72-6514

- Sold as a pair



DASH KIT

1997-2001

95-6554B

DASH KIT

- ISO Double-DIN radio provision
- Complete panel for a factory look and feel



WIRING HARNESS

1997-2001

70-1817

- Plugs into car harness at radio
- Provides power - 4 speaker connection



SPEAKER HARNESS

1997-2001

72-6512

- Sold as a pair



DASH KIT

1984-1996

99-5510

DASH KIT

- Professional Installer Series TurboKit offers quick conversion from 2-shaft to DIN
- OEM-style rear support included



WIRING HARNESS

1984-1996

70-1002

- Plugs into car harness at radio
- Provides power - 4-speaker connection



ANTENNA REPLACEMENT

1985-1996

44-CR72

- 31" (79cm) removable mast
- 80" (203cm) cable





1985-1996



DASH KIT
1986-1992

99-5510

DASH KIT

- Professional Installer Series TurboKit offers quick conversion from 2-shaft to DIN
- OEM-style rear support included

WIRING HARNESS

1986-1992

70-1002

- Plugs into car harness at radio
- Provides power - 4-speaker connection



ANTENNA REPLACEMENT

1985-1996

44-CR72

- 31" (79cm) removable mast
- 80" (203cm) cable



2006-2010

DASH KIT
2008-2010

95-6511-17

DASH KIT

- ISO DDIN radio provision
- Classic design of 95-6511
- Textured



RADIO REPLACEMENT DATA INTERFACE WITH SWC
2006-2010

AXDIS-CH13

RADIO REPLACEMENT DATA INTERFACE WITH SWC

- Provides accessory power (12-volt 10-amp)
- Retains R.A.P. (Retained Accessory Power)
- Provides NAV outputs (parking brake, reverse and speed sense)
- Retains audio controls on the steering wheel
- High level speaker input
- Can be used in non-amplified or amplified systems
- Micro "B" USB updatable





RADIO KITS AND HARNESSING

2006-2010

ANTENNA ADAPTER

2008-2010

40-EU10

EUROPEAN ANTENNA ADAPTER

- European factory antenna with mini-style plug to aftermarket radio



DASH KIT

2006-2007

108-CH4G

DASH KIT

- Designed specifically for the Pioneer DMH-C5500NEX 8" radio
- Painted gray to match the factory finish
- Also available in dark khaki 108-CH4DK



DASH KIT

2006-2007

95-6556G

DASH KIT

- ISO DDIN radio provision
- Painted gray to match the factory finish
- Also available in dark khaki 95-6556DK



ANTENNA ADAPTOR

2006-2007

40-CR10

- Chrysler factory antenna with snap-lock to aftermarket radio



SPEAKER HARNESS

2006-2010

72-6514

- Sold as a pair



RADIO KITS AND HARNESSING

2007-2019

DASH KIT

2017.5-2019

95-6545B

DASH KIT

- ISO DDIN radio provision
- Painted matte black



RADIO REPLACEMENT DATA INTERFACE WITH SWC

2017.5-2019

AXTC-CH13

RADIO REPLACEMENT DATA INTERFACE WITH SWC

- Provides accessory power (10-amp)
- Provides wires for multimedia radios (parking brake, reverse, speed sense)
- Retains audio controls on the steering wheel
- Can be used in both amplified and non-amplified models
- Retains balance and fade (non-amplified models only)
- Designed to be compatible with all major radio brands
- Auto detects vehicle type, radio connection and preset controls
- Ability to dual assign steering wheel control buttons
- Retains memory settings even after battery disconnection or interface removal (non volatile memory)
- Provides illumination output
- Micro "B" USB updatable



SPEAKER ADAPTER

2017.5-2019

82-6901

- Allows the installation of a 5.25" or 6.5" speaker and a separate 0.75" to 2" tweeter in a 6"x9" speaker location
- One pair of adapters included in each package
- Use with any Metra 6"x9" adapter for 6.5" mounting options



DASH KIT

2009-2017.5

95-6511-17

DASH KIT

- ISO DDIN radio provision
- Classic design of 95-6511
- Textured



ANTENNA ADAPTER

2017.5-2019

40-EU55

- Powered version of 40-EU10
- Mini-style plug to aftermarket radio



SPEAKER HARNESS

2017.5-2019

72-6514

- Sold as a pair



RADIO REPLACEMENT DATA INTERFACE WITH SWC 2009-2017.5

AXDIS-CH13 RADIO REPLACEMENT DATA INTERFACE WITH SWC

- Provides accessory power (12-volt 10-amp)
- Retains R.A.P. (Retained Accessory Power)
- Provides NAV outputs (parking brake, reverse and speed sense)
- Retains audio controls on the steering wheel
- High level speaker input
- Can be used in non-amplified or amplified systems
- Micro "B" USB updatable



ANTENNA ADAPTER

2009-2017.5

40-EU10 EUROPEAN ANTENNA ADAPTER

- European factory antenna with mini-style plug to aftermarket radio



SPEAKER HARNESS

2009-2017.5

72-7902

- Sold as a pair



DASH KIT 2007-2008

95-6534B

DASH KIT

- PLEASE NOTE THAT THE FACTORY RADIO BEZEL WILL HAVE TO BE MODIFIED
- ISO DDIN radio provision
- ISO DDIN radio provision with pocket
- Painted matte black

ANTENNA ADAPTOR 2006-2007

40-CR10

- Chrysler factory antenna with snap-lock to aftermarket radio





TURBO TOUCH KIT
2014-2017

99-6536S

TURBO TOUCH KIT

- ISO DIN radio provision with pocket
- ISO DDIN radio provision
- Touchscreen display for climate and personalization features
- Painted: Silver Trim
- Also available in Bronze Trim - See part 99-6536BZ



ADD-ON MULTIPLE CAN ACTIVATED CAMERAS
2014-2018

AXAC-CH5

ADD-ON MULTIPLE CAN ACTIVATED CAMERAS

- To be used when adding cameras to an OEM screen
- 4 camera inputs
- Programmable 12V 5-amp switched output (configured through the Axxess Updater program)
- Reverse signal trigger generated via CAN bus communication of the vehicle
- Turn signal trigger generated via CAN bus communication of the vehicle
- 4 programmable camera control wires (configured through the Axxess Updater program)
- Can also be manually controlled and used along with an aftermarket radio
- VSS (Vehicle Speed Sense) input and output
- Retains backup camera
- Micro "B" USB updatable



ANTENNA ADAPTER
2014-2019

40-EU55

- Powered version of 40-EU10
- Mini-style plug to aftermarket radio



DASH KIT
2011-2013

99-6513B

DASH KIT

- DIN head unit provisions with pocket
- ISO DIN head unit provision with pocket
- Painted matte black to match factory



ANTENNA ADAPTER

2008-2013

40-EU10

EUROPEAN ANTENNA ADAPTER



- European factory antenna with mini-style plug to aftermarket radio

DASH KIT

2005-2007

99-6510

DASH KIT

- ISO DIN radio provision with pocket
- ISO DDIN radio provision
- Designed for vehicles with factory navigation radios



RADIO REPLACEMENT DATA INTERFACE WITH SWC

2005-2013

AXDIS-CH13

RADIO REPLACEMENT DATA INTERFACE WITH SWC

- Provides accessory power (12-volt 10-amp)
- Retains R.A.P. (Retained Accessory Power)
- Provides NAV outputs (parking brake, reverse and speed sense)
- Retains audio controls on the steering wheel
- High level speaker input
- Can be used in non-amplified or amplified systems
- Micro "B" USB updatable



DASH KIT

1999-2004

95-6546B

DASH KIT



- ISO DDIN radio provision
- Painted matte black

WIRING HARNESS

2002-2004

70-6502

- Plugs into car harness at radio
- Provides power - 4-speaker connection



ANTENNA ADAPTER

2002-2007

40-CR10

- Chrysler factory antenna with snap-lock to aftermarket radio



SPEAKER HARNESS

1999-2017

72-6514

- Sold as a pair



DASH KIT

1996-1998

107-CH5

DASH KIT

NEW!

- Shallow chassis, L-shaped chassis, and remote mount chassis



MULTI-KIT FOR JEEP MODELS

1993-1998

99-6500

MULTI-KIT

- Includes alignment pins for fast, positive installation in Chrysler, Plymouth and Dodge vehicles
- See multi-kit guide or application chart at MetraOnline.com for vehicle specific applications



WIRING HARNESS

1993-2001

70-1817

- Plugs into car harness at radio
- Provides power - 4-speaker connection



SPEAKER ADAPTER

1993-2004, 2014-2017

82-6600

- Adapts 5.25" or 6.5" speaker to front door location
- Sold as a pair



SPEAKER HARNESS

1993-1998

72-4500

- Sold as Pair





RADIO KITS AND HARNESSING

1986-1995

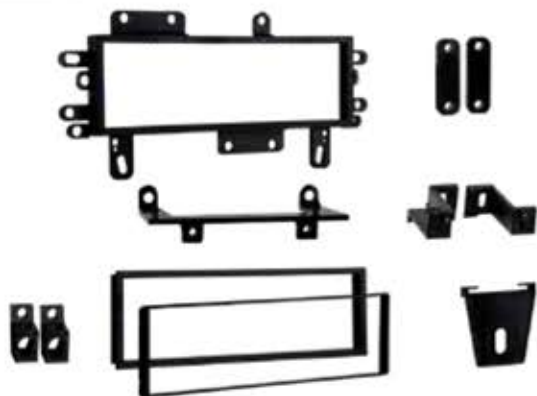

DASH KIT

1986-1995

99-5510

DASH KIT

- Professional Installer Series TurboKit offers quick conversion from 2-shaft to DIN
- OEM-style rear support included

WIRING HARNESS

1993-1995

70-1817

- Plugs into car harness at radio
- Provides power - 4-speaker connection



WIRING HARNESS

1987-1992

70-1002

- Plugs into car harness at radio
- Provides power - 4-speaker connection



RADIO KITS AND HARNESSING

2002-2012

DASH KIT

2008-2012

95-6511-17

DASH KIT

- ISO DDIN radio provision
- Classic design of 95-6511
- Textured



WIRING HARNESS

2008-2012

70-6522

- Plugs into car harness at radio



ANTENNA ADAPTER

2008-2012

40-EU10

EUROPEAN ANTENNA ADAPTER

- European factory antenna with mini-style plug to aftermarket radio



2002-2017.5

DASH KIT
2002-2007

95-6524B

DASH KIT

- Double-DIN radio provision
- Painted matte black



WIRING HARNESS
2002-2007

70-6502

- Plugs into car harness at radio
- Provides power - 4-speaker connection



ANTENNA ADAPTER
2002-2007

40-CR10

- Chrysler factory antenna with snap-lock to aftermarket radio



SPEAKER HARNESS
2009-2017.5

72-7902

- Sold as a pair



2007-2017

DASH KIT
2009-2017

95-6511-17

DASH KIT

- ISO DDIN radio provision
- Classic design of 95-6511
- Textured



RADIO REPLACEMENT DATA INTERFACE WITH SWC
2007-2017

AXDIS-CH13

RADIO REPLACEMENT DATA INTERFACE WITH SWC

- Provides accessory power (12-volt 10-amp)
- Retains R.A.P. (Retained Accessory Power)
- Provides NAV outputs (parking brake, reverse and speed sense)
- Retains audio controls on the steering wheel
- High level speaker input
- Can be used in non-amplified or amplified systems
- Micro "B" USB updatable



ANTENNA ADAPTER

2009-2017

40-EU10 EUROPEAN ANTENNA ADAPTER

- European factory antenna with mini-style plug to aftermarket radio



SPEAKER HARNESS

2009-2017

72-6514

- Sold as a pair



DASH KIT

2007-2008

95-6534B

DASH KIT

- PLEASE NOTE THAT THE FACTORY RADIO BEZEL WILL HAVE TO BE MODIFIED
- ISO DDIN radio provision
- ISO DDIN radio provision with pocket
- Painted matte black

RADIO/AMP BYPASS HARNESS

2007-2009

70-6504

RADIO/AMP BYPASS HARNESS

- 204" long
- Amp bypass
- Includes Chrysler 2002-2005 Turbo Wire - power wires only - no speaker wires



ANTENNA ADAPTER

2007-2008

40-CR10

- Chrysler factory antenna with snap-lock to aftermarket radio



SPEAKER HARNESS

2007-2008

72-7902

- Sold as a pair



DASH KIT

2015-2019

95-6532B

DASH KIT

- Designed specifically for Double-DIN installations
- Painted scratch-resistant matte black to match the factory appearance.
- Extended face plate provides depth - preventing extensive sub-dash modifications.



RADIO REPLACEMENT DATA INTERFACE

2015-2019

AXVI-6524

RADIO REPLACEMENT DATA INTERFACE

- Provides accessory power (12-volt 10-amp)
- Retains R.A.P. (Retained Accessory Power)
- Provides NAV outputs (parking brake, reverse and speed sense)
- Pre-wired AXSWC harness (AXSWC sold separately)
- Retains the factory backup camera (if applicable)
- Retains the 3.5mm AUX-IN jack and balance and fade
- Using custom Bluetooth® app, allows ability to manipulate vehicles customization settings that are usually lost when adding aftermarket radio (Android™ only at this time)
- Micro "B" USB updatable



ANTENNA ADAPTER

2015-2019

40-EU55

- Powered version of 40-EU10
- Mini-style plug to aftermarket radio





DASH KIT

1984-1990

99-5510

DASH KIT

- Professional Installer Series TurboKit offers quick conversion from 2-shaft to DIN
- OEM-style rear support included

WIRING HARNESS

1984-1990

70-1002

- Plugs into car harness at radio
- Provides power - 4-speaker connection



ANTENNA REPLACEMENT

1985-1996

44-CR72

- 31" (79cm) removable mast
- 80" (203cm) cable





PREMIUM HEADLIGHTS	PREMIUM DECODERS	MODEL AND YEAR	STANDARD HEADLIGHTS	STANDARD DECODER
WRANGLER JL/GLADIATOR				
HE-H13LED	HE-H13D	2018 - UP	DL-H13	DL-H13D
7" HL W/ JP-JBL7 PG. 2-6	JP-H4H13DE PG. 8	2018 - UP	N/A	N/A
WRANGLER JK				
HE-H13LED	HE-H13D	2007 - 2018	DL-H13	DL-H13D
7" HL PG. 2-6	JP-H4H13DE PG. 8	2007 - 2018	N/A	N/A
WRANGLER TJ				
7" HL PG. 2-6	JP-H4H13DE PG. 8	1998 - 2006	N/A	N/A
WRANGLER YJ				
5X7 SEALED HL PG. 7	JP-H4H13DE PG. 8	1987 - 1995	N/A	N/A
CHEROKEE				
5X7 SEALED HL PG. 7	JP-H4H13DE PG. 8	1997 - 2001	N/A	N/A
COMANCHE				
5X7 SEALED HL PG. 7	JP-H4H13DE PG. 8	1986 - 1992	N/A	N/A
COMMANDER				
HE-9006LED	HE-9006D	2006 - 2010	DL-9006	DL-9006D
HE-9005LED	HE-9005D	2006 - 2010	DL-9005	DL-9005D
COMPASS				
HE-9012LED	HE-9012D	2014 - 2016	DL-9012	DL-9012D
HE-H11LED	HE-H11D	2011 - 2020	DL-H11	DL-H11D
HE-9005LED	HE-9005D	2011 - 2020	DL-9005	DL-9005D
HE-H13LED	HE-H13D	2007 - 2010	DL-H13	DL-H13D
GRAND CHEROKEE				
HE-H9LED	HE-H9D	2017 - 2020	DL-H9	DL-H9D
HE-H11LED	HE-H11D	2011 - 2020	DL-H11	DL-H11D
HE-9006LED	HE-9006D	1999 - 2010	DL-9006	DL-9006D
HE-9005LED	HE-9005D	1999 - 2016	DL-9005	DL-9005D
HE-9004LED	HE-9004D	1993 - 1998	DL-9004	DL-9004D
GRAND WAGONEER				
HE-9004LED	HE-9004D	1993 - 1995	DL-9004	DL-9004D
5X7 SEALED HL PG. 7	JP-H4H13DE PG. 8	1984 - 1992	N/A	N/A
LIBERTY				
HE-H13LED	HE-H13D	2008 - 2012	DL-H13	DL-H13D
HE-9007LED	HE-9007D	2002 - 2007	DL-9007	DL-9007D
PATRIOT				
HE-H13LED	HE-H13D	2007 - 2017	DL-H13	DL-H13D
RENEGADE				
HE-H13LED	HE-H13D	2015 - 2020	DL-H13	DL-H13D
WAGONEER				
4X6 SEALED HL PG. 7	JP-H4H13DE PG. 8	1985 - 1990	N/A	N/A
5X7 SEALED HL PG. 7	JP-H4H13DE PG. 8	1984 - 1984	N/A	N/A



FOG LIGHT REPLACEMENT FIT GUIDE



PREMIUM HEADLIGHTS	PREMIUM DECODERS	MODEL AND YEAR	STANDARD HEADLIGHTS	STANDARD DECODER
WRANGLER JL/GLADIATOR				
HE-PSX24LED	HE-PSX24D	2018 - UP	DL-PSX24	DL-PSX24D
4" SEALED LIGHT* PG. 4-6,8	HE-PSX24D	2018 - UP	N/A	N/A
WRANGLER JK				
HE-PSX24LED	HE-PSX24D	2007 - 2018	DL-PSX24	DL-PSX24D
4" SEALED LIGHT* PG. 4-6,8	HE-PSX24D	2007 - 2018	N/A	N/A
WRANGLER TJ				
HE-H3LED	HE-H3D	1998 - 2006	DL-H3	DL-H3D
WRANGLER YJ				
HE-H3LED	HE-H3D	1987 - 1995	DL-H3	DL-H3D
CHEROKEE				
HE-H3LED	HE-H3D	1997 - 2001	DL-H3	DL-H3D
COMMANDER				
HE-9005LED	HE-9005D	2006 - 2010	DL-9005	DL-9005D
COMPASS				
HE-H16LED	HE-H16D	2020 - 2020	DL-H16	DL-H16D
HE-H11LED	HE-H11D	2013 - 2020	DL-H11	DL-H11D
HE-PSX24LED	HE-PSX24D	2010 - 2012	DL-PSX24	DL-PSX24D
HE-9005LED	HE-9005D	2007 - 2009	DL-9005	DL-9005D
GRAND CHEROKEE				
HE-H11LED	HE-H11D	2012 - 2020	DL-H11	DL-H11D
HE-PSX24LED	HE-PSX24D	2011 - 2013	DL-PSX24	DL-PSX24D
HE-H10LED	HE-H10D	1999 - 2010	DL-H10	DL-H10D
HE-H3LED	HE-H3D	1993, 1996 - 1998	DL-H3	DL-H3D
GRAND WAGONEER				
HE-H3LED	HE-H3D	1993 - 1993	DL-H3	DL-H3D
LIBERTY				
HE-H10LED	HE-H10D	2002 - 2012	DL-H10	DL-H10D
PATRIOT				
HE-PSX24LED	HE-PSX24D	2010 - 2017	DL-PSX24	DL-PSX24D
HE-H10LED	HE-H10D	2007 - 2009	DL-H10	DL-H10D
RENEGADE				
HE-H16LED	HE-H16D	2020 - 2020	DL-H16	DL-H16D
HE-H11LED	HE-H11D	2015 - 2020	DL-H11	DL-H11D

*Lights may require additional brackets and/or JP-JWFLAH



YEAR RANGE	FRONT TURN SIGNAL	FRONT PARKING LIGHT	DAYTIME RUNNING LIGHT	FRONT SIDE MARKER	REAR SIDE MARKER	REAR TURN SIGNAL	TAIL LIGHT	BRAKE LIGHT	REVERSE LIGHT	THIRD BRAKE LIGHT	LICENSE PLATE LIGHT
WRANGLER JL/GLADIATOR											
2018 - 2020	HE-C7440A	HE-C7443A	HE-C7443W	----	----	HE-C3157A	HE-C3157W	HE-C3157W	HE-C7440W	----	----
WRANGLER JK											
2007 - 2018	HE-C3157A	HE-C3157A	----	HE-CT10A	HE-C3157A	HE-C3157A	HE-C3157W	HE-C3157W	HE-C3157W	----	HE-CT10W
WRANGLER TJ											
1997 - 2006	HE-C3157A	HE-C3157A	----	HE-CT10A	----	HE-C1157A	HE-C1157W	HE-C1157W	HE-C1156W	HE-CT10R	HE-CT10W
WRANGLER YJ											
1994 - 1995	HE-C3157A	HE-C3157A	----	HE-CT10A	----	HE-C1157A	HE-C1157W	HE-C1157W	HE-C1156W	HE-CT10R	HE-C1156W
1987 - 1993	HE-C1157A	HE-C1157A	----	HE-CT10A	----	HE-C1157A	HE-C1157W	HE-C1157W	HE-C1156W	----	HE-C1156W
CHEROKEE											
1997 - 2001	HE-C3157A	----	----	HE-CT10A	HE-C3157A	HE-C3157A	HE-C3157W	HE-C3157W	HE-C3157W	HE-CT10R	HE-CT10W
COMANCHE											
1986 - 1992	HE-C3157A	HE-C3157A	----	HE-CT10A	HE-CT10A	HE-C1156A	HE-C3157W	HE-C3157W	HE-C1156W	----	HE-CT10W
COMMANDER											
2006 - 2010	HE-C3157A	HE-C3157A	----	HE-CT10A	HE-CT10A	HE-C3157A	HE-C3157W	HE-C3157W	HE-C3157W	----	HE-CT10W
COMPASS											
2019 - 2020	HE-C7443A	----	----	HE-CT10A	----	HE-C7443A	HE-C7443W	HE-C7443W	HE-C7440W	----	----
2017 - 2018	HE-C7443A	HE-C7443A	----	HE-CT10A	----	HE-C7440A	HE-C7443W	HE-C7443W	HE-C7440W	----	HE-CT10W
2014 - 2016	HE-C7443A	HE-C7443A	HE-3157W	HE-CT10A	----	HE-C7440A	----	----	HE-C7440W	----	HE-CT10W
2011 - 2013	HE-C7443A	HE-C7443A	----	HE-CT10A	----	HE-C7440A	----	----	HE-C7440W	----	HE-CT10W
GRAND CHEROKEE											
2014 - 2020	HE-C7440A	HE-C7440A	HE-H11LED	HE-CT10A	----	HE-C7440A	----	HE-C3157W	HE-CT10W	----	----
2011 - 2013	HE-C7440A	HE-C7440A	HE-3157W	HE-CT10A	HE-C3157A	HE-C3157A	HE-C3157W	HE-C3157W	HE-C7440W	----	HE-CT10W
2006 - 2010	HE-C3157A	HE-C3157A	----	HE-CT10A	HE-C3157A	HE-C3157A	HE-C3157W	HE-C3157W	HE-CT10W	----	HE-CT10W
1997 - 2005	HE-C3157A	HE-C3157A	----	HE-CT10A	----	HE-C3157A	HE-C3157W	HE-C3157W	HE-C3157W	HE-CT10R	HE-CT10W
1993 - 1996	HE-C1156A	HE-CT10A	----	HE-CT10A	HE-CT10A	HE-C1156A	HE-C3157W	HE-C3157W	HE-C1156W	HE-CT10R	HE-CT10W
GRAND WAGONEER											
1993 - 1993	HE-C1156A	HE-CT10A	----	HE-CT10A	HE-CT10A	HE-C1156A	HE-C3157W	HE-C3157W	HE-C1156W	HE-CT10R	HE-CT10W
LIBERTY											
2008 - 2012	HE-C3157A	HE-C3157A	----	HE-CT10A	HE-C3157A	HE-C3157A	HE-C3157W	HE-C3157W	HE-C3157W	HE-CT10R	HE-CT10W
2002 - 2007	HE-C3157A	HE-C3157A	----	HE-CT10A	----	HE-C3157A	HE-C3157W	HE-C3157W	HE-C3157W	HE-CT10R	HE-CT10W
PATRIOT											
2007 - 2017	HE-C3157A	HE-C3157A	----	HE-C3157A	HE-C3157A	HE-C3157A	HE-C3157W	HE-C3157W	HE-CT10W	----	HE-CT10W
RENEGADE											
2015 - 2020	----	----	----	HE-CT10A	----	HE-C1156A	HE-C1156W	HE-C1156W	HE-CT10W	----	HE-CT10W
WAGONEER											
1985 - 1990	HE-C3157A	HE-C3157A	----	HE-CT10A	HE-CT10A	HE-C1156A	HE-C3157W	HE-C3157W	HE-C1156W	HE-CT10R	HE-CT10W
1984 - 1984	HE-C1157A	HE-C1157A	----	HE-CT10A	HE-CT10A	HE-C1157A	HE-C1157W	HE-C1157W	HE-C1156W	----	----



RGB CONTROL BOX

RGB-CB1

4 TRIGGERS

- App controlled Android™ / iOS®
- Wireless BLE control
- 16 million color options
- Group multiple devices
- Camera color capture
- Sync lighting to your music
- Rainbow, water and fire patterns
- Fade, blink and pulsating transitions
- 4 programmable triggers
- Handles up to 10 amps of lights

4-POD ROCK LIGHT SET

RGB1-4KT

IP68



- (3) 3-watt Cree LEDs per pod
- 9 watts per pod
- Raw lumens: 720lm
- Stainless 316 hardware included
- Black die-cast aluminum housing
- Current consumption @ 13.8 volts 0.2 amps
- PC lens - IP68 rated
- Works with RGB-CB1 (sold separately)

SINGLE RGB ROCK LIGHT

HE-TL1RGB

IP68



- (3) 3-watt Cree LEDs per pod
- 9 watts per pod
- Raw lumens: 720lm
- Stainless 316 hardware included
- Black die-cast aluminum housing
- PC lens - IP68 rated
- Works with RGB-CB1 (sold separately)

"Y" ADAPTER

RGB-Y1

- 6" RGB - 1 male - 2 female
- 1 male - 2 female
- 4-pin connector works with RGB1-4KT and HE-TL1RGB

PIGTAIL ADAPTER

RGB-PT1

- 4-pin RGB hardwire pigtail

4-PIN EXTENSION

HE-EXTRGB

- 4-pin extension cable
- 10 feet
- Used with RGB-CB1 and HE-TL1RGB



RGB UNDERGLOW SET

RGB1-UNDGLED

4 PIECE



- Includes (2) 48-inch and (2) 36-inch LED tubes
- Dual connection to controller maximum current and even illumination
- Requires RGB-CB1 controller (sold separately)
- Mounting hardware and extension cables included





RGBW CONTROL BOX

RGBW-CB1

4 TRIGGERS

- App controlled Android™ / iOS®
- Wireless BLE control
- 16 million color options
- Group multiple devices
- Camera color capture
- Sync lighting to your music
- Rainbow, water and fire patterns
- Fade, blink and pulsating transitions
- 4 programmable triggers
- Handles up to 10 amps of lights



4-POD ROCK LIGHT SET

RGBW1-4KT

IP68



- RGB LED + True White LED
- (24) 3030 LEDs per pod
- 24 watts per pod
- Black die-cast aluminum housing
- PC lens - IP68 rated
- Works with RGBW-CB1 (sold separately)



SINGLE RGBW ROCK LIGHT

RGBW1-S1

IP68



- RGB LED + True White LED
- (24) 3030 LEDs per pod
- 24 watts per pod
- Black die-cast aluminum housing
- PC lens - IP68 rated
- Works with RGBW-CB1 (sold separately)



"Y" ADAPTER

RGBW-Y1

- 6" RGB Y adapter
- 1 male - 2 female
- 5-pin connector works with RGBW1-4KT and RGBW1-S1



PIGTAIL ADAPTER

RGBW-PT1

- 5-pin RGBW hardwire pigtail



5-PIN EXTENSION

RGBW1-EXT

- 5-pin 10-foot extension cable
- Used with RGBW-CB1 and RGBW1-S1
- IP68



RGB CONTROL BOX FOR 702RGB HEADLIGHTS/FOG LIGHTS

RGB-CB3

4 TRIGGERS

- Heise RGB control box
- Used for part # HE-PBHL702RGB HL and HE-JWBFL02RGB
- App controlled Android™ / iOS®
- Wireless BLE control
- 16 million color options
- Group multiple devices
- Camera color capture
- Sync lighting to your music
- Rainbow, water and fire patterns
- Fade, blink and pulsating transitions
- 4 programmable triggers
- Handles up to 10 amps
- Flat 4-pin



LIGHTBARS • INFINITE SERIES

HE-INFIN8

8 INCH

12 LED



- Wattage: 18W
- Raw Lumens: 2280lm
- Lux @ 10M: 235

- Current Consumption @ 13.8V: 1.3A
- IP Rating: IP67

HE-INFIN22

22 INCH

40 LED



- Wattage: 60W
- Raw Lumens: 7600lm
- Lux @ 10M: 1150

- Current Consumption @ 13.8V: 4.34A
- IP Rating: IP67

HE-INFIN30

30 INCH

56 LED



- Wattage: 84W
- Raw Lumens: 10640lm
- Lux @ 10M: 1426

- Current Consumption @ 13.8V: 6.1A
- IP Rating: IP67

HE-INFIN40

40 INCH

76 LED



- Wattage: 114W
- Raw Lumens: 14440lm
- Lux @ 10M: 1780

- Current Consumption @ 13.8V: 9.5A
- IP Rating: IP67

HE-INFIN50

50 INCH

96 LED



- Wattage: 144W
- Raw Lumens: 17100lm
- Lux @ 10M: 2350

- Current Consumption @ 13.8V: 14.3A
- IP Rating: IP67



RGB-CB1

RGB CONTROL BOX

- Required for RGB functionality on all Infinite Series lights. (sold separately) See pg. 44

SPECS & MEASUREMENTS

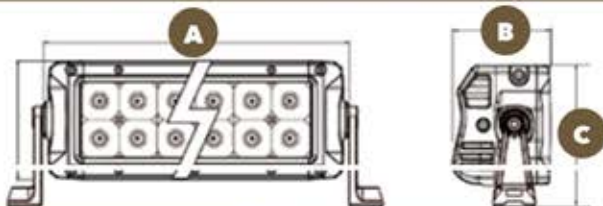

PART

A **B** **C**

HE-INFIN8	8.11"	2.56"	3.09"
HE-INFIN22	22.17"	2.56"	3.09"
HE-INFIN30	30.20"	2.56"	3.09"
HE-INFIN40	40.24"	2.56"	3.09"
HE-INFIN50	50.12"	2.56"	3.09"

COMMON FEATURES

- Housing Material: Die-cast aluminum
- Color Temp: 6000K
- Lens Material: Polycarbonate
- Included Hardware: Stainless 316
- Electronics: Integrated-epoxy encapsulated
- Operating Temperature: -40° F to 140° F
- Protection: Reverse polarity



ALL LIGHTBARS ARE

DESIGNED
— EXCLUSIVELY FOR —
OFFROAD

LIGHTBARS • SUPER SLIMLINE SERIES
HE-SS550
5.5 INCH
3 LED
NEW!

- Wattage: 9W
- Raw Lumens: 810lm
- Mounting Options: 2
- Current Consumption @ 13.8V: 0.55A
- IP Rating: IP67

HE-SS9
9 INCH
6 LED
NEW!

- Wattage: 18W
- Raw Lumens: 1620lm
- Mounting Options: 2
- Current Consumption @ 13.8V: 1.08A
- IP Rating: IP67

HE-SS2050
20.5 INCH
15 LED
NEW!

- Wattage: 45W
- Raw Lumens: 4050lm
- Mounting Options: 2
- Current Consumption @ 13.8V: 2.80A
- IP Rating: IP67

HE-SS32
32 INCH
24 LED
NEW!

- Wattage: 72W
- Raw Lumens: 6480lm
- Mounting Options: 2
- Current Consumption @ 13.8V: 4.55A
- IP Rating: IP67

HE-SS3950
39.5 INCH
30 LED
NEW!

- Wattage: 90W
- Raw Lumens: 8100lm
- Mounting Options: 2
- Current Consumption @ 13.8V: 5.78A
- IP Rating: IP67

HE-SS51
51 INCH
39 LED
NEW!

- Wattage: 117W
- Raw Lumens: 10530lm
- Mounting Options: 2
- Current Consumption @ 13.8V: 7.60A
- IP Rating: IP67

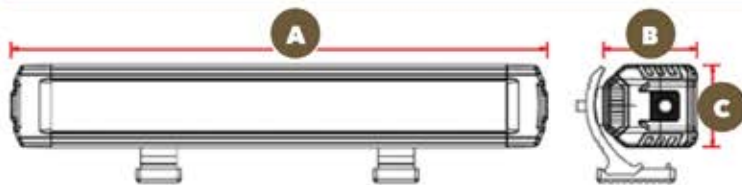
SPECS & MEASUREMENTS

PART	A	B	C
HE-SS5.5	5.59"	2.05"	1.77"
HE-SS9	9.37"	2.05"	1.77"
HE-SS20.5	20.71"	2.05"	1.77"
HE-SS32	32.05"	2.05"	1.77"
HE-SS39.5	39.61"	2.05"	1.77"
HE-SS51	50.94"	2.05"	1.77"

COMMON FEATURES

- Housing Material: Die-cast aluminum
- Color: Black
- Lens Material: Polycarbonate
- Included Hardware: Aluminum
- Electronics: Integrated-epoxy encapsulated
- Operating Temperature: -40° F to 140° F
- Protection: Reverse polarity



LIGHTBARS • DUAL ROW LEDS – HIGH OUTPUT

HE-HDR8

8 INCH

12 LED

NEW!

- Wattage: 36W
- Raw Lumens: 3240lm

- Current Consumption @ 13.8V: 2.26A
- IP Rating: IP67



M

HE-HDR14

14 INCH

24 LED

NEW!

- Wattage: 72W
- Raw Lumens: 6480lm

- Current Consumption @ 13.8V: 4.5A
- IP Rating: IP67



HE-HDR22

22 INCH

40 LED

NEW!

- Wattage: 120W
- Raw Lumens: 10800lm

- Current Consumption @ 13.8V: 4.52A
- IP Rating: IP67



HE-HDR32

32 INCH

40 LED

NEW!

- Wattage: 180W
- Raw Lumens: 16200lm

- Current Consumption @ 13.8V: 16.5A
- IP Rating: IP67



HE-HDR42

42 INCH

60 LED

NEW!

- Wattage: 240W
- Raw Lumens: 21600lm

- Current Consumption @ 13.8V: 8.8A
- IP Rating: IP67



HE-HDR50

50 INCH

60 LED

NEW!

- Wattage: 288W
- Raw Lumens: 25920lm

- Current Consumption @ 13.8V: 18.1A
- IP Rating: IP67



SPECS & MEASUREMENTS

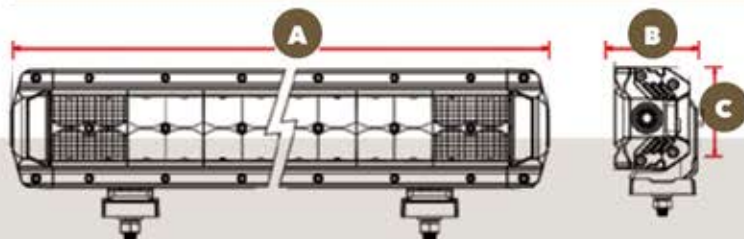

PART	A	B	C
HE-HDR8	8.11"	2.28"	3.07"
HE-HDR14	14.13"	2.28"	3.07"
HE-HDR22	22.17"	2.28"	3.07"
HE-HDR32	32.20"	2.28"	3.07"
HE-HDR42	42.24"	2.28"	3.07"
HE-HDR50	50.28"	2.28"	3.07"



HIGH OUTPUT FLOOD

HE-HCL22PK

4 LED

- 2 Light Pack
- Input Voltage: 10-30V DC
- Wattage: 12W (4-3W OSRAM LEDs)
- Lumens: 960lm
- Lux at 10M: 32 Raw
- Color Temperature: 6000K
- Beam Pattern: 90° Flood

140° HIGH OUTPUT

HE-HCL1402PK

15 LED

- 2 Light Pack
- Wattage: 30W
- Raw Lumens: 2850lm
- Lux @ 10M: 122
- IP Rating: IP67
- Beam Pattern: 140° Flood/15° Spot
- Current Consumption @ 13.8V: 2.2A



5" ROUND DRIVING LIGHT

HE-DL3

8 LED

- Input Voltage: 10-30V DC
- Wattage: 24W (8-3W OSRAM LEDs)
- Raw Lumens: 1920lm
- Color Temperature: 6000K
- Beam Pattern: 26° Spot

7" ROUND DRIVING LIGHT

HE-DL4

15 LED

- Input Voltage: 10-30V DC
- Wattage: 45W (15-3W OSRAM LEDs)
- Raw Lumens: 3600lm
- Color Temperature: 6000K
- Beam Pattern: 26° Spot



LIGHTBARS • ULTRA SLIM SERIES

DL-US725

7.25 INCH

6 LED

- Wattage: 18W
- Raw Lumens: 1080lm
- Current Consumption @13.8V: 1.3A
- IP Rating: IP67
- Input Voltage: 10-30V DC
- Color Temperature: 6000K
- Beam Pattern: Spot 8°



DL-US135

13.5 INCH

12 LED

- Wattage: 36W
- Raw Lumens: 2160lm
- Current Consumption @13.8V: 2.6A
- IP Rating: IP67
- Input Voltage: 10-30V DC
- Color Temperature: 6000K
- Beam Pattern: Spot 8°



DL-US195

19.5 INCH

18 LED

- Wattage: 54W
- Raw Lumens: 3240lm
- Current Consumption @13.8V: 3.9A
- IP Rating: IP67
- Input Voltage: 10-30V DC
- Color Temperature: 6000K
- Beam Pattern: Spot 8°



DL-US32

32 INCH

30 LED

- Wattage: 90W
- Raw Lumens: 5400lm
- Current Consumption @13.8V: 6.5A
- IP Rating: IP67
- Input Voltage: 10-30V DC
- Color Temperature: 6000K
- Beam Pattern: Spot 8°



DL-US4425

44.25 INCH

42 LED

- Wattage: 126W
- Raw Lumens: 7560lm
- Current Consumption @13.8V: 9.2A
- IP Rating: IP67
- Input Voltage: 10-30V DC
- Color Temperature: 6000K
- Beam Pattern: Spot 8°

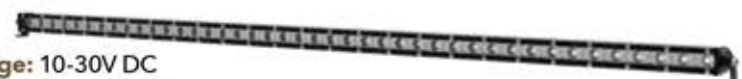

DL-US5025

50.25 INCH

48 LED

- Wattage: 144W
- Raw Lumens: 8640lm
- Current Consumption @13.8V: 10.5A
- IP Rating: IP67
- Input Voltage: 10-30V DC
- Color Temperature: 6000K
- Beam Pattern: Spot 8°



SPECS & MEASUREMENTS		A	B	C
PART				
DL-US725		7.25"	1.75"	1.0625"
DL-US135		13.5"	1.75"	1.0625"
DL-US195		19.5"	1.75"	1.0625"
DL-US32		32"	1.75"	1.0625"
DL-US4425		44.25"	1.75"	1.0625"
DL-US5025		50.25"	1.75"	1.0625"

COMMON FEATURES

- Housing Material: Die-cast aluminum
- Color: Black
- Lens Material: Polycarbonate
- Hardware: Stainless steel
- Electronics: Integrated-epoxy encapsulated
- Operating Temperature: -40° F to 140° F
- Protection: Reverse polarity

LIGHTBARS • DUAL ROW LEDs
DL-DR8
8 INCH
12 LED

- Wattage: 36W
- Raw Lumens: 2160lm
- Current Consumption @13.8V: 2.6A
- IP Rating: IP67
- Input Voltage: 10-30V DC
- Color Temperature: 6000K
- Beam Pattern: Combo - Flood 90° & Spot 8°

DL-DR14
14 INCH
24 LED

- Wattage: 72W
- Raw Lumens: 4320lm
- Current Consumption @13.8V: 5.2A
- IP Rating: IP67
- Input Voltage: 10-30V DC
- Color Temperature: 6000K
- Beam Pattern: Combo - Flood 90° & Spot 8°

DL-DR22
22 INCH
40 LED

- Wattage: 120W
- Raw Lumens: 7200lm
- Current Consumption @13.8V: 8.7A
- IP Rating: IP67
- Input Voltage: 10-30V DC
- Color Temperature: 6000K
- Beam Pattern: Combo - Flood 90° & Spot 8°

DL-DR32
32 INCH
60 LED

- Wattage: 180W
- Raw Lumens: 10800lm
- Current Consumption @13.8V: 13.1A
- IP Rating: IP67
- Input Voltage: 10-30V DC
- Color Temperature: 6000K
- Beam Pattern: Combo - Flood 90° & Spot 8°

DL-DR42
42 INCH
80 LED

- Wattage: 240W
- Raw Lumens: 14400lm
- Current Consumption @13.8V: 17.4A
- IP Rating: IP67
- Input Voltage: 10-30V DC
- Color Temperature: 6000K
- Beam Pattern: Combo - Flood 90° & Spot 8°

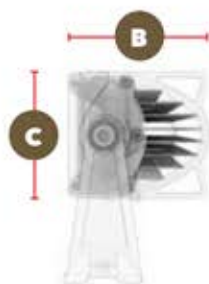
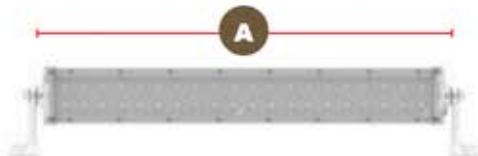
SPECS & MEASUREMENTS

PART	A	B	C
DL-DR8	8"	3.4375"	3.0625"
DL-DR14	14"	3.4375"	3.0625"
DL-DR22	22"	3.4375"	3.0625"
DL-DR32	32"	3.4375"	3.0625"
DL-DR42	42"	3.4375"	3.0625"
DL-DR50	50"	3.4375"	3.0625"
DL-DR52	52"	3.4375"	3.0625"

COMMON FEATURES

- Housing Material: Die-cast aluminum
- Color: Black
- Membrane: Military breather
- Lens Material: Polycarbonate
- Hardware: Stainless steel
- Electronics: Integrated-epoxy encapsulated
- Operating Temperature: -40° F to 140° F
- Protection: Reverse polarity



LIGHTBARS • DUAL ROW LEDs

DL-DR50	50 INCH	96 LED
----------------	----------------	---------------

- Wattage: 288W
- Raw Lumens: 17280lm
- Current Consumption @13.8V: 20.9A
- IP Rating: IP67
- Input Voltage: 10-30V DC
- Color Temperature: 6000K
- Beam Pattern: Combo - Flood 90° & Spot 8°



DL-DR52	52 INCH	100 LED
----------------	----------------	----------------

- Wattage: 300W
- Raw Lumens: 18000lm
- Current Consumption @13.8V: 21.8A
- IP Rating: IP67
- Input Voltage: 10-30V DC
- Color Temperature: 6000K
- Beam Pattern: Combo - Flood 90° & Spot 8°



COMMON FEATURES

- Housing Material: Die-cast aluminum
- Color: Black
- Membrane: Military breather
- Lens Material: Polycarbonate
- Hardware: Stainless steel
- Electronics: Integrated-epoxy encapsulated
- Operating Temperature: -40° F to 140° F
- Protection: Reverse polarity





4 INCH

DL-CL1

6 LED

- **Wattage***: 36W
- **Raw Lumens***: 2520lm
- **Current Consumption*** @13.8V: 2.6A
- **IP Rating**: IP67
- **Input Voltage**: 10-30V DC
- **Color Temperature**: 6000K
- **Beam Pattern**: Flood 90°
- **Cube Dimensions**: 4"H x 3.75"W x 2.75"D (including bracket)

**Total value for set of two lights*

140° DUAL ZONE

DL-CL3

12 LED

NEW!

- **Separate power wires** for spot LEDs and flood LEDs
- **Wattage***: 72W
- **Raw Lumens***: 2520lm
- **Current Consumption*** @13.8V: 5.2A
- **IP Rating**: IP67
- **Input Voltage**: 10-30V DC
- **Color Temperature**: 6000K
- **Beam Pattern**: Combo (Spot & Flood)
- **Cube Dimensions**: 3.0"H x 3.9"W x 3.2"D

**Total value for set of two lights*

SQUARE

DL-DL4S

9 LED

NEW!

- **Wattage***: 54W
- **Raw Lumens***: 3510lm
- **Current Consumption*** @13.8V: 3.4A
- **IP Rating**: IP67
- **Input Voltage**: 10-30V DC
- **Color Temperature**: 6500K
- **Beam Pattern**: Flood 60°
- **Cube Dimensions**: 5.0"H x 4.3"W x 2.2"D

**Total value for set of two lights*

ROUND

DL-DL4R

9 LED

NEW!

- **Wattage***: 54W
- **Raw Lumens***: 3510lm
- **Current Consumption*** @13.8V: 3.4A
- **IP Rating**: IP67
- **Input Voltage**: 10-30V DC
- **Color Temperature**: 6500K
- **Beam Pattern**: Flood 60°
- **Cube Dimensions**: 5.0"H x 4.3"W x 2.2"D

**Total value for set of two lights*



8 GANG SWITCH PANEL

HE-SWP8

- 8 gang switch panel
- Control box with cover
- Selectable switch operation; latching or momentary
- 50 switch labels
- 60 amp resettable circuit breaker
- 6 extra fuses
- Power harness
- Battery cables
- 2 switch panel brackets
- 1 control box bracket
- Mounting hardware, screws and zip ties included



FLUSH MOUNT SWITCH PANEL CASE

HE-SWP8C

FOR HE-SWP8

NEW!

- Fits HE-SWP8 switch panel
- Switch panel screws securely to the case box
- Included snap on trim plate for a clean installation
- Cut template and mounting hardware included





IBSP6	<ul style="list-style-type: none"> • 6-position rocker switch panel • Overload protection design 	<ul style="list-style-type: none"> • Rubber panel + water-resistant rubber seals • Anti-corrosion, water-resistant
IBSS	<ul style="list-style-type: none"> • CE-Cert 12-24V range output • Polarity reversal protection 	<ul style="list-style-type: none"> • Short circuit protection • Panel mount • Overload protection
IBSS2L	<ul style="list-style-type: none"> • Switch with LED indicator • Overload protection 	<ul style="list-style-type: none"> • CE-Cert 12-24V range output • Polarity reversal protection • Short circuit protection • Panel mount
IBSS6P	<ul style="list-style-type: none"> • 6-pin on/off • Overload protection 	<ul style="list-style-type: none"> • CE-Cert 12-24V range output • Polarity reversal protection • Short circuit protection • Panel mount
IBSSR	<ul style="list-style-type: none"> • CE-Cert 12-24V range output • Polarity reversal protection 	<ul style="list-style-type: none"> • Short circuit protection • Panel mount • Overload protection
IBSSL	<ul style="list-style-type: none"> • CE-Cert 12-24V range output • Overload protection 	<ul style="list-style-type: none"> • Red LED • Polarity reversal protection • Short circuit protection • Panel mount
IBSSWB	<ul style="list-style-type: none"> • CE-Cert 12- 24V range output • Overload protection 	<ul style="list-style-type: none"> • 6-pin winch with LED • Polarity reversal protection • Short circuit protection • Panel mount



WIRELESS RELAY HARNESS

HE-WRRK WIRELESS REMOTE CONTROL

- 9-function RF remote
- No need to run wires into the vehicle
- Simple 2-wire connection
- Completely sealed control box can be mounted in engine compartment
- Use with any Heise lightbar, driving light or work light

WIRING HARNESS & SWITCH KIT

HE-DLWH1 2 LAMP - UNIVERSAL



- Universal plug-n-play wiring harness with on/off rocker switch
- 12V DC relay
- 30A fuse
- With 2-pin DT connectors for 2 lamps
- With water-resistant fuse holder
- Set includes wiring harness & switch
- Easy installation
- Use with 2 Heise lights 150 watts each or less

ANL**V-ANL-H 1/0 AWG COMPACT FUSE HOLDER**

- Accepts 1 ANL or single/dual MANL fuses
- 1/0 AWG - 8 AWG In/Out
- Compact design for simpler installation
- Solid brass construction for maximum conductivity
- Nickel finish for durability
- Cover included

**MANL****V-DIST-PWR 3-POSITION DISTRIBUTION BLOCK**

- Independently MANL fused outputs
- (1) 1/0 AWG - 8 AWG In
- (3) 4 AWG - 10 AWG Out
- Compact design for simpler installation
- Solid brass construction for maximum conductivity
- Nickel finish for durability
- Cover included

BATTERY TERMINAL**V-BATT-TML 3-POSITION DISTRIBUTION BLOCK**

- (2) 1/0 AWG - 10 AWG plus (2) 4 AWG - 10 AWG In
- Compact design for simpler installation
- Solid brass construction for maximum conductivity
- Nickel finish for durability
- Positive and negative marker plates included
- Negative post sleeve included

**GROUND****V-DIST-GND 2-POSITION DISTRIBUTION**

- (2) 4 AWG - 10 AWG In
- (1) 1/0 AWG - 8 AWG Out
- Compact design for simpler installation
- Solid brass construction for maximum conductivity
- Nickel finish for durability
- Cover included



v10 AMP KITS

- Meets CEA and ANSI specification for wire gauge
- Full virgin copper construction
- Fully tinned wire
- High strand count for maximum flexibility
- BC-5W2 marine compliant RCA, speaker, power and ground wire
- Compact brass fusing and distribution



1/0 AWG AMP KIT

V10-AK1
5200 W WITH RCA CABLE

- 17' V10 1/0 AWG full tinned OFC pearl multi-strand power wire
- 3' V10 1/0 AWG full tinned OFC black multi-strand ground wire
- 17' 18 AWG full tinned OFC blue remote turn-on wire
- 17' V10 noise rejecting dual-twist RCA cable with precision machined ends and quad-split tip
- Compact brass ANL fuse holder with 250A fuse
- Nickel plated 1/0 AWG seamed crimp ring terminal with 8.5mm hole and silver boot connected at battery end and gray boot connected at ground
- 1/0 AWG spade terminals with silver and black boots for amp connection
- Miscellaneous connectors, terminals and wire ties



4 AWG AMP KIT

V10-AK4
2100 W WITH RCA CABLE

- 17' V10 4 AWG full tinned OFC pearl multi-strand power wire
- 3' V10 4 AWG full tinned OFC black multi-strand ground wire
- 17' 18 AWG full tinned OFC blue remote turn-on wire
- 17' V10 noise rejecting dual-twist RCA cable with precision machined ends and quad-split tip
- Compact brass ANL fuse holder with 125A fuse
- Nickel plated 4 AWG seamed crimp ring terminal with 8.5mm hole and silver boot connected at battery end and gray boot connected at ground
- 4 AWG spade terminals with silver and black boots for amp connection
- Miscellaneous connectors, terminals and wire ties



8 AWG AMP KIT

V10-AK8
800 W WITH RCA CABLE

- 17' V10 8 AWG full tinned OFC pearl multi-strand power wire
- 3' V10 8 AWG full tinned OFC black multi-strand ground wire
- 17' 18 AWG full tinned OFC blue remote turn-on wire
- 17' V10 noise rejecting dual-twist RCA cable with precision machined ends and quad-split tip
- Compact brass ANL fuse holder with 50A fuse
- Nickel plated 4 AWG seamed crimp ring terminal with 8.5mm hole and silver boot connected at battery end and gray boot connected at ground
- 8 AWG spade terminals with silver and black boots for amp connection
- Miscellaneous connectors, terminals and wire ties

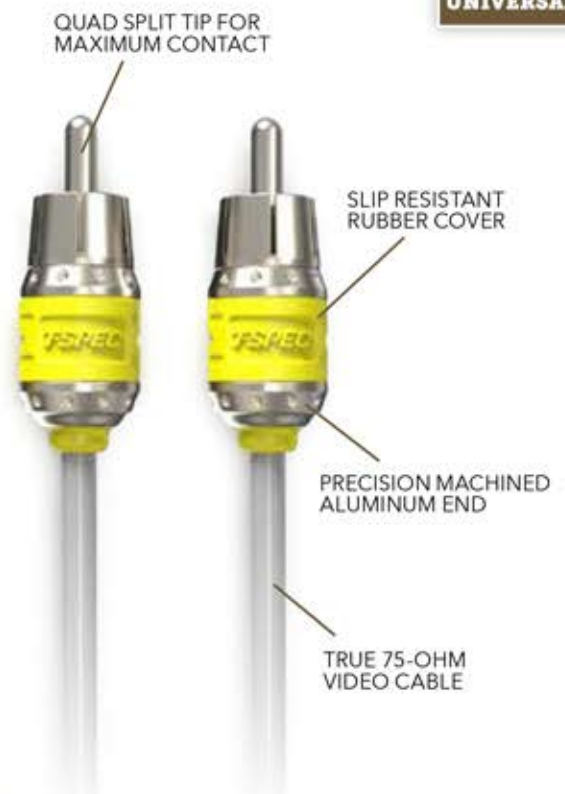
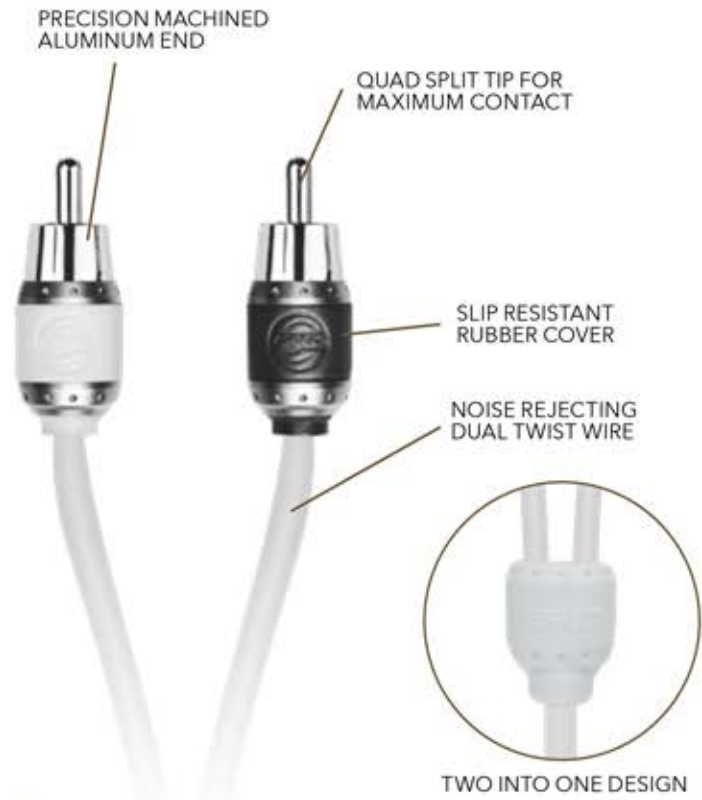

RCA

v10 SERIES AUDIO CABLES

- Dual twist for improved noise rejection
- Ultra-flexible PVC blended jacket
- Patented high tolerance compact machined metal end
- Quad split tip for maximum contact area
- Made with BC-5W2 marine-grade cable
- Packaged in high-end retail box

2-CHANNEL

V10R1-5	1.5 FT	0.45 M
V10R3	3 FT	0.91 M
V10R6	6 FT	1.83 M
V10R10	10 FT	3.05 M
V10R14	14 FT	4.27 M
V10R17	17 FT	5.18 M
V10R20	20 FT	6.10 M
V10RY1	Y-1	1F-2M
V10RY2	Y-2	1M-2F

4-CHANNEL

V10R174	17 FT	5.18 M
---------	-------	--------

6-CHANNEL

V10R176	17 FT	5.18 M
---------	-------	--------



VIDEO

v10 SERIES VIDEO CABLES

- True 75-ohm video cable
- Ultra-flexible PVC blended jacket
- Patented high tolerance compact machined metal end
- Quad split tip for maximum contact area
- Made with BC-5W2 marine-grade cable
- Packaged in high-end retail box

SINGLE CHANNEL

V10R3V	3 FT	0.91 M
V10R9V	9 FT	2.74 M
V10R20V	20 FT	6.10 M

POWER WIRE - IMPROVED
v10 SERIES SPOOLS

- Meets CEA and ANSI specification for wire gauge
- Fully tinned virgin copper construction
- High strand count for maximum flexibility
- Ultra-flexible PVC blended jacket
- BC-5W2 marine compliant

1/0 AWG

V10PW-1050	50 FT	15.24 M	MATTE PEARL
V10GW-1050	50 FT	15.24 M	MATTE BLACK
V10PW-1RD50	50 FT	15.24 M	MATTE RED

4 AWG

V10PW-4100	100 FT	30.48 M	MATTE PEARL
V10GW-4100	100 FT	30.48 M	MATTE BLACK
V10PW-4RD100	100 FT	30.48 M	MATTE RED

8 AWG

V10PW-8250	250 FT	76.20 M	MATTE PEARL
V10GW-8250	250 FT	76.20 M	MATTE BLACK
V10PW-8RD250	250 FT	76.20 M	MATTE RED

SPEAKER WIRE - IMPROVED
v10 SERIES SPOOLS

- Meets CEA and ANSI specification for wire gauge
- Fully tinned virgin copper construction
- High strand count for maximum flexibility
- Ultra-flexible PVC blended jacket
- BC-5W2 marine compliant

12 AWG

V10SW12125-BK	125 FT	38.10 M	BLACK
V10SW12125-WB	125 FT	38.10 M	WHT/BLK

16 AWG

V10SW16250-BK	250 FT	76.20 M	BLACK
V10SW16500-BK	500 FT	152.4 M	BLACK
V10SW16250-WB	250 FT	76.20 M	WHT/BLK
V10SW16500-WB	500 FT	152.4 M	WHT/BLK





BILLET WITH CARBON FIBER

50CF

5.5" billet aluminum .50 cal replica antenna mast with carbon fiber wrap

.50 CALIBER ANTENNAS

- Designed for AM/FM radio bands
- Fits most factory antenna bases
- Multiple adapters included
- Designed for vehicles with removable masts
- Threaded mounting
- Non-lethal replica



US FLAG

50US

5.5" billet aluminum .50 cal replica antenna mast with U.S. flag wrap



KRYPTEK NEPTUNE™

50KN

5.5" billet aluminum .50 cal replica antenna mast with Kryptek Neptune wrap



BLACK WITH CARBON FIBER

50CFB

5.5" billet aluminum .50 cal replica antenna mast with black carbon fiber wrap



FLAT BLACK

50FB

5.5" billet aluminum .50 cal replica antenna mast with flat black wrap



GUN METAL

50GM

5.5" billet aluminum .50 cal replica antenna mast in gun metal



MOSSY OAK®

50HC

5.5" billet aluminum .50 cal replica antenna mast with Mossy Oak® Break-Up Country™ hydro dip



GOLD

50GD

5.5" billet aluminum .50 cal replica antenna mast in gold



PINK MUDDY GIRL®

30PMG

4.25" billet aluminum .30 cal replica antenna mast with Pink Muddy Girl wrap





5" MONITOR

TE-50VS

5" MONITOR

- 2-input video monitor
- Multi-view function - image can be rotated to match any mounting orientation
- Signal sensing second input



7" MONITOR

TE-7VS

7" MONITOR

- 2-input video monitor
- Multi-view function - image can be rotated to match any mounting orientation
- Analog positive triggered second input

WATER-RESISTANT REARVIEW MIRROR

MPS-WRM45

MIRROR + 4.5" MONITOR

- 4.5" mirror/monitor
- 2 video inputs - signal sensing triggered
- IP69K
- Includes most widely used windshield mount, if vehicle does not have universal footprint on windshield, use TE-M06 (sold separately)
- If using for an off-road vehicle with a roll bar, please purchase TE-RBM from iBEAM



MOUNTS

TE-RBM

REARVIEW MIRROR ROLL BAR MOUNT



- Kit includes 3 rings: 1.5", 1.75" and 2" for different diameter roll bars
- Unique L bracket provides a standard mirror base
- Compatible with most mirrors
- Durable powder coat finish for off-road applications
- 5mm and 6mm allen keys include in box

HE-DISP-HL

HEADLIGHT DISPLAY

- High quality printed graphics
- (1) 9007 LED dual beam bulb
- AA batteries (not included)



HE-DISP-TBL3

RGB TABLE TOP DISPLAY

- High quality printed graphics
- Lightweight, rigid material
- Dimensions: 27.5" h x 18" w x 6" d
- Power supply and wiring included

PARTS:

- RGBW1-4KT
- RGB1-4KT
- RGBW-CB2
- HE-5MRGB-1
- HE-PTRGB



A-FRAME DISPLAY

- Dimensions: 76" h x 40" w x 27" d
- High quality print
- Includes reinforced holes for hanging

Products listed may change based on availability

HE-AFM3

PARTS:

- | | |
|-----------|----------|
| HE-FMTL1 | HE-WL1 |
| HE-FMTL1A | HE-WL2 |
| HE-TL1B | HE-WL3 |
| HE-TL1G | HE-SR14 |
| HE-FMML1G | HE-TR10 |
| HE-FMML1R | HE-BDR30 |
| HE-ML1 | |
| HE-ML1A | |
| HE-HCL2 | |
| HE-CL2G | |
| HE-CL3 | |
| HE-BCL2S | |
| HE-FMDL1 | |



A-FRAME DISPLAY

- Dimensions: 76"h x 40"w x 27"d
- High quality print
- Includes reinforced holes for hanging

Products listed may change based on availability

HE-AFM5

PARTS:

- HE-ICL2
- HE-HDRS14
- HE-HCL140
- HE-HDRH22
- HE-INFIN8
- HE-TSL20
- HE-BFMCL2
- HE-FMDL1
- HE-FMCL3
- HE-DGBK6
- RGB1-4KT
- RGBW1-4KT
- RGBW-CB1



JP-AFM1

PARTS:

- JP-706RGBKT
- JP-702B
- JP-704B
- JP-SML1
- JP-TSL1
- JP-TTL
- JP-TTL2
- JP-TL03T
- JP-TL04T
- 107-CH3B
- JP-1014



A-FRAME DISPLAY

- Dimensions: 76"h x 40"w x 27"d
- High quality print
- Includes reinforced holes for hanging

Products listed may change based on availability

DL-AFM1

PARTS:

DL-DR8
DL-CL1
DL-US135
DL-US32
DL-DR32
DL-H11
DL-H11D



TSPECV10KIT

T-SPEC SKINNY DISPLAY

- Black powder coated metal
- Metal pegboard for strength
- Dimensions each:
72"h x 20"w x 13.5"d

PARTS:

V10-AK8	V10RY1
V10-AK4	V10RY2
V10R6	VANL
V10R17	VMANL
V10R174	VAGU





TERMS:

Net 30 days from date of invoice on approved accounts. Minimum order: \$50 per invoice, orders less than required minimum incur a \$20 service charge.

FREIGHT:

Freight on board (F.O.B.) from point of shipment. Freight will be charged on all drop-shipment orders.

CREDIT:

In order to establish a credit line with Metra, an application for credit must be submitted listing a minimum of five (5) trade references and a bank with their addresses and phone numbers and must be signed by a principal or authorized officer of the company. A credit line will be established by our credit manager and must be maintained in a current status according to our terms (net 30 days). Credit not established or revoked requires remittance with order. Returned checks are subject to a fee of \$32.00.

RESALE TAX EXEMPTION CERTIFICATE:

CA, TX, KY, NJ & FL customers must provide a valid resale card before an order can be placed.

CLAIMS:

Title and risk of loss passes to buyer at F.O.B. shipping point and all claims must be filed with carrier. Any discrepancies must be reported to Metra within ten (10) days of receipt of shipment.

RETURNS:

All sales are final. No returns or exchanges will be allowed without prior written authorization from Metra. All returns are subject to a 20% handling charge, must be in a saleable condition, and must have been purchased within sixty (60) days of return request. No stock balancing permitted. Copies of invoices must be mailed in advance for any return authorization (R.A.).

LIMITED WARRANTY:

Metra warrants all of its products to be free from defects in material and workmanship for a period of 1-3 years from date of purchase. **Please check www.MetraOnline.com for individual product warranty information on each product.** Metra will, at its option, repair, replace or allow credit on any part which, in Metra's opinion, is found defective under normal use. Warranty void on items misused, altered in any way, tampered with or serviced by anyone other than Metra. This warranty of merchantability of fitness neither assumes or authorizes any other person to assume for it, any other liability in connection with its products. In no event shall we be liable for any incidental or *consequential damages, or do we assume any other liability except provided herein.

BACK ORDERS:

If an item is temporarily unavailable for immediate shipment, we will back-order the item and ship as soon as possible from the nearest available warehouse, unless otherwise instructed.

Metra reserves the right to make changes in or deletions of products or prices without prior notice.

*Metra will not assume any responsibility for damages to person or property due to incorrect interpretation of the material in this publication. Metra is not responsible for typographical or printing errors. Reproductions of editorial or pictorial content is strictly prohibited without prior consent from Metra.

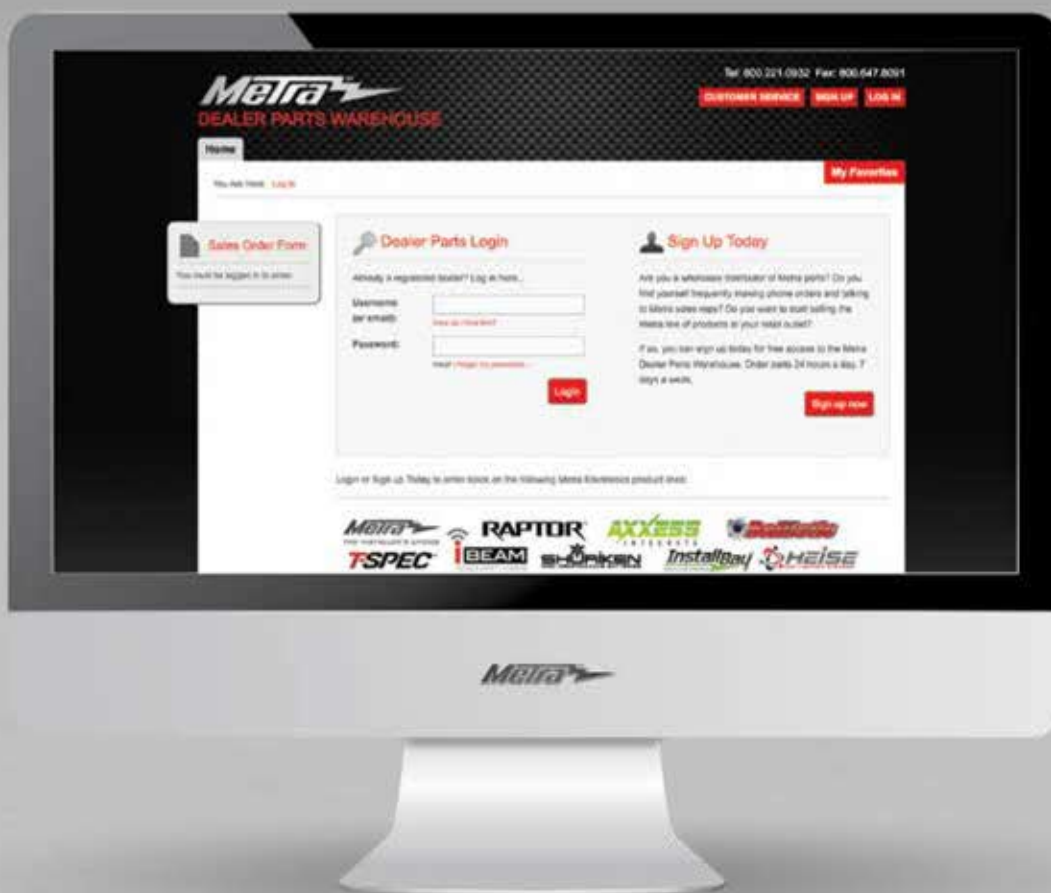

CHECK OUT OUR EXCLUSIVE DEALER WEBSITE!

MetraDealer.com

Register online today!



WARNING: This catalog does not advise whether a State of California Proposition 65 warning is required for a particular item of merchandise. To learn whether a particular item of merchandise requires a California Proposition 65 warning, please be sure to look up and read the particular merchandise's listing on Metra's website www.MetraOnline.com, as well as read the particular merchandise's packaging. When a California Proposition 65 warning is present on Metra's website listing for the particular merchandise, or on the particular merchandise's packaging, a compliant California Proposition 65 warning is to be provided to the purchasing California consumer prior to the sale of the particular merchandise.

Metra®

THE INSTALLER'S CHOICE



CORPORATE HEADQUARTERS

Metra Electronics Corporation
460 Walker Street
Holly Hill, FL 32117-2699

Metra Corporate: 386.257.1186
Metra 12volt &
International Sales: 386.257.2956
Sales Fax: 386.258.3940

WAREHOUSE OPERATIONS

Daytona Beach, FL
Dallas, TX
Freehold, NJ
Lexington, KY
Fresno, CA
Long Beach, CA

OVERSEAS OPERATIONS

Taipei, Taiwan R.O.C. • Hong Kong

MetraDealer.com

©2021 Metra Electronics Corp.



METRAONLINE.COM

386.257.2956

JEEP BRO-21



facebook.com/MetraElectronics



instagram.com/MetraElectronics



twitter.com/MetraElectronic



youtube.com/MetraElectronics



Order Anytime Day or Night
at MetraDealer.com



Download all our New Catalog
at MetraOnline.com

