

Service & Installation

Section

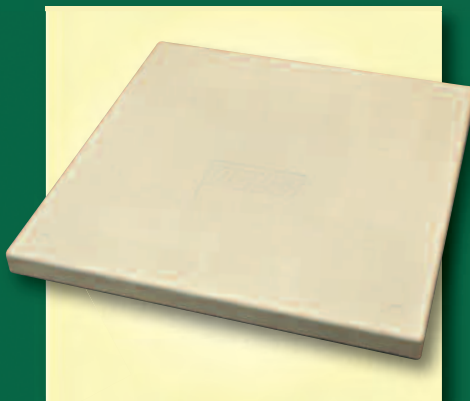
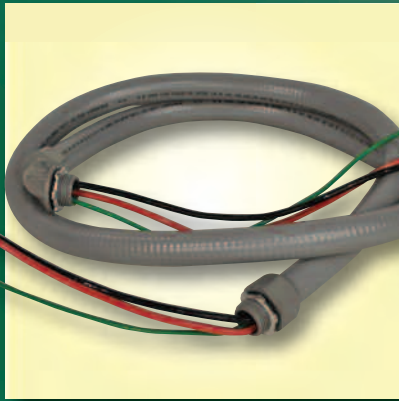

Table Of Contents



MARS Description	Page
A/C Condenser Pads	SI-3
A/C Mounting Brackets	SI-3
A/C Whips	SI-9
Access Fittings & Valves	SI-55 – SI-56
Anti Vibration Pads	SI-4
Batteries	SI-98
Brazing Alloys, Solders & Fluxes	SI-72 – SI-74, SI-83 – SI-84
Brushes	SI-110 – SI-112
Cable Cutter	SI-43
Chemicals	SI-57
Circuit Breaker Branch Panels	SI-13
Circuit Breakers	SI-12
Circuit Protection	SI-93
Clipboards	SI-143
Compressor Terminal Repair Kit	SI-76 – SI-77
Condensate Products	SI-92
Condenser Filter	SI-50
Conduit	SI-9
Cords & Cord Sets	SI-49
Disconnects & Safety Switches	SI-6 – SI-8
Duct Straps, Pipe Hangers & Hooks	SI-50, SI-52
Electrical Fittings	SI-47 – SI-48
Expansion Valves	SI-63
Filter & Heat Pump Driers	SI-58 – SI-61, SI-63 – SI-64
Fittings, Nylon & Galvanized	SI-91
Flashlights & Accessories	SI-99 – SI-101
Fuse & Power Blocks, Edison	SI-32 – SI-34
Fuse & Power Blocks, Ferraz Shawmut	SI-21 – SI-22
Fuse Pullers	SI-32, S-115
Fuses, Edison	SI-23 – SI-31
Fuses, Ferraz Shawmut	SI-14 – SI-21
Fuses, Zebra	SI-35
Garden Hoses & Sprayers	SI-139
Gas Appliance Fittings & Valves	SI-88
Gloves	SI-120, SI-140 – SI-141
Hand Cleaners	SI-121
Hardware, Screws, Washers, Nuts, Anchors	SI-107 – SI-109
Heat Pump Risers	SI-4
Heat Shrink Tubing	SI-97
Hose Clamps	SI-86 – SI-87

MARS Description	Page
Knives, Repl. Blades & Sharpeners	SI-54, SI-118
Light Bulbs	SI-44
Lines & Tubing	SI-75
Maintenance Products	SI-122 – SI-123, SI-131 – SI-138
Markers	SI-133
Outlet Boxes	SI-45 – SI-46
Plumbing & Piping Products	SI-81 – SI-85
PVC Cement, Cleaner & Primer	SI-89, SI-129, SI-134
PVC Fittings & Traps	SI-90
Refrigerant ID Labels	SI-103
Replacement Cores for Filter Driers	SI-62
Roof Flashing & Furnace Legs	SI-5
Rooftop Support Systems	SI-5 – SI-6
Rope, Tie Downs and Tarps	SI-51
Safety Products	SI-119
Scales	SI-103
Sealant Products	SI-124 – SI-128
Service Manifolds & Accessories	SI-69
Sight Glasses	SI-62
Soft Copper Refrigeration Coils	SI-75
Solderless Terminals	SI-77 – SI-80
Specialty Tools	SI-76
Tape	SI-93, SI-128 – SI-130
Test Instruments	SI-94 – SI-96, SI-102, SI-105
Test Leads	SI-97
Textbooks	SI-144
Thermometers	SI-104
Thermostat Guards	SI-10 - SI-11
Thermostat Wire	SI-41 – SI-42
Tool boxes & Bags	SI-140 – SI-142
Tools, Hand	SI-113 – SI-117
Tubing Tools	SI-65 – SI-68
Vibration absorbers, Stainless Steel	SI-70
Welding/Brazing/Cutting Tools	SI-106
Wire Caddy	SI-43
Wire Markers	SI-43
Wire Nuts	SI-37 – SI-38
Wire Products	SI-39 – SI-40
Wire Ties	SI-53
Wiring Devices	SI-35 – SI-36
Wrot Copper Fittings	SI-71



MARS A/C Condenser Pads

MARS SERIES **935**

MARS A/C Condenser Pads

MARS is pleased to offer a full line of Air Conditioning Condenser Pads. These gray plastic pads are molded from polypropylene. The lightweight, one piece constructed pads are virtually unbreakable and built to last. Two and three inch thick pads are available.

Features & Benefits:

- UV stable – prevents weathering or cracking
- Chemical resistant • Solid wall construction
- Will not chip or crack • Lightweight
- Textured surface – prevents unit from sliding
- Unique footpads – prevent unit from sinking into ground
- Size molded in side of pad
- Drillable for attachment of unit

MARS NO.	DESCRIPTION	CASE QTY.	MARS NO.	DESCRIPTION	CASE QTY.
93560	24" x 24" x 2"	44	93576	36" x 40" x 2"	22
93561	24" x 36" x 2"	22	93575	36" x 48" x 2"	22
93564	30" x 24" x 2"	22	93577	24" x 24" x 3"	16
93565	30" x 30" x 2"	22	93578	24" x 36" x 3"	16
93567	30" x 40" x 2"	22	93584	30" x 30" x 3"	16
93562	32" x 32" x 2"	22	93587	32" x 32" x 3"	16
93563	32" x 38" x 2"	22	93592	36" x 36" x 3"	16
93572	32" x 44" x 2"	22	93593	36" x 40" x 3"	16
93573	36" x 36" x 2"	22	93594	36" x 48" x 3"	16

93560

- Rugged, easy to handle
- Weed wackers won't destroy the corners

SERVICE & INSTALLATION



A/C Mounting Brackets

MARS SERIES **936**

MARS A/C Mounting Brackets

Heavy duty engineered steel A/C brackets are used for mounting A/C condensers and heat pumps on vertical walls. Brackets include mounting holes and are finished in a durable gray powder coat.

MARS NO.	DESCRIPTION	MARS PACK
93630	30" Powder Coated Steel Bracket	1 Pair
93631	36" Powder Coated Steel Bracket	1 Pair
93632	42" Powder Coated Steel Bracket	1 Pair
93636	48" Powder Coated Steel Bracket	1 Pair

93630

Anti-Vibration Pads

MARS SERIES **521**



Anti-Vibration Pads

MARS offers a complete line of anti-vibration pads. These high quality rubber pads provide maximum loading of 60 lbs. per square inch. Anti-vibration pads can be used on any type of mechanical/electrical machines such as pumps, motors, air conditioning units, generators, compressors, etc. The plain rubber pads have grooves on both sides. The cork rubber pads are the same but with the added advantage of reduction in sound level. The natural rubber Iso-Pads can be easily cut for odd sized dimensions under equipment legs and supports. The use of these pads eliminates the need for bolting down equipment to the floor. These Iso-Pads provide superior isolation, attenuation and vibration characteristics.

SERVICE & INSTALLATION

MARS NO.	DESCRIPTION	MARS PACK
52101	2" x 2" x 3/8" Rubber	1
52102	3" x 3" x 3/8" Rubber	1
52103	4" x 4" x 3/8" Rubber	1
52104	6" x 6" x 3/8" Rubber	1
52107	18" x 18" x 3/8" Rubber	1
52108	2" x 2" x 7/8" Cork/Rubber	1
52109	3" x 3" x 7/8" Cork/Rubber	1
52110	4" X 4" X 7/8" Cork/Rubber	1
52111	6" x 6" x 7/8" Cork/Rubber	1
52114	18" x 18" x 7/8" Cork/Rubber	1
52115	2" x 2" x 3/4" Iso-Pad	1
52116	4" x 4" x 3/4" Iso-Pad	1
52117	18" x 18" x 3/4" Iso-Pad	1
52119	2" x 2" x 7/8" Foam/Rubber	1
52118	4" x 4" x 7/8" Foam/Rubber	1
52120	6" x 6" x 7/8" Foam/Rubber	1
52122	18"x18"x7/8" Foam/Rubber	1

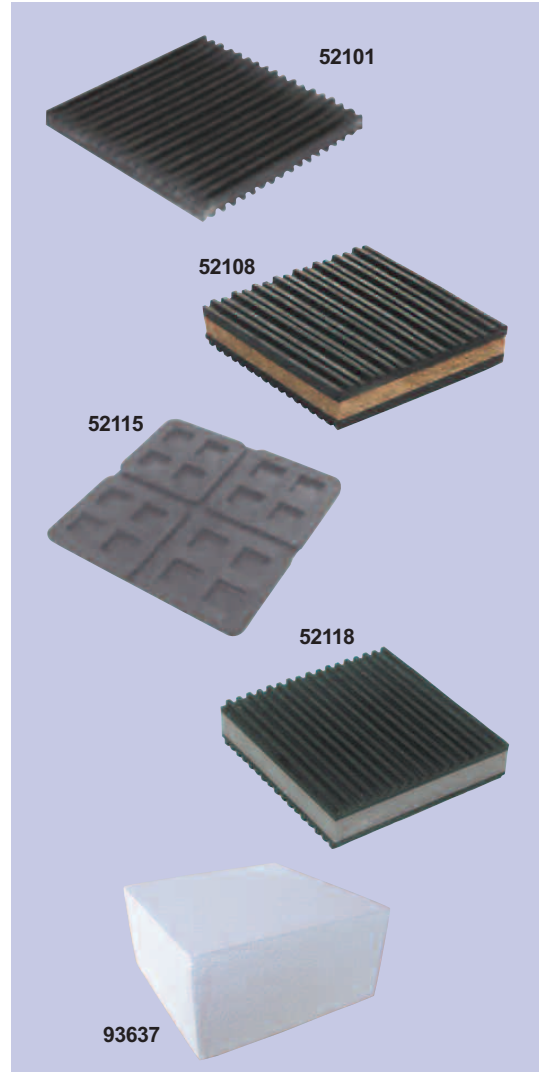

MARS Air Handler Blocks

- Lightweight 2 lb styrofoam block
- 8" x 8" x 4"

Packaged in boxes of 20 (21 boxes per pallet)

MARS NO.	DESCRIPTION	MARS PACK
93637	8" x 8" x 4" Air Handler Block	20

Heat Pump Risers

MARS SERIES **936**



MARS Heat Pump Risers

Heavy duty composite heat pump risers are available in 2 popular heights in a cost effective 1 piece design as well as a 2 piece terrain adaptable design. Each riser includes factory installed buytl mastic patches on the top and bottom to absorb vibration and reduce noise.

MARS NO.	DESCRIPTION	MARS PACK
93600	3" 1 Piece Heat Pump Riser	48
93602	3" 2 Piece Heat Pump Riser	32
93601	6" 1 Piece Heat Pump Riser	24
93603	6" 2 Piece Heat Pump Riser	16
93604	4" Riser Extension	16

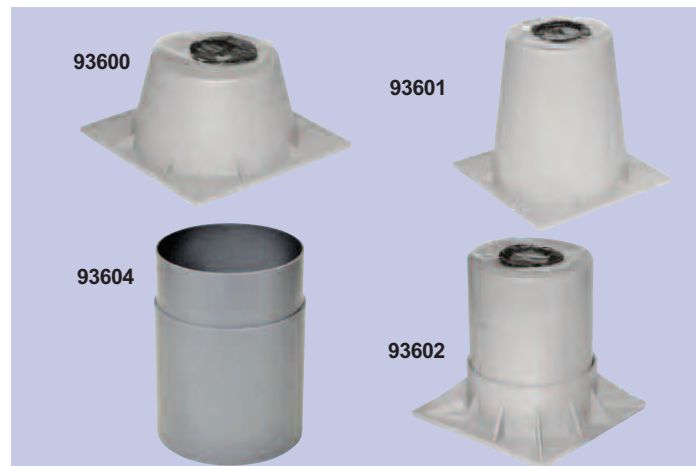

Roof Flashings & Furnace Legs

MARS SERIES **790**

Roof Flashings

Galvanized no calk® roof flashings feature a one-piece construction which insures a positive leak proof installation every time. Specially formulated elastomeric collar allows the vent stack plenty of room for expansion and contraction. The patented double seal no-calk collar "gives" with the pipe, without breaking the water tight seal. The galvanized base is made from 24 gauge deep drawing steel extra high with no seams.

Flex Flash flashings are manufactured from a special formulated elastomer material which is extremely flexible and durable. They permit the vent stack to expand and contract freely without disrupting the seal between pipe and flashing collar. The flashing adjusts to most any angle and adapts to all type of pipe; copper, cast iron, galvanized or plastic. Fits up to 45° angle.

MARS NO.	DESCRIPTION	MARS PACK
79360	1 1/4" - 1 1/2" no calk galvanized	12
79361	2" no calk galvanized	12
79362	3" no calk galvanized	12
79364	1/2", 3/4", 1" no calk galvanized solar	12

MARS Easy Leveler™ Furnace Legs

- Includes 4 easy leveler legs & sheet metal screws
- Designed to level a furnace & air conditioning coil for proper drainage.
- Proper leveling helps eliminate standing water, thus reducing bacteria
- Easily adjustable even after installation
- Legs can support up to 400 lbs.
- Adjustable from 2-3/4" to 4" in height

MARS NO.	DESCRIPTION	MARS PACK
79095	Adjustable furnace legs	12

Economy Furnace Mounting Blocks

- Holds furnace 2" off the floor
- Composite construction
- Absorbs vibration, reduces noise
- Peel & stick installation

MARS NO.	DESCRIPTION	MARS PACK
79085	Economy furnace mounting blocks	12



SERVICE & INSTALLATION



C-Port Rooftop Support Systems

MARS SERIES **939**

Rooftop Support Systems

Economy CX-Series

- Base only
- Material – 100% recycled rubber, UV resistant
- Maximum Load – 2 – 800 lbs.

CX Series rooftop support is designed as an economic alternative when a high load bearing is not required. They are perfect for supporting conduit or smaller pipe.

C-Series

- Material – 100% recycled rubber, UV resistant
- Maximum Load – 750 lbs./ft

C Series channel support is designed for superior support of gas and refrigeration piping systems, cable tray, electrical conduit multiple lines, HVAC equipment and many other applications.

MARS NO.	DESCRIPTION	MARS PACK	CASE QTY.
93950	CX-Series 4" H x 6" W x 9.6" L	1	170
93951	C-Series 4 7/8" H x 6" W x 9.6" L	1	170

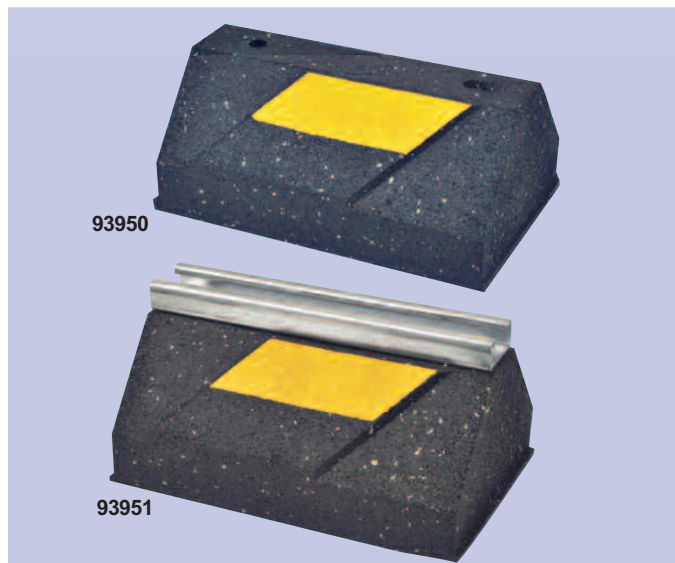

The largest selection of motors, components and accessories for the HVAC/R Industry

Rooftop Support Systems

MARS SERIES **939**



Caddy® Pyramid ST Series Rooftop Support

Caddy® Pyramid ST Series Rooftop Support is roof-friendly, high-quality, versatile and durable for roofing applications.

Features:

- Thermoplastic base is UV stabilized and weatherproof for long lasting
- Fixed-height mounting platform 4" off the roof surface and 10" of usable strut length, provides excellent load distribution
- Structurally engineered to support up to 1,000 lbs
- Hot-dipped galvanized finish
- Superior corrosion protection
- Supports the green building requirements, bases are made from recycled material and can contribute toward earning LEED credit

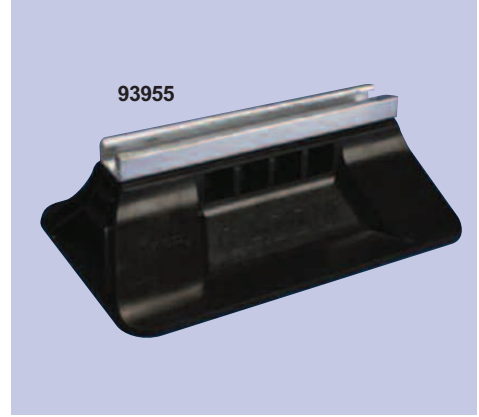

93955

MARS NO.	Mfg No.	Height	Length (1)	Length (2)	Width	Surface Area	MAX. Rec. Load
93955	RPS360400	4"	10"	12.5"	8"	94.3"	1,000 lbs.

* Max. recommended load at 10.6 psi roof loading. Contact project or roofing engineer for maximum allowable load on individual project roof system.

SERVICE & INSTALLATION

Disconnects & Safety Switches

MARS SERIES **833 & 803**



MARS Front Open Pullout Disconnect Boxes - NEMA 3R

MARS offers both fusible and non-fusible single phase air conditioner disconnects. These units provide a disconnecting means which should be located within sight from and readily accessible from the air conditioning or refrigerating equipment. UL listed. MARS #83315 is also CUL listed.

MARS NO.	DESCRIPTION	CASE QTY
83315	60 amp non-fused, single phase	6
83316	30 amp fused, single phase	6
83317	60 amp fused, single phase	6
83396	Compact 30 amp fused, single phase	6
83335	Generic brand 60 amp non-fused, single phase	6

MARS Side Open Pullout Disconnect Boxes - NEMA 3R

The MARS Side Open Disconnect Boxes are contractor friendly and feature a unique side opening door, allowing easy access to the work area. The powder coated UV rated finish provides superior esthetics and greater longevity. The patented "finger safe" pullout section prevents accidental contact with electrodes. Easy to remove knockouts and a secure locking mechanism are also featured. This Pullout Disconnect Box is the ideal choice for the busy contractor.

MARS 80328 features an on/off switch so there are no pullout handles to be lost.

Specifications:

- Single phase, 240V
- 10,000 amp rated
- NEMA 3R, rainproof
- UL & CUL rated

MARS NO.	DESCRIPTION	STD. PACK	CASE QTY
80315	60 amp non-fused	6	6
80316	30 amp fused	6	6
80317	60 amp fused	6	6
80328	60 amp fused – Switch Disconnect	6	6



83316, 17

83335

83315

80328

80315

Easy to remove concentric knockouts & secure locking mechanism

Unique side opening door permits greater visibility and access to work area

Patented "Finger Safe" Pullout section prevents accidental contact with electrodes



Disconnects & Safety Switches

MARS SERIES **833 & 803**

Midwest A/C Disconnects - NEMA 3R

MARS NO.	DESCRIPTION	CASE QTY.
83385	60 amp non-fused, single phase	6
83386	30 amp fused, single phase	6
83387	60 amp fused, single phase	6

Pullouts For MARS Disconnect Boxes

MARS offers both fusible and non-fusible single phase non-metallic air conditioner disconnects. These horse power rated units are constructed of Noryl® thermoplastic for extended and rugged durability. Units are corrosion resistant, weatherproof, and maintenance free. UL listed and CSA certified.

MARS NO.	DESCRIPTION	CASE QTY
83313	60 amp non-fused pullout for 83315	1
83314	30 amp fused pullout for 83316	1
83318	60 amp fused pullout for 83317	1
83319	30 amp fused pullout for 83396	1
80312	60 amp non-fused pullout for 80315 & 80308	1
80313	30 amp fused pullout for 80316	1
80314	60 amp fused pullout for 80317	1

MARS A/C Disconnect/GFCI Receptacle Combination

MARS A/C Disconnect/ GFCI Receptacle Combination disconnects provide a convenient low cost means to satisfy NEC Article 210.63 requirements for HVAC/R Equipment Outlets and Article 406.8(B)(1) for Receptacle – Wet Locations. The NEMA 3R design insures a safe, weather tight installation for residential, light commercial and even some industrial applications.

Features & Benefits:

- 60 amp, non-fused, pullout type
- 240 volt A/C, single phase
- 15 amp, 125V GFCI duplex receptacle included
- UL & CUL listed
- Meets NEC #210.63 & #406.8(B)(1)
- Compact size – 5"x7"x4"
- Removable cover
- Heavy galvanized 'G90' steel with highest quality electro-deposition finish resists corrosion and fading
- NEMA 3R rated

MARS NO.	DESCRIPTION	MARS PACK
83308	Pullout disconnect/receptacle	4

MARS Side Open Pullout Disconnect w/GFCI Receptacle

The MARS Side Open Disconnect w/GFCI Receptacle provides a convenient low cost means to satisfy NEC 2003 code changes requiring that a GFCI receptacle with a "while in use" cover be within a 25ft line of sight of the condenser unit. The pre-wired receptacle with stripped wire ends makes installation of disconnect and receptacle quick and easy. This unit provides a significantly lower "installed cost" to the contractor when compared to installing a standard disconnect and separate GFCI receptacle with "while in use" cover to comply with the new NEC code change.

Additional features and benefits include: Convenient electrical power cord channel w/retaining clip for easy and safe use of portable tools; Large wiring compartment for both disconnect switch and receptacle; Angled receptacle mounting to eliminate the possibility of crushing portable electrical plugs when closing "while in use" cover; Attractive side opening cover design for ease of installation; Ultra UV powder coating.

Specifications:

- 60 amp, non-fused, pullout type
- Pre-wired 15A, 125V GFCI receptacle included
- 240 volt, single phase
- 10,000 amp rated
- NEMA 3R & UL rainproof
- UL & CUL approved
- Rated for 10HP @ 240 volts
- Meets NEC #210.63 & #406.8(B)(1)
- Multiple patents pending

MARS NO.	DESCRIPTION	STD. PACK	CASE QTY
80308	Pullout disconnect W/GFCI receptacle	6	6



SERVICE & INSTALLATION



The largest selection of motors, components and accessories for the HVAC/R Industry

Disconnects & Safety Switches

MARS SERIES **833**



Midwest Non-Metallic Disconnects - NEMA 3R

Midwest Electric offers both fusible and non-fusible single phase non-metallic air conditioner disconnects. These horse power rated units are constructed of Noryl® thermoplastic for extended and rugged durability. Units are corrosion resistant, weatherproof, and maintenance free. UL listed and CSA certified.

MARS NO.	DESCRIPTION	CASE QTY
83312	60 amp non-fused, single phase	6
83306	30 amp fused, single phase	6
83307	60 amp fused, single phase	6

Midwest Three Phase Pullout Disconnects - 240V - NEMA 3R

Midwest Electric three phase pull out disconnects and single phase non-automatic switches are manufactured of heavy zinc coated steel with highest quality electro-deposition paint finish for maximum corrosion resistance. The three phase disconnects are available with and without fuse protection. Fusible units require three fuses. NEMA 3R.

MARS NO.	DESCRIPTION	CASE QTY
83321	60 amp non-fused, three phase	4
83322	30 amp fused, three phase	4
83323	60 amp fused, three phase	4

Midwest Non-Automatic Disconnects - Nema 3R

Midwest Electric has developed a new NEMA 3R, non-automatic A/C disconnect with a patent pending on/off switch mechanism so there is no pullout to lose. This UL and CSA listed disconnect features: a keyhole mounting slot for easy installation, a removable door for easy wiring access, straight in and out lugs for quick connections and six 1/2" x 3/4" x 1" concentric knockouts.

The single phase non-automatic disconnects do not provide overcurrent protection with manual internal on/off switch.

MARS NO.	DESCRIPTION	CASE QTY
83328	60 amp, 240V, 10 HP	4

Midwest Heat Pump Disconnects - NEMA 3R

Multiple disconnect devices are offered for heat pump applications that require individual disconnects for the heating and cooling cycles. The dual pull outs accommodate either a 30A/60A or 60A/60A puller combination. Units require four fuses.

MARS NO.	DESCRIPTION	CASE QTY
83324	90 amp fused	1
83325	100 amp fused	1

Midwest Evaporative Cooler Disconnects - NEMA 3R

Evaporative cooler applications not only require fusing but switching or receptacle functions depending on equipment type and local codes. The 20 ampere unit utilizes 2 T plug fuses. The 40 ampere unit utilizes 3 S plug fuses.

MARS NO.	DESCRIPTION	CASE QTY
83327	40 amp fused, receptacles	1

83312



83306



83321



83328



83324



83327



Disconnects & Safety Switches

MARS SERIES **8333**

Midwest Non-Metallic, Non-Auto Switch Residential/Construction A/C Disconnect, NEMA 3R

MARS NO.	DESCRIPTION	CASE QTY.
83388	60 amp non-fused, single phase	6

Midwest Metallic Residential/Construction, A/C Disconnects w/ Receptacle, NEMA 3R

MARS NO.	DESCRIPTION	CASE QTY.
83398	60 amp non-fused, single phase	6

I-T-E Cartridge Fuse Type - UL Listed

1 Phase/2 wire, 3 Phase/3 wire, solid neutral

MARS NO.	DESCRIPTION	TYPE	CASE QTY.
83330	30a-240V 2 pole, exterior	3R	1
83331	60a-240V 2 pole, exterior	3R	1
83333	30a-240V 2 pole, interior	1	1
83334	60a-240V 2 pole, interior	1	1
83336	30a-240V 3 pole, exterior	3R	1
83337	60a-240V 3 pole, exterior	3R	1
83339	30a-240V 3 pole, interior	1	1
83340	60a-240V 3 pole, interior	1	1
83368	100a-240V 3 pole, interior	1	1

I-T-E Plug Fuse Type - UL Listed

1 Phase, solid neutral

MARS NO.	DESCRIPTION	TYPE	CASE QTY.
83342	30a-120V 1 pole, interior	1	6

I-T-E Unfused General Duty Enclosed Switches

1 Phase, solid neutral

MARS NO.	DESCRIPTION	TYPE	CASE QTY.
83346	30a-240V 2 or 3 pole, 3 phase exterior	3R	1
83347	60a-240V 2 or 3 pole, 3 phase, exterior	3R	1
83349	30a-240V 2 or 3 pole, 3 phase interior	1	1
83350	60a-240V 2 or 3 pole, 3 phase interior	1	1
83352	60a-240V 1 or 2 pole, 1 phase exterior	3R	1

I-T-E Heavy Duty 3PH 600V - Type 1 - Indoor

MARS NO.	DESCRIPTION	CASE QTY.
83353	30a-600V fused	1
83354	60a-600V fused	1
83355	100a-600V fused	1
83356	30a-600V unfused	1

I-T-E Heavy Duty 3PH 600V - Type 3R - Outdoor

MARS NO.	DESCRIPTION	CASE QTY.
83359	30a-600V fused	1
83360	60a-600V fused	1
83361	100a-600V fused	1
83362	30a-600V unfused	1
83363	60a-600V unfused	1
83364	100a-600V unfused	1



83330



83347



83353



83361

SERVICE & INSTALLATION



The largest selection of motors, components and accessories for the HVAC/R Industry

SI-8A



MARS A/C Whips & Conduit

MARS SERIES **841**

All Whips Bagged

MARS A/C Whips Non-Metallic Fittings

MARS NO.	DESCRIPTION	MARS PACK
84131	4' x 1/2" #10 ga. non-metallic whip UL	1
84133	4' x 3/4" #8 ga. non-metallic whip UL	1
84135	6' x 1/2" #10 ga. non-metallic whip UL	1
84137	6' x 3/4" #8 ga. non-metallic whip UL	1
84139	8' x 1/2" #10 ga. non-metallic whip	1
84141	8' x 3/4" #8 ga. non-metallic whip	1
84143	10' x 3/4" #8 ga. non-metallic whip	1

MARS A/C Whips Metallic Fittings

Non-metallic conduit with metal fittings

MARS NO.	DESCRIPTION	MARS PACK
84132	4' x 1/2" #10 ga. metallic whip UL	1
84134	4' x 3/4" #8 ga. metallic whip UL	1
84136	6' x 1/2" #10 ga. metallic whip UL	1
84138	6' x 3/4" #8 ga. metallic whip UL	1

MARS A/C Whips W/Two Straight Fittings

Metallic conduit with metal fittings

MARS NO.	DESCRIPTION	MARS PACK
84148	4' x 1/2" #10 ga. non-metallic whip	1
84145	4' x 1/2" #10 ga. non-metallic whip	1

MARS A/C Whips All Metallic

MARS NO.	DESCRIPTION	MARS PACK
84125	4' x 1/2" all metallic whip	1
84126	4' x 3/4" all metallic whip	1
84127	6' x 1/2" all metallic whip	1
84128	6' x 3/4" all metallic whip	1

Sealtite® Flexible Metallic Conduit

Sealtite® flexible conduit provides protection for wet or oily locations. UL listed conduit has a continuous copper ground built into the core. All UL listed Sealtite® is UV resistant.

MARS NO.	DESCRIPTION	MARS PACK
84102	1/2", metallic conduit, UL, boxed 100 ft	1
84103	3/4", metallic conduit, UL, boxed 100 ft	1
84110	1/2", metallic conduit, boxed 100 ft	1
84111	3/4", metallic conduit, boxed 100 ft	1

Sealtite® Flexible Non-Metallic Conduit

MARS NO.	DESCRIPTION	MARS PACK
84117	3/8", non-metallic conduit, UL, boxed 100 ft	1
84118	1/2", non-metallic conduit, UL, boxed 100 ft	1
84119	3/4", non-metallic conduit, UL, boxed 100 ft	1
84120	1", non-metallic conduit, UL, boxed 100 ft	1
84121	1/2", non-metallic conduit, UL, polybag 25 ft	1
84122	3/4", non-metallic conduit, UL, polybag 25 ft	1

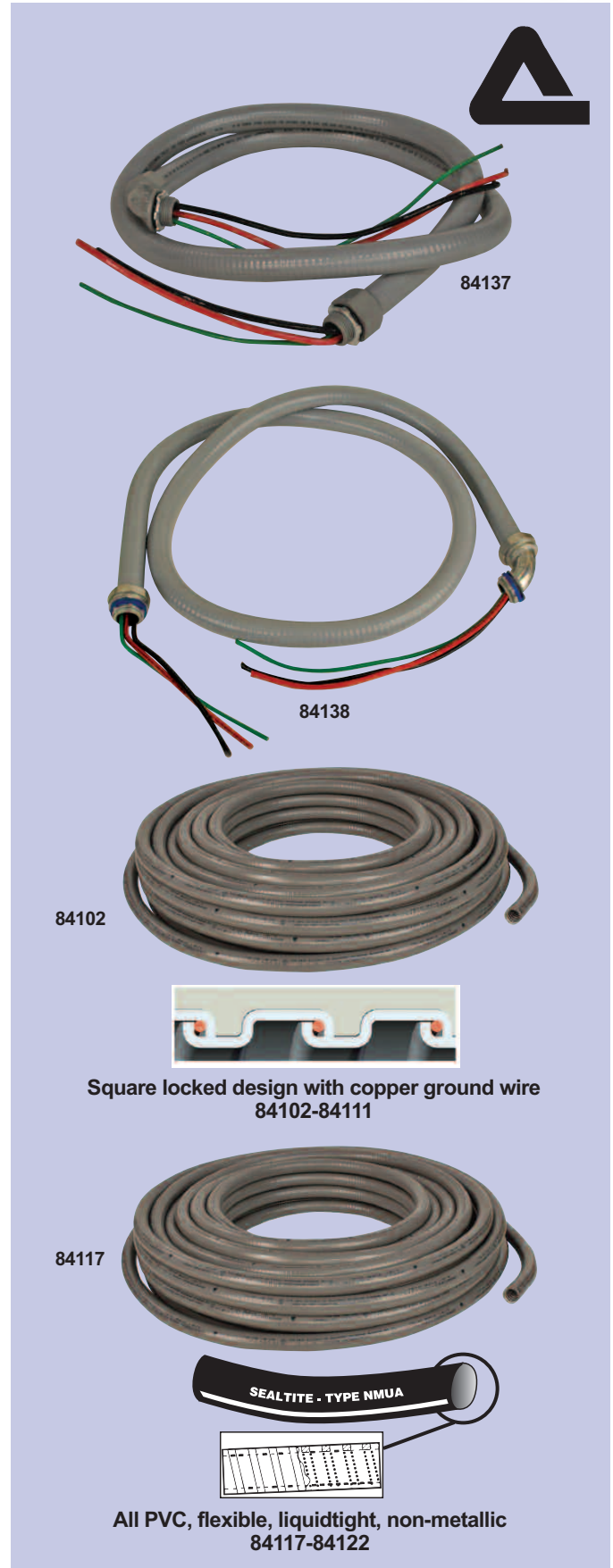

SERVICE & INSTALLATION



The largest selection of motors, components and accessories for the HVAC/R Industry

Thermostat Guards

MARS SERIES **702**



MARS Designer Series - Plastic Cover And Base

INSIDE DIMENSIONS (inches)	BASE	HEIGHT	WIDTH	DEPTH
	Solid	4.25	7.63	2.13
Ring	4.13	7.07	2.25	

MARS NO.	DESCRIPTION	BASE	MARS PACK	CASE QTY.
70217	BTG-DK clear plastic	Dual	1	12
70219	BTG-DO opaque plastic	Dual	1	12

MARS Universal Series

INSIDE DIMENSIONS (inches)	BASE	HEIGHT	WIDTH	DEPTH
	Solid	8.25	5.38	3.25
	Ring	8.13	4.63	3.63
	Solid	7.25	5.38	3.25
Ring	6.75	4.25	3.56	

MARS NO.	DESCRIPTION	BASE	MARS PACK	CASE QTY.
70220	BTG-UK2 clear plastic	Dual	1	12
70222	BTG-UO2 opaque plastic	Dual	1	12
70223	BTG-UM metal	Solid	1	12
70224	BTG-UWM metal	Ring	1	12
70236	F336, extra key for all BTG guards		1	1

MARS Universal Series - White Metal Cover & Base

INSIDE DIMENSIONS (inches)	BASE	HEIGHT	WIDTH	DEPTH
	Solid	6.25	9.38	3.00
	Ring	6.25	9.38	3.00
	Opening dim. of ring base	5.50	8.25	.38

MARS NO.	DESCRIPTION	BASE	MARS PACK	CASE QTY.
70238	BTG-UWM1 hinged wht. mtl. solid cover	Ring	1	12
70243	BTG-UM1D0H hinged wht. mtl. T-7300 Honeywell display & override opening	Solid	1	12
70247	BTG-UM1D0WR hinged wht. mtl. IF90 White Rogers override-display opening	Solid	1	12

70217

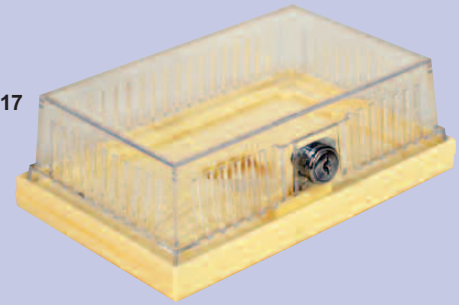

70220

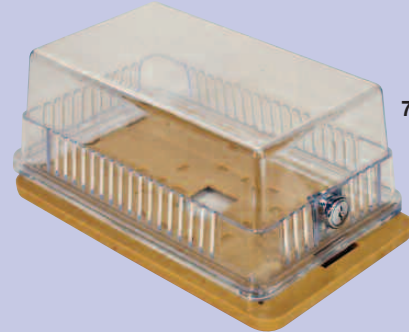

70222



70224

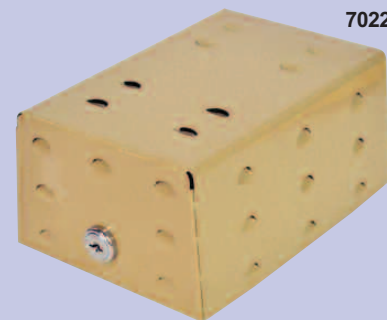

70238

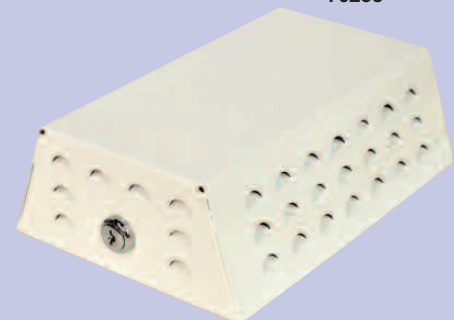

SERVICE & INSTALLATION

Thermostat Guards

MARS SERIES **702**



MARS Elite Series - Plastic Base

MARS offers a broad selection of thermostat guards. Popular models available include metal, clear plastic and opaque plastic designs. MARS thermostat guards are ideal for protecting thermostats in schools, industrial plants institutions, public facilities and other areas where unauthorized tampering could be a problem. These attractive units feature a rugged, light weight and compact design. All units supplied with key. Extra keys are available. Order part #70236 for the BTG thermostat guard key.

INSIDE DIMENSIONS (inches)	BASE	HEIGHT	WIDTH	DEPTH
	Solid	3.88	3.5	2.5

MARS NO.	DESCRIPTION	BASE	MARS PACK	CASE QTY.
70201	BTG-EK clear plastic cover	Solid	1	12
70204	BTG-EM metal cover	Solid	1	12

MARS Classic Series - Plastic Base

INSIDE DIMENSIONS (inches)	BASE	HEIGHT	WIDTH	DEPTH
	Solid	5.25	4.63	3.00
	Ring	5.25	4.63	3.25

MARS NO.	DESCRIPTION	BASE	MARS PACK	CASE QTY.
70205	BTG-K clear plastic cover	Dual	1	12
70207	BTG-O opaque plastic cover	Dual	1	12
70208	BTG-KM metal cover	Solid	1	12
70209	BTG-KWM metal cover	Sing	1	12

MARS Regal Series - Plastic Base

INSIDE DIMENSIONS (inches)	BASE	HEIGHT	WIDTH	DEPTH
	Solid	6.38	3.5	3.00
	Ring	6.38	3.5	3.25

MARS NO.	DESCRIPTION	BASE	MARS PACK	CASE QTY.
70210	BTG-RK clear plastic cover	Dual	1	12
70212	BTG-RO opaque plastic cover	Dual	1	12
70213	BTG-RM metal cover	Solid	1	12
70214	BTG-RWM metal cover	Ring	1	12
70226	F229R Plastic base for BTG-RO, RWM, RK, RB	Ring	1	10

MARS Sentinel Series - Metal Cover And Base

INSIDE DIMENSIONS (inches)	BASE	HEIGHT	WIDTH	DEPTH
	Solid	6.25	4.75	3.00
	Ring	6.00	3.82	3.13

MARS NO.	DESCRIPTION	BASE	MARS PACK	CASE QTY.
70215	BTG-54VL metal hinged	Solid	1	12
70216	BTG-54VLW metal hinged	Ring	1	12

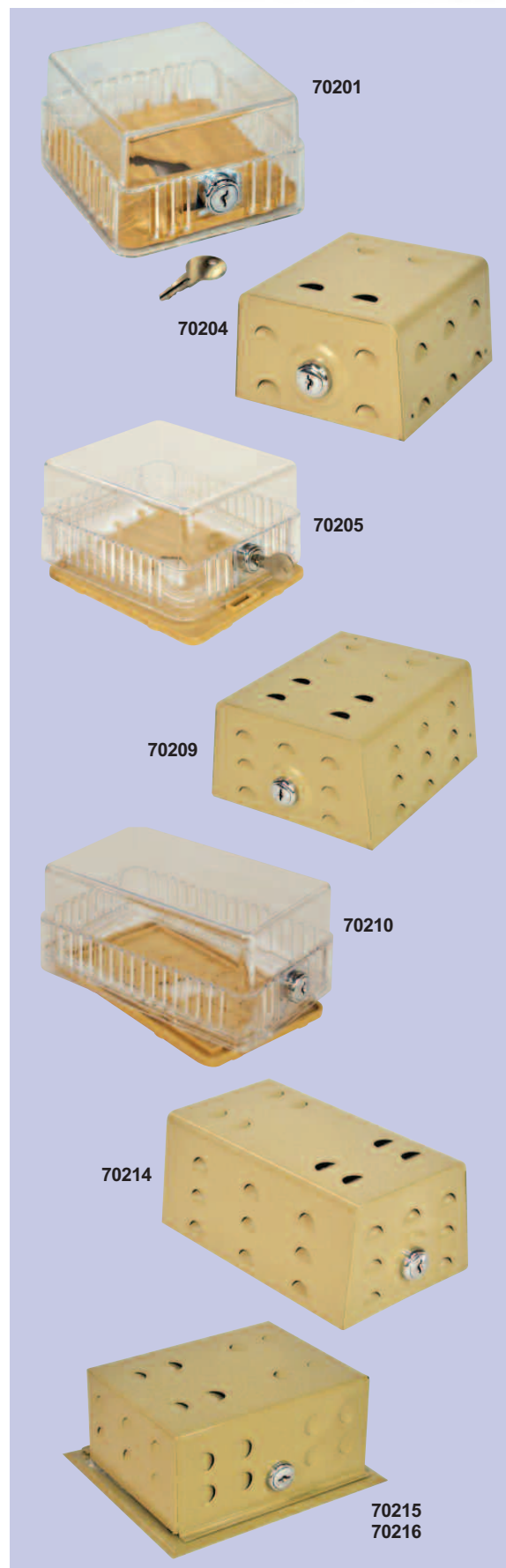

SERVICE & INSTALLATION

Circuit Breaker Branch Panels

MARS SERIES **832**



Circuit Breakers

Zbreaker is the same circuit breaker now found on many high-end transformers and systems. It protects from damage caused by shorts, overheating, or wiring problems. A sticker is included so that, if the Tech desires, he can inform his customer where to press the "reset" button and possibly save a midnight service call. Kit includes wires and pre-installed terminals that allow you to easily plug it in to the connectors where a plastic-type fuse existed.

- Crystal-Clear Clamshell Package with Hanging Hole
- Full-Color Insert with Instructions

MARS NO.	DESCRIPTION	MARS PACK
08574	3 Amp Circuit Breaker	1
08575	5 Amp Circuit Breaker	1

I-T-E® EQ® Load Center Enclosures

I-T-E EQ® load centers with main lugs feature a combination trim boxed in one package.

- The trim fits both surface and flush mounting applications saving money and space
- Interiors offer removal in seconds
- Single phase, 3-wire design, 120/240 VAC
- One piece Albus bar construction. Designed for use only with I-T-E circuit breakers. UL listed
- Rated for 100,000 A IR
- Exclusive split neutral
- Main lugs and neutral on same plane, same drive
- Simple upper pan adjustment after trim is installed
- UL listed for 60/75 °C conductors
- 100% circuit breaker twistouts
- Indoor and outdoor enclosures available

MARS NO.	DESCRIPTION	MARS PACK
83271	60a-2 pole 4 circuit, surface branch panel - type 1	1
83273	125a-4 pole 8 circuit, surface branch panel - type 1	1

Outdoor Enclosures - Type 3R

MARS NO.	DESCRIPTION	MARS PACK
83277	60a-2 pole 4 circuit, outdoor enclosure	1
83278	125a-4 pole 8 circuit, outdoor enclosure	1

EQ Load Center

Main Lug and Main Breaker with Copper Bus

Features:

- Interiors offer removal in seconds
- Single Phase
- One piece bus bar construction designed for use only with circuit breakers
- Positive load side circuit breaker hook rails
- Outdoor NEMA Type 3R devices use HS Type hubs
- UL listed

Specifications:

- 1000,000 IR
- 4-16 Circuits, 100-225 Amperes
- 1 Phase, 3-Wire, SN
- 120/240V AC

The EQ Load Center is suitable for use as service entrance equipment when a main breaker (125A maximum) is back-fed in a branch and used with main breaker retainer clip. Copper Bus load centers are recommended for those applications where the environment may be severe. (i.e. farm and coastal areas)

Main Lug Load Center - Outdoor

MARS NO.	AMP RATING	MAX 1 POLE NO. OF SPACES	NO OF CIRCUITS	QP MAX. 2-POLES	MARS PACK
83265	125	8	16	4	1

DIMENSIONS

H	W	D
14-3/4	12-1/8	4-1/4



08575

SIEMENS
I-T-E® Electrical Products



83271



83277

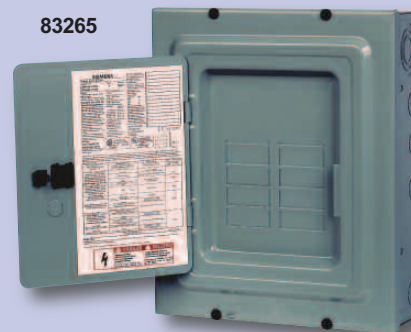

83265

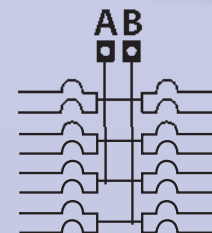

W0816ML1125CU
16-Poles Max.

SERVICE & INSTALLATION



The largest selection of motors, components and accessories for the HVAC/R Industry

SI-13

Cartridge Fuses

MARS SERIES **820**



SERVICE & INSTALLATION

Cartridge Fuses, Type TRS

Time delay (class RK5, 600 volt)

MARS NO.	DESCRIPTION	MARS PACK	CASE QTY.
82103*	2/10a - 600V, TRS fuse	10	100
82106*	1/2a - 600V, TRS fuse	10	100
82109*	1a - 600V, TRS fuse	10	100
82110*	1.6a - 600V, TRS fuse	10	100
82111*	2a - 600V, TRS fuse	10	100
82112*	2.25a - 600V, TRS fuse	10	100
82124*	5a - 600V, TRS fuse	10	200
82125*	6a - 600V, TRS fuse	10	200
82132	10a - 600V, TRS fuse	10	200
82133	12a - 600V, TRS fuse	10	200
82134	15a - 600V, TRS fuse	10	200
82136	20a - 600V, TRS fuse	10	200
82137	25a - 600V, TRS fuse	10	200
82138	30a - 600V, TRS fuse	10	200
82139	35a - 600V, TRS fuse	10	100
82140	40a - 600V, TRS fuse	10	100
82147	45a - 600V, TRS fuse	10	100
82141	50a - 600V, TRS fuse	10	100
82142	60a - 600V, TRS fuse	10	100
82143	70a - 600V, TRS fuse	5	5
82144	80a - 600V, TRS fuse	5	5
82145	90a - 600V, TRS fuse	5	5
82146	100a - 600V, TRS fuse	5	5
82154	110a - 600V, TRS fuse	1	1
82148	125a - 600V, TRS fuse	1	1
82149	150a - 600V, TRS fuse	1	1
82150	175a - 600V, TRS fuse	1	1
82151	200a - 600V, TRS fuse	1	1
82152	250a - 600V, TRS fuse	1	1
82153	300a - 600V, TRS fuse	1	1

* NOTE: SmartSpot indicating fuse not available below 8 amps

Cartridge Fuses, Type TRS Clamshell Packaging For Merchandisers

Time delay (class RK5, 600 volt)

MARS NO.	DESCRIPTION	MARS PACK	CASE QTY.
82632	10a - 600V, (3 pk) TRS fuse	1	1
82634	15a - 600V, (3 pk) TRS fuse	1	1
82636	20a - 600V, (3 pk) TRS fuse	1	1
82637	25a - 600V, (3 pk) TRS fuse	1	1
82638	30a - 600V, (3 pk) TRS fuse	1	1
82639	35a - 600V, (3 pk) TRS fuse	1	1
82640	40a - 600V, (3 pk) TRS fuse	1	1
82647	45a - 600V, (3 pk) TRS fuse	1	1
82641	50a - 600V, (3 pk) TRS fuse	1	1
82642	60a - 600V, (3 pk) TRS fuse	1	1

Gen. Purpose Cartridge Fuses, Type OT

One-Time non-renewable, Class K-5

MARS NO.	DESCRIPTION	MARS PACK	CASE QTY.
82210	10a - 250V, OT10 Fuse	10	100
82212	15a - 250V, OT15 Fuse	10	100
82213	20a - 250V, OT20 Fuse	10	100
82214	25a - 250V, OT25 Fuse	10	100
82215	30a - 250V, OT30 Fuse	10	100
82216	35a - 250V, OT35 Fuse	10	100
82217	40a - 250V, OT40 Fuse	10	100
82218	45a - 250V, OT45 Fuse	10	100
82219	50a - 250V, OT50 Fuse	10	100
82220	60a - 250V, OT60 Fuse	10	100
82221	70a - 250V, OT70 Fuse	5	100
82224	100a - 250V, OT100 Fuse	5	100

FERRAZ SHAWMUT IS NOW MERSEN

MERSEN



SmartSpot blown-fuse indicator

With SmartSpot you'll find the open fuse FAST. When a fuse opens, the SmartSpot indicator on the label of the fuse senses it and turns from SILVER to eye-catching RED.

And it stays RED so you can spot the open fuse quickly and safely.

Just open a panel and scan. Wherever you see any red in a SmartSpot indicator, you know the fuse is open.

This is a big advantage to contractors/service personnel because it helps them to identify very quickly what fuse needs to be changed thereby avoiding costly downtime.

You'll find SmartSpot on all of the most widely used industry standard fuses such as Class RK5, RK1, and Class J.



Cartridge Fuses

MARS SERIES **820**

Cartridge Fuses, Type TR

Time delay (class RK5, 250 volt)

MARS NO.	DESCRIPTION	MARS PACK	CASE QTY.
82006*	1/2a-250V, TR fuse	10	100
82009*	1a-250V, TR fuse	10	100
82016*	2a-250V, TR fuse	10	100
82017*	2 1/2a-250V, TR fuse	10	100
82019*	3a-250V, TR fuse	10	100
82020*	3 2/10a-250V, TR fuse	10	100
82021*	4a-250V, TR fuse	10	100
82024*	5a-250V, TR fuse	10	100
82025*	5 6/10a-250V, TR fuse	10	100
82026*	6a-250V, TR fuse	10	100
82027*	6 1/4a-250V, TR fuse	10	100
82029*	7a-250V, TR fuse	10	100
82030	8a-250V, TR fuse	10	100
82032	10a-250V, TR fuse	10	100
82033	12a-250V, TR fuse	10	100
82034	15a-250V, TR fuse	10	100
82035	17 1/2a-250V, TR fuse	10	100
82036	20a-250V, TR fuse	10	100
82037	25a-250V, TR fuse	10	100
82038	30a-250V, TR fuse	10	100
82039	35a-250V, TR fuse	10	100
82040	40a-250V, TR fuse	10	100
82041	45a-250V, TR fuse	10	100
82042	50a-250V, TR fuse	10	100
82043	60a-250V, TR fuse	10	100
82044	70a-250V, TR fuse	5	100
82045	80a-250V, TR fuse	5	100
82046	90a-250V, TR fuse	5	100
82047	100a-250V, TR fuse	5	100
82048	110a-250V, TR fuse	1	1
82049	125a-250V, TR fuse	1	1
82050	150a-250V, TR fuse	1	1
82051	175a-250V, TR fuse	1	1
82052	200a-250V, TR fuse	1	1
82053	225a-250V, TR fuse	1	1
82054	350a-250V, TR fuse	1	1
82056	400a-250V, TR fuse	1	1
82055	600a-250V, TR fuse	1	1

* NOTE: SmartSpot indicating fuse not available below 8 amps

Cartridge Fuses, Type TR Clamshell Packaging For Merchandisers

Time delay (class RK5, 250 volt)

MARS NO.	DESCRIPTION	MARS PACK	CASE QTY.
82532	10a - 250V, (3 pk) TR fuse	1	1
82534	15a - 250V, (3 pk) TR fuse	1	1
82536	20a - 250V, (3 pk) TR fuse	1	1
82537	25a - 250V, (3 pk) TR fuse	1	1
82538	30a - 250V, (3 pk) TR fuse	1	1
82539	35a - 250V, (3 pk) TR fuse	1	1
82540	40a - 250V, (3 pk) TR fuse	1	1
82541	45a - 250V, (3 pk) TR fuse	1	1
82542	50a - 250V, (3 pk) TR fuse	1	1
82543	60a - 250V, (3 pk) TR fuse	1	1



FERRAZ SHAWMUT IS NOW MERSEN

MERSEN



SmartSpot blown-fuse indicator

With SmartSpot you'll find the open fuse FAST. When a fuse opens, the SmartSpot indicator on the label of the fuse senses it and turns from SILVER to eye-catching RED.

And it stays RED so you can spot the open fuse quickly and safely.

Just open a panel and scan. Wherever you see any red in a SmartSpot indicator, you know the fuse is open.

This is a big advantage to contractors/service personnel because it helps them to identify very quickly what fuse needs to be changed thereby avoiding costly downtime.

You'll find SmartSpot on all of the most widely used industry standard fuses such as Class RK5, RK1, and Class J.

SERVICE & INSTALLATION

Midget & Specialty Fuses

MARS SERIES **820**



Midget Fast Acting Fuses, Type ATM

Fast acting

MARS NO.	DESCRIPTION	MARS PACK	CASE QTY.
82907	1/2a - 600V, ATM fuse	10	100
82909	1a - 600V, ATM fuse	10	100
82910	1 1/2a - 600V, ATM fuse	10	100
82911	2a - 600V, ATM fuse	10	100
82916	3a - 600V, ATM fuse	10	100
82912	4a - 600V, ATM fuse	10	100
82913	5a - 600V, ATM fuse	10	100
82914	6a - 600V, ATM fuse	10	100
82918	7a - 600V, ATM fuse	10	100
82915	8a - 600V, ATM fuse	10	100
82917	10a - 600V, ATM fuse	10	100
82919	15a - 600V, ATM fuse	10	100
82920	20a - 600V, ATM fuse	10	100
82922	30a - 600V, ATM fuse	10	100

Specialty Fuses

MARS NO.	DESCRIPTION	MARS PACK	CASE QTY.
----------	-------------	-----------	-----------

Small Dimension (Electronic) Fuses, 5 x 20mm — N. American Standards, Fast Acting

82881	GGM 2 250V fuse	5	5
82879	GGM .5 250V fuse	5	5
82882	GGM 10 250V fuse	10	10

Small Time Delay Fuses, Rejection Style (PC Boards and small Dimension Fuses)

82880	GMQ 3.2a, 300V fuse	5	100
82884	GMQ4a, 300V fuse	5	100

Fast Acting Size Rejection Special Type Fuse (PC Boards and small Dimension Fuses)

82980	GLQ 3.0a, 300V fuse	5	100
-------	---------------------	---	-----

Fast Acting Non Rejecting Special Type Fuse (Low voltage supplementary fuses)

82886	GLR 1.5a, 300V fuse	5	100
82887	GLR 1.6a, 300V fuse	5	100
82891	GLR 10a, 300V fuse	5	100
82890	GLR 15a, 300V fuse	5	100
82883	GSC 1a, 300V fuse	5	100

Slo Blo Fuses

82439	3AB-326 1a, 250V fuse	5	100
82442	3AB-326 5a, 250V fuse	5	100
82445	3AB-326 15a, 250V fuse	5	100
82444	3AB-326 20a, 250V fuse	5	100

Time Delay, 1/4 x 1 1/4", Glass Type Fuses (PC Boards and small Dimension Fuses)

82978	WVR heat limiter	10	10
82979	WUR heat limiter	10	10

Small Dimension Time Delay Non Rejecting Special Fuse (PC Boards and small Dimension Fuses)

82888	SMF 3.2a, (LMF 3.2)	5	5
-------	---------------------	---	---

FERRAZ SHAWMUT IS NOW MERSEN

MERSEN



MARS NO.	DESCRIPTION	MARS PACK	CASE QTY.
----------	-------------	-----------	-----------

Low Voltage Supplementary Time Delay Fuse, 10X38 or 13/32 X 1-1/2 Size

82956	TRM .2a, 250V fuse	10	100
82953	TRM .8a, 250V fuse	10	100
82958	TRM 1a, 250V fuse	10	100
82959	TRM 2a, 250V fuse	10	100
82960	TRM 3a, 250V fuse	10	100
82963	TRM 4a, 250V fuse	10	100
82965	TRM 5a, 250V fuse	10	100
82946	TRM 6a, 250V fuse	10	100
82954	TRM 8a, 250V fuse	10	100
82969	TRM 10a, 250V fuse	10	100
82970	TRM 15a, 250V fuse	10	100
82972	TRM 20a, 250V fuse	10	100
82973	TRM 25a, 250V fuse	10	100
82974	TRM 30a, 250V fuse	10	100

Low Voltage Branch Circuit Rated Fuses, R Class CC

82977	ATMR -2a, 600V fuse	10	100
82966	ATMR -3a, 600V fuse	10	100
82967	ATMR -4a, 600V fuse	10	100
82971	ATMR -10a, 600V fuse	10	100
82976	ATMR -12a, 600V fuse	10	100
82968	ATMR -15a, 600V fuse	10	100
82981	ATMR 20a, 600V fuse	10	100

SERVICE & INSTALLATION



Cartridge & Midget Fuses

MARS SERIES **820**

Gen. Purpose Cartridge Fuses, Type OTS

One time non-renewable, Class K-5

MARS NO.	DESCRIPTION	MARS PACK	CASE QTY.
82249	10a - 600V, OTS fuse	10	100
82251	15a - 600V, OTS fuse	10	100
82252	20a - 600V, OTS fuse	10	100
82253	25a - 600V, OTS fuse	10	100
82254	30a - 600V, OTS fuse	10	100
82255	35a - 600V, OTS fuse	10	100
82256	40a - 600V, OTS fuse	10	100
82259	60a - 600V, OTS fuse	10	100
82264	100a - 600V, OTS fuse	5	100

Midget Fuses, Type OTM

Fast acting

MARS NO.	DESCRIPTION	MARS PACK	CASE QTY.
82702	2a - 250V, OTM fuse	10	100
82705	5a - 250V, OTM fuse	10	100
82710	15a - 250V, OTM fuse	10	100
82711	20a - 250V, OTM fuse	10	100

Midget Time Delay Fuses, Type ATQ

Time delay

MARS NO.	DESCRIPTION	MARS PACK	CASE QTY.
82932	1/4a - 500V, ATQ fuse	10	100
82933	1/2a - 500V, ATQ fuse	10	100
82936	1a - 500V, ATQ fuse	10	100
82941	2a - 500V, ATQ fuse	10	100
82942	3a - 500V, ATQ fuse	10	100
82943	4a - 500V, ATQ fuse	10	100
82944	5a - 500V, ATQ fuse	10	100
82945	6a - 500V, ATQ fuse	10	100
82714	7a - 500V, ATQ fuse	10	100
82947	10a - 500V, ATQ fuse	10	100
82940	12a - 500V, ATQ fuse	10	100
82952	15a - 500V, ATQ fuse	10	100
82948	20a - 500V, ATQ fuse	10	100
82949	25a - 500V, ATQ fuse	10	100
82951	30a - 500V, ATQ fuse	10	100

Midget Time Delay Fuse, Type ATQ Clamshell Packaging For Merchandisers

Time delay

MARS NO.	DESCRIPTION	MARS PACK	CASE QTY.
82715	1a - 500V, (6 pk), ATQ fuse	1	1
82716	3a - 500V, (6 pk), ATQ fuse	1	1
82718	5a - 500V, (6 pk), ATQ fuse	1	1
82719	10a - 500V, (6 pk), ATQ fuse	1	1
82720	15a - 500V, (6 pk), ATQ fuse	1	1
82721	20a - 500V, (6 pk), ATQ fuse	1	1
82722	25a - 500V, (6 pk), ATQ fuse	1	1
82723	30a - 500V, (6 pk), ATQ fuse	1	1

FERRAZ SHAWMUT IS NOW MERSEN



SERVICE & INSTALLATION



The largest selection of motors, components and accessories for the HVAC/R Industry

Specialty Fuses & Fuse Display

MARS SERIES **820**



MARS HVACR Glass Fuse Display

MARS NO.	DESCRIPTION	MARS PACK
82395	Glass fuse assortment display-300 fuses	1
82396	Glass fuse display-empty	1

Ceramic Body Fast Acting Fuses, Type GAB

MARS NO.	DESCRIPTION	MARS PACK	CASE QTY.
82403	1/2a -250V, GAB ceramic fuse	5	5
82404	1a -250V, GAB ceramic fuse	5	5
82402	1 1/2a -250V, GAB ceramic fuse	5	5
82405	2a -250V, GAB ceramic fuse	5	100
82406	2 1/2a -250V, GAB ceramic fuse	5	5
82407	3a -250V, GAB ceramic fuse	5	5
82408	4a -250V, GAB ceramic fuse	5	5
82409	5a -250V, GAB ceramic fuse	5	5
82410	6a -250V, GAB ceramic fuse	5	5
82411	7a -250V, GAB ceramic fuse	5	5
82412	8a -250V, GAB ceramic fuse	5	5
82413	10a -250V, GAB ceramic fuse	5	5
82414	12a -250V, GAB ceramic fuse	5	5
82415	15a -250V, GAB ceramic fuse	5	5
82416	20a -250V, GAB ceramic fuse	5	5
82417	25a -250V, GAB ceramic fuse	5	5
82418	30a -250V, GAB ceramic fuse	5	5

Glass Body Non-Time Delay Fuses, Type GGC

MARS NO.	DESCRIPTION	MARS PACK	CASE QTY.
82448	1/10a -250V, GGC glass fuse	5	5
82450	1/4a -250V, GGC glass fuse	5	100
82451	3/10a -250V, GGC glass fuse	5	5
82453	1/2a -250V, GGC glass fuse	5	100
82455	3/4a -250V, GGC glass fuse	5	5
82456	1a -250V, GGC glass fuse	5	100
82457	1 1/4a -250V, GGC glass fuse	5	5
82458	1 1/2a -250V, GGC glass fuse	5	100
82460	2a -250V, GGC glass fuse	5	100
82461	2 1/2a -250V, GGC glass fuse	5	100
82462	3a -250V, GGC glass fuse	5	100
82459	3 2/10a -250V, GGC glass fuse	5	100
82463	4a -250V, GGC glass fuse	5	100
82464	5a -250V, GGC glass fuse	5	5
82465	6a -250V, GGC glass fuse	5	100
82466	7 1/2a -250V, GGC glass fuse	5	5
82467	8a -250V, GGC glass fuse	5	100
82468	10a -250V, GGC glass fuse	5	100
82474	12a -125V, GGC glass fuse	5	100
82469	15a -125V, GGC glass fuse	5	100
82471	20a -32V, GGC glass fuse	5	100
82472	25a -32V, GGC glass fuse	5	5
82473	30a -32V, GGC glass fuse	5	5

Electronic/Glass Fuses, Type GGX

Fast acting 1/4" x 1"

MARS NO.	DESCRIPTION	MARS PACK	CASE QTY.
82878	.4a -250V, GGX glass fuse	5	5
82470	2/10a -250V, GGX glass fuse	5	5
82484	1/2a -250V, GGX glass fuse	5	100
82486	1a -250V, GGX glass fuse	5	100
82488	2a -250V, GGX glass fuse	5	5
82491	5a -125V, GGX glass fuse	5	5
82877	3a -125V, GGX glass fuse	5	5

FERRAZ SHAWMUT IS NOW MERSEN

MERSEN



82395



82403



82448

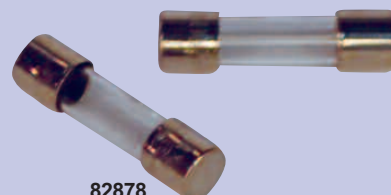

82878

SERVICE & INSTALLATION



Specialty Fuses

MARS SERIES **820**

Specialty Fuses (Cont.)

MARS NO.	DESCRIPTION	MARS PACK	CASE QTY.
Low Voltage Supplementary Fast Acting Fuses			
82608	BLS/BBS 1a, 250V fuse	10	100
82609	BLS/BBS 2a, 250V fuse	10	100
82610	BLS/BBS 3a, 250V fuse	10	100
82611	BLS/BBS 4a, 600V fuse	10	100
82612	BLS/BBS 5a, 600V fuse	10	100
Medium Voltage Fuses Class J Fast Acting			
82158	A4J -6a, 600V fuse	10	100
82160	A4J -15a, 600V fuse	10	100
82161	A4J -20a, 600V fuse	10	100
82163	A4J -30a, 600V fuse	10	100
82169	A3T -40a, 600V fuse	10	100
82170	A6T -25a, 600V fuse	10	100
82179	A6T -30a, 600V fuse	10	100
82181	A6T -35a, 600V fuse	10	100
82182	A6T -60a, 600V fuse	10	100
82964	RFS -40a, 600V fuse	10	100
Fuse Reducer			
82975	263M/H632 fuse reducer(1 pair)	1	10
Automotive Blade Type Fuse Acting 32V DC			
82230	ATC-3a, auto blade fuse(5 pk)	1	5
82232	ATC -4a, auto blade fuse	5	5
82231	ATC -5a, auto blade fuse (5 pk)	1	5
82233	ATC -7.5a, auto blade fuse	1	5
82234	ATC -10a, auto blade fuse	5	5
82235	ATC -15a, auto blade fuse	5	5
82236	ATC -20a, auto blade fuse	5	5
82237	ATC -25a, auto blade fuse	5	5
82238	ATC -30a, auto blade fuse	5	5
ATDR Time Delay Class CC (Small motors, Contactors, Branch Circuit Protection)			
82226	ATDR -6.25a, 600V fuse, class CC	10	10
82228	ATDR-10a, 600V fuse	10	10
ATQR Time Delay Class CC (Control Transformers, Solenoids, Inductive Loads)			
82227	ATQR -15a, 600V fuse	10	10

Class G Fuses 480 Volt, 600 Volt Type AG = Type SC

Time delay (above 5A) current limiting

MARS NO.	DESCRIPTION	MARS PACK	CASE QTY.
82271	1a -600V, AG fuse	4	100
82290	2a -600V, AG fuse	4	100
82272	3a -600V, AG fuse	4	100
82291	4a -600V, AG fuse	4	100
82273	5a -600V, AG fuse	4	100
82274	6a -600V, AG fuse	4	100
82275	8a -600V, AG fuse	4	100
82276	10a -600V, AG fuse	4	100
82278	15a -600V, AG fuse	4	100
82279	20a -600V, AG fuse	4	100
82280	25a -480V, AG fuse	4	100
82281	30a -480V, AG fuse	4	100
82282	35a -480V, AG fuse	2	100
82283	40a -480V, AG fuse	2	100
82285	50a -480V, AG fuse	2	100
82286	60a -480V, AG fuse	2	100



FERRAZ SHAWMUT IS NOW MERSEN

MERSEN

SERVICE & INSTALLATION

Glass Body Time Delay Fuses, Type GDL

Time delay 1/4" x 1 1/4"

MARS NO.	DESCRIPTION	MARS PACK	CASE QTY.
82502	1a -250V, GDL glass fuse	5	100
82505	1.5a -250V, GDL glass fuse	5	100
82507	2a -250V, GDL glass fuse	5	100
82508	2.5a -250V, GDL glass fuse	5	100
82510	3a -250V, GDL glass fuse	5	100
82512	4a -250V, GDL glass fuse	5	100
82513	5a -250V, GDL glass fuse	5	100
82514	7a -250V, GDL glass fuse	5	100
82517	8a -250V, GDL glass fuse	5	100
82518	10a -125V, GDL glass fuse	5	100
82519	15a -125V, GDL glass fuse	5	100



The largest selection of motors, components and accessories for the HVAC/R Industry

Glass & Plug Fuses

MARS SERIES **820**



SERVICE & INSTALLATION

Dual Element, Time Delay (Type S) UL 125V

Plug fuses all UL listed; CSA models also listed

Rejection Time delay, tamper resistant

MARS NO.	DESCRIPTION	MARS PACK	CASE QTY.
82307	1 1/4a, S plug fuse	4	100
82308	1 6/10a, S plug fuse	4	100
82311	2a, S plug fuse	4	100
82313	2 1/2a, S plug fuse	4	100
82315	3a, S plug fuse	4	100
82316	3 2/10a, S plug fuse	4	100
82318	4a, S plug fuse	4	100
82320	5a, S plug fuse	4	100
82323	6 1/4a, S plug fuse	4	100
82325	8a, S plug fuse	4	100
82326	9a, S plug fuse	4	100
82327	10a, S plug fuse	4	100
82328	12a, S plug fuse	4	100
82330	15a, S plug fuse	4	100
82331	20a, S plug fuse	4	100
82332	25a, S plug fuse	4	100
82333	30a, S plug fuse	4	100

Dual Element Time Delay Fuse-Type S Clamshell Packaging For Merchandisers

Rejection Time delay, tamper resistant

MARS NO.	DESCRIPTION	MARS PACK
82745	15 a, S plug fuse 125V, (6 pk)	1
82746	20 a, S plug fuse 125V, (6 pk)	1
82747	25 a, S plug fuse 125V, (6 pk)	1
82748	30 a, S plug fuse 125V, (6 pk)	1

Dual Element, Time Delay (Type T) UL 125V

MARS NO.	DESCRIPTION	MARS PACK	CASE QTY.
82334	1 1/4a, T plug fuse	4	100
82337	2a, T plug fuse	4	100
82344	2.5a, T plug fuse	4	100
82338	3.2a, T plug fuse	4	100
82339	4a, T plug fuse	4	100
82340	5a, T plug fuse	4	100
82341	6 1/4a, T plug fuse	4	100
82342	8a, T plug fuse	4	100
82343	10a, T plug fuse	4	100
82660	15a, T plug fuse GT15	4	100
82661	20a, T plug fuse GT20	4	100
82662	30a, T plug fuse GT30	4	100
82663	25a, T plug fuse GT25	4	100

Dual Element, Time Delay (Type TL) UL 125V

MARS NO.	DESCRIPTION	MARS PACK	CASE QTY.
82346	15a, TL plug fuse	4	100
82347	20a, TL plug fuse	4	100
82348	25a, TL plug fuse	4	100
82349	30a, TL plug fuse	4	100

FERRAZ SHAWMUT IS NOW MERSEN



82308



82337



82350



82735



Dual Element, Time Delay (Type TD) UL 125V

MARS NO.	DESCRIPTION	MARS PACK	CASE QTY.
82350	15a, TD plug fuse-CSA	4	100
82351	20a, TD plug fuse-CSA	4	100
82352	25a, TD plug fuse-CSA	4	100
82353	30a, TD plug fuse-CSA	4	100

Dual Element Time Delay Fuse-Type TL Clamshell Packaging For Merchandisers

MARS NO.	DESCRIPTION	MARS PACK
82735	15 a, 125V, TL plug fuse (6 pk)	1
82736	20 a, 125V, TL plug fuse (6 pk)	1
82737	25 a, 125V, TL plug fuse (6 pk)	1
82738	30 a, 125V, TL plug fuse (6 pk)	1



Plug Fuses

MARS SERIES **820**

S Plug Fuse Adapters, UL 125

MARS NO.	DESCRIPTION	MARS PACK	CASE QTY.
82375	2 1/2a, S plug fuse	4	100
82376	3 2/10a, S plug fuse	4	100
82379	6 1/4a, S plug fuse	4	100
82382	15a, S plug fuse	4	100
82383	20a, S plug fuse	4	100
82384	30a, S plug fuse	4	100

Fast Acting, (Type W) UL 125V

MARS NO.	DESCRIPTION	MARS PACK	CASE QTY.
82360	10a, W plug fuse	4	100
82363	15a, W plug fuse	4	100
82364	20a, W plug fuse	4	100
82365	25a, W plug fuse	4	100
82366	30a, W plug fuse	4	100

Dual Element, Time Delay Fuse - Type W Clamshell Packaging For Merchandisers

MARS NO.	DESCRIPTION	MARS PACK
82755	15a, 125V, W plug fuse (6 pk)	1
82756	20a, 125V, W plug fuse (6 pk)	1
82757	25a, 125V, W plug fuse (6 pk)	1
82758	30a, 125V, W plug fuse (6 pk)	1

"W" Fuse

FERRAZ SHAWMUT IS NOW MERSEN

MERSEN

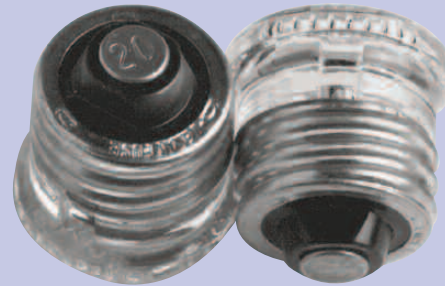

Fuse Adapters



SERVICE & INSTALLATION



Fuse Blocks

MARS SERIES **820**

Fuse Blocks - Class H & K 250 Volts

Mersen manufactures the highest quality 250 to 600 volt fuse blocks handling current capacities of 30 to 600 amperes. These durable fuse blocks are designed for class H, J, K, R, CC and Midget fuses. All blocks are UL listed and CSA certified.

Mersen fuse blocks feature a unique adder block which can be snapped on to form multi-pole segmented blocks of as many poles as desired. Multiple pole blocks thus formed save valuable space, are permanent, and can be added to in the future.

Fuse block insulators are constructed of either phenolic or molded polycarbonate. Three types of wire connectors are used. Screw type is for copper wire with terminals. Pressure plate type is for bare copper wire where vibration may be a factor. Box type connectors are the most durable and versatile for stranded or solid wire. All fuse clips are one piece high-conductivity tin-plated copper for low resistance connections and cool operation.

MARS NO.	DESCRIPTION	MARS PACK	CASE QTY.
83010	Adder 30 amp - Al box	1	50
83011	1 pole 30 amp - Al box	1	50
83012	1 pole 30 amp - screw	1	50
83013	2 pole 30 amp - screw	1	50
83015	Adder 60 amp - Al box	1	50
83017	2 pole 60 amp - Al box	1	25
83018	3 pole 60 amp - Al box	1	25

FERRAZ SHAWMUT IS NOW MERSEN

MERSEN

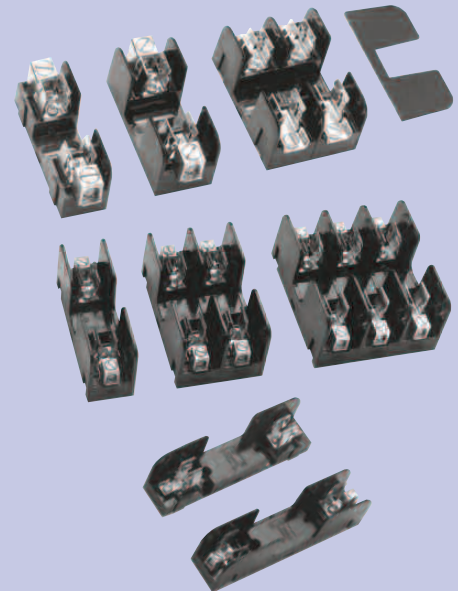

Fuse & Power Blocks

MARS SERIES **820**



SERVICE & INSTALLATION

Fuse Blocks - Midget Fuses 600 Volts

Mersen power distribution blocks (pdb), afford a safe, convenient way of splicing cables, splitting primary power into a variety of secondary circuits or providing a fixed junction tap - off point. Insulators are virtually unbreakable polycarbonate. Standard aluminum box connectors accommodate aluminum and copper wire. Connector bars are all one piece and tin plated. The pdbs are UL listed and CSA certified.

MARS NO.	DESCRIPTION	MARS PACK	CASE QTY.
83061	1 pole 30 amp - screw	1	50
83062	2 pole 30 amp - screw	1	25
83063	3 pole 30 amp - screw	1	25
83065	1 pole 30 amp - plate	1	50
83066	2 pole 30 amp - plate	1	25
83067	3 pole 30 amp - plate	1	25

Power Distribution Blocks - 600 Volts

MARS NO.	DESCRIPTION	MARS PACK	CASE QTY.
83090	1 pole pdb 1 to 4 #4-#14ga	1	50
83091	2 pole pdb 1 to 4 #4-#14ga	1	25
83092	3 pole pdb 1 to 4 #4-#14ga	1	25

Fuse Holders

MARS NO.	DESCRIPTION	MARS PACK	CASE QTY.
82994	panel mount glass holder 1/4" x 1 1/4" screw type knob	1	100
82995	panel mount midget holder 13/32" x 1 1/2" bayonet knob	1	100
82996	base mount glass fuse block 1/4" x 1 1/4"	10	100
82997	in-line midget holder-screw cap	1	100
83001	in-line glass holder-screw cap (5 pk)	1	100
83002	in-line glass holder-snap cap (5 pk)	1	100
82987	HPF-EE fuse holder	10	100
82989	HPF-SC fuse holder-panel mount	10	100
82990	HHB fuse holder	10	100
82991	HKP-HH fuse holder	1	10
82993	HRK fuse holder	10	100

FERRAZ SHAWMUT IS NOW MERSEN

MERSEN

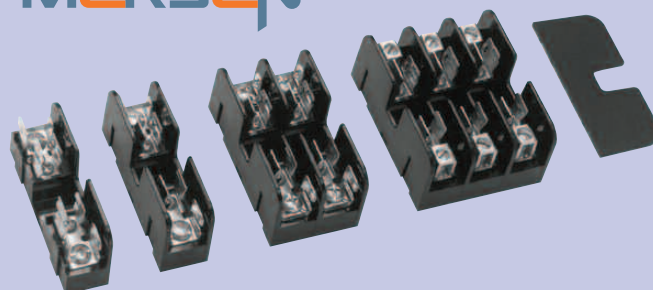



JARD Fuses

Applications:

- Recommended for AC power distribution system mains, feeders, and branch circuits.
- Protection of motors and motor branch circuits.
- Protection of transformers and other inductive loads.
- All general-purpose applications including lighting, heating and other non-inductive loads.

Benefits:

- Superior overload and cycling capabilities.
- Current limiting provides component short-circuit protection.

Specifications:

Dual-Element Time-Delay

Voltage Rating: RK5 - 250Vac, RK5 - 600Vac

Amp Rating: 1/10 - 600A

Interrupting Rating: 200,000 RMS Symmetrical Amps

Current Limiting: RK5 Fuse

Agency Approvals:

UL Listed, Class RK5, CSA Certified, DC listed to UL standard 248 TRS only

Voltage Rating: RK5 250V

- Volts: 250VAC
- : 250VDC (.1-2.8A; 35-400A)
- : 160VDC (3-30A; 450-600A)

RK5 600V

- Volts: 600VAC
- : 600VDC (.1-12A; 70-600A)
- : 160VDC (15-60A)

RK5 Time Delay Fuse 250V

Replaces: TR, ECNR, FRNR, FLNR

MARS NO.	DESCRIPTION	MARS PACK
81006	.5A - 250V	10
81009	1A - 250V	10
81016	2A - 250V	10
81017	2.5A - 250V	10
81019	3A - 250V	10
81020	3.2A - 250V	10
81021	4A - 250V	10
81024	5A - 250V	10
81025	5.6A - 250V	10
81026	6A - 250V	10
81027	6.25A - 250V	10
81029	7A - 250V	10
81030	8A - 250V	10
81032	10A - 250V	10
81033	12A - 250V	10
81034	15A - 250V	10
81035	17.5A - 250V	10
81036	20A - 250V	10
81037	25A - 250V	10
81038	30A - 250V	10
81039	35A - 250V	10
81040	40A - 250V	10
81041	45A - 250V	10
81042	50A - 250V	10
81043	60A - 250V	10
81044	70A - 250V	5
81045	80A - 250V	5
81046	90A - 250V	5
81047	100A - 250V	5
81048	110A - 250V	1
81049	125A - 250V	1
81050	150A - 250V	1
81051	175A - 250V	1
81052	200A - 250V	1
81053	225A - 250V	1
81054	350A - 250V	1
81056	400A - 250V	1
81055	600A - 250V	1

RK5 Time Delay Fuse 600V

Replaces: TRS, ECSR, FRSR, FLSR

MARS NO.	DESCRIPTION	MARS PACK
81103	.2A - 600V	10
81106	.5A - 600V	10
81109	1A - 600V	10
81110	1.6A - 600V	10
81111	2A - 600V	10
81112	2.25A - 600V	10
81077	4A - 600V	10
81124	5A - 600V	10
81125	6A - 600V	10
81078	8A - 600V	10
81132	10A - 600V	10
81133	12A - 600V	10
81134	15A - 600V	10
81076	17.5A - 600V	10
81136	20A - 600V	10
81137	25A - 600V	10
81138	30A - 600V	10
81139	35A - 600V	10
81140	40A - 600V	10
81147	45A - 600V	10
81141	50A - 600V	10
81142	60A - 600V	10
81143	70A - 600V	5
81144	80A - 600V	5
81145	90A - 600V	5
81146	100A - 600V	5
81154	110A - 600V	1
81148	125A - 600V	1
81149	150A - 600V	1
81150	175A - 600V	1
81151	200A - 600V	1
81152	250A - 600V	1
81153	300A - 600V	1



SERVICE & INSTALLATION

Edison Fuses

MARS SERIES **810**



JDL Time Delay Fuses - Class J

UL Fuses: Current Limiting

MARS NO.	DESCRIPTION	MARS PACK
81621	7 A 600V Fuse Time Dly CL-J	10
81613	10A 600V Fuse Time Dly CL-J	10
81614	15A 600V Fuse Time Dly CL-J	10
81615	20A 600V Fuse Time Dly CL-J	10
81616	30A 600V Fuse Time Dly CL-J	10
81617	35A 600V Fuse Time Dly CL-J	10
81618	40A 600V Fuse Time Dly CL-J	10
81619	45A 600V Fuse Time Dly CL-J	10
81620	60A 600V Fuse Time Dly CL-J	10
81622	80A 600V Fuse Time Dly CL-J	5

JFL Fast-Acting Fuses - Class J

UL Fuses: Current Limiting

MARS NO.	DESCRIPTION	MARS PACK
81158	6A UL CLASS J Fast Acting 600V	10
81160	15A UL CLASS J Fast Acting 600V	10
81161	20A UL CLASS J Fast Acting 600V	10
81163	30A UL CLASS J Fast Acting 600V	10
81623	70A UL CLASS J Fast Acting 600V	5

TJN (300Vac) Class T Extremely Fast-Acting Fuses

UL Fuses: Current Limiting

Compact, space saving size. These fuses are ideal as the main fuse protection for panelboards, load centers and meter stacks.

MARS NO.	DESCRIPTION	MARS PACK
81664	30A TJN Fast Acting 300V Class T	10
81665	60A TJN Fast Acting 300V Class T	10
81663	150A TJN Fast Acting 300V Class T	1

TJS (600Vac) Class T Extremely Fast-Acting Fuses

UL Fuses: Current Limiting

Compact, space saving size. These fuses are ideal as the main fuse protection for panelboards, load centers and meter stacks.

MARS NO.	DESCRIPTION	MARS PACK
81666	10A TJSFast Acting 600V Class T	10
81668	15A TJS Fast Acting 600V Class T	10
81669	40A TJSFast Acting 600V Class T	10
81670	45A TJSFast Acting 600V Class T	10
81671	50A TJSFast Acting 600V Class T	10
81672	70A TJSFast Acting 600V Class T	5
81673	80A TJSFast Acting 600V Class T	5
81674	90A TJSFast Acting 600V Class T	5
81667	100A TJSFast Acting 600V Class T	5

SEC Fast Acting & Time Delay - Class G Fuse

UL Fuses: Current Limiting

MARS NO.	DESCRIPTION	MARS PACK
81271	1A UL CLASS GTime Delay 600V	10
81290	2A UL CLASS G Time Delay 600V	10
81272	3A UL CLASS G Time Delay 600V	10
81273	5A UL CLASS G Time Delay 600V	10
81274	6A UL CLASS G Time Delay 600V	10
81275	8A UL CLASS G Time Delay 600V	10
81276	10A UL CLASS G Time Delay 600V	10
81278	15A UL CLASS G Time Delay 600V	10
81279	20A UL CLASS G Time Delay 600V	10
81280	25A UL CLASS G Time Delay 480V	10
81281	30A UL CLASS G Time Delay 480V	10
81282	35A UL CLASS G Time Delay 480V	10
81283	40A UL CLASS G Time Delay 480V	10
81285	50A UL CLASS G Time Delay 480V	10
81286	60A UL CLASS G Time Delay 480V	10

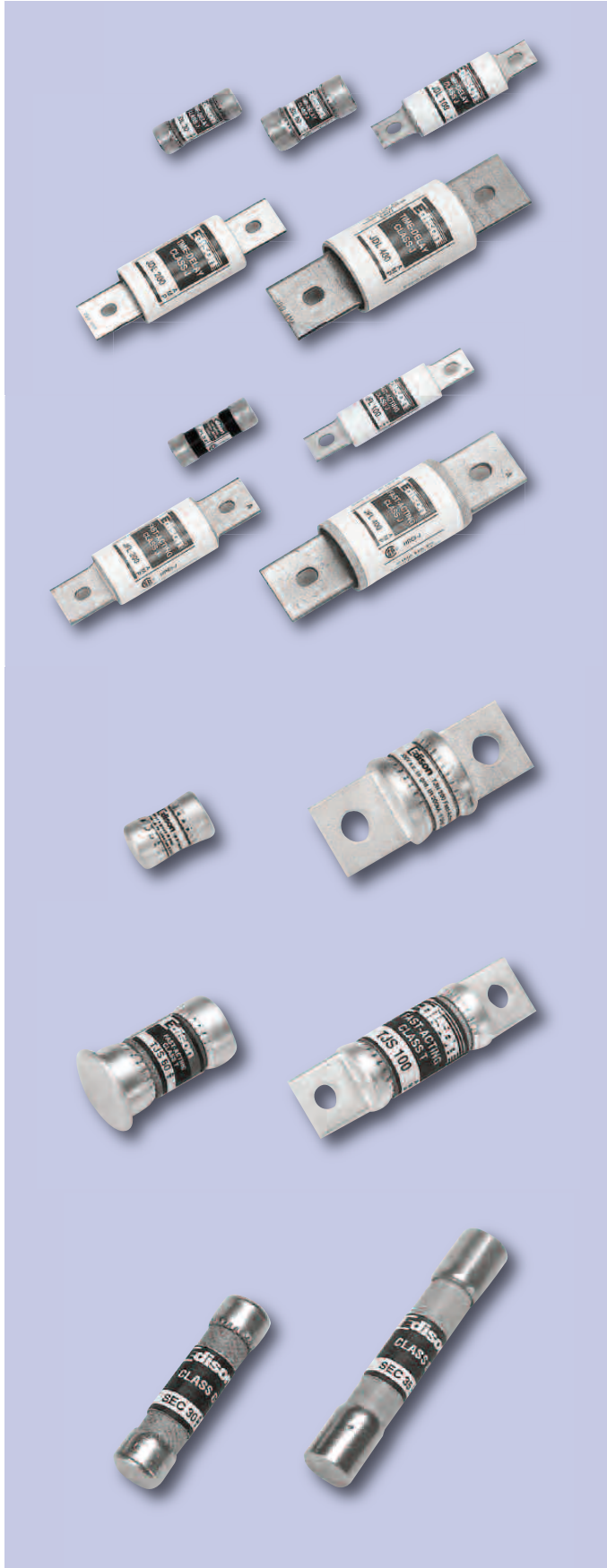

SERVICE & INSTALLATION



MOL Midget Fuses, Fast-Acting

UL Fuses: General Purpose (13/32" x 1 1/2")

MARS NO.	DESCRIPTION	MARS PACK
81702	2A UL MOL Fast Act Midget Fus 250V	10
81705	5A UL MOL Fast Act Midget Fus 250V	10
81710	15A UL MOL Fast Act Midget Fus 250V	10
81711	20A UL MOL Fast Act Midget Fus 250V	10

EBS Midget Fuses, Fast-Acting

UL Fuses: General Purpose (13/32" x 1 1/2")

MARS NO.	DESCRIPTION	MARS PACK
81608	1A UL EBS Fast Act Midget Fuse 600V	10
81609	2A UL EBS Fast Act Midget Fuse 600V	10
81610	3A UL EBS Fast Act Midget Fuse 600V	10
81611	4A UL EBS Fast Act Midget Fuse 600V	10
81612	5A UL EBS Fast Act Midget Fuse 600V	10

MEN Midget Fuses, Time Delay

UL Fuses: General Purpose (13/32" x 1 1/2")

MARS NO.	DESCRIPTION	MARS PACK
81956	.2A UL MEN Time Dly Midget Fuse 250V	10
81953	.8A UL MEN Time Dly Midget Fuse 250V	10
81958	1A UL MEN Time Dly Midget Fuse 250V	10
81959	2A UL MEN Time Dly Midget Fuse 250V	10
81960	3A UL MEN Time Dly Midget Fuse 250V	10
81644	3.2A UL MEN Time Dly Midget Fuse 250V	10
81963	4A UL MEN Time Dly Midget Fuse 250V	10
81965	5A UL MEN Time Dly Midget Fuse 250V	10
81946	6A UL MEN Time Dly Midget Fuse 250V	10
81954	8A UL MEN Time Dly Midget Fuse 250V	10
81969	10A UL MEN Time Dly Midget Fuse 250V	10
81970	15A UL MEN Time Dly Midget Fuse 250V	10
81972	20A UL MEN Time Dly Midget Fuse 250V	10
81973	25A UL MEN Time Dly Midget Fuse 250V	10
81974	30A UL MEN Time Dly Midget Fuse 250V	10

MEQ Midget Fuses, Time Delay

UL Fuses: General Purpose (13/32" x 1 1/2")

MARS NO.	DESCRIPTION	MARS PACK
81645	.1A UL MEQ Time Dly Midget Fuse 500V	10
81932	.25A UL MEQ Time Dly Midget Fuse 500V	10
81933	.5A UL MEQ Time Dly Midget Fuse 500V	10
81646	.6A UL MEQ Time Dly Midget Fuse 500V	10
81936	1A UL MEQ Time Dly Midget Fuse 500V	10
81648	1.5A UL MEQ Time Dly Midget Fuse 500V	10
81941	2A UL MEQ Time Dly Midget Fuse 500V	10
81649	2.5A UL MEQ Time Dly Midget Fuse 500V	10
81942	3A UL MEQ Time Dly Midget Fuse 500V	10
81650	3.2A UL MEQ Time Dly Midget Fuse 500V	10
81651	3.5A UL MEQ Time Dly Midget Fuse 500V	10
81943	4A UL MEQ Time Dly Midget Fuse 500V	10
81944	5A UL MEQ Time Dly Midget Fuse 500V	10
81945	6A UL MEQ Time Dly Midget Fuse 500V	10
81653	6.25A UL MEQ Time Dly Midget Fuse 500V	10
81714	7A UL MEQ Time Dly Midget Fuse 500V	10
81654	8A UL MEQ Time Dly Midget Fuse 500V	10
81947	10A UL MEQ Time Dly Midget Fuse 500V	10
81940	12A UL MEQ Time Dly Midget Fuse 500V	10
81952	15A UL MEQ Time Dly Midget Fuse 500V	10
81948	20A UL MEQ Time Dly Midget Fuse 500V	10
81949	25A UL MEQ Time Dly Midget Fuse 500V	10
81951	30A UL MEQ Time Dly Midget Fuse 500V	10



81710



81612



81969



81951

SERVICE & INSTALLATION

Edison Fuses

MARS SERIES **810**



SERVICE & INSTALLATION

EDCC Time-Delay CLASS CC Fuses

UL Fuses: Current Limiting

MARS NO.	DESCRIPTION	MARS PACK
81079	1/2A 600V T/D Class CC	10
81080	1A 600V T/D Class CC	10
81081	1.5A 600V T/D Class CC	10
81086	3A 600V T/D Class CC	10
81097	3-1/2A 600V T/D Class CC	10
81088	4A 600V T/D Class CC	10
81089	5A 600V T/D Class CC	10
81093	5 6/10 600V T/D Class CC	10
81094	6A 600V T/D Class CC	10
81095	7 A 600V T/D Class CC	10
81096	8A 600V T/D Class CC	10
81228	10A 600V T/D Class CC	10
81082	15A 600V T/D Class CC	10
81083	20A 600V T/D Class CC	10
81084	25A 600V T/D Class CC	10
81087	30A 600V T/D Class CC	10

HCTR Time Delay - Class CC

UL Fuses: Current Limiting

MARS NO.	DESCRIPTION	MARS PACK
81194	.25A UL CLASS CC Time Delay 600V	10
81195	.3A UL CLASS CC Time Delay 600V	10
81197	2A UL CLASS CC Time Delay 600V	10
81199	3.2A UL CLASS CC Time Delay 600V	10
81601	4A UL CLASS CC Time Delay 600V	10
81602	5A UL CLASS CC Time Delay 600V	10
81603	6A UL CLASS CC Time Delay 600V	10
81226	6.25A UL CLASS CC Time Delay 600V	10
81604	8A UL CLASS CC Time Delay 600V	10
81605	9A UL CLASS CC Time Delay 600V	10
81196	10A UL CLASS CC Time Delay 600V	10
81227	15A UL CLASS CC Time Delay 600V	10
81198	20A UL CLASS CC Time Delay 600V	10
81600	30A UL CLASS CC Time Delay 600V	10

HCLR Fast Acting - Class CC

UL Fuses: Current Limiting

MARS NO.	DESCRIPTION	MARS PACK
81189	1A UL CLASS CC Fast Act 600V	10
81977	2A UL CLASS CC Fast Act 600V	10
81966	3A UL CLASS CC Fast Act 600V	10
81191	3.5A UL CLASS CC Fast Act 600V	10
81967	4A UL CLASS CC Fast Act 600V	10
81192	5A UL CLASS CC Fast Act 600V	10
81193	6A UL CLASS CC Fast Act 600V	10
81971	10A UL CLASS CC Fast Act 600V	10
81976	12A UL CLASS CC Fast Act 600V	10
81968	15A UL CLASS CC Fast Act 600V	10
81981	20A UL CLASS CC Fast Act 600V	10
81190	25A UL CLASS CC Fast Act 600V	10

MCL Midget Fuses, Fast-Acting

UL Fuses: General Purpose (13/32" x 1 1/2")

MARS NO.	DESCRIPTION	MARS PACK
81907	.5A UL MCL Fast Act Midget Fus 600V	10
81909	1A UL MCL Fast Act Midget Fus 600V	10
81910	1.5A UL MCL Fast Act Midget Fus 600V	10
81911	2A UL MCL Fast Act Midget Fus 600V	10
81916	3A UL MCL Fast Act Midget Fus 600V	10
81628	3.5A UL MCL Fast Act Midget Fus 600V	10
81912	4A UL MCL Fast Act Midget Fus 600V	10
81913	5A UL MCL Fast Act Midget Fus 600V	10
81914	6A UL MCL Fast Act Midget Fus 600V	10
81918	7A UL MCL Fast Act Midget Fus 600V	10
81915	8A UL MCL Fast Act Midget Fus 600V	10
81917	10A UL MCL Fast Act Midget Fus 600V	10
81919	15A UL MCL Fast Act Midget Fus 600V	10
81920	20A UL MCL Fast Act Midget Fus 600V	10
81627	25A UL MCL Fast Act Midget Fus 600V	10
81922	30A UL MCL Fast Act Midget Fus 600V	10

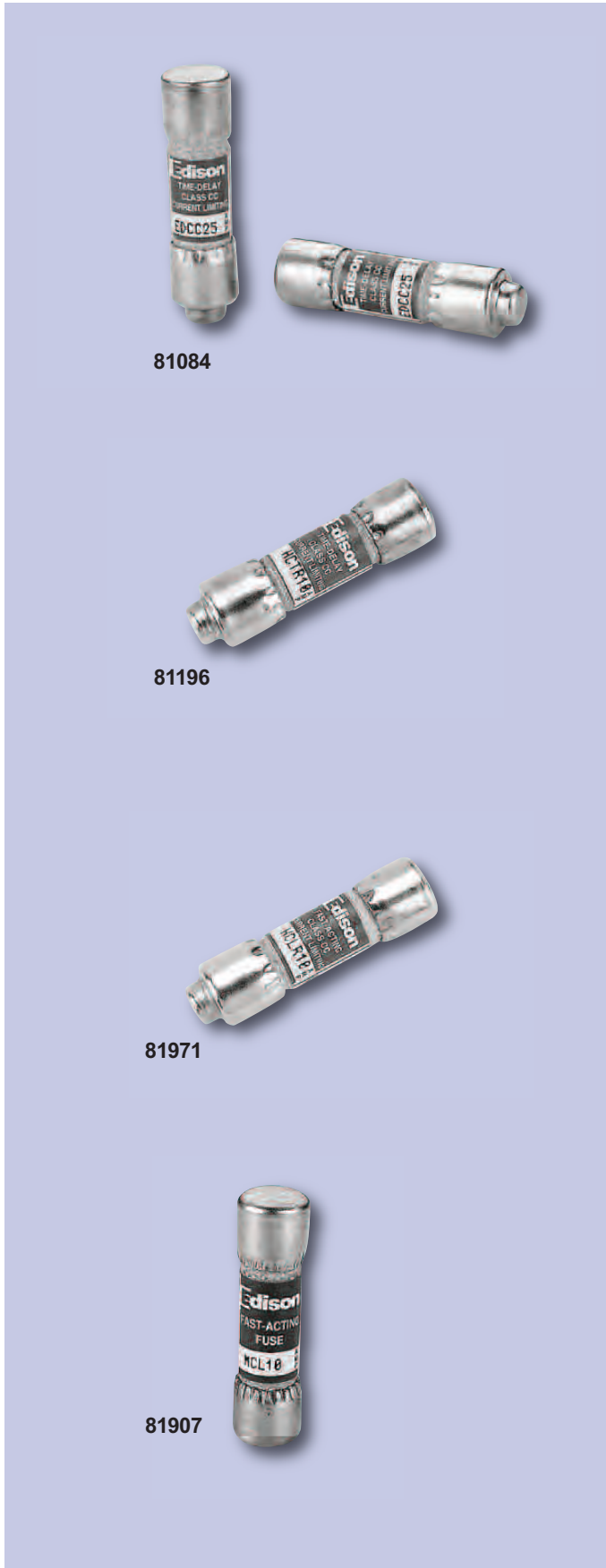



T Edison Base Plug Fuses - Dual Element, Time Delay

UL Fuses: General Purpose

MARS NO.	DESCRIPTION	MARS PACK
81334	1 1/4AT PLG Fuse Dual Element TD 125V	4
81337	2AT PLG Fuse Dual Element TD 125V	4
81344	2 1/2AT PLG Fuse Dual Element TD 125V	4
81338	3 2/10AT PLG Fuse Dual Element TD 125V	4
81339	4AT PLG Fuse Dual Element TD 125V	4
81340	5AT PLG Fuse Dual Element TD 125V	4
81341	6 1/4AT PLG Fuse Dual Element TD 125V	4
81342	8AT PLG Fuse Dual Element TD 125V	4
81343	10AT PLG Fuse Dual Element TD 125V	4
81660	15AT PLG Fuse Dual Element TD 125V	4
81661	20AT PLG Fuse Dual Element TD 125V	4
81662	30AT PLG Fuse Dual Element TD 125V	4

TL Edison Base Plug Fuses - Time Delay

UL Fuses: General Purpose

MARS NO.	DESCRIPTION	MARS PACK
81346	15A Time Dly Base Plg FS TL 125V	4
81347	20A Time Dly Base Plg FS TL 125V	4
81348	25A Time Dly Base Plg FS TL 125V	4
81349	30A Time Dly Base Plg FS TL 125V	4

TC and P Edison Base Plug Fuses - Dual Element, Time Delay

UL Fuses: General Purpose

MARS NO.	DESCRIPTION	MARS PACK
81350	15A Dual Element TimeDly TYP TC 125V	4
81370	15A Dual Element TimeDly TYP TC 125V	4
81351	20A Dual Element TimeDly TYP TC 125V	4
81352	25A Dual Element TimeDly TYP TC 125V	4
81353	30A Dual Element TimeDly TYP TC 125V	4

GDA Fast Acting Ceramic Tube Small Dimension (Electronic) Fuses

5 x 20mm — IEC Standards High-Breaking Capacity Fuses UL Fuses: General Purpose

MARS NO.	DESCRIPTION	MARS PACK
81168	630mA Fast Acting High Break GDA 250V	4

GDB Fast Acting Glass Tube Small Dimension (Electronic) Fuses

5 x 20mm — IEC Standards Low Breaking Capacity Fuses UL Fuses: General Purpose

MARS NO.	DESCRIPTION	MARS PACK
81171	630mA Fast Acting Low Break GDB 250V	5
81169	3.15A Fast Acting Low Break GDB 250V	5
81170	4A Fast Acting Low Break GDB 250V	5



81334



81346



81350



81168



81171

Edison Fuses

MARS SERIES **810**



SERVICE & INSTALLATION

KON/KOS Fast Acting - Class H & K5

“One Time” UL Fuses: General Purpose

MARS NO.	DESCRIPTION	MARS PACK
81624	1A UL CLASS K5 Fast Act KON 250V	10
81210	10A UL CLASS K5 Fast Act KON 250V	10
81212	15A UL CLASS K5 Fast Act KON 250V	10
81213	20A UL CLASS K5 Fast Act KON 250V	10
81214	25A UL CLASS K5 Fast Act KON 250V	10
81215	30A UL CLASS K5 Fast Act KON 250V	10
81216	35A UL CLASS K5 Fast Act KON 250V	10
81217	40A UL CLASS K5 Fast Act KON 250V	10
81218	45A UL CLASS K5 Fast Act KON 250V	10
81219	50A UL CLASS K5 Fast Act KON 250V	10
81220	60A UL CLASS K5 Fast Act KON 250V	10
81221	70A UL CLASS H Fast Act KON 250V	5
81625	80A UL CLASS H Fast Act KON 250V	5
81224	100A UL CLASS H Fast Act KON 250V	5
81626	5A UL CLASS H Fast Act KOS 600V	10
81249	10A UL CLASS H Fast Act KOS 600V	10
81251	15A UL CLASS K5 Fast Act KOS 600V	10
81252	20A UL CLASS K5 Fast Act KOS 600V	10
81253	25A UL CLASS K5 Fast Act KOS 600V	10
81254	30A UL CLASS K5 Fast Act KOS 600V	10
81255	35A UL CLASS K5 Fast Act KOS 600V	10
81256	40A UL CLASS K5 Fast Act KOS 600V	10
81259	60A UL CLASS K5 Fast Act KOS 600V	10
81264	100A UL CLASS H Fast Act KOS 600V	5

S Rejection Base Plug Fuses - Dual Element, Time Delay

UL Fuses: General Purpose

MARS NO.	DESCRIPTION	MARS PACK
81307	1-1/4AS Reject Base Dual Element TD 125V	4
81308	1-6/10AS Reject Base Dual Element TD 125V	4
81311	2AS Reject Base Dual Element TD 125V	4
81313	2-1/2AS Reject Base Dual Element TD 125V	4
81315	3AS Reject Base Dual Element TD 125V	4
81316	3-2/10AS Reject Base Dual Element TD 125V	4
81318	4AS Reject Base Dual Element TD 125V	4
81320	5AS Reject Base Dual Element TD 125V	4
81323	6-1/4AS Reject Base Dual Element TD 125V	4
81325	8AS Reject Base Dual Element TD 125V	4
81326	9AS Reject Base Dual Element TD 125V	4
81327	10AS Reject Base Dual Element TD 125V	4
81328	12AS Reject Base Dual Element TD 125V	4
81658	15AS Reject Base Dual Element TD 125V	4

SL Rejection Base Plug Fuses - Time Delay

UL Fuses: General Purpose

MARS NO.	DESCRIPTION	MARS PACK
81330	15A Time Dly Base Plg FS SL 125V	4
81331	20A Time Dly Base Plg FS SL 125V	4
81332	25A Time Dly Base Plg FS SL 125V	4
81333	30A Time Dly Base Plg FS SL 125V	4

SA Rejection Base Fuse Adapter

UL Fuses: General Purpose

MARS NO.	DESCRIPTION	MARS PACK
81375	2-1/2ASA Reject Base Fuse Adapter	4
81376	3-2/10ASA Reject Base Fuse Adapter	4
81379	6-1/4ASA Reject Base Fuse Adapter	4
81382	15ASA Reject Base Fuse Adapter	4
81383	20ASA Reject Base Fuse Adapter	4
81384	30ASA Reject Base Fuse Adapter	4





ABC Small Dimension (Electronic) Fuses

1/4" x 1 1/4" Fast-Acting Fuses UL Fuses:
General Purpose

MARS NO.	DESCRIPTION	MARS PACK
81402	1.5A ABC Sm Dim Fast Act 250V	5
81403	1/2A ABC Sm Dim Fast Act 250V	5
81404	1A ABC Sm Dim Fast Act 250V	5
81405	2A ABC Sm Dim Fast Act 250V	5
81406	2.5A ABC Sm Dim Fast Act 250V	5
81407	3A ABC Sm Dim Fast Act 250V	5
81408	4A ABC Sm Dim Fast Act 250V	5
81409	5A ABC Sm Dim Fast Act 250V	5
81410	6A ABC Sm Dim Fast Act 250V	5
81411	7A ABC Sm Dim Fast Act 250V	5
81412	8A ABC Sm Dim Fast Act 250V	5
81413	10A ABC Sm Dim Fast Act 250V	5
81414	12A ABC Sm Dim Fast Act 250V	5
81415	15A ABC Sm Dim Fast Act 250V	5
81416	20A ABC Sm Dim Fast Act 250V	5
81417	25A ABC Sm Dim Fast Act 125V	5
81418	30A ABC Sm Dim Fast Act 125V	5

AGC Small Dimension (Electronic) Fuses

1/4" x 1 1/4" Fast-Acting Fuses UL Fuses:
General Purpose

MARS NO.	DESCRIPTION	MARS PACK
81070	1/16AAGC Sm Dim Glass Fast Act 250V	5
81448	1/10AAGC Sm Dim Glass Fast Act 250V	5
81450	1/4AAGC Sm Dim Glass Fast Act 250V	5
81453	1/2AAGC Sm Dim Glass Fast Act 250V	5
81470	2/10AAGC Sm Dim Glass Fast Act 250V	5
81451	3/10AAGC Sm Dim Glass Fast Act 250V	5
81455	3/4AAGC Sm Dim Glass Fast Act 250V	5
81456	1AAGC Sm Dim Glass Fast Act 250V	5
81457	1-1/4AAGC Sm Dim Glass Fast Act 250V	5
81458	1-1/2AAGC Sm Dim Glass Fast Act 250V	5
81460	2AAGC Sm Dim Glass Fast Act 250V	5
81461	2-1/2AAGC Sm Dim Glass Fast Act 250V	5
81462	3AAGC Sm Dim Glass Fast Act 250V	5
81459	3-2/10AAGC Sm Dim Glass Fast Act 250V	5
81071	3.5AAGC Sm Dim Glass Fast Act 250V	5
81463	4AAGC Sm Dim Glass Fast Act 250V	5
81464	5AAGC Sm Dim Glass Fast Act 250V	5
81465	6AAGC Sm Dim Glass Fast Act 250V	5
81072	7AAGC Sm Dim Glass Fast Act 250V	5
81466	7-1/2AAGC Sm Dim Glass Fast Act 250V	5
81467	8AAGC Sm Dim Glass Fast Act 250V	5
81468	10AAGC Sm Dim Glass Fast Act 250V	5
81474	12AAGC Sm Dim Glass Fast Act 250V	5
81469	15AAGC Sm Dim Glass Fast Act 32V	5
81471	20AAGC Sm Dim Glass Fast Act 32V	5
81472	25AAGC Sm Dim Glass Fast Act 32V	5
81473	30AAGC Sm Dim Glass Fast Act 32V	5

AGX Small Dimension (Electronic) Fuses

1/4" x 1" Fast-Acting Fuses UL Fuses:
General Purpose

MARS NO.	DESCRIPTION	MARS PACK
81484	1/2AAGX Sm Dim Glass Fast Act 250V	5
81878	4/10AAGX Sm Dim Glass Fast Act 250V	5
81486	1AAGX Sm Dim Glass Fast Act 250V	5
81488	2AAGX Sm Dim Glass Fast Act 250V	5
81877	3AAGX Sm Dim Glass Fast Act 250V	5
81491	5AAGX Sm Dim Glass Fast Act 250V	5



Edison Fuses

MARS SERIES **810**



SERVICE & INSTALLATION

GDC Time Delay Glass Tube Small Dimension (Electronics) Fuses

5 x 20mm — IEC Standards Low Breaking Capacity Fuses UL Fuses: General Purpose

MARS NO.	DESCRIPTION	MARS PACK
81172	2A Time Delay Low Break GDC 250V	5
81173	3.15A Time Delay Low Break GDC 250V	5
81174	5A Time Delay Low Break GDC 250V	5
81175	FUSE Glass 6.3a 250V	5

GMA Fast Acting, Glass Fuses, Small Dimension (Electronic) Fuses

5 x 20mm — N. American Standards, Fast Acting UL Fuses: General Purpose

MARS NO.	DESCRIPTION	MARS PACK
81879	.5A GMA Glass tube Fast Act fus 250V	5
81181	1A GMA Glass tube Fast Act fus 250V	5
81179	1.25A GMA Glass tube Fast Act fus 250V	5
81881	2A GMA Glass tube Fast Act fus 250V	5
81182	3.15A GMA Glass tube Fast Act fus 125V	5
81183	3A GMA Glass tube Fast Act fus 250V	5
81184	4A GMA Glass tube Fast Act fus 125V	5
81185	5A GMA Glass tube Fast Act fus 125V	5
81882	10A GMA Glass tube Fast Act fus 125V	5

GLR Fast Acting Non Rejecting

Florescent Light

MARS NO.	DESCRIPTION	MARS PACK
81886	1-1/2A Fast Act Non Reject 300V	5
81887	1-6/10A Fast Act Non Reject 300V	5
81176	1A Fast Act Non Reject 300V	5
81177	3A Fast Act Non Reject 300V	5
81178	5A Fast Act Non Reject 300V	5
81891	10A Fast Act Non Reject 300V	5
81890	15A Fast Act Non Reject 300V	5

GLQ Fast Acting Size Rejecting

Florescent Light

MARS NO.	DESCRIPTION	MARS PACK
81980	3A GLQ Fast Act Size Reject 300V	5

GMQ Time Delay Fuses, Size Rejecting

Florescent Light

MARS NO.	DESCRIPTION	MARS PACK
81188	8/10A GLQ Time Dly Size Reject 300V	5
81186	3A GLQ Time Dly Size Reject 300V	5
81880	3-2/10A GLQ Time Dly Size Reject 300V	5
81884	4A GLQ Time Dly Size Reject 300V	5
81187	5A GLQ Time Dly Size Reject 300V	5

GMF Time delay, Non Rejecting

Florescent Light

MARS NO.	DESCRIPTION	MARS PACK
81888	3-2/10A Time Delay Non Reject 300V	5

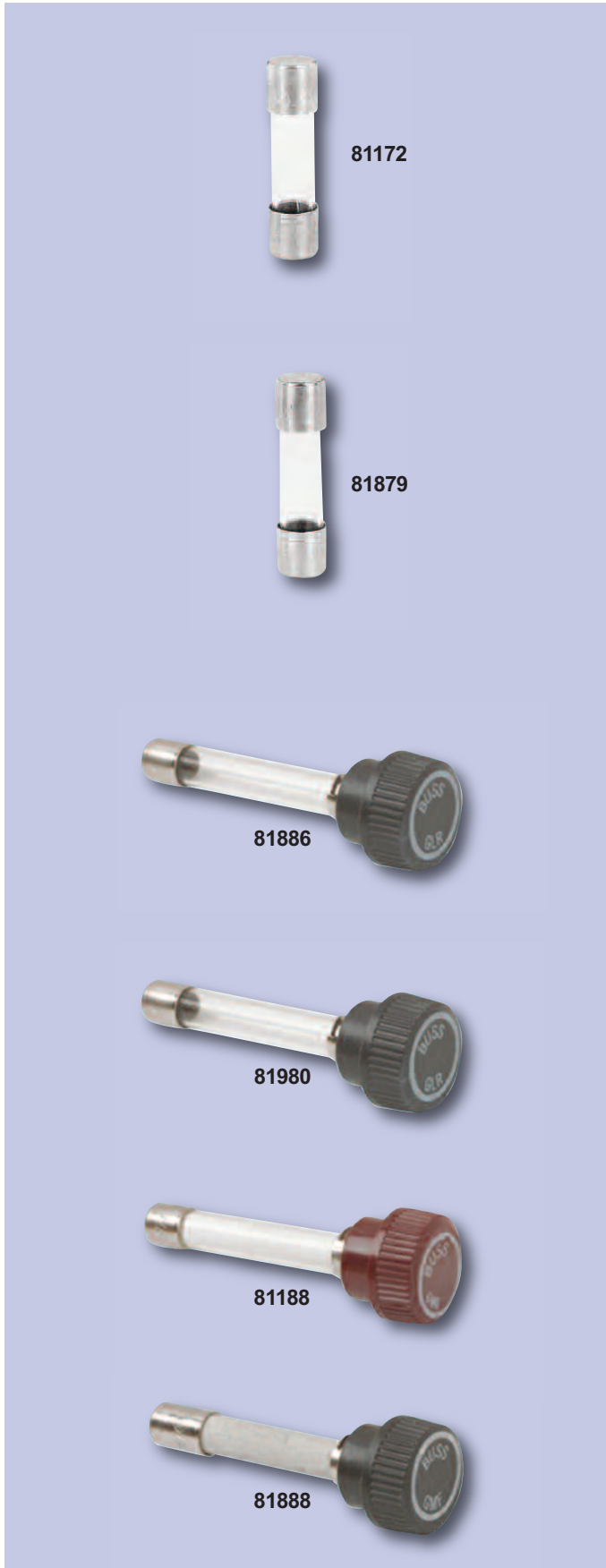



MDA Small Dimension (Electronic) Ceramic Fuses, 1/4" x 1-1/4"

Time-Delay UL Fuses: General Purpose

MARS NO.	DESCRIPTION	MARS PACK
81439	1A Ceramic Fuse Time Dly 250V	10
81629	2A Ceramic Fuse Time Dly 250V	10
81630	4A Ceramic Fuse Time Dly 250V	10
81442	5A Ceramic Fuse Time Dly 250V	5
81445	15A Ceramic Fuse Time Dly 250V	5
81444	20A Ceramic Fuse Time Dly 250V	5

MDL Small Dimension (Electronic) Fuses

1/4" x 1-1/4" Time-Delay Fuses UL Fuses: General Purpose

MARS NO.	DESCRIPTION	MARS PACK
81631	1/2A Glass Fuse Time Dly 250V	5
81635	3/10A Glass Fuse Time Dly 250V	5
81502	1A Glass Fuse Time Dly 250V	10
81505	1-1/2A Glass Fuse Time Dly 250V	10
81507	2A Glass Fuse Time Dly 250V	10
81508	2-1/2A Glass Fuse Time Dly 250V	10
81510	3A Glass Fuse Time Dly 250V	10
81512	4A Glass Fuse Time Dly 250V	5
81513	5A Glass Fuse Time Dly 250V	5
81514	7A Glass Fuse Time Dly 250V	5
81517	8A Glass Fuse Time Dly 250V	5
81518	10A Glass Fuse Time Dly 250V	5
81519	15A Glass Fuse Time Dly 250V	5
81633	20A Glass Fuse Time Dly 250V	5
81643	30A Glass Fuse Time Dly 250V	5

ATM Automotive Blade Type Fuse - Fast Acting UL Fuses

General Purpose Zinc ATM Fuses are Silver Plated

MARS NO.	DESCRIPTION	MARS PACK
81354	10A ATM Auto BLADE-TYPE, Red 32V DC	1

ATC Automotive Blade Type Fuse - Fast Acting UL Fuses

General Purpose Plastic Housing with Zinc Fuse Element

MARS NO.	DESCRIPTION	MARS PACK
81073	1AATC Auto BLADE-TYPE, Black 32V DC	5
81074	2AATC Auto BLADE-TYPE, Gray 32V DC	5
81230	3AATC Auto BLADE-TYPE, Violet 32V DC	5
81232	4AATC Auto BLADE-TYPE, Pink 32V DC	5
81231	5AATC Auto BLADE-TYPE, Tan 32V DC	5
81233	7.5AATC Auto BLADE-TYPE, Brown 32V DC	5
81234	10AATC Auto BLADE-TYPE, Red 32V DC	5
81235	15AATC Auto BLADE-TYPE, Blue 32V DC	5
81236	20AATC Auto BLADE-TYPE, Yellow 32V DC	5
81237	25AATC Auto BLADE-TYPE, Clear 32V DC	5
81238	30AATC Auto BLADE-TYPE, Green 32V DC	5



81439



81631

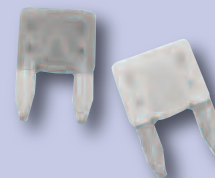

81354



81073

Edison Fuse Blocks

MARS SERIES **810**



SERVICE & INSTALLATION

2 Pole, Supplementary Fuse Block, Type M 600V

MARS NO.	DESCRIPTION	MARS PACK
81062	30A 2P Buss Fuseblk Scrw QC, BM6032SQBS	8
81066	30A 2P Buss Fseblk Prss Plt QC, BM6032PQ	10

3 Pole, Supplementary Fuse Block, Type M 600V

MARS NO.	DESCRIPTION	MARS PACK
81063	30A 3P BUSS FUSEBLK SCRW QC, BM6033SQ	6
81067	30A 3P BUSS FSEBLK PRSS PLT QC, BM6033PQ	10

Power Distribution & Terminal Blocks

MARS NO.	DESCRIPTION	MARS PACK
81090	1 Pole 600V Power Terminal Block, 16220-1	48
81091	2 Pole 600V Power Terminal Block, 16220-2	24
81092	3 Pole 600V Power Terminal Block, 16220-3	24

BG and G Series Fuse Blocks - G Series Fuses (SEC)

MARS NO.	DESCRIPTION	MARS PACK
81075	15A 3P 600V Screw w/QC, Class G, BG3013SQ	1
81167	30A 3P 480V Box Lug w/Clip G30060-3CR	1
81166	60A 3P 600V Box Lug w/clip, G30060-3C	1

Fuse Pullers

MARS NO.	DESCRIPTION	MARS PACK
81165	Class T Fuses, 0 – 60A, 300/600V for dia 13/32" to 13/16"	1
81098	0 – 60A, 250V 0 – 30A, 600V, for dia 13/32" to 13/16"	1
81099	70 – 200A, 250V 35 – 200A, 600V, for dia 1" to 1 3/4"	1

Panel-Mount and In-Line Fuse Holders Standard Fuse Holders With Screw

Type Knob: For use with 13/32" x 1 5/16" to 1 1/2" fuses

MARS NO.	DESCRIPTION	MARS PACK
81987	HPF-EE, 15A 480V (Sec) 0-15, 13/32" X 1 3/8" Fuses	10
81989	HPF-C Buss Fuseholder	10

Standard Fuseholders

For use with 1/4" x 1-1/4" fuses (Edison type ABC, AGC, MDL, MDA etc.)

MARS NO.	DESCRIPTION	MARS PACK
81991	HKP-HH, 15A 250V with 1/4" QC Terminal	10





1 Pole, Class H/K5 Fuse Block, 250V

For Use With KON, ERN, PONC, and CDNC Fuses

MARS NO.	DESCRIPTION	MARS PACK
81011	1/10 - 30 Amps, Box Lug W/Clip and Reinforced Spring, H25030-1CR-BN	1
81012	1/10 - 30 Amps, Screw W/Clip and Reinforced Spring, H25030-1Sr-Bn	1
81116	31 - 60 Amps, Box Lug W/Clip and Reinforced Spring H25060-1CR-BN	1

2 Pole, Class H/K5 Fuse Block, 250V

For Use With KON, ERN, PONC, and CDNC Fuses

MARS NO.	DESCRIPTION	MARS PACK
81117	1/10 - 30 Amps, Box Lug W/Clip and Reinforced Spring, H25030-2CR-BN	1

3 Pole, Class H/K5 Fuse Block, 250V

For Use With KON, ERN, PONC, and CDNC Fuses

MARS NO.	DESCRIPTION	MARS PACK
81018	1/10 - 30 Amps, Box Lug w/ Clip and Reinforced Spring, H25030-3CR-BN	1

1 Pole, Class H/K5 Fuse Block, 600V

For Use With KOS, ERS, and CDSC Fuses

MARS NO.	DESCRIPTION	MARS PACK
81031	1/10 - 30 Amps, Box lug w/ Clip and Reinforced Spring, H60030-1CR-BN	1
81130	1/10 - 30 Amps, Screw, H60030-1S	1

2 Pole, Class H/K5 Fuse Block, 600V

For Use With KOS, ERS, and CDSC Fuses

MARS NO.	DESCRIPTION	MARS PACK
81433	1/10 - 30 Amps, Screw, H60030-2S	1

Type M Supplementary Fuseblocks

For use with any 13/32"x1 1/2" Fuses (Bussmann KTK, FNQ, FNM, BAF, BAN, and AGU) 1 Pole, Supplementary Fuse Block, Type M 600V

MARS NO.	DESCRIPTION	MARS PACK
81061	30A 1P Buss Fuseblk Scrw QC, BM6031SQ	10
81069	30A 1P Buss Fuseblock Bx Lug, BM6031B	10
81065	30A 1P Buss Fseblk Prss Plt QC, BM6031PQ	10

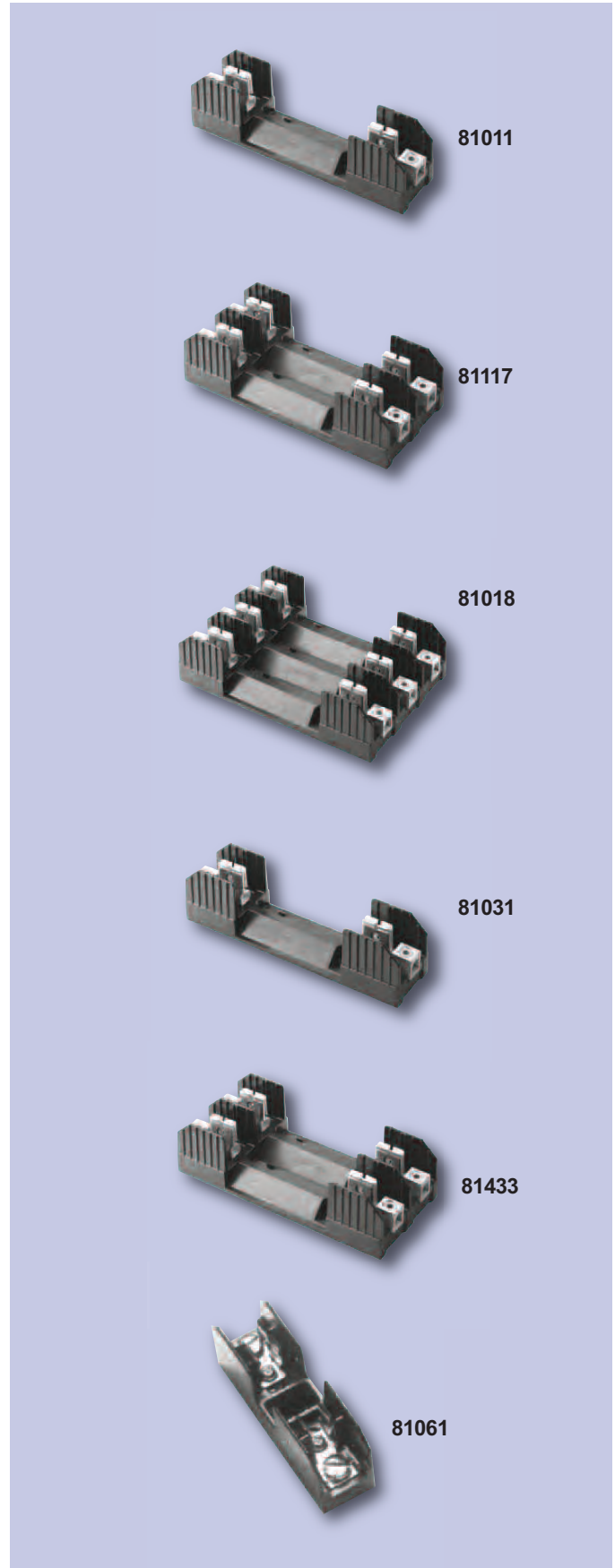

Edison Fuse Blocks

MARS SERIES **810**



Universal In-Line Fuseholder

For use with 1/4" x 7/8" to 1-1/4" fuses

MARS NO.	DESCRIPTION	MARS PACK
81993	HRK, 15A 32V 1/4" dia fuses of different lengths	10

In-Line Fuseholders For 13/32" x 1-1/2" Fuses

MOL MEN, MEQ and MCL (1/10 -30A)

MARS NO.	DESCRIPTION	MARS PACK
81997	HEB-AA 30A 1P 600V Buss Fuseholder	10

Fuse Reducers for Class H & K

Dimension Fuses KON, ERN, PONC, CDNC KOS, ERS, CDSC

MARS NO.	DESCRIPTION	MARS PACK
81975	250V, 30A, Buss Fuse Reducer	1

HLQ Fuseholder Use with: GLQ and GMQ

MARS NO.	DESCRIPTION	MARS PACK
81607	In-Line Fuse Holder HLQ-3 2/10	10
81606	Fuse Holder 16-wire, 16A	10

Class R Fuseblocks

(250V ECNR, LENRK, and NCLR & 600V ECSR, LESRK, and SCLR) Catalog Data Terminal Type (Suffix No.) Dimensions

MARS NO.	DESCRIPTION	MARS PACK
81675	60A 2P Box Lug 250V Fuse Block R25060-2CR	1
81655	30A 3P Box Lug 250V Fuse Block R25030-3CR	1
81657	100A 3P Box Lug 600V Fuse Block R60100-3CR	1
81676	FUSE BLOCK 60-AMP, 250VAC	1

Box Cover Units for Plug Fuses

Plug-Fuse Box Cover Units provide a simple inexpensive way to protect small motors with Edison dual-element type "T" or type "TL" plug fuses.

MARS NO.	DESCRIPTION	MARS PACK
81793	2-1/4" Handy Single Fuse holder 125V 15A for Plg Fuse w/Rcptcl, Max Motor Size 1/2HP SRU	1
81795*	2-1/4" Handy Single Fuse holder 125V 15A for Plg Fuse w/Rcptcl, Control Switch, Max Motor Size 1/2HP SSU (Do not use on DC)	1

*Switch turns power to fused load OFF or ON

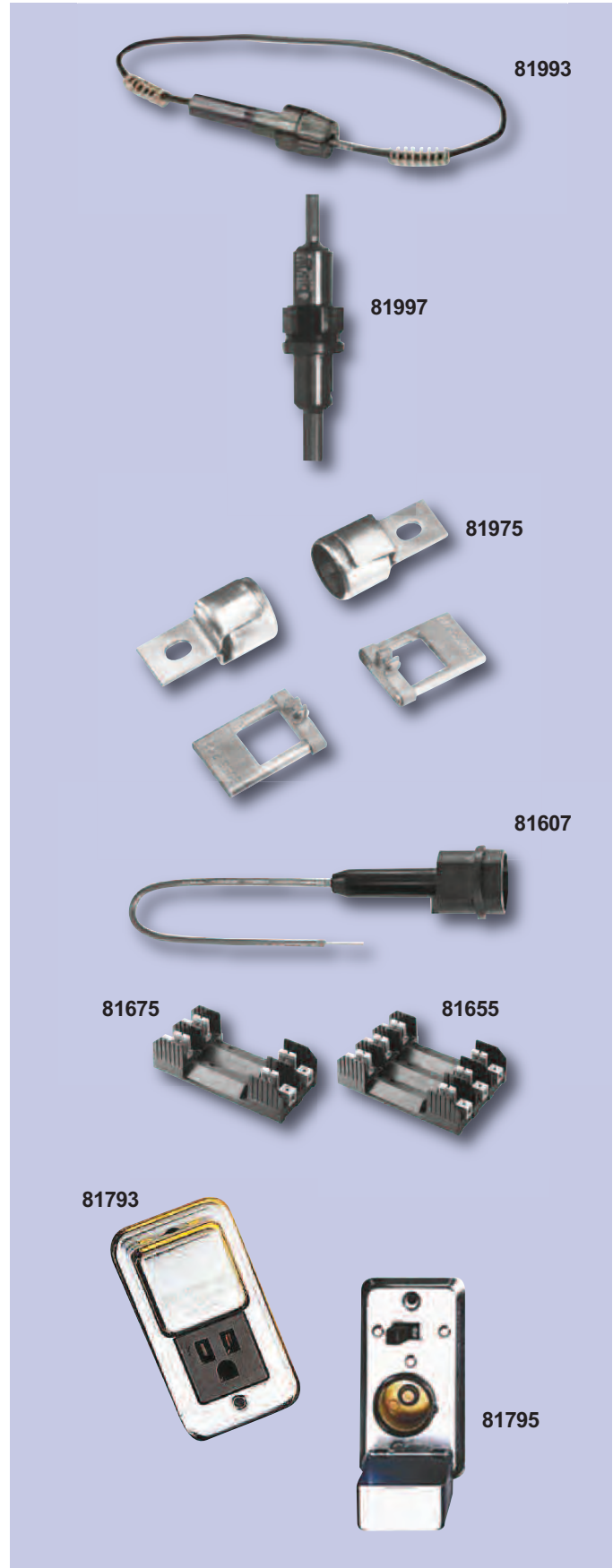



Fuses With A Resealable Plastic Pouch

MARS NO.	DESCRIPTION	MARS PACK
08569	3 Amp Standard Size Plastic, 25/pk	1
08570	5 Amp Standard Size Plastic, 25/pk	1
08571	Assorted Fuses, 25/pk	1

Fuses & Fuse Holders

Zebra Instruments offers a 4 pack Medium Duty (15A) standard size plastic fuses and fuse holder. This allows you to replace (or install) fuse protection for transformer outputs (and other devices) in HVAC systems .

MARS NO.	DESCRIPTION	MARS PACK
08568	4 kits – Medium duty 15Amp Standard Size Plastic	1



Wiring Devices

Toggle Switches With Ground

MARS NO.	DESCRIPTION	MARS PACK	CASE QTY.
84712	15a -120V, 1P, silent, brown (bulk)	10	100
84800	15a -120V, 1P, silent, ivory (bulk)	10	100
84706	15a -120/277V, 1P, silent, ivory (bulk)	10	100
84727	20a -120/277V, 1P, silent, brown (bulk)	10	100
84707	20a -120/277V, 1P, silent, ivory (bulk)	10	100
84708	15a -120/277V, 2P, silent, ivory (bulk)	10	100
84709	20a -120/277V, 2P, silent, ivory (bulk)	10	100
84799	Combo switch/receptacle ivory (bulk) switch 15a-120/277V, 1P receptacle 15a-125V, 2P, 3W	10	100
84732	Tamper resistant smartlock pro combo switch/receptacle, ivory, 15a – 125V	10	100

Toggle Switches Without Ground

MARS NO.	DESCRIPTION	MARS PACK	CASE QTY.
84798	15a -120V, 1P, silent, ivory (bulk)	10	100
84726	15a -120/277V, 1P, switch w/pilot light (card)	1	100

Metal Bat Handle Switches - Screw Terminals 10a-250V, 15a-125V, 3/4 HP 120/240

MARS NO.	DESCRIPTION	MARS PACK
84760	SPST on off	1

Straight Blade Receptacles With Ground

MARS NO.	DESCRIPTION	MARS PACK	CASE QTY.
84721	Single, ivory, 20a, 125V, 2P, 3W (bulk)	10	100
84723	Single, ivory, 20a, 250V, 2P, 3W (bulk)	10	100
84746	Single, brn, 20a, 250V, 2P, 3W (bulk)	10	100
84715	Duplex, ivory, 15a, 125V, 2P, 3W (bulk)	10	100
84748	Duplex, brn, 15a, 125V, 2P, 3W (bulk)	10	100
84797	Dup, ivory, EZ wire/screw, 15a, 125V, (bulk)	10	100
84716	Dup, ivory, 20a, 125V, 2P, 3W (bulk)	10	100
84756	Dup, brn, 20a, 125V, 2P, 3W (bulk)	10	100

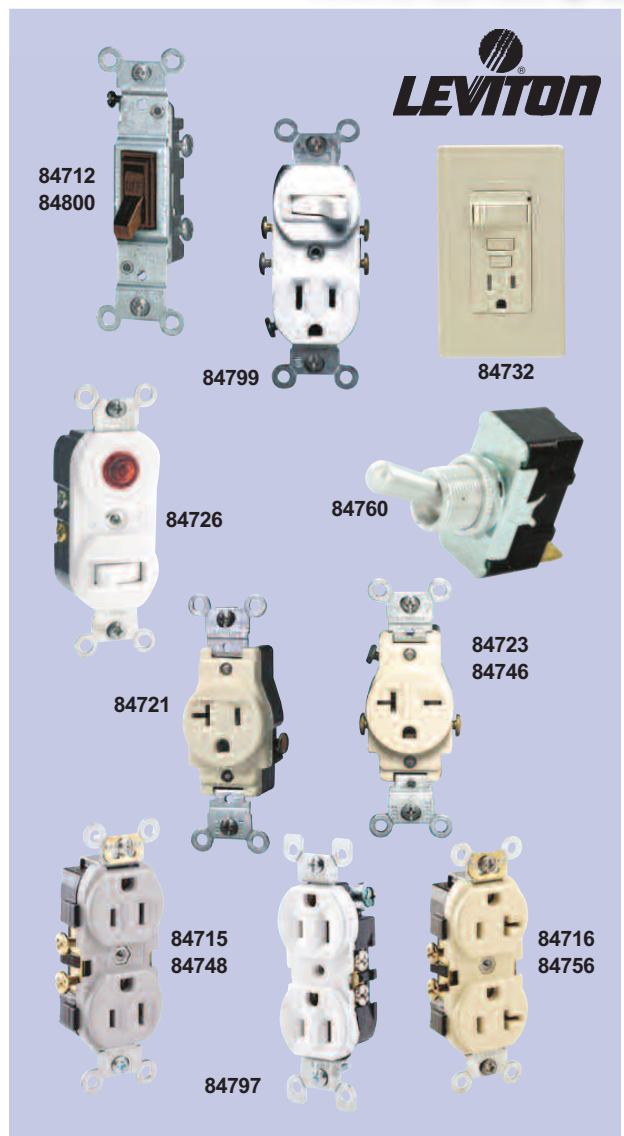

SERVICE & INSTALLATION

Wiring Devices

MARS SERIES **847**



Plugs, Connectors And Adapters

MARS NO.	DESCRIPTION	MARS PACK	CASE QTY.
84770	Grnd rubr hndl plug, 2P, 3W, 15a, 125V, black	10	100
84772	Armrd plug, 2P, 3W, 15a, 125V,	10	100
84785	Blk rubr rnd conn, 2P, 3W, 15a, 125V	10	100
84773	Blk armored conn, 2P, 3W, 15a, 125V	10	100
84786	Blk armrd conn, 2P, 3W, 15a, 125V (card)	1	10

GFCI Duplex Receptacles

MARS NO.	DESCRIPTION	MARS PACK	CASE QTY.
84767	15a, 125V, ivory, EZ wire & screw	1	10
84768	15a, 125V, ivory, EZ wire & screw (card)	1	10

Wall Plates - Plastic

MARS NO.	DESCRIPTION	MARS PACK	CASE QTY.
84751	Single toggle ivory	25	250
84809	Duplex receptacle ivory	25	100

Pullchain Lampholders - White

MARS NO.	DESCRIPTION	MARS PACK	CASE QTY.
84719	Porcelain lampholder w/ receptacle	1	50

Box Cover Units - 125V - For T Plug Fuses

MARS NO.	DESCRIPTION	MARS PACK
84793	2 1/4" handy box receptacle cover, CRU	1
84795	2 1/4" handy box switch cover, CSU	1
84794	4" square box switch cover, CSY	1
84814	4" octagon box switch cover, CSX	1



SERVICE & INSTALLATION



Wire Nut Connectors

MARS SERIES **259**

Ideal Wire Nut® Wire Connectors

IDEAL's Wire Nut® wire connectors are second to none and preferred by electricians industry wide. There are five color coded models covering every wiring combination. Some features include: positive grip design, flame retardant thermoplastic shell, longest fully seated square wire spring, threaded entry, deep skirt and wide throat entry. All Wire Nut® wire connectors are UL listed and CSA certified

Greenie® grounding connectors enjoy all the benefits of the other Wire Nut® connectors, but are designed for making ground connections with a built-in hole for copper ground hook. They have a live action, square wire spring for easy and strong connections with built-in contoured wings.

Twister® wire connectors have become widely accepted due to their unsurpassed features: ribbed cap, fluted surface, compact, swept wings, hexagonal shape, tough thermoplastic shell, live action square wire spring and deep threaded skirt entry. Nutmaster™ nutdrivers can be used to install Twister® wire connectors quickly and securely. Twister® wires are UL and CSA approved. Exceptional wire range capacity for their size, just two Twister® wire connectors handle all wire combinations. This means reduced inventories and lower costs!

Wing Nut® wire connectors were first introduced by IDEAL in 1958 and remain the most comfortable, easy to use connector on the market. The wings act as a built in wrench to provide extra leverage for secure connections...every time. Wing Nut® wire connectors handle a wide range of branch circuit and fixture wiring requirements. Just three color coded models handle UL listed wire combinations from (2) No. 18's to (1) No. 6 with (2) No. 8's, solid or stranded wire.

MARS NO.	DESCRIPTION	BOX QTY.	MFG. NO	MARS PACK	CASE QTY.
25930	Gray wire nut, 22-14 AWG	100	30-071	1	10
25931	Blue wire nut, 22-14 AWG	100	30-072	1	10
25932	Orange wire nut, 22-14 AWG	100	30-073	1	10
25933	Yellow wire nut, 18-10 AWG	100	30-074	1	10
25934	Red wire nut, 18-8 AWG	100	30-076	1	10
25935	Greenie conn., 14-10 AWG	100	30-092	1	10
25936	Tan twister conn., 22-10 AWG	100	30-341	1	10
25976	Tan twister conn., 22-10 AWG	500	30-641	1	10
25937	Gray twister conn., 16-8 AWG	50	30-342	1	20
25938	Yellow wing nut, 18-10 AWG	100	30-451	1	10
25939	Red wing nut, 18-10 AWG	100	30-452	1	10
25979	Red wing nut, bag, 18-10 AWG	500	30-652	1	10
25940	Blue wing nut, 14-6 AWG	25	30-454	1	10



SERVICE & INSTALLATION

Wire Connectors

MARS SERIES **259 & 842**



MARS Wire Connectors

MARS wire connectors are available in five color coded models: gray, blue, orange, yellow and red. Some features include a positive grip design and flame retardant thermoplastic shell. The large throat provides easy wire entrance and the deep skirt prevents shorts and grounds.

MARS NO.	DESCRIPTION	MARS PACK
25860	Gray wire connector, 300V (25/bag)	1
25880	Gray wire connector, 300V (100/bag)	1
25861	Blue wire connector, 300V (25/bag)	1
25881	Blue wire connector, 300V (100/bag)	1
25862	Orange wire connector, 600V (25/bag)	1
25882	Orange wire connector, 600V (100/bag)	1
25863	Yellow wire connector, 600V (25/bag)	1
25883	Yellow wire connector, 600V (100/bag)	1
25864	Red wire connector, 600V (25/bag)	1
25884	Red wire connector, 600V (100/bag)	1
25868	Yellow wing connector, 600V (25/bag)	1
25888	Yellow wing connector, 600V (100/bag)	1
25869	Red wing connector, 600V (25/bag)	1
25889	Red wing connector, 600V (100/bag)	1
25870	Blue wing connector, 600V (10/bag)	1
25800	Blue wing connector, 600V (50/bag)	1



25882



25878

MARS Wire Connectors - Jar

MARS NO.	DESCRIPTION	MARS PACK
25875	MARS Yellow Wire connectors, 600V, 100/Jar	1
25876	MARS Orange Wire connectors, 600V, 100/Jar	1
25877	MARS Red Wire connectors, 600V, 50/Jar	1
25878	MARS Winged Blue Wire connectors, 600V, 25/Jar	1

Wiregard Color-Coded Screw-On Wire Connectors

MARS now offers Gardner Bender wire connectors. The industry's standard screw-on connector, with high quality, performance and durability.

- UL listed, CSA approved.
- Color-coded for easy size selection.
- Makes quick, secure connections for positive continuity. Tightens without ratcheting, removable for re-use. Fluted shell surface allows for easy finger-tight connections.
- Thermoplastic shell shields against environmental extremes. Flame retardant up to 221 degrees F.
- Superior flash-over protection. High-dielectric shell features deep skirt design to prevent exposure of bare wire.
- Versatile size selection covers building wire combinations from #22 to #10 AWG.
- Complies with Federal Specification W-5-610d.

MARS NO.	MFG. NO.	MODEL/SIZE	COLOR	BOX QTY.	CASE QTY.
25950	10-001	GB-1	Gray	100 Box	10
25941	10-002	GB-2	Blue	100 Box	10
25942	10-003	GB-3	Orange	100 Box	10
25943	10-004	GB-4	Yellow	100 Box	10
25944	10-006	GB-6	Red	100 Box	10



25950



25941



25942



25944

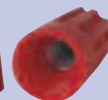

25943

GB
Gardner Bender

Stranded Copper Building Wire, 19 Strands 10-14 Ga. THHN, 16-18 Ga. TFFN, 600V, 90°C

MARS NO.	DESCRIPTION			MARS PACK
84289	16 gauge	red	100' spool	1
84292	16 gauge	black	100' spool	1
84295	16 gauge	white	100' spool	1
84301	16 gauge	blue	100' spool	1
84304	16 gauge	yellow	100' spool	1
84307	14 gauge	red	100' spool	1
84308	14 gauge	red	500' spool	1
84310	14 gauge	black	100' spool	1
84311	14 gauge	black	500' spool	1
84313	14 gauge	white	100' spool	1
84314	14 gauge	white	500' spool	1
84319	14 gauge	blue	100' spool	1

Solid Copper Building Wire, 10-14 Ga. THHN, 600V, 90°C

MARS NO.	DESCRIPTION			MARS PACK
84361	14 gauge	black	500' spool	4
84362	14 gauge	white	500' spool	4
84363	14 gauge	green	500' spool	4

Stranded Copper Building Wire, 19 Strands 10-14 Ga. THHN, 16-18 Ga. TFFN, 600V, 90°C (cont.)

MARS NO.	DESCRIPTION			MARS PACK
84322	12 gauge	red	100' spool	1
84325	12 gauge	black	100' spool	1
84328	12 gauge	white	100' spool	1
84337	10 gauge	red	100' spool	1
84340	10 gauge	black	100' spool	1
84341	10 gauge	black	500' spool	1
84343	10 gauge	white	100' spool	1
84344	10 gauge	white	500' spool	1
84346	10 gauge	green	100' spool	1
84349	10 gauge	blue	100' spool	1
84352	8 gauge	black	500' spool	1



SERVICE & INSTALLATION

Wire Products

MARS SERIES **842**



Non-Metallic Sheathed Cable - Romex Wire Cable Type NM-B 600V - 90°C

MARS NO.	DESCRIPTION	MARS PACK
84251	6 AWG, 2 conductors w/ground 125' coil	1
84253	8 AWG, 2 conductors w/ground 125' coil	1
84255	10 AWG, 2 conductors w/ground, 250' Reel, boxed	1
84257	12 AWG, 2 conductors w/ground, 250' Reel, boxed	1
84259	14 AWG, 2 conductors w/ground, 250' Reel, boxed	1

SJ Wire - 250 Foot Rolls

MARS NO.	DESCRIPTION	MARS PACK
84380	12/3 250 ft. roll	1
84381	14/3 250 ft. roll	1
84382	16/3 250 ft. roll	1

Mini-Split Installation Wire

Corra/Clad MC Cable consists of UL listed THHN soft drawn annealed solid copper conductors, cabled with fillers and wrapped with an overall solid Flexi-Rib aluminum sheath. The continuous sheath provides watertight protection and it is covered with a PVC outer jacket for outdoor use or direct burial. Cost effective, easy to strip and install. Meets all national codes and is suitable for outdoor use, under concrete, underground, and through interior walls and ceilings.

Compact 600 and Shielded Low Voltage Cables offer additional options to provide power and control to mini-split installations. Compact 600 uses a TPE jacket and is flexible, easy to strip, and is burial rated.

EZ-In™ cable is an all-purpose cable that meets code for both interior and exterior use, increasing the speed of installation and making sure the job will pass inspection. EZ-In™ Mini-Split Cable can be installed without the use of conduit and may be installed indoors and outdoors in wet locations.

Corra/Clad MC Cable: 600V, UL, NEC 330 Direct Burial

MARS NO.	DESCRIPTION	MARS PACK
84470	14/3 Solid THHN w/Ground – 50' Roll	1
84471	14/3 Solid THHN w/Ground – 250' Reel	1
84472	Liquid-tight MC Cable Connector	1

Compact 600 Cable: 600V, UL, UV Rated, Direct Burial

MARS NO.	DESCRIPTION	MARS PACK
84473	14/4 Solid THHN Compact 600 – 50' Roll	1
84474	14/4 Solid THHN Compact 600 – 250' Reel	1
84479	14/4 Stranded THHN Compact 600V – 50' Roll	1
84480	14/4 Stranded THHN Compact 600V – 250' Reel	1
84475	14/7 Stranded THHN Compact 600 – 250' Reel	1

Shielded Low Voltage Cable: 300V, NEC 725/800, ETL, CMR/CL3R

MARS NO.	DESCRIPTION	MARS PACK
84484	16/2 Stranded Shielded – 250' Reel	1
84476	18/2 Stranded BC Shielded – 50' Roll	1
84478	18/4 Stranded BC Shielded – 50' Roll	1
84482	18/2 OAS CMR/CL3R Gy – 500' Reel	1
84483	18/4 OAS CMR/CL3R Gy – 500' Reel For LG Mini-Splits	1

EZ-In™ Cable: 600V, UL, All Purpose, UV Rated, Direct Burial

MARS NO.	DESCRIPTION	MARS PACK
84486	14/4 Stranded EZ-In, 600V, 50' Roll	1
84487	14/4 Stranded EZ-In, 600V, 250' Reel	1

84251



84380



84470
84471

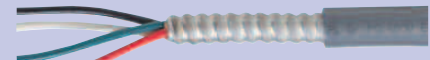

84472



84473
84474



84475



84484



84476



84478



84486
84487





Thermostat Wire

MARS SERIES **842**

MARS 18 Gauge Thermostat Cable - UL Listed

Specifications: UL type CL2. UV rated. Temp rating -20° + 60°C. Meets UL subject 13 per article 725 of the 1990 National Electric Code (NEC) for power limited circuit cable. Soft drawn bare copper, semi-rigid pvc insulation and PVC overall jacket.

MARS NO.	DESCRIPTION	LBS. MFT	MARS PACK
84201	18 AWG, 2 conductors, 500 ft. spool	15	4
84202	18 AWG, 3 conductors, 500 ft. spool	21	4
84203	18 AWG, 4 conductors, 250 ft. spool	27	4
84204	18 AWG, 5 conductors, 250 ft. spool	34	4
84205	18 AWG, 6 conductors, 250 ft. spool	40	4
84206	18 AWG, 7 conductors, 250 ft. spool	45	4
84207	18 AWG, 8 conductors, 250 ft. spool	51	4
84209	18 AWG, 10 conductors, 250 ft. spool	63	4
84210	18 AWG, 12 conductors, 250 ft. spool	74	4
84231	18 AWG, 2 conductors, 250 ft. spool	15	4
84232	18 AWG, 3 conductors, 250 ft. spool	21	4

MARS 20 Gauge Thermostat Cable - UL Listed

MARS NO.	DESCRIPTION	LBS. MFT	MARS PACK
84211	20 AWG, 2 conductors, 500 ft. spool	11	4
84212	20 AWG, 3 conductors, 500 ft. spool	15	4
84213	20 AWG, 4 conductors, 250 ft. spool	20	4
84214	20 AWG, 5 conductors, 250 ft. spool	24	4
84215	20 AWG, 6 conductors, 250 ft. spool	27	4
84217	20 AWG, 8 conductors, 250 ft. spool	35	4

Shielded Plenum T-Stat Wire - UL Listed - Type CL2P-Stranded

MARS NO.	DESCRIPTION	LBS. MFT	MARS PACK
84461	18 AWG, 2 conductors, 500 ft spool	4	4
84462	18 AWG, 3 conductors, 500 ft spool	4	4
84466	18 AWG, 8 conductors, 500 ft spool	4	4

84210



84211



SERVICE & INSTALLATION

Thermostat Wire

MARS SERIES **842**



18 Ga UL Thermostat Wire – Self Dispensing Coils

MARS thermostat wire is now available in self dispensing coil packs. These shrink wrapped coils are easier to use and more convenient to store than the traditional thermostat wire sold on spools/reels.

Features & benefits:

- Heavy duty shrink wrapped coils for durability
- No reels to bend, break, or rust
- Compact coils are easier to store – takes up less space
- Easier to handle
- Stacks better
- Easy and convenient to use

How to use:

- Simply punch hole in center of wrap.
(Do not remove wrap)
- Pull loose end of wire from center
(Wire will pull out easily)
- Snip off the required amount of wire
- Tuck loose end back into the coil for storage

MARS NO.	DESCRIPTION	MARS PACK
84401	18/2 500 ft. Coils	4
84402	18/3 500 ft. Coils	4
84403	18/4 250 ft. Coils	4
84404	18/5 250 ft. Coils	4
84405	18/6 250 ft. Coils	4
84406	18/7 250 ft. Coils	4
84407	18/8 250 ft. Coils	4

Plenum T-Stat Wire - Solid UL Listed

Temp rating (-20°C to 75°C) • UL type, CL2P

Thermoplastic jacket (2500 psi min)

Thermoplastic insulation (2000 psi min)

Can be used in overhead plenum area without conduit

MARS NO.	DESCRIPTION	MARS PACK
84241	18 AWG, 2 conductors, 500 ft. spool	4
84242	18 AWG, 3 conductors, 500 ft. spool	4
84243	18 AWG, 4 conductors, 250 ft. spool	4
84244	18 AWG, 5 conductors, 250 ft. spool	4
84245	18 AWG, 6 conductors, 250 ft. spool	4
84246	18 AWG, 8 conductors, 250 ft. spool	4

MARS NO.	DESCRIPTION	MARS PACK
84441	18 AWG, 2 conductors, 500 ft. spool	4
84443	18 AWG, 4 conductors, 500 ft. spool	4
84444	18 AWG, 6 conductors, 500 ft. spool	4

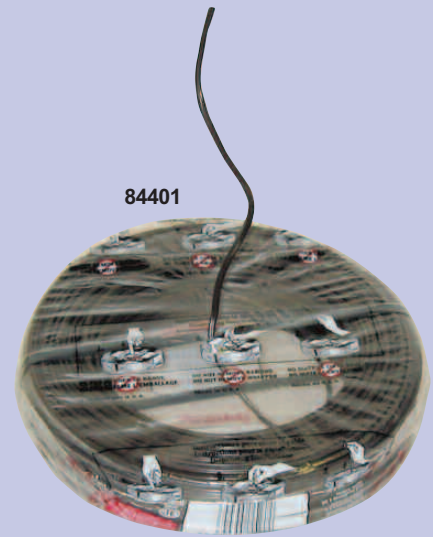

84241





BX & Flexible Cable Cutter

MARS SERIES **861 & 790**

BX & Flexible Cable Cutter

Cuts BX, MC, AC, and Liquid Tight 3/8".

Features

- High durability blade provides 2X normal wear
- Storage space for replacement blades
- 25 foot drop test
- Thumbwheel for easy blade change, no tools required
- Quick Clamp feature automatically adjusts to cable size and secures it for splitting
- Automatic release ejects cable
- Cutting depth adjustment ensures clean cuts without nicking cable

MARS NO.	DESCRIPTION	MARS PACK	CASE QTY.
86191	BX Armor Cutter, & 1/4" Length	1	5
86192	Replacement Blade for 86191, 3/pk	1	10

Hand Wire Caddy

Rugged Construction, epoxy coated to reduce chipping & peeling
Holds up to 8 reels, 7" D x 5" W, or 4 reels 7" D x 6" to 10" W

MARS NO.	DESCRIPTION	MARS PACK
86193	Wire Hand Caddy, 22-1/2" L x 13-1/2" W x 9-1/2" H	1

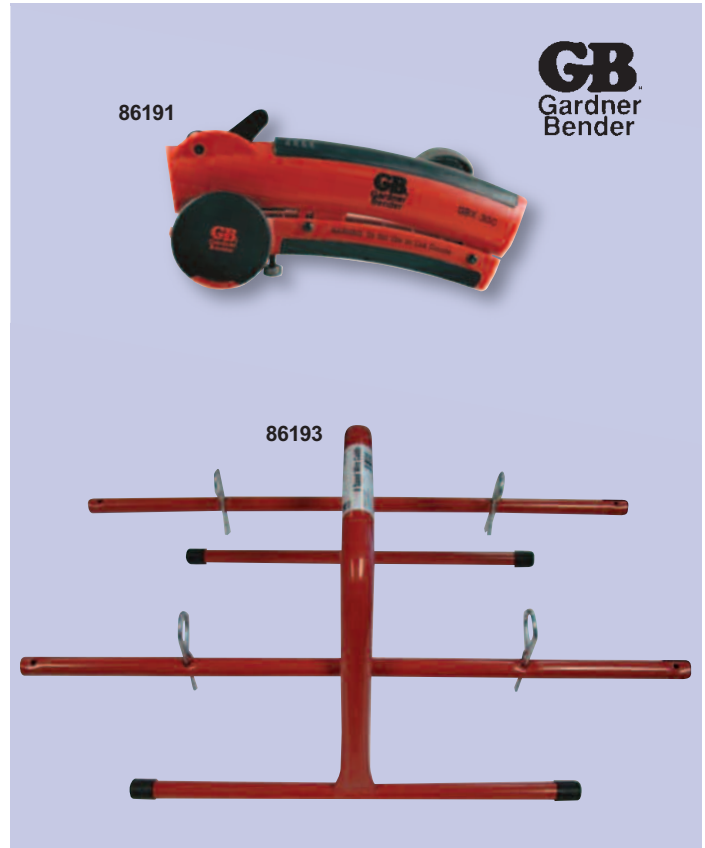

GB
Gardner
Bender

86191

86193

SERVICE & INSTALLATION



Wire Markers

MARS SERIES **256**

Adhesive Wire Markers

Wire marker dispenser measures 3" x 6" and holds 10 tape rolls at once. Rugged, sturdy case fits in your pocket. Durable long lasting tapes are excellent for wire, pipe and conduit identification.

Wire marker booklets contain 10 pages each. Plastic impregnated cloth marker resists abrasion, moisture, dirt and oil. Markers are 1-1/2" in length and can be separated into half-length sizes.

MARS NO.	DESCRIPTION	MFG. NO.	MARS PACK	CASE QTY.
25920	Wire marker dispenser, 0-9 legends	42-301	1	5
25921	Wire marker book, 0-9 legends	44-101	5	5
25922	Wire marker book, A-Z legends	44-102	5	5
25923	Wire marker book, 1-45 legends	44-103	5	5



IDEAL

25920

25923

Light Bulbs

MARS SERIES **791**



SERVICE & INSTALLATION

Appliance Bulbs - 130 Volt

MARS NO.	DESCRIPTION	MFG. NO.	CASE QTY.
79183	25W clear, intermediate screw base	25T61/2	25
79185	25W clear, intermediate base	25T8N	25
79188	40W clear, intermediate base	40T61/2	25

Pilot And Indicator Bulbs - 130 Volt

MARS NO.	DESCRIPTION	MFG. NO.	CASE QTY.
79193	7W clear, candelabra, screw base	7C7	25

Rough Service Bulbs 130 Volt

MARS supplies 130V rough service, 130V rough service shatterproof coated, and 120V long life general service light bulbs. The 130V design provides an extended life cycle of filament and increases energy savings.

MARS NO.	DESCRIPTION	MARS PACK	CASE QTY.
79171	50 watt 130V bulb	6	120
79172	75 watt 130V bulb	6	120
79173	100 watt 130V bulb	6	120

Rough Service Coated Shatterproof Bulbs 130 Volt

MARS supplies 130V rough service, 130V rough service shatterproof coated, and 120V long life general service light bulbs. The 130V design provides an extended life cycle of filament and increases energy savings.

MARS NO.	DESCRIPTION	MARS PACK	CASE QTY.
79175	75 watt 130V bulb	6	120
79176	100 watt 130V bulb	6	120

General Service Bulbs - 120 Volt

MARS NO.	DESCRIPTION	MARS PACK	CASE QTY.
79177	60 watt 120V bulb	120	120
79178	75 watt 120V bulb	120	120
79179	100 watt 120V bulb	120	120





Outlet Boxes

MARS SERIES **849**

4" Octagon Steel Boxes

MARS NO.	DESCRIPTION	MARS PACK	CASE QTY.
84931	2-1/8" D 1/2" & 3/4" K.O.	1	25
84932	1-1/2" D 1/2" K.O.	1	25

Square Steel Boxes

MARS NO.	DESCRIPTION	MARS PACK	CASE QTY.
84936	4", 2-1/2"D 1/2" & 3/4" K.O.	1	25
84937	4", 1-1/2"D 1/2" K.O.	1	25
84938	4", 1-1/2"D 1/2" & 3/4" K.O.	1	25
84939	4", 1-1/4"D 1/2" K.O.	1	25
84943	4-11/16", 2-1/8" D 1/2" & 3/4" K.O.	1	25

2-1/8" x 4" Steel Utility Boxes

MARS NO.	DESCRIPTION	MARS PACK	CASE QTY.
84947	1-1/2"D 1/2" K.O.	1	25
84948	1-7/8"D 1/2" K.O.	1	25
84949	2-1/8"D 1/2" K.O.	1	25
84950	1-7/8"D 3/4" K.O.	1	25

Steel Extension Rings

MARS NO.	DESCRIPTION	MARS PACK	CASE QTY.
84952	1-1/2"D 1/2" & 3/4" K.O. (4" sq.)	1	25
84954	1-7/8"D 1/2" K.O. (utility)	1	25

Square Steel Covers

MARS NO.	DESCRIPTION	MARS PACK	CASE QTY.
84962	4", flat blank	1	25
84963	4", 1/2" depth, single flush	1	25
84964	4", flat, 1/2" K.O. in center	1	25
84965	4", 1/2" raised, single toggle switch	1	25
84966	4", 1/2" raised, 1 duplex receptacle	1	25
84967	4", 1/2" raised, 2 toggle switch	1	25
84968	4", 1/2" raised, 1 toggle sw. & 1 dup. recept.	1	25
84969	4", 1/2" raised, 2 duplex receptacle	1	25

2-1/8" x 4" Steel Utility Box Covers

MARS NO.	DESCRIPTION	MARS PACK	CASE QTY.
84987	Duplex receptacle	1	25
84988	Toggle switch	1	25
84989	Blank	1	25
84990	Blank with 1/2" K.O. in center	1	25
84991	Single receptacle	1	25

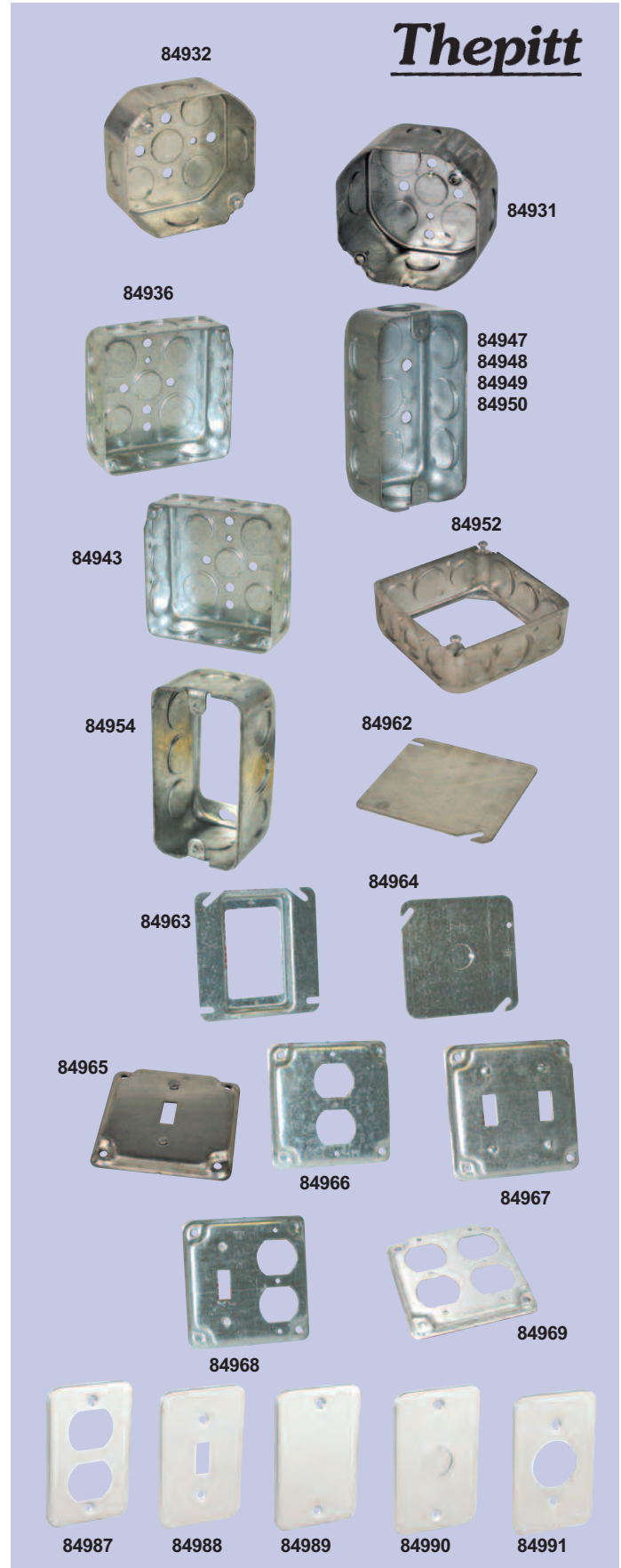

SERVICE & INSTALLATION



The largest selection of motors, components and accessories for the HVAC/R Industry

Weatherproof & PVC Outlet Boxes

MARS SERIES **849**



SERVICE & INSTALLATION

One Gang - Weatherproof Outlet Boxes

MARS NO.	DESCRIPTION	MARS PACK	CASE QTY.
85901	Three 1/2" holes with lugs	1	50
85902	Three 3/4" holes with lugs	1	50
85904	Five 1/2" holes with lugs	1	50

Two Gang - Weatherproof Outlet Boxes

MARS NO.	DESCRIPTION	MARS PACK	CASE QTY.
85910	Three 1/2" holes with lugs	1	10
85911	Three 3/4" holes with lugs	1	10

Self Closing GFCI Weatherproof Covers

MARS NO.	DESCRIPTION	MARS PACK	CASE QTY.
85932	One gang for vertical devices	1	10

Self Closing Weatherproof Covers

MARS NO.	DESCRIPTION	MARS PACK	CASE QTY.
85939	One gang vertical for single receptacle, or switch	1	50
85940	One gang for for duplex receptacle, switches or combo devices	1	50

Weatherproof Blank Covers

MARS NO.	DESCRIPTION	MARS PACK	CASE QTY.
85950	One gang for vertical devices	1	25
85951	Two gang with gasket and screws	1	10

4" Octagon Steel COVERS

MARS NO.	DESCRIPTION	MARS PACK	CASE QTY.
84980	Flat blank	1	25

Emergency Switch Cover Labels

MARS NO.	DESCRIPTION	MARS PACK	CASE QTY.
84901	Oil burner switch label; 4" x 2 1/8"	10	1
84902	Gas burner switch label; 4" x 2 1/8"	10	1

PVC Switch Boxes - Angles Nails

MARS NO.	DESCRIPTION	MARS PACK
84910	16 cubic content inches, 2 1/2"D	100

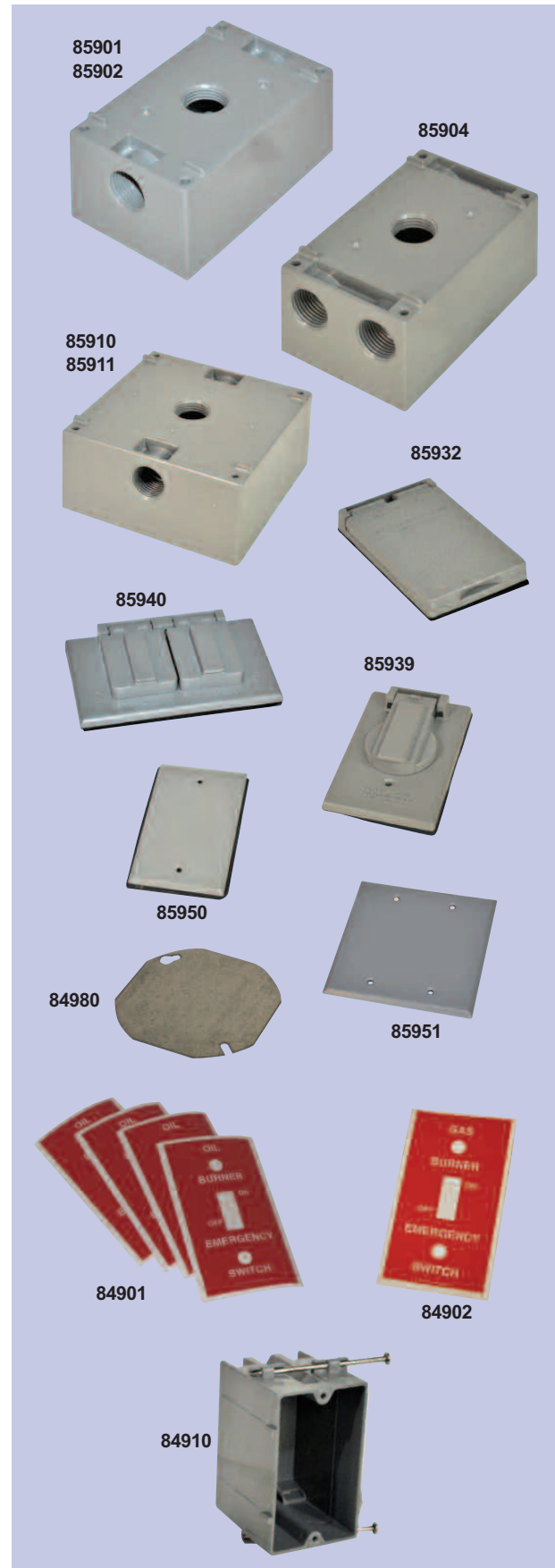



Electrical Fittings

MARS SERIES **850**

Electrical Fittings-EMT Type-Carded

MARS NO.	DESCRIPTION	CASE QTY.
85325	1/2" EMT set screw connector, 3/cd	10
85115	1/2" EMT set screw connector, bulk	50
85326	3/4" EMT set screw connector, 2/cd	5
85327	1/2" EMT set screw coupling, 2/cd	10
85329	1/2" EMT compression connector, 3/cd	10
85330	3/4" EMT compression connector, 2/cd	5
85332	1/2" EMT compression coupling, 3/cd	10
85333	3/4" EMT compression coupling, 2/cd	5
85335	1/2" EMT one-hole strap, 5/cd	10
85336	3/4" EMT one-hole strap, 4/cd	10
85302	3/4" EMT one-hole strap, bulk	100
85337	1" EMT one-hole strap, 2/cd	10
85338	1 1/4" EMT one hole strap, 4/polybag	20
85306	1/2" rigid IMC strap, bulk	100
85307	3/4" rigid IMC strap, bulk	100
85308	1" rigid IMC strap, bulk	50
85345	1/2" EMT pull elbows, 1/cd	10
85347	1/2" EMT two-hole strap, 5/cd	10
85348	3/4" EMT two-hole strap, 4/cd	10
85349	1" EMT two-hole strap, 2/cd	10

Electrical Fittings-Rigid Conduit-Carded

MARS NO.	DESCRIPTION	CASE QTY.
85355	1/2" rigid conduit offset, threaded, 2/cd	10
85356	3/4" rigid conduit offset, threaded, 1/cd	5
85359	1/2" rigid conduit locknut, 5/cd	10
85360	3/4" rigid conduit locknut, 5/cd	10
85364	3/4" x 1/2" reducing washer, 4/cd	10
85365	1" x 1/2" reducing washer, 4/cd	10
85366	1" x 3/4" reducing washer, 4/cd	10
85279	1 1/4" x 3/4" reducing washer, bulk	50
85280	1 1/4" x 1" reducing washer, bulk	50
85281	1 1/2" x 1/2" reducing washer, bulk	50
85282	1 1/2" x 3/4" reducing washer, bulk	50
85284	2" x 3/4" reducing washer, bulk	25
85374	1/2" - 1" ground clamps, 1/cd	10
85375	1/2" plastic staples, 15/cd	10
85377	1/2" KO seals, 4/cd	10
85378	3/4" KO seals, 4/cd	10

Electrical Fittings-BX/Romex/Armored-Carded

MARS NO.	DESCRIPTION	CASE QTY.
85386	1/2" arm./flex. squeeze connector, 2/cd	5
85387	3/4" arm./flex. squeeze connector, 2/cd	5
85389	3/8" arm./flex. 90° squeeze conn, 2/cd	10
85402	3/8" arm./flex. 90° squeeze conn, bulk	50
85390	1/2" arm./flex. 90° squeeze conn, 1/cd	5
85155	1/2" arm./flex. 90° squeeze conn, bulk	25
85156	3/4" arm./flex. 90° squeeze conn, bulk	10
85392	3/8" BX/Greenfield set screw conn, 4/cd	10
85393	1/2" BX/Greenfield set screw conn, 1/cd	10
85395	3/8" arm./flex. duplex connector, 1/cd	5
85175	3/8" arm./flex. duplex connector, bulk	25
85396	3/8" BX/MC/Romex connector, 3/cd	10
85403	3/8" BX/MC/Romex connector, bulk	100
85397	3/8" Romex squeeze connector, 4/cd	10
85185	3/8" Romex squeeze connector, bulk	100
85398	3/4" Romex squeeze connector, 2/cd	10
85186	3/4" Romex squeeze connector, bulk	25
85399	1" Romex squeeze connector, 2/bag	20
85187	1 1/2" Romex squeeze connector, bulk	50
85188	2" Romex squeeze connector, bulk	50



SERVICE & INSTALLATION



The largest selection of motors, components and accessories for the HVAC/R Industry

Electrical Fittings

MARS SERIES **850**



SERVICE & INSTALLATION

Liquid-Tight Flexible Metallic Fittings

MARS NO.	DESCRIPTION	MARS PACK	CASE QTY.
85000	3/8" straight metallic connector	25	250
85001	1/2" straight metallic connector	20	250
85002	3/4" straight metallic connector	10	100
85003	1" straight metallic connector	5	50
85004	3/8" 90° metallic connector	10	100
85005	1/2" 90° metallic connector	10	100
85006	3/4" 90° metallic connector	10	100
85007	1" 90° metallic connector	5	50

Liquid-Tight PVC Flexible Non-Metallic Fittings

MARS NO.	DESCRIPTION	MARS PACK	CASE QTY.
85015	3/8" straight non-metallic connector	25	250
85016	1/2" straight non-metallic connector	25	250
85017	3/4" straight non-metallic connector	10	100
85018	1" straight non-metallic connector	5	50
85019	3/8" 90° non-metallic connector	10	100
85020	1/2" 90° non-metallic connector	10	100
85021	3/4" 90° non-metallic connector	10	100
85022	1" 90° non-metallic connector	5	50

Liquid-Tight 45° PVC Connectors

Arlington's liquid-tight 45° pvc connectors are for use with non-metallic, liquid-tight conduit, type B. The 45° connector has the same smooth raceway as the 90° connector for easier pulling or pushing or wiring. These are UV rated like our other pvc fittings.

MARS NO.	DESCRIPTION	MARS PACK	CASE QTY.
85024	1/2" x 45° non-metallic connector	10	50

Liquid-Tight Screw On Connectors

This attractive one pc design allows superior liquid-tight seal & Optimum pull strength without compression nut. PVC construction produced from UV rated material for long outdoor life. Ideal for conduit assemblies & installers. "O" ring & steel locknut included.

MARS NO.	DESCRIPTION	MARS PACK	CASE QTY.
84992	1/2" Straight Screw On	25	100
84993	3/4" Straight Screw On	25	100
84994	1/2" 90 Deg Sweep Screw On	10	100
84995	3/4" 90 Deg Sweep Screw On	10	100

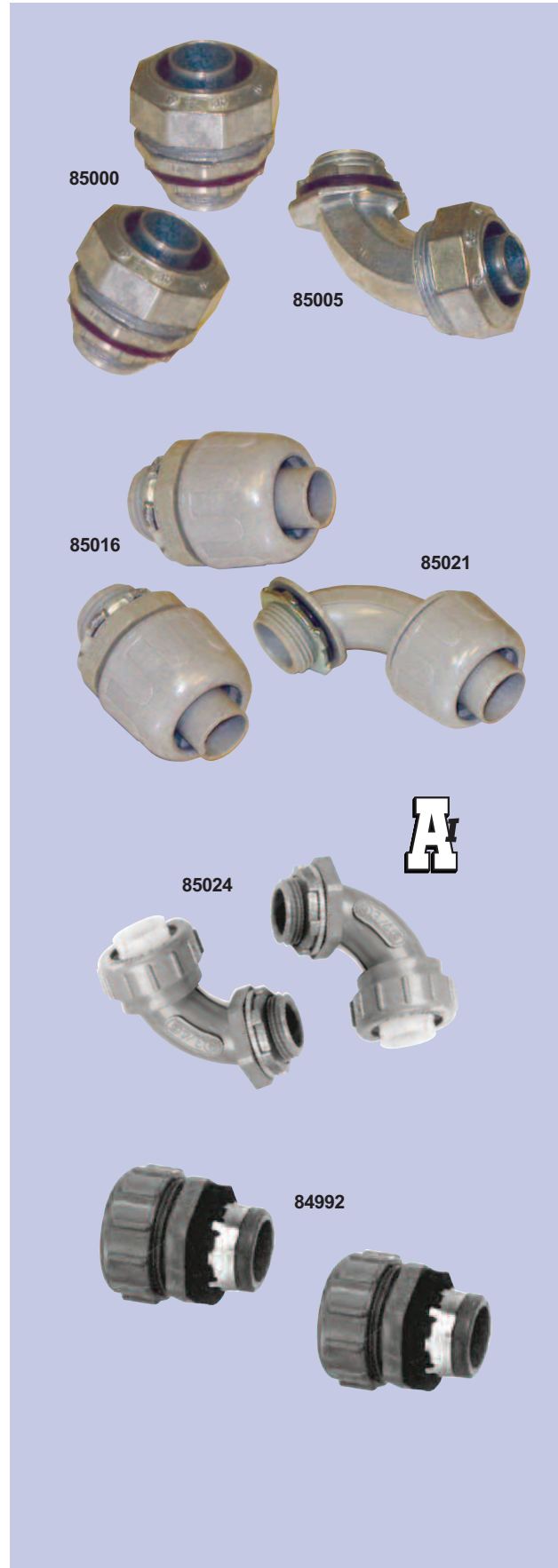



Appliance Cords & Cord Sets

MARS SERIES **846 & 847**

MARS Range And Dryer Receptacles

MARS NO.	DESCRIPTION	CASE QTY.
84700	30a-250V, surface mount dryer receptacle	10
84701	30a-250V, flush mount dryer receptacle	25
84702	50a-250V, surface mount range receptacle	10
84699	30a-250V, srfc. mnt. dryer recept., 3P4W, ground	10
84705	50a-250V, srfc. mnt. range recept., 3P4W, ground	10



MARS Major Appliance Extension Cords, UL Listed

MARS NO.	DESCRIPTION	CASE QTY.
84625	15a-125V, 14/3 spt, 3 foot appliance ext.	30
84626	15a-125V, 14/3 spt, 6 foot appliance ext.	25
84627	15a-125V, 14/3 spt, 9 foot appliance ext.	15
84629	15a-125V, 14/3 spt, 15' appl. ext., non UL	12
84633	20a-250V, 12/3 spt, 6 foot appliance ext.	25

84625

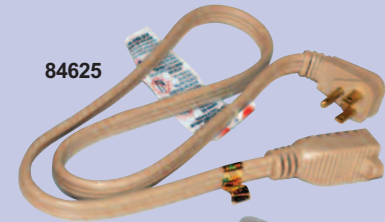

84669-71

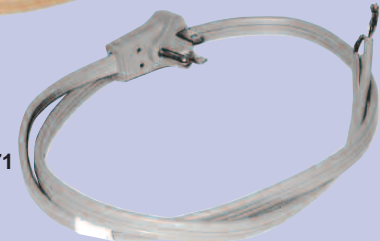

MARS Pigtails/Replacement Cords - 13 Amp, 125V

MARS NO.	DESCRIPTION	CASE QTY.
84669	16/3 pigtail 3 ft. SPT-3 RT	50
84670	16/3 pigtail 6 ft. SPT-3 RT	50
84671	16/3 pigtail 8 ft. SPT-3 RT	50
84673	16/3 pigtail 3 ft. SPT-3 STR	50
84674	16/3 pigtail 6 ft. SPT-3 STR	50
84679	16/3 pigtail 6 ft. SJT-BL STR	50
84681	14/3 pigtail 6 ft. SJT-BL STR	50

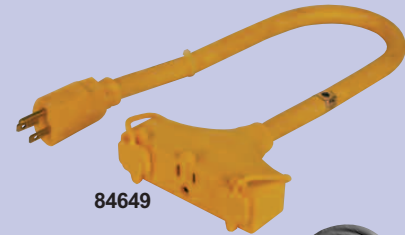

84649

Power Block Type Extension Cords, 15a-125V - UL listed

MARS NO.	DESCRIPTION	CASE QTY.
84649	Power block ext. 12/3 sjtwa, 2 foot	4

Outdoor Heavy Duty Ext. Cords, Orange - UL Listed - SJTWA

MARS NO.	DESCRIPTION	CASE QTY.
84652	Outdoor ext. 16/3, 13a-125V, 25 foot	24
84653	Outdoor ext. 14/3, 15a-125V, 25 foot	14
84655	Outdoor ext. 16/3, 13a-125V, 50 foot	12
84656	Outdoor ext. 14/3, 15a-125V, 50 foot	10
84657	Outdoor ext. 12/3, 15a-125V, 50 foot	6
84658	Outdoor ext. 16/3, 10a-125V, 100 foot	6
84659	Outdoor ext. 14/3, 13a-125V, 100 foot	6

84655



84696

Trouble Lights, One Grounded Outlet - UL Listed

MARS NO.	DESCRIPTION	CASE QTY.
84696	Metal cage trouble light, 16/3, SJT, 13a, 25'	8
84697	Metal cage trouble light, 16/3, SJT, 13a, 50'	6

Portable Lighting

MARS NO.	DESCRIPTION	CASE QTY.
84689	8-1/2" clamp light - 6 ft cord	6

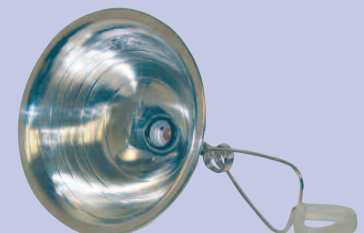

84689

SERVICE & INSTALLATION



The largest selection of motors, components and accessories for the HVAC/R Industry

Cylinder Cradles and Strap

MARS SERIES **790**



Cylinder Cradles and Strap

Cylinder cradles make transportation of cylinders easy and safe. The cradles are made with Maximum Visibility webbing for day or night work.

- Polyester webbing meets 5000 lb min breaking strength
- Hardware meets 5000 lb min breaking strength
- Specialized designed lifting solutions
- Individually colored for easy identification
- Cylinder transportation

MARS NO.	DESCRIPTION	MARS PACK
79061	Shoulder Comfort Strap - to transport cylinders safely using Cradles	1
79062	Recovery Cylinder Cradle	1
79063	B Tank Cylinder Cradle	1
79064	Refrigerant Cylinder Cradle	1
79065	Nitrogen Cylinder Cradle	1



SERVICE & INSTALLATION

Polypropylene Web Duct Strap

MARS SERIES **863**



Polypropylene Web Duct Strap

- UL 723 Flame and Smoke

MARS NO.	DESCRIPTION	MARS PACK
86126	Black 1 3/4" x 100 yds.	24
86296	Black 3" x 100 yds	8
86297	Silver 1-3/4" x 100 yds	24
86298	Silver 3" x 100 yds	8

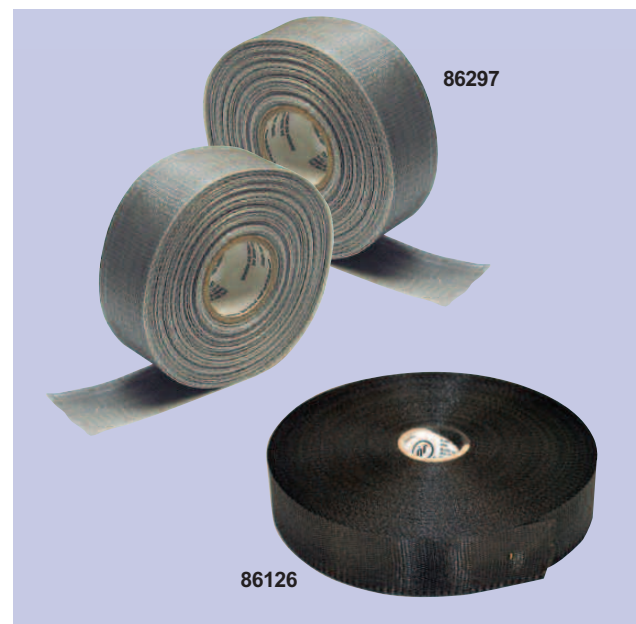



Rope, Tie Downs & Tarps

MARS SERIES **790**

Truck And Equipment Tarps

MARS equipment tarps provide a durable blue protective covering for truck beds, construction material and contractors tools.

MARS NO.	DESCRIPTION	MARS PACK	CASE QTY.
79115	8' x 10' blue tarp	1	20
79116	12' x 12' blue tarp	1	12

Molded Rubber Straps

Molded rubber straps are made of high quality black rubber. Sturdy hooks will not loosen.

MARS NO.	DESCRIPTION	MARS PACK
79591	19" length - bulk	48
79592	24" length - bulk	24
79593	35" length - bulk	24

Nylon Tie-Down Straps And Tow Straps - Clamshell Pkg

MARS NO.	DESCRIPTION	CASE QTY.
79596	10' universal tie down with non-slip cambuckle and vinyl coated steel hooks	12
79598	15' ratchet tie down with "J" hooks & "D" rings	12

Truck Rope-Polypropylene - USA

MARS truck rope is made of a polypropylene construction. All ropes are made in the USA. Applications range from hoisting, truck bed material tie down, job site tie off and a wide variety of other uses. MARS #79059 and #79060 include handy safety hook.

MARS NO.	DESCRIPTION	MARS PACK	CASE QTY.
79053	3/8" x 50' yellow	1	12
79055	3/8" x 50' blk/orange	1	12
79056	3/8" x 100' blk/orange	1	12
79057	1/2" x 50' blk/orange	1	12
79059	3/8" x 50' blk/orange with safety hook	1	12
79060	1/2" x 50' blk/orange with safety hook	1	12

Canvas Drop Cloths

MARS NO.	DESCRIPTION	MARS PACK	CASE QTY.
79118	9 Oz. Canvas Drop Cloth 9 x 12, 3 Mil	1	6
79119	6 Oz. Canvas Drop Cloth 12 x 15, 1 Mil	1	4
79120	6 Oz. Canvas Drop Cloth 4 x 12, 2 Mil	1	12



SERVICE & INSTALLATION



The largest selection of motors, components and accessories for the HVAC/R Industry

Duct Straps, Pipe Hangers & Hooks

MARS SERIES **863**



Galvanized Duct Straps

The perforated, galvanized duct strap has 1/4" and 9/64" holes for nails & bolts.

MARS NO.	DESCRIPTION	MARS PACK	CASE QTY.
86025	28 gauge 3/4" x 10' RL bulk	100	100
86026	28 gauge 3/4" x 50' RL boxed	1	1
86027	28 gauge 3/4" x 100' RL boxed	1	1
86031	20 gauge 3/4" x 10' RL bulk	100	100
86032	20 gauge 3/4" x 25' RL boxed	6	6
86033	20 gauge 3/4" x 50' RL boxed	1	1

Duct Straps And Hangers

The wire duct strap is used for all square duct run below the joist. Hammers right into duct and joist. No nails, screws or rivets are needed.

The pipe hanger is the fastest way to install round 5", 6" or 7" heating pipes below the joist. No nails needed.

Duct straps are for use on all square ducts run below the joist.

The DWV pipe hangers are designed for rapid installation of both ABS and PVC plastic DWV piping with standard flat head galvanized nails. Galvanized steel construction.

MARS NO.	DESCRIPTION	MARS PACK	CASE QTY.
86037	Duct strap DS 3	100	100
86040	DWV pipe hanger 2" x 12"	50	50
86041	DWV pipe hanger 3" x 12"	50	50

Mechanics Hanging Wire - Plasta-Reel™

MARS presents hanging wire on a Handi-Reel™. This convenient reel unwinds easily. Hangs over post or peg on truck bed, from a 2 x 4 or nail. Plasta-Reel™ prevents tangling. This polyethylene reel is smooth and safe to handle. Never blisters, burns or cuts the skin as metal might do! 4,150 ft. per roll.

MARS NO.	DESCRIPTION	MARS PACK	CASE QTY.
84418	18 gauge Black Ann 5 lbs.	50	500
84419	18 gauge Galvanized 5 lbs.	50	500

MARS Plastic Hanger Strap

- Flexible, non-conductive. 3/4" wide x .050 thick 100' roll
- 1/8" holes spaced every 3/4"
- Uses: pipe/duct hanging
- Convenient dispenser box keeps roll neat and tidy

MARS NO.	DESCRIPTION	MARS PACK	CASE QTY.
86177	Hanger strap 100L	1	1

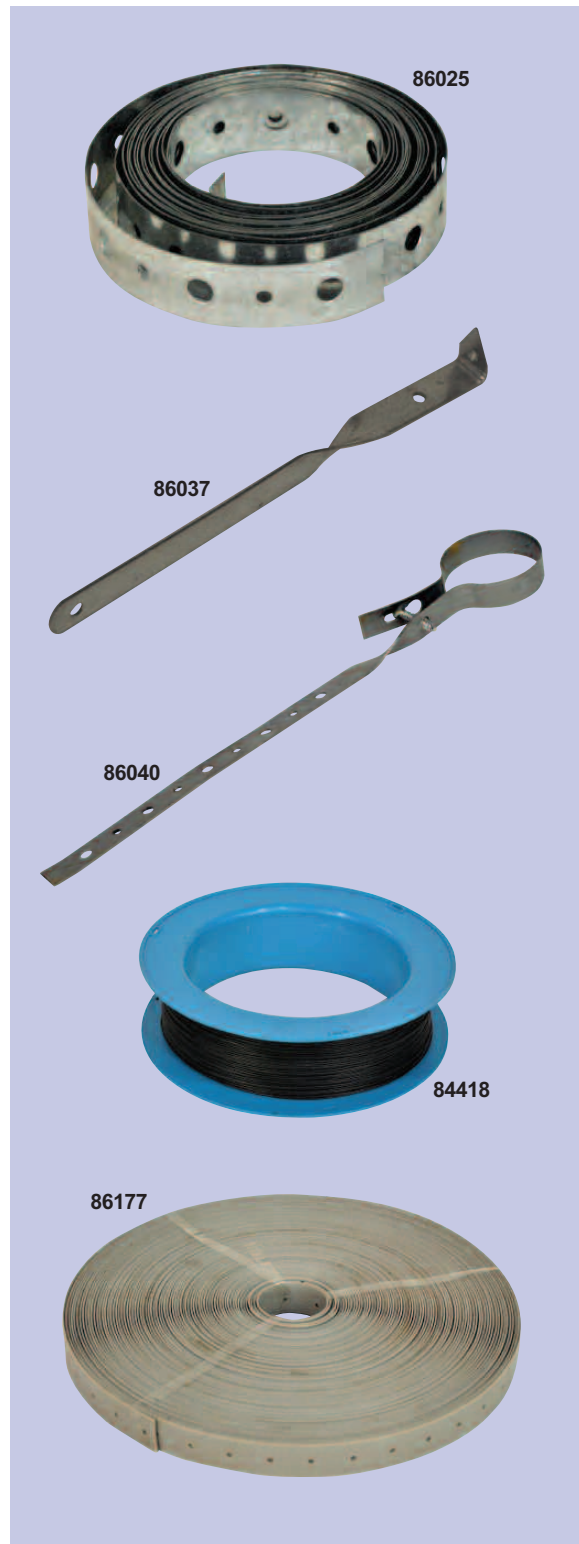

SERVICE & INSTALLATION



Wire Ties

MARS SERIES **865**

MARS Wire Ties, 100 Packs

MARS nylon wire ties and duct straps are available in a wide variety of styles, color and tensile strengths. They range in sizes from 4" to 36" with tensile strengths from 18 lbs. to 175 lbs. All MARS wire ties and duct straps feature the bent tip design for ease and insertion.

MARS NO.	DESCRIPTION			MARS PACK	
86100	4"	natural	standard	3/4" dia. x 18 lbs.	1
86101	4"	black	standard	3/4" dia. x 18 lbs.	1
86104	5.5"	natural	standard	1 1/4" dia. x 40 lbs.	1
86105	5.5"	black	standard	1 1/4" dia. x 40 lbs.	1
86106	8"	natural	standard	1 3/4" dia. x 40 lbs.	1
86107	8"	black	standard	1 3/4" dia. x 40 lbs.	1
86151	8"	blue	standard	2" dia. x 50 lbs.	1
86108	11"	natural	standard	3" dia. x 50 lbs.	1
86109	11"	black	standard	3" dia. x 50 lbs.	1
86153	14"	black	standard	4" dia. x 120 lbs.	1
86110	14.5"	natural	standard	4" dia. x 50 lbs.	1
86111	14.5"	black	standard	4" dia. x 50 lbs.	1
86112	6"	natural	screw mount	1 1/4" dia. x 30 lbs.	1
86113	6"	black	screw mount	1 1/4" dia. x 30 lbs.	1
86114	7.5"	natural	screw mount	1 3/4" dia. x 50 lbs.	1
86115	7.5"	black	screw mount	1 3/4" dia. x 50 lbs.	1
86155	11"	black	screw mount	3" dia. x 50 lbs.	1
86156	14"	black	screw mount	4" dia. x 50 lbs.	1
86157	14"	natural	screw mount	4" dia. x 50 lbs.	1

MARS Wire Ties, Bulk Packs

MARS NO.	DESCRIPTION			MARS PACK	
86116	8"	natural	standard	1 3/4" dia. x 40 lbs. (1000 pk)	1
86117	8"	black	standard	1 3/4" dia. x 40 lbs. (1000 pk)	1
86152	8"	blue	standard	2" dia. x 50 lbs. (1000 pk)	1
86118	11"	natural	standard	3" dia. x 50 lbs. (500 pk)	1
86119	11"	black	standard	3" dia. x 50 lbs. (500 pk)	1
86120	14.5"	natural	standard	4" dia. x 50 lbs. (500 pk)	1
86122	14.5"	black	standard	4" dia. x 50 lbs. (500 pk)	1

MARS Wire Ties, Assortment Packs

MARS NO.	DESCRIPTION			MARS PACK
86123	(100) 4"	(100) 8"	natural assortment	1
86124	(100) 8"	(50) 11"	natural assortment	1
86125	(200) 5"	(200) 8"	(50) 11" natural assortment	1

MARS Duct Straps, 175 lbs., 50 Packs

MARS NO.	DESCRIPTION			MARS PACK
86127	24" duct strap for up to	6" duct	natural	1
86128	36" duct strap for up to	10" duct	natural	1
86129	48" duct strap for up to	14" duct	natural	1
86102	24" duct strap for up to	6" duct	black	1
86103	36" duct strap for up to	10" duct	black	1



SERVICE & INSTALLATION

Utility Knife

MARS SERIES **256 & 274**



Ready Utility Knife

- Featuring the QUICKEST blade change in the industry.
- Rugged all steel construction
- Folds to a very compact size
- Easily and quickly change blades with the push of a button
- Set includes knife, nylon carrying case, and 5 standard blades

MARS NO.	DESCRIPTION	MARS PACK	CASE QTY.
25784	Utility knife	1	48

MARS Knife Sharpener

Finally, a Knife Sharpener anyone can use! No more messy oils or stones. Sharpen knives in about 10 seconds (even serrated knives), cleavers, axes, machetes, and many other cutting tools. The full length finger guard protects your fingers. Sharpening blades are Diamond Honed Tungsten Carbide for years of reliable use. AccuSharp Knife Sharpeners will not rust and can be cleaned with soap and water or in the dishwasher.

MARS NO.	DESCRIPTION	CASE QTY.
27520	MARS Knife Sharpener	12

Cable Tie Tool

Cable Tie Tools are economical, lightweight and easy to use.

Ideal for heavy duty ties and duct straps. Constructed from high grade steel.

- Heavy duty construction
- Installer controls tensioning
- Squeeze to cut excess

MARS NO.	DESCRIPTION	LENGTH	COLOR	BAG	CASE QTY.
25683		175 lbs	Red	1	100

Ready



Access Fittings & Service Valves

MARS SERIES **654**

Braze-On Service Valves - Saddle Valves

Braze-on self-piercing copper service valves are widely used and easily installed on a charged line. After brazing the saddle portion onto the line, the steel pin with valve core penetrates the line and is locked into place simply by tightening the cap. Available in sizes from 1/4" to 1-1/8".

MARS NO.	DESCRIPTION	MARS PACK
65425	1/4" qty 6 per bag	1
65426	5/16" qty 6 per bag	1
65427	3/8" qty 6 per bag	1
65428	1/2" qty 4 per bag	1
65429	5/8" qty 3 per bag	1
65430	3/4" qty 2 per bag	1
65431	7/8" qty 2 per bag	1
65432	1 1/8" qty 2 per bag	1

Economy Line Service Valves - Extended Copper Tubes

- With valve core & flat cap (#65408)
- 1/4" male flare access fitting

MARS NO.	DESCRIPTION	MARS PACK
65438	3/16" copper tube extension, qty. 6 / bag	1
65439	1/4" copper tube extension, qty. 6 / bag	1
65440	5/16" copper tube extension, qty. 6 / bag	1
65441	3/8" copper tube extension, qty. 6 / bag	1
65442	1/8" copper tube extension, qty. 6 / bag	1
65434	5/16" copper tube extension, bulk	100
65435	3/8" copper tube extension, bulk	100
65436	3/16" copper tube extension, bulk	100
65437	1/4" copper tube extension, bulk	100
65443	1/8" copper tube extension, bulk	100

Copper Tees - 1/4" Male Flare

Copper tees have bodies brazed on. Using copper for the tee portion allows tubing to be attached to each end and allows using a solderless than silver solder, such as 95-5. They are to be used where two line ends have not yet been attached or where it is desirable to cut a line rather than drive a hole on an uncharged system. Copper tees save time and money. • includes valve core and flat cap (#65408).

MARS NO.	DESCRIPTION	MARS PACK
65447	Tee for 1/4" O.D. tube (2 bag)	1
65448	Tee for 5/16" O.D. tube (2 bag)	1
65449	Tee for 3/8" O.D. tube (2 bag)	1
65450	Tee for 1/2" O.D. tube (2 bag)	1
65451	Tee for 5/8" O.D. tube (2 bag)	1
65452	Tee for 3/4" O.D. tube (2 bag)	1
65453	Tee for 7/8" O.D. tube (2 bag)	1
65454	Tee for 1 1/8" O.D. tube (2 bag)	1

Tees Connectors

Tee connectors are used to connect controls to check oil pressure on larger compressors having positive pressure oil pumps and to check the accuracy of oil pressure gauges installed on the equipment by the manufacturer against your gauge with known accuracy.

MARS NO.	DESCRIPTION	MARS PACK	MARS NO.	DESCRIPTION	MARS PACK
65459	1/4" m. flare x 1/4" f. flare nut w/ depressor tip x 1/4" m. flare on the branch w/one valve core (qty. 2 per bag)	1	65461	All brass tee connector 1/4" m. flare with valve core & cap x 1/4" m. flare x 1/4" f. flare nut with depressor tip on branch (qty. 1 per bag)	1
65460	1/4" m. flare with valve core x 1/4" m. flare x 1/4" f. flare nut w/ depressor tip on the branch (qty. 2 per bag)	1			

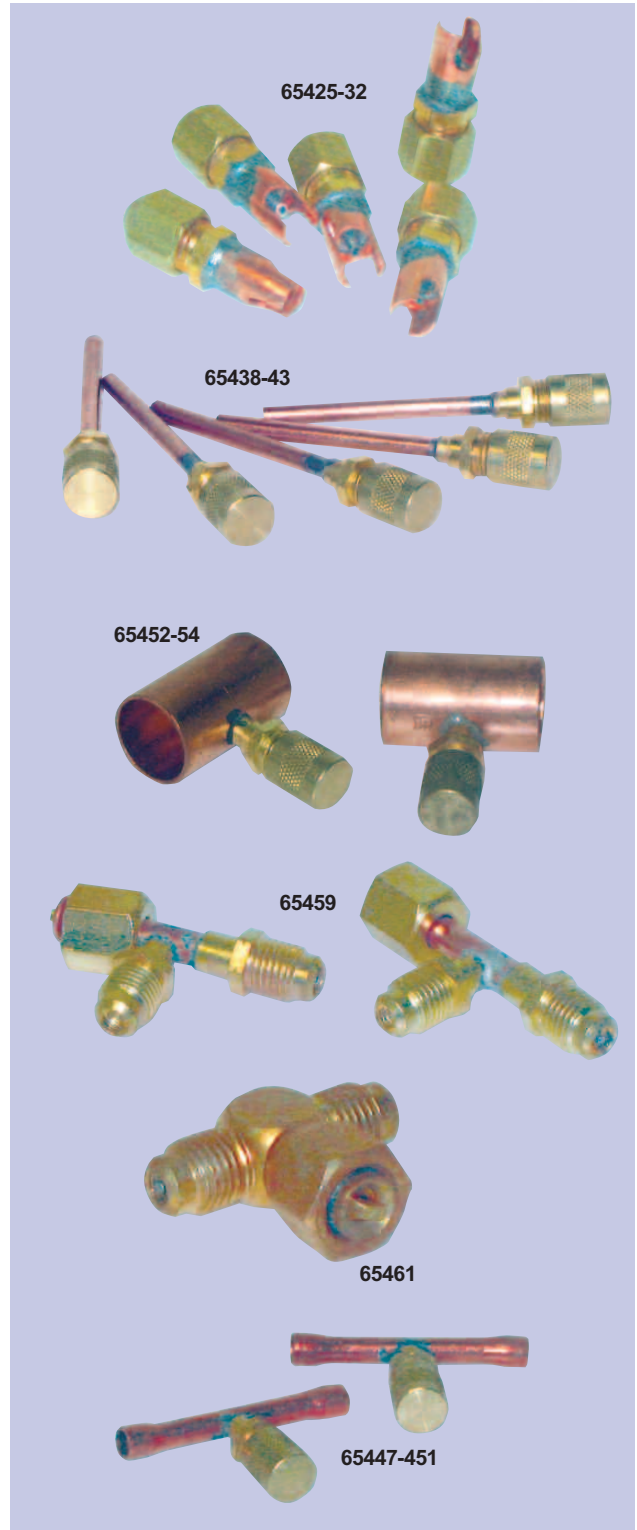

SERVICE & INSTALLATION



The largest selection of motors, components and accessories for the HVAC/R Industry

SI-55

Access Fittings & Service Valves

MARS SERIES **654**



Brass Bodies - Half Unions

MARS brass bodies have a 1/4" standard male flare above the hex. Below the hex are various threads, outside diameters and inside diameters for accepting different sizes of tubing and connections. A flat top brass cap and teflon valve core are included.

MARS NO.	DESCRIPTION	MARS PACK
65401	1/4" MPT dry seal x 1/4" male flare 5/16" I.D. hole accommodates 5/16" O.D. tube. Qty. 2 per bag	1
65402	1/8" MPT dry seal x 1/4" male flare 1/4" I.D. hole accommodates 1/4" O.D. tube. Qty. 6 per bag	1
65403	1/4" male flare for 1/8" I D hole - accommodates 1/8" O.D. tube. (3/16", 1/4", 5/16" O.D. steps) Qty 6 per bag	1

Brass Caps & Valve Cores

MARS NO.	DESCRIPTION	MARS PACK
65408	Round brass flat cap w/neoprene O-ring seal for 1/4" flare, qty 6 per bag	1
65409	Round brass cap w/ core wrench top and neoprene O-ring seal for 1/4" flare, qty 6 per bag	1
65410	Plastic core container - includes six valve cores and a core wrench and thread chaser	1
65411	Brass core remover container with wrench tip - includes three valve cores	1
65412	Valve core w/teflon seal, qty. 6 per bag	1

Core Removal Tools With Ball Valve

MARS core removal tools are used to remove and replace valve cores in a 1/4" flare without losing refrigerant. Because it has a ball valve inside rather than a stem-type valve, the tool can be closed with just a quarter turn. This convenient compact size tool is ideal for working in close quarters.

MARS NO.	DESCRIPTION	MARS PACK
65418	Core removal tool	1
65419	Core removal tool w/ 1/4" male flare side port	1

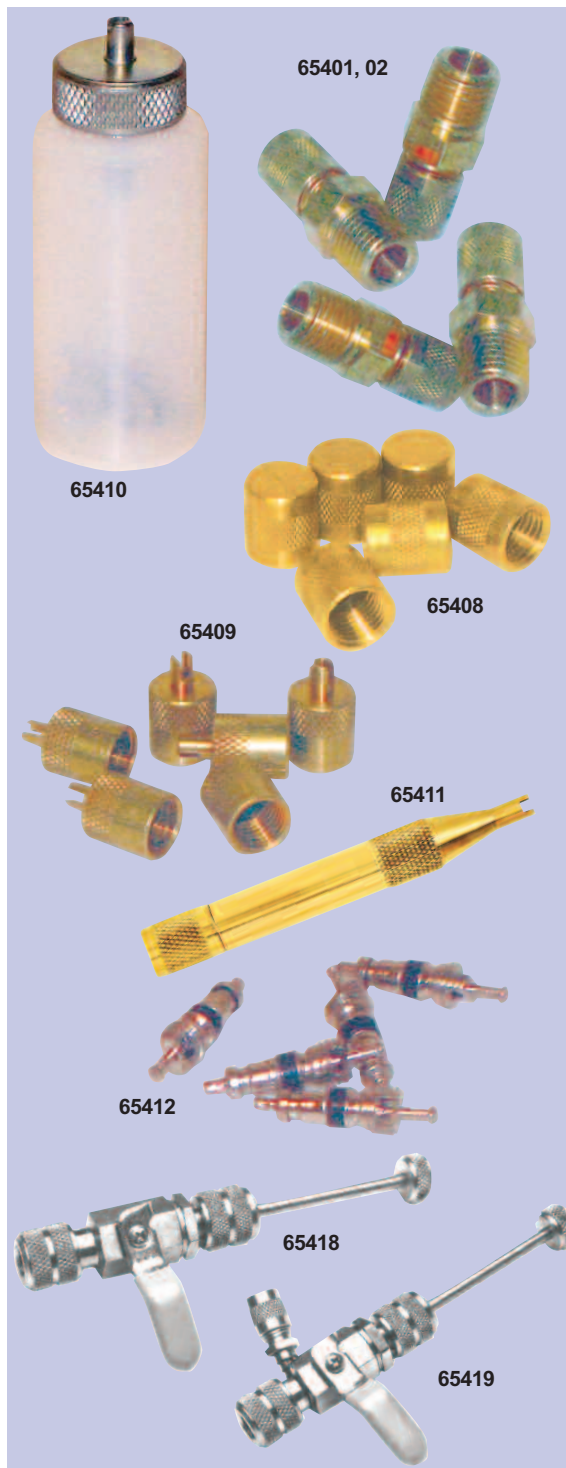



Chemicals

Thawzone liquid dehydrant chemically "dries" all refrigerants (R12, R22, R134, etc.), methyl chloride, and methylene chloride. Thawzone frees frozen systems due to moisture in five minutes. It prevents refreezing, does not leave any residue, does not contain any dissolved solids or methanol, and works with or without solid dryers. Available in 1 oz., 4 oz. and 16 oz. plastic bottles.

Leak Lock joint sealer is a soft setting pipe joint compound for sealing threaded joints, flanged joints, gasket surfaces and mating surfaces. This resin based brushable paste remains permanently flexible, adheres to internal surfaces and fills voids. It is ideal for use on metal and plastic materials subject to extreme vibrations, temperatures from -100°F (-73°C) to 400°F (204°C) full vacuums to 10,000 PSI. Leak Lock seals all refrigerants (R12, R22, R502, R134A, etc.) petroleum products, natural and manufactured gases, steam, water, air, etc. Available in 1 1/3 oz. plastic tube and 4 oz. and 1 pint brush top plastic jars.

Red Epoxy aluminum sealer is a high performance heat cured, two part epoxy kit for patching or sealing on all metals and some plastics. Red Epoxy is cured within minutes and equipment is serviceable immediately. It is excellent for sealing threaded or unthreaded pipes and is great as a field repair kit for aluminum evaporators, coils, radiators, pipes, tanks, etc. Temperature range: -100°F (-73°C) to 300°F (149°C). Tensile strength: 600psi. working pressure tested in excess of 3000 psi. Kit includes resin & hardener. (.5 oz. tube each)

Low-Temp Gas Leak Detector is non-toxic and non-hazardous and does not contain ethylene glycol. This non-freezing, viscous florescent, bubble type gas leak detector is rated to -30°F (-34°C). The leaks appear as large strong bubbles which cling to the applied surface and are florescent under a black light. For use on hot and cold piping and equipment containing most gases such as air, natural gas, all refrigerants (R12, R134A, R22, R502, etc.) ammonia, SO₂ etc.

The mid-temp gas leak detector is non-toxic and non-hazardous. It is a viscous, fluorescent, bubble-type gas leak detector rated to 27°F (-3°C). Leaks appear as large strong bubbles which cling to the applied surface and are florescent under a black light. For use on hot and cold piping equipment containing most gases such as air, natural gas, all refrigerants (R12, R134A, R22, R502A, etc.), ammonia, SO₂ etc.

Solderlene is a high quality, paste type, non-acid soldering flux with industrial strength wetting agents to promote solder flow. For use with all low and mid temperature soft solders, both lead bearing and lead-free, on all metals except aluminum and magnesium.

Trace is a red dye trace type internal leak detector for use with mineral oil base refrigerant lubricants and hydraulic systems. Leaks show as intense red stains. Trace is non-volatile, will not sludge oil or deposit gum. Trace is soluble in the lubricant and liquid refrigerant but not the gas and travels with the lubricant. Oil separators will remove trace and should be bypassed. Trace passes through solid core dryers but the color intensity may be reduced.

MARS NO.	DESCRIPTION	MARS PACK
93801	Thawzone 1 oz. bottle	24
93802	Thawzone 4 oz. bottle	12
93815	Thawzone 16 oz. bottle	6
93803	Leak Lock 1 1/3 oz. tube	12
93804	Leak Lock 4 oz. brush top jar	12
93805	Leak Lock 1 pint brush top jar	12
93806	Red Epoxy kit .5 oz. tube	24
93807	Low Temp Gas Detector 8 oz. dauber bottle	24
93808	Low Temp Gas Detector 32 oz. trigger spray	12
93809	Mid-temp gas detector 8 oz. dauber bottle	24
93810	Mid-temp gas detector 32 oz. trigger spray	12
93811	Screwloose® Solderlene 4 oz. brush top jar	24
93812	Solderlene 1 pint brush top jar	12
93813	Trace® 4 oz. bottle	12
93814	Trace® 16 oz. bottle	6



SERVICE & INSTALLATION

Liquid Line Filter Driers

MARS SERIES **201**



MARS Liquid Line Filter Driers

The MARS Liquid Line Filter Driers are designed to offer complete protection of your refrigerant system. The desiccant block is a carefully selected blend of molecular sieve and activated alumina, providing for maximum removal of moisture, acid, and foreign materials. This molded desiccant block allows for efficient filtration and retention of solid contaminants, while insuring minimum pressure drop. The solid molded block exposes maximum surface area and provides even distribution of filtered material as the refrigerant flows through the drier. These driers are intended for use on R-134A, R-404A, R-410A, R-507, R-12, R-500, R-502

Features & Benefits:

- High moisture removal
- High organic & inorganic acid removal
- Solid block desiccant core
- For use with HCFCs, CFCs, and the lubricants that go with them
- Nickel plated SAE flare and solid copper ODF fittings
- Corrosion resistant
- Maximum working pressure 600 PSIG
- Minimum burst pressure 2500 PSIG
- UL & CSA listed

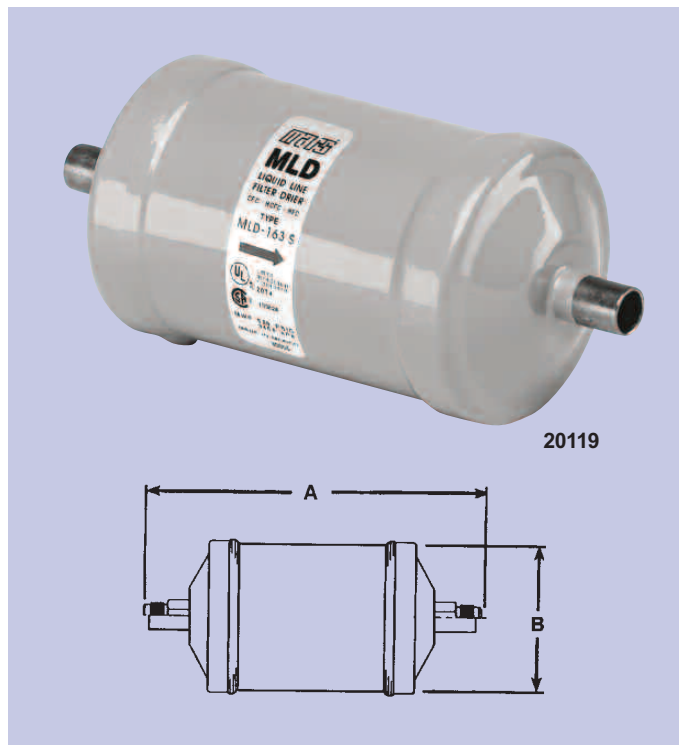

SERVICE & INSTALLATION

MARS NO.	MODEL NO.	CONNECTIONS SIZE & TYPE	DIMENSIONS		Flow Capacity ¹ Tons @ 1 PSI			CASE QTY.
			A	B	R-134A	R-22/R410A	R404A/R507	
20106	MLD-032	1/4 SAE	4.32	1.63	2.0	1.9	1.2	12
20107	MLD-032S	1/4 ODF	3.76	1.63	3.0	2.8	1.8	12
20108	MLD-052	1/4 SAE	4.88	2.50	2.1	2.0	1.3	12
20109	MLD-052S	1/4 ODF	4.33	2.50	3.0	2.9	1.9	12
20111	MLD-053S	3/8 ODF	4.53	2.50	6.0	5.8	3.8	12
20112	MLD-082	1/4 SAE	5.80	2.50	2.1	2.1	1.3	12
20113	MLD-082S	1/4 ODF	5.24	2.50	3.1	3.0	1.9	12
20114	MLD-083	3/8 SAE	6.10	2.50	4.9	4.7	3.0	12
20115	MLD-083S	3/8 ODF	5.43	2.50	6.2	5.9	3.9	12
20116	MLD-162	1/4 SAE	6.58	2.50	2.1	2.1	1.3	12
20117	MLD-162S	1/4 ODF	6.02	2.50	3.1	3.0	1.9	12
20118	MLD-163	3/8 SAE	6.89	2.50	5.1	4.9	3.2	12
20119	MLD-163S	3/8 ODF	6.22	2.50	6.4	6.2	4.0	12
20120	MLD-164	1/2 SAE	7.13	2.50	8.8	8.4	5.5	12
20121	MLD-164S	1/2 ODF	6.27	2.50	9.2	8.8	5.7	12
20123	MLD-165S	5/8 ODF	6.54	2.50	15.3	14.6	9.5	6
20125	MLD-303S	3/8 ODF	8.90	3.00	7.5	7.2	4.7	6
20126	MLD-304	1/2 SAE	9.80	3.00	9.9	9.5	6.2	6
20127	MLD-304S	1/2 ODF	8.94	3.00	12.3	11.8	7.7	6
20128	MLD-305	5/8 SAE	10.18	3.00	12.6	12.1	7.9	6
20129	MLD-305S	5/8 ODF	9.21	3.00	16.8	16.1	10.5	6
20130	MLD-306S	3/4 ODF	9.63	3.00	18.1	17.4	11.3	6
20131	MLD-307S	7/8 ODF	9.80	3.00	19.0	18.2	11.8	6

¹ All ratings in accordance with ARI standard 710-04, 86°F Liquid Refrigerant Temperature, 5°F Saturated Temperature
4.0 lbs./min./ton for R-134a, 2.9 lbs./min./ton for R-22, 4.0 lbs./min./ton for R-404A/R-507



Bi-Flow Heat Pump Driers

MARS SERIES **201**

MARS Bi-Flow Heat Pump Driers

The MARS Bi-Flow Heat Pump Driers are designed to provide complete protection to the heat pump or reverse cycle system. The molded block core exposes maximum surface area for efficient filtration and retention of solid contaminants. The internal check valves prevent the release of collected contaminants when the heat pump cycles from the heating to cooling modes.

The use of molecular sieve and activated alumina in the desiccant core block provide the heat pump drier maximum moisture and acid removal. The addition of charcoal to the desiccant core allows for the removal of wax that may occur at low evaporator temperatures, giving protection to your expansion device.

Features & Benefits:

- For use on R134A, R12, R22, R500, R404A, R410A, R507
- For heat pump or reverse cycle applications
- High organic & inorganic acid removal
- Solid block desiccant core
- Proven, nylon internal check valves
- High moisture removal
- Nickel plated SAE flare and solid copper ODF fittings
- Corrosion resistant paint
- Maximum working pressure 600 PSIG
- Minimum burst pressure 2500PSIG
- UL & CSA listed

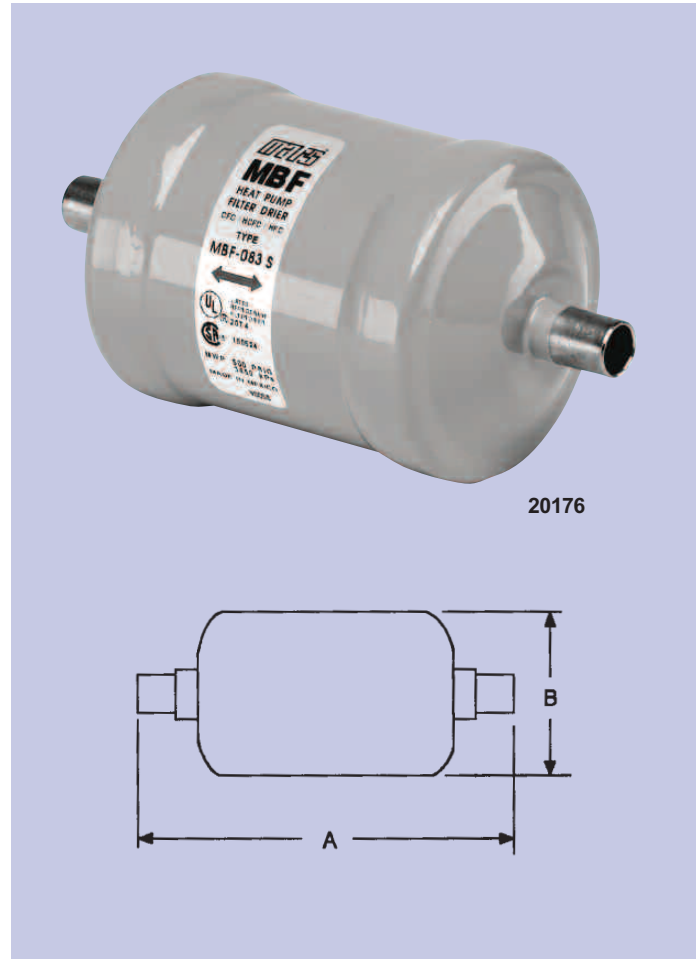

SERVICE & INSTALLATION

MARS NO.	MODEL NO.	CONNECTIONS SIZE & TYPE	DIMENSIONS		Flow Capacity ¹ Tons @ 1 PSI		CASE QTY.
			A	B	R-22/R410A		
20176	MBF-083S	3/8 ODF	5.63	2.63	7.4		12
20178	MBF-084S	1/2 ODF	5.66	2.63	9.4		12
20181	MBF-163	3/8 SAE	6.97	3.09	6.7		12
20182	MBF-163S	3/8 ODF	6.31	3.09	7.5		12
20186	MBF-165S	5/8 ODF	6.63	3.09	12.4		12

¹ All ratings in accordance with ARI standard 710-04
2.9 lbs./min./ton for R-22

Suction Line Filter Driers

MARS SERIES **201**



MARS suction line driers - flow capacities¹ in refrigerant tons at selected evaporator temps

The MARS Suction Line Filter Driers are designed to effectively clean up the refrigerant system by removing solid contaminants and harmful acids that were created during a motor burnout. As well as motor burnout applications, the MARS Suction Line Drier should be installed in remote systems with long refrigerant lines. The filter drier will collect and hold any dirt that is in the evaporator or suction line at start up. Any field built-up system requires the protection that the MARS Suction Line Drier offers.

The desiccant block core effectively removes and holds a maximum amount of contaminants with minimum pressure drop. The binding material in the core protects the core from acid decomposition and allows it to collect and hold organic and inorganic acids from motor burnout. An inlet deflector spreads the refrigerant flow evenly across the molded core to provide full filtration capacity and to prevent erosion of the core.

Features & Benefits:

- For use on R134A, R12, R22, R500, R404A, R410A, R507
- Dual access valve for accurate pressure drop readings
- Solid block desiccant core
- High organic & inorganic acid removal
- For use with HCFCs, CFCs and the lubricants that go with them
- Nickel plated SAE flare and solid copper ODF fittings
- Corrosion resistant paint
- Maximum working pressure 600 PSIG
- Minimum burst pressure 2500 PSIG
- UL & CSA listed

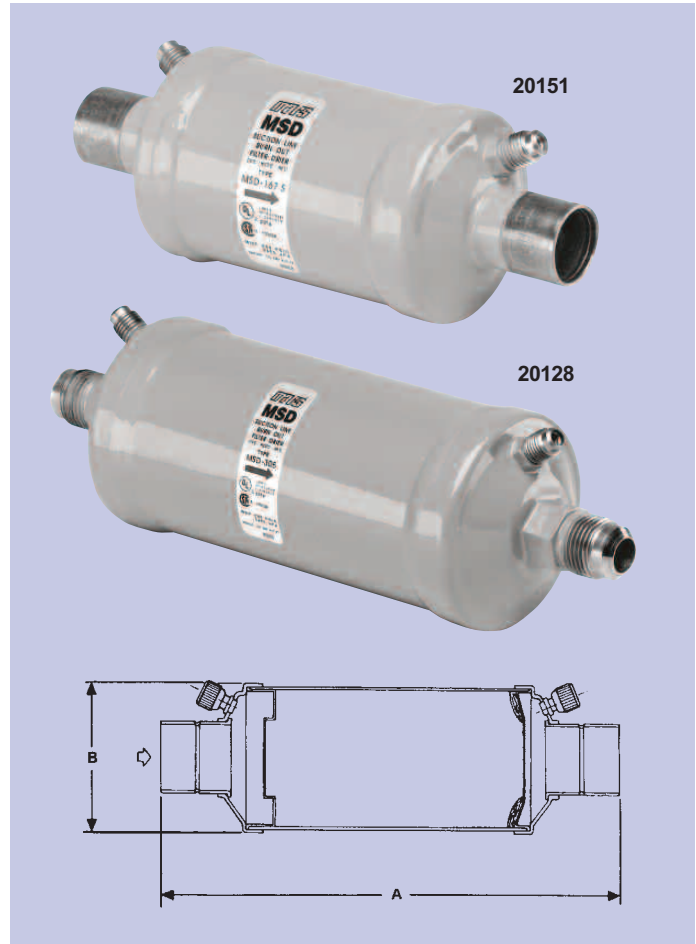

SERVICE & INSTALLATION

MARS NO.	R-134A				R-22					R-502					R410A Flow Capacity				
	Pressure Drop In P.S.I.				Pressure Drop In P.S.I.					Pressure Drop In P.S.I.					Evaporator Temperature (F°)				
	2	1.5	1	0.5	3	2	1.5	1	0.5	3	2	1.5	1	0.5	3	2	1.5	1	0.5
20141	0.8	0.5	0.3	0.2	1.3	0.8	0.6	0.4	0.2	1.0	0.7	0.5	0.3	0.1	1.7	1.1	0.8	0.5	0.3
20143	1.7	1.2	0.7	0.4	2.7	1.8	1.2	0.8	0.4	2.2	1.4	1.0	0.6	0.3	2.8	1.9	1.3	0.8	0.5
20145	2.4	1.6	1.0	0.5	3.8	2.5	1.7	1.1	0.6	3.1	2.0	1.3	0.8	0.4	3.9	2.6	1.7	1.1	0.6
20149	2.2	1.5	0.9	0.5	3.4	2.2	1.5	1.0	0.5	2.8	1.8	1.2	0.8	0.4	3.5	2.2	1.5	1.0	0.5
20150	2.6	1.8	1.1	0.6	4.1	2.7	1.8	1.2	0.6	3.4	2.2	1.5	0.9	0.5	4.2	2.8	1.8	1.2	0.6
20151	2.7	1.8	1.1	0.6	4.6	2.8	1.9	1.1	0.6	4.3	2.6	1.7	1.0	0.6	4.2	2.8	1.8	1.2	0.6
20154	3.4	2.3	1.4	0.7	5.4	3.5	2.4	1.5	0.8	4.4	2.8	1.9	1.2	0.6	5.5	3.6	2.4	1.5	0.8
20155	3.8	2.5	1.6	0.8	5.9	3.9	2.6	1.7	0.9	4.9	3.1	2.1	1.3	0.7	6.0	4.0	2.6	1.7	0.9
20156	3.9	2.6	1.6	0.8	6.1	4.0	2.7	1.7	0.9	5.0	3.2	2.2	1.3	0.7	6.2	4.1	2.8	1.7	0.9

Flow Capacity In Tons Refrigerant¹ (For kW, Multiply Tons By 3.5)

¹ All ratings in accordance with ARI standard 730-04

² Example: 1.0 tons x 3.5 = 3.5 KW

MARS NO.	MODEL NO.	SIZE & TYPE	DIMENSION	
			A	B
20141	MSD-83S	3/8 ODF	5.43	2.5
20143	MSD-84S	1/2 ODF	5.48	2.5
20145	MSD-85S	5/8 ODF	5.74	2.5

MARS NO.	MODEL NO.	SIZE & TYPE	DIMENSION	
			A	B
20149	MSD-165S	5/8 ODF	6.54	2.5
20150	MSD-166S	3/4 ODF	6.95	2.5
20151	MSD-167S	7/8 ODF	7.13	2.5

MARS NO.	MODEL NO.	SIZE & TYPE	DIMENSION	
			A	B
20154	MSD-306S	3/4 ODF	9.63	3.0
20155	MSD-307S	7/8 ODF	9.80	3.0
20156	MSD-309S	1-1/8 ODF	9.80	3.0



Compact Suction Line Driers

MARS SERIES **201**

MARS compact suction line driers - flow capacities in refrigerant tons at selected evaporator temperatures

The MARS compact suction line driers are designed for use in air conditioning, heat pump, and refrigeration systems in which the available space in the suction line is limited. This is especially useful in heat pump systems where the drier must be placed between the reversing valve and the compressor. This compact suction drier should be used for motor burnout clean-up applications, and installed in remote systems with long refrigerant lines. The filter drier will collect and hold any dirt that is in the evaporator or suction line at start up.

The molded desiccant core block effectively removes and holds a maximum amount of contaminants with a minimum pressure drop. The binding material in the core protects the core from acid decomposition and allows it to collect and hold organic acids from a motor burnout. An inlet deflector, spreads the refrigerant flow evenly to prevent erosion and effectively uses the full filtration capacity of the filtering system.

Features & Benefits:

- For use on R134A, R12, R22, R500, R404A, R507, R502
- High organic & inorganic acid removal
- Dual access valves for accurate pressure drop readings
- Solid block desiccant core
- For use with HCFCs, CFCs and the lubricants that go with them
- Solid copper ODF fittings
- Corrosion resistant paint
- Maximum working pressure 302 PSIG
- Minimum burst pressure 1510 PSIG



20168

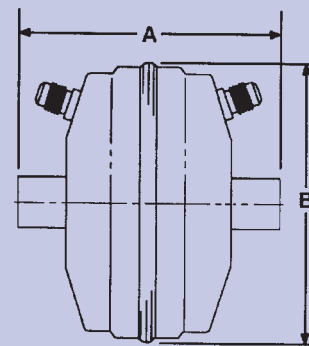

SERVICE & INSTALLATION

MARS NO.	MODEL NO.	SIZE & TYPE	DIMENSION		+40°F	+20°F	0°F	-20°F	+40°F	+20°F	0°F	-20°F	-40°F	+40°F	+20°F	0°F	-20°F	-40°F
					R-134A				R-22				R-502					
					Pressure Drop In P.S.I.				Pressure Drop In P.S.I.				Pressure Drop In P.S.I.					
			A	B	2	1.5	1	0.5	3	2	1.5	1	0.5	3	2	1.5	1	0.5
20167	MCD-14S6	3/4 ODF	4.37	4.57	3.1	2.1	1.3	0.7	4.9	3.2	2.2	1.4	0.7	3.6	2.3	1.5	0.9	0.5
20168	MCD-14S7	7/8 ODF	4.55	4.57	3.3	2.2	1.4	0.7	5.2	3.4	2.3	1.5	0.8	3.6	2.3	1.5	0.9	0.5

Replacement Cores

MARS SERIES **201**



MARS Interchangeable Replacement Core

The MARS replaceable cores are molded using selected desiccant materials for high acid, moisture and wax removal capabilities. They are molded for high mechanical strength using the same process used in our sealed liquid and suction line driers. The cores are fully activated and sealed in individual foil packages. The core is then packaged with a set of replacement gaskets that include a flange gasket, core gasket and a gasket for other manufacturer's shells.

The Burnout Core is for wax removal in low temperature R22 and R404A/R507 systems and for cleanup in all types of systems where motor burnout has occurred.



20193

MARS NO.	MODEL NO.	Core Type	Dimension		Water Capacity ¹ at 75°F			Water Capacity ¹ at 125°F		
			A	B	R-134A	R-22	R502	R-134A	R-22	R502
20193	MBRC-48	Burnout	3.66	5.50	345	345	400	224	224	277

¹R-134A = drops @ 60 ppm, R-22 = drops @ 60 ppm, R-502 = drops @ 30 ppm

Moisture Indicator Sight Glass

MARS SERIES **656**



MARS Sight Glass - Moisture Indicators

The MARS Moisture Indicators are constructed of forged brass bodies with brass fittings. The large viewing area of the sight glass allows for quick and easy inspection of the refrigerant as it flows through the system. Bubbles passing through the sight glass may be an indication of a low system charge or a restriction in the refrigerant system.

The moisture Indicators are designed to provide an accurate method of determining when the moisture content is dangerously wet in a refrigerant system and when the liquid line drier is no longer effective. An indicator element is highly sensitive to moisture and will gradually change color in reaction to the moisture content of the refrigerant system. Maximum working pressure is 500 PSIG. Minimum Burst pressure is 2500PSIG. UL and CSA listed.

MARS NO	MARS MODEL NO.	DESCRIPTION	LENGTH x HEIGHT INCHES	CASE QTY.
65634	MSG-2FM	1/4 Female x Male Flare	2.56 x 1.29	12
65635	MSG-3FM	3/8 Female x Male Flare	2.97 x 1.38	12
65636	MSG-4FM	1/2 Female x Male Flare	3.99 x 1.66	12
65638	MSG-2SS	1/4 Solder x Solder	4.57 x 1.11	12
65639	MSG-3SS	3/8 Solder x Solder	4.69 x 1.11	12
65640	MSG-4SS	1/2 Solder x Solder	4.88 x 1.29	12
65641	MSG-5SS	5/8 Solder x Solder	4.88 x 1.38	12
65642	MSG-7SS	7/8 Solder x Solder	5.90 x 1.66	12



Thermo Expansion Valves

MARS SERIES **201**

MARS Thermo Expansion Valves

The MARS Thermo Expansion Valves are used for heat pump, air conditioning, food service and commercial applications. These valves incorporate a high stability charge designed for R-22 HVAC applications. The wide range charge provides greater superheat stability, allowing two valves to cover a wide range of capabilities from 1 to 5 tons. These thermo expansion valves allow the wholesaler to consolidate inventory by replacing several valves with the two wide range valves we offer.

Features & Benefits:

- Hermetic construction eliminates external leakage
- Compact size allows installation in limited spaces
- External equalizer
- Stainless steel power element eliminates corrosion and prevents valve failure
- Integral check valve
- Maximum working pressure 600 PSIG
- Designed for R-22 applications

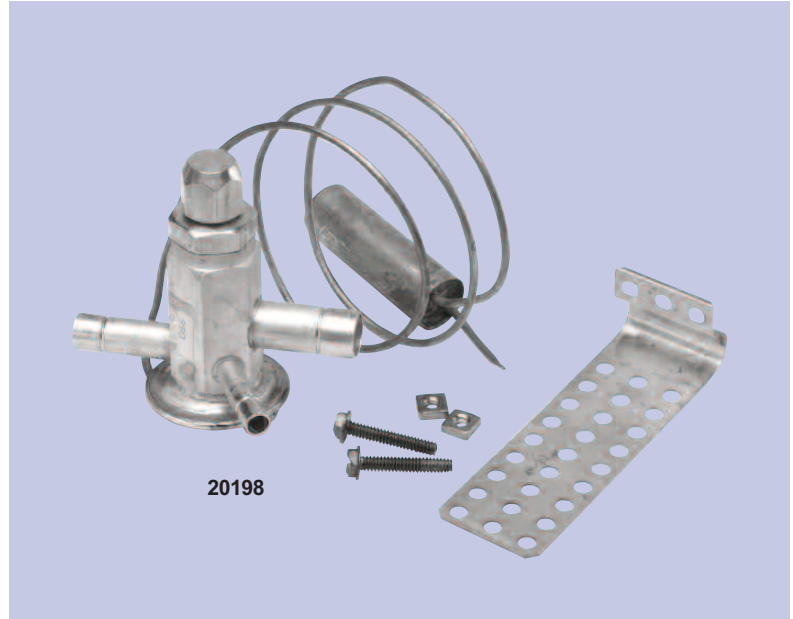

20198

MARS NO.	MODEL NO.	CAPACITY	R-22 CAPACITY RANGE	CONNECTIONS	CAP. TUBE	CASE QTY.
20198	MXV2-1/2	2-1/2 Ton	1 – 3 Tons	3/8 x 1/2 ODF S/T	30"	12
20199	MXV5	5 Ton	1 – 5 Tons	3/8 x 1/2 ODF S/T	30"	12

SERVICE & INSTALLATION



Spun Copper Driers

MARS SERIES **201**

MARS Spun Copper Driers

The MARS Spun Copper Liquid Line Filter Driers are recommended for use in original equipment or replacement residential, air-conditioning or refrigeration equipment. These driers feature 100% molecular sieve for a high capacity of water retention. They provide 100 micron filtration. MARS Spun Copper driers are to be used with R-134A blends and systems with conventional refrigerants.



20101

MARS NO.	MODEL NO.	DESCRIPTION	CONNECTIONS TONS		CAPACITY TONS R-134A	CAPACITY DESICCANT R-22	LENGTH in GRAMS	OUTER in INCHES	DIAMETER
			INLET	OUTLET					
20101	MSCD-80	Std. Duty	1/4	CAP	1/3	1/2	10	9-5/8	5/8



The largest selection of motors, components and accessories for the HVAC/R Industry

SI-63

Spun Copper Driers

MARS SERIES **201**



MARS Spun Drier Capacity Table

Features:

- Recommended for use on original equipment, residential and commercial refrigerators, freezers and air conditioners
- XH-9 beaded molecular sieve for maximum water capacity in HFC refrigerants
- High quality – high capacity
- Hermetically sealed
- Easy break off grooved ends
- Copper shells and end tubes
- Compatible with R134

MARS NO	DESCRIPTION	DROPS OF WATER REMOVED				RECOMMENDED TONNAGE	
		R-12		R-22		R-12	R-22
		75°	125°	75°	125°		
20203	Plugged Ends	37.5	34	34	32	1/3	1/2
20303	Plugged Ends	37.5	34	34	32	1/3	1/2
20209	Non-Directional	37.5	34	34	32	1/3	1/2
20210	Fused Ends	37.5	34	34	32	1/3	1/2
20310	Fused Ends	37.5	34	34	32	1/3	1/2
20211	Charging Drier	74	38	68	64	3/4	1
20311	Charging Drier	74	38	68	64	3/4	1
20212	Step Down Drier	99	93	95	90	1	2
20213	Double Inlet	74	68	68	64	3/4	1
20214	Fused Ends	74	68	68	64	3/4	1
20215	Charging Drier	37.5	34	34	32	1/3	1
20216	Step Down Drier	74	68	68	64	3/4	1

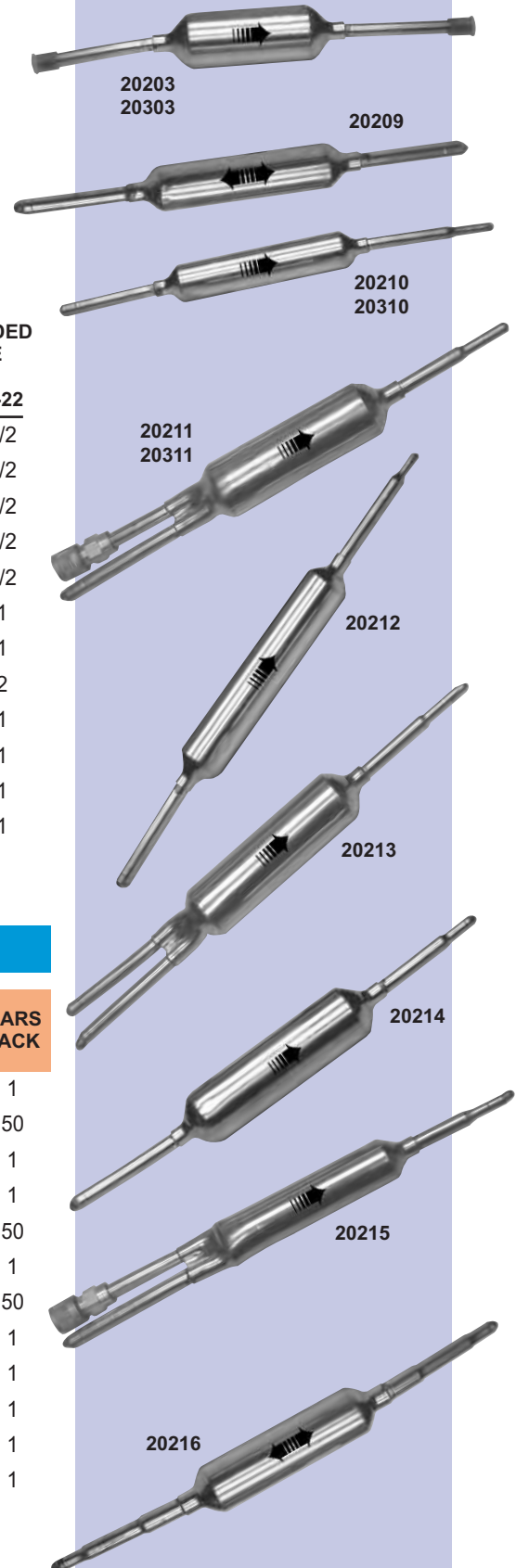

MARS Spun Copper Driers

MARS NO	DESCRIPTION	INLET	OUTLET	LENGTH	DIA.	MARS PACK
20203	Plugged Ends	1/4" OD	1/4" OD	7-3/4"	1"	1
20303	Plugged Ends	1/4" OD	1/4" OD	7-3/4"	1"	50
20209	Non-Directional	1/4" OD	1/4" OD	8-1/2"	3/4"	1
20210	Fused Ends	1/4" OD	1/4" OD	8-3/4"	3/4"	1
20310	Fused Ends	1/4" OD	1/4" OD	8-3/4"	3/4"	50
20211	Charging Drier	1/4" OD 1/4" Flare	1/4" OD or Cap.	8-3/4"	1"	1
20311	Charging Drier	1/4" OD 1/4" Flare	1/4" OD or Cap.	8-3/4"	1"	50
20212	Step Down Drier	5/16"OD	5/16" OD or Cap.	10-3/4"	1"	1
20213	Double Inlet	(2) 1/4" OD	1/4" OD	8-3/4"	1"	1
20214	Fused Ends	1/4" ID 1/4" OD	1/4" OD or Cap.	9"	1"	1
20215	Charging Drier	1/4" ID 1/4"OD 1/4"Flare	1/4" OD or Cap.	9"	3/4"	1
20216	Step Down Drier	3/16, 1/4, 5/16" ID	5/16" ID or Cap.	8-3/4"	1"	1



Tubing Tools

MARS SERIES **650**

Tubing Cutters And Accessories

Imperial Eastman offers a quality line of tube working tools, well recognized as standards of excellence in the HVACR industry. All tubing tools are made in the U.S.A. and come with a limited lifetime warranty.

Imperial tube cutters can be used on hard or soft copper, aluminum, brass, thin wall steel, stainless steel, monel, titanium and other metal tubing. The Hi-Duty® tube cutters (MARS #65001 and #65002) feature rollers with flare cut-off groove, fold away reamer and a spare cutting wheel. MARS #65003 is a combination tube constrictor and cutter. This combo cutter is used for brazed or sweat type connections. A roller is used in place of cutter wheel.

MARS #65004, Imp® tube cutter, requires only 1 1/4" swing radius and a 1 3/8" swing radius with 5/8" tube. This tube cutter features rollers on the bottom of the tool which allows for easier cutter engagement on tubing. The enclosed feed design minimizes contamination, assuring continued free operation. MARS #65005 requires only 1 11/16" swing radius.

The Big-Imp™ tube cutter, MARS #65006, requires only 1 15/16" swing radius and a 2 1/4" swing radius with 1 1/8" tube.

MARS NO.	MFG. NO.	DESCRIPTION	CASE QTY.
65001	TC1000	Hi-Duty® 1/8" to 1 1/8" OD	20
65002	312FC	Hi-Duty® 1/4" to 1 5/8" OD	10
65003	TC1020	Hi-Duty® combo 1/8" to 1 1/8" OD	10
65004	TC1050	Imp® cutter 1/8" to 5/8" OD	20
65005	TC2050	Imp® cutter 3/16" to 7/8" OD	10
65006	174F	Big Imp™ 3/8" to 1 1/8" OD	10
65008	S75015	Standard cutter wheel (10 pk) for use on #65001, 65002, 65003, 65006	10
65009	S75046	Cutter wheel for stainless steel and hard temper tubing (5 pk) for use on #65001, 65002, 65003, 65006	10
65010	S74762	Screws for cutter wheel (5 pk) for use on #65008, 65009	10
65011	TC1A	Cutter wheel service kit includes: 3 standard cutter wheels 1 screw for cutter wheel	10
65012	TC1B	Cutter wheel stainless service kit includes: 3 cutter wheels for stainless steel and hard temper tubing 1 screw for cutter wheel	10
65013	TC1C	Cutter wheel service kit includes: 2 cutter wheels for #65004 1 screw for cutter wheel	10
65014	206FB	Adj.-O-Matic® 1/8" - 2-5/8" OD	1
65072	S74761	Cutter wheel 5 pak for use on 65014	1
65076	S77511	Screw for cutter wheel for #65072	1
65056	S32633	Cutter wheel 5 pk. on 65004, 65015	1
65073	S26883	Screw for cutter wheel for 65056	1
65088	406FA	Hi Duty Adj-O-Matic® 2" - 4-1/8" OD	1
65074	S74833	Cutter wheel for 65088	1
65075	S74834	Screw for cutter wheel for #65074	1



SERVICE & INSTALLATION



The largest selection of motors, components and accessories for the HVAC/R Industry

Tubing Tools

MARS SERIES **650 & 256**



Tube Benders

Imperial lever type tube benders are used for soft copper, aluminum, brass, steel and other metal tubing. Each tool bends one size. The open size design slips over tube at any point. Our tube benders make smooth short radius bends up to 180°. Each bender tool is calibrated to show angle of bend. The wide hook grips tubing securely and the new fixed hook has easy 90° start. Our line of lever tube benders feature a swivel handle which may be repositioned to regain leverage for bends greater than 90°, eliminating bender twisting and handle crossing. The enclosed swivel mechanism provides extended life. Ideal for bending stainless steel, as well as other tubing.

Imperial Imp® triple header benders feature calibrated markings for accurate left-hand, right-hand and offset bends. 90° start requires less effort - making bending fast and easy.

Imperial spring type tube benders are for use on soft copper and aluminum tubing. These tools allow hand bending of soft tubing to any shape without collapsing walls. Special spring steel, nickel finished. End belled for quick tube removal.

MARS NO.	MFG. NO.	DESCRIPTION	CASE QTY.
65018	364FHA06	Lever type 3/8" OD	10
65063	364FHA10	Lever type 5/8" OD	10
65021*	364FHB06	Lever type with swivel handle 3/8" OD	5
65022*	364FHB08	Lever type with swivel handle 1/2" OD	5
65024	368FH	Triple header; 1/4", 5/16", 3/8" OD 15/16" radius to center	10
65025	102F04	Spring type 1/4" OD	10
65026	102F06	Spring type 3/8" OD	10
65028	102F08	Spring type 1/2" OD	10
65031	102F10	Spring type 5/8" OD	10
65032	102F12	Spring type 3/4" OD	10
65033	102F14	Spring type 7/8" OD	10
65029	163F	Spring set; 1/4", 3/8", 1/2", 5/8" OD	10

*patented

MARS Tube Benders

MARS NO.	DESCRIPTION	MARS PACK	CASE QTY.
25660	External spring type tube benders, 1/4", 3/8", 1/2" & 5/8", set of 4	1	24

Tubing Tool Kits

MARS #65059, 45° flaring and swaging tool kit is for use on 1/8", 3/16", 1/4", 5/16", 3/8", 7/16", 1/2" and 3/4" OD tubing. Flares or swages. Converts quickly. Features screw-type feed. Ideal close quarters tool. Swivel type swaging adapters and spreader cone are hard-chrome finished for easy operation. Self centering, slip-on forged steel yoke. Includes five swage adapters for 3/16", 1/4", 5/16", 3/8", 1/2" and 3/4" OD tubing. Packaged in a plastic kit.

MARS #65034, 45° flaring kit is for use on 1/8" - 3/4" OD tubing. This compact kit contains two flaring bars & one yoke. The self centering forged steel yoke has a slip-on feature. The swivel flaring cone reduces effort. Packaged in plastic case.

MARS NO.	MFG. NO.	DESCRIPTION	CASE QTY.
65059	275FS	45° flaring and swaging tool	1
65034	375FS	45° flaring kit for 1/8" - 3/4"	1

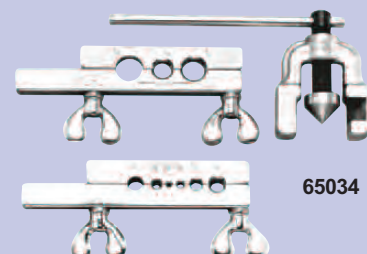
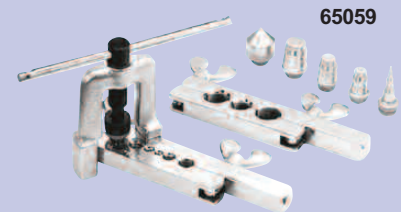
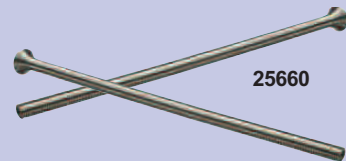
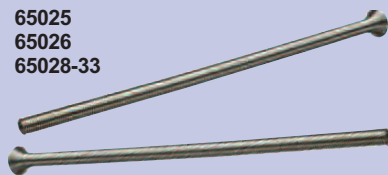
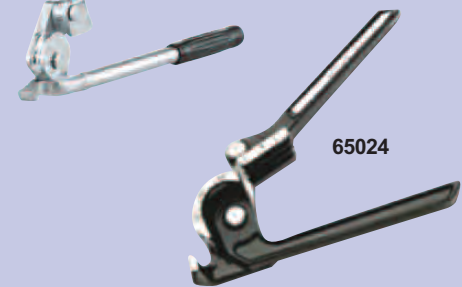



Flaring Tools

Imperial MARS #65035, Rol-Air® flaring tool, is used for soft copper, aluminum and brass. This flaring tool flares and burnishes 3/16", 1/4", 5/16", 3/8", 1/2" and 5/8" OD tubing. The faceted, hard chrome finished cone rolls out perfect 37° flares above die block - then automatically burnishes flare face. Original wall thickness is maintained at base of flare. Slip-on yoke permits use in tight quarters. The heat treated dies grip tubing without scoring.

MARS #65036, 37° flaring tool, is for use on copper, aluminum, steel, stainless steel and other metal tubing. Three rollers in flaring cone roll out a 37° flare above die block. There is an extension on the yoke for clamping in vise. This flaring tool is for 3/16", 1/4", 5/16", 3/8", 1/2" and 5/8" OD tubing and is furnished in a plastic kit.

Imperial's 45° flaring tool, MARS #65037, is for 3/16", 1/4", 5/16", 3/8", 7/16", 1/2" and 5/8" OD tubing. This tool features a self-centering yoke with swivel-type, hard chrome finished flaring cone to form better flares with less effort. The yoke is designed to permit flaring where there is little space between nut and tube end. This flaring tool is for use on soft copper, aluminum and brass tubing.

The 45° Rol-Air® flaring tool, MARS #65038, is used for flaring and burnishing 3/16", 1/4", 5/16", 3/8", 1/2" and 5/8" OD tubing. The flares are rolled out above die bar by a super-smooth faceted cone. Automatically burnishes flare face. The slip-on yoke permits use in tight quarters. Heat treated dies grip tubing without scoring. For use on soft copper, aluminum and brass tubing.

Imperial's Grabber™ Rol-Air® flaring tool flares and burnishes 3/16" to 5/8" OD tubing. This 45° flaring tool is for use on soft copper, aluminum and brass tubing. MARS #65039 features a unique, self-adjusted, tube holding mechanism which permits use in tight quarters. The faceted, hard chrome finished cone rolls out and burnishes a perfect 45° flare above the tube holding mechanism.

MARS NO.	MFG. NO.	DESCRIPTION	CASE QTY.
65035	507FB	Rol-Air® 37° for 3/16" to 5/8" OD	1
65037	195FC	45° for 3/16" to 5/8" OD	10
65038	500FC	Rol-Air® 45° for 3/16" to 5/8" OD	10
65039	525F	Grabber™ Rol-Air® 45° for 3/16" to 5/8" OD	10
65046	103FS	45° for 3/4", 7/8", 1" OD	1
65047	203FA	45° for 5/8" to 1-1/8" OD	1
65048	296FC	45° for 3/16" to 5/8" OD	1
65049	300FB	Hi Duty 45° for 3/16" to 5/8" OD	1

Pinch Off Tool

Pinch-off tool temporarily closes soft copper, aluminum or steel tubing so no liquid or gas passes. Lets you disconnect line while making repairs without loss of liquid or gas. Also opens tubing and rounds it back into shape. For use on 1/4", 3/8" and 1/2" OD tubing.

MARS NO.	MFG. NO.	DESCRIPTION	CASE QTY.
65050	105FF	Pinch off tool (copper tubing)	1



Tubing Tools

MARS SERIES **650 & 790**



Reamers, Swaging Tools, Wrenches & Tube Adapters

Imperial inner/outer reamers and deburring tools ream both inside and outside edges of tube with three hollow ground tool steel cutters. Fits comfortably in hand. MARS #65066, inner/outer reamer and deburring tool is used for copper, aluminum and brass tubing and has a blue finish.

Swaging tools are to be used on soft copper, aluminum and brass tubing. Our punch-type swaging tools make tubing connections without the use of fittings. Simply enlarge end of tube, insert another tube and solder like a sweat fitting. MARS #65069 swaging punch tool is for 1/2" OD tubing. The swaging punch kit, MARS #65070, contains four swaging punches - 1/4", 3/8", 1/2" and 5/8" OD. Packaged in vinyl case.

Imperial's tube adapter is used for charging and testing. To connect a hermetic system, pinch-off tube is cut off and adapter is slipped over cut end of tube and tightened. Synthetic rubber seal of adapter grips outside of tube. This gives a 1/4" male flare connection to system for purging, charging or testing. After system is recharged, tube is pinched off next to adapter. Adapter is then removed and tube is cut off and sealed with solder. Adapter can be used repeatedly.

MARS #65082 is a combination wrench with the four sizes most needed for servicing air conditioning units. MARS #65083 is for use on compressors with access valves in hard to reach places. This reversible ratchet is chrome plated.

MARS NO.	MFG. NO.	DESCRIPTION	CASE QTY.
65066	208F	Inner/outer reamer and deburring tool	10
65069	94S	1/2", 5/8", 7/8" OD swaging punch tool	1
65070	193S	swaging punch kit	20
65085	93S03	3/16" OD swaging punch	20
65086	93S04	1/4" OD swaging punch	1
65089	93S05	5/16" OD swaging punch	1
65093	93S12	3/4" OD swaging punch	1
65094	93S14	7/8" OD swaging punch	1
65051	241F04	Tube adapter 1/4" O.D.	1
65082	124C	9/16" and 1/2" hex; 3/16" & 1/4" sq. ratchet	1
65083	127C	1/4", 3/8", 3/16", 5/16" square ratchet	1

SURE CUT Ratchet Tubing Cutter

- Cuts copper, brass, aluminum tubing and thin-wall conduit
- Ratchets for fast, easy cuts in tight areas
- Self feeding action for automatic cutting
- Strong, lightweight nylon & fiberglass handle
- Spare cutting wheel is supplied in the handle

MARS NO.	DESCRIPTION	MARS PACK	CASE QTY.
65201	5/16" to 1 1/8" OD	1	12
65202	1/4" to 7/8" OD	1	12
65203	Replacement Blades	1	12

EASY BEND Ratcheting Tubing Bender

- For bending OD tubing sizes from 3/8" to 7/8"
- Use on soft copper, coated soft copper, thin wall hydraulic tubing and plastic coated aluminum composite pipe
- Kit includes impact resistant carry case, tubing cutter and ID/OD reamer
- Single-hand manual ratchet operation

MARS NO.	DESCRIPTION	MARS PACK	CASE QTY.
65210	Tubing Bender	1	3



Service Manifolds & Accessories

MARS SERIES **651**



Service Manifolds

Imperial and Motors & Armatures, Inc., offer refrigeration and air conditioning service manifolds. The Man Handler™ 4-valve manifolds feature up to four times faster system evacuation. The 4 valve efficiency provides vacuum, low side, high side and refrigerant lines individually connected and controlled. No need to switch charging lines. T-grip controls offer non-slip operation. Other features include swivel hanger, brass hose end closure bracket and a deep, vacuum valve design. The red and blue gauges are calibrated in psi. MARS #65101 is a standard 4 valve manifold and MARS #65102 is a 4 valve manifold with four 60" std. fitting charging lines (one 3/8" line, three 1/4" lines). MARS #65103 is a 4 valve manifold with sight glass. For R-12, R-22 and R-502 refrigerants.

Imperial's convertible 2 valve brass manifolds feature non-flutter gauges, tough gauge crystals, swivel hanger, brass hose end closure spuds, soft-seat valves and color coded controls. The red and blue gauges are calibrated in psi. MARS #65104 is the standard 2 valve manifold. MARS #65105 is the 2 valve manifold with three 36" std. fitting charging lines. For R-12, R-22 and R-502 refrigerants.

MARS NO.	MFG. NO.	DESCRIPTION	CASE QTY.
65101 ¹	620C	4 valve manifold	20
65102 ¹	621C	4 valve manifold with (4) 60" hoses	20
65103 ¹	620CS	4 valve manifold with sight glass	1
65104	495C	2 valve manifold	30
65105	496C	2 valve manifold with (3) 36" hoses	30
65108	400RL	Low side repair kit for 2 valve	1
65111	400RH	High side repair kit for 2 valve	1
65109	S8922562	Hook assembly for 4 valve	1
65110	S9449101	Closure bracket plate for 4 valve	1
65116	600R	Diaphragm replacement seal kit	1
65117	601R	Replacement VAC & REF knobs w/stems	1
65118	602R	Replacement HI & LO	1

¹Patented, UL recognized for commercial refrigeration & A/C applications

Manifold Accessories

Imperial patented, UL recognized kwik-couplers are intended for use with refrigeration/air conditioning service manifold high and low side hoses, when connecting to core valve type service fittings. Simply push to connect and pull to disconnect. Valve cores are depressed automatically without adjustments or loss of refrigerant. An automatic shut off valve retains refrigerant pressure in disconnect hose.

MARS NO.	MFG. NO.	DESCRIPTION	CASE QTY.
65139	16C	Straight coupler (45° flare) 1/4"F x 1/4"M	20
65140	17C	90° elbow coupler (45° flare) 1/4"F x 1/4"M	20
65141	18C	Coupler set (#16C and 17C)	15
65151	535C	Kwik charge liquid low side	1

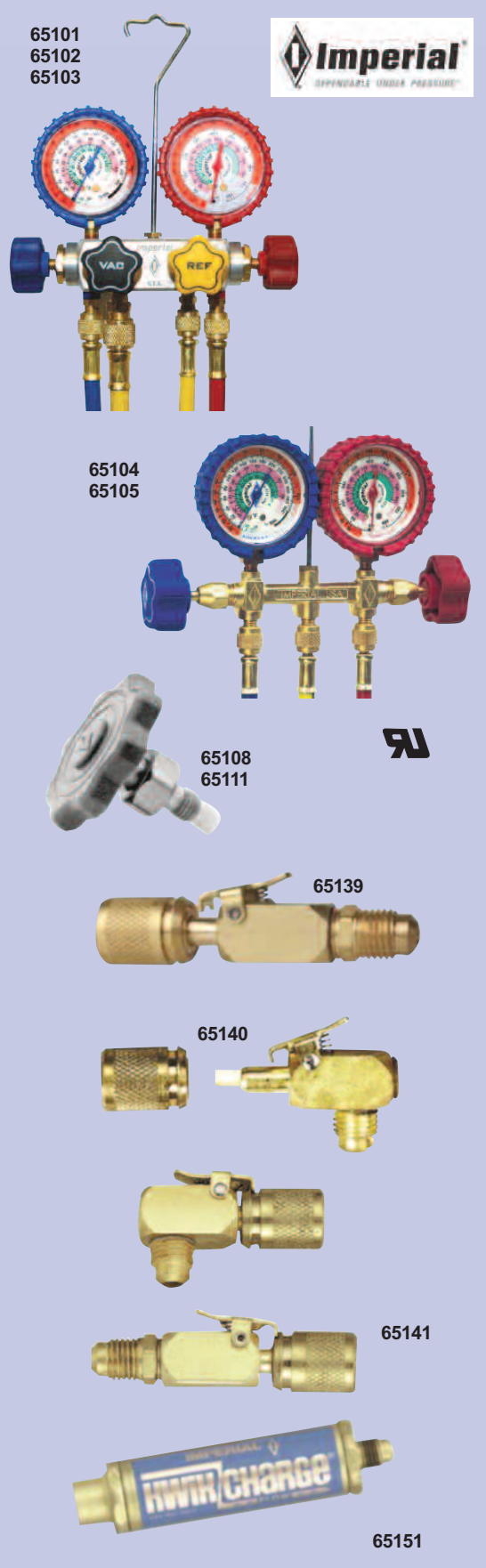

SERVICE & INSTALLATION

Vibration Absorbers

MARS SERIES **523**



Stainless Steel Vibration Absorbers

- 100% Copper connections
- Hose and copper braze welded
- Each unit dehydrated and vacuum tested
- Units individually packaged in poly bags and corrugate boxes
- UL, cUL, and CE

MARS NO.	DESCRIPTION	MARS PACK
52329	1/4" Vibration Absorber	1
52330	3/8" Vibration Absorber	1
52331	1/2" Vibration Absorber	1
52332	5/8" Vibration Absorber	1
52333	3/4" Vibration Absorber	1
52334	7/8" Vibration Absorber	1
52335	1-1/8" Vibration Absorber	1
52336	1-3/8" Vibration Absorber	1
52337	1-5/8" Vibration Absorber	1
52338	2-1/8" Vibration Absorber	1
52339	2-5/8" Vibration Absorber	1
52340	3-1/8" Vibration Absorber	1

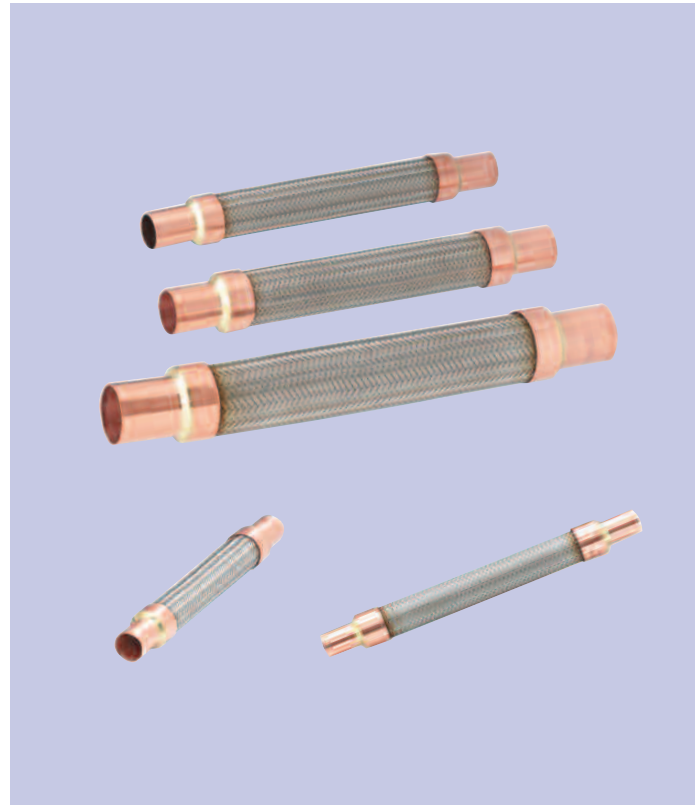



Wrot Copper Fittings

MARS SERIES **647**

9600 RS Couplings-Rolled Stop-Copper To Copper

MARS NO.	MODEL NO.	DESCRIPTION	MARS PACK	CASE QTY.
64721	W1001	3/16" O.D.	10	100
64722	W1003	1/4" O.D.	100	1000
64720	W10142	5/16" O.D.	100	4000
64723	W1009	3/8" O.D.	100	2000
64724	W1017	1/2" O.D.	100	2000
64725	W1022	5/8" O.D.	100	1000
64726	W1028	3/4" O.D.	100	500
64727	W1034	7/8" O.D.	50	500
64728	W1047	1 1/8" O.D.	25	250
64729	W1055	1 3/8" O.D.	25	250

9600 Reducing Couplings - W/Stop-Copper To Copper

MARS NO.	MODEL NO.	DESCRIPTION	MARS PACK	CASE QTY.
64734	W1010	3/8" x 5/16" O.D.	10	1000
64735	W1011	3/8" x 1/4" O.D.	50	1000
64739	W1025	5/8" x 3/8" O.D.	10	2000
64740	W1029	3/4" x 5/8" O.D.	50	500
64741	W1030	3/4" x 1/2" O.D.	10	1000
64742	W1035	7/8" x 3/4" O.D.	50	500
64745	W1049	1 1/8" x 7/8" O.D.	25	250

9607LT 90° Elbows - Long Radius Copper To Copper

MARS NO.	MODEL NO.	DESCRIPTION	MARS PACK	CASE QTY.
64823	W2715	1/4" O.D.	50	3000
64825	W2716	3/8" O.D.	50	2000
64826	W2717	1/2" O.D.	50	1000
64827	W2722	5/8" O.D.	50	500
64828	W2728	3/4" O.D.	50	500
64829	W2734	7/8" O.D.	25	250
64830	W2747	1 1/8" O.D.	10	1000
64831	W2055	1 3/8" O.D.	5	100

9607 90° Elbows-Short Radius Copper To Copper

MARS NO.	MODEL NO.	DESCRIPTION	MARS PACK	CASE QTY.
64800	W2003	1/4" O.D.	50	500
64801	W2009	3/8" O.D.	50	2000
64802	W2017	1/2" O.D.	50	1000
64803*	W2022	5/8" O.D.	100	1000
64804*	W2028	3/4" O.D.	50	500
64805*	W2034	7/8" O.D.	50	250

*intermediate radius

9607-2LT 90° Street Elbows - Long Radius

MARS NO.	MODEL NO.	DESCRIPTION	MARS PACK	CASE QTY.
64813	W2809	3/8" O.D.	50	500
64814	W2817	1/2" O.D.	50	500
64815	W2822	5/8" O.D.	50	500
64816	W2828	3/4" O.D.	25	250
64817	W2834	7/8" O.D.	25	250
64818	W2847	1 1/8" O.D.	10	100
64819	W2350	1 3/8" O.D.	10	100

NIBCO
AHEAD OF THE FLOW™



64721-64729



64734-64745



64823-31



64800-05



64813-19

SERVICE & INSTALLATION

Brazing Alloys, Solders & Fluxes

MARS SERIES **793**



Sil-Fos Brazing Alloys - 1/8" X .05" X .20"- 1 Lb. Spool

Sil-Fos® alloys allow the joining of copper to copper without a flux and copper based alloys (brass and bronze) with a flux. Sil-Fos® is the workhorse filler metal used in the a/c and refrigeration industry. A key factor is the ductility of Sil-Fos® 15. It can be readily bent (without heating), thus permitting easier access to the backsides of joints.

The Sil-Fos® 15 is the best alloy for general copper-copper brazing in the Sil-Fos® family. The phosphorus in the Sil-Fos® product serves as the fluxing agent and no separate flux is necessary. For brass applications however, flux is recommended. For use where close fit-ups cannot be maintained Sil-Fos® 15 works well to "bridge" gaps. Sil-Fos® 15 is the most ductile of the entire Sil-Fos® family to best withstand the stresses inherent in refrigeration applications. Slow Flow.

The Sil-Fos® 6M is recommended for use where close fit-ups cannot be maintained. It has the ability to fill gaps and form fillets without affecting joint strength. Slow Flow.

The Sil-Fos® 5 is designed primarily for those applications where close fit-ups cannot be maintained. It has the ability to fill gaps and form fillets without adversely affecting joint strength. Slow Flow.

Fos-Flo® 7 is an economical, very fluid medium temperature filler metal for use with copper, brass and bronze. Withstands moderate vibration. Fast Flow.

Also available for merchandising assistance is the point of purchase display rack suitable for counter top display or hanging on pegboard. This display #78300 is available at no charge upon request with a \$1500 minimum order of Lucas brazing/solder products. Cardboard display dimensions: 25"H x 23"W x 10 1/5" deep at base x 6 1/4" deep at top (30 3/4" overall height including header).



SERVICE & INSTALLATION

MARS NO.	AWS SPEC	COMPOSITION %			TEMPERATURE		MARS PACK	CASE QTY.	
		Ag	Cu	P	MELT	FLOW			
78301	Sil-Fos® 15	BCuP-5	15	80	5	1190° F	1475° F (1300°)	1	25
78302	Sil-Fos® 6M	BCuP-4	6	88	6	1190° F	1460° F (1300°)	1	25
78303	Sil-Fos® 5	BCuP-3	5	89	6	1125° F	1495° F (1300°)	1	25
78304	Fos-Flo® 7	BCuP-2		92.8	7.2	1310° F	1460° F (1350°)	1	25

Brazing Alloys, Solders & Fluxes

MARS SERIES **793**

High Silver Brazing Alloys - 1/16" Dia. Coils

In refrigeration applications, much of the brazing involves joining copper tubing. However, there are numerous applications where other materials need to be joined (steel, brass, stainless, etc.). These high silver brazing alloys facilitate the joining of these metals. The one alloy in particular which is highly recommended for virtually all above mentioned base metals is Braze® 505. It's advantages over 56% and 45% include:

- It contains 2% Nickel which enhances wetting and strength and facilitates the joining of steels, stainless steel, carbide, etc.
- It doesn't contain tin. This prevents the formation of brittle intermetallics which can cause joint failures when stresses accumulate.
- The flow characteristics can be easily manipulated by either fast or slow heating techniques - this allows bridging of gaps.
- It's available in flux-coated rod for added convenience and ease-of-use: No separate fluxing operation.

Braze® 450 is a general purpose filler metal for joining ferrous, non-ferrous and dissimilar metals with large joint clearances. Cadmium-free.

Braze® 505 is the best general purpose filler metal available. It is the only alloy recommended for stainless steel (as it retards/eliminates interface corrosion) and carbide applications. Nickel content provides superior adhesion ("wetting") to base metal surfaces. Available, and especially convenient, as flux coated rod. Cadmium-free.

Braze® 560 is the lowest temperature, Cadmium-free filler metal available. This is a good general purpose alloy for close joint tolerances.

Lucas-Milhaupt, Inc.
A Handy & Harman Company



SERVICE & INSTALLATION

MARS NO.	DESCRIPTION	AWS SPEC	COMPOSITION %					TEMPERATURE		MARS PACK	CASE QTY.
			Ag	Cu	Zn	Sn	Other	MELT	FLOW		
78305	Braze® 450 1oz	BAg-5	45	30	25			1225° F	1370° F	1	24
78306	Braze® 450 3oz									1	24
78307	Braze® 450 5oz									1	24
78308	Braze® 505 1oz	BAg-24	50	20	28	2 Ni	1220° F	1305° F		1	24
78309	Braze® 505 3oz									1	24
78310	Braze® 505 5oz									1	24
78314	Braze® 505 F/C, Flux coated rod, 18" stick x 1/4 lb tube	BAg-24	50	20	28	2 Ni	1220° F	1305° F		1	15

Brazing & Solder Fluxes

Where fluxing is required as part of the brazing operation, Handy Flux is recommended. Handy Flux is an all-purpose flux for use in brazing both ferrous and non-ferrous metals and alloys. Handy Flux conforms to: AWS Brazing Flux Type #3A, Federal Spec. O-F-499d (216185) Type B, Society of Automotive Engineers AMS-3410G. For soldering applications we offer two different flux products depending on the materials to be joined. They include Clean-n-Brite Flux for general purpose applications and TEC Liquid Flux where more aggressive fluxing is required for the more difficult-to-solder materials (e.g. steel, stainless steel, etc.).

MARS NO.	DESCRIPTION	MARS PACK	CASE QTY.
78315	Handy Flux - 7oz. jar w/brush cap	1	24
78319	TEC Liquid Flux - 4oz. squeeze bottle	1	48
78320	Clean-n-Brite Flux -4oz. paste w/brush	1	24



78319



The largest selection of motors, components and accessories for the HVAC/R Industry

SI-73

Brazing Alloys, Solders & Fluxes

MARS SERIES **793**



Silver Bearing Soft Solders - 1/8" X 1 Lb. Spool

Clean-n-Brite solders are a high strength general purpose solder. They offer a higher strength than Tin/Lead solders and are safe for potable water systems. These alloys are widely used in low stress, low pressure copper-copper and copper-steel applications (e.g. sight glasses where temperature must be kept low, etc.). For copper-copper, Clean-n-Brite Paste Flux is the flux of choice. For copper-steel applications, TEC Liquid Flux is recommended as it is more aggressive at keeping the metal surfaces to be joined free of oxides. TEC is a more corrosive flux however, and subsequent flux residue removal is recommended.

Clean-n-Brite is a Lead-free, silver-bearing high-strength solder used for applications requiring close joint clearances.

Clean-n-Brite 6 is a Lead-free, silver-bearing high-strength solder used for applications requiring large joint clearances. It is the easiest Silver-bearing soft solder to work with as temperature range permits "bridging" loose fit-ups if necessary.

Clean-n-Brite No Lead is a Silver-bearing solder with good strength used in potable water system applications requiring no lead.



Lucas-Milhaupt, Inc.
A Hanay & Harman Company

SERVICE & INSTALLATION

MARS NO.		COMPOSITION %			TEMPERATURE		MARS PACK	CASE QTY.
		Ag	Cu	P	MELT	FLOW		
78316	Clean-n-Brite	3.6		96.4	431° F	431° F	1	24
78317	Clean-n-Brite 6	6		94	431° F	535° F	1	24
78318	Clean-n-Brite No Lead	0.5	4	95.5	428° F	446° F	1	24

MARS Cross Reference Guide

MARS NO.	HANDY HARMON	LUCAS MILHAUPT	J.W. HARRIS	ENGELHARD
78301	Sil-Fos15	95150	61035 (Stay-Silv 15)	Silvaloy 15
78302	Sil-Fos 6M	95120	66000 (Dynaflow)	Silvaloy 6
78303	Sil-Fos 5	95060	41035 (Stay-Silv 5)	Silvaloy 5
78304	Fos-Flo 7	95000	21035 (Stay-Silv 0)	Silvaloy 0
78305	Braze 450 (1oz.)	98000	76310 (Safety-Silv 45)	Silvaloy A-45
78306	Braze 450 (3oz.)	98001	76313 (Safety-Silv 45)	Silvaloy A-45
78307	Braze 450 (5oz.)	98002	76315 (Safety-Silv 45)	Silvaloy A-45
78308	Braze 505 (1oz.)	98070		
78309	Braze 505 (3oz.)	98071		
78310	Braze 505 (5oz.)	98072		
78311	Braze 560 (1oz.)	98060	75310 (Safety-Silv 56)	Silvaloy A-56
78314	Braze 505 F/C	98110		
78315	Handy Flux	97030	40022 (Stay-Silv Flux)	Ultra Flux
78316	Clean-n-Brite	96000	10001 (Stay-Brite)	Silvabrite
78317	Clean-n-Brite 6	96010	10009 (Stay-Brite 8)	Silvabrite S
78318	Clean-n-Brite (no lead)	96150	15000 (Stay-Safe 50)*	Silvabrite 100
78319	Tec Liquid Flux	97000	40002 (Stay-Clean)	70001
78320	Clean-n-Brite Flux	97020	40027 (Stay-Clean Solder Flux)	71003

* While this material does not have a chemistry exactly equivalent, it is similar in composition to Clean-n-Brite no lead and typically used in similar applications.

Soft Copper Refrigeration Coils

MARS SERIES **649**

Soft Copper Refrigeration Coils

- 50' Length
- ASTMB280
- Individually shrink wrapped rolls

MARS NO.	SIZE	COILS/SKID	COILS/BOX
50014	1/4"	440	10
50516	5/16"	480	10
50038	3/8"	416	8
50012	1/2"	100	5
50058	5/8"	100	5
50034	3/4"	69	3
50078	7/8"	60	3
50118	1-1/8"	42	1

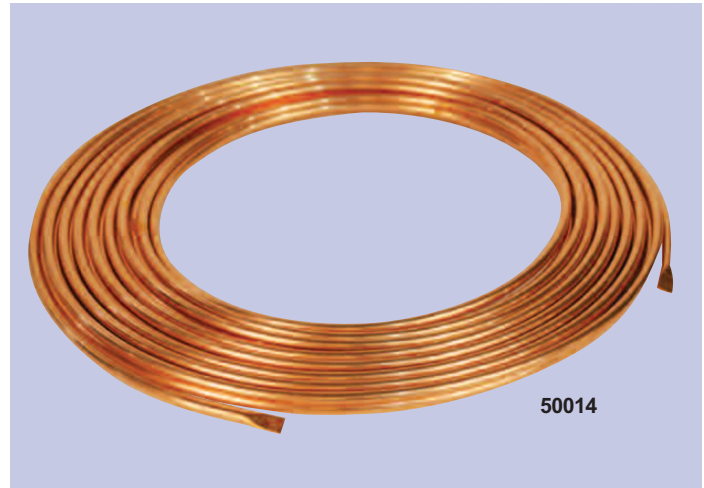

50014



Lines & Tubing

MARS SERIES **799**

MARS Pilot Burner Gas Lines

MARS pilot burner gas line is 6.5 ft of clean aluminum tubing with compression nuts and sleeves. Coiled and individually polybagged. 50' coils do not include fittings.

MARS NO.	DESCRIPTION	MARS PACK
79126	1/4" OD x 6.5' aluminum tubing	1

MARS Clear Vinyl Tubing, - Boxed

MARS NO.	DESCRIPTION	CASE QTY.
79131	1/4" ID clear tubing 32 PSI - .375 O.D.	100 feet
79132	3/8" ID clear tubing 27 PSI - .500 O.D.	100 feet
79133	1/2" ID clear tubing 24 PSI - .625 O.D.	100 feet
79134	5/8" ID clear tubing 21 PSI - .750 O.D.	100 feet
79135	3/4" ID clear tubing 19 PSI - .890 O.D.	100 feet
79136	7/8" ID clear tubing 16 PSI - 1.015 O.D.	50 feet

MARS Polyethylene Tubing, FDA Approved

MARS NO.	DESCRIPTION	CASE QTY.
79137	1/4" OD clear tubing boxed 135 PSI @ room temp.	100 feet

MARS Humidifier/Icemaker Kit

The MARS humidifier/icemaker tubing kit includes 25' of FDA approved, 1/4" OD, non-toxic polyethylene tubing. Self tapping saddle valve and compression fittings also included. Polybagged.

MARS NO.	DESCRIPTION	CASE QTY.
79129	Humidifier/icemaker kit	36
79139	MARS saddle valve	1



79126

79131-36

79137

79139



The largest selection of motors, components and accessories for the HVAC/R Industry

SI-75

SERVICE & INSTALLATION

Specialty Tools

MARS SERIES **790**



Specialty Tools

The MARS telescoping pilot match holder with magnet collapses to fit in shirt pocket. Extends to 25". Attractively packaged and barcoded for merchandising.

MARS NO.	DESCRIPTION	MARS PACK
79130	Pilot match holder	1

Inspection Mirrors

MARS offers inspection mirrors for virtually any application! Telescoping types available, along with round glass, oval glass, rectangular glass, round metal and rectangular metal. Attractively carded and barcoded.

MARS NO.	DESCRIPTION	MARS PACK
79350	1 1/4" round dia.glass mirror with 6" arm, adjustable angle	1
79351	2 1/4 round dia.glass mirror with 10 1/2" arm, adjustable angle	1
79352	1" x 2" oval glass mirror with 6" arm, adjustable angle	1
79353	2 1/8" x 3-1/2" rectangle glass mirror with 11"-12" extendible arm	1
79358	2 1/4" dia.round magnifying glass mirror with vinyl grip handle 14 1/2"	1

EVERSPARK Electronic Igniter

Designed to fit your hand. Makes igniting any burner or torch quick & easy. Stands up to the most demanding field applications.

MARS # 79275 is designed for soldering, brazing, cutting, welding, plumbing, heating, refrigeration, air conditioning and process piping, etc...

MARS # 79274 is designed for use with natural or bottled gas. Applications include: hot water heaters, pilots, gas bbq's, gas logs, gas appliances, industrial, residential, camping & RV's.

MARS NO.	DESCRIPTION	CASE QTY.
79275	Everspark Torch Ignitor	12
79274	Everspark II Long Reach Gas Ignitor	12



SERVICE & INSTALLATION

Compressor Terminal Repair Kit

MARS SERIES **862**



Compressor Terminal Repair Kit

Zebra Instruments offers a compressor terminal repair kit. The terminals are high-temp soldered to the 10ga. Fine strand, color coded wires for the best connection. These special terminals allow clearance for compressor post, and lay flat under the safety cover, Twist on wire nuts also provided.

MARS NO.	DESCRIPTION	MARS PACK	CASE QTY.
08565	Compressor Terminal Repair Kit 1 set of 3, terminals/wires/connectors	1	24





Compressor Stake On Repair Kits

MARS SERIES **862**

MARS Compressor Stake On Repair Kits

MARS Term-Lok compressor stake on repair kits are designed with the technician in mind! During servicing of the air conditioning system or refrigeration system, it is not unusual for a technician to remove the compressor cover to find the electrical connector or spade terminal broken or melted away from the compressor. In reconnecting the electrical power, the metal plate is often found to have deteriorated to such an extent that the conventional female connector will no longer attach to the spade type male connector. Technology for reattaching a metal plate to the metal pin without damaging the encapsulated block is not normally available thus requiring the technician to attempt various types of crimping arrangements to avoid replacing the compressor assembly (which normally does not work).

The MARS Term-Lok is a brass cylindrical tube with a diameter large enough to slip over the pins and has a stainless set screw to lock onto the terminal. Term-Lok comes in packages of one or three terminal locks with color coded 65 strands, 600 volt permanently attached wire, with wrench provided for easy application. Once installed the compressor cover may be placed back over the terminals without any obstructions.

It takes approximately 15 minutes to install on most systems, thus saving the technician time and the customer money, with virtually no call backs.

MARS NO.	DESCRIPTION	MFG. NO.	CASE QTY.
86386	Brass stake on 12 gauge - 3 wire	TLC-3-12	1
86388	Brass stake on 10 gauge - 3 wire	TLC-3-10	1
86390	Brass stake on 8 gauge - 3 wire	TLC-3-8	1

Term-Lok

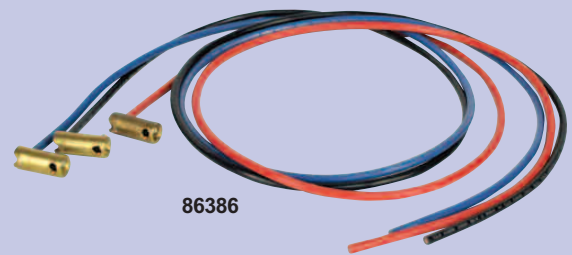

86386

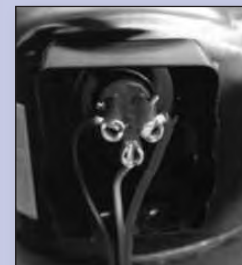

SERVICE & INSTALLATION



Solderless Terminals

MARS SERIES **862**

Quick Disconnects - Insulated (105°C)

MARS solderless terminals are competitively priced, yet manufactured of superior quality materials to rigid quality control standards. Seams are brazed to ensure perfect crimps EVERY TIME!

MARS solderless terminals are UL listed and CSA certified. Terminals are all manufactured in the USA. They are provided in clear, reclosable plastic display boxes. These attractive boxes, with clear and easy-to-read labels provide for visual inspection of the product and encourage impulse buying.

All packages display a MARS bar code for your convenience. MARS solderless terminals are available in two different package sizes. Both sizes enhance contractor self service. The MARS mini-pak display boxes contain very reasonable quantities with all types and sizes sold at one price. Perfect for the handyman, do-it-yourselfer and your sales and counter people. The MARS mini-pak is excellent for that small, unique HVACR odd job. The MARS super-pak contains much larger quantities of the more common solderless terminals at a super value. The contractor and tradesman will make great use of this size reclosable package. Ask your MARS sales representative about our solderless terminal merchandiser program!

MARS NO.	MINI-PAK QTY	SIZE	DESCRIPTION	MARS NO.	SUPER PAK QTY.
86200	20	22-18	.250 (1/4) female tab	86500	100
86201	20	16-14	.187 (3/16) female tab	86501	100
86202	20	16-14	.250 (1/4) female tab	86502	100
86203	15	12-10	.250 (1/4) female tab	86503	50
86219	20	22-18	.187 (3/16) female tab		
86205	20	16-14	.250 (1/4) male tab	86505	100
86207	12	22-18	.250 (1/4) female full insul.	86507	100
86208	12	16-14	.250 (1/4) female full insul.	86508	100
86209	8	12-10	.250 (1/4) female full insul.	86509	50
86220	7	16-14	.250 (1/4) female flag fully insul.	86520	25
86221	6 pair		combo of #86208, 09		
86211	12	16-14	.250 (1/4) male fully insul.		
86216	12	22-18	.250 (1/4) male/female p/back		
86217	12	16-14	.250 (1/4) male/female p/back	86517	100
86218	8	12-10	.250 (1/4) male/female p/back	86518	50



86200-03
86219

86205

86207-09

86211

86216-18



The largest selection of motors, components and accessories for the HVAC/R Industry

Solderless Terminals

MARS SERIES **862**



Quick Disconnects - Non-Insulated (149°C)

MARS NO.	MINI-PAK QTY.	SIZE	DESCRIPTION	MARS NO.	SUPER-PAK QTY.
86226	25	16-14	.250 (1/4) female tab	86526	100
86229	25	16-14	.250 (1/4) female flag	86529	100
86236	13	12-10	.250 (1/4) female flag		

Quick Disconnects - Hi Temp To 900°F

MARS NO.	MINI-PAK QTY.	SIZE	DESCRIPTION	MARS NO.	SUPER-PAK QTY.
86239	15	16-14	.250 (1/4) female tab		
86240	12	12-10	.250 (1/4) female tab		
86241	15	16-14	.250 (1/4) female w/crimp		
86242	15	16-14	.250 (1/4) female flag		
86243	10	12-10	.250 (1/4) female flag		
		16-14	.187 (3/16) male tab	86544	100

Rings - Insulated (105°C)

MARS NO.	MINI-PAK QTY.	SIZE	DESCRIPTION	MARS NO.	SUPER-PAK QTY.
86251	20	22-18	#8 stud 11/64 i.d.	86551	100
86252	20	22-18	#10 stud 13/64 i.d.		
86253	20	16-14	#6 stud 9/64 i.d.		
86254	20	16-14	#8 stud 11/64 i.d.	86554	100
86255	20	16-14	#10 stud 13/64 i.d.	86555	100
86258	12	12-10	#8 stud 11/64 i.d.		
86259	12	12-10	#10 stud 13/64 i.d.	86559	50
86260	12	12-10	1/4 stud 17/64 i.d.		
86262	5	8	1/4 stud 17/64 i.d.	86562	25
86263	3	6	1/4 stud 17/64 i.d.		

Rings - Non-Insulated (149°C)

MARS NO.	MINI-PAK QTY.	SIZE	DESCRIPTION	MARS NO.	SUPER-PAK QTY.
86275	15	22-18	#10 stud 13/64 i.d.	86569	100
		12-10	#10 stud 13/64 i.d.		

Rings - High Temp To 900°F

MARS NO.	MINI-PAK QTY.	SIZE	DESCRIPTION
86283	20	16-14	#10 stud 13/64 i.d.
86285	15	12-10	#10 stud 13/64 i.d.





Spade Flanged - Insulated (105°C)

MARS NO.	MINI-PAK QTY.	SIZE	DESCRIPTION
86294	15	16-14	#10 stud 13/64 i.d.
86295	12	12-10	#10 stud 13/64 i.d.

Spade - Insulated (105°C)

MARS NO.	MINI-PAK QTY.	SIZE	DESCRIPTION	MARS NO.	SUPER-PAK QTY.
86300	20	22-18	#8 stud 11/64 i.d.	86600	100
86303	20	16-14	#8 stud 11/64 i.d.	86603	100
86304	20	16-14	#6 stud 9/64 i.d.		
86301	15	16-14	#10 stud 13/64 i.d.	86601	100
86302	12	12-10	#10 stud 13/64 i.d.	86602	50

Spade Flanged - Non- Insulated (149°C)

MARS NO.	MINI-PAK QTY.	SIZE	DESCRIPTION
86307	20	22-18	#8 stud 11/64 i.d.
86308	20	22-18	#10 stud 13/64 i.d.

Spade - Non- Insulated (149°C)

MARS NO.	MINI-PAK QTY.	SIZE	DESCRIPTION
86315	25	22-18	#10 stud 13/64 i.d.
86317	15	12-10	#10 stud 13/64 i.d.

Spade Hi Temp To 900°F

MARS NO.	MINI-PAK QTY.	SIZE	DESCRIPTION	MARS NO.	SUPER-PAK QTY.
86323	20	16-14	#10 stud 13/64 i.d.	86623	100

Butt Connectors And Plugs And Receptacles

MARS NO.	MINI-PAK QTY.	SIZE	DESCRIPTION	MARS NO.	SUPER-PAK QTY.
86329	20	22-18	Insulated	86629	100
86330	20	16-14	Insulated	86630	100
86331	15	12-10	Insulated	86631	50
		16-14	Non-insulated	86633	100
86334	20	12-10	Non-insulated		
		8	Non-insulated	86635	25
		22-18	Plug insulated	86637	50 pairs
		16-14	Recept - fully insulated		
			Plug insulated	86638	50 pairs
			Recept - fully insulated		



Solderless Terminals

MARS SERIES **862 & 930**



Closed End Connectors (105°C)

MARS NO.	MINI-PAK QTY.	SIZE	DESCRIPTION	MARS NO.	SUPER-PAK QTY.
86341	25	22-18	Insulated crimp type		
86342	20	16-14	Insulated crimp type	86642	100
86343	15	12-10	Insulated crimp type	86643	50

Tab Adapters - Non Insulated (149°C)

MARS NO.	MINI-PAK QTY.	SIZE	DESCRIPTION	MARS NO.	SUPER-PAK QTY.
86350	20	-	.250 (1/4) 2 male x 1 female	86650	100
86351	15	-	.250 (1/4) 2 male x 1 female	86651	50
			8 stud, male tab, straight, .250		
86353	12	-	.250 (1/4) 2 male x 1 female		

Compressor Terminals - Non Insulated (149°C)

MARS NO.	MINI-PAK QTY.	SIZE	DESCRIPTION	MARS NO.	SUPER-PAK QTY.
86358	13	12-10	.250 (1/4) tab notched for bending	86658	50
86359	8	12-8	.250 (1/4) tab	86659	50

Spade Spring - Insulated (105°C)

MARS NO.	MINI-PAK QTY.	SIZE	DESCRIPTION	MARS NO.	SUPER-PAK QTY.
86366	20	16-14	#8 stud	86666	100
86367	20	16-14	#6 stud		

Line Tap Connectors

MARS NO.	MINI-PAK QTY.	SIZE	DESCRIPTION
86373	8	18-14	tap blue

Compressor Terminal W/Wire Kit

MARS NO.	DESCRIPTION	MARS PACK
86379	Includes 3 color coded #10AWG type AWM extra flexible lead wires in 10" lengths. One end with .250" x .032" female tab 12-10 quick disconnect. Other end stripped 5/16". Supplied with three 12-10 shrink tube butt connectors.	1

Push-On Terminal Kit

The MARS push on terminal kit includes; four push on terminal adapters and four screws. Converts screw type terminals to push on. Use with the MARS 18000 series contactors.

MARS NO.	DESCRIPTION	MARS PACK
93103	(4) push on terminal adapters (4) screws	1



SERVICE & INSTALLATION



Slic-Tite® paste - thread sealants

- Contains more Teflon particles for greater sealing power • Use on metal, PVC, CPVC, and ABS plastic pipe threads • For sealing water, air, steam, natural gas, LP gas, refrigerants, ammonia, gasoline, and oil
- Do not use on Oxygen service, use Teflon tape or Oxytite® Paste • Washes off hands and clothing easily • Non-toxic, non-drying • Sealing temperature range: -50° F to 500° F (-46° C to 260° C)
- Working pressures: 3,000 PSI (204 BAR) for Gas, 10,000 PSI (680 BAR) for liquids
- USDA approved for use in federally inspected meat and poultry plants.

MARS NO.	DESCRIPTION	MARS PACK	CASE QTY.
95400*	1.5 oz. tube	12	24
95401	1/4 pt. w/ brushcap	24	24
95402	1/2 pt. w/ brushcap	24	24
95403	1 pt. w/ brushcap	24	24
95406	1qt. w/ brushcap	12	12

* packaged in one dozen per display box

Slic-Tite® Stik w/ Teflon - Thread Sealant

- PTFE thread compound in handy stick form • use on metal and PVC pipe thread connections for water, air, natural gas, steam, gasoline, oil, refrigerants and ammonia
- Do not use on Oxygen service, use Teflon tape • working pressures: 5,000 PSI (340 BAR) - liquid to 500 PSI (34 BAR) -gas
- Temperature range: -50° F to 350° F (-46° C to 177° C)

MARS NO.	DESCRIPTION	MARS PACK	CASE QTY.
95407*	1 1/4 oz. stick	12	24

* packaged in one dozen per display box

Low Density Teflon Tape

- Thickness 3 mils. • Standard grade, low density
- Provides a highly resistant seal on pipe threads for all types of service
- Suitable for use with solvents, chemicals, oxygen, and on food lines
- Non-toxic • Permits easy disassembly, even after years of service
- Meets Mil. Spec. T-27730A
- Sealing temperature range: -450° F to 550° F (-268° C to 288° C)
- Working pressures: 2,000 PSI (136 BAR)
- Sold in case quantities only

MARS NO.	DESCRIPTION	MARS PACK	CASE QTY.
95409	1/2" x 260"	144	144
95410	1/2" x 520"	144	144
95412	3/4" x 520"	144	144

High Density Slic-Tite® Teflon Tape

- Thickness 3 mils. • High density
- Provides a highly resistant seal on pipe threads for all types of service
- Made in USA • Suitable for use with solvents, chemicals, oxygen, and on food lines
- Non-toxic • Permits easy disassembly, even after many years
- Meets Mil. Spec. T-27730A
- Sealing temperature range: -450° F to 550° F, (-268° C to 288° C)
- Working pressures: 2,000 PSI (136 BAR)

MARS NO.	DESCRIPTION	MARS PACK	CASE QTY.
95525	1/4" x 300"	12	12
95526	1/4" x 600"	12	12
95527	1/2" x 300"	12	12
95528	1/2" x 600"	12	12
95530	3/4" x 300"	12	12
95532	1" x 300"	12	12



LA·CO®

95402

95407

95409

95528

SERVICE & INSTALLATION

Plumbing & Piping Products

MARS SERIES **954**



SERVICE & INSTALLATION

T.O.T.® Pipe Joint Compound

- No-drip, siliconized for fast application on metal threads
- For water, steam, air, and natural gas service
- Lead free, non-toxic
- Certified by NSF to meet ANSI/NSF Std. 61 for use on potable water
- Do not use on Oxygen service, use Teflon® tape or Oxytite
- Sealing temperature: up to 350° F (177° C)
- Working pressures: to 500 PSI (34 BAR) for liquids to 350 PSI (24 BAR) for gases

MARS NO.	DESCRIPTION	MARS PACK	CASE QTY.
95415	1/2 pt. w/ brushcap	48	48

Pipetite® Paste - Pipe Thread Compound

- Soft set pipe thread compound
- For refrigerants, butane, gasoline, oil, as well as water, steam, air, natural and lp gas
- Use on metal threads
- Classified by Underwriters Laboratories in USA and Canada
- Do not use on oxygen service, use Teflon® or Oxytite®
- Sealing temperature: up to 400° F (204° C)
- Pressures: to 5,000 PSI (340 BAR) for liquids to 2,600 PSI (177 BAR) for gases

MARS NO.	DESCRIPTION	MARS PACK	CASE QTY.
95419	1/4 pt. w/brush cap	24	24
95420	1/2 pt. w/brush cap	24	24

Anaerobic Pipe Thread Sealant

- Contains Teflon® for a positive seal
- Anaerobic adhesive provides locking power
- Contains no solvents, won't shrink and weaken seal
- Seals and locks in the absence of air
- Ideal for threads in heavy vibration areas such as compressors and reciprocating equipment
- Classified by Underwriters Laboratories in USA and Canada
- Do not use on Oxygen service, use Teflon® tape or Oxytite
- Sealing temperature range: -65° F to 400° F (-54° C to 204° C)
- Working pressures: to 10,000 PSI (680 BAR) for liquids to 3,000 PSI (204 BAR) for gases

MARS NO.	DESCRIPTION	MARS PACK	CASE QTY.
95421	50 ml (1.69 oz.)	12	12
95422	250 ml (8.45 oz.)	6	6

Teflon Cords

- Use as packing for faucets, valves, pumps, etc. Also as gasket between flanges
- Smaller sizes come packaged in a unique Visu-Kit that keeps cord clean and ready for use. The durable kit can be mounted over the work bench or carried in a tool box
- Sealing temperature range: -450° F to 550° F (-268° C to 288° C)

MARS NO.	DESCRIPTION	MARS PACK	CASE QTY.
95425	3/32" x 50'	6	6
95426	5/32" x 50'	6	6
95427	7/32" x 10'	6	6

LA-CO®

95415



95420



95421



95425

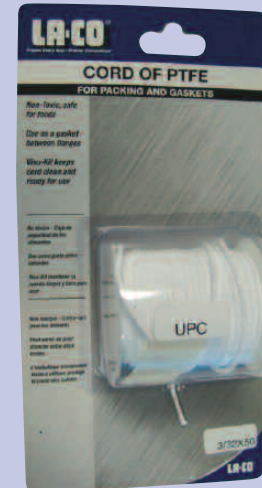



Heat-Seal Stik®

- Fast repairs completed in 90 seconds
- One part epoxy, no mixing or measuring needed
- Stick melts, seals and cures in one operation
- Use on aluminum, copper and other metals, glass and ceramics
- Ideal for use on high and low side of refrigeration systems
- Sealing temperature : up to 350° F (177° C)
- Pressures: to 600 PSI (41 Bar)

MARS NO.	DESCRIPTION	MARS PACK	CASE QTY.
95430	3/8 oz. stick, carded	12	12

Bloc-it® Heat Absorbing Paste

- Effectively absorbs surface heat
- Protects adjoining surfaces that may be damaged by excessive heat
- Safe to use: non-toxic, no asbestos, harmless to skin, and odorless
- Easy to use: apply directly to surface from tube
- Easy to clean: wipe off with cloth or wash with water. Leaves no stains
- Typical uses: protects rubber and plastic components in ball, dielectric, and solenoid valves during soldering; protects painted or finished surfaces from adjacent soldering, brazing or welding; prevents distortion to light gauge metals during brazing or welding

MARS NO.	DESCRIPTION	MARS PACK	CASE QTY.
95455	10 oz. tube	24	24

Cool Gel - Heat Dissipating Spray

- Helps prevent heat damage to components and surrounding materials during soldering, brazing, and welding
- Unique gelled formula sticks to surfaces without dripping or running off
- Clear, non-staining gel leaves no residue, eliminating cleanup
- Safe, non-toxic, harmless to skin and odorless
- Saves time - by eliminating the costly disassembly of valves and other components before soldering, brazing or welding
- Protects the seals and seats in ball, dielectric, and solenoid valves
- Protects painted and finished surfaces from discoloration due to adjacent torch operations
- Protects soldered joints from loosening when soldering adjacent joints

MARS NO.	DESCRIPTION	MARS PACK	CASE QTY.
95536	1 quart	12	12

Regular Flux Paste

- Super detergent action cleans as it solders
- Non-acid, non-toxic, lead free
- Contains no zinc chloride
- Use with all common soft solders including: tin-silver, 96/4, 94/6, 95/5, 50/50, 40/60 and 60/40
- For use on copper, brass, galvanized iron, lead, zinc, tin, silver, nickel, mild steel, terne plate, and malleable iron
- Meets Mil. Spec. Mil-F4995 Type II, Meets ASTM B813
- Water soluble for faster flushing from pipe lines

MARS NO.	DESCRIPTION	MARS PACK	CASE QTY.
95441	2 oz	48	48
95443	4 oz. w/brushcap	48	48
95444	1 lb	24	24



LA-CO®

SERVICE & INSTALLATION

Plumbing & Piping Products

MARS SERIES **954**



Silver Brazing Flux Paste

- Powerful cleaning action reduces waste of expensive silver solders
- Packed in break-resistant plastic jars
- Use with torch, furnace, resistance or induction heating
- Meets Mil. Spec. MIL-F-4883
- Certified by NSF to meet ANSI/NSF Std. 61 for use on potable water
- Temperature range: 1000° F to 1700° F (538° C to 927° C)

MARS NO.	DESCRIPTION	MARS PACK	CASE QTY.
95448	2 oz.	48	48
95449	6 oz. w/brushcap	24	24

Regular Soldering Flux Liquid

- Contains no zinc chloride or other heavy metal chloride
- Non-acid, non-toxic, lead free
- Use with new lead-free, tin/silver, plus 40/60, 50/50, 60/40 and 95/5 solders
- For high speed production and mechanized soldering equipment
- For use on copper, galvanized iron, sheet lead, zinc, nickel, tin, silver, mild steel, terne plate, malleable iron
- Packed in break resistant plastic bottles

MARS NO.	DESCRIPTION	MARS PACK	CASE QTY.
95445	1 qt.	12	12

Aluminum Flux Paste & Solder Kit

- Complete repair kit for tradesmen and repairmen
- Solders aluminum easily
- For repairing aluminum evaporators and tubing, ducts, and gutters
- Also solders aluminum to copper
- Blister carded for impulse sales

MARS NO.	DESCRIPTION	MARS PACK	CASE QTY.
95454	1 oz. of alum. flux and 1/2 oz. of #60 solder	12	12

Flux-Rite 90® Flux

- Meets ASTM B-813
- Completely water soluble for faster flushing from pipe lines
- Super detergent action cleans as it solders
- Non-acid, non-toxic, lead-free
- Contains no zinc chloride
- Use with all common soft solders including: tin-silver, 96/4, 94/6, 95/5, 50/50, 40/60 and 60/40
- For use on copper, brass, galvanized iron, lead, zinc, tin, silver, nickel, mild steel, terne plate, and malleable iron

MARS NO.	DESCRIPTION	MARS PACK	CASE QTY.
95456	4 oz.	24	24

Visu-Glow® Leak Detector

- High visibility, fluorescent color shows brightly, even in dimly lit places
- High viscosity, stays on vertical surfaces
- Makes it easy to find leaks
- Temperature range: 15° F to 200° F (-9° C to 93° C)
- Safe for oxygen
- Non-corrosive, non-toxic

MARS NO.	DESCRIPTION	MARS PACK	CASE QTY.
95462	8 oz.	24	24

Sure-Check® All Temperature Leak Detector

- All temperature formula: -55° F to 200° F (-48° C to 93° C)
- Ultra-sensitive, long-lasting bubbles
- Available in handy spray bottle
- Fluorescent for improved visibility
- Safe for oxygen
- Non-corrosive, non-toxic
- Green liquid

MARS NO.	DESCRIPTION	MARS PACK	CASE QTY.
95466	1 pint	24	24
95468	1 quart	12	12

LA-CO®



95449



95445



95454

95456



95466



95462

SERVICE & INSTALLATION



Residential Self Regulating Pipe Tracing Cable

- Cut to length (3 watts/ft @ 120VAC) up to 75 ft.
- Braided metal jacket for dry location application
- Connection kit provides end seal and plugs into standard 120 VAC outlet
- Automatically varies heat output with changes in surrounding temperature
- For use on plastic or metal pipes

MARS NO.	DESCRIPTION	MARS PACK	CASE QTY.
70701	100' Reel	1	1
70704	Connection Kit	1	10
70705	Pre-set Thermostat (38 degrees)	1	10

Commercial Pipe Freeze Protection Cable

- No thermostat, no plug
- 2 foot orange 14/3 cold lead
- Jacketed for wet or dry applications
- 120 VAC unless noted
- For use on metal pipes only

MARS NO.	DESCRIPTION	MARS PACK	CASE QTY.
70720	3.28' length, 23 watts	1	20
70721	6.56' length, 46 watts	1	20
70722	6.56' length, 46 watts (240V)	1	20
70723	9.84' length, 69 watts	1	20
70724	13.12' length, 92 watts	1	20
70725	13.12' length, 92 watts (240V)	1	20
70726	16.41' length, 115 watts	1	20
70727	19.69' length, 138 watts	1	20
70728	19.69' length, 138 watts (240V)	1	20
70729	22.97' length, 161 watts	1	10
70730	26.25' length, 184 watts (240V)	1	10
70731	29.53' length, 207 watts	1	10
70732	32.81' length, 230 watts (240V)	1	10

Residential Pipe Freeze Protection Cable

- For use on plastic or metal pipes
- Jacketed for wet or dry applications
- Preassembled ready to install
- Plugs into standard 120 VAC outlet
- Built-in fixed thermostat

MARS NO.	DESCRIPTION	MARS PACK	CASE QTY.
70710	3' length, 21 watts	1	10
70711	6' length, 42 watts	1	10
70712	9' length, 63 watts	1	10
70713	12' length, 84 watts	1	10
70714	15' length, 105 watts	1	10
70715	18' length, 126 watts	1	5
70716	24' length, 168 watts	1	5
70717	30' length, 210 watts	1	5
70718	40' length, 280 watts	1	5



EASYHEAT



SERVICE & INSTALLATION

Commercial Sr Trace Self Regulating Pipe Tracing Cable

- Cut to length, up to 458' (120VAC)
- Wet (J jacket) or dry (copper braid) applications
- Automatically varies heat output with changes in surrounding temperature

MARS NO.	DESCRIPTION	MARS PACK	CASE QTY.
70742	250' reel, J jacket 5 watts/ft, (120V)	1	1
70743	250' reel, J jacket 5 watts/ft (240V)	1	1
70744	Heat shrink end seal kit	1	5
70745	Heat shrink power/end connection kit	1	1
70746	Heat shrink splice and "T" connection kit	1	2
70747	250' reel, CB Jacket (120V)	1	1

Hose Clamps

MARS SERIES **783**



Ideal 52 Series - 1/2" Clamps

Ideal manufactures a broad line of standard worm drive and specialty hose clamps designed to satisfy a wide range of applications. The completely mechanical design locks the one piece housing directly to the band using the full strength of the material to provide maximum anti-shear protection. No spot welds to rupture under stress or corrosion, and a one piece housing can not come apart under high loading.

Ideal's 52 series clamps are comprised of a 1/2" stainless steel band with carbon steel housing and a 5/16" plated hex head screw.

MARS NO.	DESCRIPTION	MARS PACK	CASE QTY.
79310	Size 06 3/8"-7/8" clamp dia.	10	100
79311	Size 08 7/16"-1" clamp dia.	10	100
79312	Size 10 1/2"-1 1/8" clamp dia.	10	100
79313	Size 12 1/2"-1 1/4" clamp dia.	10	100
79314	Size 16 3/4"-1 1/2" clamp dia.	10	100
79315	Size 20 3/4"-1 3/4" clamp dia.	10	100
79317	Size 24 1"-2" clamp dia.	10	100
79318	Size 28 1 5/16"-2-1/4" clamp dia.	10	100
79316	Size 32 1 9/16"-2 1/2" clamp dia.	10	100
79319	Size 36 7/8"-2 3/4" clamp dia.	10	100
79345	Size 40 1-1/8"-3" clamp dia.	10	100
79309	Size 72 3-1/8"-5" clamp dia.	10	100

Ideal 67-5 Series 1/2" Clamps

Ideal's 67-5 series clamps are all stainless steel. They are comprised of a 1/2" 300 series stainless steel band, housing and a 5/16 hex head screw.

MARS NO.	DESCRIPTION	MARS PACK	CASE QTY.
79320	Size 06 3/8"-7/8" clamp dia.	10	100
79321	Size 08 7/16"-1" clamp dia.	10	100
79322	Size 10 1/2"-1 1/8" clamp dia.	10	100
79323	Size 12 1/2"-1 1/4" clamp dia.	10	100
79324	Size 16 3/4"-1 1/2" clamp dia.	10	100
79325	Size 20 3/4"-1 3/4" clamp dia.	10	100
79328	Size 24 1"-2" clamp dia.	10	100
79307	Size 28 1 5/16"-2 1/4" clamp dia.	10	100
79326	Size 32 1 9/16"-2 1/2" clamp dia.	10	100
79327	Size 36 7/8"-2 3/4" clamp dia.	10	100
79308	Size 72 3"-5" clamp dia.	10	100
79304	Size 128 6 1/2"-8 1/2" clamp dia.	50	100
79305	Size 152 8"-10" clamp dia.	50	100
79306	Size 188 10"-12" clamp dia.	50	50

Ideal 50" All Stainless 1/2" Clamp For Ducts

MARS NO.	DESCRIPTION	MARS PACK	CASE QTY.
79329	Size 248 14"-16" clamp dia.	50	100

IDEAL





Hose Clamps & Merchandisers

MARS SERIES **783**

Ideal 52 Series Micro Gear Clamps

Ideal's 52 series micro-gear clamps consist of a 5/16" stainless steel band with carbon steel housing and 1/4" plate hex-head screw.

MARS NO.	DESCRIPTION	MARS PACK	CASE QTY.
79330	Size 04 7/32"-5/8" clamp dia.	10	100
79331	Size 06 5/16"-7/8" clamp dia.	10	100
79332*	Size 12 9/16"-1 1/4" clamp dia.	10	100
79333*	Size 16 11/16"- 1 1/2" clamp dia.	10	100
79334*	Size 20 7/8"-1 3/4" clamp dia.	10	100

* size 12 and larger have a stainless steel housing

Ideal 62M Series Micro Gear Clamps

Ideal's 62M series micro gear clamps are all stainless. They are comprised of a 5/16" stainless steel band, housing and 1/4" hex-head screw.

MARS NO.	DESCRIPTION	MARS PACK	CASE QTY.
79340	Size 04 7/32"-5/8" clamp dia.	10	100
79341	Size 06 5/16"-7/8" clamp dia.	10	100
79342	Size 12 9/16"-1 1/4" clamp dia.	10	100
79343	Size 16 11/16"-1 1/2" clamp dia.	10	100
79344	Size 20 7/8"-1 3/4" clamp dia.	10	100



IDEAL

SERVICE & INSTALLATION

Flexible Gas Appliance Fittings & Valves

MARS SERIES **734 & 643**



Flexible Stainless Steel Gas Range Connectors 1/2" I.D. (5/8" O.D.) With Fittings

Brass Craft coated stainless steel gas connectors are known for superior quality and reliable performance. The ProCoat polymer based yellow coating resists corrosion from sea, salt, UV rays and the harsh chemical vapors from common household cleaning, plumbing repair and building products such as: ammonia, chlorine, solder flux, muratic acid, and bleach. These ProCoat gas connectors provide great strength and flexibility making installation easier.

MARS NO.	DESCRIPTION	MARS PACK	CASE QTY.
73402	18"L-1/2" MIP x 1/2" MIP	1	25
73403	24"L-1/2" MIP x 1/2" MIP	1	25
73404	36"L-1/2" MIP x 1/2" MIP	1	25
73405	48"L-1/2" MIP x 1/2" MIP	1	25
73410	24"L-3/4" FIP x 3/4" FIP	1	25
73411	36"L-3/4" FIP x 3/4" FIP	1	25
73412	48"L-3/4" FIP x 3/4" FIP	1	25
73418	36"L-1/2" FIP x 1/2" FIP	1	25
73419	48"L-1/2" FIP x 1/2" FIP	1	25
73422	12"L-3/4" FIP x 3/4" MIP	1	25
73423	18"L-3/4" FIP x 3/4" MIP	1	25
73424	24"L-3/4" FIP x 3/4" MIP	1	25
73425	36"L-3/4" FIP x 3/4" MIP	1	25
73426	48"L-3/4" FIP x 3/4" MIP	1	25
73427	60"L-3/4" FIP x 3/4" MIP	1	25
73429	12"L-1/2" FIP x 1/2" MIP	1	25
73430	18"L-1/2" FIP x 1/2" MIP	1	25
73431	24"L-1/2" FIP x 1/2" MIP	1	25
73432	36"L-1/2" FIP x 1/2" MIP	1	25
73433	48"L-1/2" FIP x 1/2" MIP	1	25
73434	60"L-1/2" FIP x 1/2" MIP	1	12

Flexible Stainless Steel Gas Dryer Connectors 3/8" I.D. (1/2" O.D.) With Fittings

MARS NO.	DESCRIPTION	MARS PACK	CASE QTY.
73438	24"L-1/2" MIP x 1/2" MIP	1	25
73439	36"L-1/2" MIP x 1/2" MIP	1	25
73440	48"L-1/2" MIP x 1/2" MIP	1	25
73445	24"L-1/2" FIP x 1/2" MIP	1	25
73446	36"L-1/2" FIP x 1/2" MIP	1	25
73447	48"L-1/2" FIP x 1/2" MIP	1	25
73448	60"L-1/2" FIP x 1/2" MIP	1	12

Flexible Stainless Steel Gas Dryer Connectors 3/8" I.D. (1/2" O.D.) With Valves

MARS NO.	DESCRIPTION	MARS PACK	CASE QTY.
73457	18"L-1/2" MIP x 1/2" FIP-BALL	1	25
73458	24"L-1/2" MIP x 1/2" FIP-BALL	1	25
73459	36"L-1/2" MIP x 1/2" FIP-BALL	1	25

Flexible Stainless Steel Gas Heater Connectors 1/4" I.D. (3/8" O.D.) With Fittings

MARS NO.	DESCRIPTION	MARS PACK	CASE QTY.
73461	12"L-1/2" FIP x 1/2" MIP	1	25
73464	36"L-1/2" FIP x 1/2" MIP	1	25

Steel Gas Fittings For 7/8" O.D. Connectors

With MARS male gas fittings, wholesalers need fewer items on the shelf and contractors need fewer parts on the job. Tapped gas fittings hook up gas connectors to male or female iron pipe and female in-line gas valves. One fitting does many jobs.

MARS NO.	DESCRIPTION	MARS PACK	CASE QTY.
73480	straight-5/8" OD x 1/2" MIP (tapped 3/8" FIP)	25	25
73481	straight-5/8" OD x 3/4" MIP (tapped 1/2" FIP)	25	25

Steel Gas Fittings For 1/2" O.D. Connectors

MARS NO.	DESCRIPTION	MARS PACK	CASE QTY.
73483	straight-1/2" OD x 1/2" FIP	25	25

MARS Gas Ball Valves

MARS gas ball valves are for use with natural, manufactured and mixed gases, as well as liquified petroleum and LP gas/air mixtures. Corrosion fighting chrome plated brass ball and aluminum, quarter turn handle. MARS gas ball valves feature threads that conform to all appropriate standards.

MARS NO.	DESCRIPTION	MARS PACK	CASE QTY.
73492	straight-1/2" OD x 1/2" FIP	10	10
73494	straight-5/8" OD x 3/4" FIP	10	10
73495	straight-1/2" FIP x 1/2" FIP	10	10
73496	straight-3/4" FIP x 3/4" FIP	10	10

NIBCO Gas Ball Valves - Type GB1

- Tamper proof brass ball valve
- Lever Handle
- 1/2 psi for indoor appliance connections
- Female x Female threads
- 5 psi for indoor shutoff
- AGA 3-88, CGA 9.1, CGA 9.2, CR91-002, ANSI Z21.15

MARS NO.	NOM. SIZE	DIMENSIONS (INCHES)				MARS PACK	CASE QTY.
		A	B	C	D		
64317	1/2	2.21	1.34	1.93	0.47	20	120
64318	3/4	2.38	1.41	1.93	0.59	10	120

MARS Cross Reference Guide

MARS NO.	NIBCO	MUELLER	B & K	HAMMOND	LEGEND
64317	GB1 1/2	T220012	110-523	875 1/2	T3000 1/4
64318	GB1 3/4	T220034	110-524	875 3/4	T3000 3/4

SERVICE & INSTALLATION



PVC Cement, Cleaner & Primer

MARS SERIES **730**

Oatey All Purpose Cement - ABS, PVC, CPVC

Oatey all purpose cement is a heavy bodied, clear cement recommended for use on ABS, PVC or CPVC pipe and fittings. For all pipe schedules, potable water pressure pipe, gas, conduit, drain waste and vent pipe. Flows freely and provides a thick layer of cement on the pipe. Helps to fill gaps in larger diameter pipe and loose fitting joints. Apply at temperature 40°F to 100°F. Exceeds performance requirements of ASTM D-2564, D-2864, D-2235, F-493. Special applicator brush cap for fast and easy installation.



MARS NO.	DESCRIPTION	MARS PACK
73161	4 oz. clear	24
73162	8 oz. clear	24
73163	16 oz. clear	24

Oatey Heavy Duty Cement - PVC

Oatey heavy duty cement is recommended for use on pvc pipe and fittings up to 12" in diameter for schedule 40 and schedule 80 potable water pressure pipe, gas, conduit, drain waste and vent pipe. This heavy bodied cement flows freely and provides a thick layer of cement on the pipe. A special brush cap applicator is provided. Apply at temperatures 40°F to 100°F. This clear cement helps to fill gaps in larger diameter pipe and loose fitting joints. Exceeds ASTM D-2564.



MARS NO.	DESCRIPTION	MARS PACK
73165	4 oz. clear	24
73166	8 oz. clear	24
73167	16 oz. clear	24

Oatey Regular Cement - PVC

Oatey regular cement is recommended for use on PVC pipe and fittings up to 4" for DWV or schedule 40 and up to 2" for schedule 80 potable water pressure pipe, gas, conduit, drain waste and vent pipe. It flows freely and sets up quickly. Apply at temperatures 40°F to 100°F. Exceeds ASTM D-2564. Special brush top applicator.



MARS NO.	DESCRIPTION	MARS PACK
73174	4 oz. clear	24
73175	8 oz. clear	24
73176	16 oz. clear	24
73177	32 oz. clear	12

Oatey Rain-R-Shine™ Cement - PVC

Oatey Rain-R-Shine™ is a blue colored cement recommended for PVC pipe and fittings up to 6" in diameter. A very fast setting cement formulated for wet conditions and/or when quick pressurization and fast installation is needed. For schedule 40 and schedule 80 potable water pressure pipe, irrigation, gas, conduit, drain waste and vent pipe. This medium bodied cement flows freely and covers with a thicker layer than regular PVC. Apply at temperatures 40°F to 100°F.



MARS NO.	DESCRIPTION	MARS PACK
73150	4 oz. blue	24
73151	8 oz. blue	24

Oatey Clear Primer - NSF Listed - PVC, CPVC

Oatey clear primer is a clear aggressive primer for use on PVC and CPVC pipe and fittings for all schedules and diameters. This NSF listed formula removes all surface dirt, grease and grime as well as softens pipe in preparation for solvent cement. Meets ASTM F-656.

MARS NO.	DESCRIPTION	MARS PACK
73186	16 oz. clear	24

Oatey All Weather Cement-PVC

Oatey all weather cement is recommended for use on PVC pipe and fittings up to 6" in diameter. Formulated for fast initial set up at temperatures down to 10°F, for schedule 40 and schedule 80 potable water pressure pipe, gas, conduit, drain waste and vent pipe. This medium bodied, clear cement flows freely and maintains good gap filling properties. Apply at temperatures 10°F to 100°F. Exceeds ASTM D-2564.



MARS NO.	DESCRIPTION	MARS PACK
73156	16 oz. clear	24
73157	32 oz. clear	12

Oatey Purple Primer - PVC, CPVC

Oatey purple primer is recommended for use on PVC and CPVC pipe and fittings, all schedules and diameters. This purple tinted aggressive primer is formulated to remove surface dirt, grease and grime, as well as, soften the pipe surface to allow for a fast, secure and permanent solvent weld. For use in area where code calls for verification that a primer has been used. Exceeds ASTM F-656.



MARS NO.	DESCRIPTION	MARS PACK
73178	4 oz. purple	24
73179	8 oz. purple	24
73180	16 oz. purple	24
73185	32 oz. purple	24

Oatey All Purpose Cleaner - PVC, CPVC, ABS

Oatey all purpose cleaner is recommended for use on ABS, PVC and CPVC pipe and fittings, all schedules and diameters. This fast acting cleaner removes surface dirt, grease and grime. Flows freely and evaporates quickly. Does not penetrate pipe surface. Apply at temperatures 40°F to 100°F.



MARS NO.	DESCRIPTION	MARS PACK
73170	8 oz. clear	24
73171	16 oz. clear	24
73172	32 oz. clear	12

SERVICE & INSTALLATION

Schedule 40 PVC Fittings & Traps

MARS SERIES **730**

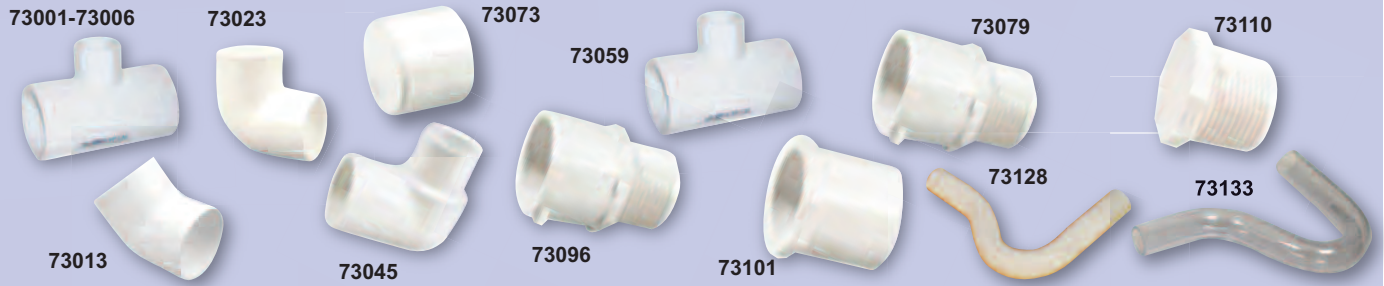

SERVICE & INSTALLATION

Schedule 40 - PVC Couplings

MARS NO.	DESCRIPTION	MARS PACK
73001	1/2" slip x slip	100
73002	3/4" slip x slip	50
73003	1" slip x slip	50
73006	2" slip x slip	25

Schedule 40 - PVC Elbow 45°

MARS NO.	DESCRIPTION	MARS PACK
73013	3/4" slip x slip	50

Schedule 40 - PVC Elbow 90°

MARS NO.	DESCRIPTION	MARS PACK
73023	1/2" slip x slip	50
73024	3/4" slip x slip	50
73025	1" slip x slip	50
73033	3/4" slip x FPT	50

Schedule 40 - PVC Street Elbow 90°

MARS NO.	DESCRIPTION	MARS PACK
73045	3/4" slip x slip	50
73051	3/4" slip x MPT	50

Schedule 40 - PVC Caps

MARS NO.	DESCRIPTION	MARS PACK
73073	3/4" slip	100
73075	3/4" FPT	100

Schedule 40 - PVC Reducing Adapters

MARS NO.	DESCRIPTION	MARS PACK
73096	3/4" MPT x 1/2" slip	50

Schedule 40 - PVC Tees

MARS NO.	DESCRIPTION	MARS PACK
73059	1/2" all slip	50
73060	3/4" all slip	50
73061	1" all slip	50
73058	3/4" slip x FPT x slip	50
73066	3/4" clean-out tee (2 pk)	1

Schedule 40 - PVC Adapters

MARS NO.	DESCRIPTION	MARS PACK
73079	1/2" slip x MPT	50
73080	3/4" slip x MPT	50
73081	1" slip x MPT	50
73086	3/4" slip x FPT	50
73087	1" slip x FPT	50

Schedule 40 - PVC Reducing Bushings

MARS NO.	DESCRIPTION	MARS PACK
73101	3/4" slip x 1/2" slip	50
73102	1" slip x 3/4" slip	50

Schedule 40 - PVC Plugs

MARS NO.	DESCRIPTION	MARS PACK
73110	3/4" MPT plug	50

Schedule 40 - PVC Traps

MARS NO.	DESCRIPTION	MARS PACK
73126	3/4" P-trap	1
73128	3/4" mini P-trap	1
73129	3/4" super P-trap	1
73131	3/4" R trap	1
73133	3/4" PVC P-trap Clear	1
73134	3/4" PVC Mini P-trap Clear	1
73135	3/4" PVC Super P-trap Clear	1
73136	3/4" PVC R-trap Clear	1

MARS Nylon & Galvanized Fittings & Nipples

MARS SERIES **730**

Excellent for clear vinyl tubing! All nylon parts are white.

Adapter Nylon Fitting

MARS NO.	DESCRIPTION	CASE QTY.
73201	Adapter 1/4 barb x 1/4 MPT - 10/pack	1
73203	Adapter 3/8 barb x 3/8 MPT - 10/pack	1
73204	Adapter 3/8 barb x 1/2 MPT - 8/pack	1
73206	Adapter 1/2 barb x 1/2 MPT - 6/pack	1
73207	Adapter 1/2 barb x 3/4 MPT - 4/pack	1
73208	Adapter 5/8 barb x 3/4 MPT - 4/pack	1
73209	Adapter 3/4 barb x 3/4 MPT - 4/pack	1

Elbow Nylon Fitting

MARS NO.	DESCRIPTION	CASE QTY.
73227	Elbow 3/8 barb x 3/8 MPT - 4/pack	1
73229	Elbow 1/2 barb x 1/2 MPT - 4/pack	1
73230	Elbow 1/2 barb x 3/4 MPT - 4/pack	1
73231	Elbow 5/8 barb x 1/2 MPT - 4/pack	1
73232	Elbow 5/8 barb x 3/4 MPT - 4/pack	1
73234	Elbow 3/4 barb x 3/4 MPT - 4/pack	1
73243	Hose mender 3/8 barb - 5/pack	1
73244	Hose mender 1/2 barb - 4/pack	1
73245	Hose mender 5/8 barb - 4/pack	1

Tee Nylon Fitting

MARS NO.	DESCRIPTION	CASE QTY.
73252	Tee 3/8 x 3/8 x 3/8 barb - 5/pack	1
73253	Tee 1/2 x 1/2 x 1/2 barb - 4/pack	1
73265	Drain plug 3/4 square head - 5/pack	1
73268	Drain plug 3/4 hex head - 5/pack	1

NIBCO DWV Couplings

MARS NO.	DESCRIPTION	CONNECTION TYPE	CASE QTY.
73269	2" coupling	hub x hub	100
73270	3" coupling	hub x hub	50
73271	3" X 2" adapter coupling	hub x hub	50

NIBCO DWV Couplings 90° Elbows

MARS NO.	DESCRIPTION	CONNECTION TYPE	CASE QTY.
73274	2" 90° elbow long turn	hub x hub	50
73275	3" 90° elbow long turn	hub x hub	25
73278	2" 90° street elbow long turn	spg x hub	20

NIBCO DWV Couplings 45° Elbows

MARS NO.	DESCRIPTION	CONNECTION TYPE	CASE QTY.
73280	2" 45° elbow	hub x hub	50
73281	3" 45° elbow	hub x hub	20
73282	2" 45° street elbow	spg x hub	50



SERVICE & INSTALLATION



The largest selection of motors, components and accessories for the HVAC/R Industry

SI-91

Condensate Products

MARS SERIES **932 & 934**



SERVICE & INSTALLATION

MARS Condensate Clean-Out Tablets

MARS **TAB**™, condensate and drip pan clean-out tablets, prevent plugging of air conditioning condensate drip pans and drain lines.

MARS **TAB**™ does not release any chlorine or other noxious fumes. This economical, simple positive protection can be used on steel, copper, galvanized, painted surfaces and other materials without damage. It is one of the few treatments that will not stain exterior wall when line drains outside.

MARS NO.	DESCRIPTION	MARS PACK
93202	MARS TAB ™ (100 tablets per bottle)	18

MARS One-Shot® Kits - 12 Applications Per Can

MARS One-Shot® is all it takes to instantly clear clogs. MARS One-Shot® drain opener kit instantly clears blockages in all types of fixtures and drains while simultaneously delivering a specially designed enzyme ingredient. This enzyme continues to dissolve grease buildup in the drain long after the initial blockage was cleared. The kit includes: One-Shot drain opener can 7 oz., three foot extension hose and twist fit adapter for ice markers and condensate drain pans.

Benefits & Features:

- Enzyme activated
- No ozone depleting chemicals
- Safe for sewers & septic systems
- Works instantly
- Sanitary and easy to use
- Universal adapter for all types of fixtures
- Seamless aluminum container will not rust
- For drains from 3/8" i.d. to 7/8 i.d.
- Made in the USA
- 12 applications per can

For Use On:

- Condensate pans
- Ice machines
- Bar sinks
- Toilets
- Bathtubs
- Kitchen sinks
- Shower drains
- Floor drains.
- Lavatories

MARS NO.	DESCRIPTION	MARS PACK
93220	MARS One-Shot® drain opener (7 oz.)	25
93221	MARS One-Shot® refill can (7 oz.)	36

Panseal

Seals and Restores Leaking and Rusted Drain Pans

Panseal is a unique multi-component 2 part epoxy designed to quickly and permanently seal, repair, and restore leaking and corroded drain pans. The product is available in caulk gun cartridges for easy application, gallon size containers for larger surfaces such as cooling towers, patch kits for vertical surfaces and single use 250 gram burst-seal bags. All contain pre-measured amounts of resin and hardener.

- Works in standing water
- Seals leaks immediately
- No surface preparation
- No system down time
- Works on both metal and plastic pans
- 100% solids and entirely free of solvents and volatile organic compounds

MARS NO.	DESCRIPTION	MARS PACK
93526	Panseal Cartridge	1
93527	Panseal Gallon	1
93528	Panseal Patch	1
93579	Panseal Bag	1
93500	Cartridge Nozzle	12



X-Treme Tape

MARS SERIES **932**

X-Treme Tape

Originally developed for the military, X-Treme Tape is a high quality wrap made from a special silicone compound that adheres to itself when wrapped under tension. 1"W x 10'L roll is packaged in a clamshell and sold in 18 count display cases. Great for emergency repairs of all kinds:

- No Adhesive, bonds to itself
- Cures into a homogeneous mass
- Won't melt up to 500° F
- Remains flexible to -60° F
- Forms a permanent air & water tight seal
- Tensile strength of 600 psi
- Insulates to 8,000 Volts
- Conforms to irregular shapes, stretches to 3x's its length

MARS NO.	DESCRIPTION	MARS PACK	CASE QTY.
93299	X-Treme tape	18	18



93299

SERVICE & INSTALLATION



Circuit Protection Products

MARS SERIES **832**

Circuit Protection

The ZBreaker set from Zebra Instruments protects systems that you install or service from damage caused by shorts, overheating, or wiring problems. A sticker is included so that, if the Tech desires, he can inform his customer where to press the "reset" button and possibly save a midnight service call.

The same circuit breakers now found on many high-end transformers and systems, but at a great price! Kit includes wires and pre-installed terminals that allow you to easily plug it in to the connectors where a plastic-type fuse existed. 3 Amp Size.

MARS NO.	DESCRIPTION	MARS PACK	CASE QTY.
08574	ZBreaker Set – 3A	1	24

The Short-Pro Tool is a 24 volt system "short-finder". This helps the tech locate a control voltage short. A built-in automatically resetting circuit breaker turns on a bright red LED when tripped. As the tech removes the short, the breaker automatically resets, the LED goes out, and the circuit is restored. Lightweight and compact, with two 18" leads.

MARS NO.	DESCRIPTION	MARS PACK	CASE QTY.
08577	Short Finder Pro Tool	1	24



08574

08577



The largest selection of motors, components and accessories for the HVAC/R Industry

MARS Multimeters

MARS SERIES **657**



MARS Digital Multimeters

MARS digital multimeter #65748 is a compact pocket sized multimeter for measuring DC and AC voltage, DC current, resistance and diode. This economy digital multimeter offers full range overload protection and low battery voltage indication. Unit comes complete with a 9V battery and test leads, and also includes a temperature probe.

SPECIFICATIONS

FUNCTION	RANGE	RESOLUTION	ACCURACY
DCV	200 mV	100 μ V	$\pm 0.5\%$ of rdg $\pm 2D$
	2 V	1 mV	
	20 V	10 mV	
	200 V	100 mV	
	1000 V	1 V	
AC (50/60Hz)	200 V	100 mV	$\pm 0.8\%$ of rdg $\pm 2D$
	750 V	1 V	
DCA	200 μ A	0.1 μ A	$\pm 1\%$ of rdg $\pm 2D$
	2000 μ A	1 μ A	$\pm 1\%$ of rdg $\pm 2D$
	20 mA	10 μ A	$\pm 1\%$ of rdg $\pm 2D$
	200 mA	100 μ A	$\pm 1.2\%$ of rdg $\pm 2D$
	10 A	10 mA	$\pm 2\%$ of rdg $\pm 2D$
OHM	200 Ω	100 m Ω	$\pm 0.8\%$ of rdg $\pm 2D$
	2000 Ω	1 Ω	$\pm 0.8\%$ of rdg $\pm 2D$
	20 K Ω	10 K Ω	$\pm 0.8\%$ of rdg $\pm 2D$
	200 K Ω	100 K Ω	$\pm 0.8\%$ of rdg $\pm 2D$
	2000 K Ω	1 K Ω	$\pm 1\%$ of rdg $\pm 2D$
Diode Test	Test current 1.6mA: Voltage 2.8V		
Transistor Test	0-1000 hFE of PNP or NPN transistors		
* Temperature	-4 $^{\circ}$ F to 2498 $^{\circ}$ F -20 $^{\circ}$ C to 1370 $^{\circ}$ C		



65748



65749

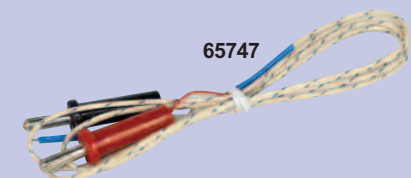

65747

MARS Digital Clamp-On Meters

Features:

- AC Current • DC/AC Voltage • Resistance • Continuity Check
- Continuity check buzzer sounds at approx. 50 ohm max
- Peak Hold & Data Hold • 1.3" (33mm) Clamp Jaw Opening
- Large 0.68", 3-1/2 digit LCD with low battery indicator
- Includes test leads, manual and carry case
- Overload protection provided for all ranges
- Meets IEC 1010 Safety Standard • 9 volt battery included

Range: 0-600 A

Resolution: 1 A

Frequency: 50/60 Hz (+/- 1.5% rdg +/- 4 dgt)
40-400 Hz (+/- 2.5% rdg +/- 4 dgt)

MARS Multimeters

MARS NO.	DESCRIPTION	MARS PACK
65748*	Digital multimeter w/temperature	1
65749	Digital clamp-on meter	1
65747	Replacement temp. leads for 65748	1

MARS Capacitor Tester

Features:

- Easy to use
- 9V battery and test leads included
- Low battery indicator

Specifications:

Range	Resolution	Accuracy	Test Frequency
200pF	0.1pF	± (0.8% + 7)	800Hz
2000pF	1pF	± (0.8% + 5)	
20nF	10 pF		
200nF	100pF	± (0.5% + 5)	80Hz
2 μF	1000pF	± (0.8% + 5)	
20 μF	0.01 μF		
200 μF	0.1 μF	± (2.0% + 5)	8Hz
2000 μF	1 μF	± (2.0% + 5)	
20mF	10 μF	± (5.0% + 5)	

MARS Analog Multimeter

The MARS analog multimeter, MARS #86143, offers fuse and diod protection. This meter is ideal for testing electrical and electronic circuits. This pocket size, lightweight meter features easy to read, two color scale, recessed safety designed input terminals and 12 ranges plus separate off position. Comes complete with test leads, battery, fuse and instruction manual.

Specifications:

- DC voltage: 0-10/50/250/500Vdc
- AC voltage: 0-50/250/500Vdc
- DC current: 0-50/250mAdc
- Battery: 1.5V button cell/1.5V "AA"
- Resistance: 0-10M Ohm (5K Ohm mid-scale)
- Decibels: -20 to +56dB (on AC ranges)

MARS Test Instruments

MARS NO.	DESCRIPTION	MARS PACK
65746	MARS capacitor tester	1
86143	MARS economy analog multimeter	1

Safety Power Adapters

Zebra'Dapter's provide visual indication of voltage levels before damage can occur. One is a fused power tap cordset & the other is a cheater cord used for a safer way to obtain and use 120V power. They are lighted to show the voltage level available, and if the indicator light is ignored, the fused circuit provides a last line of defense to protect you and your customer's equipment. These adapters are significantly a safer way to obtain 120V power.

MARS No. 08566 (Male end) has an in-Line fuse. (Two fuses included). Safer Power from Outlet to test Motors, Components & Systems

MARS No. 08567 (Female end) shows the voltage level at the plug. Used to check 120V power to run vacuum pumps, charging scales, drop lights, etc. lighting

Lighted Plug confirms Power

- No light means no power
- Normal light means 120VAC
- A brilliant light means you accidently hooked it up to 240VAC

MARS NO.	DESCRIPTION	MARS PACK	CASE QTY.
08566	Fused Cheater Power Cord (male end)	1	12
08567	Fused Power Tap Cordset (female end)	1	12



SERVICE & INSTALLATION

Electrical Testers

MARS SERIES **861**



MARS Volt Stick

The Volt Stick is an instrument for safely checking the presence of an AC voltage in cables, wall outlets, fuses, circuit breakers, junction boxes, power tools and appliances. Also, distinguishes between live and neutral wire in single or three phase supplies. No current flow is needed for correct operation of the Volt Stick. When a voltage is detected, a red indicator in the plastic tip of the Volt Stick illuminates. No contact is needed, unit operates at 1/8" distance from device.

Specifications

- Voltage range: 110 to 480 volts AC
- Not sensitive to stray electromagnetic static
- Response time: instantaneous
- Case breakdown: 4000 volts
- Operation temp: 0° to 120°F
- Batteries: two AAA, 1.5 volt alkalines included

MARS NO.	DESCRIPTION	MARS PACK	CASE QTY.
86142	Volt Stick	1	12

MARS Voltage Tester - Carded

The low voltage tester with insulated leads is the fast, easy way to trace and check low voltage AC or DC circuits from 5 to 50 volts. The built-in indicator lamp lights up dim or bright depending on the voltage tested. Comes with pocket clip.

MARS NO.	DESCRIPTION	MARS PACK
86140	Low voltage tester	1

86142

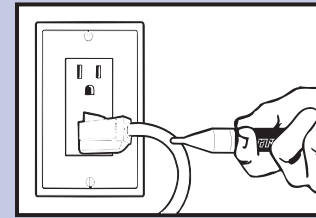
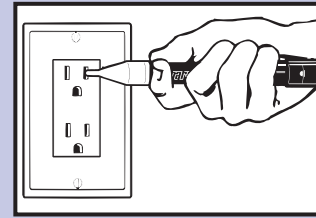

86140

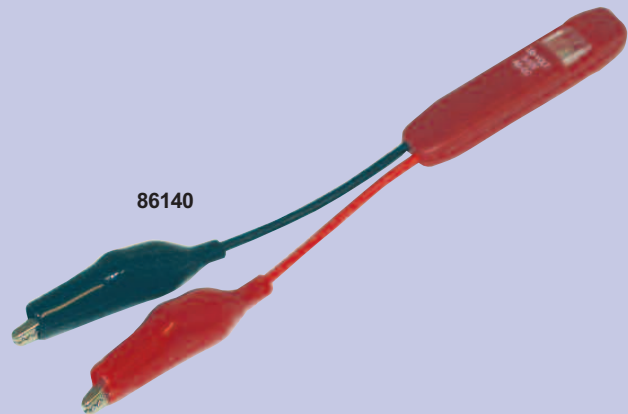



Heat Shrink Tubing & Test Leads

MARS SERIES **861**

MARS Heat Shrink Tubing - Black

The MARS heat shrink tubing shrinks to fit approximately one half its diameter. This polyolefin, flame retardent tubing insulates wiring, repairs cords, covers tool handles, makes strong rope loops and neat ends. It may be easily assembled over irregular shapes. UL and CSA rated. Operating temperature; -55°C to 110°C. Shrink temperature; 120°C to 250°C. Attractively packaged in a dispenser disk for easy dispensing. Simply unwind and cut the amount you need, then wind the unused tubing back into the disk. This clear disk permits visual stock status and keeps tubing clean and protected. Disk packs are center punched for merchandising.

MARS NO.	TUBE SIZE	EXPAND DIA.	RECOVER DIA.	LENGTH	MARS PACK	CASE QTY.
86163	3/16"	.187	.093	4'	1	10
86164	1/4"	.250	.125	4'	1	10
86165	5/16"	.312	.156	4'	1	10
86166	3/8"	.375	.187	4'	1	10
86167	1/2"	.500	.250	4'	1	10
86168	3/4"	.750	.375	4'	1	10

MARS Heat Shrink Tubing Kit And Replacement Packs

MARS NO.	DESCRIPTION	KIT QTY	MARS PACK	CASE QTY.
86170	Heat shrink tubing kit			
86173	3/8" exp. i.d. red 4"L 24/bag	12	1	1

MARS Test Leads - Pkg'd In Poly Bags

MARS NO.	CLIP SIZE	TYPE	CASE COLORS	WIRE SIZE	L	BAG QTY.
86070	Sm	Alligator	Wht, red, blk, yellow, grn	18	18"	10
86071	Med	Alligator	Red/blk w/boots	18	24"	2
86073	Lg	Alligator	Red/blk w/boots	14	24"	2
86074	Lg	Battery	Red/blk w/boots	16	36"	2

MARS Special Leads - Pkg'd In Poly Bags

MARS NO.	CLIP SIZE	DESCRIPTION	WIRE SIZE
86075	Med	6'-2 wire test cord w/red & blk insul. clips	16
86076	Med	24" - 3 wire test cord w/fem plug & 3 insul. clips	16

MARS Alligator & Battery Clips - Pkg'd in Zip Lock Bag

MARS NO.	CLIP SIZE	TYPE	DESCRIPTION	BAG QTY.
86078	Med	Alligator	Red/blk (1 ea. color boot - 2 clips)	1 pr.
86079	Sm	Battery	Red/blk (1 ea. color boot - 2 clips)	1 pr.
86080	Med	Battery	Red/blk (1 ea. color boot - 2 clips)	1 pr.
86081	Lg	Battery	Red/blk (1 ea. color boot - 2 clips)	1 pr.

Zebra Alligator Leads - Clamshell

MARS NO.	CLIP SIZE	TYPE	DESCRIPTION	BAG QTY.
08572	Sm	Alligator	5 different colors (up to 6A)	5
08573	Med	Alligator	8 different colors (up to 15A)	8



SERVICE & INSTALLATION



The largest selection of motors, components and accessories for the HVAC/R Industry

Batteries

MARS SERIES **794**



SERVICE & INSTALLATION

Eveready Industrial Alkaline - Bulk

Motors & Armatures, Inc., and the Eveready Battery Company offer a complete line of alkaline, general purpose and lantern batteries. These high quality batteries are made in the U.S.A. and are competitively priced.

The Eveready Energizer Industrial Alkaline batteries are environmentally safe. The new black and green shell signifies the "ZMA" (zero mercury added) formulation. This provides a better discharge rate, lower impedance and better low temperature performance than carbon zinc. These ZMA alkaline batteries are also less sensitive to changes in the discharge rate or duty cycle.

MARS NO.	DESCRIPTION	MARS PACK	CASE QTY.
79401	D cell - 1.5V	12	72
79402	C cell - 1.5V	12	72
79403	AA - 1.5V	24	144
79404	AAA - 1.5V	24	144
79406	6V GP lantern battery	12	72
79405	9V	12	72
79458	lithium coin - 3V	6	6

Eveready Industrial Alkaline - Carded

MARS NO.	DESCRIPTION	MARS PACK	CASE QTY.
79441	D cell - 2 pack	12	48
79442	C cell - 2 pack	12	48
79443	AA - 4 pack	12	48
79444	AAA - 4 pack	12	48
79445	9V - 2 pack	12	48
79457	AAAA - 2 pack	6	6

Bulk Battery Counter Display

Increase your battery sales with the MARS battery counter display. This attractive, eye-catching display incorporates a gravity feed design that conveniently dispenses one battery at a time. This space saver display holds (11) D cells, (14) C cells, (26) AA cells, (36) AAA cells and (14) 9V batteries. Purchase three MARS bulk packs of each alkaline battery size and receive your display FREE! Ask your MARS Representative for details!

MARS NO.	DESCRIPTION	MARS PACK
79410	Counter display (empty)	1

Eveready Watch/Calculator Batteries

MARS NO.	DESCRIPTION	MARS PACK	CASE QTY.
79467	#386 1.5V repl. SR43W, SP386, GP86, H, S150, SG12	6	480
79468	#393 1.5V repl. SR48, RW48, F, SR754W, 546, 515	5	100
79469	#357 1.5V repl. SR44, RW42, J, SR44W, 541, 547	6	480





Flashlights & Laser Engraving Program

MARS SERIES **792**

MAGLITE® Laser Engraving Program

Motors & Armatures is pleased to offer the Mag-Lite Laser Engraving Program. A Maglite® flashlight can be permanently laser engraved with your company's name or logo. This makes an outstanding gift when you, or your company want to be remembered in the very finest light.

Flashlights are available in our standard blister pack or an attractive presentation gift box for an additional nominal fee per flashlight. The minimum order quantity for the Maglite® Laser Engraving Program is 48 pieces per size.

Engraving Charges

Mini Maglite AA, AAA & Solitaire(50¢ per imprint area)
 Standard Maglite(\$1.00 per imprint area)

***Note: Engraving is not available on Mag's rechargeable flashlight**
Set Up Charge \$50.00 (ea. size)

Artwork Mag requires camera ready artwork. An authorization release to print corporate logos must be obtained prior to engraving.

Lead Time Approximately five days after receipt of artwork and order, paper proof will be sent via fax for approval. If the fax transmission is sufficient for approval, Mag must be notified so that the actual flashlights may be engraved.

Following approval of the sample, the order will be shipped within approximately ten to fifteen working days.

Special Colors A minimum 10,000 unit order and approximately three week leadtime is required on special color orders.

Imprint Area

	Head	Switch	Knurl	End
Solitaire®	N/A	N/A	5/16 x 1-1/4	5/16 x 1/4
Mini Maglite® AAA	7/16 x 5/8	5/16 x 3/8	5/16 x 1-3/4	5/16 x 1/2
Mini Maglite® AA	5/8 x 3/4	7/16 x 1/4	7/16 x 2-1/8	7/16 x 1/2
Standard Maglite® 2C	1-7/16 x 1	3/4 x 1-3/4	3/4 x 2-3/4	3/4 x 1/2
Standard Maglite® 3C	1-7/16 x 1	3/4 x 1-3/4	3/4 x 3-3/4	3/4 x 1-3/8
Standard Maglite® 4C	1-7/16 x 1	3/4 x 1-3/4	3/4 x 4-3/4	3/4 x 2-1/8
Standard Maglite® 5C	1-7/16 x 1	3/4 x 1-3/4	3/4 x 5-3/4	3/4 x 2-7/8
Standard Maglite® 6C	1-7/16 x 1	3/4 x 1-3/4	3/4 x 7-3/4	3/4 x 3-5/8
Standard Maglite® 2D	1-7/16 x 1	1 x 1-3/4	1 x 2-3/4	1 X 1-3/4
Standard Maglite® 3D	1-7/16 x 1	1 x 1-3/4	1 x 3-3/4	1 X 3
Standard Maglite® 4D	1-7/16 x 1	1 x 1-3/4	1 x 4-3/4	1 X 4/3/8
Standard Maglite® 5D	1-7/16 x 1	1 x 1-3/4	1 x 5-3/4	1 X 5-1/2

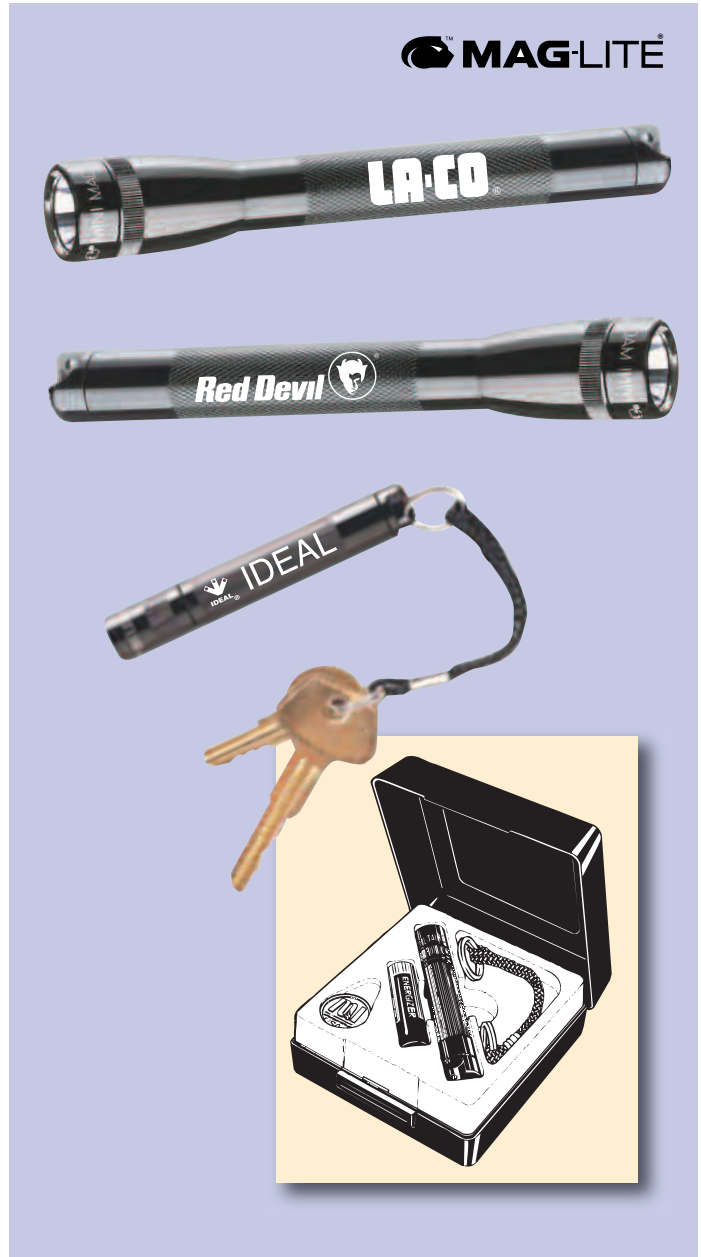

SERVICE & INSTALLATION

Flashlights

MARS SERIES **792**



SERVICE & INSTALLATION

MAGLITE® Flashlights

MARS and Maglite® are committed to providing a full selection of flashlight products designed for use by professionals. Features include anodized aircraft aluminum with knurled grip, o-ring sealed for minimum water resistance and adjustable beams from pinpoint spot to flood. All Maglite flashlights are designed and tested for high impact, precise illumination and longer use. All units have a limited lifetime warranty for repair and replacement of all internal and external components.

MARS NO.	DESCRIPTION	MAG. NO.	CASE QTY.
79205	Mini-mag AAA (black)	M3A016	12
79201	Mini-mag AA (black)	M2A016	12
79230	Mini-mag AA (blue)	M2A116	12
79252	Mini-mag AA (camouflage)	M2A026	12
79207	Mag-light 2C-cell (black)	S2C016	12
79203	Mag-light 2D-cell (black)	S2D016	12
79204	Mag-light 3D-cell (black)	S3D016	12
79210	Mag-light 4D-cell (black)	S4D016	12
79202	AA combo pack (black)	M2A01C	12
79215	AA mag holster combo (black)	M2A01H	12

MAGLITE® Led Flashlights

MARS NO.	DESCRIPTION	MAG. NO.	CASE QTY.
79238	MiniMaglite 2AA LED (black)	SP221H	6
79239	Maglite 2D-cell LED (black)	SP221H	6
79212	MiniMaglite XL200 3AAA LED (black)	XL200- S3016	6
79240	Maglite Pro 2AA LED (black)	SP2P01H	6
79241	Maglite Pro + 2AA LED (black)	SP+P01H	6

MAGLITE® Accessories

MARS NO.	DESCRIPTION	MAG. NO.	CASE QTY.
79222	AA nylon holster (black)	AM2A056	12
79226	AA leather holster (black)	AM2A026	12

MAGLITE® Replacement Lamps

MARS NO.	DESCRIPTION	MAG. NO.	CASE QTY.
79223	AA/AAA bulb 2 pack	LM2A001	12
79221	2D-2C krypton bulb	LMSA201	12
79220	3D-3C krypton bulb	LMSA301	12
79219	4D-4C krypton bulb	LMSA401	12
79278	Halogen Replacement lamp	LR00001	12

Upgrade LED Kits for MAGLITE®

MARS NO.	DESCRIPTION	MAG. NO.	CASE QTY.
79233	AA LED Upgrade	LRB-07	6
79232	AA LED Upgrade II-White	LRB2-07	6
79234	C & D LED Upgrade	LRB-07-PR	6
79227	AA MiniMaglite IQ Switch	NIQ-07-AA	6
79228	AA MiniMaglite LED Upgrade II	LRB2-07-1W	6
79229	AA MiniMaglite LED II & Switch	NIQ2-07-1WC	6



Lumilite® Lanterns & Industrial Flashlights

Motors & Armatures is pleased to re-introduce Lumilite Flashlights. Our Lumilite product offering provides the wholesaler with high quality lanterns and flashlights at competitive prices and attractive packaging.

The Lumilite 6-Volt Krypton Lanterns are constructed of heavy duty yellow plastic. These lantern flashlights use one 6 volt spring terminal battery. The MARS #79471 is a 6-volt lantern with 4-D battery adapter, 4-D batteries and provided with clamshell packaging.

The 6-Volt Z-Lite Lantern, MARS #79472, features a gray rubberized body. This floatable lantern features an adjustable stand for hands free operation. The unit is provided in clamshell packaging and includes a 4-D battery adapter and 4-D batteries. Unit will operate with a 6-volt spring terminal battery or the 4-D battery adapter.

Lumilite Industrial Flashlights feature a rugged, shockproof polypropylene body. All units come with a super bright krypton bulb and batteries. Yellow safety color. Attractive clamshell packaging. Available in 2AA, 2D, 2D with magnet and 3D sizes.

The Lumilite LED Headlight, MARS #79477, includes an adjustable strap with head cushion and 2 AA batteries. The ratchet headlight rotates up and down for directional beam.

MARS NO.	DESCRIPTION	MARS PACK	CASE QTY.
79472	6-volt Z-Lite lantern w/4D adapter & 4D batteries	1	6
79474	2D flashlight w/batteries	1	12
79475	2D with magnet and batteries	1	12
79476	3D flashlight with batteries	1	12

MARS Extendable Magnetic Flashlight

Introducing the MARS Extendable Magnetic Flashlight

The extendable, flexible, lighted, magnetic pickup tool
Tool box utility in your shirt pocket

- Flexible shaft
- Telescopes from 6" to 21"
- 3 Super bright LED's
- Durable machined aluminum body
- Powerful magnetic head and tail
- Uses 4 LR44 batteries (included)

MARS NO.	DESCRIPTION	MARS PACK
79479	Extendable Magnetic Flashlight	

MARS Accessories

MARS NO.	DESCRIPTION	MARS PACK
79460	LR44, Batteries for 79479, 4 pk	1



Electronic P/T Chart

MARS SERIES **657**



Electronic Refrigerant Pressure/Temperature Chart

"Throw away your worn out paper charts"

- Pocket sized
- Includes 61 refrigerants
- Pressure readings in PSI, BAR & MPa
- Temp readings in Fahrenheit and Celsius
- Battery included
- Clamshell packaging

MARS NO.	MARS PACK
65700	1



SERVICE & INSTALLATION

Infra-Red Thermometers

MARS SERIES **255**



MARS Infra-Red Laser Thermometer

- Built-in laser pointer
- Data hold & Auto power off
- Temperature Range: -50°C to 350°C (-58°F to 662°F)
- Accuracy: ±2% of reading or ±2°C/±4°F • D:S=8:1
- Complete with 9V battery
- Quickly and easily take the surface temperature of any object. Just point, pull the trigger, and read the temperature on the display.
- °C / °F switchable button
- Backlit LCD display

MARS NO.	DESCRIPTION	MARS PACK	CASE QTY.
25580	Infrared thermometer	1	500





Scales

MARS SERIES **790**

Pelouze Refrigerant Scales

MARS #79040, the 250 lb platform scale, is ideal for weighing heavy packages and containers. Activated by either hand or foot, the unique "memory lock" holds reading when dial is obscured. The platform and body feature a combination of steel subframe and glass fiber reinforced nylon. Scratch, rust and chemical resistant

The Pelouze electronic scale #79042 features a heavy duty "no-slip" platform, LCD display, and a wall mount control panel. Automatic shut off. Low battery indicator. Displays in 0.2lb/0.1kg increments. All steel construction. Tare functions and remote display head on a 9' cord. Operates on AC adapter (included) or a 9V battery (not included).

MARS #79043 is the ideal electronic scale for heavy duty weighing. This 400 lb x 1/2 lb scale features an easy to read LCD display, automatic shut off, and low battery indicator. The control panel can be wall mounted for easy viewing. Tare functions. Strain gauge weighing operates on AC adapter (included) or one 9V battery (not included).

MARS NO.	DESCRIPTION	MARS PACK	CASE QTY.
79040	250 lb. x 1 lb. platform scale	1	1
79042	150 lb. x .2 lb. electronic scale	1	4
79043	400 lb. x 1/2 lb. electronic scale	1	1

MARS Hand Held Scale

- Ideal for weighing and checking most gas and refrigerant cylinders
- Easy to use
- Push button for accuracy
- Auto shut off
- Max scale up to 55 lbs
- 9V battery included
- Accuracy up to +/- 2%
- LBS/KGS switch

MARS NO.	DESCRIPTION	MARS PACK
79039	Digital hand held scale	1



SERVICE & INSTALLATION



Refrigerant I.D. Labels

MARS SERIES **790**

MARS Refrigerant I.D. Labels

MARS refrigerant I.D. labels are color coded to conform to each particular refrigerant. Each label specifies the type of refrigerant, the chemical name, the UN # and a space for the name and address of the cylinder owner. These self-adhering labels are 4 1/2" x 3 1/2", except for MARS #79528, Refrigerant Evacuation Certificate, which is 7 1/2" x 4 1/2".

MARS NO.	DESCRIPTION	MARS PACK
79522	R-22 Refrigerant I.D. Labels (10 pk)	1
79523	R-134A Refrigerant I.D. Labels (10 pk)	1
79516	SUVA® HP62 Refrig. Labels (10 pk)	1
79511	R-407A Refrigerant I.D. Labels (10 pk)	1
79512	R-407C Refrigerant I.D. Labels (10 pk)	1
79536	GENETRON® AZ-20 Refrig. Labels (10 pk)	1
79526	R-421A Refrigerant I.D. Labels (10 pk)	1
79525	R-422B Refrigerant I.D. Labels (10 pk)	1
79527	R-422D Refrigerant I.D. Labels (10 pk)	1
79506	R-438A Refrigerant I.D. Labels (10 pk)	1
79513	R-507 Refrigerant I.D. Labels (10 pk)	1
79528	Refrigerant evacuation certification (5 pk)	1
79514	R-508B SUVA® refig. Label (10 pk)	1



Thermometers

MARS SERIES **255**



MARS Pocket Bi-Metal Dial Thermometers

MARS pocket dial thermometers consist of stainless steel cases with 5" stem. Thermometers are completely waterproof. Units are protected by flexible plastic case with clip. They can be recalibrated for accuracy.

MARS NO.	DESCRIPTION	MARS PACK	CASE QTY.
25510	1" dial -40° F to 160°F thermometer	1	12
25520	1" dial 0° F to 220°F thermometer	1	12



MARS Pocket Digital Thermometers

MARS #25531 deluxe digital pocket thermometer features an on/off switch and a data hold button. The easy to read LCD digits can be displayed in both fahrenheit and centigrade. The new slim design fits nicely in your pocket. Pocket clip and battery are included. $\pm 2^\circ$ accuracy. Uses MARS #79467 replacement battery. Water and drop resistant. Auto power off is also a new feature.

The multi feature round digital thermometer features an "on/off" switch and "clear" button. This pocket thermometer displays both fahrenheit and centigrade. A "min/max" button is also featured and a clear protective plastic sheath with pocket clip is included.

MARS NO.	DESCRIPTION	MARS PACK	CASE QTY.
25531	Deluxe digital pocket, -40°F to 300°F, -50°C to +150°C	1	12
79467	#386 replacement battery for #25531	6	480
79468	#393 replacement battery for #25532	6	48

Deltatrak Environmental Temperature Recorders

The 5 day **disposable** temperature recorder is an inexpensive, one-time use temperature recorder indispensable for HVAC/R uses. It gives an accurate 5-day strip chart recording of a wide ambient temperature range. It can be easily changed on the job! After use, recycle it. Drop in any mailbox using the postage paid return label.

Single-Use Deltatrak features & benefits:

- Inexpensive (cheaper than renting a recorder)
- Factory calibrated, no need for field calibration
- Security sealed, tamper proof and built rugged
- Ideal monitor/verification of performance of HVAC or refrigeration units, after installation or repair
- Worry-free from loss or breakage of an expensive recorder
- Simple to understand & use
- The DeltaTRAK cost can easily be charged to the job at a profit
- Ideal to use when a number of jobs are in progress and several recorders become necessary
- Never need to repair since they are used only once
- Ideal for the occasional user of a recorder
- Displays both Fahrenheit and Centigrade.

MARS NO.	DESCRIPTION	MARS PACK	CASE QTY.
25563	5 day disposable model	1	20

MARS Refrigerator/Oven Thermometers

Horizontal refrigerator/freezer thermometer is most often specified for commercial applications. Hang, stand, or permanent mount. Stainless steel refrigerator or oven models utilize 2" easy to read dial. Hang or stand.

MARS NO.	DESCRIPTION	MARS PACK	CASE QTY.
25540	Horizontal glass tube refrig. -40°F to 80°F, -40°C + 0° to +26°C	1	6
25542	Stainless steel refrigerator -20°F to 80°F, -29°C to +26°C	1	6

Visual Heat Exchanger Inspection System

The Visible Defects Heat Exchanger Inspection System is a tool that provides service technicians with an accurate, cost effective, and non-destructive means for evaluating heat exchangers in fuel fired furnaces. Cracked heat exchangers emit carbon monoxide gas into the living space of the dwelling which can result in sickness or death.

To perform the test, the technician simply inserts the brass spray nozzle fully into the air side of the heat exchanger and slowly pulls the nozzle out while spraying the patent pending green fluorescent dye and coating the inside of the heat exchanger. Next, the technician uses the black UV light to illuminate any dye that breaches the wall (via a crack) between the air-side and combustion-side of the heat exchanger. The test is fast, easy, and very effective. The real value lies in the fact that the service technician can easily show the furnace owner the existing problem.

The kit includes:

- Instructional Video
- Patent Pending Spray Applicator w/2 Nozzles
- Super Bright LED UV Light
- UV Blocking Safety Glasses
- Acrylic Inspection Mirror
- 2 Gallons of Crack Finder Dye
- 1 year Warranty

MARS NO.	DESCRIPTION	MARS PACK	CASE QTY.
93800	VD Detection kit	1	1
93816	Dye-Gallon Refill	1	4
93817	22" Replacement Nozzle Set	1	1
93818	Replacement Spray Bottle	1	1



93800

SERVICE & INSTALLATION

Welding/Brazing/Cutting/Heating Tools

MARS SERIES **256**



SERVICE & INSTALLATION

Oxy Fuel Outfits

These light/medium duty outfits are designed for a variety of HVAC, Plumbing, Refrigeration and general maintenance work. They include cylinders and a tough, lightweight polypropylene carrier. All components are UL listed.

- Torch Handles are machined from high quality forged brass and feature a Tube-in-a-Tube design for high handle strength.
- Oxygen and acetylene regulators are compact rear entry inlet design for better balance and come with 2" easy view gauges.
- Check valves prevent reverse flow of gases which can cause dangerous mixtures. • All cylinders are shipped empty.

MARS #26901

Kit Includes:

- | | |
|--|---------------------------------|
| 1 welding/brazing tip | 1 single flint striker |
| 1 multi-flame rosebud tip | 1 pair torch end check valves |
| 1 torch handle | 1 plastic carrier |
| 1 acetylene regulator (rear mount) | 1 "type 40" oxygen cylinder |
| 1 oxygen regulator (rear mount) | 1 "MC" acetylene cylinder |
| 1 12' grade "R" welding & soldering hose | 1 eye cup style welding goggles |

MARS #26902

Kit includes:

- All items included with 26901
1 cutting attachment

Welding/Brazing/Heating Tips

MARS welding & brazing tips have red copper tip ends and are ideal for soldering, brazing, heating and hardfacing, etc. Interchangeable with all major manufacturers.

MARS NO.	METAL THICKNESS	DRILL SIZE	OXYGEN (PSIG)	ACETYLENE (PSIG)	ACETYLENE (SCFH)
26904	3/64" – 3/32"	60(.040)	3/5	3/5	3/6
26905	1/16" – 1/8"	56(.046)	3/5	3/5	5/10
26906	1/8" – 3/16"	53(.060)	4/7	3/6	8/18
26907	3/16 – 1/4"	49(.0730)	5/10	4/7	10/25

MARS Rosebud tips are multi-flamed tips designed for heating in confined areas.

MARS NO.	OXYGEN (PSIG)	BRAZING CAPACITY FOR COPPER
26903	15	1/2" – 6"

Air Acetylene Swirl Flame Tips

MARS swirl flame tips are constructed with replaceable stainless steel tips ends, an industry exclusive, for easy repair and maintenance. These tips produce a very hot flame that expands the heat zone providing maximum combustion efficiency for fast soldering and brazing. All swirl flame tips are interchangeable with all major manufacturers.

MARS NO.	COPPER TUBING CAPACITY SOFT SOLDER	SILVER SOLDER
26911	1/4"-1"	1/8"-1/2"
26912	3/4"-1 1/2"	1/4"-3/4"
26913	1"-2"	1/2"-1"

26902

26901

26903

26904-26907

26911

26912

26913

CROSS REFERENCE

MARS #	TurboTorch	Uniweld	Victor	GOSS	Prest-O-Lite	Sure Fire
26902		K46NP-T				
26901		K23C-T				
26903	VMA-1-15	TYPE17 #30				
26904	193-02P	TYPE 17#1	1-W-J			
26905	194-02P	TYPE17#2	2-W-J			
26906	195-02P	TYPE17#3	3-W-J			
26907	196-02P	TYPE17#4	4-W-J			
26908		TYPE17#5	5-W-J			
26909		TYPE17#6	6-W-J			
26911	A-3	A-3		3	QD-SJ-3A	
26912	A-5	A-5		5	QD-SJ-4A	AA1301
26913	A-8	A-8			QD-SJ-5A	



MARS hardware and fasteners are competitively priced and exhibit superior quality required by the HVACR contractor and tradesman.

All fasteners are available in two different package configurations. Both configurations enhance contractor self service and encourage impulse purchases.

Round Head Combo Slotted/Phillips Machine Screws - Steel Zinc Plated

MARS NO.	MINI-PAK QTY.	DESCRIPTION
79808	25	1/4-20 x 3/4
79809	25	1/4-20 x 1
79811	25	1/4-20 x 1 1/2



79808

Hexagon Nuts - Steel Zinc Plated

MARS NO.	MINI-PAK QTY.	DESCRIPTION	MARS NO.	SUPER-PAK QTY.
79836	25	6-32 for 1/8 bolt		
79837	25	8-32 for 5/32 bolt		
79838	25	1/4-20 for 1/4 bolt	80038	100
79839	25	3/8-16 for 3/8 bolt	80039	100

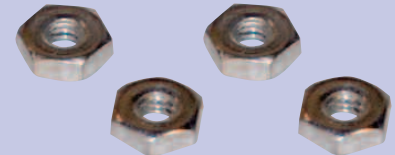

79836

Pan Hd Combo Slotted/Phillips Tap Screws - Zinc Chromate

MARS NO.	MINI-PAK QTY.	DESCRIPTION
79860	25	12 x 1



79860

Indented Hex Washer Hd Slotted Drill Screws - Zinc Plated

MARS NO.	MINI-PAK QTY.	DESCRIPTION	MARS NO.	SUPER-PAK QTY.
79871	25	8 x 1/2 x 1/4 hd	80071	100
79872	25	10 x 3/4 x 5/16 hd	80072	100
79873	25	10 x 1 x 5/16 hd	80073	100
79874	25	10 x 1 1/4 x 5/16 hd		
79875	25	10 x 1 1/2 x 5/16 hd		
79876	25	10 x 2 x 5/16 hd		

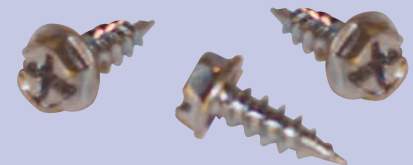

79871

Indented Hex Washer Hd Self Drill Screw - Steel Zinc Chrom.

MARS NO.	MINI-PAK QTY.	DESCRIPTION	MARS NO.	SUPER-PAK QTY.
79887	25	8 x 1/2 x 1/4 hd	80087	100
		8 x 3/4 x 1/4 hd	80088	100
79889	25	10 x 1/2 x 5/16 hd	80089	100
79890	25	10 x 3/4 x 5/16 hd	80090	100
79891	25	10 x 1 x 5/16 hd	80091	100



79887

MARS Hardware

MARS SERIES **798**



Drywall Screw - Bugle Hd Phillips 20 Ga. Max Steel Stud, Blk

MARS NO.	MINI-PAK QTY.	DESCRIPTION
79904	25	6 x 1 5/8
79905	25	6 x 2

Fender Washers - Steel Zinc Chromate

MARS NO.	MINI-PAK QTY.	DESCRIPTION	MARS NO.	SUPER-PAK QTY.
79916	25	1/4 x 1 for 1/4 bolt		
79917	25	1/4 x 1 1/4 for 1/4 bolt	80117	100
79918	25	3/8 x 1 1/4 for 3/8 bolt	80118	100
79919	25	3/8 x 1 1/2 for 3/8 bolt		

Flat Wrought Washers - Steel Zinc Chromate

MARS NO.	MINI-PAK QTY.	DESCRIPTION
79939	25	1/4 USS for 1/4 bolt
79940	25	3/8 USS for 3/8 bolt

Flat SAE Washers - Steel Zinc Chromate

MARS NO.	MINI-PAK QTY.	DESCRIPTION	MARS NO.	SUPER-PAK QTY.
79930	25	10 SAE for 3/16 bolt		
79931	25	1/4 SAE for 1/4 bolt	80131	100
79932	25	3/8 SAE for 3/8 bolt	80132	100

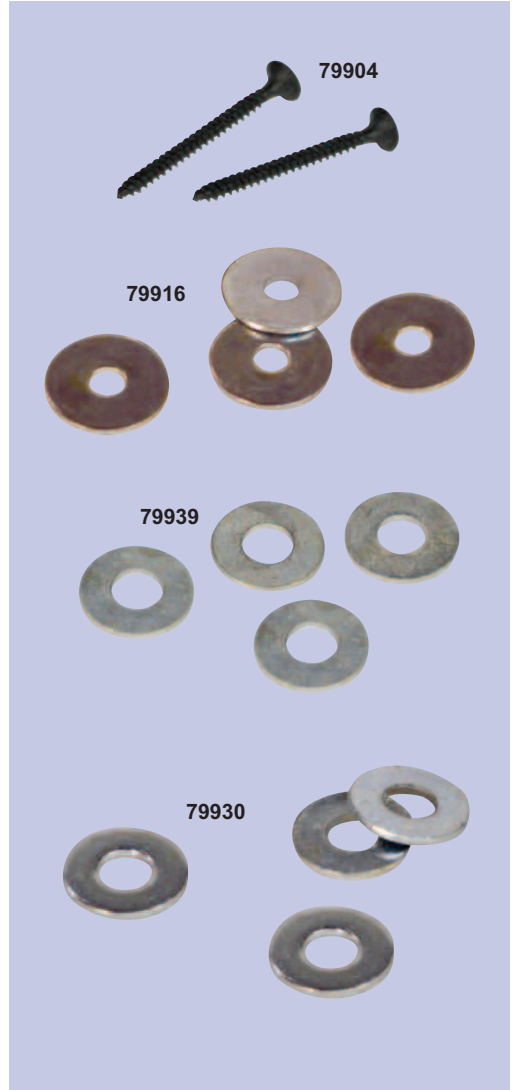

SERVICE & INSTALLATION



Spring Wing Toggle Bolts - Zinc Plated - Mushroom Head

MARS NO.	MINI-PAK QTY.	DESCRIPTION
79953	10	1/4-20 x 4

MARS Plastic Anchor Kits

MARS NO.	DESCRIPTION	MARS PACK	CASE QTY.
79974	Plastic conical anchor with pan head combo kit contents: (100) 1/4 plastic anchors, (100) #10 x 1 pan combo hd screw zinc, (1) 1/4 x4 masonry drill	1	200
79975	Plastic conical anchor with hex washer head kit contents: 100) 1/4 plastic anchors, (100) #10 x 1 hex washer hd slot screws zinc, (1) 1/4 x4 masonry drill	1	200
79976	Plastic screw-in anchor with pan head combo kit contents: (50) plastic screw-in anchors, (50) #8 1 1/2 pan combo hd screw zinc	1	100
79977	Metal screw-in anchor with pan head combo kit contents: (50) metal screw-in anchors, (50) #8 1 1/2 pan combo hd screws zinc	1	100

Green Grounding Screws & Box Clips

MARS NO.	MINI-PAK QTY.	DESCRIPTION	MARS PACK
80160	25	10-32 x 3/8" slotted hex head washer type	1

Plastic Anchor Kits

Plastic anchors are designed to be used with either woodscrews or sheet metal screws. They are recommended for quick, easy fastening of fixtures such as thermostats, thermostat guards, shelf brackets, cabinets, mirrors, pictures, etc. All plastic anchor kits include plastic anchor, screws and carbide masonry drill bit. All kits are packaged in a durable, see-through reclosable plastic storage case.

MARS NO.	DESCRIPTION	CASE QTY.
80168	8-10 x 7/8" plastic anchor kit with slotted pan screw, contains: (100) 8-10 conical anchors, (100) 8 x 1" slotted pan screw, (1) 3/16" x 4" carbide masonry drill bit	1
80169	8-10 x 7/8" plastic anchor kit with pan combo screw, contains: (100) conical anchors, (100) 8 x 1" phillips/slotted pan screw, (1) 3/16" x 4" carbide masonry drill bit	1
80171	10-12 x 1" plastic anchor kit with slotted pan screw, contains: (100) 1/4" conical anchors, (100) 10 x 1 1/4" phillips, slotted pan screw, (1) 1/4" x 4" carbide masonry drill bit	1
80172	10-12 x 1" plastic anchor kit with hex washer slotted screw, contains: (100) 1/4" conical anchors, (100) 10 x 1 1/4" hex washer slotted screw, (1) 1/4" x 4" carbide masonry drill bit	1
80174	14-16 x 1 3/8" plastic anchor kit with slotted pan screw, contains: (50) conical anchors, (50) 14 x 1" slotted pan screw, (1) 5/16" x 4" carbide masonry drill bit	1

Hollow Wall Anchor Kits

MARS NO.	DESCRIPTION	CASE QTY.
80179	#6 hollow wall anchor kit, contains: (50) #6 hollow wall plastic anchors (50) 6 x 1" slotted phillips pan screw	1
80180	#8 hollow wall anchor kit, contains: (50) #8 self drill hollow wall plastic anchors (50) 8 x 1 1/4" slotted phillips pan screw	1



SERVICE & INSTALLATION

MARS Brushes

MARS SERIES **788**



SERVICE & INSTALLATION

Tube Fitting Brushes - Heavy Duty Stainless Steel

MARS NO.	DESCRIPTION		MARS PACK
78801	1/4" OD	1/8" ID fitting brush (2 bag)	6
78802	3/8" OD	1/4" ID fitting brush (2 bag)	6
78803	1/2" OD	3/8" ID fitting brush (2 bag)	6
78804	5/8" OD	1/2" ID fitting brush (2 bag)	6
78805	3/4" OD	5/8" ID fitting brush (2 bag)	6
78806	7/8" OD	3/4" ID fitting brush (2 bag)	6
78808	1 1/8" OD	1" ID fitting brush (2 bag)	6
78809	1 3/8" OD	1 1/4" ID fitting brush (2 bag)	3

Tube Cleaning Brushes

MARS NO.	DESCRIPTION		MARS PACK
78818	3/8" x 3/4" OD	refrig. 4-1 brush tool	12
78819	1/2" x 3/4" OD	refrig. 4-1 brush tool	12
78820	5/8" x 7/8" OD	refrig. 4-1 brush tool	12

Refrigeration Coil Brush

MARS NO.	DESCRIPTION		MARS PACK
78828	5/8" to 1 5/8"	fiber condenser cleaner 32"	12
78829	5/8" to 1 5/8"	tapered condenser cleaner 29"	12
78830	3/4" to 1 5/8"	tapered refrig. coil brush 28"	12

Fin And Coil Brushes

MARS NO.	DESCRIPTION		MARS PACK
78833	Fin and coil whiskbrush, 6 3/4"		12
78834	Fin and comb scraping tool, adjustable		12
78835	6-in-one fin comb (8, 9, 10, 12, 14, 15 fins per inch)		12

Acid And Flux Brushes

MARS NO.	DESCRIPTION		MARS PACK
78839	#1 acid brush	1/4" - 48 box	1
78840	#2 acid brush	3/8" - 48 box	1
78841	#1 acid brush	1/4" - 10 bag	10
78842	#2 acid brush	3/8" - 6 bag	10





Flue And Boiler Brushes

MARS NO.	DESCRIPTION	MARS PACK
78945	1-1/2" x 1-1/8", 30" OAL, Specialty Boiler Brushes - WEIL MCLAIN	6
78946	1/2" x 1", 27" OAL, Flat, Specialty Boiler Brushes - COLUMBIA	6
78947	2-1/4", 20" OAL, Tapered, Specialty Boiler Brushes - SLANT FIN	6
78948	1-1/2" x 1-1/8" x 36" OAL, HD, Gold Series Original, Specialty Boiler Brushes - WEIL MCLAIN	6
78949	1/2" - 1" Taper, 30" OAL, Horsehair, Specialty Boiler Brushes - TAPERED	6
78950	1-7/8" - 1-1/8" Taper, 42" OAL, Horsehair, Specialty Boiler Brushes - TAPERED	6
78951	1" Dia., 16" OAL, Horsehair Brushes for Boilers Burners, Radiators, Flues, Vents and Nozzles	6
78952	2" Dia., 27" OAL, Horsehair Brushes for Boilers Burners, Radiators, Flues, Vents and Nozzles	6
78953	3" Dia., 27" OAL, Tampico/Fiber Tube Brushes for Boilers Burners, Radiators, Flues, Vents and Nozzles	6
78954	2" Dia., 42" OAL, Horsehair Brushes for Boilers Burners, Radiators, Flues, Vents and Nozzles	6
78955	3" Dia., 42" OAL, Tampico/Fiber Tube Brushes for Boilers Burners, Radiators, Flues, Vents and Nozzles	6

These brushes have 3" brush lengths and 1/2" or 3/4" loop handles for easy hanging.

MARS NO.	DESCRIPTION	MARS PACK
78956	1/2" Dia., 18" OAL, Stainless Steel Fine-Wire Single Spiral Brushes for Small Boilers, Burners, Nozzles & Fans	12
78957	3/4" Dia., 24" OAL, Stainless Steel Fine-Wire Single Spiral Brushes for Small Boilers, Burners, Nozzles & Fans	12
78958	1-1/2" Dia., 42" OAL, Carbon Steel Fine-Wire Single Spiral Brushes for Small Boilers, Burners, Nozzles & Fans	6

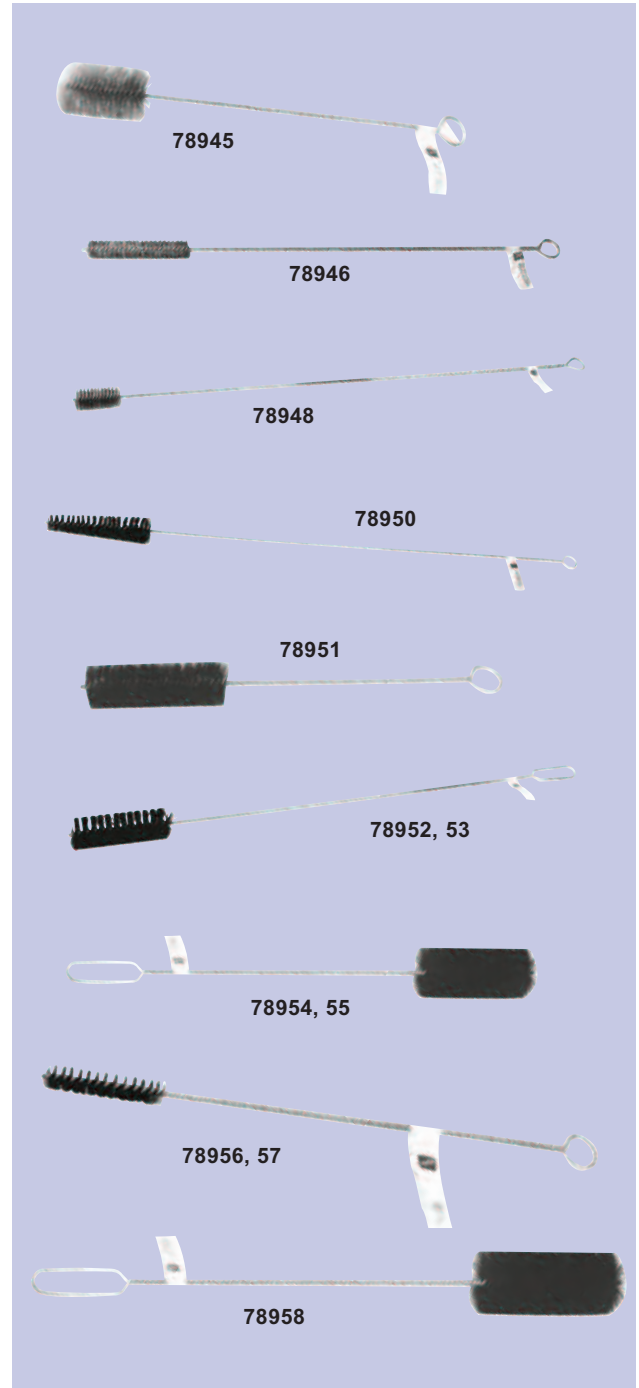

MARS Brushes

MARS SERIES **788**



SERVICE & INSTALLATION

Applicator Brushes, Natural Bristle

MARS NO.	DESCRIPTION	MARS PACK
78902	1 1/2" economy paint brush-wood handle	36
78903	2" economy paint brush-wood handle	24
78904	2 1/2" economy paint brush-wood handle	12
78905	3" economy paint brush-wood handle	12
78906	4" economy paint brush-wood handle	12

Utility And Appliance Brushes

MARS NO.	DESCRIPTION	MARS PACK
78910	Plastic handle stainless brush, 3 x 7 rows, 3 pk.	12
78911	Wood handle stainless brush, 2 x 9 rows, 3 pk.	12
78912	1 1/16" dia. parts cleaning brush	6
78913	Bent handle carbon scratch brush, 4 x 18 rows	12
78915	Shoe handle carbon scratch brush, 4 x 16 rows	12

Abrasive Cloth And Pads

MARS NO.	DESCRIPTION	MARS PACK
78920	1 1/2" x 5 yds. open coat white cloth	24
78921	1 1/2" x 10 yds. open coat white cloth	24
78922	1 1/2" x 25 yds. open coat white cloth	20
78923	1 1/2" x 5 yds. open nylon mesh cloth	24
78924	1 1/2" x 10 yds. open nylon mesh cloth	24
78925	1 1/2" x 25 yds. open nylon mesh cloth	20
78926	4" x 6" med. nylon abrasive pad, maroon, 10 pk	1
78928	1 1/2" x 10 yds. competitive abrasive cloth	1
78918	1 1/2" x 25 yds. competitive abrasive cloth	1

Accessories

MARS NO.	DESCRIPTION	MARS PACK
78930	Solder/braze heat shield, 9" x 12" x 1/2" temperatures exceeding 2500°F	10
78931	Solder heat shield, 9" x 12" temperatures up to 2500°F	10
78932	Heavy duty deburring tool, 3 blades	10
78933	Deburring tool replacement blades, 5 pack	10
78935	Heavy duty plastic stackable utility box, 12"x6"x6"	12





PowerCrown Outward Clinch Tackers

Model PC4000-OC1 & PC4000-OC2 Features:

- Easy squeeze design
- Compact, lightweight
- Convenient bottom load
- Unique design turns staple legs outward
- For pipe wrap, duct board and corrugated

MARS NO.	DESCRIPTION	MFG. NO.	CASE QTY
73349	Outward Clinch Tacker	T6-80C2	12
73346	1/4" Staples / 5M Box	STCR5019 1/4"	20
73347	3/8" Staples / 5M Box	STCR5019 3/8"	20
73350	1/2" Staples / 4M Box	STCR5019 1/2"	20
73351	9/16" Staples / 4M Box	STCR5019 9/16"	20

PowerCrown Outward Clinch Tacker - Model PC3000-OC2

Model PC3000-OC2 Features:

- Professional quality
- Drives 1/2" light wire Bostitch PowerCrown staples
- Powerful direct drive
- Unique design turns staple legs outward
- Convenient bottom load
- For pipe wrap, duct board and corrugated

MARS NO.	DESCRIPTION	MFG. NO.	CASE QTY
73343	Outward Clinch Tacker	T6-60C2	12
73348	1/2" Staples / 5.8M Box	STCR2619 1/2"	20

PowerClench™ Stapling Plier

Model P6C-8 Features:

- Ergonomic design
- Easy squeeze action
- Fast loading of staples
- Top loading

MARS NO.	DESCRIPTION	MFG. NO.	CASE QTY
73352	Stapling Plier	P6C-8	12
73353	3/8" staples / 5.8M Box	STH5019	20

MARS Multi Purpose Cutters

MARS NO.	DESCRIPTION	MARS PACK	CASE QTY.
25656	Compound ratchet action cutter, cuts hose, cable and plastic pipe 1 1/8" OD, replaceable blade, internal parts and pivots all stainless	1	12

Vise-Grip® Locking Pliers And Clamps

MARS offers Vice-Grip hand tools for the HVAC/R contractor. MARS #25700 is a "Quick Pierce" Vise-Grip for the extraction of refrigerant from A/C units and appliances. Excellent for recovery applications. This plier adjusts to various tube sizes.

MARS NO.	DESCRIPTION	MARS PACK	CASE QTY.
25700	MARS Quick Pierce tool (pouch)	1	1
25688	Quick Pierce replacement tip (bulk)	1	100



STANLEY
BOSTITCH
Stanley Fastening Systems

73343
73349



73346
73347
73348
73351
73353

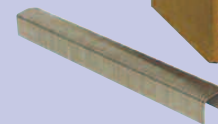

73352



25656

Master
VISE-GRIP



25700

SERVICE & INSTALLATION

Hand Tools

MARS SERIES **283**



Channellock Pliers

For over a century Channellock has been the leader in manufacturing professional quality tools for all trades. All tools are made in the U.S.A. The MARS line of Channellock tools are housed in attractive merchandiser hang type style packaging to generate impulse sales and increase your profits.

Channellock pliers are hand honed perfectly matched cutters which are heat treated to hold their edge. These pliers are precision made of fine polished, high carbon drop forged steel and features blue plastic comfort grips. MARS #28310, 9" linemans Wiremaster™ plier provides high leverage and an enclosed joint design to hold cutter in perfect alignment for the life of the plier.

Channellock Long Nose Pliers feature slender, perfectly matched jaws with no side wobble to provide a firm grip on fine work in tight places. MARS #28316 and #28317 also feature a side cutter.

The popular Tongue and Groove Pliers provide right angle teeth that grip in all directions for maximum bite and minimum wear. The undercut tongue and groove design assures the strongest non-slip jaw action and the patented PermaLock® fastener provides safer and smoother working than the old-time bolt and nut.

The Channellock crimping tool, MARS #28333, is used for crimping and cutting of both insulated and non-insulated solderless connections and terminals.

SERVICE & INSTALLATION

MARS NO.	DESCRIPTION	MFG. NO.	CASE QTY.
28301	7" cutting plier - lap joint diagonal	337	20
28303	7 3/4" cutting plier - lap joint curved diag.	447	20
28305	6" cutting plier - box joint	436	20
28310	9" Wire Master™ linemans plier	349	20
28311	9" high leverage linemans plier	369	20
28316	7 1/2" Long Nose Plier with side cutter	317	20
28317	6" Long Nose Plier with side cutter	326	20
28323	9 1/2" Tongue & Groove Plier 5 Adjustments - 1 1/2" capacity	420	20
28324	6 1/2" Tongue & Groove Plier 5 adjustments - 7/8" capacity	426	20
28325	10" Tongue & Groove Plier 7 adjustments - 2" capacity	430	20
28326	12" Tongue & Groove Plier 7 adjustments - 2 1/2" capacity	440	20
28327	16" Tongue & Groove Plier	460	20
28333	Crimping tool	909	20

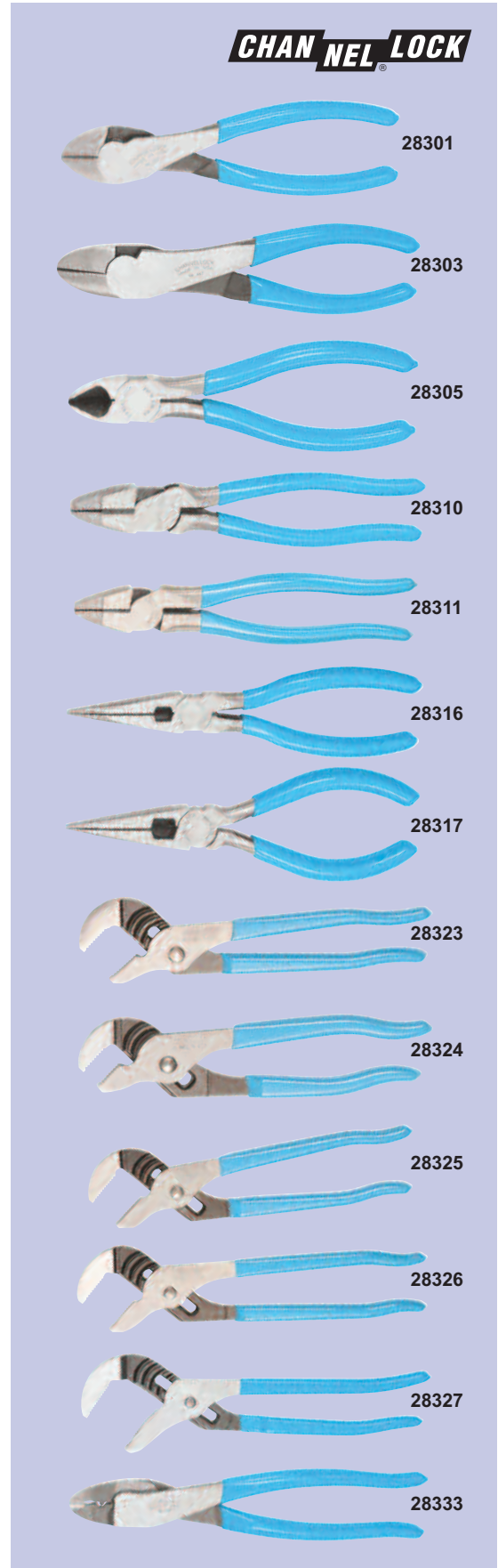



Fuse Pullers

MARS #25915, medium fuse puller is molded of tough, high impact nylon for greater strength. Handles with no-slip gripping surface, protective finger stops and yellow color are provided for extra safety.

MARS NO.	DESCRIPTION	MFG. NO.	MARS PACK	CASE QTY.
25915	7-1/4" medium puller for 0-100A fuses	34-016	1	10

Torpedo Level

Torpedo level measures 9" and consists of aluminum frame. Has magnetic edge and "v" grooved edge for pipe work. A window in each vial provides easy reading of plumb, level and 45° mitre in dim lighting.

MARS NO.	DESCRIPTION	MFG. NO.	MARS PACK	CASE QTY.
25840	9" torpedo level	35-205	1	3

Terminal Strips, 600V, 30a, UL & CSA

MARS NO.	DESCRIPTION	MFG. NO.	MARS PACK	CASE QTY.
25952	3 circuit terminal strip	89-203	1	10
25953	4 circuit terminal strip	89-204	1	10
25954	6 circuit terminal strip	89-206	1	10
25955	8 circuit terminal strip	89-208	1	10
25956	10 circuit terminal strip	89-210	1	10
25957	12 circuit terminal strip	89-212	1	10

Tap-Pak® Fish Tape

IDEAL Tape-Pak® fish tape reels and winders provide maximum strength and flexibility for fishing long runs of conduit. The case is built of high impact plastic that never dents or rusts. Use as a handle for pulling on fish tape to eliminate the dangers of bare-handed pulling as well as handy tape storage system. High grade tempered steel tape is fully protected and locked in reel when not in use so tape cannot kink spring free. Excellent for snaking long runs of thermostat wire.

MARS NO.	DESCRIPTION	MFG. NO.	MARS PACK	CASE QTY.
25849	50' fish tape - 8 1/2" dia.	31-033	1	1

Safe-T-Grip® Fuse Pullers

IDEAL's Safe-T-Grip® Fuse Pullers provide maximum efficiency and convenience when removing or replacing cartridge fuses. Constructed of fully insulated, reinforced, high-dielectric engineering plastic. Notched handles for a no-slip safe grip. Clearly marked amperage ranges. Moisture resistant...will not warp. Bright yellow in color.

MARS NO.	DESCRIPTION	MFG. NO.	MARS PACK	CASE QTY.
25911	5" midget for fuses 9/32-1/2 dia.	34-001	1	1
25912	7 1/2" pocket for 0-100A fuses	34-002	1	10
25913	11 3/4" giant for 31-600A fuses	34-003	1	1



25915

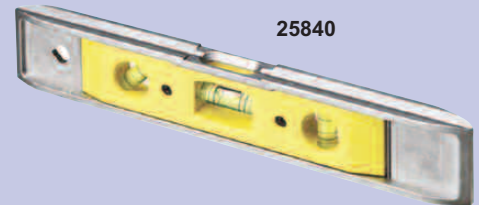

25840



25952



25849



25911
25912
25913

Electricians Hand Tools

MARS SERIES **256, 650 & 798**



Wire Strippers And Crimpers

Preferred by professionals for over three decades and originated by IDEAL, these quality built T[®]-strippers feature built in wire cutters, looping holes, cushioned plastic grips and precision knife-type blades that give an accurate, easy strip every time.

The MARS #25705 stripper is a versatile seven-function tool featuring spring loaded handles for quick and easy use, cushioned grips for comfort and a locking panel to keep jaws closed when not in use. It strips, cuts wire, crimps terminals, cuts bolts and screw, gauges 6-18 AWG wire, loops wire and reams conduit (reams and de-burrs).

The multi-crimp tool provides excellent leverage for sure, easy crimping and cutting...even in close quarters. Crimps bare or insulated terminals and splices on wire sizes 10-22 AWG.

MARS NO.	DESCRIPTION	MFG. NO.	MARS PACK	CASE QTY.
25701	T [®] -5 Stripper 10-18 AWG solid	45-120	1	10
25702	T [®] -6 Stripper 16-26 AWG strand	45-121	1	10
25703	T [®] -8 Stripper 8-16 AWG strand	45-124	1	10
25705	7-in-1 Stripper Crimper	45-777	1	5
25711	Multi-crimp Tool	30-429	1	5

Refrigeration Wrenches

The Kwik-tite[®] ratchet wrenches (MARS #65079, 80, 81, 87) feature open jaw design which makes it easy to slip wrench onto fittings and fasteners - even in tight quarters. Flips quickly into tightening position with a sure grip on all hex surfaces. MARS #65082 is a combination wrench with the four sizes most needed for servicing air conditioning units. MARS #65083 & #65084 are designed for use on compressors with access valves in hard to reach places. This reversible ratchet is chrome plated.

MARS NO.	MFG. NO.	DESCRIPTION	CASE QTY.
65082	124C	9/16" and 1/2" hex; 3/16" & 1/4" sq. ratchet	1
65083	127C	1/4", 3/8", 3/16", 5/16" square ratchet	1

MARS Drill Screw Chuck With Magnetic Insert

MARS NO.	DESCRIPTION	MARS PACK
79990	1/4" hex x 1 5/8", 1/card	12
79991	5/16" hex x 1 5/8", 1/card	12

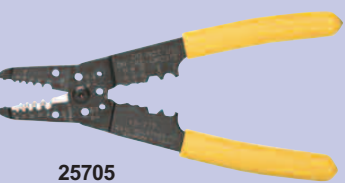
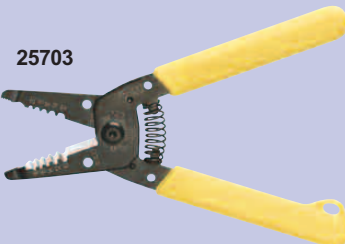
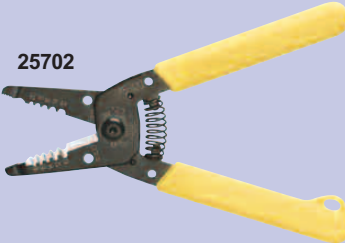
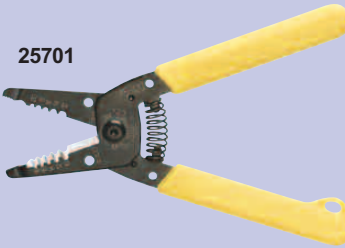

SERVICE & INSTALLATION



Hand Tools, Bits & Blades

MARS SERIES **256, 933 & 216**

MARS 6-in-1 Super Driver

The MARS Super driver features a comfort grip handle. The soft easy grip promotes excellent torque. This six-in-one driver includes 3/16" & 1/4" slotted bits, #1 & #2 phillips bits and 1/4" & 5/16" nutdriver. These screwdrivers are packaged twelve per counter display box.

MARS NO.	DESCRIPTION	MARS PACK	CASE QTY.
25984	MARS 6-in-1 super driver	12	12

Red Devil Putty Knives And Wall Scrapers

Red Devil offers professional high quality putty knives and wall scrapers. The black polypropylene comfort grip handles are shatterproof and solvent resistant for safety. Durable, high carbon, steel precision-ground blades extend through handles for maximum dependability. The blade has a mirror lacquered finish to prevent rust. Made in the U.S.A.

MARS NO.	DESCRIPTION	MARS PACK	CASE QTY.
93402	1 1/4" wide stiff putty knife	12	72
93280	1 1/2" wide stiff putty knife	12	72
93403	1 1/4" wide flexible putty knife	12	72
93281	2" wide flexible putty knife	12	72
93404	3" wide flexible putty knife	6	72

Magnetic Nut Setters

MARS NO.	DESCRIPTION	CASE QTY.
21620	1/4" mag nut setter 2 9/16"L (1/cd)	96
21621	5/16" mag nut setter 2 9/16"L (1/cd)	60
21627	1/4" mag nut setter 6"L (1/cd)	72
21628	5/16" mag nut setter 6"L (1/cd)	72

Flex A Bit™ Kits (Patented Worldwide)

MARS NO.	DESCRIPTION	CASE QTY.
21669	11" industrial flex a bit plus (1/cd)	36

Superior Tool Mini Hacksaw And Blades

MARS NO.	DESCRIPTION	MARS PACK	CASE QTY.
25668	10" mini hacksaw - cuts wood, plaster, steel, brass, etc., cushioned handle	1	6
25669	6" high carbon steel repl. blades (10/card)	1	6



SERVICE & INSTALLATION



The largest selection of motors, components and accessories for the HVAC/R Industry

Knives & Blades

MARS SERIES **274 & 932**



Utility Knives And Blades

MARS #27401, retractable utility knife features a four position metal slider which accepts any utility blade. Zinc die cast construction. One heavy duty blade is provided with tool. Replacement heavy duty utility blades, MARS #27403, fits most utility knives. Used for cutting drywall, fiberglass, wood, plastic, cardboard and more!

MARS NO.	DESCRIPTION	MARS PACK	CASE QTY.
27401	Retractable utility knife with blade	5	100
27403	H.D. utility blade (10 per dispenser)	10	60

Breakaway Knives And Blades

MARS #27410, is a heavy duty, retractable, 8 point, breakaway knife with a unique internal blade storage. The strong steel shank is molded into the durable plastic handle. Blade locks in place. Snap-cap tool accepts all standard 8 point blades. Ideal for cutting and trimming cardboard, wood, leather and more. Knife is carded and packaged with 3 blades.

The 13 point heavy duty retractable breakaway knife also features a unique internal blade storage where the steel shank is molded into the durable plastic handle. The blade locks in place and the snap-cap doubles as a pocket clip. Accepts all standard 13 point blades. Ideal for cutting and trimming wall coverings, vinyl, paper and more. Knife packaged with 3 blades.

MARS NO.	DESCRIPTION	MARS PACK	CASE QTY.
27410	H.D. 8 point knife with 3 blades	10	100
27411	8 point break blade (5/card)	10	60
27412	H.D. 13 point knife with 3 blades	10	200

Red Devil Knives And Blades

Red Devil's all purpose adjustable utility knife, #93271 is made of diecast metal and has a unique button lock blade to cut in 3 different positions. Contains an extra blade and is carded for hanging.

The heavy duty utility knife, #93274, has a breakaway blade design and has many uses. Posi-lock pull back button retains blade safely and tightly in cutting position. Stainless steel break away blade has eight sharp cutting edges. The automatic razor knife, #93275, is a heavy duty premium break away blade tool. The package includes 80 cutting edges, 3 blades in knife, 7 in dispenser. Both break away knives come attractively carded for your display.

MARS NO.	DESCRIPTION	MARS PACK	CASE QTY.
93271	Adjustable utility knife	6	72
93273	Blade for 93271, 5/card	10	120
93274	Heavy duty utility knife	6	72
93275	Automatic razor knife	12	72
93276	Blades for 93274, 93275, 3/card	10	150
93277	Blades for 93274,5, 10/dispenser	12	144

Techni Edge



SERVICE & INSTALLATION



Protective Garments & Safety Equipment

MARS SERIES **257, 795 & 782**

Knee Pads

The Superflex™ knee pads provide super duty protection for tough jobs. The long, soft rubber black cap is designed for traction and full knee coverage. Color: black. MARS #25679 includes a buckle fastening system.

MARS NO.	DESCRIPTION	CASE QTY.
25679	Superflex™ knee pads with buckle	20

Dust Masks

MARS NO.	DESCRIPTION	CASE QTY.
79170	50 pc. box, dust mask	12
79169	20 pc. box, dust & mist respirator	12

MARS Disposable Shoe Covers

Amphibious shoe covers are waterproof and made of a 6 MIL copolymer with a non slip embossed sole. In addition to providing protection to the customer's property, Amphibious shoe covers also keep the shoes dry when working in wet grass or hosing down equipment. Premium shoe covers are made of heavyweight breathable polypropylene with a non-slip PVC zigzag sole.

MARS NO.	DESCRIPTION	MARS PACK	CASE QTY.
79195	Amphibious shoe covers - 300 XL covers/box	1	10
79100	Premium shoe covers - 300 XL covers/box	1	10
79103	Premium shoe covers - 50 XL covers/box	1	1
79199	Copolymer shoe covers - 5 XL covers/box	1	1

MARS Smoke Candles

MARS NO.	DESCRIPTION	CASE QTY.
79534	4000 cu. ft. smoke, 30 seconds	12
79535	8000 cu. ft. smoke, 1 minute	12



SERVICE & INSTALLATION

Industrial Work Gloves

MARS SERIES **782**



Cotton/Jersey Gloves

MARS NO.	DESCRIPTION	MARS PACK	CASE QTY.
79143	8 oz. cotton canvas gloves/individual pack	1	12
79149	10 oz. cotton hob nob/individual pack	1	12
79151	9 oz. brown jersey glove/individual pack	1	12
79148	9 oz. hob nob jersey	1	12
79153	Fleece lined cotton jersey/individual pack	1	12

Leather Gloves

MARS NO.	DESCRIPTION	MARS PACK	CASE QTY.
79157	Leather palm safety cuff/individual pack	1	12
79159	Split cowhide leather (suede)	1	12
79166	Grain cowhide leather	1	12
79162	Medium truckers glove	1	12
79165	Large truckers glove	1	12

PVC/Nitrile/Neoprene Gloves

MARS NO.	DESCRIPTION	MARS PACK	CASE QTY.
79145	PVC long gauntlet cuff gloves	1	12
79147	Coated neoprene gauntlet cuff	1	12

MARS Disposable Gloves

Disposable vinyl, latex, and nitrile gloves are heavy weight 5 mil and powdered. Packaged in a convenient dispenser box.

MARS NO.	DESCRIPTION	MARS PACK	CASE QTY.
79096	Nitrile Gloves - L 100/box	1	10
79097	Nitrile Gloves - XL 100/box	1	10
79092	Latex Gloves - L 100/box	1	10
79098	Latex Gloves - XL 100/box	1	10
79093	Vinyl Gloves - L 100/box	1	10
79099	Vinyl Gloves - XL 100/box	1	10
79200	Black Nitrile Gloves - L 100/box	1	10

Black Mamba Gloves

- Made with a patented NITREX® polymer
- Super strong (6.0 mils) powder free nitrile glove
- 3 times the chemical and puncture resistance of a comparable thickness latex or vinyl glove
- Grip rite finish for secure handling

MARS NO.	DESCRIPTION	MARS PACK	CASE QTY.
79200	Black Nitrile Gloves – L 100/box	1	10
79138	Black Nitrile Gloves – XL 100/box	1	10



SERVICE & INSTALLATION

Hand Cleaners

MARS SERIES **931 & 932**



Goop Hand Cleaners

For nearly 50 years, Goop has been the only name you need to know in hand cleaners. It's a name that wholesalers and contractors alike know and trust. Goop is non-toxic and biodegradable. Goop will remove almost anything...from almost everything. Use Goop to clean the dirtiest, greasiest hands. Use it for other tough cleaning jobs as well, such as removing stains from washable clothing, cleaning vinyl, plastic, canvas, floor tile - or whatever else gets dirty.

MARS NO.	DESCRIPTION	MARS PACK
93150	14 oz. can	12

Orange Goop Hand Cleaners

For customers who want a fresh orange scent in a tough, natural liquid hand cleaner, get the Orange Goop. There are no harsh solvents - just natural citrus. Available in regular or pumice formula. Biodegradable, too. Orange Goop...just another example of how we're giving today's contractors what they want.

MARS NO.	DESCRIPTION	MARS PACK
93157	14 oz. can	12
93160	16 oz. liquid squeeze bottle	12
93162	1/2 gallon orange pumice liquid w/ pump	6
93163	16 oz. liquid squeeze bottle w/ pumice	12

CRC Citrus Hand Cleaner

CRC Mechanix Orange™ citrus hand cleaners are petroleum solvent free, natural formulations that effectively remove grease, oil, grime, paint and inks safely and quickly. The citrus based formula is PH balanced, highly concentrated and fortified with aloe vera, and other conditioners to help keep hands soft and smooth. All this with the great new scent of citrus. Fine pumice is easy on your skin.

MARS NO.	DESCRIPTION	MARS PACK
93228	Mechanix Orange™, 16 oz.	12

Scrubs in-a-Bucket™

Scrubs in-a-Bucket™ provide fast, easy and effective hand cleaning with portability. Can be used anywhere, anyplace, anytime on the toughest soils, greases, tar, graphite...even printers ink. Each dispensing canister contains 10 1/2" x 12 1/4" perforated high-strength absorbent cleaning towels, treated with a gentle-to-the-skin but effective heavy duty grease cutting and soil lifting formulation. Pumice performance, without the messy, gritty pumice! Leaves skin lotion-soft, with a natural citrus fragrance. Contains germ fighting Triclosan. No rinsing, no drying, no residue. Also ideal for cleaning tools, work in process and for spills.

MARS NO.	DESCRIPTION	MARS PACK	CASE QTY.
93201	Scrubs in-a-Bucket™ (72 towels)	6	42
93203	Scrubs in-a-Bucket™ (30 towels)	6	72



SERVICE & INSTALLATION



The largest selection of motors, components and accessories for the HVAC/R Industry

Maintenance Products

MARS SERIES **787, 790 & 932**



MARS Zoom Spout® Products

Used by virtually every mechanic and technician in the heating, ventilation, air conditioning and refrigeration field.

93240 Zoom Spout® Oiler

- Contains 4 oz. highest quality turbine oil
- Rust and oxidation inhibited
- Paraffin base...non-gumming
- Use on motor bearings and bushings
- Squeeze bottle action
- Spout extends to 14", wipes dry
- SAE 10 weight
- Non detergent

93241 Rust Buster

- Loosens rusted bolts, nuts, shafts, etc.
- Cleans corroded and dirty parts
- Contains no harsh chemicals such as acid or alkali
- Spout wipes itself dry
- Contents always visible
- Won't short out
- Spout extends to 14"

MARS NO.	DESCRIPTION	MARS PACK	CASE QTY.
93240	Zoom Spout® Oiler 4 oz.	12	72
93241	Rust Buster 4 oz.	12	72

MARS Maintenance Products

MARS NO.	DESCRIPTION	MARS PACK	CASE QTY.
79036	WD-40 8 oz. spray smart straw, No CA	12	24
79037	WD-40 11 oz. spray smart straw, No CA	12	12
79006	WD-40 8 oz. spray smart straw CA	12	24
79007	WD-40 11 oz. spray smart straw CA	12	12

Kimberly-Clark Disposable Wiper/Towels

Kimberly-Clark® Kimtex® wipers are heavy duty oil and solvent wipers. Strong and durable, cloth-like feel and performance.

Kimberly-Clark® Kimtowels® are highly absorbent and versatile multi-ply tissue wipers. They quickly absorb water, oil and grease. Textured side for tough jobs and soft side for personal wiping. Contains no additives or glues.

Kimberly-Clark® Teri® wiper is durable for demanding jobs. Strong, even when wet. This 4-ply tissue wiper traps dirt and absorbs liquids quickly. Made with 100% recycled paper.

Workhorse™ manufactured rags by Kimberly-Clark® are made of a Hydroknit™ fast absorbing material. Workhorse™ rags stand up to water, oil, solvents and chemicals without falling apart. Amazingly strong when wet. Highly resistant to rips and tear wet or dry. Workhorse™ is the versatile and economical alternative to rags.

MARS NO.	DESCRIPTION	MARS PACK	CASE QTY.
79110	Kimtex® 100 pc. pop-up™ box, 9-3/4" x 16-3/4"	1	5
79109	Kimtowels® 88 pc. pop-up™ box, 9-3/4" x 16-3/4"	1	10
79105	Teri® wipers 136 pc. pop-up™ box, 9-3/4" x 16-3/4"	1	10
79111	Workhorse™ manufactured rags, 150 pc. brag box, 12" x 16-3/4"	1	1

MARS Shop Towels

MARS shop towel rags are 100% cotton material. This 15" x 15" red cloth towel is extra absorbent and ideal for cleaning up grease on tools or machinery. Long lasting and machine washable. Hemmed edges.

The MARS 100% cotton terry towel is an all purpose, white terry cloth towel that can be used for drying, polishing, dusting and waxing.

MARS NO.	DESCRIPTION	MARS PACK	CASE QTY.
79025	White terry towel (12 pack)	1	12
79026	Red cloth shop towel (12 pack)	1	18
79027	Red cloth shop towel (50 pack)	1	6



SERVICE & INSTALLATION



Maintenance Products

MARS SERIES **787, 790 & 932**

32 oz. Spray Bottle

MARS NO.	DESCRIPTION	MARS PACK
79009	32 oz. Spray Bottle	12

Blue Huck Towels

- Excellent absorbency!
- 5 lb. box
- Lint free
- Prewashed
- Approx. 22" x 13"
- 30-35 towels in box

MARS NO.	DESCRIPTION	MARS PACK
79024	Blue Huck Towels	1

Dyna-Wipes

- No Water Needed
- Removes Odors From Hands
- Gentle On Hands With 4 Skin Conditioners
- Non-Flammable
- Towel Size 9" x 12", 80 Towels In Each Tub

Use Them For:

- Hands
- Vinyl Windows
- Sports Equipment
- Leather
- Vinyl
- Much More!!
- Soiled Garments
- Tools & Equipment
- Counters
- Keyboards
- Stainless Steel Surfaces

Removes:

- Coffee Stains
- Permanent Marker
- Nail Polish
- Labels & Residue
- Urethane Sealants
- Carpet Spots
- Tar & Asphalt
- Gasket Cement
- Paints & Varnishes
- Many Inks
- Caulking
- Tree Pitch
- Scuff Marks
- Pipe Cement
- Most Graffiti
- Crayon Marks
- Counter Stains
- Plumbers Cement
- Tape Residue

Keep some with you... Wherever you go!

- RV's
- Cars
- Work Vans
- Shops
- Hiking
- Kitchens
- Fishing
- Garages
- Boats
- Sports
- Camping
- Bathrooms

MARS NO.	DESCRIPTION	MARS PACK
93200	Dyna-Wipes	8



SERVICE & INSTALLATION



The largest selection of motors, components and accessories for the HVAC/R Industry

Sealant Products

MARS SERIES **934**



MARS RTV Silicone Sealants

MARS HVAC/R Silicone Sealant is a superior quality silicone which remains flexible from -85° to 500°F. Never dries out. Has excellent adhesion to metals and can be used for virtually every HVAC need.

MARS NO.	DESCRIPTION	MARS PACK	CASE QTY.
93246	Silicone sealant almond 10.1 oz.	12	12
93249	Silicone sealant clear 10.1 oz.	12	12
93251	Silicone sealant white 10.1 oz.	12	12
93252	Silicone sealant gray 10.1 oz.	12	12
93264	Silicone sealant black 10.1 oz.	12	12
93253	Silicone sealant clear 2.8 oz.	12	12
93254	Silicone sealant white 2.8 oz.	12	12

MARS Heat Resistant Silicone

MARS HVAC/R Hi-Temp Red Silicone Sealant is a superior quality silicone which was formulated to perform at temperatures ranging from -85°F to 500°F (-65°C to 260°C) for continuous operation and 600°F (316°C) for intermittent exposure. These features make MARS HVAC/R Hi-Temp red Silicone ideal for use around furnace vent pipes, restaurant hoods and heat exchangers.

MARS NO.	DESCRIPTION	MARS PACK	CASE QTY.
93255	Hi-Temp. silicone red 10.1 oz.	12	12
93247	Heat resistant silicone red 2.8 oz.	12	12

Fire Stop Caulk

Red Devil Fire Stop Caulk effectively seals penetration openings against the spread of fire, smoke, toxic gases and water when applied properly.

- A Latex-based, high-solids Fire Stop compound
- No Shrinkage
- Withstands temperatures up to 2000° F and is up to 4 hour fire rated
- Sandable and Paintable
- Meets Fed. Specs ASTM E-814 (UL 1479) and ASTM E-84 (UL 723) and many UL Classifications

MARS NO.	DESCRIPTION	CASE QTY.
93293	Firestop Caulk, 10.5 FL Oz.- Red	12

Red Devil Celulon And Acrylic Caulk

Celulon™ plumbing and HVAC adhesive sealant is sometimes preferred over silicone. This easy to apply adhesive sealant adheres to all substances, is paintable, cleans up with water and has no offensive odor. Used to seal A/C ducts and lines. Application temp: 40° to 90°F. Service temp: -25° to 200°F.

MARS NO.	DESCRIPTION	MARS PACK	CASE QTY.
93256	Celulon HVAC sealant clear 10.1 oz.	12	12
93257	Celulon HVAC sealant white 10.1 oz.	12	12
93258	35 yr. acrylic caulk gray 10.1 oz.	12	12



SERVICE & INSTALLATION



Red Devil Butyl Sealants

Red Devil's butyl sealant is a high performance rubber-like sealant that is ideal for tough outdoor jobs and below grade applications. (marine usage above waterline) It can be used wherever watertight seal is required. This paintable sealant provides excellent adhesion to most building surfaces including aluminum, stone, wood, brick, fiberglass, plastic, metal, etc. This sealant is ideal for use on window/door frames, aluminum gutters, chimney roofs, concrete foundations etc. Sealant remains rubbery and flexible from 0°F to 225°F after full cure.

MARS NO.	DESCRIPTION	MARS PACK	CASE QTY.
93290	Butyl sealant white	12	12
93291	Butyl sealant aluminum gray	12	12
93292	Butyl sealant bronze	12	12

Red Devil Specialty Products

Red Devil's blacktop & roof repair is water resistant and stays flexible. This butyl rubber asphalt sealant adheres to cinder block, wood asphalt, concrete, brick and metal. Use on blacktop driveway cracks, chimney flashings, shingles & skylights. Apply at temperatures between 10°F & 100°F. Full cure in 72 hours

Red Devil speed demon latex caulk is a general purpose caulk that applies easily, dries quickly is paintable and won't stain or bleed.

Red Devil's QPF™ tub & tile caulk provides a long lasting water-tight seal around tubs, showers & sinks. This odorless and mildew resistant caulk is paintable & wont stain or bleed. The acrylic based caulk features a quick protection formular (QPF) which forms a protective outer covering in seconds allowing a bath or shower within 3-4 hours use of application.

MARS NO.	DESCRIPTION	MARS PACK	CASE QTY.
93244	Blacktop & roof repair black	12	12
93265	Speed demon latex caulk white	12	12
93248	Tub & tile caulk white	12	12

Expanding Foam Sealing Products

MARS foam sealant is a multi-purpose expanding polyurethane foam sealant, designed for the professional contractor. Excellent for HVAC projects and wall/floor penetrations. It is ideal for sealing around air conditioners, vents, ducts, electrical and plumbing penetrations. The Handi-Foam, MARS #93243, is a two component polyurethane foam to seal, bond, retrofit, insulate and dampen sound. Excellent for use in the HVAC, plumbing, roofing, cold storage, transportation and building maintenance applications, Expands and cures within seconds. Conforms to any shape. Each kit contains 2 cans (.88 lbs. ea.) of polyurethane expanding foam, two spray nozzles with 24" hoses and 1" clamp. Covers one cubic foot (12 board feet).

MARS NO.	DESCRIPTION	MARS PACK	CASE QTY.
93268	Foam sealant 12 oz.	12	12
93267	Foam sealant 24 oz.	12	12
93243	Handi-Foam	1	12

MARS Duct Seal Putty

MARS Duct Sealing Putty is a non-hardening, non-toxic, gray putty compound used for countless applications in the refrigeration, heating and cooling, electrical trade, and plumbing fields. It can be shaped by hand to any form, and reused if necessary, for plugging openings through foundations, sealing around electrical boxes, refrigeration tube entry and so much more.

MARS NO.	DESCRIPTION	MARS PACK	CASE QTY.
93520	1 lb. slug - boxed	1	10
93521	5 lb. slug - boxed	1	10
93522	2 lb. slug - boxed	1	10



SERVICE & INSTALLATION

Sealant Products

MARS SERIES **934**



Caulking Guns

For your convenience, MARS also offers easy to load and operate caulking guns. Guns hold the standard 10.3 oz. cartridges. MARS #93269 skeleton gun is ideal for large jobs. This heavy duty but light weight unit saves time in loading for the busy contractor. The professional skeleton gun, MARS #93278, offers three times more thrusting power with a smooth rod parallel frame. The professional ratchet type caulking gun, MARS #93279, is a professional conventional type gun recommended for sealants from light to heavy consistencies.

MARS NO.	DESCRIPTION	MARS PACK	CASE QTY.
93269	Skeleton caulking gun	1	24
93278	Professional skeleton caulking gun	1	12
93270	Econo conventional caulking gun	1	24
93279	Professional ratchet caulking gun	1	24



Pipe Insulating Cork Tape

MARS SERIES **932**



MARS Cork Tape - 1/8" x 2" x 30' Roll

MARS Cork Tape is ozone resistant and specially designed for all types of climate. It insulates cold pipes for all kinds of air conditioners, freezers, and refrigerators. Cork Tape helps stop condensation problems. It is ideal for retarding heat gain in cold pipes and prevents heat loss in hot pipes. Can also be used for gasketing purposes. MARS Cork Tape sticks to all kinds of dry metals. This flexible tape seals tightly without drying. Temperature range: -20°F to 200°F / -29°C to 93°C.

Corktape is made from virgin cork specially imported from Portugal & Spain and has the following characteristics:

1. Compared to other cork tapes - our cork tape features rubber/asphalt & 100% virgin cork instead of asbestos / saw dust as used by other manufacturers.
2. The width is always 2" wide unlike other brands where size varies from 1-3/4" - 2".
3. Very good adhesion property. It sticks on the metal pipe tightly and does not come out in one piece if unwrapped.
4. A wide service temperature range -29° F - +200° F
5. Once installed the outer surface dries creating a shield against unwanted dust and dirt while the inner side remains wet. So even after a year or two, the user can remove the cork tape and reapply elsewhere without any change in the properties of the tape. Other brands such as Prestite/Virgin are mostly wet outside and inside making it vulnerable to dust and dirt which eventually deteriorates its insulation properties.

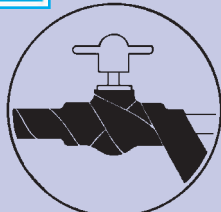

Physical properties:
Composition:
 Polymer based material containing synthetic rubbers, asphalt and approximately 50% cork by volume. It has a grainy rubber-like consistency and contains no asbestos.
Solid Contents:
 99.8%
Color:
 Black
Thermal Conductivity:
 0.60 BTU/hr /ft²/F/in at 75°F
Moisture / Vapor Transmission:
 0.02 perms.
 (ASTM E-90 Procedure C)
Water Absorption:
 0.01% by volume
 (ASTM D-1056)
Ozone Resistance:
 Good

Thickness To Prevent Pipe Condensation

Ambient Temperature & %RH	Pipe Temperature	
	50°F (10°C)	32°F (0°C)
77°F (25°C) & 50% RH	Double Layer	Triple Layer
85°F (29°C) & 70% RH	Double Layer plus Double Layer	Triple Layer Plus Triple Layer

MARS NO.	DESCRIPTION	MARS PACK	CASE QTY.
93505	Cork Tape	1	12

SERVICE & INSTALLATION



Self Adhesive Insulation Foam Tape

MARS SERIES **932**

MARS Foam Tape - 1/8"X 2"X 30' Roll

MARS Foam Tape is a self-adhering closed cell thermal insulation tape. This flexible tape is ideal for wrapping hot or cold pipings and fittings. The energy saving and very easy to use Foam Tape is excellent for preventing condensation problems. MARS Foam Tape is designed for retarding heat loss in hot pipings and preventing heat gain or frost formation on cold, chilled water pipings or refrigerant lines. Adheres firmly to all metals. Temperature range: -20°F to 200°F / -29°C to 93°C.

1. Good weather and UV resistant - reason being EPDM (Ethylene Propylene Diene Monomer) is the main compound in the manufacturing of Foamtape. In practice EPDM is also used in the manufacturing of glass window strips of cars, which lasts for more than 10 years outdoors without any replacement (inspite of being exposed to rain, heat & cold).
2. The specially coated acrylic adhesive provides extra adhering strength compared to other tapes. Once installed, the special adhesive will act as the bonding agent and won't let the tape delaminate.
3. Low thermal conductivity (0.26 BTU. in/sq. ft. hr. deg. F at 75°F) to prevent heat loss/heat gain and save energy.
4. An ozone friendly product manufactured under strict supervision of trained personnels with quality check at every production point.
5. Low halogen contents. Tests have proved that MARS Foam Tape (or FOAMTAPE excluding the adhesive) has chlorine and bromine content of 4.36% and 1.35% compared to NBR/PVC (Armstrong, Rubatex) based brand insulation which has 12.45% and 6.14% respectively.
6. Our vulcanization system uses negligible amount of Sulphur (chemical which corrodes copper tubings) and this special vulcanization process decomposes chemicals almost completely.

Thickness To Prevent Pipe Condensation

Ambient Temperature and Relative Humidity	Pipe Temperature	
	50°F (10°C)	35°F (2°C)
80°F (27°C) & 50% RH	Single Layer	50% Overlap
85°F (30°C) & 70% RH	50% Overlap plus Single Layer	50% Overlap Plus 50% Overlap

MARS NO.	DESCRIPTION	MARS PACK	CASE QTY.
93506	Foam Tape	1	12

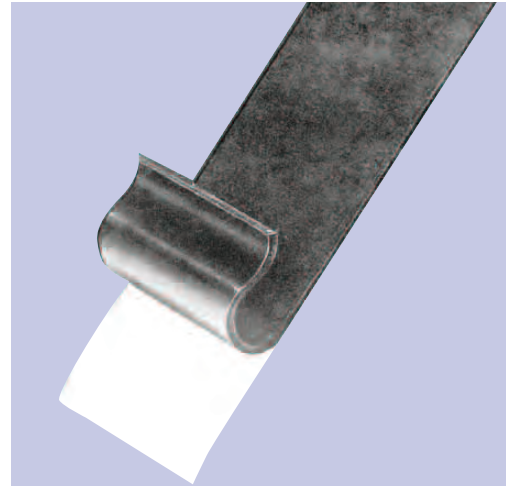

Physical properties:

Composition:

Closed cell, elastomeric thermal insulation.

Color:

Black

Density:

6±1 pounds per cubic feet.
(0.09-0.12 g/cm³)
(ASTM D-1667)

Thermal Conductivity:

0.26 BTU in./ft² hr. °F at 75°F
(0.04 W/mK at 24°C)
(ASTM C-177)

Water Absorption:

Max 5% by weight
(ASTM D-1056)

Water Vapor Permeability:

0.15 Perm-inch (ASTM C-355)

Temperature Range:

-20°F (-29°C) to +200°F (+93°C)

SERVICE & INSTALLATION



Maintenance Products

MARS SERIES **934**

Mortite Pipe Wraps

Mortite's no-drip® tape stops cold water pipe sweating permanently. Won't dry out, crack or shrink. This self-adhering tape insulates hot water pipes up to 160°F. No-drip® tape molds around valves, joints, tees and irregular fittings. The 2"W x 30'L roll covers 30 lineal feet of 1/2" O.D. pipe. Provides clean, neat appearance.

MARS NO.	DESCRIPTION	CASE QTY.
93516	No-drip® tape - 2" x 30' roll	10



93516



The largest selection of motors, components and accessories for the HVAC/R Industry

Maintenance Products

MARS SERIES **932**



Mortite Weather Stripping Products

MARS #93507, air conditioner window seal, seals the gap between window sill and air conditioner. This permanent, all season foam strip prevents heat loss in winter, cooling loss in summer. Attractively packaged in a colorful poly bag for pegboard merchandising.

Mortite's closed-cell foam tape, MARS #93509 seals better in hot and cold climates. This durable vinyl tape stands up to extreme cold temperatures and will not freeze. Closed-cell means the cells prevent air from passing through the weatherstrip tape and won't absorb moisture. Self adhering, seals out drafts, dust and insects better than open-cell tape. MARS #93509 cushions and eliminates noisy vibrations around storm windows, A/C's and small appliances.

MARS NO.	DESCRIPTION	CASE QTY.
93507	Foam strip - 1/4" x 1-1/4" x 42"L	12
93509	Closed cell foam tape 3/8"T x 3/4"W x 10'L	12

Mortite A/C Foam Filter

Mortite's air conditioner filter helps to keep the room free from outside dust and dirt while increasing efficiency. This polyurethane foam filter is easy to install. And the 15" x 24" size can be cut to fit all window and through-wall air conditioners. Easy to clean - requires only regular detergent and water. Reusable.

MARS NO.	DESCRIPTION	CASE QTY.
93524	Foam filter - 15" x 24"	24

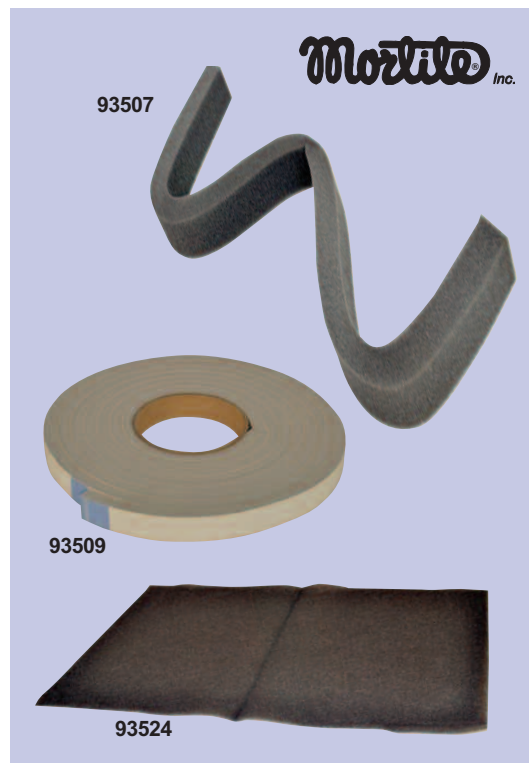

SERVICE & INSTALLATION

Tapes & Supplies

MARS SERIES **789**



Cloth Duct Tapes

MARS is committed to supply high quality tape products to the HVACR industry. MARS offers 5 grades of the most popular duct tapes for a wide variety of applications.

MARS #79070 is the tape of choice for professional contractors. This double-calendered adhesive system is designed to meet the most rigorous demands of HVAC and asbestos removal specialists. Also available in black.

MARS #79072 and 79073 are recommended for use in many heating, air conditioning, ventilating and refrigeration applications.

MARS #79074 and 79075 has an excellent adhesion for a wide variety of surfaces. Excellent for most industrial applications.

MARS econo grade is an all around economical duct tape product for binding, patching and repair applications.

MARS #79088 is a heavy duty printed duct tape used to seal metal duct work, fiberglass insulations and to cover thermal insulations. Will not twist or curl during application. Meets UL723. Max temp 200°F with 4-1/2" repeat.

MARS NO.	DESCRIPTION	SIZE	MARS PACK
79070	Premium grade silver	2" x 60 yds.	24
79071	Premium grade black	2" x 60 yds.	24
79072	Professional grade silver	2" x 60 yds.	24
79073	Professional grade black	2" x 60 yds.	24
79074	Industrial grade silver	2" x 60 yds.	24
79075	Industrial grade black	2" x 60 yds.	24
79076	Plumbers grade silver	2" x 60 yds.	24
79077	MARS econo grade silver	2" x 60 yds.	24
79088	Heavy duty printed black	2" x 60 yds.	24

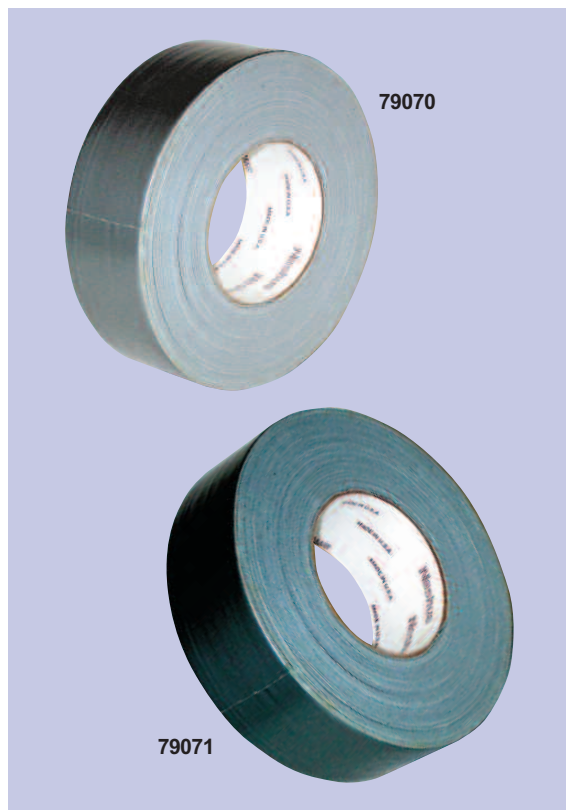



MARS Foil Duct Tapes

MARS #79081 and 79082 are dead-soft aluminum foils with aggressive adhesive properties. The FSK foil scrim kraft tape is a fiberglass scrim reinforced foil that gives the tape high tensile strength, yet it is flexible and easy to use.

MARS NO.	DESCRIPTION	SIZE	MARS PACK
79081	Aluminum foil tape	2" x 50 yds.	24
79082	Aluminum foil tape	3" x 50 yds.	16
79083	Foil scrim kraft tape	2" x 50 yds.	24
79084	Foil scrim kraft tape	3" x 50 yds.	16

U.L. Listed Tapes

MARS #79087 is a UL181A-P listed foil. This foil product has a more technically sophisticated acrylic adhesive system designed to meet the more stringent demands of UL.

MARS NO.	DESCRIPTION	SIZE	MARS PACK
79087	U.L. 181 foil tape	2 1/2" x 60 yds.	16

Spray Adhesive

MARS #79094 is especially designed to bond polyethylene to itself, concrete block, wood and other hard to bind surfaces. Does not contain methylene chloride. Very quick, aggressive tack. Excellent for HVAC insulation applications.

MARS NO.	DESCRIPTION	MARS PACK
79094	Spray adhesive, 17 fl. oz.	12

Liquid Electrical Tape

MARS NO.	DESCRIPTION	MARS PACK
86135	Liquid electrical tape (black), 4oz.	1

PVC Electrical Tape

PVC electrical tape provides excellent adhesion to aluminum and copper conductors and plastic and rubber insulations where quick identification is most needed. Due to its primary use in low temperatures, it can be stretched to conform to any shape without breaking. UL listed and CSA approved. PVC electrical tape is designed for general splicing and as a protective outer jacket. Flame retardant and cold and weather resistant. UL listed and CSA approved.

MARS NO.	DESCRIPTION	MARS PACK	CASE QTY.
86186	3/4" x 66' - red	1	100
86187	3/4" x 66' - white	1	100
86188	3/4" x 66' - green	1	100
86189	3/4" x 66' - blue	1	100
86184	3/4" x 60' - black	1	100
86133*	3/4" x 60' - black	10	100

* Non-UL



SERVICE & INSTALLATION

Tapes & Supplies

MARS SERIES **954 & 788**



Low Density Teflon Tape

- Thickness 3 mils.
- Standard grade, low density
- Provides a highly resistant seal on pipe threads for all types of service
- Suitable for use with solvents, chemicals, oxygen, and on food lines
- Non-toxic
- Permits easy disassembly, even after years of service
- Meets Mil. Spec. T-27730A
- Sealing temperature range: -450°F to 550°F (-268°C to 288°C)
- Working pressures: 2,000 PSI (136 BAR)
- Sold in case quantities only

MARS NO.	DESCRIPTION	MARS PACK	CASE QTY.
95409	1/2" x 260"	44	144
95410	1/2" x 520"	44	144
95412	3/4" x 520"	44	144

High Density Slick-Tite® Teflon Tape

- Thickness 3 mils.
- High density
- Provides a highly resistant seal on pipe threads for all types of service
- Made in USA
- Suitable for use with solvents, chemicals, oxygen, and on food lines
- Non-toxic
- Permits easy disassembly, even after many years
- Meets Mil. Spec. T-27730A
- Sealing temperature range: -450°F to 550°F (-268°C to 288°C)
- Working pressures: 2,000 PSI (136 BAR)

MARS NO.	DESCRIPTION	MARS PACK	CASE QTY.
95525	1/4" x 300"	12	12
95526	1/4" x 600"	12	12
95527	1/2" x 300"	12	12
95528	1/2" x 600"	12	12
95530	3/4" x 300"	12	12
95532	1" x 300"	12	12

MARS Teflon Tapes

MARS NO.	DESCRIPTION	MARS PACK
78940	1/2" x 260" - STD grade white teflon tape	12
78941	1/2" x 520" - STD grade white teflon tape	12
78942	1/2 x 260" - hi-density pink teflon tape	10
78944	1/2" x 260" - hi-density yellow (UL) gas tape	10

LA-CO®

95409



95528



78940



Plews Standard Grease Fitting

Standard grease fittings are precision engineered to withstand rugged use in most automotive and industrial applications. The feature steel fittings with corrosion resistant plated finish and built-in ball check.

The small grease fitting assortments contain the three most popular 1/4"-28 threaded fittings used when making a "change-over" from plugs to fittings. Ideal for the contractor.

Plews small 4-way grease fitting tool (MARS #93385) is for most popular 1/4"-28 and 6 mm fittings. Tap repairs 1/4"-28 threads. Wrench removes 5/16" and 3/8" hex fittings and plugs. Wrench installs new fittings. "Easy-out" removes broken fittings. Large tool (MARS #93384) is designed for 1/8" NPT fittings. Tap repairs 1/8" NPT threads. Wrench removes 7/16" and 3/8" hex fittings and plugs. Wrench installs new fittings. 1/8" NPT "Easy-out" removes broken fittings.

MARS NO.	DESCRIPTION	MARS PACK	CASE QTY.
93375	1/8" npt, short-straight fitting, 100/box	11-150	1
93376	1/8" npt, short-straight fitting, 10/card	11-151	10
93378	1/8" npt, short 45° fitting, 5/card	11-159	10
93372	1/8" npt, short-90° fitting, 5/card	11-167	10
93388	1/4" npt, straight fitting, 5/card	11-201	10
93383	8 assorted grease fitting kit	11-955	10
93384	Large 4-way grease fitting tool	11-901	5
93385	Small 4-way grease fitting tool	11-903	10
93386	1/4"-28 thread, short-straight fitng, 10/card	11-101	10

Standard fitting assortment includes:

93383 Qty.	Description	Thread
4	short-straight	1/4"-28
2	short 45°	1/4"-28
2	short 90°	1/4"-28

Plews Handled And Pistol Oilers

When you reach for an oiler, make sure it's a Plews! Plews oilers are truly the finest in the industry; for either the professional or the handyman. Epoxy finish handled oilers and pistol oilers are made of heavy duty, drawn steel bodies. Durable epoxy finish resists rust. Zinc plated, detachable flex spouts are featured.

MARS NO.	DESCRIPTION	MARS PACK	CASE QTY.
93390	Pint oiler w/9" flexible spout	50-337	1
93393	6 oz. oiler w/6" flexible spout	50-516	10

Plews Plastic Funnels

MARS NO.	DESCRIPTION	MARS PACK	CASE QTY.
93396	5 1/2" utility funnel, 1 pint	75-062	1
93397	7" heavy duty funnel, 2 quart	75-070	1
93398	5 3/4" utility funnel w/screen includes 13" flex extension	75-007	1



SERVICE & INSTALLATION

Maintenance Products

MARS SERIES **933**



Plews Grease Guns

Plews grease guns allow one hand operation and are perfect for hard to reach jobs. Precision pump develops up to 7000 p.s.i. Easy three-way loading by standard 14 oz. cartridge or suction filled. There is a head cap port for adding air bleeder or bulk loader fitting. Available in two different styles. Both feature tough all-steel construction with rugged baked enamel finish and tough zinc plated handles. New non-slip knurl on barrel allows for positive grip.

The mini grease gun kit is a compact "tool box" size grease gun that goes where other grease guns can't.

Features include:

- Zinc die cast head cap
- Pistol grip for easy one hand operation combined with heavy duty performance
- Uses standard 3 oz. cartridge
- Kit includes gun with rigid pipe and coupler and one 3 oz. multi purpose grease cartridge

MARS #93353 is a general purpose grease gun with professional features. This grease gun offers 2 way loading: 14 oz. cartridge or suction. The lever action gun includes 5-3/8" pipe and coupler. Develops up to 6,000 psi. Durable baked enamel finish.

MARS #93355, professional grease gun features variable/short stroke for easy use in confined areas. This lever action gun provides an air bleeder and bulk loader fitting for 3-way loading (14 oz. cartridge, bulk or suction). Grease gun includes 5-3/8" pipe and coupler. Plated lever with comfortable oversized grip is also featured. Develops up to 10,000 psi.

MARS NO.	DESCRIPTION	MARS PACK	CASE QTY.
93350	Pistol grease gun, 12" hose	30-415	1 5
93351	Pistol grease gun, with pipe ass'y	30-425	1 5
93352	Mini grease gun kit, 3 oz.	30-132	1 10
93353	Lever action grease gun, 14 oz.	30-445	1 10
93355	Professional grease gun, 14 oz.	30-475	1 10

Plews Multi Purpose Grease

Plews multi-purpose lithium grease is a long lasting, hard working formula which delivers high performance in a wide range of heavy duty applications. NLG1 #1-1/2, drop point 350° F.

MARS NO.	DESCRIPTION	MARS PACK	CASE QTY.
93361	Multi purpose cartridge, 14 oz.	11-310	1 40
93362	Multi purpose cartridge, 3 oz./4 pk	11-300	1 10

Plews Lubrication Accessories

Plews standard jaw-type couplers feature a spring loaded ball check valve. Fits all 1/8" NPT threads. For all hand operated lube equipment (not for power lubricating equipment).

Recommended working pressure is 3,000 psi. Heavy duty coupler recommended working pressure is 4,000 psi.

For use on hand operated grease guns only, heavy duty hoses have high quality 1/8" NPT male fittings on each end. Recommended working pressure is 3,000 psi. Burst pressure is 12,000 psi. Meets U.S. Government Specification MIL-L-4387C.

MARS NO.	DESCRIPTION	MARS PACK	CASE QTY.
93365	Standard grease gun coupler	05-031	1 10
93366	Heavy duty grease gun coupler	05-035	1 10
93367	Heavy duty grease hose, 12"	10-212	1 10
93369	Heavy duty grease hose, 18"	10-219	1 10



SERVICE & INSTALLATION



Maintenance Products

MARS SERIES **954**

Epoxy-Stik™

- Cures rock hard with no shrinkage
- Safe on portable water systems
- Withstands temperatures up to 250° F
- Hardens in 5-10 minutes, full cure in 24 hours
- Can be applied under water
- After 1 hour can be drilled, tapped, filed, sawed, sanded and painted

MARS NO.	DESCRIPTION	MARS PACK	CASE QTY.
95522*	4 oz. stick	24	24

* Packaged in one dozen per display box

Sharpie® #15 Fiber Tip Marker (Dura-Ink #15)

- Fine tip • Ideal for fine line marking • Extra tough tip, won't spread
- Smear resistant, water resistant
- Marks on metal, wood, cardboard, paper, plastic, glass, etc.
- For identification of parts, layout work, marking cartons and crates
- Meets U.S. Fed. Spec. TT-1-544

MARS NO.	DESCRIPTION	MARS PACK	CASE QTY.
95488	Black	12	72

Valve Action™ Paintmarker

- Marking range: -50° to 150°F / -46° to 66° C • Marks w/ real paint, dries in minutes
- Valve action nib releases paint as needed for continuous marking
- Marks on all surfaces including: metal, wood, glass, plastic, rubber, cardboard and paper • Lead - free, low halogens
- The fiber nib is replaceable to assure complete use of each marker
- Durable metal barrel • Meets California VOC regulations

MARS NO.	DESCRIPTION	MARS PACK	CASE QTY.
95480	Black	12	48
95481	Red	12	48
95485	Yellow	12	48

Dura-Ink® Fiber Tip Markers

- Larger ink supply, heavy duty metal barrel
- Water - resistant, fade - resistant
- Chisel tip makes fine lines or broad marks
- Meets Fed. Spec. TT-1- 544
- Use on cardboard, wood, metal, paper, ceramics, glass, etc.
- For identification of equipment, marking shipping cartons, sign making, etc.
- #20 is medium size, #25 is king size

MARS NO.	DESCRIPTION	MARS PACK	CASE QTY.
95500	Dura - Ink® #25 - black	12	48
95516	Markal Dura-Ink #25 Black Marker (2-pk)	1	24
95519	Black	1	36

Pipe Joint Compound

MARS NO.	DESCRIPTION	MARS PACK	CASE QTY.
95432	Oyltite Stick 1 oz.	12	24
95433	Pipertite Stick 1-1/4 oz.	12	144



95522



95488

95485



95500



95432



95433

SERVICE & INSTALLATION

Maintenance Products

MARS SERIES **954 & 730**



SERVICE & INSTALLATION

E-Z Break® Anti-Seize Compound

- Copper-based anti-seize and lubricating compound
- Resists rust and corrosion
- Recommended for coating nuts, bolts, valves, flanges, splines, for easy break out after years of service
- Meets Mil. Spec. Mil-A-907E
- Authorized by USDA for use in federally inspected meat and poultry plants
- Temperature: to 1800° F (982° C)

MARS NO.	DESCRIPTION	MARS PACK	CASE QTY.
95472	10 oz. w/brushcap	24	24

Pierce® Rust Remover Penetrant

- Drives under rust and penetrates into the tightest crevices to protect against rust and corrosion
- Removes asphalt, tar, grease, dirt from metal surfaces
- Colorless moisture repellent film guards against continuing rust and corrosion
- Use on all equipment tools, chain saws, cables, ignition systems, threaded parts, and any rotating or sliding metal surfaces.
- Lubricates and eliminates squeaks

MARS NO.	DESCRIPTION	MARS PACK	CASE QTY.
95423	12 oz. aerosol w/extension	24	24

Spray Weld

All-in-one cleaner, primer & cement in a handy aerosol can.

- Valve sprays in any angle, even when can is upside down!
- Commercial grade fast-setting, heavy-bodied, CFC's free aerosol propellant
- 11 oz. can yields up to 300 - 3/4" joints. That's over 100 more joints than a quart can of traditional brush-on cement!
- All-weather formula works Hot or Cold, Wet or Dry
- Sets in 1-2 minutes!
- Pressure test to 100 PSI in as little as 30 minutes!

For use on:
SDR 35CL200, Schedules 20, 40 & 80 up to 6" dia.

MARS NO.	DESCRIPTION	MARS PACK
73010	Clear	12
73011	Purple	12

Permatex® Adhesives & Sealants

Permatex® PermaPoxy™ 5 Minute General Purpose Epoxy and 30 Minute High Strength General Purpose Epoxy

- Versatile easy to use, clear appearance, 2 part adhesive and filler system. No need to weld or braze
- Fills gaps and will not shrink
- Temperature range -60°F to 180°F (-51°C to 82°C).
- 5 min. general purpose epoxy - permanent strength up to 3400 PSI
- 30 min high strength - permanent strength up to 3500 PSI

Permatex® Super Glue

This formulation was specially designed for a faster, long-lasting bond. It is easily applied and works on non-porous materials including metal, plastics, rubber, vinyl, paper, wood, textiles, and cork gaskets. Permanent transparent bond fills gaps to .004".

MARS NO.	DESCRIPTION	MARS PACK	CASE QTY.
95555	5 Min Epoxy, .84 fl oz	12	12
95556	30 Min Epoxy, .84 fl oz dual syringe	12	12
95557	Super Glue Gel tube, 2 grams	12	12
95558	Super Glue tube, 2 grams	12	12





CRC Lubricants

CRC products incorporate the **MSD(L)**™, a removable material safety data sheet printed on the reverse side of the label. With this new labeling system, a MSDS is always where you need it the most, right on the product you are using!

CRC 3-36 is a multi purpose lubricant and penetrant that forms a clear film that lubricates and stops corrosion. Its high affinity for metal allows it to penetrate and displace moisture leaving a long lasting rust preventing film. Available in aerosol with a nonflammable CO2 propellant and 360° valve.

CRC Screwloose® Penetrating Oil is a no compromise penetrant that attacks rust and corrosion, penetrating through oxides and soil to free corroded fasteners and mechanical components.

CRC Power Lube® is a unique new lubricant that incorporates a sophisticated additives package with Teflon® to provide long lasting protection against friction and wear. It is able to work longer and better than other lubricants under the extremes of pressure and the environment. Unlike most lubricants with Teflon®, it contains no chlorinated solvents.

CRC Cutting Oil is a superior thread cutting lubricant for use on all types of metal. The low odor formula is safe for soft metals such as brass and aluminum, and is non-staining. The same formula is also used for steel and galvanized metal, and cuts without that strong sulphur smell. Aerosol formulation with viscosity improved for increased cling, and reduces waste.

CRC White Lithium grease with Teflon® is a high purity, high quality grade 2 white lithium based grease with an additive package that includes Teflon® for superior lubrication. It is truly white, smooth and buttery in consistency for optimum surface coverage. It has both rust and oxidation inhibitors to provide durable lubrication and protection in any application.

MARS NO.	DESCRIPTION	MARS PACK
93208	3-36 Multi Purpose Lubricant, 11 oz.	12
93211	Screwloose® Penetrating Oil, 11 oz.	12
93212	Power Lube® Teflon Lubricant, 11 oz.	12
93213	Cutting Oil, 12 oz.	12
93214	White Lithium Grease, 10 oz.	12
93284	2-26 Lubricant, 11 oz.	12

CRC Specialty Products

The Wasp and Hornet Killer Plus™ is a fast acting, high strength insecticide that kills wasps, hornets, black widow spiders, fire ants and scorpions. Will not damage plastic connectors and other insulating materials. Provides a dense accurate spray that will reach over 20 feet. Excellent for the A/C contractor.

HydroForce™ Glass Cleaner Professional Strength is formulated to clean streak-free – the first time and every time. The ammonia-fortified formula quickly cleans the toughest dirt, dust, fingerprint and haze deposits without leaving unsightly streaks due to residue. HydroForce™ is versatile and safe to use on all glass surfaces. The foaming, ready-to-use formula allows for greater coverage and less run-off when cleaning vertical surfaces. HydroForce™ is biodegradable, non-corrosive, non-flammable and non-abrasive. Let us prove it to you.

CRC Rubberized Spray Undercoating is a specially formulated rubberized product that dries quickly and is exceptionally resistant to abrasion, rust and corrosion. Seals underbody, fender, panels, frame, hood, doors, weld joints, etc., against moisture, salt and road debris.

Ask your MARS representative for information on how to become a full line CRC distributor and also for details on additional CRC problem solving products.

MARS NO.	DESCRIPTION	MARS PACK
93226	Wasp and Hornet Killer Plus™, 14 oz.	12
93227	HydroForce Glass Cleaner, 18 oz.	12
93233	Rubberized spray undercoating, 16 oz.	12



SERVICE & INSTALLATION

Maintenance Products

MARS SERIES **931**



CRC Cleaners/Degreasers

CRC Heavy Duty Degreaser is a chlorinated solvent based cleaner/degreaser that is chemically stable and extremely effective in most heavy duty applications. It has no fire or flash point, evaporates quickly with no residue and is non-conductive. New formula contains no ozone depleting compounds. Effectively removes grease, tar, oil, adhesives, etc. to increase operating efficiency.

CRC Industrial Contact Cleaner is designed to quickly and effectively clean sensitive electrical and electronic components. It has no flash point and evaporates quickly, leaving no residue. Contains no CFC's or VOC's

CRC QD Contact Cleaner is an alcohol based precision cleaner that is **100% free of CFC's**. For use on non-energized equipment, it evaporates rapidly and is harmless to most plastics. For use on electrical and electronic components where precision cleaning is necessary.

The CRC Contact Cleaner 2000™ is a revolutionary precision cleaning solvent designed to meet today's environmental challenges. This high purity solvent is a new generation HCFC and does not exhibit the same ozone depleting properties as conventional CFC solvents. It evaporates rapidly, has no flash point and leaves no residue (may affect some plastics).

CRC Gasket Remover is a solvent based high strength cleaner that effectively loosens and helps remove fiber gaskets, adhesives and sealants. It helps protect equipment surfaces by eliminating damage caused by scraping. Also removes paint and graffiti.

SERVICE & INSTALLATION

MARS NO.	DESCRIPTION	MARS PACK
93215	Heavy Duty Degreaser, 19 oz.	12
93217	Industrial Contact Cleaner, 14 oz.	12
93218	QD Contact Cleaner, 11 oz.	12
93219	Contact Cleaner 2000™, 14 oz.	12
93222	Gasket Remover, 12 oz.	12
93294	Lectra Clean	12





Maintenance Products

MARS SERIES **932 & 790**

CRC Food Grade Silicone

CRC Food Grade Silicone forms a colorless, tasteless, non-toxic and non-staining film that is authorized by the USDA for use in federally inspected meat and poultry plants. Its silicone lubrication film meets FDA specifications for incidental food contact.

MARS NO.	DESCRIPTION	MARS PACK
93210	Food Grade Silicone, 10 oz.	12

CRC RTV Silicone

CRC RTV Silicone Adhesive/Sealants are the perfect way to seal, bond and protect. With the press of the nozzle, a precise bead of high purity silicone is easily applied. No lumps, gaps, bubbles or waste. The package keeps the silicone fresh with the product in the nozzle forming a self sealing plug. Convenient and easy to use.

MARS NO.	DESCRIPTION	MARS PACK
93236	8 oz. clear	12

CRC Corrosion Inhibitors

CRC Zinc-It® Instant Cold Galvanize is a high performance 95% zinc-rich coating that restores hot dipped galvanized properties to ferrous metals. Its sacrificial coating helps fight rust and corrosion creepage with a durable, flexible film.

CRC Belt Dressing extends the life of drive belts by improving traction and allowing runs under reduced belt tension. Formulated with a synthetic polymer that is non-drying, water resistant and chemically stable. It also meets FDA regulations for incidental food contact.

MARS NO.	DESCRIPTION	MARS PACK
93223	Zinc-It®, 13 oz.	12
93224	Belt Dressing, 10 oz.	12

Industrial All Purpose Spray Enamel

Krylon TOUGH COAT® acrylic alkyd enamels feature a high-solids formula that ensures maximum coverage and performance. Tough Coat delivers the ultimate in protection, durability, high gloss, color retention and applies with a smooth even coverage. Fast-drying to the touch in 15 minutes. Ideal for light to heavy duty painting projects both indoors & outdoors.

MARS NO.	DESCRIPTION	REFRIG. ID #	CASE QTY.
78976	Machinery light gray	R-23	6
78987	Machinery dark gray	R-123	6
78981	OSHA white (gloss)	R-12, R-406A	6
78982	White (flat)		6
78983	OSHA black (gloss)		6
78984	Black (flat)		6
78985	Aluminum		6

Reflect-All™ All Purpose Spray Coating

Reflect-All™ is a revolutionary light-reflective paint that can be applied to virtually any surface. The reflective microbeads capture, intensify and reflect light back to the source resulting in amazing nighttime visibility.

Reflect-All™ has unlimited applications. Wherever low-light or nighttime safety is a must, Reflect-All™ is your brilliant answer!

Goes on semi-transparent and dries in 10 minutes.

MARS NO.	DESCRIPTION	MARS PACK
78995	Reflect-All™ 12 oz.	6



SERVICE & INSTALLATION

Pipeseal

MARS SERIES **934**



Pipeseal

Pipeseal is a unique multi-component epoxy designed to quickly and permanently patch, seal and repair cracks, holes and leaks in all types of pipe.

Seals Holes in Pipe to Full Pressure in Under Five Minutes!

- Works on all types of pipes including copper, steel, lead, cast iron and aluminum.
- Heat activated - Hardens fully in less than 1 minute.
- Withstands pressures up to 1200psi.
- No wrap/plug required.
- Suitable for refrigerant lines.
- Extreme chemical resistance
- 100% solids - No VOCs
- Permanently seals holes of up to 1/4 in. in diameter.

INSTRUCTIONS:

- 1** Prepare Surface around pipe hole/crack with sand paper or file.
- 2** Remove clip and cut-off the end with the clear material and apply entire content to mixing surface; ensure mixing surface is not porous.
- 3** Thoroughly mix entire contents.
- 4** Apply to pipe with a wooden stick or trowel.
- 5** Cover a 2-inch-wide area around pipe hole/crack.
- 6** Apply heat with a heat gun/hair dryer (approx. 140°) until Pipeseal cures and hardens (usually within 1minute).

MARS NO.	DESCRIPTION	MARS PACK	CASE QTY.
93629	Pipeseal	1	12



Sprayers & Garden Hoses

MARS SERIES **797 & 790**



Chapin Sprayers & Accessories

MARS #79067, 2 gallon (1.5 gallon usable) polyethylene sprayer is a high density sprayer that resists breaking, leaking and chemical corrosion. This sprayer has a polymer shut off with lock on feature and a polymer nozzle that adjusts from fine spray to 30' stream, with a poly/brass extension that rotates 360°. Reinforced 36" hose resists crimping, cracking and leaking.

The Chapin acid sprayer is the ideal sprayer for cleaning and degreasing air conditioning coils, engines and many other uses. This 2 gallon (1.5 gallon usable) heavy-duty polyethylene tank features a new built-in relief valve/pressure gauge for added safety and polymer shut offs with lock off features to prevent accidental spraying. A 12" extension tube with adjustable poly cone nozzle ensures for better control when spraying chemically active liquids. Sprays coarse stream to fine mist. 42" hose included

MARS #79069, hand held pressure sprayer is a 48 oz. multi purpose sprayer for small areas. Heavy duty, chemical resistant poly tank features adjustable nozzle control for fine mist or straight stream spraying.

MARS NO.	DESCRIPTION	MARS PACK	CASE QTY.
79067	2 gallon polyethylene sprayer	1	1
79068	2 gallon acid sprayer	1	1
79069	48 oz. hand held sprayer	1	1

Swan Garden Hoses

Fairlawn® reinforced garden hose combines excellent quality and good value. This light duty, three-ply strength hose offers good pressure capacity and is flexible for easy handling. Solid brass couplings. Two year warranty.

MARS #79539 and 79540, premium rubber hose, provide superior flexibility and pressure capacity. Maximum kink resistance and burst strength make this hose very durable. Handles hot water up to 160°F. Seal-tite™ washerless leakproof coupling. Lifetime warranty.

The professional hot water hose is designed for a wide range of applications requiring hot water use up to 200°F. The heavy duty rubber construction offers maximum wear and abrasion resistance. Industrial style reinforcing for high burst pressure and kink resistant. Seal-tite™ washerless leakproof coupling. All hoses are made in the U.S.A.

MARS #79641 and 79642, WeatherFlex® Hose is an all-weather reinforced garden hose with its popular mint green Clear Tough™ jacket. Its medium duty construction makes it perfect in all seasons by staying pliable in cold weather. Comes with Eco couplings and patented Hose Armour™ to prevent kinking at the spigot.

MARS NO.	DESCRIPTION	MARS PACK	CASE QTY.
79538	Fairlawn® - 5/8" x 50'	1	5
79539	Premium rubber - 5/8" x 25'	1	5
79540	Premium rubber - 5/8" x 50'	1	5
79541	Hot water rubber - 5/8" x 25'	1	5
79542	Hot water rubber - 5/8" x 50'	1	5
79641	All weather - 5/8" x 50'	1	5
79642	All weather - 5/8" x 75'	1	5

Gilmour Full Size Pistol Grip Nozzles

MARS NO.	DESCRIPTION	MARS PACK	CASE QTY.
79581	Insulated chrome plated	1	24
79582	Insulated threaded front	1	24
79583	Vinyl cushioned grip	1	24
79584	Metalized threaded front	1	48
79560	Hose washers, fits 5/8" hoses, 20/pk	1	1



Features of Gilmour® Pistol Grip Nozzles				
	79581	79582	79583	79584
Nozzle features	chrome plated, full-size	chrome plated, full-size	metal full-size	metalized full-size
All brass valve stem with permanent adjusting nut on all				
Hold-open clip on all				
Patented, insul. grip & industrial strength lever	yes	yes	no	no
Unique features	brass head insert	rubber head guard, brass head insert	vinyl molded comfort grip	
Stainless steel spring on all				
Lifetime duck packing seal on all				
Male hose threaded for attaching accessories	no	yes	yes	yes
Pack carded on all				

SERVICE & INSTALLATION



The largest selection of motors, components and accessories for the HVAC/R Industry

Custom Leather Craft Products

MARS SERIES **790**



Custom Leather Craft Products

Professional contractors require professional tools and accessories. Carrying a CLC Softside Tool Carrier is like owning a workshop to go. Loads of pockets, rugged polyester fabric, reinforced bottom panels, heavy duty stitching and bar tacking at critical stress points are features that make CLC a requested brand.

MARS NO.	DESCRIPTION	MARS PACK
79279	28 Pocket Tool Pouch <ul style="list-style-type: none"> 7" x 5-1/2" multi compartment tray slides into bottom of pouch Box shaped design prevents tipping Padded carrying handle and adjustable shoulder strap 8"L x 8"W x 17"H 	1
79280	15 Pocket, 16" Center Tray Tool Bag <ul style="list-style-type: none"> 13-1/2" x 9" multi compartment tray stores in middle of bag 8 pockets outside and 7 pockets inside Padded carrying handle and adjustable shoulder strap 16"L x 9"W x 9"H 	1
79281	4 Pocket Tool Holder <ul style="list-style-type: none"> Hang, strap, or clip on workbelts, suspenders, or pants Securely holds small tools or accessories 	1
79282	23 Pocket Large Tool Carrier <ul style="list-style-type: none"> 11" x 6" multi compartment plastic tray that slides into the bottom of the carrier 16 multi use outside pockets and 7 inside to organize tools & accessories Box shaped design prevents tipping 11"L x 10"W x 19"H 	1
79283	26 Pocket Backpack Bag <ul style="list-style-type: none"> 20 inside and 6 outside pockets organize a variety of tools & accessories Exclusive Tools-In-A-Row system folds open, then open again to layout your most used tools Padded adjustable shoulder straps 	1
79285	Mini Cell Phone Holder <ul style="list-style-type: none"> Specially designed to securely hold newer and smaller cell phones Versatile 2-way attachment for belt pants, etc. Elastic side panels and inside padding for protection 	1
79286	Large Cell Phone Holder <ul style="list-style-type: none"> Hang, strap, clip onto workbelts, suspenders, and pants Holds most brands of large cell phones Elastic side pockets for pens, pencils, small tools, etc. 	1
79287	Plastic Cap Swivel Kneepads <ul style="list-style-type: none"> One size fits all Exclusive grooved cap design prevents thread abrasion Foam padded with easy on/off hook and loop fasteners 	1
79270	Ultraflex® Non-Skid Professional Kneepads <ul style="list-style-type: none"> One size fits all Upper cap design for all day comfort and protection Soft, flexible outer shell protects and grips most surfaces without scratching or scuffing Slot n dot strap connections, Memory Flex™ synthetic rubber straps 	1
79288	Work Crew Gloves-L	1
79289	Work Crew Gloves-XL <ul style="list-style-type: none"> Synthetic leather palm is tough, soft, and comfortable Lycra side panels provide flexibility Spandex back ensures snug fit 	1





Custom Leather Craft Products

MARS SERIES **790**

MARS NO.	DESCRIPTION	MARS PACK
79263	14 Pocket Large Tray tote Bag <ul style="list-style-type: none"> • 2 Pockets inside, 12 outside • 13 1/2" x 6" multi-compartment plastic tray included, slides securely into bottom of bag. • 16"L x 9"W x 12"H 	1
79290	Work Right OC™-M	1
79291	Work Right OC™-L	1
79292	Work Right OC™-XL <ul style="list-style-type: none"> • Padded synthetic palm material is soft and comfortable • Open cuff design with textured pull-on tab for easy-on, easy off • Textured fingertip pads provide added abrasion resistance • Padded knuckles for protection against bumps • Stretch spandex back for flexibility and fit 	1
79264	Tradesmen High Dexterity Gloves-M (pair) <ul style="list-style-type: none"> • Clarino® synthetic leather is tough, soft and comfortable to wear, resists shrinking, stretching and hardening • Flexible neoprene wrist cuff keeps debris out • Flex-Spot™ thumb design for better flexibility • Stretch spandex for flexibility and fit • Padded knuckles provide protection against bumps 	1
79265	Tradesmen High Dexterity Gloves-L (pair)	1
79266	Tradesmen High Dexterity Gloves-XL (pair)	1
79267	Mossy Oak® 16" Bigmouth® Bag <ul style="list-style-type: none"> • 12 Multi-use pockets inside and 10 outside to organize tools and accessories • Heavy duty stitching and bar tacking at all stress points • 16"L x 8.5"W x 10"H 	1
79268	Mossy Oak® 12" Bigmouth Bag <ul style="list-style-type: none"> • 17 Multi-use pockets inside and 6 outside to organize and accessories • Opens wide for easy access to bags contents • Adjustable shoulder strap and padded reinforced web carrying handles • 12"L x 8.5"W x 8"H 	1
79269	48 Pocket Bucket Pockets <ul style="list-style-type: none"> • 14 Double row pockets inside and 34 triple row outside to organize a wide range of tools and accessories • Security pocket with hook and loop closure • Drill pocket with hook and loop handle strap • Designed to fit most 3 1/2 - 5 gallon buckets • Measuring tape strap and key clip included 	1
79276	50 Pocket Double Zipper Tote Bag <ul style="list-style-type: none"> • 9 Multi-use pockets inside and 41 outside to organize tools and accessories • Double pull zipper for easy access • Padded bottom will not scratch, mar countertops, floors and upholstery like metal tool boxes • 18"L x 6"W x 9"H 	1
79277	75 Pocket-Tool Backpack <ul style="list-style-type: none"> • 7"x 5" multi compartment plastic tray included • Adjustable padded shoulder straps and carry handles • 13"W x 17-1/2"H x 9"D 	1
79284	5 Pocket Cell Phone <ul style="list-style-type: none"> • The cell phone, tool and accessory holder you can HANG - STRAP - CLIP on workbelts, web suspenders, pants, etc. • Holds most brands of compact cell phones • Securely holds small tools and accessories like pliers, mini-flashlight, screwdrivers, multi-tools, etc. • Versatile 3-way attachment for pants, web suspenders, work aprons, etc. 	24

"Tools Not Included"



SERVICE & INSTALLATION



The largest selection of motors, components and accessories for the HVAC/R Industry

SI-141

Tool Boxes & Organizers

MARS SERIES **790**



Tool Boxes

All Plano tool boxes and stowaway boxes are constructed of premium quality impact resistant plastics. Solid brass hardware and sturdy ABS drawbolt type latches, withstands rugged wear. All boxes are made in the U.S.A. and have a lifetime warranty!

The Plano Tote-More®, MARS #79368, features a multi compartment drawer and convenient handle for portability. Open top for easy access. Unit measures 14 3/4" L x 9 1/8" W x 6 7/8" H.

MARS NO.	DESCRIPTION	MARS PACK
79368	Tote More® w/draw - gray/black	4

Plano Tool Boxes

MARS NO.	DESCRIPTION	MARS PACK
79643	Clear StowAway 18 Fixed Compartments, 11.13" x 7.94" x 11.63"	6
79644	Clear StowAway - 5 to 9 Adj. Compt. Pro-Latch, 1' Deep Storage, 8.38"x5.38"x 9.88"	6
79645	Graphite Gray & Black 16" Tool Box with bulk storage space and tray, Removable StowAway Organizer built into the top, 19.38" x 16" x 16.63"	4
79646	Graphite Gray & Black 20" tool box with bulk storage space and tray, Heavy Duty handle, 22.38" x 20.69" x 19"	4
79647	Graphite Gray & Iron Yellow 22" tool box with extra deep storage space and tray, 21.88"x12.75"x13.75"	1

Stowaways - Plastic

MARS stowaway boxes are ideal for the professionals or do it yourselfers. These utility boxes hold bolts, screws, washers, bits, solderless terminals and many other small items. MARS #79378 has 6-18 adjustable compartments and measures 11" L x 7 1/4"W x 1 3/4"H. MARS #79379 has 4-24 adjustable compartments and measures 13 3/4"L x 9 1/8"W x 2"H.

MARS NO.	DESCRIPTION	MARS PACK
79378	6-18 adj. stowaway box - translucent gray	6
79379	4-24 adjustable stowaway box - translucent gray	6

Storage Bins

- Heavy duty bins securely stack on top of each other, sit on shelving and hang from racks, panels, rails and carts
- Anti slide stop prevents stacked bins from shifting forward
- Guaranteed not to crack or break under normal load conditions
- Sturdy one piece construction is water, rust and corrosion proof.
- Large front label are for easy coding and scanning
- Curved bottom hopper makes it easy to retrieve small parts

MARS NO.	DESCRIPTION	MARS PACK
79764	12" Blue Shelf Bin 11 5/8" L x 4 1/8" W x 4" H	24
79765	12" Blue Shelf Bin 11 5/8" L x 6 5/8" W x 4" H	12
79766	12" Blue Shelf Bin 11 5/8" L x 8 3/8" W x 4" H	12

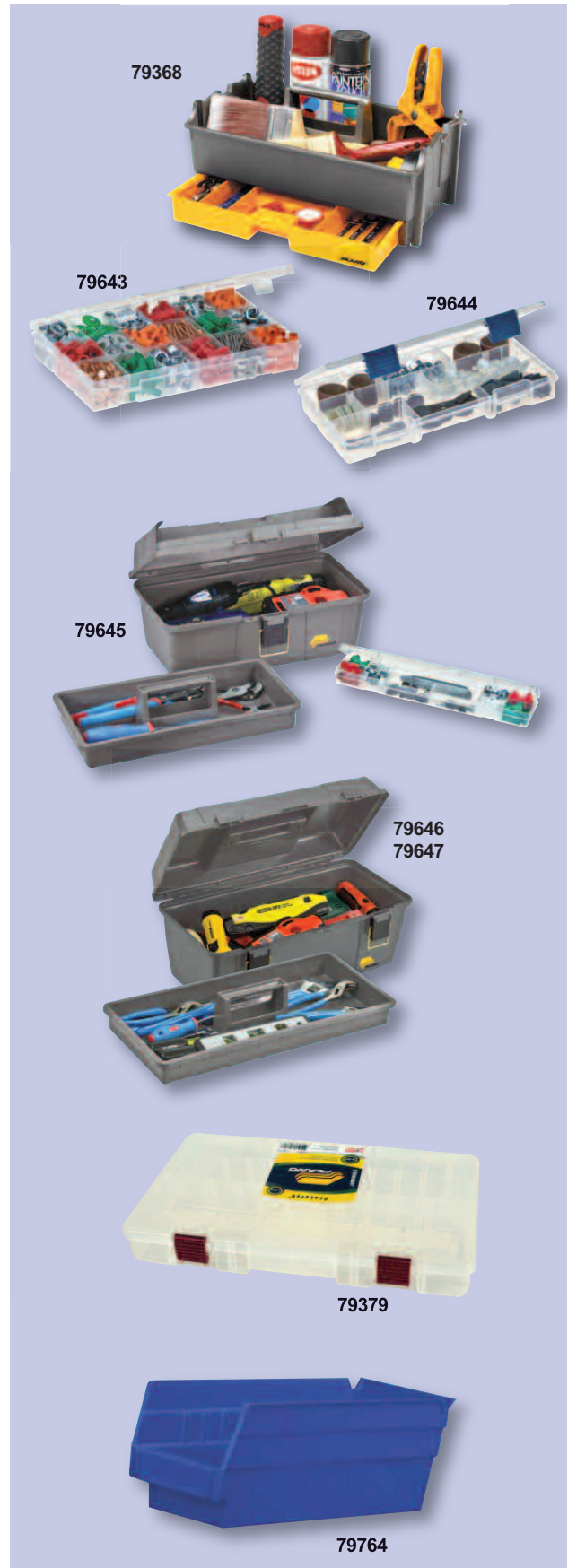

SERVICE & INSTALLATION



Clipboards & Formholders

MARS SERIES **790**

MARS Clipboards And Formholders

MARS aluminum Style A Formholder is versatile, efficient and easy to use. It can be used by both left and right handed people and will accommodate forms ruled either lengthwise or across the width. The storage compartment below keeps completed forms dry and protected.

The MARS Snapaks are very popular aluminum formholders that accommodate loose forms or sales books. Unit opens like a book. Clipboard is included on inside front cover. A hinged aluminum strap on inside back cover holds copies or sales books securely in place. The entire holder folds into a compact protective box to keep forms safe and dry.

The MARS #79558 Redi-Rite is a clipboard on a box. This is the holder to have when you need to carry many forms. Extra storage capacity. All aluminum construction.

MARS #79559 Portfolio is simple yet functional. The cover is hinged on the left with a light spring action so it stays open and stays shut. Paper will stay safe under cover from wind, rain and dirt. Aluminum construction.

MARS NO.	DESCRIPTION	CASE QTY.
79552	"A" formholder 8-1/2" x 12"	12
79555	Snapak 8-1/2" x 12"	12
79558	Redi-Rite 8-1/2" x 12"	6
79559	Portfolio 8-1/2" x 12"	12



"A" Formholder



Snapak



Redi-Rite

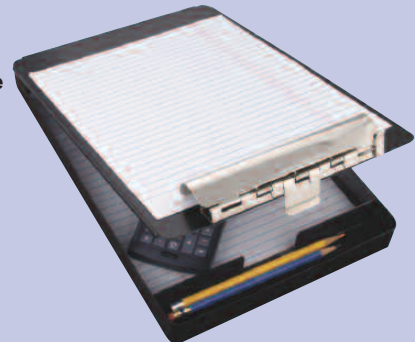

Portfolio

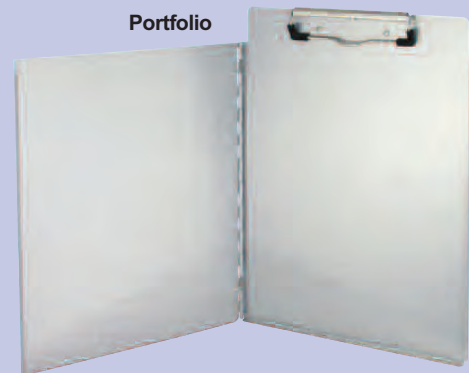

SERVICE & INSTALLATION

HVAC/R Textbooks

MARS SERIES **790**



SERVICE & INSTALLATION

Reference Textbooks

Motors & Armatures is pleased to offer textbooks for the HVAC/R and electrical professionals.

Modern Refrigeration and Air Conditioning is the leader in the refrigeration and air conditioning field! It teaches fundamental principles and service techniques. The text tells and shows how to diagnose and remedy HVAC problems. It provides an excellent blend of theory with job-qualifying skills. Fully covers the practical application of refrigeration in all its branches including: Domestic, Commercial, Air Conditioning, Heat Pumps, Automotive Air Conditioning, Thermoelectric, Solar Energy, and Special Devices. Includes up-to-date information on refrigerant recovery, recycling, and reclaiming.

Emphasizing practical skills and presenting complete, up-to-date information, **Heating and Cooling Essentials** is the ideal introductory book for individuals who plan to enter the HVAC field. Special attention is paid to skills essential to the new technician, such as the familiarity with tools, materials, and fasteners; the ability to read dimensions and perform other math-related activities; and the ability to perform installation, service, and repair techniques. **Heating and Cooling Essentials** provides the new technician with a thorough discussion on temperature/pressure relationships, refrigerants (including the new ones that are replacing CFCs) and refrigerant recycling, valves and flow controls, compressors, HVAC electrical systems and components, major types of heating systems (including heat pumps), and the vital topic of customer relations.

Doolin's Trouble Shooters Bible is used by technicians and contractors everywhere. Partial contents include: electric motors, heat pumps, ice machines, gas and electric heating, central systems, servicing of commercial equipment, basic refrigeration and basic electricity. This reference book is available in a spanish edition as well.

MARS NO.	DESCRIPTION	MARS PACK	CASE QTY.
78701	Modern refrigeration & A/C	1	8
78702	Heating & cooling essentials	1	10
78710	Doolin's trouble shooters bible	1	22
78711	Doolin's trouble shooters spanish edition	1	22

HVAC Professional Reference Books

DeWalt HVAC Technician Certification Exam Guide MARS # 78725

This comprehensive exam study guide for electricians can be utilized in every state. Based on the 2005 NEC, this book is ideal for preparing to take any one of the licensing exams currently required in the electrical industry. This book includes realistic sample exams with answer keys.

DeWalt HVAC/R Professional Reference-Master Edition MARS # 78726

This expanded edition contains approx. twice as much info as the earlier edition. This comprehensive jobsite solution for HVAC/R technicians covers formulas, design data, heating, ventilation, piping, service, troubleshooting, electrical motors & much more.

DeWalt HVAC Estimating Professional Reference MARS # 78727

This professional reference guide is the ideal pocket tool for any mechanical estimator. This book guides you through each step of the HVAC bidding process; includes checklist, worksheets, forms and more.

MARS NO.	DESCRIPTION
78725	DeWalt HVAC Technician Certification Exam Guide
78726	DeWalt HVAC/R Professional Reference-Master Edition
78727	DeWalt HVAC Estimating Professional Reference

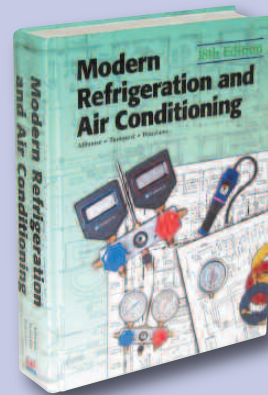

78701



78702



78710



78725

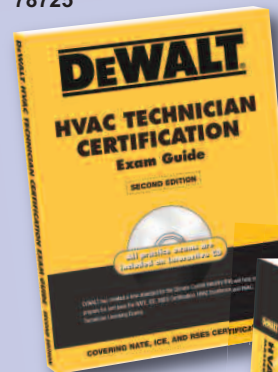

78726



78727