



**MOTOROLA**

# R-2670 FDMA Digital Communications Systems Analyzer



## **OPERATOR'S MANUAL**

68-80309F17



**MOTOROLA**

TEST EQUIPMENT

**R-2600 Series  
Communications System Analyzer**

**OPERATOR'S MANUAL**

**Motorola Test Equipment Products**  
8201 E. McDowell Rd.  
Scottsdale, Arizona  
85257

©Motorola, Inc. 1996  
All Rights Reserved  
Printed in U.S.A.

Pub #68-P30700C Rev. A

# Table of Contents

<u>Topic</u>	<u>Page</u>
LIMITED WARRANTY.....	vi
COMPUTER SOFTWARE COPYRIGHTS.....	vii
SERVICE LOCATIONS.....	viii
TEST EQUIPMENT SERVICE REQUEST FORM.....	x

## Section 1 INTRODUCTION

1-1	SCOPE OF MANUAL / VERWENDUNGSZWECK.....	1/1a
1-2	SAFETY SUMMARY / SICHERHEITSHINWEISE .....	1/1a
	1-2.1 Grounding the Analyzer / Funkmeßplatz erden.....	1/1a
	1-2.2 Unit is Live When Plugged In / Das Gerät steht auch in ausgeschaltetem Zustand unter Spannung.....	1/1a
	1-2.3 Keep Away From Live Circuits / Vorsicht vor spannungsführenden Teilen!.....	1/1a
	1-2.4 Exposing or Handling the CRT / Hinweise für den Umgang mit der Kathodenstrahlröhre .....	1/1a
	1-2.5 Explosive Atmosphere / Betrieb in einer explosionsgefährdeten Umgebung .....	2/2a
1-3	WARNINGS AND CAUTIONS / GEFAHRENHINWEISE.....	2/2a
	1-3.1 Analyzer Operating Voltage / Betriebsspannung .....	2/2a
	1-3.2 DC Power Source / Betrieb mit Gleichspannung .....	2/2a
	1-3.3 Maximum DVM Input Voltages / Maximale Eingangsspannung des Digitalvoltmeters.....	2/2a
	1-3.4 Replacement Fuses / Ersatz von Sicherungen .....	3/3a
	1-3.5 Other Cautions / Sonstige Vorsichtsmaßnahmen .....	4/4a
	1-3.6 Replacement and Disposal of Batteries / Ersatz und Entsorgung von Akkus .....	4/4a
	1-3.7 User Maintenance / Reinigung.....	4/4a
1-4	SERVICE / KUNDENDIENST .....	4/4a
1-5	REPLACEMENT PARTS ORDERS / ERSATZTEILBESTELLUNGEN.....	4/4a
1-6	INSTALLATION / INSTALLATION.....	4/4a
	1-6.1 Packing / Verpackung .....	4/4a
	1-6.2 Initial Set-up / Erste Inbetriebnahme .....	4/4a
	1-6.3 Battery Pack Operation / Betrieb mit Akkusatz .....	5/5a
	1-6.4 Battery Pack Installation / Installation des Akkusatzes .....	6/6a

## Table of Contents (CONT)

<u>Topic</u>		<u>P.</u>
<b>Section 2</b>		
<b>DESCRIPTION</b>		
2-1	DESCRIPTION .....	7
2-2	OPERATOR CONTROLS.....	7
2-2.1	Keys & Indicators .....	7
2-2.2	Knobs.....	10
2-2.3	CRT .....	10
2-2.4	Connectors .....	11
2-3	BOTTOM CONTROLS.....	12

## Table of Contents (CONT)

<u>Topic</u>	<u>Page</u>
<b>Section 3</b>	
<b>OPERATING INSTRUCTIONS</b>	
3-1	GENERAL ..... 13
3-2	BASIC OPERATION ..... 13
3-2.1	Remote Operation .....13
3-2.2	Expanded Display ..... 15
3-3	HELP ..... 15
3-4	WARNINGS ..... 17
3-5	PRIMARY OPERATING MODES ..... 18
3-5.1	MONITOR Mode..... 18
3-5.2	GENERATE Mode ..... 20
3-5.3	DUPLEX Mode ..... 22
3-5.4	SWEEP GENERATE Mode ..... 24
3-5.5	TRACKING GENERATOR Mode ..... 26
3-6	AUDIO/MODULATION SYNTHESIZER..... 28
3-6.1	Fixed 1 kHz..... 28
3-6.2	Synth..... 28
3-6.3	DTMF ..... 32
3-6.4	External ..... 32
3-7	METER AND DISPLAY ..... 32
3-7.1	Meter ..... 32
3-7.2	Display..... 42
3-8	OTHER FUNCTIONS..... 49
3-8.1	Audio Monitor ..... 49
3-8.2	Calibration ..... 49
3-8.3	Print Function .....49
3-8.4	Special Functions Menu ..... 50
3-8.5	Memory Screens ..... 51
3-8.6	Test Setups .....54

## Table of Contents (CONT)

<u>Topic</u>	<u>P.</u>
<b>Section 4</b>	
<b>APPLICATIONS</b>	
4-1	BASIC FM TRANSMITTER TESTING .....57
4-1.1	Basic FM Transmitter Testing Setup .....58
4-1.2	Transmit Power, Frequency, and Frequency Deviation Measurements .....58
4-1.3	Modulation Measurements .....59
4-1.4	Off-The-Air Measurements .....61
4-2	BASIC FM RECEIVER TESTING .....62
4-2.1	Basic FM Receiver Testing Setup.....63
4-2.2	Receiver Distortion Measurement.....64
4-2.3	SINAD Measurement .....64
4-2.4	Modulation Acceptance Bandwidth.....65
4-2.5	Receiver Sensitivity Testing (20 dB Quieting).....66
4-2.6	Squelch Sensitivity Test .....67
4-3	CABLE TESTING .....69
4-3.1	Overview .....69
4-3.2	Measuring Fault Distance .....70
4-4	TONE REMOTE TESTING.....72
4-4.1	Tone Remote Testing Setup .....73
4-4.2	Checking for Proper Tone Remote Operation.....73
4-5	LX-810S/220 PRINTER APPLICATION NOTE .....74
4-5.1	Printer Self-Test.....74
4-5.2	Printer Setup .....74
4-5.3	R-2600 Analyzer Setup .....75

## Table of Contents (CONT)

<u>Topic</u>	<u>Page</u>
<b>APPENDIXES</b>	
Appendix A LIST OF ABBREVIATIONS .....	A-1
Appendix B TONE AND CODE SPECIFICATIONS .....	B-1
Appendix C SAFE HANDLING OF CMOS INTEGRATED CIRCUIT DEVICES .....	C-1
Appendix D EXTERNAL PORT PIN ASSIGNMENTS.....	D-1

## MOTOROLA TEST EQUIPMENT PRODUCTS LIMITED WARRANTY

*(EXCLUDES EXPORT SHIPMENTS)*

Motorola Test Equipment Products (herein the "product") that are manufactured or distributed by Motorola Communications Test Equipment within the Motorola Space and Systems Technology Group (herein Motorola) are warranted by Motorola for a period of one (1) year from date of shipment against defects in material and workmanship. This express limited warranty is extended to the original purchaser (herein the "Licensee") only and applies only to such defects that: (1) produce repeatable failures resulting in product lock-ups or power downs rendering the product inoperable, or (2) cause the product to perform outside of Motorola-published specifications.

In the event of such a defect during the period of warranty, the Licensee may return the product, transportation prepaid, to Motorola Test Equipment Service Depot, 1308 N. Plum Grove Road, Schaumburg, IL 60173. The Licensee must include written notice specifying the nature of the defect and proof of purchase and evidence of the date of shipment (dated packing list or invoice). Motorola, at its option, will either repair or replace the product. If Motorola elects to repair a defective product by replacing a module or subassembly, Motorola, at its option, may replace such defective module or subassembly with a new or reconditioned replacement. This **Limited Warrantee** is not extended beyond one year from original date of shipment if Motorola repairs a product. Transportation charges for the return of the product will be paid by Motorola.

This **Limited Warranty** is void, if Motorola, determines:

- (1) The product has not been operated in accordance with the procedures in the operating instructions; or
- (2) The seals on non-user serviceable components or modules are broken; or
- (3) The product has been subject to misuse, abuse, damage, accident, negligence, attempted repair or alteration.

***Motorola does not warrant that the product will meet Licensee's requirements or that the operation of the product will be uninterrupted or error free.***

***No other warranties, whether express, implied or statutory, including implied warranties or merchantability or fitness for particular purpose, are granted to Licensee, or to licensee's transferees, customers, or users of the product.***

***In no event shall Motorola be liable for any special, incidental, or consequential damages arising from this agreement or use of the product***



## COMPUTER SOFTWARE COPYRIGHTS

The Motorola products described in this instruction manual include copyrighted Motorola computer programs stored in semiconductor memories or other media. Laws in the United States and other countries preserve for Motorola certain exclusive rights for copyrighted computer programs, including the exclusive right to copy or reproduce in any form the copyrighted computer program. Accordingly, any copyrighted Motorola computer programs contained in the Motorola products described in this instruction manual may not be copied or reproduced in any manner without the express written permission of Motorola. Furthermore, the purchase of Motorola products shall not be deemed to grant either directly or by implication, estoppel, or otherwise, any license under the copyrights, patents or patent applications of Motorola, except for the normal non-exclusive, royalty free license to use that arises by operation of law in the sale of a product.

This product contains silicon software designed by Ready Systems Corp. © 1989 Ready Systems Corp. All rights reserved. Unpublished-rights reserved under the copyright laws of the United States.

### RESTRICTED RIGHTS LEGEND

Use, duplication or disclosure by the Government is subject to restrictions as set forth in subparagraph (c)(1)(ii) of the Rights in Technical Data & Computer Software clause at DFARS 252.227-7013.

READY SYSTEMS, 470 POTRERO AVENUE, SUNNYVALE, CA 94086

**Specifications subject to change without notice.**

**Motorola, Private-Line, and Digital Private-Line are trademarks of Motorola, Inc.**

**Vertex, RSC, Ready Systems Corp. are trademarks of Ready Systems Corporation.**

**Printed in U.S.A. ©1990 Motorola Inc.**

## SERVICE LOCATIONS

### General Offices:

Motorola SSTG Communication Test Equipment  
8201 E. Mc Dowell Road  
Scottsdale, Arizona 85252  
(1-800) 505-TEST (8378)

Motorola Guangzhou RSC  
No. 271 Huang Pu Da Dao West  
Tian-He District  
Guangzhou, P R C 510620  
Ph: (86-20) 753-7888  
Fax: (86-20) 754-2712

### Test Equipment Service Centers:

#### USA:

Motorola Test Equipment  
Service Center  
1308 Plum Grove Road  
Schaumburg, Illinois 60173  
Ph: (800) 323-6967  
(708) 576-7025  
FAX: (708) 576-8113

#### Motorola Shanghai RSC

3F Central Place  
16 Henan Road South  
Shanghai, P R C 200002

#### CANADA:

Sinclabs Inc.  
1166 Gorham St.: Unit 4  
Newmarket, Ontario L3Y7V1  
Canada  
Ph: (800) 263-3275

#### KOREA:

Motorola Electronics and Communications, Inc.  
#965-5 IL-DONG Bldg. 4F1  
Daechi-Dong, Kangnam-Ku  
Seoul, Korea  
Ph: (82-2) 568-2138  
Fax: (82-2) 569-5364

#### JAPAN:

NEXTEC Japan, Ltd.  
3-24-22 Kita-Yamada, Tsuzuki-Ku  
Yokohama, Japan 224  
Ph: (81) 045-592-0994  
Fax: (81) 045-591-8425

#### AUSTRALIA:

Motorola Australia Pty Ltd  
6 Caribbean Drive  
Scoresby, Victoria 3179  
Ph:  
Fax: (61-3) 9213-7766

#### SINGAPORE:

Motorola Electronics Pte Ltd.  
85 Defu Lane 10  
#03-00 Mode Circle Building  
Singapore, 539218  
Ph: (65) 381-0431  
Fax: (65) 287-4181

#### ISRAEL:

Motorola Communications Israel Ltd. (MCIL)  
3 Kremenetski St.  
Tel Aviv, Israel  
Ph: (972-3) 565-8166  
Fax: (972-3) 565-9763

#### CHINA (PRC):

Beijing:  
Motorola Beijing RSC  
No. 29 Dong Zhi Men Wai Da Jie,  
Beijing, P R C 100027  
Ph: (86-10) 461-1155  
Fax: (86-10) 461-0277

#### EUROPE:

Motorola GMBH  
Test Equipment Service Center  
Heinrich-Hertz Str 1  
D-65232 Taunusstein, Germany  
Ph: (6128) 702179  
Fax: (6128) 951046

#### ARGENTINA:

BGH S.A.  
Brasil 731  
(1154) Buenos Aires, Argentina

**BRAZIL:**

Marketronics do Brasil  
Av. Helio Pellegrino 54- Via Nova C  
04513-100 Sao Paulo, Brazil  
Ph: (55-11) 572-6747  
Fax: (55-11) 570-4572

**CHILE:**

Inter-Export  
Av. Fco. Bilbao 2168  
Santiago, Chile  
Ph: (56-2) 635-2885  
Fax: (56-2) 204-4655

**COLOMBIA:**

Vimpex Ltda.  
Cra. 22, No.36-63 Oficina 102  
Bogota, Colombia  
Ph: (57-1) 244-5254  
Fax: (57-1) 344-0481

**ECUADOR:**

Oficina Comercial Raymond Wells  
Av. Amazonas 2374 y Eloy Alfaro  
Oficina 2A  
Quito, Ecuador  
Ph: (593-2) 222-613  
Fax: (593-2) 564-778

**EL SALVADOR:**

J. M. B. Communications  
4 Av Norte y Calle Delgado  
Edificio Letona / Apdo Postal 1902  
C.G. San Salvador, El Salvador  
Ph: (503) 222-6230  
Fax: (503) 221-2437

**MEXICO:**

Electronica Ingenieria Y Comunicaciones S.A.  
Calle 13 No. 74  
Colonia San Pedro Do Los Pinos  
03800 Mexico D.F. Mexico  
Ph: (52-5) 271-5651  
Fax: (52-5) 271-4296

**PANAMA:**

Mobile Phone de Panama  
Calle 50 #107  
P.O. Box 721  
Panama 1, Republic of Panama  
Ph: (50-7) 264-2444  
Fax: (50-7) 269-2971

**PERU:**

Master Communications  
Av Arequipa 3908 - Miraflores  
Lima, Peru  
Ph: (51-14) 422-2438  
Fax: (51-14) 442-9483

**VENEZUELA:**

Comunicaciones I T M  
Av. Andres Bello, Centro Andres Bello  
Torre Oeste, Piso 12, Oficina #123  
Mariperez, Caracas 1050, Venezuela  
Ph: (58-2) 793-5177  
Fax: (58-2) 794-0186

**Comunicaciones I T M**

Prolongacion Calle Sanchez Carrero Sur  
Zona Industrial San Miguel  
Maracay 2104, Estado Aragua, Venezuela  
Ph: (58-43) 46-2113  
Fax: (58-43) 46-1109

**CARIBBEAN:**

Radio Holland  
A. TH. ILLIDGE Road #106  
(P.O. Box 1102)  
Sint Maarten, Netherlands Antilles  
Ph: (599-5) 25414  
Fax: (599-5) 22589

**MOTOROLA, INC.**  
**COMMUNICATIONS SECTOR**  
**TEST EQUIPMENT SERVICE DEPOT**  
 1308 Plum Grove Rd.  
 Schaumburg, IL 60173

**TEST EQUIPMENT SERVICE REQUEST FORM**  
 This completed form must accompany equipment returned for service.

CUSTOMER'S PURCHASE ORDER NUMBER:	DATE:
MODEL NUMBER:	SERIAL NUMBER:
DESCRIPTION OF PROBLEM:	
REQUESTED SERVICE:	
SHIP TO ADDRESS:	
SHIP VIA:	

Providing the information below will reduce the turnaround time on your Test Equipment Service.

MOTOROLA CUSTOMER NUMBER	BILL TAG	SHIP TAG	INTERNATIONAL MOTOROLA ACCOUNT NO.
--------------------------	----------	----------	------------------------------------

SIGNED: \_\_\_\_\_

## Section 1

### INTRODUCTION

#### 1-1 SCOPE OF MANUAL

This manual contains information for using the R-2600 Series Communications System Analyzers. These Analyzers incorporate many devices and functions, permitting a technician to completely monitor and service radio communications equipment in the shop and in the field.

#### 1-2 SAFETY SUMMARY

The following general safety precautions must be observed during all phases of operation, service and repair of this equipment. Failure to comply with these precautions or warnings violates safety standards of design, manufacture, and intended use of the equipment. Motorola Inc. assumes no liability for the customer's failure to comply with these requirements.

The safety precautions and warnings listed below represent warnings of certain dangers of which Motorola is aware. You as the user of the product, should follow these warnings and all other safety precautions necessary for the safe operation of the equipment in your operating environment.

##### 1-2.1 Grounding the Analyzer

To minimize shock hazard, the Analyzer enclosure must be connected to an electrical ground. This ground connection is provided via a three wire AC power cable. The power

cable must be plugged into an approved three-contact electrical outlet. If the unit is not properly grounded while operating from an AC power source, the voltage potential between it and ground may cause an electrical shock.

##### 1-2.2 Unit is Live When Plugged In

Internal circuits are live when the power cable is plugged in, although the front panel switch is in the STANDBY position. The input power plug is the disconnect device.

##### 1-2.3 Keep Away From Live Circuits

Operating personnel must not remove equipment covers. Only Factory Authorized Service Personnel or other qualified maintenance personnel may remove equipment covers for internal subassembly or component replacement or any internal adjustment. Disconnect Analyzer from all voltage sources before removing covers for adjustments, maintenance or repairs. Capacitors inside may still be charged even if the Analyzer is disconnected from the voltage source.

##### 1-2.4 Exposing or Handling the CRT

Breakage of the Cathode Ray Tube (CRT) causes a high velocity scattering of glass fragments (implosion). To prevent CRT implosion, avoid rough handling or jarring of

the equipment. Handling of the CRT should be done only by qualified maintenance personnel using approved safety mask and gloves.

### **1-2.5 Explosive Atmosphere**

Do not operate the equipment in the presence of flammable gases or fumes. Operation of any electrical equipment in such an environment constitutes a definite safety hazard.

## **1-3 WARNINGS AND CAUTIONS**

You should observe several precautions when handling this equipment.

### **WARNING**

*The Analyzer is designed to be operated with a ground connection to the chassis via a three-wire power connection. If the unit is not properly grounded while operating from an AC power source, the voltage potential between it and ground may cause an electrical shock.*

### **CAUTION**

*This equipment contains parts that are subject to damage by static electricity. While there is normally no need for operator access to any internal components, take proper precautions in handling should the need arise. See Appendix C for safe handling procedures.*

### **1-3.1 Analyzer Operating Voltage**

Before plugging in an AC power cable, verify that the selector switch located on the underside of the unit is set to the correct operating voltage. If using a battery pack, the cover must be removed and the internal voltage selector switch set to the correct position.

### **1-3.2 DC Power Source**

The DC power input is intended to be connected to the Battery Pack accessory, or from a vehicle battery. Connecting the Analyzer DC input to a Power Supply can, in the event of a power supply fault, cause hazardous voltages to be present on the low voltage circuits of the Analyzer.

### **1-3.3 Maximum DVM Input Voltages**

To ensure the safety of the user, the voltages being measured at the DVM input must be kept below Hazardous Live limits. The maximum input levels are: 30 V r.m.s and 42.4 V peak or 60 V d.c.

### 1-3.4 Replacement Fuses

For continuous protection against risk of fire, replace only with a fuse of the same type and rating. Part numbers for replacement fuses are shown in Tables 1 and 2. Other fuses are

located inside the Analyzer and should be replaced by Factory Authorized Service Personnel or other qualified maintenance personnel.

**TABLE 1. Operator Replaceable Fuses**

LOCATION	OPERATION	FUSE RATING		FUSE TYPE	PART NUMBER
		VOLTS	AMPS		
Rear Panel	115/230 VAC L	250V	2.5A	F	65-P30222C003
* Rear Panel	115/230 VAC N	250V	2.5A	F	65-P30222C003
Front Panel	ANT	125V	1/16A	F	65-P30277C002
Front Panel	GEN	125V	1/16A	F	65-P30277C002

**TABLE 2. Internal Fuses**

LOCATION	OPERATION	FUSE RATING		FUSE TYPE	PART NUMBER
		VOLTS	AMPS		
* Inside Rear Panel	12 VDC	250V	10A	F	F03A250V10A
Power Supply	115/230 VAC N	250V	1/4A	F	65-P30308C001
Battery Pack	115/230 VAC L	250V	0.5A	F	65-P30222C002
* Battery Pack	115/230 VAC N	250V	0.5A	F	65-P30222C002
Battery Pack	12 VDC	250V	15A	F	65-P26348A004

**\*Note:** For Analyzers with one AC fuse (F02A250V3A) and one DC fuse (F03A250V10A) on the rear panel, the neutral fuse (N) does not exist.

### **1-3.5 Other Cautions**

Other cautions relating to the operation of the Analyzer are stated in *Italics* throughout this manual.

### **1-3.6 Replacement and Disposal of Batteries**

Should the batteries contained in the Battery pack ever need replacing, this work should be performed by Factory Authorized Service personnel only. Replacement batteries should be of the same type and rating. The batteries contain toxic materials and therefore must be handled with care and transported to a disposal or recycling center.

### **1-3.7 User Maintenance**

Clean only with a damp cloth and a mild detergent. Do not use abrasives, solvents or alcohol. If the Analyzer is used in a relatively dust free environment, no other periodic maintenance should be required.

## **1-4 SERVICE**

Motorola Test Equipment Service Centers service all test equipment supplied by the Motorola Communications Sector. The Center maintains a stock of original equipment replacements parts and a complete library of service information for all Motorola test equipment. A service request form along with a list of worldwide service locations is found at the front of the manual.

### **1-5 REPLACEMENT PARTS ORDERS**

Send orders for replacement parts to the nearest Motorola Test Equipment Service Center. Be sure to include the complete identification number located on the equipment. Also direct inquiries to the Test Equipment Service Center, including requests for

part number identification and test equipment calibration or repair.

## **1-6 INSTALLATION**

### **1-6.1 Packing**

Foam pieces protect the Analyzer, which is packed inside a carton. Save the packing container and materials for future use.

### **1-6.2 Initial Set-up**

1. Place the Analyzer on a workbench in the shop or mobile repair unit.
2. Lower the bail underneath to raise the Analyzer for easier viewing.
3. Remove the front cover by pressing in the spring loaded mechanism which snaps into the right front handle of the unit.
4. Before attempting to connect to AC power, set the two-position LINE switch (bottom of unit) to either the 115 or 230 position, as applicable. The factory initially sets the LINE switch for 115 VAC.
5. Take the power cord that is stored in the cover. Attach the cord's female connector to the appropriate connector on the Analyzer's rear panel. Connect the other end of the cord to the power source. For AC, use a grounded 3-wire 100-130 VAC or 200-260 VAC power source.
6. Remove accessories from the cover as needed.



7. Insert the whip antenna into the ANT port, located to the right of the tuning knob on the front panel.
8. Press the power switch ON. The Analyzer is now ready for use. Before operating the Analyzer, review the operating procedures described in this manual.

### CAUTION

*When installing the Analyzer in a vehicle, fuse the DC supply line close to the vehicle's battery. The DC-10A fuse (located on the Analyzer's rear panel) protects the Analyzer against overload but does not protect the vehicle.*

### 1-6.3 Battery Pack Operation

The optional battery pack (RPN-4000A) is designed to conveniently mount to the back of the Analyzer. Containing an internal battery charger, the battery pack is automatically recharged whenever connected direct to an ac receptacle. Battery charging is independent of the main equipment.

### NOTE

*The battery pack has an internal switch allowing the user to switch operation of the battery pack to 115 VAC or 230 VAC. Before attempting to plug the battery pack into the ac line for charging, ensure this switch is set to the correct position for your line voltage. This switch is accessible by removing six screws attaching the cover to battery pack chassis as shown in figure 1-1.*

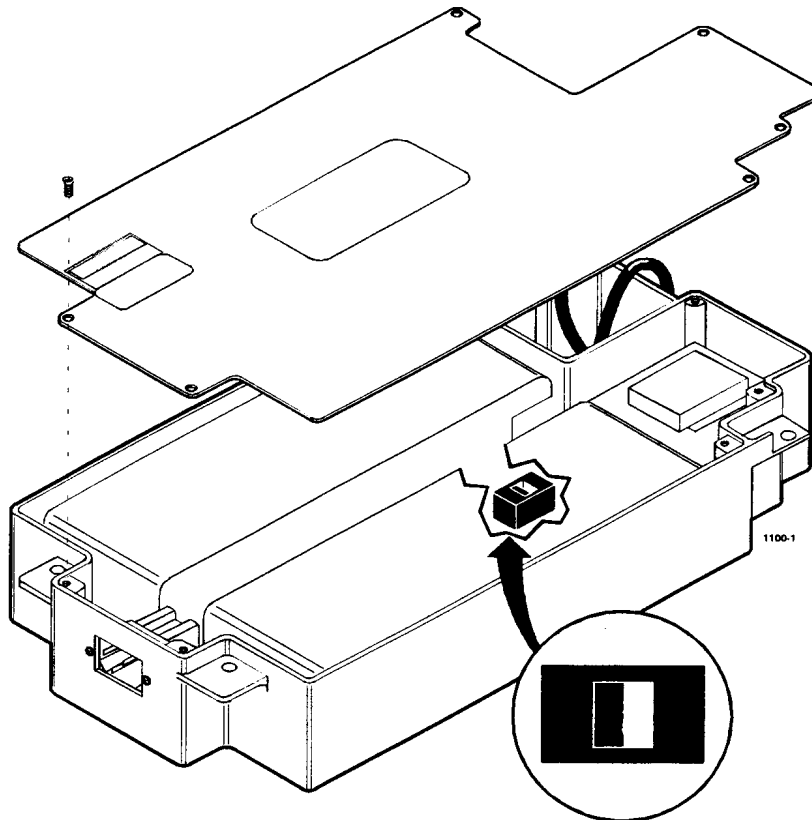

Figure 1-1. 115 VAC/230 VAC Selection Switch

### 1-6.4 Battery Pack Installation

1. Set the Analyzer in an inverted vertical position on a table with the back of the unit facing upward.
2. Lay battery pack on the back surface of the Analyzer such that the cut out in the battery, will match the locations of the power plug on the Analyzer. Do not engage the attachment screw yet.
3. Plug four-pin connector from battery pack to four-pin connector on back of Analyzer labeled DC POWER.
4. Plug AC cord from battery pack to AC power plug on back of Analyzer.
5. Dress cabling into retaining area and slide battery into position to align with mounting screws
6. Align and tighten the four slotted mounting screws.

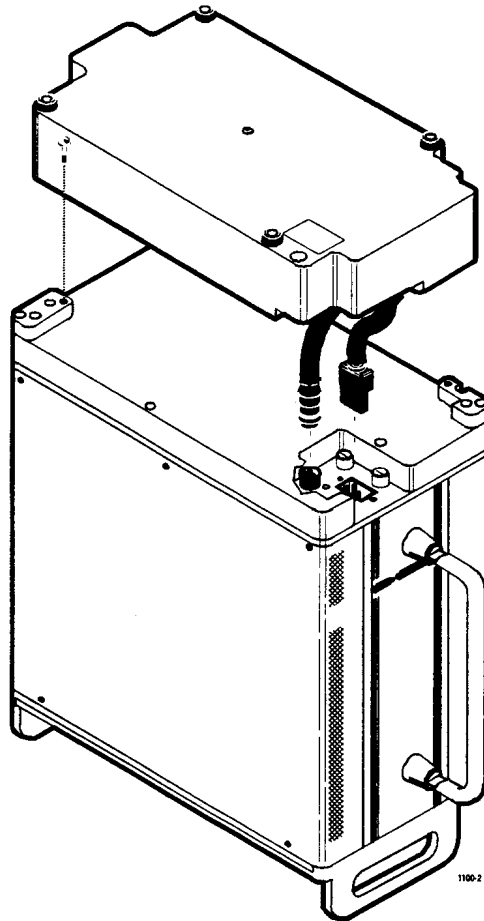

Figure 1-2. Battery Pack Installation

## Section 2

### DESCRIPTION

#### 2-1 DESCRIPTION

R-2600 Series Communication System Analyzers are portable test instruments designed to monitor and service radio communications equipment over the frequency range of 400 Hz to 999.9999 MHz. Figures 2-1 and 2-2 show the analyzer's controls, indicators, and connectors, and lists their functions. The analyzer generates signals, measures modulation and frequency, and performs a variety of tests normally associated with the following devices:

- RF Signal Generator
- Sensitive Measurement Receiver
- Spectrum Analyzer
- Duplex Offset Generator
- Oscilloscope
- Frequency Counter
- AC/DC Voltmeter
- RF Wattmeter
- Sweep Generator
- Signaling Encoder/Decoder
- Signal Strength Meter
- SINAD Meter
- Distortion Analyzer

#### 2-2 OPERATOR CONTROLS

##### 2-2.1 Keys & Indicators

###### *Power Switch*

Press ON to energize all circuitry. The unit automatically selects AC power if line power is available. Otherwise, the unit looks for a DC source. Switching is automatic upon cycling of the POWER switch.

###### *ON LED*

Illuminates when power switch is pressed ON.

###### *DC LED*

Illuminates when equipment uses DC power.

###### *Cursor Zone Keys (RF, AUD, & DISP)*

Determines the zone (third of CRT screen) that the cursor will be active in. When changing zones, the cursor moves to the same cursor location occupied the previous time it was in that zone.

###### *Cursor Position Keys (Up, Down, Left, Right, TAB)*

The five cursor movement keys are used to move the cursor to the left, right, up, down, or tab.

###### *HELP Key*

Displays help instructions for the present screen.

###### *MEM Key*

Accesses the Memory screen for nonvolatile memory presets.

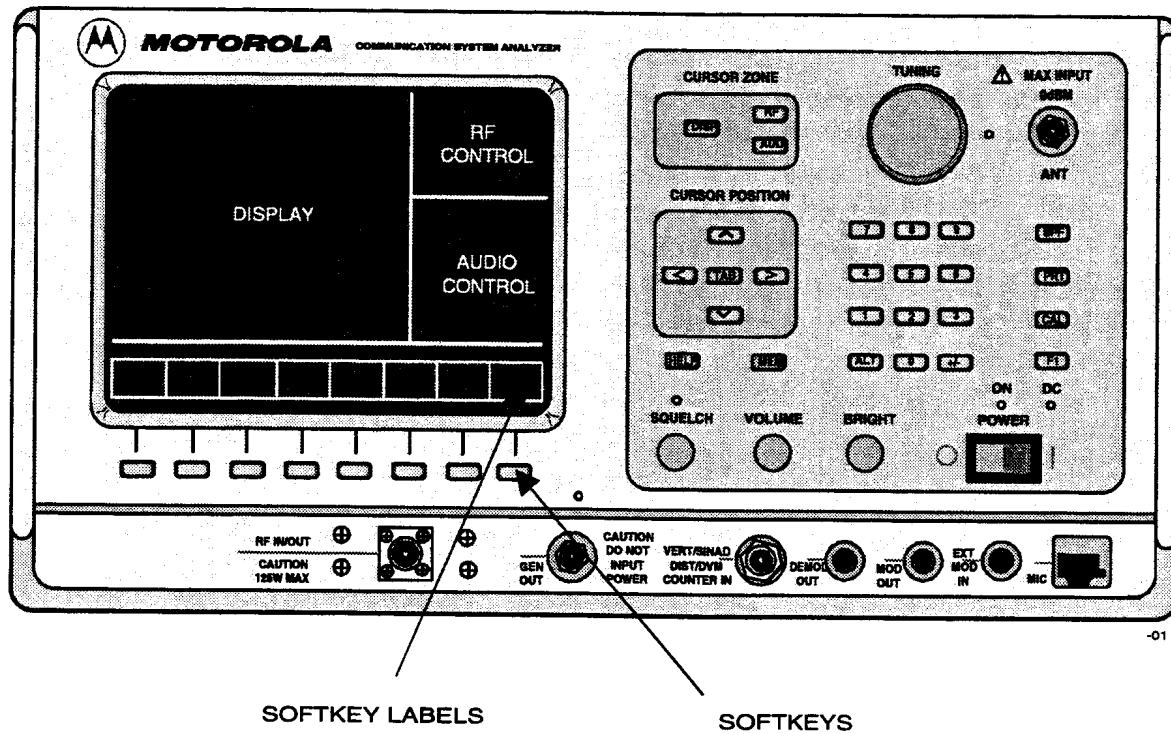

Figure 2-1. Front Panel Controls, Indicators, and Connectors

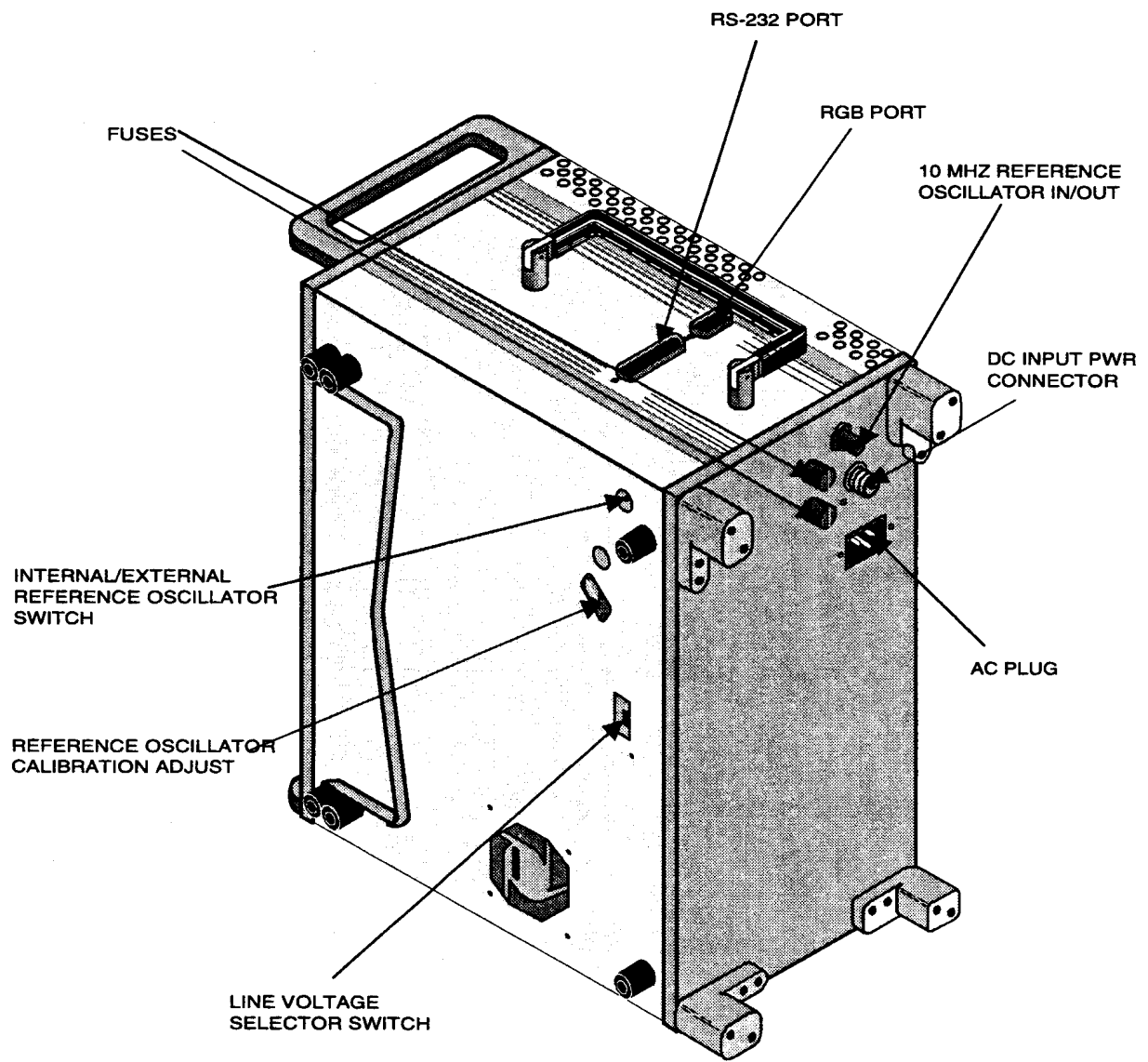

Figure 2-2. Side, Rear, and Bottom Panels

### *Keys (0-9)*

For entering numeric information into the analyzer. When a key is pressed, the existing CRT numeral (where the cursor is sitting) is replaced with the numeral represented by the keypress. The analyzer then reacts to the new information just entered. When an invalid numeric entry is attempted, the analyzer ignores the keypress and the numeral on the screen remains unchanged.

### *+/- Key*

Toggles the displayed sign from its present value to the negative of its present value.

### *ALT Key*

Enables the alternate functions on the keypad. Upon pressing the ALT key, the message ALT appears on the message line. Pressing any other key following the ALT key will cause the ALT message to disappear.

### *SPF Key*

Displays the special functions menu of the display.

### *PRT Key*

Sends the data contents of the displayed screen to a printer.

### *CAL Key*

Instructs the processor to perform a self calibration on the system.

### *F1 Key (Optional Function)*

Permits access to additional functions. Currently used to return to local mode from remote mode.

### *Softkeys*

Located below the display, the softkeys provide a menu function to indicate all possible values or entries for the current

cursor position. If the cursor moves, the softkey functions change.

## **2-2.2 Knobs**

### *SQUELCH*

Squelch control. Clockwise rotation increases the receiver threshold signal level above which the squelch opens.

### *VOLUME*

Controls volume of the speaker audio.

### *BRIGHT*

Intensity adjustment of the CRT. Clockwise rotation results in higher intensity.

### *TUNING*

Incrementally changes the digit over which the cursor is currently sitting. Clockwise rotation of the tuning knob increases the number; counter-clockwise rotation decreases the number. This provides the equivalent of an analog control for numeric cursor entry locations.

## **2-2.3 CRT**

9 cm x 11 cm bit-mapped CRT. Provides data, operating controls, and instructional information. Displays in digital, analog, and bar graph forms.

### **NOTE**

*The CRT has a screen saver feature that reduces intensity after approximately 30 minutes of inactivity. Press any key to restore the display.*

## 2-2.4 Connectors

### 2-2.4.1 Front Panel Connectors

#### *RF IN/OUT*

Provides RF input signal to the analyzer's internal monitor or output signal from the analyzer's internal generator. Also provides combined input/output in DUPLEX mode. Contains the RF wattmeter load. This is the only front panel connector to which RF power may be applied.

#### *GEN OUT*

Provides a high level generator RF output port isolated from the Monitor input. **DO NOT APPLY RF POWER.**

#### *ANT*

Input port for sensitive monitor receiver. Useful for off-the-air measurements. **DO NOT APPLY RF POWER.**

#### **NOTE**

*The GEN OUT and ANT connectors are protected from overload by an RF fuse installed in the front panel connector. This fuse may be accessed by unscrewing the front portion of the BNC connector from the panel using a 7/16 inch deep socket wrench. Replacement fuse part number is GG-6530277C002.*

#### **CAUTION**

*The RF fuse leads must be trimmed to a length of .48 ±.02 inches and the tips cut to a point to facilitate installation.*

#### *VERT/SINAD DIST/DVM COUNTER IN*

Combined input port for oscilloscope vertical, SINAD meter, DVM/counter, Distortion meter, DVM, and frequency counter inputs.

#### *DEMODO OUT*

Recovered (demodulated) audio output (MONITOR or DUPLEX mode).

#### *MOD OUT*

Composite output of internally generated modulation signals.

#### *EXT MOD IN*

External modulation input connector. Requires a fixed input level of  $1V_{pk}$  for accurate level displays.

#### *MIC*

Connector for external accessory microphone.

### 2-2.4.2 Side Panel Connectors

#### *RGB PORT (9 pin)*

Provides connection to external CGA format color monitor.

#### *RS-232 PORT (25 pin)*

Provides input/output for printer or control interface.

### 2-2.4.3 Back Panel Connectors

#### *10 MHZ STD*

BNC connector provides input/output for 10 MHz reference frequency. Input impedance is 50 ohms. Input level requirement is 70 mV to 1 Vrms. Output level is approximately 250 uVrms.

#### *AC POWER Connector*

Primary AC power input port.

#### *DC POWER Connector*

Primary DC power input port.

## 2-3 BOTTOM CONTROLS

### *Internal/External Oscillator Micro-Switch*

Used to switch between input and output configurations for the rear panel 10 MHz reference oscillator BNC connector.

#### **CAUTION**

*The analyzer will not function properly if this switch is set to external without a 10 MHz reference signal applied to the rear 10 MHz reference BNC connector.*

### *Internal Reference Oscillator Adjustment Access*

Provides convenient external access to recalibrate reference oscillator frequency setting.

#### **CAUTION**

*Use a reliable and accurate frequency standard when making this adjustment.*

### *115/230 VAC Selector Switch*

Used to switch the unit's internal power supply for either 115V or 230V operation.



## Section 3

### OPERATING INSTRUCTIONS

#### 3-1 GENERAL

R-2600 Series Communications System Analyzers are designed specifically for the service and monitoring of radio communications equipment. This product represents a breakthrough in simplicity of operation. In place of numerous meters, keys and controls, the analyzer employs a large CRT display which simultaneously presents control and data displays. A simplified front panel, utilizing soft keys, cursor movement keys, a numeric key pad, an analog tuning control and other dedicated function keys all combine to make the unit extremely easy to learn and very efficient to use.

Primary operating modes of the unit are MONITOR, GENERATE, DUPLEX and SWEEP GENERATOR. They are accessed through the RF Control display area at the upper right of the screen (figure 3-1). Within these modes of operation, various measurement functions may be selected in order to measure and diagnose many types of radio equipment under test.

RF data display, voltmeters, distortion meter, SINAD meter, frequency counter and modulation decoder functions are available through the Meter display area at the upper left of the screen.

Spectrum analyzer, oscilloscope and bar graph displays are available through the Display area at the lower left of the screen.

Control of the internal modulation synthesizer and level selection for externally applied modulation are provided through the Audio area at the lower right of the screen.

Further explanation of the function of each of these screen areas can be accessed through use of the HELP key to the lower right of the screen.

#### 3-2 BASIC OPERATION

Control of the unit and selection of data to be displayed are done through the use of three main windows which simultaneously appear on this screen.

These three main windows, or cursor zones, are accessed simply through a cluster of three CURSOR ZONE keys at the top center of the unit. The location where the cursor rests within each zone is known as a cursor field. To control the unit and enter data, all operator inputs are made at highlighted cursor field locations (brighter-face type).

For further simplicity, softkeys, with customized on-screen labels interact with the screen to provide a unique menu of entry options for each cursor field. This greatly reduces the number of keys and having to search through unrelated controls to find the one that's needed.

##### 3-2.1 Remote Operation

All R-2600 Series Communications System Analyzers are equipped with a standard RS-232 interface. Optionally, the R-2600 is equipped with an IEEE 488 interface. Either of these interfaces may be used to remotely control the analyzer using a set of commands, queries, and responses that are defined in the Motorola R-2600 Series Communications System Analyzer Programming Reference Manual (68-80309E55).

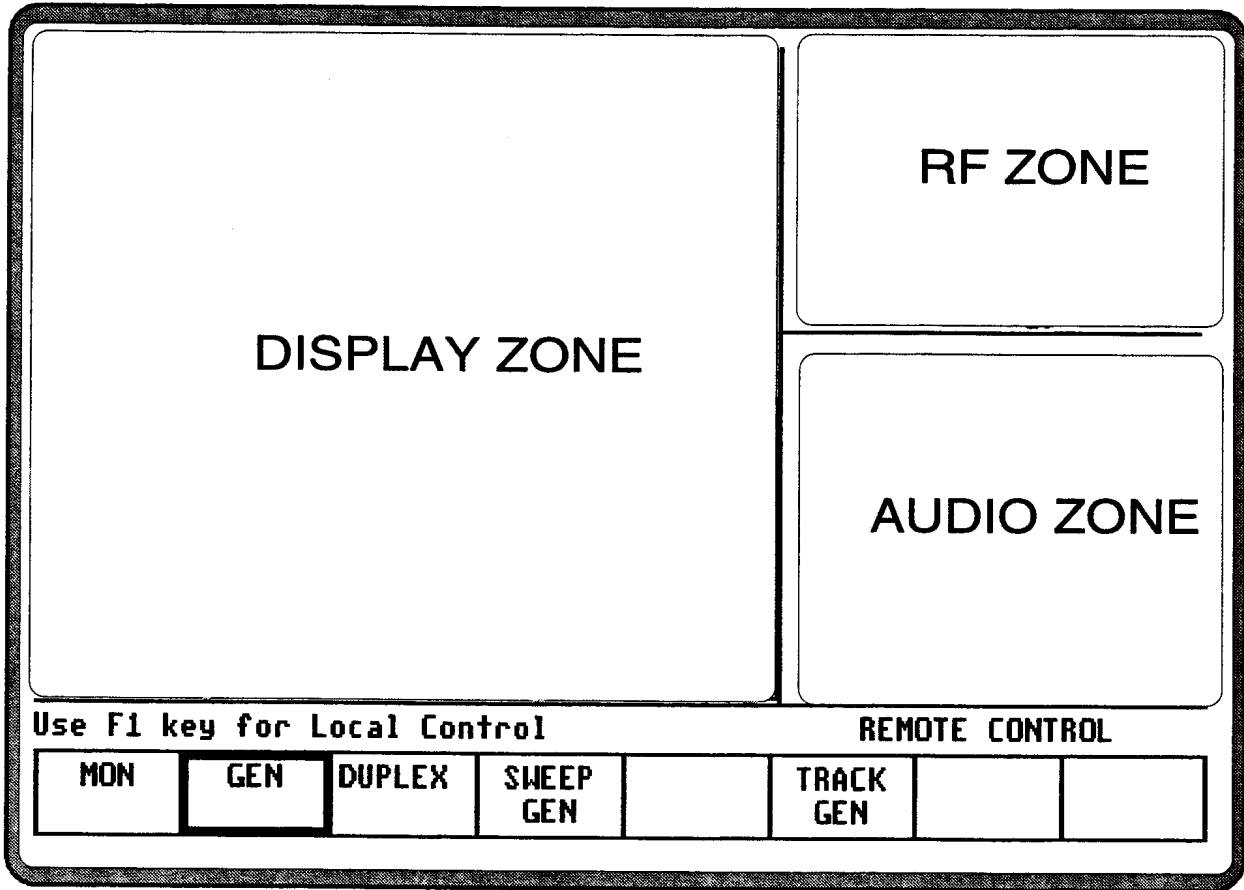

Figure 3-1. Screen Zone Arrangement

To control the cursor location and input information by:

- Use the CURSOR ZONE keys to move the cursor among the three zones.
- Use the CURSOR POSITION keys to move the cursor from field to field within a zone.
- Once at the desired field, use either the TUNING knob or the numeric keys to enter numeric information. Use the soft keys for other menu selections.

### 3-2.2 Expanded Display

Some fields have the ability to expand their contents and overwrite other display areas. These consist of the following:

- Spectrum analyzer, scope waveforms, bargraph displays
- Decode tables
- Encode tables
- Dedicated keys

#### 3-2.2.1 Spectrum Analyzer, Scope Waveforms or Bargraph Display

By pressing the expand softkey within these displays, the entire screen (with the exception of the message line and softkey area) is overwritten and replaced by an enlarged version of the display section to enable a more detailed analysis of displayed data. A return softkey causes the screen to be restored to its original size.

#### 3-2.2.2 Display Tables

Decode Tables are selected from the "Meter:" field. Selection of General Sequence, 5/6 Tone, or Select V decode modes causes the system to overwrite the meter and display zones with the display tables.

#### NOTE

*To escape from a decode display table, return the cursor to the "Meter:" field and make an alternate selection.*

Encode Tables are selected from the "Audio Mod Sum:/Mod Sum:" field. Selection of General Sequence or A/B Sequence encode modes and pressing the display table softkey causes the system to overwrite the meter and display zones with the display tables. Use the return softkey to exit to previous screen.

#### 3-2.2.3 Dedicated Keys

Refer to the Other Functions portion of this manual (paragraph 3-8) for an explanation of expanded screens in the HELP, MEM, SPF, and CAL modes.

### 3-3 HELP

The analyzer provides on-screen operating instructions via the dedicated HELP key. Help screens are organized such that each display area has an associated help screen pertaining to that area of the screen. System help (figure 3-2) is available via a softkey within each help screen. Use the return softkey to return to the function in progress.

### System Help

1. Operation of this unit is done primarily through the use of softkeys located immediately below the display screen. These keys along with the CURSOR POSITION keys located to the right of the screen provide for the entry of test requirements and the selection of data to be displayed.
2. Each highlighted cursor location has its own unique menu of selections displayed in boxes immediately above the softkeys. Simply push the key below the box to make the selection.
3. Three main windows or cursor zones are used for RF and Audio control on the right and data display on the left. The CURSOR ZONE keys provide for easy movement between these zones. Once in the zone of interest the cursor can be moved between the highlighted entry location by using the five CURSOR POSITION keys.

Page 1 of 3

Use F1 key for Local Control

REMOTE CONTROL

first page	prev page	next page				return	
---------------	--------------	--------------	--	--	--	--------	--

Figure 3-2. System Help

### 3-4 WARNINGS

The system provides warnings for the following operating conditions, which are considered detrimental to the proper functioning of the analyzer:

- RF Overload  
(Input level to monitor too great for accurate measurement)
- Recalibrate  
(Indicates that the unit's internal temperature has changed more than 10° C from where it was last self-calibrated. This may affect the accuracy of the generator output level, monitor input level below +20 dBm, and modulation level. Refer to paragraph 3-8.3 for further information.)
- RF Overtemperature  
(Excessive power to RF load)
- Optional Battery Pack Voltage Low

If any of these conditions exist:

- A warning will be displayed on the warning line of the CRT for RF overload, recalibrate, and low battery voltage.
- A continuous audible warning tone along with an overwrite of the screen with a warning message will be presented for RF overtemperature (figure 3-3). This condition may occur when the intermittent power rating of the 125 watt internal load is exceeded. Both the display and the warning tone remain on and all operator input is ignored until the condition is corrected. The Analyzer then resumes normal operation.

#### CAUTION

*Remove RF power immediately to correct the RF overtemperature condition. Otherwise damage to the unit may occur.*

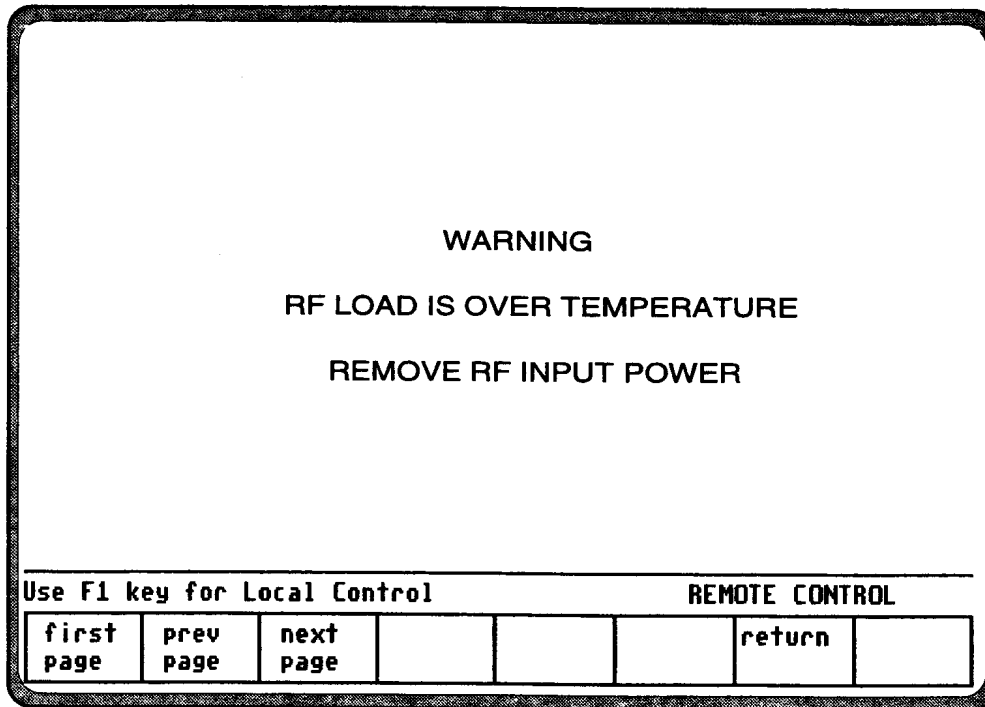

Figure 3-3. RF Overtemperature Warning Message

### 3-5 PRIMARY OPERATING MODES

Select the operating mode by placing the cursor in the "RF Control:" field in the RF zone. Use the desired softkey to make selection. Primary operating modes are:

- MONITOR
- GENERATE
- DUPLEX
- SWEEP GENERATE

#### 3-5.1 MONITOR Mode

The Monitor mode (figure 3-4) provides the analyzer's test receiver function which is used in the testing of radio transmitters. It is capable of monitoring RF input through its antenna or a direct connection to the transmitter to accurately determine the frequency, power level, and modulation characteristics. It monitors signals from 400 kHz to 999.9999 MHz. Center frequency is set in 100 Hz increments. Specific controls which further configure the MONITOR

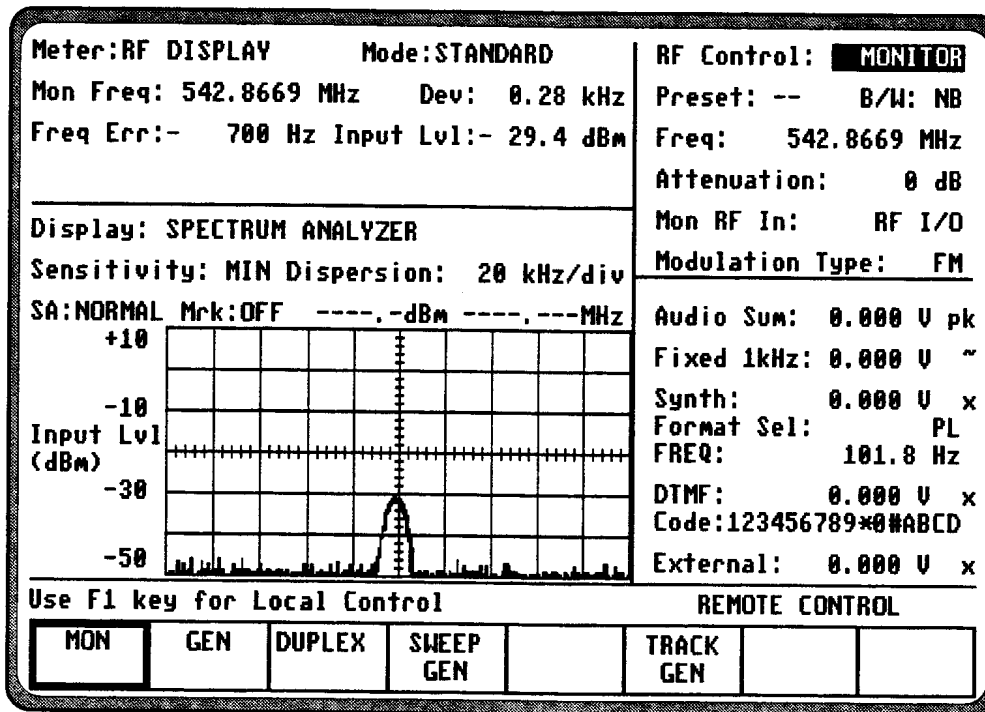

Figure 3-4. Monitor Mode

mode are located within the RF zone when MONITOR is first selected. The specific entry fields are as follows.

#### **Preset**

The preset entry field provides a convenient way to enter a bandwidth, frequency, modulation type, and code synthesizer format for the unit by recalling preset data from non-volatile memory. If a preset is not to be used, enter the desired information at each of the fields.

#### **NOTE**

*If a preset has been selected and changes are made to any of the preset values, the "Preset:" field will have dashes through it, indicating the preset is no longer selected.*

#### **B/W**

Selects either wide or narrow IF bandwidth of the unit via softkey selection.

#### **Freq**

Enter the desired monitor frequency using keypad or tuning knob.

#### **Attenuation**

Selects the amount of attenuation at the RF input to the monitor receiver using softkeys. Selectable input attenuation is useful in adjusting displays for a wide range of input levels, as well as for use in high RF field environments where intermodulation may cause desensitization of the receiver.

#### **Mon RF In**

Selects the RF input port via softkeys. The RF I/O port contains an RF load and should be used for direct connection to the radio under test. The ANT port accesses the unit's sensitive receiver and should be used with an antenna for "off-the-air" reception. Selection of the ANT port is indicated by a red LED adjacent to the ANT connector.

#### **CAUTION**

*Do not apply input power to the ANT input port. In the event RF power is inadvertently applied, the port is protected by an in-line RF fuse. This fuse may be accessed by unscrewing the front of the BNC connector out of the front panel. Refer to paragraph 2-2.4.1 for additional detail.*

#### **Modulation Type**

Selects the type of modulation via softkeys. AM and FM are standard selections. Phase modulation (option) is selected by pressing the softkey labeled PM, and provides the capability to generate and monitor PM signals.

#### **3-5.1.1 Phase Modulation**

Phase Modulation provides the capability to generate and monitor PM signals. This is an additional softkey selection in the RF Control zone for the modulation type (figure 3-5).

In Generate mode, narrow-band operation provides user control of the audio signal deviation from 0.50 to 2.00 radians in 0.01 radian steps. In wideband operation, the audio signal deviation ranges from 2.0 to 10.0 radians in 0.2 radian steps. Tones generated from the Audio zone are limited in frequency from 300 Hz to 3000 Hz for phase modulation

#### **NOTE**

*Phase Modulation is a hardware option that is installed at the factory. To determine if Phase Modulation is available in the Analyzer, examine the Standard Options display screen (accessed via SPF/Version)*

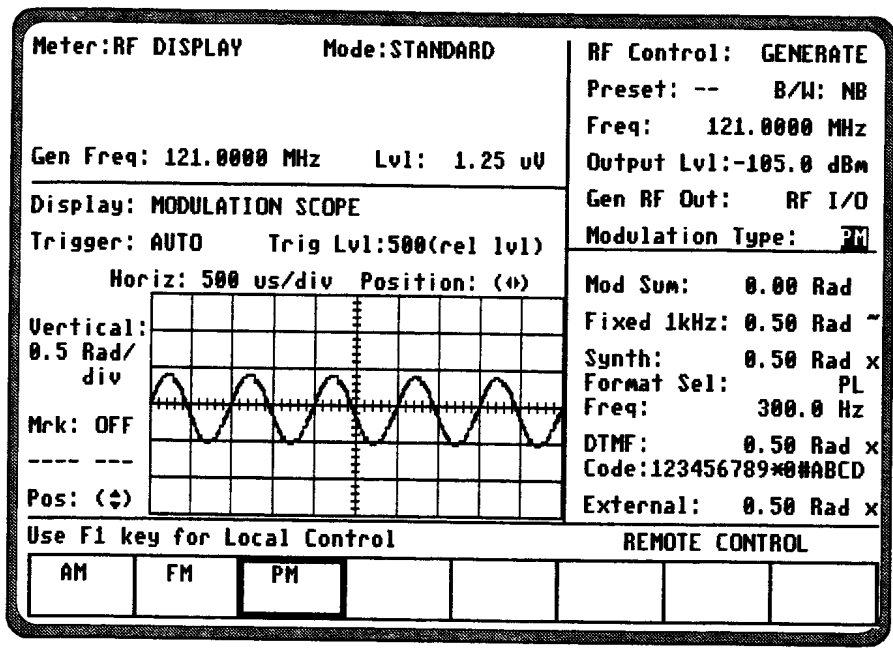

Figure 3-5. Phase Modulation

### 3-5.2 GENERATE Mode

The GENERATE mode (figure 3-6) configures the Analyzer to generate an RF signal at a controllable output level to provide for a wide range of receiver testing. Multiple internal and

external modulation signals can be simultaneously impressed on the carrier frequency to generate composite signals for servicing. Signals from 400 kHz to 999.9999 MHz may be generated. Center frequency is set in 100 Hz increments.

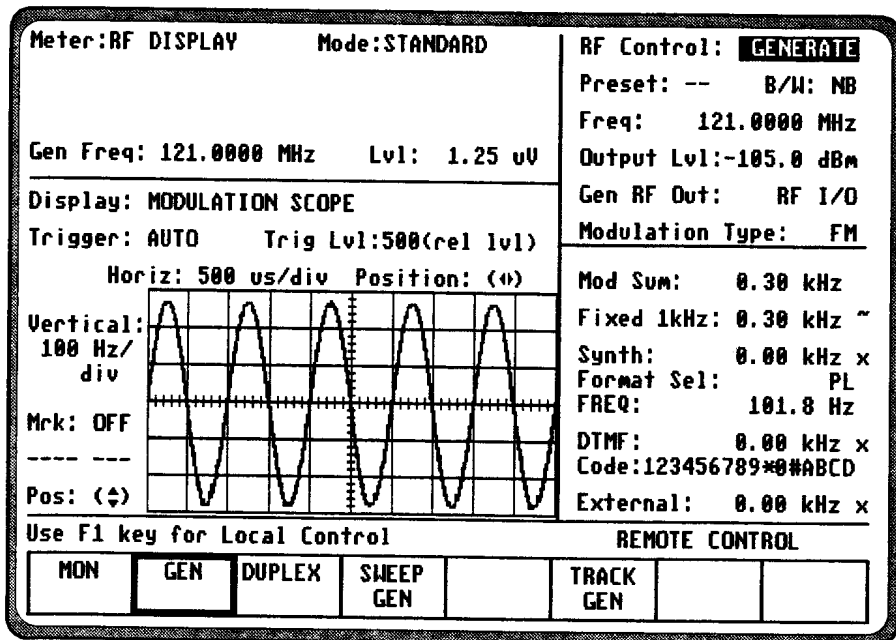

Figure 3-6. Generate Mode



Specific controls which further configure the GENERATE mode are located within the RF Control zone when GENERATE is first selected.

The specific entry fields are as follows:

**Preset**

The preset function is the same as in the MONITOR mode.

**B/W**

Selects either wide or narrow bandwidth of the unit via softkey selection.

**Freq**

Enter the desired generate RF frequency using keypad or tuning knob.

**Output Lvl**

Selects generator output level in 0.1 dBm steps over the range of -130 dBm to 0 dBm. An alternate display of generate level in microvolts is available in the "Meter:" area of the display zone. Output level is available in two ranges depending upon which output port is selected:

- The range of -80 dBm to 0 dBm is available when the high level GEN output port is selected.
- The range of -130 dBm to -50 dBm is available when the RF I/O output port is selected.

**NOTE**

*If AM modulation is selected, the maximum output at the GEN port is reduced to -6 dBm; the maximum output at the RF I/O port is reduced to -56 dBm.*

**Gen RF Out**

Selects the RF output port via softkeys. The RF I/O port is recommended for most applications where GEN and MON ports are combined for a single connection to the radio under test. The GEN port is recommended

where higher levels are needed. Selection of the GEN port is indicated by a red LED adjacent to the GEN OUT connector.

**CAUTION**

*Do not apply input power to the GEN output port. In the event RF power is inadvertently applied, the port is protected by an in-line RF fuse. This fuse may be accessed by unscrewing the front of the BNC connector out of the front panel.*

**Modulation Type**

Selects the type of modulation via softkeys.

### 3-5.3 DUPLEX Mode

The DUPLEX Mode (figure 3-7) provides a simultaneous RF generator output that is offset in frequency from the monitor center frequency and fully adjustable in output level.

This capability provides for servicing full duplex radio equipment as well as repeaters and radios operating with offset transmit and receive frequencies.

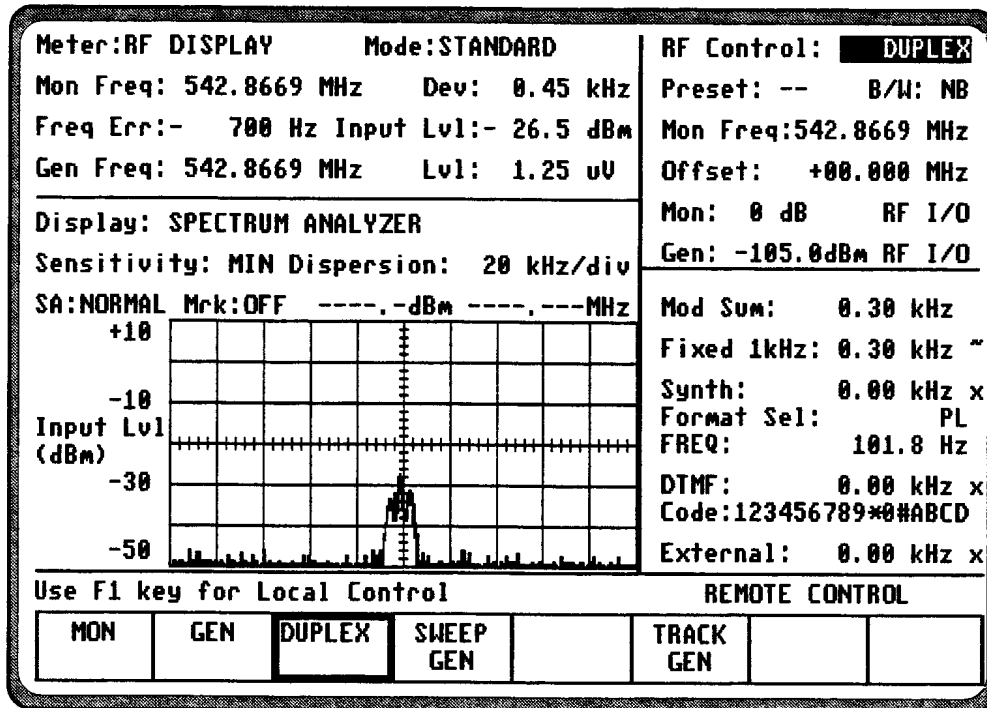

Figure 3-7. Duplex Mode

Specific controls which further configure the DUPLEX mode are located within the RF Control zone when DUPLEX is first selected.

The specific entry fields are as follows:

**Preset**

The preset function is the same as in the MONITOR mode.

**B/W**

Selects either wide or narrow bandwidth of the unit via softkey selection.

**Mon Freq**

Enter the desired monitor frequency using keypad or tuning knob.

**Offset**

Enter the generator frequency offset relative to the monitor frequency entered. Offset frequencies of + or -0 to 55 MHz are allowed. The offset frequency is set in 5 kHz steps.

**Mon**

This field actually contains two separate fields, one for monitor input attenuation and one for monitor port selection. Refer to the MONITOR description for further details.

**Gen**

This field actually contains two separate fields, one for generate output level and one for generate output port selection. Refer to the GENERATE description for further details.

**NOTE**

*Only FM modulation is provided for the duplex generator. Either FM or AM demodulation may be selected. Selection must be done in MONITOR Mode within the RF control zone. The RF I/O port combines monitor and generate signals for the duplex function. However, either the ANT or GEN ports may be independently selected.*

### 3-5.4 SWEEP GENERATE Mode

The SWEEP GENERATE Mode (figure 3-8) provides a sweep generator function with variable level, rate, and bandwidth. A sweep generator is invaluable when measuring and troubleshooting many types of RF filters and frequency variable networks such as IF filters, RF preselectors, duplexers and cavity resonators.

To sweep test connect the GEN output port to the input of the network under test.

To facilitate display of swept responses of networks under test, the units built-in scope

display can be accessed by selecting SWEEP GENERATE within the "Display:" field. A suitable RF detector probe should be used to connect from the output of the circuit under test to the VERT/SINAD/DIST input port (see ordering instructions provided in the front portion of this manual for recommended accessory RF detectors). The scope's horizontal sweep tracks the sweep of the RF Generator, thus allowing a frequency domain analysis of filterfilters, RF front ends, duplexers, etc..

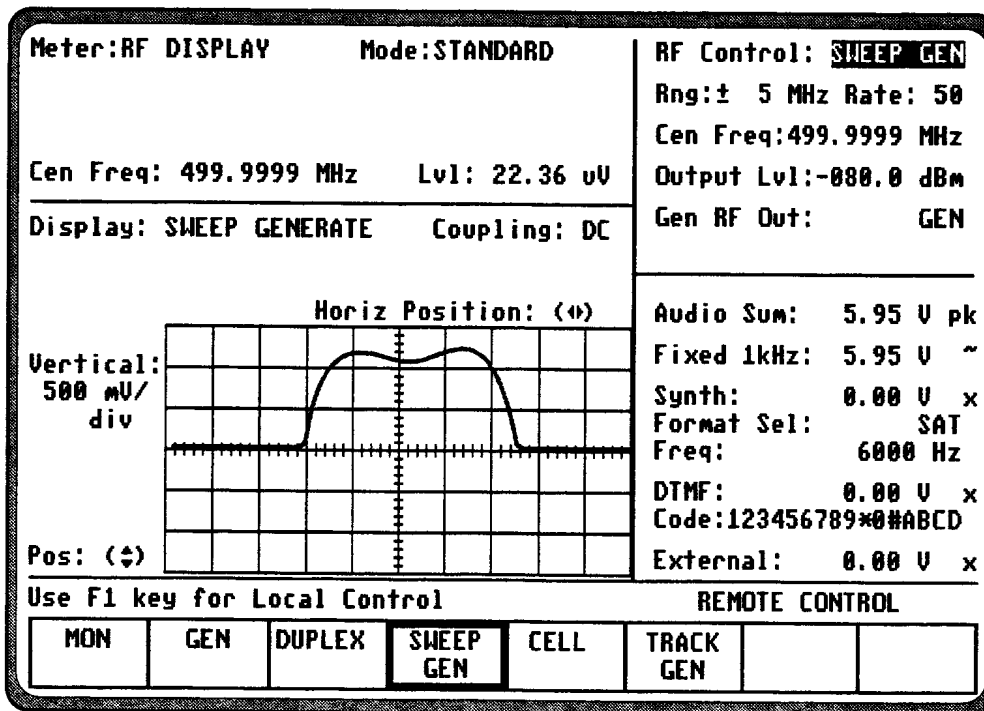

Figure 3-8. Sweep Generator Mode

Specific controls which further configure the SWEEP GENERATE mode are located within the RF Control zone when SWEEP GENERATE is first selected. The specific entry fields are as follows:

***Rng***

Selects the RF frequency range over which the generator will sweep. Specific ranges are selectable via softkeys.

***Rate***

Selects the sweep rate for the generator and corresponding scope display. Sweep rate is selectable using softkeys.

***Cen Freq***

Refer to the GENERATE mode, "Freq:" field.

***Output Lvl***

Refer to the GENERATE mode.

***Gen RF Out***

Refer to the GENERATE Mode.

### 3-5.5 TRACKING GENERATOR Mode (if equipped)

The TRACK GENERATOR mode (figure 3-9) sets up the units signal generator in a sweeping mode for use with the optional Tracking Generator display. This provides a valuable capability for measuring and servicing a wide variety of RF filtering and combining networks.

To operate the Tracking Generator simply select TRACK GEN via softkey in the "RF Control:" field in the RF Control zone. Connect the GEN OUT port to the input of the network under test.

Connect the output of the network under test to the ANT port. Be sure to activate the ANT port

thru the "Mon:" field in the RF Control zone. If input attenuation is needed as part of the measurement procedure, 20 or 40 dB attenuation may similarly be selected thru the "Mon:" field in the RF Control zone.

The Tracker display is selected thru softkeys at the "Display:" field of the DISP zone at the left center of the screen. The display is a 10 dB/div scale. By adjusting the generator level and selecting 20 or 40 dB of input attenuation, the usable measurement range is approximately 100 dB at frequencies below 500 MHz and 80 dB above 500 MHz.

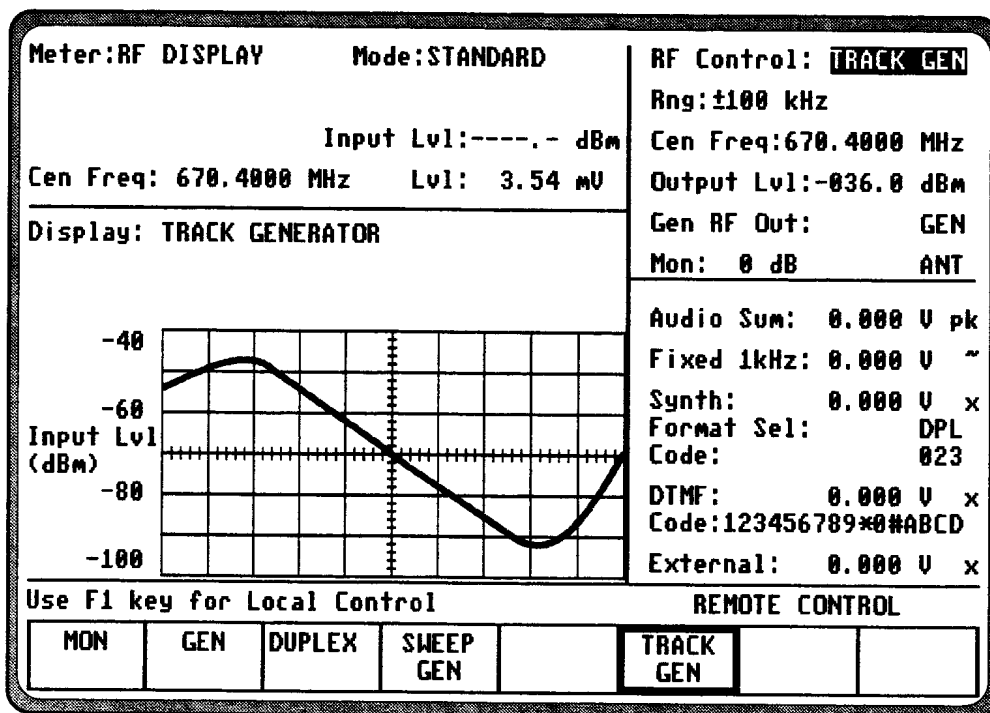

Figure 3-9. Tracking Generator Mode

All adjustments of center frequency, frequency range and generator level are made thru the RF zone at the upper right of the screen. The TUNING control is especially useful in tuning center frequency and generator level. These may all be adjusted as follows, thru softkeys or numeric entry, for the desired display, depending on the type of network being tested.

***Rng***

Selects the RF frequency range over which the generator will sweep. These are expressed in  $\pm$  full screen deflection ranges that are selectable via softkeys. The sweep rate of the tracking generator is fixed at approximately 50 ms/sweep.

***Cen Freq***

Selects the center frequency of the Tracking Generator display. See the GENERATE mode for more detail on frequency entry.

***Output Lvl***

Refer to GENERATE mode.

***Gen RF Out***

Refer to GENERATE mode.

### 3-6 AUDIO/MODULATION SYNTHESIZER

The Audio zone located at the lower right of the screen is used to control the multi-purpose audio synthesizer section of the unit. Signals generated by the audio synthesizer are coupled internally to the generator modulation input as well as to the MOD OUT front panel connector.

In the GENERATE and DUPLEX modes, levels entered in the Audio zone are shown as modulation (either deviation or % AM). The composite sum of modulation, only for those modulation sources enabled, is displayed at the top of the zone at the "Mod Sum:" location.

In the MONITOR and SWEEP GENERATE modes, levels entered in the Audio zone are shown as peak voltage values. The composite sum of the voltage value (only for those modulation sources enabled) is displayed at the top of the zone at the "Audio Sum:" location.

Each of the following modulation signals has a cursor field for entering its desired level. Use the keypad or TUNING knob to enter the desired level.

An additional cursor field, adjacent to each level entry, is used to enable or switch each selection on and off using softkeys. This field is located at the extreme right side of the zone. There are three possible conditions for this softkey selection.

- CONT activates continuous ON condition, or continuous cycling if a sequence has been selected. A ~ symbol is indicated at the extreme right, adjacent to the level to indicate continuous ON.
- OFF switches off the modulation source. Off is indicated by an "X" at the extreme right, adjacent to the level.

- BURST provides a single timed sequence of modulation only for DTMF, TONE A, TONE B, 5/6 TONE, A/B SEQUENCE, GENERAL SEQUENCE, and TONE REMOTE. A single burst sequence is shown by the "\*" symbol.

For DPL, select the START DISC TN (\*) softkey to produce a continuous disconnect tone. (Select CONT then "\*" softkeys to simulate a complete DPL transmission with disconnect tone.)

The composite sum at the top of the zone will not indicate the burst condition. To set the composite level to include bursts of signaling, temporarily select CONT for those modulation sources which will be "burst" enabled.

#### 3-6.1 Fixed 1 kHz

The analyzer has a fixed 1 kHz modulation source, which can be selected independently from the other audio synthesizers. Level control and on-off selection is described above.

#### 3-6.2 Synth

Level control and on-off selection are selectable via softkey selection. The synthesizer function encodes a broad selection of signaling formats, which are softkey selected through the "Format Sel:" field adjacent to "Syth:" level field. Use of the more softkey accesses three different menu levels for the following signaling formats.

##### *PL*

This softkey selects Motorola Private-Line tone coded squelch signaling. This selection produces two additional fields on the line below the "Format Sel:" field (figure 3-10). The first allows for softkey selection of either frequency or code entry. The second is the value corresponding to the frequency or code. Valid PL codes are found in Appendix B. All frequency entries are accepted, but only valid codes can be entered.



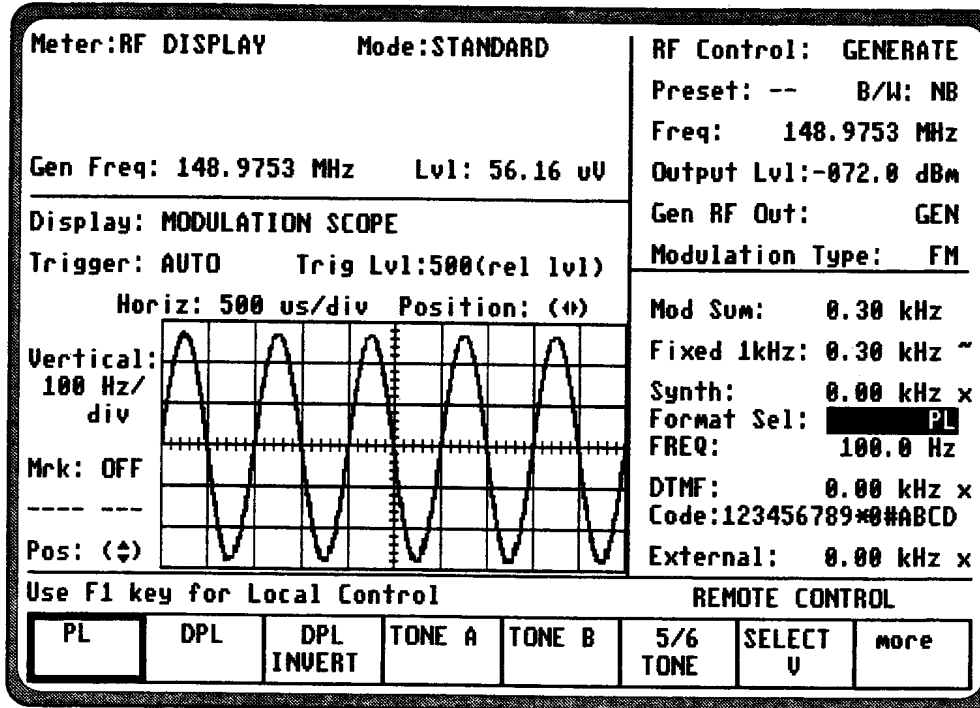

Figure 3-10. PL Format Selection

#### ***DPL/DPL INVERT***

This softkey selects standard or inverted Motorola Digital Private-Line coded squelch. A single cursor field is located below the "Format Sel:" field for entry of code. Only valid DPL codes should be entered per Appendix B.

#### ***TONE A/TONE B***

This softkey selects either of two continuous audio tones. Tone frequencies may be entered either from the "Freq:" field or from the A/B Sequence tables.

#### ***5/6 TONE***

This softkey selects 5/6 tone sequences for high-capacity tone paging systems. Only code entry is required in the "Code:" field.

#### ***SELECT V***

This softkey selects a number of international formats for five-tone sequential signaling. This selection produces two additional fields on the "Code:" line below the "Format Sel:" field. The first allows a choice of format, selectable by softkeys. The second selects the numeric code entered by keypad or softkeys.

#### ***A/B SEQ***

Selects the two-tone sequential paging format, with a choice of four timing sequences selectable through the "Sequence:" field on the line below. An expanded display table can be selected from softkeys to allow entry of A and B frequencies, select a sequence number, and view the tone and delay timing for each sequence. Sequences 1 and 2 are fixed timing for standard "tone" and "tone/voice" pagers,

while sequences 3 and 4 may be customized through numeric entries by the user.

### ***GENERAL SEQ***

Selects a free-form 20-tone sequence encoding which has full flexibility to enter unique frequency and time duration for each of the 20 tone slots. The single field below the "Format Sel:" field is used to enter the frequency code sequence. An expandable display table is selectable by softkey to allow entry of frequency and time duration data (figure 3-11). Frequencies and durations are tabulated corresponding to a given "code number" (i.e. 1], 2], 3], etc.).

Frequency and times are each selected independently. This is done through entry of independent "Code Sequence:" and "Dur Sequence:" (for example, Code 1] may be selected along with Dur 8] for the first tone slot in the sequence).

### **TONE REMOTE**

Selects the specialized tone sequence used in control of tone remote equipment. The frequencies used are the same as those for the A/B sequence with timing predetermined per Motorola Tone Remote specifications. Changes to the A and B frequencies can be made from the A/B Sequence table or directly from the Tone A and Tone B "Freq:" fields.

Meter: RF DISPLAY		Mode: STANDARD		RF Control: GENERATE	
Gen Freq: 148.9753 MHz		Lvl: 56.16 uV		Preset: -- B/W: NB	
Display: MODULATION SCOPE		Trigger: AUTO Trig Lvl: 500(rel lvl)		Freq: 148.9753 MHz	
Vertical: 100 Hz/div		Horiz: 500 us/div Position: (←)		Output Lvl: -072.0 dBm	
Mrk: OFF		Pos: (↕)		Gen RF Out: GEN	
Use F1 key for Local Control		REMOTE CONTROL		Mod Sum: 0.30 kHz	
A/B SEQ		GENERAL SEQ		Fixed 1kHz: 0.30 kHz ~	
				Synth: 0.00 kHz x	
				Format Sel: <b>GEN L SEQ</b>	
				0123456789ABCDEFGHIJ	
				DTMF: 0.00 kHz x	
				Code: 123456789*0#ABCD	
				External: 0.00 kHz x	
				display table	
				more	

Synthesizer Encode Format Sel GEN SEQ

Code Sequence: 123456789ABCDEFGHIJ  
(Same code as in Audio Control)

Dur Sequence: 0123456789ABCDEFGHIJ  
(Changeable only in Display Table)

	Freq (Hz)	Dur (sec)	Freq (Hz)	Dur (sec)	
0J	19000.0	1.000	AJ	09000.0	0.090
1J	18000.0	0.900	BJ	08000.0	0.080
2J	17000.0	0.800	CJ	07000.0	0.070
3J	16000.0	0.700	DJ	06000.0	0.060
4J	15000.0	0.600	EJ	05000.0	0.050
5J	14000.0	0.500	FJ	04000.0	0.040
6J	13000.0	0.400	GJ	03000.0	0.030
7J	12000.0	0.300	HJ	02000.0	0.020
8J	11000.0	0.200	IJ	01000.0	0.010
9J	10000.0	0.100	JJ	00000.0	0.000

Use F1 key for Local Control

REMOTE CONTROL

A	B	C	D	E	clear to end	return	more
---	---	---	---	---	--------------	--------	------

Figure 3-11. General Sequence Mode Select

### 3-6.3 DTMF

Provides a means for encoding DTMF (Dual-Tone Multi-Frequency) signaling for testing telephone interface systems. Enter level as described above and enter "Code:" in the field immediately below the "DTMF:" field.

### 3-6.4 External

Used to set the level and enable externally applied signals from both the MIC and the EXT MOD IN front panel connectors.

#### NOTE

*In the case of external signals applied to the EXT MOD connector, the accuracy of this level displayed is dependent on applying a fixed signal level of 1 V<sub>pk</sub> (2 V<sub>pkpk</sub>) to the EXT MOD IN connector.*

### 3-7 METER AND DISPLAY

The display of metered data is presented both digitally and graphically within the Display zone in the left portion of the screen (figure 3-

12). This zone is divided into two separate display areas: Meter area and Display area.

### 3-7.1 Meter

Select a measurement display from the following, using softkeys from the "Meter:" cursor field.

#### 3-7.1.1 RF Display

This area displays the RF test data for the radio under test, subject to the mode selected (MONITOR, GENERATE, DUPLEX, TRACK GENERATE, or SWEEP GENERATE).

When the GENERATE mode is selected, the RF Display area shows generator center frequency as well as generate level per the RF Control zone entry. A single cursor field at this location allows selection by softkey of either millivolts/microvolts (mV/uV), dBu, or dBm units of display.

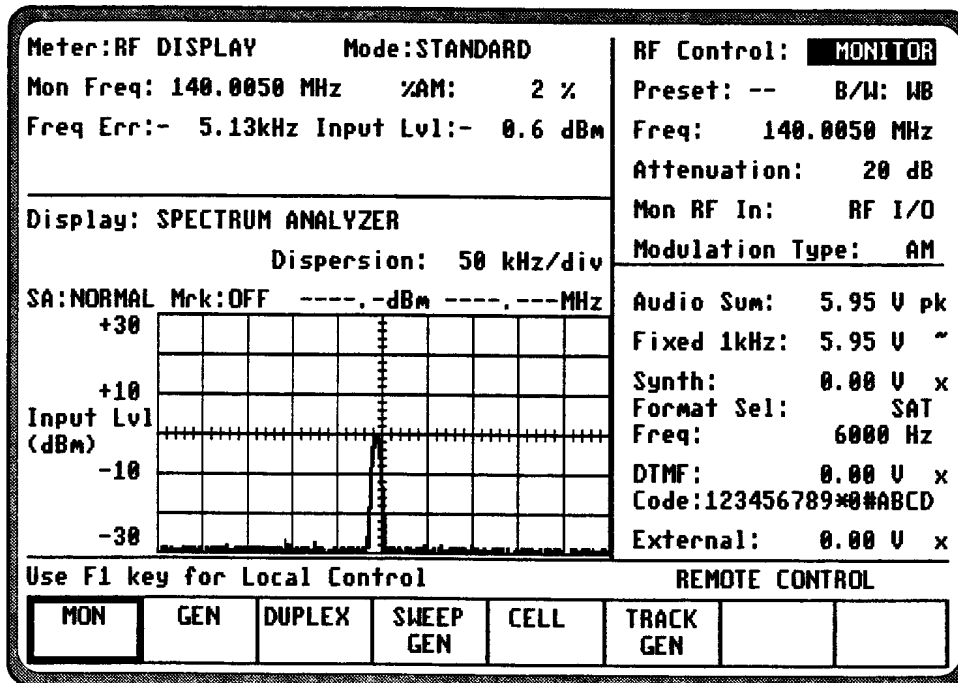

Figure 3-12. RF Display Zone

When DUPLEX mode is selected, the RF Display area reflects a combination of the monitor and generator data, as described above.

When SWEEP GENERATE mode is selected, the RF Display area reflects the same data as in GENERATE mode. Refer to the above discussion.

In the MONITOR Mode, the following data is displayed in the RF Display area.

**Mon Freq**

Center frequency of the radio under test as entered in the RF Control zone.

**Freq Err**

This area displays the plus or minus frequency offset (error) of the received carrier relative to the center frequency entered above. If the receive phase modulation option is installed and selected in the RF Control zone, this location will display in radians.

**Dev/%AM**

Indicates the modulation level of the received carrier, dependent upon the modulation type selected in the RF Control zone. If the receive phase modulation option is installed and selected in the RF Control zone, this location will display in radians.

**Input Lvl**

Displays the signal level received at the selected front panel connector. This area displays transmitter power for high levels of input as well as lower levels of field strength.

Data is displayed only for "on channel" carrier frequencies. A single cursor field at this location allows selection by softkey of either microvolts/watt or dBm units of display.

**3-7.1.2 RF Scan**

The "Meter:" RF SCAN display (figure 3-13) provides an alternate form of monitor frequency display from the main RF display.

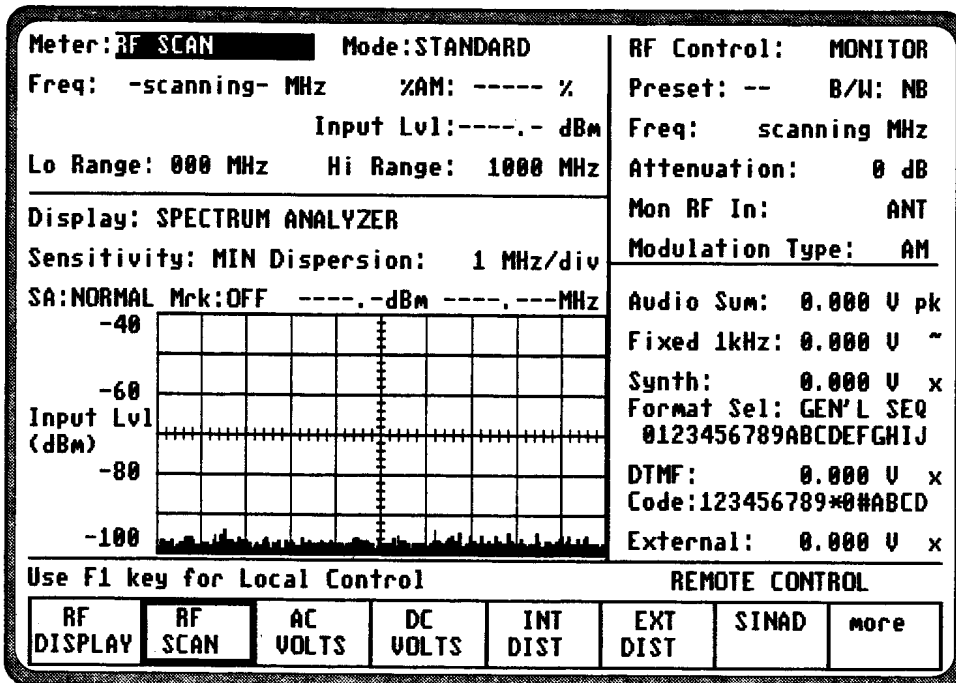

Figure 3-13. RF Control Zone; Scan Mode

It provides an RF frequency counter function where the monitor scans over a selected frequency range and locks on to the carrier that is applied to its input. The direct frequency is then displayed, eliminating the need to first enter the carrier frequency and read its error. The acquired signal is measured to a frequency resolution of 1 Hz.

The RF signal input, either from the ANT or from the RF I/O port, may be displayed. The analyzer scans a specified frequency range to automatically acquire and tune to an input signal from 20 MHz to 999.9999 MHz.

Tuning typically occurs within 5 seconds. For faster acquisition, limit the scan range to 100 MHz increments. This is done by setting the High and Low range limits to narrow the scan range. Move the cursor to the desired Hi or Lo range field in the Meter portion of the screen. Select the range desired either by using the numeric keypad or the optical TUNING knob.

#### NOTE

*The range of values for the low range setting is from 0 to 9 (x 100 MHz). The range of values for the high range setting can be from 0 to 10 (x 100 MHz), with the 10 implying maximum frequency range, or 999.9999 MHz.*

Minimum input signal level for automatic frequency acquisition is -30 dBm at the antenna port and +20 dBm at the transceiver port. When the input signal is removed, the scanning operation will resume.

When scanning, the "Freq:" field within the RF Control zone indicates **scanning**. When a carrier is acquired, this changes to **metering**. The actual measured frequency is displayed in the Meter zone along with modulation and level data as described above for RF Display.

### 3-7.1.3 AC/DC Voltmeter

The analyzer provides a general purpose AC/DC digital voltmeter (figure 3-14). The voltmeter input is the same front panel BNC port that also serves as the input for the SINAD/DIST meter, the VERT oscilloscope input, and the frequency COUNTER IN.

Move the cursor to the "Range:" field. Select either auto-ranging or a specific voltage range (AUTO, 1V, 10V, or 100V DC) by pressing the applicable softkey. Maximum AC range is 70 VAC. If the optional battery pack is installed, an additional selection is available to read the battery voltage.

#### CAUTION

*The maximum analyzer input voltage is 42.4 volts peak AC or 60 volts DC.*

The data portion of this screen will show a horizontally oriented bar graph for an analog indication along with a digital readout of the measured voltage (up to 4 digits resolution).

In the AC mode, the measured input is also displayed in dBm, referenced to 1mW into 600 ohms.

#### NOTE

*Optional "C" message or CCITT filters, along with a 600 ohm load, are available for selection at the ACVM, SINAD, and Distortion meter inputs. If your unit is equipped with one of these, they are selectable thru the Special Function screen (see section 3-8.5). If one of these is selected an appropriate message will appear on the message line just above the softkey labels. CAUTION: Selection of either filters or load can affect readings within these meter functions.*

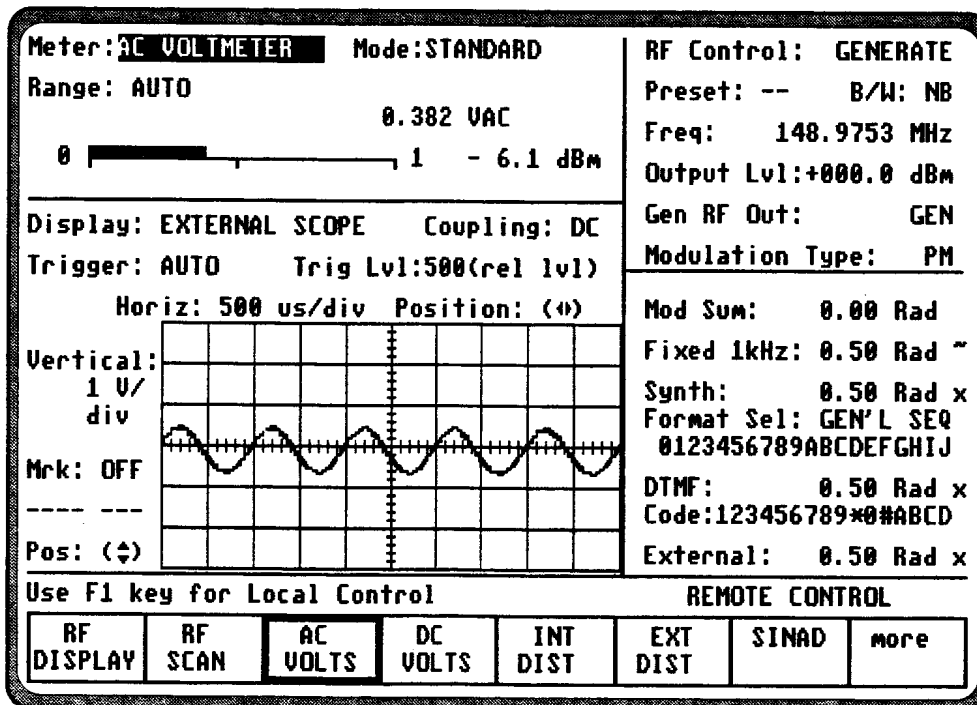
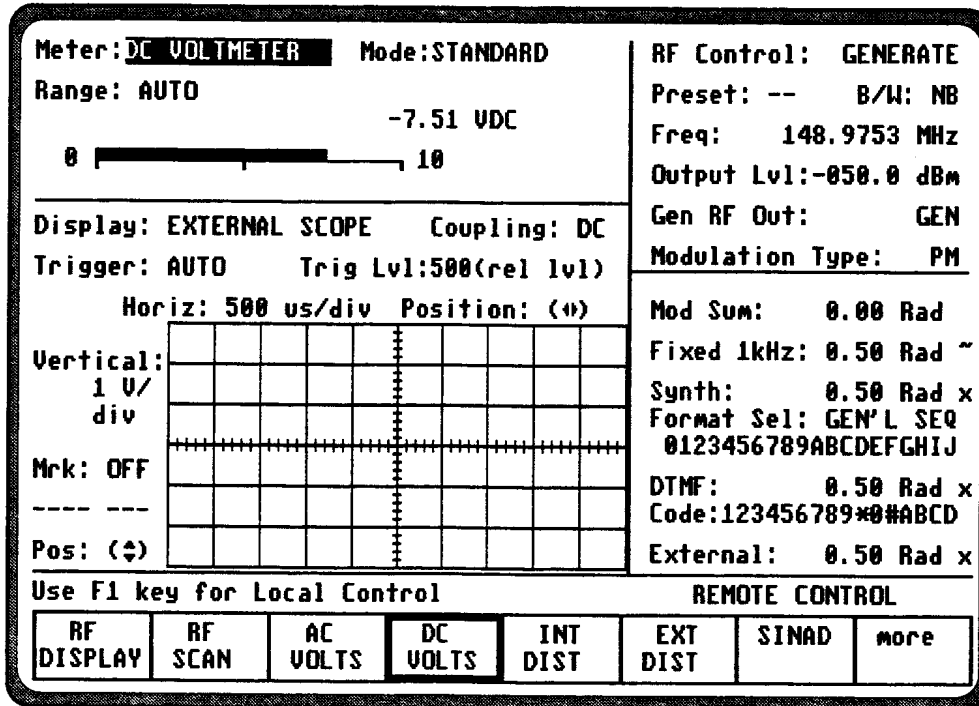

Figure 3-14. Digital Voltmeter Screens

### 3-7.1.4 INT DIST/EXT DIST Meter

The internal and external distortion meter are selectable via softkeys located within the "Meter:" field in the Display zone. Display consists of a digital readout and bar graph. Distortion is used to measure the audio quality of the transmitter and receiver modulation. The distortion meter is selectable via softkey between internal (coupled from the monitor demodulated signal) and external (through the DIST input on the front panel).

The distortion meter operates only at the fixed frequency of 1 KHz.

### 3-7.1.5 SINAD Meter

The SINAD meter is selected within the "Meter:" field in the Display zone. Display consists of a digital readout and bar graph. SINAD is used in making receiver sensitivity measurements per EIA specifications using a fixed 1 kHz modulation frequency.

Internal coupling for SINAD is not provided; input is always via the external BNC port on the front panel.

#### NOTE

*Optional "C" message or CCITT filters, along with a 600 ohm load, are available for selection at the ACVM, SINAD, and Distortion meter inputs. If your unit is equipped with one of these, they are selectable thru the Special Function screen (see section 3-8.5). If one of these is selected an appropriate message will appear on the message line just above the softkey labels. CAUTION: Selection of either filters or load can affect readings within these meter functions.*

### 3-7.1.6 Counter and Decoding Functions

The following are all accessed via softkey through the "Meter:" field within the Display zone. Their inputs are all normally internally coupled to the monitor demodulated signal for either direct or "off-the-air" testing. If use of these functions is needed for an externally applied signal, the Special Functions screen, under SYSTEM FUNCTIONS, provides a means of switching the input of the Counter/decoder from Internal to External.

These screens contain a "Sensitivity:" field where MIN or MAX may be selected via softkey. This provides a means to desensitize the counter/decoder circuits, if needed to properly measure very high level signals. Under normal operation, this field should be set to MAX.

Cursor fields are provided to access the units low-pass and high-pass baseband filter sections. Filters may be used to remove unwanted voice modulation, etc. which may interfere with decoding the PL signals. Baseband filters apply only to internal coupling.

#### CAUTION

*Entries into the high and low pass areas of this screen write information into the Special Functions screen and memory. To avoid problems with other modulation measurements, make sure settings are set to original values before leaving these screen areas.*

The display exhibits a digital frequency and equivalent PL code if applicable. Refer to Appendix B for valid codes.

#### PL/PER Counter

This softkey provides a convenient means of measuring the frequency of Motorola Private-Line (PL) or any other low frequency audio tones with 3 digit resolution. Period measurement makes it possible to measure low frequencies down to high resolution



without the need for the long gate times associated with frequency counting.

**CAUTION**

*Do not input frequencies above 400 kHz to the period counter. Slow down of system operations will result.*

**DPL DECODE**

This softkey provides decoding for valid Motorola Digital Private-Line (DPL) codes. Refer to Appendix B for applicable codes. Selection of high and low pass filters may be made from this screen as described above.

**DTMF DECODE**

This softkey provides a means of decoding DTMF (Dual Tone Multi Freq) signaling for testing telephone interfaced systems. A "reset" softkey clears the display.

**FREQ CNTR**

This softkey provides a general purpose frequency counter (figure 3-15) for Audio and IF frequency measurements up to 500 kHz. For RF frequency measurements, use the MON function.

The "Resolution:" field provides selection of auto ranging or selectable gate times which provides up to 0.1 Hz resolution (0.1 Hz resolution requires 20 sec gate time). The symbol to the right of the display is an indication of when gating occurs.

**NOTE**

*Selection of any of the General Sequence, 5/6 or Select V decoding functions produces an overwrite display table. To exit this display an alternate selection must be made from the "Meter:" field of the Display zone.*

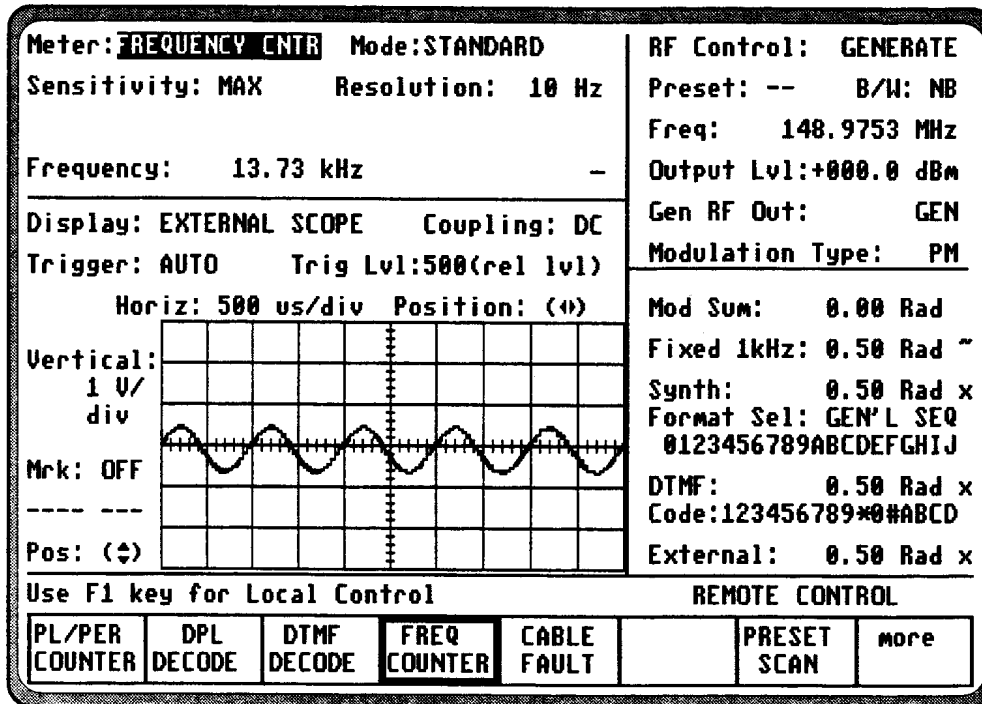

Figure 3-15. Frequency Counter

### 3-7.1.6 CABLE FAULT (if equipped))

This feature provides the capability to test 50 ohm RF cables for damage or mis-terminations through a simple connection to the input of the cable. It employs the analyzer's Sweep Generator capability to sweep the cable under test and observe any standing wave pattern caused by mis-termination. Analysis of this standing wave pattern on the scope display and the marking of two adjacent nulls in this pattern allows the analyzer to compute the distance to a fault or mis-termination. The cable fault feature is accessed by softkey from the "Meter:" field location in the Display zone as shown in figure

3-16. This automatically selects the appropriate displays in the RF Control and Display zone. The main operation of this feature is controlled thru the "Meter:" field, but the "Rng:", "Output Lvl:" and "Vertical:" fields from the other zones must be adjusted for a proper sized screen display depending on the test frequency and type of fault under test. When these have been adjusted, the test is run from the "Cen Freq:" field in the "Meter:" zone. Refer to section 4-3 in the applications section for a more detailed description of running the test.

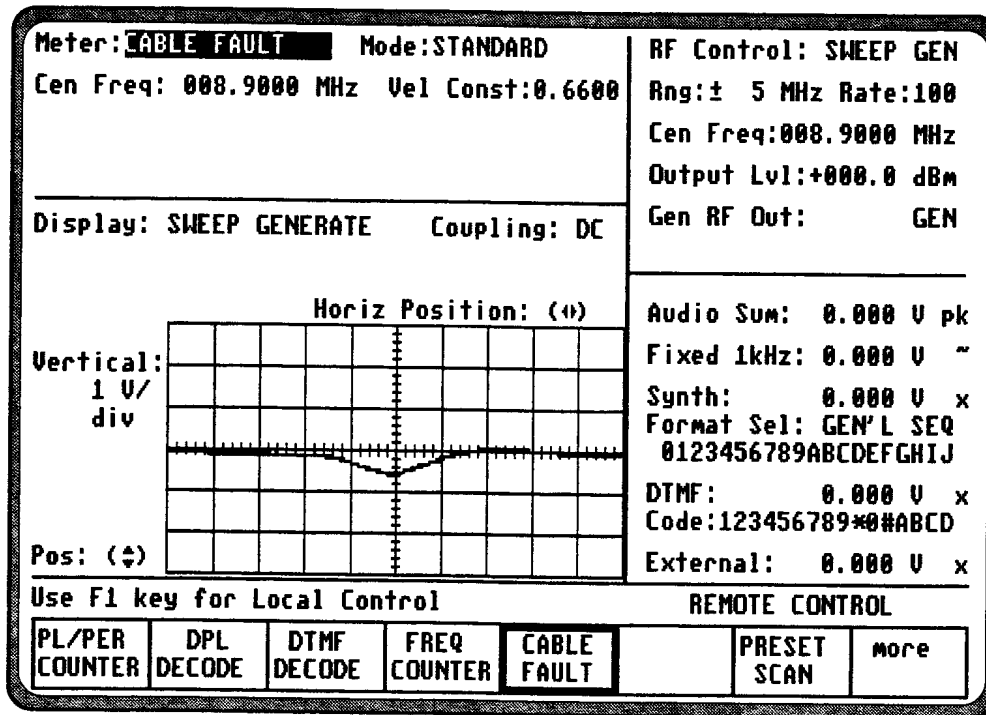

Figure 3-16. Cable Fault Screen

### **3-7.1.7 GENERAL SEQ DECODE**

This softkey provides a free-form decoding function for individual frequency and time duration of tone sequences up to 20 tones. Selection of this mode overwrites the entire display section of the screen and provides a detailed display of data. Start and stop softkeys are used to control the decoding function.

#### **5/6 DECODE**

This softkey provides a decoding function for 5/6 tone high capacity tone paging systems. Selection of this mode overwrites the entire display section of the screen and provides a detailed display of data. Start and stop softkeys are used to control the decoding function.

#### **SEL V DECODE**

This softkey provides a decoding function for a number of standard international Select V sequential tone signalling formats. Selection of this mode overwrites the entire display section of the screen and provides a detailed display of data. A "Sequence Select:" field is provided within formats (ZVEI, ZVEI MOD, ZVEI FRENCH, CCIR STD, CCIR 70ms, EEA) which are selected by softkey. Start and stop softkeys are used to control the decoding function.

#### **HANDSHAK**

Handshake testing is also provided through an additional start HANDSHK softkey. This links the SELECT V encode sequence selected in the Audio zone to the decode screen. Pressing the start HANDSHK key will send a SELECT V tone burst from the decode screen which will then decode the resulting response from the radio.

### 3-7.1.8 Preset Scan (if equipped)

The analyzer provides a preset scan function in which the preset monitor frequencies stored in the RF memory are continually scanned. The analyzer scans through the preset frequencies, stopping and dwelling on a channel whenever the receiver squelch is broken. When the receiver becomes squelched again, scanning resumes. All 30 preset monitor frequencies, or a subset consisting of a continuous block of frequencies, can be scanned. When no signals are detected, the analyzer scans through all 30 preset frequencies in less than 1/2 second. If the number of frequencies is reduced, the scanning process is faster. RF signals to be scanned can be input from either the ANT or RF I/O ports.

To activate the Preset Scan function, press the **PRESET SCAN** softkey (figure 3-17). This key not only begins the preset scanning but also serves as a "continue key" to temporarily skip past a channel with heavy radio traffic. When the analyzer is locked on a preset frequency and you wish to continue scanning, although the signal is preset, press the **PRESET SCAN** softkey again. This continues the scanning with the next preset frequency in the memory table. Pressing the **PRESET SCAN** softkey only skips over the frequency once; if radio traffic is still present on that frequency the next time that it is scanned, the analyzer will stop and dwell once again.

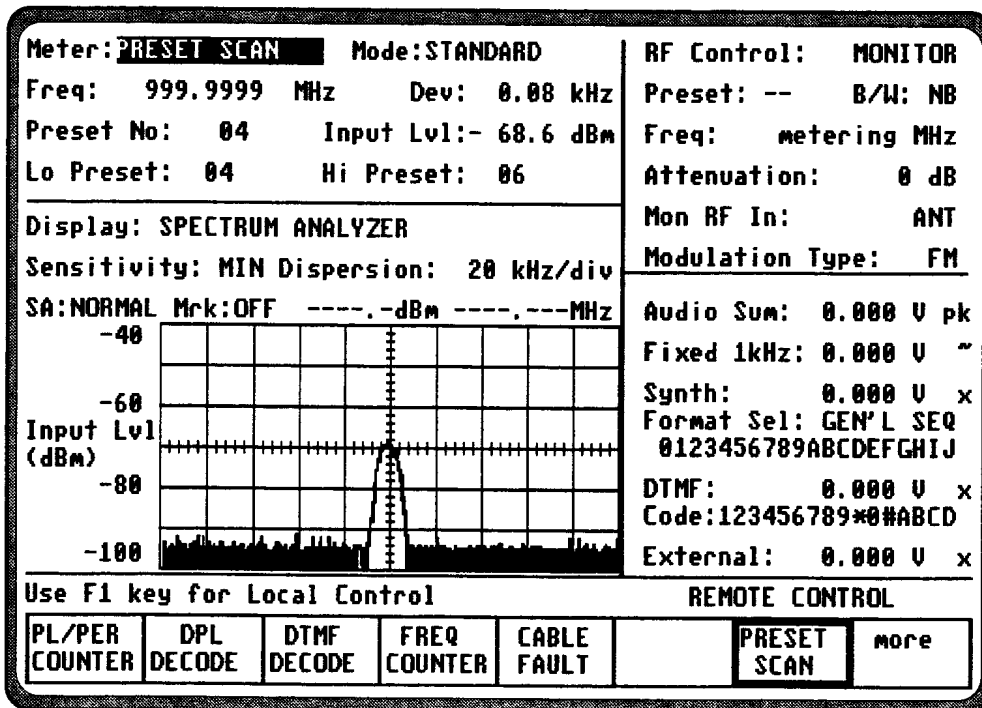

Figure 3-17. Preset Scan

The number of preset frequencies to be scanned can be limited by using the Low Preset and High Preset fields in the meter zone. Entries in these fields will cause the analyzer to only scan from the low preset number to the high preset number. By carefully arranging the preset

frequencies in the RF memory into related groups, you can make maximum use of the Low Preset and High Preset scan limiters. For example, a particularly busy preset frequency which is causing the analyzer to stop scanning and dwell for long periods of time can be

removed from the scan list by moving it within the RF memory table to a location just above or below the preset numbers being scanned.

It is recommended that frequencies in the RF memory table be grouped according to their modulation type and bandwidth because these parameters must be manually changed in the analyzer's RF Control zone. If an AM frequency (e.g. aircraft band) is intermixed with FM frequencies (e.g. public service band) in the scan list and the analyzer is set to FM mode, radio traffic on the AM frequency will cause the scanner to lock, but the received audio will be unintelligible and the modulation measurement meaningless.

Because breaking the receiver squelch causes the analyzer to stop scanning, it is important to properly adjust the squelch control. If the squelch is adjusted too loosely (counterclockwise rotation of the squelch knob), it is possible that desired signals will not be strong enough to break the squelch and the analyzer will not stop and dwell on the channel. To adjust the squelch control for proper scanning operation, turn the squelch control fully counterclockwise and activate the Preset Scan mode. The analyzer will not scan because it will lock on the first frequency due to the squelch being open. Now slowly rotate the squelch control clockwise, just until the squelch light goes out, the noise in the speaker stops and the unit begins to scan. If an actual signal is received while the squelch is being adjusted, wait until it ends before resuming the adjustment. For maximum sensitivity, the squelch level should be adjusted as loose as possible (counterclockwise) without being broken by receiver noise.

To halt the scanning operation at any time, press the **RF DISPLAY** softkey. This stops the scanning process and leaves the analyzer locked onto the last scanned frequency prior to the key press.

#### **NOTE**

*When the unit is in the Preset Scan mode, the response time to key presses will be somewhat slower than normal. For best results, it is recommended that you do not leave Preset Scan active when it is not being used.*

### 3-7.2 Display

Any of the following graphic data displays can be selected for simultaneous display along with the previously discussed meter displays. Select using softkeys from the "Display:" field in the Display zone.

#### 3-7.2.1 Spectrum Analyzer

The Spectrum Analyzer (figure 3-18) is active in the MONITOR or DUPLEX modes. Move the cursor to the "Display:" field within the Display zone.

Select SPECTRUM ANALYZER by pressing the softkey. The input frequency spectrum is displayed in a frequency-versus-amplitude (dBm) graph. Either the ANT or RF I/O port may be selected for input from the "RF Control:" zone. The amount of input attenuation may also be selected within the zone to vary the sensitivity of the Spectrum Analyzer.

If a larger display area is desired, press the expand softkey. (A return softkey is available in the expanded mode allowing return to the normal display).

#### NOTE

*If SPECTRUM ANALYZER is selected while "RF Control:" is in the GENERATE mode, the spectrum analyzer will be disabled and the background will show the message **Spectrum Analyzer Disabled in Generate Mode**. If SPECTRUM ANALYZER is selected while RF CONTROL is in the SCAN mode, the spectrum analyzer will be disabled and the background will show the message **scanning**.*

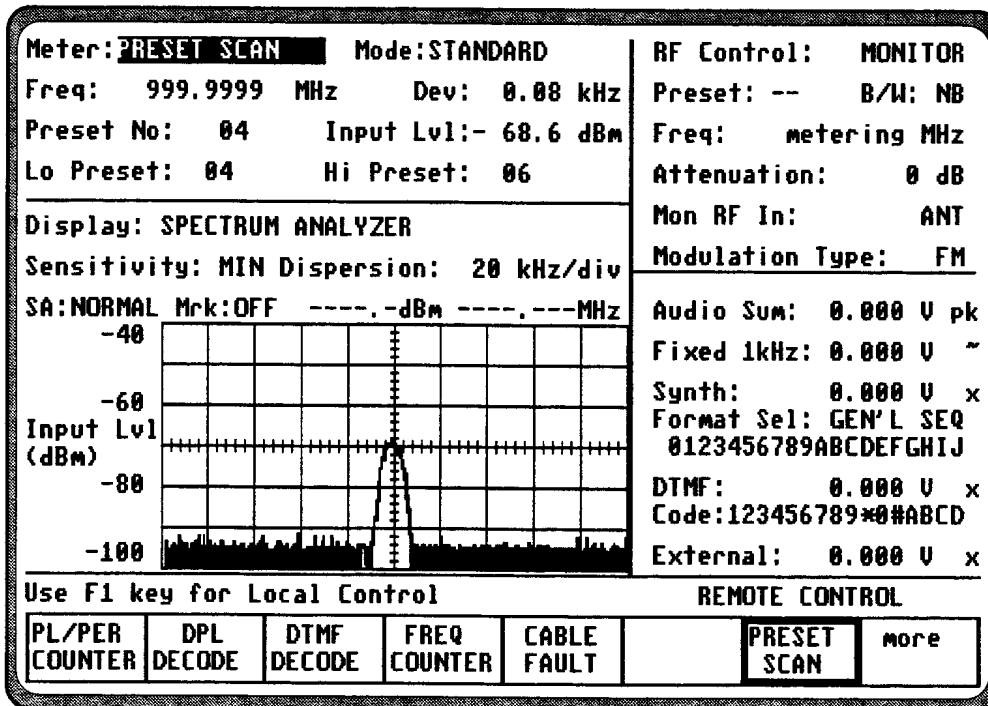

Figure 3-18. Spectrum Analyzer

### **Sensitivity**

The SA "Sensitivity: MIN/MAX" field shifts the baseline reference of the display by 10 db. This is valid only for 0 db input attenuation. Changing the input attenuation or changing from ANT to RF I/O port in the RF Control zone will change the vertical scale of the Spectrum Analyzer display. Calibration is maintained between the display and the signal level present at the input port so there is no need to compensate for added attenuation.

### **Dispersion**

Select the band width (20 kHz, 50 kHz, 100 kHz, 200 kHz, 500 kHz, 1 MHz, 2 MHz [optional], 5 MHz [optional], or 10 MHz [optional] per division) by first moving the cursor to the dispersion field, then pressing the desired softkey. When operating in the optional wider dispersion settings, it is normal for the response time of the analyzer to slow down somewhat. Center frequency is entered from the RF Control zone and may be conveniently varied with the TUNING knob.

### **NOTE**

*When operating in dispersions greater than 1 MHz/div, the normal monitor metering functions including "see and hear" audio monitoring are disabled.*

### **Storage (if equipped)**

Optional Storage modes (FREEZE, MAX HOLD, and PEAK HOLD) are selected by moving the cursor to the "SA:" field, then pressing the desired softkey.

#### **FREEZE -**

Pressing this softkey provides immediate storage of a spectrum display. This allows capture of intermittent transmissions etc. for more detailed analysis. To return to

normal "real time" analysis, simply press the NORMAL softkey.

#### **MAX HOLD -**

This softkey provides a cumulative storage of peak levels displayed over time. The time duration is indefinite subject to reset by pressing the NORMAL softkey.

The Max-Hold display can be frozen by switching to the Freeze mode. To re-start the max-hold operation, re-select the Max-Hold mode. In any case, this causes the Max-Hold feature to re-initialize and begin collecting input samples.

#### **PEAK HOLD -**

This key provides a cumulative storage capability similar to MAX HOLD. It differs in that in addition to peak responses, the lower portions of the display are also shown to permit observation of "real time" activity.

#### **AVERAGE MODE**

Operation in the Average mode continuously averages the previous 100 spectrum analyzer measurements and displays the averaged value. After averaging has been selected, the number of frames used in the averaging calculation will be displayed in the "Cnt:" field.

#### **Markers (if equipped)**

Select marker operation by moving the cursor to the "Mrk:" field, then pressing the desired softkey (OFF, DELTA, or ABS). Selection of DELTA ( $\Delta$ ) provides two markers on the SA screen (refer to figure 3-19). These permit relative measurement, between selected points on the display, of both level and frequency. The dotted marker line represents one that is movable using the Tuning Knob. Set this marker to a point of interest on the display and then press the "toggle marker" softkey to make the other marker movable for similar positioning with the Tuning Knob. Digital displays adjacent to "Mrkr:" continuously

show the relative level and frequency difference between the two points selected. Selection of ABS (absolute) mode provides one

marker set using the TUNING knob. Absolute frequency and power level of the marker location is displayed.

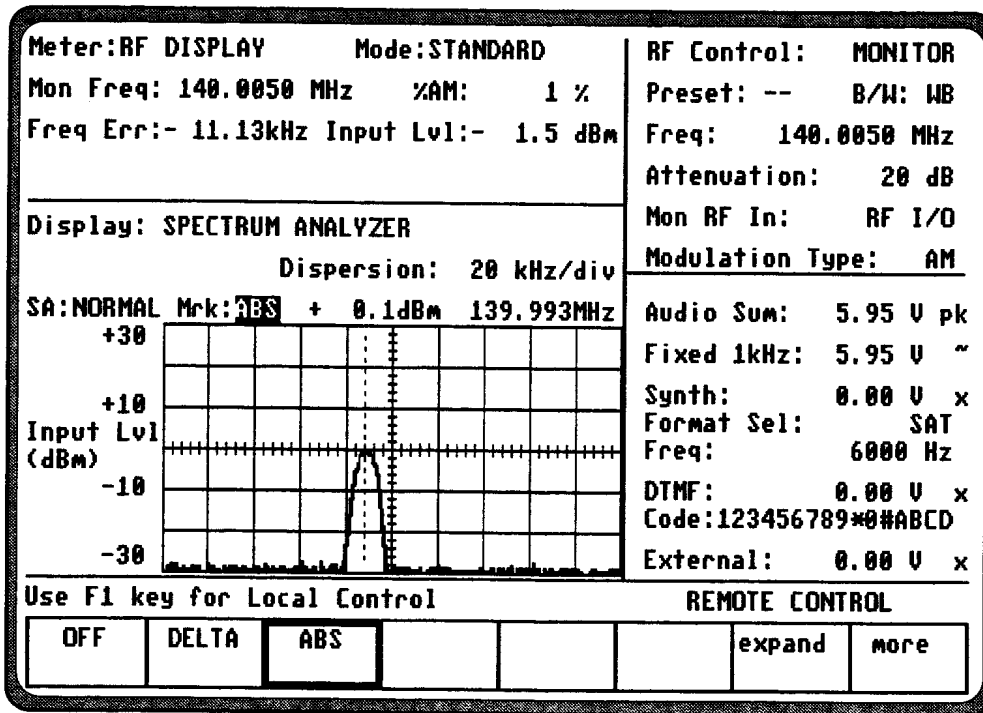

Figure 3-19. Spectrum Analyzer Markers (Option)

In conjunction with the markers are a set of softkey controls that allow the dashed marker to be moved depending upon the information displayed on the graph. These controls are available for both the DELTAT and ABS marker selections by pressing the **more** softkey.

The spectrum analyzer mode and marker functions are available in the expanded display graph. The provided functions are identical to those found in the normal size display. Normal to expanded screen selections may require readjustment of the markers positions.

**left peak**

Finds the next highest peak to the left of the current position of the dashed marker.

**max peak**

Find the maximum peak on the graph.

**right peak**

Find the next highest peak to the right of the current position of the dashed marker.

**next peak**

Find the next highest peak to the left or right of the current position of the dashed marker.

**center freq**

Move to the center frequency of the spectrum analyzer. This is equivalent to centering the dashed marker on the monitor frequency.



### 3-7.2.2 Modulation Scope

The Modulation Scope (figure 3-20) displays the internal modulation waveforms. It automatically switches between generator or monitor modulation depending on which mode is selected.

In DUPLEX mode, select either generate or monitor modulation displays by first moving the cursor to the "Select:" field within the Display area, then pressing the desired softkey.

The Display area of the screen will indicate MODULATION SCOPE with the input signal displayed in a time-versus-frequency graph.

#### NOTE

*Because the analyzer has a fully digital oscilloscope (storage scope), it inherently has some characteristics which are different from the "real-time" analog scopes familiar to most users. For best overall results, it is recommended that the trigger level be set to 500 and the triggering be set to AUTO.*

To change triggering, horizontal position, horizontal range, vertical position, or vertical range, use the cursor control keys to highlight the appropriate cursor fields as follows:

#### Trigger

Press the AUTO, NORMAL, or SINGLE SWEEP softkey to select the type of triggering desired. The trigger level synchronizes the horizontal time base to the vertical input signal.

In AUTO mode, the scope will trigger continuously. In this mode, the analyzer will always re-sweep the display even if there is no signal present. The rate will be about 1 per second with no signal present and about 10 per second with signal present.

In NORMAL mode, the scope will trigger when the vertical signal exceeds the trigger level set. In NORMAL mode the analyzer will re-sweep at a rate of 10 per second, with the last screen display remaining after removal of the signal.

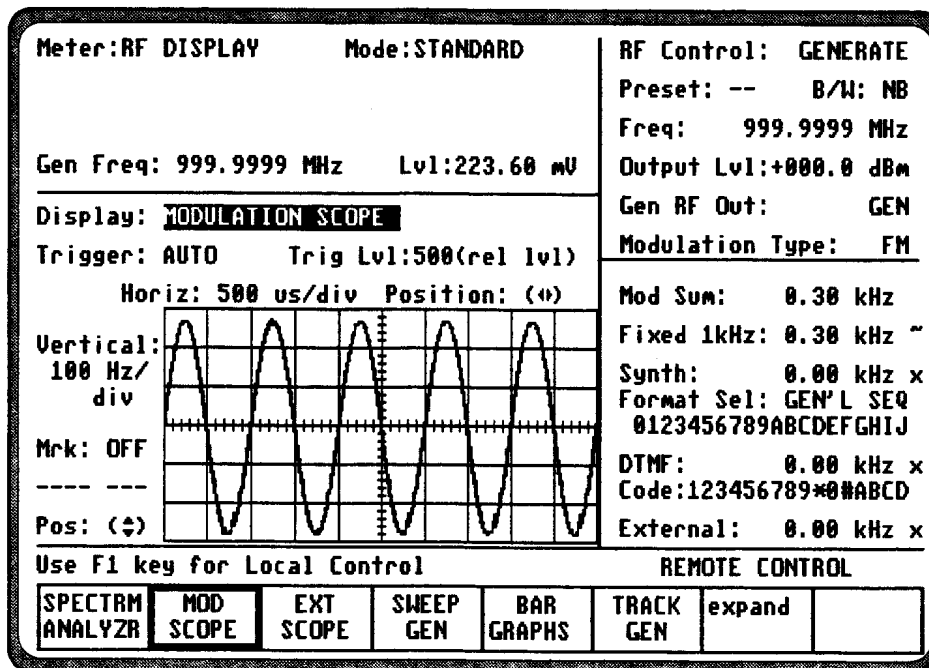

Figure 3-20. Modulation Scope

In SINGLE SWEEP mode, the scope will trigger one time for each softkey press, subject to the trigger level setting (triggering always occurs on the rising portion of the applied waveform). Messages on the line just above the softkeys indicate the status of the single sweep. The single sweep is useful in measuring one-time events, such as a tone burst at the beginning of a transmission. Such bursts may be followed by other modulation which would over-write the screen if measured in the NORMAL trigger mode.

### **Level**

Adjust the TUNING knob to select the desired trigger level. The trigger level is a relative level setting between the values of 0 and 999 (full scale) where 0 is the most negative and 999 is the most positive voltage.

#### **NOTE**

*To achieve the fastest update rate of the display a trigger level setting of 500 is recommended for most applications.*

### **Horiz**

Press the desired softkey to select the Horizontal Sweep rate (20 us to 1 sec/div). Since all ranges cannot be shown on one screen, press the **more** softkey for additional selections.

#### **NOTE**

*If horizontal sweep rates of greater than 10 msec/div are selected, the update rate will slow down. A good overall setting for most applications is 200 usec per division.*

### **Horizontal Position**

Adjust the horizontal position through the (◀▶) cursor field either by using the desired softkey (MOVE LEFT, MOVE RIGHT) or by using the rotary TUNING knob.

### **Vertical Sensitivity**

Press the desired softkey to select the Vertical Sensitivity (AM: 1%, to 50% per division, FM: 100 Hz to 50 kHz per division, dependent on bandwidth selected). When all ranges cannot be shown on one screen, press the more softkey for additional selections.

#### **NOTE**

*The vertical scales and softkeys for FM deviation will change automatically between wideband and narrowband.*

### **Vertical Position**

Adjust the vertical position through the (⬆) cursor field either by using the desired softkey (MOVE UP, MOVE DOWN) or by using the rotary TUNING knob.

Press the expand softkey from any field in the scope display window to enlarge the display for more detailed analysis. Use the return softkey to get back to the normal size display.

#### **NOTE**

*Scale and positioning adjustments are not possible for stored waveforms that are displayed through the use of single sweep or triggering on single non-periodic signals.*

### **Marker (if equipped)**

Select marker operation by moving the cursor to the "Mrk:" field, then pressing the desired softkey ( $\Delta V$ ,  $\Delta T$ , or  $1/\Delta T$ ). Selection provides two markers on the Modulation Scope screen (refer to figure 3-21). Function of the "toggle marker" softkey and Tuning Knob for positioning of markers is similar to that described in section 3-7.2.1.

#### **$\Delta V$ -**

This softkey selection provides markers that are horizontally located to permit relative readings along the scope vertical axis. The display adjacent to the "Mrk:" field shows the

relative vertical deflection between the two marker positions.

**$\Delta T$ -**

This key selection provides markers that are horizontally located to permit relative readings along the scope vertical axis. The display adjacent to the "Mrk:" field shows the relative horizontal deflection between the two marker positions in units of time.

**$1/\Delta T$ -**

This softkey selection provides markers that are also vertically located to permit relative readings along the scope horizontal axis. This selection however inverts the time reading to display the relative difference in terms of frequency.

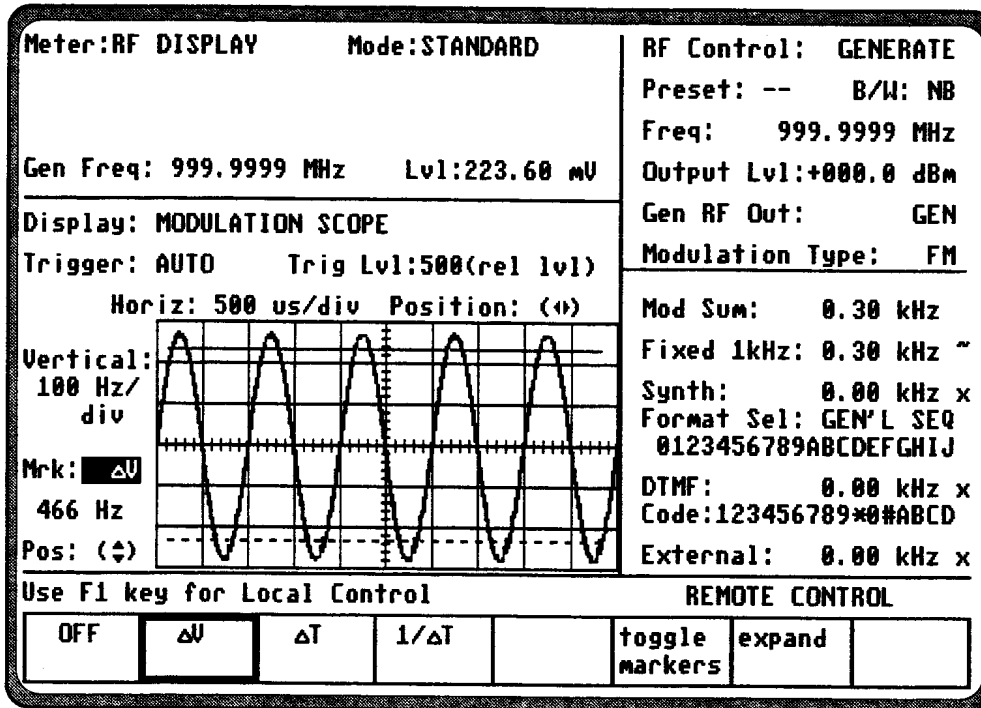

Figure 3-21. Modulation Scope Markers (Option)

### 3-7.2.3 EXT'L SCOPE

The analyzer provides a general purpose oscilloscope with calibrated vertical input sensitivities and automatic or triggered horizontal sweep rates. Use the scope to analyze waveforms, detect asymmetric modulation or audio distortion, trace signals, and troubleshoot.

The vertical (VERT) input is the same BNC port that also serves as the input for DVM, SINAD/DIST meter, and COUNTER IN.

The EXT'L SCOPE mode has an additional cursor field to select "Coupling:" AC or DC via softkey selection. Operation of triggering, ranges, trace positioning and optional markers are the same as described in MODULATION SCOPE above. Vertical ranges will always display in voltage per division in the EXT'L SCOPE mode.

### 3-7.2.4 SWEEP GENERATE

This display provides a graphic display in conjunction with the SWEEP GENERATE mode of the unit which is selected in the RF Control zone or selection of the optional cable fault test feature. Refer to Sweep Generator description under Primary Operating Modes (paragraph 3-5.4).

To change coupling from AC to DC, or vary horizontal position, vertical position, or vertical sensitivity, move the cursor to highlight that selection. Use the softkeys or TUNING knob, as applicable to each selection.

### 3-7.2.5 Bar Graphs

The bar graphs (figure 3-22) provide a graphical display of the RF Display data from the Meter area of the screen.

Press the expand softkey to expand the bar graphs to the full display area of the CRT. Return via softkey.

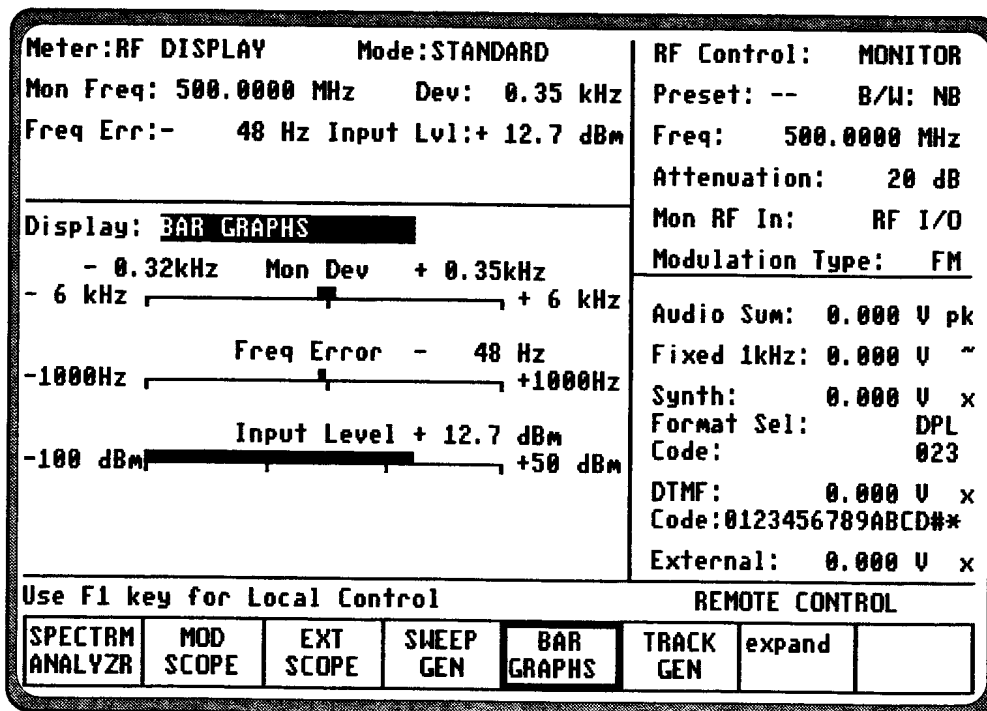

Figure 3-22. Expanded Bar Graphs

## NOTE

*The Freq. Error bar graph is not available if RF SCAN, PL/PER COUNTER, DPL DECODE or FREQ COUNTER are selected in the "Meter:" field area. Selection of the expand key restores the Freq. Error Bar Graph under the above condition.*

### 3-7.2.6 Tracking Generator (if equipped)

This display must work in conjunction with the TRACK GENERATE mode which is selected thru the "RF Control:" field of the RF zone. Refer to section 3-5.5 for a full description of Tracking Generator operation.

## 3-8 OTHER FUNCTIONS

### 3-8.1 Audio Monitor

The Analyzer has a speaker for the purpose of audibly monitoring the recovered baseband signal in the MONITOR and DUPLEX modes and the modulating signal in the GENERATE mode. Switching between the two is automatic.

Using the VOLUME control, the input signal to the speaker is adjustable to a maximum level of 0.5 watts rms.

The speaker is also used for audible warnings, such as RF overtemperature.

### 3-8.2 Calibration

Calibration of the Analyzer is performed by the following steps.

1. Press the CAL key to instruct the processor to perform a self-calibration on the system. The CAL function provides a self calibration of the unit's RF generator output level, the monitor input level and the modulation level. All other parameters are not subject to this self-calibration.

This assures the unit's specification accuracy under conditions of ambient temperature extremes and aging. Re-calibration is recomm-

ended at weekly intervals or when the re-calibrate warning appears on the screen.

## CAUTION

*Before starting self-calibration be sure that the 50 ohm load, attached by chain to the front panel, is connected to the GEN OUT port. This provides the termination which is essential to proper calibration. Also ensure all connections to the RF I/O and ANT connectors are removed.*

2. Press the START softkey to begin the calibration. While the calibration is active, the message **calibrating** appears.
3. When the calibration has been performed, the message **complete** appears. Press the return softkey or a cursor control key to return to the previous screen.

### 3-8.3 Print Function

Press the PRT key to send the data contents of the displayed screen to a compatible RS-232 serial format printer. Either an ASCII character (faster printing) or full graphic can be selected.

If ASCII is selected (refer to Special Functions Menu to select REMOTE SETUP and Display Table), all ASCII characters currently on the display are stored in a buffer and serially output to an RS-232 printer. Selection of IBM/EPSON results in a graphic printout of the screen (requires a graphic printer and takes longer to print).

## NOTE

*Subsequent presses of the PRT key before printing is complete will overwrite the printer buffer.*

If using the LX-810S/220 (220 volt operation) serial/parallel printer with the Analyzer, refer to paragraph 4-5 for a special application note.

### 3-8.4 Special Functions Menu

The Special Function mode (figure 3-23) accessed by pressing the SPF key, provides control over various system conditions as follows:

#### VERSION

Accesses a display table which provides the internal software version and checksum for the system and any options present.

#### REMOTE SETUP

Accesses a display table which allows configuration of the RS-232 and printer interface.

### SYSTEM FUNCTIONS

Accesses softkeys to select the following:

#### NVM Clear

This softkey erases the entire RF Preset memory area and front panel CAL memory. The Analyzer must be recalibrated after this key has been pressed.

#### NVM Reset

This softkey provides a less extensive system reset than NVM Clear. CAL and preset memory are not erased.

#### Save State

Sets the current condition and settings of the unit as the power up state.

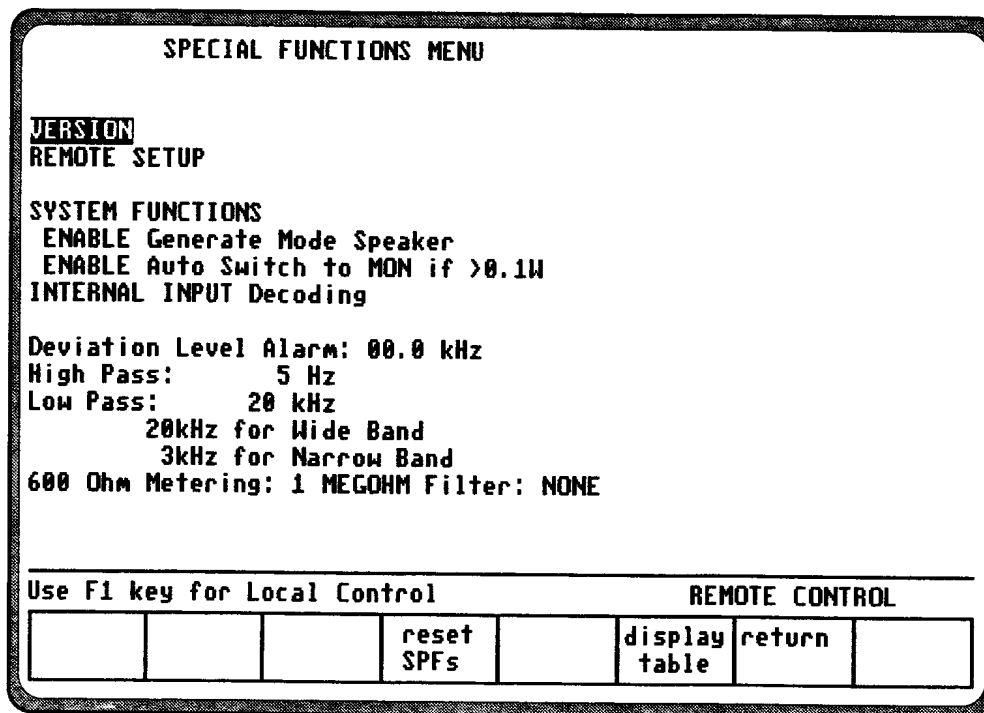

Figure 3-23. Special Functions Menu

## NOTE

When any of the following special functions are selected, the normal operating screens will flash a warning **SPF Enabled** at the lower right of the screen. This serves as a reminder since special functions inadvertently left enabled can adversely effect normal operation of the unit.

### **SPF RESET**

This softkey appears throughout the Special Function screen as a convenience in resetting of all special functions from System Functions thru Low Pass Filter to the factory standard state. This will switch all decoding to internal and provide the widest filter bandwidth.

### **ENABLE/DISABLE Generate Mode Speaker**

Provides the means to disable the internal speaker during generate mode.

### **ENABLE/DISABLE auto switch to MON if >0.1 W**

Allows the unit to automatically switch to the MONITOR mode when power levels greater than 0.1 watt are applied to the RF IN/OUT front panel connector.

### **INTERNAL/EXTERNAL INPUT Decoding**

Switches the decoder function between the internal monitor demodulated signal and the signal at the VERT/SINAD front panel connector.

### **Deviation Level Alarm**

Allows entry of the deviation level for the audible deviation limit alarm in MONITOR mode.

### **High Pass**

Provides softkey selection of monitor baseband high pass filter frequency.

### **Low Pass**

Provides softkey selection of monitor baseband low pass filter frequency.

### **600 Ohm Metering(Option)**

Allows the user to select input impedance (1 Megohm or 600 Ohm) of the ACVM, SINAD, and Distortion functions.

## CAUTION

When the 600 ohm load is selected, the maximum allowable input to these metering functions is reduced to approximately 25 VAC maximum due to power dissipation limits. Overload protection is provided by means of a reset circuit that monitors input level and switches the 600 ohm load when the maximum input level is exceeded. If this occurs, simply remove the overload and activate the **OVERLOAD RESET** softkey located at the "600 ohm metering:" field of the Special Function Screen.

### **Filter (if equipped)**

Allows the user to enable/disable internal C-MSG or CCITT filters.

### **3-8.4.1 Special Function Selection**

To select a special function follow the following procedure.

1. Press the SPF key to display the special functions menu on the display.
2. Move the cursor to highlight the field of the function desired. Applicable softkeys
3. Use the softkeys to make selections. Levels may be set using the TUNING knob or keypad.
4. Press the return key to return to the previous screen.

### **3-8.5 Memory Screens**

The Memory screens provide for viewing and entry of preset data into non-volatile memory. The actual selection of a preset number for opera-

tion of the system can only be done from the RF Control zone.

Pressing the MEM key accesses the top-level memory display (figure 3-24) which shows the 30 presets (00-29) and the monitor frequency associated with each. A second level screen provides an expanded detail of the settings stored within each preset.

To change the preset memory information, perform the following steps:

1. Press the MEM key to access the special Memory screen.
2. Move the cursor to the desired preset number. When the cursor is over the preset number, press the view preset softkey to display all of the preset's parameters. When a preset has been expanded, the operator may change:
  - The preset number being viewed
  - Monitor frequency
  - Generate frequency
  - Modulation type
  - Bandwidth
  - Duplex offset frequency
  - Audio synthesizer format with applicable frequency, code or sequence
  - DTMF code
3. To clear a particular memory field (except the monitor frequency) press the 'don't care' softkey. The value associated with that cursor location become a "-", and will not affect the current setting when that preset is selected from the RF Control zone.
4. All entries made to the expanded preset table are automatically entered into non-volatile memory. The save to preset soft key provides an added convenience allowing all of the applicable settings entered into the RF Control and Audio Control zones to be copied into the preset number selected. This will erase and overwrite all previously entered settings within that preset.
5. Press the 'return' key to return to the previous screen.



**MEMORY** Current Preset --

	<u>Mon Freq (MHz)</u>		<u>Mon Freq (MHz)</u>
00]	475.0000	15]	999.9999
01]	162.0009	16]	999.9999
02]	080.5000	17]	999.9999
03]	999.9999	18]	999.9999
04]	999.9999	19]	999.9999
05]	999.9999	20]	999.9999
06]	999.9999	21]	999.9999
07]	999.9999	22]	999.9999
08]	999.9999	23]	999.9999
09]	999.9999	24]	999.9999
10]	999.9999	25]	999.9999
11]	999.9999	26]	999.9999
12]	999.9999	27]	999.9999
13]	999.9999	28]	999.9999
14]	999.9999	29]	999.9999

---

Use F1 key for Local Control REMOTE CONTROL

save to preset#	recall preset#					view preset	return	
--------------------	-------------------	--	--	--	--	----------------	--------	--

**MEMORY** Current Preset

Presets: 02

Monitor Frequency: 080.5000 MHz  
 Modulation Type: FM  
 Generate Frequency: 999.9999 MHz  
 Modulation Type: FM  
 Bandwidth: NARROW  
 Duplex Offset: +00.000 MHz

Synth Format Sel: PL  
 FREQ: 100.0 Hz

DTMF Code: -----

---

Use F1 key for Local Control REMOTE CONTROL

save to preset#						return	
--------------------	--	--	--	--	--	--------	--

Figure 3-24. Memory Screens

### 3-8.6 Test Setups (if equipped)

Test Setups provide the capability to save the entire state of the analyzer in a preset. Fifteen additional presets numbered 30 through 44 are available for this purpose. When delivered from the factory, the analyzer is configured with default information in the Test Setups:

### NOTE

*Test setups are installed at either the factory or in the field using the Field Installation Software. To determine if test setups are available, examine the Standard Options display screen (refer to Special Function Selection paragraph 3-8.5)*

TEST SETUP	LABEL	DESCRIPTION
30	Tx Test	"RF Control:" is set to MONITOR and "Display:" is set to SPECTRUM ANALYZER; other parameters are factory default.
31	Rx Test	"RF Control:" is set to GENERATE and "Meter:" is set to SINAD. "Fixed 1kHz:" is switched on with a 3.00 kHz deviation; other parameters are factory default.
32	Dpx Test	"RF Control:" is set to DUPLEX; other parameters are factory default.
33-44	Factory Default	All configuration parameters (except those saved in the standard presets) are set to the factory preset value, which is equivalent to the power-on state of the analyzer from the factory.

### NOTE

*The default Test Setup values are provided as a convenience and may be overridden at any time.*

Each Test Setup also saves the cursor location for later recall. For example, if the analyzer is placed in the generate mode with the cursor on the tens digit of the Output Level and this Test Setup is saved, later recall of this preset will place the cursor back on the tens digit of the Output Level.

The Test Setups work in conjunction with the standard presets (labeled 00 through 29). Each standard preset stores the following information in the non-volatile memory:

- Monitor Frequency
- Monitor Modulation Type

- Generate Frequency
- Generate Modulation Type
- Bandwidth
- Duplex Offset
- Synthesizer Format Selection
- DTMF Code

The Test Setups store all other configuration information in non-volatile memory. This allows a Test Setup to be used for a set of frequencies and audio signals as defined in the separate standard presets.

Full Test Setups are accessed from either the preset cursor location or the MEMORY screen (figure 3-25). To create a test setup, modify the configuration of the analyzer to the test setup to be saved. Press the MEM hardkey to access the

MEMORY screen and then move the cursor to one of the 15 Test Setup locations. Use the **Save To Preset#** softkey to save the analyzer configuration into the Test Setup. A Test Setup can be recalled from the MEMORY screen using the **Recall Preset#** softkey or from the preset cursor location in the RF Control Zone.

Each Test Setup has a 15 character label in which alpha-numeric information can be entered to describe that Test Setup. Characters not on the front panel keypad can be entered using the rotary knob.

MEMORY		Current Preset --			
	<u>Mon Freq (MHz)</u>		<u>Mon Freq (MHz)</u>		<u>Test Setup</u>
001	999.9999	151	999.9999	301	Tx Test
011	999.9999	161	999.9999	311	Rx Test
021	999.9999	171	999.9999	321	Dpx Test
031	999.9999	181	999.9999	331	Factory Default
041	999.9999	191	999.9999	341	Factory Default
051	999.9999	201	999.9999	351	Factory Default
061	999.9999	211	999.9999	361	Factory Default
071	999.9999	221	999.9999	371	Factory Default
081	999.9999	231	999.9999	381	Factory Default
091	999.9999	241	999.9999	391	Factory Default
101	999.9999	251	999.9999	401	Factory Default
111	999.9999	261	999.9999	411	Factory Default
121	999.9999	271	999.9999	421	Factory Default
131	999.9999	281	999.9999	431	Factory Default
141	999.9999	291	999.9999	441	Factory Default

Use F1 key for Local Control				REMOTE CONTROL			
save to preset#	recall preset#				view preset	return	

Figure 3-25 . Memory Screen with Full Test Setups Option



## Section 4

### APPLICATIONS

#### 4-1 BASIC FM TRANSMITTER TESTING

This section of the manual contains information on typical test setups to perform some of the more common radio tests using R-2600 Series Communications System Analyzers.

Motorola takes no responsibility for application accuracy, applicability, or safety. Always refer to your own transceiver's service manual for recommended test methods and specifications.

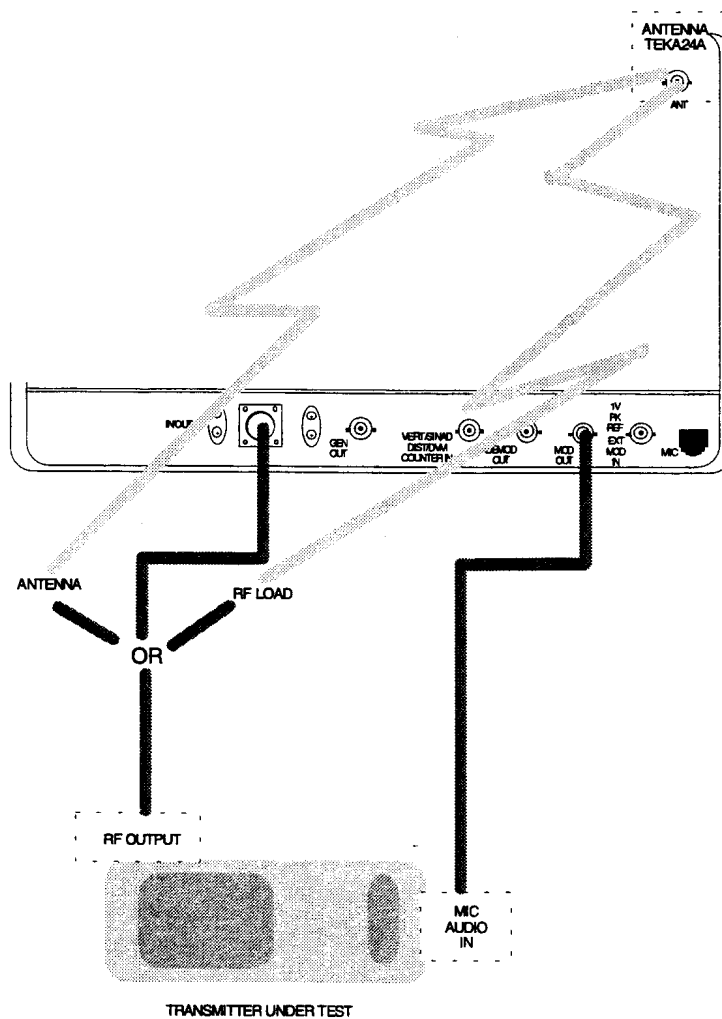

Figure 4-1. Basic FM Transmitter Testing Setup

### 4-1.1 Basic FM Transmitter Testing Setup

Refer to Figure 4-1. Connect the analyzer's RF I/O port to the RF output of the transmitter under test. Connect the analyzer's MOD OUT jack to the mic audio input of the transmitter under test.

#### CAUTION

*For transmit power output measurements, connect the transmitter under test only to the analyzer's RF I/O port. Do not connect it to the ANT port. The ANT port is used with an antenna for "off-air-" reception.*

*The built-in RF load dissipates up to 50 W for three minutes and up to 125 W for one minute. If a high-power transmitter is keyed into the analyzer for a time long enough to threaten overheating the power measuring circuitry, the system's audible alarm sounds and the display changes to the **RF LOAD OVERTEMPERATURE** warning, signaling the operator to unkey (refer to paragraph 3-4).*

### 4-1.2 Transmit Power, Frequency, and Frequency Deviation Measurements

1. With the cursor located within the RF Control zone (refer to paragraph 3-2), press the **MON** softkey to place the analyzer into its Monitor mode of operation.

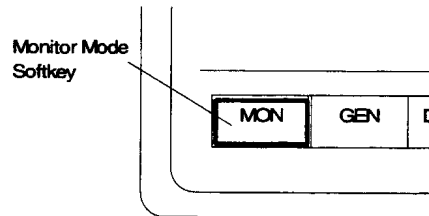

2. Within the RF Control zone, set as follows:

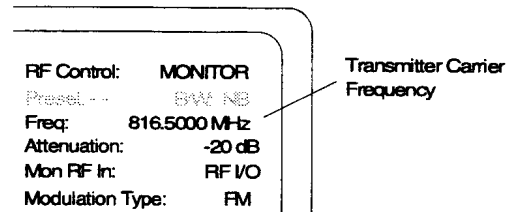

3. Set the SQUELCH control to threshold. For low-power transmitters, may be necessary to use a lower attenuation value in order to unquench the monitor (refer to paragraph 3-5.1). Too high of an attenuation setting or too tight a squelch setting inhibits the frequency error reading (refer to paragraph 3-7.1.1). Accurate measurements require sufficient signal level from the radio to fully quiet the analyzer's receiver. Use good quality cable of minimum length to prevent cable-loss which can be a significant factor in RF power

measurements, especially at UHF and above.

4. With the cursor located within the Display zone "Meter:" location, press the **RF DISPLAY** softkey:

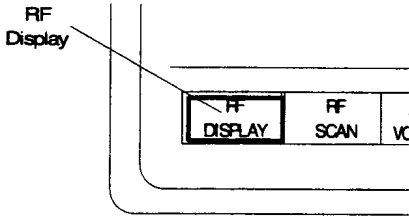

5. Key the transmitter and read the power (Input Level) and frequency error (Freq Err). Refer to your radio's service manual to determine if power and frequency are within specified limits and determine if any adjustments are required.

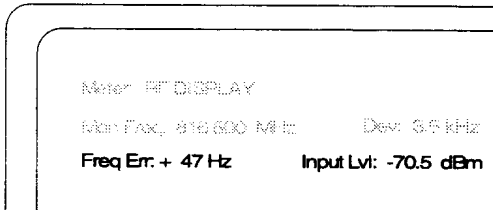

### 4-1.3 Modulation Measurements

1. Key up the transmitter with appropriate PL (or DPL) enabled.

#### NOTE

*If mic pickup results in deviation errors, install the internal 300 Hz lowpass filter as detailed in paragraph 3-8.5 before making the following measurements and verifications.*

2. When monitoring the PL (or DPL) deviation as follows, refer to your radio's service manual to determine if any adjustments are required.

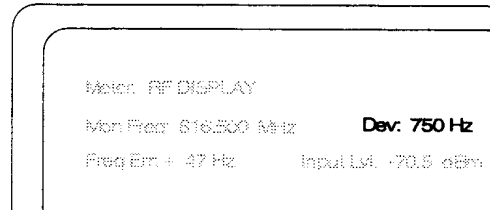

3. Remove the internal 300 Hz lowpass filter if installed.

Introduce a 1 kHz audio modulating signal from the MOD OUT connector located on the front panel of the analyzer to your radio. Check your radio's service manual to determine the minimum audio signal level required for proper MIC sensitivity as well as the maximum level required to ensure proper IDC (Instantaneous Deviation Control) function.

#### NOTE

*The voltage levels displayed in the Audio Control zone are peak open circuit voltages. Source impedance of the MOD OUT port is 100 ohms.*

- Turn the 1kHz signal on, and set for minimum level as determined in step 3.

Audio Sum:	0.00 V pk
<b>Fixed 1kHz:</b>	<b>0.40 V ~</b>
Synth:	0.00 V x
Format Set:	PL
FREQ:	181.8 Hz
DTMF:	0.00 V x
Code:	1234567890#ABCD
External:	0.00 V x

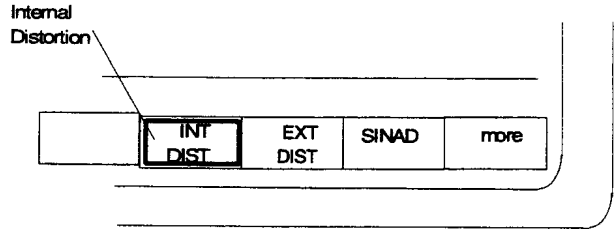

- Refer to the displayed digital readout and bar graph. Refer to your radio's service manual to determine if any adjustments are required.

- Verify proper MIC sensitivity by reading the deviation. Refer to your radio's service manual to determine maximum rated system deviation to determine if any adjustments are required.

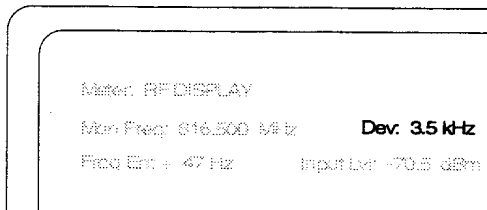
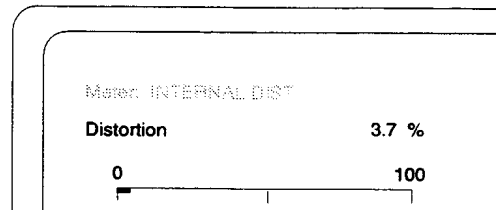

- Set the 1 kHz audio modulating signal for maximum level as determined in step 3. Repeat steps 4 and 5.
- To measure the percentage of distortion, locate the cursor within the Display Control zone, at the "meter:" field. Press the **INT DIST** softkey to measure percentage of distortion.



#### 4-1.4 Off-The-Air Measurements

1. Connect the TEKA-24A Pick-Up Antenna to the analyzer's ANT port. Operate the transmitter under test either into its own antenna or into a dummy RF load.
2. With the cursor located within the RF Control zone, press the **MON** softkey to place the analyzer into its Monitor mode of operation.

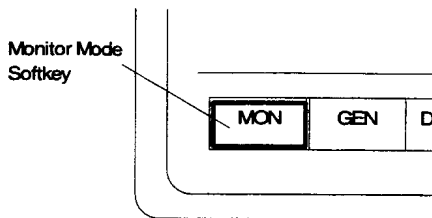

3. Set the SQUELCH control to threshold. Within the RF Control zone, set as follows:

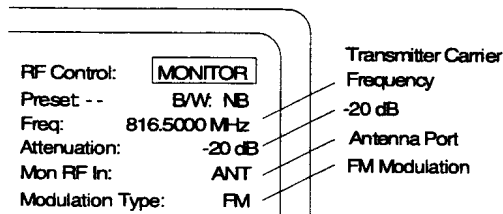

4. Check transmitter frequency and modulation as detailed in paragraphs 4-1.2 and 4-1.3.

#### NOTE

*This method may be used to verify frequency and modulation of a remotely located transmitter by reducing the attenuation setting to fully realize the sensitivity of the analyzer "Off-The-Air" monitor function.*

## 4-2 BASIC FM RECEIVER TESTING

This section of the manual contains information on typical test setups to perform some of the more common radio tests using the analyzer.

The analyzer's DVM input is unbalanced (ground referenced). Use an appropriate interface to measure balanced circuits, such as certain receiver audio outputs or telephone lines.

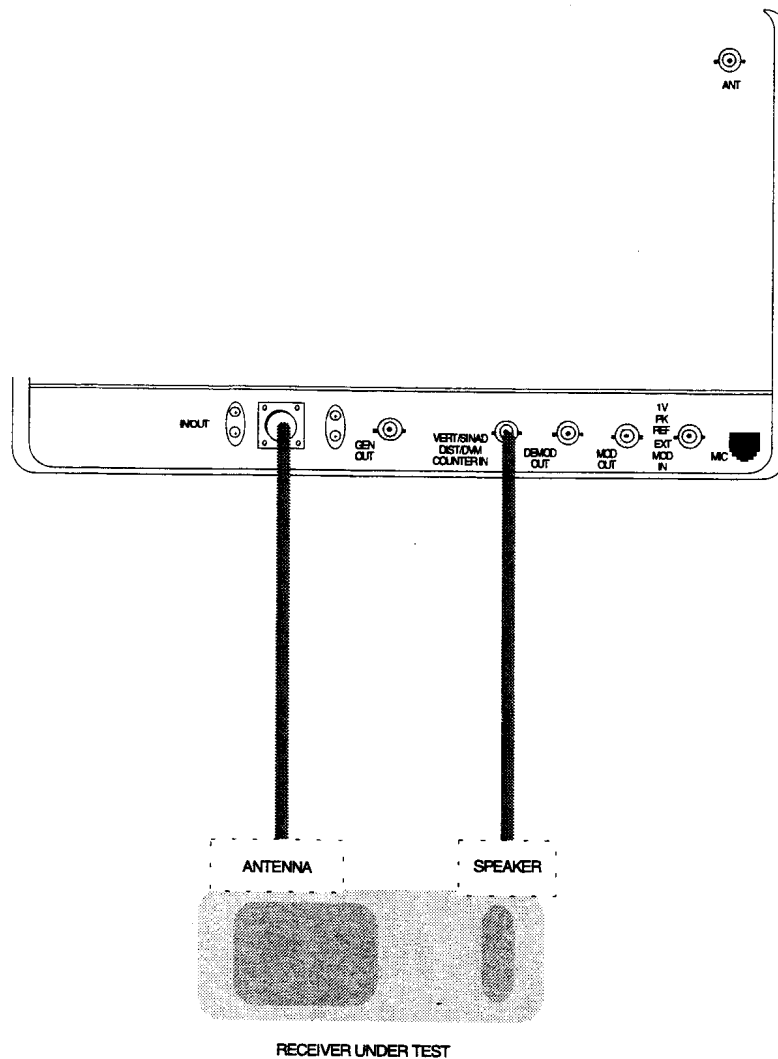

Figure 4-2. Basic FM Receiver Testing Setup

### 4-2.1 Basic FM Receiver Testing Setup

Refer to Figure 4-2. Connect the analyzer's RF I/O port to the radio antenna connector. Connect the radio audio output to VERT/SINAD port of the analyzer.

#### CAUTION

*With some radios, grounding the speaker leads will damage the audio circuitry. Use isolation techniques on these radios.*

1. With the cursor located within the RF Control zone (refer to paragraph 3-2), press the **GEN** softkey to place the analyzer into its Generator mode of operation.

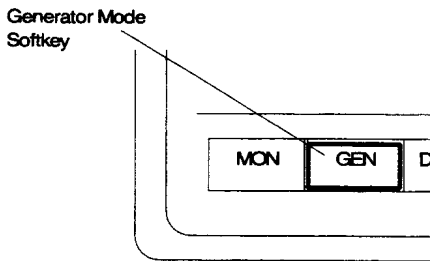

2. Within the RF Control zone, set as follows:

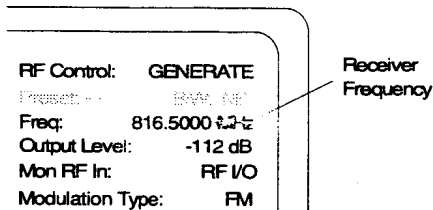

#### NOTE

*For setup and distortion measurements, set output level to at least 30 dB above sensitivity threshold (-80 dBm recommended).*

3. Within the Audio Control zone, set as follows:

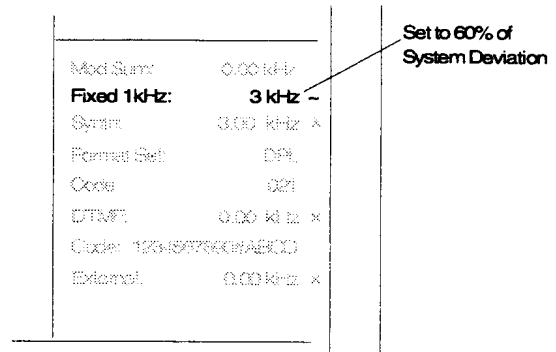

4. With the cursor located within the Display Control zone, press the **AC VOLTS** softkey to display the ac voltmeter:

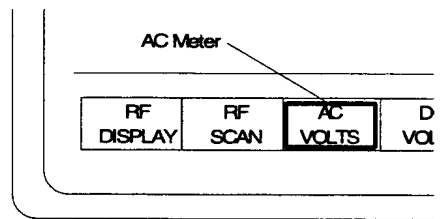

5. Adjust the radio for rated power output by computing voltage needed for rated power with load resistor/speaker in use, and setting the radio volume to produce required voltage.

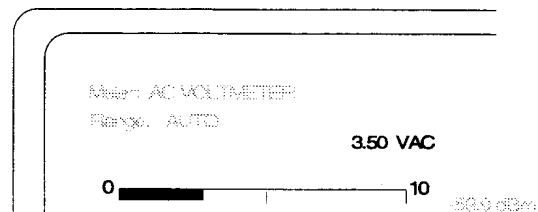

- With the cursor located within the Display Control zone (at Display:), press the **EXT SCOPE** softkey.

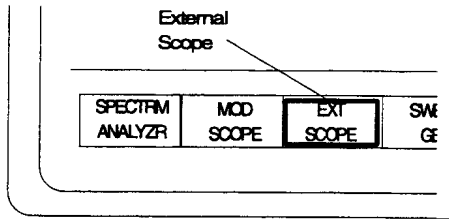

- Refer to the displayed digital readout and bar graph. Refer to your radio's service manual to determine if any adjustments are required.

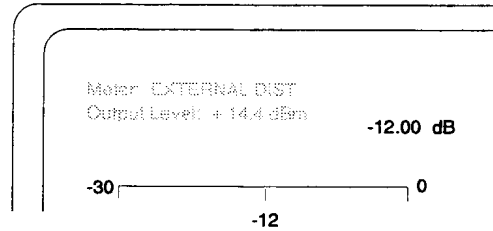

- Set scope vertical and horizontal deflection to observe sine wave from receiver audio.

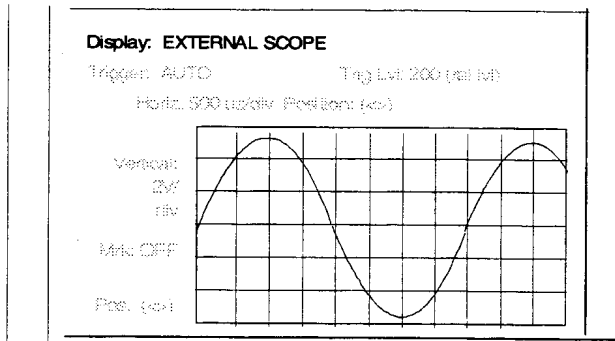

#### 4-2.3 SINAD Measurement

- With the cursor located within the Display Control zone, press the **SINAD** softkey.

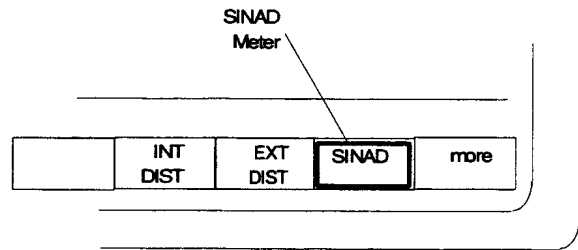

- Refer to the displayed digital readout and bar graph.

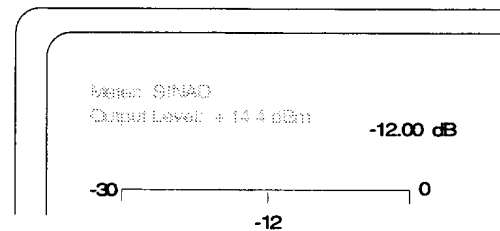

#### 4-2.2 Receiver Distortion Measurement

- With the cursor located within the Display Control zone, press the **EXT DIST** softkey to measure percentage of distortion.

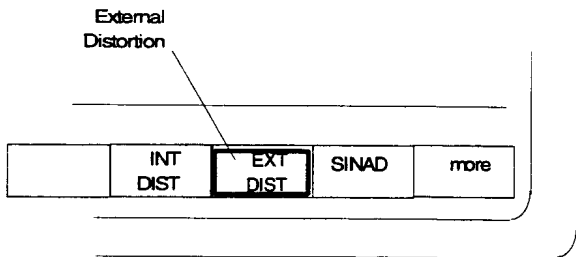

3. Within the RF Control zone, adjust the selected RF level until the SINAD reading on the SINAD meter averages 12 dB

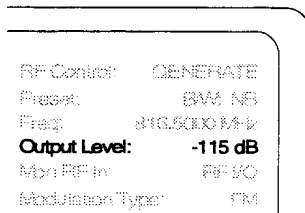

4. Note RF output level required for SINAD reading of 12 dB (-115 dBm typical dependent on manufacturers specifications).

**NOTE**

*RF output level can be referenced to mV, uV, dBu, or dBm. Selection of units is available within the Display Control zone (Output Level:).*

(instantaneous reading will vary several dB).

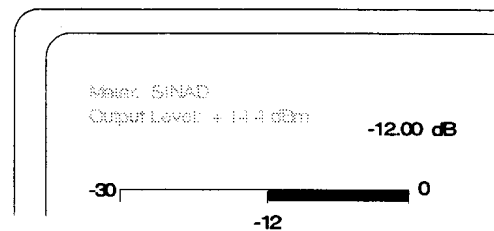
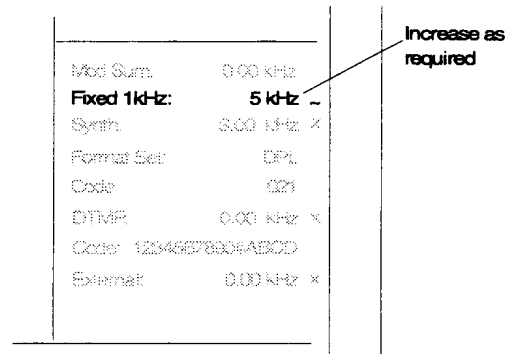

**4-2.4 Modulation Acceptance Bandwidth**

1. Set the volume control of the radio to 10% of its rated audio output level.
2. Set the RF output level 6 dB (doubles the voltage, i.e. 0.35 uV increased 6dB = 0.7 uV) above the RF output level required in paragraph 4-2.4 to achieve the SINAD reading of 12 dB.

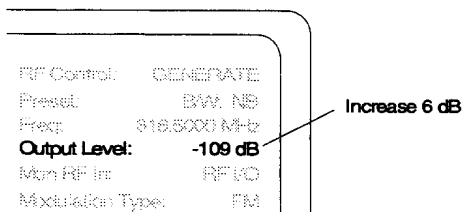

4. Read the deviation level required in step 3. A typical modulation acceptance bandwidth of a 5 kHz receiver is 7 to 8 kHz. Refer to your radio's service manual to determine if any adjustments are required.

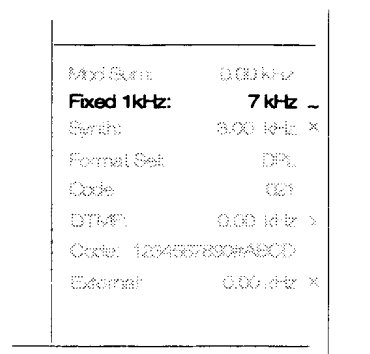

3. Increase the deviation level until the SINAD meter display returns to 12 dB.

## 4-2.5 Receiver Sensitivity Testing (20 dB Quieting)

1. With the cursor located within the RF Control zone, press the **MON** softkey to remove input signal from the radio.

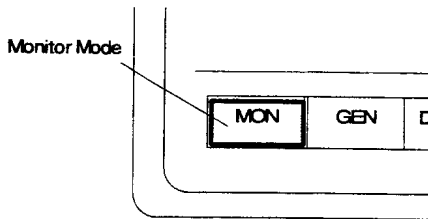

2. With the cursor located within the Display Control zone, press the **AC VOLTS** softkey to display the ac voltmeter:

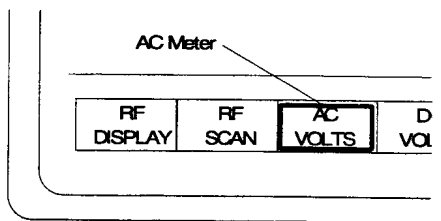

3. Turn on the receiver (unscelched). Increase the receiver volume control to feed audio noise to the analyzer (at least 1/4 the rated audio power). Record the noise reading in dBm.

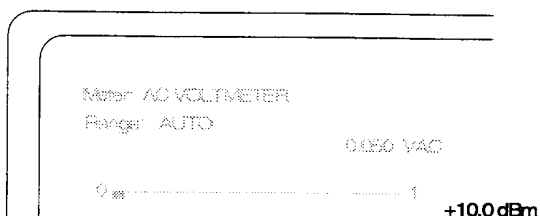

4. With the cursor within the RF Control zone, press the **GEN** softkey.

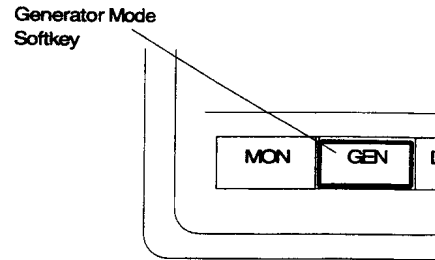

5. Within the Audio Control zone, set the modulation off.

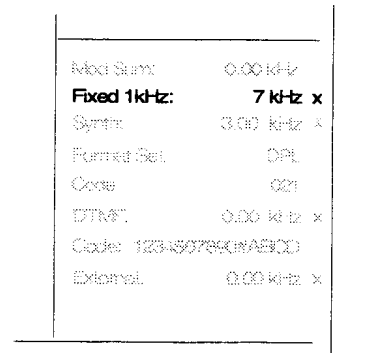

6. Within the RF Control zone, adjust the RF output level until the noise reading is less than 20 dB from the value recorded in step 3. Refer to your radio's service manual to determine if any adjustments are required.

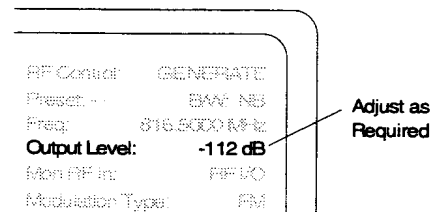

### NOTE

To convert the RF output level to  $\mu\text{V}$  or  $\text{dBV}$ , locate the cursor within the Display Control zone and press the **RF DISPLAY** softkey. Locate the cursor to units used for Lvl: and select the required unit using the softkeys.

## 4-2.6 Squelch Sensitivity Test

1. With the cursor located within the RF Control zone, press the **MON** softkey.

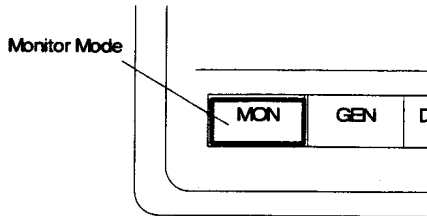

2. Disable the PL/DPL squelch if so equipped. Set the radio's squelch control to the point where the receiver barely quiets.
3. With the cursor located within the RF Control zone, press the **GEN** softkey.

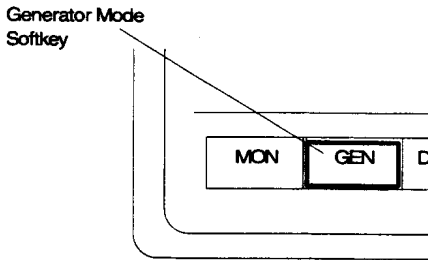

4. Within the Audio Control zone, set the modulation off.

Mod Sum:	0.00 kHz
<b>Fixed 1kHz:</b>	<b>7 kHz x</b>
Synth:	0.00 kHz x
Format Sel:	DPL
Code:	021
DTMF:	0.00 kHz x
Code:	1234567890#ABCD
External:	0.00 kHz x

5. Within the RF Control zone, increase the RF output level until the receiver just unsquelches. This is the threshold squelch sensitivity of the radio.

RF Control:	GENERATE
Presel:	-- BW, NB
Freq:	818.5000 MHz
<b>Output Level:</b>	<b>-115 dB</b>
Mon RF In:	RF/IO
Modulation Type:	FM

An arrow points from the text 'Adjust as Required' to the 'Output Level' field.

### NOTE

To convert the RF output level to  $\mu\text{V}$  or  $\text{dBV}$ , locate the cursor within the Display Control zone and press the **RF DISPLAY** softkey.

6. Repeat step 5 with the radio's squelch level set to maximum tightness to determine the tight squelch sensitivity of the radio.
7. To check PL/DPL squelch sensitivity, locate the cursor within the Audio Control zone and enter the proper PL frequency or DPL code per Appendix B.

Audio Sum:	0.00 V pk
Fixed 1kHz:	0.00 V x
Synth:	0.00 V x
<b>Format Sel:</b>	<b>PL</b>
<b>FREQ:</b>	<b>131.8 Hz</b>
DTMF:	0.00 V x
Code:	1234567890#ABCD
External:	0.00 V x

or

Audio Sum:	0.00 V pk
Fixed 1kHz:	0.00 V x
Synth:	0.00 V x
<b>Format Sel:</b>	<b>DPL</b>
<b>Code:</b>	<b>23</b>
DTMF:	0.00 V x
Code:	1234567890#A#BCD
External:	0.00 V x

- With the cursor located within the Audio Control zone, turn on the modulation and set the analyzer synthesizer to provide a nominal 750 Hz (500 - 1 kHz) deviation or to the radio's manufacturer's specifications.

Mod Sum:	0.00 kHz
<b>Fixed 1kHz:</b>	<b>5 kHz -</b>
<b>Synth:</b>	<b>0.75 kHz -</b>
Format Sel:	DPL
Code:	021
DTMF:	0.00 kHz x
Code:	1234567890#A#BCD
External:	0.00 kHz <

- Enable the radio's PL/DPL squelch circuit. Fully open the carrier squelch control.
- Within the RF Control zone, increase the RF output level until the receiver just un-squelches. This is the coded squelch sensitivity.

RF Control:	GENERATE
Preset:	EMV NB
Freq:	810.000 MHz
<b>Output Level:</b>	<b>-115 dB</b>
Mon RF In:	RF LO
Modulation Type:	FM

Adjust as Required



### 4-3 CABLE TESTING (if equipped)

#### 4-3.1 Overview

The analyzer cable fault test system can be used to find the distance to a fault in a cable

under test such as an open or shorted connector, a damaged (pinched) area of the cable, etc.

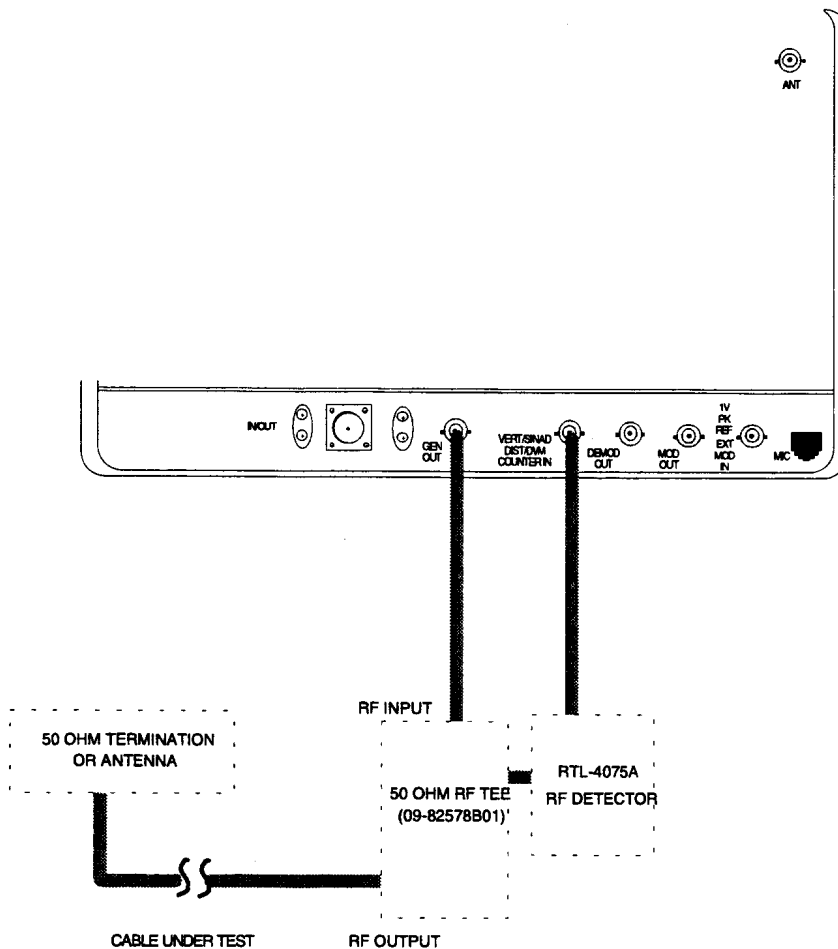

Figure 4-3. Basic Cable Testing Setup

### 4-3.2 Measuring Fault Distance

- To measure fault distance, terminate the free end of the cable with a 50 ohm load or the antenna
- To measure cable length, leave the free end of the cable open

Refer to Figure 4-3. Connect the output of the RF Detector Probe (RTL-4075A) to the VERT/SINAD connection of the R-2600 Analyzer. Attach a 50 ohm Tee (09-82578B01) to the GEN OUT/IN connection of the analyzer, and connect the RF input of the detector probe to the RF Tee. Connect the cable under test to the RF Tee.

1. With the cursor located within the Display Control zone, press the **more** softkey, then press the **CABLE FAULT** softkey.

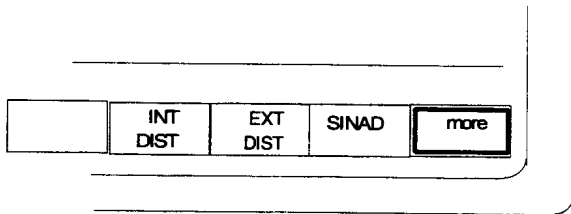

then

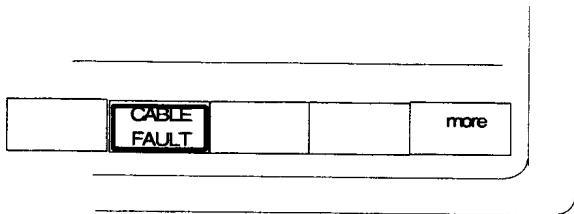

2. The sweep generator scope displays the standing wave pattern of the cable.

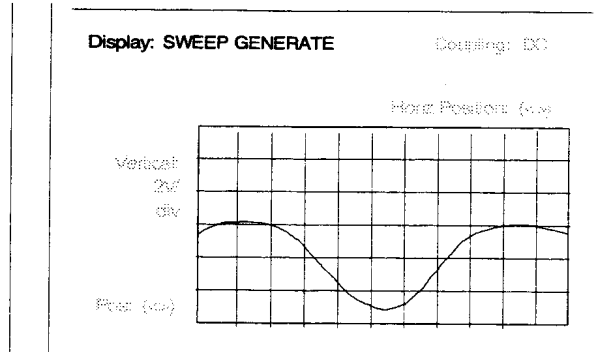

3. With the cursor located within the RF Control zone, set the range, output level and center frequency for the best display of the standing wave pattern.

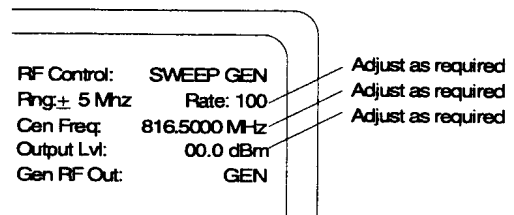

### NOTE

*This measurement generally works best with the range set between 10 and 100 MHz. When measuring fault distance, with an antenna attached to the cable, the first and second nul frequencies should be within the operating frequency range of the antenna.*

4. Within the Display zone, enter the velocity constant of the cable as required in the "Vel Const: " field.

Polyethylene	0.66
Cellular Polyethylene	0.78
Semi-Solid Polyethylene	0.84

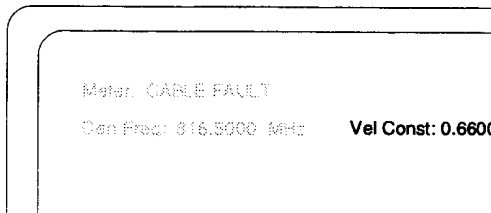

5. With the cursor located within the Display Control zone (Cen Freq:), use the tuning knob to center any null on the sweep generator scope.

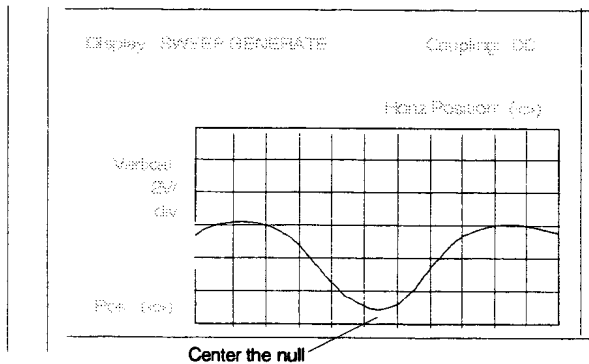
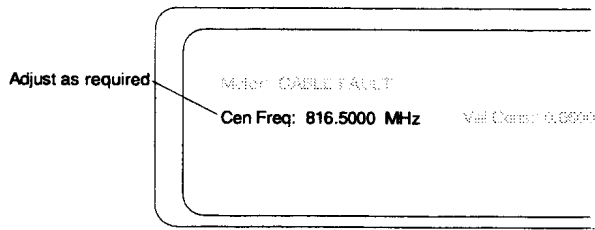

6. With the cursor located within the Display Control zone (Cen Freq:), press the **FIRST**

**NULL** softkey to display the frequency of the first null.

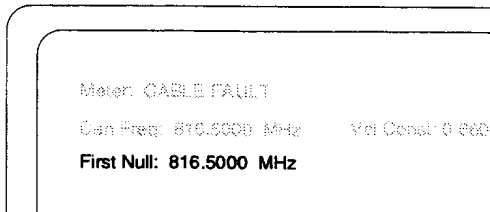
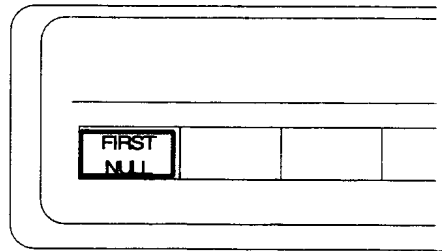

7. With the cursor still located within the Display Control zone (Cen Freq:), use the tuning knob to center an adjacent null to the same location on the sweep generator scope.
8. Press the **SECOND NULL** softkey. The cable fault distance (or cable length) will be displayed.

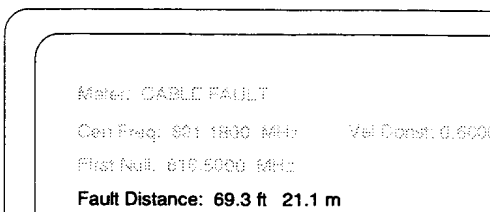
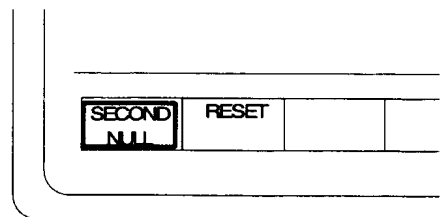

#### 4-4 TONE REMOTE TESTING

The tone remote function allows the analyzer to generate the required function tones and timing for tone controlled equipment. Specific tones are sent to remote equipment via phone lines that are connected to remotes or control consoles. Base stations and repeaters are examples of equipment using tone control commands. For example, tone commands can command transmitters and receivers to change frequencies or disable PL. The analyzer can simulate the tones and appear to the base station or repeater as a console or desk remote.

The most common use for the tone remote feature is commanding tone remote bases in order to measure all the main transmitter parameters. The main parameters would be power, frequency and system deviation. Without this capability, a technician must rely on personnel at the remote console or carry a tone remote to the base site. This can be impractical and time consuming.

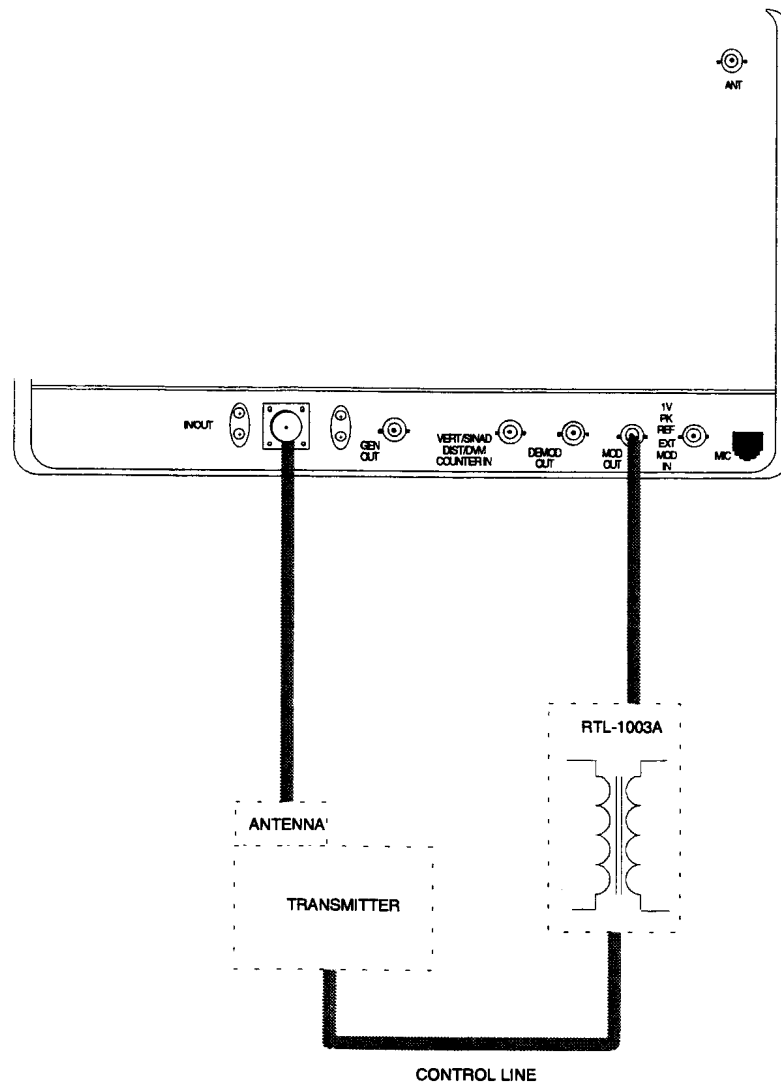

Figure 4-4. Tone Remote Testing Setup

#### 4-4.1 Tone Remote Testing Setup

Refer to Figure 4-4. Connect the analyzer RF I/O port to the radio antenna connector. Connect the phone lines, using a RTL-1003A matching transformer, to the analyzer's MOD OUT connector.

#### 4-4.2 Checking for Proper Tone Remote Operation

1. With the cursor located within the RF Control zone, press the **MON** softkey to place the analyzer into its Monitor mode of operation.

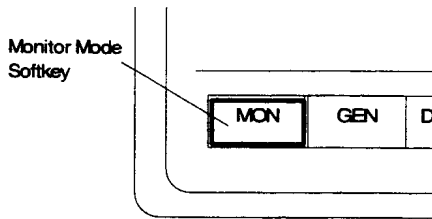

2. Tone Remote frequencies are programmed via the Tone A and Tone B memory. Set up the Audio Control zone, as follows:

Audio Sum:	78.0 kHz
Fixed 1kHz:	0.500 V ~
Synth:	0.500 V ~
Format Sel:	TONE A
Code:	021
Freq:	02175.0 Hz
DTMF:	30.0 kHz x
Code:	-----
External:	0.000 V x

or

Audio Sum:	0.500 V pk
Fixed 1kHz:	0.500 V ~
Synth:	0.500 V ~
Format Sel:	TONE B
Code:	021
Freq:	01950.0 Hz
DTMF:	0.000 V x
Code:	-----
External:	0.000 V x

3. Set the "Format Sel:" to **TONE RMT**. The base transmitter is activated when the SYNTH is turned on by pressing the **BURST** key. The level of the fixed 1 KHz tone and "Synth:" field will vary depending on the base specifications.

Audio Sum:	0.500 V pk
Fixed 1kHz:	0.500 V ~
Synth:	0.500 V *
Format Sel:	TONE RMT
Code:	021
Freq:	01950.0 Hz
DTMF:	0.000 V x
Code:	-----
External:	0.000 V x

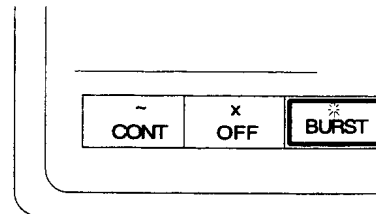

4. With the cursor located within the Display zone ("Meter:" field), press the **RF DISPLAY** softkey. Monitor the base frequency, power and deviation.

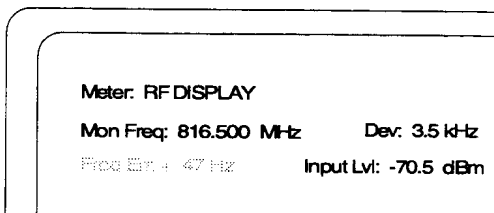
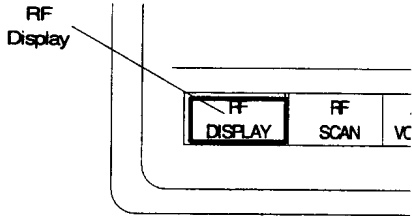

## 4-5 LX-810S/220 PRINTER APPLICATION NOTE

This note describes the use of the RT-LX810S/220 (220 volt operation) serial/parallel printer with the analyzer.

The RT-LX810S printer is a high quality dot matrix printer which can be used in many diverse applications. It comes from Motorola with the optional serial board already installed and setup for use with test equipment products using a RS-232C serial printer interface. The analyzer uses a standard RS-232C serial protocol.

### 4-5.1 Printer Self-Test

The RT-LX810S printer has a built-in selftest feature. This allows you to confirm proper operation of the printer prior to connection to other equipment. For details on the operation of this self-test feature, refer to the "Testing The Printer" section in the user manual that is shipped with your printer.

### 4-5.2 Printer Setup

As indicated above, the printer should arrive from Motorola with the serial board already installed and properly set up. If you feel the printer is improperly setup, the following details the switch setup for use with the analyzer. Since Epson may change the printer from time to time, the information is presented in a general sense so that you may check your specific printer user manual to configure your specific boards.

#### *Serial Board:*

Word length selection	8 bits
Parity check enable	disable
Even parity selection	odd

Flag polarity selection	positive
Bit rate	2400 baud
I/F board enable	enable
Buffer enable	enable
Flag reset timing	392 bytes
Selftest enable	disable
Selftest selection	loopback

*Printer*

Character spacing	10 cpi
Shape of zero	not slashed
Character table	italics
Short tear off	invalid
Draft printing speed	high
International character set	USA
Page length	off
Cut sheet feeder	off
1 inch skip over perforation	off
Auto line feed	off

### 4-5.3 Analyzer Setup

The analyzer must use the unique printer cable 30-80387B58 supplied by Motorola to properly print with any serial printer. **Do not use a standard serial cable; it will not work!** This is due to the fact that the RS-232 port is also used as a control port to remotely operate the analyzer in computer controlled applications. Different cables are required to activate each function. The printer has been set via the switches above to 8 bits, 1 stop bit, no parity and 2400 baud. Be sure in the printer setup screen that these settings have been set up in your analyzer. This information is available by pressing the **SPF** key. When in this screen, move the highlighted cursor to **RS232 SETUP** and press the softkey labeled **display table**. This table gives you the ability to configure the RS-232 output from the analyzer. Move the cursor to each field and choose the appropriate softkey entry to match the printer setup described above.





## Appendix A

### LIST OF ABBREVIATIONS

A	Ampere	Div	Division
AC	Alternating Current	DPL	Digital Private Line, a Motorola registered trademark
AM	Amplitude Modulation		
ATTEN	Attenuation	DTMF	Dual-tone multi- frequency
AUTO	Automatic	Dur	Duration
BATT	Battery	DVM	Digital Voltmeter
BNC	Coaxial RF Connector	EEA	Electronic Engineering Association
BW	Bandwidth		
C	Celsius	EIA	Electronics Industry Association
CAL	Calibrate		
CCIR	International Radio Consultative Committee	Ext'l	External
C&E	Communications and Electronics (part of Motorola)	FM	Frequency Modulation
cm	Centimeters	FREQ	Frequency
CMOS	Complementary Metal Oxide Semiconductor	GEN	Generate
Cntr	Counter	GHz	Gigahertz
CRLF	Carriage-return-line -feed	Horiz	Horizontal
CRT	Cathode Ray Tube	HPF	High Pass Filter
CW	Continuous Wave	Hz	Hertz
dB	Decibel	IC	Integrated Circuit
dBc	Decibel (referred to carrier)	IDC	Instantaneous Deviation Control
dBm	Decibel (referred to 1 mW into 50 ohms)	IEEE	Institute of Electrical and Electronics Engineers
DC	Direct Current	IF	Intermediate Frequency
Demod	Demodulation	IMTS	Improved Mobile Telephone System
DEV	Deviation	I/O	Input/Output
Disp	Dispersion	Kohm	Kilohm
DIST	Distortion	kHz	Kilohertz

## LIST OF ABBREVIATIONS-CONTINUED

LED	Light-Emitting Diode	SEQ	Sequence
LPF	Low Pass Filter	SINAD	Ratio of (Signal + Noise + Distortion)/(Noise + Distortion)
Lvl	Level		
MHz	Megahertz	SPF	Special Function
MIC	Microphone	SSB	Single Sideband
MIN	Minimum	STD	Standard
MOD	Modulation	SW	Switch
MON	Monitor	SWP	Sweep
us	Microsecond	Synth	Synthesizer
ms	Millisecond	TN	Tone
MSEC	Millisecond	Trig	Trigger
Mtr	Metering	TX	Transmitter
MTS	Mobile Telephone System	UHF	Ultra High Frequency
MV	Millivolts	V	Volts
uV	Microvolts	VAC	Volts Alternating Current
mW	Milliwatt	VDC	Volts Direct Current
n	Number	Vert	Vertical
N/A	Not Applicable	VRMS	Volts (root-mean-square)
NB	Narrow Bandwidth	W	Watts
NVM	Non-volatile memory	WB	Wide Bandwidth
ORIG	Originated	XCVR	Transceiver
PCT	Percent	XX	(Select Any Valid Number)
PL	Private Line, a Motorola registered trademark	ZVEI	Zentral-Verband der Elektro-Industrie (a German Electronics Industry Association)
+/-	Plus or minus		
PRT	Print		
RF	Radio Frequency		
RGB	Red-green-blue (refers to video connections)		
RMS	Root-Mean-Square		
Rng	Range		
RS	Receiver Specification		
SEC	Second		

## Appendix B

### TONE AND CODE SPECIFICATIONS

Table B-1. Standard DTMF Tones

TONE GROUP	STANDARD DTMF (Hz)
LOW	697
LOW	770
LOW	852
LOW	941
HIGH	1209
HIGH	1336
HIGH	1477
HIGH	1633

Table B-2. DTMF Frequency Coding\*

KEY	LOW GROUP TONE (Hz)				HIGH GROUP TONE (Hz)			
	697	770	852	941	1209	1336	1447	1633
1	•				•			
2	•				•	•		
3	•						•	
A	•							•
4		•			•			
5		•				•		
6		•					•	
B		•						•
7			•		•			
8			•			•		
9			•				•	
C			•					•
*				•	•			
O				•		•		
#				•			•	
D				•				•

The analyzer has provisions for encoding and decoding 16 different keys. Each key is assigned two frequencies: one from a low tone group and one from a high tone group. Four tones are available from each group, with 16 different combinations of low and high group tones. This table shows the tone assignments of each key.

Table B-3. Private-Line (PL) Codes

CODE	FREQUENCY (Hz)
XZ	67.0
WZ	69.3
XA	71.9
WA	74.4
XB	77.0
WB	79.7
YZ	82.5
YA	85.4
YB	88.5
ZZ	91.5
ZA	94.8
ZB	97.0
1Z	100.0
1A	103.5
1B	107.2
2Z	110.9
2A	114.8
2B	118.8
3Z	123.0
3A	127.3
3B	131.8
4Z	136.5
4A	141.3
4B	146.2
5Z	151.4
5A	156.7
5B	162.2
6Z	167.9
6A	173.8
6B	179.9
7Z	186.2
7A	192.8
M1	203.5
8Z	206.5
M2	210.7
M3	218.1
M4	225.7
9Z	229.1
M5	233.6
M6	241.8
M7	250.3

Table B-4. 5/6 Tone Paging Tones

DIGIT	FREQUENCY
0	600
1	741
2	882
3	1023
4	1164
5	1305
6	1446
7	1587
8	1728
9	1869
R	459
X	2010

Table B-5. DPL Standard Codes

023	174	445
025	205	464
026	223	465
031	226	466
032	243	503
043	244	506
047	245	516
051	251	532
054	261	546
065	263	565
071	265	606
072	271	612
073	306	624
114	311	627
115	315	631
116	331	632
125	343	654
131	351	662
132	364	664
134	365	703
143	371	712
152	411	723
155	412	731
156	413	732
162	423	734
165	431	743
172	432	

Table B-6. Select V Frequencies

CHARACTER	ZVEI STD (Hz)	ZVEI MOD (Hz)	ZVEI FRENCH (Hz)	CCIR STD (Hz)	CCIR 70MS (Hz)	EEAA (Hz)
0	2400	2200	2400	1981	1981	1981
1	1060	970	1060	1124	1124	1124
2	1160	1060	1160	1197	1197	1197
3	1270	1160	1270	1275	1275	1275
4	1400	1270	1400	1358	1358	1358
5	1530	1400	1530	1446	1446	1446
6	1670	1530	1670	1540	1540	1540
7	1830	1670	1830	1640	1640	1640
8	2000	1830	2000	1747	1747	1747
9	2200	2000	2200	1860	1860	1860
G	2800	885	885	2400	2400	1055
B	810	810	810	930	930	930
C	970	2600	2600	2247	2247	2247
D	885	2800	2800	991	991	991
F	930	930	930	873	873	873
R	2600	2400	970	2110	2110	2110
N <sub>r</sub> Tone	0	0	0	0	0	0
Length (msec)	70	70	70	100	70	40

## Appendix C

### SAFE HANDLING OF CMOS INTEGRATED CIRCUIT DEVICES

Many of the integrated circuit devices used in communications equipment are of the CMOS (Complementary Metal Oxide Semiconductor) type. Because of their high open circuit impedance, CMOS ICs are vulnerable to damage from static charges. Care must be taken in handling, shipping, and servicing them and the assemblies in which they are used.

Even though protection devices are provided in CMOS IC inputs, the protection is effective only against overvoltage in the hundreds of volts range such as are encountered in an operating system. In a system, circuit elements distribute static charges and load the CMOS circuits, decreasing the chance of damage. However, CMOS circuits can be damaged by improper handling of the modules even in a system.

To avoid damage to circuits, observe the following handling, shipping, and servicing precautions.

1. Prior to and while servicing a circuit module, particularly after moving within the service area, momentarily touch both hands to a bare metal earth grounded surface. This will discharge any static charge which may have accumulated on the person doing the servicing.

#### NOTE

*Wearing Conductive Wrist Strap (Motorola No. RSX-4015A) will minimize static buildup during servicing.*

#### WARNING

*When wearing Conductive Wrist Strap, be careful near sources of high voltage. The good ground provided by the wrist strap will also increase the danger of lethal shock from accidentally touching high voltage sources.*

2. Whenever possible, avoid touching any electrically conductive parts of the circuit module with your hands.
3. Normally, circuit modules can be inserted or removed with power applied to the unit. However, check the INSTALLATION and MAINTENANCE sections of the manual as well as the module schematic diagram to insure there are no objections to this practice.
4. When servicing a circuit module, avoid carpeted areas, dry environments, and certain types of clothing (silk, nylon, etc.) because they contribute to static buildup.

5. All electrically powered test equipment should be grounded. Apply the ground lead from the test equipment to the circuit module before connecting the test probe. Similarly, disconnect the test probe prior to removing the ground lead.
6. If a circuit module is removed from the system, it is desirable to lay it on a conductive surface (such as a sheet of aluminum foil) which is connected to ground through 100k of resistance.
7. When soldering, be sure the soldering iron is grounded.
8. Prior to connecting jumpers, replacing circuit components, or touching CMOS pins (if this becomes necessary in the replacement of an integrated circuit device), be sure to discharge any static buildup as described in procedure 1. Since voltage differences can exist across the human body, it is recommended that only one hand be used if it is necessary to touch pins on the CMOS device and associated board wiring.

**WARNING**

*If the aluminum foil is connected directly to ground, be cautious of possible electrical shock from contacting the foil at the same time as other electrical circuits.*



## Appendix D

### EXTERNAL PORT PIN ASSIGNMENTS

#### RS-232 PORT

This is a full bidirectional RS-232 port with the capability to respond to a serial input. The port serves a dual purpose in that if an RS-232 is not desired, the port can be used as a printer output. Software determines if the port functions as an RS-232 bidirectional port or as an output-only printer port. 25 pin female "D" connector on Processor Module for RS-232 interface at the side panel. Drawing shows pins as seen from a side view of the Analyzer.

PIN

1	GND
2	TXD (transmit data)
3	RXD (receive data)
4	RTS (request to send)
5	CTS (clear to send)
6	DSR (data set ready)
7	SIG GND (signal ground)
8	DCD* (data carrier detect)
9-19	not used
20	DTR* (data terminal ready)
21-25	not used

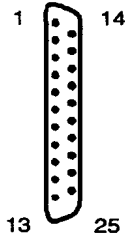

DCD\* (Data Carrier Detect) input is not used in this application.

DSR\* (Data Set Ready) is a general purpose input that is used for modem control. This line is not used when a printer is connected.

DTR\* (Data Terminal Ready) is a general purpose output to indicate the Analyzer is ready to receive more data on the RXD line.

RTS\* and CTS\* (Request-To-Send, Clear-To-Send) are handshaking signals used in RS232 communications.

RXD (Receive Data) input signal is the data received. If this connector is used as a printer output, the RXD pin is not used.

TXD (Transmit Data) output signal is the data being transmitted.

NOTE: For printer use, pins 5 and 20 of this port should be tied together inside the cable to the printer. 30-80387B58 printer cable provides the required interface.

#### RGB COLOR MONITOR PORT

9 pin female "D" connector at Processor Module for side panel interface with an external color monitor. Drawing shows pins as seen from a side view of the Analyzer.

PIN

1, 2	GND
3	RED
4	GREEN
5	BLUE
6	INTENSITY
7	not used
8	HSYNC (horizontal sync)

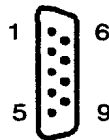

9 VSYNC (vertical sync)

---

## REAR PANEL DC INPUT PORT

Drawing shows pins as seen from a rear view of the Analyzer.

Positive DC voltage must be between +11 and +18VDC.

Either "+" pin may be used for the positive DC voltage since these two pins are tied together internally.

