



FLOAT

Owner's Manual

Bedienungsanleitung

Manuel D'Utilisation

Manuale di istruzioni

Theory of Operation / Disclaimer / Warranty

Why do I need an avalanche airbag?

Preventing or minimizing burial depth is the key to reducing avalanche fatalities. That's because the majority of time in an avalanche rescue is spent on excavating the victim. An airbag is designed to keep you at or near the surface, minimizing excavation time.

Disclaimer

The Float system is designed to help improve your chances of surviving an avalanche. It must be used correctly, following the guidelines in this manual. Perform a practice deployment at least once a year. Do not modify any aspect of this product or perform any operations not described in this manual.

Your Float cannot prevent the release of an avalanche or guarantee survival under any conditions. Any airbag must be used in conjunction with a beacon, shovel, probe, and helmet to increase your chance of survival. As with other avalanche rescue tools, your airbag should not promote taking more risks.

In addition to these rescue tools, you should acquire the necessary skills to avoid avalanche situations before heading into the backcountry. Take an avalanche safety course, practice with your equipment, and plan your route according to the regional avalanche forecast.

Warranty

The manufacturer, Backcountry Access, Inc. (BCA), expressly warrants the workmanship and components of this product for three years after the date of retail purchase. All parts will be either repaired or replaced free of charge, including labor, by the manufacturer. This warranty does not cover damage to the product caused by improper use or excessive wear and tear. Direct all warranty claims to BCA or your airbag retailer. All claims must include proof of purchase and a return authorization number.

To ensure warranty protection and periodic technical updates please register online at:

www.backcountryaccess.com/warranty

Instructions and Warnings

Failure to follow these instructions and warnings may result in death or serious personal injury.

- The purpose of the Float Avalanche Airbag is to reduce the likelihood of burial during an avalanche. Any avalanche can be deadly.
- It is important to practice before taking the system into the field. A practice deployment at least once a year is recommended.
- Before taking the Float Avalanche Airbag into the field, inspect all trigger and hose connections and ensure they are properly attached as described in this manual.
- The pressure gauge on the cylinder must read between 2500 psi – 2700 psi at 70°F (21°C) or the system may not fully inflate.
- The waist belt and leg strap must be worn to ensure the backpack stays in its intended position in the event of an avalanche.
- Avoid placing sharp object such as crampons, ice tools, poles or exposed ski/snowboard edges near or on top of the airbag compartment. Only carry skis using the diagonal ski carry. Do not use the side compression straps for A-frame carry, as they may obstruct the airbag's deployment and/or damage the airbag.
- Always fold the airbag according to the directions detailed in this manual. Failure to do so may prevent the system from inflating properly.
- To reduce the likelihood of inadvertent inflation, store the trigger handle zipped in the shoulder strap. This is recommended when you or others could be harmed by the system such as when on chairlifts, gondolas, helicopters, buses, trains, cars, etc.
- When not in use, keep the system in a cool, dry place away from direct sunlight.
- Never attempt to alter or repair the system. Only Backcountry Access, Inc. authorized service centers may work on or repair the system. Any unauthorized work or alterations will void the warranty.

Equipment Check

Compressed Air System

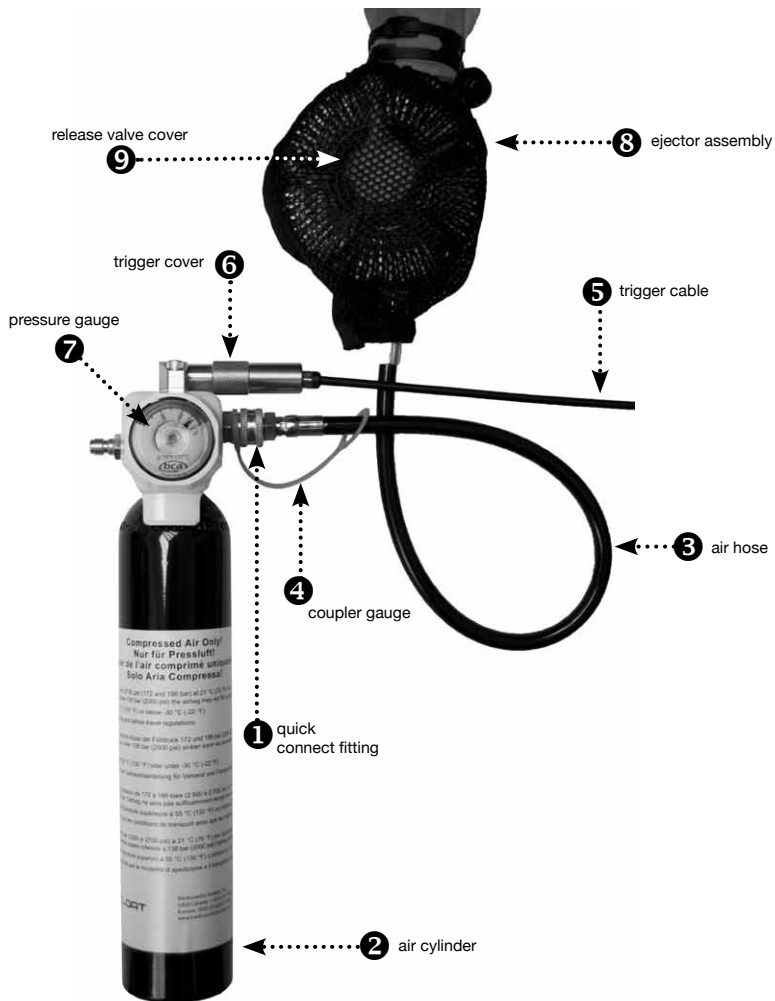

Installing Compressed Air Cylinder

1. Remove packaging caps from pressurized air cylinder. To reach the compressed air system, unzip the main storage compartment and fold back the fabric compressed air system cover.
2. Connect the quick connect fitting on the air hose **1** by pulling the large ring toward the pressure gauge **7**. It should click back into place when air hose **3** is properly connected. Coupler gauge **4** should fit in place to ensure air hose is connected properly. **WARNING: If the coupler gauge will not fit in place, the system may not inflate.**

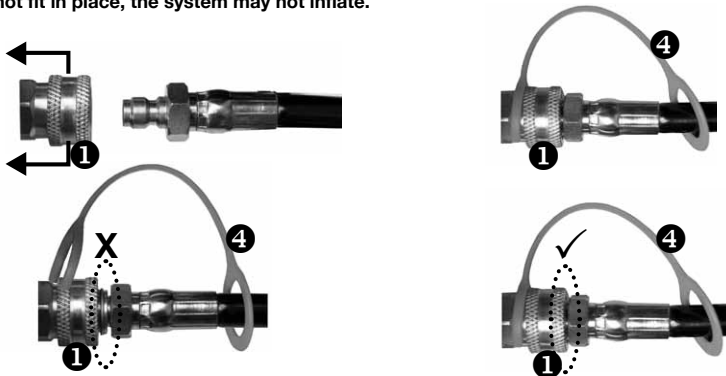

3. **IMPORTANT!** Screw the trigger cable nut **10** onto the trigger pin **11**. To expose the trigger cable nut before threading it on the trigger pin, it might be necessary to push the trigger handle **12** back into the shoulder strap. **WARNING: Failure to screw the cable nut onto the trigger pin will prevent the system from inflating.**

4. Screw the trigger cover **6** over the trigger cable nut **10**.

5. Once cylinder is placed in the sleeve, secure the Velcro closure on the cylinder compartment.

6. To disconnect an empty cylinder, follow the above steps in reverse.

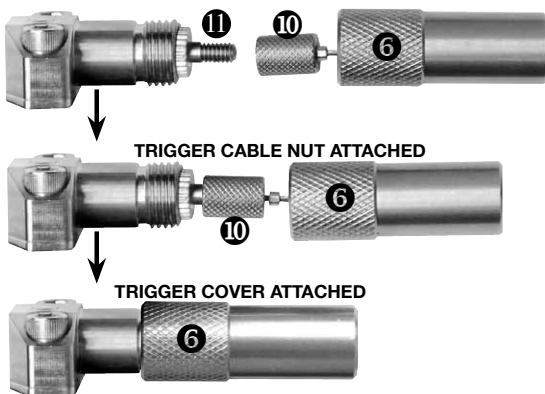

Using the Avalanche Airbag

Equipment Check – Before Every Use Check the Following:

System Fittings

Follow the previous “Installing Compressed Air Cylinder” steps to verify connections are correct. Verify the trigger cable nut connection by unscrewing the trigger cover ❸ and making sure the trigger cable nut ❶ is attached securely to the trigger pin ❶. Replace trigger cover.

Air Cylinder

Check the pressure gauge ❷ on the compressed air cylinder and make sure it is between 2500 and 2700 psi (172 to 186 bar) at room temperature (approximately 70°F or 21°C). Pressure must be checked at room temperature for the reading to be accurate. Check pressure before every use.

WARNING: PRESSURE MUST BE IN THIS RANGE OR THE SYSTEM MAY NOT FUNCTION PROPERLY. Once the system is exposed to cold, the pressure will drop. If the pressure is ever observed below 2000 psi (138 bar), at any temperature, the airbag may not fill completely.

Inspect the cylinder. Do not use a cylinder that is dented or damaged.

Pack

Make sure the Velcro flap on the top of the airbag compartment is securely fastened. This will ensure that the airbag is completely stored and secure.



Only the airbag and ejector are meant to be stored in the airbag compartment. **WARNING: Never store any additional items in this compartment; items may prevent the airbag from deploying.**

Check that nothing is loose inside the compressed air system or blocking the ejector assembly. Make sure the compartment is zipped completely shut.

Check to make sure that nothing is obstructing the airbag compartment on the outside of the pack. **WARNING: Avoid placing sharp object such as, crampons, ice tools, poles or exposed ski/snowboard edges near or on top of the airbag compartment.** Only carry skis using the diagonal ski carry. Do not use the side compression straps for A-frame carry, as they may obstruct the airbag's deployment and/or damage the airbag.

Perform visual inspection of stitching and fabric of the backpack. Ensure that the carrying system of the backpack is not torn, abraded, or worn. Damaged gear must be retired.

Pack Adjustments

Your pack should be properly fitted before you head into avalanche terrain. The forces of an avalanche can remove the pack from your back if it is not secured to your body.



Attaching Leg Strap

The leg strap is an important component of this system, and must always be worn by passing it between your legs and threading the loop over one end of the waist buckle. For more information please reference the Components and Features section in this manual.

Waist Buckle



There are two parts to the buckle: male and female. Insert the male part into the widest opening of the female part. Tighten the waist strap until snug. When attached correctly, the webbing and the buckle should lay flat against your body. **WARNING: The waist belt must be fastened for the system to function.**

Deployment

Before entering avalanche terrain, unzip the pocket where the trigger handle is stored (see image on right). In case of an avalanche, pull the trigger handle quickly in a downward motion, reaching across your body with the hand opposite the trigger. Try skiing or riding to the flanks of the avalanche to escape the debris. In the event that you are buried, preserve your airway by covering your mouth with your hand or elbow when the avalanche slows down.

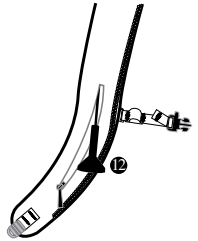

What to Expect

The airbag should exit the backpack and fill completely in approximately three seconds. The airbag will continue to build pressure for a few seconds longer until the system pressure equalizes. The airbag will hold air for several minutes until the threat of the avalanche has passed.

After Deployment

Release the air from the airbag by pressing the release valve with your finger. To locate the valve open the mesh cover on the ejector 8, the valve is underneath the orange release valve cover 9. Never use hard or sharp objects to hold the release valve open. Make sure the release valve returns to the original position after deflation. Re-pack the airbag into the airbag compartment. See "Packing the Airbag" below for details.

Maintenance

WARNING: If you have deployed your airbag in an avalanche, the airbag must be inspected by the manufacturer before additional use. Please contact BCA for a free airbag inspection and cylinder refill. Contact information can be found on the back cover.

Packing the Airbag

The airbag must be folded into the airbag compartment. DO NOT ROLL OR STUFF THE AIRBAG OR THE SYSTEM MAY NOT DEPLOY PROPERLY. If the airbag is wet, dry it completely before packing. Empty any residual air from the airbag using the release valve (you may need to do this periodically as you pack the bag). It is very important that all residual air has been released. Reseat the orange valve cover. Pull the mesh cover back over the ejector and cinch the draw string. Disconnect the air hose from the cylinder before folding the airbag.

1. Completely separate the zipper so the slider is only attached to one set of teeth.
2. Bring zipper slider back to the opposite side of pack where the zipper begins (a).
3. Begin by laying out the deflated airbag flat on the ground. Make one vertical accordion fold on each side of the airbag (b).
4. Next make two horizontal accordion folds on the airbag (c). After this step, your airbag is ready to be zipped inside the airbag compartment.
5. With the airbag folded inside the compartment, re-engage the zipper (d) and zip the compartment past the Velcro flap at the top of the compartment (e). Fasten Velcro and finish zipping the compartment closed (f). Never reverse the zipper pull over the breakaway section on the airbag compartment zipper as this may cause the zipper to jam or break.

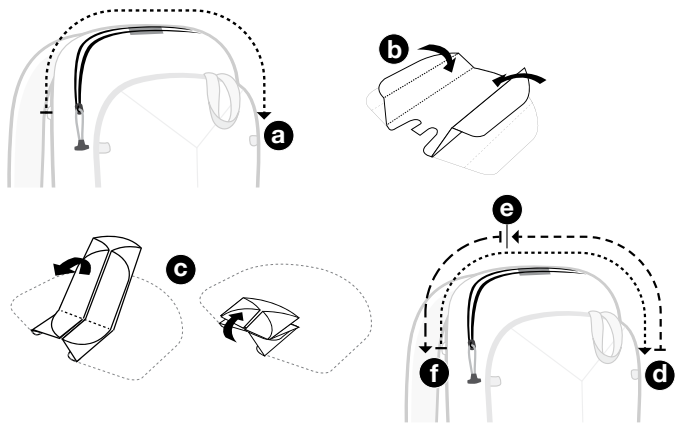

Empty Cylinder

The Float airbag will not deploy again until the cylinder is refilled or replaced. This can be done at a Float Refill or Exchange Center (see www.backcountryaccess.com/air). To install the filled cylinder, see “Installing Compressed Air Cylinder.”

Removing and Installing the Airbag System

The Float packs feature a removable and interchangeable airbag system. The airbag components can be swapped between 2012-13 or newer packs, or removed entirely.

Removing

1. To remove the airbag, open the airbag compartment by pulling the breakaway zipper apart under the Velcro flap. Never try to “unzip” the airbag compartment zipper. Doing so could result in damage to the breakaway zipper.
2. Disconnect the trigger cable and air hose from the cylinder (a).
3. Unfasten the black Velcro holding the loose end of the orange rope in place. Un-thread the rope from the webbing loops (b).
4. Once the rope is no longer threaded through the webbing loops, the airbag, ejector, trigger cable and air hose are free to remove (c). The trigger cable stays with pack, but can be removed as noted later in the section “Moving the Trigger.”

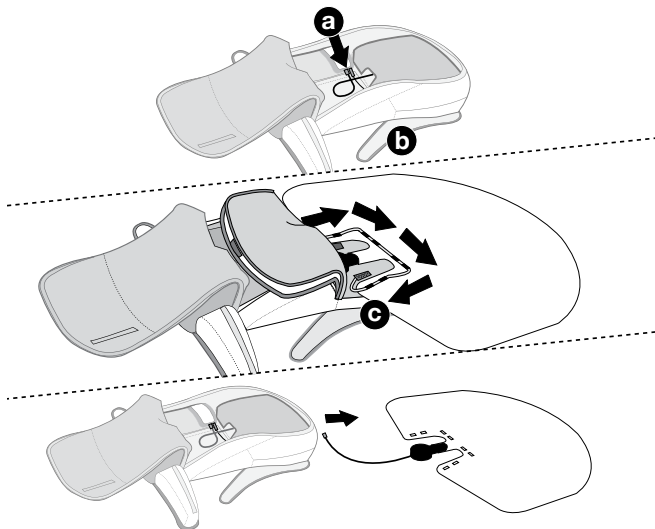

Installing

Installing

1. With the airbag unfolded, lay the ejector in the airbag compartment with the orange release valve cover facing up (a). The air hose should be fed through the designated opening (b) into the main storage compartment where the cylinder is kept.
2. Starting on the side by the fixed end of the orange rope, pull the loops of webbing through the slits in the airbag and lace the rope through the loops of webbing.
3. Once the threading is complete up to the ejector tube, pull the rope tight.
4. Bring rope over ejector tube.
5. Repeat threading technique through remaining slits and webbing loops.
6. Secure the loose end of the orange rope by running it up through the black Velcro loop, then loop it back down and fold the Velcro flap over it.
7. Repack airbag and close compartment (see above instructions for repacking).
8. Reconnect trigger cable and air hose to cylinder (d).

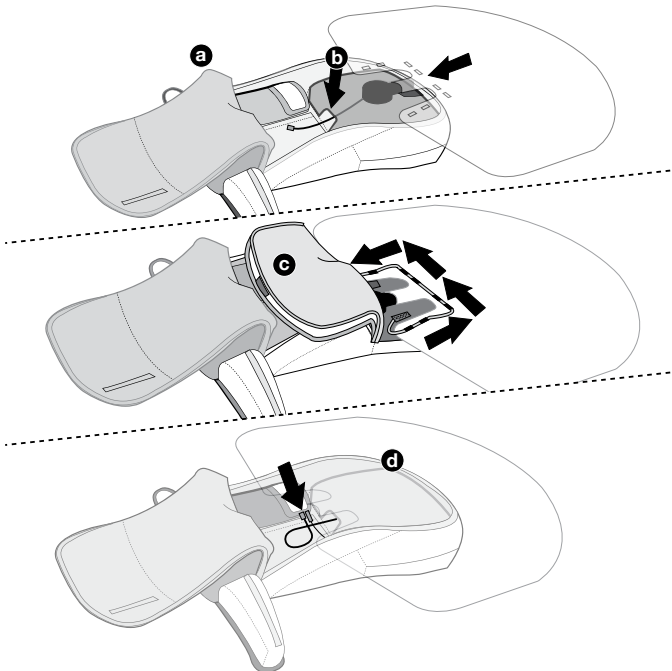

Moving the Trigger

Some Float models allow you to install the trigger in the left or right shoulder strap, depending on your preference. Models with zippered pockets on both shoulder straps allow for this feature.

Removing

1. Open the zipper on the shoulder strap containing the trigger.
2. Loosen the small screw that attaches the trigger to the webbing loop inside the shoulder strap.
3. Pull the trigger and cable out (a) through the shoulder strap zipper.

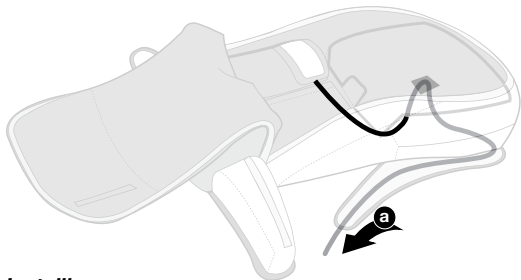

Installing

1. Starting at the shoulder strap zipper (a), thread the trigger cable, leading with the trigger cover, back into the pack (b). **WARNING: Be sure the trigger cable is fed underneath the airbag components, and take care not to kink the cable during installation.**
2. Feed trigger cable through the opening in bottom right corner of the airbag compartment (c) into the main storage pocket that stores the cylinder.
3. Inside the shoulder strap zipper, secure the trigger cable by fastening the screw on the trigger assembly to the webbing loop. Confirm that the trigger assembly screw has been properly fastened to the webbing loop by pulling on the trigger handle and ensuring that the trigger assembly is fixed to the webbing loop. **WARNING: Improper installation of trigger may prevent system from deploying.**

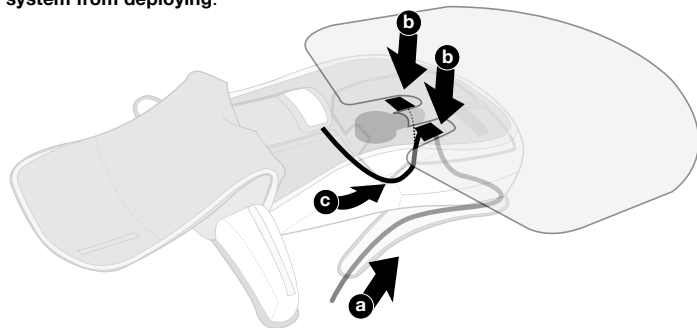

Storage

When the system is not in use store in a cool, dry place. If the system is wet, dry before storing by opening the airbag compartment and laying the airbag flat to dry. Do not expose a Float cylinder to temperatures exceeding 130°F (55°C) or below -22°F (-30°C). If subjected to adverse conditions, check that all connections are free of contaminants. Pack can be cleaned with warm water only and connections can be cleaned with a damp cloth. Do not use soaps, detergents, lubricants, or other chemicals; they may degrade or damage materials if used anywhere on the system.

Periodic Deployment/Service Life

BCA recommends deploying your Float airbag at least once per year, both to make sure the system is operating correctly and to be sure the user knows how to operate the equipment efficiently. Put it on, pull the trigger, repack the airbag and refill the cylinder before the season starts. Your Float airbag is designed to undergo a minimum of 20 deployments and is warranted for three years. With occasional use and proper care, the system can be expected to last for 5 years. Under frequent use and with proper care the system may need to be retired before 5 years. The maximum shelf life is 10 years from the date of manufacture. Factors that may reduce the lifespan of the product are: abrasion, wear, prolonged exposure to sunlight, prolonged exposure to moisture, or harsh environments. The manufacturing date can be found underneath the cylinder sleeve in the main compartment.

Discharging Compressed Air Cylinder

If the cylinder must be discharged for any reason, it may be used for a practice deployment. Simply deploy the airbag by pulling on the trigger handle.

WARNING: ALWAYS EMPTY CYLINDERS BY DEPLOYING THEM WITHIN THE AIRBAG SYSTEM. EMPTYING CYLINDERS IN ANY OTHER MANNER MAY CAUSE PERSONAL INJURY.

Shipping And Transportation Guidelines

For shipping and transportation guidelines, please visit our website at www.backcountryaccess.com.

Certifications and Markings

The following marks can be found on Backcountry Access Float Avalanche Airbags.

 The CE mark of conformity indicates that this product meets the requirements of the Personal Protective Equipment Directive (89/686/EEC).

Tested by TÜV SÜD: a globally recognized testing, inspection, and certification organization.
TÜV Süd Product Service GmbH Ridlerstr. 21 D-80339 Munich Germany

Backcountry Access Float avalanche airbags are covered under U.S. patent: #7,878,141.

Avalanche Rescue

This is a basic introduction to avalanche rescue techniques. On our website, you will also find a list of avalanche instructors. We strongly suggest taking an avalanche course in your area before venturing into the backcountry. Each person needs a working beacon, probe and shovel—and must know how to use them. Before leaving, call your local avalanche forecast center and determine the danger level in the area you intend to visit:

US: www.avalanche.org

Canada: www.avalanche.ca

Europe: www.lawinen.org

Searching for victims

If a member of your group is buried, you must perform a beacon search. The objective is to find the strongest signal (lowest distance reading) and immediately begin probing the area. In the event of a burial, switch all avalanche beacons to search mode. The guidelines below assume the use of a digital beacon.

Signal search: If there is a “last seen point,” start your signal search there. Otherwise, start your signal search at the top, bottom or side of the slide path. See diagram on right to establish a search pattern.

Coarse search: Once a signal is engaged, align your beacon so that any of the center three lights are flashing and move quickly in the direction it is pointing. Make sure the number in the distance display is decreasing. If it is increasing, turn 180 degrees. Inside ten meters, move slowly and try to keep the center search light engaged.

Fine search: Within three meters, use your beacon as close as possible to the snow surface and look for the smallest distance reading. Confirm by “bracketing” in the perpendicular direction.

Probing/Pinpointing: At the point where the distance has reached a minimum, probe the area in concentric circles, with each probe hole about 10 inches (25cm) apart. Your probe should enter the snow perpendicular to the slope. Once you have confirmed the victim’s location, leave the probe in the snow.

Shoveling: While shoveling might seem elementary, it usually consumes the majority of time during an avalanche beacon rescue. For best results, start shoveling just downhill of the probe. Make your hole one “wingspan” wide. In burials deeper than one meter, excavate downhill about 1.5 times the burial depth. For more advanced shoveling techniques, see our website: www.backcountryaccess.com/shoveling.

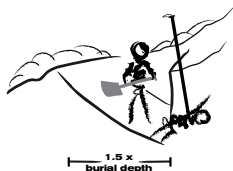
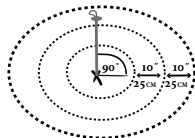
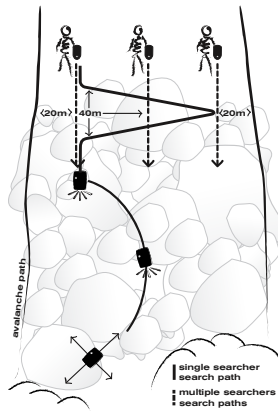



Float save in Montezuma, Colorado, USA.

Backcountry Access, Inc.

2820 Wilderness Place, Unit H
Boulder, Colorado USA
Phone: 303-417-1345
info@backcountryaccess.com
www.backcountryaccess.com

BCA/K2 Canada

1 Westside Dr. Unit #7
Etobicoke, ON
M9C 1B2
Phone, local: 416-620-4125
Phone, toll free: 866-455-2748
bca@k2canada.com

BCA/K2 Europe

K2 Sports Europe GmbH
Seeshaupter Strasse 62
82377 Penzberg
Germany
Fon: +49 8856 901 – 0
BCA@K2sports.de

BCA/Madshus AS

Madshus AS
Industriveien 29
2936 Biri
P: 61134300
M: madshus@madshus.com

BCA/K2 Japan

11F Shibaura Square Building
4-9-25 Shibaura, Minato-ku
Tokyo, 108-0023 Japan
Tel: +81-3-6858-7822
BCA@k2japan.com

