

# Vixen®

## Instruction Manual for POLARIE U Star Tracker



## **PREFACE**

### **Thank you for your purchase of the Vixen POLARIE U Star Tracker.**

This instruction manual describes the functions and uses of the POLARIE U Star Tracker. As for the usage of equipment such as a DSLR camera, a tripod, a ball head and a shutter cable release, which can be used together with this product, you can refer to the instructions for each item.

### **Read the instruction manual carefully before use and handle the product correctly.**

- Keep this manual nearby to find a quick answer to questions.
- This manual will assist you in the safe and effective use of the product. Before using the product, be sure to read the safety precautions described below.

## CAUTION

- ⊘ Do not use the product while traveling or walking, as injuries may arise from stumbling, falling or collision with objects.
- ⊘ Keep small caps, plastic bags or plastic packing materials away from children. These may cause choking or suffocation.
- ⊘ Do not use the product in a wet environment. Do not operate the product with wet hands. This could damage the mount, result in electrical shock or fire.
- ⊘ Do not turn on the power switch of the product under circumstances when internal condensation is suspected with the equipment. It may cause a failure by a short circuit.
- ⊘ Do not attempt to disassemble or alter any part of the equipment that is not expressly described in this manual. This could damage the mount, resulting in electrical shock, fire or lead to an injury.
- ⊘ Use only recommended power sources. Using other power sources could result in damage to the unit.
- ⊘ Insert the batteries in the correct direction. It may cause a malfunction.
- ⊘ Be careful not to drop the unit when handling. This may cause damage or lead to injury.
- ⊘ Vixen accepts no liability for damages if the camera mounted comes out of order by contact in use.

## HANDLING AND STORAGE

- Do not leave the product inside a car in bright sunshine, or in hot places. Keep any strong heat radiation sources away from the product.
- When cleaning, do not use a solvent such as paint thinners. It may cause deterioration.
- Do not expose the product to rain, water drops, dirt or sand. Gently wipe the product with a damp cloth for cleaning.
- For storage do not expose to direct sunlight and keep the product in a dry place.
- Remove the batteries from the battery compartment if you don't use it for a long time

# TABLE OF CONTENTS

**PREFACE** ----- P2

**CAUTION** ----- P3

**HANDLING AND STORAGE** ----- P3

**TABLE OF CONTENTS** ----- P4

## **BEFORE USE**

Check Contents -----	P 5
Consisting of: -----	P 5
Basics of the POLARIE U -----	P 5
Name of Each Part -----	P 6
Mode Change -----	P 8
Icons on the Mode Display -----	P 9
Requirements and Useful Items -----	P10

## **HOW TO USE**

I. About Power Source -----	P13
Power Supply with AA Alkaline Batteries ----	P13
Power Supply with an External Mobile Battery -----	P13
II. Setting Up the POLARIE U -----	P14
III. Practice (Taking Photography) -----	P17
Procedure to start up photographing: -----	P17
Align to the Celestial Pole -----	P17
Using a Star Map -----	P18
Locate Polaris from Cassiopeia and the Big Dipper ----	P19

Various Settings on your Camera -----	P20
Basics -----	P20
Example 1 -----	P20
Example 2 -----	P21
Focusing and Composing the shot -----	P21
Cameras without Live View feature -----	P21
Cameras with Live View function -----	P22
Photography Composition -----	P22
Setting the Mode Display -----	P23
Star-Scape Photography Mode -----	P23
Celestial Tracking Mode -----	P23
Solar Tracking Mode / Lunar Tracking Mode ----	P24
Difference from the diurnal motion of stars -----	P24
Custom Mode -----	P24
Start Shooting -----	P24
IV Application -----	P25
Using the Custom Mode and the External Setting -----	P25
Cameras Available for the Shutter Release Control ----	P25
Flow of Operation -----	P26
Autoguider -----	P26
Reset -----	P26
Using with an optional Polar Alignment Scope PF-LII ---	P27
Components Guide -----	P27

Legend on the Polar Alignment Reticle -----	P28
Illumination ON and OFF -----	P29
Adjusting the Brightness -----	P29
Focusing on the Polar Alignment Reticle -----	P29
Procedure of the Polar Alignment (in the northern hemisphere) -----	P30
Polar Alignment -----	P31
Polar Alignment in the Northern Hemisphere ----	P31
Polar Alignment in the Northern Hemisphere ----	P41
About PF-L Assist App -----	P54
Using an optional Polarie Multi Mounting Block -----	P55
Using an optional Quick Release Panorama Clamp -----	P56

**SPECIFICATIONS** ----- P57

## **APPENDIX**

Pinpoint star images at 1/2 star scape mode ----	P58
Pinpoint star images at wide-field astrophotography mode subject to a polar alignment at an error of 2 degrees -	P59

## BEFORE USE

### Check Contents

The POLARIE U box contains the items listed below. Check if all the items are included in your box.

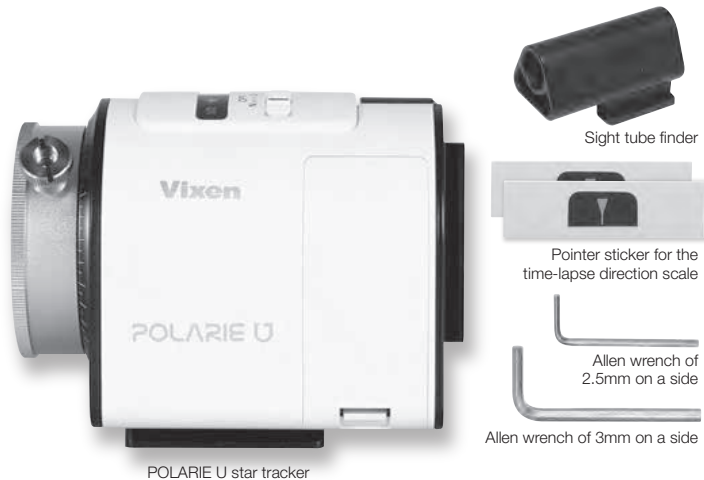

### Consisting of:

\*Batteries are not included

POLARIE U star tracker\*....1

Sight tube finder ....1

Pointer sticker for the time-lapse direction scale ....1

Allen wrench of 3mm on a side ....1

Allen wrench of 2.5mm on a side ....1

Instruction manual for POLARIE U (This book) ....1

### Basics of the POLARIE U

Stars appear to rotate around the celestial poles of the earth. This is called the diurnal motion of stars. It is because Earth makes one rotation on its axis each day.

POLARIE U tracks with the diurnal motion of the stars to eliminate “star trailing” on photographic images.

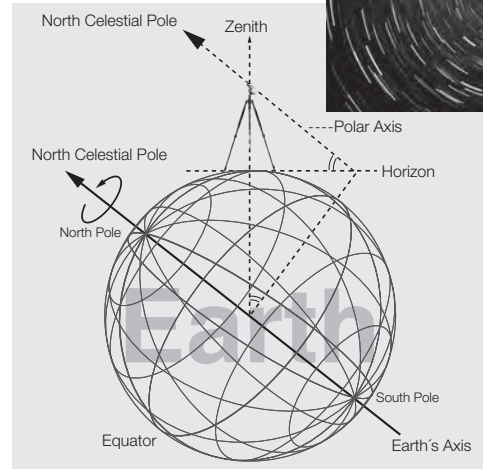

### What is a Tripod Panhead?

The panhead is the part of a tripod on which you mount a camera or other equipment to be combined with the camera for imaging. It allows for changing the orientation of the camera freely.

# BEFORE USE

## Name of Each Part

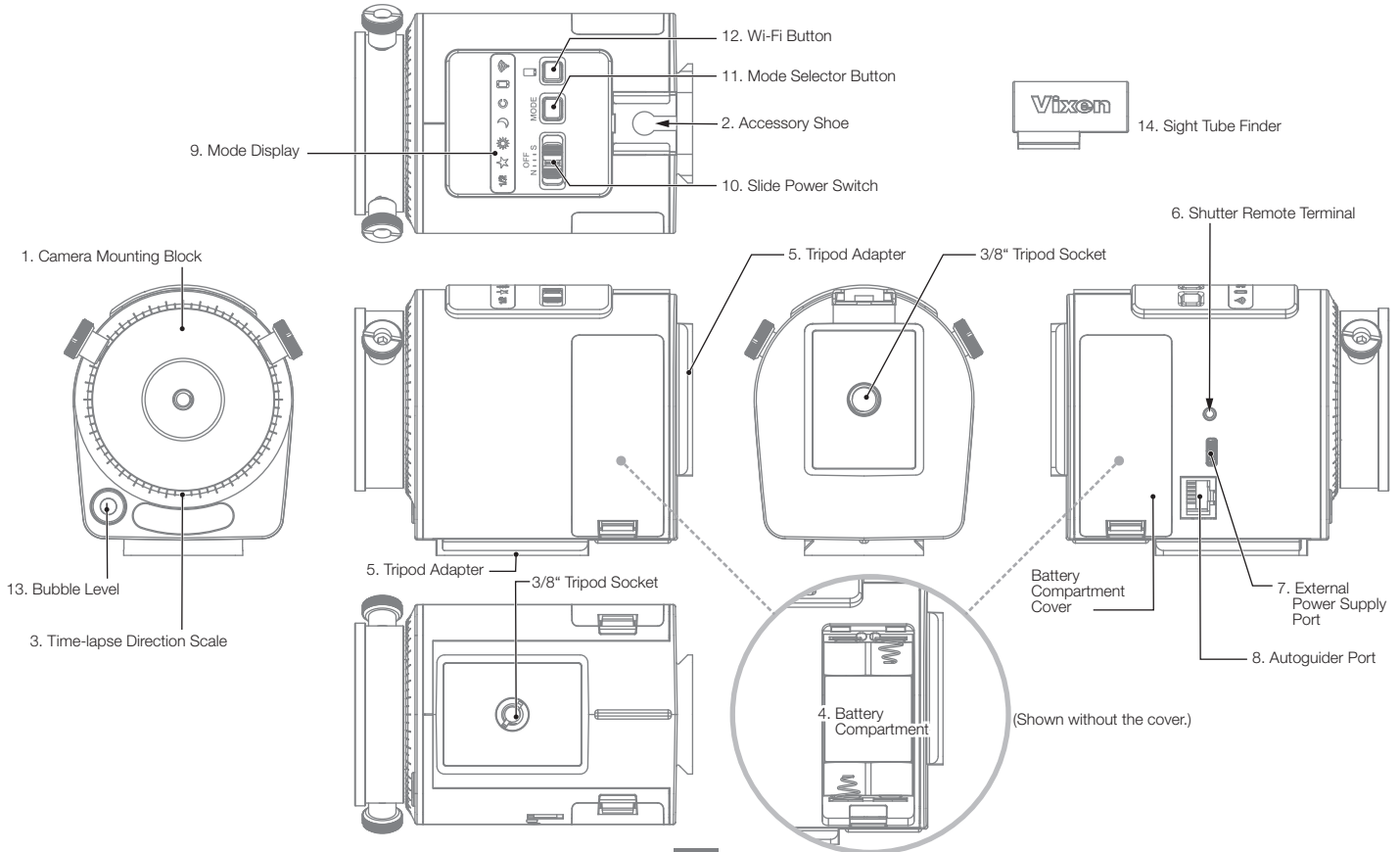

## BEFORE USE

No.	Item	Description
1.	<b>Camera Mounting Block</b>	This is used to install a ball head (UNC 1/4 tripod socket).
2.	<b>Accessory Shoe</b>	Attach the sight tube finder or any instrument which fits an accessory shoe. There is no electric contact.
3.	<b>Time-lapse Direction Scale</b>	Usable for checking the span of a turning angle in 5 degrees increments when the POLARIE U is used for time-lapse photography. A pointer sticker for pointing the direction scale is supplied to stick on the side of the camera mounting block if necessary.
4.	<b>Battery Compartment</b>	Four (4) AA batteries are required. Set two pieces each of AA Alkaline batteries to the two compartments on both sides of the POLARIE U.
5.	<b>Tripod Adapter</b>	A tripod adapter block with a 3/8" socket (with a conversion adapter for 1/4" screw) is provided on the bottom of the POLARIE U. It is compatible with attachment plates of the standard thin type.
6.	<b>Shutter Remote Terminal</b>	Connects a remote shutter release.
7.	<b>External Power Supply Port</b>	Connects an external power supply. USB Type-C female 5pin DC4.4V to 5.25V.
8.	<b>Autoguider Port</b>	General Standard autoguiders are available.
9.	<b>Mode Display</b>	Shows mode icons of various tracking speeds. The selected mode icon is illuminated, and it will blink if the batteries are drained.

No.	Item	Description
10.	<b>Slide Power Switch</b>	The power turns OFF in the center position. Sliding the power switch to the right will turn ON and start tracking in the direction of the Northern hemisphere. Sliding to the left is in the direction of the Southern hemisphere. When you slide the power switch to one direction, each of the icons on the mode display will start illuminating one after another to show the direction by flow where you slide the power switch. It implies the direction of the rotation of the camera mounting block.
11.	<b>Mode Selector Button</b>	The tracking modes change the icons to the next mode, every time the mode selector button is pressed. Pressing the selector button a little longer will allow you to adjust the brightness of the backlight illumination of the mode display window in 6 steps including OFF the light.
12.	<b>Wi-Fi Button</b>	It allows you to operate the POLARIE U with Smartphones or other devices available with Wi-Fi.
13.	<b>Battery Level</b>	Used to place the POLARIE U in a horizontal position at time-lapse photography,
14.	<b>Sight Tube Finder</b>	In the Northern hemisphere, a rough polar alignment is possible with the sight tube finder by locating Polaris.

# BEFORE USE

## Mode Change

### Settings on the Main Unit: Mode Display Illumination

The illumination of the mode display on the POLARIE U right after turning ON the power switch is always ON at point of purchase. Pressing the mode selector button a little longer will allow you to change the intensity of the illumination in 6 steps.

Finer brightness adjustments are possible with the use of a dedicated app for smartphones. The illumination will be turned off automatically after a certain interval of time. (The duration time is adjustable.) Pressing the mode selector button again will turn on the illumination.

### Hibernating

The mode and illumination start with the same settings you used last time.

### Low Battery Alert

If the batteries are exhausted, the icon you selected on the mode display will be blinking. (It will blink even if the illumination is OFF.)

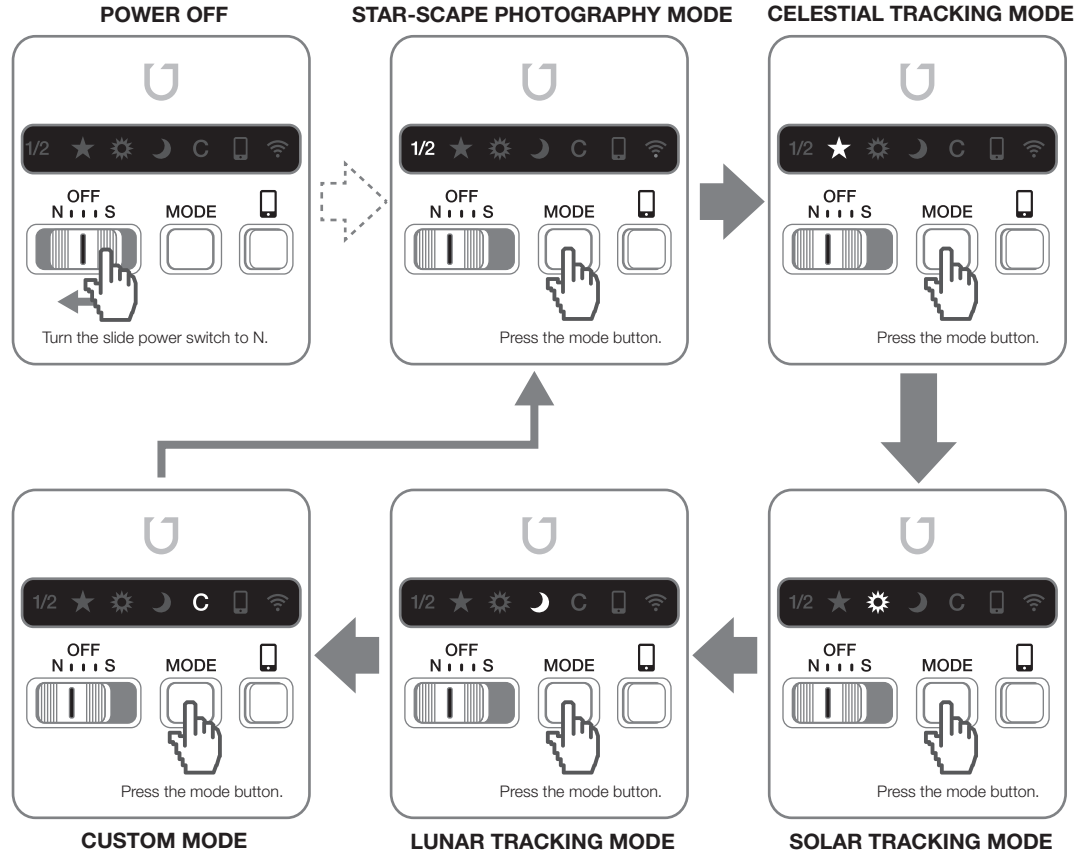



## BEFORE USE

### External Setting Mode

The present settings such as the direction of rotation and speed should be confirmed on the screen of a smartphone. If this external setting mode is activated, the direction of rotation selected via your smartphone takes precedence to the direction (N or S) of the slide power switch. The settings of operation are available with an app exclusive to the



POLARIE U and a smartphone connected to Wi-Fi. Start the setting operation with the app on the smartphone.

Stop the setting operation with either the power switch on the main body or app on the smartphone.



**App is in communication.**

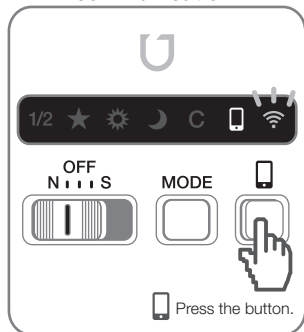

The Wi-Fi icon turns on in blue.  
(Changing the settings is possible from the app.)

**Wi-Fi is ready.**

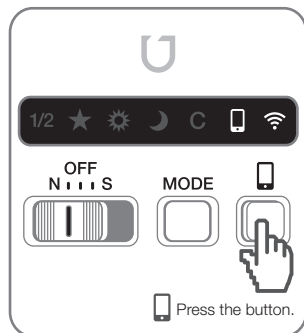

The Wi-Fi icon turns on in red.  
(Checking with the smartphone if the Wi-Fi signal is available.)

**Disconnected.**

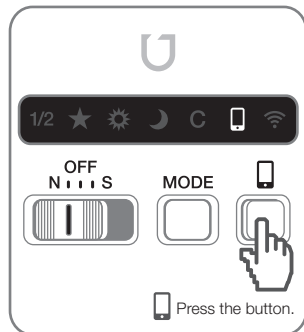

The Wi-Fi turns off  
(The Wi-Fi signal stops.)

### Icons on the Mode Display

Switching with the mode selector button:		
1/2	<b>Star-Scape Photography</b>	Works at a half speed rate of the celestial tracking rate.
★	<b>Celestial Tracking</b>	Works at celestial tracking rate.
☀	<b>Solar Tracking</b>	Works at the mean solar time.
☾	<b>Lunar Tracking</b>	Works at the mean Lunar time.
C	<b>Custom Mode (User Defined Tracking Speed)</b>	A speed arbitrarily defined by the user is memorized and is available for tracking. The setting is defaulted to 4 times of the celestial tracking rate. Smartphone or other wireless device and application software are required to change the settings.

Switching with the Wi-Fi button:		
📱	<b>External Setting Mode</b>	It allows the product to correspond to external controls. If this function is in operation, every setting in this mode takes precedence regardless of the other settings. Pressing the mode selector button will switch the display to the last used setting in the mode display. The setting mode can be changed while the Wi-Fi icon is illuminated. Smartphone or other wireless device and application software are required to use this function.
📶	<b>Wi-Fi Mode</b>	Setting values of the user-defined tracking and the external setting can be changed while the icon is illuminated. The wireless function turns ON and OFF each time the Wi-Fi button is pressed. Settings will be saved when the Wi-Fi is tuned to OFF after the external setting is finished. Electricity consumption increases during Wi-Fi communication and it is recommended to turn OFF the Wi-Fi when not in use.

## BEFORE USE

### What are Wide-Field Astrophotography and Star-Scape Photography?

#### Wide-Field Astrophotography

Photographing constellations and photographing the Milky Way in a wide field of view is called “Wide-field astrophotography”.

#### Star-Scape Photography

Adding ground lands capes intentionally to the wide-field astrophotography is called “Star-scape photography”. It is typical to use a wide-angle lens to create a photo composition that includes an entire constellation

### Requirements and Useful Items

The table below shows equipment and items that might be necessary or useful for astrophotography with the POLARIE U star tracker.

### Requirements and Useful Items

The table below shows equipment and items that might be necessary or useful for astrophotography with the POLARIE U star tracker.

Essential : ☉      Needed subject to conditions : ○      Useful : △

Necessity	Item	Description
☉	<b>POLARIE U</b>	Star tracking equipment for astrophotography.
☉	<b>AA Alkaline Batteries</b>	Four AA batteries are required. Alkaline batteries, Ni-MH or Ni-Cd rechargeable batteries are recommended. Be sure to prepare spare batteries as the batteries are easy to be exhausted in a cold environment. *1
△	<b>USB External Battery</b>	External batteries with a USB output (USB Type-C: DC4.4V to 5.25V) are available. If this is the case, no AA batteries are needed. However, the AA batteries should be held in the battery compartments as provision for long hours astrophotography. *2
☉	<b>Camera Tripod</b>	The tripod pan head with UNC 1/4" or 3/8" screw is required. Use a tripod with sturdy legs to avoid unwanted camera shake or flexure in photographing.

## BEFORE USE

Necessity	Item	Description
☉	<b>Pan Head</b>	Generally, a pan head is pre-installed on a tripod you purchased. If your tripod has no pan head, you need one equipped with UNC 1/4" or 3/8" screw or a tripod head compatible with the Arca-swiss plate system. The sturdier the better.
☉	<b>Ball Head</b>	It is used to install your camera on the camera mounting block of the POLARIE U. The ball head allows you to point a camera to your desired direction easily and quickly.
○	<b>Polar Meter</b>	It is a Polar alignment aid which is composed of a compass, an altitude meter, and a bubble level. It will be helpful in finding the direction of the celestial pole roughly if Polaris not seen from your location or you don't know the location of Polaris. (in the northern hemisphere)
△	<b>Polar Alignment Scope PF-L II</b>	It allows for a more accurate polar alignment. Attach to the POLARIE U with a dedicated bracket.
☉	<b>DSLR Camera with Lens</b>	A digital SLR camera *3 with a wide-angle lens, standard lens or telephoto lens according to your preference. The lens with manual focus setting for infinity is preferable. Remember to bring the battery for the camera and storage media with you, also.

Necessity	Item	Description
△	<b>Lens Shade</b>	Useful to avoid unwanted stray light and to reduce the condensation of dew on the front surface of your camera lens.
○	<b>Shutter Release</b>	Used to avoid shaking the camera and to control shutter exposure times. *4 Optionally available genuine parts are preferable.
△	<b>Timer or Stopwatch</b>	Used to measure the shutter exposure times.
△	<b>Adhesive Tape</b>	Used to stop moving the focus ring of a camera lens with a weak adhesive tape after focusing the camera lens to infinity. However, some autofocus lenses are unable to control a position of focusing manually. Check your camera lens before use.
△	<b>Dew Heater</b>	Used to prevent the lens surface from dew condensation during photography.
△	<b>Planisphere, Star Chart</b>	Useful for checking the row of stars in constellations and the direction of stars.
☉	<b>Flashlight or Head Lamp</b>	Useful for reading star charts, setting up and dismantling the equipment. Highly recommended to use red color light to accommodate your visibility to a dark site.

# BEFORE USE

## Requirements and Useful Items

Necessity	Item	Description
△	<b>Outfit for Cold Weather</b>	Take measures against cold weather.
△	<b>Shroud, Plastic bags</b>	Useful to protect equipment from sudden rain.

- \*1: Working duration differs depending on types and the state of the batteries used and photographing condition.
- \*2: Commercially available USB mobile batteries are recommended. Be sure to use a power cable that is applicable to USB Type-C. Low power consumption of the POLARIE U may cause a stop of power supply as a result of a malfunction. Check the instruction manual for the USB mobile battery.
- \*3: Make sure that your camera has functions that satisfy the following specifications.
- A bulb shutter mechanism (B) is needed for long exposures. If it is not available on your camera, both an ISO speed setting faster than 1600 and a shutter time setting longer than 15 seconds are required, or a function that shutter exposure times are controlled.
  - A remote shutter release is available as optional.
  - Standard or wide-angle photography lens are recommended as it makes tracking of celestial objects easier.
  - Usable in manual focus, or possible to disable autofocus and focus to infinity. The autofocus rarely works correctly in night-sky scenes.
  - DSLR cameras with an optical viewfinder (with ground glass focusing screen) or “Live Focus” are preferable.
- \*4: For long exposure photography, it is much convenient to use remote shutter releases which are not only controlling exposure times manually but also setting up exposure times. Most infrared-type remote shutter releases are not available for controlling exposure times, and they are not recommended as the infrared rays affect imaging sensors.

# HOW TO USE

## I. About Power Source

Your POLARIE U works with 4 pieces of AA batteries or a USB external power source (USB Type-C output plug: DC4.5V to 5.25V).

- It is recommended to use AA Alkaline batteries, AA Ni-MH or Ni-Cd rechargeable batteries.
- It is recommended to use USB mobile batteries available commercially. Be sure to use a power cable that is applicable to USB Type-C. Low power consumption of the POLARIE U may cause a stop of power supply as a result of a malfunction

### Power Supply with AA Alkaline Batteries

- 1 Open the battery compartment cover by pushing down on the tab of the cover. There are two battery compartments on either side face of the POLARIE U unit if viewed from the camera mounting block.



- 2 Insert two of each of AA alkaline batteries in the correct direction.



- 3 Replace the battery compartment cover so that the tab on the cover fits in place.

### Power Supply with an External Mobile Battery

Use a USB external power supply with a USB Type-C plug (DC4.4V to 5.25V). Connect the USB plug as shown in the image.



If you connect the external power supply with the batteries inserted, the external power supply takes precedence over the batteries due to its higher voltage.

# HOW TO USE

## II. Setting Up the POLARIE U

The manual explains the usage of the POLARIE U with a camera tripod and a ball head, which are sold separately, by way of example. Please be sure to read the instruction manuals associated with the equipment used.

There are two ball heads used in this manual; one for the tripod head and another for a camera. One ball head attached to the tripod head is called as Ball head 1 in this manual. Another ball head for the camera is called Ball head 2 as a matter of convenience.



- 1 Set up the tripod where you photograph. Place the tripod on solid ground so that the tripod is stable. Adjust the height of the tripod as you need arises and adjust the tripod legs to be level on the ground.

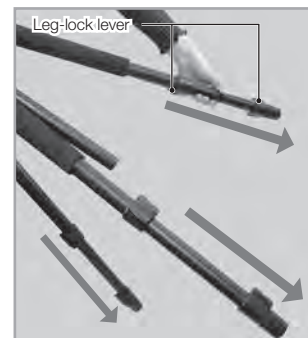

Be sure to fully extend the tripod legs outward.

For usage of the tripod, see instructions for your tripod

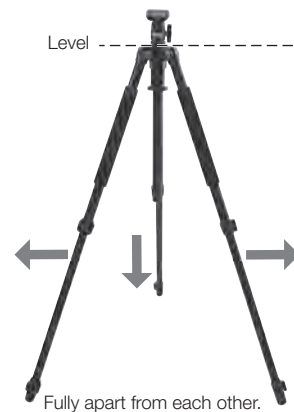

## HOW TO USE

- 2 Install the POLARIE U to the ball head 1 attached on the tripod head as shown in the figure



The POLARIE U is available for either a tripod with 1/4" or 3/8" screw. A conversion adapter for 1/4" screw is pre-installed to one of the tripod-screw sockets at Vixen's factory. If you use a tripod with a 3/8" screw, remove the conversion adapter for 1/4" in advance.

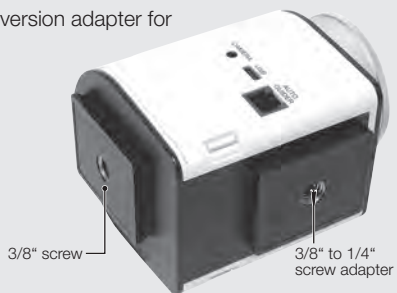

- 3 Loosen the two thumbscrews and remove the camera mounting block from the POLARIE U

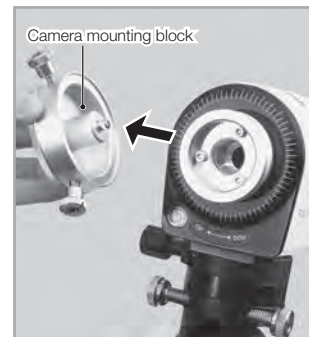
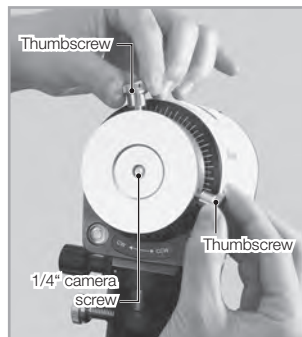

- 4 Attach the ball head 2 onto the camera mounting block. Push out the screw on the center of the disk of the camera mounting block from the back. While keeping the screw in place, insert the tip of the screw into the screw hole of the ball head 2 and thread the screw by turning the mounting block clockwise.

Make sure that the ball head 2 is attached to the mounting block firmly.

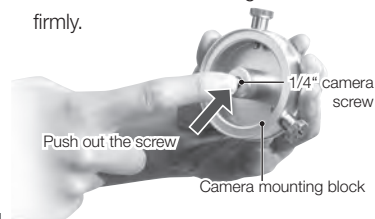

## HOW TO USE

### II. Setting Up the POLARIE U

5 The manual explains the usage of the POLARIE U with a camera tripod and a ball head, which are sold separately, by way of example.

Please be sure to read the instruction manuals associated with the equipment used.



6 Mount your camera on the ball head 2. Attach the camera onto the ball head 2 with the camera screw accompanied by the ball head.

Hold the camera securely while threading it to avoid dropping it. Make sure that both the moveable portions on the ball head 2 and the camera mounting block are tightened securely



Install a cable release if the need arises and finish the setting.





# HOW TO USE

## III. Practice (Taking Photography)

### Procedure to start up photographing:

<b>Align to the celestial pole</b>	Set up the POLARIE U so that the rotational axis of the POLARIE U is parallel to that of earth.	<b>P17~19</b>
<b>Setting your camera</b>	Set exposure, ISO, shutter speed and so on.	<b>P20~21</b>
<b>Focus and photography compisition</b>	Focus the object and determine the photography composition.	<b>P21~22</b>
<b>Setting the POLARIE U</b>	Set a mode of operation.	<b>P23~24</b>
<b>Photography</b>	Start Imaging.	<b>P24</b>

### Align to the Celestial Pole

Set up the POLARIE U so that it turns to follow the diurnal motion of stars. To do this, the rotational axis of the POLARIE U must be set to be parallel to the axis of the diurnal motion of stars.

The process is called polar alignment.

The process of the polar alignment differs between the northern hemisphere and the southern hemisphere. The polar alignment in the northern hemisphere is explained as an example here.

In case of the polar alignment in the southern hemisphere, use a conspicuous pattern of 3 stars in the constellation Octans. It is recommended to use an optional Polar alignment scope PF-LII.

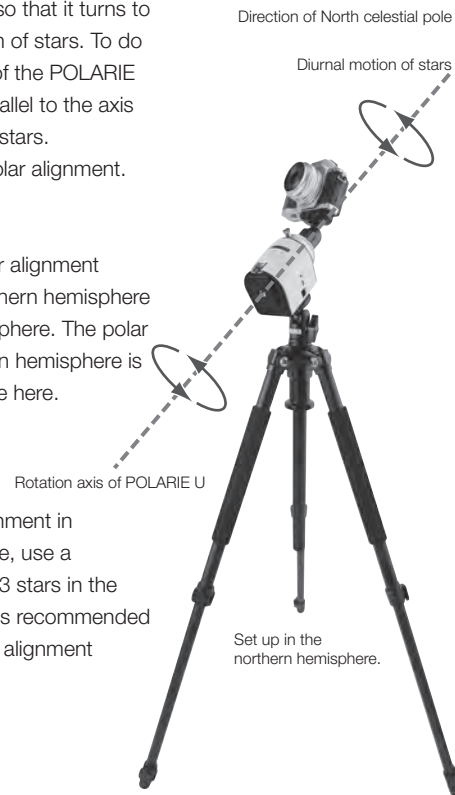

# HOW TO USE

## Using a Star Map

You can use a star map and the sight tube finder to locate Polaris so that you can align the POLARIE U to the north celestial pole. You will be able to find Polaris without difficulty if you know the position of the constellations Cassiopeia and the Big Dipper (part of Ursa Major).

1 Attach the sight tube finder onto the accessory shoe of the POLARIE U.

2 Find Polaris using the star map which is commercially available on the market.

3 Set up the POLARIE U in a location where Polaris is visible from the sight tube finder. As Polaris is in the north, it is useful to have a compass for checking the direction.



Planisphere



Sight tube finder

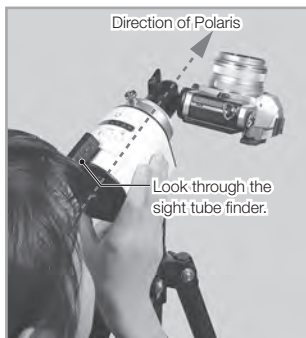

Direction of Polaris

Look through the sight tube finder.

4 Look through the sight tube finder to see if Polaris is seen somewhere in the field of view, and then center Polaris in the field of view by adjusting the orientation of the tripod.

Polaris is a conspicuous 2-grade star as no bright stars are seen around.

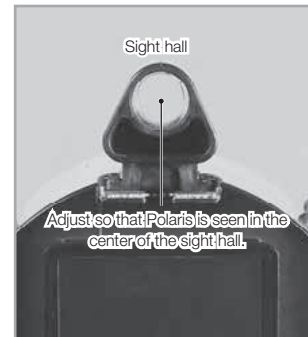

Sight hall

Adjust so that Polaris is seen in the center of the sight hall.

## HOW TO USE

### Locate Polaris from Cassiopeia and the Big Dipper

The constellations Cassiopeia and the Big Dipper are groups of noticeable stars near Polaris. You will be able to locate Polaris and align the POLARIE U through the sight tube finder if you know the position of these constellations.

- 1 Find Polaris using the guide map on this page. You will find it easier with the help of a compass since Polaris is in the north.

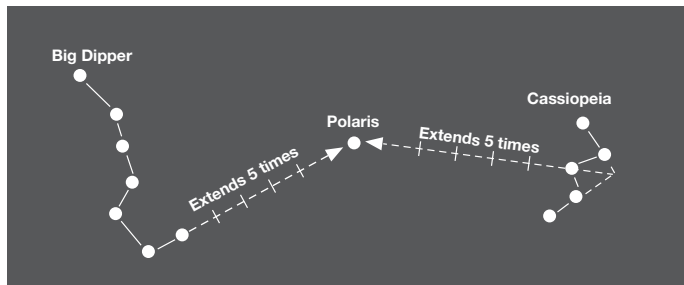

#### [Direction 1]

Locate the two stars that form the outer edge of the “dipper” in the Big Dipper. Draw an imaginary line straight through the two stars of the dipper edge and you will see Polaris ahead.

#### [Direction 2]

Cassiopeia looks like the letter “W” or the letter “M” depending on when you observe it. Draw imaginary lines from the stars that form the outer edge of the letter “W” so that the two lines intersect. Next, draw another imaginary line from the center of the “W” through the cross point of your first line. Then, extend it straight through by about 5 times to get Polaris.

- 2 Turn the POLARIE U toward Polaris and look through the sight tube finder. Confirm that Polaris is seen somewhere in the field of view.

The sight tube finder may be blocked by the camera body that is mounted on the ball head 2. If this is the case, loosen the lock knob of the ball head 2 and turn the camera body to clear the sight.



# HOW TO USE

## Various Settings on your Camera

Determine shooting mode, exposure, and aperture (F-number). Select a mode of image record and ISO speed when you use a digital SLR camera. Load film of your desired ISO speed in your camera if film is used. (Prepare film in advance.)

### Basics

#### Shutter Speed: Select B (Bulb) setting.

Set the exposure shutter speed to be more than 15 seconds if the B setting is not available on your camera.

#### Aperture (F-number): Set the aperture to be open fully or smaller by one step.

The aperture value influences image quality and depth of field and usually, it should be set according to your purpose of photographing. Since the amount of light of stars is smaller, setting the aperture larger is effective to take in as much light as possible.

#### ISO Speed: Set ISO speed higher than ISO400.

Too high an ISO speed may cause deterioration of image quality due to an increase in thermal noise. It is recommended that you take shots in different ISO speeds to determine the image you prefer.

**Exposure.** There is no recommended exposure time for everyone as it depends on your purpose of photographing.

The followings are examples of settings on your camera, which differ according to the camera and photographic lens used.

### Example 1

**Photographic Lens: 24mm focal length (Wide lens), F1.4**

**Camera: DSLR camera (applicable up to ISO3200)**

**POLARIE U Mode: Celestial tracking**

**Purpose of Photographing: Constellations**

Item	Setting	Comment
Shutter Speed	Bulb (B)	It allows for long exposure.
Aperture (F-Number)	F2.8	A good compromise between fast photographic speed and image quality.
ISO speed	ISO400	To get higher sensitivity without image deterioration. *
Exposure	10 minutes	To get accumulation of light from dark stars.

\*It is subjective views and it may differ according to the highest ISO speed of your camera.

# HOW TO USE

## Example 2

**Photographic Lens:** 14mm focal length (Ultra-wide lens), F2.8

**Camera:** DSLR camera (applicable up to ISO256000)

**POLARIE U Mode:** Star-scape astrophotography

**Purpose of Photographing:** Milky Way and terrestrial foreground

Item	Setting	Comment
Shutter Speed	Bulb (B)	It allows for long exposure.
Aperture (F-Number)	F2.8	It allows for taking as much light as possible within a short time.
ISO speed	ISO3200	To shorten exposure time within the limit of image deterioration.*
Exposure	60 seconds	It is set so that both stars and terrestrial foreground are as if they are stopped.

\*It is subjective views and it may differ according to the highest ISO speed of your camera.

## Focusing and Composing the shot

The object of imaging in wide-field astrophotography and that in star-scape photography are the light of stars which are so faint that autofocus systems may hardly function properly on many cameras. For this reason, it is necessary to focus your camera on an object manually. Set the focus to infinity as the light of the stars comes from infinite space.

## Cameras without Live View feature

Focus on the star while looking through the viewfinder of the camera. If the camera is out of focus, the star is seen as a blurred disc of light or the star is not visible on the focusing screen. If you turn the focusing ring in the direction of reaching in focus, the blurred disc will contract to become a point of light. If this is the case, the star is in focus. It is hard to determine the focal point in this way and you will need patience. It is recommended to locate the focal point by checking the focus with the LCD monitor before you start photographing if you use the DSLR camera. It is very difficult to focus on a dark star. It is recommended to choose a bright star-like 1st-magnitude to make focus.

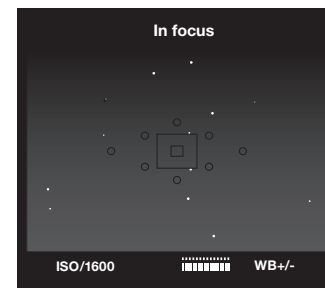
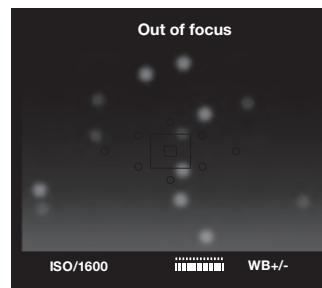

## HOW TO USE

### Cameras with Live View function

Focus on the star by magnifying the star image with the Live View function while watching the screen of the LCD monitor on your camera. If the camera is out of focus, the star is seen as a blurred disc of light or the star is not visible on the focusing screen. If you turn the focusing ring in the direction of reaching in focus, the blurred disc will contract to become a point of light. If this is the case, the star is in focus.

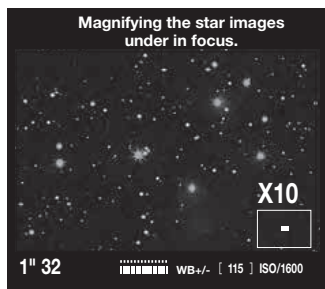
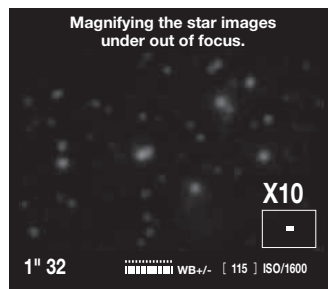

Note: The star image may go out of focus by malfunction of the camera's autofocus function if you press the shutter release after you focus on the star. To avoid this, make sure that the autofocus function is set to OFF.

It is recommended to hold the focus ring with weak adhesive tape so that you could avoid turning the focus ring accidentally.

### Photography Composition

Determine the photography composition. If you plan to take star-scape photography, a sightseeing guidebook may be of help to find a scenic spot in advance.

It will be hard to recognize stars if you look through the viewfinder in the night-time. This makes it difficult to confirm the state of focus and the composition. If you have a DSLR camera, you will be able to recognize the state of focus and the composition by raising the ISO speed, even to the maximum, for a test shooting.

If you have a film camera, the sight from the camera's viewfinder is too dark to recognize the stars. It is advisable to exchange the focusing screen for one with better visibility. A commercially available Eye Magnifier will facilitate your precise focusing.

## HOW TO USE

### Setting the Mode Display

Turn ON the POLARIE U and select your desired setting mode according to your purpose of photography.

Confirm the direction of the tracking. Move the slide power switch to the N side to use the POLARIE U in the northern hemisphere. Moving the slide power switch to the S side for use in the southern hemisphere. The tracking direction is perceptible with your eye as it is indicated through the direction of light flow with the illumination of the icons on the mode display right after you turn ON the slide power switch.

Depending on the setting, the direction of light flow with the illumination of the icons may not correspond with the position of the slide power switch while the external setting mode is used.

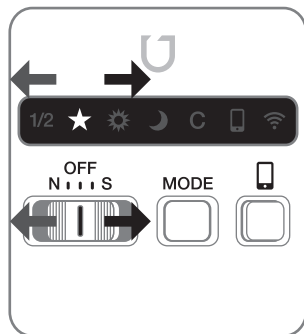

### Fixed-Tripod Astrophotography

Simple star-scape astrophotography using a camera on a tripod. Star trails will occur as exposure lengthens.



### 1/2 Star-Scape Photography Mode

If this mode is selected, the POLARIE U tracks stars at half the speed of the diurnal motion of the stars. The terrestrial objects move less as compared with images taken by wide-field astrophotography at a given exposure time. Shooting at half the speed of the star's diurnal motion increases exposure time twice. Short exposure will allow you to take images with no trails of stars.

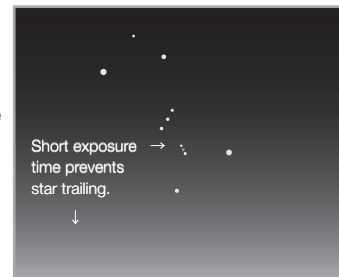

### ★ Celestial Tracking Mode

If this mode is selected, the POLARIE U tracks stars at half the speed of the diurnal motion of the stars. The terrestrial objects move less as compared with images taken by wide-field astrophotography at a given exposure time. Shooting at half the speed of the star's diurnal motion increases exposure time twice. Short exposure will allow you to take images with no trails of stars.

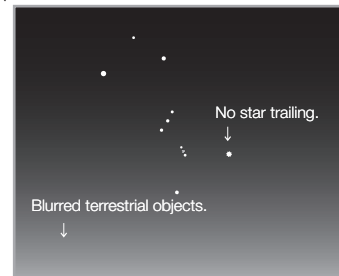

## HOW TO USE

### Solar Tracking Mode/ Lunar Tracking Mode

Since the sun and moon appear to move across the sky at a different speed than the stars, the POLARIE U includes Solar and Lunar rates option. (Remember that the solar tracking rate is slower than sidereal time, and the solar tracking rate is faster than the lunar rate.) These rates are useful especially during an eclipse, allowing the user to maintain constant tracking on the sun or moon for long hours.

### Difference from the diurnal motion of stars

The position of the same star you see in the same time moves toward west everyday and returns to the same position in one year. Since the star sets earlier than the sun sets, the diurnal motion of the star appears to be fast by one more rotation than that of the sun in a year.

Because one year is 365.25 days (0.25 day is for compensating leap year), speed of the stars based on the speed of the sun is  $1 + (1/365.25) = 1.0027$  rotation per day.

The position of the moon you see in the same time moves toward east everyday and returns to almost the same position in 29.5 days. Since the moon sets later than the sun sets, the rotation of the moon appears to be slow by one less rotation in 29.5 days than that of the sun. So, speed of the moon based on the speed of the sun is  $1 - (1/29.5) = 0.966$  rotation per day.

Therefore, difference of the speed is  $1.0027 - 0.966 = 0.0367$  rotation per day (one rotation = 24 hours). In one hour, its difference comes to  $(360/24) \times 0.0367 = 0.55$  degrees. This is nearly the same as the moon's angular diameter (about 0.50 degrees).

### C Custom Mode

This mode is for time-lapse photography and it allows you to enter your desired tracking speed (up to ten times of the sidereal rate is recommended) into the POLARIE U. Your tracking speed setting is saved. The initial setting is four times of the sidereal rate. If you change the setting for a different speed, a smartphone or other wireless device and application software are needed.

### Star Shooting

Start shooting with releasing the shutter on the camera.

If the camera has an image stabilization function, make sure that the function is turned OFF before you start photographing. It is recommended to use a shutter release cable to avoid shaking.



## HOW TO USE

### V. Application

#### Using the Custom Mode and the External Setting

The POLARIE U allows you to set, optionally, the tracking speed and the status of movements with the use of a communication terminal device (like a smartphone) that works on WEB and Wi-Fi environment. Also, the POLARIE U provides a shutter release terminal controlling the shutter of a camera. If your camera has the bulb setting and a wired shutter release terminal, it will allow you to set and control interval photographing.

Complex time-lapse photography settings are available with a smartphone, by easily linking the motion of the POLARIE U with the shutter release control.

It is necessary to download the application software to set the motion of the POLARIE U with your smartphone.

#### ⚠ Note:

You need application software for POLARIE U in addition to a smartphone or communication terminal device that works on Wi-Fi to use the custom mode, external setting and shutter release control. Please read instructions for the usage of the application software.

Get the app and customize settings on your POLARIE U!



# POLARIE U

<https://www.vixen.co.jp>

The free download POLARIE U app is available for iPhone and Android.



#### Cameras Available for the Shutter Release Control

Cameras with a 2.5mm 3-pole stereo mini-jack are available to the shutter release control. If your camera is different from the above-mentioned specification, it may be connectable with the use of a commercially available conversion adapter. The shutter release terminal is essential for the camera you use.

#### Shutter Release Cable

Shutter Release Cable: 2.5mm 3-pole stereo mini-plug

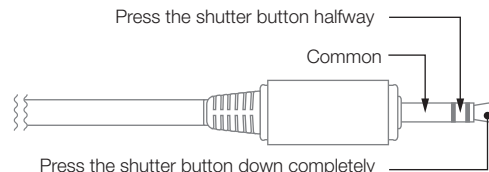

# HOW TO USE

## Flow of Operation

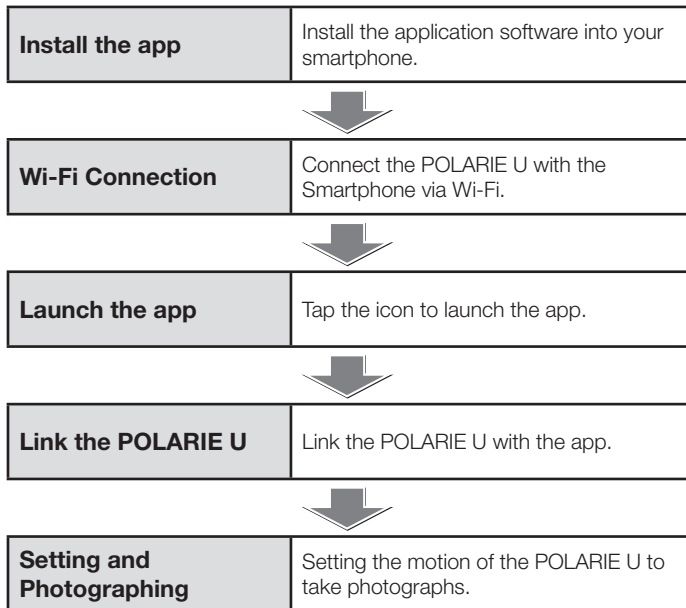

## Autoguider

The POLARIE U provides an autoguider port and it can be used with commercially available autoguiders.

The pin assignment of the autoguider port is shown below. For the usage of the autoguider, read instructions for the autoguider

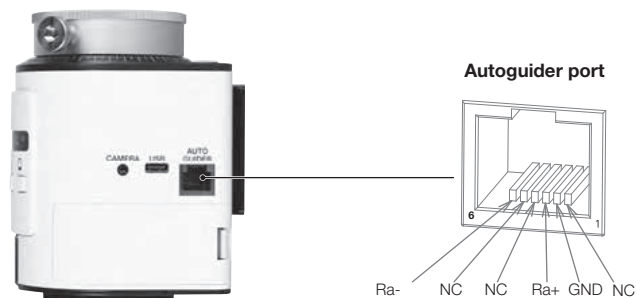

## Reset

In the state of turning OFF the power, moving the slide power switch to N or S direction while pressing both the mode selector and Wi-Fi buttons simultaneously will return the POLARIE U to the initial setting at Vixen's factory. Please remember that settings made by smartphones will be initialized, too.

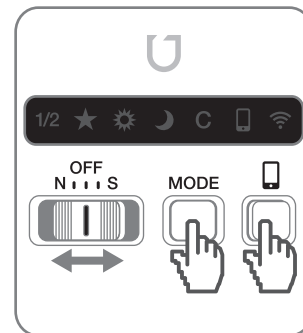

## HOW TO USE

### Using with an optional polar Alignment Scope PF-LII

The optional polar alignment scope PF-LII (sold separately) will help you increase the accuracy of the polar alignment setting more than using the sight tube finder. An optional arm bracket (sold separately) is required to attach the polar alignment scope PF-LII onto the POLARIE U. Additionally, it is necessary to use a tripod with fine-motion adjustments to ensure precise polar alignment. A Polar fine adjustment unit DX (sold separately) unit and an APP-TL130 tripod (sold separately) are shown in this manual as an example.

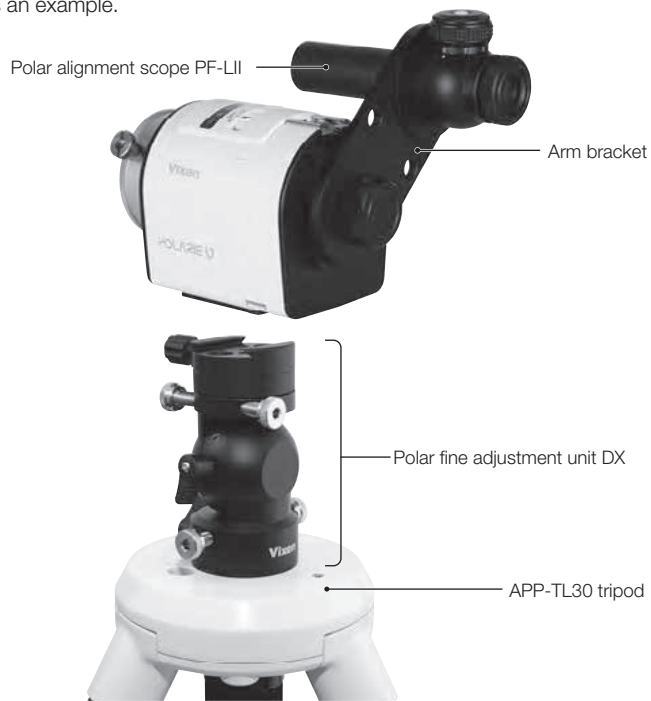

### Components Guide

Read the instruction manual for the polar alignment scope PF-LII also.



# HOW TO USE

## Legend on the Polar Alignment Reticle

	Name	Constellation
In the Northern Hemisphere	POLARIS	Little Bear
	$\delta$ UMi	Little Bear
	51Cep	Cepheus
	Useful guiding stars and constellations	
	"W" shape	Cassiopeia
In the Southern Hemisphere	Big Dipper	Big Bear
	$\sigma$ Oct	Octans
	$\tau$ Oct	Octans
	$\chi$ Oct	Octans
	Useful guiding stars and constellations	
	Southern Cross	Crux
	$\alpha$ Eri	Eridanus

Meaning of numbers

15 - the year 2015

40 - the year 2040

The position scales on the reticle are 5-year increments.

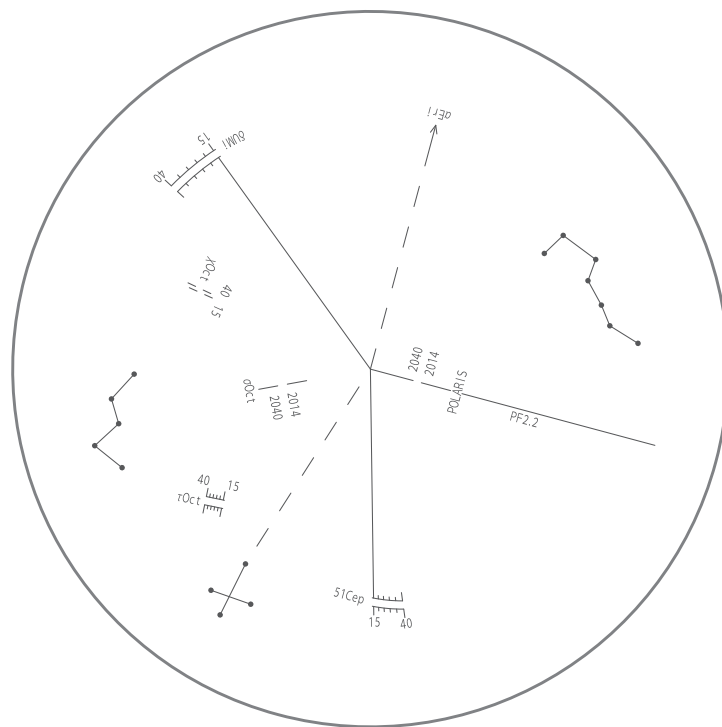

# HOW TO USE

## Basic operation

### Illumination ON and OFF

There is a push switch on the top of the brightness adjustment dial of the polar alignment scope. Pushing the switch will illuminate the polar alignment reticle in red light. The red light becomes dimmer gradually after a certain interval of illumination (about one or two minutes) and turns off automatically.



### Adjusting the Brightness

The brightness of the red light for the polar alignment reticle can be varied in 8 steps by turning the brightness adjustment dial on the polar alignment scope.



### Focusing on the Polar Alignment Reticle

You can focus on the polar alignment reticle by turning the eyepiece of the polar alignment scope. While holding the body of the polar alignment scope on one hand, turn the eyepiece part with the other hand.



## HOW TO USE

### Procedure of the Polar Alignment (in the northern hemisphere)

**1** Installing the polar alignment scope PF-LII to the arm bracket.



**2** Attaching polar alignment scope PF-LII mounted on the arm bracket to the POLARIE U.



**3** Polar aligning the POLARIE U.

### Installing the polar alignment scope PF-LII to the arm bracket

Thread the polar alignment scope into the threaded hole on the arm bracket from the side which the fixing knob faces on as shown in the figure.

Screw into the arm bracket securely to prevent it from becoming loose during the operation.

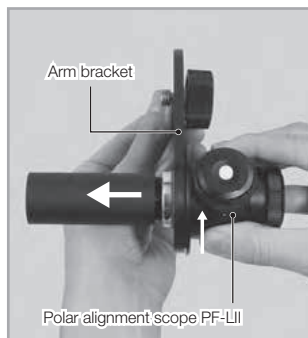

### Attaching polar alignment scope PF-LII mounted on the arm bracket to the POLARIE U

Setting the polar alignment scope PF-LII at your convenient position for use. Tighten the fixing knob securely.



# HOW TO USE

## Polar Alignment

The motor-driven POLARIE U should be set so that its rotational axis is parallel to the axis of the diurnal motion of stars. This allows you to track the camera mounted on the POLARIE U in the same direction as the stars you want to photograph. The method of the polar alignment varies between northern and southern hemispheres.

## Polar Alignment in the Northern Hemisphere

The polar axis of the POLARIE U is aligned to the North Celestial Pole in the northern hemisphere. The polar alignment scope utilize 3 stars of Polaris, Delta UMi and 51 Cep near the North Pole. Positions of the above stars are plotted on the reticle of the polar alignment scope. To locate the N.C.P., you simply match the scale position on the reticle with the designated 3 stars seen in the polar alignment scope. The patterns of the Big Dipper and Cassiopeia are engraved on the reticle for use as a guidepost for the North Pole.

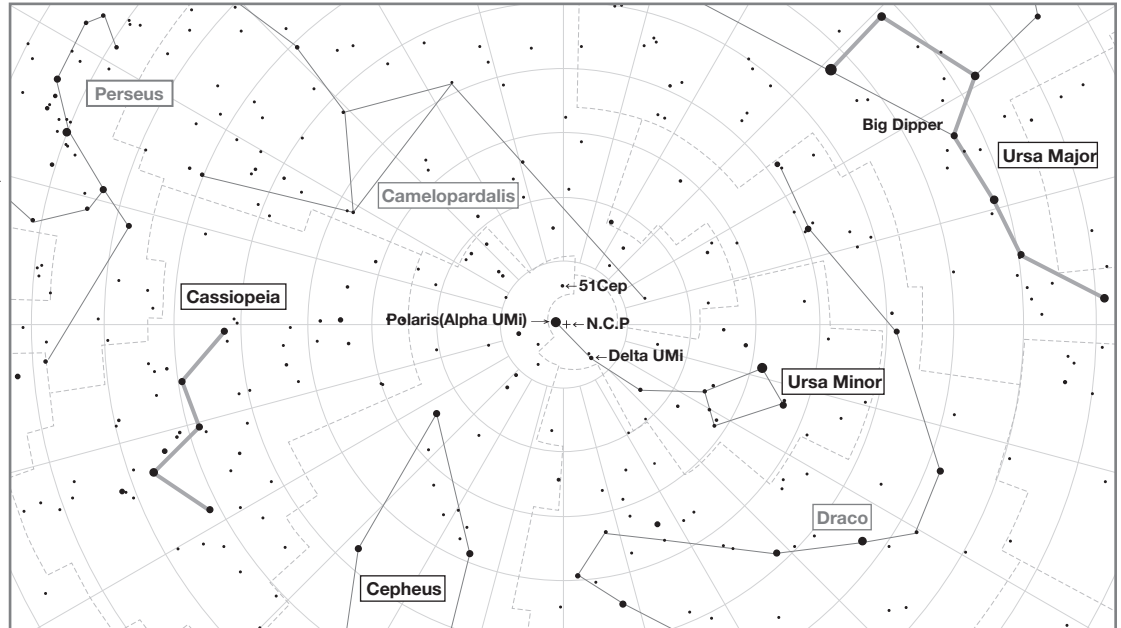

## HOW TO USE

- 1 Check your observing site with a compass, a GPS system or a map in advance to confirm that Polaris, the Big Dipper and Cassiopeia can be seen from your observing location on the date of observation

- 2 Set up the POLARIE U mounted tripod on flat and hard ground where you can see Polaris in the sky. Point the rotational axis of the POLARIE U in the direction of north. Adjust the tripod legs so that the tripod is as level as possible.

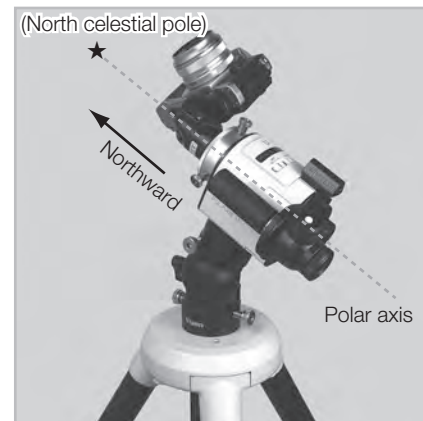



## HOW TO USE

3 While looking into the polar alignment scope, turn the polar alignment scope body so that the engraved Big Dipper (or Cassiopeia) on the reticle matches the Big Dipper (or Cassiopeia) in the real sky



## HOW TO USE

Field of view (of the polar alignment scope)

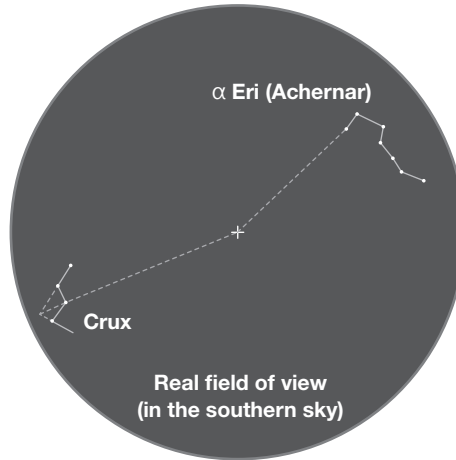
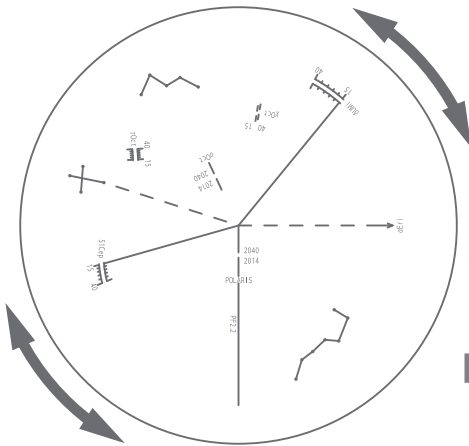

Real field of view (in the southern sky)

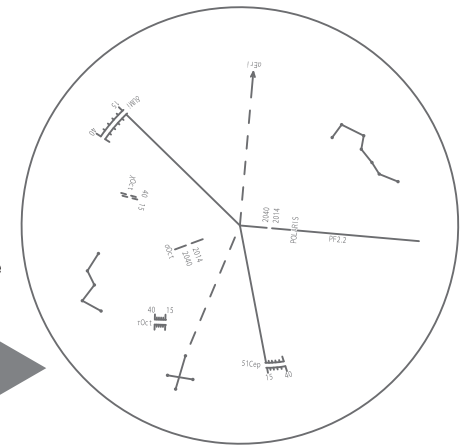

Turn the polar alignment scope body so that the orientation of the engraved constellations on the reticle matches the constellations in the real sky

The real stars of the Big Dipper (or Cassiopeia) are not visible in the field of view of the polar alignment scope.

### ⓘ Note:

The patterns of the Big Dipper and Cassiopeia on the reticle are positioned to correspond to the real sky. They are used as a guidepost to know the turning direction of the polar alignment scope's reticle. The locations of the Big Dipper and Cassiopeia on the reticle have no relation to the location of Polaris, Delta UMi and 51 Cep on the reticle.

Now you are ready to adjust the orientation of the polar scope so that its position scales on the reticle come close to actual positions of Polaris, Delta UMi and 51 Cep.

## HOW TO USE

- 4 While looking into the eyepiece of the polar scope, adjust the orientation of the POLARIE U in the altitude and azimuth directions (by using the Polarie fine adjustment unit here) so that Polaris comes as close as possible to the designated position on the reticle.



Set Polaris to the gap between the two segments of the lines marked 2040 and 2040 adjacent to a mark "POLARIS" as shown in the figure.

Polaris is relatively conspicuous in this area of the sky as it is a bright 2nd magnitude star adjacent to the north celestial pole.

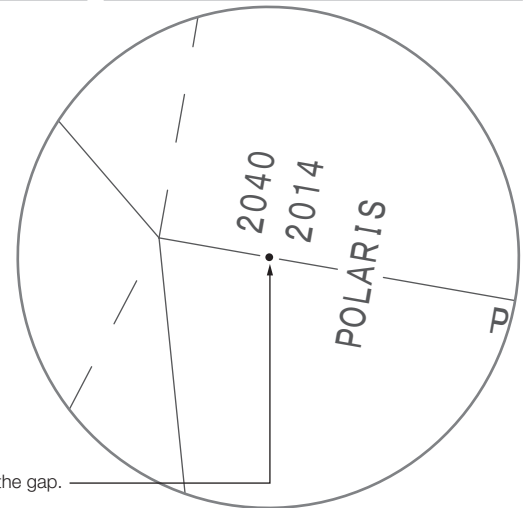

## HOW TO USE

5 As Polaris shifts to the designated position on the reticle, both Delta UMi and 51 Cep come close to their own designated position scales respectively. While looking into the eyepiece of the polar scope, turn the polar scope body so that each of the position scale for Delta UMi and 51 Cep come to the closest to actual Delta UMi and 51 Cep respectively.

The numbers 15 and 40 on the position scales for Delta UMi and 51 Cep show the years 2014 and 2040 respectively.

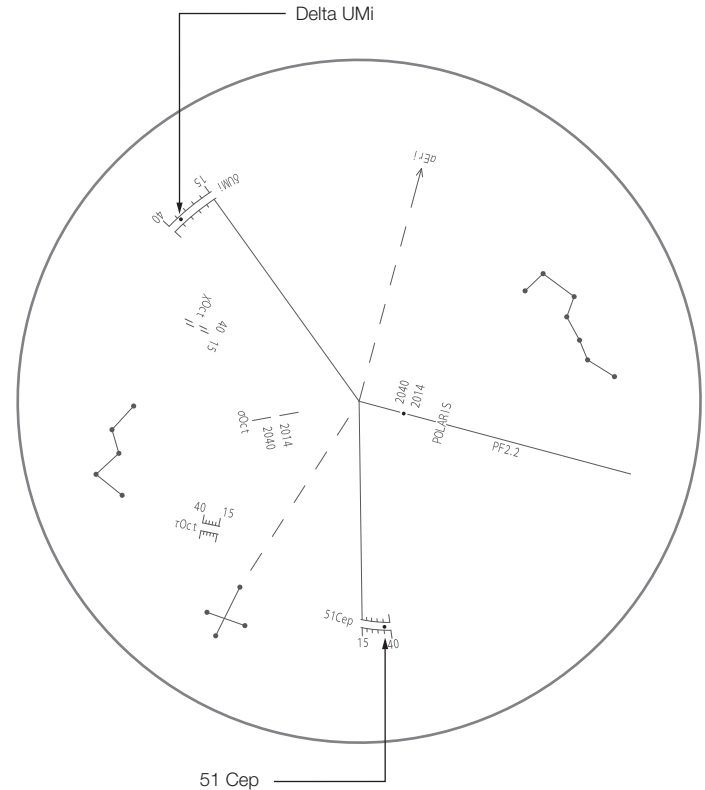





## HOW TO USE

- 6 While looking into the eyepiece of the polar scope, turn the altitude and azimuth fine adjustment bolts of the Polaris fine adjustment unit so that Polaris comes to the gap between the two segments of the lines marked 2014 and 2040.

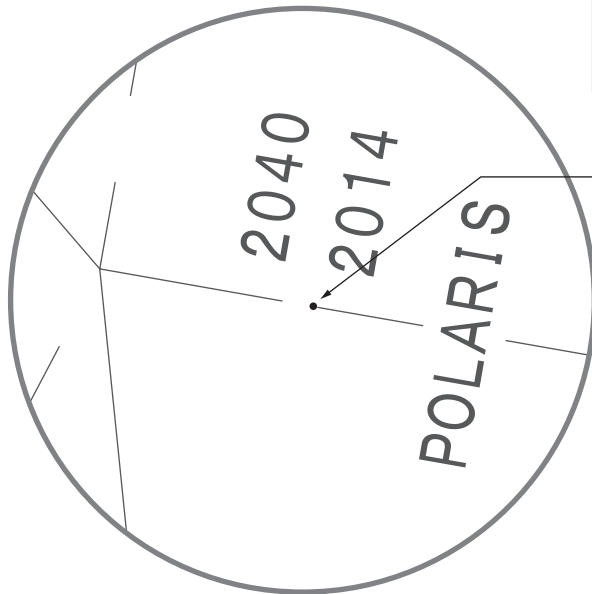

Set Polaris to an approximate position that is corresponding to the year of your observation.

Correcting the position of Polaris in the altitude and azimuth directions with the finder adjustment bolts.

Correcting the position of Delta UMi and 51 Cep with a rotation of the polar scope

## HOW TO USE

- 7 Repeat the procedures 5 and 6 until Polaris, Delta MU and 51 Cep come to the proper locations on the designated position scales respectively. Tighten the fine adjustment bolts at both sides to finish the polar alignment.

As an illustration here, Polaris is set to the edge of the line on the side of 2014, and both Delta UMI and 51 Cep are set to the middle of the curved lines of the position scale at the protruded edge on the side of 15 respectively.

(In case of the year 2014)

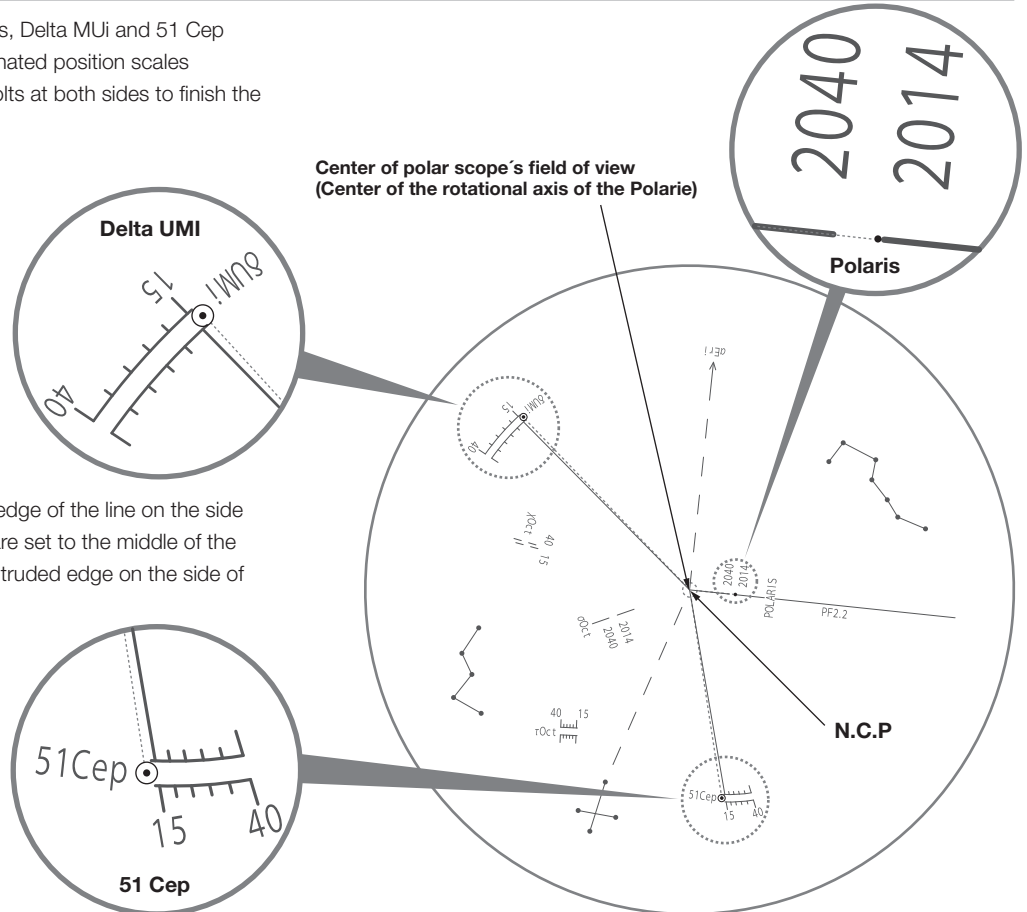



## HOW TO USE

### Polar Alignment in the Southern Hemisphere

The polar axis of the POLARIE is aligned to the South Celestial Pole in the southern hemisphere. The Polarie polar scope PF-L utilizes 3 stars of Sigma Octantis, Tau Octantis and Chi Octantis near the South Pole. Positions of these stars are plotted on the reticle of the polar scope. To locate the S.C.P, you simply match each of the position scale on the reticle with the designated 3 stars caught by the polar scope. Also, the patterns of the Southern Cross and Alpha Eridani are engraved on the reticle for use as a guidepost for the South Pole.

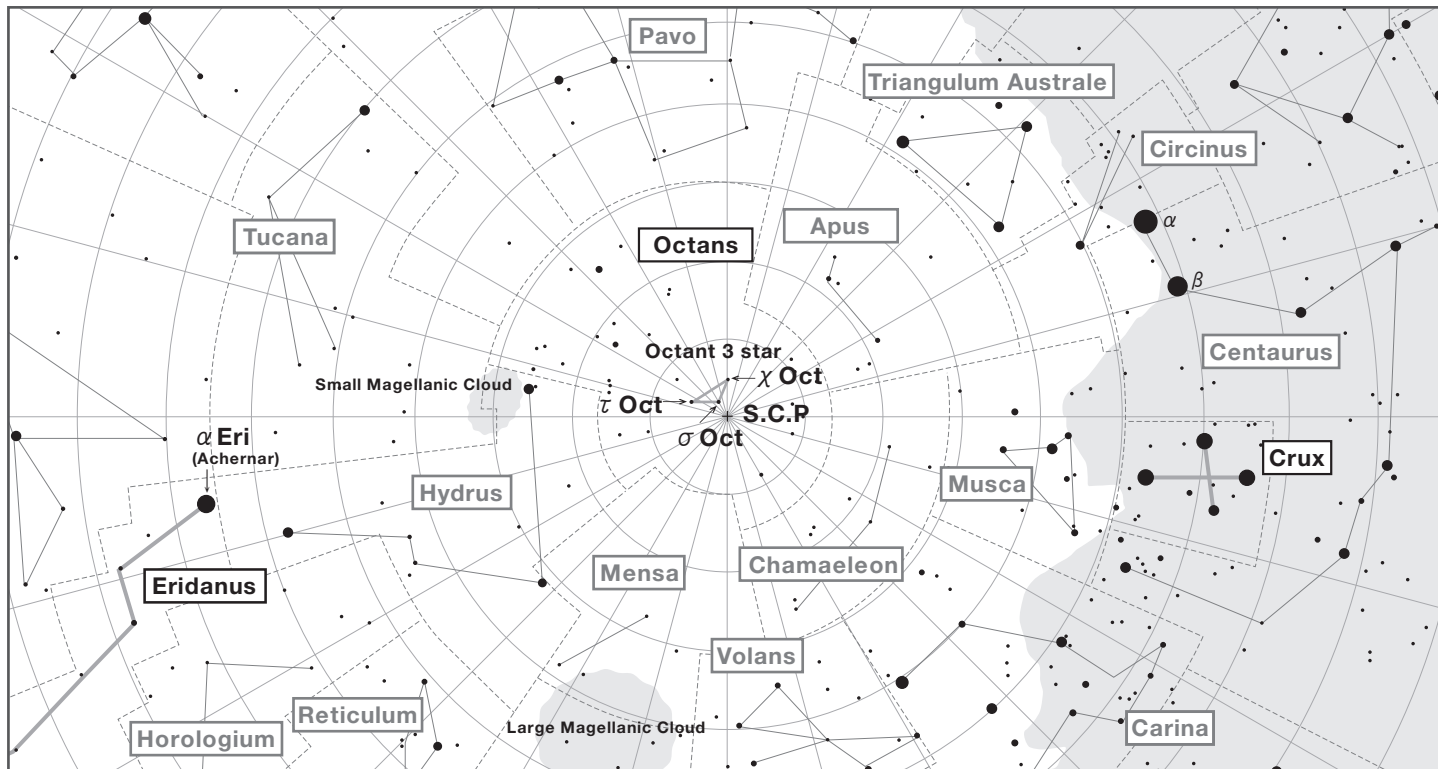

## HOW TO USE

### ⚠ HOW TO USE

Octans is a constellation located near the south celestial pole and it can be used to align the POLARIE U in the southern hemisphere. Unlike Polaris which is a bright 2nd magnitude star adjacent to the north celestial pole, Octans is made up of dark stars about 5th magnitude on average. The nearest star to the south celestial pole is Sigma Octantis, which is one of four stars forming a trapezoid in Octans, visible at 5.5th magnitude.

---

1 Check your observing site with a compass, a GPS system or a map in advance to confirm that Octans, the Southern Cross and Alpha Erini can be seen from your observing location on the date of observation.

---

## HOW TO USE

- 2 Set up the POLARIE U mounted tripod on flat and hard ground where you can see Octans in the sky.  
Point the rotational axis of the POLARIE U in the direction of south. Adjust the tripod legs so that the tripod is as level as possible.

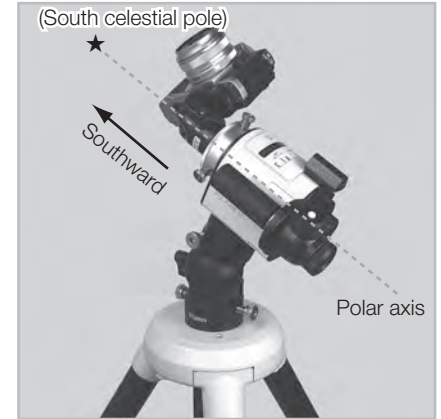

When you use the POLARIE U in the southern hemisphere, you should set up it as accurately as possible. Near the south celestial pole, there is no bright star such as Polaris adjacent to the north celestial pole, it will be not easy for you to set up the POLARIE U quickly by a sight. First, it is recommended to be familiar with the direction of Octans and the location of its three stars for polar alignment.

When you use a magnetic compass for the polar alignment, it is recommended that you consider the influence of the magnetic declination of magnetic compasses. Using an electronic compass like a GPS or your smartphone's positioning app will be a good solution.

You may obtain information on the magnetic declination of your location from the following URL: [Magnetic-Declination.com](http://magnetic-declination.com) (<http://magnetic-declination.com/>).

## HOW TO USE

3 While looking into the polar scope, turn the polar scope body so that the engraved Southern Cross (or Alpha Eridani) on the reticle matches the Southern Cross (or Alpha Eridani) in the real sky.





## HOW TO USE

- 4 While looking into the eyepiece of the polar scope, adjust the orientation of the POLARIE U in altitude and azimuth directions (by using the Polarie fine adjustment unit) so that Sigma Octantis comes as close as possible to the designated position on the reticle.

Set Sigma Octantis to the gap between the two segments of the lines marked 2014 and 2040 adjacent to a mark " $\sigma$  Oct" as shown in the figure.

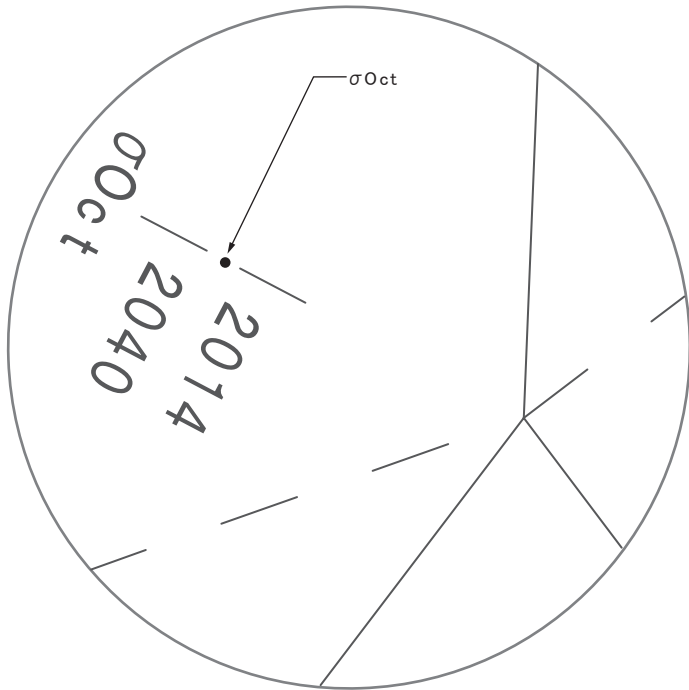

## HOW TO USE

5 As Sigma Octantis shifts to the designated position on the reticle, both Tau Octantis and Chi Octantis come close to their own designated position scales respectively. While looking into the eyepiece of the polar scope, turn the polar scope body so that each of the position scale for Tau Octantis and Chi Octantis come to the closest to actual Tau Octantis and Chi Octantis respectively.

The numbers 15 and 40 on the position scales for Tau Octantis and Chi Octantis show the years 2014 and 2040 respectively.

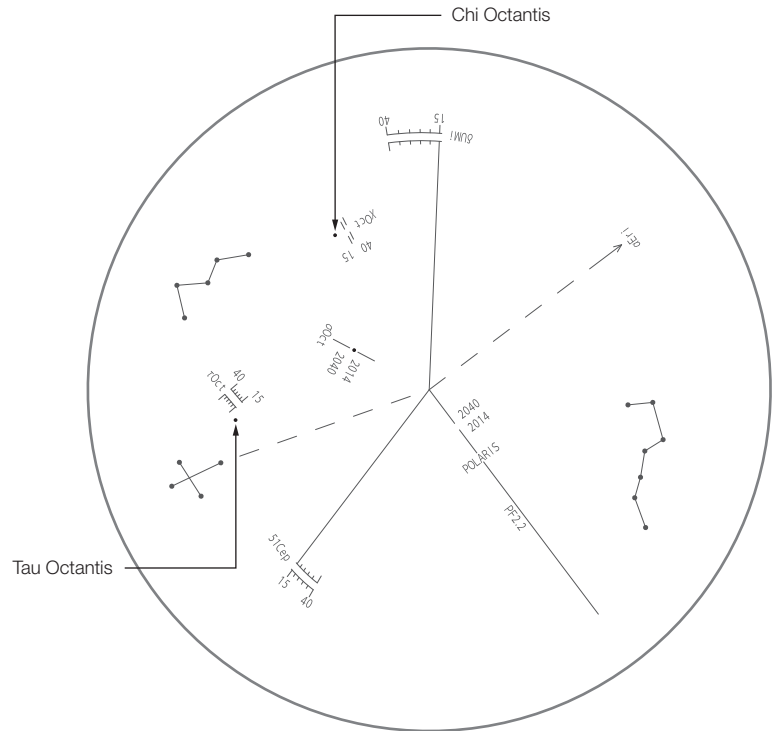

## HOW TO USE

Now, Sigma Octantis gets out of place from the designated position but it is not necessary to correct for it at this stage.

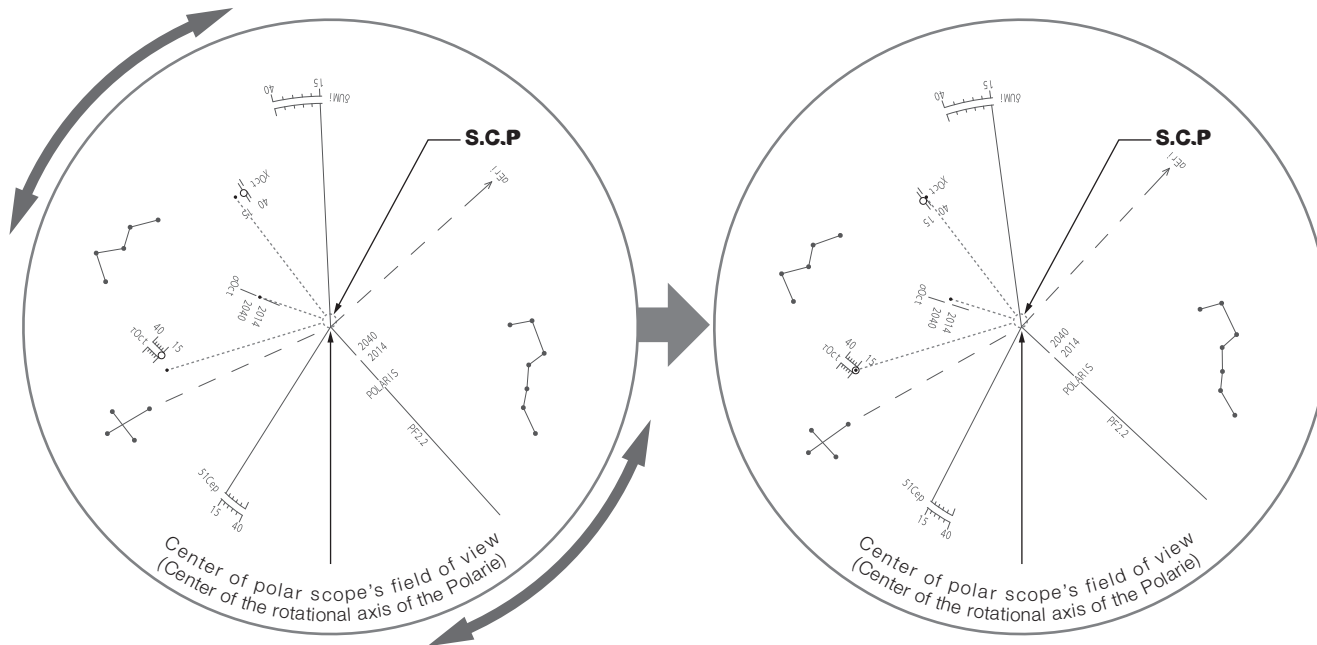

Since there is no mark that points at the South Celestial Pole, you need to match the polar axis of the POLARIE U with the S.C.P. using the relatively dim Octantis stars in the neighborhood.

As an illustration here, Sigma Octantis is set to the edge of the line on the side of 2014, and both Tau Octantis and Chi Octantis are set to the middle of the curved lines of the position scale at the protruded edge on the side of 15 respectively. (In case of the year 2014)

Turn the polar scope body so that Tau Octantis comes near to the location of the year 2014 on the scale. And then, Sigma Octantis will get out of position from the gap between the lines.

Adjust the red-light illumination to be dimmer if the reticle is too bright to see the 5th magnitude Tau Octantis.



## HOW TO USE

The movement of Sigma Octantis from 2014 to 2040 by precession

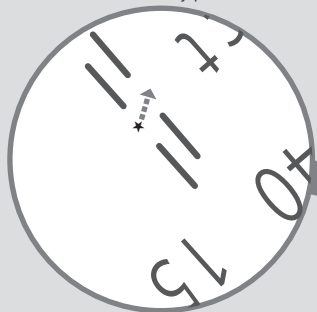

The movement of Tau Octantis from 2014 to 2040 by precession



The movement of Chi Octantis from 2014 to 2040 by precession

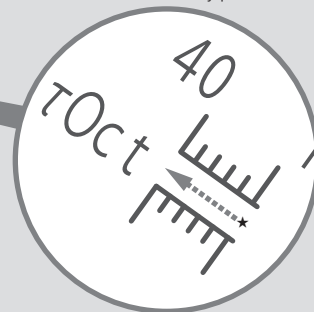

The locations of Sigma, Tau and Chi Octantis on the position scales change year by year due to precession of the Earth.

You need to compensate the locations of the 3 stars on the position scales yearly.

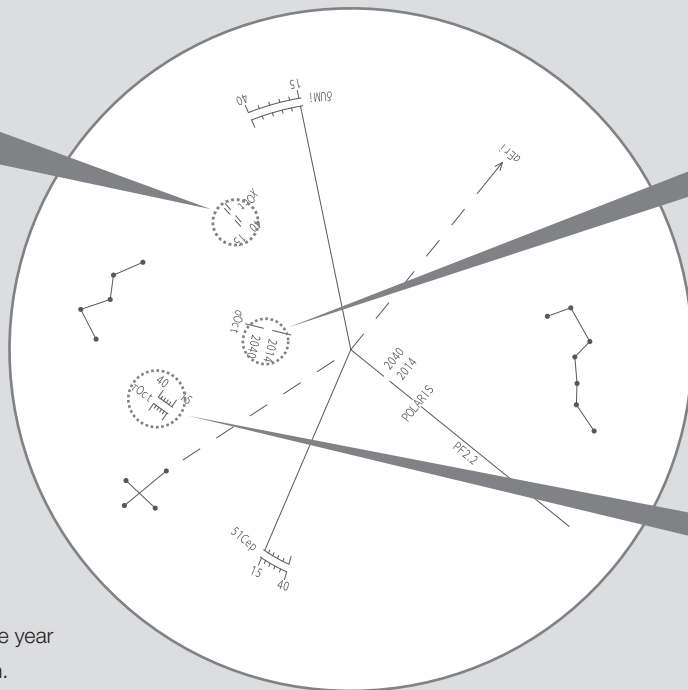

## HOW TO USE

- 6 While looking into the eyepiece of the polar scope, turn the altitude and azimuth fine adjustment bolts of the Polaris fine adjustment unit so that Sigma Octantis comes to the gap between the two segments of the lines marked 2014 and 2040



Set Sigma Octantis to an approximate position that is corresponding to the year of your observation.

Correcting the position of Sigma Octantis in the altitude and azimuth directions with the fine adjustment bolts

Correcting the position of Tau and Chi Octantis with a rotation of the polar scope

## HOW TO USE

- 7 Repeat the procedures 5 and 6 until Sigma, Tau and Chi Octantis come to the proper locations on the designated position scales respectively.  
Tighten the fine adjustment screws at both sides to finish the polar alignment.

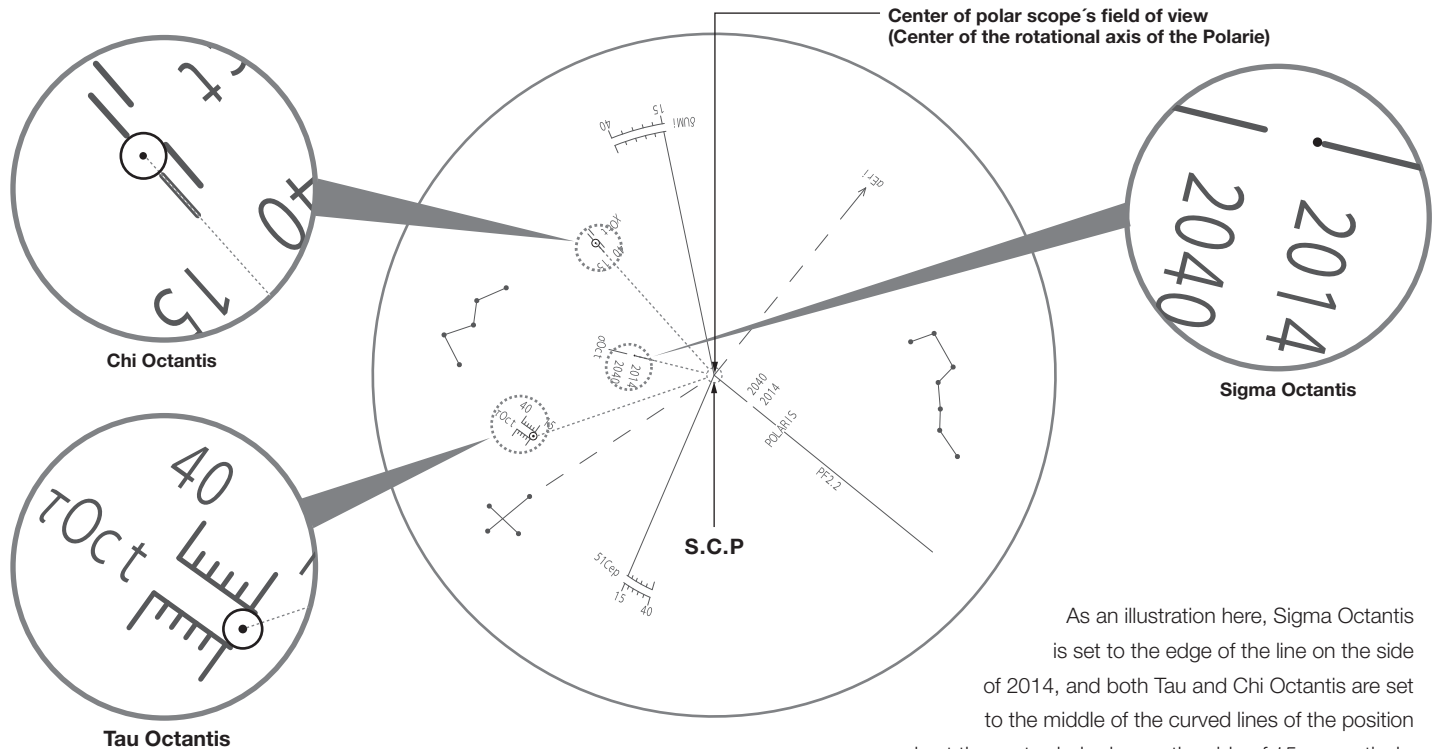

As an illustration here, Sigma Octantis is set to the edge of the line on the side of 2014, and both Tau and Chi Octantis are set to the middle of the curved lines of the position scale at the protruded edge on the side of 15 respectively.

(In case of the year 2014)

# HOW TO USE

## Tips on Finding Octans

The constellation Octans is made up of dark stars about 5th magnitude on average. The nearest star to the south celestial pole is Sigma Octantis, which is one of four stars forming a trapezoid in Octans, visible at 5.5th magnitude. There are a few methods to locate inconspicuous Octans using the surrounding stars.

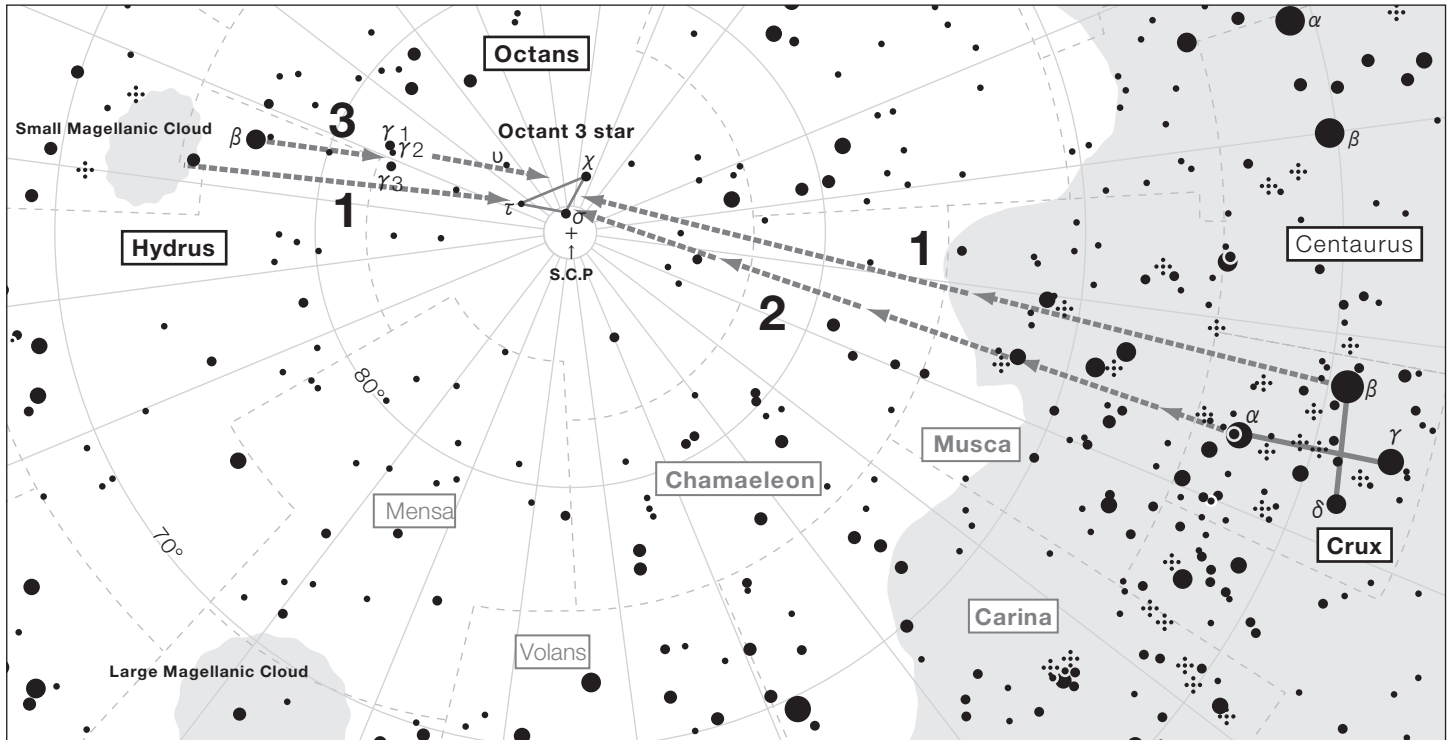

Note: The orientation of Octans changes depending on the season of the year.

## HOW TO USE

### **1. Directing to Octans using Small Magellanic Cloud and the Southern Cross (Crux) as pointers**

Draw an imaginary line between the center of Small Magellanic Cloud and Beta Crux and divide it at a ratio of one to two. You will find the four stars of Octans at the divide.

### **2. Directing to Octans using the arrangement of stars in the Southern Cross (Crux) as pointers**

Draw an imaginary line straight through the two stars (Alpha and Beta Crux) of the Southern Cross making the vertical line of the cross toward Small Magellanic Cloud. You will find the four stars of Octans at a place about 4.5 times extended from the span of the two stars.

### **3. Directing to Octans using Small Magellanic Cloud, beta Hydrus, and Gamma Octantis as pointers**

If you cast your eyes toward Crux from Small Magellanic Cloud, you will see Beta Hydrus. Going southward from Beta Hydrus will find you Gamma Octans which consists of a row of three stars. Continue your eyes by the same distance toward the Southern Cross and you will find the four stars of Octans.

## HOW TO USE

### About PF-L Assist App

The PF-L Assist app helps you to align a Vixen equatorial mount (incl. POLARIE and POLARIE U star trackers) to the north celestial pole or south celestial pole by making the R.A. axis of the equatorial mount parallel to earth's rotational axis.

The app displays the current night sky which can be seen in your location and it will guide you to match the orientation of the constellations on the reticle in the polar alignment scope with the constellations in the real sky when you set up the equatorial mount. You can easily locate the constellations necessary for polar alignment if they are hidden by trees or building, or when the night sky is affected by city lights, or when you set up your telescope at dusk.



## PF-L Assist

For details of the app, visit our web site at:  
<https://www.vixen.co.jp>

The free download PF-L Assist app is available for iPhone, Android and Kindle fire.



# HOW TO USE

## Using an optional Polarie Multi Mounting Block

The Polarie multi mounting block (sold separately) is attachable to the POLARIE U. With the use of a Dovetail slide bar DD and a Counterweight 1kg, the POLARIE U can mount the equipment up to 6.5kg (without the counterweight). Attach the Polarie multi mounting block with the following procedure.

- 1 Loosen the two thumbs crews and remove the camera mounting block from the POLARIE U.

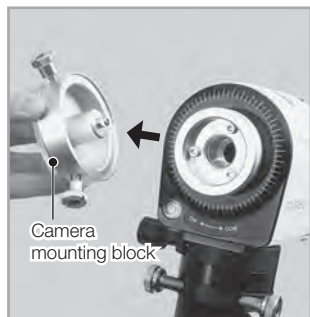
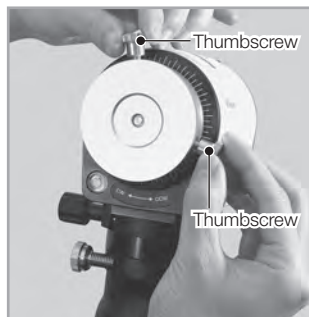

- 2 Loosen the three setscrews on the side of the multi mounting block with the supplied Allen wrench of 2.5 mm.

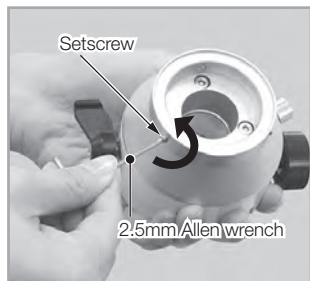

- 3 Place the multi mounting block over the POLARIE U so that the protruded portion of the POLARIE U faces the bottom of the multi mounting block as shown in the figure. Attach the multi mounting block to the POLARIE U and tighten the three setscrews securely.



- 4 Now, ready to install the Dovetail slide bar DD or other accessory plates according to your needs.

# HOW TO USE

## Using an optional Quick Release Panorama Clamp

The Quick release panorama clamp (sold separately) is attachable to the POLARIE U. It is compatible with attachment plates of the standard thin type. Attach the Quick release panorama clamp with the following procedure.

- 1** Loosen the two thumbscrews and remove the camera mounting block from the POLARIE U.

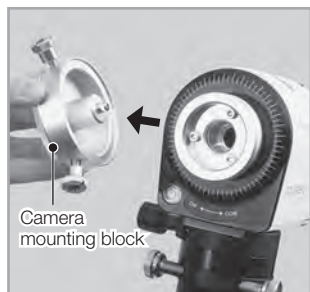
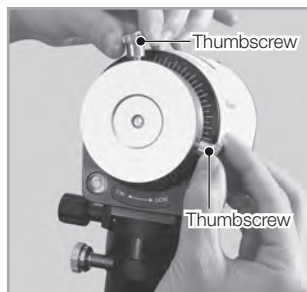

- 2** Loosen three screws in the center hollow of the protruded portion of the POLARIE U with the supplied Allen wrench of 2.5mm to remove the part of the protruded portion. Two M6 cap screws appear.



- 3** Replace with the clamp disc (lower portion of the Quick release panorama clamp) and tighten it securely with two M6 cap screws.

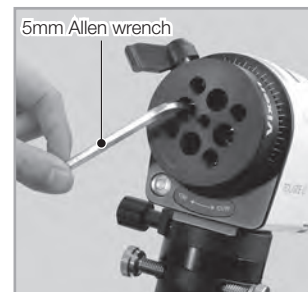

- 4** Attach the plate holder (upper portion of the Quick release panorama clamp) to the clamp disc.

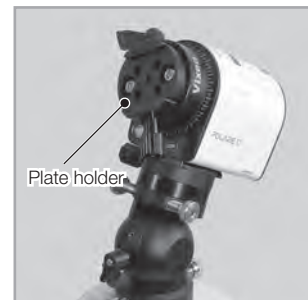

- 5** Now, ready to install a Quick release angle plate or another plate according to your needs.



## Specifications

Model	POLARIE U Star Tracker
<b>R.A. Slow Motion Control</b>	Wheel and worm gears full circle micro movement, 58.4mm in diameter, 144-tooth, made of Aluminum alloy
<b>Worm Gear Shaft</b>	9.8mm in diameter, made of brass
<b>R.A. Axis</b>	40mm in diameter, made of aluminum alloy
<b>Number of Bearings</b>	2 pieces
<b>Drive</b>	Pulse Motor
<b>Maximum Loading Capacity (Including the camera mounting block)</b>	For photography with celestial tracking rate Standard: 2.5kg / 5.5 lbs., Upgraded: 6.5 kg / 14 lbs., Time-lapse: 10kg / 22 lbs., at the distance of 10cm from the rotation axis.
<b>Tracking Rates</b>	Celestial, 0.5X Celestial, Solar, Lunar, Northern hemisphere, southern hemisphere) (Remote settings are available with a Smartphone.)
<b>Sight Tube Finder</b>	It is used in the northern hemisphere to guide the unit to Polaris. 8.9 degrees field of view with no magnification. (Fits in the accessory shoe.)
<b>Polar Scope</b>	Polar alignment scope PF-LII is optional. Polar scope arm bracket sold separately is needed.
<b>Leveling</b>	Bubble level for time-lapse photography.
<b>Tripod Adapter Block</b>	3/8-inch camera screw sockets (2 places) with a conversion adapter for 1/4" screw, compatible with attachment plates of the standard thin type.
<b>Shutter Release Terminal</b>	2.5mm female jack for tripolar stereo mini plug Pinout: Full Shutter release, half shutter and common, in order from center to outward
<b>Autoguider Port</b>	6-pole 6-wired modular jack (for an external autoguider)

<b>External Power Supply Port</b>	USB Type-C
<b>Power Source</b>	AA batteries x 4: Alkaline, Ni-MH rechargeable, Ni-Cd rechargeable External power supply: Available with USB Type-C
<b>Working Voltage / Electricity Consumption</b>	AA batteries: DC 4.8V to 6.0V, Max. 0.6A (at 2.5kg loading weight) External power supply: DC 4.4V to 5.25V, Max. 0.3A (at 2.5kg loading weight)
<b>Working Duration</b>	About 7 hours at 20 degree C (68F) temperature, with the use of Alkaline batterie.
<b>Wi-Fi</b>	Application software that works on smartphones is required.
<b>Operating Environment for Application Software</b>	OS: Android 4.4 and over or iOS 9.9 and over*, Wi-Fi: IEEE 802.11b/g, Data Encryption Method: WPA2-PSK *Be sure to confirm the operation of the application, as some smartphones do not meet the requirements.
<b>Operating Temperature</b>	0 degree to 40 degree C (104F)
<b>Dimensions</b>	88.5mm x 72mm x 110.5mm
<b>Weight</b>	575 g / 1.26 lbs. (without batteries)
<b>Optional Accessories</b>	Polar alignment scope PF-LII, Polar scope arm bracket, Polar fine adjustment unit DX, Polar meter

# APPENDIX

## Pinpoint star images at 1/2 star-scape mode

If this mode is selected, the POLARIE U tracks stars at half the speed of the diurnal motion of the stars. The terrestrial objects are trailed less as compared with images taken by wide-field photography at a given exposure time. Short exposure times will allow you to take images with no star trails. Photography at half the speed of the star's diurnal motion limits the movement seen in terrestrial objects. Adding landscape or architectural objects in the foreground will make your photos more impressive.

The table below shows recommended maximum shutter exposure times to hold pinpoint star images at star-scape mode

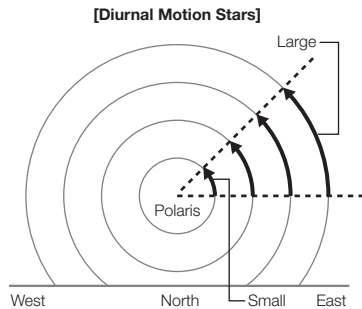

Focal length of photographic lens(mm) <sup>*1</sup> Separation from the celestial equator	f=15mm	f=20mm	f=24mm	f=28mm	f=35mm	f=50mm	f=85mm	f=100mm	f=135mm	f=200mm
0°(Celestial Equator)	18 sec.	13 sec.	11 sec.	9 sec.	7 sec.	5 sec.	3 sec.	2 sec.	2 sec.	1 sec.
± 10°	18 sec.	13 sec.	11 sec.	9 sec.	7 sec.	5 sec.	3 sec.	2 sec.	2 sec.	1 sec.
± 20°	19 sec.	14 sec.	12 sec.	10 sec.	8 sec.	5 sec.	3 sec.	2 sec.	2 sec.	1 sec.
± 30°	21 sec.	15 sec.	13 sec.	11 sec.	9 sec.	6 sec.	3 sec.	3 sec.	3 sec.	1 sec.
± 40°	23 sec.	17 sec.	14 sec.	12 sec.	10 sec.	7 sec.	4 sec.	3 sec.	2 sec.	1 sec.
± 50°	28 sec.	21 sec.	17 sec.	15 sec.	12 sec.	8 sec.	5 sec.	4 sec.	3 sec.	2 sec.
± 60°	36 sec.	27 sec.	22 sec.	19 sec.	15 sec.	10 sec.	6 sec.	5 sec.	4 sec.	2 sec.
± 70°	53 sec.	40 sec.	33 sec.	28 sec.	22 sec.	16 sec.	9 sec.	8 sec.	5 sec.	4 sec.
± 80°	105 sec.	78 sec.	65 sec.	56 sec.	45 sec.	31 sec.	18 sec.	15 sec.	11 sec.	7 sec.

Note:

\*1: The above focal lengths show actual focal lengths of your camera. It is not necessary to convert them to focal lengths in 35mm film format if APS-C, 3/4 or another format is utilized for your camera.

\*2: The above exposure times are calculated on the assumption that the pixel size of an imaging device is 0.001mm. Allowable maximum exposure times will change according to the specifications of your camera and lens. It is recommended you test your system to determine the best exposure time.

\*3: If you use a 35mm film format camera, the above exposure times will be extended by three times and more due to bigger grains of film.

# APPENDIX

## Pinpoint star images at wide-field astrophotography mode subject to a polar alignment at an error of 2 degree

If this mode is selected, the POLARIE U follows stars at the same speed as the diurnal motion of the stars. It is suitable for capturing dark skies and faint celestial objects. It is possible to avoid star trails, but the terrestrial objects are trailed in long exposure.

The table below shows allowable maximum shutter exposure times to hold pinpoint star images subject to a polar alignment at an error of 2 degrees

Focal length of photographic lens(mm) <sup>*1</sup> Separation from the celestial equator	f=15mm	f=20mm	f=24mm	f=28mm	f=35mm	f=50mm	f=85mm	f=100mm	f=135mm	f=200mm
0°(Celestial Equator)	6 min. 52 sec.	5 min. 09 sec.	4 min. 17 sec.	3 min. 41 sec.	2 min. 56 sec.	2 min. 03 sec.	1 min. 12 sec.	1 min. 01 sec.	45,8 sec	30,9 sec.
± 10°	6 min. 58 sec.	5 min. 14 sec.	4 min. 21 sec.	3 min. 55 sec.	2 min. 59 sec.	2 min. 0,5 sec.	1 min. 13 sec.	1 min. 02 sec.	46,5 sec	31,4 sec.
± 20°	7 min. 19 sec.	5 min. 29 sec.	4 min. 34 sec.	3 min. 55 sec.	3 min. 08 sec.	2 min. 11 sec.	1 min. 17 sec.	1 min. 05 sec.	48,7 sec.	32,9 sec.
± 30°	7 min. 56 sec.	5 min. 57 sec.	4 min. 57 sec.	4 min. 15 sec.	3 min. 24 sec.	2 min. 22 sec.	1 min. 24 sec.	1 min. 11 sec.	52,9 sec.	35,7 sec.
± 40°	8 min. 58 sec.	6 min. 43 sec.	5 min. 36 sec.	4 min. 48 sec.	3 min. 50 sec.	2 min. 41 sec.	1 min. 35 sec.	1 min. 20 sec.	59,8 sec.	40,3 sec.
± 50°	10 min. 41 sec.	8 min. 01 sec.	6 min. 41 sec.	5 min. 43 sec.	4 min. 35 sec.	3 min. 12 sec.	1 min. 53 sec.	1 min. 36 sec.	1 min. 11,3 sec.	48,1 sec.
± 60°	13 min. 45 sec.	10 min. 18 sec.	8 min. 35 sec.	7 min. 22 sec.	5 min. 53 sec.	4 min. 07 sec.	2 min. 25 sec.	2 min. 0,3 sec.	1 min. 31,6 sec.	1 min. 1,8 sec.
± 70°	20 min. 06 sec.	15 min. 04 sec.	12 min. 33 sec.	10 min. 46 sec.	8 min. 36 sec.	6 min. 01 sec.	3 min. 32 sec.	3 min. 00 sec.	2 min. 14 sec.	1 min. 30,4 sec.
± 80°	39 min. 17 sec.	29 min. 41 sec.	24 min. 44 sec.	21 min. 12 sec.	16 min. 58 sec.	11 min. 52 sec.	6 min. 59 sec.	5 min. 56 sec.	4 min. 23,9 sec.	2 min. 58,1 sec.

Note:

\*1: The above focal lengths show actual focal lengths of your camera. It is not necessary to convert them to focal lengths in 35mm film format if APS-C, 3/4 or another format is utilized for your camera.

\*2: The above exposure times are calculated on the assumption that the pixel size of an imaging device is 0.001mm. Allowable maximum exposure times will change according to the specifications of your camera and lens. It is recommended you test your system to determine the best exposure time.

\*3: If you use a 35mm film format camera, the above exposure times will be extended by three times and more due to bigger grains of film.

**Vixen®**

---

**Vixen®**

VIXEN - European Distributor Bresser GmbH Gutenbergstrasse 2, D-46414 Rhede, Germany

Phone: +49 (0) 2872 – 80 740

E-Mail: [info@bresser.de](mailto:info@bresser.de) [www.bresser.de](http://www.bresser.de)