



U.S. Department  
of Transportation

**National Highway  
Traffic Safety  
Administration**



---

DOT HS 812 934

March 2020

# **CAFE Model Documentation**

## **DISCLAIMER**

This publication is distributed by the U.S. Department of Transportation, National Highway Traffic Safety Administration, in the interest of information exchange. The opinions, findings and conclusions expressed in this publication are those of the authors and not necessarily those of the Department of Transportation or the National Highway Traffic Safety Administration. The United States Government assumes no liability for its contents or use thereof. If trade or manufacturers' names are mentioned, it is only because they are considered essential to the object of the publication and should not be construed as an endorsement. The United States Government does not endorse products or manufacturers.

Suggested APA Format Citation:

Shaulov, M., Bogard, D., Green, K., Jean, B., Keefe, R., & Pickrell, D. (2020, March). *CAFE Model documentation* (Report No. DOT HS 812 934). National Highway Traffic Safety Administration.

<b>1. Report No.</b> DOT HS 812 934		<b>2. Government Accession No.</b>		<b>3. Recipient's Catalog No.</b>	
<b>4. Title and Subtitle</b> CAFE Model Documentation				<b>5. Report Date</b> March 2020	
				<b>6. Performing Organization Code</b>	
<b>7. Authors</b> Mark Shaulov, Dan Bogard, Kevin Green, Brianna Jean, Ryan Keefe, and Donald Pickrell				<b>8. Performing Organization Report No.</b>	
<b>9. Performing Organization Name and Address</b> CAFE Program Office John A. Volpe National Transportation Systems Center Cambridge, MA 02142 U.S. Department of Transportation				<b>10. Work Unit No. (TRAVIS)</b>	
				<b>11. Contract or Grant No.</b>	
<b>12. Sponsoring Agency Name and Address</b> National Highway Traffic Safety Administration Fuel Economy Division 1200 New Jersey Avenue SE Washington, DC 20590				<b>13. Type of Report and Period Covered</b> Operational Handbook	
				<b>14. Sponsoring Agency Code</b>	
<b>15. Supplementary Notes</b>					
<b>16. Abstract</b> The Volpe National Transportation Systems Center (Volpe Center) of the United States Department of Transportation has developed a modeling system to assist the National Highway Traffic Safety Administration in the evaluation of potential new Corporate Average Fuel Economy (CAFE) standards. Given externally developed inputs, the modeling system estimates how manufacturers could apply additional fuel-saving technologies in response to new CAFE or CO <sub>2</sub> standards, and estimates how doing so would affect vehicle costs and fuel economy levels; vehicle sales volumes and fleet turnover; and national-scale automotive manufacturing employment, highway travel, fatalities, fuel consumption, and CO <sub>2</sub> and other emissions. Based on these impacts, the system calculates costs and benefits from private and social perspectives.					
<b>17. Key Words</b> Corporate Average Fuel Economy standards, CAFE, CO <sub>2</sub> standards, GHG standards, vehicles, fuel-saving technology, fuel savings, costs, effects, benefits.				<b>18. Distribution Statement</b> Document is available to the public from the National Technical Information Service, <a href="http://www.ntis.gov">www.ntis.gov</a> .	
<b>19. Security Classif. (of this report)</b> Unclassified		<b>20. Security Classif. (of this page)</b> Unclassified		<b>21. No. of Pages</b> 263	<b>22. Price</b>

Form DOT F 1700.7 (8-72)

Reproduction of completed page authorized

298-102

## PREFACE

The United States Department of Transportation's Volpe National Transportation Systems Center (Volpe Center) has developed and, since 2002, steadily applied, expanded, and refined a modeling system to assist the National Highway Traffic Safety Administration in the evaluation of potential new Corporate Average Fuel Economy (CAFE) standards and, more recently, to assist the U.S. Environmental Protection Agency (EPA) in the evaluation of related potential new standards regarding new vehicle carbon dioxide (CO<sub>2</sub>) emissions. Given externally developed inputs, the modeling system estimates how manufacturers could apply additional fuel-saving technologies in response to new CAFE or CO<sub>2</sub> standards, and estimates how doing so would impact vehicle costs, fuel economy levels, and CO<sub>2</sub> emission rates; vehicle sales volumes and fleet turnover; and national-scale automotive manufacturing employment, highway travel, fatalities, fuel consumption, and CO<sub>2</sub> and other emissions. Based on these impacts, the system calculates costs and benefits from private and social perspectives.

This report documents the design and function of the CAFE Model as of March 2020; specifies the content, structure, and meaning of inputs and outputs; and provides instructions for the installation and use of the modeling system.

The authors acknowledge the CAFE Model's development support from contractor Yefim Keselman, as well as the technical contributions of NHTSA and Volpe Center staff who have been involved in guiding recent changes to the modeling system, including Jonathan Badgley, Joseph Bayer, Rebecca Blatnica, Larry Blincoe, Giulio Chiuini, Paul Connet, Jane Doherty, Andrew Eilbert, Hannah Fish, Christina Foreman, Joshua Hassol, Maurice Hicks, David Hyde, Thomas Kang, Ken Katz, Matthew Keen, Russell Krupen, Jonathan Morrison, Vinay Nagabhushana, James Owens, David Pace, Sean Peirce, Ryan Posten, Gregory Powell, Sean Puckett, Ross Rutledge, Rebecca Schade, Brian Seymour, Jim Tamm, Jacob Wishart, and Seiar Zia. The authors further acknowledge former DOT executives and staff who guided and participated in the development of earlier versions of the modeling system, including Julie Abraham, Gregory Ayres, Noble Bowie, John Brewer, Coralie Cooper, Peter Feather, David Friedman, Walter Gazda, Phil Gorney, Carol Hammel-Smith, Ryan Hagen, Ryan Harrington, Heidi King, Steve Kratzke, Shoshana Lew, Kristina Lopez-Bernal, José Mantilla, Joe Mergel, Ron Medford, Amandine Muskus, Arthur Rypinski, Dan Smith, Katie Thomson, John Van Schalkwyk, Kevin Vincent, Kenneth William, Steve Wood, Lixin Zhao, and Stephen Zoepf.

The authors further acknowledge the technical contributions of people who have reviewed detailed results of the model (and/or earlier versions of the model) and/or provided specific suggestions regarding the model's design. Among these people are Ayman Moawad, Steve Plotkin, Aymeric Rousseau, and Michael Wang of the Department of Energy's Argonne National Laboratory; Jeff Alson, Kevin Bolon, William Charmley, Ben Ellies, Chet France, David Haugen, Lisa Heinzerling, Gloria Helfand, Ari Kahan, Robin Moran, Margo Oge, Richard Rykowski, and Todd Sherwood of the U.S. Environmental Protection Agency (EPA); John Maples of DOE's Energy Information Administration (EIA); Gary Rogers of FEV Engine Technology, Inc.; David Boggs, Anrico Casadei, Scott Ellsworth, and Sandy Stojkovski of Ricardo, Inc.; Jamie Hulan of Transport Canada; Jonathan Rubin of the University of Maine; Alicia Birky of Energetics, Inc.; Howard Gruenspecht of Massachusetts Institute of Technology, John Graham of the Indiana University; Walter Kreucher of Environmental Consultants of Michigan; James Sallee of University of California at Berkeley; Nigel Clark of West Virginia University; and Wallace W. Wade of Ford Motor Co. (retired).

# Contents

Contents.....	iii
Tables .....	vi
Figures.....	viii
Abbreviations.....	ix
Chapter One Introduction .....	1
Chapter Two System Design.....	3
Section 1 Overall Structure (System Overview) .....	3
Section 2 Representation of Market Data .....	5
S2.1 Initial State of the Fleet .....	5
S2.2 Vehicle Classifications .....	10
S2.3 Manufacturer-Specific Attributes .....	13
Section 3 Regulatory Scenario Definition .....	16
Section 4 Evaluation of Vehicle Technologies .....	19
S4.1 Technology Classes .....	21
S4.2 Technology Pathways .....	23
S4.2.1 Engine-Level Pathways .....	24
S4.2.2 Transmission-Level Pathways .....	26
S4.2.3 Vehicle-Level Electrification Pathways .....	27
S4.2.4 Platform-Level and Other Vehicle-Level Pathways .....	29
S4.2.5 Relationship Between Technology Pathways.....	29
S4.3 Technology Applicability.....	31
S4.4 Technology Evaluation and Inheriting.....	32
S4.5 Technology Constraints (Supersession and Mutual Exclusivity).....	33
S4.6 Technology Fuel Economy Improvements .....	38
S4.6.1 Fuel Economy Adjustments.....	41
S4.7 Technology Cost Tables.....	42
S4.7.1 Battery Costs.....	44
S4.8 Application of Mass Reduction Technology.....	46
Section 5 Compliance Simulation .....	50
S5.1 CAFE Compliance Calculations.....	52
S5.1.1 Calculation of Vehicle’s Fuel Economy .....	53
S5.1.2 Calculation of the CAFE Standard.....	55
S5.1.3 Calculation of the CAFE Rating .....	57
S5.1.4 Calculation of the CAFE Credits, Credit Value, and Fines.....	59
S5.2 CO2 Compliance Calculations .....	61
S5.2.1 Calculation of Vehicle’s CO <sub>2</sub> Rating .....	61
S5.2.2 Calculation of the CO <sub>2</sub> Standard.....	64
S5.2.3 Calculation of the CO <sub>2</sub> Rating .....	65
S5.2.4 Calculation of the CO <sub>2</sub> Credits and Credit Value .....	67
S5.3 Compliance Simulation Algorithm.....	69
S5.3.1 Determination of “Best Next” Technology Solution .....	71
S5.3.2 Calculation of Effective Cost.....	73
S5.4 Cost of Compliance.....	79
S5.4.1 Regulatory Costs.....	82

S5.5	Hybrid/Electric “Burden” Cost.....	84
S5.6	Dynamic Fleet Share and Sales Response.....	86
S5.7	Credit Transfers and Carry Forward.....	93
S5.7.1	Evaluation and Application of Credits.....	94
S5.7.2	Credit Usage Strategy.....	97
Chapter Three	Calculation of Effects.....	99
Section 1	Vehicle Lifetimes.....	100
S1.1	Dynamic Scrappage Model.....	102
S1.2	Static Scrappage Model.....	105
Section 2	Vehicle Use and Total Lifetime Mileage.....	107
S2.1	Dynamic VMT Model.....	115
Section 3	Fuel Consumption.....	119
Section 4	Greenhouse Gas Emissions.....	123
Section 5	Air Pollutant Emissions.....	127
Section 6	Emission Health Impacts.....	131
Section 7	Vehicle Safety Effects.....	133
Section 8	Private versus Social Costs and Benefits.....	137
S8.1	Increases in New Vehicle Prices.....	138
S8.2	Foregone Consumer Sales Surplus.....	138
S8.3	The Value of Fuel Consumed.....	139
S8.4	Benefits from Additional Driving.....	141
S8.5	The Value of Extended Refueling Range.....	142
S8.6	Changes in Performance and Utility.....	144
S8.7	Socially Valued Costs and Benefits.....	144
S8.7.1	Social Costs of Market Externalities.....	144
S8.7.2	Social Costs of Added Driving.....	146
S8.7.3	Social Costs of Environmental Impacts.....	151
S8.7.4	Discounting of Social Costs and Benefits.....	153
S8.8	Consumer-Valued Costs and Benefits.....	154
S8.8.1	The Value of “Rebound Miles”.....	154
S8.8.2	Ownership Costs.....	154
S8.8.3	Calculating Vehicle Payback.....	158
S8.8.4	Discounting of Consumer Costs and Benefits.....	160
S8.9	Implicit Opportunity Cost.....	161
Section 9	Fleet Analysis Calculations.....	164
Appendix A	Model Inputs.....	165
A.1	Market Data File.....	166
A.1.1	Manufacturers Worksheet.....	166
A.1.2	Credits and Adjustments Worksheet.....	167
A.1.3	Vehicles Worksheet.....	167
A.1.4	Engines Worksheet.....	170
A.1.5	Transmissions Worksheet.....	171
A.2	Technologies File.....	173
A.3	Parameters File.....	175
A.3.1	Economic Values.....	175
A.3.2	Vehicle Age Data.....	176

A.3.3	Fuel Prices .....	177
A.3.4	Scrappage Model Values .....	177
A.3.5	Historic Fleet Data .....	177
A.3.6	Safety Values .....	178
A.3.7	Fatality Rates .....	179
A.3.8	Credit Trading Values .....	179
A.3.9	ZEV Credit Values .....	179
A.3.10	Employment Values .....	180
A.3.11	Fuel Properties .....	180
A.3.12	Fuel Import Assumptions .....	180
A.3.13	Emission Health Impacts .....	181
A.3.14	Criteria Emission Costs .....	181
A.3.15	Greenhouse Emission Costs.....	182
A.3.16	Upstream Emissions .....	182
A.3.17	Tailpipe Emissions .....	183
A.4	Scenarios File .....	184
A.4.1	Target Functions.....	185
Appendix B	Model Outputs .....	188
B.1	Technology Utilization Report.....	190
B.2	Compliance Report .....	191
B.3	Societal Effects and Societal Costs Reports.....	194
B.4	Annual Societal Effects and Annual Societal Costs Reports.....	199
B.5	Annual Societal Effects and Annual Societal Costs Summary Reports .....	205
B.6	Consumer Costs Report .....	211
B.7	Vehicles Report .....	213
B.8	Vehicles Diagnostic Report.....	217
Appendix C	CAFE Model Software Manual.....	219
C.1	Warnings .....	219
C.2	Notice.....	219
C.3	Installation and System Requirements.....	220
C.4	CAFE Model Graphical User Interface .....	221
C.4.1	CAFE Model Window.....	222
C.4.2	Modeling Settings Window .....	224
C.4.2.1	General Compliance Settings Panel.....	224
C.4.2.2	I/O Settings Panel .....	225
C.4.2.3	Runtime Settings Panel .....	227
C.4.3	Session View .....	229
C.4.3.1	Session View Layout .....	229
C.4.3.2	Interacting with the Session View .....	233
C.4.4	Model Outputs.....	238
C.5	CAFE Model Usage Examples.....	240
C.5.1	Example 1 – Configuring for Standard Compliance Modeling .....	240
C.5.2	Example 2 – Configuring for “CO2 Compliance” Modeling .....	244
C.6	Known Issues .....	247

## Tables

Table 1. Fuel Types.....	8
Table 2. Regulatory Classes .....	11
Table 3. Technology Classes Overview .....	11
Table 4. Safety Classes.....	12
Table 5. Vehicle Classes .....	13
Table 6. Designation of Manufacturer Parameters by Vehicle Style.....	14
Table 7. Target Functions.....	16
Table 8. CAFE Model Technologies (1).....	19
Table 9. CAFE Model Technologies (2).....	20
Table 10. Vehicle Technology Classes .....	22
Table 11. Engine Technology Classes .....	22
Table 12. Technology Pathways.....	24
Table 13. Technology Pathway Compatibility Logic .....	30
Table 14. Technology Supersession Logic.....	33
Table 15. Technology Mutual Exclusivity Logic .....	36
Table 16. EPA Multiplier Modes.....	65
Table 17. Nominal Forecast Coefficients.....	88
Table 18. DFS Coefficients .....	92
Table 19. Credit Transfer Preference.....	95
Table 20. Survival Rates and Miles Driven Categories .....	100
Table 21. Input Files .....	165
Table 22. Manufacturers Worksheet.....	166
Table 23. Credits and Adjustments Worksheet .....	167
Table 24. Vehicles Worksheet.....	167
Table 25. Engines Worksheet.....	170
Table 26. Transmissions Worksheet.....	171
Table 27. Parameters Worksheet .....	173
Table 28. Technologies Worksheet.....	173
Table 29. Technology Assumptions.....	173
Table 30. Technology Costs .....	174
Table 31. Economic Values Worksheet .....	175
Table 32. Vehicle Age Data Worksheet.....	176
Table 33. Forecast Data Worksheet.....	177
Table 34. Scrapage Model Values Worksheet.....	177
Table 35. Historic Fleet Data Worksheet .....	178
Table 36. Safety Values Worksheet.....	178
Table 37. Fatality Rates Worksheet .....	179
Table 38. Credit Trading Values Worksheet.....	179
Table 39. ZEV Credit Values Worksheet.....	179
Table 40. Employment Values Worksheet.....	180
Table 41. Fuel Properties Worksheet.....	180
Table 42. Fuel Import Assumptions Worksheet.....	180
Table 43. Emission Health Impacts .....	181
Table 44. Criteria Emission Costs .....	182



Table 45. Greenhouse Emission Costs.....	182
Table 46. Upstream Emissions Worksheets .....	182
Table 47. Tailpipe Emissions Worksheets .....	183
Table 48. Scenarios Worksheet .....	184
Table 49. Target Functions (1) .....	186
Table 50. Target Functions (2) .....	187
Table 51. Output Files.....	188
Table 52. Technology Utilization Report.....	190
Table 53. Compliance Report .....	191
Table 54. Societal Effects Report .....	195
Table 55. Societal Costs Report.....	197
Table 56. Annual Societal Effects Report .....	199
Table 57. Annual Societal Costs Report .....	203
Table 58. Annual Societal Effects Summary Report .....	205
Table 59. Annual Societal Costs Summary Report .....	209
Table 60. Consumer Costs Report .....	211
Table 61. Vehicles Report .....	214
Table 62. Vehicles Diagnostic Report .....	217
Table 63. CAFE Model System Requirements.....	220

# Figures

Figure 1. Basic Structure of Input File Defining the Fleet’s Initial State .....	6
Figure 2. Engine-Level Paths .....	25
Figure 3. Transmission-Level Paths.....	26
Figure 4. Vehicle-Level (Electrification) Paths.....	28
Figure 5. Platform-Level and Vehicle-Level (Other) Paths .....	29
Figure 6. Technology Pathways Diagram .....	30
Figure 7. Compliance Simulation .....	50
Figure 8. Compliance Simulation Algorithm .....	70
Figure 9. Determination of “Best Next” Technology Solution .....	72
Figure 10. Warnings Dialog Box.....	221
Figure 11. CAFE Model Splash Screen .....	222
Figure 12. CAFE Model Window.....	222
Figure 13. CAFE Model File Menu .....	223
Figure 14. CAFE Model Toolbar.....	223
Figure 15. General Compliance Settings Panel .....	224
Figure 16. I/O Settings Panel (1) .....	225
Figure 17. I/O Settings Panel (2) .....	225
Figure 18. I/O Settings Panel (3) .....	226
Figure 19. I/O Settings Panel (2) .....	227
Figure 20. Runtime Settings Panel.....	229
Figure 21. CAFE Model Session View .....	229
Figure 22. Session View - Modeling Progress .....	230
Figure 23. Session View - Vehicle Scatter Plot.....	231
Figure 24. Session View - Compliance Performance Chart.....	232
Figure 25. Session View - Compliance Summary Chart .....	233
Figure 26. Initiating Chart Filtering.....	234
Figure 27. Chart Filtering Activated.....	234
Figure 28. Chart Filtering Completed .....	235
Figure 29. Manufacturer Filtering Examples .....	236
Figure 30. Compliance Summary and Compliance Performance Charts - Rotated View .....	237
Figure 31. Vehicle Scatter Plot - Zoomed View.....	237
Figure 32. Select Standard Compliance Model .....	240
Figure 33. Select Input Files.....	241
Figure 34. Save Modeling Settings.....	241
Figure 35. New Compliance Model Session Created .....	242
Figure 36. Save New Session .....	242
Figure 37. “demo” Session Saved.....	243
Figure 38. Modeling Progress from the Compliance Model.....	243
Figure 39. Compliance Model Completed .....	244
Figure 40. Open “demo” Session.....	245
Figure 41. Enable Compliance with CO <sub>2</sub> Standards.....	245
Figure 42. Modeling Progress for Compliance with CO <sub>2</sub> Standards .....	246

## Abbreviations

2b3	light truck 2b3 regulatory class
a	age of a vehicle model (produced in model year, MY, during calendar year, CY)
AC	air conditioning
ADEAC	advanced cylinder deactivation
ADSL	advanced diesel engine
AERO	aero drag reduction technology
AERO0	baseline aero
AERO10	aero drag reduction, level 2 (10% reduction)
AERO15	aero drag reduction, level 3 (15% reduction)
AERO20	aero drag reduction, level 4 (20% reduction)
AERO5	aero drag reduction, level 1 (5% reduction)
AMT	automated manual (i.e., clutch) transmission
ANL	Argonne National Laboratory
AT	automatic transmission
AT10L2	10-speed automatic transmission, level 2
AT10L3	10-speed automatic transmission, level 3
AT5	5-speed automatic transmission
AT6	6-speed automatic transmission
AT6L2	6-speed automatic transmission, level 2
AT7L2	7-speed automatic transmission, level 2
AT8	8-speed automatic transmission
AT8L2	8-speed automatic transmission, level 2
AT8L3	8-speed automatic transmission, level 3
AT9L2	9-speed automatic transmission, level 2
BEV	battery electric vehicle
BEV200	200-mile battery electric vehicle
BEV300	300-mile battery electric vehicle
BISG	belt mounted integrated starter/generator
BTU	British thermal unit
C	the category of the vehicle (derived from vehicle's VC and RC)
CAFE	Corporate Average Fuel Economy
CAFE <sub>RC</sub>	unadjusted manufacturer's CAFE rating in regulatory class RC
CAFE' <sub>RC</sub>	CAFE rating achieved by a manufacturer in regulatory class RC
CC <sub>FT</sub>	fraction of each fuel type's mass that represents carbon
C <sub>Earned</sub>	compliance category where credits are earned
CEGR1	cooled exhaust gas recirculation, level 1 (2.0409 bar)
CH <sub>4</sub>	methane
CNG	compressed natural gas engine
CNG	compressed natural gas fuel type
CO	carbon monoxide
CO <sub>2</sub>	carbon dioxide
CO2CreditsIn <sub>RC</sub>	CO <sub>2</sub> credits transferred or carried into regulatory class RC
CO2CreditsOut <sub>RC</sub>	CO <sub>2</sub> credits transferred or carried out of regulatory class RC

CO2Credits<sub>RC</sub>..... CO<sub>2</sub> credits earned by a manufacturer in regulatory class RC  
 CO2Rating<sub>RC</sub>..... CO<sub>2</sub> rating achieved by a manufacturer in regulatory class RC  
 CO2STD<sub>RC</sub>..... CO<sub>2</sub> standard in regulatory class RC  
 ΔComplianceCredits . change in manufacturer’s compliance credits  
 ΔComplianceValue ... change in manufacturer’s cost of compliance  
 CONV..... conventional powertrain (non-electric)  
 CPM ..... cost-per-mile  
 CreditsIn<sub>RC</sub>..... CAFE credits transferred or carried into regulatory class RC  
 CreditsOut<sub>RC</sub> ..... CAFE credits transferred or carried out of regulatory class RC  
 Credits<sub>RC</sub> ..... CAFE credits earned by a manufacturer in regulatory class RC  
 C<sub>Used</sub>..... compliance category where credits are used  
 CVT..... continuously variable transmission  
 CVTL2 ..... CVT, level 2  
 ΔCW ..... amount by which a vehicle’s CW is reduced (in lbs)  
 CW ..... vehicle’s curb weight  
 CY ..... calendar year  
 D..... diesel fuel type  
 DC ..... domestic car regulatory class  
 DCT..... dual-clutch transmission  
 DCT6..... 6-speed dual clutch transmission  
 DCT8..... 8-speed dual clutch transmission  
 DEAC ..... cylinder deactivation  
 DFS ..... Dynamic Fleet Share  
 DFS/SR ..... Dynamic Fleet Share and Sales Response model  
 DOHC..... double overhead camshaft engine  
 DPM10 ..... diesel particulate matter  
 DR..... discount rate  
 DS..... emissions from vehicle operation (i.e., “tailpipe” or “downstream”)  
 DSLI..... diesel engine improvements  
 DSLIAD ..... diesel engine improvements with advanced cylinder deactivation  
 E ..... electricity fuel type  
 E85 ..... ethanol/gasoline blend with up to 85% ethanol  
 ED<sub>FT</sub> ..... energy density of a specific fuel type  
 EFR ..... improved engine friction reduction  
 EffCost ..... effective cost of a technology  
 EISA..... Energy Independence and Security Act  
 EPCA..... Energy Policy and Conservation Act  
 EPS..... electric power steering  
 F ..... fuel economy improvement factor (for ANL simulated technology)  
 FC..... fuel consumption improvement factor (for “add-on” technology)  
 FCV ..... fuel cell vehicle  
 FE ..... fuel economy rating of a vehicle  
 FFV ..... flex-fuel vehicle  
 ΔFines..... change in manufacturer’s fines owed  
 Fines<sub>RC</sub>..... CAFE civil penalties owed by a manufacturer in regulatory class RC  
 FP ..... vehicle’s footprint

FS .....	percentage of miles driven by a vehicle on a specific fuel type
FT .....	fuel type a vehicle operates on
G.....	gasoline fuel type
GAP.....	gap between laboratory and on-road fuel economy
$\Delta$ GCWR.....	amount by which a vehicle's GCWR is reduced (in lbs)
GCWR.....	gross combined weight rating
GDP.....	gross domestic product
GGE.....	gasoline gallon equivalent
gpm.....	gallons per mile
$\Delta$ GVWR .....	amount by which a vehicle's GVWR is reduced (in lbs)
GVWR.....	gross vehicle weight rating
GW .....	glider weight
H.....	hydrogen fuel type
HCR0.....	high compression ratio engine, level 0
HCR1.....	high compression ratio engine, level 1
HCR2.....	high compression ratio engine, level 2
HP.....	vehicle's horsepower
HWFET .....	highway fuel economy test
IACC .....	improved accessories
IC.....	Imported Car regulatory class
kWh.....	kilowatt-hour
LDB.....	low drag brakes
LDT1 .....	class-1 light-duty truck (GVWR < 6,000 lbs)
LDT1/2a .....	combination of class-1 and class-2a light-duty trucks
LDT2a .....	class-2a light-duty truck (6,001 lbs < GVWR < 8,500 lbs)
LDT2b .....	class-2b light-duty truck (8,501 lbs < GVWR < 10,000 lbs)
LDT2b/3 .....	combination of class-2b and class-3 light-duty trucks
LDT3 .....	class-3 light-duty truck (10,001 lbs < GVWR < 14,000 lbs)
LDV.....	light-duty passenger vehicle
LFP .....	labor force participation
LR.....	learning rate multiplier for battery cost of a technology
LT.....	Light Truck regulatory class
LT2b3 .....	Light Truck 2b3 regulatory class
M.....	a vector of manufacturers
$MD_{FT}$ .....	mass density of a specific fuel type
mpg.....	miles per gallon
MR .....	mass reduction technology
MR0.....	baseline mass
MR1.....	mass reduction, level 1 (5% reduction in glider weight)
MR2.....	mass reduction, level 2 (7.5% reduction in glider weight)
MR3.....	mass reduction, level 3 (10% reduction in glider weight)
MR4.....	mass reduction, level 4 (15% reduction in glider weight)
MR5.....	mass reduction, level 5 (20% reduction in glider weight)
MR6.....	mass reduction, level 6 (28.2% reduction in glider weight)
MSRP .....	manufacturer suggested retail price
MT.....	manual (i.e., clutch) transmission

MT5.....	5-speed manual transmission
MT6.....	6-speed manual transmission
MT7.....	7-speed manual transmission
MTBE.....	methyl tertiary butyl ether
MY .....	model year
N <sub>2</sub> O.....	nitrous oxide
N <sub>MY,CY</sub> .....	number of surviving vehicles of model year MY in calendar year CY
NO <sub>x</sub> .....	oxides of nitrogen
OCC.....	off-cycle credit
OHV .....	overhead valve engine
P2HCR0.....	P2 strong hybrid/electric vehicle with HCR0 engine
P2HCR1.....	P2 strong hybrid/electric vehicle with HCR1 engine
P2HCR2.....	P2 strong hybrid/electric vehicle with HCR2 engine
PB.....	payback period
PC.....	Passenger Car regulatory class
PEF.....	petroleum equivalency factor
PHEV .....	plug-in hybrid/electric vehicle
PHEV20.....	20-mile plug-in hybrid/electric vehicle with HCR engine
PHEV20H.....	20-mile plug-in hybrid/electric vehicle with HCR engine
PHEV20T .....	20-mile plug-in hybrid/electric vehicle with turbocharged engine
PHEV50.....	50-mile plug-in hybrid/electric vehicle with HCR engine
PHEV50H.....	50-mile plug-in hybrid/electric vehicle with HCR engine
PHEV50T .....	50-mile plug-in hybrid/electric vehicle with turbocharged engine
PM.....	particulate matter
Price <sub>FT</sub> .....	price of fuel type FT
Quads.....	quadrillion British thermal units
RC .....	regulatory class
RIA.....	regulatory impact analysis
ROLL .....	low rolling resistance tires technology
ROLL0 .....	baseline tires
ROLL10.....	low rolling resistance tires, level 1 (10% reduction)
ROLL20.....	low rolling resistance tires, level 2 (20% reduction)
Sales <sub>RC</sub> .....	total manufacturer sales volume in regulatory class RC
SAX.....	secondary axle disconnect
SC.....	safety class
scf.....	standard cubic foot
SGDI .....	stoichiometric gasoline direct injection
SHEV .....	strong hybrid/electric vehicle
SHEVP2 .....	P2 strong hybrid/electric vehicle
SHEVPS .....	power split strong hybrid/electric vehicle
SOHC .....	single overhead camshaft engine
SO <sub>x</sub> .....	sulfur oxides
SS12V.....	12V micro-hybrid (stop-start)
STD <sub>RC</sub> .....	CAFE standard in regulatory class RC
SURV .....	average survival rate of a vehicle

$T_{CO_2}$  ..... vehicle's CO<sub>2</sub> target  
 $T_{FE}$  ..... vehicle's fuel economy target  
 TURBO1 ..... turbocharging and downsizing, level 1 (1.5271 bar)  
 TURBO2 ..... turbocharging and downsizing, level 2 (2.0409 bar)  
 TURBOAD ..... turbocharging and downsizing with advanced cylinder deactivation  
 TURBOD ..... turbocharging and downsizing with cylinder deactivation  
 TW ..... test weight  
 UDDS ..... urban dynamometer driving schedule  
 US ..... emissions from fuel production and distribution (i.e., "upstream")  
 V ..... a vector of vehicle models  
 $\Delta ValueCO_2Credits$  ... change in manufacturer's value of CO<sub>2</sub> credits  
 $ValueCO_2Credits_{RC}$  .. value of CO<sub>2</sub> credits in regulatory class RC  
 VC ..... vehicle class  
 VCR ..... variable compression ratio engine  
 VMT ..... vehicle miles traveled  
 VOC ..... volatile organic compounds  
 VTG ..... variable turbo geometry  
 VTGE ..... variable turbo geometry (electric)  
 VVL ..... variable valve lift  
 VVT ..... variable valve timing  
 $\Delta W$  ..... percent reduction of glider weight (for MR technology)  
 ZEV ..... zero emission vehicle

## Chapter One Introduction

The Energy Policy and Conservation Act (EPCA), as amended by the Energy Independence and Security Act of 2007, requires the U.S. Department of Transportation, to promulgate and enforce Corporate Average Fuel Economy (standards. The Department has delegated this responsibility to the National Highway Traffic Safety Administration, which has been administering these standards since 1975.

The Volpe National Transportation Systems Center (Volpe Center) provided technical support to the Department in connection with the establishment of the CAFE program in the 1970s, and has continued to provide such support since that time. The Volpe Center is a Federal fee-for-service organization within DOT.

In 2002 the Volpe Center began developing a new modeling system to support NHTSA's analysis of options for future CAFE standards. Objectives included, but were not limited to, the following: the ability to use detailed projections of light vehicle fleets to be produced for sale in the United States, the ability to efficiently estimate how manufacturers could apply available technologies in response to CAFE standards, the ability to quickly, systematically, and reproducibly evaluate various options for future CAFE standards, and the ability to estimate a range of outcomes (in particular, changes in fuel consumption and emissions) resulting from such standards.

Since 2002 the Volpe Center has made many changes to this modeling system. Some changes were made in response to comments submitted to NHTSA in connection with CAFE rulemakings, and in response to a formal peer review of the system. Some changes were made based on observations by NHTSA and Volpe Center technical staff. As NHTSA began evaluating attribute-based CAFE standards (i.e., standards under which CAFE requirements depend on the mix of vehicles produced for U.S. sale), significant changes were made to enable evaluation of such standards. At the same time, the system was expanded to provide the ability to perform uncertainty analysis by randomly varying many inputs. Later, the system was further expanded to provide automated statistical calibration of attribute-based standards, through implementation of Monte Carlo techniques, as well as automated estimation of stringency levels that meet specified characteristics (such as maximizing estimated net benefits to society).

In 2007 NHTSA and Volpe Center staff worked with technical staff of the U.S. Environmental Protection Agency on major changes to the range of fuel-saving technologies accommodated by the model, as well as the logical pathways for applying such technologies. In 2008 NHTSA and Volpe Center staff collaborated on further revisions, particularly with respect to the representation of available fuel-saving technologies, support for the reexamination of which was provided by Ricardo, Inc. In support of the 2010 rulemaking, a multi-year technology application feature was introduced into the modeling system. In 2011 a feature to evaluate voluntary overcompliance has been added as well.

In 2014 the system was adapted and expanded to allow NHTSA and Volpe Center staff to perform analysis in support of the medium-duty rulemaking. As such, a new regulatory class, covering class 2b and class 3 pickups and vans, was introduced into the modeling system. To better illustrate the behavior of the industry, a feature allowing technologies to be inherited between vehicle



platforms, engines, and transmissions has been reintroduced into the modeling system as the primary mode of operation. In 2016, the modeling system was further refined to allow simultaneous analysis of light-duty and medium-duty fleets, accounting for potential interaction between shared platforms, engines, and transmissions. Additionally, in 2016, the modeling system has undergone a major overhaul to allow for integration of vehicle simulation results from ANL's Autonomie model.

For the 2018 NPRM, covering model years 2020 to 2025, the system was further enhanced to include additional modeling features. Principal among them are: the ability to simulate separate compliance by domestic and imported car fleet (an explicit EPCA requirement), the ability to dynamically adjust the sales forecast of the light-duty fleet and the passenger car to light truck fleet share as part of compliance simulation, the ability to dynamically adjust the scrappage rates of on-road vehicle fleet for post-compliance calculations, and the ability to account for vehicles' safety performance over time. The system was also modified to be able to simulate compliance with EPA carbon dioxide (CO<sub>2</sub>) standards, including a number of programmatic elements unique to that program that do not exist under CAFE.

Following up on the 2018 NPRM version of the model, the system was further revised and enhanced to support the 2019 final rule analysis. Among the changes were updates to the existing sales and scrappage models, as well as an added ability to dynamically adjust the vehicle miles traveled in response to market changes. Furthermore, with this version of the CAFE Model, the system has fully transitioned away from using incremental cost and fuel consumption accounting methodology, instead relying on "absolute" values defined for each technology (or technology combination) that is available for simulation.

# Chapter Two System Design

## Section 1 Overall Structure (System Overview)

The basic design of the CAFE Model developed by the Volpe Center is as follows: the system first estimates how manufacturers might respond to a given regulatory scenario, and from that potential compliance solution, the system estimates what impact that response will have on fuel consumption, emissions, and economic externalities. A regulatory scenario involves specification of the form, or shape, of the standards (e.g., flat standards, or linear or logistic attribute-based standards), scope of passenger car and truck regulatory classes, and stringency of the CAFE and CO<sub>2</sub> standards for each model year to be analyzed.

Manufacturer compliance simulation and the ensuing effects estimation, collectively referred to as compliance modeling, encompass numerous subsidiary elements. Compliance simulation begins with a detailed initial forecast, provided by the user, of the vehicle models offered for sale during the simulation period. The compliance simulation then attempts to bring each manufacturer into compliance with the standards defined by the regulatory scenario contained within an input file developed by the user; for example, a regulatory scenario may define CAFE or CO<sub>2</sub> standards that increase in stringency by 4 percent per year for 5 consecutive years. The model applies various technologies to different vehicle models in each manufacturer's product line in order to simulate how each manufacturer might make progress toward compliance with the specified standard. Subject to a variety of user-controlled constraints, the model applies technologies based on their relative cost-effectiveness, as determined by several input assumptions regarding the cost and effectiveness of each technology, the cost of compliance (determined by the change in CAFE or CO<sub>2</sub> credits, CAFE-related civil penalties, or value of CO<sub>2</sub> credits, depending on the compliance program being evaluated and the effective-cost mode in use), and the value of avoided fuel expenses. For a given manufacturer, the compliance simulation algorithm applies technologies either until the manufacturer runs out of cost-effective technologies, until the manufacturer exhausts all available technologies, or, if the manufacturer is assumed to be willing to pay civil penalties, until paying civil penalties becomes more cost-effective than increasing vehicle fuel economy. At this stage, the system assigns an incurred technology cost and updated fuel economy to each vehicle model, as well as any civil penalties incurred by each manufacturer. This compliance simulation processes is repeated for each model year available during the study period.

This point marks the system's transition between compliance simulation and effects calculations. At the conclusion of the compliance simulation for a given regulatory scenario, the system contains multiple copies of the updated fleet of vehicles, corresponding to each model year analyzed. For each model year, the vehicles' attributes, such as fuel types (e.g., diesel, electricity), fuel economy values, and curb weights, have all been updated to reflect the application of technologies in response to standards throughout the study period. For each vehicle in each of the model year specific fleets, the system then estimates the following: lifetime travel, fuel consumption, carbon dioxide and criteria pollutant emissions, the magnitude of various economic externalities related to vehicular travel (e.g., noise), and energy consumption (e.g., the economic costs of short-term increases in petroleum prices). The system then aggregates model-specific results to produce an overall representation of modeling effects for the entire industry.

Different categorization schemes are relevant to different types of effects. For example, while a fully disaggregated fleet is retained for purposes of compliance simulation, vehicles are grouped by type of fuel and regulatory class for the energy, carbon dioxide, criteria pollutant, and safety calculations. Therefore, the system uses model-by-model categorization and accounting when calculating most effects, and aggregates results only as required for efficient reporting.

## Section 2 Representation of Market Data

In order to evaluate a manufacturer for compliance, the CAFE modeling system reads in and stores various engineering characteristics and technology information attributable to each vehicle, engine, and transmission produced by that manufacturer. This information provides the model with an overall view of the initial state of a manufacturer's fleet. The data that makes up this initial fleet is referred to as the "market data" or the "market forecast," and is entered into the modeling system as a user provided input file.<sup>1</sup>

Along with the engineering characteristics and technology information, the market data input also defines various classifications the model needs to use in order to properly "*bin*" vehicles for compliance simulation and effects calculations. The vehicle classifications, discussed further below, are assigned by the user and are then used by the modeling system when, e.g., determining whether to apply a passenger car or light truck functional standard to a vehicle.

Since compliance modeling within the system relies heavily on the initial fleet defined by the user, and all other results flow from compliance modeling, the initial fleet may be properly considered the foundation of any modeling exercise. The following section provides a general overview of the initial state of the fleet, highlighting some of the most significant inputs, while Section A.1 of Appendix A describe the suitable structure and content the user should use when setting up a market data input file for CAFE Model analysis.

### S2.1 Initial State of the Fleet

The fleet's initial state is developed using information contained in the manufacturers, credits and adjustments, vehicles, engines, and transmissions worksheets of the market data input file. The set of worksheets uses identification codes to link vehicle models with their engines and transmissions. Each worksheet also identifies the manufacturer that is associated with a particular vehicle, engine, or transmission, as well as the manufacturer for which the various credits and adjustments are defined. Figure 1 provides a simplified example illustrating the basic structure and interrelationship of these five worksheets, focusing primarily on structurally important inputs. The identification codes make it possible to account for the use of specific engines or transmissions across multiple vehicle models. Additionally, inputs assign each vehicle model to a specific vehicle platform, where multiple vehicle models may reference and share that same platform.<sup>2</sup>

Having the CAFE Model treat engines, transmissions, and platforms as separate entities allows the modeling system to concurrently evaluate technology improvements on multiple vehicles that may share a common engine, transmission, or platform. In addition, sharing also enables realistic propagation, or "inheriting," of previously applied technologies from, e.g., an upgraded engine down to the "users" of that engine, which have not yet realized the benefits of these upgrades.

---

<sup>1</sup> As discussed below, when applying the Dynamic Fleet Share and Sales Response model, the CAFE Model makes use of the specified production volume inputs during the first model year only; for ensuing model years, production volumes are estimated endogenously using this initial set of estimates as a starting point.

<sup>2</sup> Unlike engines and transmissions, vehicle platforms are not presently defined on a separate worksheet. Instead, the modeling system relies on the data provided in the vehicles worksheet to extract the relevant information for a specific platform.

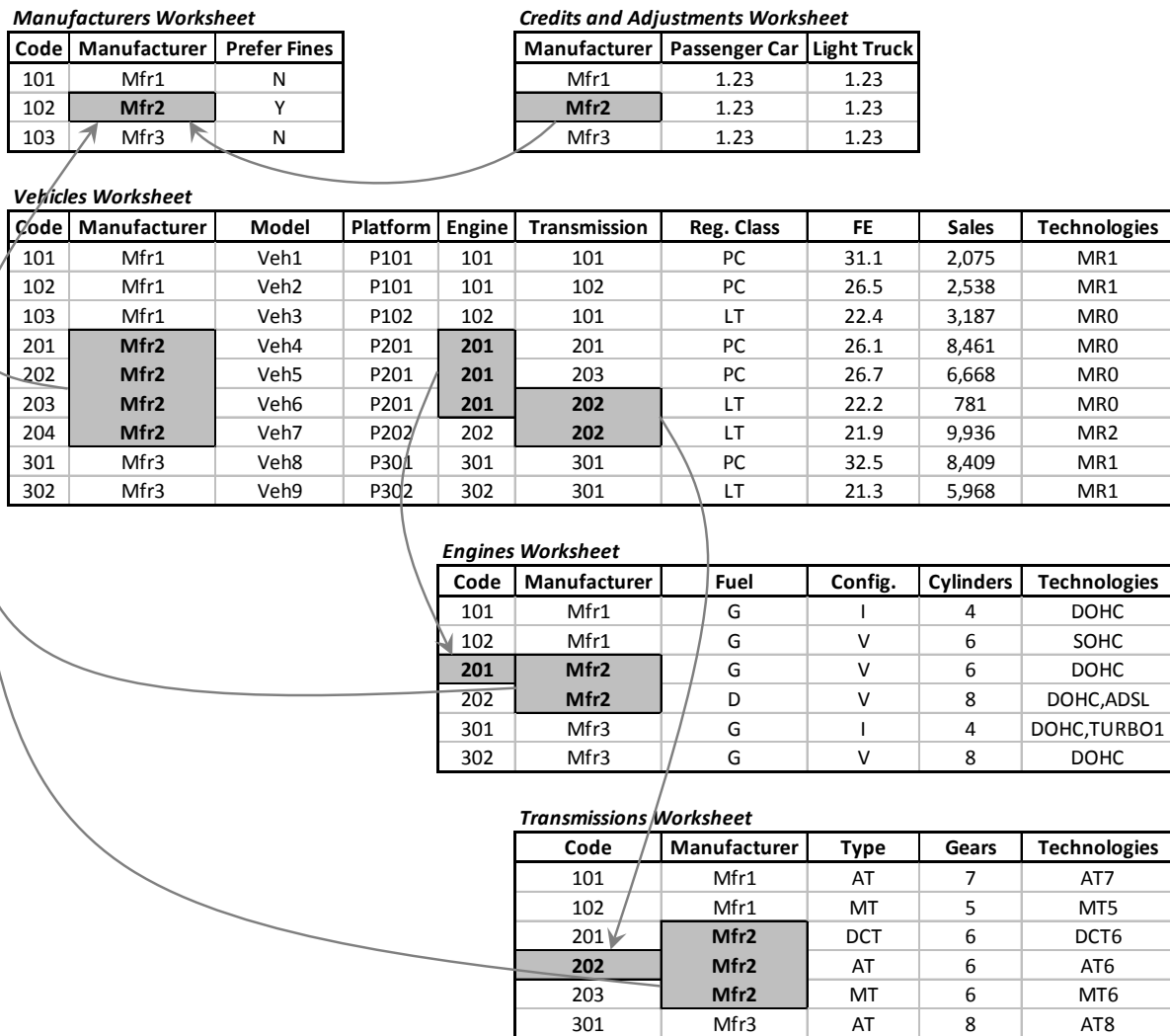

Figure 1. Basic Structure of Input File Defining the Fleet's Initial State<sup>3</sup>

In Figure 1 above, each vehicle model is shown as always having an engine and a transmission. However, this may not always be the case. In particular, battery electric vehicles (BEVs) and fuel cell vehicles (FCVs) do not make use of a traditional combustion engine or transmission. Instead, both rely on electric powertrains, having advanced, custom-built transmissions packaged with the powertrain. The system assumes that BEVs and FCVs are the sole users of their respective transmissions (i.e., the transmissions are not shared by any other vehicle) and that no further improvements may be possible on those transmissions. As such, for modeling simplicity, the system assumes that these vehicles do not have an engine or a transmission and the associated “Engine” and “Transmission” codes should be left blank. Similarly, plug-in hybrid/electric vehicles (PHEVs) and power-split strong-hybrid electric vehicles (SHEVPSs) also assume the use of an advanced, custom-built transmission that is unique to the specific vehicle. For modeling

<sup>3</sup> Note: For simplicity and illustration purposes, some column headers and data elements shown in Figure 1 were renamed, abbreviated, or combined.

simplicity, the system assumes that these vehicles do not have a transmission assigned to them as well.<sup>4</sup>

Figure 1 describes the basic relationship between different worksheets in a simplified manner; the structure and contents of the actual market data input file is significantly more involved. However, while the modeling system may load additional information provided in the input file (as outlined in Section A.1 of Appendix A), the model does not currently use all of that information. The system currently makes use of inputs essential for compliance simulation, such as vehicle’s fuel economy, curb weight or footprint, production volumes (or sales), and initial technology utilization. The CAFE Model uses fuel economy ratings to calculate corresponding CO<sub>2</sub> ratings, and uses the latter as the basis for simulating compliance with CO<sub>2</sub> standards.<sup>5</sup>

When defining a vehicle’s fuel economy for compliance purposes, the value supplied should be specified as a “rated” value, absent any adjustments, credits, special provisions for alternative fuels, or petroleum equivalency factors that NHSTA may otherwise apply to adjust the vehicle’s fuel economy rating. That is, the vehicle’s fuel economy must represent the weighted harmonic average of the values measured on the “city” (UDDS) and “highway” (HWFET) drive cycles<sup>6</sup>, as defined by the following equation:

$$FE = \frac{0.55}{FE_{City}} + \frac{0.45}{FE_{Highway}} \quad (1)$$

Where:

- 0.55* : the portion of total miles a vehicle is assumed to travel under city driving conditions,
- 0.45* : the portion of total miles a vehicle is assumed to travel under highway driving conditions,
- FE<sub>City</sub>* : the fuel economy rating of a vehicle as measured on the city (UDDS) cycle,
- FE<sub>Highway</sub>* : the fuel economy rating of a vehicle as measured on the highway (HWFET) cycle, and
- FE* : the combined city and highway fuel economy rating of a vehicle.

Additionally, the fuel economy rating must be defined for an appropriate fuel type (appearing in the input file in the columns corresponding to the fuel types used), as well as reported as individual components in the case of dual-fuel vehicles (i.e., flex-fuel and plug-in hybrid/electric vehicles). Furthermore, the associated fuel share, for each fuel type where a fuel economy value exists, must also be defined. For single fuel vehicles, the accompanying fuel share should be specified at 100 percent, while for dual fuel vehicles, the fuel share represents the assumed portion of miles, on average, a vehicle is expected to travel when operating on a given fuel. For example, inputs could

---

<sup>4</sup> The handling of transmissions (definition and assignment) with regard to hybrid/electric vehicles may be updated in the future release of the CAFE Model.

<sup>5</sup> The conversion of a vehicle’s fuel economy to an equivalent CO<sub>2</sub> rating is discussed in Section S5.2.1 below.

<sup>6</sup> UDDS and HWFET drive schedules are described at [https://ce.dot.gov/team/nhtsa.occwif/214785\\_subsite/Shared/Documents/Production/www.epa.gov/vehicle-and-fuel-emissions-testing/dynamometer-drive-schedules](https://ce.dot.gov/team/nhtsa.occwif/214785_subsite/Shared/Documents/Production/www.epa.gov/vehicle-and-fuel-emissions-testing/dynamometer-drive-schedules).

be set to indicate that a 30-mile plug-in hybrid/electric vehicle might be expected to travel 53 percent of its total miles using electricity and the remaining 47 percent using gasoline.

The fuel economy and fuel share values are assigned in the vehicles worksheet under the “Fuel Economy” section, for each supported fuel type within the modeling system. Presently, the model supports six fuel types, as defined in Table 1, for specifying the vehicle and engine fueling options, for defining fuel-specific inputs (e.g., fuel prices and emission factors), and for estimating the various modeling effects (such as amount of fuel consumed and greenhouse gas and air pollutant emissions) attributed to a vehicle when operating on a specific type of fuel. As noted above, the individual fuel types appearing in Table 1 may be combined, in the case of dual-fuel vehicles, to be interpreted by the modeling system as FFVs (flex-fuel vehicles) or PHEVs.

**Table 1. Fuel Types**

Fuel Type	Abbr.	Description
Gasoline	G	The vehicle operates on gasoline fuel
E85	E85	The vehicle operates on E85 fuel (ethanol/gasoline blend with up to 85% ethanol)
Diesel	D	The vehicle operates on diesel fuel
Electricity	E	The vehicle operates on electricity
Hydrogen	H	The vehicle operates on hydrogen fuel
CNG	CNG	The vehicle operates on compressed natural gas fuel

On the engines worksheet, the user must also indicate the fuel type that an engine uses from among the choices described in Table 1. However, since a combustion engine cannot operate on electricity or hydrogen, those are not considered to be valid options for use on an engine.<sup>7</sup> Since, as illustrated by Figure 1, each of the vehicles references a particular engine, the fuel type used by an engine must be a subset of the fuel economies defined on a vehicle. That is, if an engine is listed as operating on gasoline, the vehicle that uses that engine would specify a fuel economy and fuel share values for gasoline fuel type as well. In the case of FFVs and PHEVs, the engine would still be listed as operating on gasoline, while for a vehicle, the fuel economies and fuel shares for gasoline and either E85 or electricity would be specified.

When calculating a manufacturer’s required or achieved CAFE and CO<sub>2</sub> ratings, the modeling system relies on the vehicle’s fuel economy, footprint, and production volumes. The production volumes – or, as they are referred to within the context of the model, vehicle sales<sup>8</sup> – are assumed to be defined for the initial fleet for the same model year for which all of the other vehicle, engine, and transmission attributes are specified. In other words, if the initial fleet covers vehicles from MY 2017, the sales volumes must also be defined for MY 2017. The initial vehicle sales are then extrapolated by the modeling system for a number of model years, covering the intended study period a user wishes to analyze during compliance simulation. The default modelling settings rely on the system’s built-in Dynamic Fleet Share and Sales Response model (or, DFS/SR model), a component within the set of Dynamic Economic Models (or, DEMs). Disabling the use of DEMs

<sup>7</sup> Some users may find it helpful to define a “fake” engine entry (e.g., for tracing or cross-referencing purposes) to correspond to an electric or fuel cell vehicle. In such a case, a fuel type value of “E” or “H” may be used; however, the CAFE Model will ignore any such engines when reading in a market data input file.

<sup>8</sup> A manufacturer’s compliance is based on production-weighted CAFE and CO<sub>2</sub> ratings. The system assumes every vehicle model produced for sale in the U.S. is sold in the same year it is produced.

(and, therefore, DFS/SR model) will revert to using a static forecast, where the future sales of individual vehicle models remain the same throughout the study period.

The vehicle curb weight and footprint values are provided to the modeling system as inputs for each vehicle model available for simulation. Curb weight is measured in pounds (*lbs.*) and is defined as the actual or the manufacturer's estimated weight of the vehicle in operational status with all standard equipment, and weight of fuel at nominal tank capacity. Footprint is defined as the average of front and rear track widths (averaged, then rounded to the nearest tenth of an inch) multiplied by the vehicle's wheelbase (rounded to the nearest tenth of an inch), divided by 144, then rounded to nearest square foot, as demonstrated in the following equation:

$$FP = \text{ROUND} \left( \frac{\text{ROUND} \left( \frac{TW_{Front} + TW_{Rear}}{2}, 1 \right) \times Wheelbase}{144}, 1 \right) \quad (2)$$

Where:

- $TW_{Front}$  : the lateral distance between the centerlines of the front base tires at ground, including the camber angle, specified in inches, rounded to one decimal place (the front track width),
- $TW_{Rear}$  : the lateral distance between the centerlines of the rear base tires at ground, including the camber angle, specified in inches, rounded to one decimal place (the rear track width),
- $Wheelbase$  : the longitudinal distance between front and rear wheel centerlines, specified in inches, and rounded to one decimal place,
- $144$  : the conversion factor from square inches to square feet, and
- $FP$  : the vehicle's footprint, specified in sq. ft., rounded to one decimal place.

While past versions of the modeling system calculated vehicle footprints using inputs specifying vehicle track widths and wheelbase, the system currently makes use of inputs specifying footprint directly, and does not rely on the inputs specifying these linear dimensions. Although the user may specify any value as the curb weight or the footprint, and the modeling system will not strictly enforce any specific guidelines (other than requiring both values be greater than 1), the definitions provided above should be used.

From here, the vehicles' curb weights, footprints, and sales volumes may be used to calculate a manufacturer's standard (or the required CAFE value)<sup>9</sup>, while the vehicles' fuel economies and sales are used to calculate a manufacturer's CAFE rating (or the achieved CAFE value) for each fleet (domestic cars, imported cars, and light trucks). Additionally, the CAFE Model uses the same vehicles' attributes to calculate the accompanying CO<sub>2</sub> standard and rating for a manufacturer,

---

<sup>9</sup> The vehicle curb weight or footprint may be used when calculating an attribute-based standard for a manufacturer (for example, when the standard is defined using a linear footprint based functional form). Under an attribute-based standard, the model first calculates vehicle specific targets, which differ based on the vehicles' attributes, then the system obtains a sales weighted average based on those calculated targets.



applying the necessary fuel economy to CO<sub>2</sub> conversions as necessary. The precise details of how the modeling system calculates these values are discussed in Section 5 below.

In order for the modeling system to accurately account for the level of technological progression of the input fleet, and to gauge the potential for further fuel economy increases, the initial technology utilization should be specified for each vehicle model, engine, and transmission appearing in the market data input file. In the input file, technology utilization may be identified by column names corresponding to specific technologies supported within the model. The user would assign the appropriate usage states based on the engineering characteristics of the accompanying vehicles, engines, and transmissions. A value of “USED” would indicate that a particular technology is used in the input fleet, a value of “SKIP” would designate a technology as unavailable, and blank (or unassigned) value specifies that a technology is available for application by the model. As stated above, some of the detailed information appearing in the market data file is not used for actual analysis; however, this information is useful when populating the state of technological progression of the initial fleet. For example, if an engine’s “Valvetrain Design” column reads “DOHC” (dual overhead cam) for a specific engine, the corresponding “DOHC” column should be set to “USED.” Similarly, if a value of “T” (implying turbocharger) is shown in the engine’s “Aspiration” column, at the least, the “TURBO1” column for that engine should be set to “USED.” Likewise, on the transmission side, if the “Type” and “Num. Gears” columns are set to “A” and “8,” respectively, the analogous “AT8” column for the transmission should be set to “USED.” The complete list of technologies available for application, as well as the way these technologies are evaluated within the modeling system, is discussed in greater detail in Section 4 below.

As mentioned above, the user’s translation of vehicle attributes and engineering characteristics to actual technology assignments specified as model inputs determine the model’s treatment of vehicles’ potential for further fuel economy increases. At present, other than simply checking for the presence of certain data, the CAFE Model does not perform any form of validation on technology inputs supplied by the user.

## **S2.2 Vehicle Classifications**

The CAFE Model defines and uses various vehicle classification schemes necessary for compliance modeling. The different classifications may be used when performing compliance simulation or when calculating modeling effects. The vehicle classifications are specified by the user as part of the initial fleet preparation within the market data input file. Principal among them is the vehicle’s regulatory class assignment.

The modeling system supports regulatory classes necessary for performing compliance simulation of light-duty vehicles as well as class 2b and 3 medium-duty vehicles. The exact list of supported regulatory classes is outlined in the following table:

**Table 2. Regulatory Classes**

<b>Regulatory Class</b>	<b>Abbr.</b>	<b>Description</b>
Domestic Car	DC	Vehicles are regulated as domestic passenger automobiles
Imported Car	IC	Vehicles are regulated as imported passenger automobiles
Light Truck	LT	Vehicles are regulated as light-duty trucks
Light Truck 2b/3	2B3	Vehicles are regulated as medium-duty trucks

When assigning regulatory classes to vehicles, the user would update the “Regulatory Class” column in the vehicles worksheet using the abbreviations listed in Table 2 above. The vehicle’s assigned class would then be used by the modeling system to determine which functional standard to apply to a specific vehicle when calculating its target, and to “bin” vehicles together when evaluating a manufacturer’s standard and CAFE rating for each regulatory class. To represent actual CAFE regulations, regulatory classes should be assigned consistent with 40 CFR Chapter V. Since EPA has not adopted EPCA/EISA’s requirement that domestic and imported passenger car fleets comply separately with CO<sub>2</sub> standards, the modeling system combines domestic and imported cars into a single “Passenger Car” fleet when it is configured to evaluate the CO<sub>2</sub> compliance program.

In addition to the regulatory classes, the market data input file also contains two sets of classifications for linking vehicles to their respective vehicle technology and engine technology classes.<sup>10</sup> The technology classes allow the modeling system to identify an appropriate set of available technologies, along with their costs and improvements, for application on specific vehicle models. Section 4 below describes the technology classes and application of vehicle technologies within the model in greater detail. Conversely, this section provides a general overview and outlines the relationship between vehicle models and technology classes.

**Table 3. Technology Classes Overview**

<b>Category</b>	<b>Technology Classes</b>
Vehicle Technology Classes	SmallCar, SmallCarPerf, MedCar, MedCarPerf, SmallSUV, SmallSUVPerf, MedSUV, MedSUVPerf, Pickup, PickupHT, Truck 2b/3, Van 2b/3
Engine Technology Classes	2C1B, 3C1B, 4C1B, 4C2B, 5C1B, 6C1B, 6C1B_ohv, 6C2B, 6C2B_ohv, 8C2B, 8C2B_ohv, 10C2B, 10C2B_ohv, 12C2B, 12C4B, 16C4B

In order for the modeling system to properly evaluate technologies for application on any given vehicle, the vehicle technology class and the engine technology class must both be assigned to a value listed in Table 3 above. The system would then use the vehicle’s “Technology Class” assignment to determine the applicability of various technologies on a vehicle, as well as to obtain the numerous logical assumptions and cost tables pertaining to specific technologies. Additionally, to obtain the cost tables that cover only the cost of an engine upgrade associated with each technology, the model would use the vehicle’s “Engine Technology Class” assignment.

---

<sup>10</sup> Users may enter technology class assignments under the “Technology Class” and “Engine Technology Class” columns on the vehicles worksheet of the market data input file.

As with all values within the input fleet, technology class assignments are specified at the user’s discretion. However, in general, vehicle technology classes should be assigned based on the vehicle’s body style, size (footprint and curb weight), and performance characteristics, while engine technology classes should be assigned based on the number of cylinders, number of banks, and the degree of turbocharging and downsizing used by an engine assigned to the vehicle. For battery electric and fuel cell vehicles, since those vehicles do not include an engine, the engine technology class does not have to be assigned (may be left blank in the input).

The last vehicle classification assigned in the market data input file is the vehicle’s safety class. The safety class is used by the model during effects calculations when estimating the impact of changes in vehicle’s curb weight and reduction or increases in total vehicle travel on vehicle related fatal and non-fatal crashes. The user would update the “Safety Class” column in the vehicles worksheet using the abbreviations listed in Table 4 below:

**Table 4. Safety Classes**

<b>Safety Class</b>	<b>Abbr.</b>	<b>Description</b>
Passenger Car	PC	Vehicles use safety coefficients denoted for passenger automobiles
Light Truck/SUV	LT	Vehicles use safety coefficients denoted for light trucks and SUVs
Minivan/CUV	CM	Vehicles use safety coefficients denoted for minivans and crossover utility vehicles

The modeling system uses the vehicle safety class assignments in conjunction with the coefficients defined in the safety values worksheet of the parameters input file (described in Section A.3.6 of Appendix A) based, in part, on NHTSA’s staff analysis of vehicle mass, size, and safety, as documented in the 2019 preamble and Regulatory Impact Analysis (RIA) proposing new CAFE and CO<sub>2</sub> standards. Therefore, safety class assignments should be defined in a way that match the original vehicle assignments used in NHTSA’s study.

In addition to the aforementioned classes assigned to each vehicle as part of the initial input fleet, the modeling system also defines an additional vehicle classification internally. Namely, the model assigns a general “vehicle class” to each vehicle based on that vehicle’s style and GVWR as outlined in Table 5, below. For light-duty passenger vehicles (LDVs), the assignment is based strictly on the vehicle’s body style, where any vehicles that are identified in the market data input file as: convertible, coupe, hatchback, sedan, or wagon are assigned to the LDV class. For all truck classes (LDT1 to LDT3), the assignment is based on the gross vehicle weight rating (GVWR), as defined by the ranges shown in the table below, irrespective of the vehicle’s body style.

**Table 5. Vehicle Classes**

<b>Vehicle Class</b>	<b>Description</b>
LDV	Vehicle is classified as a light-duty passenger vehicle
LDT1	Vehicle is classified as a class-1 light-duty truck, with its GVWR ranging from 0 to 6,000 pounds
LDT2a	Vehicle is classified as a class-2a light-duty truck, with its GVWR ranging from 6,001 to 8,500 pounds
LDT2b	Vehicle is classified as a class-2b light-duty truck, with its GVWR ranging from 8,501 to 10,000 pounds
LDT3	Vehicle is classified as a class-3 light-duty truck, with its GVWR ranging from 10,001 to 14,000 pounds

During analysis, the modeling system may combine some of the classes listed in the table above when referencing certain input parameters to perform specific calculations on aggregate sets of vehicles. Specifically, vehicles belonging to the LDT1 and LDT2a classes may be binned together, forming a single LDT1/2a class, while LDT2b and LDT3 classes are binned into LDT2b/3 class. The system uses the vehicle class assignments as part of the Dynamic Fleet Share and Sales Response modeling and during the effects calculations. Both of these topics are addressed in upcoming sections of this document.

### **S2.3 Manufacturer-Specific Attributes**

While the vehicles, engines, and transmissions worksheets define various attributes and engineering characteristics of the input fleet, the “manufacturers” and “credits and adjustments” worksheets define “global” parameters attributable to the specific manufacturer required for compliance simulation and effects calculations. Sections A.1.1 and 0 of Appendix A describes the structure and content of the aforementioned worksheets, while this section provides details for the most significant portions necessary for compliance modeling.

For each manufacturer, a user defined payback period is specified, which the modeling system may use when estimating the value of the reduction in fuel consumption (or value of fuel saved) attributable to application of vehicle technologies. The payback period is defined based on the varying styles of the vehicle and represents the number of years required for an initial investment to be repaid in the form of future benefits or cost savings, and is defined from the perspective of the manufacturer, based on the manufacturer’s assumption of consumer’s purchasing behavior. In particular, the payback period represents the maximum number of years of cumulative fuel savings that consumers are expected to consider in their initial purchasing decision – this is modeled as an offset to the technology costs outlaid by manufacturers to achieve the fuel savings, as it is the amount they can transfer to consumers without reducing demand for a specific vehicle model.

In order to distinguish between varying consumer behavior when purchasing different styles of vehicles (e.g., a new car vs a new pickup truck), the inputs are segregated into and defined separately by vehicle style. With the exception of vehicles regulated as 2b/3 trucks, for which the parameters defined under the “2b/3 Trucks” column are used, Table 6, below, correlates the column names used for defining the parameters in the market data input file with the body styles of vehicles that make use of those parameters for valuing fuel savings:

**Table 6. Designation of Manufacturer Parameters by Vehicle Style**

<b>Column Name</b>	<b>Vehicle Styles</b>
Cars	Convertible, Coupe, Hatchback, Sedan, Wagon
Vans/SUVs	Sport Utility, Minivan, Van, Passenger Van, Cargo Van
Pickups	Pickup

As stated, the inputs for the payback period are user-defined. Therefore, the modeling system exercises no control on the actual values supplied, and simply makes use of them during compliance simulation. However, note that using larger input values for the payback period will generally lead to the system evaluating more technologies as cost effective, which in turn results in additional technologies (beyond what is necessary to attain compliance) being applied to vehicle models during analysis.

The “manufacturers” worksheet also allows users to control a manufacturer’s preference for paying CAFE civil penalties, instead of applying technologies deemed to be not cost-effective, for each model year analyzed during the study period. If fine preference option is enabled for a particular model year (set to “Y”), the system would only apply technology to a manufacturer as long as it is considered cost-effect. Conversely, if fine preference is disabled (set to “N”), the system would continue to apply technology until compliance is achieved or the manufacturer runs out of viable technology solutions. Since EPA’s CO<sub>2</sub> program prohibits the use of civil penalties for compliance purposes, a manufacturer’s fine preference is only applicable when evaluating compliance with CAFE standards.

Last, the user may define credit banks for each manufacturer, representing the compliance credits accrued for each regulatory class during model years up to five years prior to the start of the study period. The current version of the CAFE Model, as well as the market data input file used for analysis, provides a section for including banked credits between MYs 2010 and 2016. However, during analysis, the system would only consider banked credits starting with MY 2012.<sup>11</sup>

To allow for compliance flexibilities, the credit banks from the input fleet may implicitly incorporate trades between manufacturers.<sup>12</sup> Furthermore, the banks may also be adjusted for implicit fleet transfers and credit carry forward occurring within the same manufacturer. The current version of the modeling system does not explicitly simulate credit operations outside of the model years covered during the study period. Hence, these inputs provide the means to simulate the potential that “older” credits may actually be available for application during the study period, and should reflect proper estimated adjustments when assuming any transferring or trading of CAFE credits (i.e., adjustments necessary to preserve gallons) or CO<sub>2</sub> credits.

On the “credits and adjustments” worksheet, the user may specify the various credits and adjustments a manufacturer may claim toward compliance with a given regulatory class, for each

---

<sup>11</sup> The market data input fleet, used for compliance modeling with the current version of the CAFE Model, includes a baseline vehicle fleet defined for MY 2017. The first model year evaluated during the study period is, by extension, 2017. Therefore, the first model year for which bank credits may be used is 2012.

<sup>12</sup> For example, for a trade involving manufacturer A’s transfer of 1 million light truck credits to manufacturer B in MY 2013, inputs should deduct 1 million credits from manufacturer A’s MY 2013 light truck balance, and add these (after any required adjustment) to manufacturer B’s MY 2013 light truck balance.

model year evaluated during the study period. The values on this worksheet represent the amount of credits a manufacturer is expected to claim; however, the compliance scenario (described in Section 3 below) sets a cap on the maximum of each type of credit that a manufacturer is effectively allowed to use for compliance. As described further below (see Section 5), each of the defined credits and adjustments directly offsets the CAFE or CO<sub>2</sub> rating achieved by the manufacturer, thereby artificially reducing that manufacturer's compliance burden.

### Section 3 Regulatory Scenario Definition

Each time the modeling system is used, it evaluates one or more regulatory scenarios, which are defined in the “scenarios” input file provided by the user. Each scenario describes the overall scope of the CAFE and CO<sub>2</sub> compliance programs in terms of each programs’ coverage, the functional form and stringency of the standards applicable to passenger cars, lights trucks, and class 2b/3 trucks, applicability of multi-fuel vehicles, as well as other miscellaneous settings that may have an impact on compliance. The system is normally used to examine and compare at least two scenarios, where the first scenario is identified as the baseline, providing a reference set of results to which results for any other scenarios are compared. The full details pertaining to the structure and content of the scenarios input file are described in Section A.4 of Appendix A. This section, however, focuses on the specification of the functional form of the standard, the calculation of the fuel economy and CO<sub>2</sub> targets, and additional parameters defined within the scenario that may influence the calculated required or achieved levels.

Considering that the standards are evaluated and set independently for a given class of vehicles, the regulatory scenario definition outlines the scope and applicability of the compliance program separately for each regulatory class. However, since vehicles that are regulated as domestic and imported passenger automobiles under the CAFE compliance program adhere to the same standard, the scenario provides a combined definition for both of these classes as “Passenger Car.” Additionally, since the CO<sub>2</sub> program does not distinguish between domestic and imported cars for compliance purposes, this combined definition of the passenger car standards is applicable as well.

For each regulatory class, the scenario definition specifies the function and coefficients in each model year, which the system may use when calculating the vehicle’s fuel economy and CO<sub>2</sub> targets. The CAFE Model supports multiple functional forms for use during analysis, as outlined in the following table:

**Table 7. Target Functions**

Function	Description	Coefficients
1	Flat standard	A
2	Logistic area-based function	A - D
3	Logistic weight-based function	A - D
4	Exponential area-based function	A - C
5	Exponential weight-based function	A - C
6	Linear area-based function	A - D
7	Linear weight-based function	A - D
8	Linear work-factor-based function <sup>13</sup>	A - H
206	Dual linear area-based function	A - H
207	Dual linear weight-based function	A - H
208	Dual linear work-factor-based function <sup>13</sup>	A - I

<sup>13</sup> While the modeling system does not prohibit the use of a particular target function for any given regulatory class, the work-factor-based functions (8 and 208) are intended to only be used in conjunction with the “Light Truck 2b/3” regulatory class.

The specification for all target functions may be found in Section A.4.1 of Appendix A. As an example, function 206, which has been used during the most recent analysis, is defined here for the reader's consideration:

$$T_{FE} = \text{MIN} \left[ \text{MAX} \left( \frac{1}{A}, \text{MIN} \left( \frac{1}{B}, C \times FP + D \right) \right), \text{MAX} \left( \frac{1}{E}, \text{MIN} \left( \frac{1}{F}, G \times FP + H \right) \right) \right] \quad (3)$$

Where:

- A* : the *A* coefficient, specified in mpg (miles per gallon), representing the ceiling or the lower bound asymptote of the target function,
- B* : the *B* coefficient, specified in mpg, representing the floor or the upper bound asymptote of the target function,
- C* : the *C* coefficient, specified as the change in gpm (gallons per mile) over change in square feet, representing the slope of the target function,
- D* : the *D* coefficient, specified in gpm, representing the y-intercept of the target function,
- E* : the *E* coefficient, specified in mpg, representing the ceiling or the lower bound asymptote of the “backstop” target function,
- F* : the *F* coefficient, specified in mpg, representing the floor or the upper bound asymptote of the “backstop” target function,
- G* : the *G* coefficient, specified as the change in gpm over change in square feet, representing the slope of the “backstop” target function,
- H* : the *H* coefficient, specified in gpm, representing the y-intercept of the “backstop” target function,
- FP* : the vehicle's footprint, specified in sq. ft., as defined in Equation (2) above, and
- T<sub>FE</sub>* : the calculated vehicle fuel economy target, in gpm.

For target function 206, as defined by Equation (3), coefficients *A* - *D* specify the “core” of the target function, while coefficients *E* - *H* provide a “backstop” for that function, preventing the targets from decreasing below a certain predefined point. On rare occasions, the coefficients defining the target function in a future model year may change sufficiently enough to intersect with the target function of a preceding year, thus, causing the calculated targets for some vehicles to be lower in a future model year, while still resulting in a higher overall standard. To prevent the targets of any individual vehicle from unintentionally decreasing between model years, the system implements a set of backstop coefficients for some of the available target functions.

Each function defined in Table 7 produces vehicle targets on a gallon per mile basis (gpm), which are later used when calculating the value of the CAFE standard for compliance with the CAFE program. To support compliance with the CO<sub>2</sub> program, the modeling system calculates CO<sub>2</sub> vehicle targets from the gpm targets obtained in Equation (3). The CO<sub>2</sub> target calculation is, hence, defined by the following:

$$T_{CO_2} = T_{FE} \times CO_2Factor_{RC} + CO_2Offset_{RC} \quad (4)$$



Where:

- RC* : the regulatory classification of a vehicle,
- T<sub>FE</sub>* : the calculated vehicle fuel economy target, in gallons per mile,
- CO<sub>2</sub>Factor<sub>RC</sub>* : the CO<sub>2</sub> factor to use for converting between fuel economy values and CO<sub>2</sub> values,
- CO<sub>2</sub>Offset<sub>RC</sub>* : the absolute amount, in grams per mile, by which to shift the CO<sub>2</sub> target after conversion from fuel economy, and
- T<sub>CO<sub>2</sub></sub>* : the calculated vehicle CO<sub>2</sub> target, in grams per mile.

The *CO<sub>2</sub>Factor* and *CO<sub>2</sub>Offset* variables are specified in the scenario definition for each regulatory class. As mentioned above, for vehicles regulated as domestic or imported cars, scenario definition values associated with the combined Passenger Car class will be used.

In addition to the function and variable coefficients, the scenario definition includes additional parameters that may have an impact on compliance. When complying with the CAFE program, vehicles regulated as domestic passenger automobiles are subject to a minimum domestic car standard that is no less than 92 percent of the combined Passenger Car standard computed for the entire industry during a specific model year. Since the minimum domestic car standards are calculated and established during analysis of future model years, and since the fleet distribution may change by the time the standards take effect, during evaluation of standards set by the past rulemakings, these minimum standards are represented in absolute terms as miles per gallon, while for the future model years, they are specified as percentages. To support this, the scenario definition includes the “Min (mpg)” and “Min (%)” variables, defining the lower bounds for the minimum domestic car standard.

When complying with the CO<sub>2</sub> program, the calculated CO<sub>2</sub> ratings may be adjusted by some amount during analysis, based on the mix of vehicles present within a manufacturer’s product line. The CO<sub>2</sub> compliance program includes manufacturer incentives to encourage adoption of alternative fuel and advanced vehicle technologies. Specifically, the CO<sub>2</sub> program defines production multipliers, which are used to scale the sales volumes of CNGs, PHEVs, BEVs, and FCVs when computing the manufacturer’s CO<sub>2</sub> rating and standard toward compliance with CO<sub>2</sub> standards. To accomplish this, the scenario definition includes the “EPA Multiplier 1” and “EPA Multiplier 2” variables, where the former applies to the production multipliers of CNGs and PHEVs, and the latter includes BEVs and FCVs.

Lastly, the scenario definition specifies a series of air conditioning and off-cycle credit caps, defined separately for each compliance program, which influence the amount of adjustment or credit a manufacturer may claim toward compliance. The caps are specified in grams per mile of CO<sub>2</sub> and serve to limit the application of the associated value defined for each manufacturer in the input fleet.

The calculation of the standards and ratings for CAFE and CO<sub>2</sub> compliance programs are described in Section 5, below.

## Section 4 Evaluation of Vehicle Technologies

A vehicle technologies input file provides a set of possible improvements available for the vehicle fleet within the modeling system. The inputs for vehicle technologies, referred to below simply as “technologies,” are defined by the user in the technology input file for the modeling system. As part of the technology definition, the input file includes: additional cost associated with application of the technology, the initial year that the technology may be considered for application, whether it is applicable to a given class of vehicle, as well as other miscellaneous assumptions outlining additional technology characteristics. Section A.2 of Appendix A describes all technology attributes in greater detail.

Internally, the modeling system assigns additional properties for each technology defining the application schedule (further specifying when a technology may be considered for application) and the application level (controlling the scope of a technology’s applicability). The application schedule determines whether a technology may be applied during a vehicle’s redesign year only, during a vehicle’s refresh or redesign years, or if the technology is defined as part of the baseline input fleet and is not available for application during modeling. The application level indicates whether the technology is vehicle-level, in which case it may be applied directly to individual vehicles, or if the technology is platform, engine, or transmission-level, in which case it will be applied to all vehicles that share a common platform, engine, or transmission, respectively.

The following two tables outline all technologies available within the modeling system, along with their application levels and schedules:

**Table 8. CAFE Model Technologies (1)**

Technology	Application Level	Application Schedule	Description
SOHC	Engine	Baseline Only	Single Overhead Camshaft Engine
DOHC	Engine	Baseline Only	Double Overhead Camshaft Engine
EFR	Engine	Redesign Only	Improved Engine Friction Reduction
VVT	Engine	Redesign Only	Variable Valve Timing
VVL	Engine	Redesign Only	Variable Valve Lift
SGDI	Engine	Redesign Only	Stoichiometric Gasoline Direct Injection
DEAC	Engine	Redesign Only	Cylinder Deactivation
TURBO1	Engine	Redesign Only	Turbocharging and Downsizing, Level 1 (1.5271 bar)
TURBO2	Engine	Redesign Only	Turbocharging and Downsizing, Level 2 (2.0409 bar)
CEGR1	Engine	Redesign Only	Cooled Exhaust Gas Recirculation, Level 1 (2.0409 bar)
ADEAC	Engine	Redesign Only	Advanced Cylinder Deactivation
HCR0	Engine	Redesign Only	High Compression Ratio Engine, Level 0
HCR1	Engine	Redesign Only	High Compression Ratio Engine, Level 1
HCR2	Engine	Redesign Only	High Compression Ratio Engine, Level 2
VCR	Engine	Redesign Only	Variable Compression Ratio Engine
VTG	Engine	Redesign Only	Variable Turbo Geometry
VTGE	Engine	Redesign Only	Variable Turbo Geometry (Electric)
TURBOD	Engine	Redesign Only	Turbocharging and Downsizing With DEAC
TURBOAD	Engine	Redesign Only	Turbocharging and Downsizing With ADEAC
ADSL	Engine	Redesign Only	Advanced Diesel
DSLI	Engine	Redesign Only	Diesel Engine Improvements
DSLAD	Engine	Redesign Only	Diesel Engine Improvements With ADEAC
CNG	Engine	Baseline Only	Compressed Natural Gas Engine

In Table 8, above, note that SOHC and DOHC engine technologies are defined as baseline-only. These technologies are used to inform the modeling system of the input engine's configuration in order to correctly map an input vehicle model to an identically specified set of simulation results contained within the vehicle simulation database, which include a combination of simulation results produced by ANL and additional non-simulated technologies (the vehicle simulation database and associated vehicle mappings are discussed in the sections that follow). Note that the CNG engine technology is defined as baseline-only as well. While it may be present in the input fleet, the CNG technology is not applicable within the modeling system.

**Table 9. CAFE Model Technologies (2)**

<b>Technology</b>	<b>Application Level</b>	<b>Application Schedule</b>	<b>Description</b>
MT5	Transmission	Baseline Only	5-Speed Manual Transmission
MT6	Transmission	Redesign Only	6-Speed Manual Transmission
MT7	Transmission	Redesign Only	7-Speed Manual Transmission
AT5	Transmission	Baseline Only	5-Speed Automatic Transmission
AT6	Transmission	Refresh/Redesign	6-Speed Automatic Transmission
AT6L2	Transmission	Refresh/Redesign	6-Speed Automatic Transmission, Level 2
AT7L2	Transmission	Baseline Only	7-Speed Automatic Transmission, Level 2
AT8	Transmission	Refresh/Redesign	8-Speed Automatic Transmission
AT8L2	Transmission	Refresh/Redesign	8-Speed Automatic Transmission, Level 2
AT8L3	Transmission	Refresh/Redesign	8-Speed Automatic Transmission, Level 3
AT9L2	Transmission	Baseline Only	9-Speed Automatic Transmission, Level 2
AT10L2	Transmission	Refresh/Redesign	10-Speed Automatic Transmission, Level 2
AT10L3	Transmission	Refresh/Redesign	10-Speed Automatic Transmission, Level 3
DCT6	Transmission	Refresh/Redesign	6-Speed Dual Clutch Transmission
DCT8	Transmission	Refresh/Redesign	8-Speed Dual Clutch Transmission
CVT	Transmission	Baseline Only	Continuously Variable Transmission
CVTL2	Transmission	Refresh/Redesign	CVT, Level 2
EPS	Vehicle	Refresh/Redesign	Electric Power Steering
IACC	Vehicle	Refresh/Redesign	Improved Accessories
CONV	Vehicle	Baseline Only	Conventional Powertrain (Non-Electric)
SS12V	Vehicle	Redesign Only	12V Micro-Hybrid (Stop-Start)
BISG	Vehicle	Redesign Only	Belt Mounted Integrated Starter/Generator
SHEVP2	Vehicle	Redesign Only	P2 Strong Hybrid/Electric Vehicle
SHEVPS	Vehicle	Redesign Only	Power Split Strong Hybrid/Electric Vehicle
P2HCR0	Vehicle	Redesign Only	[Special] SHEVP2 With HCR0 Engine
P2HCR1	Vehicle	Redesign Only	[Special] SHEVP2 With HCR1 Engine
P2HCR2	Vehicle	Redesign Only	[Special] SHEVP2 With HCR2 Engine
PHEV20	Vehicle	Redesign Only	20-Mile Plug-In Hybrid/Electric Vehicle With HCR Engine
PHEV50	Vehicle	Redesign Only	50-Mile Plug-In Hybrid/Electric Vehicle With HCR Engine
PHEV20T	Vehicle	Redesign Only	20-Mile Plug-In Hybrid/Electric Vehicle With Turbo Engine
PHEV50T	Vehicle	Redesign Only	50-Mile Plug-In Hybrid/Electric Vehicle With Turbo Engine
PHEV20H	Vehicle	Redesign Only	[Special] PHEV20 With HCR Engine
PHEV50H	Vehicle	Redesign Only	[Special] PHEV50 With HCR Engine
BEV200	Vehicle	Redesign Only	200-Mile Electric Vehicle
BEV300	Vehicle	Redesign Only	300-Mile Electric Vehicle
FCV	Vehicle	Redesign Only	Fuel Cell Vehicle
LDB	Vehicle	Refresh/Redesign	Low Drag Brakes
SAX	Vehicle	Refresh/Redesign	Secondary Axle Disconnect
ROLL0	Vehicle	Baseline Only	Baseline Tires

Technology	Application Level	Application Schedule	Description
ROLL10	Vehicle	Refresh/Redesign	Low Rolling Resistance Tires, Level 1 (10% Reduction)
ROLL20	Vehicle	Refresh/Redesign	Low Rolling Resistance Tires, Level 2 (20% Reduction)
AERO0	Vehicle	Baseline Only	Baseline Aero
AERO5	Vehicle	Redesign Only	Aero Drag Reduction, Level 1 (10% Reduction)
AERO10	Vehicle	Redesign Only	Aero Drag Reduction, Level 1 (10% Reduction)
AERO15	Vehicle	Redesign Only	Aero Drag Reduction, Level 1 (10% Reduction)
AERO20	Vehicle	Redesign Only	Aero Drag Reduction, Level 2 (20% Reduction)
MR0	Platform	Baseline Only	Baseline Mass
MR1	Platform	Redesign Only	Mass Reduction, Level 1 (5% Reduction in Glider Weight)
MR2	Platform	Redesign Only	Mass Reduction, Level 2 (7.5% Reduction in Glider Weight)
MR3	Platform	Redesign Only	Mass Reduction, Level 3 (10% Reduction in Glider Weight)
MR4	Platform	Redesign Only	Mass Reduction, Level 4 (15% Reduction in Glider Weight)
MR5	Platform	Redesign Only	Mass Reduction, Level 5 (20% Reduction in Glider Weight)
MR6	Platform	Redesign Only	Mass Reduction, Level 6 (28.2% Reduction in Glider Weight)

In Table 9, above, note that MT5, AT5, AT7L2, AT9L2, and CVT transmission technologies are defined as baseline-only. Additionally, CONV, ROLL0, AERO0, and MR0 technologies are listed as baseline-only as well. As is the case with DOHC and SOHC engine technologies, the baseline technologies appearing in Table 9 are present in order to allow the CAFE Model to correctly map an input vehicle to an equivalent option available in the vehicle simulation database.

The modeling system defines several technology classes and pathways for logically grouping all available technologies for application on a vehicle. Technology classes provide costs and improvement factors shared by all vehicles with similar body styles, curb weights, footprints, and engine types, while technology pathways establish a logical progression of technologies on a vehicle.

#### **S4.1 Technology Classes**

The modeling system defines two types of technology classes: vehicle technology classes and engine technology classes. The system uses vehicle technology classes as a means for specifying common technology input assumptions for vehicles that share similar characteristics. Predominantly, these classes signify the degree of applicability of each of the available technologies to a specific class of vehicles, as well as correlate with the set of results from the vehicle simulation database that is tailored for application on vehicles with a specific technology class. Furthermore, for each technology, the vehicle technology classes also define the amount by which the vehicle's weight may decrease (resulting from application of mass reducing technology), and the cost associated with non-engine components of specific technologies.

The model supports 12 vehicle technology classes as shown in Table 10:

**Table 10. Vehicle Technology Classes**

<b>Class</b>	<b>Description</b>
SmallCar	Small Passenger Cars
SmallCarPerf	Small Performance Passenger Cars
MedCar	Medium to Large Passenger Cars
MedCarPerf	Medium to Large Performance Passenger Cars
SmallSUV	Small SUVs and Station Wagons
SmallSUVPerf	Small Performance SUVs and Station Wagons
MedSUV	Medium to Large SUVs, Minivans, and Passenger Vans
MedSUVPerf	Medium to Large Performance SUVs, Minivans, and Passenger Vans
Pickup	Light-Duty Pickups and Other Vehicles With Ladder Frame Construction
PickupHT	Light-Duty Pickups With High Towing Capacity
Truck 2b/3	Class 2b and Class 3 Pickups
Van 2b/3	Class 2b and Class 3 Cargo Vans

Of the 12 vehicle technology classes shown in the table above, the 10 relating to the light-duty vehicle fleet include simulation results produced by ANL. For the current version of the CAFE Model, which is used for evaluating compliance with the light-duty standards, the “Truck 2b/3” and “Van 2b/3” classes, do not include any actual simulation data.

Since the costs attributed to upgrading an engine vary based upon that engine’s configuration (i.e., the engine’s valvetrain design and the number of engine cylinders and banks), the model defines separate engine classes for specifying input costs associated with only a vehicle’s engine for each defined technology. The modeling system provides 28 engine technology classes as shown in Table 11, with 12 classes defined for DOHC and SOHC engines each, and 4 classes defined for OHV engines:

**Table 11. Engine Technology Classes**

<b>Class</b>	<b>Description</b>
2C1B	DOHC Engine With 2 Cylinders and 1 Bank
3C1B	DOHC Engine With 3 Cylinders and 1 Bank
4C1B	DOHC Engine With 4 Cylinders and 1 Bank
4C2B	DOHC Engine With 4 Cylinders and 2 Banks
5C1B	DOHC Engine With 5 Cylinders and 1 Bank
6C1B	DOHC Engine With 6 Cylinders and 1 Bank
6C2B	DOHC Engine With 6 Cylinders and 2 Banks
8C2B	DOHC Engine With 8 Cylinders and 2 Banks
10C2B	DOHC Engine With 10 Cylinders and 2 Banks
12C2B	DOHC Engine With 12 Cylinders and 2 Banks
12C4B	DOHC Engine With 12 Cylinders and 4 Banks
16C4B	DOHC Engine With 16 Cylinders and 4 Banks
2C1B_SOHC	SOHC Engine With 2 Cylinders and 1 Bank
3C1B_SOHC	SOHC Engine With 3 Cylinders and 1 Bank
4C1B_SOHC	SOHC Engine With 4 Cylinders and 1 Bank
4C2B_SOHC	SOHC Engine With 4 Cylinders and 2 Banks
5C1B_SOHC	SOHC Engine With 5 Cylinders and 1 Bank
6C1B_SOHC	SOHC Engine With 6 Cylinders and 1 Bank
6C2B_SOHC	SOHC Engine With 6 Cylinders and 2 Banks

<b>Class</b>	<b>Description</b>
8C2B SOHC	SOHC Engine With 8 Cylinders and 2 Banks
10C2B SOHC	SOHC Engine With 10 Cylinders and 2 Banks
12C2B SOHC	SOHC Engine With 12 Cylinders and 2 Banks
12C4B SOHC	SOHC Engine With 12 Cylinders and 4 Banks
16C4B SOHC	SOHC Engine With 16 Cylinders and 4 Banks
6C1B OHV	OHV Engine With 6 Cylinders and 1 Bank
6C2B OHV	OHV Engine With 6 Cylinders and 2 Banks
8C2B OHV	OHV Engine With 8 Cylinders and 2 Banks
10C2B OHV	OHV Engine With 10 Cylinders and 2 Banks

Once the inputs for technology classes are defined, the user assigns each vehicle in the input fleet to appropriate vehicle and engine technology classes. The model then uses the technology class assignments to obtain the appropriate applicability states and costs associated with each technology, as well as the relevant simulation results for each individual vehicle.

#### **S4.2 Technology Pathways**

The modeling system defines technology pathways for grouping and establishing a logical progression of technologies on a vehicle. Technologies that share similar characteristics form cohorts that can be represented and interpreted within the CAFE Model as discrete entities. These entities are then laid out into pathways (or paths), which the system uses to define relations of mutual exclusivity between conflicting sets of technologies. For example, as presented in the next section, technologies on the Turbo Engine path are incompatible with those on the HCR Engine or the Diesel Engine paths. As such, whenever a vehicle uses a technology from one pathway (e.g., turbo), the modeling system immediately disables the incompatible technologies from one or more of the other pathways (e.g., HCR and diesel).

Additionally, each path designates the direction in which vehicles are allowed to advance as the modeling system evaluates specific technologies for application. Enforcing this directionality within the model ensures that a vehicle that uses a more advanced or more efficient technology (e.g., AT8) is not allowed to “downgrade” to a less efficient option (e.g., AT5). Visually, as portrayed in the charts in the sections that follow, this is represented by an arrow leading from a preceding technology to a succeeding one, where vehicles begin at the root of each path, and traverse to each successor technology in the direction of the arrows.

The modeling system incorporates 20 technology pathways for evaluation as shown in Table 12. Similar to individual technologies, each path carries an intrinsic application level that denotes the scope of applicability of all technologies present within that path, and whether the pathway is evaluated on one vehicle at a time, or on a collection of vehicles that share a common platform, engine, or transmission.

**Table 12. Technology Pathways**

<b>Technology Pathway</b>	<b>Application Level</b>
Engine Configuration Path	Engine
Engine Improvements Path	Engine
Basic Engine Path	Engine
Turbo Engine Path	Engine
Advanced Cylinder Deactivation (ADEAC) Engine Path	Engine
High Compression Ratio (HCR) Engine Path	Engine
Variable Compression Ratio (VCR) Engine Path	Engine
Variable Turbo Geometry (VTG) Engine Path	Engine
Advanced Turbo Engine Path	Engine
Diesel Engine Path	Engine
Alternative Fuel Engine Path	Engine
Manual Transmission Path	Transmission
Automatic Transmission Path	Transmission
Electric Improvements Path	Vehicle
Electrification Path	Vehicle
Hybrid/Electric Path	Vehicle
Dynamic Load Reduction (DLR) Path	Vehicle
Low Rolling Resistance Tires (ROLL) Path	Vehicle
Aerodynamic Improvements (AERO) Path	Vehicle
Mass Reduction (MR) Path	Platform

Even though technology pathways outline a logical progression between related technologies, all technologies available to the system are evaluated concurrently and independently of each other. Once all technologies have been examined, the model selects a solution deemed to be most cost-effective for application on a vehicle. If the modeling system applies a technology that resides later in the pathway, it will subsequently disable all preceding technologies from further consideration, in order to prevent a vehicle from potentially downgrading to a less advanced option. Consequently, the system skips any technology that is already present on a vehicle (either those that were available on a vehicle from the input fleet or those that were previously applied by the model). This “parallel technology” approach (which is a departure from the “parallel path” methodology used in the preceding versions of the model) allows the system to always consider the entire set of available technologies, instead of foregoing the application of potentially more cost-effective options that happen to reside further down the pathway.<sup>14</sup>

#### **S4.2.1 Engine-Level Pathways**

The technologies that make up the 10 Engine-Level paths available within the model are presented in Figure 2, below. Note that the baseline-only technologies (SOHC, DOHC, and CNG) are grayed out. As mentioned earlier, these technologies are used to inform the modeling system of the input engine’s configuration, and are not otherwise applicable during the analysis. Note that the OHV technology is not supported within the model, even as a baseline-only technology. Considering that vehicles with OHV engines are rare within the input fleet, these vehicles were not included as part of Argonne’s simulation. In the absence of simulation data, in order to achieve the closest

<sup>14</sup> The previous versions of the CAFE Model followed a “low-cost” first approach, where the system would stop evaluating technologies residing within a given pathway, as soon as the first cost-effective option within that path was reached.

possible vehicle mapping, when setting up the input fleet, OHV engines should be identified as using the SOHC technology.

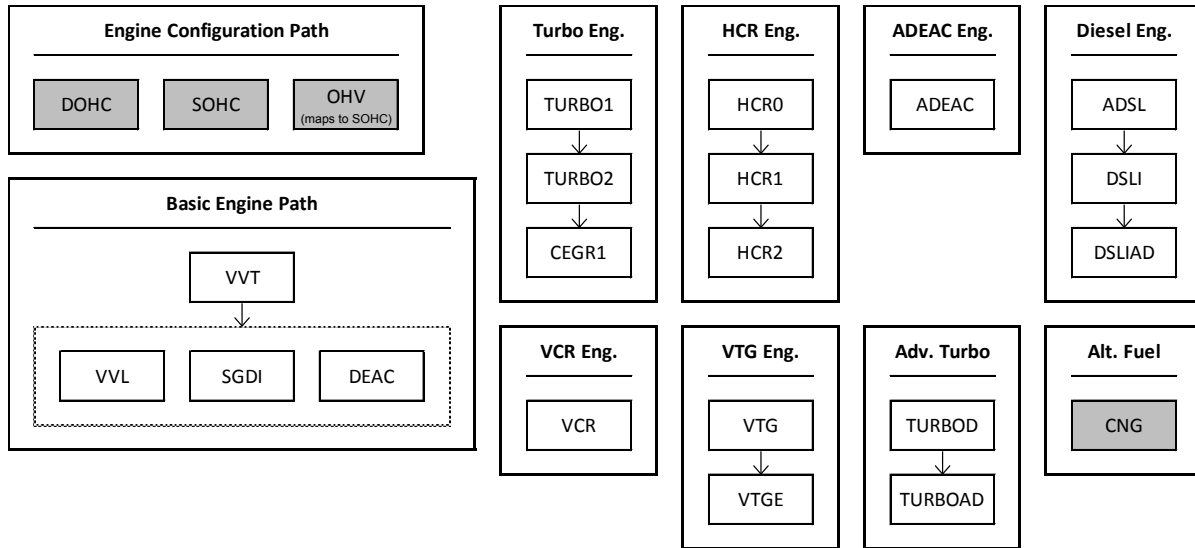

Figure 2. Engine-Level Paths

As mentioned above, the DOHC and SOHC technologies, which are found on the Engine Configuration path, are not available during modeling, instead serving to define the initial configuration of the vehicle's engine. Thus, the system begins its evaluation of the engine-level technologies starting with the VVT technology, found on the Basic Engine path. For all vehicles evaluated by the model, VVT is considered to be a *prerequisite* technology, where application of all other technologies is prohibited until the vehicle's engine is upgraded to include VVT. Given that the vehicle simulation database assumes VVT to be the starting point (or baseline state) for an engine, the modeling system enforces this constraint in order to avoid erroneous mappings of vehicles that are defined in the input fleet without VVT technology already applied.

Once the VVT technology condition is satisfied, the system may continue to progress down the Basic Engine path. At this point, the model may select one of VVL, SGDI, or DEAC technologies, based on whichever is most cost-effective for application to a vehicle at the time of evaluation. Since these technologies are not mutually exclusive, the system may continue to examine the remainder of available Basic Engine technologies after applying the selected one to a vehicle. Since application of VVL, SGDI, and DEAC technologies is strictly based on their cost-effectiveness, their order in which these technologies are applied is not immediately apparent, and may change from vehicle to vehicle, given the varying technology profiles of different vehicles. However, whether the model picks one order of application (e.g., VVL, SGDI, DEAC) over another (e.g., DEAC, SGDI, VVL), the resulting net cost and fuel economy improvement will be the same.

As with the Basic Engine path, the model may immediately consider any of the technologies for application from the remaining engine-level paths shown in Figure 2, above. However, as stated earlier, once a technology from the given pathway is applied on a vehicle, the preceding technologies, if any, are disabled (for that vehicle) from further evaluation. This means the



modeling system may evaluate and apply any technology from any of the pathways (e.g., TURBO2 technology from the Turbo Engine path) prior to exhausting the Basic Engine path.

With the exception of the Basic Engine path, the majority of the engine-level pathways available within the model are mutually exclusive. This denotes that if a vehicle is using an engine technology from one of the paths (e.g., HCR1), some or all of the other pathways will be disabled on that engine. Additionally, once the model transitions beyond the Basic Engine pathway, applying one of the more advanced engine technologies, all unused technologies on the Basic Engine path will be permanently disabled from future applications. This ensures that the model retains proper mapping of vehicles to the vehicle simulation database and that it does not inadvertently downgrade a vehicles during analysis. The mutual exclusivity of the engine pathways, as well as the conflicting relations of other paths, is discussed further in Section S4.2.5 below.

### S4.2.2 Transmission-Level Pathways

The technologies that make up the two Transmission-Level paths defined by the modeling system are shown in Figure 3, below. The baseline-only technologies (MT5, AT5, AT7L2, AT9L2, and CVT) are grayed and are only used to signify the initial configuration of the vehicle’s transmission. For simplicity, all manual transmissions with five forward gears or fewer should be assigned the MT5 technology in the input fleet. Similarly, all automatic transmissions with five forward gears or fewer should be assigned the AT5 technology.

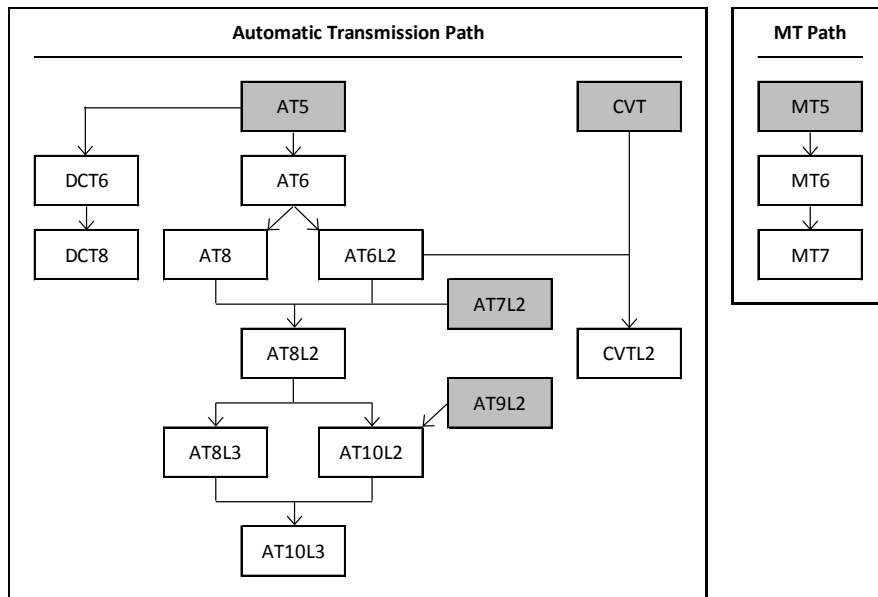

Figure 3. Transmission-Level Paths

Since the Manual Transmission path terminates with MT7, the system assumes that all manual transmissions with seven or more gears are mapped to the MT7 technology. Moreover, all dual-clutch (DCT) or auto-manual (AMT) transmissions with five or six forward gears should be mapped to the DCT6 technology, and all DCTs or AMTs with seven or more forward gears should be mapped to DCT8. These transmission technology utilization assignments provide the recommended guidance that users should follow when setting up the initial transmission

technology mappings for the input fleet. However, while the modeling system adheres to the aforementioned assumptions during analysis of a given technology, these requirements are not strictly enforced by the system for the input fleet.

As with the engine pathways, all of the technologies on both transmission paths are evaluated by the model concurrently, with the most cost-effective being selected for application. Likewise, the former transmission technologies, if any, will be disabled on a vehicle once one of the latter options are applied by the model. Additionally, the Manual and Automatic Transmission pathways defined within the model are mutually exclusive. This signifies that if a vehicle is using a transmission technology from one of the paths (e.g., AT6), the other pathway will be disabled for that transmission.

As illustrated in Figure 3 above, the Automatic Transmission path incorporates various branch points (and conversions), defining the mutual exclusivity of technologies within the pathway. The arrows connecting the individual technologies may be followed to determine the possible progression options the model may follow as it upgrades a vehicle's transmission. Traversing through the connecting arrows down one of the branches, however, will disable the conflicting technologies on one or more of the other branches. Since the Automatic Transmission path includes technologies that serve as conversion points, in some cases, only a portion of the branch may be disabled by the model. For example, if a vehicle starts with the AT5 transmission technology and continues to AT8, the AT6L2, DCT6, and DCT8 technologies will become unavailable. Since CVTL2 follows from AT6L2 (or from CVT), for this example, the CVTL2 technology is not otherwise reachable from AT8, and will thus be disabled from future applications as well. However, since AT8L2 converges from AT8 and AT6L2, that technology continues to remain available.

Generally, a technology on any pathway only remains available for application if it may be reached from the highest technology being used on a vehicle, by following through the arrows within the same path. As another example, consider a vehicle that uses or upgrades to a CVTL2 transmission. Since no other technology on the Automatic Transmission path can be reached from CVTL2, the remaining automatic technologies will be disabled for that vehicle. Likewise, if either of the DCT technologies are applied or used on a vehicle, the rest of the automatic technologies are unreachable, and hence also become unavailable.

#### **S4.2.3 Vehicle-Level Electrification Pathways**

The technologies that are included on the three Vehicle-Level paths pertaining to the electrification and hybrid/electric improvements defined within the modeling system are illustrated in Figure 4 below. As shown in the Electrification path, the baseline-only CONV technology is grayed out. This technology is used to denote whether a vehicle comes in with a conventional powertrain (i.e., a vehicle that does not include any level of hybridization) and to allow the model to properly map to simulation results found in the vehicle simulation database. As is the case with Engine- and Transmission-Level pathways, all technologies on the Vehicle-Level electrification paths are mutually exclusive and are evaluated in parallel, where, for example, the model may immediately evaluate PHEV30 technology prior to having to apply more basic technologies, such as SS12V or SHEVPS.

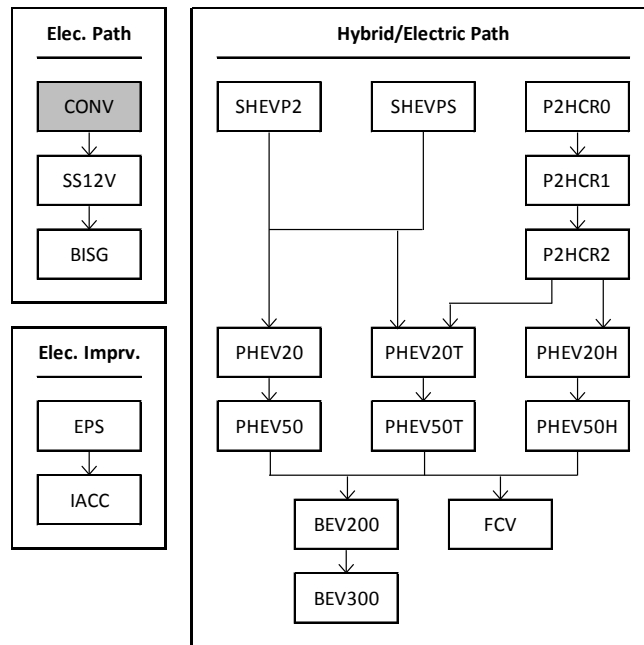

**Figure 4. Vehicle-Level (Electrification) Paths**

As can be seen in Figure 4, the Hybrid/Electric path includes three starting points, or root technologies (specifically, SHEVP2, SHEVPS, and P2HCR0), along with several branches and conversions. Since the modeling system evaluates each and every technology concurrently, the multiple starting points bear no weight on the actual traversal or analysis of the pathways, other than limiting the potential branches the system may follow, once a specific root technology is applied to a vehicle. That is, if vehicle uses SHEVPS, SHEVP2 technology and the entire P2HCR0 through PHEV50H branch will be disabled from further consideration.

As discussed earlier, the branch points found within a pathway define mutual exclusivity of technologies, preventing the model from following a specific branch, if a technology on a conflicting one is applied to a vehicle. Similarly, if multiple branches converge on a single technology, the subset of technologies that will be disabled from further application is extended only up the point of convergence. For example, if the vehicle uses the PHEV50T technology, the immediately preceding ones (SHEVPS and PHEV20T) are disabled, along with the technologies on the conflicting branches, including: SHEVP2, PHEV20, PHEV50, P2HCR0, P2HCR1, P2HCR2, PHEV20H, and PHEV50H. However, BEV200 and FCV are convergence points for all preceding technologies and, along with BEV300, remain available for application.

As noted above, a technology on any pathway is available for application only if it is reachable from the currently used technology, by following the arrows shown in the diagrams. In the preceding example, since there is no connection (direct or indirect via another technology) between PHEV50T and PHEV50, once PHEV50T (or PHEV20T, for that matter) becomes used on a vehicle, PHEV50 and the rest of unreachable technologies become unavailable from further consideration.

#### S4.2.4 Platform-Level and Other Vehicle-Level Pathways

The technologies that are included on the single Platform-Level path as well as the three remaining Vehicle-Level paths provided by the model are displayed in Figure 5 below. The baseline-only technologies (MR0, AERO0, and ROLL0) are grayed and are only used to signify the initial configuration of the vehicle. In each case, as with other baseline-only technologies, these are used to allow for appropriate vehicle mapping to the vehicle simulation database.

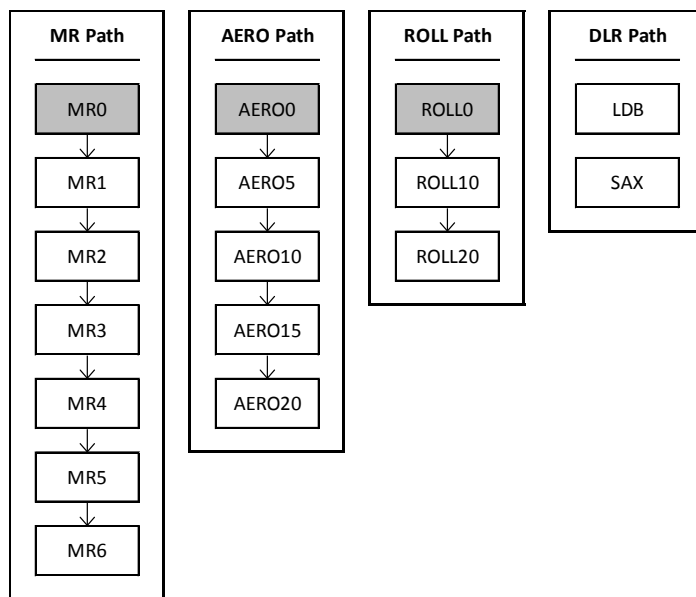
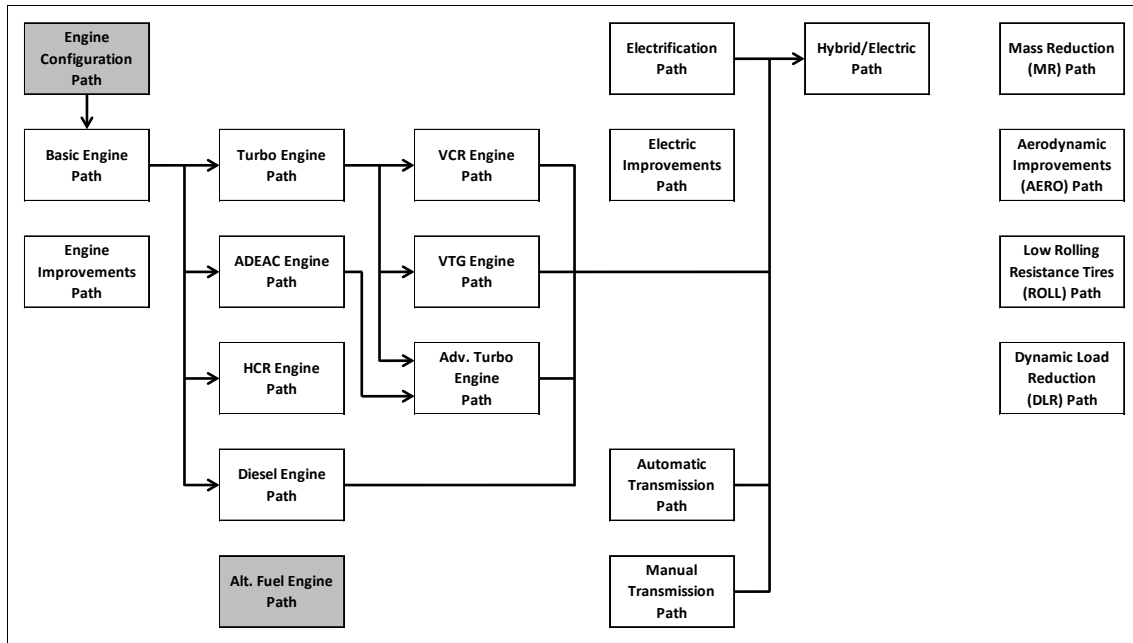

Figure 5. Platform-Level and Vehicle-Level (Other) Paths

All of the pathways shown in Figure 5 may be evaluated by the model independent of one another, with the most cost-effective being selected for application. While the Mass Reduction, AERO, and ROLL paths define a logic progression of technologies, where application of a latter technology disables all former ones, note that on the DLR path, the LDB and SAX technologies are fully independent of each other. This indicates that application of, for example, LDB on a given vehicle does not prevent SAX from being considered in the future on the same vehicle.

#### S4.2.5 Relationship Between Technology Pathways

Similar to the way the individual technologies are grouped into pathways in order to define the logical progression with a given path, most of the pathways defined within the modeling system are interconnected, signifying additional logical progression between various pathways. As before, the connections between paths designate the direction in which vehicles are allowed to advance as the modeling system evaluates technologies from these pathways for application. The directionality of the paths ensures that vehicles are only allowed to “upgrade” to a more advanced powertrain option with each successive technology application. Of the 20 technology pathways present in the model, almost all Engine paths, both Transmission paths, the Electrification path, and the Hybrid/Electric path are connected, as illustrated in Figure 6 below.



**Figure 6. Technology Pathways Diagram**

Some of the technology pathways, as defined in the CAFE Model and shown in the diagram above, may not be compatible with a vehicle given its state at the time of evaluation. For example, a vehicle with a 6-speed automatic transmission will not be able to get improvements from a Manual Transmission path. For this reason, the system implements logic to explicitly disable certain paths whenever a constraining technology from another path is applied on a vehicle. On occasion, not all of the technologies present within a pathway may produce compatibility constraints with another path. In such a case, the system will selectively disable a conflicting pathway (or part of the pathway) as required by the incompatible technology. In the preceding sections, this was referred to as mutual exclusivity of paths. The full and precise logic for conflicting and mutually exclusive pathways defined within the model is shown in the table below:

**Table 13. Technology Pathway Compatibility Logic**

<b>Technology Pathway</b>	<b>Conflicting Pathways Disabled in the Model</b>
Engine Improvements Path	Diesel Engine Path (Partially Disabled)
Turbo Engine Path	Most Other Engine Paths (Engine Improvements, VCR, VTG, and Advanced Turbo Engine Paths Are Not Disabled)
ADEAC Engine Path	All Other Engine Paths (Except Engine Improvements and Advanced Turbo Engine Paths)
HCR Engine Path	All Other Engine Paths (Except Engine Improvements Path)
VCR Engine Path	All Other Engine Paths (Except Engine Improvements Path)
VTG Engine Path	All Other Engine Paths (Except Engine Improvements Path) Electrification Path (for VTGE Only)
Advanced Turbo Engine Path	All Other Engine Paths (Except Engine Improvements Path)
Diesel Engine Path	All Other Engine Paths (Except ADSL, Where EFR Is Not Disabled) Hybrid/Electric Path (Partially Disabled)
Alternative Fuel Engine Path	All Paths Are Disabled ** (* ** if a vehicle uses any technology on the Alternative Fuel Engine path, presently this only includes CNG, the model prohibits any further technology application to that vehicle)

Technology Pathway	Conflicting Pathways Disabled in the Model
Manual Transmission Path	Automatic Transmission Path
Automatic Transmission Path	Manual Transmission Path
Hybrid/Electric Path	All Engine Paths (Except for SHEVP2, Where Only VTGE and DSLIAD Are Disabled) All Transmission Paths Electrification Path

As can be observed from the logic described in Table 13, for any interlinked technology pathways shown in Figure 6 above, the system additionally disables all preceding technology paths whenever a vehicle transitions to a succeeding pathway. For example, if the model applies SHEVPS technology on a vehicle, the system disables all Engine and Transmission paths, as well as the Electrification path, most of which precede the Hybrid/Electric pathway (e.g., Automatic Transmission path), while some are simply incompatible (e.g., Engine Improvements path).<sup>15</sup>

The compatibility logic presented in this section only outlines the interaction between the various pathways available within the modeling system. The individual technologies, however, may incorporate additional constraints related to the interaction between particular technologies. These technology-specific constraints are described in greater detail in Section S4.5 below.

### S4.3 Technology Applicability

The modeling system determines the applicability of each technology on a vehicle, engine, transmission, or platform using the combination of technology input assumptions and the technology utilization settings defined in the input fleet (as specified in the market data input file).<sup>16</sup>

For each vehicle technology class (discussed above), the technology input assumptions provide the *Applicable*, *Year Available*, and *Year Retired* fields that control the scope of applicability of each technology. If the *Applicable* field is set to **FALSE** for a specific technology, that technology will not be available for evaluation. Conversely, if this field is set to **TRUE**, the technology will be available for application. Furthermore, the *Year Available* and *Year Retired* fields determine the minimum and maximum model years during which the technology may be considered by the modeling system. If the *Year Retired* field is not specified (left as blank in the technologies input file), the technology is assumed to be available indefinitely. Additionally, technology phase-in caps may limit the availability of technologies if a particular penetration rate is reached for a vehicle's manufacturer in a model year being evaluated.

In the market data input file, the worksheets describing each vehicle model, engine, and transmission selected for simulation provide the *Technology Information* sections that are used to define the initial technology utilization state of the input fleet. Each of the technologies listed in Table 8 and Table 9 above are referenced on these worksheets, based on the application-level of

<sup>15</sup> The only notable exception to this rule occurs whenever SHEVP2 technology is applied on a vehicle. This technology may be present in conjunction with most engine-level technologies, and as such, the engine paths are not disabled upon application of SHEVP2 technology, even though these pathways precedes the Hybrid/Electric path.

<sup>16</sup> The technology utilization section is described in Sections A.1.2, A.1.3, and A.1.4 of Appendix A.

the technology, as appropriate. The user determines which technologies are initially present in the input fleet, given the characteristics of each vehicle, engine, and transmission. Since the modeling system relies heavily on the *Technology Information* settings, these sections must accurately and completely represent the initial state of each vehicle, platform, engine, and transmission in order to avoid potential modeling errors.

Lastly, the logical restrictions imposed by the technology pathways described above, as well as those applicable to individual technologies discussed in a later section, further restrict the applicability of technologies should any compatibility issues arise during modeling.

#### **S4.4 Technology Evaluation and Inheriting**

Once the system determines the applicability of all technologies, it may begin evaluating them for application on a vehicle. As stated before, the system examines all technologies concurrently and independently of one another. The model considers and applies redesign-based technologies (as defined in Table 8 and Table 9 above and listed as “Redesign Only”) whenever a vehicle is at a redesign, while refresh-based technologies (listed as “Refresh/Redesign”) may be considered during a vehicle’s refresh or redesign years.

When the system evaluates platform, engine, or transmission-level technologies, since the technology being analyzed directly modifies a shared vehicle component,<sup>17</sup> the resultant improvements must be considered on all vehicles that use a common platform, engine, or transmission simultaneously. During modeling, the system elects a “leader” vehicle, with all technology improvements being realized on that vehicle first, and afterwards, propagated down to the remainder of the vehicles (known as the “followers”) that share the leader’s platform, engine, or transmission. As such, new technologies are initially evaluated and applied to a leader vehicle during its refresh or redesign year (as appropriate for a specific technology). Any follower vehicles that share the same redesign and/or refresh schedule as the leader apply these technology improvements during the same model year. The rest of the followers inherit technologies from a leader vehicle during a follower’s refresh year (for engine- and transmission-level technologies), or during a follower’s redesign year (for platform-level technologies).

The system dynamically assigns a leader vehicle for each platform, engine, and transmission during analysis, based on the following criteria:

- 1) For vehicle platforms only, the system first determines which of the shared vehicles have the highest degree of platform-level technology utilization,<sup>18</sup>

---

<sup>17</sup> For the purposes of CAFE modeling, a vehicle component is defined as any major vehicle block that maintains its own production line and is used on multiple vehicles at a time. Vehicle platforms, engines, and transmissions are all considered to be vehicle components from the model’s perspective.

<sup>18</sup> Unlike engines and transmissions, the vehicle platforms are not discretely defined in the market data input file. Instead, technology utilization of platform-level technologies is attributed to individual vehicles. Therefore, on occasion, vehicles that share a common platform may begin the analysis with varying degrees of platform-level technologies. For this reason, the system begins the leader selection process by first filtering for vehicles with the highest utilization of these technologies.

- 2) From the filtered list of vehicles, the system selects a vehicle model with the highest production volume as the leader,
- 3) If multiple vehicles are selected (that is, they all have the same production volume), the vehicle with the highest MSRP is then chosen as the leader.

Note that, since platforms, engines, and transmissions do not always encompass the same set of vehicles, a vehicle chosen as the leader of an engine may not necessarily be selected as a leader of a platform or a transmission.

Since vehicle-level technologies affect only one vehicle at a time, all technology improvements are applied immediately to just the one vehicle model during its refresh or redesign year.

#### **S4.5 Technology Constraints (Supersession and Mutual Exclusivity)**

As the modeling system progresses through the various technology pathways, it may encounter technologies that serve the same function on a vehicle, but represent upgraded or more advanced versions of one another. For example, TURBO2 technology is an upgraded version of TURBO1, however, both may not simultaneously exist on the same vehicle. The system may also encounter technologies that represent entirely different powertrain designs, and may need to completely remove a large set of conflicting technologies that may already exist on a vehicle. For example, application of SHEVPS requires replacing the engine and transmission of a vehicle with a unique version optimized for a power-split hybrid. Additionally, as discussed earlier, some technology pathways are defined as mutually exclusive and may not be concurrently applied to a vehicle.

In order for users to diagnose the various technology application choices the CAFE Model made during compliance modeling, and to allow for incremental evaluation and application of one or more vehicle technologies on a vehicle, the modeling system includes a logical concept of *technology supersession*. In essence, when a previously applied technology is superseded on a vehicle by the modeling system, it is removed from that vehicle, and replaced by another, typically more advanced option. The system internally keeps tracks of each superseded technology, which is later reflected in the diagnostic reports produced by the model.<sup>19</sup>

The following table provides a list of technologies that may supersede one or more of the other technologies:

**Table 14. Technology Supersession Logic**

<b>Technology</b>	<b>Superseded Technologies</b>
TURBO1	SOHC, DOHC, VVT, VVL, SGDI, DEAC
TURBO2	SOHC, DOHC, VVT, VVL, SGDI, DEAC, TURBO1
CEGR1	SOHC, DOHC, VVT, VVL, SGDI, DEAC, TURBO1, TURBO2
ADEAC	SOHC, DOHC, VVT, VVL, SGDI, DEAC
HCR0	SOHC, DOHC, VVT, VVL, SGDI, DEAC
HCR1	SOHC, DOHC, VVT, VVL, SGDI, DEAC, HCR0
HCR2	SOHC, DOHC, VVT, VVL, SGDI, DEAC, HCR0, HCR1
VCR	SOHC, DOHC, VVT, VVL, SGDI, DEAC, TURBO1, TURBO2, CEGR1

<sup>19</sup> Modeling reports are discussed in greater detail in Appendix B.



<b>Technology</b>	<b>Superseded Technologies</b>
VTG	SOHC, DOHC, VVT, VVL, SGDI, DEAC, TURBO1, TURBO2, CEGR1
VTGE	SOHC, DOHC, VVT, VVL, SGDI, DEAC, TURBO1, TURBO2, CEGR1, VTG, CONV, SS12V, BISG
TURBOD	SOHC, DOHC, VVT, VVL, SGDI, DEAC, TURBO1, TURBO2, CEGR1, ADEAC
TURBOAD	SOHC, DOHC, VVT, VVL, SGDI, DEAC, TURBO1, TURBO2, CEGR1, ADEAC, TURBOD
ADSL	SOHC, DOHC, VVT, VVL, SGDI, DEAC
DSL1	SOHC, DOHC, VVT, VVL, SGDI, DEAC, ADSL
DSL1AD	SOHC, DOHC, VVT, VVL, SGDI, DEAC, ADSL, DSL1
CNG	SOHC, DOHC, VVT, VVL, SGDI, DEAC
MT6	MT5
MT7	MT5, MT6
AT6	AT5
AT6L2	AT5, AT6
AT7L2	AT5, AT6, AT6L2
AT8	AT5, AT6
AT8L2	AT5, AT6, AT6L2, AT7L2, AT8
AT8L3	AT5, AT6, AT6L2, AT7L2, AT8, AT8L2
AT9L2	AT5, AT6, AT6L2, AT7L2, AT8, AT8L2
AT10L2	AT5, AT6, AT6L2, AT7L2, AT8, AT8L2, AT9L2
AT10L3	AT5, AT6, AT6L2, AT7L2, AT8, AT8L2, AT8L3, AT9L2, AT10L2
DCT6	AT5
DCT8	AT5, DCT6
CVT	AT5
CVTL2	AT5, AT6, AT6L2, CVT
IACC	EPS
SS12V	CONV
BISG	CONV, SS12V
SHEVP2	All Transmission Technologies, CONV, SS12V, BISG
SHEVPS	All Engine and Transmission Technologies, CONV, SS12V, BISG
P2HCR0	All Engine and Transmission Technologies, CONV, SS12V, BISG
P2HCR1	All Engine and Transmission Technologies, CONV, SS12V, BISG, P2HCR0
P2HCR2	All Engine and Transmission Technologies, CONV, SS12V, BISG, P2HCR0, P2HCR1
PHEV20	All Engine and Transmission Technologies, CONV, SS12V, BISG, SHEVP2, SHEVPS, P2HCR0, P2HCR1, P2HCR2
PHEV50	All Engine and Transmission Technologies, CONV, SS12V, BISG, SHEVP2, SHEVPS, P2HCR0, P2HCR1, P2HCR2, PHEV20
PHEV20T	All Engine and Transmission Technologies, CONV, SS12V, BISG, SHEVP2, SHEVPS, P2HCR0, P2HCR1, P2HCR2
PHEV50T	All Engine and Transmission Technologies, CONV, SS12V, BISG, SHEVP2, SHEVPS, P2HCR0, P2HCR1, P2HCR2, PHEV20T
PHEV20H	All Engine and Transmission Technologies, CONV, SS12V, BISG, SHEVP2, SHEVPS, P2HCR0, P2HCR1, P2HCR2
PHEV50H	All Engine and Transmission Technologies, CONV, SS12V, BISG, SHEVP2, SHEVPS, P2HCR0, P2HCR1, P2HCR2, PHEV20H

Technology	Superseded Technologies
BEV200	All Engine and Transmission Technologies, CONV, SS12V, BISG, SHEVP2, SHEVPS, P2HCR0, P2HCR1, P2HCR2, PHEV20, PHEV50, PHEV20T, PHEV50T, PHEV20H, PHEV50H
BEV300	All Engine and Transmission Technologies, CONV, SS12V, BISG, SHEVP2, SHEVPS, P2HCR0, P2HCR1, P2HCR2, PHEV20, PHEV50, PHEV20T, PHEV50T, PHEV20H, PHEV50H, BEV200
FCV	All Engine and Transmission Technologies, CONV, SS12V, BISG, SHEVP2, SHEVPS, P2HCR0, P2HCR1, P2HCR2, PHEV20, PHEV50, PHEV20T, PHEV50T, PHEV20H, PHEV50H
ROLL10	ROLL0
ROLL20	ROLL0, ROLL10
AERO5	AERO0
AERO10	AERO0, AERO5
AERO15	AERO0, AERO5, AERO10
AERO20	AERO0, AERO5, AERO10, AERO15
MR1	MR0
MR2	MR0, MR1
MR3	MR0, MR1, MR2
MR4	MR0, MR1, MR2, MR3
MR5	MR0, MR1, MR2, MR3, MR4
MR6	MR0, MR1, MR2, MR3, MR4, MR5

Notice that the supersession logic for many technologies may be deduced by following through the Technology Pathways Diagram presented in Figure 6 of Section S4.2.5 above, as well as following through the arrows between technologies for the individual pathways.

In addition to the supersession logic applicable to individual technologies, the modeling system defines additional constraints, where some combinations of technologies may not be concurrently present on the same vehicle, and are thus considered to be mutually exclusive. Section S4.2, above, discusses such constraints as they apply to the technology pathways. However, the relationships of mutual exclusivity defined for individual paths translate and may be adopted to individual technologies found within those pathways as well. For example, since the Manual and Automatic Transmission paths are defined to be mutually exclusive, each technology found on one of these paths (e.g., AT6) is automatically interpreted by the model as being mutually exclusive with all technologies from another path (i.e., MT5, MT6, MT7). Aside from the constraint classifications carried over from the associated pathways, the individual technologies may include additional relations of mutual exclusivity that are not formalized by the rules governing the accompanying paths. For example, as detailed earlier, the branch points found within a pathway are mutually exclusive, requiring additional “disabling” logic to be defined within the CAFE Model, in order to prevent a vehicle from simultaneously using multiple incompatible technologies. The specifics of the technologies that are disabled whenever a conflicting technology is used or applied on a vehicle are represented in the following table:

**Table 15. Technology Mutual Exclusivity Logic**

<b>Technology</b>	<b>Disabled Technologies</b>
EFR	DSLI, DSLIAD
TURBO1	SOHC, DOHC, VVT, VVL, SGDI, DEAC, ADEAC, HCR0, HCR1, HCR2, ADSL, DSLI, DSLIAD, CNG, PHEV20, PHEV50
TURBO2	SOHC, DOHC, VVT, VVL, SGDI, DEAC, TURBO1, ADEAC, HCR0, HCR1, HCR2, ADSL, DSLI, DSLIAD, CNG, PHEV20, PHEV50
CEGR1	SOHC, DOHC, VVT, VVL, SGDI, DEAC, TURBO1, TURBO2, ADEAC, HCR0, HCR1, HCR2, ADSL, DSLI, DSLIAD, CNG, PHEV20, PHEV50
ADEAC	SOHC, DOHC, VVT, VVL, SGDI, DEAC, TURBO1, TURBO2, CEGR1, HCR0, HCR1, HCR2, VCR, VTG, VTGE, ADSL, DSLI, DSLIAD, CNG
HCR0	All Other Engine Technologies (Except EFR, HCR0, HCR1, and HCR2)
HCR1	All Other Engine Technologies (Except EFR, HCR1, and HCR2)
HCR2	All Other Engine Technologies (Except EFR and HCR2)
VCR	All Other Engine Technologies (Except EFR and VCR), PHEV20, PHEV50
VTG	All Other Engine Technologies (Except EFR, VTG, and VTGE), PHEV20, PHEV50
VTGE	All Other Engine Technologies (Except EFR and VTGE), CONV, SS12V, BISG, SHEVP2, PHEV20, PHEV50
TURBOD	All Other Engine Technologies (Except EFR, TURBOD, and TURBOAD), PHEV20, PHEV50
TURBOAD	All Other Engine Technologies (Except EFR and TURBOAD), PHEV20, PHEV50
ADSL	All Other Engine Technologies (Except EFR, ADSL, DSLI, and DSLIAD), SHEVPS, P2HCR0, P2HCR1, P2HCR2, PHEV20, PHEV50, PHEV20T, PHEV50T, PHEV20H, PHEV50H
DSLI	All Other Engine Technologies (Except DSLI and DSLIAD), SHEVPS, P2HCR0, P2HCR1, P2HCR2, PHEV20, PHEV50, PHEV20T, PHEV50T, PHEV20H, PHEV50H
DSLIAD	All Other Engine Technologies (Except DSLIAD), SHEVP2, SHEVPS, P2HCR0, P2HCR1, P2HCR2, PHEV20, PHEV50, PHEV20T, PHEV50T, PHEV20H, PHEV50H
CNG	All Other Technologies
MT5	All Automatic Transmission Path Technologies
MT6	All Automatic Transmission Path Technologies, MT5
MT7	All Automatic Transmission Path Technologies, MT5, MT6
AT5	MT5, MT6, MT7, CVT
AT6	MT5, MT6, MT7, AT5, DCT6, DCT8, CVT
AT6L2	MT5, MT6, MT7, AT5, AT6, AT8, DCT6, DCT8, CVT
AT7L2	MT5, MT6, MT7, AT5, AT6, AT6L2, AT8, DCT6, DCT8, CVT, CVTL2
AT8	MT5, MT6, MT7, AT5, AT6, AT6L2, AT7L2, DCT6, DCT8, CVT, CVTL2
AT8L2	MT5, MT6, MT7, AT5, AT6, AT6L2, AT7L2, AT8, DCT6, DCT8, CVT, CVTL2
AT8L3	MT5, MT6, MT7, AT5, AT6, AT6L2, AT7L2, AT8, AT8L2, AT9L2, AT10L2, DCT6, DCT8, CVT, CVTL2
AT9L2	MT5, MT6, MT7, AT5, AT6, AT6L2, AT7L2, AT8, AT8L2, AT8L3, DCT6, DCT8, CVT, CVTL2
AT10L2	MT5, MT6, MT7, AT5, AT6, AT6L2, AT7L2, AT8, AT8L2, AT8L3, AT9L2, DCT6, DCT8, CVT, CVTL2
AT10L3	MT5, MT6, MT7, AT5, AT6, AT6L2, AT7L2, AT8, AT8L2, AT8L3, AT9L2, AT10L2, DCT6, DCT8, CVT, CVTL2
DCT6	MT5, MT6, MT7, AT5, AT6, AT6L2, AT7L2, AT8, AT8L2, AT8L3, AT9L2, AT10L2, AT10L3, CVT, CVTL2

<b>Technology</b>	<b>Disabled Technologies</b>
DCT8	MT5, MT6, MT7, AT5, AT6, AT6L2, AT7L2, AT8, AT8L2, AT8L3, AT9L2, AT10L2, AT10L3, DCT6, CVT, CVTL2
CVT	MT5, MT6, MT7, AT5, AT6, AT6L2, AT7L2, AT8, AT8L2, AT8L3, AT9L2, AT10L2, AT10L3, DCT6, DCT8
CVTL2	MT5, MT6, MT7, AT5, AT6, AT6L2, AT7L2, AT8, AT8L2, AT8L3, AT9L2, AT10L2, AT10L3, DCT6, DCT8, CVT
IACC	EPS
SS12V	CONV
BISG	CONV, SS12V
SHEVP2	All Transmission Technologies, VTGE, DSLIAD, CONV, SS12V, BISG, SHEVPS, P2HCR0, P2HCR1, P2HCR2, PHEV20H, PHEV50H
SHEVPS	All Engine and Transmission Technologies, CONV, SS12V, BISG, SHEVP2, P2HCR0, P2HCR1, P2HCR2, PHEV20H, PHEV50H
P2HCR0	All Engine and Transmission Technologies, CONV, SS12V, BISG, SHEVP2, SHEVPS, PHEV20, PHEV50
P2HCR1	All Engine and Transmission Technologies, CONV, SS12V, BISG, SHEVP2, SHEVPS, P2HCR0, PHEV20, PHEV50
P2HCR2	All Engine and Transmission Technologies, CONV, SS12V, BISG, SHEVP2, SHEVPS, P2HCR0, P2HCR1, PHEV20, PHEV50
PHEV20	All Engine and Transmission Technologies, CONV, SS12V, BISG, SHEVP2, SHEVPS, P2HCR0, P2HCR1, P2HCR2, PHEV20T, PHEV50T, PHEV20H, PHEV50H
PHEV50	All Engine and Transmission Technologies, CONV, SS12V, BISG, SHEVP2, SHEVPS, P2HCR0, P2HCR1, P2HCR2, PHEV20, PHEV20T, PHEV50T, PHEV20H, PHEV50H
PHEV20T	All Engine and Transmission Technologies, CONV, SS12V, BISG, SHEVP2, SHEVPS, P2HCR0, P2HCR1, P2HCR2, PHEV20, PHEV50, PHEV20H, PHEV50H
PHEV50T	All Engine and Transmission Technologies, CONV, SS12V, BISG, SHEVP2, SHEVPS, P2HCR0, P2HCR1, P2HCR2, PHEV20, PHEV50, PHEV20T, PHEV20H, PHEV50H
PHEV20H	All Engine and Transmission Technologies, CONV, SS12V, BISG, SHEVP2, SHEVPS, P2HCR0, P2HCR1, P2HCR2, PHEV20, PHEV50, PHEV20T, PHEV50T
PHEV50H	All Engine and Transmission Technologies, CONV, SS12V, BISG, SHEVP2, SHEVPS, P2HCR0, P2HCR1, P2HCR2, PHEV20, PHEV50, PHEV20T, PHEV50T, PHEV20H
BEV200	All Engine, Transmission, Electrification Path, and Hybrid/Electric Path Technologies (Except BEV200 and BEV300)
BEV300	All Engine, Transmission, Electrification Path, and Hybrid/Electric Path Technologies (Except BEV300)
FCV	All Engine, Transmission, Electrification Path, and Hybrid/Electric Path Technologies (Except FCV)
ROLL10	ROLL0
ROLL20	ROLL0, ROLL10
AERO5	AERO0
AERO10	AERO0, AERO5
AERO15	AERO0, AERO5, AERO10
AERO20	AERO0, AERO5, AERO10, AERO15
MR1	MR0
MR2	MR0, MR1
MR3	MR0, MR1, MR2

Technology	Disabled Technologies
MR4	MR0, MR1, MR2, MR3
MR5	MR0, MR1, MR2, MR3, MR4
MR6	MR0, MR1, MR2, MR3, MR4, MR5

In the table above, notice that any superseded technology is also disabled whenever a succeeding technology is applied to a vehicle, even if a specific superseded technology was not previously used on that vehicle. As previously emphasized, this requirement exists so that the modeling system does not downgrade technologies during analysis.

#### **S4.6 Technology Fuel Economy Improvements**

For the majority of the technologies analyzed within the CAFE Model, the fuel economy improvements were derived from a database containing detailed vehicle simulation results, analyzed at ANL using the Autonomie model. In addition to the technologies found in the Argonne simulation database, the modeling system also incorporates a handful of “*add-on*” technologies that were required for CAFE modeling, but were not explicitly simulated by Argonne. The Argonne simulated and the add-on technologies were then externally combined, forming a single dataset of simulation results (from here on referred to as *vehicle simulation database*, or simply, *database*), which may then be used by the modeling system. Since the system accepts this database as an input, the way by which these technologies were combined is beyond the scope of this document, and is instead addressed in the Preamble.

In order to incorporate the results of the combined database of Argonne simulated and add-on technologies, while still preserving the basic structure of the CAFE Model’s technology subsystem, it was necessary to translate the points in this database into corresponding locations defined by the technology pathways, described in Section S4.2 above. By recognizing that most of the pathways are unrelated, and are only logically linked to designate the direction in which technologies are allowed to progress, it is possible to condense the paths into a smaller number of groups based on the specific technology. Additionally, to allow for technologies present on the Basic Engine and DLR paths to be evaluated and applied in any given combination, a unique group was established for each of these technologies.

As such, the following technology groups are defined within the modeling system: engine cam configuration (CONFIG), VVT engine technology (VVT), VVL engine technology (VVL), SGDI engine technology (SGDI), DEAC engine technology (DEAC), non-basic engine technologies (ADVENG),<sup>20</sup> transmission technologies (TRANS), electrification and hybridization (ELEC), low rolling resistance tires (ROLL), aerodynamic improvements (AERO), mass reduction levels (MR), EFR engine technology (EFR), electric accessory improvement technologies (ELECACC), LDB technology (LDB), and SAX technology (SAX). The combination of technologies along each of these groups forms a unique technology state vector and defines a unique technology combination that corresponds to a single point in the database for each technology class evaluated within the

---

<sup>20</sup> The ADVENG group includes all technologies found in the following pathways: Turbo, HCR, ADEAC, VCR, VTG, Adv. Turbo, Alt. Fuel, and Diesel.

modeling system. Utilizing these technology state vectors, the CAFE Model can then assign each vehicle in the analysis fleet an initial state that corresponds to a point in the database.

Once a vehicle is assigned (or mapped) to an appropriate technology state vector (from one of approximately three million unique combinations, which are defined in the vehicle simulation database as CONFIG;VVT;VVL;SGDI;DEAC;ADVENG;TRANS;ELEC;ROLL;AERO;MR;EFR;ELECACC;LDB;SAX), adding a new technology to the vehicle simply represents progress from a *previous state vector* to a *new state vector*. The previous state vector simply refers to the technologies that are currently in use on a vehicle. The new state vector, however, is computed within the modeling system by adding a new technology to the combination of technologies represented by the previous state vector, while simultaneously removing any other technologies that are superseded by the newly added one.

For example, consider a vehicle with a SOHC engine, variable valve timing, 6-speed automatic transmission, belt-integrated starter generator, low rolling resistance tires (level 1), aerodynamic improvements (level 2), mass reduction (level 1), electric power steering, and low drag brakes. An associated technology state vector describing this vehicle would be specified as: SOHC;VVT;;;;; AT6;BISG;ROLL10; AERO20;MR1;;EPS;LDB;. <sup>21</sup> Assume the system is evaluating PHEV20 as a candidate technology for application on this vehicle. As can be observed from Table 14, PHEV20 supersedes all engine and transmission technologies, along with CONV, SS12V, BISG, SHEVP2, SHEVPS, P2HCR0, P2HCR1, and P2HCR2. The new state vector for this vehicle is, hence, computed by removing SOHC, VVT, AT6, and BISG technologies from the previous state vector, before adding PHEV20, resulting in the following: PHEV20;ROLL10;AERO20;MR1;EPS;LDB.

From here, it is relatively simple to obtain a fuel economy improvement factor for any new combination of technologies and apply that factor to the fuel economy of a vehicle in the analysis fleet. As such, the formula for calculating a vehicle's fuel economy after application of each successive technology represented within the database is defined as:

$$FE_{New} = FE \times \frac{F_{Prev}}{F_{New}} \quad (5)$$

Where:

- $FE$  : the original fuel economy for the vehicle, in mpg,
- $F_{Prev}$  : the fuel economy improvement factor associated with the technology state vector before application of a candidate technology,
- $F_{New}$  : the fuel economy improvement factor associated with the technology state vector after application of a candidate technology, and
- $FE_{New}$  : the resulting fuel economy for the same vehicle, in mpg.

---

<sup>21</sup> In the example technology state vector, the series of semicolons between VVT and AT6 correspond to the engine technologies which are not included as part of the combination, while the gap between MR1 and EPS corresponds to EFR and the omitted technology after LDB is SAX. The extra semicolons for omitted technologies are preserved in this example for clarity and emphasis, and will not be included in future examples.

The fuel economy improvement factor is defined in a way that captures the incremental improvement of moving between points in the database, where each point is defined uniquely as a combination of up to 15 distinct technologies describing, as mentioned above, the engine's cam configuration, multiple distinct combinations of engine technologies, transmission, electrification type, and various vehicle body level technologies.

For some technologies, the modeling system may convert a vehicle or a vehicle's engine from operating on one type of fuel to another. For example, application of Advanced Diesel (ADSL) technology converts a vehicle from gasoline operation to diesel operation. In such a case, the aforementioned Equation (5) still applies, however, the  $FE_{New}$  value is assigned to the vehicle's new fuel type, while the fuel economy on the original fuel is discarded.

Moreover, whenever the modeling system converts a vehicle model to one of the available Plug-In Hybrid/Electric vehicles (e.g., PHEV20), that vehicle is assumed to operate simultaneously on gasoline and electricity fuel types. In this case, the model obtains two sets of fuel economy improvement factors,  $F_{New}$  and  $F2_{New}$ , from the vehicle simulation database for estimating the  $FE_{New}$  values on gasoline and electricity, respectively. In the case of gasoline, Equation (5) is used to obtain the new fuel economy on gasoline. For electricity, since no reference fuel economy exists prior to conversion to PHEV20, the  $F2_{New}$  value is defined as an improvement over  $FE_{Prev}$  value on gasoline. That is, for calculating the fuel economy on electricity when upgrading a vehicle to PHEV30, Equation (5) becomes:

$$FE_{New,E} = FE_G \times \frac{F_{Prev}}{F2_{New}} \quad (6)$$

Where:

- $FE_G$  : the original fuel economy for the vehicle, in mpg, when operating on gasoline,
- $F_{Prev}$  : the fuel economy improvement factor associated with the technology state vector before application of a candidate technology,
- $F2_{New}$  : the fuel economy improvement factor associated with the technology state vector after application of a candidate technology, and
- $FE_{New,E}$  : the resulting fuel economy for the same vehicle, in mpg, when operating on electricity.

Just as no reference fuel economy on electricity exists on a vehicle prior to application of PHEV20 technology, a reference fuel economy improvement factor would not exist in the database either. For this reason, Equation (6) above uses  $F_{Prev}$  factor when calculating the new vehicle fuel economy on electricity. Since both  $FE_G$  and  $F_{Prev}$  refer to the same reference state, Equation (6) mathematically applies and produces accurate results with regard to the vehicle simulation database.<sup>22</sup>

---

<sup>22</sup> Readers are invited to validate the calculations presented by this and other equations for accuracy.

Additionally for PHEVs, the *Secondary FS* field, defined in the technologies input file, specifies the assumed amount of miles driven by the vehicle when operating on electricity. The vehicle’s overall rated fuel economy is then defined as the average of the fuel economies on gasoline and electricity, weighted by the fuel shares.<sup>23</sup> If the system transitions to PHEV50 from PHEV20, the same calculation applies, however, this time,  $F2_{Prev}$  is used and the  $F2_{New}$  value is defined as a fuel economy improvement factor over  $FE_E$  (or, fuel economy on electricity):

$$FE_{New,E} = FE_E \times \frac{F2_{Prev}}{F2_{New}} \quad (7)$$

Where:

- $FE_E$  : the original fuel economy for the vehicle, in mpg, when operating on electricity,
- $F2_{Prev}$  : the fuel economy improvement factor associated with the technology state vector before application of a candidate technology,
- $F2_{New}$  : the fuel economy improvement factor associated with the technology state vector after application of a candidate technology, and
- $FE_{New,E}$  : the resulting fuel economy for the same vehicle, in mpg, when operating on electricity.

Whenever the system further improves an existing PHEV, for example, converting it from a PHEV50 to a 200-mile Electric Vehicle (BEV200), the gasoline fuel component is removed, while the electric-operated portion remains. In this case, the  $F_{Prev}$  value, obtained from the simulation database, represents a fuel economy improvement factor over  $FE_E$  on PHEV50’s electricity component. Similarly, when a vehicle is converted to a Fuel Cell Vehicle (FCV) instead of BEV200, the same conversion logic applies, except the final fuel economy,  $FE_{New}$ , is defined on hydrogen fuel type.

#### S4.6.1 Fuel Economy Adjustments

Unlike the preceding versions of the modeling system, the current version of the CAFE Model relies entirely on the vehicle simulation database for calculating fuel economy improvements resulting from all technologies available to the system. The fuel economy improvements are derived from the factors defined for each unique technology combination or state vector. As defined in Equation (5) above, each time the improvement factor for a new state vector is added to a vehicle’s existing fuel economy, the factor associated with the old technology combination is entirely removed. In that sense, application of technologies obtained from the Argonne database is “self-correcting” within the model. As such, special-case adjustments defined by the previous version of the model are not applicable to this one.

---

<sup>23</sup> The overall fuel economy for PHEVs is the rated value achieved by the vehicle assuming on-road operation specified by the *Secondary FS* field. For compliance purposes, the vehicle’s overall fuel economy is determined by the *Multi-Fuel* and the *PHEV Share* parameters defined in the scenarios input file. The scenarios input file is further discussed in Section A.4 of Appendix A.



## **S4.7 Technology Cost Tables**

The technology input assumptions, as defined in the technologies input file, provide a fully “learned-out” table of year-by-year technology costs, as specified by the *Cost Table* section. As mentioned earlier, the technology costs that are associated with a vehicle’s engine are specified for each engine technology class, while the costs associated with non-engine components of a technology are defined for each vehicle technology class. When evaluating a given technology for application on a vehicle, the modeling system, hence, combines the engine and the non-engine cost components to form the overall cost of that technology.

For almost all technologies available within the modeling system, the costs are defined in the technologies input file on an absolute basis over some reference technology state, usually within the same technology path. For example, MR0 is the reference technology state for the Mass Reduction path, with all succeeding Mass Reduction technologies being defined in terms of absolute cost (and improvement) over MR0. In most cases, when the CAFE Model computes the incremental cost of a successor technology, the cost of a predecessor technology (if one exists) will be negated. Furthermore, if the vehicle being upgraded from a reference technology state (for example, MR0), to simplify the internal accounting process, the system will still negate the cost of MR0, even though that technology is designated as a reference state. In some cases, however, a predecessor does not exist, and the technology is applied without negating any other. Specifically, the following technologies do not have a predecessor state defined, and are applied by the modeling system directly (or on an incremental basis): VVT, VVL, SGDI, DEAC, EFR, EPS, LDB, and SAX. In other cases (i.e., all technologies on the Hybrid/Electric path), multiple predecessor technologies exist, the costs of which must be negated before a new technology may be applied. Additionally, for all technologies on the Mass Reduction path, the input costs are specified on per pound basis, where the base cost value is multiplied by the amount of pounds by which a vehicle’s glider weight is reduced, in order to obtain the full cost of applying the technology.

Generally, the technology supersession logic, as defined in Table 14, dictates the predecessor technologies for which the costs will be negated when a successor technology is applied. However, note that if a technology on a superseded list was previously superseded, its cost will not be negated for a second time. As an example, consider a vehicle with a DOHC engine that also uses VVT and SGDI engine technologies (the rest of the technologies are not relevant for this example). Assume the same vehicle transitions to TURBO2 technology. From Table 14, it can be seen that when the model applies TURBO2, it also supersedes: SOHC, DOHC, VVT, VVL, SGDI, DEAC, and TURBO1 technologies. Of those on the superseded list, the costs of DOHC, VVT, and SGDI are negated prior to adding the cost TURBO2, as those technologies are currently in use on a vehicle in the example. If the same vehicle later upgrades to VTG, following the same logic (and referring back to Table 14), the cost of TURBO2 is negated prior to adding the cost of VTG. Note that, even though DOHC, VVT, and SGDI were used on the example vehicle, these technologies have previously been superseded (and accounted for) when the vehicle was upgraded to TURBO2. Thus, they are not counted for a second time.

For another example, consider the vehicle from above also uses AT8, BISG, and EPS. This time, assume it is converted to SHEVPS. Again referring back to Table 14, it can be seen that SHEVPS supersedes all engine and transmission technologies, as well as CONV, SS12V, and BISG. Thus,

the costs of engine technologies DOHC, VVT, and SGDI (as before) are negated, along with the costs of AT8 and BISG, before the cost of SHEVPS may be added. Note that EPS is not being superseded by SHEVPS, and therefore its cost is not removed.

As discussed in Section S4.6 above, application of a new candidate technology on a vehicle is a transition from a previous state vector to a new state vector. Taking this into account, the procedure outlined above, where incremental cost attributed to a specific technology is calculated by adjusting for superseded technologies, may be greatly simplified. This is achieved by computing the cumulate absolute costs for the technology combinations represented by the previous and the new state vectors, then taking the difference in order to obtain the net incremental cost. Hence, the calculation of incremental technology cost for a given vehicle during a specific model year is outlined by the following equation:

$$TechCost_{MY} = Cost_{New,MY} - Cost_{Prev,MY} \quad (8)$$

Where:

- $MY$  : the model year for which to calculate incremental cost attributed to application of a candidate technology on a specific vehicle,
- $Cost_{Prev,MY}$  : the cumulate cost associated with the technology state vector before application of a candidate technology on a specific vehicle in model year  $MY$ ,
- $Cost_{New,MY}$  : the cumulate cost associated with the technology state vector after application of a candidate technology on a specific vehicle in model year  $MY$ , and
- $TechCost_{MY}$  : the resulting net cost attributed to application of a candidate technology on a specific vehicle in model year  $MY$ .

As stated previously, in Equation (8),  $Cost_{Prev,MY}$  and  $Cost_{New,MY}$  are simply the sum of costs across individual technologies defined by the respective state vectors. The calculation of both of these costs is given by the following equation:

$$Cost_{TechState,MY} = \sum_{i=0}^n \left( (Cost_{MY,i,Veh} + Cost_{MY,i,Eng}) \times \begin{cases} GW_{Ref} \times \Delta W, & i = MR \\ 1, & i \neq MR \end{cases} \right) \quad (9)$$

Where:

- $MY$  : the model year for which to calculate the cumulative cost associated with a specific technology state vector and a specific vehicle,
- $TechState$  : the technology state vector (previous or new) for which to calculate the cumulative cost,
- $Cost_{MY,i,Veh}$  : the base cost of non-engine components, if applicable, attributed to application of the  $i$ -th technology defined within the state vector  $TechState$ , on a specific vehicle in model year  $MY$ ,

- $Cost_{MY,i,Eng}$  : the base cost of engine-specific components, if applicable, attributed to application of the  $i$ -th technology defined within the state vector  $TechState$ , on a specific vehicle in model year  $MY$ ,
- $i = MR$  : indicates whether the  $i$ -th technology is a mass reduction technology,
- $i \neq MR$  : indicates whether the  $i$ -th technology is not a mass reduction technology,
- $GW_{Ref}$  : the estimated *reference* weight of the vehicle's glider,<sup>24</sup>
- $\Delta W$  : the percent reduction of the vehicle's reference glider weight,  $GW_{Ref}$ , attributed to application of the  $i$ -th technology defined within the state vector,<sup>25</sup> and
- $Cost_{TechState,MY}$  : the resulting cumulate cost associated with the technology state vector  $TechState$ , for a specific vehicle in model year  $MY$ .

Note that the costs computed by Equations (8) and (9) above are defined strictly for the non-battery components of a technology. As discussed in Section S4.7.1 below, for some technologies (or technology combinations), the modeling system additionally accounts for costs related to varying battery sizes. Furthermore,  $GW_{Ref}$  and  $\Delta W$  in Equation (9) are applicable to mass reduction technologies only. For any  $i$ -th technology that is not a mass reduction technology within the state vector  $TechState$ , the  $GW_{Ref} \times \Delta W$  product is removed from the calculation and is substituted by a value of 1.

Along with the base *Cost Table*, the input assumptions also define the *Maintenance and Repair Cost Table*, which is also specified for each model year and accounts for the learning effect, wherever applicable. The *Maintenance and Repair Cost Table* identifies the changes in the amount buyers are expected to pay for maintaining a new vehicle,<sup>26</sup> as well as the increases in non-warranty repair costs attributed to application of additional technology. Further discussion of the technology cost input assumptions can be found in Section A.2 of Appendix A.

#### S4.7.1 Battery Costs

For some of the technologies evaluated within the CAFE Model, the system provides the ability to separately account for costs related to varying vehicle battery sizes, depending on the overall configuration of the vehicle (i.e., engine, transmission, electrification, hybridization, and other various body level improvements). As with fuel economy improvement factors (discussed earlier), the battery costs are obtained from the vehicle simulation database, which includes technologies simulated using the Autonomie model at ANL, as well as a hand full of add-on technologies. Thus,

---

<sup>24</sup> The reference glider weight,  $GW_{Ref}$ , for a vehicle is defined as the vehicle's reference curb weight multiplied by the average share of the vehicle's total curb weight attributable to its glider. The reference curb weight of the vehicle is specified as a parameter in the input fleet, and is estimated by backing out any mass reduction technology that may be present on that vehicle. The calculation of the *reference* glider weight is further discussed in Section S4.8 below.

<sup>25</sup> The percent reduction of vehicle's glider weight,  $\Delta W$ , is specified for each mass reduction technology in the input assumptions.

<sup>26</sup> The maintenance costs may lead to increases in cost to consumers, such as for advanced diesel engines, or in cost saving to consumers, such as for electric vehicles. In the case of electric vehicles, the cost savings result from avoiding traditional vehicle maintenance such as engine oil changes.

the system relies on the same unique technology state vector assignment of a vehicle (as defined in Section S4.6 above) when progressing from one technology to the next.

The CAFE Model includes discrete accounting of battery costs during analysis whenever a vehicle evaluates for application or already includes a technology from either the Electrification or Hybrid/Electric paths. Even though VTGE is an engine-level technology, the modeling system assumes that this technology explicitly includes the cost, improvement, and full utility attributable to BISG. Therefore, the system also needs to account for battery costs whenever a vehicle evaluates or includes VTGE technology.

As an example, consider a vehicle that uses a combination of technologies defined by the state vector: DOHC;VVT;AT6;CONV;ROLL0;AERO0;MR1. When this vehicle progresses to **BISG** technology (from the Electrification path), the model calculates battery costs for the resulting combination, which now includes the Belt-integrated Starter/Generator. Alternatively, consider a vehicle with a technology state vector that already includes a Hybrid/Electric technology as: PHEV20;ROLL20;AERO10;MR2. When the vehicle applies **MR3** technology, the model still calculates battery costs attributed to the new technology state vector, since the resulting combination includes PHEV20. In the latter example, however, the model would produce an incremental change in cost in order to capture the effect of different battery size requirements between a 20-mile plug-in hybrid/electric vehicle with a level-2 mass reduction and a level-3 mass reduction.

Since the vehicle simulation database provides a single cost value for each technology state vector, the modeling system accommodates an additional table of by-year learning rate multipliers defined within the technologies input file. Together, the two combine to produce a fully learned-out cost value for each technology state vector during each model year, as defined by the following equation:

$$BatteryCost_{MY} = BatteryCost_{New} \times LR_{MY,New} - BatteryCost_{Prev} \times LR_{MY,Prev} \quad (10)$$

Where:

- MY* : the model year for which to calculate the incremental battery cost of a candidate technology,
- BatteryCost<sub>Prev</sub>* : the base battery cost associated with the technology state vector before application of a candidate technology,
- LR<sub>MY,Prev</sub>* : the learning rate multiplier associated with the technology state vector before application of a candidate technology in model year *MY*,
- BatteryCost<sub>New</sub>* : the base battery cost associated with the technology state vector after application of a candidate technology,
- LR<sub>MY,New</sub>* : the learning rate multiplier associated with the technology state vector after application of a candidate technology in model year *MY*, and
- BatteryCost<sub>MY</sub>* : the resulting battery cost associated with the technology state vector attributed to application of a candidate technology in model year *MY*.

The learning rate multipliers,  $LR_{MY,New}$  and  $LR_{MY,Prev}$ , are defined in the technology input assumptions for each applicable technology.

Once the model obtains the battery cost associated with a specific candidate technology, the total cost from application of that technology may be calculated by combining the results of Equations (8) and (10) as:

$$TotalCost_{MY} = TechCost_{MY} + BatteryCost_{MY} \quad (11)$$

Where:

- $MY$  : the model year for which to calculate the total cost of a candidate technology,
- $TechCost_{MY}$  : the non-battery cost attributed to application of a candidate technology in model year  $MY$ ,
- $BatteryCost_{MY}$  : the battery cost associated with the technology state vector attributed to application of a candidate technology in model year  $MY$ , and
- $TotalCost_{MY}$  : the resulting total cost attributed to application of a candidate technology in model year  $MY$ .

#### **S4.8 Application of Mass Reduction Technology**

Each time the modeling system evaluates a mass reduction technology for application, the curb weight of a vehicle is reduced by some percentage, as defined in the technology input assumptions, with respect to that vehicle's *reference* glider weight. Within the model, the glider weight is defined as the portion of the vehicle's curb weight that is eligible for mass reduction and does not include engine, transmission, or interior safety systems.<sup>27</sup> The calculation for the reference glider weight is then defined by the following:

$$GW_{Ref} = CW_{Ref} \times \Delta GS \quad (12)$$

Where:

- $CW_{Ref}$ : the reference curb weight of the vehicle, as defined in the input fleet, assuming that any mass reduction technology present on that vehicle has been negated,
- $\Delta GS$  : the assumed average share of the vehicle's total curb weight attributable to its glider, as defined in the technology input assumptions for each technology class, and
- $GW_{Ref}$ : the calculated reference glider weight of the vehicle.<sup>28</sup>

---

<sup>27</sup> The definition of the glider weight within the CAFE Model is specified in a way that matches the vehicle simulation results from ANL's Autonomie model.

<sup>28</sup> The CAFE Model necessitates the use of a reference glider weight in order to correlate to the simulation results found in the Argonne database, where all vehicle sizing for mass reduction application is based on the glider weight using the same methodology as defined in Equation (14). In other words, since Argonne modeling assumes each vehicle simulated begins with a base weight without any mass reduction, the vehicles analyzed by the CAFE Model must also be brought back to a pre-mass reduction state.

Once the reference glider weight has been determined for each vehicle, the system may calculate the changes in vehicles' curb weights attributed to application of mass reduction technology. Since the progression of all technologies available within modeling system is specified on an absolute basis (i.e., the preceding technology is removed when a new one is added, as described in Sections S4.2.4 and S4.7), the system calculates the change in curb weight as the difference between percent reduction attributed to the new candidate technology and the percent reduction of the greatest mass reduction technology in use on a vehicle. This calculation is better demonstrated by the following equation:

$$\Delta CW = GW_{Ref} \times (\Delta W_{New} - \Delta W_{Prev}) \quad (13)$$

Where:

- $GW_{Ref}$  : the reference glider weight of the vehicle, as calculated in Equation (12) above,
- $\Delta W_{New}$  : the percent reduction of the vehicle's reference glider weight,  $GW_{Ref}$ , attributed to application of the new mass reduction technology,
- $\Delta W_{Prev}$  : the percent reduction of the vehicle's reference glider weight,  $GW_{Ref}$ , attributed to the previously used mass reduction technology, and
- $\Delta CW$  : the amount by which a vehicle's curb weight is reduced as a result of applying new mass reduction technology.

From here, the vehicle's new curb weight is obtained by subtracting the change in weight from its original curb weight, as:

$$CW_{New} = CW - \Delta CW \quad (14)$$

Where:

- $CW$  : the original curb weight of the vehicle before application of new mass reduction technology,
- $\Delta CW$  : the amount by which a vehicle's curb weight is reduced as a result of applying new mass reduction technology, and
- $CW_{New}$  : the resulting curb weight of the vehicle after application of new mass reduction technology.

In addition to affecting the vehicle's curb weight, application of mass reduction technology may also influence the vehicle's new payload and towing capacities by way of adjusting the gross vehicle weight rating (GVWR) and the gross combined weight rating (GCWR) values. With the exception of pickups (the vehicles for which the vehicle style column in the input fleet is set to "Pickup"), the GVWR and GCWR changes are presently not calculated within the model for all light-duty vehicles (i.e., vehicles regulated as passenger cars or light trucks). For light-duty pickups, however, the GVWR value is reduced by the same amount as the curb weight (as shown in Equation (15) below), while GCWR does not change.

$$GVWR_{New} = GVWR - \Delta CW \quad (15)$$

Where:

- $GVWR$  : the original gross vehicle weight rating before application of new mass reduction technology,
- $\Delta CW$  : the amount by which a vehicle's GVWR is reduced as a result of applying new mass reduction technology, and
- $GVWR_{New}$ : the resulting GVWR of the vehicle after application of new mass reduction technology.

For 2b/3 vehicles (i.e., vehicles regulated as 2b/3 trucks), the degree by which GVWR and GCWR are affected is controlled in the scenarios input file through the *Payload Return* and *Towing Return* parameters. The modeling system uses these parameters when calculating changes in vehicle's GVWR and GCWR as shown in the following formulas:

$$\Delta GVWR = \text{MAX} \left( 8501, \text{MIN} \left( GVWR - (1 - P) \times \Delta CW, CW_{New} \times \left( \frac{GVWR}{CW} \right)_{MAX} \right) \right) \quad (16)$$

Where:

- $GVWR$  : the original GVWR of the vehicle before application of new mass reduction technology,
- $\Delta CW$  : the amount by which a vehicle's curb weight is reduced as a result of applying new mass reduction technology, as defined in Equations (13) above,
- $CW_{New}$  : the curb weight of the vehicle after application of new mass reduction technology, as defined in Equations (14) above,
- $P$  : the percentage of curb weight reduction returned to payload capacity,
- $\left( \frac{GVWR}{CW} \right)_{MAX}$  : the limiting factor, defined for each input vehicle, preventing GVWR from increasing beyond levels observed among the majority of similar vehicles,
- $8501$  : the minimum GVWR at which a vehicle may be classified as a 2b/3 truck for regulatory purposes, and which is used to prevent 2b/3 vehicles from crossing into the light-duty category, and
- $\Delta GVWR$  : the amount by which a vehicle's GVWR is reduced as a result of applying new mass reduction technology.

$$\Delta GCWR = \text{MIN} \left( \begin{array}{l} GCWR - (1 - T) \times \Delta GVWR, \\ GVWR_{new} \times \left( \frac{GCWR}{GVWR} \right)_{MAX} \end{array} \right) \quad (17)$$

Where:

- $GCWR$  : the original GCWR of the vehicle before application of new mass reduction technology,
- $\Delta GVWR$  : the amount by which a vehicle's GVWR is reduced as a result of applying new mass reduction technology, as defined in Equations (16) above,
- $GVWR_{New}$  : the GVWR of the vehicle after application of new mass reduction technology, as defined in Equations (18) below,
- $T$  : the percentage of GVWR reduction returned to towing capacity,
- $\left( \frac{GCWR}{GVWR} \right)_{MAX}$  : the limiting factor, defined for each input vehicle, preventing GCWR from increasing beyond levels observed among the majority of similar vehicles, and
- $\Delta GCWR$  : the amount by which a vehicle's GCWR is reduced as a result of applying new mass reduction technology.

As with the calculation of the vehicle's new curb weight, the new GVWR and GCWR are obtained by subtracting  $\Delta GVWR$  and  $\Delta GCWR$  from the vehicle's original GVWR and GCWR, as:

$$GVWR_{New} = GVWR - \Delta GVWR \quad (18)$$

Where:

- $GVWR$  : the original GVWR of the vehicle before application of new mass reduction technology,
- $\Delta GVWR$  : the amount by which a vehicle's GVWR is reduced as a result of applying new mass reduction technology, and
- $GVWR_{New}$  : the resulting GVWR of the vehicle after application of new mass reduction technology.

$$GCWR_{New} = GCWR - \Delta GCWR \quad (19)$$

Where:

- $GCWR$  : the original GCWR of the vehicle before application of new mass reduction technology,
- $\Delta GCWR$  : the amount by which a vehicle's GCWR is reduced as a result of applying new mass reduction technology, and
- $GCWR_{New}$  : the resulting GCWR of the vehicle after application of new mass reduction technology.



## Section 5 Compliance Simulation

Having determined the applicability of technologies on each vehicle model, platform, engine, and transmission, the modeling system begins compliance simulation processing, iteratively evaluating each of the defined scenarios, model years, and manufacturers. As shown in Figure 7 below, compliance simulation follows a series of nested loops, or stages, progressing from one stage to the next, performing the necessary tasks, and then returning back to the previous stage for further processing. This process concludes when all available manufacturers, model years, iterations, and scenarios have been analyzed.

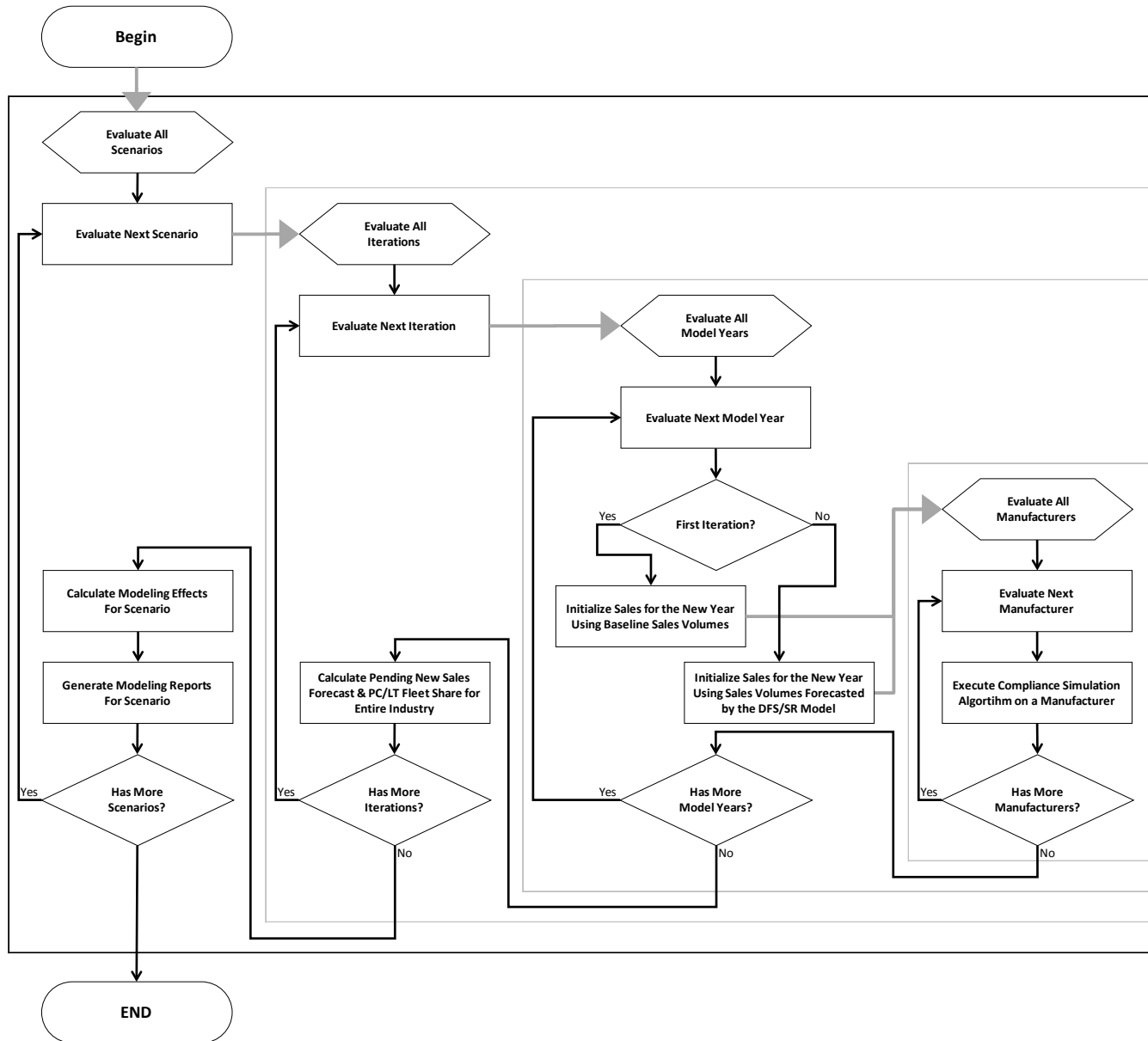

Figure 7. Compliance Simulation

Compliance simulation begins with evaluation of all of the regulatory scenarios defined in the scenarios input file. For each scenario, the system executes multiple iterations in order to achieve

a stable outcome (i.e., reach convergence), given the slightly varying sales forecasts between iterations. The first iteration is run as a reference case, relying on the sales volumes defined in the input fleet, while all subsequent iterations use the *output* of a preceding iteration to determine the *input* for the new one. The number of iterations that the modeling system considers during analysis is specified as a user input, which is available as a runtime switch within the model's user interface. However, testing conducted internally concluded that a stable solution was achieved after four iterations.

For each iteration, the system continues by examining all model years available during the study period. In each model year, the modeling system prepares the input fleet for analysis in one of two ways, depending on which iteration is being evaluated. For the first iteration, the system initializes vehicle sales for the current year based on the initial sales volumes specified in the input fleet. For all iterations after the first, the vehicle sales are initialized using the sales volumes forecasted by the Dynamic Fleet Share and Sales Response model (or, DFS/SR model), based on the outcome of the preceding iteration. Once the new sales forecast is updated for each vehicle, compliance simulation proceeds to analyzing all manufacturers defined in the input fleet. For each manufacturer, the *compliance simulation algorithm* (discussed below) is executed to determine a manufacturer's compliance state and, if necessary, apply additional technology to bring the manufacturer into compliance. After evaluating all manufacturers for a given model year, compliance simulation repeats the process with the next model year. Once all model years are exhausted, the system finalizes the evaluation of the current iteration by executing the DFS/SR model to obtain a forecast of new vehicle sales for each year evaluated, as discussed in Section S5.4 below. At the conclusion of the last iteration, the model completes the active scenario by calculating modeling effects (discussed in Chapter Three below) and generating modeling reports. This process then repeats for the next available scenario. After the system evaluates all scenarios, the compliance simulation process concludes.

In order to ascertain the compliance state of a manufacturer during compliance simulation, the modeling system continuously calculates the required and achieved levels attained by the manufacturer during each model year being evaluated. The CAFE Model supports analysis of compliance with standards defined by either the CAFE or the CO<sub>2</sub> program. Accordingly, the manufacturer's required and achieved levels computed by the model translate to either CAFE standard and rating or CO<sub>2</sub> standard and rating. However, while compliance may only be evaluated against only one compliance program at a time, in order to gauge the impact of one program upon another, the system simultaneously calculates all compliance metrics, as applicable to each program, during analysis.

In addition to calculating the required and achieved CAFE and CO<sub>2</sub> levels, the system also calculates credits earned by a manufacturer, where positive values represent overcompliance with a given standard, while negative values indicate a shortfall, or noncompliance. During analysis, the model may offset negative credits earned by transferring credits from a different regulatory class or carrying credits forward from an earlier model year. Likewise, if positive credits are earned, they may be transferred to a different regulatory class or carried forward to some later model year. To allow for this, the model maintains separate accounting of *credits in* and *credits*

*out* values, where each value is updated (as necessary) when a credit transaction is executed.<sup>29</sup> Collectively the credits earned, transferred or carried in, and transferred or carried out represent the net credits attributed to a manufacturer.

Lastly, for credits earned under the CAFE and CO<sub>2</sub> programs, the model calculates the valuation of those credits using the respective credit values defined in the regulatory scenario and the net credits accumulated by the manufacturer. When evaluating compliance with the CAFE program, the model also calculates civil penalties (or fines) incurred by a manufacturer for non-compliance based on the fine rate defined in the regulatory scenario and the manufacturer's net credits.<sup>30</sup>

The calculation of all aforementioned compliance metrics (standard, rating, credits, credit value, and fines) for both compliance programs are described in detail in the following two sections.

### **S5.1 CAFE Compliance Calculations**

When evaluating compliance with the CAFE program, the modeling system calculates the values for the standard (or the required CAFE value), CAFE rating (or the achieved CAFE value), credits earned (or for noncompliance, shortfall), value of net credits (or the value of credits earned adjusted by credits transferred in/out), and civil penalties (or fines) for each manufacturer. To determine the impact of technology application on a manufacturer's fleet, the model repeatedly performs all of the calculations before, during, and after each successive technology application. Since manufacturers are required to attain compliance independently in each class of vehicles, the standard, CAFE rating, credits, credit value, and fines are computed separately for each regulatory class.

Before the modeling system may begin compliance calculations for a manufacturer, an updated fuel economy target and fuel economy value (or rating) must be obtained for each vehicle model defined within the manufacturer's product line. The fuel economy target is calculated based on the user-supplied functional form, as described in Section 3 above, and is applicable irrespective of the fuel source the vehicle uses. The fuel economy rating, however, may be composed of one or more values corresponding to the different fuel types the vehicle operates on (i.e., flex-fuel or plug-in hybrid/electric vehicles). Prior to calculating the CAFE rating, the model computes a "combined" or average fuel economy value by harmonically averaging the individual components. Furthermore, as discussed in Section S2.1, the vehicle fuel economy value provided in the input fleet excludes all form of external credits and adjustments. When evaluating a manufacturer's compliance, in order to account for the credits accrued from vehicles that makes use of alternative fuels, the system applies a petroleum equivalency factor for any fuel type wherever appropriate. The calculation of the vehicle's "rated" and "compliance" fuel economy values is described in the next section.

---

<sup>29</sup> Credit transfers and carry forward are discussed in greater detail in Section S5.5 below.

<sup>30</sup> For calculating the value of CAFE and CO<sub>2</sub> credits and the CAFE civil penalties, the modeling system uses net credits accrued by the manufacturer, whenever it evaluates that manufacturer's compliance state. However, when the system calculates the impact and effective cost attributed to application of a candidate technology, it instead relies on the credits earned metric for the same credit valuation and civil penalty calculations.

In order to fully capture the incremental effect arising from technology application, the modeling system maintains the full precision of the vehicle’s fuel economy target and rating values (i.e., both are kept unrounded). When the standard is calculated (as specified by Equations (25) and (26) below), the resulting value is rounded to one decimal place (for light-duty vehicles) or two decimal places (for medium-duty vehicles). However, for the achieved CAFE value (as shown in Equations (29) and (30) further below), the vehicle fuel economy rating is rounded prior to use (to either one or two decimal places), while the CAFE rating remains unrounded until it is used for calculating the amount of CAFE credits earned by a manufacturer.

In each case, the rounding of any “mpg” value for compliance purposes is applied according to the following two equations. For light-duty regulatory classes (DC, IC, LT), the equation is:

$$mpg = \text{ROUND}(mpg, 1) \quad (20)$$

While for the medium-duty regulatory class (LT2b3), rounding is applied as:

$$mpg = \frac{100}{\text{ROUND}(100/mpg, 2)} \quad (21)$$

For light-duty regulatory classes, the fuel economy standards are set and regulated on a mile-per-gallon basis (mpg). Thus, with the exception of the vehicle target (which is specified as gpm), all fuel economy related calculations are computed in mpg as well. However, for the medium-duty regulatory class, the standards are set on a gallon-per-100-mile basis. To display a comparable unit of measure for all fuel economy related values produced in the model’s outputs, the modeling system converts and stores the standard and CAFE values for 2b/3 vehicles as mpg. Therefore, as shown in Equation (21) the *mpg* value is first converted from miles/gallon to gallons/100-miles, rounded to two decimal places, and then converted back to miles/gallon. The resulting value adheres to the rounding precision required when setting the standards for the medium-duty vehicles on a gallon-per-100-mile basis. However, in each case, the mpg value reported by the system will appear as unrounded.

### **S5.1.1 Calculation of Vehicle’s Fuel Economy**

As discussed in Section S2.1, the vehicle fuel economy value defined in the manufacturer’s input fleet represents a “rated” value, which specified for any fuel type the vehicle operates on. All fuel economy improvements associated with technology application are initially applied to this rated value. Then, when determining the compliance state of a manufacturer, the rated value is converted to a “compliance” value by applying a petroleum equivalency factor to select fuel types. During analysis, the modeling system uses the rated and compliance fuel economy values to produce the associated CAFE ratings for a manufacturer – one without the use of credits and adjustments, and the other with all credits and adjustments taken into account. At the end of the analysis, the system outputs both sets of the fuel economy values in the modeling reports.

As mentioned above, the fuel economy rating may be comprised of one or more subcomponents. Before it can be used for calculating the CAFE rating, an average value must be obtained. For single-fuel vehicles (i.e., vehicles operating exclusively on a single source of fuel), this equates to

the fuel economy rating on the specific fuel, while for dual-fuel vehicles, the fuel economy value is computed by harmonically averaging the individual components from the different fuel types, subject to the “Multi-Fuel,” “FFV Share,” and “PHEV Share” settings specified in the scenario definition. For all vehicles, the average fuel economy calculation may be generalized by the following equation:

$$FE = \sum_{FT} \frac{FS_{FT}}{FE_{FT}} \quad (22)$$

Where:

- $FT$  : the fuel type the vehicle operates on,
- $FS_{FT}$  : the percent share of miles driven by a vehicle when operating on fuel type  $FT$ ,
- $FE_{FT}$  : the fuel economy rating of the vehicle when operating on fuel type  $FT$ , and
- $FE$  : the average fuel economy rating of the vehicle, aggregated across all fuel types the vehicle operates on.

In Equation (22), when evaluating dual-fuel vehicles, the “Multi-Fuel” setting specified in the scenario definition may be configured to have the model ignore secondary fuel economy components when calculating the average fuel economy value.<sup>31</sup> In such a case, the system assumes that the vehicle operates exclusively on gasoline fuel for compliance purposes only. Additionally for dual-fuel vehicles, the fuel share value,  $FS_{FT}$ , may represent either the vehicle’s “on-road” share of miles or a specific regulatory value applicable for compliance purposes, as defined by the “FFV Share” and “PHEV Share” settings. Refer to Section A.4 of Appendix A for definitions of each of these scenario settings.

The value obtained from Equation (22) represents the average rated fuel economy of a vehicle. To obtain the average fuel economy value to use for compliance, the above equation is modified as in the following:

$$FE' = \sum_{FT} \frac{FS_{FT}}{(FE_{FT} \times PEF_{FT})} \quad (23)$$

Where:

- $FT$  : the fuel type the vehicle operates on,
- $FS_{FT}$  : the percent share of miles driven by a vehicle when operating on fuel type  $FT$ ,
- $FE_{FT}$  : the fuel economy rating of the vehicle when operating on fuel type  $FT$ ,
- $PEF_{FT}$ : the petroleum equivalency factor of fuel type  $FT$ , and
- $FE'$  : the average fuel economy rating of the vehicle, adjusted by the petroleum equivalency factor and aggregated across all fuel types the vehicle operates on.

---

<sup>31</sup> Within the context of the modeling system, for FFVs and PHEVs, gasoline is always assumed to be the primary fuel source for the vehicle, regardless of the actual on-road use.

In Equation (23), the petroleum equivalency factor,  $PEF_{FT}$ , varies depending on the associated fuel type. For gasoline and diesel fuels, this value is not applicable, and is thus interpreted as “1” in the equation above. For E85, hydrogen, and CNG fuel types, the  $PEF_{FT}$  is defined as:  $1 / 0.15$ . For electricity fuel type,  $PEF_{FT}$  varies depending on whether the vehicle is a BEV or a PHEV and is calculated as a “reference scalar” multiplied by the ratio of energy densities of electricity to gasoline, as shown in the equation below:

$$PEF_E = Scalar \times \frac{ED_E}{ED_G} \quad (24)$$

Where:

- Scalar*: the reference scalar for computing the petroleum equivalency factor of electricity, specified in kWh/gallon, where this value is 82.049 for BEVs (i.e., if a vehicle operates exclusively on electricity at the time of calculation) and 73.844 for PHEVs (i.e., the vehicle operates on a combination of gasoline and electricity at the time of calculation),
- $ED_E$  : the energy density of electricity, specified in BTU/kWh, as defined in the parameters input file,
- $ED_G$  : the energy density of gasoline, specified in BTU/gallon, as defined in the parameters input file, and
- $PEF_E$  : the petroleum equivalency factor of electricity.

### S5.1.2 Calculation of the CAFE Standard

The modeling system calculates the value of the CAFE standard using a sales-weighted harmonic average of the fuel economy targets applicable to each vehicle model of a specific regulatory class. This defines the manufacturer’s required fuel economy standard for regulatory class  $RC$  and is represented by the following equation:

$$STD_{RC} = \frac{\sum_{i \in V_{RC}} Sales_i}{\sum_{i \in V_{RC}} (Sales_i \times T_{FE,i})} \quad (25)$$

Where:

- $V_{RC}$  : a vector containing all vehicle models in regulatory class  $RC$ ,
- $Sales_i$  : the sales volume for a vehicle model  $i$ ,
- $T_{FE,i}$  : the fuel economy target (in gpm) applicable to a vehicle model  $i$ ,<sup>32</sup> and
- $STD_{RC}$  : the calculated fuel economy standard attributable to a manufacturer in regulatory class  $RC$ .

Equation (25) universally applies to an attribute-based standard (i.e., a functional form where a different fuel economy target is computed for each vehicle based on, for example, its footprint) as well as a flat standard (i.e., a functional form where each vehicle model has the same fuel economy

---

<sup>32</sup> Refer to Section 3 above for description and calculation of the vehicle’s fuel economy target.

target). However, for a flat standard, since with a common target the sales volumes of individual vehicle models cancel out, Equation (25) is reduced to the following:

$$STD_{RC} = T_{FE} \quad (26)$$

As stated in Section 3 above, vehicles regulated as domestic passenger automobiles are subject to a minimum domestic car standard, as specified in the scenario definition. Thus, for the Domestic Car class, the calculation of the standard is further refined as:

$$STD'_{DC} = \text{MAX}(Min_{Mpg}, Min\% \times STD_{PCAvg}, STD_{DC}) \quad (27)$$

Where:

- $Min_{Mpg}$  : the minimum CAFE standard that each manufacturer must attain, specified as a flat-standard in miles per gallon,
- $Min\%$  : the minimum CAFE standard that each manufacturer must attain, specified as a percentage of the combined Passenger Car standard,  $STD_{PCAvg}$ ,
- $STD_{PCAvg}$ : the average Passenger Car standard (for the DC and IC classes) calculated across all manufacturers defined in the input fleet,
- $STD_{DC}$  : the fuel economy standard attributable to a manufacturer in the Domestic Car regulatory class, before adjusting for the minimum domestic car standard, and
- $STD'_{DC}$  : the calculated fuel economy standard attributable to a manufacturer in the Domestic Car regulatory class, after adjusting for the minimum domestic car standard.

Since the minimum domestic car standard is applicable to vehicles regulated as domestic passenger automobiles, the  $Min_{Mpg}$  and  $Min\%$  variables are specified in the scenario definition for the Passenger Car class only. The  $STD_{PCAvg}$  value from Equation (27) is calculated by harmonically averaging the standards for the Domestic Car and Imported Car regulatory classes across all manufacturers defined in the input fleet, as shown in the following equation:

$$STD_{PCAvg} = \frac{\sum_{i \in M} (Sales_{i,DC} + Sales_{i,IC})}{\sum_{i \in M} \left( \frac{Sales_{i,DC}}{STD_{i,DC}} + \frac{Sales_{i,IC}}{STD_{i,IC}} \right)} \quad (28)$$

Where:

- $M$  : a vector containing all manufacturers defined within the input fleet,
- $Sales_{i,DC}$  : the sales volume for all vehicle models regulated as domestic passenger automobiles for a manufacturer  $i$ ,
- $Sales_{i,IC}$  : the sales volume for all vehicle models regulated as imported passenger automobiles for a manufacturer  $i$ ,
- $STD_{i,DC}$  : the fuel economy standard attributable to a manufacturer  $i$  in the Domestic Car regulatory class, before adjusting for the alternative minimum standard,

- $STD_{i,IC}$  : the fuel economy standard attributable to a manufacturer  $i$  in the Imported Car regulatory class,  
 $STD_{PCAvg}$ : the average Passenger Car standard (for the DC and IC classes) calculated across all manufacturers defined in the input fleet.

As described above, the values calculated by Equations (25), (26), and (27) are rounded to produce the final standard for a manufacturer.

### S5.1.3 Calculation of the CAFE Rating

Similar to the calculation of the standard, the CAFE rating is computed by taking a sales-weighted harmonic average of the individual fuel economies attained by each vehicle model for a specific regulatory class. The system first calculates the achieved CAFE value without any adjustments or credits that are supplied for each manufacturer in the input fleet or the off-cycle credits accrued through technology application. Within the context of the modeling system, and as reported in the model outputs, this value is referred to as the “2-cycle” CAFE rating, and is calculated for each regulatory class  $RC$  as:

$$CAFE_{RC} = \frac{\sum_{i \in V_{RC}} Sales_i}{\sum_{i \in V_{RC}} \frac{Sales_i}{FE_i}} \quad (29)$$

Where:

- $V_{RC}$  : a vector containing all vehicle models in regulatory class  $RC$ ,  
 $Sales_i$  : the sales volume for a vehicle model  $i$ ,  
 $FE_i$  : the “rated” average fuel economy (in mpg) attained by a vehicle model  $i$ , as calculated by Equation (22), and  
 $CAFE_{RC}$ : the calculated corporate average fuel economy (CAFE) achieved by a manufacturer in regulatory class  $RC$ , before application of FFV credits, off-cycle credits, or adjustments for improvements in air conditioning efficiency.

In addition to the 2-cycle CAFE rating, the modeling system also calculates the CAFE rating to use for compliance by applying any credit or adjustment available to the manufacturer. For each regulatory class, this calculation is defined by the following equation:

$$CAFE'_{RC} = \frac{CO2Factor_{RC}}{\frac{\sum_{i \in V_{RC}} Sales_i}{\sum_{i \in V_{RC}} Sales_i / FE_i} + FFVCredits_{RC}} - CrAdj_{RC} \quad (30)$$

Where:

- $CO2Factor_{RC}$  : the CO<sub>2</sub> factor to use for converting between fuel economy values and CO<sub>2</sub> values,  
 $V_{RC}$  : a vector containing all vehicle models in regulatory class  $RC$ ,



- $Sales_i$  : the sales volume for a vehicle model  $i$ ,  
 $FE'_i$  : the “compliance” average fuel economy (in mpg) attained by a vehicle model  $i$ , as calculated by Equation (23),  
 $FFVCredits_{RC}$  : the credits associated with production of flex-fuel vehicles in regulatory class  $RC$ ,  
 $CrAdj_{RC}$  : the net amount of credits and adjustments, specified in grams per mile of CO<sub>2</sub>, a manufacturer is able to claim toward compliance with the CAFE standard in regulatory class  $RC$ , subject to the applicable caps, and  
 $CAFE'_{RC}$  : the CAFE rating achieved by a manufacturer in regulatory class  $RC$ , after application of FFV credits, off-cycle credits, or adjustments for improvements in air conditioning efficiency.

In the above equation,  $CrAdj_{RC}$  is further defined by the following:

$$CrAdj_{RC} = \text{MIN} \left( \frac{ACEffAdj_{RC'}}{ACEffCap_{RC}} \right) + \text{MIN} \left( \frac{OffCycleCredits_{RC'}}{OffCycleCap_{RC}} \right) \quad (31)$$

Where:

- $ACEffAdj_{RC}$  : the amount of adjustments associated with improvements in air conditioning efficiency, specified in grams per mile of CO<sub>2</sub>, a manufacturer has accumulated toward compliance with the CAFE standard in regulatory class  $RC$ ,  
 $ACEffCap_{RC}$  : the maximum amount of AC efficiency adjustments, specified in grams per mile of CO<sub>2</sub>, a manufacturer may claim toward compliance with the CAFE standard in regulatory class  $RC$ ,  
 $OffCycleCredits_{RC}$  : the amount of off-cycle credits, specified in grams per mile of CO<sub>2</sub>, a manufacturer has accumulated toward compliance with the CAFE standard in regulatory class  $RC$ ,  
 $OffCycleCap_{RC}$  : the maximum amount of off-cycle credits, specified in grams per mile of CO<sub>2</sub>, a manufacturer may claim toward compliance with the CAFE standard in regulatory class  $RC$ , and  
 $CrAdj_{RC}$  : the net amount of credits and adjustments, specified in grams per mile of CO<sub>2</sub>, a manufacturer is able to claim toward compliance with the CAFE standard in regulatory class  $RC$ , subject to the applicable caps.

In Equations (30) and (31), the  $CO2Factor_{RC}$ ,  $ACEffCap_{RC}$ , and  $OffCycleCap_{RC}$  variables are specified in the scenario definition for each regulatory class. The  $FFVCredits_{RC}$ ,  $ACEffAdj_{RC}$ , and  $OffCycleCredits_{RC}$  variables are specified in the input fleet for each manufacturer, and for each regulatory class.

Although not explicitly shown, in Equations (29) and (30), the  $FE_i$  and  $FE'_i$  values are rounded as described in Equations (20) and (21) above, before they are used to calculate the associated CAFE ratings.

#### S5.1.4 Calculation of the CAFE Credits, Credit Value, and Fines

Once the standard and CAFE values have been computed, the model may proceed to determine the degree of noncompliance for a manufacturer by first calculating the CAFE credits, then using these credits to obtain the value of these credits and the amount of CAFE civil penalties owed by a manufacturer. Within each regulatory class  $RC$ , the amount of CAFE credit created (noncompliance causes credit creation to be negative, which implies the use of CAFE credits or the payment of civil penalties) is calculated by taking the difference between the standard and the CAFE value attributable to a specific regulatory class, then multiplying the result by the number of vehicles in that class. The calculation of credits earned differs depending on the regulatory class being evaluated by the model. For light-duty regulatory classes, the calculation of CAFE credits is expressed as follows:

$$Credits_{RC} = (\text{ROUND}(CAFE'_{RC}, 1) - STD_{RC}) \times Sales_{RC} \times 10 \quad (32)$$

Where:

- $Sales_{RC}$  : the sales volume of all vehicle models attributable to a manufacturer in regulatory class  $RC$ ,
- $STD_{RC}$  : the standard attributable to a manufacturer in regulatory class  $RC$ ,
- $CAFE'_{RC}$  : the CAFE rating achieved by a manufacturer in regulatory class  $RC$ , and
- $Credits_{RC}$  : the calculated amount of credits earned by a manufacturer in regulatory class  $RC$ , where 1 credit is equal to one-tenth of a vehicle mpg.

For the medium-duty regulatory class, credits are computed as:

$$Credits_{RC} = \left( \frac{100}{STD_{RC}} - \text{ROUND} \left( \frac{100}{CAFE'_{RC}}, 2 \right) \right) \times Sales_{RC} \times 100 \quad (33)$$

Where:

- $Sales_{RC}$  : the sales volume of all vehicle models attributable to a manufacturer in regulatory class  $RC$ ,
- $STD_{RC}$  : the standard attributable to a manufacturer in regulatory class  $RC$ ,
- $CAFE'_{RC}$  : the CAFE rating achieved by a manufacturer in regulatory class  $RC$ , and
- $Credits_{RC}$  : the calculated amount of credits earned by a manufacturer in regulatory class  $RC$ , where 1 credit is equal to one-tenth-thousand of a vehicle gpm.

The credits produced by Equations (32) and (33) may be positive or negative, where positive values represent overcompliance with a given standard, while negative values indicate a shortfall, or noncompliance. If a manufacturer is at a shortfall in specific regulatory class, the modeling system may transfer available credits from a different regulatory class within the same model year, or carry credits forward from an earlier model year within the same regulatory class. As mentioned earlier, the modeling system keeps track of credits transferred or carried into or out of a specific regulatory class. A combination of credits earned, transferred or carried in, and transferred or carried out form the net credits attributed to a manufacturer, which are then used to calculate the

value of CAFE credits and civil penalties, as well as to assess the degree of noncompliance (or if the net credits are positive, signify that the manufacturer has attained compliance).

In addition to the credits earned, as outlined by the above equation, the system also computes an alternative representation of credits earned, which are denominated in thousands of gallons and are defined as follows:

$$CreditsKGal_{RC} = \left( \frac{1}{STD_{RC}} - \frac{1}{CAFE'_{RC}} \right) \times \frac{VMT_{RC}}{1,000} \times Sales_{RC} \quad (34)$$

Where:

- $Sales_{RC}$  : the sales volume of all vehicle models attributable to a manufacturer in regulatory class  $RC$ ,
- $VMT_{RC}$  : the assumed average lifetime vehicle miles traveled by typical vehicle models in regulatory class  $RC$ ,
- $1,000$  : the conversion factor from gallons to thousands of gallons,
- $STD_{RC}$  : the standard attributable to a manufacturer in regulatory class  $RC$ ,
- $CAFE'_{RC}$  : the CAFE rating achieved by a manufacturer in regulatory class  $RC$ , and
- $CreditsKGal_{RC}$ : the calculated amount of credits earned by a manufacturer in regulatory class  $RC$ , where 1 credit is equal to one thousand gallons.

As with Equations (32) and (33), the credits produced by Equation (34) may be positive or negative. The magnitude of the credits obtained by the different equations will differ, however the directionality will remain the same. That is, in all cases, positive values represent overcompliance, while negative signify a shortfall. The  $CreditsKGal_{RC}$  calculated above is later used when calculating the effective cost of a technology application (as discussed in a section below), and are not otherwise recorded in modeling reports. As such, the CAFE standard and rating, when used by the equation above, remain unrounded.

Lastly, the value of the net CAFE credits accumulated by a manufacturer in each regulatory class is calculated as shown in the following equation:

$$ValueCredits_{RC} = (Credits_{RC} + CreditsIn_{RC} - CreditsOut_{RC}) \times CreditValue_{RC} \quad (35)$$

Where:

- $Credits_{RC}$  : the amount of credits earned by a manufacturer in regulatory class  $RC$ ,
- $CreditsIn_{RC}$  : the amount of credits transferred or carried into regulatory class  $RC$ ,
- $CreditsOut_{RC}$  : the amount of credits transferred or carried out of regulatory class  $RC$ ,
- $CreditValue_{RC}$  : the valuation of CAFE credits, specified in dollars, to apply per one credit of shortfall, and
- $ValueCredits_{RC}$  : the calculated amount of CAFE civil penalties owed by a manufacturer in regulatory class  $RC$ .

Additionally, the calculation for CAFE civil penalties, or fines, in each regulatory class is given by the following:

$$Fines_{RC} = \text{MIN}(Credits_{RC} + CreditsIn_{RC} - CreditsOut_{RC}, 0) \times FineRate_{RC} \quad (36)$$

Where:

- $Credits_{RC}$  : the amount of credits earned by a manufacturer in regulatory class  $RC$ ,
- $CreditsIn_{RC}$  : the amount of credits transferred or carried into regulatory class  $RC$ ,
- $CreditsOut_{RC}$  : the amount of credits transferred or carried out of regulatory class  $RC$ ,
- $FineRate_{RC}$  : the fine rate, specified in dollars, to apply per one credit of shortfall, and
- $Fines_{RC}$  : the calculated amount of CAFE civil penalties owed by a manufacturer in regulatory class  $RC$ .

In the Equations (35) and (36) above, the  $CreditValue_{RC}$  and the  $FineRate_{RC}$  variables are both specified in the scenario definition, separately for each regulatory class and model year.

## S5.2 CO<sub>2</sub> Compliance Calculations

When the CAFE Model is configured to evaluate compliance with the CO<sub>2</sub> program, it calculates the values for the CO<sub>2</sub> standard and rating, the CO<sub>2</sub> credits earned, as well as the value of net CO<sub>2</sub> credits for each manufacturer. As with the CAFE compliance calculations, the model repeatedly performs all of the CO<sub>2</sub> computations before, during, and after each successive technology application, independently for each regulatory class. Since the CO<sub>2</sub> compliance program does not differentiate between domestic and imported passenger automobiles, all compliance calculations are performed on the: Passenger Car (combined DC and IC), Light Truck, and Light Truck 2b/3 regulatory classes.

During analysis, the modeling system evaluates and applies all technology improvements on a vehicle's fuel economy rating. The system maintains (keeps track of and updates) the fuel economies for each vehicle model, converting them the equivalent CO<sub>2</sub> ratings, only as required for compliance calculations. Likewise, the model first calculates the vehicle's fuel economy target before converting it to an equivalent CO<sub>2</sub> target, as defined by Equation (4), described in Section 3 above. Thus, before the system may carry out the CO<sub>2</sub> compliance calculations, it obtains the updated CO<sub>2</sub> target and CO<sub>2</sub> value (or rating) for each vehicle model in the manufacturer's fleet. Similar to the vehicle's fuel economy and manufacturer's CAFE rating, the model calculates and reports CO<sub>2</sub> values unrounded, only rounding to a whole gram-per-mile when either value is used for compliance.

### S5.2.1 Calculation of Vehicle's CO<sub>2</sub> Rating

The modeling system uses a vehicle's fuel economy value to calculate a corresponding CO<sub>2</sub> rating for each fuel type the vehicle operates on. Since battery-electric and fuel-cell vehicles do not release CO<sub>2</sub> emissions during operation, the CO<sub>2</sub> rating for these vehicles is assumed to be zero for all model years where the *CO<sub>2</sub> Include Upstream* scenario setting is not set to **TRUE**. Similarly, for plug-in hybrid/electric vehicles (PHEVs), the CO<sub>2</sub> rating when operating on electricity is assumed to be zero as well, while the CO<sub>2</sub> rating on gasoline is computed from the

associated fuel economy value. For model years where the *CO2 Include Upstream* setting is **TRUE**, however, the CO<sub>2</sub> rating of a vehicle when operating on electricity or hydrogen is computed by taking into account the differences between the upstream emissions associated with electric operation and gasoline operation of a comparable vehicle. Thus, for model years that consider upstream emissions, the vehicle's CO<sub>2</sub> rating when operating on electricity or hydrogen fuel types is calculated as follows:

$$CO2Rating_{FT} = \left( \frac{1}{FE_{FT}} \times \frac{ED_G \times 1000 \times 0.534}{ED_E \times 0.935} \right) - \left( T_{CO2} \times \frac{2478}{CO2Factor_{RC}} \right) \quad (37)$$

Where:

- FT* : the fuel type the vehicle operates on (either electricity or hydrogen),
- RC* : the regulatory class of the vehicle,
- FE<sub>FT</sub>* : the fuel economy rating of the vehicle, specified in miles per gallon, when operating on fuel type *FT*,
- ED<sub>G</sub>* : the energy density of gasoline, specified in BTU/gallon, as defined in the parameters input file,
- ED<sub>E</sub>* : the energy density of electricity, specified in BTU/kWh, as defined in the parameters input file,
- 1000* : the conversion factor from kilowatt-hours (kWh) to watt-hours,
- 0.534* : the assumed average upstream emissions rate of electricity (in grams/watt-hour), used for regulatory purposes,
- 0.935* : the assumed electricity transmission losses between generation source and the wall,
- T<sub>CO2</sub>* : the calculated vehicle CO<sub>2</sub> target, in grams per mile,
- 2478* : the assumed upstream CO<sub>2</sub> emissions of a gallon of gasoline, used for regulatory purposes,
- CO2Factor<sub>RC</sub>* : the CO<sub>2</sub> factor to use for converting between fuel economy values and CO<sub>2</sub> values, and
- CO2Rating<sub>FT</sub>* : the CO<sub>2</sub> rating of the vehicle, specified in grams per mile, when operating on fuel type *FT*.

For all other fuel types, the vehicle's CO<sub>2</sub> rating in all model years is defined by the following equation:

$$CO2Rating_{FT} = \frac{CO2Content_{FT}}{FE_{FT}} \quad (38)$$

Where:

- FT* : the fuel type the vehicle operates on,
- CO2Content<sub>FT</sub>* : the mass (in grams) of CO<sub>2</sub> released by using a gallon of fuel type *FT*,

- $FE_{FT}$  : the fuel economy rating of the vehicle, specified in miles per gallon, when operating on fuel type  $FT$ , and  
 $CO2Rating_{FT}$  : the CO<sub>2</sub> rating of the vehicle, specified in grams per mile, when operating on fuel type  $FT$ .

For vehicles operating on compressed natural gas, since the model assumes the fuel economy rating is specified as gasoline gallon equivalent, the  $CO2Content_{FT}$  in the equation above refers to the mass of CO<sub>2</sub> released by using a gallon of gasoline. For each applicable fuel type, the modeling system calculates the  $CO2Content_{FT}$  using the inputs specified in the parameters file as:

$$CO2Content_{FT} = MD_{FT} \times CC_{FT} \times (44/12) \quad (39)$$

Where:

- $FT$  : the fuel type the vehicle operates on,  
 $MD_{FT}$  : the mass density of a fuel type  $FT$ , specified in grams per gallon in the parameters input file,  
 $CC_{FT}$  : the percentage of each fuel type's mass that represents carbon, specified in the parameters input file,  
 $(44/12)$  : the ratio of the molecular weight of carbon dioxide to that of elemental carbon, and  
 $CO2Content_{FT}$ : the mass (in grams) of CO<sub>2</sub> released by using a gallon of fuel type  $FT$ .

Similar to a vehicle's fuel economy value, the CO<sub>2</sub> rating as calculated in Equations (37) and (38) may be comprised of one or more subcomponents corresponding to each fuel type the vehicle uses (i.e., flex-fuel or plug-in hybrid/electric vehicles). Before it can be used for calculating a manufacturer's CO<sub>2</sub> rating, a combined or average CO<sub>2</sub> value for each vehicle must be obtained. For single-fuel vehicles, this equates to the CO<sub>2</sub> rating on the specific fuel, while for dual-fuel vehicles, the combined CO<sub>2</sub> value is computed by averaging the individual components from the different fuel types. For all vehicles, the average CO<sub>2</sub> calculation may be generalized by the following equation:

$$CO2Rating = \sum_{FT} (FS_{FT} \times CO2Rating_{FT}) \quad (40)$$

Where:

- $FT$  : the fuel type the vehicle operates on,  
 $FS_{FT}$  : the percent share of miles driven by a vehicle when operating on fuel type  $FT$ ,  
 $CO2Rating_{FT}$  : the CO<sub>2</sub> rating of the vehicle when operating on fuel type  $FT$ , and  
 $CO2Rating$  : the average CO<sub>2</sub> rating of the vehicle, aggregated across all fuel types the vehicle operates on.

Similar to the calculation of the average fuel economy rating (defined in Equation (22) above), the average CO<sub>2</sub> rating for dual-fuel vehicles depends on the "Multi-Fuel," "FFV Share," and "PHEV

Share” settings specified in the scenario definition. Using these settings, the model may be optionally configured to assume that dual-fuel vehicles (FFVs and PHEVs) operate exclusively on gasoline fuel for compliance purposes, and to also tune the assumed fuel share,  $FS_{FT}$ , to use when calculating the average CO<sub>2</sub> rating.

While the CAFE compliance program makes provisions for including the petroleum equivalency factor when computing the fuel economy rating to use for compliance purposes (see Section S5.1.1 above), the CO<sub>2</sub> program does not include such adjustments. Therefore, the CO<sub>2</sub> rating produced by Equation (40) may be used for calculating a manufacturer’s sales-weighted average CO<sub>2</sub> rating.

### S5.2.2 Calculation of the CO<sub>2</sub> Standard

The CAFE Model calculates the value of the CO<sub>2</sub> standard using a sales-weighted average of the CO<sub>2</sub> targets applicable to each vehicle model of a specific regulatory class. However, the calculation of the CO<sub>2</sub> standard varies depending on the *EPA Multiplier Mode* used by the manufacturer, as specified in the market data input file. Thus, the manufacturer’s required CO<sub>2</sub> standard for regulatory class  $RC$  is represented by the following equation:

$$CO2STD_{RC} = \frac{\sum_{i \in V_{RC}} (EPASales_i \times T_{CO2,i})}{\sum_{i \in V_{RC}} EPASales_i} \quad (41)$$

Where:

- $V_{RC}$  : a vector containing all vehicle models in regulatory class  $RC$ ,
- $EPASales_i$  : the EPA adjusted sales volume for a vehicle model  $i$ ,
- $T_{CO2,i}$  : the CO<sub>2</sub> target (in grams per mile) applicable to a vehicle model  $i$ ,<sup>33</sup> and
- $CO2STD_{RC}$  : the calculated CO<sub>2</sub> standard attributable to a manufacturer in regulatory class  $RC$ .

In equation (41) above,  $EPASales_i$  is calculated according to the *EPA Multiplier Mode* specified for a vehicle’s manufacturer, and represents either a vehicle’s unadjusted sales volume, or the sales volume adjusted by the production multiplier. When calculating the CO<sub>2</sub> standard,  $EPASales$  for a given vehicle,  $veh$ , is computed according to the following:

$$EPASales_{veh} = \begin{cases} EPAMultiplier_{RC} \times Sales_{veh}, & EPAMode = 2 \text{ or } 3 \\ Sales_{veh}, & EPAMode = 0 \text{ or } 1 \end{cases} \quad (42)$$

Where:

- $Sales_{veh}$  : the sales volume for a vehicle model  $veh$ ,
- $RC$  : the regulatory class of a vehicle model  $veh$ ,
- $EPAMultiplier_{RC}$ : a production multiplier used to scale the sales volumes of CNGs, PHEVs, BEVs, and FCVs,

---

<sup>33</sup> Refer to Section 3 above for description and calculation of the vehicle’s CO<sub>2</sub> target.

- EPAMode* : an EPA multiplier mode defining the applicability of EPA production multipliers, and  
*EPASales<sub>i</sub>* : the EPA adjusted sales volume for a vehicle model *veh*.

The *EPAMultiplier<sub>RC</sub>* variable in the above equation is specified in the scenario definition for each regulatory class. As described in Section 3, *EPAMultiplier<sub>RC</sub>* corresponds to the “EPA Multiplier 1” or “EPA Multiplier 2” variable, where the former applies to the production multipliers of CNGs and PHEVs, while the latter includes BEVs and FCVs. The *EPAMode* is then used to determine which of the CO<sub>2</sub> compliance metrics are adjusted by the production multipliers, as outlined in the following table:

**Table 16. EPA Multiplier Modes**

EPA Mode	Applies to
0	Disabled (do not consider production multipliers)
1	CO <sub>2</sub> Rating Calculation
2	CO <sub>2</sub> Standard and CO <sub>2</sub> Rating Calculation
3	CO <sub>2</sub> Standard, CO <sub>2</sub> Rating, and CO <sub>2</sub> Credits Calculation

Equation (41) universally applies to an attribute-based standard (i.e., a functional form where a different CO<sub>2</sub> target is computed for each vehicle based on, for example, its footprint) as well as a flat standard (i.e., a functional form where each vehicle model has the same CO<sub>2</sub> target). However, for a flat standard, since with a common target the sales volumes of individual vehicle models cancel out, Equation (41) is reduced to the following:

$$CO2STD_{RC} = T_{CO2} \quad (43)$$

Since under the CO<sub>2</sub> compliance program, all passenger automobiles are regulated under a single class, the calculation of the CO<sub>2</sub> standard is not subject to a minimum domestic car standard. Lastly, the values calculated by Equations (41) and (43) are rounded to a whole number to produce the final CO<sub>2</sub> standard for a manufacturer.

### S5.2.3 Calculation of the CO<sub>2</sub> Rating

Similar to the calculation of the standard, the CAFE Model calculates the manufacturer’s CO<sub>2</sub> rating by taking a sales-weighted average of the individual CO<sub>2</sub> ratings attained by each vehicle model for a specific regulatory class. As with the CO<sub>2</sub> standard, calculation of the CO<sub>2</sub> rating varies depending on the *EPA Multiplier Mode*. During calculation, the modeling system additionally applies any credit or adjustment available to the manufacturer. Hence, the calculation for a manufacturer’s CO<sub>2</sub> rating for each regulatory class is defined by the following equation:

$$CO2Rating_{RC} = \frac{\sum_{i \in V_{RC}} (EPASales_i \times CO2Rating_i)}{\sum_{i \in V_{RC}} EPASales_i} - CrAdj_{RC} \quad (44)$$



Where:

- $V_{RC}$  : a vector containing all vehicle models in regulatory class  $RC$ ,
- $EPASales_i$  : the EPA adjusted sales volume for a vehicle model  $i$ ,
- $CO2Rating_i$  : the average CO<sub>2</sub> rating (in grams per mile) attained by a vehicle model  $i$ , as calculated by Equation (40),
- $CrAdj_{RC}$  : the net amount of credits and adjustments, specified in grams per mile of CO<sub>2</sub>, a manufacturer is able to claim toward compliance with the CO<sub>2</sub> standard in regulatory class  $RC$ , subject to the applicable caps, and
- $CO2Rating_{RC}$  : the CO<sub>2</sub> rating achieved by a manufacturer in regulatory class  $RC$ , taking into consideration the application of EPA multipliers, off-cycle credits, and adjustments for improvements in air conditioning efficiency and leakage.

As with the calculation of the CO<sub>2</sub> standard,  $EPASales_i$  from Equation (44) is calculated based on the *EPA Multiplier Mode*. However, as specified in Table 16 above, different *EPAModes* are applicable when calculating a manufacturer's rating then its standard. When calculating the CO<sub>2</sub> rating,  $EPASales$  for a given vehicle,  $veh$ , is computed as follows:

$$EPASales_{veh} = \begin{cases} EPAMultiplier_{RC} \times Sales_{veh}, & EPAMode \neq 0 \\ Sales_{veh}, & EPAMode = 0 \end{cases} \quad (45)$$

Where:

- $Sales_{veh}$  : the sales volume for a vehicle model  $veh$ ,
- $RC$  : the regulatory class of a vehicle model  $veh$ ,
- $EPAMultiplier_{RC}$ : a production multiplier used to scale the sales volumes of CNGs, PHEVs, BEVs, and FCVs,
- $EPAMode$  : a mode defining the applicability of EPA production multipliers, and
- $EPASales_i$  : the EPA adjusted sales volume for a vehicle model  $veh$ .

In Equation (44) above,  $CrAdj_{RC}$  is further defined by the following:

$$CrAdj_{RC} = \text{MIN} \left( \frac{ACEffAdj_{RC'}}{ACEffCap_{RC}} \right) + \text{MIN} \left( \frac{ACLeakageAdj_{RC'}}{ACLeakageCap_{RC}} \right) + \text{MIN} \left( \frac{OffCycleCredits_{RC'}}{OffCycleCap_{RC}} \right) \quad (46)$$

Where:

- $ACEffAdj_{RC}$  : the amount of adjustments associated with improvements in air conditioning efficiency, specified in grams per mile of CO<sub>2</sub>, a manufacturer has accumulated toward compliance with the CO<sub>2</sub> standard in regulatory class  $RC$ ,

- $ACEffCap_{RC}$  : the maximum amount of AC efficiency adjustments, specified in grams per mile of CO<sub>2</sub>, a manufacturer may claim toward compliance with the CO<sub>2</sub> standard in regulatory class  $RC$ ,
- $ACLeakageAdj_{RC}$  : the amount of adjustments associated with improvements in air conditioning leakage, specified in grams per mile of CO<sub>2</sub>, a manufacturer has accumulated toward compliance with the CO<sub>2</sub> standard in regulatory class  $RC$ ,
- $ACLeakageCap_{RC}$  : the maximum amount of AC leakage adjustments, specified in grams per mile of CO<sub>2</sub>, a manufacturer may claim toward compliance with the CO<sub>2</sub> standard in regulatory class  $RC$ ,
- $OffCycleCredits_{RC}$  : the amount of off-cycle credits, specified in grams per mile of CO<sub>2</sub>, a manufacturer has accumulated toward compliance with the CO<sub>2</sub> standard in regulatory class  $RC$ ,
- $OffCycleCap_{RC}$  : the maximum amount of off-cycle credits, specified in grams per mile of CO<sub>2</sub>, a manufacturer may claim toward compliance with the CO<sub>2</sub> standard in regulatory class  $RC$ , and
- $CrAdj_{RC}$  : the net amount of credits and adjustments, specified in grams per mile of CO<sub>2</sub>, a manufacturer is able to claim toward compliance with the CO<sub>2</sub> standard in regulatory class  $RC$ , subject to the applicable caps.

In Equations (44) and (46), the  $EPAMultiplier_{RC}$ ,  $ACEffCap_{RC}$ ,  $ACLeakageCap_{RC}$ , and  $OffCycleCap_{RC}$  variables are specified in the scenario definition for each regulatory class. The  $ACEffAdj_{RC}$ ,  $ACLeakageAdj_{RC}$ , and  $OffCycleCredits_{RC}$  variables are specified in the input fleet for each manufacturer, in each regulatory class.

Although not explicitly shown, in Equation (44), the  $CO2Rating_i$  value is rounded to a whole number before it is used to calculate the manufacturer's  $CO2Rating_{RC}$ .

#### S5.2.4 Calculation of the CO<sub>2</sub> Credits and Credit Value

Using the CO<sub>2</sub> standard and rating values computed in the preceding sections, the CAFE Model calculates the amount of CO<sub>2</sub> credits earned by a manufacturer. The CO<sub>2</sub> credits may then be used to determine the degree of noncompliance for a manufacturer. Within each regulatory class  $RC$ , the amount of CO<sub>2</sub> credit created (noncompliance causes credit creation to be negative) is calculated by taking the difference between the standard and the CO<sub>2</sub> rating attributable to a specific regulatory class, then multiplying the result by the number of vehicles and the assumed lifetime VMT in that class. For each regulatory class  $RC$ , the calculation of CO<sub>2</sub> credits is expressed as follows:

$$CO2Credits_{RC} = (CO2STD_{RC} - ROUND(CO2Rating_{RC})) \times \frac{VMT_{RC}}{1,000,000} \quad (47)$$

$$\times \begin{cases} EPASales_{RC}, & EPAMode = 3 \\ Sales_{RC}, & EPAMode \neq 3 \end{cases}$$

Where:

- $Sales_{RC}$  : the sales volume of all vehicle models attributable to a manufacturer in regulatory class  $RC$ ,
- $EPASales_{RC}$  : the EPA adjusted sales volume of all vehicle models attributable to a manufacturer in regulatory class  $RC$ ,
- $EPAMode$  : an EPA multiplier mode defining the applicability of EPA production multipliers,
- $VMT_{RC}$  : the assumed average lifetime vehicle miles traveled by typical vehicle models in regulatory class  $RC$ ,
- $1,000,000$  : the conversion factor from grams to metric tons,
- $CO2STD_{RC}$  : the CO<sub>2</sub> standard attributable to a manufacturer in regulatory class  $RC$ ,
- $CO2Rating_{RC}$  : the CO<sub>2</sub> rating achieved by a manufacturer in regulatory class  $RC$ , and
- $CO2Credits_{RC}$  : the calculated amount of CO<sub>2</sub> credits earned by a manufacturer in regulatory class  $RC$ , where 1 credit is equal to one metric ton.

The credits produced by Equation (47) may be positive or negative, where positive values represent overcompliance with a given standard, while negative values indicate a shortfall, or noncompliance. If a manufacturer is at a shortfall in specific regulatory class, the modeling system may transfer available credits from a different regulatory class within the same model year, or carry credits forward from an earlier model year within the same regulatory class. As mentioned earlier, the modeling system keeps track of credits transferred or carried into or out of a specific regulatory class. A combination of credits earned, transferred or carried in, and transferred or carried out form the net credits attributed to a manufacturer, which are used to assess the degree of noncompliance (or if the net credits are positive, signify that the manufacturer has attained compliance). Even though the CO<sub>2</sub> compliance program does not allow the use of civil penalties to offset shortfalls, but instead mandates that all manufacturers must attain compliance, the modeling system may still produce results where some manufacturers are shown as noncompliant. This situation is more likely to arise under particularly stringent regulatory scenarios, if a manufacturer runs out of available technologies for application prior to reaching compliance.

In addition to the CO<sub>2</sub> credits earned, the modeling system also calculates the value of the net credits accumulated by a manufacturer as shown in the following equation:

$$ValueCO2Credits_{RC} = (CO2Credits_{RC} + CO2CreditsIn_{RC} - CO2CreditsOut_{RC}) \times CO2CreditValue_{RC} \quad (48)$$

Where:

- $CO2Credits_{RC}$  : the amount of CO<sub>2</sub> credits earned by a manufacturer in regulatory class  $RC$ ,
- $CO2CreditsIn_{RC}$  : the amount of CO<sub>2</sub> credits transferred or carried into regulatory class  $RC$ ,
- $CO2CreditsOut_{RC}$  : the amount of CO<sub>2</sub> credits transferred or carried out of regulatory class  $RC$ ,

$CO2CreditValue_{RC}$  : the valuation of CO<sub>2</sub> credits, specified in dollars, to apply per one credit of shortfall, and

$ValueCO2Credits_{RC}$  : the calculated value of CO<sub>2</sub> credits attributable to a manufacturer in regulatory class  $RC$ .

In the equation above, the  $CO2CreditValue_{RC}$  is specified in the scenario definition, separately for each regulatory class and model year. The  $ValueCO2Credits_{RC}$ , as calculated for a manufacturer in each regulatory class, is later used when calculating the effective cost of a technology application whenever the CAFE Model is configured to evaluate compliance with the CO<sub>2</sub> program.

### **S5.3 Compliance Simulation Algorithm**

As the modeling system evaluates a manufacturer for compliance, the compliance simulation algorithm begins the process of applying technologies based on the CAFE or CO<sub>2</sub> standards applicable during the current model year. This involves repeatedly evaluating the degree of noncompliance, identifying and selecting the “best next” technology (described in the following section) from a set of available technologies for application. Figure 8 provides an overview of this process.

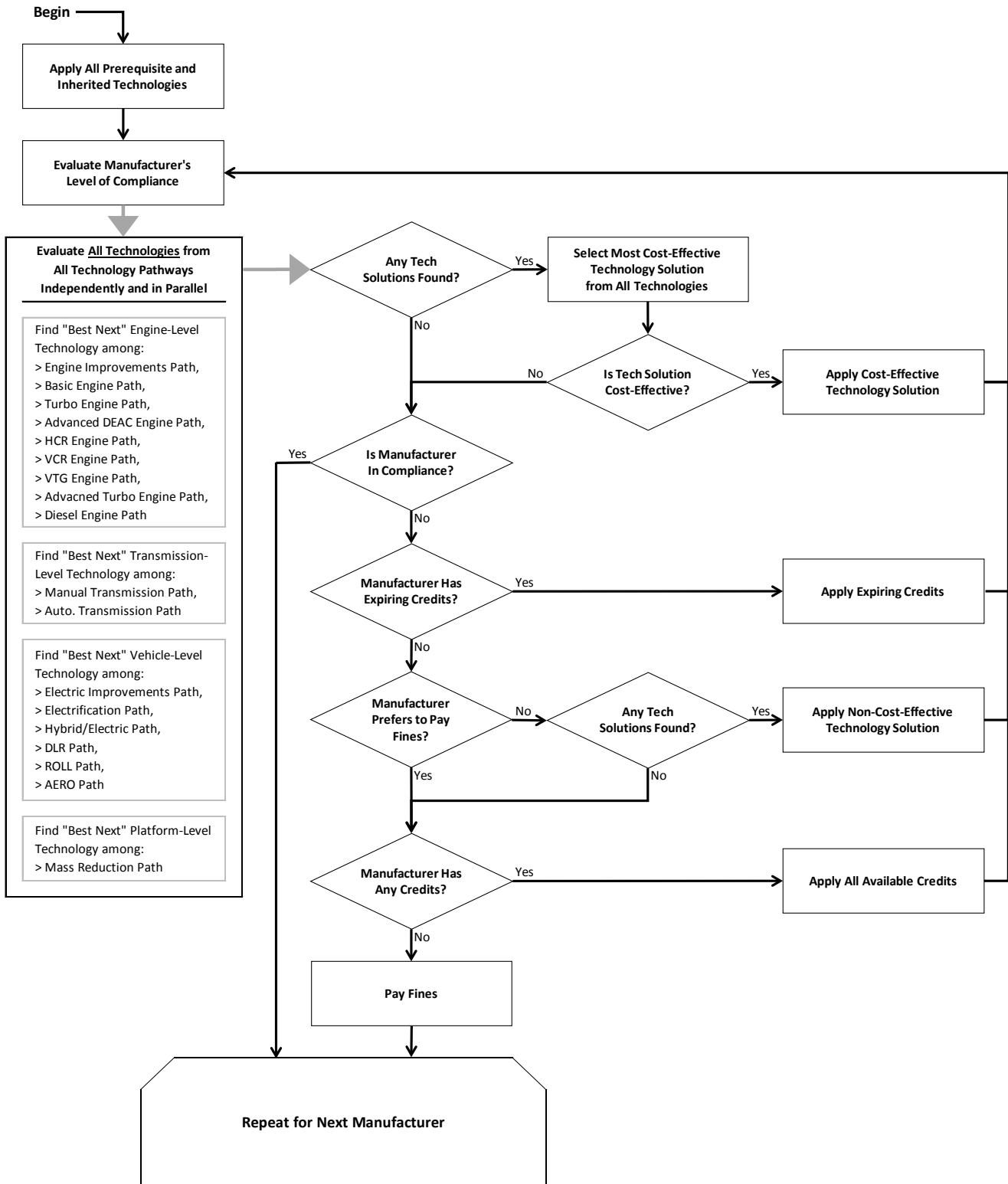

Figure 8. Compliance Simulation Algorithm

The algorithm first evaluates all technologies defined within the modeling system. For any technology that resulted in a valid solution (that is, may be applicable to at least one vehicle

model), the algorithm selects best next option for application. For any technology solution determined to be cost-effective (as defined below), the modeling system applies the selected technology to the affected vehicles, regardless of whether the manufacturer is in compliance. After exhausting all cost-effective solutions, the algorithm reevaluates the manufacturer's degree of noncompliance and applies available credits (CAFE or CO<sub>2</sub>, depending on the compliance program being evaluated), which were generated during preceding model years and which are due to expire during the analysis year<sup>34</sup>. After applying expiring credits, if a manufacturer has not attained compliance, the algorithm proceeds to evaluate and apply non-cost-effective (*aka*, ineffective) technologies on an as-needed basis. If a manufacturer is assumed to be unwilling to pay fines, the algorithm finds and applies additional technology solutions until compliance is achieved, reevaluating the manufacturer's degree of noncompliance after every successive technology application. Conversely, if a manufacturer is assumed to prefer to pay fines, the algorithm stops applying additional technology to this manufacturer's product line once no more cost-effective solutions are encountered. In either case, once all viable technology solutions have been exhausted, if a manufacturer still has not reached compliance, the algorithm uses the remainder of available credits, before generating fines for noncompliance.

In the case of the CAFE compliance program, "fines" refer to the CAFE civil penalties. However, since the CO<sub>2</sub> compliance program does not allow fine payment, the algorithm assumes that every manufacturer is unwilling to pay fines and continues to apply technology until compliance is achieved or the manufacturer exhausts all technologies during the analysis year.

At the root of the compliance simulation algorithm is the way the modeling system determines the best next technology solution and the way it calculates the effective cost of that solution. These topics are addressed in the following two sections.

### **S5.3.1 Determination of "Best Next" Technology Solution**

As discussed in preceding sections, the modeling system concurrently evaluates all available technologies for application. As such, when selecting the "best next" technology solution, the algorithm simultaneously considers all technologies, regardless of their ordering within pathways. If the phase-in limit for a specific technology has been reached during some model year, the algorithm halts application of that technology for that year. If the phase-in limit has not been reached, the algorithm determines whether or not the technology remains applicable to any sets of vehicles, evaluates the effective cost of applying the technology to each such set, and identifies the application that would yield the lowest effective cost.

As shown in Figure 9 below, the algorithm repeats this process for each technology, and then selects the technology application resulting in the lowest effective cost. As discussed above, the algorithm operates subject to expectations of each manufacturer's preference to pay fines within the model year being evaluated. However, the effective cost is calculated, as described in the following section, irrespective of the fine payment settings.

---

<sup>34</sup> Within the context of the CAFE Model, analysis year refers to the model year currently being evaluated by the modeling system.

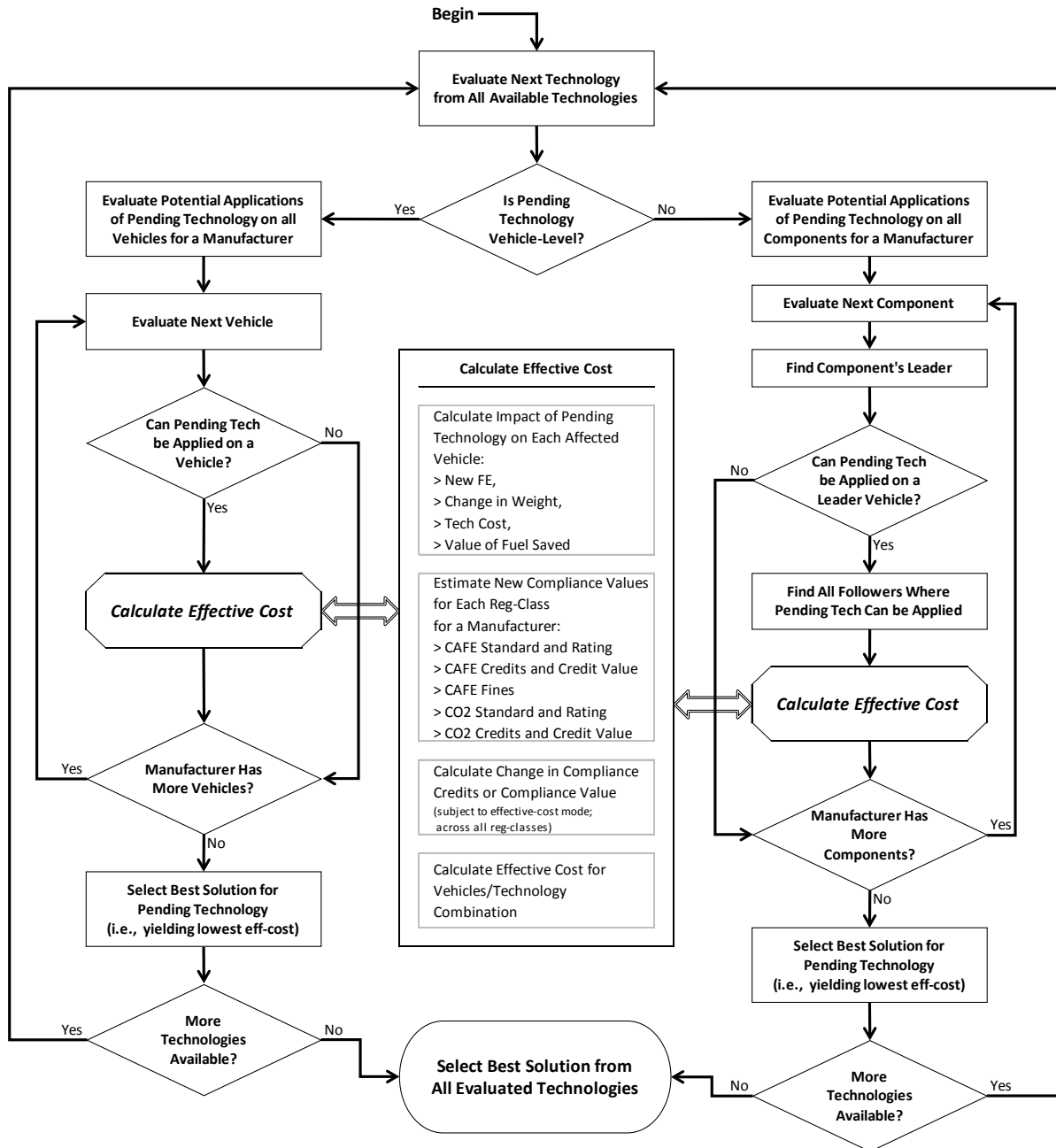

Figure 9. Determination of “Best Next” Technology Solution

Note, in the diagram above, a “component” is any platform, engine, or transmission produced by a manufacturer, where application of a technology is evaluated on a vehicle designated as a leader of that component. Any follower vehicles of the same component, for which a candidate technology is available for application in the same analysis step as the leader vehicle, will also be evaluated during technology application.

### S5.3.2 Calculation of Effective Cost

Whenever the compliance simulation algorithm is evaluating the potential application of candidate technologies, it considers the effective cost of applying those technologies on a subset (or group) of vehicles selected by the algorithm, and chooses the option that yields the lowest effective cost.<sup>35</sup> The effective cost is used for evaluating the relative attractiveness of different technology applications, and not for actual cost accounting. This calculation can span multiple model years, if the algorithm selects a candidate technology that was left unused on a vehicle during its last redesign or refresh cycle. For example, if the technology was enabled for application in a previous year and was not used, then it can remain as a candidate to be applied and then carried forward to the current model year.

The current version of the CAFE Model supports two methods (or modes) for computing the effective cost obtained from application of a candidate technology on a group of vehicles. The first is the “Legacy” mode, which has been used with all preceding versions of the modeling system. The second is the “Cost/Credit” mode, which was introduced for this analysis as the default calculation of effective cost. The effective cost method employed during compliance simulation may be selected by the user from the CAFE Model’s GUI.

The calculation of the legacy effective cost is, hence, defined by the following equation:

$$EffCost = \frac{TechCost_{Total} - FuelSavings_{Total} - \Delta ComplianceValue}{AffectedSales_{Total}} \quad (49)$$

Where:

- AffectedSales<sub>Total</sub>* : the total sales volume of all vehicles selected for evaluation,
- TechCost<sub>Total</sub>* : the total cost off all candidate technologies evaluated on a group of selected vehicles,
- FuelSavings<sub>Total</sub>* : the value of the reduction in fuel consumption (or fuel savings) resulting from application off all candidate technologies evaluated a group of selected vehicles,
- ΔComplianceValue* : the change in manufacturer’s cost of compliance in the analysis year, which depending on the compliance program being evaluated, corresponds to the CAFE fines or value of CO<sub>2</sub> credits, and
- EffCost* : the calculated effective cost attributed to application of a candidate technology evaluated on a group of selected vehicles.

In the above equation, the affected sales may span multiple vehicle models if the algorithm choses, e.g., to apply an engine-level technology to multiple vehicles that share the same engine. Additionally, as stated above, if a candidate technology that was left unused from a vehicle’s last

---

<sup>35</sup> Such groups can span regulatory classes. For example, if the algorithm is evaluating a potential upgrade to a given engine, that engine might be used by a station wagon, which is regulated as a passenger car, and a minivan, which is regulated as a light truck. If the manufacturer’s passenger car fleet complies with the corresponding standard, the algorithm accounts for the fact that upgrading this engine will incur costs and realize fuel savings for both of these vehicle models, but will only yield a change in compliance for the light truck fleet.



redesign or refresh is selected for application, the affected sales will include multiple model years ranging from the vehicle model's last redesign or refresh year to the analysis year being evaluated. Furthermore, when multiple vehicles are selected for evaluation, with the varying redesign and refresh schedules, the range of model years may differ for each vehicle model. For example, consider that the modeling system is evaluating a manufacturer's compliance during MY 2025. The algorithm proceeds to select an engine-level technology for application on a leader vehicle that is being redesigned in MY 2020.<sup>36</sup> Then, any follower vehicle that shares the same engine and is redesigned or refreshed between MYs 2020 and 2025 (inclusive) may also be selected for application by the algorithm, starting with its last redesign or refresh year (whichever is greater).<sup>37</sup>

For all selected vehicle models, covering a given range of model years, the affected sales are calculated as shown in the following equation:

$$AffectedSales_{Total} = \sum_{i \in V} \left( \sum_{j=BaseMY}^{MY} Sales_{i,j} \right) \quad (50)$$

Where:

- $V$  : a vector containing a subset of vehicle models selected by the compliance simulation algorithm from a manufacturer's entire product line, on which to evaluate the potential application of a candidate technology,
- $BaseMY$  : the first model year of the potential application of a candidate technology, which represents the last redesign or refresh year of vehicle model  $i$ ,
- $MY$  : the model year being analyzed for compliance, corresponding to the last model year for which to evaluate the potential application of a candidate technology,
- $Sales_{i,j}$  : the sales volume of a vehicle model  $i$  during model year  $j$ , and
- $AffectedSales_{Total}$  : the total sales volume of all vehicles selected for evaluation.

In addition to the affected sales, the compliance simulation algorithm first calculates each of the components in Equation (49) independently, prior to calculating the effective cost. Similar to the calculation of affected sales, with the exception of the  $\Delta ComplianceValue$  portion, each of these components spans a subset of selected vehicle models, covering a given range of model years. The calculation for  $TechCost_{Total}$  is computed according to the following:

---

<sup>36</sup> As shown in Table 8 above, with the exception of VVT, all engine-level technologies are initially applicable during a vehicle's redesign year.

<sup>37</sup> As discussed in Section S4.4, engine-level technologies are applicable to a follower vehicle during that vehicle's redesign or refresh year.

$$TechCost_{Total} = \sum_{i \in V} \left( \sum_{j=BaseMY}^{MY} (TechCost_{i,j} \times Sales_{i,j}) \right) \quad (51)$$

Where:

- $V, BaseMY, MY$  : variables as defined in Equation (50) above,
- $Sales_{i,j}$  : the sales volume of a vehicle model  $i$  during model year  $j$ ,
- $TechCost_{i,j}$  : the net cost attributed to a candidate technology selected for application on a vehicle model  $i$  during model year  $j$ , as defined by Equations (8) through (11) in Section S4.7 above, and
- $TechCost_{Total}$  : the total cost off a candidate technology aggregated for a subset of selected vehicle models.

The value for the fuel savings,  $FuelSavings_{Total}$  in Equation (49), is calculated by taking the difference between the fuel cost attributed to each vehicle model immediately before and after application of candidate technologies, aggregated across all vehicle models as follows:<sup>38</sup>

$$FuelSavings_{Total} = \sum_{i \in V} \left( \sum_{j=BaseMY}^{MY} \left( (FuelCost_{i,j} - FuelCost'_{i,j}) \times Sales_{i,j} \right) \right) \quad (52)$$

Where:

- $V, BaseMY, MY$  : variables as defined in Equation (50) above,
- $Sales_{i,j}$  : the sales volume of a vehicle model  $i$  during model year  $j$ ,
- $FuelCost_{i,j}$  : the “fuel cost” for a vehicle model  $i$  during model year  $j$ , before application of a candidate technology,
- $FuelCost'_{i,j}$  : the “fuel cost” for a vehicle model  $i$  during model year  $j$ , after application of a candidate technology,
- $FuelSavings_{Total}$  : the value of the reduction in fuel consumption (or fuel savings) resulting from application off a candidate technology aggregated for a subset of selected vehicle models.

In Equation (52), the  $FuelCost_{i,j}$  and  $FuelCost'_{i,j}$  values refer to an assumed cost a typical vehicle purchaser expects to spend on refueling a new vehicle model over a specific number of years, which is defined from the manufacturer’s perspective in the input fleet as the “payback period.” In each case, the fuel cost is given by the following equation:

---

<sup>38</sup> This is not necessarily the actual value of the fuel savings, but rather the increase in vehicle price the manufacturer is assumed to expect to be able impose without losing sales.

$$FuelCost_{veh,MY} = \sum_{FT} \left( \sum_{a=0}^{PB} \left( \frac{VMT_{veh,a} \times FS_{veh,FT} \times Price_{FT,MY}}{(1 - GAP_{FT}) \times FE_{veh,FT}} \right) \right) \quad (53)$$

Where:

- veh* : the vehicle for which to calculate the fuel cost,
- MY* : the model year being evaluated for compliance,
- FT* : the fuel type the vehicle operates on (refer to Table 1 above for fuel types supported by the model),
- PB* : a “payback period,” or number of years in the future the consumer is assumed to take into account when considering fuel savings,
- VMT<sub>veh,a</sub>* : the average number of miles driven in a year by a vehicle at a given age *a*,
- Price<sub>FT,MY</sub>* : the price of the specific fuel type in model year *MY*,
- GAP<sub>FT</sub>* : the relative difference between on-road and laboratory fuel economy for a specific fuel type,
- FS<sub>veh,FT</sub>* : the percent share of miles driven by a vehicle when operating on fuel type *FT*,
- FE<sub>veh,FT</sub>* : the fuel economy rating of the vehicle when operating on fuel type *FT*, excluding any credits, adjustments, and the petroleum equivalency factors, and
- FuelCost<sub>veh,MY</sub>* : the fuel cost attributed to a vehicle during model year *MY*.

As discussed in Section A.3 of Appendix A, *VMT<sub>veh,a</sub>*, *Price<sub>FT,MY</sub>*, and *GAP<sub>FT</sub>* are all specified in the parameters input file, while the value for *PB* is specified in the market data input file (see Section A.1.1 in Appendix A). For electricity, hydrogen, and CNG fuel types, the price of fuel is specified in either \$/kWh or \$/scf, as appropriate. For use with the equation above, however, the prices of these fuel types are converted to gasoline gallon equivalent, GGE, by multiplying the input price value by the ratio of the energy densities between gasoline and that of the affected fuel type.

The last component of the legacy effective cost calculation, *ΔComplianceValue*, differs based on the compliance program the modeling system is configured to evaluate during analysis. In the case of the CAFE program, this value represents the change in CAFE civil penalties (or fines), aggregated for each affected regulatory class, corresponding to the subset of vehicles selected by the compliance simulation algorithm. The calculation for the change in fines is defined as follows:

$$\Delta Fines = \sum_{RC \in V} (Fines_{RC,MY} - Fines'_{RC,MY}) \quad (54)$$

Where:

- $V, MY$  : variables as defined in Equation (50) above,
- $RC$  : the regulatory class obtained from a subset of vehicle models selected for evaluation,
- $Fines_{RC,j}$  : the fines owed by a manufacturer in regulatory class  $RC$  during model year  $MY$ , before application of a candidate technology,
- $Fines'_{RC,j}$  : the fines owed by a manufacturer in regulatory class  $RC$  during model year  $MY$ , after application of a candidate technology, and
- $\Delta Fines$  : the change in manufacturer's fines during model year  $MY$ , resulting from application of a candidate technology on a subset of selected vehicles.

In the equation above, the fines owed (before and after application of technologies) are calculated as defined by Equation (36) in Section S5.1.4.

When the model is configured to evaluate the CO<sub>2</sub> compliance program,  $\Delta ComplianceValue$  from Equation (49) denotes the change in the value of CO<sub>2</sub> credits, aggregated for each affected regulatory class, and is defined by the following calculation:

$$\Delta ValueCO2Credits = \sum_{RC \in V} \left( \begin{array}{l} \text{MIN}(ValueCO2Credits'_{RC,MY}, 0) \\ -\text{MIN}(ValueCO2Credits_{RC,MY}, 0) \end{array} \right) \quad (55)$$

Where:

- $V, MY$  : variables as defined in Equation (50) above,
- $RC$  : the regulatory class obtained from a subset of vehicle models selected for evaluation,
- $ValueCO2Credits_{RC,j}$  : the value of CO<sub>2</sub> credits attributed to a manufacturer in regulatory class  $RC$  during model year  $MY$ , before application of a candidate technology,
- $ValueCO2Credits'_{RC,j}$  : the value of CO<sub>2</sub> credits attributed to a manufacturer in regulatory class  $RC$  during model year  $MY$ , after application of a candidate technology, and
- $\Delta ValueCO2Credits$  : the change in manufacturer's value of CO<sub>2</sub> credits during model year  $MY$ , resulting from application of a candidate technology on a subset of selected vehicles.

In the equation above, the values of CO<sub>2</sub> credits (before and after application of technologies) are calculated as defined by Equation (48) in Section S5.2.4. Additionally in the above equation, since the change in the value of CO<sub>2</sub> credits should only capture the change in manufacturer's cost of compliance, rather than the full change in value of the credits, the compliance simulation algorithm applies a ceiling at 0 (zero) to each calculated value of the CO<sub>2</sub> credits.

In addition to the legacy effective cost calculation defined by Equation (49) above, the modeling system computes the effective cost using the cost/credit methodology, as outlined by the equations that follow:

$$EffCost = \frac{TechCost_{Total} - FuelSavings_{Total}}{\Delta ComplianceCredits} \quad (56)$$

Where:

- TechCost<sub>Total</sub>* : the total cost off all candidate technologies evaluated on a group of selected vehicles,
- FuelSavings<sub>Total</sub>* : the value of the reduction in fuel consumption (or fuel savings) resulting from application off all candidate technologies evaluated a group of selected vehicles,
- ΔComplianceCredits* : the change in manufacturer’s compliance credits in the analysis year, which depending on the compliance program being evaluated, corresponds to the change in CAFE credits (denominated in thousands of gallons) or the change in CO<sub>2</sub> credits (denominated in metric tons), and
- EffCost* : the calculated effective cost attributed to application of a candidate technology evaluated on a group of selected vehicles.

As is the case for the calculation of the legacy effective cost, the *TechCost<sub>Total</sub>* and *FuelSavings<sub>Total</sub>* values in Equation (56) are computed as previously defined by Equations (51) and (52) above. Similar to the *ΔComplianceValue*, the calculation of *ΔComplianceCredits* varies depending on the compliance program being evaluated by the modeling system. When the system is configured to evaluate compliance with the CAFE program, this value represents the change in CAFE credits, denominated in thousands of gallons, aggregated for each affected regulatory class, corresponding to the subset of vehicles selected by the compliance simulation algorithm. This calculation is then defined by the following:

$$\Delta CreditsKGal = \sum_{RC \in V} (CreditsKGal'_{RC,MY} - CreditsKGal_{RC,MY}) \quad (57)$$

Where:

- V, MY* : variables as defined in Equation (50) above,
- RC* : the regulatory class obtained from a subset of vehicle models selected for evaluation,
- CreditsKGal<sub>RC,MY</sub>* : the credits earned by a manufacturer in regulatory class *RC* during model year *MY*, before application of a candidate technology,
- CreditsKGal'\_{RC,MY}* : the credits earned by a manufacturer in regulatory class *RC* during model year *MY*, after application of a candidate technology, and
- ΔCreditsKGal* : the change in manufacturer’s credits earned during model year *MY*, resulting from application of a candidate technology on a subset of selected vehicles.

In the equation above, the credits earned (before and after application of technologies) are calculated as defined by Equation (34) in Section S5.1.4.

When the model is evaluating the CO<sub>2</sub> compliance program,  $\Delta ComplianceCredits$  from Equation (56) specifies the change in the CO<sub>2</sub> credits, aggregated for each affected regulatory class, and is calculated as follows:

$$\Delta CO2Credits = \sum_{RC \in V} (CO2Credits'_{RC,MY} - CO2Credits_{RC,MY}) \quad (58)$$

Where:

- $V, MY$  : variables as defined in Equation (50) above,
- $RC$  : the regulatory class obtained from a subset of vehicle models selected for evaluation,
- $CO2Credits_{RC,MY}$  : the CO<sub>2</sub> credits earned by a manufacturer in regulatory class  $RC$  during model year  $MY$ , before application of a candidate technology,
- $CO2Credits'_{RC,MY}$  : the CO<sub>2</sub> credits earned by a manufacturer in regulatory class  $RC$  during model year  $MY$ , after application of a candidate technology, and
- $\Delta CO2Credits$  : the change in manufacturer's CO<sub>2</sub> credits earned during model year  $MY$ , resulting from application of a candidate technology on a subset of selected vehicles.

In the equation above, the credits earned (before and after application of technologies) are calculated as defined by Equation (47) in Section S5.2.4.

#### **S5.4 Cost of Compliance**

Upon completing compliance simulation for a given manufacturer, the CAFE Model computes a number of compliance-related cost metrics for each vehicle model produced by the manufacturer, as well as the aggregate costs for the manufacturer as a whole. The various compliance costs are calculated based on each vehicle's accrued technology cost (resulting from application of additional technology), the manufacturer's civil penalties (resulting from non-compliance), and any credits and adjustments claimed by the manufacturer toward compliance (subject to the maximum cap defined by the compliance program being evaluated). For each vehicle, the system calculates and reports the "final" technology cost, which is comprised of the cost of credits and adjustments added to the technology cost accrued by the vehicle, and the estimated price increases, which also includes manufacturer's civil penalties (if applicable). For the manufacturer's cost of compliance, the system accumulates the individual vehicle-level costs (by regulatory class), however, the vehicles' accrued technology costs and the manufacturer's costs of claimed credits and adjustments are kept separate when aggregated.

For each vehicle model produced and sold by a manufacturer, the final vehicle-level technology cost is computed as shown in the following equation:

$$\begin{aligned}
TechCost'_{veh} = & TechCost_{veh} + \text{MIN} \left( \frac{ACEffAdj_{RC}}{ACEffCap_{RC}} \right) \times ACEffCost_{RC} \\
& + \text{MIN} \left( \frac{ACLeakageAdj_{RC}}{ACLeakageCap_{RC}} \right) \times ACLeakageCost_{RC} \\
& + \text{MIN} \left( \frac{OffCycleCredits_{RC}}{OffCycleCap_{RC}} \right) \times OffCyclCost_{RC}
\end{aligned} \tag{59}$$

Where:

- RC* : the regulatory class of a vehicle model *veh*,
- TechCost<sub>veh</sub>* : the technology cost accumulated by a vehicle model *veh* from application of additional technology, as described in Section S4.7 above,
- ACEffAdj<sub>RC</sub>* : the amount of adjustments associated with improvements in air conditioning efficiency, specified in grams per mile of CO<sub>2</sub>, a manufacturer has accumulated toward compliance with either the CAFE or CO<sub>2</sub> standard in regulatory class *RC*,
- ACEffCap<sub>RC</sub>* : the maximum amount of AC efficiency adjustments, specified in grams per mile of CO<sub>2</sub>, a manufacturer may claim toward compliance with either the CAFE or CO<sub>2</sub> standard in regulatory class *RC*,
- ACEffCost<sub>RC</sub>* : the estimated cost of each AC efficiency adjustment, specified in \$/grams per mile of CO<sub>2</sub>,
- ACLeakageAdj<sub>RC</sub>* : the amount of adjustments associated with improvements in air conditioning leakage, specified in grams per mile of CO<sub>2</sub>, a manufacturer has accumulated toward compliance with the CO<sub>2</sub> standard in regulatory class *RC*,
- ACLeakageCap<sub>RC</sub>* : the maximum amount of AC leakage adjustments, specified in grams per mile of CO<sub>2</sub>, a manufacturer may claim toward compliance with the CO<sub>2</sub> standard in regulatory class *RC*,
- ACLeakageCost<sub>RC</sub>* : the estimated cost of each AC leakage adjustment, specified in \$/grams per mile of CO<sub>2</sub>,
- OffCycleCredits<sub>RC</sub>* : the amount of off-cycle credits, specified in grams per mile of CO<sub>2</sub>, a manufacturer has accumulated toward compliance with either the CAFE or CO<sub>2</sub> standard in regulatory class *RC*,
- OffCycleCap<sub>RC</sub>* : the maximum amount of off-cycle credits, specified in grams per mile of CO<sub>2</sub>, a manufacturer may claim toward compliance with either the CAFE or CO<sub>2</sub> standard in regulatory class *RC*,
- OffCycleCost<sub>RC</sub>* : the estimated cost of each off-cycle credit, specified in \$/grams per mile of CO<sub>2</sub>, and
- TechCost'<sub>veh</sub>* : the final technology cost attributed to a vehicle model *veh* from application of additional technology and manufacturer's credits and adjustments.

In the equations above, the *ACEffCap<sub>RC</sub>*, *ACLeakageCap<sub>RC</sub>*, *OffCycleCap<sub>RC</sub>*, *ACEffCost<sub>RC</sub>*, *ACLeakageCost<sub>RC</sub>*, and *OffCycleCost<sub>RC</sub>* variables are specified in the scenario definition for each

regulatory class. The  $ACEffAdj_{RC}$ ,  $ACLeakageAdj_{RC}$ , and  $OffCycleCredits_{RC}$  variables are specified in the input fleet for each manufacturer, in each regulatory class. Since the manufacturers may not claim AC leakage adjustments when complying with the CAFE standards, the associated terms for AC leakage are ignored during calculation of final vehicle technology cost when the system is configured to evaluate the CAFE compliance program.

As stated earlier, when computing and reporting the final technology cost for each manufacturer, the system separates the costs of technology application from those attributed to credits and adjustments. Thus, the manufacturer's technology cost is computed as simply the sales-weighted sum of individual vehicle technology costs, aggregated for each regulatory class, as follows:

$$TechCost_{mfr,RC} = \sum_{i \in V_{RC}} (Sales_i \times TechCost_i) \quad (60)$$

Where:

- $V_{RC}$  : a vector containing all vehicle models in regulatory class  $RC$ ,
- $Sales_i$  : the sales volume for a vehicle model  $i$ ,
- $TechCost_i$  : the technology cost accumulated by a vehicle model  $i$  from application of additional technology, as described in Section S4.7 above,
- $TechCost_{mfr,RC}$  : the final technology cost attributed to a manufacturer  $mfr$  from application of additional technology, in regulatory class  $RC$ .

Meanwhile, the cost attributed to each credit or adjustment is simply based on the amount that was used by the manufacturer for compliance (subject to the cap), and is calculated for each regulatory class as in the following three equations:

$$ACEffCost_{mfr,RC} = Sales_{RC} \times \text{MIN} \left( \frac{ACEffAdj_{RC}}{ACEffCap_{RC}} \right) \times ACEffCost_{RC} \quad (61)$$

$$ACLeakageCost_{mfr,RC} = Sales_{RC} \times \text{MIN} \left( \frac{ACLeakageAdj_{RC}}{ACLeakageCap_{RC}} \right) \times ACLeakageCost_{RC} \quad (62)$$

$$OffCycleCost_{mfr,RC} = Sales_{RC} \times \text{MIN} \left( \frac{OffCycleCredits_{RC}}{OffCycleCap_{RC}} \right) \times OffCycleCost_{RC} \quad (63)$$

Where:

- $RC$  : the regulatory class for which the manufacturer-level credit/adjustment costs are being computed,
- $Sales_{RC}$  : the sales volume of all vehicle models attributable to a manufacturer in regulatory class  $RC$ ,
- $ACEffAdj_{RC}$   
- through -  
 $OffCycleCost_{RC}$  : variables as defined in Equation (59) above,



- $ACEffCost_{RC}$  : the cost attributed to a manufacturer  $mfr$ , in regulatory class  $RC$ , due to AC efficiency adjustments,
- $ACLeakageCost_{RC}$  : the cost attributed to a manufacturer  $mfr$ , in regulatory class  $RC$ , due to AC leakage adjustments, and
- $OffCycleCost_{RC}$  : the cost attributed to a manufacturer  $mfr$ , in regulatory class  $RC$ , due to off-cycle credits.

Once again since AC leakage adjustments are not applicable under the CAFE compliance program, Equation (62) is ignored and evaluates to zero for CAFE.

#### S5.4.1 Regulatory Costs

Once the final vehicle technology costs are determined, the system proceeds to calculate the estimated price increases for each vehicle model. The individual vehicle's price increases are then aggregated for each manufacturer, per each regulatory class, signifying that manufacturer's overall cost of compliance, or its regulatory cost. Since fine payment is not allowed under the CO<sub>2</sub> program, when the modeling system is configured to comply with CO<sub>2</sub> standards, the prices increases attributed to individual vehicles are simply defined as the technology costs accumulated on those vehicles. When evaluating compliance with the CAFE program, however, the system apportions the total fines owed by a manufacturer (combined from all regulatory classes) to each individual vehicle model, based on the relative fuel economy shortfall attributed to each affected vehicle model with respect to a manufacturer's standard. This is represented by the series of equations that follow.

First, the system computes the sales weighted *pseudo-fine* associated with each vehicle model, for any vehicle where its fuel economy rating is lower than the manufacturer's standard, as such:

$$PseudoFine_{veh} = \text{MAX}(0, (STD_{RC} - FE'_{veh}) \times FineRate_{RC}) \quad (64)$$

Where:

- $RC$  : the regulatory class of a vehicle model  $veh$ ,
- $STD_{RC}$  : the standard attributable to a manufacturer in regulatory class  $RC$ ,
- $FE'_{veh}$  : the average fuel economy rating of the vehicle, adjusted by the petroleum equivalency factor, as defined by Equation (23) above,
- $FineRate_{RC}$  : the fine rate, specified in dollars, to apply per one credit of shortfall, and
- $PseudoFine_{veh}$  : the resulting pseudo-fine for a vehicle model  $veh$ .

Afterwards, the associated pseudo-fine value for the manufacturer is aggregated from that of the individual vehicles, as:

$$PseudoFine_{mfr} = \sum_i (PseudoFine_i \times Sales_i) \quad (65)$$

Where:

- $Sales_i$  : the sales volume for a vehicle model  $i$ ,
- $PseudoFine_i$  : the pseudo-fine for a vehicle model  $i$ ,
- $PseudoFine_{mfr}$  : the resulting pseudo-fine for a manufacturer  $mfr$ .

From here, the model proceeds to compute the regulatory costs, or prices increases, for individual vehicle models, as specified by the following equation:

$$RegCost_{veh} = TechCost'_{veh} + PseudoFine_{veh} \times \frac{Fines_{mfr,RC}}{PseudoFine_{mfr}} \quad (66)$$

Where:

- $RC$  : the regulatory class of a vehicle model  $veh$ ,
- $Fines_{mfr,RC}$  : the amount of CAFE civil penalties owed by a manufacturer in regulatory class  $RC$ ,
- $PseudoFine_{mfr}$  : the pseudo-fine for a manufacturer  $mfr$ ,
- $PseudoFine_{veh}$  : the pseudo-fine for a vehicle model  $veh$ ,
- $TechCost'_{veh}$  : the technology cost accumulated by a vehicle model  $veh$  from application of additional technology and manufacturer's credits and adjustments, and
- $RegCost_{veh}$  : the resulting regulatory cost, or price increase, for a vehicle model  $veh$ .

In the equation above, note that  $TechCost'_{veh}$  and  $RegCost_{veh}$  are both calculated and specified for a single vehicle unit (i.e., not sales weighted).

Lastly, the manufacturer's cost of compliance, in each regulatory class, is computed by summing across regulatory cost of individual vehicles, as follows:

$$RegCost_{mfr,RC} = \sum_{i \in V_{RC}} (RegCost_i \times Sales_i) \quad (67)$$

Where:

- $V_{RC}$  : a vector containing all vehicle models in regulatory class  $RC$ ,
- $Sales_i$  : the sales volume for a vehicle model  $i$ ,
- $RegCost_i$  : the regulatory cost, or price increase, for a vehicle model  $i$ ,
- $RegCost_{mfr,RC}$  : the resulting regulatory cost, or cost of compliance, for a manufacturer  $mfr$ , in regulatory class  $RC$ .

### S5.5 Hybrid/Electric “Burden” Cost

At the conclusion of each model year, the CAFE modeling system calculates several supplemental cost values, including the “burden” cost attributed to each vehicle model as a result of applying any hybrid/electric technology – that is, the cost borne by the manufacturer and not modeled as being recovered from vehicle buyers. For each vehicle, the system begins by computing the costs of: (1) the hybrid/electric component of a vehicle, (2) the tax credits associated with a purchase of a new hybrid/electric vehicle, and (3) the consumer’s willingness to pay for a hybrid/electric vehicle. From there, the technology burden cost associated with a vehicle model due to the presence of a hybrid/electric powertrain is computed as the difference between the cost of an HEV technology, and the sum of the tax credits and consumer’s willingness to pay for an HEV. Afterwards, each of the aforementioned cost values are aggregated to the manufacturer (by regulatory class), denoting, for example, the total burden cost incurred by a given fleet for upgrading to a hybrid/electric powertrain, in part or in full.

The cost values outlined here are only applicable to vehicles that end the simulation during a given year with some form of a hybrid/electric technology. Furthermore, these values represent the incremental costs attributed to the HEV technology used on a vehicle at the end of analysis of a specific model year, as compared to the HEV technology (if any) that was in use on the same vehicle at the start of modeling. As such, the associated costs are computed by the system on an incremental basis as well. Consequently, if a vehicle model begins and ends simulation of a given model year without a hybridized powertrain, the costs noted above, including the burden cost, will all be zero during that year.

Since the battery cost of an HEV technology differs based on the configuration of the vehicle, and since the intention is to isolate the added cost associated with hybridization, the system computes the incremental cost of the hybrid/electric powertrain present on a vehicle using the final technology configuration of that vehicle during a specific model year, but substituting the initial HEV technology as appropriate. For example, if a vehicle enters the CAFE Model with the following technology configuration “SHEVPS;ROLL10;AERO10;MR0,” but is later upgraded to “BEV200;ROLL20;AERO20;MR0;EPS,” the incremental cost attributed to HEV technology would be the difference between the “BEV200;ROLL20;AERO20;MR0;EPS” and the “SHEVPS;ROLL20;AERO20;MR0;EPS” states. Likewise, if a vehicle’s initial state includes some hybrid/electric technology (e.g., SHEVPS) and it concludes simulation during a given year with the same HEV technology, that vehicle will not incur any additional tax credits or consumer’s willingness to pay costs, but the HEV technology and burden costs will be a reflection of the small difference attributed to changes in the cost of the hybrid battery (if any).

For each vehicle model produced and sold by a manufacturer, the burden cost associated with application of hybrid/electric technology on vehicle during a specific model year is calculated as follows:

$$TechBurden_{MY} = \Delta HEV Cost_{MY} - \Delta Tax Credit_{MY} - \Delta Consumer WTP_{MY} \quad (68)$$

Where:

- $MY$  : the model year for which to calculate the technology burden cost,  
 $\Delta HEVCost_{veh,MY}$  : the change in the cost of HEV component of a vehicle during model year  $MY$ ,  
 $\Delta TaxCredit_{MY}$  : the change in the Federal tax credits a buyer will receive for purchasing a vehicle with an upgraded hybrid/electric powertrain that was produced during model year  $MY$ ,  
 $\Delta ConsumerWTP_{MY}$  : the change in cost that consumers are willing to pay for an upgraded hybrid/electric vehicle produced during model year  $MY$ , and  
 $\Delta TechBurden_{veh,MY}$  : the resulting technology burden cost associated with application of hybrid/electric technology on a vehicle during a model year  $MY$ .

In the equation above, the  $\Delta TaxCredit_{MY}$  and  $\Delta ConsumerWTP_{MY}$  are computed as the differences between the associated cost values based on the HEV technology in use on a vehicle at the end of the model year, and the one (if any) that was used on a vehicle prior to start of analysis. If the vehicle initially used a conventional powertrain, the tax credits and consumer's willingness to pay, after upgrading to an HEV, will consist of the full value applicable to the technology. The inputs for each of these values are defined, per technology, in the scenarios and the technologies input files.

The  $\Delta HEVCost_{MY}$  value in Equation (68) is computed as the difference of the base HEV technology costs (defined in the technologies input file) plus the incremental battery cost between the new HEV technology used on a vehicle and the initial HEV technology that the vehicle had at the start of the analysis. The calculation of  $\Delta HEVCost_{MY}$  is, hence, given by the following equation:

$$\Delta HEVCost_{MY} = \left( \begin{array}{l} (Cost_{MY,Veh}^{NewHEV} + Cost_{MY,Eng}^{NewHEV}) \\ -(Cost_{MY,Veh}^{PrevHEV} + Cost_{MY,Eng}^{PrevHEV}) \end{array} \right) + BatteryCost_{MY} \quad (69)$$

Where:

- $MY$  : the model year for which to calculate the technology burden cost,  
 $Cost_{MY,Veh}^{NewHEV}$  : the base cost of non-engine components attributed to the new HEV technology found on a vehicle during model year  $MY$ ,  
 $e_{MY,Eng}^{NewHEV}$  : the base cost of engine-specific components attributed to the new HEV technology found on a vehicle during model year  $MY$ ,  
 $Cost_{MY,Veh}^{PrevHEV}$  : the base cost of non-engine components attributed to the HEV technology that was initially in use on a vehicle at the start of analysis, or zero, if the vehicle did not have any HEV technology present,  
 $Cost_{MY,Eng}^{PrevHEV}$  : the base cost of engine-specific components attributed to the HEV technology that was initially in use on a vehicle at the start of analysis, or zero, if the vehicle did not have any HEV technology present,  
 $BatteryCost_{MY}$  : the incremental battery cost associated with application of a new HEV technology in model year  $MY$ , and

$\Delta HEVCost_{MY}$  : the resultant change in the cost of HEV component of a vehicle veh, during model year  $MY$ .

The incremental battery cost above,  $\Delta HEVCost_{MY}$ , is calculated as demonstrated by Equation (10) in Section S4.7.1. However, when using Equation (10) for calculation of incremental HEV costs, the “New” technology state corresponds to the final configuration of the vehicle, while the “Prev” technology state is a combination of the previously used HEV technology (if applicable), but using the final non-HEV technology configuration of the same vehicle (as demonstrated in the example above).

## **S5.6 Dynamic Fleet Share and Sales Response**

When evaluating a manufacturer’s fleet for compliance, the CAFE Model may be configured to rely on a user-supplied static fleet forecast, which may be based on a combination of manufacturer compliance data, public data sources, and proprietary forecasts. In such a case, the modeling system uses predefined sales volumes for each vehicle model available within the input fleet, carrying forward the same volumes for each model year analyzed during the study period. During analysis, any increases in vehicle costs, and associated fuel economy levels, resulting from technology application will not yield changes in the volume or mix of vehicles available for sale. As such, with the static forecast, the model assumes that there is no associated growth in vehicles’ sales volumes between model years.

As an alternative to the static forecast, users may use the Dynamic Fleet Share and Sales Response model (or, DFS/SR model), by enabling the “Dynamic Economic Modeling” option within the CAFE Model’s user interface. When this option is enabled, the DFS/SR model dynamically adjusts the fleet forecast during modeling for each analysis year.<sup>39</sup> The purpose of the Sales Response component of the DFS/SR model is to allow the CAFE modeling system to estimate new vehicle sales in a given future model year, by accounting for the impact of a regulatory scenario’s stringency on new vehicle prices and associated fuel savings. Additionally, the Dynamic Fleet Share component further modifies the share of light-duty passenger cars (LDV) and class 1/2a trucks (LDT1/2a) with respect to the overall vehicle market, in view of the changes in vehicle’s curb weights and fuel economy ratings resulting from application of additional technologies.<sup>40</sup>

Since the attributed-based standards defined for the CAFE and CO<sub>2</sub> compliance programs used within the modeling system rely upon a fixed forecast, the DFS/SR model needs calculate the new vehicle sales for any future model year prior to performing compliance calculations on that year. Furthermore, as the modeling system progresses through the individual years, multiyear planning feature integrated into the system may necessitate application of additional technologies in one or more of the preceding years, thereby changing the achieved CAFE and CO<sub>2</sub> ratings, as well as potentially increasing the cost of compliance during those years. This, in turn, would require the

---

<sup>39</sup> Refer to the CAFE Model’s Software Manual (available from the model’s Help menu and in Appendix C below) for instruction on how to toggle the “Dynamic Economic Modeling” option.

<sup>40</sup> As discussed in the RIA, the CAFE Model calculates the fleet shares based on the vehicle classification (or body style) of a vehicle (per Table 5 above), rather than its regulatory class assignment. This is done to account for the large-scale shift in recent years to crossover utility vehicles that have model variants in both the passenger car and light truck regulatory classes.

recalculation of the forecast for the affected model years, in order to accurately reflect the impact of changing vehicle costs and fuel economies on the new vehicle sales. Thus, when the DFS/SR model is used, after completing analysis for all model years available during the study period, the system forecasts the pending new sales volumes of all vehicles defined within the input fleet for each model year evaluated. The model achieves this by calculating the new total vehicles sales (via the Sales Response portion of the DFS/SR model), computing the shares of the LDV and LDT1/2a fleets (using the Dynamic Fleet Share component of the model), then combing these results to produce the updated vehicle fleet. Since the system executes the DFS/SR model at the after evaluation of all model years, the pending new forecast (for each year) must be fed back into the system for another pass through the compliance simulation algorithm. In order to achieve a stable solution, multiple passes (or iterations) are required, where at the conclusion of each iteration, the DFS/SR model recalculates a new forecast, which is then available for use during the next iteration. This procedure is generally illustrated by the diagram shown in Figure 7, at the opening of Section 5, above.

Since the first model year available within the study period is considered to define the production year of the vehicles being simulated, where the vehicle configurations and forecast are predetermined, the system is typically configured to not impose application of additional fuel improving technologies during analysis of that year. Accordingly, the DFS/SR model assumes that no action is taken for the first year of simulation, or that any such action will be inconsequential. Therefore, the DFS/SR model only begins computing new vehicle sales starting with the model year after the first. Furthermore, the current version of the modeling system does not forecast new vehicle sales for class 2b and 3 trucks. If any such vehicles are present in the input fleet, the system will default to using the initial sales figures supplied by the user for those vehicles.

Depending on the scenario being evaluated, the Sales Response model uses slightly different techniques to forecast new vehicle sales in future model years. For the baseline scenario, the system computes a nominal forecast, which produces the same outcome for any given year, irrespective of the standards defined by the baseline scenario (though the sales volumes are still likely to change between model years). As such, the calculation of the nominal forecast does not depend on the changing vehicle prices or fuel consumption improvements, instead, relying on pre-specified inputs describing the overall size of the new vehicle fleet in preceding model years, as well as the various macroeconomic assumptions. Within the CAFE modeling system, the nominal forecast, or the total new vehicle sales for the baseline scenario is calculated, for each model year, as follows:

$$Sales_{Base,MY} = \left( \begin{array}{c} C \\ +\beta_1 \times SalesPerHH_{MY-1} \\ +\beta_2 \times 3YrSumPerHH_{MY-1} \\ +\beta_3 \times \ln(GDP_{MY}) \\ +\beta_4 \times \ln(GDP_{MY-1}) \\ +\beta_5 \times Sentiment_{MY} \\ +\beta_6 \times Sentiment_{MY-1} \end{array} \right) \times HH_{MY} \times 1000 \quad (70)$$

Where:

- $C, \beta_1 - \beta_6$  : the intercept term (constant) and a set of beta coefficients, as defined by Table 17 below, used for tuning the nominal forecast of the Sales Response model,
- $SalesPerHH_{MY-1}$  : the number of new vehicle sales per household in the year immediately preceding model year  $MY$ ,
- $3YrSumPerHH_{MY-1}$  : the sum of new vehicle sales over the three years prior to model year  $MY$ , divided by the number of households in the year immediately preceding model year  $MY$ ,
- $\ln(GDP_{MY})$  : the natural log of the Gross Domestic Product in model year  $MY$ ,
- $\ln(GDP_{MY-1})$  : the natural log of the Gross Domestic Product in the year immediately preceding model year  $MY$ ,
- $Sentiment_{MY}$  : the consumer sentiment in model year  $MY$ ,
- $Sentiment_{MY-1}$  : the consumer sentiment in the year immediately preceding model year  $MY$ ,
- $HH_{MY}$  : the number of U.S. households during model year  $MY$ ,
- $1000$  : the conversion factor from thousands of households to units, and
- $Sales_{Base,MY}$  : the resulting nominal forecast, representing the total new vehicle sales in the baseline scenario for model year  $MY$ .

In the equation above, the values for GDP, consumer sentiment, and the number of households, are specified in the parameters input file. The constant term,  $C$ , and the beta coefficients,  $\beta_1$  through  $\beta_6$ , are provided in the following table.

**Table 17. Nominal Forecast Coefficients**

Coefficient	Value
$C$	0.2126917
$\beta_1$	0.6989812
$\beta_2$	-0.07718095
$\beta_3$	0.4357694
$\beta_4$	-0.4541888
$\beta_5$	0.0002942706
$\beta_6$	-0.00001357582

Additionally, in Equation (70) above, the  $SalesPerHH_{MY-1}$  and the  $3YrSumPerHH_{MY-1}$  values are computed as defined by the following two equations:

$$SalesPerHH_{MY-1} = \frac{Sales_{MY-1}}{HH_{MY-1} \times 1000} \quad (71)$$

And:

$$3YrSumPerHH_{MY-1} = \frac{Sales_{MY-3} + Sales_{MY-2} + Sales_{MY-1}}{HH_{MY-1} \times 1000} \quad (72)$$

Where:

- $Sales_{MY-3}$  : the total new vehicle sales in the year three years prior to model year  $MY$ ,
- $Sales_{MY-2}$  : the total new vehicle sales in the year two years prior to model year  $MY$ ,
- $Sales_{MY-1}$  : the total new vehicle sales in the year immediately preceding model year  $MY$ ,
- $HH_{MY-1}$  : the number of U.S. households in the year immediately preceding model year  $MY$ ,
- $1000$  : the conversion factor from thousands of households to units,
- $SalesPerHH_{MY-1}$  : the resulting number of new vehicle sales per household in the year immediately preceding model year  $MY$ , and
- $3YrSumPerHH_{MY-1}$  : the resulting sum of new vehicle sales over the three years prior to model year  $MY$ , divided by the number of households in the year immediately preceding model year  $MY$ .

In the equations above, for the new vehicle sales for the model years that are outside the study period, the system relies on the observed total industry sales as defined in the “Historic Fleet Data” sheet of the parameters input file (see Section A.3.5 of Appendix A). Once the modeling system evaluates and generates the nominal forecast for the first few years, the sales volumes from the preceding model years correspond to those that were produced by the system itself.

For all action alternatives (or, alternative scenarios), the system begins with the nominal forecast, as computed for the baseline scenario, and further extends the calculation to incorporate the price elasticity effect with regard to the incremental differences of regulatory costs and fuel savings occurring between the baseline and the action alternative scenarios. The outcome of this calculation produces a forecast of total new light-duty vehicle sales in a given model year for the action alternative scenario being evaluated. Afterwards, this newly calculated forecast is dynamically adjusted to split the total light-duty sales into resulting car and truck fleets, as demonstrated further below.

For each model year, the total new vehicle sales, as applicable to the action alternative, are computed as follows:

$$Sales_{Scen,MY} = Sales_{Base,MY} \times \left( 1 + \frac{\Delta RegCost_{MY} - FuelSavings_{MY}}{Price_{StartMY-1} + RegCost_{Base,MY}} \right) \quad (73)$$

Where:

- $Sales_{Base,MY}$  : the new vehicle sales in the baseline scenario for model year  $MY$ , as calculated by Equation (70) above,
- $\Delta RegCost_{MY}$  : the incremental difference of average regulatory cost, or price increase, of new vehicle models sold during model year  $MY$ , between the action alternative and the baseline scenarios,



- FuelSavings<sub>MY</sub>*: the incremental fuel savings realized by new vehicle models sold during model year *MY*, as a result of increasing standards in the action alternative scenario versus the baseline scenario, based on the assumed number of miles during which an added investment in fuel improving technology is expected to pay back,
- Price<sub>StartMY-1</sub>* : the sales-weighted average transaction price of new vehicle models sold during the model year immediately preceding the first analysis year evaluated during the study period,
- RegCost<sub>Base,MY</sub>* : the average regulatory cost of new vehicle models sold during model year *MY*, in response to standards defined by the baseline scenario, and
- Sales<sub>Scen,MY</sub>* : the resulting total new vehicle sales for the action alternative scenario for model year *MY*.

The average transaction price, *Price<sub>StartMY-1</sub>*, is defined by vehicle style in the “Historic Fleet Data” sheet of the parameters input file. For use with the equation above, however, the values from individual vehicle styles are weighted to obtain an industry average transaction price, based on the initial production volumes of the associated model year, also defined on the “Historic Fleet Data” sheet. The  $\Delta RegCost_{MY}$  is defined as the average price increase of new vehicle models in the action alternative scenario minus that of the baseline scenario, and is given by:

$$\Delta RegCost_{MY} = RegCost_{Scen,MY} - RegCost_{Base,MY} \quad (74)$$

In each case, the average regulatory cost is computed as a sales-weighted average of the price increases of individual vehicle models, aggregated over the entire light-duty fleet, as:

$$RegCost_{MY} = \sum_{i \in V_{MY}} (RegCost_{i,MY} \times Sales_{i,MY}) \quad (75)$$

Where:

- V<sub>MY</sub>* : a vector containing all vehicle models produced for sales during model year *MY*,
- Sales<sub>i,MY</sub>* : the sales volume for a vehicle model *i*, during model year *MY*,
- RegCost<sub>i,MY</sub>* : the regulatory cost for a vehicle model *i*, during model year *MY*, and
- RegCost<sub>MY</sub>* : the resulting average regulatory cost of new vehicle models sold during model year *MY*.

Similarly, the incremental fuel savings, *FuelSavings<sub>MY</sub>*, in Equation (73) above is calculated by subtracting the average fuel cost per mile (CPM) of new vehicle models resulting from the standards imposed by the action alternative from the average CPM associated with the baseline scenario, with the difference being multiplied by the assumed number of payback miles. The specifics pertaining to the calculation of fuel cost per mile are detailed in the following chapter. Those calculations, however, are typically ascribed to individual vehicles, whereas for the purposes of estimating the total new vehicle sales during a specific model year, an aggregate measure of fuel economies across all vehicle models is used. Hence, the incremental fuel savings in each model year, for use in Equation (73), are calculated as:

$$FuelSavings_{MY} = (CPM_{Base,MY} - CPM_{Scen,MY}) \times 35000 \quad (76)$$

Where:

- $CPM_{Base,MY}$  : the fuel cost per mile of new vehicle models sold during model year  $MY$ , based on the average fuel economy attained by those vehicles in response to standards defined by the baseline scenario,
- $CPM_{Scen,MY}$  : the fuel cost per mile of new vehicle models sold during model year  $MY$ , based on the average fuel economy attained by those vehicles in response to standards defined by the action alternative scenario,
- $35000$  : the assumed number of miles during which an added investment in fuel improving technology is expected to pay back, and
- $FuelSavings_{MY}$ : the resulting incremental fuel savings realized by new vehicle models sold during model year  $MY$ , as a result of increasing standards in the action alternative scenario versus the baseline scenario.

Once the system computes the overall new vehicle sales for a given model year, the Dynamic Fleet Share component of the DFS/SR model is used to apportion those sales into individual car and truck fleets. The Dynamic Fleet Share (DFS) model is defined by a series of difference equations that determine the relative share of LDV and LDT1/2a fleets based on the average horsepower, curb weight, and fuel economy associated with the specific vehicle class, the previous year's fleet share of that class, as well as the current and past fuel prices of gasoline. As with the Sales Response model, the DFS portion uses values from one and two years preceding the analysis year when estimating the share of the fleet during the model year being evaluated. For the horsepower, curb weight, and fuel economy values occurring in the model years before the start of analysis, the DFS model uses the observed values as defined in the "Historic Fleet Data" sheet of the parameters input file. After the first model year is evaluated, the DFS model relies on values calculated during analysis by the modeling system. The Dynamic Fleet Share model begins by calculating the natural log of the new shares during each model year, independently for each vehicle class, as specified by the following equation:

$$\ln(Share_{VC,MY}) = \left( \begin{array}{l} \beta_C \times (1 - \beta_{Rho}) + \beta_{Rho} \times \ln(Share_{VC,MY-1}) \\ + \beta_{FP} \times (\ln(Price_{Gas,MY}) - \beta_{Rho} \times \ln(Price_{Gas,MY-1})) \\ + \beta_{HP} \times (\ln(HP_{VC,MY-1}) - \beta_{Rho} \times \ln(HP_{VC,MY-2})) \\ + \beta_{CW} \times (\ln(CW_{VC,MY-1}) - \beta_{Rho} \times \ln(CW_{VC,MY-2})) \\ + \beta_{MPG} \times (\ln(FE_{VC,MY-1}) - \beta_{Rho} \times \ln(FE_{VC,MY-2})) \\ + \beta_{Dummy} \times (\ln(0.423453) - \beta_{Rho} \times \ln(0.423453)) \end{array} \right) \quad (77)$$

Where:

- $\beta_C - \beta_{Dummy}$  : set of beta coefficients, as defined by Table 18 below, used for tuning the Dynamic Fleet Share model,
- $Share_{VC,MY-1}$  : the share of the total industry fleet classified as vehicle class  $VC$ , in the year immediately preceding model year  $MY$ ,

- $Price_{Gas,MY}$  : the fuel price of gasoline fuel, in cents per gallon, in model year  $MY$ ,  
 $Price_{Gas,MY-1}$  : the fuel price of gasoline fuel, in cents per gallon, in the year immediately preceding model year  $MY$ ,  
 $HP_{VC,MY-1}$  : the average horsepower of all vehicle models belonging to vehicle class  $VC$ , in the year immediately preceding model year  $MY$ ,  
 $HP_{VC,MY-2}$  : the average horsepower of all vehicle models belonging to vehicle class  $VC$ , in the year preceding model year  $MY$  by two years,  
 $CW_{VC,MY-1}$  : the average curb weight of all vehicle models belonging to vehicle class  $VC$ , in the year immediately preceding model year  $MY$ ,  
 $CW_{VC,MY-2}$  : the average curb weight of all vehicle models belonging to vehicle class  $VC$ , in the year preceding model year  $MY$  by two years,  
 $FE_{VC,MY-1}$  : the average on-road fuel economy rating of all vehicle models (excluding credits, adjustments, and petroleum equivalency factors) belonging to vehicle class  $VC$ , in the year immediately preceding model year  $MY$ ,  
 $FE_{VC,MY-2}$  : the average on-road fuel economy rating of all vehicle models (excluding credits, adjustments, and petroleum equivalency factors) belonging to vehicle class  $VC$ , in the year preceding model year  $MY$  by two years,  
 $0.423453$  : a dummy coefficient, and  
 $\ln(Share_{VC,MY})$  : the natural log of the calculated share of the total industry fleet classified as vehicle class  $VC$ , in model year  $MY$ .

In the equation above, the beta coefficients,  $\beta_C$  through  $\beta_{Dummy}$ , are provided in the following table. The beta coefficients differ depending on the vehicle class for which the fleet share is being calculated.

**Table 18. DFS Coefficients**

Coefficient	LDV Value	LDT1/2a Value
$\beta_C$	3.4468	7.8932
$\beta_{Rho}$	0.8903	0.3482
$B_{FP}$	0.1441	0.4690
$B_{HW}$	-0.4436	1.3607
$B_{CW}$	-0.0994	1.5664
$B_{MPG}$	-0.5452	0.0813
$B_{Dummy}$	-0.1174	0.6192

Once the initial LDV and LDT1/2a fleet shares are calculated (as a natural log), obtaining the final shares for a specific vehicle class is simply a matter of taking the exponent of the initial value, and normalizing the result at one (or 100%). This calculation is demonstrated by the following:

$$Share_{VC,MY} = \frac{e^{\ln(Share_{VC,MY})}}{e^{\ln(Share_{LDV,MY})} + e^{\ln(Share_{LDT1/2a,MY})}} \quad (78)$$

Where:

- $\ln(Share_{VC,MY})$  : the natural log of the calculated share of the total industry fleet classified as vehicle class  $VC$ , in model year  $MY$ ,
- $\ln(Share_{LDV,MY})$  : the natural log of the calculated share of the total industry fleet classified as light-duty passenger vehicles (LDV), in model year  $MY$ ,
- $\ln(Share_{LDT1/2a,MY})$  : the natural log of the calculated share of the total industry fleet classified as class 1/2a light-duty truck (LDT1/2a), in model year  $MY$ , and
- $Share_{VC,MY}$  : the calculated share of the total industry fleet classified as vehicle class  $VC$ , in model year  $MY$ .

The last step of the Dynamic Fleet Share and Sales Response model involves combining the results obtained by either Equation (70) (for baseline scenario) or (73) (for action alternative) with that of Equation (78), and scaling the sales volumes of each individual vehicle model present within the input fleet, as follows:

$$Sales_{veh,MY} = Sales_{veh,MY-1} \times \frac{Share_{VC,MY} \times Sales_{MY}}{Sales_{VC,MY-1}} \quad (79)$$

Where:

- $Sales_{veh,MY-1}$  : the sales volume of vehicle model  $veh$  in the year immediately preceding model year  $MY$ ,
- $Sales_{VC,MY-1}$  : total industry sales of vehicles classified as vehicle class  $VC$ , for the year immediately preceding model year  $MY$ ,
- $Share_{VC,MY}$  : the share of the total industry fleet classified as vehicle class  $VC$ , in model year  $MY$ ,
- $Sales_{MY}$  : total industry sales (aggregated across all manufacturers and vehicle models) for model year  $MY$ , and
- $Sales_{veh,MY}$  : the resulting sales volume of vehicle model  $veh$  in model year  $MY$ .

In Equation (79), the  $Share_{VC,MY}$  and  $Sales_{VC,MY-1}$  values are obtained based on the vehicle class assignment of the vehicle being evaluated. For example, if a vehicle is classified as LDT1, the corresponding shares for LDT1/2a class will be used.

### **S5.7 Credit Transfers and Carry Forward**

During analysis, the compliance simulation algorithm may, as necessary, apply credits generated by a manufacturer in some compliance category in order to offset a shortfall of another compliance category. Here, a compliance category is defined as a combination of a manufacturer, model year, and regulatory class in which credits may be earned or used. The current version of the CAFE Model supports two forms credit usage:

- 1) Credit carry forward: where credits earned by a manufacturer during some previous model year are carried forward into the analysis year, within the same regulatory class, for up to five years;

- 2) Credit transfers: where credits earned by a manufacturer in one regulatory class are transferred to another regulatory class, during the same model year, subject to a maximum transfer cap for any given year.

Whenever the modeling system initiates a credit transfer or credit carry forward operation for a manufacturer, that operation forms a new “credit transaction” for the affected compliance categories. Each transaction is subsequently recorded in a model log file upon successful completion. The modeling system performs these credit transactions regardless of whether the system is configured to evaluate compliance with the CAFE program or the CO<sub>2</sub> program. However, since the denomination and applicability of credits is specific to each compliance program, the system accumulates and maintains CAFE and CO<sub>2</sub> credits independent of one another.

The CAFE Model relies on the configuration options found in the “Credit Trading Values” sheet of the parameters input file for controlling the behavior of credit carry forward and credit transfer operations. For example, a user may elect to increase the caps for credit transfers in any of the listed model years, allowing the modeling system to transfer additional credits into a specific compliance category. Additionally, a user may disable one or both of the credit usage options within the parameters file, to have the model ignore a specific form of credit usage during analysis altogether. Although options for enabling credit trades between manufacturers and carrying credits backward into the preceding model years are listed in the parameters file, the modeling system currently does not support those options during analysis. Section A.3.7 of Appendix A provides additional information on the available credit trading configuration options.

Some of the credit usage options defined in the parameters file may not be applicable when the CAFE Model is configured to evaluate CO<sub>2</sub> standards. Specifically, since the CO<sub>2</sub> program allows for unlimited amount of fleet transfers, the transfer caps defined in the input file are not applicable. Likewise, since the CO<sub>2</sub> credits are denominated as metric tons and may be carried forward and transferred without requiring any form of fuel-preserving adjustment, the assumed lifetime VMT parameter is not applicable when evaluating the CO<sub>2</sub> compliance program as well.

#### **S5.7.1 Evaluation and Application of Credits**

As described in Section S5.3, if a manufacturer is noncompliant after exhausting all cost-effective technology solutions, the algorithm carries forward and transfers as much expiring credits as available in order to attain compliance. If the amount of expiring credits carried forward into the analysis year does not cover the entire shortfall of one or more regulatory classes, the algorithm proceeds to apply additional ineffective technologies, then carries forward and transfers the remainder of available credits. As it examines credit deficits in each compliance category attributable to a manufacturer (i.e., regulatory class and analysis year), the compliance simulation algorithm carries forward and transfers credits from other compliance categories in a specific order of precedence. The algorithm completes each step, described in the list below, for all regulatory classes, before moving on to the next step:

- 1) The algorithm begins by carrying forward credits into the analysis year, within the same regulatory class (e.g., LT-2017 to LT-2021), starting with oldest generated credits first;
- 2) The algorithm then carries forward and transfers credits earned in a previous model year of one regulatory class, into the analysis year of another regulatory class (e.g., DC-2017 to LT-2021), again, starting with the oldest available credits first; however, since direct credit carry forward is restricted to within the same regulatory class only, this step results in two credit transactions, where credits are first carried forward into the analysis year for the originating regulatory class, then transferred into the final destination class (e.g., carry forward: DC-2017 to DC-2021, then transfer: DC-2021 to LT-2021);
- 3) Lastly, if one or more of the regulatory classes has a surplus of credits during the analysis year, while some other regulatory classes are at a deficit, the algorithm concludes with transferring credits between regulatory classes (e.g., DC-2021 to LT-2021).

The modeling system follows the same logical evaluation of credits whether it is configured to evaluate compliance with the CAFE standards or the CO<sub>2</sub> standards. With the CAFE compliance program, however, fleet transfers may occur between DC and IC, DC and LT, or IC and LT classes, while for the CO<sub>2</sub> program, fleet transfers are defined as simply between PC and LT regulatory classes. In the case of the CAFE program, the algorithm has a predefined preference for the source regulatory class (where credits are earned) when transferring into a destination regulatory class (where credits are used). The model's credit transfer preference for each class is summarized by the following table:

**Table 19. Credit Transfer Preference**

<b>Regulatory Class</b>	<b>Source Regulatory Class</b>
Domestic Car	Imported Car, Light Truck
Imported Car	Light Truck, Domestic Car
Light Truck	Imported Car, Domestic Car
Light Truck 2b/3	N/A (fleet transfers not allowed)

When transferring credits into the Imported Car or Light Truck regulatory class, the algorithm considers credits originating in the Domestic Car class only after exhausting credits from the other classes. Considering that the minimum domestic car standard cannot be met via fleet transfers (though, credit carry forward is allowed), the algorithm prefers to bank as much credits earned by the Domestic Car fleet during the analysis year, in order to be able to use those credits for carry forward during later years. When transferring credits into the Domestic Car regulatory class, the algorithm prefers to begin by transferring credits earned in the Imported Car fleet, then if needed, transferring credits from the Light Truck fleet. Fleet transfers under the CAFE program require the use of an adjustment factor in order to preserve total gallons consumed. Since the calculated DC/IC adjustment factor is closer to one than the DC/LT factor, the model favors using Imported Car credits first.

The adjustment factor used by the algorithm when transferring credits between regulatory classes under the CAFE compliance program is calculated by using the assumed lifetime VMT, the CAFE standard, and the CAFE rating attributed to compliance categories where credits are earned and where credits are used, according to the following equation:

$$AdjFactor = \frac{VMT_{C_{Used}} \times CAFE_{C_{Earned}} \times STD_{C_{Earned}}}{VMT_{C_{Earned}} \times CAFE_{C_{Used}} \times STD_{C_{Used}}} \quad (80)$$

Where:

- $C_{Earned}$  : the compliance category where credits are earned,
- $C_{Used}$  : the compliance category where credits are used,
- $VMT_{C_{Earned}}$  : the assumed average lifetime vehicle miles traveled by typical vehicle models in a regulatory class corresponding to the compliance category where credits are earned,
- $VMT_{C_{Used}}$  : the assumed average lifetime vehicle miles traveled by typical vehicle models in a regulatory class corresponding to the compliance category where credits are used,
- $CAFE_{C_{Earned}}$  : the CAFE rating achieved by a manufacturer in a regulatory class corresponding to the compliance category where credits are earned,
- $CAFE_{C_{Used}}$  : the CAFE rating achieved by a manufacturer in a regulatory class corresponding to the compliance category where credits are used,
- $STD_{C_{Earned}}$  : the calculated fuel economy standard attributable to a manufacturer in a regulatory class corresponding to the compliance category where credits are earned,
- $STD_{C_{Used}}$  : the calculated fuel economy standard attributable to a manufacturer in a regulatory class corresponding to the compliance category where credits are used, and
- $AdjFactor$  : the adjustment factor to use when transferring credits between compliance categories with different regulatory classes.

As stated above, the purpose of the adjustment factor defined by Equation (80) is to preserve total gallons when transferring credits between compliance categories of different regulatory classes.

As described in previous sections, the modeling system keeps track of total credits carried forward or transferred into a regulatory class and carried forward or transferred out of a regulatory class during each model year. Each time a credit transaction is executed by the compliance simulation algorithm, the total amount of credits carried forward or transferred out of a compliance category (where credits were earned) will be added to an associated “credits out” variable, while credits carried forward or transferred into a compliance category (where credits are used) will be added to an accompanying “credits in” variable. During each credit transaction, the amount of “out” credits will not exceed the amount of credits earned by a manufacturer; likewise, the amount of “in” credits will not exceed the minimum of the amount of credits earned by a manufacturer in a “source” compliance category or the amount of credits required in a “destination” compliance category. Collectively, the credits earned, “in,” and “out” form the “net credits” which will be used to by the algorithm to determine the degree of a manufacturer’s noncompliance in each regulatory class, whether the net credits result in the fines owed (under the CAFE program) or the value of CO<sub>2</sub> credits (under the CO<sub>2</sub> program).<sup>41</sup>

---

<sup>41</sup> Refer to Equations (35) and (43) above for calculations of CAFE fines and value of CO<sub>2</sub> credits.

When carrying forward credits, the compliance simulation algorithm may equally rely upon the credit banks defined within the input fleet as well as the credits generated as part of compliance modeling. Thus, for earlier model years evaluated during the study period, credits carried forward into the analysis year are likely to originate prior to the first year analyzed. Additionally, if a manufacturer is able to achieve compliance for several consecutive model years without requiring the use of credits, it is likely that “banked” or earned credits will remain unused and may expire.

### **S5.7.2 Credit Usage Strategy**

When generating and using credits, the CAFE Model anticipates that, with each successive model year, the standards (or the required levels) for CAFE and CO<sub>2</sub> would typically become more stringent, while the potential for meeting these standards through technology application would generally become more difficult. This difficulty in meeting the standards arises since, considering the vehicle redesign and refresh schedules, manufacturers have a limited set of vehicles available for improvement during each model year. Using credits aggressively in earlier years, instead of improving vehicle fuel economies, and thereby foregoing the improvements to a manufacturer’s CAFE or CO<sub>2</sub> rating, results in higher shortfalls in all subsequent years, while simultaneously reducing the overall amount of “banked” credits. The higher shortfalls, in turn, force a manufacturer to apply additional technologies (to a set of vehicles being redesigned or refreshed) in a future model year, or use even more credits, further reducing the credit bank. In the later years, the more aggressive the model is with using the credits, the more challenging compliance for a manufacturer becomes. While multiyear modeling alleviates some of these concerns, by allowing the compliance simulation algorithm to “look back” to a preceding year and applying a technology that was left as a candidate, doing so may not always result in a cost-optimal solution. This occurs since, once the algorithm uses credits in an earlier year, further application of technology during the same year leads to a “loss” of credits, while the compliance state of a manufacturer remains the same.

For this reason, the model employs a more conservative strategy of applying technology solutions for compliance in the earlier years (when doing so is more like to decrease the shortfall of future model years), and only using credits as necessary (when a manufacturer runs out of available technology solutions). This credit use strategy varies slightly, depending on the compliance program and the manufacturer the model is presently evaluating. Under the CAFE compliance program, for manufacturers that are willing to pay civil penalties, the model would only apply technologies, provided it is cost-effective to do so, and consume existing credits more aggressively. Alternatively, for manufacturers that are unwilling to pay CAFE civil penalties, or if the CAFE Model is evaluating compliance with the CO<sub>2</sub> program (where fine payment is not an option), the model would apply as much technology as possible, only using credits that will expire during the analysis year or if a manufacturer has run out of available technology solutions.<sup>42</sup>

When the CAFE Model is configured to evaluate compliance with the CO<sub>2</sub> standards, since the CO<sub>2</sub> program allows for unlimited credit transfers between fleets, the modeling system attempts to achieve compliance with the passenger car and light truck fleets simultaneously. To accomplish

---

<sup>42</sup> Credit usage will be revisited in a future release of the CAFE Model in order to optimize the compliance simulation algorithm’s decision between applying technologies and using credits with respect to lowering the total cost of compliance.



this, the CAFE Model allows for CO<sub>2</sub> credits to be transferred, from a fleet that is in compliance to another that is at a deficit, during the same year that the credits are earned. The system, then, reevaluates and transfers CO<sub>2</sub> credits, each time and on an as-needed basis, after each successive application of technologies to a group of vehicles. This implementation allows the system to more realistically simulate a manufacturer's response to a cumulative CO<sub>2</sub> standard at each year, which while being defined independently for passenger cars and light trucks, is likely to be interpreted by manufacturers as a de facto single standard.

## Chapter Three      Calculation of Effects

This chapter describes the way the CAFE modeling system estimates the effects of potential new CAFE or CO<sub>2</sub> standards on energy use, as well as on emissions of greenhouse gases and other air pollutants. These effects on energy use and emissions are calculated based on the fuel economy of individual vehicle models that manufacturers make in response to the standards. The modeling system estimates all effects separately for each individual vehicle model and vintage (or model year) over its expected life span in the U.S. vehicle fleet. A vehicle model's life span extends from the initial model year when it is produced and sold, through the year when vehicles produced during that model year have reached the maximum age assumed in the CAFE Model.<sup>43</sup> This chapter also describes the way these energy use and environmental impacts are translated into estimates of economic benefits or costs, and identifies which of these economic impacts are borne privately by vehicle owners and by society as a whole.

Although these effects are calculated for individual vehicle models, vintages, and future calendar years over their respective lifetimes, they are typically reported at the aggregate level for all vehicle models in a regulatory class produced during each model year affected by a proposed standard. Cumulative impacts for each regulatory class and model year over its expected life span are reported both in undiscounted terms and as their present value discounted to the calendar year defined within the parameters input file. Additionally, virtually all effects calculated for the regulatory scenario considered to be the "baseline" are reported by the modeling system on an absolute basis (e.g., total amount of fuel consumed or total miles driven), while for scenarios considered to be the "action alternatives," all of the modeling effects are reported as incremental and are specified as the difference between the action alternative and the baseline scenario.

---

<sup>43</sup> We adopt the simplifications that vehicle model years and calendar years are identical, and that all vehicles produced during a model year are sold and placed into service during the corresponding calendar year.

## Section 1 Vehicle Lifetimes

The number of vehicles of a specific model and vintage that remain in service during each subsequent calendar year is calculated by multiplying the number originally produced by estimates of the proportion expected to remain in service at each age up to an assumed maximum lifetime. The modeling system applies survival rates in two different ways, depending upon whether the user elects to use the Dynamic Scrapage model (described below) or the static survival rates that appear in the parameters input file. The static survival rates vary by age of vehicle and differentiate between cars, vans and SUVs, light-duty pickups, and medium-duty trucks (class 2b and 3). The categories used to specify the survival rates (as provided in the parameters input file) are based on a combination of vehicle style (applicable to light-duty vehicles) and regulatory class (for medium-duty vehicles), and are described by the following table:

**Table 20. Survival Rates and Miles Driven Categories**

Category	Description
Cars	Vehicles with styles defined as: convertible, coupe, hatchback, sedan, or wagon
Vans/SUVs	Vehicles with styles defined as: SUV, minivan, van, passenger van, or cargo van
Pickups	Vehicles with styles defined as: pickup
2b/3 Trucks	Vehicles with styles defined as: large pickup, chassis cab, or cutaway; or Vehicles that are regulated as medium-duty trucks (class 2b/3)

The number of vehicles of a given model produced during a specific model year that remain in use during a future calendar year is defined by the following equation:

$$N_{MY,CY} = SURV_{MY,C,a} \times Sales_{MY} \quad (81)$$

Where:

- $MY$  : the production year of the vehicle for which to calculate the number of surviving units of that vehicle model,
- $CY$  : the calendar year during which to calculate the number of surviving vehicles,
- $C$  : the category of the vehicle for which to calculate the number of surviving units of that vehicle model,
- $SURV_{MY,C,a}$ : the probability that vehicles of category  $C$ , produced in model year  $MY$ , will remain in service at a given age  $a$ ,
- $Sales_{MY}$  : the forecast number of new vehicles of a specific vehicle model produced and sold during model year  $MY$ , and
- $N_{MY,CY}$  : the resultant number of vehicles produced during model year  $MY$  that remain in use during a future calendar year  $CY$ .

The age,  $a$ , of a vehicle model produced in model year,  $MY$ , during calendar year,  $CY$ , is defined as:

$$a = CY - MY^{44} \quad (82)$$

Although the modeling system calculates the number of surviving vehicles for each individual vehicle model, it aggregates these results for reporting purposes to obtain the total on-road fleet that remains in service in each calendar year, for each model year of production. Since all effects calculated by the model are reported by fuel type (as discussed in Sections B.3 through B.5 of Appendix B) the model further separates the on-road fleet for a given model year based on the individual fuel types represented within the input fleet. Hence, the total surviving fleet apportioned to each type of fuel used by all vehicle models produced in a specific model year during each calendar year is calculated by summing the number of each individual vehicle model that remains in service during a specific calendar year as follows:

$$Fleet_{MY,CY,FT} = \sum_{i \in V} (FS_{i,MY,FT} \times N_{i,MY,CY}) \quad (83)$$

Where:

- $V$  : a vector containing all vehicle models produced during model year  $MY$ ,
- $MY$  : the production year of all vehicles for which to calculate the surviving on-road fleet,
- $CY$  : the calendar year during which to calculate the surviving on-road fleet,
- $FT$  : the fuel type that all vehicles produced in model year  $MY$  operate on,
- $FS_{i,MY,FT}$  : the percent share of miles driven by vehicle model  $i$ , produced in model year  $MY$ , when operating on fuel type  $FT$ ,
- $N_{i,MY,CY}$  : the number of vehicles, of vehicle model  $i$ , produced during model year  $MY$  that remain in use during a future calendar year  $CY$ , and
- $Fleet_{MY,CY,FT}$  : the resultant number of all vehicle models produced during model year  $MY$  that remain in use during calendar year  $CY$ , allotted to fuel type  $FT$ .

Lastly, the total on-road fleet of all surviving vehicle models, attributed to each specific fuel type ( $FT$ ) produced in model year  $MY$  over their expected lifetimes is calculated by summing the number of surviving vehicle models across the individual calendar years as follows:

$$Fleet_{MY,FT} = \sum_{CY} Fleet_{MY,CY,FT} \quad (84)$$

The calendar year,  $CY$ , in the equation above ranges between the model year,  $MY$ , when the vehicle model was produced until  $MY$  plus the maximum survival age of that vehicle.

In addition to the static survival schedules that are specified in the parameters input file, the CAFE Model also accommodates a way to dynamically estimate the vehicle survival rates by using a Dynamic Scrapage model, which allows vintage, new vehicle price, relative cost per mile, and

---

<sup>44</sup> We define a vehicle's age to be 0 during the year when it is produced and sold; that is, when  $CY=MY$ . Thus, for example, a model year 2005 vehicle is defined to be 10 years old during calendar year 2015.

the GDP growth rate to affect retirement rates. In contrast, the static schedules presume constant scrappage rates for all vintages under all new vehicle prices, new vehicle fuel economies, and macroeconomic conditions. The application of both survival rates follow the logic described above, despite the different origin of the rates themselves. The Dynamic Scrappage model is presented in Section S1.1 below, while a description of the static survival rates used is presented in Section S1.2.

### **S1.1 Dynamic Scrappage Model**

The Dynamic Scrappage model was developed from a series of registration counts by vehicle classification, vintage, and age under certain economic conditions. As with the Dynamic Fleet Share and Sales Response model discussed above, the Dynamic Scrappage model is enabled by toggling the “Dynamic Economic Modeling” option within the CAFE Model’s user interface. The model predicts historical values well, but given the sparseness of data for older vehicles, it does not project remaining fleet shares that align with historical values beyond a certain age. For this reason, an exponential decay function is used to ensure that the final fleet share converges to the observed historical final fleet share for vehicles of a given classification. It is assumed that vehicles remain in use for up to 40 years, before a vehicle of a specific model year is completely scrapped. Hence, the share of each vehicle model of vintage  $MY$  and category  $C$ , surviving at age  $a$ , is defined by the following:

$$SURV_{MY,C,a} = \frac{(1 - SCRAP_{MY,C,a-1}) \times Fleet_{MY,C,a-1}}{Sales_{MY,C}} \quad (85)$$

Where:

- $MY$  : the production year for which to estimate the survival rate,
- $C$  : the category for which to estimate the survival rate,
- $SCRAP_{MY,C,a-1}$ : the probability that vehicles of category  $C$ , produced and sold in model year  $MY$ , will be scrapped by a given age  $a$ , conditional on survival to the preceding age,  $a-1$ ,
- $Fleet_{MY,C,a-1}$  : the total number of vehicles of category  $C$ , produced and sold during model year  $MY$ , that remained in use during the preceding age,  $a-1$ ,
- $Sales_{MY,C}$  : the total new vehicle sales of category  $C$ , produced and sold during model year  $MY$ , and
- $SURV_{MY,C,a}$  : the calculated probability that vehicles of category  $C$ , produced and sold during model year  $MY$ , will remain in service at a given age  $a$ .

In Equation (85) above, if the decay function has not taken effect,  $SCRAP_{MY,C,a}$  is obtained based on the following two equations:

$$SCRAP_{MY,C,a} = \frac{e^{CV_{MY,C,a}}}{1 + e^{CV_{MY,C,a}}} \quad (86)$$

And:

$$CV_{MY,C,a} = \left( \begin{array}{l} (\beta_0 \times a + \beta_1 \times a^2 + \beta_2 \times a^3) \\ + (\beta_3 + \beta_4 \times a) \times \frac{Fleet_{MY,C,a}}{Sales_{MY,C}} \\ + (\beta_5 + \beta_6 \times a + \beta_7 \times a^2 + \beta_8 \times a^3) \\ \times (Price_{CY} - FuelSav_{CY} - Price_{CY-1} + FuelSav_{CY-1}) \\ + \beta_9 \times (FuelPrice_{MY,CY,C} - FuelPrice_{MY,CY-1,C}) \\ + \beta_{10} \times (CPM_{MY,CY,C} - CPM_{MY,CY-1,C}) \\ + \beta_{11} \times \frac{GDP_{CY}}{GDP_{CY-1}} \times 100 \\ + \beta_{12} + \beta_{13} \times \text{MIN}(MY, \beta_{14}) \end{array} \right) \quad (87)$$

For:

$$a \geq 0 \text{ and } a < 39;$$

Where:

- MY* : the production year for which to estimate the probability of scrappage,
- CY* : the calendar year during which to estimate the probability of scrappage,
- a* : the age of the fleet produced during model year *MY* that remains in services during calendar year *CY*,
- C* : the category of vehicles for which to estimate the probability of scrappage,
- $\beta_0 - \beta_{14}$  : a set of beta coefficients for a given vehicle category *C*, as defined in the parameters input file (refer to Section A.3.4 of Appendix A for more),
- Fleet<sub>MY,C,a</sub>* : the total number of vehicles of category *C*, produced and sold during model year *MY*, that remain in use during age, *a*,
- Sales<sub>MY,C</sub>* : the total new vehicle sales of category *C*, produced and sold during model year *MY*,
- Price<sub>CY</sub>* : the sales-weighted average transaction price of all new vehicles produced and sold during a model year equivalent to calendar year *CY*,
- FuelSav<sub>CY</sub>* : the incremental fuel savings realized by all new vehicles produced and sold during a model year equivalent to calendar year *CY*, versus the historic vehicles that were produced and sold in 1975, based on the assumed number of miles during which an added investment in fuel improving technology is expected to pay back,
- Price<sub>CY-1</sub>* : the sales-weighted average transaction price of all new vehicles produced and sold during a model year equivalent to calendar year *CY-1*,
- FuelSav<sub>CY-1</sub>* : the incremental fuel savings realized by all new vehicles produced and sold during a model year equivalent to calendar year *CY-1*, versus the historic vehicles that were produced and sold in 1975, based on the

- assumed number of miles during which an added investment in fuel improving technology is expected to pay back,
- $FP_{MY,CY,C}$  : the average retail price of fuel in calendar year  $CY$ , weighted by fuel shares of vehicles of category  $C$ , produced and sold during model year  $MY$ ,
- $FP_{MY,CY-1,C}$  : the average retail price of fuel in calendar year  $CY-1$ , weighted by fuel shares of vehicles of category  $C$ , produced and sold during model year  $MY$ ,
- $CPM_{MY,CY,C}$  : the cost-per-mile, denominated in cents, during calendar year  $CY$ , of new vehicles of category  $C$ , produced and sold during model year  $MY$ ,
- $CPM_{MY,CY-1,C}$  : the cost-per-mile, denominated in cents, during calendar year  $CY-1$ , of new vehicles of category  $C$ , produced and sold during model year  $MY$ ,
- $GDP_{CY}$  : the Gross Domestic Product in calendar year  $CY$ ,
- $GDP_{CY-1}$  : the Gross Domestic Product in calendar year  $CY-1$ ,
- $CV_{MY,C,a}$  : the resultant covariate used to determine the probability that vehicles of category  $C$ , produced and sold during model year  $MY$ , will be scrapped by a given age  $a$ , and
- $SCRAP_{MY,C,a}$  : the resultant probability that vehicles of category  $C$ , produced and sold during model year  $MY$ , will be scrapped by a given age  $a$ .

The incremental fuel savings,  $FuelSav_{CY}$  and  $FuelSav_{CY-1}$ , in the above equation are computed by taking the difference in the average fuel costs per mile (CPMs) between the associated new vehicle models and their historic counterparts, then multiplying that difference by the assumed number of total miles necessary for the added cost of fuel improving technology to pay back. The general form of the fuel savings calculation is detailed by Equation (76) in Section S5.5 of the preceding chapter. The CPM values listed in Equation (76), however, are substituted with the ones defined here in order to adapt the calculation for use with Equation (87) above. The modified fuel savings calculation is presented here for reader's consideration:

$$FuelSav_{CY} = (CPM_{1975,CY} - CPM_{New,CY}) \times 35000 \quad (88)$$

Equations (86) and (87) above are applicable to the earlier vehicle ages, before the decay function is employed to estimate the tail end of the probabilities that vehicles will be scrapped at a specific age. The Dynamic Scrappage model switches to a decay function whenever a given age  $a$  is greater than or equal to the "Decay Age" parameter defined in the parameters input file, unless the survival rate,  $SURV_{MY,C,a}$ , for a preceding calendar year and age, as calculated by Equation (85), is less than the "Final Survival Rate" value also defined in the parameters input file. When the decay function is used,  $SCRAP_{MY,C,a}$  from Equation (85) above is calculated as follows:

$$SCRAP_{MY,C,a} = e^{\ln\left(\frac{FinalSurv_C}{Fleet_{MY,C,a}/Sales_{MY,C}}\right)/(39-a)} \quad (89)$$

For:

$$a \geq DecayAge_C \text{ and } a < 39;$$

Where:

- MY* : the production year for which to estimate the probability of scrappage,
- CY* : the calendar year during which to estimate the probability of scrappage,
- a* : the age of the fleet produced during model year *MY* that remains in services during calendar year *CY*,
- DecayAge<sub>C</sub>* : the age when the decay function begins for vehicles of category *C*,
- FinalSurv<sub>C</sub>* : the final share of the fleet applicable to vehicles of category *C*,
- Fleet<sub>MY,C,a</sub>* : the total number of vehicles of category *C*, produced and sold during model year *MY*, that remain in use during age, *a*,
- Sales<sub>MY,C</sub>* : the total new vehicle sales of category *C*, produced and sold during model year *MY*,
- SCRAP<sub>MY,C,a</sub>* : the resultant probability that vehicles of category *C*, produced and sold during model year *MY*, will be scrapped by a given age *a*.

In all of the preceding equations, note that the Dynamic Scrappage model estimates probability of surviving vehicles for ages ranging from 1 through 39 (inclusive), by using the previous fleet information from ages 0 through 38. For each model year, the surviving fleet occurring at age zero represents the initial fleet of vehicles produced and sold during that year, all of which are expected to remain on the road during the first age. Therefore, the model does not attempt to estimate the initial survival rates, instead assuming that the probability that vehicles of category *C*, produced and sold during model year *MY*, that remain in service at age zero will be 100 percent.

The inputs to the scrappage model are further described in Section A.3.4 of Appendix A. This includes a description of the independent variable set used in the Dynamic Scrappage Model, the final survival share, and the age at which the decay function begins.

### **S1.2 Static Scrappage Model**

The static survival rates are explicitly defined by vehicle age, and for each vehicle category defined in Table 20 above, in the parameters input file as described in Section A.3.2 of Appendix A. These values are assumed to be constant for all model years. Thus, when using static survival rates during analysis, Equation (81) above simplifies as follows:

$$N_{MY,CY} = SURV_{C,a} \times Sales_{MY} \quad (90)$$



These rates are based on analysis of registration data used to support the 2017-2021 final standards and the 2022-2025 augural standards. That analysis shows the maximum ages of passenger automobiles and light- and medium-duty trucks are estimated to be 30 years and 37 years, respectively.<sup>45</sup>

---

<sup>45</sup> These are defined as the ages when the number of vehicles of a model year that remain in service has declined to fewer than 2 percent of those originally produced.

## Section 2 Vehicle Use and Total Lifetime Mileage

Similar to the way the vehicle lifetimes are calculated, the modeling system uses two different methodologies for estimating vehicle mileage accumulation, depending on whether the Dynamic VMT model is enabled by the user. As is the case with other dynamic models available within the system, the Dynamic VMT model is enabled by turning on the “Dynamic Economic Modeling” setting with the CAFE Model’s user interface. If this option is disabled, however, the system reverts back to using the static schedules of average annual vehicle miles traveled (VMT), as defined in the parameters input file. Separate static VMT schedules, by vehicle age, were developed for cars, vans and SUVs, pickups, and medium-duty trucks (class 2b and 3), as discussed in Section A.3.2 of Appendix A. As with the survival rates described in the preceding section, the categories used to specify the mileage schedules are based on a combination of vehicle style (applicable to light-duty vehicles) and regulatory class (for medium-duty vehicles).

Whether the modeling system is configured to dynamically estimate the annual mileage or use the predefined static schedules, the system computes the annual miles driven by each vehicle at each age by starting with the static VMT schedules, then applying the estimated elasticity of vehicle use to the difference in fuel cost per mile (CPM) between the historic fleet used during the base calendar year when the VMT survey was taken, and the new vehicle fleet remaining on-road during each subsequent calendar year. This adjustment employs a combination of actual historic fuel prices for the calendar years prior to start of the modeling analysis, forecasts for calendar years as reported in the U.S. Energy Information Administration’s Annual Energy Outlook (AEO), and extrapolations of gasoline prices beyond the last year provided by AEO. The elasticity (or the fuel economy rebound effect) as well as the VMT growth assumptions are provided as inputs to the model and are further described in Section A.3.1 of Appendix A.

In addition to calculating annual miles driven by each vehicle model based on the elasticity relating to the changes in fuel cost per mile, or referred herein as the vehicle’s “with-rebound” miles, the system also computes per-vehicle annual miles, absent the aforementioned elasticity. These “non-rebound” miles are later used by the CAFE Model for estimating ancillary modeling effects, such as the value of additional travel and incremental fatalities arising from said additional travel. As before, whether the system is configured to rely on dynamic or static VMT, it begins the calculation of non-rebound miles by using static schedules. Since the elasticity is not included in this calculation, the average annual non-rebound miles driven by a given vehicle model is defined simply as the initial VMT schedule multiplied by the share of miles driven by that vehicle.

As previously stated, when the Dynamic VMT model is turned off, the modeling system computes non-rebound and rebound annual miles driven by a vehicle model using the static VMT schedules. If, however, the Dynamic VMT model is employed during analysis, these calculations are further extended to incorporate a dynamically estimated mileage offset, representing an adjustment necessary to preserve the total fleet-wide demand for travel. Thus, by means of the static schedules, the average number of non-rebound and rebound miles driven by a vehicle model produced in a specific model year that survives during each calendar year, when operating on each individual fuel type, is calculated as shown in the following two equations:

$$MI_{MY,CY,FT}^{NonRebound} = FS_{MY,FT} \times VMT_{C,a} \quad (91)$$

And:

$$MI_{MY,CY,FT} = FS_{MY,FT} \times VMT_{C,a} \times \left( 1 + \varepsilon \times \left( \frac{CPM_{MY,CY}}{CPM_{BaseCY-a,C}} - 1 \right) \right) \quad (92)$$

Where:

- $MY$  : the production year of the vehicle for which to calculate the miles driven,
- $CY$  : the calendar year during which to calculate the vehicle's miles driven,
- $FT$  : the fuel type that the vehicle produced in model year  $MY$  operates on (refer to Table 1 above for fuel types supported by the model),
- $C$  : the category of the vehicle for which to calculate the miles driven,
- $FS_{MY,FT}$  : the percent share of miles driven by the vehicle, produced in model year  $MY$ , when operating on fuel type  $FT$ ,
- $VMT_{C,a}$  : the average annual miles that vehicles belonging to a specific category  $C$  drive at a given age  $a$ , based on the static VMT schedule,
- $BaseCY$  : the base calendar year for static VMT usage data corresponding to the year when the VMT survey was taken,
- $BaseCY - a$  : the model year during which the historic vehicles were produced when they were age  $a$  in the base calendar year  $BaseCY$ ,
- $CPM_{BaseCY-a,C}$  : the fuel cost per mile attributed to a typical historic vehicle, belonging to category  $C$ , produced in model year  $BaseCY - a$ , using fuel prices from calendar year  $BaseCY$ ,
- $CPM_{MY,CY}$  : the fuel cost per mile attributed to the vehicle produced in model year  $MY$ , using fuel prices from calendar year  $CY$ ,
- $\varepsilon$  : the elasticity of annual vehicle use with respect to fuel cost per mile, and
- $MI_{MY,CY,FT}^{NonRebound}$  : the resultant average number of annual non-rebound miles driven in a year by the vehicle produced in model year  $MY$ , during calendar year  $CY$ , when operating on fuel type  $FT$ , and
- $MI_{MY,CY,FT}$  : the resultant average number of annual with rebound miles driven in a year by the vehicle produced in model year  $MY$ , during calendar year  $CY$ , when operating on fuel type  $FT$ .

When the Dynamic VMT model is used with the system, Equations (91) and (92) above are extended to include the fleet-wide mileage offset as follows:

$$MI_{MY,CY,FT}^{NonRebound} = FS_{MY,FT} \times VMT_{C,a} \times \left( 1 + \varepsilon \times \left( \frac{CPM_{HistMY,CY,C}}{CPM_{BaseCY-a,C}} - 1 \right) \right) + \Delta Miles_{C,CY,a} \quad (93)$$

And:

$$MI_{MY,CY,FT} = FS_{MY,FT} \times VMT_{C,a} \times \left( 1 + \varepsilon \times \left( \frac{CPM_{MY,CY}}{CPM_{BaseCY-a,C}} - 1 \right) \right) + \Delta Miles_{C,CY,a} \times \left( 1 + \varepsilon \times \frac{(CPM_{MY,CY} - CPM_{HistMY,CY,C})}{CPM_{BaseCY-a,C}} \right) \quad (94)$$

Where:

- $MY, CY, FT, C$ : variables as defined in Equation (92) above,
- $FS_{MY,FT}$ : the percent share of miles driven by the vehicle, produced in model year  $MY$ , when operating on fuel type  $FT$ ,
- $VMT_{C,a}$ : the average annual miles that vehicles belonging to a specific category  $C$  drive at a given age  $a$ , based on the static VMT schedule,
- $HistMY$ : the production year of a typical historic vehicle from which to calculate the elasticity of miles driven due to changes in fuel prices, defined as the minimum of  $BaseCY$  and  $MY$ ,
- $BaseCY$ : the base calendar year for static VMT usage data corresponding to the year when the VMT survey was taken,
- $BaseCY - a$ : the model year during which the historic vehicles were produced when they were age  $a$  in the base calendar year  $BaseCY$ ,
- $CPM_{HistMY,CY,C}$ : the fuel cost per mile attributed to a typical historic vehicle, belonging to category  $C$ , produced in model year  $HistMY$ , using fuel prices from calendar year  $CY$ ,
- $CPM_{BaseCY-a,C}$ : the fuel cost per mile attributed to a typical historic vehicle, belonging to category  $C$ , produced in model year  $BaseCY - a$ , using fuel prices from calendar year  $BaseCY$ ,
- $CPM_{MY,CY}$ : the fuel cost per mile attributed to the vehicle produced in model year  $MY$ , using fuel prices from calendar year  $CY$ ,
- $\varepsilon$ : the elasticity of annual vehicle use with respect to fuel cost per mile,
- $\Delta Miles_{C,CY,a}$ : the estimated mileage offset, representing an adjustment necessary to preserve the total fleet-wide demand for travel for vehicles of age  $a$ , belonging to category  $C$ , during calendar year  $CY$  (calculation of  $\Delta Miles$  is discussed in Section S2.1 below),
- $MI_{MY,CY,FT}^{NonRebound}$ : the resultant average number of annual non-rebound miles driven in a year by the vehicle produced in model year  $MY$ , during calendar year  $CY$ , when operating on fuel type  $FT$ , and

$MI_{MY,CY,FT}$  : the resultant average number of annual with rebound miles driven in a year by the vehicle produced in model year  $MY$ , during calendar year  $CY$ , when operating on fuel type  $FT$ .

For the “ $CPM$ ” terms that appear in the above equations, the calculation varies slightly, depending on what the cost per mile is intended to represent. For example, fuel cost per mile may be computed for an individual vehicle model during some future calendar year, or for an aggregate historic fleet during some reference calendar year. In each case, however, the calculation depends on both the price per gallon of fuel during a given calendar year (or gasoline gallon equivalent, GGE, in the case of electricity, hydrogen, and CNG), as well as the actual fuel economy that either an individual vehicle or the entire fleet achieves in on-road driving. When considering vehicles that operate exclusively on a single fuel type (typically, gasoline, diesel, or electricity) the cost per mile is calculated from just that one fuel component. However, for dual fuel vehicles (such as PHEVs and FFVs), the cost per mile is a weighted sum of individual fuel components on which the vehicle operates. In general, the calculation of fuel cost per mile takes the following form:

$$CPM_{CY} = \sum_{FT} \left( FS_{FT} \times \frac{Price_{FT,CY}}{OnRoadFE_{FT}} \right) \quad (95)$$

Where:

$CY$  : the calendar year during which to calculate CPM,  
 $FT$  : the fuel type for which the fuel share,  $FS_{FT}$ , and on-road fuel economy,  $OnRoadFE_{FT}$ , values are defined,  
 $FS_{FT}$  : the percent share of miles driven attributed to the specific fuel type  $FT$ ,  
 $OnRoadFE_{FT}$  : the on-road fuel economy rating attributed to the specific fuel type  $FT$ ,  
 $Price_{FT,CY}$  : the price per gallon (or GGE) of the specific fuel type in calendar year  $CY$ , and  
 $CPM_{CY}$  : the resultant fuel cost per mile calculated based on the specified fuel share,  $FS_{FT}$ , and on-road fuel economy rating,  $OnRoadFE_{FT}$ , using fuel prices from calendar year  $CY$ .

The CPM calculation presented in the above equation is modified for use in Equations (92), (93), and (94), by substituting the relevant values for those in Equation (95). For example, by using fuel share and fuel economy rating of a vehicle model, the cost per mile for each vehicle produced in model year  $MY$ , during calendar year  $CY$  is defined as:

$$CPM_{MY,CY} = \sum_{FT} \left( FS_{MY,FT} \times \frac{Price_{FT,CY}}{FE_{MY,FT} \times (1 - GAP_{FT})} \right) \quad (96)$$

Where:

$MY$  : the production year of the vehicle for which to calculate the cost per mile,  
 $CY$  : the calendar year during which to calculate the vehicle’s cost per mile,  
 $FT$  : the fuel type that the vehicle produced in model year  $MY$  operates on,

- $FS_{MY,FT}$  : the percent share of miles driven by the vehicle, produced in model year  $MY$ , when operating on fuel type  $FT$ ,
- $FE_{MY,FT}$  : the fuel economy rating of the vehicle, produced in model year  $MY$ , when operating on fuel type  $FT$ ,
- $GAP_{FT}$  : the relative difference between on-road and laboratory fuel economy for a specific fuel type,
- $Price_{FT,CY}$ : the price per gallon (or GGE) of the specific fuel type in calendar year  $CY$ , and
- $CPM_{MY,CY}$ : the resultant fuel cost per mile attributed to the vehicle produced in model year  $MY$ , using fuel prices from calendar year  $CY$ .

Each vehicle’s fuel economy rating is assumed to be determined during the model year when it is produced, and to remain fixed throughout its lifetime. However, its actual on-road fuel economy is assumed to fall short of that rating by the on-road fuel economy “gap” (a model input specified in the parameters input file).

Similar to the cost per mile equation for the vehicle produced during model year  $MY$ , the value of fuel cost per mile attributed to a typical historic vehicle that was age  $a$  during the calendar year  $BaseCY$ , the calendar year when the VMT survey was taken, is given by the following equation:

$$CPM_{BaseCY-a,C} = \sum_{FT} \left( FS_{MY,FT} \times \frac{Price_{FT,BaseCY}}{FE_{BaseCY-a,C,FT}} \right) \quad (97)$$

Where:

- $MY$  : the production year of the vehicle for which the miles driven from Equations (92), (93), and (94) are being calculated,
- $FT$  : the fuel type that the vehicle produced in model year  $MY$  operates on, for which the miles driven from Equations (92), (93), and (94) are being calculated,
- $C$  : the category of the vehicle for which the miles driven from Equations (92), (93), and (94) are being calculated,
- $FS_{MY,FT}$  : the percent share of miles driven by the vehicle, produced in model year  $MY$ , when operating on fuel type  $FT$ , for which the miles driven from Equations (92), (93), and (94) are being calculated,
- $BaseCY$  : the base calendar year for static VMT usage data corresponding to the year when the VMT survey was taken,
- $BaseCY - a$  : the model year during which the historic vehicles were produced when they were age  $a$  in the base calendar year  $BaseCY$ ,
- $FE_{BaseCY-a,C,FT}$ : the sales-weighted average on-road fuel economy rating that all historic vehicles, belonging to category  $C$ , achieved in model year  $BaseCY - a$ ,

when operating on fuel type  $FT$ , as defined on the “Historic Fleet Data” tab of the parameters input file<sup>46</sup>,

$Price_{FT,BaseCY}$  : the price per gallon (or GGE) of the specific fuel type in calendar year  $BaseCY$ , and

$CPM_{BaseCY-a,C}$  : the resultant fuel cost per mile attributed to a typical historic vehicle, belonging to category  $C$ , produced in model year  $BaseCY - a$ , using fuel prices from calendar year  $BaseCY$ .

Since the mileage accumulation schedule used in Equations (92) and (94) is based on the VMT survey that was conducted during the calendar year  $BaseCY$ , the elasticity of annual vehicle use correlates the cost per mile of a new vehicle model of age  $a$  during each calendar year  $CY$  to the cost per mile of a typical historic vehicle that was of the same age during the base calendar year  $BaseCY$ . The CPM of a historic vehicle is hence calculated using the fuel prices of the base VMT calendar year, while the CPM of a new vehicle model is obtained using the fuel price forecasts in the calendar years corresponding to the vehicle’s model year and age. Furthermore, in order to ensure that the resultant CPMs of the historic and new vehicles are comparable, when calculating CPM of a typical historic vehicle, the system uses percent share of miles driven by the new vehicle for which the miles driven are being calculated. This relationship between the new and existing vehicles reflects the fuel economy rebound effect, which occurs because buyers of new vehicles respond to the reduction in their operating costs – resulting from higher fuel economy of new vehicles – by driving slightly more during a particular calendar year.

Lastly, to isolate the elasticity of miles driven due to changes in fuel prices alone, Equations (93) and (94) incorporate the value of cost per mile attributed to a typical historic vehicle, however, using the same fuel prices from the future calendar years that are used when calculating CPM of new vehicle models. Therefore, the fuel cost per mile for a typical historic vehicle produced in model year  $HistMY$ , during calendar year  $CY$  is calculated as follows:

$$CPM_{HistMY,CY,C} = \sum_{FT} \left( FS_{MY,FT} \times \frac{Price_{FT,CY}}{FE_{HistMY,C,FT}} \right) \quad (98)$$

Where:

- $MY$  : the production year of the vehicle for which the miles driven from Equations (93) and (94) are being calculated,
- $CY$  : the calendar year during which to calculate the vehicle’s cost per mile,
- $FT$  : the fuel type that the vehicle produced in model year  $MY$  operates on, for which the miles driven from Equations (93) and (94) are being calculated,
- $C$  : the category of the vehicle for which the miles driven from Equations (93) and (94) are being calculated,

---

<sup>46</sup> The “Historic Fleet Data” tab in the parameters input file defines on-road fuel economies for each historic model year, rather than the associated “rated” fuel economy values. As such, application of the on-road fuel economy “gap” is not required when computing fuel cost per mile for a historic vehicle.

- $FS_{MY,FT}$  : the percent share of miles driven by the vehicle, produced in model year  $MY$ , when operating on fuel type  $FT$ , for which the miles driven from Equations (93) and (94) are being calculated,
- $HistMY$  : the production year of a typical historic vehicle from which to calculate the elasticity of miles driven due to changes in fuel prices, defined as the minimum of  $BaseCY$  and  $MY$ ,
- $BaseCY$  : the base calendar year for static VMT usage data corresponding to the year when the VMT survey was taken,
- $FE_{HistMY,C,FT}$  : the sales-weighted average on-road fuel economy rating that all historic vehicles, belonging to category  $C$ , achieved in model year  $HistMY$ , when operating on fuel type  $FT$ , as defined on the “Historic Fleet Data” tab of the parameters input file,
- $Price_{FT,CY}$  : the price per gallon (or GGE) of the specific fuel type in calendar year  $CY$ , and
- $CPM_{HistMY,CY,C}$  : the resultant fuel cost per mile attributed to a typical historic vehicle, belonging to category  $C$ , produced in model year  $HistMY$ , using fuel prices from calendar year  $CY$ .

Similar to the CPM calculation for historic vehicles produced during model year  $BaseCY - a$ , defined by Equation (97) as  $CPM_{BaseCY-a,C}$ , the fuel cost per mile from equation above is also used to correlate the cost per mile of a new vehicle model to that of a typical historic vehicle. However, since in this case the elasticity of changing fuel prices is being captured, absent any fuel economy improvements, the CPM calculation for a typical historic vehicle model uses fuel prices from the same calendar year  $CY$ , as used by the vehicle model for which the miles driven are being computed. Additionally, with the same consideration that was outlined for Equation (97), the percent share of miles driven by new vehicle models is used for computing CPM of vehicles during historic model year  $HistMY$ .

Equations (91) through (94) specify the average number of miles driven by a single surviving vehicle produced in model year  $MY$ , during calendar year  $CY$ , when operating on fuel type  $FT$ . The total number of miles driven by all vehicles of that model is calculated by multiplying the average annual miles driven by the number of vehicles produced in model year  $MY$  that remain in service during calendar year  $CY$ . Thus, the total non-rebound and rebound miles driven on each fuel type by all surviving vehicles that were originally produced during a specific model year is calculated as:

$$MI'_{MY,CY,FT}^{NonRebound} = N_{MY,CY} \times MI_{MY,CY,FT}^{NonRebound} \quad (99)$$

And:

$$MI'_{MY,CY,FT} = N_{MY,CY} \times MI_{MY,CY,FT} \quad (100)$$

Where:

- $MY$  : the production year of the vehicle for which to calculate the miles driven,  
 $CY$  : the calendar year during which to calculate the vehicle's miles driven,



- $FT$  : the fuel type that the vehicle produced in model year  $MY$  operates on,  
 $N_{MY,CY}$  : the number of vehicles produced during model year  $MY$  that remain in use during a future calendar year  $CY$  as defined in Equation (81) above,  
 $MI_{MY,CY,FT}^{NonRebound}$  : the number of non-rebound miles driven in a year by a single vehicle model produced in model year  $MY$ , during calendar year  $CY$ , when operating on fuel type  $FT$ , as defined in Equations (91) and (93) above,  
 $MI_{MY,CY,FT}$  : the number of with rebound miles driven in a year by a single vehicle model produced in model year  $MY$ , during calendar year  $CY$ , when operating on fuel type  $FT$ , as defined in Equations (92) and (94) above,  
 $MI'_{MY,CY,FT}^{NonRebound}$  : the resultant number of non-rebound miles driven in a year by all surviving vehicles, of a specific vehicle model, produced in model year  $MY$ , during calendar year  $CY$ , when operating on fuel type  $FT$ , and  
 $MI'_{MY,CY,FT}$  : the resultant number of with rebound miles driven in a year by all surviving vehicles, of a specific vehicle model, produced in model year  $MY$ , during calendar year  $CY$ , when operating on fuel type  $FT$ .

Although the modeling system calculates the number of miles driven for each individual vehicle model, it aggregates these results across all vehicles for reporting purposes. The total miles driven on each type of fuel by all vehicle models produced in a specific model year during each calendar year is calculated by summing the mileage calculated for each individual vehicle model as shown, for non-rebound and rebound miles, in the following two equations:

$$Miles_{MY,CY,FT}^{NonRebound} = \sum_{i \in V} MI'_{i,MY,CY,FT}^{NonRebound} \quad (101)$$

And:

$$Miles_{MY,CY,FT} = \sum_{i \in V} MI'_{i,MY,CY,FT} \quad (102)$$

Where:

- $V$  : a vector containing all vehicle models produced during model year  $MY$ ,  
 $MY$  : the production year of all vehicles for which to calculate the miles driven,  
 $CY$  : the calendar year during which to calculate the miles driven by all vehicle models,  
 $FT$  : the fuel type that all vehicles produced in model year  $MY$  operate on,  
 $MI'_{MY,CY,FT}^{NonRebound}$  : the number of non-rebound miles driven in a year by all surviving vehicles, of vehicle model  $i$ , produced in model year  $MY$ , during calendar year  $CY$ , when operating on fuel type  $FT$ , as defined in Equation (99) above, and  
 $MI'_{i,MY,CY,FT}$  : the number of rebound miles driven in a year by all surviving vehicles, of vehicle model  $i$ , produced in model year  $MY$ , during calendar year

$CY$ , when operating on fuel type  $FT$ , as defined in Equation (100) above,

- $Miles_{MY,CY,FT}^{NonRebound}$  : the resultant number of non-rebound miles driven in a year by all surviving vehicles (for all vehicle models) produced in model year  $MY$ , during calendar year  $CY$ , when operating on a specific fuel type  $FT$ , and
- $Miles_{MY,CY,FT}$  : the resultant number of with rebound miles driven in a year by all surviving vehicles (for all vehicle models) produced in model year  $MY$ , during calendar year  $CY$ , when operating on a specific fuel type  $FT$ .

From here, the subtotals across all model years, calendar years, or fuel types may be obtained by aggregating across the individual variables defined by the  $MY$ ,  $CY$ , or  $FT$  subscripts. For example, the total number of non-rebound or rebound miles driven on each type of fuel by all surviving vehicle models produced in model year  $MY$  over their expected lifetimes is calculated by summing the number of miles across the individual calendar years as show in the equation that follows:

$$Miles_{MY,FT} = \sum_{CY} Miles_{MY,CY,FT} \quad (103)$$

## S2.1 Dynamic VMT Model

When the Dynamic VMT model is employed, the CAFE Model switches from using static VMT schedules defined in the parameters input file, to dynamically calculating these schedules, based on the outcomes of the Dynamic Fleet Share and Sales Response (DFS/SR) model as well as the Dynamic Scrappage model. The forecast of new vehicle sales for each model year (obtained from DFS/SR model) and the estimated surviving vehicle population for each associated calendar year (resulting from Dynamic Scrappage model) combine to produce the overall fleet that remains on road during a reference calendar year that corresponds to the first model year evaluated during the study period. Using this “reference fleet,” the Dynamic VMT model computes the associated “reference VMT,” which serves as the total non-rebound miles traveled by all vehicles that are intended to remain constant across all regulatory alternatives. By comparing the reference fleet and VMT to the corresponding estimates produced when using the static VMT schedules, the system calculates the “ $\Delta Miles$ ” between the reference and the expected actual miles traveled, based on each vehicle category. This  $\Delta Miles$  value represents an adjustment necessary to preserve the total fleet-wide demand for travel, and is used in the equations discussed in the preceding section. The specifics of these and all intermediate calculations are outlined within this section in the text that follows.

The Dynamic VMT model begins by calculating the “base VMT” attributed to the on-road vehicle fleet during the calendar year equivalent to the first model year evaluated during the study period. This base VMT is determined from a combination of input fleet data (for the first model year) and historic fleet data (for all preceding model years), using the mileage accumulation defined by the static VMT schedules. The base VMT based on the first model year is calculated as follows:

$$BaseVMT = \sum_C \left( \sum_{a=0}^{39} \left( \begin{array}{l} VMT_{C,a} \\ \times \left( 1 + \varepsilon \times \left( \frac{CPM_{HistMY,CY,C}}{CPM_{BaseCY-a,C}} - 1 \right) \right) \\ \times \begin{cases} Sales_C, & a = 0 \\ Fleet_{HistMY,CY,C}, & a > 0 \end{cases} \end{array} \right) \right) \quad (104)$$

Where:

- $C$  : the category of the vehicles for which to calculate the miles driven,
- $CY$  : the calendar year equivalent to the first model year evaluated during the study period based on which to calculate the base VMT,
- $HistMY$  : the production year of a typical historic vehicle from which to obtain the historic fleet as well as calculate the elasticity of miles driven due to changes in fuel prices, defined as the minimum of  $BaseCY$  and  $(CY - a)$ ,
- $BaseCY$  : the base calendar year for static VMT usage data corresponding to the year when the VMT survey was taken,
- $BaseCY - a$  : the model year during which the historic vehicles were produced when they were age  $a$  in the base calendar year  $BaseCY$ ,
- $VMT_{C,a}$  : the average annual miles that vehicles belonging to a specific category  $C$  drive at a given age  $a$ , based on the static VMT schedule,
- $CPM_{HistMY,CY,C}$  : the fuel cost per mile attributed to a typical historic vehicle, belonging to category  $C$ , produced in model year  $HistMY$ , using fuel prices from calendar year  $CY$ , as defined by Equation (98),
- $CPM_{BaseCY-a,C}$  : the fuel cost per mile attributed to a typical historic vehicle, belonging to category  $C$ , produced in model year  $BaseCY - a$ , using fuel prices from calendar year  $BaseCY$ , as defined by Equation (97),
- $\varepsilon$  : the elasticity of annual vehicle use with respect to fuel cost per mile,
- $Sales_C$  : the total sales volume of vehicles belonging to category  $C$ , produced in the first model year,  $CY$ , evaluated during the study period,
- $Fleet_{HistMY,CY,C}$  : the historic on-road fleet belonging to category  $C$ , produced in model year  $HistMY$ , that survives during the first model year,  $CY$ , evaluated during the study period, and
- $BaseVMT$  : the resultant base VMT attributed to the on-road vehicle fleet during the calendar year equivalent to the first model year evaluated during the study period.

The  $BaseVMT$  obtained from the above equation is then used to compute the reference VMT for all calendar years equivalent to each model year available during the study period, by applying an annual growth rate defined in the parameters input file. Here, the reference VMT corresponds to the target non-rebound miles traveled by the entire on-road fleet during each calendar year that the Dynamic VMT model is benchmarking to. For each calendar year, the reference VMT is computed as the base VMT multiplied by the cumulative growth rate, as shown:

$$RefVMT_{CY} = BaseVMT \times \prod_{MinMY}^{CY} (1 + r) \quad (105)$$

Where:

- $CY$  : the calendar year for which to calculate the reference VMT,
- $MinMY$  : the minimum model year evaluated during the study period,
- $r$  : the VMT growth rate defined in the parameters input file,
- $BaseVMT$  : the base VMT attributed to the on-road vehicle fleet during the calendar year equivalent to the first model year evaluated during the study period, and
- $RefVMT_{CY}$  : the resultant reference VMT attributed to the on-road fleet during calendar year  $CY$ .

Once the reference VMT is determined, the system proceeds to compute the mileage offset,  $\Delta Miles_{C,CY,a}$ , that is used by Equations (93) and (94) above, as follows:

$$\Delta Miles_{C,CY,a} = \frac{(RefVMT_{CY} - ActualVMT_{CY}) \times \frac{Fleet_{CY,C}}{Fleet_{CY}}}{ActualVMT_{CY,C}} \times \frac{ActualVMT_{CY,C,a}}{Fleet_{CY,C,a}} \quad (106)$$

Where:

- $C$  : the category of the vehicles for which to calculate the mileage offset,
- $CY$  : the calendar year for which to calculate the mileage offset,
- $a$  : the vehicle age for which to calculate the mileage offset,
- $Fleet_{CY}$  : the on-road fleet during calendar year  $CY$ ,
- $Fleet_{CY,C}$  : the on-road fleet belong to category  $C$ , during calendar year  $CY$ ,
- $Fleet_{CY,C,a}$  : the on-road fleet of age  $a$ , belong to category  $C$ , during calendar year  $CY$ ,
- $RefVMT_{CY}$  : the reference VMT attributed to the on-road fleet during calendar year  $CY$ ,
- $ActualVMT_{CY}$  : the estimate of the actual VMT attributed to the on-road fleet during calendar year  $CY$ , calculated similar as in Equations (93) and (99) above, but aggregating across fuel types and model years, and omitting the “ $\Delta Miles_{C,CY,a}$ ” term,
- $ActualVMT_{CY,C}$  : the estimate of the actual VMT attributed to the on-road fleet belong to category  $C$ , during calendar year  $CY$ , calculated similar as in Equations (93) and (99) above, but aggregating across fuel types and model years, and omitting the “ $\Delta Miles_{C,CY,a}$ ” term,
- $ActualVMT_{CY,C,a}$  : the estimate of the actual VMT attributed to the on-road fleet of age  $a$ , belong to category  $C$ , during calendar year  $CY$ , calculated similar as in Equations (93) and (99) above, but aggregating across fuel types and model years, and omitting the “ $\Delta Miles_{C,CY,a}$ ” term,

$\Delta Miles_{C,CY,a}$  : the resultant mileage offset, representing an adjustment necessary to preserve the total fleet-wide demand for travel for vehicles of age  $a$ , belonging to category  $C$ , during calendar year  $CY$ .

The  $\Delta Miles_{C,CY,a}$  obtained in above equation may then be used in the equations presented earlier for calculating the number of annual non-rebound and “with rebound” miles driven by vehicles produced in a specific model year, during a given calendar year.

### Section 3 Fuel Consumption

Fuel consumption by vehicles of each model and vintage during a future year depends on the total mileage that the surviving vehicles are driven during that year, as well as on the fuel efficiency they obtain in actual driving. The fuel economy levels that new vehicles achieve in real-world driving falls significantly short of the rated fuel economy levels that are used to assess manufacturers' compliance with CAFE or CO<sub>2</sub> standards.

The average number of gallons of each type of fuel (or GGE for electricity, hydrogen, and CNG) consumed by a vehicle produced in a specific model year that survives during each calendar year is calculated as shown in the following equation:

$$G_{MY,CY,FT} = \frac{MI_{MY,CY,FT}}{FE_{MY,FT} \times (1 - GAP_{FT})} \quad (107)$$

Where:

- MY* : the production year of the vehicle for which to calculate the number of gallons (or GGE) of fuel consumed,
- CY* : the calendar year during which to calculate the number of gallons (or GGE) of fuel consumed by the vehicle,
- FT* : the fuel type that the vehicle produced in model year *MY* operates on,
- FE<sub>MY,FT</sub>* : the fuel economy rating of the vehicle, produced in model year *MY*, when operating on fuel type *FT*,
- GAP<sub>FT</sub>* : the relative difference between on-road and laboratory fuel economy for a specific fuel type,
- MI<sub>MY,CY,FT</sub>*: the average number of miles driven in a year by a vehicle produced in model year *MY*, during calendar year *CY*, when operating on fuel type *FT*, as defined in Equation (92) above, and
- G<sub>MY,CY,FT</sub>* : the resultant average amount of gallons (or GGE) of fuel consumed in a year by the vehicle produced in model year *MY*, during calendar year *CY*, when operating on fuel type *FT*.

Similar to the mileage accumulation equations discussed in the previous section, the fuel consumption equation above estimates the average number of gallons consumed by a single surviving vehicle model produced in model year *MY* during calendar year *CY*. The total number of gallons (or GGE) consumed by all surviving vehicles of that model is defined as follows:

$$G'_{MY,CY,FT} = N_{MY,CY} \times G_{MY,CY,FT} \quad (108)$$

Where:

- MY* : the production year of the vehicle for which to calculate the number of gallons (or GGE) of fuel consumed,
- CY* : the calendar year during which to calculate the number of gallons (or GGE) of fuel consumed by the vehicle,

- $FT$  : the fuel type that the vehicle produced in model year  $MY$  operates on,  
 $N_{MY,CY}$  : the number of vehicles produced during model year  $MY$  that remain in use during a future calendar year  $CY$  as defined in Equation (81) above,  
 $G_{MY,CY,FT}$  : the amount of gallons of fuel consumed in a year by a single vehicle model produced in model year  $MY$ , during calendar year  $CY$  as defined in Equation (107) above, and  
 $G'_{MY,CY,FT}$  : the resultant amount of gallons (or GGE) of fuel consumed in a year by all surviving vehicles, of a specific vehicle model, produced in model year  $MY$ , during calendar year  $CY$ , when operating on fuel type  $FT$ .

Although the modeling system calculates fuel consumption for each individual vehicle model, it aggregates these results across all vehicle models for reporting purposes. The total consumption of each type of fuel by all vehicle models produced in a specific model year during each calendar year is calculated by summing the fuel consumptions of each individual vehicle model as shown in the following equation:

$$Gallons_{MY,CY,FT} = \sum_{i \in V} G'_{i,MY,CY,FT} \quad (109)$$

Where:

- $V$  : a vector containing all vehicle models produced during model year  $MY$ ,  
 $MY$  : the production year of all vehicles for which to calculate the number of gallons (or GGE) of fuel consumed,  
 $CY$  : the calendar year during which to calculate the number of gallons (or GGE) of fuel consumed by all vehicle models,  
 $FT$  : the fuel type that all vehicles produced in model year  $MY$  operate on,  
 $G'_{i,MY,CY,FT}$  : the amount of gallons (or GGE) of fuel consumed in a year by all surviving vehicles, of vehicle model  $i$ , produced in model year  $MY$ , during calendar year  $CY$ , when operating on a specific fuel type  $FT$  as defined in Equation (108) above, and  
 $Gallons_{MY,CY,FT}$  : the resultant amount of gallons (or GGE) of fuel consumed in a year by all surviving vehicles (for all vehicle models) produced in model year  $MY$ , during calendar year  $CY$ , when operating on fuel type  $FT$ .

From here, the total consumption of each type of fuel by all surviving vehicle models produced in model year  $MY$  over their expected lifetimes (as an example) is calculated by summing the amount of gallons consumed across the individual calendar years as follows:

$$Gallons_{MY,FT} = \sum_{CY} Gallons_{MY,CY,FT} \quad (110)$$

The total annual consumption of each fuel by all vehicle models will differ depending on the standard that prevailed during the model year when they were originally produced. This is reflected in the outputs produced by the model, when comparing the differences of total gallons of fuel consumed between various regulatory scenarios.

In addition to calculating fuel consumption in terms of amount of gallons (or GGE) consumed for each fuel type, the modeling system also calculates corresponding energy consumption in quadrillion British thermal units (Quads) attributable to each fuel type analyzed within the model, reporting these quantities on a total and incremental basis. For non-liquid fuel types (electricity, hydrogen, and CNG), the CAFE Model also estimates energy consumption in native units of that fuel type (kWh for electricity and scf for hydrogen and CNG).<sup>47</sup>

For liquid fuel types (gasoline, E85, and diesel), the conversion of energy consumption to quadrillion BTUs is calculated within the model by simply multiplying the amount of gallons of the specific fuel consumed by the energy density of that fuel type and scaling the result from BTUs to Quads. The system computes amount of Quads consumed by each individual vehicle model as well as overall consumption across all surviving vehicle models, for any given calendar year and/or model year. Thus, the equation for calculating Quads takes general form as shown:

$$Quads_{FT} = \frac{Gallons_{FT} \times ED_{FT}}{1e15} \quad (111)$$

Where:

- $FT$  : the fuel type that one or more vehicles produced in a specific model year operate on,
- $Gallons_{FT}$ : the amount of gallons of fuel type  $FT$  consumed by one or more vehicle models,
- $ED_{FT}$  : the energy density of fuel type  $FT$ , and
- $Quads_{FT}$  : the energy consumption expressed as quadrillion BTUs for fuel type  $FT$ .

For electricity, hydrogen, and CNG fuel types, since their consumption is measured in gasoline gallon equivalents, the conversion to Quads is calculated by multiplying the amount of GGE by the energy density of gasoline. Equation (111) above then becomes:

$$Quads_{FT} = \frac{Gallons_{FT} \times ED_{Gasoline}}{1e15} \quad (112)$$

Where:

- $FT$  : the fuel type that one or more vehicles produced in a specific model year operate on,
- $Gallons_{FT}$ : the amount of gallons of fuel type  $FT$  consumed by one or more vehicle models,
- $ED_{Gasoline}$  : the energy density of gasoline, and
- $Quads_{FT}$  : the energy consumption expressed as quadrillion BTUs for fuel type  $FT$ .

---

<sup>47</sup> When reporting amounts of fuel and energy consumption, the system converts all units into thousands. Thus, liquid fuel consumed is reported in thousands of gallons, electricity in mW-h, and hydrogen and CNG in Mcf.



Additionally for electricity, hydrogen, and CNG, the conversion from GGE to native units (kWh or scf) is calculated by multiplying the amount of gallons consumed by the ratio of the energy density of gasoline to the energy density of a specific fuel type. As with the calculation of energy use in Quads, the system computes consumption of kilowatt-hours and standard cubic feet for each individual vehicle model and total consumption for all surviving vehicle models. Hence, for electricity, the equation is defined as:

$$KWH = Gallons_{FT} \times \frac{ED_{Gasoline}}{ED_{FT}} \quad (113)$$

While for hydrogen and CNG, the equation is as follows:

$$SCF = Gallons_{FT} \times \frac{ED_{Gasoline}}{ED_{FT}} \quad (114)$$

Where:

- $Gallons_{FT}$  : the amount of gasoline gallon equivalent of *Electricity*, *Hydrogen*, or *CNG* fuel types (denoted by the *FT* subscript) consumed by one or more vehicle models,
- $ED_{Gasoline}$  : the energy density of gasoline fuel,
- $ED_{FT}$  : the energy density of *Electricity*, *Hydrogen*, or *CNG* fuel types,
- $KWH$  : the amount of kilowatt-hours of *Electricity* fuel type consumed by one or more vehicle models (Equation (113)), and
- $SCF$  : the amount of standard cubic feet of *Hydrogen* or *CNG* fuel types consumed by one or more vehicle models (Equation (114)).

## Section 4 Greenhouse Gas Emissions

Fuel consumption changes attributed to imposing new standards result in the associated changes in emissions of carbon dioxide (CO<sub>2</sub>), the primary greenhouse gas emitted during the refining, distribution, and combustion of transportation fuels. Lowering overall fuel consumption reduces total carbon dioxide emissions directly, while increasing the amount of fuel consumed naturally leads to increases in quantity of carbon dioxide emitted into the atmosphere. This occurs given that the largest source of these emissions from transportation activity is fuel used by the internal combustion engines.

The CAFE Model calculates CO<sub>2</sub> emissions from vehicle operation (also referred to as “tailpipe” or “downstream” emissions) by multiplying the number of gallons of a specific fuel consumed by the carbon content per gallon of that fuel type, and then applying the ratio of carbon dioxide emissions generated per unit of carbon consumed during the combustion process.<sup>48</sup> Hence, the total emissions of carbon dioxide resulting from fuel consumption by all surviving vehicle models produced in a specific model year during each calendar year, attributed to vehicle operation on each fuel type, are calculated as:

$$CO2_{MY,CY,FT}^{DS} = \frac{Gallons_{MY,CY,FT} \times MD_{FT} \times CC_{FT} \times (44/12)}{1e6} \quad (115)$$

Where:

<i>MY</i>	: the production year of all vehicles for which to calculate downstream carbon dioxide emissions,
<i>CY</i>	: the calendar year during which to calculate the amount of carbon dioxide emitted by all vehicle models during operation,
<i>FT</i>	: the fuel type that all vehicles produced in model year <i>MY</i> operate on,
<i>Gallons<sub>MY,CY,FT</sub></i>	: the amount of gallons of fuel consumed in a year by all surviving vehicle models produced in model year <i>MY</i> during calendar year <i>CY</i> , when operating on fuel type <i>FT</i> ,
<i>MD<sub>FT</sub></i>	: the mass density of a fuel type <i>FT</i> (an input parameter specified in grams per unit of fuel type, which is either gallons, kWh, or scf),
<i>CC<sub>FT</sub></i> ( <sup>44</sup> / <sub>12</sub> )	: the fraction of each fuel type’s mass that represents carbon, : the ratio of the molecular weight of carbon dioxide to that of elemental carbon <sup>49</sup> ,
<i>1e6</i>	: the conversion factor from grams to metric tons, and

<sup>48</sup> The carbon content for each type of fuel is specified as an input to the model in the parameters input file (further discussed in Section A.3.11 of Appendix A). Although the model does not explicitly account for incomplete conversion of carbon to carbon dioxide, input values specifying carbon content can be adjusted accordingly (i.e., reduced to 99 to 99.5 percent of actual carbon content). Since electricity and hydrogen fuel types do not cause CO<sub>2</sub> emissions to be emitted during vehicle operation, the carbon content for these fuel types should be set to zero in the input file.

<sup>49</sup> This ratio measures the mass of carbon dioxide that is produced by complete combustion of mass of carbon contained in each gallon of fuel.

$CO2_{MY,CY,FT}^{DS}$  : the total downstream emissions of carbon dioxide (denominated in metric tons) resulting from fuel consumption by all surviving vehicle models produced in model year  $MY$ , during calendar year  $CY$ , when operating on fuel type  $FT$ .

Vehicles operating on electricity or hydrogen are assumed to generate no  $CO_2$  emissions during vehicle use. For vehicles operating on CNG, since mass density is specified in grams per scf, the generated  $CO_2$  emissions are calculated using amount of scf of CNG instead of amount of gallons consumed by all vehicle models. Thus, Equation (115) above becomes:

$$CO2_{MY,CY,CNG}^{DS} = \frac{SCF_{MY,CY,CNG} \times MD_{CNG} \times C_{CNG} \times (44/12)}{1e6} \quad (116)$$

As with the model's calculations of miles driven and fuel consumption, estimates of annual  $CO_2$  emissions from fuel use are summed over the calendar years that vehicles produced during each model year are projected to remain in use to obtain estimates of lifetime emissions. Specifically, lifetime  $CO_2$  emissions from fuel consumption by vehicle models produced during model year  $MY$  when operating on fuel type  $FT$  is defined by the following:

$$CO2_{MY,FT}^{DS} = \sum_{CY} CO2_{MY,CY,FT}^{DS} \quad (117)$$

The total volume of fuel consumed also affects carbon dioxide emissions from refining and distributing liquid fuels (gasoline, diesel, and E85). Carbon dioxide emissions occur during the production of petroleum-based fuels as a result of energy use for petroleum extraction, transportation, storage, and refining, as well as during storage and distribution of refined fuel. Producing the chemical feedstocks or agricultural products from which non-petroleum fuels such as ethanol are derived also entails energy use and generates  $CO_2$  emissions, as does refining, storing, and distributing those fuels. Generating electricity for use by PHEVs and BEVs, or hydrogen for use by FCVs, using fossil energy sources such as coal or natural gas also produces  $CO_2$  emissions. Additionally, extracting natural gas from wells, as well as production (consisting of compression, cooling, and dehydration) and storage of CNG, leads to  $CO_2$  emissions as well.

The modeling system calculates the amount of carbon dioxide emitted at each stage of fuel production and distribution (which are also referred to as "upstream" emissions) using aggregate estimates of emissions from all stages of these processes per unit of fuel energy supplied. These estimates are first converted to grams per quadrillion BTUs, then multiplied by the amount of Quads of each fuel type consumed to estimate total carbon dioxide emissions from production and distribution of various fuel types. Hence, the total  $CO_2$  emissions resulting from producing and distributing of fuel consumed by all surviving vehicles of a specific model year for each calendar year and fuel type is given by:

$$CO2_{MY,CY,FT}^{US} = \frac{Quads_{MY,CY,FT} \times CO2_{CY,FT}}{1e6} \quad (118)$$

Where:

- MY* : the production year of all vehicles for which to calculate upstream carbon dioxide emissions,
- CY* : the calendar year during which to calculate carbon dioxide upstream emissions attributed to the fuel consumption of vehicle models,
- FT* : the fuel type that all vehicles produced in model year *MY* operate on,
- $Quads_{MY,CT,FT}$  : the amount of quadrillion BTUs of energy consumed in a year by all surviving vehicle models produced in model year *MY*, during calendar year *CY*, when operating on fuel type *FT*,
- $CO2_{CY,FT}$  : overall emissions of carbon dioxide from all stages of feedstock production and distribution, during calendar year *CY*, for fuel type *FT* (an input parameter specified in grams per million-Btu; the input value is multiplied by  $1e9$  in order to convert it into grams per Quad),
- $1e6$  : the conversion factor from grams to metric tons, and
- $CO2_{MY,CY,FT}^{US}$  : the total upstream emissions of carbon dioxide (denominated in metric tons) resulting from production and distribution of each fuel type *FT* used by all surviving vehicle models produced in model year *MY*, during calendar year *CY*.

Annual CO<sub>2</sub> emissions generated by production and distribution of each fuel type *FT* are then summed over the lifetimes of all vehicle models produced during each model year *MY* as such:

$$CO2_{MY,FT}^{US} = \sum_{CY} CO2_{MY,CY,FT}^{US} \quad (119)$$

Finally, downstream CO<sub>2</sub> emissions from fuel consumption are combined with upstream emissions generated during the fuel supply process to yield total CO<sub>2</sub> emissions from fuel production and consumption by vehicles produced in a specific model year, during each calendar year, as well as summed over their expected lifetimes. For each fuel type the surviving vehicle models operate on, the calculation for total CO<sub>2</sub> emissions can be generalized as:

$$CO2_{MY,FT} = CO2_{MY,FT}^{DS} + CO2_{MY,FT}^{US} \quad (120)$$

Where:

- MY* : the production year of all vehicles for which to calculate total carbon dioxide emissions,
- FT* : the fuel type that all vehicles produced in model year *MY* operate on,
- $CO2_{MY,FT}^{DS}$  : the downstream emissions of carbon dioxide for model year *MY* and fuel type *FT* as calculated by either of Equations (115), (116), or (117),
- $CO2_{MY,FT}^{US}$  : the upstream emissions of carbon dioxide for model year *MY* and fuel type *FT* as calculated by either of Equations (118) or (119), and
- $CO2_{MY,FT}$  : the total emissions of carbon dioxide (denominated in metric tons) resulting from production and consumption of fuel type *FT* used by all surviving

vehicle models produced in a model year  $MY$ , during each calendar year or over the entire vehicle lifetimes.

## Section 5 Air Pollutant Emissions

Imposing new standards can result in higher or lower emissions of criteria air pollutants, by-products of fuel combustion that are also emitted during the production and distribution of fuel. Criteria pollutants that are emitted in significant quantities by motor vehicles include carbon monoxide, various hydrocarbon compounds, nitrogen oxides, sulfur dioxide, and fine particulate matter.

As discussed in the sections above, changes in vehicle fuel economies and fuel prices may lead to associated changes in the total number of miles driven and the total amount of fuel consumed during each calendar year. Typically, reduction in the cost per mile of travel will lead to additional vehicle miles driven (as a consequence of the rebound effect) while also decreasing the overall fuel consumption. In contrast, increasing the cost per single mile driven will generally produce the opposite effect. The amount of emissions of most criteria pollutants produced during vehicle operation (or, “tailpipe” or “downstream” emissions) directly correlates to the number of miles driven by vehicle models, since federal standards regulate permissible emissions of these pollutants on a per-mile basis. Additionally, similar to carbon dioxide emissions, the overall volume of fuel consumed by vehicle models influences the total emissions of criteria pollutants resulting from production and distribution of a given fuel. Thus, increases in vehicle fuel economies as a result of imposing more stringent standards is likely to result in higher downstream and lower upstream emissions, while deregulation leading to less stringent standards may produce lower downstream and higher upstream emissions.

While for most of the criteria pollutants the amount of downstream emissions are computed on a per-mile basis, the sulfur dioxide emissions are measured in terms of grams per million BTUs. As such, the modeling system calculates SO<sub>2</sub> emissions from vehicle use by multiplying the amount of quadrillion BTUs of energy consumed on each type of fuel by the quantity of SO<sub>2</sub> produced during consumption of a single unit of energy during operation on that fuel. Hence, the total emissions of sulfur dioxide resulting from fuel consumption by all surviving vehicle models produced in a specific model year during each calendar year, attributed to vehicle operation on each fuel type, are calculated as:

$$E_{MY,CY,FT}^{DS} = \frac{Quads_{MY,CY,FT} \times SO2_{FT} \times 1e9}{1e6} \quad (121)$$

Where:

- MY* : the production year of all vehicles for which to calculate downstream sulfur dioxide emissions,
- CY* : the calendar year during which to calculate the amount of sulfur dioxide emitted by all vehicle models during operation,
- FT* : the fuel type that all vehicles produced in model year *MY* operate on,
- Quads<sub>MY,CY,FT</sub>*: the amount of quadrillion BTUs of energy consumed in a year by all surviving vehicle models produced in model year *MY*, during calendar year *CY*, when operating on fuel type *FT*,

- $SO2_{FT}$  : the quantity of SO2 emitted by vehicles when operating on a specific fuel type  $FT$  (an input parameter specified in grams per million-Btu; the input value is multiplied by  $1e9$  in order to convert it into grams per Quad),
- $1e6$  : the conversion factor from grams to metric tons, and
- $E_{MY,CY,FT}^{DS}$  : the total downstream emissions of sulfur dioxide (denominated in metric tons) resulting from fuel consumption by all surviving vehicle models produced in model year  $MY$ , during calendar year  $CY$ , when operating on fuel type  $FT$ .

The CAFE Model calculates emissions for the rest of the criteria pollutants resulting from vehicle operation by multiplying the number of miles driven by individual vehicle models, during each calendar year they remain in service, by per-mile emission rates for each pollutant, which are listed in the parameters input file by model year and vehicle age. These emission rates differ among the various classes of vehicles (as defined by Table 5 in Section S2.2 above) when operating on specific fuel types. The modeling system accepts emission rate tables defined for gasoline and diesel fuel types, where the gasoline rates are also used for vehicles operating on E85.<sup>50</sup> Additionally, vehicles operating on electricity (PHEVs and BEVs), hydrogen (FCV), and CNG are assumed to generate no emissions of criteria air pollutants during vehicle use. Therefore, the total emissions of any given criteria air pollutant from the use of all surviving vehicle models produced in a specific model year during each calendar year, attributed to vehicle operation on each type of fuel, is defined as follows:

$$E_{MY,CY,FT}^{DS} = \frac{\sum_{i \in V} (MI'_{i,MY,CY,FT} \times E_{i,MY,a,FT})}{1e6} \quad (122)$$

Where:

- $V$  : a vector containing all vehicle models produced during model year  $MY$ ,
- $MY$  : the production year of all vehicles for which to calculate downstream emissions of a given pollutant,
- $CY$  : the calendar year during which to calculate the amount of a given pollutant emitted by all vehicle models during operation,
- $FT$  : the fuel type that all vehicles produced in model year  $MY$  operate on,
- $a$  : the age of the vehicle produced in model year  $MY$  during calendar year  $CY$  (as defined by Equation (82) above),
- $MI'_{i,MY,CY,FT}$  : the number of miles driven in a year by all surviving vehicles of model  $i$  produced in model year  $MY$ , during calendar year  $CY$ , when operating on fuel type  $FT$ ,
- $E_{i,MY,a,FT}$  : the per-mile rate at which vehicles of model  $i$  and model year  $MY$  emit a given pollutant at age  $a$ , when operating on a specific fuel type  $FT$ ,
- $1e6$  : the conversion factor from grams to metric tons, and

<sup>50</sup> Given that no reliable sources of information for criteria emissions resulting from vehicle operation are available for E85 fuel, and since overall utilization of E85 by all vehicle models is insignificant when compared to overall vehicle fuel consumption, the modeling system assumes a simplification that emissions generated from vehicle operation on E85 fuel are equivalent to that of gasoline.

$E_{MY,CY,FT}^{DS}$  : the total downstream emissions of a specific pollutant (denominated in metric tons) resulting from fuel consumption by all surviving vehicle models produced in model year  $MY$ , during calendar year  $CY$ , when operating on fuel type  $FT$ .

As with CO<sub>2</sub> emissions, annual emissions of each criteria air pollutant are summed over the calendar years that vehicle models originally produced during each model year are expected to be in service, in order to produce estimates of their total lifetime emissions. Thus, lifetime emissions resulting from sulfur dioxide and the rest of the air pollutants for each fuel type is defined as:

$$E_{MY,FT}^{DS} = \sum_{CY} E_{MY,CY,FT}^{DS} \quad (123)$$

Emissions of criteria air pollutants that occur during production and distribution of various fuel types are estimated using the same methodology employed for calculating carbon dioxide emissions, as discussed in the previous section and defined by equation (118) above. The modeling system uses aggregate estimates of emissions of criteria air pollutants from all stages of fuel production and distribution, which are specified in the parameters input file and are weighted by the user-defined fuel import assumptions. Thus, the total emissions of any given criteria air pollutant from producing and distributing of fuel consumed by all surviving vehicle models of a specific model year for each calendar year and fuel type is given by:

$$E_{MY,CY,FT}^{US} = \frac{Quads_{MY,CY,FT} \times E_{CY,FT} \times 1e9}{1e6} \quad (124)$$

Where:

- $MY$  : the production year of all vehicles for which to calculate upstream emissions of a given pollutant,
- $CY$  : the calendar year during which to calculate upstream emissions of a given pollutant attributed to the fuel consumption of vehicle models,
- $FT$  : the fuel type that all vehicles produced in model year  $MY$  operate on,
- $Quads_{MY,CY,FT}$ : the amount of quadrillion BTUs of energy consumed in a year by all surviving vehicle models produced in model year  $MY$ , during calendar year  $CY$ , when operating on fuel type  $FT$ ,
- $E_{CY,FT}$  : overall emissions of a given pollutant from all stages of feedstock production and distribution, during calendar year  $CY$ , for fuel type  $FT$  (an input parameter specified in grams per million-Btu; the input value is multiplied by  $1e9$  in order to convert it into grams per Quad),
- $1e6$  : the conversion factor from grams to metric tons, and
- $E_{MY,CY,FT}^{US}$  : the total upstream emissions of a specific pollutant (denominated in metric tons) resulting from production and distribution of each fuel type  $FT$  used by all surviving vehicle models produced in model year  $MY$ , during calendar year  $CY$ .



Emissions of each criteria pollutant attributable to producing and distributing each fuel type  $FT$  consumed over the lifetimes of all vehicle models produced during model year  $MY$  are then summed as:

$$E_{MY,FT}^{US} = \sum_{CY} E_{MY,CY,FT}^{US} \quad (125)$$

Finally, total emissions of each criteria pollutant over the lifetimes of all vehicles of model year  $MY$  are the sum of downstream emissions that occur as a result of their lifetime use, and upstream emissions from producing and distributing the fuel they consume during each calendar year or over their lifetimes. As with the calculation of total carbon dioxide emissions, the equation for total criteria pollutants attributed to all surviving vehicle models when operating on a given fuel type, is a specific model year, is generalized as follows:

$$E_{MY,FT} = E_{MY,FT}^{DS} + E_{MY,FT}^{US} \quad (126)$$

Where:

- $MY$  : the production year of all vehicles for which to calculate total emissions of a given pollutant,
- $FT$  : the fuel type that all vehicles produced in model year  $MY$  operate on,
- $E_{MY,FT}^{DS}$  : the downstream emissions of a given criteria pollutant for model year  $MY$  and fuel type  $FT$  as calculated by either of Equations (121), (122), or (123),
- $E_{MY,FT}^{US}$  : the upstream emissions of a given criteria pollutant for model year  $MY$  and fuel type  $FT$  as calculated by either of Equations (124) or (125), and
- $E_{MY,FT}$  : the total emissions of a given criteria pollutant (denominated in metric tons) resulting from production and consumption of fuel type  $FT$  used by all surviving vehicle models produced in model year  $MY$ , during each calendar year or over the entire vehicle lifetimes.

## Section 6 Emission Health Impacts

Emissions resulting from various criteria air pollutants, as described in Section 5 above, lead to numerous health related incidents attributed to environmental damage caused by those pollutants. Specifically, the CAFE Model estimates health impacts caused by atmospheric damage from nitrogen oxides, sulfur dioxide, and fine particulate matter. Since emissions from these pollutants are produced during vehicle operation as well as during the refining process of crude oil, the system apportions health related impacts to downstream and upstream categories, before combining the two to obtain the total count of each type of incident.

The input values for the various health impacts are specified as incidents per short ton in the parameters input file. Separate values are defined for the upstream and the vehicle-level emissions, for the three affected pollutants. Since the number of health impacts attributed to emission damage may change over time, these inputs may be specified for multiple calendar years.<sup>51</sup> For each of the defined health impact inputs, the CAFE modeling system calculates the estimated total number of resultant health impacts in each calendar year, by multiplying the amount of emissions from each affected pollutant by the associated input assumption. The system applies the same calculation when estimating the downstream-related and upstream-related health incidents, however, substituting the relevant parameters as necessary. Hence, the emission health impacts attributed to all surviving vehicle models produced in a specific model year during each calendar year, when operating on each type of fuel, are calculated as shown in the following two equations:

$$EHI_{MY,CY,FT}^{DS} = \left( \begin{array}{l} E_{MY,CY,FT}^{NOX,DS} \times EHI_{CY}^{NOX,DS} \\ + E_{MY,CY,FT}^{SO2,DS} \times EHI_{CY}^{SO2,DS} \\ + E_{MY,CY,FT}^{PM,DS} \times EHI_{CY}^{PM,DS} \end{array} \right) \times 1.10231 \quad (127)$$

And:

$$EHI_{MY,CY,FT}^{US} = \left( \begin{array}{l} E_{MY,CY,FT}^{NOX,US} \times EHI_{CY}^{NOX,US} \\ + E_{MY,CY,FT}^{SO2,US} \times EHI_{CY}^{SO2,US} \\ + E_{MY,CY,FT}^{PM,US} \times EHI_{CY}^{PM,US} \end{array} \right) \times 1.10231 \quad (128)$$

Where:

- MY* : the production year of all vehicles for which to calculate emission health impacts,
- CY* : the calendar year during which to calculate emission health impacts,
- FT* : the fuel type that all vehicles produced in model year *MY* operate on,

<sup>51</sup> When specifying input values for emission health impacts, the modeling system allows for calendar years to be intermittently defined. For example, at writing these inputs are defined for the following calendar years: 2016, 2020, 2025, and 2030. When calculating the associated emission health impact outputs for each calendar year, the system applies a nearest-neighbor interpolation method to obtain an input value for a specific calendar year.

- $EHI_{CY}^{P,DS}$  : the number of health related incidents per short ton resulting from emissions generated by  $NOx$ ,  $SO_2$ , or  $PM$  pollutants during vehicle use in calendar year  $CY$ ,
- $E_{MY,CY,FT}^{P,DS}$  : the total downstream emissions of  $NOx$ ,  $SO_2$ , or  $PM$  as calculated by Equations (121) or (122),
- $EHI_{CY}^{P,US}$  : the number of health related incidents per short ton resulting from emissions generated by  $NOx$ ,  $SO_2$ , or  $PM$  pollutants from all stages of feedstock production and distribution, during calendar year  $CY$ ,
- $E_{MY,CY,FT}^{P,US}$  : the total upstream emissions of  $NOx$ ,  $SO_2$ , or  $PM$  as calculated by Equation (124),
- $1.10231$  : the conversion factor from metric tons to short tons,
- $EHI_{MY,CY,FT}^{DS}$  : the total number of incidents of a specific emission-related health impact resulting from fuel consumption by all surviving vehicle models produced in model year  $MY$ , during calendar year  $CY$ , when operating on fuel type  $FT$ , and
- $EHI_{MY,CY,FT}^{US}$  : the total number of incidents of a specific emission-related health impact resulting from production and distribution of each fuel type  $FT$  used by all surviving vehicle models produced in model year  $MY$ , during calendar year  $CY$ .

The cumulative health impacts over the lifetimes of all vehicle models produced during model year  $MY$ , and for each fuel type  $FT$ , may be obtained for the downstream and upstream components by aggregating the results from either Equations (127) or (128) as follows:

$$EHI_{MY,FT}^{DS} = \sum_{CY} EHI_{MY,CY,FT}^{DS} \quad (129)$$

And:

$$EHI_{MY,FT}^{US} = \sum_{CY} EHI_{MY,CY,FT}^{US} \quad (130)$$

Finally, the total number of incidents, resulting from combination of downstream emissions attributed to vehicle use and upstream emissions from producing and distributing the various types of fuel, are calculated by summing the results obtained from any of the above equations, and is generalized as follows:

$$EHI_{MY,FT} = EHI_{MY,FT}^{DS} + EHI_{MY,FT}^{US} \quad (131)$$

Where:

- $MY$  : the production year of all vehicles for which to calculate emission health impacts,
- $FT$  : the fuel type that all vehicles produced in model year  $MY$  operate on,

- $EHI_{MY,FT}^{DS}$  : the number of incidents of a specific emission-related health impact resulting from fuel consumption by all surviving vehicle models produced in model year  $MY$ , when operating on fuel type  $FT$ , as calculated by either of Equations (127) or (129),
- $EHI_{MY,FT}^{US}$  : the number of incidents of a specific emission-related health impact resulting from production and distribution of each fuel type  $FT$  used by all surviving vehicle models produced in model year  $MY$ , as calculated by Equations (128) or (130), and
- $EHI_{MY,FT}$  : the total number of incidents of a specific emission-related health impact resulting from production and consumption of fuel type  $FT$  used by all surviving vehicle models produced in model year  $MY$ , during each calendar year or over the entire vehicle lifetimes.

## Section 7 Vehicle Safety Effects

As discussed in Section 2 above, vehicle miles traveled may increase or decrease due to the fuel economy rebound effect, resulting from changes in vehicle fuel efficiency and cost of fuel, as well as the assumed future growth in average vehicle use. The number of total lifetime miles traveled by all vehicle models has direct correlation to vehicle-related crashes, including those that result in fatalities. Since the use of mass reducing technology is present within the model, safety impacts may also be observed whenever a vehicle's curb weight decreases with respect to some reference point. Thus, in addition to computing total fatalities related to vehicle use, the modeling system also estimates changes in fatalities due to potential reduction in a vehicle's curb weight. Consequently, the modeling system computes total fatalities attributed to vehicle use of all surviving vehicle models produced in a specific model year during each calendar year, when operating on each type of fuel, as follows:

$$F_{MY,CY,FT} = \sum_{i \in V} \left( MI'_{i,MY,CY,FT} \times \frac{FR_{MY,CY}}{1e9} \times \left( 1 + Effect_{SC_i,CW_i} \times \frac{T_{SC_i} - CW_i}{100} \right) \right) \quad (132)$$

Where:

- $V$  : a vector containing all vehicle models produced during model year  $MY$ ,
- $MY$  : the production year of all vehicles for which to calculate vehicle related fatalities,
- $CY$  : the calendar year during which to calculate the vehicle related fatalities,
- $FT$  : the fuel type that all vehicles produced in model year  $MY$  operate on,
- $SC_i$  : the safety class that a vehicle model  $i$  belongs to,
- $CW_i$  : the curb weight of a vehicle model  $i$ , produced in model year  $MY$ ,
- $MI'_{i,MY,CY,FT}$  : the number of miles driven in a year by all surviving vehicles, of vehicle model  $i$ , produced in model year  $MY$ , during calendar year  $CY$ , when operating on fuel type  $FT$ , as defined in Equation (100) above,
- $FR_{MY,CY}$  : the estimated number of vehicle related fatalities per billion miles traveled attributed to vehicles produced in model year  $MY$ , during calendar year  $CY$ ,
- $1e9$  : the conversion factor from miles to billion miles,

- $Effect_{SC_i, CW_i}$  : the percentage by which fatalities change for every 100 lbs. that a vehicle's curb weight is reduced for vehicles within a safety class  $SC_i$  and with a curb weight  $CW_i$ ,
- $T_{SC_i}$  : the boundary, in lbs., between small and large weight effects associated with vehicle model  $i$ ,
- 100 : the conversion factor from lbs. to hundreds of lbs., and
- $FR_{MY, CY, FT}$  : the resultant fatalities associated with all surviving vehicles (for all vehicle models) produced in model year  $MY$ , during calendar year  $CY$ , when operating on a specific fuel type  $FT$ .

The  $FR_{MY, CY}$ ,  $Effect_{SC_i, CW_i}$ , and  $T_{SC_i}$  variables are specified as inputs to the model, which are defined in the parameters input file, while the safety class categorizations of vehicle models,  $SC_i$ , are specified in the input fleet.

In addition to computing the total fatalities for each vehicle, the modeling system also estimates the incremental fatalities due to rebound miles traveled as well as due to changes in vehicle's curb weight, based on the differences in the final vehicle states between the action alternative and the baseline scenarios. These "rebound" and "Δ curb weight" fatalities are intended to isolate and represent the impact on vehicle's safety resulting from the standards that prevailed during the action alternative over those that were in effect during the baseline scenario. Since these measures of fatalities are inherently incremental over the baseline scenario, they are calculated as zero during the baseline. For the action alternatives, the fatalities attributed to the additional miles traveled by surviving vehicles produced in a specific model year during each calendar year, when operating on a given fuel type, are calculated as:

$$F_{MY, CY, FT}^{Rebound} = \sum_{i \in V} \left( \begin{array}{l} FS_{i, MY, FT} \times N_{i, Base, MY, CY} \\ \times (MI_{i, MY, CY}^{ReboundOnly} - MI_{i, Base, MY, CY}^{ReboundOnly}) \times \frac{FR_{MY, CY}}{1e9} \\ \times \left( 1 + Effect_{SC_i, CW_{i, Base}} \times \frac{T_{SC_i} - CW_{i, Base}}{100} \right) \end{array} \right) \quad (133)$$

While the fatalities attributed to changes in vehicles' curb weights for the same model year, calendar year, and fuel type, are calculated as:

$$F_{MY, CY, FT}^{DeltaCW} = \sum_{i \in V} \left( \begin{array}{l} FS_{i, MY, FT} \times MI'_{i, Base, MY, CY} \times \frac{FR_{MY, CY}}{1e9} \\ \times \left( \begin{array}{l} Effect_{SC_i, CW_i} \times \frac{T_{SC_i} - CW_i}{100} \\ - Effect_{SC_i, CW_{i, Base}} \times \frac{T_{SC_i} - CW_{i, Base}}{100} \end{array} \right) \end{array} \right) \quad (134)$$

Where:

- $V, MY, CY, FT$ : variables as defined in Equation (132) above,
- $SC_i$  : the safety class that a vehicle model  $i$  belongs to,
- $CW_i$  : the curb weight of a vehicle model  $i$ , produced in model year  $MY$ ,

- $CW_{i,Base}$  : the curb weight of a vehicle model  $i$ , produced in model year  $MY$ , as applicable to the baseline scenario,
- $FS_{i,MY,FT}$  : the percent share of miles driven by vehicle model  $i$ , produced in model year  $MY$ , when operating on fuel type  $FT$ ,
- $N_{i,Base,MY,CY}$  : the number of units of vehicle model  $i$ , produced during model year  $MY$  that remain in use during a future calendar year  $CY$ , as applicable to the baseline scenario,
- $MI_{i,MY,CY}^{ReboundOnly}$  : the average number of annual “rebound-only” miles driven in a year by the vehicle produced in model year  $MY$ , during calendar year  $CY$ , when operating on fuel type  $FT$ ,
- $MI_{i,Base,MY,CY}^{ReboundOnly}$  : the average number of annual “rebound-only” miles driven in a year by the vehicle produced in model year  $MY$ , during calendar year  $CY$ , when operating on fuel type  $FT$ , as applicable to the baseline scenario,
- $MI'_{i,Base,MY,CY}$  : the total number of rebound miles driven in a year by all surviving vehicles produced in model year  $MY$ , during calendar year  $CY$ , as applicable to the baseline scenario,
- $FR_{MY,CY}$  : the estimated number of vehicle related fatalities per billion miles traveled attributed to vehicles produced in model year  $MY$ , during calendar year  $CY$ ,
- $1e9$  : the conversion factor from miles to billion miles,
- $Effect_{SC_i,CW_i}$  : the percentage by which fatalities change for every 100 lbs. that a vehicle’s curb weight is reduced for vehicles within a safety class  $SC_i$  and with a curb weight  $CW_i$ ,
- $Effect_{SC_i,CW_i,Base}$  : the percentage by which fatalities change for every 100 lbs. that a vehicle’s curb weight is reduced for vehicles within a safety class  $SC_i$  and with a curb weight  $CW_i$ , as applicable to the baseline scenario,
- $T_{SC_i}$  : the boundary, in lbs., between small and large weight effects associated with vehicle model  $i$ ,
- $100$  : the conversion factor from lbs. to hundreds of lbs.,
- $F_{MY,CY,FT}^{Rebound}$  : the resultant additional fatalities due to rebound miles traveled by all surviving vehicles (for all vehicle models) produced in model year  $MY$ , during calendar year  $CY$ , when operating on a specific fuel type  $FT$ , defined incrementally over the baseline scenario, and
- $F_{MY,CY,FT}^{DeltaCW}$  : the resultant additional fatalities due to changes in curb weights associated with all surviving vehicles (for all vehicle models) produced in model year  $MY$ , during calendar year  $CY$ , when operating on a specific fuel type  $FT$ , defined incrementally over the baseline scenario.

In Equations (133) and (134), the three terms for the “rebound-only” miles are computed as the differences between the rebound and non-rebound miles traveled by vehicles, as defined by the various equations presented in Section 2 above. The rebound-only miles may, then, be generally expressed by the following:

$$MI^{ReboundOnly} = MI - MI^{NonRebound} \quad (135)$$

As in the previous sections, for each calculation of fatalities defined in the above equations, the cumulative values of fatalities may be obtained by aggregating across model years, calendar years, or fuel types. For example, total fatalities attributed to all surviving vehicle models produced during model year  $MY$  over their expected lifetimes are accumulated across the individual calendar years as follows:

$$F_{MY,FT} = \sum_{CY} F_{MY,CY,FT} \quad (136)$$

In addition to using inputs to estimate the future involvement of modeled vehicles in crashes involving fatalities, the model also applies inputs defining other accident-related externalities estimated on a dollar per mile basis, as discussed below in S8.7.2.

## Section 8 Private versus Social Costs and Benefits

Improving the fuel efficiency of new vehicles produces a wide range of benefits and costs, many of which affect buyers of those vehicles directly. Depending upon how manufacturers attempt to recoup the costs they incur for improving the fuel efficiency of selected models, buyers are likely to face higher prices for some – and perhaps even most – new vehicle models. Purchasers of models whose fuel economy is improved benefit from lower fuel expenditures, from any increase in the range they can travel before needing to refuel, and from the added driving they do as a result of the rebound effect. Depending on the technology manufacturers use to improve fuel economy and its consequences for vehicle power and weight, these benefits may be partly offset by a slight decline in the performance of some new models.

At the same time, the reduction in fuel production and use resulting from improved fuel economy produces certain additional benefits and costs to society as a whole. Potential social benefits from reduced fuel use include any value that society or the U.S. economy attaches to saving fuel over and above its private value to new vehicle buyers, lower emissions of air pollutants and greenhouse gases generated from fuel production, distribution, and consumption, and reduced economic costs associated with U.S. imports of crude petroleum and refined fuel. By causing some additional driving through the rebound effect, improving fuel economy can also increase a variety of social costs, including the economic value of health effects and property damages caused by increased air pollution, the value of time delays to motorists from added traffic congestion, added costs of injuries and property damage resulting from more frequent traffic accidents, and economic costs from higher levels of traffic noise.

As with the calculation of modeling effects, the CAFE Model estimates and reports all private and social costs and benefits on an absolute basis for the scenario identified as the baseline. Hence, in almost all cases, all of the reported values for the baseline scenario should be interpreted as “costs” resulting from final vehicle fuel economy levels. For the action alternatives, the system calculates these values on an absolute basis as well, however, reporting the results as incremental changes over the baseline scenario. These incremental changes may be, in most cases, interpreted as “benefits” (e.g., reduction in lifetime fuel costs correlates to fuel savings) whenever the fuel economy values of vehicle models go up, on average, due to the action alternative standards being more stringent than the baseline. Conversely, the same incremental changes may be interpreted as “disbenefits” (or costs borne privately or by society, such as increases in fuel costs are reflected in added fuel expenditures) if, on average, the vehicle fuel economy decreases from the reduced stringency of the action alternative standards with respect to the baseline scenario.

For simplicity, we assume that new regulation typically increases in stringency, and therefore leads to higher fuel economy levels. Thus, the following sections discuss the way each of the benefits and costs can result from potentially improving the fuel economy of new vehicles, while also presenting all calculations on an absolute basis (i.e., assuming the full amount of gallons consumed and miles traveled, which results from vehicle’s final fuel economy, rather than using incremental fuel consumption or increases in VMT). Section 0 of Appendix A provides examples of specific unit economic values and other parameters used to estimate the aggregate value of these various benefits and costs.



### **S8.1 *Increases in New Vehicle Prices***

Depending upon how manufacturers attempt to recover the costs they incur in complying with ensuing standards, purchase prices for some new models are likely to increase. Since we assume that manufacturers fully recover all costs they incur for installing fuel economy technologies in the form of higher prices for some models, the total increase in vehicle sales prices has already been accounted for in estimating technology costs to manufacturers. Nevertheless, the total value of these price increases represent a cost of the regulation from the viewpoint of buyers of vehicle models whose prices rise.

In addition to increases in the prices paid by buyers who elect to purchase these models even at the higher price points, higher prices result in losses in welfare or consumer surplus to buyers who decide to purchase different models instead. These losses are extremely complex to estimate if prices change for a large number of models, and in any case are likely to be small even in total. Thus, the system does not attempt to estimate their value.

### **S8.2 *Foregone Consumer Sales Surplus***

Manufacturers' attempt to improve the efficiency of their fleets in response to the ensuing standards results not only in higher fuel economies, but also leads to increased vehicle prices. As a consequence of more expensive vehicles, some consumers may defer their purchasing decision until sometime in the future. This, in turn, leads to lower over sales recognized by manufacturers during the given years. The modeling system may be configured to use static sales forecast during analysis, in which case the production volumes (or sales) will be the same in the baseline scenario and the action alternatives. However, when the Dynamic Fleet Share and Sales Response model is enabled within the system, the resultant production volumes obtained in each action alternative may differ from those in the baseline scenario. The system measures this difference in the form of the forgone consumer sales surplus, signifying the collective loss of benefits (or "dis-benefits") attributed to all buyers who would have otherwise purchased new vehicles, if the prices of those vehicles have not increased.

Within the modeling system the forgone consumer sales surplus is computed as the average of the difference between regulatory costs and fuel savings, multiplied by the vehicle sales. Unlike most other social and consumer costs discussed in this section, which are calculated on a per-vehicle basis then aggregated to the industry as a whole, the forgone consumer sales surplus is computed over the entire vehicle fleet, where each term is specified as an incremental difference between the action alternative and the baseline scenarios. Furthermore, the system assumes that these losses occur entirely during vehicle age zero, when the purchasing decision by vehicle buyers is made, with the lifetime costs having the same value as that at age zero. The calculation of the forgone consumer sales surplus is, hence, demonstrated by the following equation:

$$Surplus_{MY} = \frac{(\Delta RegCost_{MY} - FuelSavings_{MY}) \times \Delta Sales_{MY}}{2} \quad (137)$$

Where:

- MY* : the production year of all vehicles for which to calculate the forgone consumer sales surplus,
- $\Delta RegCost_{MY}$  : the incremental difference of average regulatory cost, or price increase, of new vehicle models sold during model year *MY*, between the action alternative and the baseline scenarios, as given by Equations (74) and (75),
- $FuelSavings_{MY}$ : the incremental average fuel savings realized by new vehicle models sold during model year *MY*, as a result of increasing standards in the action alternative scenario versus the baseline scenario, based on the assumed number of miles during which an added investment in fuel improving technology is expected to pay back, as given by Equation (76),
- $\Delta Sales_{MY}$  : the incremental difference of the overall industry fleet produced for sale during model year *MY*, between the action alternative and the baseline scenarios, and
- $Surplus_{MY}$  : the resultant lost consumer surplus due to reduced vehicle sales attributed to all surviving vehicle models produced in model year *MY*.

Since the modeling system outputs costs and benefits by regulatory class, the foregone consumer sales surplus calculated by the equation above needs to be further disaggregated into specific regulatory classes. This is achieved by multiplying the result from above by the proportion of sales from each specific regulatory class. Thus, the consumer sales surplus for each regulatory class is computed as follows:

$$Surplus_{MY,RC} = Surplus_{MY} \times \frac{Sales_{MY,RC}}{Sales_{MY}} \quad (138)$$

### **S8.3 The Value of Fuel Consumed**

The modeling system estimates the economic value of fuel consumed by new vehicles based on the total amount of gallons that each surviving vehicle model consumes at a given age as well as over its entire lifetime. The value of fuel consumed from the buyer's perspective, or the retail fuel costs, is computed multiplying the forecast of future retail fuel prices at a specific calendar year by the number of gallons of fuel consumed at that year. Thus, the retail fuel costs associated with the total consumption of a particular type of fuel by all vehicle models produced in a specific model year that survive during each calendar year is given by the following:

$$FuelCost_{MY,CY,FT} = Gallons_{MY,CY,FT} \times Price_{FT,CY} \times Scale \quad (139)$$

Where:

- MY* : the production year of all vehicles for which to calculate the private value of fuel consumed,
- CY* : the calendar year during which to calculate the private value of fuel consumed by all vehicle models,
- FT* : the fuel type that all vehicles produced in model year *MY* operate on,
- Gallons<sub>MY,CY,FT</sub>* : the amount of gallons (or GGE) of fuel consumed in a year by all surviving vehicle models produced in model year *MY*, during calendar year *CY*, when operating on fuel type *FT*,
- Price<sub>FT,CY</sub>* : the inflation-adjusted retail price per gallon (or GGE) of the specific fuel type in calendar year *CY*,
- Scale* : the percentage by which to scale the private consumer benefits (a runtime option defined in the CAFE Model's GUI), and
- FuelCost<sub>MY,CY,FT</sub>* : the resultant private value of fuel consumed (or the retail fuel costs) in a year by all surviving vehicle models produced in model year *MY*, during calendar year *CY*, when operating on fuel type *FT*.

In addition to the retail fuel costs, the modeling system also estimates the fuel tax costs paid by the purchasers of new vehicle models during each calendar year. For all vehicle models produced in a specific model year that survive during each calendar year, the calculation of fuel taxes for each fuel type is defined by the following:

$$FuelTax_{MY,CY,FT} = Gallons_{MY,CY,FT} \times Tax_{FT,CY} \times Scale \quad (140)$$

Where:

- MY* : the production year of all vehicles for which to calculate the fuel tax costs,
- CY* : the calendar year during which to calculate the fuel tax costs,
- FT* : the fuel type that all vehicles produced in model year *MY* operate on,
- Gallons<sub>MY,CY,FT</sub>* : the amount of gallons (or GGE) of fuel consumed in a year by all surviving vehicle models produced in model year *MY*, during calendar year *CY*, when operating on fuel type *FT*,
- Tax<sub>FT,CY</sub>* : the inflation-adjusted fuel tax per gallon (or GGE) of the specific fuel type in calendar year *CY*,
- Scale* : the percentage by which to scale the private consumer, and
- FuelTax<sub>MY,CY,FT</sub>* : the resultant fuel tax costs associated with the total fuel consumed in a year by all surviving vehicle models produced in model year *MY*, during calendar year *CY*, when operating on fuel type *FT*.

## S8.4 Benefits from Additional Driving

The fuel economy rebound effect results in additional benefits to new vehicle buyers in the form of consumer surplus from the increased driving it produces. These benefits arise from the value to drivers and passengers of the social and economic opportunities made available to them by additional traveling. As evidenced by the fact that they elect to make more frequent or longer trips when improved fuel economy reduces the cost of driving, the benefits from this additional travel exceed the costs drivers and their passengers incur in making more frequent or longer trips. The amount by which these benefits from additional travel exceed its cost to them, which has been reduced by improved fuel economy, represents the increase in consumer surplus associated with additional rebound effect driving. The full “Drive Value” described below includes both this consumer surplus and the cost of driving those additional miles.

The system estimates the consumer surplus using the conventional approximation of one half of the product of the decline in fuel cost per mile driven and the resulting change in the annual number of miles traveled, with respect to the fuel cost and mileage associated with a typical historical vehicle of the same age. The cost of travel for those miles is simply the cost of the gallons consumed. For all vehicle models produced in a specific model year that survive during each calendar year, when operating on a specific type of fuel, the value of the benefits from additional driving is calculated as:

$$DriveValue_{MY,CY,FT} = \sum_{i \in V} \left( \frac{(MI'_{MY,CY,FT} - MI'_{MY,CY,FT}^{NonRebound})}{2} \times (CPM_{a,BaseCY} + CPM_{i,MY,CY}) \right) \quad (141)$$

Where:

- $V$  : a vector containing all vehicle models produced during model year  $MY$ ,
- $MY$  : the production year of all vehicles for which to calculate the value of additional driving,
- $CY$  : the calendar year during which to calculate the value of additional driving by all vehicle models,
- $FT$  : the fuel type that all vehicles produced in model year  $MY$  operate on,
- $MI'_{i,MY,CY,FT}$  : the number of with rebound miles driven in a year by all surviving vehicles, of vehicle model  $i$ , produced in model year  $MY$ , during calendar year  $CY$ , when operating on fuel type  $FT$ , as defined in Equation (100) above,
- $MI'_{MY,CY,FT}^{NonRebound}$  : the number of non-rebound miles driven in a year by all surviving vehicles, of a specific vehicle model, produced in model year  $MY$ , during calendar year  $CY$ , when operating on fuel type  $FT$ , as defined in Equation (99) above,
- $BaseCY$  : the base calendar year for VMT usage data corresponding to the year when the VMT survey was taken,
- $CPM_{a,BaseCY}$  : the average fuel cost per mile of all historic vehicles that were age  $a$  during the base calendar year  $BaseCY$ ,

- $CPM_{i,MY,CY}$  : the fuel cost per mile attributed to the vehicle model  $i$ , produced in model year  $MY$ , during calendar year  $CY$ , and
- $DriveValue_{MY,CY,FT}$ : the resultant value of the benefits from additional driving attributed to all surviving vehicle models produced in model year  $MY$ , during calendar year  $CY$ , when operating on fuel type  $FT$ .

### S8.5 The Value of Extended Refueling Range

Manufacturers' efforts to improve the fuel economy of selected new vehicle models will also increase their driving range per tank of fuel. By reducing the frequency with which drivers typically refuel their vehicles, and by extending the upper limit of the range they can travel before requiring refueling, improving fuel economy thus provides some additional benefits to their owners.<sup>52</sup> No direct estimates of the value of extended vehicle range are readily available, so the CAFE Model calculates the reduction in the annual number of required refueling events that results from improved fuel economy. The change in required refueling frequency for vehicle models with improved fuel economy reflects the increased driving associated with the rebound effect, as well as the increased driving range stemming from higher fuel economy.

For vehicles that operate on some non-liquid fuel types (hydrogen and CNG) as well as those that operate partially on electricity (i.e., PHEVs), the modeling system adopts a simplification that there is no benefit or penalty associated with refueling those vehicles. Thus, the refuel value is assumed to be zero for those fuel types. For vehicles that operate on gasoline, diesel, or E85, the modeling system estimates the refueling value based on the assumed amount of time required for vehicle owners to detour to a fueling station, pay for fuel, and return to route, and the amount of time necessary to refuel a portion of the vehicle's fuel tank. For all vehicle models produced in a specific model year that survive during each calendar year, when operating on a specific type of fuel, the refuel value is calculated as follows:

$$RefuelValue_{MY,CY,FT} = \sum_{i \in V} \left( \begin{array}{l} \left( \frac{G'_{i,MY,CY,FT}}{FuelTank_i \times RefuelVolume} \right) \\ \times \left( \frac{RefuelTime_{FT} + \frac{FuelTank_i \times RefuelVolume}{7.5}}{60} \right) \\ \times TravelValue \end{array} \right) \quad (142)$$

Where:

- $V$  : a vector containing all vehicle models produced during model year  $MY$ ,
- $MY$  : the production year of all vehicles for which to calculate the refueling value,
- $CY$  : the calendar year during which to calculate the refueling value of vehicle models,

<sup>52</sup> If manufacturers instead respond to improved fuel economy by reducing the size of fuel tanks to maintain a constant driving range, the resulting savings in costs will presumably be reflected in lower sales prices.

- $FT$  : the fuel type that all vehicles produced in model year  $MY$  operate on,
- $G'_{i,MY,CY,FT}$  : the amount of gallons of fuel consumed in a year by all surviving vehicles, of vehicle model  $i$ , produced in model year  $MY$ , during calendar year  $CY$ , when operating on a specific fuel type  $FT$  as defined in Equation (108) above, and
- $RefuelTime_{FT}$  : the fixed component of average refueling time in minutes, which includes the time required for vehicle owners to detour to a fueling station, pay for fuel of type  $FT$ , and return to route,
- $RefuelVolume$  : the average tank volume refilled during a refueling stop,
- $FuelTank_i$  : the fuel tank capacity of vehicle model  $i$ ,
- 7.5 : the average refueling rate, in gallons per minute, at the pumping station,
- 60 : the conversion factor from minutes to hours,
- $TravelValue$  : the amount that the driver of a vehicle would be willing to pay to reduce the time required to make a trip,
- $RefuelValue_{MY,CY,FT}$  : the resultant value of refueling attributed to all surviving vehicle models produced in model year  $MY$ , during calendar year  $CY$ , when operating on fuel type  $FT$ .

For vehicles that operate exclusively on electricity (i.e., BEVs), the system estimates the refueling value based on the number of recharge events, and the share of miles recharged at each event, that is necessary to travel a predetermined distance. For all vehicle models that operate on electricity, which were produced in a specific model year that survive during each calendar year, the refuel value is calculated as follows:

$$RefuelValue_{MY,CY,E} = \sum_{i \in V} \left( \left( \frac{MI'_{MY,CY,E}}{ChargeFreq} \times \frac{RefuelTime_E}{60} \right) + \frac{MI'_{MY,CY,E} \times ShareCharged}{ChargeRate} \right) \times TravelValue \quad (143)$$

Where:

- $V$  : a vector containing all vehicle models produced during model year  $MY$ ,
- $MY$  : the production year of all vehicles for which to calculate the refueling value,
- $CY$  : the calendar year during which to calculate the refueling value of vehicle models,
- $MI'_{i,MY,CY,FT}$  : the number of with rebound miles driven in a year by all surviving vehicles, of vehicle model  $i$ , produced in model year  $MY$ , during calendar year  $CY$ , when operating on electricity, as defined in Equation (100) above,
- $ChargeFreq$  : the assumed charge frequency of an electric vehicle, that is the cumulative number of miles driven before a mid-trip charging event is triggered,

<i>ChargeRate</i>	: the typical recharge rate for an electric vehicle, specified in miles/hour,
<i>ShareCharged</i>	: the percent share of miles that will be recharged mid-trip,
<i>RefuelTime<sub>FT</sub></i>	: the fixed component of average refueling time in minutes, which includes the time required for vehicle owners to detour to a fueling station, pay for fuel, and return to route,
60	: the conversion factor from minutes to hours,
<i>TravelValue</i>	: the amount that the driver of a vehicle would be willing to pay to reduce the time required to make a trip,
<i>RefuelValue<sub>MY,CY,E</sub></i>	: the resultant value of refueling attributed to all surviving vehicle models produced in model year <i>MY</i> , during calendar year <i>CY</i> , when operating on electricity.

In the equation above, the *ChargeFreq*, *ChargeRate*, and *ShareCharged* are specified in the parameters input file. However, since the modeling system supports 200-mile and 300-mile BEVs, and the assumed number of recharge events will be different between the two, the system accordingly accommodates separate inputs for “BEV200” and “BEV300” vehicle models. The computation of refuel values is the same for both types of vehicles (as shown in equation above), however, the parameter input values are substituted by the system during calculations as required.

## **S8.6 Changes in Performance and Utility**

The system currently assumes that the costs and effects of fuel-saving technologies reflect the application of these technologies in a manner that holds vehicle performance and utility constant. Therefore, the system currently does not estimate changes in vehicle performance or utility.

## **S8.7 Socially Valued Costs and Benefits**

### **S8.7.1 Social Costs of Market Externalities**

Importing petroleum into the United States is widely believed to impose significant costs on households and businesses that are not reflected in the market price for imported oil, and thus are not borne by consumers of refined petroleum products. These costs, also referred to as “market externalities,” include three components: (1) higher costs for oil imports resulting from the combined effect of U.S. import demand and OPEC market power on the world oil price; (2) the risk of reductions in U.S. economic output and disruption of the domestic economy caused by sudden reductions in the supply of imported oil; and (3) costs for maintaining a U.S. military presence to secure imported oil supplies from unstable regions, and for maintaining the Strategic Petroleum Reserve (SPR) to cushion against price increases.

The social costs of market externalities resulting from imposing new standards is estimated by assuming that the total volume of fuel consumed by new vehicle models during each future year is translated directly into a corresponding amount of U.S. oil imports during that same year. The

market externalities associated with the total consumption of a given type of fuel by all vehicle models produced in a specific model year that survive during each calendar year are calculated as follows:

$$\begin{aligned}
 \text{Externalities}_{MY,CY,FT} &= \text{Gallons}_{MY,CY,FT} \times \text{ImportAssumptions}_{CY,FT} \\
 &\times (\text{Monopsony}_{CY} + \text{PriceShock}_{CY} + \text{MilitarySecurity}_{CY})
 \end{aligned}
 \tag{144}$$

Where:

- MY* : the production year of all vehicles for which to calculate the market externalities,
- CY* : the calendar year during which to calculate the market externalities associated with fuel consumption of all vehicle models,
- FT* : the fuel type that all vehicles produced in model year *MY* operate on,
- Gallons<sub>MY,CY,FT</sub>* : the amount of gallons (or GGE) of fuel consumed in a year by all surviving vehicle models produced in model year *MY* during calendar year *CY*, when operating on fuel type *FT*,
- ImportAssumptions<sub>CY,FT</sub>* : the fuel import assumptions for fuel type *FT*, during calendar year *CY*, as defined by Equation (145) below,
- Monopsony<sub>CY</sub>* : the “monopsony” component of economic costs of oil imports, specified in \$/gallon in the parameters input file,
- PriceShock<sub>CY</sub>* : the price shock component of economic costs of oil imports, specified in \$/gallon in the parameters input file,
- MilitarySecurity<sub>CY</sub>* : the military security component of economic costs of oil imports, specified in \$/gallon in the parameters input file, and
- Externalities<sub>MY,CY,FT</sub>* : the resultant social costs of market externalities associated with all surviving vehicle models produced in model year *MY*, during calendar year *CY*, when operating on fuel type *FT*.

The fuel import assumptions used in the equation above are specified in the parameters input file, separately by various categories, for each type of fuel and for a subset of calendar years. The fuel import assumption categories define the shares of savings or reductions of crude oil imports and domestic refining of imported crude resulting from the potential reductions of total consumption of fuel by new vehicle models. The calendar years may be defined at specific intervals (e.g., at increments of 5, such as 2015, 2020, 2025), with the modeling system using the closest available year for any calendar year that is not explicitly defined in the inputs. For example, import assumptions specified in the inputs for calendar year 2020 would be used when estimating social costs of market externalities during calendar years 2018 through 2022.



$$ImportAssumptions_{CY,FT} = \left( \begin{array}{l} ReducedImports_{CY,FT} \\ + ReducedRefining_{CY,FT} \\ \times ReducedRefImports_{CY,FT} \end{array} \right) \quad (145)$$

Where:

- CY* : the calendar year during which to calculate the market externalities associated with fuel consumption of all vehicle models,
- FT* : the fuel type for which to calculate the market externalities associated with fuel consumption of all vehicle models,
- ReducedImports<sub>CY,FT</sub>* : the assumed value for share of fuel savings leading to lower fuel imports for fuel type *FT*, during calendar year *CY*,
- ReducedRefining<sub>CY,FT</sub>* : the assumed value for share of fuel savings leading to reduced domestic fuel refining for fuel type *FT*, during calendar year *CY*,
- ReducedRefImports<sub>CY,FT</sub>*: the assumed value for share of reduced domestic refining from imported crude for fuel type *FT*, during calendar year *CY*,
- ImportAssumptions<sub>CY,FT</sub>*: the calculated import assumptions for fuel type *FT*, during calendar year *CY*.

### S8.7.2 Social Costs of Added Driving

The CAFE Model estimates the way that additional driving associated with the fuel economy rebound effect may contribute to increased traffic congestion and highway noise. Additional vehicle use can contribute to traffic congestion and delays partly by increasing recurring congestion on heavily traveled facilities during peak travel periods, depending on how the additional travel is distributed over the day and on where it occurs. Added vehicle use from the rebound effect may also increase traffic noise, which causes inconvenience, irritation, and potentially even discomfort to occupants of other vehicles, pedestrians and other bystanders, and residents or occupants of surrounding property.

The modeling system calculates the total congestion and noise costs (or, collectively referred to as external costs) by multiplying the total miles driven by new vehicle models during each calendar year by the assumed amount of dollar per vehicle-mile associated with each of these external “vehicle usage” costs. While the form of the calculation remains the same, each of these variables is estimated and reported separately by the modeling system. The external costs associated with the total miles traveled by all vehicle models produced in a specific model year that survive during each calendar year, when operating on a given fuel type, are calculated as follows:

$$ExternalCosts_{MY,CY,FT} = Miles_{MY,CY,FT} \times ExternalCost \quad (146)$$

Where:

- MY* : the production year of all vehicles for which to calculate the congestion or noise costs,
- CY* : the calendar year during which to calculate the congestion or noise costs associated with total miles driven by all vehicle models,
- FT* : the fuel type that all vehicles produced in model year *MY* operate on,
- Miles<sub>MY,CY,FT</sub>* : the number of miles driven in a year by all surviving vehicles produced in model year *MY*, during calendar year *CY*, when operating on a specific fuel type *FT*,
- ExternalCost* : the congestion or noise components of external costs associated with additional vehicle use due to the “rebound” effect, specified in \$/vehicle-mile in the parameters input file, and
- ExternalCosts<sub>MY,CY,FT</sub>*: the resultant congestion or noise costs associated with all surviving vehicle models produced in model year *MY*, during calendar year *CY*, when operating on fuel type *FT*.

Then, each of the lifetime external costs attributed to all surviving vehicle models produced in model year *MY* over their expected lifetimes, when operating on each type of fuel, are aggregated as follows:

$$ExternalCosts_{MY,FT} = \sum_{CY} ExternalCosts_{MY,CY,FT} \quad (147)$$

In addition to the aforementioned external vehicle usage costs, the modeling system also computes costs associated with the cleanup of fatal and non-fatal crashes, attributed to increases in total miles driven and application of mass reduction technology. The system computes these costs based on the total fatalities attributed to surviving vehicle models, as defined by Equation (132) above, as well as incremental costs based on the additional fatalities due to rebound miles traveled by surviving vehicle models and due to changes in curb weights of those vehicles, as defined by Equations (133) and (134) of a previous section. Thus, for each model year and calendar year, the social costs associated with one of these types of fatal crashes for all surviving vehicle models, when operating on a specific fuel type, are calculated according to the following equations:

$$FatalityCosts_{MY,CY,FT} = F_{MY,CY,FT} \times FatalityCost \times (1 + r)^{CY - BaseCY} \quad (148)$$

$$FatalityCosts_{MY,CY,FT}^{Rebound} = F_{MY,CY,FT}^{Rebound} \times FatalityCost \times (1 + r)^{CY - BaseCY} \quad (149)$$

$$FatalityCosts_{MY,CY,FT}^{DeltaCW} = F_{MY,CY,FT}^{DeltaCW} \times FatalityCost \times (1 + r)^{CY - BaseCY} \quad (150)$$

Where:

- $MY$  : the production year of all vehicles for which to calculate the social costs of fatal crashes,
- $CY$  : the calendar year during which to calculate the social costs of fatal crashes associated with all vehicle models,
- $FT$  : the fuel type that all vehicles produced in model year  $MY$  operate on,
- $F_{MY,CY,FT}$  : the fatalities associated with all surviving vehicles produced in model year  $MY$ , during calendar year  $CY$ , when operating on a specific fuel type  $FT$ , as calculated in Equation (132) above,
- $F_{MY,CY,FT}^{Rebound}$  : the additional fatalities due to rebound miles traveled by all surviving vehicles produced in model year  $MY$ , during calendar year  $CY$ , when operating on a specific fuel type  $FT$ , defined incrementally over the baseline scenario, as calculated in Equation (133) above,
- $F_{MY,CY,FT}^{DeltaCW}$  : the additional fatalities due to changes in curb weights associated with all surviving vehicles produced in model year  $MY$ , during calendar year  $CY$ , when operating on a specific fuel type  $FT$ , defined incrementally over the baseline scenario, as calculated in Equation (134) above,
- $FatalityCost$  : the social costs arising from vehicle fatalities, specified in \$/fatality in the parameters input file,
- $r$  : the annual growth rate of fatality costs,
- $BaseCY$  : the base year for annual growth rate of fatality costs,
- $FatalityCosts_{MY,CY,FT}$  : the resultant fatality costs associated with travel by all surviving vehicle models produced in model year  $MY$ , during calendar year  $CY$ , when operating on fuel type  $FT$ ,
- $FatalityCosts_{MY,CY,FT}^{Rebound}$  : the resultant fatality costs associated with additional fatalities due to rebound miles traveled by all surviving vehicle models produced in model year  $MY$ , during calendar year  $CY$ , when operating on fuel type  $FT$ , and
- $FatalityCosts_{MY,CY,FT}^{DeltaCW}$  : the resultant fatality costs associated with additional fatalities due to changes in curb weights of all surviving vehicle models produced in model year  $MY$ , during calendar year  $CY$ , when operating on fuel type  $FT$ .

Similar to the various fatality costs, the accompanying non-fatal crash costs, from added driving and mass reduction, are calculated based on the various fatality metrics from Equations (132) to (134), while also applying an annual scaling factor defined in the parameters input file. Thus, for each model year and calendar year, the non-fatal crash costs are computed as in the following three equations:

$$\begin{aligned} NonFatalCrashCosts_{MY,CY,FT} & \\ &= F_{MY,CY,FT} \times FatalityCost \times NonFatalCostScalar_{CY} \end{aligned} \quad (151)$$

$$\begin{aligned} NonFatalCrashCosts_{MY,CY,FT}^{Rebound} & \\ &= F_{MY,CY,FT}^{Rebound} \times FatalityCost \times NonFatalCostScalar_{CY} \end{aligned} \quad (152)$$

$$\begin{aligned} NonFatalCrashCosts_{MY,CY,FT}^{DeltaCW} & \\ &= F_{MY,CY,FT}^{DeltaCW} \times FatalityCost \times NonFatalCostScalar_{CY} \end{aligned} \quad (153)$$

Where:

- $MY, CY, FT$  : variables as defined in Equations (132) to (134) above,
- $F_{MY,CY,FT}, F_{MY,CY,FT}^{Rebound}, F_{MY,CY,FT}^{DeltaCW}$  : variables as defined in Equation (132) to (134) above,
- $FatalityCost$  : the social costs arising from vehicle fatalities, specified in \$/fatality in the parameters input file,
- $NonFatalCostScalar_{CY}$  : the annual scaling factor used for estimating social costs arising from non-fatal vehicle crashes,
- $NonFatalCrashCosts_{FT}$  : the resultant non-fatal crash costs associated with travel by all surviving vehicle models produced in a specific model year during a specific calendar year, when operating on fuel type  $FT$ ,
- $NonFatalCrashCosts_{MY,CY,FT}^{Rebound}$  : the resultant non-fatal crash costs associated with additional fatalities due to rebound miles traveled by all surviving vehicle models produced in model year  $MY$ , during calendar year  $CY$ , when operating on fuel type  $FT$ , and
- $NonFatalCrashCosts_{MY,CY,FT}^{DeltaCW}$  : the resultant non-fatal crash costs associated with additional fatalities due to changes in curb weights of all surviving vehicle models produced in model year  $MY$ , during calendar year  $CY$ , when operating on fuel type  $FT$ .

Lastly, using the results obtained by Equations (149) and (152), the CAFE Model estimates the fatality risk internalized by the driver for traveling the additional miles due to the rebound effect:

$$FatalityRiskValue_{MY,CY,FT} = FatalityCosts_{MY,CY,FT}^{Rebound} \times FatalityRisk \quad (154)$$

And:

$$\begin{aligned} NonFatalCrashRiskValue_{MY,CY,FT} \\ = NonFatalCrashCosts_{MY,CY,FT}^{Rebound} \times FatalityRisk \end{aligned} \quad (155)$$

Where:

- $FatalityCosts_{MY,CY,FT}^{Rebound}$  : the fatality costs associated with additional fatalities due to rebound miles traveled by all surviving vehicle models produced in model year  $MY$ , during calendar year  $CY$ , when operating on fuel type  $FT$ ,
- $NonFatalCrashCosts_{MY,CY,FT}^{Rebound}$ : the non-fatal crash costs associated with additional fatalities due to rebound miles traveled by all surviving vehicle models produced in model year  $MY$ , during calendar year  $CY$ , when operating on fuel type  $FT$ ,
- $FatalityRisk$  : fatality risk internalized by the driver, attributed to the additional miles driven due to rebound,
- $FatalityRiskValue_{MY,CY,FT}$  : the resultant risk value of fatal incidents internalized by the driver, associated with additional fatalities due to rebound miles traveled by all surviving vehicle models produced in model year  $MY$ , during calendar year  $CY$ , when operating on fuel type  $FT$ , and
- $NonFatalCrashRiskValue_{MY,CY,FT}$  : the resultant risk value of non-fatal incidents internalized by the driver, associated with additional fatalities due to rebound miles traveled by all surviving vehicle models produced in model year  $MY$ , during calendar year  $CY$ , when operating on fuel type  $FT$ .

### S8.7.3 Social Costs of Environmental Impacts

The modeling system estimates the economic costs associated with emissions of criteria pollutants, including nitrogen oxides, sulfur dioxide, and fine particulates, using estimates of the economic damage costs per short ton of emissions of each of these pollutants.<sup>53</sup> As indicated previously, emissions of criteria pollutants can rise or fall whenever vehicle's fuel economy changes. Thus, the economic costs of these emissions can increase or decline in response to new fuel economy or CO<sub>2</sub> standards.

The input values for emission damage costs of criteria pollutants are specified in the parameters input file, with cost values being pre-discounted at 3 percent and 7 percent. Separate values are defined for the upstream and the vehicle-level emissions, for the three affected pollutants. Since the economic costs attributed to emission damage may change over time, these inputs may be specified for multiple calendar years.<sup>54</sup> Using the appropriate discount rate and calendar year, the modeling system computes the individual damage costs, associated with downstream-related and upstream-related emissions, before adding the two values to obtain the total economic cost of a particular pollutant. As such, the emission damage costs attributed to all vehicle models produced in a specific model year that survive during each calendar year, when operating on a given fuel type, are calculated as follows:

$$EmissionCosts_{MY,CY,FT} = \left( E_{MY,CY,FT}^{DS} \times EmissionCost_{CY,DR}^{DS} + E_{MY,CY,FT}^{US} \times EmissionCost_{CY,DR}^{US} \right) \times 1.10231 \quad (156)$$

Where:

- MY* : the production year of all vehicles for which to calculate the social costs associated with emissions of a given pollutant,
- CY* : the calendar year during which to calculate the social costs associated with emissions of a given pollutant attributed to all vehicle models,
- FT* : the fuel type that all vehicles produced in model year *MY* operate on,
- DR* : the rate at which the input emission damage costs are discounted,

---

<sup>53</sup> The EPA analysis that is the source of estimates of health impacts and damage costs from criteria air pollutants used in the current version of the CAFE Model considers only health damages caused by exposure to fine particulate matter (PM<sub>2.5</sub>), and does not specify health impacts or damage costs resulting from exposure to carbon monoxide or volatile organic compounds (including pollutants formed in the atmosphere from chemical reactions involving VOCs). Thus, the modeling system estimates only health impacts and damage costs from direct emissions of PM<sub>2.5</sub> and chemical compounds that can form fine particulates in the atmosphere, including oxides of nitrogen and sulfur.

See EPA, Technical Support Document: Estimating the Benefit per Ton of Reducing PM<sub>2.5</sub> Precursors From 17 Sectors, Office of Air and Radiation, Office of Air Quality Planning and Standards, February 2018 (available at: [www.epa.gov/sites/production/files/2018-02/documents/sourceapportionmentbptsd\\_2018.pdf](http://www.epa.gov/sites/production/files/2018-02/documents/sourceapportionmentbptsd_2018.pdf)).

<sup>54</sup> When specifying input values for emission damage costs, the modeling system allows for calendar years to be intermittently defined. For example, at writing these inputs are defined for the following calendar years: 2016, 2020, 2025, and 2030. When calculating the associated emission health impact outputs for each calendar year, the system applies a nearest-neighbor interpolation method to obtain an input value for a specific calendar year.

- $E_{MY,CY,FT}^{DS}$  : the total downstream emissions of a specific pollutant (denominated in metric tons) attributed to all surviving vehicle models produced in model year  $MY$ , during calendar year  $CY$ , when operating on fuel type  $FT$ , as calculated by Equation (122),
- $E_{MY,CY,FT}^{US}$  : the total upstream emissions of a specific pollutant (denominated in metric tons) attributed to all surviving vehicle models produced in model year  $MY$ , during calendar year  $CY$ , when operating on fuel type  $FT$ , as calculated by Equation (124),
- $EmissionCost_{CY,DR}^{DS}$  : the economic costs arising from downstream emission damage for a given pollutant, pre-discounted at a specific discount rate  $DR$ , during calendar year  $CY$ , specified in \$/short ton in the parameters input file,
- $EmissionCost_{CY,DR}^{US}$  : the economic costs arising from upstream emission damage for a given pollutant, pre-discounted at a specific discount rate  $DR$ , during calendar year  $CY$ , specified in \$/short ton in the parameters input file,
- $1.10231$  : the conversion factor from metric tons to short tons, and
- $EmissionCosts_{MY,CY,FT}$  : the resultant social costs of emission damage caused by a given pollutant, attributed to all surviving vehicle models produced in model year  $MY$ , during calendar year  $CY$ , when operating on fuel type  $FT$ .

In addition to the emission damage costs arising from criteria pollutants, the CAFE Model also estimates the social costs of damage caused by greenhouse gases, including carbon dioxide, methane, and nitrous oxide. The system estimates emission damage resulting from greenhouse gases by multiplying the total amount of a particular pollutant emitted by surviving vehicle models by the estimated value of damages per unit of emissions during each calendar year. The damage costs caused by greenhouse gases, attributed to all vehicle models produced in a specific model year that survive during each calendar year, when operating on a given fuel type, are calculated as follows:

$$EmissionCosts_{MY,CY,FT} = E_{MY,CY,FT} \times Cost_{CY} \quad (157)$$

Where:

- $MY, CY, FT$  : variables as defined in Equation (156) above,
- $E_{MY,CY,FT}$  : the total upstream and downstream emissions of a specific pollutant (denominated in metric tons) attributed to all surviving vehicle models produced in model year  $MY$ , during calendar year  $CY$ , when operating on fuel type  $FT$ , as calculated by Equations (116), (118), (120), (122), (124), and (126),
- $Cost_{CY}$  : the economic costs arising from emission damage for a given pollutant, specified in \$/metric-ton in the parameters input file during calendar year  $CY$ , specified in \$/metric ton in the parameters input file, and

$EmissionCosts_{MY,CY,FT}$  : the resultant social costs of emission damage caused by a given pollutant, attributed to all surviving vehicle models produced in model year  $MY$ , during calendar year  $CY$ , when operating on fuel type  $FT$ .

#### S8.7.4 Discounting of Social Costs and Benefits

Along with calculating the “undiscounted” social costs and benefits described in the preceding sections, the CAFE Model also estimates discounted annual and lifetime valuations of these variables, measured from the perspective of society as a whole. The modeling system applies present year discounting, using one or more discount rates defined in the parameters input file, with all costs and benefits being discounted to a user-specified calendar year (also defined in the parameters file).<sup>55</sup> Hence, the discounted costs or benefits, of each variable, attributed to all vehicle models produced in a specific model year that survive during each calendar year, when operating on a given fuel type, are calculated as follows:

$$DiscCosts_{MY,CY,FT} = Cost_{MY,CY,FT} \times (1 + DR)^{-MAX(CY-BaseCY,0)} \quad (158)$$

Where:

- $MY$  : the production year of all vehicles for which to calculate the discounted social costs,
- $CY$  : the calendar year during which to calculate the discounted social costs associated with all vehicle models,
- $FT$  : the fuel type that all vehicles produced in model year  $MY$  operate on,
- $BaseCY$  : the calendar year where all costs and benefits are discounted to,
- $DR$  : the discount rate to apply to future costs and benefits,
- $Cost_{MY,CY,FT}$  : the costs or benefits, as calculated in the preceding sections, to discount, and
- $DiscCost_{MY,CY,FT}$  : the resultant discounted costs or benefits, attributed to all surviving vehicle models produced in model year  $MY$ , during calendar year  $CY$ , when operating on fuel type  $FT$ .

As shown in the equation above, if the base calendar year,  $BaseCY$ , used for discounting is greater than the calendar year,  $CY$ , for which the costs are being discounted, the modeling system assumes that those costs and benefits remain undiscounted.

---

<sup>55</sup> With the exception of CO<sub>2</sub>, CH<sub>4</sub>, and N<sub>2</sub>O costs, for discounting of all social costs and benefits, the CAFE Model uses the discount rates specified on the “Economic Values” worksheet, as discussed in Section A.3.1 of Appendix A. For discounting of CO<sub>2</sub>, CH<sub>4</sub>, and N<sub>2</sub>O costs, the system uses a separate discount rate value, as defined on the “Economic Values” worksheet, described in Section A.3.1 of Appendix A.



## S8.8 Consumer-Valued Costs and Benefits

### S8.8.1 The Value of “Rebound Miles”

In addition to the value of additional driving, discussed in Section S8.4 above, the CAFE Model estimates the value of “rebound miles,” which is based on the final cost per mile associated with a vehicle and the change in the annual number of miles traveled between the analysis vehicle and a typical historical vehicle of the same age. For all vehicle models produced in a specific model year that survive during each calendar year, when operating on a specific type of fuel, the value of the benefits from additional driving is calculated as:

$$ReboundCost_{MY,CY,FT} = \sum_{i \in V} \left( (MI'_{MY,CY,FT} - MI'^{NonRebound}_{MY,CY,FT}) \times CPM_{i,MY,CY} \times Scale \right) \quad (159)$$

Where:

$V$	: a vector containing all vehicle models produced during model year $MY$ ,
$MY$	: the production year of all vehicles for which to calculate the value of rebound miles,
$CY$	: the calendar year during which to calculate the value of rebound miles by all vehicle models,
$FT$	: the fuel type that all vehicles produced in model year $MY$ operate on,
$MI'_{i,MY,CY,FT}$	: the number of with rebound miles driven in a year by <u>all</u> surviving vehicles, of vehicle model $i$ , produced in model year $MY$ , during calendar year $CY$ , when operating on fuel type $FT$ , as defined in Equation (100) above,
$MI'^{NonRebound}_{MY,CY,FT}$	: the number of non-rebound miles driven in a year by <u>all</u> surviving vehicles, of a specific vehicle model, produced in model year $MY$ , during calendar year $CY$ , when operating on fuel type $FT$ , as defined in Equation (99) above,
$CPM_{i,MY,CY}$	: the fuel cost per mile attributed to the vehicle model $i$ , produced in model year $MY$ , during calendar year $CY$ ,
$Scale$	: the percentage by which to scale the private consumer benefits (a runtime option defined in the CAFE Model’s GUI), and
$ReboundCost_{MY,CY,FT}$	: the resultant value of the rebound miles attributed to all surviving vehicle models produced in model year $MY$ , during calendar year $CY$ , when operating on fuel type $FT$ .

### S8.8.2 Ownership Costs

The CAFE Model estimates additional ownerships costs that consumers incur either as part of a new vehicle purchase or during the lifetime of a vehicle model. Depending on the variable being calculated, the ownership costs may occur entirely at the point of sale (i.e., during the model year the vehicle was purchased), over some number of years after purchase, or during the lifetime of

the vehicle. In each case, however, these costs are computed relative to the MSRP of a new vehicle. Since a purchaser of a new vehicle model does not expect their vehicle to be scrapped prior to the end of its useful life (or, likewise, before reselling it for a different model), the modeling system does not apply survival weighting when calculating ownership costs. Instead, the system computes these costs under the assumption that the entire number of units initially produced during a specific model year remain in use during each future calendar year.

When computing taxes and fees attributed to the sale of a new vehicle model, we assume that all costs to the buyer of that vehicle are borne upfront. Therefore, the system apportions these costs to vehicle age 0 (zero), with the lifetime costs having the same value as that at age zero. The total taxes and fees for a given vehicle model produced during a specific model year are calculated as in the following equation:

$$TaxesAndFees_{MY} = \sum_{i \in V} (Sales_{i,MY} \times MSRP_{i,MY} \times TaxesAndFees) \quad (160)$$

Where:

- $V$  : a vector containing all vehicle models produced during model year  $MY$ ,
- $MY$  : the production year of all vehicles for which to calculate the taxes and fees,
- $Sales_{i,MY}$  : the number of units of vehicle model  $i$  produced for sale during model year  $MY$ ,
- $MSRP_{i,MY}$  : the MSRP of a vehicle model  $i$  that is produced for sale during model year  $MY$ ,
- $TaxesAndFees$  : the average percentage of the vehicle's MSRP the consumer pays in taxes and fees when purchasing a new vehicle (an input value specified in the parameters input file),
- $TaxesAndFees_{MY}$  : the resultant total taxes and fees paid by purchasers of new vehicle models during model year  $MY$ .

The modeling system estimates the costs that buyers incur for financing new vehicle purchases during each calendar year, extending up to the length of the financing term (as defined in the parameters input file). We assume that some of the new vehicle models will be financed at the time of sale and that purchasers will finance a certain percentage of the value of the MSRP. For simplicity, we apply a single estimate that represents a weighted combination of consumers that elect to finance their new vehicles and the amount of the MSRP they are willing to finance. Thus, the financing costs attributed to all vehicle models produced in a specific model year that survive during each calendar year (up to the length of the term), are calculated as:

$$Financing_{MY,CY} = \sum_{i \in V} \left( \begin{array}{l} Sales_{i,MY} \times MSRP_{i,MY} \\ \times \left( \frac{r \times Share}{1 - \left(1 + \frac{r}{12}\right)^{-Term}} - \frac{Share}{12} \right) \\ \times \text{MIN} \left( \frac{Term}{12} - a, 1 \right) \end{array} \right) \quad (161)$$

Where:

- $V$  : a vector containing all vehicle models produced during model year  $MY$ ,
- $MY$  : the production year of all vehicles for which to calculate the financing cost,
- $CY$  : the calendar year during which to calculate the financing cost attributed to all vehicle models,
- $Sales_{i,MY}$  : the number of units of vehicle model  $i$  produced for sale during model year  $MY$ ,
- $MSRP_{i,MY}$  : the MSRP of a vehicle model  $i$  that is produced for sale during model year  $MY$ ,
- $Term$  : the average length of time (in months) used by consumers to finance a new vehicle purchase,
- $r$  : the average interest rate used by consumers to finance a new vehicle purchase,
- $Share$  : the percentage of consumers that choose to finance their new vehicle purchase,
- $Financing_{MY,CY}$  : the resultant total financing costs paid by purchasers of new vehicle models in model year  $MY$ , during calendar year  $CY$ .

The financing term,  $Term$ , interest rate,  $r$ , and percent share financed,  $Share$ , in the equation above are all input values specified in the parameters input file.

Since no additional costs occur after the loan amount is repaid in full, the system assigns a cost of zero to each calendar year beyond the length of the term. Since the input value for the financing term is specified in months, the system makes the determination of whether to calculate financing costs at a given calendar year based on the whether a vehicle's age,  $a$ , at a corresponding calendar year exceeds the number of whole years required to pay back the loan amount. This decision can be expressed by the following:

$$a < \text{CEILING} \left( \frac{Term}{12} \right) \quad (162)$$

Here,  $a$  is the vehicle age corresponding to the calendar year during which the costs of financing are calculated, while  $Term$  is the financing term as defined in the preceding equation.

The financing costs calculated at each vehicle age for all vehicle models produced in model year  $MY$  are summed over the individual calendar years to obtain the cumulative financing costs paid by purchasers of new vehicle models. Since the modeling system only computes the annual

financing costs up to the length of the term, the later calendar years in the summation have a value of zero, and have no impact on the computation of the lifetime costs of financing. Hence, this calculation is expressed by the following:

$$Financing_{MY} = \sum_{CY} Financing_{MY,CY} \quad (163)$$

More expensive vehicles will require more expensive collision and comprehensive (e.g., fire and theft) car insurance. Actuarially fair insurance premiums for these components of value-based insurance will be the amount an insurance company will pay out in the case of an incident type weighted by the risk of that type of incident occurring. We expect that the same driver in the same vehicle type will have the same risk of occurrence for the entirety of a vehicle's life, so that the share of the value of a vehicle paid out should be constant over the life of that vehicle. However, since the value of vehicle models is expected to decline at some depreciation rate with each subsequent calendar year, the absolute amount paid in value-related insurance also declines as the vehicle depreciates. Thus, the cost to insure all vehicle models produced in a specific model year that survive during each calendar year, is given by the following equation:

$$Insurance_{MY,CY} = \sum_{i \in V} \left( Sales_{i,MY} \times \frac{MSRP_{i,MY} \times 0.0183}{(1 + Depreciation)^a} \right) \quad (164)$$

Where:

- $V$  : a vector containing all vehicle models produced during model year  $MY$ ,
- $MY$  : the production year of all vehicles for which to calculate the insurance cost,
- $CY$  : the calendar year during which to calculate the insurance cost attributed to all vehicle models,
- $Sales_{i,MY}$  : the number of units of vehicle model  $i$  produced for sale during model year  $MY$ ,
- $MSRP_{i,MY}$  : the MSRP of a vehicle model  $i$  that is produced for sale during model year  $MY$ ,
- $0.0183$  : the share of MSRP paid on collision and comprehensive insurance,
- $Depreciation$  : the typical depreciation rate of a new vehicle (an input value specified in the parameters input file),
- $Insurance_{MY,CY}$ : the resultant total insurance costs paid by purchasers of new vehicle models in model year  $MY$ , during calendar year  $CY$ .

The lifetime financing costs accrued by consumers for purchasing new vehicle models produced during model year  $MY$  are aggregated across each calendar year as follows:

$$Insurance_{MY} = \sum_{CY} Insurance_{MY,CY} \quad (165)$$

In order to estimate whether increases in total cost of ownership (TCO) to vehicle buyers are repaid over some number of years, the CAFE Model computes all of the aforementioned ownership costs using the vehicle’s initial and final MSRPs. The initial MSRP is based on what is provided to the system in the input fleet (before application of any technologies), while the final MSRP is calculated during analysis, considering the regulatory costs incurred by each vehicle model. In either case, the initial or final vehicle MSRP is substituted into each of the above equations to obtain the associated ownership cost. From here, the vehicle’s payback and payback TCO, as discussed in the following section, may be calculated.

### S8.8.3 Calculating Vehicle Payback

Using the various consumer-valued costs and benefits calculated during analysis, the CAFE Model estimates the number of years required for additional investments in fuel economy improving technologies to be paid back in the form of fuel savings realized by purchasers of new vehicle models. The system estimates the payback period for each vehicle model independently, as well as computing the average industry-wide payback using the accumulated totals for costs and fuel savings across all vehicles.

Two methodologies are employed in calculating the payback periods: in the first, the payback calculation only considers the accumulated regulatory costs versus the associated fuel savings; while for the second, the modeling system estimates the payback period based on the total cost of ownership (TCO), which also takes into account additional maintenance and repair costs associated with new technology application, as well as changes in ownership costs related to potential increases in a vehicle’s MSRP. In both cases, the CAFE Model assumes that all costs stemming from application of vehicle technologies (along with fine payments for non-compliance, wherever applicable) are borne in the first year of a vehicle’s life (designated by vehicle age zero), with the annual changes to the fuel and ownership costs, occurring during each ensuing calendar year, being iteratively aggregated until their net sum reaches or exceeds the costs of the original technology investment. The calendar year or, equivalently, the vehicle age at which the “sum of changes” outweighs the technology-related costs is then interpreted as the length of time necessary for payback to occur. For each vehicle model, the payback periods may be obtained based on the following two equations, where the payback is determined from:

$$(RegCost_{MY}) \leq \sum_{CY} \left( \begin{array}{l} FuelCost_{ref,MY,CY} - FuelCost_{MY,CY} \\ +ReboundCost_{MY,CY} \end{array} \right) \quad (166)$$

And payback TCO is decided on:

$$\left( \begin{array}{l} RegCost_{MY} \\ +MRCost_{MY} \end{array} \right) \leq \sum_{CY} \left( \begin{array}{l} TaxesAndFees_{ref,MY,CY} - TaxesAndFees_{MY,CY} \\ +Financing_{ref,MY,CY} - Financing_{MY,CY} \\ +Insurance_{ref,MY,CY} - Insurance_{MY,CY} \\ +FuelCost_{ref,MY,CY} - FuelCost_{MY,CY} \\ +ReboundCost_{MY,CY} \end{array} \right) \quad (167)$$

Where:

- $MY$  : the production year of a vehicle for which to calculate the payback periods,
- $CY$  : the range of calendar years, extending from the model year,  $MY$ , during which the vehicle was produced and up to 40 years,
- $FuelCost_{ref,MY,CY}$  : the value of fuel consumed in a year by a vehicle model at its “initial” or reference state, which was produced in model year  $MY$ , during calendar year  $CY$ ,
- $FuelCost_{MY,CY}$  : the value of fuel consumed in a year by a vehicle model at its “final” state, which was produced in model year  $MY$ , during calendar year  $CY$ ,
- $ReboundCost_{MY,CY}$  : the value of the rebound miles attributed to a vehicle model produced in model year  $MY$ , during calendar year  $CY$ ,
- $TaxesAndFees_{ref,MY,CY}$  : the taxes and fees paid for a vehicle model at its “initial” or reference state, which was produced during model year  $MY$ , during calendar year  $CY$ ,
- $TaxesAndFees_{MY,CY}$  : the taxes and fees paid for a vehicle model at its “final” state, which was produced during model year  $MY$ , during calendar year  $CY$ ,
- $Financing_{ref,MY,CY}$  : the financing costs paid for a vehicle model at its “initial” or reference state, which was produced during model year  $MY$ , during calendar year  $CY$ ,
- $Financing_{MY,CY}$  : the financing costs paid for a vehicle model at its “final” state, which was produced during model year  $MY$ , during calendar year  $CY$ ,
- $Insurance_{ref,MY,CY}$  : the insurance costs paid for a vehicle model at its “initial” or reference state, which was produced during model year  $MY$ , during calendar year  $CY$ ,
- $Insurance_{MY,CY}$  : the insurance costs paid for a vehicle model at its “final” state, which was produced during model year  $MY$ , during calendar year  $CY$ ,
- $RegCost_{MY}$  : the regulatory cost incurred by a vehicle, from application of technologies and fine payment, in model year  $MY$ , and
- $MRCost_{MY}$  : the additional maintenance and repair cost attributed to all technologies applied to a vehicle in model year  $MY$ .

In the two equations above, the fuel costs (for initial and final vehicle) are calculated similar to what is shown in Equation (139) in Section S8.2 above. While Equation (139) defines the fuel costs for all vehicles in aggregate, it may easily be adapted for an individual vehicle model, by using the amount of gallons of fuel consumed by that vehicle. Likewise, all other variables that make up Equations (166) and (167) were previously computed for the industry as a whole (for all vehicle models), and may be modified to instead represent the associated costs for a single vehicle model. Additionally, for the variables based on the “initial” vehicle state (shown with the *ref* subscript), the values were calculated based on the vehicle configuration (e.g., fuel economy) as was read in from the input fleet, before application of new technologies by the CAFE Model.

Conversely, the values calculated for the “final” vehicle state were based on the vehicle configuration after application of any new technologies during analysis. Lastly, some of the annual values were estimated for a limited range of calendar years (e.g.,  $TaxesAndFees_{MY,CY}$ , as discussed in the preceding section). For those variables, a value of zero would be used for calendar years during which the calculation is not applicable.

In Equations (166) and (167) above, as previously stated, the regulatory and maintenance and repair costs (appearing on the left hand side of the equations) occur during the first year of a vehicle’s life. The changes in ownership costs and expenditures related to fuel use (right hand side of the equations) are accumulated over the life of a vehicle model, by summing their values over the individual calendar years. The CAFE Model estimates that the payback and payback TCO occur at the first calendar year where the cumulative sum of ownership and fuel costs (right hand side) reaches or surpasses the regulatory and maintenance/repair costs (left hand side). Then, the payback period is the difference between the resulting calendar year,  $CY$ , and the model year being evaluated,  $MY$ . If the changes in ownership and fuel costs, aggregated over the entire life of the vehicle model, do not outweigh the regulatory and maintenance/repair costs incurred by the vehicle at its first year, the system assumes that the initial investment in fuel improving technologies does not payback. In such a case, the CAFE Model produces a payback value of “99” in the modeling reports.

Along with calculating the payback periods for each vehicle model, the modeling system also estimates the associated values for the industry as a whole. In the case of the industry, the methodology employed by Equations (166) and (167) applies; however, the system uses aggregate measures of each variable (e.g., total fuel cost for all vehicle models) during the calculation of the payback and payback TCO.

#### **S8.8.4 Discounting of Consumer Costs and Benefits**

The CAFE Model estimates discounted annual and lifetime costs and benefits calculated during analysis, measuring their valuations from the perspective of a vehicle buyer. The system applies discounting to the model year during which a new vehicle model was produced for sale, using one or more discount rates defined in the parameters input file. Thus, the discounted costs or benefits, of each variable, attributed to all vehicle models produced in a specific model year that survive during each calendar year are calculated as:

$$DiscCosts_{MY,CY} = Cost_{MY,CY} \times (1 + DR)^{-a} \quad (168)$$

Where:

- $MY$  : the production year of all vehicles for which to calculate the discounted consumer costs,
- $CY$  : the calendar year during which to calculate the discounted consumer costs associated with all vehicle models,
- $DR$  : the discount rate to apply to future costs and benefits,
- $Cost_{MY,CY}$  : the costs or benefits, as calculated in the preceding sections, to discount, and

$DiscCost_{MY,CY}$ : the resultant discounted costs or benefits, attributed to all surviving vehicle models produced in model year  $MY$ , during calendar year  $CY$ .

### S8.9 Implicit Opportunity Cost

As discussed in the preceding chapter, the CAFE Model operates under the voluntary overcompliance methodology, where the system continues to apply technologies to vehicles, beyond what is necessary to attain compliance, as long as such technology applications are considered to be cost-effective. However, since manufacturers may instead elect to use some portion of these additional technologies toward improving performance or utility of the vehicle, choosing to instead improve fuel economy conveys an opportunity cost that provides an implicit benefit to consumers in the form of additional fuel savings. Thus, the CAFE Model computes the implied opportunity cost resulting from applying the additional technologies such that all efficiency gains improve fuel economy rather than also increasing the performance or utility of the vehicle.

Although the implicit opportunity cost captures changes in fuel savings occurring over multiple vehicle ages, the resulting net sum of these changes in fuel savings is attributed to and calculated at the time of vehicle purchase (i.e., age zero). Accordingly, the lifetime opportunity cost computed for a vehicle has the same value as that of age zero. The calculation for the implicit opportunity cost attributed to each vehicle model produced in a specific model year is given by the following:

$$OppCost_{MY} = \max \left( 0, Sales_{MY} \times (FuelSav_{MY,ExtPB} - FuelSav_{MY,MfrPB}) \right) \quad (169)$$

Where:

- $MY$  : the production year of the vehicle for which to calculate the implicit opportunity cost,
- $MfrPB$  : the manufacturer-specific payback period, as defined for each manufacturer in the market data input file,
- $FuelSav_{MY,MfrPB}$  : the fuel savings realized by a vehicle produced in model year  $MY$ , with respect to that vehicle's initial fuel economy, based on the total number of miles the vehicle is expected to travel over the payback period defined by that vehicle's manufacturer,
- $ExtPB$  : the extended payback period corresponding to the average resale time of a vehicle, defined more explicitly in the following equation,
- $FuelSav_{MY,ExtPB}$  : the fuel savings realized by a vehicle produced in model year  $MY$ , with respect to that vehicle's initial fuel economy, based on the total number of miles the vehicle is expected to travel before being resold,
- $Sales_{MY}$  : the forecast number of new vehicles of a specific vehicle model produced and sold during model year  $MY$ , and
- $OppCost_{MY}$  : the resultant implicit opportunity cost associated with the vehicle model produced in model year  $MY$ .



The extended payback period,  $ExtPB$ , from the preceding equation is expressed as:

$$ExtPB = \max\left(MfrPB, \frac{AverageResaleTime}{12}\right) \quad (170)$$

Where:

- $MfrPB$  : the manufacturer-specific payback period, as defined for each manufacturer in the market data input file,
- $AverageResaleTime$  : the average number of months during which the vehicle is expected to be resold, as defined in the parameters input file, and
- $ExtPB$  : the extended payback period corresponding to the average resale time of a vehicle.

In Equation (169) above, the  $FuelSav_{MY,MfrPB}$  and  $FuelSav_{MY,ExtPB}$  values represent the fuel savings attributed to a given vehicle model, calculated from the cumulative miles a vehicle is expected to travel over a number of years given by either the  $MfrPB$  or  $ExtPB$  payback periods. In each case, the fuel savings calculated for a vehicle model produced in a specific model year is given by the following equation:

$$FuelSav_{MY,PB} = (CPM_{ref,MY} - CPM_{MY}) \times \left( \sum_{a=0}^{[PB-1]} (VMT_{C,a} \times \begin{cases} 1, & PB - a \geq 1 \\ PB - a, & PB - a < 1 \end{cases}) \right) \quad (171)$$

Where:

- $MY$  : the production year of the vehicle for which to calculate the implicit opportunity cost,
- $PB$  : a “payback period,” or number of years in the future the consumer is assumed to take into account when considering fuel savings, which may either be the  $MfrPB$  or the  $ExtPB$  presented above,
- $CPM_{MY}$  : the fuel cost per mile attributed to the vehicle produced in model year  $MY$ , using fuel prices from calendar year equivalent to model year  $MY$ , as defined by Equation (96) above,
- $CPM_{ref,MY}$  : the fuel cost per mile attributed to the vehicle produced in model year  $MY$ , using fuel prices from calendar year equivalent to model year  $MY$ , based on that vehicle’s initial fuel economy, similar to what is defined by Equation (96) above,
- $VMT_{C,a}$  : the average annual miles that vehicles belonging to a specific category  $C$  drive at a given age  $a$ , based on the static VMT schedule, and
- $FuelSav_{MY,PB}$ : the fuel savings realized by a vehicle produced in model year  $MY$ , with respect to that vehicle’s initial fuel economy, based on the total number of miles the vehicle is expected to travel within the payback period  $PB$ .

For all social costs and benefits produced by the modeling system, the CAFE Model first calculates a given value without any discounting applied. Afterwards, the system discounts each cost or benefit using the rates defined in the parameters input file, from either the societal or the consumer perspective (as outlined in Sections S8.7.4 and S8.8.4 above). The implicit opportunity cost, however, is an aggregate measure of fuel savings that occur over a number of vehicle ages, which is summed into a single value and attributed to a vehicle at its point of sale. Therefore, to implement proper discounting of the opportunity cost, the system first pre-discounts the fuel savings at each vehicle age, before summing it into a cumulative value and discounting it. When pre-discounting each vehicle age, the modeling system applies the same set of discount rates (social and consumer) that are defined in the parameters input file, and which it would otherwise use during discounting of costs and benefits. However, since the opportunity cost is borne by the consumer, each age is pre-discounted to the production year of the vehicle (i.e., pre-discounting is performed from the consumer's perspective).

When computing the pre-discounted implicit opportunity cost, Equation (169) defined earlier still applies. However, the  $FuelSav_{MY,ExtPB}$  value is modified to incorporate the aforementioned pre-discounting (conversely, the  $FuelSav_{MY,Mj-PB}$  value still remains undiscounted). Thus, the calculation of fuel savings given by Equation (171) above is adapted to include vehicle age discounting as follows:

$$FuelSav_{MY,ExtPB} = (CPM_{ref,MY} - CPM_{MY}) \times \left( \sum_{a=0}^{[ExtPB-1]} ((1 + DR)^a \times VMT_{C,a} \times \begin{cases} 1, & ExtPB - a \geq 1 \\ ExtPB - a, & ExtPB - a < 1 \end{cases}) \right) \quad (172)$$

Where:

- $MY$  : the production year of the vehicle for which to calculate the implicit opportunity cost,
- $ExtPB$  : the extended payback period corresponding to the average resale time of a vehicle, as defined by Equation (170),
- $CPM_{MY}$  : the fuel cost per mile attributed to the vehicle produced in model year  $MY$ , using fuel prices from calendar year equivalent to model year  $MY$ , as defined by Equation (96) above,
- $CPM_{ref,MY}$  : the fuel cost per mile attributed to the vehicle produced in model year  $MY$ , using fuel prices from calendar year equivalent to model year  $MY$ , based on that vehicle's initial fuel economy, similar to what is defined by Equation (96) above,
- $DR$  : the discount rate to apply to future costs and benefits,
- $VMT_{C,a}$  : the average annual miles that vehicles belonging to a specific category  $C$  drive at a given age  $a$ , based on the static VMT schedule, and
- $FuelSav_{MY,PB}$  : the fuel savings realized by a vehicle produced in model year  $MY$ , with respect to that vehicle's initial fuel economy, based on the total number of miles the vehicle is expected to travel within the payback period  $PB$ .

## Section 9 Fleet Analysis Calculations

In addition to calculating modeling effects associated with new standards for the model years covered during the study period, the CAFE Model also estimates these effects for the “historic” model years, up to 40 years prior to the first model year evaluated, such that the fleet’s age of a specific vintage was at most 39 during that same initial model year analyzed. For example, if the first model year evaluated by the modeling system during analysis is 2017, the effects of historic years evaluated include model years 1978 through 2016. Extending the effects calculations to include historic model years allows the system to produce a complete overview of effects and social costs and benefits resulting from the entire on-road light-duty vehicle fleet over a substantial number of calendar years.<sup>56</sup>

When estimating the effects and social costs and benefits attributed to historic model years, the modeling system uses the average on-road fuel economy ratings and the on-road fleet distribution as the starting point for calculations. Both of these sets of data are provided as inputs to the CAFE Model in the parameters input file (refer to Section A.3.5 of Appendix A for more information). From here, the system estimates all effects as previously described in the above sections. However, since the historic fleet does not include fuel economy and sales volumes at the vehicle-level, the system follows a simplified approach for estimating historic effects by using aggregate values for all calculations.

---

<sup>56</sup> With the current revision of the CAFE Model, the system no longer computes modeling effects of some future model years by approximating a fleet during those years. Instead, the system may be explicitly configured by the user to perform full simulation (compliance and effects calculations) on future years extending to, e.g., model year 2050. Doing so allows the modeling system to more accurately estimate the state of the industry in the out years, rather than simply growing sales and fuel economies by some constant factor.

## Appendix A Model Inputs

The CAFE Model uses a set of data files used as input to the analysis. All input files are specified in Microsoft Excel format and are outline in Table 21 below. The user can define and edit all inputs to the system.

**Table 21. Input Files**

<b>Input File</b>	<b>Contents</b>
Market Data (Manufacturers Worksheet)	Contains an indexed list of manufacturers available during the study period, along with manufacturer's willingness to pay fines and other manufacturer-specific modeling settings.
Market Data (Credits and Adjustments Worksheet)	Contains various credits and adjustments that a manufacturer may use toward compliance with either NHTSA's CAFE standards or EPA's CO <sub>2</sub> standards, for all regulatory classes and model years.
Market Data (Vehicles Worksheet)	Contains an indexed list of vehicle models available during the study period, along with sales volumes, fuel economy levels, prices, regulatory classification, references to specific engines and transmissions used, and settings related to technology applicability.
Market Data (Engines Worksheet)	Contains an indexed list of engines available during the study period, along with various engine attributes and settings related to technology applicability.
Market Data (Transmissions Worksheet)	Contains an indexed list of transmissions available during the study period, along with various transmission attributes and settings related to technology applicability.
Technologies	Specifies estimates of the availability and cost of various technologies, specific to various vehicle and engine categories.
Parameters	Provides inputs used to calculate travel demand, fuel consumption, carbon dioxide and criteria pollutant emissions (upstream and downstream), and economic externalities related to highway travel and petroleum consumption.
Scenarios	Specifies coverage, structure, and stringency of CAFE and CO <sub>2</sub> standards for scenarios to be simulated.

## A.1 Market Data File

The market data input file contains four worksheets: Manufacturers, Vehicles, Engines and Transmissions. Taken together, the manufacturers, vehicle models, engines, and transmissions worksheets provide the “initial state” historical and/or forecast data for the vehicle fleet. The sections below describe each worksheet in greater detail. The market data input file may contain additional information, which was used as a reference for building the input fleet, and may not necessarily be loaded or used by the modeling system.

### A.1.1 Manufacturers Worksheet

The *Manufacturers* input worksheet contains a list of all manufacturers that produce vehicle models offered for sale during the study period. Each manufacturer has a unique code and is represented by a unique manufacturer name. For each manufacturer, the manufacturer code, name, payback period, EPA multiplier mode, and whether the manufacturer prefers to pay CAFE fines must all be specified, as these affect the model’s ability to evaluate the manufacturer for compliance. The banked credits (CAFE and CO<sub>2</sub>) are not required for compliance; however, omitting these is likely to produce higher cost of compliance for each manufacturer. Lastly, the usage of ZEV credits within the model is presently experimental.

**Table 22. Manufacturers Worksheet**

Category	Column	Units	Definition/Notes
General	Manufacturer Code	integer	Unique number assigned to each manufacturer.
	Manufacturer Name	text	Name of the manufacturer.
Prefer Fines	PF-2015	text	Represents whether the manufacturer prefers to pay civil penalties instead of applying non cost-effective technologies in each of the specified model years. - Y = pay fines instead of applying ineffective technologies - N = apply ineffective technologies instead of paying fines
	PF-2016	text	
	...	text	
	PF-2031	text	
	PF-2032	text	
Payback Period	Cars	number	The number of years required for an initial investment to be repaid in the form of future benefits or cost savings. The payback periods can be specified separately for each of the indicated vehicle types.
	Vans/SUVs	number	
	Pickups	number	
	2b/3 Trucks	number	
Banked Credits (credits)	DC-2010 to DC-2016	credits	Represents the manufacturer's available credits, banked from model years preceding the start of analysis, specified for each regulatory class between model years 2010 and 2016.
	IC-2010 to IC-2016	credits	
	LT-2010 to LT-2016	credits	
	2B3-2010 to 2B3-2016	credits	
Banked CO-2 Credits (credits; metric-tons)	PC-2010 to PC-2016	credits	Represents the manufacturer's available CO2 credits (specified as as metric-tons), banked from model years preceding the start of analysis, specified for each regulatory class between model years 2010 and 2016.
	LT-2010 to LT-2016	credits	
	2B3-2010 to 2B3-2016	credits	
ZEV Credits	CA+S177 Sales (%)	zevs	The percentage of manufacturer's total fleet assumed to be sold in California and S177 states.
	CA+S177 ZEV (%)	zevs	The percentage of manufacturer's ZEV credits assumed to be generated in California and S177 states.
EPA Multiplier Mode	PC-EPA-Multiplier-Mode	integer	Applicability of EPA production multipliers for computing a manufacturer's CO2 standard, rating, and credits earned, when evaluating compliance under EPA's CO2 program. - 0 = do not apply production multipliers during calculations - 1 = apply multipliers to CO2 rating only (achieved CO2) - 2 = apply multipliers to CO2 rating and standard (achieved and required CO2) - 3 = apply multipliers to CO2 rating, standard, and credits
	LT-EPA-Multiplier-Mode	integer	
	2B3-EPA-Multiplier-Mode	integer	

### A.1.2 Credits and Adjustments Worksheet

For each manufacturer defined on the *Manufacturers* worksheet, the *Credits and Adjustments* worksheet defines the AC efficiency and leakage adjustments, the off-cycle credits, and the FFV credits that the manufacturer claims toward compliance with CAFE or CO<sub>2</sub> standards. The credits and adjustments are defined by model year, for each regulatory class. The model year columns must be continuous (e.g., 2017, 2018, 2019, ...), however, the supplied input years do not necessarily need to cover the range of model years evaluated during the study period. In such a case, the credits and adjustments defined for the last year will be used by the modeling system for all subsequent model years.

**Table 23. Credits and Adjustments Worksheet**

Category	Column/Row	Units	Definition/Notes
	Manufacturer	text	Manufacturer for which the credits and adjustments section is defined.
Regulatory Class (by Model Year)	AC Efficiency	grams/mile	The adjustment factor associated with improvements in air conditioning efficiency a manufacturer may claim toward compliance with either EPA's CO <sub>2</sub> standards or NHTSA's CAFE standards. The adjustment factor is specified in and is applied as grams/mile of CO <sub>2</sub> .
	AC Leakage	grams/mile	The adjustment factor associated with improvements in air conditioning leakage a manufacturer may claim toward compliance with EPA's CO <sub>2</sub> standards. The adjustment factor is specified in and is applied as grams/mile of CO <sub>2</sub> .
	Off-Cycle Credits	grams/mile	The amount of initial off-cycle credits a manufacturer may claim toward compliance with either EPA's CO <sub>2</sub> standards or NHTSA's CAFE standards. The credit value is specified in and is applied as grams/mile of CO <sub>2</sub> .
	FFV Credits	mpg	The amount of FFV credit (in mpg) available for a manufacturer to use toward compliance with NHTSA's CAFE standards.

### A.1.3 Vehicles Worksheet

The *Vehicles* worksheet contains information regarding each vehicle model offered for sale during the study period. Each vehicle model is represented as a single row of input data. Data in Table 24 lists the different columns of information specified in the vehicle models worksheet. The vehicle code must be a unique number assigned to each vehicle model.

**Table 24. Vehicles Worksheet**

Category	Column	Units	Definition/Notes
General	Vehicle Code	integer	Unique number assigned to each vehicle.
	Manufacturer	text	The manufacturer of the vehicle.
	Brand	text	The brand name of the vehicle.
	Model	text	Name of the vehicle model.
	Nameplate	text	The nameplate of the vehicle.
	Platform	text	The platform of the vehicle.
	Platform For Mass Reduction Assignment <sup>57</sup>	text	The platform assignment of the vehicle, used for binning vehicle cohorts for mass reduction assignments.
	Engine Code	integer	The engine code of the engine that the vehicle uses.
Transmission Code	integer	The transmission code of the transmission that the vehicle uses.	

<sup>57</sup> Some of the vehicle configuration columns are specified for reference and are not used by the modeling system. Instead, the values in these columns are used to inform the initial utilization of vehicle-level technologies as specified in the technology applicability section.

Category	Column	Units	Definition/Notes
Fuel Economy	Primary Fuel Type <sup>58</sup>	text	The primary fuel type on which the vehicle operates.
	Primary Fuel Economy <sup>58</sup>	mpg	The CAFE fuel economy rating of the vehicle on the primary fuel type.
	Secondary Fuel Type <sup>58</sup>	text	The secondary fuel type on which the vehicle operates (if applicable).
	Secondary Fuel Economy <sup>58</sup>	mpg	The CAFE fuel economy rating of the vehicle on the secondary fuel type (if applicable).
	Fuel Economy (by Fuel Type <sup>59</sup> )	mpg	The CAFE fuel economy rating of the vehicle for each fuel type.
	Fuel Share (by Fuel Type <sup>59</sup> )	percentage	The percent share that the vehicle runs on each fuel type. This value indicates the amount of miles driven by the vehicle on each fuel type. The sum of all fuel shares for any given vehicle must add up to one.
Sales & MSRP	Sales	units	Vehicle's production for sale in the US.
	MSRP	dollars	Vehicle's average MSRP (sales-weighted, including options).
Regulatory Classification	Regulatory Class	text	The regulatory assignment of the vehicle. - DC = the vehicle should be regulated as a domestic passenger automobile - IC = the vehicle should be regulated as a imported passenger automobile - LT = the vehicle should be regulated as a light truck - LT2b3 = the vehicle should be regulated as a class 2b/3 truck
	Technology Class	text	The technology class assignment of the vehicle.
	Engine Technology Class	text	The engine technology class assignment of the vehicle.
	Engine Technology Class (Observed) <sup>57</sup>	text	The observed engine technology class assignment of the vehicle, backing out the effect of engine downsizing.
	Safety Class	text	The safety class assignment of the vehicle. - PC = the vehicle belongs to a passenger automobile safety class - LT = the vehicle belongs to a light truck/SUV safety class - CM = the vehicle belongs to a light CUV/minivan safety class
	ZEV Candidate	text	Indicates whether a vehicle is a preferred candidate for ZEV technology application. The modeling system will attempt to upgrade ZEV candidates to a PHEV or a BEV in order to meet the ZEV requirement.
Vehicle Information	Origin	text	D = domestic; I = imported (if column left blank, domestic is assumed)
	Style	text	Vehicle style. Supported values are: Convertible, Coupe, Hatchback, Sedan, Wagon, Sport Utility, Minivan, Van, Passenger Van, Cargo Van, Pickup, Large Pickup, Chassis Cab, Cutaway.
	Structure <sup>57</sup>	text	Vehicle structure (ladder or unibody).
	Drive	text	Vehicle drive (A=all-wheel drive, F=front-wheel, R=rear-wheel, 4=four-wheel drive).
	Footprint	sq. feet	The vehicle footprint; wheelbase times average track width.
	Curb Weight	pounds	Total weight of the vehicle, including batteries, lubricants, and other expendable supplies, but excluding the driver, passengers, and other payloads (SAE J1100).
	Curb Weight (MR0)	pounds	"Reference" curb weight of the vehicle (negating any mass reduction technology). This value is used when estimating effect of application of mass reduction technology.
	GVWR	pounds	Gross Vehicle Weight Rating; weight of loaded vehicle, including passengers and cargo.
	GCWR	pounds	Gross Combined Weight Rating; weight of loaded vehicle, including passengers and cargo, as well as the mass of the trailer and cargo in the trailer.
	Max GVWR/CW	proportion	Maximum ratio of GVWR to Curb Weight allowed for the vehicle. During application of mass reduction technology, vehicle's GVWR will be adjusted such that its GVWR/CW ratio does not exceed this value.
	Max GCWR/GVWR	proportion	Maximum ratio of GCWR to GVWR allowed for the vehicle. During application of mass reduction technology, vehicle's GVWR will be adjusted such that its GVWR/CW ratio does not exceed this value.
	Fuel Capacity	gallons	The capacity of the vehicle's fuel tank in gallons of gasoline, E85, or diesel fuel.
Vehicle Powertrain	Vehicle Power	hp	Maximum combined power produced by the vehicle's engine and/or motor.
	Vehicle Power (RPM) <sup>57</sup>	rpm	The RPM at which vehicle's maximum power is attained.
	Vehicle Torque <sup>57</sup>	lb-ft	Maximum combined torque produced by the vehicle's engine and/or motor.

<sup>58</sup> The “Primary Fuel Type,” “Primary Fuel Economy,” “Secondary Fuel Type,” and “Secondary Fuel Economy” columns are specified for reference and are not used by the modeling system. Instead, the values in these columns are used to inform the fuel economies and fuel shares by fuel type specified in adjacent columns.

<sup>59</sup> For each vehicle, fuel economies and fuel shares are reported independently for each of the following fuel types: gasoline, E85, diesel, electricity, hydrogen, and CNG. If the vehicle does not use a specific fuel type, the associated fuel economy and fuel share values will be zero.

Category	Column	Units	Definition/Notes
	Vehicle Torque (RPM) <sup>57</sup>	rpm	The RPM at which vehicle's maximum torque is attained.
Planning & Assembly	Refresh Years	model year	List of previous and future refresh years of the vehicle, separated by a semicolon.
	Redesign Year	model year	List of previous and future redesign years of the vehicle, separated by a semicolon.
	Dealership Employment Hours	hours	The average employment hours originating at U.S. dealerships for a single vehicle unit of a specific model.
	US Assembly Employment Hours	hours	The average employment hours associated with U.S. assembly and manufacturing of a single vehicle unit of a specific model.
	Percent US Content	percentage	The percentage (as a fraction, such that 75% = 0.75) of vehicle's content (parts and labor) originating in the United States.
Technology Applicability	EPS	text	<blank> = the technology is not used on the vehicle USED = the technology is used on the vehicle SKIP = the technology is not applicable to the vehicle
	IACC	text	
	CONV	text	
	SS12V	text	
	BISG	text	
	SHEVP2	text	
	SHEVPS	text	
	P2HCR0	text	
	P2HCR1	text	
	P2HCR2	text	
	PHEV20	text	
	PHEV50	text	
	PHEV20T	text	
	PHEV50T	text	
	PHEV20H	text	
	PHEV50H	text	
	BEV200	text	
	BEV300	text	
	FCV	text	
	LDB	text	
	SAX	text	
	ROLL0	text	
	ROLL10	text	
	ROLL20	text	
	AERO0	text	
	AERO5	text	
	AERO10	text	
	AERO15	text	
	AERO20	text	
	MR0	text	
	MR1	text	
	MR2	text	
MR3	text		
MR4	text		
MR5	text		
MR6	text		

When defining a vehicle's fuel economy, for single fuel vehicles, only one fuel economy value, along with the analogous fuel share, must be specified. For multi-fuel vehicles (i.e., FFVs and PHEVs), the fuel economy and fuel share values on each fuel must be specified. The fuel share should correspond to the on-road miles traveled by a vehicle when operating on a given fuel, and the sum of fuel shares across all used fuel types must add up to 100 percent.

The applicability of technologies considered on a vehicle model basis (as opposed, for example, on an engine basis) can be controlled for each vehicle model by using the *Technology Applicability* category. Since the modeling system relies heavily on these settings when determining the initial usage and availability of technology to a vehicle, this section must be complete and accurate in order to avoid modeling errors.



### A.1.4 Engines Worksheet

Similar to the *Vehicles* input sheet, the *Engines* worksheet contains a list of all engines used in vehicle models offered for sale during the study period. The engine code is a unique number assigned to each such engine. This code is referenced in the engine code field on the vehicles worksheet. As in the vehicles worksheet, the *Technology Applicability* for any engine technology must be complete and accurate for any specific engine. Table 25 lists all columns available on the engines worksheet.

**Table 25. Engines Worksheet**

Category	Column	Units	Definition/Notes
General	Engine Code	integer	Unique number assigned to each engine.
	Manufacturer	text	The manufacturer of the engine.
	Fuel	text	One or more fuel types with which the engine is compatible. - G = gasoline - D = diesel - G+E85 = flex fuel engine, running on gasoline and E85 - CNG = compressed natural gas - E = electricity (applicable to BEVs only; this value is for informational purposes, and if specified on an engine, that engine will be ignored by the model) - H = hydrogen (applicable to FCVs only; this value is for informational purposes, and if specified on an engine, that engine will be ignored by the model)
	Valvetrain Design	text	Design of the total mechanism from camshaft to valve of an engine that actuates the lifting and closing of a valve (per SAE Glossary of Automotive Terms).
	Displacement	liters	Total volume displaced by a piston in a single stroke.
	Configuration	text	Configuration of the engine.
	Cylinders	integer	Number of engine cylinders.
	Aspiration	text	Breathing or induction process of the engine (per SAE Glossary of Automotive Terms). - NA = naturally aspirated - S = supercharged - T = turbocharged - T2 = twin-turbocharged - T4 = quad-turbocharged - ST = supercharged and turbocharged
	Cycle <sup>60</sup>	text	Combustion cycle of the engine.
	Air/Fuel Ratio <sup>60</sup>	number	Weighted (FTP+highway) air/fuel ratio (mass).
	Fuel Delivery System <sup>60</sup>	text	The mechanism that delivers fuel to the engine.
	Valve Actuation/Timing <sup>60</sup>	text	Valve opening and closing points in the operating cycle (SAE J604). - F = fixed - VVT = variable valve timing - ICP = intake cam phasing VVT - DCP = dual cam phasing VVT - CCP = coupled cam phasing VVT
	Valve Lift <sup>60</sup>	text	The manner in which the valve is raised during combustion (per SAE Glossary of Automotive Terms). - F = fixed - VVL = variable valve lift - DVVL = discrete VVL - CVVL = continuous VVL
	Valves/Cylinder <sup>60</sup>	integer	Number of valves per cylinder.
	Deactivation <sup>60</sup>	text	Indicates whether the engine includes a cylinder deactivation mechanism. - Y = cylinder deactivation applied - N = cylinder deactivation not applied
Compression Ratio (Min) <sup>60</sup>	number	Minimum compression ratio of an engine.	

<sup>60</sup> Some of the engine configuration columns are specified for reference and are not used by the modeling system. Instead, the values in these columns are used to inform the initial utilization of engine-level technologies as specified in the technology applicability section.

Category	Column	Units	Definition/Notes
	Compression Ratio (Max) <sup>60</sup>	number	Maximum compression ratio of an engine.
Technology Applicability	SOHC	text	<blank> = the technology is not used on the engine USED = the technology is used on the engine SKIP = the technology is not applicable to the engine  *Note: "DD" technology is for informational purposes only, and is not otherwise defined within or used by the model.
	DOHC	text	
	EFR	text	
	VVT	text	
	VVL	text	
	SGDI	text	
	DEAC	text	
	TURBO1	text	
	TURBO2	text	
	CEGR1	text	
	ADEAC	text	
	HCR0	text	
	HCR1	text	
	HCR2	text	
	VCR	text	
	VTG	text	
	VTGE	text	
	TURBOD	text	
	TURBOAD	text	
	ADSL	text	
DSLI	text		
DSLAD	text		
CNG	text		
DD*	text		

### A.1.5 Transmissions Worksheet

Similar to the *Vehicles* and *Engines* input sheets, the *Transmissions* worksheet contains a list of all transmissions used in vehicle models offered for sale during the study period. The transmission code is a unique number assigned to each such transmission. This code is referenced in the transmission code field on the vehicles worksheet. As in the vehicles and engines worksheets, the *Technology Applicability* for any transmission technology must be complete and accurate for any specific transmission.

**Table 26. Transmissions Worksheet**

Category	Column	Units	Definition/Notes
General	Transmission Code	integer	Unique number assigned to each transmission.
	Manufacturer	text	The manufacturer of the transmission.
	Type	text	Type of the transmission. - M or MT = manual transmission - A or AT = automatic transmission (torque converter) - AMT = automated manual transmission (single clutch w/ torque interrupt) - DCT = dual clutch transmission - CVT = belt or chain CVT - DD = direct drive (applicable to HEVs and greater; this value is for informational purposes, and if specified on a transmission, that transmission will be ignored by the model)
	Number of Forward Gears	integer	Number of forward gears the transmission has.
Technology Applicability	MT5	text	<blank> = the technology is not used on the transmission USED = the technology is used on the transmission SKIP = the technology is not applicable to the transmission  *Note: "DD" technology is for informational purposes only, and is not otherwise defined within or used by the model.
	MT6	text	
	MT7	text	
	AT5	text	
	AT6	text	
	AT6L2	text	
	AT7L2	text	
	AT8	text	
	AT8L2	text	
AT8L3	text		
AT9L2	text		

Category	Column	Units	Definition/Notes
	AT10L2	text	
	AT10L3	text	
	DCT6	text	
	DCT8	text	
	CVT	text	
	CVTL2	text	
	DD*	text	

## A.2 Technologies File

The technologies input file contains assumptions regarding the cost and applicability of different vehicle, platform, engine, and transmission-level technologies available during the study period. As described in Section S4.1 above, input assumptions are defined for the 12 vehicle technology classes listed in Table 10 and 28 engine technology classes listed in Table 11.

In addition to the inputs defined for each technology, the input file also includes a *Parameters* worksheet defining global settings that affect applicability of all technologies. Presently, this worksheet contains limited settings, and not all of the parameters defined therein are used directly by the CAFE Model. Table 27 shows the contents of the parameters worksheet.

**Table 27. Parameters Worksheet**

Category	Column	Units	Definition/Notes
Global Parameters	Model Years Covered	integer	Defines a range of model years for which various technology related cost fields are defined. These values are only used internally within the technologies input file and are not loaded by the model.
Other	Tech Class	text	Technology class for which a parameter is specified.
	Glider Share	number	Assumed average glider share (as a fraction) for each technology class.

Input assumptions that are common for all technology classes are listed on a separate *Technologies* worksheet. Table 28 shows the contents of a *Technologies* sheet for all classes while Table 29 and Table 30 show the contents of the technology assumptions worksheets.

**Table 28. Technologies Worksheet**

Category	Column	Units	Definition/Notes
General	Index <sup>61</sup>	integer	Unique index assigned to each technology.
	Name	text	Name of the technology.
	Technology Description <sup>61</sup>	text	Description of the technology.
	Technology Pathway <sup>61</sup>	text	The path within which the technology progresses.
	Phase-in Cap	percentage	Percentage of the entire fleet to which the technology may be applied.
Other	Phase-in Start Year	model year	Reference year for accumulating phase-in caps.
	ZEV Credits	zevs	Amount of ZEV credits a vehicle will generate upon application of the technology.

The technology assumptions inputs listed in Table 29 are specified for each technology and are replicated for each of the defined vehicle technology classes as individual worksheets.

**Table 29. Technology Assumptions**

Category	Column	Units	Definition/Notes
General	Index <sup>61</sup>	integer	Unique index assigned to each technology.
	Name	text	Name of the technology.
	Technology Pathway <sup>61</sup>	text	The path within which the technology progresses.
Availability	Applicable	boolean	TRUE = the technology is available for applicability in a technology class FALSE = the technology is not available for applicability in a technology class
	Year Avail.	model year	First year the technology is available for applicability.
	Year Retired	model year	Last year the technology is available for applicability.
FC Improvements	Secondary FS	percentage	Percentage of miles a vehicle is expected to travel on its secondary fuel after applying a dual-fuel technology (applicable when a vehicle is being converted into a plug-in HEV or another form of dual fuel vehicle).

<sup>61</sup> Some of the technology-specific attributes are hard-coded into the model and listed in the technologies input file for reference. These values are not loaded by the model.

Category	Column	Units	Definition/Notes
Misc Attributes	Electric Range	number	Indicates what the range, in miles, of an electric vehicle would be when operating on a battery, as a result of applying the technology (applies to PHEV and EV technologies only).
	Electric Power	hp	Indicates what the power of an electric vehicle would be when operating on a battery, as a result of applying the technology (applies to PHEV and EV technologies only).
	Delta Weight (%)	percentage	Percentage by which the vehicle's weight changes as a result of applying the technology.
	Delta Weight (lbs)	number	Amount of pounds by which the vehicle's weight changes as a result of applying the technology.
	Consumer's Willingness to Pay	dollars	Amount of extra cost that consumers are willing to pay for a technology. Applicable to SHEV/PHEV/BEV/FCV technologies only.

The technology costs inputs shown in Table 30 are specified for each technology, for each of the defined vehicle technology classes as well as each of the defined engine technology classes. As discussed in Section S4.7 above, the CAFE Model defines technology costs separately for the vehicle's engine and for the non-engine components of the vehicle. Therefore, the technology costs that are associated with a vehicle's engine are defined on separate worksheets corresponding to the engine technology classes, while the costs associated with non-engine components of a technology are listed on the same worksheets as the technology assumptions.

**Table 30. Technology Costs**

Category	Column	Units	Definition/Notes
General	Index <sup>61</sup>	integer	Unique index assigned to each technology.
	Name	text	Name of the technology.
	Technology Pathway <sup>61</sup>	text	The path within which the technology progresses.
Cost Table	C-2015	dollars	Table of cost estimates for the technology, per model year, and after accounting for cost learning effects.
	C-2016	dollars	
	...		
	C-2049	dollars	
	C-2050	dollars	
Battery Cost Learning Rates Table	BCL-2015	dollars	Learning rate factors to be applied to battery cost estimates associated with the current technology, per model year.
	BCL-2016	dollars	
	...		
	BCL-2049	dollars	
	BCL-2050	dollars	
Maintenance and Repair Cost Table	M/R-2015	dollars	Table of maintenance and repair cost estimates for the technology, per model year, and after accounting for cost learning effects.
	M/R-2016	dollars	
	...		
	M/R-2049	dollars	
	M/R-2050	dollars	

To ensure accuracy of results, all cost values defined in Table 30 should sufficiently cover the number of model years evaluated during the study period. For the current analysis, this includes model years from 2017 to 2050.

### A.3 Parameters File

The parameters input file contains a variety of input data and assumptions used to estimate various impacts of the simulated response of the industry to CAFE or CO<sub>2</sub> standards. This file contains a series of worksheets, the contents of which are summarized below.

#### A.3.1 Economic Values

The *Economic Values* worksheet contains an estimate of the magnitude of the “rebound effect,” the rates used to compute the economic value of various direct and indirect impacts of CAFE and CO<sub>2</sub> standards, as well as the various discount rates to apply when calculating the discounted cost and benefits from the social and consumer perspectives. As mentioned above, the user can define and edit all inputs. For example, although the economic values in Table 31 were obtained from various sources of information, the system does not require that the user rely on these sources. As can be seen in Table 31, inputs defined on the *Economic Values* sheet are separated into multiple sections for discount rates, inputs by vehicle class, and inputs by calendar year.

**Table 31. Economic Values Worksheet**

Category	Model Characteristic	Units	Definition/Notes
Economic Values (Discount Rates)	Social Discount Rates	percentage	A semicolon separated list of one or more social discount rates, which is the percent rate by which the dollar value of a benefit or cost is reduced when its receipt or payment is postponed by one additional year into the future.
	Base Year for Discounting	percentage	The calendar year to use for "present year" discounting. If a base year value is used, social discounting is assumed, with all costs and benefits being discounted to that year. If no value is specified, private discounting is implied, with all costs and benefits being discounted to the model year being analyzed.
	Consumer Discount Rates	percentage	A semicolon separated list of one or more consumer discount rates.
	CO2 Discount Rates	percentage	Discount rates to apply to low, average, high, or very high estimates of the social cost of CO <sub>2</sub> emissions.
Economic Values (By Vehicle Class)	Rebound Effect	percentage	Average elasticity of demand for travel. That is, the percent change (as a fraction) in average annual VMT per vehicle resulting from a percent change in fuel cost per mile driven.
	Base Year for Average Annual Usage Data	model year	Base year for average annual VMT usage data.
	"Gap" between Test and On-Road MPG (by Fuel Type)	percentage	Difference between a vehicle's EPA fuel economy rating and its actual on-road fuel economy.
	Fixed Component of Average Refueling Time in Minutes (by Fuel Type)	minutes	Average refueling time a spent by a consumer refueling the vehicle tank or recharging the vehicle electric battery.
	Average Tank Volume Refueled	percentage	Average tank volume refilled during a refueling stop.
	Value of Travel Time per Vehicle	\$/hour	Amount that the driver of a vehicle would be willing to pay to reduce the time required to make a trip.
	<b>Electric Vehicle Recharge Thresholds (BEV200)</b>	<i>various</i>	Recharging threshold parameters applicable to a 200-mile battery-electric vehicle
	Miles until mid-trip charging event	miles	Assumed charge frequency of an electric vehicle, that is, the cumulative number of miles driven before a mid-trip charging event is triggered.
	Share of miles charged mid-trip	percentage	Percent share of miles that will be recharged mid-trip.
	Charge rate (miles/hour)	miles/hour	Typical recharge rate for an electric vehicle.
	<b>Electric Vehicle Recharge Thresholds (BEV300)</b>	<i>various</i>	Recharging threshold parameters applicable to a 300-mile battery-electric vehicle
	Miles until mid-trip charging event	miles	Assumed charge frequency of an electric vehicle, that is, the cumulative number of miles driven before a mid-trip charging event is triggered.
	Share of miles charged mid-trip	percentage	Percent share of miles that will be recharged mid-trip.
	Charge rate (miles/hour)	miles/hour	Typical recharge rate for an electric vehicle.
<b>External Costs from Additional Vehicle Use Due to "Rebound" Effect</b>	<i>\$/vehicle-mile</i>	Estimates intended to represent costs per vehicle-mile of increased travel compared to approximately current levels, assuming current distribution of travel by hours of the day and facility types.	

Category	Model Characteristic	Units	Definition/Notes
	Congestion	\$/vehicle-mile	Congestion component of external costs from additional vehicle use.
	Noise	\$/vehicle-mile	Noise component of external costs from additional vehicle use.
	<b>Ownership and Operating Costs</b>	<i>various</i>	Ownership and operating costs associated with purchase of new vehicles.
	Taxes & Fees (% of final vehicle MSRP)	percentage	Average percentage of the vehicle's final MSRP the consumer pays in taxes and fees when purchasing a new vehicle.
	Financing Term (months)	months	Average length of time used by consumers to finance a new vehicle purchase.
	Financing Interest (%)	percentage	Average interest rate used by consumers to finance a new vehicle purchase.
	Share Financed (%)	percentage	Percentage of consumers that choose to finance their new vehicle purchase.
	Vehicle Depreciation (%)	percentage	Typical depreciation rate of a new vehicle.
Economic Values (By Calendar Year)	<b>Economic Costs of Oil Imports</b>	<i>\$/gallon</i>	Economic costs of oil imports attributed to various market externalities, specified per calendar year.
	"Monopsony" Component	\$/gallon	Demand cost for imported oil, determined by a various factors, including the relative importance of U.S. imports in the world oil market and demand to its world price among other participants in the international oil market.
	Price Shock Component	\$/gallon	Expected value of cost to U.S. economy from reduction in potential output resulting from risk of significant increases in world petroleum price. This includes costs resulting from inefficiencies in resource use caused by incomplete adjustments to industry output levels and mixes of production input when world oil price changes rapidly.
	Military Security Component	\$/gallon	Cost to taxpayers for maintaining a military presence to secure the supply of oil imports from potentially unstable regions of the world and protect the nation against their interruption.
	<b>Macroeconomic Parameters</b>	<i>number</i>	Defines various additional macroeconomic parameters, specified per calendar year.
	GDP	number	Gross domestic product in the specific calendar year.
	Number of Households (thousands)	number	Number of households in thousands in the specific calendar year.
	Consumer Sentiment	number	Consumer sentiment in the specific calendar year.
	<b>VMT Growth Rate</b>	<i>percentage</i>	VMT growth rates to apply to future calendar years when estimating total VMT projections used by the overall light-duty fleet in each future year.
	Low	percentage	VMT growth rates to apply when low fuel prices are used.
	Average	percentage	VMT growth rates to apply when average fuel prices are used.
	High	percentage	VMT growth rates to apply when high fuel prices are used.

### A.3.2 Vehicle Age Data

The *Vehicle Age Data* worksheet contains age-specific (i.e., vintage-specific) estimates of the static survival rates and annual accumulated mileage schedules applicable to different vehicle categories. The values on this worksheet are used whenever the Dynamic Economic models are disabled during analysis. When the Dynamic Economic models are enabled, the system estimates survival rates and VMT schedules as described in Sections S1.1 and S2.1 above.

Separate static survival fractions and annual miles driven are used for different categories of vehicles. These categories include: cars, vans/SUVs, pickups, and class 2b/3 trucks. The survival fractions measure the proportion of vehicles originally produced during a model year that remain in service at each age, by which time only a small fraction typically remain in service.

**Table 32. Vehicle Age Data Worksheet**

Category	Model Characteristic	Units	Definition/Notes
Vehicle Age Data	Survival Rates	proportion	The baseline proportion of original vehicle sales that remain in service by vehicle age (year 1 to 30 for cars, 1 to 37 for trucks).
	Miles Driven	miles	The baseline average annual miles driven by surviving vehicles by vehicle age (year 1 to 30 for cars, 1 to 37 for trucks).

### A.3.3 Fuel Prices

The *Fuel Prices* worksheet contains historic and estimates of future fuel prices, which are used when calculating pre-tax fuel outlays and fuel tax revenues.

**Table 33. Forecast Data Worksheet**

Category	Model Characteristic	Units	Definition/Notes
Fuel Prices	Retail Fuel Prices (low, average, high)	\$/fuel unit	Forecast of retail fuel prices by calendar year starting with CY-1975, specified for each fuel type in dollars per applicable fuel unit. For gasoline, diesel, and E85, fuel prices are in \$/gallon; for electricity, \$/kwh; for hydrogen and CNG, \$/scf.
	Fuel Taxes	\$/fuel unit	Forecast of fuel taxes by calendar year starting with CY-1975, specified for each fuel type in dollars per applicable fuel unit.

### A.3.4 Scrapage Model Values

The *Scrapage Model Values* worksheet contains fine tuning parameters for dynamically calculating the proportion of vehicles scrapped during each calendar year. When the Dynamic Scrapage model is used within the modeling system, the system replaces the survival rates defined on the *Vehicle Age* worksheet with the ones obtain using the Dynamic Scrapage model.

**Table 34. Scrapage Model Values Worksheet**

Category	Model Characteristic	Units	Definition/Notes
Scrapage Model Values	Age	number	$\beta_0$
	Age <sup>2</sup>	number	$\beta_1$
	Age <sup>3</sup>	number	$\beta_2$
	Share Remaining	number	$\beta_3$
	Share Remaining *Age	number	$\beta_4$
	Diff(New Price-Fuel Savings)	number	$\beta_5$
	Diff(New Price-Fuel Savings)*Age	number	$\beta_6$
	Diff(New Price-Fuel Savings)*Age <sup>2</sup>	number	$\beta_7$
	Diff(New Price-Fuel Savings)*Age <sup>3</sup>	number	$\beta_8$
	Diff(Real Fuel Prices)	number	$\beta_9$
	Diff(CPM)	number	$\beta_{10}$
	GDP Growth Rate	number	$\beta_{11}$
	Intercept	number	$\beta_{12}$
	MY	number	$\beta_{13}$
	MY Durability Cap	number	$\beta_{14}$
Decay Age	number	Age when the decay function takes over the scrapage estimates.	
Final Survival Rate	number	The observed historical final survival rate, ensured by the decay function to occur at age 40.	

### A.3.5 Historic Fleet Data

The *Historic Fleet Data* worksheet provides information about a historic fleet based on a specific reference calendar year. This reference calendar year should be equivalent to the first model year evaluated during the study period. For the current analysis, the first model year evaluated is 2017. The historic fleet data is defined for the same category of vehicles as specified on the *Vehicle Age Data* worksheet; specifically: cars, vans/SUVs, pickups, and class 2b/3 trucks. Historic information about the initial fleet, the average transaction price, fuel economy levels, the associated fuel shares are provided. Additionally, the surviving on-road fleet during the reference calendar year is specified. To facilitate accurate functionality of the CAFE Model, historic fleet information must be defined starting with model year 1975 and extending through the year before



the first model year evaluated during the study period (or, the year before the reference calendar year). For the current analysis, since the reference calendar year is 2017, the range of historic fleet data values must be defined for model years 1975 through 2016.

**Table 35. Historic Fleet Data Worksheet**

Category	Model Characteristic	Units	Definition/Notes
Historic Fleet Data	Model Year	model year	Model year for which historic fleet data is defined.
	Vehicle Age	age	Age of the historic fleet during calendar year 2017 (the reference calendar year). For reference only.
	<i>Historic Fleet Data by Model Year and Vehicle Style in CY-2017</i>	<i>various</i>	Historic fleet information, which serves as the "seed" data for the various dynamic economic models and the effects model. The historic fleet data is defined for the fleet of a specific model year, with some values specified for a given vehicle age.
	Initial Fleet	units	Initial production (the on-road fleet at age 0) for all vehicles of a specific historic model year.
	On-road Fleet	units	Surviving on-road fleet of all vehicles produced during a specific historic model year that are still on-road during calendar year 2017.
	PC Share	percentage	Share of the on-road fleet that is regulated as passenger car. The remaining share is regulated as light truck.
	Fuel Economy (by Fuel Type)	mpg	Average on-road fuel economy for vehicles produced during a specific historic model year.
	Fuel Share (by Fuel Type)	percentage	Average fuel economy shares for vehicles produced during a specific historic model year.
	Horsepower	hp	Average horsepower for vehicles produced during a specific historic model year.
	Curb Weight	lbs.	Average curb weight for vehicles produced during a specific historic model year.
	Transaction Price	dollars	Average transaction price for vehicles produced during a specific historic model year.

### A.3.6 Safety Values

The *Safety Values* worksheet contains parameters for estimating fatalities due to changes in total vehicle miles traveled and decreases in vehicle weight. Additionally, annual multipliers used for estimating non-fatal injuries are provided.

**Table 36. Safety Values Worksheet**

Category	Model Characteristic	Units	Definition/Notes
Safety Values	<i>Values by Safety Class</i>	<i>various</i>	Parameters used to calculate the change in fatalities per 100 lbs reduction in curb weight, defined for each safety class.
	Threshold	lbs.	Boundary between "small" and "large" weight effects by safety class.
	Change per 100 lbs (Below Threshold)	percentage	Effect of weight reduction for vehicles below the weight threshold (aka, "small" effect).
	Change per 100 lbs (At/Above Threshold)	percentage	Effect of weight reduction for vehicles at or above the weight threshold (aka, "large" effect).
	<i>Safety Costs</i>	<i>various</i>	Safety related costs.
	Fatality Costs	dollars	Social costs arising from vehicle fatalities.
	Growth Rate	percentage	Annual growth rate for fatality costs per vehicle.
	Base Year for Annual Growth	model year	Base year for annual growth rate for fatality costs per vehicle.
	Internalized Rebound Fatality Risk	percentage	Fatality risk internalized by the driver, attributed to the additional miles driven due to rebound.
	<i>Non-Fatal Injuries</i>	<i>various</i>	Coefficients for estimating non-fatal injuries and non-fatal injury costs during each calendar year.
	Calendar Year	calendar year	Calendar year for which the non-fatal multipliers are defined.
	Non-Fatal Injury and Property Damage Cost Scalar	rate	Multiplier applied to the vehicle fatalities, used to obtain the social costs associated with the number of non-fatal vehicle crash-related injuries.
	Non-Fatal Injury Multiplier	rate	Multiplier applied to the vehicle fatalities, used to obtain the number of non-fatal vehicle crash-related injuries.

### A.3.7 Fatality Rates

The *Fatality Rates* worksheet contains actual and projected estimates of average fatality rates by model year and vehicle age.

**Table 37. Fatality Rates Worksheet**

Category	Model Characteristic	Units	Definition/Notes
Fatality Rates	Model Year	model year	Model year for which the fatality rates are defined.
	Calendar Year	calendar year	Calendar year for which the fatality rates are defined. For reference only.
	Vehicle Age	age	Vehicle age for which the fatality rates are defined.
	Fatality Rate (Low)	number	Fixed amount by which vehicle-related fatality incidents are offset for a specific model year and vehicle age. (For low, average, or high estimates.)
	Fatality Rate (Average)	number	
	Fatality Rate (High)	number	

### A.3.8 Credit Trading Values

The *Credit Trading Values* worksheet contains fine tuning parameters for enabling credit transfers and credit carry forward within the model.

**Table 38. Credit Trading Values Worksheet**

Category	Model Characteristic	Units	Definition/Notes
Credit Trading Values	<b><i>Credit Trading Options</i></b>		
	Trade credits between manufacturers	boolean	<b>This option is not used in this version of the model.</b>
	Transfers credits between regulatory classes	boolean	Whether to allow credit transfers between regulatory classes within the same manufacturer and model year.
	Carry credits forward into future model years	boolean	Whether to allow carrying of credits forward into the analysis year from earlier model years within the same manufacturer and compliance category.
	Maximum number of years to carry forward	integer	Maximum number of model years to look forward.
	Carry credits backward into past model years	boolean	<b>This option is not used in this version of the model.</b>
	Maximum number of years to carry backward	integer	<b>This option is not used in this version of the model.</b>
	Transfer Caps (mpg)	mpg	Transfer caps corresponding to the maximum amount of credits that may be transferred into a compliance category for each model year. The cap from the latest model year is carried forward for all subsequent years.
	Assumed Lifetime VMT by Regulatory Class	miles	Assumed lifetime VMT to use when credits are transferred between compliance categories.
	<b><i>Additional Runtime Options</i></b>		
Maximum Expiring Credit Years to Consider	integer	The modeling system will attempt to use available credits before they expire. This setting indicates maximum number of model years to consider when using expiring credits.	

### A.3.9 ZEV Credit Values

The *ZEV Credit Values* worksheet contains parameters allowing the modeling system to target the ZEV requirements of CA+S177 states during compliance simulation. Presently, usage of ZEV credits within the CAFE Model should be considered as experimental.

**Table 39. ZEV Credit Values Worksheet**

Category	Model Characteristic	Units	Definition/Notes
ZEV Credit Values	ZEV Requirement (%)	percentage	Minimum percentage of zero emission vehicle (ZEV) credits that a manufacturer must generate in order to meet the ZEV requirement in each specified model year.
	Max Credits from PHEV (%)	percentage	Maximum percentage of ZEV credits that a manufacturer may generate from PHEVs in order to meet the ZEV requirement in each specified model year.

### A.3.10 Employment Values

The *Employment Values* worksheet is used for defining input assumptions necessary for calculating total U.S. labor hours for each vehicle model, as well as changes in U.S. labor years (or jobs) as a result of additional manufacturer revenue.

**Table 40. Employment Values Worksheet**

Category	Model Characteristic	Units	Definition/Notes
Employment Values	OEM Revenue per Employee	dollars	Manufacturer's revenue per employee.
	Supplier Revenue per Employee	dollars	Manufacturer supplier's revenue per employee.
	RPE Markup	number	Retail price estimate markup applied to technology costs.
	Annual Labor Hours	hours	Annual labor hours per employee.
	US Assembly/Manufacturing Jobs Multiplier	number	Multiplier to apply to U.S. final assembly to get U.S. direct automotive manufacturing labor hours.
	Global Multiplier	number	Multiplier to apply to all labor hours.

### A.3.11 Fuel Properties

The *Fuel Properties* worksheet contains estimates of the physical properties of gasoline, diesel, and other types of fuels. The fuel properties are used to calculate the changes in vehicular carbon dioxide emissions that are likely to result from reduced motor fuel use.

**Table 41. Fuel Properties Worksheet**

Category	Model Characteristic	Units	Definition/Notes
Fuel Properties	Energy Density	BTU/unit	BTU per reported physical unit of fuel, specified by fuel type.
	Mass Density	grams/unit	Mass per physical unit of fuel, specified by fuel type.
	Carbon Content	percentage by weight	Average share of carbon in fuel, specified by fuel type.
	SO <sub>2</sub> Emissions	grams/unit	Sulfur Oxides emissions rate of gasoline and diesel fuels.

### A.3.12 Fuel Import Assumptions

The *Fuel Import Assumptions* worksheet contains certain assumptions about the effects of reduced fuel use on different sources of petroleum feedstocks and on imports of refined fuels. These assumptions about the response of petroleum markets to reduced fuel use are used to calculate the changes in “upstream” emissions (from petroleum extraction and refining and from fuel storage and distribution) that are likely to result from reduced motor fuel use. The import assumptions are defined for select calendar years evaluated by the model, and are typically specified at five year increments.

**Table 42. Fuel Import Assumptions Worksheet**

Category	Model Characteristic	Units	Definition/Notes
Fuel Import Assumptions	Calendar Year (1975-2050)	calendar year	The calendar year for which fuel import assumptions are defined.
	Share of Fuel Savings Leading to Lower Fuel Imports	percentage	Assumed value for share of fuel savings leading to lower fuel imports.
	Share of Fuel Savings Leading to Reduced Domestic Fuel Refining	percentage	Assumed value for share of fuel savings leading to reduced domestic fuel refining.
	Share of Reduced Domestic Refining from Domestic Crude	percentage	Assumed value for share of reduced domestic refining from domestic crude oil.
	Share of Reduced Domestic Refining from Imported Crude	percentage	Assumed value for share of reduced domestic refining from imported crude oil.

### A.3.13 Emission Health Impacts

The *Emission Health Impacts* worksheet contains various health impacts attributed to upstream and downstream emissions associated with vehicle use. A count of incidents per short ton is defined, for select calendar years, for NO<sub>x</sub>, SO<sub>2</sub>, and PM<sub>2.5</sub> criteria pollutants. The modeling system accepts and calculates incidents for the following health impacts:

Premature Deaths - Low (Krewski)	Work loss days
Premature Deaths - High (Lepeule)	Asthma exacerbation
Respiratory emergency room visits	Cardiovascular hospital admissions
Acute bronchitis	Respiratory hospital admissions
Lower respiratory symptoms	Non-fatal heart attacks (Peters)
Upper respiratory symptoms	Non-fatal heart attacks (All others)
Minor Restricted Activity Days	

**Table 43. Emission Health Impacts**

Category	Model Characteristic	Units	Definition/Notes
Emission Health Impacts	Calendar Year	calendar year	The calendar year for which emission health impacts are defined.
	Upstream Emissions (Refineries Sector)	incidents per short ton	Emission health impacts, associated with upstream emissions of NO <sub>x</sub> , SO <sub>2</sub> , and PM <sub>2.5</sub> criteria pollutants.
	Vehicle Emissions (On-Road Mobile Sources Sector)	incidents per short ton	Emission health impacts, associated with tailpipe emissions of NO <sub>x</sub> , SO <sub>2</sub> , and PM <sub>2.5</sub> criteria pollutants.

The EPA analysis that is the source of estimates of health impacts and damage costs from criteria air pollutants used in the current version of the CAFE Model considers only health damages caused by exposure to fine particulate matter (PM<sub>2.5</sub>), and does not specify health impacts or damage costs resulting from exposure to carbon monoxide or volatile organic compounds (including pollutants formed in the atmosphere from chemical reactions involving VOCs). Thus, the modeling system estimates only health impacts and damage costs from direct emissions of PM<sub>2.5</sub> and chemical compounds that can form fine particulates in the atmosphere, including oxides of nitrogen and sulfur.<sup>62</sup>

### A.3.14 Criteria Emission Costs

The *Criteria Emission Costs* worksheet contains emission damage costs attributed to various criteria pollutants. As with the *Emission Health Impacts* worksheet, the greenhouse emission damage costs are defined for the same subset of calendar years, separately for upstream and downstream emissions. Furthermore, the input costs associated with criteria pollutants are pre-discounted at 3 percent and 7 percent. As stated above, the EPA analysis from which the health impacts and emission damage costs of criteria pollutants are derived do not provide estimates for carbon monoxide or volatile organic compounds. Therefore, the inputs are only defined for NO<sub>x</sub>, SO<sub>2</sub>, and PM<sub>2.5</sub> criteria pollutants.

<sup>62</sup> See EPA, Technical Support Document: Estimating the Benefit per Ton of Reducing PM<sub>2.5</sub> Precursors From 17 Sectors, Office of Air and Radiation, Office of Air Quality Planning and Standards, February 2018 (available at [www.epa.gov/sites/production/files/2018-02/documents/sourceapportionmentbptsd\\_2018.pdf](http://www.epa.gov/sites/production/files/2018-02/documents/sourceapportionmentbptsd_2018.pdf)).

**Table 44. Criteria Emission Costs**

Category	Model Characteristic	Units	Definition/Notes
Criteria Emission Costs	Calendar Year	calendar year	The calendar year for which criteria emission costs are defined.
	Upstream Emissions (Refineries Sector)	\$/short-ton	Pre-discounted economic costs arising from upstream emission damage of NOx, SO2, and PM2.5 criteria pollutants. Tables of estimates pre-discounted at 3% and 7% are provided.
	Vehicle Emissions (On-Road Mobile Sources Sector)	\$/short-ton	Pre-discounted economic costs arising from tailpipe emission damage of NOx, SO2, and PM2.5 criteria pollutants. Tables of estimates pre-discounted at 3% and 7% are provided.

**A.3.15 Greenhouse Emission Costs**

The *Greenhouse Emission Costs* worksheet contains emission damage costs attributed to various greenhouse gases. Annual estimates of emission damage costs are provided at low, average, high, and very high assumptions.

**Table 45. Greenhouse Emission Costs**

Category	Model Characteristic	Units	Definition/Notes
Greenhouse Emission Costs	Calendar Year	calendar year	The calendar year for which greenhouse emission costs are defined.
	CO2 (low, average, high, very high)	\$/metric-ton	Economic costs arising from carbon dioxide damage in a specific calendar year.
	CH4 (low, average, high, very high)	\$/metric-ton	Economic costs arising from methane damage in a specific calendar year.
	N2O (low, average, high, very high)	\$/metric-ton	Economic costs arising from nitrous oxide damage in a specific calendar year.

**A.3.16 Upstream Emissions**

The *Upstream Emissions* worksheets contain emission factors for greenhouse gas and criteria pollutant emissions from petroleum extraction and transportation, and from fuel refining, storage, and distribution. The upstream emissions are separated into a set of six worksheets corresponding to each fuel type supported within the model. For each fuel type, the upstream emissions are defined for select calendar years evaluated by the model, typically specified at five year increments. For gasoline, E85, and diesel fuels, the emissions are separated by stages of production and distribution, as well as aggregated as “subtotals” according to the associated fuel import assumptions described in the preceding section. For electricity, hydrogen, and CNG fuel types, only the total emissions in each calendar year are provided.

**Table 46. Upstream Emissions Worksheets**

Category	Model Characteristic	Units	Definition/Notes
UE_Gasoline, UE_Ethanol85, UE_Diesel	Calendar Year (1975-2050)	grams/mil BTU	The calendar year for which upstream emissions attributable to a particular fuel type are defined. This field also contains subtotals from all stages of fuel production and distribution used by the modeling system during analysis.
	Petroleum Extraction	grams/mil BTU	Total emissions by stage of fuel production and distribution from petroleum extraction, specified by pollutant and fuel type.
	Petroleum Transportation	grams/mil BTU	Total emissions by stage of fuel production and distribution from petroleum transportation, specified by pollutant and fuel type.
	Petroleum Refining	grams/mil BTU	Total emissions by stage of fuel production and distribution from petroleum refining, specified by pollutant and fuel type.
	Fuel TS&D	grams/mil BTU	Total emissions by stage of fuel production and distribution from refined fuel transportation, storage, and delivery, specified by pollutant and fuel type.
UE_Electricity, UE_Hydrogen, UE_CNG	Calendar Year (1975-2050)	grams/mil BTU	The calendar year for which upstream emissions attributable to a particular fuel type are defined. This field also represents the total upstream emissions from all stages of production and distribution used by the modeling system during analysis.

### A.3.17 Tailpipe Emissions

The *Tailpipe Emissions* worksheets contain emission factors for greenhouse gas and criteria pollutant emissions resulting from vehicle operation. The tailpipe emissions are defined for gasoline and diesel fuel types only, and are specified for each model year, vehicle age, and vehicle class (LDV, LDT1/2a, and LDT2b/3). For simplicity, vehicles operating on gasoline and E85 fuels use the tailpipe emissions provided on the TE\_Gasoline worksheet, vehicles operating on diesel fuel use the emissions specified on the TE\_Diesel worksheet, while vehicles operating on the remainder of the fuel types (e.g., electricity) are assumed not to generate any emissions during on-road use.

**Table 47. Tailpipe Emissions Worksheets**

Category	Model Characteristic	Units	Definition/Notes
TE_Gasoline & TE_Diesel	Emission Rates (by Fuel Type and Fleet)	grams/mile	Vehicle emission rates from gasoline or diesel operation. Emission rates are specified for each fleet (LDV, LDT1/2a, and LDT2b/3), for historic and future model years, and for each vehicle age.

## A.4 Scenarios File

The scenarios file provides one or more worksheets that begin with “SCEN\_” and are identified as CAFE regulatory scenarios, which are defined in terms of the design and stringency of the CAFE program. Internally, the system numbers these scenarios as 0, 1, 2 ..., based on the order in which they appear in the input file. The first worksheet is assigned to “Scenario 0,” and is identified as the baseline scenario to which all others are compared. While the CAFE Model evaluates domestic and imported passenger automobiles as separate regulatory classes (as defined in Table 2 above), since NHTSA and EPA define a common functional standard for Domestic Car and Imported Car regulatory classes, the scenario definition provides a common “Passenger Car” subsection describing the regulatory requirements applicable to those classes. As discussed above, the “Regulatory Class” column on the vehicles worksheet is used to indicate whether the vehicle is regulated as a Domestic Car (DC), Imported Car (IC), Light Truck (LT), or Light Truck 2b/3 (2b3), where DC and IC vehicles would use the “Passenger Car” portion of the scenario definition.

In each *Scenario* worksheet, the specifications for each regulatory class are defined separately, using the parameters described in Table 48 below.

**Table 48. Scenarios Worksheet**

Category	Row	Units	Definition/Notes
Function Definition	Function	integer	Functional form to use for computing the vehicle target.
	A - J (function coefficients)	number	Coefficients associated with the functional form to use for computing the vehicle target.
	CO2 Factor	g/gal	The multiplicative factor (in grams of CO2 per gallon of fuel) to use for converting between fuel consumption targets and CO2 targets. If not specified, this setting will default to a value of 8887.
	CO2 Offset	g/mi	The amount (in grams of CO2 per mile) by which to shift the CO2 targets after conversion from fuel economy.
	CO2 Include Upstream	boolean	Whether to include upstream emissions when calculating the CO2 rating for electricity and hydrogen fuel types. If not specified, this setting will default to a value of false.
	EPA Multiplier 1	number	Production multiplier, used to scale the sales volumes of CNGs and PHEVs when computing the manufacturer CO2 rating toward compliance with EPA's CO2 standards. This value must be between 1 and 10. If not specified, this setting will default to a value of 1.
	EPA Multiplier 2	number	Production multiplier, used to scale the sales volumes of BEVs and FCVs when computing the manufacturer CO2 rating toward compliance with EPA's CO2 standards. This value must be between 1 and 10. If not specified, this setting will default to a value of 1.
	Min (mpg)	mpg	Minimum CAFE standard that each manufacturer must attain, specified as a flat-standard in miles/gallon, or 0 if not applicable.
	Min (%)	percentage	Minimum CAFE standard that each manufacturer must attain, specified as a percentage of the average requirement under the function-based standard, or 0 if not applicable.
Supplemental Options	Fine Rate	\$/credit	The CAFE fine rate for non-compliance in dollars per one credit of shortfall.
	Credit Value	\$/credit	Value of a single CAFE credit.
	CO2 Credit Value	\$/credit	Value of a single CO2 credit.
	Multi-Fuel	integer	The applicability of multi-fuel vehicles for compliance calculations (does not apply to single-fuel vehicles): 0 = only gasoline fuel economy value is considered (gasoline fuel share is assumed to be 100%); 1 = for Gasoline/Ethanol-85 vehicles, only the gasoline fuel economy value is considered (gasoline fuel share is assumed to be 100%); for Gasoline/Electricity vehicles, both fuel economy values are considered; 2 = for Gasoline/Ethanol-85 and Gasoline/Electricity vehicles, both fuel economy values are considered.
	FFV Share	percentage	The statutory fuel share to use for compliance for flex-fuel vehicles (FFVs), whenever the Multi-Fuel mode is 2. This fuel share applies only to vehicles operating on gasoline and ethanol-85 fuel types. If not specified or set to 0, the vehicle's assumed on-road fuel share will be used for compliance.

Category	Row	Units	Definition/Notes
	PHEV Share	percentage	The statutory fuel share to use for compliance for plug-in hybrid/electric vehicles (PHEVs), whenever the Multi-Fuel mode is either 1 or 2. This fuel share applies only to vehicles operating on gasoline and electricity fuel types. If not specified or set to 0, the vehicle's assumed on-road fuel share will be used for compliance.
	CAFE - AC Efficiency Cap	grams/mile	Maximum amount of credits, in grams/mile of CO <sub>2</sub> , associated with improvements in air conditioning efficiency a manufacturer may claim toward compliance with NHTSA's CAFE standards.
	CAFE - Off-Cycle Cap	grams/mile	Maximum amount of off-cycle credits, in grams/mile of CO <sub>2</sub> , a manufacturer may claim toward compliance with NHTSA's CAFE standards.
	CO <sub>2</sub> - AC Efficiency Cap	grams/mile	Maximum amount of credits, in grams/mile of CO <sub>2</sub> , associated with improvements in air conditioning efficiency a manufacturer may claim toward compliance with EPA's CO <sub>2</sub> standards.
	CO <sub>2</sub> - AC Leakage Cap	grams/mile	Maximum amount of credits, in grams/mile of CO <sub>2</sub> , associated with improvements in air conditioning leakage a manufacturer may claim toward compliance with EPA's CO <sub>2</sub> standards.
	CO <sub>2</sub> - Off-Cycle Cap	grams/mile	Maximum amount of off-cycle credits, in grams/mile of CO <sub>2</sub> , a manufacturer may claim toward compliance with EPA's CO <sub>2</sub> standards.
	AC Efficiency Costs	\$/credit	Estimated cost of each AC Efficiency credit that a manufacturer claims toward compliance. This value is specified in \$/credit, where each credit is in turn denominated in grams/mile of CO <sub>2</sub> .
	AC Leakage Costs	\$/credit	Estimated cost of each AC Leakage credit that a manufacturer claims toward compliance. This value is specified in \$/credit, where each credit is in turn denominated in grams/mile of CO <sub>2</sub> .
	Off-Cycle Costs	\$/credit	Estimated cost of each Off-Cycle credit that a manufacturer claims toward compliance. This value is specified in \$/credit, where each credit is in turn denominated in grams/mile of CO <sub>2</sub> .
	SHEV Tax Credit	dollar	Amount of Federal tax credits a buyer receives for purchasing a strong hybrid/electric vehicle (SHEV).
	PHEV Tax Credit	dollar	Amount of Federal tax credits a buyer receives for purchasing a plug-in hybrid/electric vehicle (PHEV).
	BEV Tax Credit	dollar	Amount of Federal tax credits a buyer receives for purchasing a battery electric vehicle (BEV).
	FCV Tax Credit	dollar	Amount of Federal tax credits a buyer receives for purchasing a fuel cell vehicle (FCV).
	TW Function	integer	The functional form to use for computing the vehicle's test weight.
	Payload Return	percentage	Percentage of curb weight reduction returned to payload capacity. This setting applies whenever mass reduction technology is installed to a vehicle. For example, if payload return is 0%, the vehicle's payload capacity remains the same; if payload return is 100%, the vehicle's reduction in curb weight goes entirely to payload.
	Towing Return	percentage	Percentage of GVWR reduction returned to towing capacity. This setting applies whenever mass reduction technology is installed to a vehicle. For example, if towing return is 0%, the vehicle's towing capacity remains the same; if towing return is 100%, the vehicle's reduction in GVWR goes entirely to towing.
	Credit Carry Fwd	integer	Maximum number of years to carry forward. If a value is specified, this setting overrides the value present in the parameters file. If not specified or set to 0, the default value from the parameters file will be used.

#### A.4.1 Target Functions

The CAFE Model supports various function types for defining the fuel economy target function (as well as the associated CO<sub>2</sub> target function) for use during analysis, as outlined by Table 7 in Section 3 above. Equation (3) (also in Section 3) provides the detailed description of the functional form commonly used during the most recent analysis. Table 49 and Table 50 below, however, present summarized descriptions of all functional forms supported within the modeling system. In each case, the CAFE Model first calculates the fuel economy target for a given vehicle model, then converts it to an associated CO<sub>2</sub> target, as described by Equation (4) in Section 3 above.



**Table 49. Target Functions (1)**

Function	Description	Specification
1	Flat standard. A: mpg	$T_{FE} = \frac{1}{A}$
2	Logistic area-based function. A: mpg ("ceiling") B: mpg ("floor") C: square feet ("midpoint") D: square feet ("width")	$T_{FE} = \frac{1}{A} + \left(\frac{1}{B} - \frac{1}{A}\right) \times \frac{e^{\left(\frac{FP-C}{D}\right)}}{1 + e^{\left(\frac{FP-C}{D}\right)}}$
3	Logistic weight-based function. A: mpg ("ceiling") B: mpg ("floor") C: pounds ("midpoint") D: pounds ("width")	$T_{FE} = \frac{1}{A} + \left(\frac{1}{B} - \frac{1}{A}\right) \times \frac{e^{\left(\frac{CW-C}{D}\right)}}{1 + e^{\left(\frac{CW-C}{D}\right)}}$
4	Exponential area-based function. A: mpg ("ceiling") B: mpg (should be > A) C: square feet (determines "height")	$T_{FE} = \frac{1}{A} - \frac{e^{\left(\frac{1-FP}{C}\right)}}{B}$
5	Exponential weight-based function. A: mpg ("ceiling") B: mpg (should be > A) C: pounds (determines "height")	$T_{FE} = \frac{1}{A} - \frac{e^{\left(\frac{1-CW}{C}\right)}}{B}$
6	Linear area-based function. A: mpg ("ceiling") B: mpg ("floor") C: change in gpm / change in square feet ("slope" of the function) D: gpm ("y-intercept")	$T_{FE} = \text{MAX}\left(\frac{1}{A}, \text{MIN}\left(\frac{1}{B}, C \times FP + D\right)\right)$
7	Linear weight-based function. A: mpg ("ceiling") B: mpg ("floor") C: change in gpm / change in pounds ("slope" of the function) D: gpm ("y-intercept")	$T_{FE} = \text{MAX}\left(\frac{1}{A}, \text{MIN}\left(\frac{1}{B}, C \times CW + D\right)\right)$
8	Linear work-factor-based function.  <b>General coefficients</b> A: 'xwd' coefficient; additional offset, in lbs, applicable to 4-wheel drive vehicles only B: weighting multiplier for payload vs. towing capacity <b>Coefficients for gasoline vehicles</b> C: change in gpm / change in work-factor ("slope" of the function) D: gallons per 100-miles ("y-intercept") <b>Coefficients for diesel vehicles</b> E: change in gpm / change in work-factor ("slope" of the function) F: gallons per 100-miles ("y-intercept") <b>Coefficients for CNG vehicles</b> G: change in gpm / change in work-factor ("slope" of the function) H: gallons per 100-miles ("y-intercept")	$T_{FE} = \begin{pmatrix} G \times WF + H, \\ E \times WF + F, \\ C \times WF + D \end{pmatrix}$ <p>The target function uses different coefficients, depending on the fuel type the vehicle operates on. WF is the work-factor, calculated as follows:</p> $WF = \left(GVWR - CW + \begin{pmatrix} A, \\ 0 \end{pmatrix}\right) \times B + (GCWR - GVWR) \times (1 - B)$ <p>For the work-factor equation, the A coefficient is only used for 4-wheel drive vehicles. For all other vehicles, a value of zero (0) is used.</p>

**Table 50. Target Functions (2)**

Function	Description	Specification
206	Dual linear area-based function.  <i>Primary function coefficients</i> A: mpg ("ceiling") B: mpg ("floor") C: change in gpm / change in square feet ("slope" of the function) D: gpm ("y-intercept") <i>Secondary function coefficients</i> E: mpg ("ceiling") F: mpg ("floor") G: change in gpm / change in square feet ("slope" of the function) H: gpm ("y-intercept")	$T_{FE} = \text{MIN} \left( \begin{array}{l} \text{MAX} \left( \frac{1}{A}, \text{MIN} \left( \frac{1}{B}, C \times FP + D \right) \right), \\ \text{MAX} \left( \frac{1}{E}, \text{MIN} \left( \frac{1}{F}, G \times FP + H \right) \right) \end{array} \right)$
207	Dual linear weight-based function.  <i>Primary function coefficients</i> A: mpg ("ceiling") B: mpg ("floor") C: change in gpm / change in pounds ("slope" of the function) D: gpm ("y-intercept") <i>Secondary function coefficients</i> E: mpg ("ceiling") F: mpg ("floor") G: change in gpm / change in pounds ("slope" of the function) H: gpm ("y-intercept")	$T_{FE} = \text{MIN} \left( \begin{array}{l} \text{MAX} \left( \frac{1}{A}, \text{MIN} \left( \frac{1}{B}, C \times CW + D \right) \right), \\ \text{MAX} \left( \frac{1}{E}, \text{MIN} \left( \frac{1}{F}, G \times CW + H \right) \right) \end{array} \right)$
208	Dual linear work-factor-based function.  <i>Primary function coefficients</i> A-H: refer to function 8 above <i>Secondary function coefficients</i> I: the model year whose function serves as the "floor" for this function	For this target function, the CAFE Model calculates the target function in a series of steps. 1) The model uses supplied coefficients <b>A-H</b> and target function 8 defined above to calculate the initial target for the vehicle, 2) Then, a secondary "floor" target for the vehicle is calculated based on the function defined in the model year given by coefficient <b>I</b> (typically, the target function defined for model year <b>I</b> should be 1, 8, or 208), 3) Lastly, the model takes the minimum of the targets calculated in steps 1) and 2) to obtain the final target for a given vehicle model.  The above steps can be summarized by the following equation: $T_{FE} = \text{MIN}(f(8, A \dots H), f(I))$

## Appendix B Model Outputs

The system produces up to 11 modeling reports in comma separated values (CSV) format. Depending on the options the user selected in the CAFE Model’s GUI, some optional reports may not be generated during runtime. The system places all modeling reports into the “reports-csv” folder, located in the user selected output path (for example: **C:\CAFE Model\test-run\reports-csv**). Table 51 lists the available reports and a brief summary of their contents. All of the modeling reports are stored as plain text (without any additional formatting), in a “database-like” style, for each scenario and model year examined during analysis. As discussed earlier, the first scenario appearing in the scenarios file is assigned to Scenario 0 and is treated as the baseline. The action alternatives are then assigned to Scenario 1, 2, and so on, in order of appearance. For all modeling reports, the baseline scenario shows absolute values (with a few exceptions), while, for the majority of reports, the action alternatives include relative changes compared to the baseline, as discussed in the sections below.

**Table 51. Output Files**

Output File	Contents
Technology Utilization Report	Contains manufacturer-level and industry-wide technology application and penetration rates for each technology, model year, and scenario analyzed. The results are disaggregated by regulatory class, as well as combined over the entire fleet.
Compliance Report	Contains manufacturer-level and industry-wide summary of compliance model results for each model year and scenario analyzed. The results are disaggregated by regulatory class, as well as combined over the entire fleet.
Consumer Costs Report	Contains industry-wide summary of consumer-related costs for each model year and scenario analyzed, using discounting from the consumer’s perspective. The results are disaggregated by regulatory class, as well as combined over the entire fleet.
Societal Effects Report	Contains industry-wide summary of energy and emissions effects for each model year and scenario analyzed. The results are disaggregated by regulatory class and fuel type, as well as combined across all fuels and over the entire fleet.
Societal Costs Report	Contains industry-wide summary of consumer and social costs for each model year and scenario analyzed, using discounting from the social perspective. The results are disaggregated by regulatory class, as well as combined over the entire fleet.
Annual Societal Effects Report	This output file is similar to the <i>Societal Effects Report</i> , except it further disaggregates the results by vehicle age. This is an optional report.
Annual Societal Costs Report	This output file is similar to the <i>Societal Costs Report</i> , except it further disaggregates the results by vehicle age. This is an optional report.
Annual Societal Effects Summary Report	This output file is similar to the <i>Annual Societal Effects Report</i> , except it aggregates the results by calendar year. Note, the <i>Societal Effects Report</i> produces results for each <u>model year</u> considered during analysis. Conversely, the summary report summarizes the annual results by <u>calendar year</u> . This is an optional report.
Annual Societal Costs Summary Report	This output file is similar to the <i>Annual Societal Costs Report</i> , except it aggregates the results by calendar year. Note, the <i>Societal Costs Report</i> produces results for each <u>model year</u> considered during analysis. Conversely, the summary report summarizes the annual results by <u>calendar year</u> . This is an optional report.

<b>Output File</b>	<b>Contents</b>
Vehicles Report	Contains disaggregate vehicle-level summary of compliance model results, providing a detailed view of the final state of each vehicle examined by the model, for each model year and scenario analyzed. This is an optional report.
Vehicles Diagnostic Report	Contains extensive diagnostic information for each vehicle model, including utilization, costs, and fuel economy improvements of each technology or a combination of technologies, as it applies to the specific vehicles. This is an optional report.

The remainder of this section discusses the contents of each of the modeling reports.

## B.1 Technology Utilization Report

The *Technology Utilization Report* contains manufacturer-level and industry-wide technology application and penetration rates for each technology. The application rates represent the amount of technology that was applied by the modeling system during analysis while the penetration rates represent the amount of technology that was either on the vehicle initially at the start of the analysis, or applied by the modeling system during analysis. If a technology was present on or applied to a vehicle, but later superseded during the modeling process by another technology (for example, AT8 superseding AT6), the superseded technology on that vehicle will not count toward the penetration or application rates.

The following table lists the contents of the *Technology Utilization Report*.

**Table 52. Technology Utilization Report**

Column	Units	Contents
Scenario	integer	Unique index of the scenario, where 0 represents the baseline, while 1 and above represent the action alternatives.
Scenario Name	text	A short name describing the key features of the scenario.
Model Year	model year	Model years analyzed during the study period.
Manufacturer	text	Manufacturers analyzed during the study period. A value of "TOTAL" is used to represent industry-wide results.
Reg-Class	text	The regulatory class for which the application and penetration rates are reported. When multiple regulatory classes are present in the output, a value of "TOTAL" is used to represent the sum across all classes.
Param Type	text	The type of parameter for which utilization data is reported. The parameter types reported in this column include one of the following: <b>App-Rate:</b> The application rate of the technology, which is the amount of technology that was applied by the modeling system during analysis. If a technology was applied to a vehicle, but later superseded during the modeling process by another technology (for example, AT6 superseding AT5), the superseded technology on that vehicle will not count toward the application rate. <b>Pen-Rate:</b> The penetration rate of the technology, which is the amount of technology that was either on the baseline vehicle at the start of the analysis, or applied by the modeling system during analysis. If a technology was present on or applied to a vehicle, but later superseded during the modeling process by another technology (for example, AT6 superseding AT5), the superseded technology on that vehicle will not count toward the penetration rate. <b>Incr.AR:</b> The incremental application rate of the technology, which represents the difference between the action alternative and the baseline scenario, where the application rate from the baseline scenario is subtracted from that of the action alternative. <b>Incr.PR:</b> The incremental penetration rate of the technology, which represents the difference between the action alternative and the baseline scenario, where the application rate from the baseline scenario is subtracted from that of the action alternative.
Technology (multiple columns)	number	The application or penetration rate of the technology, specified as a proportion of total sales, for the associated parameter type.

## B.2 Compliance Report

The *Compliance Report* contains manufacturer-level and industry-wide summary of compliance model results for each model year and scenario analyzed. The results are reported by regulatory class, as well as aggregated for the entire fleet. Most of the metrics, which are reported independently by model year, are further summed (or averaged) over the entire analysis period. The report provides various cost values associated with the rule, represented as “totals” across all vehicle models, as well as “averages” per single vehicle unit. The following table lists the contents of the *Compliance Report*.

**Table 53. Compliance Report**

Column	Units	Contents
Scenario	integer	Unique index of the scenario, where 0 represents the baseline, while 1 and above represent the action alternatives.
Scenario Name	text	A short name describing the key features of the scenario.
Model Year	model year	Model years analyzed during the study period. A value of "TOTAL" is used to represent the sums (or averages) across all model years for some of the outputs, where applicable.
Manufacturer	text	Manufacturers analyzed during the study period. A value of "TOTAL" is used to represent industry-wide results.
Reg-Class	text	The regulatory class for which the compliance results are reported. When multiple regulatory classes are present in the output, a value of "TOTAL" is used to represent the sums (or averages) across all regulatory classes for some of the outputs, where applicable.
Sales	units	Total production of vehicles for sale for a specific model year, manufacturer, and regulatory class (as well as sum across any of the attributes, where applicable).
Jobs	units	Total U.S. jobs associated with the sale of all units of a specific vehicle model in a specific model year. This includes: jobs required for vehicle manufacture and assembly originating at U.S. plants, jobs associated with the sale of new vehicle models at U.S. dealerships, and additional direct U.S. jobs resulting from vehicle fuel economy improvements.
Prelim-Stnd	mpg	Preliminary value of the required CAFE standard (before the "alternative minimum CAFE standard," as outlined in the scenarios input section, is applied).
Standard	mpg	The value of the required CAFE standard, after accounting for the alternative minimum CAFE standard.
CAFE (2-cycle)	mpg	The value of the achieved CAFE standard, using a "2-bag" test cycle, not including any adjustments for improvements in air conditioning efficiency or off-cycle credits.
CAFE	mpg	The value of the achieved CAFE standard, including any adjustments for improvements in air conditioning efficiency and off-cycle credits. This value determines whether a manufacturer is in compliance with the CAFE standards.
CO-2 Standard	grams/mile	The value of the required CO2 standard.
CO-2 Rating	grams/mile	The value of the achieved CO2 standard, including any adjustments for improvements in air conditioning efficiency, air conditioning leakage, and off-cycle credits. This value determines whether a manufacturer is in compliance with the CO2 standards.
AC Efficiency	grams/mile	Adjustment factor associated with improvements in air conditioning efficiency accrued by a manufacturer toward compliance with either NHTSA's CAFE or EPA's CO2 standards. This value is specified in grams/mile of CO2 and represents the maximum cumulative adjustment aggregated from all AC efficiency improvement technologies used by the manufacturer in its fleet. However, the actual adjustment factor applied to a manufacturer's CO2 and CAFE ratings is bound by the maximum allowable cap as defined by the compliance scenario in a specific model year.
AC Leakage	grams/mile	Adjustment factor associated with improvements in air conditioning leakage accrued by a manufacturer toward compliance with EPA's CO2 standards. This value is specified in grams/mile of CO2 and represents the maximum cumulative adjustment aggregated from all AC leakage improvement technologies used by the manufacturer in its fleet. However, the actual adjustment factor applied to a manufacturer's CO2 rating is bound by the maximum allowable cap as defined by the compliance scenario in a specific model year.
Off-Cycle Credits	grams/mile	Amount of off-cycle credits accrued by a manufacturer toward compliance with either NHTSA's CAFE or EPA's CO2 standards. This value is specified in grams/mile of CO2 and represents the maximum cumulative adjustment aggregated from all technologies used by the manufacturer in its fleet for which the fuel economy and CO2 benefit is not captured on the test cycle. However, the actual amount of credit applied to a manufacturer's CAFE and CO2 ratings is bound by the maximum allowable cap as defined by the compliance scenario in a specific model year.
Average CW	lbs.	Average curb weight of analyzed vehicles.
Average FP	sq.ft.	Average footprint of analyzed vehicles.
Average WF	lbs.	Average work-factor of analyzed vehicles. This value is reported only when the vehicles analyzed are subject to the work-factor based functional standards.
ZEV Target	zevs	Amount of ZEV credits required in order to meet the CA+S177 state's zero-emission vehicle standards.
ZEV Credits	zevs	Amount of ZEV credits generated for compliance with the CA+S177 state's zero-emission vehicle standards.

Column	Units	Contents
AC Efficiency Cost	dollars <sup>1</sup>	Total amount of costs associated with the AC Efficiency adjustment factor that a manufacturer claimed toward compliance with either NHTSA's CAFE or EPA's CO2 standards. As with the CAFE and CO2 ratings, the AC Efficiency costs are computed only for the portion of the adjustment factor that was counted toward compliance, subject to the maximum allowable cap as defined by the compliance scenario in a specific model year.
AC Leakage Cost	dollars <sup>1</sup>	Total amount of costs associated with the AC Leakage adjustment factor that a manufacturer claimed toward compliance with EPA's CO2 standards. As with the CO2 rating, the AC Leakage costs are computed only for the portion of the adjustment factor that was counted toward compliance, subject to the maximum allowable cap as defined by the compliance scenario in a specific model year.
Off-Cycle Cost	dollars <sup>1</sup>	Total amount of costs associated with the off-cycle credits that a manufacturer claimed toward compliance with either NHTSA's CAFE or EPA's CO2 standards. As with the CAFE and CO2 ratings, the off-cycle costs are computed only for the portion of the off-cycle credit that was counted toward compliance, subject to the maximum allowable cap as defined by the compliance scenario in a specific model year.
Tech Cost	dollars <sup>1</sup>	Total amount of technology costs accumulated by a manufacturer across all vehicle models.
Fines	dollars <sup>1</sup>	Total amount of fines owed by a manufacturer in a specific model year and regulatory class.
Reg-Cost	dollars <sup>1</sup>	Total amount of regulatory costs accumulated by a manufacturer across all vehicle models. The regulatory costs are based on the combination of technology costs accrued within a specific regulatory class and total fines owed by the manufacturer (across all regulatory classes), distributed based on a vehicle's relative target shortfall.
Maint/Repair Cost	dollars <sup>1</sup>	Total amount of maintenance and repair costs accumulated by a manufacturer across all vehicle models.
HEV Cost	dollars <sup>1</sup>	Total amount of incremental costs associated with application of any hybrid/electric technology on vehicle models, accumulated by a manufacturer across all SHEV, PHEV, BEV, and FCV models. The HEV costs are defined incrementally, for any given vehicle model, as the difference between the cost of the HEV technology present at the final state of a vehicle model (if applicable) and the cost of the HEV technology at the initial state of the same vehicle (if applicable).
Tax Credit	dollars <sup>1</sup>	Total amount of incremental tax breaks realized by the consumers for purchasing hybrid/electric vehicles, accumulated by a manufacturer across all SHEV, PHEV, BEV, and FCV models. As with the HEV costs, the tax credits are defined incrementally as the difference between the final and initial states of the vehicle, wherever applicable.
Consumer WTP	dollars <sup>1</sup>	Total amount of additional incremental costs that consumers are willing to pay for hybrid/electric vehicles, accumulated by a manufacturer across all SHEV, PHEV, BEV, and FCV models. As with the HEV costs, the costs of consumer's willingness to pay (WTP) are defined incrementally as the difference between the final and initial states of the vehicle, wherever applicable.
Tech Burden	dollars <sup>1</sup>	Total amount of incremental "burden" costs accumulated by a manufacturer across all SHEV, PHEV, BEV, and FCV models, as a result of applying hybrid/electric technology. As with the HEV costs, the technology burden costs are defined incrementally as the difference between the final and initial states of the vehicle, wherever applicable.
Avg AC Efficiency Cost	dollars <sup>1</sup>	Average AC efficiency costs per single vehicle unit.
Avg AC Leakage Cost	dollars <sup>1</sup>	Average AC leakage costs per single vehicle unit.
Avg Off-Cycle Cost	dollars <sup>1</sup>	Average off-cycle costs per single vehicle unit.
Avg Tech Cost	dollars <sup>1</sup>	Average technology costs per single vehicle unit.
Avg Fines	dollars <sup>1</sup>	Average fines paid per single vehicle unit.
Avg Reg-Cost	dollars <sup>1</sup>	Average regulatory costs per single vehicle unit.
Avg Maint/Repair Cost	dollars <sup>1</sup>	Average maintenance and repair costs per single vehicle unit.
Avg HEV Cost	dollars <sup>1</sup>	Average cost of hybrid/electric technology per single vehicle unit.
Avg Tax Credit	dollars <sup>1</sup>	Average cost of tax breaks per single vehicle unit.
Avg Consumer WTP	dollars <sup>1</sup>	Average cost of consumer's willingness to pay for hybrid/electric vehicles, per single vehicle unit.
Avg Tech Burden	dollars <sup>1</sup>	Average "burden" costs per single vehicle unit.
Credits Earned	credits <sup>2</sup>	Total CAFE compliance credits accumulated by the manufacturer for a specific model year and regulatory class. Manufacturers earn compliance credits whenever their achieved value of the CAFE standard is above the required value of the CAFE standard (in mpg).
Credits Out	credits <sup>2</sup>	Total CAFE compliance credits transferred out of a specific regulatory class (such as from domestic passenger cars to light trucks) or carried forward from a previous model year.
Credits In	credits <sup>2</sup>	Total CAFE compliance credits transferred into a specific regulatory class or carried forward into the present model year.
CO-2 Credits Earned	metric-tons	Total CO2 compliance credits accumulated by the manufacturer for a specific model year and regulatory class. Manufacturers earn compliance credits whenever their achieved value of the CO2 standard is above the required value of the CO2 standard (in mpg).
CO-2 Credits Out	metric-tons	Total CO2 compliance credits transferred out of a specific regulatory class (such as from passenger cars to light trucks) or carried forward from a previous model year.
CO-2 Credits In	metric-tons	Total CO2 compliance credits transferred into a specific regulatory class or carried forward into the present model year.

In the above table, note that:

- (1) For the baseline scenario, all costs are specified as absolutes; for the action alternatives, all costs are incremental and are specified as the difference between the action alternative and the baseline scenario, where the value from the baseline scenario is subtracted from that of the action alternative.
- (2) For light-duty vehicles (those regulated as domestic cars, imported cars, and light trucks), one credit equates to one mile per 10 gallons. For medium-duty vehicles (those regulated as class-2b/3 trucks), one credit equates to one gallon per 10k miles.



### **B.3 Societal Effects and Societal Costs Reports**

The *Societal Effects Report* contains industry-wide summary of energy and emissions effects, while the *Societal Costs Report* contains corresponding industry-wide summary of consumer and social costs for each model year and scenario analyzed. The results are reported by regulatory class, as well as aggregated for the entire fleet. Most of the metrics, which are reported independently by model year, are further summed (or averaged) over the entire analysis period.

The *Societal Effects Report* also disaggregates energy and emissions effects by fuel type, as well as providing aggregate totals across all fuels. The report contains calculated levels of energy consumed by fuel type in quads, thousands of gallons, and thousands of native units during the full useful life of all vehicles sold in each model year. For liquid fuel types (gasoline, diesel, and E85), amount of gallons consumed is specified in their native units (e.g., gallons of E85). For non-liquid fuel types (electricity, hydrogen, CNG), amount of gallons consumed is specified in gasoline equivalent gallons. Additionally, energy consumption in native units is specified for electricity in mW-h, and for hydrogen and CNG in Mcf. Full useful life travel (in thousands of miles) and average fuel economy levels are also presented to provide a basis for comparison. Note that the rated fuel economy levels reported are not comparable to the value of achieved CAFE standard shown in the compliance report. The values contained in the Societal Effects Report are computed as total VMT divided by total gallons (with the effect of the on-road gap backed out), and do not incorporate some of the compliance-related credits or adjustments (specifically, AC leakage adjustments or off-cycle credits).

The *Societal Effects Report* also presents estimates of full fuel cycle carbon dioxide and criteria pollutant emissions by fuel type. As shown in Table 54 below, carbon dioxide emissions are reported in million metric tons of carbon-equivalent emissions (one metric ton of carbon dioxide is equivalent to 12/44 of a metric ton of carbon), and all criteria pollutants are reported in metric tons. For the baseline scenario, VMT, energy use, fatalities and non-fatal injuries (except those due to “rebound” and “delta-CW”), and all emissions are specified as absolutes. For the action alternatives, these values are incremental and are specified as the difference between the action alternative and the baseline scenario, where the value from the baseline scenario is subtracted from that of the action alternative.

The *Societal Costs Report* contains monetized consumer and social costs including fuel expenditures, travel and refueling value, economic and external costs arising from additional vehicle use, as well as owner and societal costs associated with emissions damage. In all cases, these costs are calculated for the fleet of vehicles sold in each model year over their full useful lives, discounted using the rate specified in the parameters input file, and reported in thousands of constant dollars. Chapter Three, Section 6 of the primary text discusses these types of costs and benefits in greater detail, and Appendix A discusses corresponding input assumptions.

In the *Societal Costs Report*, for the baseline scenario, most of the costs are specified as absolutes. For the action alternatives, all costs are incremental and are specified as the difference between the action alternative and the baseline scenario. Some of the cost values computed by the modeling system, however, are inherently incremental, and are reported as zero for the baseline scenario. Specifically, of the values shown in Table 55 below, foregone consumer sales surplus, fatal and

non-fatal risk values, fatal and non-fatal costs strictly due to the rebound miles traveled or the changes in vehicle's curb weight, and the combined totals of social costs, benefits, and net benefits are all reported as zero for the baseline scenario, and incremental over the baseline for all action alternatives.

Table 54 and Table 55 that follow list the full contents of each of the societal reports.

**Table 54. Societal Effects Report**

Column	Units	Contents
Scenario	integer	Unique index of the scenario, where 0 represents the baseline, while 1 and above represent the action alternatives.
Scenario Name	text	A short name describing the key features of the scenario.
Model Year	model year	Model years analyzed during the study period. A value of "TOTAL" is used to represent the sums (or averages) across all model years for some of the outputs, where applicable.
Reg-Class	text	The regulatory class for which the societal effects are reported. When multiple regulatory classes are present in the output, a value of "TOTAL" is used to represent the sums (or averages) across all regulatory classes for some of the outputs, where applicable.
Fuel Type	text	The fuel type for which the societal effects are reported. A value of "TOTAL" is used to represent the sums (or averages) across all fuel types for some of the outputs, where applicable.
Rated FE	mpg	The average fuel economy rating of vehicles. Note, this value is not comparable to the value of achieved CAFE standard shown in the compliance report; this value is computed as total VMT divided by total gallons (with the effect of the on-road gap backed out), and does not incorporate some of the compliance credits.
On-road FE	mpg	The average on-road fuel economy of the indicated vehicle cohort.
Fuel Share	ratio	The average fuel share, indicating the amount of miles driven by all vehicles on each fuel type.
Curb Weight	lbs.	Average curb weight of analyzed vehicles.
Footprint	sq.ft.	Average footprint of analyzed vehicles.
Work Factor	lbs.	Average work-factor of analyzed vehicles. This value is reported only when the vehicles analyzed are subject to the work-factor based functional standards.
Sales	units	Total production of vehicles for sale for a specific model year, regulatory class, and fuel type (as well as sum across any of the attributes, where applicable).
kVMT	miles (k)	Thousands of miles traveled by all vehicles over their lifetime for a specific model year, regulatory class, and fuel type.
kVMT No Rebound	miles (k)	Thousands of miles traveled by all vehicles over their lifetime, assuming the absence of the fuel economy rebound effect, for a specific model year, regulatory class, and fuel type.
Quads	quads	Energy used by all vehicles over their lifetime for a specific model year, regulatory class, and fuel type.
kGallons	gallons (k)	Amount of gallons of liquid fuel consumed, or amount of gasoline equivalent gallons of fuel consumed (for non-liquid fuel types), by all vehicles over their lifetime for a specific model year, regulatory class, and fuel type.
kUnits	varies	Amount of energy consumed by all vehicles over their lifetime for a specific model year, regulatory class, and fuel type, where the units of measure vary based on fuel type. For liquid fuel types (gasoline, E85, diesel), the units are specified in thousands of gallons; for electricity, the units are specified in mW-h; for hydrogen and CNG, the units are specified in Mcf.
Fatalities	units	Amount of vehicle-related fatalities resulting from reduction in vehicle curb weight, changes in VMT due to the rebound effect, and changes in fleet age distribution, aggregated over the lifetime of all vehicles for a specific model year, regulatory class, and fuel type.
Fatalities From Rebound	units	Amount of incremental vehicle-related fatalities resulting from changes in VMT due to the rebound effect. This value is zero for the baseline scenario; for all action alternatives, this value is specified as incremental over the baseline.
Fatalities From Delta CW	units	Amount of incremental vehicle-related fatalities resulting from reduction in vehicle curb weight. This value is zero for the baseline scenario; for all action alternatives, this value is specified as incremental over the baseline.
Non-Fatal Injuries	units	Amount of non-fatal vehicle-related injuries resulting from reduction in vehicle curb weight, changes in VMT due to the rebound effect, and changes in fleet age distribution, aggregated over the lifetime of all vehicles for a specific model year, regulatory class, and fuel type.
Non-Fatal Injuries Rebound	units	Amount of incremental non-fatal vehicle-related injuries resulting from changes in VMT due to the rebound effect. This value is zero for the baseline scenario; for all action alternatives, this value is specified as incremental over the baseline.
Non-Fatal Injuries Delta CW	units	Amount of incremental non-fatal vehicle-related injuries resulting from reduction in vehicle curb weight. This value is zero for the baseline scenario; for all action alternatives, this value is specified as incremental over the baseline.
Premature Deaths Low	units	Amount of emission health impacts associated with air pollution exposure arising from upstream and tailpipe emissions of nitrogen oxides, sulfur dioxide, and particulate matter (PM2.5), aggregated over the lifetime of all vehicles for a specific model year, regulatory class, and fuel type.
Premature Deaths High	units	

Column	Units	Contents
Respiratory Emergency Room Visits	units	Amount of emission health impacts associated with air pollution exposure arising from upstream and tailpipe emissions of nitrogen oxides, sulfur dioxide, and particulate matter (PM2.5), aggregated over the lifetime of all vehicles for a specific model year, regulatory class, and fuel type.
Acute Bronchitis	units	
Lower Respiratory Symptoms	units	
Upper Respiratory Symptoms	units	
Minor Restricted Activity Days	units	
Work Loss Days	units	
Asthma Exacerbation	units	
Cardiovascular Hospital Admissions	units	
Respiratory Hospital Admissions	units	
Non-Fatal Heart Attacks (Peters)	units	
Non-Fatal Heart Attacks (All Others)	units	
CO (t)	metric-tons	Amount of carbon monoxide emissions generated from domestic crude petroleum extraction, transportation, and refining, from gasoline transportation, storage, and distribution, and from vehicle operation, aggregated over the lifetime of all vehicles for a specific model year, regulatory class, and fuel type.
VOC (t)	metric-tons	Amount of volatile organic compounds emissions generated from domestic crude petroleum extraction, transportation, and refining, from gasoline transportation, storage, and distribution, and from vehicle operation, aggregated over the lifetime of all vehicles for a specific model year, regulatory class, and fuel type.
NOx (t)	metric-tons	Amount of nitrogen oxides emissions generated from domestic crude petroleum extraction, transportation, and refining, from gasoline transportation, storage, and distribution, and from vehicle operation, aggregated over the lifetime of all vehicles for a specific model year, regulatory class, and fuel type.
SO2 (t)	metric-tons	Amount of sulfur dioxide emissions generated from domestic crude petroleum extraction, transportation, and refining, from gasoline transportation, storage, and distribution, and from vehicle operation, aggregated over the lifetime of all vehicles for a specific model year, regulatory class, and fuel type.
PM (t)	metric-tons	Amount of particulate matter (diameter of ~2.5 micrometers) emissions generated from domestic crude petroleum extraction, transportation, and refining, from gasoline transportation, storage, and distribution, and from vehicle operation, aggregated over the lifetime of all vehicles for a specific model year, regulatory class, and fuel type.
CO2 (mmt)	million metric-tons	Amount of carbon dioxide emissions generated from domestic crude petroleum extraction, transportation, and refining, from gasoline transportation, storage, and distribution, and from vehicle operation, aggregated over the lifetime of all vehicles for a specific model year, regulatory class, and fuel type.
CH4 (t)	metric-tons	Amount of methane emissions generated from domestic crude petroleum extraction, transportation, and refining, from gasoline transportation, storage, and distribution, and from vehicle operation, aggregated over the lifetime of all vehicles for a specific model year, regulatory class, and fuel type.
N2O (t)	metric-tons	Amount of nitrous oxide emissions generated from domestic crude petroleum extraction, transportation, and refining, from gasoline transportation, storage, and distribution, and from vehicle operation, aggregated over the lifetime of all vehicles for a specific model year, regulatory class, and fuel type.
Acetaldehyde (t)	metric-tons	Amount of acetaldehyde emissions generated from domestic crude petroleum extraction, transportation, and refining, from gasoline transportation, storage, and distribution, and from vehicle operation, aggregated over the lifetime of all vehicles for a specific model year, regulatory class, and fuel type.
Acrolein (t)	metric-tons	Amount of acrolein emissions generated from domestic crude petroleum extraction, transportation, and refining, from gasoline transportation, storage, and distribution, and from vehicle operation, aggregated over the lifetime of all vehicles for a specific model year, regulatory class, and fuel type.
Benzene (t)	metric-tons	Amount of benzene emissions generated from domestic crude petroleum extraction, transportation, and refining, from gasoline transportation, storage, and distribution, and from vehicle operation, aggregated over the lifetime of all vehicles for a specific model year, regulatory class, and fuel type.
Butadiene (t)	metric-tons	Amount of 1,3-butadiene emissions generated from domestic crude petroleum extraction, transportation, and refining, from gasoline transportation, storage, and distribution, and from vehicle operation, aggregated over the lifetime of all vehicles for a specific model year, regulatory class, and fuel type.
Formaldehyde (t)	metric-tons	Amount of formaldehyde emissions generated from domestic crude petroleum extraction, transportation, and refining, from gasoline transportation, storage, and distribution, and from vehicle operation, aggregated over the lifetime of all vehicles for a specific model year, regulatory class, and fuel type.
DPM10 (t)	metric-tons	Amount of diesel particulate matter (diameter of ~10 micrometers) emissions generated from domestic crude petroleum extraction, transportation, and refining, from gasoline transportation, storage, and distribution, and from vehicle operation, aggregated over the lifetime of all vehicles for a specific model year, regulatory class, and fuel type.

**Table 55. Societal Costs Report**

Column	Units	Contents
Scenario	integer	Unique index of the scenario, where 0 represents the baseline, while 1 and above represent the action alternatives.
Scenario Name	text	A short name describing the key features of the scenario.
Model Year	model year	Model years analyzed during the study period. A value of "TOTAL" is used to represent the sums (or averages) across all model years for some of the outputs, where applicable.
Reg-Class	text	The regulatory class for which the societal costs are reported. When multiple regulatory classes are present in the output, a value of "TOTAL" is used to represent the sums (or averages) across all regulatory classes for some of the outputs, where applicable.
Disc-Rate	number	Social discount rate applied to future benefits. A value of 0 indicates undiscounted costs.
Foregone Consumer Sales Surplus	dollars (k)	Lost consumer surplus resulting from reduced vehicle sales accumulated across all vehicles for a specific model year and regulatory class. Lost consumer surplus is assumed to occur entirely at the time of vehicle purchase (i.e., at age 0).
Tech Cost	dollars (k)	Total amount of technology costs accumulated across all vehicles for a specific model year and regulatory class. Technology costs are assumed to occur entirely at the time of vehicle purchase (i.e., at age 0).
Maint/Repair Cost	dollars (k)	Total amount of maintenance and repair costs accumulated across all vehicles for a specific model year and regulatory class. Maintenance and repair costs are assumed to occur entirely at the time of vehicle purchase (i.e., at age 0).
Implicit Opportunity Cost	dollars (k)	Implied opportunity cost resulting from applying technologies such that all efficiency gains improve fuel economy rather than also increasing the performance or utility of a vehicle. Although the implicit opportunity cost captures changes in fuel savings occurring over multiple vehicle ages, the resulting net sum of these changes in fuel savings is attributed to and calculated at the time of vehicle purchase (i.e., age 0). This value is accumulated across all vehicles for a specific model year and regulatory class.
Fuel Tax Revenue	dollars (k)	Total fuel tax revenues accumulated across all vehicles over their lifetime for a specific model year and regulatory class.
Retail Fuel Outlay	dollars (k)	Total retail fuel expenditures accumulated across all vehicles over their lifetime for a specific model year and regulatory class.
Drive Value	dollars (k)	Benefits from the additional driving that results from improved fuel economy, accumulated across all vehicles over their lifetime for a specific model year and regulatory class.
Refueling Time Cost	dollars (k)	Benefits from reduced refueling frequency due to the extended vehicle range and improved fuel economy, accumulated across all vehicles over their lifetime for a specific model year and regulatory class.
Fatality Risk Value	dollars (k)	Value offsetting the risk of additional vehicle-related fatalities internalized by the driver, attributed to the additional miles driven due to rebound, accumulated across all vehicles over their lifetime for a specific model year and regulatory class.
Non-Fatal Crash Risk Value	dollars (k)	Value offsetting the risk of additional non-fatal vehicle-related crashes internalized by the driver, attributed to the additional miles driven due to rebound, accumulated across all vehicles over their lifetime for a specific model year and regulatory class.
Petroleum Market Externalities	dollars (k)	Economic costs of oil imports not accounted for by price, accumulated across all vehicles over their lifetime for a specific model year and regulatory class.
Congestion Costs	dollars (k)	Congestion costs from additional vehicle use, accumulated across all vehicles over their lifetime for a specific model year and regulatory class.
Noise Costs	dollars (k)	Noise costs from additional vehicle use, accumulated across all vehicles over their lifetime for a specific model year and regulatory class.
Fatality Costs	dollars (k)	Costs attributed to vehicle-related fatalities resulting from reduction in vehicle curb weight, changes in VMT, and changes in fleet age distribution, accumulated across all vehicles over their lifetime for a specific model year and regulatory class.
Fatality Costs Rebound	dollars (k)	Incremental costs attributed to vehicle-related fatalities resulting from changes in VMT due to the rebound effect.
Fatality Costs Delta CW	dollars (k)	Incremental costs attributed to vehicle-related fatalities resulting from reduction in vehicle curb weight.
Non-Fatal Crash Costs	dollars (k)	Costs attributed to non-fatal vehicle-related crashes resulting from reduction in vehicle curb weight, changes in VMT, and changes in fleet age distribution, accumulated across all vehicles over their lifetime for a specific model year and regulatory class.
Non-Fatal Crash Costs Rebound	dollars (k)	Incremental costs attributed to non-fatal vehicle-related injuries resulting from changes in VMT due to the rebound effect.
Non-Fatal Crash Costs Delta CW	dollars (k)	Incremental costs attributed to non-fatal vehicle-related injuries resulting from reduction in vehicle curb weight.
CO Damage Costs	dollars (k)	Owner and societal costs arising from carbon monoxide damage, aggregated over the lifetime of all vehicles for a specific model year and regulatory class.
VOC Damage Costs	dollars (k)	Owner and societal costs arising from volatile organic compounds damage, aggregated over the lifetime of all vehicles for a specific model year and regulatory class.
NOx Damage Costs	dollars (k)	Owner and societal costs arising from nitrogen oxides damage, aggregated over the lifetime of all vehicles for a specific model year and regulatory class.
SO2 Damage Costs	dollars (k)	Owner and societal costs arising from sulfur dioxide damage, aggregated over the lifetime of all vehicles for a specific model year and regulatory class.

<b>Column</b>	<b>Units</b>	<b>Contents</b>
PM Damage Costs	dollars (k)	Owner and societal costs arising from particulate matter damage, aggregated over the lifetime of all vehicles for a specific model year and regulatory class.
CO2 Damage Costs	dollars (k)	Owner and societal costs arising from carbon dioxide damage, aggregated over the lifetime of all vehicles for a specific model year and regulatory class.
CH4 Damage Costs	dollars (k)	Owner and societal costs arising from methane damage, aggregated over the lifetime of all vehicles for a specific model year and regulatory class.
N2O Damage Costs	dollars (k)	Owner and societal costs arising from nitrous oxide damage, aggregated over the lifetime of all vehicles for a specific model year and regulatory class.
Total Social Costs	dollars (k)	Total societal costs, combining the incremental effect of multiple social cost metrics occurring in the action alternative over the baseline scenario. Total social costs are computed as the sum of cost changes (i.e., alternative - baseline) for the following values: Foregone Consumer Sales Surplus, Tech Cost, Maint/Repair Cost, Implicit Opportunity Cost, Congestion Costs, Noise Costs, Fatality Costs, and Non-Fatal Crash Costs; as well as the sum of cost savings (i.e., baseline - alternative) for: Fuel Tax Revenue.
Total Social Benefits	dollars (k)	Total societal benefits, combining the incremental effect of multiple social cost metrics occurring in the action alternative over the baseline scenario. Total social benefits are computed as the sum of cost changes (i.e., alternative - baseline) for the following values: Drive Value, Fatality Risk Value, and Non-Fatal Crash Risk Value; as well as the sum of cost savings (i.e., baseline - alternative) for the following values: Retail Fuel Outlay, Refueling Time Cost, Petroleum Market Externalities, and all Emission Damage Costs.
Net Social Benefits	dollars (k)	The net of social benefits, computed as: Total Social Benefits - Total Social Costs.

## B.4 Annual Societal Effects and Annual Societal Costs Reports

The *Annual Societal Effects Report* and the *Annual Societal Costs Report* contain similar results as the *Societal Effects Report* and the *Societal Costs Report*, except these outputs further disaggregate the results by vehicle age. Table 56 lists the full contents of the *Annual Societal Effects Report* and Table 57 lists the full contents of the *Annual Societal Costs Report*. The annual reports produce results as absolutes (i.e., non-incremental) for the baseline and action alternatives, except for some values (discussed above) that are calculated as zero in the baseline scenario and as incremental over the baseline for the action alternatives.

**Table 56. Annual Societal Effects Report**

Column	Units	Contents
Scenario	integer	Unique index of the scenario, where 0 represents the baseline, while 1 and above represent the action alternatives.
Scenario Name	text	A short name describing the key features of the scenario.
Model Year	model year	Model years analyzed during the study period. When "Fleet Analysis" option is enabled during modeling, the range of years is extended to include historic and future model years.
Age	integer	The vehicle's vintage, ranging from 0 to 39, where 0 corresponds to a vehicle's first year on the road.
Calendar Year	calendar year	Calendar years analyzed for the effects calculations.
Reg-Class	text	The regulatory class for which the societal costs are reported. When multiple regulatory classes are present in the output, a value of "TOTAL" is used to represent the sums (or averages) across all regulatory classes for some of the outputs, where applicable.
Fuel Type	text	The fuel type for which the societal costs are reported. A value of "TOTAL" is used to represent the sums (or averages) across all fuel types for some of the outputs, where applicable.
Fleet	units	Total on-road fleet for a specific model year, vehicle age, regulatory class, and fuel type.
kVMT	miles (k)	Thousands of miles traveled by all vehicles for a specific model year, vehicle age, regulatory class, and fuel type.
kVMT No Rebound	miles (k)	Thousands of miles traveled by all vehicles, assuming the absence of the fuel economy rebound effect, for a specific model year, vehicle age, regulatory class, and fuel type.
Quads	quads	Energy used by all vehicles for a specific model year, vehicle age, regulatory class, and fuel type.
kGallons	gallons (k)	Amount of gallons of liquid fuel consumed, or amount of gasoline equivalent gallons of fuel consumed (for non-liquid fuel types), by all vehicles for a specific model year, vehicle age, regulatory class, and fuel type.
kUnits	varies	Amount of energy consumed by all vehicles for a specific model year, vehicle age, regulatory class, and fuel type, where the units of measure vary based on fuel type. For liquid fuel types (gasoline, E85, diesel), the units are specified in thousands of gallons; for electricity, the units are specified in mW-h; for hydrogen and CNG, the units are specified in Mcf.
Fatalities	units	Amount of fatalities resulting from reduction in vehicle curb weight and increases in VMT due to the rebound effect, aggregated for all vehicles for a specific model year, vehicle age, regulatory class, and fuel type.
Fatalities From Rebound	units	Amount of incremental vehicle-related fatalities resulting from changes in VMT due to the rebound effect. This value is zero for the baseline scenario; for all action alternatives, this value is specified as incremental over the baseline.
Fatalities From Delta CW	units	Amount of incremental vehicle-related fatalities resulting from reduction in vehicle curb weight. This value is zero for the baseline scenario; for all action alternatives, this value is specified as incremental over the baseline.
Non-Fatal Injuries	units	Amount of non-fatal vehicle-related injuries resulting from reduction in vehicle curb weight, changes in VMT due to the rebound effect, and changes in fleet age distribution, aggregated for all vehicles for a specific model year, vehicle age, regulatory class, and fuel type.
Non-Fatal Injuries Rebound	units	Amount of incremental non-fatal vehicle-related injuries resulting from changes in VMT due to the rebound effect. This value is zero for the baseline scenario; for all action alternatives, this value is specified as incremental over the baseline.
Non-Fatal Injuries Delta CW	units	Amount of incremental non-fatal vehicle-related injuries resulting from reduction in vehicle curb weight. This value is zero for the baseline scenario; for all action alternatives, this value is specified as incremental over the baseline.
Premature Deaths Low - Upstream	units	Amount of emission health impacts associated with air pollution exposure arising from upstream emissions of nitrogen oxides, sulfur dioxide, and particulate matter (PM <sub>2.5</sub> ), aggregated for all vehicles for a specific model year, vehicle age, regulatory class, and fuel type.
Premature Deaths High - Upstream	units	
Respiratory Emergency Room Visits - Upstream	units	

Column	Units	Contents	
Acute Bronchitis - Upstream	units		
Lower Respiratory Symptoms - Upstream	units		
Upper Respiratory Symptoms - Upstream	units		
Minor Restricted Activity Days - Upstream	units		
Work Loss Days - Upstream	units		
Asthma Exacerbation - Upstream	units		
Cardiovascular Hospital Admissions - Upstream	units		
Respiratory Hospital Admissions - Upstream	units		
Non-Fatal Heart Attacks (Peters) - Upstream	units		
Non-Fatal Heart Attacks (All Others) - Upstream	units		
Premature Deaths Low - Tailpipe	units		Amount of emission health impacts associated with air pollution exposure arising from tailpipe emissions of nitrogen oxides, sulfur dioxide, and particulate matter (PM2.5), aggregated for all vehicles for a specific model year, vehicle age, regulatory class, and fuel type.
Premature Deaths High - Tailpipe	units		
Respiratory Emergency Room Visits - Tailpipe	units		
Acute Bronchitis - Tailpipe	units		
Lower Respiratory Symptoms - Tailpipe	units		
Upper Respiratory Symptoms - Tailpipe	units		
Minor Restricted Activity Days - Tailpipe	units		
Work Loss Days - Tailpipe	units		
Asthma Exacerbation - Tailpipe	units		
Cardiovascular Hospital Admissions - Tailpipe	units		
Respiratory Hospital Admissions - Tailpipe	units		
Non-Fatal Heart Attacks (Peters) - Tailpipe	units		
Non-Fatal Heart Attacks (All Others) - Tailpipe	units		
Premature Deaths Low - Total	units	Amount of emission health impacts associated with air pollution exposure arising from upstream and tailpipe emissions of nitrogen oxides, sulfur dioxide, and particulate matter (PM2.5), aggregated for all vehicles for a specific model year, vehicle age, regulatory class, and fuel type.	
Premature Deaths High - Total	units		
Respiratory Emergency Room Visits - Total	units		
Acute Bronchitis - Total	units		
Lower Respiratory Symptoms - Total	units		
Upper Respiratory Symptoms - Total	units		
Minor Restricted Activity Days - Total	units		
Work Loss Days - Total	units		
Asthma Exacerbation - Total	units		
Cardiovascular Hospital Admissions - Total	units		
Respiratory Hospital Admissions - Total	units		

Column	Units	Contents
Non-Fatal Heart Attacks (Peters) - Total	units	
Non-Fatal Heart Attacks (All Others) - Total	units	
CO Upstream (t)	metric-tons	Amount of carbon monoxide emissions generated from domestic crude petroleum extraction, transportation, and refining, from gasoline transportation, storage, and distribution, aggregated for all vehicles for a specific model year, vehicle age, regulatory class, and fuel type.
VOC Upstream (t)	metric-tons	Amount of volatile organic compounds emissions generated from domestic crude petroleum extraction, transportation, and refining, from gasoline transportation, storage, and distribution, aggregated for all vehicles for a specific model year, vehicle age, regulatory class, and fuel type.
NOx Upstream (t)	metric-tons	Amount of nitrogen oxides emissions generated from domestic crude petroleum extraction, transportation, and refining, from gasoline transportation, storage, and distribution, aggregated for all vehicles for a specific model year, vehicle age, regulatory class, and fuel type.
SO2 Upstream (t)	metric-tons	Amount of sulfur dioxide emissions generated from domestic crude petroleum extraction, transportation, and refining, from gasoline transportation, storage, and distribution, aggregated for all vehicles for a specific model year, vehicle age, regulatory class, and fuel type.
PM Upstream (t)	metric-tons	Amount of particulate matter (diameter of ~2.5 micrometers) emissions generated from domestic crude petroleum extraction, transportation, and refining, from gasoline transportation, storage, and distribution, aggregated for all vehicles for a specific model year, vehicle age, regulatory class, and fuel type.
CO2 Upstream (mmt)	million metric-tons	Amount of carbon dioxide emissions generated from domestic crude petroleum extraction, transportation, and refining, from gasoline transportation, storage, and distribution, aggregated for all vehicles for a specific model year, vehicle age, regulatory class, and fuel type.
CH4 Upstream (t)	metric-tons	Amount of methane emissions generated from domestic crude petroleum extraction, transportation, and refining, from gasoline transportation, storage, and distribution, aggregated for all vehicles for a specific model year, vehicle age, regulatory class, and fuel type.
N2O Upstream (t)	metric-tons	Amount of nitrous oxide emissions generated from domestic crude petroleum extraction, transportation, and refining, from gasoline transportation, storage, and distribution, aggregated for all vehicles for a specific model year, vehicle age, regulatory class, and fuel type.
Acetaldehyde Upstream (t)	metric-tons	Amount of Acetaldehyde emissions generated from domestic crude petroleum extraction, transportation, and refining, from gasoline transportation, storage, and distribution, aggregated for all vehicles for a specific model year, vehicle age, regulatory class, and fuel type.
Acrolein Upstream (t)	metric-tons	Amount of Acrolein emissions generated from domestic crude petroleum extraction, transportation, and refining, from gasoline transportation, storage, and distribution, aggregated for all vehicles for a specific model year, vehicle age, regulatory class, and fuel type.
Benzene Upstream (t)	metric-tons	Amount of Benzene emissions generated from domestic crude petroleum extraction, transportation, and refining, from gasoline transportation, storage, and distribution, aggregated for all vehicles for a specific model year, vehicle age, regulatory class, and fuel type.
Butadiene Upstream (t)	metric-tons	Amount of 1,3-Butadiene emissions generated from domestic crude petroleum extraction, transportation, and refining, from gasoline transportation, storage, and distribution, aggregated for all vehicles for a specific model year, vehicle age, regulatory class, and fuel type.
Formaldehyde Upstream (t)	metric-tons	Amount of Formaldehyde emissions generated from domestic crude petroleum extraction, transportation, and refining, from gasoline transportation, storage, and distribution, aggregated for all vehicles for a specific model year, vehicle age, regulatory class, and fuel type.
DPM10 Upstream (t)	metric-tons	Amount of Diesel particulate matter (diameter of ~10 micrometers) emissions generated from domestic crude petroleum extraction, transportation, and refining, from gasoline transportation, storage, and distribution, aggregated for all vehicles for a specific model year, vehicle age, regulatory class, and fuel type.
CO Tailpipe (t)	metric-tons	Amount of carbon monoxide emissions generated from vehicle operation, aggregated for all vehicles for a specific model year, vehicle age, regulatory class, and fuel type.
VOC Tailpipe (t)	metric-tons	Amount of volatile organic compounds emissions generated from vehicle operation, aggregated for all vehicles for a specific model year, vehicle age, regulatory class, and fuel type.
NOx Tailpipe (t)	metric-tons	Amount of nitrogen oxides emissions generated from vehicle operation, aggregated for all vehicles for a specific model year, vehicle age, regulatory class, and fuel type.
SO2 Tailpipe (t)	metric-tons	Amount of sulfur dioxide emissions generated from vehicle operation, aggregated for all vehicles for a specific model year, vehicle age, regulatory class, and fuel type.
PM Tailpipe (t)	metric-tons	Amount of particulate matter (diameter of ~2.5 micrometers) emissions generated from vehicle operation, aggregated for all vehicles for a specific model year, vehicle age, regulatory class, and fuel type.
CO2 Tailpipe (mmt)	million metric-tons	Amount of carbon dioxide emissions generated from vehicle operation, aggregated for all vehicles for a specific model year, vehicle age, regulatory class, and fuel type.
CH4 Tailpipe (t)	metric-tons	Amount of methane emissions generated from vehicle operation, aggregated for all vehicles for a specific model year, vehicle age, regulatory class, and fuel type.
N2O Tailpipe (t)	metric-tons	Amount of nitrous oxide emissions generated from vehicle operation, aggregated for all vehicles for a specific model year, vehicle age, regulatory class, and fuel type.



<b>Column</b>	<b>Units</b>	<b>Contents</b>
Acetaldehyde Tailpipe (t)	metric-tons	Amount of Acetaldehyde emissions generated from vehicle operation, aggregated for all vehicles for a specific model year, vehicle age, regulatory class, and fuel type.
Acrolein Tailpipe (t)	metric-tons	Amount of Acrolein emissions generated from vehicle operation, aggregated for all vehicles for a specific model year, vehicle age, regulatory class, and fuel type.
Benzene Tailpipe (t)	metric-tons	Amount of Benzene emissions generated from vehicle operation, aggregated for all vehicles for a specific model year, vehicle age, regulatory class, and fuel type.
Butadiene Tailpipe (t)	metric-tons	Amount of 1,3-Butadiene emissions generated from vehicle operation, aggregated for all vehicles for a specific model year, vehicle age, regulatory class, and fuel type.
Formaldehyde Tailpipe (t)	metric-tons	Amount of Formaldehyde emissions generated from vehicle operation, aggregated for all vehicles for a specific model year, vehicle age, regulatory class, and fuel type.
DPM10 Tailpipe (t)	metric-tons	Amount of Diesel particulate matter (diameter of ~10 micrometers) emissions generated from vehicle operation, aggregated for all vehicles for a specific model year, vehicle age, regulatory class, and fuel type.
CO Total (t)	metric-tons	Amount of carbon monoxide emissions generated from domestic crude petroleum extraction, transportation, and refining, from gasoline transportation, storage, and distribution, and from vehicle operation, aggregated for all vehicles for a specific model year, vehicle age, regulatory class, and fuel type.
VOC Total (t)	metric-tons	Amount of volatile organic compounds emissions generated from domestic crude petroleum extraction, transportation, and refining, from gasoline transportation, storage, and distribution, and from vehicle operation, aggregated for all vehicles for a specific model year, vehicle age, regulatory class, and fuel type.
NOx Total (t)	metric-tons	Amount of nitrogen oxides emissions generated from domestic crude petroleum extraction, transportation, and refining, from gasoline transportation, storage, and distribution, and from vehicle operation, aggregated for all vehicles for a specific model year, vehicle age, regulatory class, and fuel type.
SO2 Total (t)	metric-tons	Amount of sulfur dioxide emissions generated from domestic crude petroleum extraction, transportation, and refining, from gasoline transportation, storage, and distribution, and from vehicle operation, aggregated for all vehicles for a specific model year, vehicle age, regulatory class, and fuel type.
PM Total (t)	metric-tons	Amount of particulate matter (diameter of ~2.5 micrometers) emissions generated from domestic crude petroleum extraction, transportation, and refining, from gasoline transportation, storage, and distribution, and from vehicle operation, aggregated for all vehicles for a specific model year, vehicle age, regulatory class, and fuel type.
CO2 Total (mmt)	million metric-tons	Amount of carbon dioxide emissions generated from domestic crude petroleum extraction, transportation, and refining, from gasoline transportation, storage, and distribution, and from vehicle operation, aggregated for all vehicles for a specific model year, vehicle age, regulatory class, and fuel type.
CH4 Total (t)	metric-tons	Amount of methane emissions generated from domestic crude petroleum extraction, transportation, and refining, from gasoline transportation, storage, and distribution, and from vehicle operation, aggregated for all vehicles for a specific model year, vehicle age, regulatory class, and fuel type.
N2O Total (t)	metric-tons	Amount of nitrous oxide emissions generated from domestic crude petroleum extraction, transportation, and refining, from gasoline transportation, storage, and distribution, and from vehicle operation, aggregated for all vehicles for a specific model year, vehicle age, regulatory class, and fuel type.
Acetaldehyde Total (t)	metric-tons	Amount of Acetaldehyde emissions generated from domestic crude petroleum extraction, transportation, and refining, from gasoline transportation, storage, and distribution, and from vehicle operation, aggregated for all vehicles for a specific model year, vehicle age, regulatory class, and fuel type.
Acrolein Total (t)	metric-tons	Amount of Acrolein emissions generated from domestic crude petroleum extraction, transportation, and refining, from gasoline transportation, storage, and distribution, and from vehicle operation, aggregated for all vehicles for a specific model year, vehicle age, regulatory class, and fuel type.
Benzene Total (t)	metric-tons	Amount of Benzene emissions generated from domestic crude petroleum extraction, transportation, and refining, from gasoline transportation, storage, and distribution, and from vehicle operation, aggregated for all vehicles for a specific model year, vehicle age, regulatory class, and fuel type.
Butadiene Total (t)	metric-tons	Amount of 1,3-Butadiene emissions generated from domestic crude petroleum extraction, transportation, and refining, from gasoline transportation, storage, and distribution, and from vehicle operation, aggregated for all vehicles for a specific model year, vehicle age, regulatory class, and fuel type.
Formaldehyde Total (t)	metric-tons	Amount of Formaldehyde emissions generated from domestic crude petroleum extraction, transportation, and refining, from gasoline transportation, storage, and distribution, and from vehicle operation, aggregated for all vehicles for a specific model year, vehicle age, regulatory class, and fuel type.
DPM10 Total (t)	metric-tons	Amount of Diesel particulate matter (diameter of ~10 micrometers) emissions generated from domestic crude petroleum extraction, transportation, and refining, from gasoline transportation, storage, and distribution, and from vehicle operation, aggregated for all vehicles for a specific model year, vehicle age, regulatory class, and fuel type.

**Table 57. Annual Societal Costs Report**

Column	Units	Contents
Scenario	integer	Unique index of the scenario, where 0 represents the baseline, while 1 and above represent the action alternatives.
Scenario Name	text	A short name describing the key features of the scenario.
Model Year	model year	Model years analyzed during the study period. When "Fleet Analysis" option is enabled during modeling, the range of years is extended to include historic and future model years.
Age	integer	The vehicle's vintage, ranging from 0 to 39, where 0 corresponds to a vehicle's first year on the road.
Calendar Year	calendar year	Calendar years analyzed for the effects calculations.
Reg-Class	text	The regulatory class for which the societal costs are reported. When multiple regulatory classes are present in the output, a value of "TOTAL" is used to represent the sums (or averages) across all regulatory classes for some of the outputs, where applicable.
Disc-Rate	number	Social discount rate applied to future benefits. A value of 0 indicates undiscounted costs.
Foregone Consumer Sales Surplus	dollars (k)	Lost consumer surplus resulting from reduced vehicle sales accumulated across all vehicles for a specific model year, vehicle age, and regulatory class. Lost consumer surplus is assumed to occur entirely at the time of vehicle purchase (i.e., at age 0).
Tech Cost	dollars (k)	Total amount of technology costs accumulated across all vehicles for a specific model year, vehicle age, and regulatory class. Technology costs are assumed to occur entirely at the time of vehicle purchase (i.e., at age 0).
Maint/Repair Cost	dollars (k)	Total amount of maintenance and repair costs accumulated across all vehicles for a specific model year, vehicle age, and regulatory class. Maintenance and repair costs are assumed to occur entirely at the time of vehicle purchase (i.e., at age 0).
Implicit Opportunity Cost	dollars (k)	Implied opportunity cost resulting from applying technologies such that all efficiency gains improve fuel economy rather than also increasing the performance or utility of a vehicle. Although the implicit opportunity cost captures changes in fuel savings occurring over multiple vehicle ages, the resulting net sum of these changes in fuel savings is attributed to and calculated at the time of vehicle purchase (i.e., age 0). This value is accumulated across all vehicles for a specific model year and regulatory class.
Fuel Tax Revenue	dollars (k)	Total fuel tax revenues accumulated across all vehicles for a specific model year, vehicle age, and regulatory class.
Retail Fuel Outlay	dollars (k)	Total retail fuel expenditures (pre-tax fuel cost + fuel tax cost) accumulated across all vehicles for a specific model year, vehicle age, and regulatory class.
Drive Value	dollars (k)	Benefits from the additional driving that results from improved fuel economy, accumulated across all vehicles for a specific model year, vehicle age, and regulatory class.
Refueling Time Cost	dollars (k)	Benefits from reduced refueling frequency due to the extended vehicle range and improved fuel economy, accumulated across all vehicles for a specific model year, vehicle age, and regulatory class.
Fatality Risk Value	dollars (k)	Value offsetting the risk of additional vehicle-related fatalities internalized by the driver, attributed to the additional miles driven due to rebound, accumulated across all vehicles for a specific model year, vehicle age, and regulatory class.
Non-Fatal Crash Risk Value	dollars (k)	Value offsetting the risk of additional non-fatal vehicle-related crashes internalized by the driver, attributed to the additional miles driven due to rebound, accumulated across all vehicles for a specific model year, vehicle age, and regulatory class.
Petroleum Market Externalities	dollars (k)	Economic costs of oil imports not accounted for by price, accumulated across all vehicles for a specific model year, vehicle age, and regulatory class.
Congestion Costs	dollars (k)	Congestion costs from additional vehicle use, accumulated across all vehicles for a specific model year, vehicle age, and regulatory class.
Noise Costs	dollars (k)	Noise costs from additional vehicle use, accumulated across all vehicles for a specific model year, vehicle age, and regulatory class.
Fatality Costs	dollars (k)	Costs attributed to vehicle-related fatalities resulting from additional vehicle use and reduction in vehicle curb weight, accumulated across all vehicles for a specific model year, vehicle age, and regulatory class.
Fatality Costs Rebound	dollars (k)	Incremental costs attributed to vehicle-related fatalities resulting from changes in VMT due to the rebound effect.
Fatality Costs Delta CW	dollars (k)	Incremental costs attributed to vehicle-related fatalities resulting from reduction in vehicle curb weight.
Non-Fatal Crash Costs	dollars (k)	Costs attributed to non-fatal vehicle-related crashes resulting from additional vehicle use and reduction in vehicle curb weight, accumulated across all vehicles for a specific model year, vehicle age, and regulatory class.
Non-Fatal Crash Costs Rebound	dollars (k)	Incremental costs attributed to non-fatal vehicle-related injuries resulting from changes in VMT due to the rebound effect.
Non-Fatal Crash Costs Delta CW	dollars (k)	Incremental costs attributed to non-fatal vehicle-related injuries resulting from reduction in vehicle curb weight.
CO Damage Costs	dollars (k)	Owner and societal costs arising from carbon monoxide damage, aggregated for all vehicles for a specific model year, vehicle age, and regulatory class.
VOC Damage Costs	dollars (k)	Owner and societal costs arising from volatile organic compounds damage, aggregated for all vehicles for a specific model year, vehicle age, and regulatory class.
NOx Damage Costs	dollars (k)	Owner and societal costs arising from nitrogen oxides damage, aggregated for all vehicles for a specific model year, vehicle age, and regulatory class.

<b>Column</b>	<b>Units</b>	<b>Contents</b>
SO2 Damage Costs	dollars (k)	Owner and societal costs arising from sulfur dioxide damage, aggregated for all vehicles for a specific model year, vehicle age, and regulatory class.
PM Damage Costs	dollars (k)	Owner and societal costs arising from particulate matter damage, aggregated for all vehicles for a specific model year, vehicle age, and regulatory class.
CO2 Damage Costs	dollars (k)	Owner and societal costs arising from carbon dioxide damage, aggregated for all vehicles for a specific model year, vehicle age, and regulatory class.
CH4 Damage Costs	dollars (k)	Owner and societal costs arising from methane damage, aggregated for all vehicles for a specific model year, vehicle age, and regulatory class.
N2O Damage Costs	dollars (k)	Owner and societal costs arising from nitrous oxide damage, aggregated for all vehicles for a specific model year, vehicle age, and regulatory class.
Total Social Costs	dollars (k)	Total societal costs, combining the incremental effect of multiple social cost metrics occurring in the action alternative over the baseline scenario. Total social costs are computed as the sum of cost changes (i.e., alternative - baseline) for the following values: Foregone Consumer Sales Surplus, Tech Cost, Maint/Repair Cost, Implicit Opportunity Cost, Congestion Costs, Noise Costs, Fatality Costs, and Non-Fatal Crash Costs; as well as the sum of cost savings (i.e., baseline - alternative) for: Fuel Tax Revenue.
Total Social Benefits	dollars (k)	Total societal benefits, combining the incremental effect of multiple social cost metrics occurring in the action alternative over the baseline scenario. Total social benefits are computed as the sum of cost changes (i.e., alternative - baseline) for the following values: Drive Value, Fatality Risk Value, and Non-Fatal Crash Risk Value; as well as the sum of cost savings (i.e., baseline - alternative) for the following values: Retail Fuel Outlay, Refueling Time Cost, Petroleum Market Externalities, and all Emission Damage Costs.
Net Social Benefits	dollars (k)	The net of social benefits, computed as: Total Social Benefits - Total Social Costs.

## B.5 Annual Societal Effects and Annual Societal Costs Summary Reports

The *Annual Societal Effects Summary Report* and the *Annual Societal Costs Summary Report* contain similar results as the *Annual Societal Effects Report* and the *Annual Societal Costs Report*, except these outputs aggregate the results by calendar year, by summing across results at each vehicle age. Table 58 lists the full contents of the *Annual Societal Effects Report* and Table 59 lists the full contents of the *Annual Societal Costs Report*. The annual summary reports produce results as absolutes (i.e., non-incremental) for the baseline and action alternatives, however, as in the preceding sections, some values are inherently incremental.

**Table 58. Annual Societal Effects Summary Report**

Column	Units	Contents
Scenario	integer	Unique index of the scenario, where 0 represents the baseline, while 1 and above represent the action alternatives.
Scenario Name	text	A short name describing the key features of the scenario.
Calendar Year	calendar year	Calendar years analyzed for the effects calculations.
Reg-Class	text	The regulatory class for which the societal costs are reported. When multiple regulatory classes are present in the output, a value of "TOTAL" is used to represent the sums (or averages) across all regulatory classes for some of the outputs, where applicable.
Fuel Type	text	The fuel type for which the societal costs are reported. A value of "TOTAL" is used to represent the sums (or averages) across all fuel types for some of the outputs, where applicable.
Average Age	number	The average age of vehicles for a specific calendar year, regulatory class, and fuel type.
Fleet	units	Total on-road fleet for a specific calendar year, regulatory class, and fuel type.
kVMT	miles (k)	Thousands of miles traveled by all vehicles for a specific calendar year, regulatory class, and fuel type.
kVMT No Rebound	miles (k)	Thousands of miles traveled by all vehicles, assuming the absence of the fuel economy rebound effect, for a specific calendar year, regulatory class, and fuel type.
Quads	quads	Energy used by all vehicles for a specific calendar year, regulatory class, and fuel type.
kGallons	gallons (k)	Amount of gallons of liquid fuel consumed, or amount of gasoline equivalent gallons of fuel consumed (for non-liquid fuel types), by all vehicles for a specific calendar year, regulatory class, and fuel type.
kUnits	varies	Amount of energy consumed by all vehicles for a specific calendar year, regulatory class, and fuel type, where the units of measure vary based on fuel type. For liquid fuel types (gasoline, E85, diesel), the units are specified in thousands of gallons; for electricity, the units are specified in MWh; for hydrogen and CNG, the units are specified in Mcf.
Fatalities	units	Amount of fatalities resulting from reduction in vehicle curb weight and increases in VMT due to the rebound effect, aggregated for all vehicles for a specific calendar year, regulatory class, and fuel type.
Fatalities From Rebound	units	Amount of incremental vehicle-related fatalities resulting from changes in VMT due to the rebound effect. This value is zero for the baseline scenario; for all action alternatives, this value is specified as incremental over the baseline.
Fatalities From Delta CW	units	Amount of incremental vehicle-related fatalities resulting from reduction in vehicle curb weight. This value is zero for the baseline scenario; for all action alternatives, this value is specified as incremental over the baseline.
Non-Fatal Injuries	units	Amount of non-fatal vehicle-related injuries resulting from reduction in vehicle curb weight, changes in VMT due to the rebound effect, and changes in fleet age distribution, aggregated for all vehicles for a specific calendar year, regulatory class, and fuel type.
Non-Fatal Injuries Rebound	units	Amount of incremental non-fatal vehicle-related injuries resulting from changes in VMT due to the rebound effect. This value is zero for the baseline scenario; for all action alternatives, this value is specified as incremental over the baseline.
Non-Fatal Injuries Delta CW	units	Amount of incremental non-fatal vehicle-related injuries resulting from reduction in vehicle curb weight. This value is zero for the baseline scenario; for all action alternatives, this value is specified as incremental over the baseline.
Premature Deaths Low - Upstream	units	Amount of emission health impacts associated with air pollution exposure arising from upstream emissions of nitrogen oxides, sulfur dioxide, and particulate matter (PM2.5), aggregated for all vehicles for a specific calendar year, regulatory class, and fuel type.
Premature Deaths High - Upstream	units	
Respiratory Emergency Room Visits - Upstream	units	
Acute Bronchitis - Upstream	units	

Column	Units	Contents
Lower Respiratory Symptoms - Upstream	units	
Upper Respiratory Symptoms - Upstream	units	
Minor Restricted Activity Days - Upstream	units	
Work Loss Days - Upstream	units	
Asthma Exacerbation - Upstream	units	
Cardiovascular Hospital Admissions - Upstream	units	
Respiratory Hospital Admissions - Upstream	units	
Non-Fatal Heart Attacks (Peters) - Upstream	units	
Non-Fatal Heart Attacks (All Others) - Upstream	units	
Premature Deaths Low - Tailpipe	units	
Premature Deaths High - Tailpipe	units	
Respiratory Emergency Room Visits - Tailpipe	units	
Acute Bronchitis - Tailpipe	units	
Lower Respiratory Symptoms - Tailpipe	units	
Upper Respiratory Symptoms - Tailpipe	units	
Minor Restricted Activity Days - Tailpipe	units	
Work Loss Days - Tailpipe	units	
Asthma Exacerbation - Tailpipe	units	
Cardiovascular Hospital Admissions - Tailpipe	units	
Respiratory Hospital Admissions - Tailpipe	units	Amount of emission health impacts associated with air pollution exposure arising from upstream and tailpipe emissions of nitrogen oxides, sulfur dioxide, and particulate matter (PM2.5), aggregated for all vehicles for a specific calendar year, regulatory class, and fuel type.
Non-Fatal Heart Attacks (Peters) - Tailpipe	units	
Non-Fatal Heart Attacks (All Others) - Tailpipe	units	
Premature Deaths Low - Total	units	
Premature Deaths High - Total	units	
Respiratory Emergency Room Visits - Total	units	
Acute Bronchitis - Total	units	
Lower Respiratory Symptoms - Total	units	
Upper Respiratory Symptoms - Total	units	
Minor Restricted Activity Days - Total	units	
Work Loss Days - Total	units	
Asthma Exacerbation - Total	units	
Cardiovascular Hospital Admissions - Total	units	
Respiratory Hospital Admissions - Total	units	
Non-Fatal Heart Attacks (Peters) - Total	units	

Column	Units	Contents
Non-Fatal Heart Attacks (All Others) - Total	units	
CO Upstream (t)	metric-tons	Amount of carbon monoxide emissions generated from domestic crude petroleum extraction, transportation, and refining, from gasoline transportation, storage, and distribution, aggregated for all vehicles for a specific calendar year, regulatory class, and fuel type.
VOC Upstream (t)	metric-tons	Amount of volatile organic compounds emissions generated from domestic crude petroleum extraction, transportation, and refining, from gasoline transportation, storage, and distribution, aggregated for all vehicles for a specific calendar year, regulatory class, and fuel type.
NOx Upstream (t)	metric-tons	Amount of nitrogen oxides emissions generated from domestic crude petroleum extraction, transportation, and refining, from gasoline transportation, storage, and distribution, aggregated for all vehicles for a specific calendar year, regulatory class, and fuel type.
SO2 Upstream (t)	metric-tons	Amount of sulfur dioxide emissions generated from domestic crude petroleum extraction, transportation, and refining, from gasoline transportation, storage, and distribution, aggregated for all vehicles for a specific calendar year, regulatory class, and fuel type.
PM Upstream (t)	metric-tons	Amount of particulate matter (diameter of ~2.5 micrometers) emissions generated from domestic crude petroleum extraction, transportation, and refining, from gasoline transportation, storage, and distribution, aggregated for all vehicles for a specific calendar year, regulatory class, and fuel type.
CO2 Upstream (mmt)	million metric-tons	Amount of carbon dioxide emissions generated from domestic crude petroleum extraction, transportation, and refining, from gasoline transportation, storage, and distribution, aggregated for all vehicles for a specific calendar year, regulatory class, and fuel type.
CH4 Upstream (t)	metric-tons	Amount of methane emissions generated from domestic crude petroleum extraction, transportation, and refining, from gasoline transportation, storage, and distribution, aggregated for all vehicles for a specific calendar year, regulatory class, and fuel type.
N2O Upstream (t)	metric-tons	Amount of nitrous oxide emissions generated from domestic crude petroleum extraction, transportation, and refining, from gasoline transportation, storage, and distribution, aggregated for all vehicles for a specific calendar year, regulatory class, and fuel type.
Acetaldehyde Upstream (t)	metric-tons	Amount of Acetaldehyde emissions generated from domestic crude petroleum extraction, transportation, and refining, from gasoline transportation, storage, and distribution, aggregated for all vehicles for a specific calendar year, regulatory class, and fuel type.
Acrolein Upstream (t)	metric-tons	Amount of Acrolein emissions generated from domestic crude petroleum extraction, transportation, and refining, from gasoline transportation, storage, and distribution, aggregated for all vehicles for a specific calendar year, regulatory class, and fuel type.
Benzene Upstream (t)	metric-tons	Amount of Benzene emissions generated from domestic crude petroleum extraction, transportation, and refining, from gasoline transportation, storage, and distribution, aggregated for all vehicles for a specific calendar year, regulatory class, and fuel type.
Butadiene Upstream (t)	metric-tons	Amount of 1,3-Butadiene emissions generated from domestic crude petroleum extraction, transportation, and refining, from gasoline transportation, storage, and distribution, aggregated for all vehicles for a specific calendar year, regulatory class, and fuel type.
Formaldehyde Upstream (t)	metric-tons	Amount of Formaldehyde emissions generated from domestic crude petroleum extraction, transportation, and refining, from gasoline transportation, storage, and distribution, aggregated for all vehicles for a specific calendar year, regulatory class, and fuel type.
DPM10 Upstream (t)	metric-tons	Amount of Diesel particulate matter (diameter of ~10 micrometers) emissions generated from domestic crude petroleum extraction, transportation, and refining, from gasoline transportation, storage, and distribution, aggregated for all vehicles for a specific calendar year, regulatory class, and fuel type.
CO Tailpipe (t)	metric-tons	Amount of carbon monoxide emissions generated from vehicle operation, aggregated for all vehicles for a specific calendar year, regulatory class, and fuel type.
VOC Tailpipe (t)	metric-tons	Amount of volatile organic compounds emissions generated from vehicle operation, aggregated for all vehicles for a specific calendar year, regulatory class, and fuel type.
NOx Tailpipe (t)	metric-tons	Amount of nitrogen oxides emissions generated from vehicle operation, aggregated for all vehicles for a specific calendar year, regulatory class, and fuel type.
SO2 Tailpipe (t)	metric-tons	Amount of sulfur dioxide emissions generated from vehicle operation, aggregated for all vehicles for a specific calendar year, regulatory class, and fuel type.
PM Tailpipe (t)	metric-tons	Amount of particulate matter (diameter of ~2.5 micrometers) emissions generated from vehicle operation, aggregated for all vehicles for a specific calendar year, regulatory class, and fuel type.
CO2 Tailpipe (mmt)	million metric-tons	Amount of carbon dioxide emissions generated from vehicle operation, aggregated for all vehicles for a specific calendar year, regulatory class, and fuel type.
CH4 Tailpipe (t)	metric-tons	Amount of methane emissions generated from vehicle operation, aggregated for all vehicles for a specific calendar year, regulatory class, and fuel type.
N2O Tailpipe (t)	metric-tons	Amount of nitrous oxide emissions generated from vehicle operation, aggregated for all vehicles for a specific calendar year, regulatory class, and fuel type.
Acetaldehyde Tailpipe (t)	metric-tons	Amount of Acetaldehyde emissions generated from vehicle operation, aggregated for all vehicles for a specific calendar year, regulatory class, and fuel type.
Acrolein Tailpipe (t)	metric-tons	Amount of Acrolein emissions generated from vehicle operation, aggregated for all vehicles for a specific calendar year, regulatory class, and fuel type.

Column	Units	Contents
Benzene Tailpipe (t)	metric-tons	Amount of Benzene emissions generated from vehicle operation, aggregated for all vehicles for a specific calendar year, regulatory class, and fuel type.
Butadiene Tailpipe (t)	metric-tons	Amount of 1,3-Butadiene emissions generated from vehicle operation, aggregated for all vehicles for a specific calendar year, regulatory class, and fuel type.
Formaldehyde Tailpipe (t)	metric-tons	Amount of Formaldehyde emissions generated from vehicle operation, aggregated for all vehicles for a specific calendar year, regulatory class, and fuel type.
DPM10 Tailpipe (t)	metric-tons	Amount of Diesel particulate matter (diameter of ~10 micrometers) emissions generated from vehicle operation, aggregated for all vehicles for a specific calendar year, regulatory class, and fuel type.
CO Total (t)	metric-tons	Amount of carbon monoxide emissions generated from domestic crude petroleum extraction, transportation, and refining, from gasoline transportation, storage, and distribution, and from vehicle operation, aggregated for all vehicles for a specific calendar year, regulatory class, and fuel type.
VOC Total (t)	metric-tons	Amount of volatile organic compounds emissions generated from domestic crude petroleum extraction, transportation, and refining, from gasoline transportation, storage, and distribution, and from vehicle operation, aggregated for all vehicles for a specific calendar year, regulatory class, and fuel type.
NOx Total (t)	metric-tons	Amount of nitrogen oxides emissions generated from domestic crude petroleum extraction, transportation, and refining, from gasoline transportation, storage, and distribution, and from vehicle operation, aggregated for all vehicles for a specific calendar year, regulatory class, and fuel type.
SO2 Total (t)	metric-tons	Amount of sulfur dioxide emissions generated from domestic crude petroleum extraction, transportation, and refining, from gasoline transportation, storage, and distribution, and from vehicle operation, aggregated for all vehicles for a specific calendar year, regulatory class, and fuel type.
PM Total (t)	metric-tons	Amount of particulate matter (diameter of ~2.5 micrometers) emissions generated from domestic crude petroleum extraction, transportation, and refining, from gasoline transportation, storage, and distribution, and from vehicle operation, aggregated for all vehicles for a specific calendar year, regulatory class, and fuel type.
CO2 Total (mmt)	million metric-tons	Amount of carbon dioxide emissions generated from domestic crude petroleum extraction, transportation, and refining, from gasoline transportation, storage, and distribution, and from vehicle operation, aggregated for all vehicles for a specific calendar year, regulatory class, and fuel type.
CH4 Total (t)	metric-tons	Amount of methane emissions generated from domestic crude petroleum extraction, transportation, and refining, from gasoline transportation, storage, and distribution, and from vehicle operation, aggregated for all vehicles for a specific calendar year, regulatory class, and fuel type.
N2O Total (t)	metric-tons	Amount of nitrous oxide emissions generated from domestic crude petroleum extraction, transportation, and refining, from gasoline transportation, storage, and distribution, and from vehicle operation, aggregated for all vehicles for a specific calendar year, regulatory class, and fuel type.
Acetaldehyde Total (t)	metric-tons	Amount of Acetaldehyde emissions generated from domestic crude petroleum extraction, transportation, and refining, from gasoline transportation, storage, and distribution, and from vehicle operation, aggregated for all vehicles for a specific calendar year, regulatory class, and fuel type.
Acrolein Total (t)	metric-tons	Amount of Acrolein emissions generated from domestic crude petroleum extraction, transportation, and refining, from gasoline transportation, storage, and distribution, and from vehicle operation, aggregated for all vehicles for a specific calendar year, regulatory class, and fuel type.
Benzene Total (t)	metric-tons	Amount of Benzene emissions generated from domestic crude petroleum extraction, transportation, and refining, from gasoline transportation, storage, and distribution, and from vehicle operation, aggregated for all vehicles for a specific calendar year, regulatory class, and fuel type.
Butadiene Total (t)	metric-tons	Amount of 1,3-Butadiene emissions generated from domestic crude petroleum extraction, transportation, and refining, from gasoline transportation, storage, and distribution, and from vehicle operation, aggregated for all vehicles for a specific calendar year, regulatory class, and fuel type.
Formaldehyde Total (t)	metric-tons	Amount of Formaldehyde emissions generated from domestic crude petroleum extraction, transportation, and refining, from gasoline transportation, storage, and distribution, and from vehicle operation, aggregated for all vehicles for a specific calendar year, regulatory class, and fuel type.
DPM10 Total (t)	metric-tons	Amount of Diesel particulate matter (diameter of ~10 micrometers) emissions generated from domestic crude petroleum extraction, transportation, and refining, from gasoline transportation, storage, and distribution, and from vehicle operation, aggregated for all vehicles for a specific calendar year, regulatory class, and fuel type.

**Table 59. Annual Societal Costs Summary Report**

Column	Units	Contents
Scenario	integer	Unique index of the scenario, where 0 represents the baseline, while 1 and above represent the action alternatives.
Scenario Name	text	A short name describing the key features of the scenario.
Calendar Year	calendar year	Calendar years analyzed for the effects calculations.
Reg-Class	text	The regulatory class for which the societal costs are reported. When multiple regulatory classes are present in the output, a value of "TOTAL" is used to represent the sums (or averages) across all regulatory classes for some of the outputs, where applicable.
Disc-Rate	number	Social discount rate applied to future benefits. A value of 0 indicates undiscounted costs.
Foregone Consumer Sales Surplus	dollars (k) <sup>1</sup>	Lost consumer surplus resulting from reduced vehicle sales accumulated across all vehicles for a specific calendar year and regulatory class. Lost consumer surplus is assumed to occur entirely at the time of vehicle purchase (i.e., at age 0).
Tech Cost	dollars (k)	Total amount of technology costs accumulated across all vehicles for a specific calendar year and regulatory class. Technology costs are assumed to occur entirely at the time of vehicle purchase (i.e., at age 0).
Maint/Repair Cost	dollars (k)	Total amount of maintenance and repair costs accumulated across all vehicles for a specific calendar year and regulatory class. Maintenance and repair costs are assumed to occur entirely at the time of vehicle purchase (i.e., at age 0).
Implicit Opportunity Cost	dollars (k)	Implied opportunity cost resulting from applying technologies such that all efficiency gains improve fuel economy rather than also increasing the performance or utility of a vehicle. Although the implicit opportunity cost captures changes in fuel savings occurring over multiple vehicle ages, the resulting net sum of these changes in fuel savings is attributed to and calculated at the time of vehicle purchase (i.e., age 0). This value is accumulated across all vehicles for a specific model year and regulatory class.
Fuel Tax Revenue	dollars (k)	Total fuel tax revenues accumulated across all vehicles for a specific calendar year and regulatory class.
Retail Fuel Outlay	dollars (k)	Total retail fuel expenditures (pre-tax fuel cost + fuel tax cost) accumulated across all vehicles for a specific calendar year and regulatory class.
Drive Value	dollars (k)	Benefits from the additional driving that results from improved fuel economy, accumulated across all vehicles for a specific calendar year and regulatory class.
Refueling Time Cost	dollars (k)	Benefits from reduced refueling frequency due to the extended vehicle range and improved fuel economy, accumulated across all vehicles for a specific calendar year and regulatory class.
Fatality Risk Value	dollars (k) <sup>1</sup>	Value offsetting the risk of additional vehicle-related fatalities internalized by the driver, attributed to the additional miles driven due to rebound, accumulated across all vehicles for a specific calendar year and regulatory class.
Non-Fatal Crash Risk Value	dollars (k) <sup>1</sup>	Value offsetting the risk of additional non-fatal vehicle-related crashes internalized by the driver, attributed to the additional miles driven due to rebound, accumulated across all vehicles for a specific calendar year and regulatory class.
Petroleum Market Externalities	dollars (k)	Economic costs of oil imports not accounted for by price, accumulated across all vehicles for a specific calendar year and regulatory class.
Congestion Costs	dollars (k)	Congestion costs from additional vehicle use, accumulated across all vehicles for a specific calendar year and regulatory class.
Noise Costs	dollars (k)	Noise costs from additional vehicle use, accumulated across all vehicles for a specific calendar year and regulatory class.
Fatality Costs	dollars (k)	Costs attributed to vehicle-related fatalities resulting from additional vehicle use and reduction in vehicle curb weight, accumulated across all vehicles for a specific calendar year and regulatory class.
Fatality Costs Rebound	dollars (k) <sup>1</sup>	Incremental costs attributed to vehicle-related fatalities resulting from changes in VMT due to the rebound effect.
Fatality Costs Delta CW	dollars (k) <sup>1</sup>	Incremental costs attributed to vehicle-related fatalities resulting from reduction in vehicle curb weight.
Non-Fatal Crash Costs	dollars (k)	Costs attributed to non-fatal vehicle-related crashes resulting from additional vehicle use and reduction in vehicle curb weight, accumulated across all vehicles for a specific calendar year and regulatory class.
Non-Fatal Crash Costs Rebound	dollars (k) <sup>1</sup>	Incremental costs attributed to non-fatal vehicle-related injuries resulting from changes in VMT due to the rebound effect.
Non-Fatal Crash Costs Delta CW	dollars (k) <sup>1</sup>	Incremental costs attributed to non-fatal vehicle-related injuries resulting from reduction in vehicle curb weight.
CO Damage Costs	dollars (k)	Owner and societal costs arising from carbon monoxide damage, aggregated for all vehicles for a specific calendar year and regulatory class.
VOC Damage Costs	dollars (k)	Owner and societal costs arising from volatile organic compounds damage, aggregated for all vehicles for a specific calendar year and regulatory class.
NOx Damage Costs	dollars (k)	Owner and societal costs arising from nitrogen oxides damage, aggregated for all vehicles for a specific calendar year and regulatory class.
SO2 Damage Costs	dollars (k)	Owner and societal costs arising from sulfur dioxide damage, aggregated for all vehicles for a specific calendar year and regulatory class.
PM Damage Costs	dollars (k)	Owner and societal costs arising from particulate matter damage, aggregated for all vehicles for a specific calendar year and regulatory class.



<b>Column</b>	<b>Units</b>	<b>Contents</b>
CO2 Damage Costs	dollars (k)	Owner and societal costs arising from carbon dioxide damage, aggregated for all vehicles for a specific calendar year and regulatory class.
CH4 Damage Costs	dollars (k)	Owner and societal costs arising from methane damage, aggregated for all vehicles for a specific calendar year and regulatory class.
N2O Damage Costs	dollars (k)	Owner and societal costs arising from nitrous oxide damage, aggregated for all vehicles for a specific calendar year and regulatory class.
Total Social Costs	dollars (k) <sup>2</sup>	Total societal costs, combining the incremental effect of multiple social cost metrics occurring in the action alternative over the baseline scenario. Total social costs are computed as the sum of cost changes (i.e., alternative - baseline) for the following values: Foregone Consumer Sales Surplus, Tech Cost, Maint/Repair Cost, Implicit Opportunity Cost, Congestion Costs, Noise Costs, Fatality Costs, and Non-Fatal Crash Costs; as well as the sum of cost savings (i.e., baseline - alternative) for: Fuel Tax Revenue.
Total Social Benefits	dollars (k) <sup>2</sup>	Total societal benefits, combining the incremental effect of multiple social cost metrics occurring in the action alternative over the baseline scenario. Total social benefits are computed as the sum of cost changes (i.e., alternative - baseline) for the following values: Drive Value, Fatality Risk Value, and Non-Fatal Crash Risk Value; as well as the sum of cost savings (i.e., baseline - alternative) for the following values: Retail Fuel Outlay, Refueling Time Cost, Petroleum Market Externalities, and all Emission Damage Costs.
Net Social Benefits	dollars (k) <sup>2</sup>	The net of social benefits, computed as: Total Social Benefits - Total Social Costs.

## B.6 Consumer Costs Report

The *Consumer Costs Report* contains summary of consumer-related costs for each model year and scenario analyzed, using discounting from the consumer's perspective. The results are reported by regulatory class, as well as aggregated for the entire fleet. Most of the metrics, which are reported independently by model year, are further summed (or averaged) over the entire analysis period. For the baseline scenario, almost all of the costs are specified as absolutes, while for the action alternatives, all costs are incremental and are specified as the difference between the action alternative and the baseline scenario. As was the case for the various social costs reports, the average forgone consumer sales surplus, along with the cumulative averages of consumer costs, benefits, and net benefits, are inherently incremental over the baseline scenario, and are reported as zero in the baseline, and as incremental for the action alternatives. Table 60 lists the full contents of the *Consumer Costs Report*.

**Table 60. Consumer Costs Report**

Column	Units	Contents
Scenario	integer	Unique index of the scenario, where 0 represents the baseline, while 1 and above represent the action alternatives.
Scenario Name	text	A short name describing the key features of the scenario.
Model Year	model year	Model years analyzed during the study period. A value of "TOTAL" is used to represent the sums (or averages) across all model years for some of the outputs, where applicable.
Reg-Class	text	The regulatory class for which the consumer costs are reported. When multiple regulatory classes are present in the output, a value of "TOTAL" is used to represent the sums (or averages) across all regulatory classes for some of the outputs, where applicable.
Disc-Rate	number	Consumer discount rate applied to future benefits. This value dictates the rate at which all associated costs are discounted. A value of 0 indicates that the costs are undiscounted.
Payback	number	Number of years before increases in vehicles' average costs are repaid.
Payback TCO	number	Number of years before increases in vehicles' average total costs of ownership are repaid.
Sales	units	Total production of vehicles for sale during a specific model year and regulatory class.
Avg Foregone Consumer Sales Surplus	dollars	Average lost consumer surplus resulting from reduced vehicle sales accumulated across all vehicles for a specific model year and regulatory class. Lost consumer surplus is assumed to occur entirely at the time of vehicle purchase (i.e., at age 0).
Avg Tech Cost	dollars	Average amount of technology costs accumulated across all vehicles for a specific model year and regulatory class. Technology costs are assumed to occur entirely at the time of vehicle purchase (i.e., at age 0).
Avg Reg Cost	dollars	Average amount of regulatory costs (technology costs plus fines) accumulated across all vehicles for a specific model year and regulatory class. Regulatory costs are assumed to occur entirely at the time of vehicle purchase (i.e., at age 0).
Avg Maint/Repair Cost	dollars	Average amount of maintenance and repair costs accumulated across all vehicles for a specific model year and regulatory class. Maintenance and repair costs are assumed to occur entirely at the time of vehicle purchase (i.e., at age 0).
Avg Implicit Opportunity Cost	dollars	Average implied opportunity cost resulting from applying technologies such that all efficiency gains improve fuel economy rather than also increasing the performance or utility of a vehicle. Although the implicit opportunity cost captures changes in fuel savings occurring over multiple vehicle ages, the resulting net sum of these changes in fuel savings is attributed to and calculated at the time of vehicle purchase (i.e., age 0). This value is accumulated across all vehicles for a specific model year and regulatory class.
Avg Taxes/Fees	dollars	Average taxes and fees associated with a new vehicle purchase, accumulated across all vehicles for a specific model year and regulatory class. Taxes and fees are assumed to occur entirely at the time of vehicle purchase (i.e., at age 0).
Avg Financing Cost	dollars	Average costs associated with financing a new vehicle purchase, accumulated across all vehicles over their lifetime for a specific model year and regulatory class. Financing costs are computed for a set of vehicle ages as defined by the "financing term" value defined in the parameters input file.
Avg Insurance Cost	dollars	Average insurance costs accumulated across all vehicles over their lifetime for a specific model year and regulatory class.
Avg Retail Fuel Outlay	dollars	Average retail fuel expenditures accumulated across all vehicles over their lifetime for a specific model year and regulatory class.
Avg Rebound Fuel Cost	dollars	Average retail fuel expenditures from the additional driving that results from improved fuel economy, accumulated across all vehicles over their lifetime for a specific model year and regulatory class.
Avg Drive Value	dollars	Average benefits from the additional driving that results from improved fuel economy, accumulated across all vehicles over their lifetime for a specific model year and regulatory class.

<b>Column</b>	<b>Units</b>	<b>Contents</b>
Avg Refueling Time Cost	dollars	Average benefits from reduced refueling frequency due to the extended vehicle range and improved fuel economy, accumulated across all vehicles over their lifetime for a specific model year and regulatory class.
Avg Consumer Costs	dollars	Average consumer costs, combining the incremental effect of multiple consumer cost metrics occurring in the action alternative over the baseline scenario. Average consumer costs are computed as the sum of cost changes (i.e., alternative - baseline) for the following values: Avg Foregone Consumer Sales Surplus, Avg Reg Cost, Avg Maint/Repair Cost, Avg Implicit Opportunity Cost, Avg Taxes/Fees, Avg Financing Cost, and Avg Insurance Cost.
Avg Consumer Benefits	dollars	Average consumer benefits, combining the incremental effect of multiple consumer cost metrics occurring in the action alternative over the baseline scenario. Average consumer benefits are computed as the sum of cost changes (i.e., alternative - baseline) for: Avg Drive Value; as well as the sum of cost savings (i.e., baseline - alternative) for the following values: Avg Retail Fuel Outlay and Avg Refueling Time Cost.
Avg Net Consumer Benefits	dollars	The net of consumer benefits, computed as: Total Consumer Benefits - Total Consumer Costs.

## B.7 Vehicles Report

The *Vehicles Report* contains disaggregate vehicle-level summary of compliance model results, providing a detailed view of the final state of each vehicle examined by the model, for each model year and scenario analyzed. The report includes basic vehicle characteristics (such as vehicle code, manufacturer, engine and transmission used, curb weight, footprint, and sales volumes), fuel economy information (before and after the analysis), initial and final technology utilization (via the reported “tech-keys”), and cost metrics associated with application of additional technology.

The vehicle’s fuel economy and CO<sub>2</sub> ratings prior to the start of the analysis, as well as at the end of each compliance model year, are presented. The fuel economy and CO<sub>2</sub> values are specified per fuel type (wherever applicable) in addition to the overall values, which are used for compliance purposes. For multi-fuel vehicles, the multiple fuel economy and CO<sub>2</sub> ratings are combined according to the statutory requirements. For flex-fuel vehicles (those that operate on gasoline and E85), only the gasoline fuel economy rating is considered for compliance (subject to the “multi-fuel” mode specified in the scenario input file by the user). For plug-in hybrid/electric vehicles (PHEVs operating on gasoline and electricity), the overall fuel economy rating is harmonically averaged based on the share of each fuel type, while the CO<sub>2</sub> rating includes the portion of gasoline operation. The vehicle’s fuel share indicates the amount of miles driven by the vehicle on each fuel type. For vehicles operating on a single fuel (e.g., gasoline, diesel, or electricity), only the fuel share for that fuel type is specified. For vehicles operating on multiple fuels (FFVs and PHEVs), the fuel shares are specified for gasoline and E85 or for gasoline and electricity.

The *Vehicles Report* provides initial and final sales volumes as well as initial and final MSRPs. The initial sales and MSRP represent the starting values as obtained from the input file, and do not reflect changes associated with the modeling analysis. The final sales volumes are specified by model year and will match the initial values, unless the Dynamic Fleet Share and Sales Response model is enabled. The final MSRPs are specified by model year as well, and incorporate additional costs arising from technology application or fine payment. Table 61 below list the full contents of the *Vehicles Report*.

**Table 61. Vehicles Report**

Column	Units	Contents
Scenario	integer	Unique index of the scenario, where 0 represents the baseline, while 1 and above represent the action alternatives.
Scenario Name	text	A short name describing the key features of the scenario.
Model Year	model year	Model years analyzed during the study period.
Manufacturer	text	Manufacturers analyzed during the study period.
Veh Code	integer	Index of the vehicle (unique per manufacturer), as read from the input file.
Brand	text	Vehicle brand.
Model	text	Vehicle model.
Name Plate	text	Vehicle nameplate.
Platform	text	Name of the platform used by a vehicle.
Plt Version	text	Revision of the platform used by a vehicle. This field lists the platform version as "baseline," if the vehicle is using an original and unmodified platform. Alternatively, this field shows the model year, signifying the revision of the initial platform that the vehicle has inherited.
Powertrain	text	Vehicle's powertrain type in a specific model year. Available options are: Conventional, MHEV for mild hybridization (including 12 volt micro-hybrid and belt- or crank-mounted integrated starter/generator), SHEV for strong hybrid/electric vehicle, PHEV for plug-in hybrid/electric vehicle, BEV for battery electric vehicle, and FCV for fuel cell vehicle.
Veh Power Initial	HP	Initial power rating of a vehicle.
Veh Power	HP	Final power rating of a vehicle.
Eng Code	integer	Index of the engine used by a vehicle.
Eng Fuel Initial	text	Fuel used by the starting engine, before any modifications were made by the modeling system. Available options are: G for gasoline, D for diesel, and CNG for compressed natural gas.
Eng Type Initial	text	Brief information about the starting engine, before any modifications were made by the modeling system. The field includes: engine horsepower, displacement, configuration, number of cylinders, and aspiration.
Eng Version	text	Revision of the engine used by a vehicle. This field lists the engine version as "baseline," if the vehicle is using an original and unmodified engine. Alternatively, this field shows the model year, signifying the revision of the initial engine that the vehicle has inherited.
Eng Fuel	text	Fuel used by the engine in a specific model year.
Eng Type	text	Brief information about the engine in a specific model year. At present, only the aspiration of the engine is shown, since other attributes are assumed to remain unchanged.
Trn Code	integer	Index of the transmission used by a vehicle.
Trn Type Initial	text	Brief information about the starting transmission, before any modifications were made by the modeling system. This field includes: transmission type (A=automatic, M=manual, CVT=continuously variable transmission, AMT=automated manual transmission, DCT=dual-clutch transmission) and number of gears (if applicable).
Trn Version	text	Revision of the transmission used by a vehicle. This field lists the transmission version as "baseline," if the vehicle is using an original and unmodified transmission. Alternatively, this field shows the model year, signifying the revision of the initial transmission that the vehicle has inherited.
Trn Type	text	Brief information about the transmission in a specific model year. This field includes: transmission type (A=automatic, M=manual, CVT=continuously variable transmission, S=sequential transmission (AMT or DCT), HEV=unique transmission on a hybrid/electric vehicle) and number of gears (if applicable).
FE Primary Initial	mpg	Vehicle's initial fuel economy rating when operating on its primary fuel type. This represents the starting value as read from the input file.
FE Secondary Initial	mpg	Vehicle's initial fuel economy rating when operating on its secondary fuel type (if applicable). This represents the starting value as read from the input file.
FE Initial	mpg	Vehicle's overall initial fuel economy rating, before any modifications were made by the modeling system. For FFVs (gasoline/E85) and PHEVs (gasoline/electricity), the overall fuel economy rating may be harmonically averaged based on the share of each fuel type, according to the "Multi-Fuel" setting defined in the scenarios input file.
Fuel Initial	text	All fuel types initially used by the vehicle, before any modifications were made by the modeling system.
FS Initial	ratio	Vehicle's initial fuel share, indicating the amount of miles driven by the vehicle on each fuel type. Only the fuel types on which the vehicle operates are reported. This represents the starting value as read from the input file.
FE Primary Rated	mpg	Vehicle's fuel economy rating when operating on its primary fuel type, in a specific model year, taking into account the effect of technology additions made by the modeling system. This value does not include adjustment for improvements in air conditioning or off-cycle credits.
FE Secondary Rated	mpg	Vehicle's fuel economy rating when operating on its secondary fuel type (if applicable), in a specific model year, taking into account the effect of technology additions made by the modeling system. This value does not include adjustment for improvements in air conditioning or off-cycle credits.
FE Rated	mpg	Vehicle's overall fuel economy rating in a specific model year, taking into account the effect of technology additions made by the modeling system. For FFVs (gasoline/E85) and PHEVs (gasoline/electricity), the overall fuel economy rating may be harmonically averaged based on the share of each fuel type, according to the "Multi-Fuel" setting defined in the scenarios input file. This value does not include adjustment for improvements in air conditioning or off-cycle credits.

Column	Units	Contents
FE Primary Compliance	mpg	Vehicle's fuel economy rating when operating on its primary fuel type, in a specific model year, taking into account the effect of technology additions made by the modeling system, adjusted for improvements in air conditioning and off-cycle credits.
FE Secondary Compliance	mpg	Vehicle's fuel economy rating when operating on its secondary fuel type (if applicable), in a specific model year, taking into account the effect of technology additions made by the modeling system, adjusted for improvements in air conditioning and off-cycle credits.
FE Compliance	mpg	Vehicle's overall fuel economy rating in a specific model year, taking into account the effect of technology additions made by the modeling system, adjusted for improvements in air conditioning and off-cycle credits. For FFVs (gasoline/E85) and PHEVs (gasoline/electricity), the overall fuel economy rating may be harmonically averaged based on the share of each fuel type, according to the "Multi-Fuel" setting defined in the scenarios input file. This value is used for compliance purposes.
Fuel	text	All fuel types used by the vehicle in a specific model year.
Fuel Share	ratio	Vehicle's fuel share, indicating the amount of miles driven by the vehicle on each fuel type in a specific model year. Only the fuel types on which the vehicle operates are reported.
CO2 Primary Initial	grams per mile	Vehicle's initial CO2 rating when operating on its primary fuel type. This value is calculated based on the FE Primary Initial value.
CO2 Secondary Initial	grams per mile	Vehicle's initial CO2 rating when operating on its secondary fuel type (if applicable). This value is calculated based on the FE Secondary Initial value.
CO2 Initial	grams per mile	Vehicle's overall initial CO2 rating, before any modifications were made by the modeling system. For FFVs (gasoline/E85) and PHEVs (gasoline/electricity), the overall fuel economy rating may be harmonically averaged based on the share of each fuel type, according to the "Multi-Fuel" setting defined in the scenarios input file.
CO2 Primary Rated	grams per mile	Vehicle's CO2 rating when operating on its primary fuel type, in a specific model year, taking into account the effect of technology additions made by the modeling system. This value is calculated based on the FE Primary value.
CO2 Secondary Rated	grams per mile	Vehicle's CO2 rating when operating on its secondary fuel type, in a specific model year, taking into account the effect of technology additions made by the modeling system. This value is calculated based on the FE Secondary value.
CO2 Rated	grams per mile	Vehicle's overall CO2 rating in a specific model year, taking into account the effect of technology additions made by the modeling system. For FFVs (gasoline/E85) and PHEVs (gasoline/electricity), the overall fuel economy rating may be harmonically averaged based on the share of each fuel type, according to the "Multi-Fuel" setting defined in the scenarios input file.
Veh Class	text	Vehicle's general classification (passenger vehicle: LDV; light-duty truck: LDT1, LDT2a, LDT2b, LDT3; medium-duty truck: MDT4, MDT5, MDT6; heavy duty truck: HDT7, HDT8). Only the passenger vehicle and light-duty truck classifications are supported by the modeling system.
Reg Class	text	Vehicle's regulatory class (PassengerCar, LightTruck, or LightTruck2b3).
Tech Class	text	Vehicle's technology class (used for technology selection and application).
Eng Tech Class	text	Vehicle's engine technology class (used for determining costs of engine-level technologies).
Safety Class	text	Vehicle's safety class (PC=Passenger Car, CM=CUV/Minivan, LT=Light Truck/SUV; used for safety calculations).
Redesign State	text	Vehicle's redesign state, whether the vehicle is being redesigned in the current model year.
Refresh State	text	Vehicle's refresh state, whether the vehicle is being refreshed in the current model year.
Platform Leader	text	A flag indicating whether a vehicle serves as the leader of the engine (E), transmission (T), and/or platform (P) that it uses. During modeling, engine, transmission, and platform technologies are first applied to a leader vehicle during the leaders redesign or refresh, and subsequently inherited on all other vehicles during their redesign/refresh years.
CW (MR0)	lbs.	The "reference" curb weight of the vehicle (negating any mass reduction), as read from the input file.
GW (MR0)	lbs.	The "reference" glider weight of the vehicle (negating any mass reduction), as read from the input file.
CW Initial	lbs.	Vehicle's initial curb weight. This represents the starting value as read from the input file.
CW	lbs.	Vehicle's final curb weight in a specific model year, taking into account any mass reduction technology applied by the modeling system.
TW Initial	lbs.	Vehicle's initial test weight, before any modifications were made by the modeling system.
TW	lbs.	Vehicle's final test weight in a specific model year, taking into account any mass reduction technology applied by the modeling system.
GVWR Initial	lbs.	Vehicle's initial GVWR, before any modifications were made by the modeling system.
GVWR	lbs.	Vehicle's final GVWR in a specific model year, taking into account any mass reduction technology applied by the modeling system.
GCWR Initial	lbs.	Vehicle's initial GCWR, before any modifications were made by the modeling system.
GCWR	lbs.	Vehicle's final GCWR in a specific model year, taking into account any mass reduction technology applied by the modeling system.
Footprint	sq.ft.	Vehicle's initial footprint. This represents the starting value as read from the input file. The vehicle's footprint does not change during the analysis.
Work Factor	lbs.	Vehicle's work factor in a specific model year. This value is reported only for vehicles that are subject to the work-factor based functional standard.
FE Target	gallons per mile	Vehicle's fuel economy target in a specific model year.

Column	Units	Contents
CO2 Target	grams per mile	Vehicle's CO-2 target in a specific model year.
ZEV Credits	zevs	Amount of ZEV credits generated by a vehicle due to its full or partial operation on fuel types that do not generate downstream emissions. At present, PHEV's, EV's, and FCVs are ZEV credit generating vehicles.
Sales Initial	units	Vehicle's production volumes in a specific model year. This represents the starting value as read from the input file.
Sales	units	Vehicle's final production volumes in a specific model year. If modeling options for sales mixing are used (such as the Dynamic Fleet Share Model), this value will differ from the initial production volumes; otherwise, this value will be the same the initial one.
MSRP Initial	dollars	Vehicle's initial MSRP value in a specific model year. This represents the starting value as read from the input file.
MSRP	dollars	Vehicle's final MSRP value in a specific model year, including additional costs arising from technology application or fine payment.
k.Labor Hours	hours (k)	Thousands of employment hours associated with the production of the vehicle models in a specific model year.
Tech Cost	dollars	Unit costs accumulated by the vehicle model from technology application in a specific model year.
Price Increase	dollars	Increase in vehicle price accumulated by the vehicle model from technology application and fine payment in a specific model year.
Maint/Repair Cost	dollars	Unit maintenance and repair costs accumulated by the vehicle model from technology application in a specific model year.
HEV Cost	dollars	Incremental cost associated with the hybrid/electric technology (if any) that is in use on a vehicle. This value will be zero for any vehicle that: - does not use one of the hybrid/electric technologies (any of: SHEV, PHEV, BEV, or FCV), - was initially a hybrid/electric, but did not undergo any further upgrades within the hybrid/electric path.
Tax Credit	dollars	Amount of Federal tax credits a buyer receives for purchasing this vehicle. Tax credits are specified for strong hybrid, plug-in hybrid, and electric vehicles, only when the applicable "Tax Credit" settings are defined in the scenarios input file.
Consumer WTP	dollars	Amount of additional cost that consumers are willing to pay for a hybrid/electric vehicle in a specific model year.
Tech Burden	dollars	Amount of cost "burden" incurred by a vehicle as a result of applying hybrid/electric technology in a specific model year.
Taxes/Fees Initial	dollars	Taxes & fees paid by the consumers for purchasing a new vehicle model in a specific model year, calculated for a vehicle model at its initial state, before application of any technologies.
Taxes/Fees	dollars	Taxes & fees paid by the consumers for purchasing a new vehicle model in a specific model year.
Financing Initial	dollars	Financing costs paid by the consumers for purchasing a new vehicle model in a specific model year, calculated for a vehicle model at its initial state, before application of any technologies.
Financing	dollars	Financing costs paid by the consumers for purchasing a new vehicle model in a specific model year.
Insurance Initial	dollars	Insurance costs paid by the consumers for purchasing a new vehicle model in a specific model year, calculated for a vehicle model at its initial state, before application of any technologies.
Insurance	dollars	Insurance costs paid by the consumers for purchasing a new vehicle model in a specific model year.
Payback	years	The number of years before the cost attributed to application of additional technologies on a specific vehicle model will pay back in the form of fuel savings.
Payback TCO	years	The number of years before the "total cost of ownership" attributed to application of additional technologies on a specific vehicle model will pay back in the form of fuel savings.
TechKey Initial	string	A combination of technologies that were initially in use on a specific vehicle model (at its initial state), when it was loaded from the input file.
TechKey	string	A combination of technologies that are presently in use on a specific vehicle model. The TechKey is also used for looking up fuel economy adjustment factors and battery costs within the Argonne Simulation Database.

## B.8 Vehicles Diagnostic Report

In addition to the *Vehicles Report*, the modeling system may be configured to generate a *Vehicles Diagnostic Report*, which contains extensive diagnostic information attributed to each vehicle model. This report includes tracing information, such as input cost values and fuel economy adjustment factors for each technology or technology combination (tech-key), as they apply to a specific vehicle model, as well as the initial and final fuel economy ratings attained by that vehicle model, and the cost attributed with application of additional technology. Table 62 list the full contents of the *Vehicles Diagnostic Report*.

**Table 62. Vehicles Diagnostic Report**

Column	Units	Contents
Scenario	integer	Unique index of the scenario, where 0 represents the baseline, while 1 and above represent the action alternatives.
Model Year	model year	Model years analyzed during the study period.
Manufacturer	text	Manufacturers analyzed during the study period.
Veh Code	integer	Index of the vehicle (unique per manufacturer), as read from the input file.
Veh Class	text	Vehicle's general classification (passenger vehicle: LDV; light-duty truck: LDT1, LDT2a, LDT2b, LDT3; medium-duty truck: MDT4, MDT5, MDT6; heavy duty truck: HDT7, HDT8). Only the passenger vehicle and light-duty truck classifications are supported by the modeling system.
Reg Class	text	Vehicle's regulatory class (PassengerCar, LightTruck, or LightTruck2b3).
Tech Class	text	Vehicle's technology class (used for technology selection and application).
Eng Tech Class	text	Vehicle's engine technology class (used for determining costs of engine-level technologies).
Redesign State	text	Vehicle's redesign state, whether the vehicle is being redesigned in the current model year.
Refresh State	text	Vehicle's refresh state, whether the vehicle is being refreshed in the current model year.
Platform Leader	text	A flag indicating whether a vehicle serves as the leader of the engine (E), transmission (T), and/or platform (P) that it uses. During modeling, engine, transmission, and platform technologies are first applied to a leader vehicle during the leaders redesign or refresh, and subsequently inherited on all other vehicles during their redesign/refresh years.
TechKey Initial	string	A combination of technologies that were initially in use on a specific vehicle model (at its initial state), when it was loaded from the input file.
TechKey	string	A combination of technologies that are presently in use on a specific vehicle model. The TechKey is also used for looking up fuel economy adjustment factors and battery costs within the Argonne Simulation Database.
CW (MR0)	lbs.	The "reference" curb weight of the vehicle (negating any mass reduction), as read from the input file.
GW (MR0)	lbs.	The "reference" glider weight of the vehicle (negating any mass reduction), as read from the input file.
CW Initial	lbs.	Vehicle's initial curb weight. This represents the starting value as read from the input file.
CW	lbs.	Vehicle's final curb weight in a specific model year, taking into account any mass reduction technology applied by the modeling system.
Delta CW	lbs.	Change in vehicle's curb weight (initial - final).
FE Primary Initial	mpg	Vehicle's initial fuel economy rating when operating on its primary fuel type. This represents the starting value as read from the input file.
FE Secondary Initial	mpg	Vehicle's initial fuel economy rating when operating on its secondary fuel type (if applicable). This represents the starting value as read from the input file.
FE Initial	mpg	Vehicle's overall initial fuel economy rating, before any modifications were made by the modeling system. For FFVs (gasoline/E85) and PHEVs (gasoline/electricity), the overall fuel economy rating may be harmonically averaged based on the share of each fuel type, according to the "Multi-Fuel" setting defined in the scenarios input file.
Fuel Initial	text	All fuel types initially used by the vehicle, before any modifications were made by the modeling system.
FS Initial	ratio	Vehicle's initial fuel share, indicating the amount of miles driven by the vehicle on each fuel type. Only the fuel types on which the vehicle operates are reported. This represents the starting value as read from the input file.
FE Primary	mpg	Vehicle's fuel economy rating when operating on its primary fuel type, in a specific model year, taking into account the effect of technology additions made by the modeling system. This value does not include adjustment for improvements in air conditioning or off-cycle credits.
FE Secondary	mpg	Vehicle's fuel economy rating when operating on its secondary fuel type (if applicable), in a specific model year, taking into account the effect of technology additions made by the modeling system. This value does not include adjustment for improvements in air conditioning or off-cycle credits.
FE	mpg	Vehicle's overall fuel economy rating in a specific model year, taking into account the effect of technology additions made by the modeling system. For FFVs (gasoline/E85) and PHEVs (gasoline/electricity), the overall fuel economy rating may be harmonically averaged based on the share



Column	Units	Contents
		of each fuel type, according to the "Multi-Fuel" setting defined in the scenarios input file. This value does not include adjustment for improvements in air conditioning or off-cycle credits.
Fuel	text	All fuel types used by the vehicle in a specific model year.
Fuel Share	ratio	Vehicle's fuel share, indicating the amount of miles driven by the vehicle on each fuel type in a specific model year. Only the fuel types on which the vehicle operates are reported.
FE1 Adj Factor Initial	number	The fuel economy adjustment factor for the primary fuel type of a vehicle, corresponding to a combination of technologies (as represented by TechKey Initial) that were initially in use on a specific vehicle model.
FE2 Adj Factor Initial	number	The fuel economy adjustment factor for the secondary fuel type of a vehicle (if applicable), corresponding to a combination of technologies (as represented by TechKey Initial) that were initially in use on a specific vehicle model.
FE1 Adj Factor	number	The fuel economy adjustment factor for the primary fuel type of a vehicle, corresponding to a combination of technologies (as represented by TechKey) that are presently in use on a specific vehicle model.
FE2 Adj Factor	number	The fuel economy adjustment factor for the secondary fuel type of a vehicle (if applicable), corresponding to a combination of technologies (as represented by TechKey) that are presently in use on a specific vehicle model.
Tech Cost	dollars	Unit costs accumulated by the vehicle model from technology application in a specific model year.
Battery Tech Cost Initial	dollars	The cost of a battery-only portion of a technology in use on a vehicle (if applicable), corresponding to a combination of technologies (as represented by TechKey Initial) that were initially in use on a specific vehicle model.
Battery Tech Cost	dollars	The cost of a battery-only portion of a technology in use on a vehicle (if applicable), corresponding to a combination of technologies (as represented by TechKey) that are presently in use on a specific vehicle model.
Battery Learning Rate Initial	number	The battery learning rate associated with the combination of technologies (as represented by TechKey Initial) that were initially in use on a specific vehicle model in a specific model year.
Battery Learning Rate	number	The battery learning rate associated with the combination of technologies (as represented by TechKey) that are presently in use on a specific vehicle model in a specific model year.
Technology (multiple columns)	text	The utilization of technologies on a vehicle model in a specific model year. The following define the utilization codes used by the modeling system: U = technology was initially in use on a base vehicle before modeling began A = technology was applied to a vehicle by the modeling system I = technology was applied to a leader of a vehicle's engine, transmission, or platform by the modeling system, and later inherited on a current follower vehicle US = technology was in use on a base vehicle, but was later superseded when another technology was applied by the modeling system AS = technology was applied to a vehicle by the modeling system, but was later superseded when another technology was applied IS = technology was inherited on a vehicle by the modeling system, but was later superseded when another technology was applied P = technology has exceed its phase-in threshold in the current model year, and thus was not applied by the modeling system X = technology is not available for application on a vehicle in the current model year <blank> = technology is available for application on a vehicle in the current model year, but the modeling system has not yet applied it
Technology_VehCost (multiple columns)	number	The input "vehicle-level" costs of each technology, applicable to a vehicle in a specific model year, based on that vehicle's classification. These costs are copied directly from the technologies input file for diagnostic purposes. A vehicle may not necessarily use all of the technologies for which vehicle-level costs are shown.
Technology_EngCost (multiple columns)	number	The input "engine-level" costs of each technology, applicable to a vehicle in a specific model year, based on that vehicle's classification. These costs are copied directly from the technologies input file for diagnostic purposes. A vehicle may not necessarily use all of the technologies for which engine-level costs are shown.

## **Appendix C   CAFE Model Software Manual**

### **C.1   Warnings**

This software was developed for analysis by U.S. Department of Transportation staff of potential fuel economy requirements.

This software uses input files containing detailed information regarding vehicles manufactured for sale in the United States and creates output files containing similarly detailed information regarding such vehicles. If input files containing information in any way (e.g., based on entitlement under 5 U.S.C 552 to confidential treatment) protected from disclosure to the public are used, some output files created by this software must also be protected from disclosure to the public.

### **C.2   Notice**

The CAFE Model software is a U.S. Government work not subject to copyright pursuant to 17 USC 105; however, some of the third-party works used by the software are subject to usage agreements, as described below.

The button controls in the application toolbar of the CAFE Model use images from the Glaze Icon Set (version 0.4.6, released on 3/06/2006) obtained from [www.notmart.org](http://www.notmart.org). All icons and/or images within the Glaze Icon Set are distributed under the GNU Lesser General Public License (LGPL), version 2.1. The version 2.1 of the GNU LGPL may be obtained from: [www.gnu.org/licenses/old-licenses/lgpl-2.1.html](http://www.gnu.org/licenses/old-licenses/lgpl-2.1.html).

If users of the CAFE Model have any questions about this notice, please contact the current administrators of the CAFE Model project.

### C.3 Installation and System Requirements

The CAFE Model runs on IBM-compatible computers using the Microsoft Windows operating system. Although the software does not have strict hardware requirements, beyond what is needed to run the operating system, a dual core Intel compatible processor, with at least 4 GB of physical memory (RAM) is strongly recommended. The software has been developed and tested on computers using Windows 7/10 and Windows Server 2012, but may operate properly on machines using other versions of Windows, as long as a compatible Microsoft .NET Framework is installed.

The CAFE Model software additionally uses Microsoft Excel to read input files needed for modeling. As such, a compatible version Excel must be installed on the system. The current version of the model software was tested for proper operation having Excel versions 2010 and later installed on the user's system. The CAFE Model was developed using the Microsoft .NET Framework, version 4.6.1. If the Framework is not already present, it must be installed. Instructions for downloading and installing the .NET framework are available on the Internet at [www.microsoft.com/en-us/download/details.aspx?id=49981](http://www.microsoft.com/en-us/download/details.aspx?id=49981).

Based on the characteristics of machines used in the development of this software, the following table provides a summary of system requirements:

**Table 63. CAFE Model System Requirements**

Dual Core Intel compatible processor (64-bit Quad Core processor recommended)
4 GB RAM (8 GB recommended)
120 MB hard drive space for installation (additional disk space will be required during runtime) <sup>63</sup>
Microsoft Windows 7/10
Microsoft .NET Framework 4.6.1
Microsoft Excel 2010 or later

Once the system requirements have been met, the latest version of the CAFE Model may be obtained by contacting NHTSA or Volpe Center staff.

The current version of the software is packaged as a stand-alone executable and does not require installation. To operate the model, place the “CAFE Model.exe” file on the desktop and execute it.<sup>64</sup>

---

<sup>63</sup> Depending on how the model is operated (e.g., number of scenarios to be evaluated, types of output and log files to be produced), outputs from a single execution of the model can easily exceed 1 gigabyte.

<sup>64</sup> The CAFE Model files provided may be in a zip archive, which will need to be extracted using a zip utility such as WinZip ([www.winzip.com](http://www.winzip.com)) or 7Zip ([www.7-zip.org](http://www.7-zip.org)).

## C.4 CAFE Model Graphical User Interface

The CAFE Model graphical user interface provides users with a set of tools necessary to set up and run multiple modeling test scenarios, which are commonly referred to as CAFE Model sessions. Each CAFE Model session can be configured independently, each with its own set of model inputs and settings. Once configured, the session may be saved for future runs, or executed immediately.<sup>65</sup> When the model runs, the system displays the progress of the compliance modeling process in the main model window.

The model GUI consists of two primary screens: the main **CAFE Model** window and the **Modeling Settings** window. The **CAFE Model** window is used for managing the modeling sessions, while the **Modeling Settings** window is used to configure them.

To run the modeling system, click on the **CAFE Model** executable file located on the desktop. When the application launches, a **Warnings** dialog box is displayed (Figure 10). The user must read and understand the warnings listed prior to using the modeling system.

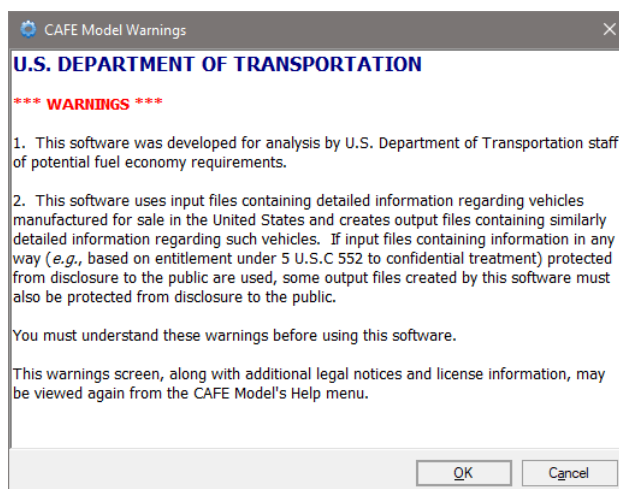

Figure 10. Warnings Dialog Box

After clicking the **OK** button in the **Warnings** dialog box, a **Splash Screen** window appears (Figure 11), prompting the user to wait for model resources to load.

---

<sup>65</sup> It is recommended that users save the sessions prior to running them in order to assign a meaningful title to each session. Doing so will cause the model to create an output file folder with the same name.

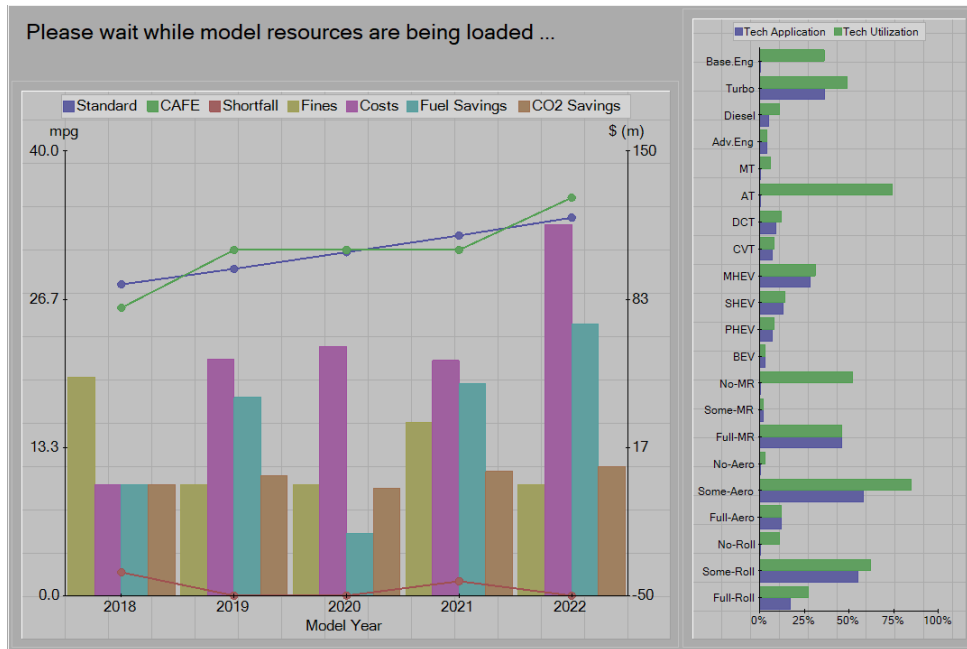

Figure 11. CAFE Model Splash Screen

Once the model resources are completely loaded, the main **CAFE Model** window, described below, opens.

#### C.4.1 CAFE Model Window

The main **CAFE Model** window (Figure 12) is used to create, configure, and manage CAFE modeling sessions. The main window also controls the model operation, allowing users to start and stop modeling simulation.

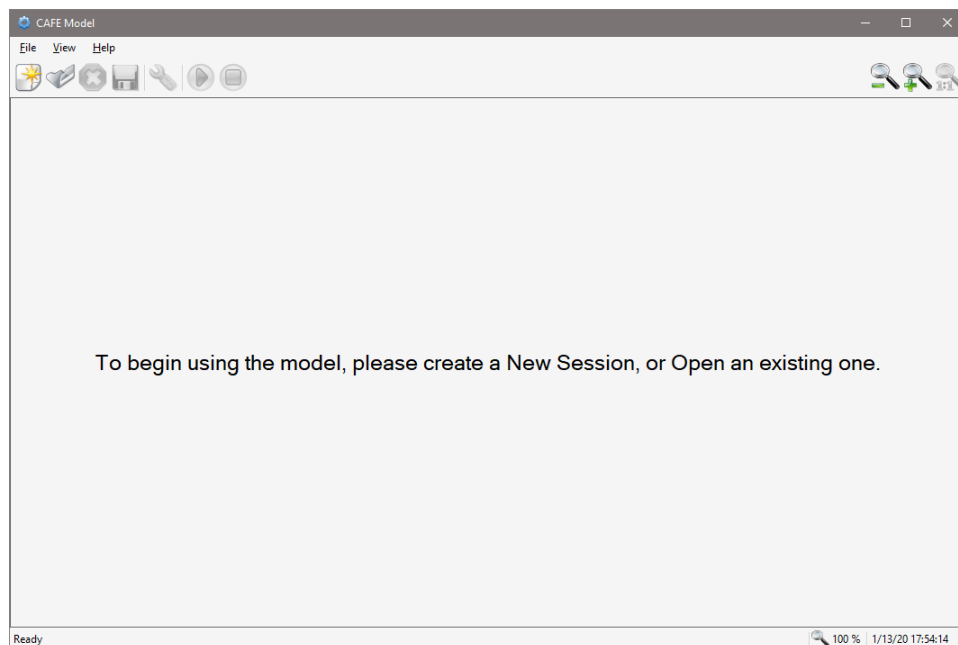

Figure 12. CAFE Model Window

When the model first starts up, most of the menu items and toolbar icons are disabled, until a new session is created, or an existing one is opened.

All of the options required for operation of the model GUI may be accessed using a file menu (Figure 13), with most commonly used shortcuts also available on the model toolbar (Figure 14). For user convenience, most of the menu entries may also be controlled using keyboard shortcuts.



Figure 13. CAFE Model File Menu



Figure 14. CAFE Model Toolbar

Some of the most commonly used file menus are the following.

- **File > New Session:** Creates a new *CAFE Model Session* and displays the **Modeling Settings** window to the user.
- **File > Open Session:** Opens an existing *CAFE Model Session*.
- **File > Close Session:** Closes the currently open *CAFE Model Session*.
- **File > Save Session:** Saves the open *CAFE Model Session*.
- **File > Start Modeling:** Begins CAFE simulation modeling for the currently open *CAFE Model Session*.
- **File > Stop Modeling:** Suspends CAFE simulation modeling.
- **File > Exit:** Exits the **CAFE Model**. If a *CAFE Model Session* is still opened, it will be closed prior to exiting the model.
- **View > Modeling Settings:** Displays the **Modeling Settings** window, where all modeling options and settings may be configured.
- **View > Output Location:** Opens a Windows Explorer window and browses to the location where the output files and reports of the current session are written to.
- **View > Argonne Simulation Results:** Extracts the vehicle simulation results, produced at ANL using the Autonomie model, that are built into the CAFE Model to a user-specified directory.

Users are encouraged to explore all of the additional file menus available within the model. For analysis involving many model runs, work flow can be accelerated and configuration errors reduced considerably by saving a session, reopening it, making desired modifications (e.g.,

selecting a different version of an input file, or changing a run-time option), and saving (before running) the modified session under a new name.

The description for the menus listed above, as well as all other menu and toolbar items are also displayed within the model GUI's status bar when the user points to that item with a mouse.

### C.4.2 Modeling Settings Window

The **Modeling Settings** window contains multiple panels for configuring all of the runtime options available to the model. The user can operate this window to set up a new session, or modifying an existing one, before starting the modeling process. Each of the available configuration panels is outlined in the sections below.

#### C.4.2.1 General Compliance Settings Panel

The **General Compliance Settings** panel (Figure 15) is used to specify what type of modeling the user would like to run. Each model is tailored to different type of analysis, using its own set of assumptions and configuration settings. Presently, only one model type is available.

- **Standard Compliance Model:** The *Standard Compliance Model* is the default mode of operation for the CAFE modeling system. This model type is used to evaluate technology costs and benefits in response to the required CAFE standards defined in the modeling scenarios.

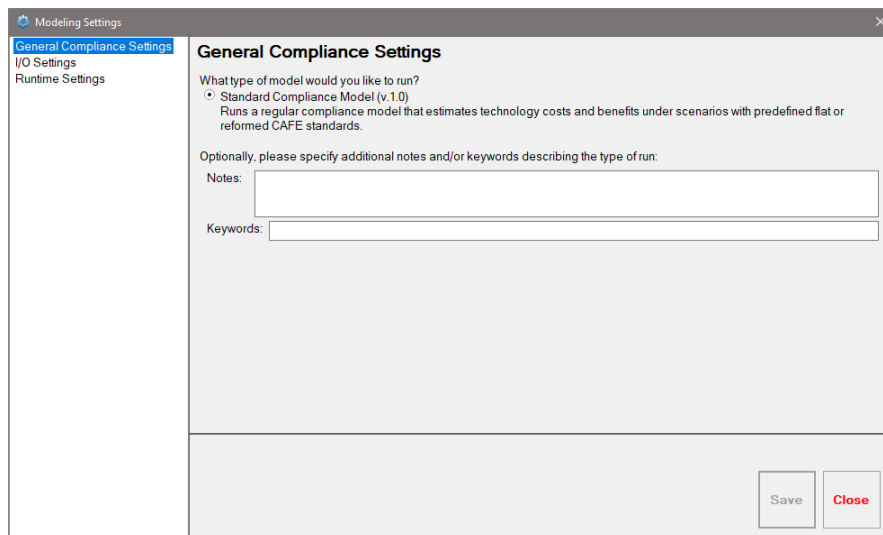

**Figure 15. General Compliance Settings Panel**

The notes and keywords portions are optional and may be specified by the user for diagnostic or information purposes. These are reflected in the summary log file produced by the system and do not affect the actual modeling process.

At present, as shown in Figure 15 above, the current version of the modeling system only supports the *Standard Compliance Model*. Future development may reintroduce additional types of analysis, such as Monte-Carlo simulation.

### C.4.2.2 I/O Settings Panel

On the **I/O Settings** panel (Figure 16), the user can select the input data files for use with the modeling system as well as the location where modeling results will be saved.

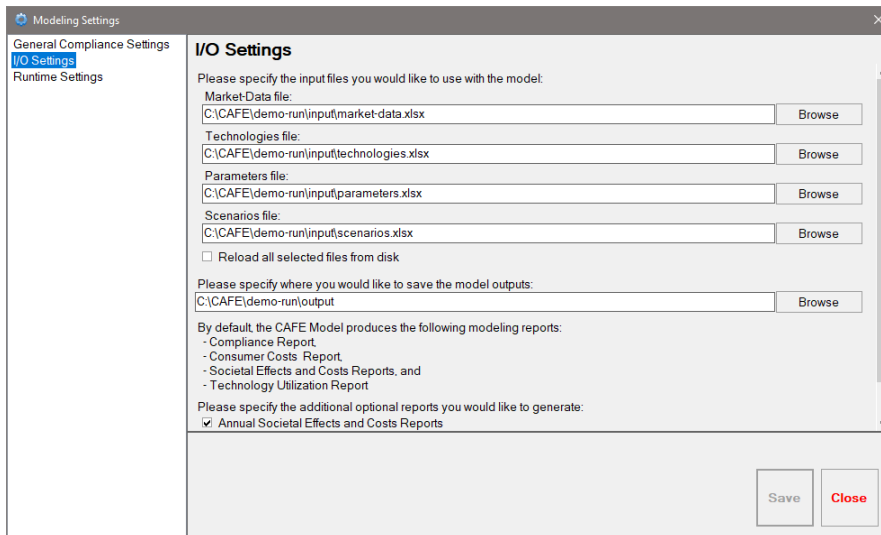

Figure 16. I/O Settings Panel (1)

Input and output locations may be entered by typing the paths into the appropriate textboxes, browsing for a specific file or folder path, or dragging-and-dropping an input file or an output folder directly onto the **I/O Settings** panel. Multiple input files may be selected and dragged-and-dropped onto the panel simultaneously. In this case, the modeling system automatically determines if the correct files were chosen by reading the “Title” field from a specific Excel file’s metadata, and populating the required inputs accordingly. As shown in Figure 17 below, when the user drags-and-drops multiple input files, the **Modeling Settings** window blocks, requiring the user to wait until all files are processed.

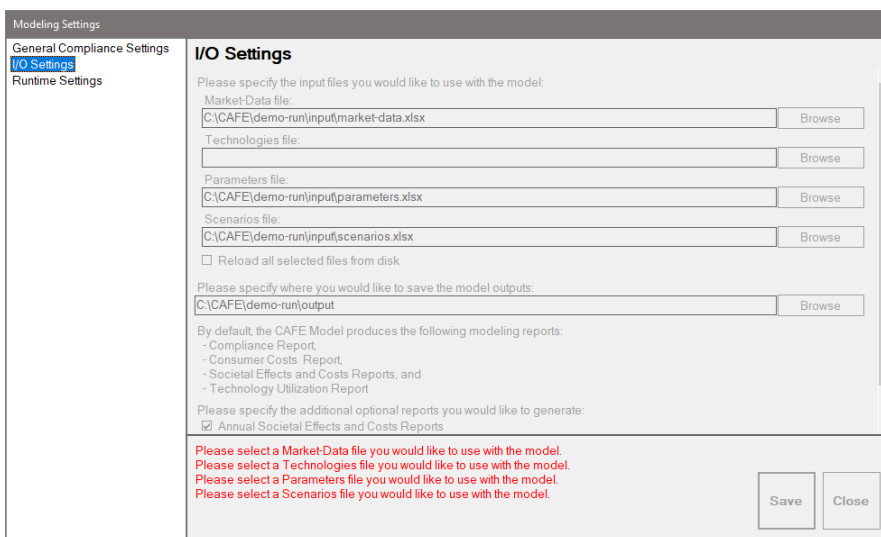

Figure 17. I/O Settings Panel (2)



When manually entering input files, the model will use the selected file’s metadata information to attempt to verify if an appropriate file was used. If incorrect file path is entered, an error message will be displayed (Figure 18).

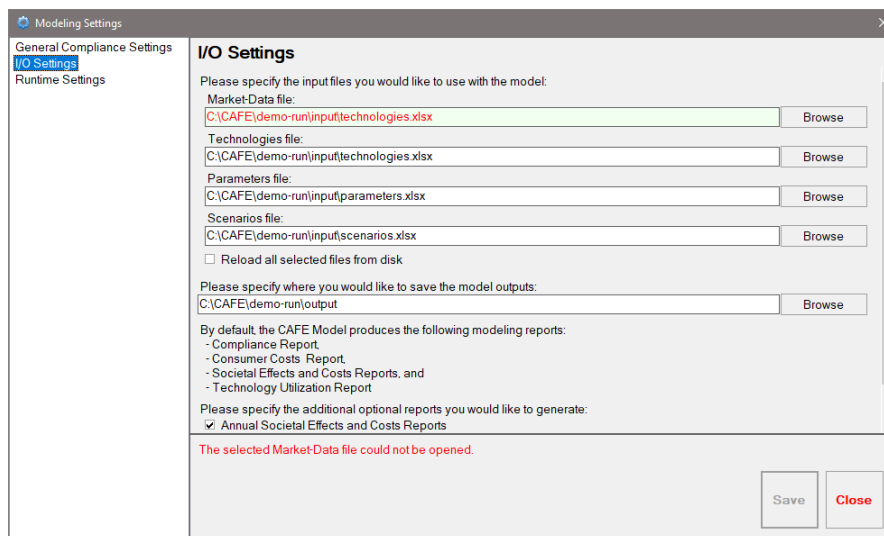

Figure 18. I/O Settings Panel (3)

As mentioned above, the system’s ability to validate an input file stems from it reading the “Title” field located in the file’s metadata. The input files used for analysis and which were distributed with the modeling system already include appropriate metadata information. However, if the user wishes to create new versions, other than adhering to the file structure described in the model’s documentation, each input file must specify the “Title” field in its metadata, according to the following list.<sup>66</sup>

- **CAFE Market Data:** Indicates that the file should be treated as a *Market-Data* input file.
- **CAFE Technologies:** Indicates that the file should be treated as a *Technologies* input file.
- **CAFE Parameters:** Indicates that the file should be treated as a *Parameters* input file.
- **CAFE Scenarios:** Indicates that the file should be treated as a *Scenarios* input file.

By default, the CAFE Model produces a number of required modeling reports during operation, while some optional ones may be toggled by the user (Figure 19).

<sup>66</sup> Users are advised to refer to Microsoft Excel’s documentation for help on setting the title information for Excel files.

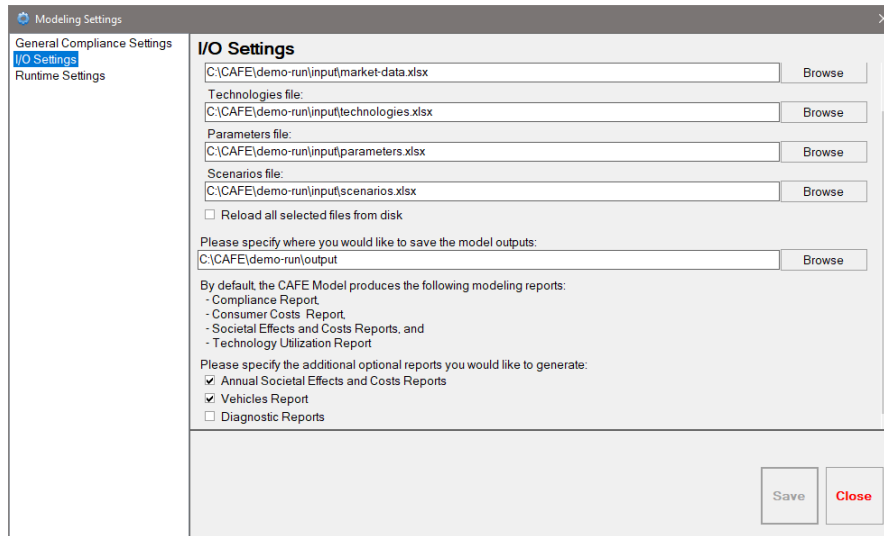

Figure 19. I/O Settings Panel (2)

#### C.4.2.3 Runtime Settings Panel

The **Runtime Settings** panel (Figure 20) provides additional modeling options to further customize the model behavior, beyond what is available in the input files. The following describe the options that may be toggled from the model's GUI by the user.

- ***Compliance Program to Enforce:*** Specifies the compliance program the model should enforce when evaluating a manufacturer's compliance state. If *CAFE* option is selected, the model will seek compliance with NHTSA's CAFE standards. If *CO-2* option is selected, the system will seek compliance with EPA's CO<sub>2</sub> standards.
- ***Effective-Cost Mode:*** Specifies the metric to use when calculating the effective cost of a compliance finding, associated with application of pending technologies on one or more vehicle models. A *Legacy* option indicates the effective cost calculation that was used with older versions of the model. A *Cost/Credit* option is the new calculation that was introduced in support of the 2020 rulemaking.
- ***Enable Dynamic Economic Modeling:*** Specifies whether the various Dynamic Economic models available within the system should be enabled for analysis. This includes the Dynamic Fleet Share and Sales Response (DFS/SR) model, the Dynamic Scrapage model, and the Dynamic VMT model.
- ***Number of Iterations for Sales Model:*** Specifies the number of iterations to examine in the convergence loop of the DFS/SR model.
- ***Price Elasticity Multiplier:*** Specifies the price elasticity multiplier to use for the sale response component of the DFS/SR model.
- ***Begin compliance modeling starting in:*** Specifies the first model year the system will evaluate for compliance. This should typically correlate to the model year for which the baseline input fleet is defined.
- ***Begin technology application starting in:*** Specifies the starting model year when the system will begin evaluating technologies for application on vehicles. Prior to this year,

the system will only determine manufacturers' compliance levels, generate available credits and fines owed, and use expiring credits (if credit trading option is enabled) to offset compliance shortfalls as needed. Any non-expiring banked credits available prior to start of the analysis (which are specified as input for each manufacturer) will not be used for model years prior to this starting year.

- ***Evaluate compliance modeling until:*** Specifies the last model year the system will evaluate for compliance.
- ***Allow Credit Trading:*** Specifies whether the model should allow manufacturers to transfer credits between passenger car and light truck fleets and to carry-forward credits forward from previous model years into the analysis year. (The model currently does not simulate either credit “carry-back” or trading between different manufacturers.)
- ***Last credit trading year:*** Specifies the last model year during which credits may be transferred or carried forward. A value of 2020 indicates that manufacturers may transfer and carry forward credits through and including model year 2020.
- ***Fuel Price Estimates:*** Specifies whether to use the low, average, or high fuel price estimates from the parameters input file. By default, average fuel price estimates are used.
- ***Social Cost of CO<sub>2</sub> Emissions:*** Specifies whether to use low, average, or high estimates of social cost of carbon dioxide emissions from the parameters input file. By default, average CO<sub>2</sub> estimates are used.
- ***Fatality Rate Estimates:*** Specifies whether to use the low, average, or high fatality rate estimates from the parameters input file. By default, average fatality rate estimates are used.
- ***Scale Consumer Benefits:*** Specifies whether the model should scale the private consumer benefits by a specific percentage during the effects calculations. Valid values are between 0 and 100.
- ***Calculate Implicit Opportunity Cost:*** Specifies whether the model should calculate implicit opportunity costs during effects calculations.

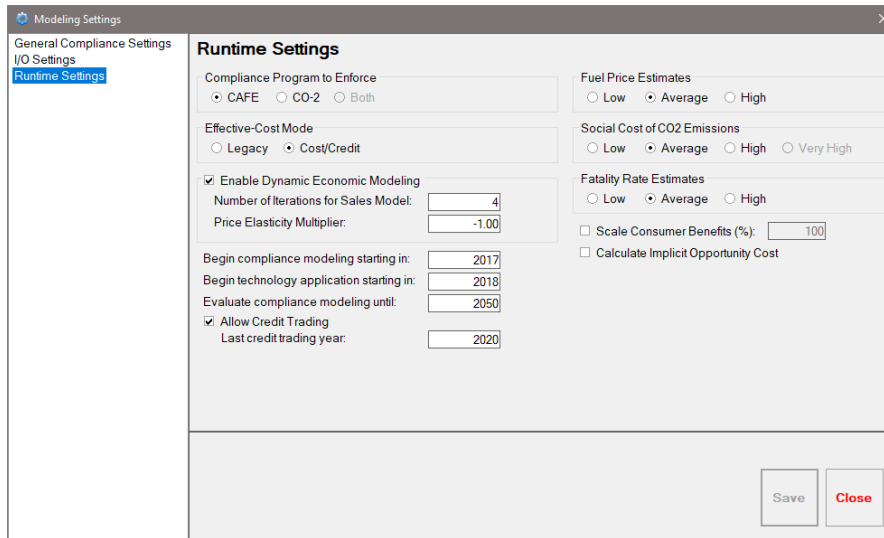

Figure 20. Runtime Settings Panel

### C.4.3 Session View

When a new session is created, or an existing one opened, the main **CAFE Model** window changes to present the user with several charts detailing the progress of the compliance modeling process. This is referred to as the modeling system’s **Session View** (Figure 21).

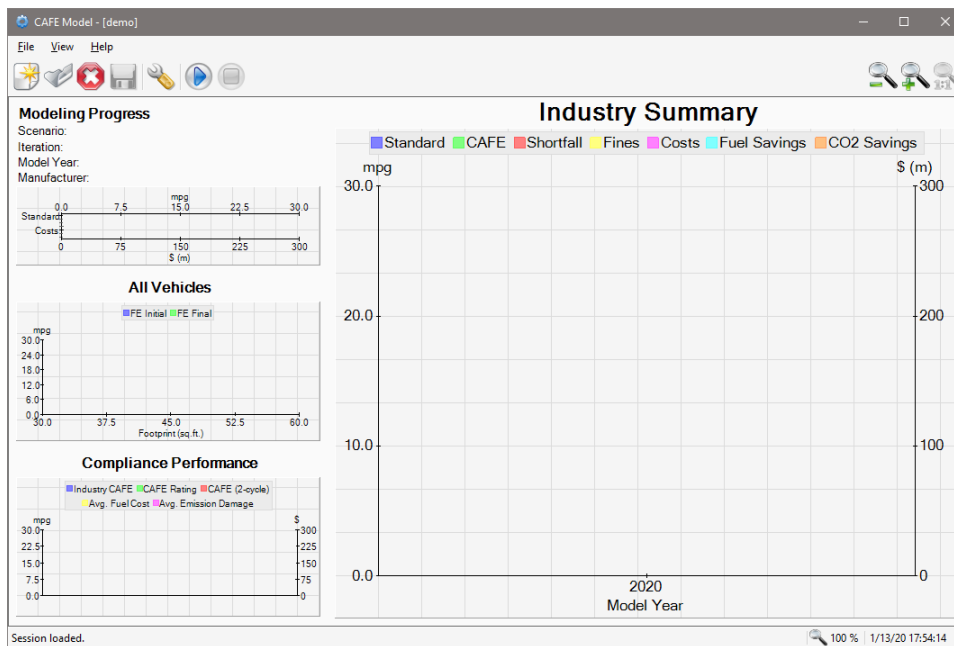

Figure 21. CAFE Model Session View

#### C.4.3.1 Session View Layout

The top-left corner of the model’s **Session View** shows the progress of compliance modeling, displaying the current scenario, iteration, model year, and manufacturer being evaluated (Figure 22). Additionally, this portion highlights the “*in-progress*” compliance state of the manufacturer

being examined during the current analysis year. The manufacturer’s standard (or required CAFE value), CAFE (or achieved CAFE value), and shortfall (the difference between the required and achieved CAFE values) are displayed along the top axis, labeled “mpg.” The fines owed, accumulated technology costs, fuel savings, and CO<sub>2</sub> savings attributable to the manufacturer are displayed along the bottom axis, labeled “\$ (m).” As the model progresses, these values change as more technologies are applied to a manufacturer or the model switches to a different manufacturer, model year, iteration, or scenario.<sup>67</sup>

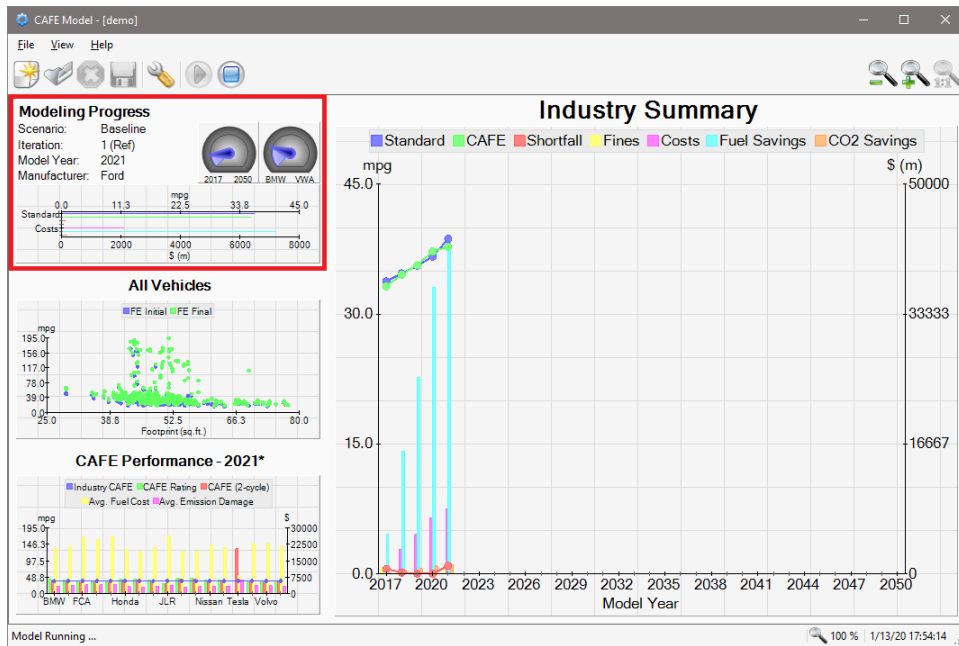
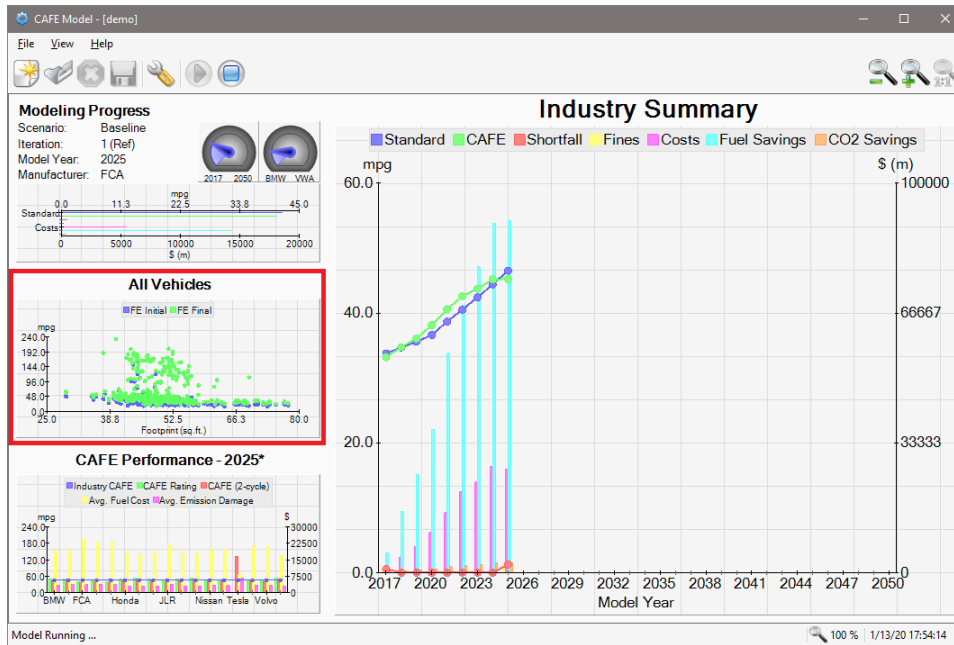

Figure 22. Session View - Modeling Progress

The center-left section of the model’s **Session View** shows the *Vehicle Scatter Plot*, with initial and final fuel economy levels displayed for the scenario, iteration, model year, and either the entire industry or the selected manufacturer being evaluated (Figure 23). The category axis displays the range of footprints that represent all modeled vehicles, while the values axis shows the mpg level achieved by those vehicles. The user may interact with the *Vehicle Scatter Plot*, which is discussed in the following section, to filter the chart’s view between each analyzed manufacturer and the entire industry.

<sup>67</sup> If some of the labels or data are not clearly visible, the **CAFE Model** window may be resized until more information comes into view.



**Figure 23. Session View - Vehicle Scatter Plot**

The bottom-left corner of the model’s **Session View** shows the “by-manufacturer” *Compliance Performance Chart* for the scenario and iteration being analyzed (Figure 24). The user may interact with this chart to filter the view between the model year currently being processed and any other model year evaluated during the study period (past or future). For model years that have not been processed yet, however, the data presented will be based on the last year examined. The category axis displays the manufacturers evaluated as part of the analysis. The CAFE Rating and CAFE (2-cycle) are displayed along the left values axis, labeled “mpg,” while average fuel cost and emission damage are displaying along the right values axis, labeled “\$.” The *Compliance Performance Chart* also displays the average CAFE rating for the entire industry, as a relative benchmark measure for each manufacturer.

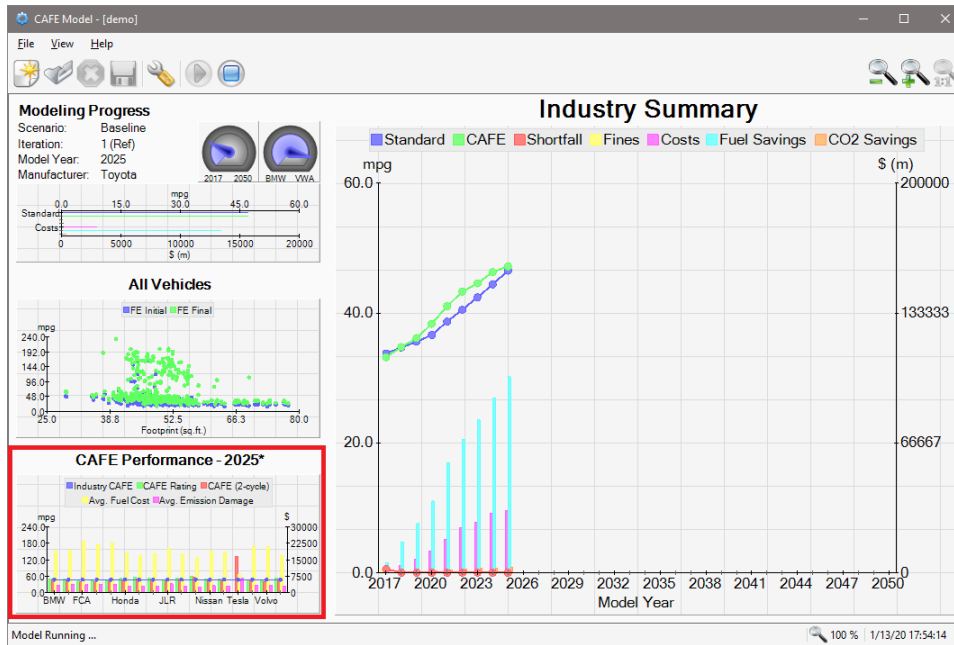

**Figure 24. Session View - Compliance Performance Chart**

The right side of the model’s **Session View** shows the “*by-model-year*” *Compliance Summary Chart* for the scenario and iteration being analyzed. As with the *Vehicle Scatter Plot*, the user may filter the view between each manufacturer and the entire industry. The category axis, labeled “Model Year,” displays the range of model years evaluated as part of the analysis. The standard, CAFE, and shortfall values attained for each model year are displayed along the left values axis, labeled “mpg,” while fines owed, accumulated technology costs, fuel savings, and CO<sub>2</sub> savings are displayed along the right values axis, labeled “\$ (m).” When modeling begins, most of the values along the Model Year axis will be empty. As the system progress through each year, additional information will be presented.

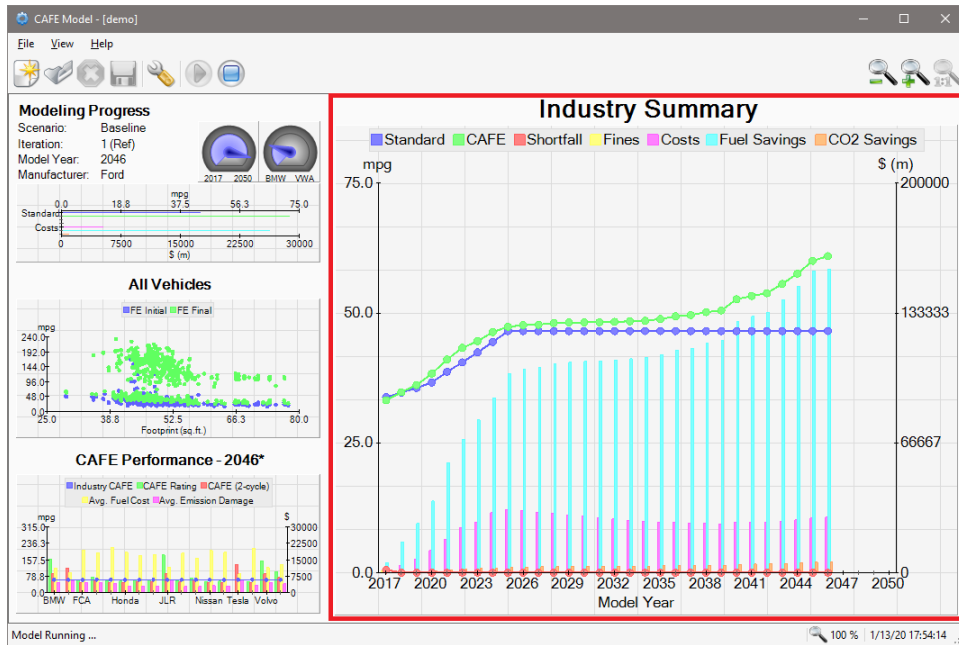

Figure 25. Session View - Compliance Summary Chart

#### C.4.3.2 Interacting with the Session View

Each of the available charts in the **Session View** may be interacted with to change the appearance of information presented to the user. For example, as mentioned above, the user may filter the *Vehicle Scatter Plot* to display fuel economy information for a specific manufacturer or for the entire industry. Additionally, the user may filter the chart's view to display data for a specific regulatory class or for the combined fleet. When filtering by regulatory classes, if a particular class is not available within the selected manufacturer or industry, it will be omitted during filtering.

Filtering is initiated by pressing on the chart's area with the left mouse button, then dragging the mouse left or right (to filter between regulatory classes), or up or down (to filter between manufacturers for the *Compliance Summary* and *Vehicle Scatter Plot*, or to filter between model years for the *Compliance Performance Chart*). As the mouse is dragged across the chart's surface area, a directional arrow appears and the chart begins to fade and move out of view (Figure 26).



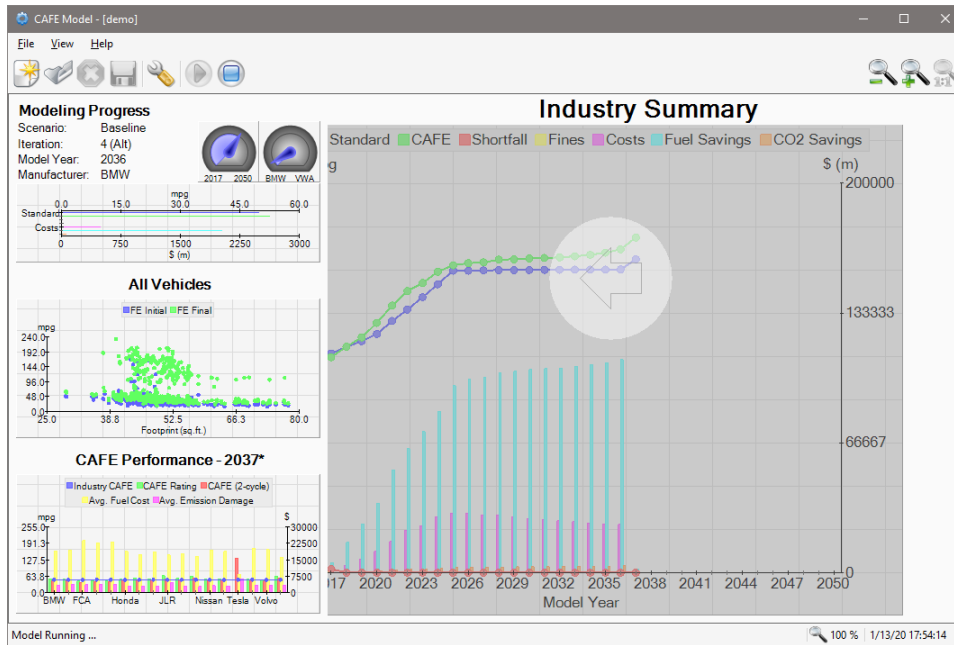

Figure 26. Initiating Chart Filtering

When the mouse is dragged an appropriate distance (roughly a quarter of the chart’s size), chart filtering becomes “activated.” This is indicated by the directional arrow becoming highlighted (Figure 27). Once the mouse is released, the chart is swiped out of view, then swiped back with the new filter applied. If mouse is released prior to activation, the chart bounces back into view without applying a new filter.

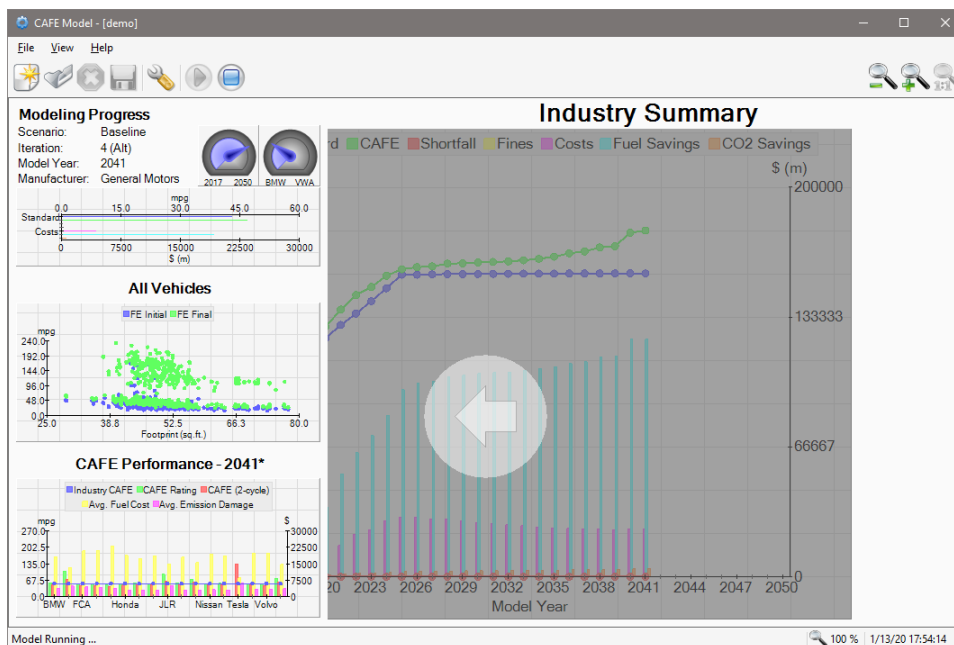

Figure 27. Chart Filtering Activated

Notice, as show in Figure 28, the *Compliance Summary Chart* has changed to include “(PC)” in its title and the data presented differs from the last view.

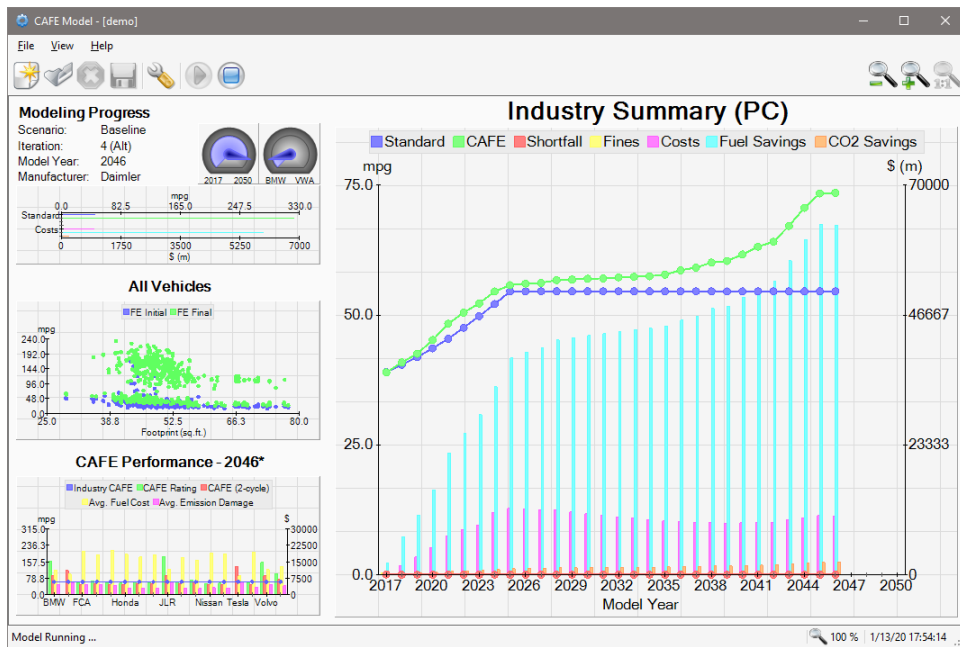
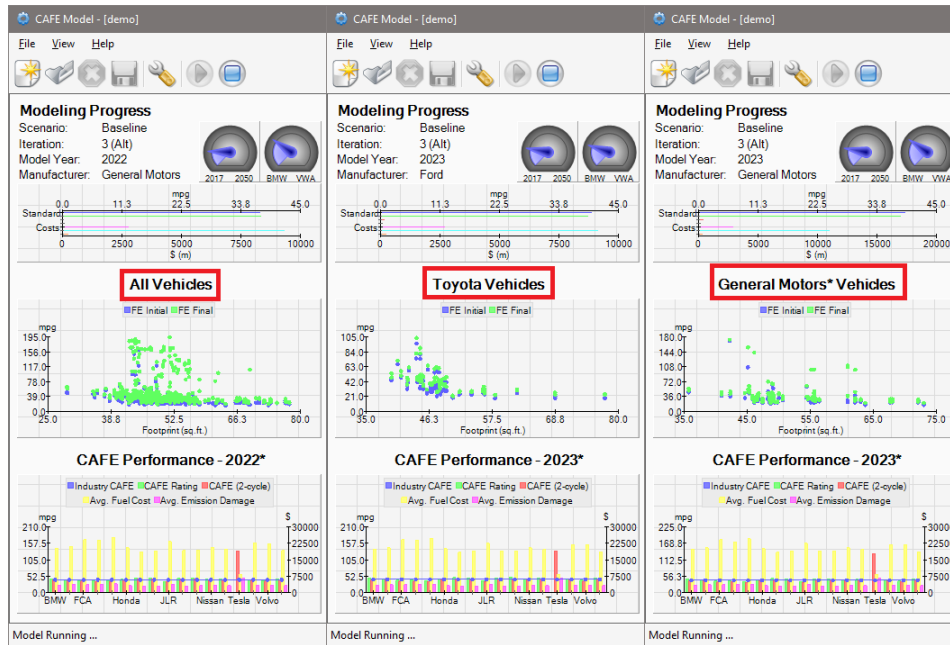

Figure 28. Chart Filtering Completed

When filtering the chart's view by manufacturer and industry (up or down), the model cycles through each available manufacturer, the entire industry, and the current manufacturer being evaluated. When filtering for the current manufacturer, the chart's title displays an asterisk next to the manufacturer's name. As modeling progresses, the compliance information will be updated as more technology is added to the current manufacturer, or the modeling system switches to analyzing another manufacturer, model year, or scenario. Similarly, when filtering the *Compliance Performance Chart* by model year (up or down), the model cycles through each model year and the current year being examined. As with other charts, filtering for the current year displays an asterisks in the chart's title.

Figure 29 shows a comparison of different views when filtering the *Vehicle Scatter Plot* by manufacturer. Notice the asterisk next to General Motors. This indicates the data for the current manufacturer being evaluated is shown.<sup>68</sup>

<sup>68</sup> If the compliance modeling process has completed, the asterisk next to the manufacturer's name represents the last manufacturer analyzed.

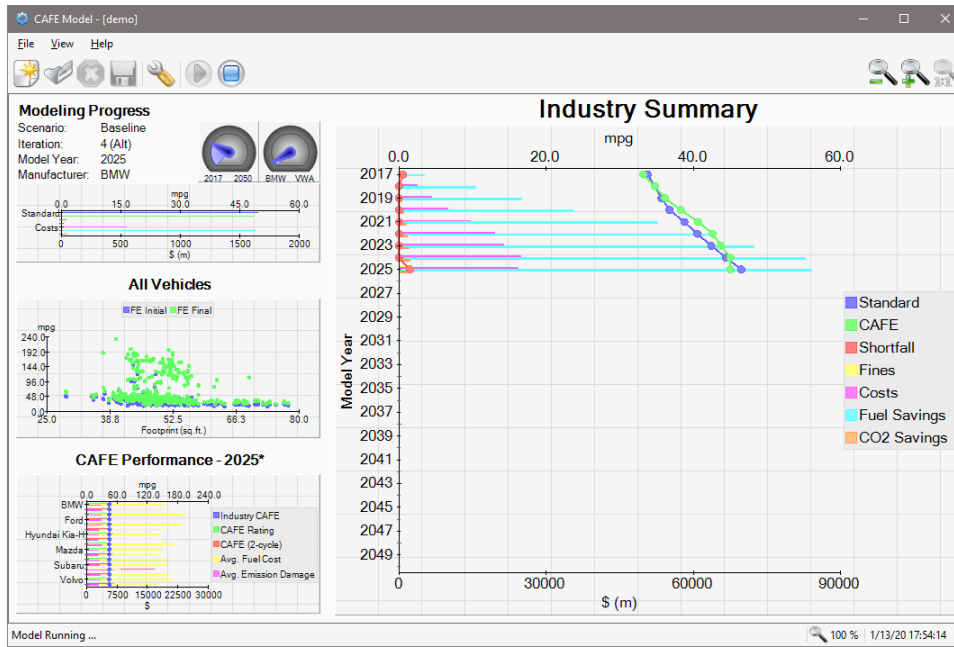

**Figure 29. Manufacturer Filtering Examples**

All of the charts provided support filtering by regulatory class, however, only the *Vehicle Scatter Plot* and the *Compliance Summary Chart* support filtering by manufacturer. Filtering may also be triggered by using the keyboard's arrow keys, pressing the left or right arrows (to filter by regulatory class) or up or down keys (to filter by manufacturer).

With the exception of the chart displaying progress information in the *Modeling Progress* section (top-left corner), all charts may be rotated to provide an alternative view of the data. In Figure 30, the *Compliance Summary* and *Compliance Performance* charts were rotated 90 degrees, with the chart's plot data realigned as shown.<sup>69</sup> Rotation is activated by pressing on the chart's area with the right mouse button, then dragging the mouse left or right. As the mouse is dragged, the chart's display area begins to rotate. Once the mouse button is released, the chart completes the rotation, clockwise or counterclockwise, and snaps into view at the nearest 90 degree angle.

<sup>69</sup> The rotation feature may not necessarily be practical (or meaningful) for the charts currently available within the CAFE Model. This feature is intended for future expansion.



**Figure 30. Compliance Summary and Compliance Performance Charts - Rotated View**

The charts may also be “zoomed” or “expanded” by double clicking on the chart’s area (Figure 31). This expands the selected chart to fit the entire contents of the model’s **Session View**, allowing for easier interpretation of the data.

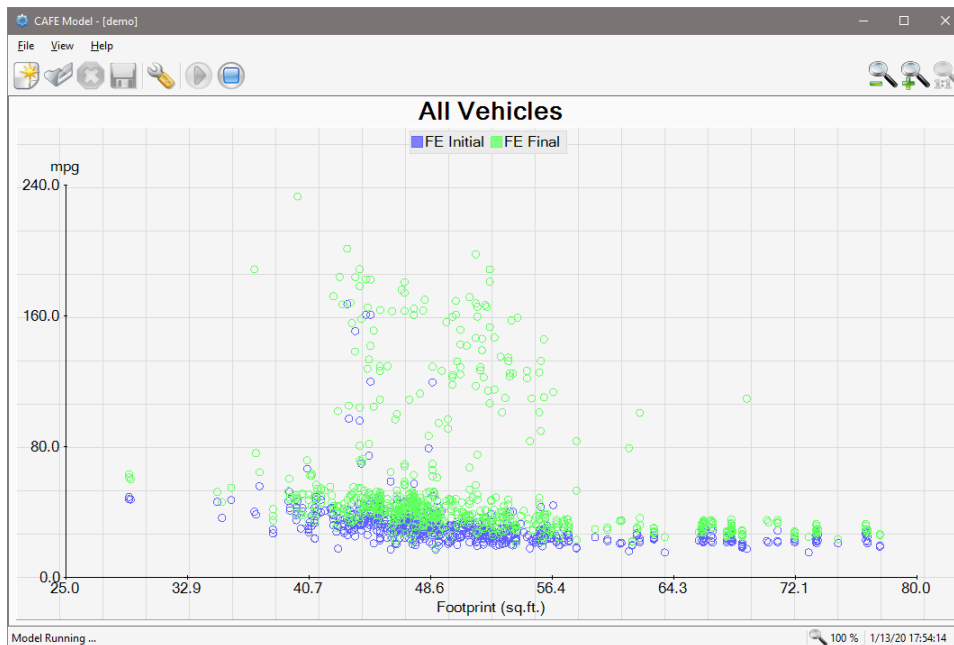

**Figure 31. Vehicle Scatter Plot - Zoomed View**

Only the current scenario being evaluated, or the last scenario analyzed if modeling has completed, is available for viewing within the model’s **Session View**. However, users may interact with each chart while the compliance modeling process is still running as well as after modeling concludes.

#### C.4.4 Model Outputs

During runtime, the CAFE Model produces several outputs, located in the user selected output path. Different types of modeling outputs are split into separate folders and are categorized as follows.

- **logs**: Contains a “summary” file describing the various settings used during modeling, as well as the log files tracing through the step-by-step applications of technologies, based on the compliance decisions the model made during analysis. A separate tracing log is generated for each compliance scenario.
- **reports-csv**: Contains the various modeling reports the CAFE Model produced during analysis.
- **debug-logs**: Contains additional log files used during debugging of the model. At present, this folder provides log files for tracing through the credit transfer and credit carry forward transactions executed by the model on behalf of each manufacturer, for each compliance scenario.

The system generates five required and six optional modeling reports (in CSV format) during runtime. The contents of these reports are discussed in greater detail in the Appendix section of the CAFE Model Documentation. The following provides an overview of the available modeling reports.

- **Technology Utilization Report**: Provides manufacturer-level and industry-wide technology application and penetration rates for each technology, model year, and scenario analyzed. The results are disaggregated by regulatory class, as well as combined over the entire fleet.
- **Compliance Report**: Provides manufacturer-level and industry-wide summary of compliance model results for each model year and scenario analyzed. The results are disaggregated by regulatory class, as well as combined over the entire fleet.
- **Consumer Costs Report**: Provides industry-wide summary of consumer-related costs for each model year and scenario analyzed, using discounting from the consumer’s perspective. The results are disaggregated by regulatory class, as well as combined over the entire fleet.
- **Societal Effects Report**: Provides industry-wide summary of energy and emissions effects for each model year and scenario analyzed. The results are disaggregated by regulatory class and fuel type, as well as combined across all fuels and over the entire fleet.
- **Societal Costs Report**: Provides industry-wide summary of consumer and social costs for each model year and scenario analyzed, using discounting from the social perspective. The results are disaggregated by regulatory class, as well as combined over the entire fleet.
- **Annual Societal Effects Report**: [Optional] This output file is similar to the *Societal Effects Report*, except it further disaggregates the results by vehicle age.

- ***Annual Societal Costs Report:*** [Optional] This output file is similar to the *Societal Costs Report*, except it further disaggregates the results by vehicle age.
- ***Annual Societal Effects Summary Report:*** [Optional] This output file is similar to the *Annual Societal Effects Report*, except it aggregates the results by calendar year. Note, the *Societal Effects Report* produces results for each model year considered during analysis. Conversely, the summary report summarizes the annual results by calendar year.
- ***Annual Societal Costs Summary Report:*** [Optional] This output file is similar to the *Annual Societal Costs Report*, except it aggregates the results by calendar year. Note, the *Societal Costs Report* produces results for each model year considered during analysis. Conversely, the summary report summarizes the annual results by calendar year.
- ***Vehicles Report:*** [Optional] Provides a detailed view of the final state of each vehicle examined by the model, for each model year and scenario analyzed.
- ***Vehicles Diagnostic Report:*** [Optional] Provides extensive diagnostic information for each vehicle model, including utilization, costs, and fuel economy improvements of each technology or a combination of technologies, as it applies to the specific vehicles.

## C.5 CAFE Model Usage Examples

This section provides examples for configuring and running the CAFE Model sessions using various model types.

### C.5.1 Example 1 – Configuring for Standard Compliance Modeling

This example demonstrates the steps necessary for configuring the modeling system to perform a regular *Compliance Model* run.

- Run the CAFE Model by clicking on the **CAFE Model** executable.<sup>70</sup> Read through the **Warnings** dialog box, and then click the **OK** button. Wait for the main **CAFE Model** window to appear.
- Select **File > New Session** to create a new modeling session. The **Modeling Settings** window appears. Note the errors at the bottom of the window; these indicate that the input files have not yet been selected.
- On the **General Compliance Settings** panel, select the *Standard Compliance Model* as shown in Figure 32 below.<sup>71</sup>

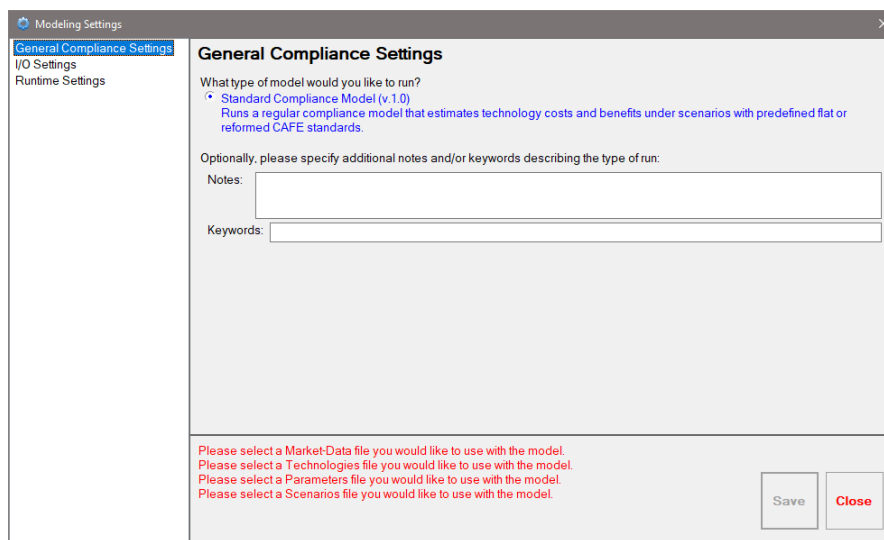
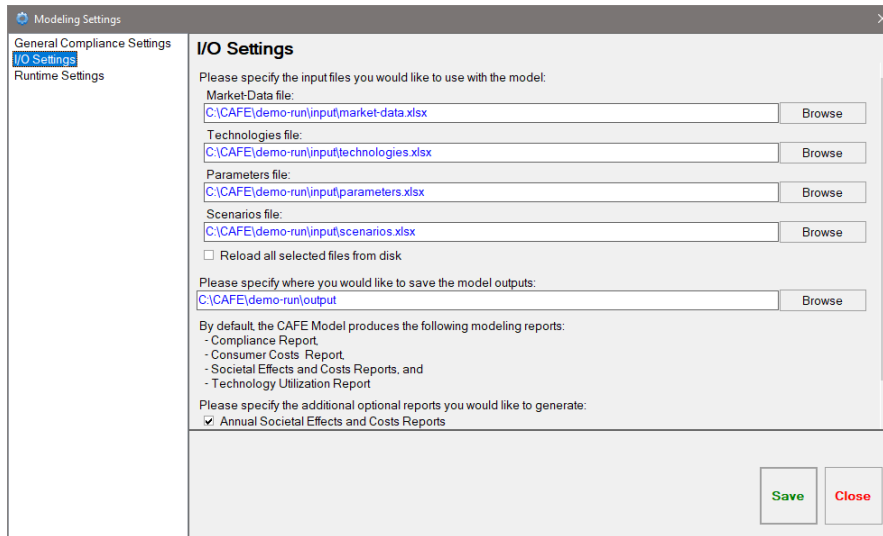

**Figure 32. Select Standard Compliance Model**

- Click on the **I/O Settings** panel to select the input files to use for modeling and the location for output files (Figure 33). Note that once all the input files have been selected appropriately, the error messages disappear.
- On the **I/O Settings** panel, users are also advised to change the output location.
- For this example, the selection of modeling reports is not changed.

<sup>70</sup> If the model was just downloaded, it is most likely located on the user's desktop.

<sup>71</sup> As discussed earlier, the current version of the modeling system only supports the *Standard Compliance Model*.



**Figure 33. Select Input Files**

- The **Runtime Settings** panel is not used for this exercise.
- Click the **Save** button to save the modeling settings and load the input files (Figure 34).

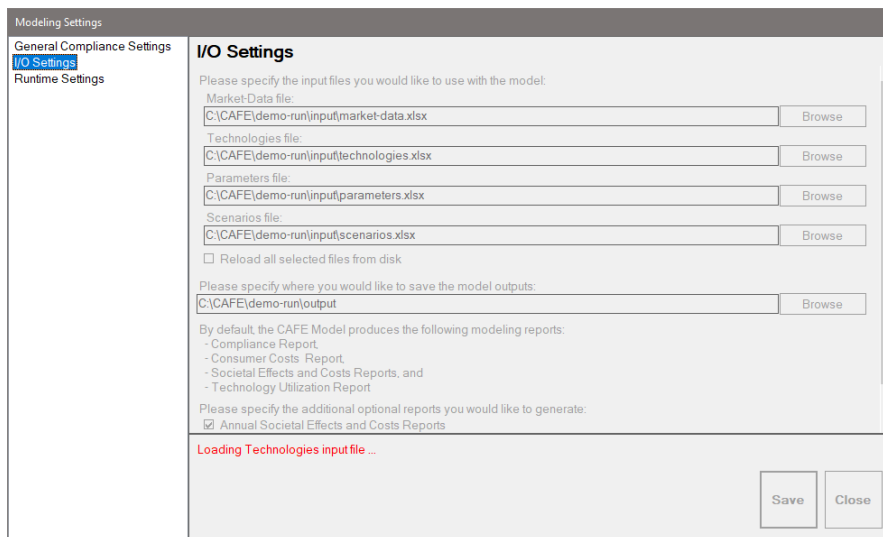

**Figure 34. Save Modeling Settings**

- Once loading completes, click the **Close** button to return the main **CAFE Model** window. A new *Compliance Model* session, titled “Session 1” has now been created (Figure 35).



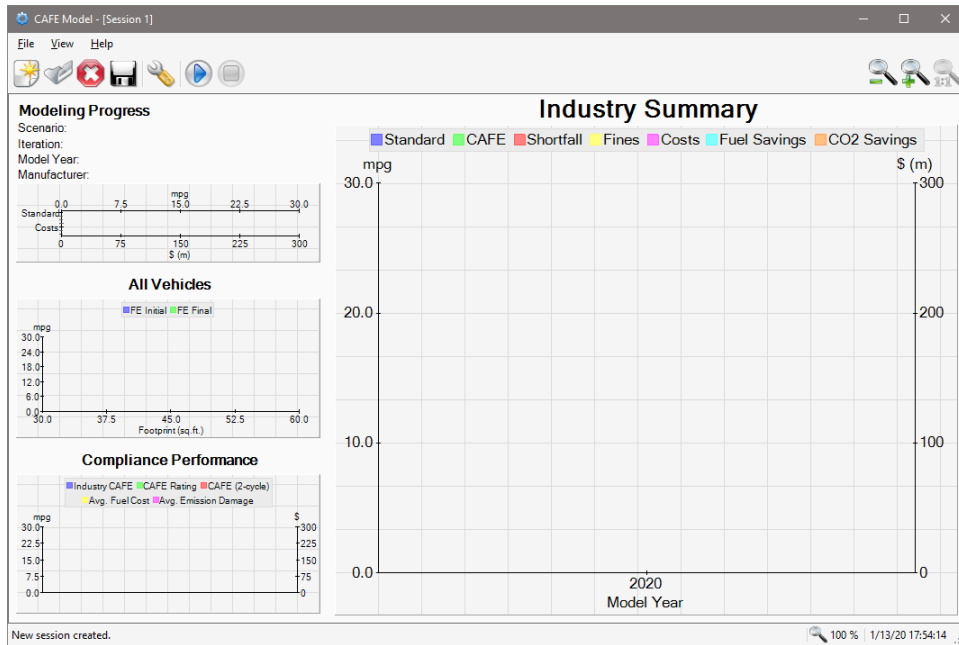

Figure 35. New Compliance Model Session Created

- Save the new session by selecting **File > Save Session As...** Enter “demo.cmsd” in the dialog box that appears, and click the **Save** button (Figure 36).<sup>72</sup>

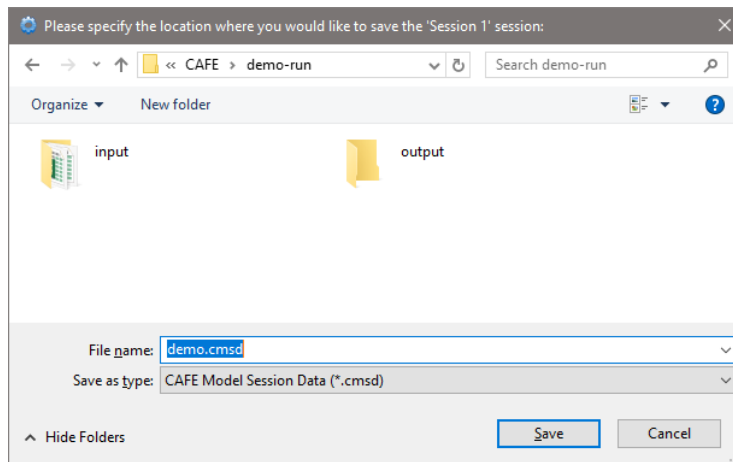

Figure 36. Save New Session

- After the session has been saved, notice the title of the session has changed to “demo” (Figure 37).

<sup>72</sup> Based on the user’s system configuration, the window in Figure 25 may look different.

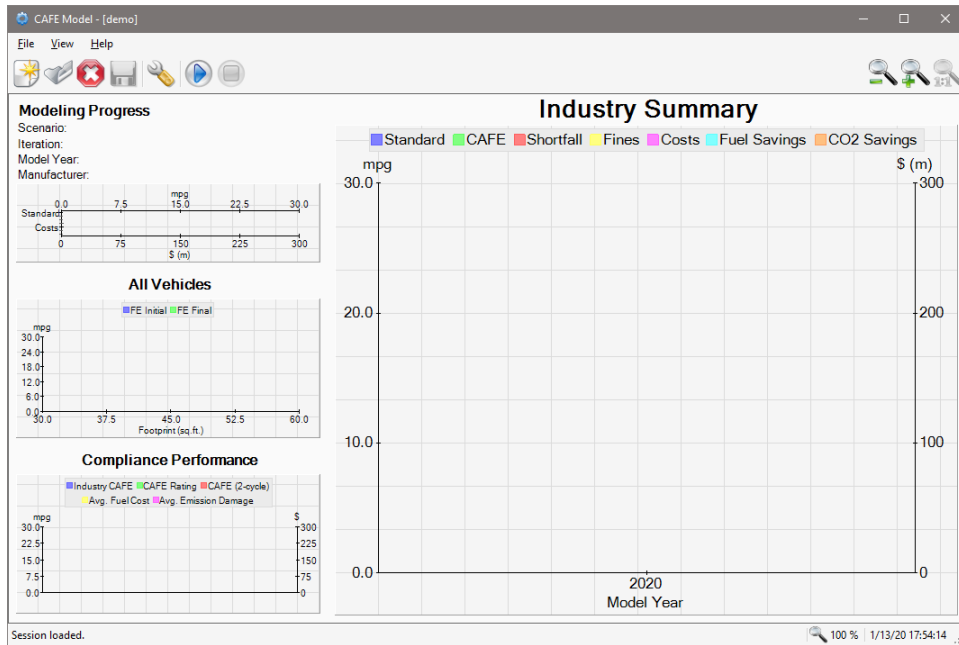

Figure 37. “demo” Session Saved

- Select **File > Start Modeling** to start the compliance modeling process. As the model runs, the progress of the *Compliance Model* is displayed in the **CAFE Model’s Session View** (Figure 38).

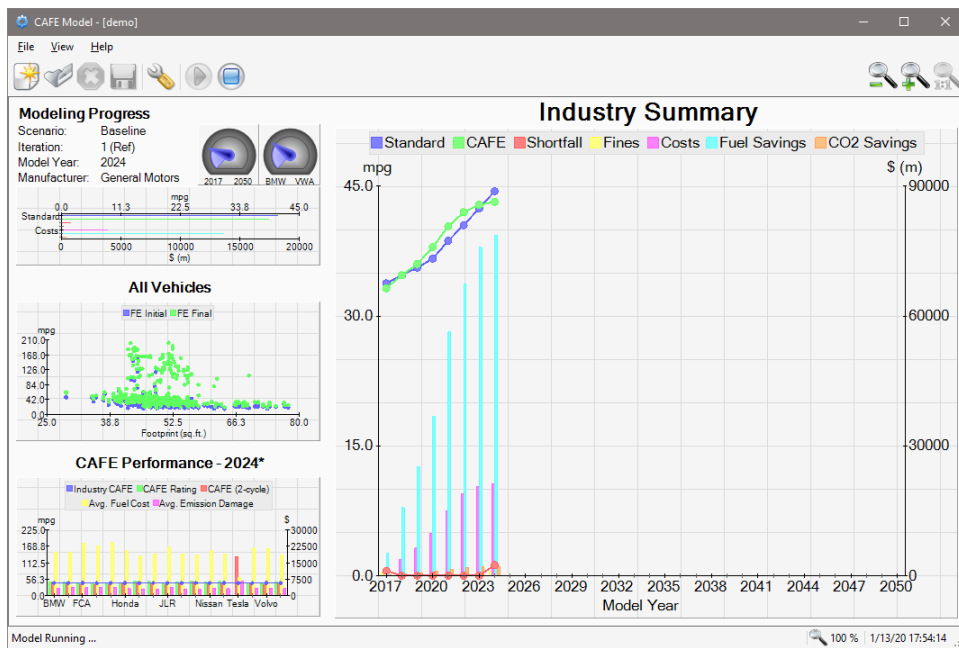

Figure 38. Modeling Progress from the Compliance Model

- After modeling has completed, the “Modeling Completed!” message appears at the bottom of the main **CAFE Model** window (Figure 39).

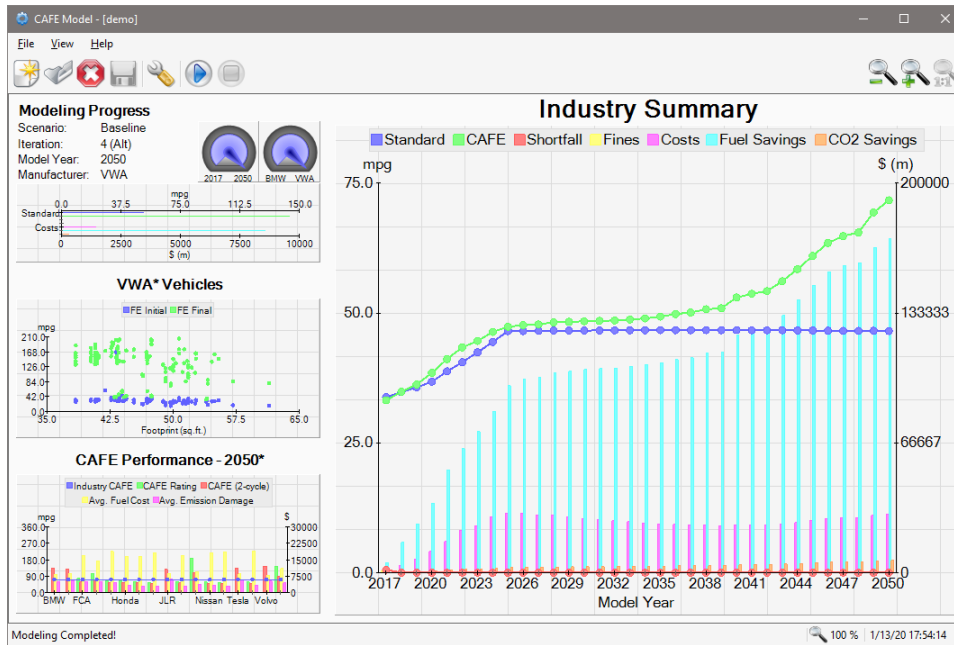

Figure 39. Compliance Model Completed

- Select **View > Output Location** to open Windows Explorer and browse to the location where model outputs for the “demo” session are saved.
- Close the session by selecting **File > Close Session**.
- Exit the **CAFE Model** by selecting **File > Exit**, or proceed to the next example.

### C.5.2 Example 2 – Configuring for “CO2 Compliance” Modeling

This example demonstrates how to take an existing session created in Example 1 – Configuring for Standard Compliance Modeling, and modify it to evaluate compliance with EPA’s CO<sub>2</sub> standards.

- Run the CAFE Model by clicking on the **CAFE Model** executable. Read through the **Warnings** dialog box, and then click the **OK** button. Wait for the main **CAFE Model** window to appear.
- Select **File > Open Session** to open an existing modeling session. Select “demo.cmsd” in the dialog box that appears, and click the **Open** button (Figure 40).<sup>73</sup>

<sup>73</sup> Based on the user’s system configuration, the window in Figure 29 may look different.

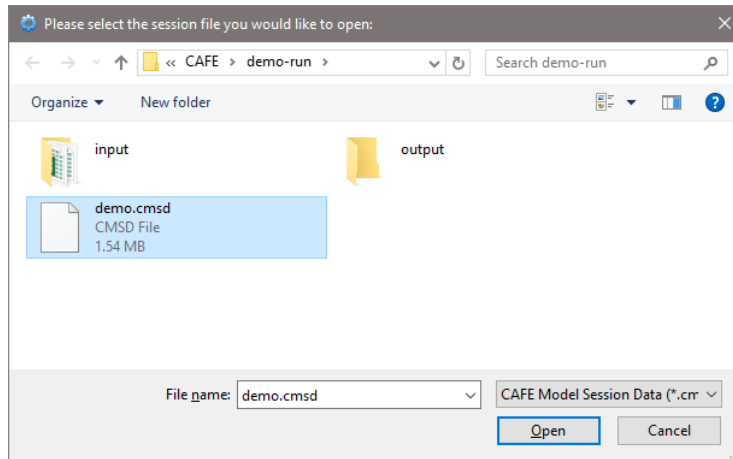

Figure 40. Open “demo” Session

- Once the session has been loaded, select **View > Modeling Settings** to bring up the **Modeling Settings** window.
- Click on the **Runtime Settings** panel and select the *CO-2* option from the *Compliance Program to Enforce* section as shown in Figure 41.

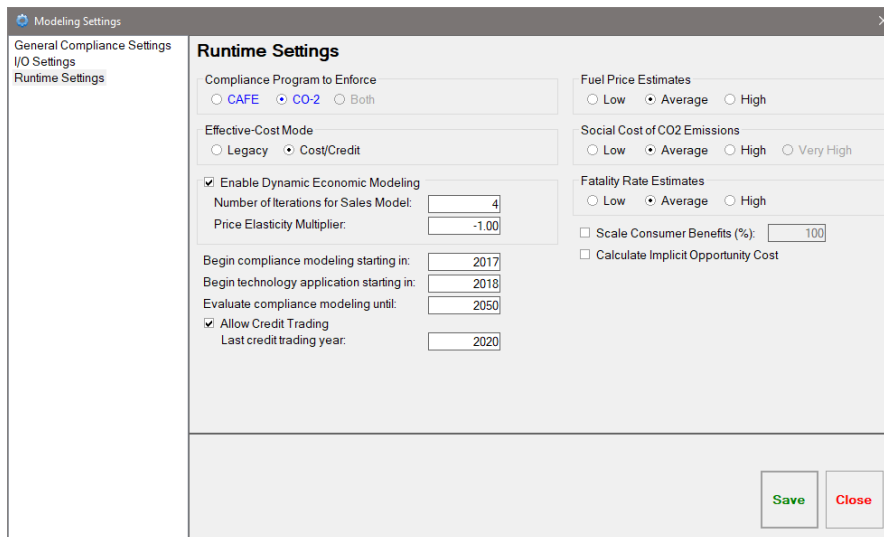
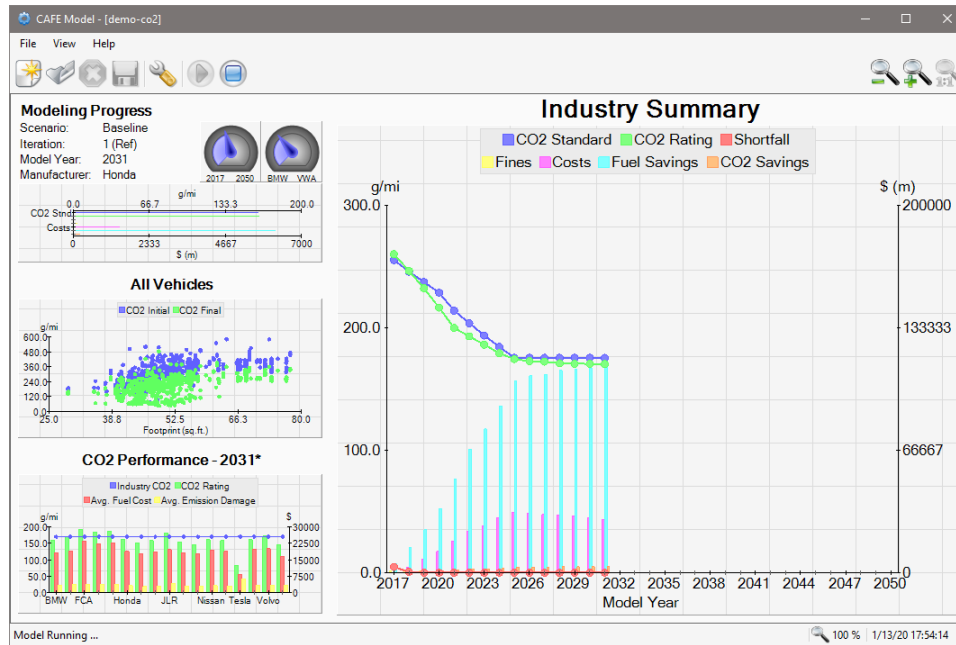

Figure 41. Enable Compliance with CO<sub>2</sub> Standards

- The rest of the panels are not used for this exercise.
- Click the **Save** button to save the updated modeling settings; then click **Close**, once saving completes.
- To prevent overwriting results from the “demo” session, select **File > Save Session As...** to save the modified session with a new name. For this example, the session was saved as “demo-co2.cmsd.”
- Select **File > Start Modeling** to start the modeling process. As the model runs, the progress of the *Compliance Model* is displayed in the **CAFE Model’s Session View**.

- Notice that the compliance-related information displayed in the model’s charts have changed from “CAFE” to “CO2” and the units have been updated from “mpg” to “g/mi” (Figure 42).



**Figure 42. Modeling Progress for Compliance with CO2 Standards**

- After modeling has completed, the “Modeling Completed!” message appears at the bottom of the main **CAFE Model** window.
- Select **File > Exit** to exit the model.

## C.6 Known Issues

The following outlines some of the known issues within the CAFE Model's user interface and provides possible workarounds. This list, however, is not comprehensive.

- If the user's DPI setting (also known as text scaling) is set to anything other than 100 percent, the contents of the **Warnings**, **Notice**, **GNU LGPL**, and **About** screens (accessible from the **Help** menu) may appear misaligned. This is especially prevalent for users with high resolution monitors.
- The description for the menu or toolbar item shown in the model's status bar may get "stuck" on rare occasions. To reset the status bar message, either open an existing session or close it if one is already opened. The "stuck" description should now disappear.
- The model may sometimes display minor visual artifacts when interacting with the charts in the model's **Session View**.

DOT HS 812 934  
March 2020



U.S. Department  
of Transportation  
**National Highway  
Traffic Safety  
Administration**

