

Application Guidelines

Copeland™ Condensing Units for Indoor Refrigeration Applications ZXDI Range



COPELAND™

EMERSON.

About these guidelines	1
1 Safety instructions	1
1.1 Icon explanation	1
1.2 Safety statements	1
1.3 General instructions	2
2 Product description	3
2.1 General information about Copeland™ ZXDI condensing units	3
2.2 EU Ecodesign Directive 2009/125/EC	3
2.3 Product range	3
2.4 Dimensions in mm	3
2.5 Product nameplate	4
2.6 Nomenclature	4
2.7 Application range	4
2.7.1 Qualified refrigerants and oils	4
2.7.2 Application limits	4
2.8 Bill of material	5
2.9 P&I diagram for ZXDI units	5
2.10 Main components description	6
2.10.1 Compressor	6
2.10.2 Condenser fans	6
2.10.3 Housing	7
2.11 XCM25D Electronic controller – Features	8
2.11.1 Description	8
2.11.2 Functionality	8
2.11.3 Main control & safety features	9
2.11.4 Additional features for customization	10
2.12 XCM25D Electronic controller – Programming	12
2.12.1 Programming the local display	12
2.12.2 Remote display CCM60	13
2.12.3 Single commands	14
2.12.4 Double commands – Entering programming level 1 "Pr1"	14
2.12.5 How to program the parameters (Pr1 and Pr2)	14
2.12.6 Entering programming level 2 "Pr2"	15
2.12.7 Fast access menu	15
2.13 Controller keyboard	15
2.13.1 How to lock the keyboard	15
2.13.2 How to unlock the keyboard	16
2.14 Parameters level 1 – Required settings	16
2.15 Digital operation	16

2.16	Reset to factory settings – Emerson "Hot Key"	17
2.16.1	How to save factory settings or user settings	17
2.16.2	Emerson "Hot Key" for ZXDI units with XCM25D controller	17
2.16.3	Location of the "Hot Key" plug connection on the XCM25D controller	18
2.16.4	How to program a "Hot Key" from the controller (upload)	18
2.16.5	How to program a controller using an Emerson "Hot Key" (download)	18
2.17	Troubleshooting – Alarm history	19
2.18	Compressor motor protection	19
2.19	System pressure protection	20
2.19.1	High-pressure safety switch	20
2.19.2	High pressure: pressure relief valve	20
2.19.3	Low-pressure safety switch – Optional	20
2.19.4	Ambient temperature sensor	20
2.20	Alarm output (DO5) of the XCM25D controller	20
2.21	Fan speed control – Ziehl-Abegg PKE-6 controller	20
3	Installation	22
3.1	Condensing unit handling	22
3.1.1	Transport and storage	22
3.1.2	Weights	22
3.2	Electrical connection	23
3.2.1	Power supply connections	23
3.2.2	Maximum operating currents for cable selection	23
3.2.3	Electrical wiring	23
3.2.4	Electrical protection standard (protection class)	23
3.2.5	Overload protection	23
3.3	Refrigeration piping connections	24
3.3.1	Refrigeration piping installation	24
3.3.2	Brazing recommendations	25
3.3.3	Brazing procedure	25
3.4	Location & fixings	26
3.5	Air ducts connection	27
4	Start-up & operation	28
4.1	Evacuation	28
4.2	Charging procedure	28
4.2.1	Refrigerant charging procedure	28
4.2.2	Oil charging procedure	29
4.2.3	Oil separator	29
4.3	Rotation direction of scroll compressors	29
4.4	Maximum compressor cycle	29
4.5	Checks before starting & during operation	30

5	Maintenance & repair	31
5.1	Replacing a compressor	31
5.2	Condenser fins	31
5.3	Electrical connections	31
5.4	Routine leak testing	32
5.5	Condenser fans & motors	32
6	Certification & approval	32
7	Dismantling & disposal.....	32
	DISCLAIMER	32
	Appendix 1: Overview of the ZXDI indoor unit components.....	33
	Appendix 2: Wiring diagram – ZXDI units (380-420 V / 3 Ph / 50 Hz).....	34
	Appendix 3: Parameter list level 1 (Pr1).....	35
	Appendix 4: Alarm menu.....	36
	Appendix 5: Additional features for customization.....	41
	Appendix 6: Temperature / resistance curve for B7 Sensor (customer option).....	43
	Appendix 7: List of tables and figures	44

About these guidelines

The purpose of these application guidelines is to provide guidance in the application of Copeland™ ZXDI condensing units. They are intended to answer the questions raised while designing, assembling and operating a system with these products.

Besides the support they provide, the instructions listed herein are also critical for the proper and safe functioning of the condensing units. The performance and reliability of the product may be impacted if the product is not used according to these guidelines or is misused.

These application guidelines cover stationary applications only. For mobile applications, contact Application Engineering as other considerations may apply.

1 Safety instructions







Copeland™ ZXDI condensing units for indoor refrigeration applications are manufactured according to the latest European safety standards. Particular emphasis has been placed on the user's safety.

These condensing units are intended for installation in machines and systems according to the Machinery directive MD 2006/42/EC. They may be put to service only if they have been installed in these systems according to instructions and conform to the corresponding provisions of legislation. For relevant standards please refer to the Manufacturer's Declaration, available at www.climate.emerson.com/en-gb.

These instructions should be retained throughout the lifetime of both the compressor and the condensing unit.

You are strongly advised to follow these safety instructions.

1.1 Icon explanation

 <p>WARNING This icon indicates instructions to avoid personal injury and material damage.</p>	 <p>WARNING This icon indicates operation with possible personal injury due to uncovered rotating parts.</p>
 <p>High voltage This icon indicates operations with a danger of electric shock.</p>	 <p>CAUTION This icon indicates instructions to avoid property damage and possible personal injury.</p>
 <p>Danger of burning or frost burn This icon indicates operations with a danger of burning or frost burn.</p>	 <p>IMPORTANT This icon indicates instructions to avoid malfunction of the compressor.</p>
 <p>Explosion hazard This icon indicates operations with a danger of explosion.</p>	<p>NOTE This word indicates a recommendation for easier operation.</p>

1.2 Safety statements

- Refrigerant compressors must be used in accordance with their intended use.
- Only qualified and authorized HVAC or refrigeration personnel are permitted to install, commission and maintain this equipment.
- Electrical connections must be made by qualified electrical personnel.
- All valid standards for connecting electrical and refrigeration equipment must be observed.
- The national legislation and regulations regarding personnel protection must be observed.



Use personal safety equipment. Safety goggles, gloves, protective clothing, safety boots and hard hats should be worn where necessary.

1.3 General instructions



WARNING

System breakdown! Personal injuries! Never install a system in the field and leave it unattended when it has no charge, a holding charge, or with the service valves closed without electrically locking out the system.

System breakdown! Personal injuries! Only approved refrigerants and refrigeration oils must be used.



WARNING

High shell temperature! Burning! Do not touch the compressor until it has cooled down. Ensure that other materials in the area of the compressor do not get in touch with it. Lock and mark accessible sections.



WARNING

Uncovered rotating parts! No safety grids on the condenser fans! Personal injuries! Never start the condensing unit or run the fans with no air ducts connected or without protective end-grids on the air outlets.



CAUTION

Overheating! Bearing damage! Do not operate compressors without refrigerant charge or without being connected to the system.



CAUTION

Contact with POE! Material damage! POE lubricant must be handled carefully and the proper protective equipment (gloves, eye protection, etc.) must be used at all times. POE must not come into contact with any surface or material that it might damage, including without limitation, certain polymers, eg, PVC/CPVC and polycarbonate.



IMPORTANT

Transit damage! Unit malfunction! Use original packaging. Avoid collisions and tilting.



IMPORTANT

This appliance is not designed to be accessible to the general public according to IEC 60335-2-40.

The contractor is responsible for the installation of the unit and should check the following points:

- Sufficient liquid sub-cooling in the line to the expansion valve(s) to avoid "flash-gas" in the liquid line;
- Sufficient amount of oil in the compressor (in case of long piping additional oil must be charged).

2 Product description

2.1 General information about Copeland™ ZXDI condensing units

Emerson has developed the Copeland™ ZXDI condensing unit for indoor applications to meet primarily the demands of the food retail and food service sectors. It is a refrigeration air-cooled condensing unit that uses the latest Copeland™ brand products patented scroll technology as the main driver and has electronic protection and diagnostics features built in the compact chassis. The combination of large condensers and low speed fans allows for particularly quiet operation.

2.2 EU Ecodesign Directive 2009/125/EC

The European Directive 2009/125/EC with regard to Ecodesign requirements for professional refrigerated storage cabinets, blast cabinets, condensing units and process chillers requires manufacturers to decrease the energy consumption of their products by establishing minimum energy efficiency standards. Copeland™ brand products condensing units are prepared and optimized to meet the requirements of the Ecodesign Directive. The integrated variable speed fan and condenser reduce the noise level and energy consumption significantly. This, combined with Copeland scroll technology, allows for high-efficiency operation.

For the rated cooling capacity, rated power input and rated COP value please refer to Copeland™ brand products Select software at www.climate.emerson.com/en-gb.

These guidelines meet the requirements of Regulation 2015/1095, Annex V, section 2(a), with regard to product information, namely:

- (v) → See chapter 2.7 "Application range"
- (vi) → See chapters 5.2 "Condenser fins" and 5.4 "Routine leak testing"
- (vii) → See chapters 2.11.3 "Main control & safety features" and 4.2 "Charging procedure"
- (viii) → See chapter 7 "Dismantling & disposal"

2.3 Product range

Copeland ZXDI condensing units are released for multiple refrigerants. They are available in one cabinet size and are equipped with two fans. They are designed for medium temperature refrigeration applications.

2.4 Dimensions in mm

The figures hereafter show the overall physical dimensions of the ZXDI indoor condensing units:

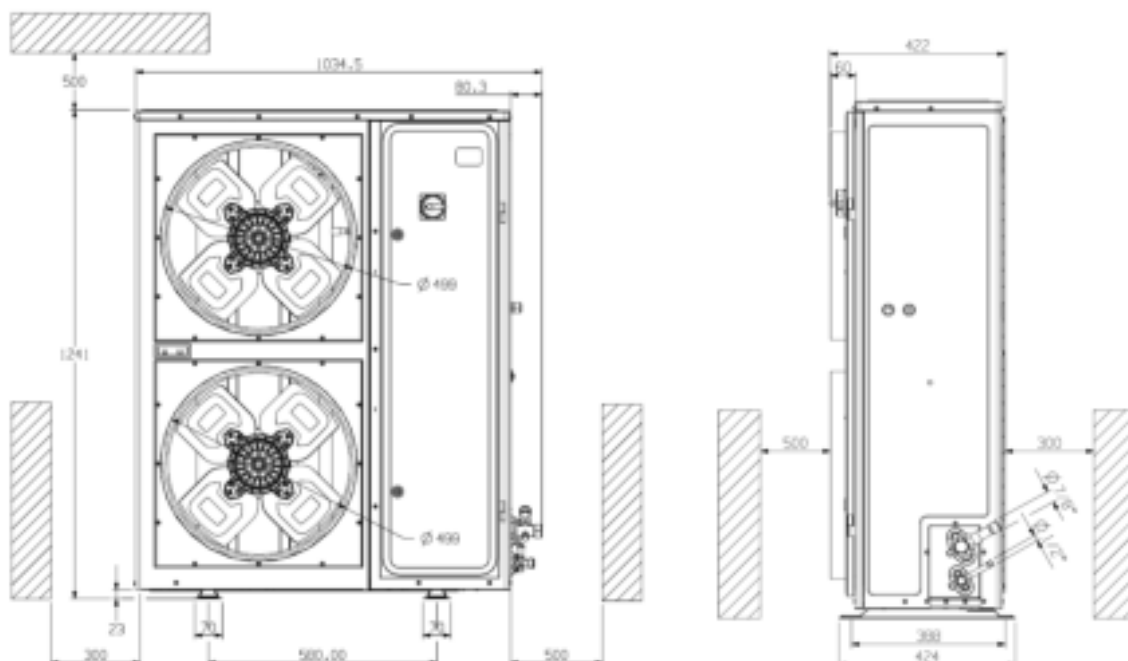

Figure 1: Dimensions of ZXDI condensing units (all models)

2.5 Product nameplate

The condensing unit nameplate shows model designation and serial number, as well as locked rotor amps, maximum operating current, safety pressures and weight.

The compressor has its own nameplate with all electrical characteristics.

2.6 Nomenclature

The model designation contains the following technical information about the condensing unit:

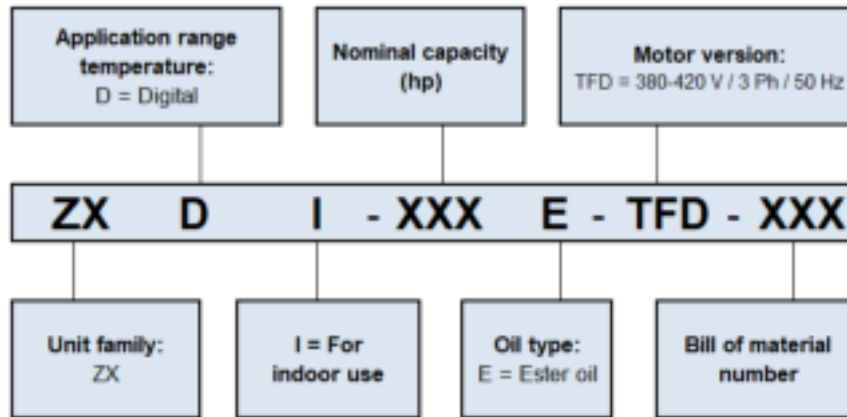

Figure 2: Nomenclature ZXDI units

2.7 Application range

2.7.1 Qualified refrigerants and oils

Qualified refrigerants	R404A, R407A, R407F, R448A, R449A R134a, R450A, R513A	
Qualified servicing oils	Emkarate RL 32 3MAF Mobil EAL Arctic 22CC	
Oil charge in litres	ZXDI040E	ZXDI050E ZXDI060E ZXDI075E
	1.36	1.89

Table 1: Qualified refrigerants and oils



WARNING

Use of R450A and R513A refrigerants! Risk of compressor damage!

Migration of R450A or R513A into the compressor crankcase could cause low oil viscosity, which could lead to compressor damage. When using R450A or R513A it is critical to meet the following requirements:

- maintain adequate superheat settings with a minimum superheat of 8-10 K;
- no liquid refrigerant migration into the compressor at any time, especially during standstill, during or after defrost, or after reverse mode for example in heat pumps;
- pump-down is not recommended;
- the use of a crankcase heater is mandatory;
- retrofit to R450A and R513A is only allowed for compressors which are approved for these refrigerants.

Contact your local Application Engineering representative for any further information.

NOTE: The ZXDI units are equipped with an oil separator. This separator is pre-charged with 0.5 liter of oil.

2.7.2 Application limits

For application envelopes, please refer to the compressor application envelopes which can be found in Copeland™ brand products Select software, available at www.climate.emerson.com/en-gb.

ZXDI indoor condensing units can be used at ambient temperatures from -15 to 45 °C. For lower ambient temperatures please contact your local Application Engineering representative.

2.8 Bill of material

BOM	Family	Introduction date	Controller concept	Oil separator	Suction accumulator
554	ZXDI	Jan 2018	XCM25D (Emerson - Dixell)	Yes	No

Table 2: BOM

2.9 P&I diagram for ZXDI units

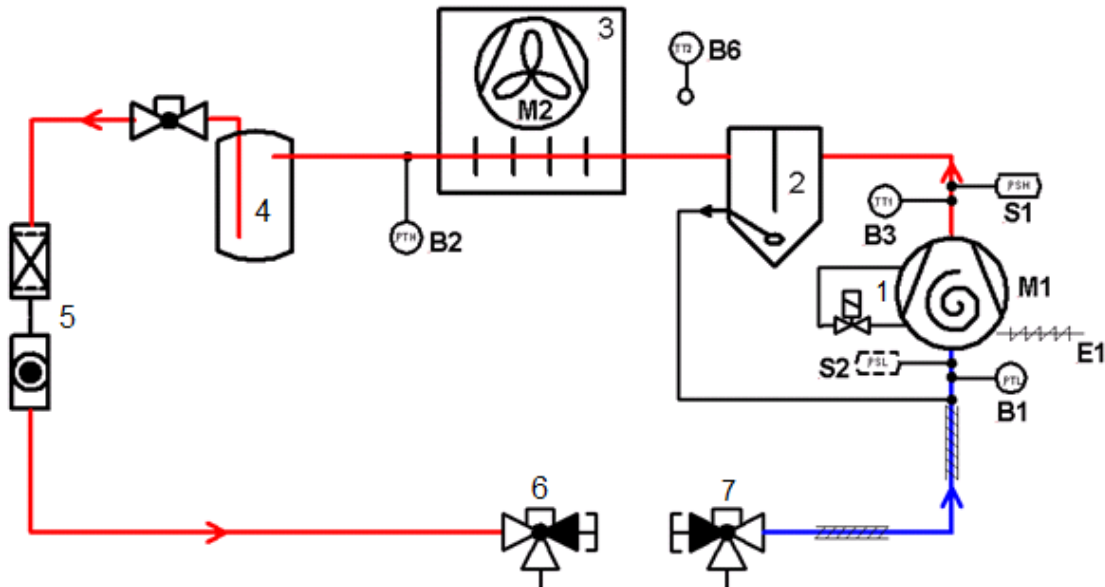

Figure 3: P&I diagram for ZXDI units

Position	Description	Comments	Fast access menu
1 (M1)	High-efficient Copeland scroll ZBD compressor		
2	Oil separator	Pre-charged with 0.5 L	
3 (M2)	Condenser with 2 fans		
4	Liquid receiver with service valve		
5	Filter drier / sight glass combination		
6	Service valve, liquid line		
7	Service valve, suction line		
PSL (S2)	Adjustable low-pressure switch (not factory mounted)	System safety (option)	
PSH (S1)	Non-adjustable high-pressure switch	System safety	
PTL (B1)	Pressure sensor, low pressure	Compressor setpoint	P1P
PTH (B2)	Pressure sensor, high pressure	Fan speed control	P2P
TT1 (B3)	Discharge temperature sensor	Compressor safety	P3t
TT2 (B6)	Ambient temperature sensor	Additional functions	P6t

Table 3: Legend of the P&I diagram for ZXDI units

2.10 Main components description

2.10.1 Compressor

Condensing unit	Compressor model (Digital)	Compressor LRA (A)	Compressor MOC* (A)	Unit rated current (A)
ZXDI040E	ZBD29KQE-TFD	48	7.9	11.3
ZXDI050E	ZBD38KQE-TFD	64	11.3	14.7
ZXDI060E	ZBD45KQE-TFD	74	11.4	14.8
ZXDI075E	ZBD48KQE-TFD	100	14	17.4

* MOC = Maximum Operating Current

Table 4: Cross-reference table units/compressor models

2.10.2 Condenser fans



WARNING

Uncovered rotating parts! No safety grids on the condenser fans! Person injuries! Never start the condensing unit or run the fans with no air duct connected or without protective end-grids on the air outlets.

The condensers of the ZXDI condensing units are equipped with single-phase fans.

Condensing unit	Nr. of fans (pcs)	Fan blade diameter (mm)	Weight per 1 fan (kg)	Maximum current @ 100 % per 1 fan (A)	Power consumption @ 100 % per 1 fan (W)
ZXDI040E	2	450	~12	1.7	375
ZXDI050E					
ZXDI060E					
ZXDI075E					

Table 5: Condenser fan technical data

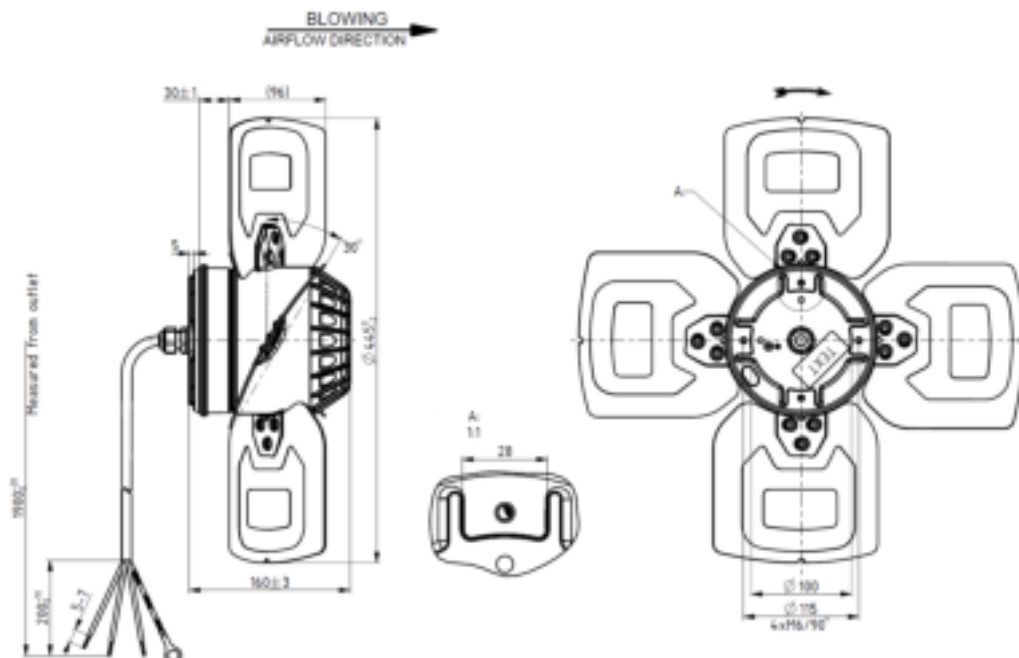

Figure 4: Fan details and dimensions

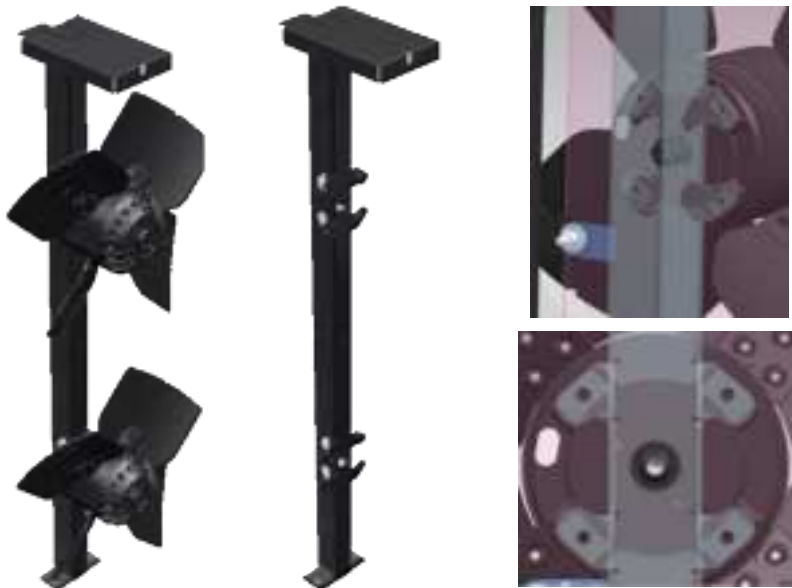

Figure 5: Fan bracket details

2.10.3 Housing

Copeland ZXDI indoor condensing units have the following housing features:

- Controller-window in front of the cabinet door. The window is IP54 and shows the current value of the electronic controller.
- The main power switch is installed on the cabinet door and allows to de-energize the unit without opening the door. To open the door the main power switch must be in off position.
- The quick-locks allow for easy and quick opening of the cabinet door by means of the cabinet key.
- The cabinet key is delivered with the unit. It is attached to one of the piping connections by means of a cable strap.

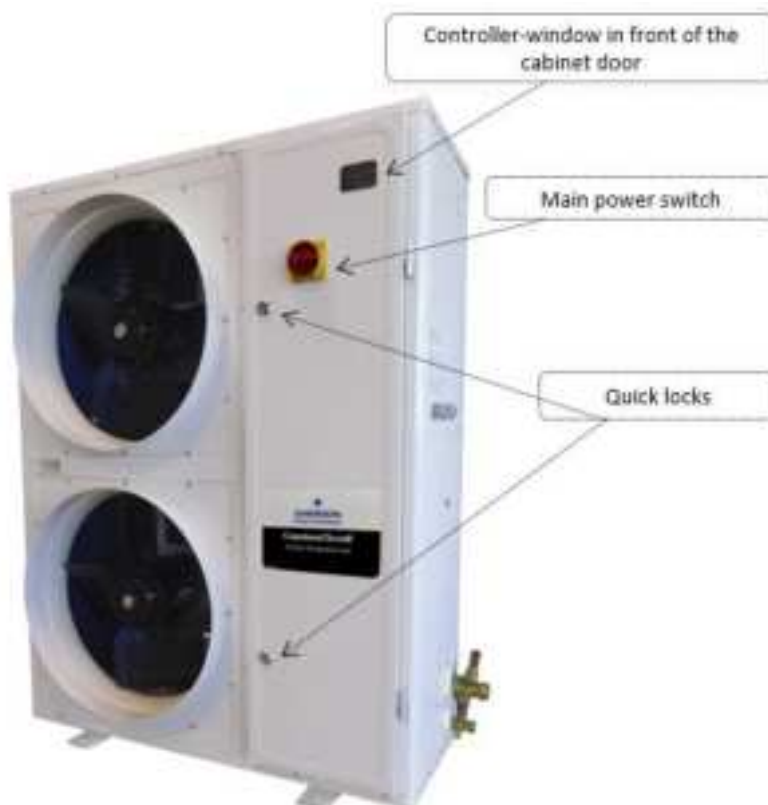

Figure 6: ZXDI unit housing

2.11 XCM25D Electronic controller – Features

The XCM25D controller is designed to be a powerful, flexible controller for use in multiple applications. It has been developed for ZXDI condensing units and allows the adjustment of all relevant parameters by the user.

2.11.1 Description



WARNING

Electrical shock hazard! Serious personal injuries! There are unused fast-on pins (C1 & DO2) on the XCM25D which could be under voltage. They are covered by insulated fast-on flags in the factory. Handle carefully when removing insulating flags during service on site.

The controller is designed for usage in an indoor refrigeration unit. It is rated to be used for the following environment:

- Outdoor controller ambient temperature for operation: -40 to 60 °C
- Ambient temperature for storage: -40 to 80 °C
- Maximum humidity: 90 % at 48 °C (non-condensing)
- Board power: 24 VAC + 15 % / - 20 %
- Voltage sensing capabilities: three phase, 200-240, 380-460, 575 VAC ± 10 %

The units of measure are selectable. The factory default unit is bar (always considered relative) for pressure and °C for temperature.



Figure 7: Electronic controller

2.11.2 Functionality

The controller allows for easy commissioning by the technician with the factory settings at the highest program level. It also offers the possibility to make substantial changes to the system optimization in further programming levels. Advanced functionality can also be activated.

The following functions are covered by the controller:

- Condensing unit control
- Condenser fan control
- Voltage and current sensing (compressor protection)
- Digital compressor control

NOTE: The XCM25D controller on ZXDI units includes all the functions necessary for unit control. For additional functionalities please contact your local Application Engineering representative.

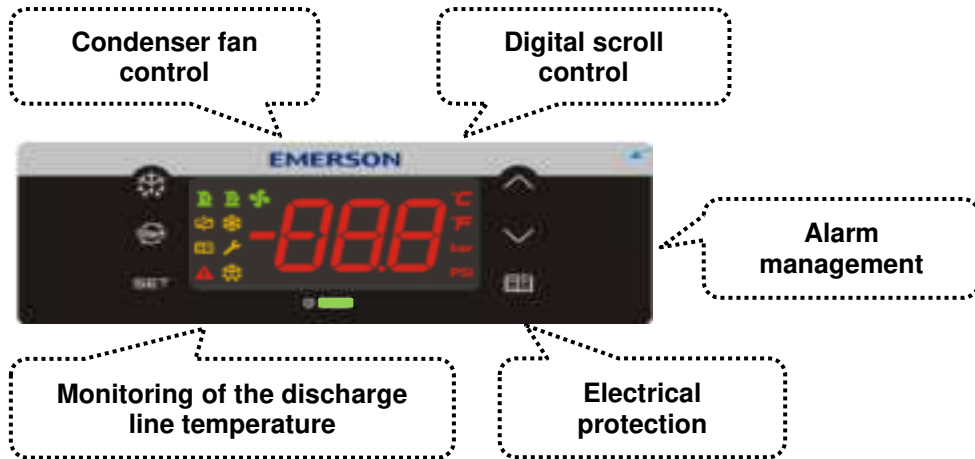

Figure 8: XCM25D controller functionality overview

2.11.3 Main control & safety features

Suction pressure control: Each unit is equipped with a suction pressure transmitter. The XCM25D controls the suction pressure by evaluating the input signal of the pressure transmitter. When using a digital unit (ZXDI), the setpoint (**C16/StC**) and proportional band (**C17/Pbd**) need to be adjusted. The signal of the suction pressure transmitter is also used for additional functionalities and to keep the compressor running within the approved envelopes.

Condensing pressure control: Each unit is equipped with a high-pressure transmitter. The XCM25D controls the condensing pressure by regulating the fan speed corresponding to the high-pressure transmitter signal. The output signal of the unit controller to the fan speed controller is a 0-10 V signal.

The unit controller can regulate the condensing pressure in two ways. The first approach is to keep a constant condensing temperature. This mode is utilized by the factory settings. The pre-adjusted setpoint is 27 °C as a universal setting. If lower condensing pressure is required set up the condenser setpoint (**E39/FSP**) to a lower value.

The second control way is fan modulation based on the compressor envelope. This mode of setpoint control is only available if a suction pressure input is not used. The parameter (**E38/FSM**) enables/disables the mode as needed. If this function is unused, the condensing temperature setpoint will be set as a parameter (**E39/FSP**) value. The compressor is allowed to run at minimum condensing temperatures based on the suction pressure of the compressor. This is the most energy-efficient way to minimize the condensing temperature as much as possible.

NOTE: The fan speed controller is a Ziehl-Abegg PKE-6 controller. For more information please refer to Chapter 2.21 "Fan speed control – Ziehl-Abegg PKE-6 controller" and to the fan speed controller user’s guide – part of the unit standard delivery.

Maximal condenser fans pressure difference: To provide the condenser with appropriate air flow the pressure drop for the fan must not exceed 60 Pa at 3500 m³/h per one fan. Additional components such as mufflers, flaps, protection grids, etc. must also be taken into account when designing the air ducts route as they will cause additional pressure drop.

The following table shows pressure drops at 3500 m³/h for most commonly used ducting components:

Spiral duct 500 mm	Ventilation bow 90°, 500 mm
1 Pa/m	10 Pa

Table 6

Example: If 8 meters spiral duct and 3 bows 90° are required on the installation, then

$$1 \text{ Pa} \times 8 + 10 \text{ Pa} \times 3 = 8 \text{ Pa} + 30 \text{ Pa} = 38 \text{ Pa}, \text{ so } \underline{38 \text{ Pa} < 60 \text{ Pa}}.$$

Compressor phase reversal: Ensures that the compressor keeps running in one direction only (clockwise = right rotation) – necessary for a compliant scroll compressor to compress and pump refrigerant. Reset is automatic once the phase rotation is correct for the compressor.

Motor current overload protection: This feature eliminates the need for external current protection for the compressor motor.

Fixed high-pressure switches: This is a non-adjustable protection device designed to prevent the compressor from operating outside of its safe high-pressure range. Reset is automatic for a set number of trips (7) then the unit will lock out and require manual restart. This feature is important to prevent the unit from cycling under these controls for a long period of time.

- Cut-out: 28.8 bar
- Cut-in: 24 bar

Adjustable high-pressure limitation: The unit controller provides the possibility to stop the unit at a required discharge pressure which is lower than the cut-out value of the fixed high-pressure switch. Detailed instructions can be found in chapter 2.11.4 "Additional features for customization" hereunder.

Discharge temperature protection: Each unit is equipped with a discharge line sensor (NTC). The XCM25D controller will stop the compressor if discharge temperatures reach unacceptable levels.

Adjustable low-pressure alarm: The unit controller features an adjustable low-pressure alarm managed by the suction pressure sensor. This alarm has been factory-set at 0.5 bar(rel), ie, the lowest permitted pressure of the refrigerant with the lowest pressure-vapour properties. If needed the user can modify this value according to the required application.

Option: Adjustable low-pressure switches PS1: This device protects the system against low-pressure operation. It must be adjusted depending on running conditions and potential special requirements like pump-down. The compressor envelopes published in Select must be respected at all times. In case of controller breakdown, the low-pressure switch could be used for emergency operation (rewiring required).

A crankcase heater is directly connected to the controller. The crankcase heater will be energized when the ambient sensor is below a given value (10 °C) and the compressor has been off for a period of time (5 minutes). The minimum off time does not apply at initial power-up.

In addition to the above, the ZXDI indoor condensing unit has the following features:

- Liquid line assembly (filter drier and sight glass/moisture indicator)
- Anti-corrosion treatment to the condenser fins

The electronic controller is also the base controller for the connection of many optional and customer supplied functions such as:

- Main load controller
- Evaporator fan contactor
- Superheat controller for one electronic expansion device

2.11.4 Additional features for customization

A lot of additional features are provided by the XCM25D controller. In the European design of the electrical panel a few of the additional functionalities are prearranged and can easily be installed by connecting additional hardware to the electrical terminals. The tables in **Appendix 5** show the parameters that have to be changed in case a special feature of the controller should be activated. The tables do not show the required settings which have to be done by the system operator, eg, choosing correct setpoints for different components and different applications.

NOTE: After programming an additional function, the system will have to be restarted. To engage system restart, switch off the main power supply, wait for 5 seconds and switch it on again.

Component	Description	Prearranged terminals / Wiring diagram
B12	Low-pressure switch, optional; can be ordered factory-installed.	Terminals: X1.2 / X1.7
Alarm contact	Sensor for evaporator or room	Terminals: X1.11 / X1.12
Sensor B7	Sensor for evaporator or room (NTC10kΩ)	Terminals: X1.13 / X1.14

Table 7: Prearranged additional connections

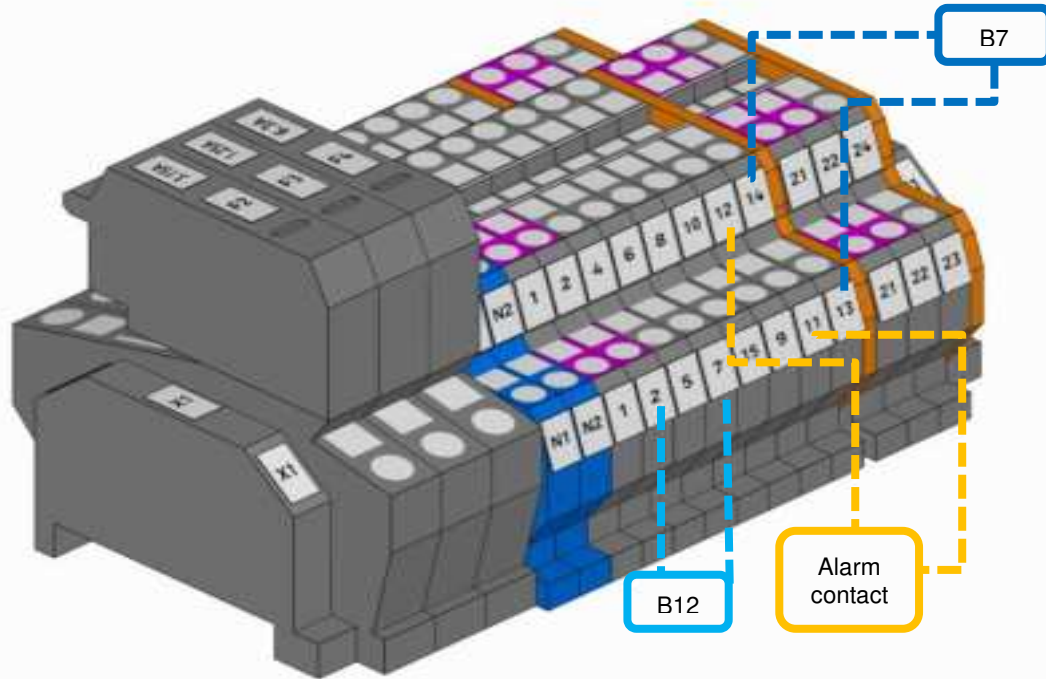

Figure 9: Prearranged additional connections

NOTE: Depending on the required functionalities additional components might be necessary. Please contact your local Application Engineering representative.

NOTE: Check the current limitations given by the controller relays.

NOTE: The solenoid valve function is not available on ZXDI indoor units.

Digital output	Specifications
DO1, DO2 and DO3	Relay SPDT 16A, 250V AC
DO3	Relay SPST 8A, 250V AC
DO4 and DO5	Relay SPST 5A, 250V AC

Table 8: Digital output specifications

Adjustable discharge pressure limitation

The controller has dedicated parameters to provide the possibility of adjustable discharge pressure cut-out.

Parameters		Description	Factory settings	Recommended settings
ZXDE	ZXDI			
E58	AU2	Condenser temperature/pressure threshold for high alarm	27	Required value
E61	AH2	Condenser temperature/pressure threshold for alarm recovery	23	Required value

Table 9: Discharge pressure limitations

Low ambient operation

Very low ambient temperatures can result in malfunction of expansion devices because of insufficient pressure difference. Therefore, pressure cut-out during system start-up can occur. For proper operation of the expansion devices, the unit running time must allow to build up sufficient condensing pressure.

At low ambient conditions, the compressor will need to run for a minimum period of time to allow the system pressures to stabilize. If the unit operates below a defined ambient temperature (ambient temp. < C12/LAO) or if the ambient sensor has failed, the compressor should run for a set period of time (C14/LAS) when it is started based on a low suction reading.

The unit will be turned on for the minimum run time when the low-pressure input is closed.

If the pressure drops below the cut-out value or the low-pressure input opens, the unit should continue to run for the remaining minimum on time (**C14/LAS**) or until a satisfactory condenser pressure is reached (**C13/LAd**).

If a suction pressure transducer is present and the suction pressure falls below a given value (**C15/LAT**) during the minimum on time (**C14/LAS**), then disregard the timer and shut the compressor off to protect against vacuum operation.

NOTE: For additional features please contact your local Application Engineering representative.

2.12 XCM25D Electronic controller – Programming



CAUTION

Low refrigerant charge! Compressor damage! Never energize the unit/controller without minimum refrigerant system charge. There is a risk of malfunction of the controller in deep vacuum operation which can cause compressor damage.

2.12.1 Programming the local display



Figure 10: Local display

LED	Mode	Function
	On	Compressor 1 enabled
	Flashing	Anti-short cycle delay enabled
	On	Condensing fans enabled
	On	Bar display
	Flashing	Programming mode
	On	PSI display
	Flashing	Programming mode
	On	When browsing the service menu
	Flashing	In fast access menu
	On	When browsing the alarm menu
	Flashing	A new alarm occurred
	On	An alarm is occurring
	On	Digital unloader solenoid On
	On	In defrost

Table 10: LED functions description

NOTE: By default, the local display will show the value of the suction pressure during operation. This can be changed by choosing another value for parameter B03/Lod (Remote Display visualization) – see Table 11.

Setting for B03/Lod	Value shown on the display	Comments
0	P1 value = Suction pressure	
1	P2 value = Mid-coil temperature (condenser)	
2	P3 value = Discharge line temperature	
3	P4 value = Vapour inlet EVI	Not applicable
4	P5 value = Vapour outlet EVI	Not applicable
5	P6 value = Ambient temperature	
6	P7 value = Not used in factory setting	
7	PEr value = Probe error	
8	Aou value = Analog output	

Table 11: Display visualisation

2.12.2 Remote display CCM60

The remote display CCM60 allows for remote monitoring and control of the XCM25D controller via cable. This device has the same interface as the unit controller therefore the commands and symbols are identical to those of the XCM25D controller. The remote display shall be mounted on a vertical panel, in a 29 x 71 mm hole, and secured using the special bracket supplied – see **Figure 11**.

The temperature range allowed for correct operation is 0 to +60 °C.

Avoid places subject to strong vibrations, corrosive gases, excessive dirt or humidity. Allow for air to circulate through the cooling holes.

When front-mounted, the remote display is IP65 rated.

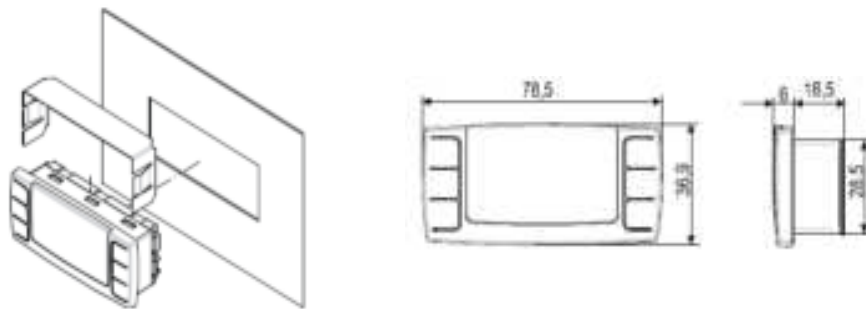

Figure 11: Remote display front panel mounting

The remote display is a proprietary bus of communication for Dixell HMI (x-rep, CCM60) interfaces. There are two connection terminals on the back of the remote display (+ and -).

NOTE: Emerson recommends using a shielded cable twisted pair 2 x 0.5 mm².

The device must be connected to the VNR-terminal on the unit controller according to the polarity. **Figure 12** shows the VNR terminal on the unit controller.



Figure 12: VNR connection for the remote display

Before connecting cables make sure the power supply complies with the hardware requirements. Separate the terminal cables from the power supply cables, the outputs and the power connections.

2.12.3 Single commands







	Press the SET button to display the target setpoint. In programming mode, this allows to select a parameter or to confirm an operation.
	Press the RESET button and hold for 5 seconds to reset any lockouts if the current state of the controller allows for it to be reset.
	(UP) To view the fast access menu. In programming mode, this browses the parameter codes or increases the displayed value.
	(DOWN) In programming mode, this browses the parameter codes or decreases the displayed value.
	(SERVICE) To enter the service and alarm menu.
	Hold for 3 seconds to start a manual defrost or terminate an active defrost.

Table 12: Single commands

2.12.4 Double commands – Entering programming level 1 "Pr1"



	Press simultaneously for about 3 seconds to lock (PoF) or unlock (Pon) the keyboard.
	Press simultaneously to leave the programming mode or menu. On submenus rtC and EEV this combination allows to go back to the previous level.
	Press simultaneously for about 3 seconds to access the first level of programming mode.

Table 13: Double commands

The device provides 2 programming levels:

- **Pr1** with direct access
- **Pr2** protected with a password (intended for experts)

2.12.5 How to program the parameters (Pr1 and Pr2)















Access pre-program level		Press simultaneously for about 3 seconds to access the pre-programming level. The message rtC (real-time clock) appears.
Access program level	 or 	Press the Up or Down key until the message Par appears.
Access Pr1		Press the SET button to enter the program level. First parameter appears.
Select item	 or 	Select the parameter or submenu using the arrows.
Show value		Press the SET button.
Modify	 or 	Use the arrows to modify the value.
Confirm and store		Press the SET button: the value will blink for 3 seconds, then the display will show the next parameter.
EXIT		Press simultaneously to exit the programming mode, or wait for 30 seconds (MTO) without pressing any key.





Table 14: Programming level 1 parameters

When entering the programming level for the first time the display will show the **rtC** (real-time clock) label.

- Press  to access parameters N01/02/03/04/05 (Min/Hr/MdY/Mon/YEr) to adjust time & date. For further details, see Chapter 2.14, "Parameters level 1 – Required settings".
- Press  or  to change from the **rtC** label to the **Par** label, in order to access programming level 1.
- Press : the parameters of programming level 1 can be changed.

2.12.6 Entering programming level 2 "Pr2"

To enter the Pr2 programming menu:

- Press  +  simultaneously for 3 seconds. The first parameter label will be displayed.
- Press  till the **T18** label is displayed, then press the **SET** key;
- The blinking **PaS** label will be displayed; wait for a few seconds;
- The display will show "0 - -" with blinking 0: insert the password [321] using the  and  keys and confirming with the **SET** key.

2.12.7 Fast access menu

This menu contains the list of probes and some values that are automatically evaluated by the board such as the superheat and the percentage of valve opening. **nP** or **noP** stands for "probe not present" or "value not evaluated", **Err** means "value out of range", "probe damaged, not connected or incorrectly configured".







Entering fast access menu		Press and release the UP arrow. The duration of the menu in case of inactivity is 3 minutes. The values that will be displayed depend on the configuration of the board.
Use the  or  arrow to select an entry, then press SET to see the value or to go on with another value.		<ul style="list-style-type: none"> ▪ P1P: Pressure value of the P1 probe (suction pressure) ▪ P2t: Temperature value of the P2 probe (not valid) ▪ P2P: Pressure value of the P2 probe (discharge pressure) ▪ P3t: Temperature value of the P3 probe (discharge line temperature) ▪ P4t: Temperature value of the P4 probe (not applicable) ▪ P5t: Temperature value of the P5 probe (not applicable) ▪ P6t: Temperature value of the P6 probe (ambient temperature) ▪ P7t: Temperature value of the P7 probe (free) ▪ SH: Value of superheat. nA = not available ▪ oPP: Percentage of step valve opening. ▪ SETd: Value of the dynamic setpoint (condenser fan SET). This information is available only if the dynamic setpoint function is enabled. ▪ AOO: Percentage of the analog output (0-10 V or TRIAC PWM Mod.). This information is available only if the 0-10 V or TRIAC PWM Mod. is enabled. ▪ dStO: Percentage of the PWM output driving the valve of the digital scroll compressor. ▪ L^ot: Minimum room temperature ▪ H^ot: Maximum room temperature ▪ HM: Menu ▪ tU1: Voltage reading V1 (not valid in standard configuration) ▪ tU2: Voltage reading V2 (not valid in standard configuration) ▪ tU3: Voltage reading V3 (not valid in standard configuration) ▪ tA1: Current reading I1 ▪ tA2: Current reading I2
Exit	 + 	Press simultaneously or wait for the timeout of about 60 seconds



Table 15: Fast access menu

2.13 Controller keyboard

2.13.1 How to lock the keyboard

Keep the  and  keys pressed simultaneously for more than 3 seconds. The "**PoF**" message will be displayed and the keyboard will be locked. At this point it is only possible to see the setpoint or the maximum or minimum temperatures stored. If a key is pressed for more than 3 seconds, the "**PoF**" message will be displayed.

2.13.2 How to unlock the keyboard

Keep the  and  keys pressed simultaneously for more than 3 seconds, till the "Pon" message is displayed.

2.14 Parameters level 1 – Required settings

The XCM25D is preconfigured to reduce the required settings on job-site to a minimum. In most cases it will not be necessary to enter programming level 2 "Pr2". **Table 16** gives an overview of the parameters available in programming level 1 "Pr1".

NOTE: When changing parameter C05 (LS) a reset of the controller (interruption of power supply) is required.

Parameters		Description	Unit	Factory setting	Comments
ZXDE	ZXDI				
C07	rEF	Refrigerant selection for regulation	-	R404A	R134a, R404A, R407A, R407F, R448A, R449A, R450A, R513A
C16	StC	Digital compressor setpoint	bar	3.3	
C17	Pbd	Proportional band for compressor regulation	bar	2.0	
C21	tdG	Cycle time for digital compressor	sec	10	
C24	PMi	Minimum capacity for digital compressor	%	20	
C25	PMA	Maximum capacity for digital compressor	%	100	
D29	LPA	Low-pressure alarm value	bar	0.5	
E39	FSP	Condenser setpoint	°C	35.0	
E46	Fbd	Regulation band of variable fan	°C	10.0	
N01	Min	Current minute	-	-	
N02	Hr	Current hour	-	-	
N03	MdY	Day of the month	-	-	
N04	Mon	Month	-	-	
N05	YEr	Year	-	-	
T18	PAS	Access to Pr2 level	-	-	Password: 3 2 1

Table 16: Parameters in programming level Pr1

NOTE: The full list of parameters in programming level "Pr2" can be found Technical Information TI_Unit_ZXDI_01 "Copeland™ ZXDI Condensing Units for Indoor Refrigeration Applications – XCM25D Controller Parameter List".

2.15 Digital operation

A digital unit is able to operate in a part-load mode. Part-load operation is achieved by loading and unloading of the digital scroll compressor for certain periods of time (time cycles). The cycle of time can be chosen between 10 and 30 seconds. Example: if the time cycle is 20 seconds at 50 % of capacity request, the compressor will run for 10 seconds loaded and 10 seconds unloaded.

The regulation starts when the suction pressure (AI1) increases and reaches the value $(SP-PB/2+(PB*PMI)/100)$ or $(StC-Pbd/2+(Pbd*PMI)/100)$. Within the adjustment range $(SP-PB/2\sim SP+PB/2)$ or $(StC-Pbd/2 \sim StC+Pbd/2)$ the digital scroll compressor is activated in PWM mode in accordance with the value of the control variable.

When the pressure is higher than $(SP+PB/2)$ or $(StC+Pbd/2)$ then the TRIAC output is at maximum capacity. When the pressure is lower than $(SP+PB/2)$ or $(StC+Pbd/2)$ but higher than $(SP-PB/2)$ the digital scroll compressor modulates the capacity according to the proportional band. If the pressure is lower than $(SP-PB/2)/ (StC-Pbd/2)$ the digital scroll compressor switches off.

For proper commissioning of the digital unit the following diagram must be considered:

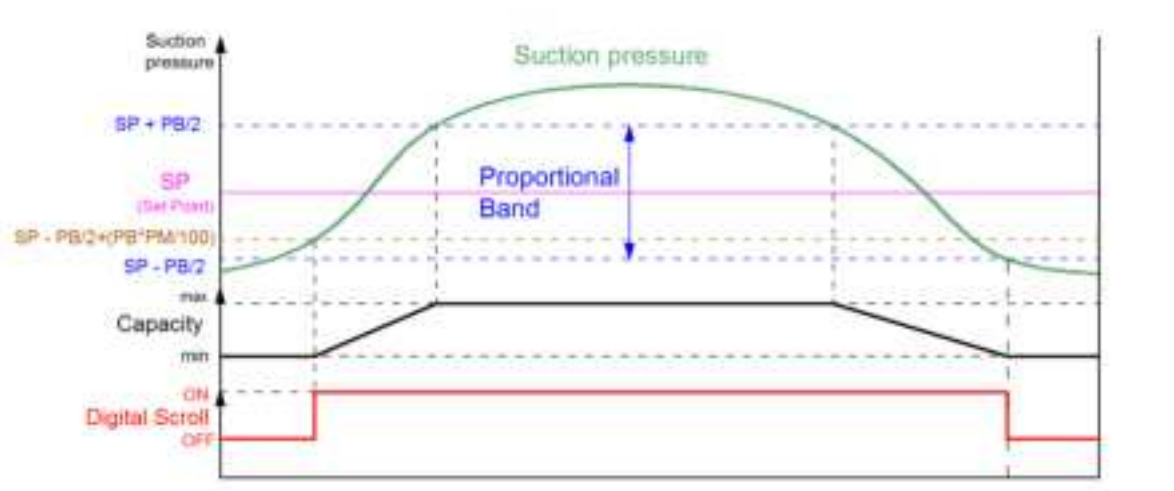

Figure 13: Digital operation

NOTE: When the digital valve on the compressor is discharged, the compressor is loaded.

NOTE: At start-up, the valve is energized for C20/Sut start-up time, ie, interval time with the digital valve energized before regulation starts. It ranges from 0 to 10 seconds.

2.16 Reset to factory settings – Emerson "Hot Key"

2.16.1 How to save factory settings or user settings

There is no way to reset the XCM25D controller to factory settings other than with additional equipment. Emerson recommends using the Emerson "Hot Key" (not part of the standard delivery) to save the factory settings at initial power up. The same hot key can also be used to save user settings.

Thanks to a special programming software (Emerson Wizmate) and corresponding hardware (Emerson Prog-Tool), the user can:

- pre-program hot keys
- copy hot keys
- change parameter levels
- compare parameter lists

For further information please visit our website at www.climate.emerson.com/en-gb or contact your local Application Engineering representative.

2.16.2 Emerson "Hot Key" for ZXDI units with XCM25D controller

The Emerson "Hot Key" **DK00000300** can be used for uploading and downloading of parameter lists. Copeland ident number 3226456.



Figure 14: Emerson "Hot Key"

2.16.3 Location of the "Hot Key" plug connection on the XCM25D controller

The "Hot Key" plug connection is located on the upper left corner of the XCM25D.

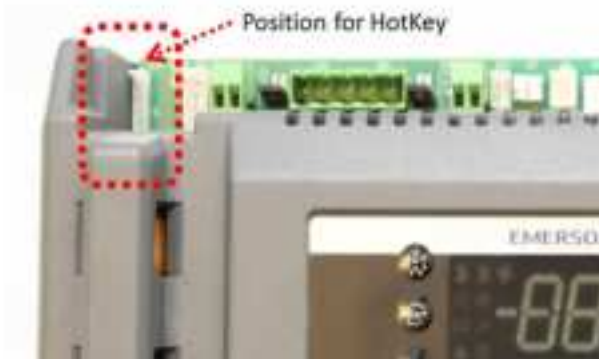

Figure 15: Location of "Hot Key" plug connection

2.16.4 How to program a "Hot Key" from the controller (upload)

- Program the controller with the front keypad.
- When the controller is on, insert the "Hot Key" and press the **UP** key; the "**uPL**" message appears followed a by a flashing "**End**" label.
- Press the **SET** key and the "**End**" label will stop flashing.
- Turn the controller off, remove the "Hot Key" and then turn it on again.

NOTE: The "Err" message appears in case of a failed programming operation. In this case push the key again if you want to restart the upload or remove the "Hot Key" to abort the operation.

2.16.5 How to program a controller using an Emerson "Hot Key" (download)

- Turn the controller off.
- Insert a pre-programmed "Hot Key" into the 5-pin receptacle and turn the controller on.
- The parameter list of the hot key will be automatically downloaded into the controller memory. The "**doL**" message will blink followed a by a flashing "**End**" label.
- After 10 seconds the controller will restart working with the new parameters.
- Remove the "Hot Key".

NOTE: The message "Err" is displayed in case of a failed programming operation. In this case turn the unit off, then on again if you want to restart the download, or remove the "Hot Key" to abort the operation.

2.17 Troubleshooting – Alarm history

The controller records the total number of alarm activations (max 50) in the alarm menu – see **Appendix 4**.

Action	Key or display	Notes
Enter menu		Push and release the ALR key.
Waiting for action	SEC	The menu to change the section will be entered. The alarm list section is active.
Enter section list		Press SET to confirm. The following list will be available to select the proper network function.
Select active alarm code from list	 or 	Scroll the list of active alarms by alarm number (letter + number, A01-A50). Press to see the alarm name or code. Press to see the next active alarm.
Select the alarm to see the detailed rtC information		Enter the sub menu with alarm time details.
Select detailed information from active alarm list	 or 	<p><u>With the rtC activated:</u> The Hur (hour) parameter is displayed. Press to see the alarm hour. Press : Min is displayed. Press to see the alarm minute. Press : dAy is displayed. Press to see the alarm day. Press : MOn is displayed. Press to see the alarm month. Press : YEA is displayed. Press to see the alarm year.</p> <p><u>NOTE:</u> The clock info indicates the START time of the alarm.</p> <p><u>Without the rtC activated:</u> The COn (hours) parameter is displayed. Press to see the compressor working hours.</p> <p>To exit: press or wait for 15 seconds without pressing any key.</p>
Exit menu		Press + simultaneously or wait for about 10 seconds without pressing any key.

Table 17: How to check the alarm list

2.18 Compressor motor protection

The electronic controller protects the compressor motor against the following:

- over current
- phase loss
- incorrect phase rotation
- voltage imbalance

If the compressor motor current exceeds a predefined (non-adjustable) current limit, the electronic controller shuts the unit down and generates an error signal. For this function two of the main phase supply lines to the compressor (compressor via the contactor) are routed through the current sensors.

2.19 System pressure protection

2.19.1 High-pressure safety switch

A high-pressure switch is registered by the electronic board. The sensing device is a non-adjustable, high-pressure switch that will open in the event of an abnormally high discharge pressure (cut-out 28.8 bar).

- The unit will stop then and restart automatically after a 5-minute delay and after unit pressure has decreased to 24 bar.
- After 7 successive high-pressure cut-outs over 1 hour, the unit will lock out. In this case a manual reset will be necessary.

2.19.2 High pressure: pressure relief valve

There is a connection port sideways on the top of the unit liquid receiver for a pressure relief valve. A 3/8"-NPT connection is used. The pressure relief valve is not factory-assembled.

2.19.3 Low-pressure safety switch – Optional

In a way similar to the high-pressure sensor, the electronic controller registers the switching action of the adjustable low-pressure switch, which will open in the event of an abnormally low suction pressure:

- The unit will stop then restart automatically after a 3-minute delay and when the unit reaches the cut-in pressure level.

The unit is always equipped with a suction pressure transmitter which also takes care for protection against vacuum operation. The use of the optional low-pressure cut-out will provide the highest protection level for the unit. In rare instances of controller breakdown, the optional low-pressure switch would allow to run the unit in emergency mode.

2.19.4 Ambient temperature sensor

An ambient temperature sensor supplied by Emerson is connected to the electronic controller. This temperature sensor has several functionalities like emergency mode control, lower fan speed limitation and crankcase heater control. The sensor is located at the housing on the backside of the compressor compartment.

2.20 Alarm output (DO5) of the XCM25D controller

The digital output **DO5** is pre-configured as an alarm contact. The relay (max. 5 A, 250 VAC) is activated in case of alarms and lock-outs. Warnings will be shown only on the controller display.

2.21 Fan speed control – Ziehl-Abegg PKE-6 controller

The PKE-6 controller is used for continuous speed control adjustment on the variable voltage motor of the fan. The electrical protection class of the controller is IP54.

The output signal of the unit controller XCM25D to the fan speed controller PKE-6 is a 0-10 V digital signal. It has two main functions: fan speed control and temperature/pressure control of the condenser.

The fan speed factory setting is 100 %.

Depending on the characteristics of the connected air ducts, eg, presence of elbows, reductions, grids, and the level of noise produced, the fan speed can be adjusted to an appropriate value considering the expected unit performance and sound level.

A 10 µF start capacitor is required for each fan.

Fan speed	U (V)	N (rpm)	Pe (W)	Airflow (m³/h)
100 %	230	1390	375	5352
98 %	206	1360	373	5237
95 %	190	1320	368	5083
87 %	170	1210	361	4659
71 %	150	985	332	3793
51 %	130	709	257	2730
37 %	110	514	178	1979

Table 18: Fan data based on changing frequency/fan speed



Figure 16: PKE-6 Fan speed controller details and dimensions

NOTE: For more information about the fan speed controller and possible adjustments, please refer to the fan speed controller user's guide – part of the unit standard delivery.

3 Installation



WARNING

High pressure! Injury to skin and eyes possible! Be careful when opening connections on a pressurized item.

Copeland ZXDI indoor condensing units are delivered with a holding charge of neutral gas.

The condensing unit should to be installed in a closed machine room. Soundproofing the machine room is highly recommended because of a potentially high sound production. The room characteristics must also be taken into account.

It is important to prevent any dirt, dust, plastic bags, leaves or papers from entering the air ducts and covering or blocking the condenser and its fins. Proper protective end-grids should be used for this purpose.

A clogged condenser will increase the condensing temperature, thus reducing the cooling capacity, which could lead to a high-pressure switch tripping. Clean the condenser fins on a regular basis.

The unit must be installed in such a way that the airflow through the connected air ducts is not restricted. The incoming air flow must be sufficient to cover the entire air needs of the unit.

3.1 Condensing unit handling

3.1.1 Transport and storage



WARNING

Risk of collapse! Personal injuries! Move units only with appropriate mechanical or handling equipment according to weight. Keep in the upright position. Respect stacking loads according to **Figure 17**. Do not stack anything on top of the unit packaging. Keep the packaging dry at all times.



Respect the maximum number of identical packages which may be stacked on one another, where "n" is the limiting number:

- **Transport: n = 1**
- **Storage: n = 1**

Figure 17: Maximum stacking loads for transport and storage

3.1.2 Weights

Condensing unit	Net weight* (kg)	Gross weight** (kg)
ZXDI040E	138	154
ZXDI050E	142	158
ZXDI060E	146	162
ZXDI075E	152	168

* Product without packaging

** Product including packaging

Table 19: Weights

3.2 Electrical connection

3.2.1 Power supply connections



WARNING

Electrical shock hazard! Serious personal injuries! There are unused fast-pins (**C1** & **DO2**) on the XCM25D which could be under voltage. They are covered by insulated fast-on flags in the factory. Handle carefully when removing insulation flags during service on site.

Copeland ZXDI indoor condensing units are designed for a 380-420 V / 3 Ph / 50 Hz power supply. A voltage tolerance of $\pm 10\%$ is acceptable.

The electrical connection of the condensing unit to the power supply must be made by qualified technicians according to the valid electrical directives, for instance DIN EN 60204-1. The voltage drop and the temperatures on line must also be considered for cable selection.

The circuit breaker must be switched off before opening the front door.

3.2.2 Maximum operating currents for cable selection

Condensing unit	Locked rotor	Rated unit current*
ZXDI040E-TFD	48	11.3 A
ZXDI050E-TFD	64	14.7 A
ZXDI060E-TFD	74	14.8 A
ZXDI075E-TFD	100	17.4 A

* At nominal voltage of 400 V

Table 20: Maximum operating currents for cable selection

3.2.3 Electrical wiring

Before commissioning, ensure that the neutral "N" and ground protection "PE" wires are connected to the main switch.

3.2.4 Electrical protection standard (protection class)

- Units: IP class IPX4.
- Scroll compressors: IP21 according to IEC 34.
- Fan: IP44 according to IEC 34.
- Solenoid valve coils: IP65 according to DIN 43650.

3.2.5 Overload protection



WARNING

Isolating switch "On"! Danger of electric shock! Before any intervention on the overload compressor protection, turn off the isolating switch to de-energize the unit.



Figure 18: Main switch & overload protection
AGL_Unit_ZXDI_E_Rev02

Condensing unit	Overload setting compressor MOC*	Overload range
ZXDI-040E-TFD	7.9 A	6 – 10 A
ZXDI-050E-TFD	11.3 A	9 – 14 A
ZXDI-060E-TFD	11.4 A	9 – 14 A
ZXDI-075E-TFD	14 A	13 – 18 A

* MOC = Maximum Operating Current

Table 21: Overload protection details

3.3 Refrigeration piping connections

3.3.1 Refrigeration piping installation



WARNING

High pressure! Risk of personal injury! The units are pressurized with dry air. Be careful when opening connections on a pressurized item.

IMPORTANT

Tube quality! Installation contamination! All interconnecting piping should be of refrigeration grade, clean, dehydrated and must remain capped at both ends until installation. Even during installation, if the system is left for any reasonable period of time, eg, 2 hours, pipes should be re-capped to prevent moisture and contaminant from entering the system.

Connection sizes! Unsuitable refrigerant flow rate! Do not assume that the service connection sizes on the unit (at the service valves) are in fact the correct size to run your interconnecting refrigeration pipes. The service valve sizes have been selected for convenience of installation and in some cases (larger units) these may be considered too small. However, for the very short pipe run within our units these service connection sizes are adequate. All interconnecting piping should be sized to satisfy the duty required.

The pipe should be sized to ensure optimum performance and good oil return. The sizing must also take into account the full capacity range through which this particular unit will need to operate.

Pipe runs should be kept as short as possible, using the minimum number of directional changes. Use large radius bends and avoid trapping of oil and refrigerant. This is particularly important for the suction line. The suction line should ideally slope gently towards the unit. Recommendation slope is 1/200 to 1/250. Upper and lower oil traps, double risers and reduced pipe diameters may be required for suction lines where long vertical risers cannot be avoided.

All pipes should be adequately supported to prevent sagging which can create oil traps. The recommended pipe clamp support distance is shown in **Table 22** below:

Tube size	Max distance between 2 clamp supports
12.7 mm (1/2 inch)	1.20 m
16.0 mm (5/8 inch)	1.50 m
22.0 mm (7/8 inch)	1.85 m
28.5 mm (1 1/8 inch)	2.20 m

Table 22: Maximum distance between 2 clamp supports

3.3.2 Brazing recommendations

IMPORTANT

Blockage! Compressor breakdown! Maintain a flow of oxygen-free nitrogen through the system at very low pressure during brazing. Nitrogen displaces the air and prevents the formation of copper oxides in the system. If allowed to form, the copper oxide material can later be swept through the system and block screens such as those protecting capillary tubes, thermal expansion valves, and accumulator oil return holes.

Contamination or moisture! Bearing failure! Do not remove the plugs until the compressor is set into the unit. This minimises any entry of contaminants and moisture.

- Remove the discharge connection cap.
- Remove the suction connection cap.
- Open both valves mid-way. Care should be taken to avoid the holding charge releasing too quickly.
- Be sure tube fitting inner surface and tube outer surface are clean prior to assembly.
- Both tubes are extended from the condensing unit housing, therefore we recommend to isolate the housing by using a wet cloth on the copper tubing.
- Recommended brazing materials: a copper/phosphorous or copper/phosphorous/silver alloy rod should be used for joining copper to copper whereas to join dissimilar or ferric metals a silver alloy rod either flux coated or with a separate flux would be used.
- Use a double-tipped torch.

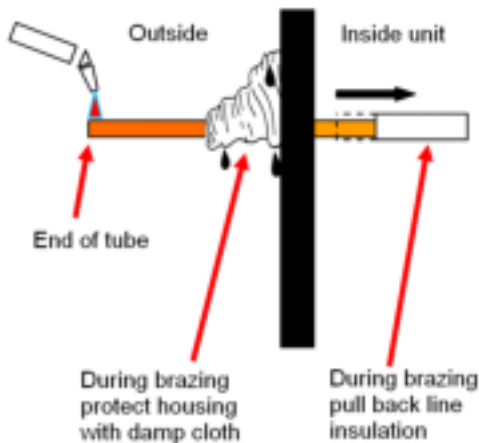

Figure 19: Brazing – Sectional view

3.3.3 Brazing procedure

For brazing of the tubes, please refer to **Figure 20** and procedure hereunder:

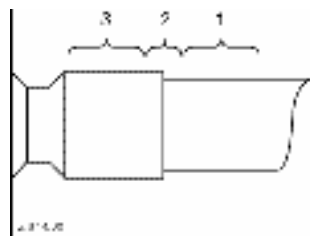

Figure 20: Suction tube brazing areas

- Fit the copper tube into the unit tube.
- Heat area 1. As the tube approaches brazing temperature,
- Heat area 2 until braze temperature is attained. It is necessary to heat the tube evenly. Move the torch up and down and rotating around the tube.
- Add braze material to the joint while moving the torch around the joint to flow braze material around the circumference.

- Then heat area 3. This will draw the brazing material down into the joint.

NOTE: The time spent heating area 3 should be minimal. As with any brazed joint, overheating may be detrimental to the final result.

To disconnect:

- Heat joint areas 2 and 3 slowly and uniformly until solder softens and tube can be pulled out of the fitting.

To reconnect:

- See procedure above.

3.4 Location & fixings

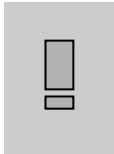

IMPORTANT

Dust and dirt contamination! Risk of unit lifetime reduction! The unit should always be installed in a location that ensures clean air flow. External fouling of the condenser fins also leads to high condensing temperatures and will reduce the lifetime of the unit.

It is recommended that a clearance of 300 mm from the wall of the room (or the next unit) be maintained from the unit left and rear panels whereas a clearance of 500 mm must be maintained from the unit right, top and front panels (seen facing the front of the unit) – see **Figure 21** below. Both service access and airflow through connected air ducts have been considered in making these recommendations.

Where multiple units are to be installed in the same room, the installer has to consider each individual case carefully. There can be many variations of unit quantities and available space and it is not the intention of this manual to go over these. However, in general terms, air by-pass around each condenser and between the units should be avoided at all times.

Ideally, the unit should be mounted level on a solid concrete slab with anti-vibration pads between unit feet and concrete. However, the ZXDI unit has also been designed for wall mounting on suitable brackets. In this case, it is equally important that the dimensional guidelines given above and in **Figure 21** be followed. Wall mounting brackets are not part of the standard delivery.

Another factor to consider in finding a good installation site is the direction of the prevailing wind. For example, if the air leaving the condenser through the air ducts faces the prevailing wind, the air flow through the condenser can be impeded, causing high condensing temperatures and ultimately resulting in reducing the lifetime of the unit.

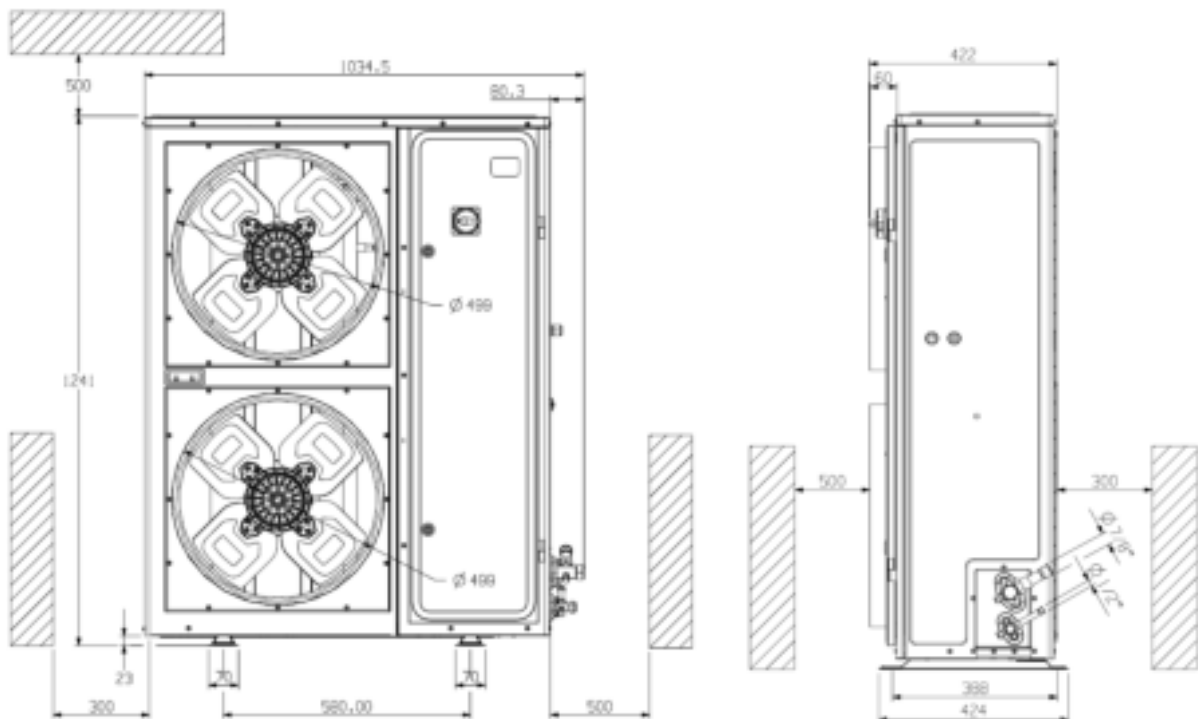

Figure 21: Fixing distances

3.5 Air ducts connection



WARNING

Uncovered rotating parts! No safety grids on the condenser fans!
Personal injuries! Never start the condensing unit or run the fans with no air ducts connected or without protective end-grids on the air outlets.

The connection of the air ducts to the condensing unit has to be made based on standard rules for air distribution ducts. Duct connection dimensions are designed based on standard EN 1506-2007, which has to be taken into consideration for all air ducts dimensioning.

The foil must be removed from the condenser fan before connecting the air ducts.

The condensing units covered in these guidelines are prepared for connection to air ducts with a diameter of 500 mm.

Before commissioning and starting the unit, check the ducts for air leaks. Look for sections that should be joined but might be separated and for possible holes in the air channels.

Two values must be taken into consideration when designing a proper air duct route and selecting component parts, ie, the total pressure drop and the airflow.

The length of the air duct has little impact on the total pressure drop and the air-flow (pressure drop approx. 0.5-1 Pa/m). An air duct length of up to 5 meters has virtually no impact at all on pressure drop.

Elbows and other components such as diameter reductions on the air duct route have a much bigger influence on total pressure drop and air flow – see **Table 23** below.

Air duct diameter Ø 500 mm (connection to condenser per fan)																
		Total straight length (m)														
		1	2	3	4	5	6	7	8	9	10	11	12	13	14	15
Number of elbows	1	✓	✓	✓	✓	✓	✓	✓	✓	✓	✓	✓	✓	✓	✓	✓
	2	✓	✓	✓	✓	✓	✓	✓	✓	✓	✓	✓	✓	✓	✓	✓
	3	✓	✓	✓	✓	✓	✓	✓	✓	✓	✓	✓	✓	✓	✓	✓
	4	✓	✓	✓	✓	✓	✓	✓	✓	✓	✓	✓	✓	✓	✓	✓
	5	✓	✓	✓	✓	✓	✓	✓	✓	✓	✓	✗	✗	✗	✗	✗
	6	✗	✗	✗	✗	✗	✗	✗	✗	✗	✗	✗	✗	✗	✗	✗

Table 23: Maximum acceptable air duct length depending on diameter and number of elbows

When taking into account all the fittings, the total linear length and additional components, the total pressure drop should be limited to 60 Pa per fan at 3500 m³/h. Please also refer to Chapter 2.11.3 "Main control & safety features".

4 Start-up & operation



WARNING

Uncovered rotating parts! No safety grids on the condenser fans! Personal injuries! Never start the condensing unit or run the fans with no air ducts connected or without protective end-grids on the air outlets.

Before commissioning, ensure that all valves on the condensing unit are fully opened.

4.1 Evacuation



CAUTION

System pressure below atmospheric pressure! Compressor damage! Never energize the unit/controller without minimum refrigerant system charge. There is a risk of malfunction of the controller in deep vacuum operation which can cause compressor damage.

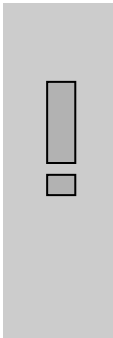

IMPORTANT

The evacuation procedure is based upon achieving an actual system vacuum standard and is **NOT TIME DEPENDENT!** The installation has to be evacuated with a vacuum pump before commissioning. Proper evacuation reduces residual moisture to 50 ppm. The installation of adequately sized access valves at the furthest point from the compressor in the suction and liquid lines is advisable. The system must be evacuated down to less than 3 mbar. If required break the vacuum with dry nitrogen. Pressure must be measured using a vacuum pressure gauge on the access valves and not on the vacuum pump. This serves to avoid incorrect measurements resulting from the pressure gradient along the connecting lines to the pump.

4.2 Charging procedure

4.2.1 Refrigerant charging procedure

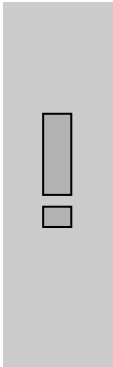

IMPORTANT

Inadequate charge! Overheating! The scroll compressor design requires system charging as quickly as possible with liquid refrigerant into the liquid line. This will avoid running the compressor under conditions whereby insufficient suction gas is available to cool not only the motor but also the scrolls. Temperature builds up very quickly in the scrolls if this is not done.

Service valve closed! Compressor damage! Do not charge the unit with vapour (gas). The suction service valve must not be fully closed at any time when the compressor is running. To do so would cause damage to the compressor in the same manner as explained above. This valve is provided for ease of connection and for the fitting of service gauges without removing the unit panel.

Pre-charging must be done with liquid refrigerant through the service valve on the liquid line. It is advisable to pre-fill the suction side with a partial charge to avoid vacuum operation. Further charging can be done by carefully filling refrigerant through the suction line while simultaneously checking the sight glass.

NOTE: In order to meet the requirements of the Ecodesign Directive 2009/125/EC with regard to efficient system operation, ensure the refrigerant charge is sufficient.

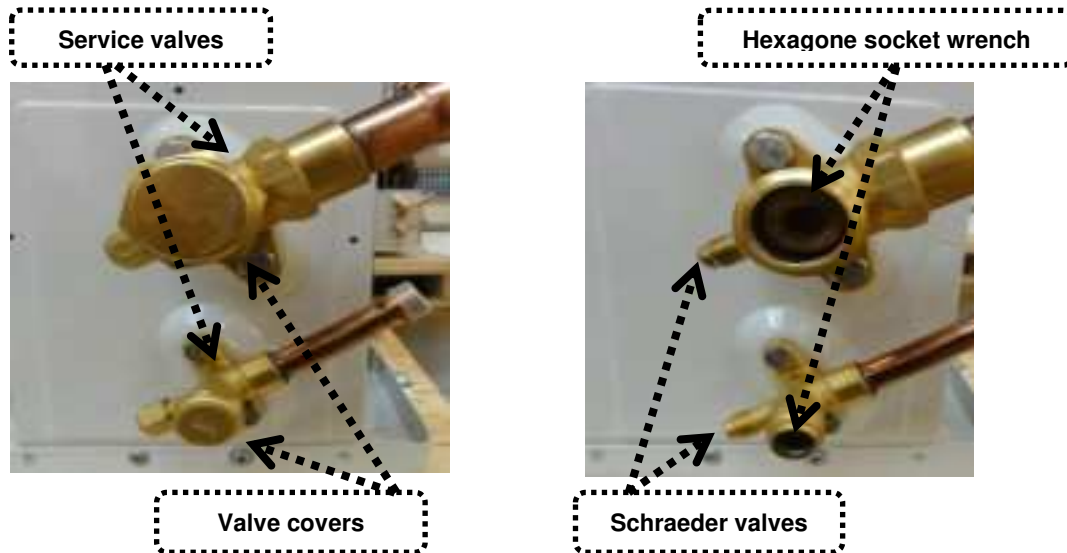

Figure 22: Service valves for refrigerant charging



Figure 23: Liquid line service port

An additional Schraeder connection is fitted on the liquid line below the filter drier in the compressor chamber. It is also possible to use this connection for charging or servicing.

Recommendation is to break vacuum in the system with partial charge of refrigerant, then start the system.

For charge adjustment it is recommended to check the liquid sight glass just before the expansion valve.

4.2.2 Oil charging procedure

Copeland ZXDI indoor condensing units are pre-charged with oil. After commissioning, the oil level should be checked and topped up if necessary.

NOTE: The oil level should be approximately halfway up the sight glass.

Emerson recommends charging with one of the following oil types:

- Emkarate RL 32 3MAF
- Mobil EAL Arctic 22 CC

Charging is done through the Schraeder valve located on the suction valve.

4.2.3 Oil separator

The ZXDI units are equipped with an oil separator. This separator is pre-charged with 0.5 liter of oil.

4.3 Rotation direction of scroll compressors

Scroll compressors, like several other types of compressors, will only compress in one rotational direction. Three-phase compressors are protected against wrong rotation field by the unit controller.

4.4 Maximum compressor cycle

Maximum permitted starts per hour: 10. The factory setting of the XCM25D system controller already takes into account the maximum permitted starts and stops of the compressor. It also controls the running time and the minimal downtime. It is recommended to change these settings only in exceptional cases.

4.5 Checks before starting & during operation



IMPORTANT

Liquid valves not fully opened! Liquid trap! Both valves should be fully opened on the liquid line, in order to avoid trapping liquid.

- Check that all valves are fully opened.
- Set the essential parameters of the electronic controller in programming level 1 (refrigerant type, compressor cut-out/cut-in settings, fan setpoint....) according to the required application.
- Emerson recommends to check the oil level in the compressor after starting and operation conditions have stabilised, and to add oil if needed to ensure a sufficient oil level (halfway up the sight glass).

5 Maintenance & repair

5.1 Replacing a compressor



CAUTION

Inadequate lubrication! Bearing destruction! Exchange the accumulator after replacing a compressor with a burned-out motor. The accumulator oil return orifice or screen may be plugged with debris or may become plugged. This will result in starvation of oil to the new compressor and a second failure.

In the case of a motor burnout, the majority of contaminated oil will be removed with the compressor. The rest of the oil is cleaned through the use of suction and liquid line filter driers. A 100 % activated alumina suction line filter drier is recommended but must be removed after 72 hours. **It is highly recommended to replace the suction accumulator, if the system contains one.** This is because the accumulator oil return orifice or screen may be plugged with debris or may become plugged shortly after a compressor failure. This will result in starvation of oil to the replacement compressor and a second failure. When a compressor is exchanged in the field, it is possible that a major portion of the oil may still be in the system. While this may not affect the reliability of the replacement compressor, the extra oil will add to rotor drag and increase power usage.

- De-energize the condensing unit before any intervention.
- Close valves to isolate the unit from the system.
- Recover the refrigerant from the unit and make sure that the compressor is not under pressure.
- Release the compressor mounting parts then lift it to replace with a new compressor.

NOTE: For more detailed instructions, please refer to the compressor application guidelines.

5.2 Condenser fins



CAUTION

Acid cleaning! Corrosion of condenser fins! Do not use acidic solutions to clean the coil. After cleaning, the fins should be brushed lightly with a proper fin comb.

Condenser fins become dirty over time as ambient air is induced to the condenser. Dirty coil surfaces result in high condensing temperatures and poor unit performance. Regular cleaning is recommended, the frequency of doing so being dependent on the installation and the surrounding environment. As a general guide, it is advisable to do this at least once every two months.

As a general rule and for a clean environment we recommend the fins be cleaned with liquid detergent diluted with clean water. The ZXDI condensing unit has a well-designed chassis with falling levels towards a large drainage hole and provided the unit is installed level, any cleaning solution should be able to drain away. A light brush downward (in the direction of the fins) should be done before washing to remove heavy deposits.

NOTE: In order to meet the requirements of the Ecodesign Directive 2009/125/EC with regard to efficient system operation, ensure the heat exchangers remain clean at all times.

5.3 Electrical connections



WARNING

Isolating switch "On"! Danger of electric shock! Before undertaking any task on electrical equipment, turn off the main power supply to de-energise the unit.

All condensing units will generate some degree of vibration. Copeland ZXDI indoor condensing units are no exception. However, the vibration level from the compliant scroll technology is less severe than in units using reciprocating compressor technology. Thanks to this reduced vibration, ZXDI units can be mounted on simple, less expensive rubber mounting pads.

Nevertheless, over time, due to these slight vibrations and to temperature fluctuations within the unit housing, electrical terminations might become loose. The components most likely to be affected are the main terminal strip and the compressor contactor. It is suggested to check the main electrical terminations for tightness and to carry out a visual inspection of the low voltage crimped terminals at least once every 6 months.

5.4 Routine leak testing

All joints inside the system should be leak-tested as part of a regular maintenance schedule.

NOTE: In order to meet the requirements of the Ecodesign Directive 2009/125/EC with regard to efficient system operation, ensure the refrigerant and oil charges are sufficient.

5.5 Condenser fans & motors

A yearly inspection of these items is recommended. Fastenings can become loose, bearings may wear and fans may require cleaning of solid deposits that can cause rotational imbalance. Motors come with lifelong lubrication bearings that do not require lubricating on a routine basis, but just need to be checked for wear.

In case the fan(s) need(s) to be replaced or serviced, follow the steps below:

- De-energize the condensing unit before any intervention.
- Remove the top cover of the unit.
- Disconnect the air ducts from the fans in order to be able to access the unit front panel.
- Remove the entire front panel of the unit to access the condenser fans.
- Replace/service the fan(s).

6 Certification & approval

- Copeland ZXDI indoor condensing units comply with the Low Voltage Directive LVD 2014/35/EU. The applied harmonised standard is EN 60335 (Household and similar electrical appliances – Safety, Part 1: General Requirements and Part 2-89: Particular requirements for commercial refrigerating appliances with an incorporated or remote refrigerant condensing unit or compressor).
- The condensing units and their piping comply with the Pressure Equipment Directive PED 2014/68/EU (Art.4 §3 - Sound Engineering Practice).
- The condensing units and their components are CE marked as far as required and thereby establish conformity with the relevant directives.
- Conformity Declarations for components are available as far as required.
- The Manufacturer's Declaration of Incorporation has to be respected when incorporating these products into a machine.

7 Dismantling & disposal



Removing oil and refrigerant:

- **Do not disperse in the environment.**
- **Use the correct equipment and method of removal.**
- **Dispose of oil and refrigerant in compliance with national legislation and regulations.**

Dispose of compressor and/or unit in compliance with national legislation and regulations.

DISCLAIMER

1. The contents of this publication are presented for informational purposes only and are not to be construed as warranties or guarantees, express or implied, regarding the products or services described herein or their use or applicability.
2. Emerson Climate Technologies GmbH and/or its affiliates (collectively "Emerson"), as applicable, reserve the right to modify the design or specifications of such products at any time without notice.
3. Emerson does not assume responsibility for the selection, use or maintenance of any product. Responsibility for proper selection, use and maintenance of any Emerson product remains solely with the purchaser or end user.
4. Emerson does not assume responsibility for possible typographic errors contained in this publication.

Appendix 1: Overview of the ZXDI indoor unit components

Components	Digital ZXDI
Compressor M1	✓
Fan M2.1	✓
Fan M2.2	✓
Y1 Stepper valve EVI	-
Y3 Stepper valve liquid	-
Y2 DGS solenoid valve	✓
E1 Crankcase heater	✓
S3 Room thermostat (optional)	-
B1 Pressure transducer suction	✓
B2 Pressure transducer discharge	✓
B3 DLT NTC discharge	✓
B4 EVI vapour in sensor NTC	-
B5 EVI vapour out sensor NTC	-
B6 Ambient temperature sensor NTC	✓
B7 Temperature sensor (optional)	-
B11 High-pressure switch	✓
B12 Low-pressure switch	-

Table 24: Overview of the ZXDI indoor unit components

Appendix 2: Wiring diagram – ZXDI units (380-420 V / 3 Ph / 50 Hz)

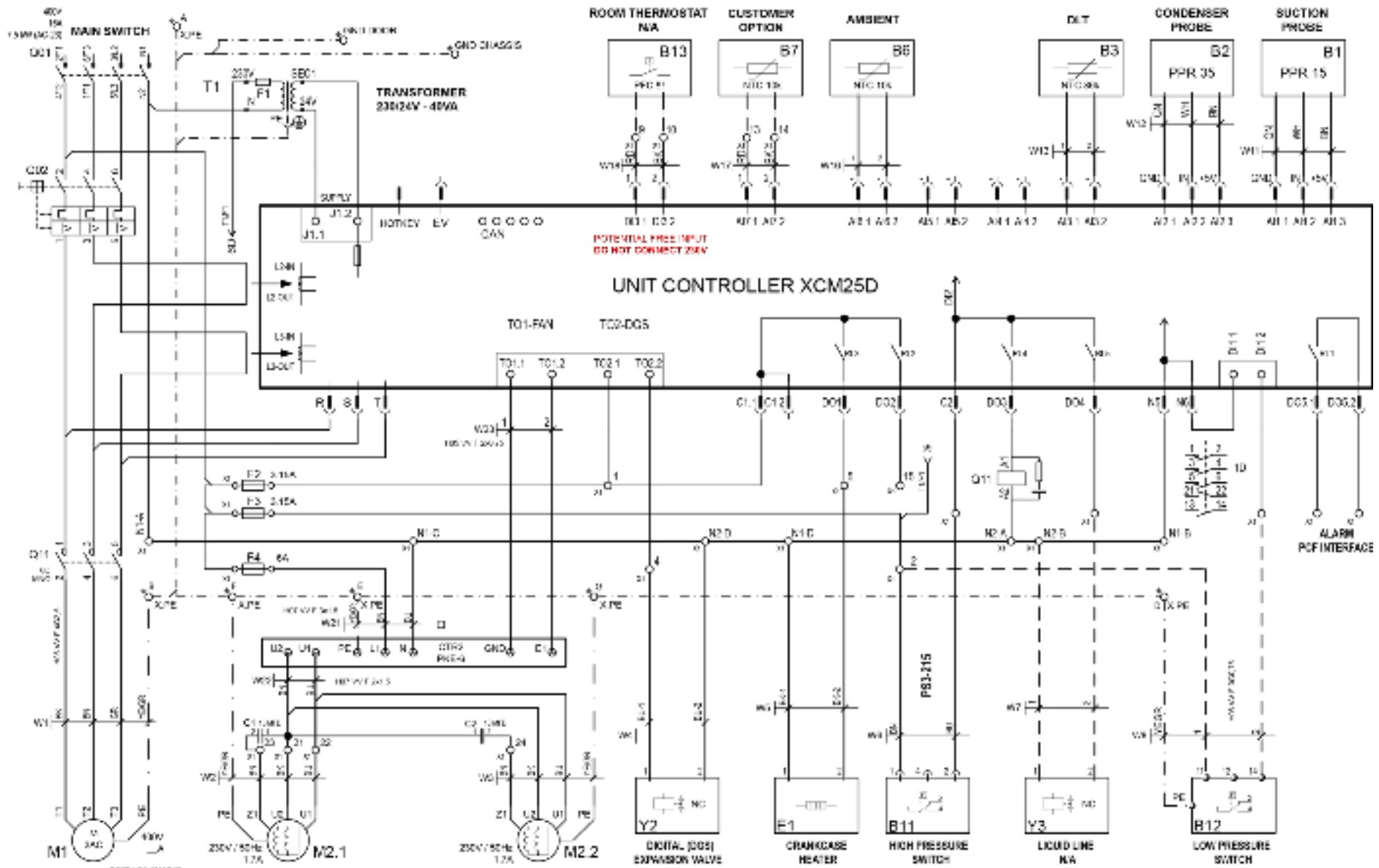

Figure 24: Wiring diagram – 3-Phase motor

Appendix 3: Parameter list level 1 (Pr1)

Legend

L1 = Parameter in Level 1 (without password)

L2 = Parameter in Level 2 (with password = 3 2 1)

N.V. = Parameter not accessible

NOTE: When changing parameter C05 (LS) a reset of the controller (interruption of power supply) is required.

Parameters		Description	Range	Level
ZXDE	ZXDI			
C07	rEF	Refrigerant selection for regulation	R404A (0-404) - R507 (1-507) - R134a (2-134) - R22 (3-R22) - R407C (4-07C) - R407A (5-07A) - R407F (6-07F) - R448A (7-48A) - R449A (8-49A) - R410A (9-410)	L1
C16	StC	Digital compressor setpoint	LS to US; C03 to C04	L1
C17	Pbd	Proportional band for compressor regulation	0.1 to 9.9 bar; 0.1 to 99.9 PSI; 1 to 999 KPA; 0.1 to 25.5 °C	L1
C21	tdG	Cycle time for digital compressor	10 to 40 sec	L1
C24	PMi	Minimum capacity for digital compressor	0 to PMA; 0 to C25	L1
C25	PMA	Maximum capacity for digital compressor	PMi to 100; C24 to 100	L1
D29	LPA	Low-pressure alarm value	0 to 15 bar	L1
E39	FSP	Condenser temperature setpoint when fan setpoint modulation is disabled	-40 to 110 °C	L1
E46	Fbd	Regulation band of variable fan	0.1 to 25.5 °C	L1
N01	Min	Current minute	0 to 59	L1
N02	Hr	Current hour	0 to 23	L1
N03	MdY	Date of month	1 to 31	L1
N04	Mon	Month	1 to 12	L1
N05	YEr	Year	0 to 99	L1
T18	PAS	Access to Pr2 level	(0÷999)	L1

Table 25: Parameters level 1

Appendix 4: Alarm menu

Code	Description	Cause	Action	Reset
E01	A11 error (Probe 1/Suction pressure transducer failure alarm)	Probe failure or out of range	Only in digital unit - compressor is activated according to C23, and compressor on & off time is according to D02 & D03	Automatically as soon as the probe restarts working
E02	A12 error (Probe 2/mid-coil temperature sensor failure alarm)	Probe failure or out of range	The fan speed control is disabled	Automatically as soon as the probe restarts working
E03	A13 error (Probe 3/discharge line temperature sensor failure alarm)	Probe failure or out of range	The discharge temperature control is disabled	Automatically as soon as the probe restarts working
E04	A14 error (Probe 4/PHE vapour inlet temperature sensor failure alarm)	Probe failure or out of range	PHE superheat control is disabled (ZXLE/ZXME unit)	Automatically as soon as the probe restarts working
E05	A15 error (Probe 5/PHE vapour outlet temperature sensor failure alarm)	Probe failure or out of range	PHE superheat control is disabled (ZXLE/ZXME unit)	Automatically as soon as the probe restarts working
E06	A16 error (Probe 6/ambient temperature sensor failure alarm)	Probe failure or out of range	The functions related to probe 6 (ambient sensor) are disabled	Automatically as soon as the probe restarts working
E07	A17 error	Probe failure or out of range		
E08	Battery error			
E09	Current sensor 1 error	Probe out of range	The functions related to current sensor are disabled	Automatically as soon as the probe restarts working
E10	Current sensor 2 error	Probe out of range	The functions related to current sensor are disabled	Automatically as soon as the probe restarts working
E11	Voltage sensor 1 error	Probe out of range	The functions related to current sensor are disabled	Automatically as soon as the probe restarts working
E12	Voltage sensor 2 error	Probe out of range	The functions related to current sensor are disabled	Automatically: as soon as the probe restarts working
E13	Voltage sensor 3 error	Probe out of range	The functions related to current sensor are disabled	Automatically as soon as the probe restarts working
E14-E19	Reserved			

Code	Description	Cause	Action	Reset
E20	Lost phase error	Power supply phase loss (3-phase unit)	The compressor will trip	Automatically: lost phase recovery and H08 delay time out. If all three phases are present but the controller still shows the error message, set parameters H06 and H25 to "No".
L20	Lost phase lockout	Power supply phase loss happened for H12 time within one hour (3-phase unit)	The compressor will be locked	Hold "start" button for 5 sec or manual power off and on. If all three phases are present but the controller still shows the error message, set parameters H06 and H25 to "No".
L21	Phase sequence lockout	Incorrect phase sequence (3-phase unit)	The compressor will be locked, rotation field has to be changed	Manual power off, invert 2 phases and power on. If the phase sequence is correct but the controller still shows the error message, set parameter H25 to "No".
E22	Phase imbalance	One phase voltage lower than H18 percentage of 3 phases average voltage (3-phase unit)	The compressor is activated according to H19	Automatically: voltage recovery and H16 setting delay time-out. If all three phases are present but the controller still shows the error message, set parameter H06 to "No".
E23	Over current	Electrical current larger than H09 setting	The compressor will trip	Automatically: H08 delay time-out. If the current is within the limits but the controller still shows the error message, set parameter H06 to "No".
L23	Over current lockout	Over current happened for H11 times within one hour	The compressor will be locked (if H11 equal to 0, no compressor lockout)	Hold "start" button for 5 sec or manual power off and on (if H11 equal to 0, compressor automatically starts after H08 delay time-out). If the current is within the limits but the controller still shows the error message, set parameter H06 to "No".
E26	Under voltage alarm	Voltage lower than H13 setting for H15 seconds	The compressor will trip	Automatically: voltage is back within acceptable range and H16 delay time-out. If the voltage corresponds to the required voltage but the controller still shows the error message, set parameter H06 to "No".
L26	Under voltage lockout	Under voltage happened for H17 times within one hour	The compressor will be locked (if H17 equal to 0, no compressor lockout)	Hold "start" button for 5 sec or manual power off and on (if H17 equal to 0, compressor automatically starts when voltage is back within acceptable range and H16 delay time-out). If the voltage corresponds to the required voltage but the controller still shows the error message, set parameter H06 to "No".

Code	Description	Cause	Action	Reset
E27	Over voltage alarm	Voltage larger than H14 setting for H15 seconds	The compressor will trip	Automatically: voltage is back within acceptable range and H16 delay time-out. If the voltage corresponds to the required voltage but the controller still shows the error message, set parameter H06 to "No".
L27	Over voltage lockout	Over voltage happened for H17 times within one hour	The compressor will be locked (if H17 equal to 0, no compressor lockout)	Hold "start" button for 5 sec or manual power off and on (if H17 equal to 0, compressor automatically starts when voltage is back within acceptable range and H16 delay time-out). If the voltage corresponds to the required voltage but the controller still shows the error message, set parameter H06 to "No".
E28	Compressor Build-in protector trip	Compressor build-in thermal protector trips	Warning signal only	Automatically: as soon as electrical current is detected. Check the voltage coming to the compressor.
E30	Main power lost	Controller power supply lost		
E40	High pressure switch	High-pressure switch open	The compressor will trip	Automatically: high-pressure switch closed and D14 delay time-out. If the high pressure is below the limit but the alarm is still on, check the overload protection.
L40	High pressure switch lockout	High-pressure switch open error happened D15 times within one hour	The compressor will be locked (if D15 equal to 0, no compressor lockout)	Hold "start" button for 5 sec or manual power off and on (if D15 equal to 0, compressor automatically starts when high-pressure switch is closed and D14 delay time-out). If the high pressure is below the limit but the alarm is still on, check the overload protection.
E41	Low pressure switch	Low-pressure switch open	The compressor will trip	Automatically: low-pressure switch closed and D28 delay time-out
E43	Low pressure alarm	The pressure is below D29	Warning signal only	To deactivate the alarm function set parameter D13 to "No".
E44	Discharge line temperature alarm	Discharge line temperature higher than D22 for D24 seconds	The compressor will trip	Automatically: discharge line temperature lower than D23 setting and D25 delay time-out

Code	Description	Cause	Action	Reset
L44	Discharge line temperature lockout	Discharge line temperature overheat happened for D26 times within one hour	The compressor will be locked (if D26 equal to 0, no compressor lockout)	Hold "start" button for 5 sec or manual power off and on (if D26 equal to 0, compressor automatically starts when discharge line temperature is lower than D23 setting and D25 delay time-out)
E45	High condenser pressure alarm	Not used		
E46	High condenser temperature alarm	Condenser temperature larger than E58 for E59 minutes	The compressor is activated according to E60	Automatically: as soon as condenser temperature is lower than E61
E47	EXV full open in EVI	EXV full open for F40 minutes	Warning signal only	Automatically: as soon as EXV is not at maximum steps
E48	Refrigerant shortage error in EVI	EXV full open and PHE super heat is larger than (F28/F29.../F37 + F39) (F28/F29.../F37 depends on refrigerant type)	Warning signal only	Automatically: as soon as PHE super heat is lower than (F28/F29.../F37 + F39)
E49	Pump-down alarm	Not used		
E50	High side floodback alarm	The differential temperature between discharge and mid-coil is lower than H21 for accumulated H22 minutes in H23 minutes	Warning signal only	Automatically: as soon as differential temperature between discharge and mid-coil is larger than H21 for H24 minutes
E60	Max pressure alarm of superheating	Not used		
E61	Min pressure alarm of superheating	Not used		
E62	High superheating alarm	Not used		
E63	Low superheating alarm	Not used		
E64	High room temperature alarm	Not used		
E65	Low room temperature alarm	Not used		

Code	Description	Cause	Action	Reset
E66	Open door alarm	If the door is open longer than dSA/G53	Warning signal only if rrd/G09 is "no" Alarm and compressor trip if rrd/G09 is "yes"	Manual or automatic – see Action
E67-E79	Reserved			
E80	rtC warning, date not correct	HW problem in the board	Disable the rtC or change the board	
E81	rtF warning, communication error	HW problem in the board	Disable the rtC or change the board	
E82	Probe configuration error			
E83	DI configuration error			
E84	Compressor configuration error			
E85	Injection probe configuration error	Injection EXV output mode is selected, but no relevant sensors	Injection EXV will not work	Automatically: as soon as the injection EXV is properly configured
E86	EEPROM R/W error (manual)	HW problem in the board	Change the board	
E87-E99	Reserved			

Table 26: Alarm code overview

Appendix 5: Additional features for customization

Required setting for proper functionality

Setting needs to be adjusted according to application

Temperature sensor in case temperature – System restart is required!				
Parameters		Parameter description	Factory setting	Required setting
ZXDE	ZXDI			
A19	P7C	Probe 7 configuration	nu = Not used	tnt = Thermostat temperature
C05	LS	Compressor regulation probe selection	SuP = Suction pressure probe	CSt = Case temperature
G01	EcS	Case temperature probe selection	nu = Not used	tnt = Thermostat temperature
G02	SEt	Cut-out temperature	+2°C	Adjust to application requirements
G03	Hy	Positive differential defines upper cut-in temperature	1K	Adjust to application requirements

Unit On/Off – System restart is required!				
Parameters		Parameter description	Factory setting	Required setting
ZXDE	ZXDI			
R07	i3F	Digital input 3 configuration	nu = Not used	OnF = On/Off
R08	i3P	Digital input 3 polarity	CL = Closed	Adjust to application requirements

Evaporator fan – System restart is required!				
Parameters		Parameter description	Factory setting	Required setting
ZXDE	ZXDI			
G42	FnC	Fans operating mode	cn	cn = Switch on and off with the compressor, stop during defrost On = Always on, stop during defrost cy = Switch on and off with the compressor, run during defrost Oy = Always on, run during defrost
S05	oA2	Relay output 2	nu = Not used	EPF = Evaporator fan
G45	Fon	Fan on time	1 min	Adjust to application requirements
G46	FoF	Fan off time	1 min	Adjust to application requirements
G55	Fnd	Fan delay after defrost	1 min	Adjust to application requirements

System EXV – System restart is required!				
Parameters		Parameter description	Factory setting	Required setting
ZXDE	ZXDI			
A19	P7C	Probe 7 configuration	nu = Not used	SLt = Suction line temp
L02	SSH	Set of superheating	5	7
S11	oA8	EXV configuration	uin or Lin	SHt = System superheat

Door switch – System restart is required!				
Parameters		Parameter description	Factory setting	Required setting
ZXDE	ZXDI			
G08	odC	Compressor and fan status with open door	Fn	nO = Normal operation Fn = Stop fan cP = Compressor off Fc = Compressor and fans off
R07	i3F	Digital input 3 configuration	nu = Not used	dOr = Door
G53	dSA	Maximum time with open door before alarm goes off	3 min	Adjust to application requirements
R08	i3P	Digital input 3 polarity	CL = Closed	Adjust to application requirements

Table 27: Additional features for customization

Appendix 6: Temperature / resistance curve for B7 Sensor (customer option)

R25 = 10 kΩ B25/85 = 3435 K

Temp. (°C)	Resistance (kΩ)	Temp. (°C)	Resistance (kΩ)	Temp. (°C)	Resistance (kΩ)	Temp. (°C)	Resistance (kΩ)	Temp. (°C)	Resistance (kΩ)	Temp. (°C)	Resistance (kΩ)
-50	329.2	-21	71.07	8	19.48	37	6.468	66	2.512	95	1.108
-49	310.7	-20	67.74	9	18.70	38	6.246	67	2.437	96	1.080
-48	293.3	-19	64.54	10	17.96	39	6.033	68	2.365	97	1.052
-47	277.0	-18	61.52	11	17.24	40	5.829	69	2.296	98	1.025
-46	261.3	-17	58.65	12	16.55	41	5.630	70	2.229	99	0.999
-45	247.5	-16	55.95	13	15.90	42	5.439	71	2.163	100	0.974
-44	234.1	-15	53.39	14	15.28	43	5.256	72	2.101	101	0.949
-43	221.6	-14	50.95	15	14.68	44	5.080	73	2.040	102	0.925
-42	209.8	-13	48.66	16	14.12	45	4.912	74	1.981	103	0.902
-41	198.7	-12	46.48	17	13.57	46	4.749	75	1.924	104	0.879
-40	188.4	-11	44.44	18	13.06	47	4.594	76	1.870	105	0.858
-39	178.3	-10	42.45	19	12.56	48	4.444	77	1.817	106	0.836
-38	168.9	-9	40.56	20	12.09	49	4.300	78	1.766	107	0.816
-37	160.1	-8	38.76	21	11.63	50	4.161	79	1.716	108	0.796
-36	151.8	-7	37.05	22	11.20	51	4.026	80	1.669	109	0.777
-35	144.0	-6	35.43	23	10.78	52	3.897	81	1.622	110	0.758
-34	136.6	-5	33.89	24	10.38	53	3.772	82	1.577	111	0.740
-33	129.7	-4	32.43	25	10.00	54	3.652	83	1.534	112	0.722
-32	123.2	-3	31.04	26	9.632	55	3.537	84	1.492	113	0.705
-31	117.1	-2	29.72	27	9.281	56	3.426	85	1.451	114	0.688
-30	111.3	-1	28.47	28	8.944	57	3.319	86	1.412	115	0.672
-29	105.7	0	27.28	29	8.622	58	3.216	87	1.374	116	0.656
-28	100.4	1	26.13	30	8.313	59	3.116	88	1.337	117	0.641
-27	95.47	2	25.03	31	8.015	60	3.021	89	1.301	118	0.626
-26	90.80	3	23.99	32	7.725	61	2.928	90	1.266	119	0.611
-25	86.39	4	22.99	33	7.455	62	2.838	91	1.233	120	0.597
-24	82.22	5	22.05	34	7.192	63	2.752	92	1.200		
-23	78.29	6	21.15	35	6.941	64	2.669	93	1.169		
-22	74.58	7	20.30	36	6.699	65	2.589	94	1.138		

Table 28: B7 A17 optional sensor >> Temperature / resistance curve

Appendix 7: List of tables and figures

Tables

Table 1: Qualified refrigerants and oils	4
Table 2: BOM.....	5
Table 3: Legend of the P&I diagram for ZXDI units.....	5
Table 4: Cross-reference table units/compressor models.....	6
Table 5: Condenser fan technical data.....	6
Table 6.....	9
Table 7: Prearranged additional connections	10
Table 8: Digital output specifications	11
Table 9: Discharge pressure limitations	11
Table 10: LED functions description	12
Table 11: Display visualisation	13
Table 12: Single commands	14
Table 13: Double commands.....	14
Table 14: Programming level 1 parameters	14
Table 15: Fast access menu	15
Table 16: Parameters in programming level Pr1	16
Table 17: How to check the alarm list.....	19
Table 18: Fan data based on changing frequency/fan speed	20
Table 19: Weights.....	22
Table 20: Maximum operating currents for cable selection.....	23
Table 21: Overload protection details	24
Table 22: Maximum distance between 2 clamp supports	24
Table 23: Maximum acceptable air duct length depending on diameter and number of elbows	27
Table 24: Overview of the ZXDI indoor unit components.....	33
Table 25: Parameters level 1	35
Table 26: Alarm code overview	40
Table 27: Additional features for customization	42
Table 28: B7 A17 optional sensor >> Temperature / resistance curve	43

Figures

Figure 1: Dimensions of ZXDI condensing units (all models)..... 3

Figure 2: Nomenclature ZXDI units 4

Figure 3: P&I diagram for ZXDI units..... 5

Figure 4: Fan details and dimensions..... 6

Figure 5: Fan bracket details 7

Figure 6: ZXDI unit housing 7

Figure 7: Electronic controller 8

Figure 8: XCM25D controller functionality overview..... 9

Figure 9: Prearranged additional connections 11

Figure 10: Local display..... 12

Figure 11: Remote display front panel mounting..... 13

Figure 12: VNR connection for the remote display..... 13

Figure 13: Digital operation 17

Figure 14: Emerson "Hot Key" 17

Figure 15: Location of "Hot Key" plug connection 18

Figure 16: PKE-6 Fan speed controller details and dimensions 21

Figure 17: Maximum stacking loads for transport and storage 22

Figure 18: Main switch & overload protection..... 23

Figure 19: Brazing – Sectional view 25

Figure 20: Suction tube brazing areas..... 25

Figure 21: Fixing distances 26

Figure 22: Service valves for refrigerant charging..... 29

Figure 23: Liquid line service port..... 29

Figure 24: Wiring diagram – 3-Phase motor..... 34

BENELUX

Josephinastraat 19
NL-6462 EL Kerkrade
Tel: +31 45 535 06 73
Fax: +31 45 535 06 71
benelux.sales@emerson.com

GERMANY, AUSTRIA & SWITZERLAND

Theo-Mack Str. 3
DE-63477 Maintal
Tel: +49 6109 605 90
Fax: +49 6109 60 59 40
ECTGermany.sales@emerson.com

FRANCE, GREECE & MAGHREB

8, Allée du Moulin Berger
FR-69134 Ecully Cédex, Technoparc - CS 90220
Tel: +33 4 78 66 85 70
Fax: +33 4 78 66 85 71
mediterranean.sales@emerson.com

ITALY

Via Ramazzotti, 26
IT-21047 Saronno (VA)
Tel: +39 02 96 17 81
Fax: +39 02 96 17 88 88
italy.sales@emerson.com

SPAIN & PORTUGAL

C/ Pujades, 51-55 Box 53
ES-08005 Barcelona
Tel: +34 93 412 37 52
iberica.sales@emerson.com

CZECH REPUBLIC

Hajkova 22
CZ - 133 00 Prague
Tel: +420 733 161 651
Fax: +420 271 035 655
Pavel.Sudek@emerson.com

ROMANIA & BULGARIA

Parcul Industrial Tetarom 2
Emerson Nr. 4 400641 Cluj-Napoca
Tel: +40 374 13 23 50
Fax: +40 374 13 28 11
ro-bg.sales@emerson.com

ASIA PACIFIC

Suite 2503-8, 25/F., Exchange Tower
33 Wang Chiu Road, Kowloon Bay
Kowloon, Hong Kong
Tel: +852 2866 3108
Fax: +852 2520 6227

UK & IRELAND

Unit 17, Theale Lakes Business Park
Reading, Berkshire RG7 4GB
Tel: +44 1189 83 80 00
Fax: +44 1189 83 80 01
uk.sales@emerson.com

SWEDEN, DENMARK, NORWAY & FINLAND

Pascalstr. 65
DE-52076 Aachen
Tel: +49 2408 929 0
Fax: +49 2408 929 525
nordic.sales@emerson.com

EASTERN EUROPE & TURKEY

Pascalstr. 65
DE-52076 Aachen
Tel: +49 2408 929 0
Fax: +49 2408 929 525
easterneurope.sales@emerson.com

POLAND

Szturmowa 2
PL-02678 Warsaw
Tel: +48 22 458 92 05
Fax: +48 22 458 92 55
poland.sales@emerson.com

RUSSIA & CIS

Dubininskaya 53, bld. 5, 4th floor
RU-115054, Moscow
Tel: +7 499 403 64 03
ECT.Holod@emerson.com

BALKAN

Selska cesta 93
HR-10 000 Zagreb
Tel: +385 1 560 38 75
Fax: +385 1 560 38 79

MIDDLE EAST & AFRICA

PO Box 26382
Jebel Ali Free Zone - South, Dubai - UAE
Tel: +971 4 811 81 00
Fax: +971 4 886 54 65
mea.sales@emerson.com

For more details, see www.climate.emerson.com/en-gb
Connect with us: facebook.com/EmersonCommercialResidentialSolutions



Emerson Commercial & Residential Solutions
Emerson Climate Technologies GmbH - Pascalstrasse 65 - 52076 Aachen, Germany
Tel. +49 (0) 2408 929 0 - Fax: +49 (0) 2408 929 570 - Internet: www.climate.emerson.com/en-gb

The Emerson logo is a trademark and service mark of Emerson Electric Co. Emerson Climate Technologies Inc. is a subsidiary of Emerson Electric Co.
Copeland is a registered trademark and Copeland Scroll is a trademark of Emerson Climate Technologies Inc. All other trademarks are property of their respective owners.
Emerson Climate Technologies GmbH shall not be liable for errors in the stated capacities, dimensions, etc., as well as typographic errors. Products, specifications, designs and technical data contained in this document are subject to modification by us without prior notice. Illustrations are not binding.

© 2019 Emerson Climate Technologies, Inc.

EMERSON. CONSIDER IT SOLVED.™