

Power Defense Molded Case Circuit-Breakers



Product Catalog

Power
Defense

A globally rated platform from Eaton.

EATON

Powering Business Worldwide



We make what matters work.*



At Eaton, we believe that power is a fundamental part of just about everything people do. That's why we're dedicated to helping our customers find new ways to manage electrical, hydraulic and mechanical power more efficiently, safely and sustainably. To improve people's lives, the communities where we live and work, and the planet our future generations depend upon. Because this is what really matters. And we're here to make sure it works.

To learn more go to: [Eaton.com/whatmatters](https://www.eaton.com/whatmatters)

EATON

Powering Business Worldwide

We make what matters work.

wa_ren_10819_1



Power Defense Molded Case Circuit-Breaker

• Introduction

- Overview	Page 5
- Electronic and thermo magnetic trip unit configurations	Page 7
- Interruption ratings	Page 9
- Power Xpert protection manager metering features	Page 10
- Power Defense Molded Case Circuit-breaker (MCCB): PDE1, 2, 3, and 4 (up to 1,000A)	Page 14
- Introduction to the Power Xpert® release trip unit	Page 15

• Technical overview

- Technical data PDE1	Page 18
- Technical data PDE2	Page 19
- Technical data PDE3	Page 20
- Technical data PDE4	Page 21
- Technical data – Switch disconnecter	Page 22
- Technical data – Motor Protection Breaker Frame Size 2	Page 24
- Technical data – Thermal trip unit and electronic trip unit	Page 26
- Electronic trip unit – Settings	Page 27

• Engineering

- Tripping characteristics – PDE1	Page 28
- Tripping characteristics – PDE2	Page 30
- Tripping characteristics – PDE3	Page 46
- Tripping characteristics – PDE4	Page 55
- Selectivity tables	Page 60
- Backup tables	Page 76

• Dimensions

- Circuit-breaker PDE1	Page 84
- Circuit-breaker PDE2	Page 87
- Circuit-breaker PDE3	Page 93
- Circuit-breaker PDE4	Page 98

• Ordering

- Catalog number key	Page 104
- Ordering list PDE circuit-breaker	Page 106
- Catalog number key accessories	Page 124
- Ordering list accessories for PDE	Page 127

Globally...

Accepted across all standards.
Adaptive to your application.
Backed by Eaton support.

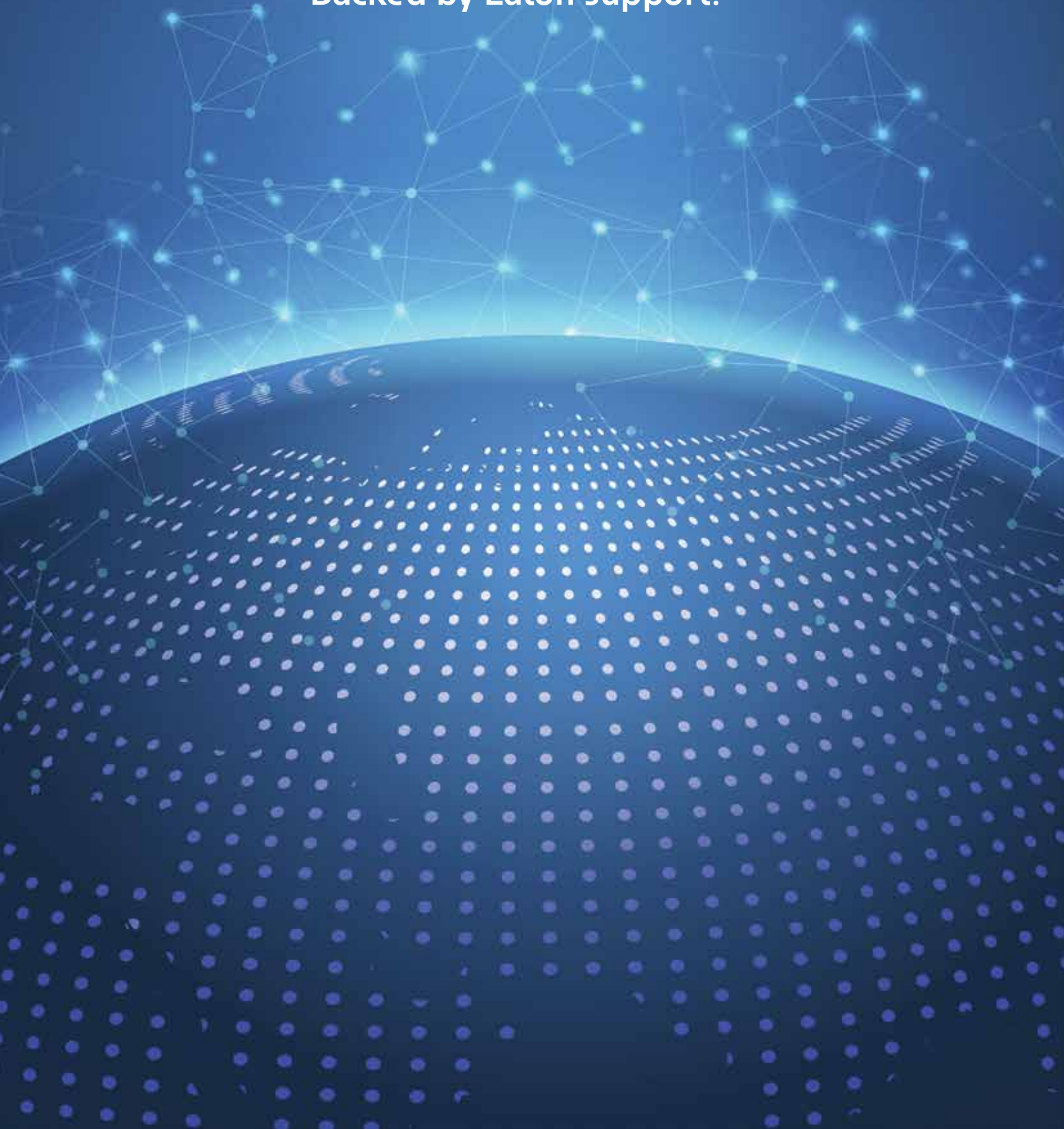

Eaton's globally rated Power Defense™ molded case circuit-breaker (MCCB) provides:

- Thermo magnetic breaker for the whole family up to 800A for 40°C and 50°C
- Latest circuit protection technology
- Power Xpert Release (PXR), Eaton's innovative and global based electronic trip unit.

The Power Defense MCCB portfolio is a globally based circuit-breaker design for regional needs. Eaton's best-in-class support enables you to order readily available product for on-time delivery.



Power Xpert® Release Electronic Trip Unit

Simpler communications. Better protection.

Embedded in the Power Defense molded case circuit-breaker portfolio, Power Xpert® Release (PXR) electronic trip units for global low-voltage commercial applications are Eaton's latest innovation in circuit protection technology. They're designed to help you simplify your application and enhance your protection.

- Unique Eaton trip unit platform enables you to easily change set points, test and configure circuit-breakers.
- Enhanced, easy-to-use interface allows you to view and adjust the trip unit settings.

Trip unit selection

The table (next page) indicates the range of trip units that are available across the frames. This range of trip units enables compatibility with global requirements and allows the breaker to be upgraded from the most basic protection functionality to a high-end intelligent power system node.

Thermal magnetic

Available with:

- Adjustable magnetic settings.
- Adjustable thermal settings.
- 40°C and 50°C calibration.
- 4 pole options with 60% and 100% protection.

Electronic

Available with:

- LI protection.
- LSI protection.
- USB connection.
- 4 pole setting for 60% (via PXPMP).



Electronic and thermo magnetic trip unit configurations

		Frame 1	Frame 2/9	Frame 3	Frame 4
POWER DEFENSE TRIP UNITS	Continuous Current Range (A)	16 - 160	160 - 250 / 63 - 100	250 - 630	800 - 1000
	Certifications	IEC	IEC	IEC	IEC

Thermal/Magnetic

THERMAL MAGNETIC TRIP UNITS	Fixed Thermal Fixed Magnetic	•			
	Adjustable Thermal Adjustable Magnetic	•	•	•	•

PXR 10

ELECTRONIC TRIP UNITS	LI	N/A	•	•	•
	LSI	N/A	•		

PXR 10

All of the advantages of an electronic trip unit in a simpler interface for easy set-up.

- Available with basic LI protection and LSI motor protection.
- Includes programmable settings so that it can be tailored for the specific application.



Interruption Ratings

The Power Defense Molded Case Circuit-breaker range is a globally rated platform, with interruption ratings across a broad range of voltages.

These interruption ratings are optimized for power distribution and meet the need for the broadest range of commercial construction applications.

Consult the detailed technical table for each frame for the specific interruption levels.

IEC Voltages and Ratings									
Interruption Rating	240 Vac			415 Vac			440 Vac		
	lcu	lcs	lcm	lcu	lcs	lcm	lcu	lcs	lcm
F	35	35	73.5	25	25	52.5	20	15	52.5
G	50	50	121	36	36	75.6	30	22.5	63
K	65	65	187	50	50	105	35	26	73.5
M	100	100	220	70	50	154	50	37	105
N	100	100	330	70	70	154	50	37	154



Power Xpert Protection Manager

Simpler operation. Reduced maintenance.

Once installed, your Power Xpert Release trip unit continues to provide cost savings and advanced functionality through the Power Xpert Protection Manager interface (PXPM). This intuitive user interface allows for simple trip unit set up and programming, to meet your application needs while decreasing maintenance and in-field testing time. The testing features and functionality, which can be run through a personal computer, offers savings through labor hour reduction and avoiding the need for expensive proprietary testing kits.

- **Set point Configuration:** Allows direct to-trip unit or offline set up, including duplication of settings between units.
- **Test Mode:** Sensor continuity test and create test reports.
- **Real-Time Data:** Provides information regarding all status from the trip unit.
- **Event Summaries:** Stores up to 200 events, detailed information on the most recent (10) trip and (10) alarm events, and time adjustments to the real-time clock.
- **Reports:** Allows for the formatting and printing of data from the testing performed.



User Interface

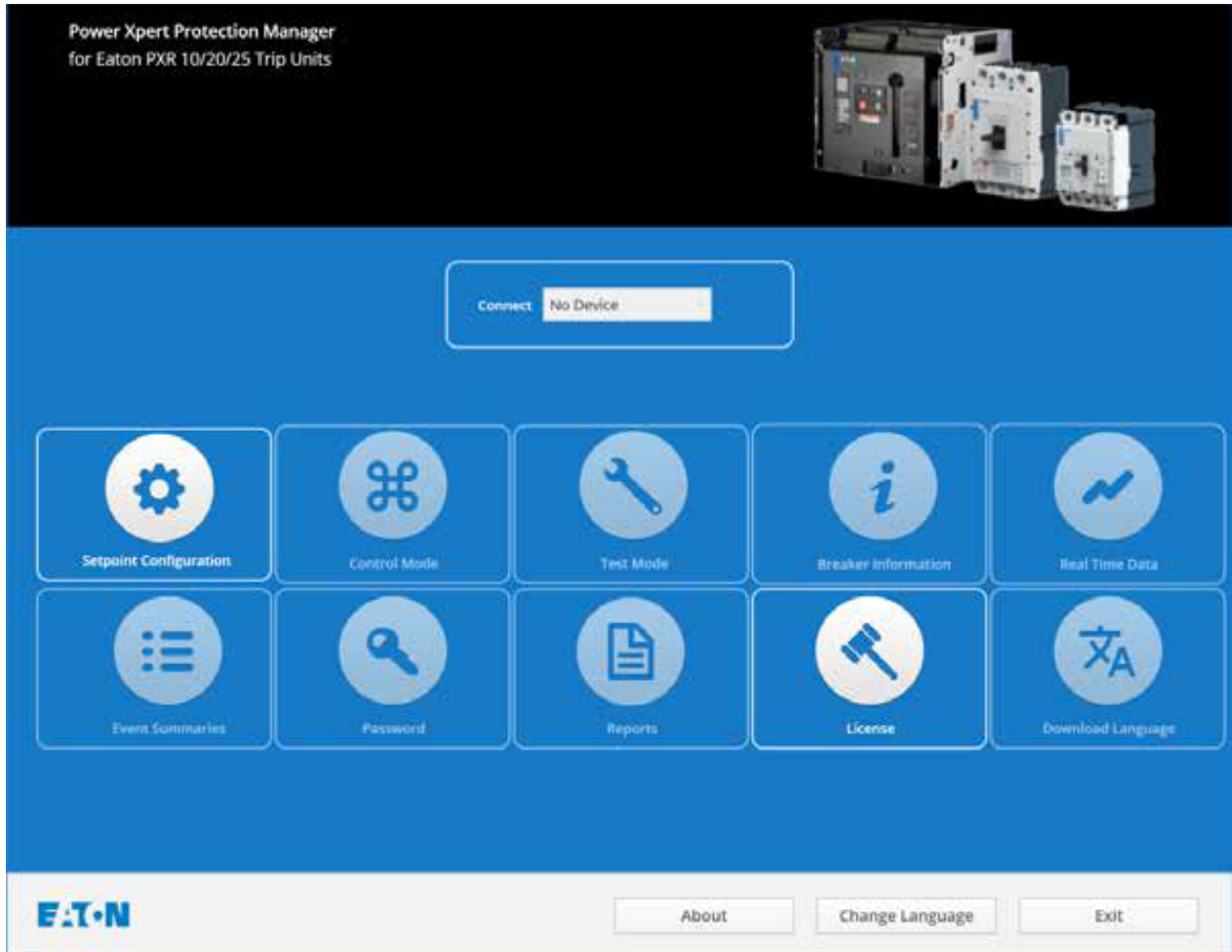

Test Report

EATON Power Xpert Protection Manager for PXR 10/25 Trip Units - Test Report

Overall: 4/17/2018 10:17:38 AM

Customer Information						
Customer Name	Energy Corporation					
Plant Location	Barrow, AK					
Unit	10001					
Device						
Manufacturer	Eaton					
Circuit Breaker Type/Model	Device: Outback 2					
Circuit Breaker Serial Number						
Circuit Breaker Phase Rating (kA)						
Electronic Trip Unit Model						
Electronic Trip Unit Serial Number						
Electronic Trip Unit In	63 A					
Voltage (kV)	480Y/277					
Frequency	60Hz					
Circuit Breaker Location						
Device Installation Location #	Device Installation name					
Cell #	1					
Environment Data						
Temperature	51F					
Humidity	30%					
Device Data						
Circuit Breaker	1001					
ICB	PXR-25					
Outboard	Module 2					
Protection / Configuration Settings #1						
Manufacturer	Eaton	Model	1001	Version	1.0	
Name	1001	ICB	100%	ICB	Enabled	
ICB Trip Level	100%	ICB	0%	ICB Setting	0%	
ICBTRIP	Disabled	ICBTRIP	1.0	ICBTRIP	0%	
ICBTRIP	0%	ICBTRIP	0.10	ICBTRIP	0.10	
ICBTRIP	10	ICBTRIP	1	ICBTRIP	0.10%	
ICBTRIP	10	ICBTRIP	Disabled	ICBTRIP	100%	
1000 Test Results #1						
Test Settings			Test Results			
Phase	Current Magnitude	Test Type	Open	Close	Open	Close
A	1200	1000	100%	100%	100%	100%

Modular Accessories

The Power Defense molded case circuit-breakers feature new, modular accessories designed to make it easier than ever before to customize the breaker for the unique requirements of each application.

- A common line of auxiliary switch and bell alarms allow for interchangeability among the different Power Defense breaker frames to enable final breaker configuration at the point of use and minimize the amount of inventory required.
- Compact, modular shunt trips and under voltage releases can be easily installed and removed as the project or application dictates.
- A wide range of rotary handles with different additional features to support your application needs.
- Plug-in adapter kits for the whole Power Defense range, to convert your standard circuit-breaker in a Plug-in unit for maintenance reduction within your system.
- State of the art remote operators for all frames to support any kind of remote control need for your system.
- The wide range of different terminal connections for all frames provides you with additional customization capability.
- External RCD for frame 1-3 and many other additional accessories to cover any need or specialization for your application.



Power Defense Molded Case Circuit Breaker (MCCB): PDE1, 2, 3, and 4 (up to 1,000A)

Product Description

Eaton's Power Defense MCCBs can safely and reliably distribute, switch and control electrical energy for commercial construction applications. They feature innovative protecting conception and offers fault diagnosis and communication functions via USB.

- Compact structure, with four current frames
- 3-pole and 4-pole (60% version)
- Rated current from 16A up to 1,000A
- Multiple mounting methods
- Auxiliary contacts of the same catalogue models are mounted at different positions, offering different functions
- Decreased types and models, with lower inventory requirement
- Universal cutout dimensions for different models
- Additional switch disconnecter offering for all frames



PDE1 circuit-breaker

- Current up to 160A
- Thermo-magnetic circuit-breaker with 40°C and 50°C calibration
- A variety of accessories can be added, including shunt, under-voltage, motor-operated and earth leakage units
- Thermo-magnetic settings are adjustable when $I > 32A$; breaking capacity available up to M rating



PDE9/2 circuit-breaker

- PDE2 thermo-magnetic circuit-breaker (up to 250A), thermo-magnetic settings adjustable
- PDE2 electronic circuit-breaker up to 250 A adjustable and a special PDE9 electronic circuit-breaker which is smaller can be adjusted down to 16 A
- A variety of accessories can be added, including shunt, under-voltage, motor-operated and earth leakage units



PDE3 circuit-breaker

- Thermo-magnetic / electronic type, with adjustable thermo-magnetic and electronic settings
- Current up to 630A
- A variety of accessories can be added, including shunt, under-voltage, motor-operated and earth leakage units



PDE4 circuit-breaker

- Thermo-magnetic / electronic type, with adjustable thermo-magnetic and electronic settings
- Current up to 1,000A
- A variety of accessories can be added, including shunt, under-voltage, motor-operated and earth leakage units



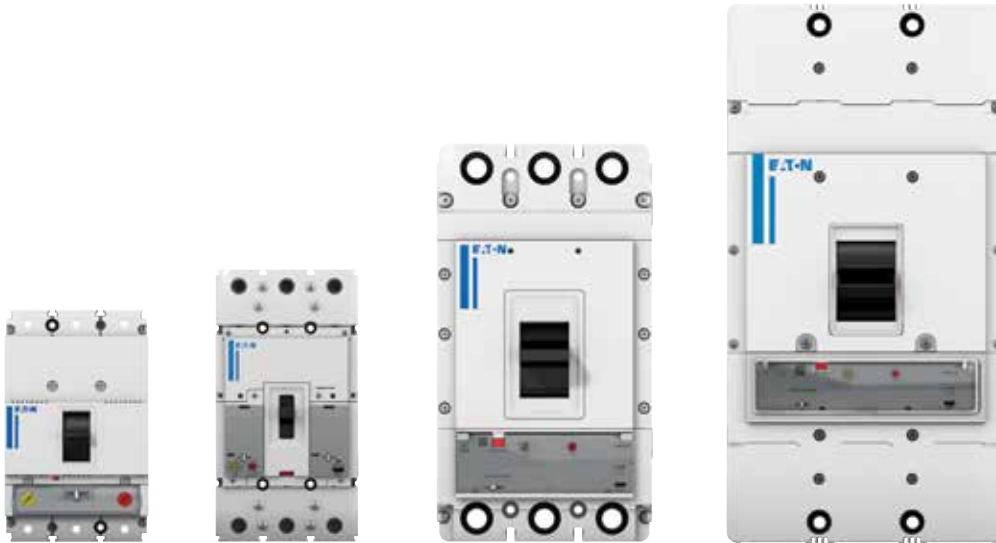

Introduction to the Power Xpert® Release Trip Unit

The Power Xpert Release (PXR) trip unit has features and flexibility that allow configuration for a wide variety of protection applications. Communication options support integration into supervisory systems to monitor performance and, if desired, control the circuit-breaker. Advanced metering of current, voltage, energy and power allow monitoring of real-time energy use.

The PXR trip unit is available in multiple MCCB and ACB models. All PXR trip units share common features including configuration of their protective functions, cause-of-trip information, built in secondary injection for testing and a USB port for connection to configuration and monitoring software. Certain models include energy metering with 1% accuracy, network connectivity, multi-language display and advanced protection features.

The PXR trip unit, along with current sensors and a trip actuator, is the subsystem of a circuit-breaker that provides the protective functions. The PXR analyzes signals from the current sensors; if current level and time delay settings are exceeded then the PXR will trip the circuit-breaker. The overload and short circuit tripping characteristics for a specific circuit-breaker are determined by the current rating and user selected protection settings.

Metering uses those same current sensors to monitor and record current. In models that include voltage metering, a rich set of power and energy data is available with 1% accuracy. Additionally the PXR supports a waveform capture mechanism by which you can monitor your systems currents and voltages.

The communication systems provide real-time status and data from the PXR for integration with business information systems, control schemes or other systems used by service personnel. The PXR trip units support several field-busses including ModbusRTU, Ethernet and ProfibusDP. Ethernet communications also includes an advanced web-interface for use with phone, tablet or PC browsers.

Certain models have a LCD display to make set-up and system monitoring possible from the face of the MCCB. Other models have rotary switches to set the available protection settings. Regardless of the interface on the PXR trip units, all aspects of the configuration and performance are available using Power Xpert Protection Manager (PXPM) software.

The Power Xpert Release trip unit is available in several product families like Power Defense, NZM and IZMX.

Visit our Homepage for more detailed information <http://www.eaton.eu>

PXR User Interface

The PXR trip unit interface is common across all frame sizes of the Power Defense Family of circuit-breaker frames. This common user interface ensures rapid configuration and makes it easier to train service personnel. In each frame size, the elements of the interface are easily recognized even when compressed into smaller frames or mounted horizontally.

The PXR 10 has the simplest user interface (UI), including the essential protection settings and status. Refer to the front panel illustrations of the PXR 10 to determine which user interface elements are provided.



Key Interface Elements

Status Indicator

All PXR trip units have an indicator in the top left labeled "STATUS". During normal operation, this indicator blinks green (on and off approximately once each second), indicating that the trip unit is operating normally.

The status indicator blinks red if the trip unit detects an internal problem. This indicates a problem with the trip actuator coil, a firmware error, or a mechanism error. Take immediate action to replace the trip unit or breaker.

When the status indicator remains off, there is no auxiliary power applied or insufficient primary current to power the trip unit. PXR trip units in MCCB will self-power at 20% of the circuit-breaker frame In.

USB – Test & Configuration Port

The lower right corner of all PXR trip units has a standard micro-B USB connector. Power Xpert Protection Manager software (PXPM) uses the USB port to configure, test and monitor the trip unit. Download the installation package for PXPM software from <http://www.eaton.com/pxpm>

A USB cable connection from a host PC will power the trip unit when the trip unit is not harvesting sufficient energy from the mains or there is no auxiliary power applied. Commercially available battery packs can also power the trip unit. This connection is intended for temporary use while a user is configuring, monitoring or testing the trip unit.

Push to Trip

A red button on the front of the trip unit or circuit-breaker provides a mechanical means of tripping the circuit-breaker. Use a small tool to depress it and trip the breaker mechanism.

Tamper Proof Cover

A clear plastic cover allows the settings to be viewed but not changed. Controlling physical access is a key element in your comprehensive security policy. Unauthorized access to change settings is prevented by insertion of a standard sealing wire through the security holes in order to meet applicable tamper-proof requirements.

PXR 10 simplified Rotary Switches

The PXR 10 trip curve configuration is simple, using the switches on the front panel. LSI trip units have 3 rotary switches, while the LI version has only 2, eliminating the center “SD Profile” switch. For all, the yellow color rotary switch sets the I_r and the red switches define short circuit behavior.

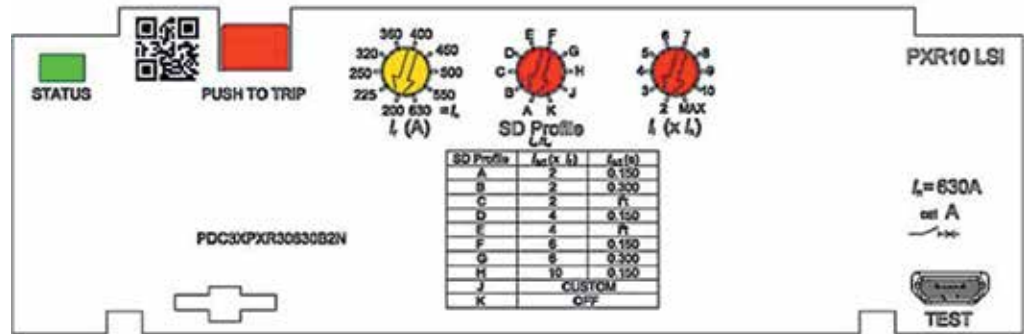

All PXR family trip units record the cause-of-trip (CoT) in memory. The CoT is available by using Power Xpert Protection Manager (PXPM) software.

Technical Data

		PDE1			
Max rated uninterrupted current/continuous current rating I_u , A		160 A			
Number of poles		3 & 4			
Maximum Breaker Capacity(kA rms) Vac 50-60 Hz		F	G	K	M
220-240 Vac	I_{cu}	35	50	65	100
	I_{cs}	35	50	65	100
380-415 Vac	I_{cu}	25	36	50	70
	I_{cs}	25	36	50	50
440 Vac	I_{cu}	20	30	35	50
	I_{cs}	15	22.5	26	37
Rated short circuit making capacity I_{cm}					
220-240 Vac	I_{cm}	73.5	121	187	220
380-415 Vac	I_{cm}	52.5	75.6	105	154
440 Vac	I_{cm}	52.5	63	73.5	105
Withstand/Threshold of the frame (kA)		I_{cw}	-		
Clearing time @ 415 V		I_{cu} kA @ 415 V	<10 ms		
Amperage range		16 - 160 A			
Selectivity Category		A			
Reference Standard		IEC/CCC			
Maximum rated current I_n depending on the version		160 A			
Rated insulation voltage U, according to IEC 60947-2					
Main conducting paths		800 V			
Auxiliary circuits		690 V			
Rated impulse withstand voltage					
Main conducting paths		U_{imp}	6 kV		
Auxiliary circuits		U_{imp}	6 kV		
Rated operational voltage Vac U_g IEC/CCC		440 V			
Permissible ambient temperature range (for storage and operation)		-20°C to 70°C			
Product complies with IEC 60-068 Shock		Yes			
Derating for		40° calibrated breaker		50°C calibrated breaker	
	40°C	100%	50°C	100%	
	45°C	97%	55°C	92%	
	50°C	95%	60°C	90%	
	55°C	92%	70°C	80%	
	60°C	90%	75°C	69%	
	70°C	80%	80°C	64%	
Altitude derating factor of voltage		2000 m	440 V		
	3000 m	418 V			
	4000 m	396 V			
Altitude derating factor of rated current		2000 m	100%		
	3000 m	95%			
	4000 m	90%			
Endurance (operating cycles) no-load (mechanical endurance)		25000			
Endurance (operating cycles) with load (electrical endurance) IEC/EN60947-4 B AC-1		10000			
Maximum switching frequency # operations per minute/min		2			
H x W x D (mm)					
3 pole		144.8 x 89.9 x 68.1			
4 pole		144.8 x 119.9 x 68.1			
Pole to pole distance		30.00 mm			
Approx Weight kg fixed		TMTU	3P 1.046 kg		
			4P 1.325 kg		
		ETU PXR10	-		
			-		
Suitable for reverse-feed applications		Yes			
Blow out dimension; Direction of blow out IEC		60 mm; top, front			
Required spacing between circuit-breakers IEC		0 mm			
Installation methods		Fixed			
IP degree		IP2X with Fingerprotection			
Pollution degree / Overvoltage category		III / III			
Power loss per circuit breaker at maximum rated current I_n		W	36.1		
Annex H IT capability 415 V		Yes			

Technical Data

		PDE2				
Max rated uninterrupted current/continuous current rating I_u , A		250 A				
Number of poles		3 & 4				
Maximum Breaker Capacity(kA rms) Vac 50-60 Hz		F	G	K	M	N
220-240 Vac	I_{cu}	35	50	65	100	100
	I_{cs}	35	50	65	100	100
380-415 Vac	I_{cu}	25	36	50	70	70
	I_{cs}	25	36	50	50	70
440 Vac	I_{cu}	20	30	35	50	50
	I_{cs}	15	22.5	26	37	37
Rated short circuit making capacity I_{cm}						
220-240 Vac	I_{cm}	73.5	121	187	220	330
380-415 Vac	I_{cm}	52.5	75.6	105	154	154
440 Vac	I_{cm}	52.5	63	73.5	105	154
Withstand/Threshold of the frame (kA)	I_{fw}	1.8				
Clearing time @ 415 V	I_{cu} kA @ 415 V	5.1 ms				
Amperage range		63 - 250 A				
Selectivity Category		A				
Reference Standard		IEC/CCC				
Maximum rated current I_n depending on the version		250 A				
Rated insulation voltage U, according to IEC 60947-2						
Main conducting paths		800 V (TM), 690 V (PXR)				
Auxiliary circuits		690 V				
Rated impulse withstand voltage						
Main conducting paths	U_{imp}	8 kV (TM), 6kV (PXR)				
Auxiliary circuits	U_{imp}	4 kV				
Rated operational voltage Vac U_e IEC/CCC		440 V				
Permissible ambient temperature range (for storage and operation)		-20°C to 70°C				
Product complies with IEC 60-068 Shock		Yes				
Derating for		40° calibrated breaker		50°C calibrated breaker		
40°C		100%		50°C	100%	
45°C		98%		55°C	93%	
50°C		96%		60°C	91%	
55°C		93%		70°C	86%	
60°C		91%		75°C	80%	
70°C		80%		80°C	68%	
Altitude derating factor of voltage		2000 m	440 V			
		3000 m	418 V			
		4000 m	396 V			
Altitude derating factor of rated current		2000 m	100%			
		3000 m	100%			
		4000 m	95%			
Endurance (operating cycles) no-load (mechanical endurance)		20000				
Endurance (operating cycles) with load (electrical endurance) IEC/EN60947-4 B AC-1		8000				
Maximum switching frequency # operations per minute/min		2				
H x W x D (mm)						
3 pole		PDE2 200.9 x 104.6 x 88.9		PDE9 152.4 x 104.6 x 88.9		
4 pole		PDE2 200.9 x 139.5 x 88.9		PDE9 152.4 x 139.5 x 88.9		
Pole to pole distance		34.93 mm				
Approx Weight kg fixed		TMTU	PDE2 3P 1.91 kg	PDE9 3P 1.82 kg		
			PDE2 4P 2.58 kg	PDE9 4P 2.46 kg		
		ETU PXR10	-	-		
			-	-		
Suitable for reverse-feed applications		Yes				
Blow out dimension; Direction of blow out IEC		25.4 mm; top, front				
Required spacing between circuit-breakers IEC		0 mm				
Installation methods		Fixed				
IP degree		IP2X with Fingerprotection				
Pollution degree / Overvoltage category		III / III				
Power loss per circuit breaker at maximum rated current I_n	W	58 for TMTU PDE2; 34 for ETU PDE2; 22 for PDE9				
Annex H IT capability 415 V		Yes				

Technical Data

		PDE3				
Max rated uninterrupted current/continuous current rating I_u , A		630 A				
Number of poles		3 & 4				
Maximum Breaker Capacity(kA rms) Vac 50-60 Hz		F	G	K	M	N
220-240 Vac	I_{cu}	35	50	65	100	100
	I_{cs}	35	50	65	100	100
380-415 Vac	I_{cu}	25	36	50	70	70
	I_{cs}	25	36	50	53	70
440 Vac	I_{cu}	20	30	35	50	50
	I_{cs}	15	22.5	26	37	37
Rated short circuit making capacity I_{cm}						
220-240 Vac	I_{cm}	73.5	121	187	220	330
380-415 Vac	I_{cm}	52.5	75.6	105	154	154
440 Vac	I_{cm}	52.5	63	73,5	105	154
Withstand/Threshold of the frame		I_{lw}	6.3 kA			
Clearing time @ 415 V		I_{cu} kA @ 415 V	8.65 ms @ 50 kA, 6.2 ms @ 70 kA			
Amperage range		250 - 630 A				
Selectivity Category		A				
Reference Standard		IEC/CCC				
Maximum rated current I_n depending on the version		630 A				
Rated insulation voltage U, according to IEC 60947-2						
Main conducting paths		800 V (TM), 690 V (PXR)				
Auxiliary circuits		690 V				
Rated impulse withstand voltage						
Main conducting paths	U_{imp}	8 kV (TM), 6 kV (PXR)				
Auxiliary circuits	U_{imp}	4 kV				
Rated operational voltage Vac U_e IEC/CCC		440 V				
Permissible ambient temperature range (for storage and operation)		-25°C to 70°C				
Product complies with IEC 60-068 Shock		Yes				
Derating for		40° calibrated breaker	50° calibrated breaker			
	40°C	100%	50°C	100%		
	45°C	96%	55°C	86%		
	50°C	91%	60°C	82%		
	55°C	86%	70°C	70%		
	60°C	82%	75°C	56%		
	70°C	70%	80°C	48%		
Altitude derating factor of voltage		2000 m	440 V			
	3000 m	418 V				
	4000 m	396 V				
Altitude derating factor of rated current		2000 m	100%			
	3000 m	91%				
	4000 m	82%				
Endurance (operating cycles) no-load (mechanical endurance)		15000				
Endurance (operating cycles) with load (electrical endurance) IEC/EN60947-4 B AC-1		5000				
Maximum switching frequency # operations per minute/min		1				
H x W x D (mm)						
3 pole	257.1 x 138.9 x 109.1					
4 pole	257.1 x 182.9 x 109.1					
Pole to pole distance		43.66 mm				
Approx Weight kg fixed		TMTU	3P 5.8 kg			
			4P 7.9 kg			
		ETU PXR10	-			
			-			
Suitable for reverse-feed applications		Yes				
Blow out dimension; Direction of blow out IEC		25.4 mm; top, front				
Required spacing between circuit-breakers IEC		0 mm				
Installation methods		Fixed				
IP degree		IP2X with Fingerprotection				
Pollution degree / Overvoltage category		III / III				
Power loss per circuit breaker at maximum rated current I_n		W	130 for TMTU; 110 for ETU			
Annex H IT capability 415 V		Yes				

Technical Data

		PDE4			
Max rated uninterrupted current/continuous current rating I_{cr} , A		1000 A			
Number of poles		3 & 4			
Maximum Breaker Capacity(kA rms) Vac 50-60 Hz		G	K	M	N
220-240 Vac	I_{cu}	50	65	100	100
	I_{cs}	50	65	100	100
380-415 Vac	I_{cu}	36	50	70	70
	I_{cs}	36	50	50	70
440 Vac	I_{cu}	30	35	50	50
	I_{cs}	22.5	26	37	37
Rated short circuit making capacity I_{cm}					
220-240 Vac	I_{cm}	121	187	220	220
380-415 Vac	I_{cm}	75.6	105	154	154
440 Vac	I_{cm}	63	73.5	105	143
Withstand/Threshold of the frame (kA)		I_{cw}	6		
Clearing time @ 415 V, ms I_{cu} kA @ 415 V		I_{cu} kA @ 415 V	5.23 ms		
Amperage range		800 - 1000 A			
Selectivity Category		A			
Reference Standard		IEC/CCC			
Maximum rated current I_n depending on the version		1000 A			
Rated insulation voltage U, according to IEC 60947-2					
Main conducting paths		800 V (TM), 690 V (PXR)			
Auxiliary circuits		690 V			
Rated impulse withstand voltage					
Main conducting paths	U_{imp}	8 kV (TM), 6 kV (PXR)			
Auxiliary circuits	U_{imp}	4 kV			
Rated operational voltage Vac U_b IEC/CCC		440 V			
Permissible ambient temperature range (for storage and operation)		-25°C to + 70°C			
Product complies with IEC 60-068 Shock		Yes			
Derating for		50° calibrated breaker	50° calibrated breaker		
	40°C	100%	50°C	100%	
	45°C	97%	55°C	90%	
	50°C	94%	60°C	88%	
	55°C	90%	70°C	80%	
	60°C	88%	75°C	69%	
	70°C	80%	80°C	63%	
Altitude derating factor of voltage		2000 m	440 V		
		3000 m	418 V		
		4000 m	396 V		
Altitude derating factor of rated current		2000 m	100%		
		3000 m	94%		
		4000 m	88%		
Endurance (operating cycles) no-load (mechanical endurance)		10000			
Endurance (operating cycles) with load (electrical endurance)		3000			
IEC/EN60947-4 B AC-1					
Maximum switching frequency # operations per minute/min		1			
H x W x D (mm)					
3 pole		406.4 x 209.6 x 111.2			
4 pole		406.4 x 279.4 x 111.2			
Pole to pole distance		70 mm			
Approx Weight kg fixed		TMTU	3P 13.2 kg		
			4P 17.55 kg		
		ETU PXR10	3P 13.6 kg		
			4P 18.088 kg		
Suitable for reverse-feed applications		Yes			
Blow out dimension; Direction of blow out IEC		60 mm; top, front			
Required spacing between circuit-breakers IEC		0 mm			
Installation methods		Fixed			
IP degree		-			
Pollution degree / Overvoltage category		III / III			
Power loss per circuit breaker at maximum rated current I_n		W	291 for TMTU; 270 for ETU		
Annex H IT capability 415 V		Yes			

Technical Data

		Frame Size 1		Frame Size 2
Max rated uninterrupted current/continuous current rating	I_u	A	160	250
General				
Standards			IEC/EN 60947	IEC/EN 60947
Protection against direct contact			Finger and back-of-hand proof to DIN EN 50274/VDE 0106 part 110	Finger Protection with IP2X Accessory
Climatic proofing				
Ambient temperature				
Ambient temperature, storage		°C	- 40 up till + 70	- 40 up till + 70
Operation		°C	- 25 up till + 70	- 25 up till + 70
Mechanical shock resistance (10 ms half-sinusoidal shock) according to IEC 60068-2-27		g	20 (half-sinusoidal shock 20 ms)	15 (half-sinusoidal shock 11 ms)
Safe isolation to EN 61140				
Between auxiliary contacts and main contacts		V AC	500	690
Between the auxiliary contacts		V AC	300	300
Mounting position			Vertical and 90° in all directions	Vertical and 90° in all directions
Rated surge voltage invariability	U_{imp}			
Main contacts		V	8000	8000
Auxiliary contacts		V	6000	6000
Rated operational voltage	U_e	V AC	440	440
Rated operating frequency	f	Hz	50/60	50/60
Rated current = rated uninterrupted current	$I_n = I_u$	A	160	250
Overvoltage category/pollution degree			III/3	III/3
Rated insulation voltage	U_i	V	690	690
Use in unearthed supply systems		V	< 440	< 440
Other technical data				
Rated short-circuit making capacity				
	I_{cm}	kA	2.8	5.2
Rated short-time withstand current				
t = 0.3 s	I_{cw}	kA	2	3.6
t = 1 s	I_{cw}	kA	2	3.6
Rated conditional short-circuit current				
With back-up fuse		A gG/gL	gG/gL: 100	250
400 ... 415 V		kA	100	100
With downstream fuse		A gG/gL	gG/gL: 100	250
400 ... 415 V		kA	100	100
Rated making and breaking capacity				
Rated operational current				
AC-22/23A				
415 V	I_e	A	160	250
Lifespan, mechanical	Operations		20000	20000
Max. operating frequency		Ops/h	120	120
Lifespan, electrical				
AC-1				
400 V 50/60 Hz	Operations		10000	8000
415 V 50/60 Hz	Operations		10000	8000

Technical Data

		Frame size 3		Frame size 4
Max rated uninterrupted current/continuous current rating	I_u	A	630	800
General				
Standards			IEC/EN 60947-3	IEC/EN 60947
Protection against direct contact			Finger Protection with IP2X Accessory / Extend terminal cover	Finger Protection with IP2X Accessory
Climatic proofing				
Ambient temperature				
Ambient temperature, storage		°C	- 40 up till + 70	- 40 up till + 70
Operation		°C	- 25 up till + 70	- 25 up till + 70
Mechanical shock resistance (10 ms half-sinusoidal shock) according to IEC 60068-2-27		g	15 (half-sinusoidal shock 11 ms)	15 (half-sinusoidal shock 11 ms)
Safe isolation to EN 61140				
Between auxiliary contacts and main contacts		V AC	800	800
Between the auxiliary contacts		V AC	690	690
Mounting position			Vertical and 90° in all directions	Vertical and 90° in all directions
Rated surge voltage invariability	U_{imp}			
Main contacts		V	8000	8000
Auxiliary contacts		V	6000	6000
Rated operational voltage	U_e	V AC	440	440
Rated operating frequency	f	Hz	50/60	50/60
Rated current = rated uninterrupted current	$I_n = I_u$	A	630	800
Overvoltage category/pollution degree			III/3	III/3
Rated insulation voltage	U_i	V	800	690
Use in unearthed supply systems		V	≤ 415	< 440
Other technical data				
Rated short-circuit making capacity				
	I_{cm}	kA	12.92	16.3
Rated short-time withstand current				
t = 0.3 s	I_{cw}	kA	7.6	9.6
t = 1 s	I_{cw}	kA	7.6	9.6
Rated conditional short-circuit current				
With back-up fuse		A gG/gL	630	800
400 ... 415 V		kA	100	100
With downstream fuse		A gG/gL	630	800
400 ... 415 V		kA	100	120
Rated making and breaking capacity				
Rated operational current				
AC-22/23A				
415 V	I_e	A	630	800
Lifespan, mechanical	Operations		15000	10000
Max. operating frequency		Ops/h	60	20
Lifespan, electrical				
AC-1				
400 V / 415 V at 50/60 Hz	Operations		5000	3000

Technical Data

Max rated uninterrupted current/continuous current rating	I_u	A	220
Switching capacity			
400/415 V 50 Hz	I_{cu}	kA	70
Highest Rated current = rated uninterrupted current	$I_n = I_u$	A	220
Setting range			
Overload trip	I_r	A	160 - 220
Short-circuit releases			
Non-delayed	$I_i = I_{n \times \dots}$		3 - 13x
Motor rating AC-3 50/60 Hz			
380 V 400 V	P	kW	22
Motor rating AC-3 50/60 Hz			
400 V	P	kW	22
Rated operational current AC-3 50/60 Hz			
400 V	I_e	A	41
Climatic proofing			Damp heat, constant, to IEC 60068-2-78 Damp heat, cyclic, to IEC 60068-2-30
Ambient temperature			
Ambient temperature, storage		°C	- 40 up till + 70
Operation		°C	- 25 up till + 70
Mechanical shock resistance (10 ms half-sinusoidal shock) according to IEC 60068-2-27		g	15 (half-sinusoidal shock 11 ms)
Safe isolation to EN 61140			
Between auxiliary contacts and main contacts		V AC	690
Between the auxiliary contacts	I_e	V AC	300
Mounting position			Vertical and 90° in all directions
Direction of incoming supply			as required
Degree of protection			
Device			IP2X with Finger protection accessory
Other technical data			
Circuit-breakers			
Rated current = rated uninterrupted current	$I_n = I_u$	A	220
Rated surge voltage invariability	U_{imp}		
Main contacts		V	6000
Auxiliary contacts		V	4000
Rated operational voltage	U_e	V AC	440
Overvoltage category/pollution degree			III/3
Rated insulation voltage	U_i	V	690
Use in unearthed supply systems		V	≤ 690
Switching capacity			
Rated short-circuit making capacity	I_{cm}		
240 V	I_{cm}	kA	330
400/415 V	I_{cm}	kA	154
440 V 50/60 Hz	I_{cm}	kA	154
Rated short-circuit breaking capacity I_{cn}	I_{cn}		
I_{cu} to IEC/EN 60947 test cycle O-t-CO	I_{cu}	kA	
240 V 50/60 Hz	I_{cu}	kA	150
400/415 V 50/60 Hz	I_{cu}	kA	70
440 V 50/60 Hz	I_{cu}	kA	70
I_{cs} to IEC/EN 60947 test cycle O-t-CO-t-CO	I_{cs}	kA	
240 V 50/60 Hz	I_{cs}	kA	100
400/415 V 50/60 Hz	I_{cs}	kA	70
440 V 50/60 Hz	I_{cs}	kA	50
Max. operating frequency		Ops/h	120
Total break time at short-circuit		ms	< 10

Power Defense Molded Case Circuit-Breaker

Technical Data Motor Protection Breaker Frame Size 2

1.1

Technical Data

Utilization category to IEC/EN 60947-2		A
Lifespan, mechanical(of which max. 50 % trip by shunt/undervoltage release)	Operations	20000
Lifespan, electrical		
AC-1		
400 V / 415 V at 50/60 Hz	Operations	10000 (up to 200A) 8000 (above 200A)
Max. operating frequency	Ops/h	120
Total break time at short-circuit	ms	< 10

1.1

Power Defense Molded Case Circuit-Breaker

Technical Data

Thermal Trip Unit

Rated Current (A)	I_u 40°C	16	20	25	32	40	50	63	80	100	125	160	200	250	320	400	500	630	800	
Frames	PDE1	•	•	•	•	•	•	•	•	•	•	•								
	PDE2											•	•	•						
	PDE3													•	•	•	•	•		
	PDE4																			•

Thermal Protection

Current Setting (A)	I_u x ...																				
	PDE1	0.8-1.0 I_n																			
	PDE2													0.8-1.0 I_n							
	PDE3																0.8-1.0 I_n				
	PDE4																			0.8-1.0 I_n	

Short-Circuit Protection

Current Setting (A)	I_i																						
	PDE1	350 A			8-10 I_n			6-10 I_n			8 I_n												
	PDE2													5-8 I_n									
	PDE3																5-8 I_n						
	PDE4																			5-8 I_n			

Neutral Protection

4 Pole																					
	PDE1	100%																			
	PDE2													60%/100%							
	PDE3																60%/100%				
	PDE4																			60%/100%	

* Without derating at 40°C, In determining the maximum permissible current loads at different ambient temperatures see the derating coefficients table.

Electronic Trip Unit PXR 10

Rated Current (A)	I_u	63	100	160	200	220	250	400	630	800	1000
Frames	PDE2		•	•	•	•	•				
	PDE9	•	•								
	PDE3							•	•		
	PDE4									•	•

Neutral Protection

	PDE2	100%		60%/100%		100%	60%/100%					
	PDE9	100%										
	PDE3								60%/100%			
	PDE4										60%/100%	

PDE2/9 PXR10 Settings (LI)

Frame	63A	100A	160A	200A	250A	All	63A	100A	160A	200A	250A
Profile	Long delay					Instantaneous					
	I_r (A)					I_i (n x I_n)					
Setting						$t_r @ 6 \times I_r$	-	2			
1	16	25	40	50	63	10	2	2	2	2	2
2	18	32	50	63	80	10	3	3	3	3	3
3	20	40	63	80	100	10	4	4	4	4	4
4	25	50	70	90	125	10	5	5	5	5	5
5	32	55	80	100	150	10	6	6	6	6	6
6	40	63	90	125	160	10	8	7	8	7	6.5
7	45	70	100	150	175	10	10	8	10	8	7
8	50	80	125	160	200	10	12	9	12	9	7.5
9	55	90	150	175	225	10	15	10	14	10	8
10	63	100	160	200	250	10	17.4	11	13.1	10.5	8.4
Instantaneous override											
						1100 A			2100 A		

PDE2 PXR10 - Motor Protection Settings (LSI)

Frame	100 A	160 A	220 A	100 A	160 A	220 A	All			
Profile	Overload			Short delay			Overload			
	I_e			$I_{sd} = nx (I_e)$			PXPM		Trip profile	
Setting							time (tsd)	SD Setting	Trip classat 6x (Ie)	Phase unbalance %
1	25	40	63	3	3	3	Instantan- eous 0,15 s, 0,30 s	A	5	OFF
2	32	50	80	4	4	4		B	10	
3	40	63	90	5	5	5		C	15	
4	50	70	100	6	6	6		D	20	
5	55	80	125	7	7	7		E	30	
6	63	90	150	8	8	8		F	5	
7	70	100	160	10	10	10		G	10	
8	80	125	175	11	11	11		H	15	
9	90	150	200	12	12	12		J	20	
10	100	160	220	13	13	13		K	30	
Instantaneous override						Instantaneous override				
			1100 A			2100 A			1100 A	

PDE3 PXR10 Settings (LI)

Frame	400 A	630 A	All	400 A	630 A
Profile	Long delay			Instantaneous	
	I_r (A)			I_i (x I_n)	
Setting	$t_r @ 6 \times I_r$				
1	100	200	10	2	2
2	125	225	10	3	3
3	140	250	10	4	4
4	160	320	10	5	5
5	200	360	10	6	6
6	225	400	10	8	7
7	250	450	10	10	8
8	320	500	10	12	9
9	360	550	10	15	10
10	400	630	10	18	11,43
Instantaneous override					
			4400 A		7200 A

PDE4 PXR10 Settings (LI)

Frame	800 A	1000 A	All	800 A	1000 A
Profile	Long delay			Instantaneous	
	I_r (A)			I_i (x I_n)	
Setting	$t_r @ 6 \times I_r$			Pickup $I_i = nx (I_n)$	
1	320	400	10	2	2
2	400	550	10	3	3
3	450	630	10	4	4
4	500	700	10	5	5
5	550	750	10	6	6
6	600	800	10	6.5	6.5
7	630	850	10	7	7
8	700	900	10	7.5	7.5
9	750	950	10	8	8
10	800	1000	10	8.5	8
Instantaneous override					
			6800 A 8000 A		

1.2

Power Defense Molded Case Circuit-Breaker

Tripping characteristics

System and line protection with PDE1

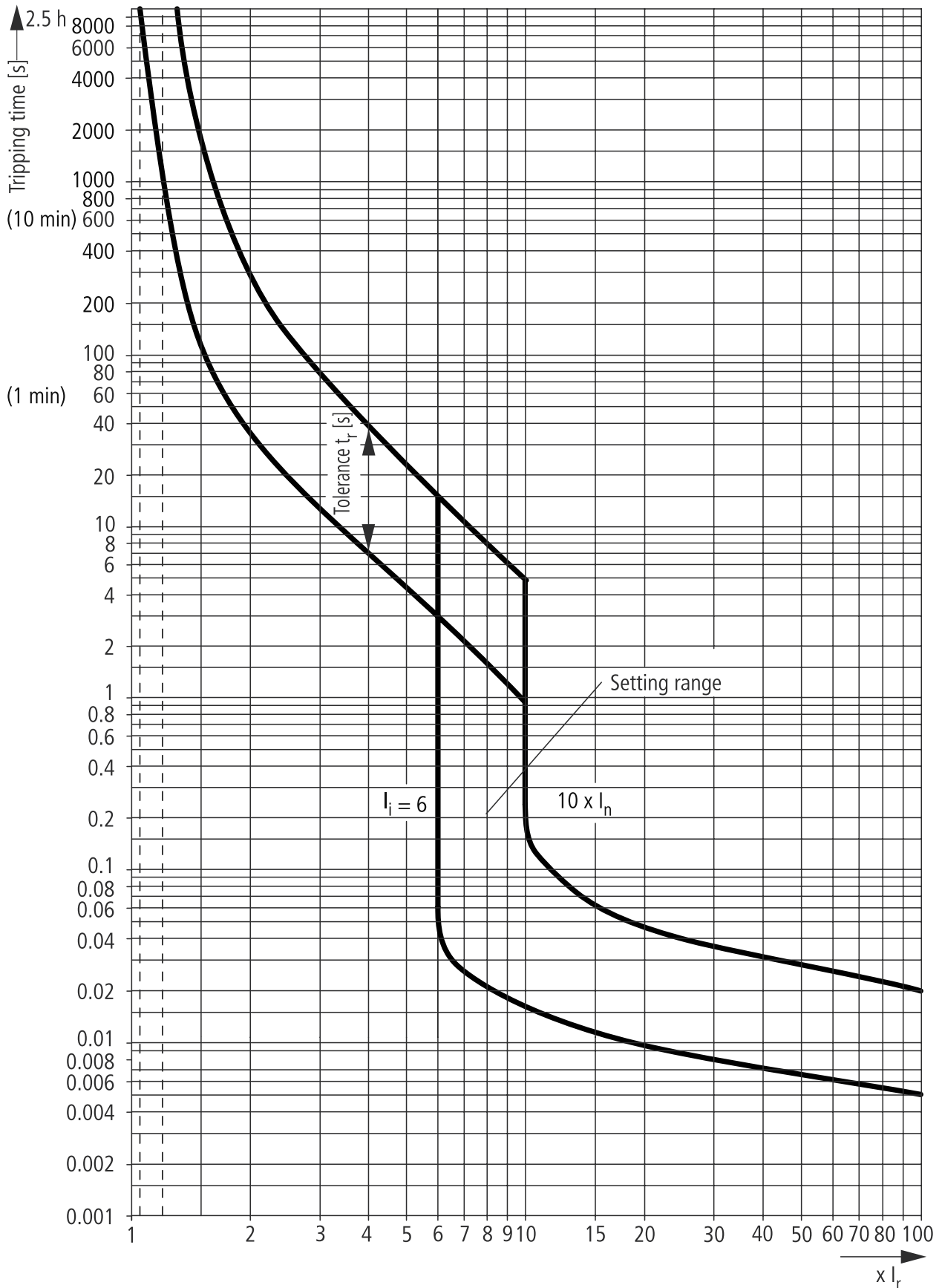

**Let-through current I_D PDE1 TMTU
PDE13(4)F..16 A (up to 160 A)**

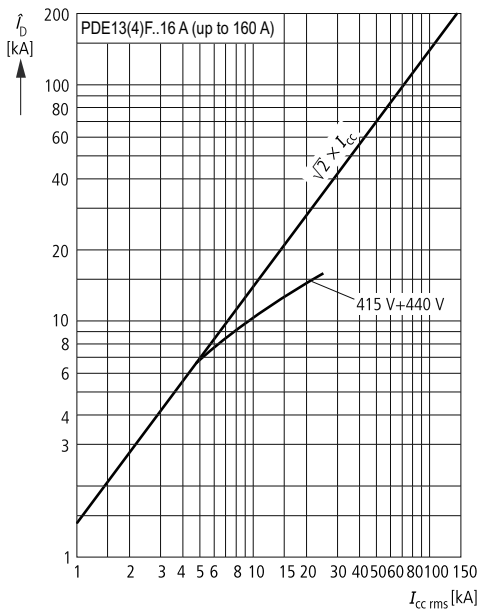

**Let-through current I_D PDE1 TMTU
PDE13(4)G..16 A (up to 160 A)**

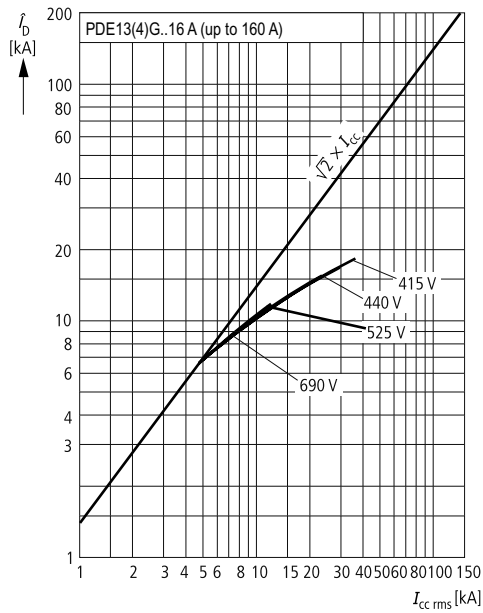

**Let-through current I_D PDE1 TMTU
PDE13(4)K..16 A (up to 160 A)**

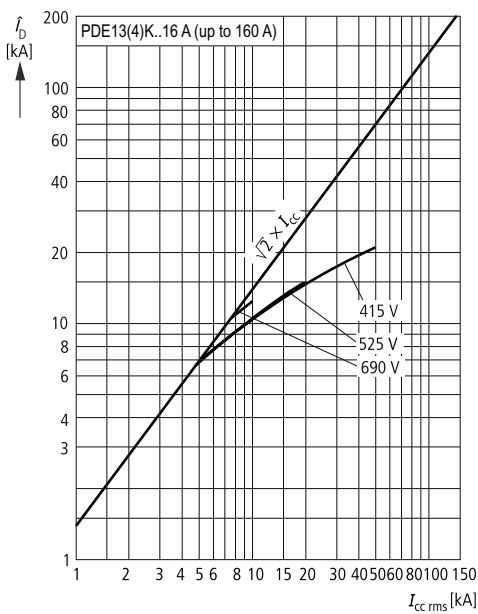

**Let-through current I_D PDE1 TMTU
PDE13(4)M..16 A (up to 160 A)**

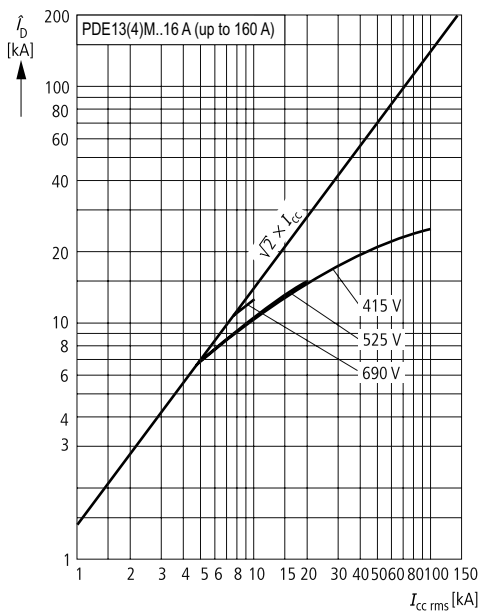

1.2

Power Defense Molded Case Circuit-Breaker

Let-through characteristics

Let-through energy I^2t ; PDE1 TMTU
PDE13(4)F..16 A (up to 160 A)

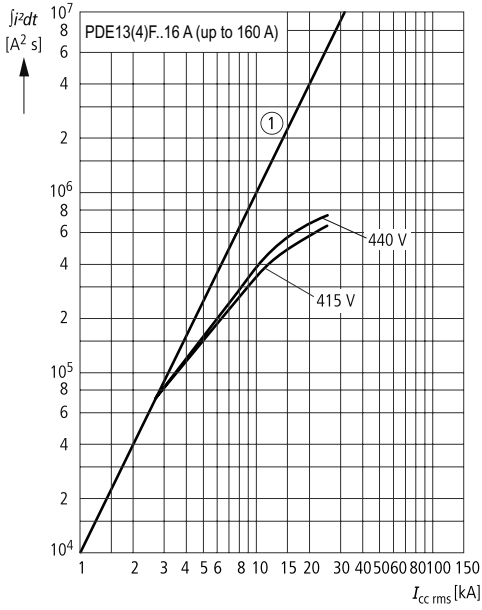

Let-through energy I^2t ; PDE1 TMTU
PDE13(4)G..16 A (up to 160 A)

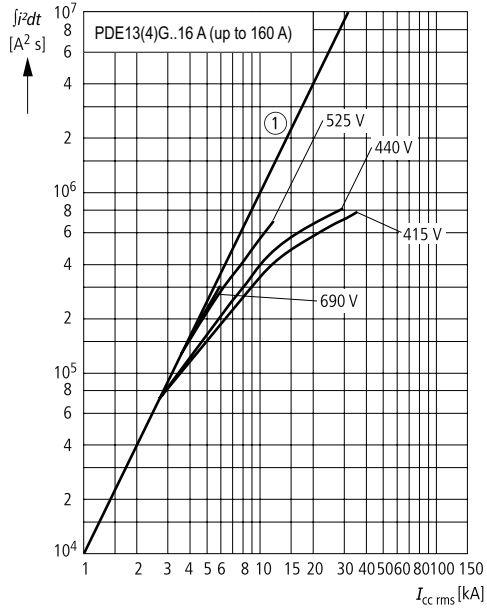

Let-through energy I^2t ; PDE1 TMTU
PDE13(4)K..16 A (up to 160 A)

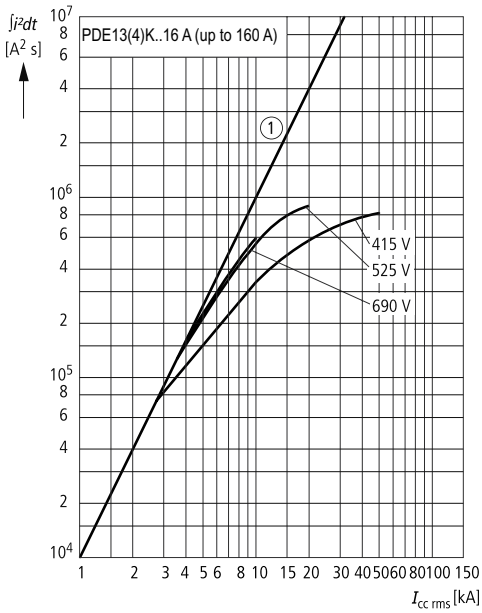

Let-through energy I^2t ; PDE1 TMTU
PDE13(4)M..16 A (up to 160 A)

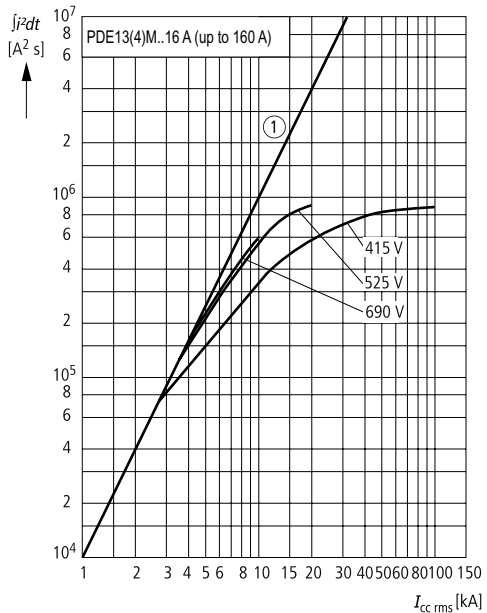

System and line protection with PDE2 TMTU; 160 A, 200 A and 250 A @ 240 V, 415 V and 440 V

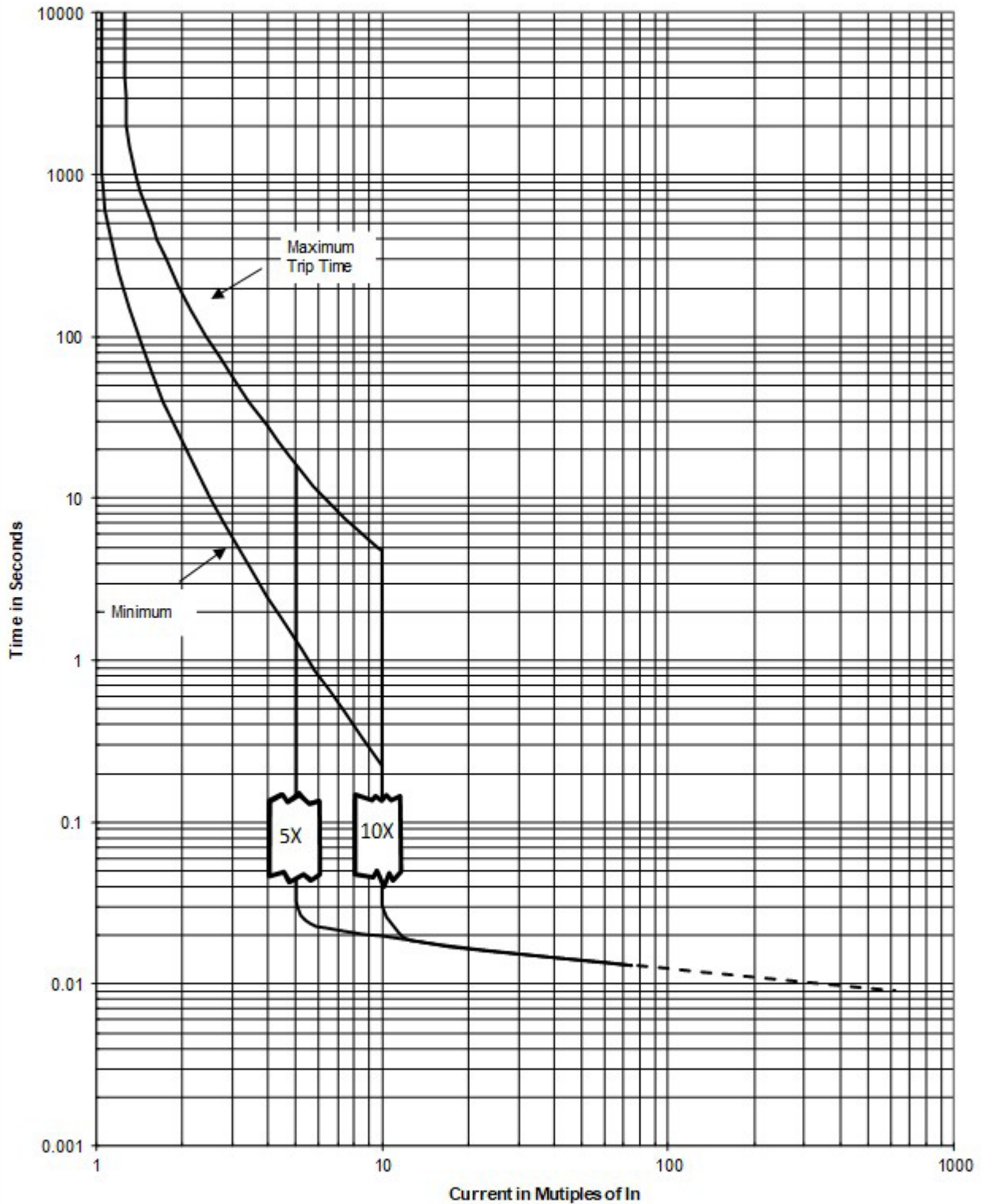

1.2

Power Defense Molded Case Circuit-Breaker

Tripping characteristics

System and line protection with PDE2 I²t Long Delay, Instantaneous, Override Curves; PDE2 ETU PXR10 LI; 160 A @ 240 V, 415 V and 440 V

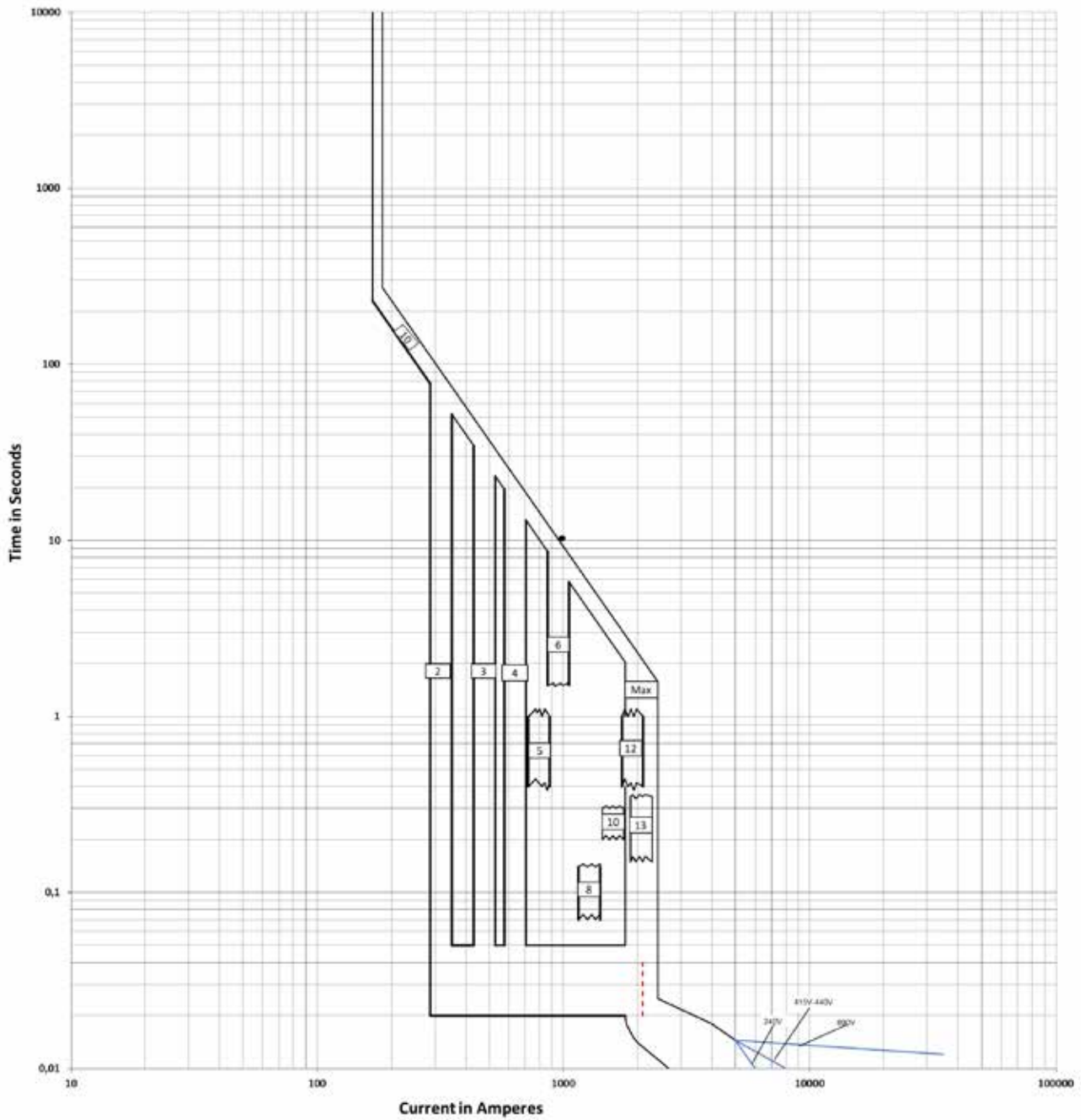

System and line protection with PDE2 I²t Long Delay, Instantaneous, Override Curves; PDE2 ETU PXR10 LI;
200 A @ 240 V, 415 V and 440 V

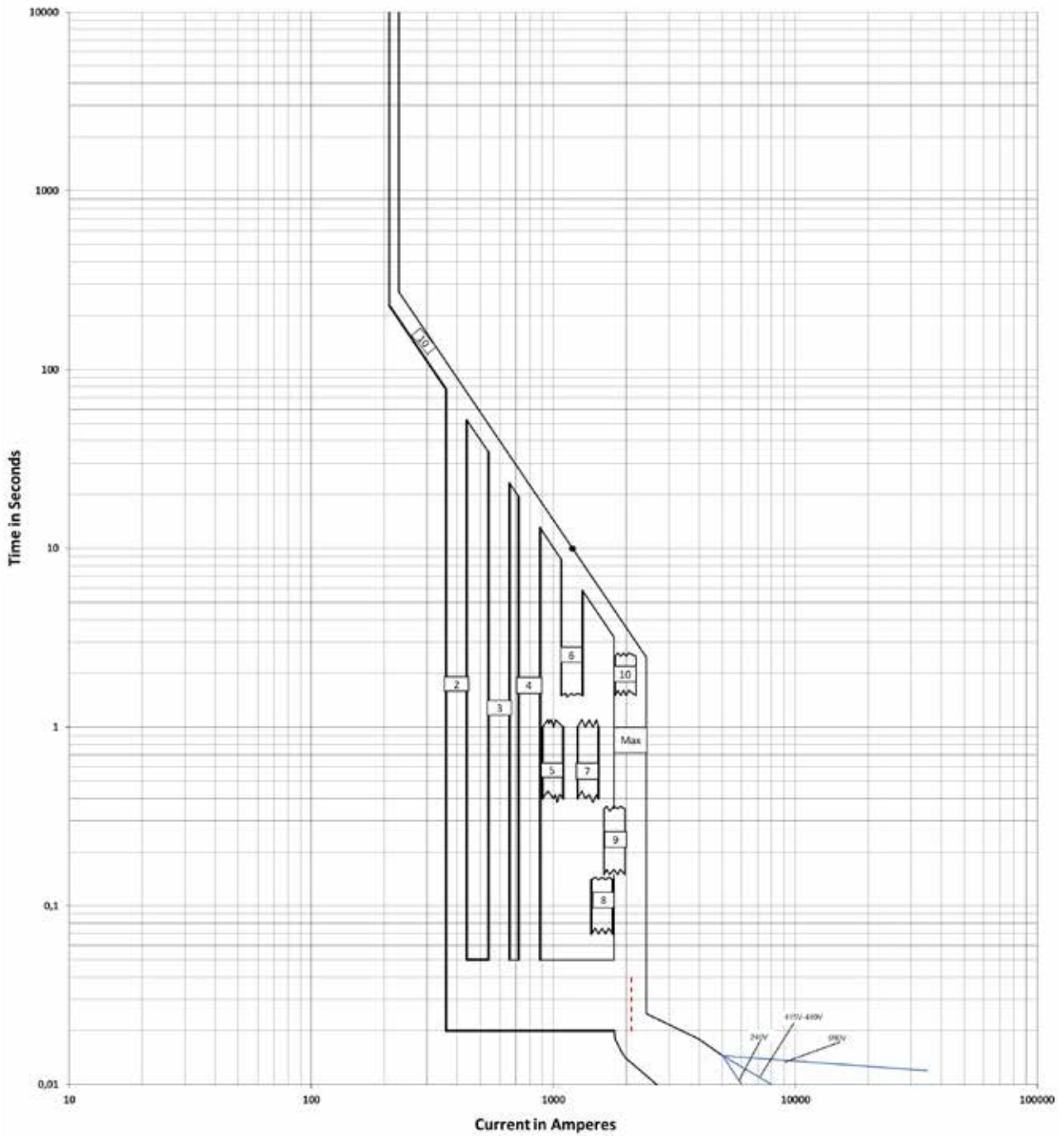

1.2

Power Defense Molded Case Circuit-Breaker

Tripping characteristics

System and line protection with PDE2 I²t Long Delay, Instantaneous, Override Curves PDE2 ETU PXR10 LI; 250 A @ 240 V, 415 V and 440 V

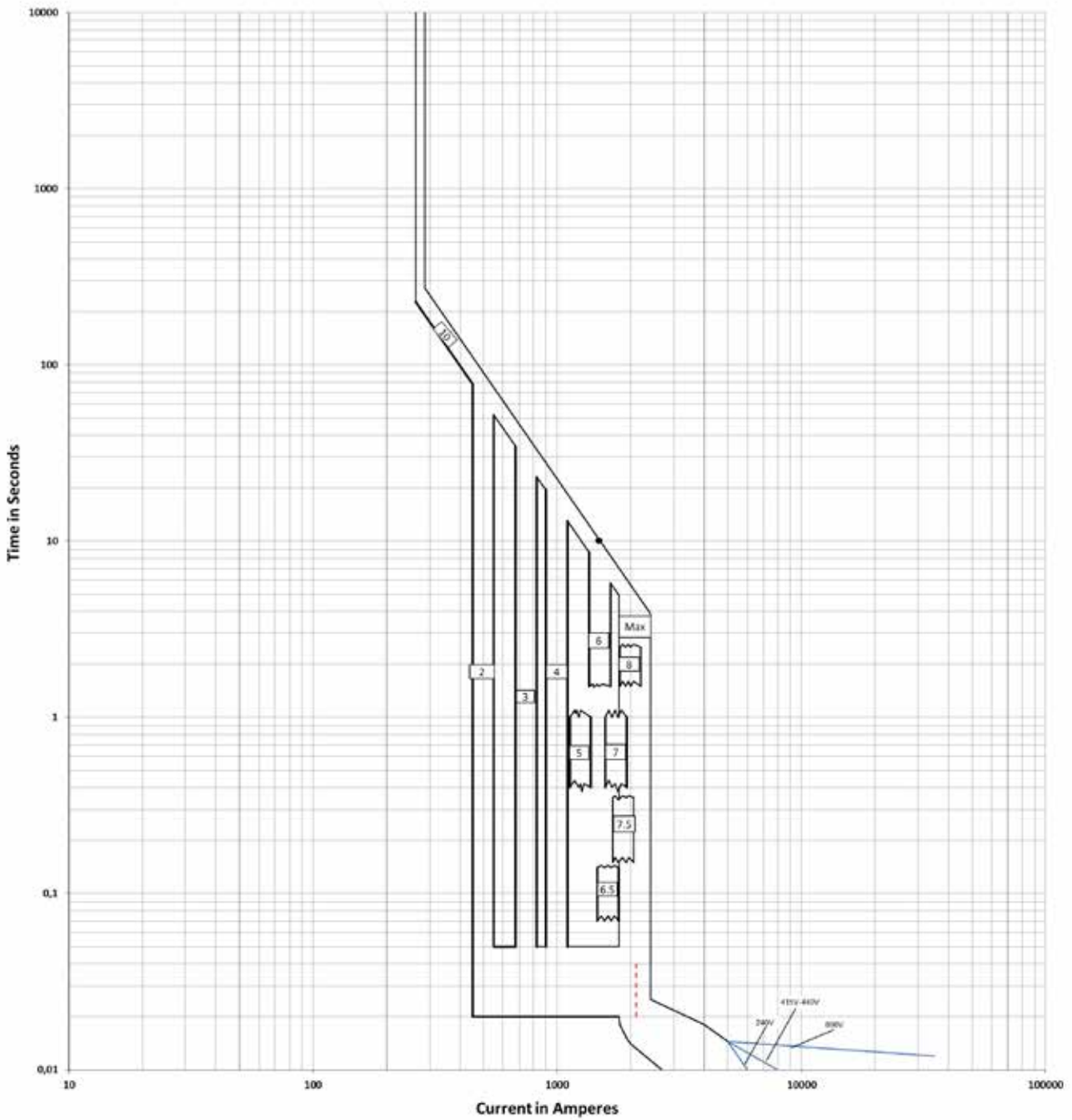

System and line protection with PDE2 I²t Long Delay, Instantaneous, Override Curves PDE9 ETU PXR 10 LI;
63 A @ 240 V, 415 V and 440 V

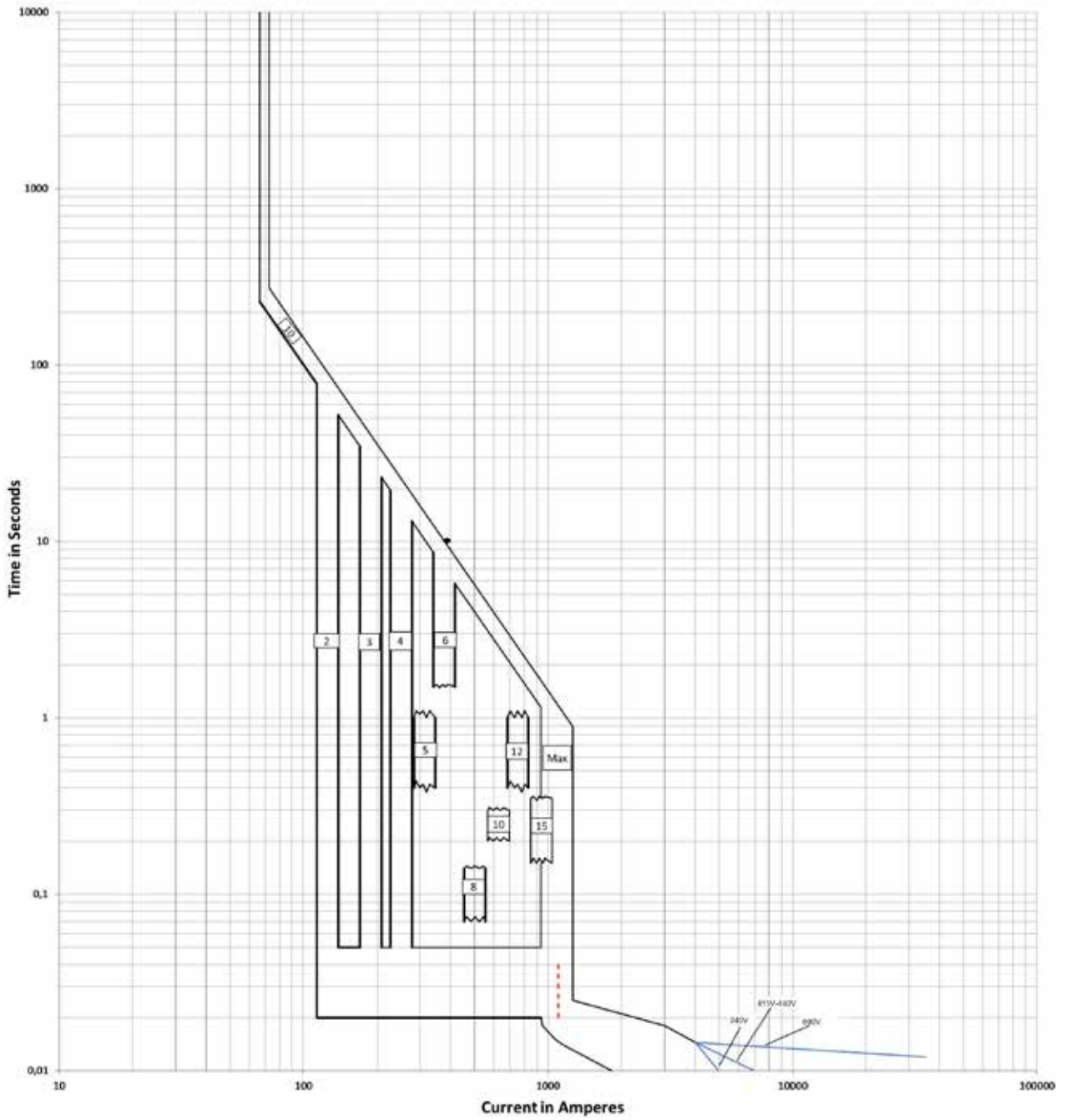

1.2

Power Defense Molded Case Circuit-Breaker

Tripping characteristics

System and line protection with PDE2 I²t Long Delay, Instantaneous, Override Curves PDE9 ETU PXR10 LI;
100 A @ 240 V, 415 V and 440 V

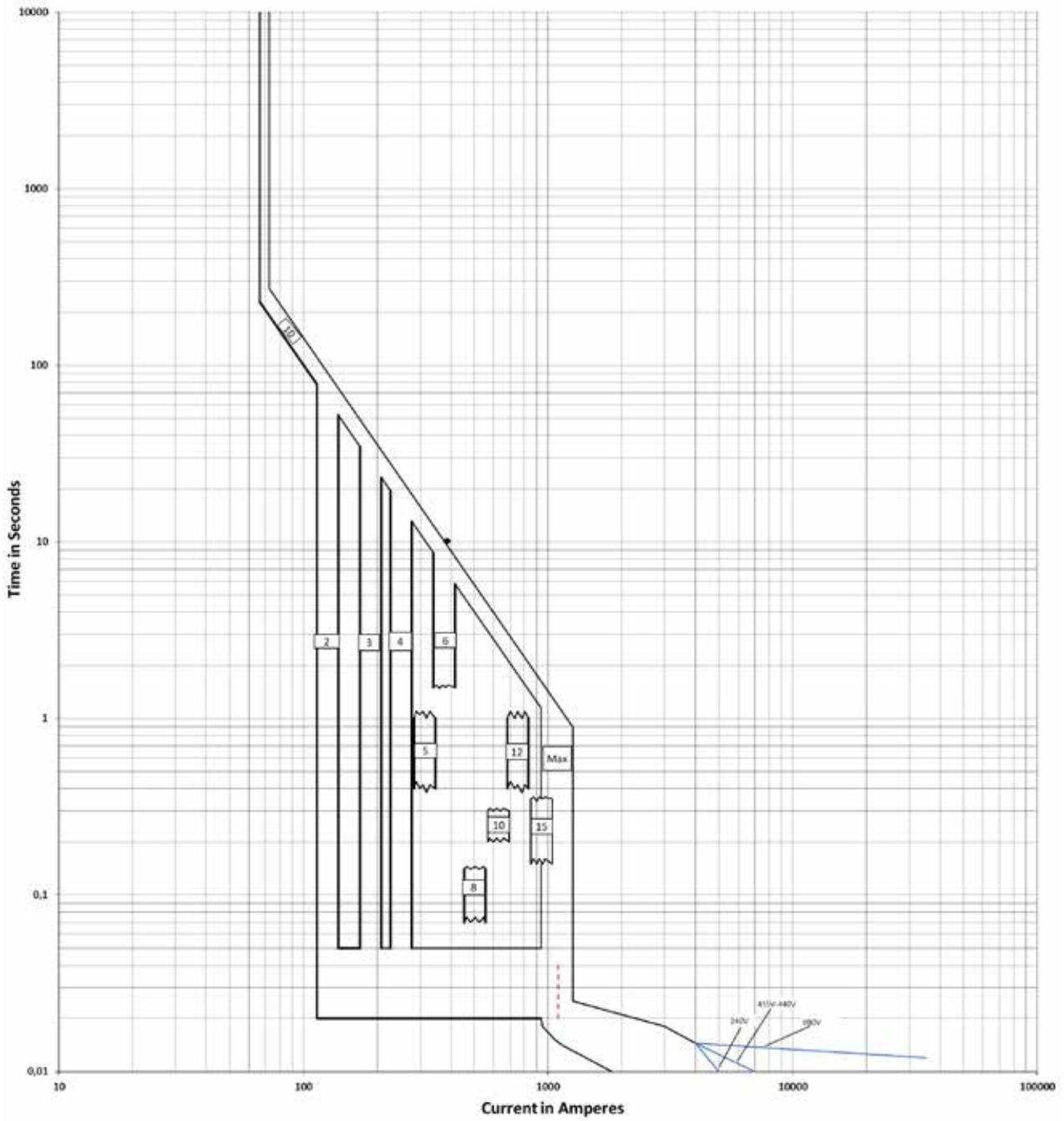

**Let-through current I_D PDE2 TMTU;
160 A @ 240 V**

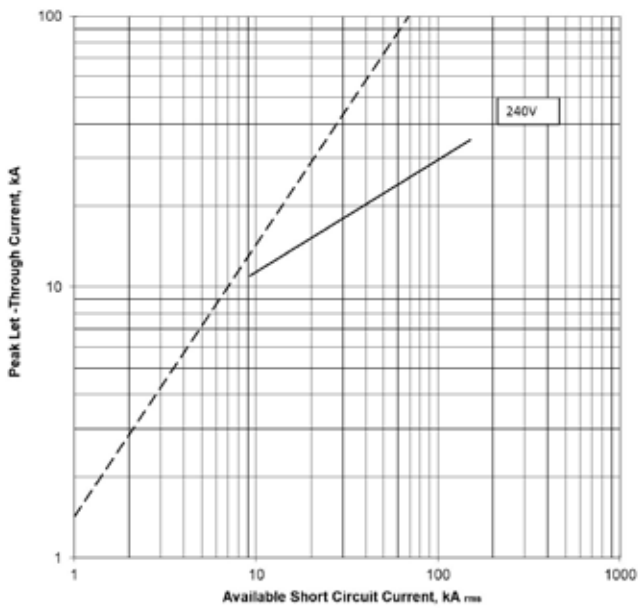

**Let-through current I_D PDE2 TMTU;
160 A @ 415 V and 440 V**

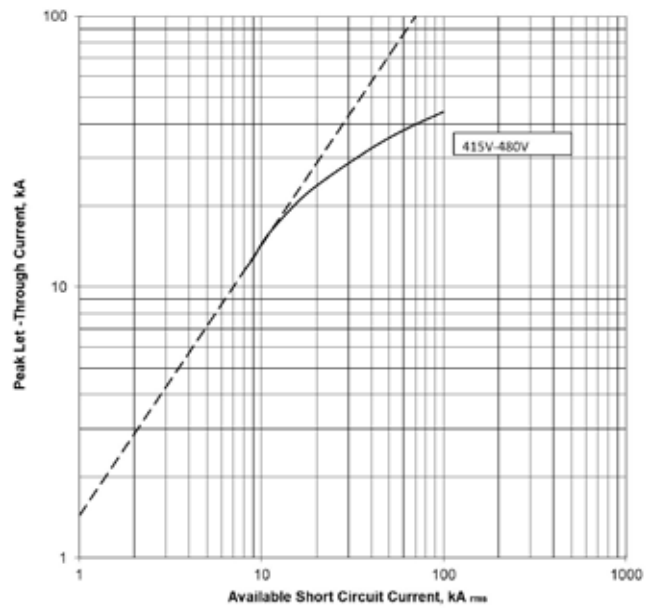

**Let-through current I_D PDE2 TMTU;
200 A @ 240 V**

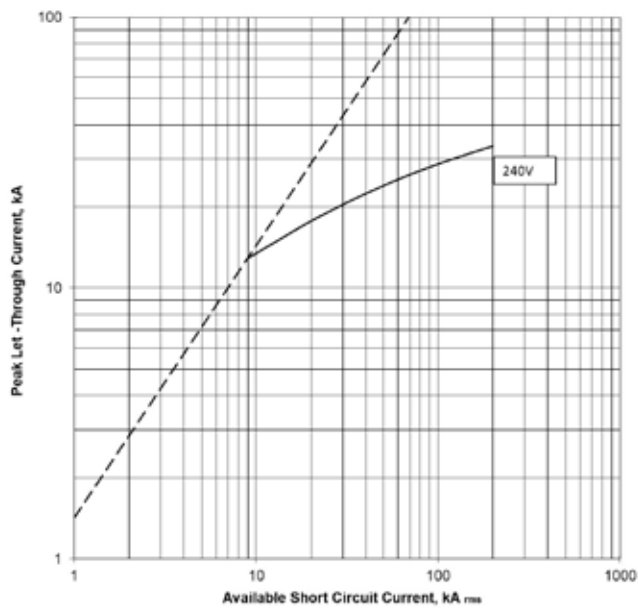

**Let-through current I_D PDE2 TMTU;
200 A @ 415 V and 440 V**

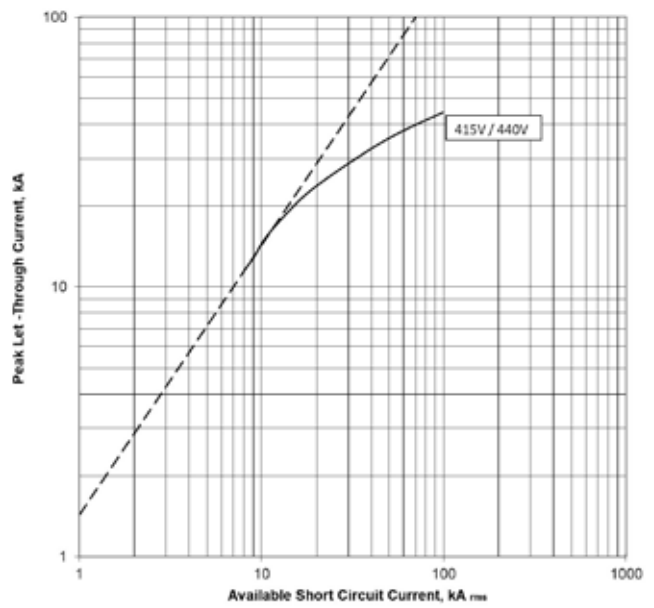

1.2

Power Defense Molded Case Circuit-Breaker

Let-through characteristics

Let-through current I_D PDE2 TMTU;
250 A @ 240 V

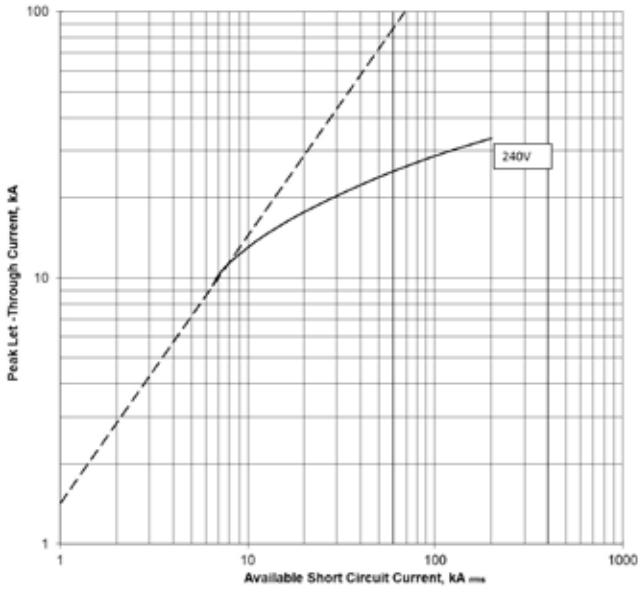

Let-through current I_D PDE2 TMTU;
250 A @ 415 V and 440 V

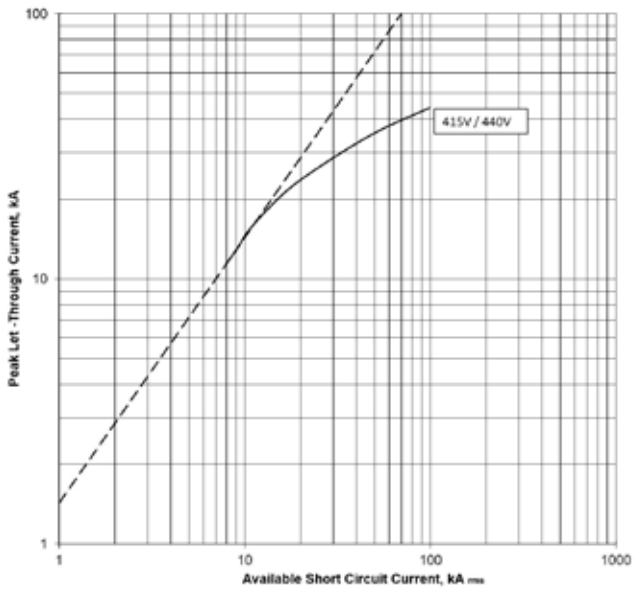

Let-through current I_D PDE2 ETU PXR10 LI;
160 A @ 240 V

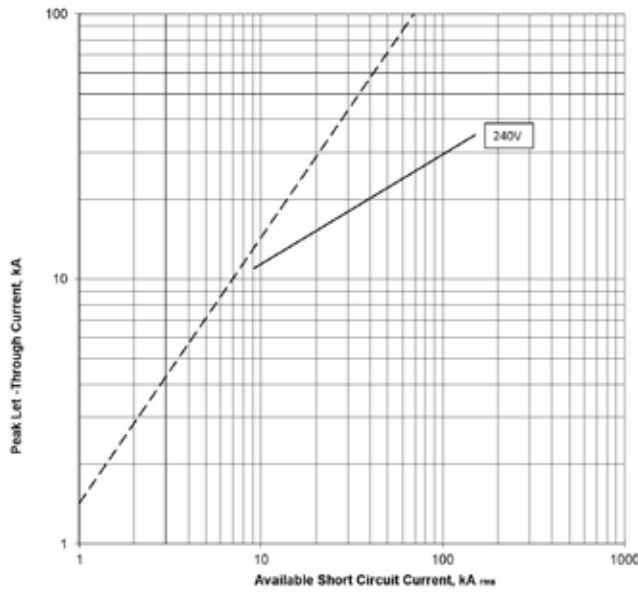

Let-through current I_D PDE2 ETU PXR10 LI;
160 A @ 415 V and 440 V

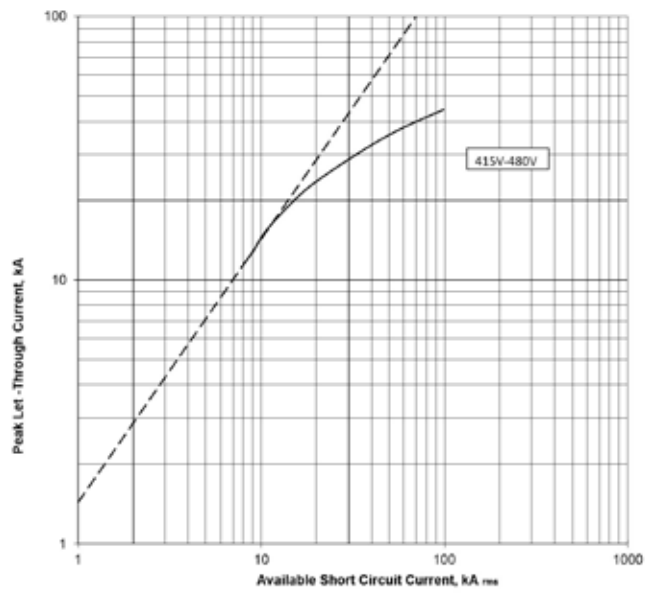

**Let-through current I_D PDE2 ETU PXR10 LI;
200 A @ 240 V**

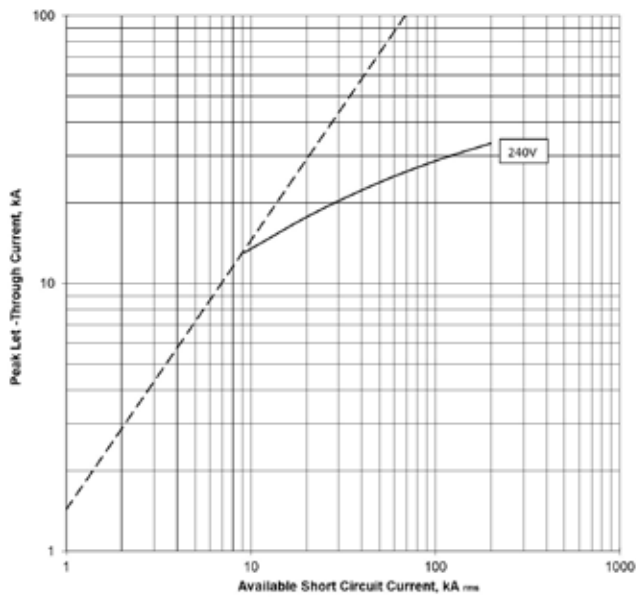

**Let-through current I_D PDE2 ETU PXR10 LI;
200 A @ 415 V and 440 V**

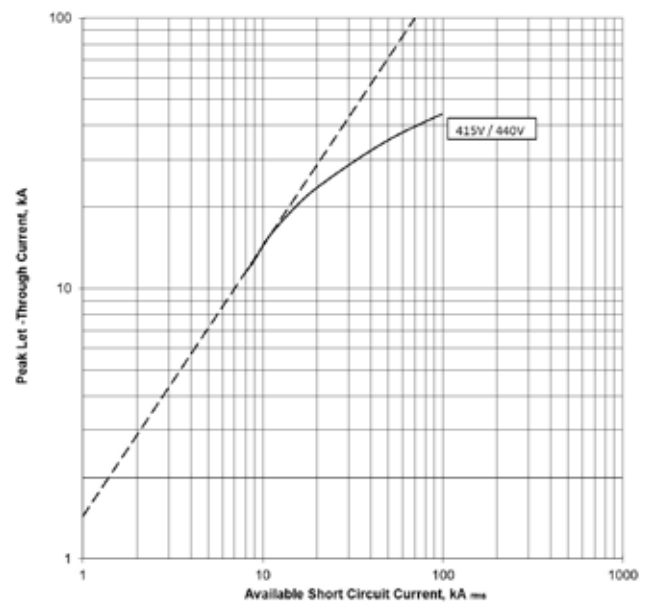

**Let-through current I_D PDE2 ETU PXR10 LI;
250 A @ 240 V**

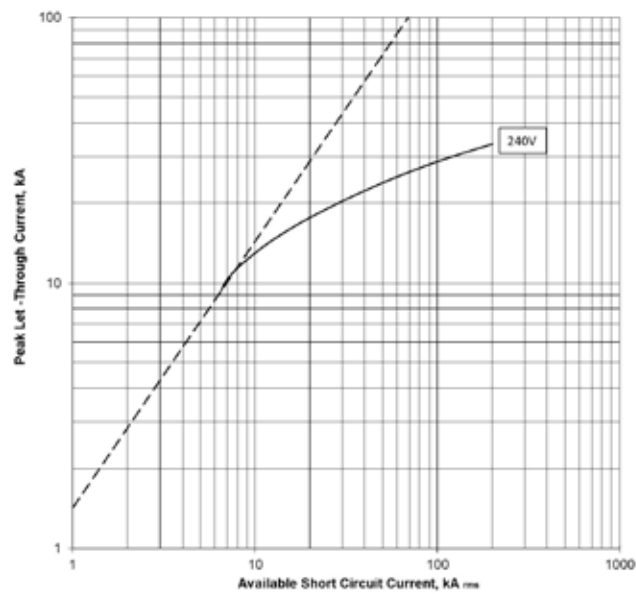

**Let-through current I_D PDE2 ETU PXR10 LI;
250 A @ 415 V and 440 V**

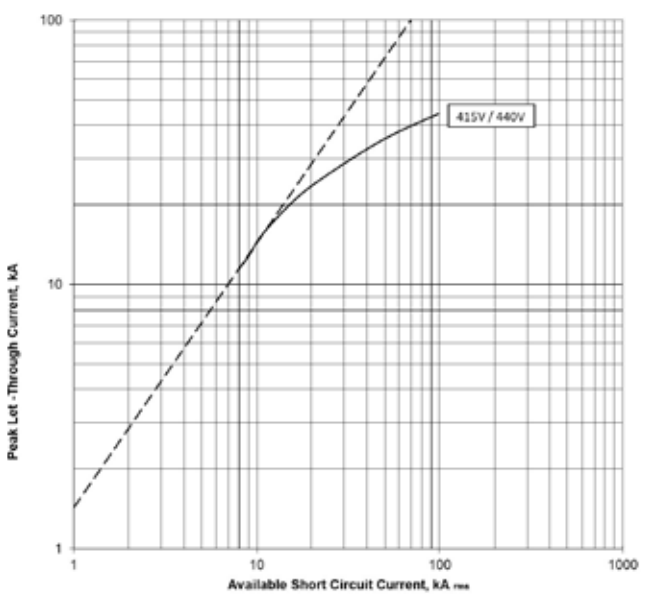

1.2

Power Defense Molded Case Circuit-Breaker

Let-through characteristics

Let-through current I_D PDE2 ETU PXR10 LSI;
100 A and 160 A @ 240 V

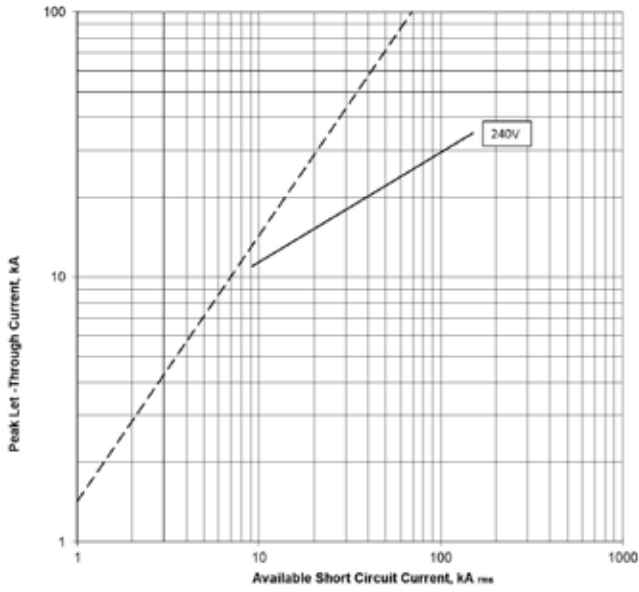

Let-through current I_D PDE2 ETU PXR10 LSI;
100 A and 160 A @ 415 V and 440 V

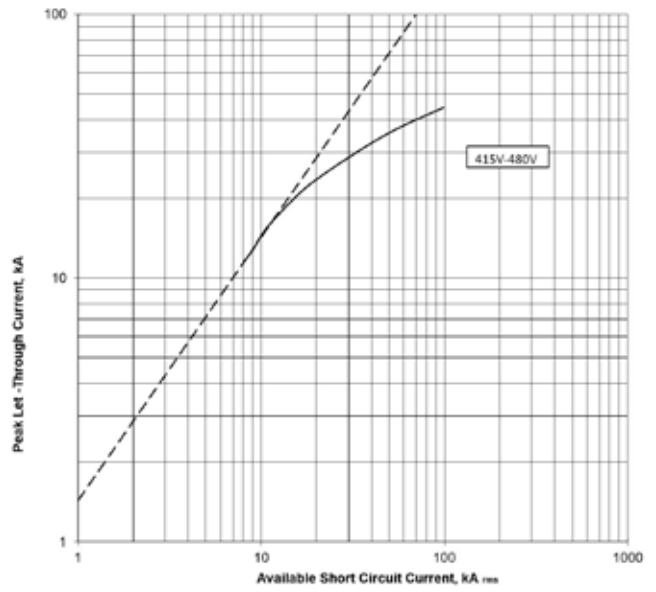

Let-through current I_D PDE2 ETU PXR10 LSI;
250 A @ 240 V

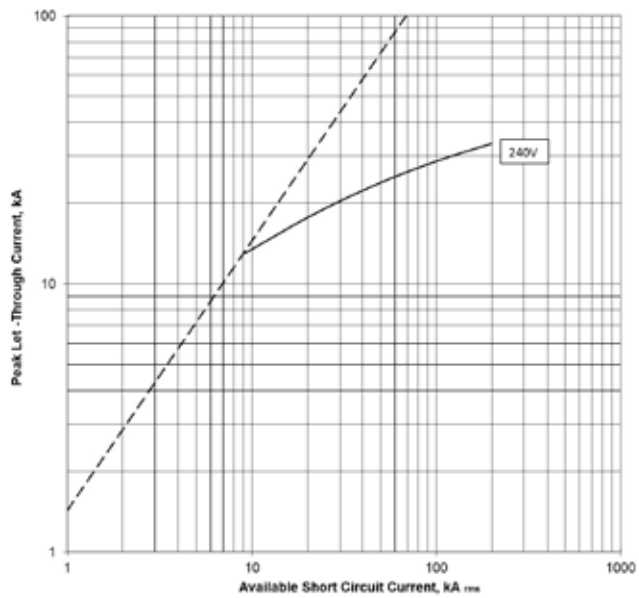

Let-through current I_D PDE2 ETU PXR10 LSI;
250 A @ 415 V and 440 V

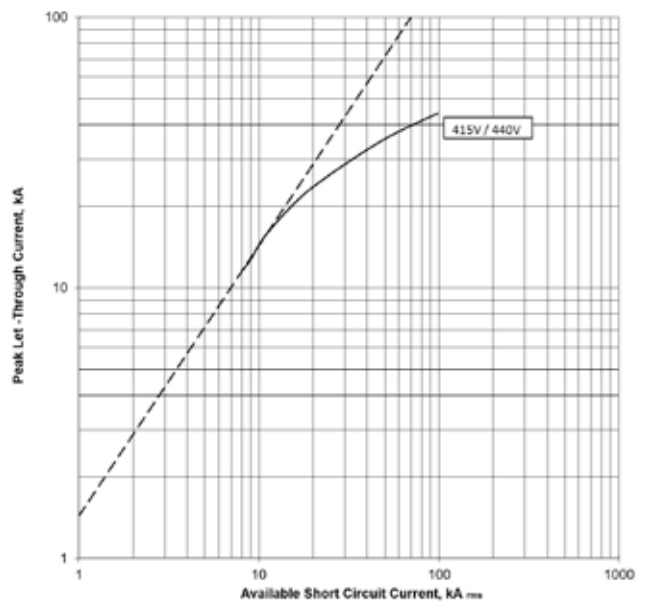

**Let-through current I_D ; PDE9 ETU PXR10 LI;
63 A and 100 A @ 240 V**

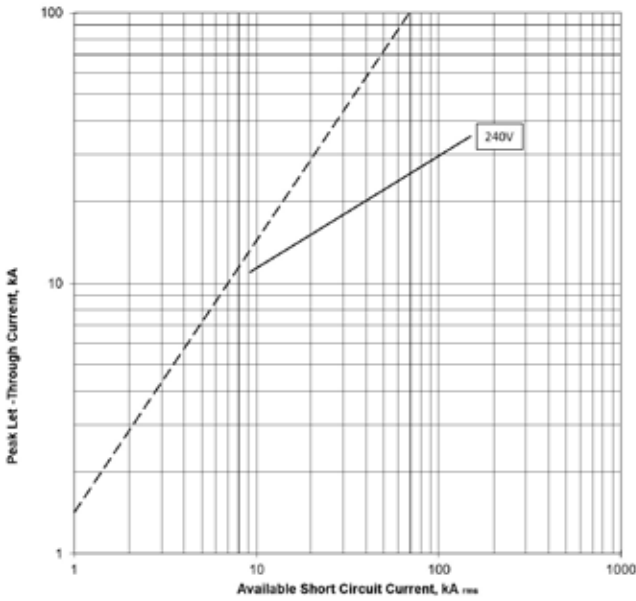

**Let-through current I_D ; PDE9 ETU PXR10 LI;
63 A and 100 A @ 415 V and 440 V**

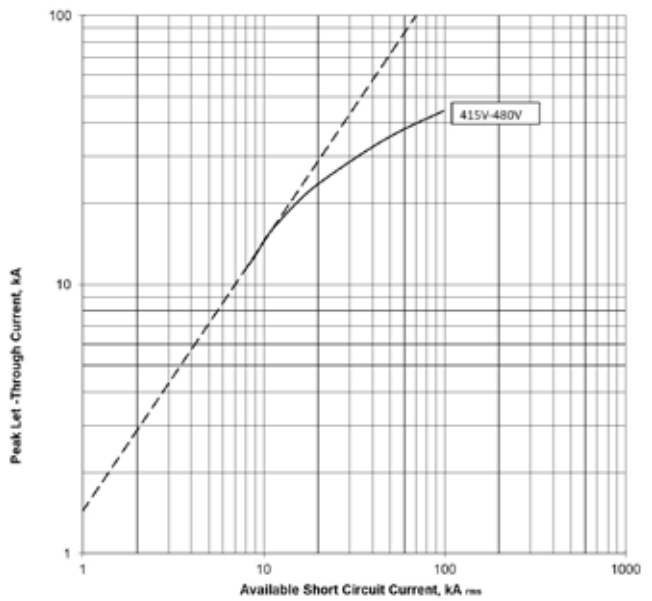

**Let-through energy I^2t ; PDE2 TMTU;
160 A @ 240 V**

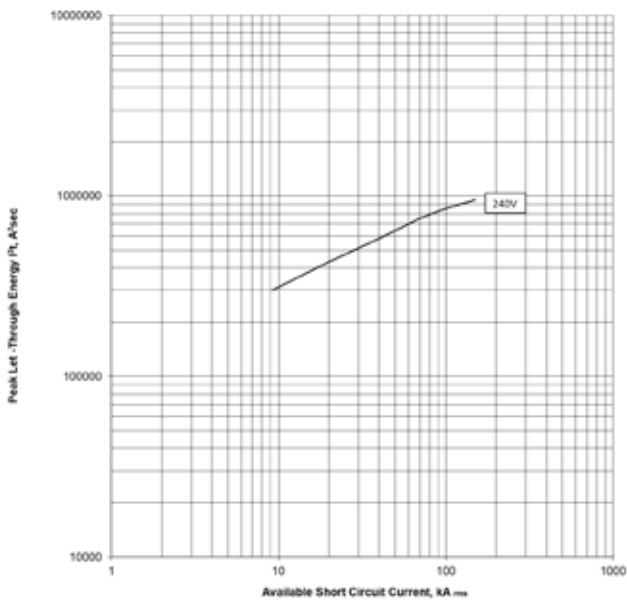

**Let-through energy I^2t ; PDE2 TMTU;
160 A @ 415 V and 440 V**

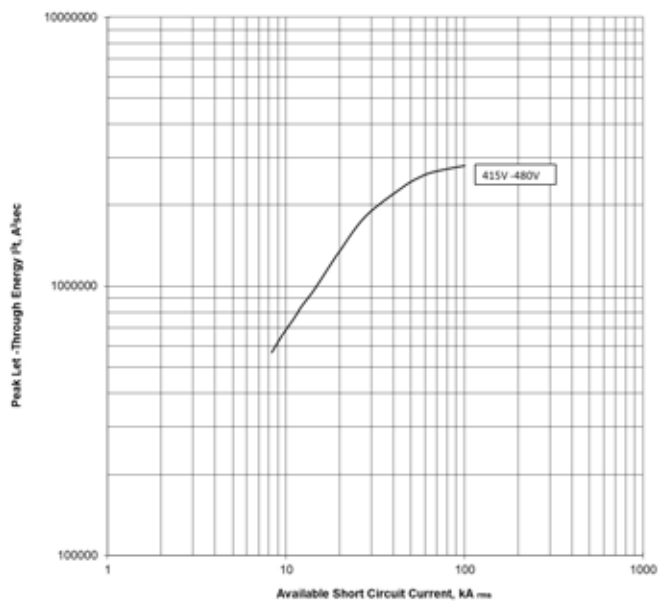

1.2

Power Defense Molded Case Circuit-Breaker

Let-through characteristics

Let-through energy I^2t ; PDE2 TMTU;
200 A @ 240 V

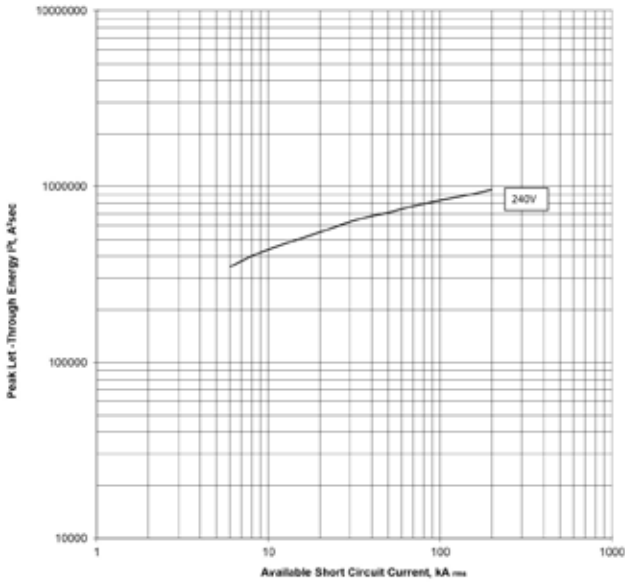

Let-through energy I^2t ; PDE2 TMTU;
200 A @ 415 V and 440 V

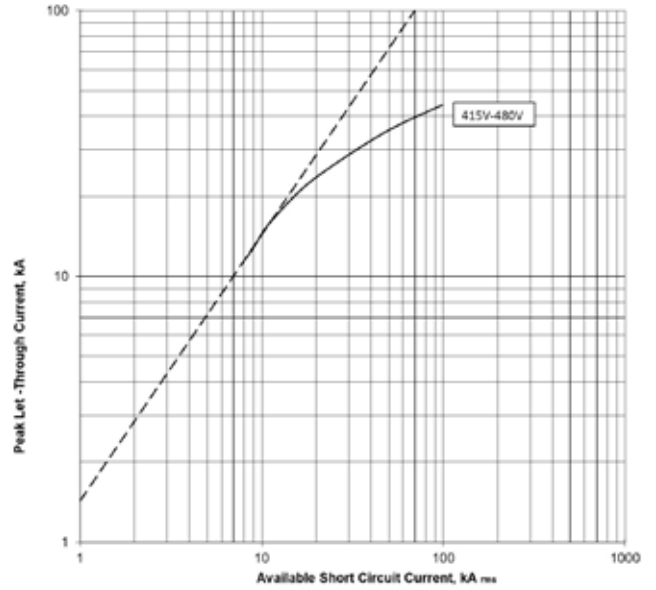

Let-through energy I^2t ; PDE2 TMTU;
250 A @ 240 V

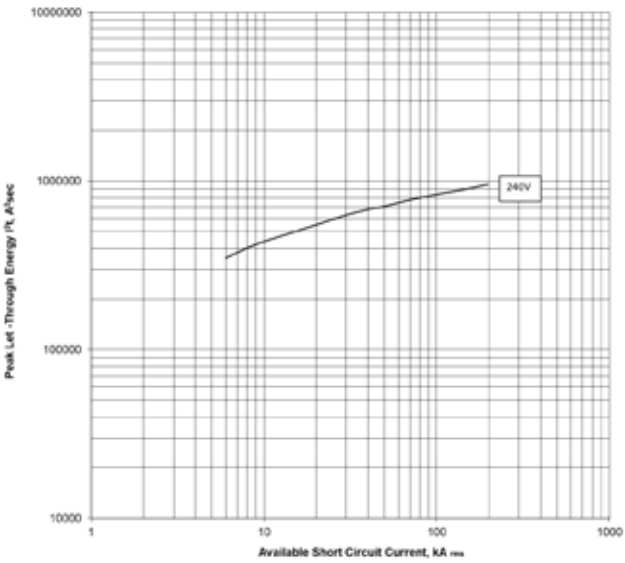

Let-through energy I^2t ; PDE2 TMTU;
250 A @ 415 V and 440 V

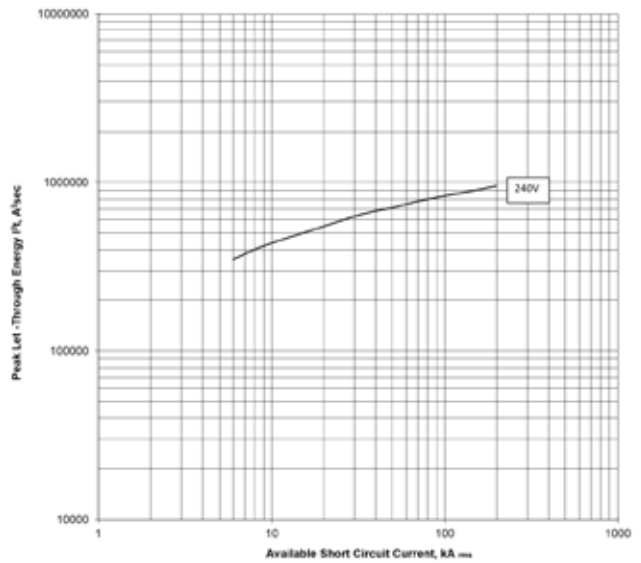

**Let-through energy I^2t ; PDE2 ETU PXR10 LI;
160 A @ 240 V**

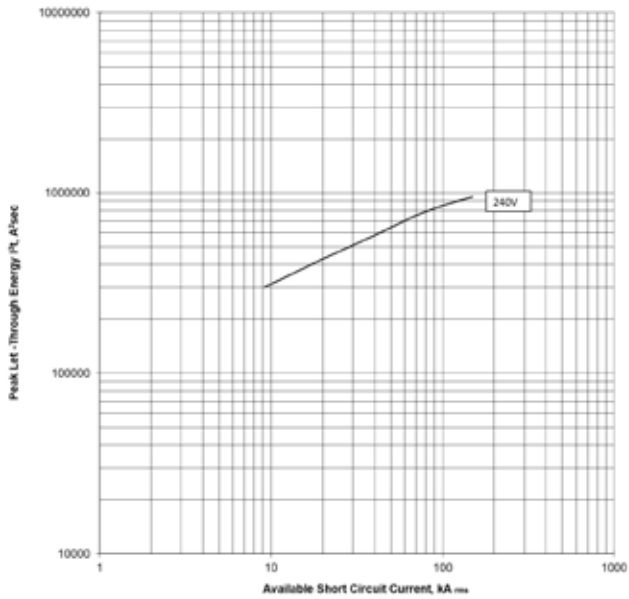

**Let-through energy I^2t ; PDE2 ETU PXR10 LI;
160 A @ 415 V and 440 V**

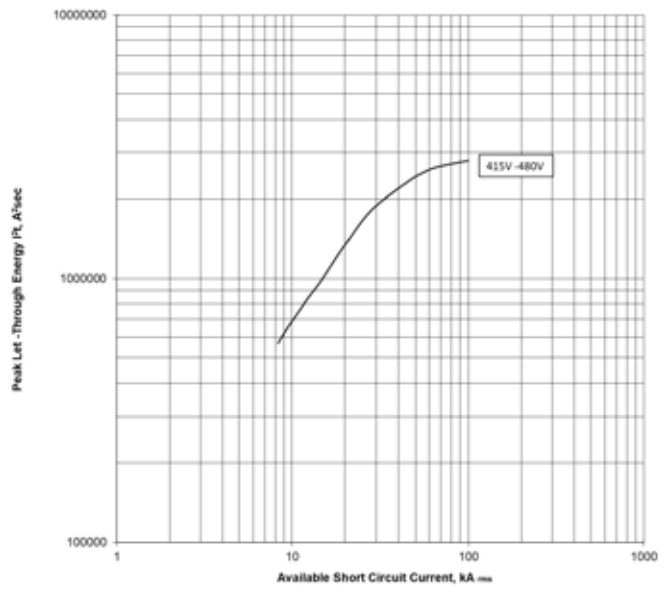

**Let-through energy I^2t ; PDE2 ETU PXR10 LI;
200 A @ 240 V**

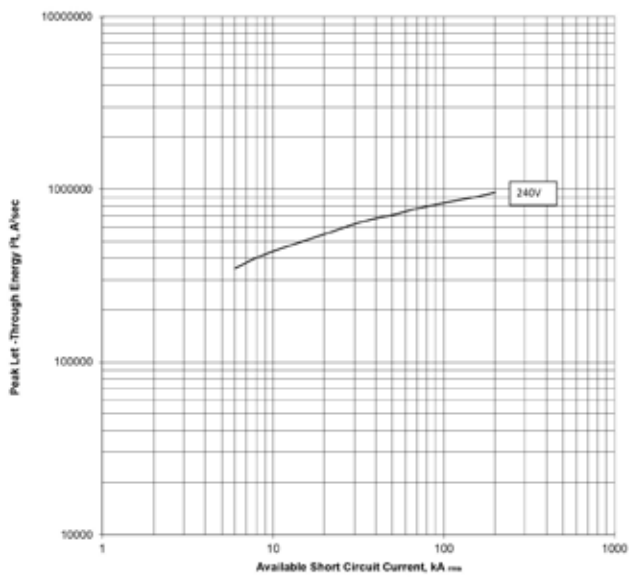

**Let-through energy I^2t ; PDE2 ETU PXR10 LI;
200 A @ 415 V and 440 V**

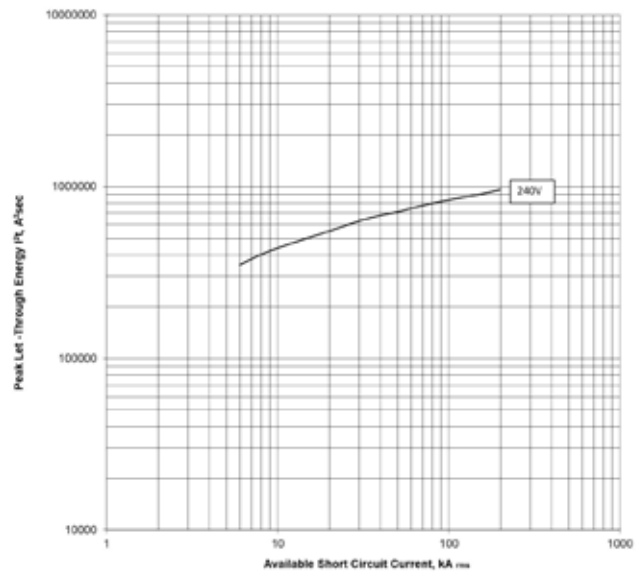

1.2

Power Defense Molded Case Circuit-Breaker

Let-through characteristics

**Let-through energy I^2t ; PDE2 ETU PXR10 LI;
250 A @ 240 V**

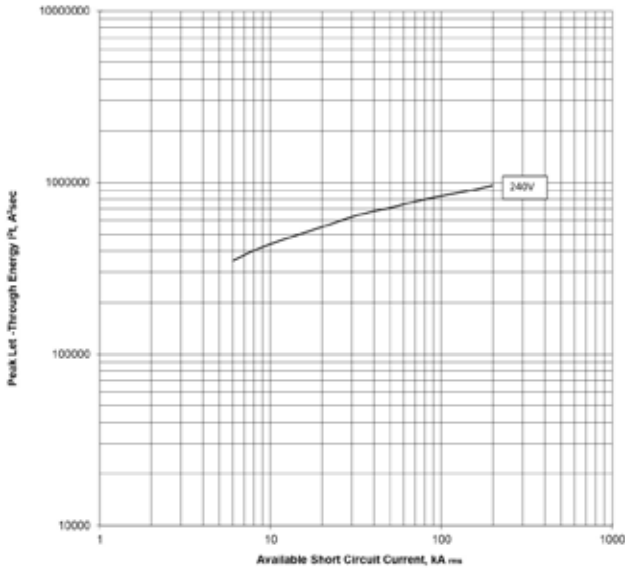

**Let-through energy I^2t ; PDE2 ETU PXR10 LI;
250 A @ 415 V and 440 V**

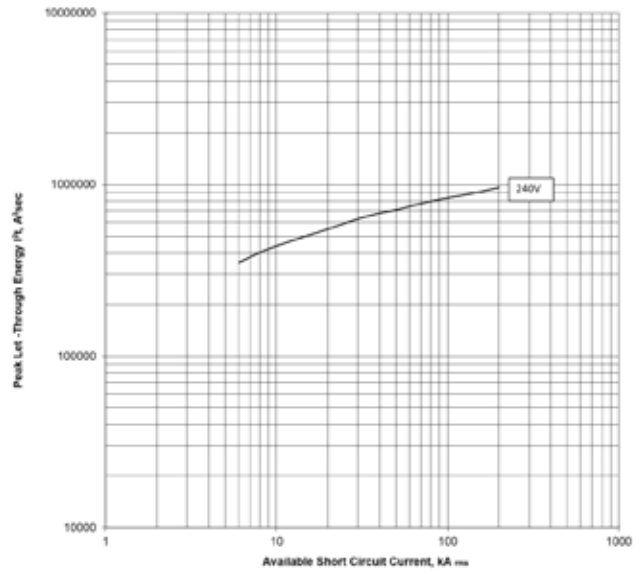

**Let-through energy I^2t ; PDE2 ETU PXR10 LSI;
100 A and 160 A @ 415 V and 440 V**

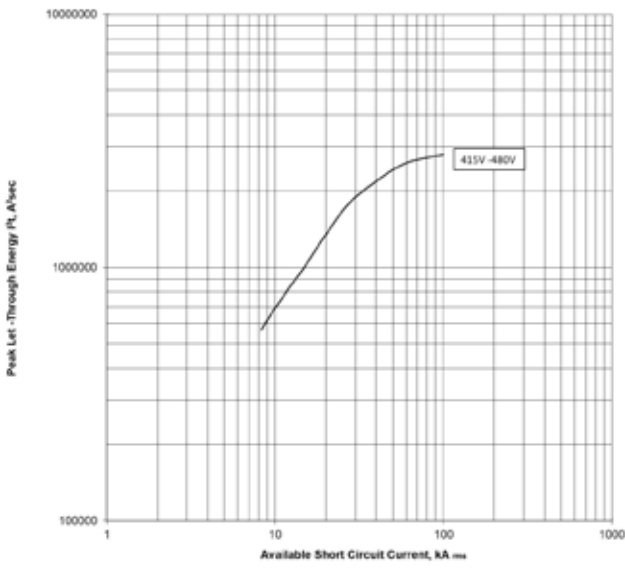

**Let-through energy I^2t ; PDE2 ETU PXR10 LSI;
220 A @ 240 V**

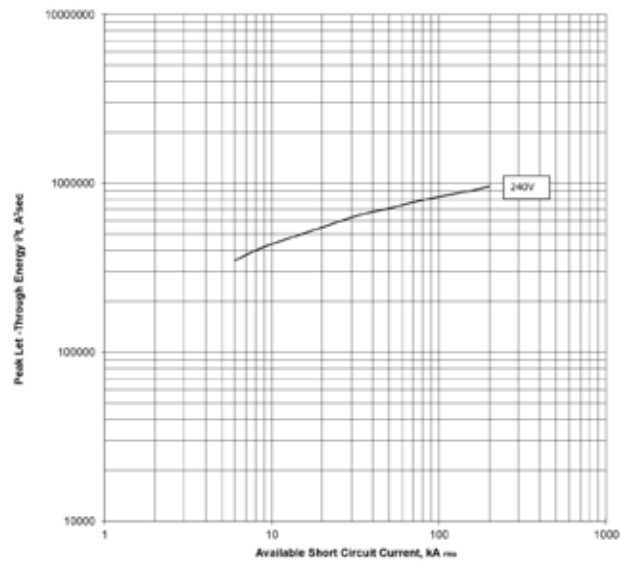

**Let-through energy I^2t ; PDE2 ETU PXR10 LSI;
100 A and 160 A @ 240 V**

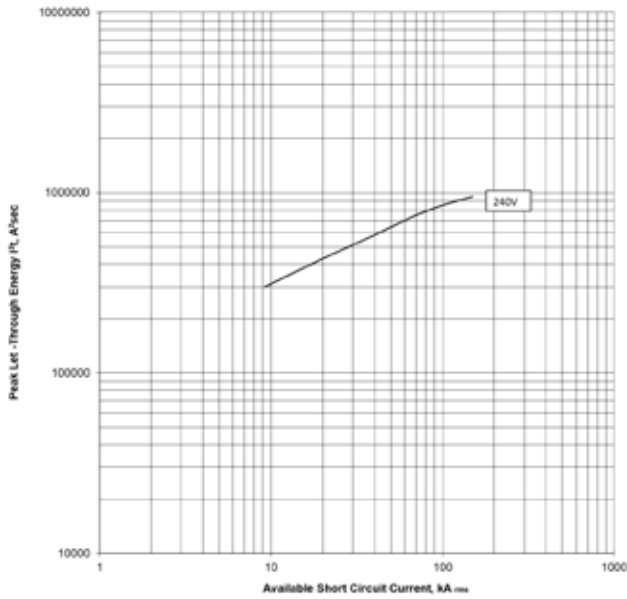

**Let-through energy I^2t ; PDE2 ETU PXR10 LSI;
220 A @ 415 V and 440 V**

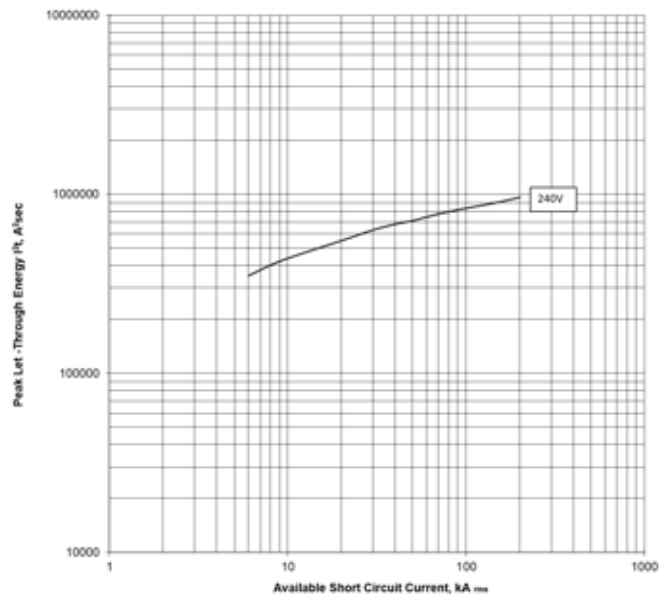

**Let-through energy I^2t ; PDE9 ETU PXR10 LI;
63 A and 100 A @ 240 V**

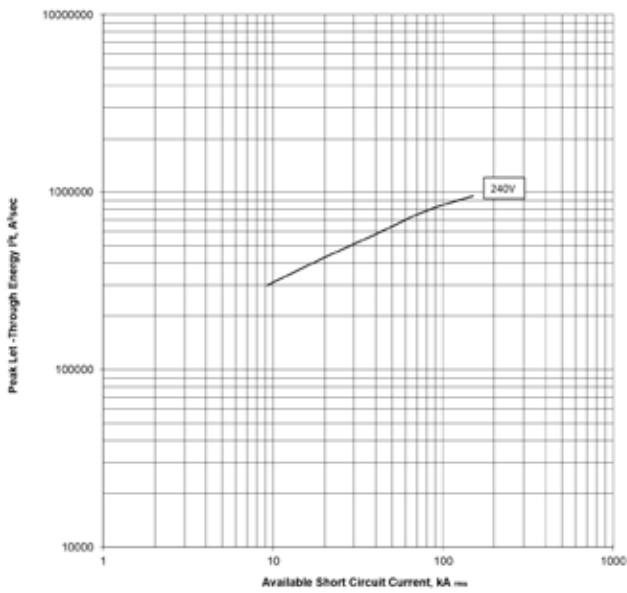

**Let-through energy I^2t ; PDE9 ETU PXR10 LI;
63 A and 100 A @ 415 V and 440 V**

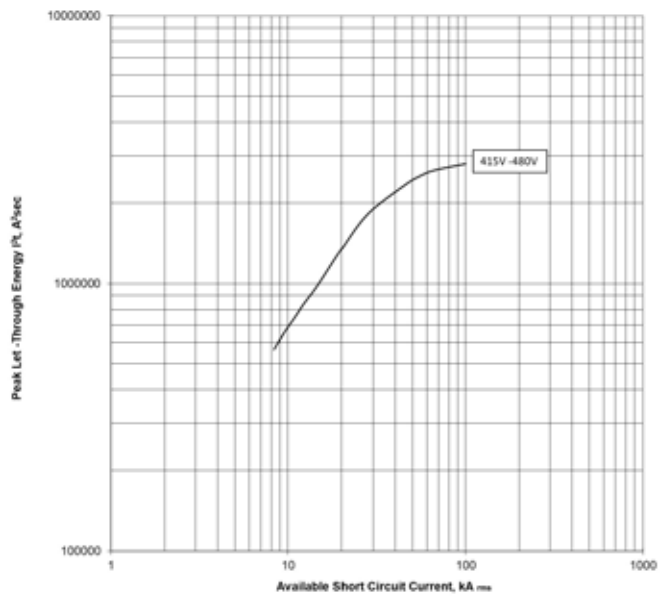

1.2

Power Defense Molded Case Circuit-Breaker

Tripping characteristics

System and line protection with PDE3 TMTU;
250 A, 320 A and 400 A @ 240 V, 415 V and 440 V

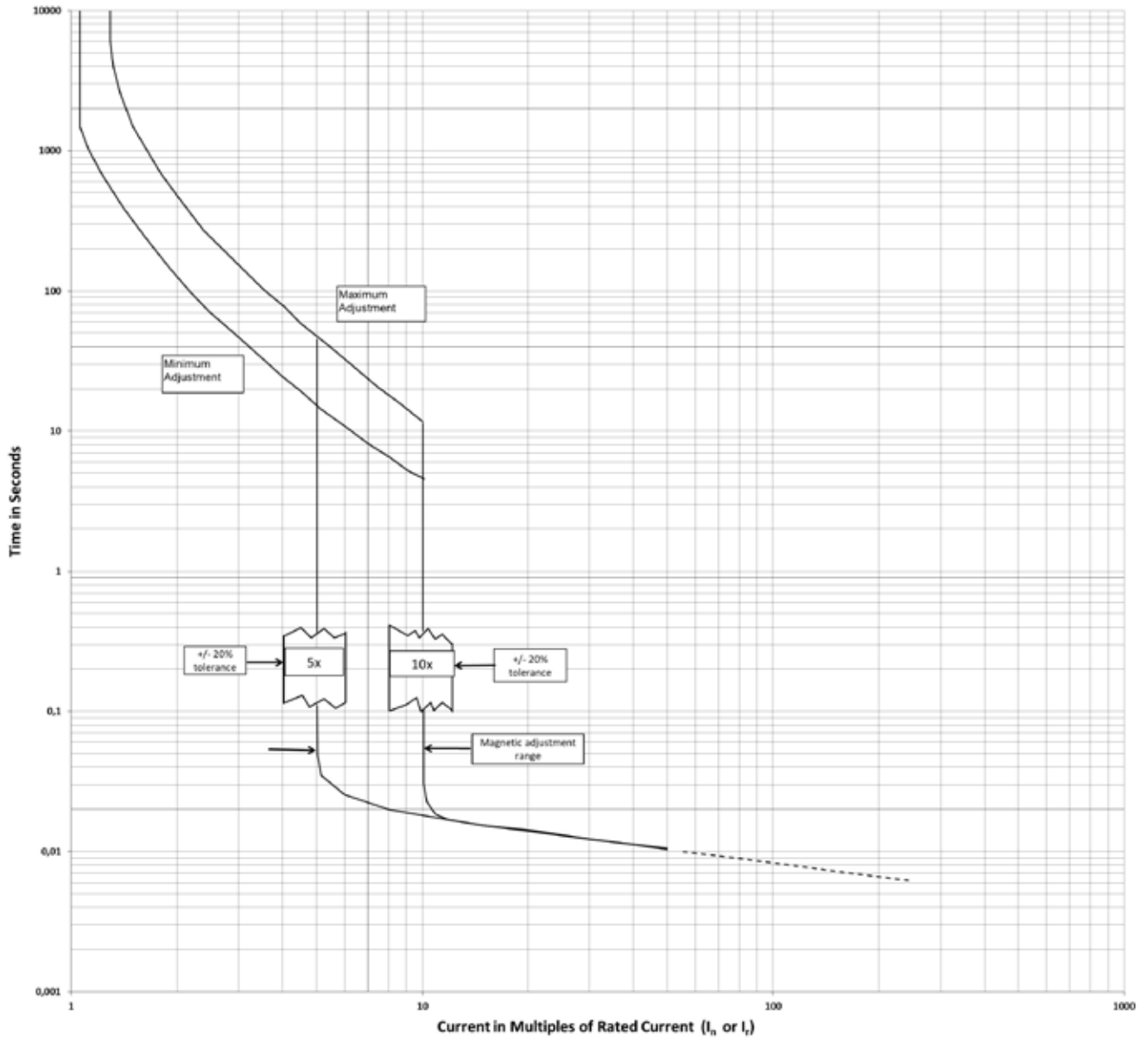

System and line protection with PDE3 TMTU;
500 A and 630 A @ 240 V, 415 V and 440 V

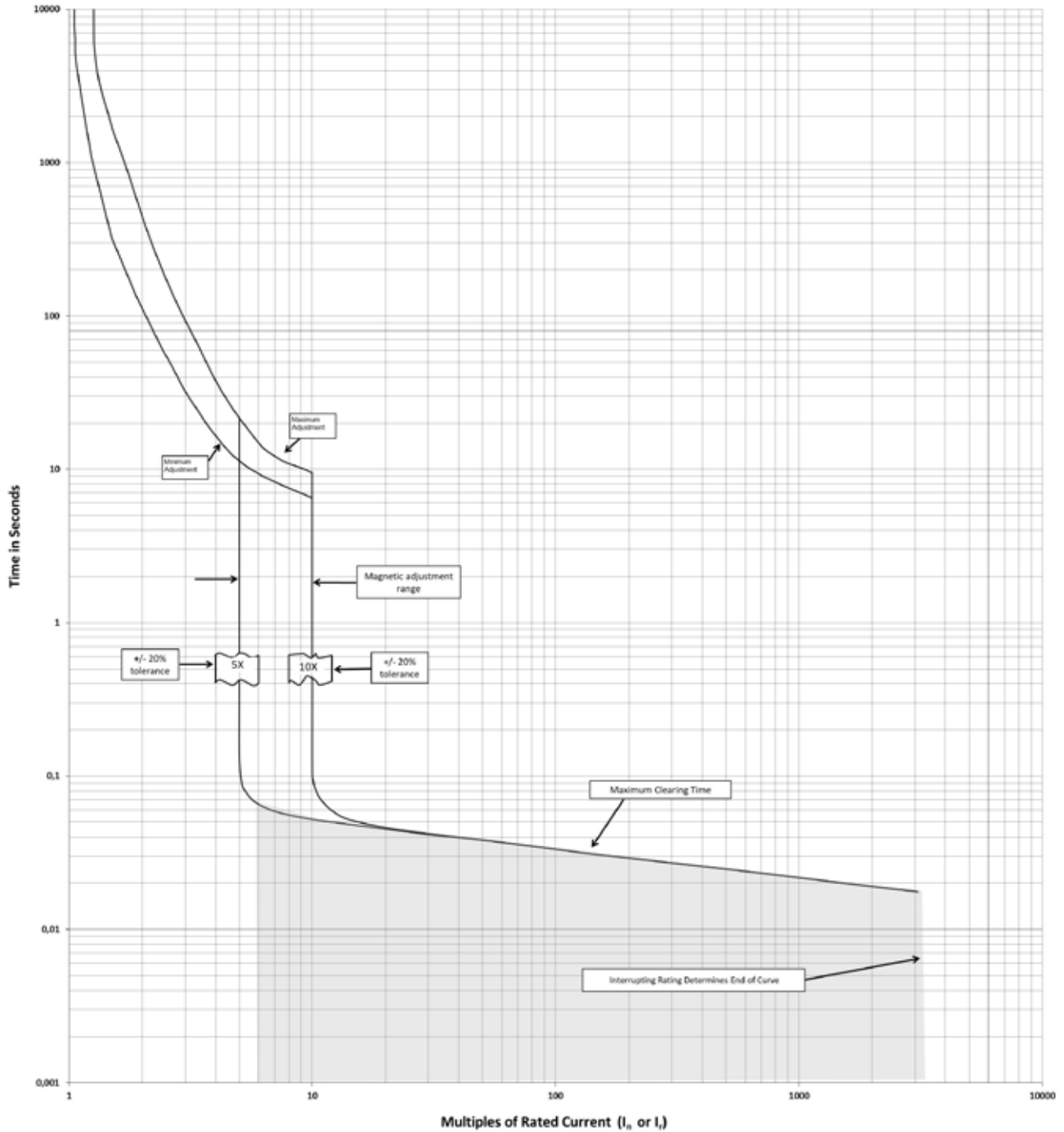

1.2

Power Defense Molded Case Circuit-Breaker

Tripping characteristics

System and line protection with PDE3; I^t Long Delay, Instantaneous, Override Curves; ETU PXR10 LI;
400 A @ 240 V, 415 V and 440 V

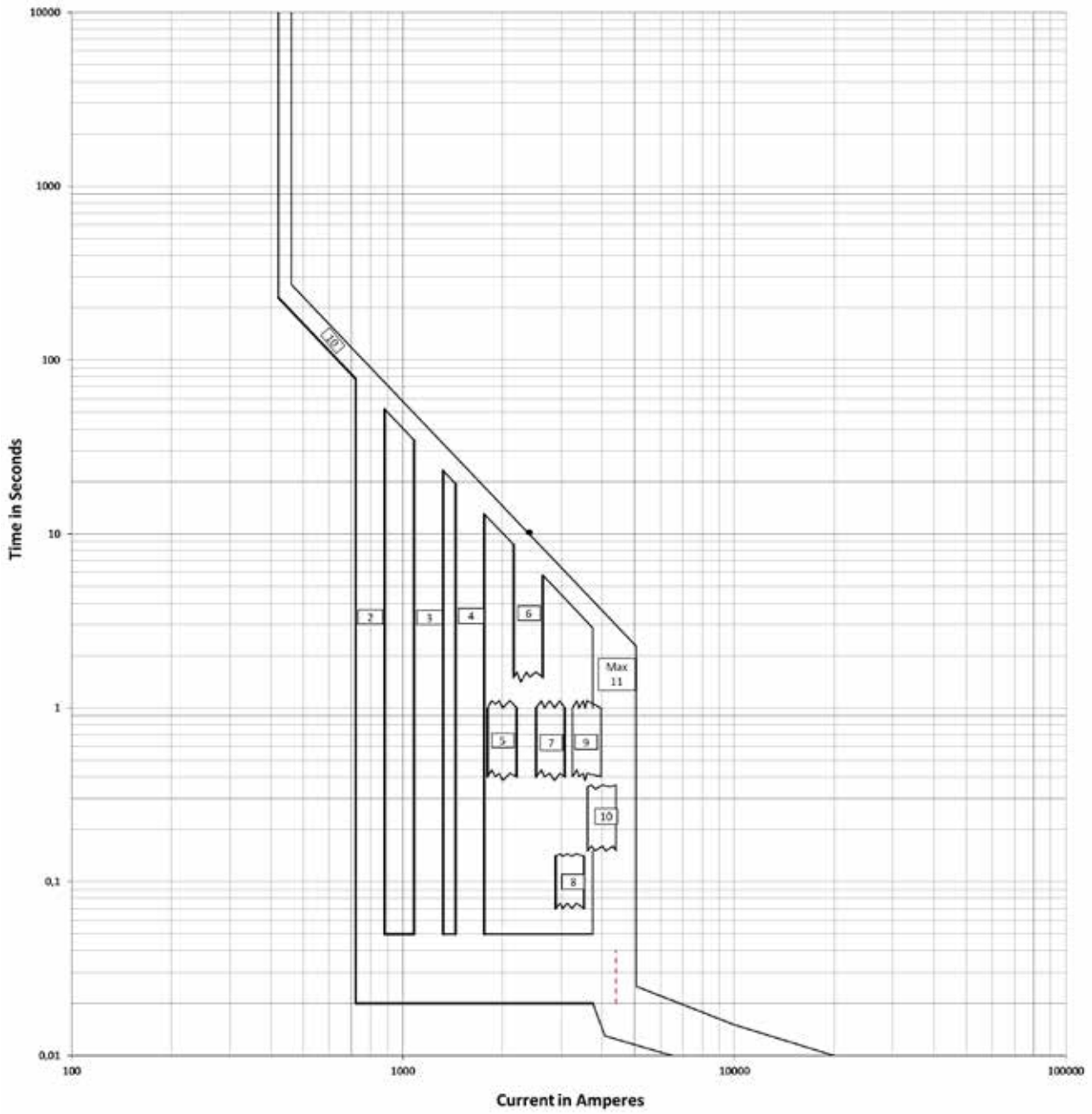

System and line protection with PDE3; I²t Long Delay, Instantaneous, Override Curves; ETU PXR10 LI;
630 A @ 240 V, 415 V and 440 V

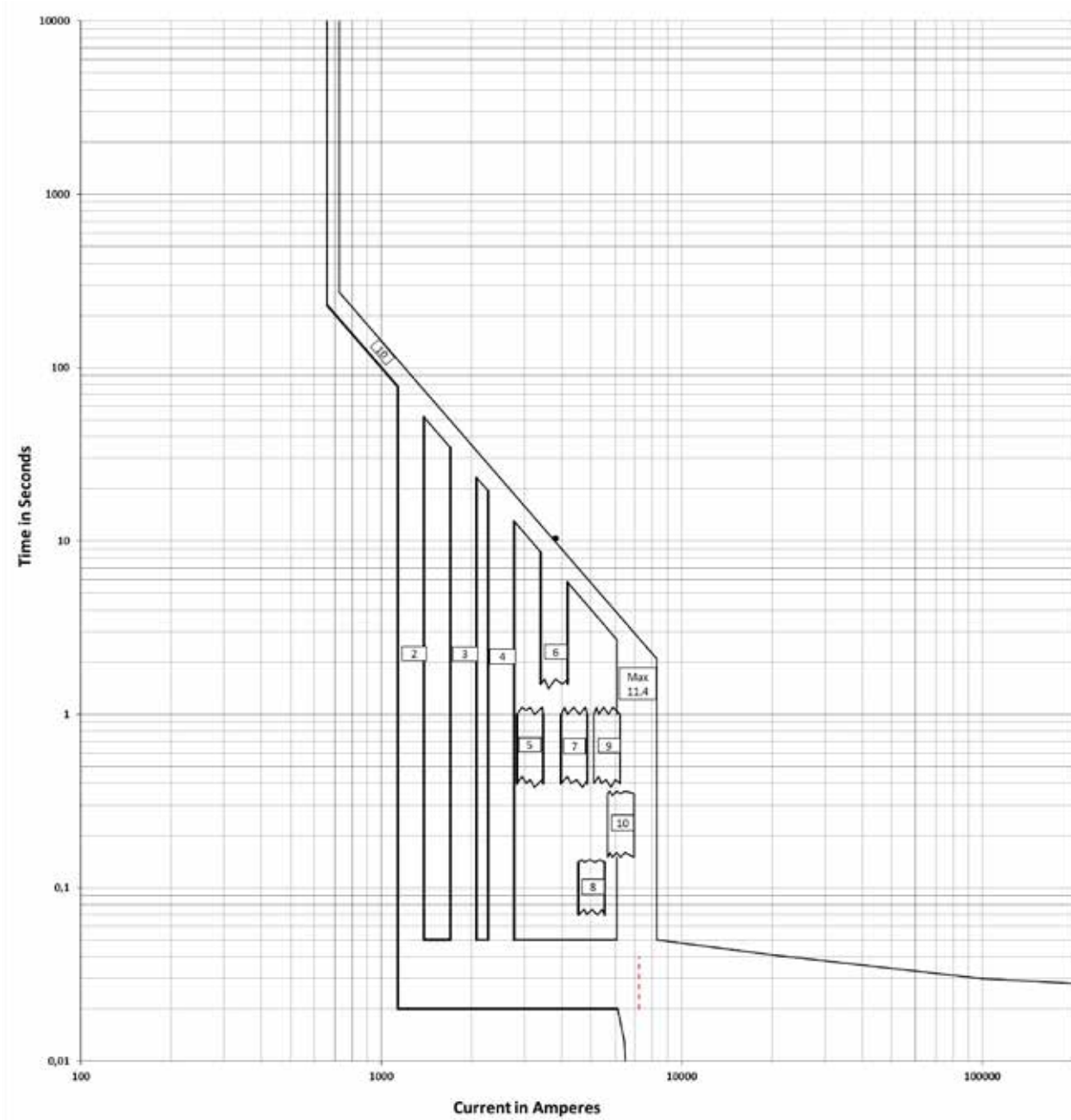

1.2

Power Defense Molded Case Circuit-Breaker

Let-through characteristics

Let-through current I_D ; PDE3 TMTU;
250, 320, 400 A @ 240 V

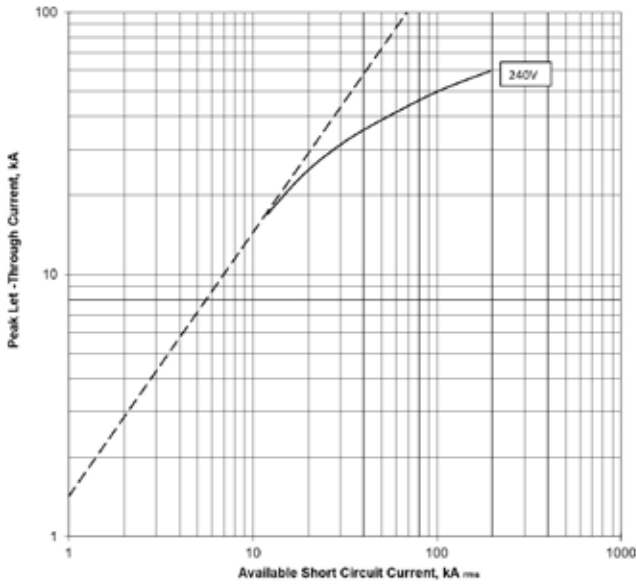

Let-through current I_D ; PDE3 TMTU;
250, 320, 400 A @ 415V and 440V

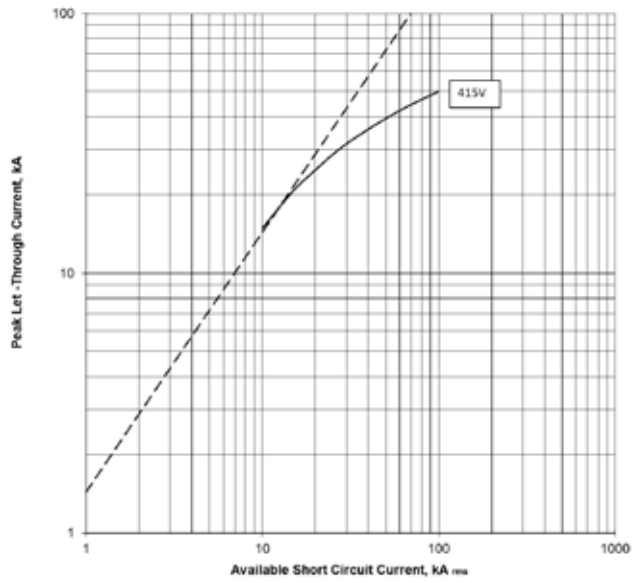

Let-through current I_D ; PDE3 TMTU;
500 A and 630 A @ 240 V

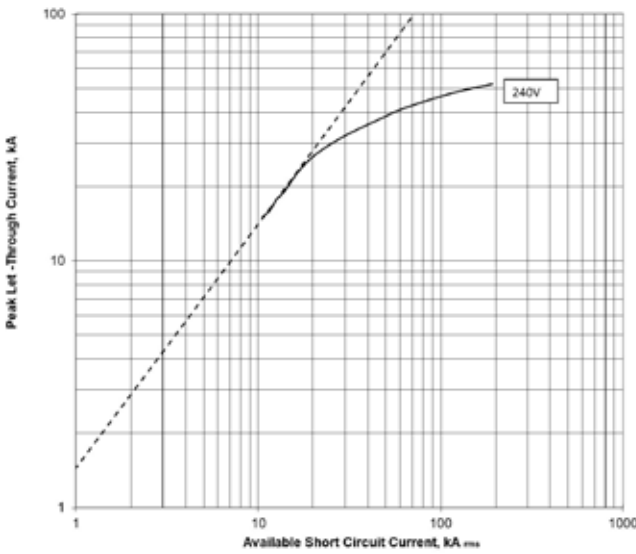

Let-through current I_D ; PDE3 TMTU;
500 A and 630 A @ 415V and 440V

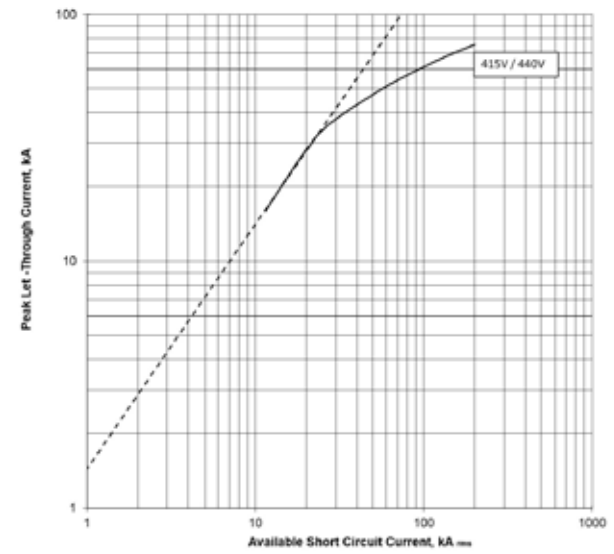

**Let-through current I_D ; PDE3 ETU PXR10 LI;
400 A @ 240 V**

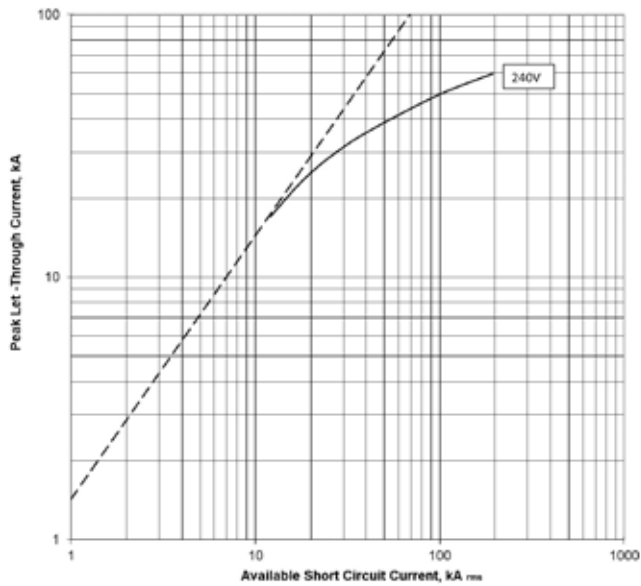

**Let-through current I_D ; PDE3 ETU PXR10 LI;
400 A @ 415 V and 440 V**

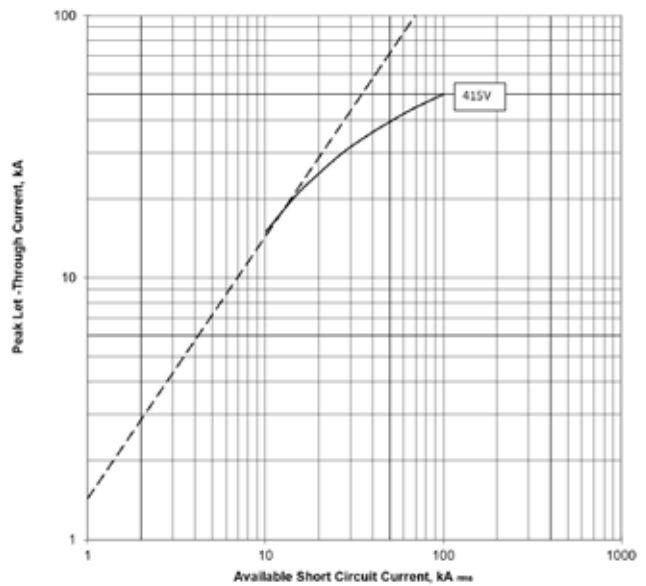

**Let-through current I_D ; PDE3 ETU PXR10 LI;
630 A @ 240 V**

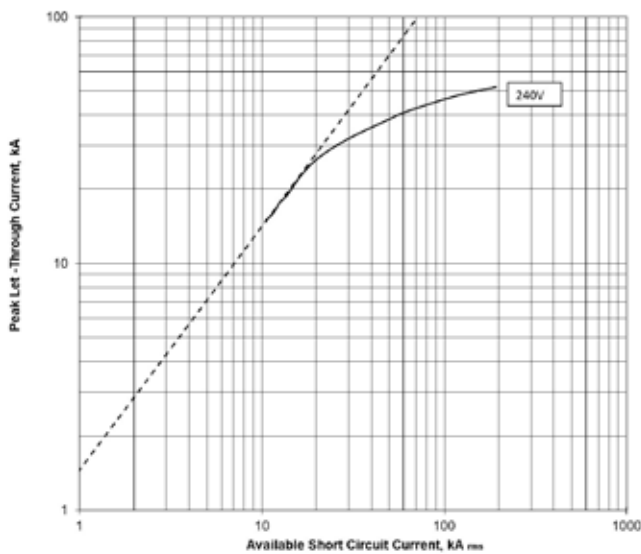

**Let-through current I_D ; PDE3 ETU PXR10 LI;
630 A @ 415V and 440V**

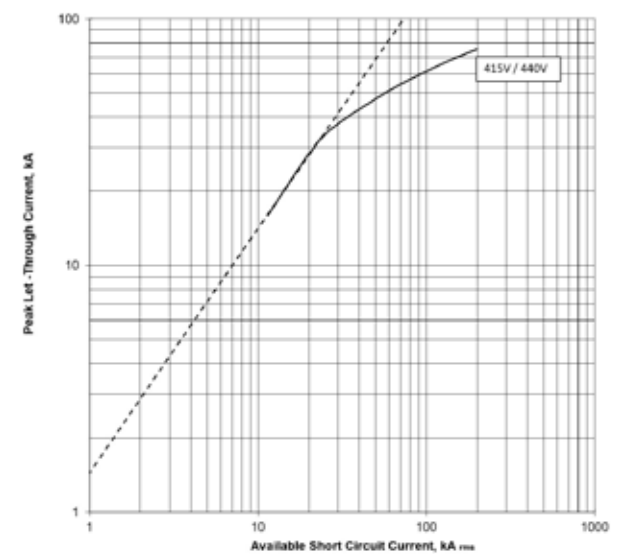

1.2

Power Defense Molded Case Circuit-Breaker

Let-through characteristics

**Let Through energy I^2t ; PDE3 TMTU;
250, 320, 400 A @ 240 V**

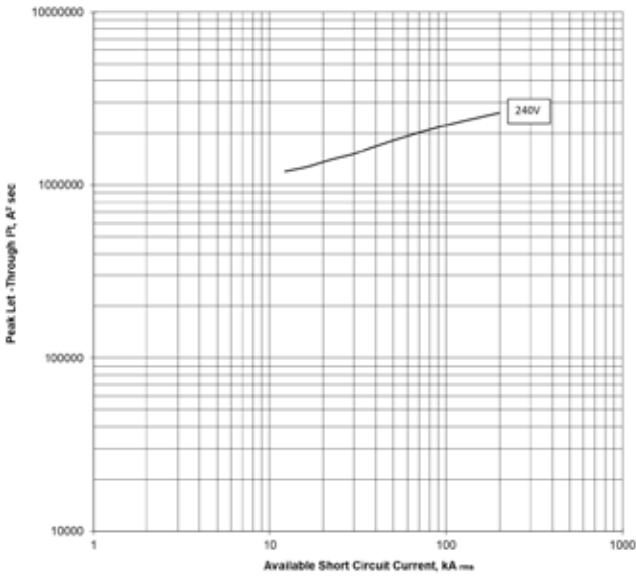

**Let Through energy I^2t ; PDE3 TMTU;
250, 320, 400 A @ 415V and 440V**

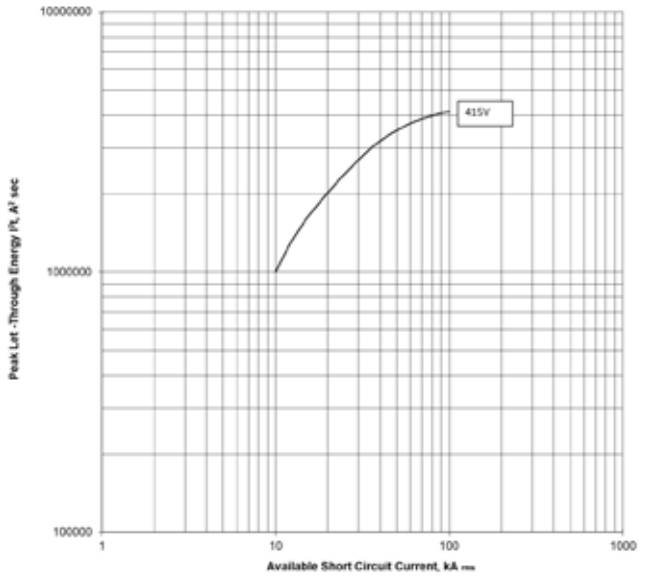

**Let Through energy I^2t ; PDE3 TMTU;
500 A and 630 A @ 240V**

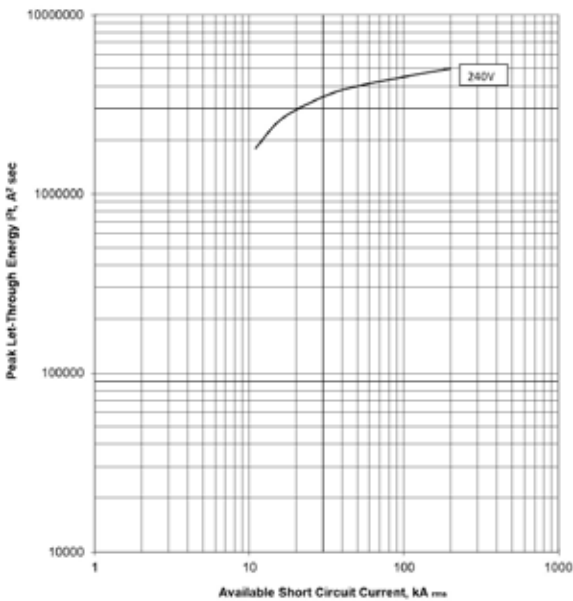

**Let Through energy I^2t ; PDE3 TMTU;
500 A and 630 A @ 415V and 440V**

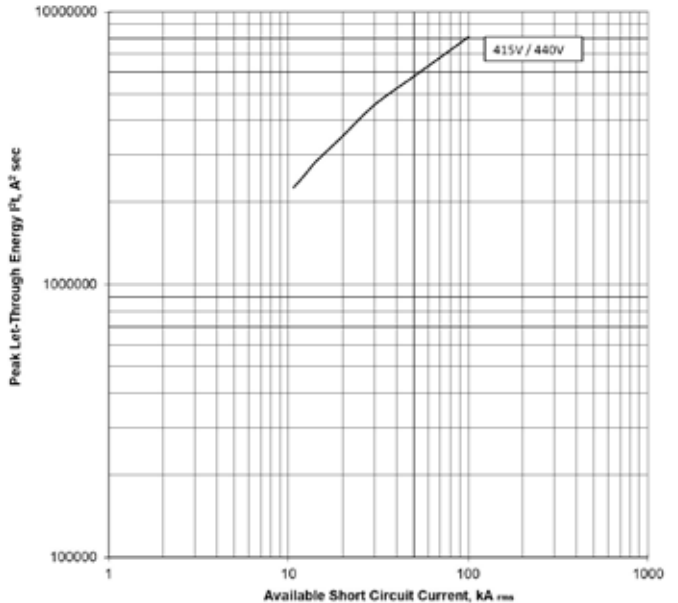

**Let Through energy I²t; PDE3 ETU PXR10 LI;
400 A @ 240 V**

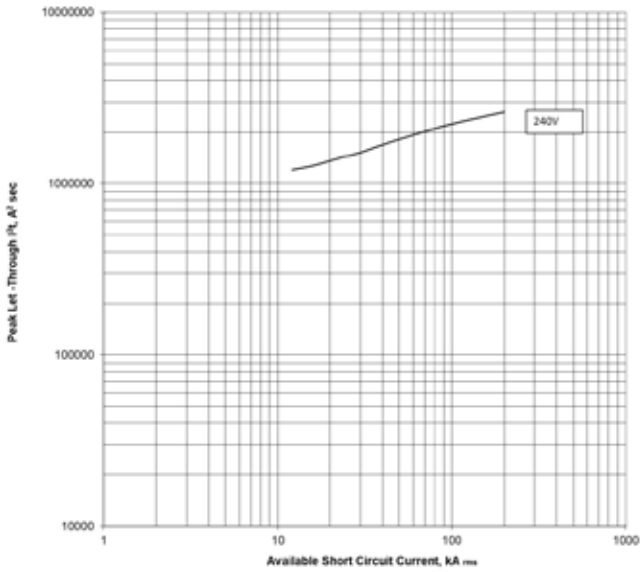

**Let Through energy I²t; PDE3 ETU PXR10 LI;
400 A @ 415 V**

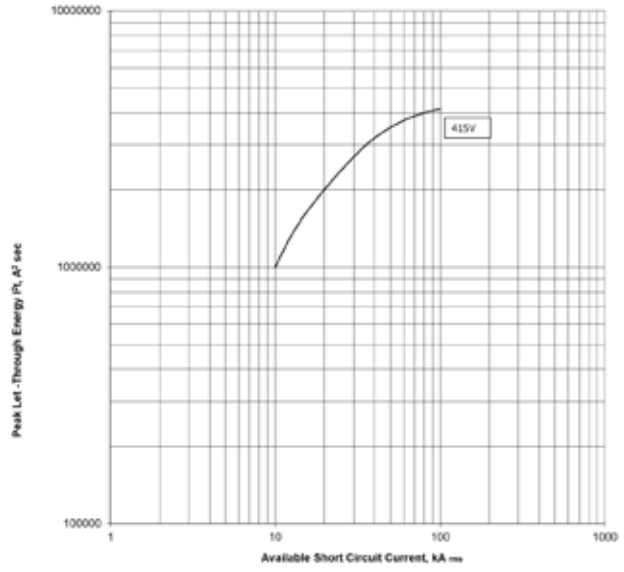

**Let Through energy I²t; PDE3 ETU PXR10 LI;
400 A @ 440 V**

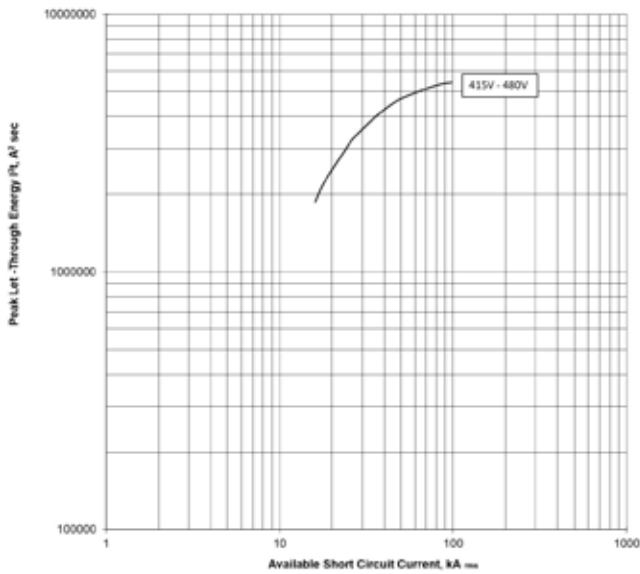

**Let Through energy I²t; PDE3 ETU PXR10 LI;
630 A @ 240 V**

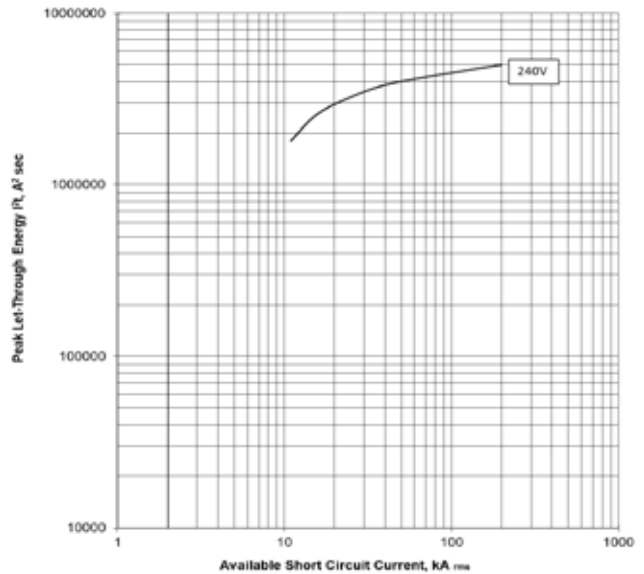

1.2

Power Defense Molded Case Circuit-Breaker

Let-through characteristics

Let Through energy I^2t ; PDE3 ETU PXR10 LI;
630 A @ 415V and 440V

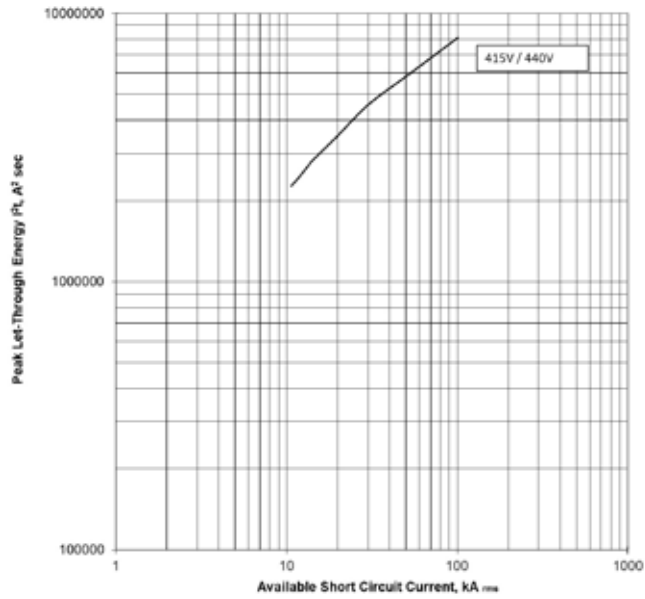

System and line protection with PDE4 TMTU;
800 A @ 240 V, 415 V and 440 V

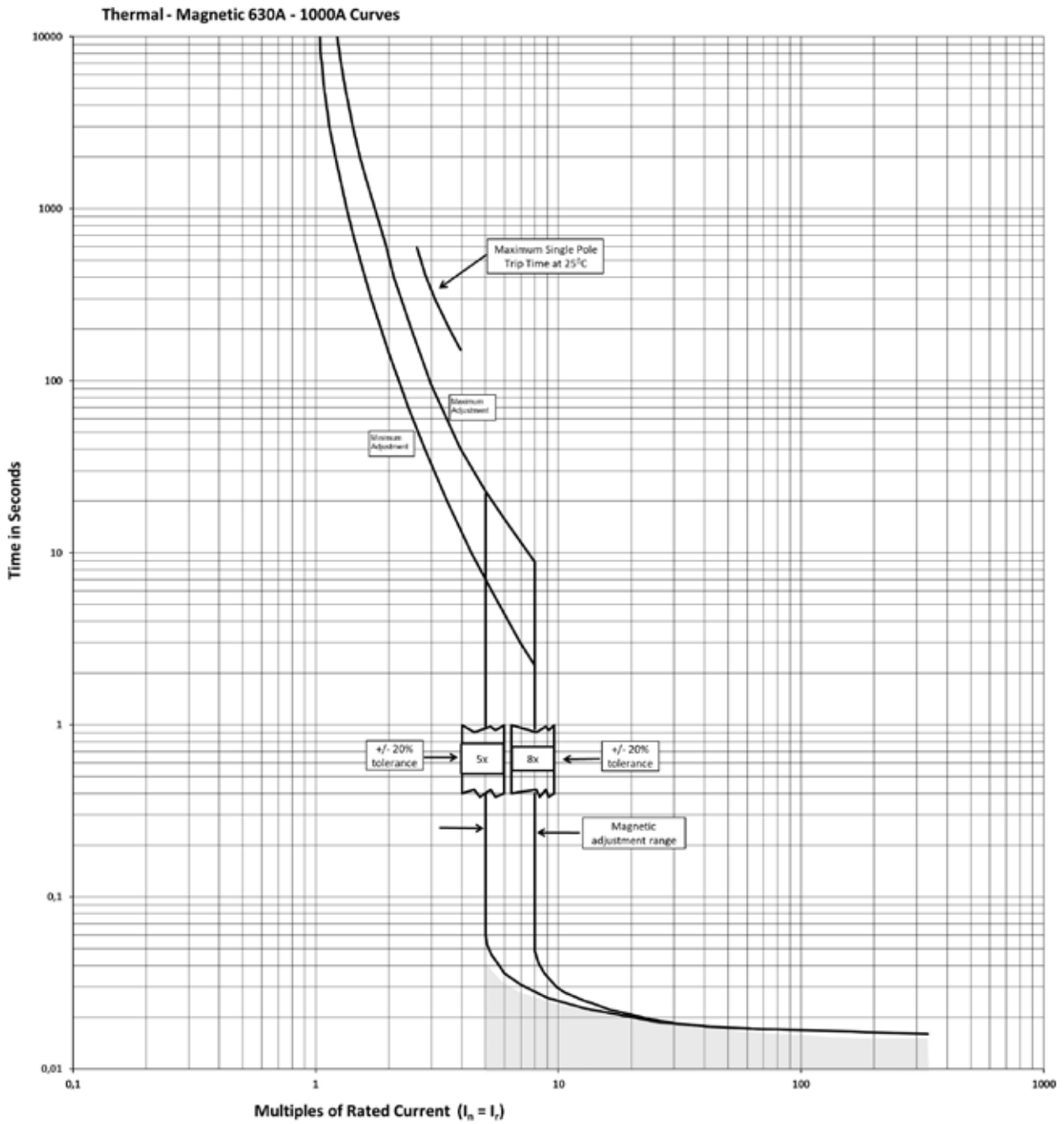

1.2

Power Defense Molded Case Circuit-Breaker

Tripping characteristics

System and line protection with PDE4; I²t Long Delay, Instantaneous, Override Curves ETU PXR10 LI;
800 A @ 240 V, 415 V and 440 V

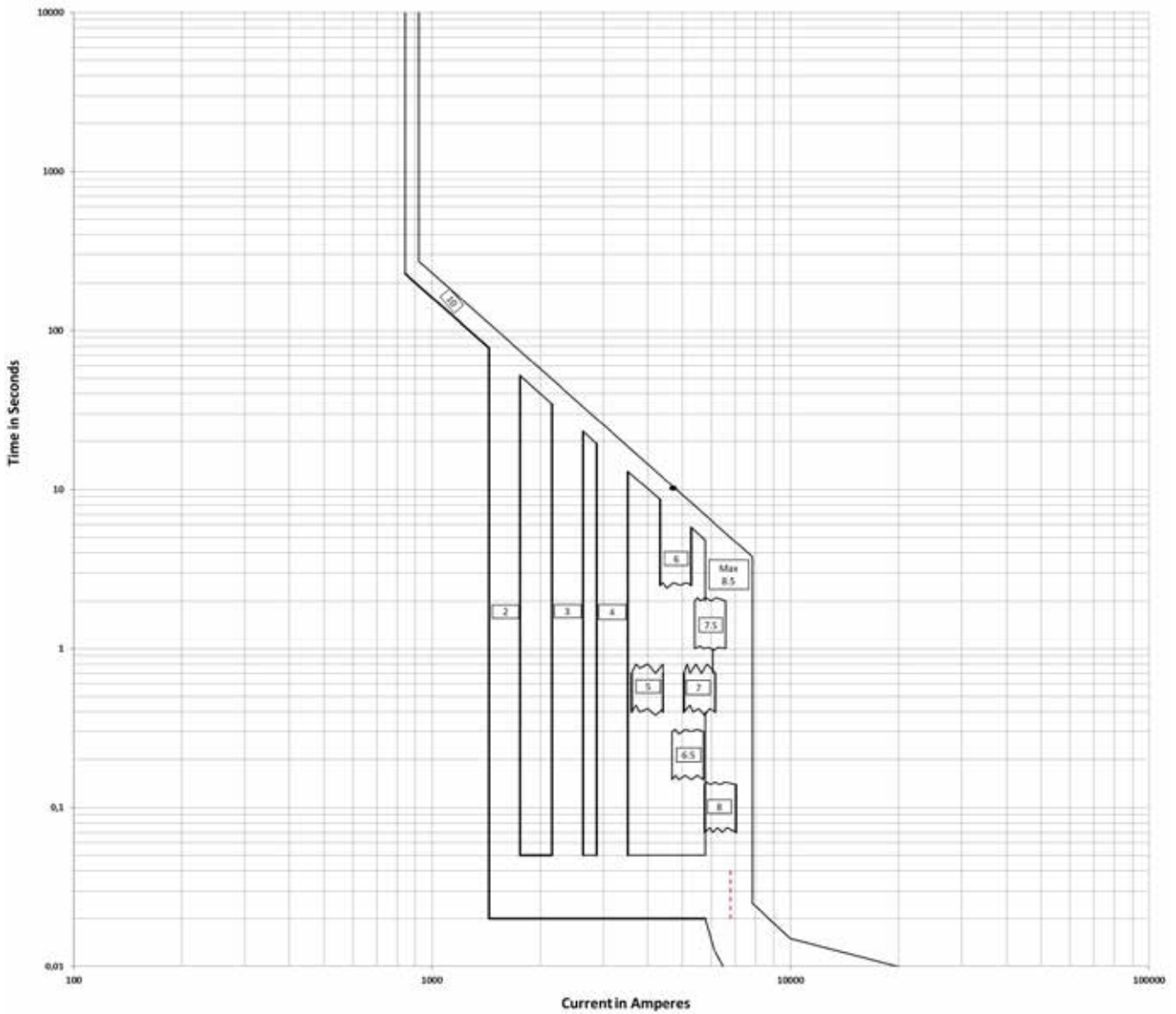

Let-through current I_D ; PDE4 TMTU;
800 A @ 240 V

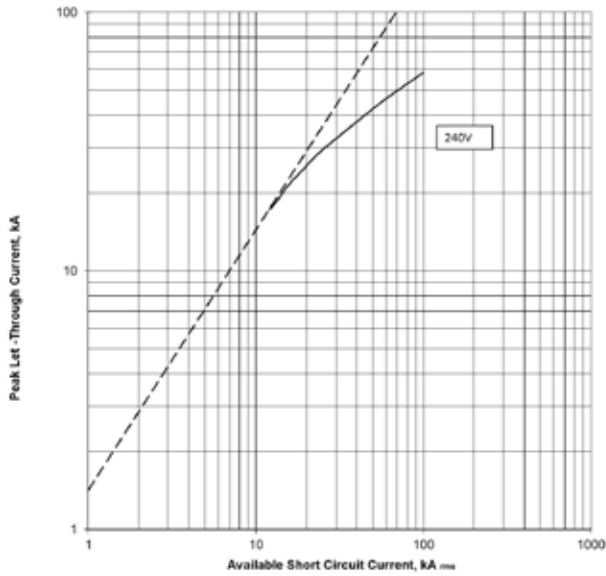

Let-through current I_D ; PDE4 TMTU;
800 A @ 415 V and 440 V

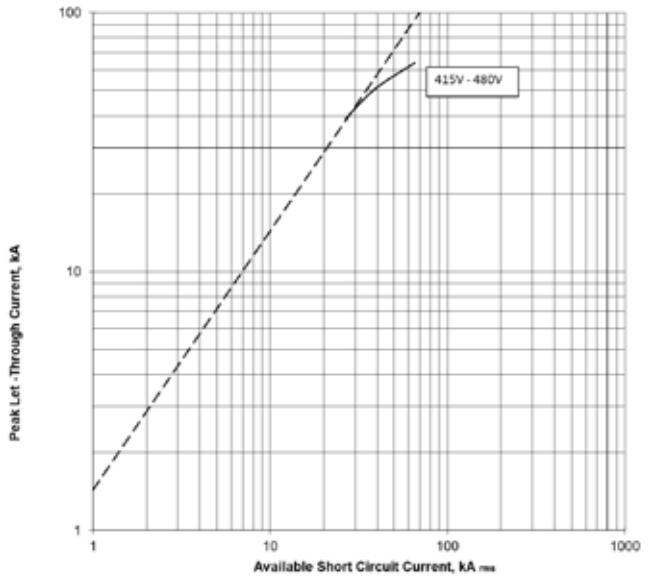

Let-through current I_D ; PDE4 ETU PXR10 LI;
800 A @ 240 V

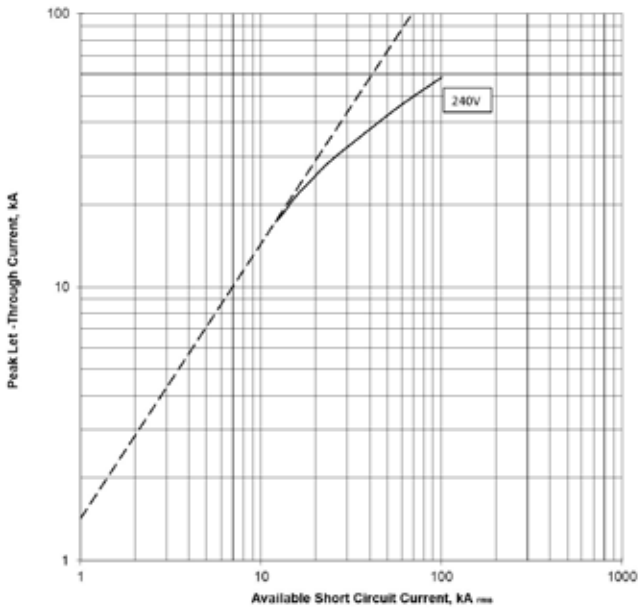

Let-through current I_D ; PDE4 ETU PXR10 LI;
800 A @ 415 V and 440 V

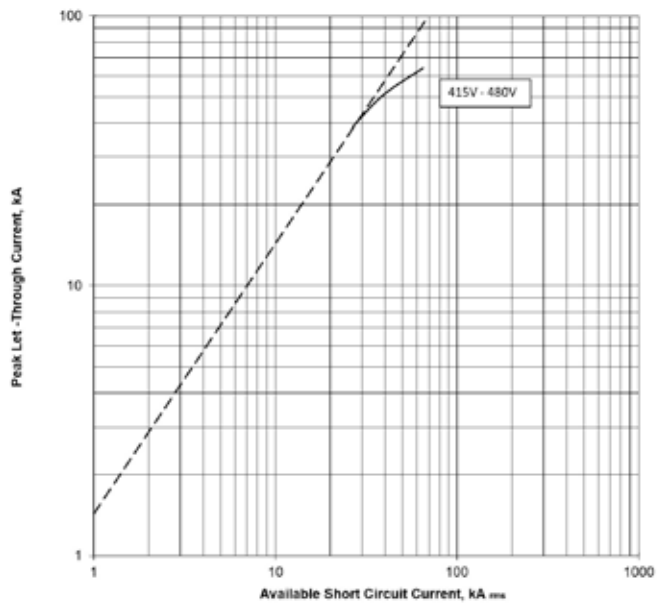

1.2

Power Defense Molded Case Circuit-Breaker

Let-through characteristics

Let-through energy I^2t ; PDE4 TMTU;
800 A @ 240 V

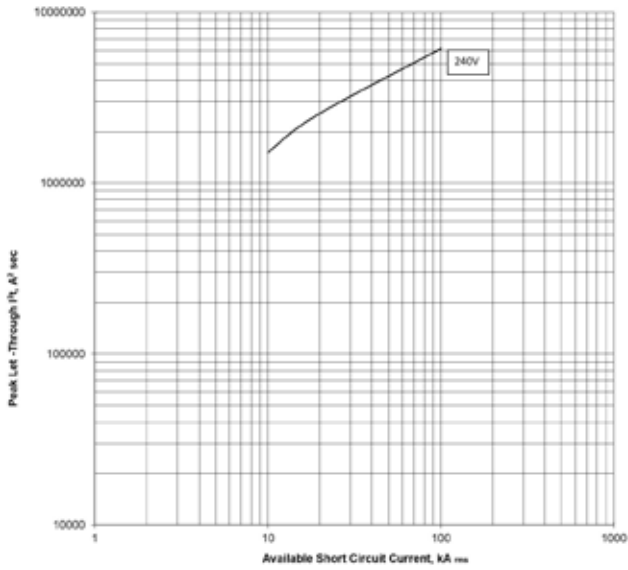

Let-through energy I^2t ; PDE4 TMTU;
800 A @ 415 V and 440 V

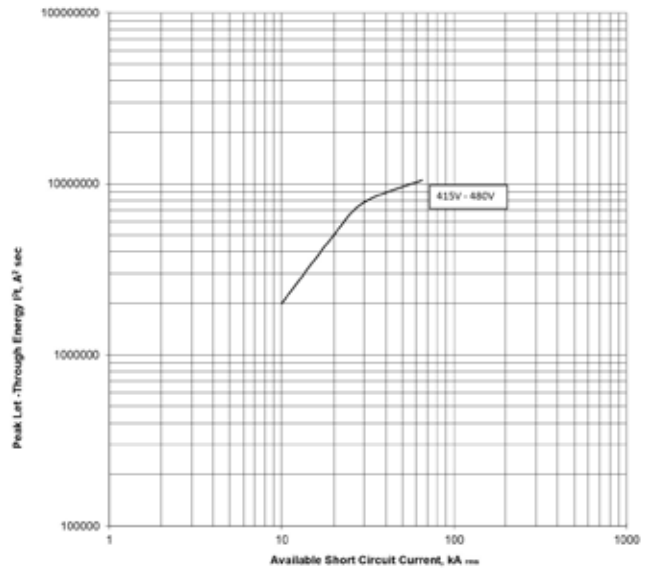

Let-through energy I^2t ; PDE4 PXR10 LI;
800 A @ 240 V

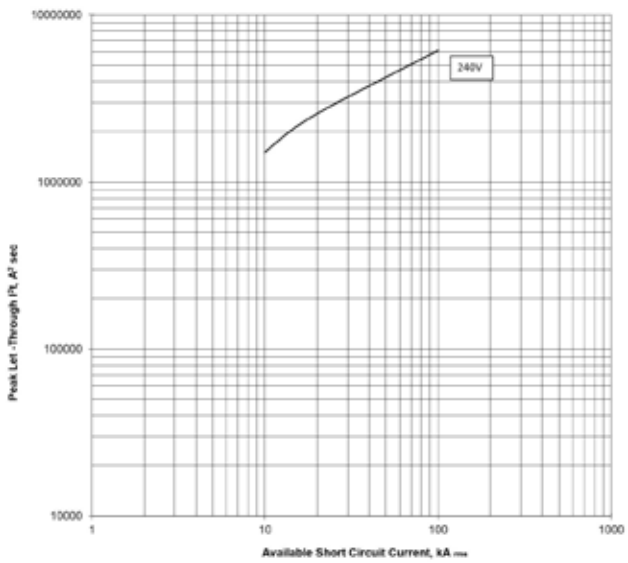

Let-through energy I^2t ; PDE4 PXR10 LI;
800 A @ 415 V and 440 V

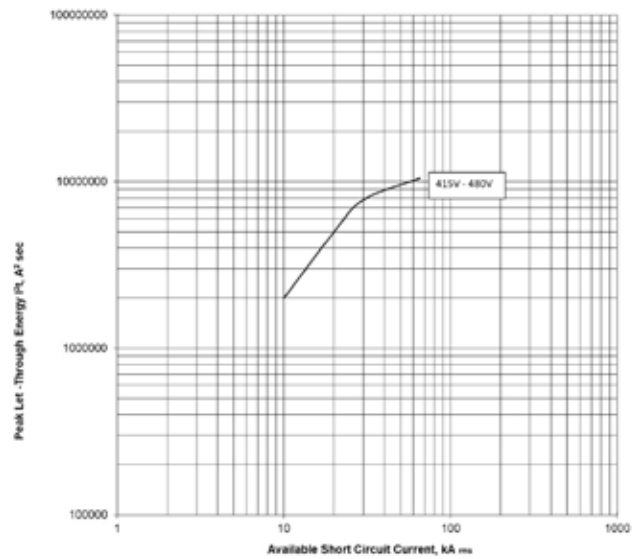

1.3

Power Defense Molded Case Circuit-Breaker

Selectivity Table

Nr of entries	Upstream	I _n [A]	PDE1 TMTU I _{cu} = 25 (36) kA						
			20-40	50	63	80	100	125	160
			II(I _{cu})						
MCBs	FAZ -B/C	I_n [A]							
FAZ	FAZ -B/C	0.5	T	T	T	T	T	T	T
All types with Tripping characteristics B, C	FAZ -B/C	1	T	T	T	T	T	T	T
	FAZ -B/C	2	2	T	T	T	T	T	T
	FAZ -B/C	3	1.2	2	3	3	10	T	T
	FAZ -B/C	4	1.2	2	3	3	8	T	T
	FAZ -B/C	6	1.2	2	2.5	3	5	10	10
	FAZ -B/C	10	1.2	1.5	2	2	4	10	10
	FAZ -B/C	13	1	1.5	2	2	4	10	10
	FAZ -B/C	16	1	1.2	1.5	2	3	8	8
	FAZ -B/C	20	0.8	1.2	1.5	1.5	3	8	8
	FAZ -B/C	25	0.7	1.2	1.5	1.5	3	7	7
	FAZ -B/C	32	-	1.2	1	1.5	2	6	6
	FAZ -B/C	40	-	-	1	1.5	2	5	5
	FAZ -B/C	50	-	-	-	1.2	1.5	4	4
	FAZ -B/C	63	-	-	-	-	1.5	3	3
FAZ -D	FAZ -D								
FAZ	FAZ -D	0.5	9	T	T	T	T	T	T
All types with Tripping characteristics D	FAZ -D	1	0.5	0.7	1.1	1.9	4.2	T	T
	FAZ -D	1.5	0.3	0.6	0.8	1.1	1.6	2.6	2.6
	FAZ -D	2	0.3	0.5	0.75	0.95	1.4	2.4	2.4
	FAZ -D	2.5	0.3	0.5	0.75	0.95	1.3	2.3	2.3
	FAZ -D	3	0.3	0.5	0.7	0.9	1.3	2.1	2.1
	FAZ -D	3.5	0.3	0.5	0.7	0.9	1.3	2	2
	FAZ -D	4	0.3	0.5	0.7	0.9	1.3	1.9	1.9
	FAZ -D	5	0.3	0.5	0.7	0.9	1.3	1.9	1.9
	FAZ -D	6	0.3	0.5	0.6	0.9	1.3	1.8	1.8
	FAZ -D	8	0.3	0.3	0.6	0.75	1	1.3	1.3
	FAZ -D	10	0.3	0.3	0.6	0.75	0.95	1.2	1.2
	FAZ -D	13	0.3	0.3	0.5	0.7	0.9	1.1	1.1
	FAZ -D	16	-	0.3	0.5	0.65	0.8	1.1	1.1
	FAZ -D	20	-	-	0.5	0.65	0.8	1.1	1.1
	FAZ -D	25	-	-	0.5	0.65	0.8	1.1	1.1
	FAZ -D	32	-	-	-	-	0.8	1.1	1.1
FAZ -D	40	-	-	-	-	-	1	1	
PLSM - B/C	PLSM - B/C								
PLSM	PLSM - B/C	0.5	T	T	T	T	T	T	T
All types with Tripping characteristics B, C	PLSM - B/C	1	T	T	T	T	T	T	T
	PLSM - B/C	2	2	T	T	T	T	T	T
	PLSM - B/C	3	1.2	2	3	3	10	T	T
	PLSM - B/C	4	1.2	2	3	3	8	T	T
	PLSM - B/C	6	1.2	2	2.5	3	5	10	10
	PLSM - B/C	10	1.2	1.5	2	2	4	10	10
	PLSM - B/C	13	1	1.5	2	2	4	10	10
	PLSM - B/C	16	1	1.2	1.5	2	3	8	8
	PLSM - B/C	20	0.8	1.2	1.5	1.5	3	8	8
	PLSM - B/C	25	0.7	1.2	1.5	1.5	3	7	7
	PLSM - B/C	32	-	1.2	1	1.5	2	6	6
	PLSM - B/C	40	-	-	1	1.5	2	5	5
	PLSM - B/C	50	-	-	-	1.2	1.5	4	4
	PLSM - B/C	63	-	-	-	-	1.5	3	3

PDE2TMTU I _{cu} = 70 kA				PDE2 ETU				PDE3TMTU I _{cu} = 70 kA				PDE3 ETU	PDE4TMTU I _{cu} = 70 kA	PDE4 ETU
125	160	200	250	63	160	200	250	250	400	500	630	630	800	800
T	T	T	T	T	T	T	T	T	T	T	T	T	T	T
T	T	T	T	T	T	T	T	T	T	T	T	T	T	T
T	T	T	T	6	T	T	T	T	T	T	T	T	T	T
T	T	T	T	2	T	T	T	T	T	T	T	T	T	T
T	T	T	T	1.5	14.1	14.1	14.1	T	T	T	T	T	T	T
T	T	T	T	1.4	7.4	7.4	7.4	T	T	T	T	T	T	T
T	T	T	T	1.4	5	5	5	T	T	T	T	T	T	T
T	T	T	T	1.3	4.8	4.8	4.8	T	T	T	T	T	T	T
12.5	T	T	T	1.3	4.6	4.6	4.6	T	T	T	T	T	T	T
11	13	T	T	1.3	4.4	4.4	4.4	T	T	T	T	T	T	T
11	13	T	T	1.3	4.2	4.2	4.2	T	T	T	T	T	T	T
7.5	10	12.5	T	1.2	3.9	3.9	3.9	T	T	T	T	T	T	T
7.5	9	12	T	1.2	3.8	3.8	3.8	T	T	T	T	T	T	T
7.5	7.5	10	T	1.1	3.5	3.5	3.5	T	T	T	T	T	T	T
5	7.5	7.5	T	-	3.1	3.1	3.1	T	T	T	T	T	T	T
T	T	T	T	T	T	T	T	T	T	T	T	-	-	-
T	T	T	T	T	T	T	T	T	T	T	T	-	-	-
T	T	T	T	3.2	T	T	T	T	T	T	T	-	-	-
T	T	T	T	3	T	T	T	T	T	T	T	-	-	-
T	T	T	T	2.9	T	T	T	T	T	T	T	-	-	-
T	T	T	T	2.6	T	T	T	T	T	T	T	-	-	-
T	T	T	T	2.4	T	T	T	T	T	T	T	-	-	-
T	T	T	T	2.3	11.3	11.3	11.3	T	T	T	T	-	-	-
T	T	T	T	2.3	10.4	10.4	10.4	T	T	T	T	-	-	-
T	T	T	T	2.1	6	6	6	T	T	T	T	-	-	-
T	T	T	T	1.4	5.4	5.4	5.4	T	T	T	T	-	-	-
T	T	T	T	1.3	5.1	5.1	5.1	T	T	T	T	-	-	-
T	T	T	T	1.2	4.5	4.5	4.5	T	T	T	T	-	-	-
12	T	T	T	1.2	4.1	4.1	4.1	T	T	T	T	-	-	-
10	12	T	T	1.2	3.9	3.9	3.9	T	T	T	T	-	-	-
10	12	T	T	1.2	3.8	3.8	3.8	T	T	T	T	-	-	-
6	8	11	T	1.2	3.6	3.6	3.6	T	T	T	T	-	-	-
6	8	11	T	1.1	3.4	3.4	3.4	T	T	T	T	-	-	-
T	T	T	T	T	T	T	T	T	T	T	T	T	T	T
T	T	T	T	T	T	T	T	T	T	T	T	T	T	T
T	T	T	T	5	T	T	T	T	T	T	T	T	T	T
T	T	T	T	1.9	T	T	T	T	T	T	T	T	T	T
T	T	T	T	1.3	T	T	T	T	T	T	T	T	T	T
T	T	T	T	1.2	7.4	7.4	7.4	T	T	T	T	T	T	T
T	T	T	T	1.2	5	5	5	T	T	T	T	T	T	T
T	T	T	T	1.2	4.8	4.8	4.8	T	T	T	T	T	T	T
T	T	T	T	1.2	4.6	4.6	4.6	T	T	T	T	T	T	T
T	T	T	T	1.2	4.4	4.4	4.4	T	T	T	T	T	T	T
T	T	T	T	1.1	4.2	4.2	4.2	T	T	T	T	T	T	T
7.5	T	T	T	1.1	3.9	3.9	3.9	T	T	T	T	T	T	T
7.5	9	T	T	1.1	3.8	3.8	3.8	T	T	T	T	T	T	T
7.5	7.5	T	T	1	3.5	3.5	3.5	T	T	T	T	T	T	T
5	7.5	7.5	T	-	3.1	3.1	3.1	T	T	T	T	T	T	T

1.3

Power Defense Molded Case Circuit-Breaker

Selectivity Table

Selectivity Table

	Nr of entries	Upstream	PDE1 TMTU $I_{cu} = 25 (36) \text{ kA}$							
			$I_n \text{ [A]}$	20-40	50	63	80	100	125	160
				$II(I_{cu})$						
PLSM - D		PLSM - D								
PLSM All types with Tripping characteristics D	PLSM - D	0.5	9	T	T	T	T	T	T	
	PLSM - D	1	0.5	0.7	1.1	1.9	4.2	T	T	
	PLSM - D	1.5	0.3	0.6	0.8	1.1	1.6	2.6	2.6	
	PLSM - D	2	0.3	0.5	0.75	0.95	1.4	2.4	2.4	
	PLSM - D	2.5	0.3	0.5	0.75	0.95	1.3	2.3	2.3	
	PLSM - D	3	0.3	0.5	0.7	0.9	1.3	2.1	2.1	
	PLSM - D	3.5	0.3	0.5	0.7	0.9	1.3	2	2	
	PLSM - D	4	0.3	0.5	0.7	0.9	1.3	1.9	1.9	
	PLSM - D	5	0.3	0.5	0.7	0.9	1.3	1.9	1.9	
	PLSM - D	6	0.3	0.5	0.6	0.9	1.3	1.8	1.8	
	PLSM - D	8	0.3	0.3	0.6	0.75	1	1.3	1.3	
	PLSM - D	10	0.3	0.3	0.6	0.75	0.95	1.2	1.2	
	PLSM - D	13	0.3	0.3	0.5	0.7	0.9	1.1	1.1	
	PLSM - D	16	-	0.3	0.5	0.65	0.8	1.1	1.1	
	PLSM - D	20	-	-	0.5	0.65	0.8	1.1	1.1	
	PLSM - D	25	-	-	0.5	0.65	0.8	1.1	1.1	
	PLSM - D	32	-	-	-	-	0.8	1.1	1.1	
PLSM - D	40	-	-	-	-	-	1	1		
PLS6 - B/C		PLS6 - B/C								
PLS6 All types with Tripping characteristics B, C	PLS6 - B/C	0.5	T	T	T	T	T	T	T	
	PLS6 - B/C	1	T	T	T	T	T	T	T	
	PLS6 - B/C	2	2	T	T	T	T	T	T	
	PLS6 - B/C	3	1.2	2	3	3	T	T	T	
	PLS6 - B/C	4	1.2	2	3	3	T	T	T	
	PLS6 - B/C	6	1.2	2	2.5	3	5	T	T	
	PLS6 - B/C	10	1.2	1.5	2	2	4	T	T	
	PLS6 - B/C	13	1	1.5	2	2	4	T	T	
	PLS6 - B/C	16	1	1.2	1.5	2	3	T	T	
	PLS6 - B/C	20	0.8	1.2	1.5	1.5	3	T	T	
	PLS6 - B/C	25	0.7	1.2	1.5	1.5	3	T	T	
	PLS6 - B/C	32	-	1.2	1	1.5	2	T	T	
	PLS6 - B/C	40	-	-	1	1.5	2	5	5	
	PLS6 - B/C	50	-	-	-	1.2	1.5	4	4	
PLS6 - B/C	63	-	-	-	-	1.5	3	3		
PLS6 - D		PLS6 - D								
PLS6 All types with Tripping characteristics D	PLS6 - D	0.5	T	T	T	T	T	T	T	
	PLS6 - D	1	0.5	0.7	1.1	1.9	4.2	T	T	
	PLS6 - D	1.5	0.3	0.6	0.8	1.1	1.6	2.6	2.6	
	PLS6 - D	2	0.3	0.5	0.75	0.95	1.4	2.4	2.4	
	PLS6 - D	2.5	0.3	0.5	0.75	0.95	1.3	2.3	2.3	
	PLS6 - D	3	0.3	0.5	0.7	0.9	1.3	2.1	2.1	
	PLS6 - D	3.5	0.3	0.5	0.7	0.9	1.3	2	2	
	PLS6 - D	4	0.3	0.5	0.7	0.9	1.3	1.9	1.9	
	PLS6 - D	5	0.3	0.5	0.7	0.9	1.3	1.9	1.9	
	PLS6 - D	6	0.3	0.5	0.6	0.9	1.3	1.8	1.8	
	PLS6 - D	8	0.3	0.3	0.6	0.75	1	1.3	1.3	
	PLS6 - D	10	0.3	0.3	0.6	0.75	0.95	1.2	1.2	
	PLS6 - D	13	0.3	0.3	0.5	0.7	0.9	1.1	1.1	
	PLS6 - D	16	-	0.3	0.5	0.65	0.8	1.1	1.1	
	PLS6 - D	20	-	-	0.5	0.65	0.8	1.1	1.1	
	PLS6 - D	25	-	-	0.5	0.65	0.8	1.1	1.1	
	PLS6 - D	32	-	-	-	-	0.8	1.1	1.1	
PLS6 - D	40	-	-	-	-	-	1	1		

PDE2TMTU I _{cu} = 70 kA				PDE2 ETU				PDE3TMTU I _{cu} = 70 kA				PDE3 ETU	PDE4TMTU I _{cu} = 70 kA	PDE4 ETU
125	160	200	250	63	160	200	250	250	400	500	630	630	800	800
T	T	T	T	T	T	T	T	T	T	T	T	-	-	-
T	T	T	T	T	T	T	T	T	T	T	T	-	-	-
T	T	T	T	2.6	T	T	T	T	T	T	T	-	-	-
T	T	T	T	2.5	T	T	T	T	T	T	T	-	-	-
T	T	T	T	2.3	T	T	T	T	T	T	T	-	-	-
T	T	T	T	2.1	T	T	T	T	T	T	T	-	-	-
T	T	T	T	2	T	T	T	T	T	T	T	-	-	-
T	T	T	T	1.9	T	T	T	T	T	T	T	-	-	-
T	T	T	T	1.9	T	T	T	T	T	T	T	-	-	-
T	T	T	T	1.8	6	6	6	T	T	T	T	-	-	-
T	T	T	T	1.3	5.4	5.4	5.4	T	T	T	T	-	-	-
T	T	T	T	1.2	5.1	5.1	5.1	T	T	T	T	-	-	-
T	T	T	T	1.1	4.5	4.5	4.5	T	T	T	T	-	-	-
T	T	T	T	1.1	4.1	4.1	4.1	T	T	T	T	-	-	-
T	T	T	T	1	3.9	3.9	3.9	T	T	T	T	-	-	-
T	T	T	T	1	3.8	3.8	3.8	T	T	T	T	-	-	-
6	8	T	T	1	3.6	3.6	3.6	T	T	T	T	-	-	-
6	8	T	T	1	3.4	3.4	3.4	T	T	T	T	-	-	-
T	T	T	T	T	T	T	T	T	T	T	T	T	T	T
T	T	T	T	T	T	T	T	T	T	T	T	T	T	T
T	T	T	T	5	T	T	T	T	T	T	T	T	T	T
T	T	T	T	1.9	T	T	T	T	T	T	T	T	T	T
T	T	T	T	1.3	T	T	T	T	T	T	T	T	T	T
T	T	T	T	1.2	T	T	T	T	T	T	T	T	T	T
T	T	T	T	1.2	5	5	5	T	T	T	T	T	T	T
T	T	T	T	1.2	4.8	4.8	4.8	T	T	T	T	T	T	T
T	T	T	T	1.2	4.6	4.6	4.6	T	T	T	T	T	T	T
T	T	T	T	1.2	4.4	4.4	4.4	T	T	T	T	T	T	T
T	T	T	T	1.1	4.2	4.2	4.2	T	T	T	T	T	T	T
T	T	T	T	1.1	3.9	3.9	3.9	T	T	T	T	T	T	T
T	T	T	T	1.1	3.8	3.8	3.8	T	T	T	T	T	T	T
T	T	T	T	1	3.5	3.5	3.5	T	T	T	T	T	T	T
5	T	T	T	-	3.1	3.1	3.1	T	T	T	T	T	T	T
T	T	T	T	T	T	T	T	T	T	T	T	-	-	-
T	T	T	T	T	T	T	T	T	T	T	T	-	-	-
T	T	T	T	2.6	T	T	T	T	T	T	T	-	-	-
T	T	T	T	2.5	T	T	T	T	T	T	T	-	-	-
T	T	T	T	2.3	T	T	T	T	T	T	T	-	-	-
T	T	T	T	2.1	T	T	T	T	T	T	T	-	-	-
T	T	T	T	2	T	T	T	T	T	T	T	-	-	-
T	T	T	T	1.9	T	T	T	T	T	T	T	-	-	-
T	T	T	T	1.9	T	T	T	T	T	T	T	-	-	-
T	T	T	T	1.8	T	T	T	T	T	T	T	-	-	-
T	T	T	T	1.3	5.4	5.4	5.4	T	T	T	T	-	-	-
T	T	T	T	1.2	5.1	5.1	5.1	T	T	T	T	-	-	-
T	T	T	T	1.1	4.5	4.5	4.5	T	T	T	T	-	-	-
T	T	T	T	1.1	4.1	4.1	4.1	T	T	T	T	-	-	-
T	T	T	T	1	3.9	3.9	3.9	T	T	T	T	-	-	-
T	T	T	T	1	3.8	3.8	3.8	T	T	T	T	-	-	-
T	T	T	T	1	3.6	3.6	3.6	T	T	T	T	-	-	-
T	T	T	T	1	3.4	3.4	3.4	T	T	T	T	-	-	-

1.3

Power Defense Molded Case Circuit-Breaker

Selectivity Table

Selectivity Table

	Nr of entries	Upstream	PDE1 TMTU $I_{cu} = 25 (36) \text{ kA}$							
			I_n [A]	20-40	50	63	80	100	125	160
				$II(I_{cu})$						
eRBM - B/C		eRBM - B/C								
eRBM	eRBM - B/C	6		1.2	2	2.5	3	5	T	T
All types with Tripping characteristics B, C	eRBM - B/C	8		1.2	1.5	2	2	4	T	T
	eRBM - B/C	10		1.2	1.5	2	2	4	T	T
	eRBM - B/C	13		1	1.5	2	2	4	T	T
	eRBM - B/C	16		1	1.2	1.5	2	3	8	8
	eRBM - B/C	20		0.8	1.2	1.5	1.5	3	8	8
	eRBM - B/C	25		0.7	1.2	1.5	1.5	3	7	7
	eRBM - B/C	32		-	1.2	1	1.5	2	6	6
	eRBM - B/C	40		-	-	1	1.5	2	5	5
eRBM - B/C	45		-	-	-	1.2	1.5	4	4	
eRBM - D		eRBM - D								
eRBM	eRBM - D	6		0.3	0.5	0.6	0.9	1.3	1.8	1.8
All types with Tripping characteristics D	eRBM - D	8		0.3	0.3	0.6	0.75	1	1.3	1.3
	eRBM - D	10		0.3	0.3	0.6	0.75	0.95	1.2	1.2
	eRBM - D	13		0.3	0.3	0.5	0.7	0.9	1.1	1.1
	eRBM - D	16		-	0.3	0.5	0.65	0.8	1.1	1.1
	eRBM - D	20		-	-	0.5	0.65	0.8	1.1	1.1
PKNM - B		PKNM - B								
PKNM	PKNM - B	16		1	1.2	1.5	2	3	8	8
All types with Tripping characteristics B	PKNM - B	20		0.8	1.2	1.5	1.5	3	8	8
	PKNM - B	25		0.7	1.2	1.5	1.5	3	7	7
	PKNM - B	32		-	1.2	1	1.5	2	6	6
	PKNM - B	40		-	-	1	1.5	2	5	5
PKNM - C		PKNM - C								
PKNM	PKNM - C	6		1.2	2	2.5	3	5	T	T
All types with Tripping characteristics C	PKNM - C	10		1.2	1.5	2	2	4	T	T
	PKNM - C	16		1	1.2	1.5	1.5	3	8	8
	PKNM - C	20		0.8	1.2	1.5	1.5	3	8	8
	PKNM - C	25		0.7	1.2	1.5	1.5	3	7	7
	PKNM - C	32		-	1.2	1	1.5	2	6	6
	PKNM - C	40		-	-	1	1.5	2	5	5
PKN6 - B		PKN6 - B								
PKN6	PKN6 - B	16		1	1.2	1.5	2	3	T	T
All types with Tripping characteristics B	PKN6 - B	20		0.8	1.2	1.5	1.5	3	T	T
	PKN6 - B	25		0.7	1.2	1.5	1.5	3	T	T
	PKN6 - B	32		-	1.2	1	1.5	2	6	6
	PKN6 - B	40		-	-	1	1.5	2	5	5
PKN6 - C		PKN6 - C								
PKN6	PKN6 - C	6		1.2	2	2.5	3	5	T	T
All types with Tripping characteristics C	PKN6 - C	10		1.2	1.5	2	2	4	T	T
	PKN6 - C	16		1	1.2	1.5	2	3	T	T
	PKN6 - C	20		0.8	1.2	1.5	1.5	3	T	T
	PKN6 - C	25		0.7	1.2	1.5	1.5	3	T	T
	PKN6 - C	32		-	1.2	1	1.5	2	T	T
	PKN6 - C	40		-	-	1	1.5	2	5	5
PD breakers		PDE1 TMTU								
PDE1 TMTU	PDE1 TMTU	20-40	70	-	-	0.5	0.7	0.8	1.5	1.5
	PDE1 TMTU	50	70	-	-	-	0.6	0.8	1.5	1.5
	PDE1 TMTU	63	70	-	-	-	-	0.8	1.5	1.5
	PDE1 TMTU	80	70	-	-	-	-	-	1.5	1.5
	PDE1 TMTU	100	70	-	-	-	-	-	-	1.5
	PDE1 TMTU	125	70	-	-	-	-	-	-	-
	PDE1 TMTU	160	70	-	-	-	-	-	-	-

PDE2TMTU I _{cu} = 70 kA				PDE2 ETU				PDE3TMTU I _{cu} = 70 kA				PDE3 ETU	PDE4TMTU I _{cu} = 70 kA	PDE4 ETU
125	160	200	250	63	160	200	250	250	400	500	630	630	800	800
T	T	T	T	1.2	7.4	7.4	7.4	-	-	-	-	-	-	-
T	T	T	T	1.2	7.4	7.4	7.4	-	-	-	-	-	-	-
T	T	T	T	1.2	5	5	5	-	-	-	-	-	-	-
T	T	T	T	1.2	4.8	4.8	4.8	-	-	-	-	-	-	-
T	T	T	T	1.2	4.6	4.6	4.6	-	-	-	-	-	-	-
T	T	T	T	1.2	4.4	4.4	4.4	-	-	-	-	-	-	-
T	T	T	T	1.1	4.2	4.2	4.2	-	-	-	-	-	-	-
75	T	T	T	1.1	3.9	3.9	3.9	-	-	-	-	-	-	-
75	9	T	T	1.1	3.8	3.8	3.8	-	-	-	-	-	-	-
75	75	T	T	1	3.5	3.5	3.5	-	-	-	-	-	-	-
T	T	T	T	1.8	6	6	6	-	-	-	-	-	-	-
T	T	T	T	1.3	5.4	5.4	5.4	-	-	-	-	-	-	-
T	T	T	T	1.2	5.1	5.1	5.1	-	-	-	-	-	-	-
T	T	T	T	1.1	4.5	4.5	4.5	-	-	-	-	-	-	-
T	T	T	T	1.1	4.1	4.1	4.1	-	-	-	-	-	-	-
T	T	T	T	1	3.9	3.9	3.9	-	-	-	-	-	-	-
T	T	T	T	1.2	4.6	4.6	4.6	-	-	-	-	-	-	-
T	T	T	T	1.2	4.4	4.4	4.4	-	-	-	-	-	-	-
T	T	T	T	1.1	4.2	4.2	4.2	-	-	-	-	-	-	-
75	T	T	T	1.1	3.9	3.9	3.9	-	-	-	-	-	-	-
75	9	T	T	1.1	3.8	3.8	3.8	-	-	-	-	-	-	-
T	T	T	T	1.2	7.4	7.4	7.4	-	-	-	-	-	-	-
T	T	T	T	1.2	5	5	5	-	-	-	-	-	-	-
T	T	T	T	1.2	4.6	4.6	4.6	-	-	-	-	-	-	-
T	T	T	T	1.2	4.4	4.4	4.4	-	-	-	-	-	-	-
T	T	T	T	1.1	4.2	4.2	4.2	-	-	-	-	-	-	-
75	T	T	T	1.1	3.9	3.9	3.9	-	-	-	-	-	-	-
75	9	T	T	1.1	3.8	3.8	3.8	-	-	-	-	-	-	-
T	T	T	T	1.2	4.6	4.6	4.6	-	-	-	-	-	-	-
T	T	T	T	1.2	4.4	4.4	4.4	-	-	-	-	-	-	-
T	T	T	T	1.1	4.2	4.2	4.2	-	-	-	-	-	-	-
T	T	T	T	1.1	3.9	3.9	3.9	-	-	-	-	-	-	-
T	T	T	T	1.1	3.8	3.8	3.8	-	-	-	-	-	-	-
T	T	T	T	1.2	T	T	T	-	-	-	-	-	-	-
T	T	T	T	1.2	5	5	5	-	-	-	-	-	-	-
T	T	T	T	1.2	4.6	4.6	4.6	-	-	-	-	-	-	-
T	T	T	T	1.2	4.4	4.4	4.4	-	-	-	-	-	-	-
T	T	T	T	1.1	4.2	4.2	4.2	-	-	-	-	-	-	-
T	T	T	T	1.1	3.9	3.9	3.9	-	-	-	-	-	-	-
T	T	T	T	1.1	3.8	3.8	3.8	-	-	-	-	-	-	-
2	2.4	2.5	3.1	1	2.6	2.6	2.6	6	13.7	50	T	T	10	10
2	2.4	2.5	3.1	-	2.6	2.6	2.6	6	13.1	47.4	T	T	10	10
1.9	2.3	2.6	3.1	-	2.6	2.6	2.6	6	11.8	43.5	T	T	10	10
1.9	2.3	2.6	3	-	2.6	2.6	2.6	6	11.2	41.3	T	T	10	10
-	2.2	2.6	3	-	2.6	2.6	2.6	6	10.9	40.4	T	T	10	10
-	-	2.6	3	-	2.6	2.6	2.6	6	10.7	39.3	T	T	10	10
-	-	2.6	3	-	-	2.6	2.6	6	10.5	38.5	T	T	10	10

1.3

Power Defense Molded Case Circuit-Breaker

Selectivity Table

Selectivity Table

	Nr of entries	Upstream	I _n [A]	PDE1 TMTU I _{cu} = 25 (36) kA						
				II(I _{cu})						
				20-40	50	63	80	100	125	160
PDE2 TMTU		PDE2 TMTU								
PDE2 TMTU	PDE2 TMTU	125	70	-	-	-	-	-	-	-
	PDE2 TMTU	160	70	-	-	-	-	-	-	-
	PDE2 TMTU	200	70	-	-	-	-	-	-	-
	PDE2 TMTU	250	70	-	-	-	-	-	-	-
PDE2 ETU		PDE2 ETU								
PDE2 ETU	PDE2 ETU	63	70	-	-	-	-	-	-	-
	PDE2 ETU	160	70	-	-	-	-	-	-	-
	PDE2 ETU	200	70	-	-	-	-	-	-	-
	PDE2 ETU	250	70	-	-	-	-	-	-	-
PDE3 TMTU		PDE3 TMTU								
PDE3 TMTU	PDE3 TMTU	250	70	-	-	-	-	-	-	-
	PDE3 TMTU	400	70	-	-	-	-	-	-	-
	PDE3 TMTU	500	70	-	-	-	-	-	-	-
	PDE3 TMTU	630	70	-	-	-	-	-	-	-
PDE3 ETU		PDE3 ETU								
PDE3 ETU	PDE3 ETU	630	70	-	-	-	-	-	-	-
PDE4 TMTU		PDE4 TMTU								
PDE4 TMTU	PDE4 TMTU	800	70	-	-	-	-	-	-	-
PDE4 ETU		PDE4 ETU								
PDE4 ETU	PDE4 ETU	800	70	-	-	-	-	-	-	-
NZM breakers		NZM...1-A								
NZM...1-A	NZM...1-A	20-40	25 - 100	-	-	0.5	0.7	0.8	1.5	1.5
	NZM...1-A	50	25 - 100	-	-	-	0.6	0.8	1.5	1.5
	NZM...1-A	63	25 - 100	-	-	-	-	0.8	1.5	1.5
	NZM...1-A	80	25 - 100	-	-	-	-	-	1.5	1.5
	NZM...1-A	100	25 - 100	-	-	-	-	-	-	1.5
	NZM...1-A	125	25 - 100	-	-	-	-	-	-	-
	NZM...1-A	160	25 - 100	-	-	-	-	-	-	-
NZM...1-M		NZM...1-M								
NZM...1-M	NZM...1-M	40	25 - 50	-	-	-	-	0.8	1	1
	NZM...1-M	50	25 - 50	-	-	-	-	-	-	1
	NZM...1-M	63	25 - 50	-	-	-	-	-	-	1
	NZM...1-M	80	25 - 50	-	-	-	-	-	-	-
	NZM...1-M	100	25 - 50	-	-	-	-	-	-	-
NZM...2-A		NZM...2-A								
NZM...2-A	NZM...2-A	20-40	25 - 150	-	-	0.5	0.6	0.8	1	1
	NZM...2-A	50	25 - 150	-	-	-	0.6	0.8	1	1
	NZM...2-A	63	25 - 150	-	-	-	-	0.8	1	1
	NZM...2-A	80	25 - 150	-	-	-	-	-	1	1
	NZM...2-A	100	25 - 150	-	-	-	-	-	-	1
	NZM...2-A	125	25 - 150	-	-	-	-	-	-	-
	NZM...2-A	160	25 - 150	-	-	-	-	-	-	-
	NZM...2-A	200	25 - 150	-	-	-	-	-	-	-
	NZM...2-A	250	25 - 150	-	-	-	-	-	-	-
NZM...2-M		NZM...2-M								
NZM...2-M...	NZM...2-M	20-120	25 - 150	-	-	-	-	-	-	-
	NZM...2-M	160	25 - 150	-	-	-	-	-	-	-
	NZM...2-M	200	25 - 150	-	-	-	-	-	-	-
NZM...2-VE		NZM...2-VE								
NZM...2-VE	NZM...2-VE	100	50 - 150	-	-	-	-	-	-	-
	NZM...2-VE	160	50 - 150	-	-	-	-	-	-	-
	NZM...2-VE	250	50 - 150	-	-	-	-	-	-	-

PDE2TMTU I _{cu} = 70 kA				PDE2 ETU				PDE3TMTU I _{cu} = 70 kA				PDE3 ETU		PDE4TMTU I _{cu} = 70 kA		PDE4 ETU	
125	160	200	250	63	160	200	250	250	400	500	630	630	800	800	800	800	
-	-	2.2	2.6	-	-	2.7	2.7	3.2	5.4	9.8	16.6	16.6	7.2	7.2	-	-	
-	-	-	2.5	-	-	-	2.4	3.2	5.4	9.8	16.6	16.6	7.2	7.2	-	-	
-	-	-	-	-	-	-	-	-	5.4	9.8	15.5	15.5	7.1	7.1	-	-	
-	-	-	-	-	-	-	-	-	5.4	9.8	13.3	13.3	7.1	7.1	-	-	
1.7	2.1	2.4	2.6	-	2.4	2.7	3	3.7	6	9.6	16.6	16.6	7	7	-	-	
-	-	-	2.5	-	-	2.7	3	3.4	5.6	9.3	13.8	13.8	6.9	6.9	-	-	
-	-	-	-	-	-	-	-	-	5.5	9.2	13.6	13.6	6.8	6.8	-	-	
-	-	-	-	-	-	-	-	-	5.5	9.2	13.5	13.5	6.8	6.8	-	-	
-	-	-	-	-	-	-	-	-	4.3	5.7	6.7	6.7	6	6	-	-	
-	-	-	-	-	-	-	-	-	-	5.6	6.6	6.6	6	6	-	-	
-	-	-	-	-	-	-	-	-	-	-	6.4	6.4	6	6	-	-	
-	-	-	-	-	-	-	-	-	-	-	-	-	-	-	-	-	
-	-	-	-	-	-	-	-	-	-	-	-	-	-	-	-	-	
-	-	-	-	-	-	-	-	-	-	-	-	-	-	-	-	-	
2	2.4	2.5	3.1	1.1	2.6	2.6	2.6	6	13.7	50	T	T	10	10	-	-	
2	2.4	2.5	3.1	-	2.6	2.6	2.6	6	13.1	47.4	T	T	10	10	-	-	
1.9	2.3	2.6	3.1	-	2.6	2.6	2.6	6	11.8	43.5	T	T	10	10	-	-	
1.9	2.3	2.6	3	-	2.6	2.6	2.6	6	11.2	41.3	T	T	10	10	-	-	
-	2.2	2.6	3	-	2.6	2.6	2.6	6	10.9	40.4	T	T	10	10	-	-	
-	-	2.6	3	-	2.6	2.6	2.6	6	10.7	39.3	T	T	10	10	-	-	
-	-	2.6	3	-	-	2.6	2.6	6	10.5	38.5	T	T	10	10	-	-	
2	2.4	2.7	3.1	1.1	2.7	2.7	2.7	6	13.9	50	T	T	10.4	10.4	-	-	
1.9	2.3	2.6	3	-	2.6	2.6	2.6	6	13.1	47.4	T	T	10	10	-	-	
1.9	2.3	2.6	3	-	2.6	2.6	2.6	6	12.2	43.4	T	T	10	10	-	-	
1.8	2.2	2.6	3	-	2.6	2.6	2.6	6	12.3	41.3	T	T	10	10	-	-	
-	2.2	2.6	3	-	2.6	2.6	2.6	6	12.2	40.4	T	T	10	10	-	-	
1.9	2.3	2.5	3	1	2.4	2.4	2.4	5.7	T	T	T	T	11.9	11.9	-	-	
1.9	2.3	2.5	3	-	2.4	2.4	2.4	5.8	T	T	T	T	10.4	10.4	-	-	
1.9	2.2	2.5	2.9	-	2.4	2.4	2.4	5.8	28.6	T	T	T	10.4	10.4	-	-	
1.9	2.2	2.5	2.9	-	2.4	2.4	2.4	5.9	26.5	T	T	T	10	10	-	-	
-	2.2	2.5	2.7	-	2.4	2.4	2.4	5.7	24.5	T	T	T	10	10	-	-	
-	-	2.3	2.7	-	-	2.4	2.4	4.5	14.1	T	T	T	10	10	-	-	
-	-	-	2.5	-	-	-	2.4	4.6	16.6	T	T	T	10	10	-	-	
-	-	-	2.5	-	-	-	-	4.4	10	T	T	T	10	10	-	-	
-	-	-	-	-	-	-	-	-	10	T	T	T	10	10	-	-	
-	1.9	2.2	2.7	-	2.4	2.4	2.4	5.9	35.9	T	T	T	11.6	10	-	-	
-	-	-	2.5	-	-	2.4	2.4	4.4	10	T	T	T	10	10	-	-	
-	-	-	2.5	-	-	-	-	2.8	10	T	T	T	10	10	-	-	
-	2	2.2	2.7	-	2.4	2.7	3	4.3	10	T	T	T	10	10	-	-	
-	-	-	2.7	-	-	2.7	3	4.2	10	T	T	T	10	10	-	-	
-	-	-	-	-	-	-	-	-	10	T	T	T	10	10	-	-	

1.3

Power Defense Molded Case Circuit-Breaker

Selectivity Table

Selectivity Table

	Nr of entries	Upstream	I_n [A]	PDE1 TMTU $I_{cu} = 25 (36) \text{ kA}$						
				20-40	50	63	80	100	125	160
			$I(I_{cu})$							
NZM...2-ME	NZM...2-ME									
NZM...2-ME	NZM...2-ME	90	50 - 150	-	-	-	-	-	-	-
	NZM...2-ME	140	50 - 150	-	-	-	-	-	-	-
	NZM...2-ME	220	50 - 150	-	-	-	-	-	-	-
NZM...3-A	NZM...3-A									
NZM...3-A (thermal-mag)	NZM...3-A	320	50 - 150	-	-	-	-	-	-	-
	NZM...3-A	400	50 - 150	-	-	-	-	-	-	-
	NZM...3-A	500	50 - 150	-	-	-	-	-	-	-
NZM...3-AE	NZM...3-AE									
NZM...3-AE	NZM...3-AE	250	50 - 150	-	-	-	-	-	-	-
	NZM...3-AE	400	50 - 150	-	-	-	-	-	-	-
	NZM...3-AE	630	50 - 150	-	-	-	-	-	-	-
NZM...3-VE	NZM...3-VE									
NZM...3-VE	NZM...3-VE	250	50 - 150	-	-	-	-	-	-	-
	NZM...3-VE	400	50 - 150	-	-	-	-	-	-	-
	NZM...3-VE	630	50 - 150	-	-	-	-	-	-	-
NZM...3-ME	NZM...3-ME									
NZM...3-ME	NZM...3-ME	220	50 - 150	-	-	-	-	-	-	-
	NZM...3-ME	350	50 - 150	-	-	-	-	-	-	-
	NZM...3-ME	450	50 - 150	-	-	-	-	-	-	-
NZM...4-AE	NZM...4-AE									
NZM...4-AE	NZM...4-AE	630	50 - 85	-	-	-	-	-	-	-
	NZM...4-AE	800	50 - 85	-	-	-	-	-	-	-
	NZM...4-AE	1000	50 - 85	-	-	-	-	-	-	-
	NZM...4-AE	1250	50 - 85	-	-	-	-	-	-	-
	NZM...4-AE	1600	50 - 85	-	-	-	-	-	-	-
NZM...4-VE	NZM...4-VE									
NZM...4-VE	NZM...4-VE	630	50 - 85	-	-	-	-	-	-	-
	NZM...4-VE	800	50 - 85	-	-	-	-	-	-	-
	NZM...4-VE	1000	50 - 85	-	-	-	-	-	-	-
	NZM...4-VE	1250	50 - 85	-	-	-	-	-	-	-
	NZM...4-VE	1600	50 - 85	-	-	-	-	-	-	-
NZM...4-ME	NZM...4-ME									
NZM...4-ME	NZM...4-ME	550	50 - 85	-	-	-	-	-	-	-
	NZM...4-ME	875	50 - 85	-	-	-	-	-	-	-
	NZM...4-ME	1400	50 - 85	-	-	-	-	-	-	-

PDE2TMTU I _{cu} = 70 kA				PDE2 ETU				PDE3TMTU I _{cu} = 70 kA				PDE3 ETU	PDE4TMTU I _{cu} = 70 kA	PDE4 ETU
125	160	200	250	63	160	200	250	250	400	500	630	630	800	800
-	2.1	2.3	2.7	-	2.4	2.4	2.4	4.3	10	T	T	T	10	10
-	-	-	2.7	-	-	2.4	2.4	4.2	10	T	T	T	10	10
-	-	-	-	-	-	-	-	2.8	10	T	T	T	10	10
-	-	-	-	-	-	-	-	-	5.4	7.2	10	10	6.2	6.2
-	-	-	-	-	-	-	-	-	-	6.9	10	10	6.2	6.2
-	-	-	-	-	-	-	-	-	-	-	-	-	6.2	6.2
-	-	-	-	-	-	-	-	-	5.4	7	10	10	6	6.2
-	-	-	-	-	-	-	-	-	-	-	10	10	6	6.2
-	-	-	-	-	-	-	-	-	-	-	-	-	-	-
-	-	-	-	-	-	-	-	-	5.3	7.1	10	10	6	6.2
-	-	-	-	-	-	-	-	-	-	-	10	10	6.1	6.2
-	-	-	-	-	-	-	-	-	-	-	-	-	6	6.2
-	-	-	-	-	-	-	-	2.8	4.5	6.5	10	10	6	6.2
-	-	-	-	-	-	-	-	-	4.3	6.5	10	10	6	6.2
-	-	-	-	-	-	-	-	-	-	-	10	-	6	6.2
-	-	-	-	-	-	-	-	-	-	-	-	-	6.4	6.4
-	-	-	-	-	-	-	-	-	-	-	-	-	-	-
-	-	-	-	-	-	-	-	-	-	-	-	-	-	-
-	-	-	-	-	-	-	-	-	-	-	-	-	-	-
-	-	-	-	-	-	-	-	-	-	-	-	-	-	-
-	-	-	-	-	-	-	-	-	-	-	-	-	-	-
-	-	-	-	-	-	-	-	-	-	-	-	-	6.4	6.4
-	-	-	-	-	-	-	-	-	-	-	-	-	-	-
-	-	-	-	-	-	-	-	-	-	-	-	-	-	-
-	-	-	-	-	-	-	-	-	-	-	-	-	-	-
-	-	-	-	-	-	-	-	-	-	-	-	-	-	-
-	-	-	-	-	-	-	-	-	-	-	-	-	6.4	6.4
-	-	-	-	-	-	-	-	-	-	-	-	-	-	-
-	-	-	-	-	-	-	-	-	-	-	-	-	-	-
-	-	-	-	-	-	-	-	-	-	-	-	-	-	-

1.3

Power Defense Molded Case Circuit-Breaker

Selectivity Table

Selectivity Table

Nr of entries	Upstream	NZM1 A						NZM2-A (25-150 kA)						
		I _n [A]	20	40	50	63	80	100	125	160	20	40	50	63
			II (I _{cu})											
PD breakers	PDE1 TMTU													
PDE1 TMTU	PDE1 TMTU	20-40	70	-	-	0.5	0.7	0.8	1.5	1.5	-	-	0.6	
	PDE1 TMTU	50	70	-	-	-	0.6	0.8	1.5	1.5	-	-	-	
	PDE1 TMTU	63	70	-	-	-	-	0.8	1.5	1.5	-	-	-	
	PDE1 TMTU	80	70	-	-	-	-	-	1.5	1.5	-	-	-	
	PDE1 TMTU	100	70	-	-	-	-	-	-	1.5	-	-	-	
	PDE1 TMTU	125	70	-	-	-	-	-	-	-	-	-	-	
	PDE1 TMTU	160	70	-	-	-	-	-	-	-	-	-	-	
PDE2 TMTU	PDE2 TMTU													
PDE2 TMTU	PDE2 TMTU	125	70	-	-	-	-	-	-	-	-	-	-	
	PDE2 TMTU	160	70	-	-	-	-	-	-	-	-	-	-	
	PDE2 TMTU	200	70	-	-	-	-	-	-	-	-	-	-	
	PDE2 TMTU	250	70	-	-	-	-	-	-	-	-	-	-	
PDE2 ETU	PDE2 ETU													
PDE2 ETU	PDE2 ETU	63	70	-	-	-	-	-	-	-	-	-	-	
	PDE2 ETU	160	70	-	-	-	-	-	-	-	-	-	-	
	PDE2 ETU	200	70	-	-	-	-	-	-	-	-	-	-	
	PDE2 ETU	250	70	-	-	-	-	-	-	-	-	-	-	
PDE3 TMTU	PDE3 TMTU													
PDE3 TMTU	PDE3 TMTU	250	70	-	-	-	-	-	-	-	-	-	-	
	PDE3 TMTU	400	70	-	-	-	-	-	-	-	-	-	-	
	PDE3 TMTU	500	70	-	-	-	-	-	-	-	-	-	-	
	PDE3 TMTU	630	70	-	-	-	-	-	-	-	-	-	-	
PDE3 ETU	PDE3 ETU													
PDE3 ETU	PDE3 ETU	630	70	-	-	-	-	-	-	-	-	-	-	
PDE4 TMTU	PDE4 TMTU													
PDE4 TMTU	PDE4 TMTU	800	70	-	-	-	-	-	-	-	-	-	-	
PDE4 ETU	PDE4 ETU													
PDE4 ETU	PDE4 ETU	800	70	-	-	-	-	-	-	-	-	-	-	

1.3

Power Defense Molded Case Circuit-Breaker

Selectivity Table

Selectivity Table

Nr of entries	Upstream	NZM...4-AE (50-85)					NZM...4-VE (50-85)							
		I_n [A]	630	800	1000	1250	1600	630	800	1000	1250	1600		
		$I_l (I_{cu})$	7560 (85kA)	9600 (85kA)	12000 (85kA)	15000 (85kA)	19200 (85kA)	7560 (85kA)	9600 (85kA)	12000 (85kA)	15000 (85kA)	19200 (85kA)		
PD breakers		PDE1 TMTU												
PDE1 TMTU	PDE1 TMTU 20-40	70	T	T	T	T	T	T	T	T	T	T	T	
	PDE1 TMTU 50	70	T	T	T	T	T	T	T	T	T	T	T	
	PDE1 TMTU 63	70	T	T	T	T	T	T	T	T	T	T	T	
	PDE1 TMTU 80	70	T	T	T	T	T	T	T	T	T	T	T	
	PDE1 TMTU 100	70	T	T	T	T	T	T	T	T	T	T	T	
	PDE1 TMTU 125	70	T	T	T	T	T	T	T	T	T	T	T	
	PDE1 TMTU 160	70	T	T	T	T	T	T	T	T	T	T	T	
PDE2		PDE2												
PDE2 TMTU	PDE2 125	70	T	T	T	T	T	T	T	T	T	T	T	
	PDE2 160	70	T	T	T	T	T	T	T	T	T	T	T	
	PDE2 200	70	T	T	T	T	T	T	T	T	T	T	T	
	PDE2 250	70	T	T	T	T	T	T	T	T	T	T	T	
PDE2 ETU		PDE2 ETU												
PDE2 ETU	PDE2 ETU 63	70	T	T	T	T	T	T	T	T	T	T	T	
	PDE2 ETU 160	70	T	T	T	T	T	T	T	T	T	T	T	
	PDE2 ETU 200	70	T	T	T	T	T	T	T	T	T	T	T	
	PDE2 ETU 250	70	T	T	T	T	T	T	T	T	T	T	T	
PDE3 TMTU		PDE3 TMTU												
PDE3 TMTU	PDE3 TMTU 250	70	11.4	37.6	39.3	39.3	39.3	11.4	37.6	39.3	39.3	39.3		
	PDE3 TMTU 400	70	11.2	35.4	38	38	38	11.2	35.4	38	38	38		
	PDE3 TMTU 500	70	11.1	31.5	37.6	37.6	37.6	11.1	31.5	37.6	37.6	37.6		
	PDE3 TMTU 630	70	-	30.7	37.3	37.3	37.3	-	30.7	37.3	37.3	37.3		
PDE3 ETU		PDE3 ETU												
PDE3 ETU	PDE3 ETU 630	70	-	30.6	37.3	37.3	37.3	-	30.6	37.3	37.3	37.3		
PDE4 TMTU		PDE4 TMTU												
PDE4 TMTU	PDE4 TMTU 800	70	-	-	18.7	25.3	25.5	-	-	18.7	25.3	25.5		
PDE4 ETU		PDE4 ETU												
PDE4 ETU	PDE4 ETU 800	70	-	-	19.4	25.3	25.6	-	-	19.4	25.3	25.6		

1.3

Power Defense Molded Case Circuit-Breaker

Selectivity Table

Selectivity Table

Nr of entries	Upstream	IZMX40...-V (66-105)								
		I_n [A]	1000	1250	1250	1250	1600	1600	1600	2000
		I_l (I_{cu})	14000 (105 kA)	17500 (66 kA)	17500 (85 kA)	17500 (105 kA)	19200 (66 kA)	19200 (85 kA)	19200 (105 kA)	24000 (66 kA)
PD breakers	PDE1 TMTU									
PDE1 TMTU	PDE1 TMTU 20-40	70	T	T	T	T	T	T	T	T
	PDE1 TMTU 50	70	T	T	T	T	T	T	T	T
	PDE1 TMTU 63	70	T	T	T	T	T	T	T	T
	PDE1 TMTU 80	70	T	T	T	T	T	T	T	T
	PDE1 TMTU 100	70	T	T	T	T	T	T	T	T
	PDE1 TMTU 125	70	T	T	T	T	T	T	T	T
	PDE1 TMTU 160	70	T	T	T	T	T	T	T	T
PDE2 TMTU	PDE2 TMTU									
PDE2 TMTU	PDE2 TMTU 125	70	T	T	T	T	T	T	T	T
	PDE2 TMTU 160	70	T	T	T	T	T	T	T	T
	PDE2 TMTU 200	70	T	T	T	T	T	T	T	T
	PDE2 TMTU 250	70	T	T	T	T	T	T	T	T
PDE2 ETU	PDE2 ETU									
PDE2 ETU	PDE2 ETU 63	70	T	T	T	T	T	T	T	T
	PDE2 ETU 160	70	T	T	T	T	T	T	T	T
	PDE2 ETU 200	70	T	T	T	T	T	T	T	T
	PDE2 ETU 250	70	T	T	T	T	T	T	T	T
PDE3 TMTU	PDE3 TMTU									
PDE3 TMTU	PDE3 TMTU 250	70	T	T	T	T	T	T	T	T
	PDE3 TMTU 400	70	T	T	T	T	T	T	T	T
	PDE3 TMTU 500	70	T	T	T	T	T	T	T	T
	PDE3 TMTU 630	70	T	T	T	T	T	T	T	T
PDE3 ETU	PDE3 ETU									
PDE3 ETU	PDE3 ETU 630	70	T	T	T	T	T	T	T	T
PDE4 TMTU	PDE4 TMTU									
PDE4 TMTU	PDE4 TMTU 800	70	T	T	T	T	T	T	T	T
PDE4 ETU	PDE4 ETU									
PDE4 ETU	PDE4 ETU 800	70	T	T	T	T	T	T	T	T

1.3

Power Defense Molded Case Circuit-Breaker

Backup Protection Table

Backup Protection Table

		Upstream	PDE1 TMTU I _n = ...160 A				PDE2 TMTU I _n = ...250 A				PDE2 ETU I _n = ...250 A			
		I _{cu} (415 V)	25 kA	36 kA	50 kA	70 kA	25 kA	36 kA	50 kA	70 kA	25 kA	36 kA	50 kA	70 kA
Downstream	I _{cu} (415 V) [kA]	I _n [A]												
PDE1 TMTU	25	...160	25	36	50	70	25	36	50	70	25	36	50	70
PDE1 TMTU	36	...160	-	36	50	70	-	36	50	70	-	36	50	70
PDE1 TMTU	50	...160	-	-	50	70	-	-	50	70	-	-	50	70
PDE1 TMTU	70	...160	-	-	-	70	-	-	-	70	-	-	-	70
PDE2 TMTU	25	...250	-	36	50	70	25	36	50	70	25	36	50	70
PDE2 TMTU	36	...250	-	-	50	70	-	36	50	70	-	36	50	70
PDE2 TMTU	50	...250	-	-	-	70	-	-	50	70	-	-	50	70
PDE2 TMTU	70	...250	-	-	-	-	-	-	-	70	-	-	-	70
PDE2 ETU	25	...250	-	36	50	70	25	36	50	70	25	36	50	70
PDE2 ETU	36	...250	-	-	50	70	-	36	50	70	-	36	50	70
PDE2 ETU	50	...250	-	-	-	70	-	-	50	70	-	-	50	70
PDE2 ETU	70	...250	-	-	-	-	-	-	-	70	-	-	-	70
PDE3B TMTU	25	...630	-	-	-	-	-	-	-	-	-	-	-	-
PDE3B TMTU	36	...630	-	-	-	-	-	-	-	-	-	-	-	-
PDE3B TMTU	50	...630	-	-	-	-	-	-	-	-	-	-	-	-
PDE3B TMTU	70	...630	-	-	-	-	-	-	-	-	-	-	-	-
PDE3B ETU	25	...630	-	-	-	-	-	-	-	-	-	-	-	-
PDE3B ETU	36	...630	-	-	-	-	-	-	-	-	-	-	-	-
PDE3B ETU	50	...630	-	-	-	-	-	-	-	-	-	-	-	-
PDE3B ETU	70	...630	-	-	-	-	-	-	-	-	-	-	-	-
PDE4 TMTU	36	...800	-	-	-	-	-	-	-	-	-	-	-	-
PDE4 TMTU	50	...800	-	-	-	-	-	-	-	-	-	-	-	-
PDE4 TMTU	70	...800	-	-	-	-	-	-	-	-	-	-	-	-
PDE4 ETU	36	...800	-	-	-	-	-	-	-	-	-	-	-	-
PDE4 ETU	50	...800	-	-	-	-	-	-	-	-	-	-	-	-
PDE4 ETU	70	...800	-	-	-	-	-	-	-	-	-	-	-	-

Power Defense Molded Case Circuit-Breaker

Backup Protection Table

1.3

PDE3 TMTU I _n =...630 A				PDE3 ETU I _n =...630 A				PDE4 TMTU I _n =...800 A			PDE4 ETU I _n =...800 A		
25 kA	36 kA	50 kA	70 kA	25 kA	36 kA	50 kA	70 kA	36 kA	50 kA	70 kA	36 kA	50 kA	70 kA
25	27	27	27	25	36	40	40	36	38	38	36	38	38
-	36	39	39	-	36	40	40	36	38	38	36	38	38
-	-	50	57	-	-	50	70	-	50	70	-	50	70
-	-	-	70	-	-	-	70	-	-	70	-	-	70
25	28	28	28	25	36	44	44	36	50	70	36	50	70
-	36	44	44	-	36	44	44	36	50	70	36	50	70
-	-	50	63	-	-	50	70	-	50	70	-	50	70
-	-	-	70	-	-	-	70	-	-	70	-	-	70
25	28	28	28	25	36	45	45	36	50	70	36	50	70
-	36	44	44	-	36	45	45	36	50	70	36	50	70
-	-	50	63	-	-	50	70	-	50	70	-	50	70
-	-	-	70	-	-	-	70	-	-	70	-	-	70
25	36	50	70	25	36	50	70	36	50	55	36	50	55
-	36	50	70	-	36	50	70	36	50	55	36	50	55
-	-	50	70	-	-	50	70	-	50	70	-	50	70
-	-	-	70	-	-	-	70	-	-	70	-	-	70
25	36	50	70	25	36	50	70	36	50	55	36	50	55
-	36	50	70	-	36	50	70	36	50	55	36	50	55
-	-	50	70	-	-	50	70	-	50	70	-	50	70
-	-	-	70	-	-	-	70	-	-	70	-	-	70
-	-	-	-	-	-	-	-	36	50	70	36	50	70
-	-	-	-	-	-	-	-	-	50	70	-	50	70
-	-	-	-	-	-	-	-	-	-	70	-	-	70
-	-	-	-	-	-	-	-	36	50	70	36	50	70
-	-	-	-	-	-	-	-	-	50	70	-	50	70
-	-	-	-	-	-	-	-	-	-	70	-	-	70

1.3

Power Defense Molded Case Circuit-Breaker

Backup Protection Table

Backup Protection Table

Downstream	Upstream I_{cu} (415 V) I_n [A]	PDE1F(G)(K)(M) $U_e = 230/400$ V			PDE1F(G)(K)(M) $U_e = 240/415$ V			
		Type B, C	Type D	Type K	Type B	Type C	Type D	Type K
FAZ All types with Tripping characteristics B, C, D	0.16	25	25	-	25	-	-	-
	0.25	25	25	-	25	-	-	-
	0.5	25	25	-	25	25	-	-
	0.75	25	25	-	25	-	-	-
	1	25	25	25	25	25	25	-
	1.5	25	25	25	25	25	25	-
	1.6	25	25	25	25	25	25	-
	2	25	25	25	25	25	25	-
	2.5	25	25	25	25	25	25	-
	3	25	25	25	25	25	25	-
	3.5	25	25	25	25	25	25	-
	4	25	25	25	25	25	25	-
	5	25	25	25	25	25	25	-
	6	25	25	25	25	25	25	-
	7	25	25	25	25	25	25	-
	8	25	25	25	25	25	25	-
	10	25	25	25	25	25	25	-
	12	25	25	25	25	25	25	-
	13	25	25	25	25	25	25	-
	15	25	25	25	25	25	25	-
	16	25	25	25	25	25	25	-
	20	20	25	25	25	25	25	-
	25	20	25	25	25	25	25	-
30	20	15	25	20	20	15	-	
32	20	15	25	20	20	15	-	
40	20	15	25	20	20	15	-	
50	15	15	25	15	15	15	-	
63	15	15	25	15	15	15	-	
FAZ All types with Tripping characteristics K	0.5	-	-	25	-	-	-	25
	1	-	-	25	-	-	-	25
	1.6	-	-	25	-	-	-	25
	2	-	-	25	-	-	-	25
	3	-	-	25	-	-	-	25
	4	-	-	25	-	-	-	25
	6	-	-	25	-	-	-	25
	8	-	-	25	-	-	-	25
	10	-	-	25	-	-	-	25
	13	-	-	25	-	-	-	25
	16	-	-	25	-	-	-	25
	20	-	-	25	-	-	-	25
	25	-	-	25	-	-	-	25
	32	-	-	20	-	-	-	20
	40	-	-	20	-	-	-	20
50	-	-	15	-	-	-	15	
63	-	-	15	-	-	-	15	

1.3

Power Defense Molded Case Circuit-Breaker

Backup Protection Table

Backup Protection Table

Downstream	Upstream	PDE1F(G)(K)(M)			PDE1F(G)(K)(M)			
	I_{cu} (415 V)	$U_e = 230/400 V$			$U_e = 240/415 V$			
	I_n [A]	Type B, C	Type D	Type K	Type B	Type C	Type D	Type K
PLSM, PL7, mMCM, PXL, PLZM, EM All types with Tripping characteristics B, C, D	0.16	25	25		25			
	0.25	25	25		25			
	0.5	25	25		25			
	0.75	25	25		25			
	1	25	25		25			
	1.5	25	25		25			
	2	25	25		25			
	2.5	25	25		25			
	3	25	25		25			
	3.5	25	25		25			
	4	25	25		25			
	5	25	25		25			
	6	25	25		25			
	8	25	25		25			
	10	25	25		25			
	12	25	25		20			
	13	25	25		20			
	15	25	25		20			
	16	25	25		20			
	20	20	25		20			
25	20	25		20				
32	20	15		20				
40	20	15		15				
50	15	15		15				
63	15	15		15				
PLS6, PL6, mMCC6, PLZ6 All types with Tripping characteristics B, C, D	0.16	20	20					
	0.25	20	20					
	0.5	20	20					
	0.75	20	20					
	1	20	20					
	1.5	20	20					
	2	20	20					
	2.5	20	20					
	3	20	20					
	3.5	20	20					
	4	20	20					
	5	20	20					
	6	20	20					
	8	20	20					
	10	20	20					
	12	20	20					
	13	20	20					
	15	20	20					
	16	20	20					
	20	15	20					
25	15	20						
32	15	12						
40	15	12						
50	12	12						
63	12	12						

PDE2F(G)(K)(M)(N) U _e = 230/400 V		PDE2F(G)(K)(M)(N) U _e = 240/415 V			PDE2F(G)(K)(M)(N) U _e = 133/230V		
Type B, C	Type D	Type K	Type B	Type C	Type D	Type K	Type B, C
25	25						
25	25						
25	25						
25	25						
25	25						
25	25						
25	25						
25	25						
25	25						
25	25						
25	25						
25	25						
25	25						
25	25						
25	25						
25	25						
20	25						
20	25						
20	25						
20	25						
20	25						
20	25						
20	15						
20	15						
15	15						
15	10						
15	10						
20	20						
20	20						
20	20						
20	20						
20	20						
20	20						
20	20						
20	20						
20	20						
20	20						
20	20						
20	20						
20	20						
20	20						
20	20						
20	20						
20	20						
20	20						
20	20						
20	20						
15	20						
15	20						
15	20						
15	20						
15	20						
15	12						
15	12						
12	12						
12	6						
12	6						

1.3

Power Defense Molded Case Circuit-Breaker

Backup Protection Table

Backup Protection Table

Downstream	Upstream I_{cu} (415 V) I_n [A]	PDE1F(G)(K)(M) $U_e = 230/400 V$			PDE1F(G)(K)(M) $U_e = 240/415 V$			
		Type B, C	Type D	Type K	Type B	Type C	Type D	Type K
eRBM	6	25	25		25	25	25	
All types with Tripping characteristics B, C, D	8	25	25		25	25	25	
	10	25	25		25	25	25	
	13	25	25		25	25	25	
	16	25	25		25	25	25	
	20	25	25		25	25	25	
	25	25	-		25	25	-	
	32	20	-		20	20	-	
	40	20	-		20	20	-	
PKNM-1N, P XK, PFL7, mRBM All types with characteristic B, C, D	45	15	-		15	15	-	
	2	35 kA @ 230V (25 kA for PDE1F)						
	4							
	6							
	10							
	13							
	16							
	20							
25								
PKN6, PFL6 All types with Tripping characteristics B, C, D	32							
	40							
	2	30 kA @ 230V (20 kA for PDE1F)						
	4							
	6							
	10							
	13							
	16							
20								
25								
32								
40								

PDE2F(G)(K)(M)(N) U _e = 230/400 V			PDE2F(G)(K)(M)(N) U _e = 240/415 V			PDE2F(G)(K)(M)(N) U _e = 133/230 V	
Type B, C	Type D	Type K	Type B	Type C	Type D	Type K	Type B, C
20	25		20	20	25		
20	25		20	20	25		
20	25		20	20	25		
20	25		20	20	25		
20	25		20	20	25		
20	15		20	20	15		
20	-		20	20	-		
20	-		20	20	-		
20	-		20	20	-		
15	-		15	15	-		
<hr/>							
36 kA @ 230V (25 kA for PDE2F)	36 kA @ 230V (25 kA for PDE2F)						
<hr/>							
30 kA @ 230V (25 kA for PDE2F)	30 kA @ 230V (25 kA for PDE2F)						
<hr/>							
30 kA @ 230V (20 kA for PDE2F)	30 kA @ 230V (20 kA for PDE2F)						
<hr/>							
25 kA @ 230V (20 kA for PDE2F)	25 kA @ 230V (20 kA for PDE2F)						
<hr/>							

1.4

Power Defense Molded Case Circuit-Breaker

Dimensions (mm)

Frame size 1

Circuit-Breakers, 3 pole

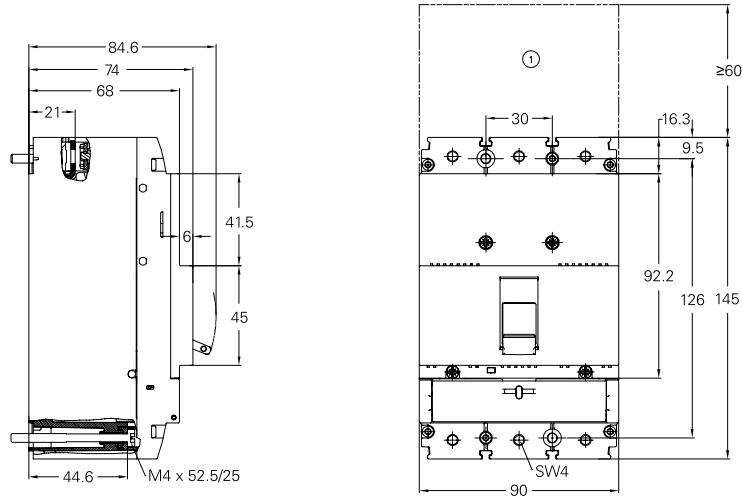

① Blow-out area, minimum distance to other parts ≥ 60 mm

Circuit-Breakers, 4 pole

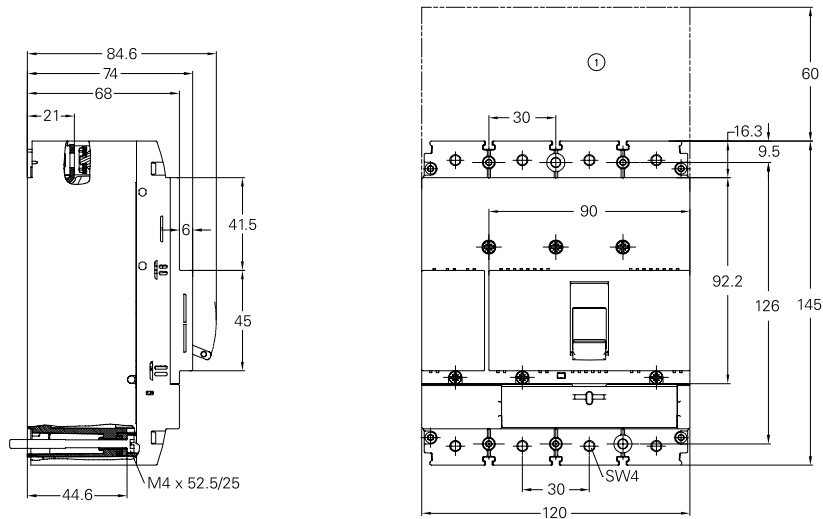

① Blow-out area, minimum distance to other parts ≥ 60 mm

IP2X Fingerprotection

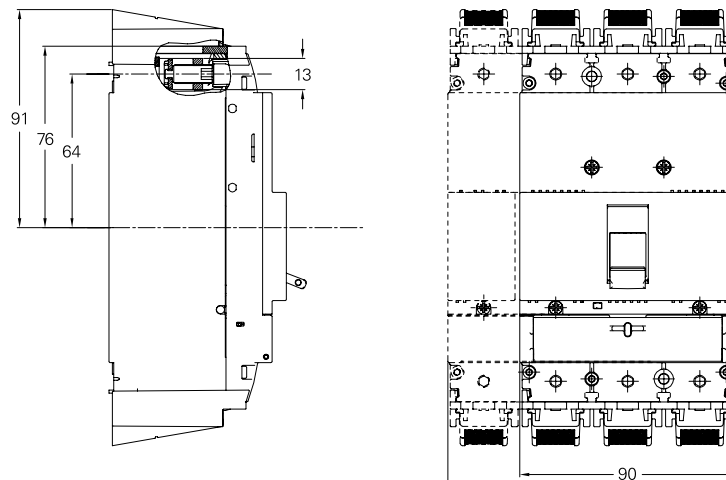

Frame size 1

Terminal Cover

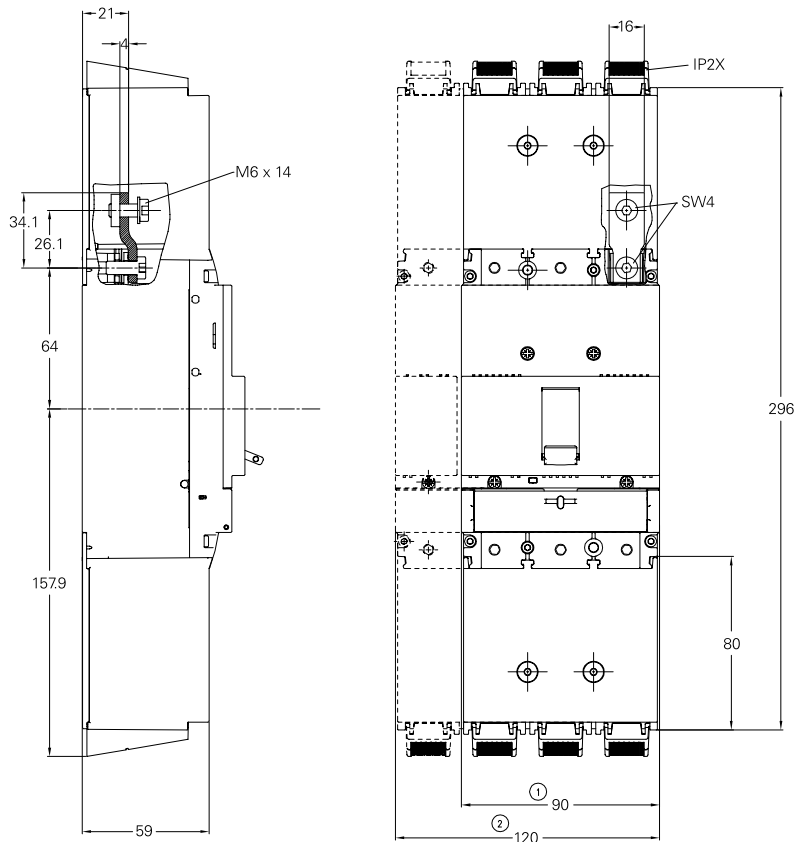

- ① 3 Pole
- ② 4 Pole

Shunt Release/Undervoltage Release

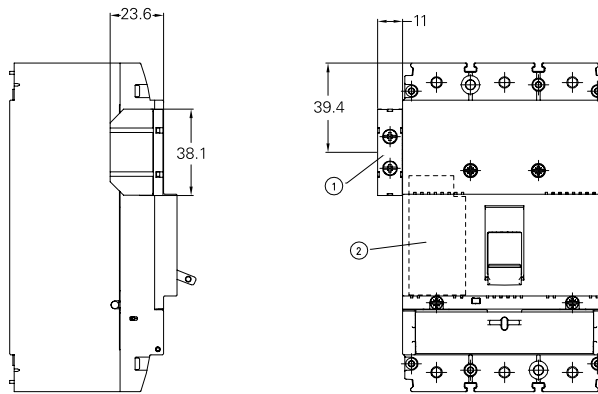

- ① PDC1XST(T)
PDC1XUV(V)
- ② PDC1XST(T)(S)(R)
PDC1XUV(V)(U)(W)

1.4

Power Defense Molded Case Circuit-Breaker

Dimensions (mm)

Frame size 1

Direct rotary handle

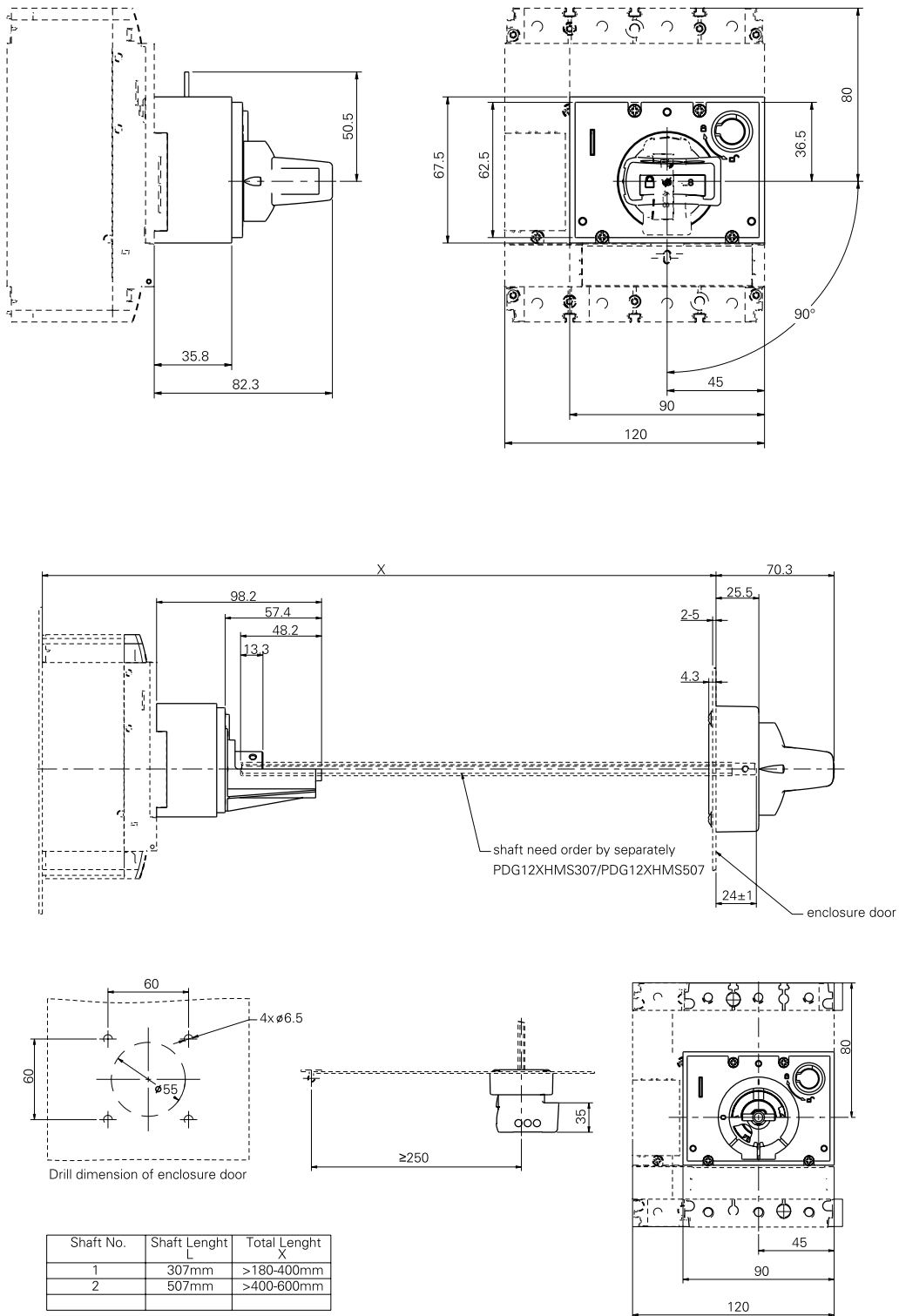

Frame size 2

Circuit-Breakers, 3 pole (63 - 160 A)

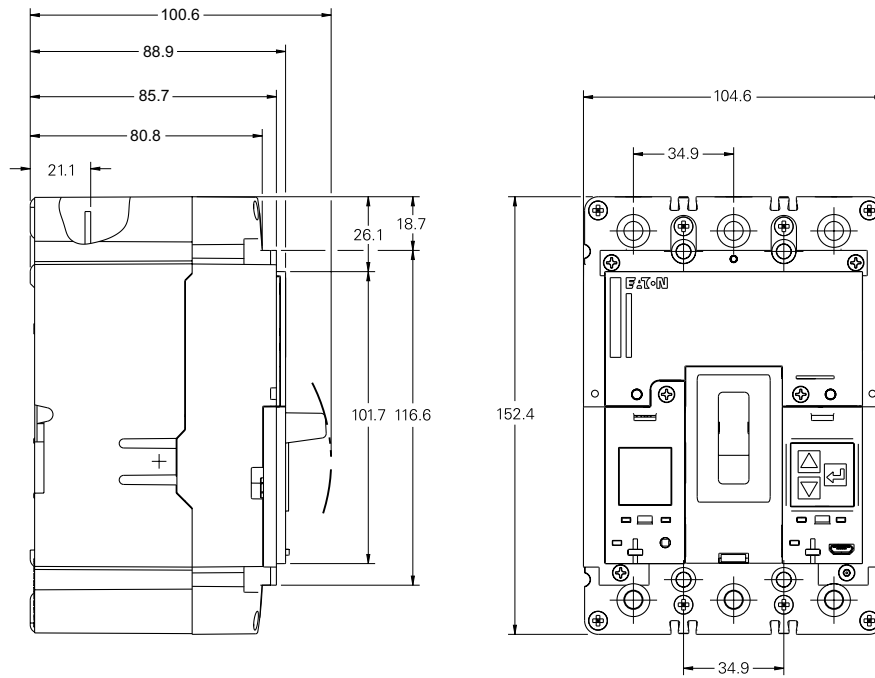

Circuit-Breakers, 4 pole (63 - 160 A)

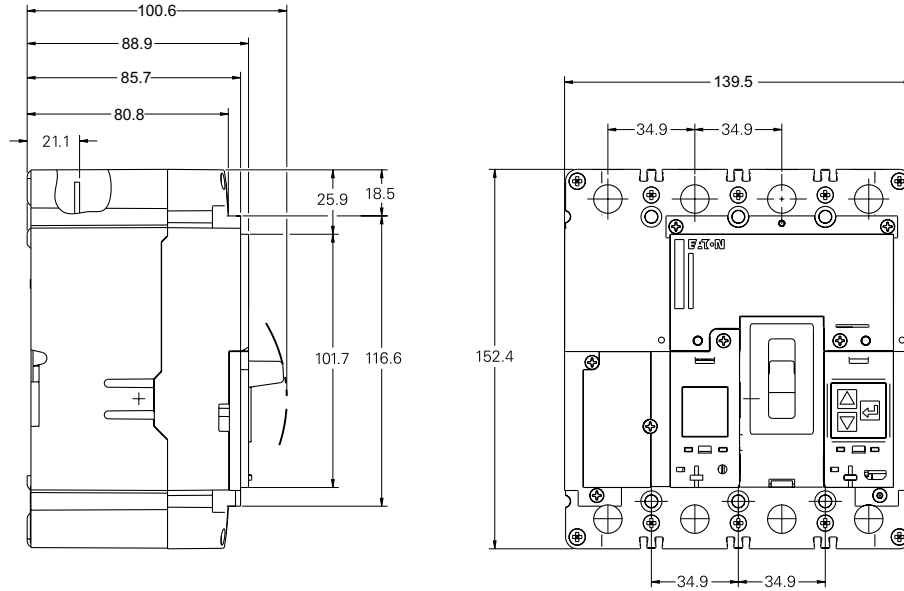

1.4

Power Defense Molded Case Circuit-Breaker

Dimensions (mm)

Frame size 2

Circuit-Breakers, 3 pole (160 - 250 A)

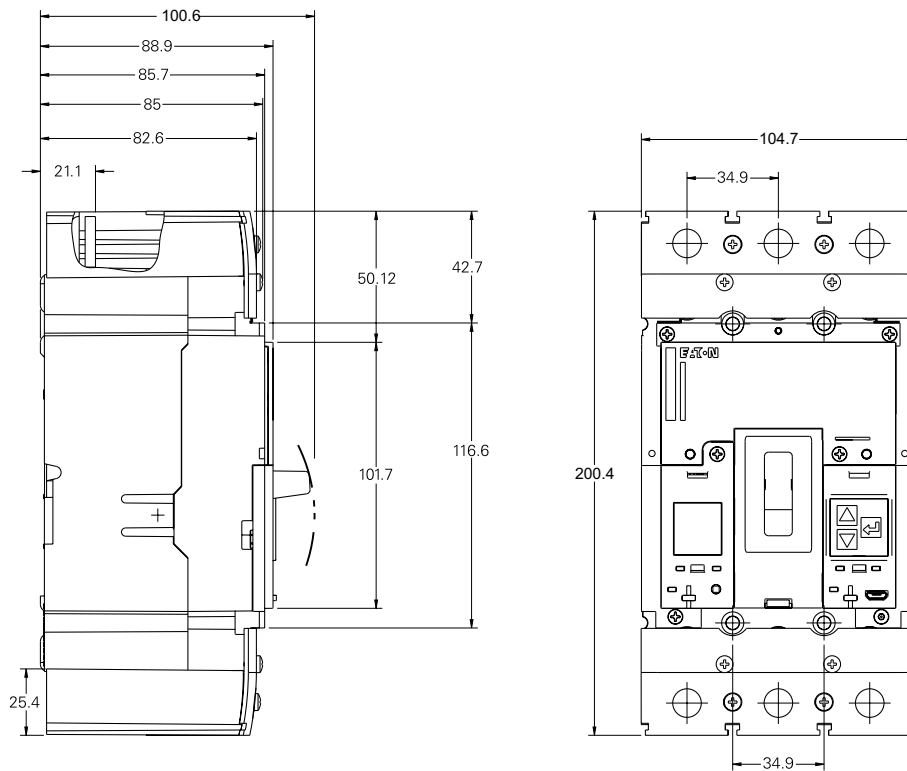

Circuit-Breakers, 4 pole (160 - 250 A)

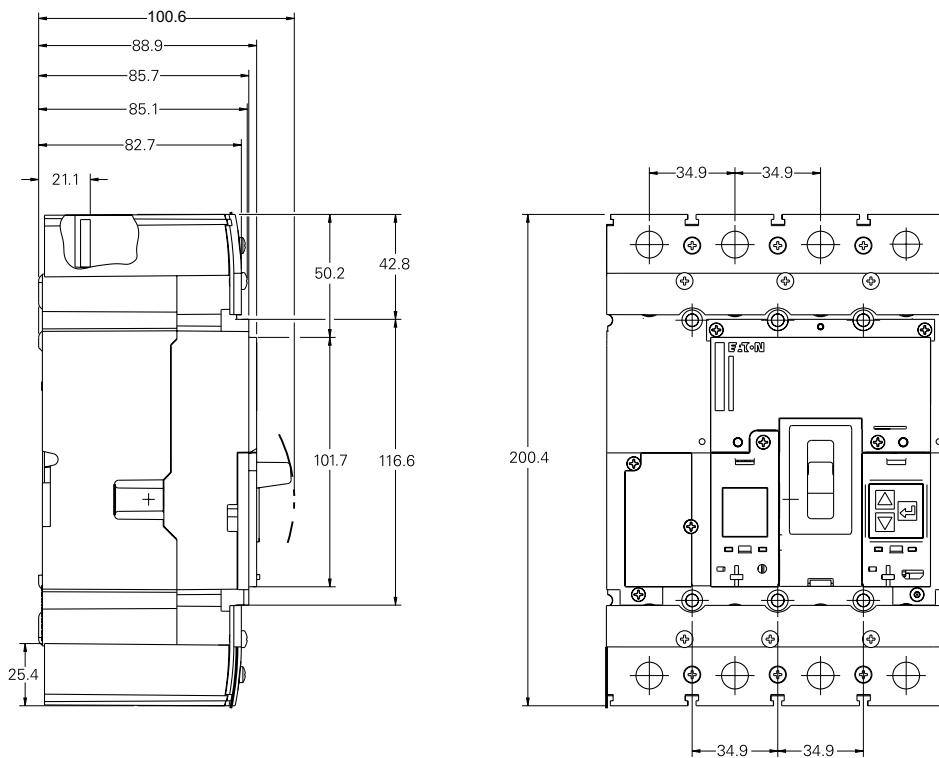

Frame size 2

Terminal Cover

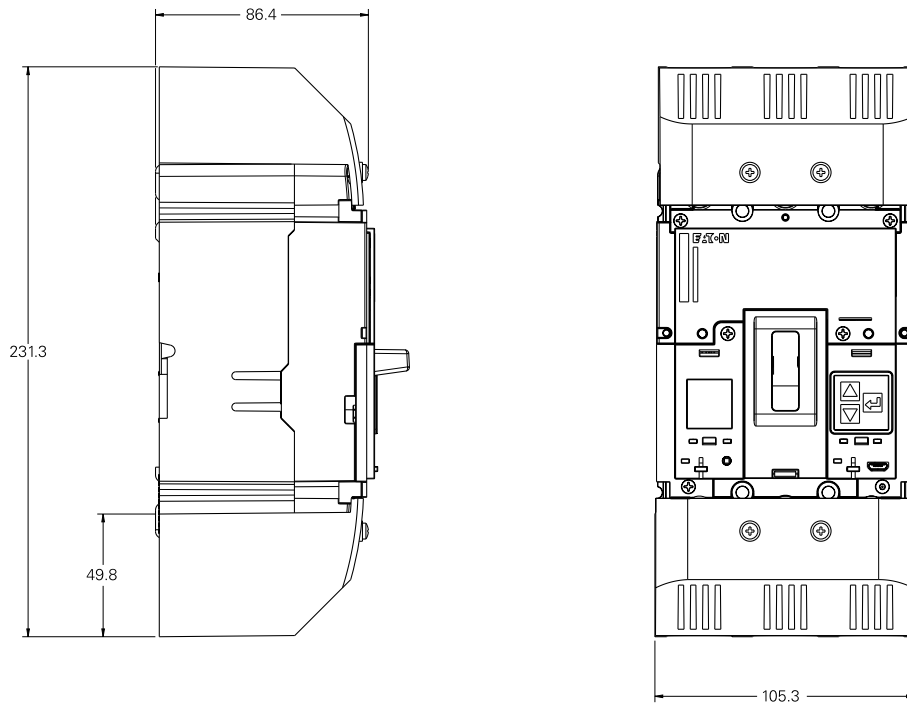

Interphase Barriers (63 - 160 A)

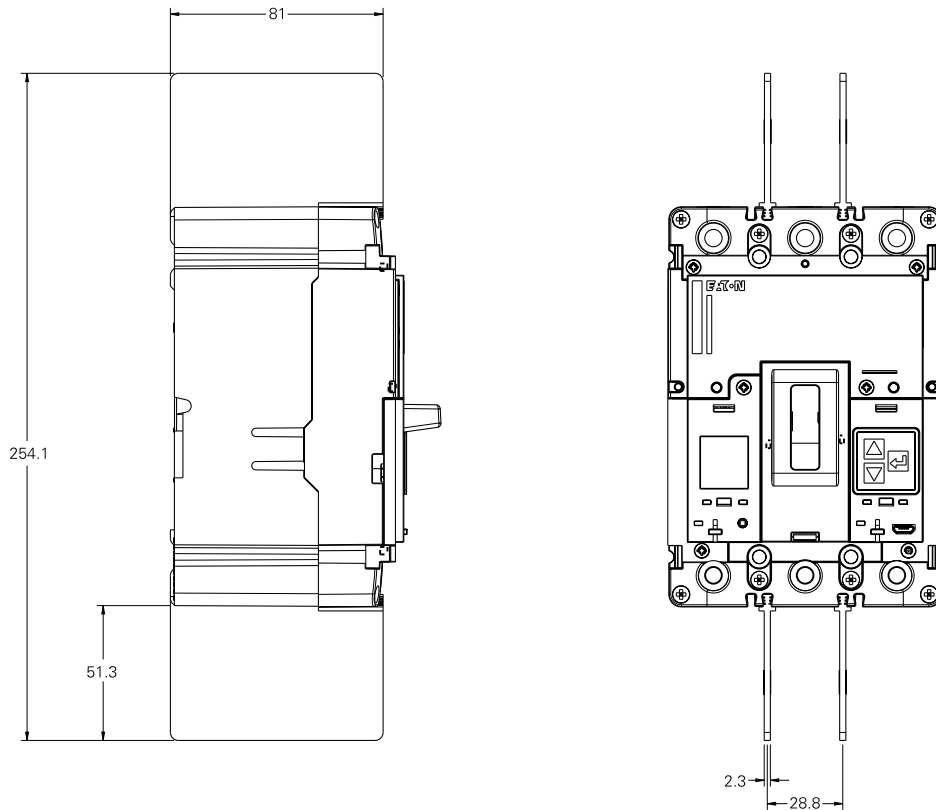

1.4

Power Defense Molded Case Circuit-Breaker

Dimensions (mm)

Frame size 2

Interphase Barriers (160 - 250 A)

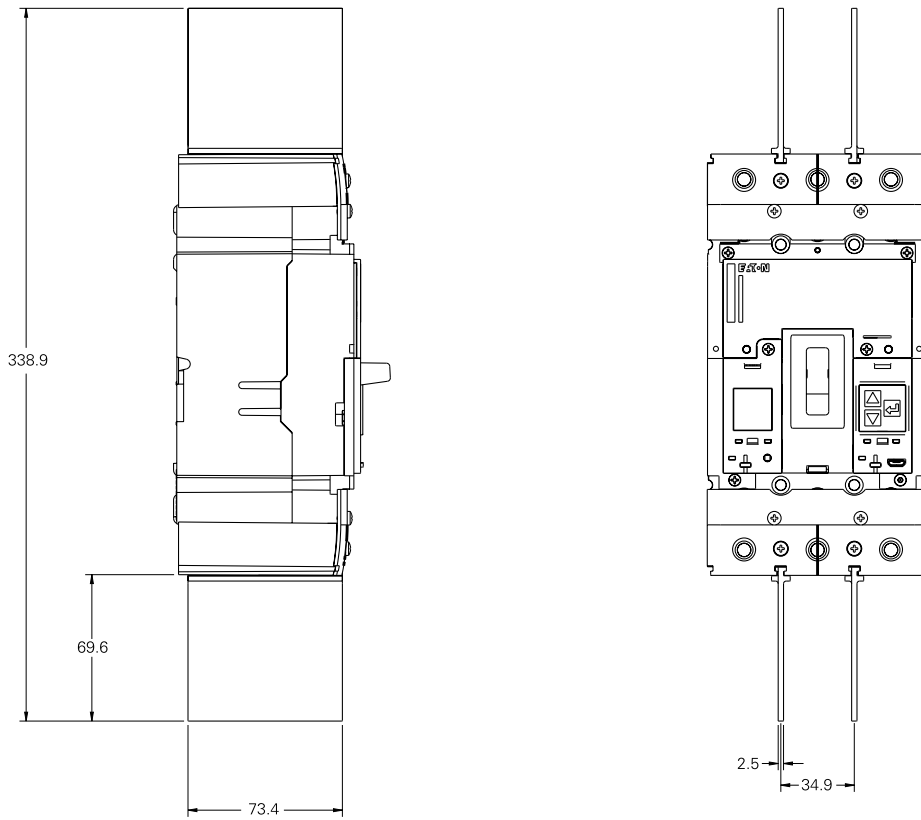

IP2X Fingerprotection (63 - 160 A)

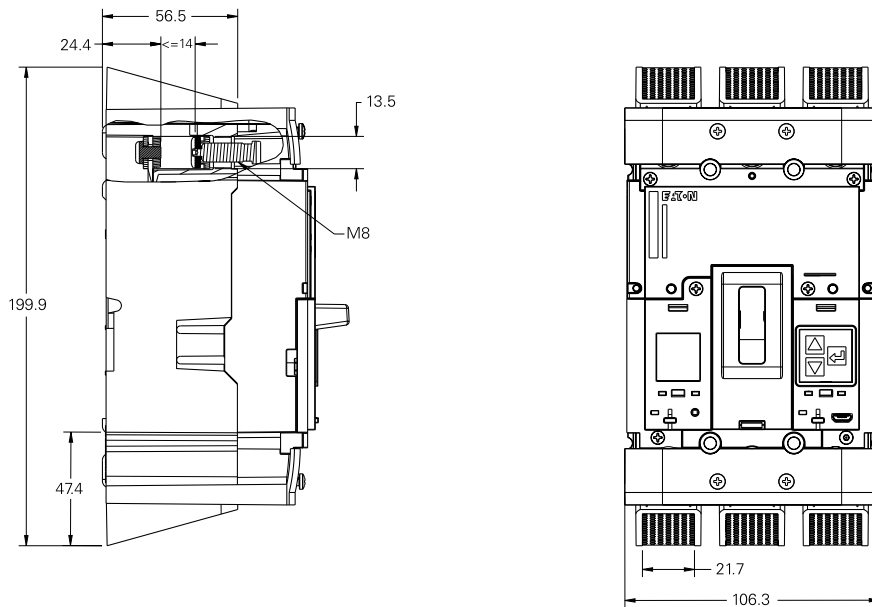

Frame size 2

IP2X Fingerprotection (160 - 250 A)

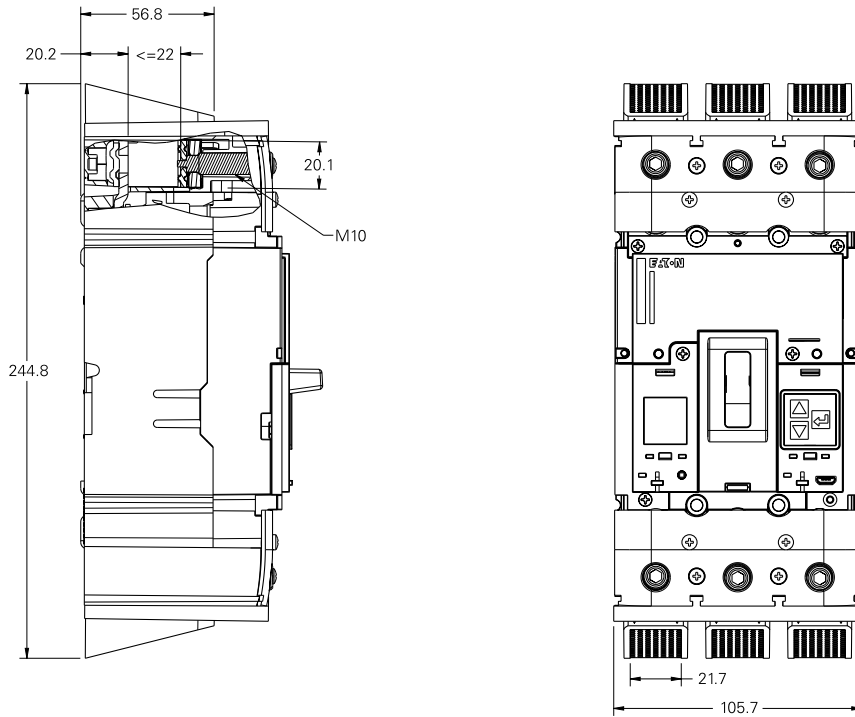

Shunt Release/Undervoltage Release

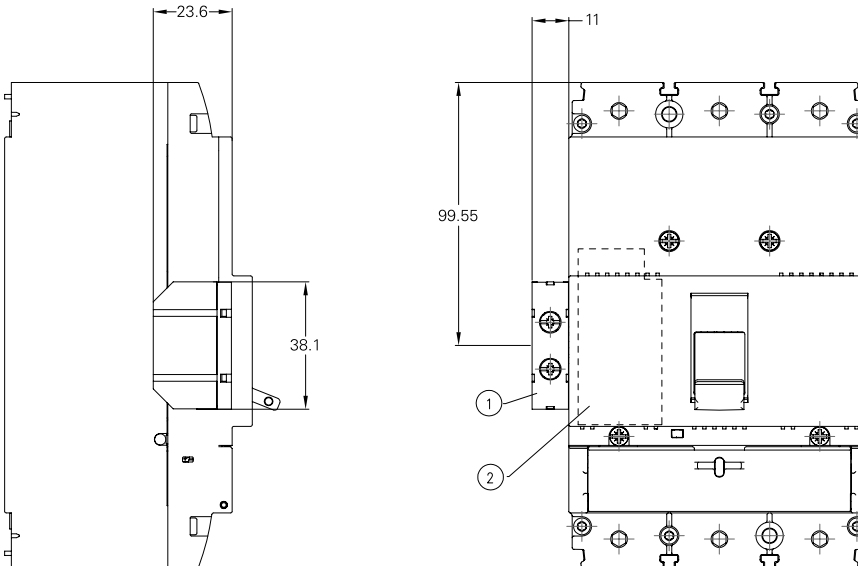

- ① PDC2XST(T)
PDC2XUV(V)
- ② PDC2XST(T)(S)(R)
PDC2XUV(V)(U)(W)

1.4

Power Defense Molded Case Circuit-Breaker

Dimensions (mm)

Frame size 2

Direct Rotary Handle

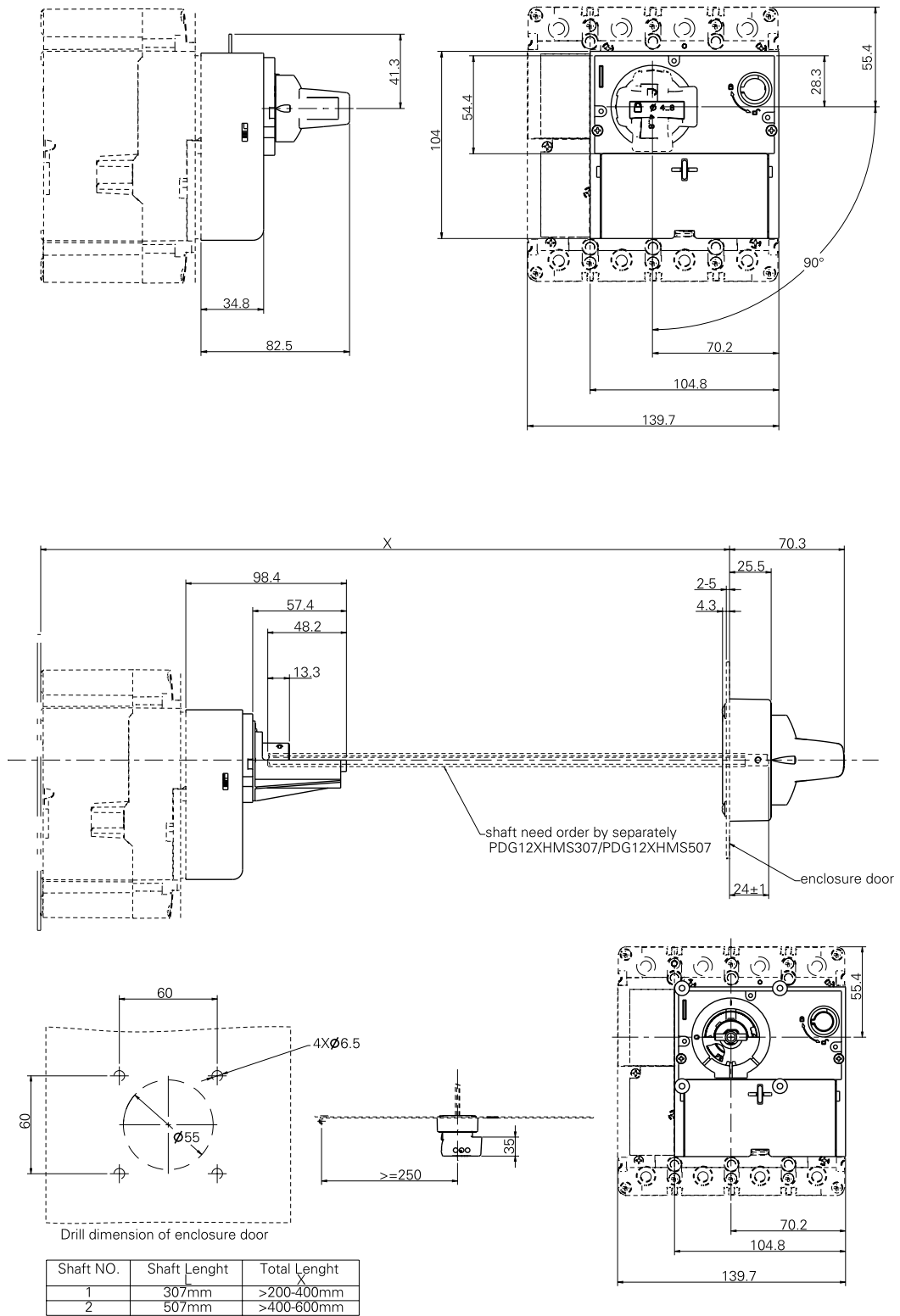

Frame size 3

Circuit-Breakers, 3 pole

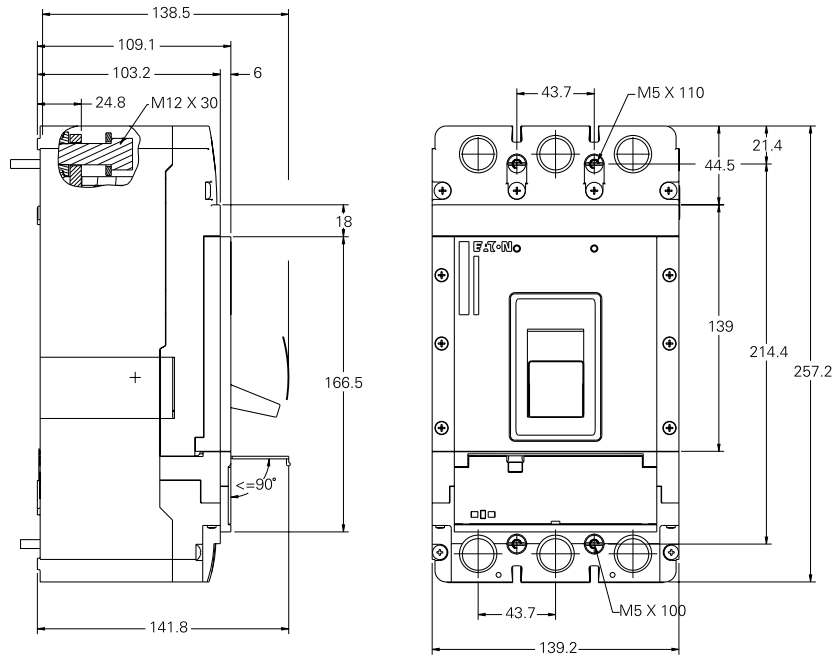

Circuit-Breakers, 4 pole

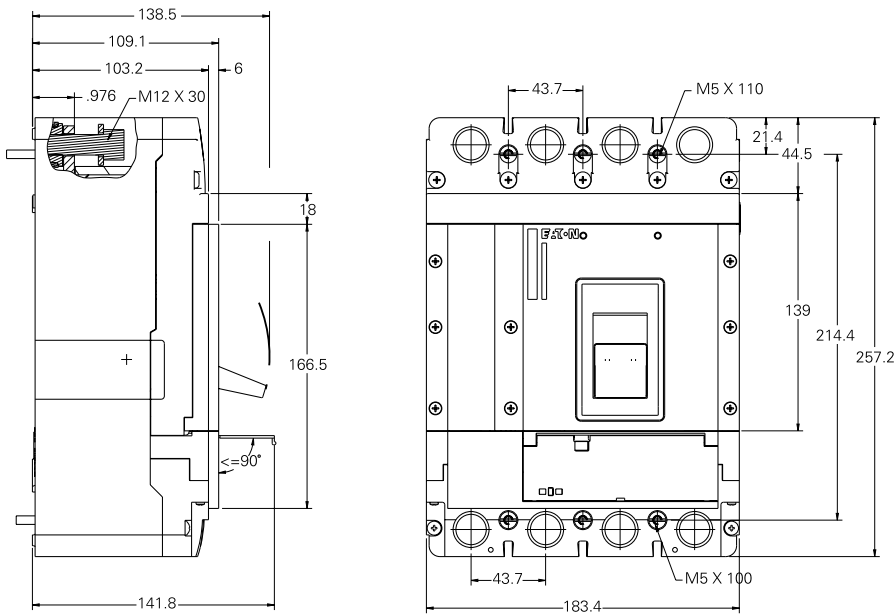

1.4

Power Defense Molded Case Circuit-Breaker

Dimensions (mm)

Frame size 3

Interphase Barriers

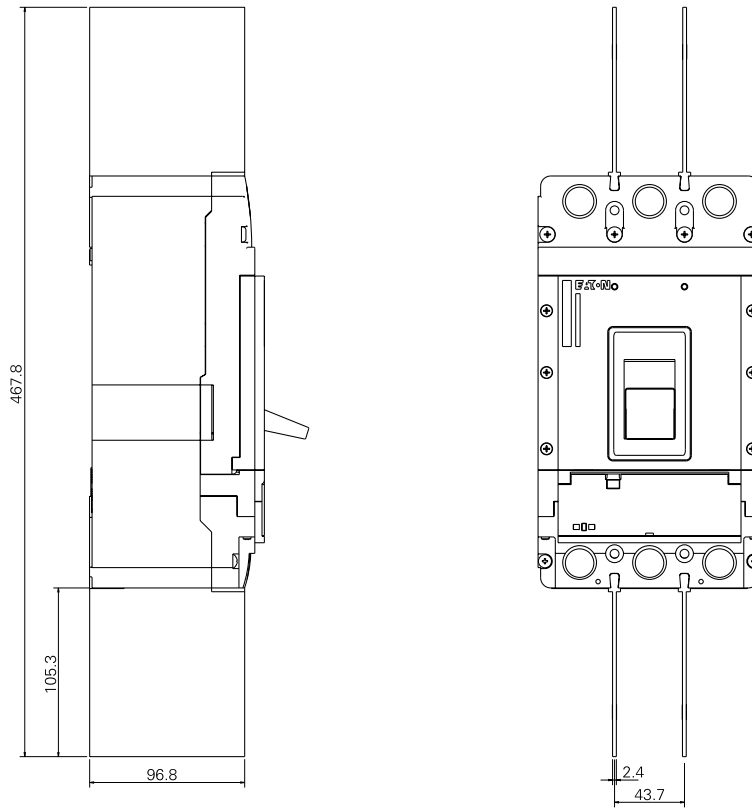

Terminal Cover

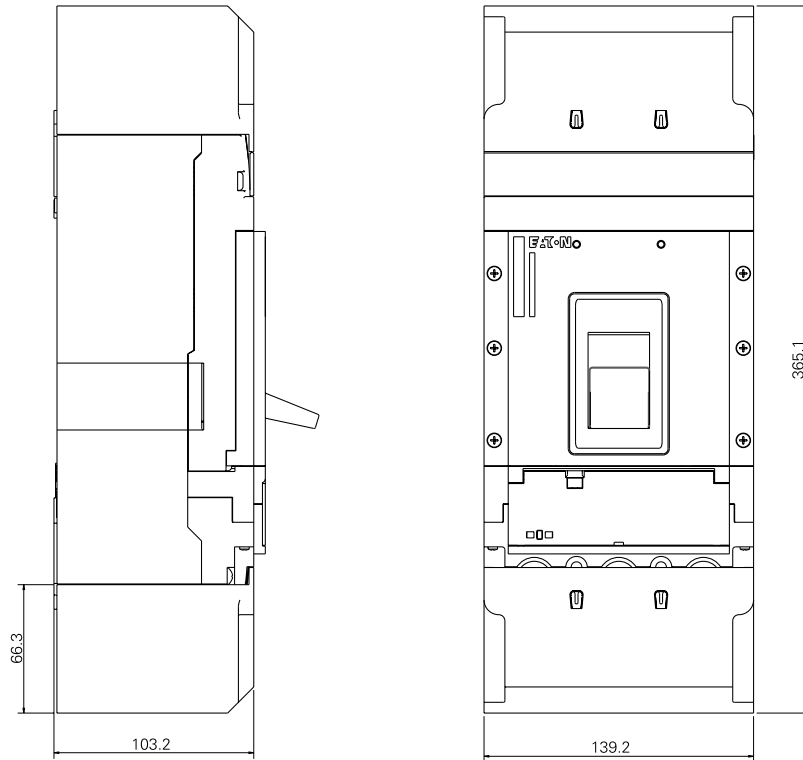

Frame size 3

IP2X Fingerprotection

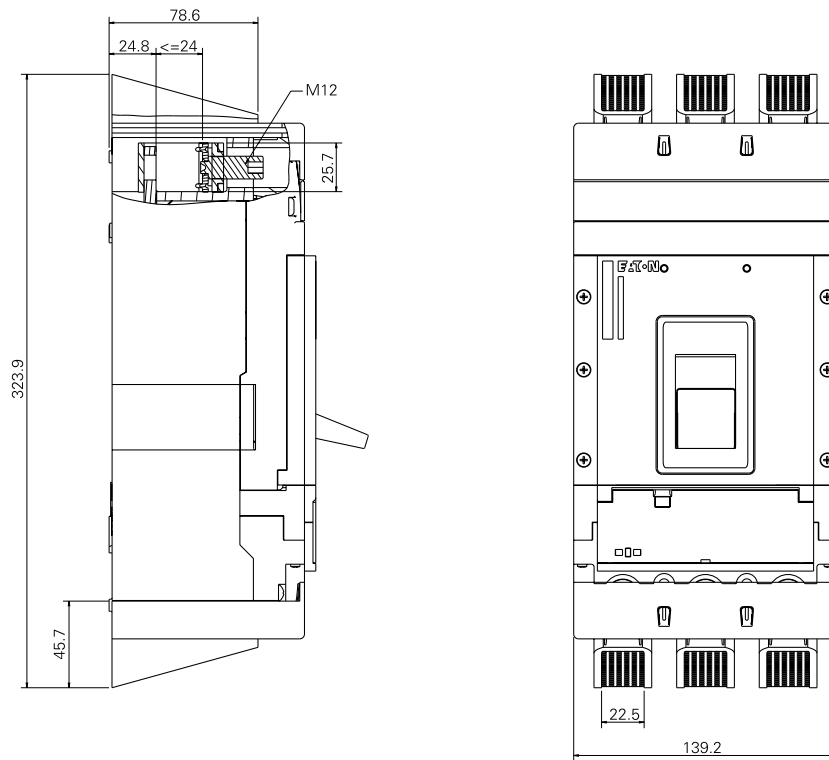

1.4

Power Defense Molded Case Circuit-Breaker

Dimensions (mm)

Frame size 3

Direct Rotary Handle

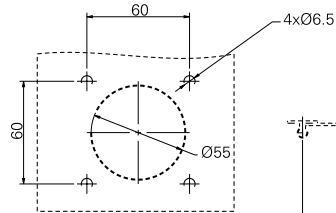
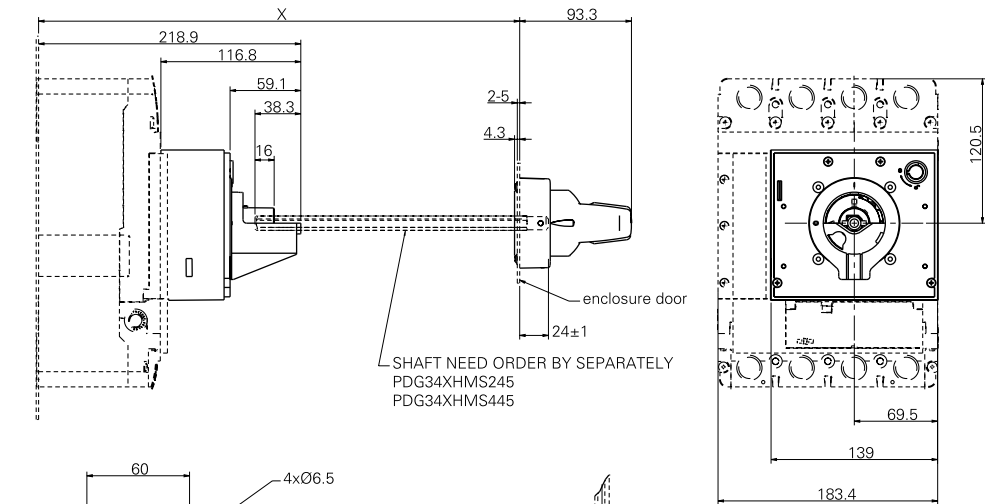
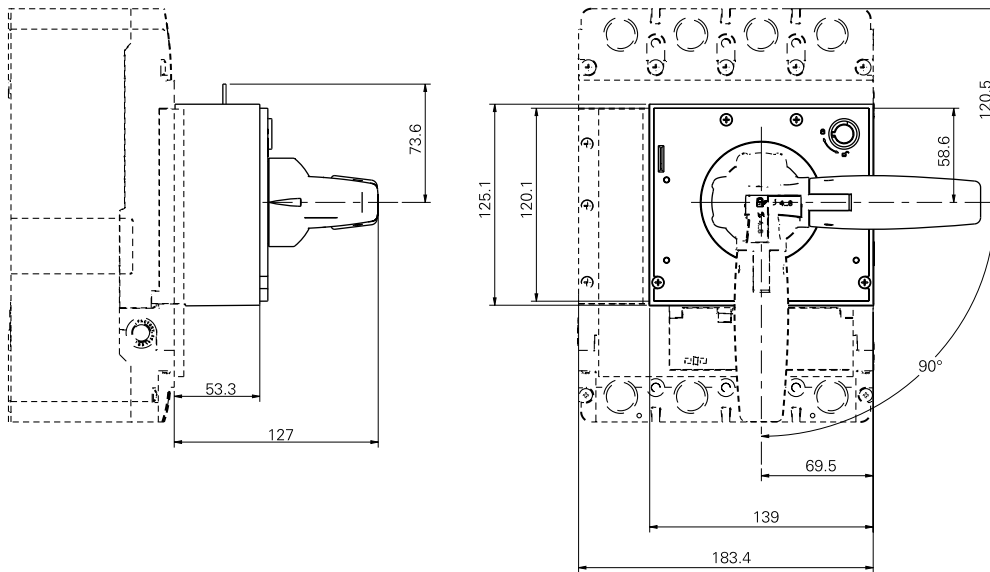

Drill dimension of enclosure door

Shaft No.	Shaft Length L	Total Length X
1	245 mm	>233-400 mm
2	445 mm	>400-600 mm

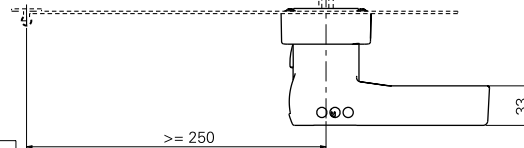

Frame size 3

Terminal extensions

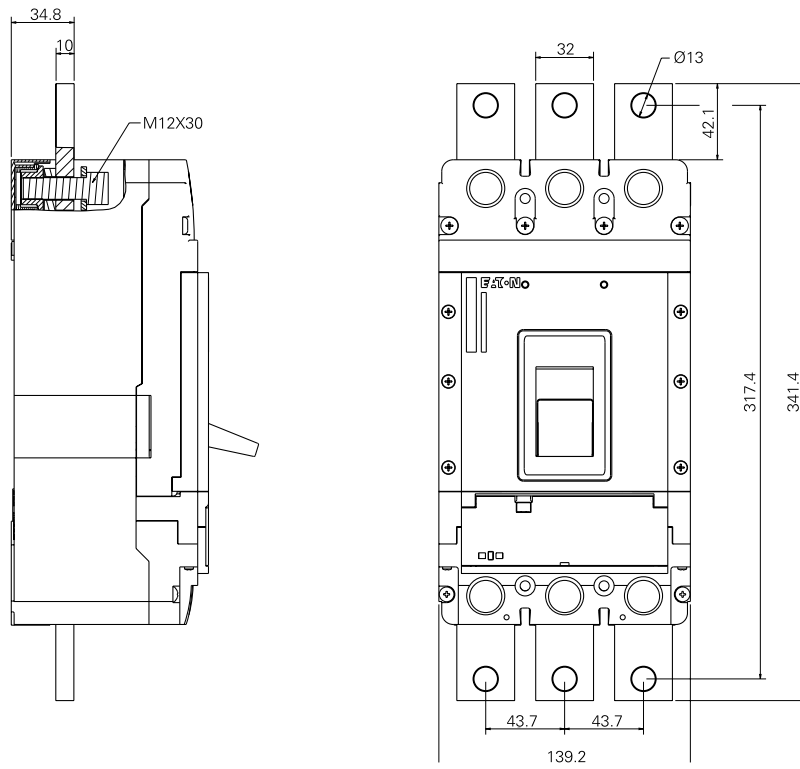

Terminal spreaders

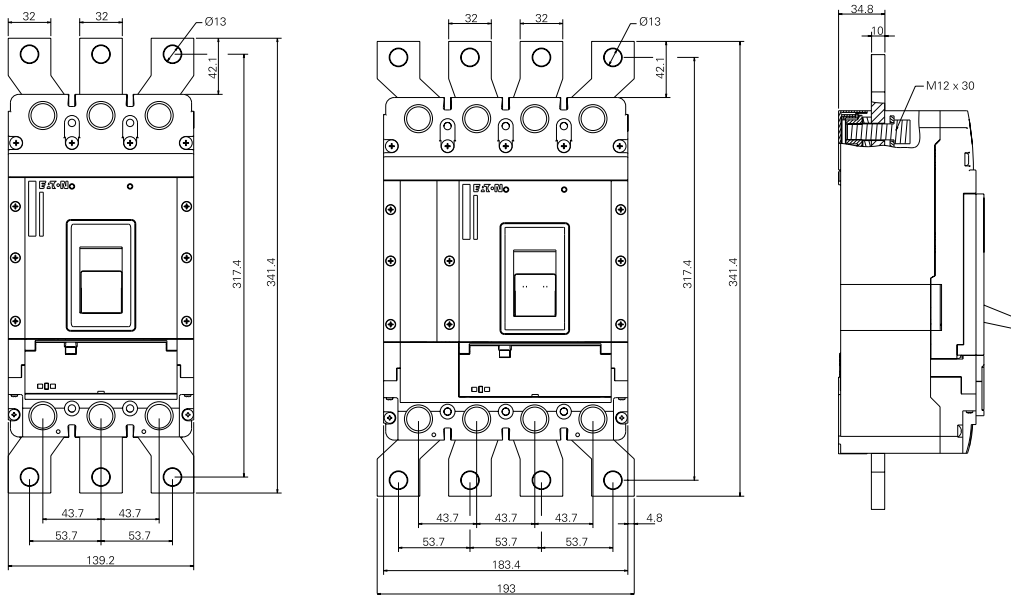

1.4

Power Defense Molded Case Circuit-Breaker

Dimensions (mm)

Frame size 4

Circuit-Breakers, 3 pole

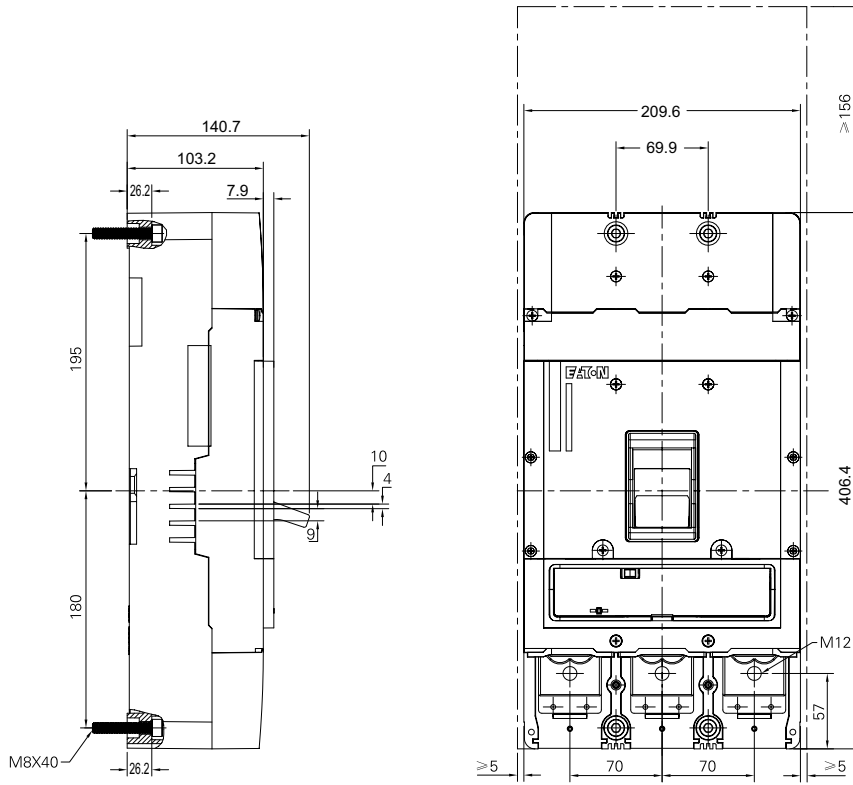

Circuit-Breakers, 4 pole

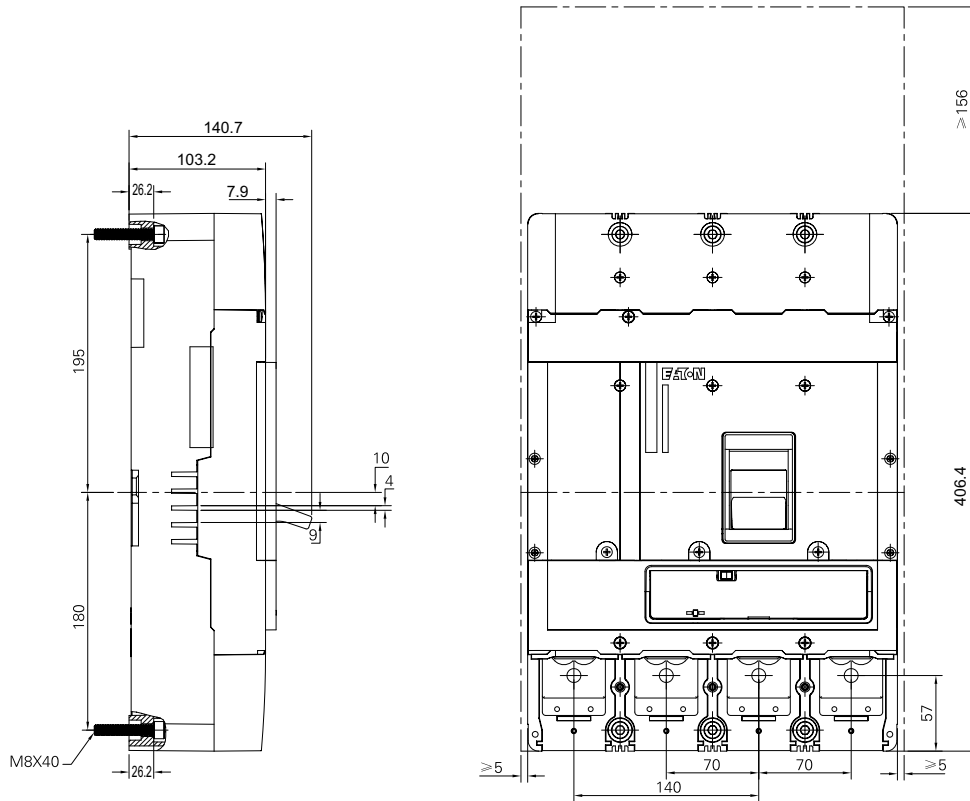

Frame size 4

Interphase Barriers

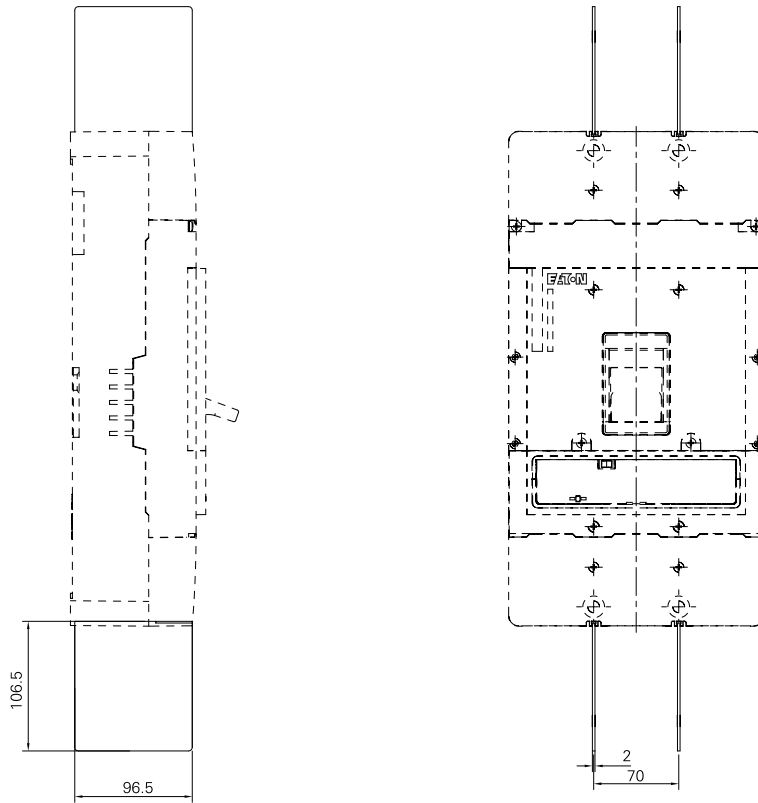

1.4

Power Defense Molded Case Circuit-Breaker

Dimensions (mm)

Frame size 4

Direct Rotary Handle

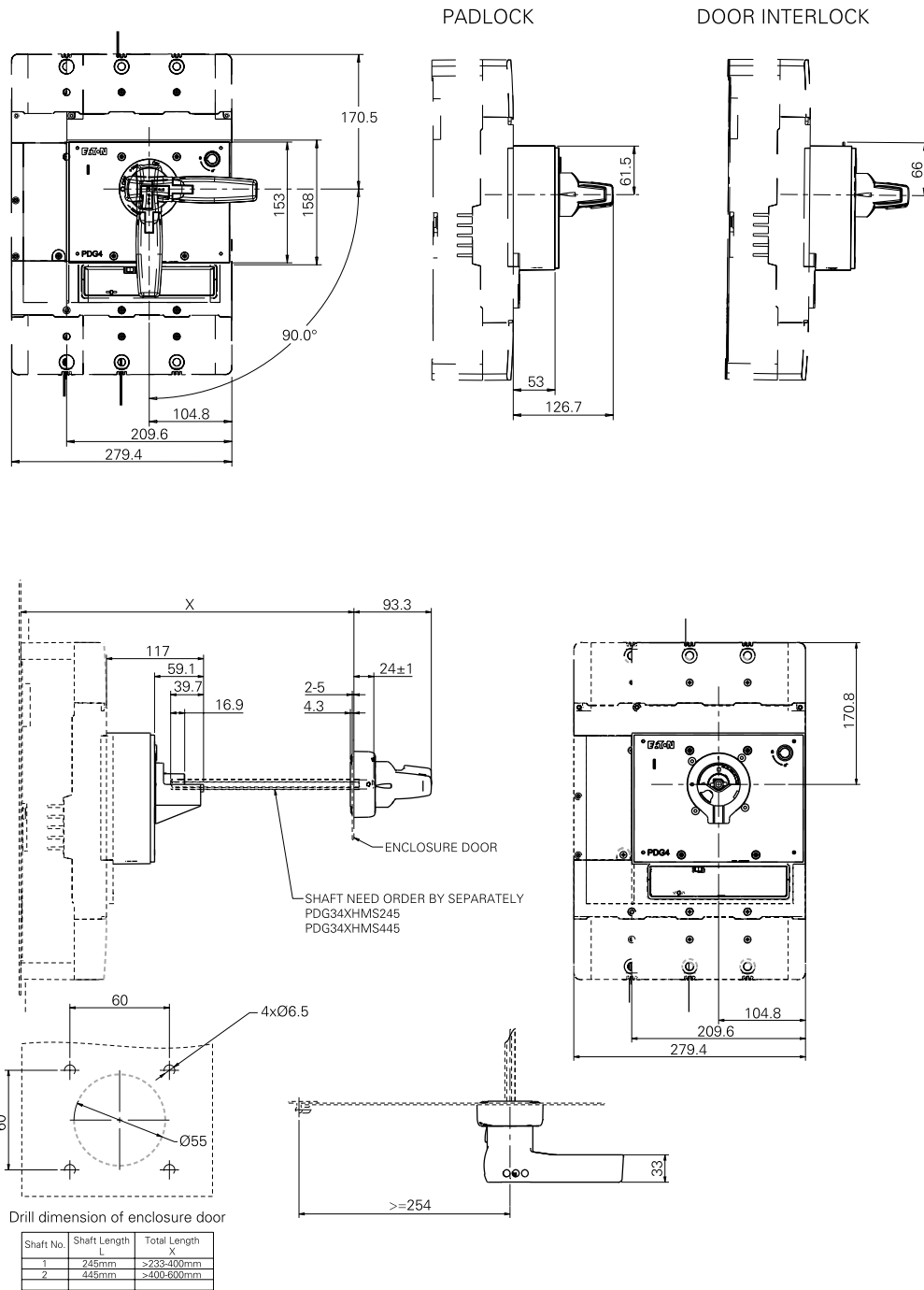

Frame size 4

Screw terminal

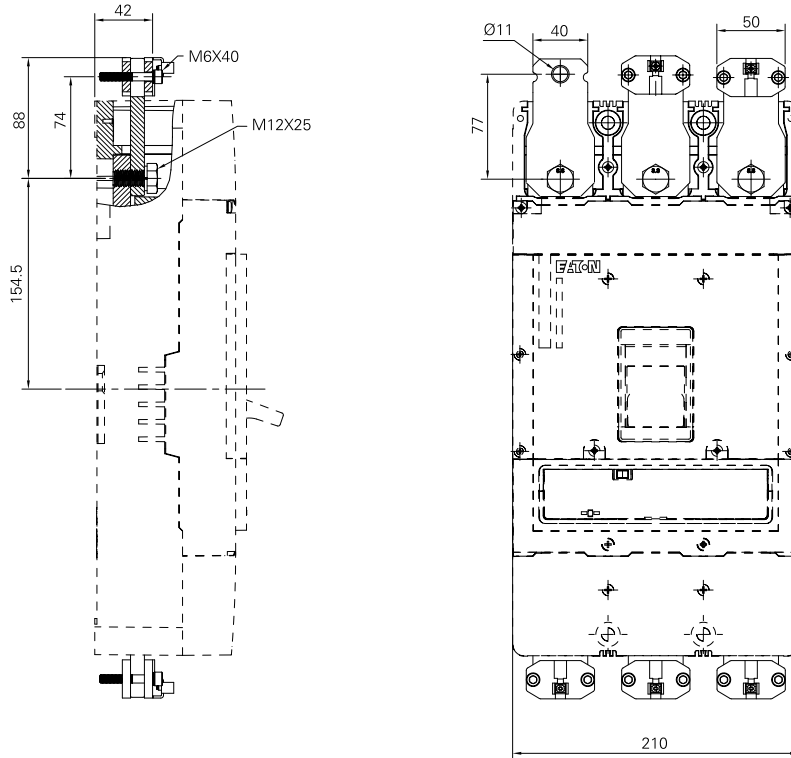

Terminal extensions

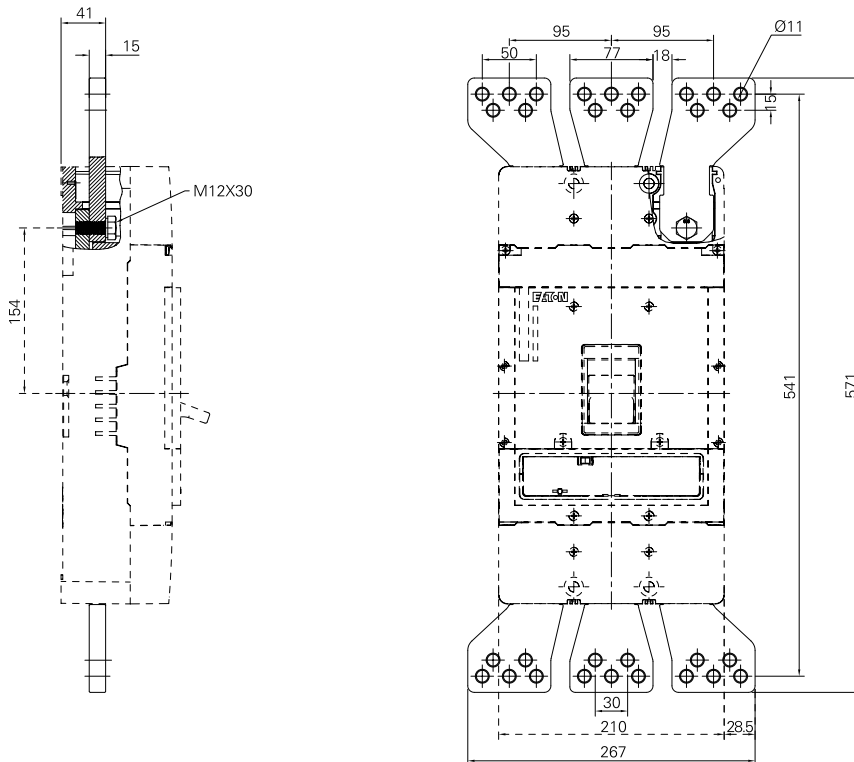

1.4

Power Defense Molded Case Circuit-Breaker

Dimensions (mm)

Frame size 4

Terminal spreaders 1

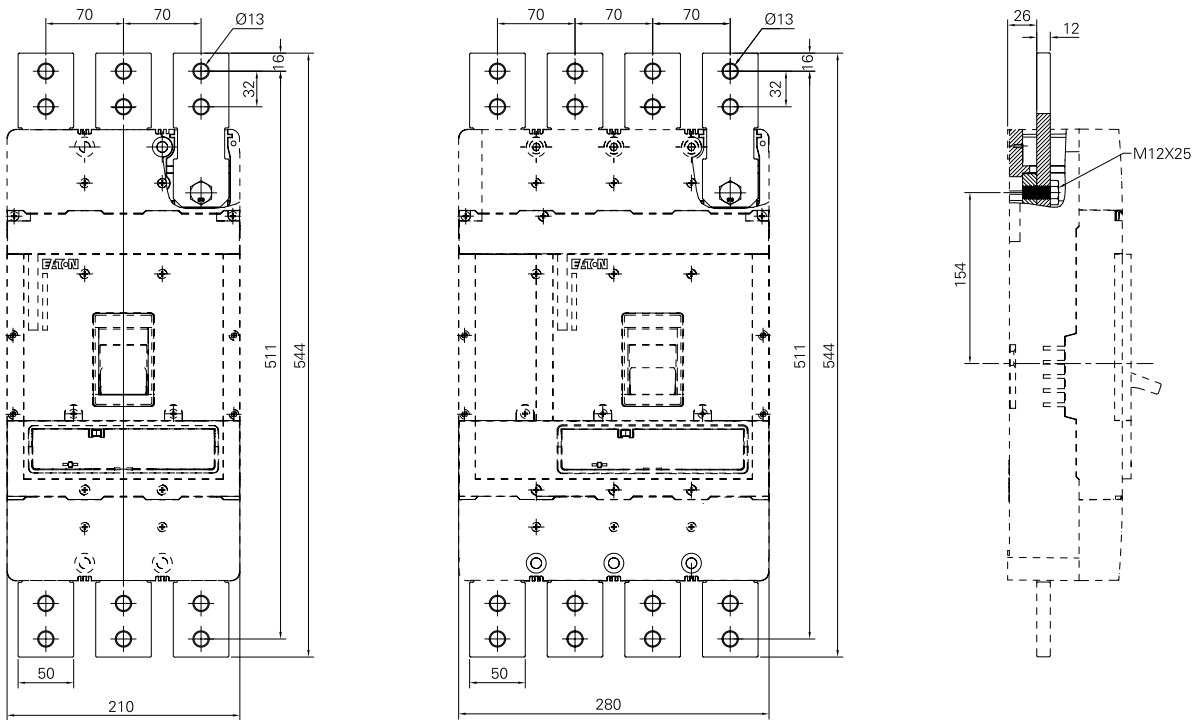

Terminal spreaders 2

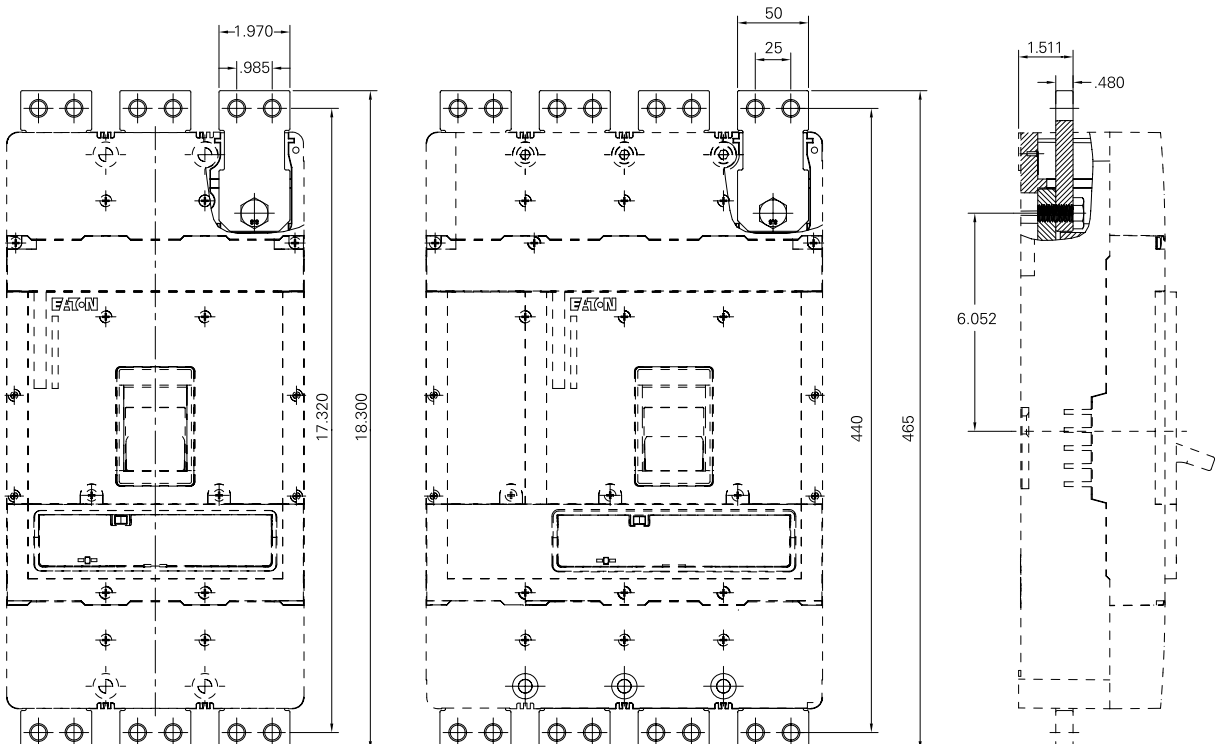

Power Defense Molded Case Circuit-Breaker

Dimensions (mm)

1.5

1.5

Power Defense Molded Case Circuit-Breaker

Catalog Number Key

Power Defense molded case circuit-breaker catalog number key

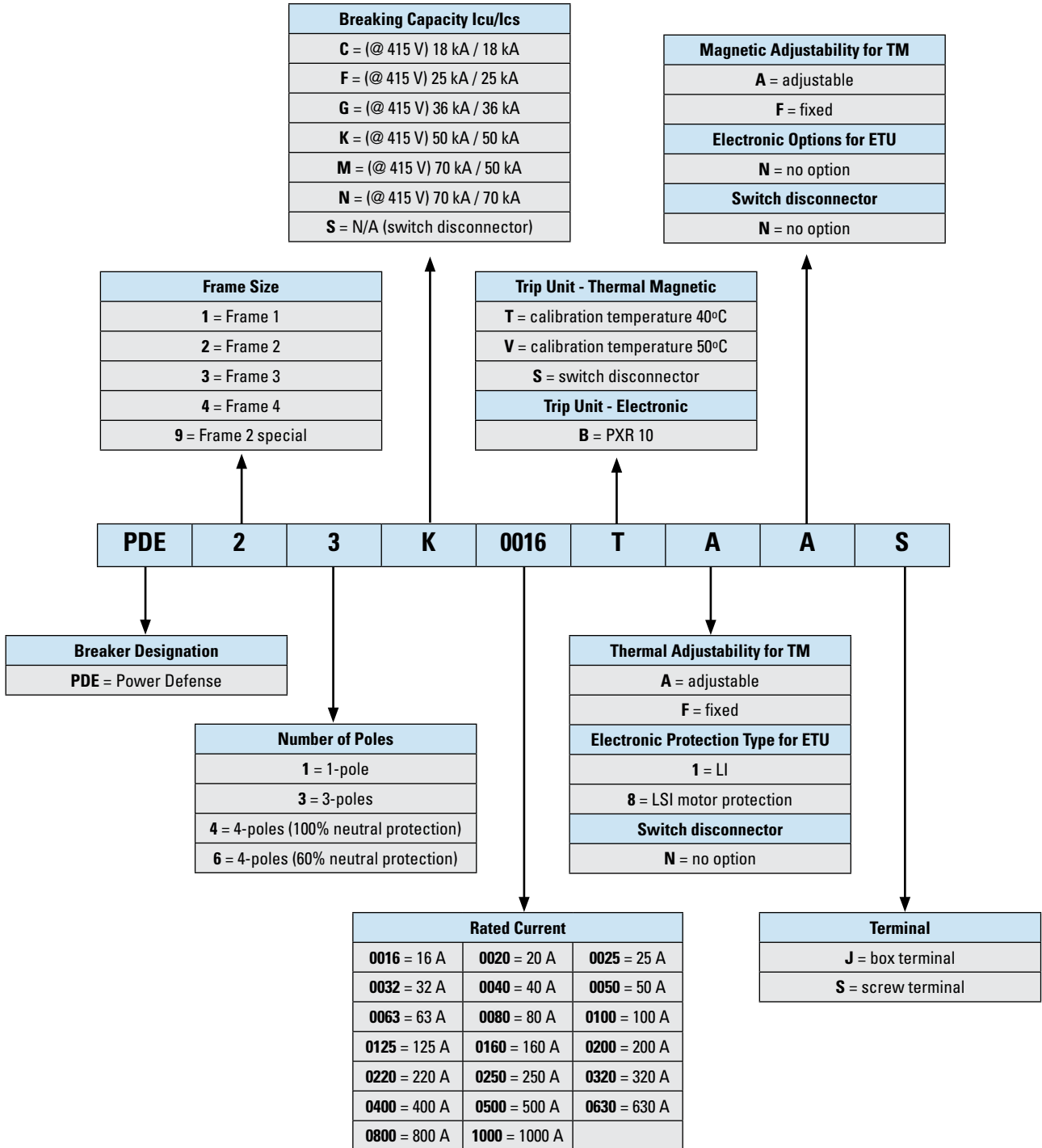

Example for the ordering process

If you would like to order a Power Defense breaker with the specification: Frame size 3, 3-poles, thermomagnetic adjustable/adjustable trip unit @ 50°C calibration temperature, with screw terminals for rated current of 400 A and braking capacity of 50kA, then you would need to proceed in the following way:

- Find the table which addresses the frame size 3, 3-poles, thermomagnetic adjustable/adjustable trip unit @ 50°C calibration temperature, with screw terminals breakers
- As next, find in the table the wished rated current vertically and the wished breaking capacity horizontally. The crossing point in the table of the two chosen parameters, defines a 5 digit code.

Article number	PDE33XXXXVAAS				
breaking capacity @415 V I_{cu}/I_{cs}	F 25 kA / 25 kA	G 36 kA / 36 kA	K 50 kA / 50 kA	M 70 kA / 50 kA	N 70 kA / 70 kA
rated current					
250 A	F0250	G0250	K0250	M0250	N0250
320 A	F0320	G0320	K0320	M0320	N0320
400 A	F0400	G0400	K0400	M0400	N0400
500 A	F0500	G0500	K0500	M0500	N0500
630 A	F0630	G0630	K0630	M0630	N0630

- And finally, insert the 5 digit code into the full article number to obtain your article number:

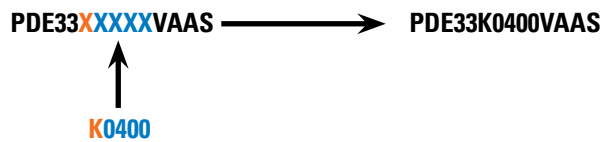

1.5

Power Defense Molded Case Circuit-Breaker

Ordering Part

Frame size 1, 1-pole

Thermomagnetic trip unit, fixed/fixe

Calibrated at 40°C
Box terminals

Article number PDE11XXXXTFFJ

breaking capacity @230 V	C	F
I_{cu}/I_{cs}	18 kA / 18 kA	25 kA / 25 kA

rated current

16 A	C0016	F0016
20 A	C0020	F0020
25 A	C0025	F0025
32 A	C0032	F0032
40 A	C0040	F0040
50 A	C0050	F0050
63 A	C0063	F0063
80 A	C0080	F0080
100 A	C0100	F0100
125 A	C0125	F0125

wa_ren_00319_r



Frame size 1, 3-poles

Thermomagnetic trip unit, adjustable/adjustable

Calibrated at 40°C
Box terminals

Article number PDE13XXXXTAAJ

breaking capacity @415 V	F	G	K	M
I_{cu}/I_{cs}	25 kA / 25 kA	36 kA / 36 kA	50 kA / 50 kA	70 kA / 50 kA

rated current

16 A	F0016	G0016	K0016	M0016
20 A	F0020	G0020	K0020	M0020
25 A	F0025	G0025	K0025	M0025
32 A	F0032	G0032	K0032	M0032
40 A	F0040	G0040	K0040	M0040
50 A	F0050	G0050	K0050	M0050
63 A	F0063	G0063	K0063	M0063
80 A	F0080	G0080	K0080	M0080
100 A	F0100	G0100	K0100	M0100
125 A	F0125	G0125	K0125	M0125
160 A	F0160	G0160	K0160	M0160

wa_ren_00319_r



Frame size 1, 4-poles

Thermomagnetic trip unit, adjustable/adjustable

Calibrated at 40°C
Box terminals

Article number	PDE14XXXXXTAAJ			
breaking capacity @415 V	F	G	K	M
I_{cu}/I_{cs}	25 kA / 25 kA	36 kA / 36 kA	50 kA / 50 kA	70 kA / 50 kA

rated current

16 A	F0016	G0016	K0016	M0016
20 A	F0020	G0020	K0020	M0020
25 A	F0025	G0025	K0025	M0025
32 A	F0032	G0032	K0032	M0032
40 A	F0040	G0040	K0040	M0040
50 A	F0050	G0050	K0050	M0050
63 A	F0063	G0063	K0063	M0063
80 A	F0080	G0080	K0080	M0080
100 A	F0100	G0100	K0100	M0100
125 A	F0125	G0125	K0125	M0125
160 A	F0160	G0160	K0160	M0160

wa_ren_00319_r



Frame size 1, 3-poles

Thermomagnetic trip unit, adjustable/adjustable

Calibrated at 50°C
Box terminals

Article number	PDE13XXXXXVAAJ			
breaking capacity @415 V	F	G	K	M
I_{cu}/I_{cs}	25 kA / 25 kA	36 kA / 36 kA	50 kA / 50 kA	70 kA / 50 kA

rated current

16 A	F0016	G0016	K0016	M0016
20 A	F0020	G0020	K0020	M0020
25 A	F0025	G0025	K0025	M0025
32 A	F0032	G0032	K0032	M0032
40 A	F0040	G0040	K0040	M0040
50 A	F0050	G0050	K0050	M0050
63 A	F0063	G0063	K0063	M0063
80 A	F0080	G0080	K0080	M0080
100 A	F0100	G0100	K0100	M0100
125 A	F0125	G0125	K0125	M0125

wa_ren_00319_r



1.5

Power Defense Molded Case Circuit-Breaker

Ordering Part

Frame size 1, 4-poles

Thermomagnetic trip unit, adjustable/adjustable

Calibrated at 50°C
Box terminals

Article number	PDE14XXXXXVAAJ			
breaking capacity @415 V	F	G	K	M
I_{cu}/I_{cs}	25 kA / 25 kA	36 kA / 36 kA	50 kA / 50 kA	70 kA / 50 kA
rated current				
16 A	F0016	G0016	K0016	M0016
20 A	F0020	G0020	K0020	M0020
25 A	F0025	G0025	K0025	M0025
32 A	F0032	G0032	K0032	M0032
40 A	F0040	G0040	K0040	M0040
50 A	F0050	G0050	K0050	M0050
63 A	F0063	G0063	K0063	M0063
80 A	F0080	G0080	K0080	M0080
100 A	F0100	G0100	K0100	M0100
125 A	F0125	G0125	K0125	M0125

wa_ren_00319_r



Frame size 1, 3-poles

Switch disconnectors

Box terminals

Article number	PDE13XXXXXSNNJ			
rated current				
63 A	S0063			
100 A	S0100			
125 A	S0125			
160 A	S0160			

wa_ren_00619_r



Frame size 1, 4-poles

Switch disconnectors

Box terminals

Article number	PDE14XXXXXSNNJ			
rated current				
63 A	S0063			
100 A	S0100			
125 A	S0125			
160 A	S0160			

wa_ren_00619_r



Frame size 2, 3-poles

Thermomagnetic trip unit, adjustable/adjustable

Calibrated at 40°C
Screw terminals

Article number	PDE23XXXXTAAS				
breaking capacity @415 V	F	G	K	M	N
I_{cu}/I_{cs}	25 kA / 25 kA	36 kA / 36 kA	50 kA / 50 kA	70 kA / 50 kA	70 kA / 70 kA

rated current

160 A	F0160	G0160	K0160	M0160	N0160
200 A	F0200	G0200	K0200	M0200	N0200
250 A	F0250	G0250	K0250	M0250	N0250

wa_ren_01619_r



Frame size 2, 4-poles

Thermomagnetic trip unit, adjustable/adjustable

Calibrated at 40°C
Screw terminals

Article number	PDE24XXXXTAAS				
breaking capacity @415 V	F	G	K	M	N
I_{cu}/I_{cs}	25 kA / 25 kA	36 kA / 36 kA	50 kA / 50 kA	70 kA / 50 kA	70 kA / 70 kA

rated current

160 A	F0160	G0160	K0160	M0160	N0160
200 A	F0200	G0200	K0200	M0200	N0200
250 A	F0250	G0250	K0250	M0250	N0250

wa_ren_01619_r



1.5

Power Defense Molded Case Circuit-Breaker

Ordering Part

Frame size 2, 4-poles (60% neutral protection)

Thermomagnetic trip unit, adjustable/adjustable

Calibrated at 40°C
Screw terminals

Article number	PDE26XXXXTAAS				
breaking capacity @415 V	F	G	K	M	N
I_{cu}/I_{cs}	25 kA / 25 kA	36 kA / 36 kA	50 kA / 50 kA	70 kA / 50 kA	70 kA / 70 kA

rated current

160 A	F0160	G0160	K0160	M0160	N0160
200 A	F0200	G0200	K0200	M0200	N0200
250 A	F0250	G0250	K0250	M0250	N0250

wa_ren_01619_r



Frame size 2, 3-poles

Thermomagnetic trip unit, adjustable/adjustable

Calibrated at 50°C
Screw terminals

Article number	PDE23XXXXVAAS				
breaking capacity @415 V	F	G	K	M	N
I_{cu}/I_{cs}	25 kA / 25 kA	36 kA / 36 kA	50 kA / 50 kA	70 kA / 50 kA	70 kA / 70 kA

rated current

160 A	F0160	G0160	K0160	M0160	N0160
200 A	F0200	G0200	K0200	M0200	N0200
250 A	F0250	G0250	K0250	M0250	N0250

wa_ren_01619_r



Frame size 2, 4-poles

Thermomagnetic trip unit, adjustable/adjustable

Calibrated at 50°C
Screw terminals

Article number	PDE24XXXXVAAS				
breaking capacity @415 V	F	G	K	M	N
I_{cu}/I_{cs}	25 kA / 25 kA	36 kA / 36 kA	50 kA / 50 kA	70 kA / 50 kA	70 kA / 70 kA

rated current

160 A	F0160	G0160	K0160	M0160	N0160
200 A	F0200	G0200	K0200	M0200	N0200
250 A	F0250	G0250	K0250	M0250	N0250

wa_ren_01619_r



Frame size 2, 4-poles (60% neutral protection)

Thermomagnetic trip unit, adjustable/adjustable

Calibrated at 50°C
Screw terminals

Article number	PDE26XXXXVAAS				
breaking capacity @415 V	F	G	K	M	N
I_{cu}/I_{cs}	25 kA / 25 kA	36 kA / 36 kA	50 kA / 50 kA	70 kA / 50 kA	70 kA / 70 kA

rated current

160 A	F0160	G0160	K0160	M0160	N0160
200 A	F0200	G0200	K0200	M0200	N0200
250 A	F0250	G0250	K0250	M0250	N0250

wa_ren_01619_r



1.5

Power Defense Molded Case Circuit-Breaker

Ordering Part

Frame size 2, 3-poles

Electronic trip unit

Screw terminals

Article number	PDE23XXXXXB1NS				
breaking capacity @415 V	F	G	K	M	N
I_{cu}/I_{cs}	25 kA / 25 kA	36 kA / 36 kA	50 kA / 50 kA	70 kA / 50 kA	70 kA / 70 kA
rated current					
160 A	F0160	G0160	K0160	M0160	N0160
200 A	F0200	G0200	K0200	M0200	N0200
250 A	F0250	G0250	K0250	M0250	N0250

wa_ren_10819_I



Frame size 2, 4-poles

Electronic trip unit

Screw terminals

Article number	PDE24XXXXXB1NS				
breaking capacity @415 V	F	G	K	M	N
I_{cu}/I_{cs}	25 kA / 25 kA	36 kA / 36 kA	50 kA / 50 kA	70 kA / 50 kA	70 kA / 70 kA
rated current					
160 A	F0160	G0160	K0160	M0160	N0160
200 A	F0200	G0200	K0200	M0200	N0200
250 A	F0250	G0250	K0250	M0250	N0250

wa_ren_10819_I



Frame size 2 (special version), 3-poles

Electronic trip unit

Box terminals

Article number	PDE93XXXXXB1NJ				
breaking capacity @415 V	F	G	K	M	N
I_{cu}/I_{cs}	25 kA / 25 kA	36 kA / 36 kA	50 kA / 50 kA	70 kA / 50 kA	70 kA / 70 kA
rated current					
63 A	F0063	G0063	K0063	M0063	N0063
100 A	F0100	G0100	K0100	M0100	N0100

wa_ren_10819_I



Frame size 2 (special version), 4-poles

Electronic trip unit

Box terminals

Article number	PDE94XXXXXB1NJ				
breaking capacity @415 V	F	G	K	M	N
I_{cu}/I_{cs}	25 kA / 25 kA	36 kA / 36 kA	50 kA / 50 kA	70 kA / 50 kA	70 kA / 70 kA
rated current					
63 A	F0063	G0063	K0063	M0063	N0063
100 A	F0100	G0100	K0100	M0100	N0100

wa_ren_10819_I



Frame size 2, 3-poles

Electronic trip unit, motor protection

Screw terminals

Article number	PDE23XXXXXB8NS				
breaking capacity @415 V	F	G	K	M	N
I_{cu}/I_{cs}	25 kA / 25 kA	36 kA / 36 kA	50 kA / 50 kA	70 kA / 50 kA	70 kA / 70 kA
rated current					
100 A	F0100	G0100	K0100	M0100	N0100
160 A	F0160	G0160	K0160	M0160	N0160
220 A	F0220	G0220	K0220	M0220	N0220

wa_ren_10819_I



Frame size 2, 4-poles

Electronic trip unit, motor protection

Screw terminals

Article number	PDE24XXXXXB8NS				
breaking capacity @415 V	F	G	K	M	N
I_{cu}/I_{cs}	25 kA / 25 kA	36 kA / 36 kA	50 kA / 50 kA	70 kA / 50 kA	70 kA / 70 kA
rated current					
100 A	F0100	G0100	K0100	M0100	N0100
160 A	F0160	G0160	K0160	M0160	N0160
220 A	F0220	G0220	K0220	M0220	N0220

wa_ren_10819_I



1.5

Power Defense Molded Case Circuit-Breaker

Ordering Part

Frame size 2, 3-poles

Switch disconnectors

Screw terminals

Article number	PDE23XXXXSNNS
-----------------------	----------------------

rated current

160 A	S0160
200 A	S0200
250 A	S0250

This assortment will be available soon

wa_ren_01519_r



Frame size 2, 4-poles

Switch disconnectors

Screw terminals

Article number	PDE24XXXXSNNS
-----------------------	----------------------

rated current

160 A	S0160
200 A	S0200
250 A	S0250

This assortment will be available soon

wa_ren_01519_r



Frame size 3, 3-poles

Thermomagnetic trip unit, adjustable/adjustable

Calibrated at 40°C
Screw terminals

Article number	PDE33XXXXTAAS				
breaking capacity @415 V	F	G	K	M	N
I_{cu}/I_{cs}	25 kA / 25 kA	36 kA / 36 kA	50 kA / 50 kA	70 kA / 50 kA	70 kA / 70 kA

rated current

250 A	F0250	G0250	K0250	M0250	N0250
320 A	F0320	G0320	K0320	M0320	N0320
400 A	F0400	G0400	K0400	M0400	N0400
500 A	F0500	G0500	K0500	M0500	N0500
630 A	F0630	G0630	K0630	M0630	N0630

wa_ren_01819_r



Frame size 3, 4-poles

Thermomagnetic trip unit, adjustable/adjustable

Calibrated at 40°C
Screw terminals

Article number	PDE34XXXXTAAS				
breaking capacity @415 V	F	G	K	M	N
I_{cu}/I_{cs}	25 kA / 25 kA	36 kA / 36 kA	50 kA / 50 kA	70 kA / 50 kA	70 kA / 70 kA

rated current

250 A	F0250	G0250	K0250	M0250	N0250
320 A	F0320	G0320	K0320	M0320	N0320
400 A	F0400	G0400	K0400	M0400	N0400
500 A	F0500	G0500	K0500	M0500	N0500
630 A	F0630	G0630	K0630	M0630	N0630

wa_ren_01819_r



1.5

Power Defense Molded Case Circuit-Breaker

Ordering Part

Frame size 3, 3-poles (60% neutral protection)

Thermomagnetic trip unit, adjustable/adjustable

Calibrated at 40°C

Screw terminals

Article number	PDE36XXXXTAAS				
breaking capacity @415 V	F	G	K	M	N
I_{cu}/I_{cs}	25 kA / 25 kA	36 kA / 36 kA	50 kA / 50 kA	70 kA / 50 kA	70 kA / 70 kA

rated current

320 A	F0320	G0320	K0320	M0320	N0320
400 A	F0400	G0400	K0400	M0400	N0400
500 A	F0500	G0500	K0500	M0500	N0500
630 A	F0630	G0630	K0630	M0630	N0630

wa_ren_01819_r



Frame size 3, 3-poles

Thermomagnetic trip unit, adjustable/adjustable

Calibrated at 50°C

Screw terminals

Article number	PDE33XXXXVAAS				
breaking capacity @415 V	F	G	K	M	N
I_{cu}/I_{cs}	25 kA / 25 kA	36 kA / 36 kA	50 kA / 50 kA	70 kA / 50 kA	70 kA / 70 kA

rated current

250 A	F0250	G0250	K0250	M0250	N0250
320 A	F0320	G0320	K0320	M0320	N0320
400 A	F0400	G0400	K0400	M0400	N0400
500 A	F0500	G0500	K0500	M0500	N0500
630 A	F0630	G0630	K0630	M0630	N0630

wa_ren_01819_r



Frame size 3, 4-poles

Thermomagnetic trip unit, adjustable/adjustable

Calibrated at 50°C
Screw terminals

Article number	PDE34XXXXVAAS				
breaking capacity @415 V	F	G	K	M	N
I_{cu}/I_{cs}	25 kA / 25 kA	36 kA / 36 kA	50 kA / 50 kA	70 kA / 50 kA	70 kA / 70 kA

rated current

250 A	F0250	G0250	K0250	M0250	N0250
320 A	F0320	G0320	K0320	M0320	N0320
400 A	F0400	G0400	K0400	M0400	N0400
500 A	F0500	G0500	K0500	M0500	N0500
630 A	F0630	G0630	K0630	M0630	N0630

wa_ren_01819_r



Frame size 3, 4-poles (60% neutral protection)

Thermomagnetic trip unit, adjustable/adjustable

Calibrated at 50°C
Screw terminals

Article number	PDE36XXXXVAAS				
breaking capacity @415 V	F	G	K	M	N
I_{cu}/I_{cs}	25 kA / 25 kA	36 kA / 36 kA	50 kA / 50 kA	70 kA / 50 kA	70 kA / 70 kA

rated current

320 A	F0320	G0320	K0320	M0320	N0320
400 A	F0400	G0400	K0400	M0400	N0400
500 A	F0500	G0500	K0500	M0500	N0500
630 A	F0630	G0630	K0630	M0630	N0630

wa_ren_01819_r



1.5

Power Defense Molded Case Circuit-Breaker

Ordering Part

Frame size 3, 3-poles

Electronic trip unit

Screw terminals

Article number	PDE33XXXXXB1NS				
breaking capacity @415 V	F	G	K	M	N
I_{cu}/I_{cs}	25 kA / 25 kA	36 kA / 36 kA	50 kA / 50 kA	70 kA / 50 kA	70 kA / 70 kA
rated current					
400 A	F0400	G0400	K0400	M0400	N0400
630 A	F0630	G0630	K0630	M0630	N0630

wa_ren_00119_r



Frame size 3, 4-poles

Electronic trip unit

Screw terminals

Article number	PDE34XXXXXB1NS				
breaking capacity @415 V	F	G	K	M	N
I_{cu}/I_{cs}	25 kA / 25 kA	36 kA / 36 kA	50 kA / 50 kA	70 kA / 50 kA	70 kA / 70 kA
rated current					
400 A	F0400	G0400	K0400	M0400	N0400
630 A	F0630	G0630	K0630	M0630	N0630

wa_ren_00119_r



Frame size 3, 3-poles

Switch disconnectors

Screw terminals

Article number	PDE33XXXXSNNS
-----------------------	----------------------

rated current

400 A	S0400
630 A	S0630

wa_ren_01719_r



Frame size 3, 4-poles

Switch disconnectors

Screw terminals

Article number	PDE34XXXXSNNS
-----------------------	----------------------

rated current

400 A	S0400
630 A	S0630

wa_ren_01719_r



1.5

Power Defense Molded Case Circuit-Breaker

Ordering Part

Frame size 4, 3-poles

Thermomagnetic trip unit, adjustable/adjustable

Calibrated at 40°C
Screw terminals

Article number	PDE43XXXXTAAS			
breaking capacity @415 V	G	K	M	N
I_{cu}/I_{cs}	36 kA / 36 kA	50 kA / 50 kA	70 kA / 50 kA	70 kA / 70 kA

rated current

800 A	G0800	K0800	M0800	N0800
-------	-------	-------	-------	-------

wa_ren_01319_r



Frame size 4, 4-poles

Thermomagnetic trip unit, adjustable/adjustable

Calibrated at 40°C
Screw terminals

Article number	PDE44XXXXTAAS			
breaking capacity @415 V	G	K	M	N
I_{cu}/I_{cs}	36 kA / 36 kA	50 kA / 50 kA	70 kA / 50 kA	70 kA / 70 kA

rated current

800 A	G0800	K0800	M0800	N0800
-------	-------	-------	-------	-------

wa_ren_01319_r



Frame size 4, 4-poles (60% neutral protection)

Thermomagnetic trip unit, adjustable/adjustable

Calibrated at 40°C
Screw terminals

Article number	PDE46XXXXTAAS			
breaking capacity @415 V	G	K	M	N
I_{cu}/I_{cs}	36 kA / 36 kA	50 kA / 50 kA	70 kA / 50 kA	70 kA / 70 kA

rated current

800 A	G0800	K0800	M0800	N0800
-------	-------	-------	-------	-------

wa_ren_01319_r



Frame size 4, 3-poles

Thermomagnetic trip unit, adjustable/adjustable

Calibrated at 50°C
Screw terminals

Article number	PDE43XXXXVAAS			
breaking capacity @415 V	G	K	M	N
I_{cu}/I_{cs}	36 kA / 36 kA	50 kA / 50 kA	70 kA / 50 kA	70 kA / 70 kA

rated current

800 A	G0800	K0800	M0800	N0800
-------	-------	-------	-------	-------

wa_ren_01319_r



Frame size 4, 4-poles

Thermomagnetic trip unit, adjustable/adjustable

Calibrated at 50°C
Screw terminals

Article number	PDE44XXXXVAAS			
breaking capacity @415 V	G	K	M	N
I_{cu}/I_{cs}	36 kA / 36 kA	50 kA / 50 kA	70 kA / 50 kA	70 kA / 70 kA

rated current

800 A	G0800	K0800	M0800	N0800
-------	-------	-------	-------	-------

wa_ren_01319_r



Frame size 4, 4-poles (60% neutral protection)

Thermomagnetic trip unit, adjustable/adjustable

Calibrated at 40°C
Screw terminals

Article number	PDE46XXXXVAAS			
breaking capacity @415 V	G	K	M	N
I_{cu}/I_{cs}	36 kA / 36 kA	50 kA / 50 kA	70 kA / 50 kA	70 kA / 70 kA

rated current

800 A	G0800	K0800	M0800	N0800
-------	-------	-------	-------	-------

wa_ren_01319_r



1.5

Power Defense Molded Case Circuit-Breaker

Ordering Part

Frame size 4, 3-poles

Electronic trip unit

Screw terminals

Article number	PDE43XXXXXB1NS			
breaking capacity @415 V	G	K	M	N
I_{cu}/I_{cs}	36 kA / 36 kA	50 kA / 50 kA	70 kA / 50 kA	70 kA / 70 kA

rated current

800 A	G0800	K0800	M0800	N0800
1000 A	G1000	K1000	M1000	N1000

1000 A breaker will be available soon

wa_ren_00219_r



Frame size 4, 4-poles

Electronic trip unit

Screw terminals

Article number	PDE44XXXXXB1NS			
breaking capacity @415 V	G	K	M	N
I_{cu}/I_{cs}	36 kA / 36 kA	50 kA / 50 kA	70 kA / 50 kA	70 kA / 70 kA

rated current

800 A	G0800	K0800	M0800	N0800
1000 A	G1000	K1000	M1000	N1000

1000 A breaker will be available soon

wa_ren_00219_r



Frame size 4, 3-poles

Switch disconnectors

Screw terminals

Article number

PDE43XXXXSNNS

rated current

800 A

S0800

This assortment will be available soon

wa_ren_01119_r



Frame size 4, 4-poles

Switch disconnectors

Screw terminals

Article number

PDE44XXXXSNNS

rated current

800 A

S0800

This assortment will be available soon

wa_ren_01119_r



1.5

Power Defense Molded Case Circuit-Breaker

Catalog Number Key Accessories

Power Defense molded case circuit-breaker catalog number key

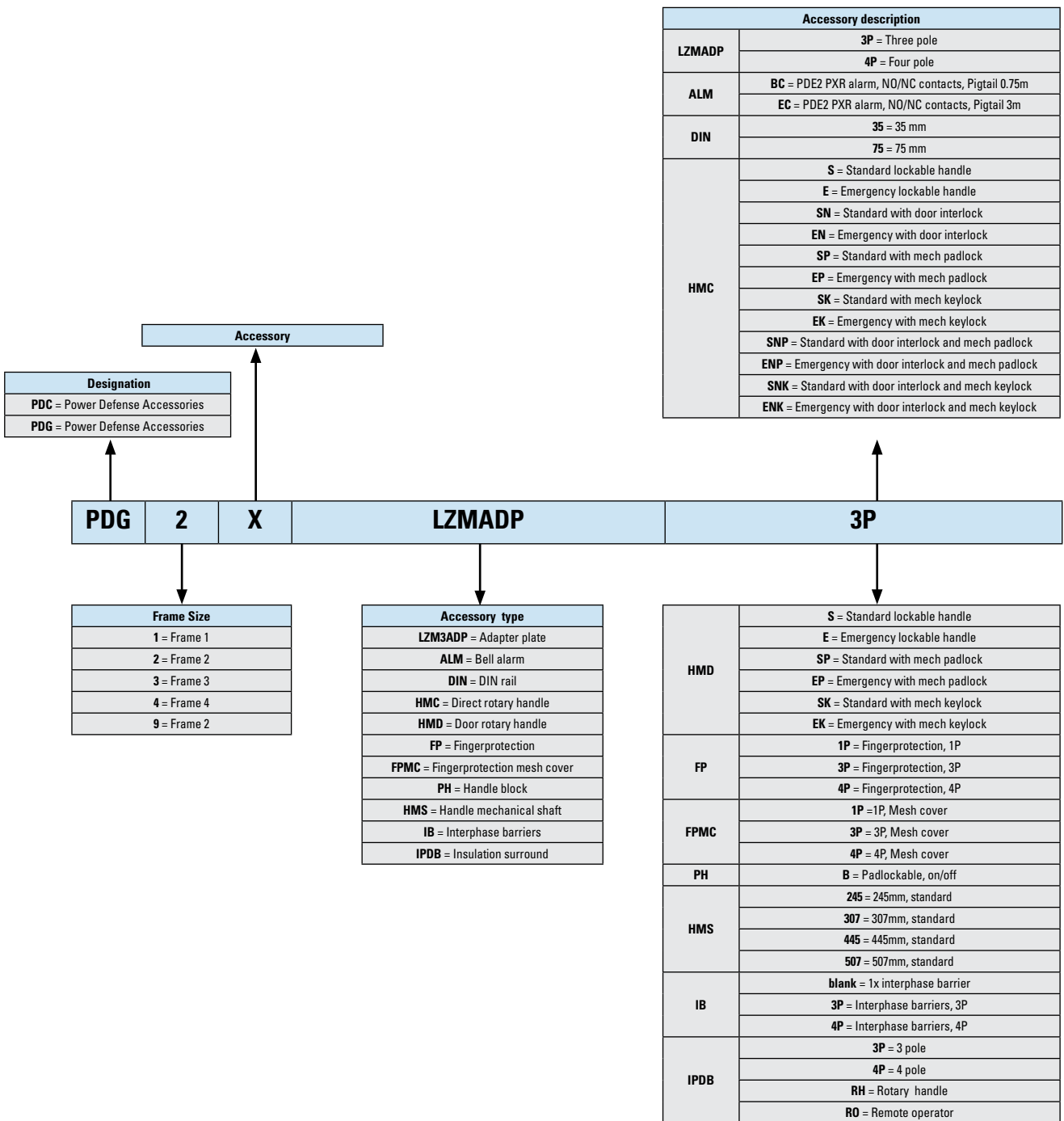

Power Defense molded case circuit-breaker catalog number key

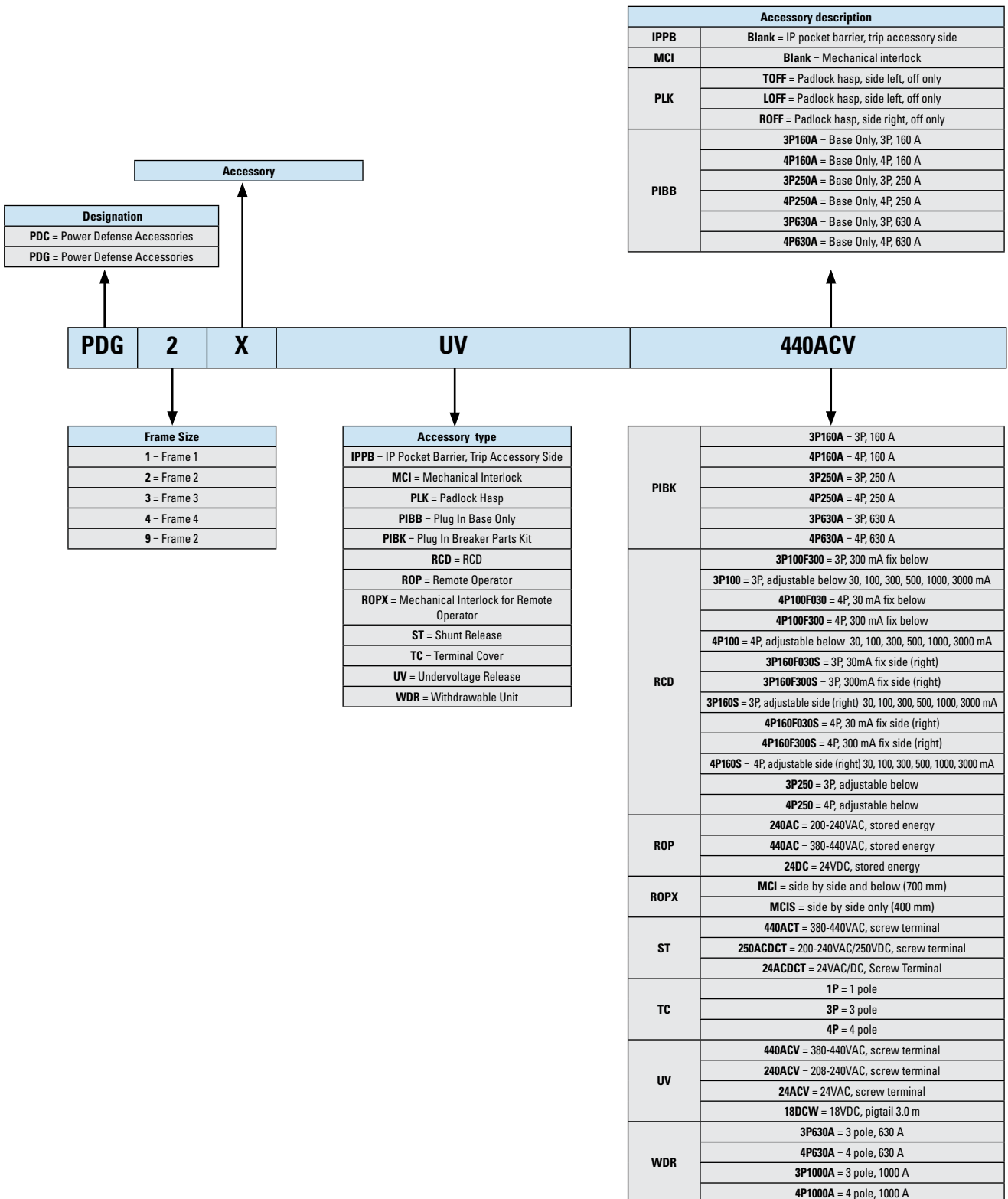

1.5

Power Defense Molded Case Circuit-Breaker

Catalog Number Key Accessories

Power Defense molded case circuit-breaker catalog number key

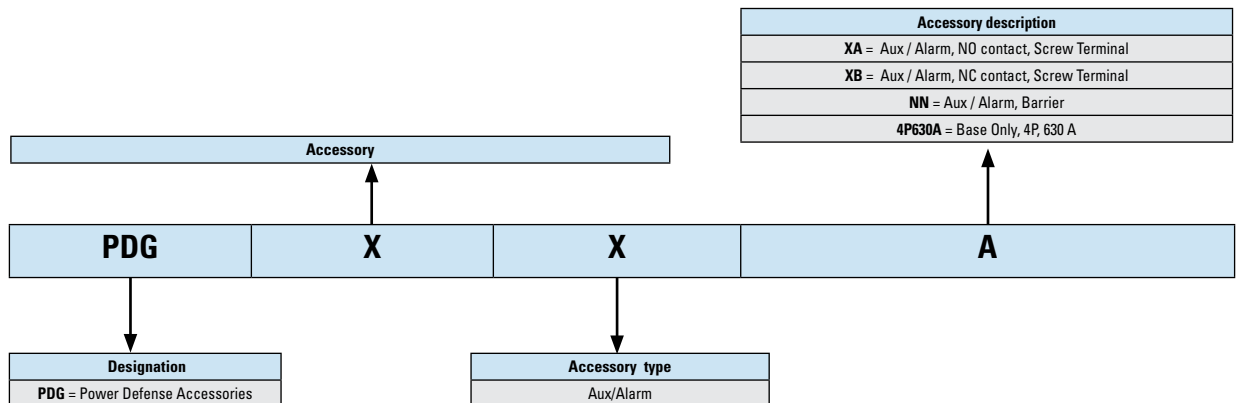
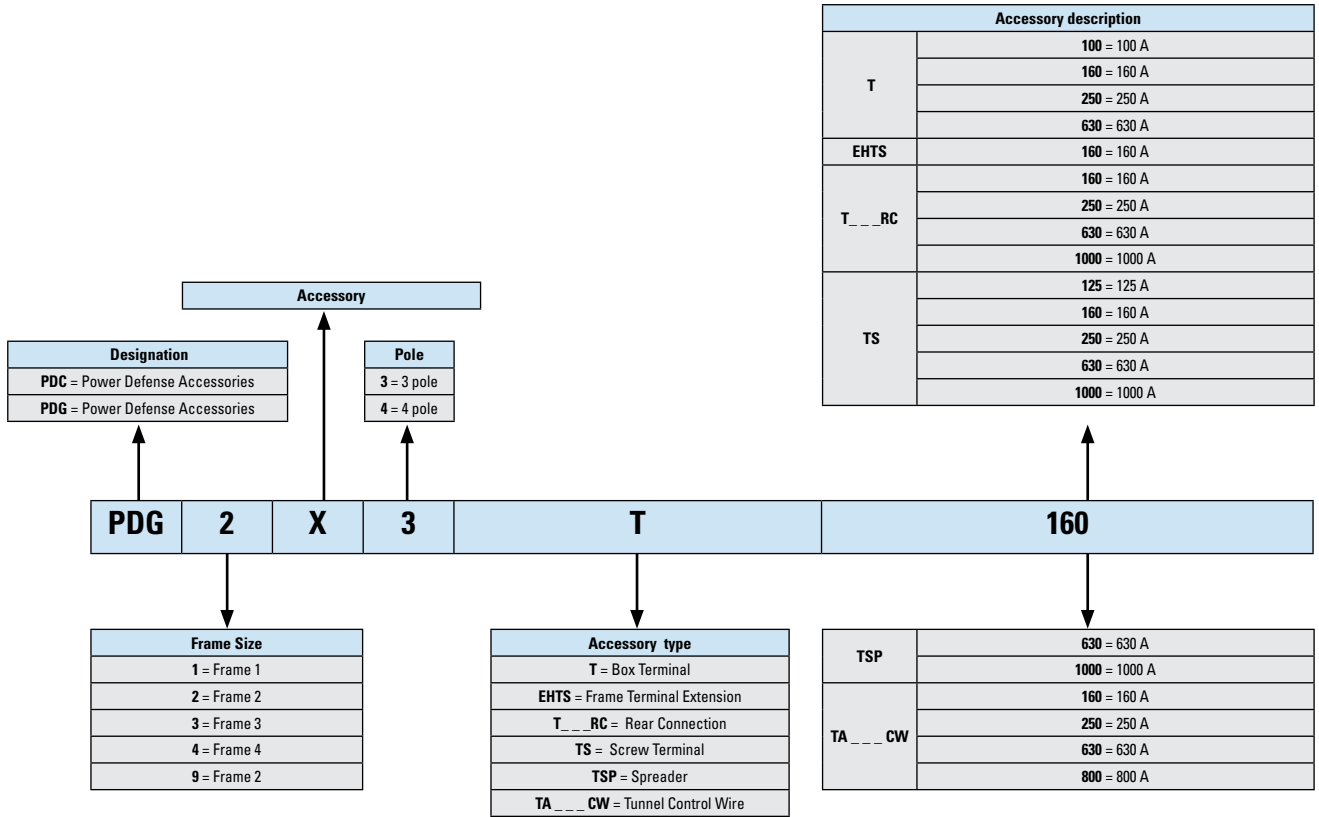

Adapter plate

zg_PDC3XLZM3ADP3P

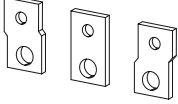

Specification	Frame	Type Designation	Article No.
Adapter plate (Conversion kit)	3	PDC3XLZM3ADP3P	PDC710369
Adapter plate (Conversion kit)	3	PDC3XLZM3ADP4P	PDC710457
Adapter plate (Conversion kit)	4	PDC4XLZM4ADP3P	PDC710464
Adapter plate (Conversion kit)	4	PDC4XLZM4ADP4P	PDC710465

Aux/Alarm

00044385_0

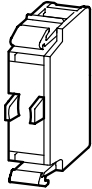

Specification	Frame	Type Designation	Article No.
Aux/Alarm	1, 2, 3, 4, 9	PDGXXA ¹	185150
Aux/Alarm	1, 2, 3, 4, 9	PDGXXB ¹	185149
IP Pocket Barrier Aux/Alarm	1, 2, 3, 4, 9	PDGXNN ¹	185154

¹ (not applicable for right pocket side of PXR breaker)

Bell alarm

sg02720_1



Specification	Frame	Type Designation	Article No.
Bell alarm of PDE PXR	2, 9	PDG2XALMBC	PDC710009
Bell alarm of PDE PXR	2, 9	PDG2XALMEC	PDC710010

Only for the left pocket of the PXR breaker

Box terminal

sg00520



Specification	Frame	Type Designation	Article No.
Box Terminal	1	PDC1X3T160	PDC710395
Box Terminal	1	PDC1X4T160	PDC710396
Box Terminal	2	PDC2X3T160	PDE710018
Box Terminal	2	PDC2X4T160	PDE710019
Box Terminal	2	PDC2X3T250	PDE710020
Box Terminal	2	PDC2X4T250	PDE710021
Box Terminal	9	PDC9X3T100 *	PDC719200
Box Terminal	9	PDC9X4T100 *	PDC719201
Box Terminal	3	PDC3X3T630	PDC710398
Box Terminal	3	PDC3X4T630	PDC710397

* This assortment will be available soon

1.5

Power Defense Molded Case Circuit-Breaker

Ordering Part Accessories

DIN rail

Specification	Frame	Type Designation	Article No.
DIN Rail	1	PDC1XDIN35	PDE710008
DIN Rail	2, 9	PDG2XDIN75	PDC710394

zg_PDC1XDIN35

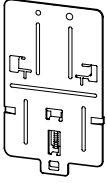

Direct Rotary Handle

z9_PDC1XHMCS

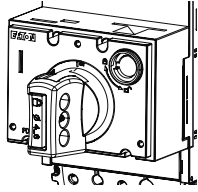

Specification	Frame	Type Designation	Article No.
Direct Rotary Handle	1	PDC1XHMCS	PDC710257
Direct Rotary Handle	1	PDC1XHMCE	PDC710258
Direct Rotary Handle	1	PDC1XHMCSN	PDC710259
Direct Rotary Handle	1	PDC1XHMCEM	PDC710260
Direct Rotary Handle	1	PDC1XHMCSM	PDC710261
Direct Rotary Handle	1	PDC1XHMCEP	PDC710262
Direct Rotary Handle	1	PDC1XHMCSK	PDC710263
Direct Rotary Handle	1	PDC1XHMCEK	PDC710264
Direct Rotary Handle	1	PDC1XHMCSNP	PDC710265
Direct Rotary Handle	1	PDC1XHMCENP	PDC710266
Direct Rotary Handle	1	PDC1XHMCSNK	PDC710267
Direct Rotary Handle	1	PDC1XHMCEM	PDC710268
Direct Rotary Handle	2, 9	PDG2XHMCS	PDC710275
Direct Rotary Handle	2, 9	PDG2XHMCE	PDC710276
Direct Rotary Handle	2, 9	PDG2XHMCSN	PDC710277
Direct Rotary Handle	2, 9	PDG2XHMCEM	PDC710278
Direct Rotary Handle	2, 9	PDG2XHMCSM	PDC710279
Direct Rotary Handle	2, 9	PDG2XHMCEP	PDC710280
Direct Rotary Handle	2, 9	PDG2XHMCSK	PDC710281
Direct Rotary Handle	2, 9	PDG2XHMCEK	PDC710282
Direct Rotary Handle	2, 9	PDG2XHMCSNP	PDC710283
Direct Rotary Handle	2, 9	PDG2XHMCENP	PDC710284
Direct Rotary Handle	2, 9	PDG2XHMCSNK	PDC710285
Direct Rotary Handle	2, 9	PDG2XHMCEM	PDC710286
Direct Rotary Handle	3	PDG3XHMCS	PDC710293
Direct Rotary Handle	3	PDG3XHMCE	PDC710294
Direct Rotary Handle	3	PDG3XHMCSN	PDC710295
Direct Rotary Handle	3	PDG3XHMCEM	PDC710296
Direct Rotary Handle	3	PDG3XHMCSM	PDC710297
Direct Rotary Handle	3	PDG3XHMCEP	PDC710298
Direct Rotary Handle	3	PDG3XHMCSK	PDC710299
Direct Rotary Handle	3	PDG3XHMCEK	PDC710300
Direct Rotary Handle	3	PDG3XHMCSNP	PDC710301
Direct Rotary Handle	3	PDG3XHMCENP	PDC710302
Direct Rotary Handle	3	PDG3XHMCSNK	PDC710303
Direct Rotary Handle	3	PDG3XHMCEM	PDC710304
Direct Rotary Handle	4	PDG4XHMCS	PDC710311
Direct Rotary Handle	4	PDG4XHMCE	PDC710312
Direct Rotary Handle	4	PDG4XHMCSN	PDC710313
Direct Rotary Handle	4	PDG4XHMCEM	PDC710314
Direct Rotary Handle	4	PDG4XHMCSM	PDC710315
Direct Rotary Handle	4	PDG4XHMCEP	PDC710316
Direct Rotary Handle	4	PDG4XHMCSK	PDC710317
Direct Rotary Handle	4	PDG4XHMCEK	PDC710318
Direct Rotary Handle	4	PDG4XHMCSNP	PDC710319
Direct Rotary Handle	4	PDG4XHMCENP	PDC710320
Direct Rotary Handle	4	PDG4XHMCSNK	PDC710321
Direct Rotary Handle	4	PDG4XHMCEM	PDC710322

1.5

Power Defense Molded Case Circuit-Breaker

Ordering Part Accessories

Door Rotary Handle (shaft not included)

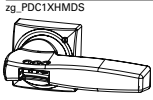

Specification	Frame	Type Designation	Article No.
Door Rotary Handle	1	PDC1XHMDS	PDC710269
Door Rotary Handle	1	PDC1XHMDE	PDC710270
Door Rotary Handle	1	PDC1XHMDS	PDC710271
Door Rotary Handle	1	PDC1XHMDEP	PDC710272
Door Rotary Handle	1	PDC1XHMDSK	PDC710273
Door Rotary Handle	1	PDC1XHMDEK	PDC710274
Door Rotary Handle	2, 9	PDG2XHMDS	PDC710287
Door Rotary Handle	2, 9	PDG2XHMDE	PDC710288
Door Rotary Handle	2, 9	PDG2XHMDS	PDC710289
Door Rotary Handle	2, 9	PDG2XHMDEP	PDC710290
Door Rotary Handle	2, 9	PDG2XHMDSK	PDC710291
Door Rotary Handle	2, 9	PDG2XHMDEK	PDC710292
Door Rotary Handle	3	PDG3XHMDS	PDC710305
Door Rotary Handle	3	PDG3XHMDE	PDC710306
Door Rotary Handle	3	PDG3XHMDS	PDC710307
Door Rotary Handle	3	PDG3XHMDEP	PDC710308
Door Rotary Handle	3	PDG3XHMDSK	PDC710309
Door Rotary Handle	3	PDG3XHMDEK	PDC710310
Door Rotary Handle	4	PDG4XHMDS	PDC710323
Door Rotary Handle	4	PDG4XHMDE	PDC710324
Door Rotary Handle	4	PDG4XHMDS	PDC710325
Door Rotary Handle	4	PDG4XHMDEP	PDC710326
Door Rotary Handle	4	PDG4XHMDSK	PDC710327
Door Rotary Handle	4	PDG4XHMDEK	PDC710328

Fingerprotection

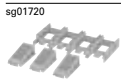

Specification	Frame	Type Designation	Article No.
Fingerprotection	1	PDC1XFP3P	PDE710012
Fingerprotection	1	PDC1XFP4P	PDE710013
Fingerprotection	1	PDC1XFP1P	PDE710014
Fingerprotection	2	PDC2XFP3P *	PDC719202
Fingerprotection	2	PDC2XFP4P *	PDC719203
Fingerprotection	9	PDG2XFP3P *	PDC710331
Fingerprotection	9	PDG2XFP4P *	PDC710332
Fingerprotection	3	PDG3XFP3P	PDC710333
Fingerprotection	3	PDG3XFP4P	PDC710334

* This assortment will be available soon

Fingerprotection - Mesh Cover

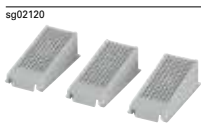

Specification	Frame	Type Designation	Article No.
Fingerprotection - Mesh Cover	1	PDC1XFPMC3P	PDE710015
Fingerprotection - Mesh Cover	1	PDC1XFPMC4P	PDE710016
Fingerprotection - Mesh Cover	1	PDC1XFPMC1P	PDE710017
Fingerprotection - Mesh Cover	2, 9	PDC2XFPMC3P *	PDC719400
Fingerprotection - Mesh Cover	2, 9	PDC2XFPMC4P *	PDC719401
Fingerprotection - Mesh Cover	3	PDG3XFPMC3P	PDC710498
Fingerprotection - Mesh Cover	3	PDG3XFPMC4P	PDC710499

* This assortment will be available soon

Frame Terminal Extension

Specification	Frame	Type Designation	Article No.
Frame Terminal Extension	9	PDC9X3EHTS160	PDC719207
Frame Terminal Extension	9	PDC9X4EHTS160	PDC719208

This assortment will be available soon

zg_PDGXXA1

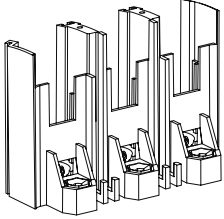

Handle Block

Specification	Frame	Type Designation	Article No.
Handle Block	1	PDC1XPHB	PDC710423
Handle Block	2, 9	PDG2XPHB	PDC710424
Handle Block	3	PDG3XPHB	PDC710425
Handle Block	4	PDG4XPHB	PDC710426

zg_PDG2XPHB

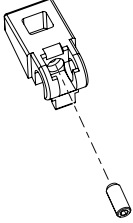

Handle Mechanical Shaft

Specification	Frame	Type Designation	Article No.
Handle Mechanical Shaft	1, 2, 9	PDG12XHMS307	PDC710343
Handle Mechanical Shaft	1, 2, 9	PDG12XHMS507	PDC710344
Handle Mechanical Shaft	3,4	PDG34XHMS245	PDC710345
Handle Mechanical Shaft	3,4	PDG34XHMS445	PDC710346

00095913_0

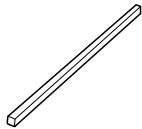

Insulation Surround

Specification	Frame	Type Designation	Article No.
Insulation Surround	1	PDC1XIPDB3P	PDC710443
Insulation Surround	2, 9	PDC2XIPDB3P	PDC710444
Insulation Surround	3	PDC3XIPDB3P	PDC710445
Insulation Surround	4	PDC4XIPDB3P	PDC710446
Insulation Surround	1	PDC1XIPDB4P	PDC710447
Insulation Surround	2, 9	PDC2XIPDB4P	PDC710448
Insulation Surround	3	PDC3XIPDB4P	PDC710449
Insulation Surround	4	PDC4XIPDB4P	PDC710450
Insulation Surround	1	PDC1XIPDBRH	PDC710451
Insulation Surround	2, 9	PDC2XIPDBRH	PDC710452
Insulation Surround	1, 2	PDC12XIPDBRO	PDC710453
Insulation Surround	3	PDC3XIPDBRORH	PDC710454
Insulation Surround	4	PDC4XIPDBRORH	PDC710455

zg_pdc1_xipdb3p

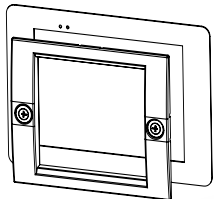

1.5

Power Defense Molded Case Circuit-Breaker

Ordering Part Accessories

Interphase barriers

z9_PDG1XIBiz

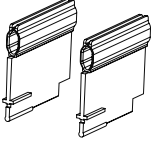

Specification	Frame	Type Designation	Article No.
Interphase Barriers	1	PDC1XIB3P	PDC710359
Interphase Barriers	1	PDC1XIB4P	PDC710360
Interphase Barriers	2	PDC2XIB3P *	PDC710361
Interphase Barriers	2	PDC2XIB4P *	PDC710362
Interphase Barriers	2	PDG2XIB3P	PDC710363
Interphase Barriers	2	PDG2XIB4P	PDC710364
Interphase Barriers	3	PDG3XIB3P	PDC710365
Interphase Barriers	3	PDG3XIB4P	PDC710366
Interphase Barriers	4	PDG4XIB3P *	PDC710367
Interphase Barriers	4	PDG4XIB4P *	PDC710368

* This assortment can be ordered starting in Q4/2020

Interphase barriers for side by side mounting

Specification	Frame	Type Designation	Article No.
Interphase Barriers	1	PDC1XIB	PDC710468
Interphase Barriers	2	PDC2XIB *	PDC719215

* This assortment will be available soon

Interphase Barriers (not usable for side by side mounting)

Specification	Frame	Type Designation	Article No.
Interphase Barriers	2	PDG2XIB *	PDC710808
Interphase Barriers	3	PDG3XIB	PDC710469
Interphase Barriers	4	PDG4XIB *	PDC710810

* This assortment will be available soon

IP Pocket Barrier, Trip Accessory Side

z9_PDG2XIPPB

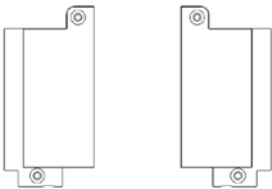

Specification	Frame	Type Designation	Article No.
IP Pocket Barrier, Trip Accessory Side	2, 9	PDG2XIPPB	PDC719468
IP Pocket Barrier, Trip Accessory Side	3	PDG3XIPPB	PDC719469
IP Pocket Barrier, Trip Accessory Side	4	PDG4XIPPB *	PDC719470

* This assortment will be available soon

Mech interlock

z9_PDC2XMCI

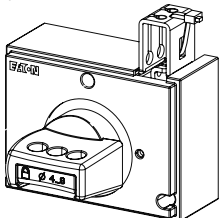

Specification	Frame	Type Designation	Article No.
Mech interlock	1	PDC1XMCI	PDC710460
Mech interlock	2	PDC2XMCI	PDC710461
Mech interlock	3	PDC3XMCI	PDC710462
Mech interlock	4	PDC4XMCI	PDC710463

Padlock Hasp

zg_PDC1XPLKTOFF

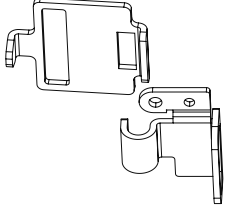

Specification	Frame	Type Designation	Article No.
Padlock Hasp	1	PDC1XPLKTOFF	PDC710428
Padlock Hasp	2, 9	PDG2XPLKLOFF	PDC710430
Padlock Hasp	2, 9	PDG2XPLKROFF	PDC710431
Padlock Hasp	2, 9	PDG2XPLKTOFF	PDC710433
Padlock Hasp	3	PDG3XPLKTOFF	PDC710436
Padlock Hasp	4	PDG4XPLKTOFF	PDC710438

Plug In Base Only

zg_PDC1XPIBB3P160A

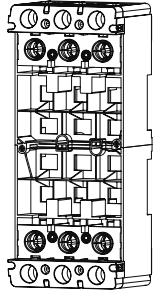

Specification	Frame	Type Designation	Article No.
Plug In Base Only	1	PDC1XPIBB3P160A	PDC710470
Plug In Base Only	1	PDC1XPIBB4P160A	PDC710471
Plug In Base Only	2	PDC2XPIBB3P250A	PDC710476
Plug In Base Only	2	PDC2XPIBB4P250A	PDC710477
Plug In Base Only	9	PDC9XPIBB3P160A	PDC710474
Plug In Base Only	9	PDC9XPIBB4P160A	PDC710475
Plug In Base Only	3	PDC3XPIBB3P630A	PDC710480
Plug In Base Only	3	PDC3XPIBB4P630A	PDC710481

Plug In Breaker Parts Kit

Specification	Frame	Type Designation	Article No.
Plug In Breaker Parts Kit	1	PDC1XPIBK3P160A	PDC710484
Plug In Breaker Parts Kit	1	PDC1XPIBK4P160A	PDC710485
Plug In Breaker Parts Kit	2	PDC2XPIBK3P250A	PDC710490
Plug In Breaker Parts Kit	2	PDC2XPIBK4P250A	PDC710491
Plug In Breaker Parts Kit	9	PDC9XPIBK3P160A	PDC710488
Plug In Breaker Parts Kit	9	PDC9XPIBK4P160A	PDC710489
Plug In Breaker Parts Kit	3	PDC3XPIBK3P630A	PDC710494
Plug In Breaker Parts Kit	3	PDC3XPIBK4P630A	PDC710495

1.5

Power Defense Molded Case Circuit-Breaker

Ordering Part Accessories

RCD

zg_PDE1XRCD3P100F030

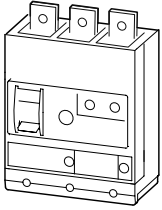

Specification	Frame	Type Designation	Article No.
RCD	1	PDE1XRCD3P100F030	PDE710026
RCD	1	PDE1XRCD3P100F300	PDE710027
RCD	1	PDE1XRCD3P100	PDE710028
RCD	1	PDE1XRCD4P100F030	PDE710029
RCD	1	PDE1XRCD4P100F300	PDE710030
RCD	1	PDE1XRCD4P100	PDE710031
RCD	1	PDE1XRCD3P160F030S	PDE710032
RCD	1	PDE1XRCD3P160F300S	PDE710033
RCD	1	PDE1XRCD3P160S	PDE710034
RCD	1	PDE1XRCD4P160F030S	PDE710035
RCD	1	PDE1XRCD4P160F300S	PDE710036
RCD	1	PDE1XRCD4P160S	PDE710037
RCD	2	PDE2XRCD3P250 *	PDC719001
RCD	2	PDE2XRCD4P250 *	PDC719002
RCD	3	PDE3XRCD3P630 *	PDC719005
RCD	3	PDE3XRCD4P630 *	PDC719006

* This assortment will be available soon

RCD - auxillary contact only for frame size 1

zg_M22-K10

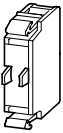

Specification	Frame	Type Designation	Article No.
RCD - auxillary contact only for frame size 1	1	M22-K10	216376
RCD - auxillary contact only for frame size 1	1	M22-K01	216378

Rear Connection

Specification	Frame	Type Designation	Article No.
Rear Connection	1	PDC1X3T160RC	PDE710006
Rear Connection	1	PDC1X4T160RC	PDE710007
Rear Connection w/ Extended Housing	2, 9	PDC2X3T250RC	PDE710024
Rear Connection w/ Extended Housing	2, 9	PDC2X4T250RC	PDE710025
Rear Connection	3	PDC3X3T630RC	PDC710400
Rear Connection	3	PDC3X4T630RC	PDC710399
Rear Connection	4	PDC4X3T1000RC *	PDC710401
Rear Connection	4	PDC4X4T1000RC *	PDC710402

* This assortment will be available soon



Remote operator

Specification	Frame	Type Designation	Article No.
Remote operator	1	PDE1XROP240AC	PDC719017
Remote operator	1	PDE1XROP440AC	PDC719018
Remote operator	1	PDE1XROP24DC	PDC719019
Remote operator	2	PDE2XROP240AC	PDC719027
Remote operator	2	PDE2XROP440AC	PDC719028
Remote operator	2	PDE2XROP24DC	PDC719029
Remote operator	3	PDE3XROP240AC	PDC719037
Remote operator	3	PDE3XROP440AC	PDC719038
Remote operator	3	PDE3XROP24DC	PDC719039
Remote operator	4	PDE4XROP240AC	PDC719047
Remote operator	4	PDE4XROP440AC	PDC719048
Remote operator	4	PDE4XROP24DC	PDC719049
Remote operator for TMTU breaker only	2	PDE2XROPT240AC	PDC719421
Remote operator for TMTU breaker only	2	PDE2XROPT440AC	PDC719422
Remote operator for TMTU breaker only	2	PDE2XROPT24DC	PDC719423

This assortment will be available soon

Mechanical interlock for remote operator

Specification	Frame	Type Designation	Article No.
Mechanical interlock for remote operator	1	PDC1XROPXMCIS	PDC719056
Mechanical interlock for remote operator	2	PDG2XROPXMCIS	PDC719057
Mechanical interlock for remote operator	3	PDG3XROPXMCIS	PDC719058
Mechanical interlock for remote operator	4	PDG4XROPXMCIS	PDC719059
Mechanical interlock for remote operator	1	PDC1XROPXMCI	PDC719060
Mechanical interlock for remote operator	2	PDG2XROPXMCI	PDC719061
Mechanical interlock for remote operator	3	PDG3XROPXMCI	PDC719062
Mechanical interlock for remote operator	4	PDG4XROPXMCI	PDC719063

This assortment will be available soon

1.5

Power Defense Molded Case Circuit-Breaker

Ordering Part Accessories

Screw terminal

Specification	Frame	Type Designation	Article No.
Screw Terminal (terminal cover needed)	1	PDC1X3TS160	PDE710001
Screw Terminal (terminal cover needed)	1	PDC1X4TS160	PDE710002
Screw Terminal (terminal cover needed)	1	PDC1X1TS125	PDE710003
Screw Terminal	9	PDC9X3TS160 *	PDC719209
Screw Terminal	9	PDC9X4TS160 *	PDC719210

sg01120



Screw Terminal	2	PDC2X3TS250 *	PDC719307
Screw Terminal	2	PDC2X4TS250 *	PDC719308
Screw Terminal	3	PDC3X3TS630	PDC710406
Screw Terminal	3	PDC3X4TS630	PDC710405
Screw Terminal	4	PDC4X3TS1000	PDC710407
Screw Terminal	4	PDC4X4TS1000	PDC710408

sg01220



* This assortment will be available soon

Shunt release

Specification	Frame	Type Designation	Article No.
Shunt Release	1	PDC1XST440ACT	PDC710173
Shunt Release	1	PDC1XST250ACDCT	PDC710185
Shunt Release	1	PDC1XST24ACDCT	PDC710209
Shunt Release	2, 9	PDG2XST440ACT	PDC710174
Shunt Release	2, 9	PDG2XST250ACDCT	PDC710186
Shunt Release	2	PDG2XST24ACDCT	PDC710210
Shunt Release	3	PDG3XST440ACT	PDC710175
Shunt Release	3	PDG3XST250ACDCT	PDC710187
Shunt Release	3	PDG3XST24ACDCT	PDC710211
Shunt Release	4	PDG4XST440ACT	PDC710176
Shunt Release	4	PDG4XST250ACDCT	PDC710188
Shunt Release	4	PDG4XST24ACDCT	PDC710212

zg_PDC1XUV440ACV

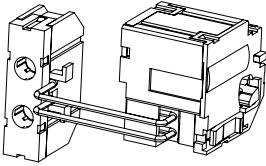

Spreader

Specification	Frame	Type Designation	Article No.
Spreader	3	PDC3X3TSP630	PDC710412
Spreader	3	PDC3X4TSP630	PDC710411
Spreader	4	PDC4X3TSP1000	PDC710414
Spreader	4	PDC4X4TSP1000	PDC710413

zg_PDC3X3TSP630

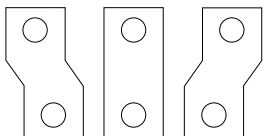

Terminal cover

sg02520



Specification	Frame	Type Designation	Article No.
Terminal Cover	1	PDC1XTC3P	PDE710009
Terminal Cover	1	PDC1XTC4P	PDE710010
Terminal Cover	1	PDC1XTC1P	PDE710011
Terminal Cover	2	PDC2XTC3P	PDC719309
Terminal Cover	2	PDC2XTC4P	PDC719310
Terminal Cover	9	PDG2XTC3P	PDC710337
Terminal Cover	9	PDG2XTC4P	PDC710338
Terminal Cover	3	PDG3XTC3P	PDC710339
Terminal Cover	3	PDG3XTC4P	PDC710340

Tunnel Control Wire

sg00320



Specification	Frame	Type Designation	Article No.
Tunnel Control Wire	1	PDC1X3TA160CW	PDE710004
Tunnel Control Wire	1	PDC1X4TA160CW	PDE710005
Tunnel Control Wire	2	PDC2X3TA250CW	PDE710022
Tunnel Control Wire	2	PDC2X4TA250CW	PDE710023
Tunnel Control Wire	3	PDG3X3TA630CW	PDC710348
Tunnel Control Wire	3	PDG3X4TA630CW	PDC710349
Tunnel Control Wire	4	PDG4X3TA800CW	PDC710811
Tunnel Control Wire	4	PDG4X4TA800CW	PDC710812

This assortment will be available soon

Undervoltage release

zg_PDC1XUV440ACV

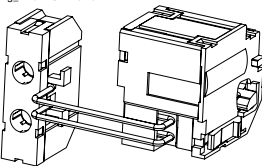

Specification	Frame	Type Designation	Article No.
Undervoltage Release	1	PDC1XUV440ACV	PDC710032
Undervoltage Release	1	PDC1XUV240ACV	PDC710044
Undervoltage Release	1	PDC1XUV24ACV	PDC710068
Undervoltage Release	1	PDC1XUV24DCV	PDC710128
Undervoltage Release	2, 9	PDG2XUV440ACV	PDC710033
Undervoltage Release	2, 9	PDG2XUV240ACV	PDC710045
Undervoltage Release	2, 9	PDG2XUV24ACV	PDC710069
Undervoltage Release	2, 9	PDG2XUV24DCV	PDC710129
Undervoltage Release	3	PDG3XUV440ACV	PDC710034
Undervoltage Release	3	PDG3XUV240ACV	PDC710046
Undervoltage Release	3	PDG3XUV24ACV	PDC710070
Undervoltage Release	3	PDG3XUV24DCV	PDC710130
Undervoltage Release	4	PDG4XUV440ACV	PDC710035
Undervoltage Release	4	PDG4XUV240ACV	PDC710047
Undervoltage Release	4	PDG4XUV24ACV	PDC710071
Undervoltage Release	4	PDG4XUV24DCV	PDC710131
Undervoltage Release	1	PDC1XUV18DCW *	PDC710355
Undervoltage Release	2, 9	PDG2XUV18DCW *	PDC710356
Undervoltage Release	3	PDG3XUV18DCW *	PDC710357
Undervoltage Release	4	PDG4XUV18DCW *	PDC710358

* Only for combination with UVU

1.5

Power Defense Molded Case Circuit-Breaker

Ordering Part Accessories

UVU-NZM

Specification	Frame	Type Designation	Article No.
UVU-NZM		UVU-NZM	260154

zg_UVU_NZM

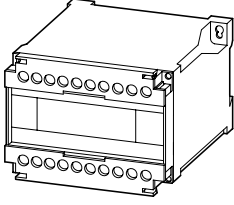

Withdrawal Unit

Specification	Frame	Type Designation	Article No.
Withdrawal Unit	3	PDG3XWDR3P630A	PDC719220
Withdrawal Unit	3	PDG3XWDR4P630A	PDC719221
Withdrawal Unit	4	PDC4XWDR3P1000A	PDC719222
Withdrawal Unit	4	PDC4XWDR4P1000A	PDC719223

This assortment will be available soon

Eaton's mission is to improve the quality of life and the environment through the use of power management technologies and services. We provide sustainable solutions that help our customers effectively manage electrical, hydraulic, and mechanical power – more safely, more efficiently, and more reliably. Eaton's 2020 revenues were \$17.9 billion, and we sell products to customers in more than 175 countries. We have approximately 92,000 employees.

For more information, visit [Eaton.com](https://www.eaton.com).



Eaton Industries (Austria) GmbH
Scheidgasse 42
1210 Vienna
Austria

Eaton
EMEA Headquarters
Route de la Longeraie 7
1110 Morges, Switzerland
Eaton.eu

© 2021 Eaton
All Rights Reserved
Publication No. CA013004EN
Article number 300374-MK
August 2021

Changes to the products, to the information contained in this document, and to prices are reserved; as are errors and omissions. Only order confirmations and technical documentation by Eaton is binding. Photos and pictures also do not warrant a specific layout or functionality. Their use in whatever form is subject to prior approval by Eaton. The same applies to trademarks (especially Eaton, Moeller, and Cutler-Hammer). The Terms and Conditions of Eaton apply, as referenced on Eaton Internet pages and Eaton order confirmations.

Eaton is a registered trademark.

All other trademarks are property of their respective owners.

Follow us on social media to get the latest product and support information.

